

**BROADCAST AND
COMMUNICATIONS
EQUIPMENT**

**HARRIS
INTERTYPE
CORPORATION**

GATES

INTRODUCTION

Listed herein, is what we at Gates believe to be the most comprehensive selection of AM, FM and shortwave broadcasting equipment ever offered to an illustrious industry. Many models of commercial communication equipment for single sideband, CW and DSB transmission, along with the world's most extensive broadcast audio equipment, will also be found between these covers. We at Gates are proud of every product, and firmly believe each is without equal and represents excellence both in quality and technological supremacy.

Field sales and service is extensive. Branch offices are located in New York, Washington, Houston and Los Angeles. Direct Gates employed sales engineers cover all of the continental United States. The Houston branch is a complete sales and warehouse division carrying a generous inventory of equipment and service parts serving the entire South and Southwest. Overseas, local agents are in most countries in the world with most international marketing directed by Rocke International Corporation at 13 E. 40th Street in New York City. In Canada, sales are handled by the Canadian Marconi Company with headquarters in Montreal and branches throughout Canada. The Gates dealer in Puerto Rico is Acosta Frequency Standard Measurements in Rio Piedras.

Established in 1922, Gates is recognized as a senior member in a manufacturing industry of many fine companies. The growth of the Gates Radio Company has been a dynamic chapter in the history of radio broadcasting. We maintain strict quality control standards and place demanding emphasis for advanced design on our engineering and technical staff. These are gladly accepted as challenges vital for continuance of our leadership position.

Today, Gates is a wholly owned subsidiary of the Harris-Intertype Corporation, world leaders in the graphic arts industry and listed by *Fortune* Magazine as one of the nation's 500 largest corporations. Like Gates, a leader in the broadcast equipment industry, other divisions of the corporation are also leaders in the printing, graphic arts and electronics equipment fields. Harris-Intertype presses print *Life*, the *Saturday Evening Post*, *National Geographic*, hundreds of other publications and even the containers on super market shelves. Yes, even this catalog is printed on a Harris Offset Press. Other corporate factories are located in Cleveland, Brooklyn, Westerly R.I., Dayton, Los Angeles, Fort Worth, Champlain N.Y., Easton Pa., and London, with other manufacturing plants in West Berlin and Paris.

Your patronage is genuinely desired. If given, you will find that Gates customers are far more than an order number, and you will experience a very warm and personal association with the objective being your success. It is then ours.

GATES RADIO COMPANY

A Subsidiary of Harris-Intertype Corporation

QUINCY, ILLINOIS, 62302

HIGH POWER TRANSMITTER INSTALLATIONS

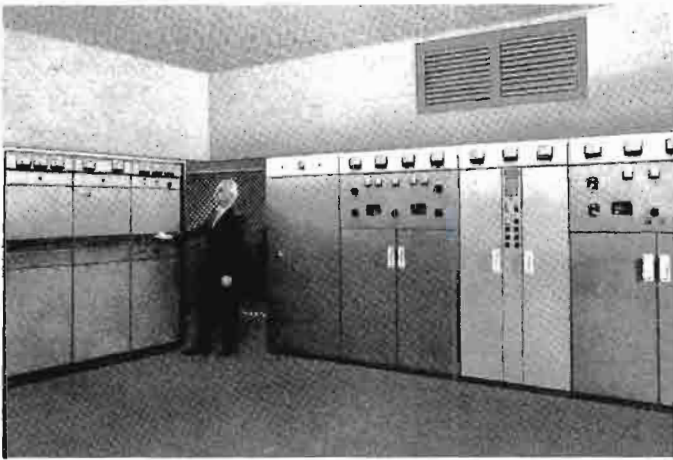

WIBC—INDIANAPOLIS—50,000 watt Model BC-50C and 10,000 watt Model BC-10P transmitters in this ultra-modern installation.



RADIO SAIGON—20,000 watt Model HF-20B and 10,000 watt Model HF-10B transmitters receive official inspection.



VOICE OF AMERICA—Six Gates 50,000 watt Model HF-50C transmitters are in use at the Greenville, N.C. transmitting station.

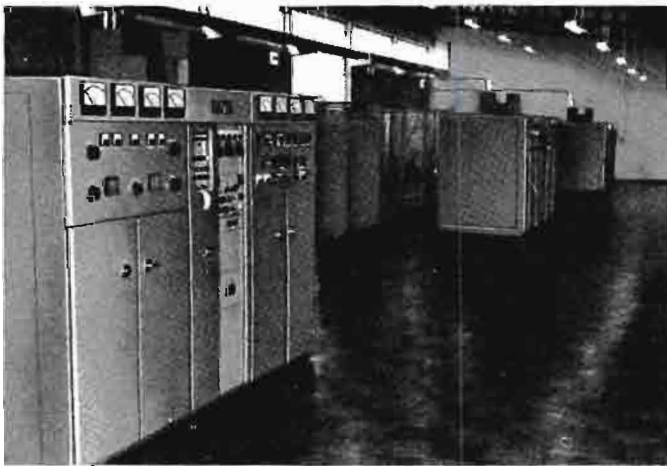

RADIO SINGAPORE—Three Gates 50,000 watt transmitters Model HF-50C used for high power short wave broadcasting. Note the outstanding installation arrangement.

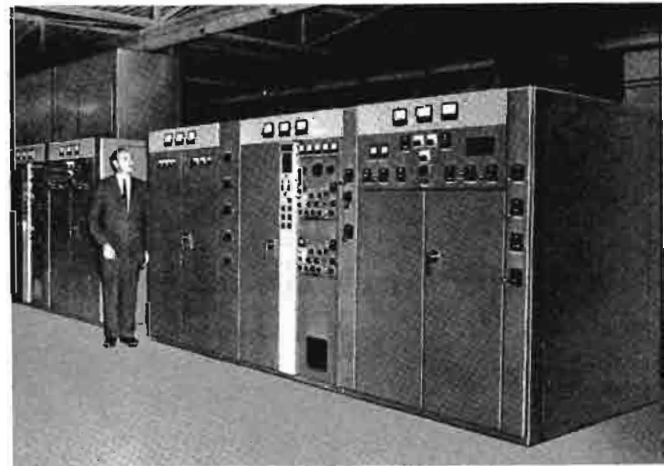

ON TEST FOR RADIO MALAYSIA—Two of the three 100,000 watt short wave broadcast transmitters Model HF100 at the Gates plant prior to shipment.

TABLE OF CONTENTS

| | PAGE |
|---|------|
| AM BROADCAST TRANSMITTERS | |
| <i>100 KW to 100 watt transmitters • Phasing and coupling equipment • Broadcast accessories • Monitors • Dummy antennas</i> | 4 |
| FM BROADCAST TRANSMITTERS | |
| <i>20 KW to 10 watt transmitters • FM relay packages • Stereo and SCA Generators • Antennas • Monitors</i> | 36 |
| BROADCAST TRANSMITTER ACCESSORIES | |
| <i>Remote control • Transmission line • Antenna towers • Tower lights • Transformers • Inductors and Mica Capacitors • Receivers</i> | 61 |
| TELEVISION TRANSMITTERS | |
| <i>5 KW to 100 watt transmitters • Television Antennas • TV monitors</i> .. | 75 |
| AUDIO EQUIPMENT | |
| <i>Audio control consoles • Transcription equipment • Modular audio desks • Cartridge recording equipment • System-type audio amplifiers • Automatic gain-control amplifiers • Microphones • Rack cabinets • Speakers and baffles • Proof of Performance equipment • Tape recorders • Accessories</i> | 83 |
| HIGH FREQUENCY BROADCAST TRANSMITTERS | |
| <i>250 KW to 1000 watt transmitters • High speed modulation monitor</i> | 157 |
| SINGLE SIDEBAND TRANSMITTERS | |
| <i>20 KW to 1000 watt transmitters • HF matching transformers • Tranceivers • Receivers • HF Linear amplifiers</i> | 180 |
| COMMUNICATIONS TRANSMITTERS | |
| <i>50 KW to 65 watt transmitters • HF antennas • Transportable systems</i> | 200 |
| ACCESSORY EQUIPMENT | |
| <i>Remote pick-up equipment • Voltage regulators • Emergency generators • RF exciters • Transmitting tubes • Reference Information</i> | 212 |
| INDEX | 220 |

The mechanical and electrical design of the equipment described herein is subject to change without notice as deemed necessary by Gates Radio Company or its suppliers in the interest of advancing industry requirements or the state of the art.

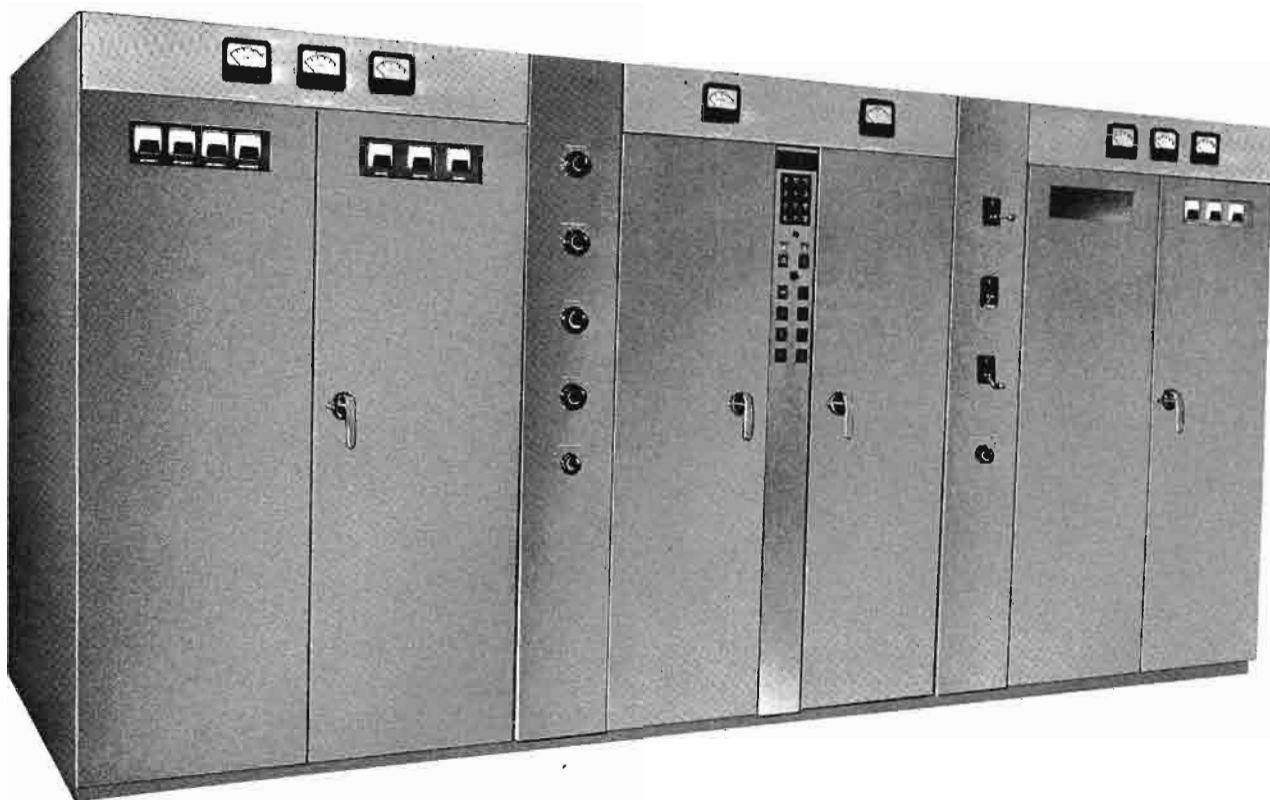

MODEL BC-100G

The vast experience and knowledge acquired by Gates in over 40 years of designing broadcast equipment is reflected in this powerful 100 KW transmitter. Designed for reliable and continuous operation in areas of extreme temperature, humidity and of high altitude, the BC-100G transmitter produces high fidelity broadcasting transmission in the 535 kc. to 1620 kc. medium wave band.

Silicon rectifiers throughout; oversized magnetic components; dual HV power supplies and high level plate modulation are some of the features which assure dependable and uninterrupted on air service for high standards of reliability.

Straight-forward design with only six major tube types; efficient air cooling; interchangeable PA and modulator tubes and walk-in construction provide a very modern 100 KW transmitter which is economical to operate and easy to maintain. This is a quality transmitter in every respect.

GENERAL DESIGN: The Gates BC-100G consists of three main transmitter cubicles mounted in line . . . modulator, control, and power amplifier sections. The remaining equipment is floor mounted externally. This includes two cabinets that house the main AC contactors and high voltage power supplies, the blower, HV capacitor frame and the modulation and power transformers and reactors.

RF CIRCUITS: Two parallel connected type F-8550 triode tubes are employed as the output power amplifier to provide 100 kilowatts of transmitter power. Since each tube is capable of producing 65 KW output as a plate modulated class "C" amplifier, an abundant reserve of tube rating is

inherent in the design. More than ample RF drive is developed by the type 4CX10,000D driver tube, since this tube is normally operating at about 40% of its maximum capability. The second buffer stage in the BC-100G transmitter consists of two parallel connected type 6146 tubes operating well under rating. The crystal oscillator and first buffer stages are type 12BY7 tubes. All tubes used in the BC-100G transmitter are operated well under the tube manufacturer's maximum ratings. The conservative design approach assures long tube life and consequently very low hourly operating tube cost.

MODULATOR AND AUDIO CIRCUITS: Two type F-8550 triodes are used in push-pull as class "B" audio modulators. The use of the F-8550 tubes provides a large rating reserve. As the modulator tubes are directly interchangeable with the power amplifiers, the number of spare tubes is reduced, resulting in lower operating cost. Four rugged type 304-TH triodes operate as a cathode follower audio driver for the class "B" modulators. Another 304-TH tube provides concurrent modulation of the RF driver stage. Two type 4-250A tubes are the intermediate amplifiers, preceded by two type 6146 tubes as audio input amplifiers. Completely separate high voltage power supplies, along with concurrent modulation result in exceptionally low carrier shift, well within the 1% range. Because of this factor and other design considerations such as over-all audio feedback and the use of oversize components, extremely low audio distortion is a primary characteristic of this transmitter and will definitely deliver one of the highest quality signals obtainable with any system of modulation.

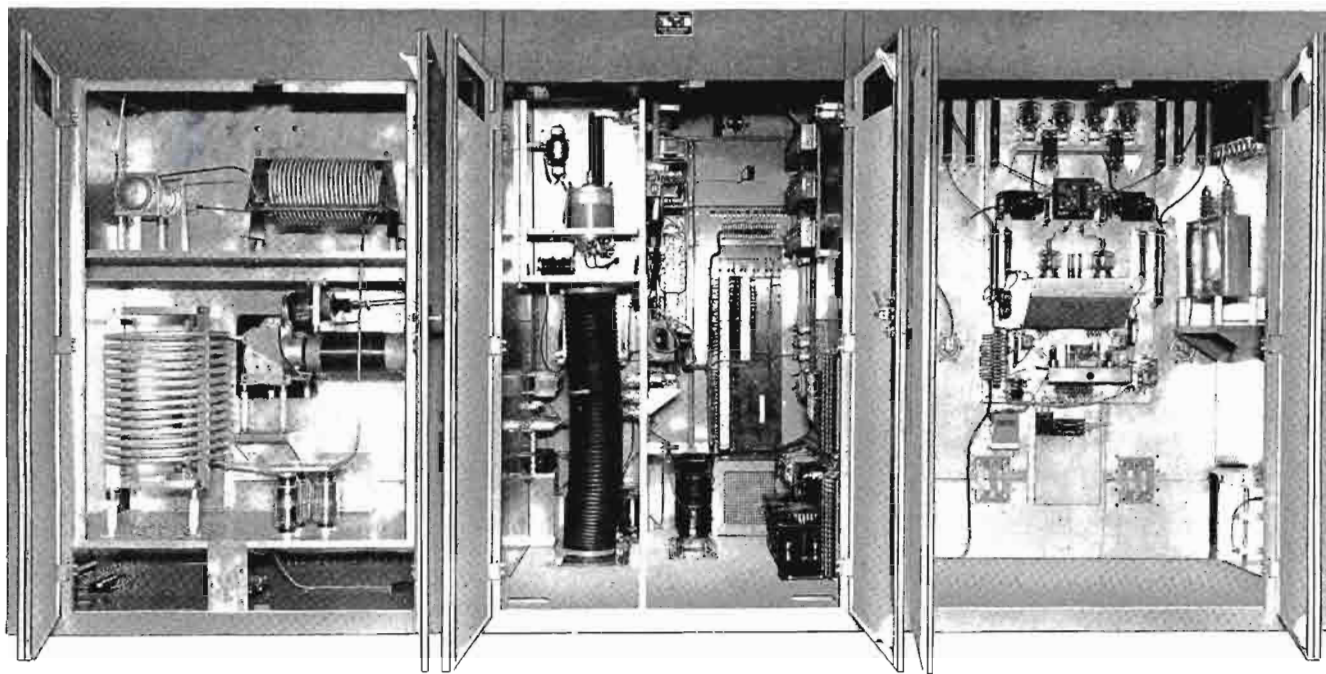

Rear View BC-100G. Note easy walk-in construction.

AIR COOLING: The use of a highly efficient forced air cooling system provides a quietness of operation almost unbelievable for a 100 KW broadcast transmitter. Abundant controlled air cooling, with a minimum of air noise, is provided by one external centrifugal blower. By mounting the blower external to the transmitter cabinets, greatly improved accessibility to the main cabinets is afforded. Also, air noise is reduced to the lowest possible levels. Filtering and air distribution problems are simplified. Separate inbuilt small blowers are provided to assure complete cooling of the silicon rectifiers even under extreme climatic conditions.

DUAL SILICON HIGH VOLTAGE POWER SUPPLIES: Separate silicon high voltage power supplies are used for the modulator and power amplifier. This feature assures greater reliability and better regulation. Both HV supplies utilize silicon rectifiers selected to provide long life and the utmost in reliability. All silicon cells used have con-

servative current and voltage ratings.

TRANSIENT PROTECTION: The greatest possible protection, in a practical sense, is provided by means of shunting each silicon cell with suitable resistors and capacitors.

PROTECTIVE DEVICES: Husky DC overloads are provided for each of the four type F-8550 power triodes and for the 4CX10,000D RF driver. AC overloads are used in conjunction with the start contactors in both of the HV power supplies. Magnetic breakers are used to protect the bias, screen and intermediate high voltage supplies. All filaments are fully voltage regulated. In addition to affording protection, the regulator assures maximum tube life through maintaining correct filament voltage. This condition also contributes greatly to over-all stability of operation. Automatic recycling after an overload is provided in this transmitter.

Simplified block diagram
100 KW Medium Wave Broad-
cast Transmitter Model BC-
100G.

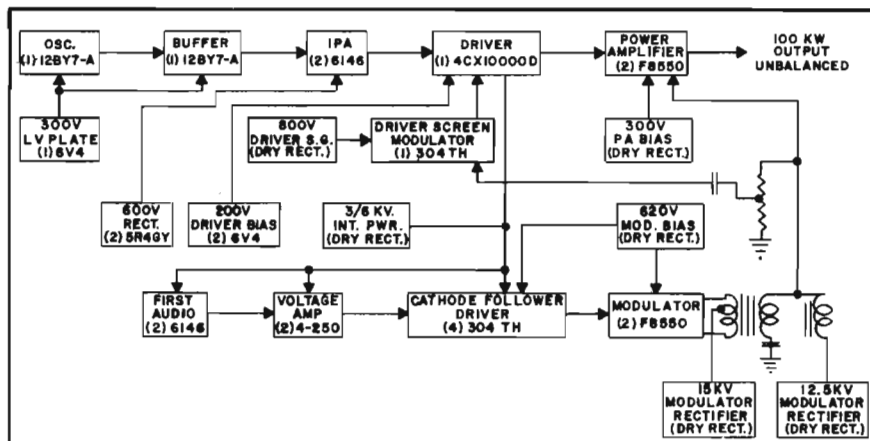

100,000 Watt Medium Wave Broadcast Transmitter—BC-100G

Front view of power amplifier contactor and rectifier cubicle. Note the husky AC contactors and the control unit for the regulated filament supply. A similar assembly is used for the modulator.

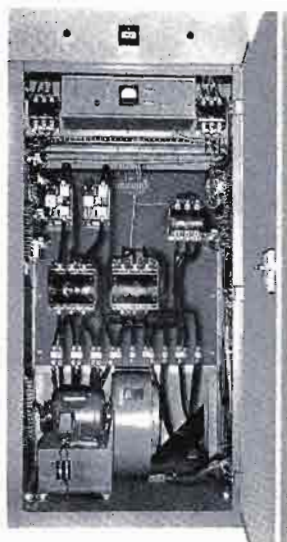

New F-8550 modulator tube weighs 65 pounds and only 90 pounds with socket assembly. Standardization on this new high power air cooled triode for both the modulator and power amplifier permits interchangeability of tubes for longer useful life. This reduces the number of tubes required as spares and lowers the cost of operation.



OPERATING SIMPLICITY: Automatic sequence control circuits are provided. This assures simple and fool-proof operation and helps avoid costly errors.

With a total of 25 meters including 22 located on the front of the main transmitter assembly, all vital transmitter circuits can be monitored constantly.

Front panel controls are provided for all circuits which might require slight adjustment after the original set-up.

Indicator and target lights on the front show the status and operation of control circuits and overload relays.

INSTALLATION: The BC-100G has been designed for maximum installation flexibility to fit different types of buildings. A very compact unit, the main transmitter assembly occupies only 70 square feet of space. The three main transmitter cubicles are easily accessible from both front and rear and built-in intercubicle wiring reduces installation time. The external centrifugal blower can be supplied with bottom horizontal discharge for a one floor building plan or with "up draft" or top horizontal discharge for a two floor or basement installation.

SPECIFICATIONS

POWER OUTPUT:
100 KW rated, 106 KW maximum.

FREQUENCY RANGE:
535 Kc. to 1620 Kc. (as ordered).

RF OUTPUT IMPEDANCE:
230 ohms unbalanced, or as otherwise specified.

FREQUENCY STABILITY:
± 5 cycles.

CARRIER SHIFT:
3% or less at 100% modulation.

MODULATION:
High level plate.

AUDIO RESPONSE:
± 1.5 db. 50-10,000 cycles at 95% modulation.

AUDIO DISTORTION:
3% or less, 50-7500 cycles at 95% modulation.

NOISE:
55db. below 100% modulation.

AUDIO INPUT IMPEDANCE:
600 ohms balanced.

AUDIO INPUT LEVEL:
+ 10 dbm. for 100% modulation, ± 2 db.

RF HARMONICS:
Suppression of harmonics meets or exceeds CCIR requirements.

POWER LINE REQUIREMENTS:
Available for any one primary voltage. 380 to 480 VAC, 3 phase, 3 wire or 4 wire, 50 or 60 cycles, as specified.

POWER FACTOR:
At least 90%.

POWER CONSUMPTION:
170 KW at 0% modulation, 184 KW at average program, 252 KW at 100% modulation.

SIZE:
Largest individual cubicle dimension: 5' wide, 6½' high and 5' deep. Transmitter assembly: 14 feet wide, 5 feet deep and 6½ feet high. Transmitter assembly occupies 70 square feet floor space. The main blower, HV plate transformer, modula-

tion transformer, modulation and filter reactors, HV capacitors, and HV rectifier cabinets all mount external to the transmitter proper.

ALTITUDE:
To 6000 feet, higher on special order.

TEMPERATURE RANGE:
0° to + 45° C.

WEIGHT:
Unpacked, 22,655 lbs.; 27,500 lbs. export packed.

CUBAGE:
1580 cu. ft.

FINISH:
Hand rubbed lacquer in two-tone Gates Gray.

TUBE COMPLEMENT:
Audio and RF:
2—Oscillator and first amplifier—12BY7.
2—Buffers—6146.
1—RF driver—4CX 10,000D.
2—Power amplifier—F-8550.
2—First audio—6146.
2—Second Audio—4-250A.
1—Screen Modulator—304-TH.
4—Audio drivers—304-TH.
2—Class B modulators—F-8550.

VOLTAGE REGULATOR:
(2) 5R4GY, (2) OB2, (3) 6V4 and (1 each) 12AT7, 6AU6, 6X4 and 6AQ5.

ORDERING INFORMATION

Model BC-100G Broadcast Transmitter, 100,000 watts, with tubes and two crystals (Cat. No.) M-5967A
Spare 100% set of tubes for BC-100G TK-376
Recommended minimum set of spare tubes for BC-100G TK-377
Please specify line voltage, line frequency, carrier frequency and R.F. output impedance with order.



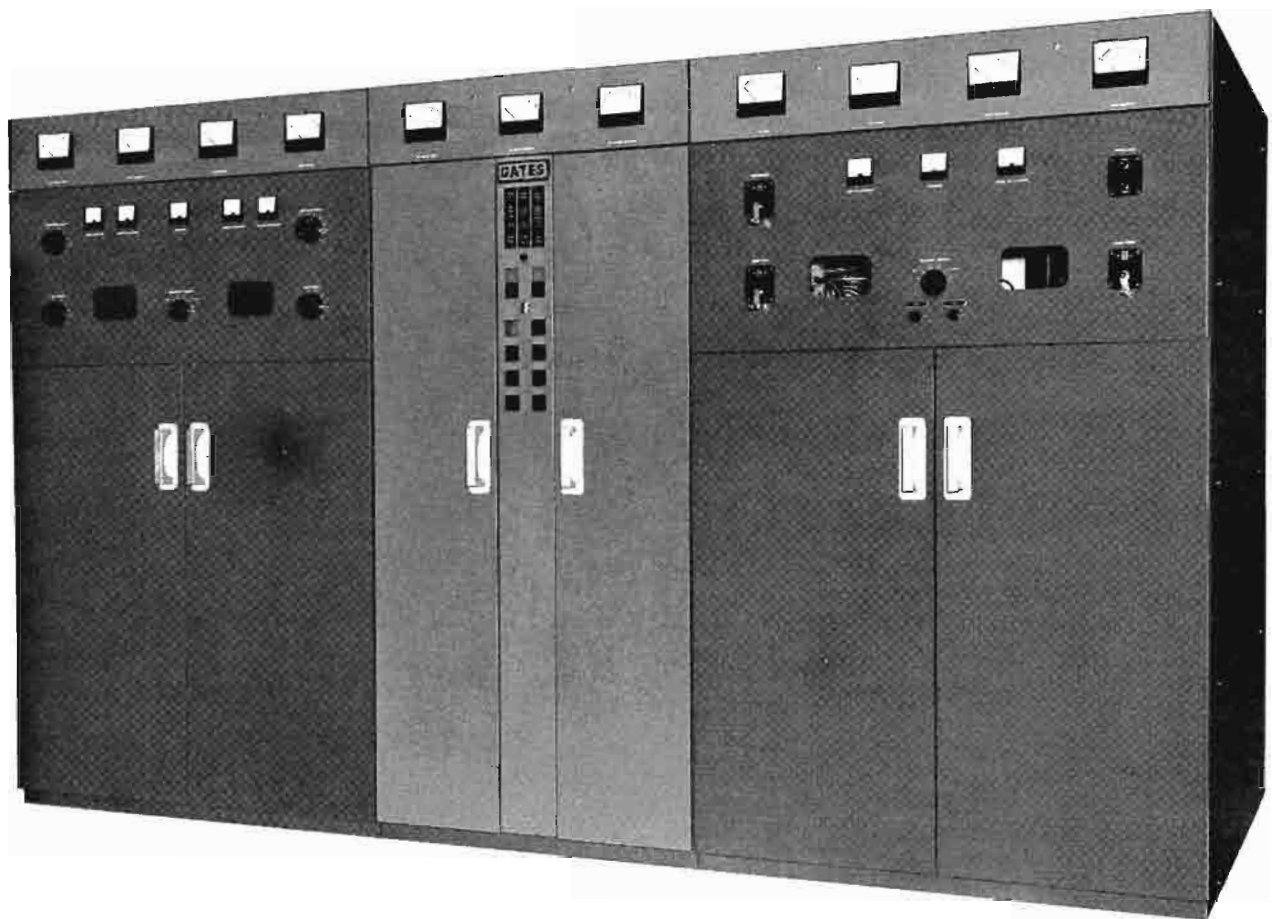

MODEL BC-50C

The excellence of Gates 50 KW broadcast transmitters is demonstrated by the fact that more Gates medium and short wave 50 KW transmitters have been purchased by world-wide users in recent years than any other make. In the last five years Gates has delivered more 50 KW broadcast transmitters than any other known manufacturer, and that total number now is in excess of 40 units on the air world-wide. The best testimonial to the superb performance of Gates 50KW broadcast transmitters is the long list of satisfied users.

GENERAL DESIGN: The BC-50C medium wave broadcast transmitter incorporates a multitude of design exclusives and operating benefits, including: the lowest hourly tube cost of any 50 KW transmitter; high level plate modulation; choice of internal or external transmitter cooling; the reliability of oversized components; a proven high level electrical design; the safety factor provided by a generous number of silicon rectifiers in the high voltage power supply (each rated at 25 amperes and 500 volts peak); and the skillful combination of compact design and complete accessibility. Fully FCC type approved, the BC-50C transmitter is capable of better than 20% extra power output above the 50 kilowatt level. The design of every section of the transmitter is in keeping with this reserve margin.

CONSTRUCTION: Three cubicles of walk-in construction; modulator, exciter/driver and power amplifier, join together to form the attractive main transmitter assembly. Other equipment external to the transmitter are the high voltage rectifier/contacter cabinet, HV capacitor frame, HV power transformers; modulation transformer and reactors. The complete transmitter should fit into any existing 50 kilowatt building plan, or can be installed in a new one-floor arrangement, using as little as 750 square feet.

RADIO AND AUDIO FREQUENCY SECTION: The RF section of the BC-50C transmitter employs two premium grade vacuum ovenless crystals that provide excellent stability and require no maintenance. The oscillator and first buffer stages employ 12BY7 tubes, followed by parallel type 6146 tubes which, in turn, excite the type 6076 tetrode RF driver. Final RF power amplifiers are two type WL-5891 long life triodes operating in parallel. Because of the extremely conservative mode of operation, and the proven excellence of the tube itself, operating life up to 40,000 hours has been experienced. This conservative and proven design assures more than ample reserve in power output and modulation capability.

Four push-pull amplifier stages make up the audio section. Two type 6146 tubes are used as the first audio amplifier,

50,000 Watt Medium Wave Broadcast Transmitter—BC-50C

followed by two type 813 second amplifiers. The driver stage consists of two type 304-TH triodes connected as a linear cathode-follower amplifier. Two type WL-5891 triodes operating in class "B" are used as modulators, and are directly interchangeable with the tubes used as R.F. power amplifiers. Very low distortion is the result of the combined cathode-follower and unique feedback arrangement in an all push-pull system.

ECONOMY OF OPERATION: Approximately twice the required minimum air flow is provided in the BC-50C to assure long life for tubes and components. As heat is a major factor in determining tube life, approximately 8700 CFM of cooling air flows through this transmitter to provide longer useful life. The effect is lower operating cost, and assurance of dependable and uninterrupted on-air service.

High over-all efficiency is achieved in the plate modulated BC-50C transmitter. Consequently, power consumption is at a minimum. With unmodulated carrier only, the power consumption is 91 KW. Power consumption is only 105 KW under average programming conditions. The maximum power consumption is a conservative 144 KW under 100% sine wave modulation. The high over-all efficiency of the BC-50C transmitter is equal to or better than any existing 50 KW equipment, yet retains the full advantages of high level modulation.

As the modulator tubes are interchangeable with the power amplifier tubes, the user of the BC-50C broadcast transmitter enjoys the savings resulting from a reduction in the number of spare tubes required. Tubes which have delivered maximum service in the power amplifier section often can be utilized in the modulator for many additional operating hours and the resulting economy. The Gates BC-50C transmitter is the lowest tube cost transmitter available today. This is based on tube cost divided into much longer tube hour life.

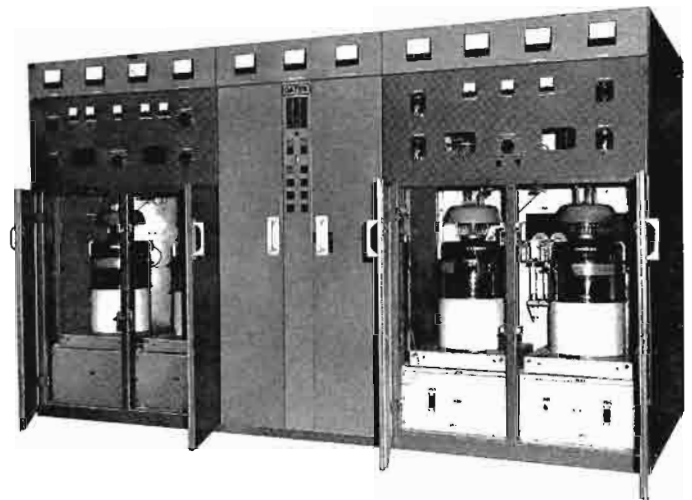

Three main transmitter cubicles house (from left to right) the modulator, RF driver, and power amplifier.

REMOTE CONTROL: There are many variables to an in-the-field remote control installation. Gates' anticipation of these problems is reflected in the over-all construction of the BC-50C transmitter to make it an easy transmitter to adapt for remote control. An elaborate system of automatic controls, whereby the transmitter "thinks" its sequencing of ON-OFF functions, adds to worry-free remote control or localized operation.

All normal tuning adjustments are located on the front panel of the transmitter. The control circuitry is arranged to simplify remote control, and facilitate ease of operation. For remote control operation, extensive transmitter modifications are not required. In many areas of the world the BC-50C is operated completely unattended, even when feeding a directional antenna system. High-level modulation and the resultant simplicity and common knowledge of the system itself offer a major advantage of reduced maintenance, and less demand on the operator.

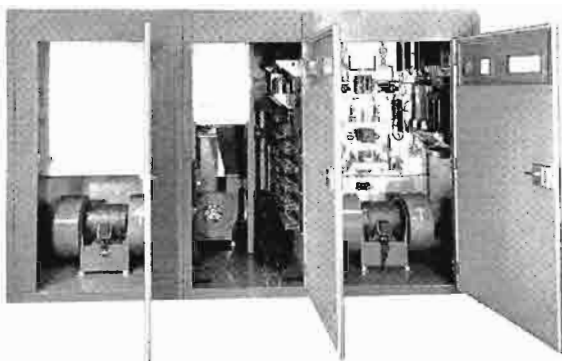

Above—Rear view of internal blower model showing walk-in construction and open accessibility.

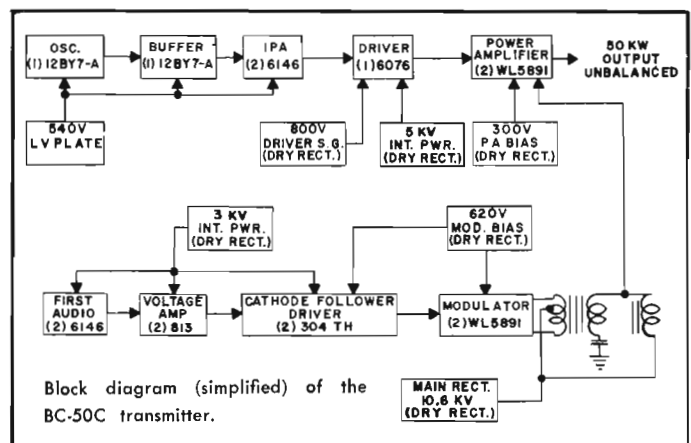

COOLING SYSTEM: Gates BC-50C transmitter is available with internal air blowers, or with a single external centrifugal type blower, as ordered. For internal cooling, the power amplifier cubicle and the modulator cubicle are each supplied with dual turbine blowers. A generous complement of air filters is provided as standard equipment to filter the air before entering the transmitter.

HEAVY DUTY COMPONENTS: Major external heavy components are of the oil-filled type. Weatherproofed, they may be located outside, if desired. Oil-filled components are recognized as the ultimate in design for dependability, and the initial investment is returned many times in replacement savings. These components teamed with silicon rectifiers throughout, and all having a very great design reserve, complete the "brute force" power section of the transmitter. To date, no Gates 50 KW transmitter has ever "lost" a major oil-filled heavy component in service.

SILICON RECTIFIERS: 456 silicon diodes are used in the high voltage power supplies of the BC-50C transmitter. Each diode is rated at 25 amperes and 500 volt peak, giving a 500% current and 100% voltage safety factor in the silicon rectifier system. The design objective has been to provide a power supply absolutely reliable under any condition.

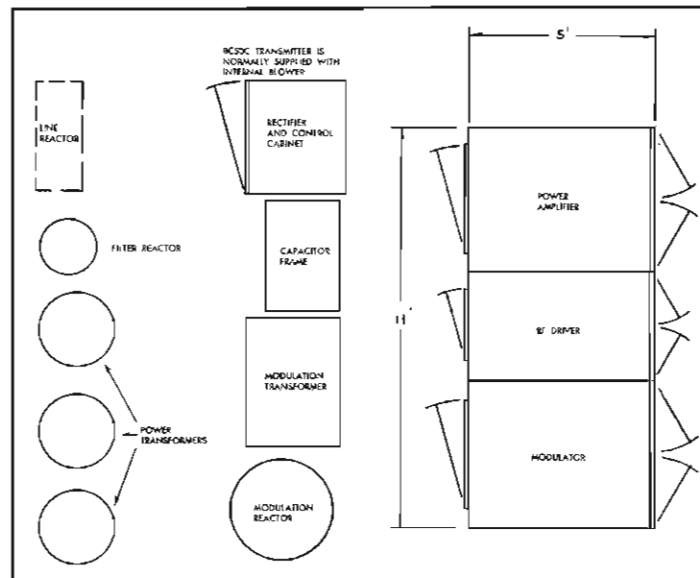

Typical floor plan Gates model BC-50C.

SPECIFICATIONS

- POWER OUTPUT:**
Rated 50 KW, capable 60 KW.
- FREQUENCY RANGE:**
535 Kc. to 1620 Kc. as ordered.
- RF OUTPUT IMPEDANCE:**
Any impedance between 50 and 250 ohms, as ordered.
- FREQUENCY STABILITY:**
± 5 cycles.
- CARRIER SHIFT:**
3% or less at 100% modulation.
- MODULATION:**
High-level plate.
- AUDIO RESPONSE:**
± 1.5 db., 30-10,000 cycles.
- AUDIO DISTORTION:**
3% or less 50-7500 cycles at 95% modulation.
- NOISE:**
60 db. below 100% modulation.
- AUDIO INPUT IMPEDANCE:**
150/600 ohms.
- AUDIO INPUT LEVEL:**
Approx. 10 dbm. for 100% modulation.
- RF HARMONICS:**
Meets CCIR and FCC Specifications.
- MONITORS:**
Will accommodate all current frequency and modulation monitors.
- POWER INPUT:**
480 volts, 60 cycle, 3 phase. Other voltages and frequencies available on special order.
- POWER CONSUMPTION:**
91 KW at zero modulation.
105 KW at average program modulation.
144 KW at 100% sine wave modulation, 1000 cps.

- TEMPERATURE:**
- 20°C to + 50°C.
- ALTITUDE:**
To 6000 ft. (Available for higher altitudes, on special order.)
- POWER FACTOR:**
90% or better.
- SIZE:**
Transmitter proper: 11 ft. wide, 5 ft. deep and 6½ ft. tall. External components can be accommodated in a space of 6 ft. by 14 ft.
- WEIGHT AND CUBAGE:**
Domestic packed: 21,000 lbs. 1300 cu. ft.
Export packed: 25,000 lbs. 1410 cu. ft.
- FINISH:**
Gates two-tone hand rubbed gray lacquer with trim in brushed aluminum and black.
- TUBES:**
RF Section
(2) type 12BY7, (2) type 6146, (1) type 6076, (2) type WL-5891.
Audio section
(2) type 6146, (2) type 813, (2) type 304TH, (2) type WL-5891.
- COMBINED REGULATION AND VARIATION:**
± 5%

ORDERING INFORMATION

- Model BC-50C broadcast transmitter with tubes, two vacuum mounted crystals (state frequency and RF output impedance when ordering) (Cat. No.) M-5913
- Spare 100% tube kit for BC-50C transmitter TK-367
- Recommended minimum spare tube kit for BC-50C TK-368



20,000 WATT AM BROADCAST TRANSMITTER

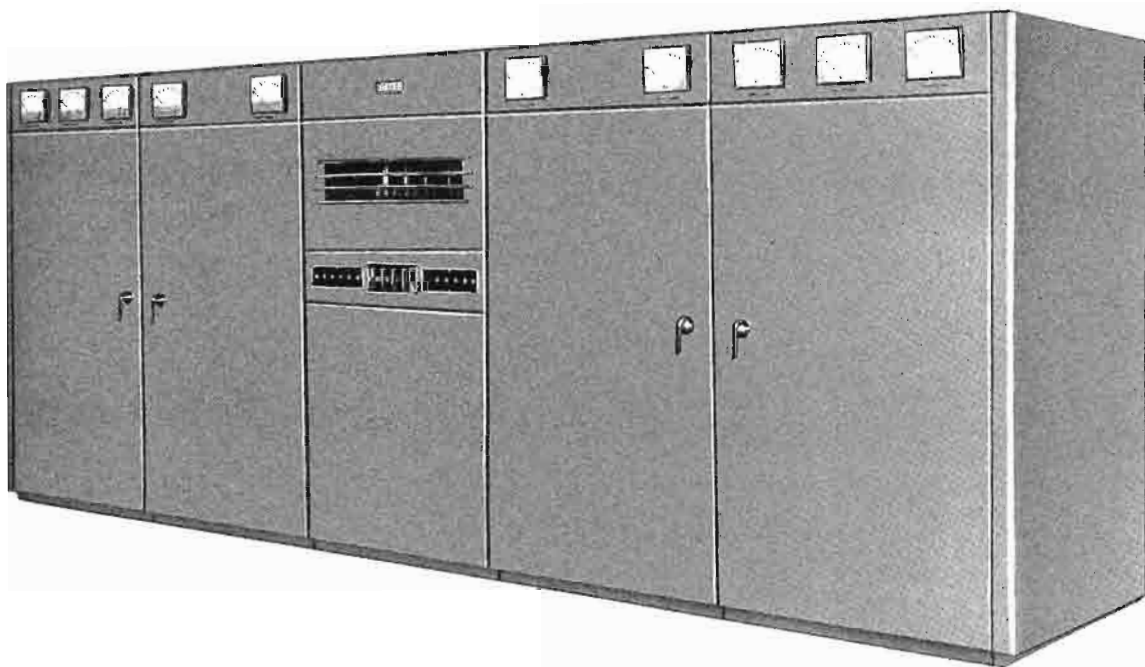

MODEL BC-20B

For AM broadcasting in the 540-1600 Kc. band, the Gates BC-20B transmitter will operate in all climates on 24-hour a day schedules with superb transmission quality and a reliability factor that is intentionally ultra conservative knowing that installation will often be in areas where repair parts are not quickly available.

Five R. F. stages include four long life 3X2500F3 tubes in the push-pull power amplifier. Operating at only 5000 plate volts, the reliability factor is again emphasized. Three push-pull audio stages precede the four push-pull 3X3000F1 triodes to provide high level Class B modulation to the R. F. power amplifiers. Inverse feedback and low leakage modula-

tion transformer design produces sparkling audio quality. Five power supplies include separate high voltage supplies for the radio and audio frequency power tubes. The reliability factor is again accentuated. All external power and modulation transformers are oil filled. There are no multi-meters. A full complement of 30 meters read individual circuits.

Housed in five cubicles with full size front and back doors, dead front design, walk-in service from the rear, complete relay protection and recycling, each cubicle bolts together to form an impressive transmitter that radiates quality and the willingness to go to work as broadcasting's finest.

SPECIFICATIONS

POWER OUTPUT:
20,000 watts.

FREQUENCY RANGE:
540-1600 kcs. (as ordered)

RF OUTPUT IMPEDANCE:
50-300 ohms. (as ordered)

FREQUENCY STABILITY:
± 10 C.P.S.

CARRIER SHIFT:
5% or less.

MODULATION:
High level.

AUDIO RESPONSE:
± 1½ db., 50-10,000 cps.

AUDIO DISTORTION:
3% or less, 50-7500 cycles at 95% modulation.

NOISE:
55 db. below 100% modulation.

AUDIO INPUT IMPEDANCE:
500/600 ohms.

AUDIO INPUT LEVEL:
+ 8 dbm. ± 2 db.

MONITORS:
Will accommodate all modern fre-

quency and modulation monitors.

POWER INPUT:
230 volts, 3 phase, 50 or 60 cps.
Other voltages and frequencies on special order.

POWER CONSUMPTION:
37.6 kw. at 0 modulation, 42.5 kw. at average modulation, 57.5 kw. at 100% modulation.

TEMPERATURE:
0° to 45° C.

ALTITUDE:
Up to 6000 ft.

POWER FACTOR:
90%.

SIZE:
(transmitter cabinets) 78" high, 205" long and 49" deep.

WEIGHT:
14,700 lbs. net; 18,000 lbs. export packed.

CUBAGE:
1100

FINISH:
Medium gray with trimmings in

chrome, brushed aluminum and anodized black.

TUBES:
(Radio Frequency) 6V6 osc., 807 IPA, 6146 IPA, (2) 4-250A IPA, (4) 3X2500F3 power amplifier. (Audio) (2) 6J7 1st audio, (2) 807 2nd audio, (2) 845 3rd audio, (4) 3X3000F1 modulators. (Power Supplies) (12) 673 H.V. rectifiers, (6) 8008 L.V. rectifiers.

ORDERING INFORMATION

BC-20B Broadcast Transmitter, 20,000 watts, with tubes, one crystal and oven (Cat. No.) M-4779
100% spare tube complement for above TK-229
Spare crystal and oven JK-57M
Note: Be sure and state frequency and preferred R.F. output impedance when ordering.

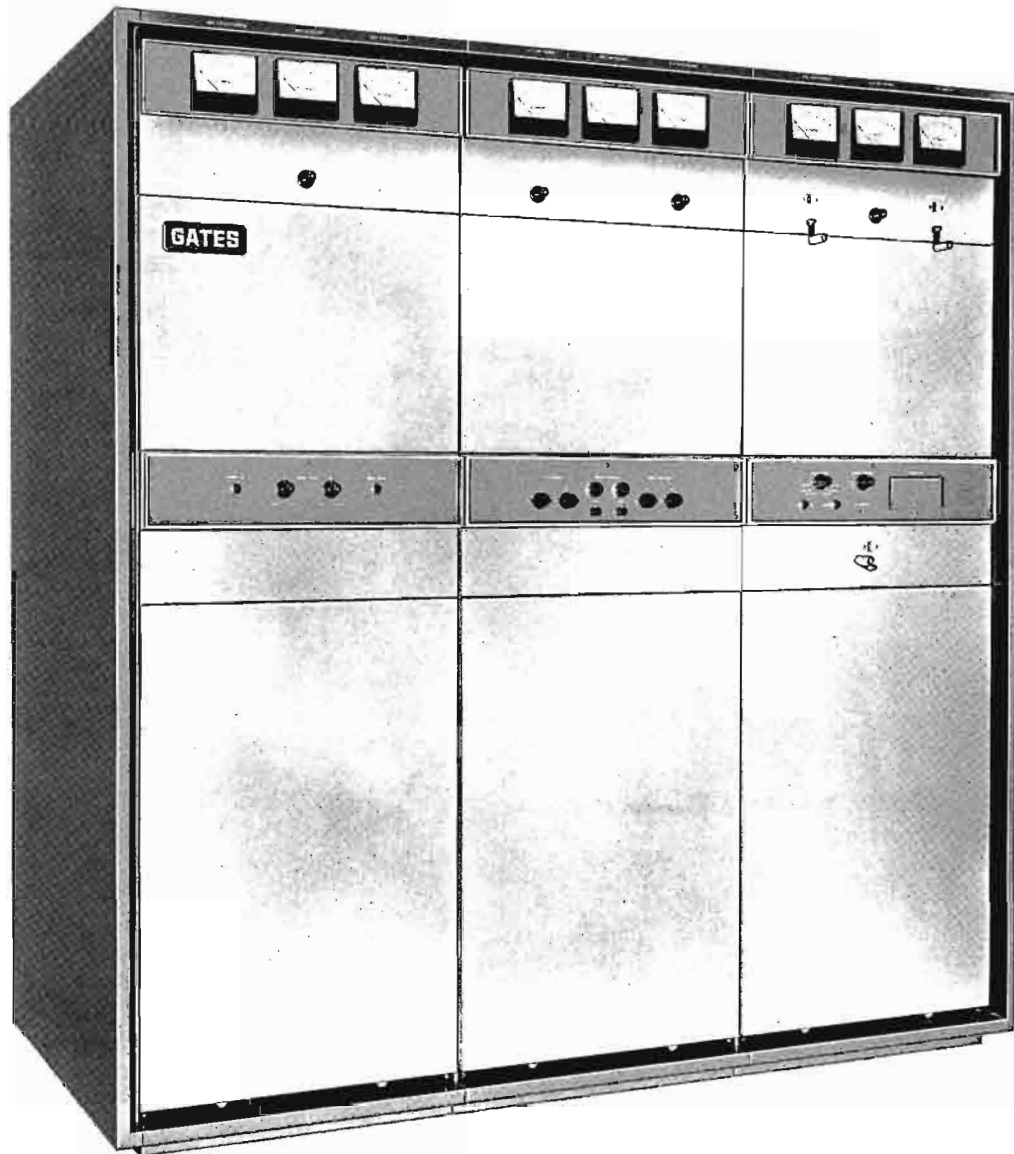

MODEL BC-10P

Three major initial design objectives for the Gates BC-10P, 10,000 watt transmitter were (a) superb on-air quality, (b) high reliability and (c) operating economy. These objectives were achieved, and since proven, in several score of radio broadcasting stations all over the world.

ON-AIR QUALITY: is best defined as unusually good audio transmission. High grid drive, cathode follower audio drive, low leakage reactance modulation transformer design, inverse feedback and high level modulation all combine to produce a truly superb on-air signal.

HIGH RELIABILITY: is expected of all reputable equipment. Gates engineers went another step to assure dependability and researched reasons for little troubles such as sluggish relays, aging flashovers (where collection of grime eventually presents problems); hot air pockets that deteri-

orate components faster; and the lasting quality of wire insulation—to name a few.

OPERATING ECONOMY: is much more than the lowest public utility power bill. Certainly reliability is part of economy. Long tube life combined with a low new tube cost, the ability to rotate power and modulator tubes to add more hours, and the lower power bill that has to do with high efficiency and the transmitter being easy to modulate (requiring less modulator power) are all reasons why the BC-10P transmitter is noted for its economy of operation.

Beautifully styled with the shadow mold concept, the "Gates Ten" is totally self-contained with no external transformers of any kind and requires only 74" x 40" of floor space. Three cubicles quickly bolt together. Interconnections are by associated terminal boards and jumpers. No cabling at installation is required. Each cubicle is individually cooled. As

10,000 Watt AM Transmitter—BC-10P

a result, warm air from one cubicle is forced out the top of the same cubicle and not spilled into an adjoining cubicle. This is a Gates exclusive of major significance for reliability.

HIGH FIDELITY: Frequency response of the Gates BC-10P extends well beyond the normal limits for broadcast transmitters. Typical response is within 1 db. from 30-14,000 cycles at 90% modulation. This kind of response along with very low residual noise and low distortion results in a signal that is outstanding for its richness of sound.

HARMONIC RADIATION: To meet the rigid FCC regulations for low harmonic radiation, the entire radio frequency section is contained within a heavy aluminum enclosure or, a cabinet within a cabinet. Snap-on panels assure instant accessibility. In addition, a full Tee network output is assurance that the BC-10P can exceed harmonic reduction regulations within the transmitter itself without relying on the normally expected harmonic attenuation in a phasor or coupler, which then becomes an additional bonus in harmonic elimination.

INTERCHANGEABLE TUBES: R. F. Power Amplifier and modulator tubes are the same type 3X2500F3 triode, and are directly interchangeable. This Gates feature reduces the number of spares required, permits tube rotation and adds many hours to useful tube life. The result is lower tube cost and greater economy in operation.

EFFICIENT COOLING: With individual heavy duty blowers in the power amplifier and RF cubicle and air exhaust system in the power supply cubicle, the Gates BC-10P is the coolest operating 10 kilowatt broadcast transmitter ever produced. Each cubicle is complete in itself with individual cooling and filtering facilities. Blowers are shock mounted and air filters may be removed and cleaned while the transmitter is on the air.

R. F. SECTION: Starting from a vacuum mounted ovenless crystal, the RF signal is amplified by two type 12BY7 tubes, one type 6146, one type 4-400A RF driver and finally the two parallel 3X2500F3 power amplifiers. All tubes are operated considerably below their maximum ratings. For instance, maximum input for the 3X2500F3 triodes as plate modulated RF amplifiers is 22 KW. In the BC-10P transmitter typical PA input power is approximately 13 KW. Complicated multi-tower phasors are easily handled by the available 10,600 watts of output power. Power amplifier tuning is via variable coils. No variable air condensers are used. Vacuum tank padding capacitors are used exclusively.

AUDIO SECTION: Four push-pull audio amplifier stages amplify the audio signal from slightly over 1 milliwatt to full modulator power. A type 6SN7 dual triode first audio

amplifier is followed by two type 6BG6 tubes. Four type 6528 tubes operate as cathode follower audio drivers for the two Class "B" type 3X2500F3 modulators which are capable of 11 KW. audio output. Inverse feedback and a new design very low leakage reactance modulation transformer/reactor group results in signal quality often spoken of as both rich and crisp.

SOLID STATE POWER SUPPLIES: Though available in a tube rectifier model, Gates recommends the model BC-10PS transmitter which has silicon rectifiers in all power supplies. As silicon rectifiers are free from temperature sensitivity, this feature eliminates cold weather mercury tube arc-back problems. Particularly for remote control unattended operation, the silicon rectifier power supply can save lost air time as well as infrequent component failures in case of a severe mercury arc-back.

CONTROL CIRCUITRY: Careful attention has been given to the design of the control circuitry. No major mechanical modifications or outboard devices are necessary to adapt the transmitter to remote control. Complete AC and DC overload protection is standard equipment. A unique recycling feature, which will automatically turn the transmitter on or off when an overload occurs, is inbuilt.

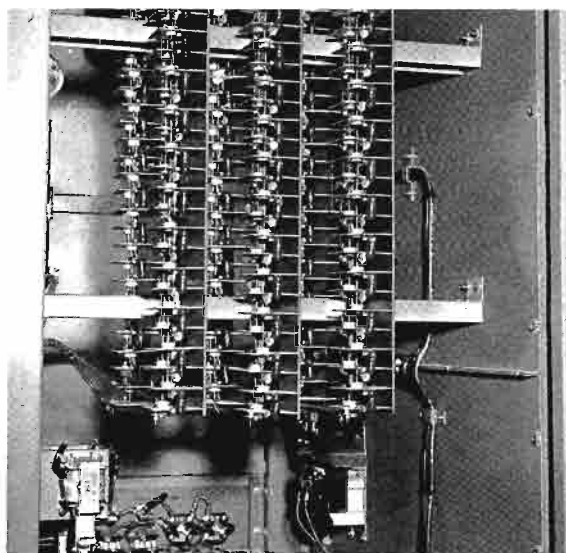

One hundred and Fifty Silicon Cells each Rated at 400 P.F.V. at 18 Amperes Provide a 3 to 1 Voltage and 10 to 1 Current Safety Factor.

10,000 Watt AM Transmitter—BC-10P

SPECIFICATIONS

POWER OUTPUT:
Rated 10,000 watts. Capable of 10,600 watts.

FREQUENCY RANGE:
535 Kc. to 1620 Kc. (as ordered).

RF OUTPUT IMPEDANCE:
40-250 ohms (as ordered).

FREQUENCY STABILITY:
± 5 cycles.

CARRIER SHIFT:
3% or less at 100% modulation.

AUDIO RESPONSE:
± 1.5 db. 30-12,000 cycles. Typical is ± 1.0 db. 30-14,000 cycles.

AUDIO DISTORTION:
3% or less 50-7500 cycles at 95% modulation.

NOISE:
60 db. or better below 100% modulation.

AUDIO INPUT IMPEDANCE:
150/600 ohms.

AUDIO INPUT LEVEL:
Approximately 0 db. for 100% modulation.

MONITORS:
Will accommodate any modern frequency or modulation monitor.

A.C. INPUT:
230 volts AC, 3 phase, 50 or 60 cycles (as ordered). Other voltages available on special order. Power consumption 19.2 KW at 0 modulation, 21.7 KW at average program modulation, 28.8 KW at 100% modulation.

SIZE:
78" high, 73½" wide and 93½" deep.

WEIGHT:
Domestic packed—3615 lbs. Export packed—4465 lbs. Cubage: 300.

FINISH:
Two-tone Gates gray, brushed aluminum trim and black.

TEMPERATURE:
- 20° to + 50°C. (silicon)
+ 5° to + 50° C. (mercury rectifier)

TUBES:
(Model BC-10PS) (2) 12BY7 as oscillator and first RF amplifier, (1) 6146 as RF IPA, (1) 4-400A as RF driver, (2) 3X2500F3 as power amplifier, (1) 6SN7 first audio, (2) 6BG6 second audio, (4) 6528 audio drivers, (2) 3X2500F3 as modulators (see Note 1).

ORDERING INFORMATION

Model BC-10PS, complete with one set of tubes and one crystal, solid state rectifier model (Cat. No.) M-6079

100% set of spare tubes for BC-10PS TK-381

Recommended minimum set of spare tubes for BC-10PS TK-382

Model BC-10P, complete with one set of tubes and one crystal (mercury rectifier tube model) M-6064

100% set of spare tubes for BC-10P TK-314

Recommended minimum spare tubes for BC-10P TK-315

Spare vacuum crystal for either model A-35177-1

NOTES: (1) Model BC-10P tube rectifier model has added: six type 673, two 6W4 and three 5U4 tubes. (2) Be sure and specify carrier frequency and line impedance when ordering.

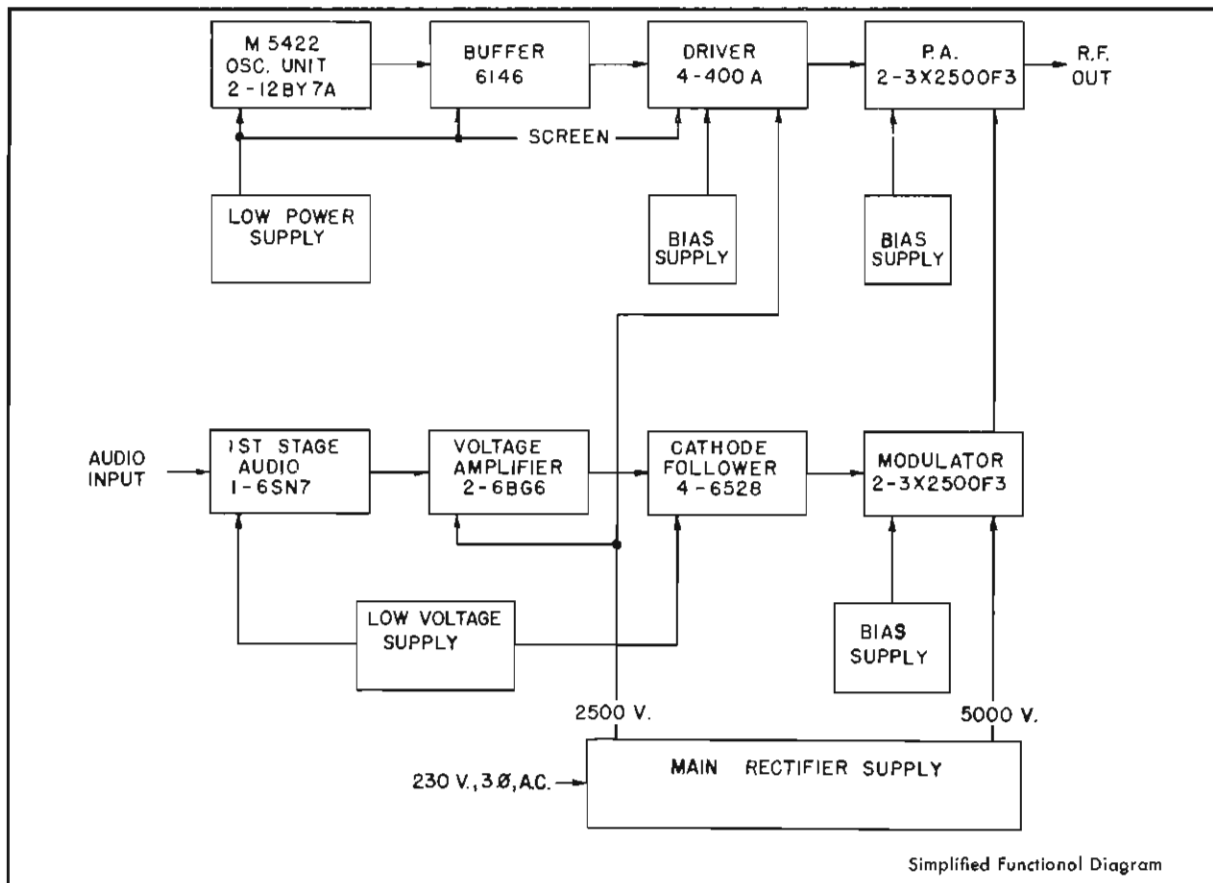

Simplified Functional Diagram



MODEL BC-5P-2

Without question, the "Gates Five" is the most used and most accepted 5000 watt broadcast transmitter in the world today. Over 325 transmitters in the BC-5P series are broadcasting in nearly every language with, of course, a generous number in the United States. The universal acceptance of this equipment evolved naturally because of superb BC-5P transmitter performance and reliability and the word of mouth endorsement from one broadcaster to another.

Completely self-contained, with no external transformers, a floor space requirement of only 74" wide and 40" deep usually permits a power increase installation without building modification. For remote control unattended operation the transmitter building cost is greatly reduced. Swinging front and rear doors have been omitted in favor of quick latch-on doors to further conserve space. Commercial beauty through shadow mold styling makes BC-5P-2 a show piece to advertisers. The fine reputation of the BC-5P-2 transmitter is justified. Large edgewise silver plated tank and Tee network coils, a new low leakage reactance modulation transformer for a new high in sound quality, designed for easy attachment of remote control, a triple cooling system, high efficiency, low tube cost and research attention to the little things that can cause big problems are some of the reasons why so many broadcasters have selected the "Gates Five."

TRANSMISSION FIDELITY: The quick response to dynamic range action demands a transmitter which modulates easily. Intermodulation distortion is felt to be even more important than harmonic distortion. Wide frequency response is necessary. Low carrier shift has much to do with the fine sound. All of these functions have been carefully engineered to develop what many agree is a better signal at the listener's receiver.

HARMONIC ATTENUATION: Rigid FCC regulations for harmonic reduction are carefully adhered to by constructing the R.F. power section in a separate aluminum enclosure or a cabinet within a cabinet. By use of a complete Tee network in the output circuit, harmonic reduction regulations are met within the transmitter itself. The phasor or antenna coupler is not relied on as a harmonic filter and of course, becomes a bonus for still greater harmonic reduction to generously exceed regulations.

COOLING: Each of the three transmitter cubicles is a separate entity and each are separately cooled. There is no spill over of warm air from one cubicle to another. The R.F. and modulator cubicles have 220 CFM blowers with ¼ horsepower motors. The center power supply cubicle utilizes a cabinet top exhaust fan. Cool transmitters are trouble-free transmitters with long tube life.

RADIO FREQUENCY SECTION: Vacuum sealed ovenless crystals hold an easy ± 5 cycle tolerance. Five R.F. stages include oscillator, isolation stability amplifier, 6146 IPA, a 4-250A driver to deliver an abundance of grid drive to the single ended 3X2500F3 power amplifier. This tube operates at 5000 volts, 1.28 amperes, as compared to the tube manufacturer's maximum rating of 5500 volts at 2 amperes. Heavy edgewound silver plated coils are used in the power amplifier tank and output network. Variable coils are used for tuning and vacuum capacitors are employed in the tank circuit. No variable air condensers are used.

TUBE INTERCHANGE: Both the R.F. power amplifier and modulators use 3X2500F3 long life tubes. By periodic rotation, many added tube life hours are possible, resulting in less on-the-shelf spare tubes.

AUDIO SECTION: The audio design is unique and an engineering natural. The low impedance of the 3X2500F3 tubes as modulators effects a near one to one impedance ratio between modulators and the Class C radio frequency amplifier, considered a perfect situation for high modulator efficiency and the resultant low intermodulation distortion. About 3400 watts of audio power is required for 100% modulation. The manufacturer's tube rating for two 3X2500F3 tubes as Class B modulators is 11,000 watts output. This conservatism need not be amplified as related to performance and long tube life. The famous Gates ultra linear audio driver, over-all feedback and the application of metallurgical research in transformer design for improved frequency range all contribute to a superb audio system.

POWER SUPPLIES: Five separate power supplies assure fine regulation and add greatly to reliability. The transmitter is available in two models: (a) with tube rectifiers, or (b) with solid state rectifiers.

SOLID STATE RECTIFIERS: Lifetime silicon solid state power supplies, in the BC-5P-2 transmitter, provide a 3 to 1 voltage and 10 to 1 current safety factor. In the solid state version, the main HV rectifier has six banks of silicon cells in a full wave configuration. Each bank consists of 25 individual cells each rated at 18 amperes and 400 peak inverse volts. Voltage equalizing resistors and capacitors are connected across each cell. The very high margin of safety assures trouble-free performance.

REMOTE CONTROL: The exclusive use of relays in the control circuits makes installation of remote control simple. By providing factory installed terminals, circuits to be remote controlled are easily connected. Outboard devices and additional relays are not needed for remote control.

PROTECTIVE CIRCUITS: Relays are provided for overload, start/stop and interlock circuits, plus pressure protective type switches. Circuit breakers are not employed as major protection devices.

RECYCLING: A unique time-constant circuit automatically determines the severity of the overload and reacts accordingly. In the event of direct short in the high voltage

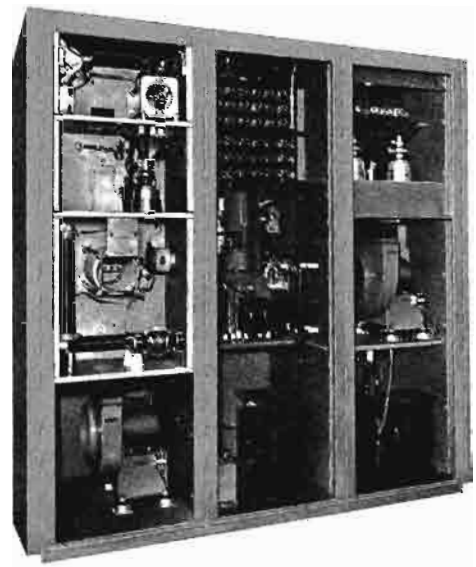

Back view of BC-5P-2 Transmitter.

supply, the transmitter will recycle once and then shut down. In the event of flashover, due to an electrical storm, the transmitter will momentarily shut down and then return to the air with no mechanical limit on the number of times recycling may occur.

TRANSFORMERS: Transformers are all made for 50 cycle service, a 20% bonus safety for 60 cycle users.

WIRING: Every wire is permanently and individually numbered each inch of its length. This Gates exclusive is a tremendous aid in maintenance and routine circuit tracing.

PRE-TESTING: The BC-5P-2, 5000 watt transmitter is completely pretested at the factory on the buyer's operating frequency and only minimum adjustments are necessary at time of final installation.

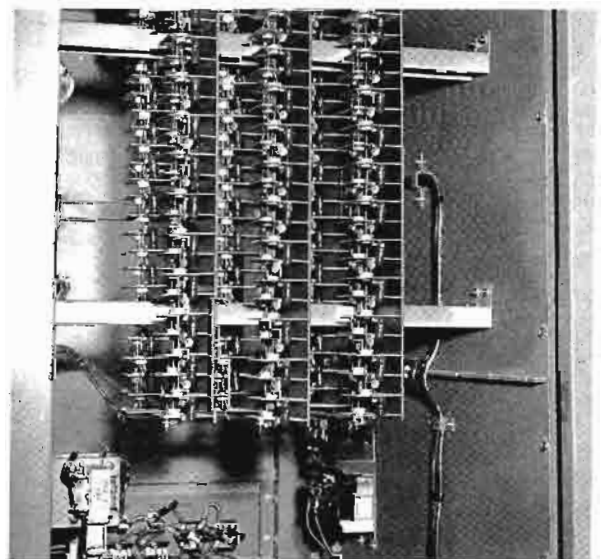

Close up silicon rectifiers.

SPECIFICATIONS

POWER OUTPUT:
 Rated 5000 watts, capable of 5600 watts.

FREQUENCY RANGE:
 535 Kc. to 2000 Kc. (as ordered).

RF OUTPUT IMPEDANCE:
 40-370 ohms unbalanced (as ordered).

FREQUENCY STABILITY:
 ± 5 cycles.

CARRIER SHIFT:
 3% or less at 100% modulation, assuming constant primary voltage.

AUDIO RESPONSE:
 ± 1.5 db. 30-12,000 cycles. Typical to 14,000 cycles.

AUDIO DISTORTION:
 2.5% or less from 50 to 10,000 cycles at 90% modulation.

NOISE:
 60 db. below 100% modulation at 5000 watts.
 55 db. below 100% modulation at 1000 watts (see Note 1).

AUDIO INPUT IMPEDANCE:
 150/600 ohms.

AUDIO INPUT LEVEL:
 - 5 db. for 100% modulation, ± 2 db.

MONITORS:
 Will accommodate all modern frequency and modulation monitors.

A.C. INPUT:
 240 volts AC, 3 phase, 50 or 60 cycle. 208 volts is available on special order. Power Consumption: (with tube rectifiers)
 11.7 KW at zero modulation, 12.9 KW at average program modulation, 16.6 KW at 100% tone modulation. (Silicon model is less).

R.F. HARMONICS:
 Meets or exceeds FCC specifications.

SIZE:
 78" high, 73½" wide, 39½" deep. No external components.

WEIGHT & CUBAGE:
 Domestic packed, 3350 lbs. Export packed, 3850 lbs. Cubage: 265.

FINISH:
 Two-tone Gates gray, brushed aluminum trim and black.

TUBES:
 (2) 12BY7, (1) 6146, (1) 4-250A, (3) 3X2500F3, (4) 6CA7, (2) 6SN7 (see Note 2).

MAXIMUM ELEVATION:
 6000 feet (see Note 3).

TEMPERATURE:
 - 20° C. to + 50° C. (silicon)
 + 5° C. to + 50° C. (mercury rectifier)

ORDERING INFORMATION

Model BC-5P-2S, complete with tubes and one crystal (silicon rectifiers) (Cat. No.) M-6062
 100% set of operating tubes for Model M-6062 TK-363
 Recommended minimum set of spare tubes for Model M-6062 TK-364
 Model BC-5P-2, complete with tubes and one crystal (tube rectifiers) M-6061
 100% set of operating tubes for Model M-6061 TK-321
 Recommended minimum set of spare tubes for Model M-6061 TK-322
 Spare vacuum type crystal for either model A-35177-1

NOTES: (1) Power reduction to about 1250 watts incorporated for use with 1000 watt LS. (2) Model BC-5P-2 tube rectifier model, add two 6W4, three 5U4, six 8008 tubes. (3) A model for higher altitudes is quickly available. (4) Be sure and state frequency and R.F. line impedance when ordering.

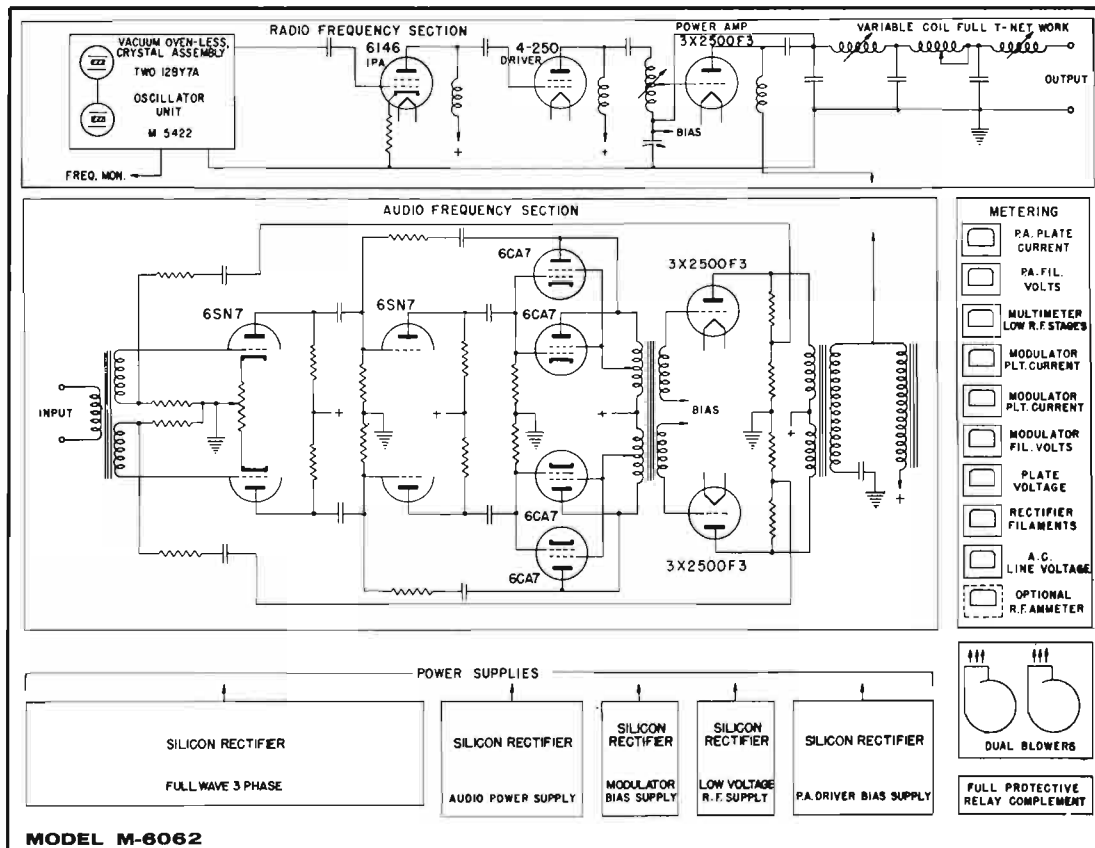

Block Diagram BC-5P-2.

MODEL BC-1G

More 1000 watt radio broadcasting stations are served by Gates transmitters than any other make. The Gates BC-1G 1000/250 watt AM transmitter, often called the Big G, adds new facility and performance features to illustrious earlier Gates models.

Solid state power supplies replace mercury tubes*. The cold weather and often damaging mercury flash back is history. Total front of transmitter serviceability is welcome. No longer must the operator walk around back to see what's going on inside or to make a quick tube change. Inbuilt dummy antenna is standard equipment. Transmitter performance measurements can be made without waiting for the experimental period or you use the dummy antenna as a check point if a bigger problem develops. There is no quicker way than the use of a dummy antenna to determine if the problem is inside or outside the transmitter building. For remote control unattended operation, everything is terminated. No tool kit and soldering iron are required to attach remote control equipment to the BC-1G broadcast transmitter. Cathode follower audio drive, modulation of both the R.F. driver stage and the power amplifier stage, a new low leakage modulation transformer design combined with inverse feedback to a 3-stage, all push-pull audio system, creates a quality of transmission that is noticeably improved even on the least expensive radio receiver. The reason? Intermodulation distortion, not to be confused with harmonic distortion, is greatly reduced.

GENERAL DESIGN: Shadow mold styling accents the sturdy steel cabinet finished in medium gloss gray and shadow molded in black. With the front door closed, only the four major indicating meters and start-stop push switches are in view. Swing open this door to quickly reach all tuning and adjustment controls. Behind the interlocked and quickly removable perforated grill is the transmitter itself. Certainly a marked forward step in operator convenience for servicing. So accessible is BC-1G from the front that you may place the back against the wall.

Four big meters read every necessary current and voltage including separate modulator tube currents for balancing. The R.F. line current meter is viewed when opening the front door, if touch-up tuning is necessary. Because of the roomy vertical design, convection cooling would be adequate, but a quiet cabinet ceiling exhaust fan is added and assures still cooler operation for extra tube life and added reliability. Air intake is filtered with twin disposable spun-glass filters.

CONSTRUCTION: The picture inside is one of large conservative design. Big Gates-built silver plated edgewound tank and output coils replace the often found wirewound coils. The transformers invite 24 hour a day schedules. Manufacturing for 50 and 60 cycles creates an inbuilt 20%

*A mercury rectifier model is available.

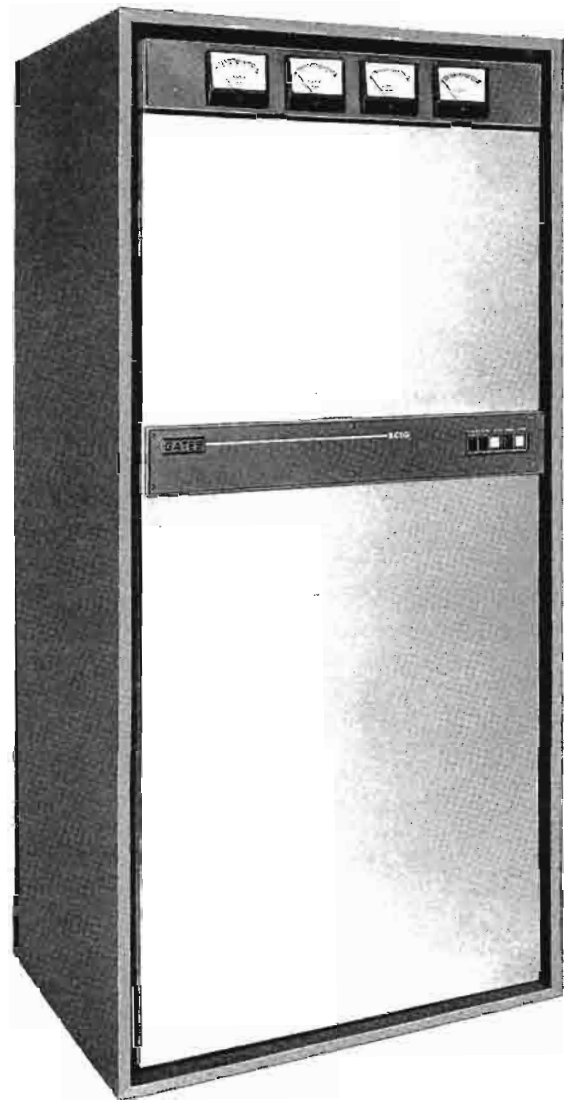

bonus safety factor for the 60 cycle user. The swing-out chassis to house lower power sections of the transmitter reminds us again that Gates engineers are also broadcasting station engineers. Yes, you can reach the transmitter from the rear by slipping off the full length rear door, even though total accessibility is from the front.

RADIO AND AUDIO FREQUENCY: Four R.F. stages and three audio stages combine together for stable high efficiency performance. All R.F. stages are self-neutralized except the power amplifier stage. Modern vacuum type crystals replace temperature controlled ovens. Dual 833A power amplifiers, known for longest tube life, operate into a Pi-Tee network. The "Big G" does not rely on the antenna

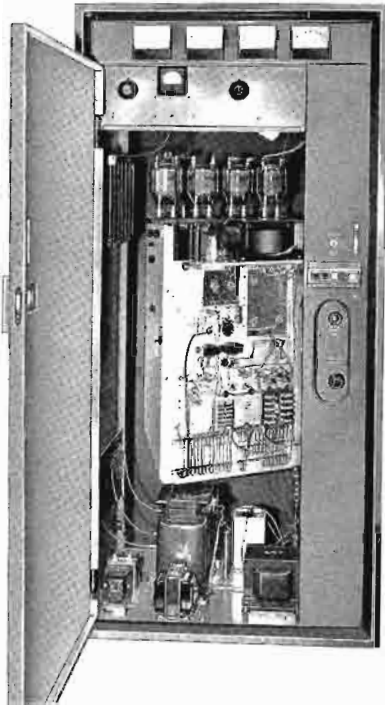

Completely self-contained, the BC-1G transmitter stands 78" high, 37" wide and 29" deep.

coupler to meet FCC harmonic reduction regulations. The complete output network assures meeting them within itself. The added harmonic reduction often developed in the antenna coupler then provides a system that far exceeds FCC regulations. Tuning in the power stage is exclusively by variable coils. No variable air condensers, vulnerable to flash-over, are used. The R.F. driver stage and the Class "C" power amplifier are both modulated. Grid drive is automatically increased with modulation. Antenna current virtually jumps with modulation, a big reason for "Big G" better transmission quality. Three all push-pull audio stages include 833A modulator tubes directly interchangeable with the R.F. power tubes. Periodic rotation will add hundreds of tube hour life. Over-all inverse feedback and a new low leakage modulation transformer complete an audio system with typical low distortion readings of 1½% at such difficult frequencies as 50 and 7000 cycles.

POWER REDUCTION: Important to Class IV broadcasters operating at 250 watts night-time is that power reduction is in the primary of the main power transformer. Plate voltage is reduced on both R.F. power and modulator tubes. No power consuming voltage dropping resistors are used. Power reduction may be either local or by remote control.

REMOTE CONTROL: Gates feels that reliable unattended operation is best accomplished with a full relay complement in the transmitter. Circuit breakers are omitted as they usually require either so-called outboard attachments or the addition of relays where remote control is added. Remote control equipment such as the Gates RDC-10 listed on Page 61 may be easily added. The M-6326 output power remote control kit may be attached in minutes with space and termination provided.

DUMMY ANTENNA: The inbuilt dummy antenna feature was first introduced by Gates and is demanded today as an integral part of the modern 1 KW broadcasting equipment. The dummy antenna may be 100% modulated. Complete transmitter performance tests may be conducted without waiting for after 1:00 A.M. testing hours. If system trouble comes, the engineer must know if the problem is in the equipment or in the more vulnerable transmission line, antenna coupler and antenna. As a valuable "process of elimination" item in trouble shooting, the inbuilt dummy antenna is indispensable.

SOLID STATE POWER SUPPLIES: Though available with tube rectifiers, Gates strongly recommends the BC-1G transmitter with solid state rectifiers. The advantages are lower replacement tube cost, not subject to arc-back such as sometimes happens with mercury rectifiers in unheated buildings, and lower power consumption as silicon rectifiers do not require filament transformers as do rectifier tubes. There are three power supplies in the "Big G," (1) main H.V. supply, (2) intermediate supply, and (3) bias supply.

BC-1G BEAUTY: Commercial attractiveness has been built into the "Big G." Gates believes that advertisers must react favorably when equipment is on display (open house for example) and that employees are the best employees when pride of ownership exists. The "Big G" reflects modern electronic packaging, both inside and out.

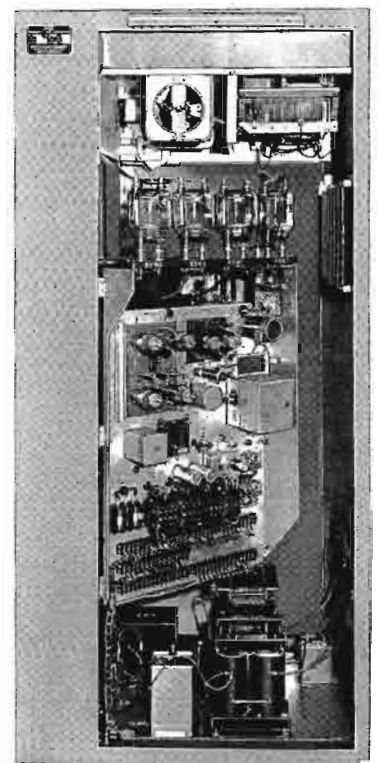

Swing-out construction provides a new dimension in total transmitter accessibility.

1000/250 Watt AM Broadcast Transmitter—BC-1G

SPECIFICATIONS

POWER OUTPUT:
1000/250 watts. Capable output to accommodate phasor loss, etc., 1100 watts. Also available in a 1000/500 watt model.

R.F. FREQUENCY RANGE:
540-2000 Kc. (as ordered).

R.F. OUTPUT IMPEDANCE:
50/70 ohms (entrance either top or bottom). Other output impedances available on special order.

R.F. FREQUENCY STABILITY:
± 5 cycles or better.

CARRIER SHIFT:
3% or less with adequate power mains. Typical is 2%.

AUDIO RESPONSE:
± 1½ db. 30-12,000 cycles 95 % modulation. Under practical programming conditions ± 1½ db. 30-16,000 cycles.

AUDIO DISTORTION:
3% or less 50-10,000 cycles 90% modulation. Under practical programming conditions 2% or less 50-16,000 cycles.

NOISE:
(1000 watts) 60 db. or better below 100% modulation.
(250 watts) 55 db. or better below 100% modulation.

AUDIO INPUT:
150 or 600 ohms at + 16 db. ± 2 db.

MONITORS:
Accommodates all current frequency and modulation monitors. Gates M-4990 frequency monitor (Page 31) and M-5693 modulation monitor (Page 32) recommended.

A.C. INPUT*
230 volt, 1 phase, 3 wire, 50/60 cycles. (208 volts also available when specified).

DUMMY ANTENNA:
50 ohms. Capable 100% program modulation continuous or 100% sine wave modulation for 20 minutes on and 5 minutes off.

MODULATION:
High level Class B.

POWER CONSUMPTION*:
1 KW; 0 modulation, 2650 watts; program modulation, 3150 watts; 100% modulation, 3850 watts.

250 watts; 0 modulation, 1650 watts; programming modulation, 1825 watts; 100% modulation, 2050 watts.

MECHANICAL DATA*:
(size) 78" high, 37" wide, 29" deep. Front door swing 32". (weight) Net, 1000 lbs. Domestic packed, 1140 lbs. Export packed, 1490 lbs. Cubage: 110. (Finish) Two-tone medium gloss gray with trim in brushed aluminum and black.

TEMPERATURE:
- 20° to + 50°C. (silicon)
+ 5° to + 50°C. (mercury rectifier)

TUBES:
(2) 12BY7A crystal osc., 1st Int. amplifier, (2) 807 Int. driver amplifiers, (2) 833A R.F. power amplifiers, (2) 807 1st audio amplifiers, (2) 807 2nd audio amplifiers, (2) 833A modulators. (If tube rectifiers model purchased), add: (2) 800B H.V. rectifiers, (2) 866/866A intermediate voltage rectifiers.

ORDERING INFORMATION

BC-1G transmitter, 1000/250 watts, solid state rectifier model, with tubes, and 1 vacuum crystal (Cat. No.) M-6245

BC-1G transmitter, 1000/250 watts, tube rectifier model, with tubes and 1 vacuum crystal M-6245B

Spare vacuum crystal A-35177

Spare 100% tube complement for M-6245 model TK-471

Spare 100% tube complement for M-6245B model TK-472

Output power remote control kit M-6326

*NOTES: (1) Be sure and specify carrier frequency when ordering. (2) Available for 208 volts, 3 wire, at slightly additional cost (3) Packed weight of model M-6245B tube rectifier model is 25 lbs. greater. (4) Power consumption of the BC-1G with tube rectifiers is slightly higher due to addition of filament transformers.

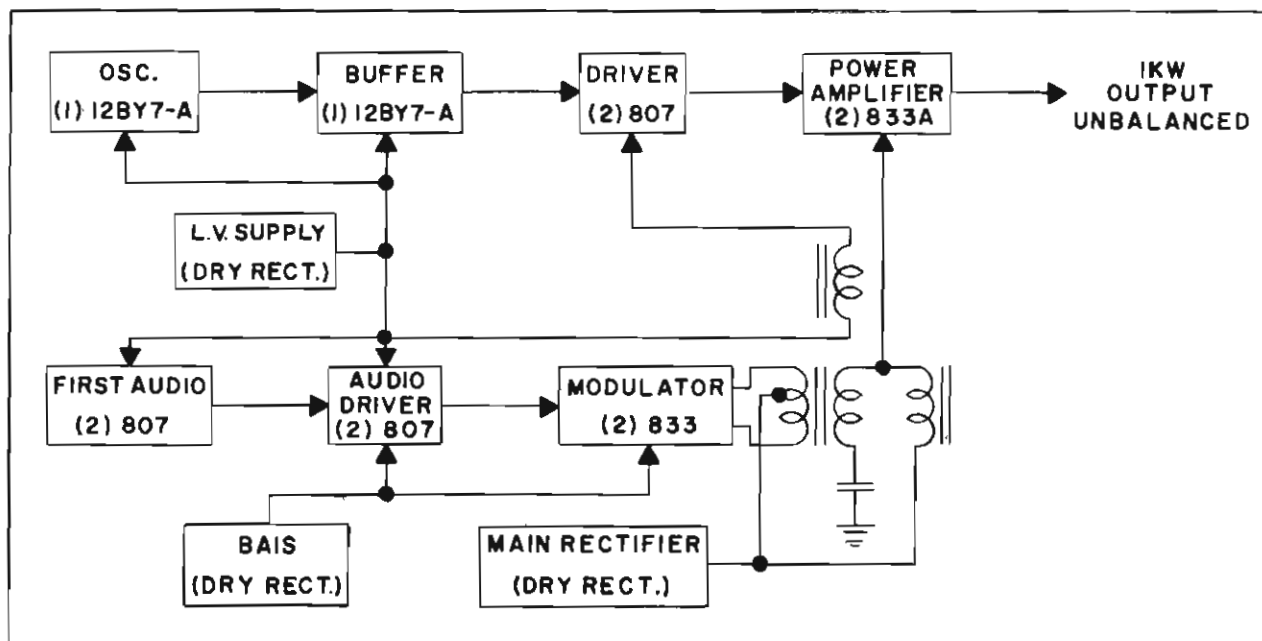

Simplified functional diagram.

1000 WATT TRANSISTORIZED AM BROADCAST TRANSMITTER

VANGUARD I One Tube---One Kilowatt

Vanguard I, by Gates, represents the latest state-of-the-art in AM broadcasting and engineering design. In this remarkable transmitter, only one tube used as the power amplifier is combined with the outstanding reliability and performance characteristics of solid state circuitry for a dynamic new sound that rivals FM fidelity. Completely self-contained in a slim line, "compact" cabinet, the Vanguard I features revolutionary transistorized approach to modulation, and electrical and mechanical design engineering innovations which open new vistas in AM broadcast transmitters.

PERFORMANCE: Operating as a broadcast transmitter under standard programming conditions, which includes keeping modulation percentage at fundamental frequencies up to the top, Vanguard I is rated as a 1½% distortion transmitter. Distortion measurements at most frequencies will frequently read even below 1%. Transmitters are not tested, however, on laboratory standards but the standard expected at the buyer's station. Therefore, the superb 1½% rating, instead of being the best of the production, is a run of the mill rating, usually exceeded by each transmitter.

REASON AND RESULT: At the point of modulating the radio frequency portion of Vanguard I, less than 2 watts of audio power are used. Gates product research in Solid-Staterman audio equipment has resulted in distortion in the ¼% or less area. Therefore, in Vanguard I, distortion to start with is close to the absolute minimum. In Class B

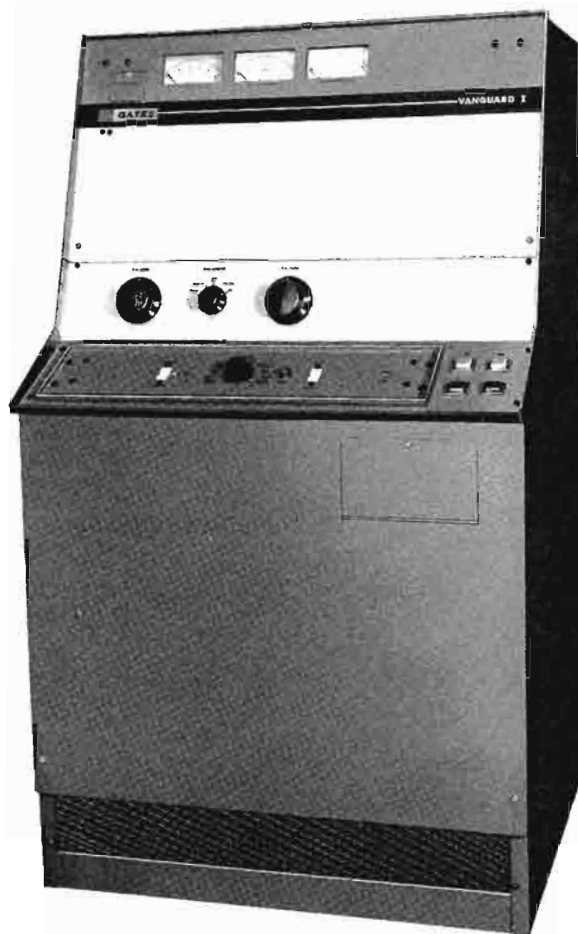

Complete front accessibility is an outstanding feature of Vanguard I.

modulators, the audio power for a 1000 watt transmitter would be about 750 watts. To obtain 750 watts power in the 1% distortion range is only possible with components so costly they are not practical. High level transmitters therefore are usually in the 3% to 5% distortion range, which by no means is inferior. Logically 1½% or less distortion is superior. Vanguard I is superior.

SINGLE TUBE: Only one tube is found in Vanguard I. All other circuits are transistorized and power supplies are all solid state. A single type 4CX3000A final amplifier tube operates well below rated capacity to assure longer life and outstanding performance. Intermodulation distortion is substantially less than in typical Class C stages.

DRIVER/MODULATOR: A complete transistorized driver modulator sets the pace for a new standard of AM transmitter reliability. Continuous maximum modulation is easily obtained and this modulation is produced with lower distortion and wider frequency response. The driver has

1000 Watt Transistorized AM Broadcast Transmitter—Vanguard I

two oscillators, switchable from the front panel. Stability of these solid state oscillators exceeds tube-type oscillators. Crystal trimmers are adjustable from the front panel while a Zener controlled voltage supply to the oscillator and modulator assures proper operation even with line voltage changes.

COOLING AND RELIABILITY: As transistors radiate essentially no heat, require less than 100 D. C. volts and no filament transformers, heat is a minimal problem to start with. Only the single tube and the high voltage plate transformer are heat producing devices of any substance. Class F insulation eliminating the use of deteriorating paper or varnish is used in the transformers thereby contributing to added reliability. The blower, moving double the air required, cools the tube, transformers and all components to the unbelievable low point of being able to place the hand on the power tube within 30 seconds after the transmitter is shut down. The abundance of air movement is done so quietly that it is not noticed even close by. This extra air is also very attractive to high altitude users. It is very interesting to note that other than the power amplifier tube, the highest D. C. voltage used is 90 volts. The inherent reliability of transistors and diodes coupled with the natural adaptation to mechanical reliability in the transmitter design offers a wholly new concept in ruggedness as well as superb performance.

DESIGN AND CONSTRUCTION: Vanguard I has *Computer Age* styling, standing 53" high, 30" wide and 28" deep. Easy access is a design keynote. It is 100% serviceable from the front. Lift up the top cover and Vanguard's only tube is at the finger tips. Lift off the lower front panel and power supplies are in full view. The transistorized R. F. driver/audio unit slips out if servicing is ever necessary. It has its own power supply. All access doors interlock for

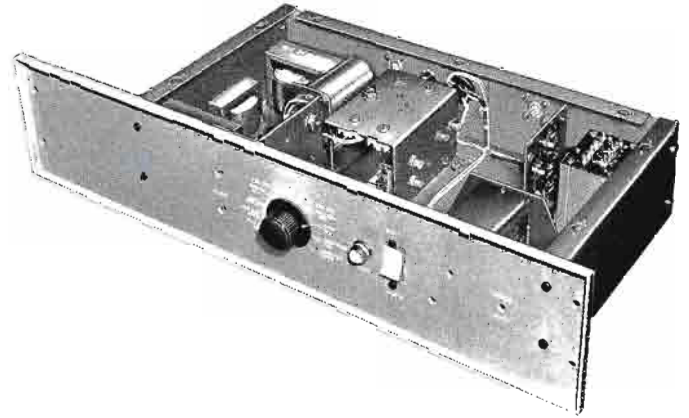

Built-in multimeter constantly monitors the operating conditions of the complete driver/modulator. A front panel switch permits instant switching from one oscillator to the other.

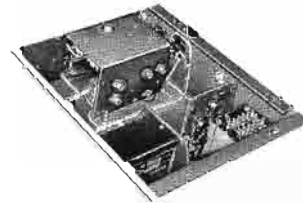

Solid state components are used in every stage except for the one tube final amplifier.

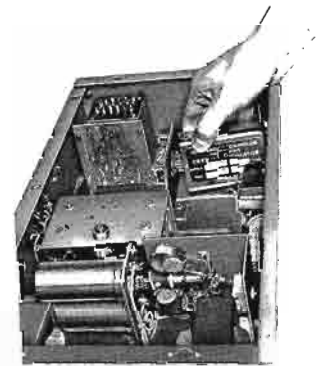

Temperature controlled transistorized solid state oscillators are contained in this plug-in unit.

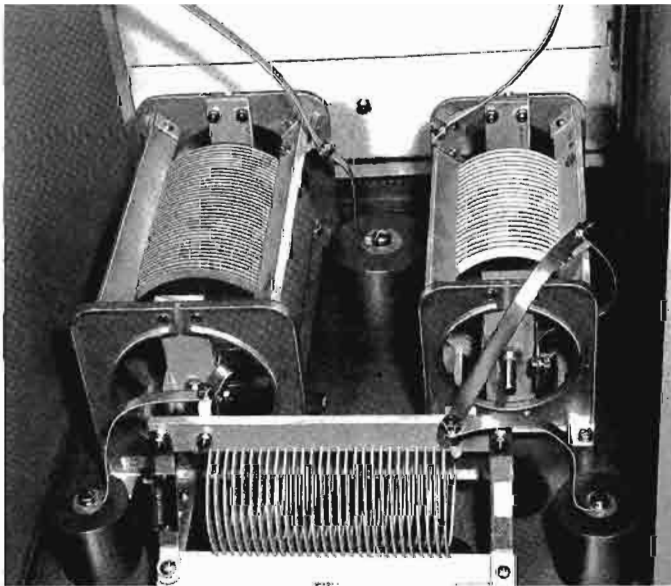

The final amplifier and Tee network are tuned by these large heavy duty edgewise type coils.

personnel protection. The back door is removable too for complete access to the rear. Sixteen meter functions are read from four front panel meters. The three mandatory FCC functions are indicated constantly. Control circuitry is complete, effective and designed with remote control in mind. Remote control has all needed voltage and current sampling devices inbuilt. The power output adjustment in Vanguard I is a motor driven rheostat. Attachment of remote control is again no more than connecting wires to terminals. Inbuilt dummy antenna is provided for running tests anytime and indispensable for trouble shooting. If the transmitter performs on the dummy antenna, you know the trouble is out of doors. Full Tee output network means FCC harmonic reduction regulations are met within the transmitter and the antenna coupler becomes an added bonus for still further harmonic suppression. Power reduction for Class 4 stations to 250 watts is standard.

Vanguard I is today in use in some of broadcasting's leading major market stations. These broadcasters agree with the claim—there is a difference!

1000 Watt Transistorized AM Broadcast Transmitter—Vanguard I

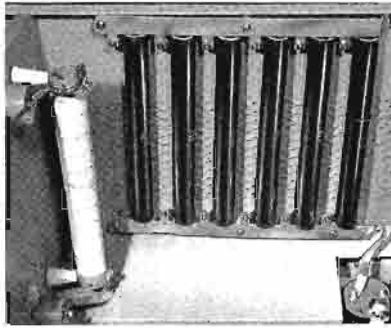

Inbuilt Dummy Antenna with 1 KW capacity handles full 100% modulation when used for testing the transmitter.

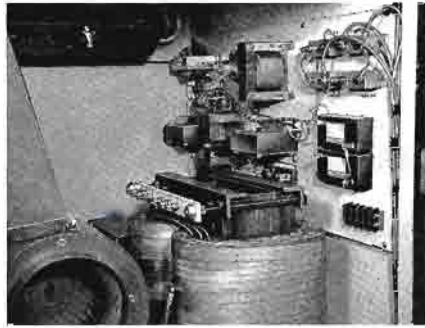

Power supply assembly (bias, screen and plate) can be reached quickly. Husky transformers invite 24-hour schedules.

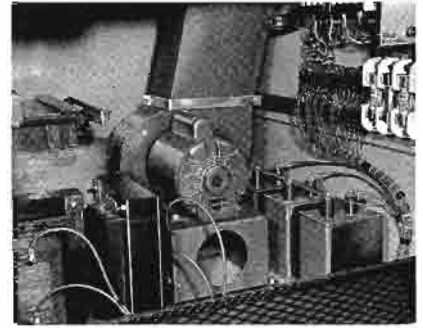

Blower provides 100% more air moving capacity than required. Incoming air is filtered through a washable air filter which can be changed while the transmitter is on-air.

SPECIFICATIONS

POWER OUTPUT:

1000/250 watts, capable 1100 watts. Also available in 1000/500 watt model.

AUDIO INPUT:

600 ohms, + 5 dbm. \pm 2 db.

AUDIO RESPONSE:

\pm 1 db. 20-16,000 cycles.

NOISE:

55 db. below 100% modulation at 1000 watts output. 50 db. at 250 watts.

FREQUENCY RANGE:

540-1700 Kc. (as ordered).

TUBE COMPLEMENT:

1 Type 4CX3000A.

R.F. OUTPUT IMPEDANCE:

50 ohms (see Note 1).

FREQUENCY STABILITY:

\pm 5 cycles or better.

DUMMY ANTENNA:

Inbuilt 50 ohms for 1 KW output power or less.

SIZE:

53" high, 30" wide, 28" deep.

WEIGHT:

(Domestic) 720 lbs. (Export) 850 lbs. (Cubage) 60. (Net unpacked) 640 lbs.

POWER INPUT:

230 or 208 volts, 60 cycles, 1 phase, 3 wire. Supplied wired for 230 volts unless 208 volts specified.

POWER CONSUMPTION:

4800 watts, or less, at 100% modulation at 1000 watts output.

POWER FACTOR:

90% or better.

CARRIER SHIFT:

3%, or less, (typical, less than 2%).

DISTORTION:

1½% or less, 20-15,000 cycles (see Note 2).

TEMPERATURE:

- 4° F. to + 122° F.

ALTITUDE:

To 7500 feet. Higher on special order.

MONITORS:

Will accommodate all modern frequency and modulation monitors.

Notes: (1) R.F. output impedances up to 250 ohms can be provided without appreciable delay. (2) Based on 95% modulation between 20-7500 cycles and 70% modulation at all overtone or harmonic frequencies above 7500 cycles. Where modulation of frequencies above 7500 cycles is 95%, the distortion is still less than 2½%. (3) For 1000/500 watts, specify same catalog number as only difference is in power reduction inbuilt adjustment.

ORDERING INFORMATION

Vanguard I, 1000/250 watts, with tube and one crystal (see

Note 3 above) (Cat. No.) M-6408

Spare crystal NE6-A

Spare power tube 4CX3000A

Vanguard I is fully F.C.C. approved.

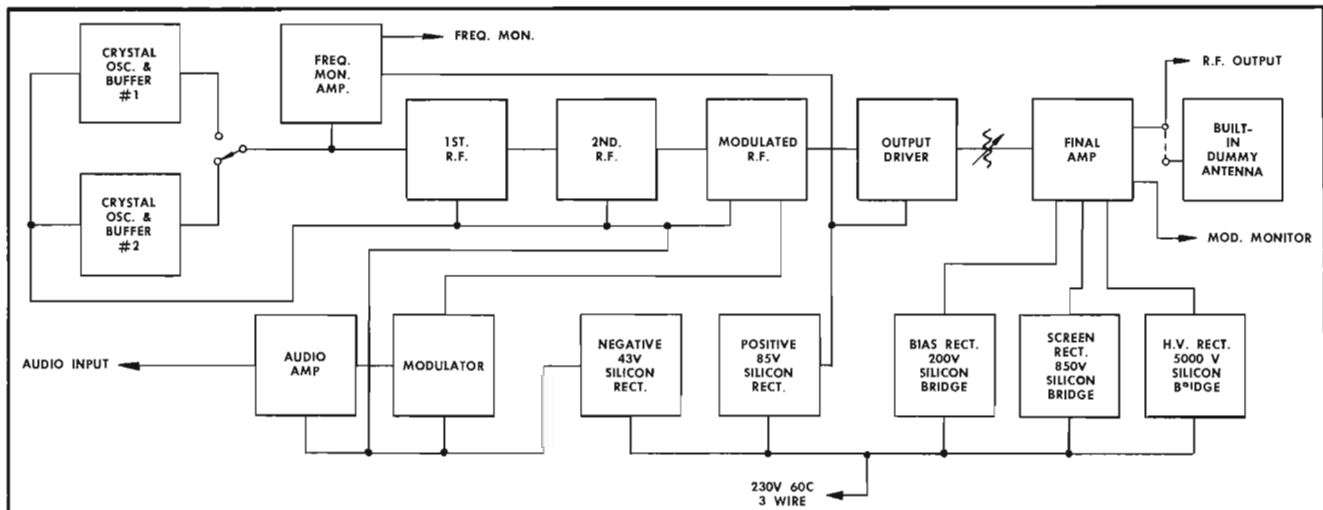

MODEL BC-500G

Standardization in manufacturing always assures higher quality, improved workmanship and lower cost. The BC-500G broadcast transmitter is essentially the same transmitter as the BC-1G, 1000 watt model described on Page 17. It differs only in the use of a single type 833A R.F. power amplifier and slightly smaller power and modulation transformer components. So complete is standardization that increase to 1000 watts at any later date is easily accomplished. As the basic design is around 1000 watt construction, a bonus of conservatism is built into this 500 watt model.

All of the features found in the 1000 watt BC-1G (Page 17) are also in the BC-500G five hundred. Standard features include: a built-in dummy antenna for easy time saver maintenance, solid state power supplies throughout, total accessibility from the front, dual modulation of the R.F. driver and power amplifiers, inverse feedback and a new audio specification for lower distortion and intermodulation. R.F. harmonic reduction meets FCC regulations within the transmitter itself as the Pi-Tee output network does not assume that the outside antenna coupler will perform this function. The specifications herein are pertinent to the Model BC-500G, 500 watt transmitter. Any other data is the same as the Model BC-1G.

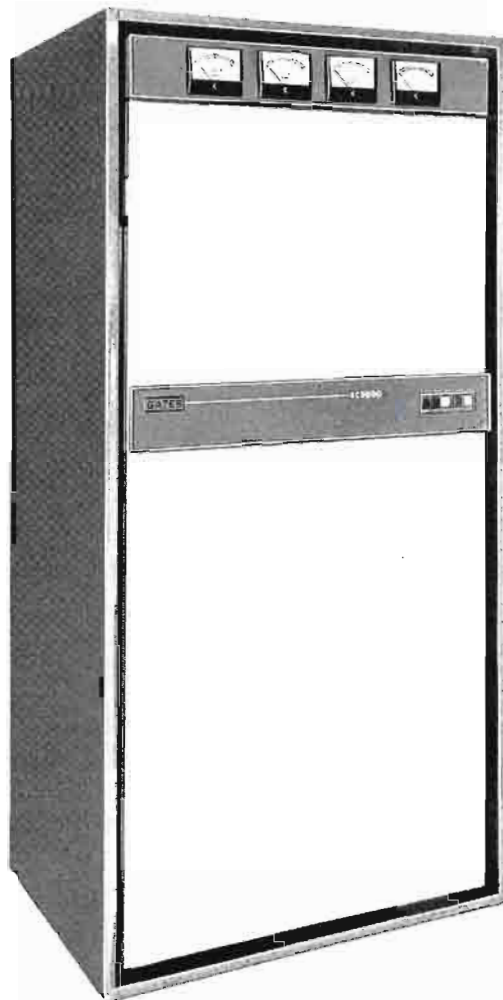

SPECIFICATIONS

POWER OUTPUT:

FCC rated 500 watts. Capability 550 watts.

AUDIO INPUT:

150 or 600 ohms. + 9 db. \pm 2 db. for 100% modulation.

AUDIO RESPONSE:

\pm 1½ db., 30-12,000 cycles. (Typical: \pm 1½ db., 30-16,000 cycles under practical programming conditions.)

AUDIO DISTORTION:

3% or less 50-10,000 cycles at 95% modulation.

NOISE:

60 db., or better, below 100% modulation level.

FREQUENCY RANGE:

540 kc. to 2000 kc. (as ordered).

RF OUTPUT IMPEDANCE:

50/70 ohms.

FREQUENCY STABILITY:

\pm 5 cycles.

MONITORS:

Will accommodate all current models. Gates FCC approved M-4990 Frequency Monitor and M-5693 Modulation Monitor recommended.

A.C. INPUT:

230 volts, 3 wire, 50/60 cycles single phase.
Power consumption (0 modulation) 1900 watts; (program modulation) 2200 watts; (100% modulation) 2600 watts.

CARRIER SHIFT:

3% or less at 100% modulation.

DUMMY ANTENNA

51½ ohms.

SIZE:

78" high, 37" wide, 29" deep. Front door swing 32".

FINISH:

Two tone medium gloss gray with trim in brushed aluminum and black.

WEIGHT AND CUBAGE:

(Domestic) 950 lbs. net, 1100 lbs. packed.
(Export) 1350 lbs. packed. Cubage: 100.

TUBES:

12BY7A oscillator, 12BY7A 1st. IPA, (2) 807 2nd. IPA, (1) 833A power amplifier, (2) 807 1st. audio, (2) 807 2nd. audio, (2) 833A modulators.

ORDERING INFORMATION

Model BC-500G AM broadcast transmitter, 500 watts, with tubes, one crystal, silicon rectifiers (Cat. No.) M-6333
Spare 100% tube complement for BC-500G TK-481
Recommended minimum spare tube kit for BC-500G TK-479
Spare vacuum crystal A-35177

NOTES (1) Be sure and specify carrier frequency when ordering, (2) available for 208 volts, 3 wire, at slightly additional cost, (3) on special order available with tube rectifiers at no increase in price, (4) 500 watt stations may use a 1000 watt transmitter operated at 500 watts power. If 1000 watts is later contemplated, the customer should purchase the Model BC-1G.

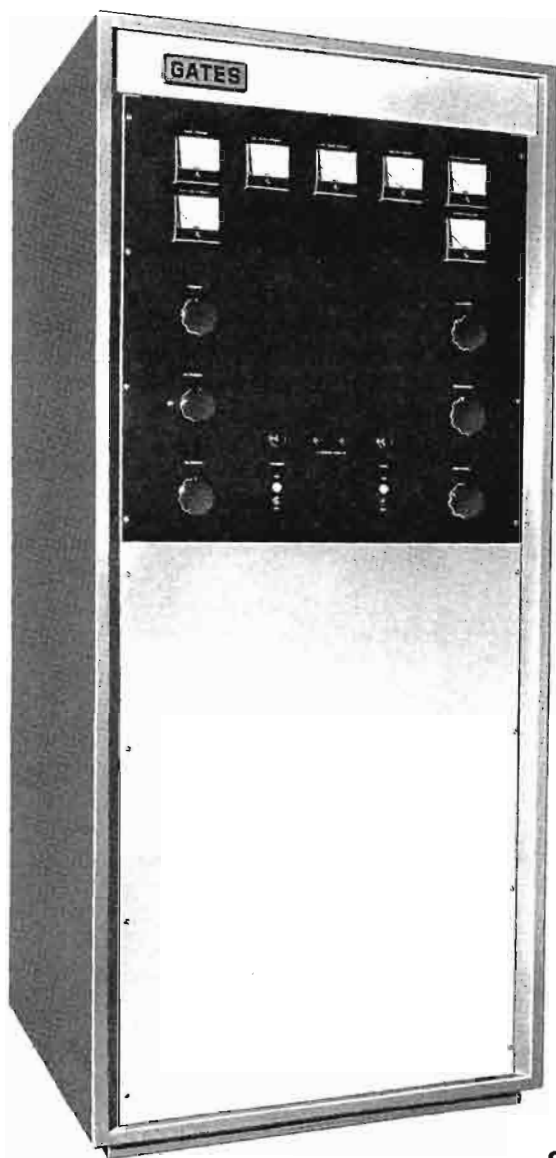

MODEL BC-250GY

Gates 250 watt AM Broadcast Transmitter is a modern 250 watt high fidelity broadcast transmitter with attractive shadow mold styling, vacuum crystal, full size back door for 100% accessibility and complete in every detail for today's modern broadcasting. Fully FCC type approved, this BC-250GY transmitter has a world-wide reputation for long trouble-free service. From Greenland to the Marianas, broadcasters world-wide acclaim the excellence and simplicity of this most widely used 250 watt medium wave transmitter.

RADIO FREQUENCY AND AUDIO: Four R.F. stages start with a vacuum type crystal into a 12BY7 oscillator and first intermediate power amplifier stage, and 813 R.F. driver stage to generously energize the dual 810 power amplifier tubes. The audio section is push-pull with 6L6G driver tubes operating the Class B 810 modulator tubes. Interchange of power amplifier and modulator tubes gives added economy and longer tube life.

OPERATING FEATURES: The emphasis is on roomy, easy to service and well ventilated design. Convection cooling is employed. As a result, the BC-250GY transmitter is silent in operation, and may be operated adjacent to a microphone. Vertical construction permits "walk-in" access. The audio section is a hinged sub-section to complete the *reach every part in seconds* method of construction. Seven meters allow direct simultaneous reading of all important circuitry. For a conservative, superb performing transmitter, the Model BC-250GY will fill the needs of the most discriminating broadcaster.

SPECIFICATIONS

POWER OUTPUT:

Rated 250 watts, capable 280 watts.

FREQUENCY RANGE:

540-1620 Kc., as ordered.

RF OUTPUT IMPEDANCE:

30-300 ohms unbalanced, as ordered.

FREQUENCY STABILITY:

± 5 cycles.

CARRIER SHIFT:

3% or less, 95% modulation.

MODULATION:

High-level plate.

AUDIO RESPONSE:

± 1.5 db. 30-10,000 cycles.

AUDIO DISTORTION:

3% or less, 50-7500 cycles at 90% modulation.

NOISE:

55 db. below 100% modulation.

AUDIO INPUT IMPEDANCE:

500/600 ohms at + 8 db. for 100% modulation.

MONITORS:

Will accommodate all modern frequency and modulation monitors.

POWER INPUT:

230 volts AC, 2 wire, single phase, 50/60 cycles.

POWER CONSUMPTION:

1.6 KW at 90% tone modulation.

POWER FACTOR:

Better than 90%.

SIZE:

78" high, 34" wide, 33" deep.

WEIGHT (Packed) & CUBAGE:

Domestic—770 lbs.; export—900 lbs. Cubage: 112.

FINISH:

Two-tone gray lacquer with trim in brushed aluminum and back.

TUBES:

(4) 810, (2) 6L6, (2) 12BY7, (1) 813, (2) 8008, (1) 5Y4G.

ORDERING INFORMATION

Broadcast transmitter, 250 watts, complete with one set of tubes and one vacuum crystal (Cat. No.) BC-250GY
 Spare 100% set of tubes TK-507
 Recommended minimum set of spare tubes TK-508
 Spare vacuum crystal A-35177-1

Please state carrier frequency and R.F. output impedance when ordering.



100 WATT MEDIUM WAVE BROADCAST TRANSMITTER

MODEL BC-01-GA (with optional self-contained audio input equipment)

TRANSISTORIZED: Completely solid state except for the single power output tube, this new 100 watt medium wave broadcast transmitter is available with an optional audio input system. When using the audio input, this solid state transmitter becomes a complete broadcast station ready to attach microphones, turntables and antenna. The use of transistors throughout the transmitter provides unusual reliability for unattended operation. Remote activation by time clock is highly practical as there are no warm-up or time delay circuits.

TRANSMITTER: To fill a world-wide demand for a reliable, fine performing, low power medium wave broadcast transmitter, Gates had developed this new one-tube, 100 watt model. Supplied factory tuned to the customer's operating frequency, only minimum touch up tuning is required on installation. The use of transistors throughout, with the exception of a single power output tube, assures unusual reliability, as the maximum D.C. voltage to any transistor is 95 volts. The type 8122 power tube is cooled by a small blower which, combined with the high efficiency radiator on the tube and 400 watt plate dissipation, develops extremely long tube life to complement the unlimited life of transistors.

The transmitter has unusually wide frequency response and low distortion. The third intermediate stage is modulated. The fifth and final stage is a linear amplifier employing the type 8122 tube operating AB1. Plate tuning and load tuning are the only primary front panel controls. The crystal oscillator houses the transistor and crystal for superb stability. Three front panel meters, including a multimeter, indicate (a) bias voltage, (b) filament voltage, (c) screen voltage, (d) power amplifier screen current, (e) relative power output, (f) plate voltage of power amplifier, (g) power amplifier plate current plus voltages and currents in all transistor stages.

An overmodulation indicator is provided. This is a visual neon type flasher on the front of the transmitter. The power output may be reduced to as much as 40 watts where the full 100 watts is not desired. An optional antenna coupler is available to match a wide variety of antennas as well as allowing the transmitter to be located several hundred feet from the antenna. Servicing is ideal as the entire rear panel detaches for immediate access.

AUDIO SYSTEM: With the audio system (Model BC-

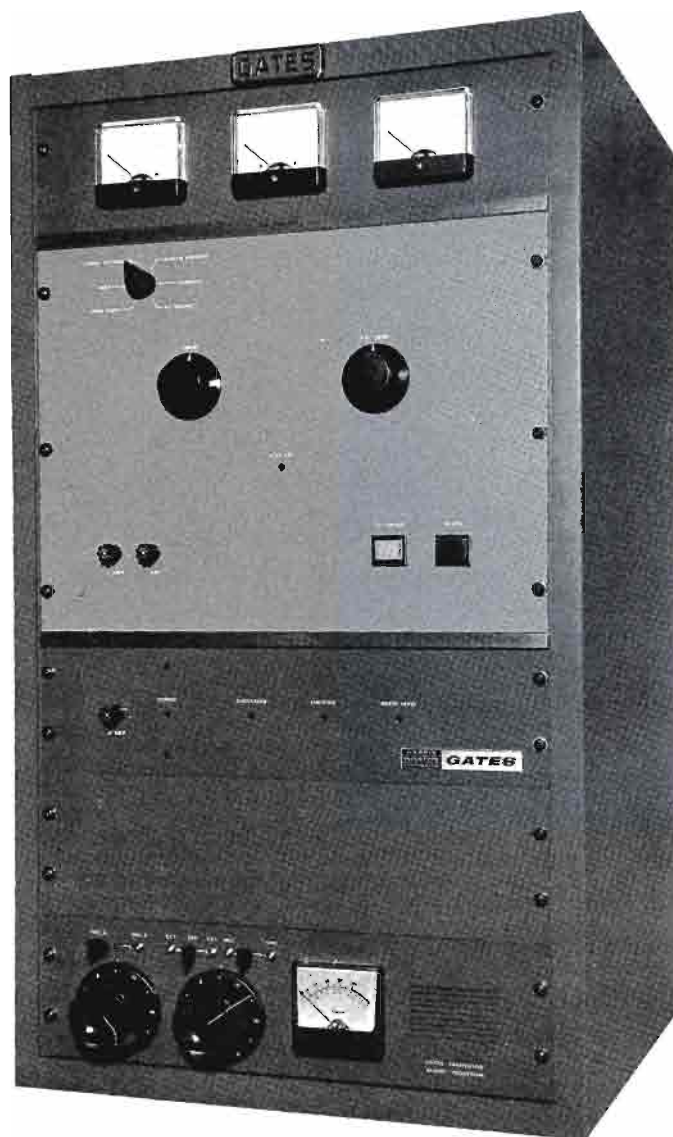

Above, the BC-01-GA complete 100 watt Medium Wave broadcasting system includes transmitter and audio input facilities. Two microphones, two turntables and two outside lines (such as remotes) may be accommodated. A small self-contained loudspeaker is provided for monitoring. The audio system is 100% solid state.

01-GA), a complete 100 watt radio station is provided. Two mixing channels accommodate two microphones selected to one preamplifier/mixer and four lines selected to the second mixer. Program amplifier is of the automatic gain control type with 20 db. limiting. Speaker on the panel permits direct off-air monitoring from the transmitter. The speaker is muted when the adjacent microphone is in use. The volume level meter is a combined level and limiter meter. Fully transistorized, the audio system includes a power supply.

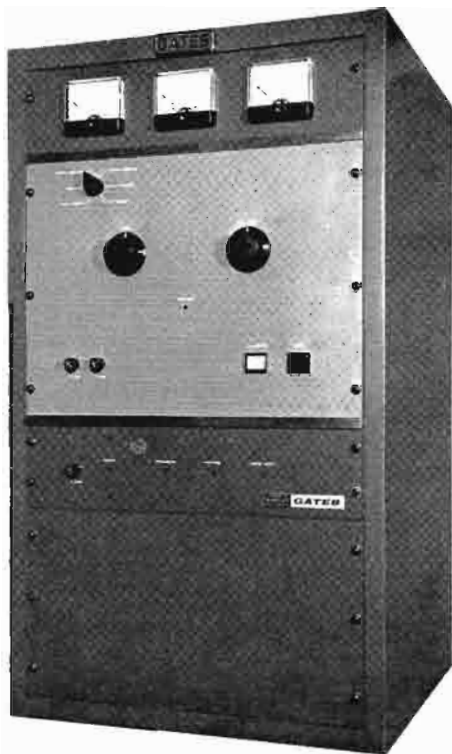

Above, the BC-01G transmitter is shown without audio input system. The audio input is 600 ohms and RF output is 50 ohms. Transmitter is fully transistorized except the single power output tube and no warm-up cycle is required.

SPECIFICATIONS—AUDIO SYSTEM

- MICROPHONES:**
Two microphones key selected into first mixer 150/250 ohms.
- LINES:**
Four lines key selected into second mixer for turntables, tapes, remote lines, etc. Includes isolation transformer. 150 or 600 ohms.
- AMPLIFIERS:**
1 preamplifier and 1 automatic gain program amplifier. Output 600 ohms.
- SPEAKER:**
48 ohms fed from RF diode and filter connected to transmitter.
- PERFORMANCE:**
Response 30-12,000 cycles \pm 2 db. Distortion 50-10,000 cycles 2%.
Noise: 60 db. below -50 db. input or, -110 db. relative input noise.
Gain: 80 db. over-all mic to output. 35 db. lines to output.
- CABINET DATA:**
Size—36" high, 23½" wide, 22" deep.
Finish—two-tone gray, black trim.
- SHIPPING DATA:**
Estimate total weight packed, 250 lbs.
Estimate total weight export, 275 lbs.
Net weight (unpacked), 220 lbs.
Cubage: 11

Note: This equipment will meet all FCC specifications. As 100 watt transmitters are not generally used in the United States, no request has been made to the FCC for type approval.

SPECIFICATIONS—TRANSMITTER

- POWER OUTPUT:**
(Rated) 100 watts. (Capable) 110 watts, power reduction to 40 watts.
- RF FREQUENCY RANGE:**
540 kc to 2000 kc, (supplied for one specified frequency).
- RF OUTPUT IMPEDANCE:**
50 ohms.
- RF FREQUENCY STABILITY:**
 \pm 20 cycles or better.
- CARRIER SHIFT:**
5% or less, with stable primary service.
- AUDIO RESPONSE:**
Rated 50 cycles to 10,000 cycles \pm 2.5 db. (Sine wave full modulation.) Capable under normal programming: 30 to 12,000 cycles.
- AUDIO DISTORTION:**
Rated 3% from 50 cycles to 7500 cycles, full modulation. Capable 3% from 30 cycles to 12,000 cycles, under normal program modulation.
- NOISE (unweighted):**
50 db. or better below 100% modulation at 100 watts.
- AUDIO INPUT:**
600 ohms at 0 db. \pm 10 db.
- POWER INPUT:**
105-125 volts, 1 phase, 60 cycles. 500 watts at 100% modulation. For 50 cycles or 230 volts, see "Ordering Information."
- TEMPERATURE:**
0 to 45° centigrade.
- ALTITUDE:**
6000 feet
- RF HARMONICS:**
CCIR or better
- POWER FACTOR:**
90%
- TUBES USED:**
One only, type 8122.

ORDERING INFORMATION

- BC-01-G Transmitter only, 115 volts, 60 cycles (Cat. No.) M-6427
- BC-01-GA Transmitter including audio input system 115 volts, 60 cycles M-6428
- NOTE: For 50 cycles, either 115 or 230 volts, see price list for slight added cost.
- Antenna Coupler (shown below) M-5178



The Model M-5178 antenna coupler matches 50 ohm output of transmitter to antennas of wide variety—either vertical or long wire. It consists of edgewound coil with clips and wide range of fixed capacity in an L or TEE arrangement. The coupler may be mounted up to several hundred feet from transmitter by use of RG11U coaxial cable. Size: 21" high, 10" wide, 9" deep.

ANTENNA PHASING EQUIPMENT

CUSTOM DESIGNED: Gates phasing equipment is always custom built, utilizing Gates manufactured inductors and other quality components for precise coverage patterns requiring a minimum of adjustment and a maximum of stability. Some of the most complex phasing systems in existence, from 12 tower 50 KW arrays, numerous multi-tower 50 KW installations and 100 KW systems for critical overseas applications, have been built by Gates.

ADVANCED RESEARCH: As the world leader in the design and manufacture of phasing equipment, Gates engages heavily in highly advanced phasor research and development, backed up by the industry's largest full time phasor production department. Headed by a registered professional engineer, this experienced group is staffed by design and production experts, with years of continuous phasor background.

Since 1948, over 400 custom designed and engineered phasing systems have been manufactured by Gates for installations world-wide. Including antenna couplers, diplexers, triplexers, and other specialized RF network systems, the total number of delivered systems exceeds 2,000—unmatched proof of the long experience, advanced capability and proven performance of Gates phasing equipment.

STABILITY AND EFFICIENCY: All directional phasing equipment is designed to the parameters provided by the station's consulting engineer and work is not initiated until the consultant and customer approve the design. To provide



Gates Standard Cabinet.

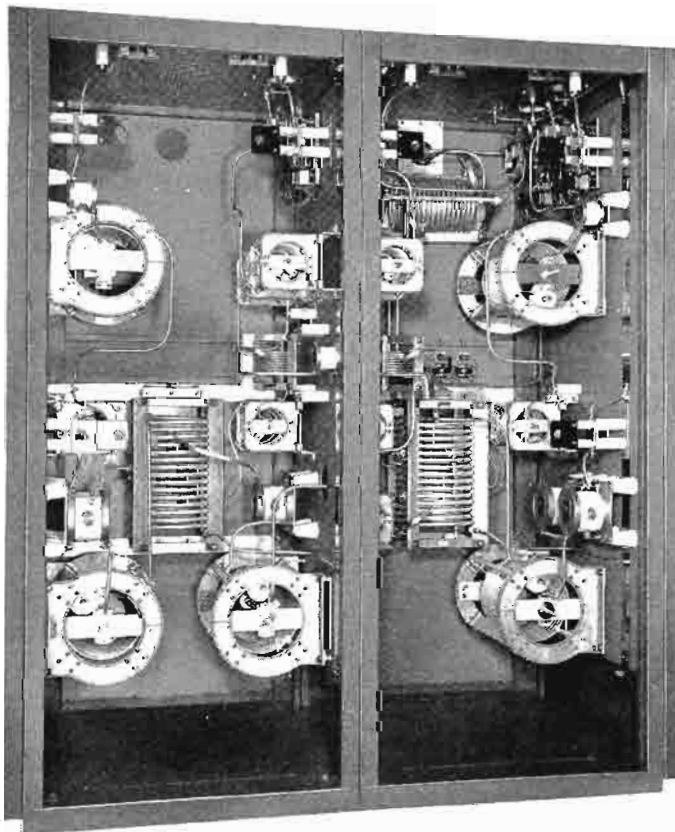

Typical Four Tower Layout.

custom designed phasors suited for the specific broadcasting needs, Gates provides detailed specifications for your equipment, so you may determine exactly what you are buying. The full range of adjustment can be precisely determined—before it is delivered. You need not be faced with having to replace inadequate components, or to make costly field modifications of design to relieve difficult adjustment. The careful design and construction practices maintained by Gates give you more than reasonable assurance of the best possible long term stability and efficiency. This avoids expensive readjustment and reproof of pattern later on.

Gates Phasors are constructed to give a safety factor of 1.4 times on RMS current and four times on maximum RMS voltage based on expected operating adjustments.

CONSTRUCTION: Antenna tuning units are constructed as panel and shelf type for wall mounting in a doghouse, or in weatherproof metal cabinets. Phasor cabinetry built to your specifications is available and becomes an integral planning factor in the coordination of design and styling to reflect over-all system compatibility and appearance.

Gates manufactures phasing equipment, including 50 KW or 100 KW in power and for any number of towers; 250 watt to 250 KW antenna tuning units; diplexers for medium wave and for 2-30 mc short wave; triplexers, rejection filters and a wide range of radio frequency networks. Each is custom tailored for the particular application.



HIGH POWER PHASING, TUNING AND RF NETWORKS

HIGH POWER ANTENNA COUPLERS

For custom designed couplers in the 50,000 and 100,000 watt range, Gates can call upon a great deal of experience and skill. With the substantial supply of components on hand at all times, there is a minimum of delay when designing a particular coupler.

Illustrated, at the right, is a typical 100,000 watt medium wave shelf-type antenna tuning unit employed with a Gates BC-100C, 100 KW transmitter, in Sudan. All materials are of the highest possible quality and exact specifications are always met. Couplers are available in weatherproof cabinets if desired.

WHEN ORDERING, please supply all available information such as (1) power, (2) frequency, (3) tower height, (4) tower measurements, if known, (5) transmission line impedance such as 50 ohms, 70 ohms, 250 ohms, etc., and whether coupler will be mounted in an out-building or if weatherproof type is desired.

Price of coupler can be quickly quoted with the above data supplied.

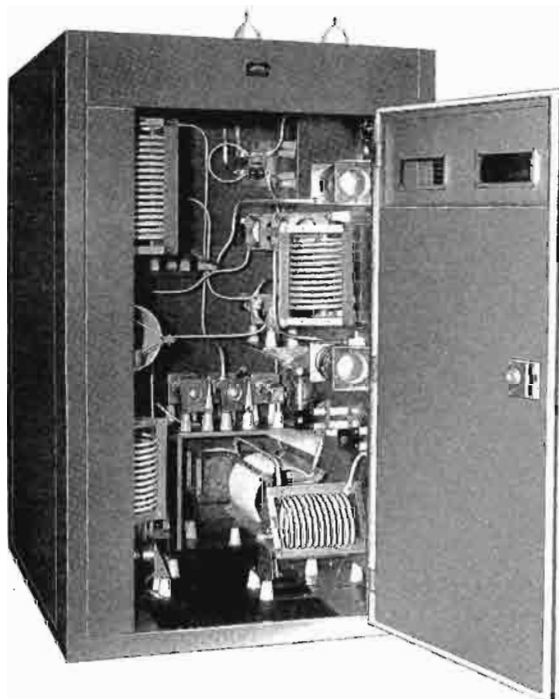
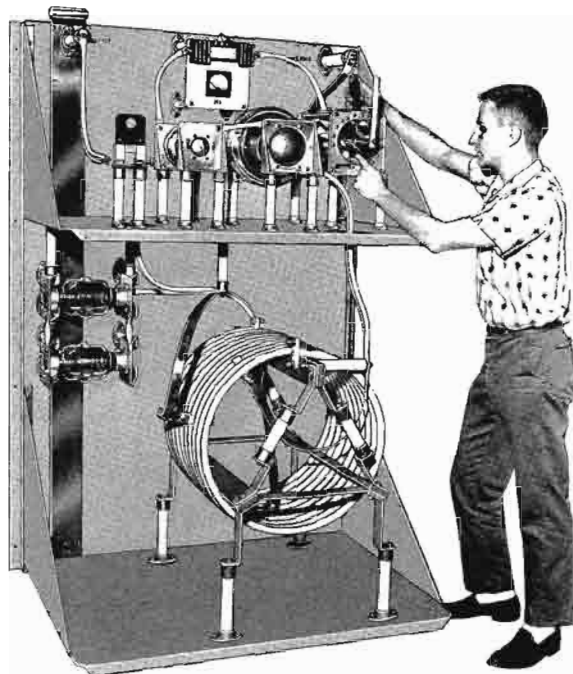

◀ 50 KW PHASOR

50 KW phasor constructed in transmitter matching cabinet. Note easy access and clean mechanical layout. Gates 50 KW phasing equipment is in use at many prominent stations in the U.S. and overseas.

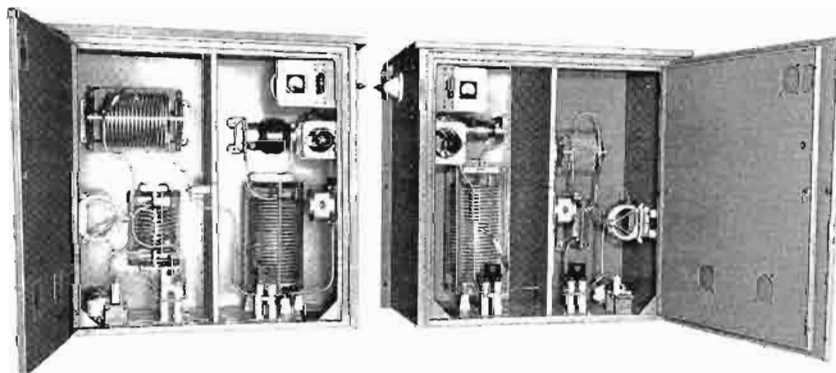
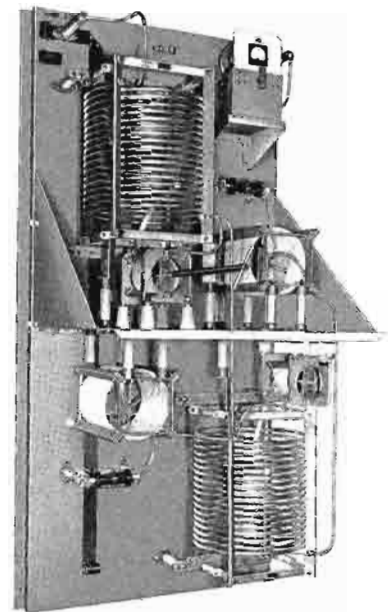

10 KW MEDIUM WAVE DIPLEXER

Numerous diplexers, triplexers, RF filters and custom designed networks are considered normal design and construction activity at Gates. The above illustrates a 10 KW medium wave diplexer to permit two AM transmitters to feed a common vertical radiator.

TWO TOWER 50 KW PHASOR

Two tower 50 KW phasor on panel and shelf for wall mounting. Gates phasing equipment is manufactured specifically to the customer's needs either in cabinets or on open panel.

AM ANTENNA COUPLING EQUIPMENT

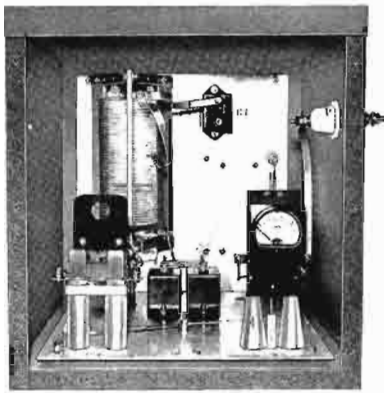

ANTENNA COUPLER 1250 WATTS

Fully weatherproof, this series feed antenna coupler is recommended for broadcast transmitter powers of 1000, 500 and 250 watts, 100% modulated. Heavy edgewound micalex insulated silver plated coil has generous inductance for a full Tee network along with fixed mica capacitors supplied. Extra room is provided to install either diode or thermocouple remote metering equipment. Heavy duty meter shorting switch eliminates antenna meter from the circuit when not in use for lightning protection. Meter is observed through glass porthole. Front door of cabinet has been removed for illustrative purposes.

SPECIFICATIONS

CARRIER POWER:
1250 watts or less, 100% modulated.
INPUT IMPEDANCE:
50 to 360 ohms concentric or open line.
ANTENNA RESISTANCE:
10 to 1000 ohms.
ANTENNA REACTANCE:
Plus J 600 to minus J 300 ohms from 540 to 1000 Kc. Plus J 600 to minus J 500 ohms above 1000 Kc.
CIRCUIT:
Tee network.
SHIPPING WEIGHT:
98 lbs. Cubage: 8 cu. ft.
SIZE:
20" high, 20 1/4" wide, 18 3/4" deep.

ORDERING INFORMATION

Antenna Coupler with antenna meter model 44A

NOTE: When ordering, state transmission line impedance, frequency, tower height, and tower measurements, if known. For remote meters, see below.

5-10 KW ANTENNA COUPLING UNITS

A heavy duty full weatherproof series feed antenna coupler in two models for 5 KW and 10 KW broadcasting stations. Housed in aluminum cabinet with double front doors. Porthole for meter reading and heavy duty meter shorting switch operates with doors closed. Large edgewound micalex insulated silver plated coils combined with capacitors of generous voltage and current ratings to assure a lifetime of service under extreme heat or cold. A large antenna lead in bowl is provided. Mounting is with metal flanges on the back of the tuning unit for attachment to wooden poles set in ground or if inside an out building for mounting to wall.

SPECIFICATIONS

POWER RATING 100% MODULATED:
Model M-5309A, 6000 watts. Model M-5309B, 11,000 watts.
FREQUENCY RANGE:
540-1700 Kc., as ordered.
INPUT IMPEDANCE:
45-360 ohms, as ordered.
ANTENNA RESISTANCE:
20-1000 ohms.
REACTANCE:
+ J500 to - J500.
SIZE:
38" high, 37" wide, 21 1/2" deep.
WEIGHT:
Packed, 315 lbs. (export); 200 lbs. (domestic). Cubage: 25.

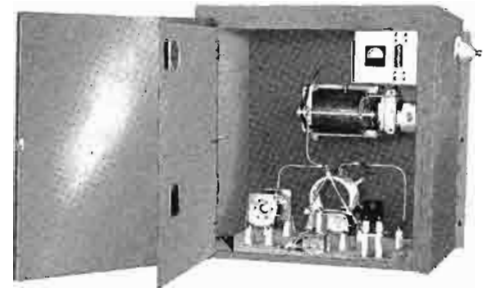

ORDERING INFORMATION

Antenna Coupling Unit, 5 KW M-5309A
Antenna Coupling Unit, 10 KW M-5309B

NOTE: When ordering, state carrier frequency, transmission line impedance, tower height and tower resistance measurements if known.

SERIES AND SHUNT FEED COUPLERS



Both series and shunt feed models are constructed in a non-weatherproof cabinet with slip off front door and large lead in bowl at top. Coil is micalex insulated edgewound silver plated and capacitors are supplied to tune to buyer's specific frequency. Antenna meter is external and optional equipment. Size: 21" high, 10" wide, 9" deep. Finish: Medium gloss gray. Usually mounted in small dog house at base of tower. Rating 1250 watts, 100% modulated.

SERIES FEED MODEL: Provides full Tee network inductance with capacitors to match wide range of input and output impedances. State frequency and tower height when ordering. M-5178

SHUNT FEED MODEL: Includes inductor and capacitors to tune out reactance in shunt led antenna coupling. If tower measurements are known, these are always especially helpful. M-5179

ISOLATION COIL



This isolation coil is quickly made to customer's order by carrying all basic materials in stock. The same type of coaxial cable is used in winding the coil as is used for sampling line. If the customer used Heliax sampling line, then the isolation coil would be wound with Heliax coaxial cable. Inductance 85 uh. Available in weather-proof or open model. Sizes (weatherproof model), 20" wide, 12 1/2" high, 18 1/2" deep. (open model), 16" wide, 10" high and 16" deep. When ordering, please state: (a) carrier frequency, (b) transmitter power, and (c) type or make of sampling line or preferred coaxial cable for coil construction.

ORDERING INFORMATION

Weatherproof isolation unit M-3073
Open unit coil only, less cabinet M-4561A

R.F. ANTENNA METERS

Internal thermocouple standard scale Weston Model 308, three-inch square case. Other ranges not listed below are available with many carried in stock. Also expanded scale meters in inventory.

ORDERING INFORMATION

Meter, 0-3 R.F. amperes 634-0206
Meter, 0-6 R.F. amperes 634-0238
Meter, 0-8 R.F. amperes 634-0209
Meter, 0-10 R.F. amperes 634-0210

DIODE TYPE REMOTE METER EQUIPMENT

For remote indication of antenna current. Consists of a carefully constructed pickup loop attached through a short coaxial cable to a solid state rectifier assembly. With this unit the antenna current is measured without breaking the main antenna lead wire or inductively. No AC power is required. May be used with any good 1 MA. movement. Several meters with proper scales are listed below. Power range: 250 watts to 50,000 watts. Frequency range: 540 Kc. to 10 Mc.



ORDERING INFORMATION

Diode remote meter unit, less meter M-6112
Meter 3" sq. case, scale 0-3 R.F. amperes 632-0418
Meter 3" sq. case, scale 0-5 R.F. amperes 632-0419
Meter 3" sq. case, scale 0-8 R.F. amperes 632-0420
Meter 3" sq. case, scale 0-10 R.F. amperes 632-0421
Meter 4" sq. case, scale 0-3 R.F. amperes 632-0425
Meter 4" sq. case, scale 0-8 R.F. amperes 632-0426
Meter 4" sq. case, scale 0-10 R.F. amperes 632-0361
Meter 4" sq. case, scale 0-15 R.F. amperes 632-0428

NOTE: Other meter scale ranges available with only slight delay. Above for use with diode remote unit and not thermocouple type.

THERMOCOUPLE REMOTE METER KITS



Thermocouple Type: Includes 3" square case meter, thermocouple, adjusting rheostat, chokes and capacitors. May be used with up to 1000 ft. of 2-conductor No. 18 or larger line for remote metering between antenna coupling equipment and transmitter. Also available with 4" meters on special order.

ORDERING INFORMATION

Complete kit (meter range 0-3 R.F. amperes) M-3383
Complete kit (meter range 0-5 R.F. amperes) M-3133
Complete kit (meter range 0-8 R.F. amperes) M-4394
Complete kit (meter range 0-10 R.F. amperes) M-3386

NOTE: Other meter ranges available with only slight delay.



AM BROADCASTING ACCESSORIES

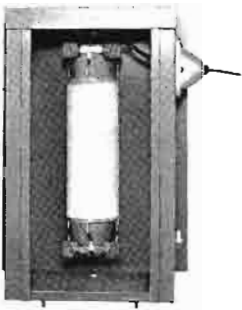

SOLENOID TOWER CHOKES

Most popular of all tower light isolation chokes. Available in 2 or 3 section and in open type, or weatherproof as illustrated. Wound on heavy triple X tubing with mica-by-pass condensers on each circuit end. Inductance approximately 350 uh. 3" stand-off insulators are part of coil. Size: (tower choke only), 19 1/2" long, 5" diameter, 7 1/2" from bottom of insulator to top of coil. (Weatherproof type), 24" high, 17 3/4" wide, 10 3/4" deep. Illustration to left shows weatherproof unit with front cover removed.

ORDERING INFORMATION

| | |
|---|--------|
| Tower Choke, 2 wire, weatherproof, Fig. A | M-3937 |
| Tower Choke, 3 Wire, weatherproof, Fig. A | M-3938 |
| Tower Choke, 2 wire, open type, Fig. B | M-3935 |
| Tower Choke, 3 wire, open type, Fig. B | M-3936 |



AUSTIN RING TYPE TOWER CHOKE

Ring type tower choke is a transformer with clear air space between primary and secondary and minimum antenna shunting effects. Independent of frequency. All models are for 115/230 volt primary and 115 volt secondary. Base insulator in photo for illustration purposes only.



ORDERING INFORMATION

| CAP—KVA | MFG. STYLE | LBS. | ATTACHMENTS | TYPE |
|---------|--------------|------|---------------|--------|
| 1-1.75 | Side Bracket | 81 | none | A-2100 |
| 1-1.75 | Side Bracket | 85 | lightning gap | A-2101 |
| 1-1.75 | Pedestal | 82 | none | A-2102 |
| 1-1.75 | Pedestal | 86 | lightning gap | A-2103 |
| 2-3 | Side Bracket | 188 | none | A-1970 |
| 2-3 | Side Bracket | 201 | lightning gap | A-1971 |
| 2-3 | Pedestal | 182 | none | A-1972 |
| 2-3 | Pedestal | 200 | lightning gap | A-1973 |

METER SHORTING SWITCH



A heavy duty make before break meter shorting switch of the plunger or push type. Designed for power ranges through 10 KW (see Note 1). Model M-5557 has inbuilt compensating loop. Heavy bronze tempered spring grip on both sides assures accuracy and durability. Gates has many types of radio frequency switches up to 100 KW accuracy and durability. Gates has many types of radio frequency switches up to 100 KW and will gladly quote on request.

ORDERING INFORMATION

| | |
|---|--------|
| Meter Shorting Switch, rating 1 KW modulated | M-3493 |
| Meter Shorting Switch, rating 10 KW modulated | M-5557 |
| Meter Shorting Switch, rating 50/100 KW | M-3283 |

NOTE 1: Illustrated is M-5557. In certain abnormal instances where voltage at base of tower is abnormally high, the power ratings would be less than stated.



METER JACK AND SHORTING BAR—MOUNTING PLUG

A great convenience to allow RF current measurements to be made by simply plugging in a meter. Will accommodate most 3" or 4" meters. A "must" in critical RF circuit areas in phasors, couplers, etc. Rating up to 50 KW on a 50 ohm line.

ORDERING INFORMATION

| | |
|-----------------------------|--------|
| Meter jack and shorting bar | M-3280 |
| Meter mounting plug | M-3281 |



RADIO FREQUENCY CONTACTOR



A heavy duty solenoid operated RF contactor for most switching applications through 50 KW power. Available in either SPDT or DPDT types and in two voltage ratings. Will operate on 115/230 volts AC, latching type. Will handle up to 25 amperes RF.

ORDERING INFORMATION

| | |
|---|---------|
| Contactors SPDT insulated 17 kv. peak voltage | 145-101 |
| Contactors DPDT insulated 17 kv. peak voltage | 145-102 |
| Contactors SPDT insulated 22 kv. peak voltage | 145-201 |
| Contactors DPDT insulated 22 kv. peak voltage | 145-202 |

HEAVY DUTY SAMPLING LOOP

This is a very rugged fixed non-shielded RF sampling loop. It is heavily galvanized after welding, and is fitted with large steatite insulators and heavy duty tower leg clamps for easy and positive mounting. Because of the extremely wide variety of sampling lines that will function with this loop. If a coaxial connector is desired, it is optional equipment. The loop is drilled to accept the more usual end terminals, coaxial receptacles, etc. For 50 to 70 ohm sampling line.

ORDERING INFORMATION

| | |
|--------------------------|--------|
| Heavy duty sampling loop | M-6126 |
|--------------------------|--------|



ROTATING PHASE SAMPLING LOOPS

This model is especially applicable where high current ratios are to be sampled. May be rotated so that phase monitor amplitude values are nearly equal. Electrostatically shielded and insulated from tower. May be used with or without isolation coil at base of tower. Coil is single loop, heavily insulated from base frame. Matches either 50 or 70 ohm line. Size: 48" wide, 32" high.

ORDERING INFORMATION

| | |
|------------------------|---------|
| Rotating Sampling Loop | M-3283A |
|------------------------|---------|



LARGE INVENTORY OF METERS

In the manufacture of transmitting and audio equipment for broadcasting, communications and defense, Gates is required to carry thousands of meters in inventory. Whether AC, DC or RF, or microammeter, milliammeter or ammeter, it is very likely the meter you need in emergency or expansion is quickly available. Give us desired case size, range and type of movement and we will serve you speedily. Many meters are also carried at our Houston, Texas branch.



AM FREQUENCY MONITOR

MODEL M-4990

The major requisite of a broadcast frequency monitor is reliability and extreme accuracy in indication of the carrier frequency. The FCC approved M-4990 AM frequency monitor is another new Gates product where progressive engineering has contributed a frequency monitor the operator may feel confident is accurately guarding his correct frequency at all times. Significant improvements include a heavily amplified intermediate frequency that is limited prior to the discriminator circuit. As a result, heavy modulation or a wide change in R.F. input level will have essentially no effect on the accuracy of the frequency meter reading. The precision vacuum type crystal will easily meet FCC standards and along with oscillator components is mounted in a temperature controlled chamber resulting in one half part per million frequency accuracy. Another engineering improvement is the greatly simplified balanced discriminator circuit. The older and often troublesome meter reactance box has been discarded.

For remote control operation, the M-4990 frequency monitor may be operated as an *off the air* monitor, or over telephone lines when used with the Gates M-5631 Extension Meter Panel described on Page 63. For *off the air* monitoring, the Gates M-5549 Whip Antenna is suggested.

Frequency is direct reading. The same meter, by switching, also indicates (a) carrier level and (b) oscillator current. Controls include: A.F. level for correct input signal, phone jack for 1000 cycle tone, power switch and OVEN ON pilot light.



Front panel hinges down for maintenance and easy to reach operating adjustments. Note the circular temperature controlled oven containing all oscillator components and the precision vacuum type crystal. A rear slip-on dust cover protects tubes and terminations.



Fully FCC approved for broadcast service.

SPECIFICATIONS

FREQUENCY RANGE:

540-1600 Kc. (as ordered).

METER:

Reads direct 30-0-30 cycles above and below carrier frequency.

OSCILLATOR AND STABILITY:

Electron coupled, 1000 cycles below assigned frequency. Accuracy of ± 0.5 parts per million. Over-all monitor stability, ± 2.0 parts per million.

INPUT:

50/70 ohms. When used with M-5549 whip antenna will operate on input as low as 5 MV. When direct connected, will accommodate input voltages from 5 to 50 volts. The input signal may be either modulated or unmodulated.

POWER INPUT:

105/125 volts, 50/60 cycles, 85 watts.

TUBES:

(5) 6AU6, (3) 6AQ5, (2) 6AL5 and (1 each) 12BY7A, 6C4, 12AT7, 6X4, OB2 and 13-4 ballast tube.

FCC APPROVAL:

No. 3-102.

MECHANICAL:

19" x 10 $\frac{1}{2}$ " x 10 $\frac{1}{2}$ " deep. Weight packed (domestic) 53 lbs., (export) 77 lbs. Cubage: 4. Finish: Medium gloss gray with escutcheons in black.

ORDERING INFORMATION

Frequency Monitor with tubes (Cat. No.) M-4990
Remote Control Extension Meter (see Page 63) M-5631
Whip Antenna and Coupler for Air Monitoring M-5549
Spare 100% tube kit for Monitor TK-281



BROADCAST MODULATION MONITOR



MODEL M-5693

The only truly new AM modulation monitor in recent years, the Gates Model M-5693 monitor is not just an indicating device, but an instrument that will assure maximum transmitter performance through fullest utilization of the R.F. carrier. Manufactured by Gates under U. S. Patents, these "full performance" advantages include: (1) extremely accurate self-calibration—no oscilloscope or other external device is needed to calibrate for exact modulation percentage, (2) long term accuracy—no false modulation percentage readings to either reduce signal strength or over-modulate, (3) a new derivative controller circuit—this circuit provides high speed meter response to indicate even the fastest transient program peaks, and (4) new exclusive design—no need to down rate performance to prevent over-modulation.

MONITOR ACCURACY: Modulation monitor accuracy is retained even as the tubes age. A new derivative controller circuit provides high speed meter response that will indicate even the fastest transient program peak. Correct peak indications on single program pulses as short as 50 milliseconds assure true peak measurement of program amplitude regardless of wave forms encountered.

OVER-MODULATED INDICATOR: The flashing over-modulation light indicator is directly calibrated. It has the same superior accuracy as the meter. As all measuring circuits are direct-coupled to the detector output, carrier shift has no adverse effect on meter readings.

PROOF OF PERFORMANCE: When feeding a 600 ohm unbalanced load a - 20 dbm. output level, with noise 65 db. below the maximum output of - 20 dbm., and 0.25% distortion between 20-15,000 cycles, provides laboratory standards for proof of performance measurements.

CONTROLS: All controls are located on the front panel except the calibration and power switch controls, which are conveniently located behind a small drop-down front panel. Exclusive is the ability to calibrate the monitor quickly and easily without the use of any other test or measuring instrument.

REMOTE CONTROL: Also included in the new Gates M-5693 Monitor are controls for compensation of varying telephone line characteristics to permit location of the monitor at the transmitter site. Operation by remote control is then initiated by Gates optional M-5837 Remote Meter Panel. Maximum accessibility has been emphasized, as is characteristic of all Gates equipment. The drop-down front panel permits nearly all maintenance and servicing operation, as required, from the front, and every part can be reached in a matter of seconds.

Finish is in Gates gloss gray with escutcheons, knobs and meter cases in black.



M-5837 remote meter panel is installed at studios and connected to the modulation monitor via a standard telephone line. The remote 4" meter reads modulation percentage corresponding to the monitor meter. Size: 19" x 5 1/4" x 3" deep. Finish: Medium gloss gray and black.

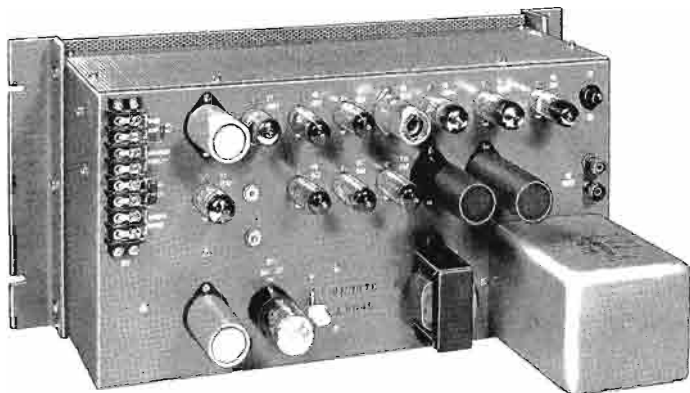

Rear view showing easy access to tubes and terminations.

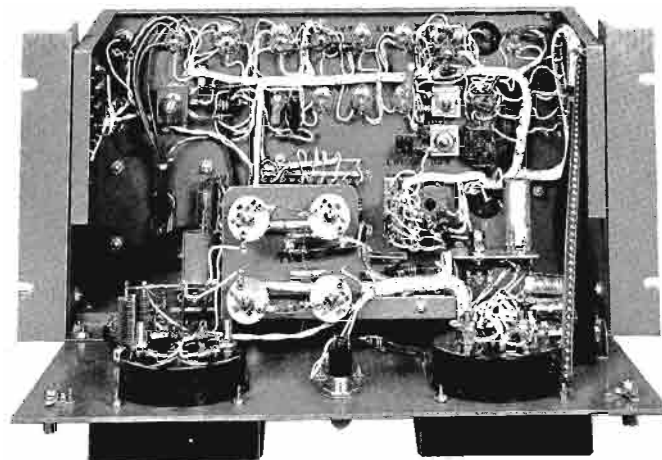

The front panel drops down to reach all inner components and easy cleaning.

SPECIFICATIONS

FREQUENCY RANGE:

540 kc. to 1600 kc.

R.F. INPUT:

For 50/70 ohm line at approximately 10 volts.

MODULATION INDICATION:

- (meter) 0% — 100% negative peaks.
0% — 110% positive peaks.
- (flasher) 50% to 100% in 5% steps on negative peaks, 0.6 db. 20-7500 cycles.
- (accuracy) Meter: 2% full scale at 1000 cycles.
Flasher: 2% at 1000 cycles.
- (response time) Meter responds to correct reading with a 50 millisecond pulse. Returns to 10% of reading in 500-800 milliseconds after signal is removed.

DETECTOR LINEARITY:

Negative peak clipping negligible up to 7500 cycles and 5% or less at 10,000 cycles.

LOADING EFFECT:

1000 mmf.

FIDELITY AT MEASURING OUTPUT:

± 0.5 db. 20-30,000 cycles at less than 0.5% distortion at 4½ volts into a 100,000 ohm load. Noise: 75 db. below 4.5 volts RMS.

REMOTE OUTPUT:

To extend modulation percentage meter, use Gates Model M-5837.

TUBES:

(3) OA2, (2) 12B4A, and (1 each) 6X4, 5879, OB2, OC2, 5687, 12AU7, 2D21 and 8-4 (ballast tube).

POWER:

105/125 volts, 50/60 cycles, 70 watts.

FCC APPROVAL NO.:

3-109.

MECHANICAL:

19" x 8¾" x 11½" deep. Weight packed (domestic) 35 lbs., (export) 85 lbs. Cubage: 3 cu. ft. Finish: Medium gloss gray and black.

LICENSE:

Exclusively licensed to Gates (other than to U.S. Government) under U.S. Patent 2,984,796.

ORDERING INFORMATION

- AM Modulation Monitor with tubes (Cat. No.) M-5693
- 100% spare tube kit TK-345
- Remote Meter Panel M-5837

AM FREQUENCY MONITOR

NOTE: The Gates M-4990 AM Frequency monitor described on the preceding page is an excellent companion unit, both in appearance and performance, for complete AM frequency and modulation monitor requirements. Both are fully FCC type approved and represent the latest engineering developments. Gates suggests that the broadcaster may wish to determine if his present monitors meet current FCC requirements.

PHASE MONITOR

Used with AM directional antenna systems. Available in standard models up to five towers and special models for larger arrays. When ordering, state: (1) frequency, (2) number of towers, (3) carrier power, (4) sampling line impedance or type number, and (5) full scale meter calibrations. Each meter reads antenna current from the phase sampling loop or current transformer at the tower. See Page 30 for sampling loops and isolation coils.

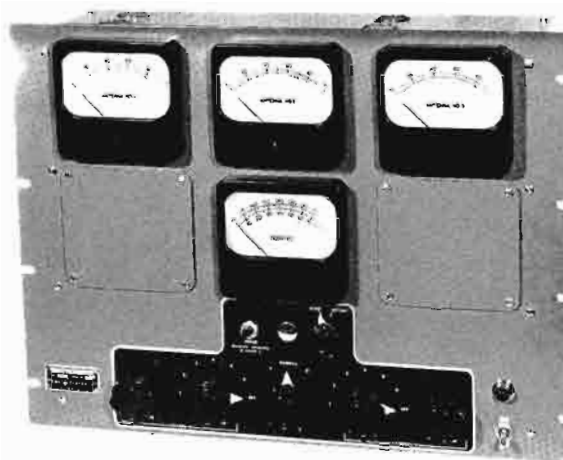

Model 108E Phase Monitor.

SPECIFICATIONS

FREQUENCY RANGE:
540 kc-1600 kc. Others available.

PHASE READING RANGE:
0-360 degrees.

ACCURACY:
1 degree.

RESOLUTION:
1/2 degree.

RF INPUT IMPEDANCE:
50/70 ohms at 1-7 volts RF.

SIZE:
14" high, 19" wide, 7" deep. Mounts in standard rack cabinet.

POWER REQUIRED:
115 volts AC, 50/60 cycles at 80 watts.

TUBES:
(2) 6AU6, (2) OB3, (1) 5Y3, (3) 6AL5.

WEIGHT:
Domestic packed 30 lbs. Export packed 50 lbs. Cubage 2.2.

ORDERING INFORMATION

Phase Monitor, 2 towers (Cat. No.) 731-0023
 Phase Monitor, 3 towers 731-0024
 Phase Monitor, 4 towers 731-0025
 Phase Monitor, 5 towers 731-0026

FIELD INTENSITY METER

Battery operated, the Model 120E field intensity meter is universally used to measure field strength in the 540-1600 Kc. broadcast band. A necessary item for initial and periodic directional antenna measurements and proof of performance.



Model 120E Field Intensity Meter.

SPECIFICATIONS

FREQUENCY RANGE:
540-1600 KC.

MEASUREMENT RANGE:
10 microvolts to 10 volts per meter.

ACCURACY:
2%.

INDICATOR:
Direct reading. Provision for recorder.

WEIGHT:
12 1/2 pounds, including batteries.

SIZE:
9" high, 13" wide, 5 3/4" deep.

TUBES:
(4) 1T4, (2) 1R5, plus two IN34A diodes.

BATTERIES:
(5) 1.5 volt flashlight type, (2) midget 67 1/2 volt "B".
 Note: These standard type universally available batteries are not supplied—but may be purchased locally.

WEIGHT:
Domestic packed 18 lbs. Export packed 40 lbs. Cubage 1.7

ORDERING INFORMATION

Field Intensity Meter (less batteries) (Cat. No.) Model 120E

NOTE: Items on this page manufactured by Nems-Clarke.

DUMMY ANTENNAS

The dummy antenna is perhaps the most needed test device in a broadcasting station. As a test device, it can eliminate hours or days of time and anguish. Its principal use is tune-up, test and proof of performance without the signal being on the air. For the daytime stations, this means routine work may be done after supper instead of after 1 A.M. The dummy antenna is most

valuable when trouble comes. The first question is always, "Where is the trouble?" An open transmission line, short in the coupler or phasor, short in a tower light, etc., will usually react by operating the overload relay in the transmitter. By quickly attaching the dummy antenna the source of trouble is quickly isolated as either in the transmitter or outside the transmitter.



10 KW AIR COOLED DUMMY ANTENNA

An air cooled 10,000 watt dummy antenna that will accept 100% modulation sine wave for long periods of time. Essentially non-reactive and can be used at full rating between 200 Kc. and 2000 Kc. Resistance, 50 ohms. The air cooled dummy antenna eliminates need for water connections and is considered a good practical device for tune-up and measurement. Model M-6107.

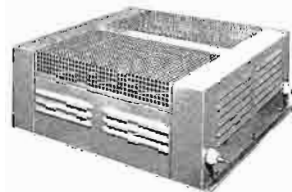

5 KW DUMMY ANTENNA AIR COOLED

For use with standard broadcast transmitters in the 5 KW power range for tune-up, efficiency tests and proof of performance tests. Essentially non-reactive. Handles 5000 watts 100% sine wave modulated. For operation between 200 Kc. and 2000 Kc. Available in 50 ohm (Model DU-551) and 70 ohms (Model DU-570).

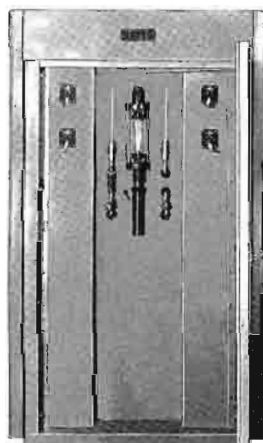

50 KW WATER COOLED DUMMY ANTENNA

The Gates 50 KW water cooled dummy antenna is available either for medium wave or short wave application. The high frequency version is provided with a suitable radio frequency network which can be adjusted for the desired impedance and reactance characteristics. The medium wave unit is essentially non-reactive in the 200-2000 Kc. band and does not usually require a matching network. Both models will easily handle a full 50 KW 100% modulated when provided with a suitable amount of water flow. Water of reasonable purity can be used, normal required flow is approximately 15 gallons per minute. Dual thermo-meters and flow meter are provided for precise power measurement by the calorimetric method. Available in medium wave type at 50, 70, 150, 300 and 600 ohms as ordered. High frequency type is available only for 300 or 600 ohms. Size: 78" high, 42" wide, 48½" deep.



100 KW WATER COOLED DUMMY ANTENNA

Designed for high power application, the Model WDL-1000A water cooled dummy load will dissipate a generous 100 KW AM at any frequency up to 30 Mc. Operating impedance is 300 ohms balanced. Other impedances are available on special order.

This model employs its own captive water system and an external heat exchanger. Water required for cooling need only be reasonably clean and free from mineral content. Heat is dissipated in an external heat exchanger of the water to air type. Approximately 150 gallons of water fill the system.

Size, of the dummy load only, is approximately 4' wide, 5' tall, 4' deep. Total weight, including heat exchanger, is 3850 pounds packed for shipment. Operates on 230 volts A.C., single phase.



AIR COOLED 1 KW DUMMY ANTENNA

This unit may be used for any medium wave transmitter at a maximum power rating of 1 KW, 100% modulated. Consists of non-inductive resistors heavily banded together to arrive at correct load resistance. Size: 20¼" x 12¾" x 5" high. Available in 50 ohm and 70 ohm models. For 200 Kc. to 2000 Kc.

ORDERING INFORMATION

| | |
|--|-------------------|
| Dummy Antenna, 10 KW, 50 ohms | (Cat. No.) M-6107 |
| Dummy Antenna, 5 KW, 50 ohms | DU-551 |
| Dummy Antenna, 5 KW, 70 ohms | DU-570 |
| Dummy Antenna, 50 KW, medium wave (see Note 1) | M-5497 |
| Dummy Antenna, 50 KW, high frequency (see Note 1) | M-5497A |
| Dummy Antenna, 100 KW, high frequency (see Note 2) | WDL-1000A |
| Dummy Antenna, 1 KW, 50 ohms | DU-151 |
| Dummy Antenna, 1 KW, 70 ohms | DU-170 |

NOTES: (1) Be sure and state resistance such as 50 ohms, etc., (2) Give power line frequency when ordering such as 50 or 60 cycles.

MODEL FM-20G

A full 20,000 watts of power and superb operating performance is built into this solidly designed high power FM broadcast transmitter. Latest of the new series of Gates FM transmitting equipment, the FM-20G FM transmitter represents careful application of the value analysis concept. The result is a completely new equipment with numerous added performance and mechanical advantages to increase quality and reliability and reduce the "per hour" operating cost.

The entire 20 KW transmitter except the power supply is housed in one attractive cabinet utilizing only ten square feet of floor space. A long accepted practice for higher powered transmitters is the external power supply. This permits use of less valuable out of the way space for the power supply and retains a roomy, easy to service transmitter.

All modes of FM operation are available. The FM-20G transmitter as standard is for monaural operation. Stereo and SCA may be quickly added as both space and terminations are provided for the Gates FM stereo generator, and if subscription music is desired now or later, the Gates sub-carrier generator. Power supply rectifiers are 100% solid state. Only two power tubes are used, the 4CX1000A driver amplifier and the 4CX-15,000A single ended power amplifier. The popular Gates direct crystal controlled cascade exciter, used by the majority of newly equipped FM stations, has the advantage of wide low distortion frequency response, natural adaption to stereo and multiplexing but absent of complicated difficult to maintain circuitry.

DIRECT CRYSTAL CONTROLLED CASCADE MODULATION: Heart of the high fidelity, Twenty-G FM system is the Gates Direct Crystal Controlled Cascade Exciter. It provides an R. F. signal modulated with the main channel FM signal, (stereo if desired) and accommodates SCA with the simplest and most direct method of operation now

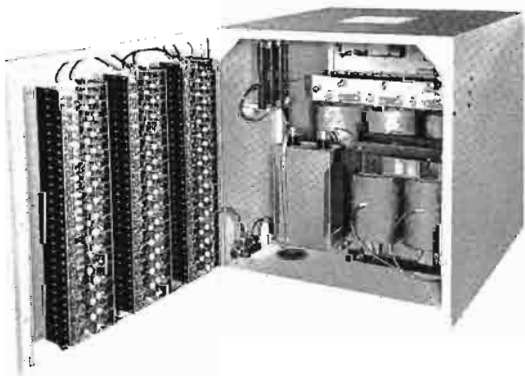

Compact high voltage power supply cubicle may be installed adjacent or at a distance from the FM-20G transmitter proper. Note silicon rectifiers and heavy duty components for long life and insured reliability.

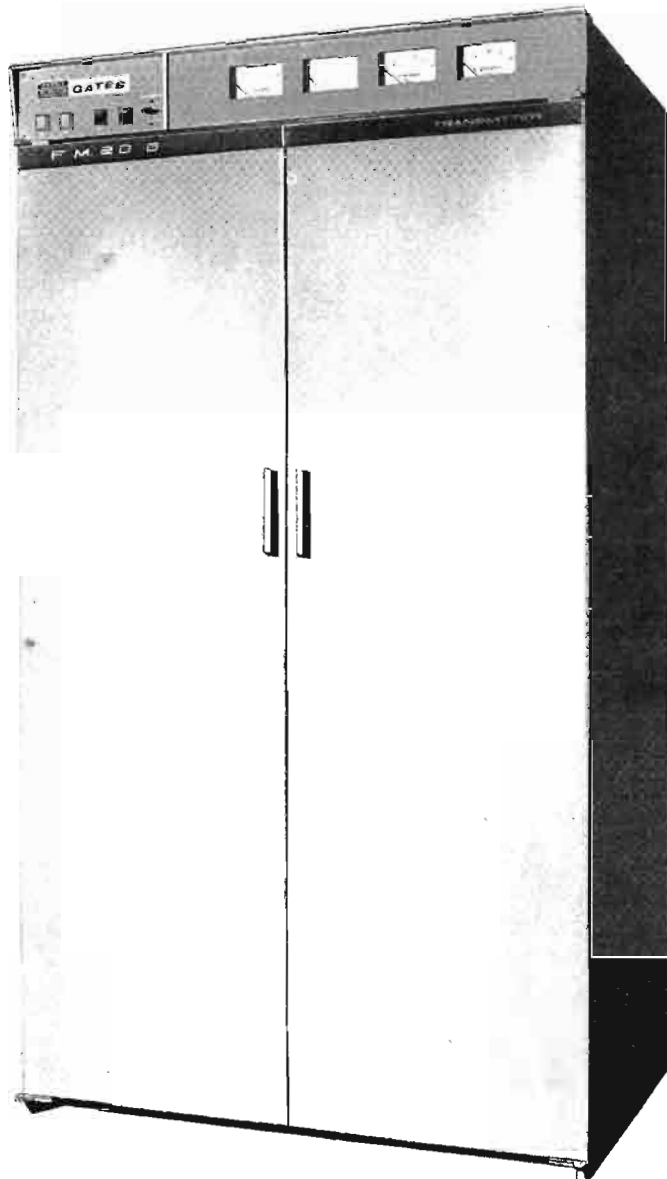

available to the broadcaster. With the Direct Crystal Controlled Cascade FM Exciter providing full rich response from 30 to 15,000 cycles, a whole new world of sound is yours in the dependable Twenty-G.

HARMONIC FILTERS STANDARD EQUIPMENT: Included as standard equipment is a "Tee-type" notch filter for second harmonic reduction, a micromatch VSWR section for direct meter reading on the transmitter of both power output and standing wave ratio, and a low pass filter which substantially eliminates third and higher order harmonics. Adjustment is made at the factory on the customer's frequency.

INTERMEDIATE & POWER AMPLIFIER STAGES: From exciter output to transmission line at 20,000 watts power there are only two radio frequency stages. Approximately 5 watts are required from the exciter to drive the 4CX1000A driver stage. This supplies generous drive to the 4CX-15,000D final power amplifier.

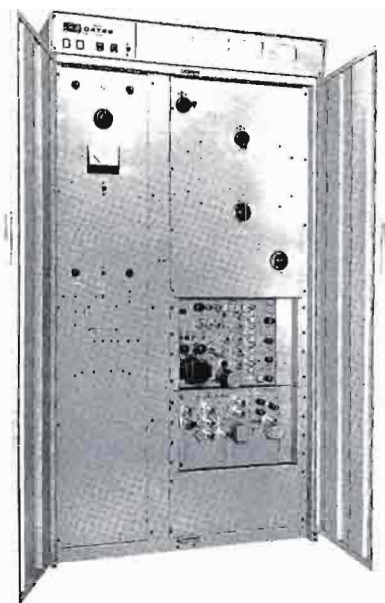

FM-20G, Front View—doors open. The optional stereo generator is shown below the cascade exciter.

SOLID STATE POWER SUPPLY: The high voltage power supply for the FM-20G transmitter is contained in a separate interlocked enclosure. Measuring 32" high, 30" wide and 36" deep, this cubicle houses the high voltage plate transformer, filter capacitors, filter reactor and the silicon rectifier stacks. No circuit breakers, contactors, or moving parts critical to the transmitter operation are contained in this unit but in the transmitter proper. Installation of the power supply may be made in the basement, or other seldom used areas of the transmitter building. A fan is provided to move air within the enclosure. The advantages with respect to flexibility, space savings and convenience in maintenance afforded by a separate HV enclosure has long been recognized by engineers operating Gates high powered AM transmitters.

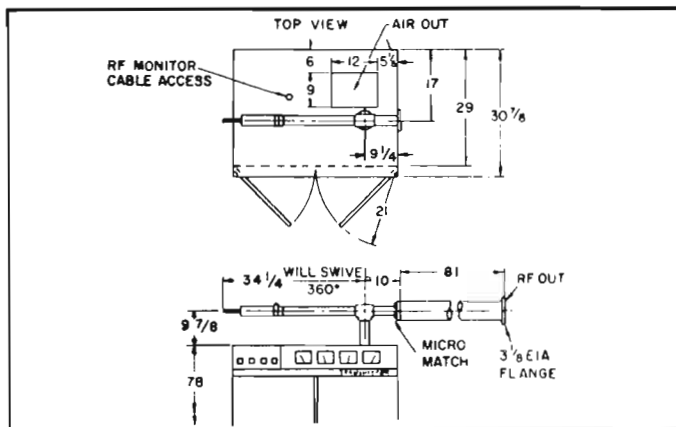

Included as standard equipment is a "tee-type" notch filter for second harmonic reduction, a micro-match VSWR section for direct meter reading on transmitter of both power output and standing wave ratio, and a low pass filter which substantially eliminates third and higher order harmonics.

Silicon rectifiers are used in the FM-20G transmitter as in all Gates FM transmitters. The result is greatly improved performance, as silicon cells are particularly resistant to aging, moisture and wide temperature variations. Safety factor is provided with individual rectifiers rated several times the voltage and current demands.

OPERATION: Functional design makes daily operation of the FM-20G transmitter most convenient. On-off functions are controlled by the four lighted push switches at the top left of the transmitter. These are plainly marked filament "on-off"; plate "on-off." The switch for the control of the multimeter is located just to the right of the push switches. No need to open the front doors to turn the transmitter on or off.

AUTOMATIC RECYCLING: In case of momentary overload, the transmitter recycles and is again turned on. Where the overload occurs three or four consecutive times, the Twenty-G will then remain off until it is manually reset, either locally or by remote control. A valuable feature for unattended operation.

REMOTE CONTROL: As supplied, the transmitter is ready to attach Gates remote control equipment for unattended operation. Connect the Twenty-G to a transmitter control unit, tie in the telephone lines to the studio and you are ready for complete remote control operation. Optional remote control equipment is listed on Pages 61 & 62.

SERVICEABILITY: The Twenty-G is an FM transmitter allowing maintenance and service from both the front and rear. A full length front access door is interlocked to protect personnel and all components are within easy reach of the maintenance engineer.

OPERATIONALLY TESTED: During development and before entering production, FM-20G was tested under most severe operating conditions. Environmental tests that surpass conditions of any location a transmitter is likely to encounter have been imposed upon Twenty-G. Each transmitter is fully tuned and tested to the customer's operating frequency before shipment from the Gates factory.

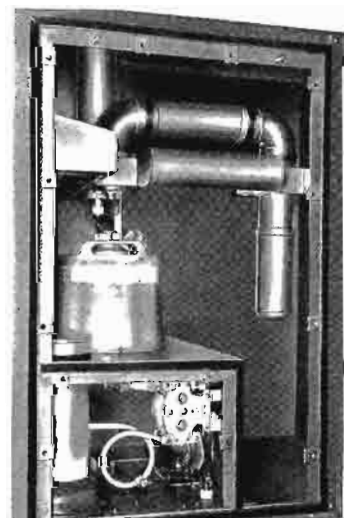

The Power Amplifier stage, which uses a 4CX15000A ceramic tube, has its driver amplifier located directly below for added efficiency of operation.



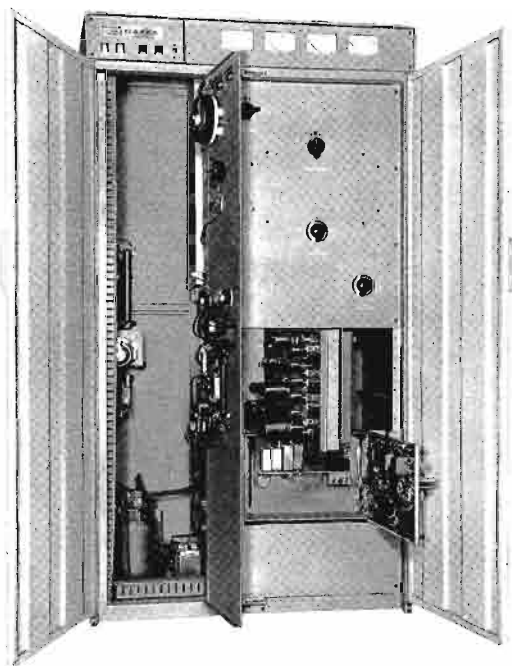

Front view with all doors open to indicate quick access for maintenance.

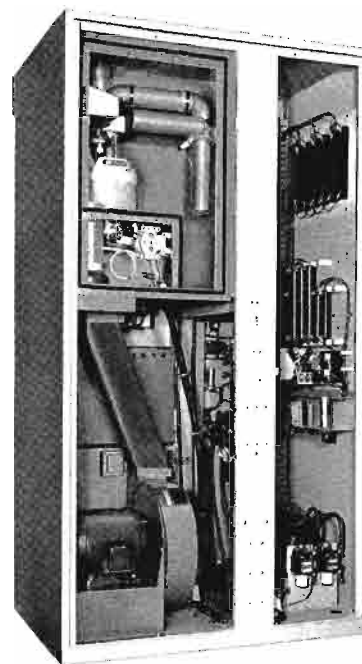

Rear view. Accessibility to all components is a major feature of the FM-20G.

SPECIFICATIONS

POWER OUTPUT:
20,000 watts.

FREQUENCY RANGE:
88-108 Mcs. (to frequency as ordered).

R. F. OUTPUT IMPEDANCE:
50 ohms.

OUTPUT TERMINATION:
EIA 3 1/8" flange.

FREQUENCY STABILITY:
± .001%.

TYPE OF MODULATION:
Cascade with Direct Crystal Control.

MODULATION CAPABILITY:
± 100 Kc. (FCC specifies ± 75 Kc.).

AUDIO INPUT:
600 ohms, + 10 db. ± 2 db.

AUDIO FREQUENCY RESPONSE:
± 1 db.—50,15,000 cycles — 2 db. at 30 cycles.

AUDIO DISTORTION:
1% or less—30-15,000 cycles.
1/2% or less—100-10,000 cycles.

FM NOISE LEVEL:
65 db. below 100% FM modulation.

AM NOISE LEVEL:
50 db. below equivalent 100% AM modulation.

TUBE COMPLEMENT:
(3) 6201, 6J6, 7025, (7) 6AU6, (2) OA2 and (1 each)
6AQ5, 12AX7, 6080, 6360, 4CX-1000A, 4CX-15,000D.

POWER SOURCE:
208/240 volts, 3 phase, 60 cycle, 115 volts, single phase, 60
cycles, (50 cycles available on special order).

INPUT AC POWER REQUIREMENT:
Approximately 34 KW at 90% power factor.

ALTITUDE:
7500 feet or less.

AMBIENT TEMPERATURE RANGE:
— 20°C. to 45°C.

MAXIMUM VSWR:
1.7 to 1.

SIZE:
(Transmitter Cabinet) 42" wide x 78" high x 32 3/4" deep (see
Note 1).
(HV Power Supply Cabinet) 30" wide x 32" high x 36" deep.
(see Note 2.)

FRONT DOOR SWING:
21".

FINISH:
Two-tone, Aqua Mist, trim in black and brushed aluminum.

WEIGHT:
Domestic packed, 2900 lbs. Export packed, 3500 lbs. Cubage:
130.

ORDERING INFORMATION

20,000 watt transmitter with one set of tubes, crystal and oven,
for monaural operation (see Note 3)(Cat. No.) FM-20G
Spare crystal and oven (see Note 3) M-6484
Spare 100% tube kit TK-528
Stereo Generator (see Page 52) M-6146
Sub-carrier Generator (see Page 53) M-6160

NOTES: (1) For installation, if door clearance is critical, by removing door handles the depth is reduced to 29 3/4". (2) Power supply enclosure may be slightly larger for 50 cycle service. (3) Please state frequency when ordering.

MODEL FM-10G

Quality engineered all the way under the new Gates *Value Analysis* concept, the FM-10G 10,000 watt FM transmitter provides the broadcaster with an unusually high quality product for monaural, stereo and SCA service. FM by Gates means cascade modulation that is entirely new, greatly simplified and more dependable. Direct crystal control of the main carrier frequency makes it inherently stable for either monophonic or stereo program transmission. There has been no compromise anywhere in the objective to assure maximum quality in the design and manufacture of the FM-10G transmitter. The power amplifier utilizes the type 4CX-10,000D final amplifier tube which operates at a leisurely pace and provides reserve power to deliver the high fidelity signal that listeners expect and with the economy of operation desired.

DIRECT CRYSTAL CONTROLLED CASCADE MODULATION: Heart of the high fidelity FM-10G transmitter is the Gates M-6095 *Direct Crystal Controlled Cascade Exciter*. It provides an RF signal modulated with the main channel FM signal or stereo, and accommodates SCA with the simplest and most direct method of operation available to the broadcaster today. The direct crystal controlled cascade FM exciter provides a full rich response from 30 to 15,000 cycles and the most accurate frequency stability because the carrier frequency is controlled independent of modulation. The exciter has fewer and simpler circuits, thus increasing reliability which is often directly related to the number of circuit components. All components in the Gates FM Exciter are standard and easily available. Remote switching from monaural to stereo and one or two SCA channels is provided.

SELF-CONTAINED: The FM-10G transmitter is completely self-contained. Plate transformer, blowers and stereo generating/SCA (optional) equipment are all housed in the handsomely styled, well shielded cabinet.

SERVICEABILITY: Routing maintenance is made easy as complete total access to the entire transmitter is possible from both front and rear. Fully interlocked wide swing front doors insure protection for station personnel.

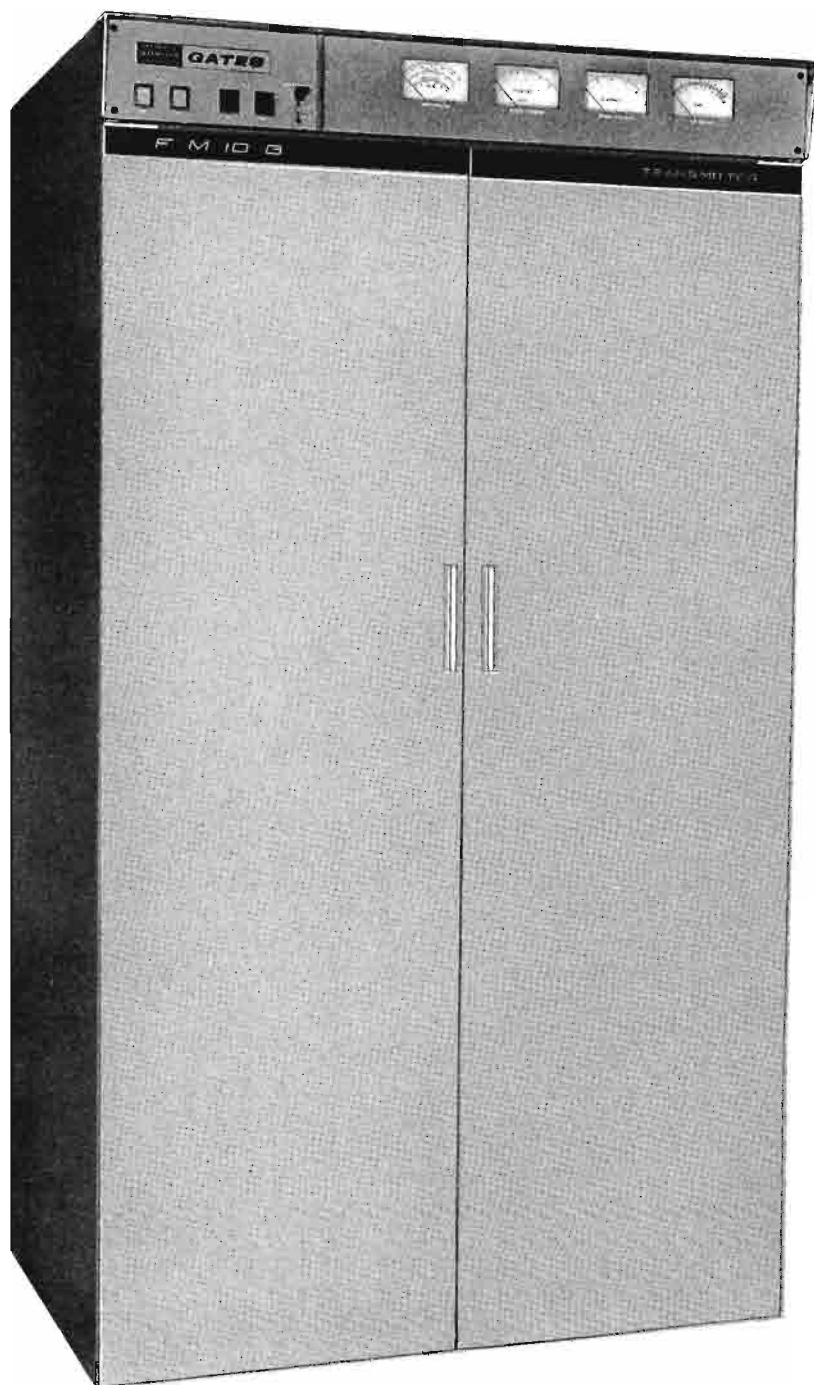

OPERATIONALLY TESTED: Before entering production, the FM-10G transmitter was tested under the most severe operating conditions. Environmental tests that surpassed conditions of any situation a transmitter is likely to encounter were imposed upon the FM-10G equipment. Each transmitter is fully tuned and tested on frequency prior to shipment.

PUSH-SWITCH OPERATION: On-Off functions are controlled by the push-switches at the top left of the trans-

10,000 Watt FM Broadcast Transmitter—FM-10G

mitter. These switches are plainly marked **FILAMENT ON-OFF**, **PLATE ON-OFF**. The switch for multimeter selection is located to the right of the push-switches. There is no need to open the front doors to turn the unit on or off.

REMOTE CONTROL: No additional equipment is required within the transmitter for remote control. Simply connect a transmitter control unit of the remote control equipment (optional) and remote operation is ready. The Gates RDC-10 remote control system (Page 61) is suggested.

AUTOMATIC RECYCLING: In case of momentary overload, the transmitter will automatically recycle and return to the ON position. Where the overload occurs three or four consecutive times, the transmitter will then remain off until it is manually reset, either locally or by remote control.

INTERMEDIATE AND POWER AMPLIFIER STAGES: From exciter output to the full 10,000 watts delivered to the transmission line, there are only two radio frequency stages. Approximately 5 watts are required from the exciter to drive the 4CX-300A driver tube stage. This supplies a nominal 250 watts to drive the 4CX10,000D final amplifier. The 4CX10,000D power tetrode is used as a single ended amplifier to produce a generous 10 kilowatts of power.

HARMONIC FILTERS STANDARD EQUIPMENT: Included as standard equipment is a "tee-type" notch filter for second harmonic reduction, a micro-match VSWR section for direct meter reading on transmitter of both power output and standing wave ratio, and a low pass filter which substantially eliminates third and higher order harmonics.

SOLID STATE POWER SUPPLIES: All power supplies are of the silicon diode design with full transient protection and generous safety factor. The main power supply develops 6600 volts from a 3 phase full wave rectifier supply. Silicon rectifiers offer greatly improved performance since they are largely resistant to aging, moisture and wide temperature variations.

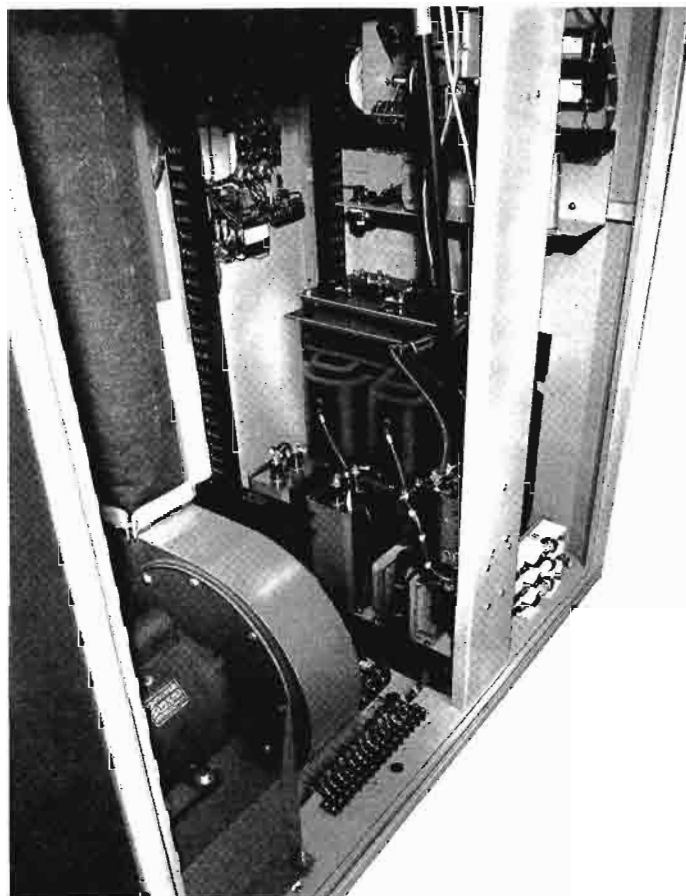

Accessibility, logical design and excellent workmanship are all illustrated in this back view with door and panel removed.

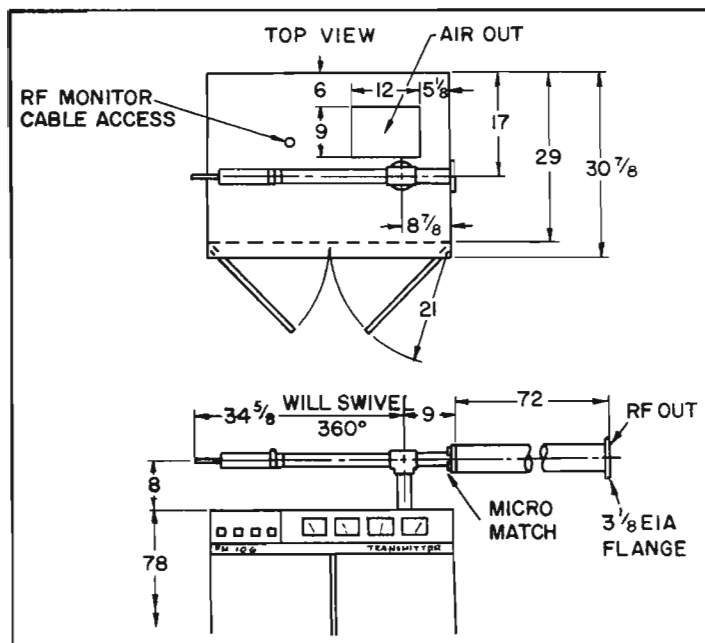

On-Off and multimeter switching functions are located on the top front panel of the FM-10G transmitter.

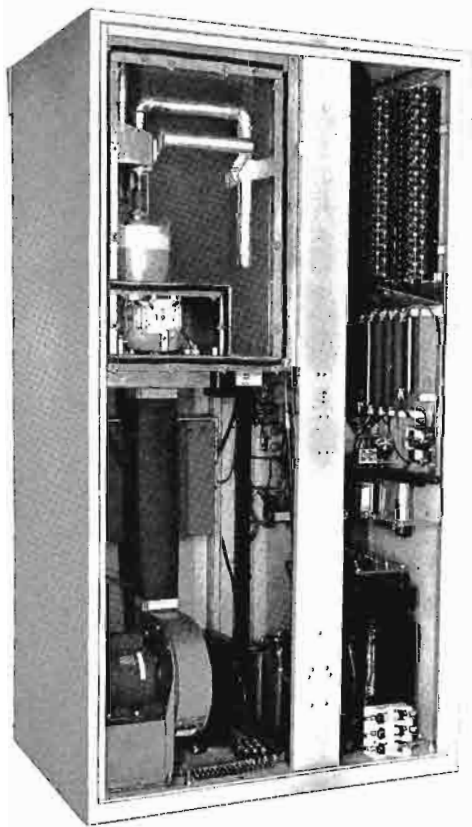

FM-10G—Rear view door and R.F. shield removed.

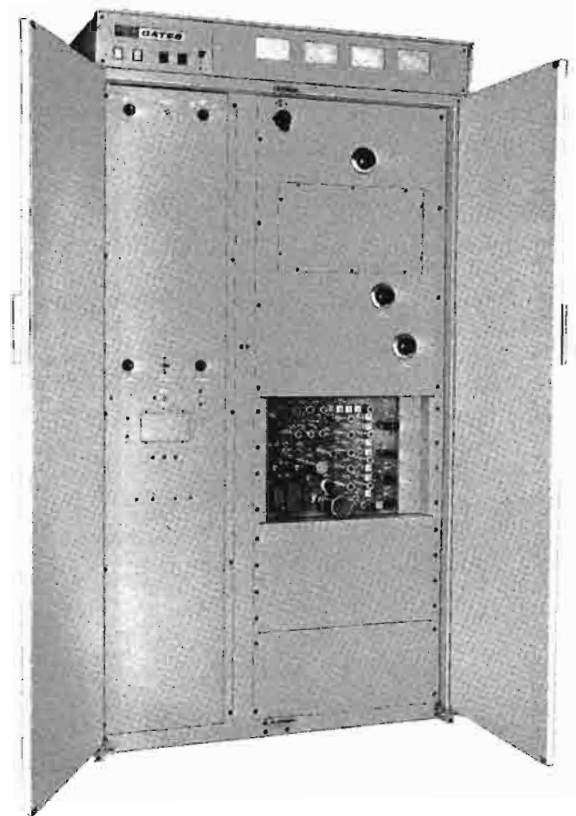

FM-10G—Front doors open.

SPECIFICATIONS

- POWER OUTPUT:**
Rated 10 KW. May be operated at lower power to meet ERP requirements.
- FREQUENCY RANGE:**
88-108 Mcs.
- RF OUTPUT IMPEDANCE:**
50 ohms.
- OUTPUT TERMINATION:**
EIA 3 1/8" flange.
- MAXIMUM VSWR:**
1.7 to 1.
- FREQUENCY STABILITY:**
± .001%.
- TYPE OF MODULATION:**
Cascade with Direct Crystal Control.
- MODULATION CAPABILITY:**
± 100 Kc. maximum.
- AUDIO INPUT IMPEDANCE:**
500/600 ohms.
- AUDIO INPUT LEVEL:**
Approximately + 10 dbm.
- AUDIO FREQUENCY RESPONSE:**
± 1 db. 50-15,000 cps.
(- 2 db. at 30 cycles)
- AUDIO DISTORTION:**
1% or less - 30-15,000 cps.
1/2% or less - 100-10,000 cps.
- FM NOISE LEVEL:**
65 db. below 100% FM modulation.
- AM NOISE LEVEL:**
50db. below equivalent 100% AM modulation.

- AC INPUT:**
208/240 volts, 3 phase, 60 cycles at 18 KW, full 10 KW output.
115 volts, 60 cycles at 500 watts for exciter and crystal oven.
(50 cycles available for overseas customers).
- ALTITUDE:**
7500 feet.
- AMBIENT TEMPERATURE RANGE:**
- 20° C to + 50° C.
- OVER-ALL CABINET SIZE:**
42" wide x 78" high 32 3/4" deep. To accommodate a narrow door for installation, the depth is reduced to 29 3/4" by removing front and rear door handles. Harmonic filter and connections extend 9 1/2" above cabinet top when installed. Front door swing: 21".
- FINISH:**
Two-tone, Aqua Mist with trim in brushed aluminum and black.
- WEIGHT:**
Packed (domestic) 1500 lbs., (export) 1700 lbs. Cubage: 120.

ORDERING INFORMATION

FM Broadcast Transmitter, 10 KW, with one set of tubes, crystal and oven, for 60 cycle operation (Cat. No.) M-6410
Spare 100% tube kit for above 990-0513

Note: For stereo and SCA equipment, see Pages 52 & 53. For monitors, see Page 58.

MODELS FM-5G—FM-7.5G

In the new FM-5G, 5000 watt, and FM-7.5G, 7500 watt FM broadcast transmitters the application of the value analysis concept by Gates has produced equipment of the very finest in technical excellence, superb styling and reliability.

Since the beginning of FM broadcasting, Gates engineers have continually advanced the state of the art in the field of FM broadcast transmitters. Even during the inactive days of FM, Gates continued aggressive product research. Knowing that the FM of tomorrow would demand much more than just a pleasant appearance of design, a new product development program was initiated. Through an integrated company-wide program, the objective was to produce equipment with maximum dollar value for the buyer. The resulting value analysis program developed the superior FM-5G and FM-7.5G FM transmitters which offer the maximum value to broadcasters. Today the FM-5G and its companion FM-7.5G are the most wanted transmitters anywhere making the Gates trademark synonymous with FM.

DIRECT CRYSTAL CONTROLLED CASCADE MODULATION: Part of the high-fidelity technically perfect FM-5G sound is the Gates direct crystal controlled cascade exciter. The radio frequency signal is modulated with a main channel FM signal (stereo may be added) and accommodates SCA with the simplest and most direct method of operation available to the broadcaster today. The Gates direct crystal controlled cascade FM exciter provides full rich response from 30 to 15,000 cycles. FM by Gates means cascade modulation that is entirely new, greatly simplified and more dependable. Direct crystal control of the main carrier frequency makes it inherently stable. Because the carrier frequency is controlled independent of modulation, fewer and simpler circuits are possible with direct crystal control. Reliability is greatly improved as the number of circuits and components are reduced. Components are standard and easily available. No difficult-to-obtain tubes, transistors, or diodes are used. Gates direct crystal controlled cascade exciter modulator has the sound that keeps dials set. Wide response, very low distortion and day-in and day-out stability assure the quality results that are demanded of and expected from leading FM broadcasting stations.

SELF-CONTAINED: The FM-5G is completely self-con-

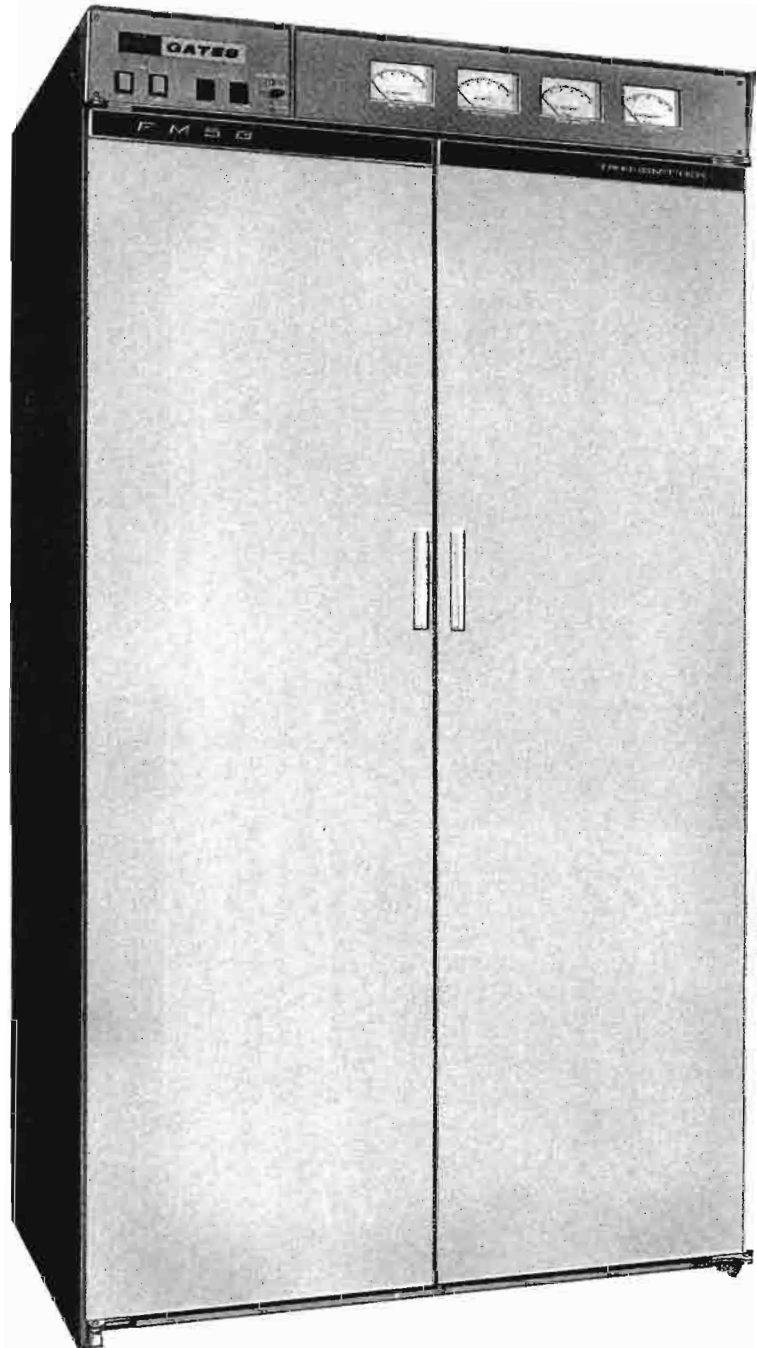

tained. Plate transformer, blowers and stereo generating/SCA equipment are all contained in the handsomely styled, ruggedly built and well-shielded cabinet.

SERVICEABILITY: Here is the first FM transmitter allowing maintenance and service from both the front and rear. A full length front access door is fully interlocked to protect personnel. All components are within quick and

easy reach for the periodic maintenance program of your engineering department.

PUSH-SWITCH OPERATION: Daily operation of this transmitter is simple. On-off functions are controlled by the four lighted push switches at the top left of the transmitter. These switches are plainly marked FILAMENT ON-OFF; PLATE ON-OFF. The selector switch for the control of the multimeter is located to the right of the push switches. There is no need to open the front doors to turn the transmitter on or off.

COMPOSITE SIGNAL: The transmitter accepts the composite signal from the exciter and increases power from 5 watts to a full 5KW or 7.5KW as ordered. The transmission can be a simple main channel monaural signal, a stereophonic signal, stereophonic with 67 Kc. SCA (multiplex), or main channel with 41 Kc. and 67 Kc. SCA channels. All meet or exceed prescribed FCC rules and regulations. Stereo and SCA equipments are optional at only modest increase in price.

REMOTE CONTROL: No additional equipment is required in the transmitter for remote control. Simply connect the FM-5G transmitter to a transmitter portion of the remote control unit, tie in the telephone line to the studio and you are ready for complete remote control operation. The suggested Gates RDC-10 remote control system is fully described on Page

AUTOMATIC RECYCLING: In case of momentary overload, the transmitter will automatically recycle and turn on again. When the overload causes recycling three consecutive times, the FM-5G will then remain off. When the problem is located, the transmitter is turned on either locally or by remote control, and recycling once again is in operation if needed.

HARMONIC FILTERS STANDARD EQUIPMENT: Unusual design care has been taken to assure very low radio frequency harmonic radiation. A Tee notch type filter is supplied with the transmitter. This filter lowers the second harmonic in many instances to 100 db. reduction and assures meeting the FCC 80 db. specification. The VSWR meter, located on the transmitter to read power output and standing wave ratio, connects to this filter as part of the outgoing transmission line. A low pass filter is also incorporated to substantially eliminate third and higher order R.F. harmonics. All filters are factory adjusted to the buyer's frequency prior to shipment of the transmitter.

INTERMEDIATE AND POWER AMPLIFIER STAGES: From exciter output to the full power delivered to the transmission line, there are only two radio frequency stages. Approximately 5 watts are required from the exciter to drive the 4CX250B driver stage. This supplies a nominal 250 watts to drive the 4CX5000A power amplifier. This power tetrode is used as a single ended amplifier to produce 5KW of power for the FM-5G and 7.5KW of power for the Model FM-7.5G.

OPERATIONALLY TESTED: Before entering production, prototype models were tested under the most severe operating conditions. Environmental tests that surpass conditions of ambient temperature, humidity and abuse that the transmitter is never likely to encounter were imposed upon the FM-5G and FM-7.5G equipments. Each FM transmitter is carefully tuned and fully tested at the factory, on the customer's operating frequency, prior to shipment.

STEREO-SCA: Within a matter of minutes you may equip your FM-5G or FM-7.5G transmitter with a Gates M-6146 Stereo Generator. Space is provided directly below the M-6095 cascade exciter to mount the stereo generator. Actually mounting areas are provided for two M-6160 SCA Sub-carrier Generators. These units will permit the simultaneous broadcasting of the stereo signal and an added 67 Kc. SCA. When not broadcasting stereo, a 41 Kc. SCA channel also becomes available.

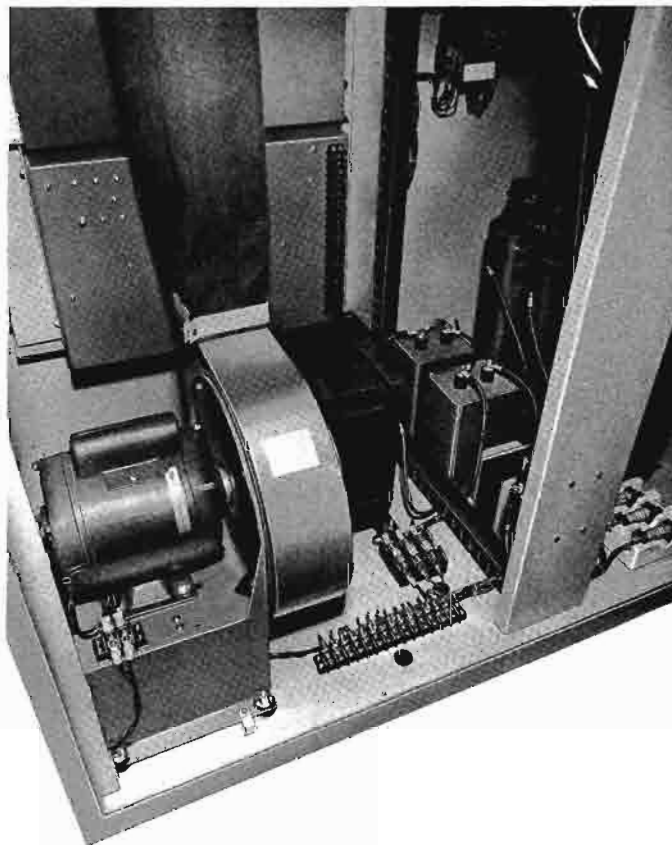

Spaciousness, rugged components and design innovations, such as the new fiberglass wire raceways are all the result of Value Analysis planning.

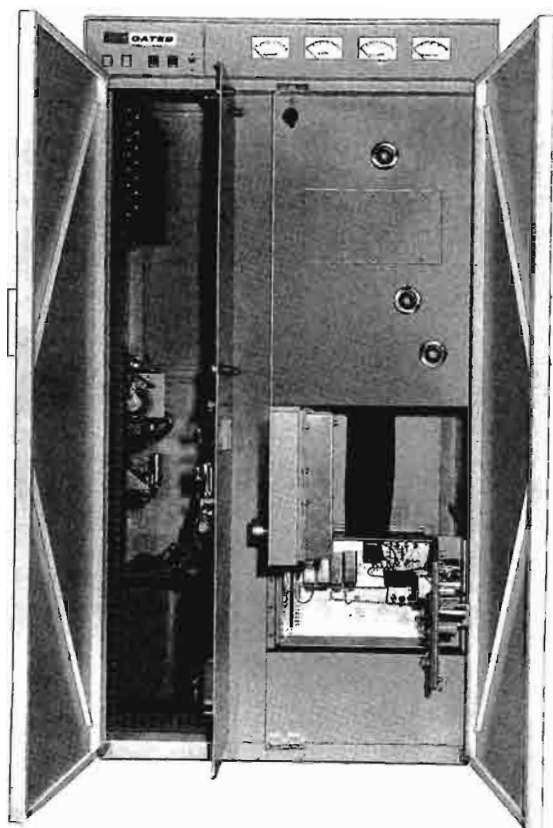

With all front doors and panels open, the Five-G virtually bursts into a new standard of accessibility. The full length access door is fully interlocked.

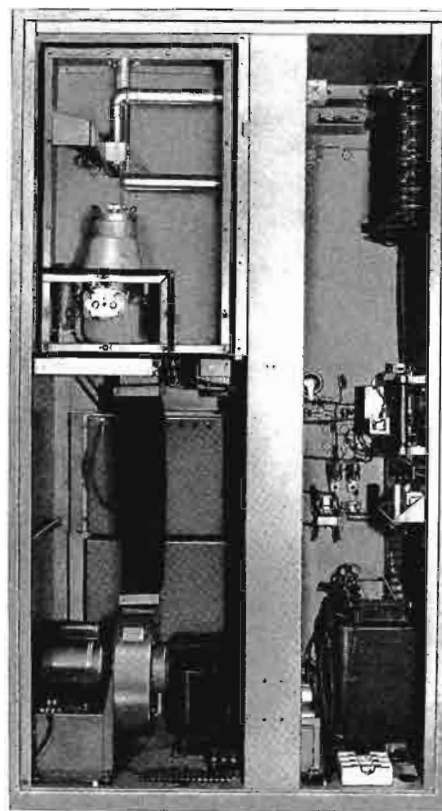

Accessibility, logical design and excellent workmanship are all illustrated in this back view with door and power amplifier panel removed.

SPECIFICATIONS

POWER OUTPUT:
Model FM-5G; 5000 watts. Model FM7.5G; 7500 watts.

FREQUENCY RANGE:
88-108 Mcs.

RF OUTPUT IMPEDANCE:
50 ohms.

OUTPUT TERMINATION:
Standard EIA 3 1/8" flange.

FREQUENCY STABILITY:
± .001%.

MAXIMUM VSWR:
Up to 1.7 to 1.

TYPE OF MODULATION:
Cascade with Direct Crystal Control.

MODULATION CAPABILITY:
Max. ± 100 Kc. (FCC requires max. ± 75 Kc.)

AUDIO INPUT IMPEDANCE:
600 ohms.

AUDIO INPUT LEVEL:
Approx. + 10 dbm.

AUDIO FREQUENCY RESPONSE:
± 1 db. 50-15,000 cps
(response at 30 cycles — 2 db.)

AUDIO DISTORTION:
1% or less 30-15,000 cps, 1/2% or less 100-10,000 cps.

FM NOISE LEVEL:
65 db. below 100% FM modulation.

AM NOISE LEVEL:
50 db. below equivalent 100% AM modulation.

POWER INPUT:
208/240 volts, 3 phase, 60 cycles at 11 KW consumption at 240 volts.
115 volts, 60 cycles, at 500 watts for exciter and crystal oven.
(50 cycles available on special order.)

TUBES:
(Exciter Section) (7) 6AU6, (3) 6J6, (2) 6201, (3) 7025 and
(1 each) 12AX7, 6AQ5, 6080, 6360, 5AR4/
GZ-30.
(Transmitter Section) (1 each) 4CX250B, 4CX5000A.

ALTITUDE:
7500 feet.

AMBIENT TEMPERATURE RANGE:
— 20° to + 45° C.

CABINET SIZE:
42" wide x 78" high x 32 3/4" deep. (Front door swing, 21").
For installation purposes, by removing front and rear door
handles depth is 30" to clear a narrow door. R.F. output
connector and Tee notch filter extends 9 1/2" above cabinet top.

FINISH:
Two-tone Aqua Mist with trim in brushed aluminum and black.

SHIPPING WEIGHT:
Packed (domestic) 1500 lbs., (export) 1625 lbs.

CUBAGE:
117.

ORDERING INFORMATION

Model FM-5G 5KW Transmitter, one set of tubes, crystal and oven,
Tee notch and harmonic filter (Cat. No.) M-6394
Model FM-7.5G 7.5KW Transmitter, one set of tubes, crystal and
oven, Tee notch and harmonic filter M-6412
Spare 100% tube kit for FM-5G or FM-7.5G Transmitter TK-408
Minimum spare tube kit for FM-5G or FM-7.5G Transmitter TK-463

Note: For stereo, see Page 52. For SCA, see Page 53. For monitors, see Page 58.

1000 WATT FM BROADCAST TRANSMITTER

MODEL FM-1G

There is only one power tube in the totally new FM-1G transmitter for 1000 watts FM operation. Power supplies are all solid state and only small low voltage tubes are used in the exciter which directly drives the single ended single tube power amplifier. This new FM transmitter is another "Value Analysis" product where emphasis is placed on quality construction by putting construction dollars where it counts—in performance! In the new FM-1G transmitter, Gates has provided every practical feature for reliability with solid state power supply, built-in VSWR/output power meter, automatic recycling, and a low pass filter as well as separate "T" type notch filter for assured harmonic reduction.

Quality all the way, nothing has been spared to assure transmission of a superb FM signal. For stereo, room is provided to mount the optional Gates M-6146 Stereo Generator which in turn can house the optional 41 Kc. or 67 Kc. Sub-carrier Generators. Operation of the Gates FM-1G transmitter is a pleasure. Push switch control, front panel tuning of all RF circuits and complete metering illustrate operating convenience. Quick accessibility to all components for maintenance is through the full length rear door. The transmitter is pre-tuned at the factory on the customer's assigned operating frequency. Only connection of the AC power, audio and RF cables are required to begin final testing.

POWER AMPLIFIER: Driven directly by the exciter output, the final and only RF power stage uses a single 4CX1000A tube. This ceramic tetrode, mounted in a fully shielded enclosure, is forced air cooled. Spurious radiation is held to absolute minimum and the entire unit has a high degree of stability enhanced by the neutralization of the final power amplifier. A VSWR output meter clearly indicates the power output in watts and the standing wave ratio. This meter and the plate voltage, the plate current and the filament voltage meters are visible at all times on the metering and control panel at the top front of the transmitter.



Filament and high voltage "On-Off" functions are operated by attractive illuminated push switches. All other adjustments are behind the full length front door, resulting in a clean functional appearance and protection against advertent operation by non-technical personnel.

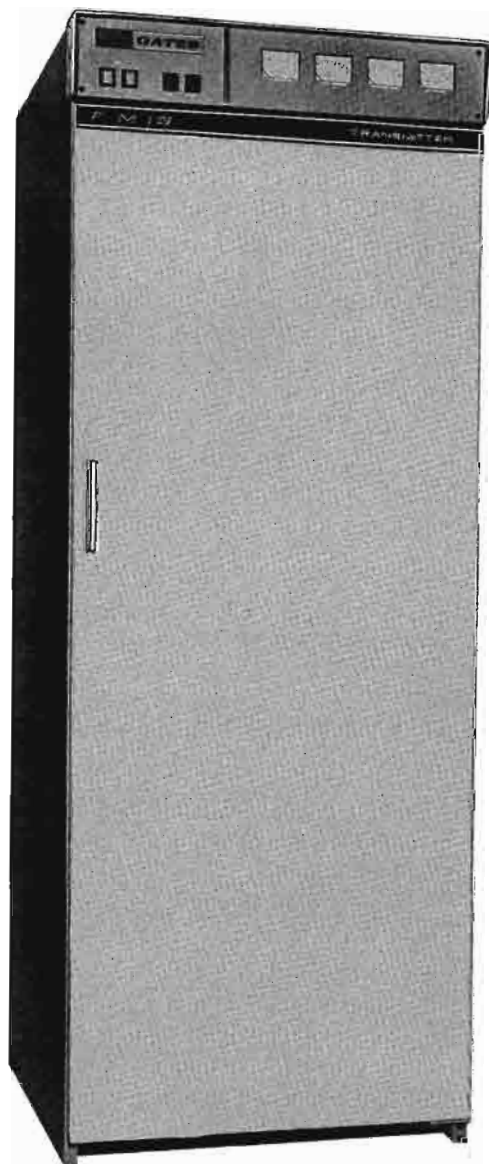

HARMONIC FILTERS: To meet rigid FCC regulations on harmonic radiation, Gates has built in a T Notch filter for second harmonic radio frequency reduction. For the third and higher order harmonics an external low pass filter is supplied. It mounts as part of the outgoing coaxial line and is factory adjusted.

CASCADE EXCITER: The popular Gates direct crystal controlled cascade exciter utilizes two modulators operating in series for improved low-frequency response. A saw-tooth generator is driven by a crystal controlled oscillator. The saw-tooth signal is modulated by the first modulator. This modulated signal is reformed into another saw-tooth wave shape and is modulated again by modulator No. 2. The results are superior audio frequency response and lower

1000 Watt FM Broadcast Transmitter—FM-1G

distortion to develop the richness and quality so important in low frequencies. The cascade exciter is unusually fine for stereo or multiplexing by addition of the slip-in Stereo Generator or Sub-channel units.

REMOTE CONTROL: FCC required voltage and current sampling and power output adjustment is brought to terminals ready to attach any Gates remote control system (see Page 61). Even the motor tuned power output control is self-contained. This is often a costly accessory and is a definite savings when unattended operation is desired.

AUTOMATIC RECYCLING: In case of momentary overload, the transmitter recycles and is again turned on. The number of recycles is adjustable (usually set at 3 or 4) when the overload presents itself, the FM-1G will recycle through the established sequence, then remain off until it is manually reset, either locally or by remote control, an especially valuable feature for unattended operation.

CONVENIENCE OPERATION: On/Off functions are controlled by the four lighted push switches at the top left of the transmitter. These are plainly marked "filament ON/OFF," "plate ON/OFF." No need to open the front door to turn the transmitter on or off. The output power control key switch, VSWR/Power Selector Switch, adjustable filament control, and other tuning controls are located on the front panel of the transmitter, exposed when the door is opened.

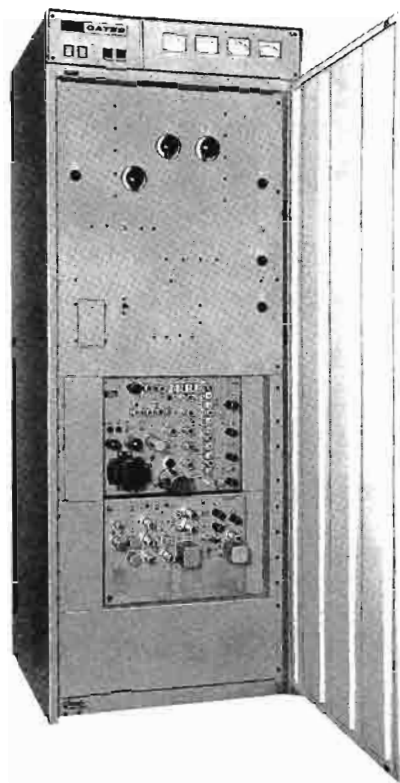

Front door open. The direct crystal controlled cascade exciter is illustrated above the stereo generating equipment below the cascade exciter. Note the two slip off panels below the stereo generator. Multiplex sub-channel generators fit here.

SPECIFICATIONS

POWER OUTPUT:
1000 watts.

FREQUENCY RANGE:
88-108 Mc. (see Notes 3 and 4).

RF OUTPUT IMPEDANCE:
50 ohms.

RF OUTPUT CONNECTOR:
1 5/8" coax E.I.A. flange.

FREQUENCY STABILITY:
± .001%.

TYPE OF MODULATION:
Direct crystal controlled cascade modulation.

MODULATION CAPABILITY:
± 100 Kc. (FCC requirements are ± 75 Kc.)

AUDIO INPUT IMPEDANCE:
600 ohms, + 10 dbm. ± 2 db.

FREQUENCY RESPONSE:
± 1 db., 50-15,000 cycles, — 2 db. at 30 cycles.

DISTORTION:
1% or less 30-15,000 cycles, 1/2% or less 100-10,000 cycles.

NOISE:
65 db. below 100% modulation (FM).
50 db. below equivalent 100% (AM) modulation.

POWER INPUT:
208/230 volts, 50/60 cycles, single phase, 3 wire, 2.8 KVA approximate demand. 115 volts, 50/60 cycles, single phase, 500 watts. (See Note 1).

TUBES:
(7) 6AU6, (3 each) 6J6, 6201, 7025, (2) OA2, (1 each) 12AX7, 6360, 6AQ5, 6080, GZ34/5AR4 and 4CX1000A power tube.

POWER SUPPLY:
Solid state.

MAXIMUM ALTITUDE:
7500 feet or less.

MAXIMUM AMBIENT:
— 20° to 45° C.

MAXIMUM VSWR OF LOAD:
1.7 to 1 maximum.

SIZE:
29" wide x 78" high x 32 3/4" deep.

WEIGHT & CUBAGE:
Net 600 lbs. Domestic packed, 700 lbs. Export packed, 835 lbs. Cubage: 72.

FINISH:
Two-tone Aqua Mist, trim in black and brushed aluminum.

ORDERING INFORMATION

1000 watt FM transmitter with tubes and one crystal with oven (see Note 2) (Cat. No.) FM-1G
Spare 100% tube kit for FM-1G transmitter TK-526
Minimum spare tube kit for FM-1G TK-527
Spare crystal and oven (see Note 2) M-6484
For stereo, order the M-6146 Stereo Generator. For SCA, order the M-6160 Sub-carrier Generator. See Page 53.

NOTES: (1) Factory wired for 230 volts unless 208 volts stated when ordering. 115 volts is for exciter only. (2) Please state frequency when ordering. (3) State exact frequency for factory adjustment and test. (4) Also available on special order and only slight delay on any frequency up to 200 Mc.

1000 WATT FM BROADCAST TRANSMITTER

MODEL FM-1C

In use by more stations than any other 1 KW model, the popularity of the FM-1C transmitter reflects its quality construction and economy of operation. From exciter to transmission line, Gates FM-1C transmitter offers a multitude of preferred features including: New Vane tuned power tank for higher reliability and efficiency; Gates exclusive direct crystal control cascade exciter for extended frequency response; automatic recycling in case of momentary outage; inbuilt remote control metering facilities standard equipment, and packaged in a completely self-contained unit with no external components.

OPERATION: The noteworthy operating characteristics of the Gates FM-1C transmitter include $\frac{1}{2}\%$ distortion or lower between 100 and 10,000 cycles and 1% distortion between 30-100 and 10,000 to 15,000 cycles. The board frequency response of 30-15,000 cycles, combined with low distortion, assures superb stereo and unsurpassed monaural performance. As supplied, the transmitter will tune from 88 to 108 megacycles without changes of components other than crystal. Each transmitter, however, is factory tuned to the customer's specified operating frequency before shipment.

SELF-CONTAINED: Completely self-contained in one modern transmitter cubicle, 78" high, 26" wide and 36 $\frac{1}{2}$ " deep, a full size swinging front door and lift-off rear door permits instant access to all components. The front door may be opened without disengaging any interlocks as the transmitter has a dead front panel. Low noise cooling is developed by special impeller design of the blower. Input power from the AC mains is single phase, 208 to 230 volts, plus 115 volts for the exciter and crystal oven.

A VSWR output meter clearly indicates both power output in watts and standing wave ratio. Metering is complete and the meter panel is of the lift-up type for easy exchange of meters if ever necessary.



SPECIFICATIONS

POWER OUTPUT:
1000 Watts, Capable 1100 Watts.

FREQUENCY RANGE:
88 to 108 Mc.

RF OUTPUT IMPEDANCE:
50 ohms.

RF OUTPUT CONNECTOR:
1 $\frac{1}{8}$ " coax. E.I.A. flange.

MAX. VSWR OF LOAD:
1.7 to 1 maximum.

FREQUENCY STABILITY:
 $\pm .001\%$.

TYPE OF MODULATION:
Direct Crystal Control Cascade Modulation.

MODULATION CAPABILITY:
 ± 100 KC.

AUDIO INPUT IMPEDANCE:
600 ohms.

AUDIO INPUT LEVEL:
 $+ 10$ dbm. ± 2 db.

FREQUENCY RESPONSE:
 ± 1 db. 50-15,000 cycles — 2 db.
— 30 cycles.

DISTORTION:
1% or less 30 to 15,000 cycles.
 $\frac{1}{2}\%$ or less 100 to 10,000 cycles.

FM NOISE LEVEL:
65 db. below 100% modulation.

AM NOISE LEVEL:
50 db. below equivalent 100% modulation.

POWER INPUT:
230/208 volts, 50/60 cycles, single phase three wire, 5 KVA demand.
115 volts, 50/60 cycles single phase, 500 watts. (for exciter only).

ALTITUDE:
7,500 feet or less.

AMBIENT TEMPERATURE RANGE:
— 20° to 45°.

POWER SUPPLIES:
Silicon rectifiers.

OVERALL CABINET SIZE:
26" wide x 78" high x 36 $\frac{1}{2}$ " deep.
Front door swing: 21".

FINISH:
Two-tone gray with black accent.

Brushed aluminum trim.
WEIGHT:
Packed—1140 lbs. Net 880 lbs. Cubage: 70.

ORDERING INFORMATION

FM-1C, 1000 Watt FM Transmitter
with tubes, crystal and oven M-5597*
100% Tube Kit for FM-1C . . . (Cat. No.) TK-312
Minimum Tube Kit for FM-1C TK-460
For FM Stereo Operation order
Stereo Generator M-6146

*Includes new cascade FM exciter for monaural broadcasting. If stereo is desired, order should include M-6146 stereo generator, (Listed on page 52), making complete compatible monaural or stereo transmitter.



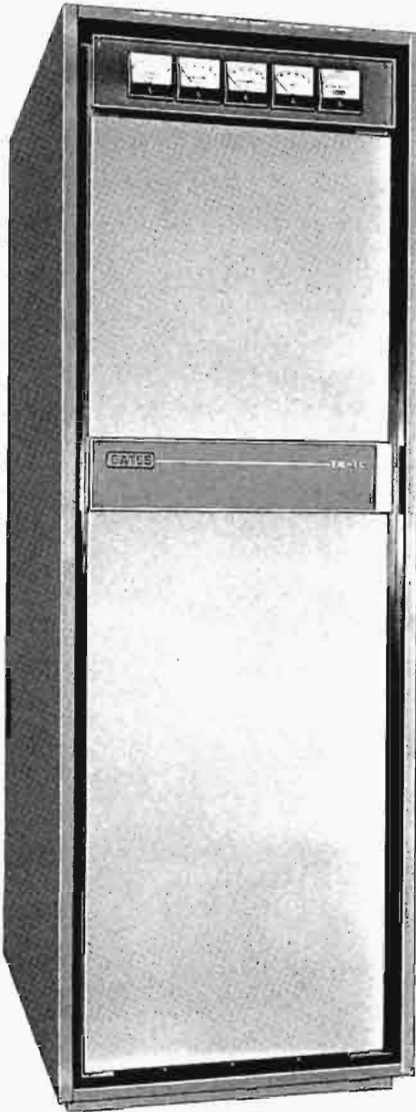

MODEL FM-250C

Features found in higher powered Gates FM equipment yet, seldom found in most 250 watt models, are definitely part of Gates FM-250C transmitter. Standard equipment includes: (a) automatic recycling, (b) VSWR meter, (c) solid state power supplies and (d) 100% accessibility.

With the exclusive Gates cascade exciter, a 1% or less distortion range is held between 30 and 15,000 cycles along with essentially flat frequency response in the same range. Stereo or SCA may be included or added later. Air cooled, completely self-contained and with facilities provided for remote control operation, the Gates FM-250C is certainly the most complete transmitter in the 250 watt FM field.

CASCADE EXCITER: Heart of the transmitter is the advanced M-6095 direct crystal controlled "cascade exciter." For improved low frequency response, a sawtooth generator is driven by a crystal controlled oscillator and its signal is modulated. This modulated signal is reformed into another sawtooth wave shape and modulated again by the second modulator. The result improved low frequency, audio response and lower distortion.

ELECTRICAL DESIGN: The cascade exciter drives the single 4CX250B power amplifier for an easy 250 watts output. A modified Pi plate circuit with a series tuned grid circuit assures reliable, stable, and conservative operation. Solid state rectifiers are used in all power supplies for dependable uninterrupted performance.

SPECIFICATIONS

POWER OUTPUT:
250 watts.

FREQUENCY RANGE:
88 to 108 Mc. (Available up to 150 Mc. on special order).

RF OUTPUT IMPEDANCE:
50 ohms. (Type N female connector).

FREQUENCY STABILITY:
± .001%.

TYPE OF MODULATION:
Direct crystal control cascade modulation.

MODULATION CAPABILITY:
± 100 Kc.

AUDIO INPUT:
600 ohms at + 10 dbm. ± 2 db.

FREQUENCY RESPONSE:
± 1 db. 50-15,000 cycles. — 2 db. at 30 cycles.

DISTORTION:
1% or less 30 to 15,000 cycles. ½% or less 100-10,000 cycles.

NOISE:
65 db. below 100% modulation (FM).
50 db. below equivalent 100% modulation (AM).

POWER INPUT:
115 or 230 volts 50/60 cycles, (as ordered), at 950 watts (approx.).

MAX. VSWR OF LOAD:
1.7 to 1 max.

TUBES:
(6) 6AU6, (3 each) 6J6, 6201, 7025, (2) OA2 and (1 each) 12AX7, GZ34/5AR4, 6360, 6AQ5, 6080, 4CX250B.

MAX. ALTITUDE:
7500 feet.

MAX. AMBIENT:
— 20° to 45°C.

SIZE:
Depth, 36½", width, 24", height, 78".

FRONT DOOR SWING:
21" (back door lift off type).

WEIGHT:
Net—510 lbs. Domestic packed—850 lbs. Export packed—975 lbs. Cubage: 70.

FINISH:
Two-tone gray with black accent. Brushed aluminum trim.

ORDERING INFORMATION

FM-250C, 250 Watt FM Transmitter with tubes, crystal and oven .. M-6173
100% Tube Kit for FM-250C TK-411
Spare crystal T9D
Spare oven for T9D crystal NE-91
NOTE: See Pages 52 & 53 for stereo and SCA equipment.

10 AND 50 WATT FM BROADCAST TRANSMITTERS



Model BFE-10C Ten Watt FM Transmitter

THREE MODELS AVAILABLE

Gates has consistently offered the most complete line of low powered wide band FM broadcast transmitters in the industry. Especially designed for educational FM broadcasting and for STL (studio-transmitter link) service, three popular models featuring direct crystal controlled cascade modulation are available. Included are the 10 watt BFE-10C and 50 watt BFE-50C versions for the standard FM broadcast band of 88 to 108 Mc., and the 50 watt Model BFR-50C which operates in the 40 to 220 Mc. FM band. The BFR-50C is specifically designed for high fidelity program relay and STL service and is unusually popular with broadcasters abroad. The same low distortion, wide frequency response and reliability, so characteristic of Gates higher powered FM models, will be found in these three lower powered equipments.

Metering consists of an audio level meter to indicate proper modulation level and individual meters for RF output, plate current and plate voltage. The transmitters are 100% complete without external accessories other than antenna and audio equipment.

MODEL BFE-10C: The BFE-10C ten watt FM transmitter is FCC type approved for educational FM broadcasting and is equally excellent for STL service or in any applications where 10 watts FM output is required. Monaural, stereophonic, single or dual channel multiplexing equipment is optional for use with the BFE-10C transmitter. A compact self-contained unit designed specifically for desk or external mounting, this 10 watt model incorporates the M-6095 exciter featuring direct crystal controlled cascade modulation, the same as employed in all Gates FM transmitters regardless of power. If stereo is desired, the M-6146 stereo generator is added.

Construction and design is pleasing to the eye and convenient to service. Immediate "full view" access is available by removing the front grill or the rear full length slip-off door.

This complete 10 watt FM transmitter is used by many schools, colleges, universities and overseas broadcasters in conjunction with the Gates FM-11 single ring or the FM-22 double ring FM antenna. As part of this FM broadcast package, the Gates Studioette or Yard audio console is recommended (see Pages 104 and 102). This complete educational broadcasting system is modern and equal only to the best, yet will fit into the conservative budget.

MODEL BFE-50C: For 88 to 108 Mc. FM service, the BFE-50C is similar in design to the BFE-10C transmitter but delivers 5 times as much power or 50 watts. A 50 watt power amplifier is added to the 10 watt section to provide the higher powered output. The amplifier consists of two M-6146 tubes and a 600 volt power supply. Identical in appearance to the standard BFE-10C transmitter, the cabinet easily houses the 50 watt amplifier and power supply.

MODEL BFR-50C: This compact 50 watt transmitter is probably the world's most widely used FM relay transmitter. Designed to relay broadcast programs from studio to transmitter or between special program originating points, the Model BFR-50C operates on any one specific frequency (as ordered) within the 40 Mc. to 220 Mc. band. When operating below 80 Mc., the maximum swing is ± 40 Kc. or less. Above 80 Mc. the frequency swing is ± 75 Kc. The 50 watt amplifier consists of two radio frequency stages powered by a built-in 600 volt power supply. The range of this transmitter is greatly increased by use of a directional antenna. The corner reflector antenna when used at both transmitting and receiving ends, will result in several hundred watts of effective power. A relay link up to nearly 100 miles is possible, depending on the antenna height of both transmitter and receiver as well as terrain.



Front view (cover removed) of Model BFE-10C, ten watt FM transmitter. Models BFE-50C and BFR-50C are essentially identical in appearance.

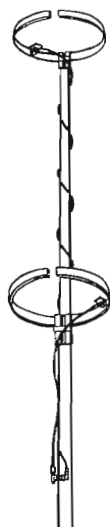

Left, FM11 single ring omni-directional antenna with power gain of 0.8 db. Right, two bay FM-22 omni-directional antenna with gain of 1.3 db. These are broad band, easy to install antennas.

Front view (cover removed) of BFE-50C fifty watt FM transmitter.

SPECIFICATIONS

POWER OUTPUT:

BFE-10C, 10 watts; BFE-50C, 50 watts; BFR-50C, 50 watts.

FREQUENCY RANGE:

Models BFE-10C and BFE-50C, 88-108 Mc., as ordered.
Model BFR-50C, 40 to 220 Mc., as ordered.

STABILITY:

0.001% or better.

MODULATION:

Direct crystal controlled cascade modulation.

RESPONSE:

Within 1 db. of standard 75 microsecond pre-emphasis curve or flat ± 1 db., 50-15,000 cycles. Note: Will supply with 75 microsecond pre-emphasis curve unless ordered for flat curve.

FREQUENCY SWING:

± 100 Kc.: (± 75 Kc. = 100% modulation in FM broadcasting). Model BFR-50C. Models below 80 Mc have maximum swing of ± 40 Kc or less, as desired. Above 80 Mc. may be ± 75 Kc or less, as desired.

DISTORTION:

1% or less 30-15,000 cycles. $\frac{1}{2}$ % 100-10,000 cycles.

RF HARMONICS:

Suppression meets or exceeds all FCC requirements.

INPUT:

+ 10 dbm. ± 2 db. at 600 ohms impedance.

POWER:

117 volts, 50/60 cycles. BFE-10C, 120 watts; BFE-50C, 230 watts; BFR-50C, 230 watts.

RF OUTPUT:

50 ohms (Type N connector).

OSCILLATOR:

Direct crystal controlled.

NOISE:

65 db. below 100% modulation (FM).

TEMPERATURE:

- 20° to + 50° C.

TUBES:

BFE-10C: (6) 6AU6, (3) 6J6, (3) 6201, (3) 7025, (2) OA2, and (1 each) 12AX7, 6AO5, GZ34/5AR4, 6080, 6360.

BFE-50C: Same as above, with (2) 6146 and (1) 5R4GYA tube added.

BFR-50C: Same as BFE-10C with (1) 5894, (1) 6AQ5, and (1) 5R4GYA tube added.

ALTITUDE:

7500 feet.

FINISH:

Medium gloss gray with trim in brushed aluminum and black.

SIZE:

26 $\frac{1}{2}$ " high, 28" wide, 14" deep.

WEIGHT (Packed):

BFE-10C (domestic) 100 lbs.; (export) 205 lbs.; 15 cu. ft.

BFE-50C (domestic) 125 lbs.; (export) 230 lbs.; 16 cu. ft.

BFR-50C (domestic) 125 lbs.; (export) 230 lbs.; 16 cu. ft.

ORDERING INFORMATION

- BFE-10C, 10 Watt FM Transmitter, 88-108 Mc, with tubes and crystal (Cat. No.) M-5594B
- Spare 100% tube kit for BFE-10C TK-319
- Manufacturer's recommended minimum tube kit for BFE-10C TK-488
- BFE-50C, 50 Watt FM Transmitter, 88-108 Mc, with tubes and crystal M-5595B
- Spare 100% tube kit for BFE-50C TK-489
- Manufacturer's recommended minimum tube kit for BFE-50C TK-490

- BFR-50C, 50 Watt Relay Transmitter for 40-220 Mc, with tubes, crystal and oven M-5599B
- Spare 100% tube kit for BFR-50C TK-310
- Manufacturer's recommended minimum tube kit for BFR-50C TK-458
- FM-11 Single Ring Educational (88-108 Mc) FM Antenna M-5765
- FM-22 Double Ring Educational (88-108 Mc) FM Antenna M-5766
- State carrier frequency when ordering all models and antennas and frequency swing desired when ordering Model BFR-50C transmitter.



FM BROADCAST LINK AND RELAY SYSTEM

SYSTEM A

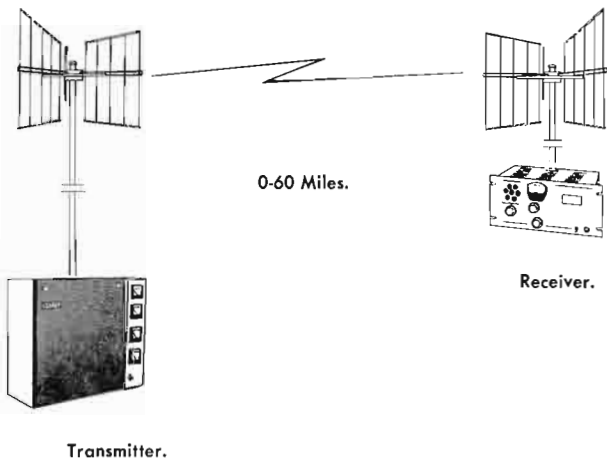

DIRECTIONAL: System A is a directional FM system operating in the 148-174 mcs. band which results in an effective 750 watts signal and will provide a line-of-sight high fidelity transmission link over distances up to 50 to 60 miles (subject to antenna heights and terrain). Applications include studio to transmitter link, point to point relay service, or remote pickup. Featured is the Gates BFR-50C, 50 Watt Transmitter. All Gates FM transmitters feature modern electrical and mechanical design, and provide unusually low distortion and wide frequency response—resulting in a higher quality transmitted signal.

ORDERING INFORMATION

- 1—50 Watt FM Transmitter (see page 49) (Cat. No.) BFR-50C
- 1—Receiver, 148-174 mcs. (see Below) CM-150
- 2—Corner reflector, high gain, broadband antennas 3605A
- 100'—Coaxial Cable RG-8/U
- 100'—Twin line 300 ohm 8235
- Complete system as described above FML-50D

NOTE: State operating frequency when ordering.

SYSTEM B

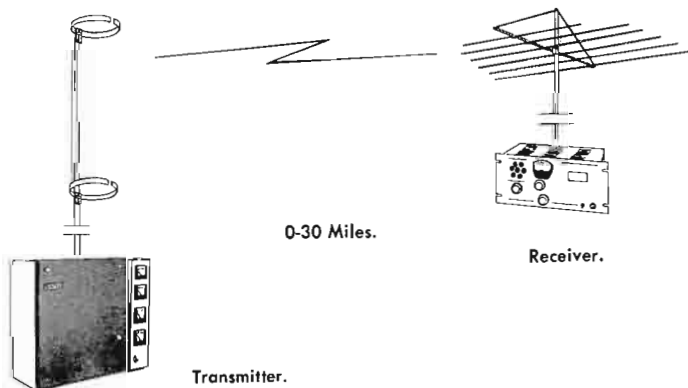

NON-DIRECTIONAL: System B is a non-directional 88-108 mcs. FM system using a non-directional antenna for transmitting and a high gain directional antenna for receiving. This system provides a high fidelity studio-to-transmitter link, and, where regulations permit, allows simultaneous FM broadcasting of the AM program. The system features the Gates BFE-50C 50 Watt Trans-

mitter, which has, among its many fine attributes, built-in RF output indicator and audio level meters. Line-of-sight reception with 50 watt transmitter is estimated at 30 miles.

ORDERING INFORMATION

- 1—50 Watt FM Transmitter (see page 49) (Catalog No.) BFE-50C
- 1—Receiver, 88-108 mcs. (see Below) CM-100
- Alternate Transmitter for shorter distances: 10 watt FM Transmitter, 88-108 mcs. (see page 49) BFE-10C
- 1—Two ring FM transmitting antenna, gain 1.3 FM-22
- 1—FM receiving antenna LPL-FM-6
- 100'—Coaxial Cable, for transmitter RG-8/U
- 100'—Twin line 300 ohm, for receiver 8235
- Complete 50 watt system as described above FML-50ND
- Complete 10 watt system using alternate transmitter described above FML-10ND

NOTE: State operating frequency when ordering.

MULTIPLEX CHANNELS: Facilities for two additional auxiliary audio channels (normally on 41 Kc and 67 Kc) to be simultaneously operated with the main channel of either the directional or non-directional links described above, can be provided by Gates multiplex generators. These generators are intended for operation with any Gates FM Transmitter. Described in detail on Page 53.

ORDERING INFORMATION

- FM Stereo (Multiplex) Generator (Catalog No.) M-6146
- Sub-carrier generator with Mute (specify frequency between 25 and 75 kcs.) M-6160

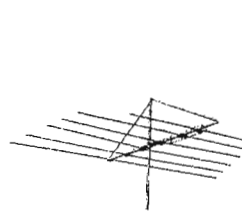

LPL-FM-6.

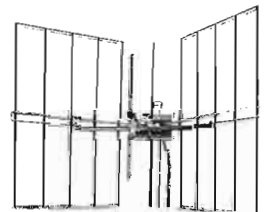

3605A.

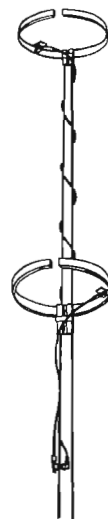

FM-22.



Broadcast Monitor and Relay Receiver

SPECIFICATIONS: Designed specifically for pickup of FM broadcasting and retransmitting at full 30-15,000 cycle response at distortion of 1% or better 50-15,000 cycles. Band width 150 Kc., 88 to 225 Mc., antenna 72 or 300 ohms, output 150/600 ohms. Crystal controlled oscillator for absolute negative drift. Sensitivity 2 Mv. for 20 db. quieting or 10 Mv. for 40 db. quieting. Has monitor speaker, signal strength meter and 12 tubes plus rectifier. Rack mount 8 3/4" 1 x 19". Please state frequency when ordering.

- Receiver, 148-174 mcs. (Cat. No.) CM-150
- Receiver, 88-108 mcs. CM-100
- Other receivers available from 88-225 mcs.

FM STEREO GENERATOR

MODEL M-6146

ADVANCED DESIGN: Precision engineered by Gates for the exacting demands of FM stereophonic broadcasting, the M-6146 stereo generator is acclaimed by broadcasters and listeners as producing "the finest sounding stereo signal of all stereo stations in our area." The M-6146 generator may be either factory installed when a new Gates transmitter is purchased, or may be added to existing modern FM transmitters within a matter of minutes. All FCC requirements for type approved stereo generators are met by the M-6146 as it provides an output which consists of L+R audio signal containing frequencies from 30 to 15,000 cycles, the 19 Kc. pilot and a 38 Kc. double sideband suppressed carrier signal modulated with the L-R component. The circuits employed are conventional and broadcast engineers will be familiar with the design concepts. The equipment is factory tuned to the specified operating frequency and the controls are sealed. More than adequate stereo channel separation is maintained to assure transmission of a superb stereo signal. Although the FCC specification for stereophonic channel separation is 29.7 db., Gates precision design should provide separation capability up to 35 db.

SELF-CONTAINED: The Gates M-6146 stereo generator is a completely self-contained unit utilizing swing out construction for complete accessibility from the front panel which makes maintenance easy. A built-in matrix is featured which produces the L+R and L-R signals by the simplest and most used method known. The regulated power supply is self-contained and features 100% silicon rectifiers. Gates stereo generating equipment is FCC type approved and reflects Gates determination to provide FM stereo without compromising the broadcasters SCA multiplex performance requirements. In addition to delivering superb stereo performance, the M-6146 stereo generator provides space for two M-6160 multiplex sub-carrier generators with inbuilt mute. This is a Gates exclusive and one compact and stable Gates M-6160 multiplex generator will permit simultaneous broadcasting of a 67 Kc. SCA and stereo. When not broadcasting stereo, the 41 Kc. SCA channel can be used simul-

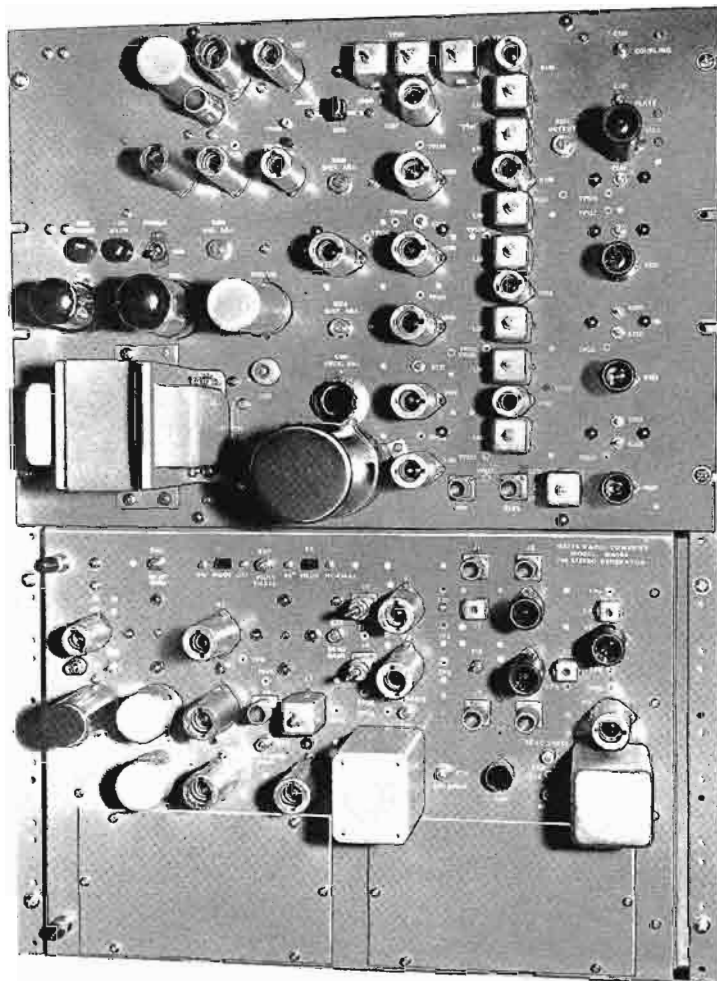

Installation of stereo is simple and can be accomplished in less than one hour. Space is provided below the exciter in all Gates FM transmitters for the M-6146 stereo generator.

taneously with the 67 Kc. generator. The Gates M-6249 stereo SCA remote switching kit is available which allows switching from stereo to monaural or stereo to 41 Kc. SCA operation.

SPECIFICATIONS

AUDIO INPUT IMPEDANCE (left and right):
600 ohms.

AUDIO INPUT LEVEL (left and right):
Approximately + 5 dbm each channel.

DISTORTION:
Less than 1.0% 50 to 15,000 cps.

FREQUENCY RESPONSE (left or right):
± 1.0 db, 50-15,000 cps.
(At 30 cycles response is - 2 db.)

FREQUENCY STABILITY:
(19 Kc Pilot): ± 1 cps (- 20° to + 140° C).

PILOT OSCILLATOR:
Crystal controlled in 60° C oven.

NOISE:
- 60 db.

PERCENT MODULATION OF MAIN CARRIER BY PILOT: 8 to 10%.

STEREO SEPARATION:
Meets or exceeds FCC specifications of 30 db.

CROSSTALK (Sub-channel to main channel):
40 db or better.

(Main channel to sub-channel):
40 db or better.

SUBCARRIER SUPPRESSION (38 Kc.):
40 db.

SCA PROVISIONS:
Space provided for 41 Kc. and 67 Kc. sub-channel generators.

POWER INPUT:
117 volts, 50/60 cycles, single phase, 50 watts.

TUBES:

(5) 7025/12AX7, (2) 6201/12AT7,
(2) 6BY6 and (1 each) 6AK5 and
6AK6. Power supply is solid state.

SIZE:

Width 19", height 12½", depth 8".

WEIGHT:

Packed (domestic) 80, (export) 105.
Cubage, 8.

ORDERING INFORMATION

FM Stereo Generator (Cat. No.) M-6146
Stereo SCA Remote Switching Kit M-6249
(see Page 53 for SCA equipment and
Page 58 for monitors)

SUB-CARRIER GENERATOR

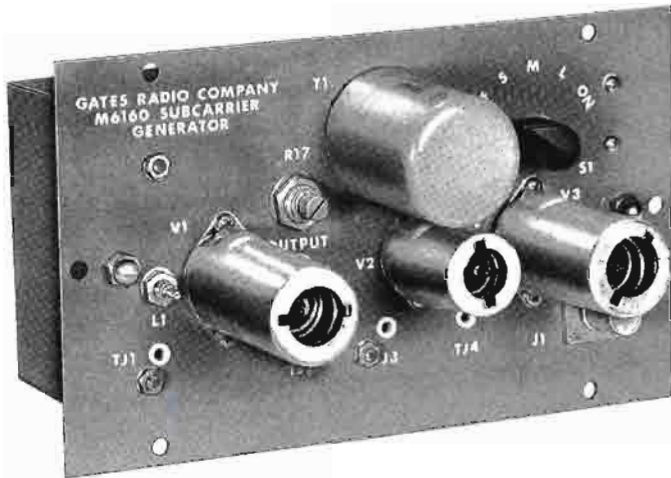

MODEL M-6160

Gates Sub-Carrier Generators are used for SCA service in the United States or to provide a second or third FM program relay or STL channel where government regulations of a country permit. This sub-carrier generator is designed to operate with any Gates FM transmitter which is equipped with a Gates stereo generator. For SCA or multiplex broadcast service, the stereo generator acts as the companion inserter. A compact and extremely stable unit, it is easily installed in all Gates stereo generators which provide space to mount two units. The M-6160 Sub-Carrier Generator permits simultaneous broadcasting of a 67 Kc. SCA channel and FM stereo. When not broadcasting stereo, the two generators may be used, and a second SCA channel on 41 Kc. may be programmed.

AUTOMATIC MUTING: Muting facilities are incorporated in the M-6160 SCA Generator with variable time constants. A front panel control switch having five positions, controls the mute time constant. Positions 2, 3 and 4 vary the "on" time from 5 milliseconds to 150 milliseconds while position 5 defeats the mute and provides continuous sub-carrier output.

The mute is indispensable for subscription music service which completely quiets the channel during periods of no music such as the pause between musical selections.

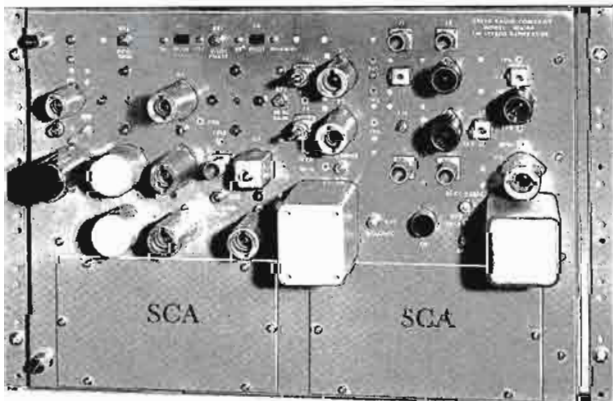

INSTALLATION: Installed in less than 30 minutes, blank panels are removed on the M-6146 stereo generator (see illustration below) and the M-6160 multiplex generator is connected to the 150 volt, D.C. regulated power supply and filament supply of 6.3 volts AC in the transmitter. Audio input connections are arranged so that input impedance is 600 ohms, and ± 5 Kc. swing at 400 cycles audio input is obtained with + 10 dbm. input level. 150 ohm audio input impedance is also available by changing transformer input leads.

FM MONAURAL/STEREO/S.C.A. SWITCHING KIT

The M-6249 switching kit is designed to switch from Monaural FM to Stereo by controlling the 19 Kc. pilot oscillator signal.

Since it is not possible to broadcast stereo and 41 Kc. SCA programming simultaneously, the M-6249 switching kit may also be used to control the M-6160 Sub-Carrier Generator operating on 41 Kc.

The kit is primarily intended to operate with Gates Remote Control systems such as the RDC-10C and RDC-200.

SPECIFICATIONS

- FREQUENCY:**
Any SCA channel between 25 and 75 Kc.
- FREQUENCY STABILITY:**
 ± 500 cycles.
- INPUT IMPEDANCE:**
600 ohm impedance balanced.
- INPUT LEVEL:**
+ 10 dbm., ± 2 db. for ± 5 Kc. deviation at 400 cycles.
- DISTORTION:**
Less than 1.5%, 30-15,000 cycles with ± 7.5 Kc. deviation.
- AUDIO RESPONSE:**
Flat or with 50 microsecond pre-emphasis. (as ordered)
- FM NOISE:**
- 55 db.
- OUTPUT LEVEL:**
1.5 VPP. adjustable by front panel control.
- POWER REQUIREMENTS:**
150 volts D.C. @ 5 Ma.
6.3 volts A.C. @ .75 A.
- TUBE COMPLEMENT:**
(2) 12AX7, (1) 5725/6AS6.
- AUTOMATIC MUTE LEVEL:**
Variable from 0 to - 40 db. by front panel control.
- WEIGHT:**
1 lb. 7 oz. Export packed 15 lbs. Cubage 1 1/2.
- DIMENSIONS:**
Front panel; 7" x 4 1/8" rear cover, 6" x 3 1/2" x 2 1/2" deep (designed to fit in panel slot of 6 1/4" x 3 3/8").

ORDERING INFORMATION

- S.C.A. Generator complete with tubes (Cat. No.) M-6160
- Remote switching modification kit M-6249



CYCLOID FM RING ANTENNA

The *Cycloid* FM antenna fills the need for a modern easy to install and highly efficient antenna with minimum standing wave ratio for FM stereo and monaural service. The field proven *Cycloid* antenna offers high gain and high power handling capabilities incorporated in a new electrical design available exclusively from Gates. Mounting brackets are supplied as a standard item with the Gates *Cycloid* FM antenna.

BINARY ADJUSTMENT: *Binary Adjustment* is the first major technological advance in antenna design since the initial development of ring type radiating elements. With this patented** product exclusive, the Gates FM antenna is adjusted for capacitive tuning while the same adjustment changes the inductance of the ring.

The nature of *Binary Adjustment* permits the antenna to be tuned to a low standing wave ratio over an extended bandwidth on either side of the carrier. Fine tuning of the inductance is achieved by moving the feed strap up or down the middle semicircular element. Since all of the adjustment is incorporated in the antenna, it is not necessary to buy costly extras such as transformers, or field tuning kits, to achieve the optimum low standing wave ratio.

The Gates *Cycloid* FM antenna is factory pretuned to the customer's frequency, assuring optimum on air performance.

VOLTAGE STANDING WAVE RATIO: A voltage standing wave ratio of 1.1 to 1 is attainable with the Gates *Cycloid* antenna by field tuning the array on the customer's premises. If the antenna is pretuned at the factory, a voltage standing wave ratio of 1.2 to 1 or better over the bandwidth of + 200 Kc. from the carrier should be expected. The wide bandwidth capability of the Gates *Cycloid* antenna is ideal for



stereo and multiplexing and is sufficient to minimize the detuning effect sometimes caused by atmospheric conditions.

GAIN: Gain of the Gates *Cycloid* FM antenna is nearly in direct relation to the number of bays in the antenna array. This is possible due to rigid quality controls that assure identical electrical and mechanical characteristics of the antenna rings. Gates *Cycloid* antennas are available in one to sixteen element arrays to cover any FM antenna application. A reference chart (next page) provides quick information on antenna gain and antenna length corresponding to the number of bays.

CIRCULARITY: The most important determining factor for a good horizontal pattern is the circularity of the antenna element in free space. The Gates *Cycloid* FM antenna is circular within ± 1 db. in free space, providing an optimum horizontal pattern.

A radiation pattern is influenced by many factors including: location of transmission lines, guy wires and other conducting elements near the antenna, as well as the nature of the supporting structure and other antennas in the area. As these factors are all variables, they can be easily controlled by requesting factory recommendations for proper installation procedures.

HEATERS: Gates offers a choice of two heating elements with the *Cycloid* antenna. For extreme icing, the FMH-400 heater is recommended. It provides 400 watt elements, operating on 115 volts to handle the most rugged and demanding icing conditions. Where limited icing is encountered, but heaters are still desirable, the FMH-200 200 watt elements, operating on 115 volts, are available. The cartridge type heater elements are flexible and extend the full circumference of the ring. They can be replaced in the field, if necessary, without disturbing any critical antenna adjustments.

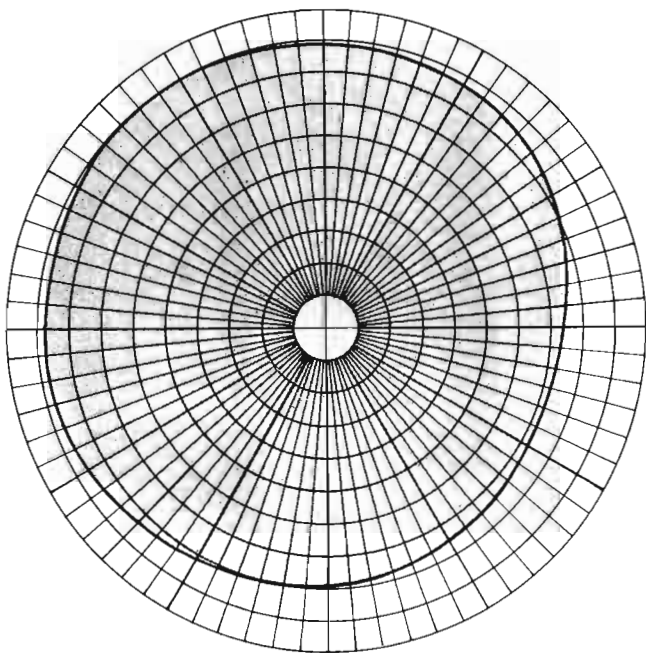

CIRCULARITY . . . ± 1 db in free space.

Cycloid FM Ring Antenna

MOUNTING: Mounting brackets are tailored to each installation and are furnished for pole or side mounting. The mechanical simplicity of the feed system allows for easy installation, side mounted on an existing tower, or top mounted with a special mounting pole. In some instances the antenna may be mounted inside the tower, thus offering the widest choice of installation possibilities. A single, interconnecting feed line consisting of standard EIA rigid 1 5/8" or 3 1/8" coaxial line is used to feed the antenna. The rings are actually supported by this sturdy Teflon insulated line.

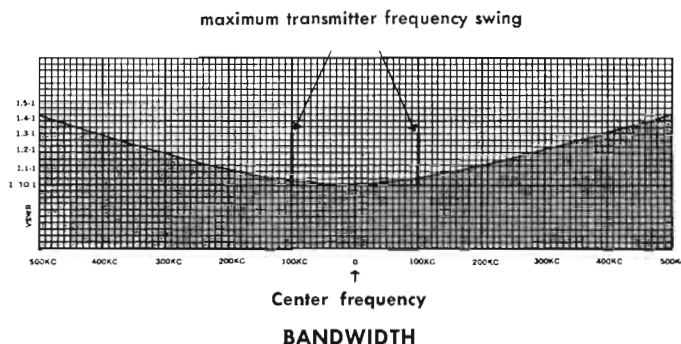

SPECIFICATIONS

FREQUENCY RANGE:

Factory tuned to specified frequency in 88-108 mcs. band.

POLARIZATION:

Horizontal.

HORIZONTAL PATTERN:

Circular, ± 1.0 db. in free space.

INPUT IMPEDANCE:

50 ohms, on 1 5/8" or 3 1/8" coax.

FEED POINT

1 to 8 bays inclusive—End Feed.

9 to 16 bays inclusive—Center Feed.

POWER RATING:

3 KW per section on 1 5/8" line.

VSWR (with field tuning):

Top Mounting—1.1 to 1.

Side Mounting—1.1 to 1.

(factory tuned):

Top Mounting—1.2-1.

Side Mounting—1.5-1.

WINDLOAD:

20 lbs. per square foot.

DIMENSIONS (1 bay):

Height (Over-all)—6 inches.

Ring Diameter—Approx. 18 inches (depends on frequency).

WEIGHT:

Antenna—25 lbs. per ring.

1 5/8" Line—12 1/2 lbs. per 10 ft. section.

3 1/8" Line—27 1/2 lbs. per 10 ft. section.

EQUIPMENT FURNISHED:

Antenna mounting hardware—(specify tower make, height and type number when ordering.)

Correct number of antenna elements as ordered.

Interconnecting rigid coax (1 5/8" or 3 1/8") as ordered.

Standard EIA (1 5/8" or 3 1/8") flanges as ordered.

ACCESSORY EQUIPMENT (Optional):

Deicers: 200 watts—FMH-200.

Deicers: 400 watts—FMH-400.

Thermoswitch for Control of Deicers.

FIELD AND POWER GAIN FOR CYCLOID ANTENNA

| TYPE NUMBER | FMA-1 | FMA-2 | FMA-3 | FMA-4 | FMA-5 | FMA-6 | FMA-7 | FMA-8 | FMA-9 | FMA-10 | FMA-11 | FMA-12* |
|------------------|-------|--------|--------|--------|--------|--------|--------|--------|--------|--------|---------|---------|
| NO. OF BAYS | 1 | 2 | 3 | 4 | 5 | 6 | 7 | 8 | 9 | 10 | 11 | 12 |
| Field Gain | .95 | 1.41 | 1.73 | 2.02 | 2.28 | 2.51 | 2.70 | 2.90 | 3.07 | 3.24 | 3.40 | 3.56 |
| Power Gain | .9 | 2 | 3 | 4.1 | 5.2 | 6.3 | 7.3 | 8.4 | 9.4 | 10.5 | 11.5 | 12.5 |
| Length in feet | 6 in. | 10 ft. | 20 ft. | 30 ft. | 40 ft. | 50 ft. | 60 ft. | 70 ft. | 80 ft. | 90 ft. | 100 ft. | 110 ft. |
| Weight in lbs.** | 25 | 50 | 75 | 100 | 125 | 150 | 175 | 200 | 225 | 250 | 275 | 300 |

*Power and field gain of additional number of bays quoted on request.

**Weight does not include interconnecting transmission line.

1. It is not advisable to use more than 7.5 KW on a 1 5/8" line. For powers above 7.5 KW, use 3 1/8" line.
2. Windloads are based on 20 pounds per sq. ft. on projected areas of cylindrical surfaces with all sections considered round.
3. Power gains compared to 1/2 wave dipole.
4. Type number will be followed by "A" or "B" indicating coax cable size.
Example—FMA-4(A), the A = 1 5/8" coaxial cable. FMA-4(B) = 3 1/8" coaxial cable (see price list for type numbers).
5. Where field tuned on customer's premises, extra engineering and travel charge will be quoted on request.

ORDERING INFORMATION

The Cycloid antenna is available with any number of bays from 1 to 16 and with 1 5/8" or 3 1/8" line (see price list).

If heaters are required, 200 watt and 400 watt are available (see price list).

VERTICAL POLARIZED FM ANTENNA



MODEL 300-G

GENERAL: Vertical polarization using the type 300-G antenna provides a means for the FM broadcaster to reduce null effect, improve fringe area reception and fill in shadow area. In addition, stereo and SCA service should benefit both in quality and in coverage. Vertical polarization is especially desirable for FM car radios and the millions of home receivers that do not employ an outside antenna.

The Type 300-G vertically polarized FM dipole antenna enables an FM station to transmit a supplemental vertically polarized signal to achieve elliptical or circular polarization as authorized in the FCC Rules and Regulations. It may be used in combination with any type of horizontally polarized FM antenna, and is designed to improve and maximize monaural, stereo and SCA multiplex operation. It can be added readily to any existing horizontally polarized antenna system.

DESCRIPTION: The antenna consists of two basic parts: (1) radiating dipoles and (2) interconnecting transmission line sections. The dipoles in any array are all identical electrically and mechanically.

The Type 300-G dipole is a product of straightforward electrical and mechanical design. It has low Q which results in a broad-band antenna that minimizes cross-coupling between main and subcarrier channels. Although rugged, it is light-weight and presents a low windload, thus reducing the cost of supporting structures. It is mainly fabricated of high tension copper tubing which is durable, weather-resistant, and has excellent electrical properties.

Antenna elements are normally spaced one wave length apart with interconnecting transmission line sections, and fed through a common system input terminating in a 50 ohm. EIA flange. A typical antenna might consist of several dipoles fed through a power divider to apportion the transmitter power between separate horizontally and vertically polarized antennas. Alternatively, the vertical dipoles can be interspersed between horizontally polarized elements on a common feed line to form a single antenna which is both horizontally and vertically polarized.

MOUNTING: The antenna is mounted on its supporting structure as a unit, using brackets specially fabricated to match the tower and mounting arrangement specified by the purchaser. Antennas are usually side mounted on either guyed or self-supporting towers. Pole or top mounting is available on special order.

If there are guy wires in close proximity to the antenna, it is recommended that they be insulated from the tower and broken by insulators every 3 ft. for a minimum of 15 ft. from the tower to avoid detuning or distortion of the radiation pattern.

In the case of a large supporting structure, several dipoles may be mounted around the periphery to obtain coverage 360° in azimuth. These dipoles would be fed in parallel by individual equal-length feed lines from a power divider.

CIRCULARITY: The horizontal radiation pattern of the Type 300-G dipole is omni-directional within ± 1 db. in free space. When side mounted, the antenna pattern may be only slightly affected by the supporting structure. The extent of deviation from a perfect circular pattern will vary with the size of the supporting structure, but is seldom by a substantial nature.

BANDWIDTH & VSWR: The voltage standing wave ratio of the Type 300-G antenna can be maintained at better than 1.1 to 1. This close tolerance usually assures at least 1.5 to 1 VSWR or lower when side mounted to the tower. Wide bandwidth capability virtually eliminates detuning effects caused by changes in atmospheric conditions. Heaters for de-icing are not necessary. Antennas are carefully tuned to the customer's operating frequency before they are shipped, thus assuring optimum performance. Normally, no field adjustment is required where properly installed.

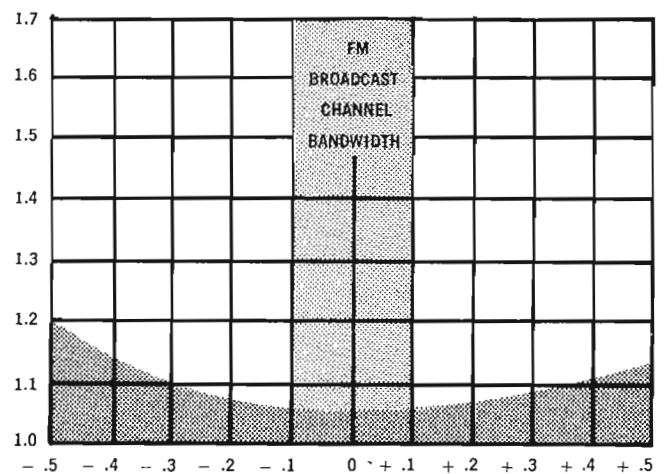

VOLTAGE STANDING WAVE RATIO VS. FREQUENCY
Measured VSWR of Type 300-G Antenna

TYPE 300G ANTENNA—SIDE MOUNTED

| TYPE | NO. OF DIPOLES | POWER GAIN | FIELD GAIN | DB GAIN | POWER RATING ON | | LENGTH | | WEIGHT | | WIND LOAD* | | OVER TURNING MOMENT** | |
|----------|----------------|------------|------------|---------|-----------------|--------------|---------------|----------------|--------------|----------------|--------------|----------------|-----------------------|---------|
| | | | | | ON 1 1/8" LINE | ON 3/8" LINE | FEET & INCHES | ON 1 1/8" LINE | ON 3/8" LINE | ON 1 1/8" LINE | ON 3/8" LINE | ON 1 1/8" LINE | ON 3/8" LINE | |
| 300G-1 | 1 | .950 | .975 | -.002 | 3 | 3 | 3 | 9 | 50 | 55 | 104 | 104 | 0 | 0 |
| 300G-2 | 2 | 1.969 | 1.400 | 2.942 | 6 | 6 | 13 | 7 | 111 | 135 | 259 | 307 | 1,190 | 1,430 |
| 300G-3 | 3 | 3.120 | 1.767 | 4.942 | 9 | 9 | 23 | 4 | 171 | 215 | 414 | 510 | 3,900 | 4,840 |
| 300G-4 | 4 | 4.198 | 2.045 | 6.230 | 10 | 12 | 33 | 2 | 232 | 295 | 569 | 713 | 8,350 | 10,200 |
| 300G-5 | 5 | 5.310 | 2.305 | 7.251 | 10 | 15 | 42 | 11 | 292 | 375 | 724 | 916 | 14,300 | 17,600 |
| 300G-6 | 6 | 6.393 | 2.528 | 8.057 | 10 | 18 | 57 | 9 | 353 | 455 | 879 | 1119 | 21,100 | 27,000 |
| 300G-7 | 7 | 7.500 | 2.738 | 8.751 | 10 | 21 | 62 | 7 | 413 | 535 | 1034 | 1322 | 29,900 | 38,400 |
| 300G-8* | 8 | 8.571 | 2.927 | 9.330 | 20 | 24 | 72 | 4 | 474 | 615 | 1189 | 1525 | 40,200 | 51,700 |
| 300G-9* | 9 | 9.755 | 3.124 | 9.892 | 20 | 27 | 82 | 2 | 534 | 695 | 1344 | 1728 | 52,100 | 67,100 |
| 300G-10* | 10 | 10.960 | 3.311 | 10.398 | 20 | 30 | 91 | 11 | 595 | 775 | 1499 | 1931 | 65,400 | 84,400 |
| 300G-12* | 13 | 13.195 | 3.633 | 11.204 | 20 | 36 | 111 | 7 | 716 | 935 | 1809 | 2337 | 96,600 | 125,000 |
| 300G-14* | 14 | 15.290 | 3.910 | 11.844 | 20 | 42 | 131 | 2 | 837 | 1095 | 2119 | 2743 | 133,965 | 173,000 |
| 300G-16* | 16 | 17.483 | 4.181 | 12.426 | 20 | 48 | 150 | 9 | 958 | 1255 | 2429 | 3149 | 177,000 | 230,000 |

*Wind load in the direction through the mounting toward the tower computed for 60 lbs. on flat surfaces and 40 lbs. on projected areas of cylindrical surfaces.

**For 60 lbs. wind loading direction through the mounting toward the tower and referred to the center line of the bottom bay.

SPECIFICATIONS

ELECTRICAL

FREQUENCY RANGE:

Factory tuned to specified frequency in 88-108 Mc. band.

POLARIZATION:

Vertical.

POWER GAIN:

Approximately equal to number of dipoles. (See table.)

HORIZONTAL LINEARITY:

Dipole circular ± 1 db. in free space.

INPUT IMPEDANCE:

50 ohms on 1 1/8" or 3/8" coax.

FEED POINT:

For 9 bays or less, the antenna is end fed. For 10 bays or more, the antenna is center fed where number of bays is even, and for odd number of bays feed point is 1/2 bay length below center.

POWER RATING:

3KW per dipole.

VSWR:

Tuned to 1.1:1 or less; less than 1.5:1 when mounted on side of tower.

Note: Where transmitter power is 7500 watts or less, 1 1/8" coax line is suggested. For transmitter powers above 7500 watts, 3/8" coax line recommended.

MECHANICAL

WINDLOAD:

60 psf. on flat surfaces, 40 psf. on cylindrical surfaces (123 mph. actual wind velocity).

DIMENSIONS:

Length of dipole—3.75 ft. From center of transmission line to center of dipole—2.83 ft.

WEIGHT:

1 1/8" dipole—26.5 lbs.

3/8" dipole—34.0 lbs.

Typical mounting bracket—22.0 lbs. per bay.

EQUIPMENT FURNISHED:

Antenna dipoles.

Custom mounting brackets.

Interconnecting rigid coax 1 1/8" or 3/8" as specified.

Standard EIA flange. 1 1/8" or 3/8".

DECIBERS:

Not required.

ORDERING INFORMATION

Both the 1 1/8" and 3/8" vertical antennas carry type number 300-G. As these antennas are usually ordered as a system of several bays with connecting lines and brackets to attach to tower and often with the Gates horizontal Cycloid ring antenna, the Gates price list is employed for more complete listings.

Power division networks both variable and fixed are available to combine vertical and horizontal antennas. For ease of listing, these are also part of the Gates price list.

FM FREQUENCY AND MODULATION MONITORS

FCC APPROVED

Fully FCC approved, the McMartin TBM-3000 is a completely self-contained frequency monitor and the Model TBM-3500 is a separate self-contained modulation monitor,

each independent of the other. A combination of these units provides complete monitoring facilities for monaural transmission in accordance with FCC regulations.

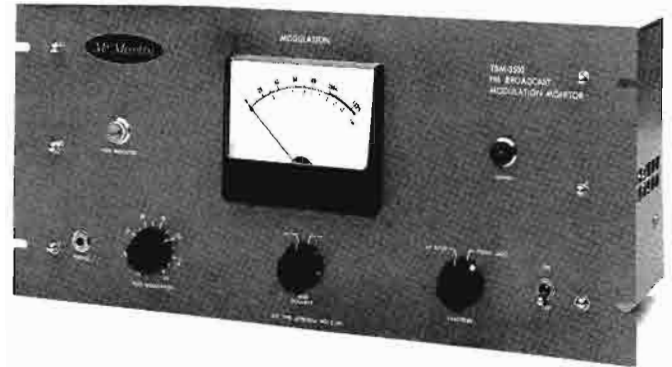

MODEL TBM-3000/FM FREQUENCY MONITOR

- Type approval number 3-113.
- Single purpose FM Frequency Monitor.
- Completely self-contained.
- Accuracy .001%.
- Unaffected by modulation.
- External metering available.
- Reliable double regulated silicon rectifier power supply.
- Special meter for good visibility.

McMARTIN TBM-3500 FM MODULATION MONITOR FEATURES:

- Self contained single purpose FM modulation monitor.
- Accuracy 1/2 db., 50-75,000 cycles.
- External metering available.
- High speed indicator reads 10 millisecond peaks.
- Measures total modulation carried by the FM transmitter.
- Measures separately main channel audio modulation with subchannels.
- Output provisions for optional stereo and SCA monitors and proof-of-performance tests.

SPECIFICATIONS

FREQUENCY MONITOR:

- FREQUENCY RANGE:**
88 to 108 mc.—on single frequency
- DEVIATION RANGE:**
+ 4 kc. to - 4 kc. of specified frequency.
- ACCURACY:**
Better than .001% or better than 1000 cps. @ any frequency.
- STABILITY:**
75 to 150 cps. within 24 hours.
- RF INPUT:**
1 to 5 volts @ 50 ohms—1/2 watt maximum.
- FRONT PANEL INDICATORS:**
Frequency deviation meter, AC power, crystal oven.
- FRONT PANEL CONTROLS:**
Selector switch: RF input, calibrate, operate meter zero, crystal tuning, power on-off.
- CHASSIS CONTROLS:**
RF level.
- OUTPUTS:**
Provisions for external remote meter (optionally available).
- TUBES & DIODES:**
(3) 6201; (2) 6265; (1) 5814A; (1) OB2; (1) OA2; (4) 1N56. Power supply solid state.
- POWER SUPPLY:**
100-125 VAC; 55 watts; 60 cps.
- DIMENSIONS:**
Standard rack 19" width x 8 3/4" height x 7 1/2" deep.
- SHIPPING WEIGHT:**
18 lbs. (domestic packed), 22 lbs. (export packed).
- CUBAGE:**
2 cubic feet.

MODULATION MONITOR:

- FREQUENCY RANGE:**
Main channel 88 to 108 mc. on single frequency.
- MODULATION RANGE:**
Full scale meter deflection indicates deviation of ± 100 kc. or 133% modulation. Scale calibration indicates 100% modulation @ ± 75 kc.
- METERING ACCURACY:**
Within 5% over entire scale (FCC standard for FM).
- METER CHARACTERISTICS:**
Well within FCC requirements. Pointer reaches 90% value of a modulation peak, with a duration of only 70 milliseconds. Overshoot is less than 3%. Meter decays from full reading to 10% of value in 720 milliseconds.
- PEAK FLASH INDICATOR:**
Responds to modulation peaks with a duration of 10 milliseconds or less.
- FREQUENCY RESPONSE (METER & FLASHER):**
 $\pm 1/2$ db; 50 cps to 75 kc @ 100% modulation.
- STABILITY:**
Maintained by special inverse feedback.
- AUDIO FREQUENCY RANGE:**
Follows FCC de-emphasis curve. ± 1.0 db. 50 to 15,000 cps.
- AUDIO DISTORTION:**
Main Channel — 0.5% 50 to 15,000 cps.
- AUDIO HUM AND NOISE:**
Main Channel — 65 db. below 100% modulation @ low audio frequencies.
- RF INPUT:**
1 to 5 volts @ 50 ohms (1/2 watt max.) coaxial input.

SPECIFICATIONS (TBM-3500 CONT'D)

FRONT PANEL INDICATORS:

- 1) Main channel modulation peak flasher (neon).
- 2) AC power (neon).

FRONT PANEL METERS:

- 1) Main channel modulation (RF input-total modulation-main channel modulation).

FRONT PANEL CONTROLS:

- 1) AC power on-off.
- 2) Main channel modulation meter function switch.
- 3) Main channel \pm modulation polarity switch.
- 4) Main channel peak modulation flasher control.

REAR CHASSIS CONTROLS:

- RF attenuator.

OUTPUTS (front panel):

- 1) Main Hi-Z phone jack.

OUTPUTS (rear chassis):

- 1) External main channel modulation meter.

- 2) Multiplex.

- 3) Main channel audio Hi-Z.

- 4) Main channel audio 600 ohms.

TUBES:

- 12-Types: 2-12AT7; 1-6BH6; 2-6AK5; 1-12AX7; 1-6BE6; 1-6EM7; 1-2D21; 1-6B4; 1-6AB4; 1-7581.

DIODES:

- 3 (1N51).

RECTIFIERS:

- 4 type 1N2095 silicon.

POWER SUPPLY:

- 105-125 VAC; 60 watts; 60 cps.

DIMENSIONS:

- Standard rack 19" width x 8 $\frac{3}{4}$ " height x 8" deep.

SHIPPING WEIGHT:

- 25 lbs. (domestic), 29 lbs. export packed.

CUBAGE:

- 2 cu. feet.

FM MODULATION—SCA MULTIPLEX MONITOR

MODEL TBM-4000



- Self contained independent modulation monitor, measures all modulation carried by the FM transmitter.
- Separate meter for direct reading of main channel modulation.
- Provisions for measuring all characteristics of one or two subchannels separately.
- Direct reading of subchannel injection at any time.
- Metering of either subchannel frequency.
- Continuous metering of either subchannel modulation. Referred to either 5 or 7.5 kc. deviation.
- Subchannel metering characteristics identical to main channel requirements as outlined by FCC.
- Direct reading of noise of crosstalk on either subchannel from any source without auxiliary equipment.

This instrument measures all main channel modulation characteristics as well as all SCA-multiplex operating characteristics of an FM transmitter. The TBM-4000 is completely compatible with FM stereo multiplex.

Audio output of both main channel and either subchannel available for aural monitoring and proof of performance checks.

Separate high speed main and sub peak modulation lamps respond to 10 millisecond peaks.

Automatic subchannel muting.

Output terminals for external subchannel failure alarm.

Output terminals for main channel and subchannel modulation extension meters.

Reliable double regulated silicon rectifier power supply.

Total modulation output jack to feed either McMartin TBM-2000 (separate SCA-multiplex monitor) or TBM-4500 (stereo monitor).

SPECIAL FEATURE

The TBM-4000 combines with the TBM-3000 FM Frequency Monitor to provide complete main carrier monitoring (in accordance with FCC requirements) as well as SCA-Multiplex monitoring.

ORDERING INFORMATION

FM Frequency Monitor with tubes (Cat. No.) TBM-3000
 Modulation Monitor with tubes TBM-3500
 SCA Multiplex Monitor with tubes TBM-4000

NOTE: Please state frequency of transmitter when ordering monitors.

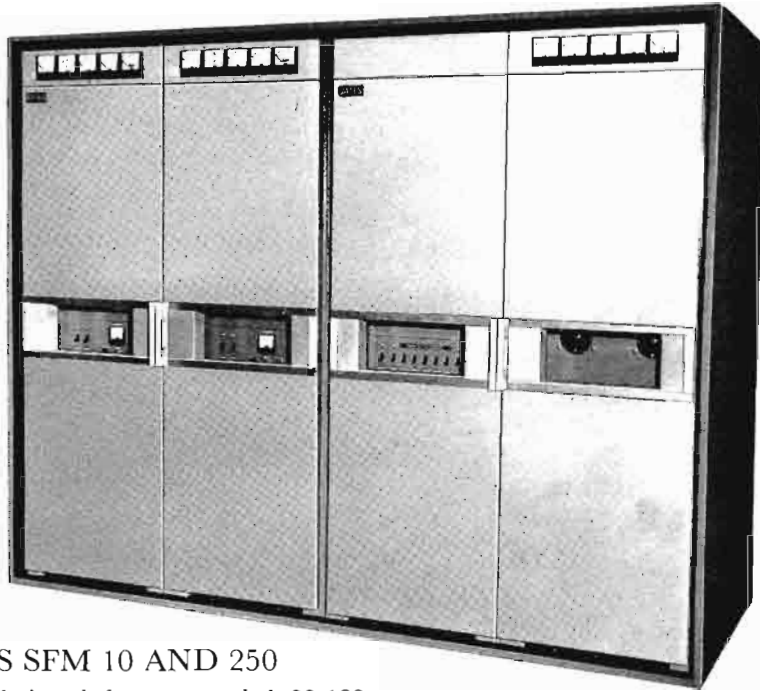

The SFM-10 FM Transmitter consists of two complete 1000 watt transmitters, (either one may be used as the driver) and the 10,000 watt amplifier.

MODELS SFM 10 AND 250

SFM-250: Especially designed for unattended 88-108 mc FM broadcasting, in overseas areas, the SFM-250 Broadcast Transmitter incorporates automatic switching to permit continuous operation at either 250 watts or 50 watts output. This versatile system consists of two complete 50 watt transmitters, either one of which can serve as a driver for the 250 watt amplifier, or can be used independently at 50 watts output. This model meets CCIR standards.

Control circuitry embodies a recycling unit which will, at the time of malfunction of any one unit, make three attempts to restore the unit to operating status. If, after three attempts, the 50 watt driver unit still malfunctions, the system will de-energize the disabled unit and switch to, and energize, the reserve 50 watt driver unit to restore normal operation. If the malfunction is in the 250 watt power amplifier, the system will de-energize the 250 watt section and connect the operating driver to the transmission line, and automatically bring the driver up to full power output. By this unique design, on-air broadcast service will be maintained despite most outages.

Direct crystal controlled Gates exclusive cascade exciters are used to provide exceptional frequency stability and reliability. Solid state silicon rectifiers are used throughout. All components are conservatively rated.

SFM-10: A higher powered version of the SFM-250 system, the SFM-10 transmitter consists of two complete 1000 watt transmitters and a 10,000 power amplifier. By automatic switching, either 1 KW unit can be used as a driver for the 10,000 watt amplifier, or can be used independently at a full 1 KW output.

To meet special requirements, Gates can supply FM transmitters with dual drivers to meet FCC or CCIR standards. Power outputs from 250 watts to 20,000 watts are available with dual drivers, dual power amplifiers, or other configurations.

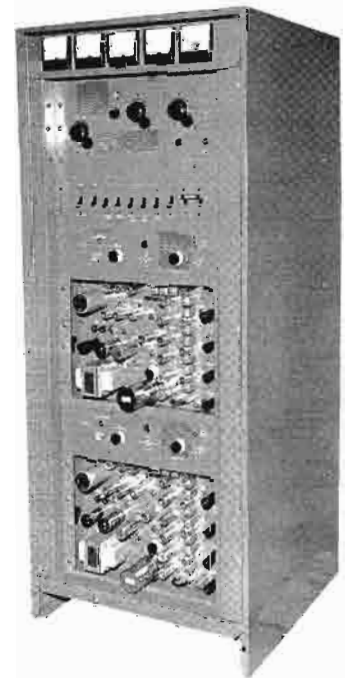

The 250 Watt FM Transmitter with dual 50 watt driver's, Model SFM-250 is shown with front panel removed.

ORDERING INFORMATION

| | |
|--|------------|
| 250 Watt Dual Driver FM Transmitter | SFM-250 |
| 1000 Watt Dual Driver FM Transmitter | SFM-1000 |
| 5000 Watt Dual Driver FM Transmitter | SFM-5000 |
| 7500 Watt Dual Driver FM Transmitter | SFM-7500 |
| 10,000 Watt Dual Driver FM Transmitter | SFM-10,000 |
| 20,000 Watt Dual Driver FM Transmitter | SFM-20,000 |

MODEL RDC-10AC

Used in hundreds of AM and FM stations, this Gates remote control equipment is a direct current system without tubes or transistors and has only one major moving part which is the rugged gold contact stepper. Facilities are provided for as many as ten metering positions and 23 control functions. Standard equipment includes: (a) the studio control unit, Fig. A, (b) the transmitter control unit, Fig. B, (c) plate current and (d) plate voltage metering kits, plus (e) the tower light indicator unit. Items (c), (d) and (e) are described on Page 63. A wide variety of accessories are available and also listed on Page 63.

Capacity of the RDC-10AC equipment ranges from the one transmitter, one tower installation to a multi-tower directional system as well as combination AM-FM separate transmitters with only one RDC-10A system.

The studio control unit (Fig. A) has three large easy-to-read meters. These meters read plate current, plate voltage and antenna current. The meters may be switched to several circuits on one or two transmitters, coupling units, etc. As an example, the tower light function is indicated on the plate current meter. Many combinations are possible with the selection of the proper accessory as listed on Page 63. The transmitter control unit mounts at the transmitter at which the various functions to be remote controlled are attached. Relays are of highest quality to assure freedom from malfunction. A switch is provided to transfer operation back to manual during transmitter maintenance or servicing. Only two metallic telephone pairs are required. Usually the order phone between studio and transmitter is connected to one of the remote functions to eliminate the need for a third order phone line. The RDC-10AC system will operate up to 30 miles of telephone line or 3000 ohms loop resistance, whichever is the greater. Both studio and transmitter units are 19" wide, 8 $\frac{3}{4}$ " high and 10" of depth space should be allowed. Drop down to service front panels are standard construction. Shipping weight: Domestic, 50 lbs. Export, 85 lbs. Cubage: 4.

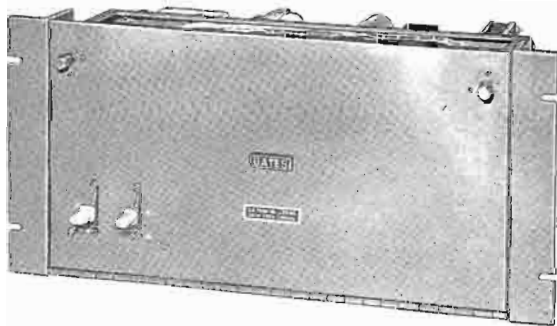
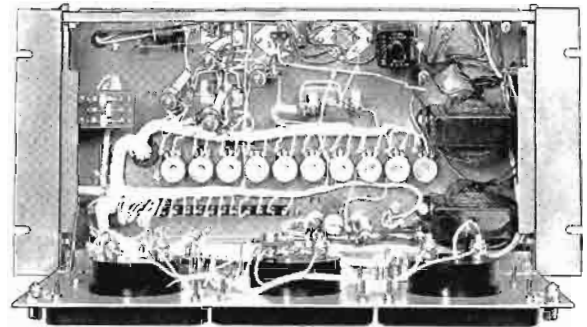

Fig. B Transmitter unit may mount in rack or small size permits mounting directly in most transmitters. Power supply is self-contained.



Fig. A Studio unit provides complete metering and selection/operation of up to 23 control functions. Power supply is self-contained. Front drop down panel (illustrated below) allows immediate access to all components.



ORDERING INFORMATION

- (A) Complete RDC-10AC system includes studio and transmitter units and Items H, I and J below M-5862
- (B) Antenna diode to remote control antenna meter M-6112
- (C) Motor driven rheostat for power control of 250 watt transmitter M-4703A
- (D) Motor driven rheostat for power control of 500 watt transmitter M-4703B
- (E) Motor driven rheostat for power control of 1000 watt transmitter M-4703C
- (F) Motor assembly to drive variable coil for load power adjustment such as for 5 KW or 10 KW transmitters. (Relay below) necessary .. M-5066
- (G) Relay assembly to operate M-5066 motor M-4806
- (H) Plate current unit to extend plate current readings M-4720A
- (I) Plate voltage unit to extend plate voltage readings M-4719A
- (J) Tower light indicator M-5145

IMPORTANT: When ordering, give as much transmitter detail as possible such as: (a) Make and type number, (b) plate rheostat in ohms and watts. If not a Gates transmitter, state method of power output control such as rheostat, variable loading, etc. Gates will gladly assist. If you are in doubt, please contact us.

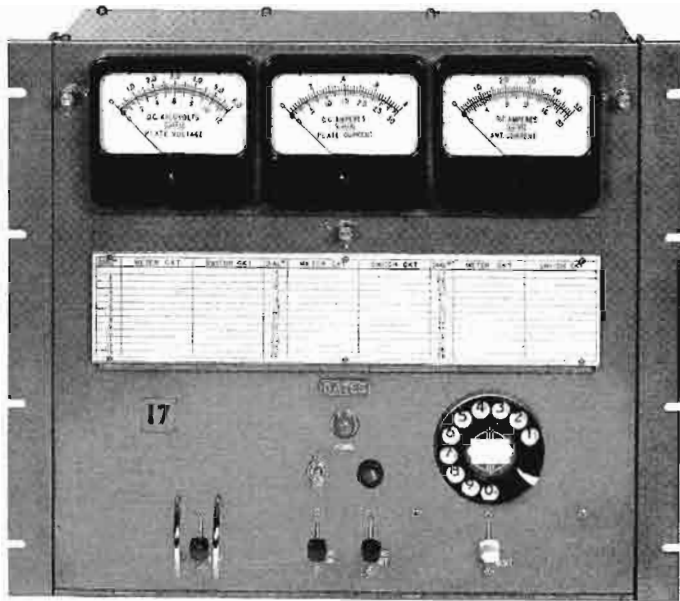

Studio Unit



Transmitter Unit

MODEL RDC-200A

Designed for the simple or most complex unattended operation, the Gates RDC-200A system will handle as many as 39 metering functions and 78 switching operations. Remote functions are dialed on the studio unit. A reference chart is mounted on the front of both the transmitter and studio units. For example if remote function No. 17 is dialed, this appears in illuminated numerals on both units. By referring to the chart, position 17 may indicate you are ready to adjust the loading control or whatever function is on circuit 17.

All powers of equipment from 250 watts to 50,000 watts and the more complicated multi-tower directional system may be easily handled with facilities left to accommodate the FM or standby transmitter. Only two metallic telephone pairs are required. If desired, the order phone may be on one of these pairs as a dialed function.

There are no tubes or transistors as the system operates on direct current. The greatest current used is only 6 MA. This permits very positive results over lines up to 60 miles in length or 5000 ohms loop resistance, whichever is greater. All metering is with three large 4" meters, each with multi-scales. DC voltage, DC current and R.F. current is indicated. For A.C. voltage indications, the M-4825 accessory (next page) may be added.

Power supplies for both units are self-contained. Each occupy 19" x 15 3/4" of rack space. No simplex, phantom or ground return circuits are used. Over size slave relays provide abundant contact rating for flawless switching. This combined with the sensitive control relays, polarizing diodes and biasing for low current operation insures a type of reliability expected from the modern and often complex broadcasting installation. All switching functions including pulse and reset may be controlled from the transmitter unit for local operation during maintenance and servicing periods. The popular Gates drop down to service front panels are standard construction. Finished in medium gloss gray. Weight: (domestic packed) 110 lbs., (export packed) 170 lbs. Cubage: 15.

ORDERING INFORMATION

Complete remote control system (see Notes 1 and 3) RDC-200A
 Extra tower light indicators (see Note 2) M-5145
 A.C. Rectifier to indicate A.C. voltages M-4825

NOTES: (1) Standard equipment includes: plate voltage metering unit, plate current metering unit, plate start-stop relays for one transmitter and tower light indicator. (2) For more than 1 tower, order M-5145 units for each additional tower. (3) See next page for other accessories such as additional metering units, motor driver, etc.



FREQUENCY MONITOR EXTENSION METERS



Used for extending Gates M-2890 monitors. Has 4" frequency indicating meter reading 30-0-30 cycles. Includes resistor pad for sampling voltage. Tubes: 6AW6, 6AQ6, 6AL5, 6X4 and 0A2. For 115 volts, 50/60 cycles.

Size: 7" x 19" x 7" deep.
 Frequency monitor extension unit M-5270
FOR M-4990 FREQUENCY MONITOR
 Meter is exact duplicate of the M-4990 monitor for extending frequency indication to studios.
 Extension meter M-5631

MONITOR EXTENSION METERS



Several types available as listed below for extending both frequency and modulation monitors. Mounted on standard 19" rack panel 5 1/4" high.

Remote meter for extending Gates M-5693 modulation monitor M-5837
 For extending Gates M-2639 modulation monitor M-5210
 For GR1931A or RCA WM43A modulation monitors M-5206
 For GR1181A or RCA WF48A frequency monitors M-5208
 For RCA 311A monitor M-5209

RF FM AMPLIFIER M-4791

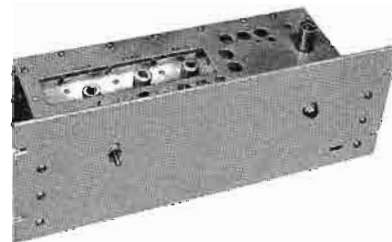

Operates with any approved FM frequency/modulation monitor where the signal is taken off the air and monitor is at studio. Amplifier supplied fixed tuned to your frequency. Power supply is not supplied. Requires 300 volts DC at 100 MA and 6.3 volts AC at 3 amperes.

SIZE: 7" x 19" x 8" deep.
 TUBES: 6AK5, 6BA6, 6AH6, 2E26, 0A2.
 RF FM Amplifier with tubes M-4791

MOTOR OPERATED RHEOSTAT



Recommended for regulating the plate voltage in transmitters of 1 KW and less. Available in three sizes for 250, 500 and 1000 watt transmitters. Motor is one RPM and operates from 115 volts, 60 cycles.

Motor Rheostat for 250 watts M-4703A
 Motor Rheostat for 500 watts M-4703B
 Motor Rheostat for 1 kw M-4703C
 Motor Control for Rheostat in BC-500G and BC-1G M-6326

WIDE BAND FM DETECTOR



The FMD-1 WIDE BAND FM DETECTOR is designed to make proof-of-performance measurements and adjustments on stereo as well as mono systems. It is an invaluable aid in maintaining FM systems at peak performance levels for the finest stereo or mono broadcasting.

Frequency 88-108 MC
 Response DC to 400 KC
 Stereo Separation in Excess of 45 db
 Distortion Less Than 0.1% (75 KC Dev.)
 Input 50 Ohms at Maximum of 1/2 watt
 Output Impedance 10 K Ohms

FM OUTPUT INDICATOR

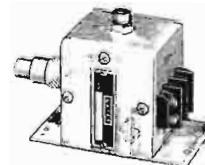

Designed to sample the 50 ohm transmission line of an FM transmitter for measuring transmitter output as required by FCC. Provides a DC voltage which is measured on the studio unit meter system.

Solid state device requires no AC power.
 FM Output Indicator M-4845

M-6112 RF DIODE UNIT



The M-6112 RF diode is designed for use as a remote R.F. indicating device in standard broadcast installations for sampling base currents or common point currents. It is not a directly calibrated R.F. ammeter, but is adjustable to indicate current linearity with the R.F. meter.

It is not necessary to break the lead to the antenna to install the unit. The M-6112 RF diode consists of an inductive loop attached to a rectifier assembly which is clamped to the antenna lead. The M-6112 is a solid state device and requires no AC power.
 Power Range: 250 to 50 Kw.
 Frequency Range: 540 to 1600 Kc.
 RF Diode Unit M-6112

AC RECTIFIER

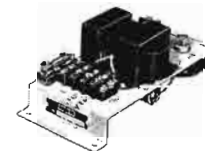

Rectifies the AC voltage, either line or filament, at the transmitter and feeds back DC to studio unit for measuring AC by remote control.
 AC Voltage Unit M-4825

TUNING MOTOR



This unit for tuning variable inductor, capacitor or other controls, has inbuilt limit switches. Five wire reversible motor 1 RPM. Requires M-5806 relay assembly for control, 115 V. 50/60 cycles.
 Tuning Motor M-5066

OUTPUT LOADING CONTROL KIT.

Complete kit to control output loading of Gates BC-5P-2 5-KW transmitter. It includes M-5066 and M-4806 relay and all necessary mounting hardware.
 Output Loading Control Kit M-4848A

TUNING MOTOR ASSEMBLY

For operating rheostat, variable condenser, or any variable control. Three wire reversible motor 1 RPM. Torque 15 lb. inches. 115 volts, 50/60 cycles.
 Tuning Motor M-4800

OVERLOAD RELAY

Replaces circuit breakers in current or older models as circuit breakers are usually undependable for remote control. Tripping current adjustable. Inserted in cathode circuit of RF power amplifier. Some engineers prefer an additional unit in modulator circuit.
 Overload Relay .. M-5129



TOWER LIGHT UNIT

This unit is used to provide a DC voltage for indication of proper tower light operation. Includes current transformer.
 Tower Light Metering Kit M-5145

AUXILIARY RELAY ASSEMBLY



Auxiliary relay assembly to provide one on-off momentary switching facility. These relays provide two sets of double throw double contacts rated at 8 amperes.
 Auxiliary relay assembly M-5249
 Same as above but latching (holding) type with 5 ampere contacts M-5248

PLATE CURRENT UNIT

Included with the Gates Remote Control System. Furnishes a sample of plate current which is returned to the studio unit and measured on the directly calibrated plate current meter. The unit is provided with a high voltage fuse for personnel and line protection, and can be used for current ranges of .8 ampere and 3 amperes. Units can be used in parallel if higher current range is required.
 Plate Current Unit M-4720A

PLATE VOLTAGE UNIT

Supplied with all Gates Remote Control Systems. One unit is used with voltages up to and including 6000 volts. For higher voltages, additional units may be connected in series. Also available as an accessory item for metering additional stages or transmitters.
 Plate Voltage Unit M-4719A

SPECIAL EQUIPMENT FOR REMOTE CONTROL

Gates has made every effort to provide a complete line of equipment for unattended operation. It is recognized that unusual situations may demand special accessories. Gates engineers will happily work with our customers on any special application.

FLEXIBLE COAXIAL CABLE

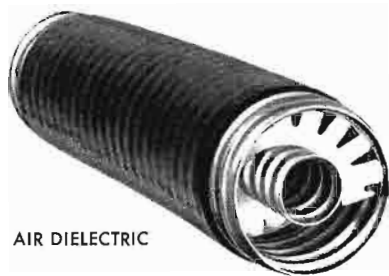

AIR DIELECTRIC



FOAM DIELECTRIC

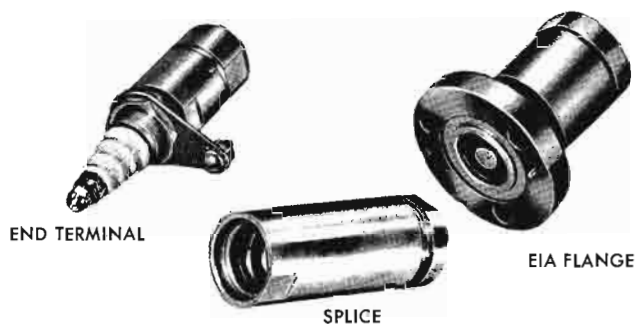

END TERMINAL

SPLICE

EIA FLANGE

HELIAX

Produced in continuous splice free lengths, Heliax low loss cable is ideally suited for any application where use of coaxial transmission line is indicated. For Medium Wave VHF and UHF applications, long continuous lengths provide ease of installation and maintenance free service. Corrugated copper conductors provide a combination of flexibility and low loss. For direct burial, exposure to rough handling or where the outer conductor must be insulated, Heliax jacketed with polyethylene is also available. Although Heliax connectors and fittings are easily attached, it is recommended that all cable assemblies be ordered with

fittings factory attached using specialized manufacturing equipment. Please order by type number.

Foam Heliax is used in those broadcast installations requiring low loss coaxial cable in which pressurizing is not desirable. A corrugated copper outer conductor and foam dielectric provide a combination of high strength, low loss and power handling not available in solid dielectric cables. The flexibility of foam Heliax provides maximum resistance to crushing, kinking or denting and enables it to be pulled through conduits and around obstructions. Please order by type number.

| AIR DIELECTRIC | | | |
|--------------------------------|----------|----------|----------|
| SIZE: | 7/8" | 1 1/8" | 3" |
| TYPE NUMBER: | H5-50 | H7-50A | H8-50A |
| TYPE NUMBER, JACKETED: | HJ5-50 | HJ7-50A | HJ8-50A |
| IMPEDANCE: | 50 ohms | 50 ohms | 50 ohms |
| ATTENUATION @ 100 Mc, db/100': | 0.37 | 0.21 | 0.14 |
| VELOCITY, %: | 91.6 | 92.1 | 93.3 |
| AVERAGE POWER, @ 100 mc-kw: | 6.4 | 14.5 | 34.0 |
| BEND RADIUS (MINIMUM)—INCHES: | 10 | 20 | 30 |
| NET WEIGHT—POUNDS/FT.: | .43 lbs. | .72 lbs. | 1.2 lbs. |
| NET WEIGHT—JACKETED: | .51 lbs. | .92 lbs. | 1.5 lbs. |

SPECIFICATIONS

| FOAM DIELECTRIC | | |
|----------------------------------|----------|----------|
| SIZE: | 1/2" | 7/8" |
| TYPE NUMBER: | FH4-50A | FH5-50 |
| TYPE NUMBER, JACKETED: | FHJ4-50A | FHJ5-50 |
| IMPEDANCE: | 50 ohms | 50 ohms |
| ATTENUATION @ 100 mc, db/100': | 0.82 | 0.44 |
| VELOCITY, %: | 79 | 79 |
| AVERAGE POWER, @ 100 mc, kw: | 2.3 | 4.8 |
| BENDING RADIUS (MINIMUM)—INCHES: | 5 | 10 |
| NET WEIGHT—POUNDS/FT.: | .19 lbs. | .36 lbs. |
| NET WEIGHT—JACKETED: | .24 lbs. | .44 lbs. |

COMPONENTS

| | 1/2" | 7/8" | 7/8" | 1 1/8" | 3" |
|----------------------------|----------|---------|---------|---------|-----------|
| Style | Foam | Foam | Air | Air | Air |
| Type Numbers | | | | | |
| Unjacketed: | FH4-50A | FH5-50 | H5-50 | H7-50A | H8-50A |
| Jacketed: | FHJ4-50A | FHJ5-50 | HJ5-50A | HJ7-50A | HJ8-50A |
| EIA Flange: | — | 45AR | 75AR | 87R | 78R (2) |
| UHF Jack: | 44AU | 45AU | 75AU | 87U | — |
| N Jack: | 44AN | 45AN | 75AN | 87N | 78R-2262 |
| End Terminal: | 44AT | 45AT | 75AT | 87T | 78R-2062 |
| Connector and reducer: | — | — | — | 87S | 78S |
| Connector and Gas Barrier: | — | — | 75AG | 87G | 78G (2) |
| Splice Kit: | 44AZ | 45AZ | 75AZ | 87Z | 78Z |
| Hoist Kit: | — | 29958 | 29958 | 24312 | 26985 |
| Hoist Kit, jacket: | — | 19256B | 19256A | 24312 | 26985 |
| Grounding Kit: | 26892-1 | 24810-1 | 24810-1 | 24811-1 | 28708-1 |
| Ground Kit, jacket: | 26892-2 | 24810-2 | 24810-2 | 24811-2 | 28708-2 |
| Rigid Hanger: | 12395-1 | 12395-1 | 12395-1 | — | 22417 (1) |
| Insulated Rigid Hanger: | — | 11662-2 | 11662-2 | 24622 | 22418 |

(Please order by type number)

- (1) Also available stainless wraplock, Type 12395-1, 100 feet per can.
- (2) Have captivated connector, use adaptor Type 23187 to connect male component, connectors mate with 3/8" EIA Flange.



RIGID TRANSMISSION LINES—PRESSURIZATION EQUIPMENT

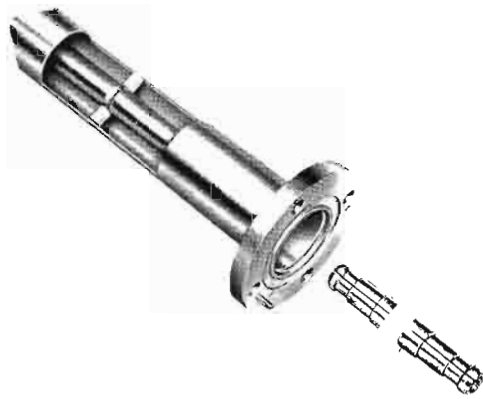

Rigid Line: Teflon insulated rigid copper coaxial transmission lines for broadcast application. Line and connectors meet all EIA applicable standards. Mitered elbows are compensated to provide low VSWR. All rigid sections and components include inner connectors, "O" ring and hardware. Please order by type number.

SPECIFICATIONS

| SIZE: | 7/8" | 1 1/8" | 3 1/8" |
|--------------------------------|---------|---------|---------|
| TYPE NUMBER: | 560 | 561 | 562A |
| IMPEDANCE: | 50 ohms | 50 ohms | 50 ohms |
| ATTENUATION @ 100 mc, db/100': | 0.40 | 0.20 | 0.11 |
| VELOCITY, %: | 99.8 | 99.8 | 99.8 |
| AVERAGE POWER, @ 100 mc: | 4.3 KW | 15.0 KW | 48.0 KW |
| NET WEIGHT—POUNDS/FT. | .65 | 1.25 | 2.75 |

COMPONENTS

| SIZE: | 7/8" | 1 1/8" | 3 1/8" |
|---------------------------|----------|---------|---------|
| 20 FT. SECTION, TYPE: | 560 | 561 | 562A |
| INNER CONNECTOR: | 18275 | 15069 | 15093A |
| MITER ELBOW: | 1060 | 1061 | 1062 |
| GAS BARRIER: | 1260A | 1261B | 1262A |
| REDUCER: | — | 1860 | 1861 |
| N ADAPTOR: | 2260 | 2261 | 2262 |
| END TERMINAL: | — | 2061 | 2062 |
| FLEX SECTION: | — | 20695 | 19209B |
| INNER 51.5 OHM ADAPTOR: | 4850 | 4851 | 4852 |
| FIXED FLANGE KIT: | 18630 | 18631 | 15840 |
| SWIVEL FLANGE KIT: | 18096 | 18041 | 18200 |
| HARDWARE KIT: | 11381-1 | 11381-2 | 11381-3 |
| "O" RING GASKET: | 10683-11 | 10683-2 | 10683-3 |
| RIGID HANGER: | 14328 | 13924 | 13927 |
| SLIDING HANGER: | 14327 | 14378 | — |
| SPRING HANGER: | 13889 | 14379 | 13925 |
| INSULATED RIGID HANGER: | 11662-1 | — | — |
| INSULATED SLIDING HANGER: | 11662-2 | 14442 | — |
| INSULATED SPRING HANGER: | — | 14441 | 13926 |



2061, END TERMINAL

1061, ELBOW

20695, FLEXIBLE SECTION

PRESSURIZATION EQUIPMENT



DEHYDRATORS: Type 1920A is a heatless, fully automatic dehydrator capable of delivering a continuous supply of dry air. No down time is necessary to reactivate drying agent. The unit will operate over an ambient range of 0° to 125°F with an input humidity of 95%. Twenty feet of 3/8" poly tubing is included for connection to the line. Please order by type number 1920A.

SPECIFICATIONS

| | |
|------------------------------|----------------------|
| OUTPUT: | 1 CFM @ 8 psig |
| POWER*: | 115v 60 cycle |
| INTERNAL OPERATING PRESSURE: | 60 psig |
| OUTLET DEW POINT: | Below — 37°F |
| NET WEIGHT, POUNDS: | 80 |
| DIMENSIONS, INCHES: | 15 3/8 x 24 x 14 1/4 |

*220v 50/60 cycle option available.

DRY AIR HAND PUMP

Type 878, Dry Air Hand Pump, pressurizes up to 1,000 feet of 7/8" cable or 250 feet of 1 1/8" line. One pound of silica gel and 8 feet of hose is supplied. Please order by type number 878.



NITROGEN TANK FITTINGS

Type 858A, Nitrogen Tank Fittings, includes pressure regulator, high and low pressure gauges and 10 feet of 3/8" O.D. poly tubing and fittings to fit 1/8" MPT.

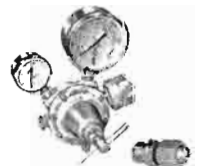

OPEN WIRE TRANSMISSION LINE

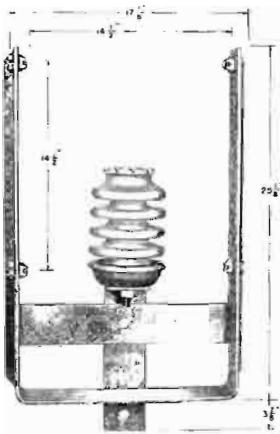

M-3327 Bracket

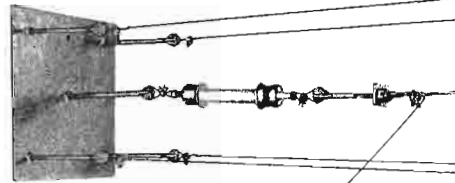

M-3328 End Plate

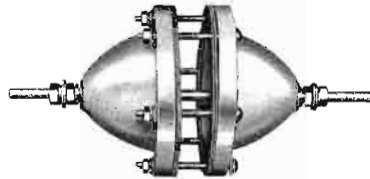

M-2870D Feed-Thru Bowl

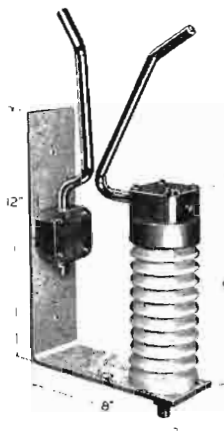

M-3322 Horn Gap



M-3864 Center Post

TRANSMISSION LINE BRACKET

For 5 or 6 wire transmission line. Rating up to 150 KW modulated. Made of 1/4" steel 3" wide with welded L section on each side to fully prevent twisting under ice or wind load. Supplied with 8 1/4" ribbed insulator, wire guides and all hardware. Galvanized throughout.

Line Bracket (Catalog No.) M-3327

LINE END PLATE

To terminate the open wire line at each end. Plate is 1/4" thick, 20" square. Fully galvanized. Includes turnbuckles, 25 1/2" strain insulator and all hardware. Rating up to 150 KW modulated.

End Plate M-3328

FEED-THRU BOWLS

A large feed-thru bowl with 50 KW modulated rating. Available in single and double units and with solid or hollow studs as listed below. Bowls are Alsimag. Hardware heavy brass. Velutex seals are provided for weather-tight installation.

- Solid stud, 2 bowls, for walls to 10 1/2" thick M-2870D
- Same as above but hollow stud M-3254
- Solid stud, single bowl, for walls 1" thick M-5280
- Same as above but hollow stud M-5281

HORN GAP

A very desirable item where higher power is employed. Connects to hot side of line and ground to drain off lightning and heavy static discharges. Usually one is employed for each 200' of line. Insulator for 150 KW arc gaps heavy chrome plate. Galvanized throughout.

Horn Gap M-3322

CENTER POST ASSEMBLY

Has variety of uses such as end or corner angling of transmission line, support insulator for two wire line or rhombic antennas, and a guide insulator such as end of building or coupling unit. Rating 150 KW galvanized throughout.

Center Post Insulator M-3864

HARD DRAWN WIRE

If desired, when ordering transmission line components, Gates will gladly supply No. 6, 8 or 10 hard drawn copper wire at current market prices. State length in feet desired, remembering to multiply the length of line by the number of wires in line, either 5 or 6.

SPECIAL OPEN WIRE LINES

Gates engineers have designed many special open wire lines for both short and long distances. Most celebrated was a 30-mile line supplied for use in the Arctic Circle. Upon receipt of a sketch or word description of the requirements, Gates engineers will gladly submit layout and quotation.

DESIGN AND IMPEDANCE CHART

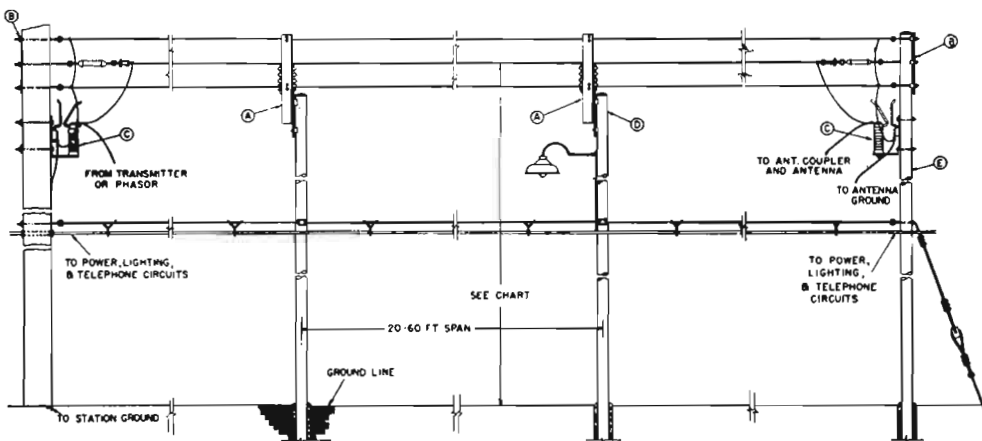

AVERAGE SURGE IMPEDANCE FOR 6 WIRE TRANSMISSION LINES

| HEIGHT OF CENTER WIRE | WIRE SIZE | | |
|-----------------------|-----------|-------|-------|
| | 6 | 8 | 10 |
| 9' | 232 Ω | 246 Ω | 250 Ω |
| 10' | 234 Ω | 250 Ω | 256 Ω |
| 12' | 240 Ω | 252 Ω | 260 Ω |

AVERAGE SURGE IMPEDANCE FOR 5 WIRE TRANSMISSION LINES

| HEIGHT OF CENTER WIRE | WIRE SIZE | | |
|-----------------------|-----------|-------|-------|
| | 6 | 8 | 10 |
| 9' | 330 Ω | 346 Ω | 364 Ω |
| 10' | 333 Ω | 350 Ω | 365 Ω |
| 12' | 332 Ω | 348 Ω | 363 Ω |

Chart above illustrates typical five or six wire open type transmission line. Table is provided to show impedances with various wire sizes at certain heights above ground. Transmission line brackets are M-3327, end plate M-3328. Horn gap is M-3322. The power, lighting and telephone circuits shown are optional, according to requirements of installation. Open wire line will average about the same per foot cost as 7/8" coaxial copper cable.

ANTENNA TOWERS—AVAILABLE IN EIGHT BASIC DESIGNS

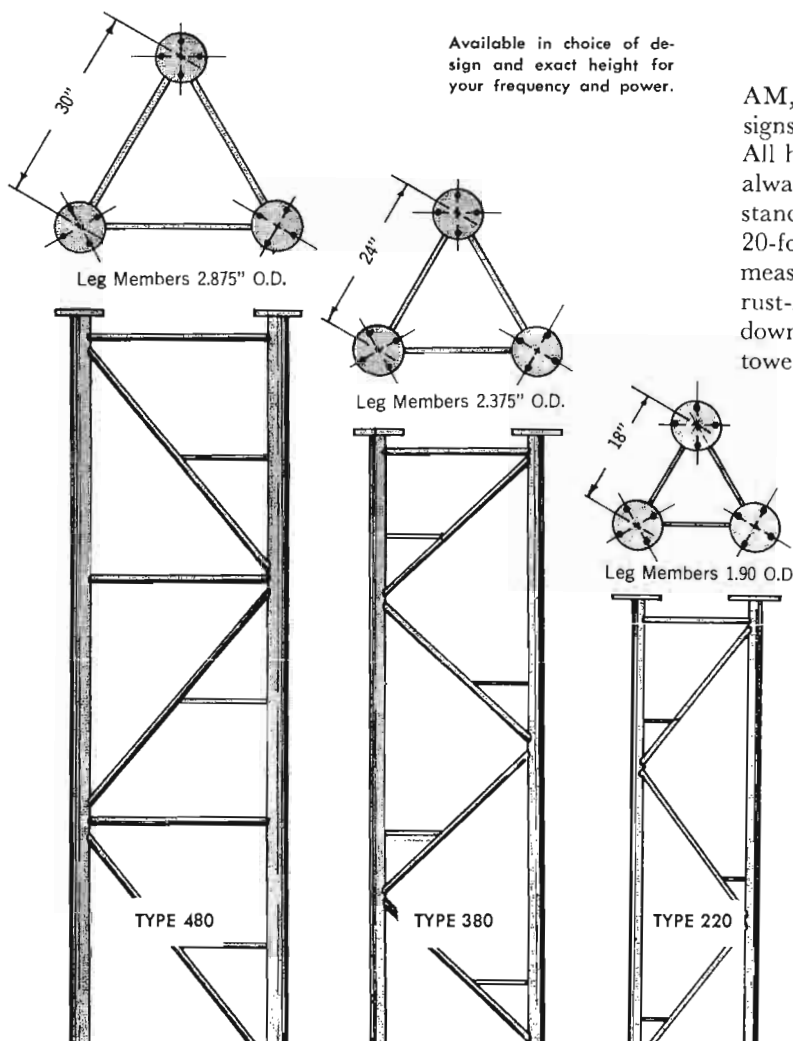

Available in choice of design and exact height for your frequency and power.

AM, FM and TV TOWERS

AM, FM and TV Towers are available in eight basic designs, insulated or noninsulated, six of which are shown here. All have superior Utility engineering and workmanship and always meet or exceed EIA specifications. In the seven standard models, round members are welded together in 20-foot sections except for top section which is to your measurement. You have choice of hot dip galvanized or rust-inhibitive primer finish. All models available in knock down design for compact export shipping. The Type 170KD tower is of bolted angle iron construction in 10 foot sections.

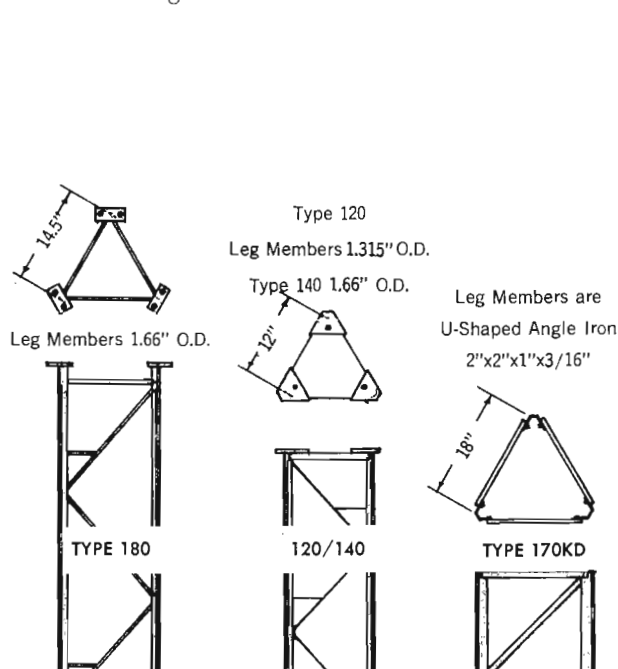

Leg Members are U-Shaped Angle Iron 2"x2"x1"x3/16"

RIGID ANCHOR BEAMS: Anchors are individually designed to meet the requirements of each tower installation. Utility uses the I-beam with its proven structural rigidity. When installed by *Utility* tower crews, on normal soil, this beam is imbedded in concrete slab reinforced with steel rods and with earth fill on top.

SOLID BASE INSULATORS: Insulated vertical radiators are equipped with the latest *Utility* 3401 or *Utility* 2201 pivot base insulators for positive insulation between base and ground. *Utility* base insulators have much higher compression rating than hollow insulators of similar size. They are resilient and shatter-proof. Each insulator is proof tested for a load approximately eight times greater than ever carried in normal broadcast service.

GALVANIZED HARDWARE: All *Utility* tower hardware is hot dipped galvanized to prevent rust and corrosion.

EASY MAINTENANCE: Round members and welded construction provide smooth surfaces for easy painting and servicing. Steps are built into bracing to eliminate need for scaffolding and to make entire height of tower easy for maintenance men to reach.

SPECIFICATIONS

| TOWER TYPE | MAXIMUM RECOMMENDED HEIGHT | TOWER WIDTH | WEIGHT PER FOOT* | TYPE OF BASE INSULATION |
|------------|----------------------------|-------------|------------------|----------------------------|
| 480 | 480 FT. | 33 IN. | 28 LBS. | LOCKE OR LAPP UTILITY 3401 |
| 380 | 400 FT. | 24 IN. | 19 LBS. | UTILITY 3401 |
| 340 | 350 FT. | 19-7/8 IN. | 17 LBS. | UTILITY 3401 |
| 220 | 250 FT. | 19-7/16 IN. | 12.5 LBS. | UTILITY 3401 |
| 180 | 200 FT. | 16-3/16 IN. | 10 LBS. | UTILITY 2201 |
| 140 | 200 FT. | 12 IN. | 12 LBS. | UTILITY 2201 |
| 120 | 200 FT. | 13-1/4 IN. | 8 LBS. | UTILITY 2201 |
| 170KD | 320 FT. | 18 IN. | 17 LBS. | UTILITY 3401 |

*Tower steel only—Weight of guys, insulators, etc., not included.

ORDERING INFORMATION

Specify: type of tower; tower height; insulated or non-insulated; galvanized or non-galvanized. Self-supporting, tall TV towers, or towers over 480' will be quoted upon request. Installation services for towers, FM, TV antennas, transmission line, AC lighting and ground systems also available by request.



TOWER LIGHTS AND ACCESSORIES

SOLID STATE BEACON FLASHER

The Gates Solid State Beacon Flasher represents an entirely new concept in tower light flashers with no moving parts—no motor, no relay contacts to char and give trouble, and no cams. Silicon controlled rectifier switching circuits are employed to replace all moving parts and fully meet FAA flash time interval requirements. A silicon controlled rectifier is triggered by an avalanche switching device. Beacon ON-OFF intervals are determined by two separate RC constants. Voltage is supplied to the beacon when the control rectifier is in open circuit condition. Factory adjusted for correct FCC/FAA flashing rate but fully adjustable from 10 to 75 flashes per minute. Not affected by temperature variations and with no motor to slow down or stop in extreme cold weather, the advantages of this new unit are substantial.

SPECIFICATIONS (MODEL C-6369)

- CONTACTS:**
Single pole single throw.
- POWER CONSUMPTION:**
Negligible.
- SIZE (M-6369):**
9" x 7" x 3 1/4".
- (M-6369A):**
12 1/4" x 8 1/2" x 4".
- WEIGHT (M-6369):**
2 lbs.
- (M-6369A):**
9 lbs.
- CONDUIT ENTRANCE: (M-6369A):**
1" and 3/4" knockouts on all four sides.
- VOLTAGE:**
115 volts, 50 or 60 cycles.



With no moving parts and operable in sub-zero or torrid temperatures, the new M-6369 solid state flasher totally removes the problem of the slow motors, relay contact trouble and cam deficiencies.

ORDERING INFORMATION

- Beacon Flasher, panel type, less housing (Cat. No.) M-6393
- Beacon Flasher, indoor switch box housing M-6393A

ACCESSORIES

- TOWER LIGHTS:** Single Obstruction Light, bottom entrance conduit fitting furnished with lamp receptacle to accommodate either a 100 or 111 watt, 115V medium screw base lamp, or lumen medium pre-focus series lamp OB-20-3
- Single Obstruction Light, same as Model OB-20 above but side entrance conduit fitting OB-21-4
- Double Obstruction Light, provided with two lamp receptacles, each accommodating either 100 or 111 watts, medium screw base lamp, or lumen medium pre-focus lamp. Bottom entrance fitting type for 1" conduit.
- For Medium Screw Base OB-22-4
- For Pre-Focus Base OB-22P-4
- Code Beacon 300 MM, standard fully approved FCC and CAA model supplied with two red filters.
- For 3/4" Conduit KG-114-3
- For 1" Conduit KG-114-1
- Clear Traffic Signal Lamp
- 107 watt, 115V 107A21-TS
- 116 watt, 115-120V 116A21-TS
- Beacon Lamp, 500 Watt 500PS-40
- Beacon Lamp, 620 Watt 620PS-40

- PHOTO CELL UNITS:** Single Unit, indoor housing, lighting control unit with outdoor remote weather photo tube, includes complete code flasher for flashing of three towers and photo-electric cell control for automatic turning on and off 115/230 V, 50/60 cycle, 3 conductors to each tower LC-2077
- Single Unit, indoor housing, same as LC-2077 above but for 4 towers instead of 3 LC-2076
- PHOTO-CELL AND BEACON FLASHER:** A combination unit in weatherproof housing. Photo-cell may be rotated to north regardless of mounting position on tower. Turns on at 35 foot candles and off at 58 foot candles. Fully approved. For 1 pole 30 amperes, flashes one circuit LC-2074
- FISHER-PIERCE PHOTO-CELL UNIT:** A unit completely weatherproof, fully approved for turning on and off tower lights; has time delay of 5-7 seconds to prevent operating lights by change exposure such as walking in front of unit.
- PHOTO-CELL UNIT:** Designed for 105-130 volts, 3000 watt rating, SPST, double break 63305DA
- PHOTO-CELL UNIT:** Same as above but for 210-250 volts 63364D



HOUSTON—This large panoramic display of fine broadcast equipment including the Vanguard I, highlights the features found in broadcasting's most unique sales and service center.

GATES HOUSTON: Located three hours or less from the farthest metropolitan airport in the United States, Gates-Houston carries thousands of sundry items just for broadcasters. The order of only a few cents is given the same attention as the large order. Now located adjoining a freeway direct to Houston International Airport, fast service is intentional. The Houston branch of Gates is perhaps the only fully stocked supply center in the world devoted exclusively to broadcasters.

GATES-HOUSTON
4019 Richmond Ave., Houston, Texas
Telephone (Area 713) 666-4333



LOS ANGELES—Attractive Western field sales offices are located at 1945 S. Figueroa, Los Angeles 7, California. Phone R17-7129. Area Code 213.



NEW YORK—Centralized Eastern facilities of Gates field sales offices are located at 800 Second Avenue, New York 10, New York. Phone MU7-7971. Area Code 212.

WASHINGTON—Convenient to the nation's capital the Gates Washington sales offices are located at 523 Pennsylvania Building, Washington D.C. Phone ME8-0522. Area Code 202.

SALES CENTERS



TRANSFORMERS FOR BROADCASTING

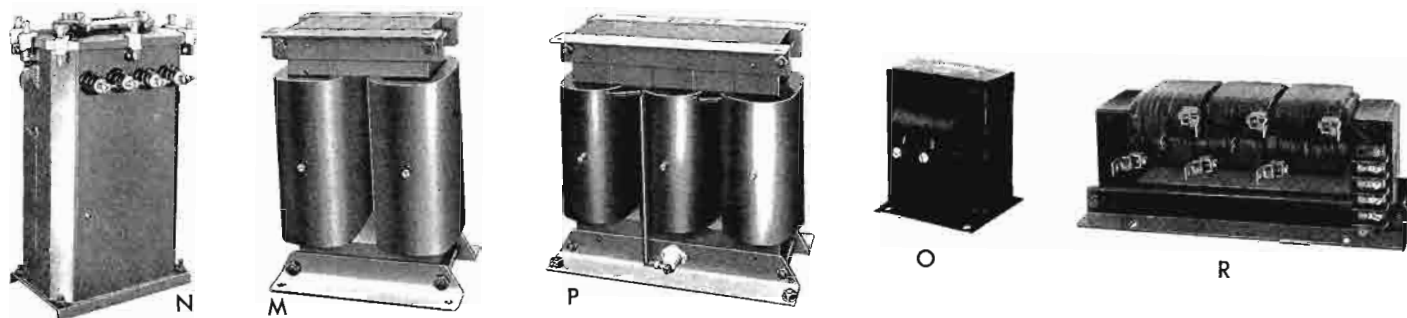

These quality transformers for radio broadcasting, communications and television transmitters are regularly carried in stock and are of such specialized design they may not be found elsewhere. If you are modernizing, building your own or need a replacement transformer, you need not wait for it to be specially built as the Gates stock is in most cases immediately available.

High Voltage Power Transformers for AM

| Transmitter Power | Description | Order No. |
|-------------------|---|-----------|
| 250 watts AM | Primary: 215/230/245, 1 phase, 50/60 cycles. Secondary: 1700-0-1700 volts at 0.6 amps. 3% reg. under Class B modulation. Case style M. | 472-0234 |
| 500 watts AM | Pri.: 230 volts, 1 ph., 50/60 cy. Sec.: 2335-0-2335 volts at 0.46 amps. 3% reg. under Class B modulation. Delivers 2000 volts D.C. with choke input. Case M. | 472-0259 |
| 1000 watts AM | Pri.: 230 volts, 1 ph., 50/60 cy. Sec.: 3100-0-3100 volts to produce 1 amp. D.C. @ 2600 volts with choke input. 3% reg. under Class B modulation. Case M. | 472-0250 |
| 5000 watts AM | Pri.: 218/230/242 volts, 3 ph., 50/60 cy. Delta. Sec.: 2160 volts per leg Y. Delivers 5000 volts D.C. @ 2.3 amps. with six 8008/872A rectifiers. Dry type. Case M. Companion to AC-7719E reactor. | 472-0242 |
| 5000 watts AM | Pri.: 230 volts, 3 ph., 50/60 cy. Delta. Sec.: 2160 volts per leg Y. Delivers 5000 volts D.C. @ 2.3 amps. with six 8008/872A rectifiers. Oil filled for indoor or outdoor service. Case N. Companion to AC-7719M reactor. | 472-0243 |
| 10,000 watts AM | Pri.: 230 volts, 3 ph., 50/60 cy. Delta. Sec.: to deliver 5500/5250 or 5000 volts D.C. @ 4.5 amps. with six 673 rectifiers Y connected choke input. Dry type. Case style P. | 472-0231 |
| 10,000 watts AM | Pri.: 230 volts, 3 ph., 50/60 cy. Delta. Sec.: to deliver 5500/5250/5000 volts D.C. @ 4.5 amps. with six 673 rectifiers Y connected choke input. Oil filled indoor or outdoor service. Case N. | 472-0253 |
| 50,000 watts AM | Pri.: 460 volts, 1 ph., 50/60 cy. ± 5% voltage taps. Sec.: 8050 volts. Use 3 transformers WYE connected to supply 10,500 volts at 7 amps. Continuous duty and 7-14 amps. 50% duty. Oil filled similar case N but round. | 472-0358 |
| 100,000 watts AM | Pri.: 415 volts, 3 ph., 50/60 cy. ± 5% voltage taps. Sec.: Delta, line to line voltage 9800 volts RMS. Delivers 12,500 volts at 11.5 amps. with bridge silicon rectifiers. Dry type. Similar to case P with ter- | 472-0466 |

minals out top. Used for R.F. plate supply.

100,000 watts AM Pri.: 415 volts, 3 ph., 50/60 cy. ± 5% voltage taps. Sec.: Delta, line to line voltage 11,600 volts RMS. Delivers 15,000 volts 7.7 amps. 50% duty cycle with silicon rectifiers. Use for modulator D.C. supply. Dry type. Similar to case P. Terminals out of top. 472-0465

Note: Any transformer listed for use with rectifier tubes may also be used with properly designed silicon rectifier stacks.

High Voltage Power Transformers For FM

| | | |
|-----------------|---|----------|
| 250 watts FM | Pri.: 120 volts, 1 ph, 50/60 cy. Sec.: 2200-0-2200 volts A.C. @ 300 MA. to deliver 2000 V. D.C. with two 8008 rectifiers choke input. Case M. | 472-0456 |
| 1000 watts FM | Pri.: 115/230 volts, 50/60 cy., 1 ph. Sec.: 4600/4050/3400-0-3400/4050/4600 volts A.C. to deliver 4000/3500/3000 volts D.C. @ 600 MA. with choke input and (2) 673 rectifiers. | 472-0307 |
| 5000 watts FM | Pri.: 208-230-240 volts, 3 ph., 60 cy. Delta. Sec.: 1840 V per leg at 2.45 amps. WYE. Delivers 4200 volts D.C. with either tube or silicon rectifiers choke input. Case P. | 472-0494 |
| 7500 watts FM | Pri.: 208-230-240 volts, 3 ph., 60 cy. Delta. Sec.: 2380 V per leg at 2.04 amps. WYE. Delivers 5570 volts D.C. at 2.5 amps. choke input with silicon rectifiers or tube rectifiers. Case P. | 472-0397 |
| 10,000 watts FM | Pri.: 208-230-240 volts, 3 ph., 60 cy. Delta. Sec.: 2840 volts per leg at 2.45 amps. WYE. Delivers 6600 volts D.C. choke input with silicon or tube rectifiers. Case P. | 472-0509 |

Modulation Transformers and Reactors

| | | |
|------------|--|----------|
| 250 watts | Modulation trans. Pri.: P.P. 810 tubes Class B to 4000 ohm secondary. Use with reactor below. Fully cased. | |
| | Modulation reactor. About 40 henry at 300 MA. Use with mod. trans. above. Fully cased. | 482-0001 |
| 500 watts | Modulation trans. Pri.: Class B 833A tubes. Sec.: 4750 ohms. Use with reactor below. Case M. | 478-0084 |
| | Modulation reactor. 50 henry at 350 MA. 254 ohms resistance. Use with mod. trans. above. Case M. | 476-0179 |
| 1000 watts | Modulation trans. Pri.: 833A tubes Class B. Sec.: 4750 ohms. Also tertiary winding to deliver 2, 4 or | 478-0084 |

Transformers for Broadcasting

| | | | | | |
|--------------|--|----------|--|--|------------------|
| | 8 watts to modulate R.F. driver stage. Case M. | | 5000 watts | Input or smoothing choke. 4 hy. at 1.5 amps. 24 ohms. Case M. | 476-0166 |
| | Modulation reactor. 32 henry at 600 MA. 240 ohms resistance. Use with mod. trans. above. Case M. | 476-0243 | 10,000 watts | Input or smoothing choke. 2 hy. at 3 amps. 10 ohms. Case M. For 10 KW, 2 chokes are used for R.F. power amplifier and the second for modulators. Case M. | 476-0168 |
| 5000 watts | Modulation trans. Pri.: Class B 3X2500F3 or 3X2500A3 tubes. Sec.: 3600 ohms. Dry type. Use with reactor below. Case M. | 478-0080 | 20,000 watts | Input and smoothing choke. 2 hy. 5.3 amps. Oil filled indoor or outdoor type. In 20 KW transmitters, 1 used for R.F. power amplifier and 1 for modulators. Case N. | 476-0175 |
| | Modulation reactor. 30 henry at 1.4 amps. Use with mod. trans. above. Dry type. Case M. | 482-0013 | 50,000 watts | Input and smoothing choke. 1 hy. 13 amps. Oil filled indoor or outdoor style. Case N. | 476-0206 |
| 5000 watts | Modulation trans. Pri.: Class B 3X2500F3 or 3X2500A3 tubes. Sec.: 3600 ohms. Oil filled similar case N. Indoor or outdoor type. Use reactor below. | 478-0079 | Filament Transformers | | |
| | Modulation reactor. 52 henry 1.4 amps. Use with mod. trans. above. Oil filled similar to case N. Indoor or outdoor type. | 482-0014 | Typical Tubes | Description | Order No. |
| 10,000 watts | Modulation trans. Pri.: 3X2500F3 or 3X2500A3 tubes. Sec.: 1780 ohms. Case M. Use reactor below. Dry type. | 478-0073 | (1) 3X2500F3 or 3X2500A3 | Pri.: 215/230/245 volts, 1 phase, 50/60 cy. Sec.: 7.8 volts C.T. @ 51 amps. Case R. | 472-0202 |
| | Modulation reactor. 20 henry 3 amps. Dry type. Use mod. trans. above. Case M. | 482-0017 | (3) 3X2500F3 or 3X2500A3 | Pri.: 215/230/245 volts, 1 phase 50/60 cy. Sec.: 3 windings each 7.8 V.C.T. @ 51 amps. Case R. | 472-0178 |
| 10,000 watts | Modulation trans. Pri.: 3X2500F3 or 3X2500A3 tubes. Sec.: 1780 ohms. Use reactor below. Case N. Oil filled indoor or outdoor type. | 478-0071 | (1) 5891 | Pri.: 230 volts, 1 phase, 50/60 cy., 2 1/2% taps. Sec.: 11 volts at 95 amps. 3 required for 3 phase Delta-WYE connection. | 472-0330 |
| | Modulation reactor. 20 henry 3 amps. Oil filled indoor or outdoor type. Use with mod. trans. above. Case N. | 482-0009 | (4) 833A | Pri.: 230 volts, 50/60 cy., 1 phase. Sec.: 3 windings, 2 each, 10 V.C.T. at 10 amps. and 1 winding 10 V.C.T. at 20 amps. Case R. | 472-0452 |
| 50,000 watts | Modulation trans. Pri.: 5891 tubes Class B. Sec.: 1700 ohms. Use reactor below. Oil filled indoor or outdoor type. Case N. | 478-0238 | (6) 8008, 872A, 673 | Rectifier fil. trans. Pri.: 230 volts, 50/60 cy., 1 phase. Sec.: 6 windings of 5 V.C.T. at 10 amps. each. 15,000 volt ins. Case R. Use in 5 KW, 10 KW, and 20 KW transmitters. | 472-0175 |
| | Modulation reactor. 25 henry 6.5 amps or 20 henries 7.8 amps. Use with mod. trans. above. Oil filled indoor or outdoor type. Case N. | 482-0033 | Audio Input And Output Transformers | | |
| | | | Purpose | Description | Order No. |
| | | | Transmitter input | Pri.: 150/250/500 ohms at + 14 db. input. Sec.: Single or P.P. 120,000 ohm grids. Quadruple shielding. 20-20,000 cycles. Round case, chassis mtg. | 478-0142 |
| | | | Preamplifier input | Pri.: 50/150 ohms (for 250 ohm microphones). Sec.: Single 60,000 ohm grid. Triple shielding. Round case. Wide response. 1 3/8" high, 1 3/4" diam. | 478-0143 |
| | | | Preamplifier input | Identical to 478-0143 above only primary is 150/600 ohms. | 478-0144 |
| | | | Preamplifier output | Pri.: 15,000 ohms no D.C. in winding. Sec.: 150/250 and 600 ohms. Wide response. Well shielded. Matches 478-0142 and 478-0143 in size and mounting. | 478-0118 |
| | | | Remote amplifier output | Pri.: 10,000 ohms with up to 15 MA. in winding. Sec.: 150/600 ohms. Wide response, well shielded. 2" wide, 1 3/4" deep, 2 3/4" high. | 478-0120 |
| | | | Repeater transformer | Line to line isolation. Primary and secondary, 62, 150, 250, 600 ohms. Max level + 16 db. Wide response. Fully shielded. Round case, chassis mounting. | 478-0030 |
| | | | 50,000 Transformers | | |
| | | | Transformers listed herein cover only major items. Nearly every conceivable type of transformer or reactor, large or small, is available for either your upgrading, maintenance or emergency needs, and many in addition are carried for your convenience at our Houston branch. (AC713) 666-4333. | | |
| | | | Audio Driver Transformers | | |
| 250 watts | Driver trans. Pri.: 6L6 or 1622. Sec.: Class B 810 tube grids. Fully cased chassis mtg. | 478-0038 | | | |
| 500 watts | Driver trans. Pri.: 845 tubes Class A. Sec.: 833A Class B grids, chassis mtg. Fully eased. | 478-0048 | | | |
| 1000 watts | Driver trans. Pri.: Push-pull parallel 845 tubes Class A to 3X2500F3 or 3X2500A3 Class B grids. Chassis mtg. | 478-0045 | | | |
| 5000 watts | | | | | |
| 10,000 watts | | | | | |
| | | | Filter Reactors | | |
| 250 watts | Swinging choke. 5-25 hy., 500 MA., 52 ohms. Round case, base terminals. | 476-0138 | | | |
| | Smoothing choke. 25 hy. at 300 MA. 90 ohms. Round case, base terminals. | 476-0137 | | | |
| | Swinging choke. 5-25 hy. 500 MA. 52 ohms. Round case, base terminals. | 476-0138 | | | |
| 500 watts | Smoothing choke. 2 1/2 hy. at 700 MA. 20 ohms resistance. Case O. | 476-0176 | | | |
| | Swinging choke. High inductance type. 5-16 henries at 1.5 amps. 30 ohms. Case M. | 476-0177 | | | |
| 1000 watts | Smoothing choke. 2 1/2 henries at 700 MA. 20 ohms. Case O. | 476-0176 | | | |



HEAVY DUTY INDUCTORS AND CAPACITORS

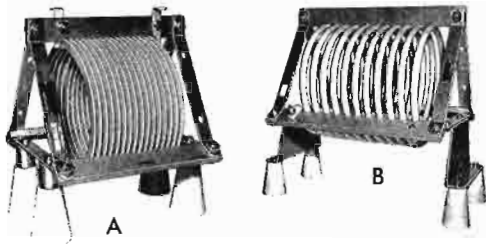

Gates manufactured inductors have the emphasis on solid mechanical construction. All coils are micaex insulated and silver plated with cold water dip to delay tarnishing. Variable coils have cast aluminum end bells and double gripping contact wheels. Mounting insulators in pictures are for illustrative purposes only. Other sizes and ratings available on special order.

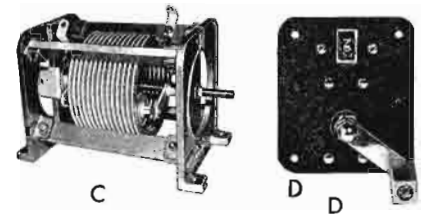

SPECIFICATIONS AND ORDERING INFORMATION

| Inductance UH | Size in inches | Coil Style | Rating | Fig. | Order |
|---------------|----------------|-------------|--------|------|-----------|
| 87 | 12 x 4 | Ed Fixed | 10 | A | 87FA4634 |
| 6 | 6¼ x 4 | Ed Fixed | 20 | A | 6FC0854 |
| 10 | 6¼ x 5 | Ed Fixed | 20 | A | 10FC0855 |
| 13 | 6¼ x 6 | Ed Fixed | 20 | A | 13FC0856 |
| 17 | 8¾ x 4 | Ed Fixed | 20 | A | 17FC1654 |
| 24 | 8¾ x 5 | Ed Fixed | 20 | A | 24FC1655 |
| 32 | 8¾ x 6 | Ed Fixed | 20 | A | 32FC1656 |
| 42 | 12½ x 6 | Ed Fixed | 20 | A | 42FC2266 |
| 67 | 13 x 6 | Ed Fixed | 20 | A | 67FC2856 |
| 78 | 16 x 8 | Ed Fixed | 20 | A | 78FC2568 |
| 10 | 12½ x 6 | CT Fixed | 30 | B | 10FBT1066 |
| 32 | 15 x 8 | CT Fixed | 30 | B | 32FBT1658 |
| 45 | 18½ x 8 | CT Fixed | 30 | B | 45FBT2158 |
| 65 | 24½ x 9 | CT Fixed | 30 | B | 65FBT2559 |
| 17 | 14 x 8 | CT Fixed | 40 | B | 17FCT1178 |
| 35 | 24½ x 9 | CT Fixed | 40 | B | 35FCT1779 |
| 6 | 8 x 4 | Ed Variable | 20 | C | 6VC0854 |
| 15 | 9 x 4 | Ed Variable | 20 | C | 15VC1444 |
| 26 | 10¾ x 4 | Ed Variable | 20 | C | 26VC2144 |
| 16 | 9 x 4 | Ed Variable | 15 | C | 16VB1544 |
| 30 | 11 x 4 | Ed Variable | 15 | C | 30VB2344 |
| 105 | 12½ x 5 | Ed Variable | 15 | C | 105VB3735 |

Legend: Ed = Edgewise. CT = Copper Tubing.

Coil clip for FA coils
Coil clip for FC coils
Coil clip for FBT coils
Coil clip for FCT coils

LC4 Counter dial for variable coils reads 1/10 turns.
LC8 Size: 3" wide, 3½" high. Figure D.
RC6 With non-removable crank handle
RC8 With removable crank handle

M5521
M6233



MICA CAPACITORS FOR TRANSMITTERS AND PHASORS

Designed for continuous service with each sheet of mica carefully gauged for thickness and inspected for absence of impurities. Tolerance plus or minus 5%. Cast end bells and ceramic insulated. Sizes over-all: Model G1: 3¾" x 2½". Model G2: 4¼" x 3". Model G3: 6½" x 4". Model G4: 6½" x 5¾". Usually all sizes carried in stock. Please order by type number and capacity. Example: Model G2, capacity .0003 mfd.

| Capacity mfd. | Model G1 | | Model G2 | | Model G3 | | Model G4 | |
|------------------|----------|-------|----------|--------|----------|--------|----------|--------|
| | Amps | Volts | Amps | Volts | Amps | Volts | Amps | Volts |
| .0001 | 2.0 | 6000 | 3 | 10,000 | 5.6 | 20,000 | 5.1 | 30,000 |
| .00015 | 2.4 | 6000 | — | — | — | — | 6.2 | 30,000 |
| .0002 | 3 | 6000 | — | — | 5.6 | 20,000 | — | — |
| .00025 | — | — | 5.1 | 10,000 | — | — | 8.2 | 30,000 |
| .0003 | — | — | 5.6 | 10,000 | 6.8 | 20,000 | 9.1 | 30,000 |
| .0004 | 4.7 | 6000 | 6.2 | 10,000 | 8.2 | 20,000 | — | — |
| .0005 | 5.1 | 6000 | 6.8 | 10,000 | 9 | 20,000 | 12 | 30,000 |
| .0008 | — | — | — | — | 12 | 20,000 | 15 | 30,000 |
| .001 | 7.5 | 6000 | 10 | 10,000 | 13 | 20,000 | 16 | 30,000 |
| .0015 | 9.1 | 6000 | 12 | 10,000 | 16 | 15,000 | 20 | 25,000 |
| .002 | 11 | 6000 | 13 | 10,000 | 20 | 15,000 | 22 | 20,000 |
| .003 | 13 | 6000 | 16 | 8,000 | 24 | 12,000 | 27 | 20,000 |
| .004 | 15 | 6000 | 18 | 8,000 | 27 | 12,000 | 30 | 20,000 |
| .005 | 16 | 4000 | 20 | 6,000 | 30 | 10,000 | 33 | 15,000 |
| .006 | 18 | 4000 | — | — | — | — | 36 | 15,000 |
| .008 | — | — | — | — | 36 | 10,000 | 39 | 12,000 |
| .01 | 20 | 4000 | 24 | 5,000 | 39 | 8,000 | 43 | 10,000 |
| .015 | 20 | 3000 | — | — | — | — | — | — |
| .02 | 22 | 2000 | — | — | — | — | — | — |

AM—FM—FM STEREO—SCA TUNER

MODEL FMR-88

Designed specifically for aural monitoring of the complete AM-FM broadcast facilities, this Gates tuner receives AM, FM, AM/FM Simulcast, FM Stereo, and SCA.

SEPARATE TUNING: The FMR-88 tuner is a complete integrated equipment with separate AM and FM tuning, and is beautifully cabined and trimmed in a golden bronze panel. This lightweight unit contains 13 tubes (3 dual), plus 6 crystal diodes and dual silicon power rectifiers, and FM signal drift is eliminated by use of the automatic frequency control with defeat switch.

Additional features which compliment this unique multiple broadcast tuner include: Separate "Ray-O-Beam" precise tuning indicators for AM and FM; built-in ferrite rod for AM; built-in FM line cord antenna (also provision for external FM antenna); separate power switch; power receptacle (switched) for amplifier or phono; and



long-life service-free components.

SUB-CARRIER: The Gates FMR-88 tuner is capable of receiving SCA when tuned to the sub-carrier of an FM station engaged in this subsidiary form of transmission.

SPECIFICATIONS

| | FM | AM |
|-----------------------|------------------------|---------------------|
| Tuning Range | 87.4 to 108.3 MC. | 535 to 1610 KC |
| Sensitivity | 2.25 V IHFM* | 10 V/U for 10 DB |
| | | S/N |
| Bandwidth (6 DB Down) | 350 KC. @ Limiting | 9 KC. |
| Image Rejection | - 41.5 DB. | - 60 DB. |
| I.F. Rejection | - 87.5 DB. | - 43 DB. |
| Output Volts | 0.45 Volts RMS | 0.8 Volts RMS |
| Frequency Response | 50-15,000 CPS. ± 1 DB. | - 6 DB. @ 5000 CPS. |
| Harmonic Distortion | 1% | 1% |
| Hum & Noise | - 54 DB. | - 30 DB. |

*30 DB QUIETING SENSITIVITY, 75 KC DEVIATION.

| | FM STEREO | FM SCA (Sub-carrier) |
|---------------------|-------------------|--|
| Channel Separation: | 30 DB. @ 1 KC. | Tuning Range: 32-75 KC. Hum & Noise: - 60 DB. |
| 38 KC. Suppression: | - 44 DB. | |
| SCA Suppression | - 45 DB. | |
| Hum & Noise: | - 31 DB. | |

CONTROLS: (5 total) FM Tuning; AM/FM Tuning; Selector Switch 5 positions (AM, FM, FM Stereo, MX, FM/AM); AFC Switch, Power Switch. **TUBE COMPLEMENT:** 13 total: (6) 6BA6, (2) DM70 and (1 each) 6AU6, 6C9, 6C4, 12AU7, 6JH8; plus (6) Germanium crystal diodes; plus dual silicon power rectifier. **A.V. INPUT:** 117 volts, 50/60 cycles at 47 watts. **DIMENSIONS:** 15" x 9½" x 4½" high. Rack mounting brackets available for 19" mounting. **SHIPPING WEIGHT:** 15½ lbs.

ORDERING INFORMATION

| | |
|-------------------------------------|-----------------------|
| AM-FM Stereo/SCA Tuner W/Cabinet | (Catalog No.) FMR-88C |
| AM-FM Stereo/SCA Tuner Rack Mounted | FMR-88R |
| 35-watt Stereo Amplifier | AP-35 |
| Case for AP-35 Amplifier | TP-35 |

AP-35 35-WATT STEREO/MONAUURAL AMPLIFIER



SPECIFICATIONS: The AP-35, 35-watt stereo/monaural amplifier is a companion amplifier to the FMR-88 tuner. Plenty of power to handle any and all stereo music sources delivering 17½ watts IHF per channel. **FREQUENCY RESPONSE:** ± 1 db., 20-20,000 cps. **DISTORTION:** 0.6% at rated power. **HUM & NOISE:** Phono and Tape, - 55 db.; Tuner and Auxiliary - 70 db. **SENSITIVITY:** Phono and Tape, 4.5 Mc.; Tuner and Auxiliary 0.5 V. **CONTROLS:** Input selector, Balance, Loudness/Volume, Treble, Bass, Mode Selector Switch, Speaker/Phones Switch, Power On-Off Switch. **OUTPUTS:** 8 and 16 ohms to speaker; Stereo Tape. **INPUTS:** Mag. phono. Tape, Tuner, Aux. Front panel headphones jack. **SIZE:** 15" wide, 4¾" high, 11⅝" deep. For 117 volts, 50/60 cycle AC. Shipping weight, 21 lbs. For ordering information—see above.

GLOSSARY FOR LAYMEN

Many industry words, familiar to most engineers are given herein to assist non-technical people in reading and understanding catalog copy. The most used are defined below:

AF—Audio Frequency
AMBIENT—The temperature range in which equipment should be operated. Frequently stated in degrees Centigrade.
AMPLITUDE MODULATION (AM)—Modulation applied to a radio frequency carrier by varying the carrier above and below its normal value.
ATTENUATOR—Also known as a fader or volume control. A device to increase or decrease audio signal level.
BOOSTER AMPLIFIER—In a larger system the large number of circuits in parallel may reduce audio level below usable values. In this case a booster amplifier is used.
BUS—A number of circuits tied together such as the mixer circuits in a console where all faders can be tied together into a matched common circuit.
CARRIER SHIFT—The change in power of the radio frequency carrier due to other factors. Usually 5% or less is considered very good.
CFM—Cubic feet per minute. Expresses air movement of a blower or exhaust fan.
CHANNEL—A channel is a complete sound path. Single-channel or monophonic systems have one output channel. A stereophonic system has at least two full output channels designated as left (A) and right (B).
COAX—Coaxial cable or the electrical pipe that sends the signal from the transmitter to the tower or antenna.
CROSSTALK—When talking on a telephone, if you faintly hear another conversation in the background, that's crosstalk. In audio equipment, one circuit must be well shielded from another to prevent this occurrence.
CUBAGE—Cubic measurement of a package. Often ocean freight charges are based on cubage as well as weight.
CUE SYSTEM—A separate circuit usually independent of the normal broadcast functions, used to listen on a preview basis to program material coming up. Some cue systems also permit talk-back where the cueing loudspeaker can function as a microphone to talk to studio or remote locations.
DECIBEL (db)—A unit of audio measurement expressing an electrical ratio such as the relative intensity of a sound or signal. Two to three decibels (db) is about the smallest change in sound perceptible to the ear.
DIRECTIONAL ARRAY—Two or more towers to shape the direction of a broadcast signal. Used in conjunction with a phasor, often called a directional phasor.
DISTORTION—A measurement of impurity. Harmonic distortion disturbs the original relationship between a tone and other tones naturally related to it. Intermodulation distortion (IM) introduces new tones caused by mixing of two or more original tones. Expressed in percentage.
DUMMY ANTENNA—An artificial or simulated antenna that does most every function but radiate a signal. Allows testing without interfering with other stations.
EQUALIZER—A device to change the frequency response or tonal quality by attenuating or accentuating certain parts of the audio spectrum.
FIDELITY—The degree of faithfulness to the original sound accuracy in reproduction, implying minimum distortion, and suitably wide, uniform frequency response.
FREQUENCY MODULATION (FM)—Modulation by variance in width of a radio frequency signal.
FREQUENCY RANGE—Likened to the amount of the radio receiver dial a transmitter can adapt to. Example: 540 Kc. to 1600 Kc. means the transmitter will adapt to the standard AM broadcast requirements.
FREQUENCY RESPONSE—The capable range of reproduction of an amplifier or system. For example, the bass note of the tuba might be 40 cycles per second and the highest tone on the violin near 5000 cycles, with harmonic overtones as high as 15,000 cycles. The response of broadcast audio equipment must be wider than the normal range of musical instruments.
FREQUENCY STABILITY—The accuracy at which a transmitter holds to its assigned frequency or dial spot.
GAIN—The amount of amplification in an amplifier or system, usually stated in decibels.
HUM—Noise from the power line, either its actual frequency or harmonics of it, that intrudes into the audio signal and mars listening quality.

IMPEDANCE—Simply described as an electrical size or match. The correct impedance provides the optimum transfer of electrical energy. Stated in ohms, impedance is the load into which a circuit or electrical or acoustical device works.

INDUCTOR—A coil to resonate at the operating frequency desired.

INPUT OR SOURCE—Audio input equipment such as: microphones, turntables, network, etc.

IPS—"Inches per second," usually applied to tape speed in a tape recorder.

ISOLATION TRANSFORMER—A device frequently used between a telephone line and the audio system to assure circuit balance and eliminate hum from a line if unbalanced.

JACK—A receptacle into which a mating connector, such as a headphone plug, may be connected.

KEY—Actually a high quality switch that usually operates in a vertical or lateral action to activate or deactivate a circuit.

LOW LEVEL—Microphones are low level devices and require much more amplification. Usually a low level input is associated with a microphone.

MEDIUM OR HIGH LEVEL—Commonly indicates a circuit to accommodate an accessory not requiring additional preamplification such as turntables with preamplifiers, remote lines or tape recorders.

MIXER—Similar to an attenuator or fader but more specifically is a control associated with other like controls and all feeding the same bus. In this way, one input, such as a microphone, may be blended with other signals such as more microphones, turntables or projectors.

MODULATION—The applied signal such as voice or music to the radio frequency portion of the transmitter.

MONITOR AMPLIFIER—Amplifies program material to loudspeaker listening level. This amplifier must have good power output.

MUTE—When a loudspeaker is silenced to prevent feedback from a live microphone, this is called muting. Usually relays in the console operated by the microphone switch do the muting.

NOISE—Any extraneous sound or signal that intrudes into the original such as hum, normal tube noise and much else that is not wanted. Measured in decibels below (quieter than) program level.

OUTPUT OR LOAD—Termination of an amplifier or console to the next item of equipment. Examples: A transmitter, telephone line, or a loudspeaker.

PLUG—The part that fits into a jack. Headphone plug is an example.

PREAMPLIFIER—Preliminary amplifier, used before mixing circuits to amplify very low signal sources such as microphones or transcription pickup cartridges.

PRIMARY VOLTAGE—Thought of as the voltage supplied by the Public Utility Company.

PROGRAM AMPLIFIER—The main amplifier in an audio system. Boosts the output of the mixer bus to output level for feeding the next circuit such as the transmitter or telephone line.

RECYCLING—A transmitter may leave the air because of a lightning flash or a rodent electrocuting itself. The recycling device turns the transmitter back on automatically.

RF—Radio frequency.

RPM—The revolutions per minute such as 45 RPM means 45 revolutions each minute.

RUMBLE—Unwanted low-frequency mechanical noise from a turntable or tape transport that reproduces electrically.

SCA—Subsidiary Communication Authorization. A portion of the FM band allocated for special services such as subscription music.

SOLID STATE—A general reference to transistors and diodes and infers the non-use of tubes.

SPURIOUS RADIATION—The radiating of an unwanted signal such as a harmonic of the fundamental signal.

STL—Studio Transmitter Link. Usually a transmitter and receiver to replace telephone wires to connect studio with transmitter.

TRANSIENT—A very high momentary voltage.

VSWR—Voltage standing wave ratio. A method of stating the amount of reflected power that can be tolerated without damage to equipment.

V.U. METER—A meter to visually monitor audio level. Tells the operating engineer how loud his program is.

WOW AND FLUTTER—Variations in the speed of a turntable or tape transport. If too much is present, causes an audible change in musical pitch.

5000 WATT VHF TELEVISION TRANSMITTER

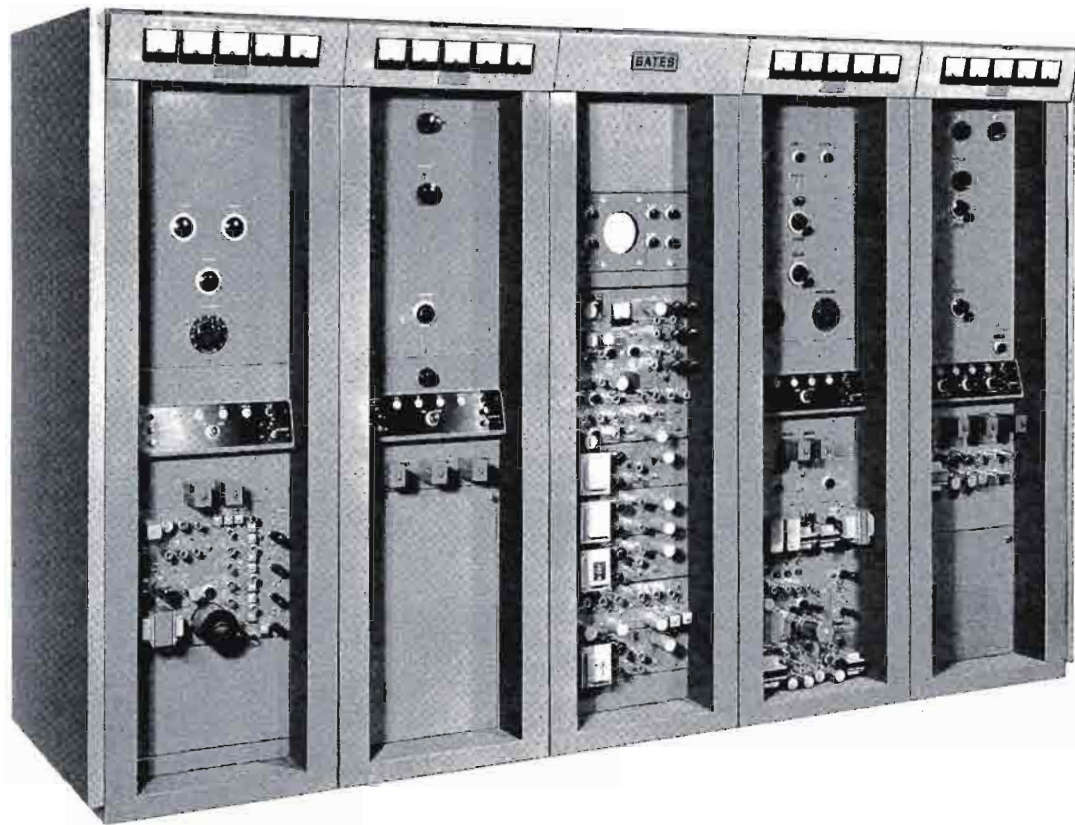

MODEL BT-5C: Designed for the most exacting color and monochrome television transmission on FCC Channels 2 to 13, the Gates BT-5C five kilowatt VHF TV Transmitter is completely self-contained. The two aural transmitter cabinets and three visual transmitter cabinets can be assembled in line to make the complete transmitter, or, they can be mounted in operating positions separate from one another. As the blowers and power components are mounted internally, the BT-5C transmitter requires a total floor space of only 10 feet by 3 feet. A vestigial sideband filter supplied as standard equipment is mounted externally. The same long life type 6076 tetrode tubes are used as final amplifiers for both visual and aural transmitters reducing the number of spare tubes and providing added operating economy.

IMPROVED VIDEO MODULATOR: The BT-5C transmitter includes a video modulator with keyed clamping and automatic switch over to AC coupling with reduced carrier power in case of sync or program failure. Sync-tip keyed clamping is used to avoid disturbing color signal components. Sync-tip clamping means no "back porch" disturbances of the color synchronizing burst. Built-in and operating from the composite signal input, the keyer clamp generator uses a delay-line controlling keying pulse for maximum stability. Fail-safe protection circuits are provided which reduce power to mid-gray level in event of clamp or signal failure. The video modulator is also equipped with RF bias failure alarm lamp, test meter, and front panel test jacks. Where color transmission is employed, the Gates M-5892 color video filter should also be included (see Ordering Information).

VISUAL TRANSMITTER: The visual transmitter is grid-modulated in the 500 watt driver, which is followed by a linear amplifier output section. The final amplifier uses the 6076 tetrode, the same type as employed in the aural transmitter. The visual oscillator output is multiplied three times for low band and nine times for high band channels. Under normal operating conditions the oscillator will hold carrier frequency to within 300 cycles. This transmitter provides superb color performance and, of course, FCC requirements are exceeded whether used as a color or monochrome transmitter.

AURAL TRANSMITTER: The aural transmitter consists of a 10 watt exciter which drives a single intermediate power amplifier stage. With a conservatively rated tube complement and rugged construction, trouble-free performance may be expected. Lack of frequency multiplication after the exciter unit aids in eliminating spurious frequencies and increases tube life. The 250 watt aural intermediate power amplifier is totally enclosed in a non-ferrous housing containing air-cooled tubes and components. The 4CX250B tube drives the final amplifier which is a 6076 tetrode, providing the full 2,500 watts of aural power for the BT-5C transmitter. Direct crystal controlled cascade modulation is employed to provide the high fidelity aural modulation. A flat frequency response within 1 db of the standard 75 microsecond pre-emphasis curve from 50 to 15,000 cycles, is expected performance in the BT-5C, 5000 watt VHF television transmitter.

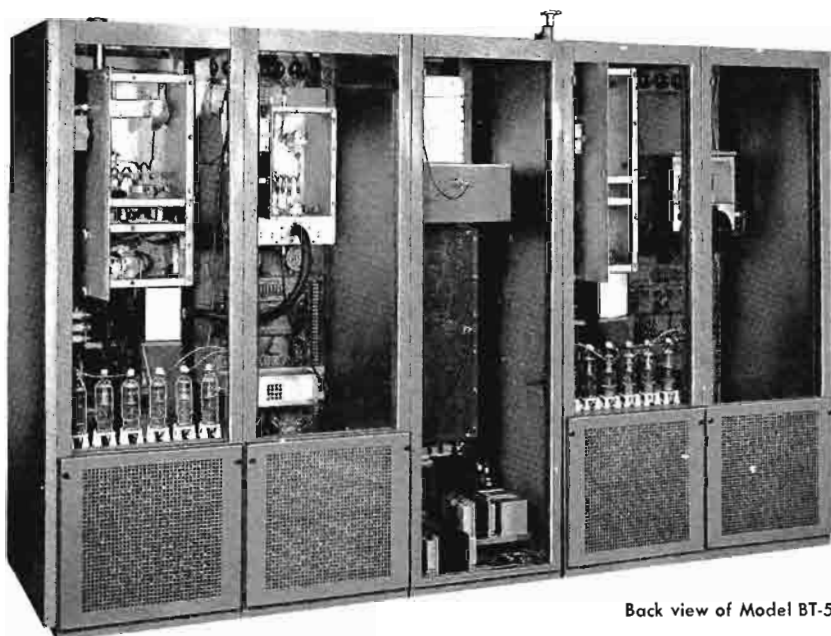

Back view of Model BT-5C

SPECIFICATIONS

POWER OUTPUT:

Channels 2 thru 6: Visual 5000 watts.
Aural 2500 watts.
Channels 7 thru 13: Visual 4000 watts.
Aural 2000 watts.

(Generous excess to rated power is available for sideband filter and system losses.)

FREQUENCY RESPONSE:

Visual + 2 to - 2 db. at 0.5 mcs.
Visual + 2 to - 2 db. at 1.25 mcs.
Visual + 2 to - 2 db. 2/0 mcs.
Visual + 2 to - 2 db. at 3.58 mcs.

The amplitude response will not vary more than + 1 db. to - 2 db. from the 3.58 mcs. response between 2.1 mcs. and 4.18 mcs. The amplitude at 4.75 mcs. is attenuated 20 db. and frequencies higher than 4.75 mcs. are attenuated 20 db. or greater. Lower sideband response is: Visual - 20 db. at 1.25 mcs., and - 42 db. at 3.58 mcs.

Aural within 1.0 db. of standard 75 microsecond preemphasis curve, 50-15,000 cycles.

RF OUTPUT IMPEDANCE:

50.0 ohms, 1 5/8" EIA Flange.

FREQUENCY STABILITY:

Visual ± 500 cycles.
Aural ± 500 cycles.

MODULATION CAPABILITIES:

Visual to 12 1/2% ± 2 1/2% of sync level.
Aural ± 40 Kc.

AUDIO FREQUENCY DISTORTION:

Between 50 and 15,000 cycles, 1 1/2% or less at 25 Kc. swing.
Distortion between 100 and 10,000 cycles is 1% or less.

NOISE:

Aural 60 db. below 100% modulation (FM).
50 db. below equivalent 100% modulation (AM).
Visual 40 db. below 100% AM modulation.

INPUT IMPEDANCE:

Video signal 75 ohms, unbalanced. Audio signal 600 ohms, balanced.

POWER INPUT:

230 volts, 50/60 cycles, three phase. Power consumption, 20 K.W.

HARMONIC ATTENUATION:

60 db. or better.

INPUT LEVEL:

Visual 1.0 V. ± 0.4 V. peak to peak. Aural + 10 dbm. ± 2 db. for 100% modulation.

SUBCHANNEL PHASE vs BRIGHTNESS:

± 7° maximum.

LINEARITY:

± 15% maximum.

REGULATION OF OUTPUT:

7% from black to all white.

INPUT POLARITY:

Black negative.

ENVELOPE DELAY TOLERANCE:

(From FCC Specified Curve).
± 0.08 microseconds from 0.2-2.1 mc.
± 0.04 microseconds at 3.58 mcs.
± 0.08 microseconds at 4.18 mcs.

TYPE OF MODULATION:

Phase shift employing pulse techniques (Aural).

TYPE OF OSCILLATOR:

Direct crystal controlled (both aural and visual).

TUBES:

Visual:

(11) OA2, (9) 12AT7, (7) 6CA7, (6) 8008, (6) GZ34/5AR4, (5) 6080, (5) OD2, (5) 12AX7, (4) 866/866A, (3) 6AU6, (3) 6AU8, (2) 4X250B, (2) 6076, (2) 6CL6 and (1 each) 6AK6, 6X4 and 5R4.

Aural:

(7) 6AU6, (6) 8008, (3) 12AX7, (3) 6J6, (3) 12BH7, (2) OA2, (2) 866/866A and (1 each) 12AT7, 6360, 6AQ5, 6080, GZ45/5AR4, 4X250B, 6076, 6360 and 6CS6.

SIZE (over-all):

Width 96" (less end bells), 99" (with end bells), height 78", depth 36 1/2".

WEIGHT:

Packed (domestic) 3000 lbs., (export) 3700 lbs.

CUBAGE:

312.

SIDE BAND FILTER:

Mounted external to cabinet. Supplied with transmitter.

COOLING:

Forced air.

ORDERING INFORMATION

- BT-5CL Transmitter for channels 2-6 (Cat. No.) M-6066
- BT-5CH Transmitter for channels 7-13 M-6067
- Spare 100% tube complement for BT-5CL TK-341
- Spare 100% tube complement for BT-5CH TK-343
- Color video filter (with power supply) M-5892



500 WATT VHF TELEVISION TRANSMITTER

MODEL BT-500C

This popular 500 watt VHF Television Transmitter is used as the driver for the Gates BT-5C 5000 watt model and can be increased in power at any time. Field proven, the fine performance of the BT-500C is acknowledged by world wide users in Alaska, the Virgin Islands, Panama, Korea and other areas using 525 line standards.

Designed to meet FCC color specifications on VHF Channels 2 to 13, the Gates BT-500C TV Transmitter will provide the most exacting color and monochrome transmission. Rated power output is 500 watts peak visual and 250 watts aural. Except for the externally mounted vestigial sideband filter, the BT-500C transmitter is completely self-contained in three cabinets. The left hand cubicle contains the aural transmitter while the center and right hand cubicle make up the visual transmitter. Separate high voltage power supplies are provided for the aural and visual section to assure better regulation and improve overall performance. Interchangeable 4CX250B tetrode tubes are used as final amplifiers for both visual and aural amplifiers reducing the number of spares and providing added operating economy.

VISUAL TRANSMITTER: Two type 4CX250B triode tubes, which are grid bias modulated by a dynamic cathode load modulator circuit, are used as final power amplifiers in the visual section. The video modulator is equipped with bias failure alarm lamp, test meters, and front panel test jacks. Sync-tip keyed clamping is used to avoid disturbances of the color signal components and the color synchronizing burst. The keyed clamp generator uses a delay-line controlled keying pulse. Fail-safe protection circuits are provided to reduce power to mid-gray level in case of clamp or signal failure. A white peak clipper reduces the

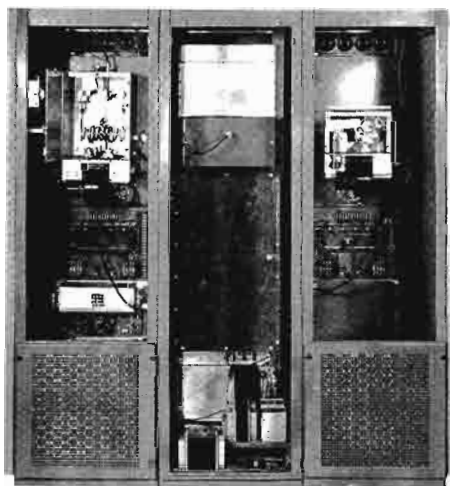

Rear view Model BT-500C.



TV TRANSMITTERS

possibility of sync-buzz while a white stretcher circuit improves differential gain. Inbuilt feedback restoration is used to reduce hum and/or tilt. The visual oscillator output is multiplied 3 times for low band and 9 times for high band channels. Under normal operating conditions, the oscillator will hold the carrier frequency to within ± 300 cycles.

AURAL TRANSMITTER: The high fidelity FM signal for aural transmission is supplied with a direct crystal controlled phase shift modulator delivering a flat frequency response within 1 db. of the standard 75 microsecond pre-emphasis curve, 50 to 15,000 cycles. Audio frequency distortion is a maximum of 1.5% over the frequency range of 50 to 15,000 cycles. The output of the 10 watt exciter is fed to a 4CX250B aural power amplifier tube which delivers the full 250 watts output required of the aural transmitter.

OPERATIONAL FEATURES: Tuning adjustments are from the front and eleven meters provide monitoring of all essential circuits either directly or by multi-metering.

Latch on back doors provide quick access for ease in maintenance. All incoming air is filtered through removable filters.

With a conservatively rated tube complement, straightforward design and quality construction, trouble free performance may be expected from this carefully engineered transmitter.



SPECIFICATIONS

POWER OUTPUT:

Visual 500 watts peak. Aural 250 watts. (Excess to rated power is available for sideband filter and system losses.)

RF OUTPUT IMPEDANCE:

50.0 ohms, type N female.

INPUT IMPEDANCE:

Video—75 ohms, unbalanced.

Audio—600 ohms, balanced.

FREQUENCY RESPONSE:

Visual: + 2 to - 2 db. at 0.5 mcs.

+ 2 to - 2 db at 1.25 mcs.

+ 2 to - 2 db at 2.0 mcs.

+ 2 to - 2 db at 3.58 mcs.

(The amplitude response will not vary more than + 1 db to - 2 db from the 3.58 mcs. response between 2.1 mcs. and 4.18 mcs. The amplitude at 4.75 mcs. is attenuated 20 db and frequencies higher than 4.75 mcs. are attenuated 20 db or greater).

Lower sideband response is:

Visual: - 20 db at 1.25 mcs. and - 42 db. at 3.58 mcs.

Aural: Within 1.0 db of standard 75 microsecond preemphasis curve, 50-15,000 cycles.

FREQUENCY STABILITY:

Visual ± 500 cycles.

Aural ± 500 cycles.

MODULATION CAPABILITIES:

Visual to 12½% ± 2½% of sync level.

Aural ± 40 Kc.

INPUT LEVEL:

Visual 1.0 V. ± 0.4 V. peak to peak.

Aural + 10 dbm. ± 2 db. for 100% modulation.

NOISE:

Aural 60 db. below 100% modulation (FM). 50 db. below equivalent 100% modulation (AM). Visual approximately 45 db. below 100% AM modulation.

AUDIO FREQUENCY DISTORTION:

Between 50—15,000 cycles, 1½% or less at 25 Kc. deviation. Distortion between 100—10,000 cycles is 1% or less.

AMPLITUDE VARIATION:

5% or less of peak sync. (One field).

SUBCARRIER PHASE vs. BRIGHTNESS:

± 7° maximum.

LINEARITY:

± 15% maximum.

ENVELOPE DELAY TOLERANCE:

(From FCC Specified Curve).

± 0.08 microseconds from 0.2-2.1 mc.

± 0.04 microseconds at 3.58 mcs.

± 0.08 microseconds at .18 mcs.

HARMONIC ATTENUATION:

60 db. or better.

REGULATION OF OUTPUT:

7% from black to all white.

INPUT POLARITY:

Black negative.

TYPE OF MODULATION:

Phase shift employing pulse techniques. (Aural).

TYPE OF OSCILLATOR:

Direct crystal controlled (both aural and visual).

TUBES:

Visual:

(3) 6AU6, (1) 6AK6, (4) 6080, (8) OA2, (9) 12 AT7, (2) 6CL6, (7) 6CA7, (3) 5651, (4) OB2, (3) 6AU8, (1) 6CS6, (3) 12BH7, (4) 12AX7, (1) 6X4, (1) 5894, (2) 4CX250B, (2) 866, (1) 5R4, (1) 6360L, (5) 5AR4.

Aural:

(1) 12AT7, (7) 6AU6, (3) 12AX7, (3) 6J6, (2) OA2, (1) 6360L, (1) 6AQ5, (1) 6080, (1) 4CX250B, (2) 866, (1) 5AR4.

TOTAL NUMBER TUBES:

Visual 65. Aural 23.

POWER INPUT:

230 volts, 50/60 cycles, single phase. (120 volts for crystal heaters.) Power consumption, 3.5 KW.

SIZE (OVER-ALL):

Width 72" (less end bells), 75" (with end bells), Height 78", Depth 36½".

WEIGHT AND CUBAGE:

Domestic packed 2350 lbs. Export packed 3200 lbs. Cubage 394 cu. ft.

SIDEBAND FILTER:

Mounted external to cabinet. (Supplied with transmitter)

COOLING:

Forced air.

ORDERING INFORMATION

- BT-500CL Broadcast Television Transmitter, 500 watts, with tubes, crystals and ovens for channels 2-6 as specified (Cat. No.) M-6068
- BT-500CH Broadcast Television Transmitter, 500 watts, with tubes, crystals and ovens for channels 7-13 as specified M-6069
- Spare 100% tube complement for BT-500CL TK-357
- Spare 100% tube complement for BT-500CH TK-358
- FCC minimum tube complement:
- For BT-500CL TK-365
- For BT-500CH TK-366
- Color video filter (with power supply) M-5892

NOTE: The Gates BT-500C should be ordered with the optional M-5892 color video filter for color transmission. The filter replaces a blank panel space in the monochrome transmitter.

For detailed information on the TV Antennas see page 81.

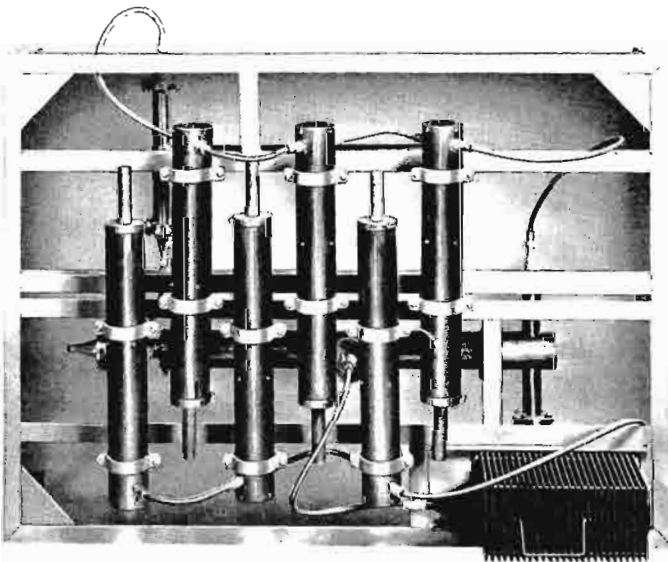

The above vestigial sideband filter employed at the output of the visual amplifier is supplied with the BT-500C VHF transmitter as standard equipment.



120 WATT VHF TELEVISION TRANSMITTER

MODEL BT-100C

Although designed for use as the main transmitter in low power VHF television stations, the BT-100C VHF television transmitter is ideally suited as standby equipment in any size VHF television station and will provide sparkling picture and sound transmission quality. The transmitter is rated for continuous duty service at 120 watts peak visual and 60 watt aural power on Channels 2 through 13.

Compact and self-contained, the complete transmitter including the vestigial sideband filter is housed in one cabinet. All tuning is from the front panel and for ease of serviceability, lift off rear and side panels are provided. A forced air cooling system with one quiet operating low speed blower cooling the entire transmitter.

The vestigial sideband filter is carefully tuned to the operating channel specified. A visual demodulator is included as standard equipment and provides 1 volt peak to peak, 75 ohm monitoring output which is terminated in a type "UHF" jack. The video modulator uses the latest design techniques which is the key to the sparkling high resolution picture transmitted. A multimeter and test jacks are provided for ease of modulator adjustment. Remote control or unattended operation is a special design consideration. The rugged design and easy attachment of remote control equipment enhances satellite or high elevation unattended installations.

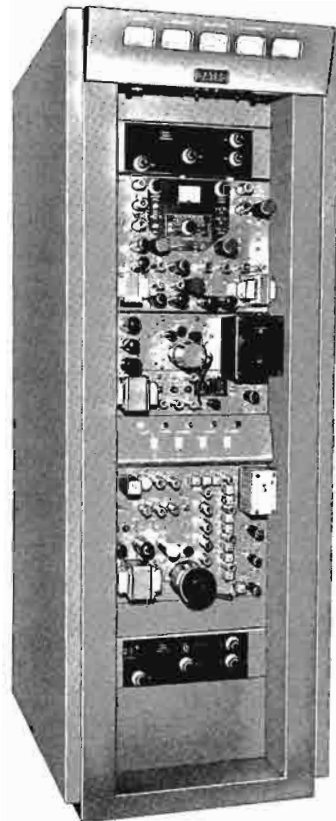

SPECIFICATIONS

FREQUENCY RANGE:

54-88 Mc., FCC Channels 2-6 and 174-216 Mc., FCC Channels 7-13 (any one channel as ordered).

RF POWER OUTPUT:

120 watts peak visual. 60 watts average aural. Type "LC" jack type output connectors both visual and aural. Output impedance 50 ohms, both visual and aural.

AC POWER INPUT:

107-120/214-240, 50/60 cycles, single phase. Power consumption, aural and visual, at black level; 1500 watts maximum.

VIDEO INPUT IMPEDANCE:

75 ohms unbalanced, ± 15 ohms adjustable, type UHF female jack input connector.

VIDEO INPUT:

1.0 volt p-p ± 0.5 volt input polarity; black negative.

AUDIO INPUT:

600 ohms, balanced, + 10 dbm. + 0 to - 4 dbm.

VISUAL FREQUENCY RESPONSE (below ideal demodulated curve; 200 Kc. reference):

Upper sideband ± 2 db. at 0.5 through 4.0 Mc. more than - 20 db. at 4.75 Mc. or higher. Lower sideband + 0, - 4 db. at 0.75 Mc. more than - 20 db. at 1.25 Mc.

AURAL FREQUENCY RESPONSE (below ideal 75 micro-second pre-emphasis curve):

+ 0, - 2 db. at 30-15,000 CPS.

AURAL HARMONIC DISTORTION:

50-100 CPS, 1.0% or less. 100-10,000 CPS, 0.5% or less. 10-15 Kc., 1.0% or less.

TYPE OF OSCILLATOR:

Direct crystal control Visual and Aural. ± 500 cycles Visual and Aural stability.

VISUAL CARRIER FREQUENCY ABOVE BAND EDGE:

1.25 Mc.

AURAL CARRIER FREQUENCY ABOVE VISUAL:

4.5 Mc. ± 1 Kc.

AURAL FREQUENCY MODULATION:

Phase shift employing pulse techniques, ± 25 Kc. Capable of + 40 Kc.

MODULATION, VISUAL:

Amplitude. Capable 90%.

VISUAL OUTPUT AMPLITUDE:

Sync 100%. Black 75% $\pm 2.5\%$. White 12.5% $\pm 2.5\%$.

REGULATION OF VISUAL OUTPUT:

(all white to all black picture), 7% maximum.

VISUAL AMPLITUDE VARIATION (hum and tilt over one frame):

5% of maximum of peak sync.

SYSTEM CAPABLE OF OPERATING INDEPENDENTLY OF POWER SUPPLY FREQUENCY:

Yes.

BLACK LEVEL INDEPENDENT OF PICTURE CONTENT:

Yes.

VISUAL MONITOR OUTPUT:

Visual RF demodulator and white reference chopper built in with 1.0 volt p-p output across 75 ohms.

NOISE:

Aural below 100% FM, - 60 db. Aural below 100% AM, - 50 db. Visual hum and noise, - 40 db.

AMBIENT TEMPERATURE:

+ 5° C. to + 50° C.

ALTITUDE:

7500 ft. maximum. (Available for 10,000 ft.)

DIMENSIONS:

78" high x 36½" deep x 27" wide. If end bells omitted, width is 24 inches.

WEIGHT AND CUBAGE:

Net 800 lbs. Domestic pack, 890 lbs. Export pack, 985 lbs. Cubage: 86.

ORDERING INFORMATION

| | |
|---|--------|
| BT-100CL Transmitter for Channels 2-6 | M-6179 |
| BT-100CH Transmitter for Channels 7-13 | M-6180 |
| Spare 100% tube complement for BT-100CL | TK-491 |
| Spare 100% tube complement for BT-100CH | TK-418 |

NOTE: For TV antenna, see Page 81. Also available in CCIR model, see Page 80.

100 WATT CCIR TELEVISION TRANSMITTER

MODEL CCIR 100

To serve viewers on Band I and Band III channels, the Gates CCIR-100, 100 watt, peak visual, television transmitter was designed specifically for the CCIR 625 line standards. The economy of this out-standing new television transmitter makes it an ideal choice for any new television service. When combined with a high gain antenna, the effective radiated power is increased substantially. Many Gates designed CCIR-100 transmitters are on the air in countries such as Nigeria, Ghana, Sudan, Sierra Leone, Aden and Mauritius.

Housed in one cabinet the CCIR-100 transmitter is a compact completely self-contained unit including the in-built vestigial sideband filter. All tuning controls are accessible from the front panel, and lift off rear and side panels are provided for ease of maintenance. The air cooling system efficiently cools the entire transmitter with one low speed blower and a well engineered air distribution system which assures superb cooling of all components.

The video modulator includes linearity correction, white stretch, sync stretch, white clip and a DC restorer which operates on the sync tip. The video modulator provides 50 volts output which is more than adequate to grid modulate the 4CX250B visual final power amplifier to 100 watts peak power output.

The aural exciter supplies 2 to 10 watts average power to drive the aural power amplifier which is also a type 4CX250B. The aural power amplifier can be operated from 20 to 75 watts which is more than that required by CCIR standards.

The CCIR-100 transmitter has a generous supply of meters and test jacks which can be used for tune-up and checking

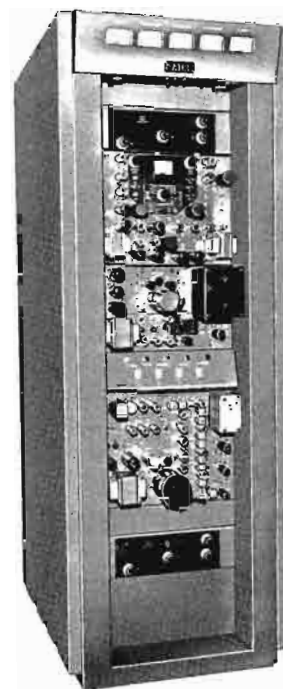

the performance of the entire transmitter. A visual demodulator, with an electronic chopper for establishing visual modulation white reference level, is also included.

The control circuit of the CCIR-100 transmitter is designed so that remote control or unattended operation is easily accomplished making the transmitter suitable for satellite or remote control operation.

SPECIFICATIONS

FREQUENCY RANGE:
40 to 88 mcs. Band I. 174 to 223 mcs. Band III.

RF POWER OUTPUT:
100 watts peak visual. 20 watts average aural.

RF OUTPUT CONNECTOR:
Type "N" female jack visual, 50 ohms. Type "N" female jack aural, 50 ohms.

AC POWER INPUT:
107-120/214-240, 50/60 cycles, single phase. Power consumption, aural and visual, at black level 1500 watts maximum.

VIDEO INPUT IMPEDANCE:
75 ohms unbalanced, ± 15 ohms adjustable, Type "UHF" female jack input connector.

VIDEO INPUT LEVEL:
1.0 V p-p ± 0.5 V.

VIDEO INPUT POLARITY:
Black negative.

AUDIO INPUT IMPEDANCE:
600 ohms, balanced, + 10 dbm. ± 2 db.

VESTIGIAL SIDEBAND FILTER:
Built-in mounted inside transmitter cabinet.

VISUAL FREQUENCY RESPONSE:
(Below ideal diode demodulated curve. 200 Kc. reference). Upper Sideband: Less than 2 db. at 0.5 Mcs., 2 db. at 1.25 Mcs., 2 db. at 2.0 Mcs., 3 db. at 3.0 Mcs., 4 db.

at 4.0 Mcs., 6 db. at 5.0 Mcs. Lower Sideband: Less than 4 db. at 0.75 Mcs., more than 20 db. at 1.25 Mcs.

AURAL FREQUENCY RESPONSE:
0 db. to - 2 db. 30-15,000 cycles (50 microsecond pre-emphasis curve).

AURAL HARMONIC DISTORTION:
1.5% 50 to 15,000 cps.

TYPE OF OSCILLATOR:
Direct crystal control visual and aural.

CARRIER FREQUENCY STABILITY:
 ± 500 cycles visual and aural.

VISUAL CARRIER FREQUENCY ABOVE CHANNEL EDGE:
1.25 Mcs.

AURAL CARRIER ABOVE VISUAL CARRIER FREQUENCY:
5.5 Mcs. ± 1 Kc.

AURAL FREQUENCY MODULATION:
Phase shift employing pulse techniques.

MODULATION, AURAL:
 ± 50 Kc.

MODULATION, VISUAL:
Amplitude (grid bias).

VISUAL OUTPUT AMPLITUDE:
Sync 100%, Blanking 75% $\pm 2.5\%$, White 12.5% $\pm 2.5\%$.

REGULATION OF VISUAL OUTPUT:
7% maximum. (All white to all black picture.)

VISUAL AMPLITUDE VARIATION:
5% maximum of peak sync. (Hum and tilt over one frame.)

CAPABLE OF OPERATING INDEPENDENTLY OF POWER SUPPLY FREQUENCY:

Yes.

BLACK LEVEL INDEPENDENT OF PICTURE CONTENT:

Yes.

VISUAL MONITOR OUTPUT:

Visual RF demodulator and white reference chopper built-in with 1.0 volt p-p output across 75 ohms.

NOISE:

Visual: hum and noise - 40 db.
Aural: below 100% AM - 50 db.
Aural: below 100% FM - 60 db.

AMBIENT TEMPERATURE:

+ 5° C. to + 50° C.

ALTITUDE:

7500 ft. maximum. (Available for 10,000 ft.)

DIMENSIONS:

78" high x 36½" deep x 27" wide.
Width if end bells removed is 24".

WEIGHT & CUBAGE:

Net 800 lbs. Domestic packed, 860 lbs. Export packed, 985 lbs. Cubage: 85.3.

ORDERING INFORMATION

CCIR-100L for Band I M-6110

CCIR-100H for Band III M-6111

Spare 100% tube complement for

CCIR-100L TK-491

Spare 100% tube complement for

CCIR-100H TK-418

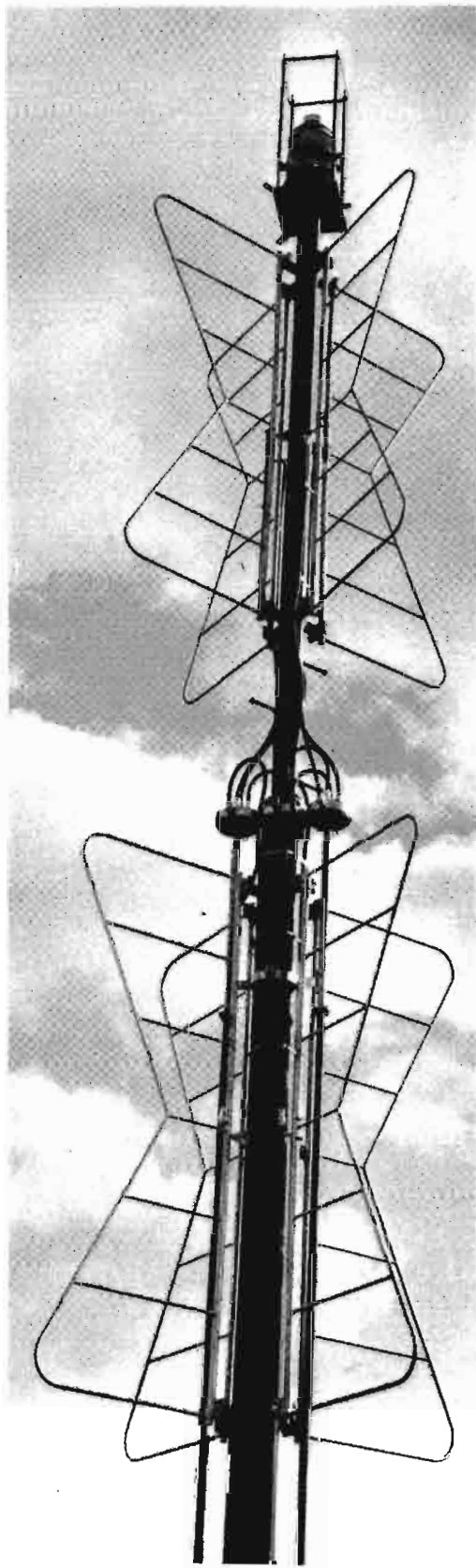

JAMPRO JAT 2/5 TWO BAY CHANNEL FIVE
BATWING ANTENNA

TELEVISION BATWING ANTENNA

Popular batwing design.

Wide variety of gains.

Power rating to 50 kw.

Improved mechanical construction.

Antennas completely assembled and tested prior to shipment.

Beam tilting and null fill is available without additional cost.

For channels 2 thru 13—patterns generously meet FCC specifications.

The Jampro JAT Series of low and high channel VHF transmitting antennas feature the time proven batwing-design to radiate high power television signals on channels 2 thru 13. With three or more bays, the antennas are designed to accept full 50 kilowatts. The one and two bay antennas are rated at 20 kilowatts. The entire series is designed for tower top mounting. Special types are available.

These turnstile batwing TV antennas, provide a means for radiating visual and aural transmitter power with definite gains and pre-determined patterns. Accessories include bridge diplexers, deicers and controls. Antennas are furnished with top beacon mounting plate, lightning rods, pole guide flange and pole socket flange.

Jampro Batwing TV Antennas are available from one thru six bays for channels 2 to 6, and one thru twelve bays for channels 7 thru 13. This large variety permits choosing the antenna with the gain most favorable for the particular application.

ACCESSORIES: Also available are the following: Towers to support all *JAMPRO* antennas; co-axial transmission line ($\frac{7}{8}$ ", $1\frac{5}{8}$ " and $3\frac{1}{8}$ ") hybrid diplexers, visual and aural harmonic filters; tower lighting kits; and de-icers for all *JAMPRO* JAT series of TV antennas. De-icers will be factory installed without cost, when ordered with antennas.

Antennas will be shipped completely assembled whenever possible. Where transportation facilities do not permit one piece shipment, antennas will be shipped in smaller pieces for on the site assembly. Complete instruction books are provided. The services of a *JAMPRO* antenna engineer are also available at the installation site for assembly and test supervision where necessary.

ORDERING INFORMATION

Due to the wide variety of television antenna combinations, all antennas are quoted immediately on receipt of: (a) frequency or channel, (b) video ERP, (c) approximate length of transmission line between antenna and transmitter, (d) make and size of coaxial line if not to be supplied by Gates, and (e) approximate height of antenna above ground.

PROFESSIONAL TELEVISION MONITORS

TRANSISTORIZED PROFESSIONAL MONITORS



CZB8C Monitor.

MODELS CZB 8", 14", 17" SCREEN: INPUT POWER: 117/234 volts, 50/60 cycles, 180 watts. VIDEO SIGNAL: 0.2 volt pp (minimum for 50 volts at kinescope). Sync, negative at monitor input. Two input channels with built-in diode switcher. VIDEO INPUT IMPEDANCE: High impedance bridging (equivalent to 100 K ohms in parallel with 5 mmfd.) can be terminated by an internal 75 ohm load ($\pm 1\%$) through a switch located on rear apron. VIDEO RESPONSE: 10 cycles to 10 Mc. ± 1 db. Differential gain below 3% with 100 volts kinescope drive. BLACK LEVEL SHIFT: Less than 2 volts between 10% and 90% duty cycle. DC RESTORATION: Keyed backporch clamp. EXTERNAL SYNC: 1 to 8 volts. Parallel connectors. Monitor will operate from either composite video and sync signals or separate external composite sync. LINEARITY: Within 2% of picture height. SIZE (8" monitor) 9 $\frac{5}{8}$ " W, 10 $\frac{1}{8}$ " H, 17 $\frac{3}{16}$ " D. NET WEIGHT: 37 lbs. SHIPPING WEIGHT: 45 lbs. SIZE (14" monitor): 17 $\frac{3}{4}$ " W, 10 $\frac{5}{16}$ " H, 19 $\frac{1}{16}$ " D. NET WEIGHT: 56 lbs. SHIPPING WEIGHT: 65 lbs. SIZE (17" monitor): 17 $\frac{3}{4}$ " W, 16 $\frac{1}{4}$ " H, 20 $\frac{1}{4}$ " D. NET WEIGHT: 86 lbs. SHIPPING WEIGHT: 104 lbs.



CFD-17C Monitor

WVA-21C Monitor



CLD-14 Monitor

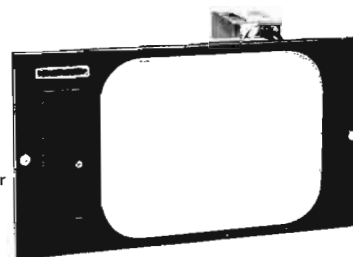

MODEL CFD-17C: INPUT POWER: 117/234 volts, 50/60 cycles, 180 watts, fused. VIDEO SIGNAL: 0.25 volt, pp (minimum for 50 volts at kinescope). Sync, negative at monitor input. VIDEO INPUT IMPEDANCE: High impedance bridging (equivalent to 470 K ohms in parallel with 15 mmfd.) can be terminated by an internal 75 ohm load through a switch located on rear apron. VIDEO RESPONSE: 10 mc ± 1 db. (800 line resolution). Differential gain below 5% with 50 volt kinescope drive. LINEARITY: Within 1% of picture height. SIZE: 17 $\frac{3}{4}$ " W, 17 $\frac{1}{2}$ " H, 20 $\frac{1}{2}$ " D. NET WEIGHT: 87 lbs. SHIPPING WEIGHT: 98 lbs.

21", 24", 27" REGULATED UTILITY MONITOR (FOR INDUSTRIAL APPLICATIONS)

MODEL WVA INPUT POWER: 117/234 volts, 50/60 cycles, 180 watts. VIDEO SIGNAL: 0.25 volt, pp (minimum for 50 volts at kinescope). 4.0 volts maximum. Sync negative at monitor input. VIDEO INPUT IMPEDANCE: High impedance bridging (equivalent to 470 K ohms in parallel with 15 mmfd.) can be terminated by an internal 75 ohm load through a switch located on rear apron. VIDEO RESPONSE: 10 Mc. ± 1 db. (800 line resolution). Differential gain below 5% with 50 volt kinescope drive. LINEARITY: Within 2% of picture height. SIZE: 24" W, 22" H, 24 $\frac{3}{4}$ " D. NET WEIGHT: 125 lbs. SHIPPING WEIGHT: 152 lbs.

14" RACK MOUNT MONITORS (BROADCAST-INDUSTRIAL)

MODEL CLD-14: INPUT POWER: 117/234 volts, 50/60 cycles, 180 watts, fused. VIDEO SIGNAL: 0.25 volt, pp (minimum for 50 volts at kinescope). Sync negative at monitor input. VIDEO INPUT IMPEDANCE: High impedance bridging (equivalent to 470 K ohms in parallel with 15 mmfd.) can be terminated by an internal 75 ohm load through a switch located on rear apron. VIDEO RESPONSE: 10 Mc. ± 1 db. (800 line resolution). Differential gain below 5% with 50 volt kinescope drive. LINEARITY: Within 1% of picture height. SIZE: (Rack mounted): 19" W, 10 $\frac{1}{2}$ " H, 17 $\frac{1}{2}$ " D. NET WEIGHT: 58 lbs. SHIPPING WEIGHT: 75 lbs.

ORDERING INFORMATION

| CZB Series Monitors | Rack Mount | Cabinet Type | Chassis Only |
|-------------------------------|------------|--------------|--------------|
| Monitor 8" screen | CZB 8/2R | CZB 8C | CZB 8N |
| Monitor 14" screen | CZB 14R | CZB 14C | CZB 14N |
| Monitor 17" screen | CZB 17R | CZB 17C | CZB 17N |
| CFD Series Monitors | | | |
| Monitor 17" screen, regulated | CFD 17R | CFD 17C | CFD 17N |
| WVA Series Monitors | | | |
| Monitor 21" screen | WVA21R | WVA21C | WVA21N |
| Monitor 24" screen | — | WVA24C | WVA24N |
| Monitor 27" screen | — | WVA27C | WVA27N |
| CLD Industrial Monitor | | | |
| Rack mount 14" screen | CLD-14 | — | — |

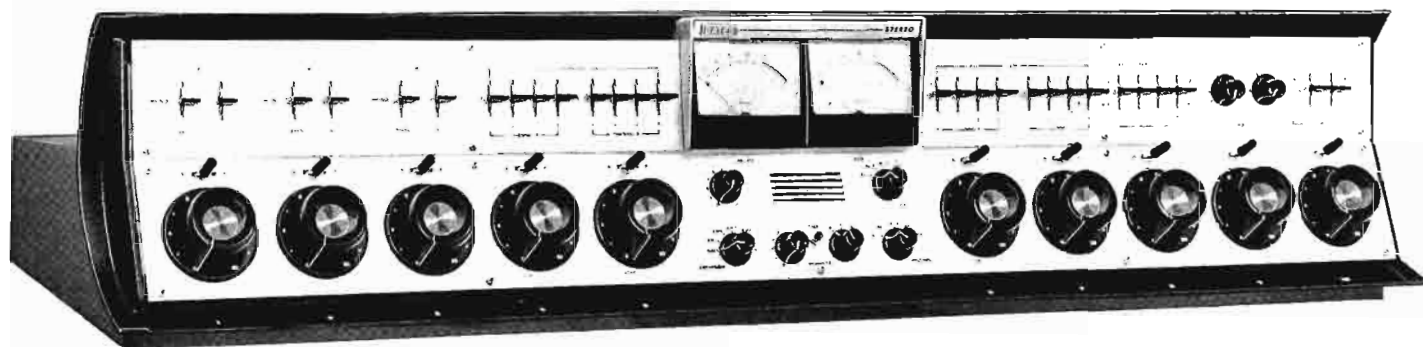

THE EXECUTIVE

Containing ten full stereo mixers, the dual channel Executive is considered to be the world's most complete transistorized speech input console for stereo or monaural programming. Complete transistorization, beautiful styling, and amazing versatility qualify this premium quality Gates product for the *Solid-Statesman* family name that is earned only by meeting superior engineering and manufacturing requirements specified for Gates-made transistorized equipment.

STEREO AND MONAURAL: The Executive is a 10-channel, *full* facility console which even provides the network fader wired for future stereo growth. Yet, any portion or all of the console may be operated monaurally if stereo is in your future. By simply adding the third optional plug-in program amplifier, a compatible "left plus right" signal is available to feed, for example, monaural programming to AM while broadcasting stereophonically on FM. Likewise, stereo may be carried on FM with completely different monophonic programming being broadcast on AM.

AMPLIFIER COMPLEMENT: Includes six microphone preamplifiers (three stereo pairs), two program amplifiers, two high fidelity monitoring amplifiers and a cue/intercom amplifier. Also supplied are two audition booster amplifiers which are part of the internal circuit arrangement. Space is provided for two additional preamplifiers and one additional program amplifier. The power supply is also self-contained and is fully regulated. The amplifiers and power supply are completely solid state.

MIXING SYSTEM: The mixing system contains 10 channels with all dual (stereo) controls. Channels 1, 2 and 3 are for microphones. Channels 4 and 5 will accept *four* stereo turntables in any combination, while channels 6 and 7 accommodate *four* stereo tape inputs, channel 8 handles *four* remote lines, and channels 9 and 10 are network and auxiliary channels respectively. The separate fader for incoming network programming is especially convenient for taping delayed-broadcast material without tying up other high-level inputs to the console. Faders 4 through 10 are all cueing attenuators which feed the inbuilt cue/intercom system.

MICROPHONE INPUTS: Six preamplifiers in three stereo pairs are terminated to dual-position input selector keys, permitting 12 microphones (6 stereo pairs) to be selected without patching to channels one through three. Space is provided for two added optional M-6034 preamplifiers, if desired.

TURNTABLE-TAPE INPUTS: Four turntables may be switched to mixers 4 and 5, and four tape sources may be switched into channels 6 and 7 in any sequence. All faders are stereo, and cue positions are provided on each of these attenuators.

REMOTE-NET INPUTS: Four remote lines may be switched into channel 8 through a line isolation transformer provided. Channel 9 is for network input. Both channels are stereo control equipped but have splitting pads attached (quickly removable) for present monophonic signals. Cue positions are provided on these attenuators.

AUXILIARY CHANNEL: This 10th channel has dual line isolation transformers and is uniquely equipped to accommodate extra stereo or monaural functions either in the studio or from an external source. A cue position is provided on this fader.

CUE-INTERCOM SYSTEM: An inbuilt cue intercom amplifier is included with its speaker centered below the VU meters. The cue signals from mixers 4-10 feed this system. The cue-intercom also provides remote talk-back, studio intercom and flawless network preview monitoring. The console muting system also protects against feedback from the cue-intercom speaker.

OPERATING MODES: Stereo only, or monaural only, may be fed to either program or audition mixer circuits. Likewise, monaural FM may be broadcast separately from monaural AM. When the optional M-5700 program amplifier is added, stereo FM and monaural AM may be broadcast either simultaneously, or separately.

The Executive—10 Channel Stereophonic or Monaural Transistor Console

V.U. METERS: Both meters are dual 4 inch and illuminated. The left meter connects to the left channel while the right meter connects to the right channel, or it may be switched to the output of the optional M-5700 program amplifier. The right meter also switches to parallel the left meter for stereo calibration or to check incoming network level. A third external VU meter in an attractive "shadow mold" housing is available for larger installations where simultaneous metering of three program channels is required.

MUTING RELAYS: Three are supplied to mute three pairs of loudspeakers. Warning light contacts are also provided. These relays operate from the microphone keys and cue-intercom system.

OTHER FUNCTIONS: Additional facilities include dual headphone jacks, cue-intercom selector switch, left and right master gain controls for the program amplifier and a dual monitoring amplifier gain control, fully regulated power supply, plus 28 tab keys (top row) performing a large number of switching functions.

STYLING: Exclusively styled by one of America's leading industrial designers, the Executive's satin anodized aluminum control panel floats in a 3-dimensional setting, and the shadow mold styling presents conservative but striking ultra-modern appeal. The front panel hinges down and the cabinet top cover hinges up.

Block Diagram.

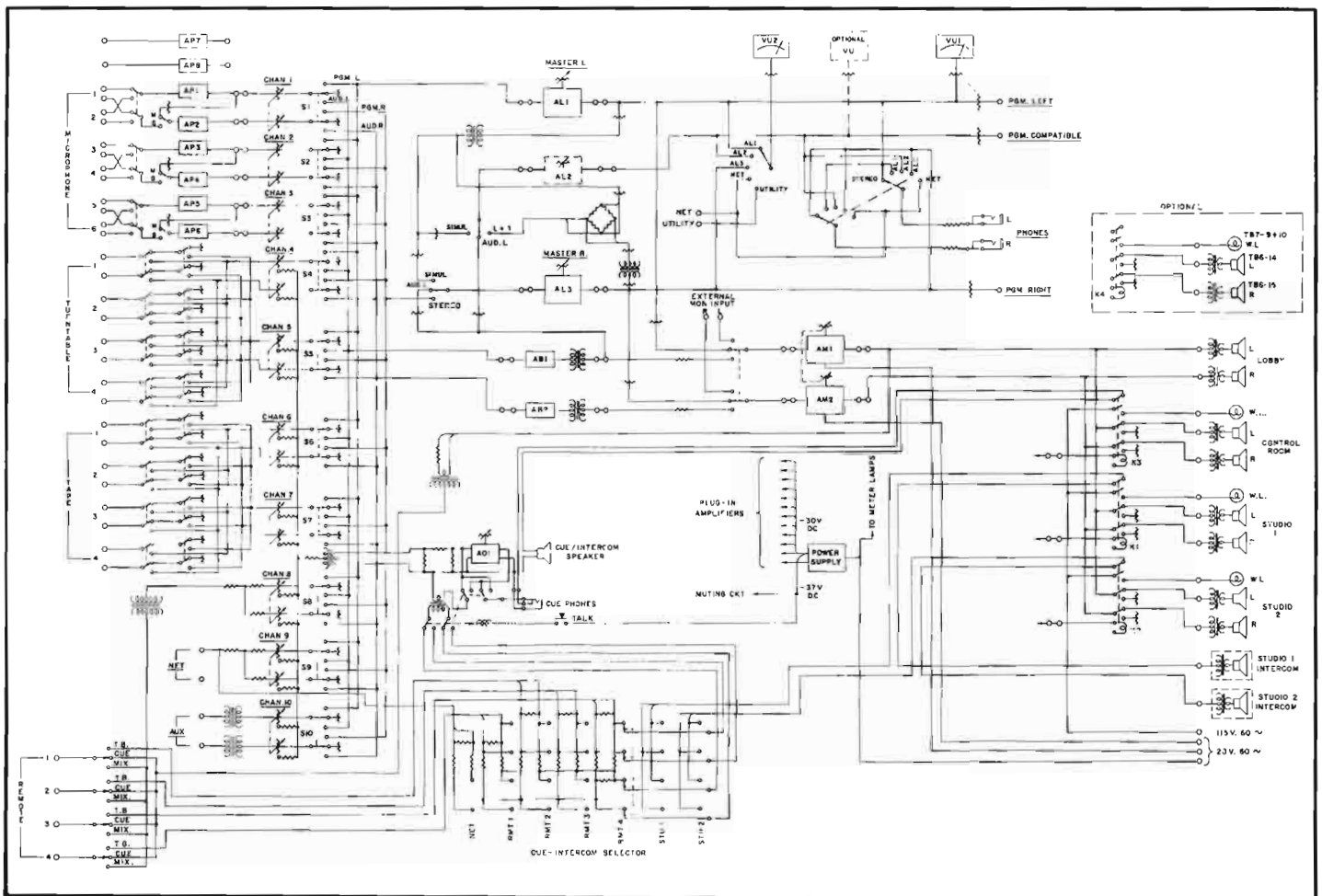

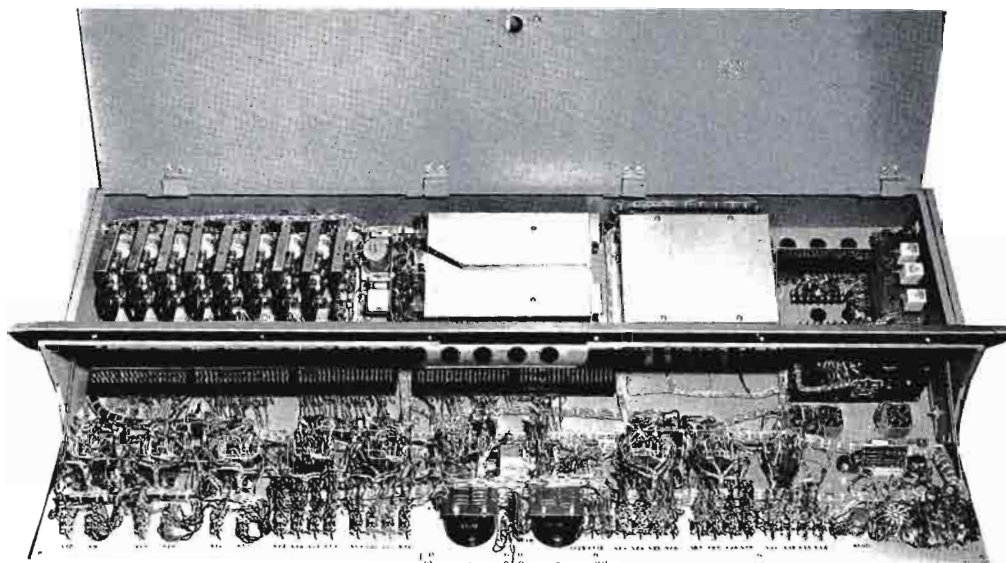

SPECIFICATIONS

MIXING CHANNELS:

Total 10. All stereo. (3) microphone, (2) turntables, (2) tape or projectors, (1) remote, (1) network, (1) all purpose.

AMPLIFIERS PROVIDED:

2 program, 2 booster, 2 monitor, 6 preamplifiers (3 pairs), 1 cue amplifier. Space provided for two optional added pre-amplifiers and one optional added program amplifier.

OPERATING MODE:

Stereo and monaural.

INPUT CIRCUITS:

12 for mics., 4 turntables, 4 tape/projectors, 4 remote lines, 1 network line, 1 all purpose utility. All inputs stereo with mixers 8 and 9 with quickly removable splitting pads for monaural operation.

OUTPUT LINES:

2 program, 6 muted speaker (3 pairs), 2 non-muted speaker, 2 intercom, 2 headphones, 2 record. NOTE: Add one more program output if optional program amplifier purchased.

IMPEDANCES:

Microphones 30/50 or 150/250 ohms, turntable/tape unbalanced 150/250 ohms, balanced remote lines 500/600 ohms, network 500/600 ohms. Utility 500/600 ohms. Programming output 500/600 ohms. Recording output 500/600 ohms. Intercom output 48 ohms. Monitor speaker output 8/16 ohms.

GAIN:

Turntable, tape, network (high level) input to program line output 55 db.

To monitor amplifier output 55 db.

From microphone input to program line output 102 db. To monitor amplifier output 102 db. NOTE: All measurements ± 2 db.

RESPONSE:

All segments of program circuit \pm db. 30-15,000 cycles.

Monitoring circuit $\pm 1\frac{1}{2}$ db. 30-15,000 cycles. NOTE: Typical response all circuits: 20-20,000 cycles ± 2 db.

DISTORTION:

Any segment of program circuit 0.5% or less between 30-15,000 cycles at + 8 dbm. output level or 0.5% at + 18 dbm., 50-15,000 cycles. Monitor amplifier 1% at + 39 dbm. which is 8 watts.

NOISE:

Program circuits, 60 db. or better below + 8 dbm. output, with - 60 db. input (equivalent noise input is - 120 dbm)—Monitor circuits, 60 db. below + 39 dbm. output. Crosstalk: all circuits below noise level with normal gain settings for proper programming.

STEREO ISOLATION:

Below noise level all channels.

POWER:

115 volts, 50/60 cycles, 1 phase. Power consumption 50 watts at 60 cycles.

CABINET DATA:

Size, 53 $\frac{1}{2}$ " wide, 11 $\frac{1}{2}$ " high, 17 $\frac{1}{2}$ " deep.

Finish: Cabinet, medium gray. Panel, natural anodized aluminum lettered in black. Knobs with decal color inserts.

SHIPPING DATA:

Packed weight: Domestic, 220 lbs. Export, 270 lbs. Cubage: 27.

OPTIONAL ACCESSORIES:

Space is provided to add, when desired, 2 Model M-6034 preamplifiers, 1 Model M-5700 program amplifier.

Note: To properly match the output impedance of the monitoring amplifiers and where several loudspeakers are used, the A-30601 matching transformer described on Page 148 should be ordered for each loudspeaker. For example, four 8 ohm speakers in parallel would be 2 ohms. This mismatch would damage performance and endanger the output transistor.

ORDERING INFORMATION

Executive Audio Console complete includes 4 type

- A-30601 speaker matching transformers M-6158
- Optional preamplifier M-6034
- Optional program amplifier M-5700
- Speaker matching transformer (see Page 148) A-30601
- Optional 3rd VU meter (see Page 148) M-6208
- Intercom sub-station (see Page 148) M-6424

IMPORTANT: Performance of transistorized loudspeaker amplifiers such as the monitoring amplifier in all Gates Solid-Statesman consoles is made unusually fine by use of a speaker matching transformer for each loudspeaker used. Because of this, 4 transformers are supplied with each Solid-Statesman console for mounting at each of the loudspeakers. If more than 4 speakers are used, the customer should order a transformer for each speaker. See Page 148 for description.

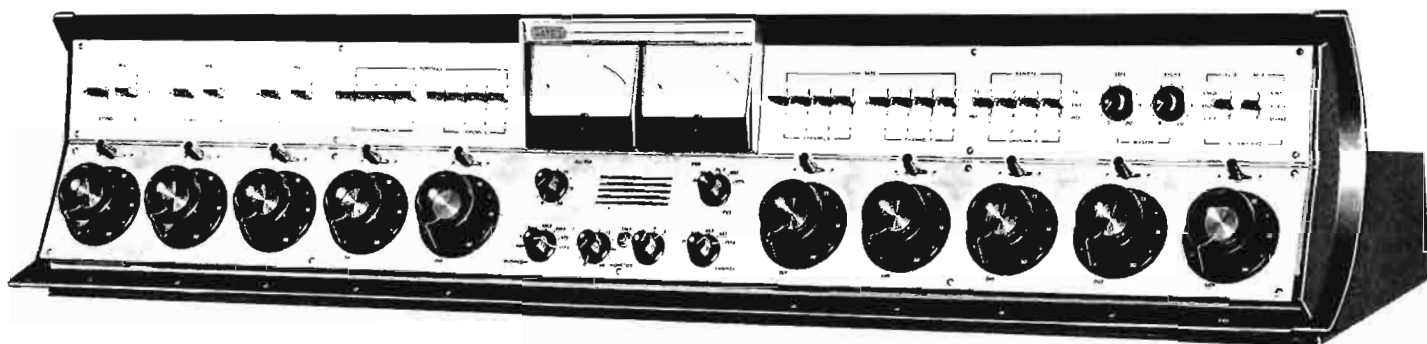

THE DIPLOMAT

The Diplomat is the senior partner in the fully transistorized Gates line of *Solid-Statesman* monaural consoles. It is completely dual channel, has 10 mixing channels, cue-intercom, 28 upper level tab keys for nearly every conceivable input and output circuit function, and features the new VA knob and shadow-mold styling—designed exclusively for Gates by one of the country's leading industrial stylists.

MIXING SYSTEM: The mixing system is a ten channel, low impedance type, using ladder controls throughout and minimum loss circuit design. The key above each control selects mixers to either program amplifier with center "OFF."

MICROPHONE CHANNELS: Six microphones are tab key selected into 3 preamplifiers and associated mixing channels 1, 2 and 3. Channel keys operate the three muting relays.

TURNTABLE CHANNELS: Mixing channels 4 and 5 handle four turntables into either mixer in any sequence. Four upper level tab keys on each channel select the turntable to be used. Cue position on faders connects any input to the cue amplifier.

TAPE CHANNELS: Mixing channels 6 and 7 handle four tape or projector inputs into either mixer in any sequence. Four upper level tab keys on each channel select input to be used. Cue position on faders connects any input to cue amplifier.

REMOTE CHANNEL: Mixing channel 8 accommodates four remote lines by upper tab key selection. A line isolation transformer is part of this circuit. Cue position on fader connects any remote line to cue amplifier.

NETWORK CHANNEL: Mixing channel 9 is for network or similar input. Cue position on fader connects net to cue amplifier for preview.

AUXILIARY CHANNEL: Mixing channel 10 is for any

input source such as a second network or much used remote. This auxiliary channel has a cue position on the fader connected to cue amplifier.

CUE-INTERCOM SYSTEM: The built-in intercom system provides flawless network monitoring, remote over-ride, remote talk-back, studio intercom, turntable cueing, tape cueing and general previewing and cueing. The control room and studio speakers are muted by the channel keys and muting relays when there is a live microphone in any of these locations. The cue amplifier and speaker/microphone is self-contained, and the cue speaker/microphone is located directly under the VU meters.

PROGRAM SWITCHING FUNCTIONS: A single key changes the master operation of the console from simultaneous to separate operation as desired by the operator. Dual program amplifiers are standard equipment. Space is provided for an optional third program amplifier. If the third program amplifier is utilized, this will permit, for example, recording while broadcasting AM and FM simultaneously from the second of the dual channels.

VU METERS: Two 4" illuminated VU meters are supplied. The left meter is connected to program channel 1 at all times. The right meter may be switch selected to (a) program channel 1 for calibration, (b) program channel 2, (c) output of optional third program amplifier, (d) network input, and (e) external connections.

MONITORING AMPLIFIER: The self-contained 8 watt monitoring amplifier is switch input selected to (a) output of master program channel, (b) output of program channel 2 or (c) external input. Amplifier output feeds the loud-speaker system.

MUTING RELAYS: Three relays mute speakers and operate studio warning lights in the control room and are controlled from microphone mixer channel keys. Intercom is also interlocked to prevent feedback.

The Diplomat—10 Channel Dual Programming Console

PHONE JACKS: Phone jacks are provided on a separate mounting plate for attachment to a desk, thus eliminating phone cords over the desk top.

POWER SUPPLY: The power supply is fully regulated and self-contained except for the small A.C. transformer, which is external to assure extremely low noise.

SERVICING: The Diplomat front panel hinges down and cabinet lid hinges up to expose all components for easy

maintenance. All terminations are in the rear.

RECOMMENDED USE: The Diplomat may be described as an unusually wide facility audio console of network or large station caliber. It is excellent for television as well as radio. Shadow mold styling provides the ultra modern in appearance without distracting from the conservative surroundings associated with this class of equipment. The Diplomat is a *Solid-Statesman* premium product.

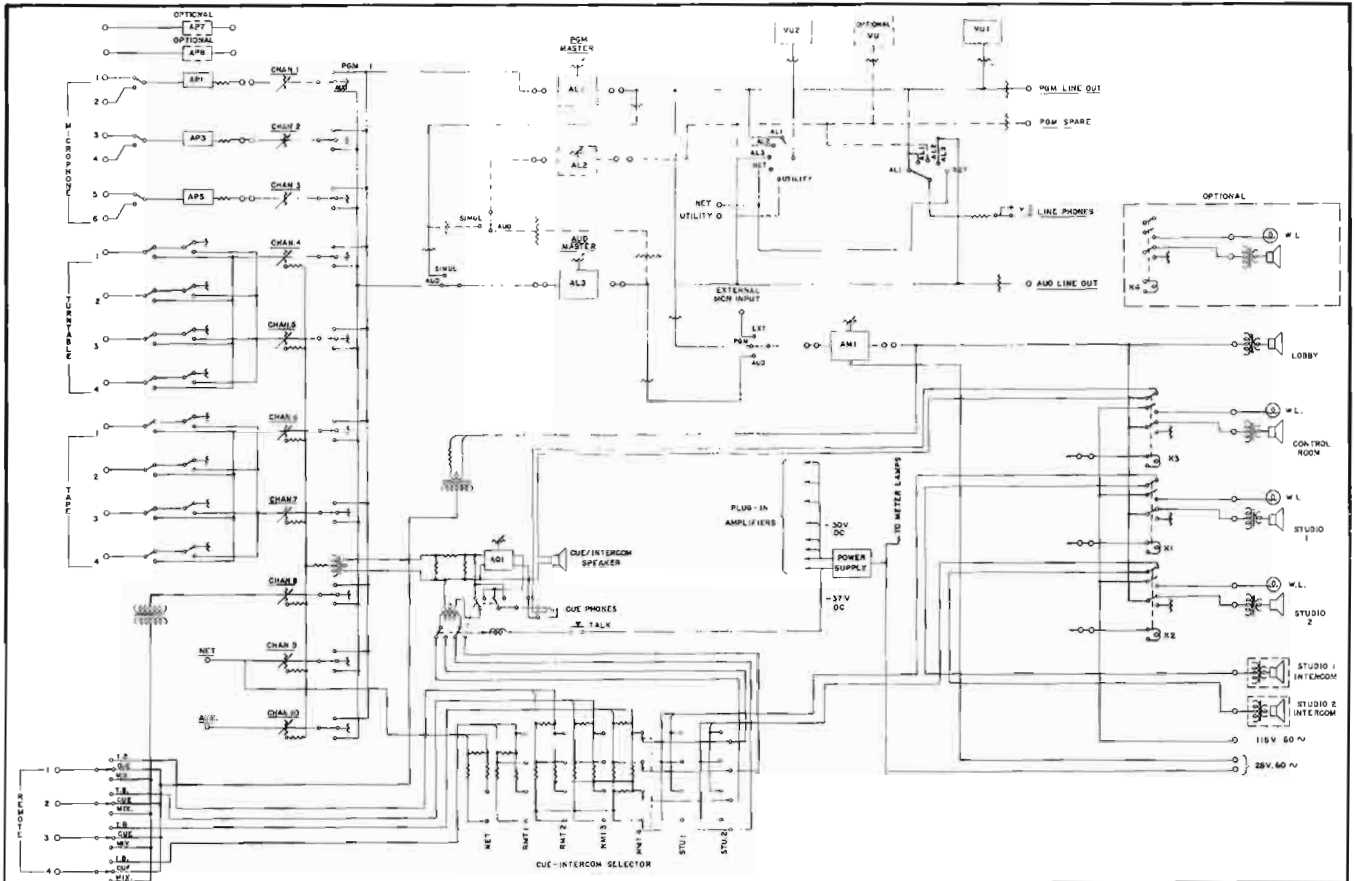

SPECIFICATIONS

MIXING CHANNELS:

Total 10. Three microphone, two turntable, two tape/projector, one remote, one network and one auxiliary.

AMPLIFIERS PROVIDED:

2 program, 1 monitor, 3 preamplifiers, 1 cue amplifier. Room provided for 1 additional program amplifier and 2 additional preamplifiers.

OPERATING MODE:

Dual channel monaural.

INPUT CIRCUITS:

6 for microphones, 4 turntables, 4 tape/projectors, 4 remote lines, 1 network line, 1 auxiliary line.

OUTPUT CIRCUITS:

2 program, 1 audition, 3 muted speakers, 1 non-muted speaker, 2 intercom, 2 headphones.

IMPEDANCES:

Microphones: 30/50 or 150/250 ohms. Turntable: 600 ohms. Tape/projector: 600 ohms. Remote lines: 600 ohms. Network: 600 ohms. Auxiliary: 600 ohms. Programming output: 600 ohms. Audition output: 600 ohms. Intercom output:

48 ohms. Monitor speakers: 8/16 ohms. Recording outputs: 600 ohms.

Note: Where more than two loudspeakers are used, it is mandatory that the A-30601 speaker matching transformer or similar be used with each loudspeaker. This assures correct loudspeaker performance and protects power transistors in the monitoring amplifier.

GAIN:

Turntable, tape, network (medium level) input to program line output 55 db. From microphone input to program line output 102 db. All measurements ± 2 db.

RESPONSE:

All segments of program circuit ± 1 db. 30-15,000 cycles. Monitoring circuit $\pm 1\frac{1}{2}$ db. 30-15,000 cycles.

Note: Typical response: 20-20,000 cycles.

DISTORTION:

Any segment of program circuit 0.5% or less between 30-15,000 cycles at + 8 dbm. output level, or at + 18 dbm. output 0.5% 50-15,000 cycles. Monitor amplifier 1% at + 38 dbm. which is 8 watts. Intermodulation distortion: 0.5% program and 1.0% monitor circuits.

SPECIFICATIONS (CONT'D)

NOISE:

Program circuits: 60 db. or better below + 8 dbm. output, with — 60 db. input (equivalent noise input — 120 dbm.).

Monitor circuits: 60 db. below + 39 dbm. output.

Crosstalk: All circuits below noise level with normal gain settings for proper programming.

POWER:

117 volts, 50/60 cycles, 1 phase. Power consumption 34 watts at 60 cycles.

CABINET DATA:

Size: 53½" wide, 11¾" high, 17¾" deep.

Finish: Satin anodized aluminum panel with lettering in black. Cabinet in medium non-reflecting gray with shadow mold in black. Knob color insert decal kit included.

SHIPPING DATA:

Packed weight: Domestic, 220 lbs. Export, 242 lbs.

Cubage: 26.

Speaker matching transformer (see page 148) A-30601
Studia cue/intercom speaker (see page 148) M-6424

IMPORTANT: Performance of transistorized loudspeaker amplifiers such as the monitoring amplifier in all Gates Solid-Statesman consoles is made unusually fine by use of a speaker matching transformer for each loudspeaker used. Because of this, 4 transformers are supplied with each Solid-Statesman console for mounting at each of the loudspeakers. If more than 4 speakers are used, the customer should order a transformer for each speaker. See Page 148 for description.

ORDERING INFORMATION

Diplomat audio console complete with 4 type

A-30601 speaker matching transformers (Cat. No.) M-6377

Optional program amplifier M-5700

Optional preamplifier M-6034

STUDIO CUE-INTERCOM SPEAKER

Beautifully styled to match all Gates Solid-Statesman products. Cast aluminum housing in non-reflecting black with heavy fabric grill cloth front. Speaker 600/48 ohms to match console intercom impedances. Size" 5½" wide, 6¾" high, 4" deep. ORDER MODEL M-6424.

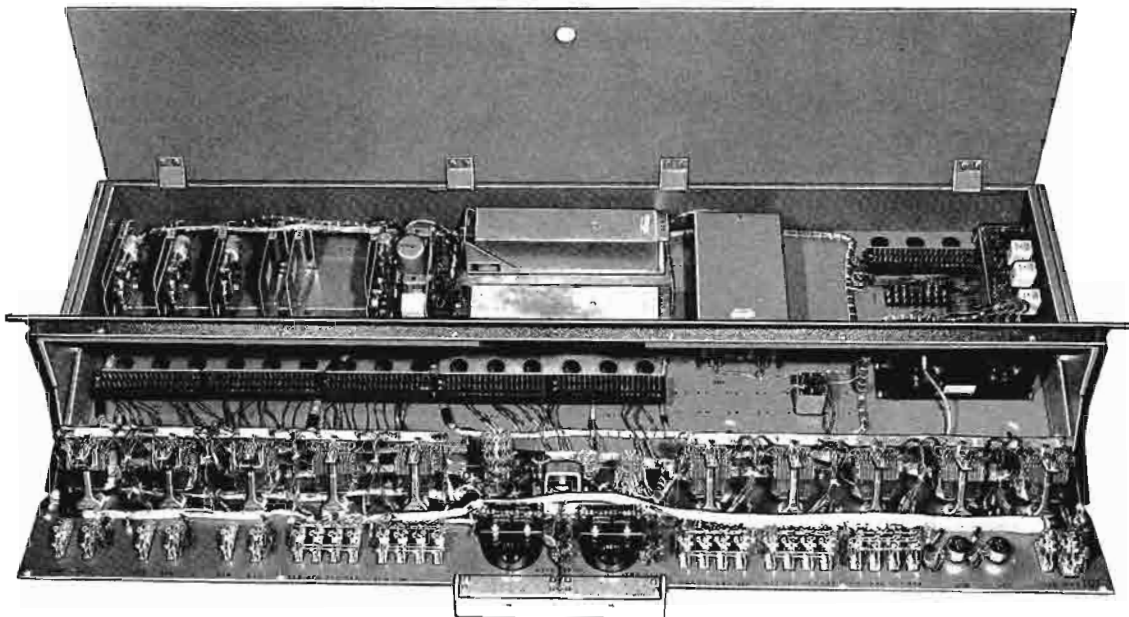

Typical of the Gates Solid Statesman line is this view, showing immediate top accessibility to every component, plug-in amplifier, and cable connection in the Diplomat console. Note the spacious layout and logical access to terminal strips for neat, professional installations.

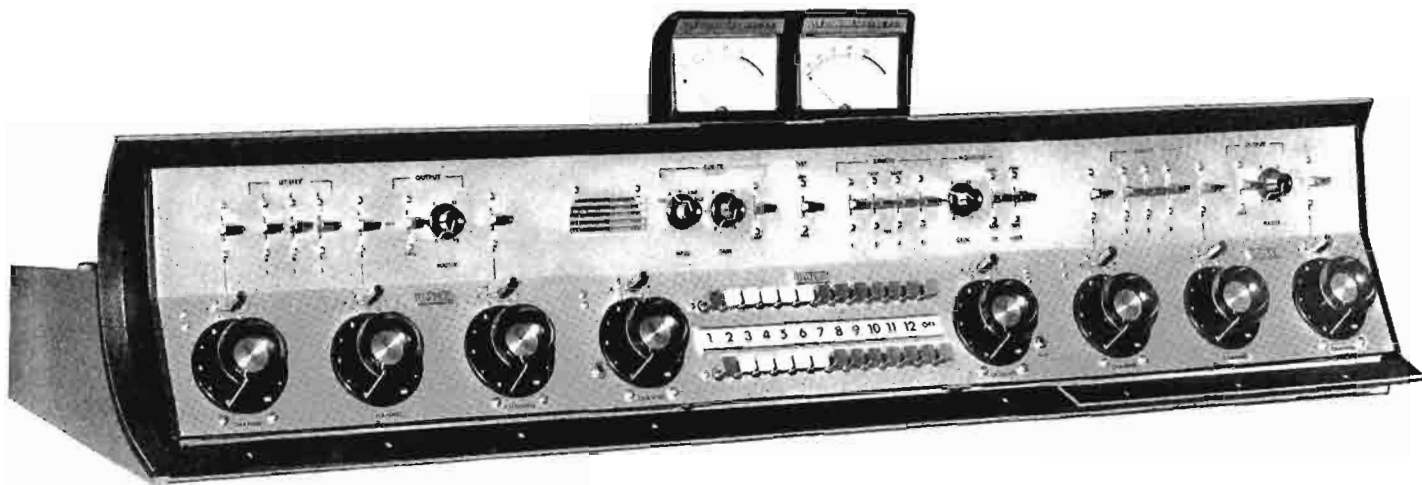

THE PRESIDENT

Featuring the new and exclusive "Control Center," the President is a completely transistorized dual channel, 8 mixer audio control console that is the most distinctively different audio console built today. The modern styling and performance versatility of the President firmly establishes this unit in the *Solid-Statesman* family of fine consoles. The most outstanding feature of the President is the Gates unique *Control Center* with its extreme versatility, yet marvelous simplicity. *Control Center* is engineered to easily and speedily accommodate the programming complexities of today's fast paced operations. *Control Center* frees operating engineers from the mechanics of patching, yet all program inputs are available instantly. In addition, *Control Center's* extra switch contacts may be used to start equipment motors such as turntables, *Carritape*, etc.

MIXING SYSTEM: Eight monophonic mixing channels are provided, utilizing low impedance, ladder type controls. Key selection allows any mixer to feed either program channel. Cue positions are on several controls (see Cue-Intercom System).

MICROPHONE INPUTS: This standard console provides eight microphone inputs switchable into four channels. Channels 1, 2, 6 and 7 each handle two microphones. Speaker muting is switched with microphone selection. Channels 3 and 8 each provide two medium level inputs, or additional microphones can be mixed by use of the optional plug-in microphone preamplifiers. If the preamplifiers are connected ahead of the input selector switch on these channels, each fader can then fill the dual role of a microphone and medium level channel.

MEDIUM LEVEL INPUTS: *Control Center* consists of two banks of twelve push keys, plus OFF. The upper bank feeds the left mixer. The lower bank feeds the right mixer. Any push key when inserted automatically releases any other key in the same row. All push keys, not inserted, automatically connect to the cue amplifier/speaker which is part of *Control Center*. Each bank of push keys has four red, four white, four blue colors, plus green for OFF. They may be

placed in any sequence, and illuminate when the respective key is depressed. For example: red could be for turntables, white for tapes, blue for incoming lines, etc. Likewise, each push key is numbered with a large block figure. A typewritten identification card, identifying each source in the system, may be substituted if desired.

Any of twelve medium level circuits may be punched into either mixing channel, assuring full fader control. Two faders do the work of twelve in the President *Control Center*. Isolation transformers are used in both circuit banks to assure balance whether the input is in studio or out of studio.

Push key switches, utilizing gold program circuit contacts, provide reliable maintenance-free operation. Silver alloy DC switching contacts used to illuminate the "in use" stations also provide 30 volts DC for the control of external equipment. The Gates KCP-5 relay is available as optional equipment. It has D.P.D.T. contacts and requires 5 MA. to operate.

CUE-INTERCOM SYSTEM: A fully interlocked cue-intercom system is incorporated. The cue position of mixing channels 3 and 8, the network input, or any of the twelve pushbutton stations may feed the cue amplifier, regardless of the position of the cue amplifier input selector switch. Completely self-contained, the cueing system also provides talk-back control to two studios and remote lines.

MUTING RELAYS: Speaker muting relays are provided for the control room and two studio speakers. These have extra intercom muting contacts to prevent feeding an intercom signal into the studios when a live microphone is in use. The control room muting relay is factory wired to mute the console speaker with any signal source when the control room microphone is in use. A cue phone jack permits headphone monitoring of the cue-intercom circuits during these periods. Added contacts are provided for studio warning lights.

AMPLIFIER COMPLEMENT: The President is completely transistorized, incorporating Gates exclusive *Solid-Statesman* transistor amplifiers. The standard amplifier

President—Dual Channel Audio Control Console

complement consists of four plug-in microphone preamplifiers, two plug-in program amplifiers, one cue-intercom amplifier, and a full-level transistorized monitoring amplifier. Space is provided for two optional additional preamplifiers. The power supply is self-contained and is fully regulated. Everything is solid state. No tubes are used.

The 10 db. overload capacity of the M-5700 program amplifier used in the President, coupled with at least a 20 db. overload capacity in the microphone preamplifiers, makes the President almost impervious to excessive program levels. A 6 db. line isolation pad permits the connection of this console to highly reactive telephone lines without any noticeable interaction.

The + 39 dbm. (8 watt) capability of the transistor monitor amplifier is combined with flat response, low harmonic and intermodulation distortion that is typical of *Solid-Statesman* engineering.

The regulated power supply protects the console amplifiers from variations due to line and load regulation. In addition, the power supply ripple is reduced to almost non-existence to insure uniformly low noise in all of the console circuits. The power supply is short-circuit protected to prevent damage should the output be shorted accidentally during operation or maintenance.

VU METERS: Four-inch, illuminated, VU meters provide visual monitoring of both output channels. The meters can be mounted anywhere along the top rail of the console, or placed on the console desk for visual coordination in the control room between such items as the meters, studio clock, and announcer's copy.

VERSATILITY: Versatility of the President dual channel console is unequaled. *Control Center*—activated by an array of 24 illuminated touch control keys into two channels, plus six more medium or low level mixing inputs together with their respective input switching provides a total of 28 input sources. When all three positions of the six utility tab keys are used, a total of 45 inputs is available. With a full amplifier complement, the President console is particularly suited for television operation. Six of twelve microphones can be mixed simultaneously, while still providing mixing facilities for the extensive medium level signals in television such as: film projectors, video tape recorders, auxiliary mixers, and the usual turntable, cartridge and reel-to-reel equipment. Also, cue-intercom talk-back facilities are vitally important in television for microphone boom operator communication, preview and program direction.

STYLING: The styling concept of the President follows the distinctive symbol of Gates exclusive *Solid-Statesman* line. The free floating front panel and hinged lid provide full accessibility to all internal components.

The Gates President *Solid-Statesman* audio console will find a place in the broadcasting station that wants a mixing system which is definitely superior to the average, and Gates recommends the *Solid-Statesman* President as perhaps the most versatile dual channel standard production console ever conceived.

"Control Center" and the *Solid-Statesman* Gates President console combine as one integral functionally advanced equipment to meet the demanding needs of today's radio and television programming.

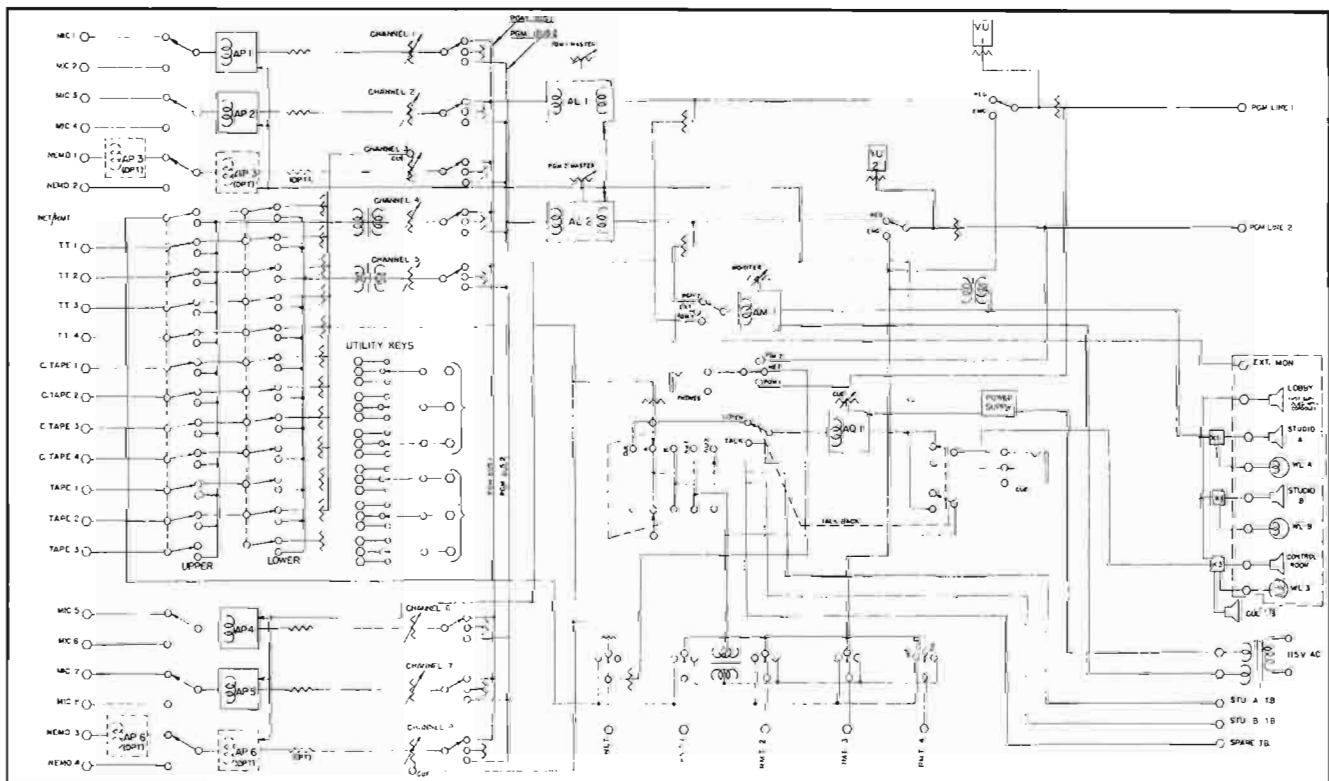

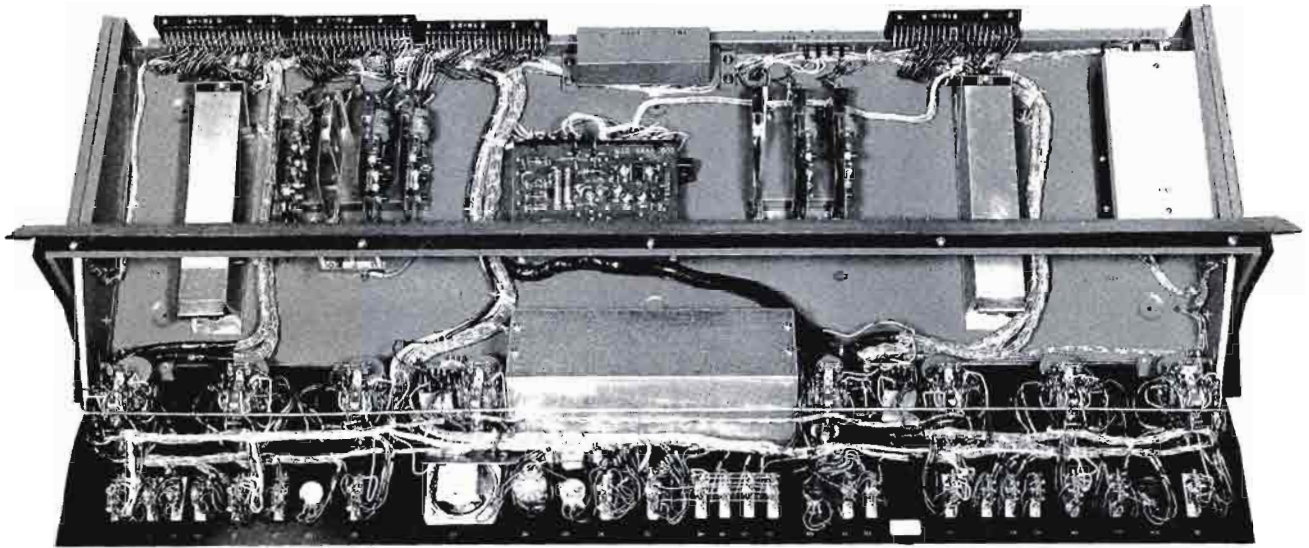

SPECIFICATIONS

MIXING CHANNELS:

Total 8, monophonic.

AMPLIFIERS PROVIDED:

2 program*, 1 monitor, 4 preamplifiers*, 1 cue/intercom amplifier. (2 additional preamplifiers* optional.) *Plug-in.

OPERATING MODE:

Dual channel monaural.

INPUT CIRCUITS:

8 microphones into 4 preamplifiers, standard.
 12 microphones into 6 preamplifiers, by use of two optional preamplifiers.
 11 turntables, tape, projector or external inputs into 2 mixers.
 4 remote lines. 1 network line into 12th "Control Center" push key.

OUTPUT LINES:

2 program lines, 3 muted speaker outputs, 1 unmuted speaker output, 2 interlocked studio intercom speakers, 1 intercom, 2 headphone outputs.

IMPEDANCES:

(input) Mics: 30/50 or 150/250 ohms.
 Mixing channels 3 and 8: 600 ohms unbalanced if optional preamplifiers not used.
 (24 push keys) Push key No. 1 (either bank) accommodates, by switching, 4 remote and 1 network line. Eleven other push keys (either bank) are for turntables, tapes, projectors and any input local or external. No. 13 is OFF (either bank).
 (output) 2 program lines each 500/600 ohms.
 Monitor amplifier: 8/16 ohms*.
 Intercom speakers: 45 ohms**.

*For matching transformers, see Page 148.

**For intercom studio unit, see Page 148.

GAIN:

Microphone input to line output: 104 db. ± 3 db.
 Turntable input to line output: 56 db. ± 2 db.
 Microphone input to speaker output: 104 db. minimum.

Turntable input to speaker output: 56 db. minimum.

FREQUENCY RESPONSE:

Rated ± 1.0 db. from 30 to 15,000 cps. in all regular program circuits. Capable: 20-20,000 cycles.
 Rated ± 1.5 db. from 30 to 15,000 cps. in all monitoring speaker circuits. Capable: 20-20,000 cycles.

HARMONIC DISTORTION:

Rated 0.5% maximum, 30 to 15,000 cps at + 8 dbm. output in all regular program circuits. Capable: 20-20,000 cycles.
 Rated 0.5% maximum, 50 to 15,000 cps + 18 dbm. output in all regular program circuits.
 Rated 1.0% maximum, 50 to 15,000 cps at + 39 dbm. (8 watts) in speaker outputs. Capable: 1% or less 20-20,000 cycles at + 38 dbm.

NOISE:

Program circuits, 60 db. or better below + 8 dbm. with - 60 db. input (equivalent noise input is - 120 dbm.). Turntable, tape and all *Control Center* input circuits 70 db. below + 8 dbm. output. Monitoring circuits 60 db. below + 39 dbm. output.

CROSSTALK:

Below noise level in all channels.

POWER:

115 volts, 50/60 cycles, 44 watts.

CABINET DATA:

52½" wide, 11½" high, 17½" deep.
 Finish, cabinet medium gray. Panel, natural aluminum with knobs and lettering in black. Mixer knobs supplied with decal color insert kit. *Control Center* knobs in four colors and illuminated.

SHIPPING DATA:

Packed (domestic) 220 lbs., (export) 290 lbs.
 Cubage: 27

OPTIONAL ACCESSORIES:

Space provided for 2 added M-6034 plug-in preamplifiers.

ORDERING INFORMATION

- The President, dual channel audio control console, complete, includes 2 external VU meters and 4 type A-30601 speaker matching transformers (Cat. No.) M-6209A
 Optional plug-in microphone preamplifiers M-6034
 External VU meter with housing (see Page 148) M-6208
 Intercom sub-station, deluxe (see Page 148) M-6424
 Spare 100% semi-conductor kit TK-503

- Relay, 30 volt D.P.D.T. to start-stop external equipment KCP-5
IMPORTANT: Performance of transistorized loudspeaker amplifiers such as the monitoring amplifier in all Gates Solid-Statesman consoles is made unusually fine by use of a speaker matching transformer for each loudspeaker used. Because of this, 4 transformers are supplied with each Solid-Statesman console for mounting at each of the loudspeakers. If more than 4 speakers are used, the customer should order a transformer for each speaker. See Page 148 for description.

CONTROL CENTER—HEART OF THE PRESIDENT AND AMBASSADOR

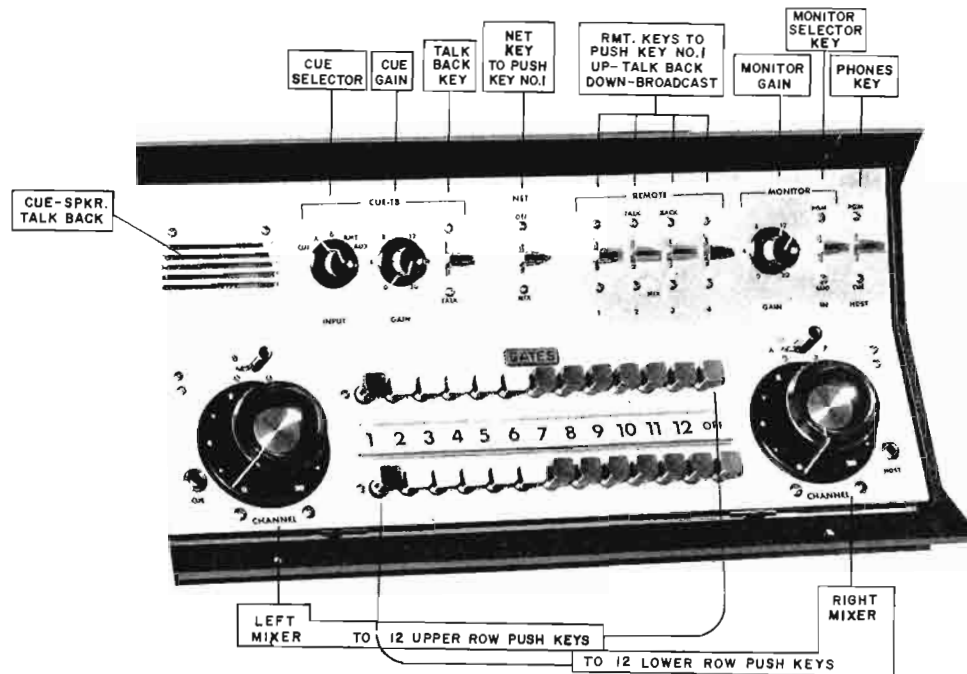

CONTROL CENTER

Control Center brings to broadcasting the efficiency of push-key switching. In telephone communications, data processing, space capsule control—today's fast, accurate method of handling many circuits with a minimum error factor is through push key circuitry. In *Control Center*, long awkward banks of faders are substantially replaced by 24 push keys in two rows of 12. In the language of the space age, "Punch Up" a signal through *Control Center* and you are in GO condition.

On the Gates President and Ambassador Consoles, each *Control Center* key handle illuminates when in GO position. The upper bank feeds the left mixer. Lower bank feeds the right mixer. All push keys not depressed automatically connect to the cue amplifier/speaker which is part of *Control Center*. Each bank of push keys has four red, four white and four blue colors, plus green for OFF. These may be placed in any color sequence, tailored to a particular studio arrange-

ment. A large designation strip between the keys is numbered in large block figures. These numbers may be removed and typewritten inserts substituted if desired.

Automatic control of turntables, recorders, etc., is also possible with *Control Center*. Each push key (when activated) provides 30 volts DC at 30 ma. to a terminal pair to operate a small pilot relay (the Gates KCP-5 is available). With this feature, recorders, turntables or other equipment may be controlled with the same action that places the signal on the air.

In brief, *Control Center* does the work of twelve mixers faster and better, with complete identification of the circuit in use. Circuits not in use are always at cue. Any push key may also control an external mechanical device. Signals may be cross-faded in any sequence. All of this requires only two faders. Modern programming concepts demand *Control Center*. The Solid Statesman *President* and *Ambassador* Consoles incorporate this outstanding advance in audio design.

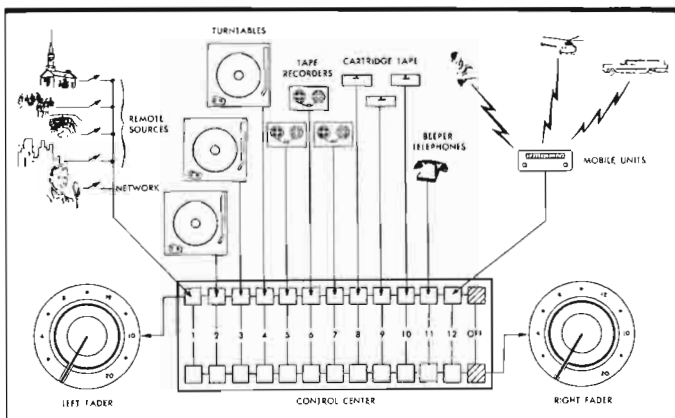

These are top quality roller activated keys have positive wiping action with gold contacts. Note easily replaceable telephone type lamp. Pull off push key handle and insert new light. *Control Center* will be found in the President and Ambassador consoles only.

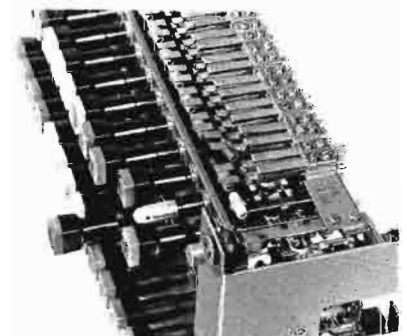

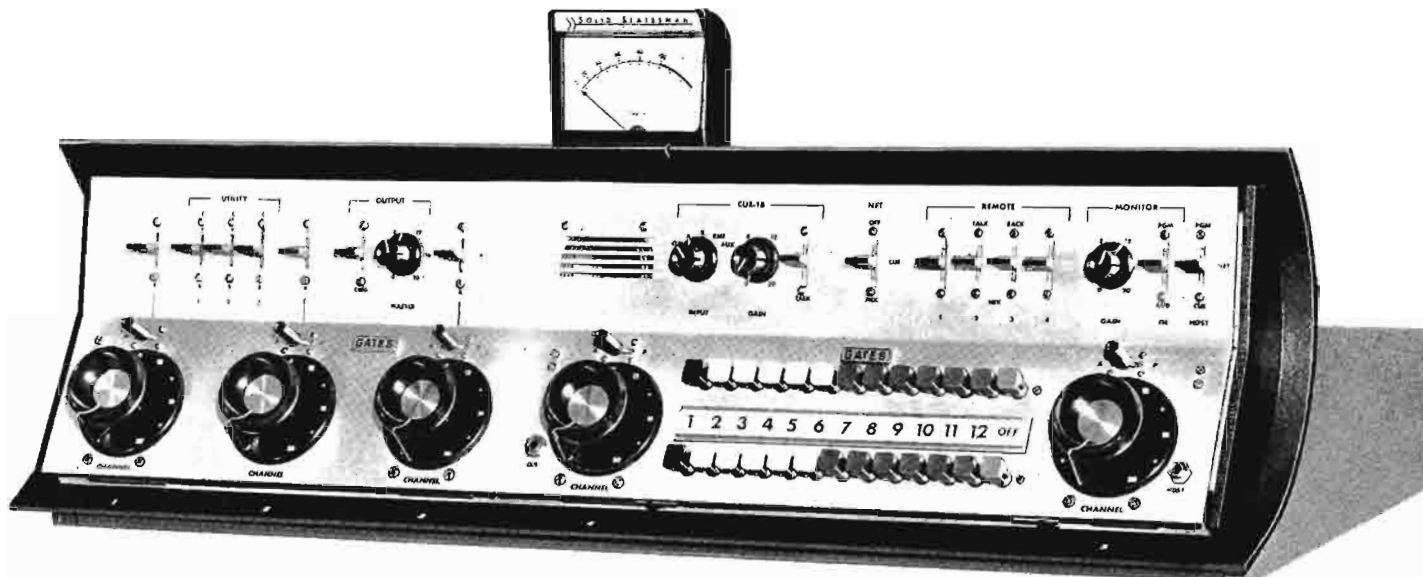

AMBASSADOR CONSOLE

One of the family of premium quality *Solid-Statesman* consoles, the Ambassador features *Control Center* and superb electrical performance to provide one of the truly advanced audio control equipments of our day.

Control Center, exclusive from Gates, has two mixing channels doing the work of 12. This, combined with the multiple microphone facilities, cue-intercom and many other features, has resulted in a superb console featuring a magnitude of facilities yet retaining simplicity of operator control.

AMPLIFIER COMPLEMENT: The Ambassador is completely transistorized, incorporating *Solid-Statesman* plug-in transistor amplifiers to meet superior performance and reliability standards. It includes: (2) plug-in microphone preamplifiers (space provided for optional 3rd preamplifier), (1) plug-in program amplifier, (1) plug-in audition booster amplifier, (1) plug-in cue/intercom amplifier and (1) eight-watt monitoring amplifier. The preamplifiers have a full 20 db. overload capacity. The distortion is actually lower than that of many test oscillators. The program amplifier has a full 10 db. overload factor above the + 14 dbm. rating used to feed the 6 db. line isolation pad to the program line. Performance standards are not altered by substantial level variations and high telephone line reactances, while also providing quality that only the more sophisticated test systems are capable of measuring.

The monitoring amplifier provides a full + 39 dbm. (8 watts) output to the speakers with low harmonic and intermodulation distortion. The response of all amplifiers is flat over a very wide audio spectrum. An isolation transformer bridges the output of the monitor amplifier for emergency program feed and remote program cue. The cue-intercom system is peaked for maximum intelligibility with a pen-

trating, yet pleasing, difference from the monitoring system. A fully regulated power supply protects the console amplifiers from variations due to line and load regulation. Power supply ripple is reduced to the point of almost non-existence to assure uniformly low noise in all of the console circuits. The power supply is also protected to prevent damage to any of the transistors in either the power supply or amplifiers from a momentary or sustained short in any of the load circuits.

MIXING SYSTEM: Five monophonic input mixing channels are provided, utilizing low impedance, ladder-type controls. The *Ambassador* accommodates 22 inputs with expansion facilities to 31 by using the three unwired utility switches left available for the user's discretion. Key selection allows any mixer to feed program amplifier or audition output through the audition booster amplifier.

CONTROL CENTER: The heart of the *Ambassador* is *Control Center*, operating into mixers 4 and 5. Consisting of two rows of 12 push-keys, plus an OFF key, the upper bank of 12 push-keys feeds the left mixer (#4). The lower bank of 12 push-keys feeds the right mixer. (#5). Any push-key, when inserted, automatically releases any other key in the same row. All push-keys not inserted are connected to the cue amplifier/speaker which is part of the *Ambassador*. Push-keys are color-coded for convenience in identifying inputs such as turntables, tapes, etc.

To further expand the medium level facilities in the *Ambassador*, push-key #1 selects from any one of four remote lines or network as switched by the upper row tab keys above the *Control Center*. A large numbered designation strip between the push-key rows may be replaced with typewritten identification cards. Any of the 12 circuits may be switched into either mixing channel, assuring full fader control.

Ambassador Console—Single Channel Audio Control

From each push-key, (illuminated when inserted) the 30 volt circuit for illumination is also brought to a pair of terminals. In this manner, the push-keys may start a mechanical device such as a *Cartritape*, projector or turntable at the same time as the audio is engaged. A relay kit (M6482) is available for this service and is listed under ordering information.

Mixing channels one through three provide six more inputs for either microphone or medium-level signals. The standard *Ambassador* is equipped with two plug-in preamplifiers to accommodate up to four studio and control room microphones through faders 1 and 2. Fader 3 is a cueing attenuator also and is often used for medium-level inputs. Provision for a third, optional, plug-in preamplifier is included. This optional M-6034 preamplifier may be connected ahead of the input selector switch of channel three for a dual function of microphone input plus medium-level input—or, it may be wired after the input selector to provide two additional microphone inputs.

CUE/INTERCOM SYSTEM: Indispensable in today's modern broadcasting, the inbuilt cue/intercom system permits preview listening as well as talk back. Preview listening is from all *Control Center* circuits such as remotes, network, turntables, tapes, projectors. In addition, preview from mixing channel 3 and auxiliary is provided. Talk back is possible to two studios, remote lines and a spare input circuit. The M-6424 sub-station illustrated herein is suggested for studio use in talk back service.

MUTING RELAYS: Three muting relays, energized by microphone channel keys, disconnect loudspeakers adjacent to a live microphone, provide contacts for warning lights and additional contacts to mute the intercom system when a studio is in use. A cue phone jack is provided to allow headphone monitoring of cue circuits where necessary in case of a live microphone.

MOVABLE VU METER: Mounted in a cast aluminum housing, the illuminated VU meter may be located anywhere desired, along the top rail of the console cabinet or at either side of the console. In this way, the VU meter may be located in the most convenient visual path which varies from one studio to another. A connecting cable and plug is part of the meter assembly.

VERSATILITY: The creative ingenuity of the *Ambassador* makes it very nearly a custom console. *Control Center*, with its array of 24 illuminated touch control keys, into two channels, plus 3 additional mixing inputs with their associated switching, and three utility keys, provides many new exciting possibilities in audio control not heretofore thought possible.

Not to be overlooked is the new VA mixer knob used on all faders. Designed first in a similar style for the Voice of America Studios, it is without question a substantial advance in the *feel of the board* concept. Shadow mold styling is the contribution of one of America's leading industrial stylists, engaged by Gates just for the *Solid-Statesman* series of equipment.

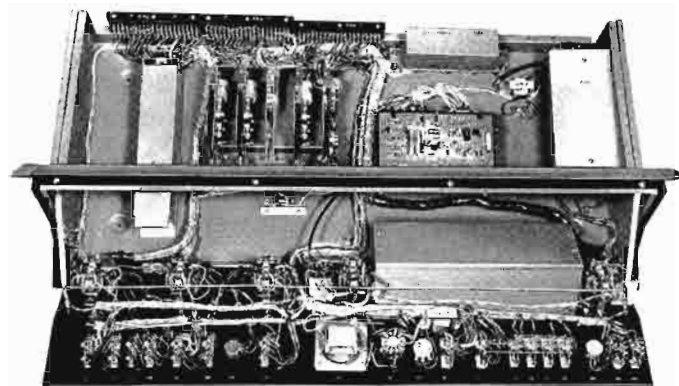

The smooth and easy to service design combined with the smaller size of transistorized components is best evidenced by the open view above. Note the plug-in amplifiers to the left, cue intercom speaker near center front and hinge down front panel and hinge up cabinet cover. "Control Center" is the shielded portion to the right of the cue speaker.

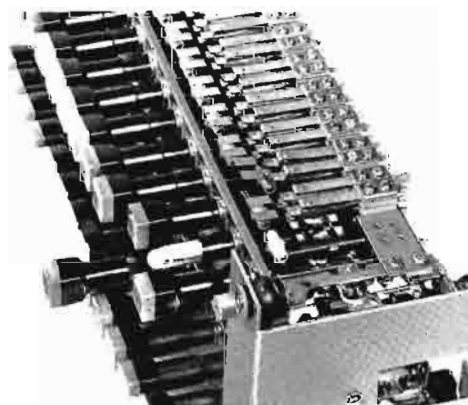

"Control Center" is built as heavy as the service demanded of it. Strong PBX type push keys with gold plated contacts automatically release if another is inserted. Handles are color coded and illuminated when circuit is in use. Control Center also provides voltage to operate mechanical devices. In "Control Center" two mixing channels do the work of 12.



The M-6424 deluxe intercom sub-station is for studio use. Matches symmetry of console and particularly VU meter. Has 30° slope in cast aluminum housing finished in non-reflecting black.

SPECIFICATIONS

MIXING CHANNELS:

Total 5. 4 microphones into 2 preamplifiers, as supplied; 6 microphones into 3 preamplifiers, 3rd preamplifier optional; 12 turntables, tape, projector, or any medium-level input into 2 mixers; 4 remote lines; 1 network line.

AMPLIFIERS PROVIDED:

1 plug-in program, 1 plug-in booster, 1 eight-watt monitor, 2 plug-in preamplifiers, 1 plug-in cue amplifier.

OPERATION MODE:

Single channel monaural.

OUTPUT LINES:

1 program, 1 audition, 3 muted speaker, 1 non-muted speaker, 2 studio intercom, 1 spare intercom.

IMPEDANCES:

Microphones 30/50 or 150/250 ohms, turntable/tape 600 ohms unbalanced, remote lines 600 ohms, network 600 ohms, programming output 600 ohms, audition output 600 ohms, intercom output 45 ohms, monitor output 8-16 ohms.

GAIN:

Turntable, tape, network (high level) input to program line output 56 db. To monitor amplifier output 56 db., minimum. From microphone input to program line output 104 db. To monitor amplifier output 104 db., minimum.
Note: All measurements ± 2 db.

RESPONSE:

All segments of program circuit: ± 1.0 db. 30-15,000 cycles. Capable: 20-20,000 cycles. Monitoring circuit + 1.5 db. 30-15,000 cycles. Capable: 20-20,000 cycles.

DISTORTION:

Any segment of program circuit 0.5% or less between 30-15,000 cycles at + 8 dbm. output level. Capable: 20-20,000 cycles. Monitor amplifier: 1.0% between 30-15,000 cycles, at + 39 db., which is 8 watts output level. Capable: 20-20,000 cycles.

NOISE:

Program circuits: - 60 db. or better below + 8 dbm. output, with - 60 db. input (equivalent noise input is - 120 dbm.).

Monitor circuits: 60 db. below + 39 dbm. output. Crosstalk: all circuits below noise level with normal programming gain settings.

POWER:

117 volts, 50/60 cycles, single phase. Power consumption 40 watts at 60 cycles.

CABINET DATA:

Size: 37 $\frac{1}{2}$ " long, 11 $\frac{3}{8}$ " high, 17 $\frac{3}{8}$ " deep.

Finish: Panel: Natural satin anodized aluminum with black nomenclature. Decal color insert kit supplied for mixer knobs.

Cabinet: Medium gray textured with black trim.

SHIPPING DATA:

Packed weight: domestic, 245 lbs.; export, 265 lbs. Cubage: 20.5.

OPTIONAL ACCESSORIES:

Space is provided to add, when desired, 1 Model M-6034 pre-amplifier.

ORDERING INFORMATION

Ambassador, single channel console, complete with 2 preamplifiers and 4 type A-30601 speaker matching transformers (Cat. No.) M-5564A
Extra plug-in microphone preamplifier M-6034
Intercom Sub-station, deluxe M-6424
Speaker matching transformer (see Page 148) A-30601
Relay kit for use with Control Center to start mechanical device M-6482
Plug-in jumper board 913-6060

NOTES: (1) Four speaker matching transformers are supplied with each console. If more than 4 speakers are to be used, order an added A-30601 transformer for each added speaker. (2) If it is desired to use mixing channels 1 or 2 less preamplifiers or as medium level inputs, order 913-6060 plug-in jumper board to replace preamplifiers.

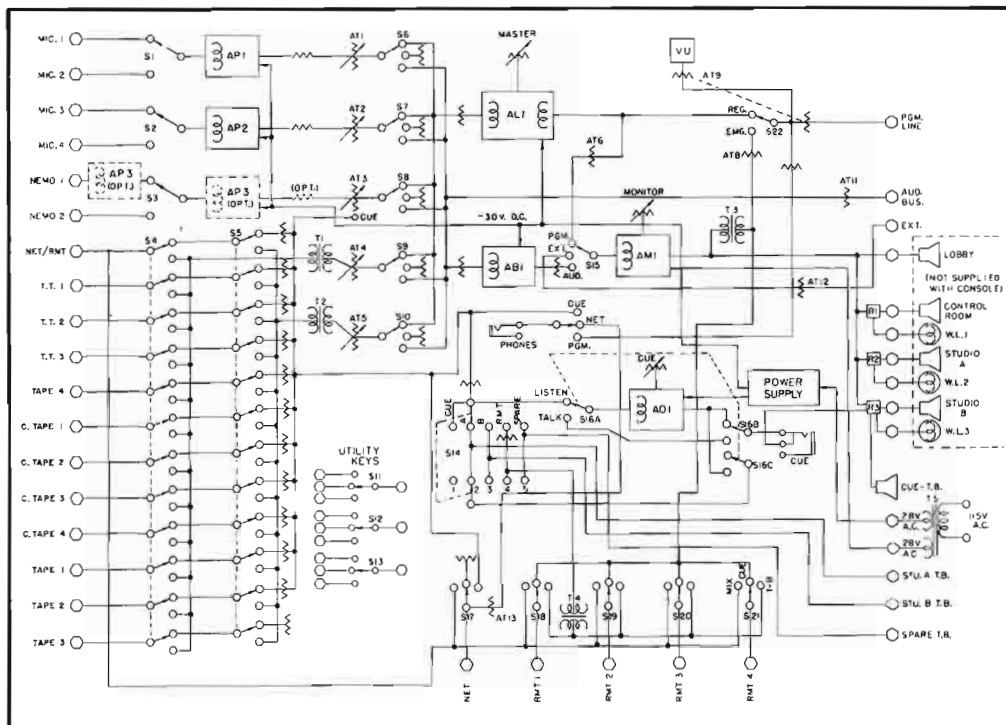

THE DUALUX—9 MIXER DUAL CHANNEL CONSOLE

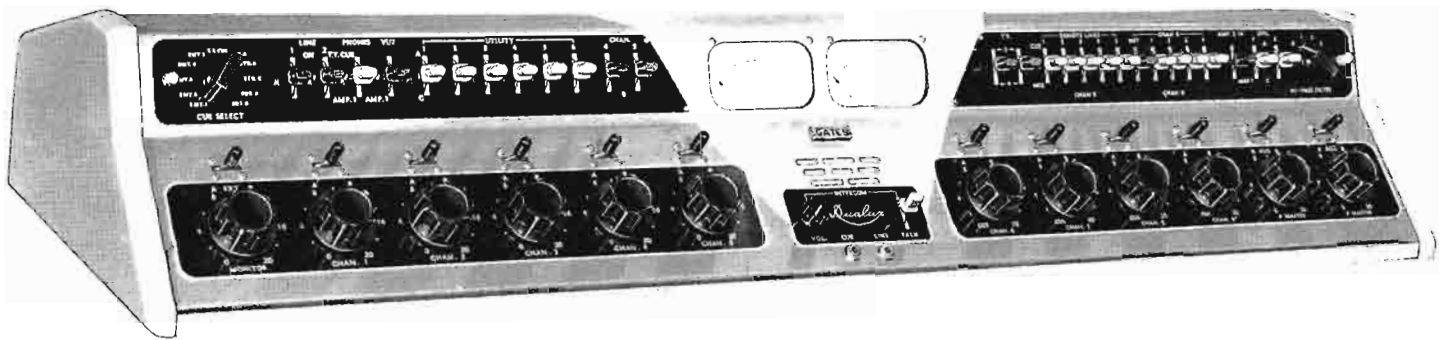

FOR TELEVISION OR RADIO

One of the truly fine consoles for broadcasting, the *Dualux*, offers unusually broad facilities, classic commercial appearance, unique functional design and proven performance. Long referred to as the standard of comparison, the *Dualux* accommodates 21 inputs into 9 mixing channels for dual programming use. A cue intercom system with speaker and switching facilities at the front center of the console permits instant program preview and offers independent talk-back to studios or remotes. The exclusive front panel 3-position hi-pass filter allows immediate correction of a poor program circuit which might otherwise be unusable due to low frequency hum or noise.

Five microphone preamplifiers, supplied as standard equipment, can handle up to 7 microphones. Fourteen high level circuits provide inputs for turntables, tapes, projectors, remotes and network. All of these facilities feed dual program amplifiers from the choice of two mixer buses. Additional flexibility is provided by eight unwired utility keys and space to add two more microphone preamplifiers. The 10 watt ultra linear amplifier is rack mounted and assures generous power for faultless loudspeaker monitoring and distribution.

Complete relay speaker muting and warning light control is standard equipment.

FOR TELEVISION: The dual channel facility combined with unusually wide input facilities allows broadcasting one studio program while making ready for the following program. Station break spots may be handled with ease and the intercom feature is a necessity in TV operation. Color inserts are provided for the mixer knobs for easy studio or circuit identification. Dual master gain controls to the right and monitor master gain to the left are the features which make the *Dualux* functionally ideal for television.

FOR RADIO: The dual program facility design provides two independent program buses for centralized control of two separate programs. Whether simultaneous or separate AM/FM programming, the *Dualux* is an ideal choice. The second complete program channel is equally suited for recording. The four high level mixing channels with cue preview can handle four turntables, four tapes, five remote lines and network. When added to the seven microphone inputs and independent cue-intercom the total flexibility of 21 inputs into nine mixers assures positive production handling.

The *Dualux* top cover hinges up and the front panel swings down to reach every "behind the panel" component. This spacious layout and logical access is typical of the complete line of Gates consoles, and reflects the engineering and planning required for neat, professional installations.

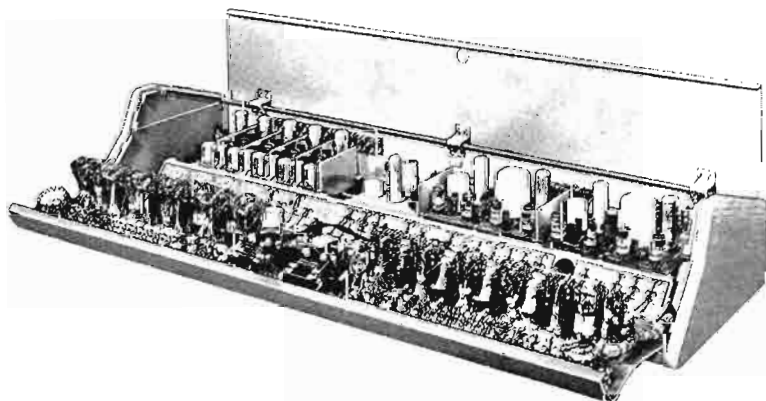

The Dualux—9 Mixer Dual Channel Console

SPECIFICATIONS

MIXING CHANNELS:

Total 9: 5 microphone, 2 turntable, 1 remote and 1 net/tape. Turntable, remote and net/tape have cue position on fader.

AMPLIFIERS PROVIDED:

2 program, 1 monitor, 5 preamplifiers, 1 cue amplifier. Space for 2 additional preamplifiers.

OPERATING MODE:

Dual channel monaural.

INPUT CIRCUITS:

7 for mics., 4 turntables, 5 remote lines, 1 network line, 4 tape/projector.

OUTPUT LINES:

2 program, 2 audition, 3 muted speaker, 1 non-muted speaker, 3 intercom.

IMPEDANCES:

Microphones 30/50, 150/250 ohms, turntable/tape unbalanced 150/250 ohms, remote lines 600 ohms, network 600 ohms. Programming output 600 ohms. Audition output 600 ohms. Intercom output 600 ohms. Monitor speakers 8/16 ohms.

TUBES:

(18) EF-86/6267, (3) 12AX7, (2) 12AU7, (2) EL-84, and (1 each) OA2, 6AK6, 6080, 6Z34.

GAIN:

Turntable, tape, network (high level) input to program line output 61 db. From microphone input to program line output 104 db. Monitor amplifier bridges either program amplifier with gain in excess of output capability.

Note: All measurements ± 2 db.

RESPONSE:

All segments of program circuit $\pm 1\frac{1}{2}$ db. 30-15,000 cycles. Monitoring circuit ± 2 db. 30-15,000 cycles.

DISTORTION:

Any segment of program circuit 1% or less between 30-15,000

cycles at + 8 dbm. output level, or $1\frac{1}{2}\%$ at + 18 dbm. output level. Monitor amplifier 1% at + 40 dbm. which is 10 watts.

NOISE:

Program circuits: 60 db. or better below + 8 dbm. output, with - 60 db. input (equivalent noise input is - 120 dbm.)— Monitor circuits: 60 db. below + 40 dbm. output. Crosstalk: all circuits below noise level with normal gain settings for proper programming.

POWER:

105/125 volts, 50/60 cycles, 1 phase. Power consumption 155 watts at 60 cycles.

CABINET DATA:

Size: (console) 46 $\frac{1}{2}$ " wide 7 $\frac{1}{2}$ " high, 15" deep. (power/monitor unit) 19" wide, 7" high, 8" deep.

Finish: Panel: 2 tone gray with escutcheons in black anodized aluminum.

Cabinet: Medium gloss gray. Mixer knobs supplied with color variety disc insert kit.

SHIPPING DATA:

Packed weight: Domestic 205 lbs. Export 290 lbs. Cubage: 12.

OPTIONAL ACCESSORIES:

Space is provided to add, when desired, 2 Model M-5304A preamplifiers.

ORDERING INFORMATION

| | |
|---|---------|
| Dualux Audio Console complete | M-5236B |
| 100% spare tube kit | TK-499 |
| Optional preamplifier | M-5304A |
| Speaker matching transformer (see page 148) | A-30601 |
| Studio cue/intercom speaker (see page 148) | M-6424 |

AUDIO

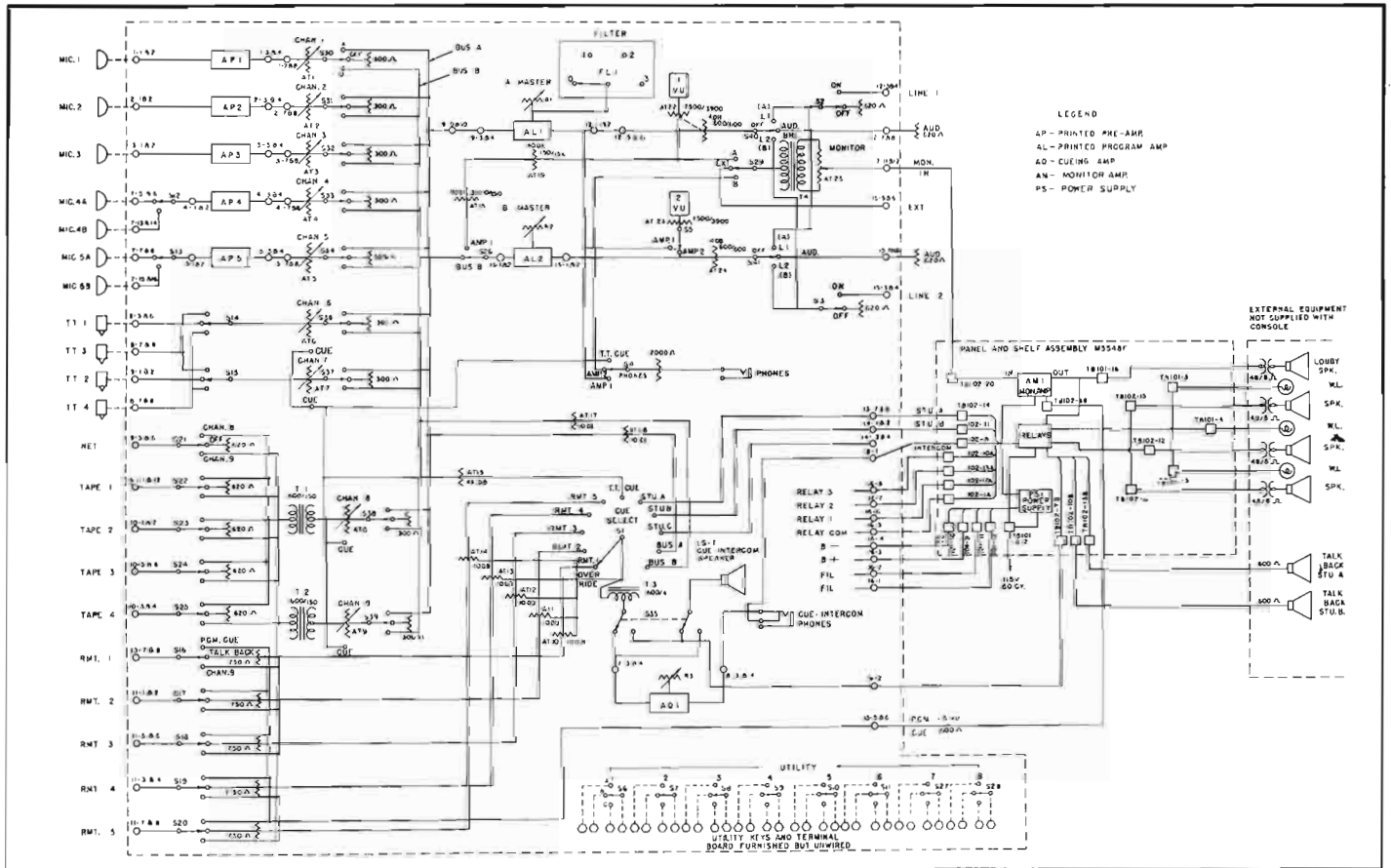

THE GATESWAY—8 CHANNEL AUDIO CONTROL CONSOLE

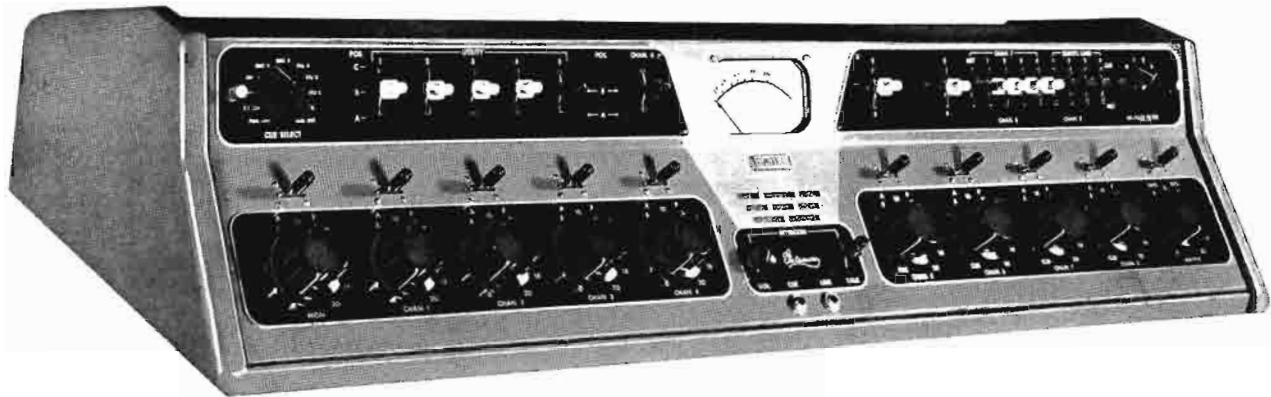

THE GATESWAY

Broadcasting's most widely used audio control console, the *Gatesway*, is in daily use in over 1000 AM, FM and TV stations the world over. A complete high fidelity speech input system, the *Gatesway* provides for easy audio control of multiple studios, and control room with generous facilities for turntables, tape, cartridge tape, network and remote program sources. Eight mixing channels handle 5 microphones, 4 turntables, 4 tape/projectors, 4 remote lines and network. A total of 18 inputs are provided. Inbuilt cue-intercom with speaker/microphone located in the center of the console allows preview of remote lines, turntables, tape/projectors, audition bus and one external line—plus talk-back to studios and remote lines. Also exclusive is the variable hi-pass filter for quick improvement of a low quality audio circuit such as unlooked for problems from a remote pickup. Four preamplifiers, program amplifier, a 10 watt ultra-linear monitoring amplifier, cue-intercom amplifier and a fully regulated power supply are all standard equipment. Designed for maximum flexibility, 27 keys accommodate 52 switching functions. A study of the functional diagram will reveal facility after facility available to accommodate varied circuit combinations. Five unwired utility keys are provided for the specific needs of each individual broadcaster. Circuit flexibility is the by-word of the *Gatesway*.

AMPLIFIERS: Preamplifiers, program and monitor amplifiers are all wide response, low noise units with an abundance of gain. The monitor amplifier is of the ultra-linear type, with 1% maximum distortion at full output of 10 watts.

CUE SELECTOR: Rotary switch selects cue speaker/amplifier for talk or listen to three studios, remote lines, and utility line. This selector switch provides monitoring to turntables, tapes, audition bus and one external source.

UTILITY KEYS: Five DPDT unwired upper level tab keys are provided for custom designed application.

OUTPUT EMERGENCY KEY: In case of failure in the program amplifier, the monitor amplifier may be instantly switched into the program circuit.

MONITOR INPUT KEY: This input key permits switching monitor input to (a) program amplifier output, (b) audition bus, and (c) external input.

MUTING: Three relays are provided to mute speakers in three studios and operate warning lights. Additional space is provided for two optional added relays for customers' particular needs.

POWER SUPPLY: Power supply is fully regulated and mounted on separate 19" x 7" rack panel. This panel also houses the 10 watt ultra-linear monitor amplifier and muting relays.

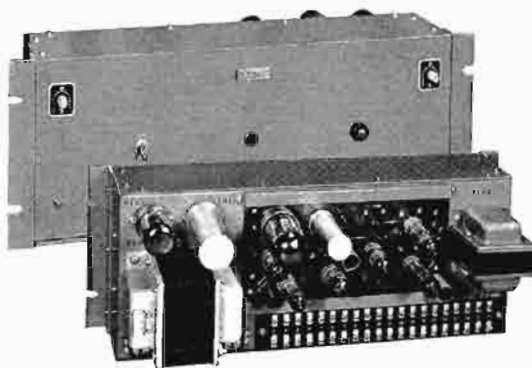

Rack mount power/monitor unit.

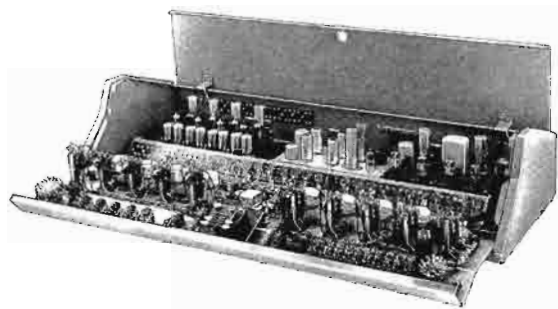

Open view showing complete accessibility.

The Gateway—8 Channel Audio Control Console

SPECIFICATIONS

MIXING CHANNELS:

Total 8. Four microphone, two turntable*, one tape/network* and one remote*.

*Cue position on mixer faders.

AMPLIFIERS PROVIDED:

1 program, 1 monitor, 4 preamplifiers, 1 cue amplifier.

OPERATING MODE:

Single channel monaural.

INPUT CIRCUITS:

5 microphones, 4 turntables, 4 remote lines, 1 network line, 4 tape/projectors, 1 external monitor input.

OUTPUT LINES:

1 program, 1 audition, 3 muted speaker, 1 non-muted speaker, 3 intercom, 1 audition.

IMPEDANCES:

Microphones 30/50 150/250 ohms. Turntable 150/250 ohms unbalanced. Tape, network and remote lines 600 ohms. External monitor input 150 ohms. Programming output 600 ohms. Audition output 150 ohms. Intercom output 600 ohms. Monitor speakers 8/16 ohms.

NOTE: Where more than two loudspeakers are used, the A-30601 speaker matching transformer should be used (see Page 148).

TUBES:

(13) EF86/6267, (4) 12AX7, (2) EL84, and (1 each) 12AU7, 6AK6, 6080, GZ34, OA2.

GAIN:

Turntable, tape network (high level) input to program line output 60 db. From microphone input to program line output 104 db. Monitor gain in excess of output capability in all circuits. All measurements ± 2 db.

RESPONSE:

All segments of program circuit $\pm 1\frac{1}{2}$ db. 30-15,000 cycles. Monitoring circuit ± 2 db. 30-15,000 cycles.

DISTORTION:

Any segment of program circuit 1% or less between 30-15,000 cycles at + 8 dbm. output level or $1\frac{1}{2}\%$ at + 18 dbm. output. Monitor amplifier 1% at + 40 dbm. which is 10 watts.

NOISE:

Program circuits: 60 db. or better below + 8 dbm. output, with - 60 db. input (equivalent noise input is - 120 dbm.). Monitor circuits: 60 db. below + 40 dbm. output. Crosstalk: all circuits below noise level with normal gain settings for proper programming.

POWER:

117 volts, 50/60 cycles, 1 phase. Power consumption 105 watts at 60 cycles.

CABINET DATA: Size:

(console) 39" wide, $7\frac{1}{2}$ " high, 15" deep.
(power/monitor unit) 19" wide, 7" high, 8" deep.

Finish:

Panel 2-tone gray with escutcheons in anodized black. Cabinet 2-tone gray.

SHIPPING DATA:

Packed weight: Domestic, 175 lbs. Export, 265 lbs. Cubage: 12.

OPTIONAL ACCESSORIES:

Space is provided to add, when desired 1 Model M-5304A preamplifier.

ORDERING INFORMATION

| | |
|---|-------------------|
| Gateway Audio Console complete | (Cat No.) M-5133B |
| 100% spare tube kit | TK-451 |
| Optional preamplifier | M-5304A |
| Speaker matching transformer (see Page 148) | A-30601 |
| Studio cue/intercom speaker (see Page 148) | M-6424 |
| Extra muting relay | AK-11939 |

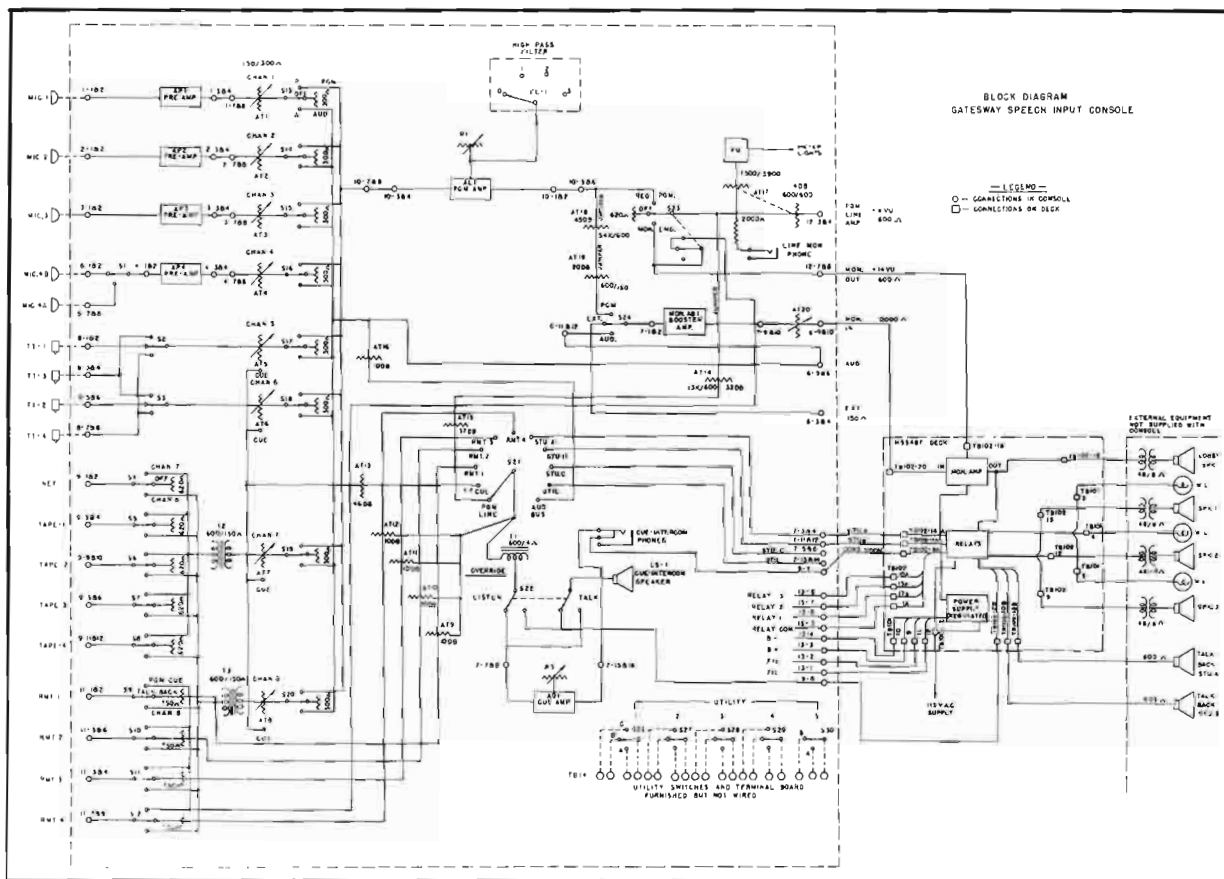



THE STEREO YARD

For the broadcaster who is going stereo now or has stereo in his future, the Gates *Stereo Yard* Console offers complete versatility. It can provide total stereo operation on all 8 mixing channels or part monaural and part stereo, or all monaural, as designed. Cue amplifier speaker is in-built to preview the five mixing channels normally used for turntables, tapes, network and remotes. Everything is in pairs for stereo—dual faders on all 8 channels, dual program amplifier and dual monitoring amplifiers. The *Stereo Yard* contains six preamplifiers (3 dual sets) and dual VU meters. The low, wide styling is especially attractive where stereo studio presentation requires good control room to studio visibility.

GENERAL DESIGN: External to the console for rack mounting are two 10-watt ultra linear monitoring amplifiers with muting relays, one program amplifier with power supply and one isolation transformer panel for balanced input circuits. The console contains six pre-amplifiers, one program amplifier, two booster amplifiers and cue amplifier. This design assures minimum crosstalk, so important in stereophonic performance.

STEREO/MONAURAL: A front panel selector switch permits operator selection of: full stereo programming, separate feeds to each of the two program lines (as a dual channel console) for monaural broadcasting, or simultaneous monaural programming on both lines. If stereo programming is in your future, this console will function as a versatile dual-channel monophonic system today, yet is instantly ready for stereo tomorrow by the mere flick of a front panel switch.

MICROPHONE SWITCHING: In stereo, often one announce microphone is used which must transmit to both left and right channels. In the Gates *Stereo Yard*, a selector switch can connect the input of the right preamplifier to bridge the output of the left preamplifier and yet maintain full stereo separation on all remaining mixing channels. This “center stages” the announcer, while keeping full stereophonic realism on all other channels.

MIXER CHANNEL SWITCHING: Above each fader is the mixer selector key. Center position is off. Right position connects this mixer to the program circuit for either stereo or monaural operation. Left connects this channel to the audition bus which connects to the monitoring amplifiers through the booster amplifiers. If desired, the audition bus may be used for recording.

AMPLIFIERS: Six preamplifiers are provided for three stereo channels. Dual matched program amplifiers, dual 10-watt ultra linear monitoring amplifiers with regulated power supplies, dual booster amplifiers and self-contained cue amplifier and speaker are all standard equipment.

OTHER FEATURES: Dual VU meters operate across both left and right program channels adjusted to read +8 VU at zero on the meter. Input to each monitor amplifier may be switched to (a) bridge program output, (b) audition mixer bus, or (c) external input. Mixing faders 4 thru 8 have cue at off position, connecting each fader to the cue amplifier. Muting of 3 pairs of loudspeakers and cue/intercom amplifier is provided.



Left: Rack-mounted program amplifier. A second program amplifier is in the console cabinet. Right: Two, rack mounted, 10-watt ultra linear monitor amplifiers are also standard equipment.



The Stereo Yard—8 Channel Stereo and Monaural Console

SPECIFICATIONS

MIXING CHANNELS:

Total 8 stereo or monaural; 3 for dual microphones, 2 for turntables, 2 for tape and 1 for general service such as network, remote or utility. Channels 4, 5, 6, 7 and 8 have cue position on fader.

AMPLIFIERS PROVIDED:

2 program, 2 monitor, 6 preamplifiers, 1 cue amplifier, plus 2 booster amplifiers.

OPERATING MODE:

Stereo and monaural single channel.

INPUT CIRCUITS:

6 for microphones (2 pairs stereo), 4 turntables/tape, 1 remote line, 1 network line or general high level service. All inputs either stereo or monaural.

OUTPUT LINES:

2 program (left to right), 6 muted speakers, 2 non-muted speakers, left and right.

IMPEDANCES:

Microphones: 30/50 or 150/250 ohms. Turntables: 150/250 ohms. Tapes: 150/250 ohms or 500/600 ohms, balanced or unbalanced. Utility lines: 600 ohms balanced. Programming output: 600 ohms, left and right. Monitor output: 8 or 16 ohms.

Note: Where more than two loudspeakers are employed, the A-30601 speaker matching transformer (see Page 148) should be purchased for each loudspeaker. With a 48 ohm primary and voice coil secondary, many speakers may be connected to the 8/16 ohm monitor output with excellent impedance match and performance. The transformer is mounted at the speaker location.

GAIN:

Turntable, tape, network (medium level) input to program line output: 60 db. To monitor amplifier output: 87 db. from microphone input to program line output: 103 db. to monitor amplifier output: 130 db. All measurements ± 2 db.

RESPONSE:

All segments of program circuit $\pm 1\frac{1}{2}$ db. 30-15,000 cycles, or

± 3 db. 20-20,000 cycles. Monitoring circuit ± 2 db., 30-15,000 cycles.

DISTORTION:

Any segment of program circuit 1% or less between 30-15,000 cycles at + 8 dbm. output level, or 1½% at + 18 dbm. output. Monitor amplifier 1% at + 40 dbm. which is 10 watts.

NOISE:

Program circuits; 60 db. or better below + 8 dbm. output, with - 60 dbm. input (equivalent noise input is - 120 dbm.). Monitor circuits; 62 db. below + 40 dbm. output. Crosstalk—all circuits below noise level with normal gain settings for proper programming.

POWER:

117 volts, 50/60 cycles, 1 phase. Power consumption 250 watts at 60 cycles.

CHANNEL SEPARATION:

50 db. or better.

TUBES:

(20) EF86/6267, (7) 12AX7, (4) EL84, (2) 6080, (2) OA2, (2) 5V4, (2) 12AU7, and (1 each) 6AK6, 6X4.

CABINET DATA:

Size: (console), 36" wide, 6½" high, 14" deep.
(external units), rack space of 19" x 26¼".

Finish: Medium gloss gray with panel in natural and black anodized aluminum. Decal color insert kit supplied for mixer knobs.

SHIPPING DATA:

Packaged weight: Domestic 200 lbs. Export 280 lbs.
Cubage: 13 cu. ft.

ORDERING INFORMATION

Stereo Yard Audio Console complete (Cat. No.) M-6188

100% spare tube kit TK-417

Speaker matching transformer (see page 148) A-30601

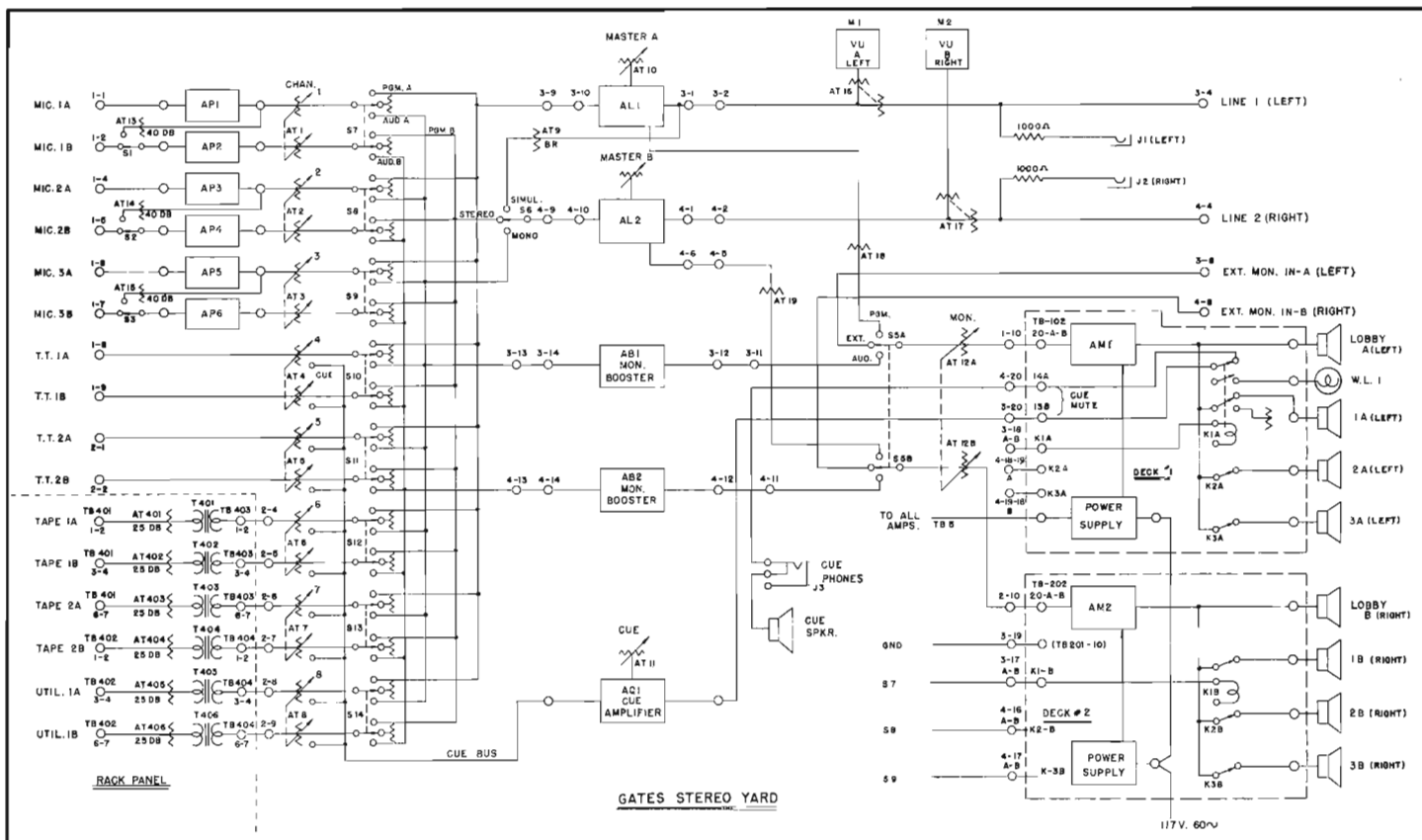

AUDIO



THE YARD

One yard wide and only 5 $\frac{3}{4}$ " high, the Gates *Yard* is one of the industry's most popular consoles. With 13 inputs and 8 mixing positions it provides all control room facilities normally needed by medium size radio or TV stations. Functionally placed, the 8 mixing channels are in the center with the VU meter and master gain control to the extreme right. To the left are the controls for the monitor gain, monitor selector and cue selector, and six lever keys for microphone and remote line selection. Because of the simplicity of design and functional styling, broadcasters have warmly endorsed the *Yard* as an "operating natural."

The Gates *Yard* Console is a complete eight mixing channel console of low silhouette design. This low height is particularly valuable when the console is located in the line of sight with programming functions. To complement the *Yard's* 8 mixing channels a complete amplifier system is supplied. Cue amplifier/speaker, 10 watt ultra linear monitoring amplifier, relay muting and fully regulated power

supply are included as standard equipment. Space is provided for 4 optional preamplifiers and 3 optional muting relays. This add-on versatility is especially useful for those broadcasters or recordists that require a full microphone complement.

INPUTS: Six microphones may be switched into 3 preamplifiers. Two remote and one network line key select to mixer number 8 with built-in isolation transformer. Mixers 4 thru 7 are for any medium level circuit such as turntables, tape, etc. Mixers 6 and 7 have cue feed to the inbuilt cue amplifier/speaker.

CUE AMPLIFIER: The cue speaker is incorporated in the hinged console lid. The output from remote lines and turntables (mixers 6 and 7) are switchable to the cue amplifier.

BOOSTER AMPLIFIER: A monitor booster amplifier is provided as standard equipment to allow switching the monitor amplifier from program to audition without volume level changes. The output of this amplifier is also brought to a pair of terminals for recording from the audition bus of the 8 mixer circuit.

MUTING RELAYS: Two muting relays are supplied as standard equipment to mute control room and one studio speaker plus operating warning lights. Additional space is also provided for 3 optional relays if needed.

V.U. METER: Four-inch illuminated scale "B" VU meter is provided and is flush mounted with front panel.

CONTROL CODING: Mixer knobs are supplied with varied color disc inserts to color code controls such as, red for turntables, green for studio A, etc.

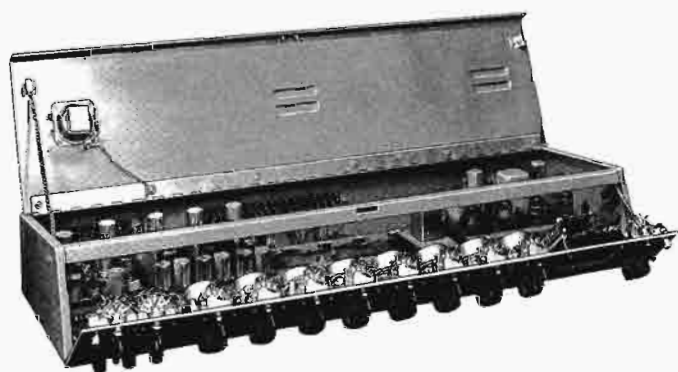

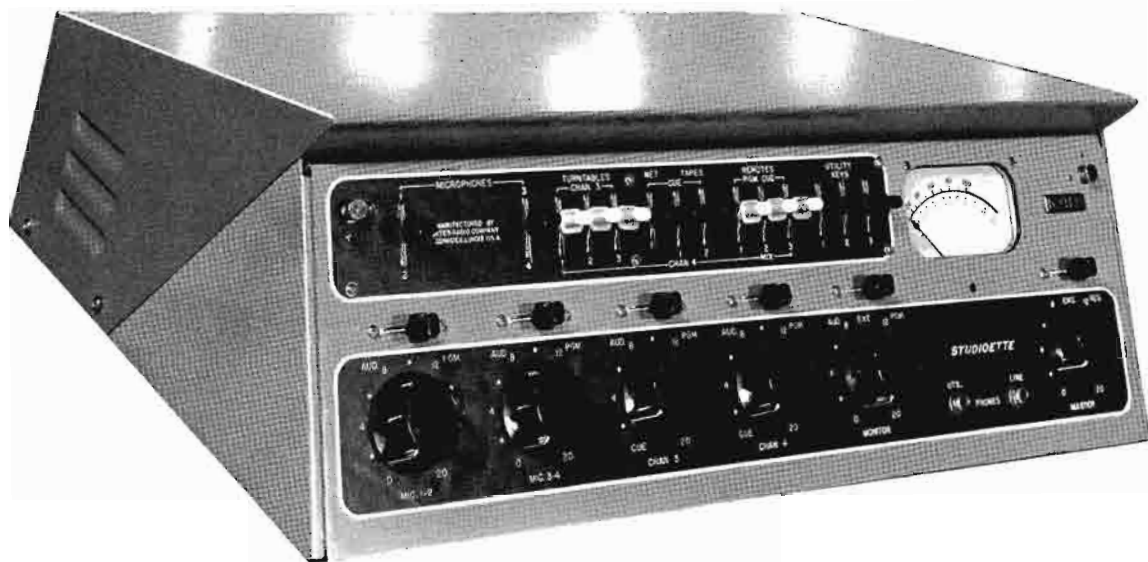

STUDIOETTE

The *Studioette* is a single channel monophonic console with 13 inputs into four mixing channels. It has found wide application as a main console in modest sized stations, as a sub-console for large installations or as a second console for independent programming or recording. The demand for an attractive, compact, large facility console has made the *Studioette* equally popular in mobile audio installations.

OPERATION: Completely self-contained including power supply, the *Studioette* provides 4 mixing channels with channel keys and a row of 14 tab keys for multiple circuit combinations. Three utility keys are provided for specialized station needs and may be wired into any input. Step type ladder mixing controls, illuminated 4" VU meter, the same quality amplifiers found on larger Gates consoles are all included in the *Studioette*.

Four microphones may be key selected into two preamplifiers. Three turntables, two tape/projectors, three remote lines and network are also accommodated. The 10 watt ultra linear monitoring amplifier is standard equipment. Dual muting relays handle speaker and warning light functions. Space is provided for a third (optional) preamplifier. The *Studioette* is indeed a functional all-purpose console proven by well over 1000 broadcasting and recording users around the world.

When mixing channels 3 and 4 are in cue position, they automatically connect to terminals from which a cueing amplifier may be fed. The Gates M-5377 cueing amplifier is ideal for this service (see Page 147). With this feature, all circuits feeding mixing channels 3 and 4 may be prechecked, including turntables, network, tape inputs and remote lines.

MONITOR BOOSTER: A two-stage amplifier is located between the audition bus of the mixer and input to the monitoring amplifier. This feature provides balanced level between the program and audition outputs so, when switch-

ing, there is no need for readjustment of gain settings.

RELAYS: Two relays are supplied for operating warning lights and muting loudspeakers. There is also space for two additional relays. These relays operate in conjunction with the microphone keys and nearly any muting arrangement is possible with this design.

ADDITIONAL FACILITIES: Additional facilities include an output emergency key for switching the program line to the monitoring amplifier output in case of a noisy tube, etc., in the program amplifier. A monitor selector key switches the monitoring amplifier input to: (1) program line for monitoring, (2) terminals for external monitor input, and (3) audition output of the mixing system. A headphone jack is always available across the program line. The 4" illuminated VU meter is flush mounted. This meter is connected to the program line to indicate +8 VU at 0 scale reading.

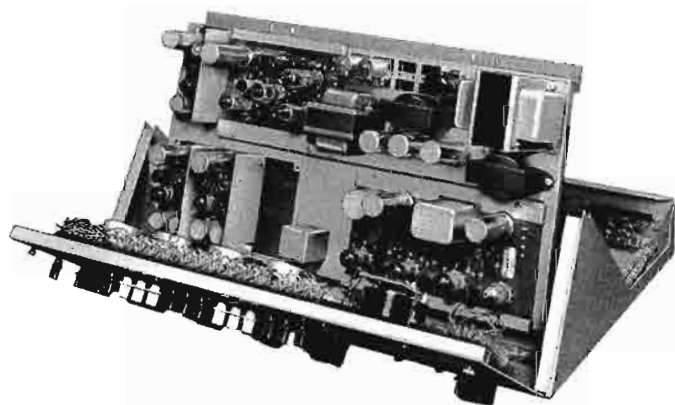

Studioette top cover is completely removed. Front panel hinges out to reach every "behind the panel" component. The amplifier deck hinges up so that muting relay contacts are at finger tip when touch-up burnishing is required.

SPECIFICATIONS

MIXING CHANNELS:

Total 4. Key selected to program or audition bus. Channels 1 and 2 for microphones, 3 and 4 for multi-input use such as turntables, tapes, etc. Cue position on faders 3 and 4.

AMPLIFIERS PROVIDED:

1 program, 1 monitor, 2 preamplifiers.

OPERATING MODE:

Single channel monaural.

INPUT CIRCUITS:

4 microphones, 3 turntables, 2 tapes or projectors, 3 remote lines, 1 network line. (1 external monitor amplifier input).

OUTPUT LINES:

1 program, 1 audition, 2 muted speaker, 1 non-muted speaker, 1 turntable cue, 1 remote/tape cue.

IMPEDANCES:

Microphones 30/50 or 150/250 ohms; turntable/tape 150/250 ohms unbalanced, remote lines 600 ohms, network 600 ohms. Programming output 600 ohms. Audition output 20,000 ohms. Monitor speakers 8/16 ohms. Note: Where more than two loudspeakers are used, the A-30601 speaker matching transformer should be used.

TUBES:

(9) EF86/6267, (3) 12AX7, (2) EL84, (2) OAT and (1 each) 12AU7, GZ34.

GAIN:

Turntable, tape, network (medium level) input to program line output 63 db; to monitor amplifier output 100 db. From microphone input to program line output 103 db; to monitor amplifier output 103 db. All measurements ± 2 db.

RESPONSE:

Program circuit $\pm 1\frac{1}{2}$ db. 30 to 15,000 cycles. Monitoring circuit ± 2 db. 30 to 15,000 cycles.

DISTORTION:

Program circuit 1% or less between 30-15,000 cycles at + 8 dbm. output level. Monitor amplifier 2% at + 40 dbm. which is 10 watts.

NOISE:

Program circuits: 70 db. or better below + 8 dbm. output, with - 50 db. input (equivalent noise input is - 120 dbm.). Monitor circuits: 55 db. below + 40 dbm. output. Crosstalk: all circuits below noise level with normal gain settings for proper programming.

POWER:

117 volts, 50/60 cycles, 1 phase. Power consumption 120 watts at 60 cycles.

CABINET DATA:

Size: 24" wide, 8 $\frac{1}{4}$ " high, 17" deep.
Finish: Panels, anodized black and gray.
Cabinet, medium gloss gray.

SHIPPING DATA:

Packed weight: (domestic) 70 lbs., (export) 110 lbs.
Cubage: 12.

OPTIONAL ACCESSORIES:

Space is provided to add 1 Model M5304A preamplifier and two AK-12626 muting relays.

ORDERING INFORMATION

Studioette Audio Console (Cat. No.) M-5381A
100% spare tube kit TK-440
Optional preamplifier M-5304A
Speaker matching transformer (see page 148) A-30601
Extra muting relay AK-12626

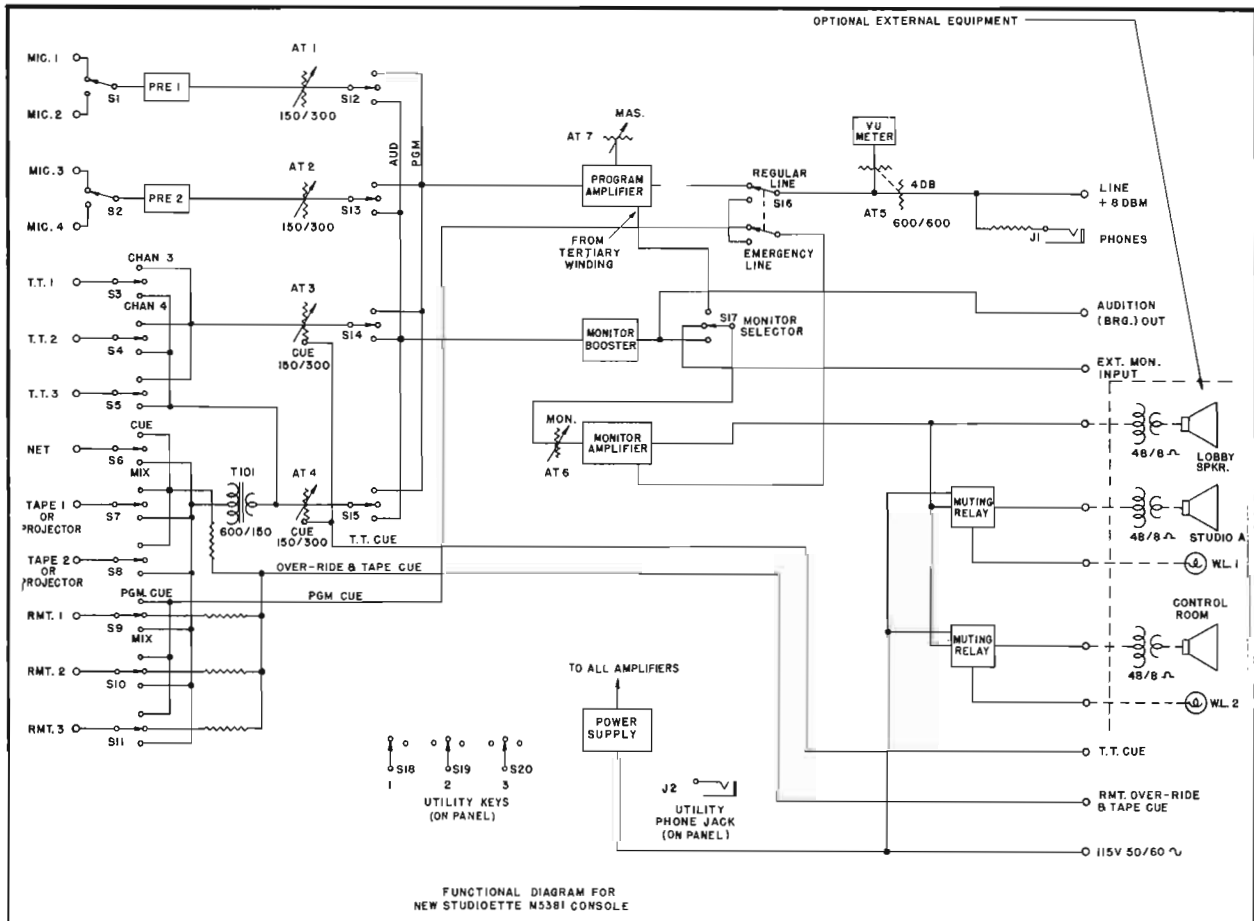

THE TV-10—TEN CHANNEL DUAL PROGRAMMING CONSOLE

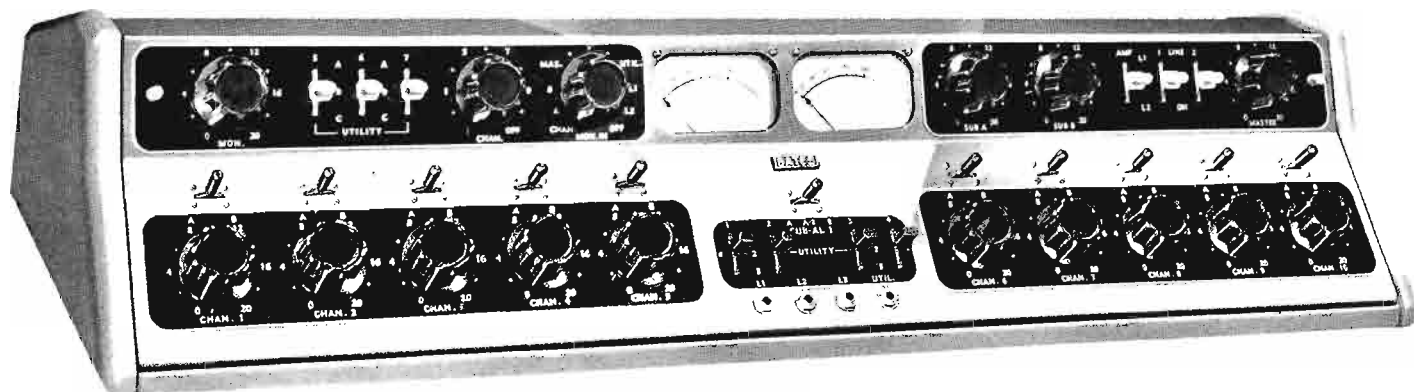

DESIGNED FOR TELEVISION

The Gates TV-10 console is actually two sizable consoles in one. Any combination of the 10 mixing channels may broadcast one program, and any second combination may be used for dual programming, recording or audition. For a large broadcast production, all 10 mixing channels may be used for one program. Ten microphones may be mixed simultaneously when the full complement of preamplifiers is installed.

Ten mixing channels are key selected into two program buses—each with its own program amplifier. Each program bus has its own submaster gain control, and any or all input channels may be switched to either of the two submasters and faded in and out as a group. Or, either submaster may be used simultaneously or individually with no switching required.

The TV-10 console contains six microphone preamplifiers as standard equipment, and four high level channels for turntables, tape devices, projectors, remote lines or network. Room is provided in the console for four additional M5304A preamplifiers where it is desired to have ten microphone channels.

EXTERNAL UNITS: Dual program amplifiers and power supply are on one rack mount 19" x 7" panel, 14" deep. Monitor amplifier, muting relays, and power supply are on second 19" x 7" rack panel and 8" deep.

UTILITY KEYS: As the input circuit functions vary widely from station to station, 7 unwired keys (3 top row and 4 center bottom row) with terminal board are supplied for the user's particular needs.

PATCH PANEL FACILITY: All major circuits are jumpered at a convenient terminal board for attachment to a patch panel if desired. As an example, all mixer inputs, program amplifier inputs, program amplifier outputs, plus several other circuits, may be normaled through a patch panel.

MUTING: Three relays are supplied to mute speakers and operate warning lights. These may be re-connected to mixer channel keys to suit muting requirements over the 10 mixing channels.

MONITOR SELECTOR: Two rotary switches permit selection of the monitor amplifier input independently to any of the 10 mixing channels, mixer buses A and B, program amplifier outputs A and B, combined A and B output, and 4 external inputs.

VU METERS: Each VU meter monitors the output of the two program amplifiers.

OTHER USES: Though designed for TV production, the TV-10 console is ideal for any major production speech input service, as demonstrated by the use of the TV-10 console in conjunction with the New York Metropolitan Opera.

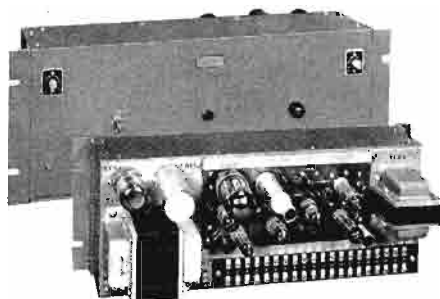

Dual plug-in program amplifiers and regulated power supply for TV-10 console. Standard rack mounting, 7" high, 14" deep.

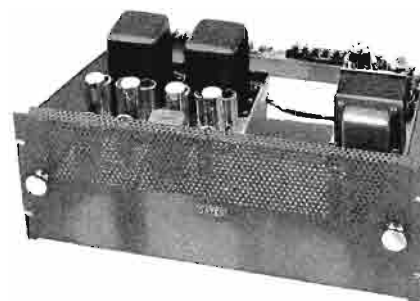

The TV-10—Ten Channel Dual Programming Console

SPECIFICATIONS

MIXING CHANNELS:

Total 10. As supplied: 6 for microphones and 4 for tape, turntables, projectors, and network. Space provided for 4 additional preamplifiers to equip all ten channels for microphones—if desired.

AMPLIFIERS PROVIDED:

2 program, 1 monitor, 6 preamplifiers, 2 booster.

OPERATING MODE:

Dual or single output monaural.

INPUT CIRCUITS:

6 for microphones, 4 turntables/tape/projector/network. Also, 7 un-wired utility keys permit 21 input circuits, as preferred by customer.

OUTPUT LINES:

3 program, 3 muted speaker, 1 un-muted speaker line, 4 headphones.

IMPEDANCES:

Microphones 30/50, 150/250 ohms. Turntable/tape, projector, network unbalanced 150/250 ohms. Programming output 600 ohms. Monitor amplifier output 8/16 ohms. NOTE: Where more than 2 speakers are to be used, the A-30601 speaker matching transformer, listed on Page 148, should be used.

TUBES:

(20) EF86/6267, (6) 12AU7, (2) 12AX7, (2) GZ-34, (2) 6080, (2) EL84 and (3) OA2.

GAIN:

Turntable, tape, network (high level) input to program line output 65 db. From microphone input to program line output 106 db. Monitor amplifier gain exceeds usable power output capability.

RESPONSE:

All segments of program circuit $\pm 1\frac{1}{2}$ db. 30-15,000 cycles. Monitoring circuit ± 2 db. 30-15,000 cycles.

DISTORTION:

Any segment of program circuit 0.5% or less between 50-15,000

cycles at + 18 dbm. output level or 1% 30-15,000 cycles at + 8 dbm. output. Monitor amplifier 1% at + 40 dbm. which is 10 watts.

NOISE:

Program circuits; 60 db. or better below + 8 dbm. output, with - 60 db. input (equivalent noise input is - 120 dbm.) . . . Monitor circuits; 60 db. below + 40 dbm. output. Crosstalk: all circuits below noise level with normal gain settings for proper programming.

POWER:

117 volts, 50/60 cycles, 1 phase. Power consumption 230 watts at 60 cycles.

CABINET DATA:

Size: (console) 39" wide, 7 $\frac{1}{2}$ " high, 15 $\frac{1}{2}$ " deep. (external) Rack space of 19" x 14" required. 14" deep. Finish: Two tone medium gloss gray with escutcheons in anodized black. Color decal insert kit provided for mixer knobs.

SHIPPING DATA:

Packed weight: Domestic—250 lbs. Export—320 lbs.

OPTIONAL ACCESSORIES:

Space is provided to add, when desired, 4 Model M5304A preamplifiers and 2 Model AK-12626 muting relays.

ORDERING INFORMATION

- TV-10 Audio Console complete (Cat. No.) M-5421B
- 100% spare tube kit TK-445
- Optional preamplifier M-5304A
- Speaker matching transformer (see page 148) A-30601
- Optional muting relay AK-12626

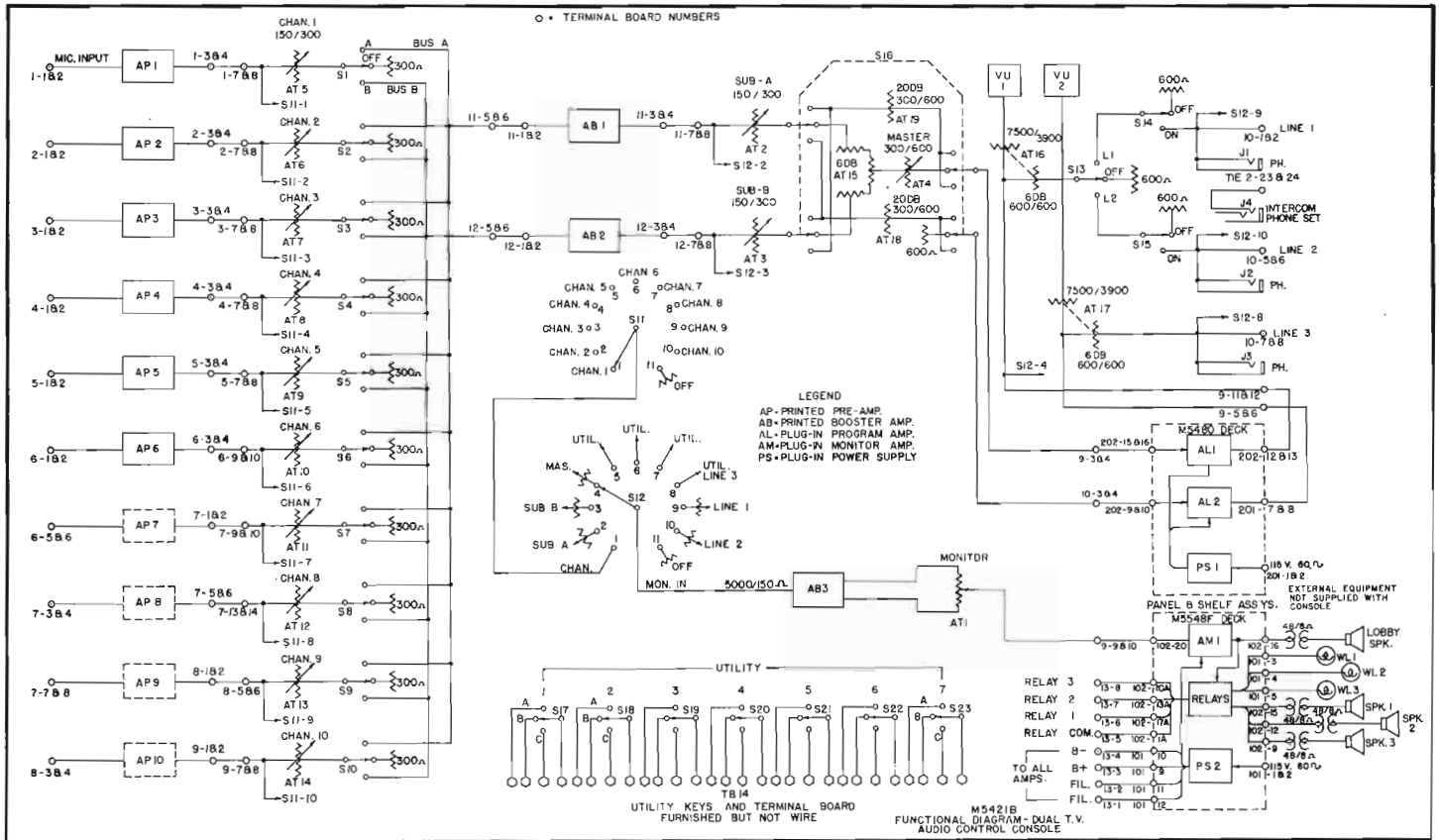

AUDIO INSTALLATIONS



CUSTOM AUDIO SYSTEM
VOICE OF AMERICA



"SOLID STATESMAN" STUDIO
ABC NEWS BUREAU, WASHINGTON, D.C.

THE DIPLOMAT CONSOLE
MUTUAL BROADCASTING SYSTEM
NEW YORK



From basic to complex studio or control requirements, Gates audio equipment is designed to the highest quality standards, with versatility to meet individual needs of stations and networks. In addition to the industry's largest selection of standard audio control consoles, Gates has the proven capability of designing and manufacturing complete speech input systems for any requirement.

TELEVISION AUDIO CONSOLE
CBS TELEVISION NETWORK
NEW YORK



Audio Installations



CUSTOM AUDIO SYSTEM
WXYZ-DETROIT
AMERICAN BROADCASTING COMPANY

The Gates experienced engineering staff understands the programming concepts of modern broadcasting. Installation photos on these pages illustrate how Gates standard and custom audio systems contribute to the total communication flexibility of a dynamic media. In planning new installations, assistance is available to every AM, FM, TV, educational or government agency upon request.



THE PRESIDENT CONSOLE
NEWS BUREAU, WASHINGTON, D.C.



WXYZ-DETROIT
AMERICAN BROADCASTING COMPANY

"CONTROL CENTER"
WASHINGTON, D.C.



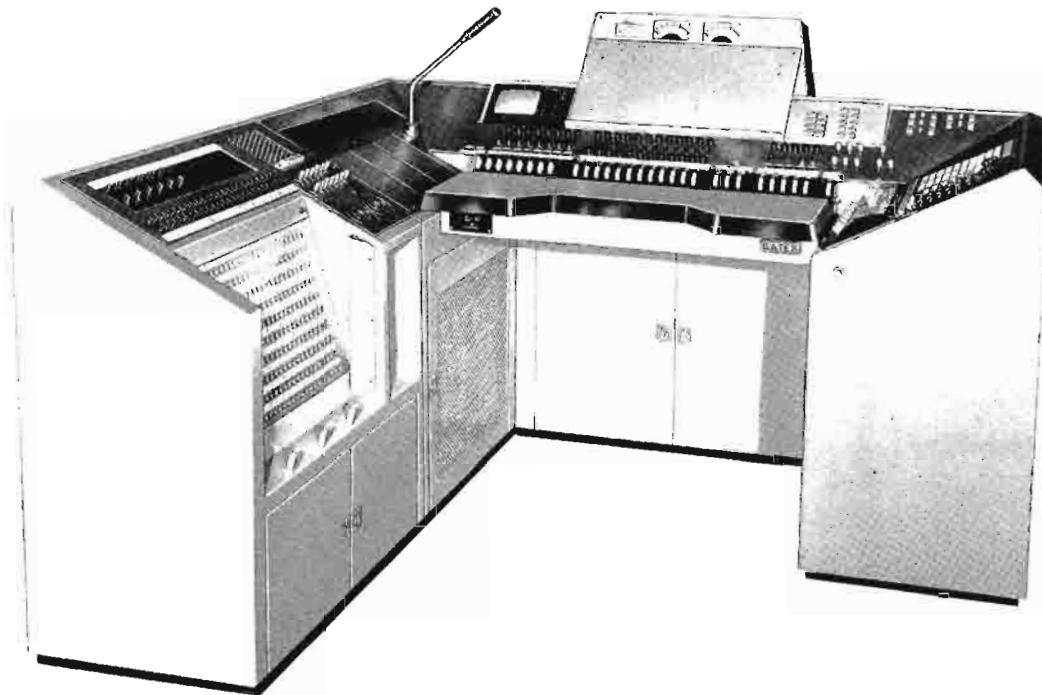

SPECIFICATIONS

Extensive facilities for a very wide range of television audio control situations are contained in the Gates M-6337 Console. It is unexcelled in audio fidelity, versatility, and operating features. Totally transistorized and completely self-contained, this unique system is capable of simultaneously mixing audio from more than 25 program sources directly into nine output channels. The M-6337 Console includes: a built-in video monitor; 10 audio monitoring channels; 12 microphone equalizers; 2 graphic program equalizers; 5 sound effects filters; 3, five-channel microphone sub-mixers; and vertical lever attenuators for almost every circuit level control. Key circuits are remotely actuated by DC-controlled microphone and master gain attenuators.

The console has an elaborate intercom section with provisions for two separate telephones and dials. Also provided is a 240 jack, patch panel.

Additional operation details of the M-6337 television production console are available upon request. Variations from the standard model are easily accomplished for specific individual engineering requirements.

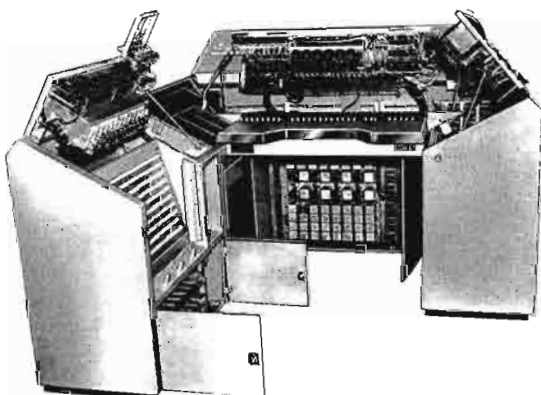

MIXING CHANNELS:

(Total 25), standard. 12 studio microphones, 1 announce booth, 1 sound effects, 1 reverberation return, 2 turntable/projector, 8 video tape recorders.

AMPLIFIER COMPLEMENT:

39, M-6313 Preamplifier.
9, M-6314 Program/AGC Amplifier.
9, M-6315 Monitor Amplifier
4, M-6338 Power Supply.
2, M-6339 Power Supply.
3, M-6340 Power Supply.

(See Page 125 for Specifications on these units).

OUTPUT CHANNELS:

(Total 9), 4 standard program, 1 utility, 1 reinforcement, 2 reverberation send, 1 pre-hear.

IMPEDANCES:

All circuits, 150 ohms.

GAIN:

Microphone input to program line output, 121 db.
To monitor output, 141 db.
High-level, (VTR) input to program line output, 43 db.
To monitor output, 63 db. All measurements ± 1 db.

RESPONSE:

All program circuits, ± 1 db., 30 to 16,000 cycles.
Monitoring circuits, ± 1 db., 30 to 16,000 cycles.

Note: Typical response, all circuits, ± 0.25 db. 20 to 20,000 cycles.

DISTORTION:

Any segment of program circuit, 0.5% or less from 30 to 15,000 cycles at + 32 dbm.
Monitor Amplifiers, 1% at + 40 dbm which is 10 watts.

Note: Typical distortion any channel, less than 0.25%.

NOISE:

- 121 dbm. relative input noise overall, Crosstalk: All circuits below noise level with normal gain settings. (30-16,000 cycles).

POWER:

117 volts, 50/60 cycles.

SIZE:

Overall: 69" wide, 70" deep, 43½" high.

ORDERING INFORMATION

Television Audio Control Console (Cat. No.) M-6337

PRECISION ENGINEERED

Today's program format places heavy reliance on transcribed music, commercials and prepared programs. A typical 18-hour broadcasting station will often have 12 hours or more of transcribed programming. The importance of quality and performance is far more important today than ever before. Recent advances in recording techniques have made new demands on reproducing equipment. Now, stereo broadcasting adds to these demands. Vertical rumble must now be as negligible as lateral rumble. Rumble is actually an industry coined word to define all unwanted mechanical noises in a transcription equipment that, if existing above a certain level, will be transmitted through the pickup cartridge in the form of objectionable noises.

To meet these necessary improved standards and the greater lasting ability required by increased usage, Gates designed two turntables in 12" and 16" sizes with an entirely new drive principle. The result is a new low in rumble content without sacrifice of quick cue and greatly improved reliability factor. As Gates turntables are a precision machined device, they are not the lowest in initial cost but are far less expensive on the basis of per-hour operating cost.

Heart of Gates turntable design is a drive hub which is part of the machine's turntable platter and about one-half the radius of a 45 RPM disc. The single idler wheel for all



speeds is floating and self-aligning. A 600 RPM hysteresis synchronous motor with 3-speed pulley engages the idler wheel to the inner hub. The combination of lower motor speed (one-third that of other models) and a drive section located inside the playing surface, results in remarkably low rumble, without sacrificing pickup-to-speed.

Speed change is exact and functionally correct. All three speeds shift across a single indexed plate. A mercury-type stop/start switch illuminates when on. The smooth felt platter surface offers slipcueing if desired. A captive pop-up spindle is provided for 45 RPM discs.



This cut-away illustration of a Gates turntable shows the fine machining and workmanship inherent in Gates 12 inch and 16 inch turntables.

Chrysler oilite bearings are used at all bearing points including the large center spindle bearing. Speed shift linkages are through monoball self-aligning bearings for smooth, silent and trouble-free operation. There are no belts, planetary drives or gear trains to wear.

Shift speeds to 78, 45 or 33½ RPM by simply moving shift lever to the desired index point. Then touch the mercury-type switch to either start or stop. Switch illuminates when on. Complete one-hand operation leaves the other hand free for cueing or control boards.

NEW DESIGN PRINCIPLE

OLD METHOD

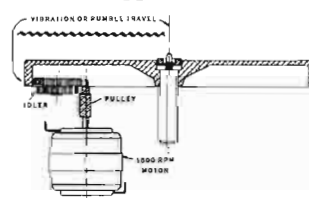

Rim drive turntables, as the word implies, drive against the outer rim of the platter. Vibration, commonly called rumble, is returned to the center spindle or bearing across the entire playing surface of the platter. This type drive usually requires an 1800 R.P.M. motor for proper speed ratios. The greater the motor speed, the greater the vibration. Likewise, higher motor speeds raise the audio frequency of this vibration or rumble.

NEW GATES METHOD

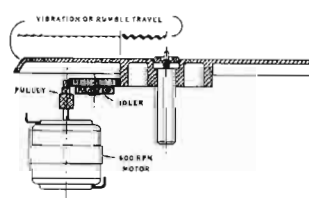

In both the 12 and 16 inch Gates turntables, the drive is against a solid inner hub, away from the usable playing surface of the platter. Likewise, any minute vibration or rumble is pushing against the center bearing instead of pulling away as in outer rim drive turntables. With this exclusive drive system, a 600 R.P.M. hysteresis synchronous motor is used. Lower motor speed assures lower vibration or rumble. The lower speed substantially drops the audio frequency of this much lower motor vibration to where nearly all of the rumble is in the subaudible spectrum.

16" TURNTABLE SERIES

GENERAL: The Gates CB-500 is the most widely used 16 inch turntable in the broadcasting industry. Thousands are in use worldwide.

Designed for continuous 24-hour commercial service, the CB-500 is ruggedly constructed to meet the strain of modern control room operation.

Time proven features include heavy machined aluminum platter, rubber shock mounted cast aluminum chassis, "oilite" hub bearings, self-centering neoprene idler wheel, "monoball" self-aligning speed shift bearing, and a functional speed selector mechanism.

This turntable will come up to speed at 33 $\frac{1}{3}$ RPM in $\frac{1}{8}$ turn, and at 45 RPM in $\frac{1}{6}$ turn for fast-up to speed cueing. Model CB-500 is a 16-inch chassis only, without reproducing equipment.

FULLY EQUIPPED: CB-510 complete operation transcription turntable includes CB-500 low noise chassis with synchronous motor, GRAY 208-S/G viscous damped pickup arm, twin turn-around 1 mil and 3 mil variable-reluctance cartridge, 2-position equalizer to

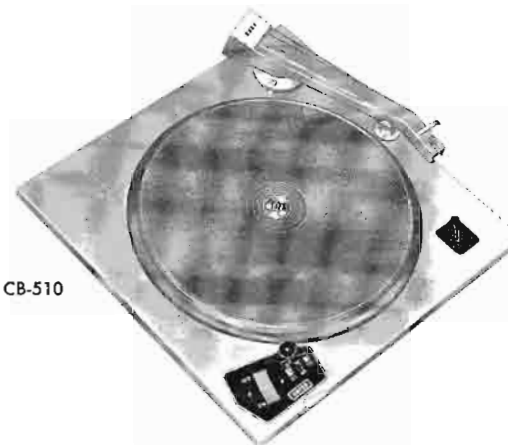

CB-510

NAB/RIAA and high frequency roll off curves and M-6244 transistorized preamplifier with self-contained power supply. Output: 150 or 600 ohms adjustable from - 22 dbm. to - 12 dbm. Will superbly reproduce all monaural recordings to mixer level without additional preamplification.

SPECIFICATIONS

CHASSIS SIZE: 21 $\frac{1}{4}$ " x 21 $\frac{1}{4}$ " x 1 5/16". **MOTOR HANG BELOW BOTTOM OF CHASSIS:** 4 $\frac{3}{4}$ ". **CONSTRUCTION:** Both platter and base of machined aluminum. **FINISH:** Gray enamel with escutcheon in black and turntable platter cover in heavy green felt. **PLATTER SIZE:** 17". **STROBOSCOPE:** Inbuilt on platter for all 3 speeds. **CENTER SPINDLE:** Spring locking type, snaps up for 45 RPM hub, locks down for smaller spindle records. **CENTER BEARING:** 1" diameter hardened steel rotates in Chrysler oilite bearing. **MOTOR:** Hysteresis synchronous, single phase, 600 RPM with 2 mfd. running capacitor and 40°C temperature rise. **CUE ALLOWANCE:** At 33 $\frac{1}{3}$ RPM. $\frac{1}{8}$ turn. At 45 RPM. $\frac{1}{6}$ turn. At 78 RPM. $\frac{3}{8}$ turn. **NOISE OR**

RUMBLE: At 33 $\frac{1}{3}$ RPM, rated - 45 db. At 45 RPM, rated - 40 db. At 78 RPM, rated - 35 db. **WOW:** Rated 0.1% at 33 $\frac{1}{3}$ RPM, capable .08%. **FLUTTER:** Rated 0.07 at 33 $\frac{1}{3}$ RPM, capable .05%. **MOTOR START:** Rocker type mercury switch. Push front for "ON" and back for "OFF." Switch illuminates when on. **IDLER WHEEL:** Special shear action neoprene, self-aligning. **SPEED CHANGE:** To 33 $\frac{1}{3}$, 45 or 78 RPM by single indexed lever control. **POWER:** 117 volts, 60 cycles, 35 watts. (50 cycles available.) **SHIPPING WEIGHT & CUBAGE:** Basic turntable, 45 lbs. (net weight, 34 lbs.). Export, 70 lbs. 6 cu. ft.

12" TURNTABLE SERIES

GENERAL: Here are professional 12-inch transcription turntables, built identically to the companion 16-inch models. In the new CB-77 chassis will be found the same inner hub drive system, the same speed change system, the same rocker arm, illuminated off-on switch . . . the only difference being reduced size, affording broadcasters a more compact turntable arrangement in today's busy control room.

Model CB-77 is the 12" chassis only, ready to attach pickup arm of your choice. For 33 $\frac{1}{3}$, 45 and 78 RPM speeds. Hysteresis synchronous motor.

FULLY EQUIPPED: CB-88 complete ready-to-operate 12" turntable assembly. Includes CB-77 12" chassis, M-6244 transistor preamplifier, dual viscous damped Gray arm, twin turnaround 1 mil and 2 $\frac{1}{2}$ mil styli, variable reluctance cartridge with your choice



CB-88

of sapphire or diamond styli, 2-position equalizer to NAB/RIAA and high frequency roll-off curves and self-contained power supply (part of preamplifier). Will superbly reproduce all monaural recordings to mixer level without additional preamplification.

SPECIFICATIONS

CHASSIS SIZE: 16" x 16" x 1 5/16". **MOTOR HANG BELOW BOTTOM OF CHASSIS:** 5 $\frac{3}{4}$ ". **CONSTRUCTION:** Both platter and base of machined aluminum. **FINISH:** Gray enamel with escutcheon in black and turntable platter cover in heavy green felt. **PLATTER SIZE:** 13 $\frac{3}{8}$ ". **STROBOSCOPE:** Inbuilt on platter for all 3 speeds. **CENTER SPINDLE:** Spring locking type, snaps up for 45 RPM hub, locks down for smaller spindle records. **CENTER BEARING:** 1" diameter hardened steel rotates in Chrysler oilite bearing. **MOTOR:** Hysteresis synchronous, single phase, 600 RPM with 2 mfd. running capacitor and 40°C temperature rise. **CUE ALLOWANCE:** At

33 $\frac{1}{3}$ RPM, $\frac{1}{8}$ turn. At 45 RPM, $\frac{1}{6}$ turn. At 78 RPM, $\frac{3}{8}$ turn. **NOISE OR RUMBLE:** At 33 $\frac{1}{3}$ RPM, rated - 45 db., at 45 RPM, rated - 40 db. at 78 RPM, rated - 35 db. **WOW:** 0.1% maximum, capable .08%. **FLUTTER:** .07% maximum .05%. **MOTOR START:** Rocker type mercury switch. Push front for "ON" and back for "OFF." Switch illuminates when on. **IDLER WHEEL:** Special shear action neoprene, self-aligning. **SPEED CHANGE:** To 33 $\frac{1}{3}$, 45 or 78 RPM by single indexed lever control. **POWER:** 117 volts, 60 cycles, 35 watts. (50 cycle model available, see below.) **SHIPPING WEIGHT:** 40 lbs. (net weight, 30 lbs.). Export packed 65 lbs.



CB-1525

COMPLETE 16" SYSTEM

COMPLETE 16" SYSTEM: A complete transcription system, including CB-510 turntable with an attractive M-6448A floor cabinet. Beautiful Walnut Formica styling and 28" over-all height meets NAB standard for reproduction equipment. M-6448A cabinet has adjustable leveling screws, removable grill for record storage or rack-mounting control room equipment, (see page 113). Size 24" x 24" x 26", (plus 2" to platter surface). Shipping weight, 124 lbs.

ORDERING INFORMATION

- 16-inch transcription turntable chassis only, 60 cycles (Cat. No.) CB-500
 - Complete 16-inch transcription equipment including turntable, self-contained preamplifier, power supply, 2-position equalizer, pickup arm and dual sapphire styli CB-510
 - Complete transcription equipment as above, but with dual-diamond styli CB-510A
 - Complete 16" transcription equipment in floor cabinet; consisting of CB-510 equipment and M-6448A cabinet CB-1525
 - Complete transcription equipment in cabinet, consisting of CB-510A equipment and M-6448A cabinet CB-1525A
 - Floor cabinet only with cutout for CB-500 Chassis M-6448A
 - Step-down transformer, primary 230 V, 50/60 cycles, secondary 115 volts M-5830
- (NOTE: Any of above turntables available in 50 cycle models when specified.)

STEREO . . .



STEREO TURNTABLE EQUIPMENT

Superbly reproduces stereo and monaural recordings and many broadcasters, now monaural but having stereo in their future, will desire this transcription turntable. Likewise, stereo and monaural record libraries need not be separate if all turntables are stereo. Includes CB-77 low rumble chassis with Gray 212-TN viscous-damped transcription arm, M44-7 stereo dynetic cartridge with diamond stylus and the new Gates M-6442 compatible stereo-monaural preamplifier with self-contained power supply. Switching from monaural to stereo is by one switch. RIAA/NAB, flat and roll off curves are rotary switch selected. See Page 115 for further detail on the pre-amplifier and pickup units used herein.

ORDERING INFORMATION

- Complete Stereo Turntable equipment with diamond stylus and M-6448B cabinet M-6465
- Stereo equipment, same as above but less floor cabinet M-6143A



CB-1880

COMPLETE 12" SYSTEM

COMPLETE 12" SYSTEM: This complete 12" transcription unit consists of CB-88 equipment housed in the functionally attractive M-6448B floor cabinet. Beautifully styled in walnut and neutral tone formica. Accents in satin black, including expanded metal grill which is removable to reveal 16" standard rack mounting angles. Size: 24" x 24" x 26", (plus 2" to platter surface). Shipping weight 110 lbs.

ORDERING INFORMATION

- 12-inch transcription turntable chassis only, 60 cycle (Cat. No.) CB-77
 - CB-88, complete 12-inch transcription equipment including turntable, self-contained preamplifier, power supply, 2-position equalizer, pickup arm and dual sapphire styli M-5890
 - CB-88A, complete transcription equipment as above, but with dual-diamond styli M-5890A
 - Complete 12" transcription equipment in floor cabinet, consisting of CB-88 equipment and M-6448A cabinet CB-1880
 - Complete transcription equipment in cabinet consisting of CB-88A (diamond styli) and M-6448B cabinet CB-1880A
 - Floor cabinet only with cutout for CB-77 chassis M-6448B
 - Floor cabinet only, less cut-out M-6448
- (NOTE: Any of above systems available in 50 cycle models when specified.)



DOUBLE TURNTABLE CABINET

Beautifully styled, and dimensioned to accommodate either twelve- or sixteen-inch Gates Turntables. See page 116 for complete specifications of the M-6449 dual turntable pedestal. Size 24" x 46" x 26".

ORDERING INFORMATION

- Dual Turntable Cabinet, with cutouts for two CB-77 or CB-88 equipments (Cat. No.) M-6449B
- Dual Turntable Cabinet, with cutouts for two CB-500 or CB-525 equipments M-6449A



16" TRANSCRIPTION ARM

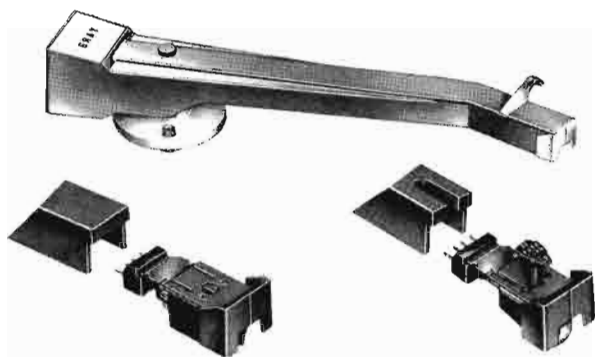

A fine 16" professional tone are available in two models. The model 208-S comes with a slide and modular weights for mounting single play stereo or monophonic cartridges.

The model 208-S/G has a special slot cut into the front of the arm to clear the stem of a G.E. turn-around cartridge allowing plug-in operation, and comes with specific hardware for this application. For 16" turntables only, such as CB-500 chassis. Made by Gray.

Gray viscous-damped arm Model 208-S
 Gray viscous-damped arm for turn-around cartridge Model 208-S/G

12" TRANSCRIPTION ARM

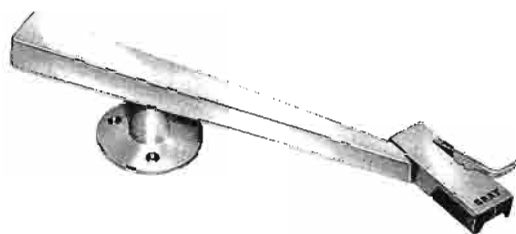

This new micro-balanced tone arm has sealed viscous-damping on both vertical and horizontal axis for better tracking and lower resonance. It is statically balanced around the vertical pivot, providing maximum tracking stability. Designed for records up to 12 inches in diameter. Stylus force adjustable from zero to 15 grams, thus eliminating cartridge weights. Can be used with all popular stereo or monaural cartridges. Use with 12" turntables only, such as CB-77 chassis.

Gray viscous-damped arm (Cat. No.) 212-TN

OMNI-BALANCED TRANSCRIPTION ARMS

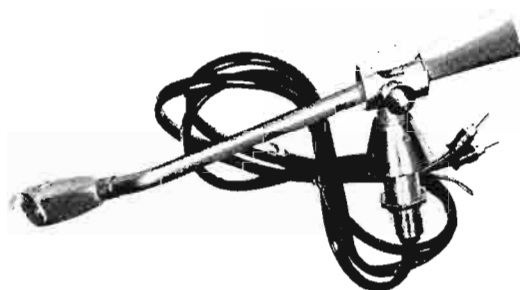

For broadcast and other applications where a dynamically-balanced, non-viscous tone arm is preferred. Has exclusive "Omni-Balance" to ensure exact lateral balance. Isolated counterweight. Single-hole mounting. Mounts all popular monaural and stereo cartridges.

Omni-Balance tone arm for 12" turntables S-320
 Omni-Balance tone arm for 16" turntables S-260

PICKUP EQUALIZER



Four-position monophonic equalizer for use with low impedance pickup cartridges. Includes switching provision for two separate tone arms and equalization settings for 78 RPM, LP, noisy and dull sounding records. Use with low impedance cartridges only. Output impedance 150/250 ohms. Gates M-5530 (tube-type) preamplifier, or M-6431 (transistorized) single channel amplifier are ideal companion units. See pages 142,134. Made by Gray.

Equalizer complete (Cat. No.) 602-C

CONVENTIONAL TURNTABLE CABINETS

Where Gates turntables are purchased to augment existing control room equipment, conventional CAB-6 (sixteen-inch) and CAB-8 (twelve-inch) floor cabinets are available. Leveling screws provided and has full size back door.

MODEL CAB-6: Designed for CB-500 chassis. Birch wood finished in gray with black trim. Size: 21 1/4" x 21 1/4" x 30".

Turntable Cabinet M-5269

MODEL CAB-8: Designed for the 12-inch CB-77 chassis. Steel construction with finish in gray and black. Size: 16 1/8" x 16 1/8" x 30".

Turntable Cabinet M-5937



For information on other Gates audio cabinets see pages 116, 117. For preamplifiers, see page 115. For cueing amplifier, see page 147. For pickup cartridges, see page 115.

TURNTABLE PREAMPLIFIERS AND PICKUPS

MONOPHONIC



A single channel monophonic preamplifier designed for use in broadcasting, recording, and general sound requirements where low distortion and exacting frequency response characteristics are demanded. Features self-contained power supply and transformer output. Includes two-position equalizer with escutcheon and knob for RIAA/NAB or Rolloff equalization.

SPECIFICATIONS

INPUT: 47,000 ohms or with M44-7 stereo cartridge listed below. **OUTPUT LEVEL:** Adjustable from - 22 dbm. to + 12 dbm. from 8 MV input. **RESPONSE:** Within ± 1 db. of RIAA/NAB standard curve. Additional high frequency roll-off and flat response position switch selected. **DISTORTION:** Less than 0.5% at normal level (- 22 to + 12 dbm. out). Less than 1.0% at 10 db. overload (above 8 MV input). **NOISE:** 60 db. or lower, with - 63 dbm. input. (123 db. relative input noise). **LOAD IMPEDANCE:** 600 ohms or 150 ohms, balanced or unbalanced. **MAXIMUM OPERATING AMBIENT TEMP.:** + 60°C (+ 140°F). **POWER:** 117 volts, 50/60 cps. 1 watt. **MOUNTING:** Two holes for mounting with Gates Turntable or inside any cabinet. May be mounted in any position. **SIZE:** 3" wide, 9½" long, 5" high. **WEIGHT:** Net 2 lbs. Packed 8 lbs. Cubage: 1.

ORDERING INFORMATION

Stereophonic Transistor Equalizer Turntable Preamplifier M-6442

SPECIFICATIONS

INPUT: 6200 ohms, use with high impedance cartridges (see below). **OUTPUT:** Adjustable from - 22 dbm. to + 12 dbm., with 12 MV input. **RESPONSE:** Within ± 1 db. of RIAA/NAB standard curve. Additional high frequency roll-off filter position provided. **DISTORTION:** Less than 0.5% at normal levels (- 22 to + 12 dbm. out). Less than 1.0% at 10 db. overload (above 12 MV input). **NOISE:** 58 db. or lower, below - 12 dbm. output (with 12 MV input). **LOAD IMPEDANCE:** 600 ohms or 150 ohms balanced or unbalanced. **MAXIMUM OPERATING AMBIENT TEMP.:** + 60°C (+ 140°F). **POWER:** 115 volts, 50/60 cps. 1 watt. **MOUNTING:** Two holes for mounting to Gates Turntable or inside of any cabinet. May be mounted in any position. **SIZE:** 2 9/16" wide, 8 3/8" long, 2 7/8" high. **WEIGHT & CUBAGE:** Net 1 1/4 lbs. Packed 8 lbs. Cubage: 1.

ORDERING INFORMATION

Monophonic Transistor Equalizer Turntable Preamplifier .. (Cat. No.) M-6244

STEREOPHONIC



Designed for superior performance in stereophonic transcription systems, the M-6442 offers these new features: Three position response selector switch for flat, RIAA/NAB, and roll-off equalization; plus a two position switch to provide a monophonic output from stereo discs, important in many AM/FM and special library situations. Fully shielded, and completely self-contained, including power supply. The M-6442 input impedance of 47,000 ohms makes it compatible with virtually all magnetic stereo cartridges.

MONOPHONIC PICKUPS

Proven, rugged broadcast transcription cartridges for monophonic recordings. Response 20-20,000 cycles with output of 12 MV @ 7 CM/Sec. Tracking pressure 4 grams. Have replaceable clip-in styli. Use high impedance type with M-6244 equalized preamplifier, low impedance with Gray 602-C type passive equalizer.

GE TYPE VR-11 PICKUP

| | |
|---|----------|
| High Impedance VR-11 Triple Play (turnover cartridge) | Cat. No. |
| Sapphire .001" and sapphire .003" | 4G050 |
| Diamond .001" and sapphire .003" | 4G052 |
| Diamond .001" and diamond .003" | 4G053 |

| | |
|--|------------|
| Low Impedance VR-11 Triple Play (turnover cartridge) | |
| Sapphire .001" and sapphire .0025" | 4GD-01S02S |
| Diamond .001" and sapphire .0025" | 4GD-01D02S |
| Diamond .001" and diamond .0025" | 4GD-01D02D |

| | |
|------------------------------------|--------|
| High Impedance Single Stylus VR-11 | |
| Sapphire .003" | 4G-040 |
| Sapphire .001" | 4G-041 |
| Diamond .001" | 4G-061 |
| Diamond .003" | 4G-063 |

| | |
|-----------------------------------|---------|
| Low Impedance VR-11 Single Stylus | |
| Diamond .001" | 4GS-01D |
| Diamond .0025" | 4GS-02D |
| Sapphire .001" | 4GS-01S |
| Sapphire .0025" | 4GS-02S |

Replacement Styli for VR-11

| | | | |
|-----------------------|--------|----------------------|--------|
| Sapphire .001" | 4G-01S | Diamond .001" | 4G-01D |
| Sapphire .0025" | 4G-02S | Diamond .0025" | 4G-02D |
| Sapphire .003" | 4G-03S | Diamond .003" | 4G-03D |

STEREOPHONIC PICKUP

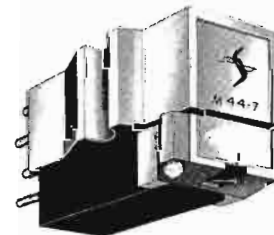

The Model M44-7 stereo dynamic cartridge is recommended for faithful reproduction of stereophonic recordings with the M-6442 preamplifier. It offers superior stereo separation, smoother response, and is designed to complement the 15° effective cutting angle now being used on stereo disc recordings. It has exceptional ease in changing stylus assembly. Being completely compatible, the M44-7 plays both stereo and monaural recordings with full studio realism.

SPECIFICATIONS

FREQUENCY RESPONSE: From 20 to 20,000 cps. **CHANNEL SEPARATION:** More than 25 db. @ 1,000 cps. **OUTPUT VOLTAGE:** 9 millivolts per channel @ 5 CM/Sec. **LOAD IMPEDANCE:** 47,000 ohms per channel. **TRACKING:** 1.5 to 3.0 grams. **STYLUS:** Features "No Scratch" retractable design. **INDUCTANCE:** 680 Millihenries. **D.C. RESISTANCE:** 650 ohms. **MOUNTING:** Std. ½" mounting center. **WEIGHT:** 7 grams, net.

ORDERING INFORMATION

M44-7 Stereophonic cartridge with 0.7 mil. diamond stylus 723-0236
Replacement 0.7 mil stereo stylus (diamond) 723-0237



MODULAR AUDIO EQUIPMENT CABINETS

The fullest flexibility of custom cabinetry with the economy of standard production units combine to offer broadcasters a totally new and modern concept in control room desks. Beautifully styled in walnut grain and textured Formica, these desks have the appearance of fine furniture, but with strength and durability to last for years.

"Building blocks" of single-width pedestal, double pedestal, uniform top section, plus two decorator leg sections can be assembled in dozens of configurations. Pedestal base sections have removable grill front and cabinet-finish rear doors to reveal standard 19" rack mounting rails. Cartridge tape equipment, levelling amplifiers, jack fields, etc., may be mounted for operator convenience. The interior of each cabinet is also finished, so cabinets may be used for disc or tape storage by removing the panels entirely.

When used with turntables, the pedestals conform to NAB standards for transcription cabinets. For console wiring, a cable trough is concealed under the top section, near the rear.

The "horse-shoe" or "combo" configuration shown provides an attractive and functional control center in keeping with the aesthetic beauty of modern communications equipment.

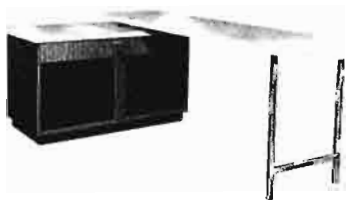

Construction of the M-6450 uniform top section is of durable 3/4" base material, laminated with neutral finish Formica. A steel cable trough runs the length of the top for easy and neat console installations. Steel mounting brackets elevate the top section, 4 inches from the side pedestals for very modern appearance yet retaining commercial conservatism. Shown above is a single-wing configuration, utilizing a top section, double pedestal and double leg section.

NEW FLEXIBLE STYLING

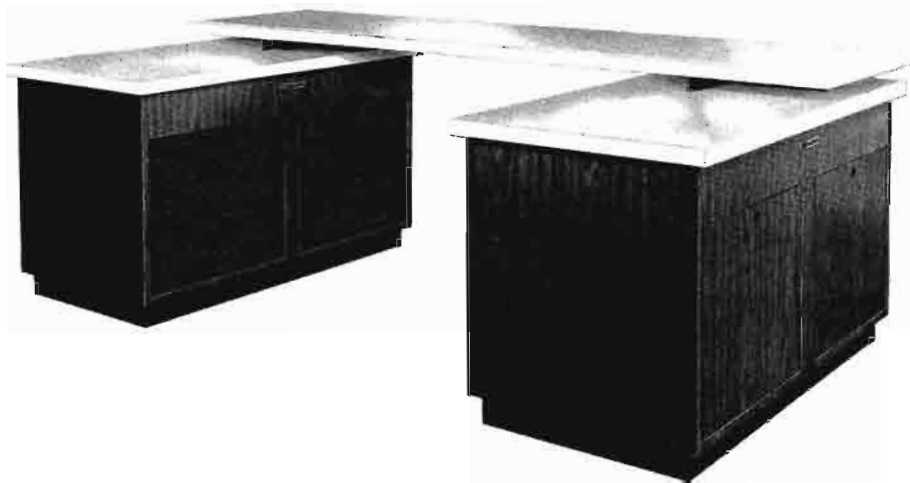

"Combo" Desk consisting of an M-6450 Top Section and two, M-6449 Double Pedestals.

Many interesting variations in control room desks are "tailor-made" for specific station operations. Shown below, the single pedestal serving as a right-hand desk base, may also provide rack space for cartridge, reel-to-reel recorder or storage. All pedestals have sturdy black steel bases with leveling feet. Each expanded metal grill or finished access door removes to reveal 16" of standard 19" rack space. Double and single leg assemblies are of sturdy 1" satin chrome, square steel tubing with leveling feet.

Both 12" and 16" Gates turntables and all types of speech input consoles may be used with these cabinets.



SPECIFICATIONS



SINGLE PEDESTAL, M-6448

Mounts one 12" or 16" turntable. 16" rack mount space front with expanded metal grill. 16" rack mount space rear with wood-grain door. Constructed of 3/4" solid Flake board, laminated with Formica. Furnished with 2 1/2" steel base and floor levelers.

FINISH:

Walnut. Top in Champagne and trim in Satin Black.

SIZE: Height 26", Width 23", Depth 23".

WEIGHT: Net, 60 lbs.; Packed, 70 lbs.

CUBAGE: 12.



DOUBLE PEDESTAL, M-6449

Mounts two 12" or 16" turntables. Total of 64" of 19" rack mount space available front and back both sections. 3/4" Flake board with Formica laminate. 2 1/2" steel base and floor levelers.

FINISH: Walnut. Top in Champagne and trim in Satin Black.

SIZE: Height 26"; Width 45"; Depth 23".

WEIGHT: Net, 108 lbs.; Packed, 140 lbs.

CUBAGE: 18.



DOUBLE LEG, M-6456

For supporting top section. Square, 1" steel welded construction with cross-brace. Complete with mounting flanges and floor levelers.

FINISH: Satin Chrome Steel.

SIZE: 1" x 1" x 28", overall width 21".

WEIGHT: Packed, 10 lbs.

CUBAGE: 2.

SINGLE LEG, M-6455

Mounts beneath desk top section. Square, 1" steel tubing with mounting flange and floor leveler.

FINISH: Satin Chrome Steel.

SIZE: 1 x 1 x 28".

WEIGHT: Packed, 5 lbs.

CUBAGE: 1.

TOP SECTION, M-6450

Complete with wiring trough, and angle brackets for assembly with pedestals or legs. When assembled, desk surface is 29" from floor.

FINISH: Neutral Champagne Formica.

SIZE: Length 84"; Depth 29"; Thickness 1 5/16".

(Other lengths on special order).

WEIGHT: Net 55 lbs.; Packed, 70 lbs.

CUBAGE: 7.5.

Modular Audio Equipment Cabinets

A VARIETY OF COMBINATIONS

A few of the many variations and combinations of Gates modular cabinets are shown below. These examples serve to suggest how a modular system may be assembled to fit specific equipment requirements.



1—M-6449 Dual Pedestal
1—M-6450 Top
1—M-6456 Double Leg
1—M-6455 Single Leg



M-6454 "Combo" Desk Complete:
2—M-6449 Dual Pedestal
1—M-6450 Top

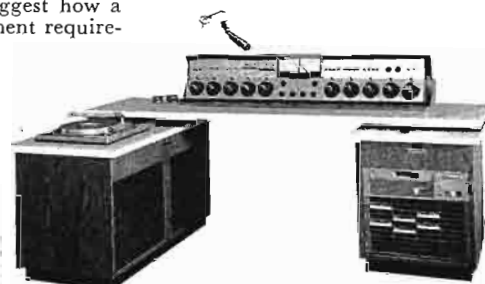

1—M-6449 Dual Pedestal
1—M-6450 Top
1—M-6448 Single Pedestal



M-6449
Double turntable pedestal



M-6448
Single turntable pedestal

ORDERING INFORMATION

| | |
|--|----------------------|
| Single Turntable Pedestal, complete | (Catalog No.) M-6448 |
| Double Turntable Pedestal, complete | M-6449 |
| Uniform top section, complete with mounting angles & cable trough | M-6450 |
| Single leg assembly | M-6455 |
| Double leg assembly | M-6456 |
| Combo desk system, complete with 2 double pedestals and top section | M-6454 |

METAL GRILL REPLACEMENTS: Where the expanded metal grill used on cabinet fronts, such as the M6448 or M6449, is to be eliminated in part,

for rack mounted items, other size grills are listed below to fill the unused portion. Example, full grill is 16" high. If 5 1/4" rack space used, order M6453B to fill remaining space.

| | |
|------------------------------|---------|
| Grill 10 1/2" high | M-6453B |
| Grill 5 1/4" high | M-6453C |
| Grill 3 1/2" high | M-6453D |

NOTE: Cabinets normally supplied less cut-outs for turntables. If cut-outs desired, a slight added cost is involved. Please send template if not a Gates turntable.

FUNCTIONAL CONTROL DESKS



CB-4 Horseshoe Desk.

SPECIFICATIONS

CONSTRUCTION: Seasoned 7-ply birch plywood with black linoleum top and gray lacquer base. End wings each 22 1/2" wide, 25" high, 45" deep. Wings have removable rear door and hinged front door with width to accommodate 19" rack panel equipment.

FINISH: Medium gray lacquer. Black top. Chrome trim.

SIZE: Height 29"; Width 84"; Depth 48".

WEIGHT: Packed, 390 lbs.

CUBAGE: 120 ft.

Horseshoe Desk (Cat. No.) CB-4



SPECIFICATIONS

CONSTRUCTION: 16 gauge steel back and sides, plywood/micarta top.

FINISH: Medium Gray w/Charcoal gray top.

SIZE: M-5371—39 1/2" wide, 30" deep; 29" high.
M-5372—47" wide; 30" deep; 29" high.

WEIGHT: M-5371—Net, 60 lbs., Packed, 70 lbs.
M-5372—Net, 65 lbs., Packed, 75 lbs.

CUBAGE: M-5371—4.5.
M-5372—5.

Functional Control Desks, (Standard) M-5371
(Large) M-5372

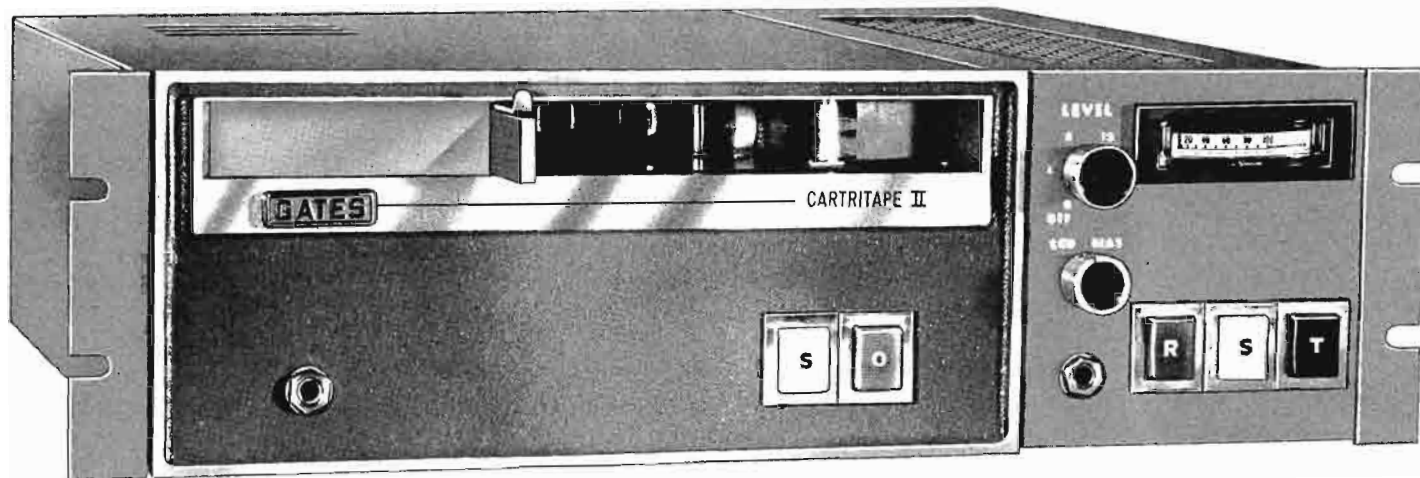

Monaural record/playback unit shown with 19" rack adapters.

CARTRITAPE II

Gates advanced design *Carritape II* is a truly professional cartridge tape system designed to conform fully with all NAB standards, and with many added features for convenience, quality and dependability. Models are available for recording and playback in both stereo or monaural with 1, 2 or 3 cue-tone automated programming.

BASIC RECORD PLAYBACK SYSTEM: The basic system shown above consists of modular playback and record units. These two units have a combined size of 17" wide, 5 1/4" high and 16 1/2" deep. Standard with the basic system are adaptors for 19" rack mounting and rubber feet for desk mounting. Receptacles for plug-in amplifiers for 1, 2 or 3 tone and stereo operation are provided. It should be noted that the basic system is single tone and the broadcaster need not procure more facilities than he actually wants. Order only the amplifiers needed. The system can be increased any time the user desires additional automated programming.

PLAYBACK UNIT: Modular plug-in construction and transistor circuitry are two major features of the *Carritape II* playback unit. Constructed with the plug-in cue tone amplifiers and program amplifiers on glass epoxy chassis assemblies with gold plated connectors. The receptacles for a full complement of amplifiers (3 tone, stereo) are installed and wired into the basic unit making conversion of the system very simple. Plug-in relays are also utilized.

The motor deck plate is wear resistant, nonmagnetic stainless steel for absolute rigidity and is an aid to quick cartridge insertions. The non-magnetic feature contributes greatly to the low signal-to-noise ratio of *Carritape II*. The motor of *Carritape II* is of the synchronous type.

All of the inherent beneficial characteristics of transistors such as low heat, low power requirements (1.5 watts powers a full complement of 5 plug-in amplifiers), low noise, long

life, small size and reduced electrical maintenance are found in the *Carritape II* playback unit. In addition, transistor circuits by nature operate at low impedance which makes them less susceptible to hum, RF and switching transients.

RECORDING UNIT: The compact modular record unit of *Carritape II* plugs into the side of a playback unit to provide complete professional recording versatility. Operation of *Carritape II* is free from complexity and with new, quiet, touch control switches which show operating status at a glance.

Unique circuitry in this system is designed to accommodate 1, 2 or 3 cue tone operation in monaural or stereo—depending upon the amplifiers ordered. As most broadcasters still desire one tone monaural operation, the *Carritape II* basic unit is designed for that purpose. With the later addition of inexpensive plug-in amplifiers, the system can be quickly extended to 2 or 3 tones.

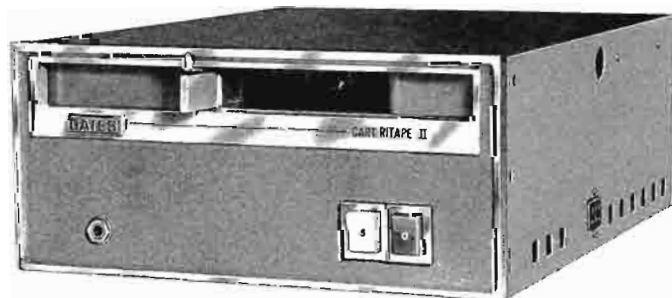

Compact playback unit for desk or rack mounting.

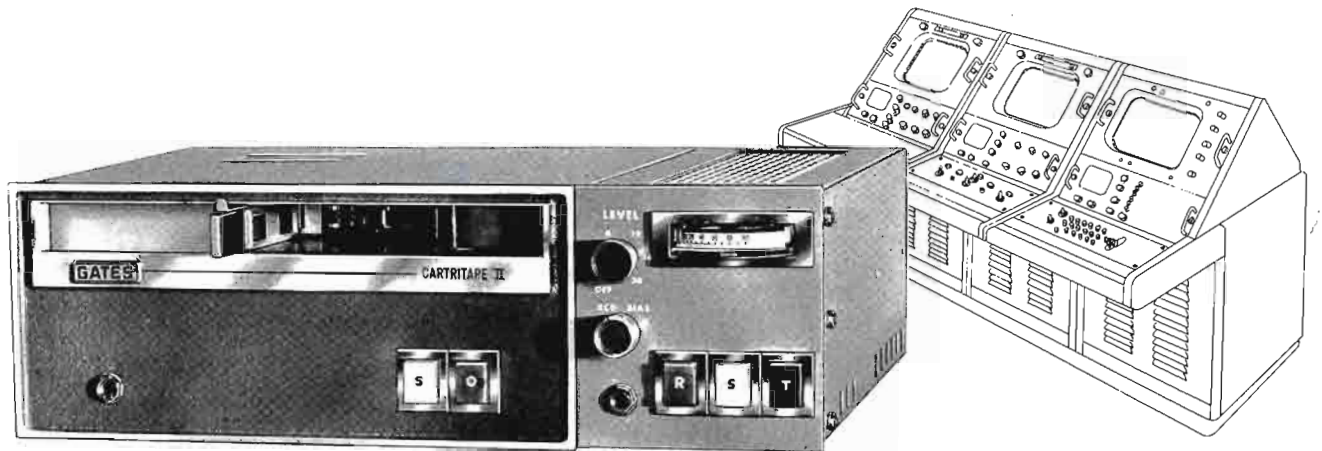

AUTOMATICALLY CONTROLLED STATION BREAKS . . . Many of the cueing and control features in Gates *Carritape II* were incorporated for the benefit of modern, fast-paced television operation. By making full use of *Carritape* techniques in daily telecasting, not only will audio announcements be aired flawlessly, but entire station breaks and program segments can be controlled automatically by cues from the *Carritape* playback equipment. Cartridge recording for broadcast use provides a high fidelity program channel (or two for stereo) and a separate channel for the cue-tone control track. A primary, or stop tone is standard and serves to recue each cartridge automatically for instant use. Most radio operations and an increasing number of television broadcasters use cartridges for repetitious themes, program introductions and commercial announcements. The single tone system of cueing has earned a very definite place in certain broadcast applications, but with the additional capabilities of Gates *Carritape II*, television operations are enhanced.

In the one tone mode of operation, a 1 KC. tone is applied to the tape, automatically, when the record/operate switch is touched. During playback, the tape runs until it again reaches this tone, and then stops.

CUE TONES: Two additional auxiliary cue tones are also readily available and can be added in seconds.

The 150 cycle secondary or "end of message" cue tone is applied while preparing a recorded announcement or theme. When played back, the "end of message" cue will cause a relay to momentarily close, to automatically activate the next program source whether it is another tape machine, projector, video switcher, or some other preset program. The audio portion of a program is presented perfectly timed, and the next audio and/or video event is controlled automatically. The second cue tone does not stop the cartridge. It continues to run until it reaches the first cue tone, where it stops—ready to use again.

THIRD CUE TONE: By simple addition of the third, 8 Kc., cue tone during recording a "random" or "trip-cue" permits any number of impulses to be placed at any point desired during a single message, such as for slide changes.

RESULTS: With "end of message" and "random" switching, Gates offers the ultimate in cartridge systems for truly automatic operation. The one-time complex TV station break becomes a smoothly programmed time segment. A typical break might use as many as four cartridges and display twenty or thirty slides. Previously, even with a two-tone system, there was no additional provision for separate slide-changing and end of message switching. This necessitated the manual starting of consecutive events in sequence to complete the break. With *Carritape II*, one impulse could cut away from network, start *Carritape*, take audio and video from slides, change slides in sequence, roll and take a projector, completing a smooth transition from network to local programming. The applications of *Carritape II* are almost unlimited.

STEREO . . .



MAGNIFICENT REALISM: For magnificent realism and automatic control of commercial announcements or recorded music, Gates *Stereo Carritape II* delivers separation and depth surpassing the finest stereo disc recordings. Separation, for instance, is better than 55 db. between channels.

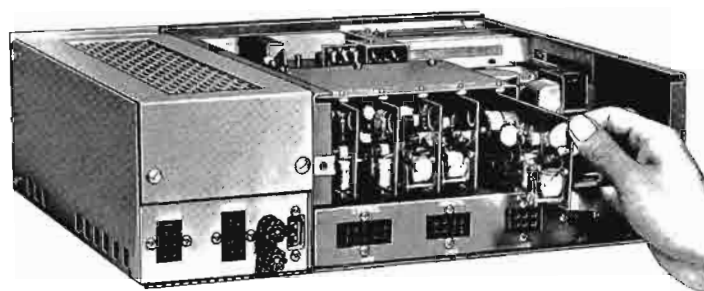

Rear view shows plug-in amplifiers which tailor system to meet individual requirements. Cartritape II can be expanded at any time with additional plug-in amplifiers. (Fig. 1).

Stereophonic cartridge tape utilizes three tracks, as compared to two for monaural. In compliance with industry standards, the upper two tracks carry the left and right program material, and the third track, is for automatic cue tones. Recordings made on a Gates stereophonic recorder are compatible with any other NAB standard stereo cartridge equipment. Stereo cartridges and standard monophonic cartridge recordings are not compatible, however.

SEPARATE HEADS: Separate recorder/playback heads are utilized eliminating head switching and the associated noise problems. Separate heads also provide playback monitoring from the tape during recording.

REMOTE CONTROL: In *Cartritape II*, remote control circuitry is included in the record and playback units. It is only necessary to purchase the inexpensive remote unit desired, and plug into the space provided.

AUTOMATIC AUDIO SWITCHING UNIT: An automatic switcher is also available which permits up to four playback units to be fed into one console input. With this addition to the system it is not necessary to manually switch the audio each time a unit is started.

POSITIVE CARTRIDGE ALIGNMENT: A new, exclu-

sive, three position index assembly, customizes the playback unit to any of the three cartridge sizes. This is accomplished with a sliding mechanism which automatically locks into the position selected. The advantages of less dust and straight cartridge insertions every time contributes greatly to increased efficiency of operation. Internal-left, right and vertical guides have also been designed into the *Cartritape II* playback unit to further insure a perfect cartridge alignment.

QUIET SOLENOID OPERATION: A power multiplying toggle arrangement on the pressure roller of the playback mechanism of *Cartritape II* permits the use of a new design smaller solenoid. Older cartridge tape machines frequently utilized bulky solenoids for this important electro-mechanical function. These big solenoids had a tendency to magnetize heads, which in turn, created unwanted noise on the tapes and even erased them in extreme cases. This problem is eliminated with the *Cartritape II* power toggle arrangement.

SIMPLIFIED AZIMUTH ADJUSTMENT: As shown above. New Gates *Cartritape II* features simplified vernier azimuth adjustment for convenience in aligning the separate record and playback heads. Premium grade laminated heads are also used, with hyperbolic metal faces for better response and longer life.

ACCESSORIES



M-5986 Cartridge Storage Rack. Conveniently stores forty "type A," 300 series cartridges in only 10½" of standard rack space.

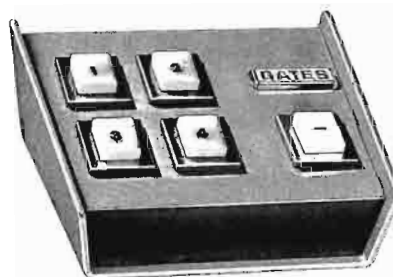

Remote Control—For utmost flexibility in the system, remote control is often desirable. In *Cartritape II*, remote circuitry is included in the record and playback units. It is only necessary to purchase an inexpensive remote unit and plug into the space provided. Like the switches on the record/playback units, the remote control switches light to show the operating status of the system at all times. The M-6221 playback remote control pictured will control up to four units. The matching M-6234 Record/play remote control is also available to control all functions of individual recorders.



M-6219 Automatic audio switching unit, for monophonic units, permits up to four playback units to be fed into one console input.

CARTRITAPE II SPECIFICATIONS

FREQUENCY RESPONSE:

± 2 db. 50-12,000 cps. @ 7½ IPS.
 ± 4 db. 50-15,000 cps. @ 7½ IPS.

DISTORTION:

Less than 1% at normal record level (limited by tape).

SIGNAL-TO-NOISE RATIO:

50 db.

CROSS TALK BETWEEN CHANNELS:

55 db. at 1 kc.

WOW AND FLUTTER:

Less than 0.2% RMS.

TAPE SPEED:

7.5 IPS ± 0.4%.

EQUALIZATION:

NAB Standard.

PLAYBACK TIME:

1 second to 31 minutes in 3 basic cartridge sizes.

CUEING ACCURACY:

Within 0.1 second.

STARTING TIME:

Essentially instantaneous.

RECORDING INPUT:

150/600 ohms balanced @ - 20 dbm.
 10,000 ohm bridging @ + 4 to + 18 dbm.

OUTPUT:

- 15 dbm. @ 150/600 ohms balanced or unbalanced.

CUE SIGNALS:

1,000 cycle primary tone, standard.

150 cycles secondary—"end of message" cue tone. (optional)
 8 kc. tertiary—"random" cue tone. (optional)

POWER:

117 AC volts nominal, 60 cycles. 50 cycle units available.

POWER CONSUMPTION:

Playback, 35 watts maximum.
 Record/play, 40 watts maximum.

SIZE:

(All models supplied with 19" rack adaptors and rubber feet for desk mounting).

Playback unit: 5¼" x 12" x 16½" deep.

Record unit: 5¼" x 5" x 16½" deep.

Note: Record unit mounts to side of playback unit for one complete rack mount unit.

WEIGHT:

Record unit 12 lbs. Playback unit 21 lbs.

CUBAGE:

Record/playback unit, 2 cu. ft.

AUTOMATIC AUDIO SWITCHER:

Input Capacity—For 4 playback units, monaural or stereo.
 Size: 1⅞" x 15" with 19" rack adaptors.

REMOTE UNIT:

2¾" high, 5¾" wide, 5⅞" deep. Wt. 2 lbs.

CONNECTIONS:

Quick disconnect plugs in 3 groups; Remote—Audio out—Control.

ORDERING INFORMATION

| | |
|---|--|
| Cartritape II Playback Unit for Monaural, 1 Tone (Cat. No.) M-6211F | Cartritape II 150 Cycle Cue Amplifier M-6216A |
| Cartritape II Playback Unit for Monaural, 2 Tone M-6211G | Cartritape II 8000 Cycle Cue Amplifier M-6216B |
| Cartritape II Playback Unit for Monaural, 3 Tone M-6211H | Cartritape II Switcher, Monaural M-6219 |
| Cartritape II Playback Unit for Stereo, 1 Tone M-6212C | Cartritape II Switcher, Stereo M-6220 |
| Cartritape II Playback Unit for Stereo, 2 Tone M-6212D | Cartritape II Remote Unit, Playback M-6221 |
| Cartritape II Playback Unit for Stereo, 3 Tone M-6212E | Cartritape II Remote Unit, Record M-6234 |
| Cartritape II Record/Play Unit for Monaural, 1 Tone M-6213I | Cartritape II Cartridge Storage Rack M-5986 |
| Cartritape II Record/Play Unit for Monaural, 2 Tone M-6213J | Azimuth Alignment Cartridge, 15 KC. ALT-1 |
| Cartritape II Record/Play Unit for Monaural, 3 Tone M-6213K | Bluk Tape Eraser (see Page 150) HD-11M |
| Cartritape II Record/Play Unit for Stereo, 1 Tone M-6214F | Tape Head Demagnetizer (see Page 150) 732-0168 |
| Cartritape II Record/Play Unit for Stereo, 2 Tone M-6214G | |
| Cartritape II Record/Play Unit for Stereo, 3 Tone M-6214H | |

NOTE: 50 cycle versions of above available on special order.

TAPE CARTRIDGES—PORTABLE TURNTABLE

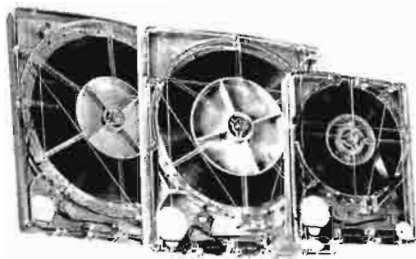

Gates cartridges comply fully with all applicable standards adopted by the National Association of Broadcasters and may be used with all professional cartridge machines.

Shown are the three popular sizes: NAB-A in lengths 40 seconds to 10½ minutes; NAB-B in lengths to 16 minutes; NAB-C in lengths to 31 minutes. (All timing @ 7½ IPS.) Other sizes are listed below and all are in stock in large quantities both at Quincy and Houston.

Automatic tape cartridges are recommended for use with Gates *Carritape II* and other professional cartridge tape equipment. Continuous, self-contained, single reel type, operating on an endless loop principle. Tape is pulled from the center and, after passing the recording or playback head, is automatically rewound on the outside of the reel contained in the cartridge. Special lubricated tape is completely

contained in the plastic magazine and is never touched by the operator. Advantages of cartridge recording include: no threading, no rewinding, simplified storage and indexing, extended tape life.

ORDERING INFORMATION

NAB-A SERIES

| TIME @ 7½ IPS | CATALOG NO. |
|-------------------|-------------|
| Empty | A-300 |
| 40 Seconds | A-300A |
| 70 Seconds | A-300B |
| 100 Seconds | A-300C |
| 3½ Minutes | A-300D |
| 5½ Minutes | A-300E |
| 10½ Minutes | A-300G |

NAB-B SERIES

| | |
|------------------|--------|
| Empty | B-600 |
| 16 Minutes | B-600H |

NAB-C SERIES

| | |
|------------------|---------|
| Empty | C-1200 |
| 31 Minutes | C-1200J |

PORTABLE AUDIO/TURNTABLE CONSOLE

The portable KD-20A audio system is a compact, 68 pound, all-transistorized dual turntable and audio system for quick and easy program origination. Included are two, 3-speed, 12-inch turntables complete with transcription arms and magnetic cartridges. Mixing is provided for two turntables, two microphones and a remote input. Each of the turntables has individual mixing controls. Two microphones and the remote input are selectable by a three-position switch. (High level source such as a tape recorder or remote amplifier can be fed into remote input). Headphone cueing of the turntables is provided, as is a bridging output to feed an external monitoring or public address amplifier. All amplifiers are fully transistorized and power supply is also solid state.

The console base is a one-piece fiberglass unit. Legs are detachable and the unit has convenient handles for carrying. Base of console is flat when legs are in storage position for ease of transportation.



KD-20A Disc Jockey System.

SPECIFICATIONS

MODE:
Monaural.

MIXING CHANNELS:
Three.

INPUTS:
Five, (2) phono, (2) 50-250 ohm microphones and (1) high level 600 ohm.

CUEING:
Push-buttons on turntable channels to headphone jack.

FREQUENCY RESPONSE:
(Audio System) ± 2 db., 50-15,000 cycles. (Pickups) Standard RIAA Curve.

OUTPUT:
600 ohms @ + 6 V.U.

SIZE:
44" long, 16½" wide, 10" high, (legs removed).
Operating height, 31" (with legs).

POWER:
115 Volts AC, 60 cycle.

WEIGHT:
68 lbs., net. Packed 90 lbs. Cubage: 6.

ORDERING INFORMATION

Portable Audio Console (Catalog No.) KD-20A





THE PRODUCER

The rapid growth of cartridge tape recorders and increased use of reel-to-reel recorders in radio and television broadcasting demanded an audio control system specifically designed for production mixing. Completely transistorized, the Gates *Producer* provides the facilities for direct recording, dubbing, sound-on-sound recording, editing and monitoring. Also, the use of the VA mixing control knob, the same as used on all Gates *Solid-Statesman* consoles, adds to the accuracy and speed called for in handling of a production operation.

ADAPTABILITY: Though designed primarily for recording, the engineer will quickly note the *Producer* adaptability to other services not requiring a complete speech input console but having adequate facilities for such services as news rooms, mobile units and small sub-studios.

INPUTS: Professional in every respect, the *Producer* provides transformer balanced inputs on each channel. Twelve inputs through the four mixing channels provide six microphones into two faders plus six turntables, cartridges, or reel-to-reel recorders into two faders. Two-stage, 45 db. preamplifiers on microphone channels 1 and 2, provide high level mixing. Completely self-contained, the *Producer* also includes a high gain program amplifier which furnishes a 600 ohm balanced output at + 8 VU, after a 6 db. pad. A high fidelity monitor amplifier is provided, driving the 3" x 5" loudspeaker mounted internally, or an external speaker,

if desired.

Monitor speaker muting on the microphone channels is standard. Muting defeat is provided as well.

SOUND-ON-SOUND: An exclusive feature in the *Producer* is the ability to make "sound-on-sound" recordings with ease. The monitoring amplifier normally bridges the program amplifier output. If it is desired to add voice over a pre-recorded voice or music track, this amplifier is switched to monitor either high level input, ahead of the mixers, and without fear of feedback.

Four inch illuminated VU meter, headphone monitor jack, and self-contained power supply are all standard on the *Producer*.

DESIGN: The *Producer* is a fine example of functional design and versatility, tailored specifically for broadcast production requirements. All amplifier components are on two printed boards, one containing the two microphone pre-amplifiers and program amplifier, the other housing the monitor amplifier and power supply. All transistors are plug-in for ease of maintenance. The regulated power supply is short-circuit protected by a self-restoring sealed circuit breaker, eliminating the need for fuses. Installation of the *Producer* is fast and simple, with all cable connections made to barrier-type terminal strips. The stylish large "VA" fader control knobs, exclusive from Gates and used on all *Solid-Statesman* consoles, is also used in the *Producer*.

The Producer—Four Channel Recording Mixer

Note complete transistorized construction and immediate access to all components. Self-contained 3" x 5" speaker located at top rear is excellent for cueing and production.

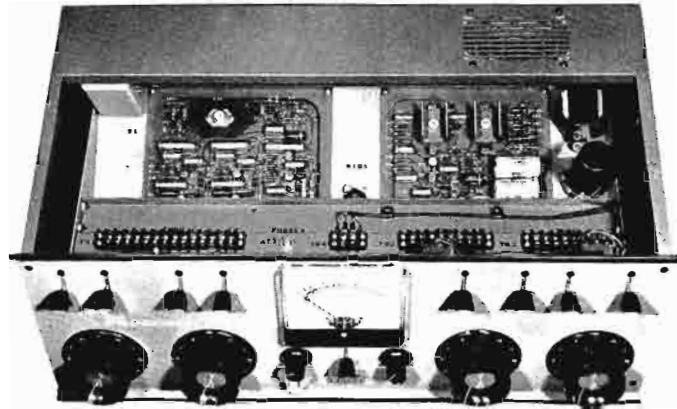

SPECIFICATIONS

MIXING CHANNELS:

Total four. 2 microphone channels, 2 TT/tape/projector channels. Cue provision on high level channels.

AMPLIFIERS PROVIDED:

1 program, 2 preamplifiers, 1 monitor amplifier and power supply.

OPERATING MODE:

Single-channel monophonic.

INPUT CIRCUITS:

6 microphone or low level, 6 turntables/tape or high level.

OUTPUT LINES:

600 ohms balanced. One, 45/48 ohm internal or external loudspeaker. One, high-impedance headphone monitor.

IMPEDANCES:

Microphones, 30/50 or 150/250 ohms. Turntable, tape, or cartridge, 150 or 600 ohms. Programming output, 600 ohm balanced. Loudspeaker, 45/48 ohm.

GAIN:

Microphone input to line output, 100 db. \pm 3 db.
Turntable input to line output, 55 db. \pm 3 db.
Microphone input to speaker output, 125 db. \pm 3 db.
Turntable input to speaker output, 80 db. \pm 3 db.

FREQUENCY RESPONSE:

\pm 1.0 db. from 30 to 15,000 cps in program circuits. \pm 1.5 db. from 30 to 15,000 cps in monitoring circuits.

HARMONIC DISTORTION:

0.5% maximum, 30 to 15,000 cps at + 8 dbm. output in program circuits.

INTERMODULATION DISTORTION:

0.5% maximum in program circuits.

NOISE:

— 120 dbm. relative input noise on microphone channels.
— 75 dbm. relative input noise on turntable channels.

POWER:

117 volts, 50/60 cycles, power consumption 30 watts.

CABINET DATA:

Size: 24" long, 10 1/4" high, 15" deep.
Finish: Medium Pebbletex Gray with black trim.

SHIPPING DATA:

Packed weight, domestic, 50 lbs.; export, 80 lbs. Cubage: 4.6.

ORDERING INFORMATION

The PRODUCER recording mixer M-6407

Speaker matching transformer A30601

NOTE: When using external monitoring loudspeakers, the A30601 matching transformer must be used to match the 45/48 ohm monitor output to the voice coil impedance of a loudspeaker.

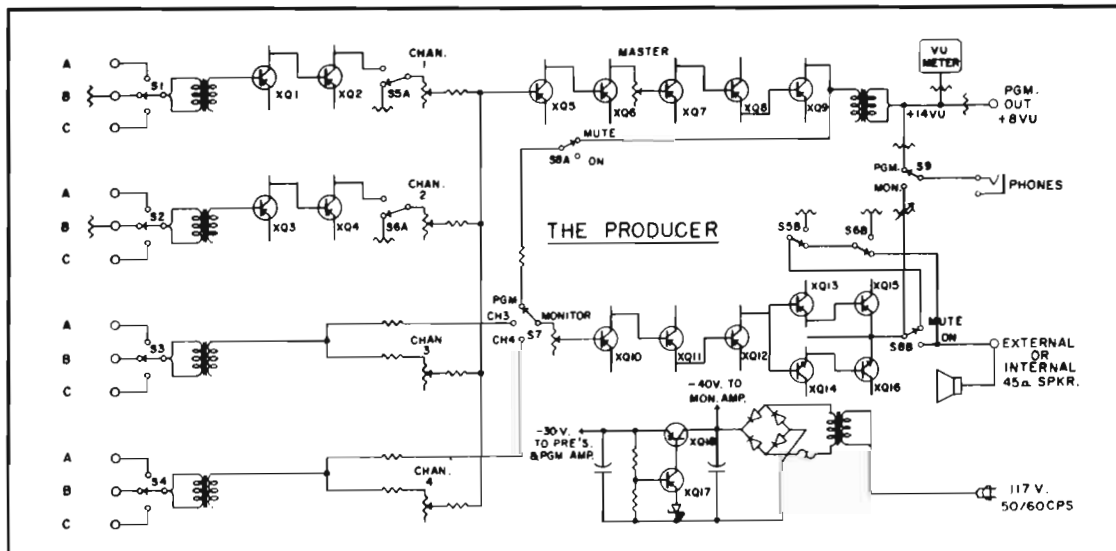

PREMIUM SOLID STATE AUDIO AMPLIFIERS

6300 SERIES

Brand new and already used extensively in one of the nation's leading television networks, this totally modern plug-in *Solid-Statesman* amplifier family is recommended for use where nothing but the very finest will suffice. These fully transistorized audio amplifiers incorporate the latest state-of-the-art engineering advances, resulting in performance standards that in many instances exceed previous industry achievements.

Exhaustive laboratory testing, over a period of several man-years, have established each amplifier as absolutely the finest in its field. Included in this complete line are: Preamplifier,

Program Amplifier, Program/AGC (automatic gain control) Amplifier, Monitor Amplifier, Power Supplies, mounting trays and a compact shelf assembly for rack mounting.

These new amplifiers are acknowledged as the standard to which all other audio amplifiers must be compared for performance, reliability and quality. There are no compromises in the design or construction of these premium-grade *Solid-Statesman* amplifiers and power supply units, all compact and plug-in.

For the most critical applications, Gates recommends the "6300" *Solid-Statesman* series.



M6313

TRANSISTOR PREAMPLIFIER

SPECIFICATIONS

- GAIN:**
40 db., or 46 db. (by receptacle strapping), ± 0.3 db.
- FREQUENCY RESPONSE:**
 ± 0.5 db. from 20 to 20,000 cps, or ± 0.25 db. from 30 to 15,000 cps.
- DISTORTION:**
0.25% maximum from 30 to 15,000 cps., @ + 20 dbm. output.
- NOISE:**
— 123 dbm. relative input noise.
- SOURCE IMPEDANCE:**
150 ohms, balanced or unbalanced, center tapped*.
- LOAD IMPEDANCE:**
150 ohms, balanced or unbalanced*.
- POWER:**
48 volts D.C. @ 30 ma.
- CONNECTORS:**
16 terminal, self-aligning, recessed to prevent accidental damage.
- MONITORING:**
Indicator lamp provides warning of short-circuit condition.
- TEST POINT:**
Pin jacks provide audio output monitoring.
- MOUNTING TRAY:**
M-6341 tray and receptacle. Tray attaches to M-6345 panel and shelf assembly for mounting up to eight preamplifiers in $3\frac{1}{2}$ " of vertical rack space.
- SIZE:**
2" wide x $3\frac{1}{8}$ " high x $14\frac{3}{4}$ " long, over-all.
- WEIGHT:**
 $4\frac{1}{2}$ lbs., net.



M6314

TRANSISTOR PROGRAM-AUTOMATIC GAIN CONTROL AMPLIFIER

SPECIFICATIONS

- GAIN:**
62 db., ± 0.3 db.; or 80 db., ± 0.5 db., (by receptacle strapping).
- FREQUENCY RESPONSE:**
 ± 0.5 db. from 20 to 20,000 cycles or ± 0.25 db. from 30 to 15,000 cps. (62 db. gain)
 ± 0.5 db. from 30 to 15,000 cps. (80 db. gain)
- DISTORTION:**
0.25% maximum from 30 to 15,000 cps., (62 db. gain @ + 32 dbm. output level). 0.5% maximum from 30 to 15,000 cps., (80 db. gain @ + 32 dbm. output level).
- NOISE:**
— 116 dbm. relative input noise (62 db. gain mode) from 30 to 15,000 cps. — 118 dbm. relative input noise (80 db. gain mode) from 30 to 15,000 cps.
- GAIN REDUCTION (AGC):**
Amplifier input/output characteristics linear below threshold of AGC @ + 20 dbm. output level. 6 db. gain reduction maximum in 62 db. gain mode. After maximum of 6 db. AGC, amplifier input/output characteristics become linear again. An input level of — 24 dbm. will result in 6 db. gain reduction and an output level of + 32 dbm. Approximately 21 db. AGC in the 80 db. gain mode. Amplifier characteristics linear below the threshold of AGC @ + 20 dbm. output level. An input level of — 27 dbm. will result in 21 db. gain reduction

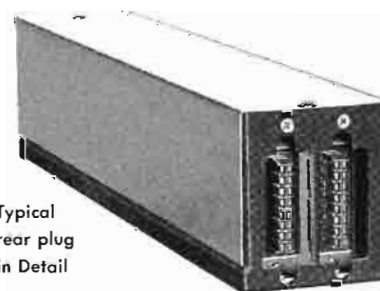

Typical rear plug in Detail

- and an output level of + 32 dbm. An external switch permits disabling the AGC action, without thumps or clicks in the program circuit.
- ATTACK TIME:**
AGC attack time = 25, ± 3 milliseconds.
- RECOVERY TIME:**
AGC recovery time = 0.5, ± 0.1 second.
- SOURCE IMPEDANCE:**
150 ohms, balanced or unbalanced, center tapped*.
- LOAD IMPEDANCE:**
150 ohms, balanced or unbalanced, center tapped*.
- POWER:**
48 volts D.C. @ 140 ma.
- CONNECTORS:**
16 terminal (2), self-aligning, connectors recessed to prevent accidental damage.
- MONITORING:**
Indicator lamp provides warning of short-circuit condition.
- TEST POINT:**
Pin jacks provide audio output monitoring.
- MOUNTING TRAY:**
M-6342 tray and receptacle. Six PGM/AGC amplifiers mount in $3\frac{1}{2}$ " of vertical rack space.
- SIZE:**
 $2\frac{3}{4}$ " wide x $3\frac{1}{8}$ " high x $14\frac{3}{4}$ " long, over-all.
- WEIGHT:**
5 lbs., net.



M-6315

TRANSISTOR MONITOR AMPLIFIER

SPECIFICATIONS

- GAIN:**
80 db., ± 1.0 db. (may be reduced with gain control).
- FREQUENCY RESPONSE:**
 ± 1 db. from 20 to 20,000 cycles or ± 0.5 db. from 30 to 15,000 cps.
- DISTORTION:**
0.5% maximum from 50 to 15,000 cps. at + 40 dbm. output.
1% maximum from 30 to 15,000 cps at + 40 dbm. output.
- NOISE:**
— 121 dbm. relative input noise, 30 to 15,000 cycles.
- SOURCE IMPEDANCE:**
150 ohms, balanced or unbalanced, center tapped*.
- LOAD IMPEDANCE:**
150 ohms, balanced or unbalanced, center tapped*.
- POWER:**
Self-contained power supply, 117 volts nominal, 50/60 cycles, 60 watts maximum.
- GAIN CONTROL:**
Two lamp operated photo-cells controlled by a remote actuator (Maximum control current of 30 ma, at 30 volts D.C.—supplied from Monitor Amplifier) with line distance of up to one thousand feet. A 10,000 ohm Log Taper potentiometer will provide control of the pump-operated photo-cells. (Potentiometer is optional equipment.)
- CONNECTOR:**
16 terminal, self-aligning. Connector recessed to prevent damage.
- SWITCH AND FUSE:**
Switch and illuminated indicating fuse holder located on the front escutcheon for A.C. control of the Amplifier.
- TEST POINT:**
Pin jacks provide audio-output monitoring.
- MOUNTING TRAY:**
M-6343 tray and receptacle. Four M-6315 Monitor Amplifiers mount in $3\frac{1}{2}$ " of vertical rack space.
- SIZE:**
 $4\frac{1}{8}$ " wide x $3\frac{1}{4}$ " high x $14\frac{3}{4}$ " long, over-all.
- WEIGHT:**
 $9\frac{1}{2}$ lbs., net.



M-6338

TRANSISTOR POWER SUPPLY

SPECIFICATIONS

- CAPACITY:**
Up to 50 M-6313 Transistor Pre-amplifiers, or up to 10 M-6314 Program/AGC Amplifiers or any combination with a maximum rated current of 1.5 amps. Use for large systems or where growth is anticipated.
- OUTPUT:**
48 volts D.C. at 0 to 1.5 amps. continuous.
- RIPPLE:**
Less than 1.0 mv. from 0 to full load.
- INTERNAL IMPEDANCE:**
0.05 ohms.
- REGULATION:**
0.3%.
- POWER:**
117 volts nominal, 50/60 cps., 130 watts maximum.
- SHORT CIRCUIT PROTECTION:**
Resistive short circuit protection allows full operation to resume after momentary short circuits on the output. Primary fuse prevents component damage with sustained short circuits.
- UNDERVOLTAGE ALARM:**
Self-contained relay actuates with approximately 10% undervoltage. Contacts are connected to the output plug to permit the operation of an external alarm.
- CONNECTORS:**
16 terminal, self-aligning, recessed to prevent damage.
- SWITCH AND FUSE:**
Switch and illuminated indicating fuse holder located on the front escutcheon for A.C. control of the Power Supply.
- MONITORING:**
Neon lamp (to indicate presence of AC supply voltage), and load lamp (to indicate output voltage). Output sampling jack located on the front escutcheon.
- MOUNTING TRAY:**
M-6344 tray and receptacle. Four M-6338 Power Supplies mount in $3\frac{1}{2}$ " of vertical rack space.
- SIZE:**
 $4\frac{1}{8}$ " wide x $3\frac{1}{8}$ " high x $14\frac{3}{4}$ " long, over-all.
- WEIGHT:**
 $7\frac{1}{2}$ lbs., net.



A-6321

PROGRAM AMPLIFIER

SPECIFICATIONS

- GAIN:**
62 db., ± 0.3 db., unterminated input.
- FREQUENCY RESPONSE:**
 ± 0.5 db. from 20 to 20,000 cycles or ± 0.25 db., 30-15,000 cycles.
- DISTORTION:**
0.25% maximum from 30 to 15,000 cps @ 32 dbm. output.
- NOISE:**
— 116 dbm. relative input noise, 30 to 15,000 cps.
- SOURCE IMPEDANCE:**
150 ohms, balanced or unbalanced, center tapped*.
- LOAD IMPEDANCE:**
150 ohms, balanced or unbalanced, center tapped*.
- POWER:**
48 volts D.C. @ 140 ma.
- CONNECTORS:**
16 terminal self-aligning, recessed to prevent damage.
- MONITORING:**
Indicator lamp provides warning of short-circuit condition.
- TEST POINT:**
Pin jacks provide audio output monitoring.
- MOUNTING TRAY:**
M6426 tray and receptacle for up to six program amplifiers in $3\frac{1}{2}$ " of vertical rack space.
- SIZE:**
 $2\frac{3}{4}$ " wide x $3\frac{1}{8}$ " high x $14\frac{3}{4}$ " long, over-all.
- WEIGHT:**
 $4\frac{1}{2}$ lbs., net.



Above illustrates preamplifier and accessory tray assembly. Plugs on all amplifiers are recessed to assure no damage to pins.



**TRANSISTOR POWER SUPPLY
SPECIFICATIONS**

- CAPACITY:**
Up to ten M-6313 Preamplifiers, or two M-6314 Program/AGC amplifiers, or any system combination with a maximum rated current not exceeding 300 ma. for use in smaller systems.
- OUTPUT:**
48 volts D.C. at 0 to 300 ma. continuous.
- RIPPLE:**
Less than 1.0 mv. from 0 to full load.
- INTERNAL IMPEDANCE**
0.05 ohms.
- REGULATION:**
0.3%.
- POWER:**
117 volts nominal, 50/60 cps., 30 watts.
- SHORT CIRCUIT PROTECTION:**
Resistive for momentary short circuits on output. Primary fuse prevents damage from sustained short circuits.
- CONNECTORS:**
16 terminal, self-aligning, recessed to prevent damage.
- SWITCH AND FUSE:**
Located on front escutcheon.
- MOUNTING TRAY:**
M-6422 tray and receptacle. Six M-6421 power supplies mount in 3½" of vertical rack space.
- SIZE:**
2¾" wide x 3¼" high x 14¾" long, over-all.
- WEIGHT:**
5½ lbs., net.

ACCESSORIES

Complete mounting accessories are available for the 6300 Series *Solid-Statesman* Amplifiers. The M-6345 Panel and Shelf Assembly unit occupies only 3½" of 19" wide rack space. Built of heavy gauge plated, non-corrosive steel, finished in medium satin gray, and with hinged front panel. The shelf assembly is provided with an upper cross-bar to prevent damaging amplifier plugs or tray receptacles. Individual mounting trays have been designed for each model of amplifier and power supply.

In system practice a typical audio input signal may pass through four amplifiers, four faders, nine transformers, and be bridged a dozen or so times, yet the system performance at the output is equal or better than any individual amplifier specification. Of particular importance is the higher rated output levels of both pre-amplifiers and program amplifiers to accommodate greater dynamic range at no increase in distortion.



Above M-6345 Panel and Shelf Assembly showing for illustrative purposes one each of preamplifier, program amplifier, monitoring amplifier and power supply. Only 3½" of rack panel space is required.

ORDERING INFORMATION

| | |
|--|---|
| Preamplifier (Catalog No.) M-6313 | Panel and Shelf Assembly M-6345 |
| Program Amplifier M-6321 | Television Audio Control Console M-6337 |
| Program/AGC Amplifier M-6314 | |
| Monitor Amplifier M-6315 | |
| Potentiometer for Monitor | |
| Amplifier Gain Control 550-0255 | |
| 300 Ma. 48 Volt Power Supply M-6421 | |
| 1.5 Amp 48 Volt Power Supply M-6338 | |
| Mtg. Tray for Preamplifier M-6341 | |
| Mtg. Tray for Program Amplifier M-6426 | |
| Mtg. Tray for PGM/AGC Amplifier M-6342 | |
| Mtg. Tray for Monitor Amplifier M-6343 | |
| Mtg. Tray for M-6421 Power Supply . . . M-6422 | |
| Mtg. Tray for M-6338 Power Supply . . . M-6344 | |

*The source of load impedance of the amplifiers as listed in the specifications is the recommended impedance of the connecting device (such as a microphone, attenuator, line or loudspeaker). However, the input impedance of all four amplifiers is approximately ten times higher than the source impedance, giving the systems designer greater flexibility.

The output impedance is approximately 1/10 the load impedance, which permits multiple bridging without any degradation of the output signal.

TELEVISION AUDIO CONSOLE

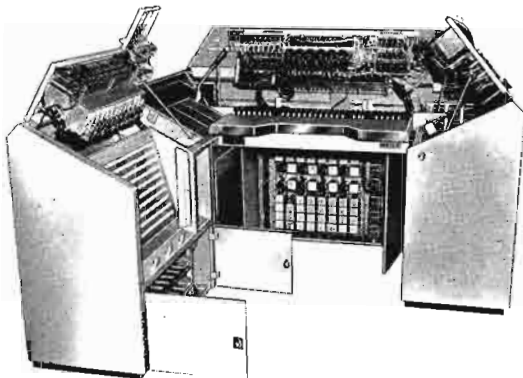

The above production console made for a leading television network houses 57 of the 6300 Series Solid Statesman transistorized units described herein.

The production console at the left is now in use in a leading television network, and houses 57 of these "6300" series *Solid-Statesman* transistorized units. This Television Audio Console marks a significant advance in the development of solid state equipment for broadcasting. The remarkable capabilities of this completely self-contained console include: mixing from 25 input audio sources simultaneously into nine separate program channels, each with automatic level control; built-in video monitoring, ten audio monitoring channels; twelve microphone equalizers; two graphic program equalizers; five sound effects filters; two reverberation send and return channels; vertical attenuators; three video controlled audio channels, plus many other special features, described in detail on page 110.

SOLID-STATESMAN PLUG-IN AUDIO AMPLIFIERS

5700 SERIES

For any audio system application in AM, FM, TV, recording or sound distribution, the "5700" Series *Solid Statesman* transistor plug-in amplifiers offer uniformly high quality performance exceeding the capabilities of vacuum tube amplifiers. An added benefit to the superb performance is space-saving compactness achieved by advanced solid state technology. Conservative design provides a 50% safety factor so that all amplifiers are capable of operation with a continuous sine wave at maximum ambient temperatures, and at full rated output levels.

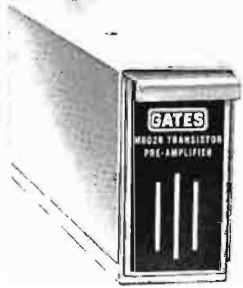

- GAIN:**
40 db.
- RESPONSE:**
± 0.5 db., 30 to 15,000 cycles.
- HARMONIC DISTORTION:**
Under 0.75% at 30 cps, under 0.5% from 50 to 15,000 cycles at + 18 dbm. output.
- NOISE:**
— 122 dbm. relative input noise, 30 to 15,000 cycles.
- MOUNTING:**
Use Gates M-6030 mounting tray listed below.
- POWER REQUIREMENTS:**
30V. DC at 30 Ma.
- SOURCE IMPEDANCE:**
30/50—150/250—500/600 ohms (balanced or unbalanced).
- LOAD IMPEDANCE:**
150/250—500/600 ohms (balanced or unbalanced).

All circuits in the "5700 Series" utilize carefully chosen components with printed wiring on glass epoxy boards for uniformity, strength, and reliability. Connectors are gold-plated for absolute contact. Floating-type receptacles on the mating trays assure positive, fast alignment. All transistors are plug-in, triple A industrial type which essentially eliminates any possibility of thermal damage during operation.

Whether your audio amplifier needs are for new total system installations, facility expansion, or upgrading of present systems, the "5700 Series" *Solid-Statesman* audio amplifiers meet the most exacting demands of today's discriminating broadcaster.

M6028 PREAMPLIFIER

Usually used to feed a mixing bus or program amplifier, the M6028 pre-amplifier operates from a microphone or similar low-level source and has sufficient gain to drive a line or monitor amplifier. With + 18 dbm. maximum output capability, this amplifier may also serve as a booster amplifier.

SPECIFICATIONS

- CONNECTORS:**
Gold plated Blue Ribbon Type.
- SIZE:**
1¾" wide, 3⅛" high, 10¾" long, up to 9 units mount in one M-6029 Shelf Assembled (see next page).
- FINISH:**
Cadmium plated enclosure with black anodized escutcheon plate.
- WEIGHT:**
3½ lbs. net.

ORDERING INFORMATION

- Transistor plug-in Pre-amplifier (Catalog No.) M-6028
- Mounting tray for M6028 M-6030

M5700B PROGRAM AMPLIFIER

A high performance program or line amplifier of the plug-in type and companion unit to all other 5700 Series models. Has gain control mounted on front. As many as seven amplifiers mount in one 19" x 3½" panel and shelf assembly. This program amplifier is used in all Gates *Solid-Statesman* consoles shown elsewhere in this catalog.



SPECIFICATIONS

- GAIN:**
70 db., or less as adjusted by gain control.
- RESPONSE:**
± 1 db. from 30 to 15,000 cycles.
- HARMONIC DISTORTION:**
Under 0.75% at 30 cycles under 0.5% from 50 to 15,000 cycles at + 24 dbm. output.
- NOISE:**
— 115 dbm. relative input noise, 65 db. below — 50 dbm. input.
- MOUNTING:**
Use Gates M-6031 mounting tray listed below.
- POWER REQUIREMENTS:**
30V. DC at 90 Ma.
- SOURCE IMPEDANCE:**
150/250 or 500/600 ohms (balanced or unbalanced).
- LOAD IMPEDANCE:**
150/250—500/600 ohms (balanced or unbalanced).

- CONNECTORS:**
Gold plated Blue Ribbon type.
- SIZE:**
2¼" wide, 3⅛" high, 10¾" long, up to 7 units mount in one M-6029, Shelf Assembly (see next page).
- FINISH:**
Cadmium plated enclosure with black anodized escutcheon plate.
- WEIGHT:**
4¼ lbs. net.

ORDERING INFORMATION

- Transistor plug-in Program Amplifier (Catalog No.) M-5700B
- Mounting tray for M-5700B M-6031



Solid Statesman Plug In Audio Amplifiers—5700 Series

M-5701 MONITOR AMPLIFIER

To complete the *Solid-Statesman* 5700 Series, this 8-watt, low distortion monitoring amplifier will supply flawless loud-speaker distribution. The power supply is self-contained. Plug-in type. Has gain control, start-stop switch and fuse receptacle on front. High gain permits use from wide variety of input sources. Four units mount in one 19" x 3½" panel and shelf assembly.



SPECIFICATIONS

- GAIN:**
90 db., or less as adjusted by gain control.
- RESPONSE:**
± 1 db. from 30 to 15,000 cycles.
- HARMONIC DISTORTION:**
Under 1% from 50 to 15,000 cycles at + 39 dbm. (8 watts.)
- NOISE:**
— 120 dbm. relative input noise.
- MOUNTING:**
Use Gates M-6032 mounting tray listed below.
- POWER REQUIREMENTS:**
117 volts, 50/60 cps, 18 watts.
- SOURCE OF IMPEDANCE:**
30/50, 150/250 or 500/600 ohms. (balanced or unbalanced).
- LOAD IMPEDANCE:**
8 ohms nominal (unbalanced). Order A-30601 speaker matching transformer, Page 148 for multiple speakers.

- CONNECTORS:**
Gold plated Blue Ribbon type.
- SIZE:**
4⅛" wide, 3⅛" high, 12¾" long. Up to 4 units mount on one M-6029 Shelf Assembly. (see below.)
- FINISH:**
Cadmium plated cover, black cast aluminum heat sink sides, and black anodized escutcheon plate.
- WEIGHT:**
8½ lbs., net.

ORDERING INFORMATION

- Transistor plug-in Monitor Amplifier (Catalog No.) M-5701
 Mounting tray for above M-6032
 Speaker matching transformer A-30601



M-5702 POWER SUPPLY

A fully regulated power supply designed for use with Gates "5700 Series" amplifiers. Features automatic short circuit protection, electronically preventing damage due to any type of short circuit or overload. Plug-in design. Start-stop switch and fuse receptacle on front.

SPECIFICATIONS

- OUTPUT:**
30 V. DC at 400 Ma. Maximum.
- INPUT:**
117 volts, 50/60 cps, 18 watts with maximum load.
- NOISE:**
0.1 MV. (RMS) ripple or better.
- MOUNTING:**
Use Gates M-6032 mounting tray listed below.
- SUPPLIES POWER FOR:**
13—M-6028 Preamplifiers or 4—M-5700B Program Amplifiers or 7—M-6028 Preamplifiers and 2—M-5700B Program Amplifiers or any combination not exceeding 400 Ma. load current. As power supply is fully regulated, any lesser number of units may be used without voltage change.

- CONNECTORS:**
Gold plated Blue Ribbon type.
- SIZE:**
4⅛" wide, 3⅛" high, 12¾" long, Up to 4 units to mount on one M-6029 Shelf Assembly listed below.
- FINISH:**
Cadmium plated cover, black sides and black anodized escutcheon plate.
- WEIGHT:**
8¼ lbs., net.

ORDERING INFORMATION

- Transistorized, plug-in Power Supply (Catalog No.) M-5702
 Mounting tray for M-5702 M-6032

ACCESSORIES



PANEL AND SHELF ASSEMBLY

Fast and foolproof connections are assured every time a Gates transistor plug-in amplifier is placed in its mounting tray. A floating type receptacle gives positive alignment and the steel "key pin" prevents any possible mix-up of amplifiers in the system. Three types required for entire 5700 Series of Solid-Statesman amplifiers and power supplies. For ordering information refer to specific amplifier or power supply listed on these pages.



MOUNTING TRAY

Designed to mount the 5700 Series *Solid-Statesman* amplifiers and power supplies in conjunction with the mounting trays. Requires only 19" x 3½" rack space and is 14½" deep. Finish (panel): medium gloss gray. Shelf is cadmium plated for long wear. Panel hinges down to remove any plug-in unit from the front and clears rack cabinet trim strips in downward swing.

Accommodates: 9 preamplifiers with M-6030 mounting trays. 7 program amplifiers with M-6031 mounting trays. 4 monitoring amplifiers with M-6032 mounting trays. 4 power supplies with M-6032 mounting trays—or any combination of the above such as 4 preamplifiers, 1 program amplifier and 1 monitoring amplifier, etc.

- Panel and Shelf Assembly (Cat. No.) M-6029

FOUR CHANNEL SOLID STATESMAN REMOTE AMPLIFIER



DYNAMOTE "70"

Dynamote is a trade-mark applied to premium remote amplifiers in the Gates line for nearly 35 years. The new four channel Dynamote "70" is broadcasting's finest. Both facility and performance specifications challenge the latest design studio consoles as Dynamote "70" is indeed a studio system away from home.

SOLID STATESMAN FEATURES: Foremost among the Dynamote '70' outstanding features are: Complete transistorization with new circuitry to allow longer use of batteries; a new functional design based on human engineering studies; and nine input sources into four mixing channels. Also; a new slide-rule type illuminated VU meter; built-in tone oscillator; Power Amplifier feed; and amplified cue from remote program line. Optional for the Dynamote '70' is an 'In-Line' AC power supply that operates with the batteries for failsafe performance. Best of all is the inbuilt Gates quality. Dynamote '70' is designed for the finest performance possible, utilizing quality components for lasting durability.

INPUT CIRCUITS: All mixing is high level. Four microphones feed four preamplifiers. All four preamplifier inputs are balanced and have input transformers as standard equipment. Five other input circuits are switch selectable into the mixing system. These are: (1) tone oscillator, (2) dual turntable inputs, and (3) two high level inputs.

FRONT PANEL CONTROLS: Four mixing channels are operated by a new design Gates knob created specifically for remote control functions. The knob is coordinated with the panel slope for *positive feel* mixing. Other panel controls are (1) master gain, (2) P.A. gain control, (3) amplified cue selector control, (4) VU meter light control (the VU meter light operates from separate batteries), and (5) the slide rule VU meter.

REAR PANEL CONTROLS: All secondary switching is at the rear. The tone oscillator, dual turntable and dual high level inputs switch into mixing channels 2, 3 and 4. As the total front to back depth is only 12", this is a feature that eliminates front panel cluttering. All input and output circuits connect to a recessed panel with standard XL receptacles for the microphones.

AMPLIFIERS: Four preamplifiers each with transformer input feed four mixing channels which in turn feed the program amplifier. *Solid-Statesman* premium performance is emphasized with the 1% or less distortion specification at +18 dbm. to the line after the 6 db. line isolation pad.

VERSATILE MIXING: (Mixing channel 1) is for a microphone only, (channel 2) accommodates a microphone or the in-built tone oscillator, (channel 3) a microphone, one turntable and one level input, and (channel 4) a microphone and one turntable and one high level input.

PROGRAM CUE: A front panel lever key switches in amplified cue from the program line to headphone jacks for receiving cues from the main studio location.

VU METER: VU meter is of the new slide rule type with full lateral scale area as on all approved VU meters. Illumination is from two separate batteries and meter light may be turned off with the pull out switch on the Power Amplifier.

Constructed of steel and aluminum vinyl-clad exterior and natural satin trim, the Dynamote "70" has an attractive snap-on aluminum front cover which protects controls when not in use or when carrying.



Four Channel Solid Statesman Remote Amplifier

fier feed control. Batteries will light meter for 60 hours. Rear panel switch allows meter to read either VU or battery condition.

P.A. FEED: Supplies an isolated output adjustable from the front panel to supply 0.5 volts RMS into a 100,000 ohm unbalanced load.

TERMINAL FEATURES: Dual headphone jacks for operator and director. Amplifier turns on when either headphone plug is inserted or a dummy plug. Microphone inputs are standard XL connectors. Jacks provided for two turntables and two high level inputs, terminals for telephone line and P.A. feed, and optional A.C. in-line power supply receptacle.

BATTERY AND A.C. POWER: Twelve "C" size standard 1½ volt dry batteries power the amplifier for 200 hours service from one battery set. As amplifier design is based on full gain and output level at rated 1% distortion with as little as 12 volts, the useful battery life is greatly extended. The optional in-line power supply operates about 2 volts above the batteries with diodes disabling the battery voltage.

If power fails for any reason, batteries automatically take over without evidence in the program.

DYNAMOTE "70" PARALLELING: Any reasonable number of units may be paralleled for a large field broadcast. Rear panel jacks permit feeding additional Dynamotes directly to the mixer bus of the master Dynamote without even losing a mixing channel on the master unit. Six Dynamotes would provide 24 microphone inputs, yet require only about 75" of width or about 38" if two sets were stacked one on top of the other.



Rear view—Dynamote "70".

SPECIFICATIONS

OPERATING MODE:

Single channel monaural.

MIXING CHANNELS:

Total four; three switchable for other functions.

INPUT CIRCUITS:

Channel 1, microphone input; Channel 2, microphone and tone oscillator; Channel 3, microphone, turntable and high level input; Channel 4, microphone, turntable and high level input. Input levels: Microphones — 60 dbm., High level 600 ohm circuits rated — 15 dbm. to + 8 dbm. Turntable inputs have RIAA equalization and accept standard VR-type phono cartridges without further preamplification.

OUTPUT CIRCUITS:

1 program line, 1 isolated P.A. feed, 1 mixer multiple output, 2 headphone monitoring jacks.

SOURCE IMPEDANCES:

Microphones—30/50 and 150/250 ohms, balanced or unbalanced, with input transformers all channels.

High Level—600 ohms, unbalanced. (— 15 dbm. to + 8 dbm. input level.)

Turntables—6200 ohms for VR type pickup cartridge equalization.

Mixer Multiple Input—600,000 ohms.

INPUT IMPEDANCE:

Preamplifiers, 1500 ohms or higher 30-15,000 cycles.

LOAD IMPEDANCES:

Program Output—600/150 ohms, balanced or unbalanced, (factory connected for 600 ohms).

P.A. Feed—100,000 ohms unbalanced.

Amplifier Paralleling—600,000 ohms bridging.

OUTPUT IMPEDANCE:

Program Amplifier, 490 ohms nominal.

GAIN:

Microphone input to line output, 97 db. ± 2 db.

RESPONSE:

± 1½ db., 25 to 16,000 cycles.

DISTORTION:

1.0% maximum, 30 to 15,000 cycles @ + 18 dbm. output (after 6 db. isolation pad).

NOISE:

62 db. or better below + 8 dbm. output with — 60 dbm. input. (Relative input noise — 122 dbm.)

BATTERY COMPLEMENT:

12 Size "C" 1½ volt cells for amplifier.

2 Size "D" 1½ volt cells for VU light.

BATTERY LIFE:

Approximately 200 hours for amplifier pack, and 60 hours for meter light.

EXTERNAL POWER:

Four terminal plug on rear accepts optional M-6435 in-line power pack for 117 volt AC operation.

CABINET DATA:

Size: 12¾" wide, 4¾" high, 12⅞" deep. Finish: Charcoal gray vinyl with satin chrome trim accents. Weight: 12¼ pounds, including batteries.

SHIPPING DATA:

Packed Weight: Domestic, 16 lbs.; export, 35 lbs. Cubage, 2.

ORDERING INFORMATION

Dynamote "70" 4-channel remote amplifier, complete but

less male microphone connectors and batteries M-6434

Microphone plugs, male (four required) XLR3-12C

Battery complement for Dynamote "70" M-6441

Vinyl cover with accessory pocket M-6445

IN-LINE POWER SUPPLY

Compact accessory power unit for any of the new Gates Solid Statesman remote amplifiers: Dynamote "70," Attache, Courier "70," and Unimote "70." "IN-LINE" Type, with four foot output cord, terminating in mating plug for all units. Six foot line cord. For 117 volt, 50/60 cycle operation of Gates Remote Amplifiers in permanent installations. Dual supply design provides power for amplifiers and VU meter illumination. Easily carried in accessory pocket of Vinyl remote amplifier covers.

SPECIFICATIONS:

POWER INPUT: 117 volts, 50/60 cycles. **POWER OUTPUT:** 4 prong plug, mates with remote amplifier. **SIZE:** 5½" x 4" x 1¾" case. **DC Supply Cable,** 48" long. **AC Power Cord,** 72" long. **FINISH:** Charcoal gray vinyl-clad steel. **WEIGHT:** 2 lbs. net.

ORDERING INFORMATION

In-Line DC Power Supply, complete M-6435

THREE-CHANNEL SOLID-STATESMAN REMOTE AMPLIFIER



ATTACHE "70"

Unexcelled remote pickup performance is provided by this stylish new three channel, fully transistorized audio remote amplifier. An honor member of the Gates Solid Statesman product line, the Attache '70' brings new convenience, ease, and status to remote broadcast origination. Attache '70' provides: Three microphone channels with one magnetic phono and one high level input; long, 200 hour battery life; optional in-line AC power supply; slide-rule VU meter; and superior performance with wider response and lower distortion.

INPUTS: Three channels, all with preamplifiers, include: Channel 1, Microphone only with input transformer for long microphone lines; Channel 2, Microphone, tone oscillator or high level input; Channel 3, Microphone or phono cartridge. The depth of only 12 1/8" allows switching of secondary circuits such as turntable and high level inputs at the rear to assure freedom from front panel cluttering.

TOTAL FACILITY: The Attache '70' is complete in every detail, even to the newly styled mixing knob for comfortable "touch control" fading. The front panel also contains the master gain control and isolated P.A. feed control. An illuminated slide-rule VU meter has the same lateral scale area as conventional meters.

- MODE:**
Monaural.
- MIXING CHANNELS:**
3 with channels 2 and 3 switchable to other functions.
- INPUT CIRCUITS:**
Channel 1, Microphone only, includes input transformer; Channel 2, Microphone or 400 cycle tone oscillator or high level input; Channel 3, Microphone or turntable.
- OUTPUT CIRCUITS:**
Program line for 600/150 ohms, P. A. feed, and headphone monitoring jack.
- SOURCE IMPEDANCES:**
Microphones, 30/50 ohms or 150/250 ohms. Turntable, 6200 ohms for VR pickup cartridges and RIAA equalized. High level, 600 ohms unbalanced - 15 dbm. to + 8 dbm. (see Note 1).

The optional power supply is diode protected from the batteries, when in use. If power fails, batteries take over automatically. The long battery life does not suggest basic need for the power supply unless it is desired. VU meter reads battery status as well as volume.

DESIGN: Only 10" wide, 4 3/8" high and 12 1/8" deep and weighing 10 lbs. with batteries, yet very rugged. Case is in lightweight aluminum and vinyl clad steel. A snap-on cover protects mixing controls when not in use.

PERFORMANCE: The Attache "70" extended response of 25-16,000 cycle, 1% or less distortion at + 18 dbm. output, and reliability gives the broadcaster studio console performance in the *Solid-Statesman* tradition of premium quality equipment.



The rear panel shows the logical grouping of line terminations.

SPECIFICATIONS

- GAIN:**
Microphone input to program line output is 94 db. ± 2 db.
- RESPONSE:**
± 1.5 db. 25-16,000 cycles.
- DISTORTION:**
1% or less at + 18 dbm. into the program line (6 db. isolation pad incorporated).
- NOISE:**
62 db. below + 8 dbm. output with - 60 dbm. input. (Relative noise - 122 dbm).
- BATTERIES:**
12 standard 1 1/2 volt type "C" cells for amplifier and 2 standard 1 1/2 volt type "D" cells for meter light. Battery life 200 hours or more, 60 hours on meter.
- A.C. POWER:**
Gates in-line M-6435 power pack for 117 volt, 50/60 cycles.

- SIZE AND WEIGHT:**
10" wide, 4 3/8" high, 12 1/8" deep. Finish: Charcoal gray, black and satin chrome trim. Net weight with batteries, 10 lbs. Packed weight (domestic), 20 lbs., (export), 35 lbs. Cubage, 1 1/2.

Note 1: Source and output impedances stated as suggested working loads. Actual input impedance is 1500 ohms or higher and nominal output impedance is 490 ohms.

ORDERING INFORMATION

- Attache 3-channel remote amplifier, less batteries (Cat. No.) M-6433
Microphone connector, 3 required .. XLR3-12C
Battery kit complete M-6441
Optional mic. input xformer 478-0221
Power supply, in-line type M-6435
Pliable vinyl cover M-6444



TWO CHANNEL SOLID-STATESMAN REMOTE AMPLIFIER



COURIER "70"

Two mixing channels fill the basic needs of many remote pickups, and the Gates Courier "70" provides a Solid Statesman quality amplifier for such situations. Premium features include: separate preamplifier for each mixing channel, slide rule illuminated VU meter, very long battery life, optional in-line A.C. power supply, 1% or less distortion at high output levels, studio quality frequency response and total weight or less than 9 pounds with batteries.

PERFORMANCE: The outstanding performance of the ultra-



compact Courier '70' is a result of extensive product research. At full-rated + 18 dbm output, distortion is less than 1%, even when full new battery power is down more than 30%. Courier '70' battery life is normally in excess of 200 hours. Front panel controls in addition to mixers are master gain control, meter light switch and slide-rule VU meter, which also checks battery status.

POWER SUPPLY: An optional in-line A.C. power supply is diode protected from the batteries when in use. If power fails, change-over to batteries is instant and automatic. The amplifier turns on when inserting the headphone plug or dummy plug. Also optional is a pliable vinyl carrying case.

STYLING: the Courier "70" is indeed Jet Age in its flight line styling, only 4 3/8" high and a new mixing fader knob designed just for remote service where feel is often more important than seeing. For any broadcast it will produce studio quality. To many, it will be known as the Sportsman's remote amplifier.

SPECIFICATIONS

MIXING CHANNELS:
2 for microphones.

OUTPUT CIRCUITS:
1 program line, 1 headphone monitor.

SOURCE IMPEDANCE:
Microphone 30/50 to 150/250 ohms, unbalanced. Input transformers optional (see Notes 1 and 2).

LOAD IMPEDANCE:
600/150 ohms, balanced or unbalanced. Factory connected for 600 ohms.

MAXIMUM INPUT LEVEL:
- 35 dbm. into either microphone channel.

MAXIMUM OUTPUT LEVEL:
+ 18 dbm. to program line. 6 db. line isolation pad inbuilt.

GAIN:
Microphone input to line output, 94 db. \pm 2 db.

RESPONSE:
 \pm 1 1/2 db. 25 to 16,000 cycles.

DISTORTION:
1.0% maximum, 30 to 15,000 cycles

@ + 18 dbm. output.

NOISE:
62 db. or better below + 8 dbm. output with - 60 dbm. input. (Relative input noise, - 122 dbm.).

BATTERY COMPLEMENT:
12, Size "C" cells for amplifier. 2, Size "D" cells for VU light.

BATTERY LIFE:
200 hours or more for amplifier pack, and 60 hours for meter light.

EXTERNAL POWER:
Four-terminal plug on rear accepts external M-6435 in-line power pack for 117 volt A.C. operation.

CABINET DATA:
Size: 10" wide, 4 3/8" high, 12 1/8" deep. Finish: Charcoal gray vinyl with satin chrome trim. Weight: 8 3/4 lbs., including batteries.

SHIPPING DATA:
Packed weight (domestic), 14 lbs., (export), 32 lbs. Cubage, 1 1/2 ft.

Notes: (1) An input transformer is not

required for normal length microphone lines but an optional microphone transformer is available if desired. (2) Impedances stated are operating load impedances. Actual input impedance is about 2000 ohms from 30-15,000 cycles and output impedance is nominal at 490 ohms.

ORDERING INFORMATION

Courier "70" 2-channel transistorized remote amplifier, complete with transistors, less batteries . (Cat. No.) M-6432
100% battery kit for Courier "70" . . . M-6441
Microphone input transformer 478-0221
Vinyl cover, with accessory pocket . . . M-6444
"In-Line" power supply for 117 volt operation (see page 131) M-6435
Microphone connectors, male (2 required) XLR3-12C





UNIMOTE "70"

Imagination in engineering and styling distinguish the new Unimote "70," all transistorized single channel audio remote amplifier. Gates engineers have combined the latest electronic circuitry techniques in a compact, functional and attractive unit. At least 300 hours of battery life with this new all transistor single channel unit can be expected. If A.C. power is desired, the in-line power unit is available. Performance is studio quality while weight is only five pounds, complete with batteries.

DESIGN: Gates engineers designed exclusively for the Unimote "70" a new encapsulated amplifier. All components except the output transformer and gain control are sealed. This provides an amplifier that will function totally submerged in water or subjected to rigorous temperature and climatic conditions. Carefully quality control checked prior to encapsulation, this solid state unit should be trouble-free for a lifetime.

All controls and terminations are on the front. Operation is of the turn on—turn off type after the gain control setting is determined. Unimote "70" may be desk mount, attached to the wall by screws, mounted under a lectern or pulpit, or carried with less effort than a good book. Though designed as a single channel microphone amplifier, it has many other uses the engineers will quickly recognize.



View of encapsulated amplifier. After thorough quality check, the amplifier is sealed then thoroughly tested to specifications.

SPECIFICATIONS

OPERATING MODE:

Monaural.

INPUT CIRCUIT:

One 30/50 or 150/250 ohm microphone at maximum input level of - 35 db. (see Note 1).

OUTPUT CIRCUITS:

One program line, one headphone monitor.

LOAD IMPEDANCE:

600/150 ohms, balanced or unbalanced, (factory connected for 600 ohms). 6 db. isolation pad self-contained (see Note 1)

GAIN:

Microphone input to line output, 82 db. ± 2 db.

OUTPUT LEVEL:

+ 18 dbm. to program line.

RESPONSE:

± 1½ db., 30 to 15,000 cycles.

DISTORTION:

1.0% maximum, 30 to 15,000 cycles @ + 18 dbm. output.

NOISE:

- 122 dbm. relative input noise.

BATTERY COMPLEMENT:

12, Size "C" cells.

BATTERY LIFE:

Approximately 300-400 hours, average duty cycle.

EXTERNAL POWER:

External M-6435 in-line power pack for 117 volt AC operation.

(Instantaneous automatic changeover to battery in event of power failure.)

CABINET DATA:

Size: 10" wide, 5¼" high, 4¼" deep.

FINISH:

Anodized aluminum front panel with charcoal gray Royalite case.

WEIGHT:

5 lbs., including batteries.

SHIPPING DATA:

Packed weight, 6.5 lbs. Cubage, 1 ft.

ORDERING INFORMATION

- Unimote "70" single channel remote amplifier, less batteries M-6431
- Battery complement for above M-6441
- Input transformer (see Note 2) 478-0221
- In-line power supply (see Page 131) M-6435
- Microphone connector, male (1 required) XLR3-12C

NOTES: (1) Impedances shown are recommended load impedances. Actual input impedance is approximately 1500 ohms and nominal output impedance is 490 ohms. (2) If above normal microphone lengths are to be used, the optional 478-0221 input transformer may be quickly attached to bracket provided.



DUAL PEAK LIMITING AMPLIFIER

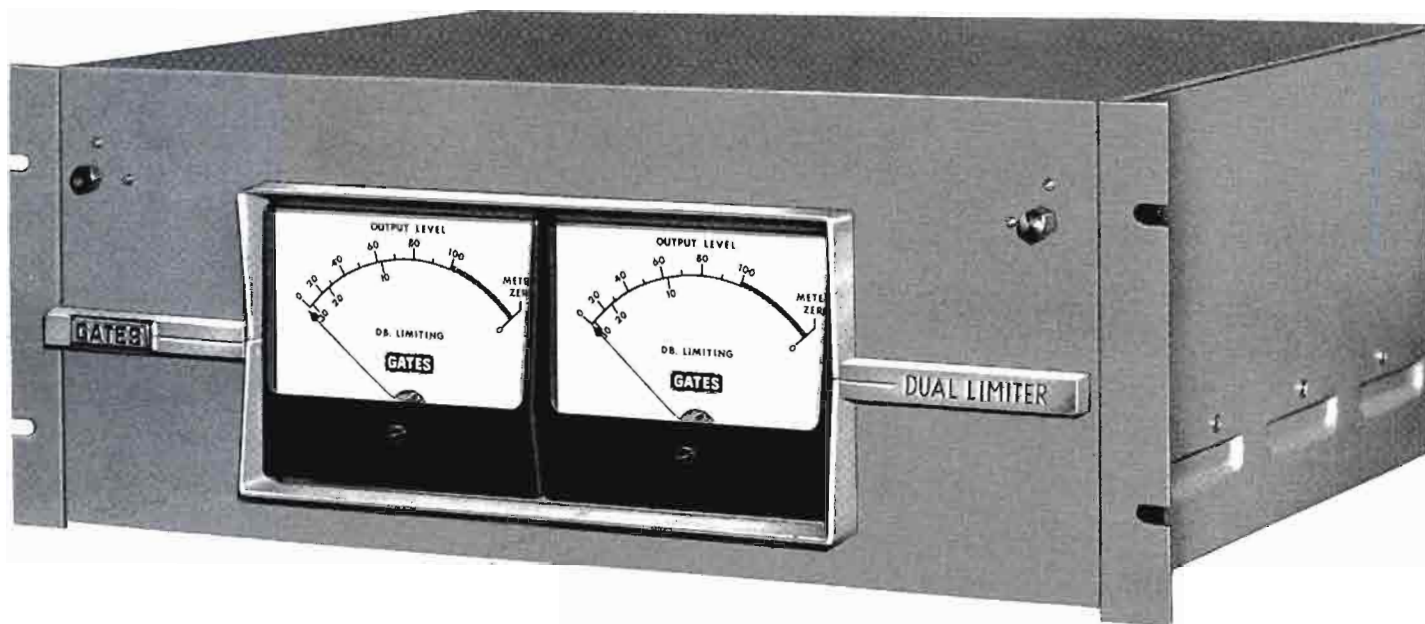

MODEL M-6144
(Stereo or Dual Monaural)

Although this very new Gates product was designed with exclusive features for stereo balance, it may also be used as two totally separate monaural limiters for AM and FM operation. One solid state regulated power supply operates both limiter sections, and the complete dual limiter requires only seven inches of rack space. Direct current is applied to input stage filaments to assure extremely low noise.

Many broadcasters will recognize the advantages of the dual limiter as a monaural device. For example, one limiter may be used in the program circuit, with the second for recording. Or, the second limiter may be on the FM program line, or even as a standby.

STEREO OPERATION: For stereo operation, program balance is always retained. The stereo channel that is limiting the highest determines the amount of peak limiting applied to the other stereo channel. The stereo signal balance is not altered, and yet the functions of the limiter are fully utilized. Likewise, in stereo, the limiters must have essentially identical characteristics in response, distortion

and phase to prevent undesirable differences in the two channels. Otherwise, one channel may limit heavily while the other is not limiting at all, thus destroying the stereo effect.

MONAURAL OPERATION: For dual limiter monaural operation, each limiter is independent in all functions. A switch instantly changes the mode from stereo to dual separate limiters. Operating controls include input and output level controls for each limiter. Each meter, by switch selection reads (a) db. of limiting, (b) output level, and (c) balance. The limiter may be inserted either at the studio, or the transmitter end of the telephone line.

PRACTICAL APPLICATION: The use of the limiting amplifier to obtain maximum signal level is well recognized. The importance of the dual limiting amplifier designed for stereo permits maximum peak limitation without stereo unbalance, thus providing the advantages of the peak limiting amplifier without disturbing the dynamic range, channel separation or third dimension effect in stereo programming.

Dual Peak Limiting Amplifier

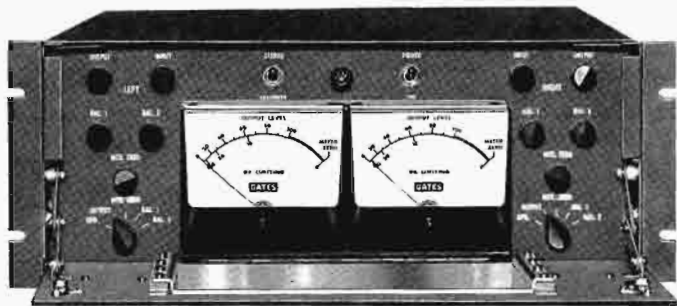

Front view with convenient flip down cover open.

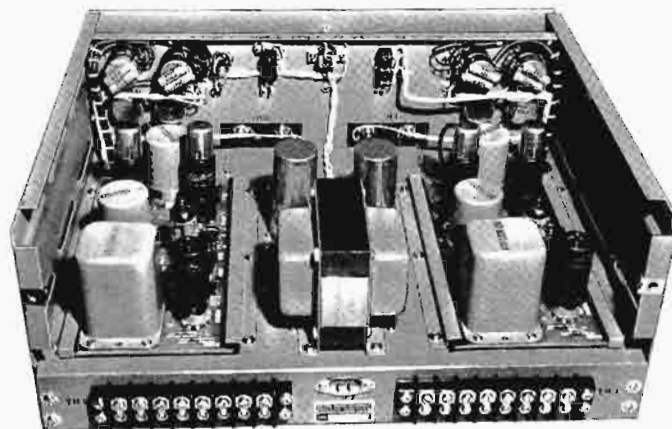

Rear view with top cover removed.

SOLID STATE POWER SUPPLY: The common solid state power supply operates both limiting amplifiers. Complete balancing controls are built-in to insure uniform characteristics. No tubes are used in the power supply and direct current is applied to the low level filament circuits. A power transistor is connected in a "capacitor multiplier" circuit to essentially eliminate ripple on the low level filaments. This contributes greatly to the outstanding low noise level of - 70 db.

AUDIO STAGES: Each amplifier of the Gates Dual Limiter has four audio stages consisting of a push-pull variable gain stage, a voltage amplifier, phase inverter and push-pull output stage. An extremely fast attack time of up to 600 microseconds is accomplished through new engineering circuitry. The signal to thump ratio is extremely low because of dynamic and static balancing controls in the first audio stage. Intermodulation distortion is less than 1.5% up to 20 decibels of limiting, while channel separation/crosstalk is substantially below noise level at all frequencies.

SPECIFICATIONS

- MODE:**
Stereo or dual monaural.
- CONTROLS:**
Input and output both limiters. Input balance both limiters. Meter mode selector both limiters. Meter zeroing both limiters. Stereo-dual separate limiters switch. Power on switch.
- IMPEDANCES:**
500/600 ohms input and output both limiters.
- AUDIO LEVELS:**
Input, - 45 dbm. at full open gain threshold of limiting or up to 0 dbm. by reduced gain adjustment. Output, + 24 dbm. into 6 db. self-contained isolation pad, also may be reduced with output level control. Maximum gain 63 dbm. \pm 2 db.
- RESPONSE:**
 \pm 1 db. 30-15,000 cycles.
- DISTORTION:**
1% or less at 10 db. limiting. 1½% or less at 25 db. limiting, 30-15,000 cycles.
- NOISE:**
70 db. below + 18 dbm. at output.
- LIMITER ACTION:**
Attack time up to 600 microseconds. Signal to thump ratio typical - 35 db. up to 25 db. limiting. Rated - 20 db. Crosstalk where used as stereo or separate limiters is - 70 db. or better.
- POWER:**
117 volts, 50/60 cycles, 60 watts.
- MECHANICAL:**
19" x 7" x 16" deep, weight packed: 50 lbs. domestic, 65 lbs. export. Cubage: 3. Finish: Medium gloss gray, trimmed in brushed aluminum and black.
- DIODE TRANSISTOR COMPLEMENT:**
(1) 2N1539 or 2N554 and (4 each) X5A6, X5A2, GO-1.
- TUBES:**
(4) 6K7, and (2 each) 12AX7, 12BH7, OB2.

ORDERING INFORMATION

Dual Peak Limiting Amplifier with tubes (Cat. No.) M-6144
Spare 100% tube kit TK-420



"TOP LEVEL" FOR FM TRANSMITTERS



TOP LEVEL

Brand new, this remarkable transistorized audio instrument is designed specifically for the FM broadcaster, and when properly adjusted, will positively prevent overmodulation. Gates *Top Level* is intended for use between a station's limiting amplifier and the FM transmitter. It is designed for both stereo and monaural service.

PREVENTS OVERMODULATION: With the advent of better recording equipment, reproducing systems, and the special equalization effects used by recording artists and studios, the high frequencies fed into today's FM broadcast transmitters are often of sufficient amplitude (after pre-emphasis) to cause overmodulation. The increasing number of incidents of FM overmodulation indicate the real need for this important instrument. *Top Level* allows maximum modulation level without the usual fears of overmodulation.

SOLID-STATE: Gates *Top Level* is a fully transistorized frequency sensitive audio processor for FM, utilizing a precise 75 microsecond pre-emphasis curve for its sampling. In FM transmission, amplifiers must handle high frequency signals (15,000 cycle Region) up to 17 db. higher than, as an example, a nominal 1000 cycle audio signal. When adequate signal levels are maintained at mid-range frequencies, there is a definite problem of overmodulation at the higher frequencies because of the pre-emphasis curve.

CLAMPING: *Top Level* samples the pre-emphasized audio

material and instantaneously clamps the high frequency high amplitude signals that cause overmodulation.

OPERATION: With *Top Level*, the FM receiver will reproduce a signal that is measurably louder than where this high quality instrument is not employed. This is because average modulation can be higher. The signal will sound cleaner because of the effect of de-emphasizing (in the receiver) a non-pre-emphasized portion of the curve while clamping is in effect. Also, *Top Level* affords precision control with low distortion, while, in comparison, transmitter overmodulation contributes to serious intermodulation and distortion in the FM discriminator of average receivers.

SCA ADVANTAGE: For broadcasters with SCA for background music, *Top Level* greatly reduces crosstalk and signal degradation due to pre-emphasis splatter from the main channel.

Top Level is not intended to replace a station limiter but functions as an economical companion unit to increase protection against overmodulation. It may be used without a limiting amplifier if desired.

MONAURAL OR STEREO: With dual channel capability, Gates *Top Level* is all set for stereo or monaural as supplied. Whether used for monaural or stereo, with *Top Level*, FM listeners enjoy full-range reproduction at an audio level that will please both the audience and broadcaster. Of course, this equipment is not intended for AM service.

SPECIFICATIONS

MODE:
Dual channel, stereophonic or monophonic.

INPUTS:
Two .600 ohms balanced or unbalanced.

GAIN:
28 db., maximum.

RESPONSE:
± 1 db., 30-15,000 cycles.

DISTORTION:
0.5% max., 30-15,000 cycles.

NOISE:
75 db. below normal output level.

ATTACK & RELEASE TIMES:
Instantaneous.

INPUT LEVEL:
- 10 to + 24 dbm. Adjustable.

OUTPUT:
2 channels at + 18 dbm. (adjustable), 600 ohms balanced or unbalanced.

POWER:
117 volts, 50/60 cycles, 30 watts.

MECHANICAL DATA:
19" wide, 5¼" high, 12" deep. Finish: medium gloss gray and black. Weight packed, 24 lbs. Cubage: 12.



ORDERING INFORMATION

Gates FM Top Level, complete (Catalog No.) M-6467



PEAK LIMITING AMPLIFIER



MODEL SA-39B

The SA-39B Limiting Amplifier is the trusted guardian of the audio signal in thousands of broadcast stations around the world. The unique circuitry developed by Gates engineers years ago and continually upgraded has been accepted as the world standard. By positive and smooth prevention of overmodulation with consistently louder audio signals, the SA-39B provides better station coverage, (a 3 decibel increase in over-all average audio signal is equivalent to doubling power). Usually installed near the transmitter it is an ideal replacement for older, slow acting limiters.

The very fast attack time, essentially instantaneous, is as-

sociated with six switch selectable release times. In this manner the engineer may adopt the mode of operation best suited for him. Limiting action is by full wave rectification of the output voltage with the resultant negative direct current fed to the second control grid of the push-pull input stage. Although action is extremely fast, no added distortion is introduced at compression levels as high as 20 db.

The circuit design provides separate input and output level controls and three push-pull stages. The regulated power supply assures limiter calibration over wide ranges of line voltage. A wide scale 4" meter is calibrated in decibels of compression for direct reading.

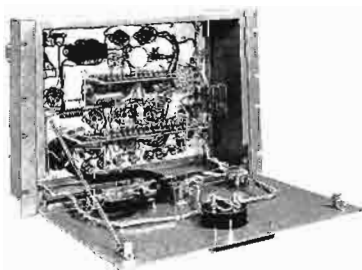

Note accessibility and logical design as shown (left) front open, and (right) rear views of this outstanding Limiting Amplifier.

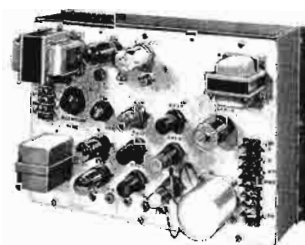

SPECIFICATIONS

MODE:

Monaural.

CONTROLS:

Input and output level controls on front panel.

METER:

Reads directly in decibels of limiting.

IMPEDANCES AND LEVELS:

Input; 500/600, 150/250, 30/50 ohms.
Input level; from - 20 dbm. to + 20 dbm.
Output; 500/600 ohms.
Output level; up to + 19 dbm.

GAIN:

Maximum 50 db.

RESPONSE:

± 1½ db. 30-15,000 cycles.

DISTORTION:

1½% or less 30-15,000 cycles up to 15 db. compression. Only slightly higher up to 25 db. of compression.

NOISE:

65 db. or better below any adjustable output level.

LIMITER ACTION:

Attack time, essentially instantaneous. Release time: six positions from 0.2 to 1.2 seconds.

SERVICING:

Front panel drops down. Tubes in rear.

POWER:

117 volts, 50/60 cycles, 90 watts.

MECHANICAL:

Size, 19" x 14" x 9½" deep. Weight packed: 74 lbs. domestic, 96 lbs. export. Cubage: 9 cu. ft. Finish: Medium gloss gray with escutcheons in black.

TUBES:

(3) 6SJ7, (2) 1612, (2) 6V6GT, and (1 each) 6H6, 6X5GT, 6L6G, and 5V4G.

ORDERING INFORMATION

SA-39B Peak Limiting Amplifier with tubes M-3529B
Spare 100% tube kit TK-150



THE LEVEL DEVIL—PROGRAM GATED AMPLIFIER



LEVEL DEVIL

Today, the widely used Gates *Level Devil* is accepted as the industry standard in automatic gain control amplifiers. The *Level Devil* accepts varying input signals and holds the output constant. Depending on input signal level, the *Level Devil* operates as (1) a linear amplifier, (2) a volume expander, or (3) a limiting amplifier. Unlike usual expander-compressors, however, the *Level Devil* does not expand or “pump” background noise.

PERFORMANCE: *Level Devil* accepts input signals over a 30 db. range and holds a constant output ± 3 db. The expander threshold is -10 db. relative and below this the amplifier operates as any other good linear amplifier. At -10 db. or above the amplifier will expand to 0 db. Above 0 db. it will limit.

OPERATIONAL FEATURES; With average program content at normal input level, the *Level Devil* operates as a linear amplifier. With above normal audio input level it operates as a limiting amplifier, and maintains the desired output level. If the average input level should drop below normal by as much as 10 db., the *Level Devil* functions as a volume expander. But, when there is no signal for a period of 1 to 4 seconds, the *Level Devil* returns to the linear amplifier mode of operation, and does not emphasize or increase background noise. This is ideal for controlling the audio of a dramatic show in which there are long periods of silence enhanced only by the background of soft music or the rustling of leaves. To expand this background would destroy the desired audio effect.

VERSATILITY: When selected by the operator, two switches are provided so that *Level Devil* may be used for expansion only, without limiting; or vice versa, for limiting only, without expansion. Though *Level Devil* is particularly

adaptable to TV and FM broadcasting, it is equally suitable for AM where the exclusive features of *Level Devil* are preferred.

APPLICATION: In most instances a peak limiting amplifier should be used with *Level Devil*. The limiter, often at the transmitter location, is the over-all guardian against over-modulation as well as permitting higher average audio levels. *Level Devil*, usually at the studios, preferably operates independent of other total equipment functions to obtain the fullest benefit of its outstanding capabilities.

Radio and television stations alike have reported an increase in coverage with a louder sound, minimum background noise in absence of a signal, and constant output level as salient operating advantages obtained from *Level Devil*.

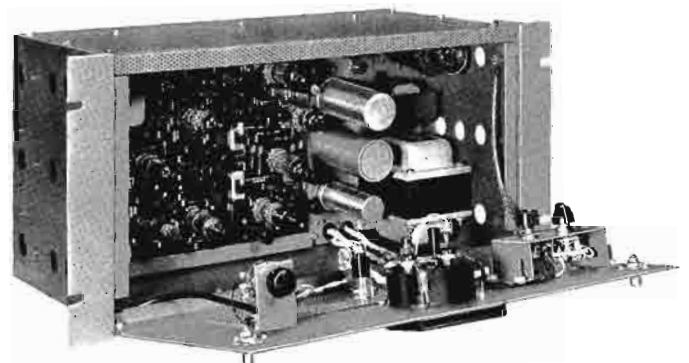

The *Level Devil* front panel hinges down for fast access to tubes and controls. As controls once adjusted are seldom changed, this feature prevents accidental changing of the important automatic gain control functions. The controls accessible with front panel closed include on-off switch, pilot light and fuse.

The Level Devil—Program Gated Amplifier

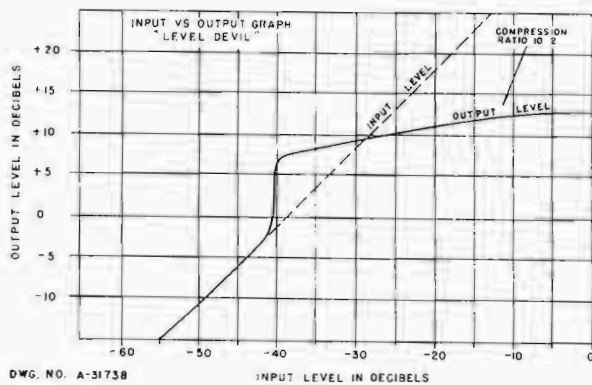

Above: Graph shows compression or limiting curve as related to input.

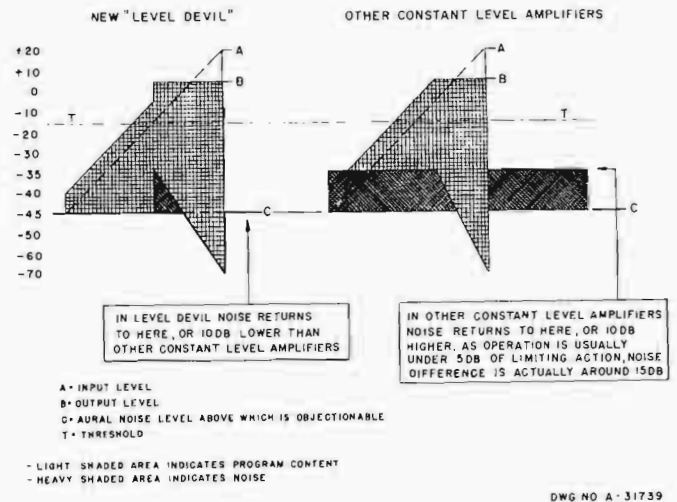

Above: Graphically illustrates the difference between Level Devil and all other leveling amplifiers. Noise referred to in graphs is defined in this instance as lower level program content.

SPECIFICATIONS

MODE:

Monaural.

CONTROLS:

Input and output levels. Switches to select operating modes.

METER:

Reads direct in (a) limiting, (b) normal, and (c) expansion.

IMPEDANCES:

500/600 ohms input and output.

INPUT LEVEL:

- 35 VU to + 27 VU (10 db. and 20 db. input pads incorporated).

OUTPUT LEVEL:

+ 8 VU after 6 db. line isolation pad.

GAIN:

50 db. without limiting or expansion.

RESPONSE:

± 1 db. 30-15,000 cycles.

DISTORTION:

1% or less 50-10,000 cycles to 10 db. limiting. 2% or less to 25 db. limiting.

MAXIMUM VOLUME EXPANSION:

10 db. Note that Level Devil can release 5 db. of compression and expand 10 db., giving effective signal increase of 15 db.

EXPANSION RISE TIME:

2 seconds.

EXPANDER RECOVERY TIME:

4 seconds.

MAXIMUM LIMITING:

25 db.

LIMITER ATTACK TIME:

10 milliseconds.

LIMITER RELEASE TIME:

1.5 to 2.0 seconds.

NOISE:

- 60 db. or better below 10 db. limiting.

POWER:

117 volts, 50/60 cycles, 55 watts.

SIZE:

19" x 8¾" x 8½" deep.

WEIGHT:

Domestic packed 35 lbs.; export packed 45 lbs. Cubage: 2 cu. ft.

FINISH:

Medium gloss gray and black.

TUBES:

(2 each) 5749, 12AU7, 12AT7, 12AX7, OB2. (1 each) EF86, 5V4G.

ORDERING INFORMATION

Level Devil with tubes (Cat. No.) 5546A
Spare 100% tube kit TK-331

DID YOU KNOW?

Did you know that Gates manufactures more radio broadcasting equipment than any other manufacturer in the world? *Did you know* that three of the four major United States networks have their key originating studios for either radio or television equipped with Gates manufactured audio equipment? *Did you know* that Gates short wave 50,000 watt transmitters are used by Voice of America for world-wide broadcasting? *Did you know* that the world's largest radio studios are Gates manufactured (VOA in

Washington, D.C.)? *Did you know* that the Harris-Intertype Corporation, by whom Gates is wholly owned, is a world leader in the graphic arts industry and manufactures the presses that print Life, Saturday Evening Post and National Geographic among many others? *Did you know* that Gates, established in 1922, and enjoying its 43rd year, is one of the very few electronic equipment manufacturers in the world with such lengthy seniority. And most important—*Do you know* that 100% of our effort is directed to *you* our customer.

THE STA-LEVEL—AUTOMATIC PROGRAM LEVEL AMPLIFIER



THE STA-LEVEL

Perhaps no single equipment in all of broadcasting has done so much for so little cost as the Gates *Sta-Level*. The basic function is to provide constant level output. *Sta-Level* might be likened to a gentle electronic hand on the master gain control. When the volume is too low, *Sta-Level* will raise it. If volume is too high, *Sta-Level* will automatically reduce it. This automatic adjustment for different input levels allows average output levels to be higher (for there is automatic protection)—while the low soft passages are automatically raised in level—resulting in a uniformly higher level of transmission and the equivalent of greater signal output.

RECOVERY SPEED: As supplied, *Sta-Level* recovers $\frac{2}{3}$ level in 7 seconds and 90% level in about 28 seconds. This is considered typical. However, a kit of small fixed resistors

is supplied. If the operator feels this is too slow or too fast, he may, by changing two resistors, increase recovery to as fast as $2\frac{1}{4}$ seconds for $\frac{2}{3}$ level, and 10 seconds for 90% level; or as slow as $11\frac{1}{4}$ seconds for $\frac{2}{3}$ level, and 45 seconds for 90% level.

ACCESSORIES: None are needed for the *Sta-Level* is a self-contained one-chassis unit complete with regulated power supply.

GAIN: As *Sta-Level* has up to 62 db. gain, if your present system is short of gain, *Sta-Level* will pick it up. Both input and output level controls are on the front panel to adjust for any gain you wish right down to unity or up to the full 62 db.



Right: Front panel drops down for easy servicing of all inner parts.

Left: rear view shows terminations and tube locations.

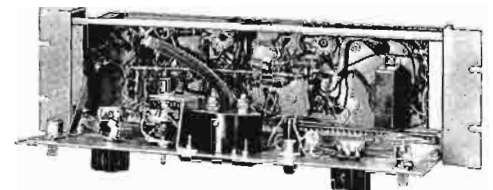

SPECIFICATIONS

MODE:
Single channel monaural.

CONTROLS:
Input and output level controls.

METER:
Reads decibels of compression.

IMPEDANCES:
500/600 ohms input and output.

GAIN:
62 db. adjustable at both input and output.

RESPONSE:
 ± 1 db. 30-15,000 cycles.

DISTORTION:
1% or less 50-15,000 cycles at 30 db. compression or less and at + 20 dbm. output threshold level.

NOISE:
65 db. below 0-30 db. compression at + 20 dbm. threshold level.

MAXIMUM VOLUME EXPANSION:
Variable as set by input control.

EXPANSION RISE TIME:
Factory set at 7 seconds. Kit provided for faster or slower action as desired.

EXPANSION RECOVERY TIME:
Approximately 25 milliseconds.

MAXIMUM COMPRESSION:
30 db. at 1% distortion. 40 db. at slightly greater distortion.

COMPRESSION ATTACK TIME:
Approximately 25 milliseconds.

COMPRESSION RECOVERY TIME:
Normal 7 seconds for 63% recovery.
Faster as compression becomes greater.

SERVICING:
Drop down front panel. Tubes on rear.

POWER:
117 volts, 50/60 cycles, 45 watts.

MECHANICAL:
Size, 19" x 5 $\frac{1}{4}$ " x 7" deep. Weight packed: 40 lbs. domestic; 50 lbs. export. Cubage: 2 cu. ft.
Finish: Medium gloss gray and black.

TUBES:
(2) 6V6, and (1 each) 6386, 12AT7, 6AL5, OB2, 5Y3GT.

ORDERING INFORMATION

Sta-Level with tubes (Cat. No.) M-5167
Spare 100% tube kit TK-243

AMPLIFIERS FOR BROADCASTING

2 CHANNEL REMOTE AMPLIFIER

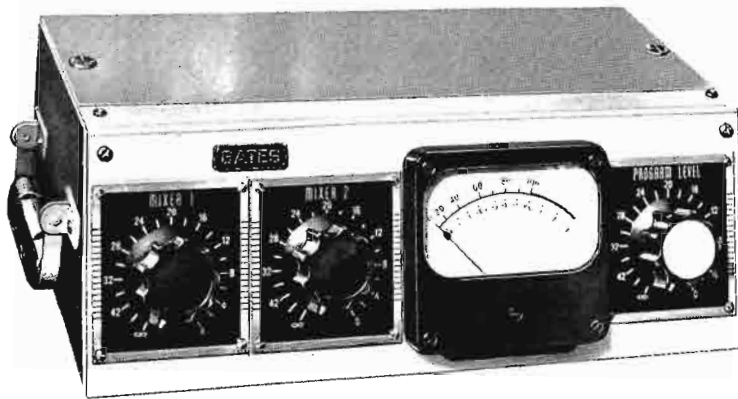

BIAMOTE

This two-channel A.C. operated self-contained remote amplifier will satisfy a wide variety of remote programming needs from sports to the most exacting musical program. The sloping front panel, twin mixers to the left of the 4" illuminated VU meter and master gain to the right have much operator acceptance. Carrying handle at left side. Finish is medium gloss gray with black anodized dials. Weighs only 15 lbs. All terminations are to the rear including phones, line, microphones and A.C. power switch. Standard type XL microphone connectors are used.

SPECIFICATIONS

MIXING CHANNELS:
2 channels, each for 30/50 or 150/250 ohm microphones.

GAIN:
90 db. \pm 3 db. microphone to output line.

PERFORMANCE:
Response: 30-15,000 cycles \pm 2 db. Distortion: 1% or less 50-15,000 cycles at + 18 dbm. output. Noise: 60 db. below + 8 dbm. output.

OUTPUT:
500/600 ohms, isolation pad self-contained.

TUBES:
(3) EF86/6267 and (1 each) 12AU7, 6X4.

POWER:
115 volts, 50/60 cycles, 25 watts.

WEIGHT:
Packed—30 lbs. Cubage: 2.

SIZE:
14" wide, 5" high, 8½" deep.

ORDERING INFORMATION

Biamote 2-channel remote amplifier with tubes, less male microphone connectors (Cat. No.) M-5136A
Microphone connector (2 required) XLR-3-12C
Spare 100% tube kit TK-443

SINGLE CHANNEL UTILITY AMPLIFIER

Often called the most important of amplifiers as it answers nearly any unexpected call. Every broadcaster should have at least one M-5530 utility amplifier. A.C. operated and self-contained the M-5530, all purpose amplifier, operates excellently as (a) a single microphone remote amplifier, (b) turntable preamplifier with ample gain for passive equalizers, (c) standby program amplifier and (d) a microphone amplifier for medium level tape recording. Size: 11" x 5" x 5¾" deep. Mounts nicely in turntable cabinet. Ideal for permanent remotes.



SPECIFICATIONS

INPUT:
30/50 or 150/250 ohms.

OUTPUT:
150/250 or 500/600 ohms.

GAIN:
81 db.

RESPONSE:
30-15,000 \pm 1½ db.

DISTORTION:
1% or less 50 to 15,000 cycles at + 8 dbm. output or 2% at + 18 dbm.

NOISE:
60 db. below + 8 dbm.

POWER:
115 volts, 50/60 cycles. Consumption 15 watts.

TUBES:
(2) EF86/6267, and (1 each) 12AU7, 6X4.

WEIGHT:
Net 9½ lbs. Packed 20 lbs. Cubage: 2.

ORDERING INFORMATION

Single Channel Utility Amplifier with tubes (Cat. No.) M-5530
Chassis connector (female) optional XL3-13
Microphone connector (male) XLR-3-12C
Spare 100% tube kit TK-280

PROGRAM OR LINE AMPLIFIER



MODEL M-5576B

Studio equipment facilities often may be expanded by adding a second or third program amplifier. In single channel consoles the audio bus may be used for separate programming of FM by inserting the M-5576B program amplifier between the bus and the line. For bridging, standby and network feeds, this amplifier mounted in the equipment rack is ideal.

This high gain, low distortion, 4-stage program amplifier includes a self-contained power supply and requires only 5¼" of rack space. A dual gain control with one section in the second stage grid and the other section in the third stage

grid assures very low noise ratio at any gain setting. Front panel drops down to service inner components. Front panel equipment includes gain control, power switch, fuse and pilot light.

SPECIFICATIONS

- GAIN:**
75 db. \pm 2 db.
- RESPONSE:**
 \pm 1½ db. 30-15,000 cycles.
- DISTORTION:**
0.75% at + 12 dbm. output 30-15,000 cycles.
1% at + 22 dbm. output 50-15,000 cycles.
- NOISE:**
60 db. below + 12 dbm. output or equal to - 120 dbm. relative input noise.
- IMPEDANCES:**
Input and output: 150/250 or 500/600 ohms.
- POWER:**
117 volts, 50/60 cycles, 45 watts.
- TUBES:**
(3) EF86 and (1 each) 12AU7, 6X4.
- MECHANICAL:**
19" x 5¼" x 7½" deep. Weight packed (domestic) 27 lbs., (export) 50 lbs. Cubage: 2 cu. ft. Finish: Medium gloss gray and black.

ORDERING INFORMATION

- Program Amplifier with tubes (Cat. No.) M-5576B
Spare 100% tube kit TK-450

ULTRA LINEAR MONITORING AMPLIFIER

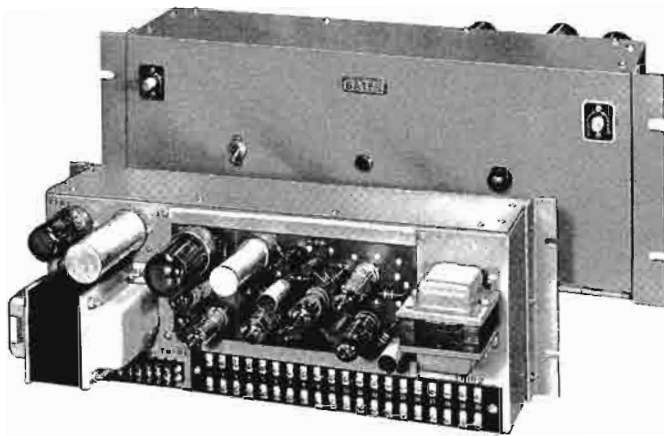

In quality audio systems, the need for excellence in loud-speaker distribution is paramount. Here is an outstanding amplifier offering a variety of input impedances, very low distortion, excellent power output and high gain. Designed primarily for the exacting needs of broadcasting, the M-5575 ultra linear monitoring amplifier also has found wide acceptance in industry, theatre, schools and even home audio systems where the ultimate in audio reproduction is desired.

Input impedances for matching 30/50 and 150/250 ohm lines or bridging at 30,000 ohms are available. Unusual in monitoring amplifiers is the high gain of 100 db., thus the

M-5575 amplifier may be used directly from a mixer program bus, low level turntable output or a microphone. Yet, producing full 10 watts power output from a - 60 dbm. input, the distortion is less than 1%.

SPECIFICATIONS

- GAIN:**
100 db. or bridging 50 db.
- RESPONSE:**
+ 1½ db. 30-15,000 cycles.
- DISTORTION:**
1% or less 50-15,000 cycles at + 40 db. (10 watts).
- NOISE:**
60 db. or better below + 40 dbm. measured at - 50 dbm. input.
- IMPEDANCES:**
(input) 30/50 or 150/250 ohms at 100 db. gain.
30,000 ohms bridging at 50 db. gain.
(output) 8 and 16 ohms.
- POWER:**
117 volts, 50/60 cycles, 85 watts.
- TUBES:**
(3) 12AX7, (2) EL84, (1) GZ34 (1) OA2, (1) OB2.
- MECHANICAL:**
19" x 7" x 8" deep. Weight packed (domestic) 34 lbs., (export) 59 lbs. Cubage: 3 cu. ft. Finish: Medium gloss gray and black.

ORDERING INFORMATION

- Ultra Linear Monitoring Amplifier, with tubes (Cat. No.) M-5575
Spare 100% tube kit TK-303
Speaker Matching Transformer, see Page 148 A-30601

GATES BROADCAST MICROPHONES

PROFESSIONAL QUALITY MICROPHONES

DESIGNED FOR BROADCASTERS: The microphones on this page are manufactured to very exacting specifications with the commercial broadcaster foremost in mind. These are professional microphones with design specifications and quality approved by Gates engineers to meet the particular type of service required in broadcast studios and remote pickups.

MODEL G-100 MICROPHONE

The Gates G-100 microphone is a dynamic, omnidirectional type designed for high quality pickup of music and speech. Recommended for News, Sports and general applications. Excellent as an announce microphone and for remote pickups.



SPECIFICATIONS

FREQUENCY RESPONSE: Uniform from 60 to 12,000 cycles. **IMPEDANCE:** 150 ohms balanced. **OUTPUT LEVEL:** - 55 db. **POLAR PATTERN:** omnidirectional. **DIAPHRAGM:** Acoustalloy. **FINISH:** Non-reflecting Gates Gray. **CABLE:** 18 ft., two-conductor, shielded, synthetic rubber jacketed, broadcast type. **STAND COUPLER:** 5/8 in. - 27 thread. **DIMENSIONS:** Diameter: 2 in., Length: 6 1/4 in. **NET WEIGHT:** 1 lb., microphone only.

ORDERING INFORMATION

Gates Dynamic, Omnidirectional Microphone (Cat. No.) G-100
Matching Desk Stand Model 418



MODEL G-200 MICROPHONE

A dynamic type, omnidirectional microphone, the Gates G-200 combines slim-trim styling with outstanding performance characteristics. Ideal for Control Room work or floor-stand use as in television studios. This is a fine microphone in the modest price range for any broadcast pickup.

SPECIFICATIONS

FREQUENCY RESPONSE: Uniform from 60 to 13,000 cycles. **IMPEDANCE:** 150 ohms balanced. **OUTPUT LEVEL:** - 55 db. **POLAR PATTERN:** Non-directional. **DIAPHRAGM:** Acoustalloy. **FINISH:** Non-reflecting Gates Gray. **CABLE:** 18 ft., two-conductor, shielded, synthetic rubber jacketed, broadcast type. **STAND COUPLER:** 5/8 in. - 27 thread. **DIMENSIONS:** Diameter: 1 1/4 in.; Length: 10 1/4 in. **NET WEIGHT:** 15 oz., microphone only.

ORDERING INFORMATION

Gates Dynamic, Omnidirectional Microphone G-200
Matching Desk Stand Model 418

MODEL G-300 MICROPHONE

The G-300 is a cardioid microphone of the dynamic type. Provides discrimination against unwanted sound from the back. Excellent for music, live studio work and where a directional pickup is required. As a sports, rostrum or church microphone, this model is highly favored.



SPECIFICATIONS

FREQUENCY RESPONSE: Uniform from 40 to 15,000 cycles. **IMPEDANCE:** 150 ohms balanced. **OUTPUT LEVEL:** - 55 db. **POLAR PATTERN:** Cardioid. **DIAPHRAGM:** Acoustalloy. **FINISH:** Non-reflecting Gates Gray. **CABLE:** 18 ft., two-conductor, shielded, synthetic rubber jacketed, broadcast type. **STAND COUPLER:** 5/8 in. - 27 thread on stud. **DIMENSIONS:** Diameter: 1 1/8 in., max. Length: 7 3/16 in., not including stud. **NET WEIGHT:** 1 lb. 10 oz., microphone only.

ORDERING INFORMATION

Gates Dynamic, Cardioid Microphone G-300
Matching Desk Stand Model 419

MODEL G-400 MICREMOTE, REMOTE MICROPHONE/AMPLIFIER

A fully transistorized single-channel remote amplifier together with a miniature dynamic microphone. Built-in earphone jack monitors output and line cues. 5.4 volt mercury battery provides average 50 hour service. Turns on automatically when telephone line plug is inserted. Hand type for interview, man on street and similar. Excellent for broadcast tape recorders often without preamplification.



SPECIFICATIONS

RESPONSE: 70-10,000 cycles. **DISTORTION:** 2% or less. **OUTPUT LEVEL:** + 6 V.U. **LOAD IMPEDANCE:** 600 ohms. **FINISH:** Low-lustre gray.

ORDERING INFORMATION

Micromote, complete with 20' output cable, earphone, battery and carrying case G-400
Spare battery 660-0016

MODEL G-500 DYNAMIC LAVALIER MICROPHONE

Newest in Gates line. A studio quality unit designed in size and performance for TV and similar applications where a miniature, tailored response, microphone is required. For news, weather, television interview shows.



SPECIFICATIONS

RESPONSE: 50 to 12,000 cycles, rising to 6 kc. **IMPEDANCE:** 50-250 ohms, balanced. **OUTPUT LEVEL:** - 59 db. **POLAR PATTERN:** Omnidirectional. **FINISH:** Non-reflecting gray with stainless steel grill. **CABLE:** 30 foot, 2 conductor shielded. **DIMENSIONS:** 25/32 inches diameter, 2 1/2 in. length. **NET WEIGHT:** 2 ounces (less cable).

ORDERING INFORMATION

Gates Dynamic Lavalier Microphone, with Lavalier cord and clip G-500
Other microphones on Page 145. Accessories, Page 150.

SELECTED PROFESSIONAL MICROPHONES

CARDIOID MODEL 642



SPECIFICATIONS

TYPE: Dynamic, modified cardioid. **RESPONSE:** Flat 30 to 10,000 cps or choice of 5 to 10 db. low frequency reduction steps by screwdriver adjustment. **IMPEDANCE:** 50, 150 or 250 ohms. **OUTPUT LEVEL:** — 48 db. **FINISH:** Cast aluminum with non-reflecting gray finish. **SIZE:** 17 7/8" long; 3 3/16 max. diameter. **WEIGHT:** 3 lbs. 4 oz., net.

Perfect for television, film, sports, or wherever a highly directional top quality microphone is required. Combines the best characteristics of cardioid and distributed front opening designs. Essentially cardioid unidirectional up to 500 cycles. Highly directional over balance of range. Working distance several times greater than conventional microphones. Excellent for boom use. Must be used with the model 356 shock mount. Made by Electro-Voice.

ORDERING INFORMATION

Microphone, complete with connector and 20' cable Model 642
Shock mount (required) Model 356

CONDENSOR MICROPHONE MODEL U-67



SPECIFICATIONS

TYPE: Pressure gradient, condenser. **RESPONSE:** 20-16,000 cps. **IMPEDANCE:** 30/50 or 150/250 ohms. **OUTPUT LEVEL:** — 48 dbm. **POWER REQUIREMENTS:** NU-67 Power Supply: 110/127/220 volts, 50/60 cycles. **FINISH:** Matte Satin Chrome. **SIZE:** U-67 microphone—7 7/8" x 2 3/4" diameter; NU-67 power supply 4" x 4" x 8 1/2". **WEIGHT:** Microphone, 1 lb.; Power Supply, 4 lbs.

An outstanding condenser microphone system made famous by its performance in major recording studios and recommended as one of the finest professional microphones available. Frequency response perfectly linear \pm 1 db., 20 to 16,000 cycles. Electronically switched directional characteristics: cardioid, omni-directional, or figure 8. Flat response to 40 cycles with sharp roll-off below makes the U-67 microphone virtually "pop" proof for close talking. Switchable for flat low end response below 10 cycles or voice cutoff at 100 cycles for TV and film. Sensitivity switch prevents overloading. Supplied with 25 ft. cable and separate power supply. Manufactured by Neuman.

ORDERING INFORMATION

Condenser microphone system with power supply & 25 ft. cable U-67
Elastic suspension for boom use Z-48

CARDIOID MICROPHONE MODEL D24-E



SPECIFICATIONS

RESPONSE: 30-15,000 cycles. **IMPEDANCE:** 200 ohms (excellent in 150/250 ohm circuits). **OUTPUT LEVEL:** — 54 db. **FINISH:** Low lustre gray. **SIZE:** 6 1/2" long, 1 9/16" diameter. **WEIGHT:** 6 ozs., net.

The popular dynamic cardioid microphone as seen in nightclubs and on television for vocalists. Excellent for stand use or hand held, with screen protected element to reduce breath "popping." Has bass attenuation switch for close speaking. Directional with 20 db. front to back discrimination. Made by AKG Div. of North American Phillips.

ORDERING INFORMATION

Dynamic cardioid microphone with cable D-24E

RIBBON MICROPHONE MODEL 300



SPECIFICATIONS

TYPE: Moving ribbon, bidirectional. **RESPONSE:** 40 to 15,000 cycles. **IMPEDANCE:** 30/50, 150/250 and high impedance. **OUTPUT LEVEL:** — 59 db. **FINISH:** Bronze-tone enamel. **SIZE:** 6" high, 1 7/16" wide, 2 1/16" deep. **WEIGHT:** 1 lb., net.

Gradient bidirectional microphone. For the many broadcasters who prefer the "warm" sound which is characteristic of ribbon microphones. The 300 is a wide-range, quality ribbon microphone with bidirectional pickup pattern making it ideal for dialogs, interviews and other applications where front and back pickup is desirable. Equipped with live rubber shock mount. Made by Shure.

ORDERING INFORMATION

Microphone, complete with connector and 20 ft. cable SH-300

CARDIOID MODEL 666



SPECIFICATIONS

TYPE: Cardioid dynamic. **RESPONSE:** 30 to 16,000 cps. **IMPEDANCE:** 50, 150 or 250 ohms. **OUTPUT LEVEL:** — 58 db. **FINISH:** Cast aluminum with non-reflecting gray finish. **SIZE:** 7 3/4" long; 1 3/4" diameter. **WEIGHT:** 11 oz., net.

A truly professional cardioid microphone widely used by network broadcasters and recording studios. Variable-D principle for high discrimination against sounds from back. Permits close talking without bass accentuation. Working distance increased 1.7:1 over pressure microphones, supplied with clamp-on stand mount, or use optional Model 420 desk stand, described on Page 150.

ORDERING INFORMATION

Microphone, complete with 20' cable and connector Model 666
Desk stand Model 420

CONDENSOR MICROPHONE MODEL U-64



SPECIFICATIONS

RESPONSE: 40-18,000 cps. **IMPEDANCE:** 30/50 or 150/250 ohms. **OUTPUT LEVEL:** — 43 dbm. **POWER REQUIREMENTS:** N6U Power Supply, 110/127 volts, 50/60 cycles. **FINISH:** Matte Satin Chrome. **SIZE:** Microphone: 7/8" diam. x 4"; Power Supply: 8 3/4" x 4" x 4". **WEIGHT:** Microphone, 1 lb.; Power Supply, 4 lbs.

Newest condenser microphone in the Neumann tradition. The linear admittance microphone is designed to provide a precise cardioid pattern at all frequencies, permitting a greater working distance from instrumentalists, as in orchestra pickups, with no coloration in frequency response. Now, the off-axis saxophone player will be heard with the same clarity as the string players in the front row. Perfect for "one microphone" symphony broadcasts or recording. Uses Nuvistor for low noise and flat response. Supplied with microphone cable and separate power supply.

ORDERING INFORMATION

Linear Admittance Condenser Microphone, with power supply U-64

CARDIOID MICROPHONE MODEL D-25



SPECIFICATIONS

TYPE: Dynamic Cardioid. **RESPONSE:** \pm 2.5 db., 30-16,000 cycles. **IMPEDANCE:** 50 or 200 ohms. **OUTPUT LEVEL:** — 54 db. **FINISH:** Low lustre bronze tone. **SIZE:** 7 7/8" x 5 7/8" x 3 3/8". **WEIGHT:** 1 lb. 12 oz.

In a uni-directional microphone, when performance counts most, the Model D-25 offers a very high quality instrument. Especially good for broadcast studio work or music recording. Popular among FM "Good Music" stations. Supplied shock-mounted in metal frame on rubber suspension. Made by AKG Div. of North American Phillips.

ORDERING INFORMATION

Microphone, complete with cable D-25

PROBE MICROPHONE MODEL 576



SPECIFICATIONS

TYPE: Dynamic, omnidirectional. **RESPONSE:** 40-20,000 cps. **IMPEDANCE:** 30/50 or 150/250 ohms. **OUTPUT LEVEL:** — 60 db. **FINISH:** Non-reflecting gray. **SIZE:** 3/4" diameter, 8 3/8" length. **WEIGHT:** 7 ounces (less cable).

A new, superb, dynamic probe microphone designed for television and radio broadcasting. Strikingly modern in ultra-slim 3/4 inch diameter case that provides maximum view of performers. An ideal interview microphone because of its feel and balance with an 8 inch "reach". Furnished with clamp type swivel connector. Omni-directional. Made by Shure.

ORDERING INFORMATION

Microphone, complete with 25' cable and swivel adaptor SH-576

Other microphones on Page 144. Microphone accessories, Page 150.

RACK CABINETS

RAK-1

Utilizing welded open frame construction, with removable side panels, each basic rack of the RAK-1 may be mounted singly or bolted to others to form a uniform multirack installation. This design permits mounting of equipment within the rack cabinet or flush with the front. Front and rear doors may be hinged left or right as specified. Vertical panel mounting angles have tapped holes at RMA standard locations to provide 77 inches of standard 19 inch panel mounting. The basic RAK-1 cabinet includes 2 panel mounting angles, 2 terminal board mounting angles, full size rear door and panel mounting screws. Other accessories available:

SINGLE CORNER TRIM TRM-1: Covers the rack mounting bolts on each corner. Two used for single cabinet or any number of cabinets.

DOUBLE CORNER TRIM TRM-2: Covers rack mounting bolts and joins two cabinets together. One used to join second cabinet to first, third to second, etc.

LARGE SIDE SHIELD SH-1: An electrical shield plate 15 $\frac{1}{8}$ " x 28" in size.

SMALL SIDE SHIELD SH-2: Same as SH-1 above only 15 $\frac{1}{8}$ " x 21" in size.

TERMINAL BOARD MOUNTING BRACKET BRK-1: Mounts at bottom rear of cabinet for the support of audio and power terminal blocks.

SIDE PANELS SP-1: Commonly known as end bell. Two used for single cabinet or any number of cabinets joined together.

SPECIFICATIONS

HEIGHT OVERALL:
84".

WIDTH:
(less SP-1 side panel): 22".

WIDTH OF SP-1 SIDE PANEL:
3".

DEPTH OVER-ALL:
21".

DOOR SWING:
22 $\frac{1}{2}$ ".

PANEL SPACE:
19" x 77".

MAXIMUM CLEARANCE BEHIND FRONT PANEL:
17".

PANEL MOUNTING:
Standard rack multiples 12/24 mounting screws provided.

FINISH:
Gates Gray.

WEIGHT:
Net 100 lbs.; Domestic packed 110 lbs.;
Export packed 190 lbs. Cubage 18 cu. ft.

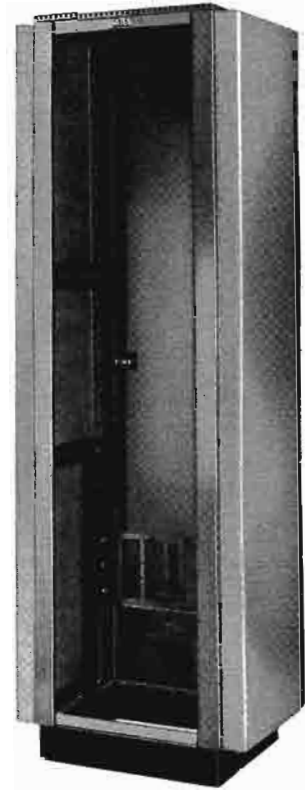

RAK-7

The RAK-7 is one of the finest solid side rack type cabinets designed specifically to accommodate all types of broadcast equipment. Built of lightweight steel construction, this well built value packed cabinet has solid sides, a solid base, full size rear door with louvers at top and bottom for efficient ventilation. Finish is medium gray for both smart appearance and easy cleaning. The 78" height matches almost all Gates AM, FM & TV transmitters. Standard cabinet is supplied with corner trim strips to cover panel mounting hardware. M-5577 joiner trim is used when joining two cabinets together.

SPECIFICATIONS

HEIGHT OVERALL:
78".

WIDTH OVERALL:
23 $\frac{1}{2}$ ".

DEPTH OVERALL:
19 $\frac{1}{2}$ ".

DOOR SWING:
20 $\frac{1}{2}$ ".

PANEL SPACE:
19" x 71 $\frac{3}{4}$ ".

CLEARANCE BEHIND PANEL:
17".

PANEL MOUNTING:
Standard rack multiples 12/24 mounting screws provided.

FINISH:
Medium gray.

WEIGHT:
Net 100 lbs.; Domestic packed 115 lbs.;
Export packed 200 lbs. Cubage 18 cu. ft.

ORDERING INFORMATION

RAK-1:
Basic Cabinet assembly less side panels
but including rear door RAK-1.
Single Corner Trim TRM-1.
Double Corner Trim TRM-2.
Side Panel SP-1.

Shield SH-1.
Terminal Board Mounting Bracket BRK-1.
Ventilating Fan RAK-F-1.
RAK-7:
Rack Cabinet RAK-7
Joiner Trim M-5577

AUDIO ACCESSORIES

CUEING AMPLIFIER



Program preview of 10 audio circuits may be selected by a rotary switch with this high gain, compactly designed cueing amplifier. Requiring only 3½" of rack space, the Gates *Uni-Que* amplifier has a self-contained loudspeaker and is easily adaptable to convenient desk mounting. High gain allows cueing direct from turntable, tape, projector circuits and microphone preamplifier outputs. Input is either low impedance or bridging. Speaker has terminals for muting when used in the control room. Even when other cue facilities are available, many broadcasters have added the *Uni-Que* for the rapid selection and cueing of a wide number of circuits. Front panel includes gain control, 10 selector switch plus OFF position, power switch, pilot light and fuse.

SPECIFICATIONS

- GAIN:**
70 db. low impedance matching, 35 db. bridging, ± 2 db.
- INPUT LEVEL:**
— 20 dbm. matching or + 22 dbm. bridging.
- RESPONSE:**
Peaked for high intelligibility.
- IMPEDANCES:**
(Input) 30/50, 150/250 or 10,000 ohms bridging.
(Output) to self-contained speaker with muting terminals external.
- NOISE:**
50 db. or better below speaker level of about + 30 dbm.
- POWER:**
105/125 volts, 50/60 cycles, 25 watts.
- POWER SUPPLY:**
Solid state, transformer input (Not AC/DC).
- TUBES:**
(1) 12AX7, (1) 50C5.
- MECHANICAL:**
19" x 3½" x 6½" deep. Weight packed (domestic) 16 lbs., (export) 30 lbs. Cubage: 2 cu. ft. Finish: Medium gloss gray and black.

SWITCH AND FUSE PANEL



Each rack of audio and radio frequency equipment should have a master switch and fuse panel. Usually mounted at the bottom of the rack, the Gates M-4242 Switch and Fuse Panel includes dual pilot lamps to indicate input and output voltage, dual fuses and D.P.D.T. primary switch. Rating 15 amperes at 115 volts, A.C. Size: 19" x 3½" x 3" deep. Finish: Medium gloss gray. Weight packed: 10 lbs. Cubage: 1 cu. ft.

VU METER AND RANGE PANEL

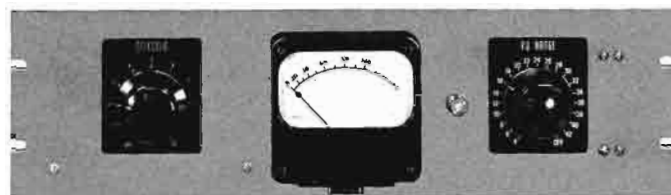

This accurate VU panel is a necessity for the completely equipped audio installation. A 5% or better accuracy is maintained throughout the 2 VU per step, + 4 to + 42 VU range. A 10-position input selector switch permits permanent installation to regularly checked circuits. For proof of performance measurements, equipment calibration, input level measurements from remote circuits and output levels (up to 10 watts), the V-22 meter panel offers complete versatility. Input: 7500 ohms to bridge a 500/600 ohm line. Frequency response: Flat 20-20,000 cycles. Size: 19" x 5¼" x 3" deep. Finish: Medium gloss gray and black. Shipping weight packed: 12 lbs. Cubage: 1. To order:

STUDIO WARNING LIGHTS



An unusually attractive studio fixture with edgewise lighting of a plexiglass transparent plate. Incandescent lamp is housed in gun-metal casing. Mounting is usually above studio door. Standard lettering is listed below but special lettering is available. "On Air" lettering is in red with other nomenclatures, such as "Studio A", etc. supplied in black. Housing well ventilated without light leakage. Size: 18" wide, 3" front to back, and 6½" from bottom of glass to top of housing. 117 volts, 50 watts.

ORDERING INFORMATION

| | |
|-----------------------------------|-------------------|
| Cueing Amplifier with tubes | (Cat. No.) M-5377 |
| Spare 100% tube kit | TK-305 |
| Switch and Fuse Panel | M-4242 |
| VU Meter and Range Panel | V-22 |

| LETTERING | ORDER |
|---|-------|
| Studio A | AM-1 |
| Studio B | AM-2 |
| Control Room | AM-3 |
| On Air (in red) | AM-4 |
| Information | AM-6 |
| Ladies | AM-7 |
| Gentlemen | AM-8 |
| Special lettering up to 12 characters (Specify) | AM-5 |



AUDIO ACCESSORIES

VA BIG PROGRAM FADER KNOBS



The VA program knobs are used on all Solid-Statesman consoles and specifically recommended for mixer and master gain functions. Designed to meet human engineering concepts, these VA fader knobs are fashioned for the control operator's hands where touch and feel are of major importance. The wing index fits naturally between fingers. Matching black anodized dial available (see Solid-Statesman console for matched appearance). A six color knob insert kit is also available for circuit color identification of controls.

VA Knob only (Cat. No.) 826-7824
 Dial for VA Knob 826-7773
 Knob color insert kit—(6 colors—5 of each) DC-53

STUDIO CUE/INTERCOM SPEAKER

The Studio Cue/Intercom Speaker is a modern designed, high efficiency cue speaker mounted in a cast aluminum housing and finished in black with attractive grill and may be used for cue listen or cue talk-back. Matches either 48 or 600 ohms. Size: 5 1/4" wide, 6 1/2" high and 4" deep, with a 30° slope when placed on desk.



Studio Cue/Intercom Speaker M-6424

DESK OR CONSOLE TOP V.U. METER

Used on the President and Ambassador Solid-Statesman consoles, this completely housed V.U. meter is ideal for many audio applications, such as duplicate V.U. metering in the studio to help the D.J. to maintain full level. Standard scale B illuminated 4" V.U. meter in cast aluminum housing 5 1/4" wide, 6 1/2" high and 4" deep and sets on desk at a 30° slope.



Desk or console top V.U. meter M-6208

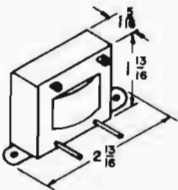

SPEAKER MATCHING TRANSFORMER

In broadcasting often a number of loudspeakers are employed. Where many speakers are used, the normal 8 ohm voice coil impedance will cause a mismatch. This transformer has a primary of 48 ohms and a secondary of 8 ohms. Thus, six transformers in parallel will reflect the normal 8 ohms output impedance of the studio monitor amplifier.

Speaker Matching Transformer A-30601

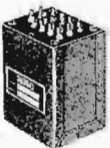

FIXED EQUALIZER

A general response correction equalizer of the parallel resonant type for 150 or 600 ohm circuits. A kit of resistors and capacitors is supplied to provide 1 ohm steps to 111 ohms and capacitance of .05 and .025 mfd. Though normally used to correct deficient telephone lines, it is excellent for other circuit corrections as well. Size: 2 1/2" square and 3" high.

Fixed Equalizer complete LE-1

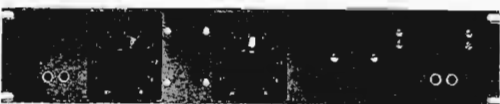

VARIABLE EQUALIZER

Consists of 2 Type LE-1 equalizers described above with two variable controls to insert resistance in 1 ohm steps to 111 ohms. A double jack input is provided for each of the two equalizers for parallel patching. Panel drilling and space is also provided to add a variable attenuator, often desirable in controlling line level. Size: 19" wide and 3 1/2" high. Finish: Medium Gloss Gray.

Variable Equalizer LE-2

PATCH PANELS AND CORDS



Above: Three PJ-341 jacks strips on PD-3 jack mat. Provides 144 jacks (72 pairs). Rack space 7" x 19".

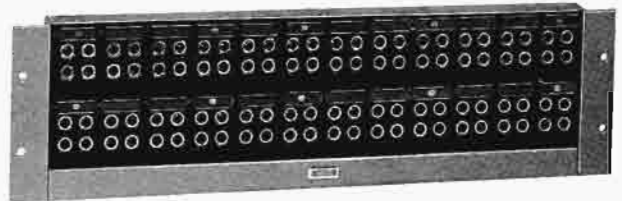

Illustrated above are two PJ-341 jack strips on a PD-2 jack mat to supply 48 pairs or 96 jacks on a 19" x 5 1/4" rack space.



Twenty-four pairs or 48 jacks is a PJ-341 jack strip on a PD-1 jack mat. Rack space 19" x 3 1/2".



Shown above is the PJ-343 twenty-four jack, 12-pair unit requiring only 19" x 1 1/4" rack space. No jack mat is required.

Industry standard double jack panels. Jack strips and jack mats listed separately below for ease in ordering. Jacks are closed circuit type to normal through audio circuits when patch cord plugs are not inserted. Contacts are silver alloy with springs, non-aging, non-ferrous metal to assure lasting tension. Molded bakelite form, steel reinforced. Individual designation strips with slip-in holders for each jack pair.



Patch cords have double plug each end with cords in 4 lengths. Cords shielded and covered with double black braid with extra reinforcement 6" from each plug end.

ORDERING INFORMATION

Jack strip only, 24 jacks or 12 pairs (no jack mat required) PJ-343
 Jack strip only, 48 jacks or 24 pairs (less mat) PJ-341
 Jack mat for one PJ-341 jack strip PD-1
 Jack mat for two PJ-341 jack strips PD-2
 Jack mat for three PJ-341 jack strips PD-3
 Double patch cord with 2' cord PJ-12
 Double patch cord with 3' cord PJ-13
 Double patch cord with 4' cord PJ-14
 Double patch cord with 5' cord PJ-15

AUDIO ACCESSORIES

TRANSCRIPTION STORAGE CABINETS



DISC CABINET

For convenient filing and protection of records or tapes, use the modern Wallach Storage Cabinets. Models available for all sizes of discs, and tape reels. Modular systems for desk and floor mounting with doors and locks are also available.

Protect those expensive and fragile 12" LP's as they should be. Holds 540 12" LP's with a heavy red wallet for each. Includes two sets of numbers, 1620 printed catalog cards and card file. Size: 60" high, 29" wide and 14" deep. Double door with lock and key.

Disc Storage Cabinet Cat. No. C-540



DOUBLE DOOR TAPE CABINETS WITH LOCK

Cabinet for 7" reel boxes. 29" wide x 60" high x 10" deep. 18 compartments capacity to 288 reel boxes. Shipping Wt. 150 lbs.

Cabinet for 10 1/2" reel boxes. 29" wide x 60" high x 10" deep. 12 compartments capacity to 192 reel boxes. Shipping wt. 160 lbs.



TAPE CABINETS

Holds 42 reel boxes of 7" tape reels. 13 1/8" wide, 12 5/8" high, 8 5/8" deep. Has six compartments. May be stacked as desired.

Holds 21 reel boxes of 10 1/2" tape reels. 13 1/8" wide, 12 5/8" high, 12" deep. Has three compartments. May be stacked as desired.

COMPACT DISC-CABINET FOR LP ALBUMS

Locate any album in seconds. LP's slide out for easy removal from storage pocket. Holds sixty 7", 10" or 12" albums. Includes cataloging system with index cards for fingertip control. Size: 13 1/8" wide, 15 5/8" high, 14" deep. Gray crackle finish. Shipping weight, 30 lbs.

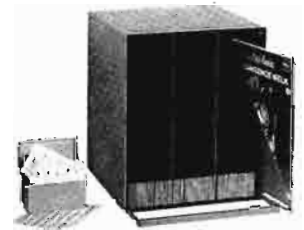

Disc-cabinet for sixty albums LP-12
As above, with snap catch door . LP-12D

CANNON XLR CONNECTORS

Popular small size Cannon Connector used universally in radio and TV.

| Symbol | Description | |
|--------|---------------------------------------|-----------|
| G | Single, 3 prong, female, 1 wall plate | XLR-35-2G |
| H | Cable plug, 3 prong, male | XLR3-12G |
| I | Cable receptacle, female, 3 prong | XLR3-11C |
| J | Chassis receptacle, female, 3 prong | XLR3-13 |
| K | Chassis receptacle, male, 3 prong | XLR3-14 |

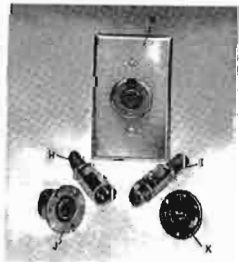

AUDIO TERMINAL BLOCKS

For inter-rack or jack field wiring. Molded one-piece black phenolic with base 3 1/2" x 6 5/8". Height 3 1/2". Plated brass terminals. Polished phenolic finish makes removal of solder splash easy. Mounts in Gates RAK-1 rack cabinet with BRK-1 bracket (see page 146). Has 120 terminals in six rows.

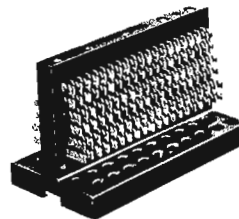

Audio terminal block PJ-106

STUDIO AND MICROPHONE CABLE

STUDIO CABLE: Shielded 2-conductor No. 20 stranded, cloth and heavy cotton fabric with tinned copper shield over-all. Finest quality for studio audio wiring. Packaged in 250', 500' and 1000' lengths Cat. No. SH-20

Shielded 2-conductor No. 22 solid enameled, cotton wrap and cotton braid waxed. Tinned copper shield. Has 22 AWG tinned solid copper wire under shield and tubed chrome vinyl plastic jacket. Small size 0.185" diameter. Packaged 100', 500', 1000' spools 8440

A very small 2-conductor shielded cable frequently used in rack wiring. Outside diameter .125". Has 2-conductor 16/36 stranded plastic insulation of each conductor with tinned copper shield over-all. Packaged 250', 500' and 1000' spools 1261

Shielded 2-conductor No. 18 stranded wire for power cabling. Has rubber insulation and over-all rubber jacket. OD .9295". Available in 50' and 100' spools. 8428

Shielded 2-conductor No. 22 solid, spiral wrap shield, vinyl jacket 8436

MICROPHONE CABLE

Rubber jacketed shielded highly flexible 2-conductor microphone cable of high commercial quality. Available any length as ordered. Per foot MIC-100

Single conductor shielded rubber jacketed microphone cable 8410

AUDIO ACCESSORIES

BOOM STANDS



Provide convenient and proper microphone placement where correct position cannot be reached with conventional stands. Boom length 62 inches, height adjustable from 4 ft. to 6 ft. Base diameter 17 inches, tubular sections superchrome plated. "Snap On" hangers provided for microphone cable. Shipping weight 33 lbs.

Boom Stand without casters . (Cat. No.) BS-36
 Boom Stand with silent casters BS-36W

Adjustable Microphone Arm



Flexo Mikester Mike Support Arm clamps or screws to any position. Swings to 36 inches fully extended. Mounts any microphone up to 4 lbs. Shipping weight 7 lbs.

Flexo Mikester (Cat. No.) FM-1

HEADPHONES



BA-200 Brush. Smartly styled, unusually sensitive high impedance crystal headset. Dual earpieces. Monophonic service.

Dual Headset BA-200

BA-201 Brush. Single headpiece version of above. High impedance crystal type.

Single Headset BA-201

TRIM economy headset. Featherweight dual earpiece model, recommended for utility monitoring use such as remotes, etc. Impedance 24,000 ohms.

TRIM Dual Headset Model 107

STEREOPHONIC Headphones. High impedance dual headset for control room monitoring with stereophonic consoles such as the Gates Executive or Stereo Yard.

Stereo Headset BA-206B

DESK STANDS



Model 418. Heavy cast iron stand finished in medium gray. Specifically designed for microphones using small type stud such as Gates G-100 and G-200. Net weight 3 lbs.

Desk Stand 418



Model 419. Heavy weight desk stand similar to the Model 418, but for use with the Gates G300 or similar microphones.

Desk Stand 419



DS-7. Adjustable desk stand for all popular microphones. Tubular section adjusts from 8 to 13 inches. Heavy chrome-plated stem and gray cast base with felt feet. Shipping weight 3 lbs.

Desk Stand DS-7



DS-5. Non-adjustable desk stand. Chrome-plated tube 4" high. 6" diameter cast iron base with rubber feet. Weight 2 lbs.

Desk Stand DS-5

TS-8. Banquet stand. Adjustable 14 1/2" to 26". Chrome stem sections with velvet-action clutch adjustment. 8" diameter base. Weight 5 lbs.

Banquet Stand TS-8

TAPE SPLICER



Deluxe "Stereo 4" tape splicer with integral tape dispenser for splicing tape. Two-position, replaceable cutting blades. Makes diagonal splice, cuts tiny trims on sides. Made of strong "Implex" plastic. With 100' roll of 1/2" splicing tape and instructions. Shipping wt., 1 lb. Made by Robbins.

"Stereo 4" Tape Splicer TS-8D

EDIT-ALL PROFESSIONAL SPLICER



The standard editing device used by professional recording engineers. It is the only precision editing block especially designed with a curved groove to hold the tape firmly without damage. Designed by a network tape editor. Precision machined, will never wear out. Kit complete with block, Mylar splicing tape, blade, marking pencil, and instructions. Wt., 1 lb.

Edit-all Splicing Kit KS-3

FLOOR STANDS



MS-25. Professional microphone floor stand. "Air-Lock" cushion controls drop, prevents slippage and microphone damage. Adjusts from 37 to 66 inches. Heavy, triangular base 17 inches in diameter. Full chrome with medium gray base. Fits all microphones listed in this catalog. Weight, 25 lbs.

Professional Floor Stand MS-25

MS-10C. Excellent for average weight microphones. Has 10" diameter base, chrome 2-section tube. Adjusts 35 to 64 inches. Wt., 13 lbs.

Utility Floor Stand MS-10C

BB-1. "Baby Boom" stand attachment. Converts any floor stand with 5/8"-27 thread to boom-type stand. 32" boom, adjustable counter balance for various microphones. Wt., 6 lbs.

Baby Boom attachment BB1

NOTE: All micro stands on this page have 5/8"-27 thread, which is standard in the industry.

BULK TAPE ERASER



Professional model HD-11M. Heavy duty unit erases entire reel of tape at once, in seconds. Lowers residual noise 3 to 6 db. below most erase-head levels. Recommended for tape cartridges or reels up to 10 1/2". Adaptor hub available for 10 1/2" NAB reels. 117 volts, 50/60 cycles. Weight, 9 lbs. Made by Microtran.

Bulk Eraser HD-11M

Adaptor Hub for 10 1/2" reels HD-11AD

JIFFY TAPE ERASER



Compact unit erases tape conveniently. For cartridges or any size reel. Holds in hand with momentary pushbutton operation. 117 volts, 60 cycles, Weight, 5 lbs.

Jiffy Hand-Type Tape Eraser P-30

TAPE HEAD DEMAGNETIZER



Removes residual magnetism from tape heads for optimum signal-to-noise ratio and protects tapes against deterioration. For 117 volts, 60 cycles. Wt., 1 lb.

Head Demagnetizer 730-0180

SPEAKERS AND BAFFLES

"GATESPEAKER" AND "GATESOUND" have been developed for the broadcasting industry by the world's leading manufacturer of broadcast equipment. The purpose of this development program is to provide the finest transition possible from electrical energy to sound energy for monitoring of studio and transmitting equipment. The "Gatespeak-

er" is designed primarily for use in offices, reception rooms and other points where a high quality wide-range speaker is desired. The "Gatesound" is for use in the control room, audition booth and transmitter, and when used with the new Gates high-frequency tweeter, provides a superior 2-way monitoring system.

GATESPEAKER 8



The Gatespeaker 8 offers wide range, sturdy construction and minimum cost to make this one of the finest utility monitor speakers available. The 4.64 oz. magnet and 11 watt power handling capability will reproduce lows to 50 cycles and highs out to 12,000 cycles.

SPECIFICATIONS:

SIZE: 8"; MAGNET WEIGHT: 4.64 oz.; VOICE COIL, 8 ohms; POWER: 11 watts.

GATESPEAKER 8 (Cat. No.) GRS-800



GATESPEAKER 12

High quality, big performance and heavy duty construction identify the Gatespeaker 12. It is an ideal monitor speaker for the broadcaster. Thirteen watts power handling capability and response from 35 to 17,000 cycles. Voice coil impedance of 8 ohms and 5 1/2" overall depth. An excellent replacement speaker.

SPECIFICATIONS:

SIZE, 12"; MAGNET WEIGHT: 4.64 oz.; VOICE COIL: 8 ohms; POWER: 13 watts.

GATESPEAKER 12 (Cat. No.) GRS-1200

GATESOUND 12



The Gatesound 12 is a high-fidelity bass-range speaker for use in two and three way systems where full range reproduction is required. Extra heavy 24 ounce magnet supplies a rich, full bass sound. Recommended for use with Gates Tweeter, GRS-550.

SPECIFICATIONS:

SIZE: 12"; MAGNET WEIGHT: 24 oz.; VOICE COIL: 8 ohms; POWER: 20 watts; RESPONSE: 35 to 5000 cycles.

GATESOUND 12 (Cat. No.) GRS-1250



GATESTWEETER 5

An excellent high frequency speaker for use with Gatesound 12 in a two way system, or for extending the range in any loudspeaker array. Special cone design and 5" diameter provides crystal clear highs with uniform dispersion. Includes cross-over kit.

SPECIFICATIONS:

SIZE: 5"; MAGNET WEIGHT: 1.47 oz.; CROSS-OVER @ 1 KC (Use with 40 mfd. cross-over); RESPONSE: 1,000 to 14,000 cycles.

GATESTWEETER 5, with crossover kit (Cat. No.) GRS-550

STUDIO MONITOR SYSTEM

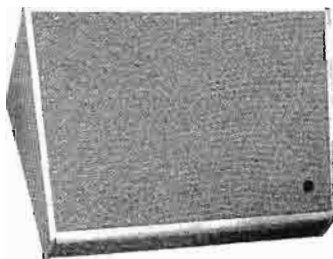

SPECIFICATIONS
FREQUENCY RESPONSE:
 30-20,000 cps.
EIA SENSITIVITY RATING:
 49 db.
POWER CAPACITY:
 20 watts.
IMPEDANCE:
 Tapped transformer accommodates 16, 150, or 600 ohms.
FINISH:
 Sanded and sealed with neutral cane grill.
SIZE:
 17" x 37" x 21 3/4".
WEIGHT:
 82 lbs., net.

Attractive wall or ceiling mount integrated loudspeaker system designed for critical monitoring in recording and broadcast studios. Permits precise audio monitoring and equalization uncolored by monitor speaker. Extremely wide, flat response allows use as studio reference standard. Precision driver components include 12" Radax loudspeaker, diffraction horn high frequency driver and special crossover. Quality hardwood cabinet smooth sanded and sealed. Neutral cane grille cloth.

ORDERING INFORMATION

Studio Quality Loudspeaker System (Cat. No.) 722-0044

WALL BAFFLES



Modern looking, space saving baffles for easy mounting. Entire front covered with attractive grill cloth. Constructed of plywood and hardboard for deep rich bass and clean highs. Available in Blond or Walnut finish. Use with GRS-800 or GRS-1200 speaker.

SLANTING CORNER BAFFLES

8", fabric covered. Walnut or blond (specify) (Cat. No.) SCB-8D
 12", fabric covered. Walnut or blond (specify) SCB-12D

WALL BAFFLES

8" deluxe wood. Walnut or blond (specify) (Cat. No.) DWB-8A
 12" deluxe wood. Walnut or blond (specify) DWB-12A
 8" fabric covered. Walnut or blond (specify) WB-8D
 12" fabric covered. Walnut or blond (specify) WB-12D



SPEAKER TRANSFORMERS AND PADS

TR-15 Matching Transformer. 15 watt capacity. ± 2 db., 35-20,000 cps. Pri 333/500/1000/2000 ohms; Sec 4/8/16 ohms.

Matching transformer TR-15 (Cat. No.) 478-0250
 Transformer, Primary 45/48 ohms Sec. 8 ohms A-30601*
 Volume Control, 8 ohm T-Pad 554-0227
 Volume Control, 4 ohm T-Pad 554-0180

*Use with Gates Audio Consoles.



PROOF OF PERFORMANCE EQUIPMENT

The FCC requires that proof of performance measurements be made on the equipment of a broadcasting station at least once a year. The measurements must be recorded in writing and kept on file at the station for inspection by the FCC. The intent of the FCC requirement is to assure that the equipment be maintained in top condition. To live up to the intention, past experience proves that complete measurements must be made more than once a year, the expense of which dictates the economic purchase of quality performance measuring equipment.

For complete proof of performance measurements, the SA-131 package consists of a Type 210 Oscillator, Type 410 Noise and Distortion Meter, M-3625 Gain Measuring Set, and M-3626 Rectifier Unit with RF Pickup Coil and Transmission Line Cable. The complete package provides all facilities for proof of performance of both audio frequency and AM radio transmitters. Included in this package is a detailed instruction book covering not only instructions for operating the equipment but helpful methods in making proof of performance measurements that are accurate and reliable.

DISTORTION METER

The Model 410 Distortion Meter measures audio distortion, noise level, audio gain or loss in db. and AC voltages.

In measuring distortion the instrument suppresses the fundamental frequency and measures the amplitude of all unwanted frequencies, including noise, as a percentage of the fundamental.



Model 410

SPECIFICATIONS

DISTORTION RANGES PROVIDED:

1% full scale, 3%, 10%, 30% and 100%. Distortion levels as low as .1% can be measured.

INPUT IMPEDANCES:

Designed for optimum accuracy at 600 ohms. Operates excellently on sources up to 100,000 ohms.

FREQUENCY RANGE:

20 to 200,000 cps.

CALIBRATION:

In 1 db. steps from 0 db. to - 15 db. Attenuator provides additional ranges from - 60 db. to + 50 db. in 10 db. steps.

POWER SUPPLY:

115 watts AC, 50/60 cycles, single phase. Power consumption 50 watts.

SIZE AND WEIGHT:

Width 11 1/4", height 9". Domestic packed, 16 lbs. Export packed, 35 lbs. Cubage: 1.7.

AUDIO OSCILLATOR

The Model 210 Audio Oscillator is a source for low distortion signals from 10 to 100,000 cycles. The circuit consists of an RC audio circuit followed by an amplifier of extremely low distortion.



Model 210

SPECIFICATIONS

FREQUENCY RANGE:

10 cps. to 100 KC.

FREQUENCY RESPONSE:

± 1 db. over entire range when connected to its characteristic 600 ohm output. Referenced at 5 KC.

CALIBRATION:

± 2%, over entire range. 10 cps. to 100 KC.

POWER OUTPUT:

Up to 10 volts into 600 ohm load.

WAVE FORM DISTORTION:

Less than 0.2% at 5 volts output from 50 to 20,000 cycles. Slightly higher at greater output levels and frequency extremes.

INTEGRAL POWER SUPPLY:

Operates from 115 volts AC, 50/60 cycles single phase. Power consumption 50 watts.

SIZE AND WEIGHT:

Width 6", height 9", depth 12". Domestic packed, 16 lbs. Export packed, 35 lbs. Cubage: 1.5.

GAIN AND MEASURING SET

Ideal for use with above oscillator and distortion meter but may be used with any similar equipment. Consists of VU meter and associated switches to accommodate all usable ranges for measuring. Attenuation circuit includes a 10 step, 2 db. per step, variable attenuator, balanced ladder type; and three fixed plug-in pads. Pads are used for attenuation and impedance matching. Two pads have 40 db. attenuation at 600/600 ohms and one has 20 db. at 600/250 ohms, all balanced H. Additional pads of any loss or impedance obtainable on special order.

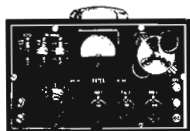

Model M-3625

SPECIFICATIONS

INPUT IMPEDANCE:

600 ohms balanced.

OUTPUT IMPEDANCE:

30 to 600 ohms balanced.

OUTPUT LEVEL:

Variable from - 21 dbm. to - 36 dbm.

RESPONSE:

± 1/2 db. 30-15,000 cycles.

DISTORTION AND NOISE:

Negligible.

SIZE AND WEIGHT:

Domestic packed, 22 lbs. Export packed, 40 lbs. Cubage: 2.10.

DIODE AND PICKUP COIL

A desirable accessory used with AM transmitters in conjunction with Model 410 Distortion Meter to pick up RF from tank circuit for measuring noise and distortion. Includes RF pickup coil, 15-foot section of coaxial cable, and germanium diode. Complete RF filtering guarantees pure audio output.

ORDERING INFORMATION

Complete Proof of Performance Package, consists of one each,

| | |
|--|-----------|
| Models 210, 210, M-3625 and M-3626 units | SA-131 |
| Audio Oscillator | Model 210 |
| Distortion Meter | Model 410 |
| Gain Set | M-3625 |
| Diode and Pickup | M-3626 |

PROFESSIONAL RECORDERS AND ACCESSORIES

1-CHANNEL MONOPHONIC RECORDER/REPRODUCER

AMPEX 351



One of the finest commercial tape recorders available anywhere. The Ampex Series 351 sets the highest standards in professional recording performance. The uncompromising quality characteristics, both electronic and mechanical, inherent in Ampex 351 models, result in superiority of performance and exceptionally long, trouble-free operation. Transport control buttons are recessed so that they cannot be accidentally pressed; all can be remote controlled. The 351 series is the professional Broadcast version of Ampex recorders used by leading Hollywood recording companies. Rack, Portable, or Console mount, half or full-track monaural, dual-speed: 7½-15, or 3¾-7½ IPS. (Specify which.) Full specifications for 351 series shown below.

ORDERING INFORMATION

Type 351C Console Mount. Size: 48" x 24½" x 28½".
Shipping Weight, 200 lbs. 7½-15 IPS, full track 730-0057
Type 351P Portable Unit. (2 carrying cases). Total weight, 103 lbs.
Case No. 1, transport unit. Size: 15½" x 17" x 20¼". Case
No. 2, electronics unit. Size: 9" x 13" x 21". 7½-15 IPS, full track .. 730-0058
Type 351U For Rack Mounting. Size: total 22" x 19" rack
space. Weight 80 lbs. 7½-15 IPS, full track 730-0198

NOTE: Models for 3¾-7½ IPS speed or half-track models are also available with minimum delay.

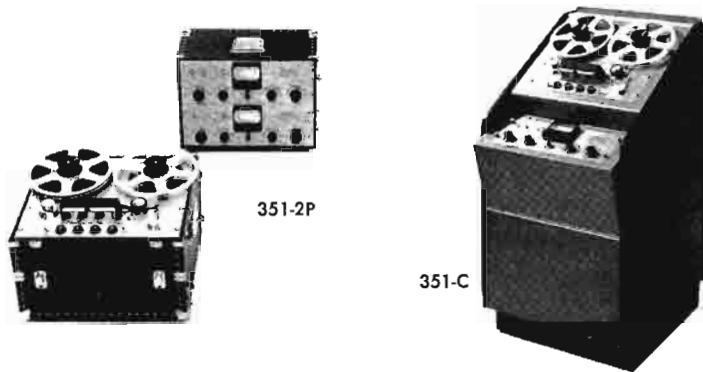

351-2P

351-C

AMPEX 351-2



2-CHANNEL STEREOGRAPHIC RECORDER/REPRODUCER

Professional recorder designed for stereophonic sound. Two 351 single-channel electronics are used with bias oscillators interlocked but retaining all individual controls. Two-track heads with separate erase for each channel. Also available with optional 4-position head assembly and quarter-track reproduce head. Specifications below.

SPECIFICATIONS

NOTE: Fourth position ¼ track head available on special order. TAPE SPEEDS: 7½ and 15 IPS or 3¾ and 7½ IPS (please specify). FREQUENCY RESPONSE: Response: 15 IPS ± 2 db. 30-18,000 cycles. SIGNAL-TO-NOISE RATIO: Full track, 60 db. Half track, 55 db; 2-channel stereo, 55 db. PLAYBACK TIMING ACCURACY: ± 0.02% (± 3.6 seconds in thirty minute recording). RECORD INPUT: Switch allows either microphone level low impedance input or bridging a 600 ohm line balanced or unbalanced. PLAYBACK OUTPUT: + 8 dbm. output into 600 ohms, balanced or unbalanced. DIMENSIONS: Transport (rack size), 19" wide, 15¾" high; Amplifier 19" wide, 7" high. POWER: 117 VAC, 60 cycles. Other voltages and frequency on special order. WEIGHTS (Net): Transport, 50 lbs.; Amplifier, 18 lbs.

ORDERING INFORMATION

Type 351-2U Two track stereo, for rack mount. Size, total
rack space 29" x 19". Weight 94 lbs. 7½-15 IPS 730-0060
Type 351-2U As above, but 3¾-7½ IPS 730-0283
Type 351-2P Two track stereo. In two portable cases.
7½-15 IPS. Weight 120 lbs. 730-0282

AMPEX 602-1

PROFESSIONAL FIELD RECORDER

Monophonic portable tape recorder. This is the recorder that will fit your field recording needs precisely. It offers matchless "studio quality" performance because of outstanding features such as: separate record and playback amplifiers; large V.U. meter for accurate level checks; separate erase, record, and playback heads; dual inputs; 600 ohm output to feed broadcast lines; precision synchronous motor drive; and program monitoring of either recording signal or playback. Housed in attractive, rugged Samsonite carrying case. Full specifications and ordering information below.

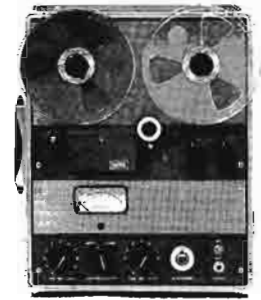

PORTABLE STEREOGRAPHIC RECORDER

AMPEX 602-2



Two-channel stereophonic recorder. A remarkably flexible system for professional stereo recording in the field. Magnificent Ampex quality, with the same professional features of the famous monophonic version. Consists of two separate electronics channels and a standard 602 model tape transport with in-line stereophonic head assembly. Selective erase and record gives the 602-2 all the versatility of 2-track stereo or half-track monaural in one unit. Complete with sturdy Samsonite luggage-type case.

SPECIFICATIONS

FREQUENCY RESPONSE: 40 to 15,000 cps; ± 4 db. SIGNAL-TO-NOISE RATIO: Model 602-1; with full track head over 57 db. Model 602-2; Stereo 52 db. TIMING ACCURACY: ± 0.2% at 7½ IPS. SPEEDS: 7½ IPS. INPUTS: (each channel) Two inputs, individual gain controls on each. Low impedance microphone input. Line input may be used as input for second microphone by use of optional accessory plug-in preamplifier (allowing 2 microphones to be mixed on one channel) and line bridging. OUTPUTS: (each channel ± 4 dbm. into 600 ohms. Balanced or unbalanced load. DIMENSIONS: Transport panel size: 9 5/16" x 12½". Electronic panel size: 6½" x 12½". Over-all size (including carrying case): Model 602-1—8" x 13¾" x 16½". Weight 28 lbs. Model 602-2—8" x 13¾" x 23". Weight 28 lbs. Model 602-1 with #864 Adapter Panel takes only 17½" of 19" vertical rack space. Model 602-2 with #865 Adapter Panel takes only 23¾" of 19" vertical rack space.

ORDERING INFORMATION

Type 602-01 Portable half track monaural, 60 cps.,
7½ IPS, w/case 730-0397
Type 602-02 Portable full track monaural, 60 cps.,
7½ IPS, w/case 730-0398
Type 864 Rack mount adapter for 602-1 monaural recorders 730-0408
Type 6022-01 Portable two track stereo, 60 cps., 7½ IPS,
w/case, weight 42 lbs. 730-0402
Type 865 Rack mount adapter for 602-2 stereo recorder 730-0409
Plug-in preamplifier, low impedance, 40 db. gain 730-0362
Plug-in preamplifier, low impedance, 60 db. gain 730-0363

AMPEX 622

SPEAKER/AMPLIFIER



622 Speaker/Amplifier. An ideal companion to the Ampex 602 equipments. Provides "on-the-spot" studio-quality monitoring. Speaker, enclosure, and amplifier especially designed to work together.

OVER-ALL FREQUENCY RESPONSE:
65-10,000 cps.

POWER OUTPUT:
10 watts.

IMPEDANCE:
Input, 100,000 ohms. Output, 12 ohms.

Model 622 Speaker/Amplifier, over-all size in carrying case: 13" x 16" x 8".
Weight, 25 lbs.

ORDERING INFORMATION

Type 622 Amplifier-Speaker, with case 730-0405



LOGGING RECORDER

AMPEX CL-10



Two-channel slow-speed recorder built for reliability and long life under heavy and continuous use. Keeps an accurate, permanent log of programming, 2-way radio dispatch, etc. Provides 8½ hours of continuous, uninterrupted recording—single or two channels—up to 34 hours on a single reel of ½ mil tape (four-track mono) with only three reel turnovers. Uses standard ¼ inch tape.

SPECIFICATIONS

FREQUENCY RESPONSE: 200-3,000 cps ± 3 db. at 15/16 IPS. 200-5,000 cps ± 3 db. at 1⅞ IPS. SIGNAL-TO-NOISE RATIO: 40 db. SPEED ACCURACY: ± 0.6% at 1⅞ IPS. ± 1.0% at 15/16 IPS. OUTPUT: + 4 dbm. into 600 ohm balanced or unbalanced load. INPUTS: Two inputs, one per channel. Both inputs are unbalanced bridging with provision for optional plug-in line transformers or low impedance plug-in microphone preamps. POWER: 117 volts AC, 60 cycles. DIMENSIONS: Total rack space: 19" x 14". Transportation unit: 8¾" high x 19" wide x 6" deep. Electronics unit: 5¼" high x 19" wide x 5⅞" deep. In portable case: 15 7/16" high x 20½" wide x 9 1/16" deep. Weight: 44 lbs. Add 9 lbs. for portable model.

ORDERING INFORMATION

Type CL-10 Logging Recorder, 2-channel, 4-track less case (Cat. No.) 730-0431
 Portable case for above 730-0071

STEREOPHONIC RECORDER

AMPEX PR 10-2



PR-10-2 Ampex Stereophonic studio-quality recorder. The new Ampex PR-10 series incorporates the very latest advances in fine recording techniques. Quick loading, pushbutton relay/solenoid operation, and complete remote control of all functions permit instantaneous selection of desired operation with ease. Two-speed operation and other professional features such as: plug-in equalizers and transformers; hysteresis synchronous drive motor, precision-made four-position head assembly; and exclusive electro-clutch system. Fully portable when used with portable case listed below. Available in stereophonic or monaural version.

SPECIFICATIONS

OVER-ALL FREQUENCY RESPONSE: ± 4 db. 30-15,000 cycles. SIGNAL-TO-NOISE RATIO: 60 db. at 15 and 7½ IPS. TIMING ACCURACY: ± 0.25% at 15 and 7½ IPS. OUTPUT: ± 4 dbm. into 600 ohm balanced or unbalanced load. INPUTS: (PR-10-2 Stereo) 2 inputs each channel. Channel 1: dual Low-Z microphone inputs. Channel 2: dual unbalanced bridging input with provision for optional plug-in preamplifier and transformers (see Ordering Information below). (PR-10-1 Monaural) 2 inputs one channel for Low-Z microphones, plus unbalanced bridging or optional preamplifier and plug-in transformers (see Ordering Information below). SPEEDS: 7½ and 15 IPS. RACK SPACE: Transport: 8¾" x 19" x 6" deep. Electronics: 5¼" x 19" x 5⅞" deep.

ORDERING INFORMATION

Type PR-10-2 Two-track stereo recorder, 60 cps., 7½-15 IPS, unmounted, weight 53 lbs. 730-0386
 Type PR-10-1 Full-track manual recorder, 60 cps., 7½-15 IPS, unmounted, weight 53 lbs. 730-0061
 Plug-in line transformer, 600 ohms 730-0073
 Plug-in line transformer, balanced bridging 730-0072
 Preamplifier, low impedance, 40 db. gain 730-0362
 Portable Case for PR-10-1, or PR-10-2 recorders 730-0071

NOTE: Also available in 3¾-7½ IPS models. If this speed desired so state when ordering.

ACCESSORIES

REMOTE CONTROL FOR MODELS 351 AND PR-10 RECORDERS

Use of Remote Control greatly expands the facility of your recorder. Plugs into receptacle provided and permits recorder to be controlled from any desired location. Duplicates all functions of record, play, fast forward and fast rewind buttons on tape transport. Record button prevented from functioning when record selector is in "safe" position. Available as a boxed or flush plate unit.

ORDERING INFORMATION

Remote Control with housing and 30' cable (Cat. No.) 730-0117
 Remote Control unwired and flush mounting 730-0118

Remote Control

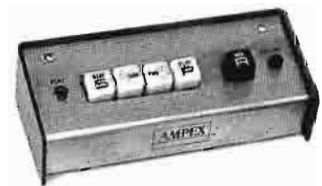

MX-10 MONOPHONIC/STEREO MIXER

The MX-10 mixer was designed to extend the flexibility and operation of the PR-10 recorders, permitting up to four microphones, or two microphones and two lines to be controlled and fed to either or both output channels.

ORDERING INFORMATION

Mixer, 4-position, 2-channel MX-10

Monaural/Stereo Mixer.



MAGNECORD RECORDER/REPRODUCERS



MODEL 1021: Transistorized Monophonic Recorder/Reproducer

Fully transistorized, the Magnecorder Model 1021 is as smooth a machine as you'll ever see, even with the thinnest tapes. It has a cueing speaker with separate volume control and the amplifier will drive an external speaker. There is a provision for phones and a mixing input with a separate gain control to mix or make echoes. This model has all the standard features you expect in a top notch recorder, plus a host of others that will please and surprise the most discriminating engineer.

SPECIFICATIONS

TAPE SPEEDS:
3.75 and 7.5 in. per second.

FLUTTER AND WOW:
0.25% at 3.75 ips; 0.2% at 7.5 ips.

TIMING ACCURACY:
± 0.2%.

REEL SIZE:
5, 7, and 8 inch E.I.A. hubs.

REWIND TIME:
1200 feet in 80 seconds.

FREQUENCY RESPONSE—OVERALL RECORD/REPRODUCE:
45 to 18,000 cps.
± 2 db. at 7.5 ips.

SIGNAL-TO-NOISE RATIO:
53 db., both speeds.

INPUTS:
Lo-Z microphone, balanced bridge, unbalanced bridge, mixing bridge and auxiliary bridge.

OUTPUTS:
line 150/600 ohm balanced, auxiliary unbalanced (+4 dbm).

HEADS:
Full-track erase, record and half-track play.

WEIGHT:
Transport—33 pounds; Amplifier—14 pounds.

DIMENSIONS:
(Transport); 19" wide, 10½" high, 7¼" deep; (Amplifier); 19" wide, 5¼" high, 12" deep; (Transport Reel Overhang); 1¾".

ACCESSORIES:
Transport Carrying Case, Amplifier Carrying Case.

ORDERING INFORMATION

1021 Monaural, 3¾–7½ ips., full track record—full track erase, half track playback, less case(Cat. No.) 730-0418
Transport case for 1021 730-0425
Amplifier case for 1021 730-0426



MODEL 1022: Stereophonic Recorder/Reproducer

No gadgets, only necessities. No need to worry about loading thin tapes; it will reel from payout reel and back again without stretch or break. Power consumed by the fully transistorized electronic circuits is less than twenty watts. Power supply is regulated so it can cope with both line voltage and load variations. Also features in-built input and output transformers, front panel input selectors, and durable, easily cleaned vinyl finish.

SPECIFICATIONS

TAPE SPEEDS:
7.5 and 15 inches per second.

FLUTTER AND WOW:
0.17% at 7.5 ips; 0.15% at 15 ips.

TIMING ACCURACY:
± 0.2%

REEL SIZE:
5, 7, and 8 inch. E.I.A. hubs.

REWIND TIME:
1200 ft. in 80 seconds.

FREQUENCY RESPONSE—OVERALL RECORD/REPRODUCE:
30 to 16,000 cps ± 2 db. at 7.5 ips.

SIGNAL-TO-NOISE RATIO:
53 db., both speeds.

INPUTS PER CHANNEL:
Lo-Z microphone, balanced bridge, unbalanced bridge, auxiliary bridge.

OUTPUTS PER CHANNEL:
150/600-ohm balanced, auxiliary A and auxiliary B unbalanced (+ 4 dbm).

WEIGHT:
(Transport); 33 lbs. (Amplifier); 14 lbs.

DIMENSIONS:
(Transport): 19" wide, 10½" high, 7¼" deep; (Amplifier): 19" wide, 5¼" high, 12" deep; (Reel Overhang): 1¾".

ACCESSORIES:
Transport Carrying Case, Amplifier Carrying Case.

ORDERING INFORMATION

1022X Stereo, 7½–15 ips., half track stereo. Fourth head included for ¼ track stereo play, less case 730-0419
Transport case for 1022 730-0425
Amplifier case for 1022 730-0426

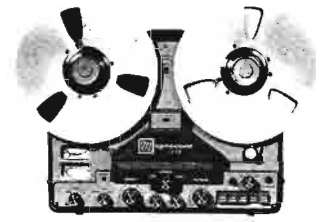

MODEL 1028: Stereophonic Recorder/Reproducer

This model features advanced circuit design, utilizing the latest tube types, and printed wiring to insure uniform high performance from recorder to recorder. The die cast main frame insures permanent mechanical stability and the die cast head mount guarantees accurate permanent alignment of the heads. The solenoid-operated tape gate provides precision alignment of the tape.

SPECIFICATIONS

TAPE SPEEDS:
7.5 and 15 inches per second.

FLUTTER AND WOW:
0.15% at 7.5 ips; 0.1% at 15 ips.

TIMING ACCURACY:
± 0.2%.

REEL SIZE:
5, 7 and 10½ inch.

REWIND TIME:
2400 ft., less than 60 sec.

FREQUENCY RESPONSE—OVERALL RECORD/REPRODUCE:
35 to 16,000 cps ± 2 db. at 7.5 ips.

SIGNAL-TO-NOISE RATIO:
55 db. per channel.

INPUTS:
Hi-Z microphone and Hi-Z unbalanced bridge; Lo-Z microphone and Hi-Z balanced bridge with input transformers.

INPUT SENSITIVITY:
— 90 dbm. to — 35 dbm.

OUTPUTS:
Cathode follower, 2.5 volts ± .5 volt. 150/600-ohm balanced, + 3 dbm. with output transformers.

HEADS:
Selectable erase 2-channel record and 2-channel play.

WEIGHT:
47 lbs. (55 lbs. encased).

DIMENSIONS:
17½" wide, 12⅞" high, 12" deep (17 ⅝" wide, 14⅞" high, 12" deep encased). Rack adapter panel available.

ORDERING INFORMATION

1028-2 Stereo, 7½–15 ips., half track stereo, less case(Cat. No.) 730-0421
1028-4 As above, ¼ track version .. 730-0428
91X3168 Carrying case for 1028 .. 730-0372
32X33—Input transformer, plug-in. 50/250 ohm (2 required for Stereo) 730-0007
32B90—Output transformer, plug-in. 600 ohm (2 required for Stereo) 730-0336
66X152 Transformer hold-down clip (1 required per transformer) 730-0337
91C2959 Rack adapter panel 730-0338

PORTABLE TAPE RECORDER—RECORDING TAPE

UHER—MODEL 4000-S

All new, the Uher Model 4000-S professional recorder is the ultimate in portability. In this popular portable tape recorder, the recording quality of fine AC-powered recorders is combined with the compactness and portability of battery-operated equipment. A piano type keyboard selects rewind, start/playback, pause, stop, record and fast forward. The built-in monitoring speaker has its own volume control and on/off switch. Volume indicator meter is illuminated for recording in the dark. Accepts high impedance microphone, radio, or phono inputs. Fully transistorized with rechargeable battery plus provision for auxiliary D-size energizer or alkaline batteries.

Use the 4000-S for exceptionally fine recording of live music or record up to 8½ hours on a 5-inch reel at 15/16 IPS. with a fidelity equal to that of many recorders at 3¾ IPS. Four speeds with front panel speed selection, 7½", 3¾", 1⅞", and 15/16 IPS.

SPECIFICATIONS

FREQUENCY RESPONSE:

50-22,000 cps @ 7½ IPS. to 70-5,000 cps @ 15/16 IPS.

SIGNAL-TO-NOISE:

50 db. or better @ 7½ IPS.

HEADS:

Half-track erase and record/play.

INPUTS:

Microphone, 1000 ohms. Radio, 20,000 ohms. Phono, 1000 ohms.



OUTPUTS:

4 ohm External Speaker, 15,000 ohm External Amplifier, Remote Control and External Power Connections.

SHIPPING DATA:

Size, 10½" x 8½" x 3¼". Weight, 8 lbs. (less battery). Shipping weight: 20 lbs.

ORDERING INFORMATION

Portable Recorder, complete with remote control dynamic microphone, leather case, AC power unit, battery charger and battery (Catalog No.) 4000-S

MAGNETIC RECORDING TAPE



Fine quality "Scotch" brand audio recording tape is carried in generous quantity at both Quincy and Houston. Rapid turnover assures fresh stock at all times. Recording tape is shipped prepaid parcel post or rail express anywhere in the United States, and lowest quantity prices are available (see price list).

TYPE 111 GENERAL PURPOSE 1½ MIL ACETATE

Famous for flawless sound reproduction at lowest cost and a favorite of engineers everywhere.

¼" x 300', plastic 3" reel (Cat. No.) 111-3
¼" x 600', plastic 5" reel 111-6
¼" x 1200', plastic 7" reel 111-12
¼" x 2500', aluminum 10½" reel 111-25R

TYPE 200 DOUBLE-PLAY ½ MIL TENSILIZED POLYESTER

Plays twice as long as standard tape, and tensilized for strength and resistance to stretching.

¼" x 1200', 5" plastic reel (Cat. No.) 200-12
¼" x 2400', 7" plastic reel 200-24

TYPE 150 EXTRA-LENGTH 1 MIL POLYESTER

Provides 50% more recording time from a conventional size reel. Made with tough durable polyester.

¼" x 900', 5" plastic reel (Cat. No.) 150-9
¼" x 1800', 7" plastic reel 150-18
¼" x 3600', 10½" aluminum reel 150-36R

TYPE 151 LUBRICATED TAPE

Recommended for re-loading continuous loop cartridges. Heavy duty lubricant on back side of tape for long trouble-free service.

¼" x 1600', 7" plastic reel (Cat. No.) 151-16

TYPE 190 EXTRA-LENGTH 1 MIL ACETATE

Super sensitive high-potency oxide, and 50% extra recording length.

¼" x 900', 5" plastic reel (Cat. No.) 190-9
¼" x 1800', 7" plastic reel 190-18
¼" x 3600', 10½" aluminum reel 190-36R

TYPE 290-36 EXTRA-LONG PLAY ½ MIL POLYESTER

Revolutionary new tape providing three times the recording time than standard reels. Seven-inch reel contains 3600'.

¼" x 3600', 7" plastic reel (Cat. No.) 290-36

TYPE 175 HEAVY DUTY "TENZAR," 1½ MIL

For applications requiring frequent repeat, fast starts and stops. High quality with 15 times greater tear resistance than conventional tape.

¼" x 600', 5" plastic reel (Cat. No.) 175-6
¼" x 1200', 7" plastic reel 175-12

ACCESSORIES

Splicing tape ½" x 150' (Cat. No.) 41-1/2S
Mylar Splicing Tape (for cartridges) ½" x 66' ST-466
Plastic Leader Tape ¼" x 100' 24W¼-100
Aluminized Sensing Tape, 7/32" x 150' 51-7/32S

Full stock of empty reels, boxes, and special purpose tapes available in inventory.



250,000 WATT AUTOMATICALLY TUNED HF BROADCAST TRANSMITTER

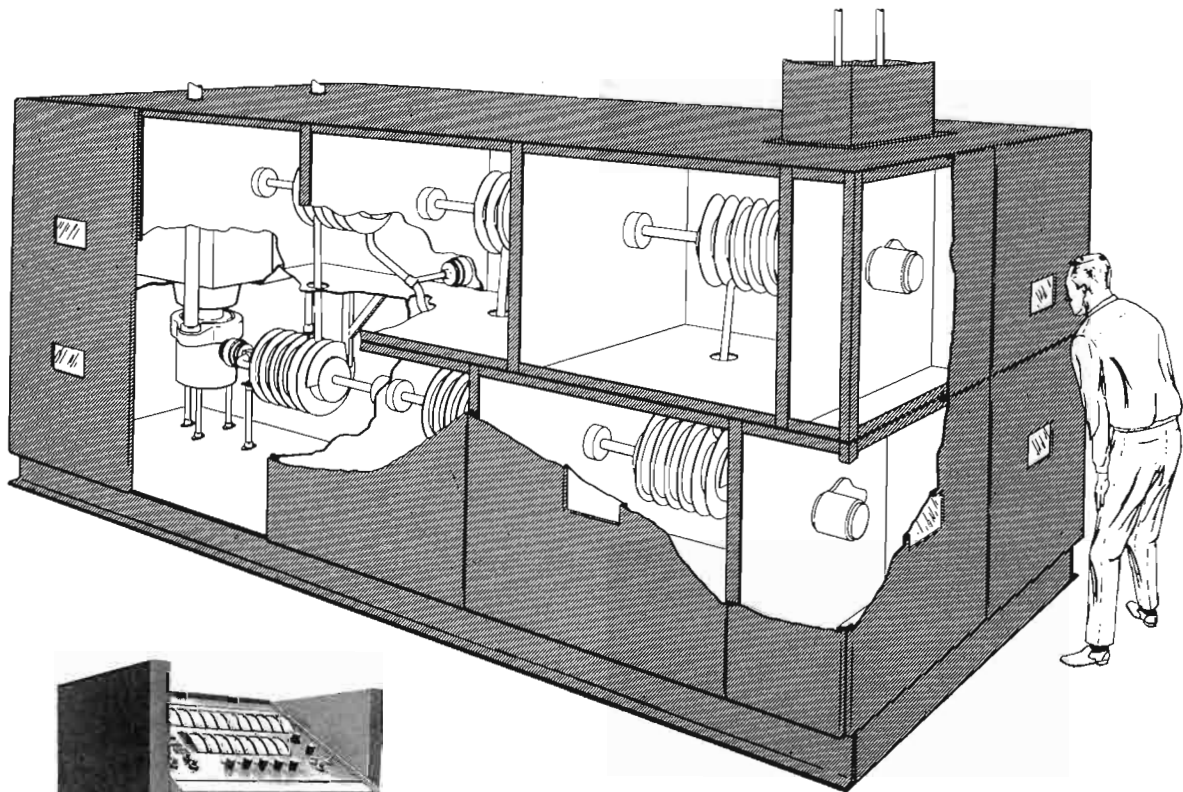

Cutaway illustration showing 250 KW power amplifier and output filter networks. Left: Standard control console contains complete frequency change capability and extensive metering. A similar console for remote control of the transmitter is optional.

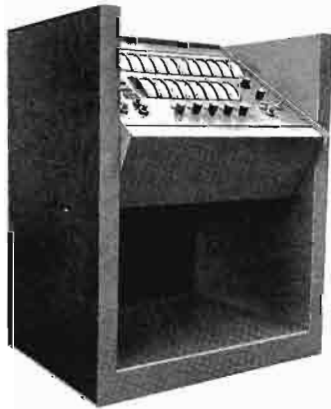

MODEL HC-114

In this new 250,000 watt high frequency broadcast transmitter, complete tuning to any one of twenty channels or, with optional synthesizer, to any frequency between 3.95 Mc. and 26.5 Mc. can be made in 20 seconds or less from either a local control or a remote console located up to two miles from the transmitter. The automatic tuning feature eliminates most of the down time for frequency change which can now be performed in the same amount of time normally used for station breaks. This time saving provides as much as one hour per day of additional on air programming for short wave broadcasters. The result is much more efficient operation due to maximum utilization of frequency and program schedule.

DESIGN: Originally developed for Voice of America long range high frequency broadcast service, the Model HC-114 transmitter delivers 250,000 watts of R.F. carrier power at any frequency between 3.95 and 26.5 mc. Plate modulated, the transmitter is capable of 100% amplitude modulation on a continuous basis.

Transistor circuitry, rapid 20 second automatic tuning, vapor phase cooling, and trapezoidal modulation are combined with all of the most advanced state-of-the-art techniques in this outstanding new product.

FEATURES: High efficiency, high reliability and low maintainability have been achieved in the powerful HC-114 high frequency transmitter.

In addition to unique operating and design features, other advantages include:

1. Use of a 12 phase power supply that requires no filter reactor and increases low frequency audio response.
2. A newly designed variable inductor with no sliding contacts.
3. An optional 2 mile remote control system with facilities for returning frequency and modulation information to the control site.
4. Supply of a portable test console, as a standard item, which can be moved to any point within the equipment and is capable of essentially complete operational controls for simplified servicing and adjustment of the transmitter.
5. A gang balanced four section harmonic filter with total rejection of harmonics in excess of 80 db.

CONSTRUCTION: The HC-114 transmitter consists of the following major functional sections: The radio frequency source and amplifier chain, the audio modulator, the power supplies, control circuitry including the operating console, and the heat exchanger and cooling systems. The heat exchanger may be placed on the roof of the building and the local control console may be located up to 150 feet away from the transmitter room. Maximum area required is less than 1000 sq. ft.

R.F. CIRCUITS: The radio frequency channel begins with two solid state crystal oscillators, each with 10 selectable crystals, which drive three multipliers to generate the output frequency between 3.95 mc. and 26.5 mc.

This frequency is amplified by an 8122 buffer stage to provide radio frequency drive to the 4CX15,000 intermediate power amplifier. There is provision for two synthesizer inputs in the exciter.

The final radio frequency power amplifier consists of two 4CV100,000C vapor phase cooled tetrodes in a grounded grid input circuit and a unique push-pull output tank circuit. Tetrode vacuum tubes are used throughout to reduce the number of stages of amplification and to ease the neutralization requirements.

Tuning is accomplished by automatic bandswitching in low level broadband stages and prepositioning and closed-loop servo tuning for the intermediate power amplifier and power amplifier stages. A digital to analog converter is used to provide information for automatic inductor and capacitor tuning.

Harmonic suppression is accomplished by a five-section tunable low pass output filter positioned by programmed instruction from digital frequency selection. Spurious signal radiation does not exceed - 80 db. There are no sliding or rolling contacts in use while the power is on.

AUDIO MODULATOR: A + 10 dbm. level broadcast quality signal is fed into a triode voltage amplifier which drives an 8122 Class A push-pull driver RC-coupled to the grids of the Class AB1 4CV100,000C modulator stage. The output network transfers the audio power to the R.F. amplifier and also supplies modulation to the IPA driver stage.



One of several 4160 volt primary power breakers with 150 megavolt ampere rating.

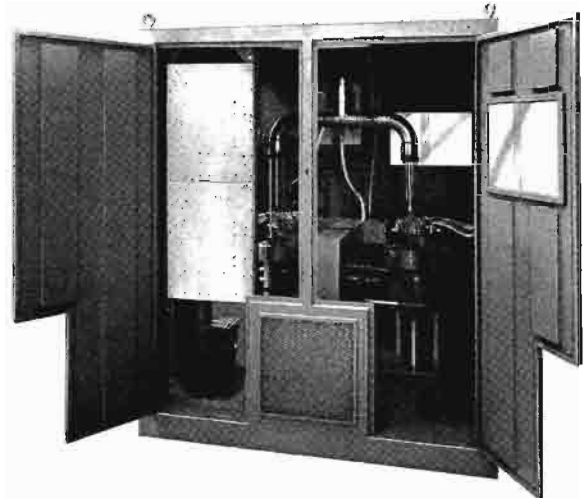

Modulator cabinet showing 4CV100,000C tubes and vapor phase cooling system.

Several valuable features provide linearity of operation, high efficiency, circuit simplicity, and economics in initial costs. These features include voltage and current feedback, extremely low unbalanced direct current in the modulator output transformer, no taps or extra windings on the output transformer, and lower losses in A.C. return paths. Ample reserve power capacity to 294,000 watts under trapezoidal wave modulation will aid in cooler operation and greater reliability.

POWER SUPPLIES: All power supplies are 100% solid state. Designed with a generous reserve capacity to meet trapezoidal modulation requirements the power supply provides greater protection from power line and load transients. The high voltage supply consists of two 7.5 KV. supplies in series rated at 38 amps in a 12-phase system. Oil cooled semiconductor rectifiers are used throughout. This design provides smaller components, less costly maintenance, and easier installation.

R.F. driver showing type 4CX15000 stage with grid circuits and cooling plenum.

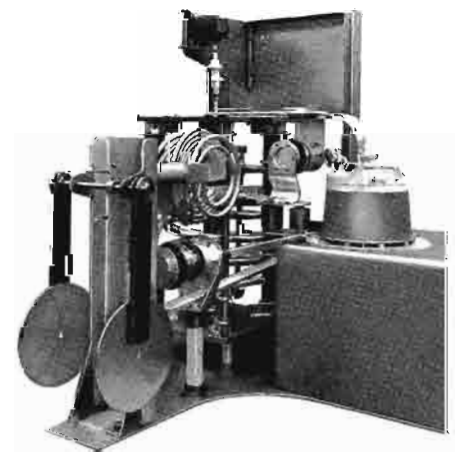

250,000 Watt Automatically Tuned High Frequency Broadcast Transmitter—HC-114

Power supplies for the modulator and R.F. amplifiers are designed to be installed within a wire-screened enclosure approximately 16 feet wide by 25 feet long and no more than 12 feet high. This arrangement allows complete accessibility to all components with a lift truck. Main line breakers are mounted in a separate vault and are capable of interrupting 150 Mva. Extensive use is made of interlocking protective circuitry to achieve a high degree of safety for personnel and equipment.

CONTROL CIRCUITRY: Automatic control circuitry is mounted in a relay rack with the exciter units. The main programmer and logic controls are simple and direct. Basically, the digital to analog converter develops commands to tune the complete R.F. chain of the transmitter. All servo amplifiers are solid state and are directly interchangeable. Manual override is provided so that in event of servo failure the transmitter can be tuned manually.

As standard equipment, a control console with full operation capability is supplied with the transmitter for use up to 150 feet from the transmitter room and aids materially in operating ease and quick servicing.

The portable test station which controls the transmitter operation can be plugged in during the maintenance period. All major meter values are monitored and operating adjustments and test at any point within the transmitter room can be made. The value of this aid will be appreciated by station engineers.

Protective circuitry is completely integrated with the automatic control system and manual override on all servos gives 100 percent back-up. In addition, a turns counter driven by the control gearing will provide records of settings for all frequencies.

COOLING SYSTEM: Ambient air is used for forced air cooling throughout the equipment, with the exception of the final R.F. tank inductor and the vapor-phase 4CV100,000C tubes used in the R.F. final amplifier and modulator stage.

All incoming air is filtered. The main heat exchanger system for the vapor phase tubes is an air-cooled condenser which can mount outdoors on the roof of the transmitter building.

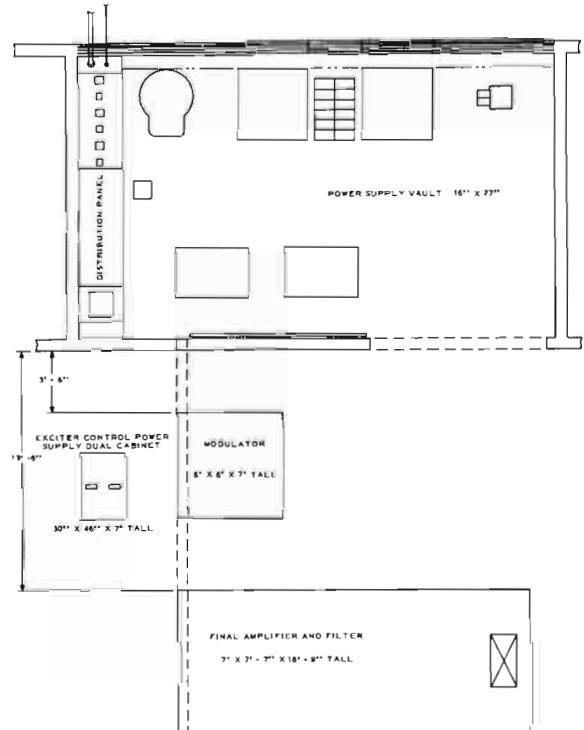
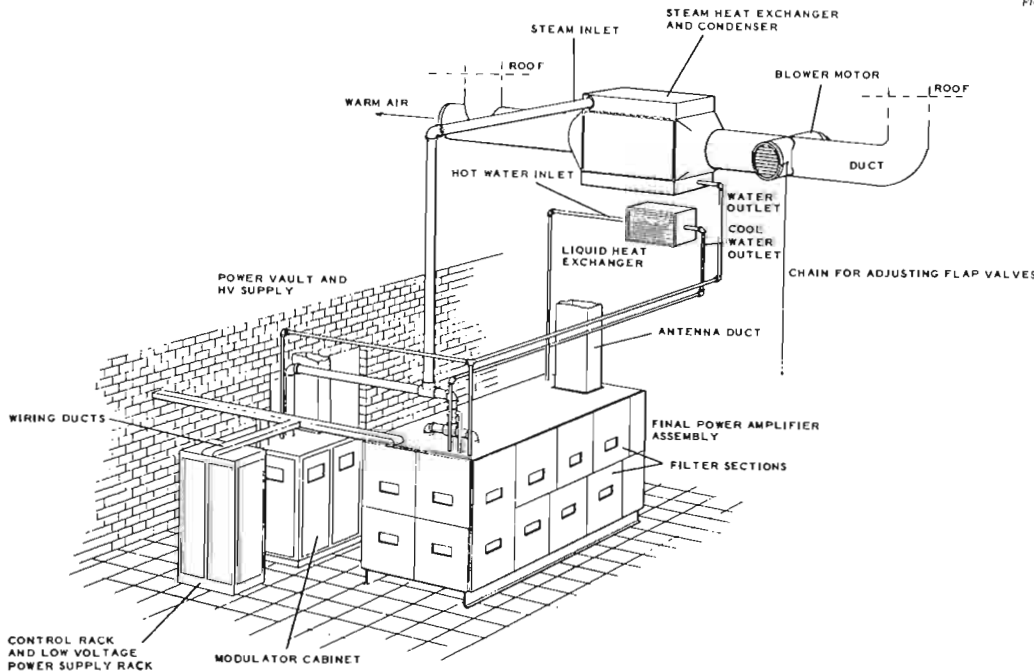

FIGURE 1-5. PROPOSED FLOOR PLAN.



Outline drawing illustrates typical HC-114 transmitter installation and placement of various independent transmitter sections. The power supply vault and primary AC power distribution section external to the main transmitter assembly are not shown.

HF TRANSMITTERS

SPECIFICATIONS

POWER OUTPUT:
250,000 Watts.

FREQUENCY RANGE:
3.95 Mc. — 26.50 Mc.

FREQUENCY STABILITY:
± 5 ppm.

TUNING TIME:
20 sec. max.

CARRIER SHIFT:
5% max.

OUTPUT IMPEDANCE:
300 ohm balanced.

VSWR:
1.5 to 1.0.

MODULATION CAPABILITY:
100% trapezoidal.

MODULATION DUTY FACTOR:
Continuous.

AUDIO INPUT LEVEL:
+ 10 dbm.

AUDIO INPUT IMPEDANCE:
600/150 ohms.

AUDIO RESPONSE:
50—10,000 cps., ± 2 db.

AUDIO DISTORTION:
5% maximum.

NOISE LEVEL:
— 50 db. unweighted.

HARMONIC & SPURIOUS RADIATION:
— 80 db. or better.

POWER INPUT VOLTAGE:
4160 V ± 3%, 3 phase, 3 wire, 50 or 60 cycles as ordered.

POWER FACTOR:
.94.

POWER CONSUMPTION:
0% modulation 400 KW. approx.
30% modulation 500 KW. approx.
100% modulation 590 KW. approx.

OVER-ALL EFFICIENCY:
Approximately 55% at 100% modulation.

ALTITUDE:
Sea level to 6,000 feet.

TEMPERATURE:
0°C to + 50°C.

HUMIDITY:
0-95% max.

PACKED WEIGHT:
52,000 lbs.

CUBAGE:
2899

SIZE:
Power amplifier 20' L. x 8' H. 7' D.
Modulator 6' L. x 7' H. x 6' D.
Power supply 16' L. x 25' W. x 12' H.

SIZE OF LARGEST UNIT:
20' L. x 8' H. x 7' D.

COOLING:
Vapor phase cooling for power amplifier and modulator. Closed circuit water for PA inductor. Other units forced air cooled.

ORDERING INFORMATION

250,000 watt short wave broadcast transmitter with one set of tubes, less crystals and without remote control. For 50 cycle operation HC-114-5

250,000 watt short wave broadcast transmitter with one set of tubes, less crystals including remote control unit. For 50 cycle operation . . . HC-114-5R

250,000 watt short wave broadcast transmitter with one set of tubes, less crystal and without remote control unit. For 60 cycle operation . . . HC-114-6

250,000 watt short wave broadcast transmitter with one set of tubes, less crystal including remote unit. For 60 cycle operation HC-114-6R

Complete set of spare tubes 250 KW. high frequency transmitter . . . TK-524

Set of lamps and fuses for 250 KW. transmitter M-6458

Set of installation materials for 250 KW. transmitter M-6459

Set of recommended spare parts for vapor phase cooling system . . M-6460

Running spare part kit for 250 KW. transmitter M-6461

Crystal for 250 KW. transmitter CR-27A/U

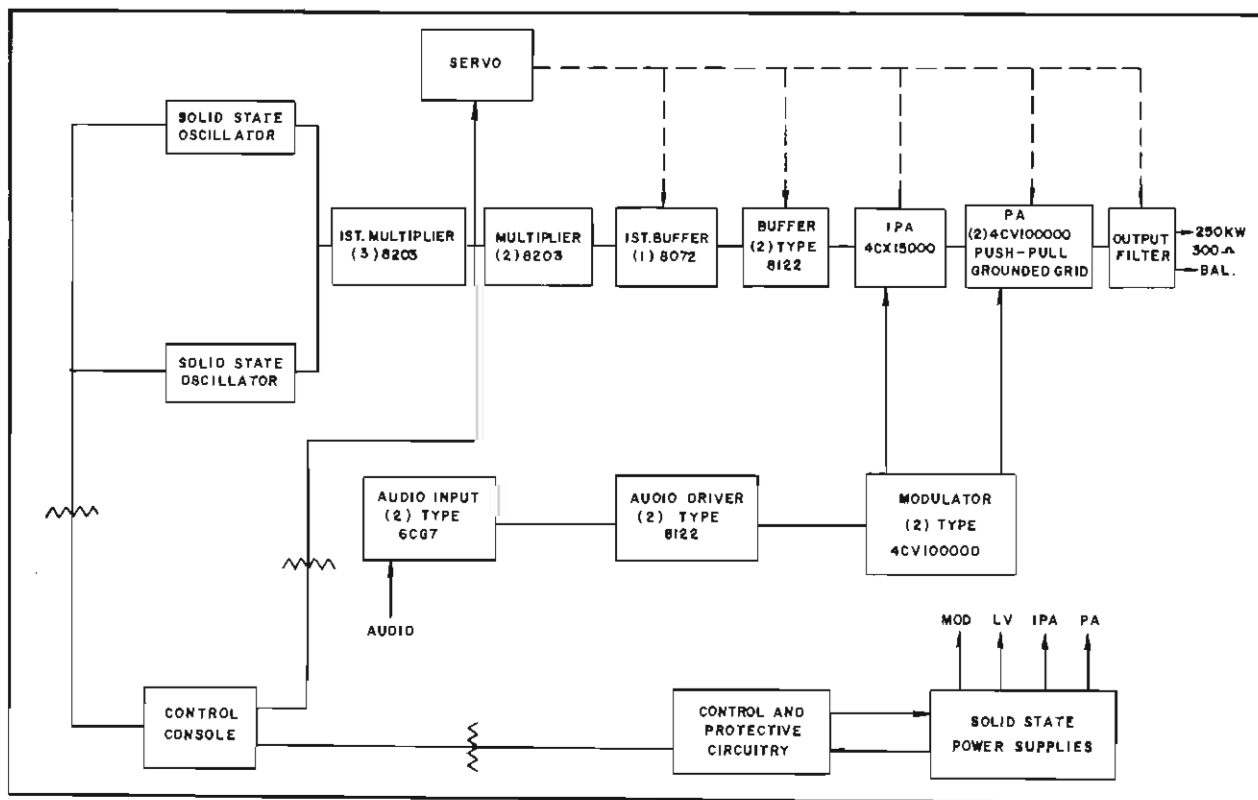

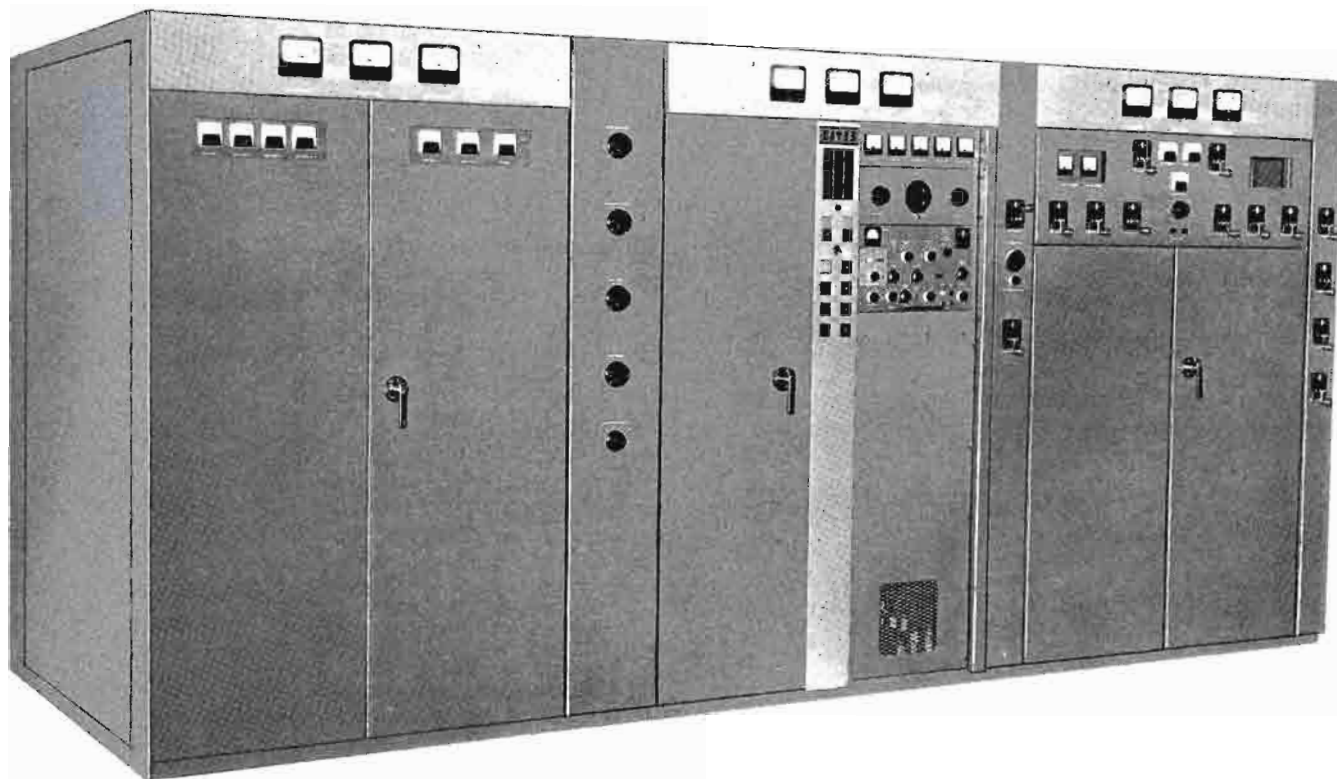

MODEL HF-100

Continuous tuning from the front panel over the entire High Frequency band of 3 Mc. to 26.1 Mc. is only one of the many outstanding and exclusive features of the Gates HF-100 transmitter. Delivering 100 KW power output, the transmitter employs reliable high level modulation for high fidelity broadcasting in the international short wave bands. Air cooled and designed with conservatively rated components, unsurpassed reliability is provided even when operated in areas of extreme temperature and humidity and in 24-hour a day service. Silicon rectifiers that operate well below maximum ratings are included in all power supplies. Added reliability is obtained by the use of oil-filled modulation and power components and the use of variable vacuum capacitors in all major amplifier circuits.

The HF-100 transmitter is also available for telegraph service and can be supplied without the modulator for 100KW CW operation, with high speed keying and frequency shift keying easily accommodated.

CONTINUOUS TUNING: A new, field-proven concept of plate tank circuit design permits continuous tuning over the entire frequency range from the front panel.

This advanced design incorporates only one tuned line tank circuit to allow continuous coverage of the wide frequency range (3 to 26.1 Mc.). As this circuit is permanently mounted within the transmitter, complete coverage is obtained without the inconvenience of plug-in or manually changed power amplifier or output coils. Time-consuming

internal component changes and storage problems are eliminated in the Gates 100 KW transmitter. With continuous front panel tuning, the transmitter can be adjusted from one pre-logged operating frequency to another within three minutes or less. This unique Gates design achievement contributes significantly to maximize on-air time for short wave broadcasters.

COMPACT SIZE: The electrical design of the Gates HF-100 transmitter utilizes new, efficient, high-power, air-cooled tubes and tuned lines that permitted a simplicity of mechanical construction resulting in a compact size. Three main transmitter cubicles are mounted in line . . . modulator, control and power amplifier sections. Other equipment consisting of the blower, high voltage and magnetic components are floor-mounted externally.

All three main HF-100 transmitter cubicles are easily accessible from both front and rear. Vertical and walk-in construction design permits easy servicing and fast accessibility to components and tubes. Removable sides provide quick access to the power amplifier tank and output sections, if necessary. Service lights and outlets are provided for convenience in servicing and maintenance.

DUAL SILICON HIGH VOLTAGE POWER SUPPLIES: For greater reliability and better regulation, two separate HV supplies are used in the HF-100 transmitter. One HV supply provides 15KV for the modulator and the other HV supply provides 12.5KV for the power amplifier.

100,000 Watt High Frequency Broadcast Transmitter—HF-100

Both HV supplies utilize conservatively rated silicon rectifiers for long trouble-free service over a wide range of temperature, humidity and altitude conditions.

As an example, the high voltage silicon bridge rectifier diodes are capable of a direct current output of 75 amperes, as related to an average demand of approximately 10 amperes.

Full transient protection is provided for silicon cells in every power supply. Each is shunted with a transient suppressing capacitor and resistor.

QUIET OPERATION: The use of a highly efficient forced air cooling system provides a quietness of operation almost unbelievable for a 100,000 watt transmitter. Air flow is controlled to insure maximum cooling with a minimum of air noise. The rugged construction aids in the achievement of the ultimate in low noise operation.



New F-8550 (PA and modulator) tube weighs 65 pounds and is a highly efficient, high-powered, long life, air-cooled tube. Standardization on this type tube for both the modulator and power amplifier permits interchangeability of tubes for longer useful life. This reduces the number of tubes required as spares and lowers the cost of operation.

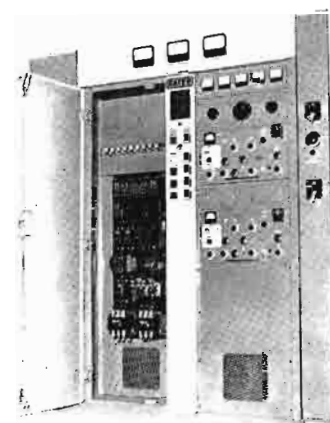

The exciter is located in the center cubicle and also includes the heart of the control system as shown above. There is sufficient space for optional dual exciters permitting operation on twenty crystal controlled channels where desired.

RADIO FREQUENCY CIRCUITS: The exciter is an independent self-powered unit of pull-out construction built into the control cubicle. It has provision for selecting from any one of ten crystal positions and also provides an input for an external VFO and for FSK operation.

Only three amplifier stages are employed to raise the output of the RF exciter to the rated 100 KW transmitter power output. The intermediate power amplifier utilizes one type 4-65 tube followed by two type 6076 RF drivers. Continuously adjustable, the RF driver is conservatively rated with a capability of 8KW, providing generous reserve power to drive the final amplifier.

The power amplifier consists of two type F-8550 triode power tubes. This well-designed push-pull output stage has many advantages in feeding high frequency antennas, stability, tuning throughout the full frequency range and aids in suppression of spurious and harmonic emission.

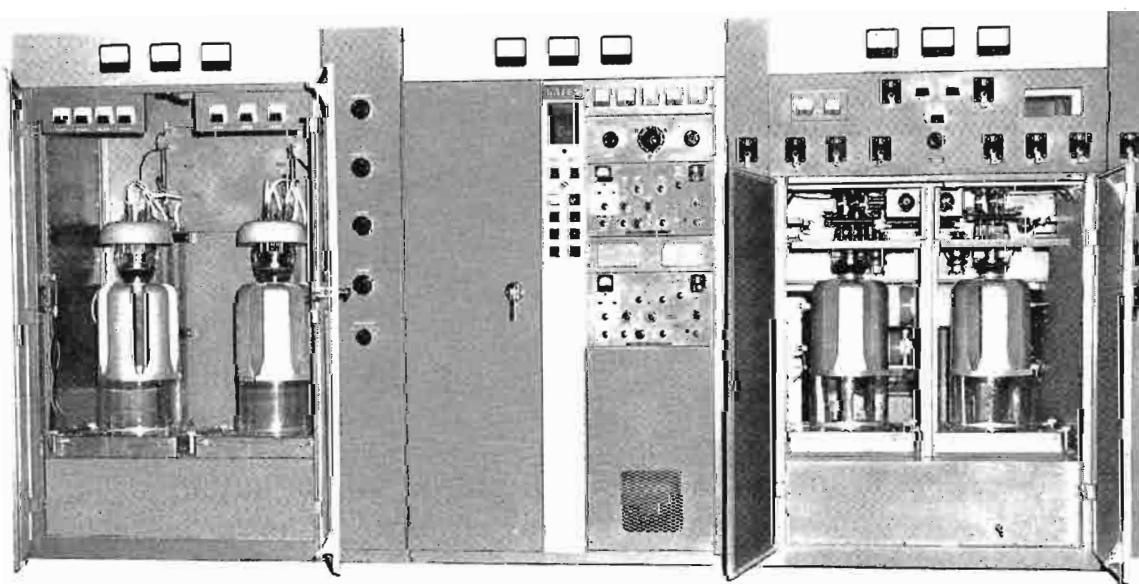

Three main transmitter cubicles house (from left to right) the modulator, control and power amplifier.

100,000 Watt High Frequency Broadcast Transmitter—HF-100

RELIABILITY: Design features which make the HF-100 transmitter the ultimate in reliability and operating performance are:

High Level Plate Modulation: The efficiency of a plate modulated power amplifier is a distinct advantage in a 100 KW transmitter as it is least sensitive to changes in RF loading. Complete tube interchange between modulator and the radio frequency power amplifier reduces spare tube needs and adds strictly to tube life by periodic rotation.

Variable Vacuum Capacitors: Vacuum type variable capacitors are used in all stages above the 100 watt power level. The new more reliable ceramic vacuum capacitors are used generously throughout. All capacitors are operated well below maximum voltage and current ratings.

Metering: The operation of the HF-100 transmitter can be constantly monitored with the 30 indicating meters provided, of which nine are located along the top of the main transmitter assembly.

Protective Devices: Protective devices are used in all circuits. DC overload devices protect all modulator tubes, power amplifier tubes, and RF driver, and each of the two high voltage supplies. AC overload devices are an integral part of the start contactors in the high voltage supply. Blower start contactors are provided with thermal overload protection. And, magnetic circuit breakers protect the bias supplies, intermediate high voltage supplies, the RF driver screen supply, the 230 volt bus and control circuitry and other power sources.

INSTALLATION: The HF-100 transmitter has been designed for maximum installation flexibility to fit different types of buildings. Installation does not require any special tools and built-in inter-cubicle wiring ducts reduce installa-



Power amplifier section with top cover removed showing the single continuously tuned line tank and separate tuned line output circuits. Note the accessibility and ease of service due to the excellent mechanical arrangement.

tion time. The transmitter is completely air cooled. An external centrifugal 20 hp. blower provides approximately 10,000 CFM of forced air to the transmitter. The blower can be supplied for single floor or lower floor installation as specified.

HF TRANSMITTERS

All Gates Transmitters are carefully tuned and checked to operating frequency before shipment. Here, two 100 kw broadcast transmitters are shown undergoing final test in the extensive Gates manufacturing plant.

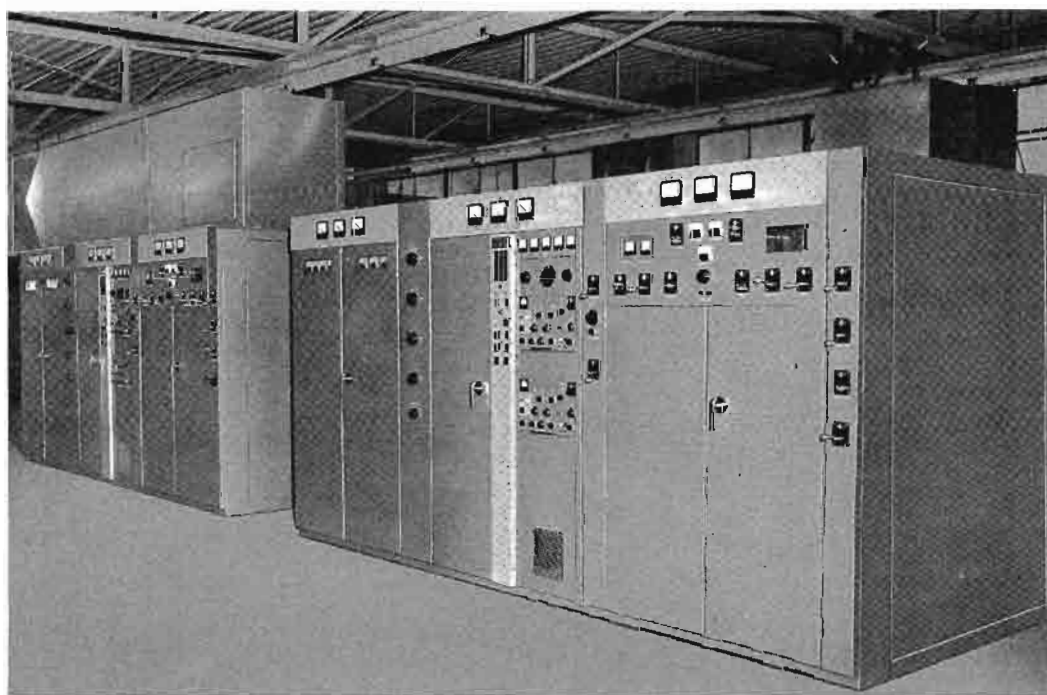

SPECIFICATIONS:

- CARRIER POWER OUTPUT:**
100 KW.
- FREQUENCY RANGE:**
3 Mc. to 26.1 Mc. Continuously variable from front panel tuning.
- TYPE OF EMISSION:**
A₃.
- METHOD OF MODULATION:**
High level plate modulation.
- FREQUENCY STABILITY:**
Rated .0015. Capable of .0001%.
- CARRIER SHIFT:**
5% or less at 100% modulation.
- RF HARMONICS:**
Suppression of harmonics meets or exceeds CCIR requirements.
- CRYSTAL FREQUENCY:**
Ten, front panel selected on Gates exciter built into transmitter. Provision is made for external VFO.
- OUTPUT IMPEDANCE:**
Supplied for 300 ohms balanced; (adjustable 200 to 600 ohms balanced).
- POWER LINE REQUIREMENTS:**
Available for any one primary voltage 380 to 480 V., 3 wire or 4 wire, 3 phase, 50 or 60 cycles, as specified.
- POWER FACTOR:**
At least 90%.
- POWER CONSUMPTION:**
195 KW at 0% modulation.
215 KW at average modulation.
300 KW at 100% modulation.
- FREQUENCY RESPONSE:**
± 1.5 db. 50 to 10,000 cycles at 90% modulation.
- AUDIO DISTORTION:**
3% or less 50 to 7500 cycles at 90% modulation.
- RESIDUAL CARRIER NOISE:**
55 db. below 100% modulation.
- AUDIO INPUT LEVEL:**
Approximately + 10 dbm.
- AUDIO INPUT IMPEDANCE:**
500/600 ohms.
- TUBE COMPLEMENT:**
Exciter (part of transmitter)
(1 each) 5763 oscillator, 5763 buffer/multiplier, 6146

- buffer amplifier, 6AQ5 screen clamper and OB2 voltage regulator.
- Transmitter**
(radio frequency section): (1) 4-65 intermediate amplifier, (2) 6076 driver amplifiers and (2) F-8550 power amplifiers.
(audio section): (2) 6146 first amplifier, (2) 4-250A second amplifier, (4) 304TH A.F. driver amplifier and (2) F-8550 modulators.
- TEMPERATURE RANGE:**
- 20° to + 50° C.
- ALTITUDE:**
To 5000 feet, higher on special order.
- SIZE:**
Largest individual cubicle dimensions: 5' W x 6½' H x 5' D.
Main Transmitter Assembly: 14' W x 6½' H x 5' D (except PA tank and output circuit section which is only 4' H and 7½' D). Transmitter assembly occupies 107.5 square feet floor space.
- Blower, oil filled high voltage and modulation transformers and reactors mount externally.
- WEIGHT:**
Export packed 29,000 lbs. cubage 2050.

ORDERING INFORMATION

- Model HF-100 High Frequency Broadcast Transmitter, 100,000 watts, with tubes, less crystals M-5966
- Model HF-100TX High Frequency Telegraph Transmitter, 100,000 watts, with tubes, less crystals M-5966A
- Crystals (transmitter accommodates 10) CR27A/U
- Crystal Oven (holds two crystals) (transmitter accommodates 5) ... JK-09C
- Spare 100% tube complement for HF-100 TK-510
- Additional exciter with power supply M-5569F

Note: When ordering, state: (a) primary voltage, (b) primary frequency, (c) R.F. output impedance and (d) carrier frequencies.

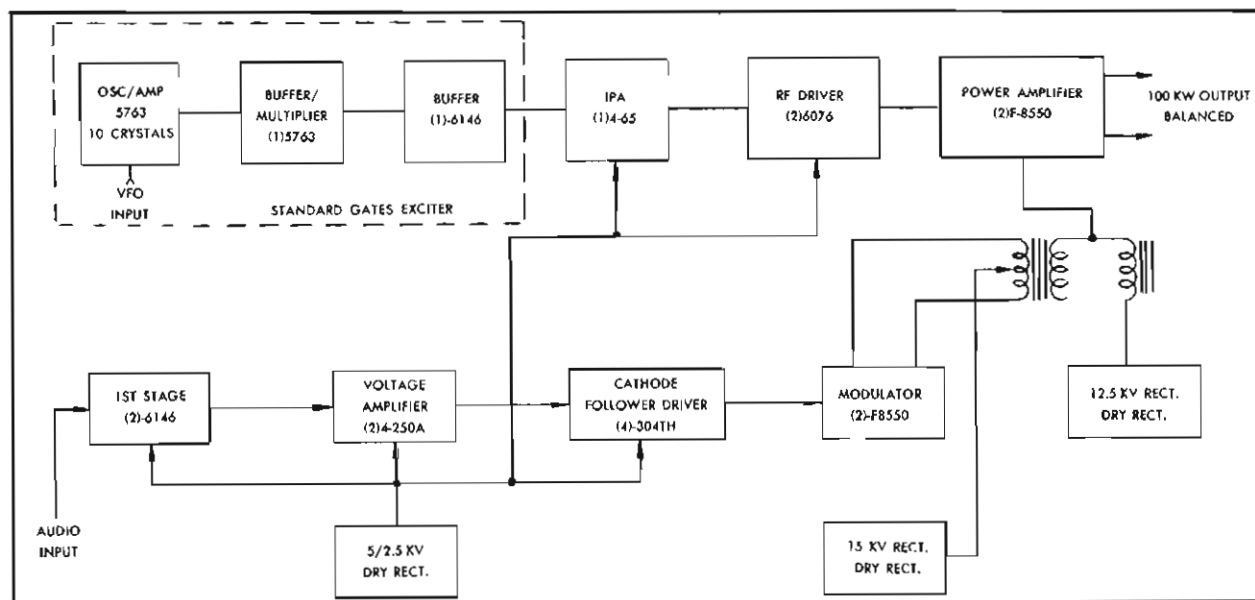

Block Diagram 100 KW High Frequency Broadcast Transmitter Model HF-100.

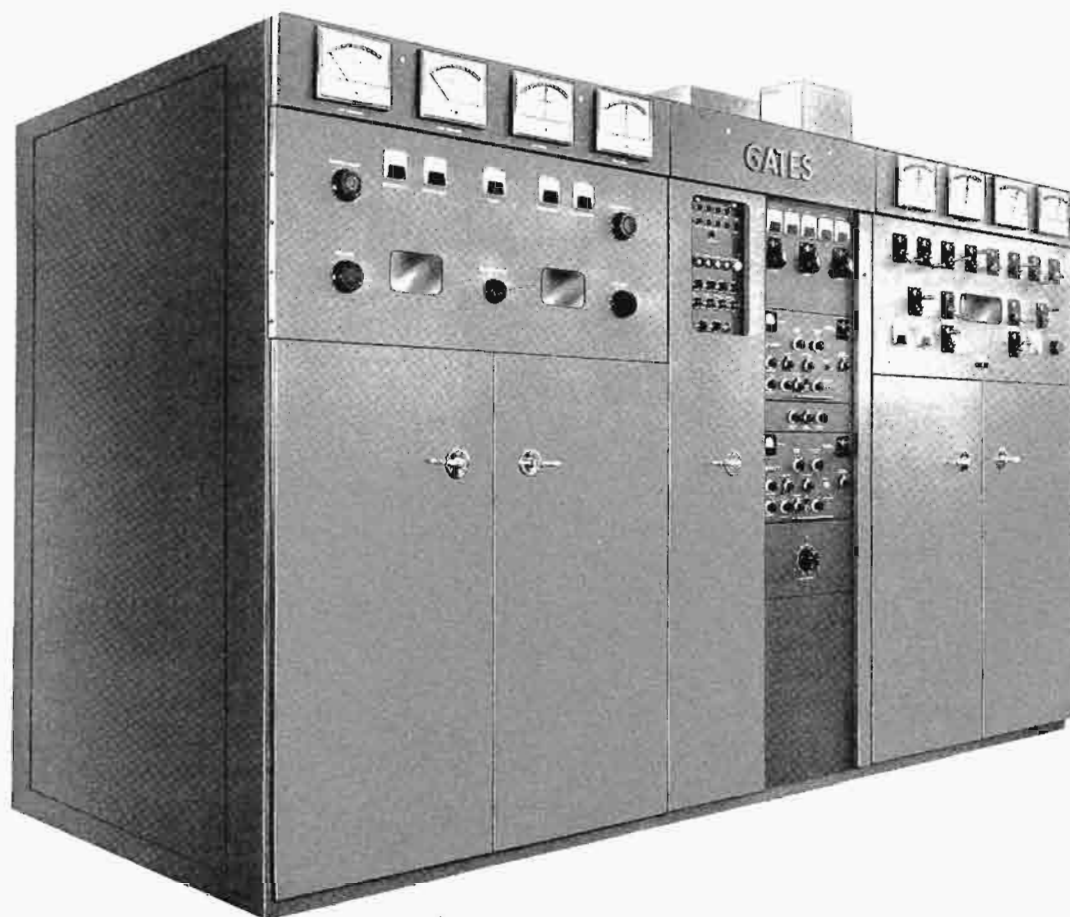

MODEL HF-50C

This powerful transmitter stands out as the world standard to which all other 50 KW short wave transmitters must be compared not only in performance but in the massive construction, rapid tuning, and the long record of trouble free service.

Continuous tuning between 4 Mc. and 30 Mc. for fast frequency change, solid state power supplies for reliability, interchangeable power amplifier and modulator tubes for economical operation and efficient air cooling for added dependability are some of the many features found in this carefully engineered high frequency 50,000 watt broadcast transmitter.

Probably the most widely used 50,000 watt high frequency transmitter, several dozen Gates HF-50C Transmitters are serving world listeners from four continents with a substantial number in Voice of America stations.

Still many years ahead of today's rugged high powered broadcasting needs and outstanding in every respect, the plate modulated Model HF-50C Transmitter has earned a worldwide reputation as the pacesetter in the 50 KW field.

CONTINUOUS TUNING: Rapid tuning to any frequency from 4 Mc. to 30 Mc. provides an operating advantage to users of the HF-50C transmitter. Gates engineers developed

a new concept of plate tank circuit design permitting frequency change to be made in less than 3 minutes—and all from the front of the transmitter.

One tuned circuit in the power amplifier plate tank is used in the transmitter to allow the wide range of frequency coverage. Another tuned line in the output circuit permits proper matching to the load, also by front panel controls. These circuits are permanently mounted within the transmitter to provide complete coverage and loading without the necessity for time consuming manual change of plug in coils. As the transmitter can be adjusted from one pre-logged frequency to another in less than 3 minutes, on-air time is at an optimum, thereby making short wave operation more efficient.

RELIABILITY: Gates engineers selected components carefully chosen to provide that extra tolerance which assures conservative operation. Air cooled, the transmitter has been especially designed to operate in world climates and for the most extreme demands of continuous duty. As an example, fully cased oversized modulation and power transformers are oil filled and may be mounted outdoors, if desired. There has never been a reported outage of any oil filled magnetic component among the several dozen HF-50C transmitters used worldwide. For added reliability, vacuum capacitors are used generously in amplifier circuits. Silicon rectifiers

50,000 Watt High Frequency Broadcast Transmitter—HF-50C

that operate well below maximum ratings are found in all power supplies. Three individual high voltage plate transformers are used to provide for more dependable service and for easier installation.

RADIO FREQUENCY SECTION: For standardization, the precision engineered Gates M-5569D self-powered 85 watt exciter is an integral part of the HF-50C transmitter. This independent unit, featuring convenient pull-out construction, together with the RF driver and associated separate power supplies, is built into the center transmitter cubicle. The exciter has provision for selection any one of ten crystal positions and incorporates an input for an external VFO and Frequency Shift Keyer.

Two exciter units can be mounted in the transmitter thus permitting operation on 20 channels where desired. The second exciter is optional equipment.

Only two amplifier stages raise the exciter output to 3 KW to drive the 50 KW power amplifier. Conservatively rated, the 3 KW driver is continuously adjustable providing generous reserve power to drive the final amplifier.

POWER AMPLIFIER: Push-pull operation of the output tubes provides an efficient power amplifier, definitely aids in suppression of spurious and harmonic emissions and has accepted engineering advantages with respect to feeding high frequency antennas. The power amplifier uses two proven F-6804 forced air cooled triodes. Since one tube is capable of delivering 50 KW output, a tremendous reserve of power is available. Design of the final RF stage with tubes of twice the necessary power capability in a push-pull configuration provides a reliable and stable amplifier for optimum performance.

Front view PA cubicle with internal shields removed.

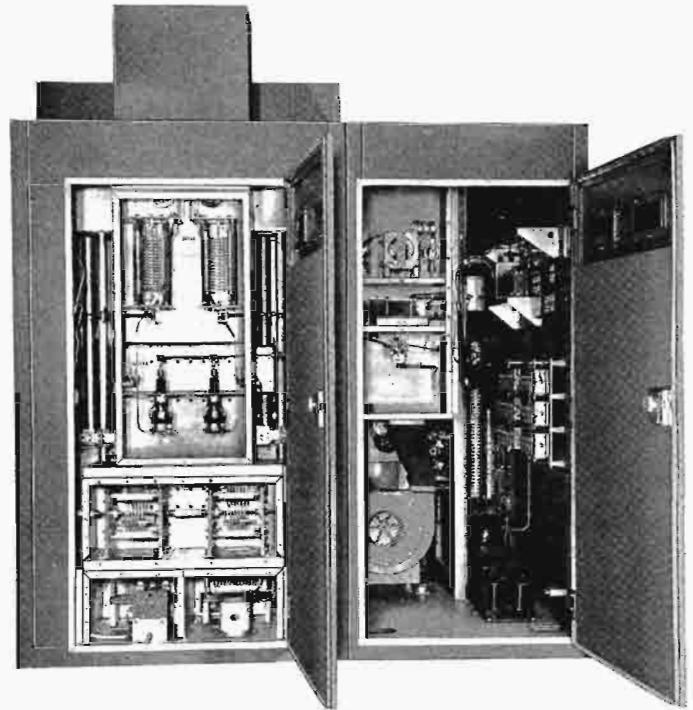
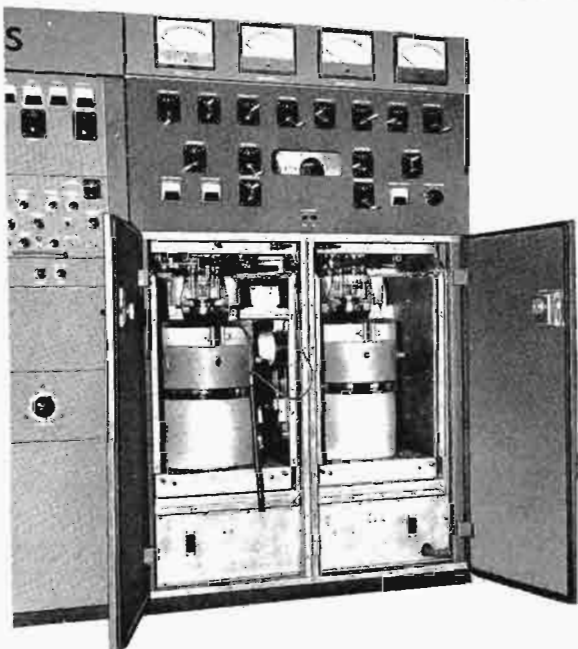

Rear view of PA and RF driver/exciter cubicle.

AUDIO SYSTEM: Several valuable design features in the Class B modulator provide linearity of operation, high efficiency, circuit simplicity and savings in operating cost. Following the three balanced audio stages, the same type F-6804 tubes as used in the final RF amplifier are also used as modulators. Standardization on this efficient high power triode permits interchangeability of tubes for longer useful life, reduces the number of spare tubes and lowers operating cost. The audio driver stage uses two type 304TH triodes operating in a direct coupled cathode follower circuit. Adjustment of bias voltage and feedback is easily accomplished. Over-all feedback is approximately 10 db., an optimum value for minimum distortion and noise. The result is transmission of an unusually fine signal quality. Designed for continuous duty at extremely high levels of average modulation, the HF-50C transmitter modulator has excess reserve audio power capacity for the greatest possible reliability.

POWER SUPPLIES: To eliminate warm-up time and arc-overs, common to mercury vapor tubes, power supplies in the HF-50C transmitter utilize solid state rectifiers. Long trouble-free service through a wide range of temperature and humidity can be expected from this design. The solid state high voltage rectifier provides approximately 10.6 KV for the final amplifier and modulator. All silicon cells have conservative ratings as to voltage and current. Each diode is rated at 25 amperes and 500 volt PIV providing a 500% current and 100% voltage safety factor in the power supply.

50,000 Watt High Frequency Broadcast Transmitter—HF-50C

OPERATION: Design features that make the HF-50C transmitter convenient to operate with a minimum of maintenance include:

Control: A generous supply of overload and under voltage relays are provided. Every circuit large or small is protected most adequately.

Protective Devices: Extensive use is made of interlocking protective circuitry to achieve a high degree of safety for personnel and components.

Metering: 22 meters are provided. Eight easy to read primary meters are located along the top of the power amplifier and modulator cubicle. Other metering provides for complete monitoring of all circuits. Easy, quick readings can be taken at any time.

Filament Regulation: Filament voltages for the entire transmitter are regulated. This is handled by a Gates three-phase voltage regulator with electronically controlled motor driven variable transformers keeping filament voltage within 1% at all times.

Construction: The HF-50C transmitter consists of three main cubicles; (1) audio driver and modulator, (2) RF exciter/driver control cubicle, and (3) power amplifier cubicle. Other associated equipment is floor mounted externally and consists of the HV rectifier and AC distribution cabinet, HV capacitor frame, the blower and the modulation and power transformers/reactors. All cabinets are accessible from front and rear. Vertical construction design permits easy walk-in servicing.

Quiet Operation: Use of an efficient forced air cooling

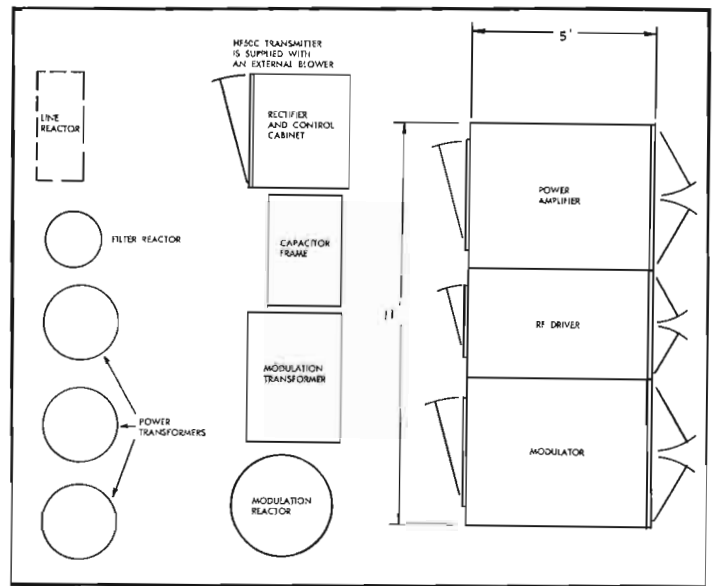

Floor Plan. HF-50C Transmitter

system provides quiet operation as air flow is controlled to assure maximum cooling of all important areas with a minimum of noise. In addition to the large centrifugal blower, HV rectifier and driver amplifier cabinets have self-contained blowers.

INSTALLATION: The advantage of 100% air cooling, provides the HF-50C transmitter with a maximum of installation flexibility to fit different types of buildings. It can be supplied with (a) an externally mounted blower of bottom horizontal discharge for a one floor building plan; (b) an updraft or top horizontal discharge for a two floor or basement installation; (c) an internal blower for installations where new air ducting cannot be provided, or where existing equipment precludes any building modification. With an internal blower arrangement, a 3 foot wide cubicle is added to the right side of the transmitter with the air supplied directly to the power amplifier plenum chamber. A separate modulator blower is then mounted in the modulator cubicle. This arrangement increases over-all transmitter length to 14 ft., but, of course, removes the necessity of providing space and ducting for an external blower. For a new installation, the external blower is recommended as blower motor noise can be isolated.

RADIO TELEGRAPH MODEL: The Gates Model HF-50TX Radio Telegraph Transmitter is identical to the transmitter described herein except it does not include the modulator cubicle. It is designed for high-speed keying or FSK service. Size is 4 ft. narrower than broadcast model. It is described on Page 200.

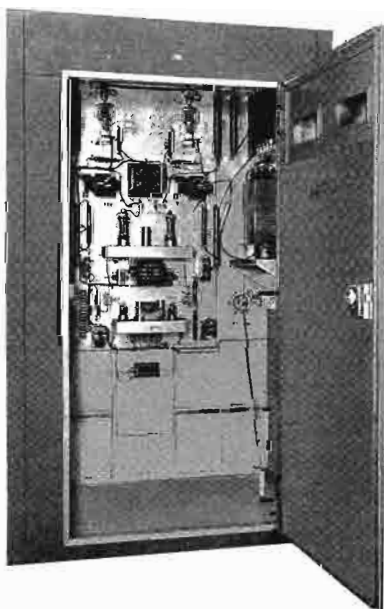

Rear view of modulator cubicle. Note walk-in construction.

50,000 Watt High Frequency Broadcast Transmitter—HF-50C



Front view of HV and AC contactor cabinet.
Note electronic filament regulator.

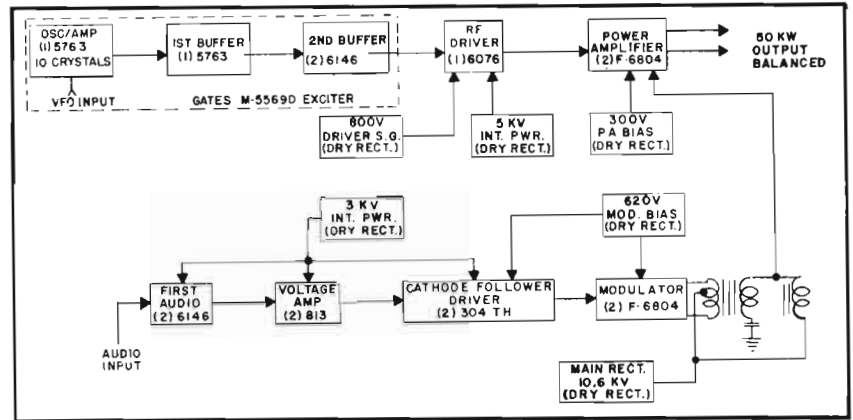

Block diagram

SPECIFICATIONS

- CARRIER POWER OUTPUT:**
50,000 watt.
- FREQUENCY RANGE:**
3.9 to 30 Mc. or 3 to 26.5 Mc. (as ordered) in one band with front panel tuning.
- TYPE OF EMISSION:**
A₁, A₂, A₃, and F₁. (See Note 2.)
- METHOD OF MODULATION:**
High level plate modulation.
- FREQUENCY STABILITY:**
.0015 capable of .0001%.
- CARRIER SHIFT:**
5% or less at 100% modulation.
- RF HARMONICS:**
— 80 db. or better (exceeds CCIR requirements).
- RF DRIVE:**
Provided by standard Gates M-5569D exciter built into transmitter which has 10 crystal positions and provision for external VFO.
- OUTPUT IMPEDANCE:**
Adjustable 300 to 800 ohms balanced.
- POWER LINE REQUIREMENTS:**
Available for any one primary voltage 380 to 480 v.; 3 wire or 4 wire, 3 phase, 50 or 60 cycles, (See Note 3.)
- POWER FACTOR:**
At least 90%.
- POWER CONSUMPTION:**
105 KW at 0% modulation.
130 KW at average modulation.
160 KW at 100% modulation.
- FREQUENCY RESPONSE:**
± 1.5 db. 50 to 10,000 cycles.
- AUDIO DISTORTION:**
3.5% or less 50 to 7500 cycles at 95% modulation.
- RESIDUAL CARRIER NOISE:**
55 db. below 100% modulation.
- AUDIO INPUT LEVEL:**
+ 10 dbm. ± 2 db.
- AUDIO INPUT IMPEDANCE:**
600 ohms.
- TUBE COMPLEMENT:**
Exciter: 5763 oscillator, 5763 buffer/multiplier and two 6146

buffer amplifiers.

Audio and Radio Frequency Sections: (1) 6076 RF driver, (2) F-6804 RF power amplifiers, (2) 6146 first audio amplifiers, (2) 813 second audio amplifiers, (2) 304TH cathode follower audio amplifiers, (2) F-6804 modulators. Power supplies are all solid state.

TEMPERATURE RANGE:
— 20° to + 45°C.

ALTITUDE:
To 5000 feet (higher on special order).

SIZE:
Largest individual cubic dimensions 4' W x 6½' H x 5' D.
Transmitter Assembly: 11' W x 6½' H x 5' D (except PA section which has 1½' extension of plate tank across rear top of cubicle). Transmitter assembly occupies 55 square feet floor space. Blower, high voltage and modulation component mount externally.

WEIGHT:
Domestic packed: 23,500 lbs. Export packed: 25,900 lbs.
Cubage: 1700.

ORDERING INFORMATION

- Model HF-50C High Frequency Broadcast Transmitter.
50,000 watts, with tubes, less crystals (see Notes 1, 3 and 6) M-5924
Same as above for 50 cps operation M-5924A
Crystals (see Note 4) CR-27A/U
Crystal Oven (holds two crystals) (see Note 5) JK-09C
Spare 100% tube complement for HF-50C TK-510
Additional exciter with power supply M-5569D

NOTES: (1) When ordering, state preferred frequency range. (2) For F₁ required frequency shift keyer is optional equipment. (3) Please specify exact primary voltage and frequency when ordering. (4) Please state crystal frequencies when ordering. (5) Two crystals mount in one JK-09C temperature controlled oven. If 10 crystals ordered, then 5 ovens required, etc. (6) Three blower options are given in paragraph entitled "Installation." When ordering, please state type of blower installation desired.



MODEL HF-20B

A proven performer for reliable high power short wave broadcasting, the Gates HF-20B enjoys world-wide popularity for uninterrupted 20 KW service. This remarkable transmitter, used in over 16 different countries, represents proven quality and is the ultimate in 20 KW High Frequency transmitter performance. Designed for continuous 24-hour a day operation in all areas of the world including tropical climatic conditions.

Air cooled and employing high level plate modulation, the HF-20B transmitter is tunable over the entire frequency spectrum between 4 and 22 Mc. A telegraph version for 20 KW CW communications service is also available and is designated as the Model HF-20TX.

FAST TUNING: Once the frequency band is selected, transmitter tune-up can be made within one minute from front panel controls. Except for the final tank coil, all circuits are continuously variable and front panel tuned between 4 Mc. and 22 Mc. Changing of the final tank coil, which sets on a sliding carriage in the PA tank frame assembly, is speedily accomplished. Five coils are supplied for full 4-22 Mc. coverage. Counter type controls read to 1/10 turn

to permit accurate logging of all tuned circuits and quick return to any previously employed frequency.

RADIO FREQUENCY AND AUDIO SECTIONS: A two-stage radio frequency exciter unit incorporates switching positions for four crystals and input provisions for an external VFO or frequency shift keyer. The 6146 straight amplifier or doubler stage is followed by two type 4-250A tubes which provide an abundance of RF drive to the final amplifier. Four 3X2500F3 triodes operate push-pull parallel in the power output stage. A superb audio system consisting of four stages all push-pull is employed in the HF-20B. Four type 3X3000F1 triodes operating push-pull are used as Class B modulators.

OUTPUT COUPLING: To accommodate a wide variety of transmission lines, a balanced matching output network is incorporated, using series variable coils and parallel variable vacuum capacitors designed to match 300 to 800 ohm balanced lines. Both variable coils and capacitors have counter type tuning controls for accurate logging. (A 50 ohm unbalanced output is also available on special order.)

20,000 Watt High Frequency Broadcast Transmitter—HF 20B

METERING: With 29 meters, few transmitters are so well complemented for full circuit monitoring. There are no multimeters. Individual current meters are used in major circuits. This feature permits instant checking of important tubes without switching, and is most valuable in daily operation and maintenance.

POWER SUPPLIES: Five major power supplies deliver plate and bias voltage to the HF-20B transmitter. To assure greater reliability and better regulation, separate high voltage supplies are used for the modulator and power amplifier. Each of these two independent HV power supplies are of full wave, three phase, six tube design. Three other individual supplies provide modulator bias voltage, power amplifier bias voltage and intermediate voltage for driver stages.

RELAYS AND PROTECTION: Magnetic AC contactors are inserted in all main primary lines. All major tubes are protected by individual supervisory overload relays. Protection devices are included for door interlock and air failure. Automatic shorting relays immediately discharge all filter capacitors when the door interlocks are disengaged.

RECYCLING: If the carrier is interrupted, a unique control circuit allows recycling to the fourth consecutive overload—permitting the carrier to turn back on automatically. As carrier interruption is often caused by static discharges across the transmission line or tower base, this recycling feature is indispensable.

PERFORMANCE: Controlled engineering and quality manufacturing provide assurance that the Gates HF-20B transmitter is the finest high frequency transmitter in its power range that is available today. The long list of users includes major governments world-wide, as well as international transoceanic radio communications and press services. The HF-20B transmitter is definitely commercial all the way. Whether used 24 hours daily or in equatorial climate with high temperature and humidity, unsurpassed performance and reliability can be expected.

MODEL HF-20BX: Identical to the HF-20B transmitter described herein but has 400 word per minute keyer added. This model may be used for broadcasting, voice communications, telegraph or with optional frequency shift keyer.

MODEL HF-20CX: The audio frequency response is for voice only in this model and otherwise is the same as the HF-20BX including keyer and provision for FSK. Audio response is rated 200-3500 cycles \pm 3 db.

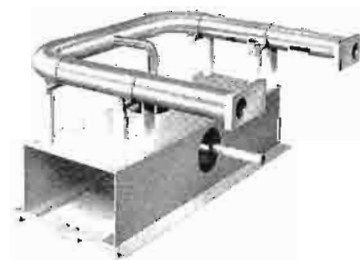

"Latch-on" 18-22 Mc. Tank coil assembly. Rapid change of tank coils permits frequency change-over to be made in three minutes.

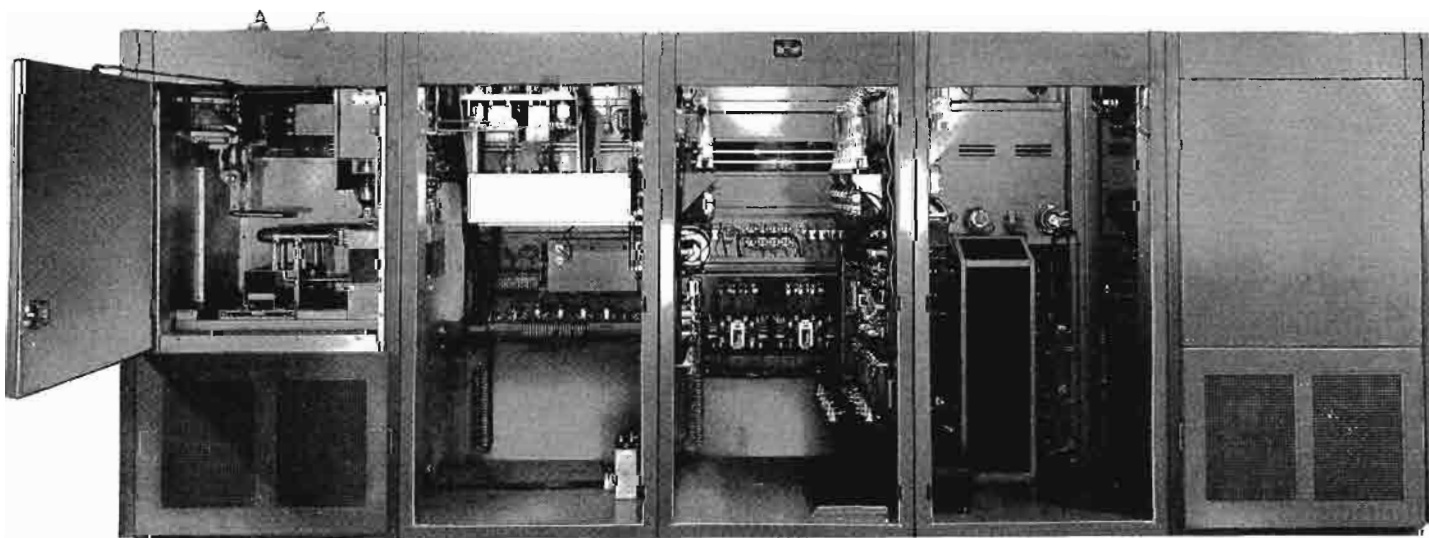

Rear view of the HF-20B.

20,000 Watt High Frequency Broadcast Transmitter—HF 20B

SPECIFICATIONS

FREQUENCY RANGE:
4-22 Mc.

OUTPUT IMPEDANCE:
300-800 ohms balanced. (50 ohms unbalanced, optional).

POWER OUTPUT:
4-18 Mc., 20,000 watts, 18-22 Mc., 16,000 watts modulated (A3). Full 20KW output 4-22 Mc. telegraph.

POWER REDUCTION:
Low power tune-up switch provided.

POWER CONSUMPTION:
0% modulation 37 KW. Average modulation, 43 KW.
100% modulation (sine wave) 55 KW.

POWER FACTOR:
90% or better.

PRIMARY VOLTAGE:
230 volts, 3 phase, 50/60 cycles. Other primary voltages or line frequencies available on special order.

AUDIO RESPONSE:
± 1½ db. 50-10,000 cycles.

DISTORTION:
3% or less 100-5000 cycles.
4% or less 50-7500 cycles.

NOISE:
55 db. or better below 100% modulation.

CRYSTAL POSITIONS:
Four; input for external VFO or FSK provided.

RF STABILITY:
.003% or better, with JK-09C oven.

KEYING:
400 WPM with essential square top wave form, on-off keying.
Keyer supplied on Models HF-20BX and HF-20CX only.

TUBES:
(Radio frequency section) 6AG7 oscillator, 6AG7 buffer, 6146 buffer/doubler, (2) 4-250A RF driver, (4) 3X2500F3 power amplifiers.

(Audio section) (2) 6J7 first audio, (2) 807 second audio, (2) 845 audio driver, (4) 3X3000F1 modulators.

(Power supplies) (12) 673 HV rectifiers, (4) 8008 LV rectifiers, (2) 866A LV rectifiers.

(Keyer) (1) 812 keyer tube.

SIZE:
HF-20B and HF-20BX, 205" wide, 48½" deep, 78" high. Door swing, 40" front and rear. Floor space for external transformers: 10' x 9'. Largest cabinet size uncrated: 45" wide, 50" deep, 78" high.
HF-20TX, 175" wide, 48½" deep, 78" high. Door swing, 40" front and rear. Floor space for external transformers: 5' x 6'.

WEIGHT AND CUBAGE:
(Packed) domestic 11,000 lbs., export 13,900 lbs.
Cubage: 1050.

ORDERING INFORMATION

Transmitter, 20 KW Broadcast, 4-22 Mc., with tubes, less crystals HF-20B

Transmitter, 20 KW Broadcast, with tubes and with keyer added, 4-22 Mc., less crystals HF-20BX

Transmitter, 20 KW Telephone and Telegraph, with tubes and keyer, 4-22 Mc., less crystals HF-20CX

Spare 100% tube kit for all models above TK-139

Crystal and holder, .02% accuracy CR-27A/U

Temperature controlled crystal oven holds two CR-27A/U crystals for 0.003% accuracy JK-09C

NOTE: A 20 KW telegraph only model is described on Page 201.

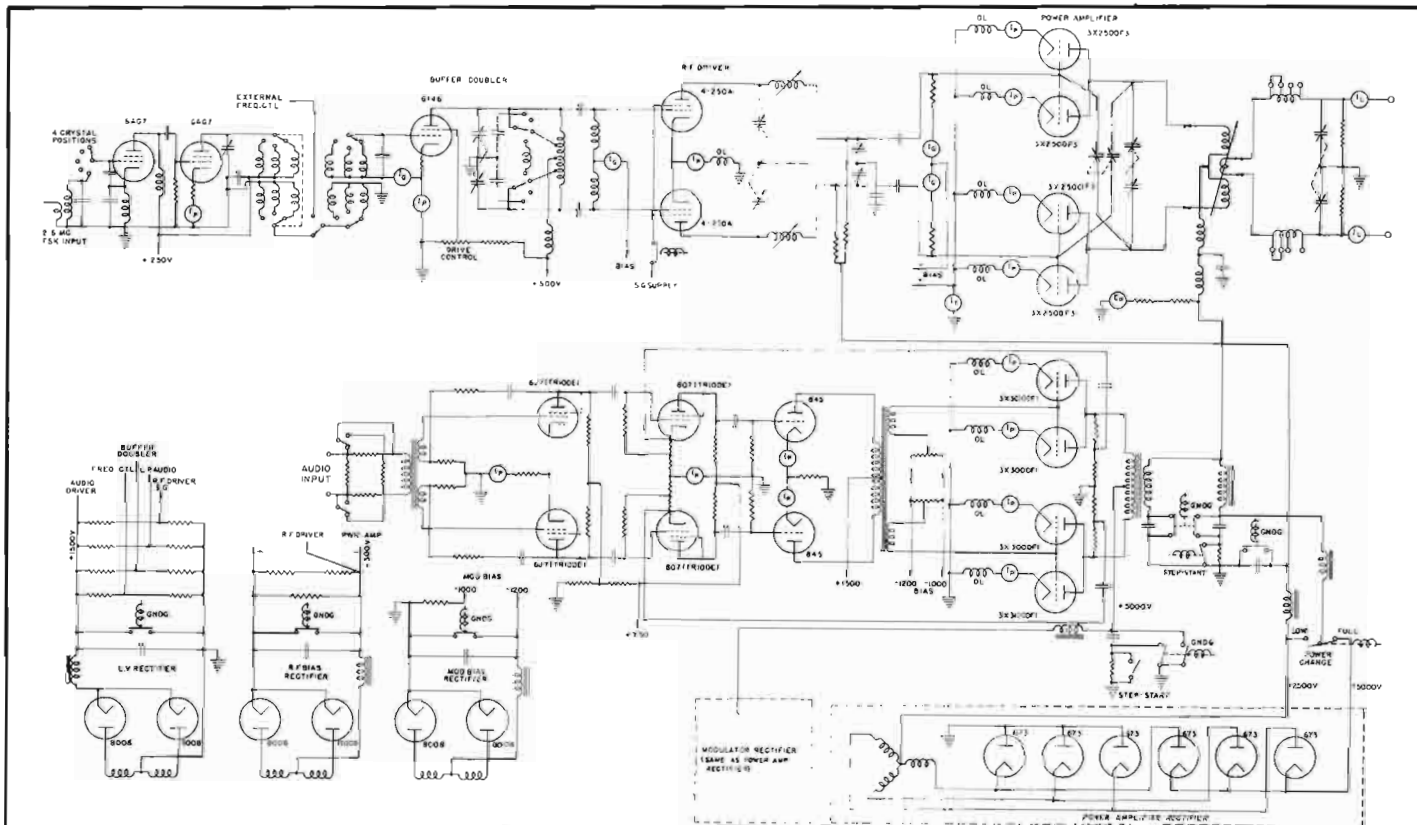

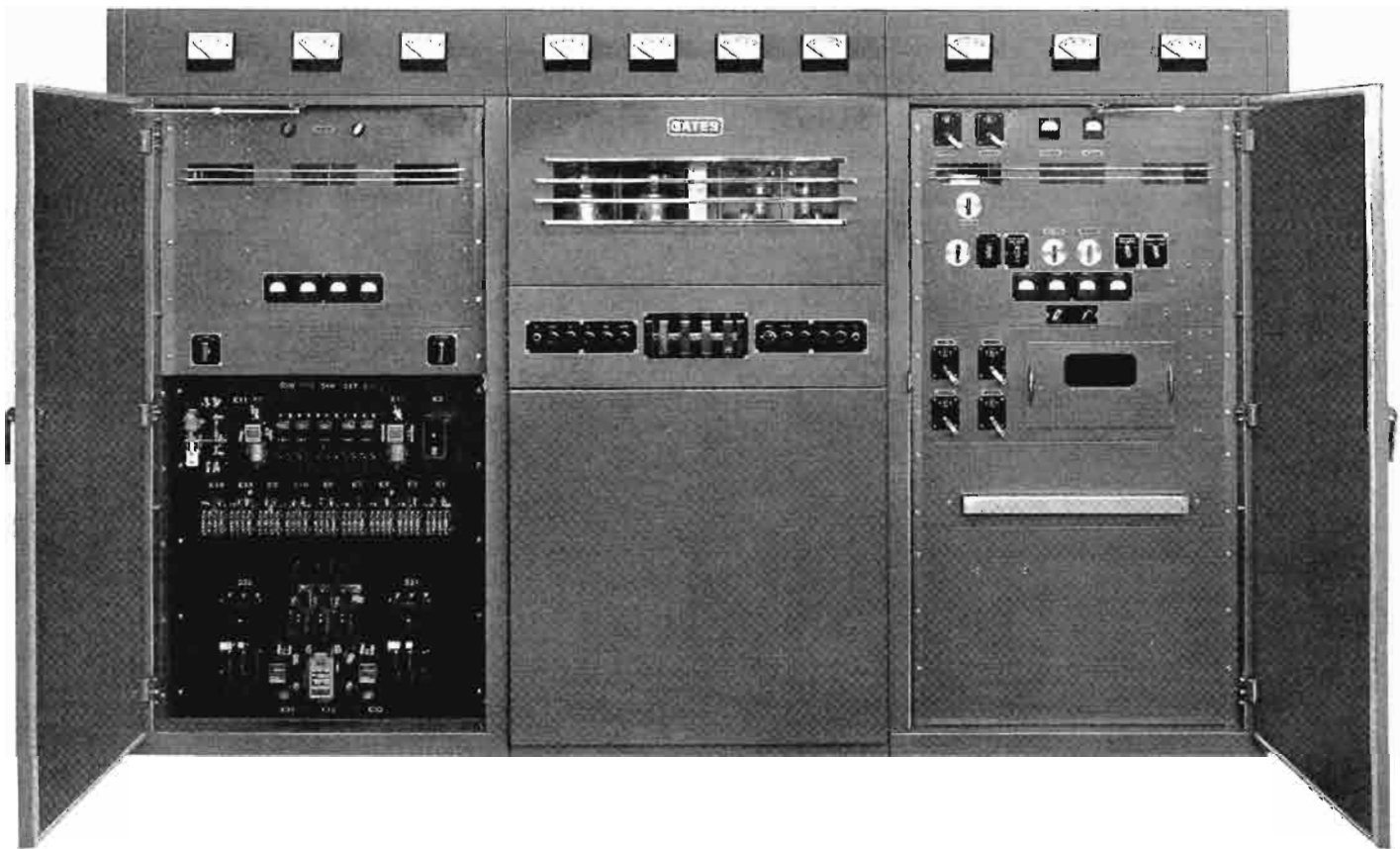

MODEL HF-10B

Designed for 10 KW continuous duty operation, this popular transmitter is renowned for reliable broadcasting service in the 2-22 Mc. band. The HF-10B transmitter employs reliable high level modulation, and provides superb low distortion audio response between 30 and 10,000 cycles. The same tube types are used for both power amplifier and modulator. As the proven long life 3X2500F3 power tube is employed, the interchangeability feature adds to tube life and reduces the number of spare tubes required. Low power consumption and low tube cost provide an economy of operation unmatched for 10 KW high frequency broadcast service.

MODELS AVAILABLE: Companion versions of the HF-10B transmitter for continuous 10 KW double sideband communications service include the Models HF-10C, and HF-10CX with built-in electronic keyer. These transmitters are identical to the HF-10B except that the audio components are for voice quality transmission only, such as for point to point radio telephone service.

FAST TUNING: Frequency change is fast and convenient. Once the frequency band is selected, transmitter tune-up can be made within one minute with front panel controls.

Except for the final tank coil, all circuits are continuously variable between 2 and 22 Mc. Full band change can be made in minutes as the Gates design allows fast changing of final tank coil which sets on a sliding pin guided carriage in the PA tank frame assembly and is racked into position quickly. Four coils are supplied for complete 2 to 22 Mc. coverage. Variable vacuum condensers are used to tune the power amplifier tank. Tuning of the pi-network output loading is handled by continuously variable coils and capacitors to match 300 to 800 ohm balanced lines. (Available for 50 ohm unbalanced output on special order.)

RADIO FREQUENCY & AUDIO SECTION: A two stage exciter unit containing 4 crystal positions (and an input for external frequency shift keying or VFO) is followed by an 807 amplifier/doubler stage and two type 4-250A RF driver tubes which supply more than ample RF drive to the 2 type 3X2500F3 push-pull power amplifiers.

The four stage audio section is all push-pull with inverse feedback and an abundance of modulation capacity. The Class B modulator consists of two long life type 3X2500F3 triodes which are interchangeable with the RF power amplifier tubes. The audio system is true high fidelity.

10,000 Watt High Frequency Broadcast Transmitter—HF-10B

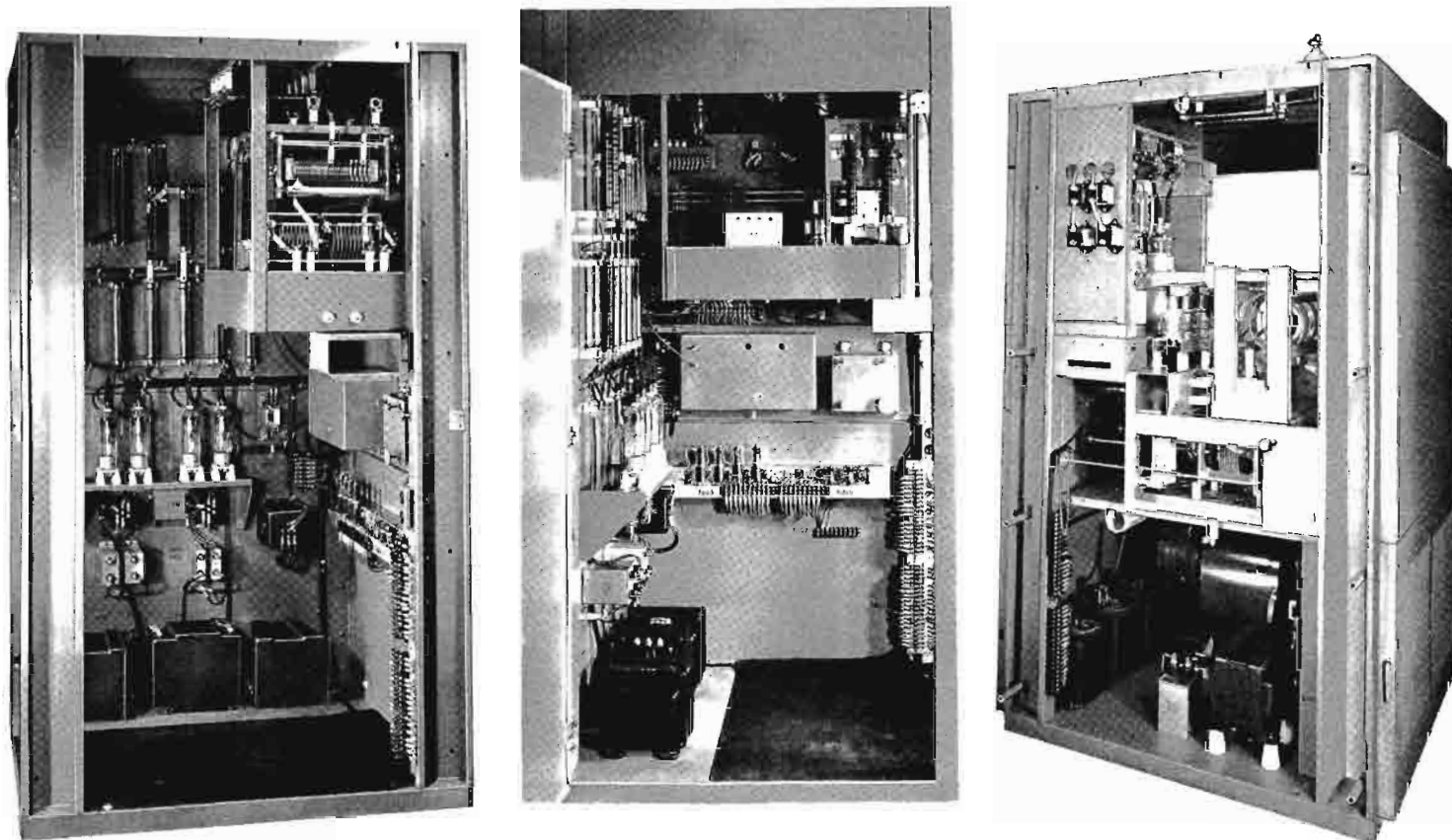

Rear view front left to right of RF drive cubicles and RF power amplifier center cubicle.

POWER SUPPLIES: The main high voltage power supply is a three phase full wave system, utilizing six type 673 tubes. Separate supplies are incorporated for low voltage and bias circuits.

OPERATING FEATURES:

Protective Devices: Protective design for both equipment and personnel is complete. All tubes except those in the exciter and the first two audio stages are protected by overload relays. Primary circuit breakers are in all major circuits. Individual supervisory relays are used in all overload circuits. Time delay relays, door and air pressure interlocks are standard equipment.

Recycling: A unique control circuit automatically returns the transmitter to the air by recycling up to the fourth overload, if, for any reason, the carrier is interrupted.

Air Cooling: A large centrifugal blower efficiently cools

the two pair of 3X2500F3 tubes. Some of this air is blown into the transmitter proper for total cooling of components. Another small blower directs cooling air to the base of each HV mercury rectifier to increase tube life and prevent mercury tube arc back.

CONSTRUCTION: Three cabinets of walk-in construction attach together, forming an attractive, serviceable transmitter assembly. Terminal strips at the bottom of each cabinet transfer all internal wiring. This feature eliminates tedious inter-cabinet wiring and saves valuable installation time and cost. Internal service lights and utility AC receptacles are standard equipment.

Compact in size, the transmitter requires only 42 square feet of floor space as all components including the power transformer, modulation transformer, and reactor are mounted within the transmitter. These heavy duty components are of a new dry type with high density core, especially designed for extremes in climatic conditions.

10,000 Watt High Frequency Broadcast Transmitter—HF-10B

SPECIFICATIONS

POWER OUTPUT:
10,000 watts.

FREQUENCY RANGE:
2-22 Mc. (4-30 Mc. on special order).

OUTPUT IMPEDANCE:
300 to 800 ohms balanced. (50 ohms unbalanced on special order).

FREQUENCY STABILITY:
.003%, with oven.

CARRIER SHIFT:
5% or less at 100% modulation.

FREQUENCY RESPONSE:
(Model HF-10B) ± 1.5 db. 30-10,000 cycles.
(Model HF-10C) ± 3 db. 150-4000 cycles.

DISTORTION:
(Model HF-10B) 3% or less 50 to 7500 cycles.
(Model HF-10C) 10% or less 150 and 4000 cycles.

RF HARMONICS:
Suppression or harmonics meets or exceeds CCIR requirements.

AUDIO INPUT:
+15 dbm. ± 2 db.

NOISE:
(Model HF-10B) 60 db. or better below 100% modulation.
(Model HF-10C) 45 db. or better below 100% modulation.

POWER LINE REQUIREMENTS:
230 volts, 3 phase, 50 or 60 cycles (as ordered). (Other voltages or line frequencies available on special order.)

POWER CONSUMPTION:
0% modulation—21KW; average modulation—23KW;
100% modulation—30KW.

POWER FACTOR:
90% or better.

CRYSTAL POSITIONS:
4 front panel selected.

TYPE OF EMISSION:
(Model HF-10B) A3.
(Model HF-10BX, HF-10C, HF-10CX) A1, A2, A3 and F with external frequency shift keyer.

SIZE:
125" long, 78" high, 48½" deep. Front door swing, 19"; back door swing 40". Size of largest cubicle uncrated 45" wide, 50" deep, 78" high. (Space required to accommodate optional

external oil-filled magnetic components 8' long x 3' wide.)

TUBES:
(2) 6AG7, (2) 4-250A, (2) 6J7, (4) 845, (4) 3X2500F3,
(4) 8008, (6) 673, 3) 807. (Keyer is type 812A).

WEIGHT AND CUBAGE:

| MODEL | DRY COMPONENTS | OIL-FILLED COMPONENTS (Optional) |
|--------|---------------------------|----------------------------------|
| HF-10B | 6600 lbs. domestic packed | 8000 lbs. domestic packed |
| | 6815 lbs. export packed | 10,174 lbs. export packed |
| | 533 cu. ft. | 566 cu. ft. |
| HF-10C | 6150 lbs. domestic packed | 6950 lbs. domestic packed |
| | 6360 lbs. export packed | 9125 lbs. export packed |
| | 523 cu. ft. | 533 cu. ft. |

ALTITUDE:
6000 ft. (Higher on special order.)

ORDERING INFORMATION

Broadcast transmitter, 10 KW, with tubes, less crystals HF-10B
Broadcast transmitter, 10 KW, with tubes, electronic keyer, less crystals HF-10BX
Communications transmitter, 10 KW, with tubes, less crystals HF-10C
Communications, transmitter, 10 KW, with tubes, electronic keyer, less crystals HF-10CX
Spare 100% tube kit for all models TK-253
Crystal and holder (.02% accuracy) CR27A/U
Temperature controlled oven, holds two CR27A/U (.003% accuracy) JK-09C

Notes: (1) State line frequency as 50 or 60 cycles. (2) Above models are for 2-22 Mc. and with self-contained dry type power components. (3) All models available for 4-30 Mc. at slight extra cost. (4) All models available with external oil-filled plate transformer, modulation transformer, and modulation reactor at extra cost. (5) Be sure and state carrier frequency/s, primary voltage and frequency when ordering.

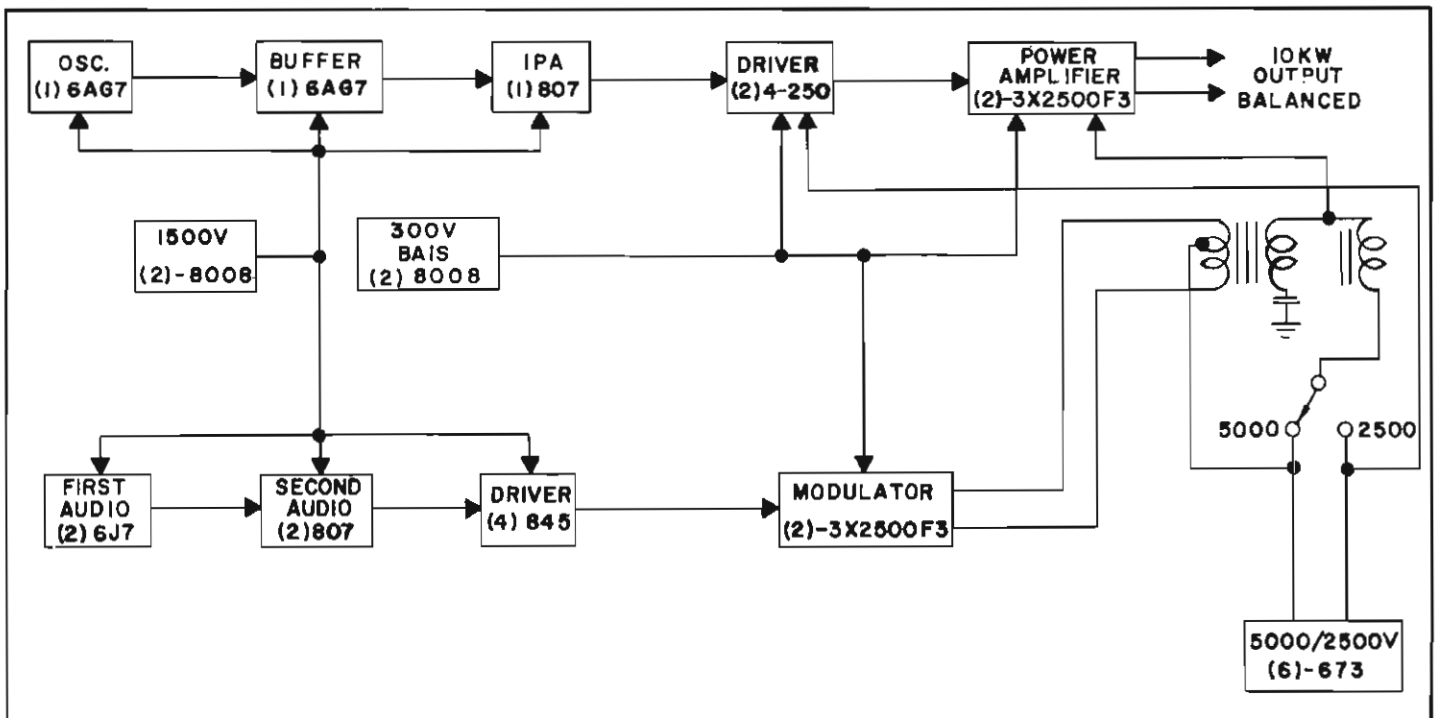

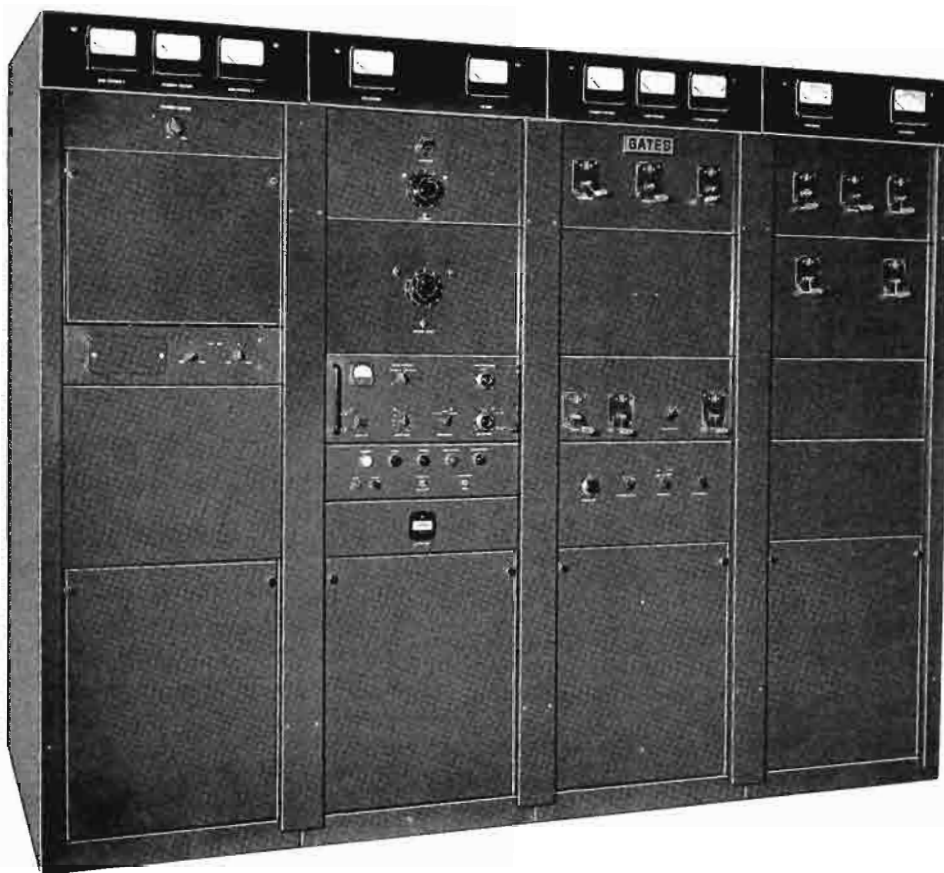

MODEL BHF-10

A deluxe top commercial grade, high frequency, high level modulated 10 KW transmitter designed for 24-hour schedules in either telephone communication or high fidelity radio broadcasting. The BHF-10 transmitter is 100% tuned from the front over the entire 4 Mc. to 30 Mc. range. No coil changes are required. Counter type tuning dials provide accurate logging and return to any previously logged frequency in less than one minute. Even the output balun is continuously variable and the transmitter will feed either 600 ohm or 50 ohm transmission lines. The BHF-10 transmitter may also be used as a 15,000 watt high speed telegraph transmitter with adaption to optional frequency shift keying. One major international communications company uses the BHF-10 transmitter with a Kahn SSB adaptor.

DESIGN: Four cubicles bolt together to form the transmitter, which is totally self-contained with no external components and occupies a floor space of 100" wide and 41" deep. Solid state power supplies are used throughout. Ten crystal positions for .003% frequency accuracy excites five radio frequency stages including dual 4CX5000A power tubes in a single ended circuit.

RF SECTION: High level modulation with 3X2500F3 modulator tubes provides generous over-capacity. There are four audio stages.

If the transmitter is for telephone service only, the M-5263 communications limiter filter amplifier is suggested. RF harmonic reduction, because of the unique output balun, easily meets or exceeds both FCC and CCIR specifications. Unusual attention has been given to internal shielding and prevention of cabinet radiation. The maximum DC voltage is 5000. This design greatly enhances minimizing of insulation and corona problems.

CONTROL CIRCUITRY: Control circuitry is complete including under-voltage and overload relays, circuit breakers, air interlock switches, and door interlocks throughout. Recycling is automatic and provides positive protection for closely spaced carrier interruptions.

RUGGED COMPONENTS: Nothing has been spared to make this transmitter the finest. A glance at the rear view illustrates the very sizable blowers, coils with cast aluminum end supports, vacuum capacitors, large filter capacitors, excellent accessibility and workmanship. The BHF-10 is a transmitter with a totally new design and Gates is proud to recommend it for the most demanding service.

SPECIFICATIONS

POWER OUTPUT:
10 KW. A-3 (see Note 1 below).

FREQUENCY RANGE:
4-30 Mc. continuous.

RF OUTPUT IMPEDANCE:
600 ohms balanced and 50 ohms unbalanced.

FREQUENCY STABILITY:
.003% or better (see Note 2 below).

CARRIER SHIFT:
3% or less at 100% modulation.

AUDIO RESPONSE:
± 1.5 db., 30-12,000 cycles (see Note 3 below).

AUDIO DISTORTION:
3% or less, 50-7500 cycles at 95% modulation.

NOISE:
60 db. below 100% modulation.

AUDIO INPUT IMPEDANCE:
150/600 ohms at 0 dbm. for 100% modulation.

A.C. INPUT:
208/240 volts AC, 3 phase, 50/60 cycles. Power consumption approximately 19.9 KW carrier only. 22.7 KW at average program modulation (see Note 4 below).

SIZE:
100" wide, 41" deep and 78" high (see Note 5 below).

WEIGHT AND CUBAGE:
5355 lbs. export packed. 430 cu. ft.

FINISH:
Two-tone Gates gray, aluminum trim and black (see Note 6 below).

TUBES:
(4 each) 5763, 6528, (3) GZ34, (2 each) 4CX5000A, 3X2500F3, 6BG6, 5R4G, (1 each) 6V4, OA2, 6SN7, 4-250A. Power supplies use silicon rectifiers throughout.

ORDERING INFORMATION

10 KW High Frequency transmitter, complete with one set of tubes, but less crystals or ovens BHF-10
 Crystals only for BHF-10 CR27A/U
 Oven for crystals (holds two crystals) JK02C
 100% set spare tubes for BHF-10 transmitter TK-518
 Limiter Amplifier for telephone service M-5263

NOTES: (1) Will produce 15 KW as telegraph model with modulator idle, (2) each temperature controlled oven accommodates two CR27A/U crystal/holder, (3) available for other line voltages on special order, (4) 100" width divided into 4 cubicles 25" wide for easy entrance through standard door, (5) other colors available on special order.

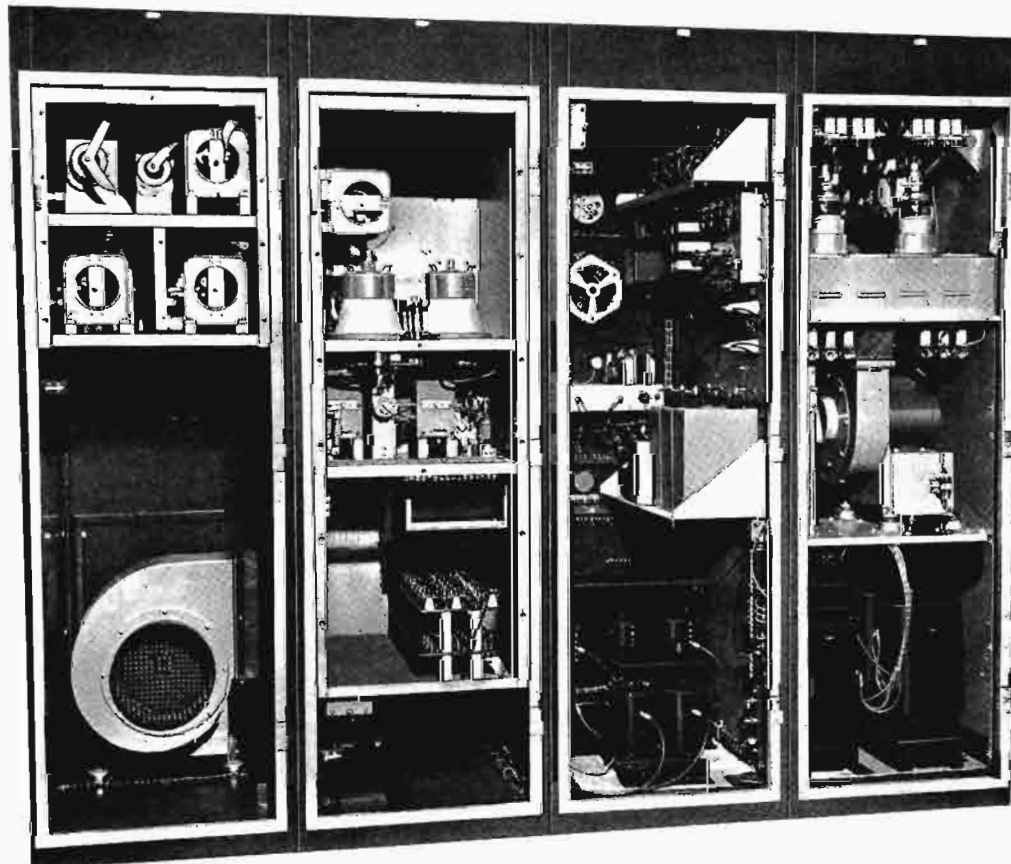

Rear view of BHF-10, 10,000 watt high level modulation 4-30 Mc. transmitter. Doors and shields have been removed for photography. Transmitter is 78" high, 8½ feet wide and 3½ feet deep and is 100% self-contained.

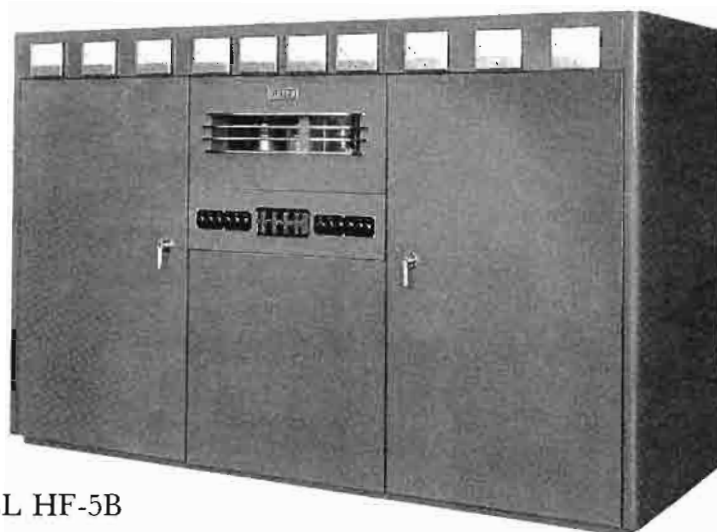

MODEL HF-5B

Available in two models for high fidelity short wave broadcasting or voice communications, the HF-5B transmitter covers the entire 2-22 Mc. band (with an optional model for 4-30 Mc.) Essentially the same as the model HF-10B high frequency 10 KW transmitter other than smaller transformers, R. F. driver and rectifier tubes. As a result of this standardization, this 5000 watt model may be increased to 10 KW at any time with a power increase kit.

OPERATION: All of the features found in the HF-10B transmitter described on page 172 are found in this companion 5 KW model. The HF-5B transmitter employs high level modulation, uses the same type 3X2500F3 triode tube for power amplifier and modulator, and the broadcast model

provides high fidelity response between 30 to 10,000 cycles. Except for the final tank coil all circuits are continuously variable. Once the frequency band is selected, transmitter tune up can be made within one minute with front panel controls. Where desired, the transmitter can be supplied with externally mounted oil filled modulator and power transformers as optional equipment.

A superior equipment with an excellent global reputation, the HF-5B transmitter is rugged, easy to service and gives top performance under rigorous duty in every type of climate. Companion model for CW use only or for voice communications service are available.

SPECIFICATIONS

POWER OUTPUT:
5000 watts.

FREQUENCY RANGE:
2-22 Mc. (4-30 Mc. on special order).

OUTPUT IMPEDANCE:
300 to 800 ohms balanced. (50 ohms unbalanced on special order).

FREQUENCY STABILITY:
.003% or better.

CARRIER SHIFT:
5% or less at 100% modulation.

FREQUENCY RESPONSE:
(Model HF-5B) ± 1.5 db. 30-10,000 cycles.
(Model HF-5C) + 3 db. 150-4000 cycles.

DISTORTION:
(Model HF-5B) 3% or less 50 to 7500 cycles.
(Model HF-5C) 10% or less 150 to 4000 cycles.

R.F. HARMONICS:
Suppression of harmonics meets or exceeds CCIR requirements.

AUDIO INPUT:
+ 14 dbm. ± 2 db, 600 ohms.

NOISE:
(Model HF-5B) 60 db. or better below 100% modulation.
(Model HF-5C) 45 db. or better below 100% modulation.

POWER LINE REQUIREMENTS:
230 volts, 3 phase, 50 or 60 cycles (as

ordered). (Other voltages or line frequencies available on special order.)

POWER CONSUMPTION:
0% modulation—12.5 KW; average modulation — 15.5 KW; 100% modulation — 18.5 KW.

POWER FACTOR:
90% or better.

CRYSTAL POSITIONS:
4, front panel selected.

TYPE OF EMISSION:
(Model HF-5B) A3.
(Model HF-5BX, HF-5C, HF-5CX) A1, A2, A3 and F1 with optional external frequency shift keyer.

SIZE:
125" long, 78" high, 48½" deep. Front door swing, 19"; back door swing 40". Size of largest cubicle uncrated 45" wide, 50" deep, 78" high.

TUBES:
(2) 6AG7, (2) 4-125A, (2) 6J7, (4) 845, (4) 3X2500F3, (10) 8008, (3) 807. (Keyer is type 812A).

WEIGHT AND CUBAGE:
HF-5B with dry components—6200 lbs. domestic packed. 6815 lbs. export packed. Cubage—533.
With oil filled components (optional) —7500 lbs. domestic packed. 10,000 lbs. export packed. Cubage—560.

ALTITUDE:
6000 ft. (Higher on special order.)

ORDERING INFORMATION

Broadcast transmitter, 5 KW, with tubes, less crystals (Cat. No.) HF-5B

Broadcast transmitter, 5 KW, with tubes, electronic keyer, less crystals . . HF-5BX

Communications transmitter, 5 KW, with tubes less crystals HF-5C

Communications transmitter, 5 KW, with tubes, electronic keyer, less crystals . . HF-5CX

Spare 100% tube kit for all models . . TK-252

Crystal and holder (mounts in JK-09C below) CR27A/U

Temperature controlled oven, holds two CR27A/U (.003% accuracy) . . JK-09C

NOTES: (1) State power line frequency such as 50 or 60 cycles. (2) Above models are for 2-22 mc. and with self-contained dry type power components. (3) All models available for 4-30 Mc. at slight extra cost. (4) All models available with external oil-filled plate transformer, modulation transformer, and modulation reactor at extra cost. (5) Be sure and state carrier frequency/s, primary voltage and frequency when ordering.

MODEL HF-1M

This 1000 watt high level modulated, high frequency transmitter may be used for (a) high quality short wave broadcasting, (b) as a voice communication transmitter, or (c) as a 1300 watt telegraph transmitter. Frequency range is from 3 Mc. to 32 Mc. and continuously tunable from the front panel. Operation between 2 Mc. and 3 Mc. is quickly attainable by inserting a padder capacitor provided. The R.F. exciter section accommodates as many as 10 crystals, rotary switch selected.

BROADCAST OPERATION: The HF-1M transmitter is an ideal short wave broadcast transmitter with wide audio response, low distortion and noise. The heavy design allows 24-hour schedules under wide extremes of temperature and humidity conditions.

COMMUNICATIONS OPERATION: The HF-1M transmitter may be used for point to point communication service with 1000 watt modulated output or up to 1300 watts output when operated as a CW transmitter. When operating in voice (A3) service, it is suggested that the Gates M-5263 Limiter/Filter Amplifier be employed. This operation permits a very high level of voice modulation and intelligibility. In CW service, keying speeds of 60 wats per minute are obtainable, and a frequency shift keyer, described on Page 217, may be added for radio teletype service.

GENERAL DESIGN: (*Radio Frequency Section*). A 3-stage, 85 watt exciter drives a single ended 4-1000A Class C power amplifier. Output to the 45-75 ohm transmission line is via a PI-L network. Any frequency between 3 Mc. and 32 Mc. may be set from the front panel and logged for quick return.

(*Audio Section*). High level Class B modulators utilizing the famed long life 833-A modulator tubes develops generous audio power to modulate the Class C power amplifier. There are 3 push-pull audio stages with inverse feedback

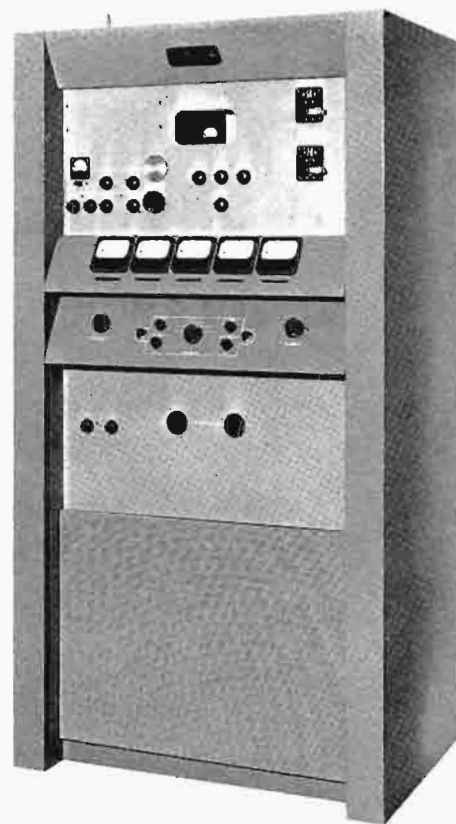

adding to the already excellent performance.

A complete relay control and protection system, 4 intermediate power supplies plus the high voltage supply, 7 meters with five at center line, forced air blower cooling to the PA tube, cabinet exhaust fan, 10 crystal positions, filament and plate rheostat are all contained in a rugged very-easy-to-service cabinet finished in medium gloss gray. —The HF-1M transmitter for moderate power short wave broadcasting or communications is a proven equipment used world-wide.

SPECIFICATIONS

- POWER OUTPUT:**
1000 wats (100% modulated) 2-26 Mc.
800 wats (100% modulated) 26-32 Mc.
- FREQUENCY RANGE:**
2-32 Mc. Continuously variable from 3 to 32 Mc.
- TYPE OF EMISSION:**
A1, A2, A3 and F1 with external FSK.
- FREQUENCY STABILITY:**
.003%.
- R.F. HARMONICS:**
Meets or exceeds CCIR standards.
- CRYSTAL POSITIONS:**
10 with each JK-09C temperature controlled oven holding two CR-27A/U crystals and holders.
- R.F. OUTPUT:**
Single ended into PI-L network to match 45 to 75 ohm lines unbalanced. Other R.F. output impedances accommodated by special coupler available to buyer's specific needs.
- CARRIER SHIFT:**
3% or better at 100% modulation when installed with adequate primary mains.
- AUDIO PERFORMANCE:**
(Response) ± 2½ db. 30-10,000 cycles*.
(Distortion) 3½% or less 50-7500 cycles, 95% modulation.
(Input) 150/600 ohms at + 10 db. for 100% modulation.
- NOISE:**
55 db. or better below 100% modulation.

- TUBES:**
(4 each) 1622, 5R4GY, (2 each) 6146, 6Y6G, 6SN7, 833A, 8008, 5763, and (1 each) 4-1000A, OB2, 6AQ5.
- AC INPUT:**
230 volts, 50/60 cycles, 1 phase, 3 wire. Power consumption at 0% modulation, 3.2 KW; at average modulation, 3.7 KW; at 100% modulation, 4.5 KW.
- SIZE AND WEIGHTS:**
78" high, 42" wide, 30" deep. Weight packed (domestic) 1300 lbs., (export) 1450 lbs. Cubage: 152.

*For voice communications only when used with Gates M-5263 limiter/filter amplifier, response is 200-2500 with sharp cut-off above 2500 cycles.

ORDERING INFORMATION

- High frequency transmitter with tubes, less crystals HF-1M
 - 100% tube complement for HF-1M TK-249
 - Crystal and holder to mount in JK-09C oven CR-27A/U
 - Temperature controlled oven for 1 or 2 type CR-27A/U crystals JK-09C
 - Limiter/filter amplifier for telephone service M-5263
- Note:** Be sure to state carrier frequencies when ordering.



MODULATION MONITOR—HIGH FREQUENCY

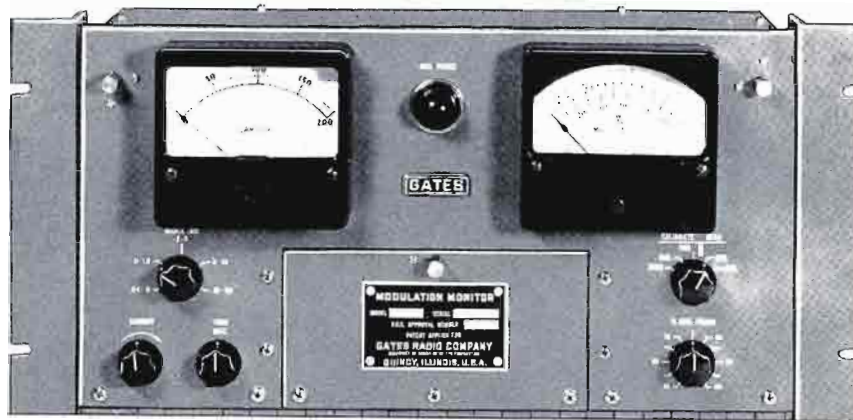

MODEL M-5774

Developed especially for use in the 2-30 Mc. short wave broadcast band, the Gates M-5774 Modulation Monitor will give the most reliable indication of modulation percentage as is now possible with any known meter device. The response time is extremely fast with the meter within 90% of correct reading with only a 5 millisecond modulation pulse. Operating under an entirely new principle, this high accuracy is possible because of a new derivative controller circuit. International short wave broadcasters, U. S. Government agencies and other High Frequency communication services almost exclusively use this monitor. Renowned broadcasting organizations all over the world have determined that the use of the M-5774 monitor is a must to maintain maximum transmitter modulation. In addition, the self-calibrating feature eliminates dependence on other equipment such as an oscilloscope or tone modulator to

check and correct accuracy. Recalibration, if needed, can be made in seconds.

PATENTED: The exclusive derivative controller circuit is used only by Gates under U. S. Patent 2,984,796. To add to superiority, the detector is DC coupled to the measuring circuits to avoid errors when transmitted wave forms are not symmetrical.

DESIGN: The design objective of this modulation monitor was to provide short wave broadcasters, of all powers, an instrument that would directly read modulation percentage faster and more accurately than any other known direct reading instrument. It is faster by 35 milliseconds than monitors used in standard broadcasting service. As all engineers know, the maximum use of the carrier without over-modulation results in maximum total signal strength. In lower power stations, the value is indispensable. In higher power stations, the correct use of this monitor could have the same effect as several thousand additional watts of power.

SPECIFICATIONS

FREQUENCY RANGE:

2 Mc. to 30 Mc.

MODULATION RANGE:

(Meter) 0-100% on negative peaks; 0-110% on positive peaks.
(Flasher) 50% to 100% on negative peaks in steps of 5%.

RESPONSE:

(Meter) 0.2 db., 50-15,000 cycles.
(Flasher) 0.6 db., 20-7500 cycles.

ACCURACY:

(Meter) $\pm 2\%$ full scale at 1 Kc. any modulation percentage.
(Flasher) $\pm 2\%$ at 1000 cycles.

R. F. INPUT:

Approx. 70 ohms at 14 volts.

RESPONSE TIME:

(Meter) Responds to within 90% of correct reading with a single 15 millisecond pulse of modulation. Needle returns to 10% of reading in 1100 to 1400 milliseconds after signal is removed.

(Flasher) Responds to a 15 m.s. pulse of modulation and remains on for about 1/5 second.

CIRCUITS:

- (Meter) (1) Direct coupled amplifier responds correctly to any modulation waveform.
(2) High speed meter circuit.
(3) Self-calibration without external equipment.
- (Flasher) (1) Direct coupled flasher shows accurately negative peaks of modulation regardless of waveform.
(2) Flasher uses a DC plate supply permitting all over-modulation peaks to be indicated.
(3) Self-calibration.

DETECTOR LINEARITY:

Negative peak clipping in the detector is negligible up to 7500 cycles. Does not exceed 5% at 15,000 cycles at 100% modulation.

OUTPUT TERMINATIONS:

For (a) extension modulation meter, (b) extension flasher, (c) distortion analyzer and (d) a 600 ohm output at - 20 dbm. for proof of performance measurements. Performance at 600 ohm terminations is: (Response) ± 0.2 db. 50-15,000 cycles. (Distortion) 0.25% 20-15,000 cycles. (Noise) 65 db. or better below output level.

POWER:

105-125 volts or 115-135 volts, 50/60 cycles, 100 watts.

MECHANICAL:

19" x 8 3/4" x 11 1/2" deep. Weight packed (domestic) 41 lbs., (export) 64 lbs. Cubage: 4. Finish: Medium gloss gray with black.

ORDERING INFORMATION

Modulation Monitor, 2 Mc.-30 Mc., with tubes M-5774
Spare 100% tube kit TK-346
Extension modulation percentage meter M-5837

NOTE: This monitor is also available as Model M-5774A which carries FCC approval 3-108. It varies only in the slower attack time which is 50 milliseconds. This model will be supplied without extra cost or delay, when specified.



HIGH FREQUENCY SIDEBAND GENERATOR



Modes: ISB, SSB, DSB, CW, FSK.

MODEL SG-70

All new, the advanced SG-70 sideband generating equipment features fewer tuning controls, protection against mis-tuning, modular construction, a proportional oven with transistorized oscillator for near 10^7 frequency stability, and rapid channel change via a new turret system. Outstanding in the SG-70 is this new ease of tuning, provided by a simplified turret approach for accurate and rapid channel change and tune-up. Completely new, this all purpose exciter has ample output for use with many modern power amplifiers to provide an extremely versatile high frequency transmitter. Continuously tuned from 2 to 32 Mc., with only 2 front panel controls, the Gates Model SG-70 sideband generator permits a broad choice of operating modes. Emission capabilities include: single or double sideband, independent sideband, compatible AM, CW, MCW and FSK with an external frequency shift keyer. Carrier may be suppressed from - 55 db. below rated PEP output to + 0 db. and exceptional frequency stability of two parts in 10^7 is approached at 32 Mc.

SELF-CONTAINED: Complete with self-contained silicon rectifier power supply, the SG-70 sideband generator requires only $8\frac{3}{4}$ inches mounting space in a standard 19 inch rack. All Gates sideband transmitters from 1 KW to 20 KW use this carefully engineered product which is manufactured to precise quality standards.

OPERATION: The SG-70 sideband generator is independently crystal controlled on ten discrete frequencies. Each of these frequencies may be applied to one of fifteen bands, making a total of 150 channel frequencies available. The exciter may also be operated from an external synthesizer or VFO.

Designed to permit simultaneous or independent transmission of voice and/or data, mode selector switches are provided to switch all inputs to either upper sideband or lower sideband. A full 6100 cycle bandwidth, in each channel, accommodates four 3 KC. multiplexed channels.

Two independent 600 ohm balanced or unbalanced input channels and one high impedance microphone channel are provided. The 600 ohm channels will operate the exciter at full power with a minimum input audio level of - 20 dbm.

TUNING: For the accurate and rapid tuning changes required in modern high frequency communications, simplified tuning in the SG-70 sideband generator provides more circuit utilization. Any one of ten crystal controlled channels may be selected by the turn of a knob. A second selector switch chooses one of 15 frequency bands within the 2-32 Mc. range.

The two final adjustments remain: R.F. tune and injection tune—and the exciter is operational. Exceptional frequency stability is achieved through the use of a proportional oven containing the master transistorized frequency oscillator. Generator stability of two parts in 10^7 is approached at 32 Mc. The absolute drift never exceeds 8 cycles at any point in the spectrum.

Assurance of instant, accurate tuning is provided by the SG-70 sideband generator design which prevents the possibility of accidentally tuning to a spurious or unwanted signal.

CONSTRUCTION: The solid state power supply is self-contained, reducing size and cabling problems. The three generator modules: I.F. frequency generator, R.F. section, and injection generator, are of the plug-in type removable from the front panel for both easy access to tubes, and simplified maintenance.

The Gates SG-70 sideband generator uses modern state-of-the-art techniques in engineering design while the styling is both attractive and functional. Ease of tuning and stability are provided by the sound engineering approach used in the planning and engineering of this most modern all purpose exciter.

High Frequency Sideband Generator—Model SG-70

SPECIFICATIONS

FREQUENCY RANGE:
2-32 Mc. continuous, bandswitched.

OPERATING MODES:
Single Sideband, Double Sideband, Independent Sideband, A.M., CW, MCW, FSK w/external adaptor (See Note 1).

FREQUENCY CONTROL:
Temperature controlled crystals; or external VFO or synthesizer.

STABILITY:
1 PPM for 24 hour period.

CRYSTAL POSITIONS:
Ten, selectable from front panel, with independent trimmer.

TUNING CONTROLS:
Two peak controls; RF tune, and RF injection.

OUTPUT POWER:
Rated 100 MW, continuously adjustable from zero to 250 MW PEP. (2.0 watt available as option) (See Note 2).

OUTPUT IMPEDANCE:
50 ohms.

CARRIER SUPPRESSION:
— 55 db. from PEP level, adjustable upward to 0 db.

DISTORTION PRODUCTS:
At rated output third and higher order products are at least 45 db. below either tone of a standard two-tone test signal.

SPIROUS SIGNALS:
At least 60 db. below rated PEP output.

UNWANTED SIDEBAND REJECTION:
500 cycles single tone at least 60 db. down.

AUDIO INPUT:
Two independent 600 ohm channels, balanced or unbalanced, — 20 db. for full RF output. One high impedance mike channel requiring 1 MV for full PEP.

AUDIO RESPONSE:
Within ± 1.5 from 250 to 6350 cps. (3 kc bandpass available.)

INPUT POWER:
115/230 volts, 50/60 cycles at 140 watts.

TUBES:
(5) 6EW6, (4) 12AT7, (3) 6J11, (2) 6M11 and (1 each) 6AU6, (6D10, 7788, 8233, 6J6, 12AX7. Power supplies are solid state.)

SIZE:
19" wide, 8 $\frac{3}{4}$ " high, 17" deep.

WEIGHT:
56 lbs. net. Domestic packed 65; export packed 105; cubage: 2.1.

ENVIRONMENT:
Ambient temperature — 20°C to + 50°C. Humidity up to 95%.

COMPONENTS:
All components meet JAN/MIL specifications where practicable.

Notes: (1) Indicates capability of emission but does not include accessories for MCW or FSK. (2) SG-70 sideband generator is used in Gates 1, 3, 10 and 20 KW SSB transmitters.

ORDERING INFORMATION

SG-70 Sideband Generator (Cat. No.) M-6411
Complete set spare tubes TK-517

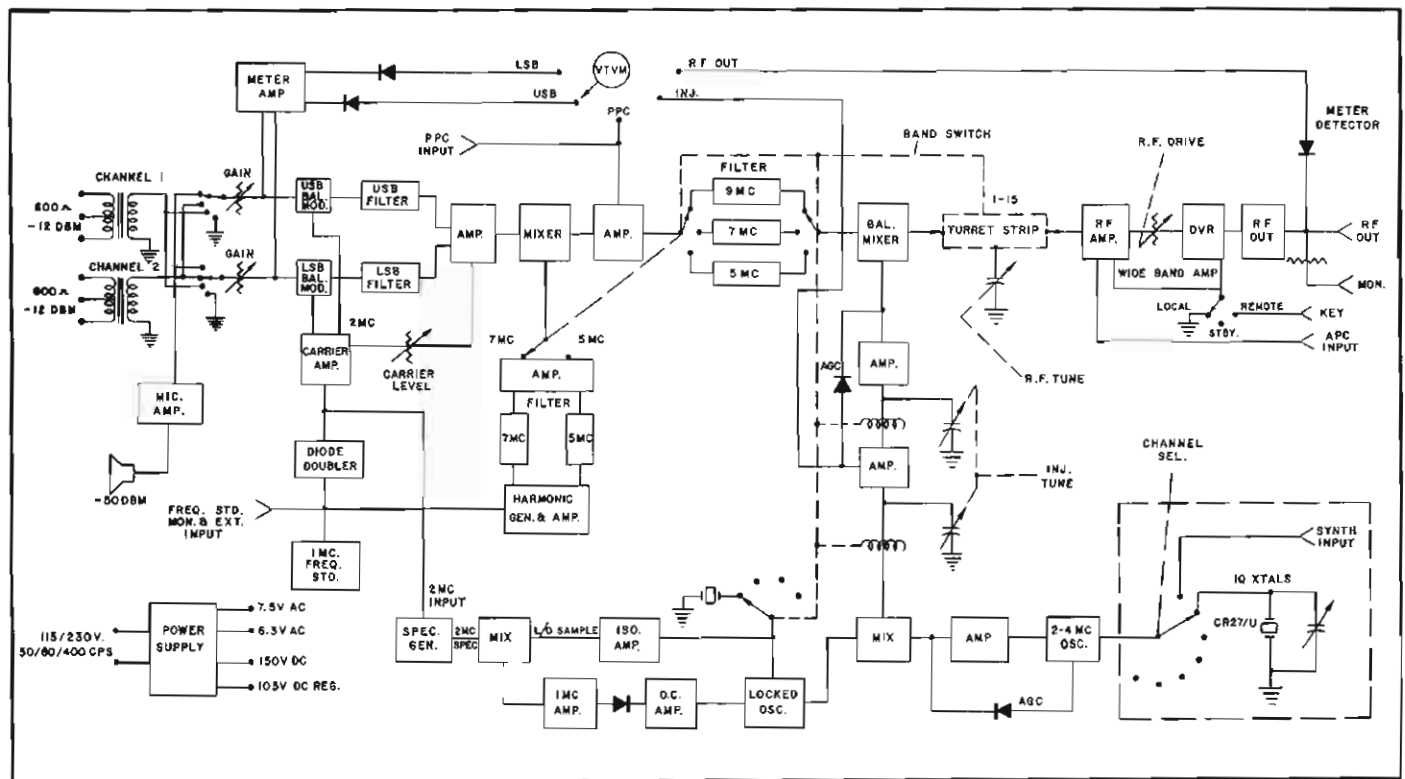

BLOCK DIAGRAM—SG-70

SSB TRANSMITTERS

20,000 WATT HIGH FREQUENCY SIDEBAND TRANSMITTER

MODEL ST-20A

To fill higher power sideband transmitter requirements, Gates has provided this new 20,000 watt complete sideband transmitter designed specifically for single sideband transmission of voice, teletype and data over point-to-point high frequency circuits for long distance communications. The broadband modulation capabilities and low noise characteristics provide for improved quality program material. Power supplies are solid state silicon.

Creative engineering has produced a compact transmitter incorporating carefully chosen components with conservative rating of operating characteristics. Designed for 24-hour continuous service at full rated CW output power. Operating models are: SSB, ISB, DSB, CW, MCW and FSK. For MCW and FSK, optional accessories are available.

MECHANICAL DESIGN: The transmitter consists of four basic units: power supply cabinet, power amplifier cabinet, SG-70 sideband generator (described on Page 180) and external blower cabinet. Use of the external blower permits efficient cooling of the transmitter and greatly minimizes ambient acoustical noise. The entire transmitter, exclusive of blower, is only 60" wide x 30" deep x 66" high. An external blower is suggested where comparatively quiet air movement noise is preferred. A larger and slower turning blower is used which greatly reduces the air aural level. This blower may be mounted in a sub-basement, adjoining room or in an out-building. A metal cabinet is available to house the blower, if desired. The transmitter can be supplied with an internal blower, however, but should be specified when ordering. Internal blower air volume capacity is reduced and noise is substantially higher, than external model.

The power amplifier is constructed on a ball-bearing slide section for pull out to service and maintain. The large front door allows full access to other internal equipment.

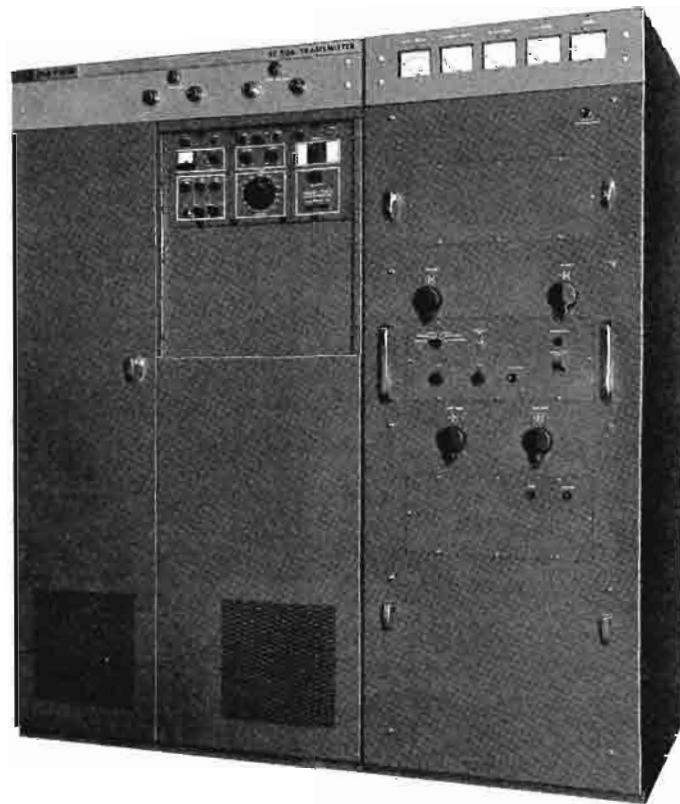

ELECTRICAL DESIGN: Following the SG-70 sideband generator, only three RF stages are utilized in the 20,000 watt linear amplifier section. This notable reduction in amplifier stages reduces tube inventory requirements (only 3 tube types) and greatly simplifies tuning. All tuning is accomplished with 6 front panel tuning controls. Continuous tuning over the entire 2-30 megacycle range is accomplished without the necessity of component change. A rugged type 4CX-15,000A power tetrode operating Class AB₁ is used as the power amplifier. The high efficiency of this linear power amplifier added to the high gain provides the transmitter with a high over-all efficiency and, therefore, the power consumption of the ST-20A transmitter is only 43 KW at full 20 KW CW power output. This is a definite advantage when used in transportable systems.

OPERATION: Extensive metering is employed for monitoring and to facilitate easy tuning. A directional coupler for forward/reflected power indications is supplied as standard. Conservatively rated silicon rectifiers are used throughout for added reliability. Provision is made in the control circuits for the addition of a remote circuit which also incorporates a sequential start circuit which will bring the entire amplifier to full output in a minimum amount of elapsed time consistent with safe application of voltages to all components. All components used in the transmitter are equal to or exceed the latest EIA standards and are operated well under applicable manufacturers' ratings.

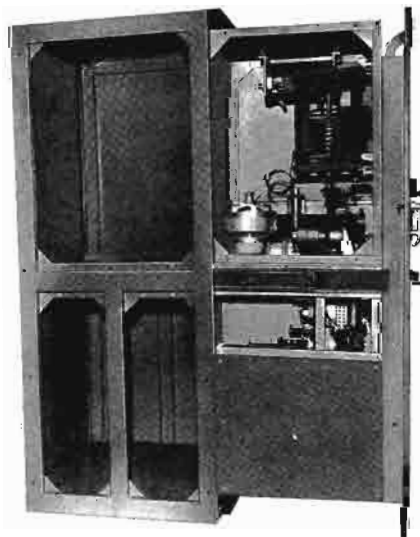

ACCESSIBILITY: Entire R. F. amplifier assembly pulls out on slides. The power supply has front door access. The exciter modules each plug in from the front. The entire transmitter can be installed against the wall without sacrificing accessibility.

20,000 Watt High Frequency Sideband Transmitter—ST-20A

SPECIFICATIONS

FREQUENCY RANGE:
2-30 Mc.

POWER OUTPUT:
20,000 watt PEP (nominal)
20,000 watt CW, continuous (see Note 1).

BANDWIDTH:
16 Kc. or more to the 1 db. point.

OPERATING MODES:
A0, A1, A2, A3, A3A, A3B, A3J, F1, F2, P0, P1D, P2D, P2E (see Note 2).

AUDIO INPUTS:
Two independent 600 ohm input channels balanced or unbalanced at -20 dbm. for full RF output.

OUTPUT IMPEDANCE:
50 ohm unbalanced, capable of matching a 2:1 VSWR. 600 ohm balanced output available with external balun.

OUTPUT CONNECTOR:
1 5/8" E.I.A. flange.

HARMONIC & SPURIOUS ATTENUATION:
Second harmonic at least 50 db. or better below full rated PEP output, third and higher order harmonics at least 60 db. from PEP output.

DISTORTION PRODUCTS:
At rated 20,000 watts PEP, third order distortion products are at least 35 db. below either tone of a standard two-tone test.

FREQUENCY STABILITY:
Better than 1 part in 10⁶ per 24-hour period from 10 oven controlled crystal positions.

EXTERNAL FREQUENCY CONTROL:
Frequency may be controlled by external oscillator or a frequency synthesizer.

AUDIO RESPONSE:
Within ± 1 1/2 db. from 250 to 6350 cycles (see Note 3).

UNWANTED SIDEBAND REJECTION:
At least 60 db. over entire passband.

CARRIER INSERTION:
Adjustable, minus 55 db. to full output.

CARRIER SUPPRESSION:
Carrier is 55 db. below full rated PEP output.

AIC:
Provided to limit distortion during high drive peaks or load changes.

PRIMARY POWER:
208 or 230 volts AC ± 10%, three phase, 4 wire, plus 110/220 volts AC, single phase, for exciter. Consumes 43 KW for 20 KW CW output.

POWER SUPPLIES:
Silicon rectifier columns.

TUBES:
(5) 6EW6, (3) 6J11, (2 each) 6M11, 6J6, 4CX350A, (1 each) 7788, 6D10, 6AU6, 8233, 12AX7, 5894 and 4CX15,000A.

KEYING:
Capable of following bit lengths as short as 2.0 milliseconds. (500 bauds.)

DUTY CYCLE:
Continuous at full rated output throughout the full environmental range specified.

TEMPERATURE RANGE:
-20° to +50° C. (-4° to +122° F.).

HUMIDITY:
0 to 95%.

ALTITUDE:
Operating to 6000 ft.

SIZE:
(Transmitter) 66" high, 60" wide, 30" deep. With pull out sections extended, total depth is 60". (Blower) 30" high, 48" wide, 30" deep. Optional cabinet for blower, 48" high, 60" wide, 60" deep.

WEIGHT:
3900 lbs. net. 4500 lbs. domestic packed. 4700 lbs. export packed. Cubage: 150. (Excludes weight and cubage of optional blower cabinet.)

Notes: (1) For compatible AM or double sideband with inserted carrier, the power output is 5 KW. (2) Indicates capability of emission but transmitter does not include accessories for MCW and FSK. (3) Also available with 3500 cycle audio cut-off.

ORDERING INFORMATION

Sideband Transmitter, 20,000 watts PEP, complete with tubes (see note below), less crystals (Cat. No.) ST-20A
100% set of tubes for ST-20A TK-523
Crystal with holder (state carrier frequency) CR27A/U
Optional blower cabinet only (blower with transmitter) M-6481

NOTE: Transmitter will be supplied with external blower unless internal blower is specified.

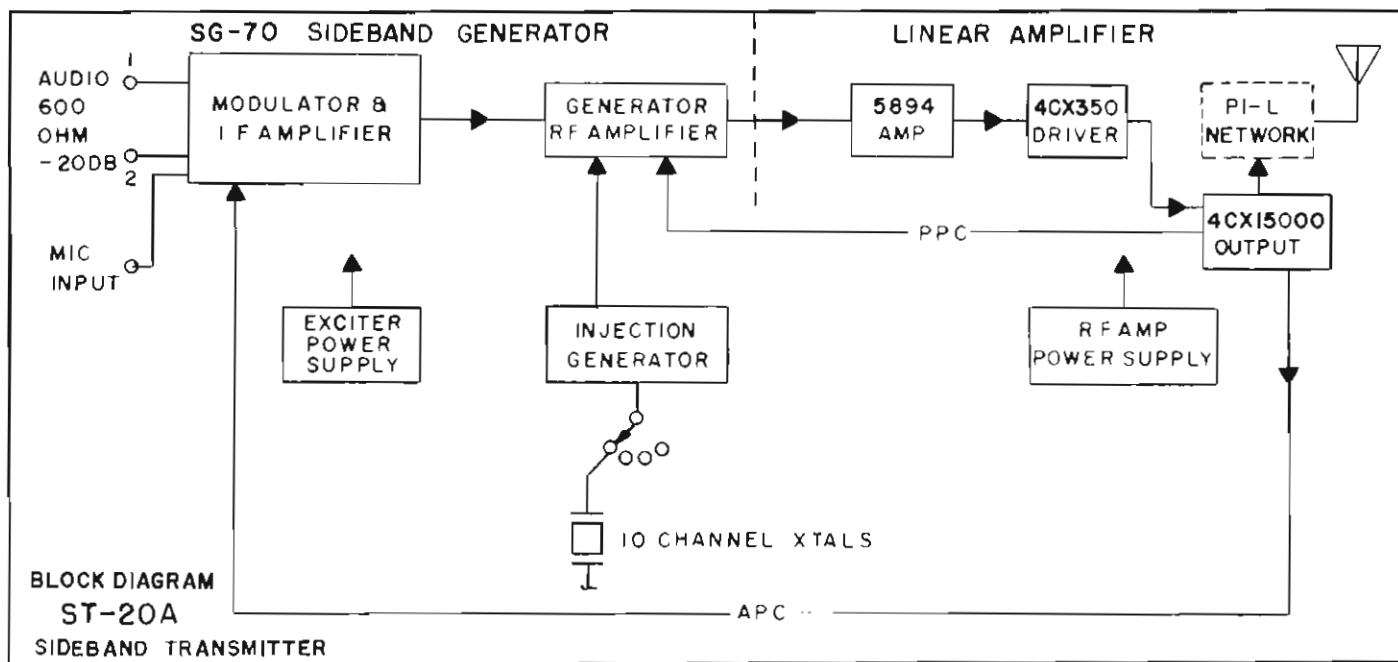

HIGH POWER HF TRANSMITTER MULTICOUPLER

CONSERVES ANTENNA SPACE

The Gates Transmitter Multicoupler is a **tunable** network which permits the operation of two high power transmitters into the same antenna without detrimental effect to either transmitter. These units are capable of providing close operation of the two transmitters at any point within the band without restriction except for the minimum frequency ratio of 1.1:1. Developed for use in either shipboard, transportable or fixed station High Frequency communication service and for short wave broadcasting, the multicoupler is a valuable asset to any installation where antenna space is at a premium.

COMPLETELY TUNABLE: The Gates Transmitter Multicoupler is completely tunable across the band of 3-28 Mc. Each of two pass-reject filters is tuned specifically for extremely low loss transmission of one transmitter and simultaneously for the rejection of the directly coupled adjacent transmitter. Tuning and metering is so precise that a minimum of 30 db. isolation is possible between transmitters separated in frequency by as little as 10 per cent of the higher frequency.

A typical 40 KW. equipment is contained in one compact cabinet measuring 72" high, 40" deep and 36" wide. The multicoupler requires surprisingly little space. This makes it possible to install the unit adjacent to the active component, thereby facilitating ease of tuning. All adjustments are made from the front panel and returning to a previously logged set of frequencies can be accomplished very quickly.

MAXIMUM UTILIZATION: The flexibility of frequency selection permits operation in several equipment configurations:

Redundant Pair—For short wave broadcasting, two transmitters separated in frequency and both modulated by the same program material can be operated into one antenna. This not only eliminates the need for two independent antennas, but provides for increased reliability of voice and data transmission.

Frequency Diversity—When ionospheric sounding is used to determine the frequency of optimum traffic (FOT), one transmitter may be tuned five per cent above the FOT and the other five per cent below the FOT, both operating into the same antenna. This is made possible by the ten per cent separation adjustments of the multicoupler. One antenna can thereby be utilized to either increase transmission reliability by virtue of closely straddling the FOT or to increase message density by doubling the subcarrier channels available to a given path.

Azimuth and Space Diversity—When it is necessary to transmit simultaneously to both NEAR and FAR locations within the antenna sector orientation, the tunable multicoupler will permit

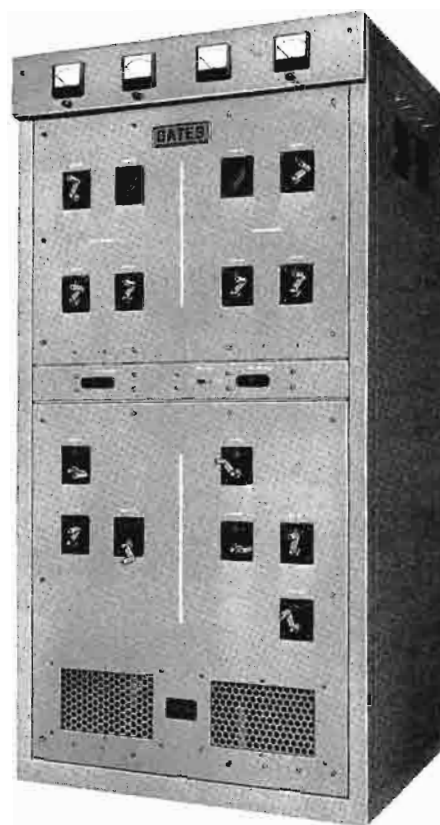

the antenna to be loaded with the appropriate direct and multihop frequencies.

Operation of a pair of transmitters into each of two separate antennas is also possible with the use of the multicoupler. This permits frequency diversity or redundant operation simultaneously on two non-related azimuths or antenna orientations. Certain possible antenna configurations may result in an amount of energy being coupled into the transmitters of the adjacent antennas. When these energies are sufficient to cause interference with the operation of the transmitters, reject filters can be supplied as an accessory to the multicoupler to provide additional isolation, if necessary.

Since specifications will depend on transmitter power, number of transmitters and other factors, the specifications for the 20 KW. input power handling unit are summarized below. Additional information regarding other power levels or multiple input devices is available upon request.

SPECIFICATIONS

FREQUENCY:

3-28 Mc.

Note: The ratio between input frequencies must be equal to or greater than 1.1 to 1.

POWER:

25 KW. Max. (PEP or avg.) each of two inputs.

IMPEDANCE:

50 ohm unbalanced with a maximum VSWR of 2:1.

ISOLATION:

30 db. or better for all allowable input frequency separation down to a minimum separation of 10% of the upper frequency.

INSERTION LOSS:

0.25 db. or less to each transmitter.

CONTROL & MONITORING:

All tuning controls are on the front panel. Meters are provided to measure forward and reflected power at each port.

SIZE:

Maximum dimensions: 72" high, 30" deep, 48" wide, not including optional output filter.

ENVIRONMENTAL:

Operating: 0° to 40° C, 95% humidity, 5,000 ft. altitude.
Non-operating: - 40° to 50° C, 95% humidity, 50,000 ft. altitude.

ORDERING INFORMATION

The Gates Model 2X20TC, 40 KW tunable 3-28 Mc. diplexer to combine two 20 KW. High Frequency transmitters 790-0463-1

Information regarding other power levels and up to four input ports is available on request.



10,000 WATT SIDEBAND TRANSMITTER

ST-10A

Modern in every respect, the Gates Model ST-10A is a complete 10 KW sideband transmitter developed specially for portable and fixed station HF communication service. With a built-in reserve capacity, the ST-10A transmitter provides a full 10,000 watts average as well as 10,000 watts PEP power. Emission capabilities include: SSB, ISB, DSB, AM, CW and MCW with the FSK mode available when the transmitter is operated with a frequency shift exciter. The transmitter features continuous front panel tuning between 2 Mc. and 30 Mc. All new, this complete transmitter is composed of the Gates SG-70 sideband generator, 10,000 watt linear amplifier and solid state power supply all in one cabinet.

OPERATION: Designed for operation on any one of 10 crystal controlled positions, providing 150 possible channels, all tuning is accomplished by only six front panel controls and one channel selector.

Mode switches select operation on upper, lower and both sidebands. At maximum power, each of the two independent sidebands has a full 6 Kc. capability. Flat crystal filter response provides the capability of effectively multiplexing four 3 Kc. channels for voice and teletype communications. Third order distortion products are at least 35 db. below the level of one tone of a two tone test.

TUNING: A new ease of operation for 10 KW transmitters is provided by the ST-10A which permits accurate and rapid tuning utilizing only six front panel precision controls. The design incorporates a compact and efficient turret tuner used to switch each of the 10 crystal controlled positions into one of the 15 frequency bands. This permits tuning the transmitter to a pre-logged frequency within one or two minutes. Positive tuning to the desired operating frequency is assured as the equipment is designed to eliminate accidental tuning to a spurious or unwanted signal. Essential voltage, current and RF power levels are monitored by five front panel meters.

Every channel is clean with the Gates ST-10A sideband transmitter as hum and noise are reduced 50 db. or better. Harmonics are reduced at least 50 db. and spurious emission is suppressed more than 70 db. Third order distortion

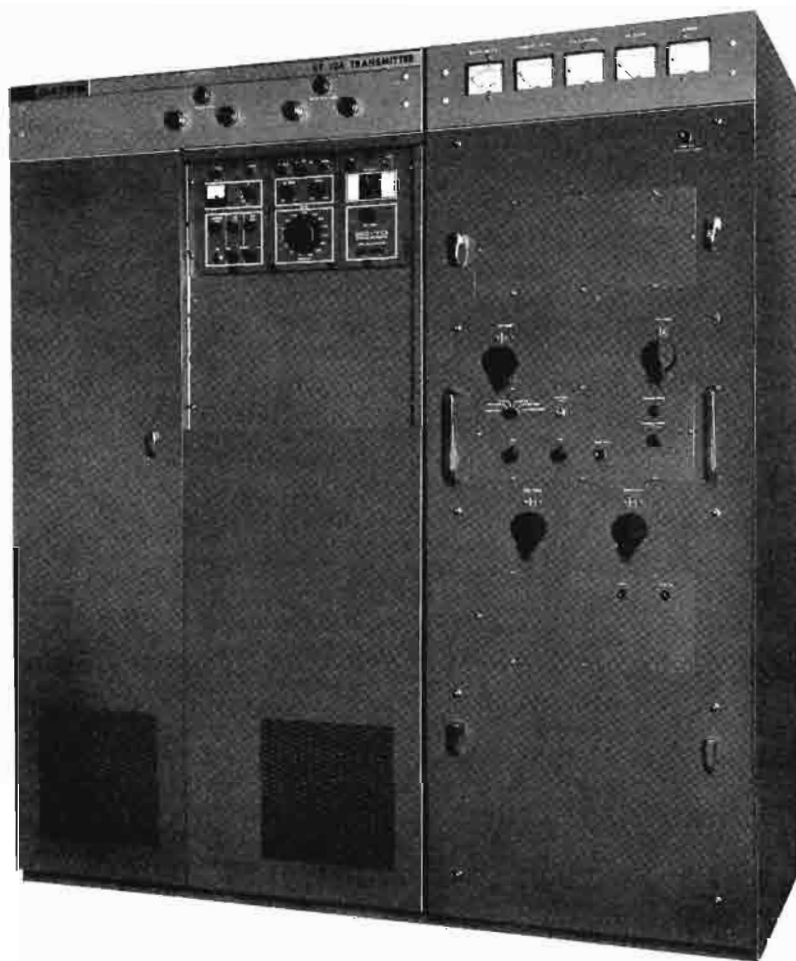

ST-10A—10 KW PEP/AVERAGE 2-30 MC.

products are 35 db. or more below the level of one tone of a two tone test.

RADIO FREQUENCY CIRCUITS: Frequency generation and mode selection for the transmitter originate in the SG-70 sideband generator. The ease of tuning and exceptional frequency stability of this unit are described on Page 180. The SG-70 generator provides the basic characteristics of the transmitted signal and insures dependable, stable operation, while permitting rapid channel change. Provisions are made for two simultaneous 6 Kc. audio inputs and external VFO or synthesizer if required.

10,000 Watt Sideband Transmitter—ST-10A

The transmitter power output stage uses the new type 4CX-10000D ruggedized ceramic tetrode tube specifically designed for linear service. By operating the screen grid at ground potential, broadband stability is designed into this high gain circuit. A variable vacuum capacitor is used for final amplifier plate tuning, together with a rugged Gates built edge-wise inductor with a heavy duty rotor contact. Excellent harmonic rejection is obtained from the carefully designed "Pi-L" filter section which also permits a wide tuning range. A bi-directional coupler with meter to measure both forward and reflected R.F. power in the 50 ohm transmission line is standard equipment.

The use of conservatively rated components, power transformers and amplifier tubes allows short term overloads even in the CW mode. Design criteria and component selection assures reliable operation within a wide range of temperature and humidity conditions, and at altitudes up to 6,000 ft. above sea level with carrier on continuously.

Four BNC monitor jacks are provided: (1) synthesizer input, (2) output of 1 Mc. standard in the sideband generator, (3) to monitor sideband generator output (same as power amplifier system input) and (4) final R.F. output sampling from the "Pi-L" network.

SERVICEABILITY: Easy accessibility for maintenance and service is assured with new modular, slide out construction. The entire power amplifier slides out on permanent tracks, thereby permitting the removal of panels on both sides and exposes the rear of the transmitter for access. The transmitter can be operated in this open position, if interlocks are disabled.

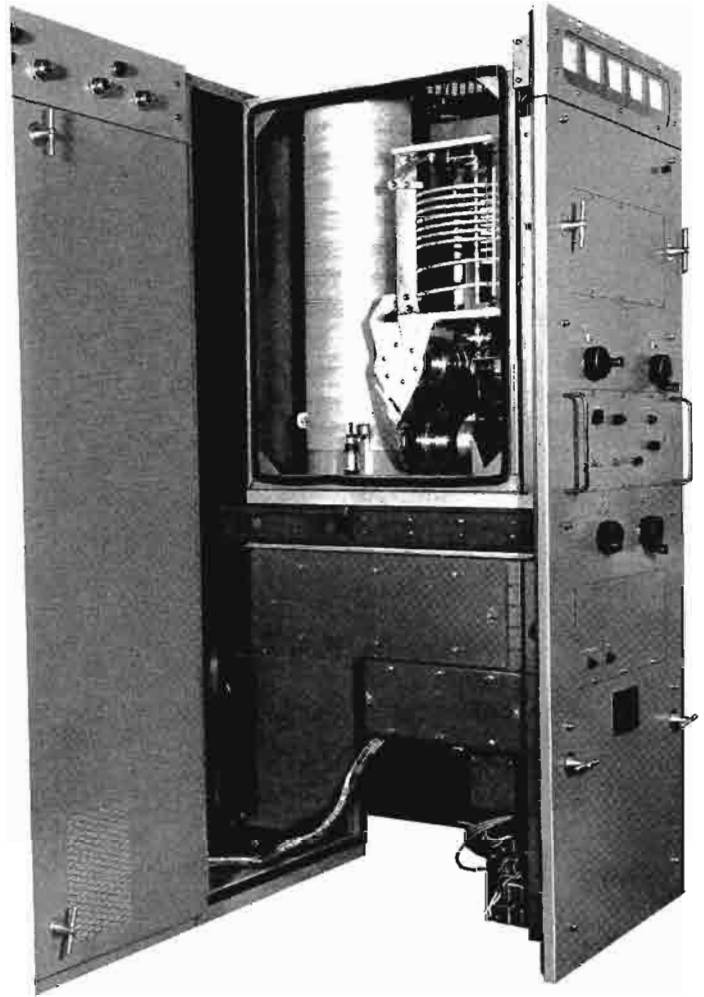

10 KW Power Amplifier extended to provide immediate access to vital components. This slide out construction is a design feature of the entire new line of Gates Sideband Equipment.



The modular design of the SG-70 Sideband Generator provides convenience and serviceability.

COOLING: Maximum attention has been given for efficient cooling of the entire transmitter. The air exhaust is located at the upper rear of the transmitter cabinet and filtered air input is at the lower rear. All filtering is accomplished by washable or disposable filters. The blower is self-contained for altitudes up to 6000 feet.

NOTE: For complete information on High Frequency Linear Amplifiers consult pages 198 and 199.

SPECIFICATIONS

FREQUENCY RANGE:
2-30 Mc. continuous tuning.

OPERATING MODES:
A0, A1, A2, A3, A3A, A3J, A3B, A7A, A9B, F1, F2, P0, P1D, P2D, P2E. (See Note 1).

FREQUENCY CONTROL:
Temperature controlled crystals; or external VFO or synthesizer.

POWER RATING:
10,000 watts PEP, 10,000 watts CW, continuous. (See Note 2.)

STABILITY:
1 PPM for 24-hour period.

CRYSTAL POSITIONS:
10, selectable from front panel, with independent trimmer.

TUNING CONTROLS:
6 tuning controls and 1 handswitch all on the front panel.

OUTPUT IMPEDANCE:
50 ohms (600 ohm balun available, see Note 3), with 1 5/8" EIA swivel flange output connectors.

CARRIER SUPPRESSION:
— 55 db. from PEP level, adjustable upward to rated output.

DISTORTION PRODUCTS:
At rated output, third and higher order products are at least 35 db. below either tone of a standard two tone test signal.

SPURIOUS SIGNALS:
At least 70 db. below PEP output.

UNWANTED SIDEBAND REJECTION:
500 cycles single tone at least 60 db. down.

HARMONIC RADIATION:
2nd harmonic: — 50 db. from PEP output, 3rd and higher: — 60 db. or better.

KEYING:
Capable of following bit length as short as 2.0 milliseconds (500 bauds).

AUDIO:
Two independent 600 ohm channels balanced or unbalanced at — 20 db. for full R.F. output. One high impedance microphone channel requiring 1 Mv. Response: within ± 1.5 db. from 250 to 6350 cycles (see Note 4).

ALC:
Provided to limit distortion during high drive peaks or load changes.

TUBES:
(5) 6EW6, (4) 12AT7, (3) 6J11, (2 each) 6M11, 6J6, 4CX350A, (1 each) 7788, 6D10, 6AU6, 8233, 12AX7, 5894, 4CX10,000D. Power supplies 100% solid state.

TEMPERATURE RANGE:
— 20° to + 50° C (operational).
— 50° to + 70° C (non-operating).

HUMIDITY:
0-95%.

ALTITUDE:
Sea level to 6,000 feet.

POWER INPUT:
208/230/240 volts ± 5%, 50/60 cycles, 3 phase, 4 wire, plus 110/220 volts, single phase, 2 wire.

Note: Operation from other power sources on special order.

SIZE:
60" wide, 66" high, 30" deep.

WEIGHT:
3700 lbs. net. Domestic packed, 4300 lbs. Export packed, 4500 lbs. Cubage: 150 cu. ft.

COMPONENTS:
All components meet JAN/MIL Specifications where practicable.

FINISH:
Two-tone gloss gray.

Notes: (1) Indicates capability of emission but transmitter does not include accessories for MCW or FSK. (2) Capable of higher power for short period intermittent service. For compatible AM or double sideband with inserted carrier, the power output is 2500 watts. (3) See Page 197 for baluns. (4) Available with 3500 cycle audio cut-off where desired.

ORDERING INFORMATION

Sideband Transmitter, 10,000 watts PEP, complete with tubes, less crystals (Cat. No.) ST-10A
100% set of tubes for above TK-522
Crystal and holder, state carrier frequency CR27A/U

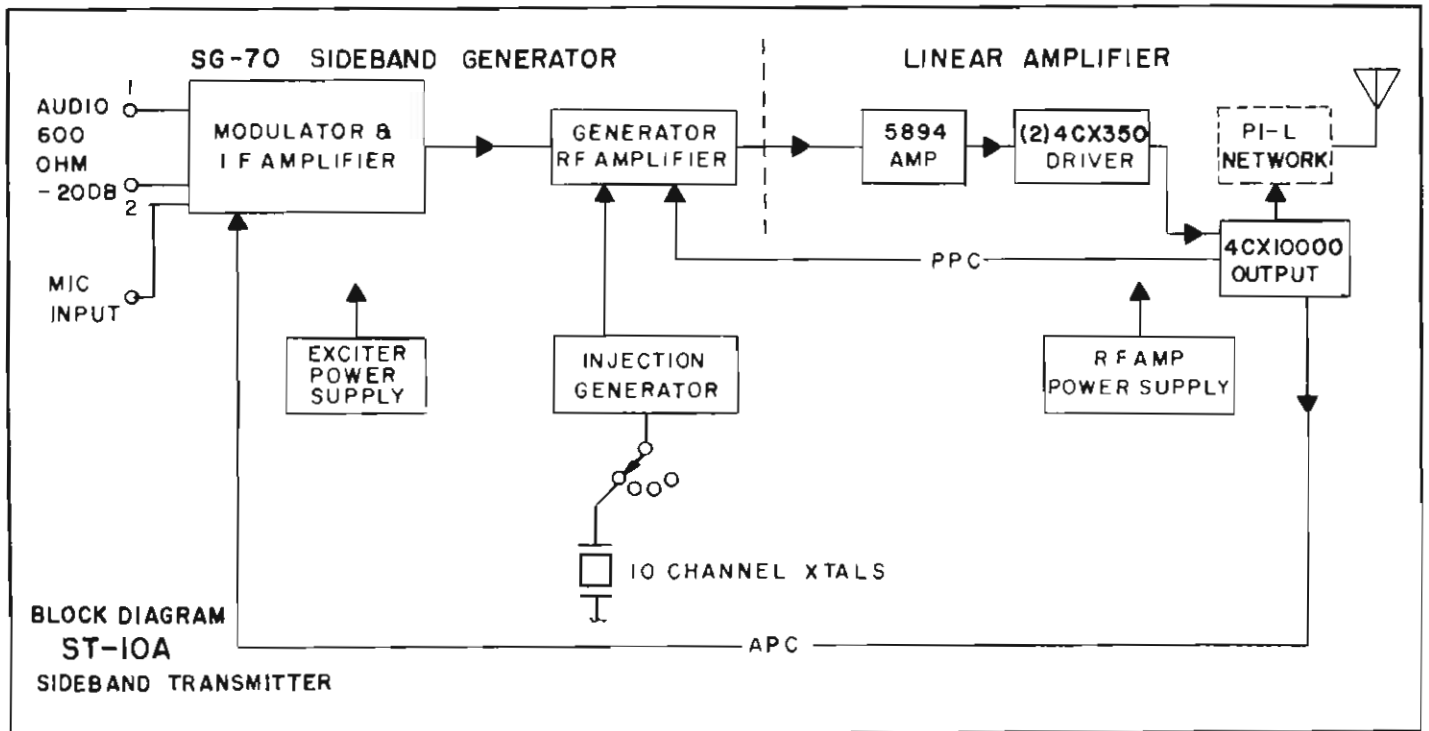

**BLOCK DIAGRAM
ST-10A
SIDE BAND TRANSMITTER**

SSB TRANSMITTERS

MODEL ST-3A

Gates offers a new sideband transmitter with unexcelled performance for high frequency communications service in either fixed station or transportable operation. Conservatively rated at 3000 watts average as well as 3000 watts PEP, the ST-3A transmitter provides SSB, ISB, DSB, AM, CW, MCW and FSK modes of operation with continuous front panel tuning between 2 Mc. and 30 Mc.

The ST-3A is a complete transmitter consisting of the Gates SG-70 sideband generator, power amplifier and solid state power supply all in one extremely accessible cabinet.

OPERATION: Designed for operation on any one of 10 crystal controlled positions, providing 150 possible channels, all tuning is accomplished by only six front panel controls and one channel selector.

Mode switches select operation on upper, lower and both sidebands. At maximum power, each of the two independent sidebands has a full 6 Kc. capability. Flat crystal filter response provides the capability of effectively multiplexing four 3 Kc. channels for voice and teletype communications. Third order distortion products are at least 40 db. below the level of one tone of a two tone test.

EASILY TUNABLE: The ST-3A transmitter has been designed to provide accurate and rapid tuning, utilizing only six front panel precision controls. A compact and efficient turret tuner is used to switch each of the 10 crystal controlled positions into one of the 15 frequency bands. This permits tuning the transmitter to a pre-logged frequency usually within one minute and at widest extremes no more than two minutes. Positive tuning to the desired operating frequency is assured as the equipment is designed to eliminate accidental tuning to a spurious or unwanted signal. Essential voltage, current and RF power levels are monitored by four front panel meters.



Heart of the all-new ST-3A is the advanced SG-70 sideband generator, which features fewer tuning controls, protection against mis-tuning, and rapid channel change.



3 KW PEP/AVERAGE 2 Mc. to 30 Mc.

With the ST-3A transmitter every channel is clean. Hum and noise are 55 db. down or better. Harmonics are at least 55 db. down and spurious emission is suppressed more than 60 db. Third order distortion products are 40 db. or more below the level of one tone of a two tone test.

RADIO FREQUENCY CIRCUITS: Frequency generation and mode selection for the ST-3A transmitter originate in the SG-70 Sideband Generator. The SG-70 generator provides the basic characteristics of the transmitter signal and insures dependable, stable operation, while permitting rapid channel change. Provisions are made for two simultaneous 6 Kc. audio inputs and optional external VFO or synthesizer, if required.

The power output stage employs the new type 4CX3000A ruggedized ceramic tetrode tube specifically designed for linear service. By operating the screen grid at ground potential, broadband stability is designed into this high gain circuit. A variable vacuum capacitor is employed for the final amplifier plate tuning, together with a rugged Gates-built edgewise variable inductor with a heavy duty rotor contact. The output network is in a PI-L configuration followed by a two section m-derived harmonic filter. This filter provides excellent harmonic rejection while permitting a wide tuning range. The automatic power control and automatic load control circuit as well as the feedback control have been built with solid state components. Door and air interlocks are provided. A bi-directional coupler with meter to measure both forward and reflected RF power in the 50 ohm transmission line is standard equipment.

RELIABILITY: The use of conservatively rated components, transformers and amplifier tubes permits short term overloads even in the CW mode. Design criteria and component selection assures reliable operation within a wide range of temperature and humidity conditions, and at altitudes up to 10,000 feet above sea level with carrier on continuously.

Four BNC jacks are provided on the front panel directly above the exciter. One jack provides for synthesizer input (if used) and a second jack monitors the output of the 1 Mc. standard crystal from the SG-70 generator. This signal may be used for comparison with an external standard, or for use as a standard itself. A third jack monitors exciter RF output (or power amplifier input) and the fourth jack monitors the final R.F. output by sampling energy from the output network, immediately ahead of the transmission line connector.

SERVICEABILITY: Easy accessibility for maintenance and service is assured with new modular and slide out construction. With an optional mounting base, the entire transmitter slides out on tracks, thereby permitting access doors to open on the front and both sides and also exposes the rear of the transmitter for access in space restrictive installations.

Maximum attention has been given the provisions for efficient cooling of the entire transmitter. The air exhaust is located at the upper rear of the transmitter cabinet and filtered air input is at the lower front. Provision for air inlet at the rear of the transmitter is optional on special order. All filtering is accomplished by non-metallic washable or disposable filters.

For mobile operation, an optional shock mount kit is available where the optional roll out base of the transmitter is equipped with shock mounts, and the upper rear of the transmitter is supplied with snubber shock mounts which have a quick disconnect feature that permits rapid slide out of the transmitter.

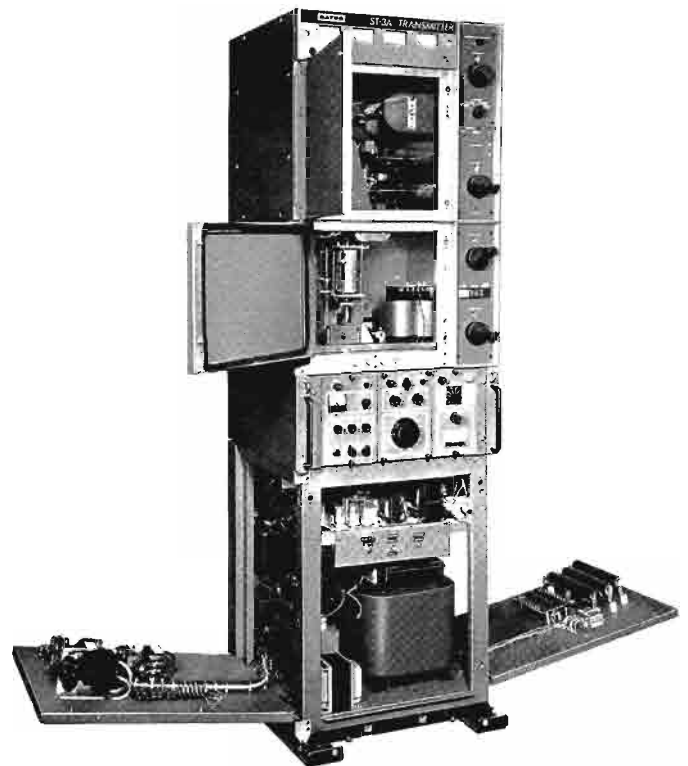

Complete side access available without sacrifice to adjacent equipment due to optional roll out feature.

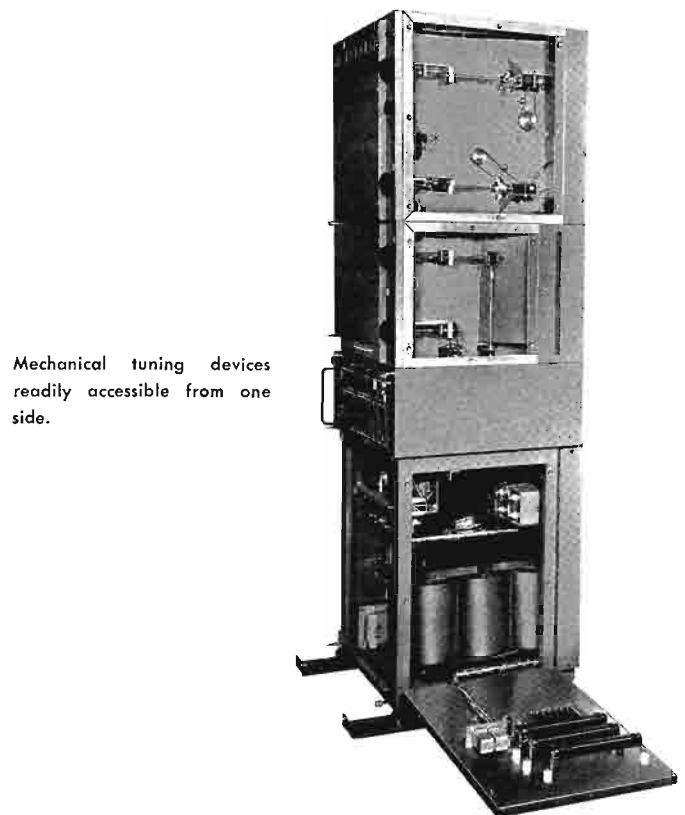

Mechanical tuning devices readily accessible from one side.

SPECIFICATIONS

FREQUENCY RANGE:
2-30 Mc. continuous, bandswitched.

OPERATING MODES:
A0, A1, A2, A3, A3J, A3B, A7A, A9B, F₁, F₂, P0, P1D, P2D, P2E, P2F, P3D, P3E, P3G. (See Note 1.)

FREQUENCY CONTROL:
Temperature controlled crystals; or optional external VFO or synthesizer.

POWER RATING:
3000 watts PEP, 3000 watts CW, continuous. (See Note 2.)

STABILITY:
1 PPM for 24-hour period.

CRYSTAL POSITIONS:
10, selectable from front panel, with independent trimmer.

TUNING CONTROLS:
6 tuning controls and 1 bandswitch all on front of transmitter.

OUTPUT IMPEDANCE:
50 ohms. 600 ohm balun available. Output connector, type LC.

CARRIER SUPPRESSION:
— 55 db. from PEP level, adjustable upward to rated output.

DISTORTION PRODUCTS:
At rated output, third and higher order products are at least 40 db. below either tone of a standard two-tone test signal.

SPURIOUS SIGNALS:
At least 60 db. below PEP output.

UNWANTED SIDEBAND REJECTION:
At least 60 db. at any point in the passband.

HARMONIC RADIATION:
2nd harmonic: — 55 db. from PEP output.
3rd and higher: — 60 db. or better.

KEYING:
Capable of following bit length as short as 2.0 milliseconds. (500 bauds.)

AUDIO INPUT:
Two independent 600 ohm channels balanced or unbalanced. — 20 db. for full RF output. One high impedance mike channel requiring 1 MV. for full PEP.

AUDIO RESPONSE:
Within ± 1.5 db. from 250 to 6350 cps. (See Note 3.)

AUTOMATIC LOAD CONTROL:
Provided to limit distortion during high drive peaks or load changes.

TUBES:
(Generator) (5) 6EW6, (4) 12AT7, (3) 6J11, (2) 6M11 and (1 each) 6AU6, 6D10, 7788, 8233, 6J6, 12AX7. (Amplifier) (1 each) 6CL6, 8122, 4CX3000A. (Power Supplies) All solid state silicon rectifiers.

ENVIRONMENTAL:
(Temperature) — 20° to + 50° C operating or — 50° to + 70° C non-operating. (Humidity) 0-95%. (Altitude) Up to 10,000 feet above sea level.

POWER INPUT:
208/230/240 volts ± 5%, 50/60 cps, 3 phase, 3 or 4 wire, plus 115/230 volts, 2 wire.

POWER CONSUMPTION:
Key down CW 7.5 KW. Power factor, 90%.

SIZE:
22" wide, 72" high, 24" deep.

WEIGHT:
800 lbs. net. Domestic packed, 925 lbs. Export packed, 975 lbs. Cubage: 41.

COMPONENTS:
All components meet JAN/MIL specifications where practicable.

FINISH:
Two-tone gloss gray and black.

ORDERING INFORMATION

Transmitter, sideband 3000 watts with tubes, less crystals ST-3A
Spare 100% tube kit for above TK-520
Balun, 5 KW, to match 50 ohms to 600 ohms 478-0246
Roll out base for fixed station operation M6477
Roll out base for transportable operation including shack
mounts and wall snubber kit M6478
Crystal and holder, (please state operating frequency) CR-27A/U

NOTES: (1) Indicates capability of emission but transmitter does not include accessories for MCW and FSK. (2) Capable of higher power for short period intermittent service. For compatible AM or double sideband with inserted carrier, the power output is 750 watts. (3) A 3000 cycle band pass filter may be supplied if 6350 cycles not desired.

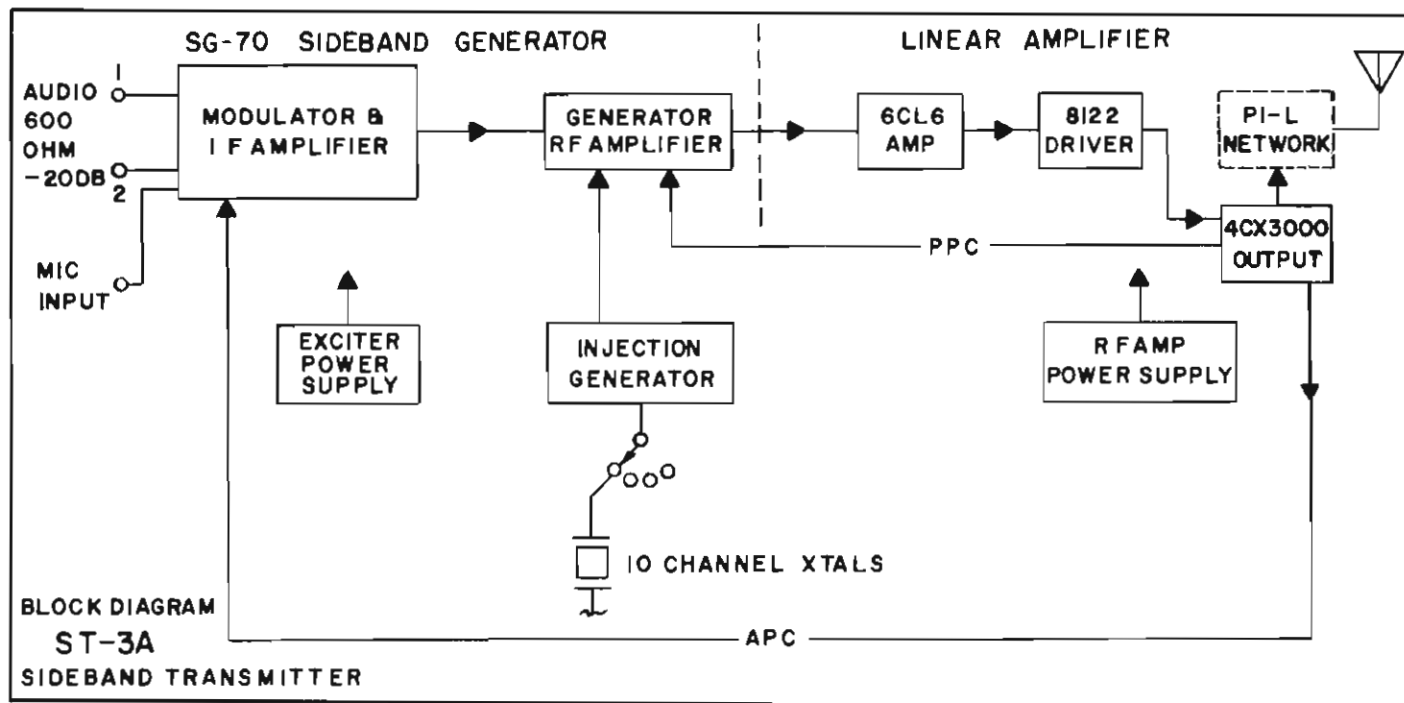

1000 WATT SIDEBAND TRANSMITTER

MODEL ST-1A

A new continuous duty sideband transmitter, the ST-1A is conservatively rated at 1000 watts CW as well as 1000 watts PEP. Powers up to 1500 watts (50% overload) may be handled on an intermittent basis without damage to the equipment. The transmitter is continuously tunable over the entire frequency band of 2 Mc. to 32 Mc. All tuning is accomplished in less than two minutes by means of only six controls and a channel selector. The complete transmitter, with SG-70 sideband generator and solid state power supply, is housed in a cabinet only 34 inches high. Designed for operation on any one of 10 crystal positions and 150 possible channels, the ST-1A equipment will transmit ISB, SSB, DSB, CW and compatible AM as supplied. MCW and FSK may be transmitted with added accessories. Third order distortion products are at least 35 db. below the level of one tone of a two tone test. At maximum power, each of the two independent sidebands has a full 6 KC capability.

This new, carefully engineered product, has a field proven background as well over 150 Gates 1000 watt linear amplifiers have demonstrated superb operating performance in government service.

R.F. CIRCUITS AND RELIABILITY: The 1000 watt CW power rating for the ST-1A transmitter is obtained by circuit design and component selection based on providing a transmitter of utmost reliability using conservatively rated components. The power output stage uses the new type 4CX1000A ruggedized ceramic tetrode tube, specifically designed for linear service. A new type ceramic vacuum capacitor is used for final amplifier plate tuning together with

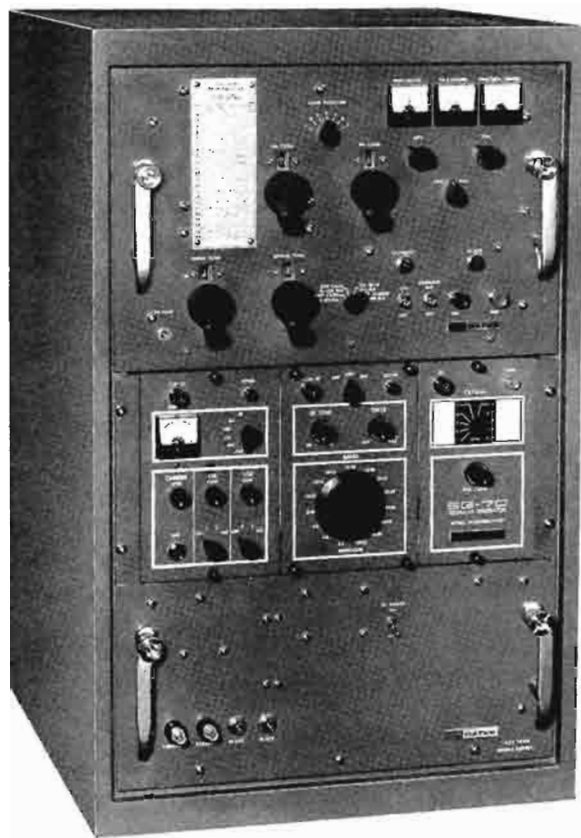

1 KW PEP/AVERAGE 2 Mc. to 32 Mc.

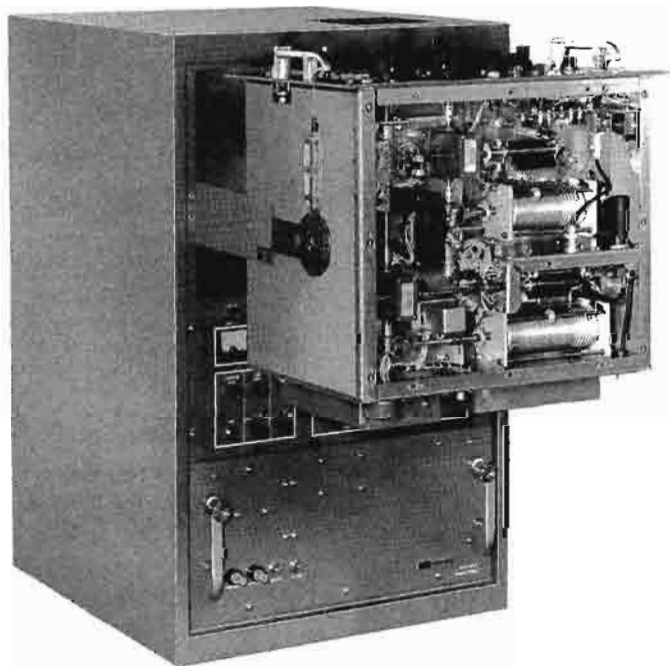

Note immediate accessibility to all service areas as a result of slide out tilt type construction.

a rugged Gates-built edgewise variable inductor with heavy duty contact.

All necessary meters for tuning and operation are built in. A bi-directional coupler with meter is provided as standard equipment for forward and reflected power indication. Also provided is a VSWR interlock device which automatically removes high voltage when an external sensing unit determines that abnormal VSWR conditions exist. The standard unit also includes both thermal and mechanical protective interlock devices.

Design criteria and component selection assures reliable operation within a wide range of temperature and humidity conditions. The ST-1A transmitter may be operated at altitudes up to 10,000 feet above sea level with carrier on continuously.

SERVICEABILITY: In physical size the ST-1A transmitter is the smallest 1 KW sideband transmitter in the heavy duty commercial class. This compactness has been achieved without crowding, resulting in excellent accessibility to all components.

Accessibility is enhanced by new modular and tilt-over slide out construction. The power amplifier section slides out and can be tilted at a 90° upward angle providing immediate availability of all under chassis components. With a 45°

1000 Watt Sideband Transmitter—ST-1A

downward tilt quick access is provided to the 4CX1000A final amplifier tube and associated RF components.

The solid state power supply section is also equipped with slides for maintenance and servicing. Modular construction is employed in the SG-70 sideband generator, which is re-

movable from the front.

Maximum attention is given to provide high efficiency cooling for the entire transmitter. The air exhaust is located at the top of the transmitter cabinet and filtered air input is at the rear of the power amplifier section.

SPECIFICATIONS

FREQUENCY RANGE:

2-32 Mc. continuous front panel tuned.

OPERATING MODES:

A0, A1, A2, A3, A3A, A3J, A3B, A7A, A9B, F₁F₂, P2E, P2F, P3D, P3E, P3F, P3G, (See Note 1.)

FREQUENCY CONTROL:

Temperature controlled crystals or external VFO or synthesizer.

POWER RATING:

1000 watts PEP, 1000 watts CW, continuous. (See Notes 2 & 3)

STABILITY:

1 PPM for 24-hour period.

OUTPUT IMPEDANCE:

50 ohms. 600 ohms with optional balun. Type UHF output connector.

CARRIER SUPPRESSION:

— 55 db. from PEP level, adjustable upward to rated output.

DISTORTION PRODUCTS:

At rated output, third and higher order products are at least 35 db. below either tone of a standard two tone test signal.

SPURIOUS SIGNALS:

At least 60 db. below PEP output.

UNWANTED SIDEBAND REJECTION:

At least 60 db. at any point in the passband.

HARMONIC RADIATION:

2nd harmonic 40 db. below PEP output. 3rd and higher 50 db. or better.

KEYING:

Capable of following bit length as short as 2.0 milliseconds. (500 bauds.)

AUDIO INPUT:

Two independent 600 ohm channels balanced or unbalanced. — 20 db. for full RF output. One high impedance mike channel requiring 1 MV. for full PEP.

AUDIO RESPONSE:

Within ± 1.5 db. from 250 to 6350 cycles. (3 Kc. bandpass available.)

ENVIRONMENTAL:

Temp. range: — 20° C to + 50° C. Humidity: 0-95%.

Altitude: Sea level to 10,000 feet.

POWER INPUT:

115/230 volts, single phase, 2 or 3 wire, 50/60 cycles at 3.45 KW maximum demand (1000 watts average power output).

SIZE:

21" wide, 33 $\frac{3}{8}$ " high, 23 $\frac{1}{2}$ " deep.

FINISH:

Two-tone gloss gray and black trim.

WEIGHT:

580 lbs. Domestic packed—650 lbs. Export packed—700 lbs. Cubage: 19.5.

COMPONENTS:

All components meet JAN/MIL specifications where practicable.

TUBES:

(Generator) (5) 6EW6, (4) 12AT7, (3) 6J11, (2) 6M11, and (1 each), 6AU6, 6D10, 7788, 8233, 6J6, 12AX7. (Amplifier) (1 each) 6CL6, 8117, 4CX1000A.

POWER SUPPLY:

Silicon rectifiers throughout.

ORDERING INFORMATION

Transmitter, 1000 watt sideband with tubes but less crystals ST-1A
 Spare 100% tube kit for above TK-519
 Crystal and holder (please state operating frequency) CR-27A/U
 Balun, 1000 watts for 600 ohm operation 478-0262

NOTES: (1) Indicates capability of emission but transmitter does not include accessories for MCW and FSK. (2) Capable of higher power for short period intermittent service. (3) For compatible AM or double sideband with inserted carrier, the power output is 250 watts.

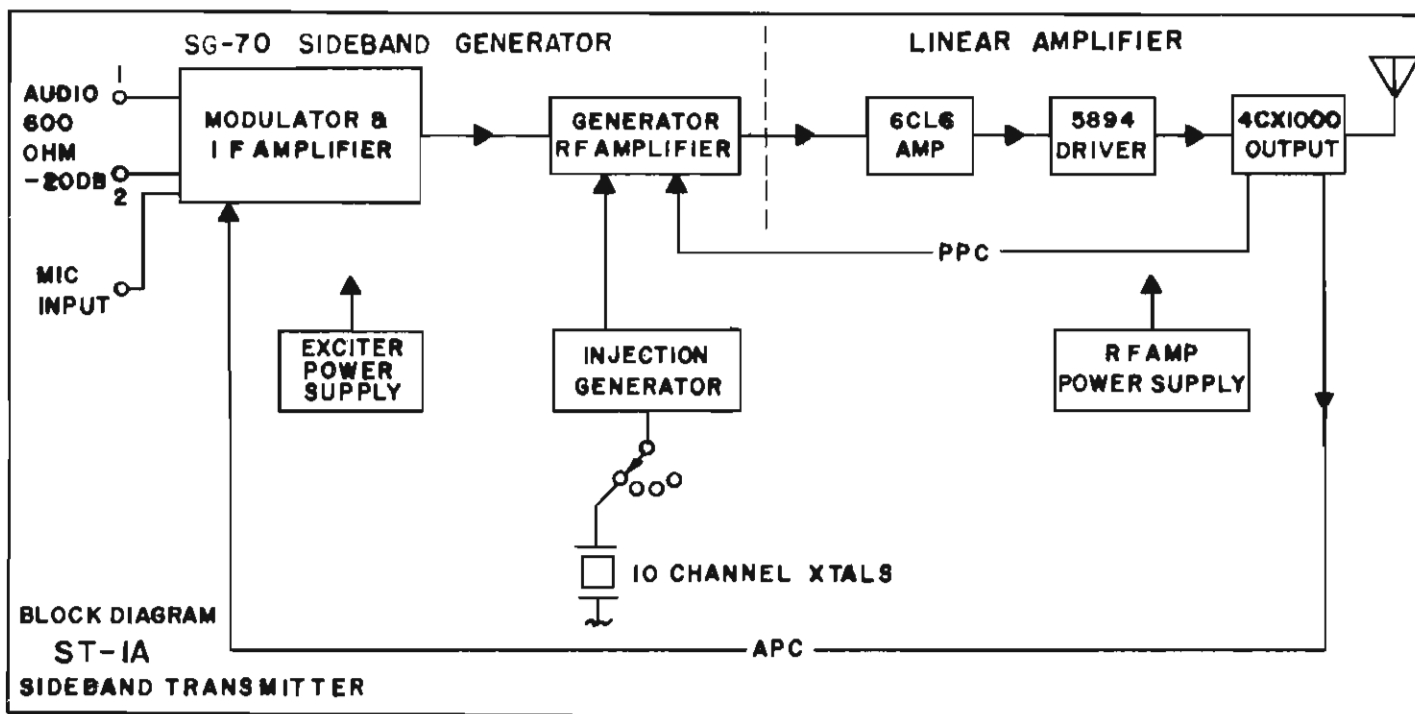

HIGH FREQUENCY BALUN TRANSFORMERS

For use with its complete line of communication transmitters, Gates has available several types of high frequency, high quality, broadband output transformers. These transformers or baluns are designed to match the 50 ohm unbalanced output of high frequency transmitters into 300 ohm or 600 ohm balanced transmission lines. Use of baluns permits the user to enjoy the advantages of coaxial lines inside the equipment building without sacrificing the efficiency and economy of open wire transmission lines between the shelter and the tower or antenna.

A coaxial termination, at the transmitter, enables a station to take advantage of the safety, flexibility, isolation and switching ease of coaxial lines within the transmitter building. This transformation is also necessary at the antenna end of an open wire line when a special antenna of the "log periodic" variety is utilized.

HIGH EFFICIENCY: The Gates supplied matching transformers or "baluns" are all broadband devices which transfer power at high efficiency at any frequency from 2 Mc. to 30 Mc. This permits the transmitter to operate normally and without restrictions within the power rating specified, while transferring power to the transmission line with less than 3% loss at any frequency from 2 Mc. to 30 Mc. Reflected power to the transmitter is not significantly affected and the balun output will operate into a load VSWR as high as 2 to 1.

RUGGED OUTDOOR APPLICATION: All baluns listed below are dependably designed for rugged outdoor applications. Transmitter equipment room space may be con-

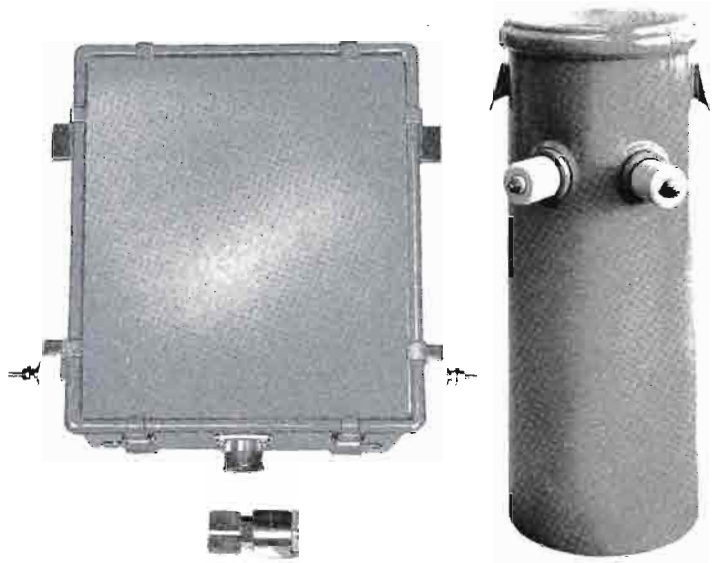

Above illustrates two of the many high frequency matching transformers available from Gates. Power rating and impedance level be determined by the requirements of your application.

served by locating the matching transformer on the outside wall or on the pole at which the open wire line is terminated. Cooling is provided by natural convection and no maintenance is necessary other than an occasional inspection and cleaning.

TYPICAL APPLICATIONS OF BALUN TRANSFORMERS

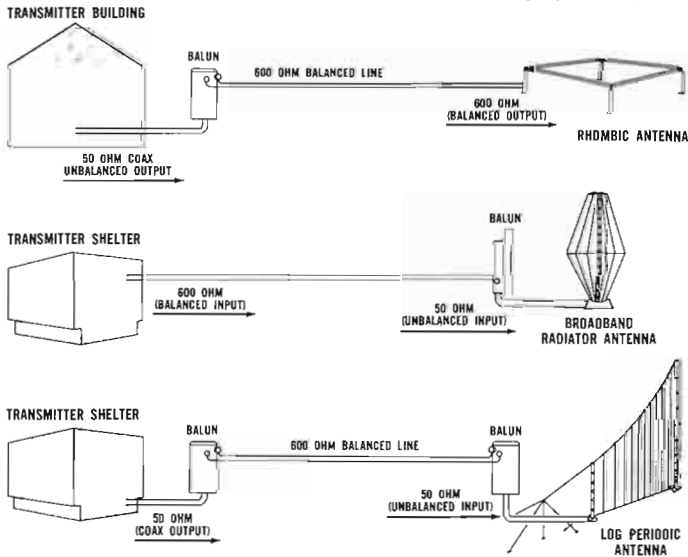

ORDERING INFORMATION

- Model HFT-1K One kilowatt transformer, 2 KW PEP, matching 50 ohm to 600 ohm (other impedances on request) . . (Cat. No.) 478-0262
- Model HFT-5K Five kilowatt transformer, 10 KW PEP, matching 50 ohm to 600 ohm (other impedances on request) . . 478-0246
- Model 555-1 Twenty-five kilowatt transformer, 100 KW PEP, matching 50 ohm to 600 ohm 478-0264

SPECIAL BALUNS—Baluns of other power ratings and impedances can be supplied on special order. To assist in making an accurate and prompt quotation, the following data will be helpful: (1) Power handling capacity in terms of anticipated PEP and Average ratings. (2) Input coaxial impedance rating. (3) Input connector type required if a preference. (4) Output transmission line impedance. (5) Output connector type required if a preference.

Note: Input coaxial connectors are type LC for transformers up to 5 KW in power. 5 KW units may be type LC or 1 1/2" EIA flange (specify when ordering). 25 KW units are equipped with 3 1/2" EIA coax flange. All high impedance connectors are insulated bushings with terminal lugs.

BALUNS

SINGLE SIDEBAND TRANSCEIVER



MODEL STR-125

High quality mechanical filters for sideband rejection on transmitting and receiving functions is but one of the modern single sideband techniques used in this completely integrated 125 watt transceiver. For single sideband transmission and reception, the STR-125 Transceiver provides exceptionally flexible operation anywhere in the High Frequency spectrum from 1.6 to 16 mc. Its compact design makes this new Gates transceiver ideal for commercial communication applications. A companion "add on" 1 KW linear amplifier, available for higher power, enhances system flexibility.

DESIGN FEATURES: The STR-125 Transceiver is frequency controlled by precision crystals in constant temperature ovens. Excellent sensitivity and signal-to-noise ratio is designed into the receiver which incorporates a dual conversion IF system. The transmitter has an RF output of

125 watts PEP and is capable of nearly any type emission when used with appropriate accessories. The equipment can be operated by non-technical personnel for reliable two-way radio communication service. Modern circuit techniques are employed throughout. All tubes and not regularly used adjustments are quickly accessible by lifting the hinged cover.

The STR-125 is completely self-contained in one compact desk mount cabinet. All controls not necessary in day-to-day operation are located inside the cabinet, leaving the front panel controls uncluttered and orderly. Utilizing modern tubes and circuits specifically designed for single sideband applications, the design is a part of Gates' new complete line of high performance single sideband communications equipment. A broad line of operating accessories for use with this 125 watt transceiver are available.

ACCESSORIES

Voice Operated Transmit Module: The voice operated transmit module (VOX) adds the capability to the STR-125 Transceiver of voice operated transmit function. With this unit the transmitter of the STR-125 is automatically turned on when the operator speaks into the microphone or handset. Operation by non-technical personnel is simplified by eliminating the need for using the button on the headset. The VOX unit is entirely self-contained on a small sub-chassis, and fits directly onto the transceiver chassis. The unit is easily installed with simple jumper connections.

Selectable Sideband Adaptor Module: This module provides selectable upper and lower sideband capabilities to the STR-125 Transceiver supplied as a plug-in module, installation does not require any electrical changes in the transceiver. The transceiver normally is equipped for the upper sideband mode of operation. This accessory permits upper or lower sideband selection by a front panel selector knob at frequencies above 3.5 mc.

125 Watt Antenna Coupler: The antenna coupler is designed to match the STR-125 Transceiver to the various types of antennas usable with this type of equipment (whips, wire and doublets). Rated at a full 150 watts of RF power in the 1.6 to 16 mc. fre-

quency range, the coupler automatically switches to the proper channel when transceiver band switching is accomplished.

Antenna Kits: Antenna kits are available in 75 feet and 150 feet antenna packages. Each antenna is complete with suitable wire, nylon rope, ceramic insulators, ground stake and set of installation instructions.

A doublet antenna kit is also offered that can be cut by the customer to any specific frequency in the 1.6 to 16 mc. range. The kit is preassembled and consists of: (1) 300 ft. of # 7/22 copper wire; (2) 50 ft. nylon rope; (3) 2 ceramic end insulators; (4) 1 junction box; (5) 50 ft. RG-8/U coax cable; with UHF connector.

C.W. Adaptor: The C. W. adaptor is used to add the CW capability to the STR-125 Transceiver. The adaptor is completely self-contained and is styled to match the transceiver. Available as an option, the adaptor contains a phase-shift keyed audio oscillator, operating at 800 cycles.

Sidetone capability is included for monitoring both the transmitter tone and receive signals with standard earphones.

Power for the adaptor is taken from the transceiver's 24 volt DC supply and when used, the transceiver must be equipped with the VOX module capability.

Single Sideband Transceiver—STR-125

Remote Handset and Handset Adaptor: The handset adaptor allows operation from any one of three telephone positions away from the transceiver location. When the adaptors are connected to the transceiver, an operator at the transceiver location could be in charge of the station and perform such functions as channel and remote selection. As necessary, he can signal any of the three remote handset positions, and connect that handset to the transceiver audio circuits.

Telephone Patch: The Gates telephone patch is intended to connect the audio circuits of the Gates STR-125 Receiver into a commercial

two-wire telephone system. The unit incorporates a hybrid transformer circuit, and can be used with the VOX or manual keying.

1 KW Linear Power Amplifier: System versatility is provided by the Gates LA-1K Linear Power Amplifier. This optional amplifier provides a full 1 KW. PEP output when driven by the STR-125 Transceiver. The LA-1K Power Amplifier operates over the frequency range of 1.6 to 16 mc. on any of the six preset channels and automatically changes frequency with the band switch on the STR-125 transceiver.

SPECIFICATIONS

COMPLETE TRANSCEIVER

OPERATING MODES:

SSB and Compatible AM.

CHANNELS:

(Total 6.) As normally supplied, Channels 1 and 2 are 1.6-3.5 Mc. Channels 3 and 4 are 3.5-7.5 Mc. Channels 5 and 6 are 7.5-16.1 Mc.

MECHANICAL DATA:

Est. weight packed, 70 lbs. Cubage, 2. Finish: Medium gloss gray, trim in black and brushed aluminum. Size: 20" wide, 10" high, 18" deep.

CONTROLS:

Audio gain, mode switch, receiver gain R. F. and A. F., speaker on, channels, receiver off-on, transmitter off-on.

POWER:

115/230 volts, 50/60 cycles, 280 watts.

AMBIENT RANGE:

(Temp.) - 20° C to + 50° C (Humidity) 0-95% relative.

ALTITUDE:

Up to 10,000 feet above sea level.

TRANSMITTER SECTION

POWER OUTPUT:

125 watts upper sideband PEP, 30 watts AM.

R. F. STABILITY:

± 2 PPM or better.

HARMONIC REDUCTION:

50 db.

SPURIOUS RADIATION:

Suppressed at least 50 db.

UNWANTED SIDEBAND SUPPRESSION:

- 50 db.

INTERMOD. DISTORTION:

- 30 db.

BANDWIDTH (AUDIO):

350-2450 cycles, 6 db. attenuation—2.1 Kc nominal and 60 db. attenuation—5.3 Kc. nominal.

OUTPUT:

50 ohms into a UHF connector.

RECEIVER SECTION

ANTENNA:

50 ohms.

OUTPUT:

1½ watts to speakers max.

SENSITIVITY:

For SSB 0.5 microvolts for about 10 db.)
 For AM 1.5 microvolts for about 10 db.) S + N/N

AGC:

Operates on high speed attack and slow release factor with threshold at 5 microvolts.

R. F. STABILITY:

± 2 PPM.

Notes: Other channel arrangements available with only slight delay. Other variations also available such as lower sideband, upper and lower sideband and a wide variety of accessories. (See Ordering Information.)

ORDERING INFORMATION

| | |
|--|-------------------|
| STR-125 | (Cat. No.) M-6468 |
| Voice Operated Transmit Module | M-6469 |
| Selectable Sideband Adaptor Module | M-6470 |
| 125 Watt Antenna Coupler | M-6480 |
| Antenna Kits—75 foot | M-6471A |
| 150 foot | M-6471B |
| Doublet Antenna Kit | M-6472 |
| C.W. Adaptor | M-6473 |
| Remote Handset & Handset Adaptor | M-6474 |
| Telephone Patch | M-6475 |
| 1 KW Linear Power Amplifier | M-6476 |

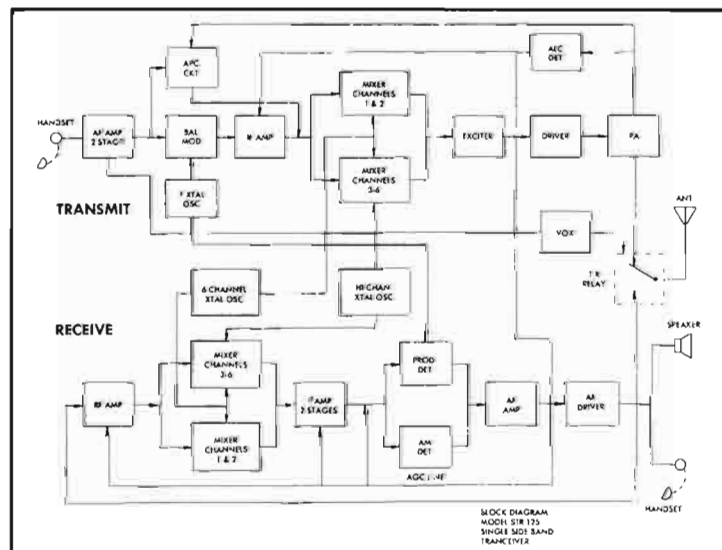

TRANSCEIVER

SINGLE CHANNEL SSB RECEIVER



MODEL SR-100

Offering compactness for space saving applications, the Model SR-100 SSB Single Channel Receiver is ideal for continuous monitoring duty of point to point, ship to shore, air to ground, and other high frequency communications service. It is particularly suited for any application when a day to night frequency change is required, or where multiple frequencies must be continually monitored.

This new fixed frequency high quality radio receiver operates on a single frequency in the range of 1.6 to 30 Mc. Double conversion, super-heterodyne circuitry is employed to provide the highest degree of unwanted signal rejection consistent with sensitivity requirements for a single channel receiver. The receiver is designed for, and comes equipped

with, upper and lower sideband facilities and may also be used for AM reception.

Using an AGC circuitry with a fast attack and slow release time, the AGC threshold is 5 microvolts. Output of 1 watt into a 3.2 ohm speaker is available in addition to 100 milliwatts into a 600 ohm line. The single sideband IF band width at the 6 db. point is 2.1 kc, with a band width of 5.3 kc. 60 db. down.

The SR-100 receiver is designed for standard 19" rack mounting, requiring only 3½" of rack space with an accessory cabinet available for desk top mount. Several of these receivers can be used to simultaneously monitor a number of communication channel frequencies. Twenty receivers will mount in one RAK7 rack cabinet, which is 78" high.

SPECIFICATIONS

FREQUENCY RANGE:

1.6 to 30 mc. (Pretuned to a single specified frequency.)

SENSITIVITY:

SSB; 0.5 microvolts for 10 db. S + N/N.

AM; 1.5 microvolts for 10 db. S + N/N.

RECEPTION:

Voice, MCW, or CW. (SSB upper and lower and AM).

STABILITY:

± 2 PPM.

AUDIO OUTPUT:

1 watt into 3.2 ohms, 100 milliwatts into 600 ohms.

ANTENNA IMPEDANCE:

50 ohms unbalanced.

AGC THRESHOLD:

5 microvolts.

AGC CHARACTERISTICS:

Fast attack—slow release.

CIRCUIT:

Double conversion.

IF BANDWIDTH:

SSB 2.1 kc. at 6 db. point, 5.3 kc. at 60 db. point.

AM 7 kc.

POWER SOURCE:

115/230 volts, 50/60 cycles, consumes 75 watts.

DIMENSIONS:

3½" high x 19" wide x 12" deep.

WEIGHT:

(Net) 15 lbs., 22 lbs. (domestic packed), 31 lbs. (export packed). Cubage, 2.

ORDERING INFORMATION

Single channel SR-100 crystal-controlled receiver, rack mount,

complete with tubes and crystal (please state frequency) M-6488

Spare 100% set of tubes for SR-100 receiver TK-530

Cabinet for desk mounting SR-100 receiver M-6489

SIX-CHANNEL SSB RECEIVER



MODEL SR-6

A six-channel fixed frequency receiver for SSB and DSB (AM) reception that occupies only 5¼" of rack panel space and is entirely self-contained including power supply for either 115 or 230 volts. For any SSB or AM communications service in the 1.6 Mc. to 16 Mc. band. Reception is single sideband, upper or lower sideband, and AM.

Each of the six crystal controlled receiving frequencies is selected by a front panel rotor switch. Audio output is at loudspeaker level. Receiver has fast attack time and a slow release automatic gain control circuit to provide optimum sideband reception. The AGC threshold is 5 microvolts with a double super conversion heterodyne circuit. The result is a high image rejection over the entire 1.6 Mc. to 16.0 Mc. frequency range. The IF bandwidth is 2.1 Kc. at the 6 db. point and 5.3 Kc. at the 60 db. point, while the AM bandwidth is 7 Kc.

Excellent for any SSB or AM reception up to 16 Mc., the

SR-6 receiver is suggested with any transceiver such as the Gates STR-125 to provide full duplex capability. Thirteen of these receivers will mount in one Gates RAK-7 relay rack cabinet which is 78" high.

NOTE: Use of the single fixed frequency receiver in communications has long been a favorite of communications engineers. It is particularly desirable where non-technical personnel are employed and reception becomes a turn on-off function and tuning from one frequency to another is avoided. The fixed frequency receiver has further advantages. Receiver failure for any reason only disables one channel instead of all channels. A spare receiver on the rack quickly solves this potential emergency. Another advantage is multiple aural channels as, of course, several loudspeakers or headphones may operate at once if several fixed frequency receivers are used in place of one variable tuned receiver.

SPECIFICATIONS

FREQUENCY RANGE:

(Channels 1 and 2) 1.6 Mc. to 3.5 Mc. (Channels 3 and 4) 3.5 Mc. to 7.5 Mc. (Channels 5 and 6) 7.5 to 16.0 Mc. Pre-tuned to any channel as ordered by crystal frequency.

SENSITIVITY:

SSB is 0.7 microvolts for 10 db. S + N/N.
AM is 1.5 microvolts for 10 db. S + N/N.

RECEIVING MODES:

SSB upper and lower sidebands, AM including voice, MCW and CW.

AUDIO OUTPUT:

1 watt to 3.2 ohms or 100 Mw. to 600 ohms.

STABILITY:

± 2 P.P.M.

AGC THRESHOLD:

5 microvolts.

AGC CHARACTERISTICS:

Fast attack—slow release.

CIRCUIT:

Double super heterodyne.

I. F. BANDWIDTHS:

SSB is 2.1 Kc. AM is 7 Kc.

SIZE:

19" wide, 5¼" high, 12" deep.

WEIGHT:

(Net) 15 lbs., (domestic packed) 23 lbs., (export packed) 31 lbs. Cubage, 2.

POWER INPUT:

115/230 volts, 50/60 cycles at 75 watts.

PANEL CONTROLS:

R. F. gain, audio gain, oscillator adjust, channel selector, mode selector, squelch, phone jacks, pilot light, power on-off switch.

ORDERING INFORMATION

Receiver 6-channel Model SR-6, for rack mounting, with

tubes but less crystals (Cat. No.) M-6485

Crystal for above, state frequency (1 to 6 required) M-6486

Cabinet for desk mounting SR-6 receiver M-6487

Spare 100% tube set for SR-6 receiver TK-529

HIGH FREQUENCY LINEAR AMPLIFIERS

FOUR BASIC MODELS—1 KW, 3 KW, 10 KW, 20 KW POWER RATINGS

Four linear amplifiers in power ranges from 1 KW to 20 KW are continuously front panel tuned between 2 Mc. and 30 Mc. Operating modes are SSB, CW, FSK and compatible AM when operated with appropriate radio frequency generators of the mode desired. All models have high average power rating and power supplies in all models are solid state. Complete SSB transmitters with R. F. generators are listed on Pages 182-192.

COMMON FEATURES

MULTIPLE CAPABILITIES: Gates Linear Power Amplifiers will provide operation in the SSB, ISB, DSB, CW, MCW and FSK modes when used with appropriate excitors. Conventional excitation or frequency generation can be used, provided that the power output and bandwidth ratings are not exceeded. As little as 100 milliwatts of excitation will drive any model to full rated output.

HIGH GAIN: Each amplifier is a high gain unit employing a single tube final stage in class AB₁ operation. A modern ceramic tetrode power output type in a grounded screen configuration is used in each model to improve over-all stability and supply regulation.

SOLID STATE: All power and bias supplies use solid state silicon diode rectifiers selected for their efficiency, reliability and compact size. High voltage control circuits are interlocked through time delay relays to protect against accelerated turn-on. Thermal and mechanical devices also offer protection to components and personnel.



3 KW Amplifier, model HFL-3000



1 KW Amplifier, model HFL-1000

STABLE OPERATION: Separate ALC and PPC rectifier circuits are provided to insure stable operation when coupled to the associated exciter or driver. These components are solid state and located on printed circuit boards for reliability and space conservation.

COMPLETE METERING: Each amplifier is equipped with a bi-directional coupler and meter for forward or reflected power indications. Complete metering is provided to enable the amplifier to be tuned and loaded to full rated output on any operating frequency, with exclusive use of front panel controls.

CONTINUOUS FRONT PANEL TUNING: The entire 2-30 mc. frequency range is continuously tunable without a physical change in any component. Where capacitors are used in power circuits for either tuning or loading, they are of the vacuum type. Each amplifier has been developed with efficient and quick maintenance in mind. All controls and meters are front panel mounted. The entire power amplifier sections of every amplifier can be extended on slides for access to sides, top and bottom without adversely affecting adjacent equipment. Easily removable panels permit each component to be readily available for servicing from the front of the open cabinet.

SPECIFICATIONS Common to all models

INPUT IMPEDANCE:

50 ohms.

BANDWIDTH:

16 Kc. or more to the 1 db. point.

TUNING TIME:

Time to change frequency between any two previously logged operating frequencies is less than 2 minutes.

ALC:

ALC rectifiers are provided for use with most excitors.

TEMPERATURE RANGE:

— 20° to 50° C.

HUMIDITY:

0 to 95%.

ALTITUDE:

Operating: 6,000 ft.

HFL-20,000

POWER OUTPUT:
 20,000 watts PEP (nominal)
 20,000 watts CW, continuous

OUTPUT CONNECTOR:
 1 3/8" EIA flange.

HARMONIC & SPURIOUS:
 Second at least 50 db. below full rated PEP output, third and higher order at least 60 db. from PEP output.

DISTORTION PRODUCTS:
 At rated 20,000 watts PEP, third order distortion products are at least 35 db. below either tone of a standard two-tone test.

PRIMARY POWER:
 230 volts AC \pm 5%, 50/60 cycles three phase, four wire. Total demand is 43 KW. for full rated CW operation.

TUBE COMPLEMENT:
 (1) 5894, (2) 4CX350A, (1) 4CX15,000A (silicon rectifiers).

SIZE:
 60" wide x 66" high x 30" deep.

WEIGHT:
 Net; 3,500 lbs. Export pack, 4700 lbs. Cubage, 150.

HFL-10,000 AMPLIFIER

POWER OUTPUT:
 10,000 watts PEP (nominal)
 10,000 watts CW (continuous)

OUTPUT CONNECTOR:
 1 3/8" EIA flange.

HARMONIC & SPURIOUS:
 Second at least 50 db. or better below full rated PEP output, third and higher order at least 60 db. from PEP output.

DISTORTION PRODUCTS:
 At rated 10,000 PEP, third order distortion products are at least 35 db. below either tone of a standard two-tone test.

PRIMARY POWER:
 230 volts AC \pm 5%, 50/60 cycles three phase, four wire. Total demand is approximately 24 KW at full rated CW operation.

TUBE COMPLEMENT:
 (1) 5894, (2) 4CX350A, (1) 4CX10,000D.

SIZE:
 60" wide, 66" high, 30" deep.

WEIGHT:
 Net; 3,300 lbs. Export pack, 4500 lbs. Cubage, 150.

HFL-3,000 AMPLIFIER

POWER OUTPUT:
 3,000 watts PEP (nominal)
 3,000 watts CW, continuous

OUTPUT CONNECTOR:
 Type N.

HARMONIC & SPURIOUS:
 Second at least 55 db. below full rated PEP output, third and higher order at least 60 db. from PEP output.

DISTORTION PRODUCTS:
 At rated output, third and higher order products are at least 40 db. below either tone of a standard two-tone test signal.

PRIMARY POWER:
 208/230/240 volts \pm 5%, 50/60 cps. three phase. Total demand is less than 8 KW for full rated CW operation.

TUBE COMPLEMENT:
 (1) 6CL6, (1) 8122, (1) 4CX3000A.

SIZE:
 22" wide, 72" high, 24" deep.

WEIGHT:
 Net; 800 lbs. Export pack, 1100 lbs. Cubage, 35.

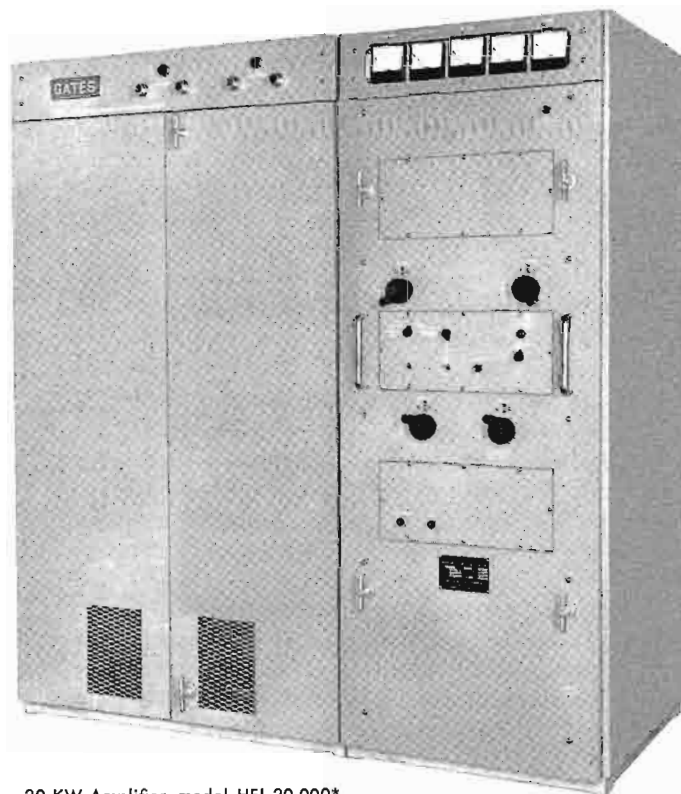

20 KW Amplifier, model HFL-20,000*

HFL-1000 AMPLIFIER

POWER OUTPUT:
 1,000 watts PEP (nominal)
 1,000 watts CW (continuous)

OUTPUT CONNECTOR:
 Type N.

HARMONIC & SPURIOUS:
 Second at least 40 db. below full rated PEP output, third and higher order at least 50 db. from PEP output.

DISTORTION PRODUCTS:
 At rated 1000 watts PEP, third order distortion products are at least 35 db. below either tone of a standard two-tone test.

PRIMARY POWER:
 115/230 volts AC, 50/60 cps, single phase. Total demand is 3.4 KW for full rated CW operation.

TUBE COMPLEMENT:
 (1) 6CL6, (1) 8177, (1) ACX1000A.

SIZE:
 21" wide, 24 3/4" high, 18 1/4" deep.

WEIGHT:
 Net; 280 lbs. Export pack, 350 lbs. Cubage, 8.

ORDERING INFORMATION

20 KW Linear Amplifier, complete with tubes HFL-20,000
 10 KW Linear Amplifier, complete with tubes HFL-10,000
 3 KW Linear Amplifier, complete with tubes less roll out base HFL-3000
 Optional roll out base for HFL-3000 transmitter fixed
 station operation M-6477
 Optional roll out base for HFL-3000 transmitter transportable
 operation including shock mounts and wall snubber kit M-6478
 1 KW Linear Amplifier, complete with tubes HFL-1000

*Not shown but similar in cabinet design, is the outstanding field proven HFL-10,000 linear amplifier.

MODEL HF-50TX

Designed to meet exacting commercial needs for heavy duty long range telegraph and FSK service, the Gates HF-50TX Transmitter is an outstandingly reliable and proven CW transmitter. This high powered model delivers a conservative 50,000 watts output power into a balanced line of 300-800 ohms on any frequency between 3.9 to 30.0 mcs. Outstanding features include: continuous front panel tuning permitting rapid frequency change, minimum tube types, long life tubes, and low power consumption (only 85 kw. key down with 90% or better power factor) for operating economy, and small compact size.

Carefully designed to meet a rigid 80 db. down specification for the suppression of harmonic and spurious radiation, the HF-50TX transmitter permits front panel tuning over the entire range of 3.9-30 mcs. Only one tuned circuit in the power amplifier plate tank is used in the transmitter to allow the wide range of frequency coverage. Another tuned line in the output circuit permits proper matching to the load by front panel controls. The result is complete all band coverage and loading from the front of the transmitter without the necessity for time consuming plug-in coils. As the transmitter frequency can be changed from one pre-logged frequency to another in less than three minutes, actual down time is held to a bare minimum.

Operating modes can be either A₁, ON-OFF keying up to 400 W.P.M., or F₁ with an optional external frequency shift keyer.

DESCRIPTION: The Gates HF-50TX High Frequency Telegraph Transmitter consists of the radio frequency driver and power amplifier cubicles, plus associated power components, high voltage rectifier and blower. Designed to meet various installation needs, the HF-50TX transmitter may be supplied with the main blower located adjacent to the transmitter in a matching cabinet, with the air being ducted through the transmitter side, or it can be installed on a lower floor or in another nearby room. All cabinets are accessible from front and rear permitting easy servicing and maintenance.

RADIO FREQUENCY SECTION: The exciter RF/driver along with associated separate power supplies are built into



the driver cubicle. Rated at 85 watts output, provision is made in the exciter for selecting any one of ten crystals. Inputs for an external frequency shift keyer or an external VFO are available. (Dual exciter units can be provided as an optional accessory.) The 3 kw. driver power output is continually adjustable, and is conservatively rated, providing reserve power for driving the final amplifier. Two type F6804 triodes are used in push-pull as power amplifiers. Since one tube is capable of 50 kw. output, a large reserve of power is available as well as expected very long tube life. All power supplies are of the 100% silicon rectifier solid state type, eliminating mercury rectifier tubes and providing a minimum maintenance power supply system.

SPECIFICATIONS

POWER OUTPUT:

50 kw. At intermittent operation output power may be exceeded depending on load conditions.

OUTPUT IMPEDANCE:

300-800 ohms balanced.

FREQUENCY RANGE:

3.9 to 30 mcs.

FREQUENCY STABILITY:

.003%

EMISSION:

A₁ ON-OFF keying up to 400 W.P.M. F₁ (with external optional frequency shift keyer). See page 217 for frequency shift keyer.

CARRIER NOISE:

55 db. or better below equivalent modulated carrier.

SUPPLY VOLTAGE:

480 volts, 3 phase, 50 or 60 cps. Available on special order at other voltages and frequencies.

POWER CONSUMPTION:

Not more than 85 kw. with 90% or better power factor. ICCS power consumption is, of course, less.

HARMONIC SUPPRESSION:

80 db. or better below fundamental.

DIMENSIONS:

6½' high, 7' wide and 5' deep plus external components.

WEIGHT:

11,500 lbs. net, 14,000 lbs. export packed.

CUBAGE:

900

ORDERING INFORMATION

Model HF-50TX, High Frequency Telegraph transmitter, 50,000 watts, with tubes, less crystals 60 cps M-6016 for 50 cps M-6016A

Optional accessory—second exciter which adds 10 more crystal positions M-5569D

Spare 100% tube set for HF-50TX TK-388

Crystal for HF-50TX CR-27A/U

Temperature controlled oven (holds two CR-27A/U crystals) JK-09C



20,000 WATT HIGH FREQUENCY TELEGRAPH TRANSMITTER

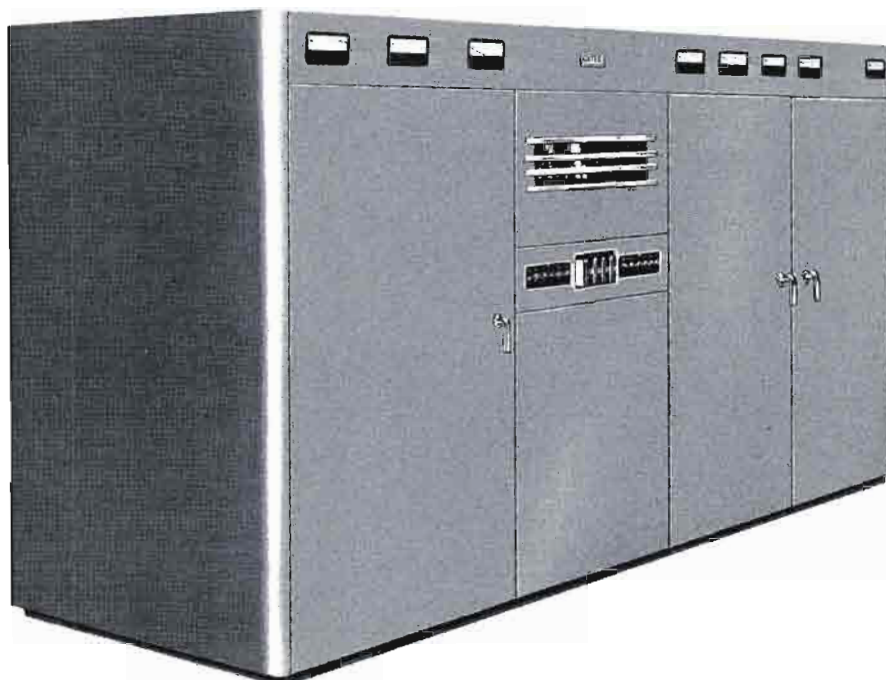

MODEL HF-20TX

Designed for around the clock international communications service, the Gates HF-20TX 20,000 watt CW transmitter is a complete high speed telegraph transmitter operating between 4 and 22 megacycles, and may be used with a frequency shift keyer or an external VFO. Emphasis on design for continuous duty under extreme operating conditions assures huge traffic handling capability with minimum attention.

FREQUENCY COVERAGE: The standard model will tune to any frequency between 4 and 22 Mc. Where operation down to 2 Mc. is necessary, an additional set of frequency determining components is available. Tuning is continuously variable other than the power amplifier where four rapid-change tank coils cover the entire frequency range. It is possible to tune to frequency within one minute after selection of the frequency band. Counter type dials on major circuits assure accurate logging for quick return from another frequency.

RADIO FREQUENCY SECTION: Three RF stages are preceded by a two stage exciter containing four crystal positions. RF drive to the final amplifier is amply furnished by push-pull 4-250A

tetrodes. Four long-life 3X2500F3 tubes are operated in push-pull parallel in the final amplifier to provide a generous 20,000 watts and a stable low impedance amplifier insensitive to self-oscillation.

KEYING: Speeds up to 400 words per minute with excellent square top wave form is accomplished by electronic keying in the IPA/doubler stage. Inputs for an external FSK and VFO are provided.

POWER SUPPLIES: A well filtered, three phase, full wave, six tube, high voltage supply is fitted with heavy components to permit continuous key down service without overload. Individual supplies provide voltage for: (1) power amplifier bias, (2) IPA/doubler stage and (3) the R.F. exciter.

RELAYS AND PROTECTION: Primary magnetic circuit breakers are installed in all main power lines. Individual supervisory overload relays are incorporated for the transmitter main overload, R.F. driver, and power amplifier with full protection against air failure, and door interlocks for personnel protection are provided.

RECYCLING: An automatic control circuit takes over when the carrier is disrupted and permits the transmitter to return to normal operation up to and including the fourth overload. After the fourth attempt to reset the carrier, the transmitter will turn off.

SPECIFICATIONS

POWER OUTPUT:
20 KW.

FREQUENCY RANGE:
Standard at 4 to 22 Mc. or 2 to 22 Mc. with optional M-6436 frequency determining kit.

CRYSTAL POSITIONS:
Four. Also has input for external VFO or FSK.

FREQUENCY STABILITY:
.003% in JK-09C oven or .02% when oven not used.

R.F. OUTPUT:
300-800 ohms balanced. 50 ohms available on special order.

NOISE:
0.5% or less modulation of carrier.

TUBES:
(1) 6AG7 oscillator, (1) 6AG7 int.

amplifier, (1) 6146 int. amplifier/doubler, (2) 4-250A R.F. drivers, (4) 3X2500F3 power amplifiers, (6) 673 high voltage rectifiers, (4) 8008 low voltage rectifiers and (1) 811A electronic keyer.

AC INPUT:
230 volts, 3 phase, 50 cycles at 35 KW key down. Other primary voltages and frequencies readily available. 50 cycle model operates excellently on 60 cycles.

POWER FACTOR:
90% or better.

SIZE:
165" wide, 78" high, 48½" deep. Door swing 40".

FINISH:
Medium gloss gray.

WEIGHT:
Packed (domestic)—6000 lbs., (export)—8280 lbs. Cubage: 760.

ORDERING INFORMATION

Model HF-20TX 20 KW CW Transmitter, 4-22 Mc., complete with tubes, less crystals and ovens M-4780
Spare 100% tube kit for HF-20TX transmitter TK-140
Crystal in holder for .02% accuracy CR-27A/U
Temperature controlled oven, holds 2 type CR-27A/U crystals JK-09C

HARRIS
INTERTYPE
CORPORATION **GATES**

10,000 WATT HIGH FREQUENCY TELEGRAPH TRANSMITTER

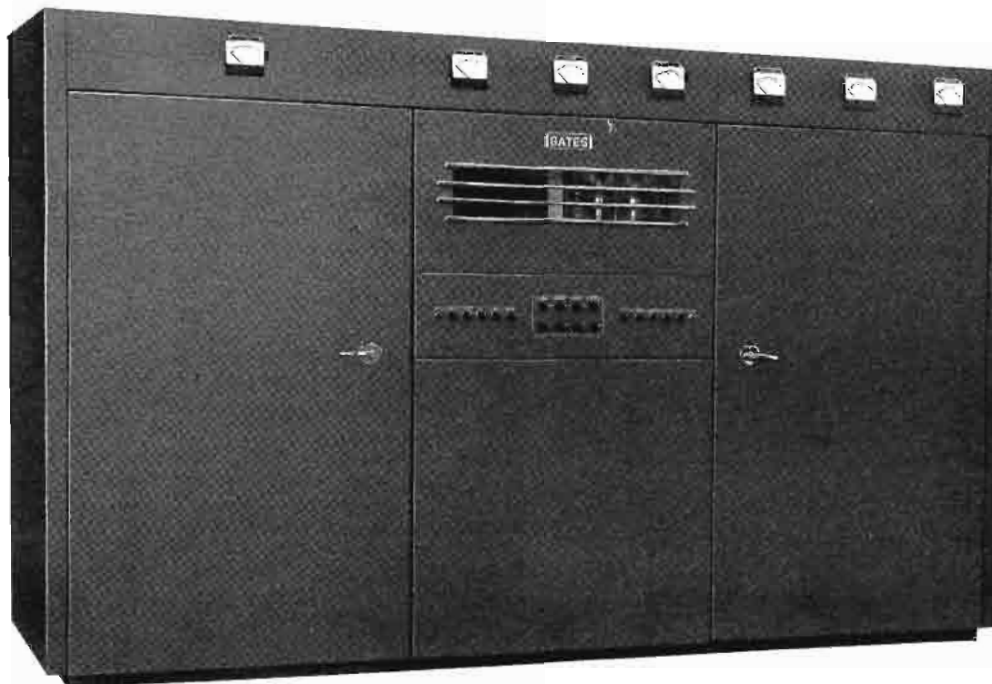

MODEL HF-10TX

Operated by international radio communication and press services and government agencies for telegraphic transmission, the HF-10TX transmitter is designed for heavy continuous commercial duty operation. Available for either 2 to 22 mc. or 4 to 30 mc. service, complete reliability can be expected from this 10,000 watt transmitter. A built-in electronic keyer for high speed make and break carrier keying is standard equipment.

FAST TUNING: Once one of the four wide frequency bands is selected, transmitter tune up can be made within one minute by front panel controls. Except for the final tank coil all circuits are continuously variable over the full 2 to 22 mc. or 4 to 30 mc. band. Four individual tank coils are supplied for complete frequency coverage. Full band change can be made in minutes as the Gates design allows fast changing of the power amplifier tank coil which sets on a sliding pin guided carriage and racks into position quickly. The use of only one removable coil makes frequency change-over time very short and convenient as all tuning and loading is from the front panel.

Variable vacuum condensers are used to tune the power amplifier tank. Tuning of the Pi network output loading is handled by continuously variable capacitors and coils to match 300 to 800 ohms balanced loads. (Or, this transmitter can be supplied for 50 ohm unbalanced output, if desired).

5 KW MODEL: A 5000 watt model is also available and differs from the Model HF-10TX transmitter only in component size. Performance specifications are generally the same as for the Model HF-10TX transmitter, except, of

course, the power output is 5000 watts and the power input accordingly lower too.

RF SECTION: Excitation for the HF-10TX is provided by a two stage exciter containing 4 crystal positions and an input for an external frequency shift keyer or variable frequency oscillator. This is followed by an 807 amplifier/doubler and two type 4-250A tubes which supply generous RF drive to the type 3X2500F3 push-pull power amplifiers.

POWER SUPPLIES: The main high voltage supply is a full wave, three phase, rectifier using six type 8008 tubes. Separate supplies are incorporated for low voltage and bias circuits.

OPERATION FEATURES:

Protective Devices: All tubes except those in the exciter are protected by overload relays. Primary circuit breakers are in all major circuits. Time delay relays, door and air pressure interlocks are standard equipment.

Recycling: A unique circuit automatically turns the transmitter back on the air by recycling up to the fourth overload if, for any reason, the carrier is interrupted.

Air Cooling: A large squirrel cage blower efficiently cools the two 3X2500F3 power amplifiers and a smaller blower directs cooling air to the base of each HV mercury rectifier.

CONSTRUCTION: The HF-10TX telegraph transmitter consists of three cabinets of walk-in construction which attach together to form an attractive and easy to maintain installation. Compact in size, the transmitter is self-contained and requires only 42 square feet of floor space. Even the power transformer is mounted within the transmitter.

10,000 Watt High Frequency Telegraph Transmitter— HF-10TX

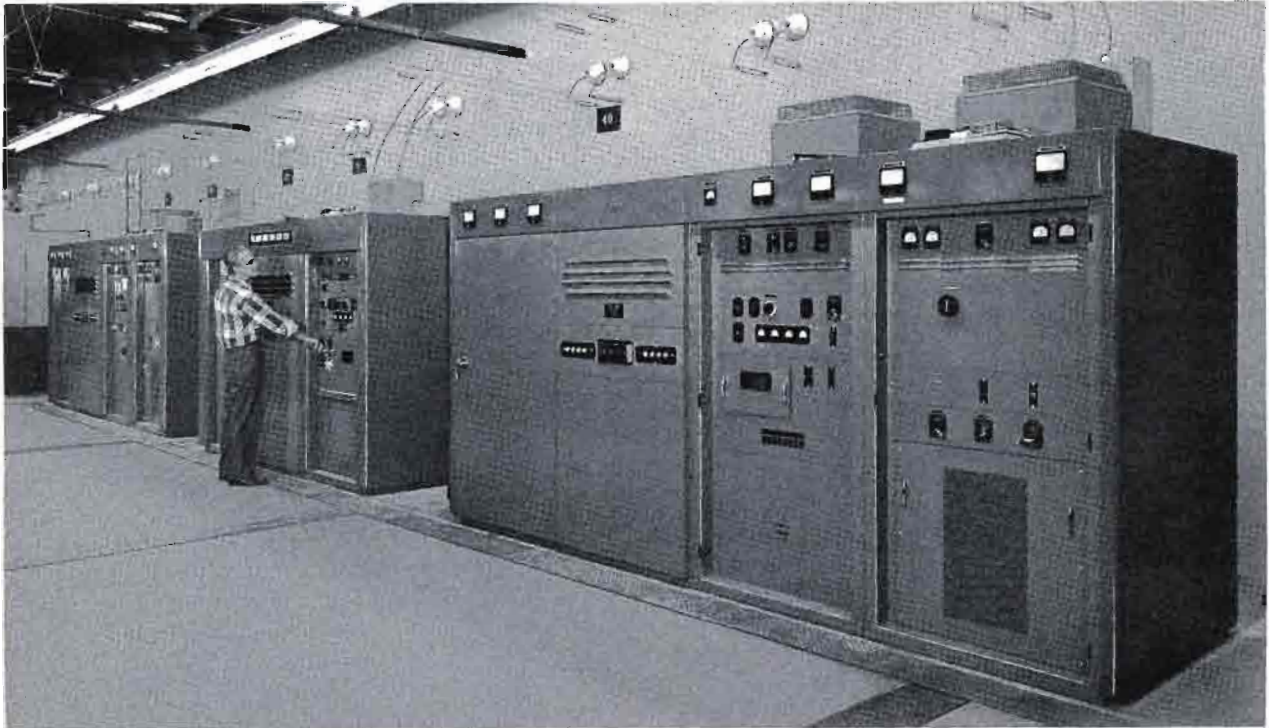

Two of Six Gates Model HF-10TX transmitters along with the 30KW model in continuous operation at the Press Wireless Transmission Center, Centereach, Long Island.

SPECIFICATIONS

POWER OUTPUT:

10,000 watts.

FREQUENCY RANGE:

2-22 Mc. or 4-30 Mc. (as ordered).

EMISSION:

A₁ or F₂ with frequency shift keyer added.

CRYSTAL POSITIONS:

4, plus input for external VFO or FSK.

FREQUENCY STABILITY:

.003% with temperature controlled JK-09C oven. With CR-27A/U crystal and holder, less oven; 0.02%.

OUTPUT IMPEDANCE:

300-800 ohms balanced. Or, 50 ohms unbalanced on special order.

TUBES:

Oscillator—(1) 6AG7; Buffer—(1) 6AG7; Buffer-Doubler—(1) 807; Keyer—(1) 811A; R.F. Driver—(2) 4-250A; PA—(2) 3X2500F3; Bias Rectifier—(2) 8008; LV rectifier—(2) 8008; HV Rectifier—(6) 8008.

POWER LINE REQUIREMENTS:

230 volts, 3 phase, 50 or 60 cycles, as ordered.

POWER CONSUMPTION:

19.0 K.W.

POWER FACTOR:

90% or better.

KEYING SPEED:

High speed. 400 WPM with essentially square top wave form. Speeds up to 600 WPM possible.

HARMONIC SUPPRESSION:

Meets or exceeds CCIR or FCC requirements.

DIMENSIONS:

125" long, 48½" deep, 78" high. Largest cubicle uncrated 45" wide, 50" deep, 78" high.

WEIGHT AND CUBAGE:

(Domestic packed) 4000 lbs., (export packed) 5500 lbs. Cubage: 450.

ORDERING INFORMATION

HF-10TX Telegraph Transmitter, 10,000 watts for 2-22 Mc., high speed electronic keyer, one set of operating tubes, less crystals and ovens(Cat. No.) for 60 cycles—M-3795 for 50 cycles—M-3795A

HF-10TX Telegraph Transmitter, 10,000 watts, same as above except 4-30 Mc for 60 cycles—M-3795B for 50 cycles—M-3795C

HF-5TX—Telegraph Transmitter, 5000 watts for 2-22 Mc., with high speed electronic keyer, set of operating tubes but less crystals and ovens for 60 cycles—M-3794 for 50 cycles—M-3794A

Crystal for either FH-10TX or HF-5TX CR-27A/U

Oven for crystal (holds two CR-27A/U) JK09-C

100% set spare tubes for HF-10TX TK-255

100% set spare tubes for HF-5TX TK-254

15,000 WATT HIGH FREQUENCY TELEGRAPH TRANSMITTER

MODEL THF-15

The THF-15 Telegraph Transmitter is the latest model in the full line of Gates high frequency transmitting equipment already in use in Government and private communications service. Featuring continuous front panel tuning from 2 to 30 Mc., this high power 15 KW transmitter is comprised of the same exciter, driver and power amplifier as used in the popular Gates BHF-10B broadcast version.

DESIGN: The power output is a full 15 KW average, under conditions of either continuous CW operation or frequency shift keying. Spurious radiation is extremely low. Solid state rectifiers are used throughout. Only six tube types are used in the complete transmitter, including a pair of 4CX5000A tetrodes in parallel, as the final RF amplifier.

OPERATION: Tuning is continuously variable from the front panel without coil change. Compact for 15 KW output, the entire transmitter is housed in three cabinets, totalling 75" wide, 41" deep and 78" high. Each individual cubicle has a fully hinged rear door and a smaller front access door providing quick accessibility to every part of the transmitter. A dual output to feed either a 50 ohm or 600 ohm balanced line simply by changing jumpers is a unique feature made possible by a self-contained balun network incorporated in the transmitter. The separate output connections for either a 600 ohm balanced line, or a 50 ohm 1 $\frac{5}{8}$ " coaxial transmission line, are located at the top of the right hand cubicle which also contains the large forced-air blower.



SPECIFICATIONS

POWER OUTPUT:

16 KW. CW power into either 50 ohm unbalanced, or 600 ohm balanced line.

FREQUENCY RANGE:

2-30 Mc. continuously tunable.

TYPE OF FREQUENCY CONTROL:

Crystal, 10 selectable positions, also provision for external VFO and FSK.

TYPE CRYSTALS AND OVENS:

CR-27/U to MIL Specification C-3098B.

JK-02C oven or equivalent.

TYPE OF EMISSION:

CW, using grid block keying.

OUTPUT IMPEDANCE:

600 ohm balanced, or 50 ohm unbalanced with a VSWR equal to or better than 2:1.

FREQUENCY STABILITY:

± .003% within the temperature range of - 30° to + 50° C.

RF HARMONICS:

80 db. below full ratio power output or better.

TUBE COMPLEMENT:

(4) 5763, (2) 4CX5000A and (1 each) 4-250A, GZ34, 6V4/EZ80, OA2.

PRIMARY POWER REQUIREMENTS:

208/240 volts AC, 50/60 cycle, 3 phase.

POWER CONSUMPTION:

2.6 KW standby, 23.3 KW key down. Power factor 90%.

WEIGHT:

2750 lbs. net. Domestic packed—3405 lbs. Cubage: 315.

Export packed—3600 lbs. Cubage: 345.

ORDERING INFORMATION

THF-15, 15 KW Telegraph Transmitter with tubes, less crystals M-6198

Spare 100% tube kit for above TK-416

Crystal in holder CR-27A/U

Temperature controlled oven, accommodates two CR-27A/U crystals

and holders per oven JK-09C



1000 WATT 6-CHANNEL CW/FSK TRANSMITTER

MODEL FS-1000

Supplied complete with frequency shift keyer, this 1000 watt transmitter is designed for heavy duty commercial service on either FSK or CW. The Model FS-1000 transmitter is continuously tunable in one minute or less from the transmitter front panel over the entire 2 Mc. to 32 Mc. high frequency band. As the power amplifier is a standard Gates HFL-1000 listed on Page 199, the FS-1000 transmitter may also become a versatile SSB transmitter for all modes of operation by adding the Gates SG-70 Sideband Generator.

BUILT-IN FSK: To handle teletype transmission with complete reliability, the Northern Type 105 Model 6 frequency shift keyer and the Northern Type 108 Model 2 master crystal oscillator multiplier is combined with the Gates HFL-1000 power amplifier to deliver an easy 1000 watts output. In this custom transmitter the frequency shift keyer provides 6 crystal controlled channels and, manual FS or ON-OFF keying. Long life silicon rectifiers are used in the main high voltage DC supply for dependability and to eliminate mercury rectifier start up problems in cold weather. Altitudes up to 10,000 feet as well as high humidity are part of the design specifications. Power output is single ended employing the long life 4CX1000A tube. This transmitter is recommended, without reservations, where a most dependable 1000 watt telegraph and teletypewriter equipment is required. It is complete with tubes, connecting cables, hardware and ready for installation.



SPECIFICATIONS

POWER OUTPUT:

1000 watts.

FREQUENCY RANGE:

2.0 to 32.0 Mcs. continuous.

NUMBER OF CHANNELS:

Six crystal controlled channels.

EMISSION:

A₁, F₁.

FREQUENCY STABILITY:

.005% below 4000 Kcs. and .0015% above 4000 Kcs.

RF OUTPUT IMPEDANCE:

50 ohms unbalanced, capable of matching a 2:1 VSWR.
(See Note 1 below).

NOISE:

At least 45 db. below 100% modulation.

HARMONIC & SPURIOUS RADIATION:

At least 60 db. below the mean power of the fundamental without external filters.

KEYING SPEED:

200 bauds.

KEYING CIRCUIT:

Dry contact keying; keying voltage is supplied internally.

EXTERNAL EXCITATION:

Provision is made for external excitation requiring approximately 100 milliwatts driving power (see Note 2).

DUTY CYCLE:

Continuous on a 24-hour per day basis with full power output of frequency shift.

CLIMATIC RANGE:

- 20° to + 50° C. (- 4° to + 122° F). Humidity, 0-95%.

FINISH:

Medium gloss gray, brushed aluminum and black trim.

DIMENSIONS:

78" height x 23½" width x 19½" depth.

WEIGHT:

Net 480 lbs. Export packed, 810 lbs. Cubage: 63.

A.C. INPUT:

For either 120 or 230 volts, 50/60 cycles, 2 wire. Power consumption key down CCS is 3570 watts. Power factor: 90% (see Note 3).

ORDERING INFORMATION

One KW six channel CW/FSK Transmitter FS-1000
Crystal and holder for FS-1000 (state operating frequency) M-6446
Spare 100% tube kit TK-521

NOTES: (1) On special order, an antenna coupler or balun can be supplied to match the antenna of the customer's preference. (2) By use of the Gates SG-70 Sideband Generator, the FS-1000 transmitter also becomes a 1000 watt SSB transmitter. (3) For other voltages an inexpensive step-down transformer is available.



250 WATT SHORT WAVE TRANSMITTER

MODEL CMG-1

The Gates CMG-1 has world-wide popularity as a 250 watt short wave communications transmitter. Continuously variable over the full 2 to 32 Mc. frequency range, it is ideal for telephone and telegraph use especially where fast frequency change and reliability is needed.

This high-level modulated transmitter may be instantly tuned direct from the front panel over the entire wide frequency range, and logged and returned in seconds.

GENERAL DESIGN—Construction in three sturdy chassis that mount into a custom designed cabinet each unit is quickly removable for ease of inspection and service. The top chassis contains the complete radio frequency unit with output coupling network, and the center chassis houses the modulator. A third assembly houses the main power supply.

RF CHASSIS—Only three RF stages are employed to produce a full 250 watts carrier at any frequency between 2-26 Mc., and 200-225 watts from 26 to 32 Mc. Two type 4-65 tubes are used as power amplifiers. Provision is made for four crystals which mount (2 per oven) in a JK09-C temperature controlled oven for .003% or better stability. Connections for external VFO are provided. There are no coils to remove or plug in when changing transmitter frequency. Dial and veeder counter indicators allow accurate logging for quick frequency change. Output is a Pi-network allowing a wide variety of impedance matching.

MODULATOR—The CMG-1 modulator includes a microphone amplifier with push-to-talk facilities, provides a 600 ohm line input and has an inbuilt peak limiter allowing compression of as much as 25 db. with excellent intelligibility. A 3000 cycle cutoff filter and high level Class B 811A modulator tubes assure 100% modulation at all times.

POWER SUPPLIES—Two power supplies are provided. Main D.C. supply is well filtered and uses full wave rectifier

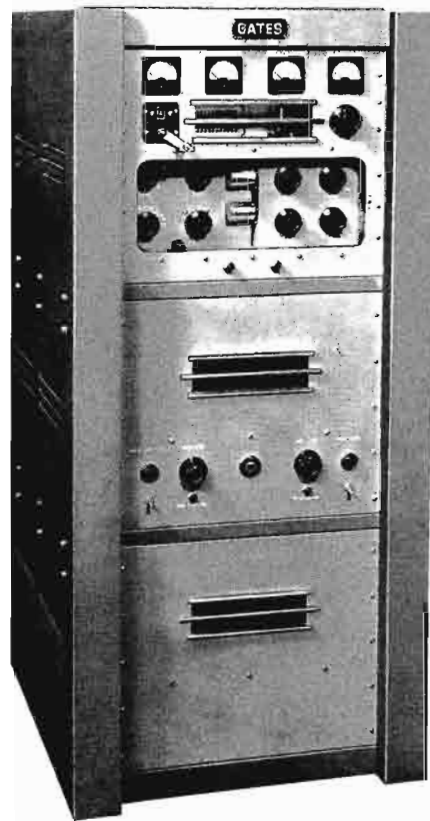

circuit with 866A tubes. Plate and bias voltages for low power stages are supplied by a full wave rectifier and filter circuit with a 5V4 tube.

SECOND HARMONIC FILTERS—Where unusually low reduction of the second harmonic is desired, three optional filters are available for 50, 72 and 250 ohms line impedance.

SPECIFICATIONS

POWER OUTPUT:

250 watts to 26 Mc. 200-225 watts to 32 Mc.

FREQUENCY RANGE:

2-32 Mc. continuously variable.

OUTPUT IMPEDANCE:

40-300 ohms.

STABILITY:

When used as above, 0.003%.

CARRIER SHIFT:

5% or less at 100% modulation.

MODULATION:

High level Class B.

FREQUENCY RESPONSE:

± 2 db. 200-300 cycles with sharp cutoff above 3000 cycles.

DISTORTION:

Less than 8% at all frequencies 200-3000 cycles. 100% modulation.

RF HARMONICS:

Meets or exceeds CCIR requirements.

AUDIO INPUT:

Hi-Z for microphone at - 55 db. input. 600 ohms at 0 dbm. input level.

KEYING SPEED:

60 WPM.

VFO INPUT:

Provided on receptacle rear terminal board of transmitter.

POWER INPUT:

115 volts, 50/60 cycles, 1000 watts at average modulation.

POWER FACTOR:

90%.

SIZE:

50" high, 23" wide, 26" deep. Door swing 20".

ESTIMATED WEIGHT:

500 lbs. packed. Export packed, 720 lbs. Export cubage, 54.

FINISH:

Medium gray.

TUBES:

6AG7 oscillator; 6146 IPA; (2) 4/65A power amplifiers; (2) 866/866A HV rectifiers; 5V4 rectifier; 6SJ7 mic. amplifier; 6L7 second amplifier and line input; 6C5 third audio stage; 6L6 audio driver; (2) 811 A modulators; 6H6 limiter; and 6U4G modulator rectifier.

NUMBER OF CRYSTALS:

Maximum of four (Type H-17 in JK09-C oven).

TEMPERATURE RANGE:

- 20° to 45° C.

ALTITUDE:

5000 feet.

ORDERING INFORMATION

Model CMG-1 Telephone and Telegraph Transmitter, with one set of tubes, less crystals (Cat. No.) M-5697
Crystal in holder (less oven) for 0.02% accuracy H-7
Crystal in holder for .005% accuracy .. H-17
Oven to accommodate two H-17 crystals JK09-C
100% spare tube complement TK-136
Microphone assembly complete (push-to-talk) M-4576
Filters for added second harmonic attenuation:
For 50 ohms LPF-52
For 72 ohms LPF-72
For 250 ohms LPF-250
NOTE: State crystal frequencies when ordering.



85 WATT CW TRANSMITTER —65 WATT TELEPHONE CW TRANSMITTER

MODEL—M5569G

Complete with power supply, the M-5569G is a compact 85 watt CCS rated CW communications transmitter, continuously tunable from the front panel to any frequency between 2 and 32 mc.

When used with the Gates M-5570 Amplifier/Modulator, the M-5569 CW transmitter converts to an excellent 65 watt (power input) double sideband transmitter for point-to-point radio-telephone service. Keying is accomplished by a time sequence system permitting oscillator keying for fast "break in" operation. The design provides capability for FSK operation when used with a frequency shift keyer or A3 with a modulator. A wide range highly efficient Pi-network permits matching to output loads with impedances of 50 to 600 ohms unbalanced.

As an exciter for higher powered High Frequency transmitters, the M-5569G provides ample power to drive a variety of RF power amplifiers.

Any of 10 crystal positions can be selected from the front panel of the removable crystal tray unit. Calibrated tuning dials and a counter type dial for final amplifier tank variable inductor tuning assure precision logging. A multimeter indicates oscillator, IPA, PA grid and PA plate current. Silicon rectifiers are used for low voltage and bias supply.



2-32 mc.

SPECIFICATIONS

- FREQUENCY RANGE:**
2-32 mc. continuously tunable from front panel.
- OUTPUT IMPEDANCE:**
50 to 600 ohms unbalanced.
- CRYSTAL POSITIONS:**
10 Type CR-27 which mount in five Type JK-09C temperature controlled ovens (2 crystals to an oven) for .003% accuracy—or when not mounted in oven, 0.02% accuracy.
- KEYING:**
Electronic differential keying. Permits fast break-in operation. Keying speed is 60 WPM.
- TEMPERATURE RANGE:**
- 20°C to 50°C.

- POWER INPUT:**
85 watts CW, CCS rated.
- TUNING CONTROLS:**
Crystal switch, oscillator/1st multiplier tune, oscillator/1st multiplier band switch, buffer tune, buffer band switch, PA tank tune, PA output loading.
- AC POWER:**
115 volts, 50/60 cycles. Power Consumption: 175 watts.
- SIZE:**
For rack mount—10½" high, 19" wide and 14¼" deep.
In cabinet—11¾" high, 20¾" wide and 15" deep.
- TUBES:**
5763 osc., 5763 IPA, (2) 6146 power amplifiers, OB2 screen regulator tube, 6AQ5 screen clamper, 12AU7 keyer tubes, (2) 5R4GYA rectifier.
- WEIGHT:**
Domestic packed—90 lbs. Export packed—130 lbs. Cubage 7.

ORDERING INFORMATION

- Transmitter, 85 watt CW with tubes, less crystals, rack mount M-5569G
- Transmitter, 85 watt CW with tubes, less crystals, cabinet mount M-5569H
- Spare 100% tube kit for above TK-291
- Crystal and holder for 0.02% accuracy CR-27A/U
- Oven to accommodate two CR-27A/U crystals for .003% accuracy JK-09C

MODEL—CM-65

The CM-65 consists of the M-5569G CW Transmitter described above and the M-5570 modulator/amplifier and is a complete 65 watt double sideband transmitter. This transmitter accommodates 10 crystals, tunes continuously from 2 to 32 mc., has sharp voice quality and will match a wide variety of antennas. Separate power supplies in the modulator and RF unit make them independent of each other.

Ideal for commercial High Frequency voice and CW service, the CM-65 will handle 24 hour a day schedules with complete reliability.

MODULATOR: The separate M-5570 modulator has four stages with low-pass filter and peak limiting amplifier. Meter switch selects to read either compression or modulator swing. A microphone receptacle, compressor setting, gain control, and phone-CW switch are on the front panel. Push-to-talk function operates in keying circuit of the M-5569G transmitter. The CM-65 operates with a Hi-Z microphone to supply 100% modulation to the 65 watt input carrier.

SPECIFICATIONS

- Note: All specifications shown above for the M-5569G apply to the CM-65 with the addition of those applicable to voice transmitters as follows:
- FREQUENCY RANGE:**
2-32 mc.
 - POWER INPUT:**
65 watts high level modulated or 85 watts CW.
 - KEYING:**
Electronic differential keying permitting fast break-in operation. Push-to-talk circuit operates same as keying.
 - TUBES: (For M-5570 Modulator):**
12AT7, (2) 6146, (2) 5R4GY, (2) VR-105, (1) 5879, (1) 6AK6.
 - AUDIO INPUT:**
Hi-Z dynamic or crystal microphone.
 - LIMITER:**
Fast acting with limiter action indicated on meter.



M-5570

M-5569G

- LOW-PASS FILTER:**
Cuts off audio response at 5000 cycles 40 db. or better.
- RESPONSE:**
+ 3 db., 300 to 2500 cycles. Down 20 db. at 50 cycles and 40 db. at 5000 cycles.
- DISTORTION:**
8% or less, 300 to 2500 cycles.
- NOISE:**
40 db. or better below 100% modulation.
- AC POWER:**
115 volts, 50/60 cycles.
- SIZE:**
M-5569G Exciter: 19" wide, 10½" high and 14¼" deep.
M-5570 Modulator: 19" wide, 10½" high and 14¼" deep.
- WEIGHT:**
Domestic packed—220 lbs. Export—310 lbs. Cubage 14.

ORDERING INFORMATION

- Telephone transmitter with tubes, less crystals, rack mount CM-65
- Telephone transmitter with tubes, less crystals, in cabinet CR-65
- Microphone, push-to-talk with cable and plug M-4576A
- Crystal and holder for 0.02% accuracy CR-27A/U
- Oven to accommodate two CR-27A/U crystals for .003% accuracy JK-09C
- Spare 100% tube kit for transmitter TK-292



HIGH FREQUENCY TRANSMITTING ANTENNAS

For high frequency communications or broadcasting, and from microphone or keyer to antenna, Gates can supply the necessary equipment and materials for a "package" installation. Whatever the requirements may be, antennas to do the job are available from Gates. Choose from simple dipoles to modern "state-of-the-art" log periodic structures; from highly directional to omnidirectional types (either fixed or rotatable); all of them complete with the required accessories. A comprehensive selection of high quality antennas are available with all Gates transmitters, making Gates a single source for the best in high frequency transmitting facilities. Described below are some of the many types of antennas available.

HORIZONTAL LOG PERIODIC ANTENNA

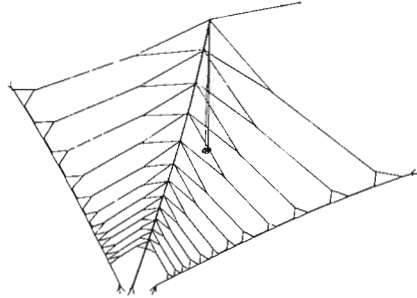

This new Horizontal Log Periodic Antenna is designed for use with transmitters up to 50 KW as a broadband transmitting antenna in the range of 4 to 30 megacycles. It may also be used for receiving. The antenna is supplied complete with steel cables, Fiberglas insulating blocks. Dacron drop ropes and all material ready to install. Consisting of twenty-four radiating elements, the antenna is designed for support at the back end from a 100 foot high structure of required vertical load and horizontal thrust (optional equipment). Typical characteristics are:

| | |
|---|--------------|
| Frequency Range | 4 to 30 mcs. |
| Polarization | Horizontal |
| Azimuth Beam Width (average) | 60 Degrees. |
| Input Impedance (nominal) at Feeder Line Assembly | 300 ohms. |
| Antenna Element Input Impedance | 100 ohms. |
| Operating Power (maximum peak) | 50 KW. |
| VSWR (maximum) | 2 to 1. |

Horizontal Log Periodic Antenna (Cat. Order No.) Type 28231.

VERTICAL LOG PERIODIC ANTENNA

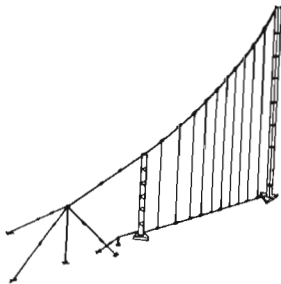

A vertically polarized broadband antenna designed for either transmitting or receiving in the range of 2.5 to 30 megacycles, the Vertical Log Periodic Antenna consists of the antenna element, which is fabricated from steel cables and insulating blocks; and the antenna center support (optional equipment). Designed with a 50 ohm unbalanced input, this LP antenna matches the output of modern SSB communications transmitters. Normally, this antenna can be installed on less than one acre of ground. It measures 200 feet along the widest rod and extends 210 ft. from the single supporting tower.

Typical characteristics are:

| | |
|--------------------------------|---|
| Frequency Range | 2.5 to 30 mcs. |
| Polarization | Vertical |
| Azimuth Beam Width (average) | 110 degrees |
| Azimuth Plane Pattern | Cardioid |
| Elevation Plane Pattern | Upper half-power point less than 45 degrees above horizontal. |
| Input Impedance (nominal) | 50 ohms. |
| Operating Power (maximum peak) | 2.5 KW. |
| VSWR (maximum) | Between 3 mcs. and 30 mcs. ... 2 to 1. Between 2.5 mcs. and 3 mcs. ... 3 to 1. |

Vertical Log Periodic Antenna (Cat. Order No.) Type 28230.

BROADBAND VERTICAL RADIATOR

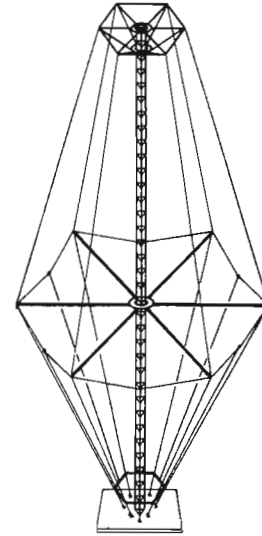

This antenna fills a need in applications requiring a broadband high frequency transmitting antenna for omnidirectional service. Input impedance, which is extremely constant over a wide frequency range, power handling capacity up to 150 KW or more (depending on coaxial line used), and radiation performance equal to or better than a conventional vertical radiator without the need and expense of special impedance matching equipment, are three of the outstanding features of the BVR series of antennas for high frequency transmitting, or receiving systems. Typical characteristics include:

| | |
|--------------------------------------|---|
| Frequency Range; BVR 2-6 | 2 to 6 mcs. |
| BVR 4.5-13.5 | 4.5 to 13.5 mcs. |
| BVR 11-33 | 11 to 33 mcs. |
| Polarization | Vertical. |
| Input Impedance | 50 or 70 ohms as specified. |
| Operating Power | Power handling capacity is limited only by the cable used. Example—5 KW with RG-17/U. |
| VSWR | Less than 2:1. |
| Broadband Vertical Radiator 2-6 mcs. | (Cat. Order No.) BVR 2-6 |
| 4.5-13.5 mcs. | BVR 4.5-13.5 |
| 11-33 mcs. | BVR 11-33 |

NOTE 1. Broadband Vertical Radiators are available for a large range of cutoff frequencies.

NOTE 2. Antenna Kits include center support structure.

RHOMBIC ANTENNAS

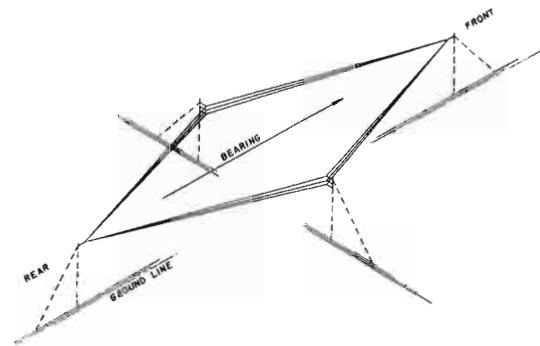

For applications where a highly directional fixed type antenna is needed, Gates offers a complete line of rhombic antenna kits. Each kit includes all the necessary materials and instructions for the installation of a rhombic antenna to operate on a specific frequency range with power up to 30 KW. In addition to the antenna materials, transmission line, dissipation line and towers are required, and can also be supplied by Gates. Typical characteristics are:

| | |
|-----------------|--------------|
| Frequency Range | 4 to 22 mcs. |
| Polarization | Horizontal. |
| Input Impedance | 600 ohms. |
| Operating Power | 30 KW. |

Rhombic Transmitting Antenna (Cat. Order No.) RTA-330
 Transmission Line for Rhombic Transmitting Antenna TRL-300
 Dissipation Line for Rhombic Transmitting Antenna TDL-340



LOW FREQUENCY HOMING BEACON TRANSMITTER



Manufactured to JAN/MIL specifications, the Gates low frequency homing beacon transmitter operates between 200 Kc. and 800 Kc. at maximum power of 400 watts with power reduction to 25 watts by means of a tapped auto transformer and front panel power selector switch. The main transmitter may be augmented with the M-4033 re-

mote control/audio amplifier unit (illustrated lower left). By use of this accessory, the transmitter may be remotely operated over a 2-wire simplex telephone line, or where the M-4033 unit is adjacent to the transmitter, a 3-wire line is usually employed. Another attractive optional accessory is the M-4116 antenna coupler to match the 51 ohm transmitter output impedance to a T antenna 200 feet long with a vertical down lead from 15 to 50 feet.

The transmitter is built to stand the extremes of -54°C to $+65^{\circ}\text{C}$ and Class B shock test. Pressurized forced air cooling, slide out decks for quick servicing, a 36 code keyer, high level modulation, automatic carrier reset, complete metering and 115 volt, single phase operation are all outstanding features. (Available but not illustrated is a pre-fabricated, insulated and ventilated building specifically designed for use with this equipment.)

Xenon gas type high voltage rectifier tubes are employed to permit operating in extremely low ambient temperatures.

The remote control audio amplifier, illustrated below, consists of a complete speech amplifier and a transmitter ON-OFF control. The amplifier is provided with decibel meter, level control, self-contained power supply and is designed for either desk or rack mount. The optional M-4124 push-to-talk microphone and desk stand is another companion item to complete this well-performing system.



SPECIFICATIONS

POWER OUTPUT:
400 watts or less.

R.F. IMPEDANCE:
(Transmitter) $51\frac{1}{2}$ ohms. When used with M-4116 coupler, will match typical T antenna.

FREQUENCY BAND:
200 Kc. to 800 Kc.

FREQUENCY STABILITY:
0.003%

MODULATION:
Class AB₁ high level modulation in either A₂ or A₃ mode of emission.

AUDIO INPUT:
(Transmitter) 600 ohms approximately — 10 dbm. (M-4033 Remote/Audio Amplifier): Includes complete compression type amplifier to accommodate 50 ohm push-to-talk dynamic microphone, decibel meter, transmitter Off-On switch, and self-contained power supply. For operation over 3-wire line or 2-wire simplex telephone line to operate transmitter.

KEYING:
36 code keyer at 8 R.P.M. equal to 4/6 R.P.M. Code wheel: 60 segments stainless steel for any 3 letter identification and code signal.

PERFORMANCE:
Audio response: 400-3000 cycles \pm 2 db. Distortion: 6% or less. Noise: 40 db. below 100% modulation at 400 watts.

TUBES (Transmitter):
(3 each) VR150/OD3, VR105/OC3, (2 each) 4-250A, 6SJ7, 4B32, 5U4G, 6L7, 6SN7, (1 each) 5670/2C51, 6AC7, 807, 4-400A, 6X5, 6L6, 6H6, 6SH7, 6SL7. (Remote Control/Audio Amplifier): (3) 6SJ7 and (1 each) 5U4G, VR105.

AC INPUT:
115 volts, 60 cycles, single phase at 2200 watts at maximum power of 400 watts modulated.

METERING:
(Transmitter) AC line volts, elapsed time in hours, 2nd IPA plate, PA grid, PA plate, modulator plate and R.F. line current, one multimeter indicator, oscillator plate, 1st IPA plate, 2nd IPA grid.
(Remote/Audio Unit) Decibel output meter.
(Antenna Coupler) R.F. antenna current.

SIZE AND WEIGHT:
(Transmitter) 72" high, 26" wide, 30" deep. Add 24" to depth for drawer pull out. Weight packed, 1400 lbs. Cubage: 60 ft.
(Remote Control/Audio Amplifier) 19" wide, 10 $\frac{1}{2}$ " high, 12" deep. Weight packed, 80 lbs. Cubage: 4 ft. (Antenna Coupler) 8" wide, 8" deep, 30" high. Weight packed, 120 lbs. Cubage: 8'.

FINISH:
Light medium gloss gray with escutcheons in black.

ORDERING INFORMATION

Transmitter with code keyer, tubes, less crystal (Cat. No.) M-3975
Remote Control/Audio Amplifier with tubes, less microphone M-4033
Microphone, push-to-talk stand, cord and connector M-4124
Antenna Coupler M-4116
Crystal and holder (state frequency when ordering) H-17

TRANSPORTABLE 50,000 WATT BROADCAST AND SSB SYSTEM

HELICOPTER SYSTEM AN/TRQ-20

Designed and manufactured by Gates for the U.S. Army Signal Corps, the AN/TRQ-20 represents one of the largest mobile broadcast and SSB communications systems ever produced. Helicopter transportable, the equipment is manufactured in S-141 shelters and portable skids with a maximum weight of 4000 lbs. each and permits easy transportation by 6 x 6 vehicles and a standard cargo plane.

SYSTEM DESCRIPTION: Two powerful 50 KW. radio broadcasting stations, one medium wave and one high frequency, each complete with studio/control shelters, and diesel powered generators are portable down to their transmitting antennas. A complete 2.5 KW. PEP single sideband communications link, using a Gates linear amplifier for 2-30 mc. operation together with broadband LP antennas is part of this system. Facilities are provided for 1 six KC. program channel, 2 three kc. voice channels and 2 teletype channels. Circuits are full duplex providing simultaneous communications in both directions over distances of 600 to 1200 miles.

Also included is a monitor facility with receiving and recording capabilities for MW, HF, and FM from 50 Mc. to 260 Mc. Military nomenclature has been assigned to the various integral facilities of the complete AN/TRQ-20 system as follows:

- AN/TRT-22 () 50 kilowatt medium wave broadcasting station.
- AN/TRT-21 () 50 kilowatt short wave broadcasting station.
- AN/TRR-18 () An integrated receiving monitor station.
- OA-6021 () TRQ-20 Main studio control.
- AN/TRC-95 () 2.5 KW SSB communication link.

The entire system consists of four shelters for the 50 KW. medium wave transmitter, four for the high frequency transmitter, four for the SSB link, two for each receiving station, three for master control equipment, three for studios, one for announce teletype and two shelters for 50 KW. dummy antennas. Diesel generators provide all power needs. Studio and control shelters have individual heating and air conditioning.

LOG PERIODIC ANTENNAS: For High Frequency SSB transmitting and receiving, vertically polarized log periodic antennas are utilized. These broadband antennas require no adjustment or change throughout the entire frequency range of 3 to 30 megacycles. Three identical antennas are used for each SSB link shelter; one for transmitting and two for diversity reception.

50,000 WATT TRANSMITTERS: A standard Gates 50,000 watt medium wave broadcast transmitter is used, redesigned mechanically to be housed in the S-141 shelters. With its own diesel power system, the complete 50 KW. station consists of four shelters, housing the transmitter, a 50 KW. dummy load shelter and independent studio and control room shelters.

Completing the AN/TRQ-20 system is a short-wave 50,000 watt broadcasting facility which is identical to the medium wave system, with the exception of its antenna system and the 3.9 Mc. to 30 Mc. transmitter frequency coverage. The complete main studio system is independent and may be used in combination with the 50 KW. medium wave transmitter facility at the same location to provide an expanded studio and control room installation.



TRANSPORTABLE EXPERIENCE AND CAPABILITIES

USED IN WORLD-WIDE THEATERS . . . Gates' pioneering in the manufacture of transportable broadcasting and communications systems goes back to 1950 and the Korean conflict. Numerous mobile facilities built for commercial and for government applications with military nomenclature are used in world-wide theaters. This long experience combined with Gates' broad engineering and extensive manufacturing facilities have resulted in numerous contracts for both mobile broadcasting systems from 1 KW. to the largest 50,000 watt capability, and for transportable SSB communications service.

OTHER SYSTEMS: The AN/TRQ-20 is one of many transportable systems manufactured by Gates. The AN/MRT-5 transmitting and AN/MRR-4 receiving systems, in addition to the Signal Corps air transportable television broadcasting systems are some of the previous military units built by Gates. These, together with commercial mobile systems are illustrated herein.

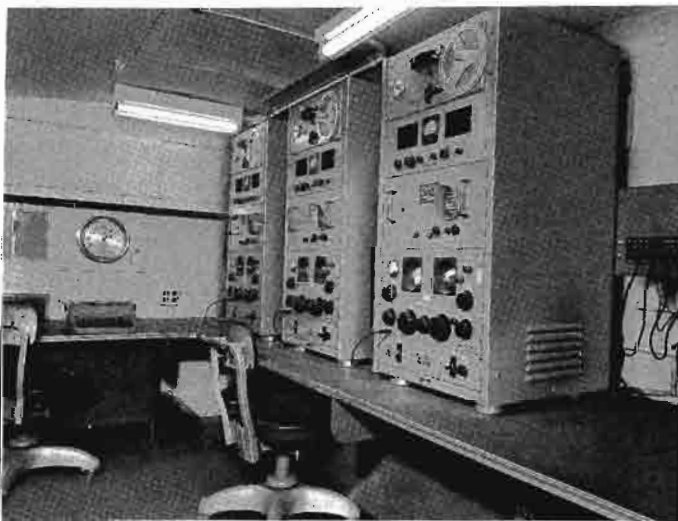

MOBILE RADIO STATION AN/MRT-5 and AN/MRR-4 FOR ARMY SIGNAL CORPS

For the U.S. Signal Corps, Gates designed and constructed a large number of complete mobile 5000 watt radio stations designated AN/MRT-5. A van containing a combined mobile studio and control room was acoustically treated and completely air conditioned. The transmitter van housed a 5000 watt AM broadcast transmitter. Military shelters contained the portable 200 ft. antenna tower, tuning unit, balloon antenna and other apparatus. The AN/MRR-4 was the companion radio receiving, monitor and teletype facility all housed in two shelters.

In Korea, program material produced in the mobile studio in Seoul, Korea, was sent by wire lines to the AN/MRT-5 transmitter trailer 10 miles distant.

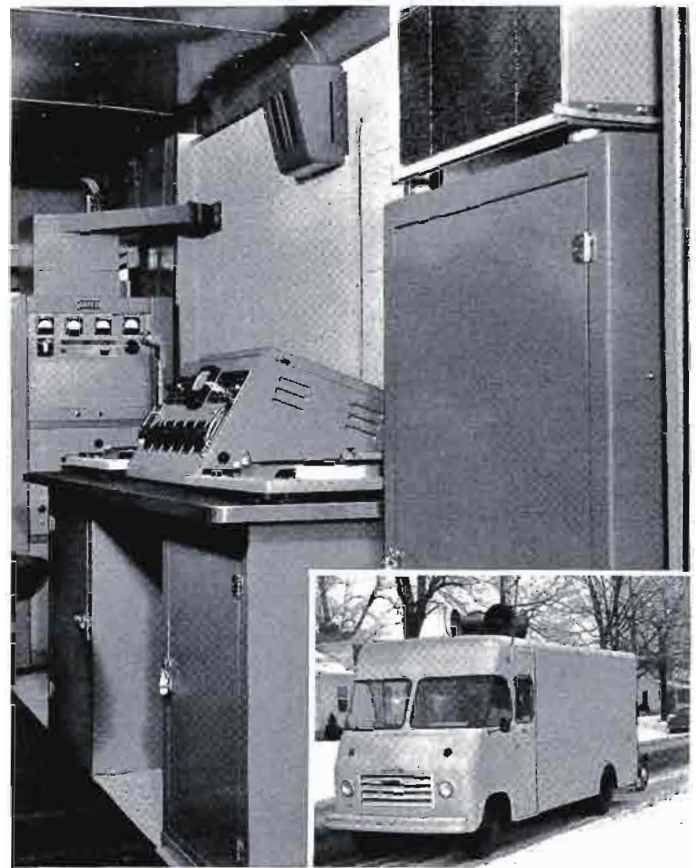

Mobile radio system designed and constructed by Gates for the Radio Bureau of the Republic of Korea provides complete medium and short wave broadcasting and public address facilities in a compact, specially designed van.



MOBILE TELEVISION STATION FOR SIGNAL CORPS

Gates designed, developed and constructed a complete 100 watt mobile television station for the Signal Corps. Housed in a 50' x 8' air-conditioned van were live pickup equipment, two film camera chains, and completely self-contained studio control room and transmitter. Several antennas for either omni-directional or uni-directional coverage were supplied.

REMOTE PICK-UP EQUIPMENT

M-30B/TPS REMOTE PICK-UP TRANSMITTER



- APPLICATION:**
Broadcast Remote Pick-up.
- R.F. OUTPUT:**
30 Watts, continuous.
- FREQUENCY:**
152-172 megacycles.
- CRYSTAL MULTIPLICATION:**
36.
- SPURIOUS EMISSION:**
Spurious radiation attenuated at least 70 db. below carrier level.
Harmonics suppressed at least 60 db.
- FREQUENCY STABILITY:**
 $\pm 0.0005\%$.
- TEMPERATURE RANGE:**
- 30 degrees C. to + 60 degrees C.
- MODULATION:**
30 F3 Maximum (Normally adjusted for ± 10 Kcs. swing).
- AUDIO INPUTS:**
Two (2). Can be adjusted for either 150 ohm or 600 ohm input.
Use of a 50, 150, or 250 ohm microphone will function satisfactorily into the 150 ohm input.
- AUDIO INPUT LEVEL:**
- 70 db.
- AUDIO CONNECTORS:**
Cannon XLR-3-31.
- POWER REQUIREMENTS:**
120 Volts AC or 12.6 Volts DC. (12 volt battery).
- MODULATION CONTROL:**
Push-pull Limiter.
- NOISE LEVEL OF TRANSMITTER:**
Better than - 45 db.
- OVERALL RESPONSE WITH MATCHED RECEIVER:**
 ± 2 db. from 75 to 7500 cycles.
- DISTORTION IN TRANSMITTER:**
Less than 3%.
- NET WEIGHT:**
16 pounds.
- DIMENSIONS:**
14" wide, 10" long, and 7" high.
- ORDERING INFORMATION:**
Remote Pick-Up Transmitter M30B/TPS (Specify frequency).

M-25C/MR-30/150-170 BASE STATION

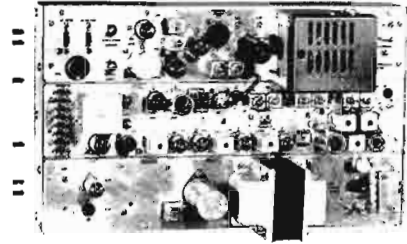

- APPLICATION:**
Base Station, communications-quality.
- R.F. OUTPUT:**
25 watts, Intermittent (EIA.).
- FREQUENCY:**
152-172 Mcs.
- CRYSTAL MULTIPLICATION:**
36 times.
- SPURIOUS EMISSION:**
Spurious Radiation attenuated at least 70 db. below carrier level. Harmonics suppressed at least 60 db.
- FREQUENCY STABILITY:**
 $\pm .0005\%$
- TEMPERATURE RANGE:**
- 30 degrees C. to + 60 degrees C.
(+ 25 Deg. C. is reference).
- MODULATION:**
25F3: Adjusted at factory; normally for a ± 7.5 Kcs. for 100% modulation at 1000 cycles.
- AUDIO INPUTS:**
Two (2). One for local control—a carbon microphone. Other for remote control—a two-wire telephone line.
- REMOTE CONTROL FACILITIES:**
Built-in line termination unit.
- POWER REQUIREMENTS:**
117-123 volts AC, 50 or 60 cycles.
- DUTY CYCLE:**
Intermittent (EIA.).
- FREQUENCIES POSSIBLE:**
Two; maximum spacing 120 Kcs.
- METERING:**
Multiple pin test socket.
- TUBE COMPLEMENT:**
Two 6BL8; one 7059; one 6360-A and one 8150.
- POWER SUPPLY:**
Silicon Rectifiers.
- DIMENSION:**
10½" x 19" (standard relay rack mounting).
- NET WEIGHT:**
28 pounds.
- ORDERING INFORMATION:**
Base Station M-25C/MR-30/150-170 (Specify frequency)

MR-30/150-170 RECEIVER



- APPLICATION:**
Remote Pickup.
- SENSITIVITY:**
0.6 microvolts or less for 20 db. quieting.
- FREQUENCY RANGE:**
152-172 megacycles.
- SELECTIVITY:**
- 100 db. at ± 32 kc; - 6 db. or less at ± 15 kc.
- SPURIOUS RESPONSE:**
All spurious and image responses attenuated at least 90 db.
- OVERALL RESPONSE:**
 ± 2 db; 60 to 7500 cycles with matching transmitter.
- FREQUENCY STABILITY:**
 $\pm 0.0005\%$ with crystal oven.
- TEMPERATURE RANGE:**
- 30 degree C. to + 60 degree C.
- AUDIO INPUT:**
+ 8 VU at 600 ohms.

Remote Pick-Up Equipment

METERING:

Signal strength and VU brought out to test Jacks. Visual metering optional.

TUBE COMPLEMENT:

(15 required. 8 tube types).
 6DS4—1st RF Amp. (Nuvistor), 6DS4—2nd RF Amp. (Nuvistor), 6DS4—1st Mixer (Nuvistor), 6DS4—HF Osc. Trip (Nuvistor), 6HS6—1st IF Amp., 12AT7—2nd Mixer & LF Osc., 6HS6—2nd IF Amp., 6HS6—3rd IF Amp., 6BH6—1st Limiter, 6BH6—2nd Limiter, 6AL5—Discriminator, 12AX7—Noise Amp., 12AT7—Noise Rect. & Relay Amp., 6CG7—Audio Amp., OB2—Voltage Reg.

DIMENSIONS:

10½" high; 19" wide, 9" deep. Panel finish—Hammer-tone Gray.

NET WEIGHT:

20 pounds.

ORDERING INFORMATION:

Receiver—M-30/150-170 Receiver (specify frequency).

Note: Extended frequency response to 12,000 cycles available upon special order.

ALSO, the same high quality radio remote pick-up equipment in use in over 750 radio and TV stations, is packed for Civil Defense application.

RA-4 BASE STATION ANTENNA

NOMINAL IMPEDANCE:

50 Ohms.

POLARIZATION:

Horizontal.

INPUT CONNECTOR:

SO-239.

AVERAGE GAIN:

6.0 db.

TYPICAL VSWR:

Under 1.5

POWER HANDLING CAPACITY:

60 Watts.

ORDERING INFORMATION:

Base Station Antenna RA-4



RA-4 Base Station Antenna.



Single Ring Antenna

SINGLE RING ANTENNA

Non-directional— ± 3.0 db; Horizontally polarized; Unity gain—Available with either a 22 inch support rod—tapped with a standard ⅜"-27 thread for mounting on a standard microphone floor stand (PA-1), or with a 50 inch support rod designed to be mounted on a standard communication type chain link bumper mount (MA-1).

ORDERING INFORMATION:

Antenna Single Ring for Floor Stand Mount PA-1.
 Bumper Mount Single Ring for Bumper Mount MA-1.

SPECIFICATIONS YC-ANTENNAS

NOMINAL IMPEDANCE:

50 Ohms.

INPUT CONNECTOR:

Type "AN"—SO-239.

POLARIZATION:

Horizontal or Vertical.

AVERAGE GAIN:

9 db.

TYPICAL VSWR:

Under 1.5.

TYPICAL REAR SIGNAL REJECTION:

25 db.

POWER HANDLING CAPACITY:

60 watts.

OPERATING FREQUENCIES:

(Model)

YC-153

YC-161

YC-166

YC-170

(Frequencies)

152.80—153.40 Mcs.

161.30—161.90 Mcs.

159.95—166.55 Mcs.

169.85—170.45 Mcs.

ORDERING INFORMATION:

Antennas YC-(Model Numbers), Specify Frequency.

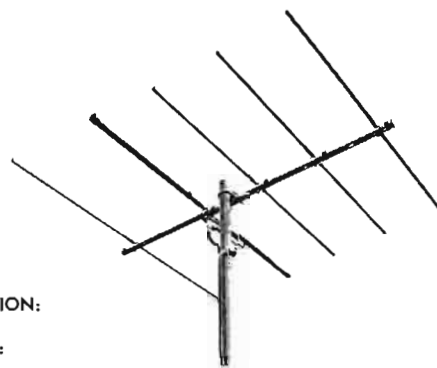

AVERAGE COVERAGE OF MODEL M-30B REMOTE PICK-UP TRANSMITTER OVER FLAT TERRAIN

| RECEIVING ANTENNA HEIGHT | ANTENNA COMBINATIONS | EXPECTED COVERAGE IN MILES |
|--------------------------|--------------------------|----------------------------|
| * 75 ft. | Receiving 5 Element Yagi | Transmitting Single Ring 9 |
| ** 150 ft. | 5 Element Yagi | Single Ring 13 |
| * 75 ft. | Stacked 5 Element Yagi's | Single Ring 11 |
| ** 150 ft. | Stacked 5 Element Yagi's | Single Ring 13 |
| * 75 ft. | 5 Element Yagi | 5 Element Yagi 14 |
| ** 150 ft. | 5 Element Yagi | 5 Element Yagi 18 |
| * 75 ft. | Stacked 5 Element Yagi's | 5 Element Yagi 16 |
| ** 150 ft. | Stacked 5 Element Yagi's | 5 Element Yagi 20 |
| ** 150 ft. | RA-4 Antenna | Single Ring 10 |
| *** 300 ft. | RA-4 Antenna | Single Ring 14 |
| ** 150 ft. | RA-4 Antenna | 5 Element Yagi 16 |
| *** 300 ft. | RA-4 Antenna | 5 Element Yagi 20 |

CODE:

- * Measurement based on length of RG-8U Transmission Line not to exceed 80 ft.
- ** Measurement based on length of RG-17U Transmission Line not to exceed 200 ft.
- *** Measurement based on length of ⅞" Heliac Line not to exceed 350 ft.

Note: The RA-4 antenna is not recommended on tower heights of less than 150 ft. in height.

The above measurements are based on a transmitting antenna height of 6 feet above surrounding objects. An increase in height of the transmitting antenna to 30 feet will increase the coverage by approximately 50%. It is suggested that RG-58U cable be used to assure minimum loss.

The Ring Antennas are non-directional within ± 3 db. The Yagi Antennas are uni-directional. The gain of the single Ring Antenna is unity. The gain of a YC-Series Yagi Antenna is 9.0 db. The gain of stacked YC-Series Yagi Antennas is 12.0 db. When using Yagi Antennas for receiving, we recommend a standard TV-Type Rotator.

TRANSMITTER CONTROL CONSOLES—VOLTAGE REGULATORS

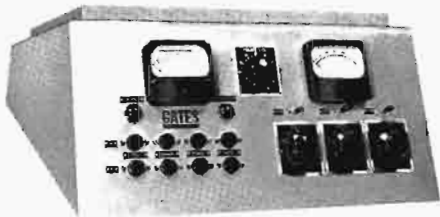

CCD-2 Transmitter control console.



Custom transmitter control console.

CONTROL CONSOLES

Transmitter control consoles are designed for use with any medium wave or short wave transmitter to provide a convenient and centralized "control center" to operate the transmitter. The CCD-2 Console pictured above is designed to accommodate the average single transmitter. Pictured top right is a custom designed console built to control three separate transmitters. Gates can design and build consoles for high powered 50 KW, or 100 KW transmitters or for any special application which cannot be served by the Model CCD-2 equipment.

SPECIFICATIONS For CCD-2 Console

- AUDIO INPUTS:**
Three 600 ohm channels provided with line isolation transformers.
- OUTPUT:**
600 ohms.
- MASTER GAIN:**
Balanced 30 steps, 1.5 db. per step.

- VU METER:**
4" square case with range control.
- MODULATION METER:**
4" square case illuminated. (see Note 1)
- PUSH BUTTONS:**
Four pairs provided for transmitter start-stop functions.
- PILOT LIGHTS:**
indicate transmitter filament and plate on.
- FINISH:**
Medium hand rubbed gloss gray with escutcheons in black.
- SIZE:**
24" wide, 10" high, 21½" deep.
- SHIPPING WEIGHT:**
60 lbs. Export packed 125. Cubage 6.0.

ORDERING INFORMATION

CCD-2 Transmitter Control Console (Cat. No.) M-4055

NOTE: Modulation extension meter supplied is to match Gates M-5693 or M-5774 modulation monitors. If other make of monitor is to be used, please specify. Price may be slightly higher in this case.

ELECTRONIC VOLTAGE REGULATORS

Available in ranges from 1 KVA to 70 KVA and in one or three phase systems. All models consist of two units: (1) the rack or cabinet type electronic control unit requiring only 5¼" x 19" of panel space, and (2) the rack or cabinet model motor driven variable transformer in 1 KVA or 2 KVA sizes. Sizes over 2 KVA have the motor driven variable transformer on a channel iron base as illustrated below. As the electronic voltage regulator is a device to move forward or backward a motor driven variable transformer, there is no problem in wave form, distortion such as often accompanies many types of regulators. Likewise the speed of voltage reset is fast enough for excellent operation with varying loads such as a Class B modulator. In addition, lesser than maximum loads will in no way upset either the regulation or wave form.

For all power ratings the M-5295 electronic control unit is identical. The electronic regulator may be adjacent or several hundred feet from the motor driven variable transformer. Six No. 16 AWG interconnecting wires are required between the two units.

Models for 115 volts and 230 volts, as well as single and 3 phase are available. All models are rated for either 50 or 60 cycles.

Outstanding feature of all models is the absolute regulation regardless of load conditions. As the electronic regulator actually operates from the output of the regulated supply, it is continually seeking to find the correct voltage if the load is full or zero. The operator may adjust from the front panel of the M-5294 regulator, the exact output voltage desired. For example, a 230 volt model may be set for 208 volts output and maintain regulation at this point.

SPECIFICATIONS

- SIZE:**
M-5294 regulator; rack model, 5¼" x 19" x 8½" deep.
M-5294A cabinet model regulator, 5¼" x 19" x 10" deep.
M-5295 complete 1 KVA regulator, 12¼" x 19" x 8½" deep.
M-5295A complete 1 KVA cabinet model, 14" x 21" x 10" deep.
M-5314 complete 2 KVA regulator, 12¼" x 19" x 8½" deep.
M-5314A complete 2 KVA cabinet model, 14" x 21" x 10" deep.
- Note:** Models 6 KVA and above have channel base mounting of motor driven variable transformers. Sizes vary as to power rating.
- REGULATION:**
± 20% variation of input voltage will allow constant output voltage as close as ± 1%, regardless of load.
- TUBES:**
6X4, 12AT7, 6AU6, OB2.
- FINISH:**
Medium gloss gray.
- RATINGS:**
The ratings shown under "Ordering Information" are for 60 cycles. For 50 cycles the rating is 80% of the 60 cycle rating.

For powers above 2 KVA. The motor driven variable transformer is channel mounted allowing use of the regulation transformer near the load, even though the electronic regulator may be several hundred feet away.



ORDERING INFORMATION

115 Volt, 50/60 Cycle Automatic Voltage Regulators, Single Phase

| Cat. | Rating | Style |
|---------|--------|--------------------------------|
| M-5295 | 1 KVA | Rack Mounted |
| M-5295A | 1 KVA | With Wall Mounted Control Unit |
| M-5314 | 2 KVA | Rack Mounted |
| M-5314A | 2 KVA | With Wall Mounted Control Unit |
| M-5315 | 6 KVA | With Rack Mounted Control Unit |
| M-5315A | 6 KVA | With Wall Mounted Control Unit |
| M-5316 | 15 KVA | With Rack Mounted Control Unit |
| M-5316A | 15 KVA | With Wall Mounted Control Unit |

230 Volt, 50/60 Cycle Automatic Voltage Regulators, Single Phase

| Cat. | Rating | Style |
|---------|----------|--------------------------------|
| M-5317 | 2.4 KVA | Rack Mounted |
| M-5317A | 2.4 KVA | With Wall Mounted Control Unit |
| M-5318 | 7.5 KVA | With Rack Mounted Control Unit |
| M-5318A | 7.5 KVA | With Wall Mounted Control Unit |
| M-5319 | 27.5 KVA | With Rack Mounted Control Unit |
| M-5319A | 27.5 KVA | With Wall Mounted Control Unit |

230 Volt, 50/60 Cycle Automatic Voltage Regulators, Three Phase

| Cat. | Rating | Style |
|---------|--------|--------------------------------|
| M-5320 | 10 KVA | With Rack Mounted Control Unit |
| M-5320A | 10 KVA | With Wall Mounted Control Unit |
| M-5321 | 20 KVA | With Rack Mounted Control Unit |
| M-5321A | 20 KVA | With Wall Mounted Control Unit |
| M-5322 | 45 KVA | With Rack Mounted Control Unit |
| M-5322A | 45 KVA | With Wall Mounted Control Unit |
| M-5323 | 70 KVA | With Rack Mounted Control Unit |
| M-5323A | 70 KVA | With Wall Mounted Control Unit |



EMERGENCY POWER GENERATORS

12 KW, 10 KW and 7½ KW GENERATORS

Six models to deliver 12,000 watts, 10,000 watts and 7,500 watts continuous duty. Powered by Wisconsin 4-cycle, L-head, V-cylinder, air-cooled gasoline engine. Exhaust valves are Stellite faced. Includes oil filter, fuel pump with filter, oil bath air cleaner and built-in flyball type adjustable governor. Has 12-volt electric starter and may be remote starting if desired. Generator is heavy duty 4-pole, 1800 RPM rotating armature design.* Control box is integrally mounted with the generator and contains: (a) starter solenoid, (b) charge rate ammeter, (c) reverse current protection, (d) start-stop switch and (e) high-low rate switch for charging 12-volt battery. Automatic remote starting and transfer panels listed below. Supplied less 12-volt battery and fuel tank (listed below). All models are electric start and have provision for remote starting.

Use one of these models for a 1000, 500 or 250 watt transmitter, AM or FM, with ample extra power to operate audio, nominal building lights, heating system and tower lights.

12 KW, 115/230 volts A.C., 1 phase, 3 wire (52 amperes) 12RKPBW-3R
 12 KW, 230 volts A.C., 3 phase, 3 wire (30 amperes) 12RKPBW-5R



10 KW, 115/230 volts A.C., 1 phase, 3 wire (43.5 amperes) . . 10RPBW4D-3RS
 10 KW, 120/208 volts A.C., 3 phase, 4 wire (27.8 amperes) . 10RPBW4D-4RS
 7.5 KW, 115/230 volts A.C., 1 phase, 3 wire (33 amperes) . . 705RPBW4D-3R
 7.5 KW, 230 volts A.C., 3 phase, 3 wire (18.8 amperes) . . . 705RPBW4D-5R
 *3600 R.P.M. for 12,000 watt models.

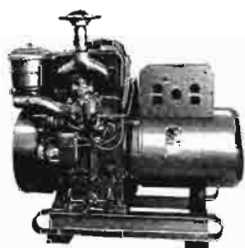

5000 WATT GENERATORS

This model will handle a 1 KW transmitter alone or a 250 watt transmitter with nominal lights, audio and heat. Should supply studio-only standby needs beautifully and many homes find this model the correct size. Has 4-cycle, L-head, 2-cylinder Wisconsin

engine with heavy duty, 4-pole, 1800 RPM rotating armature A.C. generator. Manual start models have 3½ gallon fuel tank and hand choke. Electric start models have diaphragm type fuel pump and electric choke but gasoline tank is not supplied (see accessories below). Control box for remote models includes: (a) battery charging ammeter, (b) start-stop buttons, (c) Hi-Lo rate battery charging control, (d) reverse current protection and terminals for battery and remote control starting. Electric models have same starting and battery charging equipment as remote models but no terminals for remote control.

5 KW, 115/230 volts A.C., 1 phase, 3 wire (22 amperes)
 manual start (Cat. No.) 5RPBW40-3M
 5 KW, 115/230 volts A.C., 1 phase, 3 wire (22 amperes)
 remote start 5RPBW40-3R
 5 KW, 115/230 volts A.C., 1 phase, 3 wire (22 amperes)
 electric start 5RPBW40-3E

1500 WATT GENERATORS

This generator will operate a complete radio studio with nominal lights. It is also excellent for field work such as mobile vans with low power transmitter, public address and nominal lighting. Briggs and Stratton 4 H.P., 4-cycle engine with Pulsa-Jet carburetor. Gas tank has 3-quart capacity. Consumes about 1 quart per kilowatt hour. Generator is designed for high efficiency and long life. Integral control box has grounding type duplex receptacle. Screw type light socket is provided on top of control panel for light bulb where needed for local lighting around generator. Available in electronic and manual start models.

1.5 KW, 115 volts A.C., 1 phase, 2 wire (13 amperes)
 electric start 105RPBB40-1E16
 1.5 KW, 115 volts A.C., 1 phase, 2 wire (13 amperes)
 manual start 105RPBB40-1M16

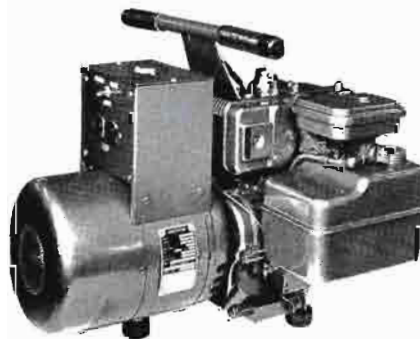

ACCESSORIES FOR GENERATORS

55 Gallon underground gasoline tank (Cat. No.) 22314
 15 Gallon gasoline tank 43697
 5 Gallon gasoline tank 23878
 25 ft. fuel line kit for use with 55 and 15 gd. tanks. 22312
 Manual transfer switch, outside type, 200 ampere rating
 3 pole to transfer from public utility to generator 23255

60 amperes, 115/230 V.A.C., 1 phase, 3 wire* 60ETC3
 60 amperes, 230 V.A.C., 3 phase, 3 wire 60ETC5
 100 amperes, 115/230 V.A.C., 1 phase, 3 wire* 100ETC3
 100 amperes, 230 V.A.C., 3 phase, 3 wire 100ETC5
 200 amperes, 115/230 V.A.C., 1 phase, 3 wire* 200ETC3
 200 amperes, 230 V.A.C., 3 phase, 3 wire 200ETC5

*Neutral switched line side only.

Emergency transfer controls automatically switch from public utility to generator. Amperage rating should be equal to that of service to building by public utility. Be sure and state type and size of generator when ordering. Wall mount.

NOTES: (1) A 12-volt storage battery can be supplied by Gates but as it is universally available, we suggest local purchase. (2) Models in 750, 1000, 2000, 2500 and 3500 watts also available, prices on request. (3) All models listed are 60 cycles but are available for 50 cycles at about 20% reduction in output rating.

Emergency Power Generators

25KW AND 50KW GASOLINE POWERED

Perhaps the finest higher power generating systems made today. Ratings are absolute continuous duty which means they will power your equipment for days, weeks or months with only routine maintenance. All of the usually additional extras are included such as: (1) engine-generator base, (2) radiator, (3) control panel switchboard, and (4) engine controls. **Engine features** include International Harvester engine, mechanical governor, 3% regulation, starting motor, battery charging system, oil pressure gauge, water gauge, high water temperature shut down and alarm, low oil pressure shut down and alarm and much else. **Generator features** include General Electric brushless A.C. generator, flexible steel coupling disc for correct alignment, revolving type field, static voltage regulator for 1% regulation and

plant mounted switchboard.

COMPLETE READY TO RUN PACKAGE: Yes, all you have to do is add lubricating oil, fuel, and water or coolant; it is a complete packaged electric-power generating plant; ready to go to work for you. Before leaving the factory, every Engine Generator has been completely checked, inspected, run-in, and approved. This does not mean that the unit has just been started up and run. It does mean that all gauges, relays, governor-controls, etc., have been checked out by test engineers. Engine and generator are mounted on a common welded structural-steel base, assuring permanent alignment and sturdy installation without costly foundation. Instrument Control Cabinet and Load Terminal Box are mounted and completely wired at our plant. Engine-cooling is ample even for the tropics.

25 KW — 60 CYCLES OR 21 KW — 50 CYCLES
(continuous duty 6 cylinder engine)

60-CYCLE ENGINE GENERATORS

| MODEL | KW RATING | VOLTAGE | PHASE | WIRE | Y OR Δ | ENGINE SPEED | STARTING CONTROLS (ELECTRIC) |
|---------|-----------|---------|-------|------|--------|--------------|------------------------------|
| 25G60-1 | 25 | 120 | 1 | 2 | | 1800 | Push-Button |
| 25G60-2 | 25 | 240 | 1 | 2 | | 1800 | Push-Button |
| 25G60-3 | 25 | 120/240 | 1 | 3 | | 1800 | Push-Button |
| 25G60-4 | 25 | 240 | 3 | 3 | Y | 1800 | Push-Button |
| 25G60-5 | 25 | 480 | 3 | 3 | Y | 1800 | Push-Button |
| 25G60-6 | 25 | 120/208 | 3 | 4 | Y | 1800 | Push-Button |
| 25G60-7 | 25 | 277/480 | 3 | 4 | Y | 1800 | Push-Button |
| 25G60-8 | 25 | 120/240 | 3 | 4 | Δ | 1800 | Push-Button |

50-CYCLE ENGINE GENERATORS

| MODEL | KW RATING | VOLTAGE | PHASE | WIRE | Y OR Δ | ENGINE SPEED | STARTING CONTROLS (ELECTRIC) |
|---------|-----------|---------|-------|------|--------|--------------|------------------------------|
| 25G50-1 | 21 | 100 | 1 | 2 | | 1500 | Push-Button |
| 25G50-2 | 21 | 200 | 1 | 2 | | 1500 | Push-Button |
| 25G50-3 | 21 | 100/200 | 1 | 3 | | 1500 | Push-Button |
| 25G50-4 | 21 | 200 | 3 | 3 | Y | 1500 | Push-Button |
| 25G50-5 | 21 | 400 | 3 | 3 | Y | 1500 | Push-Button |
| 25G50-6 | 21 | 120/208 | 3 | 4 | Y | 1500 | Push-Button |
| 25G50-7 | 21 | 220/380 | 3 | 4 | Y | 1500 | Push-Button |
| 25G50-8 | 21 | 240/416 | 3 | 4 | Y | 1500 | Push-Button |

KW ratings are continuous. Standby ratings are 10% higher.

Approx. weights and content: net, 2050 lbs. ... gross (domestic) 2190 lbs. ... (export) 2515 lbs. ... 105 cubic feet

50 KW — 60 CYCLES OR 42 KW — 50 CYCLES
(continuous duty 8 cylinder engine)

60-CYCLE ENGINE GENERATORS 1 Phase 1.0 PF, 0.8 PF—3 Phase 0.8 PF

| MODEL | KW RATING | VOLTAGE | PHASE | WIRE | Y OR Δ | ENGINE SPEED | STARTING CONTROLS (ELECTRIC) |
|---------|-----------|---------|-------|------|--------|--------------|------------------------------|
| 50G60-1 | 50 | 120 | 1 | 2 | | 1800 | Push-Button |
| 50G60-2 | 50 | 240 | 1 | 2 | | 1800 | Push-Button |
| 50G60-3 | 50 | 120/240 | 1 | 3 | | 1800 | Push-Button |
| 50G60-4 | 50 | 240 | 3 | 3 | Y | 1800 | Push-Button |
| 50G60-5 | 50 | 480 | 3 | 3 | Y | 1800 | Push-Button |
| 50G60-6 | 50 | 120/208 | 3 | 4 | Y | 1800 | Push-Button |
| 50G60-7 | 50 | 277/480 | 3 | 4 | Y | 1800 | Push-Button |
| 60G60-8 | 50 | 120/240 | 3 | 4 | Δ | 1800 | Push-Button |

50-CYCLE ENGINE GENERATORS 1 Phase 1.0 PF, 0.8 PF—3 Phase 0.8 PF

| MODEL | KW RATING | VOLTAGE | PHASE | WIRE | Y OR Δ | ENGINE SPEED | STARTING CONTROLS (ELECTRIC) |
|---------|-----------|---------|-------|------|--------|--------------|------------------------------|
| 50G50-1 | 42 | 100 | 1 | 2 | | 1500 | Push-Button |
| 50G50-2 | 42 | 200 | 1 | 2 | | 1500 | Push-Button |
| 50G50-3 | 42 | 100/200 | 1 | 3 | | 1500 | Push-Button |
| 50G50-4 | 42 | 200 | 3 | 3 | Y | 1500 | Push-Button |
| 50G50-5 | 42 | 400 | 3 | 3 | Y | 1500 | Push-Button |
| 50G50-6 | 42 | 120/208 | 3 | 4 | Y | 1500 | Push-Button |
| 50G50-7 | 42 | 220/380 | 3 | 4 | Y | 1500 | Push-Button |
| 50G50-8 | 42 | 240/416 | 3 | 4 | Y | 1500 | Push-Button |

Approx. weights and content: net, 3400 lbs. ... gross (domestic) 3600 lbs. ... (export) 3900 lbs. ... cubic feet, 140

OTHER GENERATORS: Gates supplied Ready Power A.C. generating equipments are available up to 200 KW in gasoline and diesel engine models. Quotations will be speedily

handled on receipt of your power needs. A wide variety of accessories are available for immediate quotation.

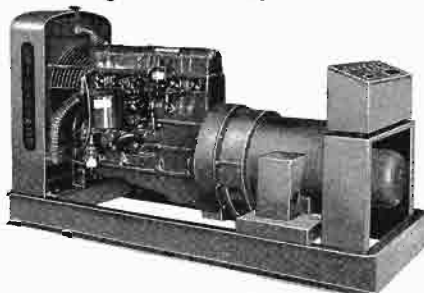

Model 25G60 Generator for 25 KW continuous duty service.

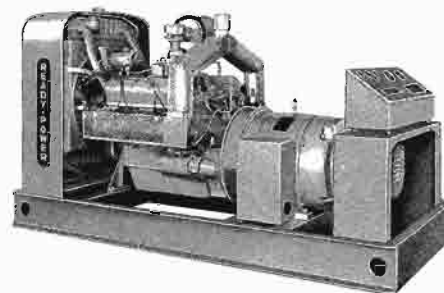

Model 50G60 Generating Plant for 50 KW continuous duty service.

RADIO FREQUENCY OSCILLATORS



Frequency Shift Keyer



Crystal Oscillator-Multiplier



Variable Master Oscillator

FREQUENCY SHIFT KEYS

The frequency shift keyer with its power supply, is a very high stability radio frequency oscillator which provides a means for shifting an RF carrier in accordance with the intelligence. This exciter replaces the crystal oscillator in a transmitter and produces "mark" and "space" carrier shift for transmission of teleprinter or telegraph signals or a linear carrier shift for transmission of FM telephone, facsimile or telephoto.

The frequency shift keyer is composed of 6 main sections; a keying circuit, reactance tube shifted oscillator, crystal oscillator, modulator, buffer amplifier and power amplifier. A keying signal passing through the keying stage is limited in amplitude and then fed to the reactance tube oscillator where it is used to vary frequency in accordance with the applied intelligence. This shift frequency is mixed in the modulator stage with the output from one crystal oscillator and the sum frequency is fed to the buffer amplifier for improved selectivity. The buffer output is used to drive the power amplifier.

SPECIFICATIONS

FREQUENCY RANGE: 1.0-7.0 Mc. **FREQUENCY SHIFT:** Adjustable from 0 to 1000 cycles. **OUTPUT POWER:** 3 watts into 50 to 75 ohms. **SPURIOUS OUTPUT:** - 50 db. or better. **KEYING SIGNAL INPUT:** 0 volts for space (lower) frequency; and + 15 to + 150 volts for mark (higher) frequency. **INPUT:** 120,000 ohms. **KEYING SPEED:** 240 dot cycles per second. **OVERALL STABILITY:** 10 cycles for ambient range from 0° C to 50° C (Mark and space frequencies). **CRYSTAL SOCKETS:** 3 crystal sockets are provided with an associated switch. **POWER REQUIREMENTS:** Frequency 50/60 cycles per second, voltage 115 volts ± 10% or 230 volts ± 10%. **POWER INPUT:** 270 watts. **NET WEIGHT:** 60 lbs.—domestic packed, 89 lbs., export packed, 121 lbs. **Cubage:** 8.0 **DIMENSIONS:** Power supply 19" wide, 5¼" high, 9" deep, keyer 10½" high, 19" wide, 15" deep.

MASTER CRYSTAL OSCILLATOR-MULTIPLIER:

The master crystal oscillator-multiplier, is a stable crystal controlled, high frequency oscillator (HFO) covering the range of 2 Mc. to 4 Mc. and low frequency oscillator (BFO) covering the range of IF frequencies in general use in communications receivers. This BFO is used particularly with diversity receivers or where crystal stability is desired.

In addition to the oscillator, the unit contains a multiplier to extend the HFO range or to multiply the frequency from an external HFO oscillator. It is particularly useful as an adjunct to the variable master oscillator, type 173, model 2, where it extends the output frequency range of the variable oscillator to cover the 4 to 32 Mc. range and increases the power to 2 watts in the 2 Mc. to 4 Mc. range. It also provides for four crystal controlled frequencies in the 2 Mc. to 32 Mc. range, two of which may be the precision temperature control type having self-contained ovens. Heater supply power for this type oven is provided by the type 108, model 2 equipment.

SPECIFICATIONS

CRYSTAL SOCKETS: (2) standard 5 prong, (2) 2 prong, ¼" pin ¾" center-center. **OUTPUT FREQUENCIES:** 2-32 Mcs. **CRYSTAL FREQUENCIES:** 2-4 Mcs. **OUTPUT IMPEDANCE:** 75 ohms. **OUTPUT LEVEL:** 2 watts at 2-4 Mcs. 0.5 watts at 4-32 Mcs. **OUTPUT VOLTAGE:** Sinusoidal for all frequencies. **OUTPUT CONNECTIONS:** Coaxial (3) located at rear of chassis.

FREQUENCY MULTIPLIER: INPUT CONNECTION: Coaxial (1) located at rear of chassis. **INPUT IM-**

PEDANCE (J2): 75 ohms. **INPUT FREQUENCIES (J2):** 2-4 Mcs. **INPUT LEVEL: (J2):** 4-12 volts.

BF CRYSTAL OSCILLATOR: **CRYSTAL SOCKETS:** (2) 2 prong, ¼" pin ¾" center-center. **OUTPUT FREQUENCIES:** 400-800 KC (nominal). **CRYSTAL FREQUENCIES:** 400-800 KC (nominal). **OUTPUT LEVEL:** Approximately 3 volts across 1,000 ohms. **OUTPUT CONNECTIONS:** Coaxial (3) located on rear of chassis. **OUTPUT VOLTAGE:** Sinusoidal for all frequencies. **PRIMARY POWER:** 110/220 volts 50/60 cycles approximately 80 watts. **DIMENSIONS:** 19" wide, 3½" high, 14" deep. **WEIGHT:** Export packed, 50 lbs. **Cubage** 2.8.

VARIABLE MASTER OSCILLATOR:

The variable master oscillator provides a continuously variable source of radio frequency energy with a stability of approximately 1 cycle per megacycle in the range of 2 Mc. to 4 Mc. It has sufficient output to replace existing oscillators wherever a more stable and variable unit is required. It may be used as a base control oscillator for diversity receivers, high frequency transmitters, and other communications devices, or as a laboratory standard for test and measurement functions.

Its ease of operation and direct reading of frequency make it an outstandingly useful device where precise frequency control must be maintained by completely unskilled personnel. No curves and calculations of any kind are required in its use. The frequency is set approximately to the desired value by rotating the oscillator dial. The last three digits of the frequency are set up on switches and when the locking switch is thrown on, the frequency automatically pulls into the value preset on the switches and holds with an accuracy that exceeds that of most temperature control crystal oscillators.

SPECIFICATIONS

OUTPUT FREQUENCY: 2-4 Mc. continuously variable. **STABILITY FOR ANY COMBINATION OF AMBIENT TEMPERATURE RANGE FROM 0 to 50°C. AND LINE VOLTAGE OF 115 or 230 ± 10%:** Better than 0.2 parts per million ± 2.5 cycles for any 12 hour period. Better than one part per million ± 2.5 cycles for any 30 day period. **OUTPUT LEVEL:** ½ watt into 75 ohm load. Level control on rear of chassis. **OUTPUT CONNECTIONS:** Two female coaxial type 83-1R (SO-239) in parallel. **READABILITY:** ± 2.5 cycles per second. **Direct digital readout on mechanical and electronic counters. RESET-ABILITY:** Absolute.

BEAT FREQUENCY OSCILLATOR: **OUTPUT FREQUENCY:** 400-800 KC crystal controlled. **OUTPUT LEVEL:** 3.5 volts into 1000 ohm load. Level control on rear of chassis. **OUTPUT CONNECTIONS:** Two female coaxial type 83-1R (SO-239) in parallel. **CRYSTAL:** (2).

TIME BASE CRYSTAL OSCILLATOR: **OUTPUT FREQUENCY:** 100 KC. **STABILITY FOR 0 to 50°C. AND ± 10% LINE VOLTAGE CHANGE:** 0.2 parts per million for any 12 hour period. 1.0 part per million on a thirty day period. **OUTPUT LEVEL:** Approximately 2 volts. **OUTPUT IMPEDANCE:** Approximately 100,000 ohms. **PRIMARY POWER:** 115/230 volts 50/60 cps. Approximately 350 watts. **MOUNTING:** Standard 19" rack. **DIMENSIONS:** Main Chassis: 19" wide, 15½" deep, 10½" high. Power Supply: 19" wide, 13" deep, 5¼" high. **WEIGHT:** Oscillator: Approximately 42 pounds. Power Supply: Approximately 55 pounds. Total weight export packed: 185 lbs. **Cubage:** 8.0

ORDERING INFORMATION

Frequency shift keyer with power supply, for 115/230 volts (supplied wired for 115 volts), with tubes but less crystal .. 105, Model 6
 Crystal for FSK unit (state frequency) MC-8
 Master crystal oscillator 108, Model 2
 Crystal for Master crystal oscillator CR27A/U
 Variable Master Oscillator, complete with tubes 173, Model 2

TRANSMITTING TUBES



3CX2500F3



F-8550



6076



4CX5000A



WL5891

FAST SHIPMENT

Gates carries in inventory tens of thousands of tubes, large and small. Because of fast turnover, tubes are always fresh. This is important for warantee as all tubes are coded by the manufacture. Freshness is of vital importance for large transmitting tube where long shelf periods sometimes make tubes gaseous. Listed below are a few of the popular tubes for broadcasters. Scores of other types are on hand also.

HOW TO ORDER

Tubes may be ordered from Quincy, Ill. or Houston, Texas. Shipment will be made as you direct, airex, air freight, rail express. The price you pay is no more as Gates is in the business to sell tubes. The freshness is always a Gates exclusive. Order by tube type number or IBM number as you prefer. Example: tube number is OA2. The IBM number is 370-0001.

Small Tubes for Audio, Exciters and Monitors

| TUBES | NUMBER | TUBES | NUMBER |
|-----------|----------|---------|----------|
| OA2 | 370-0001 | 6H6 | 370-0080 |
| OA3/VR75 | 370-0005 | 6J6 | 370-0082 |
| OB2 | 370-0002 | 6J7 | 370-0083 |
| OB3/VR90 | 370-0006 | 6L6GC | 370-0086 |
| OC3/VR105 | 370-0007 | 6SA7 | 370-0090 |
| OD3/VR150 | 370-0008 | 6SC7 | 370-0091 |
| 1X2A | 370-0012 | 6SQ7 | 370-0092 |
| 1612 | 370-0146 | 6SH7 | 370-0093 |
| 1622 | 370-0149 | 6SJ7 | 370-0094 |
| 3B28 | 374-0002 | 6SK7 | 370-0095 |
| GZ34/5AR4 | 370-0133 | 6SN7GTB | 370-0097 |
| 5BP1A | 378-0003 | 6SG7 | 370-0092 |
| 5U4GB | 370-0017 | 6V6GT | 370-0102 |
| 5V4GA | 370-0230 | 6W4GT | 370-0103 |
| 5Y3GT | 370-0020 | 6X4 | 370-0105 |
| 6AC7 | 370-0023 | 6X5GT | 370-0106 |
| 6AG7 | 370-0025 | 6Y6G | 370-0108 |
| 6AH6 | 370-0027 | 6386 | 370-0213 |
| 6AK6 | 370-0029 | 12AT7 | 370-0112 |
| 6AL5 | 370-0030 | 12AU7 | 370-0114 |
| 6AQ5A | 370-0032 | 12AX7 | 370-0116 |
| 6AS7GA | 370-0171 | 12AY7 | 370-0017 |
| 6AU6 | 370-0040 | 12BY7A | 370-0123 |
| 6BA6 | 370-0046 | 12SA7 | 370-0125 |
| 6BG6GA | 370-0052 | 12SJ7 | 370-0126 |
| 6C5 | 370-0065 | 12SK7 | 370-0127 |
| 6CA7 | 370-0066 | 12SQ7 | 370-0129 |
| 6CB5A | 370-0067 | 5749 | 370-0153 |
| 6CD6GA | 370-0176 | 5879 | 370-0155 |
| 6CL6 | 370-0071 | EF86 | 370-0144 |
| 6F6 | 370-0079 | 6080 | 370-0158 |

Transmitting Tubes to 20 KW

| TUBES | NUMBER | TUBES | NUMBER |
|------------|----------|--------------|----------|
| 3CX2500F3 | 374-0093 | 812A | 374-0033 |
| 3X2500F3 | 374-0004 | 813 | 374-0034 |
| 4CX2500F3 | 374-0093 | 815 | 374-0036 |
| 4-1000A | 374-0011 | 829B | 374-0038 |
| 4-400A | 374-0010 | 833A | 374-0039 |
| 4-250A | 374-0009 | 845 | 374-0040 |
| 4CX250B | 374-0081 | 857B | 374-0041 |
| 4CX5000A | 374-0016 | 866A | 374-0042 |
| 4CX10,000D | 374-0077 | 872A | 374-0043 |
| 4X150A | 374-0018 | 885 | 378-0008 |
| 4X250B | 374-0019 | 891R | 374-0044 |
| 4-65A | 374-0007 | 892R | 374-0046 |
| 250TH | 374-0023 | 5763 | 374-0048 |
| 4-125A | 374-0008 | 5894A AX9903 | 374-0049 |
| 450TH | 374-0025 | 6076 | 374-0050 |
| 5R4GY | 374-0020 | 6146 | 374-0051 |
| 575A | 374-0026 | 6360 | 374-0054 |
| 673 | 374-0027 | 8008 | 374-0058 |
| 807 | 374-0030 | 8008XE | 374-0059 |
| 810 | 374-0031 | WL5891 | 374-0067 |
| 811A | 374-0032 | 4CX3000A | 374-0074 |
| | | 8122 | 374-0096 |

Transmitting Tubes Above 20 KW

| TUBES | NUMBER | TUBES | NUMBER |
|--------|----------|-------------|----------|
| W-5891 | 374-0067 | 4CX15,000 | 374-0097 |
| F-6804 | 374-0056 | 4CV100,000C | 374-0098 |
| F-8550 | 374-0091 | 4CX35,000 | 374-0099 |



FIXED ATTENUATOR DATA

The data shown below provides information to construct H pads, commonly used in audio applications. Usually 1/2 watt resistors are sufficient. 5% resistors are recommended.

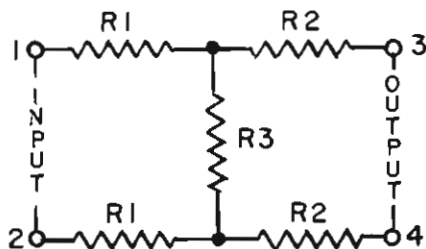

| DB LOSS | R1 OHMS | R2 OHMS | R3 OHMS |
|--------------------------------|---------|---------|---------|
| 600 OHMS Input/600 OHMS Output | | | |
| 1 | 18 | 18 | 2700 |
| 2 | 36 | 36 | 1300 |
| 3 | 51 | 51 | 820 |
| 4 | 68 | 68 | 620 |
| 5 | 82 | 82 | 470 |
| 6 | 100 | 100 | 390 |
| 7 | 110 | 110 | 330 |
| 8 | 130 | 130 | 240 |
| 9 | 150 | 150 | 220 |
| 10 | 160 | 160 | 200 |
| 12 | 180 | 180 | 150 |
| 15 | 220 | 220 | 110 |
| 20 | 240 | 240 | 62 |
| 25 | 270 | 270 | 33 |
| 30 | 270 | 270 | 18 |
| 35 | 300 | 300 | 10 |
| 40 | 300 | 300 | 5.6 |
| 600 OHMS Input/150 OHMS Output | | | |
| 12 | 270 | ±3.3 | 82 |
| 15 | 270 | 24 | 56 |
| 20 | 270 | 47 | 30 |
| 25 | 270 | 56 | 18 |
| 30 | 300 | 62 | 10 |
| 35 | 300 | 68 | ±4.7 |
| 40 | 300 | 75 | ±3.3 |
| 150 OHMS Input/150 OHMS Output | | | |
| 1 | 3.9 | 3.9 | 620 |
| 2 | 10 | 10 | 330 |
| 3 | 13 | 13 | 220 |
| 4 | 18 | 18 | 160 |
| 5 | 20 | 20 | 120 |
| 6 | 24 | 24 | 100 |
| 7 | 30 | 30 | 82 |
| 8 | 33 | 33 | 62 |
| 9 | 36 | 36 | 56 |
| 10 | 39 | 39 | 47 |
| 12 | 47 | 47 | 39 |
| 15 | 51 | 51 | 27 |
| 20 | 62 | 62 | 15 |
| 25 | 68 | 68 | 8.2 |
| 30 | 68 | 68 | 4.7 |
| 35 | 75 | 75 | 2.7 |
| 40 | 75 | 75 | 1.5 |
| 150 OHMS Input/50 OHMS Output | | | |
| 10 | 62 | 0 | 30 |
| 12 | 62 | 4.7 | 24 |
| 15 | 62 | 10 | 15 |
| 20 | 68 | 18 | 8.2 |
| 25 | 68 | 20 | 4.7 |
| 30 | 68 | 22 | 3.3 |
| 35 | 75 | 24 | 1.5 |
| 40 | 75 | 24 | 1.0 |

FREQUENCY VERSUS TOWER HEIGHT

For medium wave broadcast frequencies, the most used one-quarter wave tower height is shown as related to the operating frequency. For 3/8 wave length, multiply height shown by 1 1/2 and for 1/2 wave length, multiply height shown by 2. For insulated towers the height is usually considered above base insulators.

| Frequency in Kilocycles | Tower Height in Feet | Frequency in Kilocycles | Tower Height in Feet |
|-------------------------|----------------------|-------------------------|----------------------|
| 550 | 446.8 | 1080 | 227.7 |
| 560 | 439.5 | 1090 | 225.6 |
| 570 | 431.3 | 1100 | 223.6 |
| 580 | 423.9 | 1110 | 221.6 |
| 590 | 417.3 | 1120 | 219.7 |
| 600 | 410.0 | 1130 | 217.7 |
| 610 | 403.1 | 1140 | 215.6 |
| 620 | 396.8 | 1150 | 213.9 |
| 630 | 390.3 | 1160 | 211.9 |
| 640 | 386.5 | 1170 | 210.2 |
| 650 | 378.8 | 1180 | 208.6 |
| 660 | 373.1 | 1190 | 206.7 |
| 670 | 367.3 | 1200 | 205.0 |
| 680 | 361.1 | 1210 | 203.2 |
| 690 | 356.2 | 1220 | 201.5 |
| 700 | 351.2 | 1230 | 199.7 |
| 710 | 346.8 | 1240 | 198.4 |
| 720 | 341.9 | 1250 | 196.8 |
| 730 | 337.0 | 1260 | 195.2 |
| 740 | 332.1 | 1270 | 193.6 |
| 750 | 328.0 | 1280 | 192.2 |
| 760 | 323.4 | 1290 | 190.7 |
| 770 | 319.8 | 1300 | 189.2 |
| 780 | 315.7 | 1310 | 187.7 |
| 790 | 311.6 | 1320 | 186.5 |
| 800 | 307.5 | 1330 | 184.9 |
| 810 | 303.4 | 1340 | 183.6 |
| 820 | 300.1 | 1350 | 182.2 |
| 830 | 296.0 | 1360 | 180.5 |
| 840 | 292.7 | 1370 | 179.5 |
| 850 | 289.4 | 1380 | 178.1 |
| 860 | 286.1 | 1390 | 176.5 |
| 870 | 282.9 | 1400 | 175.6 |
| 880 | 279.6 | 1410 | 174.2 |
| 890 | 276.3 | 1420 | 173.4 |
| 900 | 273.0 | 1430 | 172.0 |
| 910 | 270.6 | 1440 | 170.9 |
| 920 | 267.3 | 1450 | 169.6 |
| 930 | 264.8 | 1460 | 168.5 |
| 940 | 261.5 | 1470 | 167.3 |
| 950 | 259.1 | 1480 | 166.5 |
| 960 | 256.6 | 1490 | 165.0 |
| 970 | 253.3 | 1500 | 164.0 |
| 980 | 250.9 | 1510 | 162.9 |
| 990 | 248.4 | 1520 | 161.7 |
| 1000 | 246.0 | 1530 | 160.8 |
| 1010 | 243.7 | 1540 | 159.9 |
| 1020 | 241.1 | 1550 | 158.6 |
| 1030 | 238.8 | 1560 | 157.8 |
| 1040 | 236.5 | 1570 | 156.7 |
| 1050 | 234.2 | 1580 | 155.8 |
| 1060 | 232.0 | 1590 | 154.7 |
| 1070 | 229.9 | 1600 | 153.7 |

INDEX

| Item | Page | Item | Page |
|--|------------------|--|-----------------------|
| AM Broadcast Accessories | 30 | Cabinets, Compact Disc for LP Albums | 149 |
| AM Frequency Monitor | 31 | Cabinets, Rack | 146 |
| AM Transmitters | 4 thru 26 | Cabinets, Tape | 149 |
| Air Dielectric Coaxial Cable | 64 | Cabinets, Transcription | 113, 114, 149 |
| Ambassador Audio Console | 93-95 | Cable, Audio | 149 |
| Ampex Tape Recording Equipment | 153, 154 | Cable, Coaxial | 64, 65 |
| Amplifiers, Audio Plug-In | 128, 129 | Capacitors, Mica | 72 |
| Amplifiers, Broadcasting | 142 | Cartridges, Pickup | 115 |
| Amplifier, Cueing | 147 | Cartridges, Tape | 118-121 |
| Amplifiers, High Frequency Linear | 198, 199 | Carritape II | 122 |
| Amplifier, Limiting Dual Peak | 135, 136 | Charts: | |
| Amplifier, Monitor | 129 | Fixed Attenuator Data | 219 |
| Amplifier, Program or Line | 143 | Frequency Versus Tower Height | 219 |
| Amplifiers, Transistorized—System Type | 125 thru 129 | Chokes, Tower | 30 |
| Amplifier, Utility (single channel) | 142 | Coaxial Cable | 64, 65 |
| Amplifier, Ultra Linear | 143 | Coils, Isolation | 29 |
| Antenna Couplers | 26, 28, 29 | Communications Equipment | 182 thru 209 |
| Antenna Diode Units for Remote Control | 63 | Connectors, Audio | 149 |
| Antenna Meter, Remote | 29 | Conrac TV Monitors | 82 |
| Antenna Phasing Equipment | 27, 28 | Consoles, Audio Control | 83 thru 107, 110, 123 |
| Antenna Towers, AM, FM, TV | 67 | Consoles, Portable Audio | 122 |
| Antenna Tuning Equipment | 28-30 | Consoles, Speech Input | 83 thru 107, 110, 123 |
| Antennas, Cylindroid | 54, 55 | Consoles, Transmitter Control | 214 |
| Antennas, Dummy | 35 | Control Center | 92 |
| Antennas, FM Horizontal | 54, 55 | Control Desks | 116, 117 |
| Antennas, FM Vertical | 56, 57 | Control, Remote | 61, 62 |
| Antennas, High Frequency | 208 | Couplers, Antenna | 26, 28 |
| Antennas, Rhombic | 208 | Courier, 2-Channel Remote Amplifier | 133 |
| Antennas, Television | 81 | Cueing Amplifier | 147 |
| Arms, Pickup | 114 | Cue-Intercom Speaker | 148 |
| Attache, 3-Channel Remote Amplifier | 132 | Cycloid Antenna | 54, 55 |
| Audio Accessories | 147 thru 150 | | |
| Audio Amplifiers, System Type | 125 thru 130 | Desks, for Audio Control Consoles | 116, 117 |
| Audio Consoles | 83 thru 107, 123 | Diode & Pickup Coil | 152 |
| Audio Installations | 109 | Diplexer, High Frequency Multicouplers | 184 |
| Audio Oscillator | 152 | Diplomat Audio Control Console | 86-88 |
| Audio Terminal Blocks | 149 | Directional Antenna Phasing Equipment | 27, 28 |
| Automatic Gain Control Amplifiers, Audio | 135 thru 142 | Disc Cabinets | 149 |
| Average Level Amplifier (Level Devil) | 139, 140 | Distortion Meter | 152 |
| | | Dual Limiter, Audio | 135, 136 |
| Baffles & Speakers | 151 | Dualux Audio Control Console | 96, 97 |
| Baluns, High Frequency Transformers | 193 | Dummy Antennas | 35 |
| Base Station, Remote Pickup | 212 | Dynamote, 4-Channel Remote Amplifier | 130, 131 |
| Beacon Flasher, Solid State | 68 | | |
| Biamote, 2-Channel Remote Amplifier | 142 | Electronic Voltage Regulators | 214 |
| Boards, Control | 83 thru 107, 123 | Engine Generators, Emergency Power | 215, 216 |
| Boom Stands | 150 | Executive Audio Control Console | 83-85 |
| Broadband Vertical Radiator Antenna | 208 | Equalizers, Audio | 148 |
| Broadcast Modulation Monitor | 32, 33 | Equalized Preamplifiers | 115 |
| Broadcast Systems, Transportable | 210, 211 | Equalizers, Line | 148 |
| Bowls, Feed Thru | 66 | Equalizers, Transcription Turntable | 138 |
| Broadcast Transmitters, AM, FM, TV | 4 thru 80 | Eraser, Bulk-type Tape | 150 |
| | | Exciter, SSB | 180 |
| Cabinets, Console | 116, 117 | Exciters, RF | 217 |

| Item | Page | Item | Page |
|--|--------------|---|--------------|
| FM Antenna Towers | 67 | Limiting Amplifier, SA-39B | 138 |
| FM Antennas | 54 thru 57 | Line Amplifier, Rack Mount | 143 |
| FM Frequency Monitor | 58 | Linear Amplifiers, High Frequency— | |
| FM Link & Relay System | 51 | 1 KW thru 20 KW | 198, 199 |
| FM Monitors | 58, 59 | Loudspeakers & Enclosures | 151 |
| FM Relay Receiver | 51 | Low Frequency Homing Beacon Transmitter | 209 |
| FM SCA Generator, M-6160 | 53 | Magnacord Recorder/Reproducers | 155 |
| FM Stereo Generator, M-6146 | 52 | MeMartin FM Frequency Monitor | 58 |
| FM Top Level | 137 | Meter, Field Intensity | 34 |
| FM Transmitters | 36 thru 50 | Meter, Remote Antenna | 29 |
| FMR-88, Tuner-AM, FM, Stereo, SCA | 73 | Meter, VU, Desk or Console Top Mounting | 148 |
| Fader Knobs | 148 | Meter, VU and Range Panel | 147 |
| Feed-thru Bowls | 66 | Mica Capacitors | 72 |
| Filter Capacitors | 72 | Microphone Accessories | 150 |
| Fixed Equalizer | 148 | Microphones | 144, 145 |
| Field Intensity Meter | 34 | Modular Audio Equipment Cabinets | 116, 117 |
| Flasher, Beacon, Solid State | 68 | Modulation Monitor, AM | 32 |
| Flexible Coaxial Cable | 64 | Modulation Monitor, FM | 59 |
| Foam Dielectric Coaxial Cable | 64 | Modulation Monitor, HF | 179 |
| Frequency Monitor, AM Model 4990 | 31 | Monitor Amplifier | 129 |
| Frequency Monitor Extension Meters | 63 | Monitor, Frequency, AM | 31 |
| Frequency Monitor, FM | 58 | Monitor, Frequency, FM | 58 |
| Gain & Measuring Set | 152 | Monitor, Modulation, AM | 32, 33 |
| Gateway Audio Control Console | 98, 99 | Monitor, Modulation, FM | 58 |
| Generating Plants, Emergency Power | 215, 216 | Monitor, Modulation, HF | 179 |
| Generator, Stereo | 52 | Monitor, Phase | 34 |
| Generator, Sub-Carrier | 53 | Monitors, Television | 82 |
| Glossary Of Terms For Laymen | 74 | Multicoupler, High Power HF Transmitter | 184 |
| HF Antennas | 208 | Multiplex Generator, SCA | 53 |
| HF Transmitters, Broadcast | 157 thru 178 | Open Wire Transmission Line | 66 |
| HF Transmitters, Communications | 182 thru 209 | Ordering Procedures | 224 |
| HF Transmitter Multicoupler | 184 | Oscillator, Audio | 152 |
| Headphones | 150 | Panel and Shelf Assemblies | 127, 129 |
| Heliac Coaxial Cable | 64 | Patch Panels and Patch Cords | 148 |
| High Frequency Linear Amplifiers | 198, 199 | Peak Limiting Amplifier, SA-39B | 125 |
| High Frequency Matching Transformers | 193 | Phasing Equipment | 27, 28 |
| Homing Beacon Transmitter | 209 | Phase Monitor | 34 |
| Horizontal Log Periodic Antenna | 208 | Pickup Arms | 114 |
| Isolation Coil | 29 | Pickup Equalizer | 114 |
| Inductors | 72 | Pickup Cartridges | 115 |
| Installations, Audio | 108, 109 | Portable Tape Recorders | 153 thru 156 |
| Installations, High Power Transmitters | 2 | Power Supply, Plug-In Audio Amplifiers | 129 |
| Intercom, Studio Sub-Station | 148 | Preamplifiers, Turntable | 115 |
| Jack Strips and Accessories | 148 | President Audio Control Console | 89 |
| KD-20 Portable Console | 122 | Pressurization Equipment | 65 |
| Level Devil Amplifier | 139, 140 | Producer, Audio Recording Mixer | 123 |
| Leveling Amplifier | 139, 140 | Program Amplifier, Rack Mount | 143 |
| Lights, Studio Warning | 147 | Proof of Performance Equipment | 152 |
| Lights, Tower Accessories, etc. | 68 | RF Contactor | 30 |
| | | RF Meter Jack | 30 |
| | | Rack Cabinets | 146 |

| Item | Page | Item | Page |
|---|------------------|--|--------------|
| Recorders, Tape | 153 thru 156 | Terminal Blocks, Audio | 149 |
| Radio Frequency Oscillators | 217 | Terms, A Glossary For Laymen | 74 |
| Receiver, Remote Pickup | 212 | Test Equipment, Audio | 152 |
| Receiver, Single Channel SSB | 195 | Tower Chokes | 30 |
| Receiver, Six Channel Fixed Frequency SSB | 196 | Tower Lighting Isolation Coil | 29 |
| Recorders, Audio Cartridge | 118-121 | Tower Lights & Accessories | 68 |
| Recorders, Audio | 153-156 | Towers, Antenna, AM, FM, TV | 67 |
| Recording Tape | 156 | Top Level | 137 |
| Relay System, FM | 51 | Transceiver, Single Sideband | 194 |
| Remote Amplifiers, Audio | 130-134, 142 | Transcription Equipment Turntables, Amplifiers & Accessories | 111-115 |
| Remote Antenna Meters | 29 | Transcription Pickups | 115 |
| Remote Control Accessories | 63 | Transformers | 70, 71 |
| Remote Control System | 61, 62 | Transformers, High Frequency (Baluns) | 193 |
| Remote Metering Kits | 29 | Transformers, Speaker Matching | 148 |
| Remote Monitoring Meters | 63 | Transistor Audio Systems Amplifiers | 125 thru 129 |
| Remote Pickup Equipment | 212, 213 | Transmission Line, Coaxial | 64-65 |
| Rhombic Antenna, HF Antennas | 208 | Transmission Line, Open Wire | 66 |
| Sampling Loops | 30 | Transmitter Accessories | 34 |
| SCA Multiplex Generator | 53 | Transmitters (Broadcast/AM) | |
| SCA Multiplex Monitors | 29 | 100,000 Watt Model BC-100G Transmitter | 4-6 |
| Sideband Generator | 180, 181 | 50,000 Watt Model BC-50C Transmitter | 7-9 |
| Single Channel SSB Receiver | 195 | 20,000 Watt Model BC-20B Transmitter | 10 |
| Single Sideband Generator, SG-70 | 180, 181 | 10,000 Watt Model BC-10P Transmitter | 11-13 |
| Single Sideband Transceiver | 194 | 5,000 Watt Model BC-5P-2 Transmitter | 14-16 |
| Single Sideband Transmitters | 182 thru 195 | 1,000/250 Watt Model BC-1G Transmitter | 17-19 |
| Six Channel SSB Receiver | 196 | 1,000 Watt Model Vanguard I | 20-22 |
| Solid State Beacon Flasher | 68 | 500 Watt Model BC-500G Transmitter | 23 |
| Speech Input Systems | 83 thru 107, 123 | 250 Watt Model BC-250GY Transmitter | 24 |
| Speakers & Baffles | 151 | 100 Watt Model BC-01-GA Transmitter | 25, 26 |
| Speaker Matching Transformer | 148 | Transmitters (Broadcast/FM) | |
| Splicers, Tape | 150 | 20,000 Watt Model FM-20G Transmitter | 36-38 |
| Sta-Level Amplifier | 141 | 10,000 Watt Model FM-10C Transmitter | 39-41 |
| Stereo Audio Control Consoles | 83, 100 | 5,000-7,500 Watt Models FM-5G-7.5G Trans. | 42-44 |
| Stereo Audio Limiting Amplifier | 135, 136 | 1,000 Watt Model FM-1G Transmitter | 45, 46 |
| Stereo Generator | 52 | 1,000 Watt Model FM-1C Transmitter | 47 |
| Stereo Turntable Equipment | 113 | 250 Watt Model FM-250C Transmitter | 48 |
| STL System, FM | 51 | 50 Watt Model BFE-50C Transmitter | 49, 50 |
| Studio Cue/Intercom Speaker | 148 | 50 Watt Model BFR-50C Transmitter | 49, 50 |
| Studioette Audio Control Console | 104, 105 | 10 Watt Model BFE-10C Transmitter | 49, 50 |
| Studio Warning Lights | 147 | 50 Watt FM Relay System | 51 |
| Sub-Carrier Generator | 53 | 50 Watt STL System | 51 |
| Switch & Fuse Panel | 147 | Transmitters (Communications) | |
| Tape Cartridges | 122 | 50,000 Watt Model HF-50TX Transmitter | 200 |
| Tape Eraser, Bulk-Type | 150 | 20,000 Watt Model HF-20TX Transmitter | 201 |
| Tape Head Demagnetizer | 150 | 15,000 Watt Model THF-15 Transmitter | 204 |
| Tape Recorders | 153-156 | 10,000 Watt Model HF-10TX Transmitter | 202, 203 |
| Tape, Recording | 156 | 1,000 Watt Model FS-1000 Transmitter | 205 |
| Tape Splicer | 150 | 250 Watt Model CMG-1 Transmitter | 206 |
| Television Antennas | 81 | 85 Watt CW Transmitter Model M-5569G | 207 |
| Television Audio Control Console | 106, 110 | 65 Watt Telephone CW Trans. Model CM-65 | 207 |
| Television Monitors | 82 | Homing Beacon Transmitter | 209 |
| Television Transmitters | 75 thru 80 | | |

| Item | Page | Item | Page |
|--|----------|---|----------|
| Transmitters (Single Sideband) | | | |
| 20,000 Watt Model ST-20A Transmitter | 182, 183 | Transmitter, Remote Pickup | 212 |
| 10,000 Watt Model ST-10A Transmitter | 185-187 | Transmitting Tubes | 218 |
| 3,000 Watt Model ST-3A Transmitter | 188-190 | Transportable Systems, AN/TRQ-20 | 210, 211 |
| 1,000 Watt Model ST-1A Transmitter | 191, 192 | Tuner, 5 Way | 73 |
| 125 Watt Model STR-125 Transceiver | 194, 195 | Tuning Units, Antenna | 28-30 |
| Single Channel Receiver, Model SR-100 | 196 | Turntable Preamplifiers | 115 |
| Six-Channel Fixed Frequency Receiver | 197 | Turntables, Transcription | 111-114 |
| High Frequency Linear Amplifiers, 1 KW | | TV-10 Audio Control Console | 106, 107 |
| thru 20 KW | | TV Towers | 67 |
| Model HFL-1000 | 198 | Uher Portable Tape Recorder | 156 |
| Model HFL-3000 | 198 | Unique, Cueing Amplifier | 147 |
| Model HFL-10000 | 199 | Unimote, 1-Channel Remote or Microphone Amplifier | 134 |
| Model HFL-20000 | 199 | Utility Audio Amplifier | 142 |
| Transmitters (Television) | | | |
| 5,000 Watt Model BT-5C Transmitter | 75, 76 | Vanguard I | 20-22 |
| 500 Watt Model BT-500C Transmitter | 77, 78 | VA Program Fader Knobs | 148 |
| 120 Watt Model BT-100C Transmitter | 79 | Variable Equalizer | 148 |
| CGIR Television Transmitter | 80 | Vertical Log Periodic Antenna | 208 |
| Transmitters (High Frequency Broadcast) | | | |
| 250,000 Watt Model HC-114 Transmitter | 157-160 | Vertical Polarized FM Antenna | 56, 57 |
| 100,000 Watt Model HF-100 Transmitter | 161-164 | Voltage Regulators | 214 |
| 50,000 Watt Model HF-50C Transmitter | 165-168 | VU Meter, Desk or Console Top | 148 |
| 20,000 Watt Model HF-20B Transmitter | 169-171 | VU Meter & Range Panel | 147 |
| 10,000 Watt Model HF-10B Transmitter | 172-174 | Wall Baffles | 151 |
| 10,000 Watt Model BHF-10B Transmitter | 175, 176 | Warning Lights, Studio | 147 |
| 5,000 Watt Model HF-5B Transmitter | 177 | Yard Audio Control Console (Monophonic) | 102, 103 |
| 1,000 Watt Model HF-1M Transmitter | 178 | Yard Audio Control Console (Stereo) | 100, 101 |
| Transmitter, Control Console | 214 | Yagi Antennas, Remote Pickup Equipment | 213 |
| Transmitter, Multicoupler | 184 | | |

The mechanical and electrical design of the equipment described herein is subject to change without notice as deemed necessary by Gates Radio Company or its suppliers in the interest of advancing industry requirements or the state of the art.

HOW TO ORDER

ORDERING PROCEDURE: All sales are made in accordance with the standard Gates Terms and Conditions of Sale. No order shall be binding upon Gates until accepted by it in writing at its home office in Quincy, Illinois.

PRICES: Catalog prices are net, f.o.b. Quincy, Illinois, or point of shipment. Our prices are based on cash transactions and all applicable discounts have been deducted. Prices are subject to change without notice. Orders are filled at prices in effect at time of shipment. You will be billed for any price increase and credited for any price reduction. We reserve the right to add any federal, state, or local taxes required by law. If you have a tax exemption number, please include it with your order. These prices and terms apply only to the U.S. For prices and terms in other countries, please contact Export Department, Gates Radio Company.

PAYMENT: There are five ways to pay for your equipment purchases:

1. Cash—This means full payment with order.
2. C.O.D.—The amount due is collected by the delivery agent. A 25% down payment is required on C.O.D. orders.
3. Sight draft—Your local bank releases payment to us upon receipt of bill of lading. A 25% down payment is normally required.
4. Open Account—Payment to be remitted by you within 30 days after date of each invoice. This privilege is extended to established accounts with good payment records. If you do not have an established account, please provide a current financial statement, plus trade and bank references with your order. Allow about ten days to process the information.
5. Gates Finance Plan—On major purchases, by domestic customers, a portion of the cost may be financed through a monthly payment plan. A finance charge of 6% per annum will be added when the total amount of the order is less than \$4,000.00. On orders of \$4,000.00 or over, the finance charge is 4½% per annum. Title to and/or rights to the merchandise remain with Gates Radio Company until the balance is fully paid. Finance laws vary from state to state, but all states require the execution and acceptance of conditional sales contract, chattel mortgage, notes, or other documentation prior to shipment. You may not sell, remove, or encumber the merchandise covered by such contracts without Gates Radio Company's prior written consent, and you assume all responsibility for loss or damage. Acceptable insurance, with a loss payable clause naming Gates Radio Company,

is required for the full term of the contract. Since Gates financing plans are subject to change from time to time, contact our Credit Manager or your nearest Gates Sales Engineer for full information. The Gates finance plan applies only to the United States.

SHIPPING: Please specify method of shipment on your order. Shipping charges, insurance, and C.O.D. fees (when applicable) will be collected at time of delivery when shipment is by air, rail or motor freight, or express. If you request parcel post shipment, postage and insurance fees will be billed to your account. Purchaser assumes all responsibility for and risk of loss of, or damage, to, equipment upon shipment from Gates shipping point(s).

Should you receive merchandise damaged in shipment, it is your responsibility to file a damage claim immediately with the delivering carrier. Export packing for overseas shipment is available at slight extra charge.

RETURNS AND EXCHANGES: Do not return any merchandise without our written approval and return authorization. We will provide special shipping labels and a code number that will assure proper handling and prompt issuance of credit. Please furnish a detailed report to assure prompt handling of returned merchandise. Custom built equipment or merchandise specially ordered for you is not returnable. Where return of standard equipment is allowed by Gates, a restocking fee of 15% will be charged. All returned merchandise must be sent freight prepaid and properly insured by the customer. When writing to Gates Radio Company about your order, it will be helpful if you specify the Gates Factory Order Number or Invoice Number.

WARRANTY ADJUSTMENTS: In the event of equipment failure during the warranty period, replacement or repair parts may be provided in accordance with the provisions of the Gates Warranty. In most cases you will be required to return the defective merchandise or part to Gates f.o.b. Quincy, Illinois, for replacement or repair. Cost of repair parts or replacement merchandise will be billed to your account at the time of shipment and, as to repairs or replacement within warranty, compensating credit will be issued to offset the charge.

MODIFICATIONS: Gates reserves the right to modify the design and specifications of the equipment shown in this catalog without notice or to withdraw any item from sale provided, however, that any modification shall not adversely affect the performance of the equipment so modified.

PRICE LIST

(Applies to Catalog #96, Effective April 1st, 1965)

This is your price list for items listed in your Gates catalog. Each price has been carefully checked for accuracy. Rapidly changing conditions as well as the human element, will necessitate price changes or corrections from time to time. Therefore, the prices herein are subject to change without notice.—All prices are F.O.B. Quincy, Illinois or point of manufacture.

| CAT. PAGE | TYPE NUMBER | PRODUCT DESCRIPTION | UNIT PRICE | CAT. PAGE | TYPE NUMBER | PRODUCT DESCRIPTION | UNIT PRICE |
|---------------------------|----------------------|--|-------------|-----------|----------------------|---|------------|
| AM BROADCAST TRANSMITTERS | | | | | | | |
| 6 | BC-100G (M-5967A) | 100 KW AM broadcast transmitter, with one set of tubes and two crystals | On Request | 16 | BC-5P-2 (M-6061) | 5 KW AM broadcast transmitter with tubes and one crystal and tube rectifiers | 14,995.00 |
| | TK-376 | Spare tubes | \$ 7,500.00 | | TK-321 | Spare tubes | 753.00 |
| | TK-377 | Recommended minimum spare tubes for BC-100G | 2,400.00 | | TK-322 | Recommended minimum set spare tubes for BC-5P-2 | 288.00 |
| 9 | BC-50C (M-5913) | 50 KW AM broadcast transmitter, with tubes, two vacuum mounted crystals, (state frequency and RF output impedance when ordering) | 95,000.00 | | BC-5P-2S (M-6062) | 5 KW AM broadcast transmitter with tubes and one crystal and silicon rectifiers | 15,995.00 |
| | TK-367 | Spare tubes | 6,210.00 | | TK-363 | Spare tubes | 683.00 |
| | TK-368 | Recommended minimum spare tubes for BC-50C | 3,260.00 | | TK-364 | Recommended minimum set spare tubes for Model BC-5P-2S | 469.00 |
| 10 | BC-20B (M-4779) | 20 KW AM broadcast transmitter with tubes, one crystal and oven | 48,500.00 | | A-35177-1 | Spare vacuum type crystal for either model | 90.00 |
| | TK-229 | 100% spare tube complement | 2,144.00 | 19 | BC-1G (M-6245) | 1 KW AM broadcast transmitter, 1000/250 watts, solid state rectifier model, with tubes and 1 vacuum crystal | 5,295.00 |
| | JK-57M | Spare crystal and oven | 79.00 | | BC-1G (M-6245B) | 1 KW AM broadcast transmitter, 1000/250 watts, tube rectifier model, tubes and 1 vacuum crystal | 5,150.00 |
| 13 | BC-10P (M-6064) | 10 KW AM broadcast transmitter with one set tubes, one crystal (mercury rectifier tube model) | 17,995.00 | | A-35177-1 | Spare vacuum crystal | 90.00 |
| | TK-314 | Spare tubes | 1,105.00 | | TK-471 | Spare tube complement, Model M-6245 | 236.00 |
| | TK-315 | Recommended minimum spare tubes for BC-10P | 581.00 | | TK-472 | Spare tube complement, Model M 6245B | 261.00 |
| | BC-10PS (M-6079) | 10 KW AM broadcast transmitter with one set tubes, one crystal, solid state rectifier model | 19,250.00 | | M-6326 | Output power remote control kit | 105.00 |
| | TK-381 | Spare tubes | 971.00 | 22 | M-6408 | Vanguard 1, 1000/250 watts, with tube and two crystals | 5,975.00 |
| | TK-382 | Recommended minimum spare tubes for BC-10PS | 513.00 | | 4CX3000A | Spare power tube | 420.00 |
| | A-35177-1 | Spare vacuum type crystal for either model | 90.00 | | | | |

| CAT. PAGE | TYPE NUMBER | PRODUCT DESCRIPTION | UNIT PRICE | CAT. PAGE | TYPE NUMBER | PRODUCT DESCRIPTION | UNIT PRICE |
|-----------|--|--|------------|--------------------------------|------------------------------|-----------------------------|------------|
| 23 | BC-500G | 500 watt AM broadcast transmitter, with tubes, one crystal, silicon rectifiers | 4,750.00 | | 632-0419 | Meter 3" sq. case, scale | |
| | TK-481 | Spare tubes | 183.00 | | 632-0420 | 0-5 R.F. amperes | 22.00 |
| | TK-479 | Recommended minimum spare tube kit | 65.00 | | 632-0421 | Meter 3" sq. case, scale | |
| | A-35177-1 | Spare vacuum crystal | 90.00 | | 632-0425 | 0-10 R.F. amperes | 22.00 |
| 24 | BC-250GY | 250 watt AM broadcast transmitter, one set of tubes and one vacuum crystal | 3,795.00 | | 632-0426 | Meter 4" sq. case, scale | |
| | TK-507 | Spare tubes | 160.00 | | 632-0361 | 0-3 R.F. amperes | 27.00 |
| | TK-508 | Recommended minimum set of spare tubes | 94.00 | | 632-0428 | Meter 4" sq. case, scale | |
| | A-35177-1 | Spare vacuum crystal | 90.00 | | | 0-15 R.F. amperes | 27.00 |
| 26 | BC-01-GA (M-6427) | 100 watt Medium Wave Transmitter only, 115 volts, 60 cycles | 1,650.00 | THERMOCOUPLE REMOTE METER KITS | | | |
| | BC-01-GA (M-6428) | 100 watt Medium Wave Transmitter including audio input system 115 volts, 60 cycles | 2,325.00 | M-3383 | | Complete kit (meter range | |
| | M-5178 | Antenna coupler | 195.00 | | | 0-3 R.F. amperes) | 85.00 |
| 28 | ANTENNA PHASING EQUIPMENT. SEE INSIDE BACK COVER OF PRICE LIST | | | M-3133 | | Complete kit (meter range | |
| | ANTENNA COUPLER 1250 WATTS | | | | | 0-5 R.F. amperes) | 85.00 |
| 29 | 44A | Antenna coupler with antenna meter | 360.00 | M-4394 | | Complete kit (meter range | |
| | 5-10 KW ANTENNA COUPLING UNITS | | | | | 0-8 R.F. amperes) | 120.00 |
| | M-5309A | Antenna Coupling Unit, 5 KW | 650.00 | M-3386 | | Complete kit (meter range | |
| | M-5309B | Antenna Coupling Unit, 10 KW | 890.00 | | | 0-10 R.F. amperes) | 85.00 |
| | SERIES & SHUNT FEED COUPLERS | | | AM BROADCASTING ACCESSORIES | | | |
| | M-5178 | Antenna coupler, 1 KW, direct series feed | 195.00 | 30 | Austin Ring Type Tower Choke | | |
| | M-5179 | Antenna coupler, 1 KW, direct shunt feed | 195.00 | | A-2100 | Side Bracket | 333.30 |
| | ISOLATION COIL | | | | A-2101 | Side Bracket | 344.30 |
| | M-3073C | Weatherproof isolation unit . | 280.00 | | A-2102 | Pedestal | 333.30 |
| | M-4561A | Open unit coil only, less cabinet | 165.00 | | A-2103 | Pedestal | 344.30 |
| | R. F. ANTENNA METERS | | | | A-1970 | Side Bracket | 371.80 |
| | 634-0206 | Meter, 0-3 R.F. amperes | 30.00 | | A-1971 | Side Bracket | 389.40 |
| | 634-0238 | Meter, 0-6 R.F. amperes | 58.15 | | A-1972 | Pedestal | 371.80 |
| | 634-0209 | Meter, 0-8 R.F. amperes | 30.00 | | A-1973 | Pedestal | 389.00 |
| | 634-0210 | Meter, 0-10 R.F. amperes ... | 30.00 | | Meter Shorting Switch | | |
| | DIODE TYPE REMOTE METER EQUIPMENT | | | 30 | M-3493 | Meter Shorting Switch, | |
| | M-6112 | Diode remote meter unit, less meter | 75.00 | | | rating 1 KW modulated | 27.50 |
| 29 | 632-0418 | Meter 3" sq. case, scale | | | M-5557 | Meter Shorting Switch, | |
| | | 0-3 R.F. amperes | 22.00 | | | rating 10 KW modulated ... | 37.40 |
| | | | | | M-3823 | Meter Shorting Switch, | |
| | | | | | | rating 50/100 KW | 60.50 |
| | | | | | Heavy Duty Sampling Loop | | |
| | | | | | M-6126 | Heavy duty sampling loop .. | 120.00 |
| | | | | | Solenoid Tower Choke | | |
| | | | | | M-3937 | Tower Choke, 2 wire, | |
| | | | | | | weatherproof | 105.00 |
| | | | | | M-3938 | Tower Choke, 3 wire, | |
| | | | | | | weatherproof | 125.00 |
| | | | | | M-3935 | Tower Choke, 2 wire, | |
| | | | | | | open type | 70.00 |
| | | | | | M-3936 | Tower Choke, 3 wire, | |
| | | | | | | open type | 90.00 |

| CAT. PAGE | TYPE NUMBER | PRODUCT DESCRIPTION | UNIT PRICE | CAT. PAGE | TYPE NUMBER | PRODUCT DESCRIPTION | UNIT PRICE |
|-----------|-------------|--|------------|-----------|----------------------|--|------------|
| | | Radio Frequency Contactor | | | | FM BROADCAST TRANSMITTERS | |
| | 145-101 | Contacto SPDT insulated 17 kv. peak voltage | 125.00 | 38 | FM-20G | 20,000 watt transmitter, one set of tubes, crystal and oven, for monaural operation | 24,500.00 |
| | 145-102 | Contacto DPDT insulated 17 kv. peak voltage | 135.00 | | M-6484 | Spare crystal and oven | 72.60 |
| | 145-201 | Contacto SPDT insulated 22 kv. peak voltage | 145.00 | | TK-528 | Spare 100% tube kit | 1,255.00 |
| | 145-202 | Contacto DPDT insulated 22 kv. peak voltage | 155.00 | | M-6146 | Stereo Generator | 1,595.00 |
| | | Rotating Phase Sampling Loops | | 41 | FM-10G (M-6410) | 10 KW FM broadcast trans- mitter, with tubes, crystal and oven, for 60 cycle operation | 14,995.00 |
| | M-3283A | Rotating Sampling Loop | 125.00 | | 990-0513 | Spare 100% tube kit | 596.00 |
| | | Meter Jack and Shorting Bar—Mounting Plug | | 44 | FM-5G (M-6394) | 5 KW transmitter, with tubes, crystal and oven, Tee notch and harmonic filter | 10,950.00 |
| | M-3280 | Meter jack and shorting bar | 12.00 | | FM-7.5G (M-6412) | 7.5 KW transmitter, with tubes, crystal and oven, Tee notch and harmonic filter .. | 12,950.00 |
| | M-3281 | Meter mounting plug | 7.00 | | TK-408 | Spare 100% tube kit for FM-5G or FM-7.5G | |
| | | AM Frequency Monitor | | | TK-463 | Transmitter | 577.00 |
| 31 | M-4990 | Frequency Monitor with tubes .. | 895.00 | | TK-463 | Minimum spare tube kit for FM-5G or FM-7.5G | |
| | M-5631 | Remote Control Extension Meter | 77.50 | | FM-1G | Transmitter | 559.00 |
| | M-5549 | Whip Antenna and Coupler for Air Monitoring | 52.50 | 46 | FM-1G | 1000 watt FM transmitter, with tubes and one crystal with oven | 5,995.00 |
| | TK-281 | Spare 100% tube kit for Monitor | 17.00 | | TK-526 | Spare 100% tube kit | 224.00 |
| | | Broadcast Modulation Monitor | | | TK-527 | Minimum spare tube kit | 78.00 |
| 33 | M-5693 | AM Modulation Monitor with tubes | 655.00 | | M-6484 | Spare crystal and oven | 72.60 |
| | TK-345 | 100% spare tube kit | 22.00 | 47 | FM-1C (M-5597) | 1000 watt FM transmitter with tubes, crystal & oven .. | 5,995.00 |
| | M-5837 | Remote Meter Panel | 104.50 | | TK-312 | 100% tube kit | 147.00 |
| | | Phase Monitor | | | TK-460 | Minimum tube kit | 78.00 |
| 34 | 731-0023 | Phase Monitor, 2 towers | 750.00 | | M-6146 | For FM stereo operation order stereo generator | 1,595.00 |
| | 731-0024 | Phase Monitor, 3 towers | 800.00 | 48 | FM-250C (M-6173) | 250 watt FM broadcast transmitter with tubes, crystal and oven | 3,995.00 |
| | 731-0025 | Phase Monitor, 4 towers | 850.00 | | TK-411 | 100% Tube Kit | 82.00 |
| | 731-0026 | Phase Monitor, 5 towers | 900.00 | | T9D | Spare crystal | 23.10 |
| | | Field Intensity Meter | | | NE-91 | Spare oven for T9D crystal .. | 49.50 |
| 34 | 120E | Field Intensity Meter (less batteries) | 950.00 | 50 | BFE-10C (M-5594B) | 10 watt FM broadcast trans- mitter with tubes and crystal | 1,395.00 |
| | | Dummy Antennas | | | TK-391 | Spare 100% tube kit | 41.00 |
| 35 | M-6107 | Dummy Antenna, 10 KW, 50 ohms | 495.00 | | TK-488 | Recommended minimum tube kit | 24.00 |
| | DU-551 | Dummy Antenna, 5 KW, 50 ohms | 350.00 | | BFE-50C (M-5595B) | 50 watt FM broadcast trans- mitter with tubes and crystal | 1,850.00 |
| | DU-570 | Dummy Antenna, 5 KW, 70 ohms | 350.00 | | TK-489 | Spare 100% tube kit | 54.00 |
| | M-5497 | Dummy Antenna, 50 KW, medium wave | 4,350.00 | | TK-490 | Recommended minimum tube kit | 28.00 |
| | M-5497A | Dummy Antenna, 50 KW, high frequency | 4,350.00 | | | | |
| | WDL-1000A | Dummy Antenna, 100 KW, medium wave | 10,425.00 | | | | |
| | | Heat Exchanger for WDL 1000A | 3,575.00 | | | | |
| | DU-151 | Dummy Antenna, 1 KW, 50 ohms | 125.00 | | | | |
| | DU-170 | Dummy Antenna, 1 KW, 70 ohms | 125.00 | | | | |

| CAT. PAGE | TYPE NUMBER | PRODUCT DESCRIPTION | UNIT PRICE | CAT. PAGE | TYPE NUMBER | PRODUCT DESCRIPTION | UNIT PRICE |
|-----------|----------------------|---|------------|-----------|--|---|------------|
| | BFR-50C (M-5599B) | 50 watt relay transmitter (40-220 Mc) with tubes, crystal and oven | 1,950.00 | | FMA-5A | Five ring, 1 1/2" | 2,600.00 |
| | TK-310 | Spare 100% tube kit | 63.00 | | FMA-5B | Five ring, 3 1/2" | 2,800.00 |
| | TK-458 | Recommended tube kit | 49.00 | | FMA-6A | Six ring, 1 1/2" | 3,120.00 |
| | M-5765 | FM-11 Single Ring Educa- tional (88-108 Mc) FM Antenna | 150.00 | | FMA-6B | Six ring, 3 1/2" | 3,360.00 |
| | M-5766 | FM-22 Double Ring Educa- tional (88-108 Mc) FM Antenna | 400.00 | | FMA-7A | Seven ring, 1 1/2" | 3,680.00 |
| | | FM BROADCAST LINK & RELAY SYSTEM | | | FMA-7B | Seven ring, 3 1/2" | 3,920.00 |
| 51 | BFR-50C | 50 watt FM transmitter | 1,950.00 | | FMA-8A | Eight ring, 1 1/2" | 4,150.00 |
| | CM-150 | Receiver, 148-174 mcs | 350.00 | | FMA-8B | Eight ring, 3 1/2" | 4,500.00 |
| | 3605A | 2 Corner reflector, high gain, broadband antennas | 105.00 | | FMA-10A | Ten ring, 1 1/2" | 5,200.00 |
| | RG-8/U | Coaxial cable, 100' | .13 ft. | | FMA-10B | Ten ring, 3 1/2" | 5,600.00 |
| | 8235 | Twin line 300 ohm, 100' | .06 ft. | | FMA-12A | Twelve ring, 1 1/2" | 6,250.00 |
| | FML-50D | Complete system (as above) | 2,429.00 | | FMA-12B | Twelve ring, 3 1/2" | 6,750.00 |
| | BFE-50C | 50 watt FM transmitter | 1,850.00 | | FMH-200 | Deicer, 200 watt (Price per bay) | 80.00 |
| | CM-100 | Receiver, 88-108 mcs | 295.00 | | FMH-400 | Deicer, 400 watt (price per bay) | 130.00 |
| | BFE-10C | Alternate transmitter for shorter distances: 10 watt FM transmitter, 88-108 mcs | 1,395.00 | | | VERTICAL POLARIZED FM ANTENNA | |
| | FM-22 | Two ring FM transmitting antenna, gain 1.3 | 400.00 | 57 | 300G-1 | Single Bay—1 1/2" line | 540.00 |
| | LPL FM-6 | FM receiving antenna | 18.00 | | | 3 1/2" | 635.00 |
| | FML-50ND | Complete 50 watt system | 2,588.00 | | 300G-2 | 2-bay—1 1/2" | 1,050.00 |
| | FML-10ND | Complete 10 watt system using alternate transmitter described above | 2,138.00 | | | 3 1/2" | 1,120.00 |
| | M-6146 | FM Stereo Generator | 1,595.00 | | 300G 3 | 3-bay—1 1/2" | 1,560.00 |
| | M 6160 | Sub-carrier generator with Mute (specify freq. between 25 and 75 kcs.) | 395.00 | | | 3 1/2" | 1,680.00 |
| 52 | M-6146 | FM Stereo Generator | 1,595.00 | | 300G 4 | 4-bay—1 1/2" | 2,080.00 |
| | M 6249 | Stereo SCA Remote Switching Kit | 46.50 | | | 3 1/2" | 2,240.00 |
| | | SUB CARRIER GENERATOR | | | 300G-5 | 5-bay—1 1/2" | 2,600.00 |
| 53 | M 6160 | S.C.A. Generator complete with tubes | 395.00 | | | 3 1/2" | 2,800.00 |
| | M-6249 | Remote switching mod. kit | 46.50 | | 300G 6 | 6-bay—1 1/2" | 3,120.00 |
| | | CYCLOID FM RING ANTENNA | | | | 3 1/2" | 3,360.00 |
| 55 | FMA-2A | Two ring, 1 1/2" | 1,050.00 | | 300G 7 | 7-bay—1 1/2" | 3,680.00 |
| | FMA-2B | Two ring, 3 1/2" | 1,120.00 | | | 3 1/2" | 3,920.00 |
| | FMA-3A | Three ring, 1 1/2" | 1,560.00 | | 300G 8 | 8-bay—1 1/2" | 4,150.00 |
| | FMA-3B | Three ring, 3 1/2" | 1,680.00 | | | 3 1/2" | 4,500.00 |
| | FMA-4A | Four ring, 1 1/2" | 2,080.00 | | 300G-10 | 10 bay—1 1/2" | 5,200.00 |
| | FMA-4B | Four ring, 3 1/2" | 2,240.00 | | | 3 1/2" | 5,600.00 |
| | | | | | 300G-12 | 12-bay—1 1/2" | 6,250.00 |
| | | | | | | 3 1/2" | 6,750.00 |
| | | | | | | Note: Also available up to and including 16 Bays on special order. | |
| | | | | | 401G | Fixed power divider—custom designed to divide power to customer's specifications (assuming exactly matched loads on each output) | 525.00 |
| | | | | | | Variable transformer (to match line and load) | 487.50 |
| | | | | | Combination Antennas Without Power Divider | Engineering charges for com- binations, when feasible, of horizontal and vertical bays without power divider (based on number of bays): | |

| CAT. PAGE | TYPE NUMBER | PRODUCT DESCRIPTION | UNIT PRICE | CAT. PAGE | TYPE NUMBER | PRODUCT DESCRIPTION | UNIT PRICE |
|-----------|--------------------------------------|---|--------------|-----------|----------------------------|--|------------|
| | (cont.) | a. Combination of 1 vertical bay and 1 horizontal | 300.00 | | M-5631 | Frequency monitor extension unit for M-4990 Frequency Monitor | 77.50 |
| | | b. Combination of up to 6 vertical and 6 horizontal | 450.00 | | M-5837 | Remote meter for extending Gates M-5693 modulation monitor | 104.50 |
| | | c. Combination of up to 12 vertical and 12 horizontal | 750.00 | | M-5210 | For extending Gates M-2639 modulation monitor | 60.00 |
| | FM FREQUENCY AND MODULATION MONITORS | | | | M-5206 | For GR1931A or RCA WM43A modulation monitors | 65.00 |
| 59 | TBM-3000 | FM Frequency Monitor with tubes | 495.00 | | M-5208 | For GR1181A or RCA WF48A frequency monitors | 65.00 |
| | TBM-3500 | Modulation Monitor with tubes | 995.00 | | M-5209 | For RCA 311A monitor | 65.00 |
| | TBM-4000 | SCA Multiplex Monitor with tubes | 1,495.00 | | M-4791 | RF FM Amplifier with tubes .. | 395.00 |
| | CUSTOM FM BROADCAST TRANSMITTERS | | | | M-5000A | PWR 3 Power Supply | 98.00 |
| 60 | SFM-250 | 250 watt dual driver FM transmitter | } On Request | | M-4619 | BA-21 Base for PWR 3 | 7.00 |
| | SFM-1000 | 1000 watt dual driver FM transmitter | | | M-4703A | Motor Rheostat for 250 watts .. | 120.00 |
| | SFM-5000 | 5000 watt dual driver FM transmitter | | | M-4703B | Motor Rheostat for 500 watts .. | 120.00 |
| | SFM-7500 | 7500 watt dual driver FM transmitter | | | M-4703C | Motor Rheostat for 1 KW ... | 125.00 |
| | SFM-10,000 | 10,000 watt dual driver FM transmitter | | | M-6326 | Motor Control for Rheostat in BC-500G and BC-1G | 105.00 |
| | SFM-20,000 | 20,000 watt dual driver FM transmitter | | | PWR-3 | Power Supply with tray for FM-RF Amplifier | 105.00 |
| | REMOTE CONTROL SYSTEM | | | | M-4845 | FM Output Indicator | 55.00 |
| 61 | M-5862 | Complete RDC-10AC system includes studio and transmitter units and plate current unit, plate voltage unit and tower light indicator | 1,075.00 | | M-4848A | Output Loading Control Kit .. | 225.00 |
| | M-6112 | Antenna diode | 75.00 | | M-6112 | RF Diode Unit | 75.00 |
| | M-4703A | Motor/rheostat for 250 watt .. | 120.00 | | M-4825 | AC Voltage Unit | 43.00 |
| | M-4703B | Motor/rheostat for 500 watt .. | 120.00 | | M-4720A | Plate Current Unit | 20.50 |
| | M-4703C | Motor/rheostat for 1 KW ... | 125.00 | | M-4800 | Tuning Motor | 85.00 |
| | M-5066 | Tuning motor assembly | 85.00 | | M-5129 | Overload Relay | 32.50 |
| | M-4806 | Relay assembly to operate M-5066 motor | 50.00 | | M-4719A | Plate Voltage Unit | 23.95 |
| | M-4720A | Plate current metering kit ... | 20.50 | | M-5249 | Auxiliary relay assembly | 50.00 |
| | M-4719A | Plate voltage metering kit .. | 23.95 | | M-5248 | Same as above but latching (holding) type with 5 ampere contacts | 55.00 |
| | M-5145 | Tower light indicator | 45.00 | | M-5145 | Tower Light Metering Kit | 45.00 |
| 62 | RDC-200A | Complete remote control system | 2,400.00 | | FLEXIBLE COAXIAL CABLE | | |
| | M-5145 | Extra tower light indicators .. | 45.00 | | $\frac{3}{8}$ " Air Heliax | | |
| | M-4825 | A.C. Rectifier to indicate A.C. voltages | 43.00 | 64 | H5-50 | 50 ohms | 1.45ft. |
| 63 | M-5270 | Frequency monitor extension unit | 225.00 | | HJ5-50 | 50 ohms, jacketed | 1.60ft. |
| | | | | | Components | | |
| | | | | | 75AR | EIA flange | 18.00 |
| | | | | | 75AU | UHF jack | 18.00 |
| | | | | | 75AN | N jack | 18.00 |
| | | | | | 75AT | End terminal | 30.00 |
| | | | | | 75AG | Connector and gas barrier .. | 36.00 |
| | | | | | 75AZ | Splice | 30.00 |
| | | | | | Hanger Accessories | | |
| | | | | | 29958 | Hoist Kit | 10.00 |
| | | | | | 19256A | Hoist Kit, jacket | 10.50 |
| | | | | | 24810-1 | Grounding Kit | 2.25 |
| | | | | | 24810-2 | Ground Kit, jacket | 4.25 |
| | | | | | 12395-1 | Rigid Hanger | 12.50 |
| | | | | | 11662-2 | Insulated rigid hanger | 4.00 |

| CAT. PAGE | TYPE NUMBER | PRODUCT DESCRIPTION | UNIT PRICE |
|--------------------------|-------------|---------------------------|------------|
| 1 1/2" Air Heliac | | | |
| 64 | H7-50A | 50 ohm | 3.20ft. |
| | HJ7-50A | 50 ohm, jacketed | 3.55ft. |
| Components | | | |
| | 87R | EIA flange | 40.00 |
| | 87U | UHF jack | 65.00 |
| 64 | 87N | N jack | 50.00 |
| | 87T | End terminal | 75.00 |
| | 87S | Connector and reducer | 55.00 |
| | 87G | Connector and gas barrier | 55.00 |
| | 87Z | Splice | 55.00 |
| Hanger Accessories | | | |
| | 24312A | Hoist kit | 13.00 |
| | 24312A | Hoist kit, jacket | 13.00 |
| | 24811-1 | Grounding kit | 3.00 |
| | 24811-2 | Ground kit, jacket | 5.00 |
| | 24622 | Insulated rigid hanger | 8.00 |
| 3" Air Heliac | | | |
| 64 | H8-50A | 50 ohm | 6.00ft. |
| | HJ8-50A | 50 ohm, jacketed | 6.50ft. |
| Components | | | |
| | 78R | EIA flange | 70.00 |
| | 2262 | N jack | 85.00 |
| | 2062 | End terminal | 85.00 |
| | 78S | Connector and reducer | 110.00 |
| | 78G | Connector and gas barrier | 85.00 |
| | 78Z | Splice | 80.00 |
| Hanger Accessories | | | |
| | 26985A | Hoist kit | 20.00 |
| | 26985A | Hoist kit, jacket | 20.00 |
| | 28708-1 | Grounding kit | 3.50 |
| | 28708-2 | Ground kit, jacket | 5.50 |
| | 13927 | Rigid hanger | 13.50 |
| | 22418 | Insulated rigid hanger | 20.00 |
| 1/2" Foam Heliac | | | |
| 64 | FH4-50A | 50 ohm | .50ft. |
| | FHJ4-50A | 50 ohm, jacketed | .57ft. |
| Components | | | |
| | 44AU | UHF jack | 5.00 |
| | 44AN | N jack | 4.00 |
| | 44AT | End terminal | 20.00 |
| | 44AZ | Splice | 20.00 |
| Hanger Accessories | | | |
| | 26892-1 | Grounding kit | 1.50 |
| | 26892-2 | Ground kit, jacket | 3.50 |
| | 12395-1 | Rigid hanger | 12.50 |
| 3/8" Foam Heliac | | | |
| 64 | FH5-50 | 50 ohm | 1.21ft. |
| | FHJ5-50 | 50 ohm, jacketed | 1.40ft. |
| Components | | | |
| | 45AR | EIA flange | 15.00 |
| | 45AU | UHF jack | 12.00 |
| | 45AN | N jack | 15.00 |

| CAT. PAGE | TYPE NUMBER | PRODUCT DESCRIPTION | UNIT PRICE |
|---------------------------------|-------------|--------------------------|------------|
| | 45AT | End terminal | 25.00 |
| | 45AZ | Splice | 24.00 |
| Hanger Accessories | | | |
| | 29958 | Hoist kit | 10.00 |
| | 19256A | Hoist kit, jacket | 10.50 |
| | 24810-1 | Grounding kit | 2.25 |
| | 24810-2 | Ground kit, jacket | 4.25 |
| | 12395-1 | Rigid hanger | 12.50 |
| | 11662-2 | Insulated rigid hanger | 4.00 |
| RIGID COAXIAL TRANSMISSION LINE | | | |
| 7/8", 50 ohms | | | |
| 65 | 560 | 20 ft. section, type | 75.00 |
| Components | | | |
| | 18275 | Inner connector | 4.00 |
| | 1060 | Miter elbow | 27.00 |
| | 1260A | Gas barrier | 28.00 |
| | 2260A | N adaptor | 25.00 |
| | 4850 | Inner 51.5 ohm adaptor | 10.00 |
| | 18630 | Fixed flange kit | 4.00 |
| | 18096 | Swivel flange kit | 8.50 |
| | 11381-1 | Hardware kit | 1.00 |
| | 10683-11 | "O" ring gasket | .15 |
| | 14328 | Rigid hanger | 6.00 |
| | 14327 | Sliding hanger | 4.00 |
| | 13889 | Spring hanger | 4.00 |
| | 11662-1 | Insulated rigid hanger | 4.00 |
| | 11662-2 | Insulated sliding hanger | 4.00 |
| 1 1/2", 50 ohms | | | |
| | 561 | 20 ft. section, type | 80.00 |
| Components | | | |
| | 15069 | Inner connector | 8.00 |
| | 1061 | Miter elbow | 40.00 |
| | 1261B | Gas barrier | 40.00 |
| | 1860 | Reducer | 35.00 |
| | 2261 | N adaptor | 36.00 |
| | 2061 | End terminal | 54.00 |
| | 20695 | Flex section | 125.00 |
| | 4851 | Inner 51.5 ohm adaptor | 10.00 |
| 65 | 18631 | Fixed flange kit | 6.00 |
| | 18041 | Swivel flange kit | 9.00 |
| | 11381-2 | Hardware kit | 1.75 |
| | 10683-2 | "O" ring gasket | .25 |
| | 13924 | Rigid hanger | 8.50 |
| | 14378 | Sliding hanger | 6.50 |
| | 14379 | Spring hanger | 12.00 |
| | 14442 | Insulated sliding hanger | 12.50 |
| | 14441 | Insulated spring hanger | 19.50 |
| 3/8", 50 ohms | | | |
| | 562A | 20 ft. section, type | 130.00 |
| Components | | | |
| | 15093 | Inner connector | 20.00 |
| | 1062 | Miter elbow | 67.00 |
| | 1262 | Gas barrier | 75.00 |
| | 1861 | Reducer | 70.00 |

| CAT. PAGE | TYPE NUMBER | PRODUCT DESCRIPTION | UNIT PRICE | CAT. PAGE | TYPE NUMBER | PRODUCT DESCRIPTION | UNIT PRICE |
|-----------|------------------------------|---|------------|-----------|-------------------------------|--|------------|
| | 2262 | N adaptor | 85.00 | | LC-2076 | Flasher and photo-cell | 320.00 |
| | 2062 | End terminal | 85.00 | | LC-2074B | Photo-cell and beacon flasher | 179.95 |
| | 19209B | Flex section | 275.00 | | 63305DA | Photo-cell unit | 55.00 |
| | 4852 | Inner 51.5 ohm adaptor | 10.00 | | 63364DA | Photo-cell unit | 55.00 |
| | 15840 | Fixed flange kit | 10.00 | | TRANSFORMERS FOR 250 WATTS | | |
| | 18200 | Swivel flange kit | 14.00 | 70 | 472-0234 | High voltage power transformers for AM | 174.10 |
| | 11381-3 | Hardware kit | 2.70 | | 472-0456 | High voltage power transformers for FM | 190.50 |
| | 10683-3 | "O" ring gasket | .45 | | 482-0001 | Modulation reactor | 83.52 |
| | 13927 | Rigid hanger | 13.50 | | 478-0038 | Driver transformer | 33.00 |
| | 13925 | Spring hanger | 16.50 | | 476-0138 | Swinging choke | 27.00 |
| | 13926 | Insulated spring hanger | 30.00 | | 476-0137 | Smoothing choke | 15.00 |
| | PRESSURIZATION EQUIPMENT | | | | TRANSFORMERS FOR 500 WATTS | | |
| 65 | 1920A | Heatless, automatic dehydrator | 600.00 | | 472-0259 | High voltage power transformers for AM | 168.90 |
| | 878 | Dry air hand pump | 48.00 | | 478-0084 | Modulation transformer | 345.00 |
| | 858 | Nitrogen tank fittings | 48.00 | | 476-0179 | Modulation reactor | 154.10 |
| | OPEN WIRE TRANSMISSION LINE | | | | 478-0048 | Driver transformer | 79.50 |
| 66 | M-3327 | Line Bracket | 40.00 | | 476-0176 | Smoothing choke | 90.00 |
| | M-3328 | End Plate | 55.00 | | 476-0177 | Swinging choke | 165.45 |
| | M-2870D | Solid stud, 2 bowls, for walls to 10 1/2" thick | 16.00 | | TRANSFORMERS FOR 1000 WATTS | | |
| | M-3254 | Same as above but hollow stud | 18.00 | | 472-0250 | High voltage power transformers for AM | 259.00 |
| | M-5280 | Solid stud, single bowl, for walls 1" thick | 15.00 | | 472-0307 | High voltage power transformers for FM | 335.00 |
| | M-5281 | Same as above but hollow stud | 17.00 | | 478-0084 | Modulation transformer | 345.00 |
| | M-3322 | Horn Gap | 80.00 | | 476-0243 | Modulation reactor | 105.00 |
| | M-3864 | Center post insulator | 20.00 | | 478-0048 | Driver transformer | 79.50 |
| 67 | ANTENNA TOWERS | | | | 476-0176 | Smoothing choke | 90.00 |
| | Utility Type | Specify: type of tower: tower height: insulated or non-insulated: galvanized or non-galvanized. Self-supporting, tall | | | TRANSFORMERS FOR 5000 WATTS | | |
| | 170-KD | TV towers, or towers over 480' | | | 472-0242 | High voltage power transformers for AM | 753.50 |
| | 120 | will be quoted upon request. | | | 472-0243 | High voltage power transformers for AM | 1,154.65 |
| | 140 | Installation services for towers, | | | 472-0494 | High voltage power transformers for FM | 495.00 |
| | 180 | FM, TV antennas, transmission line, | | | 478-0080 | Modulation transformer | 866.75 |
| | 220 | AC lighting and ground systems | | | 482-0013 | Modulation reactor | 685.45 |
| | 340 | also available by request. . On Request | | | 478-0079 | Modulation transformer | 1,490.55 |
| | 380 | | | | 482-0014 | Modulation reactor | 1,142.10 |
| | 480 | | | | 478-0045 | Driver transformer | 201.10 |
| | TOWER LIGHTS AND ACCESSORIES | | | | 476-0166 | Input or smoothing choke | 117.85 |
| 68 | M-6393 | Beacon Flasher, panel type, less housing | 95.00 | | TRANSFORMERS FOR 7500 WATTS | | |
| | M-6393A | Beacon Flasher, indoor switch box housing | 99.00 | | 472-0397 | High voltage power transformers for FM | 820.00 |
| | OB-20-3 | Single Obstruction Light | 13.35 | | TRANSFORMERS FOR 10,000 WATTS | | |
| | OB-21-4 | Single Obstruction Light | 13.35 | | 472-0231 | High voltage power transformers for AM | 1,348.25 |
| | OB-22-4 | Double Obstruction Light | 26.70 | | 472-0253 | High voltage power transformers for AM | 1,654.20 |
| | OB-22P-4 | Double Obstruction Light | 30.00 | | | | |
| | KG-114-3 | Code Beacon 300 MM | 293.35 | | | | |
| | KG-114-4 | Code Beacon 300 MM | 293.35 | | | | |
| | 107A21-TS | Clear Traffic Signal Lamp | .52 | | | | |
| | 116A21-TS | Clear Traffic Signal Lamp | .52 | | | | |
| | 500PS-40 | Beacon Lamp | 2.90 | | | | |
| | 620PS-40 | Beacon Lamp | 2.90 | | | | |

| CAT. PAGE | TYPE NUMBER | PRODUCT DESCRIPTION | UNIT PRICE | CAT. PAGE | TYPE NUMBER | PRODUCT DESCRIPTION | UNIT PRICE |
|-----------|-------------|--|------------|-----------|-------------|---|------------|
| | 472-0509 | High voltage power trans- formers for FM | 630.00 | | 26VC2144 | Ed variable | 76.30 |
| | 478-0073 | Modulation transformer | 1,303.00 | | 16VB1544 | Ed variable | 55.25 |
| | 482-0017 | Modulation reactor | 946.05 | | 30VB2344 | Ed variable | 72.00 |
| | 478-0071 | Modulation transformer | 1,892.15 | | 105VB3735 | Ed variable | 73.90 |
| | 482-0009 | Modulation reactor | 1,563.55 | | LC4 | Coil clip for FA coils | .41 |
| | 478-0045 | Driver transformer | 201.10 | | LC8 | Coil clip for FC coils | .98 |
| | 476-0168 | Input or smoothing choke | 226.60 | | RC6 | Coil clip for FBT coils | 2.63 |
| | | TRANSFORMERS FOR 50,000 WATTS | | | RC8 | Coil clip for FCT coils | 3.15 |
| | 472-0358 | High voltage power trans- formers for AM | 1,500.00 | | M-5521 | With non-removable crank handle | 30.00 |
| | 478-0238 | Modulation transformer | 5,632.00 | | M-6233 | With removable crank handle | 40.00 |
| | 482-0033 | Modulation reactor | 5,324.00 | | | | |
| 70 | 476-0206 | Input and smoothing choke | 1,279.20 | 72 | | MICA CAPACITORS | |
| | | FILTER REACTORS | | | G1 | .0001 and .0002 mfd. | 24.36 |
| | 476-0175 | Input and smoothing choke .. | 940.40 | | | .0004 mfd. | 26.61 |
| | | FILAMENT TRANSFORMERS | | | | .0005 mfd. and .001 mfd. | 27.99 |
| | 472-0202 | For single 3X2500F3 or 3X2500A3 tubes | 85.90 | | | .0015 and .002 mfd. | 29.34 |
| | 472-0178 | For three 3X2500F3 or 3X2500A3 tubes | 154.15 | | | .003 thru .005 mfd. | 30.36 |
| | 472-0330 | For 5891 tube | 258.50 | | | .006 thru .02 mfd. | 30.87 |
| | 472-0452 | For four 833A tubes | 99.00 | | G2 | MICA CAPACITORS | |
| | 472-0175 | Rectifier fil. trans. (6) 8008, 872A, 673 | 170.00 | | | .00025 and .005 mfd. | 39.33 |
| | | AUDIO INPUT AND OUTPUT TRANSFORMERS | | | | .006 thru .02 mfd. | 41.49 |
| | 478-0142 | Transmitter input | 56.65 | | G3 | MICA CAPACITORS | |
| | 478-0143 | Preamplifier input | 20.40 | | | .0001 mfd. | 72.60 |
| | 478-0144 | Preamplifier input | 22.95 | | | .0002 thru .0003 mfd. | 78.66 |
| | 478-0118 | Preamplifier output | 18.15 | | | .0005 thru .002 mfd. | 85.92 |
| | 478-0120 | Remote amplifier output | 22.65 | | | .003 thru .03 mfd. | 90.75 |
| | 478-0030 | Repeater transformer | 23.85 | | G4 | MICA CAPACITORS | |
| | | INDUCTORS | | | | .0001 and .00015 mfd. | 126.18 |
| 72 | 87FA4634 | Ed fixed | 51.50 | | | .00025 thru .0008 mfd. | 132.70 |
| | 6FC0854 | Ed fixed | 36.00 | | | .001 thru .003 mfd. | 137.46 |
| | 10FC0855 | Ed fixed | 34.00 | | | .004 mfd. | 140.61 |
| | 13FC0856 | Ed fixed | 34.75 | | | .005 mfd. | 142.80 |
| | 17FC1654 | Ed fixed | 42.25 | | | .006 mfd. | 151.35 |
| | 24FC1655 | Ed fixed | 47.25 | | | .008 mfd. | 156.00 |
| | 32FC1656 | Ed fixed | 46.00 | | | .01 thru .04 mfd. | 163.46 |
| | 42FC2266 | Ed fixed | 44.00 | | | TUNER | |
| | 62FC2856 | Ed fixed | 71.50 | 73 | FMR-88C | AM-FM Stereo/SCA Tuner | 199.50 |
| | 78FC2568 | Ed fixed | 76.00 | | FMR-88R | AM-FM Stereo/SCA Tuner, including bracket for rock mounting | 215.00 |
| | 10FBT1066 | CT fixed | 62.00 | | AP-35 | 35-watt Stereo Amplifier | 79.96 |
| | 32FBT1658 | CT fixed | 96.50 | | TP-35 | Case for AP-35 Amplifier | 11.96 |
| | 45FBT2158 | CT fixed | 162.50 | | M-6479 | Rack mounting brackets for FMR-88 Tuner | 15.50 |
| | 65FBT2559 | CT fixed | 130.00 | | | TELEVISION TRANSMITTERS | |
| | 17FCT1178 | CT fixed | 97.25 | 76 | BT-5CL | BT-5CL Transmitter for | |
| | 35FCT1679 | CT fixed | 155.50 | | (M-6066) | channels 2-6 | 46,000.00 |
| | 6VC0854 | Ed variable | 59.25 | | BT-5CH | BT-5CH Transmitter for | |
| | 15VC1444 | Ed variable | 58.25 | | (M-6067) | channels 7-13 | 46,000.00 |

| CAT. PAGE | TYPE NUMBER | PRODUCT DESCRIPTION | UNIT PRICE | CAT. PAGE | TYPE NUMBER | PRODUCT DESCRIPTION | UNIT PRICE |
|-----------|-----------------------------|--|------------|-----------|----------------|---|------------|
| | TK-341 | Spare 100% tube complement for BT-5CL | 1,405.00 | | | | |
| | TK-343 | Spare 100% tube complement for BT-5CH | 1,466.00 | | | | |
| | M-5892 | Color video filter, (with power supply) | 795.00 | | | | |
| 78 | BT-500CL (M-6068) | 500 watt television transmitter, with tubes, crystals and ovens (channels 2-6) | 22,500.00 | | | | |
| | BT-500CH (M-6069) | 500 watt television transmitter, with tubes, crystals and ovens, (channels 7-13) | 22,500.00 | | | | |
| | TK-357 | Spare tubes for BT-500CL .. | 348.00 | | | | |
| | TK-358 | Spare tubes for BT-500CH .. | 411.00 | | | | |
| | TK-365 | FCC spare tubes for BT-500CL | 217.00 | | | | |
| | TK-366 | FCC spare tubes for BT-500CH | 246.00 | | | | |
| | M-5892 | Color video filter, (with filter supply) | 795.00 | | | | |
| | VHF TELEVISION TRANSMITTER | | | | | | |
| 79 | BT-100CL (M-6179) | BT-100CL Transmitter for Channels 2-6 | 11,950.00 | | | | |
| | BT-100CH (M-6180) | BT-100CH Transmitter for Channels 7-13 | 11,950.00 | | | | |
| | TK-491 | Spare 100% tube complement for BT-100CL | 197.00 | | | | |
| | TK-418 | Spare 100% tube complement for BT-100CH | 254.00 | | | | |
| | CCIR TELEVISION TRANSMITTER | | | | | | |
| 80 | CCIR-100L (M-6110) | CCIR-100L for Band I | 11,950.00 | | | | |
| | CCIR-100H (M-6111) | CCIR-100H for Band III | 11,950.00 | | | | |
| | TK-491 | Spare 100% tube complement for CCIR-100L | 197.00 | | | | |
| | TK-418 | Spare 100% tube complement for CCIR-100H | 254.00 | | | | |
| | TELEVISION BATWING ANTENNA | | | | | | |
| 81 | JAT-() | Due to the wide variety of television antenna combinations, all antennas are quoted immediately on receipt of: (a) frequency or channel, (b) video ERP, (c) approximate length of transmission line between antenna and transmitter, (d) make and size of coaxial line if not to be supplied by Gates, and (e) approximate height of antenna above ground. | On Request | | | | |
| | | | | | | TELEVISION MONITORS | |
| | | | | 82 | CZB8C | Cabinet | 725.00 |
| | | | | | CZB8/2R | Rack | 1,395.00 |
| | | | | | CZB8N | Chassis only | 675.00 |
| | | | | | CZB14C | Cabinet | 775.00 |
| | | | | | CZB14R | Rack | 765.00 |
| | | | | | CZB14N | Chassis only | 695.00 |
| | | | | | CZB17C | Cabinet | 755.00 |
| | | | | | CZB17R | Rack | 745.00 |
| | | | | | CZB17N | Chassis only | 675.00 |
| | | | | | CFD17C | Cabinet | 350.00 |
| | | | | | CFD17R | Rack | 340.00 |
| | | | | | CFD17N | Chassis only | 270.00 |
| | | | | | WVA21C | Cabinet | 390.00 |
| | | | | | WVA21R | Rack | 370.00 |
| | | | | | WVA21N | Chassis only | 290.00 |
| | | | | | WVA24C | Cabinet | 430.00 |
| | | | | | WVA24N | Chassis only | 310.00 |
| | | | | | WVA27C | Cabinet | 475.00 |
| | | | | | WVA27N | Chassis only | 350.00 |
| | | | | | CLD-14 | Rack | 355.00 |
| | | | | | AUDIO CONSOLES | | |
| | | | | 85 | M-6158 | Executive Audio Console complete, includes 4 type A-30601 speaker matching transformers | 3,995.00 |
| | | | | | M-6034 | Optional preamplifier | 75.00 |
| | | | | | M-5700 | Optional program amplifier .. | 150.00 |
| | | | | | A-30601 | Speaker matching transformer | 3.75 |
| | | | | | M-6208 | Optional 3rd VU meter | 49.50 |
| | | | | | M-6424 | Intercom sub-station | 32.50 |
| | | | | 88 | M-6377 | Diplomat audio console complete, with 4 type A-30601 speaker matching transformers | 3,195.00 |
| | | | | | M-5700 | Optional program amplifier .. | 150.00 |
| | | | | | M-6034 | Optional preamplifier | 75.00 |
| | | | | | A30601 | Speaker matching transformer | 3.75 |
| | | | | | M-6424 | Studio cue/intercom speaker | 32.50 |
| | | | | 91 | M-6209A | President, dual channel audio console, complete, includes 2 external VU meters and 4 type A-30601 speaker matching transformers | 2,795.00 |
| | | | | | M-6034 | Optional plug-in microphone preamplifiers | 75.00 |
| | | | | | M-6208 | External VU meter with housing | 49.50 |
| | | | | | M-6424 | Intercom sub-station, deluxe . | 32.50 |
| | | | | | TK-503 | Spare 100% semi-conductor kit | 89.00 |
| | | | | | KCP-5 (M6482) | Relay, 30 volt D.P.D.T. to start-stop external equipment | 17.50 |

| CAT. PAGE | TYPE NUMBER | PRODUCT DESCRIPTION | UNIT PRICE | CAT. PAGE | TYPE NUMBER | PRODUCT DESCRIPTION | UNIT PRICE |
|-----------|-------------|--|------------|-----------|-------------|--|------------|
| 95 | M-5564A | Ambassador, single channel console, complete with 2 pre-amplifiers and 4 type A-30601 speaker matching trans. | 2,195.00 | | CB-510 | Complete 16-inch trans. equipment including turntable, self-contained preamp., power supply, 2-position equalizer, pickup arm and dual sapphire stylus | 439.00 |
| | M-6034 | Extra plug-in microphone preamplifier | 75.00 | | CB-510A | Complete trans. equip., as above, but with dual-diamond styli | 446.00 |
| | M-6424 | Intercom Sub-station, deluxe | 32.50 | | CB-1525 | Complete 16-inch trans. equip., in floor cabinet, consisting of CB 510 equipment and M 6448A cabinet | 545.00 |
| | A-30601 | Speaker matching transformer | 3.75 | | CB-1525A | Complete trans. equip. in cabinet, CB-510A equip. & M-6448A cabinet | 552.00 |
| | M-6482 | Relay kit for use with Control Center to start mechanical device | 17.50 | | M-6448A | Floor cabinet only with cutout for CB-500 chassis | 110.00 |
| | 913-6060 | Plug-in jumper board | 3.25 | | M-6448 | Floor cabinet less cutout for turntable | 110.00 |
| 97 | M-5236B | Dualux Audio Console complete | 2,295.00 | | 474-0011 | Step-down transformer, primary 230 V, 50/60 cycles, secondary 115 volts | 8.00 |
| | TK-499 | 100% spare tube kit | 76.00 | | CB-77 | 12-inch trans. turntable, chassis only, 60 cycle | 260.00 |
| | M-5304A | Optional preamplifier | 55.00 | | M-5890 | CB-88, complete 12-inch trans. equipment including turntable, self-contained preamp., power supply, 2-position equalizer, pickup arm & dual sapphire styli | 409.00 |
| | A-30601 | Speaker matching transformer | 3.75 | | M-5890A | CB-88A, complete trans. equip. as above, with dual-diamond styli | 416.00 |
| | M-6424 | Studio cue/intercom speaker. | 32.50 | | CB-1880 | Complete 12" trans. equip. in floor cabinet, consisting of CB-88 equip. & M-6448A cabinet | 515.00 |
| 99 | M-5133B | Gateway Audio Console complete | 1,695.00 | | CB-1880A | Complete trans. equip. in cabinet consisting of CB-88A (diamond styli) & M-6448B cabinet | 522.00 |
| | TK-451 | 100% spare tube kit | 38.00 | | M-6448B | Floor cabinet only with cutout for CB-77 chassis | 110.00 |
| | M-5304A | Optional preamplifier | 55.00 | | M-6448 | Floor cabinet only, less cutout | 110.00 |
| | A-30601 | Speaker matching transformer | 3.75 | | 474-0011 | Step-down transformer, primary 230 V, 50/60 cycles, secondary 115 V | 8.00 |
| | M-6424 | Studio cue/intercom speaker . | 32.50 | | | | |
| | AK-11939 | Extra muting relay | 14.85 | | | | |
| 101 | M-6188 | Stereo Yard Audio Console complete | 2,595.00 | | | | |
| | TK-417 | 100% spare tube kit | 65.00 | | | | |
| | A-30601 | Speaker matching transformer | 3.75 | | | | |
| 103 | M-5526A | Yard Audio Console complete | 1,395.00 | | | | |
| | TK-446 | 100% spare tube kit | 33.50 | | | | |
| | M-5304A | Optional preamplifier | 55.00 | | | | |
| | A-30601 | Speaker matching transformer | 3.75 | | | | |
| | AK-12626 | Optional muting relay | 14.85 | | | | |
| 105 | M-5381A | Studioette Audio Console ... | 1,095.00 | | | | |
| | TK-444 | 100% spare tube kit | 22.50 | | | | |
| 105 | M-5304A | Optional preamplifier | 55.00 | | | | |
| | A-30601 | Speaker matching transformer | 3.75 | | | | |
| | AK-12626 | Extra muting relay | 14.85 | | | | |
| 107 | M-5421B | TV-10 Audio Console complete | 2,495.00 | | | | |
| | TK-445 | 100% spare tube kit | 61.00 | | | | |
| | M-5304A | Optional preamplifier | 55.00 | | | | |
| | A-30601 | Speaker matching transformer | 3.75 | | | | |
| | AK-12626 | Optional muting relay | 14.85 | | | | |
| | | CBS CONSOLES | | | | | |
| 110 | M-6337 | Television Audio Control Console | On Request | 113 | M-6465 | Complete stereo turntable equip. with diamond stylus & M-6448B cabinet | 668.00 |
| | | TRANSCRIPTION TURNTABLES | | | M-6143A | Stereo equipment, same as above, but less floor cabinet | 558.00 |
| 113 | CB-500 | 16-inch trans. turntable, chassis only, 60 cycles | 275.00 | | | | |

| CAT. PAGE | TYPE NUMBER | PRODUCT DESCRIPTION | UNIT PRICE | CAT. PAGE | TYPE NUMBER | PRODUCT DESCRIPTION | UNIT PRICE |
|-----------|-------------|--|------------|-----------|-------------|---|------------|
| | M-6449B | Dual turntable cabinet, with cutouts for two CB-77 or CB-88 equipments | 185.00 | | M-6450 | Uniform top section, complete with mounting angles & cable trough | 40.00 |
| | M-6449A | Dual turntable cabinet, with cutouts for two CB-500 or CB-525 equipments | 185.00 | | M-6455 | Single leg assembly | 8.50 |
| | | | | | M-6456 | Double leg assembly | 18.00 |
| | | | | | M-6454 | Combo desk system, complete with 2 double pedestals and top section | 380.00 |
| 114 | 208-S | Gray viscous-damped arm | 52.00 | | M-6453B | Grill 10½" high | 6.00 |
| | 208-S/G | Gray viscous-damped arm for turn-around cartridge | 52.00 | | M-6453C | Grill 5¼" high | 5.75 |
| | 212-TN | Gray viscous-damped arm | 37.50 | | M-6453D | Grill 3½" high | 5.50 |
| | S-320 | Omni-balance tone arm for 12" turntables | 34.95 | | CB-4 | Horseshoe desk | 595.00 |
| | S-260 | Omni-balance tone arm for 16" turntables | 39.95 | | M-5371 | Equipment desk | 105.00 |
| | 602-C | Equalizer complete | 62.50 | | M-5372 | Equipment desk | 115.00 |
| | M-5269 | Turntable cabinet | 90.00 | | | | |
| | M-5937 | Turntable cabinet | 75.00 | | | | |
| | | TRANSCRIPTION ARMS | | | | | |
| 115 | M-6244 | Monophonic Transistor Equalizer Turntable Preampifier | 99.00 | 121 | M-6211F | Carritape II Playback Unit for Monaural, 1 Tone | 580.00 |
| | M-6442 | Stereophonic Transistor Equalizer Turntable Preampifier | 250.00 | | M 6211G | Carritape II Playback Unit for Monaural, 2 Tone | 615.00 |
| | | TURNTABLE PREAMPLIFIERS | | | M-6211H | Carritape II Playback Unit for Monaural, 3 Tone | 650.00 |
| | | PICKUP CARTRIDGES | | | M-6212C | Carritape II Playback Unit for Stereo, 1 Tone | 760.00 |
| | 4G050 | Pickup Cartridge | 12.95 | | M-6212D | Carritape II Playback Unit for Stereo, 2 Tone | 795.00 |
| | 4G052 | Pickup Cartridge | 16.95 | | M 6212E | Carritape II Playback Unit for Stereo, 3 Tone | 830.00 |
| | 4G053 | Pickup Cartridge | 19.95 | | M-6213I | Carritape II Record/Play Unit for Monaural, 1 Tone | 995.00 |
| | 4G040 | Pickup Cartridge | 9.95 | | M-6213J | Carritape II Record/Play Unit for Monaural, 2 Tone | 1,035.00 |
| | 4G041 | Pickup Cartridge | 9.95 | | M-6213K | Carritape II Record/Play Unit for Monaural, 3 Tone | 1,070.00 |
| | 4G061 | Pickup Cartridge | 13.95 | | M-6214F | Carritape II Record/Play Unit for Stereo, 1 Tone | 1,295.00 |
| | 4G063 | Pickup Cartridge | 13.95 | | M-6214G | Carritape II Record/Play Unit for Stereo, 2 Tone | 1,330.00 |
| | 4GD-01S02S | Pickup Cartridge | 12.95 | | M-6214H | Carritape II Record/Play Unit for Stereo, 3 Tone | 1,365.00 |
| | 4GD-01D02S | Pickup Cartridge | 16.95 | | M-6216A | Carritape II 150 Cycle Cue Amplifier | 40.00 |
| | 4GD-01D02D | Pickup Cartridge | 19.95 | | M-6216B | Carritape II 8000 Cycle Cue Amplifier | 40.00 |
| | 4GS-01D | Pickup Cartridge | 13.95 | | M-6219 | Carritape II Switcher, Monaural | 139.50 |
| | 4GS-02D | Pickup Cartridge | 13.95 | | M-6220 | Carritape II Switcher, Stereo | 184.00 |
| | 4GS-01S | Pickup Cartridge | 9.95 | | M-6221 | Carritape II Remote Unit, Playback | 36.00 |
| | 4GS-02S | Pickup Cartridge | 9.95 | | M-6234 | Carritape II Remote Unit, Record | 36.00 |
| | 4G-01S | Pickup Stylus | 2.29 | | M-5986 | Carritape II Cartridge Storage Rack | 37.50 |
| | 4G-02S | Pickup Stylus | 2.29 | | ALT-1 | Azimuth Alignment Cartridge, 15 KC | 7.50 |
| | 4G-03S | Pickup Stylus | 2.29 | | | | |
| | 4G-01D | Pickup Stylus | 5.95 | | | | |
| | 4G-02D | Pickup Stylus | 5.95 | | | | |
| | 4G-03D | Pickup Stylus | 5.95 | | | | |
| | 723-0236 | M44-7 Stereophonic cartridge with 0.7 mil diamond stylus .. | 19.95 | | | | |
| | 723-0237 | Replacement 0.7 mil stereo stylus (diamond) | 9.75 | | | | |
| | | NEW CONTROL DESKS | | | | | |
| 117 | M-6448 | Single Turntable Pedestal, complete | 110.00 | | | | |
| | M-6449 | Double Turntable Pedestal, complete | 170.00 | | | | |

| CAT. PAGE | TYPE NUMBER | PRODUCT DESCRIPTION | UNIT PRICE | CAT. PAGE | TYPE NUMBER | PRODUCT DESCRIPTION | UNIT PRICE |
|-----------|-------------|---|------------|-----------|-------------|--|------------|
| | HD-11M | Bulk Tape Eraser | 18.95 | | M-5702 | Transistorized, plug-in power supply | 175.00 |
| | 732-0168 | Tape Head Demagnetizer ... | 6.00 | | M-6032 | Mounting tray for M-5702 ... | 9.00 |
| | | TAPE CARTRIDGES—PORTABLE TURNTABLE | | | M-6029 | Panel and Shelf Assembly | 35.00 |
| 122 | | NAB-A SERIES | | | | REMOTE AMPLIFIERS | |
| | A-300 | Empty | 2.00 | 131 | M-6434 | Dynamote "70" 4-channel remote amplifier, complete but less male microphone connectors and batteries | 550.00 |
| | A-300A | 40 seconds | 2.25 | | XLR3-12C | Microphone plugs, male (4 required) | 1.13 |
| | A-300B | 70 seconds | 2.35 | | M-6441 | Battery complement | 2.25 |
| | A-300C | 100 seconds | 2.40 | | M-6445 | Vinyl cover with accessory packet | 8.50 |
| | A-300D | 3½ minutes | 2.70 | | M-6435 | In-line D.C. power supply, complete | 29.50 |
| | A-300E | 5½ minutes | 3.00 | 132 | M-6433 | Attache 3-channel remote amplifier, less batteries and male microphone connectors.. | 375.00 |
| | A-300G | 10½ minutes | 4.00 | | XLR3-12C | Microphone connector, 3 req. . | 1.13 |
| | | NAB-B SERIES | | | M-6441 | Battery kit complete | 2.25 |
| | B-600 | Empty | 3.25 | | 478 0221 | Optional microphone input transformer | 22.50 |
| | B-600H | 16 minutes | 6.45 | | M-6435 | Power supply, in-line type | 29.50 |
| | | NAB-C SERIES | | | M-6444 | Pliable vinyl cover | 7.50 |
| | C-1200 | Empty | 4.25 | 133 | M-6432 | Courier "70" 2-channel transistorized remote amplifier, complete with transistors, less batteries . | 295.00 |
| | C-1200J | 31 minutes | 10.25 | | M-6441 | 100% battery kit | 2.25 |
| | KD-20A | Portable Audio Console | 813.75 | | 478-0221 | Microphone input transformer.. | 22.50 |
| 124 | M-6407 | Producer recording mixer | 695.00 | | M-6444 | Vinyl cover, with accessory pocket | 7.50 |
| | A-30601 | Speaker matching transformer.. | 3.75 | | M-6435 | In-line power supply for 117 volt operation | 29.50 |
| | | PREMIUM SOLID STATE AUDIO AMPLIFIERS—6300 SERIES | | | XLR3-12C | Microphone connectors, male (2 required) | 1.13 |
| 127 | M-6313 | Preamplifier | 164.00 | 134 | M-6431 | Unimote "70" single channel remote amplifier, less batteries | 125.00 |
| | M-6321 | Program amplifier | 227.00 | | M-6441 | Battery complement | 2.25 |
| | M-6314 | Program/AGC amplifier | 279.00 | | 478-0221 | Input transformer | 22.50 |
| | M-6315 | Monitor amplifier | 358.00 | | M-6435 | In-line power supply | 29.50 |
| | 550-0255 | Potentiometer for monitor amplifier gain control | 5.35 | | XLR3-12C | Microphone connector, male (1 required) | 1.13 |
| | M-6421 | 300 Ma. 48 volt power supply | 156.00 | | | DUAL PEAK LIMITING AMPLIFIER | |
| | M-6338 | 1.5 Amp. 48 volt power supply | 205.00 | 135 | M-6144 | Dual peak limiting amplifier with tubes | 925.00 |
| | M-6341 | Mtg. Tray for preamplifier | 9.50 | | TK-420 | Spare 100% tube kit | 18.50 |
| | M-6426 | Mtg. Tray for program amplifier | 9.50 | 137 | M-6467 | Gates FM Top Level, complete | 525.00 |
| | M-6342 | Mtg. Tray for PGM/AGC amplifier | 11.50 | 138 | M-3529B | SA-39B Peak Limiting Amplifier with tubes | 485.00 |
| | M-6343 | Mtg. Tray for monitor amplifier | 9.50 | | | | |
| | M-6422 | Mtg. Tray for M-6421 power supply | 9.50 | | | | |
| | M-6344 | Mtg. Tray for M-6338 power supply | 9.50 | | | | |
| | M-6345 | Panel and shelf assembly | 35.00 | | | | |
| | M-6337 | Television Audio Control Console | On Request | | | | |
| | | SOLID-STATESMAN PLUG-IN AUDIO AMPLIFIERS | | | | | |
| 128 | M-6028 | Transistor plug-in preamplifier.. | 115.00 | | | | |
| | M-6030 | Mounting tray for M-6028 | 9.00 | | | | |
| | M-5700B | Transistor plug-in program amplifier | 150.00 | | | | |
| | M-6031 | Mounting tray for M-5700B .. | 9.00 | | | | |
| 129 | M-5701 | Transistor plug-in monitor amplifier | 275.00 | | | | |
| | M-6032 | Mounting tray | 9.00 | | | | |
| | A-30601 | Speaker matching transformer.. | 3.75 | | | | |

| CAT. PAGE | TYPE NUMBER | PRODUCT DESCRIPTION | UNIT PRICE | CAT. PAGE | TYPE NUMBER | PRODUCT DESCRIPTION | UNIT PRICE |
|-----------|-----------------------------------|--|------------|-----------|-----------------------|---|------------|
| 140 | TK-150 | Spare 100% tube kit | 27.00 | | SH-300 | Microphone, complete with connector and 20 ft. cable | 90.00 |
| | M-5546A | Level Devil with tubes | 425.00 | | 666 | Microphone, complete with 20' cable and connector | 153.00 |
| | TK-331 | Spare 100% tube kit | 30.00 | | 420 | Desk stand | 12.00 |
| 141 | M-5167 | Sta-Level with tubes | 265.00 | | U-64 | Linear admittance condensor microphone, with power supply | 360.00 |
| | TK-243 | Spare 100% tube kit | 15.00 | | D-25 | Microphone, complete with cable | 210.00 |
| | AMPLIFIERS FOR BROADCASTING | | | | SH-576 | Microphone, complete with 25' cable and swivel adaptor | 105.00 |
| 142 | M-5136A | Biamote 2-channel remote amplifier with tubes, less male microphone connectors | 325.00 | | RACK CABINETS | | |
| | XLR-3-12C | Microphone connector (2 required) | 1.13 | 146 | RAK-1 | Basic cabinet assembly less side panels but including rear door | 175.00 |
| | TK-443 | Spare 100% tube kit | 7.00 | | TRM-1 | Single corner trim | 12.00 |
| | M-5530 | Single Channel Utility Amplifier with tubes | 110.00 | | TRM-2 | Double corner trim | 13.20 |
| | XLR3-13 | Chassic connector (female) optional | 1.85 | | SP-1 | Side panel | 35.00 |
| | XLR-3-12C | Microphone connector (male) | 1.13 | | SH-1 | Shield | 7.50 |
| | TK-280 | Spare 100% tube kit | 5.00 | | BRK-1 | Terminal board mounting bracket | 7.00 |
| 143 | M-5576B | Program Amplifier with tubes | 230.00 | | RAK-F-1 | Ventilating fan | 39.50 |
| | TK-450 | Spare 100% tube kit | 6.50 | | RAK-7 | Rack cabinet | 100.00 |
| | M-5575 | Ultra Linear Monitoring Amplifier, with tubes | 240.00 | | M-5577 | Joiner trim | 12.50 |
| | TK-303 | Spare 100% tube kit | 12.00 | | AUDIO ACCESSORIES | | |
| | A-30601 | Speaker matching transformer | 3.75 | 147 | M-5377 | Cueing Amplifier with tubes | 175.00 |
| | GATES BROADCAST MICROPHONES | | | | TK-305 | Spare 100% tube kit | 2.50 |
| 144 | G-100 | Gates Dynamic, Omnidirectional Microphone | 39.00 | | M-4242 | Switch and fuse panel | 38.50 |
| | 418 | Matching desk stand | 6.00 | | V-22 | VU meter and range panel | 130.00 |
| | G-200 | Gates Dynamic, Omnidirectional Microphone | 55.00 | | STUDIO WARNING LIGHTS | | |
| | 418 | Matching desk stand | 6.00 | | AM-1 | Studio A | 19.00 |
| | G-300 | Gates Dynamic, Cardioid Microphone | 62.50 | | AM-2 | Studio B | 19.00 |
| | 419 | Matching desk stand | 6.00 | | AM-3 | Control Room | 19.00 |
| | G-400 | Micremote, complete with 20' output cable, earphone, battery and carrying case | 231.25 | | AM-4 | On Air (in red) | 19.00 |
| | 660-0016 | Spare battery | 1.95 | | AM-6 | Information | 19.00 |
| | G-500 | Gates Dynamic Lavalier Microphone, with Lavalier cord and clip | 45.50 | | AM-7 | Ladies | 19.00 |
| | SELECTED PROFESSIONAL MICROPHONES | | | | AM-8 | Gentlemen | 19.00 |
| 145 | 642 | Microphone, complete with connector and 20' cable | 234.00 | | AM-5 | Special lettering up to 12 characters | 19.00 |
| | 356 | Shock mount (required) | 30.00 | 148 | 826-7824 | VA Knob only | 2.15 |
| | U-67 | Condensor microphone system with power supply and 25 ft. cable | 435.00 | | 826-7773 | Dial for VA Knob | 1.45 |
| | Z-48 | Elastic suspension for boom use | 32.50 | | DC-53 | Knob color insert kit—(6 colors—5 of each) | 3.00 |
| | D-24E | Dynamic cardioid microphone with cable | 150.00 | | M-6424 | Studio Cue/Intercom Speaker | 32.50 |
| | | | | | M-6208 | Desk or console top V.U. meter | 49.50 |
| | | | | | A-30601 | Speaker matching transformer | 3.75 |
| | | | | | LE-1 | Fixed equalizer complete | 50.00 |
| | | | | | LE-2 | Variable equalizer | 125.00 |
| | | | | | PJ-343 | Jack strip only, 24 jacks or 12 prs. (no jack mat required) | 25.14 |

| CAT. PAGE | TYPE NUMBER | PRODUCT DESCRIPTION | UNIT PRICE | CAT. PAGE | TYPE NUMBER | PRODUCT DESCRIPTION | UNIT PRICE |
|-----------|-------------|---|------------|-----------|-------------|---|------------|
| | PJ-341 | Jack strip only, 48 jacks or 24 prs. (less mat) | 42.75 | | 730-0180 | Head demagnetizer | 6.00 |
| | PD-1 | Jack mat for one PJ-341 jack strip | 8.75 | | | SPEAKERS & BAFFLES | |
| | PD-2 | Jack mat for two PJ-341 jack strips | 8.75 | 151 | GRS-800 | Gatespeaker 8" speaker | 4.95 |
| | PD-3 | Jack mat for three PJ-341 jack strips | 9.75 | | GRS-1200 | Gatespeaker 12" speaker | 6.30 |
| | PJ-12 | Double patch cord with 2' cord | 6.75 | | GRS-1250 | Gatesound 12" speaker | 19.95 |
| | PJ-13 | Double patch cord with 3' cord | 6.90 | | GRS-550 | Gatestweeter 5" speaker, with crossover kit | 7.95 |
| | PJ-14 | Double patch cord with 4' cord | 7.13 | | 722-0044 | Studio quality loudspeaker system | 149.00 |
| | PJ-15 | Double patch cord with 5' cord | 7.28 | | SCB-8D | Corner baffle, 8" (specify blond or walnut) | 8.50 |
| | | AUDIO ACCESSORIES | | | SCB-12D | Corner baffle, 12" (specify blond or walnut) | 11.95 |
| 149 | C-540 | Disc Storage Cabinet | 249.00 | | DWB-8A | Wall baffle, 8" (specify blond or walnut) | 6.00 |
| | TR-742 | 7" Tape cabinet | 15.75 | | DWB-12A | Wall baffle, 12" (specify blond or walnut) | 8.40 |
| | TR-1021 | 10 1/2" Tape cabinet | 11.55 | | WB-8D | Wall baffle, 8" (specify blond or walnut) | 4.35 |
| | TR-7288 | 7" Double cabinet | 127.05 | | WB-12D | Wall baffle, 12" (specify blond or walnut) | 6.00 |
| | TR-192 | 10 1/2" Double cabinet | 130.50 | | | SPEAKER TRANSFORMERS | |
| | LP-12 | Disc-cabinet for sixty albums . . | 37.50 | | 478-0250 | Matching transformer TR-15 . . | 3.60 |
| | LP-12D | As above, with snap catch door | 45.00 | | A-30601 | Transformer, primary 45/48 ohms: Sec. 8 ohms | 3.75 |
| | XLR-3-35-2G | Single, female, wall plate . . | 7.42 | | 554 0227 | Pad, 8 ohm T pad | 5.90 |
| | XLR3-12G | Cable plug, 3 prong, male . . . | 1.13 | | 554-0180 | Pad, 4 ohm T pad | 5.90 |
| | XLR3-11C | Cable receptacle, female . . . | 1.29 | | | PROOF OF PERFORMANCE EQUIPMENT | |
| | XLR3-13 | Chassis receptacle, female . . . | 1.85 | 152 | SA-131 | Complete Proof of Performance Package, consists of one each, Models 210, 410, M-3625 & M-3626 units | 676.50 |
| | XLR3-14 | Chassis receptacle, male | .79 | | 210 | Audio Oscillator | 186.50 |
| | SH-20 | Studio cable | .06 ft. | | 410 | Distortion Meter | 215.00 |
| | 8440 | Studio cable | .05 ft. | | M-3625 | Gain Set | 215.00 |
| | 1261 | Studio cable | .06 ft. | | M-3626 | Diode and Pickup | 60.00 |
| | 8428 | Studio cable | .11 ft. | | | PROFESSIONAL RECORDERS & ACCESSORIES | |
| | 8436 | Studio cable | .05 ft. | 154 | 730-0386 | Type PR-10-2 two-track stereo recorder, 60 cps., 7 1/2-15 ips., unmounted, weight 53 lbs. . . . | 1,245.00 |
| | MIC-100 | Microphone cable | .08 ft. | | 730-0061 | Type PR-10-1 full-track monaural recorder, 60 cps., 7 1/2-15 ips., unmounted, weight 53 lbs. | 1,045.00 |
| | 8410 | Microphone cable | .08 ft. | | 730-0073 | Plug-in line transformer, 600 ohms | 15.00 |
| | PJ-106 | Audio terminal block | 9.45 | | 730-0072 | Plug-in line transformer, balanced bridging | 15.00 |
| | | AUDIO ACCESSORIES | | | 730-0362 | Preamplifier, low impedance, 40 db., gain | 45.00 |
| 150 | BS-36 | Boom stand without casters . . | 39.90 | | 730-0071 | Portable case for PR-10-1, or PR-10-2 recorders | 75.00 |
| | BS-36W | Boom stand with silent casters | 45.90 | | | | |
| | FM-1 | Flexo Mikester | 16.95 | | | | |
| | 418 | Desk stand | 6.00 | | | | |
| | 419 | Desk stand | 6.00 | | | | |
| | DS-7 | Desk stand | 3.30 | | | | |
| | DS-5 | Desk stand | 1.95 | | | | |
| | TS-8 | Banquet stand | 6.15 | | | | |
| | MS-25 | Professional floor stand | 16.80 | | | | |
| | MS-10C | Utility floor stand | 6.00 | | | | |
| | BB-1 | Baby boom attachment | 4.80 | | | | |
| | BA-200 | Dual headset | 17.25 | | | | |
| | BA-201 | Single headset | 14.95 | | | | |
| | 107 | Trim dual headset | 6.60 | | | | |
| | BA-206B | Stereo headset | 33.20 | | | | |
| | TS-8D | "Stereo 4" tape splicer | 9.56 | | | | |
| | KS-3 | Editoll splicing kit | 8.95 | | | | |
| | HD-11M | Bulk eraser | 18.95 | | | | |
| | HD-11AD | Adaptor hub for 10 1/2" reels . | 2.30 | | | | |
| | P-30 | Jiffy hand-type tape eraser . . | 17.25 | | | | |

| CAT. PAGE | TYPE NUMBER | PRODUCT DESCRIPTION | UNIT PRICE | CAT. PAGE | TYPE NUMBER | PRODUCT DESCRIPTION | UNIT PRICE |
|-----------|-------------|--|------------|-----------|-------------|--|------------|
| | 730-0431 | Type CL-10 Logging Recorder, 2-channel, 4-track, less case .. | 1,245.00 | | 150-9 | 1/4" x 900', 5" plastic reel .. | 2.40 |
| | 730-0071 | Portable case for above | 75.00 | | 150-18 | 1/4" x 1800', 7" plastic reel .. | 4.13 |
| | 730-0117 | Remote control with housing and 30' cable | 85.00 | | 150-36R | 1/4" x 3600', 10 1/2" aluminum reel | 9.57 |
| | 730-0118 | Remote control unwired and flush mounting | 57.50 | | 190-9 | 1/4" x 900', 5" plastic reel .. | 2.34 |
| | MX-10 | Mixer, 4-position, 2-channel .. | 395.00 | | 190-18 | 1/4" x 1800', 7" plastic reel .. | 3.67 |
| | | MAGNECORD RECORDER/REPRODUCERS | | | 190-36R | 1/4" x 3600', 10 1/2" aluminum reel | 8.53 |
| 155 | 730-0418 | 1021 Monaural, 3 3/4-7 1/2 ips., full track record-full track erase, half track playback, less case | 708.00 | | 290-36 | 1/4" x 3600', 7" plastic reel .. | 7.97 |
| | 730-0425 | Transport case for 1021 | 30.00 | | 175-6 | 1/4" x 600', 5" plastic reel .. | 1.60 |
| | 730-0426 | Amplifier case for 1021 | 30.00 | | 175-12 | 1/4" x 1200', 7" plastic reel .. | 2.50 |
| | 730-0419 | 1022X Stereo, 7 1/2-15 ips., half track stereo. Fourth head included in 1/4 track stereo play, less case | 788.00 | | 41 1/2 S | Splicing tape 1/2" x 150' | .39 |
| | 730-0425 | Transport case for 1022 | 30.00 | | ST-466B | Mylar splicing tape (for cartridges 1/2" x 66' | .90 |
| | 730-0426 | Amplifier case for 1022 | 30.00 | | 24W 1/4-100 | Plastic leader tape 1/4" x 100' | .60 |
| | 730-0421 | 1028-2 Stereo, 7 1/2-15 ips., half track stereo, less case | 995.00 | | 51 7/32 S | Aluminized sensing tape, 7/32" x 150' | 1.89 |
| | 730-0428 | 1028-4 As above, 1/4 track version | 995.00 | | | HIGH FREQUENCY BROADCAST TRANSMITTER | |
| | 730-0372 | 91X3168 Carrying case for 1028 models | 50.00 | 160 | HC-114-5 | 250,000 watt short wave broadcast trans., with one set of tubes, less crystals and without remote control, for 50 cycle operation | On Request |
| | 730-0007 | 32X33-Input transformer, plug-in. 50/250 ohm (2 req. for Stereo) | 26.25 | | HC-114-5R | 250,000 watt short wave broadcast trans., one set of tubes, less crystals including remote control unit, for 50 cycle operation | On Request |
| | 730-0336 | 32B90-Output transformer, plug-in. 600 ohm (2 req. for Stereo) | 26.25 | | HC-114-6 | 250,000 watt short wave broadcast trans., one set of tubes, less crystal and with- out remote control unit, for 60 cycle operation | On Request |
| | 730-0337 | 66X152 Transformer hold-down clip (1 req. per transformer) | .81 | | HC-114 6R | 250,000 watt short wave broadcast trans., one set of tubes, less crystal including remote control unit, for 60 cycle operation | On Request |
| | 730-0338 | 91C2959 Rack adapter panel .. | 19.00 | | TK-524 | Spare tubes for 250 KW, HF Transmitter | On Request |
| | | PORTABLE TAPE RECORDER | | | M-6458 | Set of lamps and fuses for 250 KW transmitter | On Request |
| 156 | 4000-S | Portable Recorder, complete with remote dynamic microphone, leather case, AC power unit, battery charger and battery | 399.95 | | M-6459 | Set of installation materials for 250 KW transmitter .. | On Request |
| | | RECORDING TAPE | | | M-6460 | Set of recommended spare parts for vapor phase cooling system | On Request |
| | 111-3 | 1/4" x 300', plastic 3" reel .. | .90 | | M-6461 | Running spare part kit for 250 KW transmitter | On Request |
| | 111-6 | 1/4" x 600', plastic 5" reel .. | 1.50 | | CR-27A/U | Crystal for 250 KW transmitter | On Request |
| | 111-12 | 1/4" x 1200', plastic 7" reel .. | 2.34 | | | | |
| | 111-25R | 1/4" x 2500', aluminum 10 1/2" reel | 7.20 | | | | |
| | 200-12 | 1/4" x 1200', 5" plastic reel .. | 3.63 | | | | |
| | 200-24 | 1/4" x 2400', 7" plastic reel .. | 6.33 | | | | |
| | 151-16 | 1/4" x 1600', 7" plastic reel .. | 6.68 | | | | |

| CAT. PAGE | TYPE NUMBER | PRODUCT DESCRIPTION | UNIT PRICE | CAT. PAGE | TYPE NUMBER | PRODUCT DESCRIPTION | UNIT PRICE |
|-----------|-----------------------|---|------------|-----------|-------------------|---|------------|
| 164 | HF-100 (M-5966) | HIGH FREQUENCY BROADCAST TRANSMITTER 100,000 watts, High Frequency Broadcast Transmitter, with tubes, less crystals On Request | | | HF-10BX | Broadcast transmitter, 10 KW, with tubes, electronic keyer, less crystals | 25,700.00 |
| | HF-100TX (M-5966A) | 100,000 watts, High Frequency Telegraph Transmitter, with tubes, less crystals On Request | | | HF-10C | Communications transmitter, 10 KW, with tubes, less crystals | 24,700.00 |
| | CR27A/U | Crystals (transmitter accommodates 10) | 15.30 | | HF-10CX | Communications transmitter, 10 KW, with tubes, electronic keyer, less crystals | 24,900.00 |
| | JK-09C | Crystal oven (holds two crystals) (transmitter accommodates 5) | 12.50 | | TK-253 CR27A/U | Spare 100% tube kit | 1,193.40 |
| | TK-510 | Spare 100% tubes for HF-100 On Request | | | JK-09C | Temperature controlled oven, hold two CR27A/U (.003% accuracy) | 12.50 |
| | M-5569F | Additional exciter with power supply | 993.00 | | | | |
| 168 | HF-50C (M-5924) | 50,000 watts, High Frequency Broadcast Transmitter, with tubes, less crystals | 110,000.00 | | | HIGH FREQUENCY AM TRANSMITTER | |
| | M-5924A | Same as above for 50 cps operation | 113,000.00 | 176 | BHF-10 | 10 KW High Frequency trans- mitter, complete with one set of tubes, but less crystals or ovens | 27,500.00 |
| | CR-27A/U | Crystals | 15.30 | | CR27A/U | Crystals only for BHF-10 | 15.30 |
| | JK-09C | Crystal Oven (holds two crystals) | 12.50 | | JK09C | Oven for two crystals | 12.50 |
| | TK-510 | Spare 100% tubes for HF-50C | 6,845.00 | | TK-518 | 100% set spare tubes | 1,515.00 |
| | M-5569D | Additional exciter with power supply | 993.00 | | M-5263 | Limiter Amplifier | 295.00 |
| 171 | HF-20B | Transmitter, 20 KW Broad- cast, 4-22 Mc., with tubes, less crystals | 49,500.00 | 177 | HF-5B | Broadcast transmitter, 5 KW, with tubes, less crystals ... | 23,500.00 |
| | HF-20BX | Transmitter, 20 KW Broad- cast, with tubes and with keyer added, 4-22 Mc., less crystals | 49,700.00 | | HF-5BX | Broadcast transmitter, 5 KW, with tubes, electronic keyer, less crystals | 23,700.00 |
| | HF-20CX | Transmitter, 20 KW Telephone and Telegraph, with tubes and keyer, 4-22 Mc., less crystals | 48,200.00 | | HF-5C | Communications transmitter, 5 KW, with tubes less crystals | 22,700.00 |
| | TK-139 | Spare 100% tube kit for all models above | 2,146.00 | | HF-5CX | Communications transmitter, 5 KW, with tubes, electronic keyer, less crystals | 22,900.00 |
| | CR-27A/U | Crystal and holder, .02% accuracy | 15.30 | | TK-252 | Spare 100% tube kit | 1,110.90 |
| | JK-09C | Temperature controlled crystal holds two CR-27A/U crystals for 0.003% accuracy | 12.50 | | CR27A/U | Crystal and holder (mounts in JK 09C below) | 15.30 |
| | | HIGH FREQUENCY BROADCAST TRANSMITTER | | | JK-09C | Temperature controlled oven, holds two CR27A/U (.003% accuracy) | 12.50 |
| 174 | HF-10B | Broadcast transmitter, 10 KW, with tubes, less crystals | 25,500.00 | | | HIGH FREQUENCY BROADCAST TRANSMITTER | |
| | | | | 178 | HF-1M | High frequency transmitter with tubes, less crystals | 6,950.00 |
| | | | | | TK-249 | 100% tube complement | 309.00 |
| | | | | | CR-27A/U | Crystal and holder to mount in JK 09C oven | 15.30 |
| | | | | | JK-09C | Temperature controlled oven for 1 or 2 type CR-27A/U crystals | 12.50 |

| CAT. PAGE | TYPE NUMBER | PRODUCT DESCRIPTION | UNIT PRICE | CAT. PAGE | TYPE NUMBER | PRODUCT DESCRIPTION | UNIT PRICE | |
|-----------|--|---|------------|-----------|-----------------------------------|---|--|------------|
| | M-5263 | Limiters/filter amplifier for telephone service | 295.00 | | CR-27A/U | Crystal and holder (please state frequency) | 15.30 | |
| | MODULATION MONITOR—DELUXE | | | | 478-0262 | Balun, 1000 watts for 600 ohm operation | 315.00 | |
| 179 | M-5774 | Modulation Monitor, 540-1600KC, 2-30 Mc., with tubes | 995.00 | | HIGH FREQUENCY BALUN TRANSFORMERS | | | |
| | TK-346 | Spare 100% tube kit | 33.00 | 193 | HFT-1K | One kilowatt trans., 2 KW PEP, matching 50 ohm to 600 ohm | 315.00 | |
| | M-5837 | Extension modulation percentage meter | 104.50 | | HFT-5K | Five kilowatt trans., 10 KW PEP, matching 50 ohm to 600 ohm | 485.00 | |
| | SINGLE SIDEBAND GENERATOR | | | | 478-0246 | Twenty-five kilowatt trans., 100 KW PEP, matching 50 ohm to 600 ohm | 325.00 | |
| 181 | M-6411 | SG-70 Sideband Generator .. | 3,500.00 | | SINGLE SIDEBAND TRANSCEIVER | | | |
| | TK-517 | Complete set of spare tubes .. | 59.50 | 195 | M-6468 | STR-125 | On Request | |
| | 20,000 WATT SIDEBAND TRANSMITTER | | | | M-6469 | Voice operated transmit module | On Request | |
| 183 | ST-20A | Sideband transmitter, 20,000 watts PEP, complete with tubes, less crystals .. | On Request | | M-6470 | Selectable sideband adaptor module | On Request | |
| | TK-523 | 100% set of tubes | On Request | | M-6480 | 125 watt antenna coupler .. | On Request | |
| | CR27A/U | Crystal with holder | 15.30 | | M-6471A | Antenna kit, 75' | On Request | |
| | M-6481 | Optional blower cabinet only (blower with transmitter) | On Request | | M-6471B | Antenna kit, 150' | On Request | |
| | HIGH POWER HF TRANSMITTER MULTICOUPLER | | | | M-6472 | Doublet antenna kit | On Request | |
| 184 | 790-0463-1 | Model 2X20TC, 40 KW tunable 3-28 Mc., diplexer to combine two 20 KW, HF transmitters | On Request | | M-6473 | C. W. adaptor | On Request | |
| | 10,000 WATT SIDEBAND TRANSMITTER | | | | M-6474 | Remote handset & handset adaptor | On Request | |
| 187 | ST-10A | Sideband Transmitter, 10,000 watts PEP, complete with tubes, less crystals .. | On Request | | M-6475 | Telephone patch | On Request | |
| | TK-522 | 100% set of tubes | On Request | | M-6476 | 1 KW Linear power amplifier | On Request | |
| | CR27A/U | Crystal and holder | 15.30 | | SINGLE CHANNEL SSB RECEIVER | | | |
| | 3,000 WATT SINGLE SIDEBAND TRANSMITTER | | | | 196 | M-6488 | Single channel SR-100 crystal-controlled receiver, rack mount, complete with tubes and crystal | On Request |
| 190 | ST-3A | Transmitter, sideband 3000 watts with tubes, less crystals | 12,500.00 | | TK-530 | Spare tubes | On Request | |
| | TK-520 | Spare 100% tube kit | 508.00 | | M-6489 | Cabinet for desk mounting | On Request | |
| | 478-0246 | Balun, 5 KW, to match 50 ohms to 600 ohms | 485.00 | | SIX-CHANNEL SSB RECEIVER | | | |
| | M-6477 | Roll out base for fixed station operation | 50.00 | 197 | M-6485 | Receiver 6-channel Model SR-6, for rack mounting, with tubes, less crystals | On Request | |
| | M-6478 | Roll out base for transportable operation including shock mounts and wall snubber kit | 100.00 | | M-6486 | Crystal for above | On Request | |
| | CR-27A/U | Crystal and holder (please state frequency) | 15.30 | | M-6487 | Cabinet for desk mounting | On Request | |
| | HIGH FREQUENCY LINEAR AMPLIFIERS | | | | TK-529 | Spare tubes | On Request | |
| 192 | ST-1A | Transmitter, 1000 watt sideband with tubes but less crystals | 8,695.00 | 199 | HFL-20,000 | 20 KW Linear Amplifier, complete with tubes | On Request | |
| | TK-519 | Spare 100% tube kit | 263.00 | | HFL-10,000 | 10 KW Linear Amplifier, complete with tubes | On Request | |
| | | | | | HFL-3000 | 3 KW Linear Amplifier, complete with tubes less roll out base | 9,000.00 | |

| CAT. PAGE | TYPE NUMBER | PRODUCT DESCRIPTION | UNIT PRICE | CAT. PAGE | TYPE NUMBER | PRODUCT DESCRIPTION | UNIT PRICE |
|-----------|--------------------------------------|---|------------|-----------|--|--|------------|
| | M-6477 | Optional roll out base for HFL-3000 trans., fixed station operation | 50.00 | | HF-5TX | For 50 cycles | 16,500.00 |
| | M-6478 | Optional roll out base for HFL-3000 trans., transportable operation including shock mounts and wall snubber kit | 100.00 | | (M-3794A) | | |
| | HFL-1000 | 1 KW Linear Amplifier, complete with tubes | 5,195.00 | | CR27A/U | Crystal for either HF-10TX or HF-5TX | 15.30 |
| | HIGH FREQUENCY TELEGRAPH TRANSMITTER | | | | JK09-C | Oven for crystal | 12.50 |
| 200 | HF-50TX | High Frequency Telegraph Transmitter, 50,000 watts with tubes, less crystals | 85,000.00 | | TK-255 | 100% set spare tubes for HF-10TX | 617.80 |
| | (M-6016) | 60 cps | 85,000.00 | | | 100% set spare tubes for HF-5TX | 596.80 |
| | M-6016A | For 50 cps | 94,000.00 | 204 | TK-254 | HF-5TX | 596.80 |
| | M-5569D | Optional accessory-second exciter which adds 10 more crystal positions | 993.00 | | THF-15 | 15 KW Telegraph Transmitter, with tubes, less crystals | 18,000.00 |
| | TK-388 | Spare 100% tube set | On Request | | (M-6198) | Spare 100% tube kit | 1,052.00 |
| | CR-27A/U | Crystal for HF-50TX | 15.30 | | TK-416 | Crystal in holder | 15.30 |
| | JK-09C | Temperature controlled oven (holds two CR-27A/U crystals) | 12.50 | | CR-27A/U | Crystal in holder | 15.30 |
| | HF-20TX | 20 KW CW Transmitter, 4-22 Mc., complete with tubes, less crystals and ovens | 27,500.00 | | JK-09C | Temperature controlled oven, accommodates two CR-27A/U crystals and holders per oven | 12.50 |
| 201 | (M-4780) | | | | 6-CHANNEL CW/FSK TRANSMITTER | | |
| | TK-140 | Spare 100% tube kit | 1,090.65 | 205 | FS-1000 | One KW six channel CW/FSK Transmitter | 6,950.00 |
| | CR-27A/U | Crystal in holder for .02% accuracy | 15.30 | | M-6446 | Crystal and holder | 15.30 |
| | JK-09C | Temperature controlled oven, (holds 2 CR-27A/U crystals) | 12.50 | | TK-521 | Spare 100% tube kit | 390.00 |
| | HIGH FREQUENCY TELEGRAPH TRANSMITTER | | | | 250 WATT SHORT WAVE TRANSMITTER | | |
| 203 | HF-10TX | Telegraph Transmitter, 10,000 watts for 2-22 Mc., high speed electronic keyer, one set of operating tubes, less crystals and ovens, for 60 cycles | 17,750.00 | 206 | CMG-1 | Telephone and Telegraph Transmitter with one set of tubes, less crystals | 1,995.00 |
| | (M-3795) | | | | (M-5697) | | |
| | HF-10TX | For 50 cycles | 17,750.00 | | H-7 | Crystal in holder (less oven) for .02% accuracy | 14.95 |
| | (M-3795A) | | | | H-17 | Crystal in holder for .003% accuracy | 14.95 |
| | HF-10TX | Telegraph Transmitter, 10,000 watts same as above except 4-30 Mc., for 60 cycles | 17,750.00 | | JK-09C | Oven to accommodate two H-17 crystals | 12.50 |
| | (M-3795B) | | | | TK-136 | 100% spare tube complement | 102.00 |
| | HF-10TX | For 60 cycles | 17,750.00 | | M-4576 | Microphone assembly complete (push-to-talk) | 39.50 |
| | (M-3795C) | | | | Filters for added second harmonic attenuation: | | |
| | HF-5TX | Telegraph Transmitter, 5000 watts for 2-22 Mc., with high speed electronic keyer, set of operating tubes, less crystals and ovens, for 60 cycles | 16,500.00 | | LPF-52 | For 50 ohms | 60.00 |
| | (M-3794) | | | | LPF-72 | For 72 ohms | 60.00 |
| | | | | | LPF-250 | For 250 ohms | 60.00 |
| | | | | | 85 WATT CW TRANSMITTER | | |
| | | | | 207 | M-5569G | Transmitter, 85 watt CW with tubes, less crystals, rack mount | 993.00 |
| | | | | | M-5569H | Transmitter, 85 watt CW with tubes, less crystals, cabinet mount | 993.00 |
| | | | | | TK-291 | Spare 100% tube kit | 22.59 |
| | | | | | CR-27A/U | Crystal and holder for 0.02% accuracy | 15.30 |
| | | | | | JK-09C | Oven to accommodate two CR27A/U crystals for .003% accuracy | 12.50 |

| CAT. PAGE | TYPE NUMBER | PRODUCT DESCRIPTION | UNIT PRICE | CAT. PAGE | TYPE NUMBER | PRODUCT DESCRIPTION | UNIT PRICE |
|-----------|---|--|------------|-----------|------------------------------|---|------------|
| 207 | CM-65 | Telephone transmitter with tubes, less crystals, rack mount | 1,660.00 | | MA-1 | Bumper Mount—Single Ring for Bumper Mount | 19.95 |
| | CR-65 | Telephone transmitter with tubes, less crystals, in cabinet | 1,660.00 | | YC-(Model Numbers) | Antennas, specify frequency .. | 29.95 |
| | M-4576A | Microphone, push-to-talk with cable and plug | 39.50 | | TRANSMITTER CONTROL CONSOLES | | |
| | CR-27A/U | Crystal and holder for .02% accuracy | 15.30 | 214 | M-4055 | CCD-2 Transmitter Control Console | 1,495.00 |
| | JK-09C | Oven to accommodate two CR-27A/U crystals for .003% accuracy | 12.50 | | VOLTAGE REGULATORS | | |
| | TK-292 | Spare 100% tube kit for transmitter | 23.41 | | M-5295 | 1 KVA rack mounted | 322.85 |
| | HIGH FREQUENCY TRANSMITTING ANTENNAS | | | | M-5295A | 1 KVA with wall mounted control unit | 346.50 |
| 208 | 28230 | Vertical Log Periodic Antenna | On Request | | M-5314 | 2 KVA rack mounted | 379.50 |
| | 28231 | Horizontal Log Periodic Antenna | On Request | | M-5314A | 2 KVA with wall mounted control unit | 402.00 |
| | BVR 2-6 | Broadband Vertical Radiator, 2-6 mcs. | 7,110.00 | | M-5315 | 6 KVA with rack mounted control unit | 489.50 |
| | BVR 45-135 | Broadband Vertical Radiator, 4.5-13.5 mcs. | 3,221.00 | | M-5315A | 6 KVA with wall mounted control unit | 514.80 |
| | BVR 11-33 | Broadband Vertical Radiator 11-33 mcs. | 1,259.00 | | M-5316 | 15 KVA with rack mounted control unit | 727.65 |
| | RTA-330 | Rhombic Transmitting Antenna | 520.00 | | M-5316A | 15 KVA with wall mounted control unit | 751.30 |
| | TRL-300 | Transmission Line for Rhombic Transmitting | 400.00 | | M-5317 | 2.4 KVA rack mounted | 386.10 |
| | TDL-340 | Antenna | 300.00 | | M-5317A | 2.4 KVA with wall mounted control unit | 409.00 |
| | LOW FREQUENCY HOMING BEACON TRANSMITTER | | | | M-5318 | 7.5 KVA with rack mounted control unit | 544.50 |
| 209 | M-3975 | Transmitter with code keyer, tubes, less crystal .. | On Request | | M-5318A | 7.5 KVA with wall mounted control unit | 568.70 |
| | M-4033 | Remote Control/Audio Amplifier, with tubes, less microphone | On Request | | M-5319 | 27.5 KVA with rack mounted control unit | 778.80 |
| | M-4124 | Microphone, push-to-talk stand, cord and connector .. | On Request | | M-5319A | 27.5 KVA with wall mounted control unit | 806.50 |
| | M-4116 | Antenna Coupler | On Request | | M-5320 | 10 KVA with rack mounted control unit | 867.80 |
| | H-17 | Crystal and holder | 14.95 | | M-5320 | 10 KVA with wall mounted control unit | 889.50 |
| | REMOTE PICK-UP EQUIPMENT | | | | M-5321 | 20 KVA with rack mounted control unit | 1,074.15 |
| 212 | M30B/TPS | Remote Pick-Up Transmitter. | 625.00 | | M-5321A | 20 KVA with wall mounted control unit | 1,098.35 |
| | M-25C/MR-30/150-170 | Base Station | 650.00 | | M-5322 | 45 KVA with rack mounted control unit | 1,648.90 |
| | M-30/150-170 | Receiver | 375.00 | | M-5322A | 45 KVA with wall mounted control unit | 1,675.30 |
| 213 | RA-4 | Base Station Antenna | 131.75 | | M-5323 | 70 KVA with rack mounted control unit | 2,083.40 |
| | PA-1 | Antenna—Single Ring for Floor Stand Mount | 19.95 | | M-5323A | 70 KVA with wall mounted control unit | 2,107.60 |
| | GENERATING PLANTS | | | 215 | 12RKPBW-3R | 12 KW, 115/230 volts A.C., 1 phase, 3 wire (52 amperes) | 1,377.00 |

| CAT. PAGE | TYPE NUMBER | PRODUCT DESCRIPTION | UNIT PRICE | CAT. PAGE | TYPE NUMBER | PRODUCT DESCRIPTION | UNIT PRICE |
|-----------|----------------|--|------------|-----------|-------------|---|------------|
| | 12RKPBW-5R | 12 KW, 230 volts A.C., 3 phase, 3 wire (30 amperes) | 1,377.00 | | | 25 KW—60 CYCLES OR 21 KW—50 CYCLES (continuous duty 6 cylinder engine) | |
| | 10RPBW4D-3RS | 10 KW, 115/230 volts A.C., 1 phase, 3 wire (43.5 amperes) | 1,289.00 | 216 | 25G60-1 | 60 cycle engine generator, 1 phase, 2 wire | 3,440.00 |
| | 10RPBW4D-4RS | 10 KW, 120/208 volts A.C., 1 phase, 3 wire (27.8 amperes) | 1,289.00 | | 25G60-2 | 60 cycle engine generator 1 phase, 2 wire | 3,440.00 |
| | 705RPBW4D-3R | 7.5 KW, 115/230 volts A.C., 1 phase, 3 wire (33 amperes) | 1,141.00 | | 25G60-3 | 60 cycle engine generator, 1 phase, 3 wire | 3,440.00 |
| | 705RPBW4D-5R | 7.5 KW, 230 volts A.C., 3 phase, 3 wire (18.8 amperes) | 1,141.00 | | 25G60-4 | 60 cycle engine generator, 3 phase, 3 wire | 3,080.00 |
| | 5RPBW4D-3M | 5 KW, 115/230 volts A.C., 1 phase, 3 wire (22 amperes) manual start | 766.00 | | 25G60-5 | 60 cycle engine generator, 3 phase, 3 wire | 3,080.00 |
| | 5RPBW4D-3R | 5 KW, 115/230 volts A.C., 1 phase, 3 wire (22 amperes) remote start | 826.00 | | 25G60-6 | 60 cycle engine generator, 3 phase, 4 wire | 3,080.00 |
| | 5RPBW4D-3E | 5 KW, 115/230 volts A.C., 1 phase, 3 wire (22 amperes) electric start | 807.00 | | 25G60-7 | 60 cycle engine generator, 3 phase, 4 wire | 3,080.00 |
| | 105RPBB4D-1E16 | 1.5 KW, 115 volts A.C., 1 phase, 2 wire (13 amperes) electric start | 315.00 | | 25G60-8 | 60 cycle engine generator, 3 phase, 4 wire | 3,080.00 |
| | 105RPBB4D-1M16 | 1.5 KW, 115 volts A.C., 1 phase, 2 wire (13 amperes) manual start) | 296.00 | | 25G50-1 | 50 cycle engine generator, 1 phase, 2 wire | 3,440.00 |
| | 22314 | 55 gallon underground gasoline tank | 78.00 | | 25G50-2 | 50 cycle engine generator, 1 phase, 2 wire | 3,440.00 |
| | 43697 | 15 gallon gasoline tank | 59.00 | | 25G50-3 | 50 cycle engine generator, 1 phase, 3 wire | 3,440.00 |
| | 23878 | 5 gallon gasoline tank | 13.00 | | 25G50-4 | 50 cycle engine generator, 3 phase, 3 wire | 3,080.00 |
| | 22312 | 25 ft. fuel line kit for use with 55 and 15 gd. tanks | 10.00 | | 25G50-5 | 50 cycle engine generator, 3 phase, 3 wire | 3,080.00 |
| | 23255 | Manual transfer switch, outside type, 200 ampere rating 3 pole to transfer from public utility to generator | 140.00 | | 25G50-6 | 50 cycle engine generator, 3 phase, 4 wire | 3,080.00 |
| 215 | 60ETC3 | 60 amperes, 115/230 V.A.C., 1 phase, 3 wire | 395.00 | | 25G50-7 | 50 cycle engine generator, 3 phase, 4 wire | 3,080.00 |
| | 60ETC5 | 60 amperes, 230 V.A.C., 3 phase, 3 wire | 395.00 | | 25G50-8 | 50 cycle engine generator, 3 phase, 4 wire | 3,080.00 |
| | 100ETC3 | 100 amperes, 115/230 V.A.C., 1 phase, 3 wire | 546.00 | | | 50 KW—60 CYCLES OR 42 KW—50 CYCLES (continuous duty 8 cylinder engine) | |
| | 100ETC5 | 100 amperes, 230 V.A.C., 3 phase, 3 wire | 546.00 | | 50G60-1 | 60 cycle engine generator, 1 phase, 2 wire | 4,970.00 |
| | 200ETC3 | 200 amperes, 115/230 V.A.C., 1 phase, 3 wire | 889.00 | | 50G60-2 | 60 cycle engine generator, 1 phase, 2 wire | 4,970.00 |
| | 200ETC5 | 200 amperes, 230 V.A.C., 3 phase, 3 wire | 889.00 | | 50G60-3 | 60 cycle engine generator, 1 phase, 3 wire | 4,970.00 |
| | | | | | 50G60-4 | 60 cycle engine generator, 3 phase, 3 wire | 4,520.00 |
| | | | | | 50G60-5 | 60 cycle engine generator, 3 phase, 3 wire | 4,520.00 |
| | | | | | 50G60-6 | 60 cycle engine generator, 3 phase, 4 wire | 4,520.00 |
| | | | | | 50G60-7 | 60 cycle engine generator, 3 phase, 4 wire | 4,520.00 |
| | | | | | 50G60-8 | 60 cycle engine generator, 3 phase, 4 wire | 4,520.00 |

HOW TO ORDER

ORDERING PROCEDURE:

All sales are made in accordance with the standard Gates Terms and Conditions of Sale. No order shall be binding upon Gates until accepted by it in writing at its home office in Quincy, Illinois.

PRICES:

Catalog prices are net, f.o.b. Quincy, Illinois, or point of shipment. Our prices are based on cash transactions and all applicable discounts have been deducted. Prices are subject to change without notice. Orders are filled at prices in effect at time of shipment. You will be billed for any price increase and credited for any price reduction. We reserve the right to add any federal, state, or local taxes required by law. If you have a tax exemption number, please include it with your order. These prices and terms apply only to the U.S. For prices and terms in other countries, please contact Export Department, Gates Radio Company.

PAYMENT:

There are five ways to pay for your equipment purchases:

1. Cash—This means full payment with order.
2. C.O.D.—The amount due is collected by the delivery agent. A 25% down payment is required on C.O.D. orders.
3. Sight draft—Your local bank releases payment to us upon receipt of bill of lading. A 25% down payment is normally required.
4. Open Account—Payment to be remitted by you within 30 days after date of each invoice. This privilege is extended to established accounts with good payment records. If you do not have an established account, please provide a current financial statement, plus trade and bank references with your order. Allow about ten days to process the information.
5. Gates Finance Plan—On major purchases, by domestic customers, a portion of the cost may be financed through a monthly payment plan. A finance charge of 6% per annum will be added when the total amount of the order is less than \$4,000.00. On orders of \$4,000.00 or over, the finance charge is 4½% per annum. Title to

and/or rights to the merchandise remain with Gates Radio Company until the balance is fully paid. Finance laws vary from state to state, but all states require the execution and acceptance of conditional sales contract, chattel mortgage, notes, or other documentation prior to shipment. You may not sell, remove, or encumber the merchandise covered by such contracts without Gates Radio Company's prior written consent, and you assume all responsibility for loss or damage. Acceptable insurance, with a loss payable clause naming Gates Radio Company, is required for the full term of the contract. Since Gates financing plans are subject to change from time to time, contact our Credit Manager or your nearest Gates Sales Engineer for full information. The Gates finance plan applies only to the United States.

SHIPPING:

Please specify method of shipment on your order. Shipping charges, insurance, and C.O.D. fees (when applicable) will be collected at time of delivery when shipment is by air, rail or motor freight, or express. If you request parcel post shipment, postage and insurance fees will be billed to your account. Purchaser assumes all responsibility for and risk of loss of, or damage, to, equipment upon shipment from Gates shipping point(s).

Should you receive merchandise damaged in shipment, it is your responsibility to file a damage claim immediately with the delivering carrier. Export packing for overseas shipment is available at slight extra charge.

RETURNS AND EXCHANGES:

Do not return any merchandise without our written approval and return authorization. We will provide special shipping labels and a code number that will assure proper handling and prompt issuance of credit. Please furnish a detailed report to assure prompt handling of returned merchandise. Custom built equipment or merchandise specially ordered for you is not returnable. Where return of standard equipment is allowed by Gates, a restocking fee of 15% will be charged. All returned merchandise must be sent freight prepaid and properly insured

by the customer. When writing to Gates Radio Company about your order, it will be helpful if you specify the Gates Factory Order Number or Invoice Number.

WARRANTY ADJUSTMENTS:

In the event of equipment failure during the warranty period, replacement or repair parts may be provided in accordance with the provisions of the Gates Warranty. In most cases you will be required to return the defective merchandise or part to Gates f.o.b. Quincy, Illinois, for replacement or repair. Cost of repair parts or replacement merchan-

dise will be billed to your account at the time of shipment and, as to repairs or replacement within warranty, compensating credit will be issued to offset the charge.

MODIFICATIONS:

Gates reserves the right to modify the design and specifications of the equipment shown in this catalog without notice or to withdraw any item from sale provided, however, that any modification shall not adversely affect the performance of the equipment so modified.

DIRECTIONAL ANTENNA PHASING EQUIPMENT

| POWER | PATTERN | TWO TOWER | THREE TOWER | FOUR TOWER | FIVE TOWER | SIX TOWER |
|--------------|----------------|------------------|--------------------|-------------------|-------------------|------------------|
| 1 KW | DA-1 | \$2,390.00 | \$3,550.00 | \$4,690.00 | \$ 5,750.00 | \$ 6,870.00 |
| 5 KW | DA-1 | 3,250.00 | 4,595.00 | 6,150.00 | 7,430.00 | 8,870.00 |
| 10 KW | DA-1 | 3,650.00 | 5,250.00 | 7,160.00 | 8,850.00 | 10,100.00 |
| 1 KW | DA-N | 2,900.00 | 4,290.00 | 5,550.00 | 6,910.00 | 8,250.00 |
| 5 KW | DA-N | 3,750.00 | 5,540.00 | 7,280.00 | 9,000.00 | 10,695.00 |
| 10 KW | DA-N | 4,100.00 | 6,160.00 | 7,750.00 | 9,820.00 | 11,750.00 |
| 1 KW | DA-2 | 3,690.00 | 5,390.00 | 7,170.00 | 8,910.00 | 10,500.00 |
| 5 KW | DA-2 | 4,690.00 | 6,990.00 | 9,110.00 | 10,800.00 | 12,900.00 |
| 10 KW | DA-2 | 5,140.00 | 7,600.00 | 9,500.00 | 12,300.00 | 14,500.00 |

For power rating of 5 KW non-directional day, 1 KW direction night, figure 1 KW phasor price and add \$450.00 for daytime power.

- 1) Prices are for standard Gates color. If a special cabinet color is required, add \$100. Gates phasors are built in standard Gates phasor cabinets. The number of cabinets varies with power and type of array. Special cabinets can be provided, but at additional cost.
- 2) Deduct \$75 per tower for panel and shelf coupling units (for indoor mounting).
- 3) *Tower lighting chokes* are not included.
- 4) *Diode rectifiers* are not included.
- 5) Prices are based on Gates standard design. If special consideration or consultant's requirements make the use of vacuum capacitors necessary, there will be an additional charge.

GATES SALES ENGINEERS

ALABAMA—Moats
 ALASKA—Denes
 ARIZONA—Wilder
 ARKANSAS—U. Whitman
 CALIFORNIA—Wilder
 CALIFORNIA—Eureka & North Denes
 COLORADO—Dempsey
 CONNECTICUT—Engle
 DELAWARE—Shuey
 DISTRICT OF COLUMBIA—Shuey
 FLORIDA—Spruill
 GEORGIA—Spruill
 HAWAII—Wilder
 IDAHO—Denes
 ILLINOIS—(north) Morgan
 ILLINOIS—(south) Timpe
 INDIANA—(north) Morgan
 INDIANA—(south) Timpe
 IOWA—S. Whitman
 IOWA—(Lee Co.) Timpe
 KANSAS—U. Whitman
 KENTUCKY—Timpe
 LOUISIANA—England
 MAINE—Hallenbeck
 MARYLAND—Shuey
 MASSACHUSETTS—Hallenbeck
 MICHIGAN—(U.P.) S. Whitman
 MICHIGAN—(L.P.) Morgan
 MINNESOTA—S. Whitman
 MISSISSIPPI—Moats
 MISSOURI—(northeast) Timpe
 MISSOURI—(west & south) U. Whitman
 MONTANA—Denes
 NEBRASKA—(east) S. Whitman
 NEBRASKA—(west) Dempsey
 NEVADA—Wilder
 NEW HAMPSHIRE—Hallenbeck
 NEW JERSEY—Engle
 NEW MEXICO—Dempsey
 NEW YORK—(N.Y. metropolitan) Engle
 NEW YORK—(N.Y. state) Hallenbeck
 NORTH CAROLINA—Cole
 NORTH DAKOTA—S. Whitman
 OHIO—(northwest) Morgan
 OHIO—(southwest) Timpe
 OHIO—(east) Shuey
 OKLAHOMA—U. Whitman
 OREGON—Denes
 PENNSYLVANIA—(east) Engle
 PENNSYLVANIA—(west) Shuey
 RHODE ISLAND—Hallenbeck
 SOUTH CAROLINA—(north) Cole
 SOUTH CAROLINA—(south) Spruill
 SOUTH DAKOTA—S. Whitman
 TENNESSEE—(east) Cole
 TENNESSEE—(west) Moats
 TEXAS—(south) England
 TEXAS—(panhandle) U. Whitman
 UTAH—Dempsey
 VERMONT—Hallenbeck
 VIRGINIA—(south) Cole
 VIRGINIA—(north) Shuey
 WASHINGTON—Denes
 WEST VIRGINIA—Shuey
 WISCONSIN—S. Whitman
 WYOMING—Dempsey

WALTON AYER
 523 Pennsylvania Building
 Washington, D.C. 20004
 Phone: ME8-0522 (202)

JOE COLE
 P.O. Box 246
 Halifax, Virginia 24558
 Phone: 476-4514 (703)

HOWARD T. DEMPSEY
 8171 Orchard Drive
 Denver, Colorado 80221
 Phone 429-5758 (303)

LEWIS J. DENES
 11848 N.E. Marris St.
 Portland, Oregon 97220
 Phone: 253-5147 (503)

LONDON ENGLAND
 4019 Richmand Avenue
 Houston, Texas 77027
 Phone: MO6-4333 (713)

JOE ENGLE
 800 Second Avenue
 New York, New York 10017
 Phone: MU7-7971 (212)

ROBERT HALLENBECK
 11 Ridgecrest
 Latham, New York 12110
 Phone: ST5-9144 (518)

WILLIAM MOATS
 P.O. Box 20160
 (3220 Mockingbird Lane)
 Birmingham, Alabama 35216
 Phone: 822-3625 (205)

CLARENCE MORGAN
 292 East Elm Street
 Villa Park, Illinois 60181
 Phone: TE2-9227 (312)

EDWARD SHUEY
 523 Pennsylvania Bldg.
 Washington, D.C. 20004
 Phone: ME8-0522 (202)

RICHARD SPRUILL
 P.O. Box 8735
 Jacksonville, Florida 32211
 Phone: 721-2779 (305)

PAUL TIMPE
 123 Hampshire
 Quincy, Illinois 62302
 Phone: 222-8202 (217)

STANLEY WHITMAN
 246 Baltimore
 Waterloo, Iowa 50701
 Phone: AD3-0561 (319)

URLIN WHITMAN
 2719 S. Hudson Avenue
 Tulsa, Oklahoma 74114
 Phone: TE6-4835 (918)

ED WILDER
 1945 S. Figueroa
 Los Angeles, California 90007
 Phone: RI7-7129 (213)

JOE E. WOODS
 4019 Richmond Avenue
 Houston, Texas 77027
 Phone: MO6-4333 (173)



Thank You

FROM _____

U. S. POSTAGE
PAID
Quincy, Illinois
Permit No. 1



BUSINESS REPLY ENVELOPE

No Postage Stamp Necessary if Mailed in The United States

POSTAGE WILL BE PAID BY:

ORDER DEPT.

GATES RADIO COMPANY

123 Hampshire Street
Quincy, Illinois

Did You Enclose Your Check?

SALES TAX

Please include all applicable sales taxes, city, county, and state; or if you have a Sales Tax exemption, show number in the comment section on the reverse side.

OPEN ACCOUNT

Open account net payment due 30 days after shipment. If establishing an open account with Gates, please include the name of your bank in the comment section provided. Please allow 15 days for establishing an account.

TIME PAYMENT PLAN

The modest finance charge is 1/2% per month on the balance to be financed, and shipment will be made promptly as soon as your documents have been signed and accepted and acknowledged by Gates.

YOUR ORDER will be carefully checked by highly qualified and well trained experts in broadcast equipment. We want to give your order prompt and careful handling. You can help by giving us complete and accurate information on your equipment needs. Whenever possible, order by Gates catalog numbers. Where applicable, specify "Operating Frequency" — "Tape Speed" — "Meter Scale Range" — "Voltage and Current Ratings" or any other technical data we may need to fill your order. When ordering replacement parts for Gates equipment you should give us the Model No. "(M-5025)" — part designation "(T201)" and drawing no. (DWG-062375609) in instruction book, with this information your order can be on its way in a few hours.

We pack your delicate electronic equipment carefully in approved cartons and crates. All shipments are insured. Should your order be damaged in transit, report the damage and file a claim immediately with the carrier. To avoid delay, do not return the damaged equipment to Gates unless authorized. Thank You.