

SPEECH INPUT EQUIPMENT

Scanned and Prepared
by Dale H. Cook



GATES RADIO COMPANY

MANUFACTURING ENGINEERS SINCE 1922

QUINCY, ILLINOIS, U. S. A.

SA-50 Dual Speech Console

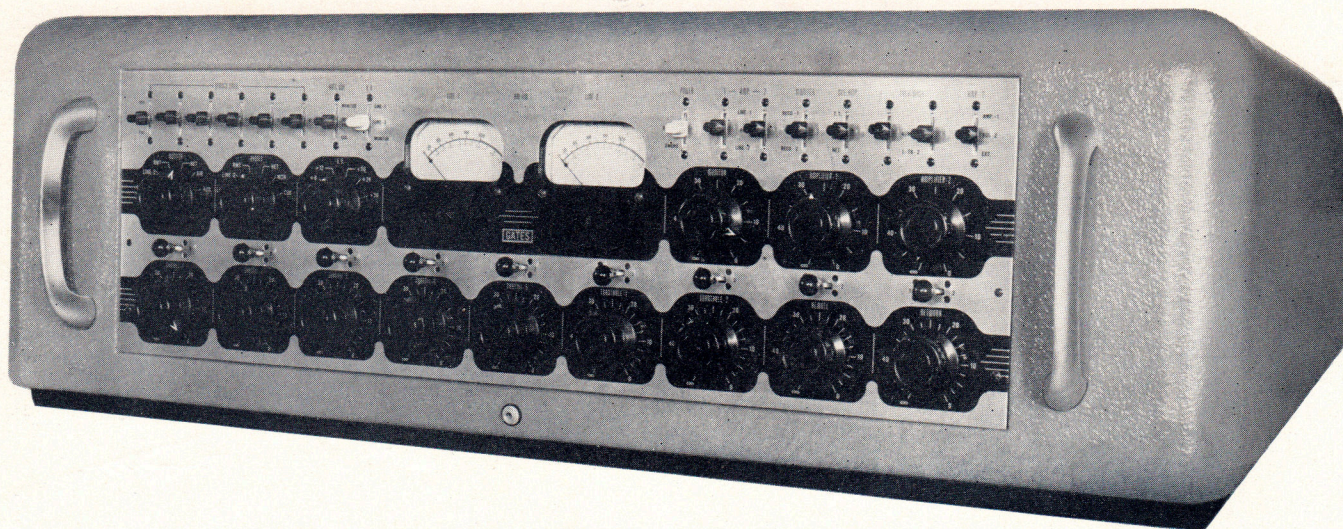

The Gates SA-50 Dual Console is one of the most complete speech input equipments of the console type manufactured, being complete, not only facility-wise, but also from the standpoint of an abundance of amplifiers and circuit switching provisions. The SA-50 equipment consists of the main console as illustrated above and either the rack or wall mount power supply as illustrated on the opposite page; the power supply unit containing, in addition to the power supply, a complete 10-watt monitoring amplifier, a two-watt cueing amplifier and plug-in relays for speaker muting and warning light service. As is always the case in a comprehensive equipment such as the SA-50 console, word descriptions are difficult, and reference to the functional diagram on page three will be of considerable help. To assist in following the functional diagram, a brief comment is made herein on the various divisions of this equipment.

Cabinet: Constructed of cast aluminum, tilt back type for servicing, with all terminations on base plate. Power supply constructed on cast aluminum SA housing (see page 18) with choice of wall or rack mounting. The SA-50 console is also available on the CB-60 desk shown on page 33 and the opposite page. Where this desk is used the cast aluminum cabinet is omitted and the console is constructed into a well in the desk itself which is covered by a hinged formed steel enclosure.

Mixing Channels: Nine are provided with Daven ladder type controls throughout. Five are for microphones with associate preamplifiers, two are for turntables and one each for remote and network service. Each mixing channel has above it a PBX type key, allowing the selection of any mixing channel into the choice of the two identical program amplifiers. Turntable channels have cue provision.

Amplifiers: Supplied as standard equipment are five two-stage preamplifiers, transformer coupled in and out with extreme shielding of the input transformer. There are two four-stage high gain program amplifiers, one three-stage ten-watt low distortion monitoring or audition amplifier and one two-watt cueing amplifier.

Power Supply: Provides all filament and plate voltage for the complete equipment along with voltage for operating the muting relays.

VU Meters: Duplicate 4" illuminated Weston No. 862 VU meters are supplied. Meters are flush with the panel, providing both attractive appearance and excellent observation. The left VU meter operates across the program amplifier No. 1 at all times. The right VU meter is selectable across either of the two program amplifiers as well as the monitoring amplifier with adjustable range control.

Remote Keys: Six provided with three operating positions: (a) Broadcast, (b) Override through the cueing amplifier, (c) Cueing of preceding program to remote.

Cue Key: Connects selected remote line to input of the monitoring amplifier, order phone or cue.

Power Switch: Provided so that emergency power supply Model SA-51 illustrated herein can be instantly switched into the circuit when desired. The SA-51 emergency power supply is not standard equipment.

Line Amplifier Output Keys: Allows selection of output of either line amplifier to choice of either broadcast line or audition bus. A 6 Db. pad is always in the line circuit.

Monitor Amplifier Output Keys: Selects output to three positions: (a) Normal, or speakers, (b) Record I, (c) Record II. The record positions obviously may be used for any other service.

For Control Desks Refer to Pages 33, 34 and 35

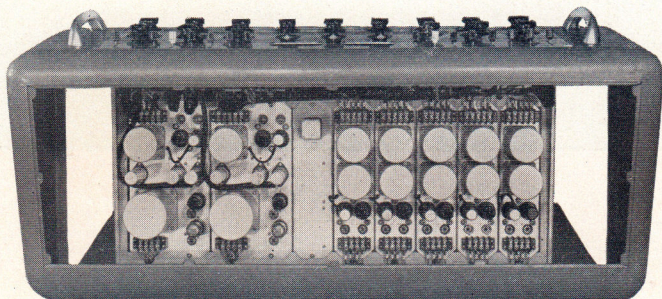

Top view SA-50 Dual Console. Note unit construction and additional room available each end of cabinet for added preamplifiers where desired.

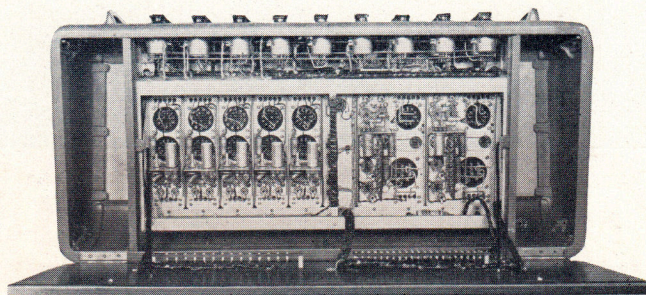

SA-50 Dual Console tilted back showing under-chassis design and terminations. Note excellent workmanship for which Gates has long been noted.

SA-50 Dual Speech Console

Cue Amplifier Keys: Selects cueing amplifier into three circuits: (a) Cueing of turntables, (b) Override of net work, (c) Override for remotes.

Talk Back Keys: Selects the output of preamplifiers 4 and 5 to an external circuit where talk back is desired.

Dual Programming Keys: Allows both program amplifiers to carry the same or separate programs. Also allows connecting the input of program amplifier 2 to an external pair of terminals for use with external mixer such as in master control.

Monitor Selector Switch: Selects the input of the monitoring amplifier to six positions: (a) Broadcasting line I, (b) Broadcasting line II, (c) Remote, (d) Network, (e) Air, (f) Audition.

Phones Selector Switch: Allows selection of headphone monitoring to (a) Line I, (b) Line II, (c) Remote, (d) Network, (e) Monitoring amplifier output, (f) Cueing amplifier output.

VU Range Switch: Provides six positions to +4 to +30 VU in conjunction with VU meter number 2.

Gain Controls: Individual master gain controls are provided for line amplifiers 1 and 2, being wiping contact types in the grid circuit and an additional gain control for the monitoring amplifier level.

Speaker Muting Relays: Three provided, of the plug-in telephone type. Provides contacts for both speaker muting and operation of warning lights. Muting relays operate on the applied current principle so that failure of voltage to muting relays will not place loud speakers in a feedback condition.

General Construction: The unit construction plan is followed with all preamplifiers, program amplifiers and other sub-chassis units being individually removable for servicing without disrupting the operation of the balance of the console. The use of aluminum throughout, both in the chassis, cabinet and panel design, assures extremely low noise level and the elimination of varied chassis voltages. The front panel is an attractive anodized three color panel with the base color in natural anodized aluminum, the second color in rich black and a third color in dark red. Cabinet is gray with base plate in black.

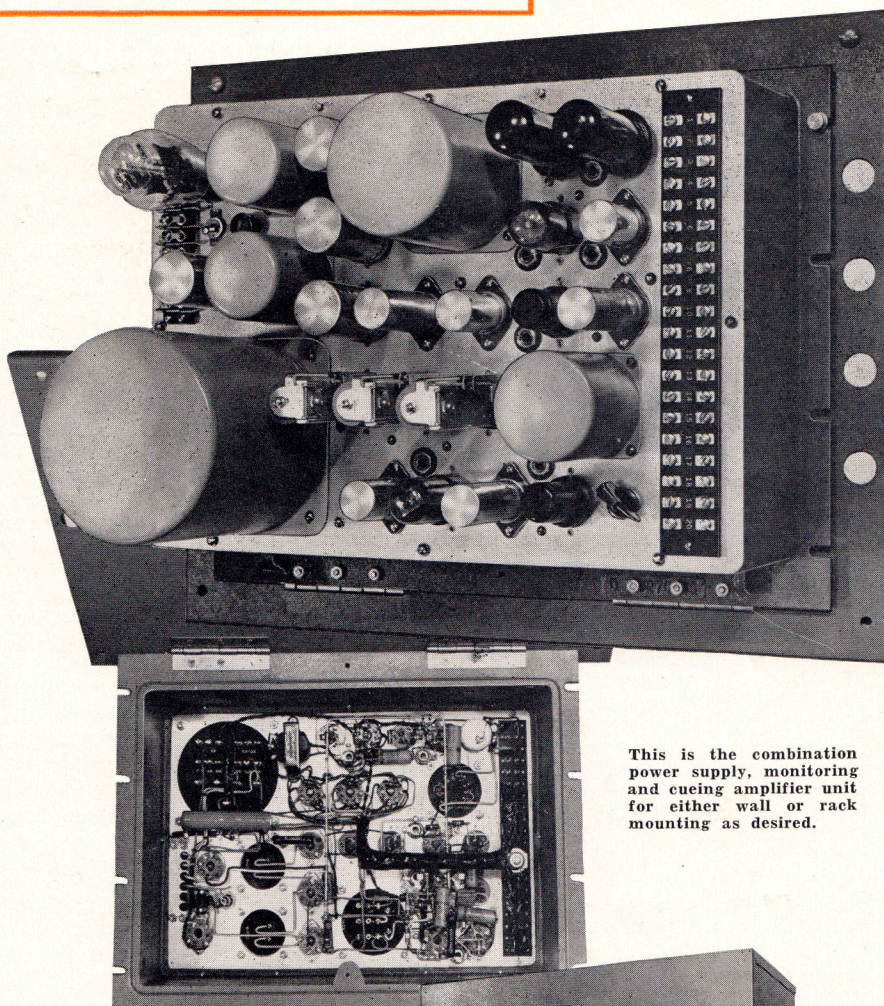

This is the combination power supply, monitoring and cueing amplifier unit for either wall or rack mounting as desired.

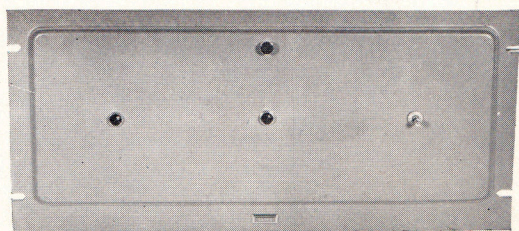
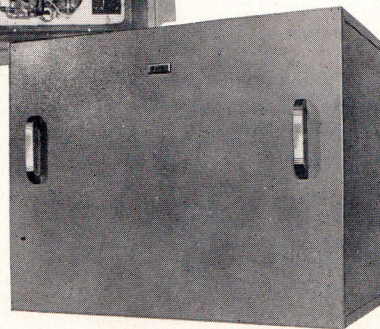

SA-51 EMERGENCY POWER SUPPLY

For complete reliability many broadcasters prefer a stand-by power supply which may be instantly switched into the circuit in case of a tube or component failure in the main power supply. The SA-51 Emergency Power Supply is an economical well-built unit supplying sufficient filament and plate voltage to operate all of the SA-50 Console except the monitoring amplifier. It may be instantly switched into the circuit by the emergency power key on the console and a relay provided on the SA-51 power unit.

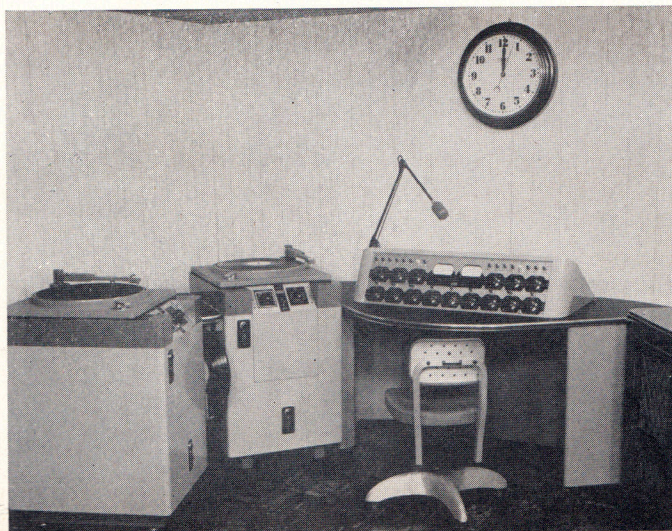

Illustration of CB-60 Desk with SA-50 Dual Console. Pages 33, 34 and 35 list many desk combinations.

SA-50 Dual Speech Console

SPECIFICATIONS

PROGRAM AMPLIFIERS—Two supplied, each four stages using one each 6J7, 6C5, 6SJ7 and 6SN7 tubes. Has 90 Db. shielding of input transformer. Test jacks provided for all cathodes.

PREAMPLIFIERS—Five supplied with room in SA-50 cabinet for two additional preamplifiers where needed. Each preamplifier has two stages employing one each 6J7 and 6C5 tubes. Has gain control between first and second stage for use in circuit balancing where desired. Test jacks for all cathodes.

MONITORING AMPLIFIER—Has three stages employing one each 6SJ7, 6SN7 and two 6L6 tubes in push-pull. Full ten watts output at 2% distortion or less. Test jacks for all cathodes.

CUEING AMPLIFIER—A two-stage high gain amplifier using one each 6SJ7 and 6V6 tubes. Has bridging input and output impedance of six ohms. Test jacks for all cathodes.

POWER SUPPLY—Choice of wall or rack mount (specify when ordering). Included on same chassis monitoring and cueing amplifiers, also muting relays. Uses 5U4G rectifier tube; power transformer maximum 40° C rise.

MIXER—Nine channels, ladder type controls having 2 Db. steps. Firm gripping skirt knob.

KEYS—Above each mixing control PBX type key with choice of key knob colors, such as red for Announce Microphone, black for Studio A, etc. Specify if any preference. Keys for remote and other miscellaneous circuits lever type with firm gripping silver plated contacts. Also choice of knob colors of the flat tabular type. See page 39 for knobs.

GAIN—From preamplifier input to either broadcast line, 105 Db. From turntable or remote input to either broadcast line, 60 Db. From network input to either broadcast line, 57 Db. Monitoring amplifier, 60 Db.

NOISE—At microphones: 60 DBM input to preamplifier noise is at least 60 Db. below +8 VU output.

DISTORTION—At output of either program amplifier 0.8% or better at all frequencies. At output of monitoring amplifier not exceeding 2% at 10 watts.

RESPONSE—From 30 to 15,000 cycles within 1½ Db. except cueing amplifier which cannot be used in broadcast circuit.

INPUT IMPEDANCES—To all preamplifiers, 50/200/250/500 ohms. Turntables, 250 ohms, net and remote circuits, 500/600 ohms.

OUTPUT IMPEDANCES—500/600 ohms for each program amplifier and monitoring amplifier and 6 ohms for cueing amplifier. Monitoring amplifier in conjunction with speaker muting relays is normally wired for four 2000 ohm speakers.

TUBES—Six each 6J7 and 6C5; three 6SJ7; two each 6SN7 and 6L6; one each 6V6 and 5U4G.

SIZE—Console 48" wide, 14½" high, 21" deep with 12° slope of front panel.

POWER SUPPLY—Wall Mount, 17¼" high, 22" wide, 12¼" deep. Rack Mount, 19" wide, 14" high, 11" deep.

FINISH—Medium gray aluminum, gloss anodized black and medium black with varied knob colors as desired.

POWER CONSUMPTION—300 watts from 115 volts 60 cycle line.

Ordering Information

Model SA-50 Dual Console complete with wall type power supply, tubes and relays. Code ZEHCO.

Model SA-50 Dual Console complete with rack mount power supply, tubes and relays. Code ZEHEZ.

Model SA-50 Dual Console on CB-60 Control Desk (see page 33). Code ZEHIB.

Model SA-51 Emergency Power Supply complete with tubes and relays. Code ZEHOC.

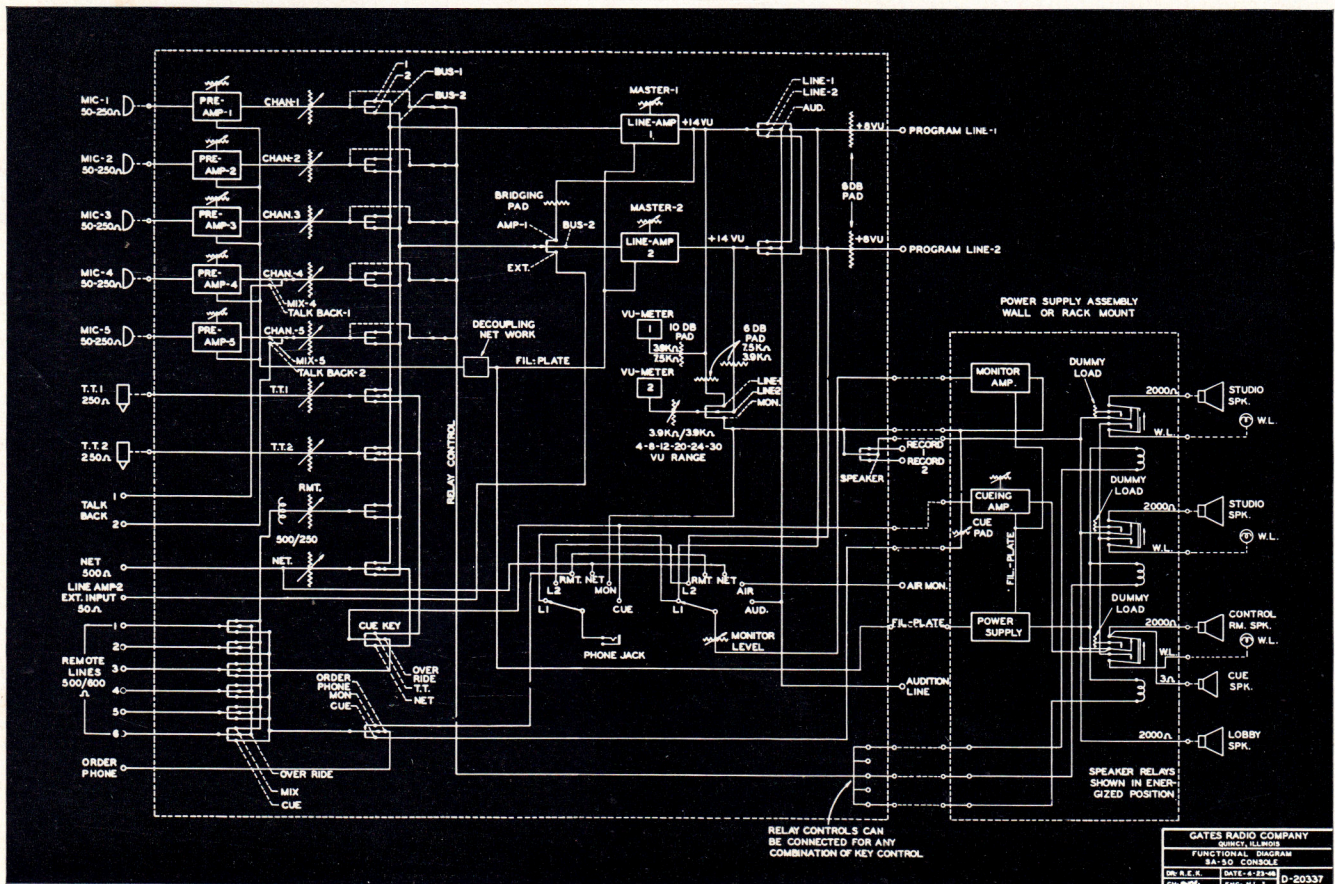

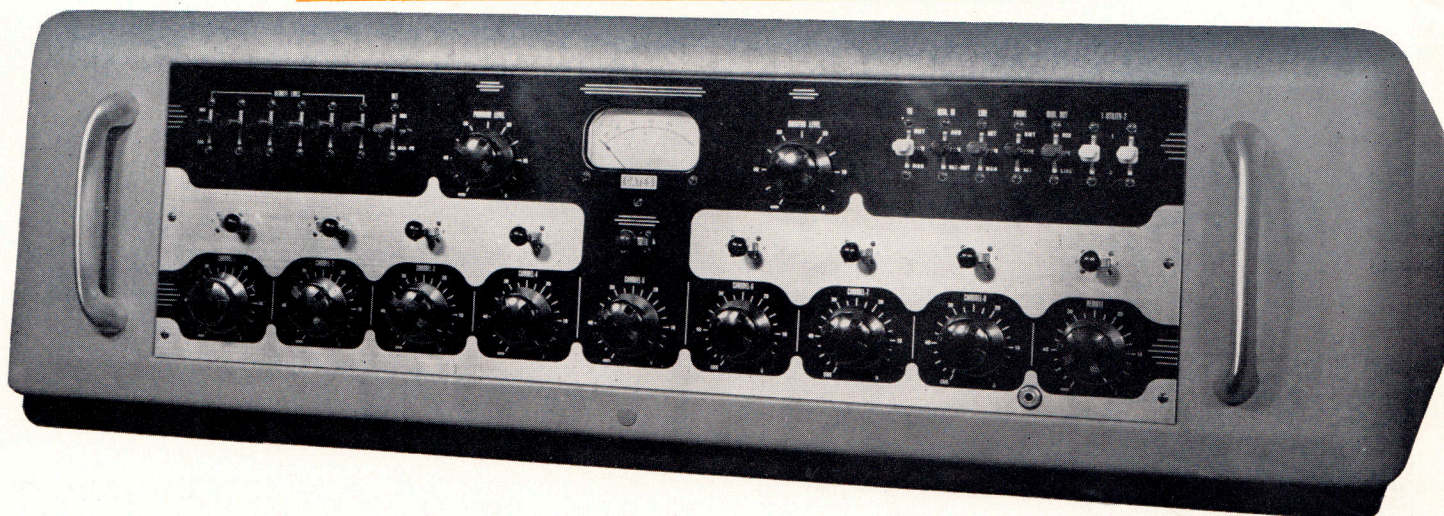

In standard AM, FM and TV stations the SA-40 Console, with its wide facilities and modern design, is generously equipped for a most comprehensive installation. Entirely new in its design, the SA-40 Console has many additional circuit and switching facilities that will not be found in other similar consoles on the market today. Like any comprehensive piece of speech equipment, it is necessary that the block diagram on the next page be studied, along with the descriptive matter contained herein, to become acquainted with a few of the many things that can be accomplished with the SA-40 equipment.

This console, in size and symmetry, is very similar to the SA-50 Dual Console. It has its power supply as an external unit for rack or wall mounting. The console is complete in every respect and comes with tubes, relays and all necessary accessories for operation. The tilt-back-to-service feature is provided and all

terminations are on the base of the console. The outstanding and exclusive feature of the SA-40 Console is that many of the circuits such as pre-amplifier outputs, mixing channel inputs and program and monitoring amplifier inputs are brought to terminal strips which are, in turn, bridged to other terminals and back into the normal circuit, thus allowing breaking any major circuit in the console for a patch panel extension, giving unusual flexibility.

Mixer: There are nine channels, five for preamplifiers, three for transcription turntables and one for net-remote. Each turntable channel is provided with a cue attenuator whereby, when the attenuator is at off position, the turntable channel is connected directly to an external pair of terminals to which a cueing amplifier such as the SA-22 listed on page 20 may be connected.

For Control Desks Refer to Pages 33, 34 and 35

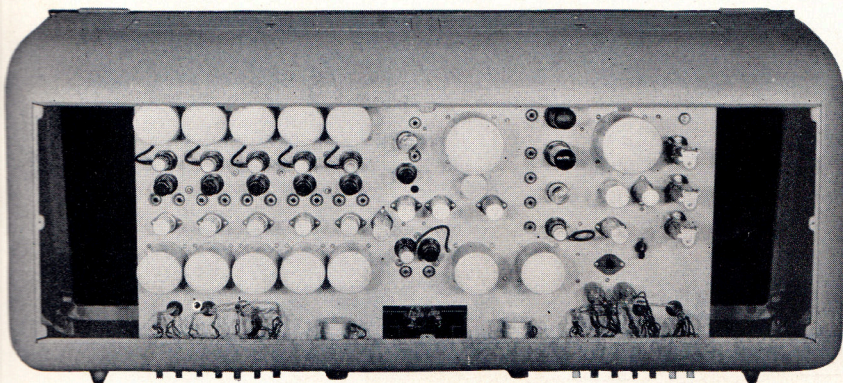

SA-40 Console looking from top. All preamplifier tubes are shock mounted. Note heavy sturdy construction of cabinet.

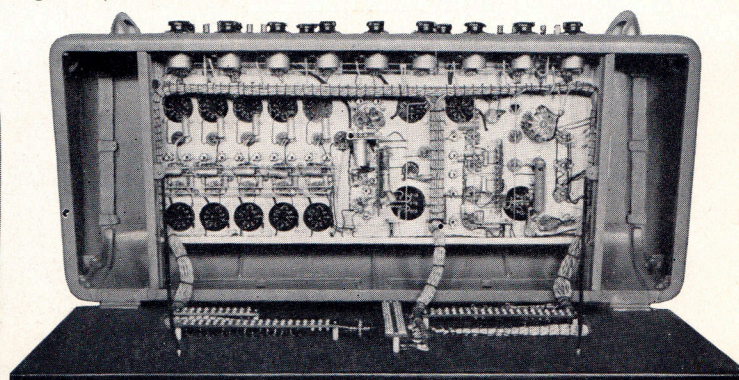

The tilt-back-to-service feature of the SA-40 Console, along with complete accessibility of all components and terminal connections is one of the outstanding features.

SA-40 Speech Input Console

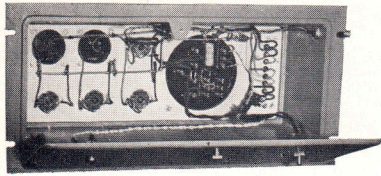
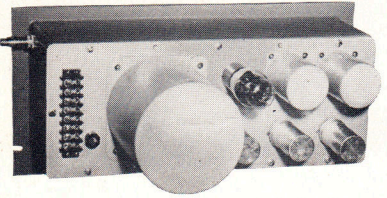
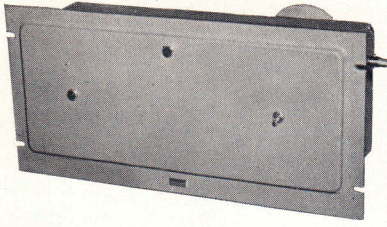

Above are front, internal and rear views of the rack mount power supply part of the SA-40 equipment. Also available at slight extra cost is a drawer type wall cabinet to accommodate this power supply where rack space is not available.

Keys: Each mixing channel includes a PBX type key which enables a selection of each channel to either the program or monitoring amplifiers. The five microphone channel keys operate the muting relays in any sequence desired.

Remote Keys: Provision for six remote lines, three positions per key. (a) Broadcast, (b) Override, (c) Cue.

Net Key: An extra key provided for network operation only, selecting either into the broadcast circuit or monitor-phones circuit.

Other Keys: Are provided for selection of the VU meter across the remote, program or monitor circuits: a **monitor key** selecting the monitoring amplifier input to any mixing channel, to the output of the program amplifier or to network or remote lines for override purposes; **line key** connecting program line direct to network so console may be turned off and broadcasting continue direct from transmitter; **monitor-out key** provides connecting monitoring amplifier output directly to terminals for recording, normal speaker circuit or through 10 Db. pad to program line for emergency purposes.

Utility Keys: Are provided and wired directly to terminals, allowing the engineer to add any circuit combination he might desire.

Amplifiers: Five two-stage transformer coupled preamplifiers, one four-stage program amplifier and one three-stage monitoring amplifier.

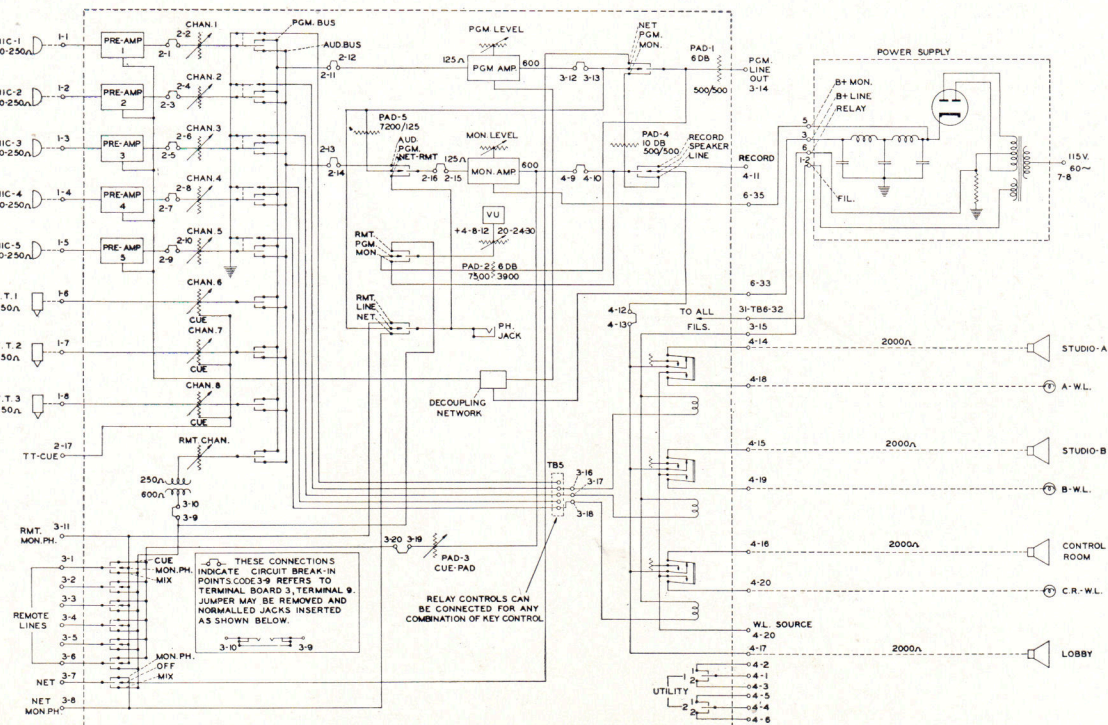

SA-40 Functional Block Diagram

Construction: The SA-40 Console is constructed on a single-piece chassis. All input transformers have high shielding and no unorthodox circuits of any kind are employed. It should be particularly noted that all preamplifiers and other amplifiers are fully transformer coupled both input and output. By viewing the under-chassis design the unusual workmanship and generous use of shielded wire throughout will be noted. All tubes may be

measured at their cathodes by jacks adjacent to each tube. The heavy cast aluminum tilt-back cabinet is standard equipment, while the power supply is constructed in the popular cast aluminum SA housing with front panel servicing as described on page 18. The SA-40 Console is also available with the CB-60 Desk as illustrated on page 33. Also illustrated is the SA-40 Console on the popular CB-4 horseshoe desk with turntables on each side. See page 35.

SPECIFICATIONS

AMPLIFIERS—Five two-stage preamplifiers with accommodation in cabinet for two additional model SA-70 preamplifiers (see page 26). Also one four-stage program amplifier and one three-stage 10 watt monitoring amplifier.

MIXING CHANNELS—Nine; ladder type controls, two decibels per step. Turntable attenuators have cue position.

GAIN—From preamplifier input to program line, 105 Db.
From preamplifier input to monitoring amplifier output, 95 Db.

From turntable, remote or net input to program line, 58 Db.

From turntable, remote or net input to monitoring amplifier output, 68 Db.

From turntable, remote or net input to program line when using monitoring amplifier and emergency pad, 38 Db.

DISTORTION—Less than 1% from 50 to 15,000 cycles overall from microphone to program line. 2% from microphone to monitoring amplifier output.

NOISE—From preamplifier input measured at minus 60 Dbm. to program line measured at plus 8 Dbm; 65 Db. below output level. All other circuit combinations equal or superior to above.

RESPONSE—Within 1.5 Db., 30-15,000 cycles.

INPUT IMPEDANCES—Preamplifiers, 50/200/250/500 ohms.
Turntables, 250 ohms.

Remote and net lines, 500/600 ohms.

TUBES—7 type 6J7, 6 type 6C5, 2 type 6SN7 and 6L6;
1 each 6SJ7 and 5U4G.

SIZE—40" wide, 14½" high, 21" deep.

Power Supply: 19" wide, 8¾" high, 11" deep (rack mount).

FINISH—Medium gray with base trim in black, handles in brushed aluminum, panel anodized natural aluminum and gloss black with varied color key knobs.

CUE LEVEL CONTROL—Provided on chassis so that the amount of signal fed to remote lines may be adjusted.

ORDERING INFORMATION

Model SA-40 Console complete with tubes, relays and rack mount power supply. Code ZASFA.

Model SA-40 Console with tubes, relays wall mount power supply. Code ZASGE.

Model SA-40 Console with tubes, relays, rack mount power supply and mounted on CB-60 desk, illustrated on page 33. Code ZEHUD.

Model SA-2008 drawer type wall cabinet for mounting SA-40 power supply to wall. Code ZEHYA.

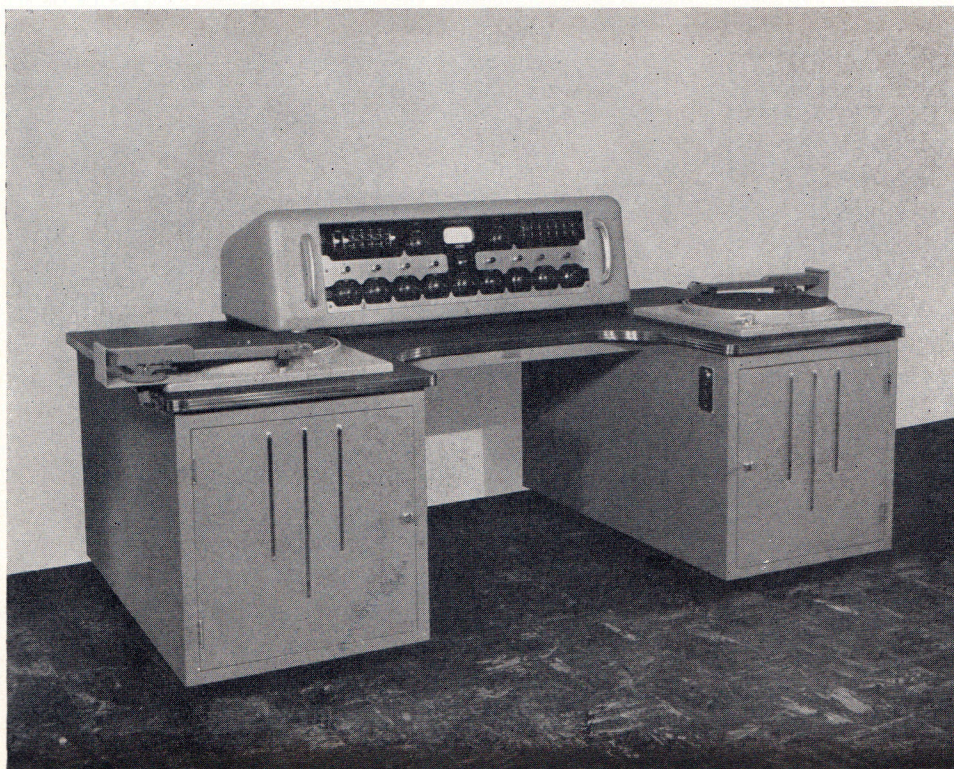

Illustrated to the left is the SA-40 Console mounted on the popular Gates CB-4 horseshoe desk with CB-11 transcription turntables on each wing of the horseshoe. The CB-4 desk offers commanding appearance and will be found in leading broadcasting stations throughout the country. See page 35.

Program Switching Equipment

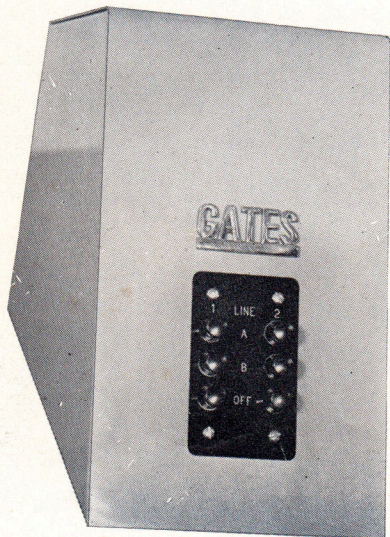

Illustrated above, the SA-104 program switching equipment which mounts usually to the side of a speech input console. Also available in rack mount. The SA-105 is the same physical size but has double the switching circuits as illustrated in Figure B below.

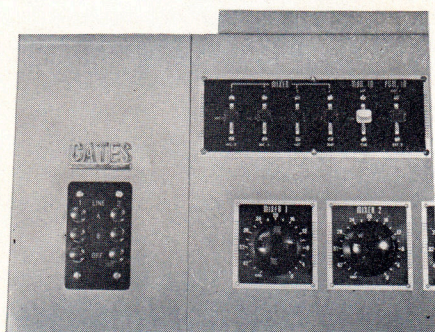

Above, the SA-104 switching equipment adjacent to a Gates 52-CS console. It fits equally well beside other Gates consoles and most competitive makes.

Program switching equipments described on this page are designed for the multiple handling of audio circuits to multiple lines. Two types are available: the SA-104 which provides the switching of any two output circuits such as two speech input consoles into any combination of two program lines, and the SA-105 which handles any four output circuits into any combination of two telephone lines. Illustrated on this page is the SA-104, a popular model for broadcast use. The SA-105, not illustrated, includes switching for four console outputs. Both models are shown in the block diagrams at the bottom of this page. The principle of operation involves coupling transformers with dual secondaries for each input circuit and the use of interlocking switches which prevents any two programs on the same line but at the same time allows any one program to be broadcast either on the same line or on separate lines. In the case of the larger model SA-105, the same is true, only allowing the selection of any four programs. The insertion loss is only 4 Db., frequency response is linear from 30-15,000 Kc., and distortion is less than 0.1%. The cabinet is particularly designed for placing next to any standard console such as Gates SA-40, SA-50, or 52-CS as well as all competitive models. Size: $6\frac{3}{4}$ " wide, $10\frac{1}{8}$ " high, 12" deep, with a 30° slope to the front panel. Finish is in medium gray.

Model SA-104, as illustrated to the left and as in block diagram Figure A. Input and output impedances 500/600 ohms. Also available in Model SA-104R for rack mounting (not illustrated) and supplied on $3\frac{1}{2}$ "x19" standard rack panel in medium gray finish.

Model SA-105, same physical size as Model SA-104, for cabinet mounting and providing selection of four output circuits as from four single consoles or two dual consoles. Full circuit description in Figure B below. Also available for rack mount as Model SA-105R (not illustrated) and mounted on $3\frac{1}{2}$ "x19" panel finished in medium gray.

SA-104 Program Switching Unit. Code ZEANF.
SA-104R Program Switching Unit. Code ZEARJ.
SA-105 Program Switching Unit. Code ZEASK.
SA-105R Program Switching Unit. Code ZEATL.

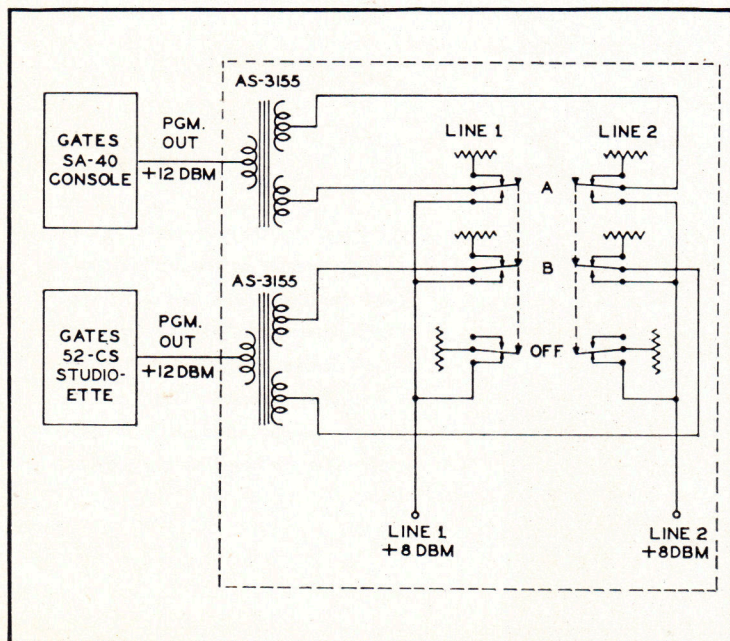

FIGURE A—The SA-104 circuit arrangement showing how two program circuits can be multiplied into two lines, adding greatly to the reserve facilities of the speech input equipment when not in use for separate AM and FM broadcasting.

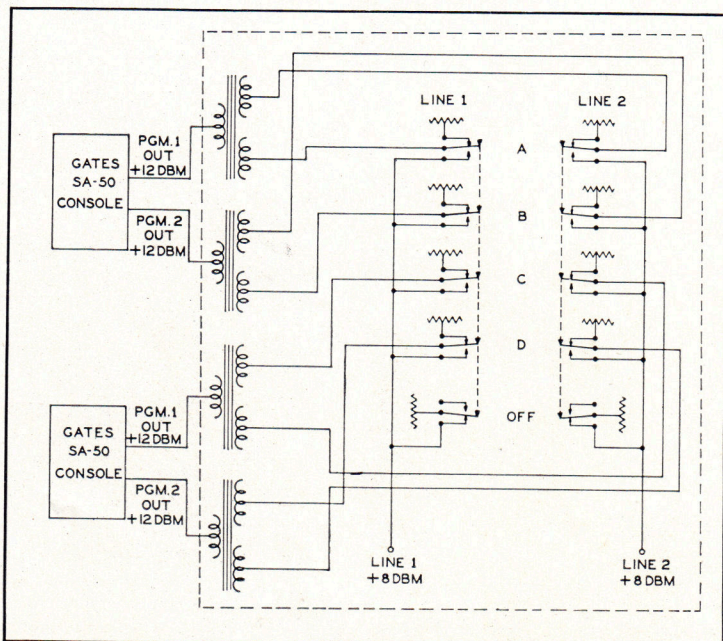
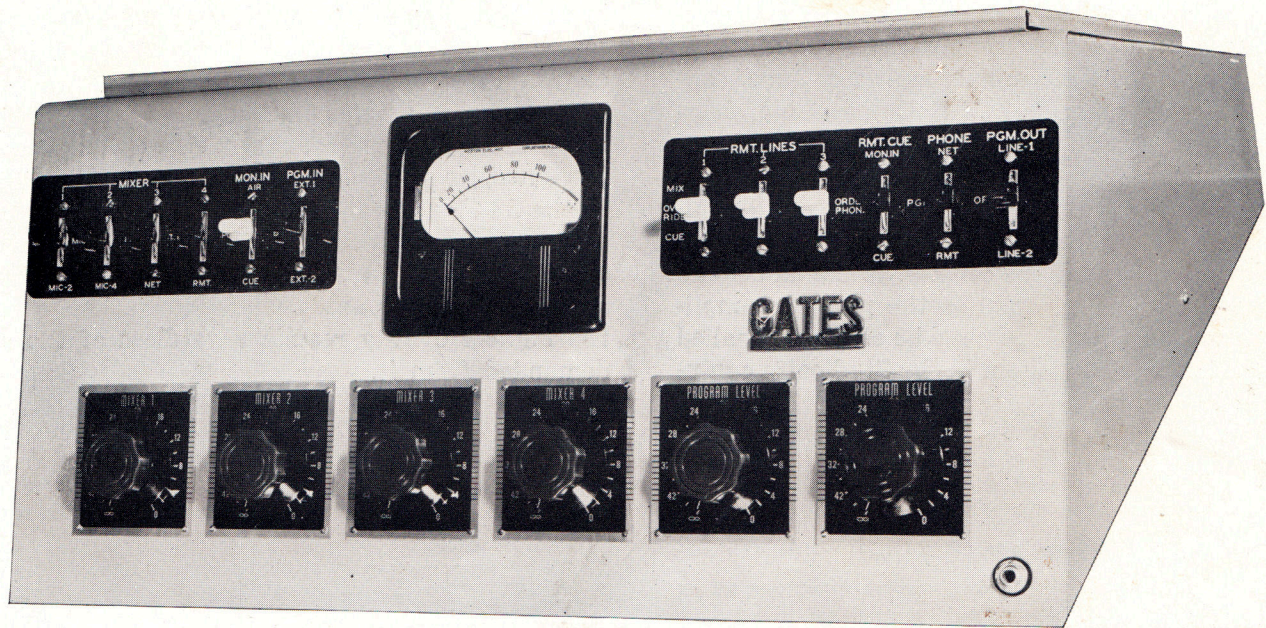
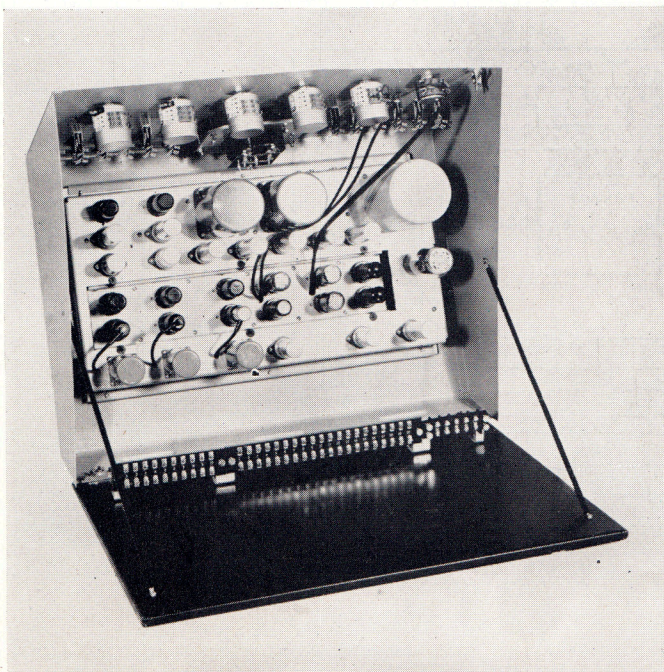

FIGURE B—Model SA-105 program switching equipment. Here four output circuits may be arranged in any combination to two program lines without danger through switch interlocking of interposing two programs on one circuit.



The 52-CS Studioette has been provided for all AM, FM, and TV service where fidelity, noise and distortion requirements are most rigid and where moderate facilities are required. This unit then becomes ideally suited for small station studio application or as part of a larger master control type of installation. Basically, the Studioette has all of the necessary facilities for complete studio operation, accommodating three remote lines with complete override and cue facilities, having four mixing channels, two of which

are associated with two-stage preamplifiers for microphone service and the remaining two accommodate turntables on separate attenuators. Each of these attenuators are switchable so that one accommodates a network and the other the incoming remote lines. There is provided a four-stage high gain program amplifier and a three-stage 4-watt 50 Db. gain, monitoring amplifier. The power supply is self-contained. By viewing the functional diagram on the next page, a very complete understanding of the wide facilities of the 52-CS Studioette will be had. The Studioette is constructed in an attractive steel cabinet, having a front panel slope of approximately 15°. The large 4-inch illuminated VU meter is recessed flush with the cabinet while all attenuators and lever keys are mounted on attractive anodized plates. The mechanical construction is unique in the respect that the top is removable, exposing all under-chassis wiring, making it possible to do any intricate servicing that might be required as pertaining to under-chassis components without even tilting back the cabinet. For changing tubes, cleaning attenuators, and reaching the terminal strips, the cabinet tilts back as shown in the illustration on this page. All components are of the highest quality, with input transformers having three internal shields and all transformers being potted and well impregnated. Temperature rise of 40 degrees centegrade on power components is followed in the Studioette engineering. All preamplifier tubes and first-stage high level amplifier tubes are shock mounted. The fact that the power supply is self-contained makes the 52-CS Studioette extremely easy to install. Lever keys are provided with tabular knobs of assorted colors for circuit indication to inexperienced operating personnel. Relays provide speaker muting and warning



The above illustrates the tilt back arrangement of the Studioette cabinet, reaching tubes, attenuators, and terminal connections instantly. For reaching under chassis parts, the top of the cabinet removes, making complete instantaneous 100% accessibility.

52-CS Studioette

light indication contacts. Relays may be wired to the mixing system in any combination desired, their coils being brought to terminals which, in turn, connect to the microphone keys. Both turntable channels are provided with cue attenuators so that turntables, network or remote lines may be connected to an external cueing amplifier where desired. Termination of all circuits is made to numbered screw type terminals on the base of the console. It should be particularly noted that the input to the program amplifier, by means of a lever key, may be either normalled through to the mixing system in the Studioette equip-

ment or, by two other positions of the key, connected to external terminals which would be required for certain types of master installations. Due to the unique design of the 52-CS Studioette and the unusual wiring scheme for a console of this type, many broadcasting stations will find favor in using several of the 52-CS console units in place of one larger console. The construction of the Studioette employs Gates standard SA amplifiers as used in all console and rack mount equipment and will produce the highest quality results regardless of the service demanded from it.

SPECIFICATIONS

SIZE—24" wide, 21½" deep, 10" high. Panel slopes at 30 degree angle.
FINISH—Hand rubbed rose gray with escutcheons in anodized black and natural aluminum.
CONSTRUCTION—Cabinet 16 gauge cold rolled furniture steel with sub-chassis of aluminum.
TERMINATIONS—To numbered and lettered terminal strips, mounted on base of console.
GAIN—From microphone input to program line output, 105 Db. From remote, network or turntable input to program line output, 60 Db.
INPUT IMPEDANCE—Microphones, 50/250 ohms, network and remote 500/600 ohms, turntables 250 ohms; program amplifier external input circuit 250 ohms.
NUMBER OF NETWORK LINES—1.
OUTPUT IMPEDANCE—Program line 500/600 ohms. Cueing circuit, 250 ohms. Monitoring amplifier, 500 ohms designed to operate into three 1500 ohm loudspeakers.
OUTPUT LEVEL—Program amplifier plus 8 DBM to line (adjustable to higher or lower levels where required). Monitoring Amplifier, 4 watts.
NUMBER OF MICROPHONE INPUTS—4. (2 mixed at any one time)
NUMBER OF TURNTABLE INPUTS—2.
NUMBER OF REMOTE LINES—3.

RESPONSE—Plus or minus 1½ Db., 30-15,000 cycles.
DISTORTION—Program circuit including preamplifiers, less than 1% from 50-15,000 cycles. Monitoring amplifier, 2% or less at 4 watts output, 50 to 15,000 cycles.
NOISE—Program circuit overall 65 Db. below plus 8 DBM.
TUBES USED—Three each 6J7 and 6SN7. Six each 6C5. Two each 6V6. One each 5U4G.
POWER LINE REQUIREMENTS—115 volts, 50-60 cycles, 125 watts.
METER—Weston 4" type 862 illuminated.
RECOMMENDED USAGE—For all speech input requirements within its limitations for AM, FM and TV. Also recording of all types, high quality control unit for public address and centralized radio installations.

MODEL 52-CS STUDIOETTE (MO-3388)—Complete with tubes, ready to operate for 115 volts, 50/60 cycles. Code ZAWJA.

MODEL 52-CS STUDIOETTE (MO-3501)—Complete with tubes ready to operate on odd voltage and frequency as specified when ordering. Code ZAWKE.

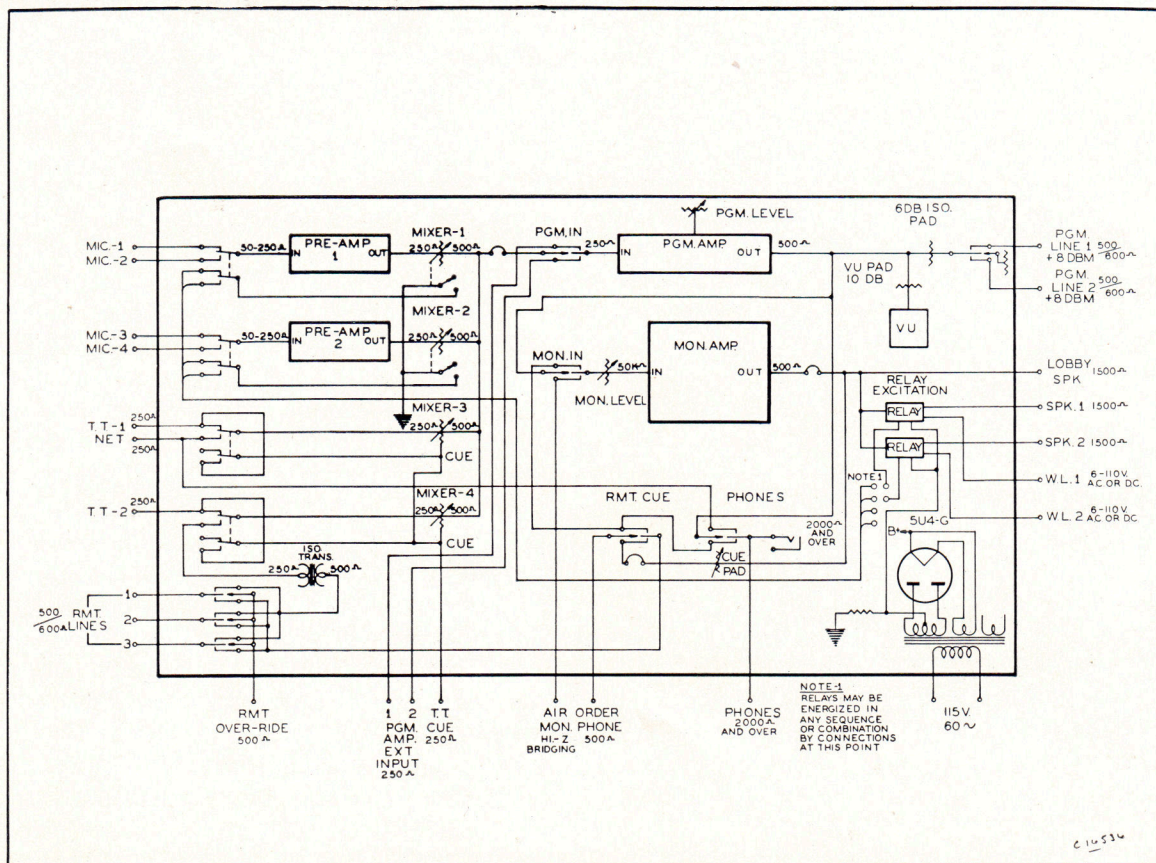

Block Diagram of 52-CS Studioette

Loud Speakers — Receivers

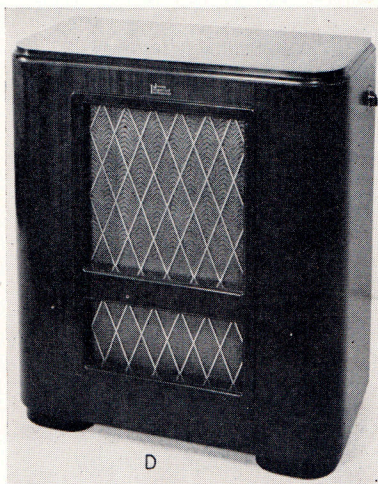

CABINETS WITH AND WITHOUT SPEAKERS

Illustrated to the left is the Jensen Imperial Type D cabinet, handsomely styled and constructed of beautifully striped satin finish veneer walnut with interlaced bronzed strip grilles over matching fabric. Available for either 12" or 15" speakers. To the right is illustrated the Type B utility cabinet for those who desire a highly attractive, but not expensive, enclosure constructed of impregnated composition board and finished in hammered brown lacquer. Available for 8", 12" and 15" speakers. Both the Imperial and utility cabinets are of the bass reflex type.

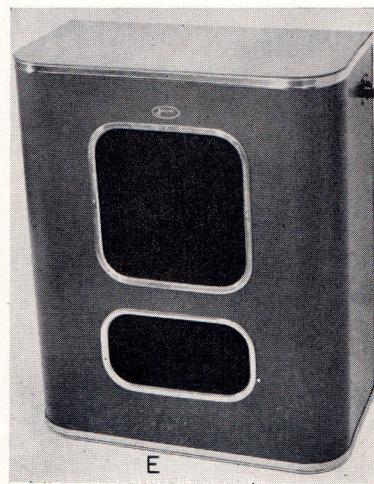

Illus.	Type	Speaker Type	Height	Width	Depth
D	D-151	*15"	31"	27 3/4"	13 3/8"
D	D-121	*12"	31"	27 3/4"	13 3/8"
E	B-151	*15"	30 3/4"	27 1/4"	12 1/4"
E	B-121	*12"	28 1/2"	23 3/4"	11 1/8"
E	B-81	*8"	22 3/4"	18"	9"
D	RD-153	JHP52	31"	27 3/4"	13 3/8"
D	RD-122	JRP40	21"	27 3/4"	13 3/8"
E	RB-153	JHP52	30 3/4"	27 1/4"	12 1/4"
E	RB-121	JRP40	28 1/2"	23 3/4"	11 1/8"

*Indicates speakers not supplied.

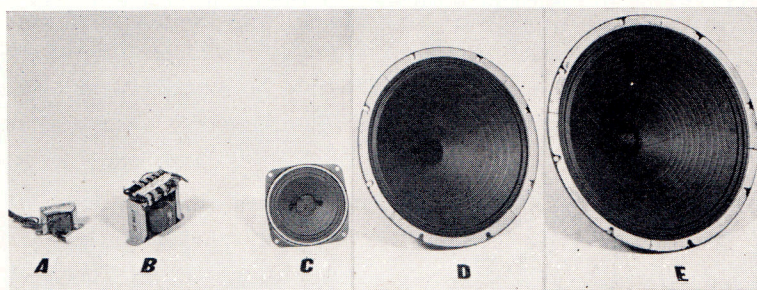

CONE LOUD SPEAKERS AND MATCHING TRANSFORMERS

All manufactured by Jensen in varying models as shown below, from 4" to 15" in size. Manufactured to RMA standards.

Illus.	Type	Size	V. C. Imped.	Watts	Suggested Xformer
C	P-4X	4"	3-4 Ohms	2.0	Z-3300, ZL-2021
C	P-6X	6"	3-4 Ohms	3.0	ZL-2021
D	P-8T	8"	3-4 Ohms	7.0	ZY-4004
D	P-10T	10"	6-8 Ohms	8.0	ZY-2002
D	P-10Q	10"	8 Ohms	12.0	ZY-2003
E	P-12T	12"	6-8 Ohms	9.0	ZY-2002
E	P-12Q	12"	8 Ohms	14.0	ZY-2003
E	P-15Q	15"	8 Ohms	16.0	ZY-2003

Coaxial Speakers—Jensen

JRP-40	12"	6-8 Ohms	12.0	ZY-2003
JHP-52	15"	500-600 Ohms	16.0	None Req'd.
HNP-51	15"	16 Ohms	25.0	Z-3423

SPEAKER MATCHING TRANSFORMERS

Illus.	Type	V. C. Imped.	Line Imped.	Watts	For Use With
A	Z-3300	3-4 Ohms	500 Ohms	3.5	P4X
A	ZL-2021	3-4 Ohms	500-1000-1500-2000	6.5	P4X, P6X
B	ZY-4004	3-4 Ohms	500-1000-1500-2000	10.0	P8T
B	ZY-2002	6-8 Ohms	500-1000-1500-2000	10.0	P10T, P12T
B	ZY-2003	6-8 Ohms	500-1000-1500-2000	16.0	P10Q, P12Q
B	Z-3423	16 Ohms	500 Ohms	25.0	P15Q, JRP-40
					HNP-51

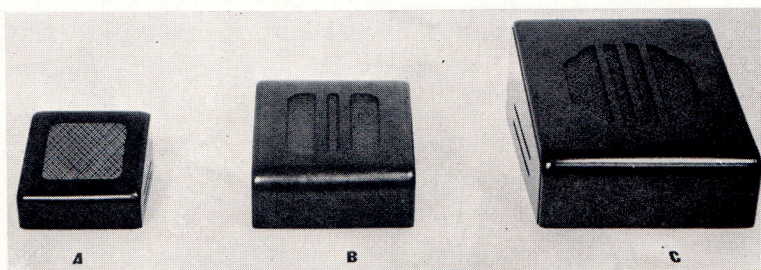

WALL SPEAKER CABINETS

Illustrated above are three popular size wall mount cabinets for studio and reception room use. Have air release on side and will produce unusually fine results. Finished in walnut.

Illus.	Type	Speaker Size	Height	Width	Depth
A	M6	6"	8"	7 1/4"	4 3/8"
B	M8	8"	11"	10 1/2"	6 1/2"
C	M12	10" & 12"	16 1/2"	14 3/4"	8 1/2"

RACK MOUNT RECEIVER

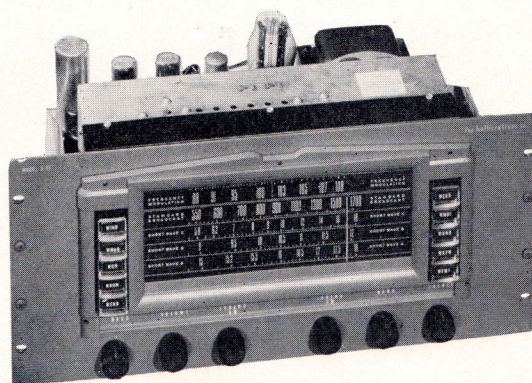

Illustrated above and below is the Hallicrafters high-fidelity all-frequency receiver for standard and short wave AM and FM operation. Frequency range is from 88-108 Mc. FM and 18 Mc. to 550 Kc. AM. This is considered the finest receiver manufactured for either re-broadcast purposes or for checking broadcast transmission quality directly from the air. Automatic frequency control gives unprecedented ease of tuning on FM with unequalled accuracy. As a station is approached, the automatic frequency control takes over electronically and holds the station in perfect tune, a necessity for the re-broadcasting of other FM stations. Has 14 tubes: 6BA6 RF. Amp., 6BE6 Mixer, 6J6 HFO and Auto. Freq. Control, two 6SG7 IF. Amps., 6SG7 FM 3rd IF. Amp., and AM Det., 6SH7 FM 4th IF., 6AL5 FM Det., two 6J5 and two 6SQ7 AF. Amps., two 6V6GT Output, 5U4G Rect.

Panel size: 8 3/4" x 19". 16" behind chassis. Manufacturer states response is uniform from 30 to 15,000 cycles.

Model S-47C Rack Receiver. Code ZEGUC.

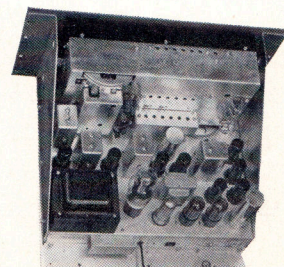

Master Control Equipment

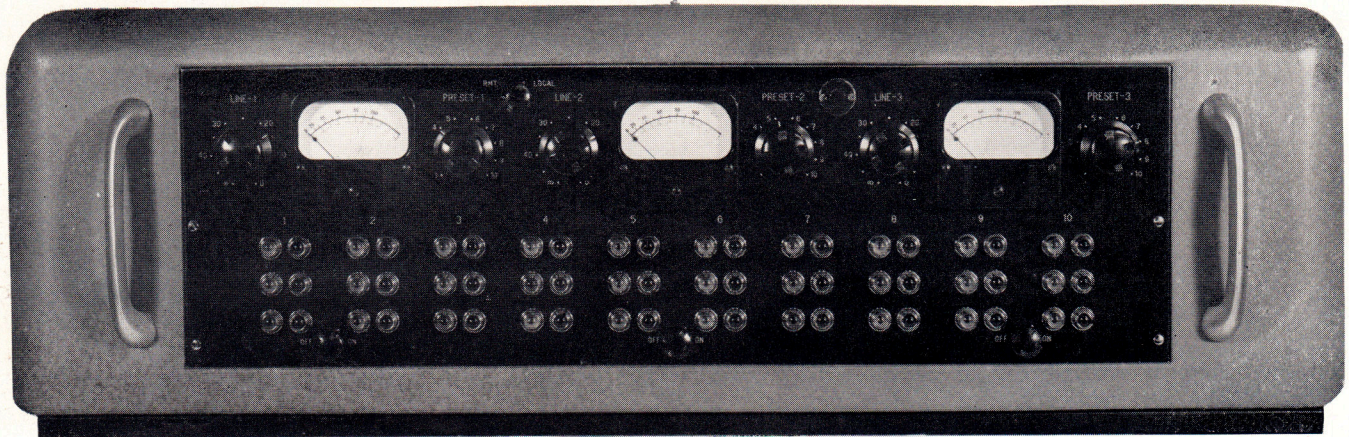

FIGURE A: The SA-110 master pre-set switching console exhibits extreme simplicity to control the most complex studio installation found in American broadcasting stations today.

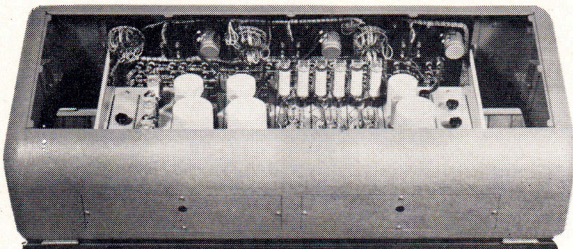

FIGURE B: The top view of the SA-110 pre-set console. The cabinet is of the tilt-back-to-service type identical to the SA-50 in mechanical design, shown on Page 1.

SA-110 MASTER PRE-SET SWITCHING CONSOLE

Master control studio installations need not be necessarily expensive installations and many broadcasters will be pleasantly surprised when they investigate the cost of master control for their studio requirements. On these pages it is not intended to outline any particular mode of master control equipment but instead to illustrate several master control items which can be assembled in multiple ways and likewise used with equipment already possessed in many instances, even if of competitive make.

Figure A above illustrates the master pre-set switching console, Model SA-110, designed to serve as a centralized control medium in speech input and dispatching systems involving any number of control consoles, up to ten, of any size. The SA-110 console is capable of pre-setting and then automatically switching ten input lines to any or all of three master output lines. At the same time there is provided status light switching circuits for both the

local lights on the SA-110 master console and the remote status lights which would be located on each of the sub-consoles, such as illustrated on each end of the SA-50 console shown on Figure D on page 13, or where the console is already possessed and does not have the necessary materials for master control the SA-112 remote pre-set box illustrated in Figure C may be located next to the console to provide complete master control operation. The panel arrangement of the SA-110 master console is such that one operator can have complete control over the entire studio system no matter how large. Quite frequently more elaborate speech input systems may require a master pre-set console of slight or major modification to that of the SA-110, but as the general physical design is such that these modifications can be made without manufacturing inconvenience, special designs outlined by broadcast studio engineers are welcome.

The control circuits are set up manually by front panel rotary switches and then automatically by a combination of telephone type control relays and stepping relays. The operation is almost instantaneous. After a momentary actuation of a master pushbutton, it requires less than two seconds for complete switching operation to be accomplished. The panel equipment contains all necessary status lights for full visual indication of the position of the system and its remotely located consoles at any one time. The various circuits are pre-set manually from the front of the SA-110 master console and amber "Ready" lights with numbered jewels will indicate the circuits which have been pre-set and waiting for final operation. Circuits which are in program use are

Master Control Equipment

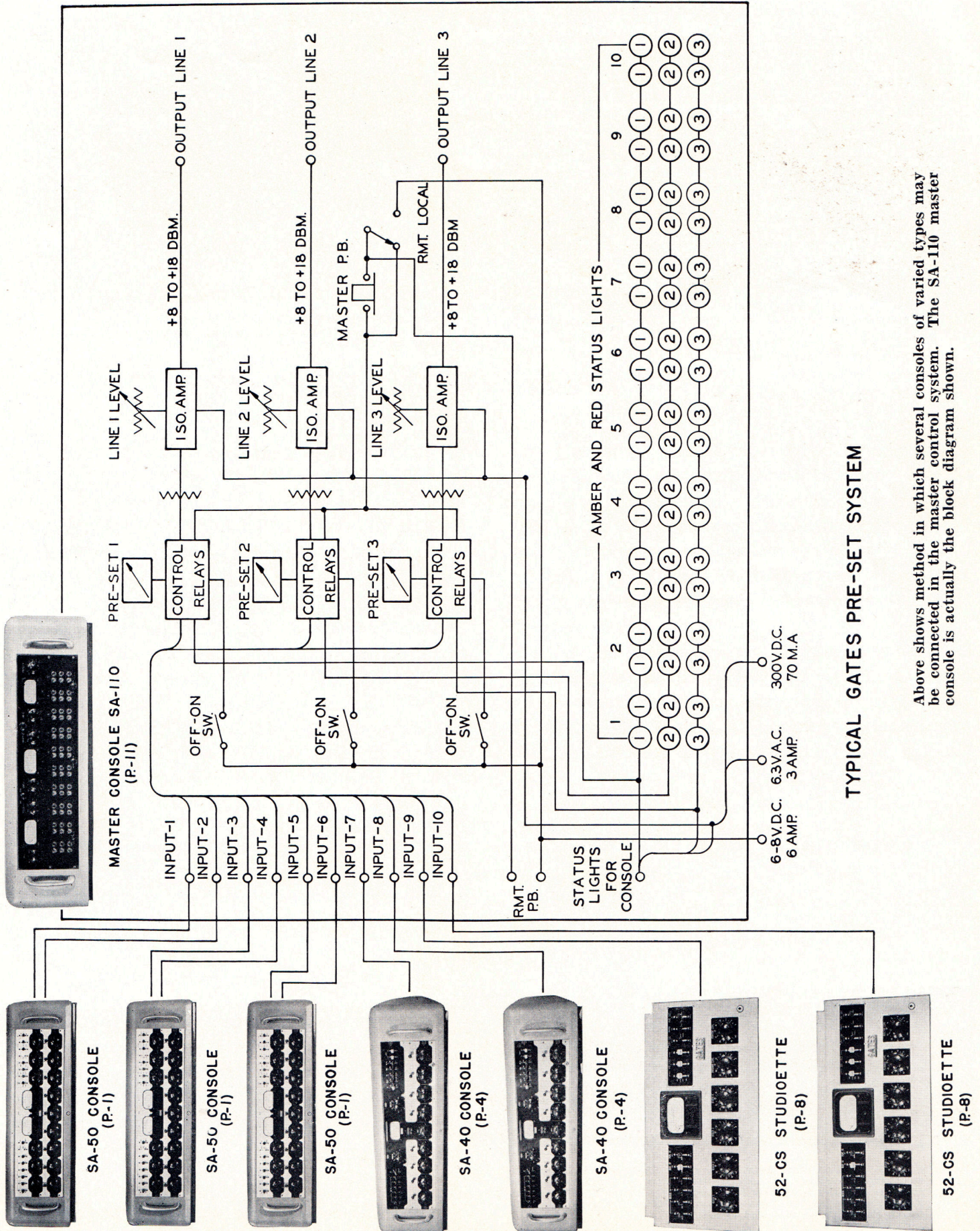

TYPICAL GATES PRE-SET SYSTEM

Above shows method in which several consoles of varied types may be connected in the master control system. The SA-110 master console is actually the block diagram shown.

Master Control Equipment

SA-112 REMOTE PRE-SET CABINET

The Gates SA-112 remote pre-set cabinet is designed to operate with the SA-110 master pre-set console on the preceding page and is usually placed adjacent to any standard console which will be operated with the master control system to furnish complete control circuits and status lights; thus making it unnecessary, where a good console is now possessed, to purchase completely new equipment for any of the sub-console operations in conjunction with master control. The SA-112 remote pre-set cabinet provides an audio switching circuit for two program lines, a monitor selection circuit for three master output lines, and complete numbered status light and remote facilities for two separate lines. Status lights consists of amber "Ready" lights with numbered jewels and red "On Air" lights in use when actual broadcasting is taking place. Excitation for these lights is derived from the master pre-set console. Size: $8\frac{1}{8}$ inches wide, 10 inches high, $9\frac{3}{4}$ inches deep, with panel slope of 45° . Where the cabinet is not desired, it may be purchased in panel form only, with panel size $8\frac{1}{2} \times 14\frac{1}{2}$ ". Terminations are to a twenty pair screw type numbered terminal strip.

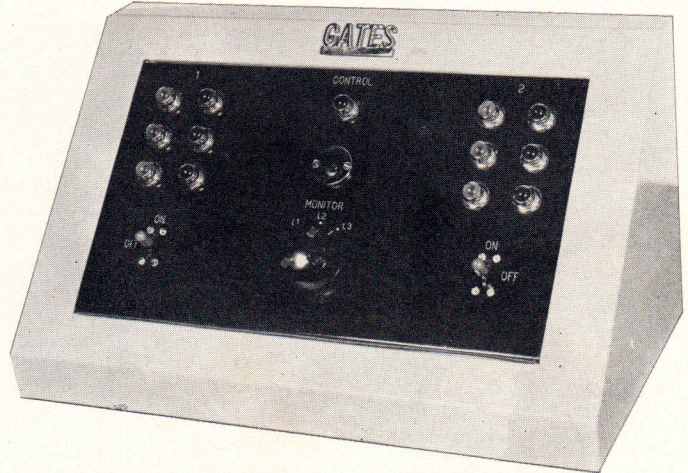

FIGURE C: Illustrated above is the SA-112 remote pre-set cabinet for use with any standard console to adapt it to master control operation.

visually indicated by red "On Air" lights and also contain numbered jewels for circuit identification. Duplication of status light circuits which are present in the master control console are provided on all other consoles used in the pre-set system, such as shown in Figure C, or the modified Gates SA-50 console in Figure D, guaranteeing complete knowledge of circuit function for both the master control operator and all operators at sub-console points. Provision is also made for locking various circuits so that they cannot be moved from their position as demanded by programming sequences. Facilities for actuating the pre-set system from remote points are also built into to SA-110 master control.

The audio portion of the master pre-set console consists of three isolation amplifiers similar to the SA-93 shown on Page 26, but with bridging inputs. The level controls for these amplifiers are located on

the front panel, providing accurate control of audio level on all circuits. Three standard 862 illuminated VU meters are provided for each outgoing line with fixed pads for +8 DBM level. Other levels, of course, can be provided. The input of the various isolation amplifiers are placed across any one of the ten input lines by means of the stepping relays. As the amplifiers are bridging, it is possible to place all isolation amplifiers across any one input line simultaneously without impedance or level changes. The isolation amplifiers are completely muted during the circuit switching operations so that undesirable noises are at all times eliminated from the outgoing lines.

To complete the SA-110 master console, two external power supplies are suggested; namely, the SA-102 direct current supply for the relays, and the SA-7 power supply to operate the three amplifiers. Both are shown on Page 28.

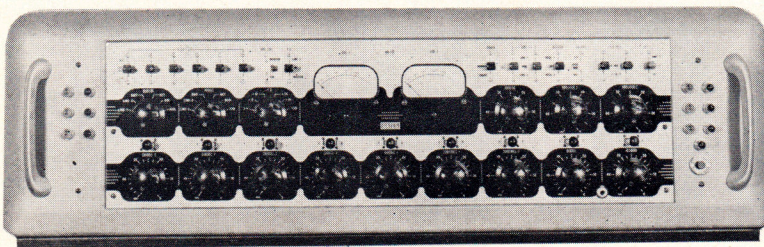

FIGURE D: Illustrated above is the Gates SA-50 console, described on Page 1, modified with status lights, remote pushbuttons, and complete facilities to operate in conjunction with the SA-110 master pre-set console on the preceding page. Status lights and pre-set switch are shown on each end of cabinet.

The console illustrated on page 11 is for operation of from 1 to 10 input lines and 3 output lines, however they may be supplied to handle up to twenty input lines and an indefinite number of output lines as required on special order.

For Control Desks Refer to Pages 33, 34 and 35

Relay Rack Cabinets-Blank Panels

DE LUXE DM-1

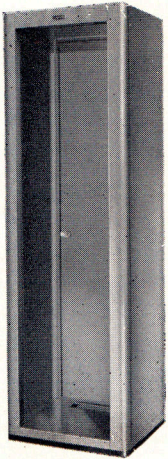

These are the finest available in superior quality rack cabinets, manufactured of heavy cold rolled steel and finished in high gloss. Each is provided with space for a lumiline lamp at the top front for casting an attractive glow over the front panel equipment mounted therein. Cabinet, which is provided with a base trim in black, is medium gray, hand rubbed and polished. Style strips are removable. Depth between front of style strip and front of rack panel is two inches, thus preventing any knobs or other control equipment from extending beyond the front of the cabinet. Multiple DM-1 deluxe cabinets are illustrated to the right. The DM-1-ST connecting strip is available for lining up two or more cabinets in a row with continuous unbroken modernistic effect. Size: 78 inches high, 23 $\frac{3}{4}$ inches wide, 20 $\frac{1}{2}$ inches deep. Rack mounting space 71 $\frac{3}{4}$ inches high, 19 inches wide, tapped for 12/24 rack mounting screws.

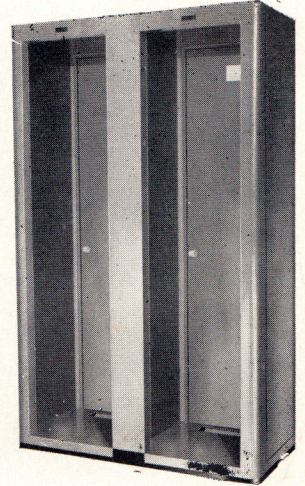

DM-1 Rack Cabinet. Code ZACTY.
DM-1-ST Connecting Strip. Code ZACYT.

WAIST HIGH RACK CABINETS

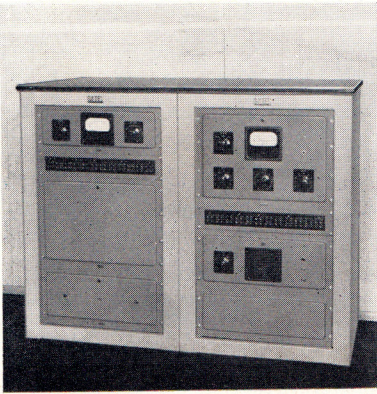

Illustrated to the right is a single waist high rack cabinet, while to the left illustrates how two or more cabinets can be joined together whereby rack cabinets may be conveniently located in transmitter or studio control rooms without obstructing window space. When purchased with linoleum covered work tops, may also be used for a utility table. Each cabinet is 37 $\frac{3}{4}$ inches high, 23 $\frac{3}{8}$ inches wide, and 23 inches deep. There is also available a modernistic base, very handy for wiring purposes as well as a protection when cleaning, which extends the height an additional 2 $\frac{1}{2}$ inches. Work tops are of 5-ply first quality lumber covered with battleship linoleum in black and trimmed in stainless steel. They are available in single, double, triple, or quad units. Also available are casters, particularly desirable in use with multiples of three or more cabinets, so that the cabinets may be quickly pulled out from the wall for rear servicing. A complete brochure on Gates waist high rack cabinets, and other Matched Control studio furniture and accessories, is available by writing for the 12-page brochure entitled "Matched Control".

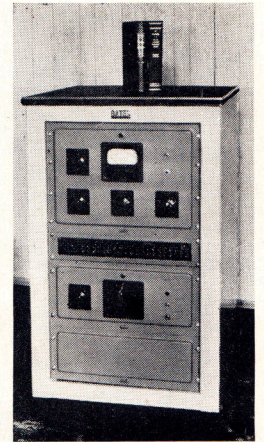

TYPE "C" CABINET

A professional type of cabinet enclosure with rear corners finished with rectangular style trim and door trim at top and bottom, but with side louvers omitted so that more than one cabinet can be mounted side by side. Rack is of 1/16" cold rolled steel rigidly braced and bottom is of 7/64" steel. Where racks are to be set up in gangs of two or more they may be joined together by means of a flat trim fastened to the front, finished in black ripple and gloss enamel.

- Type PG-3618**—Stands 42 $\frac{1}{2}$ inches high, 22 inches wide, 18 inches deep, with 36 $\frac{3}{4}$ inch rack panel space. Code ZEBSE.
Type PG-6618—Stands 67 $\frac{3}{8}$ inches high, 22 inches wide, 18 inches deep, with 61 $\frac{1}{4}$ inch rack panel space. Code ZEBVO.
Type PG-8318—Stands 83 $\frac{1}{2}$ inches high, 22 inches wide, 18 inches deep, with 77 inch rack panel space. Code ZEBYX.

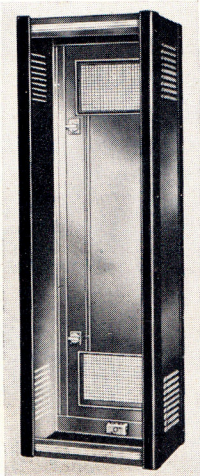

TYPE "A" RACK CABINET

An excellent quality, medium priced cabinet, finished in black ripple enamel with quickly removable gloss black style trims. Has perforations at top and bottom of rear door and louvers on the side. Shipped knocked down. Constructed of 1/16" cold rolled steel with base 7/64" in thickness and employs 10/32 machine screws for rack mounting. Available in three popular sizes as listed below:

- Type ER-232**—Stands 44 $\frac{1}{4}$ inches high, 22 inches wide, 18 inches deep, with 36 $\frac{3}{4}$ inch rack panel space. Code ZECAS.
Type ER-225—Stands 67 $\frac{3}{8}$ inches high, 22 inches wide, 18 inches deep, with 61 $\frac{1}{4}$ inch rack panel space. Code ZECET.
Type ER-227—Stands 83 $\frac{1}{2}$ inches high, 22 inches wide, 18 inches deep, with 77 inch rack panel space. Code ZECIV.

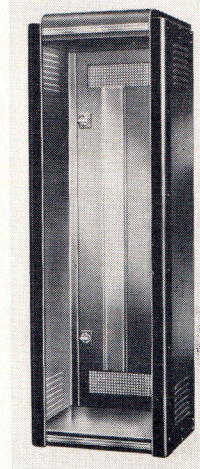

SA CAST ALUMINUM BLANK PANELS

These panels are designed particularly as fillers or on which the construction of special apparatus can be made, or where Gates SA amplifiers, with complete cast aluminum construction, listed elsewhere in this catalog, are to be used. Panel design is to match dimensionally the drop down door, a feature of Gates SA speech equipment. Available in three sizes, with panel thickness 3/16". Finish is in gray.

- SA-1350 Panel**—3 $\frac{1}{2}$ x 19 inches. Code ZECSA.
SA-1525 Panel—5 $\frac{1}{4}$ x 19 inches. Code ZECTE.
SA-1700 Panel—7 x 19 inches. Code ZECUX.

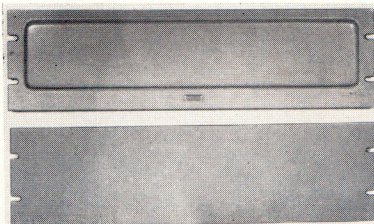

STANDARD ALUMINUM BLANK PANELS

Of high quality flat stock 3/16" 2SH aluminum for standard blank panel service of all kinds. Completely slotted for standard relay rack mounting and available in all rack multiples of 1 $\frac{1}{4}$ ". When ordering, specify size of panel and if special finish other than standard gray is desired. A small charge is made for special colors but special finished panels are available with a slight delay.
Standard Blank Panels per inch. Code ZECWO.

Dial Circuit Selectors

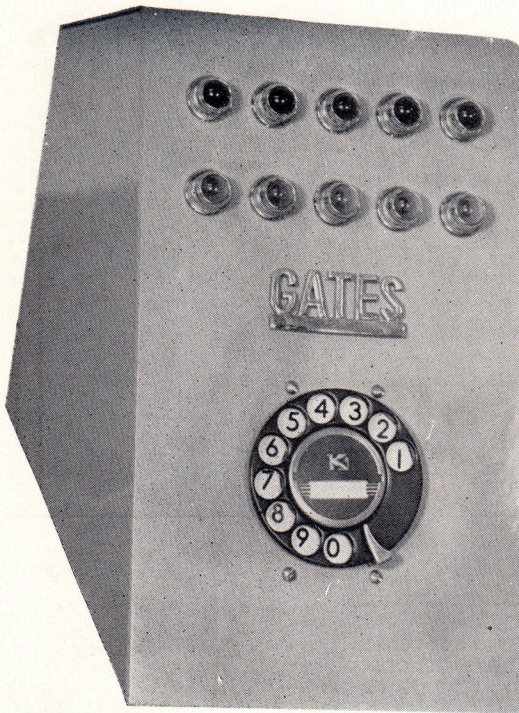

FIGURE A—Illustrates above the desk type dial circuit selector. This houses the dialing unit, circuit indicating lights and terminal connections which operate the stepping and control relays mounted on a separate rack panel. Its small size of $6\frac{3}{4}$ inches wide and $10\frac{1}{2}$ inches high makes it convenient for any type of desk mounting.

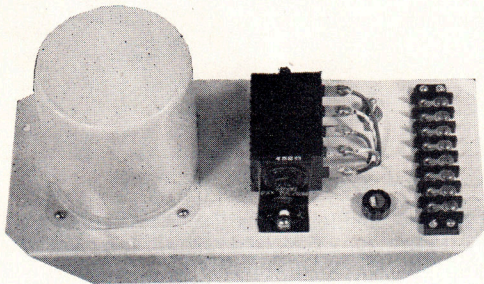

FIGURE B—The SA-108 DC power supply (rack panel not shown) which uses $5\frac{1}{4}$ x 19 inches of rack space and delivers 6 volts DC at 4 amperes. Uses copper sulphide rectifier in full wave circuit.

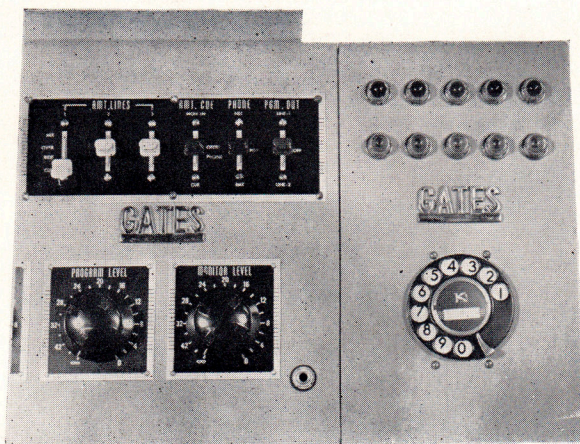

FIGURE C—A typical desk mounting is shown with the SA-106 dial circuit selector adjacent to a Gates 52-CS studioette. The Gates dial circuit selector unit is in no way limited to use with Gates equipment only and is a completely self-contained, independently operating instrument.

Dial type circuit selectors have become very popular in progressive broadcasting stations. Illustrated on this page is the SA-106 desk type unit, designed to mount either next to a console or on one corner of the control desk. The Model SA-106 consists of three units: the dial selector cabinet illustrated in Figure A; the rack mount DC power supply which consumes $5\frac{1}{4}$ x 19" of rack space illustrated in Figure B (rack panel not shown); and the rack mount relay panel containing the stepping and control relays, also constructed on a $5\frac{1}{4}$ x 19" panel. Connections between the control cabinet and the rack are by means of a twenty pair cable which may be purchased by the foot. A second model, which is entirely rack mount, is also available, but is not illustrated. It consists of two units; namely, the dial selector panel with the stepping and control relays on the same panel, which is $5\frac{1}{4}$ x 19"; and the rack mount DC power supply.

Ten circuits are provided which may be dialed from 1 thru 0. Where used to select remote lines, relay contacts are provided on the stepping relay so that all circuits except the one being used are normally closed for cueing purposes. Each circuit can therefore be considered as controlled by a D.P.D.T. relay contact action. The SA-108 power supply provides 6 volts at 4 amperes for operation of the stepping and control relays. Accordingly if a similar DC power supply is on hand, another would not be necessary. The operation of the dial selector unit is identical to telephone types. As only one digit is dialed, operation may be considered essentially instantaneous. Any number of dial selector units may be used, in the most part completely eliminating patch panels. It is equally successful for use with low level input circuits, such as microphones; as it is for remote lines, loud-speaker circuits, program line selection, etc. The experienced engineers will recognize the practical value of placing such things as remote circuits on a dial selection, thus making for better broadcasting. Numbered indicating lights from 1 to 0 are provided on the control cabinet, indicating which circuit is in use. Terminations both on the cabinet and rack panel units are to screw type barrier terminal strip. Installation may be made speedily and the unit is as reliable and foolproof as a patch panel. Size of control cabinet: $6\frac{3}{4}$ " wide, $10\frac{1}{2}$ " high, 12" deep, with panel on 30° slope.

Model SA-106—Dial Circuit Selector, including desk type cabinet, illustrated in Figure A, and rack mount relay panel. Code ZEAWN.

Model SA-107—Same as SA-106, only complete rack mount. Code ZEBAR.

Model SA-108—DC Power Supply, rack mount, to operate either SA-106 or SA-107. Code ZEBIT.

Type 20P—Twenty Pair Connecting Cable per foot. Code ZEBOV.

SPECIAL DIAL EQUIPMENT

For special and more complex dial circuit selecting equipment Gates engineers will be happy to plan with you for any equipment to suit your individual and special needs. The SA-106 and SA-107 units described on this page are only one of the many dial selector combinations that have been manufactured by Gates. Your inquiries for your special needs are cordially invited.

GATES RADIO COMPANY, Quincy, Illinois

Patch Panels and Cords

Described on this page is a wide variety of double jack patch panels, both on jack mats and unmounted, that will fit every conceivable situation. All jacks are of the closed circuit type so that normalled through circuits may be employed in the inter-wiring of audio equipment. Type C-150 and C-1500 listed below are unmounted but provided with brackets for direct attachment to a rack with Type C-150 being 19"x1 $\frac{3}{4}$ " in panel size, and C-1500 being 19"x2 $\frac{1}{8}$ ". The SA Series listed below are all mounted on rigidly constructed jack mats provided complete with easily detachable dust cover and wiring strap for each row of jacks. The dust cover is so constructed that wiring cables may exit from either end of the patch panel and, of course, the dust cover may be removed without disturbing wiring in any way. Types SA-160 and SA-1600 require 3 $\frac{1}{2}$ "x19" rack panel space while type SA-1601 requires 5 $\frac{1}{4}$ " rack panel space. Jacks are of approved welded box type construction, assuring rigid alignment of all parts. Non-aging, non-ferrous springs provide permanent proper tension with silver alloy contacts riveted through the plates. Jack panels proper are of bakelite reinforced with steel for greatest strength and rigidity. Individual designation strips are provided for each pair of jacks. For those desiring the very finest in patch panel equipment the items listed on this page cannot be excelled.

SA-160—24 Jacks (12 pairs) single row patch panel mounted on jack mat, complete with dust cover and wiring strap. Code ZECZY.

SA-1600—48 Jacks (24 pairs) double row patch panel mounted on jack mat, complete with dust cover and wiring strap. Code ZEDAT.

SA-1601—96 Jacks (48 pairs) quad row patch panel mounted on jack mat, complete with dust cover and wiring strap. Code ZEDEV.

C-150—24 Jacks (12 pairs) patch panel unmounted or without jack mat or wiring strap. Code ZEDDY.

C-1500—48 Jacks (24 pairs) patch panel unmounted or without jack mat or wiring strap. Code ZEDTA.

SPECIAL PATCH PANELS

Though the combinations shown on this page or described above will fit nearly all conceivable applications for rack mounting, Gates will gladly construct special patch panels either in special housings or of greater multiples of jacks. We cordially invite your inquiries along with a simple sketch and word description of what is desired. A quotation will be mailed promptly.

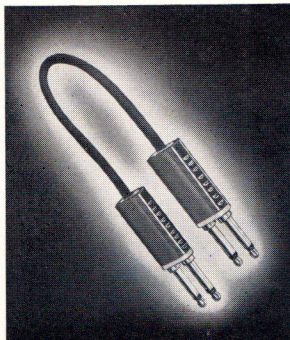

Patch Cords

The type E patch cords are provided in four different lengths, with a heavy double plug attached to each end. They will provide years of service without cord or plug breakage. Cords are shielded and covered with a durable black braid reinforced six inches on each end. The plugs are accurately machined to assure comfortable fitting and positive circuit make.

- | | |
|-----------------------------|-------------|
| E2 Patch Cord, 2 ft. | Code ZACEP. |
| E7 Patch Cord, 3 ft. | Code ZAPYH. |
| E4 Patch Cord, 4 ft. | Code ZACNA. |
| E6 Patch Cord, 5 ft. | Code ZARAD. |

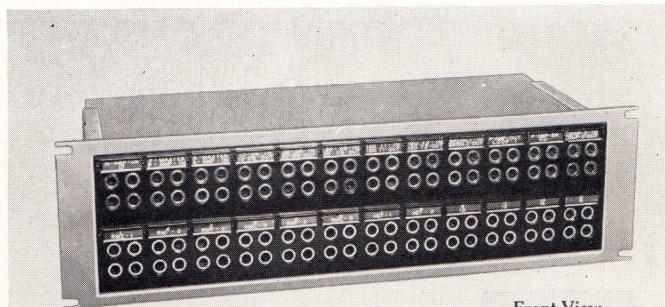

Front View
C-1500-M2 and
SA-1601

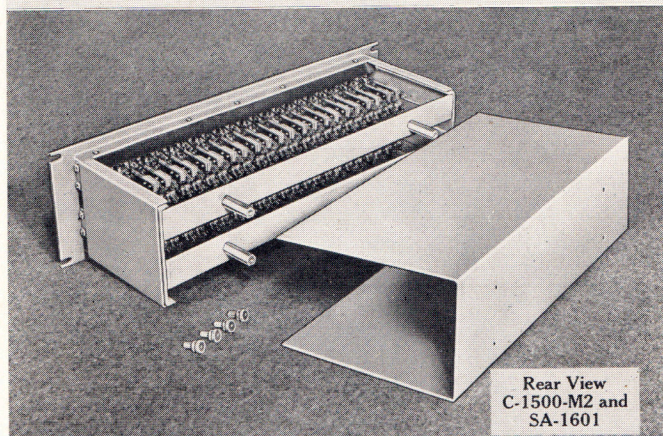

Rear View
C-1500-M2 and
SA-1601

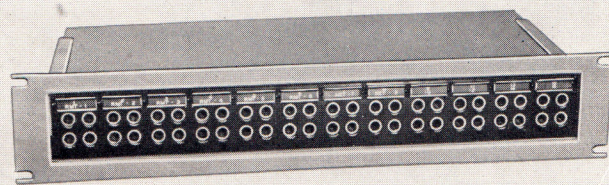

Front View
C-1500-M1 and
SA-1600

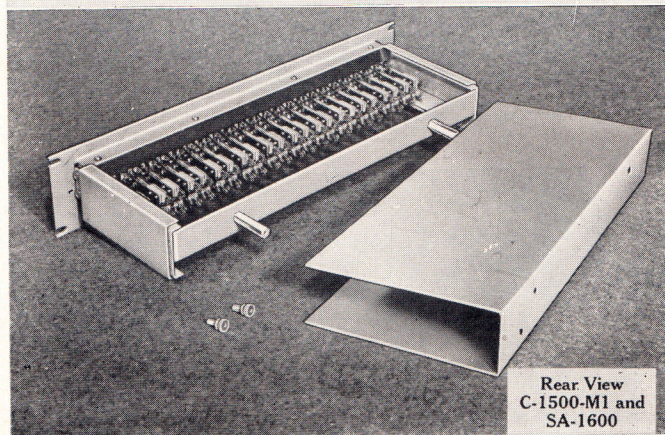

Rear View
C-1500-M1 and
SA-1600

GATES—Since 1922

Custom Built Equipment

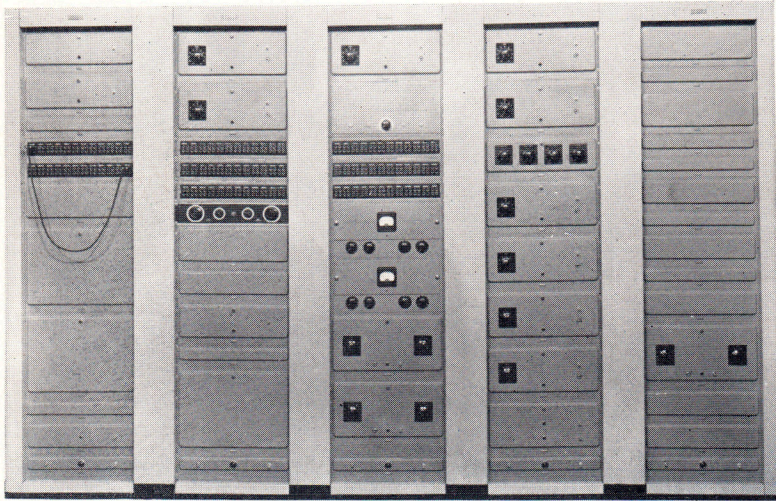

The adjoining pictures illustrate a five-cabinet custom speech input system made for WSOY-AM and FM. In most instances standard Gates equipment was used throughout. Five type DM1 deluxe illuminated rack cabinets house all types of SA amplifiers including fifteen preamplifiers, three isolation amplifiers, two SA-10 monitoring amplifiers, and nine SA-20 program amplifiers. Note neat way in which SA equipment lines up for inter-wiring.

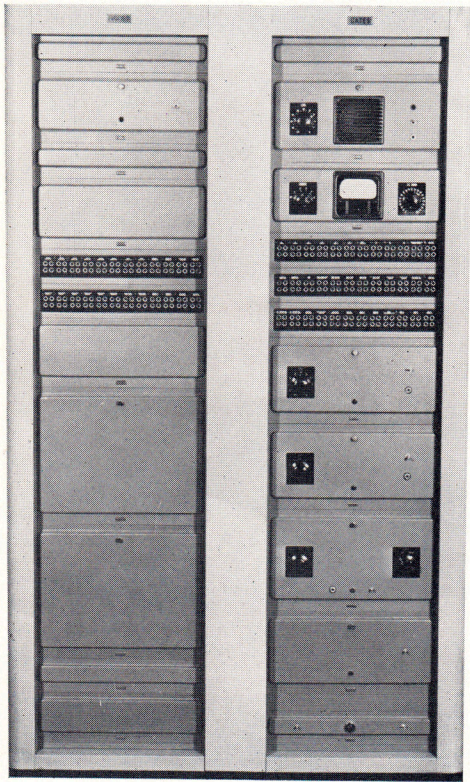
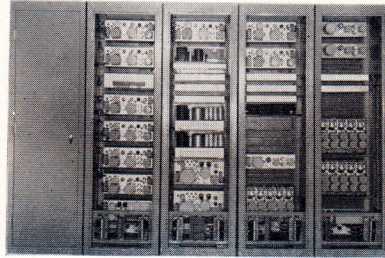

Illustrated in these three photographs are front and back views of a typical two-cabinet speech input installation embodying SA amplifiers throughout. In this picture is shown the SA-5 speech input system. Along with these two cabinets is a special built dual console, identical in appearance to the SA-50, which interlocks with the many circuits provided in the rack mount SA construction. The experienced engineer will again note the many service advantages in the exclusive Gates SA design, allowing much more equipment per rack cabinet. In fact, two standard rack cabinets will handle more SA equipment than four rack cabinets with earlier design rack apparatus.

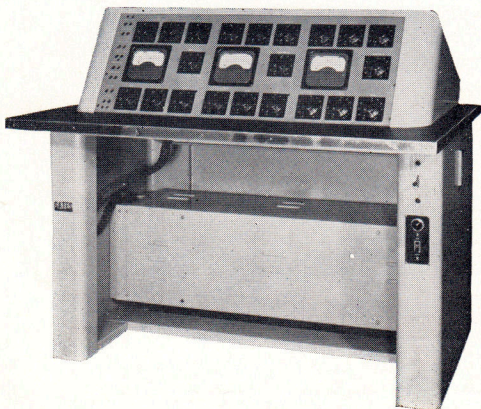
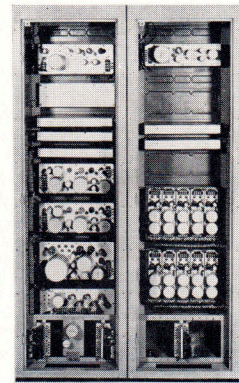
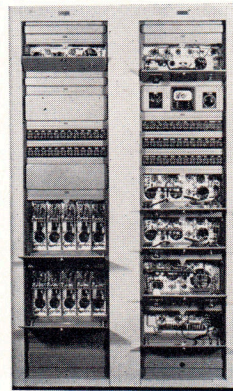

Special construction has long been a highlight in Gates service and, when properly planned and designed, custom equipment is never excessive in price. Illustrated here is a complex control console constructed on a typical Matched Control desk and complete with amplifiers, power supplies, and other necessary materials for low level operation. This unit was specially built for use at the St. Louis Municipal Opera, largest of its kind in the world, and which reputedly has one of the most complex stage pickups known to the show business. The customer in this instance was able to adapt certain other units of competitive make without deviating from the general Gates design, which is usually the case when special apparatus is constructed by Gates. Whether the needs are small or for a large multi-studio installation, Gates engineers will consider it a privilege to work with our customers in planning and making suggestions for better broadcasting.

SA Rack Mount Housing

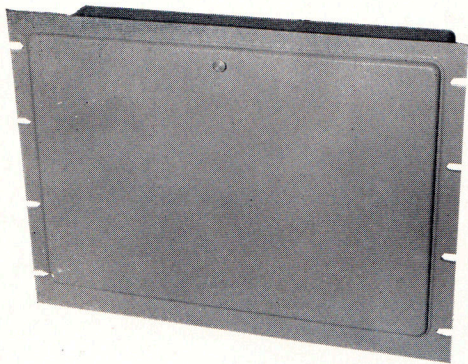

Above, the SA rack mount housing front view with drop-down door closed. Entire construction is of cast aluminum.

The SA housing for the rack mounting of speech input equipment is an exclusive Gates design, the outstanding feature being the 100% cast aluminum construction, including the drop-down front panel which has the hinges as part of the main body casting. Though the SA housing has been principally designed to accommodate the many models of Gates SA amplifiers, it obviously can be used for practically any application where standard rack panel equipment is required. The SA housing consists of two pieces:

- (a) The main body, which is the rack panel itself, and extending six inches from the back of this panel as part of the one piece casting, is a 5/8" thick cast aluminum wall which holds rigidly the heaviest chassis.
- (b) The drop-down front door is so hinged that the door may become a shelf on which tools or test instruments may be laid without danger of breakage while the under chassis components are serviced from the front of the rack cabinet. It should be particularly noted that the drop-down door is so designed that on any type of rack cabinet **there is no need to remove the style strips**, where existing, before the door can be lowered.

The design of the SA housing in cast aluminum offers particular advantages in audio circuits, where noise level is much reduced, over that of steel. Each housing is attractively finished in medium gray, though other colors are available on special order with minimum delay. At the bottom of this page are dimensional drawings for the various sizes of SA housings available from stock.

ORDERING INFORMATION

- Model SA-400 complete housing Code ZAWMO
- Model SA-500 complete housing Code ZAWPY
- Model SA-600 complete housing Code ZAWYP
- Model SA-700 complete housing Code ZAYAK
- Model SA-800 complete housing Code ZAYBS

(See bottom of page for sizes)

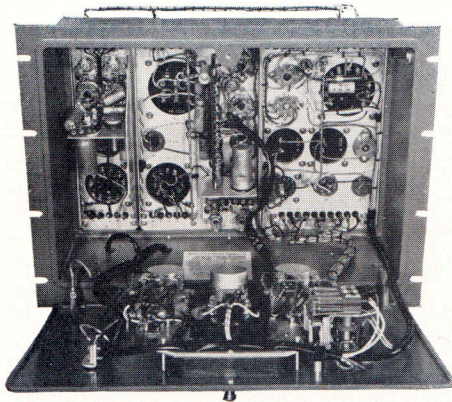

To service equipment mounted on SA housings, drop down the rigid cast front door. Note how every under chassis component can be reached. Cabinet style strips need not be removed to drop down front door.

FOR SA MATCHING BLANK PANELS SEE PAGE 14

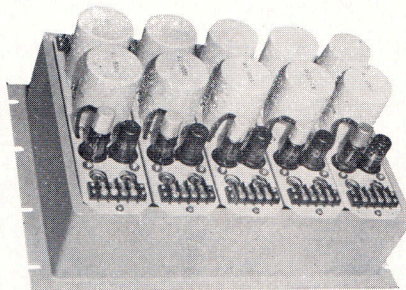

Here is how five Gates SA-70 or SA-74 preamplifiers are mounted on one SA-800 housing, providing more compactness and still more serviceability.

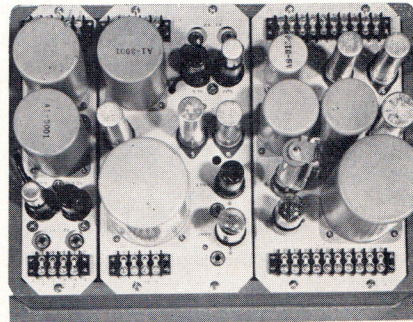

Any combination of amplifiers or power supplies may be mounted on one rack housing. This illustrates a preamplifier, program amplifier, and power supply all on one SA-800 housing.

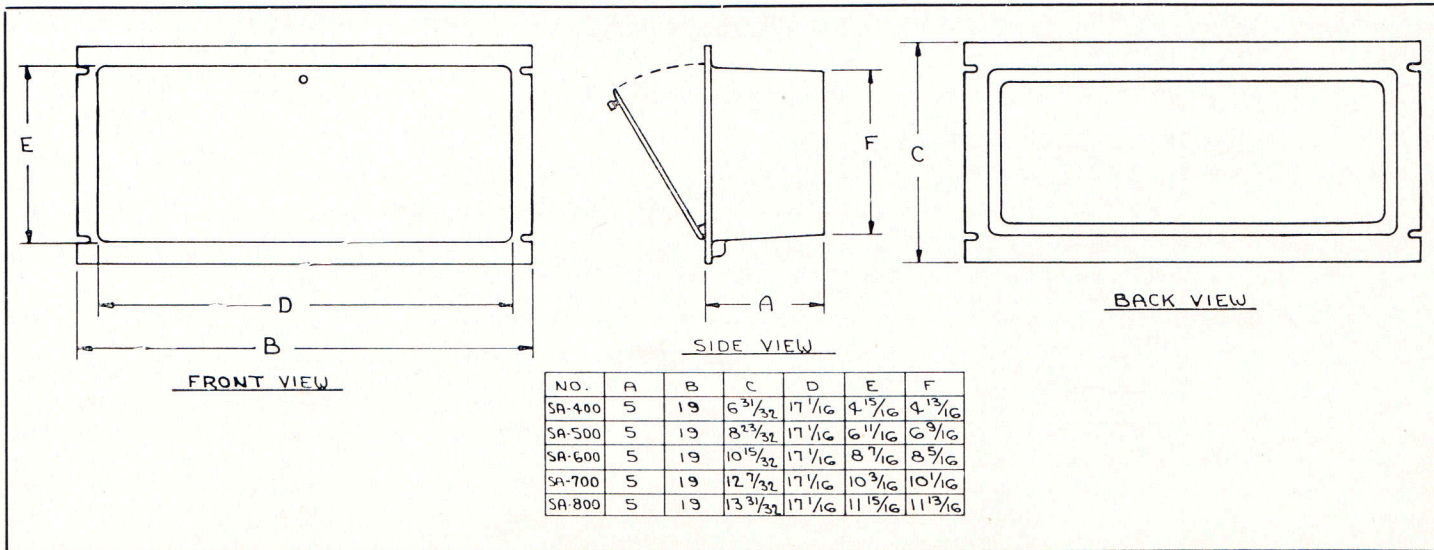

SA-38 Limiting Amplifier

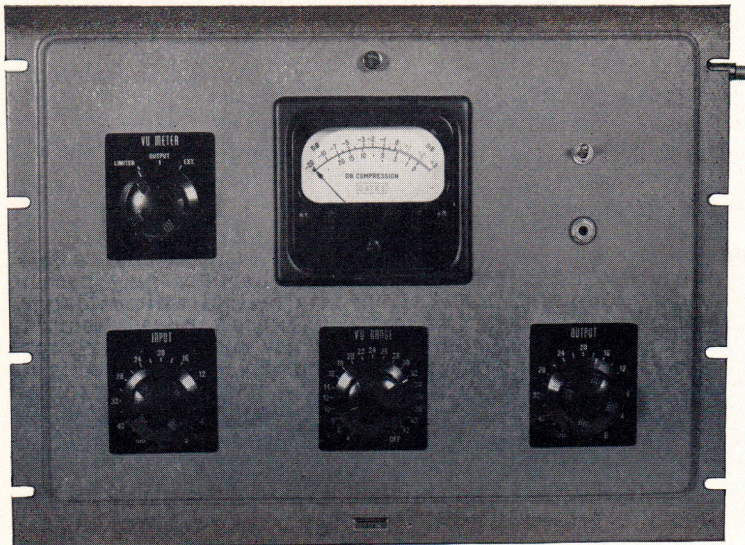

//

GATES SA-38 AND SA-39
LIMITERS HAVE ALL
POWER AND FILTERING
COMPONENTS DESIGNED
FOR A 40° C. MAXIMUM
TEMPERATURE RISE
WHEN OPERATED INSIDE
A RACK CABINET

//

The Gates SA-38 Limiting Amplifier has been designed to fulfill the exacting requirements of the modern mid-century broadcasting station, whether it be AM, FM or TV. It is an extremely low distortion, low noise, fast acting limiter, completely void of thumps or chirps at the attack time—which were characteristic of many earlier model compression equipments. Limiting action is obtained by feeding a portion of the output voltage through a full-wave rectifier and a negative DC voltage applied to the second control grid of the push-pull 1612 first stage amplifier tubes. As the output voltage increases the grid becomes more negative, retarding flow of current, thus lowering the gain of the first stage. As a result, unusually high compression may be attained without increasing distortion, which is evidenced by the rated 1½% maximum distortion at as much as 20 decibels of compression. Three all push-pull stages are employed, which obtain their voltage from an accurately designed regulated power supply. The limiter attack time can be considered instantaneous while six varied release times, between 0.2 and 1.2 seconds, are available through a selector switch on the chassis. A large 4" dual scale meter provides reading of limitation in direct decibels of compression and by a switch on the front panel provides a second scale reading directly in VU. There is provided a T network range control with two decibel steps from +4 to +42 VU which may be connected either across the output of the limiting amplifier, or to an external circuit for other measuring purposes. Ladder type attenuators are provided at both the input and output circuits. Headset jack and starting toggle switch complete the front panel equipment. The VU meter is mounted flush with the panel, and is a 4" illuminated Weston unit. The exclusive Gates SA type housing is used for easy front-of-cabinet servicing. All audio terminations are made to a separate terminal strip on the back chassis, with power terminations to a different terminal strip. Jacks allow measurement of each tube cathode current. All transformers are fully impregnated, with the input transformer having 90 Db. shielding and power components a maximum of 40° C. temperature rise, inside a rack cabinet.

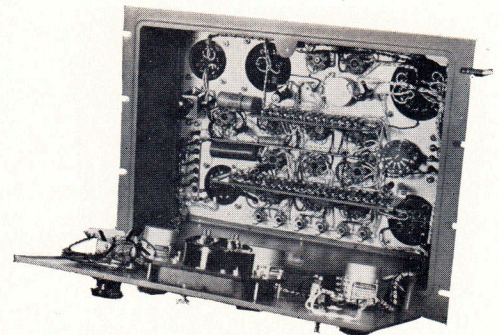

SPECIFICATIONS

INPUT IMPEDANCE—500/600 ohms.
 OUTPUT IMPEDANCE—500/600 ohms.
 INPUT LEVEL—From -20 VU to +20 VU.
 OUTPUT LEVEL—+25 VU or less as adjusted by output attenuator.
 MAXIMUM GAIN—60 Db.
 RESPONSE—30 to 15,000 cycles within 1½ Db.
 DISTORTION—1½% or less at all frequencies and up to 20 Db. of compression.
 NOISE—70 Db. below any output level.
 DIMENSIONS—19" wide, 14" high, 9½" deep.
 FINISH—Medium gray.
 POWER SUPPLY—Regulated to plus or minus 5 volts DC.
 TUBES—Two each 1612, 6V6GT; three each 6SJ7; one each 6H6, 6S5GT, 6Y6G, 5V4G.
 SHIPPING DETAIL—Net weight, 38 lbs.
 Domestic packed, 74 lbs.
 Export packed, 96 lbs.
 Cubage, 12.

Model SA-38 Limiting Amplifier. Code Word ZANEB.

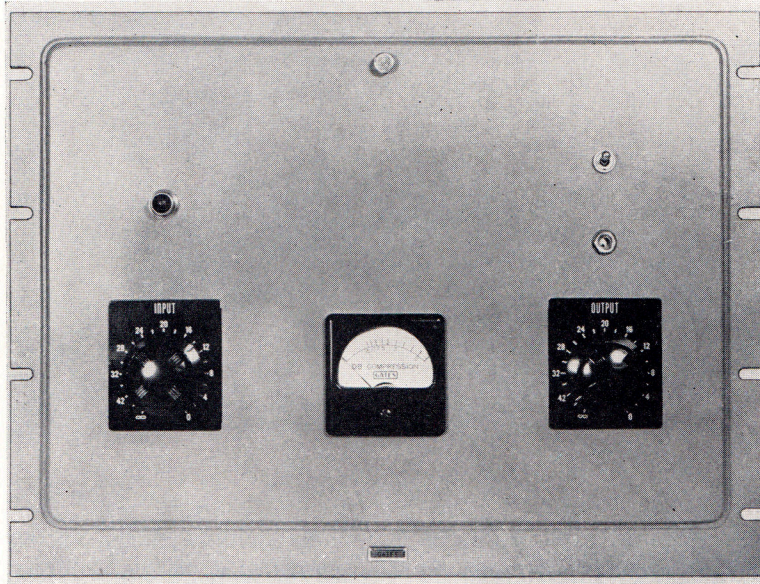

SA-39 LIMITING AMPLIFIER

This Limiting Amplifier is identical in every respect to the SA-38 equipment described on the preceding page, except that the combination compression and VU meter has been eliminated and in its place has been provided a 3" meter reading directly in decibels of compression. The SA-39 Limiter is available to those stations already having adequate VU measuring equipment and not requiring that feature of the SA-38 equipment. In all other respects the SA-39 and the SA-38 are identical.

Model SA-39 Limiting Amplifier. Code Word ZAYEL.

SA-22 CUEING AMPLIFIER

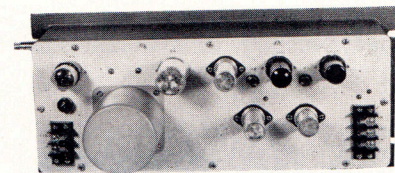
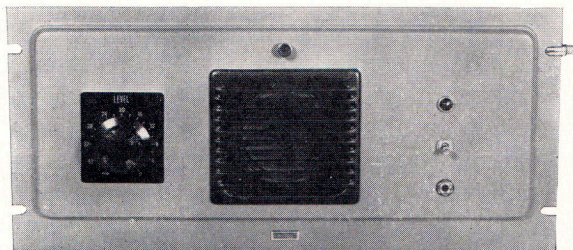

Rear View SA-22

Complete independence in cueing of turntable, network, or remote circuits is desirable in each speech input installation. The SA-22 Cueing Amplifier is a compact, complete, self-contained rack mount equipment including loud-speaker, providing a good level for cueing and with proper tonal reproduction to provide carrying power over that of the full fidelity monitoring speaker used in the control room. A headphone jack is provided which, when the plug is inserted, disconnects the cueing speaker. A two-stage high gain amplifier with bridging input, having a gain of 50 Db., is provided. The power supply is self-contained and construction is on the popular Gates SA cast aluminum housing. Recommended for use with Gates CB-10 Master Turntable listed on page 30.

SPECIFICATIONS

- TUBES USED—One each 6SJ7, 6V6, 6X5GT.
- INPUT IMPEDANCE—50,000 ohms, bridging unbalanced.
- SPEAKER—5" PM type.
- INPUT LEVEL—Up to +10 VU.
- OUTPUT WATTAGE—2 watts.
- GAIN—50 Db.
- RESPONSE—Including speaker capabilities, 150 to 7000 cycles.
- NOISE—50 Db. below +30 VU.
- POWER REQUIREMENTS—50 watts from 115 V, 50/60 cycle line.
- SIZE—19" wide, 8³/₄" high, 9" deep.
- FINISH—Medium gray.
- SHIPPING DETAIL—Net weight, 17 lbs.
Domestic packed, 34 lbs.
Export packed, 52 lbs.
Cubage, 2.9.

Model SA-22 Cueing Amplifier with Tubes. Code Word ZAKIX.

SA-20 Program Amplifier

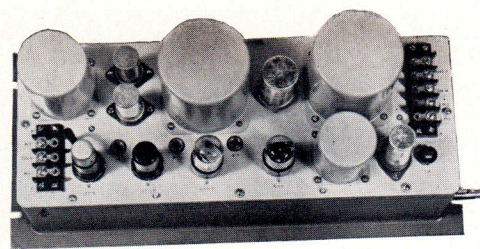
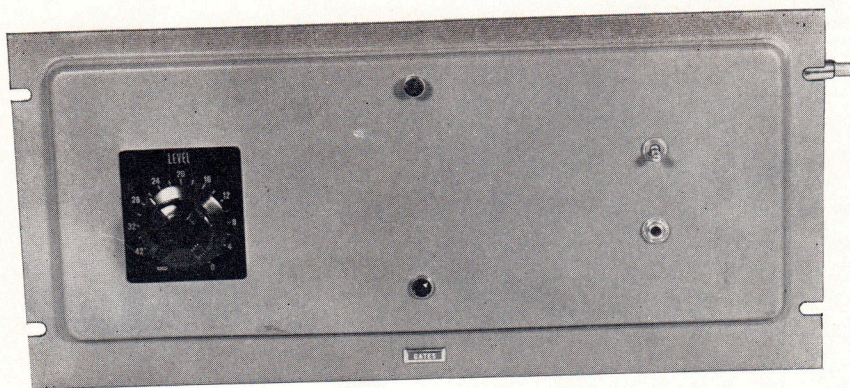

Rear View SA-20

The Gates SA-20 Program or Line Amplifier is a high quality, medium gain, 3-stage amplifier with power supply self-contained. It is constructed on the exclusive Gates SA housing described on Page 18, providing complete under-chassis accessibility from the front of the rack cabinet. Input impedances are over a range of 50 to 600 ohms and output impedances of 250/500/600 ohms are provided. Audio terminations are to a barrier type terminal block on the right rear chassis, while power connections are to an isolated terminal block on the left rear chassis. Test jacks are provided for current measurements of each tube. All transformers are well impregnated, with the input transformer having 90 Db. shielding and power and filter components a maximum temperature rise of 40° C.

when inside a closed rack cabinet. Master gain control is of the wiping contact design and operates in the grid circuit. From the standpoint of engineering design, performance and economy, the SA-20 Program Amplifier will find many uses in the modern station. It has approved specifications for AM, FM or TV use. For Rack Cabinets see Page 14.

APPLICATION

The SA-20 Amplifier has been designed basically as a wide response, low noise and distortion program or line amplifier. However, because of these excellent qualities it will find favor as a booster or isolation amplifier where higher than normal gain is required. It may also be used in connection with certain types of tape recording. Because of the reasonable cost of the SA-20 Amplifier it may be used to provide added facilities.

SPECIFICATIONS

- TUBES USED—One each 6J7, 6SJ7, 6SN7, 6X5.
- INPUT IMPEDANCES—50, 250, 500, or 600 ohms, by input transformer taps.
- OUTPUT IMPEDANCES—250, 500 or 600 ohms.
- INPUT LEVEL—Minimum —40 VU for maximum output level.
- OUTPUT LEVEL—At 1% distortion or less, +26 VU.
- RESPONSE—30 to 15,000 cycles within 1½ Db.
- NOISE—70 Db. below +18 VU.
- GAIN—60 Db.
- WATTAGE—50 watts from 115 volts 50/60 cycle power line.
- COLOR—Medium gray (other colors on request).
- SIZE—19" wide, 8¾" high, 9" deep.
- SHIPPING DETAIL—Net weight, 21 lbs.
Domestic weight, 40 lbs.
Export weight, 89 lbs.
Cubage, 7.1.

Model SA-20 Program Amplifier with tubes. Code ZAJVE.

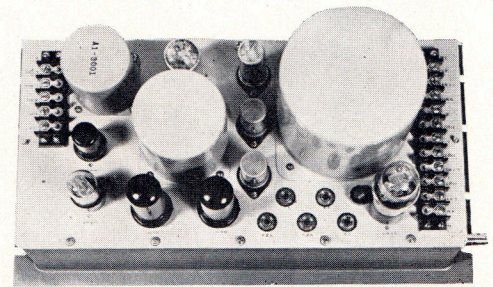
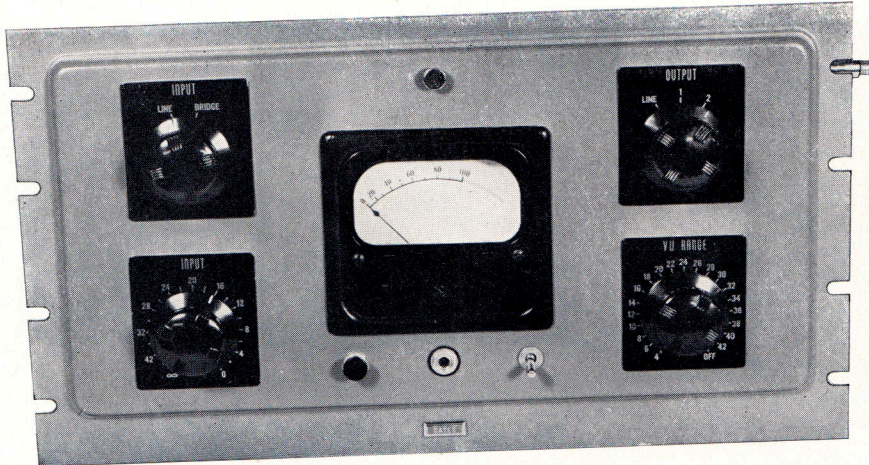

Rear View SA-66

In every broadcasting station there is need for an all purpose amplifier. The SA-66 equipment is a highly flexible unit that may be used as a program, audition, recording, or monitoring amplifier. The input of the amplifier, by a front panel switch, may be selected to either line or bridging impedance. The output of the amplifier may be selected to three circuits:

- (a) Program line which is padded 20 Db. when the unit is used as a program amplifier.
- (b) A second high level line capable of up to +40 VU output.
- (c) A third high level line also capable of +40 VU output.

Also is provided a Weston Type 862 illuminated and recessed VU meter with T network range control in two VU steps from +4 to +42 VU. This VU meter may also be switched to an external circuit for other measuring purposes. The master gain control in the grid circuit is the wiping contact type. Headset jack and starting switch are also front panel equipment. The SA-66 equipment is capable of a full 10

watts output at less than 2% distortion at all frequencies and yet, when used as a program amplifier through the padded output, the noise level is comparable to that of any high quality program amplifier and meets all AM, FM and TV specifications. The exclusive SA housing design is part of the SA-66 construction. Jacks are provided to measure emission of all amplifier tubes. For Rack Cabinets see page 14.

APPLICATION

The SA-66 amplifier is definitely an all purpose equipment that may be used for about any requirement in the broadcasting station. As a line or program amplifier it is excellent. The ten watts low distortion output, with its associated VU meter and complete range set, lends excellent usage for recording. The SA-66 may be used as an audition or monitoring amplifier and, with the padded output provision, is just as well adapted as a medium gain booster or line feeding equipment. When considering the complete facilities in the SA-66 equipment it becomes one of the most economical amplifiers in our line.

SPECIFICATIONS

- TUBES USED**—One each 6J5, 6SN7, 5V4; two each 6L6.
- INPUT IMPEDANCES**—50, 250, 500 or 600 ohms line; also 20,000 ohms bridging.
- OUTPUT IMPEDANCES**—Three 500/600 ohm lines by switch selection from front panel, one of which is padded 20 Db. Also available 5, 7.5, and 15 ohms.
- GAIN**—From line input to high level output, 68 Db.
From line input to program line output, 48 Db.
From bridging input to high level output, 38 Db.
- RESPONSE**—30 to 15,000 cycles within 1½ Db.
- DISTORTION**—1% or less at +38 VU. 1½% at +40 VU.
- NOISE**—65 Db. below +38 VU to high level line or +18 VU to program line.
- SIZE**—19" wide, 10½" high, 10½" deep.
- COLOR**—Medium gray.
- POWER REQUIREMENTS**—125 watts from 115 volts 50/60 cycle line.
- SHIPPING DETAIL**—Net weight, 34 lbs.
Domestic weight, 68 lbs.
Export weight, 92 lbs.
Cubage, 7.1.

Model SA-66 General Purpose Amplifier with tubes. Code ZAKAV.

SA-10 Monitoring Amplifier

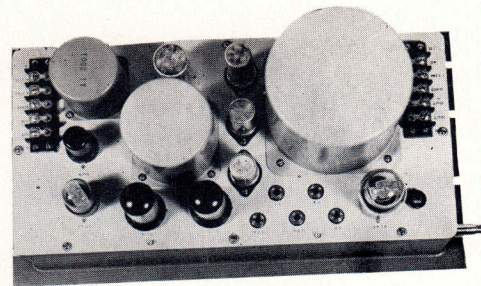
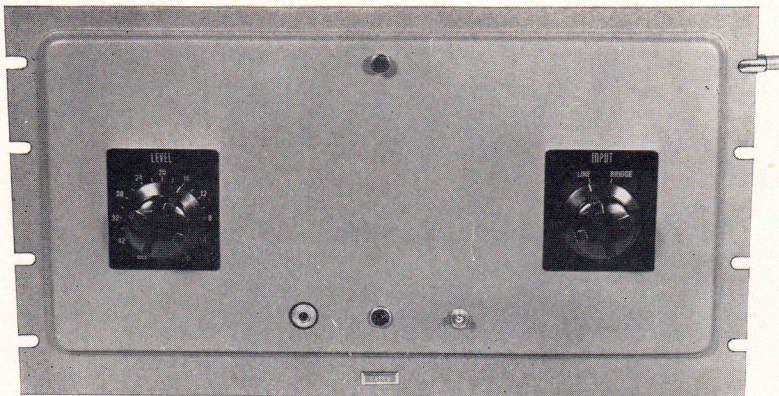

Rear View SA-10

In the design of a high quality monitoring amplifier, Gates engineers have taken into consideration when developing the SA-10 equipment the many instances it will be called upon for high quality service other than that of excellent loud speaker supply. For this reason the SA-10 amplifier could well be termed a utility amplifier, giving excellent service as a standby program or line amplifier or as a recording amplifier. The SA-10 amplifier is capable of a full 10 watts output at a maximum distortion of 1.5% and with a distortion of less than 1% at levels up to +38 VU. Likewise, its frequency response being linear and its noise very low, it will easily fit the rigid requirements of a utility amplifier.

There are three audio stages with the final stage push-pull. The power supply is self-contained and, as is true with all SA equipment, the power components are designed for a maximum of 40° C. temperature rise when operated continuously inside a rack cabinet. A wide variety of input impedances are provided, including bridging input; likewise a wide variety of both line and voice coil impedances are included in the output circuit.

The equipment is built on an SA-600 housing which is described in detail on Page 18 and provides the drop-down front panel feature for complete servicing of all under chassis parts from the front of the rack cabinet. Test jacks are provided for measuring the plate current of each amplifier tube. Control equipment includes the master gain control, which is the wiping contact type, and input selector switch selecting the line input to that of either line or bridging impedance. The front panel equipment is complete with a headset jack, pilot light and master starting switch. Construction is of aluminum, which is responsible for the unusual noise reduction in all SA Series amplifier equipment. The front and rear illustrations above show the sturdy and excellent engineering design of the SA-10 amplifier. Note that all input circuits are segregated at their terminal strip from that of output and power line connections.

APPLICATION

As a monitoring, audition, recording and general utility amplifier. By inserting a 20 Db. fixed pad in the output circuit the unit may be used, also, as a high quality line or program amplifier. See page 39 for pads and page 14 for rack cabinets.

SPECIFICATIONS

- TUBES USED**—One each 6J5, 6SN7 (phase inverter), 5V4G.
Two 6L6 (1622).
- GAIN**—70 Db. (500 ohms input) or 38 Db. bridging input.
- FREQUENCY RESPONSE**— ± 1.5 Db, 30 to 15,000 cycles.
- DISTORTION**—1% or less at all frequencies from 50 to 15,000 cycles at levels up to +38 DBM, or 1½% up to 40 DBM.
- NOISE**—70 Db. or better below +38 DBM.
- MAXIMUM INPUT LEVEL**—0 Db.
- MAXIMUM OUTPUT LEVEL**—+40 DBM.
- INPUT IMPEDANCES**—500, 250, 150, 50 and 20,000 ohm bridging.
- OUTPUT IMPEDANCES**—500, 250, 15, 7.5 and 5 ohms.
- POWER REQUIREMENTS**—125 watts from 115 volts 50/60 cycle line.
- FINISH**—Medium gray with dial plates in anodized aluminum.
- SIZE**—19" wide, 10½" high, 10¾" deep.
- SHIPPING DETAIL**—Net weight, 31 lbs.
Domestic weight, 55 lbs.
Export weight, 89 lbs.
Cubage, 6.8.

Model SA-10 Monitoring Amplifier complete with tubes. Code ZAKCY.

Two-Watt Monitoring Amplifier, Volume Indicator, Switch and Fuse Panel

SA-98 MONITORING AMPLIFIER

This unit provides a high quality, medium gain amplifier for loud speaker distribution, auditioning, many types of recording, and utility purposes. With a gain of 45 Db., its application with master control systems or as part of a complex loud speaker distribution system will be particularly desirable. This amplifier has the power supply self-contained and is constructed on an SA-500 housing, fully described on Page 18 of this catalog.

Specifications

TUBES USED—One each 6SL7, 6X5. Two each 6V6 PP.
GAIN—45 Db.
RESPONSE—Plus or minus 1.5 Db., 30-15 Kc.
DISTORTION—1.5% or less, 50-15 Kc. at +33 DBM.
NOISE—65 Db. or better below +33 DBM.
MAXIMUM INPUT—Zero DBM.
MAXIMUM OUTPUT—+33 DBM.
INPUT IMPEDANCES—500, 250, 150, 50 ohms.
OUTPUT IMPEDANCES—500, 250, 15, 7.5, 5 ohms.
GAIN CONTROL—Wiping contact type directly to secondary of input transformer.
SIZE—19" wide, 8 $\frac{3}{4}$ " high, 10 $\frac{1}{4}$ " deep.
POWER CONSUMPTION—90 watts at 115 volts, 60 cycles.
FINISH—Medium gray.
SHIPPING DETAIL—Net weight, 29 lbs.
 Domestic weight, 54 lbs.
 Export weight, 73 lbs.

Model SA-98 Monitoring Amplifier with tubes. Code ZAZEM.

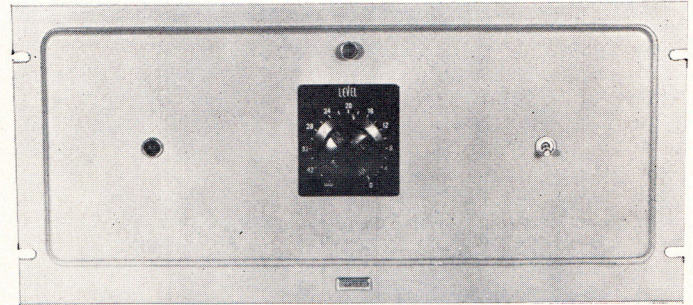

Illustrated above and below, the SA-98 two-watt monitoring amplifier with the exclusive Gates SA rack mounting feature for front-of-cabinet serviceability.

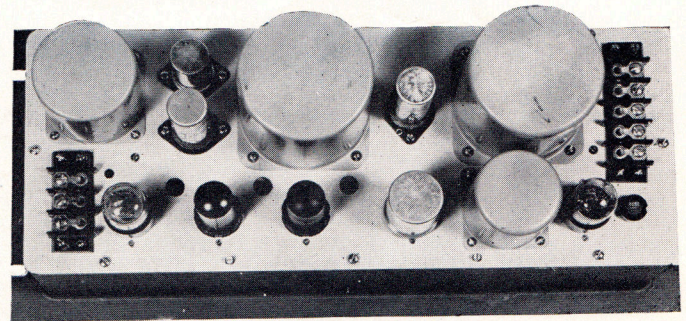

SA-8 VOLUME INDICATOR

Here is a complete volume indicator panel especially designed for commercial broadcasting stations. It selects five different input circuits directly from the front panel and is switchable to five major audio circuits in the studios. Meter is an illuminated 4" Weston type 862 mounted flush with the panel to provide greater visibility and easier servicing for changing of lights. Range control is a T network wiping contact type in 2 VU steps from +4 to +42 VU and also having an "Off" position. Input impedance, 7500 ohms to operate across a 500/600 ohm line. Panel size, 19"x5 $\frac{1}{4}$ ". Completely protected by dust cover. Weight, net 9 lbs.; Domestic weight, 28 lbs.; Export weight, 37 lbs.

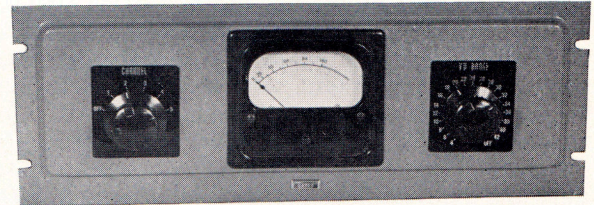

SA-8 Volume Indicator Panel. Code ZAJYO.



SA-17 SWITCH AND FUSE PANEL



Each rack installation should be provided with a master switch. The Gates SA-17 switch and fuse panel is designed to provide complete fuse protection, heavy duty starting switch, and pilot light. There is also a 6.3 volt transformer with starting switch, to provide voltage for the Serva-lite feature on all SA housings which includes a small light on the inside of the housing. Provided as standard equipment is a heavy duty double-pole double-throw primary switch, a pair of 30 ampere Buss fuses, a 115 volt bull's-eye pilot light, a 6.3 volt Serva-lite transformer and switch, all constructed on an SA panel 19" wide and 3 $\frac{1}{2}$ " high. May be used for either 115 volts or 230 volts for the master supply. Color is medium gray to match all Gates SA equipment.

SA-17 Switch and Fuse Panel. Code ZANDO.

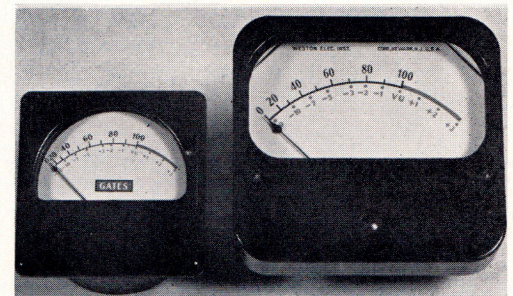

VU METERS, 3" and 4"

For those who require an additional VU meter or prefer to assemble their own range sets, listed herein are three VU meters of standard design. Appropriate range controls will be found listed on Page 39. The Model 802 meter is 4" non-illuminated, having the standard VU Scale B. The Model 862 is a 4" meter, illuminated, provided with 6V lamps of the bayonet type for illumination purposes. The Model 301 is a 3" square case meter commonly used where space is confined, such as in remote equipment. Gates will gladly provide special mounting housings or special fixed or variable pads to operate in conjunction with these VU meters where standard items cannot be used. For range controls see Page 39.

Model 802 VU Meter. Code ZAZLA.
Model 862 VU Meter. Code ZAZME.
Model 301 VU Meter. Code ZAZOP.

SA-89 Station Control Unit

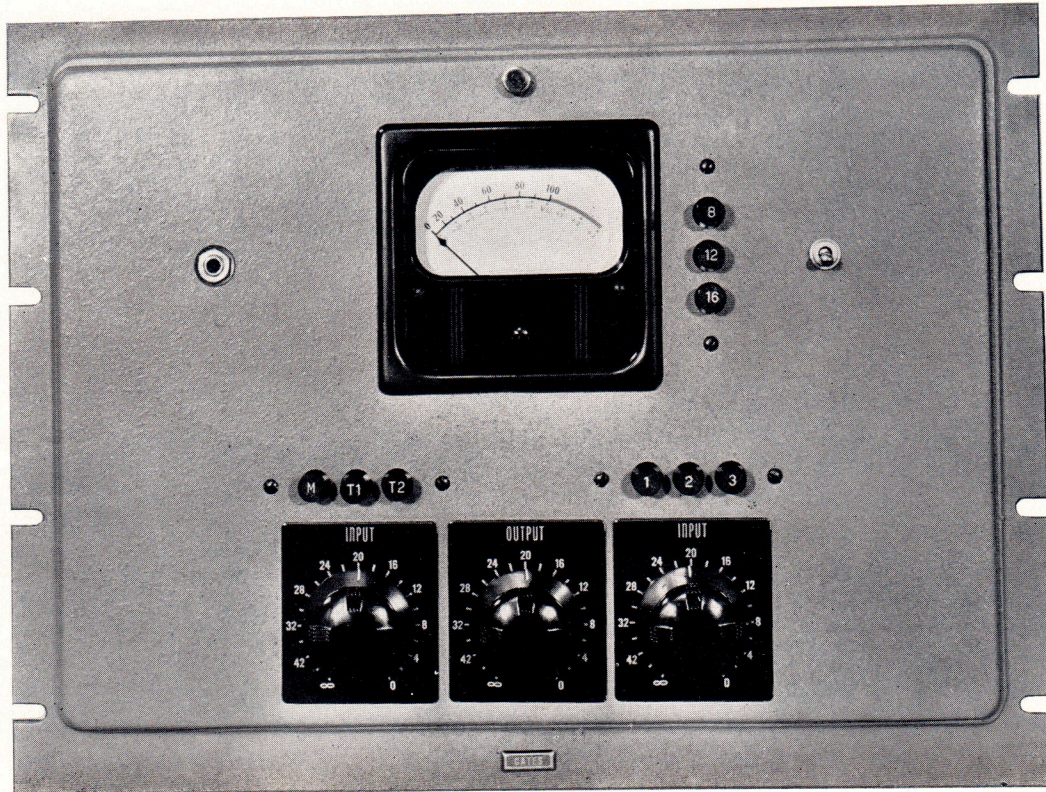

Many broadcasting stations prefer emergency equipment in the transmitting plant whereby transcription turntables and microphone may be employed, either because of failure of the studio line or in instances where the studios are closed down at a specified time in the evening and announcements, network and transcriptions are accommodated at the transmitting building. The SA-89 Station Control Unit provides a compact way of handling this service and includes a two-channel mixer, a two-stage preamplifier, a four-stage line amplifier and a combination power supply and loud speaker muting relay. There is also provision for three incoming lines complete with isolation transformer and complete pushbutton switching facilities to handle all circuits and three meter levels of plus 8, 12 and 16 VU. Attenuators are the wiping contact type; VU meter is a 4" illuminated Weston type 862, flush with the front panel. The popular SA cast aluminum housing with front-of-cabinet serviceability is employed and is outlined in detail on page 18.

SPECIFICATIONS

AMPLIFIERS—Model SA-70 two-stage preamplifier, Model SA-94 four-stage line amplifier and special power supply with plug-in muting relay. See pages 26 and 27 for amplifiers.

TUBES—Two each 6J7, 6C5, one each 6SJ7, 6SN7, 6X5GT.

GAIN—From microphone input to program line output: Maximum 110 Db. Turntable channels: 70 Db. Line input channels: 64 Db.

RESPONSE—30 to 15,000 cycles with 1½ Db.

DISTORTION—1% or less at +16 Db. output.

NOISE—60 Db. or more below +16 Db.

POWER REQUIREMENTS—60 watts from 115 volts, 60 cycle line.

SIZE—19" wide, 14" high, 8⅞" deep.

FINISH—Medium gray.

SHIPPING DETAIL—Net weight, 36 lbs.

Domestic shipping weight, 55 lbs.

Export shipping weight, 84 lbs.

Cubage, 12.

Model SA-89 Station Control Unit with tubes. Code Word ZAPAB.

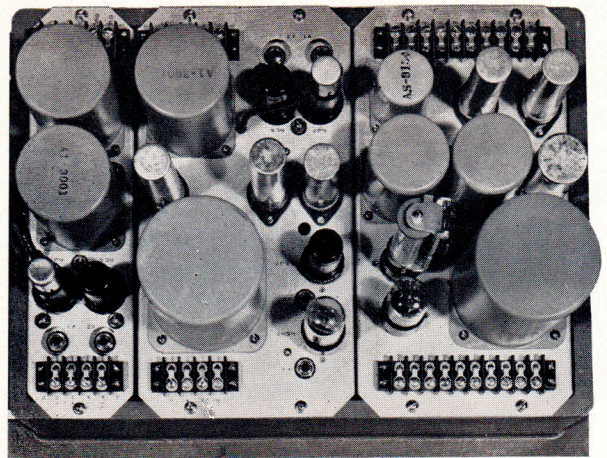

Back View SA-89

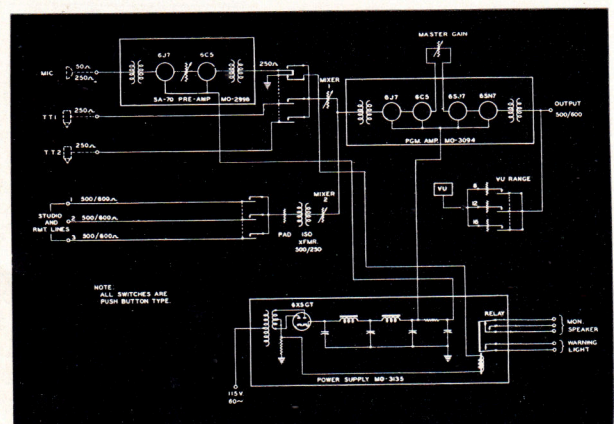

Block Diagram SA-89

Preamplifiers - Isolation Amplifiers

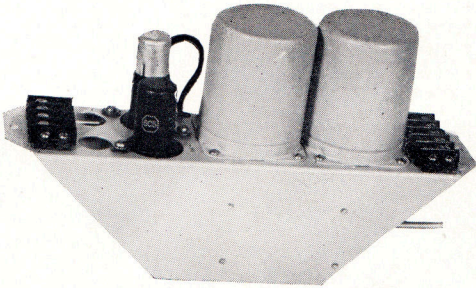

Figure A—The SA-70 and SA-73 preamplifiers. The gain control included allows any gain adjustment. Tubes are shock mounted.

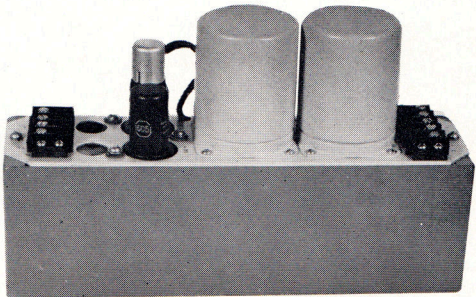

Figure B—The SA-71 and SA-74 preamplifiers in housing for turntable cabinet mounting or similar application. Mounting holes are provided in bottom of housing.



Figure C—The SA-72 or SA-75 preamplifiers for rack mounting require 3½ inches of rack space.

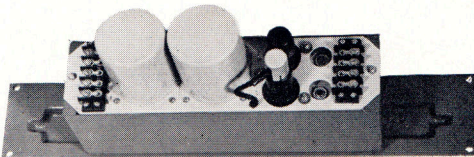

Figure D—Back view of SA-72 or SA-75 rack mount preamplifiers. Note the shock mounting of tubes, test jacks for plate current, metering and isolation of input and output terminations.

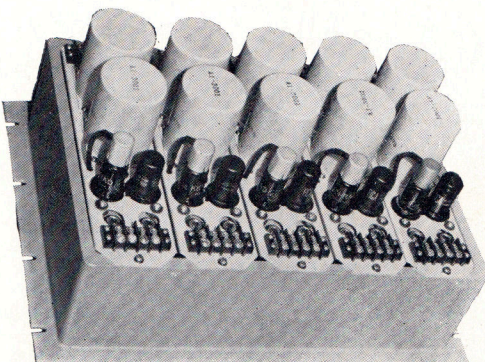

Figure E—Illustrates mounting five either SA-70 or SA-73 preamplifiers on an SA-800 housing described on Page 18. This is the space saving and efficient way to mount Gates SA preamplifiers.

Gates preamplifiers are designed with the highest quality audio transformers, the input transformer being designed for 90 Db. shielding. Thus very low noise level is a natural result. Model SA-70 is a 2-stage preamplifier normally used for microphone and many types of turntable preamplification, while the Model SA-73 is a 3-stage preamplifier, required primarily in very low level circuits such as turntable preamplification with high loss in the pickup equalizing circuit.

The Model SA-93 isolation amplifier is somewhat similar in design to the SA-70 preamplifier but has provided in the output circuit a type 6SN7 tube to allow a higher output level of +20 DBM. All models of preamplifiers, as well as the SA-93 isolation amplifier, have standard input impedances of 500/250/150/50 ohms and output impedances of 500/250 ohms and are provided with test jacks for measuring the plate current of each amplifier tube. Numerous power supplies that may be associated with these preamplifiers to provide filament and plate voltage are listed on Page 28. All models require 6.3 volts AC for filaments with Model SA-70 requiring 0.6 amperes and Models SA-73 and SA-93 0.9 amperes. Models SA-70 and SA-73 require 180 to 250 volts at approximately 3 MA., while Model SA-93 requires 300 volts at 23 MA.

Model SA-70 (2-stage chassis)

TUBES USED—One 6J7, one 6C5.
GAIN—42 Db. (adjustable).
RESPONSE—Plus or minus 1.5 Db., 30-15 Kc.
DISTORTION—1% 50-15 Kc. at -6 DBM.
NOISE—75 Db. below zero DBM.
MAXIMUM INPUT—Minus 35 DBM.

MAXIMUM OUTPUT—Plus 4 DBM.
SIZE—11¼ inches long, 3 inches wide, 3¼ inches above chassis, 3¾ inches below chassis.
FINISH—Gloss gray.
SEE FIGURE A—Code ZAMYA.

Model SA-71 (2-stage chassis and housing)

Illustrated in Figure B. Employs SA-70 preamplifier as outlined above, mounted in housing. This type normally used in transcription turntable cabinets or any other service where rack mounting is not required. Size: 11¼ inches long, 3 inches wide, 6¾ inches high overall. Code ZAMZE.

Model SA-72 (2-stage rack mount)

This is a combination of the SA-70 and SA-71 units outlined above, attached to a 3½x19 inch SA cast aluminum panel for rack mounting of the single preamplifier. Size: 3½ inches high, 19 inches long, 6¾ inches deep. Finish is medium gray. See Figure C. Code ZANAZ.

Model SA-73 (3-stage chassis)

Very similar to SA-70 preamplifier described above but has three amplifier stages providing gain of 60 Db.

TUBES USED—One 6J7, one 6SL7.
RESPONSE—Plus or minus 2 Db., 30-15 Kc.
All other characteristics identical to Model SA-70.
Gain control is provided under chassis for lower than maximum gain adjustment where desired.

DISTORTION—1% 50-10 Kc. at -6 DBM.
NOISE—55 Db. below zero DBM.

Code ZAYHZ.

Model SA-74 (3-stage chassis and housing)

Identical in every respect to Model SA-71 described above but incorporates Model SA-73 amplifier. Commonly used for mounting in transcription turntable cabinets. Code ZAYKA.

Model SA-75 (3-stage rack mount)

This is a combination of the SA-73 and SA-74 units as outlined above. It is identical in every respect as to dimension, finish, and general construction to the SA-72 unit outlined above, but incorporates the SA-73 3-stage amplifier chassis. Code ZAYLE.

Model SA-93 (2-stage isolation amplifier)

Illustrated in Figures F and G below. For rack mounting an SA-800 housing, described on Page 18, is used. Is commonly used as an isolation amplifier for program or remote lines, a booster amplifier, or for certain types of line amplifier applications where medium gain is required.

TUBES USED—One 6SJ7, one 6SN7.
GAIN—42 Db.
RESPONSE—Plus or minus 1.5 Db. 30-15 Kc.
DISTORTION—1% at plus 18 DBM, 50-15 Kc.
NOISE—75 Db. below plus 18 DBM.

MAXIMUM INPUT—Zero DBM.
MAXIMUM OUTPUT—Plus 20 DBM.
SIZE—11¼ inches long, 4½ inches wide, 4¼ inches above chassis, 1½ inches below chassis.

Code ZAYNO.

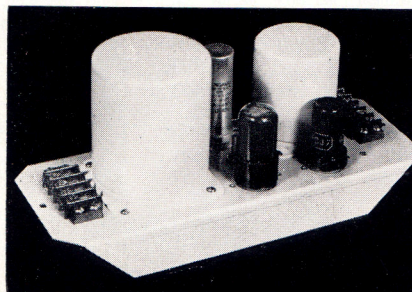

Figure F—Model SA-93 isolation amplifier. For rack mounting use SA-800 housing described on Page 18.

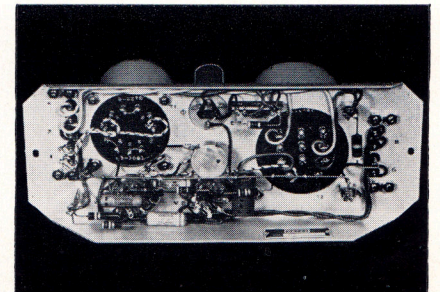

Figure G—The under chassis wiring of the SA-93 isolation amplifier illustrates the excellent workmanship of even the simplest of amplifier equipments.

Space Line SA Amplifiers

The amplifiers listed on this page are identical in quality to any other SA amplifier of comparable type found in the Gates catalog. These units, being small in size, are properly termed "space line" amplifiers. They are designed for use on SA-800 rack mount housings, fully illustrated on Page 18. Also the Type SA-70 and Type SA-73 preamplifiers and the Type SA-93 isolation amplifier on Page 26 are exact matching units to the space line amplifiers. Several space line power supplies for use with one or several amplifiers will be found described on Page 28. Also dial plates, skirt knobs, pilot light brackets, and other accessories that would normally complete an amplifier complement on the SA-800 rack mount housing will be found on Pages 39 and 40. All space line amplifiers are supplied with tubes.

Where desired, Gates will be happy to mount any combination of amplifiers, power supplies, etc., on SA housings, without additional charge. A simple sketch and instructions with the order will be sufficient.

SA-94 LINE AMPLIFIER

Is used in such items as SA-50 console and SA-89 station control unit; has four audio stages, employing one each 6J7, 6C5, 6SJ7 and 6SN7 tubes. Gain control of wiping contact type is provided with 16-inch low capacity leads for mounting on front panel of SA housing. Chassis construction is of heavy aluminum with input audio terminations segregated from output and power terminations.

SPECIFICATIONS—Gain: 82 Db.; Response: plus or minus 1.5 Db., 30-15 Kc.; Distortion: 1% or less, 50-15 Kc. at plus 18 DBM; Noise: minus 60 Db. at maximum gain setting or minus 70 Db. at normal gain setting; Maximum input: minus 40 DBM; Maximum output: plus 20 DBM; Input impedances: 50, 150, 250, 500 ohms; Output impedances: 500, 250 ohms; Application: Line amplifier, emergency high gain preamplifier, high gain booster or isolation amplifier; Voltage requirements: 6.3 volt AC at 1.5 amperes and 300 volts DC at 25 MA.; Size: 11¼ inches long, 5¼ inches wide, 4¼ inches above chassis, 1% inches below chassis.

Model SA-94 Line Amplifier. Code ZAYON.

SA-95 TEN WATT MONITORING AMPLIFIER

Another in the space line amplifiers providing high wattage output for loud speaker distribution, recording and auditioning. May also be used as an emergency line amplifier. Employs three stages with push-pull output, using one each 6J5 and 6SN7 tubes and two 6L6 (1622) output tubes. Gain control is located on chassis for semi-fixed gain adjustments, however may be extended to front panel at only slight additional cost. As the SA-95 amplifier has much of its filtering supply self-contained, its power supply need not be extensive in this respect and the SA-100 power supply described on Page 28 is ideal.

SPECIFICATIONS—Gain: From line input 69 Db., from bridging input 42 Db.; Input impedances: 10,000 ohms by use of bridging pad supplied or 500, 250, 150, 50 ohms; Output impedances: 500, 250, 15, 7.5, 5 ohms; Response: plus or minus 1.5 Db., 30-15 Kc.; Distortion: less than 1.5%, 50-15 Kc. at plus 40 DBM or full 10 watts; Noise: 65 Db. or better below maximum output; Maximum input: Zero DBM; Maximum output: plus 40 DBM; Application: as a monitoring amplifier, utility amplifier, recording amplifier or emergency program amplifier; Power requirements: 6.3 volts AC at 2.7 amperes, 350-400 volts DC at 130 MA.; Size 11¼ inches long, 5¼ inches wide, 4¼ inches above chassis, 1% inches below chassis.

Model SA-95 Monitoring Amplifier. Code ZAYUP.

SA-96 TWO WATT MONITORING AMPLIFIER

Similar to the ten watt unit described above and serves the purpose of normal radio station loud speaker distribution where higher wattage service is undesirable. It, likewise, has lower gain which in many monitoring applications is desirable, has two audio stages, employing one 6SL7 and two 6V6 push-pull output tubes. Chassis construction is of heavy aluminum. Gain control is located on the chassis for semi-fixed adjustments but may be extended to the panel at only slight additional cost. Input terminations are isolated from the output terminations for convenience in wiring and low noise level.

SPECIFICATIONS—Gain: 44 Db. from line input, 15 Db. from bridging input; Input impedances: 10,000 ohms bridging through pad supplied and 500, 250, 150, 50 ohms; Output impedances: 500, 250, 15, 7.5, 5 ohms; Response: plus or minus 1.5 Db., 30-15 Kc.; Distortion: 1.5% or less, 50-15 Kc. at plus 33 DBM; Noise: 65 Db. or better below plus 33 DBM; Maximum input level: Zero DBM; Maximum output level: plus 33 DBM; Size: 11¼ inches long, 5¼ inches wide, 4¼ inches above chassis, 1% inches below chassis; Application: As high quality monitoring amplifier, audition amplifier, booster amplifier and emergency line amplifier; Power requirements: 6.3 volts AC at 1.5 amperes, 250-300 volts DC at 50 MA.

Model SA-96 Two Watt Monitoring Amplifier. Code ZAZAL.

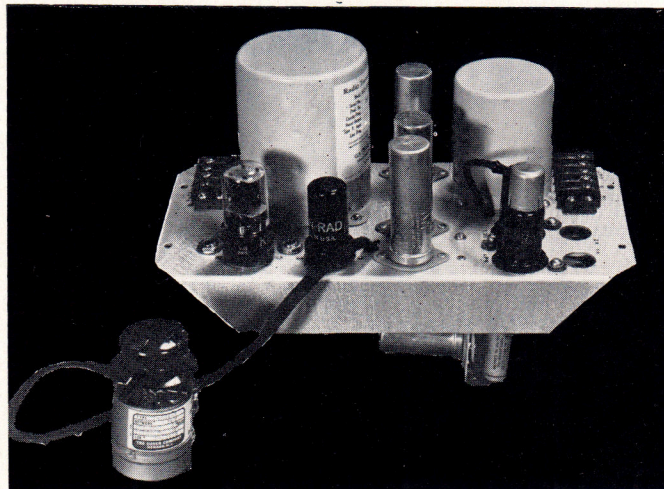

SA-94 line amplifier illustrated above shows compact and highly efficient design of space line equipment. Technical specifications meet all requirements for AM, FM or TV.

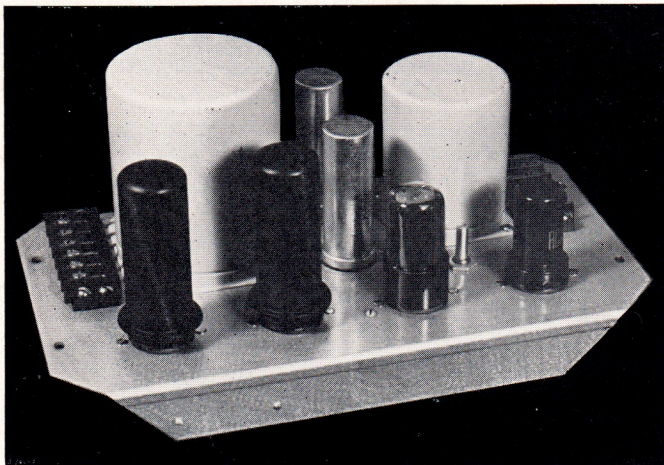

SA-95 ten watt monitoring amplifier illustrated above is another companion unit to the many space line amplifiers in the Gates audio line.

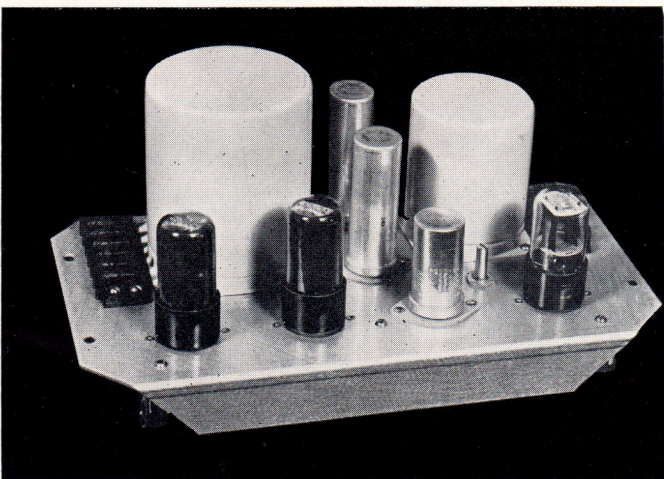

SA-96 two watt monitoring amplifier illustrates another compact yet highly convenient way of obtaining the most from rack cabinet space. SA housings described on Page 18 are suggested.

Power Supplies for Speech Equipment

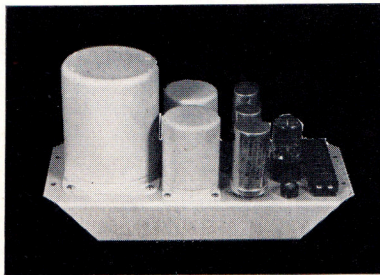

SA-99 Power Supply

A well filtered DC power supply providing 325 volts at 120 MA. Has dual reactors providing both high inductance and high capacitance for filtering. Provides 6.3 volts AC at 5 amperes. 11 $\frac{3}{4}$ inches long, 5 $\frac{1}{4}$ inches wide, 4 $\frac{1}{2}$ inches above chassis, 1 $\frac{1}{2}$ inches below chassis. Will supply nine SA-70 preamplifiers or six SA-73 preamplifiers or four SA-93 isolation amplifiers or three SA-94 line amplifiers. Mounts on SA-800 housing described on Page 18. Main filter condenser plug-in type. Chassis of heavy aluminum. Uses 6X5GT tube.

SA-99 Power Supply. Code ZAZPO.

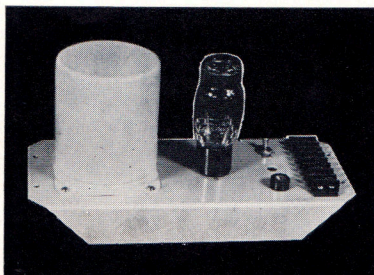

SA-100 Power Supply

Is designed for use with the SA-95 or SA-96 amplifiers described on Page 27 and is constructed without filter, as the filter components are provided in the amplifiers, thus making an economical power supply equally efficient when used with these amplifiers, from the standpoint of noise, to any other high quality SA amplifiers in the Gates catalog. Uses a 5U4G tube. Delivers 6.3 volts AC at 5 amperes and 350 volts DC at 130 MA. Operates from 115 volt 50/60 cycles. Size: 11 $\frac{1}{4}$ inches long, 5 $\frac{1}{4}$ inches wide, 4 $\frac{1}{2}$ inches above chassis, 1 $\frac{1}{2}$ inches below chassis. Will supply current for either one Model SA-95 or one Model SA-96 amplifier.

SA-100 Power Supply. Code ZAZRY.

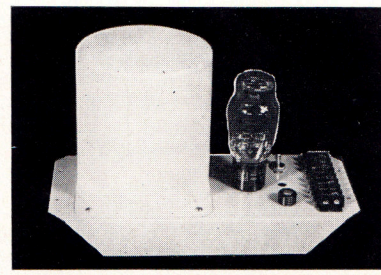

SA-101 Power Supply

Similar to the SA-100 described to left but provides 6.3 volts AC at 8 amperes and 400 volts DC at 200 MA. An unfiltered power supply designed primarily to furnish voltage to Models SA-95 or SA-96 amplifiers described on Page 27. Operates from 115 volts 50/60 cycles. Size: 11 $\frac{3}{4}$ inches long, 5 $\frac{1}{4}$ inches wide, 5 $\frac{3}{8}$ inches above chassis, 1 $\frac{1}{2}$ inches below chassis. Will supply two SA-95 or two SA-96 amplifiers. Mounts on SA-800 housing listed on page 18.

SA-101 Power Supply. Code ZAZZR.

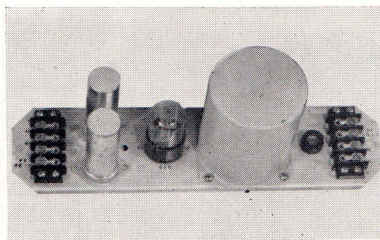

SA-77 Power Supply

Designed to supply filament and plate voltage to either two SA-70 or two SA-73 preamplifiers, providing 6.3 volts AC at 2 amperes and 200-250 volts DC at 10 MA. Mounts either on SA-800 housing or as SA-78 or SA-79 units pictured to the right. Size: 11 $\frac{3}{4}$ inches long, 3 inches wide, 3 $\frac{3}{8}$ inches above chassis, 2 $\frac{1}{2}$ inches below chassis. Uses 6X5GT tube and operates from 115 volts 50/60 cycles.

SA-77 Power Supply. Code ZEACS.

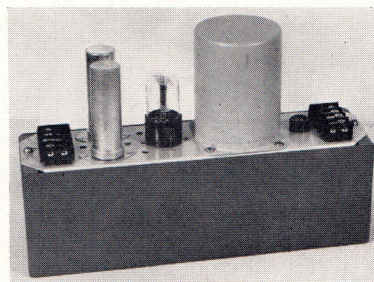

SA-78 Power Supply

Identical electrically to SA-77 pictured at left but chassis mounted for use with turntable pre-amplifier or similar. Size: 11 $\frac{3}{4}$ inches long, 3 inches wide, 4 inches below chassis.

SA-78 Power Supply. Code ZEADT.

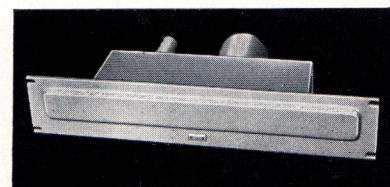

SA-79 Power Supply

Same as SA-77 and SA-78 but attached to 3 $\frac{1}{2}$ inch by 19 inch rack panel. Finish in medium gray. On SA cast panel to match other SA rack mount equipment.

SA-79 Power Supply. Code ZEAYH.

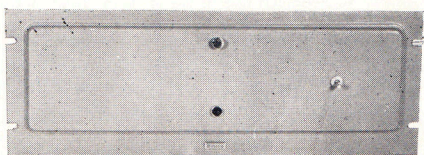

SA-7 Power Supply

A rack mount power supply fully filtered for use with as many as ten SA-70 or seven SA-73 preamplifiers. Provides 180-300 volts DC (adjustable on tap voltage divider) at 75 MA and 6.3 volts AC at 6.5 amperes. Uses 5V4G tube. Operates from 115 volts 50/60 cycles and consumes 55 watts. Mounts on SA-400 housing described on Page 18. An excellent power supply where extreme low noise level is mandatory.

SA-7 Power Supply. Code ZAJUZ.

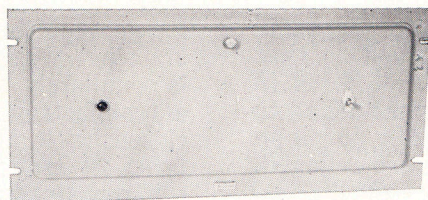

SA-102 DC Power Supply

This power supply is designed to provide 6-8 volt DC at 6 amperes and, though specifically for use with master control systems where stepping relays are embodied, it may be used wherever a good quality continuous duty DC supply is required. Operates from 115 volts 50/60 cycles and employs three oversized copper sulphide DC rectifiers in a full wave circuit and with plug-in high capacity filter condensers. Constructed on SA-500 housing illustrated on Page 18, using rack space 19x8 $\frac{3}{4}$ inches, and is 10 $\frac{1}{2}$ inches deep. Front panel equipment consists of starting switch and pilot light.

SA-102 DC Power Supply. Code ZEALC.

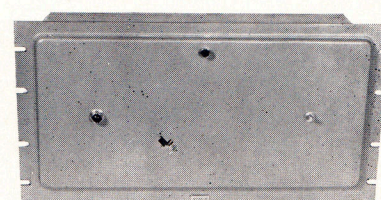

SA-103 Power Supply

An all purpose heavy duty power supply providing 6.3 volts AC at 8 amperes and 350 volts DC at 200 MA. in a well filtered circuit and 6-8 volts DC at 2 amperes. Operates from 115 volts 50/60 cycles. Constructed on SA-600 housing described on Page 18. Size: 19 inches wide, 10 $\frac{1}{2}$ inches high, 10 $\frac{1}{2}$ inches deep. May be used for a multitude of services. An excellent power supply for speech input consoles and multiple rack amplifier installations. Uses 5U4G rectifier tube and copper sulphide DC rectifier.

SA-103 Power Supply. Code ZEAMD.

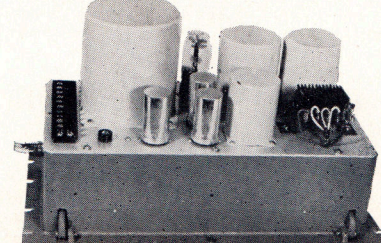
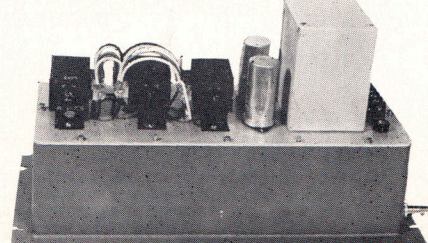
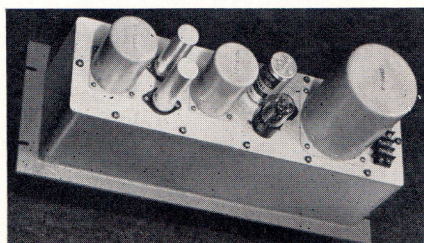

Transcription Equipment



CB-11 CHASSIS

This chassis which is basic for all Gates turntables, employs the uni-power drive illustrated below. The unique shear action neoprene drive wheel (Figure A), virtually eliminates noise conduction between the motor drive pulley and the inside rim of the platter. Also note the mechanical construction of the one-piece aluminum chassis where ribs and reinforcement have been scientifically studied for less rumble. The motor is a special, dynamically balanced, synchronous, capacitor start, quiet operating unit. The speed shifting mechanism is as simple as turning a switch, throw in one direction for 33 $\frac{1}{3}$ RPM and the opposite for 78 RPM. A slip-on capstan is provided so that the 33 $\frac{1}{3}$ RPM speed may be changed to 45 RPM in a matter of a second. A micro-switch is attached to the speed change lever which automatically turns on and off the motor when the drive wheels are engaged.

Size: 21 $\frac{1}{4}$ " square and 3" from bottom of casting to top of guard. Accuracy, 0.4% or better over extended periods. Lateral or vertical noise, 40 DBM or better below average sound track. Cue allowance, $\frac{1}{8}$ RPM ahead of sound track for 33 $\frac{1}{3}$ speed. Power requirements, 115 volts, 60 cycles (50 cycles on special order), 60 watts.

CB-14 TRANSCRIPTION TURNTABLE

This equipment is possibly the most popular transcription turntable in use today. It is available with the pickup of your choice and illustrated above with the popular Gray Research arm, filter and diamond stylus reluctance pickup. It is constructed in an attractive, well seasoned 5-ply cabinet with recessed kickboard, levelling screws, and finished in two-tone gray. Transcription chassis is the CB-11 described to the left and illustrated below. Three turntable speeds of 33 $\frac{1}{3}$, 45, and 78 RPM are provided. Four position variable filter is located on the chassis proper and a mercury type starting switch is provided on the side. Equipment is completely wired with barrier terminal connections at the bottom rear. Back of cabinet is completely closed with a removable door. Available with all types of transcription pickups and with or without self-contained preamplifiers. Price list for this catalog indicates all available models as associated with pickups and other accessories.

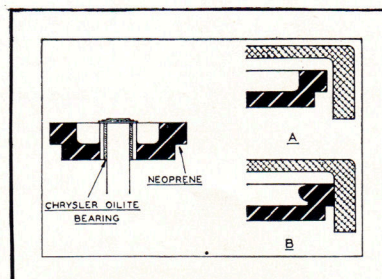
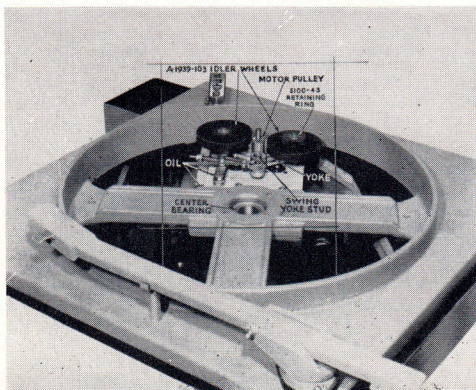

Figure A—Shear action of drive pulleys means drive pressure against air and is illustrated herein. To right, the speed change and master starting lever.



Transcription Equipment



Figure B—The front section drops down for instantaneous accessibility of preamplifier and power supply tubes.

Figure C—All necessary operational functions may be controlled from the front of the CB-10 master turntable.

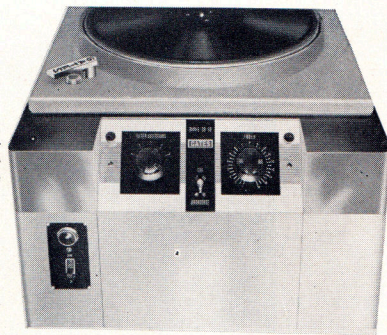

CB-10 Turntable

CB-10 MASTER TRANSCRIPTION TURNTABLE

In modern broadcasting techniques multiple transcription turntables and remote location of these turntables from studio control facilities are often preferred. The CB-10 master turntable is, as the word implies, a complete self-contained turntable with mixing control, broadcast-cue switch, and filter control all on a sloping front panel. It also has a three-stage preamplifier and a power supply as part of the self-contained equipment. This design permits any number of master turntables to be used on one parallel circuit. As the output is always high level, the turntables may be distributed throughout the studios, if so desired. This turntable is also excellent for audition as it may be fed into any average gain amplifier without externally mounted preamplifiers.

The CB-11 chassis described on the opposite page is a standard part of the CB-10 master turntable. The pickup may be of the purchaser's choice and pickup combinations are specified in detail in the price list

for this catalog. Unusually attractive styling has been followed in the design of the CB-10 master turntable. The cabinet is finished in two-tone gray with the front control panel sloping at a 45° angle. Cabinet size: 22 inches wide, 26 inches deep, and 33 inches high. A master switch is provided at the bottom center and a mercury type starting switch to the left of the control panel. The mixing attenuator is a ladder type in 1¾ Db. steps and it operates at the output of the preamplifier at an impedance of 250 ohms. The cue-broadcast switch is the PBX type. When at cue position, the attenuator is disconnected. The Gates SA-22 cueing amplifier described on Page 20 is an excellent accessory with the CB-10 master turntable.

Transcription Turntable Catalog

Gates has available a separate catalog of transcription turntables illustrating 24 different models of all conceivable types for the progressive broadcasting station. Write for your copy.

Tape Recording Equipment

MR-10 TAPE RECORDER

A complete rack mounted tape recorder of the professional type to produce a quality of tape recording equivalent in every respect to that of the original. It consists of the popular Magnecord PT-6A recording mechanism mounted in the PT-6R rack mount amplifier. Full provision is made for both recording and playback with zero Db. input for recording level and zero Db. output for playback level. In both instances the output is variable by means of a wiping contact attenuator on the front panel and proper recording level is determined by a calibrated VU meter. Switching from record to playback is indicated by adjacent lights and a third switching provision is available for using the amplifier only. Operates from 115 volts 60 cycles and requires a panel size of 19"x14" and extends 12½" behind the panel. Finished in a hammerloid gray. Erase mechanism is positive and the unique heavily constructed driving mechanism assures wow-free and flutter-free performance under all conditions. A synchronous type motor is employed for recording and a shaded pole type motor for rewind purposes. For the finest possible recordings, the MR-10 tape recorder is preferred by leading broadcasters everywhere.

SPECIFICATIONS

RECORDING SPEEDS—15" / Sec. or 7½" / Sec. providing 30 or 15 minutes continuous.

FIDELITY—At 15", 40-15 Kc. within 2 Db.; at 7½", 40-7000 cycles within 2 Db.

FLUTTER—Maximum of 0.3%.

DISTORTION—2% or less at all frequencies.

RESPONSE—Three provided, (1) Recording with pre-emphasis curve, (2) Playback with post-emphasis curve, (3) Flat response.

TUBES—One each 12AX7 and 6X4; two each 12AU7.

MR-10 Tape Recorder complete as illustrated, with tubes, less Cannon connectors. Code ZARCH.

MODEL 102 PORTABLE TAPE RECORDER

Webster Ekotape is the very popular model for broadcasting stations, operating zero level 500 ohms input and output and from a 115 volts 60 cycle line. A most complete portable recorder in every respect. Provided with playback loud-speaker or may be used with external loud-speaker; has fast forward speed as well as high speed rewind; positive erasing mechanism, and provided with recording time indicator scale, recording interlock button and recording volume indicator of the tube type. Records continuously at 7½" or 30 minutes of continuous recording. Guaranteed frequency range within 2 Db. is from 80 to 6000 cycles. An excellent unit for both portable and studio use that will exceed in fidelity, most network lines, and produce highly acceptable quality for the finest broadcasting station. Carrying case is sturdily constructed with well balanced handle, metal corners and latches. Size 18"x16"x11¾". Net weight, 50 lbs.

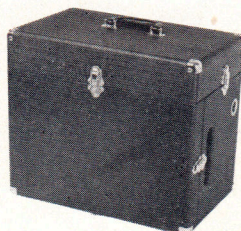

Figure D

Model 102 Portable Tape Recorder.
Code ZEFOZ.

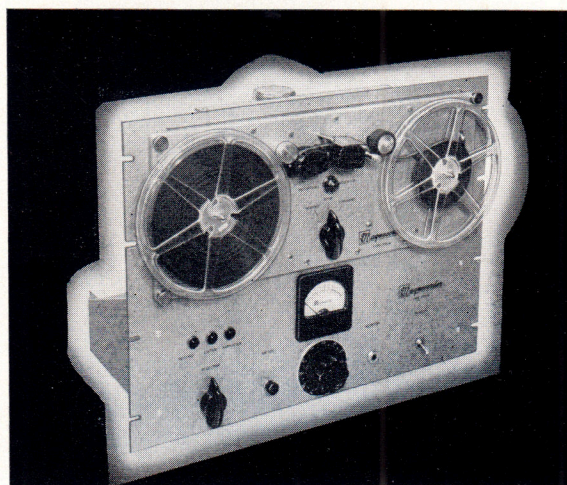

Figure A—The MR-10 tape recorder, front view, for rack mounting.

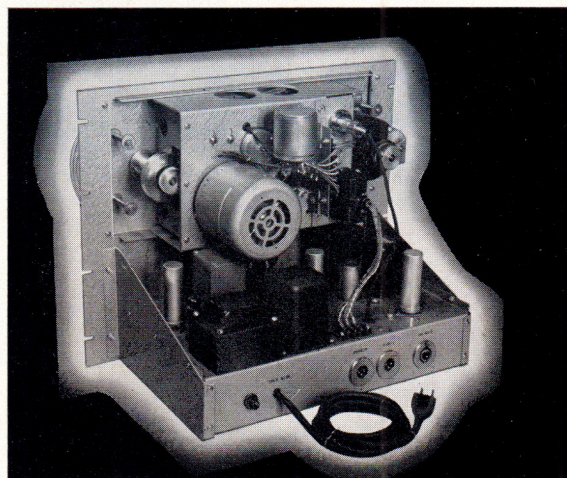

Figure B—Rear view of MR-10 tape recorder showing sturdy construction.

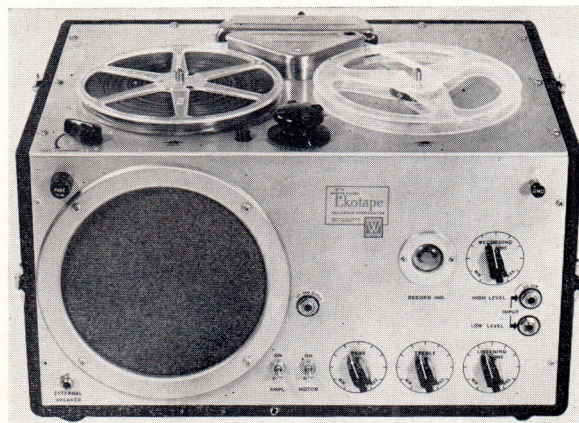

Figure C—The Model 102 portable tape recorder. Carrying case is illustrated in Figure D, to left.

The disc recorder has a permanent place in every broadcasting station. Offered herein is the CB-8R complete floor type disc recorder along with various individual units to be used where the broadcaster prefers to install the equipment in his own desk or has certain portions of the recording equipment and does not need the complete assembly.

The CB-8R recorder illustrated in Figure A is constructed in a heavy acoustically treated cabinet with rubber shock suspended leveling feet. Approximate cabinet size: 22"x22"x49" high, finished in an attractive two-tone gray. It is provided with a complete overhead mechanism with time scale and spiralling attachment together with playback pickup, Audak D39H—impedance 200 ohms, and a DU4 reed type recording head having an impedance of 500 ohms. The starting switch is of the mercury type. Complete wiring and termination to barrier terminals is provided. The microscope, not shown in Figure A but illustrated in Figure C, may be added as well as the equalizer assembly described below.

The CB-12R recording turntable is very similar to the CB-11 transcription turntable described on Page 29, but provided with heavier driving mechanism consisting of a 1/40 H. P. synchronous capacity starting motor, dynamically balanced, which drives a steel recording turntable. Machining is exceptionally accurate and performance is wow-free with speed accuracy of .4% or better over extended periods of time.

The overhead mechanism consists of an accurately machined lead screw available for either outside-in or vice versa at choices of 96, 104, 112 or 120 lines per inch. A spiralling attachment is provided on the right end and the time scale for all lead screw sizes and record speeds clips into two slots directly behind the carriage.

The microscope assembly consists of a Bausch & Lomb 40 power microscope mounted on a rugged swivel arm, chromium plated, which fits into a socket on the turntable base. A light is provided directing its rays onto the surface of the record proper. The light operates from any 6 volt source. It is not necessary to have two microscopes for dual recording turntables as the construction is such that this microscope assembly may be moved from one turntable to the other.

The equalizer assembly, not illustrated on this page because of its simplicity, consists of a spring return attenuator, usually mounted under the recording table chassis and connected to the cutting head through a dial cable drive. An equalizer panel 3 1/2"x19" is also provided with an LC network which, when controlled by the resistive element which is the unit on the recording table chassis, automatically provides compensation for high frequency fall-off as the cutter approaches the center of the disc. The equalizer panel is actually designed for two turntables and a changeover switch is provided on this panel. Impedance is 500 ohms.

CB-8R complete recorder, as illustrated in Figure A, with playback pickup but less microscope or equalizer. Code ZEFUB.

CB-12 recording chassis only, less overhead mechanism. Code ZEFVA.

No. 258 overhead mechanism complete with choice of feed screw, spiralling attachment, and time scale, but less cutter head. Code ZEFWE.

AH4 cutter head, a high fidelity 500 ohm magnetic type recorder for use with 258 overhead mechanism. Code ZEFZO.

DU4 cutter head, a professional recording head of reed type, extremely low distortion, and peaked at 4000 cycles. Ideal for acetate recordings, Code ZEGBO.

Microscope assembly, as described above, complete with swivel, socket and light. Code ZEGIZ.

Equalizer assembly, as described above, with dual equalizer panel and single equalizer attachment. Code ZEGOB.

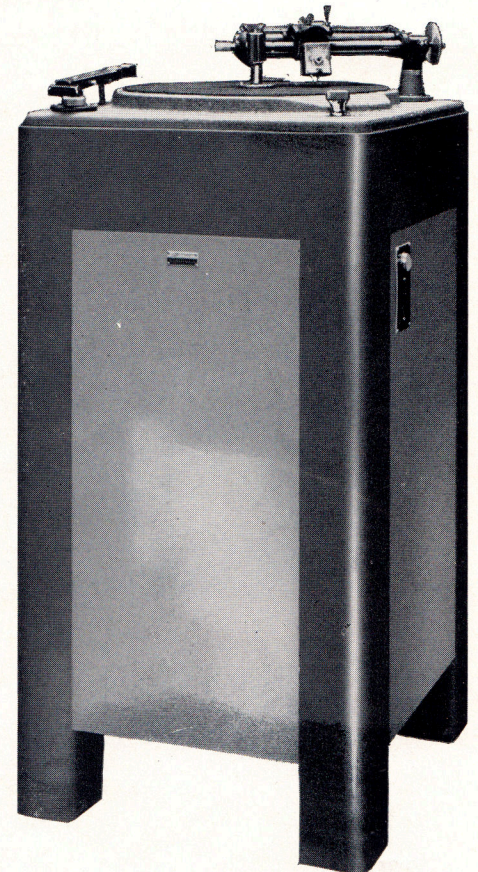

Figure A—The CB-8R complete recorder illustrated above will produce professional disc recordings of the finest quality.

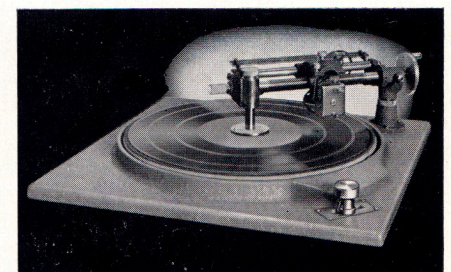

Figure B—The CB-12 recording chassis with overhead mechanism and DU4 cutter. See Page 29 for technical drive information.

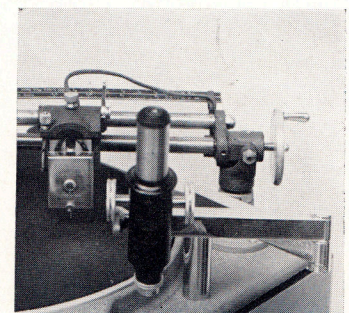

Figure C—The microscope assembly contains the finest lens money will buy, fully adjustable and interchangeable between turntables.

Control Room Accessories

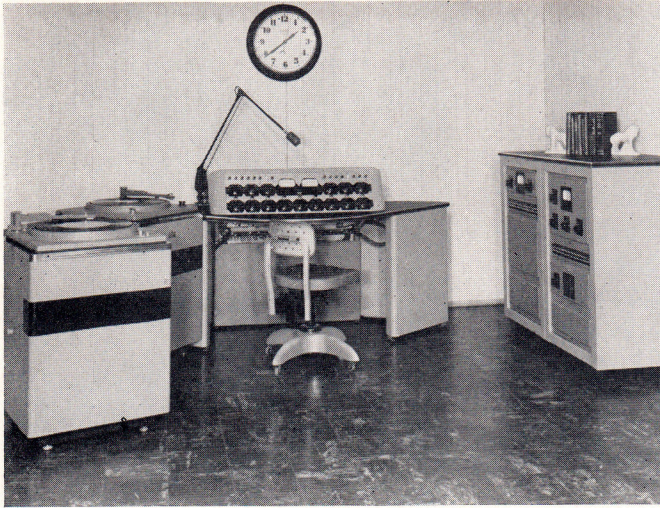

Figure A

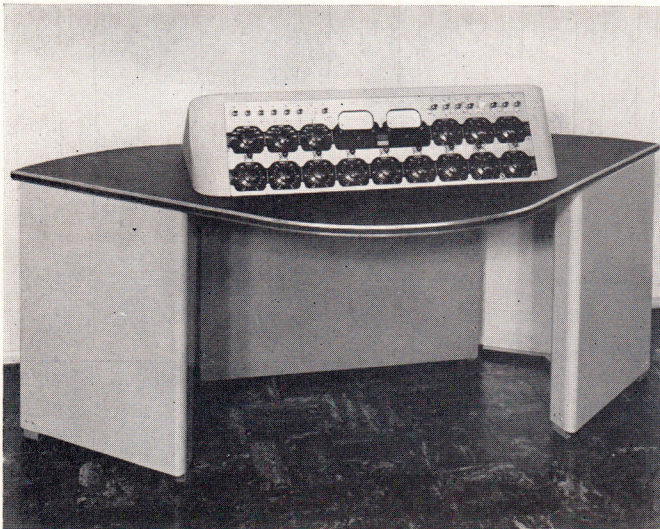

Figure B

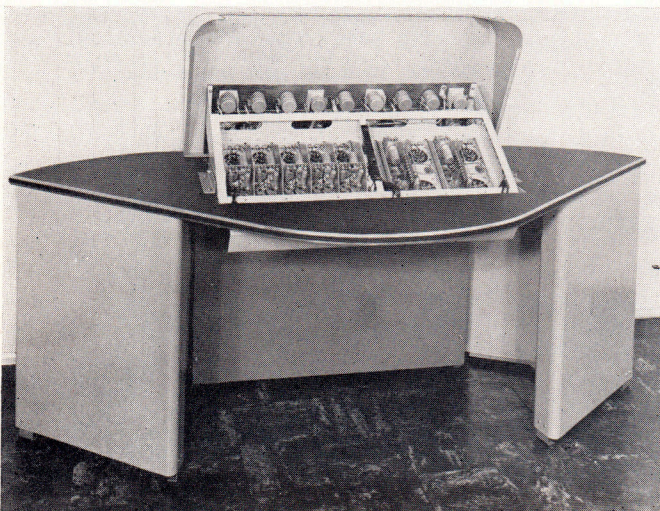

Figure C

MATCHED CONTROL FOR YOUR STUDIOS

It is well known that performance of broadcasting equipment is only as good as its convenience. The many Gates Matched Control desks, chairs, and other items, part of which are shown on these pages and the rest of which are listed in a brochure entitled "Matched Control" and available upon request, are all designed to lend utmost convenience, modernistic appearance, and better operation. Desks are designed so that transcription turntables may be mounted adjacent, providing exact arm reach to the transcription pickups and with desk sizes to provide proper fingertip reach of console controls and correct above-the-floor height for restful operation. Wiring terminations, quality of workmanship, and every factor has been taken into consideration. Matched control is not a re-make of standard office desks. All Gates Matched Control equipment, with the exception of chairs, are manufactured in our own plant so that symmetry both in design and finish as well as moderate price, will be assured.

CB-60 CONTROL DESK

Designed particularly for use with the Gates SA-40 and SA-50 standard consoles and the SA-110 master pre-set console. Its design is such that other Matched Control items may be fitted to either side, such as Gates waist-high cabinets, transcription turntables, or recording desks. Figures A and D illustrate two typical installations built around the CB-60 desk. When the Gates SA-40 or SA-50 consoles are used they are purchased without their cabinet housing, which provides a substantial savings and defrays a large part of the cost of the CB-60 desk. When used with other consoles the top may be provided either with special cutouts or in the form of the CB-60A without any cutout. The basic construction of the CB-60 desk is 5-ply No. 1 grade, the top covered with heavy battleship linoleum in black with an edged trim in stainless steel. This is mounted on rolled steel side pieces heavily reinforced which join to the top. In the center back is provided an enclosed wiring trough which, for wiring convenience and substantial construction consists of two pieces of 5-ply material, the front of which is removable and conceals any wiring from the floor up to the console. Finish is in gloss hand rubbed gray. Size: 74 $\frac{1}{4}$ " at its greatest width, 35" at its greatest depth, and 29" high. Figures B and C give excellent illustrations as to the method of construction and it should be particularly noted that transcription turntables fit within its greatest width. When purchased with Gates consoles, the consoles are balanced on a single swivel so that they may be tilted back for servicing with as little pressure as that exerted by the small finger. The console cover is hinged on the back and is of formed cold rolled steel finished in hand rubbed gloss gray to match the desk proper. Provided as excellent matching accessories are the CB-101 control room chair, constructed of cast aluminum and adjustable both in back tilt and seat height; also, the CB-103 fifteen inch electric studio clock, and the CP-94 joiner cable which is a completely pre-formed cable to join the SA-50 console to the main terminal strips on the CB-60 desk.

CB-60 desk complete, ready to mount either SA-40 or SA-50 consoles, including swivel attachments and console cover. Code ZASJO.
 CB-60A desk without cutouts, swivel, or console cover. Code ZASOJ.
 CP-94 joiner cable to connect SA-50 console to desk. Code ZAVNY.
 CB-101 adjustable control room chair. Code ZAVHA.
 CB-103 fifteen inch electric studio clock. Code ZAVJE.

See Page 38 for Clock and Pages 2 thru 14 for Consoles.

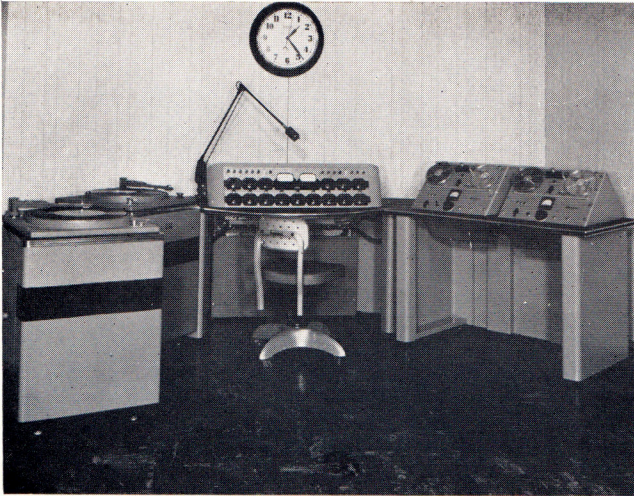

Figure D

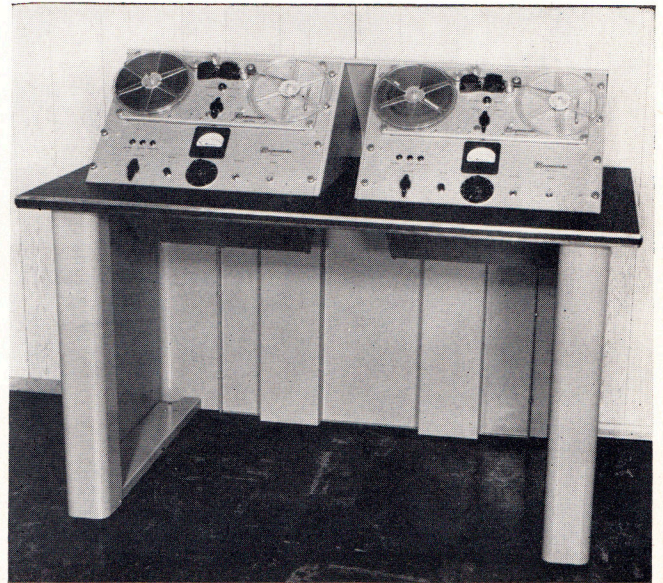

Figure E

MATCHED CONTROL: This means better temperaments and resultant better broadcasting. With controls at the fingertips, recorders under full observation, and transcription turntables as easy to reach as any other part of the installation, experienced broadcasters agree this develops improvement in the quality of program production throughout. Matched Control actually means more interested operating personnel, providing that massive appearance and sparkling appeal that reacts through the entire studio organization.

CB-62 DESK: Illustrated in Figure E above as accommodating a pair of tape recorders and is also shown in Figure D adjacent to the CB-60 desk. Though shown in this instance with recorders, the desk will accommodate any rack panel equipment with each section providing 14"x19" of rack panel space. Cutouts are provided in the table top proper so that extensions behind the panel can be accommodated in full and a top cover is also provided for protection of back of panel apparatus. Size: 48" wide, 30" deep, and 30" between floor and table top. Panels are at 45° angle. Finish is hand rubbed gloss gray with top of black battleship linoleum. For tape recorders see page 31.

CB-62 Desk. Code ZASYL.

CB-62A DESK: This is the same as the CB-62 listed above but is a plain flat desk such as illustrated in Figure G below. It is provided without cutouts, angle brackets for panel mountings, or cover. Size is same as Model CB-62.

CB-62A Desk. Code ZATAG.

CB-63 DESK: Is illustrated in Figure F, designed primarily to accommodate any standard speech input console of 48" in width or less. Illustrated on the desk is a Gates SA-40 console. Built of heavy 16-gauge cold rolled formed steel finished in hand rubbed gloss gray and having heavy 5-ply top covered with black battleship linoleum trimmed in stainless steel. It is 36" deep to provide ample arm room in front of consoles and stands 50" wide and 30" from floor to desk top. See page 5 for SA-40 consoles.

CB-63 Desk. Code ZATGA.



Figure F

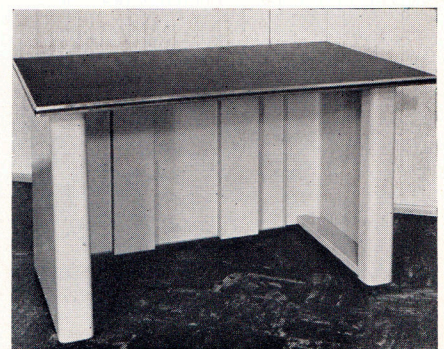

Figure G

TRANSCRIPTION TURNTABLES

Gates manufactures a complete line of transcription turntables. See pages 29 and 30. A complete and separate catalog on Gates transcription turntables is available for the asking. It lists over two dozen different models of transcription equipments plus sound effects tables and auditioning turntable equipment. You will want this catalog.

In Figure G above is illustrated the design of either the CB-62A or CB-63 desks.

Horseshoe Studio Control Desk

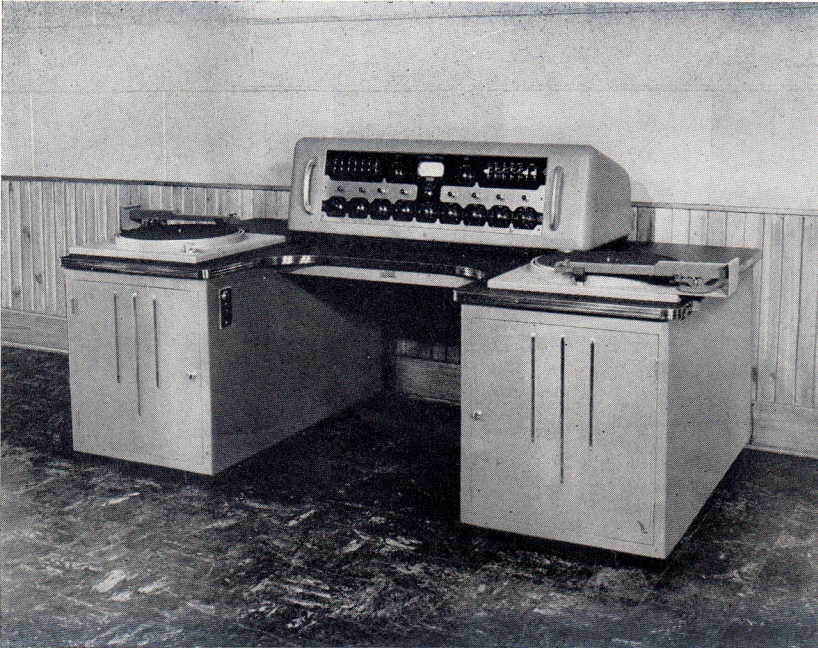

THE CB-4 CONTROL DESK WILL BE FOUND IN AMERICA'S FINEST BROADCASTING STATIONS, PROVIDING THE MOST COMPACT AND COMPLETE STUDIO INSTALLATION AVAILABLE TODAY.

With present day modern speech input console design, many broadcasting stations are more than adequately equipped with a fine console such as the SA-40 or SA-50 equipments, described elsewhere in this catalog and illustrated again herein mounted on the popular Gates CB-4 desk. This horseshoe control desk is designed to accommodate on each wing of the horseshoe, a Gates CB-11 chassis with pickup of your choice, described on Page 29. The under compartment of each wing is very roomy as illustrated at the bottom of the page, may be used for turntable preamplifiers and their power supplies as well as record storage. The design of the cabinet is such that a standard 19" panel may be accommodated. The construction is of heavy 7-ply seasoned grade one lumber, attractively finished in gloss gray and black. The top is covered with battleship linoleum

and trimmed in stainless steel. Back panels of each wing are removable. Size: 84" wide, 48" deep, and 30" high. Shipping weight packed without accessories is 490 pounds.

Combination 159—Consists of CB-4 desk only without cut-outs, alterations, or equipment. Code ZEEPH.

Combination 413—Consists of CB-4 desk, dual turntables, dual SA-74 preamplifiers, SA-78 power supply, dual RCA MI-4875G pickups, SA-50 console, and complete wiring, switches and accessories. Code ZEERK.

Combination 415—Identical to Combination 413 except dual Gray Research arms, filters and diamond stylus reluctance pickups supplied. Code ZEEWP.

Combination 423—Consists of CB-4 desk, dual turntables, dual SA-74 preamplifiers, SA-78 power supply, dual RCA MI-4875G pickups, SA-40 console, complete wiring assembly and all accessories. Code ZEFAY.

Combination 425—Identical to Combination 423 except dual Gray Research arms, filters and diamond stylus reluctance pickups supplied. Code ZEFIX.

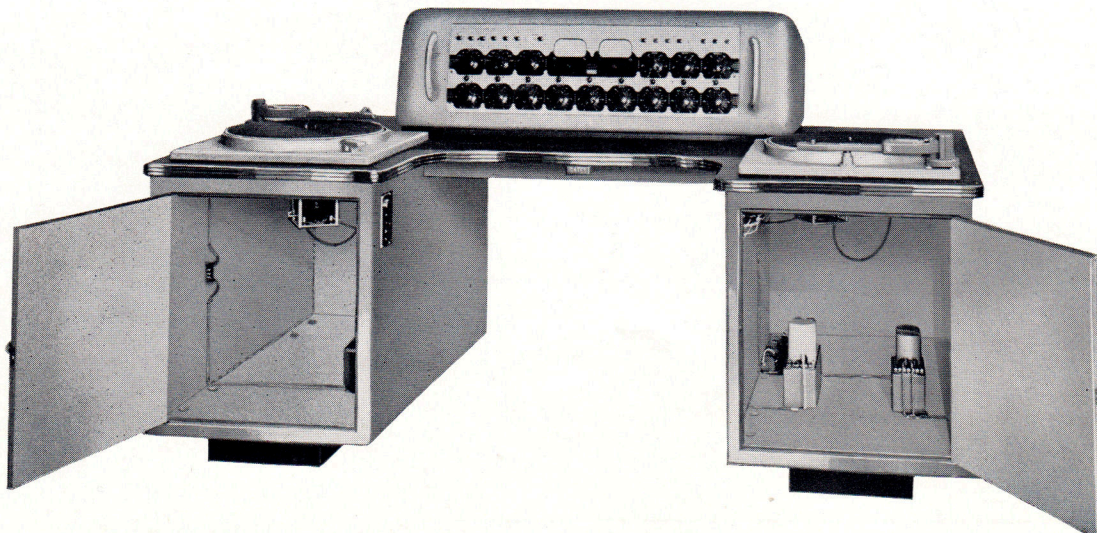

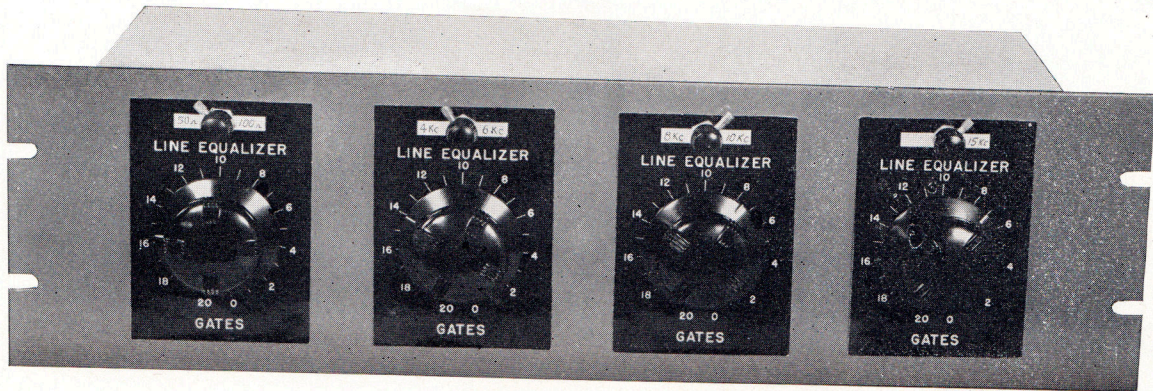

Fig. A

GATES SA LINE EQUALIZERS

Are designed to fill the exacting needs of broadcasting stations in the equalization of audio lines whether program, remote, network, or recording. They are supplied in individual units complete with dial, knob and switch as illustrated in Figure B. These may be mounted in any combination on a standard $5\frac{1}{4} \times 19$ inch rack panel which is provided in several styles listed herein and already drilled and with dust cover so that assembly is only a matter of a few minutes. Physical size of each unit is 4 inches high, 3 inches wide, and $5\frac{1}{2}$ inches behind the panel. Mounting is by means of two $\frac{8}{32}$ machine screws on $1\frac{1}{2}$ inch horizontal centers. A quarter-inch shaft, modernistic skirt knob, and attractive anodized dial completes the assembly. The potentiometer is of the wiping contact type, accurately calibrated in steps of 1 Db., there being 20 steps. The basic circuit consists of a high "Q" coil capacitively tuned to the desired frequency. On dual frequency units the frequency is selected by a high quality turn key. This key is located so that it may be adjusted from the front panel. Degree of equalization is controlled by the precision rheostat and the dial indicates the extent of equalization in decibels so that the equalizer may be used in a number of circuits and calibrated for the required equalization for each of these circuits.

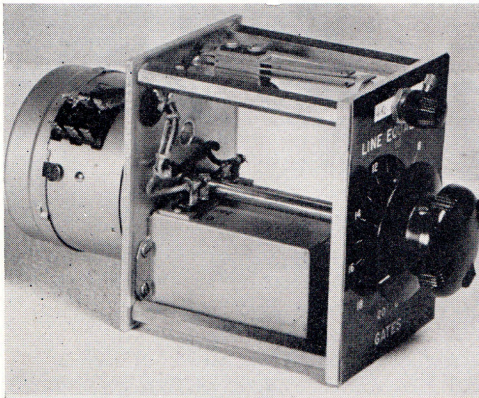

Fig. B

SA-116 Equalizer—Figure B, for 30 cycles only. Code ZEDUZ.

SA-117 Equalizer—Figure B, for 50 and 100 cycles. Code ZEDVE.

SA-118 Equalizer—Figure B, for 4000 and 6000 cycles. Code ZEDYO.

SA-119 Equalizer—Figure B, for 8000 and 10,000 cycles. Code ZEEBS.

SA-120 Equalizer—Figure B, for 15,000 cycles. Code ZEECT.

SA-121 Panel— $5\frac{1}{4} \times 19$ inches, with dust cover, drilled for mounting from one to four SA equalizers. Code ZEEGY.

SA-122 Panel— $5\frac{1}{4} \times 19$ inches, with dust cover, drilled for five SA equalizers. Code ZEENG.

The equalizer is connected in parallel to the line to be equalized. The range key is then placed in the desired frequency position and the degree of equalization control is rotated until the desired equalization is obtained. The degree of equalization indicates the drop in decibels between the equalizer frequency and the 1000 cycle reference level. Several equalizers of different frequency ranges may all be operated in parallel where desired without affecting the other. Five standard units are available while other special units may be had on order without appreciable delay. These standard units are 30 cycles; 50 and 100 cycles; 4000 and 6000 cycles; 8000 and 10,000 cycles; and 15,000 cycles. These equalizer units are moderately priced and a panel of four or five of these equalizers such as illustrated at the top of the page is almost indispensable in the modern broadcasting station.

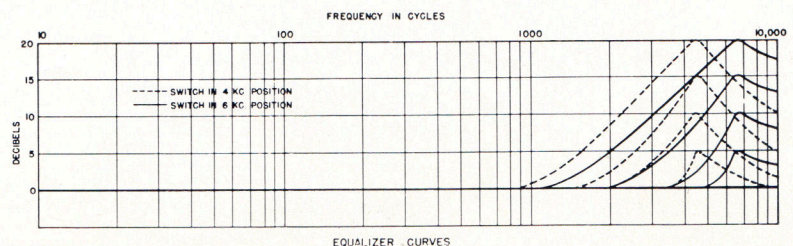

Typical curve of SA-118 equalizer for 4000 and 6000 cycles. Other frequencies are similarly covered.

Microphones and Stands

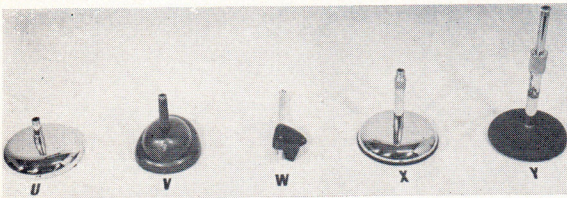
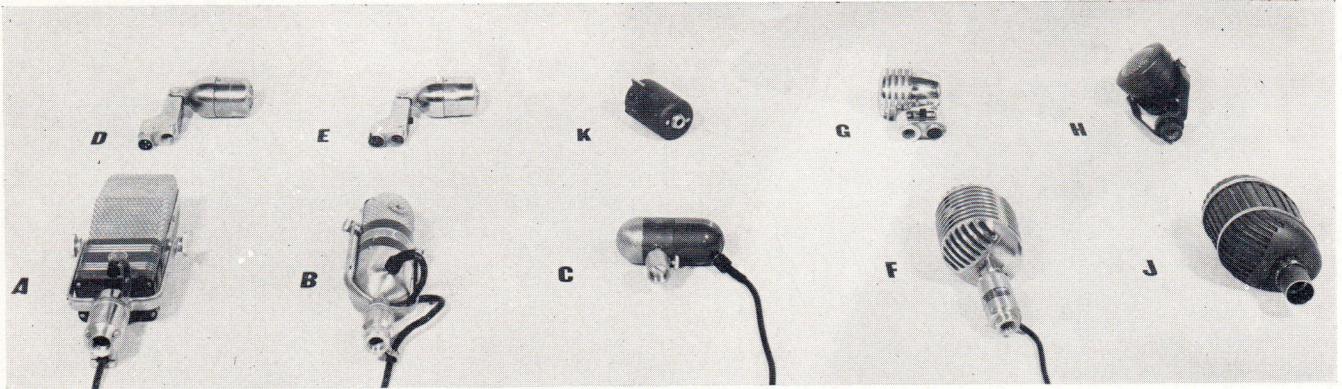

MICROPHONES

Type	Figure	Pattern	Output Imp.	Fitting
RCA 44BX	A	Bi-Directional	50/250	1/2" Pipe Thread
RCA 77-D	B	Poly-Directional	50/250/600	1/2" Pipe Thread
RCA 88-A	C	Non-Directional	50/250	1/2" Pipe Thread
RCA KB-2C	*	Bi-Directional	30/150/250	5/8"-27
RCA MI-6203-C	*	Poly-Directional	50/250/600	1/2" Pipe Thread
Electro-Voice 635	D	Non-Directional	50/250	5/8"-27
Electro-Voice 630	E	Non-Directional	50/250	5/8"-27
Electro-Voice 731	*	Cardioid	50/250	5/8"-27
Shure 556	F	Cardioid	50/250/Hi	5/8"-27
Amperite PGL	G			
Western Elec. 639A	J	Selective	50	Adaptors Required
Western Elec. 633A	K	Non-Directional	50	Adaptors Required
Stephens C-1C	*	Non-Directional	50/250/600	5/8"-27
Altec M11	*	Non-Directional	50/250/600	5/8"-27

*The above group of microphones lists those which are most commonly used in broadcast circles. The Gates Radio Company can furnish information and prices on any type of microphone.

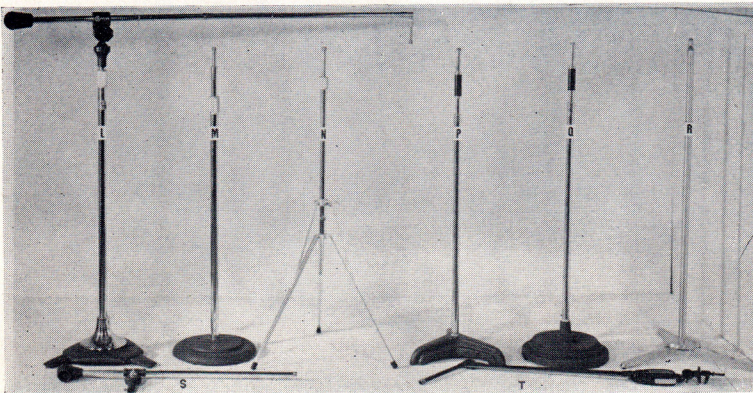

FLOOR STANDS

Type	Figure	Thread	Weight	Base Finish	Tube Finish	Height Adj.
MS-24 Atlas	M	5/8"-27	24 lbs.	Chrome and Gray Shrivel	Full Chrome	42"—72"
CS-1 Atlas	N	5/8"-27	5 lbs.	Cad Plate	Full Chrome	23"—62"
EF-161 Eastern	P	5/8"-27	25 lbs.	Gray Wrinkle	Polished Chrome	44"—68"
EF-162 Eastern	Q	5/8"-27	18 lbs.	Gray Wrinkle	Polished Chrome	44"—68"
425 Electro-Voice	R	5/8"-27	7 1/2 lbs.	Satin Chrome	Satin Chrome	37"—66"
MP-107 Dazor	*			Black Wrinkle	Chrome	39"

DESK STANDS

Type	Figure	Thread	Weight	Base Finish	Tube Finish	Height Adj.
ED-16 Eastern	U	5/8"-27	2 lbs.	Chrome	Chrome	2 1/4"
S36A Shure	V	5/8"-27	1 1/2 lbs.	Pearl Gray	Pearl Gray	2 1/2"
BC-1 Atlas	W	5/8"-27		Gray Shrivel	Chrome	6"
ED-11 Eastern	X	5/8"-27	2 1/2 lbs.	Chrome	Chrome	6"—10"
DS-7 Atlas	Y	5/8"-27	3 lbs.	Gray Shrivel	Chrome	8"—13"

BOOM STANDS

Type	Figure	Thread	Weight	Base Finish	Tube Finish	Height Adj.
BS-35 Atlas	L	5/8"-27	35 lbs.	Chrome and Gray Shrivel	Chrome	48"—72"
BB-1 Atlas	S	5/8"-27		(Can be attached to any microphone stand)		
Universal Model Dazor	§					

*Not illustrated.

§Each Dazor arm is adjusted at the factory to provide correct spring counterbalance for microphone with which it is to be used. Arm will also be provided with the correct microphone coupling. Please mention the name and model of your microphone when ordering.

MICROPHONE ADAPTORS AND FITTINGS

Part No.	Description
AD1 Atlas	5/8"-27 female to 1/2" pipe thread male (RCA adaptor)
AD2 Atlas	1/8" pipe female to 1/4"-27 male
AD3 Atlas	1/8" pipe female to 5/8"-27 female
AD4 Atlas	3/4" long, 5/8"-27 male running thread
AD5 Atlas	5/8"-27 female to 5/8"-27 female, coupling
AD6 Atlas	7/8"-27 female to 7/8"-27 female, coupling
AD7 Atlas	3" long tube 5/8"-27 male each end
AD8 Atlas	6" long tube 5/8"-27 male each end
AD9 Atlas	7/8"-27 female to 5/8"-27 female
AD10 Atlas	5/8"-24 female to 5/8"-27 female (W. E. Adaptor)
AD11 Atlas	Flange, 5/8"-27 female, base diameter 1 1/4"
AD12 Atlas	Flange, 5/8"-27 male, base holes on 7/8" mounting centers
11A W. E.	For Suspension Mounting of Type 639 Microphone
9A W. E.	Swivel Joint for Type 633A Microphone
713A W. E.	Slotted Connector for Type 633A and 639 Microphone
8B W. E.	Baffle for Type 633A Microphone

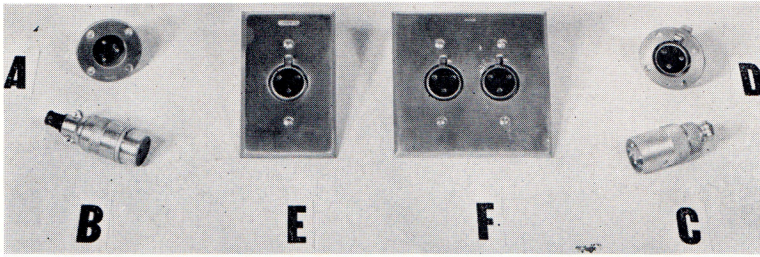

CANNON P SERIES CONNECTORS

Illus.	Type	Description
A	P3-14 Cannon	Receptacle—Male
B	P3-CG-11 Cannon	Connector—Female
C	P3-CG-12 Cannon	Connector—Male
D	P3-13 Cannon	Receptacle—Female
E	P3-35 Cannon	Wall Receptacle—Female
F	P3-35-2G Cannon	Double Wall Receptacle—Female

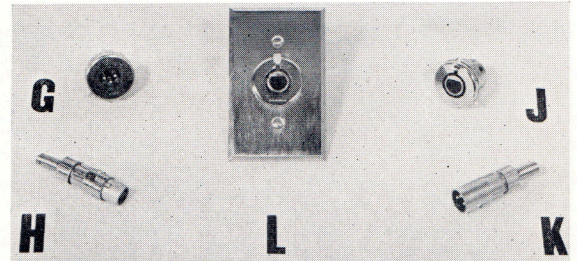

CANNON XL CONNECTORS

Illus.	Type	Description
G	XL-3-14 Cannon	Receptacle—Male
H	XL-3-11 Cannon	Connector—Female
J	XL-3-13 Cannon	Receptacle—Female
K	XL-3-12 Cannon	Connector—Male
L	XL-3-35 Cannon	Wall Receptacle—Female

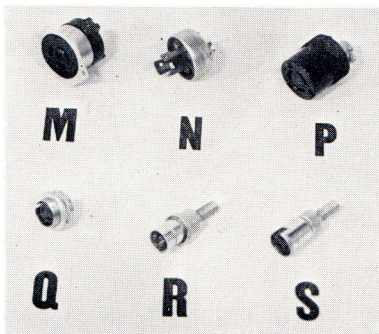

HUBBELL—AMPHENOL CONNECTORS

Illus.	Type	Description
M	7557 Hubbell	Receptacle—Female
N	7572 Hubbell	Connector—Male
P	7559 Hubbell	Connector—Female
Q	91-PG3F	Receptacle—Female
R	91-MC3M	Connector—Male
S	91-MC3F	Connector—Female

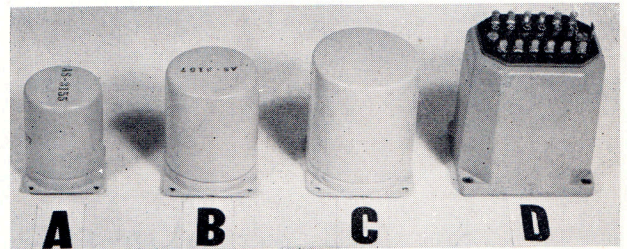

COUPLING TRANSFORMERS

Illus.	Type	Description
A	AS-3155	Line Dividing Transformer. One primary (600 ohms) to two 600 ohm secondaries.
B	AS-3157	Line Dividing Transformer. One primary (600 ohms) to three 600 ohm secondaries.
C	AO-3031	Bridging Transformer. 15,000 ohm primary, 600, 250, 125, 50 ohm secondary.
D	A-3580	Repeater or Isolation Transformer 600, 250, 125, 50 to 600, 250, 125, 50.

WIRE FOR STUDIOS AND MICROPHONES

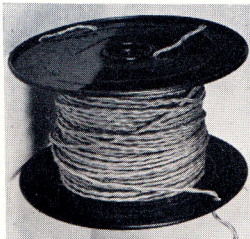

2 CONDUCTOR SHIELDED WIRE

Is required in all broadcast studios. Available in two sizes, stranded pair 20 gauge and stranded pair 14 gauge, with cloth and heavy cotton fabric insulation, twisted and with tightly woven tinned shield overall, of highest quality and will not puncture.

- Two C. shielded No. 20 pair, per 1000 ft. Code ZEGWA.
- Two C. shielded No. 14 pair, per 1000 ft. Code ZEGYE.

MICROPHONE CABLE

Two Conductor No. 20, individual conductors, stranded for extreme high flexibility, with cloth and cotton covering on each conductor over which is a heavy flexible rubber jacket for waterproofing.

Microphone Cable, per 100 ft. Code ZEHAY.

NOTE—Studio wire or microphone cable may be purchased in any quantities. Quantities shown above are illustrative only.



STUDIO WARNING LIGHTS

These fixtures are conservative, yet necessary and highly attractive studio fixtures. Letters are placed on plexiglass which transfers light rays edgewise through the glass, illuminating letters only. All lights are provided with yellow fluorescent tubes, providing gold lettering; except "On Air" fixture, which is an incandescent tube for immediate illumination. Metal portion is of steel finished in a medium brown to harmonize with Walnut, Maple, Mahogany, or Oak. Special colors will be provided to meet exacting studio schemes.

Type	Wording	Light	Code
AM-1	Studio A	Fluorescent	ZAHSA
AM-2	Studio B	Fluorescent	ZAHTE
AM-3	Control Room	Fluorescent	ZAHUX
AM-4	On Air	Incandescent	ZAHWO
AM-5	With lettering and type of light to your specifications. ZAHZY		

NOTE—Models AM-1 thru AM-4 carried in stock. About 48 hours delay for special lettering for AM-5.

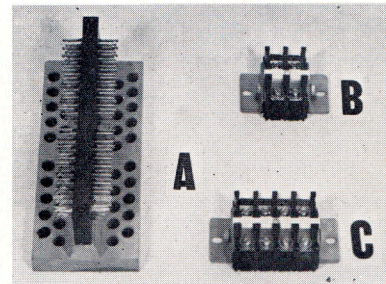

TERMINAL BOARDS

Illustrated herein are three popular type terminal boards, used in rack mounting, with Type 46 usually employed for terminating audio wires and the CDM type for power connections.

Illus.	Type	Description
A	46	Telephone Board, 80 Terminals
B	CDM-2	Heavy Duty Power Board, 2 Terminals
C	CDM-4	Heavy Duty Power Board, 4 Terminals

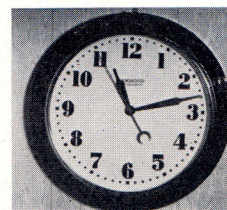

STUDIO CLOCK

For those areas where Western Union time service is not available or where a high quality clock is desired for office or studio, the CG-103 fifteen-inch electric studio clock is ideal. Has block type face with easily visible second hand. Operates on 115 volts, 60 cycles.

Model CB-103 Studio Clock.
Code ZAVJE.

OVER 5000 ITEMS IN STOCK

Gates is a 100% source for all broadcast equipment requirements. Thousands of items are carried for immediate delivery that are not listed in this catalog. No matter what your needs, Gates can supply them at lowest current market prices.

GATES RADIO COMPANY, Quincy, Illinois, U. S. A.

Attenuators, Pads, Keys, Dials, Knobs

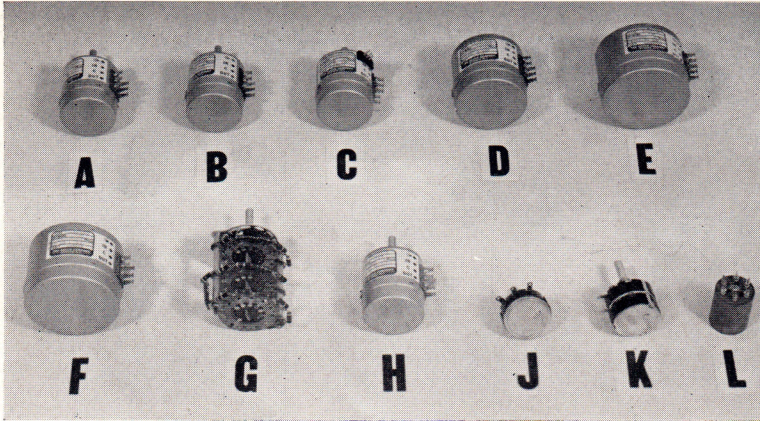

ATTENUATORS AND PADS

ATTENUATORS

Illus.	Type	Ohms	Network	Steps	Taper
A	LA-350-A	30/30	Ladder	20-2DB	Infinity
A	LA-350-E	250/250	Ladder	20-2DB	Infinity
A	LA-350-F	500/500	Ladder	20-2DB	Infinity
A	LA-350-EF	250/500	Ladder	20-2DB	Infinity
B	*LAQ-350-EF	250/500	Ladder	20-2DB	Infinity
D	LA-730-A	30/30	Ladder	30-1.5DB	Infinity
D	LA-730-E	250/250	Ladder	30-1.5DB	Infinity
D	LA-730-F	500/500	Ladder	30-1.5DB	Infinity
D	LA-730-EF	250/500	Ladder	30-1.5DB	Infinity
E	T-330-A	30/30	Tee	30-1.5DB	Infinity
E	T-330-E	250/250	Tee	30-1.5DB	Infinity
E	T-330-F	500/500	Tee	30-1.5DB	Infinity
E	T-330-EF	250/250	Tee	30-1.5DB	Infinity
F	**TA-1000-4	7100/3900	Tee	20-2DB	+4 to +42 VU and OFF
G	A-4311-101	7500/3900	Tee	6-	+4 to +30DB

*With T. T. cue switch.

**For use as Meter Multiplier with Types 802, 862 and 301 meters, listed on Page 24, or any standard VU meter.

NOTE—Miniature switches may be added to any LA-350 series controls at slight additional cost. See illustration C.

POTENTIOMETERS

Design	Sections	Taper	Illus.	Type	Sections	Taper
J	A-3404-5	500 Ohms		Wire Wound	1	Linear
J	A-3404-8	1000 Ohms		Wire Wound	1	Linear
J	A-3404-14	1000 Ohms		Carbon	1	Linear
J	A-3404-7	5000 Ohms		Carbon	1	Audio
J	A-3404-11	25,000 Ohms		Carbon	1	Linear
J	A-3404-2	50,000 Ohms		Carbon	1	Audio
J	A-3404-4	100,000 Ohms		Carbon	1	Audio
J	A-3404-1	250,000 Ohms		Carbon	1	Audio
J	A-3404-3	500,000 Ohms		Carbon	1	Audio
H	CP-354X	250,000 Ohms		20 Steps 2 Db.	1	Infinity
K	A-5544-1	500/500 Ohms		Carbon	2	Audio
K	A-5544-2	100K/100K Ohms		Carbon	2	Audio

FIXED PADS (1 Watt)

Illus.	Type	Circuit	Loss	Impedance
L	C-16240-105	Bal. H	5 DB	500/500
L	C-16240-101	Bal. H	6 DB	500/500
L	C-16240-102	Bal. H	10 DB	500/500
L	C-16240-103	Bal. H	15 DB	500/500
L	C-16240-104	Bal. H	20 DB	500/500
L	C-16240-106	Bal. H	30 DB	500/500
L	C-16241-101	T	5 DB	500/500
L	C-16241-102	T	10 DB	500/500
L	C-16241-103	T	15 DB	500/500
L	C-16241-104	T	20 DB	500/500
L	C-16241-105	T	30 DB	500/500

The above pads are standard stock pads. The Gates Company can supply pads of a wide variety of impedances and attenuation as requested by the customer. When ordering special pads, please indicate the type of circuit ("H", "T", "O", or "L"), loss in DB, input and output impedances, and maximum audio level applied.

KNOBS AND KEY HANDLES

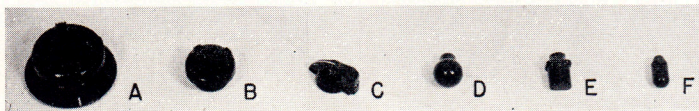

Illus.	Type	Description	Color
A	S-489-64L-BB	Large Skirt Knob	Black
B	483-64-40	Small Knob with Pointer	Black
C	2921-L	Small Bar Knob	Black
D	4901-H	Ball Knob for Gates console keys	Black
D	4901-H	Ball Knob for Gates console keys	Red
E	5149-A	Rectangular Knob for Lever keys	Black
E	5149-A	Rectangular Knob for Lever keys	Red
E	5149-A	Rectangular Knob for Lever keys	Ivory
F	4926	Knob for Nos. 172, 175, 179 keys	Black
F	4926	Knob for Nos. 172, 175, 179 keys	Red

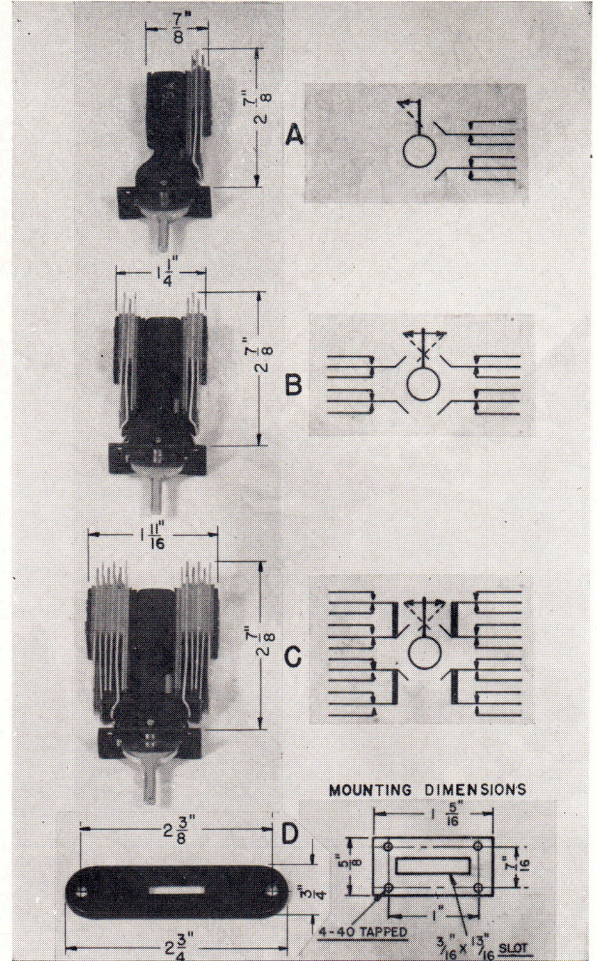

KEYS AND MOUNTINGS

Illus.	Type	Description
A	179A	Telephone Type Key
B	172A	Telephone Type Key
C	175A	Telephone Type Key
D	55	Mounting Plate for Telephone Keys

FOR KEY HANDLES, SEE BOTTOM OF PAGE

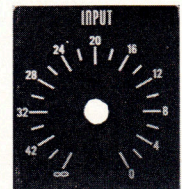

DIAL PLATES

Illustrated to the left are available in Program Level; Monitor Level; Mixer 1; Mixer 2; Mixer 3; Mixer 4. Dials to the right are available for reading Input; Output; Audio Level; VU Range; Channel (1-2-3-4-5); Output (Line 1-2); Input (Line-Bridge).

Both types are approximately 3" square, in anodized aluminum, with natural aluminum letters for construction of special equipment; or used with attenuators on this page they are ideal. Use knob S-489-64L-BB.

Switches and Relays

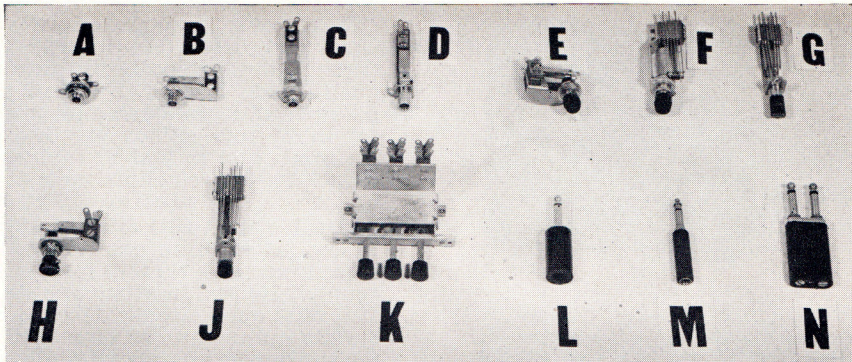
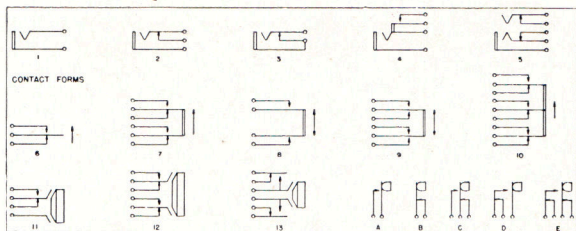

SWITCHES JACKS AND PLUGS

JACK SWITCHES

Illus.	Type	Contact Form	Mounting	Positions	Frame Depth
E	730 Mallory	6	Single Hole	2	1 3/8"
E	760 Mallory	7	Single Hole	2	1 3/8"
E	732 Mallory	8	Single Hole	3	1 3/8"
E	762 Mallory	9	Single Hole	3	1 3/8"
F	30 Mallory	6	Single Hole	2	3 1/2"
F	60 Mallory	7	Single Hole	2	3 1/2"
F	32 Mallory	8	Single Hole	3	3 1/2"
F	62 Mallory	9	Single Hole	3	3 1/2"
G	HT-69 Clare	7	Screw	2	3 1/2"
G	HT-70 Clare	10	Screw	2	3 1/2"

JACKS

Illus.	Type	Contact Form	Mounting	Positions	Frame Depth
A	2A Mallory	2	Single Hole	—	13/16"
B	701 Mallory	1	Single Hole	—	1 3/8"
B	702 Mallory	3	Single Hole	—	1 3/8"
B	703 Mallory	4	Single Hole	—	1 3/8"
B	704B Mallory	5	Single Hole	—	1 3/8"
C	1 Mallory	1	Single Hole	—	3 1/8"
C	2 Mallory	3	Single Hole	—	3 1/8"
C	2A Mallory	2	Single Hole	—	3 1/8"
C	3 Mallory	4	Single Hole	—	3 1/8"
C	4B Mallory	5	Single Hole	—	3 1/8"
D	PJ-123 ADC	1	Screw	—	3 1/2"
D	PJ-118 ADC	2	Screw	—	3 1/2"
*	139 Stromberg	5	Single Hole	—	2 1/2"

PUSH KEYS AND SWITCHES

Illus.	Type	Contact Form	Action	Mounting	Frame Depth
H	2003 Mallory	11	Non-Lock	Single Hole	1 3/8"
H	2006 Mallory	12	Non-Lock	Single Hole	1 3/8"
H	2008 Mallory	13	Non-Lock	Single Hole	1 3/8"
H	2003-L Mallory	11	Locking	Single Hole	1 3/8"
H	2006-L Mallory	12	Locking	Single Hole	1 3/8"
H	2008-L Mallory	13	Locking	Single Hole	1 3/8"
J	HN-47 Clare	11	Non-Lock	Screw	3 1/2"
J	HN-48 Clare	12	Non-Lock	Screw	3 1/2"
J	HL-47 Clare	11	Locking	Screw	3 1/2"
J	HL-48 Clare	12	Locking	Screw	3 1/2"
K	MC3 Mallory	7	Interlocked	Screw	2 1/8"

PLUGS

Illus.	Type	Description
L	211	Phone Plug, 2 Conductor
M	53X Stromberg	Single Patch Panel Plug, 3 Conductor
N	PJ-1 ADC	Double Patch Panel Plug, 3 Conductor

ROTARY AND LEVER SWITCHES

ROTARY SWITCHES

Illus.	Type	Circuits	Position	Sect.
A	1316-L	1	6	1
A	B-11139-3	3	3	1
A	B-11139-2	2	8	2
A	1325-L	4	5	2
A	1346-L	4	6	4
A	1335-L	6	5	3

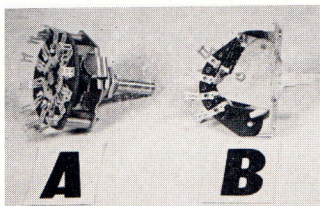

LEVER ACTION KEYS

Illus.	Type	Description
B	N-10076	Double Pole, Triple Throw, 3 Position
B	N-10078	Three Single Pole, Double Throw, One SPST, Spring Return, 2 Position
B	N-9735	Three SPDT, One SPST, 2 Position

NOTE—For Key Handles, see page 39.

TOOLS AND SUPPLIES

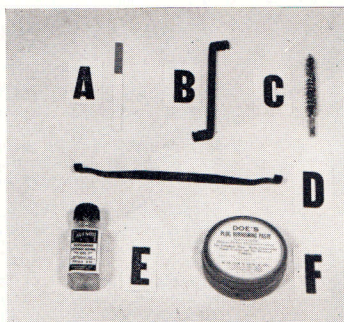

Illus.	Type	Description
A	TM-1	Relay Burnishing Tool
B	TM-5	Armature Adjuster
C	No. 32	Jack Brush
D	TM-2	Spring Bender
E	Davenoil	Attenuator Lubricant
F		Plug Burnishing Paste

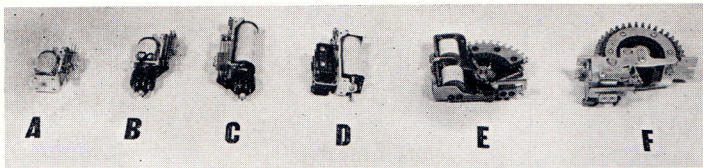

RELAYS—Standard and Stepping

Illus.	Type	Coil Voltage	Coil Z	Contact Form	Mounting
A	A-42105	6-8 V. DC	200 Ohms	1A; 1D	Standard Mounting
B	A-43249	6-8 V. DC	200 Ohms	1A; 1D	Plug-in
C	A-37331	6-8 V. DC	400 Ohms	2-C	Octal Plug-in
D	B-36313	6 V. AC, 60 Cy.		D.P.D.T.	Standard Mounting
E	Special				Stepping Switch, Direct Driven
F	Special				Stepping Switch, Spring Driven

The above relays are standard stock types. If other relays are required, write for prices giving coil voltage, resistance or operating current required, contact form and specify standard or plug-in mounting. Use Contact Forms A, B, C, D, and E on this page.

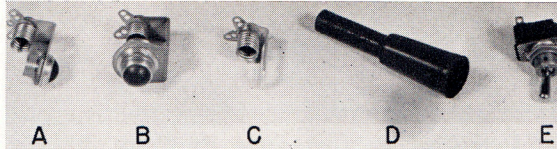

DIAL LIGHTS AND SWITCHES

Illus.	Type	Description
A	510-MF	Miniature Screw Base—Faceted Lens
A	510-MS	Miniature Screw Base—Smooth Lens
A	510-BF	Miniature Bayonet Base—Faceted Lens
A	510-BS	Miniature Bayonet Base—Smooth Lens
B	810-MF	Miniature Screw Base—Faceted Lens
B	810-MS	Miniature Screw Base—Smooth Lens
B	810-BF	Miniature Bayonet Base—Faceted Lens
B	810-BS	Miniature Bayonet Base—Smooth Lens
C	505	Lamp Bracket—Miniature Screw Base
D	L-73	Lamp Installer
E	8280	SPST Toggle Switch

NOTE—On illustrations A and B Specify Red or Green

Test Equipment—Call Letter Plates

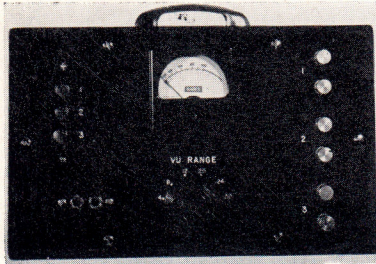

Fig. A

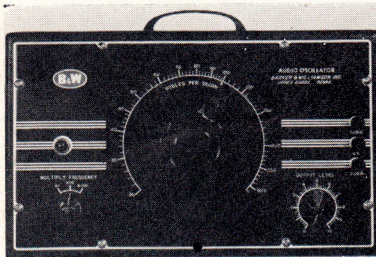

Fig. B

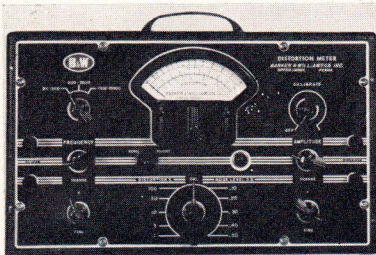

Fig. C

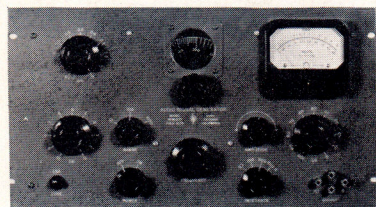

Fig. D

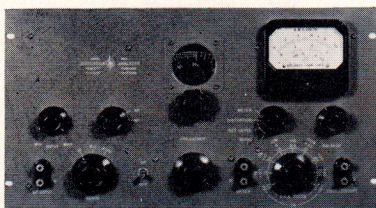

Fig. E

FCC Proof of Performance Package

To meet new FCC regulations where all broadcasting stations must submit response, noise, and distortion data on the overall broadcasting station, by assembling the Model 200 oscillator and Model 400 distortion analyzer together with the Gates MO-3625 impedance matching unit and the Gates MO-3626 RF rectifier unit, the broadcaster is provided with an economical and yet highly satisfactory package for complete proof of performance measurements. As the MO-3625 impedance matching unit is provided with all necessary pads for measuring inputs at microphone levels as well as standard levels and the MO-3626 rectifier unit allows measurement of transmitter performance as well as audio performance, the package of these four units will find wide acceptance and will not be excessive in cost.

Model SA-131 Package, consisting of four units as outlined herein. Code ZEJBE.

SA-129 PORTABLE VU METER (Illustrated Fig. A)

Consists of a 3" square case VU meter, Scale B, and variable range control in six equal steps from +4 to +30 VU. Three input circuits can be accommodated through binding posts to the right and selected by an interlocking three button push switch located to left of meter. Also provided is a double jack wherein a patch cord of the double plug variety, such as illustrated on Page 16, can be used for input connections in place of the binding posts. Constructed of the finest materials and in a steel cabinet 12 $\frac{3}{4}$ " wide, 8 $\frac{3}{4}$ " high, and 4" deep. Net weight, 8 lbs. Input 7500 ohms for a 500/600 ohm line.

Model SA-129 Portable VU Meter. Code ZEHZE.

MODEL 200 AUDIO OSCILLATOR (Illustrated Fig. B)

A low priced, fine quality oscillator for all distortion and frequency response measurements. No zero reset or line calibration is required. Self-contained power supply. Housed in attractive steel cabinet 13 $\frac{3}{4}$ "x7 $\frac{1}{4}$ "x9 $\frac{1}{2}$ " in size. Voltage output 12.5 volts open circuit; 11 volts on 500 ohm load; wave form; RMS harmonics at 5 volts output on 500 ohm load less than 1%. On open circuit (10,000 ohms or more); approximately 0.5% all frequencies between 50 and 15,000 cycles. Response: ± 1 Db., 30-30,000 cycles; Stability: Better than 1%; Calibration: ± 2.5 %.

Model 200 Oscillator. Code ZEIBT.

MODEL 400 DISTORTION METER (Illustrated Fig. C)

An economical high quality distortion measuring equipment with variable frequency selective filter, providing a single frequency suppression circuit between 50 and 15,000 cycles. In steel cabinet 13 $\frac{3}{4}$ "x7 $\frac{1}{4}$ "x9 $\frac{1}{2}$ ".

FREQUENCY RANGE: (a) Distortion meter. For fundamentals from 50-15,000 cycles, measuring harmonics to 45,000 cycles; (b) Has voltmeter and Db. meter 30-30,000 cycles. **SENSITIVITY:** (a) Noise and distortion measurements. Minimum input 0.3V; (b) Voltmeter full scale readings of 0.3, 0.1, 0.03, 0.01, and 0.003 volts. **CALIBRATION:** For distortion measurements, plus or minus 10%. For noise measurements, plus or minus 1 Db. For voltage measurements, plus or minus 5%. 1.

Model 400 Distortion Meter. Code ZEIFY.

MODEL 206A AUDIO SIGNAL GENERATOR (Illustrated Fig. D)

A topflight laboratory audio generator provided with precision attenuator varying output signal level 111 Db. in 0.1 Db. steps. The resistance tuned oscillator is followed by an automatic tracked amplifier whose high selectivity reduces oscillator harmonics. Can be matched to loads of 50, 150 and 600 ohms.

FREQUENCY RANGE: 20-20,000 cycles on lowest band. **STABILITY:** 2%. **OUTPUT:** Plus 115 DBM into 600 ohm load. **RESPONSE:** 0-2 Db., 30-15,000 cycles. **DISTORTION:** 0.1% above 50 cycles; 0.25% below 50 cycles. **NOISE:** 70 Db. below output signal or 100 Db. below zero level. **OUTPUT METER:** Reads in DBM or volts.

Model 206A Audio Signal Generator. Code ZEIKD.

MODEL 330C NOISE AND DISTORTION ANALYZER (Illustrated Fig. E)

A laboratory instrument with meter providing VU characteristics meeting FM and AM requirements. Employs resistance tuned circuit and develops infinite attenuation at any one frequency, with total distortion measurements at any frequency from 20-20,000 cycles. Also a vacuum tube voltmeter, flat to 100 Kc., nine full scale readings from 0.03 to 300V.

FREQUENCY RANGE: 20-20,000 cycles in three bands. **RESPONSE:** Flat to 100 Kc. **SENSITIVITY:** 0.3% full scale. **INPUT IMPEDANCE:** 200,000 ohms.

Model 330C Noise and Distortion Analyzer. Code ZEILF.

MO-3625 MATCHING UNIT

Similar to the SA-129 unit illustrated in Figure A, consisting of a 3" VU meter, switch for selecting three indicating ranges and provided with balanced H attenuator having 10 steps of 2 Db. Three standard plug-in pads may be used to provide any loss of impedance match desired. Especially designed for making FCC proof of performance tests.

Model MO-3625 Impedance Matching Unit and Meter. Code ZEIRL.

MO-3626 RADIO FREQUENCY RECTIFIER

A unit similar in size to the SA-129 unit illustrated in Figure A, designed for use in conjunction with an AM transmitter and either the Model 400 or Model 330C distortion and noise analyzer illustrated on this page. Consists of a 6X5 rectifier tube, feeding into an RF filter and includes DC milliammeter with variable adjustment of the RF input voltage so that the correct value indicated by the meter can always be applied, eliminating danger of damage to the distortion measuring equipment. Provided with fuse so that excessive RF will not damage rectifier.

Model MO-3626 RF Rectifier Unit. Code ZEJAZ.

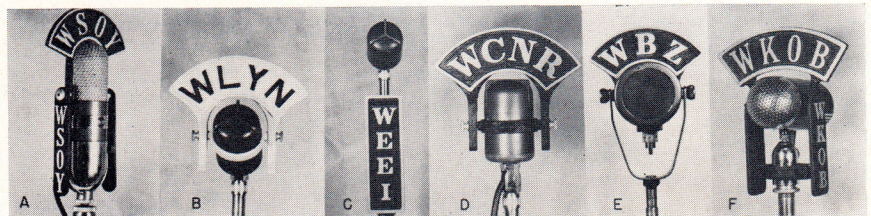

CALL LETTER PLATES

Available in many sizes and styles shown above. White letters with black background. If black letters and white background desired, cost slightly higher.

Model	For Make of Microphone or Stand	Figure	Code
A125	Western Electric 618 Series	E	ZEJDO
A118A	Western Electric 633 Series	B, D	ZEJEB
A110	Shure 55, 555 and 556	—	ZEJIC
A105	Clip on mic. stand; state diameter of pipe	C	ZEJOD
A115	For RCA 77 Series Microphone	A	ZEFUF
A118	For RCA 88 Series Microphone	F	ZEJYG
A127	For W. E. 639 Series Microphone	—	ZEJZA
A117	For RCA 44 Series Microphone	Similar to A	ZEKAB
A116	For RCA 74 Series Microphone	Similar to A	ZEKBA

NOTE—A-116 and A117 have side plates and rectangular top plate instead of curved.

Fixed Attenuator Data

The table below gives the correct resistance values for "T", "H", balanced "H" and "O" type pads. The audio circuit will, in most cases, demand the type of pad to be used. For example, in an unbalanced circuit a "T" pad should be used. In a balanced circuit an "H" or and "O" pad, and in a circuit balanced to ground, a balanced "H" pad should be employed. In constructing these pads good quality accurate resistors are desirable.

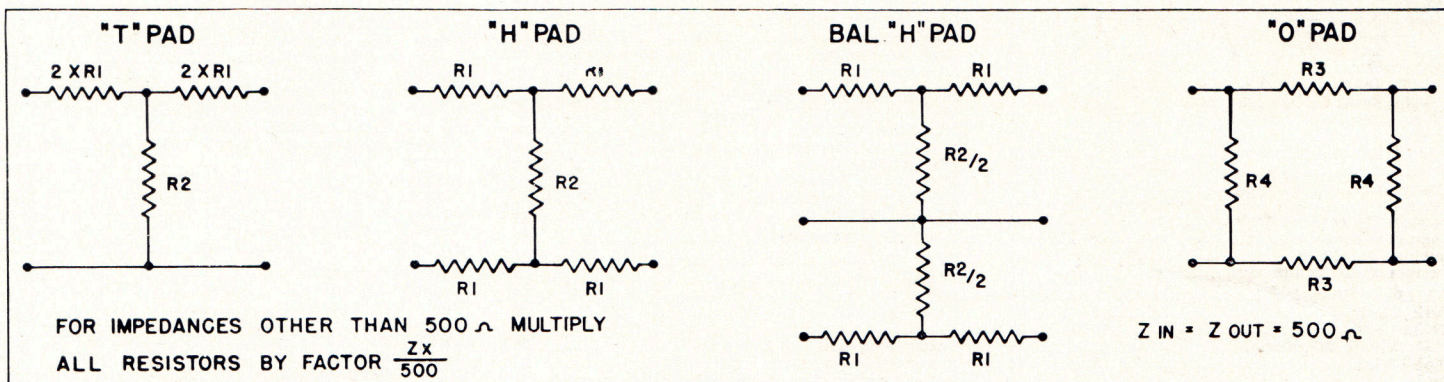

Loss in DB	R1	R2	R3	R4
0.1	1.440	43420	2.879	86850
0.2	2.878	21720	5.755	43440
0.3	4.318	14480	8.635	28950
0.4	5.758	10850	11.52	21710
0.5	7.193	8685.	14.40	17380
0.6	8.635	7232.	17.29	14480
0.7	10.07	6198.	20.17	12420
0.8	11.51	5421.	23.06	10870
0.9	12.95	4818.	25.95	9656.
1.0	14.38	4333.	28.85	8690.
2.0	28.65	2152.	58.08	4364.
3.0	42.75	1420.	88.08	2925.
4.0	56.58	1049.	119.3	2209.
5.0	70.03	822.4	152.0	1785.
6.0	83.08	669.4	186.8	1505.
7.0	95.65	558.0	224.0	1308.
8.0	107.7	473.1	264.3	1162.
9.0	119.1	405.9	308.0	1050.
10.0	129.9	351.3	355.8	962.5
15.0	174.5	183.6	680.8	756.3
20.0	204.5	101.0	1238.	611.2
25.0	223.5	56.40	2216.	559.5
30.0	234.7	31.65	3949.	532.7
35.0	241.3	17.79	7027.	518.0
40.0	245.1	10.00	12500	510.1

VOLUME LEVEL TO POWER AND VOLTAGE CONVERSION TABLES

REFERENCE LEVEL
0 DB = 1 Milliwatt, 600 Ohms

REFERENCE LEVEL
0 DB = 6 Milliwatt, 500 Ohms

Milliwatts	Volts	DB	Milliwatts	Volts
.000001	.0007746	-60	.000006	.001732
.000010	.002449	-50	.000060	.005477
.000100	.007746	-40	.000600	.01732
.001	.02449	-30	.006	.05477
.010	.07746	-20	.060	.1732
0.100	.2449	-10	0.600	.5477
1.000	.7746	0	6.000	1.73205
Watts	Volts	DB	Watts	Volts
.001000	.7746	0	.006000	1.73205
.002512	1.228	+4	.01507	2.745
.006310	1.946	+8	.03786	4.351
.01000	2.449	+10	.060	5.477
.1000	7.746	+20	.600	17.32
1.000	24.49	+30	6.000	54.77
10.00	77.46	+40	60.00	173.2

INDEX — TERMS — GENERAL

ITEM	Page	ITEM	Page	ITEM	Page
Adapters and Fittings (Microphone)	37	Isolation Amplifiers	26	Rack Mount Housings (SA)	18
Attenuator Dials	39	Jacks	16, 40	Radio Receiver	10
Attenuator Knobs	39	Jack Switches	40	Recorders (Disc)	32
Attenuators	39	Keys (Lever)	40	Recorders (Tape)	31
Blank Panels	14	Keys (Telephone)	39	Relay Power Supply	15, 28
Booster Amplifier (See Isolation Amplifiers)		Knobs	39	Relays	40
Cabinets (Loud-speaker)	10	Level Indicators	24, 41	Remote Pre-set Cabinet	13
Cabinets (Rack)	14	Lever Switches	40	Rotary Switches	40
Cable (Microphone)	38	Limiting Amplifiers	19, 20	SA-50 Console modified for Master Control	13
Call Letter Plates	41	Line Amplifiers	21, 22, 25, 27	SA Rack Mount Housings	18
CB-4 Desk	35	Line Equalizers	36	Space Line Amplifiers	26, 27
CB-60 Desk	33	Loud-speakers	10	Space Line Power Supplies	28
CB-62 Desk	34	Master Control Equipment	11, 12, 13	Speakers (Loud)	10
CB-62A Desk	34	Matched Control	33, 34	Speech Input Console (52-CS)	8, 9
CB-63 Desk	34	Microphone Cable	38	Speech Input Console (SA-40)	4, 5, 6
Chair	33	Microphone Connectors	38	Speech Input Console (SA-50)	1, 2, 3
Circuit Selector (Dial)	15	Microphones	37	Speech Input Master Control (SA-110)	11, 12, 13
Clock	38	Microphone Stands	37	Station Control Unit	25
Connectors	38	Monitoring Amplifiers	23, 24, 27	Stepping Relays	40
Consoles (See Speech Consoles)		Muting Relays	40	Studio Clock	38
Control Room Accessories	33, 34	Oscillators (Audio)	41	Studio Warning Lights	38
Coupling Transformers	38	Pads (Fixed)	39	Switch and Fuse Panel	24
Cueing Amplifier	20	Panels (Blank)	14	Switches	40
Custom Built Equipment	17	Patch Cords	16	Tape Recorders	31
DC Power Supplies	15, 28	Patch Panels	16	Terminal Boards	38
Desk Chair	33	Plugs	40	Tools and Supplies	40
Desks	6, 33, 34, 35	Power Supplies (AC and DC)	28	Transformers	38
Dial Circuit Selector	15	Power Supplies (Direct Current)	28	Turntables	29, 30
Dial Lights	40	Power Supply (Emergency for SA-50 Console)	3	Test Equipment	41
Dials	39	Preamplifiers	26	Volume Level Indicators	24
Disc Recorders	32	Program Amplifiers	21, 22, 25, 27	VU Meter Attenuators	39
Distortion (Analyzer)	41	Program Switching Equipment	7	VU Meters	24
Emergency Power Supply (for SA-50 Console)	3	Push Keys	40	Warning Lights	38
Engineering Data (Sketches, etc.)	39	Rack Cabinets	14	Wire (Microphone)	38
Equalizers	36			Wire (Shielded Studio)	38

As the human element enters into the preparation of this catalog and its associated price list, we must waive responsibility for any error that might appear, though every effort has been made to ascertain its accuracy.

TERMS AND SHIPPING

We cordially invite our customers to investigate us through the Dun & Bradstreet agency or any other bonafide credit organization. You can easily check on us by visiting your nearest bank which has a Dun & Bradstreet reference book. You will find Gates carries a top credit rating.

We invite your open account business. Hundreds of our customers already have well established credit with us. For those that do not, our credit department would be happy to receive your application for credit, which is most speedily handled by forwarding your recent financial statement and three or four credit references. Where, for reasons best known to the customer, financial information cannot be disclosed, shipments will be made on a sight draft bill of lading or Express C. O. D. basis. This is in no way a reflection on the customer's credit standing but only because credit information is not available.

As establishing new credit takes a few days, we feel that delays in shipment, unless otherwise instructed, should not prevail; and in this case, shipments will be released on a payment on delivery basis. However, by the time your next shipment is ready, credit arrangements may likely have been established. Where the amount of the purchase is sizeable and it is desired to take advantage of the Gates term payment policy, this can be easily and quickly arranged. As many state laws governing term payments are such that they prevent shipment of materials purchased on term payments prior to receipt of the signed term payment papers, shipments are necessarily delayed a few days.

Shipments can be made by rail, highway or air. When ordering, specify the method of transportation desired. Shipping terms are F. O. B. cars, Quincy, Illinois. Prices include standard packing. As the Gates plant is located in the center of America, transportation time by air is within a few hours of any point in the United States, Canada, and Mexico, and by other means of transportation most convenient.

SERVICE ORGANIZATION

The Gates Radio Company maintains paid field sales engineers throughout the United States. These men are directly responsible to our company for proper, highly ethical selling of Gates products as well as servicing of these products to the best of their ability. For this reason we believe you will find the Gates organization throughout the United States unusual in its scope, interest in you, and interest in the company of which they are a part.

Gates maintains an extensive eastern office located in Washington, D. C., to serve those broadcasters in any way possible when visiting the nation's capitol. Gates products in Canada are sold by the Canadian Marconi Company of Montreal, with branches throughout Canada. Gates products are sold in all other parts of the world, with the exception of continental United States and its territories, by Roche International Corporation, 13 East 40th Street, New York 16, New York.

A service policy around-the-clock is maintained at the Gates main plant at Quincy, Illinois, and service may be obtained at any time, day or night, by simply placing a telephone call to the Gates Radio Company, Quincy, Illinois.

A Word About the Gates Company

All of us are interested in with whom we do business and if you are contemplating purchase of some Gates item, large or small, no doubt a word about us will be helpful.

The Gates Radio Company was established in 1922 by the late Henry C. and Cora B. Gates and is probably the oldest active manufacturer of radio broadcasting equipment in business today. Incorporated under the laws of the state of Illinois, the big majority of its stockholders are actively engaged in the management of its business. Henry C. Gates, the founder, better known to his friends as Wink, guided the business through the hectic days of radio evolution, from Crystal to Morehead Vacuum tubes, from Hartley to Crystal control, from a novelty to a bonafide business. Henry C. Gates and his beloved wife, Cora, founded an institution that today more than ever before believes in following the pattern they set; simply, giving the best we have in us to you, the customer.

Henry C. Gates was an alumnus of Purdue University and believed solidly in good engineering. As a result, Gates has established one of the finest engineering departments in the country for the advancement of the electronic industry. The Gates plant occupies 55,000 square feet of modern 100% sprinklered premises. Those interested are cordially invited to visit us at any time. They can reach us, as can our products reach our customers, via rail, air and highway. All Gates workers are dedicated to the principle that no business can be successful unless it makes the best possible product and ascertains that this product is properly attended after its sale. After nearly thirty years of electronic manufacturing, these things are more than words—they are symbolic.

GATES RADIO COMPANY

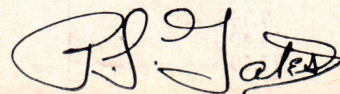

PRICE LIST

SPEECH INPUT EQUIPMENT

Page	Speech Input Equipment	Price	Page	Speech Input Equipment	Price
1, 2, 3	SA-50 Console, MO-2950, with wall mount power supply. Code ZEHCO	\$1495.00	14	Type A Cabinet, ER-225. Code ZECET	50.10
	SA-50 Console, MO-2950, with rack mount power supply. Code ZEHEZ	1495.00		Type A Cabinet, ER-227. Code ZECIV	59.70
	SA-50 Console, MO-2950, on CB-60 Desk, MO-3364. Code ZEHIB	1560.00		CR-70 Waist High Cabinet, MO-3368, with base and single linoleum top	84.50
	(Add \$39.50 if CP-94 joiner cable desired)			Pair CR-70 Waist High Cabinets, MO-3368, with double base and double linoleum top	158.00
	SA-51 Emergency power supply, MO-3003A, for rack mounting. Code ZEHOC	110.00		Triple CR-70 Waist High Cabinets, MO-3368, with triple base and triple linoleum top	235.50
	SA-51 Emergency power supply, MO-3003, in wall mount drawer type cabinet	150.00		Four CR-70 Waist High Cabinets, MO-3368, with quad base and quad linoleum top	313.00
4, 5, 6	SA-40 Console, MO-3107A, with rack mount power supply. Code ZASF A	1095.00		NOTE—Where casters are added to above, add \$6.00 per set. Only one set required for any combination.	
	SA-40 Console, MO-3107, with wall mount power supply. Code ZASGE	1125.00		CR-71 Waist High Cabinet only, MO-3368, less base or top	52.00
	SA-40 Console, MO-3107, on CB-60 Desk, MO-3364. Code ZEHUD	1160.00		CR-71 Base only, MO-3373	13.50
	(If joiner cable desired, add \$39.50)			TR-80 Single linoleum top, MO-3370	19.00
	SA-2008 Wall Cabinet only, MO-3437-D. Code ZEHYA	30.00		TR-81 Double linoleum top, MO-3371	27.00
7	SA-104 Program Switching Unit, MO-3602. Code ZEANF	105.00		TR-82 Triple linoleum top, MO-3372	39.00
	SA-104R Program Switching Unit, MO-3602A, Code ZEARJ	95.00		TR-83 Quad linoleum top, MO-3416	51.00
	SA-105 Program Switching Unit, MO-3674. Code ZEASK	157.50		SA Cast Blank Panels	
	SA-105R Program Switching Unit, MO-3674A. Code ZEATL	145.00	14	SA-1350, MO-3013, 3½"x19". Code ZECSA	3.00
8, 9	Model 52-CS Studioette, MO-3388. Code ZAWJA	575.00		SA-1525, MO-3102, 5¼"x19". Code ZECTE	3.50
	Studioette for odd voltage or frequency	595.00		SA-1700, MO-3011, 7"x19". Code ZECUX	4.00
	Loud Speakers			Standard 19" Blank Panels	
10	Model P-4X Speaker	2.50	14	Size 19"x1¾"	1.05
	Model P-6X Speaker	3.00		Size 19"x3½"	2.10
	Model P-8T Speaker	5.70		Size 19"x5¼"	3.15
	Model P-10T Speaker	6.40		Size 19"x7"	4.20
	Model P-10Q Speaker	15.80		Size 19"x8¾"	5.25
	Model P-12T Speaker	7.15		Size 19"x10½"	6.30
	Model P-12Q Speaker	16.65		Size 19"x12¼"	7.35
	Model P-15Q Speaker	22.20		Size 19"x14"	8.40
	Model JRP-40 Coaxial Speaker	20.00		Size 19"x15¾"	9.45
	Model JHP-52 Coaxial Speaker	58.00		Size 19"x17½"	10.50
	Model HNP-51 Coaxial Speaker	41.70		Size 19"x19¼"	11.55
	Model RD-153 Speaker in cabinet	107.66		NOTE 1—For other sizes compute at 60c per inch of height.	
	Model RD-122 Speaker in cabinet	81.70		NOTE 2—Deduct 10% for unfinished panels.	
	Model RB-153 Speaker in cabinet	91.20		NOTE 3—Add 10% for special finishes with minimum charge of \$1.00 for special finish.	
	Model RB-121 Speaker in cabinet	59.70		Dial Circuit Selectors	
	Model D-151 Cabinet only	51.70	15	SA-106 MO-3671 Dial Circuit Selector. Code ZEAWN	215.00
	Model D-121 Cabinet only	51.70		SA-107 MO-3672 Dial Circuit Selector. Code ZEBAR	215.00
	Model B-151 Cabinet only	35.20		SA-108 MO-3673 DC Power Supply. Code ZEBIT	40.00
	Model B-121 Cabinet only	29.70		20P Twenty pair cable. Code ZEBOV (per ft.)20
	Model B-81 Cabinet only	21.00		Patch Panels and Cords	
	Model M-6 Wall Cabinet	3.30	16	SA-160 MO-3333 24 jacks on mat. Code ZECZY	34.30
	Model M-8 Wall Cabinet	4.15		SA-1600 MO-3004 48 jacks on mat. Code ZEDAT	52.90
	Model M-12 Wall Cabinet	7.50		SA-1601 MO-2879 96 jacks on mat. Code ZEDEV	100.00
	Model Z-3300 Transformer90		C-150 MO-2921 24 jacks less mat. Code ZEDOY	25.80
	Model ZL-2021 Transformer	1.30		C-1500 MO-2922 48 jacks less mat. Code ZEDTA	42.90
	Model ZY-4004 Transformer	3.00		E2 Patch Cord, 2 feet. Code ZACEP	7.80
	Model ZY-2002 Transformer	3.00		E7 Patch Cord, 3 feet. Code ZAPYH	7.95
	Model ZY-2003 Transformer	4.32		E4 Patch Cord, 4 feet. Code ZACNA	8.28
	Model Z-3423 Transformer	5.20		E6 Patch Cord, 5 feet. Code ZARAD	8.52
	Model ST-760 Level Control	1.35	17	Custom built equipment	As per specifications
	Model ST-276 Level Control	1.35		SA Rack Mount Housings	
	Model ST-411 Level Control	1.80	18	Model SA-400, MO-3010. Code ZAWMO	14.00
	Model ST-761 Level Control	2.10		Model SA-500, MO-3009. Code ZAWPY	14.50
	Master Control Equipment			Model SA-600, MO-3008. Code ZAWYP	15.00
11-13	Master Control Equipment	On Application		Model SA-700, MO-3007. Code ZAYAK	15.50
	Rack Cabinets			Model SA-800, MO-3006. Code ZAYBS	16.00
14	DM-1 Rack cabinet. Code ZACTY	129.00			
	DM-1-ST Connecting strip. Code ZACYT	18.00			
	Type C Cabinet, PG-3618. Code ZEBSE	54.00			
	Type C Cabinet, PG-6618. Code ZEBVO	72.00			
	Type C Cabinet, PG-8318. Code ZEBYX	93.00			
	Type A Cabinet, ER-223. Code ZECAS	39.30			

Page		Price	Page		Price
19	SA-38 MO-2996 Limiting Amplifier. Code ZANEB	375.00	29, 30	Model CB-14B MO-3230 Transcription turntable equipment with RPX-046 variable reluctance lateral pickup, RPJ-002 diamond stylus, Gray type 103S transcription arm, No. 602 equalizer, four position filter and switch assembly, SA-74 MO-3268 preamplifier and SA-78 MO-3044 power supply. For lateral reproduction only. Output impedance 250 ohms	459.00
20	SA-39 MO-3529 Limiting Amplifier. Code ZAYEL	295.00		Model CB-14C MO-3231 Transcription turntable equipment with RCA MI4875G Universal pickup and variable equalizer. For vertical and lateral reproduction. Output impedance 250/500 ohms	408.00
	SA-22 MO-2994 Cueing Amplifier. Code ZAKIX	90.00		Model CB-14 MO-3232 Transcription turntable equipment with SA-74 MO-3268 preamplifier, SA-78 MO-3044 power supply, RCA MI-4875G Universal pickup and variable equalizer. For vertical and lateral reproduction. Output impedance 250 ohms	498.00
21	SA-20 MO-2993 Program Amplifier. Code ZAJVE	145.00		Model CB-14J MO-3595 Transcription turntable equipment. For both standard and micro-groove playback; including two reluctance pickups with Gray variable equalizer and switch (one pickup for micro-groove and one for standard). SA-74 three-stage preamplifier and SA-78 power supply. For lateral reproduction only. Output impedance 250/500 ohms	523.00
22	SA-66 MO-2997 General Purpose Amplifier. Code ZAKAV	295.00		Model CB-10C MO-3037 Transcription turntable equipment with RCA MI-4875G Universal pickup, mixer, three-stage preamplifier and SA-78 power supply. For vertical and lateral reproduction. Output imp. 250/500 ohms	570.00
23	SA-10 MO-2992 Monitoring Amplifier. Code ZAKCY	178.00		Model CB-10E MO-3144 Transcription turntable equipment with G. E. RPX-025 variable reluctance lateral pickup, diamond stylus, Gray type 103S arm, Gray 602 variable equalizer, three-stage preamplifier, SA-78 power supply, 4 position filter and switch assembly. For lateral reproduction only. Output impedance 250/500 ohms	524.00
24	SA-98 MO-3554 Monitoring Amplifier. Code ZEZEM	135.00		Model CB-10G MO-3592 Transcription turntable with two reluctance pickups (one for micro-groove and one for standard transcriptions). Includes Gray variable equalizer with change-over switch and Gray arms for each pickup. Three-stage preamplifier and SA-78 power supply. For lateral reproduction only. Output impedance 250/500 ohms	588.00
	SA-8 MO-2991 Volume Indicator. Code ZAJYO	110.00		NOTE—If pickups desired are not listed herein, please write for quotation.	
	SA-17 MO-3005 Switch and Fuse Panel. Code ZANDO	25.00			
	V. U. Meter Model 802. Code ZAZLA	38.40			
	V. U. Meter Model 862. Code ZAZME	44.40			
	V. U. Meter Model 301. Code ZAZOP	32.40			
25	Model SA-89 MO-3134 Station Control Unit. Code ZAPAB	435.00			
26	Model SA-70 MO-2298 Preamplifier. Code ZAMYA	52.50			
	Model SA-71 MO-3031 Preamplifier. Code ZAMZE	57.00			
	Model SA-72 MO-3052 Preamplifier. Code ZANAZ	61.50			
	Model SA-73 MO-3267 Preamplifier. Code ZAYHZ	57.50			
	Model SA-74 MO-3268 Preamplifier. Code ZAYKA	62.00			
	Model SA-75 MO-3269 Preamplifier. Code ZAYLE	66.50			
	Model SA-93 MO-3578 Isolation Amplifier. Code ZAYNO	75.00			
27	SA-94 MO-3094 Line Amplifier. Code ZAYON	105.00			
	SA-95 MO-3555 Ten-watt Monitor Amplifier. Code ZAYUP	100.00			
	SA-96 MO-3556 Two-watt Monitor Amplifier. Code ZAZAL	85.00			
28	SA-99 MO-3601 Power Supply. Code ZAZPO..	62.00			
	SA-100 MO-3599 Power Supply. Code ZAZRY	35.00			
	SA-101 MO-3600 Power Supply. Code ZAZYR	42.50			
	SA-77 MO-3036 Power Supply. Code ZEACS..	25.00			
	SA-78 MO-3044 Power Supply. Code ZEADT..	27.00			
	SA-79 MO-3045 Power Supply. Code ZEAHY	31.50			
	SA-7 MO-2999 Power Supply. Code ZAJUZ....	68.00			
	SA-102 MO-3582 DC Power Sup. Code ZEALC	80.00			
	SA-103 MO-3548 Power Supply. Code ZEAMD	120.00			
29, 30	CB-11 MO-2705 Turntable Chassis only	145.00	31	MR-10 MO-3334 Tape Recorder. Code ZAROH	645.00
	CB-11 MO-2843 Chassis in CB-7 cabinet with motor switch but less pickup	235.00		NOTE—MR-10 requires two Cannon XL-3-11 connectors at 75c each and one XL-3-12 at 72c to complete.	
	Model CB-11A MO-3587 Chassis with reluctance pickup, sapphire stylus, Gray 103S arm and Gray 602 four position variable equalizer. For lateral only. Output impedance 250/500 ohms	239.00		Model 102 Portable tape recorder. Code ZEFOZ	348.00
	Model CB-11B MO-3588. Same as CB-11A above, except pickup has diamond stylus	263.83		NOTE—All makes of Magnecord and Webster in stock. Also recording tape, etc.	
	Model CB-11C MO-3589 Chassis with RCA MI4875G Universal pickup. Complete with variable equalizer. For vertical and lateral reproductions. Output impedance 250/500 ohms	310.00	32	CB-8R MO-2812 Complete Recorder. Code ZEFUB	795.00
	Model CB-14A MO-3169 Transcription turntable equipment with RPX-046 variable reluctance lateral pickup, RPJ-002 diamond stylus, Gray type 103S transcription arm, No. 602 equalizer and four position filter and switch assembly. For lateral reproduction only. Output impedance 250 ohms	362.00		Model AH4 cutting head, 500 ohms. Code ZEFZO	93.75
				Model DU4 cutting head, 500 ohms. Code ZEGBO	150.00
				Feed screw only inside-out, 104 lines	60.00
				Feed screw only inside-out, 112 lines	60.00
				Feed screw only inside-out, 120 lines	60.00
				Feed screw only outside-in, 104 lines	60.00
				Feed screw only outside-in, 112 lines	60.00
				Feed screw only outside-in, 120 lines	60.00
				Complete overhead mechanism with feed screw to be stated as above, with time scale and spiraling attachment, less head. Code ZEFWE	215.00
				Model CB-12 MO-2855 recording chassis only, no cabinet or other attachments. Code ZEFVA	195.00

