

**Collins**  
**Broadcast Catalog**

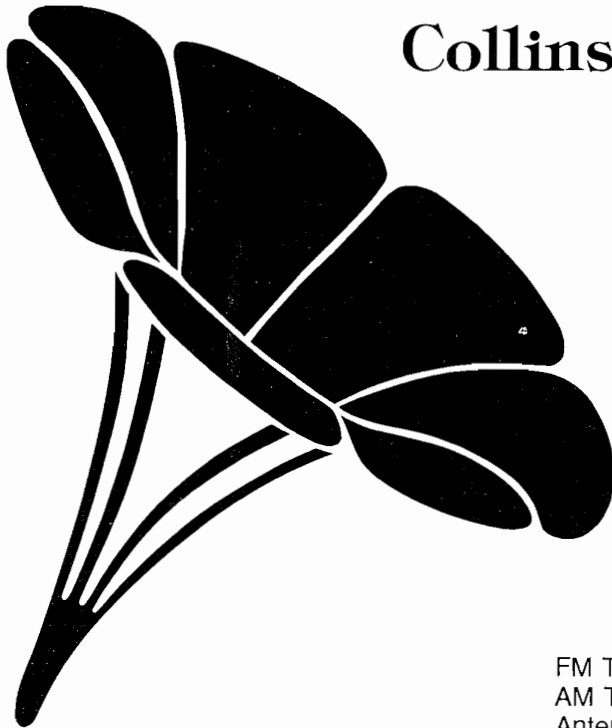



# Collins Broadcast Catalog

No. 48.

## Table of Contents

	page
FM Transmitters .....	1
AM Transmitters .....	21
Antenna Systems .....	35
Audio .....	57
STL and Remote Equipment .....	101
Monitoring and Test Equipment .....	113
Services .....	127
Engineering Data .....	129
Conditions of Sale .....	139
Index of Manufacturers .....	143
Product Index .....	144



# FM Transmitters



# FM Transmitters

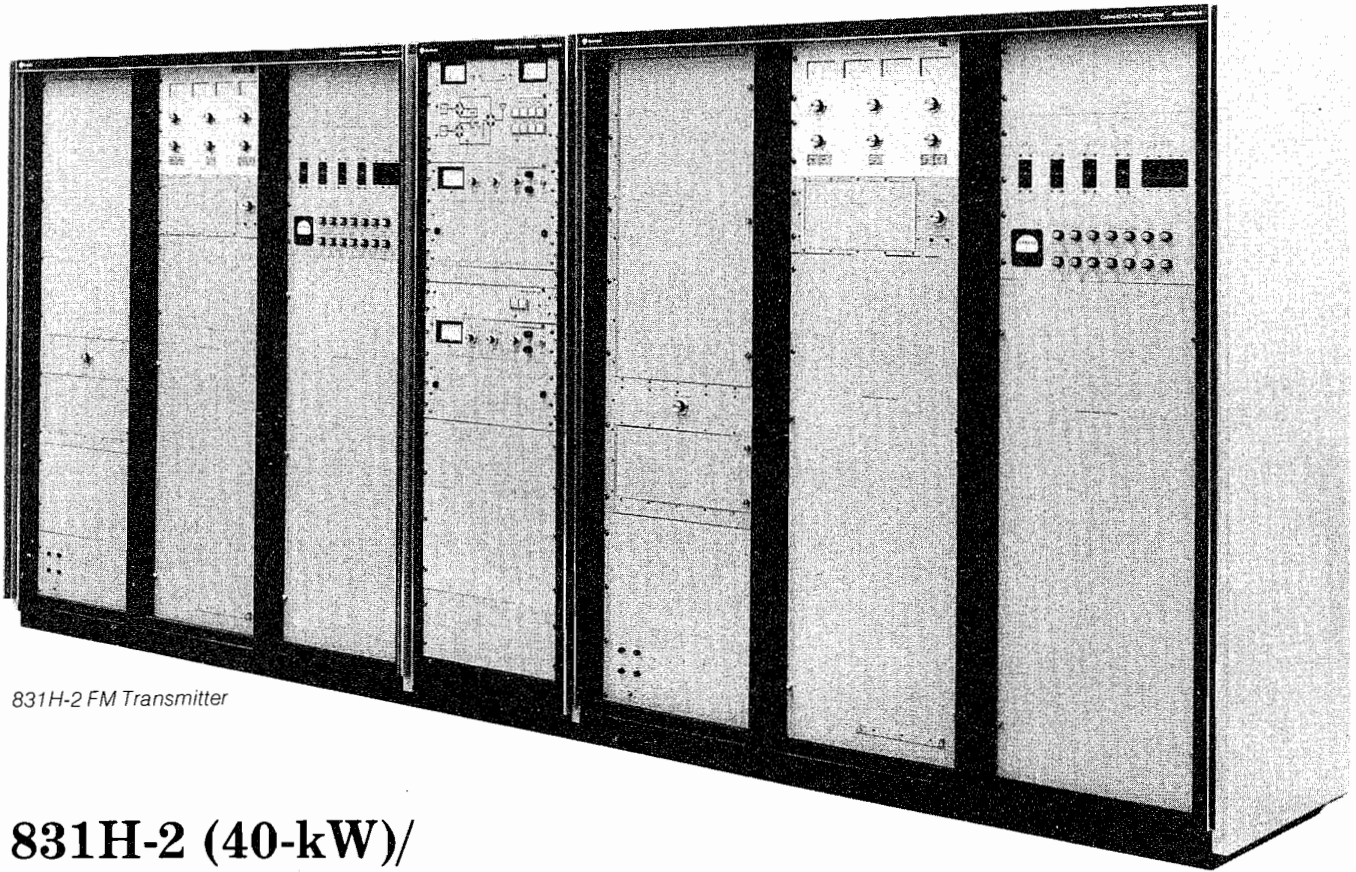

831H-2 FM Transmitter

## **831H-2 (40-kW)/ 831H-2C(50-kW) Transmitters**

Collins 831H FM transmitter series offers the broadcaster reliable, high fidelity FM performance and modular flexibility for both small and large market stations. Quality engineering, precision manufacturing, and conservatively rated components produce "the Collins sound," an extra dimension in clarity and long-life operation. The 831H FM transmitter series offers features, such as those highlighted below, that make day-to-day operation as simple and troublefree as possible, at a competitive price.

- Automatic power output control
- Automatic filament voltage regulation
- Automatic overload recycling
- Overload fault indicators
- Completely self-contained
- Maximum accessibility
- Conservative component ratings

# FM Transmitters

Automatic power output control ensures that maximum authorized power is available at all times. Once the output level is set, no further adjustments are needed.

Automatic filament voltage regulation, within 2 percent of optimum level, extends tube life far beyond normal hours.

Automatic overload recycling ensures fast return to the air after minor interruptions. An internal card may be strapped for either two or four recycle sequences in a 30-second timeframe. If resumption of normal operation is not possible after this recycle attempt, the transmitter powers down completely, thus preventing component failure due to overloading. This feature is especially helpful in a remote control operation. In addition, fault indicator lights pinpoint trouble areas and expedite troubleshooting. Thus, even in the event of a failure, "off air" time is kept to a minimum.

The entire transmitter is self-contained, including harmonic filter and transformer. There are no external components, except normal monitoring and audio processing equipment.

Accessibility for both troubleshooting and routine maintenance is simplified by the use of vertical component placement and easily removable panels. Although the panels on all four transmitter sides are removable, only the front panels require removal for normal maintenance. This access ease allows transmitter operation in a confined area.

Another Collins product concept, whether in hybrid microcircuits or complex computer-controlled space communication systems, is conservative component ratings. Collins proved its ability to design and build the ultimate in reliable products by providing all the communication equipment for all the manned space missions.

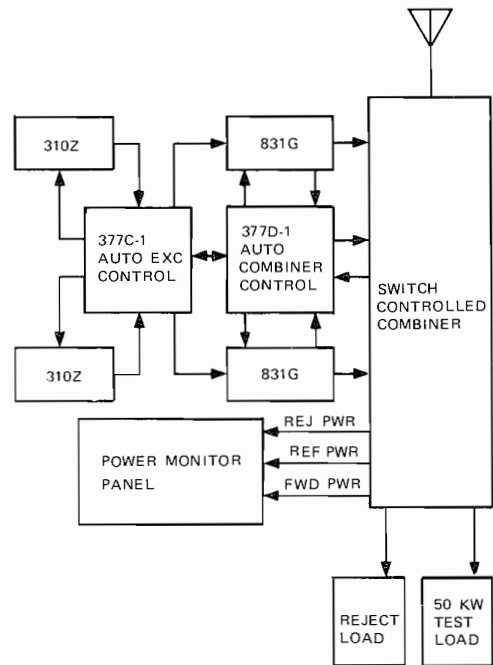

831H-2/2C With Automatic Switching, Block Diagram

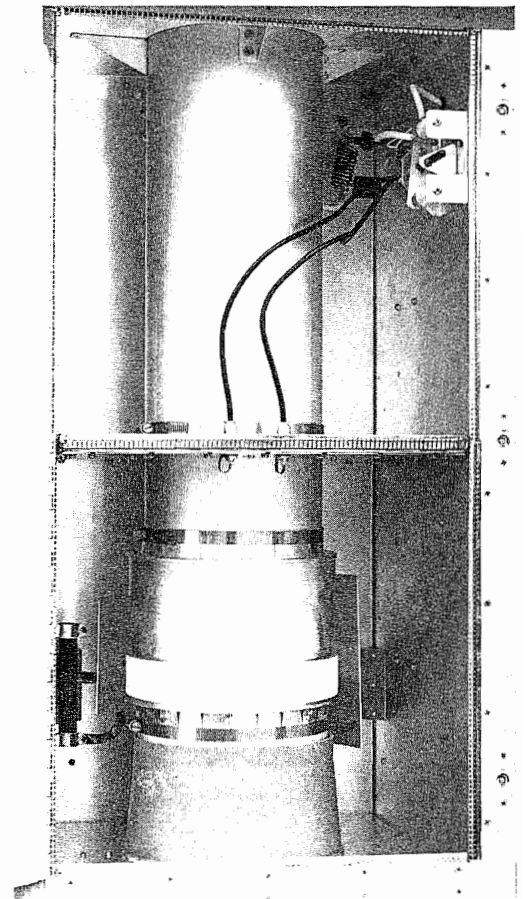

831G Cavity



# FM Transmitters

## 831H-2/2C

The 831H-2 and 831H-2C Transmitters are essentially identical in design concept, with the 831H-2 rated at 40 kW and the 831H-2C at 50-kW RF power output. Both transmitters utilize two 831G Amplifiers combined in a single output to feed one transmission line. A single 310Z-2 Phase 4 Broadcast Exciter is used to drive both amplifiers, thus eliminating problems with phase relationships. If desired, two exciters may be utilized to provide a hot-standby mode of operation.

Since two completely separate power amplifiers are used to achieve total power output, one amplifier may be used in the event the other fails. In addition, the system may be set up so that one amplifier may be serviced while the other remains on the air. With the addition of the optional 377C-1 and 377D-1 Exciter and Combiner Controls, the 831H-2 and 831H2C Transmitters may be operated into either the antenna at full power, the dummy load at full power, the antenna at half power, or any combination that may be required for maintenance.

Both power amplifiers use a neutralized 4CX15000A tube operating Class C, giving typically 73-percent efficiency. The grid circuit is a PI network, tuned with a single vacuum variable capacitor. Motor-driven tuning and loading capacitors provide output adjustment, while a sliding plate provides coarse adjustment for the plate cavity. The RF power is automatically held to within  $\pm 2$  percent of a predetermined value by a circuit that compares actual power output to a predetermined level set by the station engineer. Long tube life is assured by an automatic voltage regulator system that maintains the filaments within 2 percent of optimum value. For remote control ease and safety, all interlock, control, and indicator functions operate on 28 V dc. Filament and plate controls are separate pushbuttons on the front panel, with a built-in 120-second delay between filament and plate initiation to allow for tube warmup. Overload sensors are located in both the driver and final sections of the amplifiers, as well as in the transmission line to detect abnormally high vswr.

After tripping, the recycle circuit will attempt to start the transmitter again, either two or four times in a 30-second time period after failure. If, after that time, the overload condition still exists, the transmitter will remain off, and indicator lamps will flash the location of the malfunction.

The reliability of the Collins 831H-2/2C is enhanced by the use of solid-state components, with the exception of the driver and final amplifier tubes. A neutralized power amplifier improves stability, and minimizes tuning and loading adjustment problems.

The entire transmitter is contained in two cabinets. The only external components are those associated with the combiner and optional automatic switching gear. Collins 831H-2/2C Transmitters give the broadcaster a fully redundant system with the flexibility that enables full-time operation with a minimum of down time. This, coupled with Collins 24-hour field service operation, and unparalleled warranty, gives more value per dollar than any competitive system on the market.

As an option, an automatic switching system consisting of the 377C-1 Exciter Control, and the 377D-1 Combiner Control, is available to facilitate a completely redundant operation. These units monitor all parameters of operation, and make decisions as to what exciter/transmitter/antenna combination will give best service in the event of equipment failure. A complete description of system options for all Collins FM transmitters will be found at the end of this section.

Before Collins transmitters are shipped to a customer, they are set up on the exact frequency that will be used in operation, and lab-tested at full rated power for extended periods of time under every conceivable operating condition. After determining that the unit satisfies every stringent Collins standard, it is shipped to the installation site, complete with all test data and instructions for installation.

# FM Transmitters

## 831H- 2/2C Specifications

Output Power	831H-2C: 50 kW 831H-2: 40 kW
Output Impedance	50 ohms, vswr 2:1, maximum
Frequency Range	88 to 108 MHz
Frequency Stability	$\pm 500$ Hz ( $\pm 100$ Hz, typical)
Modulation Capability	$\pm 150$ kHz
Audio Input Level	10 dB mW $\pm 2$ dB
Audio Frequency Response	$\pm 1$ dB of preemphasis curve
Audio Frequency Distortion	0.25% maximum monaural; 0.5% maximum stereo; 50 to 15,000 Hz
Stereo Separation	50 to 15,000 Hz, 35 dB minimum (40 dB or more typical)
Harmonic Attenuation	80 dB, minimum
FM Noise Level	65 dB below 100% modulation (70 dB typical)
AM Noise Level	55 dB rms (58 dB, typical)
Altitude	Operating 2286 m (7500 ft) at 30°C (86° F)
Power Source	200 to 250 volts ac 50/60 Hz 3-phase. Available taps on transformers are for 200, 210, 220, 230, 240 and 250 volts
Permissible Line Voltage Variation	$\pm 5$ . In addition, each phase voltage shall be within 5% of the average of all three phases
Power Requirements	Nominal 40-kW output requires 70 kVA at 0.95 pf; nominal 50-kW output requires 86 kVA at 0.95 pf
Size	175.1 cm (68-15/16") H; 363.2 cm (143") W, plus 55.8 cm (22") cabinet for control and switching panels; 73.6 cm (29") D.
Weight	From 2090 kg (4800 lb) to 2495 kg (5500 lb) depending on configuration.

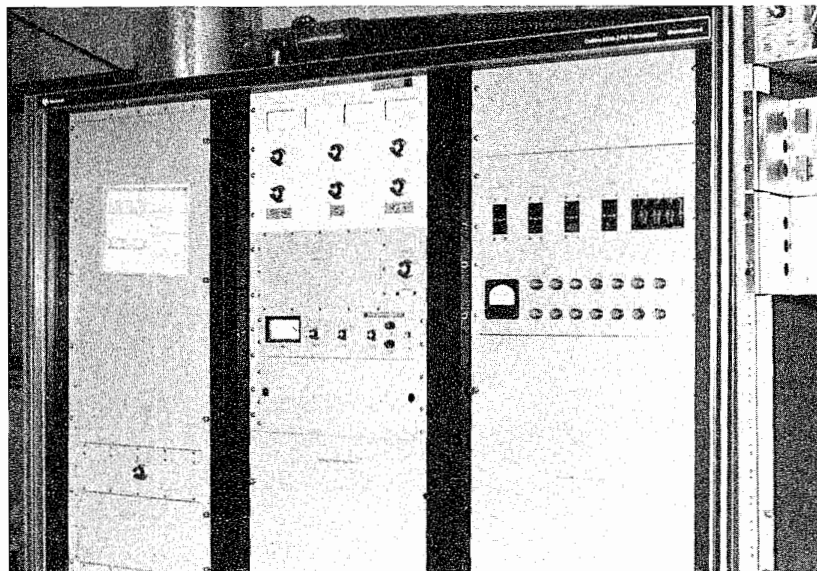

# FM Transmitters

## 377C-1

Collins 377C-1 Automatic Exciter Switcher provides monitoring and control for two 310Z-2 Phase 4 FM Exciters or similar units. If one unit fails, the 377C-1 automatically transfers the standby unit on-line.

While in the hot-standby mode, an exciter is maintained at 5 to 10 percent of normal power, thus conserving both power and equipment. When the unit is switched on the air, it comes to full power in less than 100 milliseconds. In addition, an indicator flashes to show the defective exciter, eliminating the possibility of turning off the wrong unit for servicing. Facilities included in the 377C-1 switch station monitors to the dummy load for servicing of the exciter that is not on the air.

Panel space is 8.9 cm (3-1/2 in) H, 48.3 cm (19 in) W.

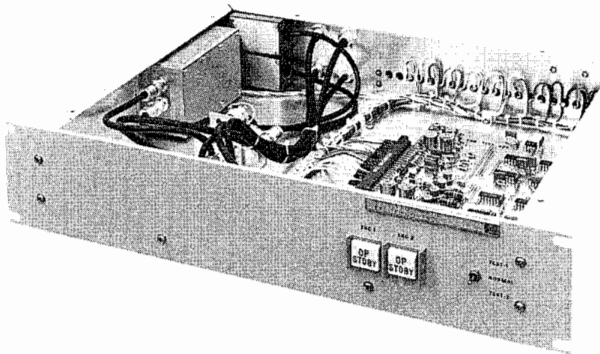

377C-1 Automatic Exciter Switcher

## Automatic Transmitter Switching Equipment

Broadcasters using the 831H FM transmitter series can realize optimum reliability and maintenance ease through addition of the optional automatic switching and control equipment. This provides switching to a hot-standby exciter in the dual configuration, or the complete isolation of a power amplifier in the case of failure or routine maintenance. These automatic switching units are completely solid-state, utilizing integrated circuits to perform the necessary logic, and light emitting diodes (LED's) for condition indicators. In addition to providing local control, the units may be remotely controlled for convenience. The combination of logic circuits and motor-driven coaxial switches gives complete and accurate switching in seconds instead of minutes, as required for manual operation. A complete interlock prevents inadvertent operation of the amplifiers into a no-load condition.

## 377D-1

Collins 377D-1 Automatic Combiner Control provides automatic or manual control of two power amplifiers and a 3-switch combiner for parallel transmitter operation. The 377D-1 automatically ensures maximum available power to the antenna at all times. If a failure occurs in either power amplifier, the unit actuates external switches so that the remaining amplifier is switched to the antenna, while the defective amplifier is switched to the dummy load. The 377D-1 provides all interlock functions for two amplifiers to ensure proper sequencing and powering up.

The 377D-1, completely solid-state, utilizes integrated circuits to provide the reliable digital control that this unit offers. To provide an indication of the several available modes of operation, a series of red and green light emitting diodes are used in the form of a flow chart on the front panel. At a glance, the engineer can identify the transmitter on-line, and the path taken by the RF to get to the antenna. In the event of total power failure, an internal ni-cad battery supply across the dc power supply ensures that the logic circuits remember the system operating mode, thus making return to the air as simple as possible.

# FM Transmitters

In actual operation, the 377D-1 monitors the outputs of two independent power amplifiers continuously. In the event of outright failure of either amplifier, the 377D-1 automatically initiates a transfer command to place the other amplifier directly on the air, bypassing the combiner. Time delay between failure and automatic transfer initiation is adjustable from 1 second to several minutes.

Logic circuitry generates the command signal that is routed to both the proper switching elements, and a logic comparison system. Before ac power is applied to the coaxial switches, two RF sensing gates must be opened, denoting that there is no RF present on the switches. This process is accelerated by supplying a muting pulse to the exciter in use, and by opening the power amplifier interlock circuits. When complete shut-down is confirmed by the RF gates, ac power is applied to the coaxial switches. When the switches have transferred to their assigned positions, interlock readback logic is compared to the preprogrammed logic for the selected mode, and the proper amplifier or amplifiers are returned to the air. The defective power amplifier is automatically placed on the dummy load for servicing. Its interlock circuits are opened until the dummy load air or water flow interlock is closed.

Panel size is 14.0 cm (5-½ in) H, 48.3 cm (19 in) W.

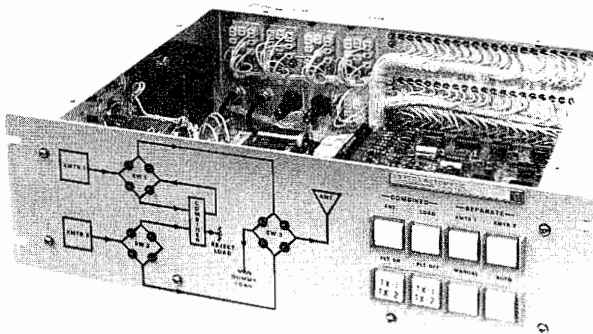

377D-1 Automatic Combiner Control

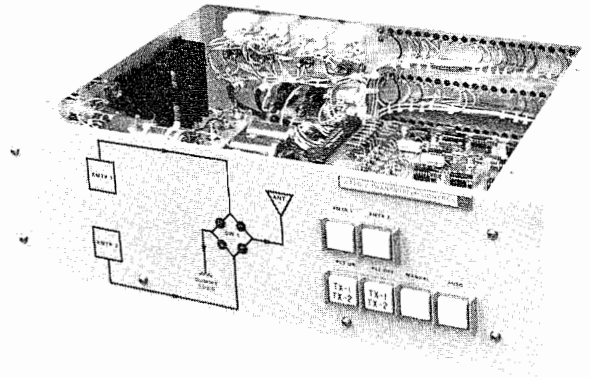

377D-2 Automatic Transmitter Switcher

## 377D-2

Collins 377D-2 Automatic Transmitter Switcher is similar to the 377D-1, except that it is designed to control two transmitters in an alternate/main or hot-standby configuration. The LED flow chart shows RF routing to an antenna system and a dummy load. As in the 377D-1, the 377D-2 has a ni-cad power supply across the dc lines to hold memory during a primary power outage. Front panel controls include transmitter 1, transmitter 2, plate on, plate off, manual, automatic.

The 377D-2, designed to be used with any two AM or FM transmitters of any power level, occupies 14 cm (5¼ in.) of rack space and has standard BNC connectors on the back for RF, and barrier strips for control connections. When placing an order, specify whether the 377D-2 is to be used in AM or FM application.

# FM Transmitters

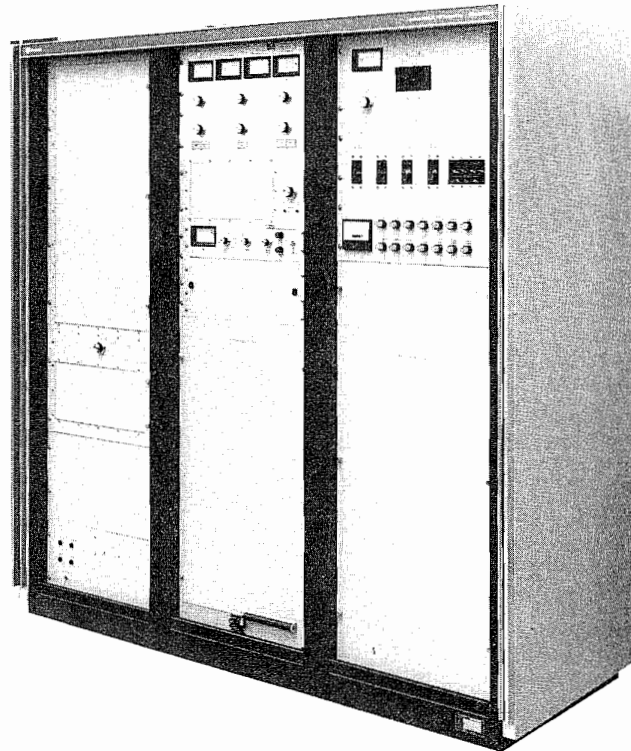

831G-2C FM  
Transmitter

## 831G-2/2C FM Transmitters

The 831G FM transmitter series is offered in two configurations: 20 kW and 25 kW. This transmitter line is the basic equipment used to provide the various high power transmitters that Collins offers. All of the benefits and automatic features offered in the 831H transmitter line are present in the 831G line in addition to the following operational advantages.

The 831G-2/2C transmitters have only three tubes; two in the driver, one in the final. The entire transmitter is contained in one 3-bay cabinet that lends itself to restricted space, and ease of maintenance. A high-Q final cavity and efficient self-contained low-pass filter provide attenuation of harmonics that is far below FCC regulations. The all front panel tuning and control functions simplify operation and maintenance. The control panel may be removed from the transmitter and located up to 15.2 m (50 ft) from the unit (cable extra cost).

As in all Collins FM transmitters, the 831G series uses the Collins 310Z-2 Phase 4 FM Exciter to provide a signal that is second to none for quality and reliability. This all solid-state exciter, added to the proven quality of the 831G-2 or 831G-2C Power Amplifier, offers the broadcaster unparalleled savings in operation costs.

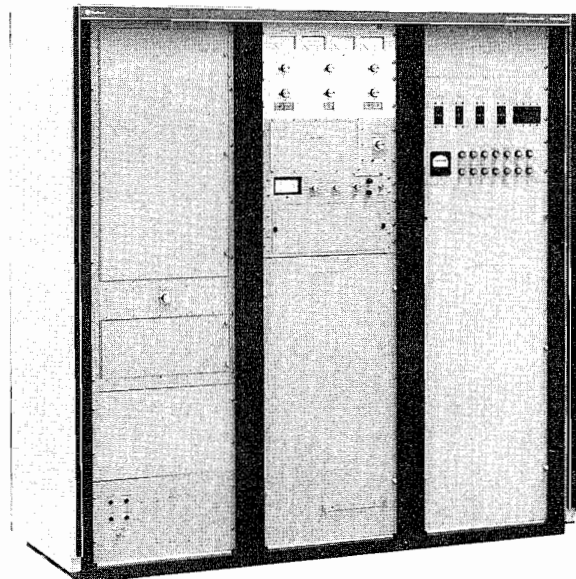

831G-2 FM Transmitter

# FM Transmitters

## 831G-2/2C Specifications

Output Power	831G-2, 20 kW 831G-2C 25 kW
Frequency Range	88 to 108 MHz
Output Impedance	50 ohms, vswr 2:1, maximum
Frequency Stability	±500 Hz (typical ±100 Hz)
Modulation Capability	±150 kHz
Audio Input Level	10 dB mW ±2 dB
Audio Frequency Response	±1 dB of standard preemphasis curve
Audio Frequency Distortion	0.25% maximum monaural 0.5% maximum stereo
Stereo Separation	50 to 15,000 Hz, 35 dB minimum, (40 dB or more typical)
Harmonic Attenuation	-80 dB minimum
FM Noise Level	65 dB below 100% modulation (70 dB typical)
AM Noise Level	55 dB rms (58 dB, typical)
Altitude	Operating 2286 m (7500 ft) at 30° C (86° F)
Power Source	200 to 250 volts ac 50/60 Hz, 3-phase. Available taps of trans- formers are 200, 210, 220, 230, 240, and 250 volts
Permissible Line Voltage Variation	±5%. Each phase voltage shall be within 5% of the average of all three phases
Power Requirements	831G-2, 35 kVA at 0.95 pf 831G-2C, 43 kVA at 0.95 pf
Size	175.1 cm (68-15/16")H; 81.6 cm (71-1/2")W; 69.8 cm (27-1/2")D
Weight	1088 kg (2400 lb)—831G-2 1179 kg (2600 lb)—831G-2C

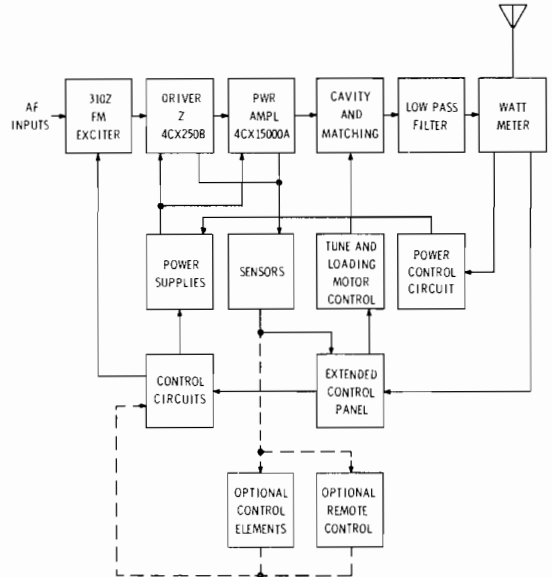

831G Block Diagram

831G-Control Panel

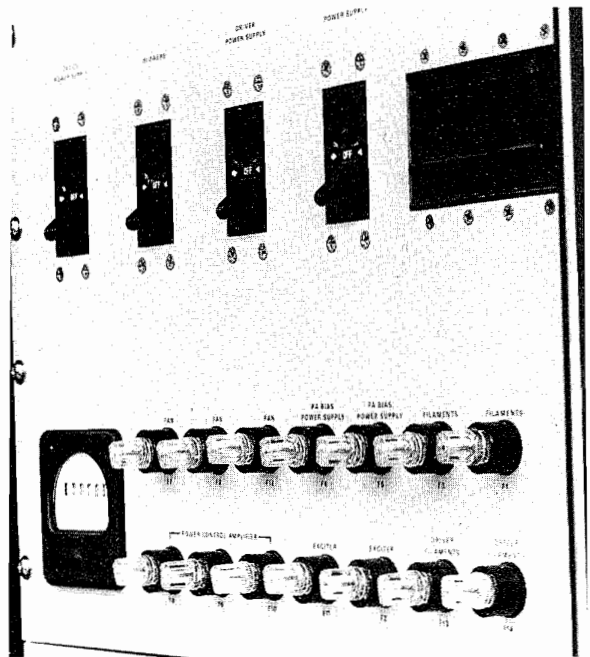
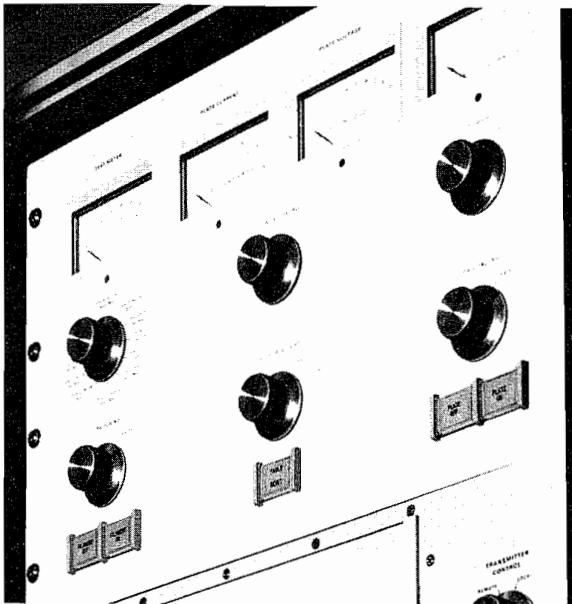

831G-Circuit Breaker Panel

# FM Transmitters

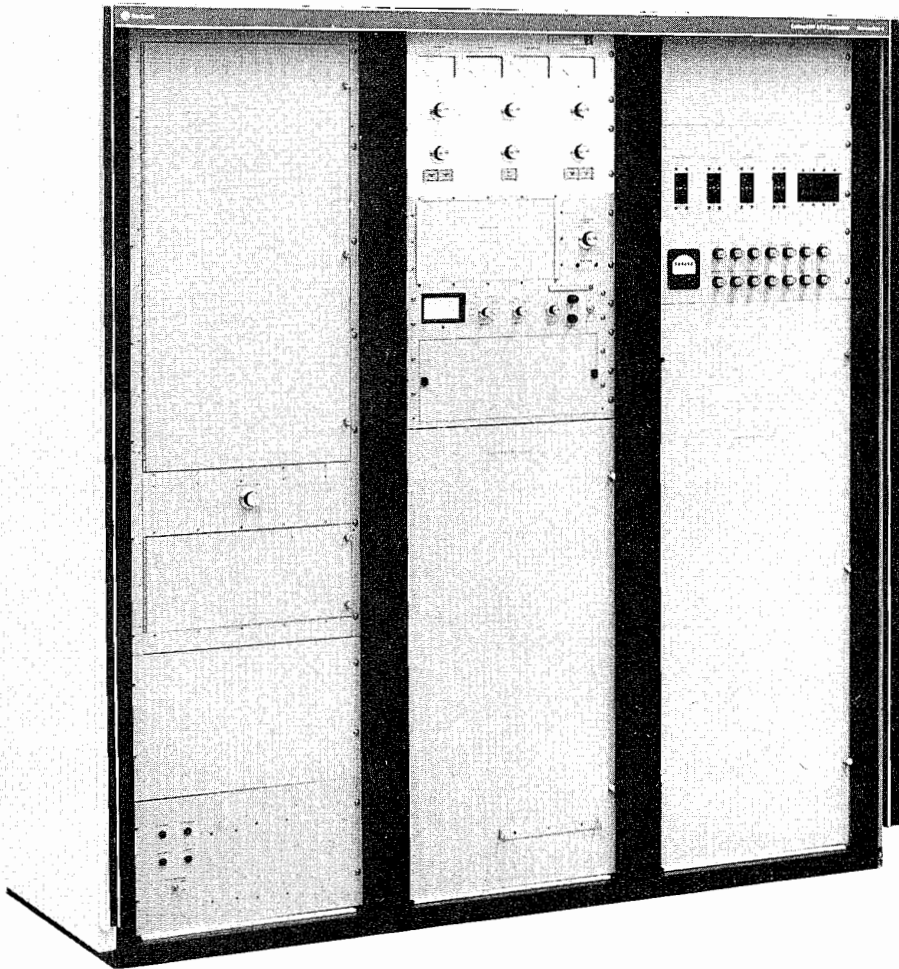

831F-2 FM Transmitter

## 831F-2 FM Transmitters

Collins 831F-2 10-kW FM Transmitter, through sound design concepts and state-of-the-art components and methods, provides the same low cost operation as the high power 831G series. The same modular construction and vertical component placement simplify routine maintenance procedures. As in Collins other lines, the 10-kW 831F-2 FM Transmitter utilizes Collins 310Z-2 Phase 4 solid-state exciter for a sound as clean and distortion-free as a live performance.

Automatic power output control is a standard feature, as well as automatic filament voltage regulation to within 2 percent. Another automatic function is the overload recycling and fault indicator system. In the event of a failure, whether internal or external, the automatic recycle function will attempt to put the transmitter back on the air. After a predetermined number of tries, the recycle function will cease to operate, thus protecting the transmitter system components.

The transmitter is completely assembled and tested on the customer's frequency and power level to ensure rapid installation and troublefree operation over a long time span. A complete set of test data is supplied, showing all the operating parameters of the specific transmitter received. Since Collins entire transmitter line is designed to exceed FCC minimums, future concern about obsolescence is minimized.

The 831F-2 has only two tubes, a 4CX250B driver, and a 4CX5000A power amplifier operating at Class C. Neutralizing provides stable operation and tuning ease. A completely solid-state power supply ensures long life and steady performance.

# FM Transmitters

## 831F-2 Specifications

Output Power	10 kW
Output Impedance	50 ohms, vswr 2:1, maximum
Frequency Range	88 to 108 MHz
Frequency Stability	$\pm 500$ Hz (typical $\pm 100$ Hz)
Modulation Capability	$\pm 150$ kHz
Audio Input Level	10 dB mW $\pm 2$ dB
Audio Frequency Response	$\pm 1$ dB at preemphasis curve
Audio Frequency Distortion	0.25% maximum monaural; 0.5% maximum stereo
Stereo Separation	35 dB, minimum, 50 to 15,000 Hz (40 dB or more typical)
Harmonic Attenuation	-80 dB, minimum
FM Noise Level	65 dB below 100% modulation (70 dB, typical)
AM Noise Level	-55 dB rms (-58 dB, typical)
Altitude	Operating 2286 m (7500 ft) at 30°C (86°F). Nonoperating 3048 m (10,000 ft)
Power Source	200 to 250 volts ac 50/60 Hz 3-phase. Available taps on transformers are for 200, 210, 220, 230, 240, and 250 volts
Permissible Line Voltage Variation	$\pm 5\%$ . In addition, each phase voltage shall be within 5% of the average of all three phases
Power Requirements	Nominal 10-kW output requires 21 kVA at 0.95 pf
Size	175.1 cm (68-15/16") H; 181.6 cm (71 1/2") W; 69.8 cm (27 1/2") D
Weight	1025 kg (2300 lb)
831F-2	FM Transmitter, 10 kW

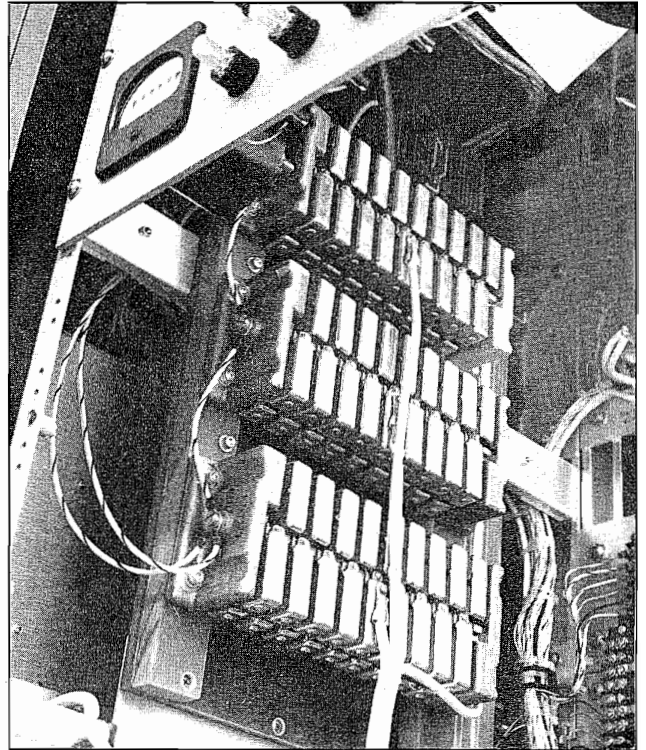

831F-2 Rectifier Stack



# FM Transmitters

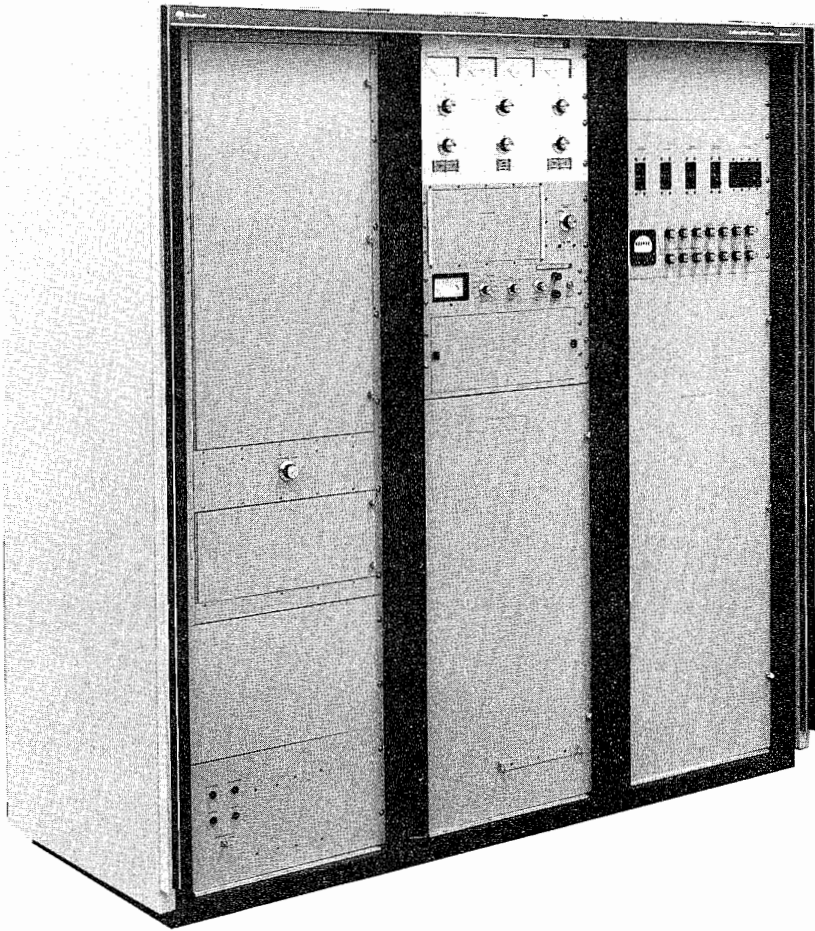

831E-2 FM Transmitter

## 831E-2 FM Transmitter

Collins 831E-2 5-kW FM Transmitter is similar in construction to the 831F-2 10-kW FM Transmitter. Physically identical to the higher power transmitters previously described except for power supply components, the 831E-2 uses Collins 310Z-2 Phase 4 solid-state exciter to supply the RF signal to the transmitter. At that point, it is amplified by a 4CX250B driver and a neutralized 4CX5000A tetrode operating in Class C. Because of the method of neutralization, tuning and output adjustments are simple and straightforward. To promote long tube life, the filament voltage is automatically controlled within 2 percent of optimum value. Output is also controlled automatically by a servo system that maintains it within 2 percent of authorized level.

All interlocks, controls, and indicators are operated by a 28-volt dc system, eliminating problems with remote control interfacing, and providing additional safety for the operator.

Filament and plate controls are located on the front panel, with a built-in 120-second delay in the plate circuit to provide for the tube warmup. Overload sensors in both the driver and final amplifier monitor transmitter operation, and fault indicators pinpoint trouble areas, easing maintenance efforts. If a fault occurs, an automatic recycle system will attempt to restart the transmitter either two or four times in a 30-second period, as set by the station engineer.

As in all other Collins FM transmitters, the 831E-2 features vertical component placement, and removable panels for maintenance ease. Also, when necessary, the control panel may be removed and located up to 15.2 m (50 ft) from the transmitter, solving installation problems and providing operation according to FCC regulations (added cable extra cost).

# FM Transmitters

## 831E-2 Specifications

Output Power	831E-2: 5 kW
Output Impedance	50 ohms, vswr 2:1, maximum
Frequency Range	88 to 108 MHz
Frequency Stability	$\pm 500$ dB, $\pm 500$ Hz
Modulation Capability	$\pm 150$ kHz
Audio Input Level	10 dB mW $\pm 2$ dB
Audio Frequency Response	$\pm 1$ dB of preemphasis curve
Audio Frequency Distortion	0.25% maximum monaural; 0.5% maximum stereo
Stereo Separation	35 dB, minimum, 50 to 15,000 Hz (40 dB or more typical)
Harmonic Attenuation	-80 dB, minimum
FM Noise Level	65 dB below 100% modulation (70 dB, typical)
AM Noise Level	-55 dB rms (-58 dB, typical)
Altitude	Operating 2286 m (7500 ft) at 30°C (86°F) Nonoperating 3048 m (10,000 ft)
Power Source	200 to 250 volts ac 50/60 Hz 3-phase. Available taps on transformers are for 200, 210, 220, 230, 240, and 250 volts
Permissible Line Voltage Variation	$\pm 5\%$ . In addition, each phase voltage shall be within 5% of the average of all three phases.
Power Requirements	Nominal 5-kW output requires 14 kVA at 0.95 pf
Size	175.1 cm (68-15/16") H; 181.6 cm (71 1/2") W; 69.8 cm (27 1/2") D.
Weight	1025 kg (2300 lb)
831E-2	FM Transmitter, 5 kW

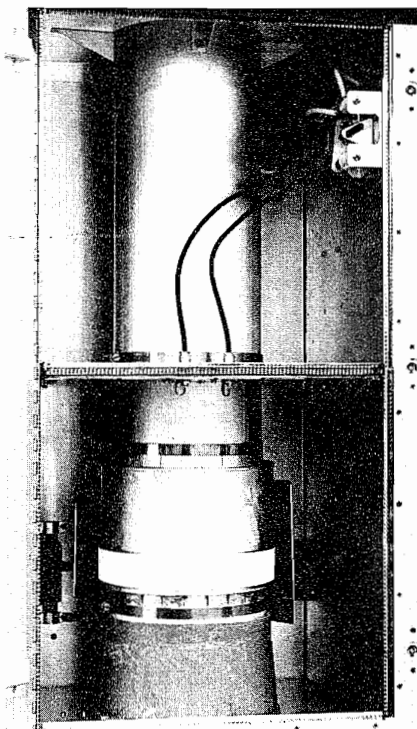

831E Cavity

# FM Transmitters

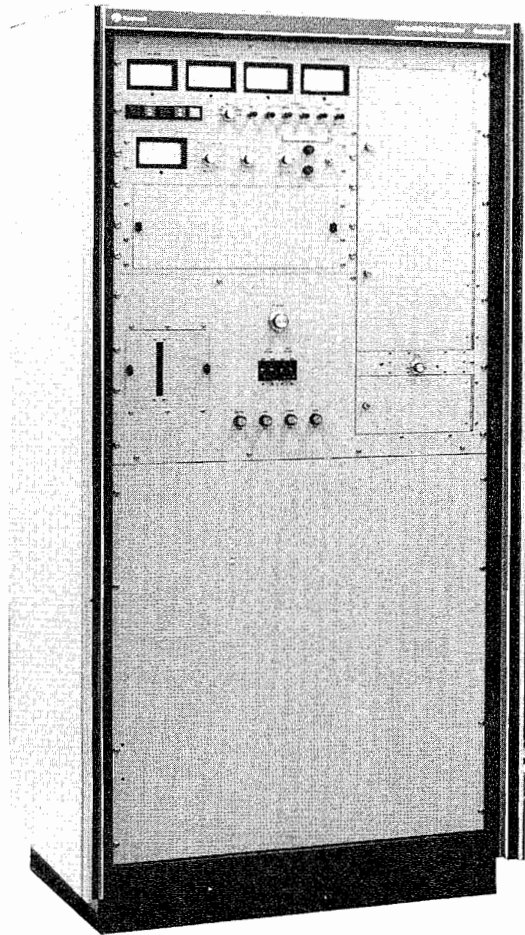

831D-2

## 831D-2 2.5-kW FM Transmitter

The 831D-2 2.5-kW FM Transmitter is housed in a single 91.4-cm (35 in.) wide space saving cabinet, yet provides excellent accessibility to all components for servicing. This all-new design features a complete solid-state transmitter except for the single 5CX1500A tube of the final amplifier. The 831D-2 uses IC logic for its control functions and incorporates a computer-like memory to restart the transmitter after a power failure, eliminating the need for periodic checks of the power source. A built-in battery supply and charger enables the logic circuits to remember their state in the event of a power interruption. As with all of the new Generation 4 transmitter line, the 831D-2 incorporates the 310Z-2 Phase 4 FM exciter with total harmonic distortion less than 0.25 percent in the monaural mode and 0.5 percent in the stereo mode of operation. Filament voltage regulation and automatic power control features are incorporated in this transmitter as standard items. Additional options such as remote control and automatic overload/recycle are available for the 831D-2.

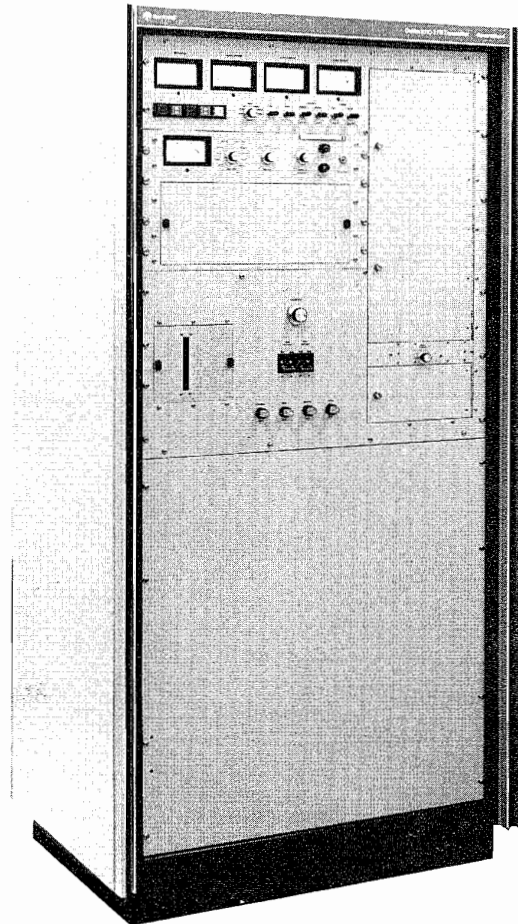

831C-2

## 831C-2 1-kW FM Transmitter

The 831C-2 1-kW FM Transmitter is identical in physical and electrical specifications to type 831D-2 except for the specifications as noted and power components within the transmitter.

# FM Transmitters

## 831D-2 Specifications

Output Power ..... 2.5 kW  
 Frequency Range ..... 88 to 108 MHz  
 Output Impedance ..... 50 ohms, vswr 2:1 maximum  
 Frequency Stability .....  $\pm 500$  Hz (typical  $\pm 100$  Hz)  
 Modulation Capability .....  $\pm 150$  kHz  
 Audio Input Level ..... 10 dB mW  $\pm 2$  dB  
 Audio Frequency Response .....  $\pm 1$  dB of preemphasis curve  
 Audio Frequency Distortion ..... 0.25% maximum monaural; 0.5% maximum stereo  
 Stereo Separation ..... 50 Hz to 15,000 Hz 35 dB minimum (typical 40 dB or more)  
 Harmonic Attenuation ..... -80 dB  
 FM Noise Level ..... 65 dB below 100% modulation (70 dB, typical)  
 AM Noise Level ..... -55 dB rms (-60 dB, typical)  
 Altitude ..... Operating 2286 m (7500 ft)  
 Power Source ..... 200-250 V, single phase, 50/60 Hz  
 Power Requirements ..... 4.9 kVA at 0.97 pf  
 Permissible Line Voltage Variation .....  $\pm 5\%$   
 Size ..... 175 cm (69")H, 89 cm (35")W, 61 cm (24")D  
 Weight ..... 340 kg (750 lb)

## 831C-2 Specifications

Output Power ..... 1 kW  
 Power Requirements ..... 2.0 kW 0.97 pf  
 Weight ..... 318 kg (700 lb)

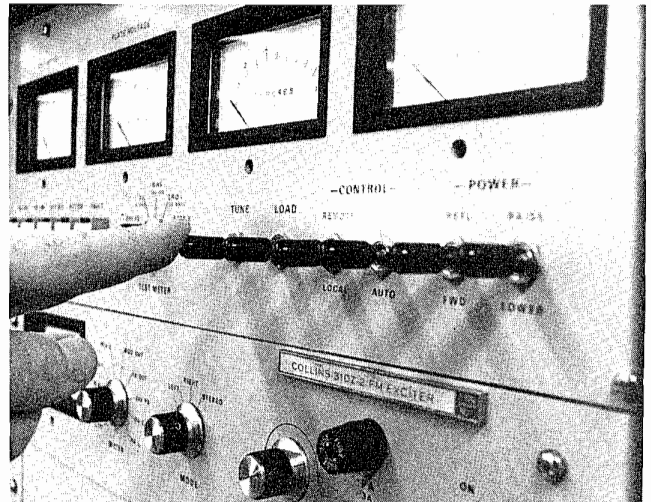

831D/C-2 Controls

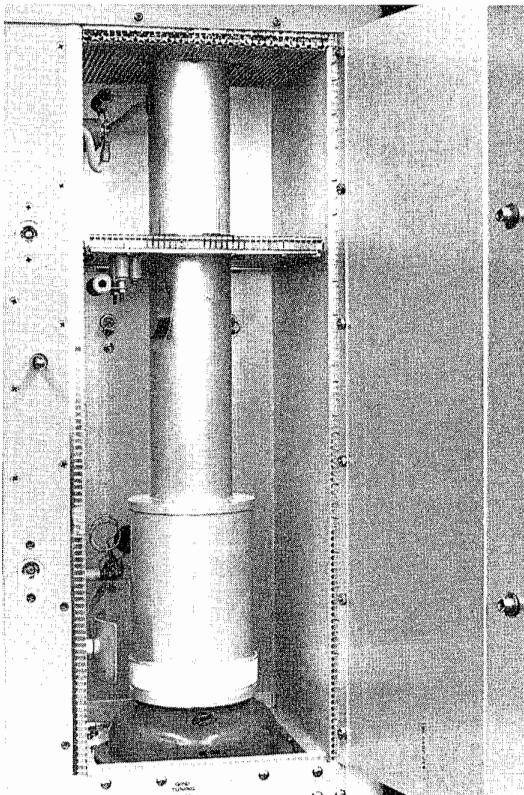

831D-2 Cavity

# FM Transmitters

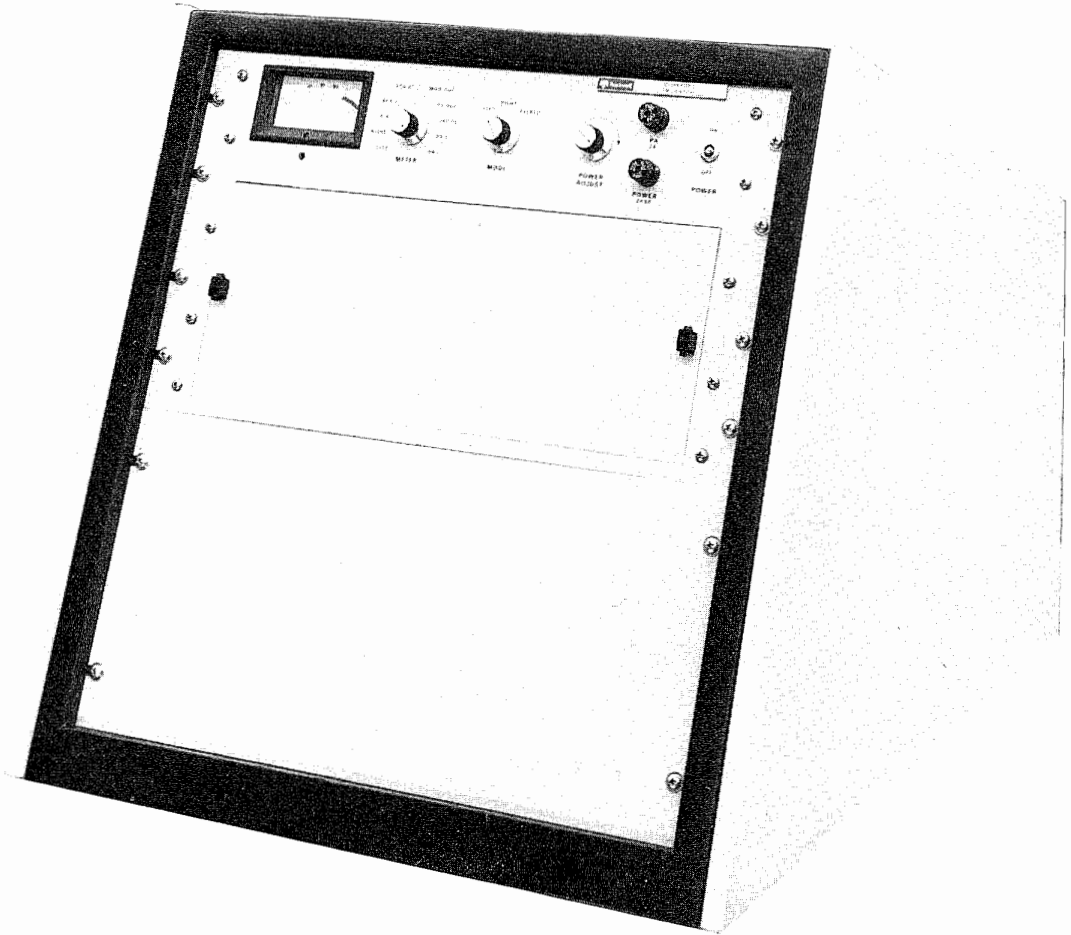

831A-2 Desk Mounted

## 831A-2 10-Watt FM Educational Transmitter

The 831A-2 10 Watt FM Transmitter employs the use of type 310Z-2 Phase 4 FM Exciter as its basic unit. All of the electrical specifications of this transmitter are the same as the 310Z-2. Thus a low power station can compete quality-wise with the surrounding commercial stations. The unit is available for standard rack mounting or housed in a cabinet for desk-top mounting. The 786V-1 Stereo Generator, 786W-2 SCA Generator and 785E-1 STL Interface are all available options for the 831A-2 transmitter. A built-in harmonic filter is supplied as a standard item.

# FM Transmitters

## 831A-2 Specifications

Ambient Temperature Range	... 0 to 55° C (32° to 131° F)
Ambient Humidity Range	..... up to 95%
Maximum Altitude	..... 2300 m (7500 ft)
Power Source	..... 117/234 Vac $\pm$ 10%, 50/60 Hz, single phase
RF Power Output	..... 10 W
Operating Range	..... 88 to 108 MHz
Output Impedance	..... 50 to 70 ohms, unbalanced
Carrier Frequency Stability	..... $\pm$ 500 Hz ( $\pm$ 100 Hz, typical)
Harmonic Radiation	..... more than 53 dB below unmod- ulated carrier
Type of Modulation	..... Direct frequency modulation
Modulating Frequencies	..... 20 Hz to 100 kHz
Audio Input Level	..... 10 $\pm$ 2 dB mW
FM Noise Level	..... 65 dB below 100% modulation (70 dB, typical)
AM Noise Level	..... 55 dB below carrier level (70 dB, typical)
Distortion	..... 0.25% total harmonic-distortion monaural (typical 0.1%) 0.5% total harmonic-distortion stereo (typical 0.25%)

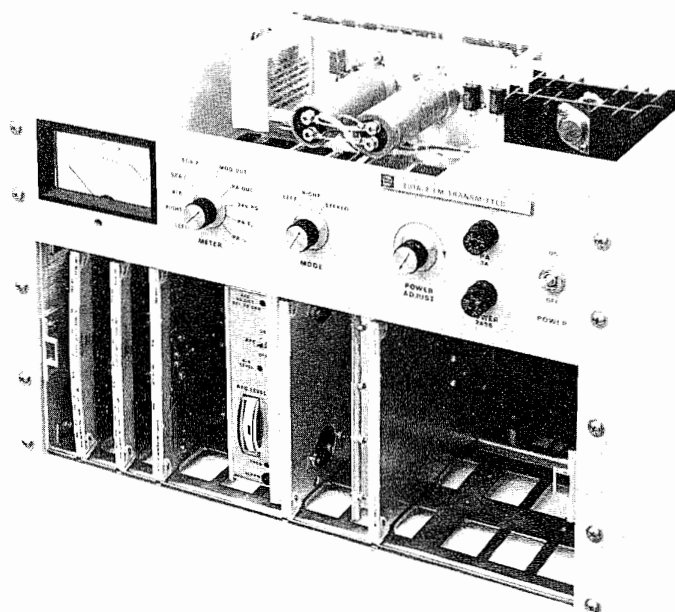

831A-2 Rack Mounted with covers removed

# FM Transmitters

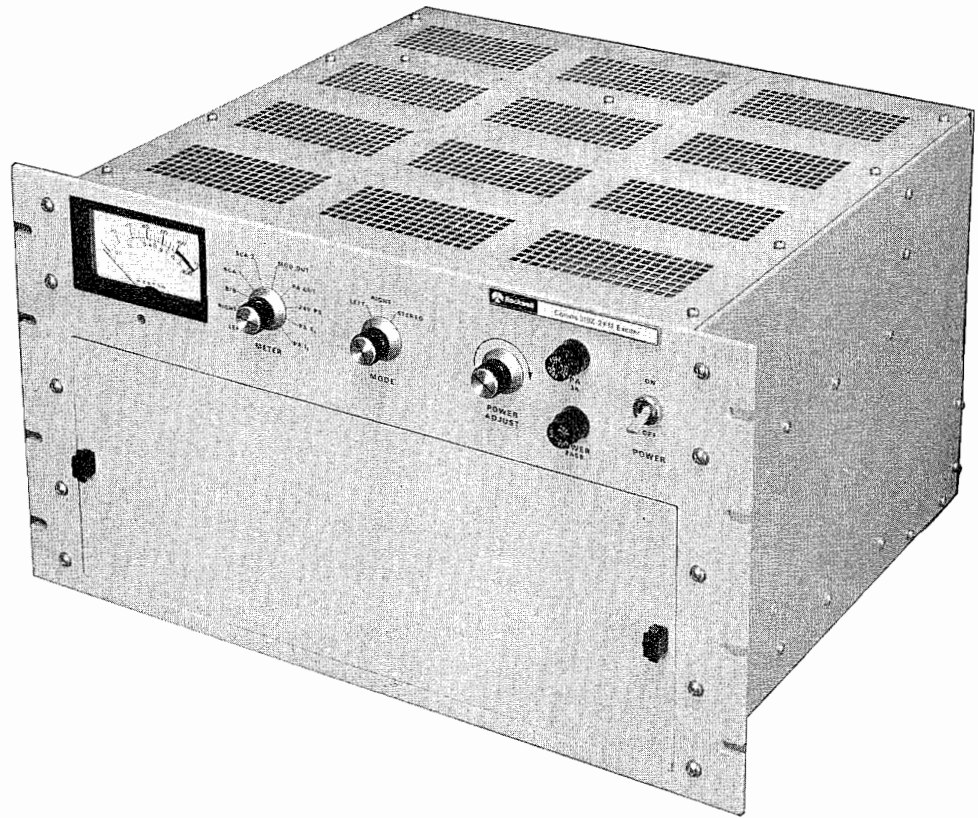

310Z-2 Phase 4 FM Exciter

## 310Z-2 Phase 4 FM Exciter

The exceptional 310Z-2 Phase 4 FM Exciter has rapidly become the standard of the industry. The 310Z-2 Phase 4 FM Exciter is the heart of all Collins new Generation 4 transmitters and can be used as a replacement driver for all existing FM transmitters that require an on-frequency driving source of not more than 20 watts. The unusually clean sound of the Phase 4 exciter can be attributed largely to the low inter-modulation distortion capability of this exciter. The Phase 4 exciter carries a guaranteed IM distortion figure of less than 0.5 percent in the stereo mode and less than 0.25 percent in the monaural mode of operation.

A direct FM exciter that employs a phase-locked loop AFC to provide frequency stability of better than  $\pm 500$  Hz ( $\pm 100$  Hz typical), the Phase 4 exciter has complete metering facilities on the front panel. Servicing is facilitated by plug-in modules, all accessible from the front of the unit. The 786V-1 Stereo Generator, 786W-2 SCA Generator, and 785E-1 STL Interface are plug-in options to the 310Z-2 Phase 4 FM Exciter. The 785E-1 is substituted for the 786V-1 Stereo Generator when a composite STL signal is used and the stereo generator is located at the studio site; it also provides an interface between other modes of operation such as quadraphonic.

# FM Transmitters

## 310Z-2 Phase 4 FM Specifications

Ambient Temperature Range . . . 0 to 55°C (32° to 131° F)  
 Ambient Humidity Range . . . . . Up to 95%  
 Maximum Altitude . . . . . 2300 m (7500 ft)  
 Input Power . . . . . 117/234 V ac  $\pm$ 10%, 50/60 Hz,  
 single phase  
 RF Power Output . . . . . 3 to 20 watts  
 Operating Range . . . . . 88 to 108 MHz  
 Output Impedance . . . . . 50 to 70 ohms, unbalanced  
 Carrier Frequency Stability . . . .  $\pm$ 500 Hz, with ac line voltage  
 $\pm$ 10% ( $\pm$ 100 Hz typical) and  
 temperature 0 to 50°C (32° to  
 131° F)

### Harmonic and Spurious

Radiation . . . . . 30 dB below level of unmodulated  
 carrier for frequency removed  
 from carrier by between 120 and  
 240 kHz  
 35 dB below level of unmodulated  
 carrier for frequency removed  
 from carrier by between 240 and  
 600 kHz  
 80 dB below level of unmodulated  
 carrier beyond 600 kHz

Type of Modulation . . . . . Direct frequency modulation  
 Modulating Frequencies . . . . . 20 Hz to 100 kHz  
 Modulation Capability . . . . .  $\pm$ 150 kHz  
 FM Noise Level . . . . . 65 dB below 100% modulation  
 (70 dB, typical)  
 AM Noise Level . . . . . 55 dB below carrier level (70 dB,  
 typical)

## Monaural FM Specifications

Modulating Frequencies . . . . . 20 Hz to 100 kHz  
 Audio Input Level . . . . . +10  $\pm$ 2 dB mW for 100% mod-  
 ulation  
 Frequency Response . . . . . Standard 75-microsecond pre-  
 emphasis, other optional  
 Distortion . . . . . Not more than 0.25% total har-  
 monic distortion (typical 0.1%)  
 Not more than 0.25% intermodu-  
 lation distortion (typical 0.1%)

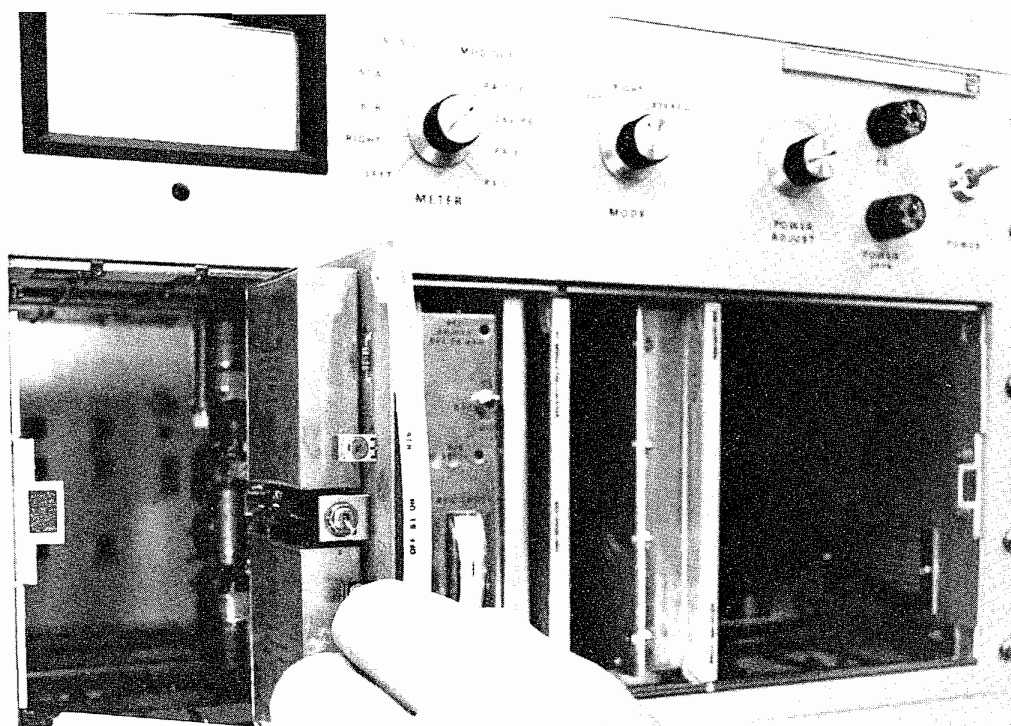

Interior of 310Z Exciter



# FM Transmitters

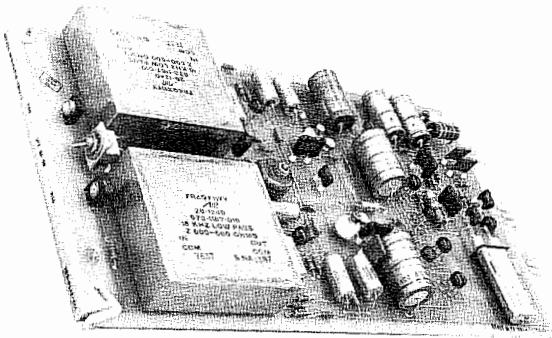

786V-1 Stereo Generator

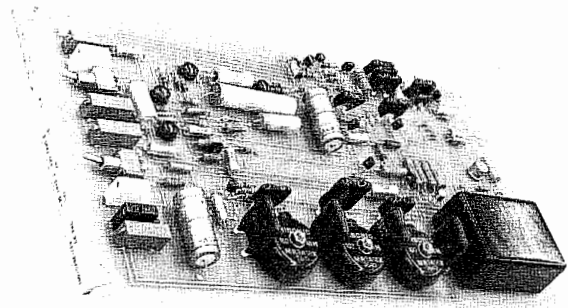

786W-2 SCA Generator

## 786V-1 Stereo Generator

The 786V-1 Stereo Generator performs the conversion of the stereophonic input signals to an output that conforms to the standards approved by the FCC for transmission of stereophonic signals. To provide a realistic stereo effect, the 786V-1 maintains the difference in time delay and signal amplitude from the sound source to both the right and left channels through the entire stereo system. Channel separation, which is the isolation between the two channels, is held to greater than 35 dB (40 dB or more is typical) by the 786V-1 to enhance the stereo effect to the listener. This unit is a plug-in option to the 310Z-2 Phase 4 FM Exciter.

## 786W-2 SCA Generator

The 786W-2 SCA Generator amplifies the SCA audio input and frequency-modulates a 67-kHz or 41-kHz subcarrier oscillator. Signals from the 786W-2 SCA Generator become part of the audio baseband signal that is used to modulate the carrier. The subcarrier oscillator is a free-running multivibrator, which generates a 67-kHz or 41-kHz center frequency that is frequency modulated by the SCA audio input signal. During normal stereo broadcast operation, modulation is limited to  $\pm 3.5$ -kHz deviation to avoid interference with frequencies in the baseband signal. During monophonic broadcasts,  $\pm 7.5$ -kHz deviation is used. The modulation output from the oscillator is filtered to remove unwanted harmonics. This unit is a plug-in option to the 310Z-2 Phase 4 FM Exciter.

# FM Transmitters

## 786V-1 Specifications

Audio Impedance	600 ohms, balanced
Audio Input Level	10 ±2 dB mW for 100% modulation
Frequency Response	Standard 75-microsecond pre-emphasis for both right and left channels; others optional
Distortion	Less than 0.5% total harmonic distortion for 50 Hz to 15 KHz audio modulation (typical 0.25%); less than 0.5% intermodulation distortion for 50 Hz to 15 kHz (typical 0.25%)
Stereo Channel Separation	At least 35 dB, 50 Hz to 15 kHz (40 dB or more typical)
Crosstalk	At least 45 dB below either single channel level (main to subcarrier and subcarrier to main; typical 50 dB)
38-kHz Suppression	45 dB below 90% modulation of the main carrier (typical 55 dB)
19 kHz Frequency Stability	±2 Hz
Pilot Carrier Level	Adjustable from 0 to 12% modulation of main carrier
SCA	
Audio Level	-10 to 15 dB mW
Injection Level	0 to 10% adjustable
Frequency	67 kHz only
FM Noise Level	
Left Channel	65 dB below 100% modulation (68 dB, typical)
Right Channel	65 dB below 100% modulation (68 dB, typical)
AM Noise Level	55 dB below carrier (typical 70 dB)

## 786W-2 Specifications

Audio Impedance	600 ohms, balanced
Audio Input Level	-10 to +15 dB mW, adjustable from 0 to 10% modulation
SCA Center Frequency	67 kHz or 41 kHz (monaural only); 67 kHz stereo
SCA Frequency Stability	±0.5% (335 Hz at 67 kHz, 205 Hz at 41 Hz)
Frequency Response	Standard 150-microsecond pre-emphasis
FM Noise Level	Less than -55 dB (typical 60 dB)
Distortion	1.0% 50 Hz to 5.0 kHz with 4.0-kHz deviation
Crosstalk	From main channel and stereo subchannel into SCA channel at least 50 dB below 10% modulation of the main channel; reference 4.0-kHz SCA deviation. Crosstalk from 67-kHz SCA into stereo subchannel at least 60 dB below 100% modulation of main channel (5 ±4-kHz tone deviation)
SCA Filtering	
Audio Input	50 to 5000 Hz low-pass filter
67/41 - kHz Output	Bandpass filter centered around output frequency

## 785E-1 STL Interface Card

The 785E-1 STL Interface Card provides an interface between commonly used composite STL systems or other operating modes such as quadrasonic operation requiring an external baseband input to the modulator. The 785E-1 provides input processing and the necessary gain and phase linearity to accommodate these systems. A bridging input of approximately 4700 ohms is provided in a differential input configuration to avoid any degradation of signal-to-noise ratio through ground loops. An adjustable common mode rejection control is provided to minimize hum. A high-frequency phase adjustment is provided to compensate for minor phase degradation at high frequencies because of receiver and transmitter bandwidth limitation. This unit is a plug-in option to the 310Z-2 Phase 4 FM Exciter.

## 785E-1 Specifications (Composite Stereo STL)

External Baseband Input	3.5 V p-p into 4700 ohms when used with the 785E-1 STL Interface Card
External Telemetry Input	1 V rms 20 to 30 Hz when used with 786W-2 SCA Generator

# AM Transmitters



# AM Transmitters

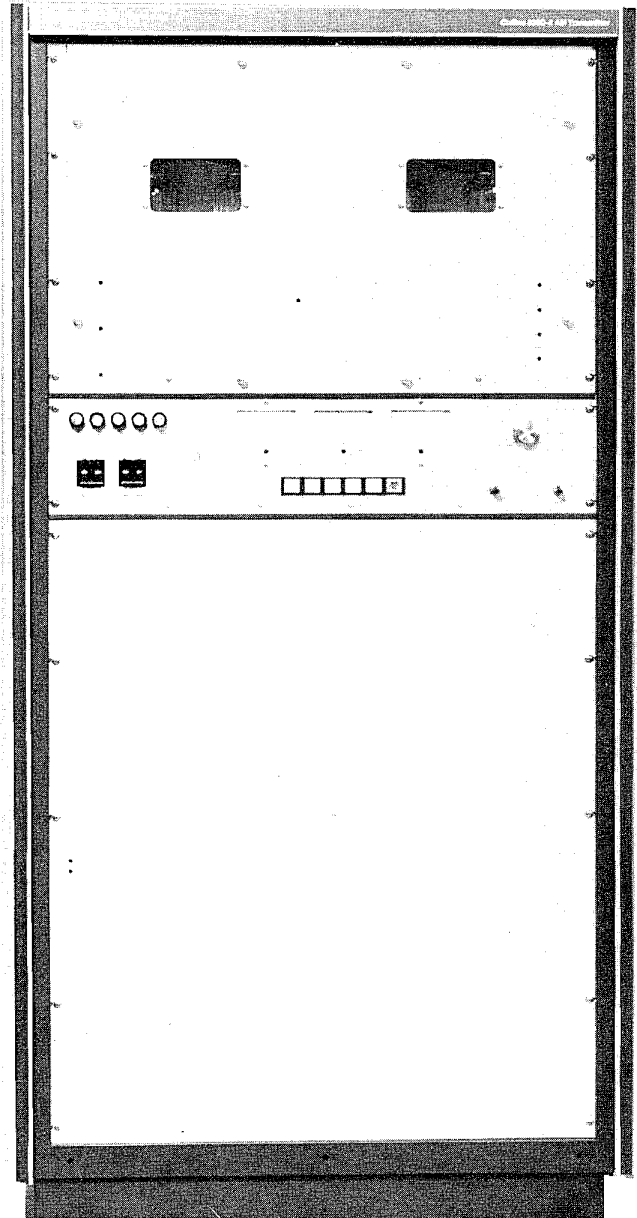

820D-2 AM Transmitter

## 820D-2 1-kW AM Transmitter

The 820D-2 1-kW AM Transmitter offers many new and innovative features to improve AM performance and reliability. By utilizing effective cost-control methods, Collins is now able to offer a transmitter, of superior design, at a lower price than ever before. In addition, the 820D-2 Transmitter performs up to specifications that used to apply to FM broadcasting only.

An all new cabinet design places every component within easy reach for maintenance. The modulator and final RF tubes are at shoulder height, making removal as troublefree as possible.

By using straightforward design concepts, Collins built a 1-kW AM transmitter that will operate efficiently for many trouble free hours. In addition, maintenance costs have been reduced by using standard components and conservative ratings.

**Exciter.** The exciter for the 820D-2 AM Transmitter consists of a dual oscillator to develop the necessary input to the RF driver. A 2-position switch enables the operator to select the oscillator that is to be used on the air. At any point in time, the other oscillator may be used, providing a ready standby in the event of failure. The frequency of both oscillators may be adjusted from the front panel. Since quartz crystals are most stable at frequencies above the broadcast band, Collins operates them in that range, and then divides them with an integrated circuit multivibrator to derive the station's frequency.

# AM Transmitters

**RF Driver.** The RF driver is completely solid-state, utilizing one 2N5039 transistor operating in Class C. To achieve the high gain necessary to drive the PA, the transistor circuit employs a common emitter configuration, driving a matching network consisting of a tuned secondary RF transformer.

**Power Amplifier.** The power amplifier is designed to deliver 1100 watts nominal output into a 50-ohm load. Two long-life 5-500A pentodes are operated in parallel Class C, and are modulated in a conventional manner by a transformer-coupled modulator. Bridge neutralization is used to reduce RF intermodulation products. Power cutback to either 500 or 250 watts is possible by reducing plate voltage. The power output of the 820D-2 is controlled automatically to within 2½ percent.

**Output Network.** Collins exclusive Q-Taper™ three-node bandpass output network is flatter over the entire bandpass range for better sideband performance than the common lowpass network used by others, giving the 820D-2 a fuller, richer and cleaner sound. This design gives sharper cutoffs and steeper skirts at each end of the bandpass for superior harmonic and spurious attenuation, plus greater cross-modulation protection caused by nearby strong signals typical in major market areas.

**Audio Driver.** Two push-pull driver stages amplify audio to drive the modulator. The relatively low voltage required by the modulator eliminates the necessity of stepping up the audio signal by means of an interstate transformer. The final stage of the audio driver is a regulated 290 V dc, ensuring ample collector swing capability. Both driver stages operate Class A, common emitter, to achieve high gain.

**Modulator.** Two 5-500A pentodes are operated Class AB<sub>1</sub> push-pull, to supply a modulating signal to the PA. Transformer coupling provides correct impedance matching, while a reactor is employed in series with the plate supply to provide a path for the dc PA plate current. This transformer is a special low distortion design. At transmitter power cutback, the modulator plate voltage is reduced simultaneously with the PA plate voltage. The modulator screens are coupled together through stabilizing resistors to the screen supply. RF bypassing is used to prevent high frequency oscillations. Modulation capability of 125 percent on positive peaks is assured, allowing high average modulation with a minimum of distortion. Use of the 5-500A pentodes lengthens tube life and reduces operating costs.

**Metering Circuits.** Individual meters are provided for measuring PA plate voltage and PA plate current. Accuracy of measurement is within 2 percent of full scale. An 8-position multimeter is also provided to meter additional parameters, including screen voltage, PA grid current, bias voltage, RF driver collector current, 28-V dc supply voltage, screen current, modulator cathode current, and the 290-volt supply voltage.

**Power Supplies.** The 28-V dc supply provides power to the control circuits, pilot lamps, and RF and audio drivers. Power to the supply is routed via the low voltage circuit breaker through a protective fuse to the transformer primary. A full wave bridge is used for rectification, while the output is filtered and regulated to reduce ripple.

820D-2 PA Compartment

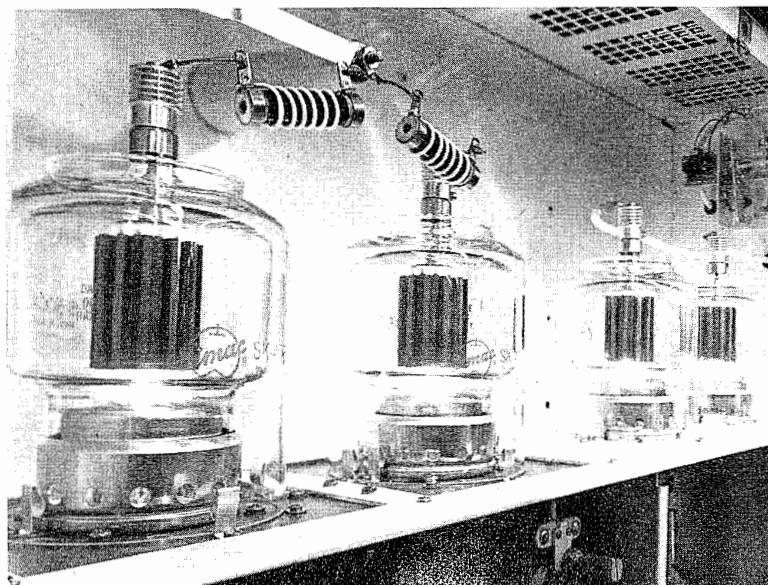

# AM Transmitters

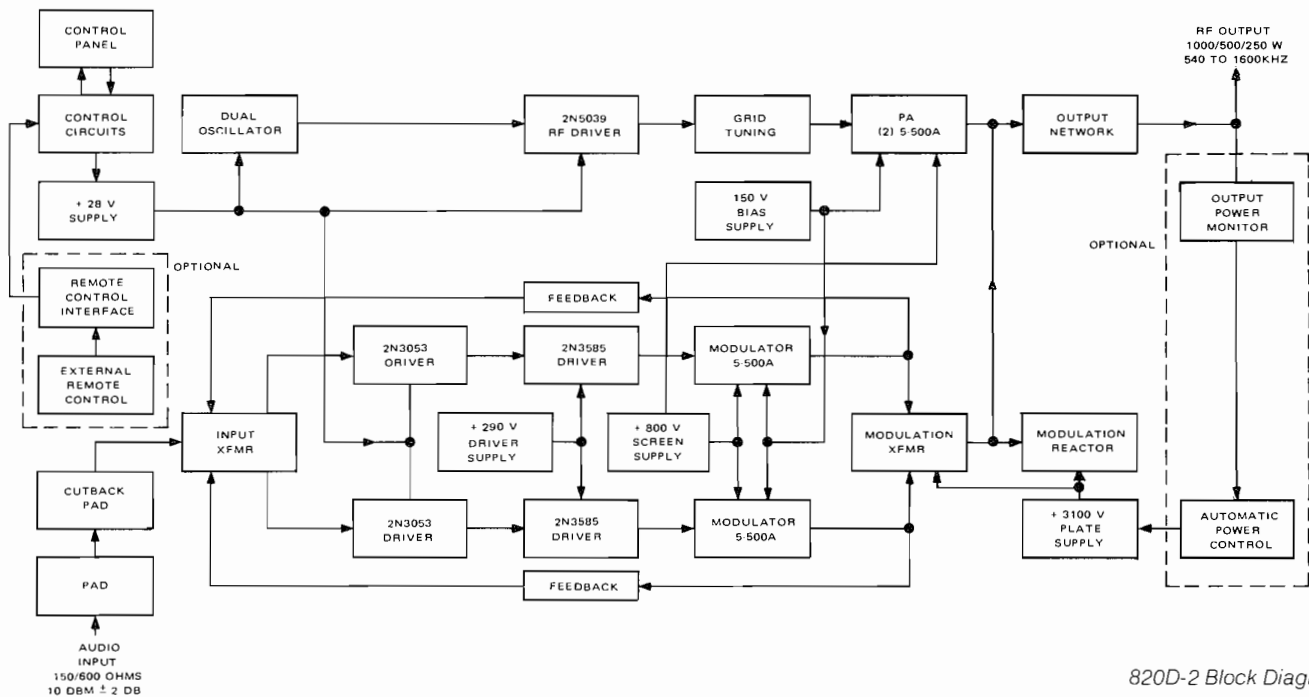

820D-2 Block Diagram

**Filament Supply.** PA and modulator filament voltages are regulated by an optional constant voltage transformer. Adjustment is provided for each pair of tubes by rheostats on the two filament transformer primaries.

**Bias Supply.** A bias voltage of  $-150$  V dc is developed for the PA and modulator control grids. Full-wave rectification and filtering follow transformer voltage conversion to the proper level. The bias supply is fed through the low voltage breaker, and is also fused for further protection.

**Audio Driver Supply.** The audio driver final stage voltage of  $290$  V dc is obtained from the screen supply.

**Screen Supply.** The screen transformer derives its power through the high voltage breaker, and is further protected by a separate fuse.

**Plate Supply.** The plate supply consists of a power transformer full-wave bridge rectifier, and filter components. The transformer is equipped with taps on the primary for switching to low power operation. Transmitter power output is adjusted by a motor-driven rheostat in the power amplifier plate supply circuit. Overload protection is provided by the high voltage breaker, and by overload relays in the power amplifier and modulator circuits.

**Control Circuits.** Control circuits have been simplified as much as possible for safety and reliability. Complete remote control facilities are designed into the transmitter for rapid interface with any remote control unit.

**Control Functions.** Five pushbutton switches are provided for transmitter control: FILAMENT OFF, FILAMENT ON, PLATE OFF, HIGH POWER ON, AND LOW POWER ON. Power change between full and reduced power is accomplished by pressing the proper button. Sequencing is completely automatic, requiring no plate deenergizing before change. Pressing the FILAMENT OFF switch powers down the entire transmitter, including the filaments and cooling air. No postoperative tube cooling is necessary.

**Overload Protection.** Excessive current in either the PA or the modulator causes a current sensitive relay to energize, removing both plate and screen voltage. Automatic recycling is included to return the transmitter to the air, while indicator lamps for both modulator and PA sections pinpoint trouble areas, and expedite troubleshooting.

**Remote Control.** The following functions may be remote controlled: Filament off, filament on, high power on, low power on, power increase/decrease, manual/auto power control, and remote failsafe. Also provided are samples of plate voltage and plate current that appear on a terminal board for remote metering.

**Accessibility.** Accessibility on the 820D-2 is among the best available today with straightforward and uncluttered component layout. Tubes are at shoulder height, easing removal and replacement. All other components are accessible by removing one front panel. The 820D-2 is truly an improved version of the 820D-1, already a leader in its class!

# AM Transmitters

## 820D-2 Specifications

RF Output	Power output capability is 1.1 kW into a 50-ohm unbalanced load. Facilities for reduced power operation are provided at either 550 or 275 watts. Other unbalanced output impedances can be supplied on special order.
Emission	Amplitude modulation (A3)
Harmonics	75 dB below carrier or better
Frequency Range	5.40 kHz to 12 MHz
Frequency Stability	±5 Hz, 0°C to +35°C ±10 Hz, -10°C to +45°C ±20 Hz, -25°C to +45°C
Audio Input	±10 dB mW ±2 dB
Response	±1 dB from 50 to 10,000 Hz
Distortion	Less than 2% from 50 to 10,000 Hz for 95% modulation
Carrier Shift	Less than 3% from 0 to 100% modulation
Hum and Noise	60 dB below 100% modulation
Type of Service	Continuous duty, attended or unattended, local or remote control
Service Conditions	Designed for continuous duty operation
Ambient Temperature	
Range	-25°C to +45°C
Ambient Humidity	Up to 95% R.H.
Altitude	Up to 2286 m (7500 ft)
Power Source	208/230/240 volts, 50/60 Hz, single phase
	Filaments 0.4 kW 90% pf
	Carrier 2.2 kW 90% pf
	30% Mod 2.5 kW 90% pf
	100% Mod 3.4 kW 90% pf
Size	173.6 cm H x 91.1 cm W x 62.6 cm D (68 1/3" H x 35 7/8" W x 24 3/8" D)
Weight	Approximately 500 kg (1100 lb)
Part No: 622-2017-001	820D-2 Transmitter
Part No: 627-9734-001	Automatic Power Control-optional
Part No: 627-9721-001	Remote Control Relay System-optional
Part No: 627-9733-001	Filament Voltage Regulator-optional
Part No: 627-9735-01	50-Hz Conversion Kit-optional

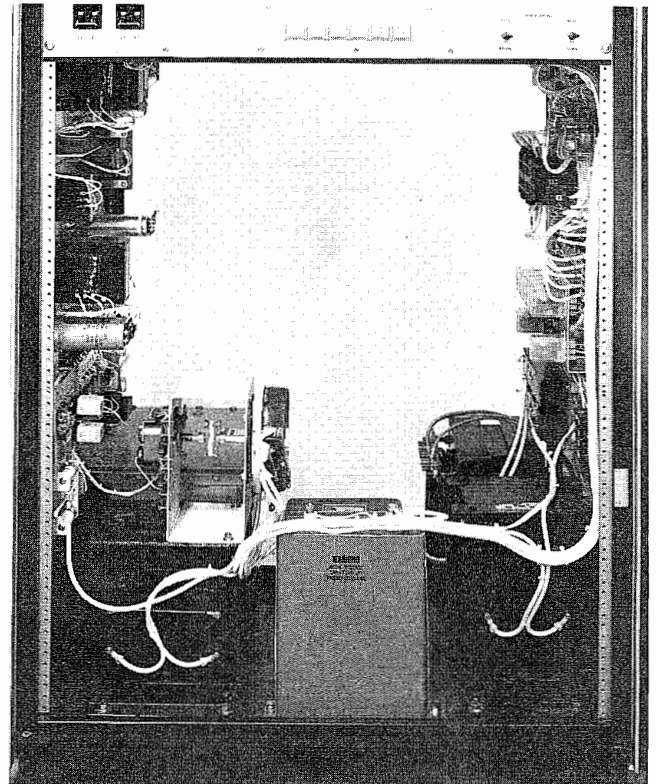

820D-2 Lower Compartment

## Distortion — Guaranteed Vs Typical

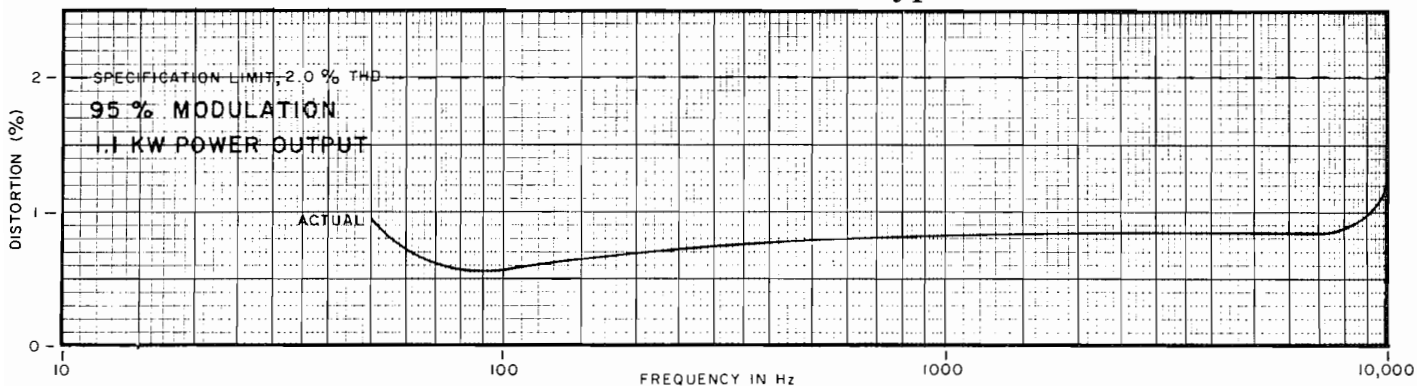



# AM Transmitters

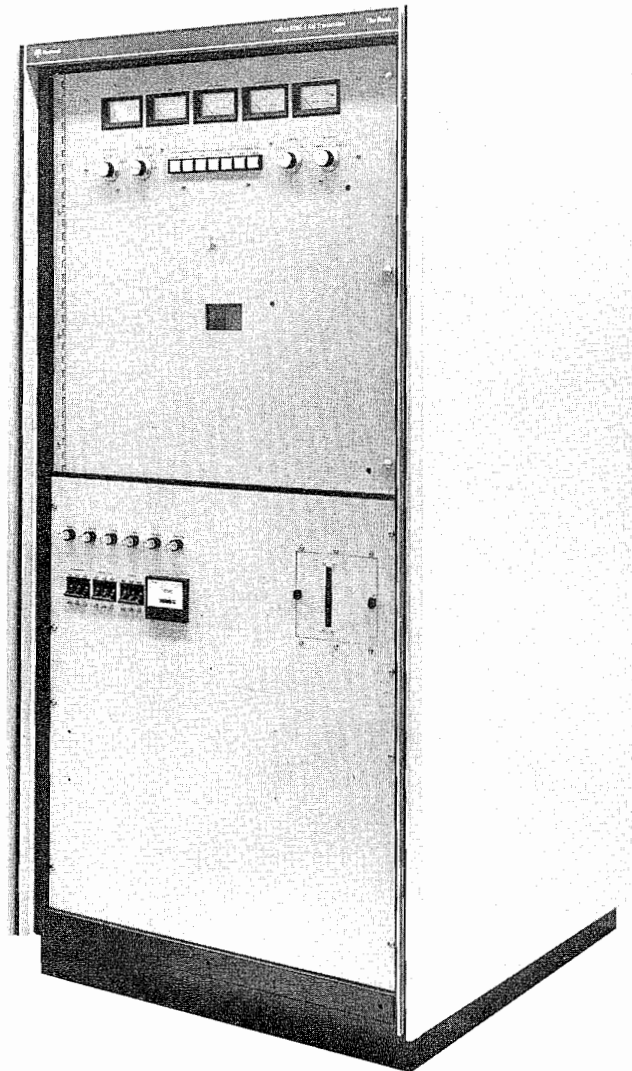

828E-1

## 828E-1 5 KW AM Transmitter

The all new Collins type 828E-1 Power Rock™ 5 KW high efficiency AM transmitter employs a series switching modulator (class D) to provide high performance amplitude modulation up to 125% positive, with lower power consumption. Audio and DC feedback from the modulated voltage, but excluding the RF output network and load, are utilized to provide nearly perfect power output control and to improve distortion, response, and transient performance with processed audio waveforms. By avoiding the RF output network and load in the feedback loop, the stability and response problems associated with high-Q non-symmetrical antenna loads are eliminated. Automatic modulation control maintains the desired modulation level with changes in power output settings or line voltage fluctuations.

The RF power amplifier utilizes a high efficiency circuit with third harmonic resonators to increase the RF power amplifier efficiency to nearly 90% for significant power cost savings. In combination with the cathode-driven high efficiency modulator, the total transmitter nominal power requirement is only 9.3 KW carrier and 12.7 KW at 100% modulation. The RF amplifier operates with its plate at DC ground. This eliminates the usual RF blocker, by-pass and RF choke in the high voltage feed and simplifies maintenance. This exclusive Collins design also allows direct metering at ground potential for both the local and remote metering functions.

# AM Transmitters

The RF amplifier and switching modulator each employ the use of a single low cost high-mu triode tube, Eimac type 3CX3000F7. The low amount of drive required for these tubes simplifies the driver circuits and power requirements. Spare tube costs are reduced by the use of a single tube type.

The superior performance of the bandpass Q Taper™ RF output network over that of the common low-pass network has been demonstrated in the Collins type 820D-2 1 KW AM transmitter. This design improvement is incorporated in the Collins type 828E-1 to give a flatter, wider, passband response for better sideband performance and steeper skirts for better harmonic and spurious attenuation. No traps are required and the network stress is reduced by operating with lower Q circuits. Intermodulation, generated by nearby strong RF signals, is reduced by virtue of the bandpass characteristics and design of the network.

Other outstanding features for generation-ahead performance and sound included in the 828E-1 transmitter are:

1. 12 Phase high voltage power supply for stability, low ripple and superior square wave performance.
2. RF Power metering with reflected power overload.
3. LED operational and fault indicators.
4. Automatic overload recycling.
5. Built-in over modulation protection.
6. One tube type — two 3CX3000F7 for minimum spares stocking.
7. Small physical size, requires only 7.6 square feet of floor space.
8. Filament voltage regulation (optional).
9. Remote control (optional).
10. Power output range 500 to 5,500 watts.

## Type 828D-1 2.5 KW AM Transmitter

Identical in every way to the type 828E-1, except for power supply components and associated changes, the 828D-1 2.5 KW transmitter offers all of the same outstanding features of the 828E-1 transmitter. This highly reliable Power Rock™ transmitter offers the Broadcaster a true State of the Art design unequaled by any other manufacturer.

## Specifications Type 828D-1 2.5 KW and 828E-1 5 KW AM Transmitters

Frequency Range	540 to 1600 KHz
RF output Impedance	50 Ohms, 1% EIA
Audio Response	± 1dB, 20 to 10,000 Hz
Audio Distortion	less than 1.5%, 20 to 10,000 Hz
Modulation Capability	125%
Harmonic Suppression	Greater than -80dB
Audio Input Level	+10dBm ±2 dB
Audio Input Impedance	600/150 ohms
Power Source	200 to 250 Vac or 345 to 415 Vac, 3 phase, 50 or 60 Hz, 4 wire.
Dimensions	Single bay 33" x 33" x 69" 828D-1
RF Power Output	250 to 2750 Watts
Power Requirements	5.7 Kw (carrier) 7.4 Kw (100% Mod.)
	828E-1
	500 Watts to 5500 Watts 9.3 Kw (carrier) 0.95 pf 12.7 Kw (100% Mod.) 0.95 pf.

## Typical Output Network Response

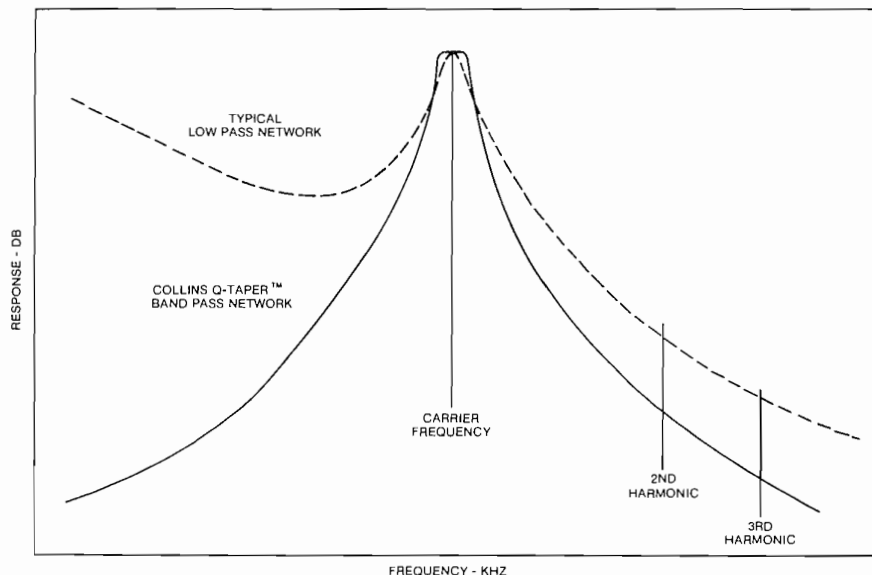

# AM Transmitters

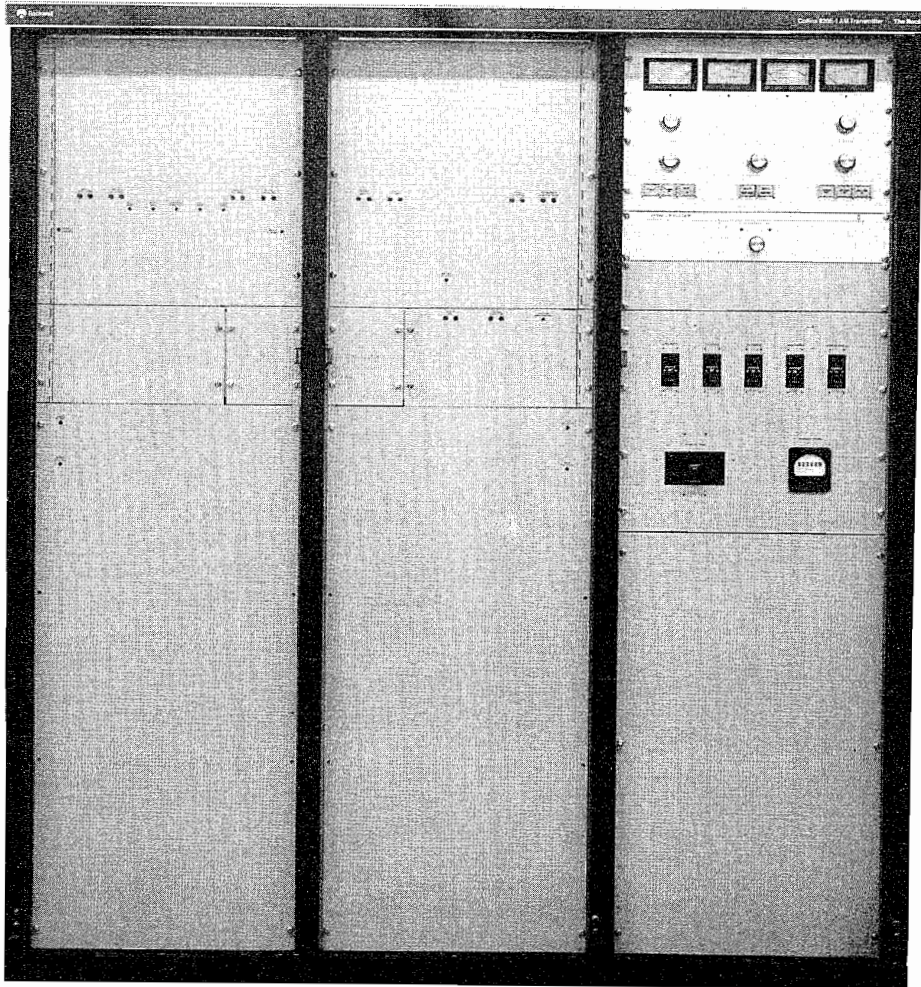

*820E/F AM Transmitter*

## **820E/F** AM Transmitters

Collins 820E/F-1 series of broadcast transmitters is one of the most extensively transistorized series of transmitters available in the 5-kW to 10-kW power range. The series feature solid-state devices in low level audio and driver, power supply circuits, and the RF exciter. In addition, this line of transmitters is capable of modulation levels in excess of 125 percent, with an optional modulation kit allowing higher average positive peaks than ever before.

The exciter used in the 820E/F-1 has a highly stable dual ovenless crystal oscillator operating in the 2.1-MHz to 4.3-MHz range, with division to standard broadcast frequencies by integrated circuit digital dividers. The 10-kW model uses a total of six tubes in the RF driver, power amplifier, and modulator circuits, and requires only two tube types. The 5-kW model uses one less tube in the final RF section.

# AM Transmitters

Collins designed this transmitter for rapid space-saving installation, as well as extended performance. Field reports over the years from both domestic and international users indicate that the 820E/F-1 transmitters may well be the most reliable and maintenance-free transmitters ever produced by Collins. These reports also show that the 820E/F-1 may establish greater long-life performance records than ever experienced from any other transmitter. The cabinet measures 175 cm H, 171 cm W, by 81 cm D (69 in H, 67-7/16 in W, by 32 in D). All power supply components are completely self-contained. For attended operation, all transmitter metering and control is accomplished from a control panel which may be located away from the transmitter, and requires no remote control authorization.

**Extended Control Panel.** The transmitter, suitable for installation at an unattended site, may be remotely controlled from a distant studio location in the conventional manner. As a convenience for attended operation and maintenance, the meters and operating controls are grouped on a 31.1 x 48.2-cm (12¼ x 19-in.) control panel that may be removed and operated from an adjoining room (added cable extra cost).

**RF Exciter.** An all solid-state unit, the 310W-1 Exciter offers increased frequency stability through operation of the oscillator at two or four times the station frequency. Division to standard broadcast frequencies is obtained through the use of digital integrated circuits.

**RF Driver.** The RF driver uses two 6146B tubes in parallel, operating Class C. Tuned grid and tuned plate circuits are employed, with frequency monitor sampling taken from the plate tank coil.

**Output Network.** Low pass L-sections transform the 50-ohm output impedance to 1000-ohm plate impedance for the 10-kW transmitter, and to 2000 ohms for the 5-kW version. The combined network consists of three series inductances, and three shunt capacitances, plus a second harmonic shunt trap to ground. Overall phase through the network is  $-360^\circ$ , giving a favorable plate impedance characteristic when operating into loads within the EIA limit for normal loads. Motor-driven variable vacuum capacitors in the PA tuning and loading circuits are controlled from switches on the extendable control panel. PA loading is used to adjust transmitter power output, and can be extended to the remote point through a conventional remote control unit. A phase comparator circuit is used in the PA stage to automatically control the PA tuning motor as loading changes. Tuning corrections occur at a rapid rate, well within the time required for loading changes. To ensure fail-safe operation, the automatic tuning adjustment is disabled until loading changes take place. A manual/automatic tuning switch is provided on the control panel to disable the automatic mode when it is desired to perform manual tuning.

As in every transmitter that Collins produces, the 820E/F-1 series feature superior accessibility and ease of maintenance through the use of vertical parts placement and straightforward design concepts. All cabinet panels may be removed for maintenance and troubleshooting. All voltage test points are brought out to the front panel, and all components are accessible with the removal of the front panels. When space is at a premium, this feature alone will save many hours of valuable time.

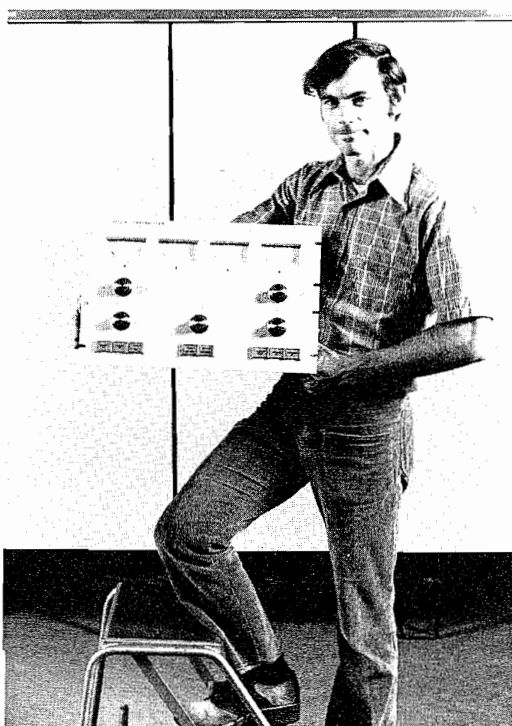

820E/F Extended Control Panel

# AM Transmitters

## 820E/F Specifications

Frequency Range	540 to 1600 kHz
Power Requirements	208/240 volts, $\pm 5\%$ , 50/60 Hz, 3 phase
	820E-1, 5500 W
	100% mod, 18.3 kW 0.98 pf
	0% mod, 14.7 kW 0.98 pf
	820F-1, 10,600 kW
	100% mod, 31.75kW 0.97 pf
	0% mod, 23.5kW 0.97pf
Power Output	820E-1. 5.5 kW, maximum, with built-in reduction to 1kW
	820F-1. 10.6 kW, maximum, with built-in reduction to 5 kW
Frequency Stability	trimmer capacitors provided on the RF exciter for adjusting crystals to exact center frequency. Stability as follows: $\pm 5$ Hz, 0°C to +35°C (32°F to 95°F) $\pm 10$ Hz, -10°C to +45°C (14°F to 113°F)
Outer Impedance	Designed for feeding standard 50-ohm coaxial transmission lines. Matching to other impedance options can be supplied on special order.
Harmonic and Spurious Radiation	Complies with or exceeds FCC regulations regarding harmonic and spurious radiation
Modulation Characteristics	Equipment incorporates high level modulation with most desirable response characteristics for broadcast use; 125% capability on special order
Audio Input Impedance	150/600 ohm, balanced
Audio Input Level	+10 dB mW $\pm 2$ dB
Audio Frequency Response	Typically $\pm 1$ dB from 50 Hz to 10,000 Hz.
Audio Frequency Distortion	Less than 3% from 50 to 7500 Hz for 95% modulation (typical less than 2%)
Noise	60 dB below 100% modulation, maximum
Carrier Shift	Less than 3% from zero to 100% modulation
Ambient Temperature Range	-25°C to +45°C (-13°F to 113°F)
Altitude	Up to 2286 m (7000 ft); higher altitudes on special order
Size	175 cm H x 171 cm W x 81 cm D (69" H x 67 7/16" W x 32" D)
Total Weight Including Transformers	820E-1 — 910 kg (2000 lb) 820F-1 — 1115 kg (2450 lb)

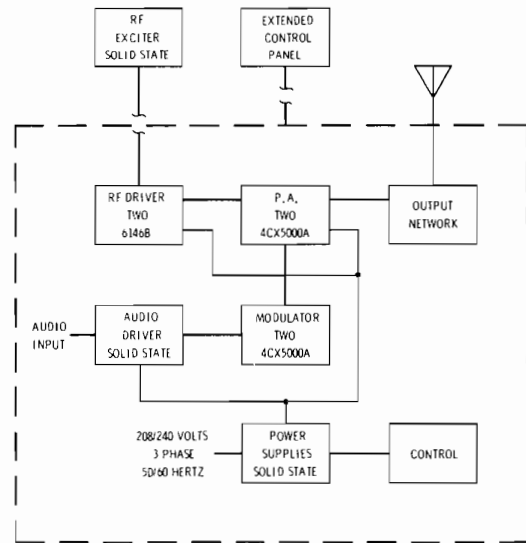

820E/F Diagram

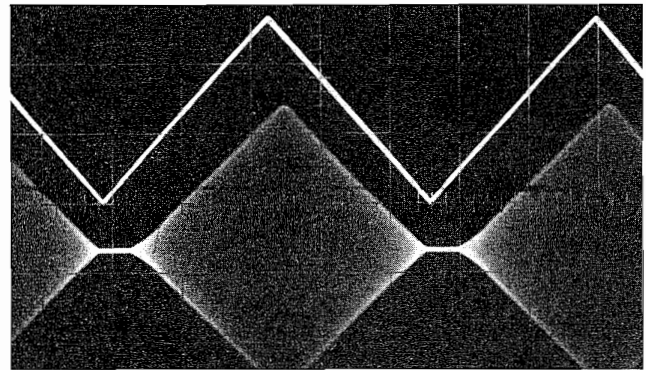

A 1 KHz triangle waveform applied to the 820E-1. The upper trace is the input and the lower trace the RF output of the transmitter. Peak positive modulation is 125%. Note the excellent linearity of the RF envelope.

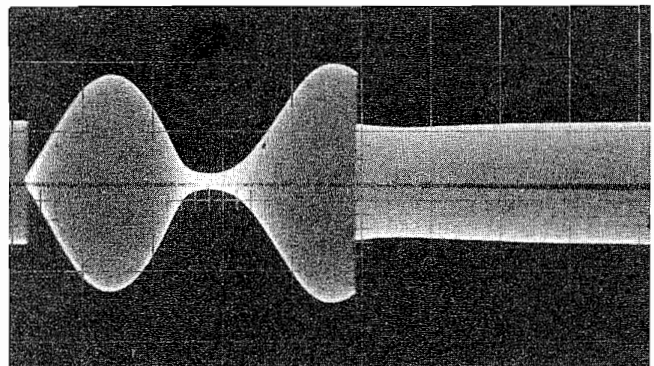

A 30 Hz sinewave keyed at a 10 Hz rate at 90% modulation vividly demonstrates the freedom from power supply resonances (commonly called "bounce") which limit the average modulation level. This is a direct result of the use of a 12 phase power supply used in the Collins 820E/F-1 since its inception.

# AM Transmitters

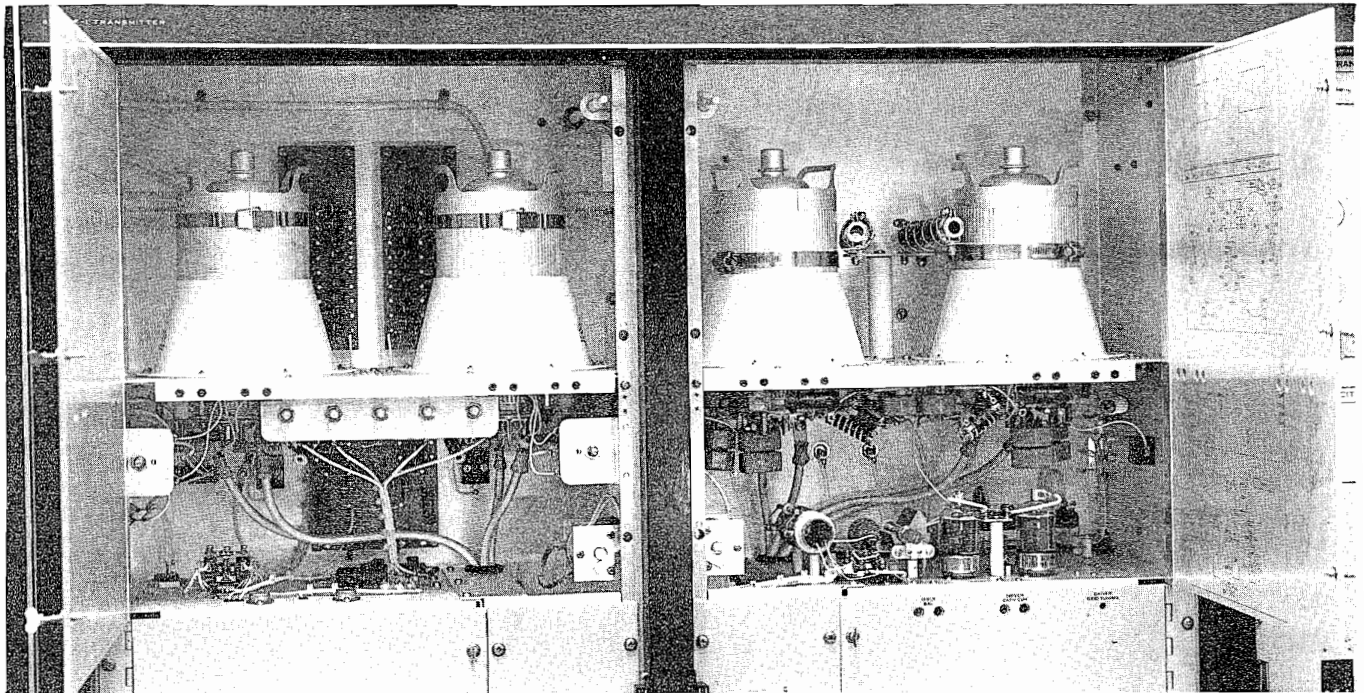

820E/F PA Compartment

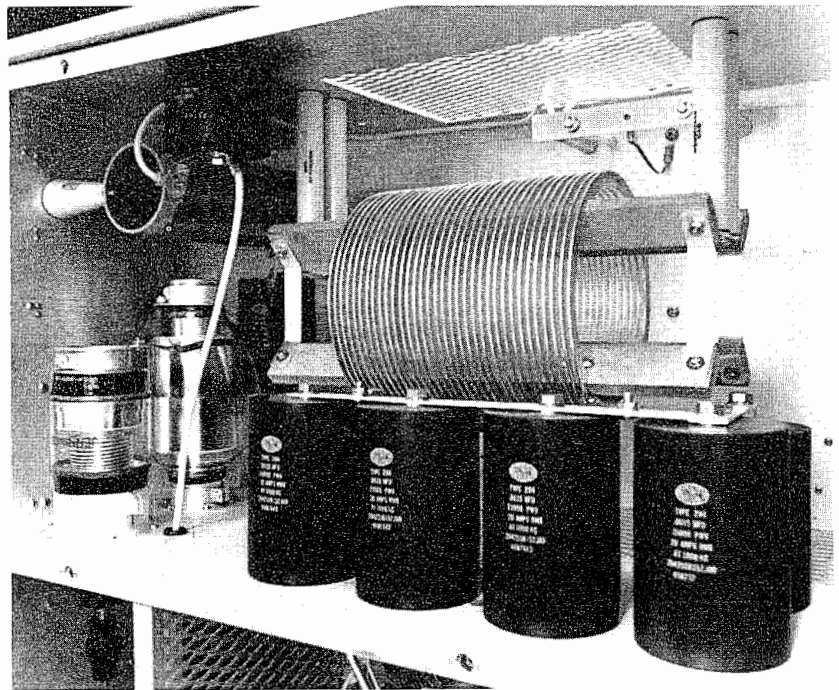

820E/F Tuning Compartment

# AM Transmitters



AM Meter Panel

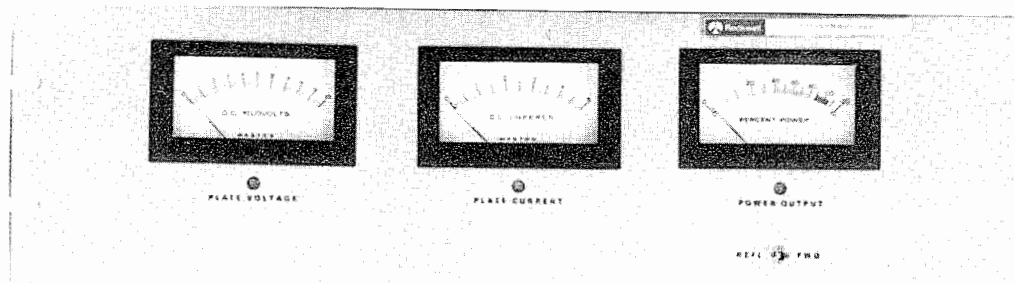

FM Meter Panel

## AM and FM Transmitter Extended Meter Panels

AM and FM transmitter extended meter panels can be provided for the situation where the operator can view the transmitter but is too far removed to be able to read critical meters. The AM transmitter meter panel provides meters for plate voltage, plate current and RF line current. The FM transmitter meter panel provides meters for plate voltage, plate current, and power output with provisions also for reading reflected power. All panels are the rack-mounting type.

636 7173 001	820D-2	AM Meter Panel
636 7173 002	820E-1	AM Meter Panel
636 7173 003	820F-1	AM Meter Panel
636 1444 001	831C/D-2	FM Meter Panel
636 1444 002	831E-2	FM Meter Panel
636 1444 003	831F-2	FM Meter Panel
636 1444 004	831G-2/2B/2C	FM Meter Panel

Size: 48.3 cm (19")W, 13.3 cm (5¼")H, 13.9 cm (5½")D

Weight: 2.27 kg (5 lb)

# AM Transmitters

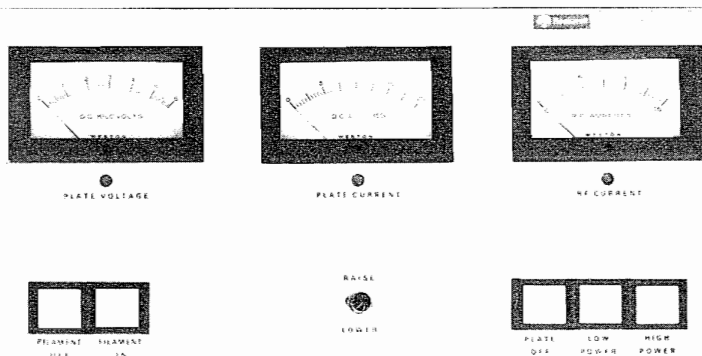

AM Extended Control Panel

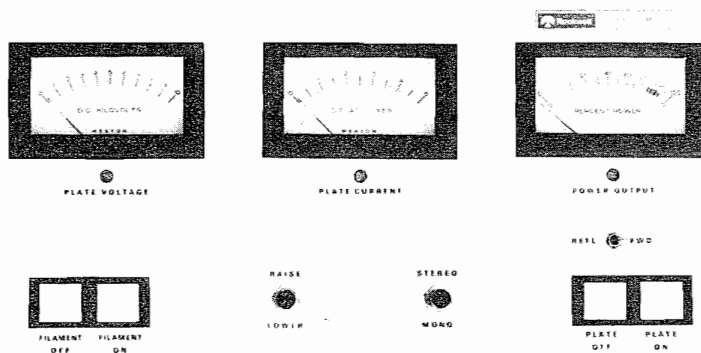

FM Extended Control Panel

## AM and FM Transmitter Extended Control Panels

AM and FM transmitter extended control panels can be provided for the situation where the operator can not view the transmitter but must be able to control it and read critical meters. The AM control panels provide meters for reading plate voltage, plate current, and RF line current. Controls are provided for filament on/off, raise/lower power, plate off, low power, and high power. The FM control panels provide meters for reading plate voltage, plate current, and power output with provisions for reading reflected power. Controls are provided for filament on/off, raise/lower power, stereo-mono mode, plate on, and plate off. These panels will satisfy FCC requirements (Code 73.276) for operation of the transmitter in the same building, on the same floor, or not more than one story above or below

the transmitter location and where the operators ready path to the transmitter is not more than 30.5 m (100 ft). Other situations require the use of a remote control system. All panels are the rack-mounting type.

636 7171 001	820D-2	AM Transmitter Control Panel
636 7171 002	820E-1	AM Transmitter Control Panel
636 7171 003	820F-1	AM Transmitter Control Panel
636 1442 001	831C/D-2	FM Transmitter Control Panel
636 1442 002	831E-2	FM Transmitter Control Panel
636 1442 003	831F-2	FM Transmitter Control Panel
636 1442 004	831G-2/2B/2C	FM Transmitter Control Panel

Size: 48.3 cm (19")W, 17.78 cm (7")H, 13.9 cm (5½")D

Weight: 31.7 kg (7 lb)



# AM Transmitters

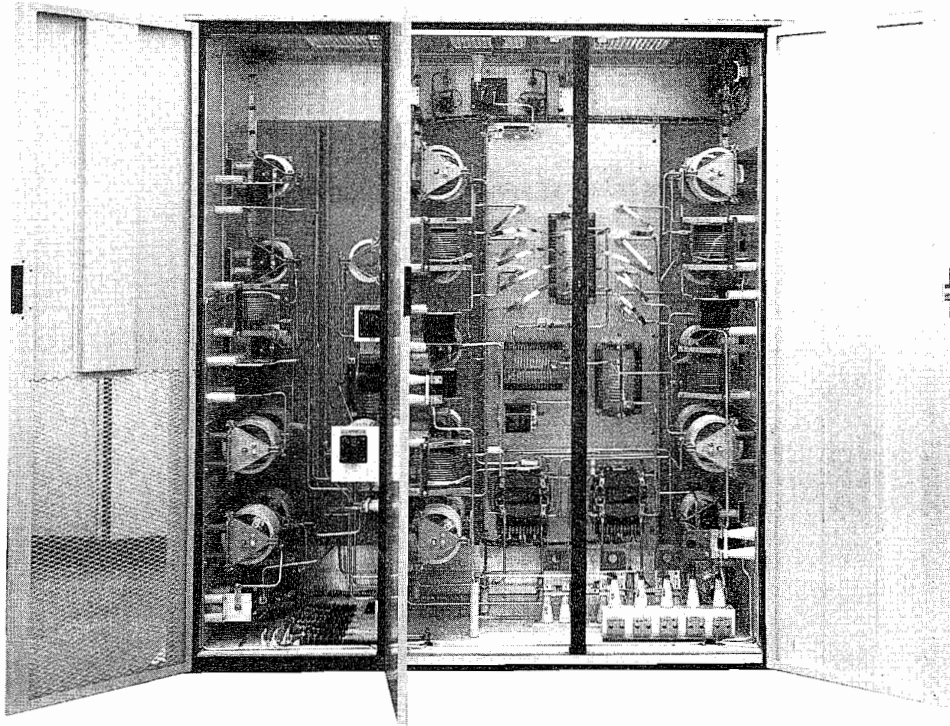

81M Phasor

## Collins 81M Phasing Equipment

Whether your requirement is for a complete directional system or replacement of a coupling unit, your station will profit from Collins custom designed units. Engineered into each installation are easily adjusted networks, highest stability, adequate voltage and current safety, and maximum economy.

A typical directional antenna phasing and branching system consists of: a branching circuit in which the power is divided in precisely the amounts of power necessary to give the proper ratio of fields from the individual antennas; an impedance matching circuit to match the power divider input impedance to the common point impedance at which the power input is measured; phase shifting networks in series with each of the transmission lines going to the individual antenna towers; the transmission lines themselves; and the impedance matching network between each of the transmission lines and associated antenna towers.

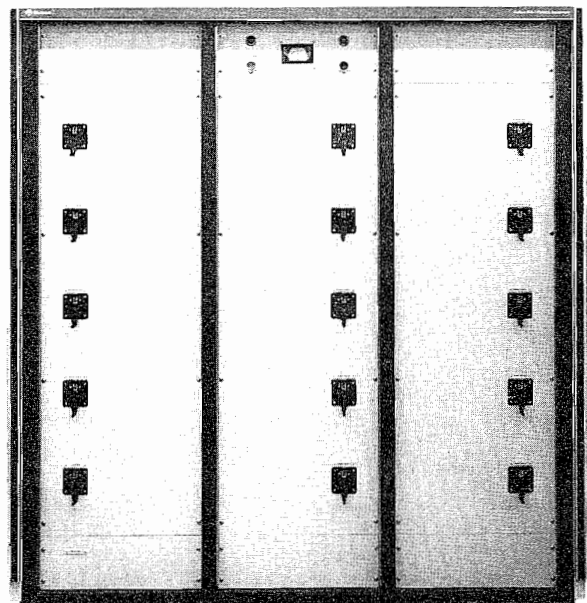

Typical Five Tower Phasing System

# AM Transmitters

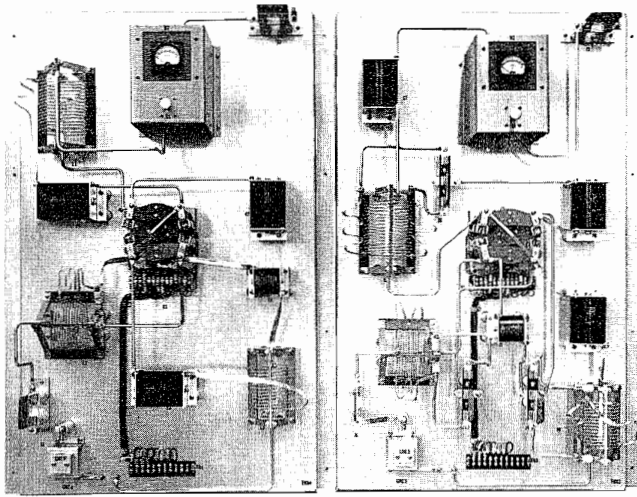

Shelf-mounted Tuning Units

The power divider in Collins 81M equipment is usually a resonant tank circuit consisting of a large fixed coil tapped with smaller variable coils for power adjustment. An alternate design uses a group of variable coils, each one feeding a tower; this group then becomes the tank coil of the circuit.

For 1 kW or lower, the capacitive arm of the tank circuit is a capacitor and variable coil connected in series. The variable coil provides tuning adjustment by varying the overall negative reactance in this branch of the tank. In higher powers, the tank capacitance is usually a variable vacuum capacitor in parallel with one or more fixed capacitors.

## Typical Phasing System

Phase shifting networks are "T" designed, with variable coils mechanically connected in tandem for the series arms and a coil and capacitor in series for a shunt arm. Wherever possible, 90° networks, capable of being adjusted  $\pm 30^\circ$  from the design value, are supplied.

Wherever a phase shift network is not required, a series variable coil and capacitor are used to supply variation of  $\pm 20^\circ$  around a 0° setting. They are used for trimming phase shift of current in the towers in which they are used.

"T" networks are also used for impedance matching at the tower base. The network has sufficient latitude of adjustment to match the transmission line impedance to any expected base operating impedance and still permit adjustment of phase shift.

Switching of circuits for day and night operation or directional and nondirectional operation is typically ac-

complished by impulse-type, toggle-operated RF relays, energized by pushbutton switches on the front panel. The pushbutton automatically removes the plate voltage of the transmitter before pattern switching and restores it when switching is completed. Interlocks on the cabinet doors also remove the plate voltage when doors are opened.

Amplitude and phase controls have counters to ensure accurate resetability. In complex arrays requiring additional controls, the controls and counters may be behind the tilt-out panel in the lower half of the cabinet.

Power dividing circuits and phase shift networks utilize heavy edge-wound copper ribbon inductors and ceramic cased mica capacitors. Vacuum capacitors are used where made necessary by high circulating currents.

Plated 0.79-cm (5/16-in) copper tubing is used for all RF buses; insulation is steatite or Mycalex.

Input and out put connections are provided at the top of the phasing cabinet unless otherwise specified. Special terminations are provided for solid dielectric cables in both the phasing cabinet and antenna coupling units.

An input common point RF ammeter is supplied along with line current meter jacks. Antenna current meters have make-before-break switches that can be operated without opening the cabinet door on the weather-proofing coupling units.

## Specifications

Power: 1, 2.5, 5 and 10 kW in 2-, 3-, 4-, 5-, and 6-tower arrays.

Patterns: Directional day and night, same pattern; directional nighttime only; or different pattern day and night.

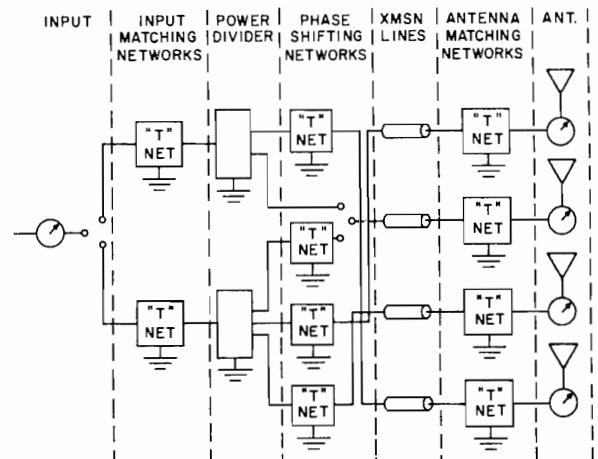

# Antenna Systems



## Antennas

### Collins G5/G4CP Circularly Polarized FM Antennas

Collins offers a complete line of high-medium-and low-powered circularly polarized FM antennas for stereo and multiplex FM Broadcast applications. These antennas radiate a circularly (clockwise) polarized wave for improved reception in FM automobile, portable, and home receivers. The antennas are rugged in design and capable of withstanding wind velocities of at least 241 km (150 miles) per hour. The design is flexible and permits side, corner leg, or top mounting on any type of tower. The rings, balun, and interconnecting lines are all constructed of 85-15 brass and all support brackets and hardware are made of stainless steel. No galvanized steel is used in the construction of these antennas and no painting is ever required.

### G5/G4CP Antennas — General Specifications

Frequency Range	88 to 108 MHz, factory tuned to one frequency
Polarization	Circular (clockwise)
Power Gain	See tables
Azimuthal Pattern	$\pm 2$ dB in free space, both horizontal and vertical
Ellipticity	$\pm 3$ dB in free space
VSWR at Input (without field tuning)	1.1:1 top mounting, 1.5:1 or better side mounting
VSWR at Input (with field tuning)	1.1:1 or better
Input Connections	See tables
Power Input	See tables
Wind Load	See tables
Dimensions	See tables
Weight	See tables

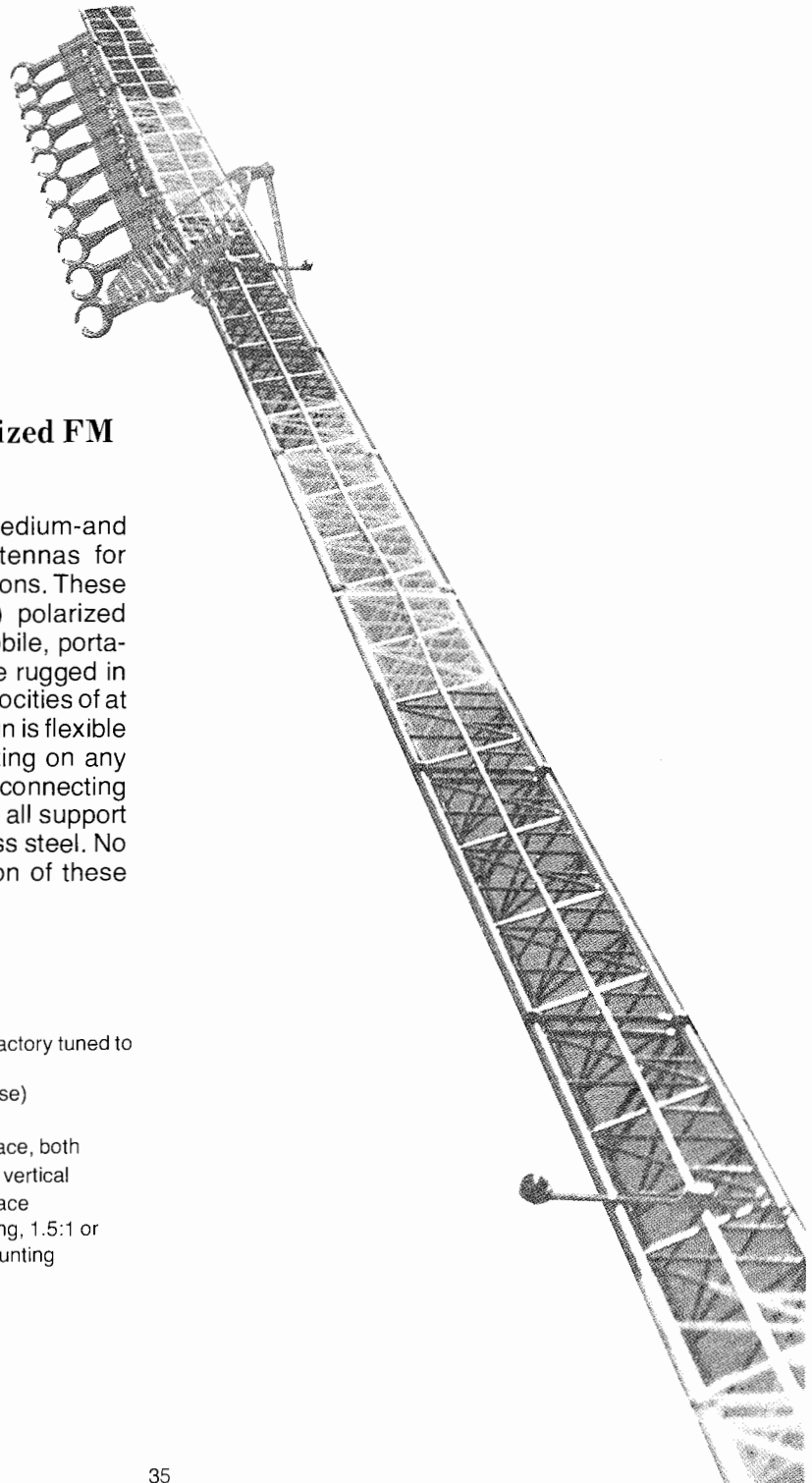

# Antenna Systems

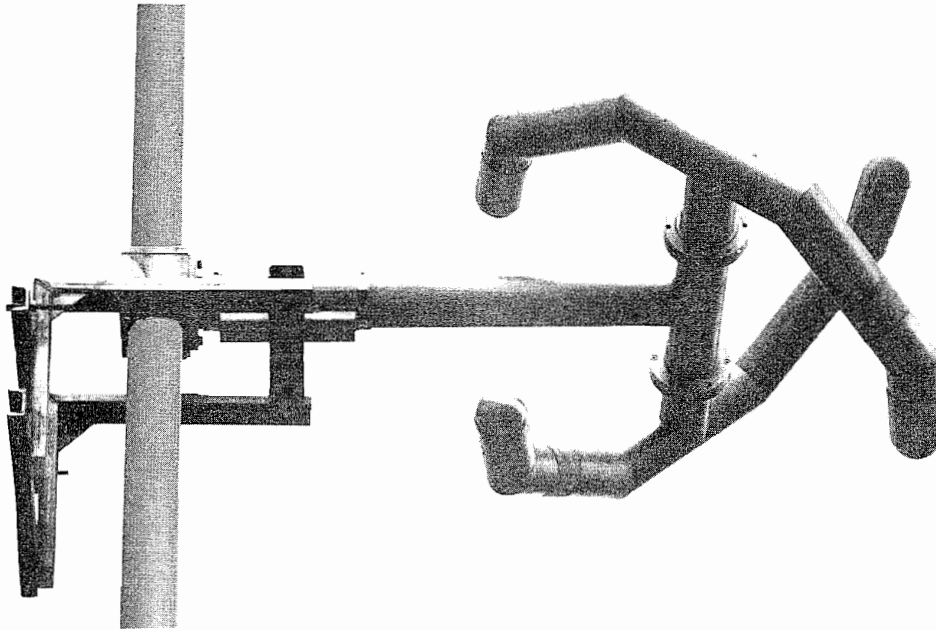

*G5CPS Antenna*

## **G5CPS Super Power Circularly Polarized FM Antenna**

Collins offers a new series of super power circularly polarized FM antenna, using the same rugged construction available in Collins other high power models. The brass-constructed radiating element has an outside diameter of 7.9 cm (3 in). The feed point is completely internal, with a pressurized environment up to this feed point. The radiating element, rated at 40 kW as limited by the average power capability of 7.9 cm (3 in) rigid coaxial line, has been conservatively derated from 48 to 40 kW. The element stem of heavy-wall brass tubing can withstand rugged environmental conditions; wind velocities to 241 km (150 miles) per hour. Deicers are not required in a normal environment as the typical vswr is 1.5:1 or less, with 1.3 cm (1/2 in) of radial ice. Heaters for deicing are available; radomes are not available.

All G5CPS antennas use silver-plated inner conductor connectors throughout to reduce losses and heating. Each antenna, supplied with a 1.8 m (6 ft) input transformer, has 50-ohm EIA input. Depending on model type, the input is either a 7.9 cm (3 in) flange, or 15.5 cm (6 in) flange.

Each antenna, completely assembled and factory-tuned to the customer's frequency, is also pressure

tested to ensure that the antenna's leak-free prior to proper installation by a qualified erector.

The antenna system feed point is 1.8 m (6 ft) below the bottom bay for end fed antennas, and approximately 1.8 cm (6 ft) below the center of the antenna for center fed antenna systems.

Horizontally polarized horizontal-plane radiation pattern is omnidirectional when pole-mounted atop a tower; a  $\pm 2$  dB circularity is typical when mounted on a 35.6 cm (14 in) diameter steel pole. When side-mounted on a tower, the antenna pattern will be affected by the tower structure.

Complete antenna patterning facilities, for antenna radiation pattern measurement, includes a 6.1 m (20 ft) long electrically equivalent full size tower section set up on the antenna range. This tower section duplicates the exact size and location of the ladder, coaxial transmission lines, conduits, cables, and antenna element. Pattern optimization for both vertical and horizontal polarization components is available for improving pattern circularity; however, directionalizing requires FCC compliance regarding directional FM antennas.

# Antenna Systems

Antenna patterning and pattern optimizations are at additional cost on a quotation basis.

The G5CPS has a low standing-wave ratio of 1.07:1, or less,  $\pm 200$  kHz for a given channel, with field trimming. The vswr at antenna input, without field trimming, is 1.1:1 for pole mounting atop a tower; 1.5:1, or less, when side mounted on a tower.

\* Power input capability up to 2000 feet above sea level, derating required above 2000 feet.

Multistation operation is possible, using a common antenna system, because of the radiating element excellent bandwidth characteristics. Collins has the necessary filtering components for the diplexing or multiplexing operation.

Stations with a frequency separation to 4 MHz may be diplexed on a common antenna; for 40 kW transmitters, however, a 1.2 MHz minimum frequency separation is advisable to avoid filter component excessive heating.

Series A								
3 1/8" interbay line, 79.4 mm, 3 1/8" element stem								
Collins Type	Power Gain	dB Gain	Type Feed	Female 50-Ohm Input mm (in.)	Input Power Rating kW *	Calculated Weight kg (lb)	Wind Load Based on 244/161 kg/sq m (50/33 lbs/sq ft) kg (lb)	Approx. Length m (ft)
G5CPS-1	0.4611	-3.3623	End	79.4 (3 1/8)	32	51.7 (114)	62.1 (137)	—
G5CPS-2	0.9971	-0.0128	End	(3 1/8)	32	102 (225)	138 (304)	3 (10)
G5CPS-2	0.9971	-0.0128	Center	(3 1/8)	39	113 (250)	145 (319)	3 (10)
G5CPS-2	0.9971	-0.0128	Center	155.6 (6 1/8)	64	137 (301)	191 (421)	3 (10)
G5CPS-3	1.5588	1.9278	End	(3 1/8)	32	152 (336)	213 (470)	6 (20)
G5CPS-4	2.1332	3.2903	End	(3 1/8)	32	203 (447)	289 (637)	9 (30)
G5CPS-4	2.1332	3.2903	Center	(3 1/8)	39	214 (472)	296 (652)	9 (30)
G5CPS-4	2.1332	3.2903	Center	(6 1/8)	64	237 (523)	344 (758)	9 (30)
G5CPS-5	2.7154	4.3384	End	(3 1/8)	32	253 (558)	365 (804)	12 (40)
G5CPS-6	3.3028	5.1888	End	(3 1/8)	32	303 (669)	440 (971)	15 (50)
G5CPS-6	3.3028	5.1888	Center	(3 1/8)	39	315 (694)	447 (986)	15 (50)
G5CPS-6	3.3028	5.1888	Center	(6 1/8)	64	338 (745)	497 (1096)	15 (50)
G5CPS-7	3.8935	5.9034	End	(3 1/8)	32	354 (780)	516 (1138)	18 (60)
G5CPS-8	4.4872	6.5197	End	(3 1/8)	32	404 (891)	592 (1305)	21 (70)
G5CPS-8	4.4872	6.5197	Center	(3 1/8)	39	415 (916)	599 (1320)	21 (70)
G5CPS-8	4.4872	6.5197	Center	(6 1/8)	64	439 (967)	650 (1433)	21 (70)
G5CPS-10	5.6800	7.5435	Center	(3 1/8)	39	516 (1138)	750 (1653)	27 (90)
G5CPS-10	5.6800	7.5435	Center	(6 1/8)	64	539 (1189)	803 (1770)	27 (90)
G5CPS-12	6.8781	8.3747	Center	(3 1/8)	39	617 (1360)	901 (1987)	34 (110)
G5CPS-12	6.8781	8.3747	Center	(6 1/8)	64	640 (1411)	956 (2108)	34 (110)
Series B								
4 1/8" interbay line, 104.8 mm, 4 1/8" element stem								
G5CPS-1	0.4611	-3.3623	End	(6 1/8)	40	72 (159)	91 (201)	—
G5CPS-2	0.9971	-0.0128	End	(6 1/8)	56	135 (297)	185 (407)	3 (10)
G5CPS-2	0.9971	-0.0128	Center	(6 1/8)	80	152 (336)	212 (468)	3 (10)
G5CPS-3	1.5588	1.9278	End	(6 1/8)	56	197 (435)	278 (613)	6 (20)
G5CPS-4	2.1332	3.2903	End	(6 1/8)	56	260 (573)	371 (818)	9 (30)
G5CPS-4	2.1332	3.2903	Center	(6 1/8)	112	278 (612)	399 (879)	9 (30)
G5CPS-5	2.7154	4.3384	End	(6 1/8)	56	323 (711)	464 (1024)	12 (40)
G5CPS-6	3.3028	5.1888	End	(6 1/8)	56	385 (849)	557 (1229)	15 (50)
G5CPS-6	3.3028	5.1888	Center	(6 1/8)	112	403 (888)	585 (1290)	15 (50)
G5CPS-7	3.8935	5.9034	End	(6 1/8)	56	448 (987)	651 (1435)	18 (60)
G5CPS-8	4.4872	6.5197	End	(6 1/8)	56	510 (1125)	744 (1641)	21 (70)
G5CPS-8	4.4872	6.5197	Center	(6 1/8)	112	528 (1164)	772 (1702)	21 (70)
G5CPS-10	5.6800	7.5435	Center	(6 1/8)	112	653 (1440)	958 (2113)	27 (90)
G5CPS-12	6.8781	8.3747	Center	(6 1/8)	112	778 (1716)	1145 (2524)	34 (110)
Series C								
6 1/8" interbay line, 155.6 mm, 4 1/8" element stem 104.8 mm								
G5CPS-1	0.4611	-3.3623	End	(6 1/8)	40	93 (205)	118 (260)	—
G5CPS-2	0.9971	-0.0128	End	(6 1/8)	80	186 (410)	236 (520)	3 (10)
G5CPS-3	1.5588	1.9278	End	(6 1/8)	120	279 (615)	354 (780)	6 (20)
G5CPS-4	2.1332	3.2903	End	(6 1/8)	120	372 (820)	472 (1040)	9 (30)
G5CPS-5	2.7154	4.3384	End	(6 1/8)	120	465 (1025)	590 (1300)	12 (40)
G5CPS-6	3.3028	5.1888	End	(6 1/8)	120	558 (1230)	708 (1560)	15 (50)

# Antenna Systems

## G4CPH High Power FM Antenna

The G4CPH series of FM antennas, with rugged heavy duty design, are capable of handling powers from 10 kW (single bay) to 40 kW (four or more bays). The antenna may be purchased in any number of bays from 1 to 16. These antennas are end fed in combinations from one to eight bays. Antennas of nine or more bays are center fed if an even number of bays, or at a point one-half bay below the center of the antenna if an odd number of bays. Antennas of one through eight bays are end fed with a 1.8 m (6 ft) matching transformer connected to the bottom bay. Antennas of nine or more bays are fed with a 3 m (10 ft) matching transformer that extends downward from an elbow connected to the center feed of the antenna. The rings of the antenna are mounted on 7.9 cm (3<sup>1</sup>/<sub>8</sub>-in) transmission line with a 7.9 cm (3<sup>1</sup>/<sub>8</sub>-in) input flange on standard antennas. Antennas that are to have 40 kW input are provided with a 15.5 cm (6<sup>1</sup>/<sub>8</sub>-in) flange and center feed block (extra cost). 7.6 cm (3-in) diameter Corona balls are provided at the outer extremity of the arms of each bay of the antenna. The antenna is designed to withstand wind velocities to 241 km (150 miles) per hour.

Factory-installed deicers are available in powers of 300 and 500 watts per bay. Specify 120- or 230-volt operation when ordering. Shielded interbay heater cable and junction boxes are supplied as a part of the heater system. Heater weight including junction boxes and cable is 3.2 kg (7 lb) additional per bay. Heaters are field replaceable.

Special power splits, other than 50/50 (vertical and horizontal), beam tilt and/or null fill are available at extra cost.

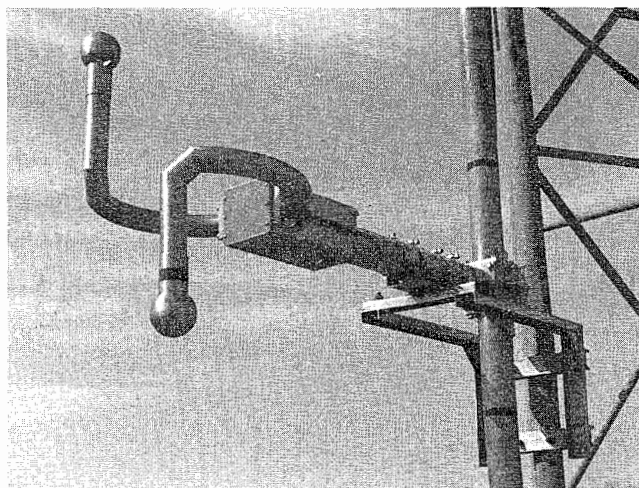

G4CPH Antenna

## G4CPH High Power Circularly Polarized FM Antennas

Collins Type	Power Gain		dB Gain		Field Gain		Input Power Rating kW	Approx. Length m (ft)	Weight (Including Brackets) kg (lb)	Wind Load Based on 244/161 kg/sq.m (50/33 lb/sq ft) kg (lb)	Weight (With Radomes Incl. Brackets) kg (lb)	Wind Load With Radomes Based on 244/161 kg/sq.m (50/33 lb/sq ft) kg (lb)
	Horiz	Vert	Horiz	Vert	Horiz	Vert						
G4CPH-1	0.4611	0.4611	-3.3623	-3.3623	0.6790	0.6790	10	—	38 (84)	65 (144)	47 (104)	120 (265)
G4CPH-2	0.9971	0.9971	-0.0128	-0.0128	0.9985	0.9985	20	3 (10)	83 (184)	144 (318)	102 (224)	254 (560)
G4CPH-3	1.5588	1.5588	1.9278	1.9278	1.2485	1.2485	30	6 (20)	124 (274)	223 (492)	152 (334)	388 (855)
G4CPH-4	2.1332	2.1332	3.2903	3.2903	1.4605	1.4605	40	9 (30)	165 (364)	302 (666)	201 (444)	522 (1150)
G4CPH-5	2.7154	2.7154	4.3384	4.3384	1.6478	1.6478	40	12 (40)	206 (454)	381 (840)	251 (554)	655 (1445)
G4CPH-6	3.3028	3.3028	5.1888	5.1888	1.8174	1.8174	40	15 (50)	247 (544)	460 (1014)	301 (664)	789 (1740)
G4CPH-7	3.8935	3.8935	5.9034	5.9034	1.9732	1.9732	40	18 (60)	288 (634)	538 (1187)	351 (774)	923 (2034)
G4CPH-8	4.4872	4.4872	6.5197	6.5197	2.1183	2.1183	40	21 (70)	328 (724)	617 (1361)	401 (884)	1056 (2329)
G4CPH-9	5.0826	5.0826	7.0608	7.0608	2.2545	2.2545	40	24 (80)	379 (835)	729 (1608)	460 (1015)	1223 (2697)
G4CPH-10	5.6800	5.6800	7.5435	7.5435	2.3833	2.3833	40	27 (90)	420 (925)	808 (1782)	510 (1125)	1357 (2992)
G4CPH-11	6.2783	6.2783	7.9785	7.9785	2.5057	2.5057	40	30 (100)	460 (1015)	887 (1956)	560 (1235)	1491 (3287)
G4CPH-12	6.8781	6.8781	8.3747	8.3747	2.6226	2.6226	40	34 (110)	501 (1105)	966 (2130)	610 (1345)	1625 (3582)
G4CPH-13	7.4785	7.4785	8.7381	8.7381	2.7347	2.7347	40	37 (120)	542 (1195)	1045 (2303)	660 (1455)	1758 (3876)
G4CPH-14	8.0800	8.0800	9.0741	9.0741	2.8425	2.8425	40	40 (130)	583 (1285)	1124 (2477)	710 (1565)	1892 (4171)
G4CPH-15	8.6818	8.6818	9.3861	9.3861	2.9465	2.9465	40	43 (140)	624 (1375)	1202 (2651)	760 (1675)	2026 (4466)
G4CPH-16	9.2846	9.2846	9.6776	9.6776	3.0471	3.0471	40	46 (150)	665 (1465)	1281 (2825)	810 (1785)	2160 (4761)

All antenna brackets are stainless steel. All weights given include brackets, interbay line, and transformer section. Factory-installed deicers are available using 300 watts per bay. Specify 120 volts or 230 volts. Heater elements replaceable in field. Shielded interbay heater cable and junction boxes are supplied. Heater weight, including junction boxes and interbay cable, is 2.7 kg (6 lb) additional per bay.



# Antenna Systems

## G4CPM Medium Power FM Antenna

The G4CPM medium power antenna is a rugged antenna but lower in weight, windloading, and power handling capability than the G4CPH antenna. This antenna is built in 4 to 12 bays and is designed to handle powers up to 12 kW input. The G4CPM is designed to withstand wind velocities to 241 km (150 miles) per hour. All of these antennas are center fed, if an even number of bays, or at a point one-half bay below the center of the antenna if an odd number of bays. The low dead weight and wind loading make this antenna ideally suited for mounting on lightweight tower structures. The rings of the antenna are mounted on 2.86 cm (1<sup>5</sup>/<sub>8</sub>-in) line but the center feed point is 7.9 cm (3<sup>1</sup>/<sub>8</sub>-in) EIA, 50 ohm flange. A 3 m (10 ft) matching transformer is connected to an elbow at the center feed point and extends downward from this point.

Factory-installed deicers are available in powers of 300 and 500 watts per bay. Specify 120- or 230-volt operation when ordering. Shielded interbay heater cable and junction boxes are supplied as a part of the heater system. Heater weight including junction boxes and cable is 3 kg (7 lb) additional per bay. Heaters are field replaceable.

Special power splits, other than 50/50 (vertical and horizontal), beam tilt and null fill are available at extra cost.

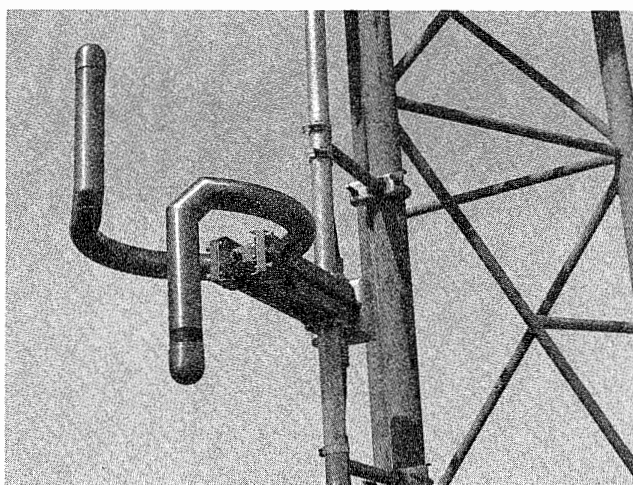

G4CPM

## G4CPM Medium Power Circularly Polarized FM Antennas

Collins Type	Power Gain		dB Gain		Field Gain		Input Power Rating kW	Approx. Length m (ft)	Weight (Including Brackets) kg (lb)	Wind Load Based on 244/161 kg/sq.m (50/33 kg/sq ft) kg (lb)	Weight (With Radomes Incl. Brackets) kg (lb)	Wind Load With Radomes Based on 244/161 kg/sq.m (50/33 lb/sq ft) kg (lb)
	Horiz	Vert	Horiz	Vert	Horiz	Vert						
G4CPM-4	2.1332	2.1332	3.2903	3.2903	1.4605	1.4605	12	10 (30)	89 (197)	188 (415)	122 (269)	347 (764)
G4CPM-5	2.7154	2.7154	4.3384	4.3384	1.6478	1.6478	12	12 (40)	108 (238)	229 (505)	149 (328)	427 (941)
G4CPM-6	3.3028	3.3028	5.1888	5.1888	1.8174	1.8174	12	15 (50)	127 (279)	270 (595)	176 (387)	507 (1118)
G4CPM-7	3.8935	3.8935	5.9034	5.9034	1.9732	1.9732	12	18 (60)	145 (320)	311 (685)	202 (446)	588 (1296)
G4CPM-8	4.4872	4.4872	6.5197	6.5197	2.1183	2.1183	12	21 (70)	164 (361)	352 (775)	229 (505)	668 (1473)
G4CPM-9	5.0826	5.0826	7.0608	7.0608	2.2545	2.2545	12	24 (80)	182 (402)	392 (865)	256 (564)	748 (1650)
G4CPM-10	5.6800	5.6800	7.5435	7.5435	2.3833	2.3833	12	27 (90)	201 (443)	433 (955)	283 (623)	829 (1828)
G4CPM-11	6.2783	6.2783	7.9785	7.9785	2.5057	2.5057	12	30 (100)	220 (484)	474 (1045)	309 (682)	909 (2005)
G4CPM-12	6.8781	6.8781	8.3747	8.3747	2.6226	2.6226	12	34 (110)	238 (525)	515 (1135)	336 (741)	990 (2182)

All antenna brackets are stainless steel. All weights given include brackets, interbay line, and transformer section. Factory-installed deicers are available using 300 watts per bay. Specify 120 volts or 230 volts. Heater elements replaceable in field. Shielded interbay heater cable and junction boxes are supplied. Heater weight, including junction boxes and interbay cable, is 2.7 kg (6 lb) additional per bay.

# Antenna Systems

## G4CPL Low Power FM Antenna

The general construction of the G4CPL FM antenna is the same as the G4CPM medium power antenna except that it is only offered in one to eight bays, is end fed, and has a power handling capability of 3 kW for one bay, 6 kW for two bays and 7½ kW for antennas with three to eight bays. The rings of the antenna are mounted on 2.86 cm (1<sup>5</sup>/<sub>8</sub> in) line and are end fed. A 1.8 m (6 ft) matching transformer extends below the lower bay and terminates in a 2.86 cm (1<sup>5</sup>/<sub>8</sub> in) EIA, 50-ohm flange.

Factory-installed deicers are available in powers of 300 and 500 watts per bay. Specify 120- or 230-volt operation when ordering. Shielded interbay heater cable and junction boxes are supplied as a part of the heater system. Heater weight including junction boxes and cable is 3 kg (7 lb) additional per bay. Heaters are field replaceable.

No special power splits other than 50/50, nor beam tilt nor null fill are offered for this antenna.

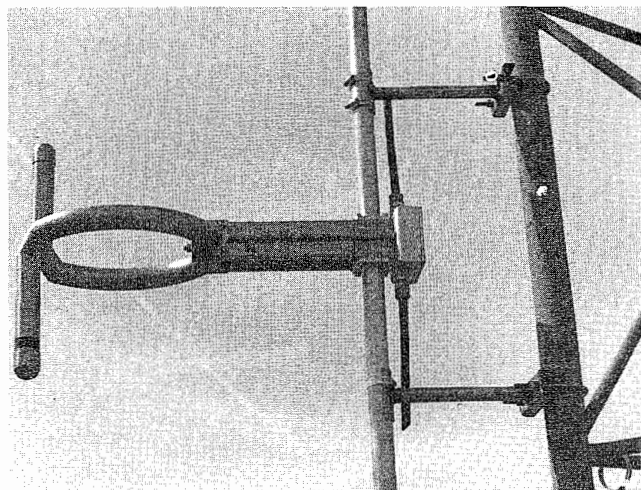

G4CPL Antenna

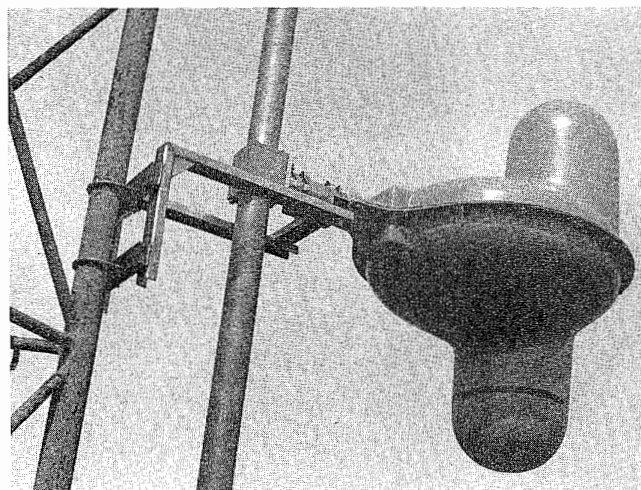

Radome for G4CP Series

## G4CPL Low Power Circularly Polarized FM Antennas

Collins Type	Power Gain		dB Gain		Field Gain		Input Power Rating kW	Approx. Length m (ft)	Weight (Including Brackets) kg (lb)	Wind Load Based on 244/161 kg/sq.m (50/33 lb/sq ft) kg (lb)	Weight (With Radomes Incl. Brackets) kg (lb)	Wind Load With Radomes Based on 244/161 kg/sq.m (50/33 lb/sq ft) kg (lb)
	Horiz	Vert	Horiz	Vert	Horiz	Vert						
G4CPL-1	0.4611	0.4611	-3.3623	-3.3623	0.6790	0.6790	3	—	16 (36)	34 (74)	24 (54)	73 (161)
G4CPL-2	0.9971	0.9971	-0.0128	-0.0128	0.9983	0.9983	6	3 (10)	35 (77)	47 (104)	52 (115)	153 (338)
G4CPL-3	1.5588	1.5588	1.9278	1.9278	1.2485	1.2485	7.5	6 (20)	54 (118)	115 (254)	78 (172)	234 (515)
G4CPL-4	2.1332	2.1332	3.2903	3.2903	1.4605	1.4605	7.5	10 (30)	72 (159)	156 (344)	105 (231)	314 (693)
G4CPL-5	2.7154	2.7154	4.3384	4.3384	1.6478	1.6478	7.5	12 (40)	91 (200)	197 (434)	132 (290)	395 (870)
G4CPL-6	3.3028	3.3028	5.1888	5.1888	1.8174	1.8174	7.5	15 (50)	109 (241)	238 (524)	158 (349)	475 (1047)
G4CPL-7	3.8935	3.8935	5.9034	5.9034	1.9732	1.9732	7.5	18 (60)	128 (282)	279 (614)	185 (408)	555 (1224)
G4CPL-8	4.4782	4.4782	6.5197	6.5197	2.1183	2.1183	7.5	21 (70)	147 (323)	319 (704)	212 (467)	636 (1402)

All antenna brackets are stainless steel. All weights given include brackets, interbay line, and transformer section. Factory-installed deicers are available using 300 watts per bay. Specify 120 volts or 230 volts. Heater elements replaceable in field. Shielded interbay heater cable and junction boxes are supplied. Heater weight, including junction boxes and interbay cable, is 2.7 kg (6 lb) additional per bay.

# Antenna Systems

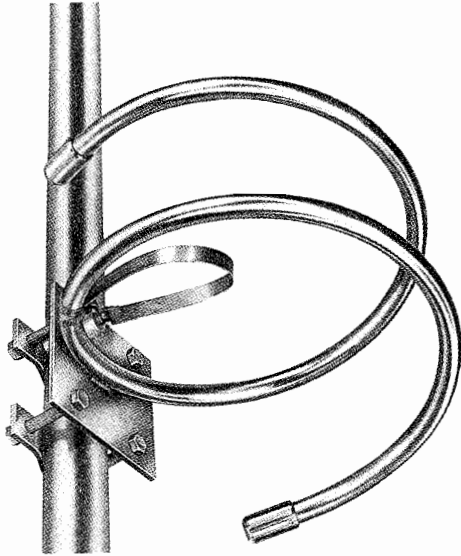

*Circularly Polarized Educational Antenna*

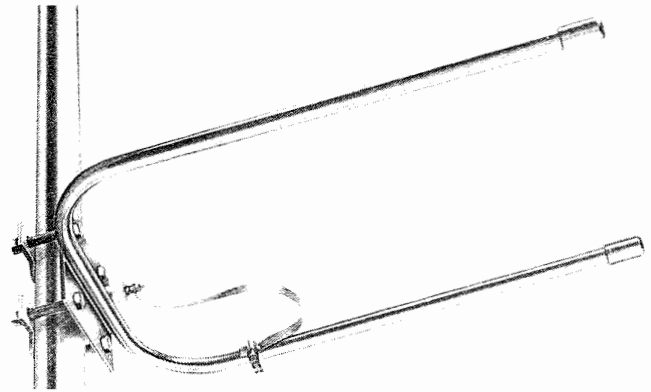

*Horizontally Polarized Educational Antenna*

For low power educational broadcasting applications, Collins Radio offers the economical Educational FM antennas produced by Phelps Dodge.

Available in either horizontally or circularly polarized models, these antennas, because of the normally lower power required in the educational service, are fabricated of  $\frac{7}{8}$ " stainless steel tube. The circularly polarized antenna is a  $1\frac{1}{2}$  turn helix and the horizontal polarized element has a U configuration. The educational antennas are complete with a matching harness of RG type cables and are designed to mount on tower legs or support pipes  $1\frac{1}{4}$ " to  $2\frac{3}{4}$ " diameters. The multi-element arrays have an element spacing of 10 feet.

## Circularly Polarized FM Educational Antenna Specifications

Type No. And Bays	Power Gain	Gain In dB	Field Gain	FS @ 1 Mile 1 kW, $\mu$ V/mi	Net Wt. Lb	Power Rating kW	Wind Load 50/33 lb/ft <sup>2</sup>
ECFM-1	0.43	-3.66	0.65	90	9	0.2	19
ECFM-2	0.90	-0.46	0.95	131	21	0.4	40
ECFM-3	1.42	1.52	1.19	165	32	0.5	62
ECFM-4	1.95	2.9	1.39	192	43	0.5	84
ECFM-5	2.42	3.84	1.56	215	54	0.5	107
ECFM-6	2.99	4.76	1.73	239	65	0.5	130

Educational FM Antennas are designed to mount on tower legs or support pipes having diameters up to 7 cm ( $2\frac{3}{4}$ "). The spacing between bays is 3.1 m (10 ft).

Educational FM Antennas are fed with RG-8 and RG-11 cables and all have type N Male Input Connector.

## Horizontally Polarized FM Educational Antenna Specifications

Type No. And Bays	Power Gain	Gain In dB	Field Gain	FS @ 1 Mile 1 kW, $\mu$ V/mi	Net Wt. Lb	Power Rating kW	Wind Load 50/33 lb/ft <sup>2</sup>
EHFM-1	1.0	0	1.0	138	9	0.2	19
EHFM-2	1.8	2.55	1.34	184	21	0.4	40
EHFM-3	2.8	4.47	1.67	230	32	0.5	62
EHFM-4	3.7	5.7	1.92	264	43	0.5	84
EHFM-5	4.6	6.6	2.1	289	54	0.5	107
EHFM-6	5.5	7.4	2.3	317	65	0.5	130

Educational FM Antennas are designed to mount on tower legs or support pipes having diameters up to 7 cm ( $2\frac{3}{4}$ "). spacing between bays is 3.1 m (10 ft).

Educational FM Antennas are fed with RG-8 and RG-11 cables and all have a type N Male Input Connector.

# Antenna Systems

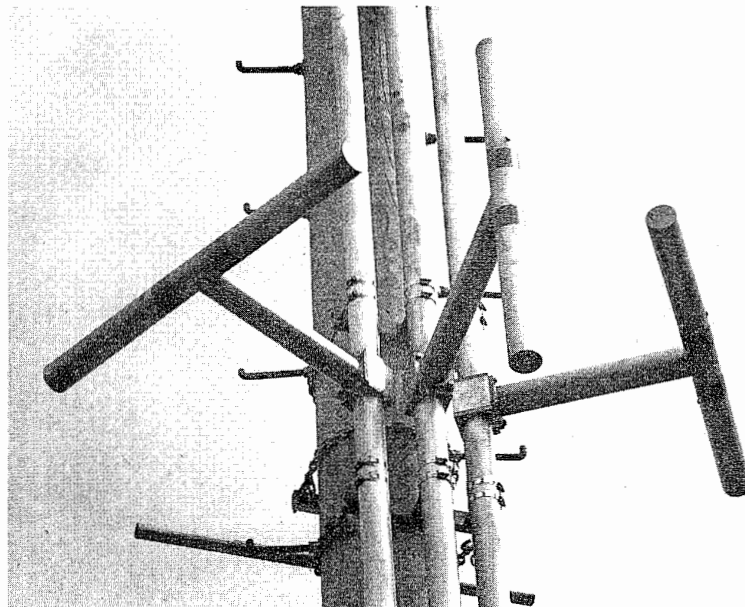

G4D Antenna

## Collins G4D Dual Polarized Directional FM Antenna

The G4D antenna series replaces Collins earlier DA-100 series. This antenna, supplied with a custom matching pole\*, permits support pole drop shipment directly to the customer. Each pole type is available at the antenna pattern range for testing.

The G4D uses broadband 7.9 cm ( $3\frac{1}{8}$  in) diameter dipole elements; in normal environmental conditions, elements do not require deicing. Each bay level normally uses two driven horizontal elements; one horizontal parasitic reflector and one driven vertical element. In some cases, vertical parasitic elements may be used on each bay to further shape the vertical polarization component.

The G4D antenna, with maximum 8-bay availability, uses a suffix after the type number to note the number of bays. Vertical spacing between bays is one wavelength.

The interbay lines use 7.9 cm ( $3\frac{1}{8}$  in) rigid. Three such lines are used between bays; two for horizontal element feeds and one for vertical element feeds. A combiner for the three transmission line feeds is used below the bottom bay; a 1.8 m (6 ft) transformer section is used directly below this combiner.

The G4D is available with 2.86 cm ( $1\frac{5}{8}$  in) [type number and suffix A], or 7.9 cm ( $3\frac{1}{8}$  in) EIA 50-ohm female input [type number and suffix B]. Maximum power input capability is 12 kW for A series; 20 kW for B series single bay, 40 kW for B series, 2 through 8 bays.

Heaters are not normally required for antenna deicing because of the excellent bandwidth characteristics of the antenna. Typically, measured between 1.5:1 vswr points, the bandwidth is between 5 to 7 MHz. As a result, the antenna can probably experience maximum icing of 1.9 cm ( $\frac{3}{4}$  in) thickness without the vswr going above 1.5:1.

Four typical directional FM antenna patterns are shown in the following four figures. The final pattern achieved may differ slightly from the initial pattern proposed, so that the customer may be required to file an application to modify the construction permit to comply with the pattern achieved on Collins antenna pattern range.

Orders for the G4D should specify the desired true azimuth orientation, maximum ERP permitted, radiated power limitations and their true orientation, transmission line efficiency (or type of transmission line and length), and the transmitter power output capability. Such antenna pattern requirements are normally specified by the station consultant.

Table 1 gives typical gain figures for each of the patterns shown. Table 2 lists the pole length for each antenna type, height of the electrical center above the support tower, weight, wind loading, etc.

\*The directional antenna may be purchased without the pole only on a special quotation basis; an added engineering charge will be made, and cost of the pole deducted from the total price.

# Antenna Systems

## Type G4D-( ) Dual Polarized Directional FM Antenna

Number of Bays	Pattern 1		Pattern 2		Pattern 3		Pattern 4	
	Maximum Power Gain		Maximum Power Gain		Maximum Power Gain		Maximum Power Gain	
	Horiz	Vert	Horiz	Vert	Horiz	Vert	Horiz	Vert
1	0.81	0.72	0.79	0.70	0.76	0.70	0.72	0.69
2	1.74	1.53	1.70	1.49	1.63	1.50	1.54	1.47
3	2.71	2.39	2.64	2.33	2.54	2.34	2.39	2.29
4	3.70	3.26	3.61	3.18	3.47	3.19	3.26	3.13
5	4.71	4.14	4.58	4.03	4.40	4.05	4.14	3.98
6	5.71	5.03	5.56	4.90	5.35	4.92	5.03	4.83
7	6.73	5.92	6.55	5.77	6.29	5.79	5.92	5.68
8	7.75	6.82	7.55	6.64	7.25	6.67	6.82	6.54

Note: The listed power gain figures are approximate only, but are useful as a guide in determining the number of bays required. The gain figures will vary with the pattern shape, and the exact gain figures are determined when the final antenna pattern is achieved.

The power gain for the vertical polarization component is less than the horizontal polarization component since it will differ a bit in shape, and in addition, the vertically polarized component can not exceed the horizontally polarized component at any azimuth.

## G4D-( ) Dual Polarized Directional FM Antennas

Collins Type	PATTERN 1				Input Power Rating kW	Female Input Flange cm (in)	Pole Length m (ft)	Weight Pole and Antenna kg (lb)	Total Wind Load Based on 244/161 kg/sq.m (50/33 lb/sq ft) kg (lb)	Moment kg/m (ft/lb)	Height of Electrical Center Above Top of Tower m (ft)	Bolt Circle Diameter cm (in)
	Power Gain		dB Gain									
	Horiz	Vert	Horiz	Vert								
G4D-1A	0.75	0.68	-1.22	-1.67	12	4.1 (1 $\frac{5}{8}$ )	6 (20)	275 (606)	361 (796)	1327 (9595)	4.8 (16)	23 (9)
G4D-1B	0.75	0.68	-1.22	-1.67	20	7.9 (3 $\frac{1}{8}$ )	6 (20)	284 (626)	372 (832)	1383 (10000)	4.8 (16)	23 (9)
G4D-2A	1.62	1.47	2.11	1.66	12	4.1 (1 $\frac{5}{8}$ )	9 (30)	1016 (2240)	826 (1821)	4152 (30024)	6.4 (21)	43 (17)
G4D-2B	1.62	1.47	2.11	1.66	40	7.9 (3 $\frac{1}{8}$ )	9 (30)	1025 (2260)	842 (1856)	4231 (30593)	6.4 (21)	43 (17)
G4D-3A	2.50	2.25	3.98	3.53	12	4.1 (1 $\frac{5}{8}$ )	12 (40)	1358 (2994)	1160 (2557)	7595 (54917)	7.9 (26)	43 (17)
G4D-3B	2.50	2.25	3.98	3.53	40	7.9 (3 $\frac{1}{8}$ )	12 (40)	1367 (3014)	1176 (2593)	7700 (55682)	7.9 (26)	43 (17)
G4D-4A	3.39	3.06	5.30	4.86	12	4.1 (1 $\frac{5}{8}$ )	15 (50)	1926 (4245)	1583 (3490)	12351 (89308)	9.4 (31)	43 (17)
G4D-4B	3.39	3.06	5.30	4.86	40	7.9 (3 $\frac{1}{8}$ )	15 (50)	1935 (4265)	1599 (3526)	12482 (90254)	9.4 (31)	43 (17)
G4D-5A	4.29	3.88	6.33	5.88	12	4.1 (1 $\frac{5}{8}$ )	19 (62)	2677 (5901)	2123 (4680)	21189 (153210)	11.5 (38)	43 (17)
G4D-5B	4.29	3.88	6.33	5.88	40	7.9 (3 $\frac{1}{8}$ )	19 (62)	2685 (5921)	2139 (4716)	21354 (154407)	11.5 (38)	43 (17)
G4D-6A	5.19	4.68	7.15	6.70	12	4.1 (1 $\frac{5}{8}$ )	22 (72)	3609 (7956)	2505 (5523)	28795 (208204)	13.1 (43)	43 (17)
G4D-6B	5.19	4.68	7.15	6.70	40	7.9 (3 $\frac{1}{8}$ )	22 (72)	3618 (7976)	2522 (5559)	28985 (209581)	13.1 (43)	43 (17)
G4D-7A	6.05	5.46	7.81	7.37	12	4.1 (1 $\frac{5}{8}$ )	25 (82)	4196 (9250)	2880 (6350)	37523 (271315)	14.6 (48)	43 (17)
G4D-7B	6.05	5.46	7.81	7.37	40	7.9 (3 $\frac{1}{8}$ )	25 (82)	4205 (9270)	2897 (6386)	37738 (272872)	14.6 (48)	43 (17)
G4D-8A	6.93	6.26	8.41	7.96	12	4.1 (1 $\frac{5}{8}$ )	28 (92)	5128 (11305)	3262 (7192)	47459 (343159)	16.1 (53)	43 (17)
G4D-8B	6.93	6.26	8.41	7.96	40	7.9 (3 $\frac{1}{8}$ )	28 (92)	5137 (11325)	3278 (7227)	47692 (344847)	16.1 (53)	43 (17)

# Antenna Systems

**Pattern 1**

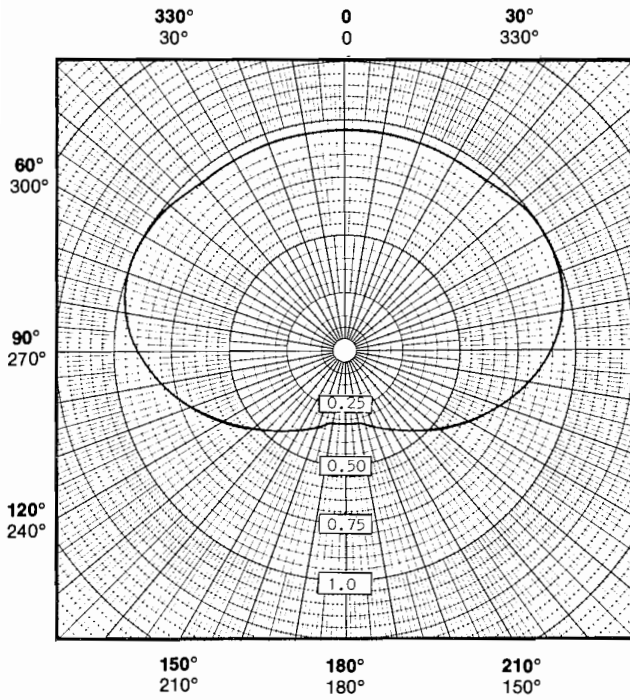

**Pattern 2**

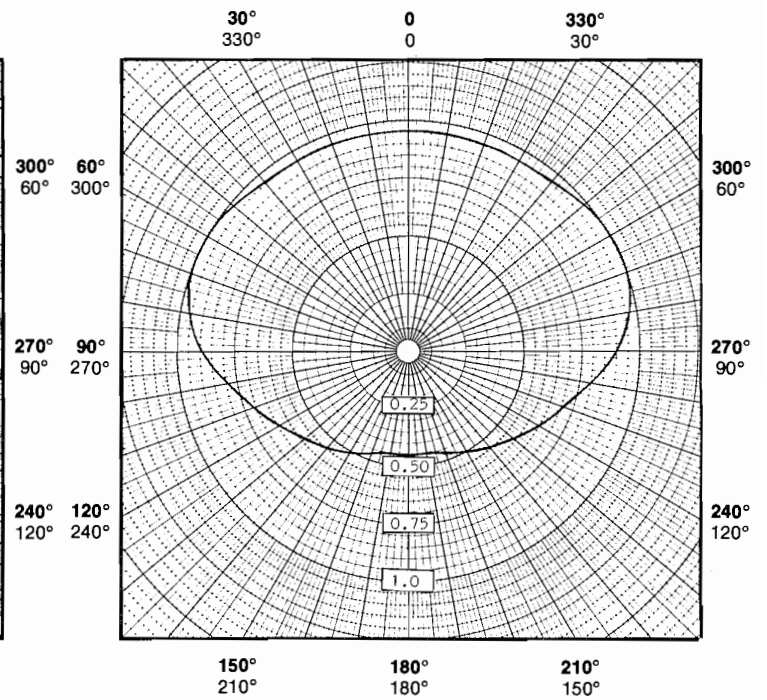

**Pattern 3**

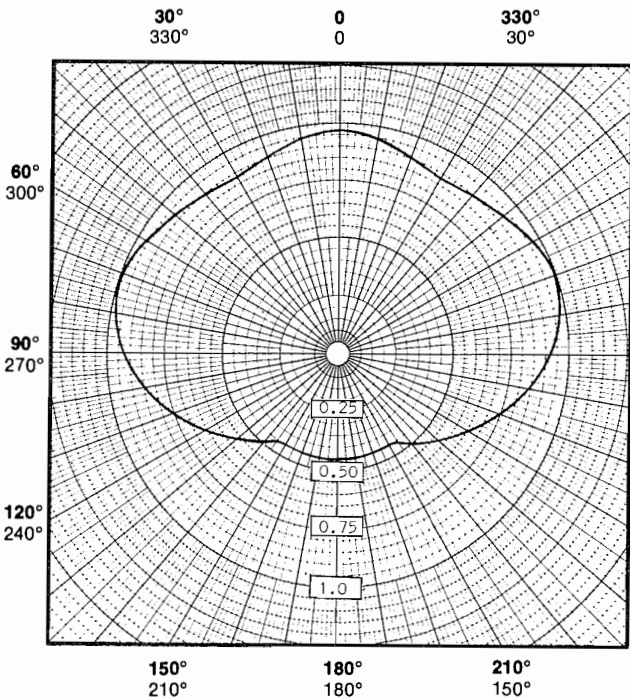

**Pattern 4**

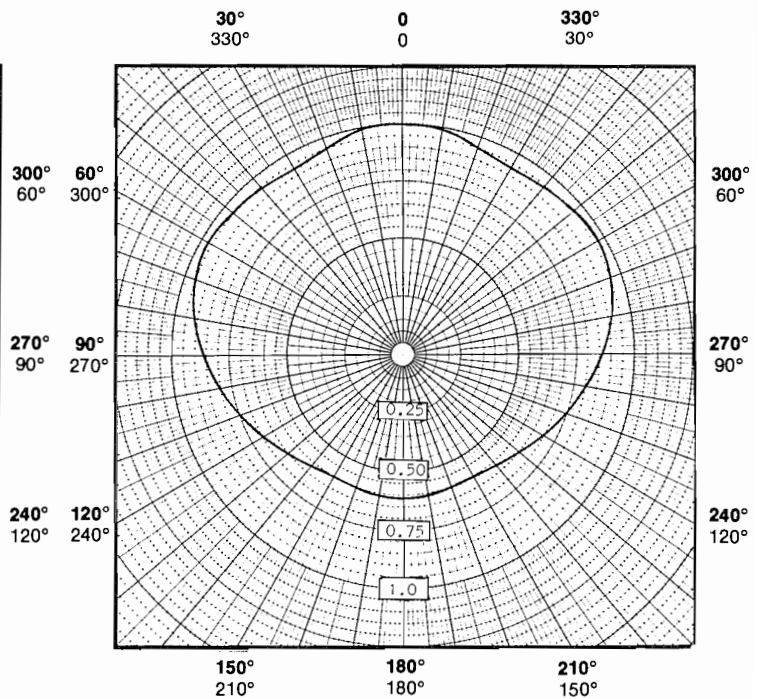

# Antenna Systems

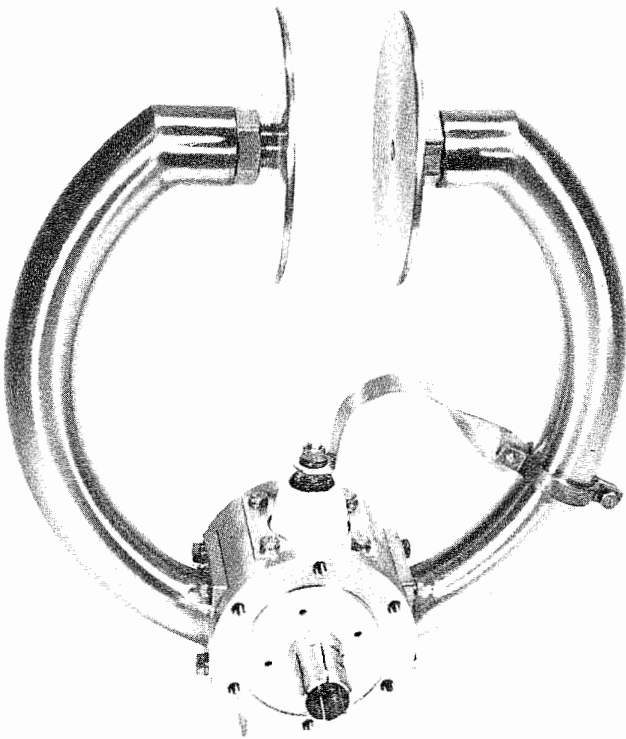

37M FM Antenna

## Collins 37M FM Antenna

A proven design that has been imitated but never duplicated in efficiency during the past decade, the Collins 37M Antenna still maintains its position of leadership in FM broadcasting.

The advanced design features of the unit make it an ideal antenna for stereo and multiplex operations. The aerodynamic simplicity and low weight of the 37M provide greater efficiencies and savings in new tower costs, erection time and maintenance expense. These features also eliminate undue oscillating and weaving of the tower and antenna.

The Collins 37M Ring Antenna consists of only two basic parts: the radiating ring and the connecting inter-ring transmission line. Any number of rings, either odd or even, may be used to provide maximum flexibility in high power gain.

Antenna arrays mounted on 1 $\frac{5}{8}$  or 3 $\frac{1}{8}$ -inch lines are available for handling transmitter powers up to 20 kw. Antenna assemblies on a 1 $\frac{5}{8}$ -inch line are rated for power inputs at base of antenna up to 2.5 kw for a single ring array; 10 kw for four or more rings. Antenna assemblies on a 3 $\frac{1}{8}$ -inch line are rated for power inputs up to 2.5 kw per ring at base of antenna with maximum of 20 kw for eight or more rings.

The horizontal radiation pattern of the Collins 37M FM Antenna is essentially circular for both top-mounting and side-mounting arrays. The extent of deviation from a circular pattern in the side-mounted antenna is dependent on the type and size of tower on which the antenna is mounted. In cases of very large supporting structures and in all cases where guy wires are used, expert recommendations should be requested on spacing of insulators and guy wires and mounting of the antenna.

The voltage standing wave ratio of the Collins 37M Antenna can be maintained at better than 1.15:1 when field tuned because of the inherently high stability of the tuning system. The capacitor plates of the 37M are adjustable for optimum performance and equal power distribution through all rings. These features allow an accurate prediction of the gain from the given number of loops in the array. Adequate bandwidth virtually eliminates detuning effects caused by changes in atmospheric conditions. The bandwidth and linearity of the antenna are more than adequate for multiplexing service.

The compactness and simplicity of the 37M allow maximum efficiency in ice removal. Each ring may be equipped with an internally mounted, 300-watt heating unit consisting of a cartridge type element inside each of the tuning capacitor plates and an additional flexible heating element extending the full circumference of the

# Antenna Systems

inside of the ring. The simplicity of the heating arrangement makes it possible to replace the elements in the field if necessary. The absence of large masses of metal assures efficient and practical deicing of the antenna and capacitor, which are the most critical parts of the antenna when icing occurs.

Further information and quotations on the 37M FM Directional Antenna will be supplied upon request.

Because 37M FM Antennas are made to order, specify frequency, number of elements, and size of transmission line when ordering.

## Part No. 013 0099 000

Deicer pay bay installed at the factory

## Part No. 124 0061 672

Replacement heating element. Two required per ring — 115v, 150w

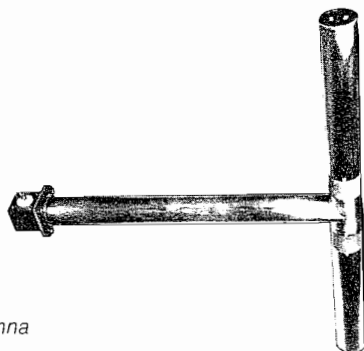

300C FM Antenna

## Collins 300C Vertically Polarized FM Antenna

Collins 300C vertically polarized FM antennas can significantly improve present horizontal - only coverage.

FCC regulations permit simultaneous FM radiation in both horizontal and vertical planes. For example, if your station is authorized for 5-kw ERP horizontal, vertical radiation can be added up to the same power.

Two methods are commonly used:

- (1) A single power amplifier and transmission line to provide power for each antenna.
- (2) Two power amplifiers fed from a common exciter-driver and two transmission lines. The antennas are fed separately.

The preferred method will be dictated by your power situation. If minimum initial investment is your primary concern, the first method is preferred. If redundancy is important, the second method permits either amplifier to be operated individually or both simultaneously. The recommended ratio of vertical to horizontal ERP is unity.

Collins Type 300C costs no more than your present horizontal bays, can be installed on your present tower, and is compatible with your FM transmitter.

Vertical polarization with Collins 300C:

- Fills in shadow areas
- Reduces null effects
- Improves fringe area reception
- Vastly improves car FM radio reception
- Maintains FM stereo quality
- Improves SCA operation.



# Antenna Systems

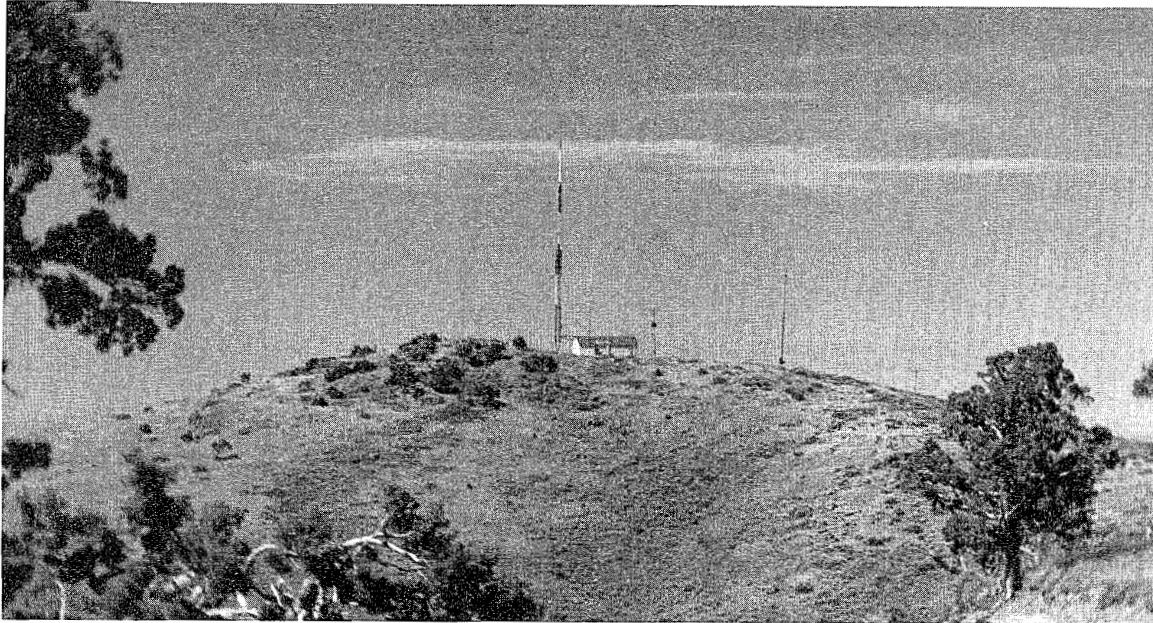

## Towers

### AM and FM Towers

Collins furnishes a wide selection of both self-supporting and guyed antenna towers custom-designed to meet the requirements of any AM or FM installation.

Towers are normally supplied with a protective coating of rust inhibitive paint prior to shipment, although they can be supplied with a galvanized finish at a slightly higher price. The galvanized finish is recommended in locations where the tower will be subjected to salt water spray, extreme humidity, or other corrosive conditions. The finish coat is normally supplied by the tower erector and is in keeping with FAA requirements.

All hardware, fittings, guy insulators, anchor steel and base insulator (where required) are supplied with each tower. The applicable FCC (FAA) lighting kit and wiring are also available.

### Pi-rod Solid-Steel Towers

Pi-rod offers a complete broadcasting, communication, and microwave tower service including design, fabrication, and erection. This equipment equals or exceeds AISC and EIA specifications. Pi-rod produces towers that are both functional and aesthetically acceptable. Solid rod, all-welded construction offers greatest strength with minimum surface exposure to wind and icing conditions. Local wind and icing conditions are analyzed for optimum design efficiency. Structures are designed by registered professional engineers to meet specific location requirements. Modular fabrication, with prefit factory components minimizes erection requirements. All tower sections are hot-dipped galvanized after fabrication for maximum protection.

# Antenna Systems

Pi-rod towers are tapered to reduce the face width of the tower in the area of the FM antenna to reduce the effect of tower influence on the radiated FM pattern. Both self-supporting and guyed models are available as follows:

Three models of self-supporting towers are available up to heights of 121.9 m (400 ft):

SRHS-30-50 — 13.6-kg (30-lb) wind load

SRHS-40-100 — 18.1-kg (40-lb) wind load

SRHS-70-200 — 31.8-kg (70-lb) wind load

Guyed tower models are available in heights up to 304.8 m (1000 ft). The width of the face (in) is denoted by the model number: 14, 18, 24, 30, 36, 42, and 52.

Established in 1950 to specialize exclusively in broadcast and communication towers, Pi-rod maintains a complete inventory of all tower components including: lighting kits; guy cable, grips and associated hardware; base insulators; guy line insulators for FM towers; and copper ground screens, wire, and strap.

## Utility Towers

Utility Tower Company offers a complete line of welded tubular steel or solid-member towers; guyed and self-supporting. Towers are normally fabricated in 6.096 m (20 ft) sections for ease of erection. 3.048 m (10 ft) sections are available for export shipping convenience. The normal tower section configuration is triangular with face widths varying from 45.7 to 106.7 cm (18 to 42 in) depending on the height of the tower. Tower sections can be purchased either hot-dipped galvanized or nongalvanized to suit customer requirements.

Utility Tower offers complete installation service by their own crews. This service includes installation of tower bases and anchors, erection of the tower, painting of tower installation of lighting equipment, hanging of FM and communication antennas, hanging of transmission lines, and installation of ground systems.

## Union Metal Monotube® Self-Supporting Antenna Poles

Monotube steel poles permit the erection of high antenna supports in the most confined areas without guy wire support problems. These cold processed steel poles, to a height of 76.2 m (250 ft), taper from a 60.9 cm (24 in) bottom diameter to approximately 7.6 cm (3 in) at the top. Monotube poles are manufactured from basic open hearth, hot rolled steel sheet and plate. These cold processed round tapered steel tubes meet all the requirements of ASTM A595 and have a minimum yield strength of 3866.5 kg/cm<sup>2</sup> (55,000 lb/in<sup>2</sup>).

These poles are designed for weather and wind loads up to a hurricane force of 273.5 km/h (170 mi/h), and offer safety and low maintenance. Ground assembly, painting, and wiring enable the erection of the assembled unit in one piece and set on its concrete foundation securely bolted.

# Antenna Systems

## Transmission Lines

### Transmission Line and Accessories

Collins supplies a complete complement of transmission lines and accessories for use in flexible (foam or air dielectric) and rigid applications.

All items receive careful factory inspection by the manufacturer through continuing quality control processes. Each production length of cable is tested for pulse reflection, high voltage, leakage, and continuity. Air dielectric cables are pressure checked before shipment and shipped with dry air pressure. Lengths are normally custom cut and fittings factory attached. Standard cutting tolerance is +2 percent. Closer tolerance is available on order.

If desired, coaxial cables may be phase-stabilized to provide a repeating (or "stable") phase-temperature characteristic. This is obtained through factory heat treatment of the cable.

Collins can provide any item in the Andrew, Cablewave, Phelps Dodge, or Prodelin line. In addition, Collins now offers the new Andrew 10.1 cm (4 in.) air dielectric Heliax line for high power FM installations and the Cablewave type HCC 312-50J 3½ in. air Wellflex cable. Some of the most commonly used items include:

Flexible line (foam dielectric) in 0.95, 1.2, 2.2 and 4.1 cm ( $\frac{3}{8}$ ",  $\frac{1}{2}$ ",  $\frac{7}{8}$ ", and  $1\frac{5}{8}$ ") sizes.

Flexible line (air dielectric) in 2.2, 4.1, 7.6, 8.9, 10.1, and 12.7 cm ( $\frac{7}{8}$ ",  $1\frac{5}{8}$ ", 3",  $3\frac{1}{2}$ ", 4" and 5") sizes.

Rigid line (50-ohm) in 12.7, 7.9, and 15.2 cm ( $1\frac{5}{8}$ ",  $3\frac{1}{8}$ ", and 6") sizes.

All necessary jacks, plugs, flanges, barriers, splices, terminals, and reducers.

All necessary hangers and accessories.

Pressurizing equipment and coaxial switches.

Information on special items is available from your Collins Broadcast Sales Representative.

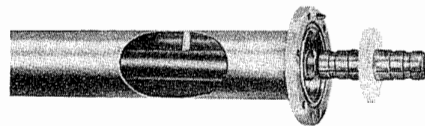

Andrew Rigid

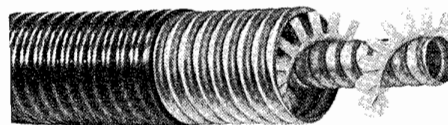

Andrew Air Heliax

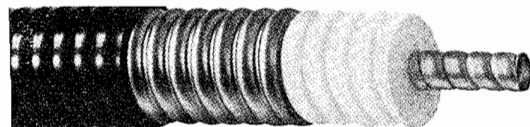

Andrew Foam Heliax

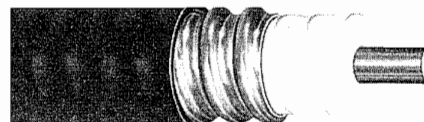

Cablewave Foam Wellflex

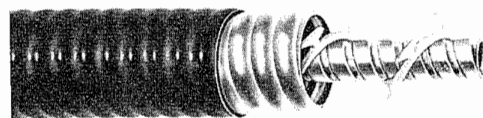

Cablewave Air Wellflex

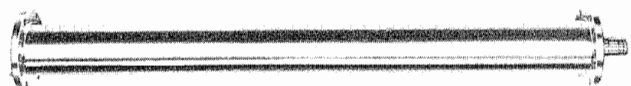

Cablewave Rigid

# Antenna Systems

## Typical Installations

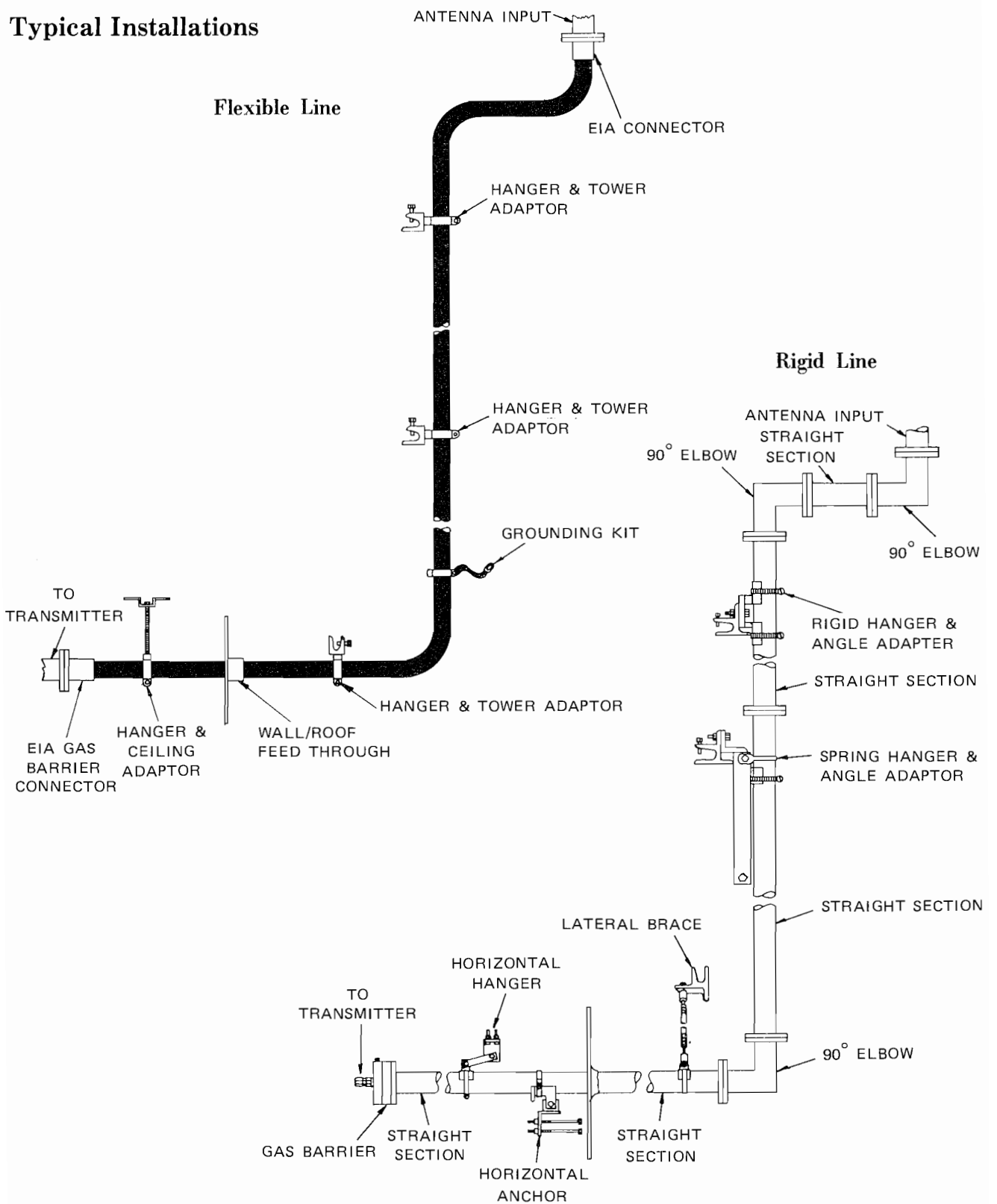

# Antenna Systems

## Accessories

### Copper Ground Wire

Bare #10 copper ground wire is used for ground radials. Wire attaches to mesh ground screen.

Weight: 9.69 m (31.8 ft) per kg (lb)

Part No. 421 1010 000

### Copper Ground Strap

This fine quality copper ground strap is available in four sizes of 0.086 cm (0.032 in.) thickness. 5.08 cm (2 in.) strap, 4.02 ft/lb 7.6 cm (3 in.) strap, 3.015 ft/lb 10.1 cm (4 in.) strap, 2.01 ft/lb 15.2 cm (6 in.) strap, 1.34 ft/lb.

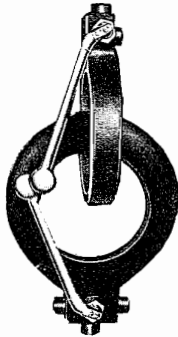

### Hughey and Phillips Ring Transformer

The ring transformer is used wherever 60-Hz energy must be transferred across two points with very low capacitance or at very high voltages. It provides a high reliable, low capacity means of supplying power across base insulator or insulated radio towers employed as radiators. The relatively large spacing and low capacity between windings make these isolation transformers desirable for use in directional arrays, and especially with radiators that develop very high voltages across the base insulators. No tuning or RF adjustments are necessary. Available in load capacities of 1750 watts (Model TI 2017) and 3500 watts (Model TI 2035) 115/230 volts. Mounting hardware not supplied.

Part No. 097 6920 00 (Type TI 2017)

Part No. 099 0365 00 (Type TI 2035)

### Hughey and Phillips Lighting Systems KG114 300 mm Code Beacon

The model KG114 300 mm code beacon is approved for use with red filters as a marker light for obstructions to air navigation such as TV, radio, microwave, and transmission line towers etc. This beacon is in full com-

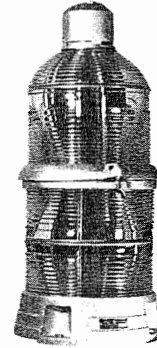

KG114

pliance with FAA code beacon requirements. The unit features heavy aluminum castings, weatherproof construction, ventilated dome with screened vents and hinged center frame to provide easy access for inspection and replacement of lamps.

Size: 38.1 cm (15") D, 51.6 cm (33.5") H  
Weight: 34.47 kg (76 lb)

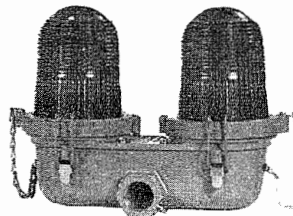

OB24

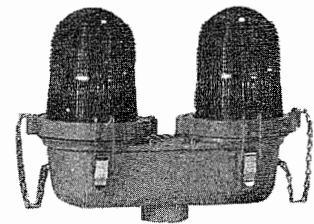

OB22

### OB22/24 Obstruction Lights

The OB22/24 double obstruction lights have two lamp receptacles, each to accommodate a choice of either an A21/TS medium screw base lamp of 100(107 or 116) watts, or a medium prefocus base lamp — 100 watt A21P — or 1020 lumen series (1020/66/A21). The OB22 has side entrance conduit while the OB24 has base entrance conduit (¾ or 1 in).

Weight: 2.94 kg (6.5 lb)

Quotations on Hughey and Phillips complete lighting systems and specialized lighting items can be made upon request.

# Antenna Systems

## Fisher-Pierce 63305-DB Beacon Light Control

Designed to mount in a standard commercial meter socket, the 63305-DB will automatically control broadcast tower lights directly or with auxiliary contactors. Adjustable potentiometer allows adjustment for operation from 0 to 50 footcandles.

- Power Requirements: 105 to 130 volts, 50/60 Hz
- Built-in Load Contactor: Single-pole, single-throw, Double-Break, 30 A
- Load Rating: 3000 watts
- Part No. 124 0032 559

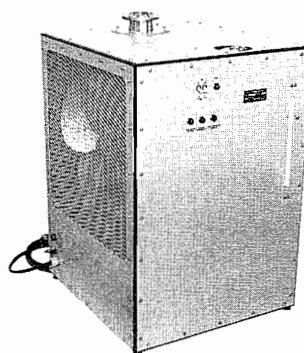

CPTC-30K

## Collins 172G-1 Dummy Antenna

This air-cooled unit provides a load to dissipate transmitter output for off-the-air testing. Consisting of eight ferrule type, noninductive resistors, with insulated end brackets and clips, it may be mounted on the transmitter or adjacent wall. The 172G-1 has an impedance of 52 ohms.

- Power Rating: 1 kW
- size: Approximately 15.24 cm W, 22.86 cm H, 31.75 cm D (6" W, 9" H, 12½" D)
- Weight: 2.27 kg (5 lb)
- Part No. 522 1410 004

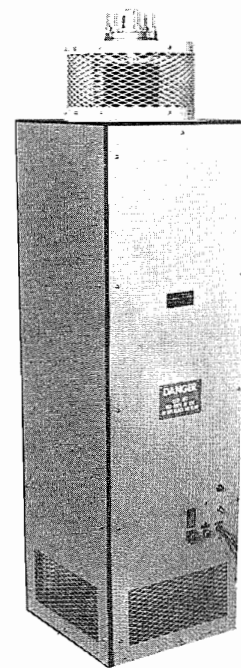

DPTC-20KFM

## States WG-50 Dummy Antenna

An air-cooled 50-ohm RF load that will dissipate the output of the Collins 820E/F AM Transmitters.

- Part No. 124 0061 794 (WG-50) 7.5 kW
- Part No. 124 0061 801 (2 each 33836-5) 15 kW

## Electro Impulse CPTC-30k, AM Load

Consists of a highly reliable, liquid-cooled load and heat exchanger rated at 30 kW continuous load at 40°C (105°F) ambient temperature.

- Frequency Range: 60 Hz to 1 GHz, 1.1:1 vswr. 3¼ in. EIA input flange, 208/220 vac, 1 ph, 60 Hz, 12 A.
- Size: 88.9 cm (35 in.) HX 60.9 cm (24 in.) WX 63.5 cm (25 in.) D.

## Electro Impulse RF Loads

MODEL	AVG PWR (watts)	FREQ RANGE (DC MHz)	MAX VSWR	EIA CONNECTOR cm (in)	SIZE			WT kg (lb)	REQD PWR (V ac 1 phase)
					D cm (in)	W cm (in)	H cm (in)		
CPTC-30K	30K	108	1.2:1	7.9 (3¼)	63.5 (25)	60.9 (24)	88.9 (35)	136.1 (300)	220
DPTC-10KFM	10K	108	1.2:1	7.9 (3¼)	27.9 (11)	40.6 (16)	96.5 (38)	16.8 (37)	110
DPTC-20KFM	20K	108	1.2:1	7.9 (3¼)	43.1 (17)	43.1 (17)	160.0 (63)	45.4 (100)	110
DPTC-50KFM	50K	108	1.2:1	15.5 (6¼)	53.3 (21)	53.3 (21)	165.1 (65)	54.4 (120)	220
DPTC-75KFM	75K	108	1.25:1	15.5 (6¼)	66.0 (26)	66.0 (26)	165.1 (65)	68.0 (150)	220

# Antenna Systems

## IC-1 Isolation Coil

The IC-1 Isolation Coil provides isolation for the phase sampling loop line in directional arrays, presenting a high impedance for the line across the base insulator of the AM tower. The unit consists of a phenolic coil form wound with approximately 37 turns of RG8/U or similar solid dielectric line.

Inductance: Approximately 180 microhenrys  
Size: 46 cm L, 25.4 cm D. (18" L, 10" D.)  
Weight: 2.7 kg (6 lb).

## Collins Antenna Current Transformer

The antenna current transformer is used with remote thermocouple and meter for remote monitoring of antenna current up to 25 amperes. Thermocouple is not included.

Part No. 543 3917 003

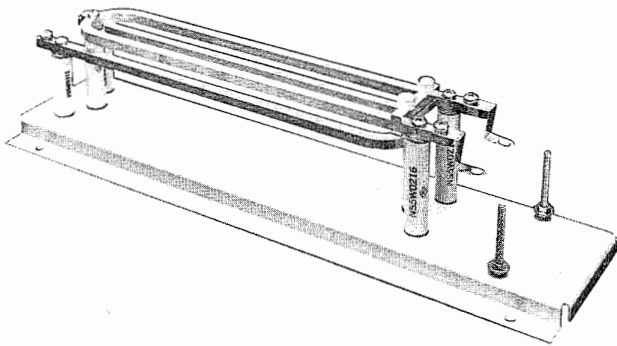

## Tower Lighting Filter Chokes

LC-2, 2-wire, 2000 watts  
LC-3, 3-wire, 2000 watts  
Aluminum weatherproof housing optional item available.

## Dale SPA Lightning Arresters

The SPA series of lightning arresters; SPA-100/200/400, provide excellent protection for solid-state devices against lightning, (direct or indirect), and other transient voltages. A hermetically sealed, preionized spark gap improves response and stabilizes breakdown voltage. The SPA series is engineered to maintain physical integrity when conducting lightning strokes in excess of 60,000 amperes. The SPA arrester meets or exceeds MIL-A-21907A, Type I, Class 1, Size 0 requirements, and all applicable NEMA, USAS, and IEEE standards. The SPA series protects equipment operating from nominal voltages of 120 volts (SPA-100), 247 volts (SPA-200), and 480 volts (SPA-400). The arrester may be installed on a fuse box or on building sides or utility poles.

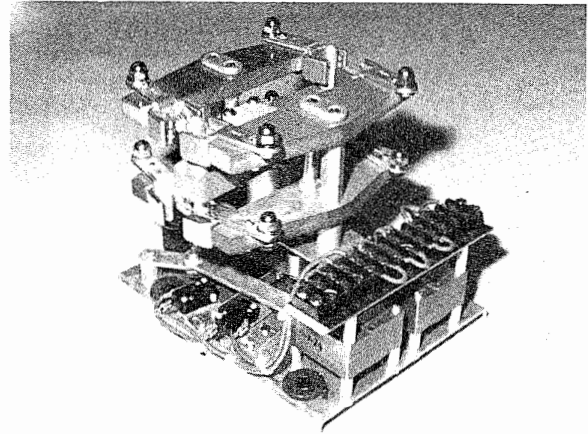

*Kintronics RF Contactors*

## Kintronics Labs RF Contactors

The Kintronics Labs RFC-40-20 series of RF contactors are available in single-pole and double-pole configurations for use in RF switching applications. In normal service, the applied solenoid voltage is automatically disconnected by the normally closed micro-switch at the time the rotating contact arm completes its movement. This automatic disconnect feature ensures momentary application of voltage regardless of the "on" time of the external control switch. A convenient terminal board with barriers is provided for connection to solenoids and auxiliary switches.

RFC-40-20-1, SPDT, 40 A, 20 kV, 110/220 V solenoid.

RFC-40-20-2, DPDT, 40 A, 20 kV, 110/220 V solenoid

Size: 21.6 cm (8.5")DX 19 cm (7.5")WX 17.8 cm (7")H



*Dale SPA Lightning Arrester*

# Antenna Systems



601-48 Sampling Loop

## Electronic Research Sampling Loop

The 601 series adjustable phase sampling loops sample the phase relationship of RF energy in the 550- to 1600-kHz range. The loops are constructed of heavy stainless steel and terminate in a type N female plug.

NPN 601-48 Loop, 121.9 x 30.4 cm (48 x 12")

NPN 601-91 Loop, 231 x 30.4 cm (91 x 12")

## Feedthrough Bowl Insulator

Designed to carry RF transmission line through a wall. Assembly includes a bowl, or bowls, 17.8 cm (7 in.) in diameter and 13.9 cm (5.5 in.) high with stud length as described below:

CPN 124 3015 153 Bowl Insulator, single with fittings, 17.8 cm (7") diameter, 13.9 cm (5½") high, 26.6 cm (10½") stud.

CPN 124 3015 154 Bowl Insulator, single with fittings, 17.8 cm (7") diameter, 13.9 cm (5½") high, 26.6 cm (10½") hollow stud.

CPN 124 3015 155 Double Bowl Insulator with fittings, bowls are each 17.8 cm (7") diameter, 13.9 cm (5½") high, 45.7 cm (18") stud.

CPN 124 3015 156 Double Bowl Insulator with fittings, bowls are each 17.8 cm (7") diameter, 13.9 cm (5½") high, 45.7 cm (18") hollow stud.

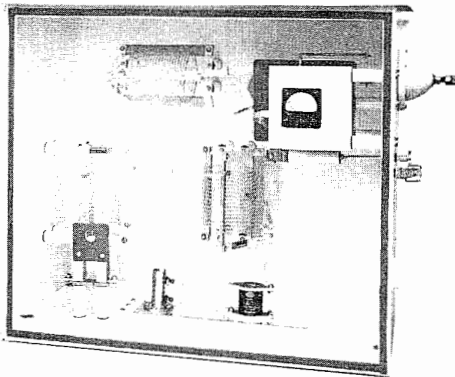

LTU Tuning Unit

## LTU Antenna Tuning Units

Collins LTU series of antenna tuning units are custom-designed for each individual application and are available in either 1-kW, 5-kW, 10-kW, 25-kW, or 50-kW

power ratings. They are mounted in a weatherproof aluminum housing with a full-width door. A window facilitates reading of the antenna current meter. The meter is actuated by an external operating handle. The custom-designed full "T" network uses high quality, conservatively rated components. A silver-plated bus, located at the bottom of the housing, provides a ready low-resistance connection to the antenna ground system. A special terminating connector allows connection to any coaxial cable with a 2.54 cm (1 in.) outer conductor diameter or smaller. Other sizes may be accommodated as required. The housing is finished with light-colored paint to minimize internal temperatures; weatherproof screened vents allow air circulation.

LTU-1B 1 kW

LTU-5B 5 kW

LTU-10B 10 kW

LTU-25B 25 kW

LTU-50B 50 kW



Micro-Trak 2570 Antenna Heater Control System

## Micro-Trak 2570 Antenna Heater Control System

The 2570 senses ambient atmospheric conditions and controls power to the element heaters in FM, TV, and other electrically heated antenna arrays. The system provides aural and visual indication of status, monitors the condition of the heater elements, and provides an alarm in the event of a failure. The 2570 reduces operational costs by continually sensing atmospheric conditions, thus restricting heater turn-on to ice-causing conditions: freezing temperatures and precipitation. The 2570 system consists of four basic components: 2570 Control Unit, 2570-TT Temperature Sensing Unit, 2570-PD Precipitation Detector, and the 2570-HF Heater Failure Sense Transformer. The system has been field-tested in depth to optimize design and ensure performance and reliability. Optional accessories (Remote Display Output Circuit, Remote Display Panel, Calibration Box, Power Contactors and Enclosures, and Slow Start Kit) are available.

Size: Standard 8.8 × 48.2 cm  
(3½ × 19") Rack Panel  
20.3 cm (8") D

2570	NPN	Control Unit
2570-TT	NPN	Temperature Sensing Unit
2570-PD	NPN	Precipitation Detector
2570-HF	NPN	Heater Failure Sense Transformer



# Antenna Systems

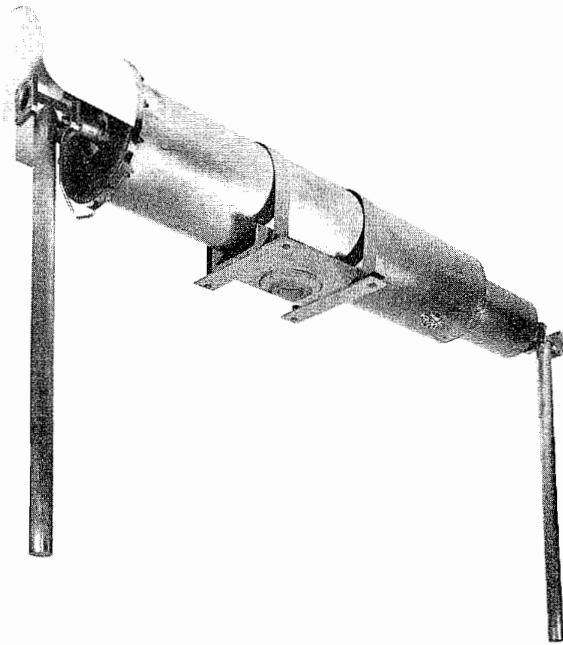

403-403A Isolation Transformers

## AM/FM Isolation Transformers

Isolation transformers are designed to couple the FM power across the base insulator of a transmitting tower used jointly as an AM and FM radiator without introducing a mismatch into the FM feedline. An isolation transformer is especially desirable for feeding high impedance AM radiators, or AM radiators that are part of an AM directional antenna system which might be adversely affected by a "bazooka" type isolation system. Each unit is factory tuned to station FM frequency.

## Type 403-403A Isolation Transformer

Frequency	88 to 108 MHz.
VSWR	Less than 1:05 to 1 at the station frequency.
Bandwidth	Over 2 MHz between 1.1 to 1 vswr points, 50-ohm load.
FM Power	10 kW, 50-ohm line.
AM Peak Voltage	7500 volts.
AM Shunt Capacity To Ground	Approximately 200 pf.
Lightning Protection	Quarter-wave shorted stubs on input and output.
Connectors	403-2.86 cm (1 <sup>5</sup> / <sub>8</sub> " ) male swivel input, 2.86 cm (1 <sup>5</sup> / <sub>8</sub> " ) female swivel output. 403A-7.9 cm (3 <sup>1</sup> / <sub>8</sub> " ) male swivel input, 7.9 cm (3 <sup>1</sup> / <sub>8</sub> " ) female swivel output.
Weight	47.6 kg (105 lb) including cradle.
Length	170 to 185 cm (67" to 73" ) depending on frequency.
Diameter	25.4 cm (10" ) maximum.
Mounting	Cradle supplied with 5 cm (2" ) pipe flange on bottom. Pipe stand not supplied.
Pressurization	4.5 kg (10 lb) line pressure maximum pass through.

# Antenna Systems

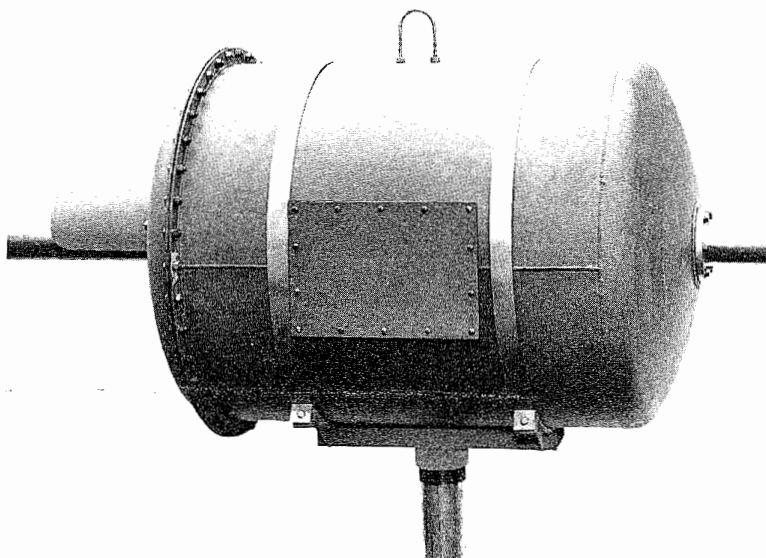

425-426 Isolation Units

## Type 425 and 426 Isolation Units

Frequency	88 to 108 MHz.
VSWR	Less than 1:05 to 1 at station frequency.
Bandwidth	Over 2 MHz between 1.1 to 1 vswr points, 50-ohm load.
FM Power	425-25 kW FM. 426-40 kW FM.
AM Peak Voltage	40,000 volts.
AM Shunt Capacity to Ground	60 to 70 pf.
Lightning Protection	Heavy duty dc shorts between inner and outer conductors on input and output.
Connectors	425-Input 7.9 cm (3 <sup>1</sup> / <sub>8</sub> " ) male, output 7.9 cm (3 <sup>1</sup> / <sub>8</sub> " ) male. 426-Input 7.9 cm (3 <sup>1</sup> / <sub>8</sub> " ) male, output 7.9 cm (3 <sup>1</sup> / <sub>8</sub> " ) female.
Weight	425-116 kg (256 lb). 426-136 kg (300 lb).
Length	425-99 cm (39"). 426-111 cm (44").
Diameter	425-66 cm (28 <sup>1</sup> / <sub>2</sub> " ). 426-66 cm (28 <sup>1</sup> / <sub>2</sub> " ).
Mounting	Cradle supplied with 7.6 cm (3") pipe flange on bottom. Pipe stand not supplied.
Pressurization	Gas passthrough from line: 4.5 kg (10 lb) maximum.

# Audio Equipment





## Consoles, Mixers

### Collins IC Console Series

Collins IC-10A and IC-6A all solid-state consoles offer the broadcaster versatility and custom configuration capability for practically every requirement. The consoles may be used for AM, FM, FM stereo, and custom audio installations. Both may be configured for programming separate monaural, stereo, or dual-channel monaural, simultaneously.

The IC-10A can be configured to suit customer requirements by plugging in the necessary amplifiers or transformers to provide proper matching and amplification. All controls are dual, controlling the left and right channels simultaneously. All inputs may be used for balanced or unbalanced microphone level, high level balanced line, or high level equalized phonograph. The phonograph equalizer is remotely located at the turntable to eliminate RF interference.

The inputs of channels 1 through 8 are connected to the console circuits through 2-position input selector switches. Channels 9 and 10 are connected through a pair of 6-position rotary switches. These inputs may be used for either remote lines or normal inputs, either low or high level.

# Audio

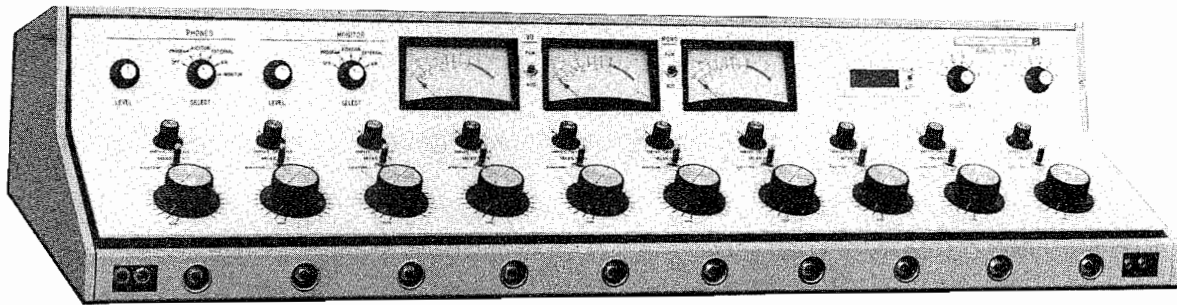

IC-10A 10-Channel Console

In addition to the many features that the IC-10 offers the broadcaster in the way of performance and flexibility, human engineering has made possible a level of operator convenience that is truly remarkable. Included as part of the standard IC-10A, are recessed pushbutton switches, located under each mixer, that may be used for remote starting of turntables, tape machines, or any other remotable equipment. These switches are wired through contacts on the input selector switches for further usefulness in operation. The IC-10A cabinet is of modern design, and offers ease of maintenance.

Similar in construction to the IC-10A, the IC-6A is designed for the smaller AM or FM station that does not require as many inputs as the IC-10A. The IC-6A incorporates all the design features and versatility of the larger unit. The IC-6A, like the IC-10A, may readily be expanded from monaural to stereo capability by simply adding the required plug-in amplifiers. An additional option is a digital readout time/elapsed time display, mounted in the front panel.

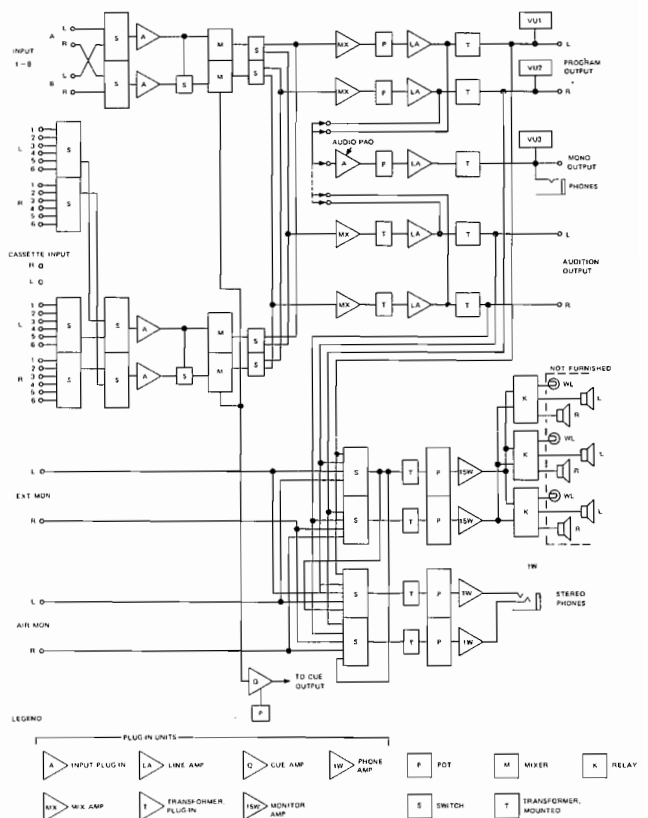

IC-10A Block Diagram

## Specifications

### Power Source

117 or 230 V ac, 50 to 60 Hz, single phase

### Input Characteristics

#### IC-10A

Eight stereo channels for use as balanced or unbalanced microphone or high-level line signals.

Two stereo channels with multiple inputs.

#### IC-6A

Five stereo channels for use as balanced or unbalanced microphone or high-level line signals.

One stereo channel with multiple inputs.

### Input Impedances

High Level: 10-kilohm bridging, 600-ohm termination

Microphone: 200 ohms or 50 ohms

External Monitor: 10 kilohms

### Input Levels

High level: -10 dB mW to +10 dB mW

Microphone: -65 dB mW to -50 dB mW

External Monitor: -10 dB mW to +10 dB mW

### Output Characteristics

Monaural Program

Stereo Program

Stereo Audition

Three Separate Stereo Monitors

Stereo Headphone Jack

Monaural Headphone Jack

### Output Load Impedances

Program Audition Outputs: 600 ohms, balanced

Monitor Outputs: 4 to 16 ohms, unbalanced

Headphone Outputs: 8 ohms to 50 kilohms

### Output Levels

Program, Audition Outputs: +18 dB mW nominal,

+27 dB mW maximum

Monitor Outputs: 15 watts into 8 ohms, maximum

### Frequency Response

Program Audition Outputs:  $\pm 1$  dB, 30 Hz to 15 kHz

Monitor Outputs:  $\pm 1.5$  dB, 30 Hz to 15 kHz

### Distortion Characteristic

Program Audition Outputs: Less than 0.5% THD

Monitor Outputs: Less than 1.5% THD

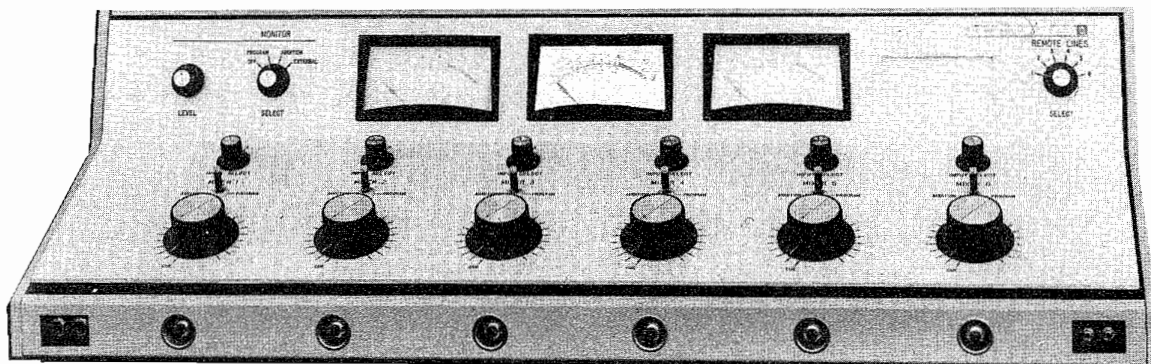

IC-6A 6-Channel Console

# Audio

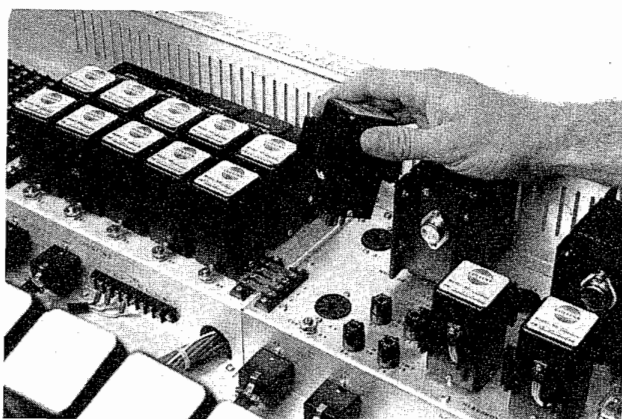

Plug-in Module (IC6A and IC10A)

## Equivalent Input Noise

Program Audition:  $-120$  dB mW  
 Monitor:  $-110$  dB mW

## Gain

100 dB, minimum

## Service Condition

### Ambient Temperature

0 to  $+40^{\circ}\text{C}$  ( $32^{\circ}$  to  $100^{\circ}\text{F}$ )

### Humidity

0 to 95% relative humidity

### Altitude

3,048 m (10,000 ft)

### Vibration and Shock

Normal handling and shipping

IC-6A Block Diagram

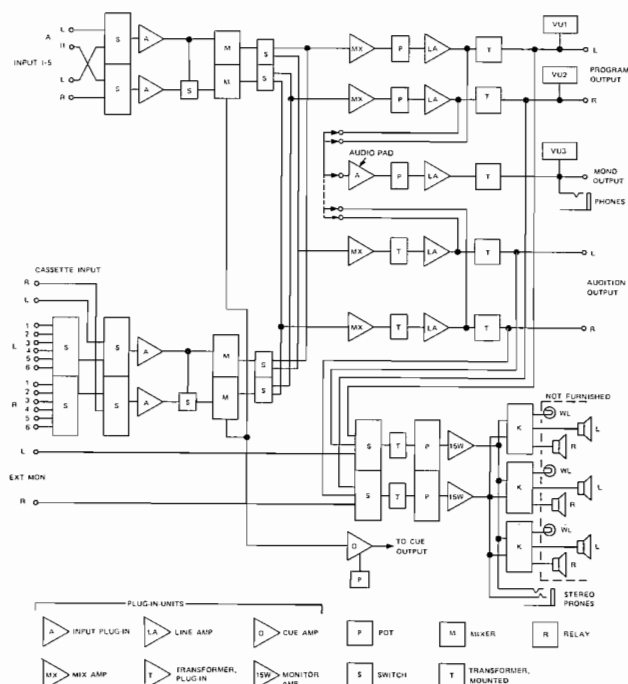

## Dimensions

### IC-10A Series

25.4 cm (10") H  
 50.8 cm (20") D  
 118 cm (44") W

### IC-6A Series

25.4 cm (10") H  
 50.8 cm (20") D  
 91.5 cm (36") W

## Weight

IC-10A series, approximately 18.5 kg (40 lb)  
 IC-6A series, approximately 13.88 kg (30 lb)



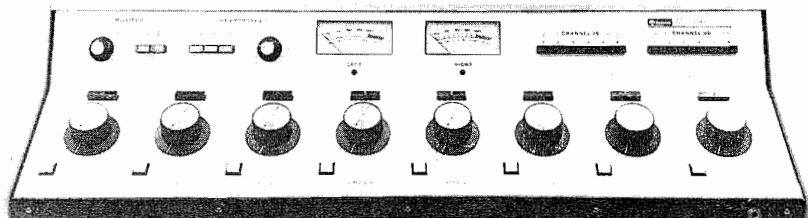

Mark 8 Stereo Console

## Mark 8 Stereo Console

The Mark 8 Stereo Audio Console is an eight mixer audio console serving an unfilled need for a high quality console in the low cost broadcast market. This new console offers broadcasters four major benefits.

1. Maximum on-air time . . . the result of combined Collins renowned manufacturing quality with modern design technology.
2. Unsurpassed on-air sound . . . the result of the outstanding performance specifications described below.
3. Most efficient operator performance . . . the result of human factors engineering design.
4. Minimum maintenance time and cost . . . the result of modular plug-in design and the use of conservatively rated components.

Eight mixing channels accommodating 26 stereo input pairs are provided as follows:

- Six mixers with two independent inputs per mixer
- Two mixers with one direct input and six indirect inputs per mixer

All inputs are balanced, transformer coupled inputs which may be strapped for either 150 or 600 ohms. Nominal input level is  $-20\text{VU} / -10\text{ dBm}$ . The six indirect inputs to channels seven and eight may be connected as 10,000 ohm bridging inputs if desired.

Single button control of external machines (turntables, cartridge tape players and reel to reel tape players) is easily accomplished with an optional machine control interface assembly. This interface assembly permits start/stop control of a machine to be slaved to the channel on/off pushbutton associated with the particular unit.

Noise free switching is assured through the use of solid state switching circuitry. Attenuators are long life step type ladder attenuators.

Two independent unassigned microphone preamplifiers, each with two isolated outputs are provided. They may be assigned as one stereo pair or as two independent monaural preamps to any of the inputs to the console. This assures added flexibility for any particular installation.

Placement of switches has been optimized for operator comfort and operation. Silent alternate action switches replace lever type switches for channel on/off control. These pushbuttons are located below and to the left of the channel attenuator knob to allow easy operation with the thumb while the fingers control the attenuator setting. Input selection for each channel is accomplished by a two position pushbutton switch assembly located above each attenuator.

The mixer bus output is available for driving two-way telephone interface systems and a postmixing input to the program amplifier is provided for mixing the output of a two-way telephone device or other such systems.

Stereo monitor amplifiers are provided which deliver 25 watts RMS per channel. Each monitor amplifier has three outputs for monitor speakers.

Two outputs feed individual muting relays for studio speakers and one direct output is provided for unmuted speaker use. The monitor amplifier may be switched to monitor the program output of the console or an external off air monitor.

A stereo headphone amplifier is provided to drive any headphones of four ohms or greater impedance. The headphone amplifier delivers a minimum of five watts into 8 ohms. It is selectable to monitor the program output of the console, an external air monitor or the console cue buss.

A built-in cue amplifier and speaker are provided for cueing purposes. The built-in cue speaker is muted by the control room muting relay. An external high quality speaker may be employed for quality evaluation of program material if desired.

## Specifications:

### Inputs

#### Impedance

Microphones:	Nominal 150 ohms
Medium Level:	Nominal 150/600 ohms

# Audio

## Level

Microphones:	- 50 dBm Nominal
Medium Level:	- 10 dBm Nominal
Number of Inputs:	26 Medium Level

Any two inputs may be strapped for microphones.

## Outputs

### Program

Level:	+ 18 dBm Nominal + 30 dBm Maximum
Impedance:	600 Ohms

### Monitor

Level:	25 watts RMS into 8 ohm load
Impedance:	Total load must not be less than 8 ohms

Level:	5 watts RMS into 8 ohm load
Impedance:	4 ohms Minimum

## Noise:

- 125 dBm in 20 KHz Bandwidth

## Distortion:

Less than 0.5% Harmonic  
Less than 0.25% I.M.  
(60 Hz and 7000 Hz: 4 : 1)

## Frequency

### Response:

± 1.0 dB 30 Hz to 15 KHz

## Power Source:

120/240 volts 50/60 Hz AC

## Size

Console Shell:	34" W X 9" H X 18¾" D
Power Transformer:	6¾" W X 10" H X 6" D

## Rank Audio Visual Audio Consoles

Rank Audio Visual offers a wide line of standard audio components as well as customized audio mixing consoles to suit the requirements of the Radio, Television, and Recording Industry. Typical of these custom consoles is the Model B102. The standard system comprises 14 equalized microphone/line inputs which may be routed to any or all of 4 groups and 2 master output groups. When larger numbers of input channels are

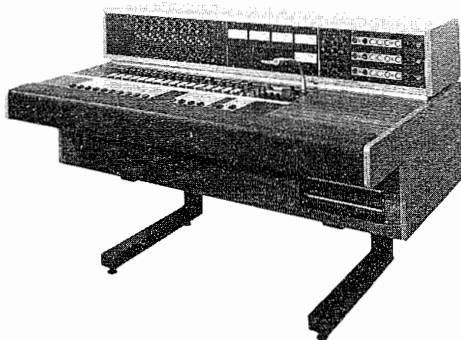

Rank B102 Console

required, the B102 can be expanded to accommodate up to 36 input modules. A wide range of ancillary modules, all having the same modular dimensions such as

compressor/limiters, oscillators, etc, are available and can be incorporated when custom-built equipment is required.

All electronics inclusive of the meter panel, pre-fade listen loudspeaker, monitoring controls, and talkback facilities are designed on the modular, plug-in principle. Each section of the main frame of the console, such as the connector and transformer panels, is hinged to ensure that all parts of the console are easily accessible. For information on other Rank Industries consoles, contact your Collins sales representative.

## Specifications

Input	14 channels equipped with mic/line selection, sensitivity control (-80 to +10 dB)
Output	Normal output level 0 or +4 db mW into 600 ohms Maximum output level greater than +24 dB mW into 600 ohms
Response	Better than ±0.5 dB over the frequency range of 20 Hz to 20 kHz
Noise	Channel and group faders set to give 0 dB mW out for 0 dB into line input with sensitivity switch set to zero: (1) From mic input set to higher impedance and terminated in 600 ohms and sensitivity control set to -80 dB, output noise level shall be -45 dB mW or better, measured 20 Hz to 20 kHz (equivalent noise level of -125 dB) (2) From line input terminated in 600 ohms and sensitivity control set to 0, output noise level shall be -76 dB mW or better, 20 Hz to 20 kHz.
Distortion	Total harmonic distortion from any input to any output terminated in 600 ohms at an output level of +18 dB mW shall not exceed 0.07%. Typically for an output level of 0 dB mW, the distortion will be 0.02%.
Size	143.0 cm (56.3") width 89.0 cm (35.0") depth 96.5 cm (38.0") height Fader and script height 71 cm

## Ancillary Modules

3B02	Microphone Amplifier, with preset 5 dB steps
3B04	Distribution Amplifier
4B02	Compressor/Limiter
4B01	Voice/Over Module
4B04	Oscillator
3B02	Stereo Line Input (stereo fader required)
2B04	Channel Routing Module, equipped 4 auxiliary outputs
2B04/B	Group Routing Module, equipped 4 auxiliary outputs

# Audio

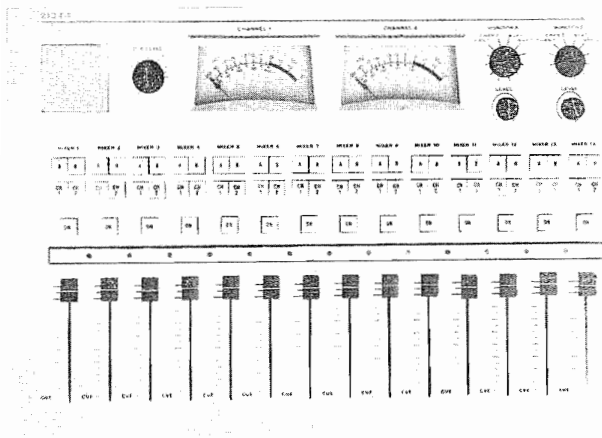

212T-2 Console

## Collins 212T-1 Console

Designed especially for television, large AM facilities, and recording studios, the 212T-1 is a dual-channel console providing 28 inputs to 14 faders, two program output channels, a VU meter for each program output channel, two auxiliary program outputs, two 10-watt monitor outputs, and a built-in cueing speaker.

Each fader is engraved and has illuminated pushbuttons for A and B input selection and channel 1 or 2 selection. These buttons are the push-on, push-off type and are normally preset prior to air time. Two levels of illumination show the status of all switches during operation. The overall level is adjustable by a single control knob on the rack-mounted assembly. This feature is especially useful in dimly lighted areas, such as a TV control room.

Size: 40 cm H x 61 cm W x 15 cm D (15 $\frac{3}{4}$ " H x 24" W x 6"D).

Weight: Rack — 19 kg (41 lb); panel — 15 kg (32.5 lb).

212T-1 772-5108 Audio Console

## Micro-Trak 6440 Disco Audio Mixer Amplifier

The 6440 series professional audio mixer amplifier is a self-contained, self-powered stereo audio control console engineered for high reliability. The console accommodates the inputs of two turntables, two low impedance microphones (a primary and a selectable auxiliary input), and three additional high level auxiliary stereo inputs. All inputs, except the primary microphone for operator use, may be monitored via the internal cue amplifier and speaker. This professional configuration is ideal for the one man announce/operate situation in broadcasting. Professional quality potentiometers, audio components, and FET switching are used throughout to ensure reliability

and top performance. The 6440 series is available as a standalone unit, desk top housing, or installed as a part of the Micro-Trak System D Audio Control Center.

Size: 31.1 cm (12 $\frac{1}{4}$ ") H

30.4 cm (12") W

11.4 cm (4 $\frac{1}{2}$ ") D

6440 NPN Audio Mixer Amplifier



Micro-Trak 6440 Audio Mixer Amplifier

## Micro-Trak 6444 Stereo Broadcast Audio Console

The 6444 series professional broadcast audio console is a self-contained, self-powered, stereo audio mixer designed in a broadcast configuration. The console has inputs for two turntables, two low impedance microphones (a primary and a selectable auxiliary input), and three additional high level auxiliary stereo inputs. All inputs may be monitored by the cue amplifier and its built-in speaker, or by switch selection through the studio monitor circuit. The 6444-program output matches a 600-ohm balanced line, the line impedance of the typical broadcast station. Operating level is available to +4 dB mW, with headroom to +12 dB mW. Output metering is internally adjustable for meter readings of 0 at -10 dB, 0 dB mW or +4 dB mW. The 6444 is available as a standalone unit, as part of a System D Audio Control Center, desk top unit, or for 48.2 cm (19 in.) rack mounting.

Size: 31.1 cm (12 $\frac{1}{4}$ ") H

30.4 cm (12") W

11.4 cm (4 $\frac{1}{2}$ ") D

6444 NPN Broadcast Audio Console

# Audio

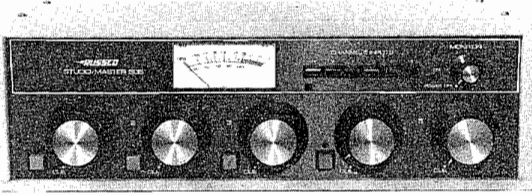

*Studio/Master 505 Audio Mixer*

## Russco Studio/Master 505 Monaural Audio Mixer

The compact, all solid-state 505, available in either rack-mount or desktop configuration, is designed for AM or monaural FM broadcast applications. It has five mixing channels; four of the channels have built-in preamplifiers. Each preamplifier can be quickly modified to accept microphone, phonograph, or high-level inputs. The fifth channel accepts five high-level inputs, selectable by front panel pushbuttons. The model 505 features pushbutton "on air" switches with indicator lamps, a built-in 25-watt monitor amplifier, and a cue amplifier driving a built-in speaker.

### Outputs:

#### Monitor:

- Power: 25 watts average (14.14 volts rms across 8-ohm load at 1 kHz)
- Impedance: 8 ohms
- Total Harmonic Distortion: Less than 1% at full rated output
- Program
- Level: +4 or +8 dB mW, for O VU, +17 dB mW, maximum
- Impedance: 600 ohms
- Frequency Response: 20 Hz to 15 kHz,  $\pm 1$  dB
- Total Harmonic Distortion: Less than 0.5% at 1 kHz, +8 dB mW out
- Noise: Greater than 60 dB below +4 dB mW output referenced to -50 dB mW input level
- Headphone:
  - Level: 0 dB mW
  - Impedance: Hi down to 8 ohms
- Cue:
  - Power: 1 watt average
  - Speaker: 8 ohm, 3"
- On-Air Light  
(Relay Driver):
  - Voltage: -24 V dc
  - Current: 40 mA (600-ohm coil)

## TEAC Audio Mixer

TEAC designed the Model 2 for true multichannel recording. It accepts a combination of several different selectable inputs and presents them altered or unaltered at a variety of selectable outputs. Within the system chain, Model 2 fits in two places: just ahead of the

tape recorder so that the broadcaster can make decisions about recording, overdubbing, storing; at the multichannel tape recorder output to allow decisions on retrieval and mix down. Power requirements are 117 V ac, 60 Hz, 3 W.

Model 10 contains 8 input modules, 4 submaster modules, and the master module. On the input module, mic attenuation includes a 3-position switch (0, 20, and 40 dB), and a feedback-type rotary pot (0 to 20 dB) for trim. The input selector has a 3-position switch for mic, test, or line. Power requirements are 117 V ac, 50/60 Hz, 25 W.

TEAC's latest generation mixer, Model 5, offers the broadcaster versatility, flexibility, and portability. This mixer has nominal 200-ohm balanced mic inputs, XL-type connectors; auxiliary outputs in parallel with the line outputs with a switchable output level (-10 dB or -2 dB) per output channel; cascade patch points for connecting two Model 5's; an echo receive switch to distribute a mono echo on all output buses; 3 studio headphone feeds: 100 mW, 1 W, and -2 dB; auxiliary inputs to the monitor circuit for a stereo source. Power requirements are 117 V ac, 50/60 Hz, 40 W.

	Model 2	Model 5	Model 10
Size:	8.2 cm	19 cm	28.8 cm
	(3 $\frac{1}{4}$ " H	(7 $\frac{1}{2}$ " H	(11 $\frac{3}{8}$ " H
	33.6 cm	58.7 cm	101.6 cm
	(13 $\frac{1}{4}$ " W	(23 $\frac{1}{8}$ " W	(40" W
Weight:	26 cm	62.2	75.5 cm
	(10 $\frac{1}{4}$ " D	(24 $\frac{1}{2}$ " D	(29 $\frac{3}{4}$ " D
	6.8 kg	28.1 kg	45.3 kg
	(15 lb)	(62 lb)	(100 lb)
Model 2	NPN	Audio Mixer	
Model 5	NPN	Audio Mixer	
Model 10	NPN	Audio Mixer	

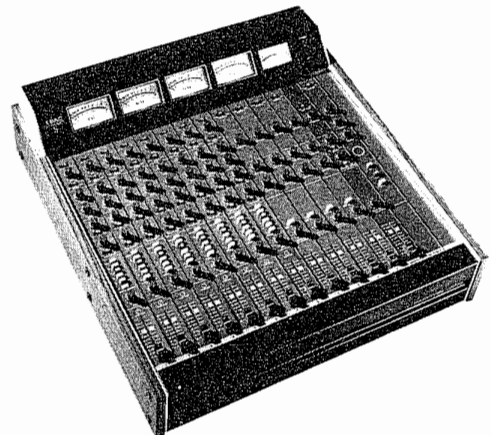

*Teac Model 5 Audio Mixer*

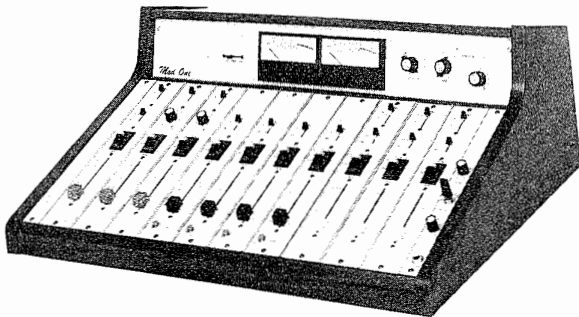

*Mod One Broadcast Console*

## UREI Mod One AM and FM Broadcast Consoles, Models 110 Mono, 210 Stereo

The Mod One modern, modular broadcast audio console system utilizes design concepts developed for contemporary recording studio consoles. Mod One is specifically radio oriented — physically, electronically, and human engineered for AM and FM broadcasting.

Four types of input modules are available in either monaural or stereo configuration. Any input module may be plugged into the housing in any of 10 positions; all interfacing between the module and the console housing is via a single printed-circuit edge connector on the module which mates with any of 10 identical sockets on the console mother board. Program, audition, monitor booster, cue booster, and headphone amplifiers are plug-in cards located under the hinged top of the meter panel.

The Mod One console is all steel with solid walnut trim. When all module spaces are filled (either by input modules or blanks), complete RF shielding is effected. All inputs and outputs are balanced and transformer isolated for best hum and rfi rejection. External power supply is furnished, and dc connection is through a Jones-type plug in the rear of the console. Monitor and cue power amplifiers are not included.

The Mod One may be installed on a 76.2 cm (30-in.) deep table top, leaving 25.4 cm (10 in.) of table space in front for log keeping and arm rest. Module width is 5.4 cm (2<sup>1</sup>/<sub>8</sub> in.).

Up to 10 input modules will provide maximum of 30 inputs, high level or microphone, monaural or stereo. Silent-action switches are used for all on-air functions. Longlife conductive plastic vertical faders have detented cue position (line and cartridge modules). Other features include automatic muting of monitor and cue speakers, monitor select switch with aux and tape inputs, VU meter switching, and built-in headphone amplifier.

Input Levels:	+50 to +4 dB mW (selectable by input pads at each input)
Nominal Gain:	54 dB (allowing normal settings, faders, and submasters)
Maximum Gain:	80 dB (faders and submasters maximum)
Output Levels:	All channels +4 dB mW nominal (may be optionally +8)
Frequency Response:	±1 dB 30 Hz to 20 kHz
Distortion (THG):	Less than 0.5%, +20 dB mW, 30 Hz to 20 kHz
Signal-to-Noise Ratio:	Better than 70 dB (15.7 kHz noise bandwidth)
Crosstalk (stereo):	60 dB mW (minimum) to 10 kHz, 50 dB to 20 kHz
Power Supply:	±24 V dc (bipolar) 1.5 A maximum (actual current depends on number and type of amplifiers and modules). Operates from 110 to 120 V ac, 50/60 Hz
Size:	Width 23.9 cm (9 <sup>2</sup> / <sub>5</sub> " ) H Depth 62.9 cm (24 <sup>3</sup> / <sub>4</sub> " ) W Height 50.2 cm (19 <sup>3</sup> / <sub>4</sub> " ) D

On special order, at additional cost, meter panel is available with four meters. Two meters are permanently assigned to PROGRAM outputs; the other two are switchable between AUDITION output and the remaining meter functions.

## UREI Mod One Plug-In Amplifier Cards

For MOH 110, MOH 210 Broadcast Consoles

MOA-150	Monaural Line Amplifier
MOA-250	Stereo Line Amplifier
MOA-170	Monaural Cue Booster Amplifier
MOA-160	Monaural Monitor Booster
MOA-260	Stereo Monitor Booster
MOA-180	Monaural Headphone Amplifier
MOA-280	Stereo Headphone Amplifier

## UREI Mod One Input Modules

For MOH 110, MOH 210 Broadcast Consoles

Mod 23220	Stereo Microphone Module
Mod 13210	Monaural Microphone Module
Mod 13220	Monaural Microphone Module With Stereo Panpot
Mod 24120	Stereo Cartridge Module
Mod 14100	Monaural Cartridge Module
Mod 25320	Stereo Triple-Line Module
Mod 15310	Monaural Triple-Line Module
Mod 00000	Blank Module

# Audio

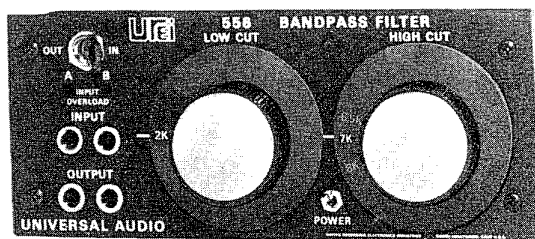

Universal Audio Variable Bandpass Filters, Models 555 (mono) and 556 (stereo)

## Universal Audio Variable Bandpass Filters, Model 555 (Mono) and 556 (Stereo)

Model 555 and 556 filters are variable-frequency cutoff filters designed to allow adjustment of the audio frequency bandwidth of program material. TRS jacks on the front panel normalled to barrier strips on the rear allow for easy connection and patching. LED indicators are provided to warn of input levels approaching overload.

The filters are 18-dB/octave-state variable types designed for Butterworth response. The cutoff frequencies are continuously tunable, making possible fine adjustment to any desired frequency within their ranges.

The low end cutoff filter can be adjusted to any frequency from 20 to 200 Hz. The high end cutoff filter may be set to any frequency from 2 to 20 kHz. An in-out switch is provided for A-B comparisons.

Model 556 is a stereo version with close channel-to-channel tracking and is therefore ideal for use in any stereo chain, or in disc mastering for equal filtering of program and preview channels.

- 555 NPN Audio Variable Bandpass Filter, Mono
- 556 NPN Audio Variable Bandpass Filter, Stereo

## Turntables, Tone Arms, Cartridges, Furniture

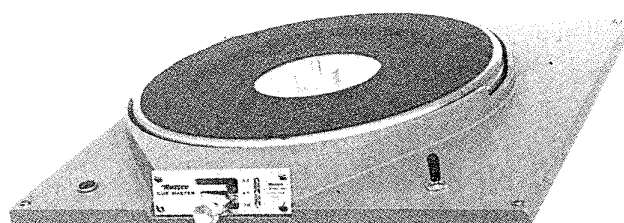

Russco Cue Master Turntable

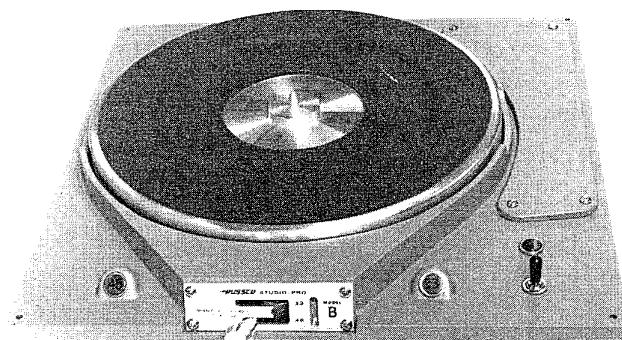

Russco Studio-Pro Turntable

## Turntables

### Russco

Designed to meet exacting requirements of fine music stations, Russco turntables provide the broadcaster with a ruggedly constructed, highly reliable system. Two models are available: the 3-speed Cue-Master and 2-speed Studio-Pro. Both feature no-slip starting with full 33-rpm speed at less than  $1/16$  revolution, heavy-duty synchronous motor, 45-rpm record indentation, platter offset for more compact turntable arrangement, solid cast aluminum chassis, and Oilite bronze bearings throughout.

## Specifications

	Cue Master	Studio Pro
Speed:	33, 45, 78	33, 45
Platter	2.5 kg (5.5 lb)	3 kg (6.5 lb)
Weight:		
Acceleration:	$\frac{1}{16}$ rev. at 33 rpm	$\frac{1}{16}$ rev at 33 rpm
Wow and Flutter:	Less than 0.3%	Less than 0.3%
Rumble:	36 dB below NAB level	38 dB below NAB level
Size:	39.4 cm (15½") H 39.4 cm (15½") W 16.5 cm (6½") below chassis	39.4 cm (15½") H 13 cm (7½") below chassis
Unit		
Weight:	7.3 kg (16 lb)	9 kg (20 kg)
Cue-Master	124 0083 416	Turntable
Studio-Pro	124 0052 098	Turntable

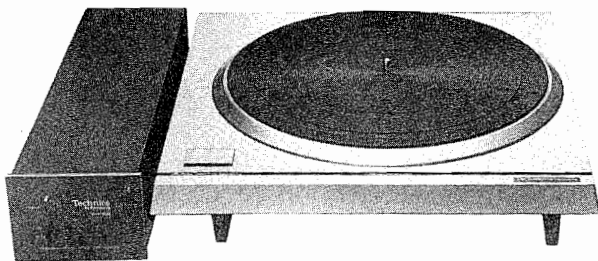

SP-10MKII

## Panasonic Technics SP-10MKII Turntable

The sensational new Technics model SP-10MKII Quartz-Controlled Direct-Drive Turntable sets a new standard of accuracy in disc reproduction. With its quartz-controlled direct-drive system and a multitude of toally new engineering achievements, it represents a standard of accuracy that has never before been attained.

The SP-10MKII, 3-speed direct-drive turntable is controlled by elaborate servo circuitry which uses a quartz oscillator as its reference. This quartz oscillation principle is the most accurate method of electronic timekeeping known. The rotation speed of the SP-10MKII is totally independent from the ac power line and its frequency variations, from temperature and other external factors, and from the passage of time. Expressed mathematically, speed drift remains with  $\pm 0.002\%$

which translates into a maximum aberration of  $\pm 0.036$  second over the 30-minute playing time of a typical LP side.

The enormous starting torque of the SP-10MKII 6 kg/cm (5.2 lb/in.) accelerates the heavy platter within 0.25 second. This compares with the 1-second build-up time considered satisfactory in professional broadcast equipment. Rated platter speed is attained after only a 25-degree turn.

The SP-10MKII employs a quartz-locked stroboscope lamp with only a single row of strobe markings. Strobe lamps in conventional turntables are locked to the (sometimes unstable) ac line frequency and therefore indicate speed changes that are not really there. In the SP-10MKII, quartz oscillation control also governs the strobe lamp, for maximum "truth" in indication. Also, only a single row of strobe markings needs to be watched for all speeds, which helps avoid confusion.

A separately housed power supply is contained in a separate unit. The power transformer cannot interfere (through magnetic leak) with the electronic "brain" in the turntable proper.

## SP-10MKII Specifications

Type	Direct-drive turntable
Motor	Brushless dc motor, electronic rectification, quartz-controlled phase-locked servo circuit
Turntable Platter	Aluminum diecast, 32 cm (12 $\frac{19}{32}$ ") diameter, 2.9 kg (6.4 lb)
Speeds	33 $\frac{1}{3}$ , 45, and 78.26 rpm
Starting Torque	6 kg cm (5.2 lb)
Build-up Time	0.25 s (25° rotation) to 33 $\frac{1}{3}$ rpm
Braking Time	0.3 s (30° rotation) from 33 $\frac{1}{3}$ rpm to standstill
Speed Fluctuation by Load Changes	0% with 5 kg cm (4.3 lb)
Speed Drift	Within $\pm 0.002\%$
Wow and Flutter	0.025% WRMS (JIS C5521) $\pm 0.035\%$ weighted, zero-to-peak (DIN 45507)
Rumble	-50 dB (DIN 45539A) -70 dB (DIN 45539B)
Power Consumption	20 W
Dimensions (Turntable Only)	10.25 cm (4 $\frac{1}{64}$ ")H, 36.85 cm (14 $\frac{31}{64}$ ")W, 38.85 cm (14 $\frac{31}{64}$ ")D
Weight	9.5 kg (20.9 lb)
Base and Dust Cover	Model SH-10B3 (optional)

# Audio

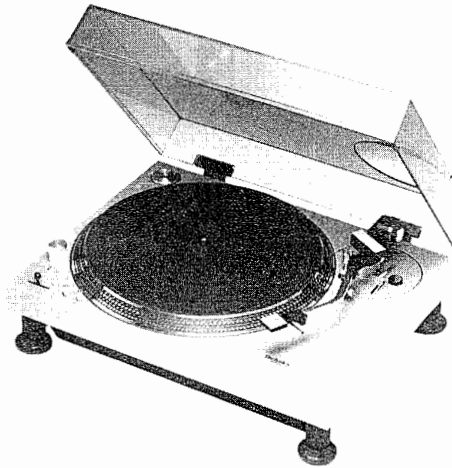

Technics SL-1200 Turntable

## Panasonic Technics SL-1100A, SL-1200

For broadcasters requiring exceptional high fidelity in audio systems. Two models of Technics turntables are available: SL-1100A, and SL-1200. Both employ a brushless dc direct drive motor providing table speed constancy of 33.29 rpm to 33.36 rpm. "Fine tuning" of table speed is effected by electronic control. Both tables operate at both 33 and 45 rpm. The SL-1100A and SL-1200 are supplied with precision tone arms. Wow, flutter, and rumble effects all but disappear in these models; rumble is better than -70 dB (Din B) and wow and flutter is less than 0.03% WRMS. Turntable acceleration time is less than 1/2 revolution at 33 rpm.

### Specifications

Platter Size:	SL-1100A 33.8 cm (13 <sup>25</sup> / <sub>32</sub> "	SL-1200 33 cm (13")
Platter Weight:	2 kg (4.4 lb) — Static-balanced tubular	1.7 kg (3.86 lb) Static-balanced tubular
Tracking Force:	0 to 5 g (0 to 18 oz)	0 to 4 g (0 to 14 oz)
Tracking Error Angle:	Within ± 1.75°	Within ± 2°
Size:	19.5 cm (7 <sup>11</sup> / <sub>16</sub> " H 51 cm (20 <sup>3</sup> / <sub>32</sub> " W 39 cm (15 <sup>3</sup> / <sub>8</sub> " D	18 cm (7 <sup>3</sup> / <sub>32</sub> " H 41.3 cm (16 <sup>9</sup> / <sub>32</sub> " W 35.3 cm (13 <sup>29</sup> / <sub>32</sub> " D
SL-1100A	NPN	Turntable w/Tone Arm
SL-1200	NPN	Turntable w/Tone Arm

## Tone Arms

### Micro-Trak 303/306

Modern styling and plug-in memory balance head highlight the Micro-Trak tone arms. The 303/306 also have sapphire jewel bearings for virtually frictionless vertical rotation, and fluid antiskate mechanism. Laminated wood and epoxy body contribute to both lightness and strength. Stylus force, once set, is temperproof, and adjusted by counterweight.

303	124 0061 741	30.4 cm (12") Tone Arm
306	124 0061 775	40.6 cm (16") Tone Arm

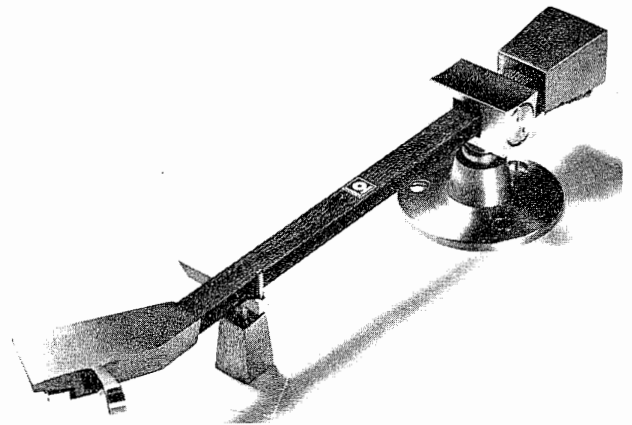

Micro-Trak 303 Tone Arm

### Shure M232/236 Tone Arm

A rugged, simple arm for tracking at 1 1/2 grams (0.05 oz) or higher, the M232 has a full range of adjustments for static and dynamic balance, cartridge overhang, height, and direct reading force scale. It accommodates any stereo or monaural cartridge. The M232 is designed for 3.4 cm (12 in.) tables; for 40.6 cm (16 in.) tables, the M236 should be specified.

M232	098118 000	30.4 cm (12") Tone Arm
M236	097 8122 000	40.6 cm (16") Tone Arm

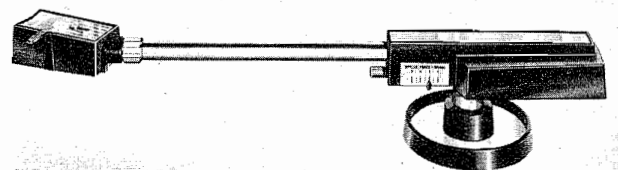

Shure M232 Tone Arm



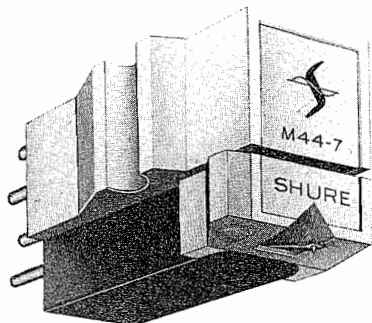

Shure M44-7 Cartridge

## Shure M44-7 Cartridge

The M44-7 is an ideal cartridge for professional applications. It has a spherical stylus with a medium tracking force 1½ to 3 grams (0.05 to 0.10 oz); and is 0.0017 cm (0.0007 in.) in size.

M44-7 099 3018 000 Stereo Cartridge w/stylus

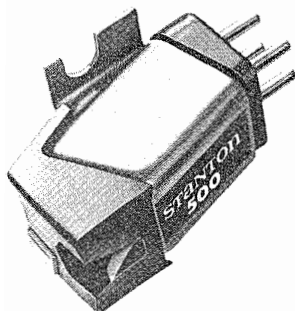

Stanton 500 Cartridge

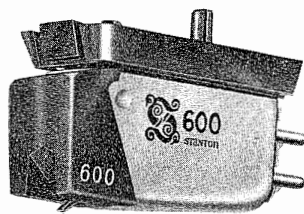

Stanton 600 Cartridge

## Stanton Cartridges

Stanton offers a complete line of cartridges and styli for the most exacting broadcast and audio applications. All Stanton cartridges are designed for use with all 2- and 4-channel matrix-derived compatible systems. The 600 HP Series features reduced tip mass for outstanding frequency response and can stand the rugged handling of on-the-air use. They are available in both spherical and elliptical stylus point models. The 500 series is available in several configurations depending on application: auditioning up to ultrahigh reproduction of fine music. For information on other Stanton models, call your Collins sales representative.

600( ) NPN HP Series Cartridges  
 500( ) NPN Broadcast Series Cartridges

## Turntable Accessories

### Collins PA-1A Phono Preamplifier/Equalizer

The PA-1A Phono Preamplifier/Equalizer plugs into the PMA-1 Mount which in turn fits into a turntable cabinet. The PMA-1 accepts two of these units for stereo operation. The PA-1A receives power from either the IC-6A or IC-10A Stereo Console. When using a PA-1A, a type MT-1 600/600-ohm matching transformer is installed in the IC console in lieu of the usual MPA-1 Microphone Preamplifier. Frequency response of the PA-1A is 50 Hz to 15 kHz, ±1 dB of RIAA curve; output impedance is 600 ohms; input is low impedance.

PA-1 124 3015 327 Phono Preamplifier/Equalizer  
 PMA-1 124 0052 892 Phono Preamplifier Mounting Assembly

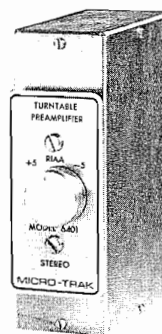

Micro-Trak 6400 Series Turntable Preamplifier

### Micro-Trak 6400 Series Turntable Preamplifier

The 6400-Monaural and 6401-Stereo professional turntable preamplifiers are self-contained, self-powered, RIAA/NAB equalized units designed to provide high quality disc reproduction. Application of state-of-the-art, low noise integrated circuits allow higher output levels (0 dB mW into 600 ohms) and smaller package sizes. The 6400 Series preamplifiers are available in two configurations: model 6400-monaural AM/FM, and model 6401 for full 2-channel recording and FM stereo requirements. The 6400/6401 have three selectable output curves: RIAA/NAB standard, 5 dB high frequency roll-off to minimize record scratch effect, and 5 dB high frequency boost for added brilliance. Output levels are adjustable to match console requirements; independent controls on the 6401-stereo allow the station engineer to set and maintain proper stereo balance. Both models accept a

# Audio

47-kilohm stereo cartridge. Output impedances are selectable to either 150 or 600 ohms by a simple push-pin jumper change.

Size: 15.2 cm (6") H  
 5.3 cm (2<sup>1</sup>/<sub>8</sub>") W  
 12 cm (4<sup>3</sup>/<sub>4</sub>") D

Weight: 1.3 kg (3 lb)

6400 NPN Turntable Preamplifier, Monaural  
 6401 NPN Turntable Preamplifier, Stereo

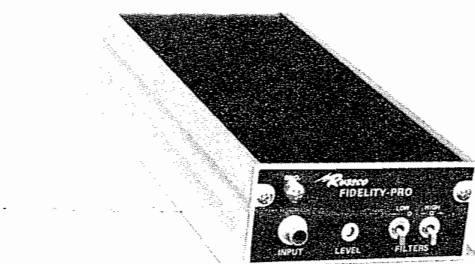

Russco Phono Preamplifier

## Russco Phono Preamplifiers

Two series are available: the Fidelity-Master Series for straight RIAA equalization, and the Fidelity-Pro Series with switchable high and low frequency filters. Both feature integrated circuit construction, built-in power supplies and easy access to all components for maintenance and testing. Each is available in four models: unbalanced monaural output, balanced monaural output, unbalanced stereo output, and balanced stereo output. Frequency response is 20 Hz to 20 kHz, ± 1 dB of RIAA curve; noise is 65 dB below NAB reference level; output is +18 dB mW into 600-ohm load; input impedance is 47,000 ohms; power requirement is 40 milliwatts at 117 volts ac, 60 Hz.

Size: 4.4 cm (1<sup>3</sup>/<sub>4</sub>") H; 12 cm (4<sup>3</sup>/<sub>4</sub>") W; 27.9 cm (11") D.  
 Weight: 1.8 kg (4 lb) maximum (depending on model).

FMMU	NPN	Phono Equalizer, mono, unbalanced output
FMMB	124 0052 727	Phono Equalizer, mono, balanced output
FMSV	NPN	Phono Equalizer, stereo, unbalanced output
FMSB	NPN	Phono Equalizer, stereo, balanced output
FPMU	NPN	Phono Equalizer, Fidelity Pro, mono, unbalanced
FPMB	124 3015 004	Phono Equalizer, Fidelity Pro, mono, balanced output
FPSU	124 0052 773	Phono Equalizer, Fidelity Pro, stereo, unbalanced output
FPSB	124 3015 005	Phono Equalizer, Fidelity Pro, stereo, balanced output



Micro Trak Series L Turntable Furniture

## Micro-Trak Series L Turntable Furniture

Modular in design and human-engineered, the Micro-Trak Series L furniture provides functional workspace for the studio engineer or disc jockey. Turntables, tape machines, cueing, and switching control panels all may be located within easy reach of the operator. Side panels are finished in easy care pecan Formica with tops in an attractive gold Formica. Construction features include: standard EIA equipment mounting configuration for standard 48.2 cm (19 in.) panels; factory-made turntable cutouts; replaceable tops, sides, spreaders, and closure panels, and full 1.9 cm (3/4 in.) particle board construction for low acoustical transfer. Items in the series include a single-bay cabinet, a double-bay cabinet, and a console table surface.

Size: (single-bay cabinet) 73.7 cm (29") H; 55.9 cm (22") W; 55.9 cm (22") D.  
 (double-bay cabinet) 73.7 cm (29") H; 106 cm (41<sup>3</sup>/<sub>4</sub>") W; 55.9 cm (22") D.  
 (console surface) 203.2 cm (80") W; 61 cm (24") D.  
 Weight: (single-bay cabinet) 29.9 kg (66 lb)  
 (double-bay cabinet) 53 kg (117 lb)

## Limiters and Amplifiers



*Discriminate Audio Processor*

### Dorrough Discriminate Audio Processor

The Discriminate Audio Processor is a new concept in the area of audio processing. It utilizes the latest state-of-the-art circuitry, parts, and logic to provide the user with the finest broadcast limiter compressor available. It can take the place of all other compressors, equalizers, and limiters in the studio-transmitter loop.

The Discriminate Audio Processor consists of five high-quality audio processing systems performing the following functions: (1) equalizer board; (2) low-frequency AGC; (3) mid-frequency AGC; (4) high-frequency AGC; and (5) output peak limiter.

The audio input to the device is fed to an active 3-way bandpass filter network which develops three different outputs:

Low-frequency range	20 to 120 Hz
Mid-range	120 Hz to 6.5 kHz
High-frequency range	6.5 to 15 kHz

These active filters exhibit a 3 dB/octave slope. This gentle slope ensures that there will be no obvious effect when a gliding tone crosses over from one band to another, and that the filters will have the negligible phase shift necessary for high fidelity response.

The output of each bandpass filter is fed to the input of an individual processing system. Each has a total capability ranging from 17 dB of expansion to 30 dB of compression independently over the entire audio spectrum.

Expansion in these circuits is the result of the control voltage nullifying approximately 17 dB of quiescent reduction, thereby giving the appearance of an equal amount of expansion. With no audio input the combination of expander and compressor can provide up to 17 dB reduction and therefore reduce noise by that figure. This helps eliminate the effects of turntable rumble, tape hiss, and noise.

The three discriminate channel outputs are then combined and amplified to produce a composite output. This is variable to  $\pm 16$  dB mW, with a front-panel control. Modification of a feedback resistor on the line amplifier board will allow up to +25 dB mW before clipping.

Frequency response	$\pm 1$ dB, 30 to 15,000 Hz
Signal-to-noise	60 dB, wide band
Distortion	less than 1%
Minimum input	-35 dB mW
Maximum output	+24 dB mW
Dimensions	48.2 cm (19") W x 8.8 cm (3½") H x 33 cm (13") D
Power source	115 v ac, 60 Hz

310A NPN	For Recording service (no limiting)
310B NPN	For AM service
310C NPN	For FM service (two required for stereo)
310D NPN	For Dolby applications

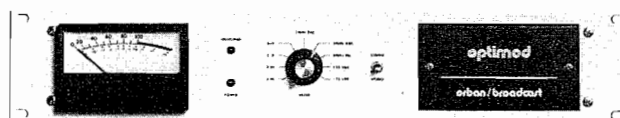

*8000 Limiter/Compressor/Stereo Generator*

### OPTIMOD 8000 Limiter/Compressor/Stereo Generator

The OPTIMOD 8000 is the result of a careful reexamination of every accepted principle of FM audio processing, and its effectiveness is due to a whole series of novel technical developments. The most revolutionary of these is OPTIMOD's system concept: the compressor, limiter, and stereo generator are engineered as a single system and incorporated in a single package.

# Audio

Orban/Broadcast engineering has succeeded in designing a low-pass filter with the proper frequency response which overshoots a maximum of 3% rather than the 30% to 40% of conventional filters. Therefore, peak modulation control in the OPTIMOD is "brick-wall," without the sloppiness of conventional systems, and average modulation levels can be raised 2 to 3 dB. This gain in loudness is accomplished totally by eliminating sloppiness, rather than by further increases in compress and limiting. Thus, audio quality is not degraded. In addition, the tight peak control of OPTIMOD means no more insecurity over where to set modulation to avoid FCC citation.

The OPTIMOD stereo generator utilizes a Gilbert-linearized multiplier to generate the L-R subcarrier directly. This subcarrier is then summed with the left and right audio signals and with the 19 kHz pilot to form the composite stereo signal. As opposed to the conventional switching approach, this highly refined matrix approach offers superior separation across the audio band, as no composite low-pass filter is necessary. High frequency intermodulation distortion is outstandingly low.

The composite output of the OPTIMOD has been designed to look like the output of a composite STL receiver. The OPTIMOD will interface with the Collins 310Z-1 and 310Z-2 exciters.

## Specifications

Input Impedance	600 ohms balanced and floating, RF suppressed
Input Level	-10 dB mW produces 10 dB gain reduction with input attenuator controls full cw. Removal of internal 20 dB pad permits -30 dB mW to produce 10 dB gain reduction
Total System Distortion	0.5% THD maximum, 50 to 15,000 Hz with any degree of gain reduction. 0.25% THD typical. In test mode, below 0.1% typical.
Frequency Response	Follows standard 75 $\mu$ s preemphasis curve $\pm$ 1 dB. 50- and 25 $\mu$ s preemphasis available on special order.
System Noise	-80 dB max; -85 dB typical (50 to 15,000 Hz through 75 $\mu$ s deemphasis).
Output Impedance	Varies from 0 to 1250 ohms depending on setting of output attenuator.

Output Level	4 volts peak-to-peak max. May be varied down to 0 volt by means of 10-turn output attenuator control.
Crosstalk, Main Channel To Subchannel or Sub-channel to Main Channel	Better than -40 dB, 50 to 15,000 Hz, as measured at input terminals of stereo generator per interpretation of part 73.322 of FCC Rules. Crosstalk representing distortion components is typically better than -70 dB, as measured on baseband spectrum analyzer.
Power Requirements	115 to 230 volts $\pm$ 15%, 50 to 60 Hz, approx 20 watts, RF suppressed.
Dimensions	48.3 cm (19")W x 8.9 cm (3.5")H x 21.6 cm (8.5")D

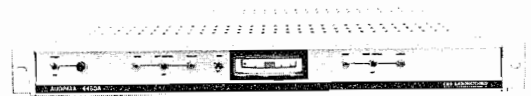

Thomson-CSF 4450A Limiter

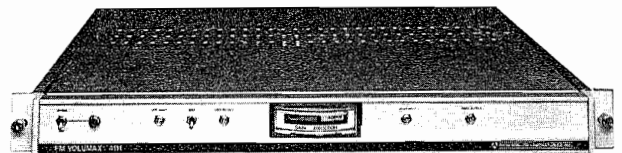

Thomson-CSF 4111 Limiter

## Thomson-CSF FM Limiting Amplifiers

This family of units provides the FM broadcaster with an effective means to prevent overmodulation caused by preemphasized signals, prevent SCA crosstalk, achieve higher modulation levels without distortion, and maintain automatic level control. The Model 4101 automatic peak controller processes low, middle, and high frequencies independently; overall instantaneous limiting ensures that no overmodulation will occur. Frequency response is flat  $\pm$ 1 dB below the limiting threshold; harmonic distortion is less than 1%; attack

# Audio

time is less than 1  $\mu$ s (depending on waveform); and recovery time varies between 200 ms and 1  $\mu$ s (depending on frequency). Model 4111 is similar in all respects, except that it is configured for stereo operations. Model 4450A automatic level control automatically rides gain and features an expanded return-to-zero function. Recovery time is adjustable for optimum compatibility with program format. Its control characteristic is  $\pm 10$  dB of gain control; maximum gain is 40 dB.

Size: (4101, 4111) 4.4 cm (1 $\frac{3}{4}$ " H); 48.2 cm (19" W); 47.6 cm (18 $\frac{3}{4}$ " D).

Weight: (410) 5.9 kg (13 lb)  
(4111) 6.4 kg (14 lb)

Size: (4450A) 4.4 cm (1 $\frac{3}{4}$ " H); 48.2 cm (19" W); 27.9 cm (11" D).

4101 NPN Monaural Peak Level Controller  
4111 NPN Stereo Peak Level Controller  
4450A NPN Stereo Automatic Level Controller

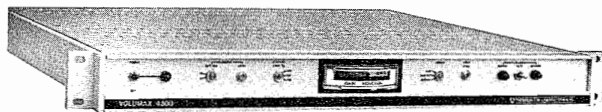

Thomson-CSF 4300 Limiter

## Thomson-CSF AM Limiting Amplifiers

For the AM broadcaster, Thomson-CSF provides a complete line of limiters, equalizers, level controllers, and distribution amplifiers. The Volumax Model 4300 automatic peak controller provides control of speech asymmetry: it ensures that the highest amplitude peaks always positively modulate the transmitter. Silent polarity switching occurs during the split-second pauses in a speech program with no obtrusive clicks. Negative peaks are controlled at 24 dB mW; positive peaks at 24, 25.5, or 30 dB mW. The companion automatic level control for this unit is the Model 4440. It is essentially the monaural version of the 4450A described previously.

Size: 4.4 cm (1 $\frac{3}{4}$ " H); 48.2 cm (19" W); 36.8 cm (14 $\frac{1}{2}$ " D).

4300 NPN Automatic Peak Controller

Size: 4.4 cm (1 $\frac{3}{4}$ " H); 48.2 cm (19" W); 27.94 cm (11" D).

4440A Automatic Level Controller

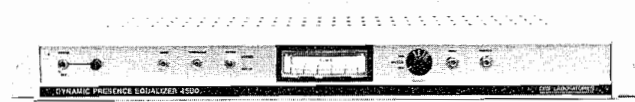

Thomson-CSF 4500 Equalizer

## Thomson-CSF 4500 Dynamic Presence Equalizer

Model 4500 is designed to increase amplitude of the presence band (2 to 4 kHz) to overcome poor microphone technique, incorrect equalization, or excessive tape recording levels. Use of the speech-music discriminator module is optional and permits enhancing just speech, all programming, or removing control completely. The 4500 has a response of maximum boost to 10 dB at 3.4 kHz, or flat (with no control) within 0.5 dB, 50 to 15,000 Hz. Input level is 0 to 23 dB mW; maximum peak output level is 24 dB mW; maximum gain is 19 dB.

Size: 4.4 cm (1 $\frac{3}{4}$ " H); 48.2 cm (19" W); 38.1 cm (15" D).  
4500 NPN Dynamic Presence Equalizer

## Thomson-CSF 1602 Distribution Amplifier

This dual-channel unit has two balanced bridging inputs rated at 15,000 ohms each. The 8 outputs are wired for 600 ohms, but each is field-convertible by changing two resistors. Input/output connections are on the rear panel; output jacks are located on the front panel for setup convenience. Both sections of the amplifier are delay-compensated to 3° at 15 kHz for stereo operation. Response is  $\pm 0.5$  dB, 20 Hz to 20 kHz; nominal gain is 20 dB, maximum gain is 40 dB.

Size: 4.4 cm (1 $\frac{3}{4}$ " H); 48.2 cm (19" W); 22.9 cm (9" D).  
Weight: 1.4 kg (3 lb)

1602 NPN Distribution Amplifier



Moseley TFL-280 Audio Limiter

## Moseley TFL-280 Audio Limiter

The Moseley Associates model TFL-280 Audio Limiter precisely controls the modulation levels of FM and TV aural transmitters. The unit is designed for FM mono, stereo, quad, FM SCA and TV audio and features ex-

# Audio

cellent leverage — greater than 50:1, extended control range — over 35 dB, clipping not routinely produced, fast AGC attack times—less than 20 microseconds, very low harmonic and intermodulation distortion, optional plug-in audio low pass filter, operation over wide temperature range, and no test mode-run proofs thru TFL-280. Two units needed for stereo operation.

Size 4.5 cm (1¾")H x 48.4 cm (19")W x 28 cm (11")D.



Universal Audio Compressor/Limiter LA-4

## Universal Audio Compressor/Limiter, Model LA-4

The LA-4 Compressor/Limiter makes use of patented Electro-Optical Attenuator technology owned by UREI. The LA-4 offers smooth, predictable performance coupled with ease of operation. Its electroluminescent light source is a light-emitting semiconductor, which will not change or deteriorate with age.

Compression is adjustable by an easily resettable multiposition switch to allow ratios from a soft, smooth 2:1 compression through super tight-sounding 20:1 limiting. The gain reduction circuitry is rms responding.

The differential input and transformer isolated output ensure troublefree patching with freedom from grounding problems. The natural-sounding gain control action of the LA-4 makes it an ideal tool for the professional recording studio, offering superior performance in all phases of recording and rerecording.

Because its gain reduction circuitry is rms responding, the LA-4 is not recommended for overmodulation protection of broadcast transmitters, disc or optical recorders, unless followed by a peak limiter, such as the UREI 1176LN.

LA-4 NPN Audio Compressor/Limiter

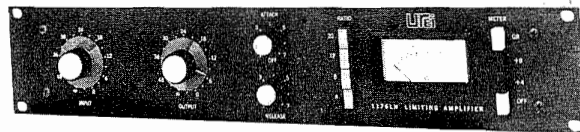

Universal Audio 1176LN Limiting Amplifier

## Universal Audio Solid-State Limiting Amplifier, Model 1176LN

The 1176 Solid-State Limiting Amplifier was a major breakthrough in limiter technology. It brought to the professional audio industry for the first time a true peak limiter with all transistor circuitry and superior performance on all types of program material. The 1176LN retains all of the features of the 1176, but generates 6 dB less noise. In addition, a redistribution of noise spectrum leaves even less noise in the sensitive 500 Hz to 3 kHz range.

Limiting is accomplished in the 1176LN by utilizing an FET as a voltage variable resistor, ahead of the first stage of amplification. Unique circuitry permits severe limiting without added distortion, and no balancing is ever required. Attack time is adjustable from less than 20 to 800 microseconds. (This is the time in which complete recovery to the limited level is accomplished . . . there is no undershoot.) Using the tone burst method, a 50 kHz peak is fully stabilized at the limited level within 1 cycle. Release time is also adjustable on the front panel from 50 ms to 1.1 seconds.

A feature of the 1176LN is the use of pushbutton switches to select compression ratios of 20:1, 12:1, 8:1, or 4:1. Another pushbutton switch assembly selects meter functions and applies power to the unit. Provision is made for remote metering.

The compact 1176LN requires only 8.9 cm (3½" in.) of vertical space in a 48.2 cm (19 in.) rack, with self-contained regulated power supplies, operable from either 110 or 125 V ac or 220 to 240 V ac, 50/60 Hz.

1176LN NPN Audio Solid-State Limiting Amplifier

## Universal Audio Modulimiter, Model BL-40

The BL-40 Modulimiter is specifically designed for AM broadcasting, but will also find wide application in TV and CCTV audio signal processing, background music systems, and commercial sound systems.

For the AM broadcaster, the Modulimiter eliminates unwanted overmodulation without clipping. Independent adjustments are provided for rms and peak limit-

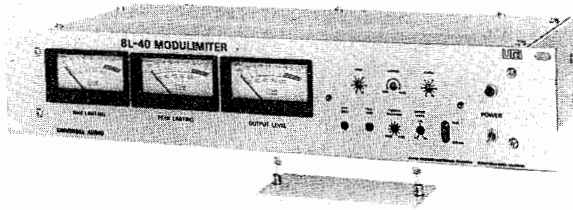

*BL-40 Audio Modulimiter*

ing, and variable positive overmodulation up to 125 percent. This permits tailoring of the modulation envelope to any program format or transmitter characteristics: constant, full modulation or a more conservative approach.

A proprietary phase optimizer circuit automatically maintains most favorable signal polarity, reversing phase whenever negative peaks exceed positive peaks by a preset amount. Its action is instantaneous and silent — no relays are used.

The BL-40 employs UREI's patented Electro-optical Attenuator for unobtrusive, smooth, true rms limiting. Its characteristics cannot be duplicated by any other compressor or limiter.

An ultrafast FET peak-limiting section ensures absolute protection from unwanted overmodulation, with no peak clipping. Attack time is essentially instantaneous. Unique proprietary circuitry results in low distortion combined with fast recovery.

The Modulimiter features low noise, low distortion integrated circuitry, and occupies only 8.9 cm (3½ in.) of rack space. Three separate meters indicate RMS LIMITING, PEAK LIMITING, and OUTPUT LEVEL simultaneously. The output meter can be adjusted to match the input level of any transmitter.

All critical adjustments are located behind a removable security panel.

BL-40 NPN Audio Modulimiter  
 Power: 110 to 120 V, 50 to 60 Hz, 10 W  
 or 220 to 240 V, 50 to 60 Hz 10 W  
 Weight: 4.98 kg (11 lb)

## Crown Stereo Audio Amplifiers

The Crown series of stereo amplifiers are ideal where exceptionally high fidelity is required. The all solid-state systems are designed and engineered to handle all types of loads, including electrostatic speaker systems. They also may be used as add-on units for quad-

raphonic installations. Model D-60, a 60-watt unit has power response of ±1 dB 5 Hz to 30 kHz at 30 watts, both channels. Frequency response is ±0.1 dB, 20 Hz to 20 kHz; total harmonic distortion is less than 0.05% at 30 watts. The D-150 model is rated at 75 watts per channel. Its characteristics are similar to the D-60. For larger applications, the DC-300A model is available with a rating of 150 watts per channel. It has similar characteristics to the D-60 model. An optional rack-mounting kit is available as are oiled walnut enclosures.

Size: (D-60) 4.4 cm (1¾") H; 43.2 cm (17") W; 22.1 cm (8¾") D.

(D-150) 13.3 cm (5¼") H; 43.2 cm (17") W; 22.9 cm (9") D.

(DC-300A) 17.8 cm (7") H; 48.5 cm (19") W; 24.8 cm (9¾") D.

D-60 NPN Stereo Audio Amplifier, 60 watts  
 D-150 NPN Stereo Audio Amplifier, 150 watts  
 DC-300A NPN Stereo Audio Amplifier, 300 watts

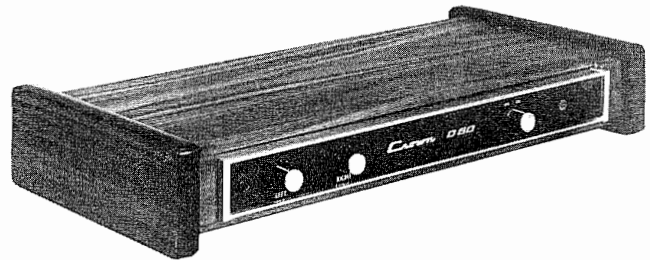

*Crown D-60 Stereo Amplifier*



*Dolby 334 FM Broadcast Unit*

## Dolby 334 FM Broadcast Unit

The Dolby 334 provides FM broadcasting stations with encoding of stereophonic signals for Dolby B-type noise reduction and with simultaneous conversion of the standard 75-microsecond preemphasis to an effective preemphasis of 25 microseconds. Such transmissions are approved in the USA by the FCC as compatible with normal reception equipment.

All listeners benefit, depending on previous station practice, either from an increase in station signal level or a reduction in high frequency compression or limiting, or by a combination of both. For owners of equipment incorporating the Dolby B-type noise reduction circuit, which is in widespread use, there is a further gain arising from the substantial improvement in signal-to-noise ratio provided by the circuit.

# Audio

Size: 4.4 by 48.2 cm (1<sup>3</sup>/<sub>4</sub> by 19")  
rack mount

Weight: 5.5 kg (12 lb)  
334

FM Broadcast Unit

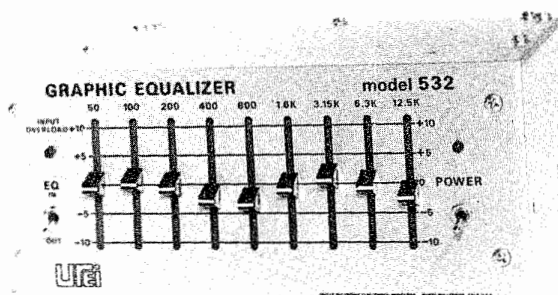

Universal Audio Octave Graphic Equalizer, Model 532

## Universal Audio Octave Graphic Equalizer, Model 532

The 532 Octave Graphic Equalizer has wide application in recording, sound reinforcement, radio and TV production, and monaural music systems.

The 532 is identical to one channel of the Model 530 Dual Graphic Equalizer, offering real economy where two channels are not required. The circuit begins with a differential input stage, includes nine variable active equalizers centered at each octave from 50 Hz to 12.5 kHz, and ends in an output amplifier capable of delivering  $\pm 20$ -dB mW into a 600-ohm load. The input may be fed from a balanced or unbalanced source. The output amplifier is transformer isolated, and will accommodate balanced or unbalanced loads. Signal-to-noise ratio at maximum output is an outstanding 110 dB, harmonic distortion below 0.5 percent.

State-of-the-art design techniques and components ensure uncompromised performance at a reasonable price.

Size: 8.89 cm (3<sup>1</sup>/<sub>2</sub>") H x 21.59 cm (8<sup>1</sup>/<sub>2</sub>") W x 20.3 cm (8") D.

Weight: 14.3 kg (6<sup>1</sup>/<sub>2</sub> lb)

532 NPN Octave Graphic Equalizer

DR-21 NPN Double Rack-Mount Kit

5R-21 NPN Single Rack-Mount Kit

## Quadraphonic Equipment

### SANSUI QSE-5B Encoder

The QSE-5B Encoder allows a station to take any 4-channel material (Q8 cartridges, 4 microphones, etc) and encode them into a 2-channel signal into the synthesizer circuit and create a 4-channel effect,

which, when decoded, gives a very natural and lifelike reproduction. The QSE-5B Encoder offers the broadcast maximum power in mono reception while maintaining 4-channel and 2-channel separation required for compatible broadcasting.

Input impedance is 10 kilohms unbalanced, and output impedance is below 600 ohms balanced. Maximum output levels of +21 dB mW to maintain full dynamic range and linear phase accuracy. Phase tolerance of  $\pm 2$  degrees at 1 kHz and  $\pm 5$  degrees at all frequencies is maintained.

Power: 115 V, 60 Hz, 20 W

Size: 48.2 cm (19") W, 8.8 cm (3<sup>1</sup>/<sub>2</sub>") H, 32.3 cm (12<sup>3</sup>/<sub>4</sub>") D

Weight: 6.23 kg (13.7 lb)

## QSD- Monitor Decoder

The QSD-1 Monitor Decoder incorporates three band-split QS vario-matrix decoders, the state-of-the-art 4-channel technology to optimize the performances of the reproduced 4-channel sound with excellent inter-channel separation characteristics of more than 20 dB even beyond the audible frequency spectrum. This unit is designed specifically for professional studio monitor applications.

## Cartridge Tape Systems and Accessories

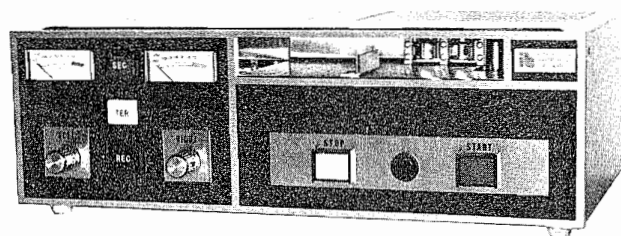

ITC RP Recorder

## ITC RP Series Recorder/Reproducer

This compact recorder/reproducer, available in several models and with several options, includes the most-wanted features for the broadcast industry. The RP models accept NAB cartridges A, B, and C (2 seconds to 31 minutes with 1 mil lubricated tape at 7<sup>1</sup>/<sub>2</sub> ips. Start



# Audio

and stop time is 0.1 second. Tape speed is 7½ ips with other speeds available on special order. Wow and flutter is 0.2% rms or less; noise is 55 dB or better below reference of 400 Hz; distortion is 2% or less at 0 VU record level. The capstan is directly driven by a hysteresis synchronous motor. Optional auxiliary cue tone oscillators permit secondary and tertiary tones to be added during recording or playback. Another option is a high-speed (30 ips) tape advance to the next cue tone. The models come in either monophonic or stereophonic configurations; with or without secondary and tertiary cues, and with or without high-speed tape advance.

Size: 13.3 cm H (5¼") H  
 44.4 cm W (17½") W  
 27.9 cm D (11") D  
 Weight: 17.7 kg (39 lb)  
 RP-( ) NPN Recorder/Reproducer

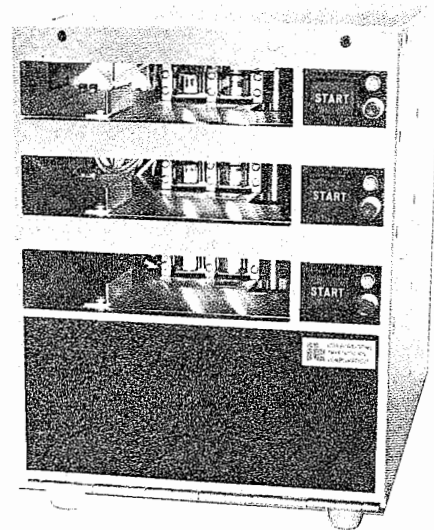

*ITC 3D Reproducer*

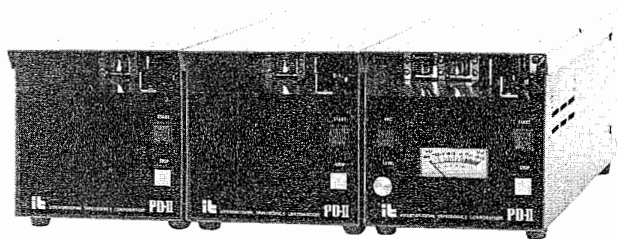

*ITC — PD-II Series Cartridge Recorder/Reproducer*

## ITC PD-II Series Cartridge Recorder/Reproducer

The totally automatic PD-II series offers long life expectancy, studio quiet operation, and minimum maintenance. The direct-capstan, 450-rpm, hysteresis-synchronous drive motor with an electrolyzed shaft minimizes wow and flutter, improves pulling power, and eliminates need for rubber belts and separate flywheel assembly. The rugged, reliable PD-II has plug-in printed circuit cards with gold plated contacts for replacement ease or repair. The PD-II has a 7½ ips tape speed, and a timing accuracy of ±0.2 percent or better. Wow and flutter is 0.2 percent or less, NAB weighted. Frequency response is ±2 dB from 50 to 12,000 Hz. Distortion is 2 percent or less, record to playback at 0 VU record level.

PD-II NPN Recorder/Reproducer Cartridge Machine  
 Size: 14.6 cm (5¾") W x 38.1 cm (15") D x 13.3 cm (5¼") H  
 Weight: 6.8 kg (15 lb)

## ITC Reproducers

Compact, flexible, and highly versatile, the ITC 3D series of reproducers performs a variety of functions. The three decks may be operated simultaneously or independently and may be fed to separate consoles or a single console, according to programming format. The unit accepts both NAB A and B cartridges. Automated breaks may be set up through use of the optional 150-Hz (secondary) cue. Physical size permits mounting a pair of these units in a standard 48.2 cm (19-in.) rack if desired. The addition of the WRA Recording Amplifier makes the unit a complete recorder/reproducer system. Four models are available: monophonic, stereophonic, mono with cue oscillators, stereo with cue oscillators. All indicators and controls may be remotored with the exception of the meter switch. A single-play reproducer also is available for less demanding installations.

Size: 13.3 cm (5¼") H  
 21.6 cm (8½") W  
 27.9 cm (11") D  
 Weight: 5.4 kg (12 lb)  
 30D-( ) NPN Reproducer

# Audio

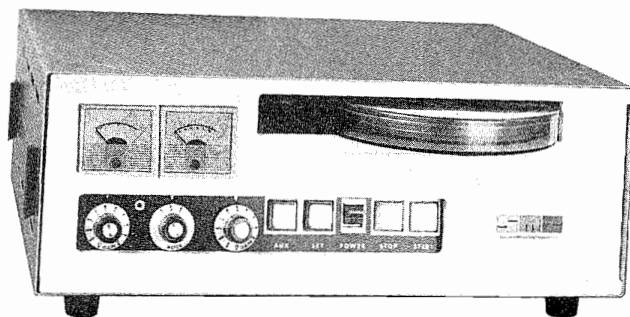

SMC Recorder

## SMC Record/Playback Systems

Ease of service, up-front controls, and many features make SMC systems ideal for broadcast applications. All electronics are plug-ins, making conversion from mono to stereo operation in a simple step. Capstan drive is by a hysteresis synchronous motor. The record unit features 1-kHz and 150-Hz cue tones; external control tone input for logging encoding; full metering of record, play, and bias; and complete remote control connections. The unit accepts all three NAB cartridge sizes. The companion playback unit has similar design and electronic features. The units may be stacked and strapped for multiple operation. Switching functions are all solid-state.

Size:	(each unit)	15.2 cm (6") H 38.1 cm (15") W 35.6 cm (14") D
Weight:	(each unit)	13.6 kg (30 lb)
790D/R	NPN	Mono Record/Playback
792D/R	NPN	Stereo Record/Playback
710D/R	NPN	Mono Playback Unit
712D/R	NPN	Stereo Playback

## Spotmaster® Series 3000 Tape Cartridge Machine

The 3000 series of cartridge machine incorporates an automatic release deck, a large air-damped solenoid, and rugged machined deck surface for continuous troublefree operation. An efficient hysteresis synchronous drive motor and power-conserving solenoid circuit keep total consumption to less than 45 watts. The series is available in a full range of mono and stereo models to fit all size cartridges. Units can be desk-top or rack-mounted. Model 3100 is available in mono or stereo playback units that accept A size cartridges. Three 3100 models can be placed in a 48.2-cm (19-in.) rack. Model 3200 is available as playback only or record/playback in either mono or stereo. The 3200

accepts both A and B cartridges so that two units mount in a 48.2 cm (19-in.) rack. Model 3300 is available in the same configurations as the 3200 but accepts A, B, and C cartridges. A 3100 player may be mounted by the 3300 in the rack configuration.

3100 Series	NPN	Mono/Stereo, Playback Only, A size cartridge
3200 Series	NPN	Mono/Stereo, Playback Only/Record/Playback A/B size cartridges
3300 Series	NPN	Mono/Stereo, Playback Only/Record/Playback, A/B/C size cartridge

## Spotmaster® Series 4000 Tape Cartridge Machine

The series 4000 cartridge machines are equipped with an exclusive Phase Lok III head bracket with independent azimuth adjustment. This model is equipped with an automatic release deck with direct drive and air-damped solenoid. Timing accuracy (7.5 ips) is 0.1 percent. Model 4300 for A, B, and C size cartridges is available in mono or stereo playback only or record/playback configurations. Space saving Model 4200 for A and B size cartridges is available in mono or stereo playback only versions. Two Model 4200 units mount side by side in a 48.2-cm (19-in.) rack. All series 4000 models are equipped with balanced transformer output with FET switching to permit paralleling of machines.

Size:	Model 4200	13.3 cm (5 1/4") H 21.5 cm (8 1/2") W 30.7 cm (12 1/8") D
	Model 4300	13.3 cm (5 1/4") H 43.1 cm (17") W 30.7 cm (12 1/8") D
4000	NPN	Mono/Stereo, Playback Only, A/B size cartridge
4300	NPN	Mono/Stereo, Playback Only/Record/Playback, A/B/C size cartridge

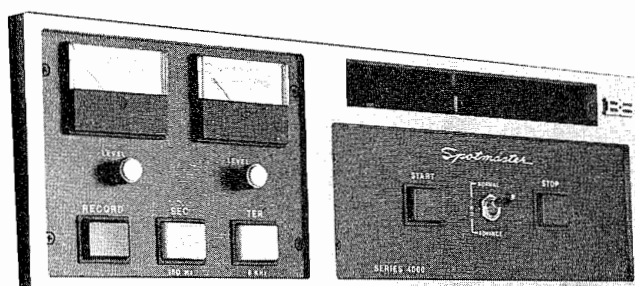

Spotmaster Series 4000 Tape Cartridge Machine

## Spotmaster® Series 5000 Multi-Deck Tape Cartridge Machine

Versatile, accessible, and reliable describe the new 5000 Series multi-deck cartridge reproducer from Spotmaster. Versatility in design lets you choose from a 3- or 5-deck model in either mono or stereo, with or without cue tones, record, and other options. Accessibility from fold-down front panel and slide-out deck plates for easy cleaning and adjustment of the PHASE LOK III head bracket, plus a completely removeable electronics package with modular components and easy troubleshooting with LED indicators of front panel functions. Reliability means the use of the best switches and components available including ribbon cable to replace bulky multiple wire harnesses, massive machined deck plates, a direct drive hysteresis synchronous motor and a supersilent air-damped solenoid.

### Specifications

Equalization	NAB Standard (CCIR Standard). Adjustable to compensate for head wear
Frequency Response	50 to 15,000 Hz $\pm 2$ dB
Distortion	1% or less at 0 vu (400 Hz)
Signal-to-Noise	-60 dB or better below 400 Hz at 3% THD unweighted
Wow and Flutter	$\pm 0.15\%$ NAB weighted
Crosstalk	Better than 50 dB at 1 kHz
Output Impedance	600 ohms balanced, alternate strapping for 150 ohms at 18 dB mW
Speed Accuracy	0.1% or better at 7.5 ips
Motor	Direct drive hysteresis synchronous
Cue Trip	Stop cue (1 kHz), cue trip I (150 Hz optional), cue trip II (8 kHz optional). Normally open or normally closed isolated contacts
Cueing Accuracy	0.1 second
Tape Capacity	Size A or B NAB Standard cartridge
Remote Control	All front-panel controls and indicators. Individual cue audio output
Power Requirements	120 watts, 117 V ac 60 Hz. Other voltages and frequencies on special order
Mounting	Table top or optional rack mounting
Size	5300 series (3 deck) 41.3 cm (10GNk")H x 21.9 cm (8GNk")W x 33.9 cm (13DNk")D 5500 series (5 deck) 37.4 cm (14DNf")H x 14.6 cm (5DNf")W x 43.2 cm (17")H

## Spotmaster® Tape Cartridge Audio Delay

This cartridge unit performs delay or temporary storage of audio signals for the broadcaster. The Spotmaster® delay cartridge has continuous operation for hundreds of hours, adjustable delay time, and a wide delay range from 6 seconds to 62 minutes. In daily studio use, the cartridge preserves network or remote program continuity that must be interrupted with local material, station ID's, or just fill material. A cartridge delay unit takes as little as 0.18 square meters (2 square feet) of table top or 14.6 cm (5DNf in.) of rack space.

NTN NPN Tape Cartridge Audio Delay

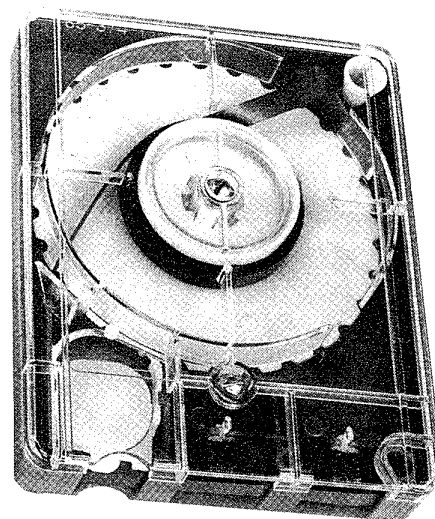

*Fidelipac Master Cart*

## Fidelipac Master Cart Tape Cartridge

Master Cart gives a high level of tape guidance repeatability from cartridge to cartridge in many types of tape transport configurations. Circular brake ensures proper head-to-cartridge penetration. Wide pressure pads provide a constant tape-to-head contact over the entire tape surface. Precision front corner post and center post ensure repeatability of tape position and interchangeability. Available in sizes from 20 seconds to 10½ minutes.

Size: 2.2 cm (0.875") H  
10.1 cm (4") W  
13.1 cm (5.175") D

Weight (empty per cartridge): 85 g (3 oz)  
Master Cart NPN Tape Cartridge

**Quotations available on Aristocart and Audiopak type cartridges.**



# Audio

tape cartridges and all audio, video, and computer tapes up to 26.6 cm (10.5 in.) in diameter and 2.54 cm (1 in.) in width.

Size: 7.6 cm (3") H  
 13.3 cm (5 1/4") W  
 18.4 cm (7 1/4") D  
 Weight: 4.3 kg (9.5 lb)  
 TD-1 NPN Tape Eraser

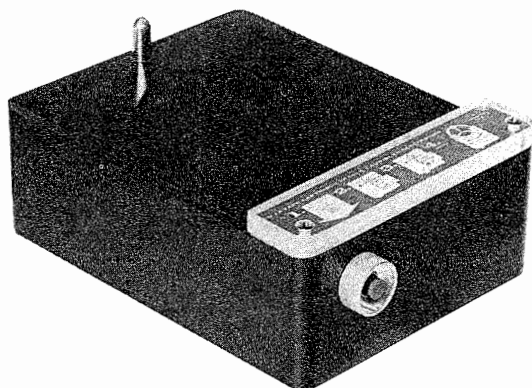

TD-1A Tape Eraser

## Abco Lazy Susan Cartridge Rack

This sturdy rack holds 500 of the Series 300 automatic programming equipment tape cartridges. Ten chrome-plated racks with 50 slots each make storage and selection of cartridges fast and simple. Revolves easily on roller bearing hub and will not tip regardless of cartridge arrangement. Cartridges held in wire holders at an angle to prevent slipping out while the rack is being revolved. Shipped knocked down.

Size: 183 cm (72") H  
 91 cm (36") D  
 Weight: 23 kg (50.7 lb)  
 NTN 097-7559-000 Cartridge Rack, Lazy Susan  
 NTN 097-756-000 Wall Cartridge Rack to hold 50 series 300 or Master Carts.

## Fidelipac Cart-A-round Cartridge Racks

Fidelipac engineered the welded-steel, chrome-plated WR-25 as a single 25-cartridge wall rack or as one of units comprising the MR-200 mobile rack. The MR-200, with tip-proof design and large swivel casters, holds 200 cartridges. The carousel rotates independent of the black japanned steel base.

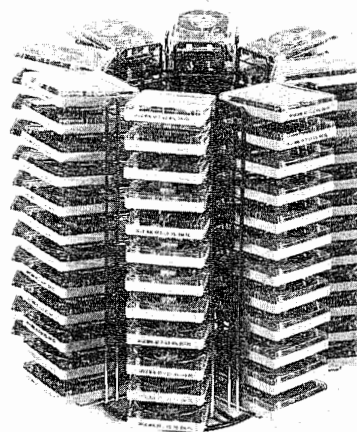

Fidelipac TR-96 Table Top Cartridge Storage Rack

Two versatile table top models, the TR-96 and TR-48, hold 96 and 48 cartridges respectively.

WR-25 4.3 kg (9 1/2 lb)  
 MR-200 125.5 to 154.9 cm (51" to 61") adjustable H  
 TR-96 50.8 cm (20") H; 50.8 cm (20") outside D  
 TR-48 50.8 cm (20") H; 38.1 cm (15") outside D

WR-25 NPN 25-Cartridge Wall Rack  
 MR-200 NPN 200-Cartridge Mobile Rack  
 TR-96 NPN 96-Cartridge Tabletop Rack  
 TR-48 NPN 48-Cartridge Tabletop Rack

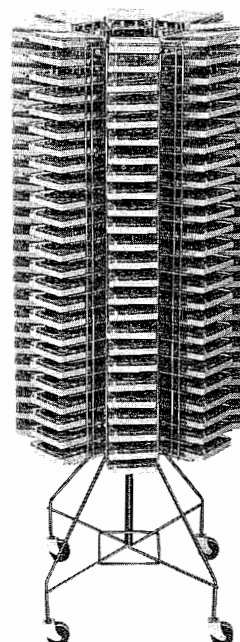

Fidelipac MR-200 Mobile Cartridge Rack

# Audio

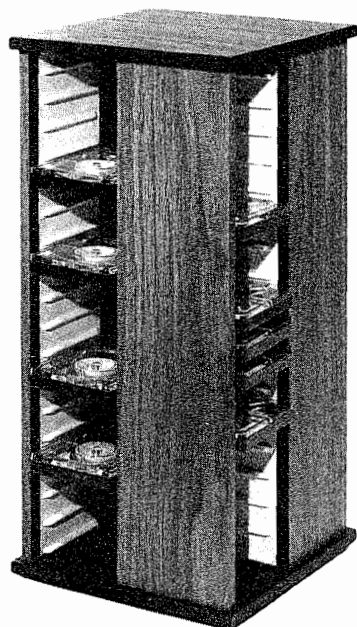

Micro-Trak L-72-S Cartridge Rack

## Micro-Trak Cartridge Cabinets

Designed to meet studio decor, two cartridge racks are available: a lazy susan type and a wall or console rack. The lazy susan, a substantial rotary rack, holds 72 cartridges. It is finished in summer pecan Formica with black and white trim. The wall/console rack, designed to mount on a wall or on the console table, accommodates 90 cartridges. It, too, is finished in pecan Formica.

Size:	(lazy susan)	55.9 cm (22") H
		26.7 cm (10½") W
		26.7 cm (10½") D
	(wall unit)	55.9 cm (22") H
		58.4 cm (23") W
L-72-S	NPN	Lazy Susan Cartridge Rack
L-90	NPN	Wall-Mount Cartridge Rack

## Reel to Reel Tape Systems and Accessories



Ampex AG-440C Recorder/Reproducer

## Ampex AG440 Series Recorders/Reproducers

This studio-quiet series of equipment is engineered to operate in a "live" studio. It is available in a variety of configurations: full track, 2-track, or 4-track; speeds of 7½ and 15 ips or 3¾ and 7½ ips; as a full recorder/reproducer or as a reproducer only. The units may be converted between 0.6- and 1.2-cm (¼ and ½ in.) tapes with ease. The units, available in console, portable or rack-mounted configurations, accept up to 26.6 cm (10½ in.) reels and are adjustable to accept 29.2 cm (11½ in.) reels. Frequency response is ±2 dB, 30 — 25,000 Hz (15 ips); flutter is below 0.06% rms (15 ips); distortion is less than 0.4% (500 Hz at peak record level). For extreme technical versatility, the system may be converted to an 8-track, 2.54 cm (1 in.) tape version.

Size:	(single-channel)	102.9 cm (40½") H
		62.2 cm (24½") W
		69.8 cm (27½") D
		Add 8.9 cm (3½") to height for each additional channel.
AG-440C	NPN	Recorder/Reproducer

## Ampex ATR-700

The Ampex ATR-700 is the new replacement for old series 600 units. The ATR-700 provides a machine with concert hall quality in a road show package. It fills the need for more versatility and built-in convenience with many standard features that either are not available or cost extra on other compact recorders.

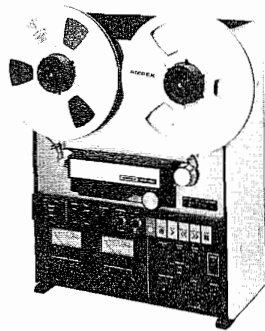

ATR-700

Every ATR-700 includes the following features:

2-Channel electronics	Order a single track machine now have 2-channel capability later by simply plugging in the appropriate heads later.
Synchronous Reproduce is Standard	This feature lets you record a second channel in sync with the second on the first channel.
Capstan Servo D.C. Motor	Direct drive type for greater torque and speed control.
Two Speed operation	Switchable between either 3¾ - 7½ or 7½ - 15 ips. specified at time of order.
Universal power supply	A voltage selector permits operation on AC power anywhere in the world.
Electron motion sensing	Affords operation between operating modes without touching the stop button.
Automatic shut-off	Shut-off is actuated by the tape tension arm.
Separate switches	Are located on the front panel for bias, equalization and reference levels.
Three reel sizes	Can be used with 5, 7, and 10½ inch reels.
Standard equipment	Includes 2 NAB reel hold down knobs, 3 to 2 pin AC cord adapter, rack-mount adapter, 4 Cannon XLR connectors, 10½" take-up reel (NAB), operation manual and extender board.
Size	54.8cm (21¾")H x 44.0cm (17¾")W x 24.6cm (9¾")D.
Weight	28 Kg (62 lbs.)
Power	100/120/220/240V ± 10%, 50/60 Hz. switchable, 110 watts.

## ITC 850 Series Reel to Reel Tape Recorders

The 850 ITC series gives the broadcaster a reel-to-reel tape machine with rugged reliability in both the 26.6 and 35.5-cm (10½- and 14-inch) reel models. 32 different configurations are offered to meet all of the broadcasters requirements.

To save space, all playback electronics are housed in the transport deck assembly; and therefore, a separate electronics chassis is not required on reproducer only units. All 850 series reproducers are wired to accept the optionally available 25 KHz sensor required in program automation systems. This circuit card is plug-in and offers a variety of operating modes.

The ITC 850 series offers the ultimate in ease of servicing. For reliability, only the latest silicon transistors, diodes and integrated circuits have been included. All printed circuit cards with active components are of plug-in design and have gold plated contacts. Extender cards are available for added accessibility of components during repair work. The hinged swing-out design of the electronics chassis permits easy access to both electronic components and mechanical adjustments.

Tape Speeds:	3.77/7.5 ips or 7.5/15 ips
Motors:	Capstan direct drive, hysteresis synchronous
Timing Accuracy:	0.2% or better
Flutter:	NAB Weighted    15 pis    .05%
	7.5 ips    .07%
	3.75 ips   .1%
Audio Input:	15k ohms bridging or 600 ohms balanced by strappable option.



ITC 850 Series Reel to Reel Tape Recorders

Audio Output:	+24dBm before clipping, factory adjusted for +8dBm, 600 ohms balanced. May be strapped for 150 ohms.
Equalization:	NAB or CCIR adjustable
Remote Control:	All indicators and controls except meter and edit switches.
Dimensions:	10 ½" reel reproducers — 19"W x 11"D (7¾" penetration into housing), 15¾"H. 14" reel reproducers — 19"W x 11"D (7¾" penetration into housing), 24½"H. Recording amplifiers — 19"W x 8"D x 3½"H.
Weight:	10½" reel reproducers 70 lbs. 14" reel reproducers 80 lbs. Recording amplifiers 15 lbs.

# Audio

Power:	105-125 Vac, 60 Hz, 200 volt amperes. 50 Hz and other voltages — special order.
855-0001	10½" reel, record/reproducer, 7½-15 ips, full track mono.
855-0002	10½" reel, record/reproducer, 3¾-7½ ips, full track mono.
855-0005	10½" reel, record/reproducer, 7½-15 ips, ½ track stereo (2 ch.)
855-0006	10½" reel, record/reproducer, 3¾-15 ips, ½ track stereo (2 ch.)
857-0001	14" reel, record/reproducer, 7½-15 ips, full track mono.
857-0002	14" reel, record/reproducer, 3¾-7½ ips, full track, mono.
857-0005	14" reel, record/reproducer, 7½-15 ips, ½ track stereo (2 ch.)
857-0006	14" reel, record/reproducer, 3¾-7½ ips, ½ track stereo (2 ch.)
864-0002	Console cabinet for 10½" record/reproducer.
864-0004	Console cabinet for 14" record/reproducer.
864-0007	Remote control for record/reproducer.

Reel Size	7" plastic or 10½" EIA or NAB
Inputs	0 dB mW unbalanced 50,000 ohms, 0 dB mW balanced 600 ohms with optional transformer. Microphone — 70 dB unbalanced 600 ohms
Outputs	Line — 0 dB unbalanced 600 ohms, 0 dB balanced 600 ohms with optional transformer
Equalization	NAB standard for 3¾, 7½, and 15 ips
Flutter and Wow	15 ips less than 0.04% 7½ ips less than 0.08% 3¾ ips less than 0.12%
Distortion	Less than 1% at 1000 Hz at 0 dB
Power	117 V, 50/60 Hz, 80 W
Weight	20.4 kg (45 lb)
Size	2-channel: 49.5 cm H x 43.2 cm W x 18.7 cm D (19½" x 17" x 7¾") ½-track 2-channel, 15-7½ ips 7½-track 2-channel, 7½-15 ips ¼-track 2-channel, 15-7½ ips ¼-track 2-channel, 7½-15 ips
MX-5050-2SH NPN	½-track 2-channel, 15-7½ ips
MX-5050-2SL NPN	7½-track 2-channel, 7½-15 ips
MX-5050-4SH NPN	¼-track 2-channel, 15-7½ ips
MX-5050-4SL NPN	¼-track 2-channel, 7½-15 ips

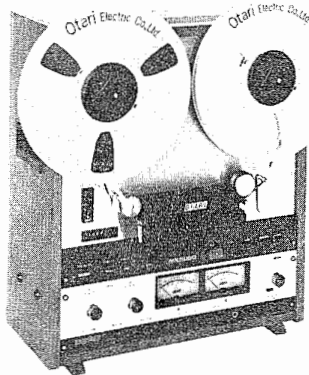

MX-5050-2S

## Otari MX-5050 Series Tape Recorders

The MX-5050 MINI-PRO is a full professional recorder scaled down in size but not in performance, features, or reliability. Basically, it is a 10½-in. reel, 3-motor, 4-head machine that offers 15 and 7½ ips or 7½ and 3¾ ips tape speeds. It can also be easily converted in the field to the other speed range if desired.

Among its many professional features are synchronous reproduce, front panel edit control (which allows both spilling and rocking), IC digital control system with motion sensing, adjustable cueing control for audible monitoring in fast forward and rewind, optional dc capstan servo system, front adjustable bias, record lock-out, capstan location on nonoxide side of tape, built-in test and cue oscillator, optional portable case or rack-mounting panel. Cannon-type connectors for input and 600-ohm (0 dB) output, standard reference level calibrate position, separate line and mic input level controls for each channel, versions for two or four channels, four heads, plug-in balanced line transformers, mic preamps, and easy-carry handles.

Tape Speeds                      7½ — 15 ips or 3¾ — 7½ ips



Revox A77 Recorder/Reproducer

## Revox A77 MK III Recorder

For the broadcaster requiring a versatile, ultrahigh fidelity recorder, the A77 MK III offers many distinct advantages. Wow and flutter is less than 0.04% total rms at 7½ ips; frequency response is 2 dB, 30 — 20,000 Hz at 7½ ips. Distortion is less than 2% (1 kHz at peak record level). An electronically regulated capstan motor keeps tape speed (either 7½ ips or 3¾ ips) within 0.2% deviation. Up-front controls permit "instinctive" operation. A 3-head design permits on/off tape monitoring as well as provision for mixing, multitrack, or echo effects. There are dual inputs for front or rear microphone connection plus switchable choice of either high or low impedance. All functions can be controlled remotely (optional). The unit is easily carried from place to place and may be operated either vertically or horizontally. For the ultimate in noise reduction, a specialized version is available with Dolby circuitry.

Size:                                      52.4 cm (20<sup>5</sup>/<sub>8</sub>") H  
38.1 cm (15") W  
22.2 cm (8<sup>3</sup>/<sub>4</sub>") D  
A77 MK III NPN Recorder



# Audio

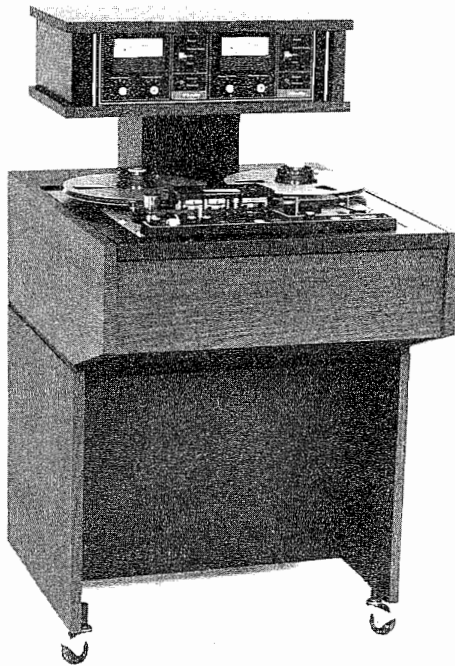

*Scully/Metrotech 280B-2 Recorder/Reproducer*

## Scully/Metrotech 280 Series Recorder/Reproducer

The Scully/Metrotech series of recorders/reproducers offers the broadcaster an efficient, reliable, and versatile means of tape production. The units come in rack, console, or portable versions. They will accept either 0.6- or 1.2- cm (¼- or ½-in.) tape with up to 4-channel capacity. Tape speeds are 3¾ — 7½ ips and 7½ — 15 ips with other speeds available on special order. They will accommodate up to 27.9-cm (11-in.) reels with an option on certain models for 35.5-cm (14-in.) reels. All functions may be remoted (option) and all usual alignment controls are front-mounted. Frequency response is ±2 dB, 30 to 15,000 Hz (15 ips); flutter and wow at 15 ips is 0.08% rms or better. Innovative features include motion sensing system, an edit function permitting tape movement without takeup reel winding, and optional selective synchronization for multichannel over dub effects.

Size: (console unit) 127 cm (50") H  
63 cm (24<sup>13</sup>/<sub>16</sub>") W  
72.6 cm (28<sup>1</sup>/<sub>2</sub>") D  
280B-2 NPN Recorder/Reproducer

## Scully 285B Tape Reproducer

The Scully 285B tape reproducer is a professional quality playback or editing system for broadcast and studio applications. Available with ac hysteresis or dc servo capstan motors. All the transport features found in the

popular 280B/284B family are standard, such as functionally illuminated controls, motion direction sensing logic, and dynamic braking. All adjustments are accessible by removing the head cover. Monitor earphone jack and level controls are mounted on the transport. 600-ohm line and speaker outputs are standard.

Configurations include full-track, 2-track, or ¼-track stereo. Slope front consoles are offered as optional items.

## Specifications 285 Series

Frequency Response	15 in/s, ±2 dB, 30 Hz to 18,000 Hz 7.5 in/s, ±2 dB, 30 Hz to 15,000 Hz 3.5 in/s, ±2 dB, 30 Hz to 10,000 Hz
Wow and Flutter	DC Servo AC Motor 15 in/s 0.04% 0.08% 7.5 in/s 0.06% 0.1% 3.75 in/s 0.1% 0.2%
Speed Accuracy	±0.1% with dc servo; ±2% with ac motor throughout reel at all speeds using 1.5-mil tape
Outputs	Line +17 dB mW into 600 ohms. Speaker 3.0 watts into 8 ohms
Equalization	Automatically switched with transport speed. Specify NAB or IEC (CCIR)
Reel Size	To 11.5 in. (CCIR)
Brakes	Dynamic plus disc
Power	105 to 125 V ac 60 Hz, 250 VA, (50 Hz and/or 220 V optional extra)
Size	Unmounted 48.2 cm (19")W x 40 cm (15.75")H x 22.8 cm (9")D
Weight	Unmounted 40.8 kg (90 lb) Empty console 47.6 kg (105 lb)

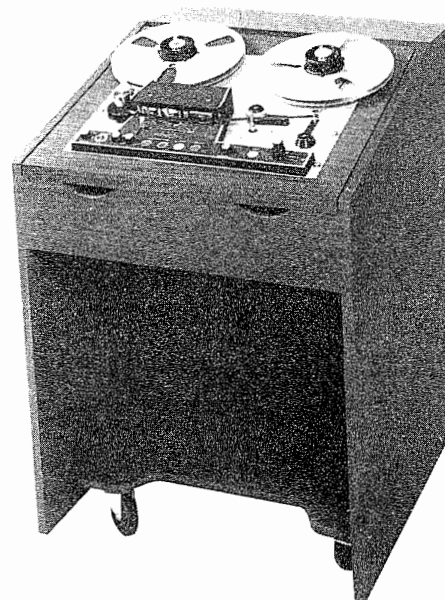

*Scully/Metrotech 285B Stereo Reproducer*

# Audio

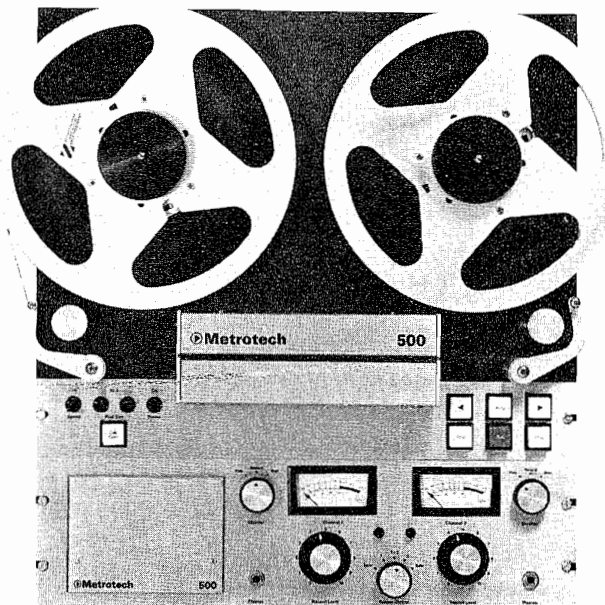

Scully/Metrotech 500

## Metrotech Series 500 Record/Reproduce and Reproduce

For any recording job, or for long-play programming, the Metrotech 500 series offers professional quality at a modest cost. Combining outstanding performance with many general utility features, the 500 series represents a solid investment for the broadcaster, background music service, educators, civil and other governmental facilities. Features of the series are:

1. Five different  $\frac{1}{4}$ " tape track formats: full track,  $\frac{1}{2}$  track, and  $\frac{1}{4}$  track mono, and 2 and 4 track stereo.
2. Bidirectional models provide for extended play time.
3. Auto-reverse ( $\frac{1}{4}$  track stereo models or  $\frac{1}{2}$  track mono) or full-sequencing ( $\frac{1}{4}$  track mono)
4. OPTAC tape motion sensing and solid-state logic prevent accidental tape spill, stretch, or breakage.
5. 2-speed switch selectable for any two adjacent speeds are available.
6. 3-motor system for maximum performance in heavy-duty applications.
7. 3-mode Edit/Cue Control. Record/Reproduce models offer (1) Tape spill mode. (2) Tape lifter defeat for aural monitoring in Fast wind modes. (3) Play Cue mode to release brakes for quick-cueing. Note: Edit/Cue not available in Reproducer only models.
8. Front panel setup controls.

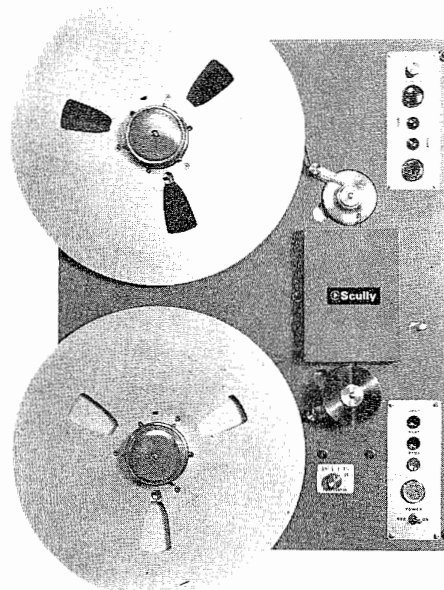

Scully/Metrotech 270

## Scully/Metrotech Long-Play Tape Reproducer

The Scully 270 professional long-play reproducer has become the standard of excellence in the automated broadcast industry. Designed to run for long periods with reliable and with trouble-free performance, the 270 is an extra rugged heavy-duty reproducer designed and built with typical Scully craftsmanship. Features include such items as; disc brakes, fully transistorized plug-in amplifiers, rugged cast frame, direct drive heavy-duty motors, removable face plate, instant access for maintenance, automatic start torque tension control, and reversing capability with mono  $\frac{1}{2}$  track and stereo  $\frac{1}{4}$  track units only; accomplished by foil-sensing low-current transistor switching with mechanical memory.

## Specifications

Head Configuration	Mono $\frac{1}{2}$ or full track; stereo 2 or $\frac{1}{4}$ track
Tape Speed	$3\frac{3}{4}$ to $7\frac{1}{2}$ ips, $7\frac{1}{2}$ to 15 ips
Tape Width	$\frac{1}{4}$ "
Reel Size	Up to 14"
Control System	All relay and solenoids 24 V dc; plug-in relays
Frequency Response	Mono and 2 track, $\pm 2$ dB 50 to 7500 Hz at $3\frac{3}{4}$ ips, +2, -3 dB, 50 to 15,000 Hz at $7\frac{1}{2}$ ips; $\pm 2$ dB, 50 to 15,000 Hz at 15 ips
Distortion	Less than 0.5% total harmonic distortion at $\pm 18$ dB mW
Equalization	Front panel switch

# Audio

Output	+18 dB mW from 600-ohm balanced line (normally supplied +4 dB mW = Zero VU)
Power	117 V ac, 60 Hz, 275 watts (50 Hz optional)
Size	48.2 cm (19")W x 62.2 cm (24½")W x 22.2 cm (8¾")D
Weight	45.4 kg (100 lb)



*Dictaphone 400L Logger System*

## Dictaphone 400L Logger Systems

The 400L Logger System provide three basic models for use as single logging systems or they can be combined into fail-safe logger systems. These systems provide up to 153.6 hours of single channel service. The 400L systems employ metallic-tab actuated automatic reversing mechanisms, plus special interlaced head stacks. On all models, the number of hours logged on a single reel can be doubled by transposing reels on the hubs.

Dictaphone 400L logging recorders are designed for long-term hands-off operation. Confidence lights not only show "fail" or "recording" conditions, but they indicate the track being recorded. The monitor selector and pushbuttons enable the monitoring of any channel individually or in combination in the record or play modes. The VU meter allows accurate checking of bias. All electronics in the 400L series loggers are

solid-state and are contained in a sliding drawer. The entire transport tilts forward on hinges for ready access to all mechanisms and is fully operational in the tilt position.

The dual system does more than double the unattended logging capacity (to 307 hours of single channel operation). It also protects the entire recording operation by automatically switching to the stand-by logger in the event of a failure of the first logger. Meanwhile one logger can be used for playback while the other is recording. In case of power failure, the logic will remember which deck was recording and the pass and direction last in use.

414L	NPN	1 channel, auto 4 pass, 153.6 hours
422L	NPN	2 channel, auto 2 pass, 76.8 hours
441L	NPN	4 channel, one pass, 76.8 hours
414L-2	NPN	1 channel, auto 4 pass dual logger
422L-2	NPN	2 channel, auto 2 pass dual logger
441L-2	NPN	4 channel, one pass dual logger

☞



*TEAC Tascam Series Recorder/Reproducer 80-8*

## TEAC Reel-to-Reel Tape Recorders

TEAC 3-motor, 3-head tape recorders meet the most demanding conditions of high fidelity performance. The servo motor is engineered for quiet tape movement precisely at the selected speed. Full IC logic on the touchbutton transport controls makes it virtually impos-

# Audio

sible to spill tape. TEAC engineering is continually refining and perfecting fundamentals while reshaping features and functions to meet a variety of broadcasting needs. The TEAC line comes in reel sizes up to 26.6 cm (10½ in.), and tape speeds of 15, 7½, and 3¾ ips. Harmonic distortion is less than 1 percent at 1 kHz normal operating level on all models except the A-7300 2T, which has less than 0.8 percent. Model A-3340S has four VU-type loudness meters; all other models are equipped with two VU meters. Remote control capability is optional.



*A-7300 Master Recorder*

A-2300S/SD	NPN	¼-Track, 2-Channel Stereo/Mono, Record Playback, 7½, 3¾ ips
A-3300S/ST	NPN	¼-½-Track, 2-Channel Stereo/Mono, Record/Playback, 7½, 3¾/15, 7½ ips
A-4300	NPN	¼-Track, 2-Channel Stereo/Mono, Record/Playback, 7½, 3¾ ips
A-6300	NPN	¼-Track, 2-Channel Stereo/Mono, Record/Playback, 7½, 3¾ ips
A-7300/2T	NPN	¼-½-Track, 2-Channel Stereo/Mono, Record/Playback, 7½, 3¾/15, 7½ ips
A-3340S	NPN	4-Track Multichannel w/Simul-Sync, Stereo/Mono, Record/Playback, 15, 7½ ips
A-6100	NPN	2-Track, 2-Channel Stereo/Mono (¼-Track Stereo Playback), 15, 7½ ips
80-8	NPN	8-Track, 8-Channel Recorder/Reproducer, 15 ips

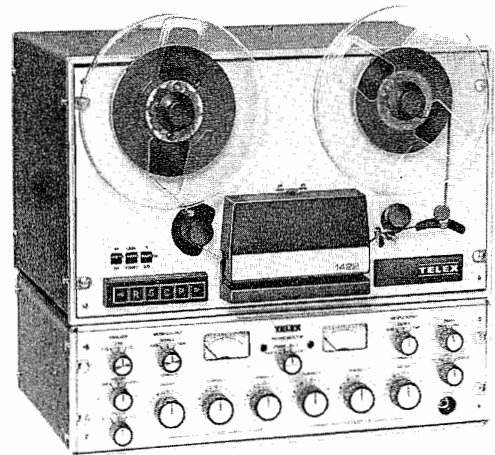

*Telex 1400 Series Recorder/Reproducers*

## 3M Bulk Tape

Collins supplies a complete line of 3M brand recording tape for reel-to-reel recorders/reproducers. Item 206 is high output/low noise tape providing 30 minutes in one direction at 7½ ips. Item 211 is low noise/high dynamic tape providing 30 minutes in one direction at 7½ ips. Item 213 is the same as 211, except that it provides 60 minutes in one direction at 7½ ips. Item 228 is a low noise, economical tape providing 30 minutes in one direction at 7½ ips.

## Telex 1400 Recorder/Reproducer

The Telex 1400 series of recorder/reproducers is designed and engineered for commercial sound applications. The units, in stereo or monaural, combine rugged reliability with current state-of-the-art functions. A dc servo drive system ensures outstanding timing accuracy. Solid-state controls eliminate contact noise and allow minimum EMI. The bilevel control illumination shows activated operating mode at a glance. The solid-state electronics has separate gain controls for mike and line inputs as well as master gain. The series is available in single or dual channel with all standard head configurations.

1400 Series NPN Mono/Stereo, Record/Playback, Single or Dual Channel

## Microphones and Accessories

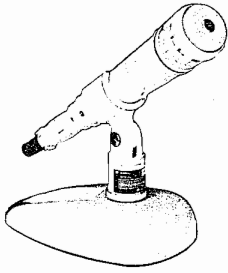

M-70

### Collins Microphones

The Collins series of microphones fit every application normally encountered by broadcasters. These mikes are high-quality, durable instruments with the versatility demanded by both broadcast and recording personnel. The M-21 lavalier microphone, ideal for both television and broadcast work, is an omnidirectional model, easily hidden behind lapel or necktie. Response is 60 to 12,000 Hz; input impedance is 50 to 150 ohms. The Collins M-70 provides highly directional sound selectivity, doubling the conventional working distance. Its cardioid pattern cuts out unwanted background noise. The M-70 is equipped with desk stand and 6-m (20 ft) cable. Response is 40 to 15,000 Hz; input impedance is 50 or 200 ohms, selectable. Collins M-80 cardioid dynamic is ideal for night clubs, combos, recording, and public address. A 4-stage blast filter controls mike "pop," wind noise, and feedback. Response is 50 to 15,000 Hz; input impedance is 150 ohms (matches 50 to 250 ohms). Collins M-90 cardioid dynamic features ball screen construction. Undesirable background noise, pops, squeals, and wind noise are all but eliminated. Response is 40 to 15,000 Hz; input impedance is 150 ohms (matches 50 to 250 ohms), discrimination is typically 20 dB over the entire frequency range.



M-80

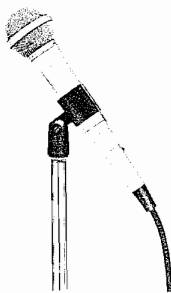

M-90

- |      |              |                                |
|------|--------------|--------------------------------|
| M-21 | 124-0083-377 | Lavalier Microphone            |
| M-70 | 099-2402-000 | Cardioid Microphone            |
| M-80 | 124-0083-378 | Cardioid Dynamic<br>Microphone |
| M-90 | 124-0083-379 | Cardioid Dynamic<br>Microphone |

# Audio

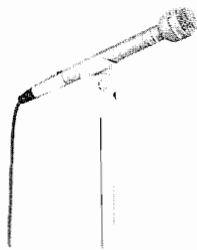

RE-15

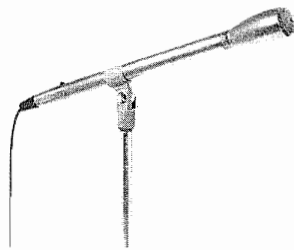

RE-55

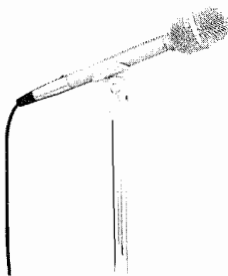

RE-16

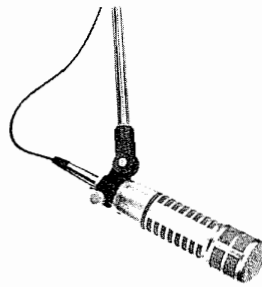

RE-20

## Electro-Voice Microphones

Collins provides a complete line of Electro-Voice microphones for every possible application of the radio, television, entertainment, and recording industries. Omnidirectional models include the 649B miniature lavalier, ideal for programming where unobtrusive placement is desirable. It matches all low impedance inputs and comes with a 9-m (30 ft) shielded cable. Frequency response is 70 to 10,000 Hz. Model RE-55 is a wide-range dynamic omnidirectional unit with flat response 40 to 20,000 Hz. It is ideal for orchestral or instrumental sound reinforcement, and matches low impedance inputs. The RE-50 omnidirectional has a 4-stage pop and dust filter and is ideal for interviews, vocals, and instrumental music. It is windscreened for outdoor use. Response is 80 to 13,000 Hz; inputs is low impedance. The redesigned and lightweight 635A, especially designed for vocals and interviewing, also features a 4-stage blast and pop filter. Response is 80 to 13,000 Hz; input is low impedance. A neck cord is furnished for lavalier-type applications. For discriminating sound applications, many super-cardioid dynamic models are available. Model RE-20 features wide, uniform response for exacting studio applications. It has a uniform cardioid polar pattern with off-axis response virtually identical to on-axis response. Response is 40 to 20,000 Hz; impedance is 50, 100, or 150 ohms. Model RE-15 meets handheld, boom, or stand applications. The directional pattern provides maximum rejection of 150° off axis. Response is 80 to 15,000 Hz; input is low impedance. The RE-16 is similar to the RE-15, but is designed for less exacting applications. The RE-11 is similar to the RE-10 and has characteristics of the RE-15, except that it has an integral blast and pop filter.

649B	NPN	Lavalier Microphone
RE-55	NPN	Omnidirectional Microphone
RE-50	NPN	Omnidirectional Microphone
635A	NPN	Omnidirectional Microphone
RE-20	NPN	Cardioid Microphone
RE-15	NPN	Cardioid Microphone
RE-16	NPN	Cardioid Microphone
RE-10	NPN	Cardioid Microphone
RE-11	NPN	Cardioid Microphone

## Primo Microphones

Primo, the world's largest manufacturer of microphones and microphone cartridges and a major supplier of other worldwide microphone manufacturers now offers a complete line of studio condenser and studio dynamic microphones under their own name.

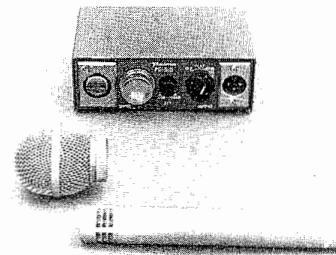

CMU-503 Studio Condenser Microphone

## CMU-503 Studio Condenser Microphone

This professional studio microphone offers excellent transient and full frequency response making it ideal for percussion as well as strings and woodwinds. The self-contained preamplifier section utilizes a very select FET combining with unique circuitry and voltage generator to provide superior characteristics such as a low 20 dB self-noise and 140 dB maximum input. The separate power supply (includes 9 volt battery) also includes level attenuation switch, low frequency response switch, power ON-OFF switch, and front panel battery removal.

Directivity	Unidirectional
Frequency Response	20 to 18,000 Hz $\pm$ 2.5 dB
Output Impedance	200 ohms
Output Level	-72 $\pm$ 1.5 dB
Signal-to-Noise	53 $\pm$ 2 dB
Max Input	140 dB SPL
Power	Dc 9-V battery supplied
Cable	6 m (19.7 ft) with cannon XLR-3-11c
Accessories	Complete with carrying case, battery, wind screen, cable and mic stand adapter

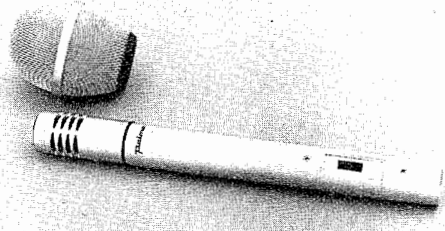

EMU-4520 Unidirectional Electret Microphone

## EMU-4520 Unidirectional Electret Microphone

The EMU-4520 is a professional studio and broadcast electret condenser microphone. It has the ultra wide response expected of condenser microphones with excellent transient characteristics making it an ideal studio microphone for use on all types of instruments. It has a host of professional features yet remains within the price of even the smallest studio. It features a 10 dB attenuator to prevent preamp overload on very high sound levels, a low frequency rolloff switch for close vocal work, removable wind screen and can be converted to omnidirectional or ultradirectional characteristics. A sturdy metal carrying case is supplied.

Directivity	Unidirectional
Frequency Response	50 to 15,000 Hz
Output Impedance	200 ohms balanced
Output Level	-76 ±2.5 dB
Low Frequency Attenuation	10 dB at 50 Hz
Level Attenuation	10 dB switchable
Signal-to-Noise	50 dB minimum
Power	9.1-V battery supplied

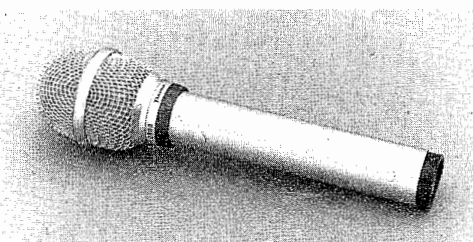

P-88 Unidirectional Dynamic Microphone

## P-88 Unidirectional Dynamic Microphone

The P-88 dynamic cardioid microphone is designed for studio and broadcast applications. As a professional type cardioid it will meet the most stringent requirements for public address including tuned sound systems. Its light weight and small size make it an ideal handheld entertainment microphone. The P-88 utilizes

a multiscreen and foam windscreens to protect against wind noise and breath blasts. Mechanical noise has been greatly reduced by a special smooth finish on the P-88 case, and the cable connector is mounted in a unique rubber dampening material. All P-88 cardioid microphones are precision adjusted for uniform front and rear response to provide smooth off axis response.

Directivity	Unidirectional
Frequency Response	50 to 15,000 Hz
Output Impedance	250 ohms balanced
Output Level	-76 ±3 dB
Output Connector	Cannon XLR-3-11C
Cable Length	6 m (19.7 ft) detachable
Weight	220 g (7.9 oz) less cable
Stand Adapter	5/8"-27 thread

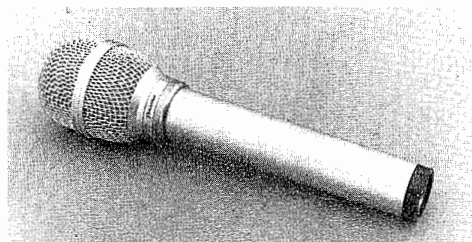

P-77 Unidirectional Dynamic Microphone

## P-77 Unidirectional Dynamic Microphone

The P-77 is a unidirectional type dynamic microphone designed to fulfill the exacting demands of broadcast, recording, and professional entertainers. The P-77 has an extended smooth response making it well suited for "tuned sound systems." Its integral windscreens is effective in eliminating breath blasting and "P" sound popping. The windscreens is a multilayer screen to provide excellent rejection of wind noise. The cartridge is shock mounted and additional shock mounting is provided for the professional 3-pin connector to eliminate cable noise which is frequently a problem with handheld microphones. A good front-to-back ratio reduces pickup of unwanted sound from the rear of the microphone.

Directivity	Unidirectional, cardioid
Frequency Response	50 to 15,000 Hz
Output Impedance	250 ohms balanced
Output Level	-79 ±3 dB
Output Connector	Cannon XLR-3-11C
Cable Length	6 m (19.7 ft)
Weight	195 g (6.9 oz)
Stand Adapter	5/8"-27 thread

# Audio

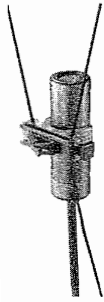

SM51

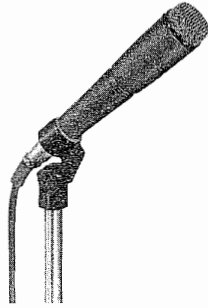

SM50

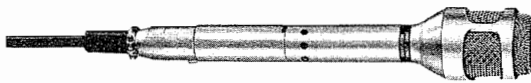

SM53

## Shure Microphones

The SM53 unidirectional microphone is ideal for tight instrument and vocal pickup and for high-quality sound reinforcement applications. It has an extremely broad front working angle, holds tonal quality constant, and has a built-in hum rejection system and integral pop filter. Response is 70 to 16,000 Hz; impedance is 50 to 150 ohms. For studio and remote applications, the SM50 self-windscreened omnidirectional model is ideal. Its primary applications are for news, sports, and special events. Response is 40 to 15,000 Hz; it has dual impedance: 50 and 150 ohms. The SM60 omnidirectional model, designed for handheld applications: performers, interviews, remotes, news, and sports, has a built-in breath and pop filter. Response is 45 to 15,000 Hz; it matches any input from 50 to 250 ohms. Model SM51 meets lavalier requirements of broadcast, TV, and motion picture industries where a small unobtrusive mike is required. It is omnidirectional, with a frequency response of 70 to 12,000 Hz. It matches any input impedance from 50 to 250 ohms.

- SM53 NPN Unidirectional Microphone
- SM50 NPN Omnidirectional Microphone
- SM60 NPN Omnidirectional Microphone
- SM51 NPN Lavalier Microphone

## Shure Microphone Accessories

To complement the line of microphones, Shure provides a complete line of mike accessories. The A15A Microphone Attenuator prevents input overload. Insertion loss is 15 dB. The A15HP High Pass Filter provides a low frequency cutoff to eliminate rumble or environmental sounds. Slope is 12 dB per octave. The A15LP Low Pass Filter provides high frequency cutoff for suppressing sibilance and hiss. Slope is 12 dB per octave. The A15PA Presence Adapter provides a response rise of 4 dB in the 3- to 5-kHz region, adding extra brilliance. The A15RS Response Shaper provides sibilance filtering and flattens response in mikes that show a rising characteristic in the 6-kHz region.

A15A	NPN	Attenuator
A15HP	NPN	High Pass Filter
A15LP	NPN	Low Pass Filter
A15PA	NPN	Presence Adapter
A15RS	NPN	Response Shaper

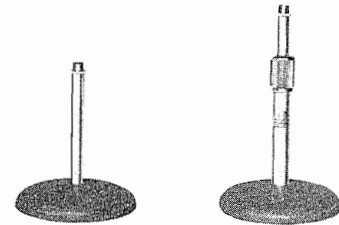

DS5

DS-7

## Atlas Microphone Stands

Functional and modern in design, all Atlas stands feature chromed seamless tubing. All models terminate with standard 5<sup>8</sup>/<sub>27</sub> threads for mike or mike holder. Model DS-7 has an adjustable tube from 20.3 to 33 cm (8 to 13 in.). MS-10C popular floor stand with grip action clutch, charcoal wrinkle base, adjustable 87.9 to 160 cm (35 to 63 in.). Model MS-25, for stage and studio, has an integral air suspension system to counterbalance mike weight. It is adjustable from 96 to 170 cm (38 to 67 in.). Model BS-36 is a heavy-duty boom stand. The boom is 157 cm (62 in.) long; the height is adjustable from 122 to 183 cm (48 to 72 in.).



# Audio

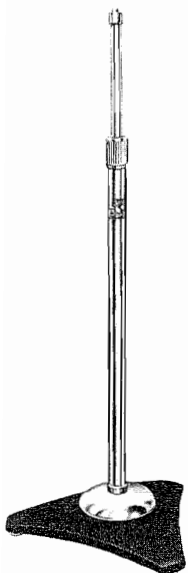

MS-25



BS-36

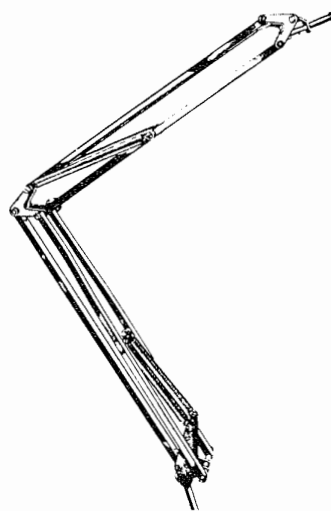

Luxo Mike Arm

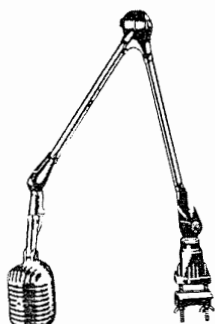

Flexo Mikester

## Luxo Microphone Arms

Luxo arms are perfectly balanced to carry microphones to any desired position and remain there. LM-1 has a 104 cm (41-in.) reach; LM-2, 66 cm (26-in.) reach. Mike weights of 198 to 368 (7 to 13 oz) can be accommodated. Heavier mike capacities are available on special order. Order mounting brackets as a separate item.

LM-(1)	124 3015 384	Microphone Arm, 104.1 cm (41")
LM-(2)	124 3015 511	Microphone Arm, 66 cm (26")
A	124 3015 385	Clamp bracket
B	124 3015 386	Wall bracket
C	124 3015 512	Horizontal mounting bracket

## Flexo Mikester FM-1

This arm will handle any mike up to 1.8 kg (4 lb). It can be instantly positioned, incorporates a patented enclosed spring-controlled swiveling device, and swings out 91 cm (36-in.) in any direction when fully extended. The arm clamps or screws to position; clips hold the cable in place.

FM-1    097-1499-00    Microphone Arm

# Audio

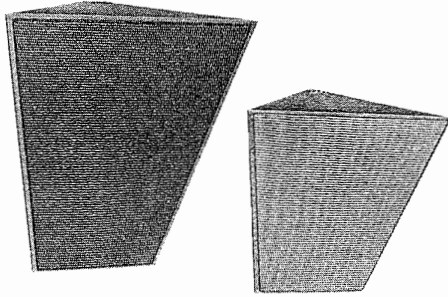

SCB-12D

SCB-8D

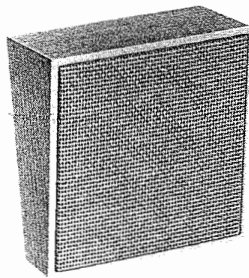

WB-8D

## Speakers and Headphones

### Argos Baffles

Argos wall baffles enhance the decor of any studio. They are ruggedly constructed and finished in wood grain vinyl with modern cane grille in either blond or walnut finish. There are no unsightly mounting brackets. Special clips are provided which mount to the wall, and the baffle is hung like a picture. Model WB-12D is a regular baffle which will accommodate a 30.48-cm (12-in.) speaker. WB-8D is similar, but smaller, accommodating a 20.3-cm (8-in.) speaker. SCB-12D is a slanting corner mount unit designed for a 30.48-cm (12-in.) speaker; SCB-8D is similar in design, but sized for a 20.3-cm (8-in.) speaker.

WB-12D	124-0032-297	Wall Baffle, 30.48-cm (12")
WB-8D	124-0032-295	Wall Baffle, 20.3-cm (8")
SCB-12D	099-2376-000	Corner Baffle, 30.48-cm (12")
SCB-8D	099-2374-000	Corner Baffle, 20.3-cm (8")

### Davis Speakers

The Davis shelf-size XEB-50 speaker system utilizes a modified Heimholtz design. Three speakers are used: 20.3-cm (8-in.) free-edge cone full range, a 3x5 mid-tweeter, and a 15.2-cm (6-in.) super-tweeter. Only 1 watt of power is required for the normal room. Power capacity is 25 watts; response is 37 to 19,000 Hz; impedance is 8 ohms. The cabinet is finished in walnut grain vinyl. The XEB-40 is a 4-speaker system featuring a 38.1-cm (15-in.) woofer, 20.3-cm (8-in.) mid-range, 3x5 enclosed tweeter, and 15.2-cm (6-in.) super-tweeter. Response is from 24 Hz to beyond audio range; impedance is 8 ohms, and power capacity is 50 watts. Bass response and brilliance controls are mounted on the rear of the cabinet.

Size: XEB-50	30.5 cm (12") H 67 cm (24") W 26.7 cm (10½") D
XEB-40	62.2 cm (24½") H 76.2 cm (30") W 38.8 cm (14½") D
XEB-50	124-3015-026 3-Way Speaker System
XEB-40	NPN 4-Way Speaker System

### Electro-Voice LS-12 Speakers

The LS-12 30.4-cm (12-in.) high fidelity loudspeaker produces a consistently stable and precise definition. The speaker is designed to operate equally well at full range or as woofers in multiway systems. The LS-12 features Radax construction, which divides the sound between the two cones. A mechanical crossover, when the small cone responds to the higher frequencies, occurs at 1800 Hz.

An edge-wound voice coil, which gains an equivalent of 5 extra watts from most amplifiers over round-wire coils, is wound with precision, flattened ribbon conductor.

Frequency response is 30 to 13,000 Hz; power capacity is 40 watts peak; impedance is 8 ohms.

LS-12	124-0061-907	30.4 cm (12") Speaker
-------	--------------	-----------------------

# Audio

## Electro-Voice Sentry Speakers

The Sentry series of studio speakers offers a precise audio reference standard for the most exacting use.

	IA/IIA	III	IV A
Frequency Response:	30-20,000 Hz	40-18,000 Hz	50-18,000 Hz
EIA Sensitivity:	48 dB	48 dB	52 dB
Sound Pressure:	110 dB	113 dB	117 dB
Impedance:	8 ohms	8 ohms	8 ohms
Power Handling Capacity:	20 W	50 W	50 W
Size:	IA	IIA	
	55.2 cm (21 <sup>3</sup> / <sub>4</sub> " H)	50.8 cm (20" H)	
	93.9 cm (37" W)	80.9 cm (31 <sup>7</sup> / <sub>8</sub> " W)	
	41.5 cm (16 <sup>3</sup> / <sub>8</sub> " D)	33 cm (13" D)	
Weight:	37.1 kg (82 lb)	33.5 kg (74 lb)	
Size:	III	IVA	
	87.6 cm (34 <sup>1</sup> / <sub>2</sub> " H)	129 cm (50 <sup>3</sup> / <sub>4</sub> " H)	
	72.4 cm (28 <sup>1</sup> / <sub>2</sub> " W)	70.5 cm (27 <sup>3</sup> / <sub>4</sub> " W)	
	52.1 cm (20 <sup>1</sup> / <sub>2</sub> " D)	52.3 cm (20 <sup>5</sup> / <sub>8</sub> " D)	
Weight:	70.8 kg (156 lb)	67 kg (148 lb)	

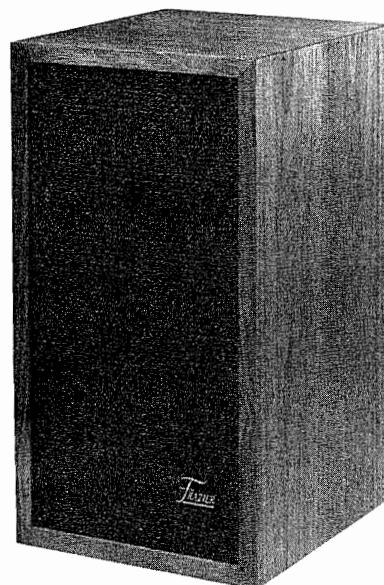

Frazier F8-4SH-A

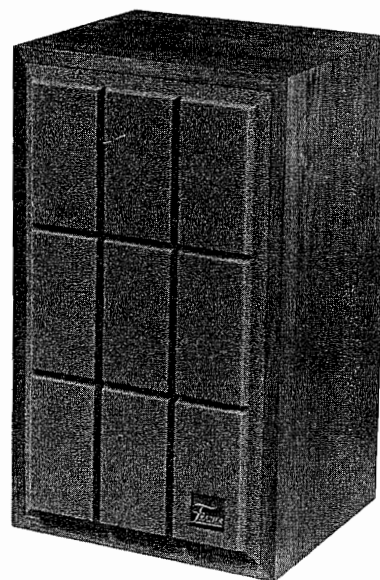

Frazier Speaker F-10-HA

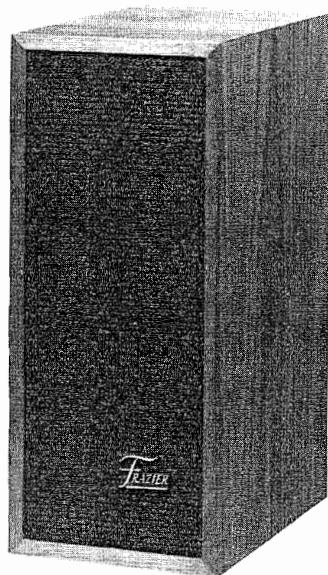

Frazier Speaker F4-4

## Frazier Speakers

Frazier's newest bookshelf model, the F-10-HA, has 30 watts of continuous power. It uses a 25.4-cm (10-in.) woofer joined to a new, special tweeter by a unique network with fixed acoustical tuning. Frequency response is 30 Hz to 17,000 Hz; impedance is 8 ohms. The cabinet is oiled walnut finish with acoustically transparent removable sculptured foam. Model F8-4SH-A has 20 watts of continuous power and an

# Audio

8-ohm impedance. The piezoelectric high frequency driver, with a natural crossover point of 4000 Hz, reproduces high frequencies beyond audibility. Model F4-4 has 10-watt continuous power and an 8-ohm impedance.

Size:	F-10-HA	61 cm (24") H 35.6 cm (14") W 30.5 cm (12") D
	F8-4SH-A	48.26 cm (19") H 26.67 cm (10½") W 30.48 cm (12") D
	F4-4	40 cm (15¾") H 17.15 cm (6¾") W 24.13 cm (9½") D
F-10-HA	NPN	Speaker System
F8-4SH-A	NPN	Speaker System
F4-4	NPN	Speaker System

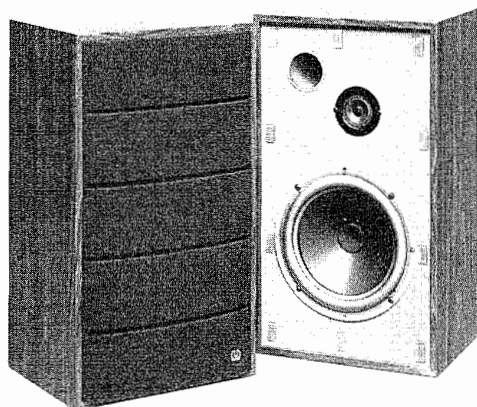

60A Speaker

## Pioneer Model 60A 2-Way, 2-Speaker System

Two ideally balanced cone-type speaker units are featured in this versatile and dependable speaker system. The 20-cm (8-in.) woofer and 4.4-cm (1¾-in.) tweeter are united by a carefully designed crossover network (3000-Hz crossover frequency). Maximum power input is 20 watts.

Size:		46.9 cm (18½") H 27.3 cm (10¾") W 23.3 cm (9¾") D
Weight:		5.8 kg (13 lb)
60A	NPN	2-Way Speaker System
100A		10" 3-Way System, 60W
CS-66G		10" 3-Way System, 40W
CS-500G		10" 3-Way System, 50W
CS-700G		12" 3-Way System, 60W
CS-99A		15" 3-Way System, 100W
CS-63DX		15" 4-Way System, 200W

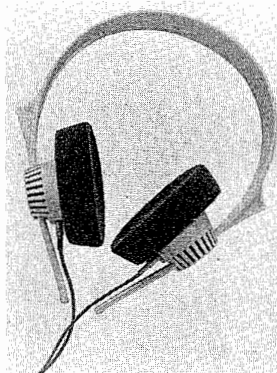

Sennheiser HD 414 Headphone

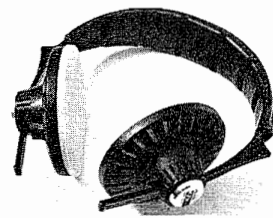

Sennheiser HD 424 Headphone

## Sennheiser HD 414/424 Headphones

Acoustical quality and headphone comfort are built into these high fidelity stereo headphones. Model 414 has a frequency response of 20 to 20,000 Hz; Model 424 has a frequency response of 16 to 20,000 Hz. Both models have an impedance of 2000 ohms. The HD 414 weighs 135 g (4.7 oz); the HD 424 weighs 170 g (5.9 oz). The cable length on both models is 3 m (9.8 ft).

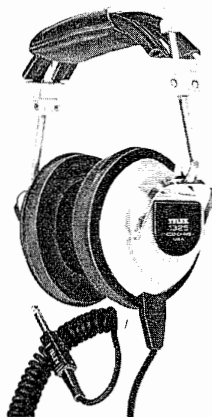

Telex 1325

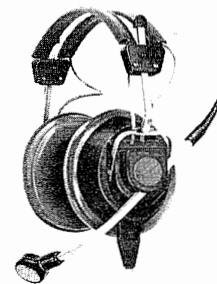

Telex CS-61

## Telex Headsets

The Telex 1325 is a 2-channel broadcast monitor headphone incorporating audiometric transducers. Either 600-ohm or 6000-ohm models are available. It is ideally suited to monitor stereo broadcasts or monaural broadcasts where program bus and cue bus are received on separate channels. Muffs and headband are foam-filled and the 3.6-cm (12-ft) cord is detachable. The Telex 1320 series is designed for a variety of communication requirements. Model CS-61 has dual muffs and dynamic mike; Model CS-75 has single muff

# Audio

and dynamic mike; Model CS-7 has dual muffs; Model CS-11 has single muff. Impedance of all these 1320 models is 600 ohms; usable response is 20 Hz to 20,000 Hz.

1325	124-3015-019	Stereo Broadcast Headset, 600-ohm
1325	124-3015-020	Stereo Broadcast Headset, 6000-ohm
1320		Communications Headsets
CS-7	124-0052-320	Dual Muff, 600 ohms
CS-11	124-0052-321	Single Muff, 600 ohms
CS-61	124-3015-197	Dual Muff, 600 ohms with boom mic
CS-75	124-3015-198	Single Muff, 600 ohms with boom mic

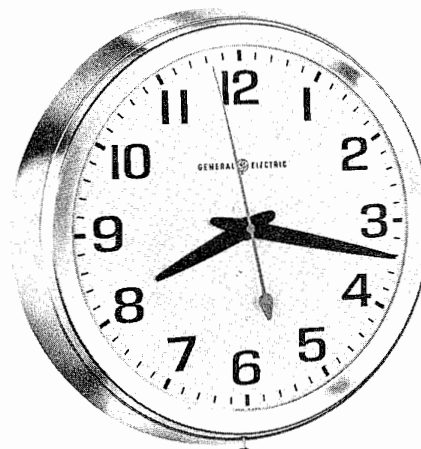

## Telechron 2012 Studio Clock

The Telechron "Commerce" clock has a 30.48-cm (12-in.) dial and rich brown case.

124-0083-705 Studio Clock

## Audio Accessories

### Trimm Patchcords

Most widely used broadcast types. Two live circuits go to tip when used on balanced lines, grounded sleeves of both plugs connected together through shield. Standard color black.

840-IX-PP	124-3015-106	30.5 cm (12"), 2-circuit
840-2X-PP	124-3015-107	61.0 cm (24"), 2-circuit
840-3X-PP	124-3015-108	91.4 cm (36"), 2-circuit

### Trimm Jack Panels

These panels are available in 12-pair, single row and 24-pair, double row models to fit any standard 48.26-cm (19-in.) rack and include such features as: solid 1.58-cm ( $\frac{5}{8}$ -in.) thick Bakelite panel with steel reinforcing; heavy gauge, special spring temper nickel/silver alloy leaves; ground lugs aligned to allow single ground bus to be run full length of strip; large palladium silver contacts; connection lugs fanned out for ease of soldering.

NTN 097-3561-000	12-pair, single row, 96-01
NTN 097-4200-000	24-pair, double row, 96-02

### Quartzmatic 46377 Clock

The Quartzmatic Model 46377 battery-operated 30.5-cm (12") studio clock offers accuracy within 1 minute per year. This clock is ideal for control room and studio applications. The unit has a full sweep second hand and a brown finished case.

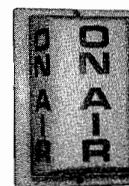

*Broadcast Sound Studio Alertlite*

### Broadcast Sound Studio Alertlite Warning Light

The Alertlite is a heavy-duty indoor/outdoor weather-tight warning light with vertical lettering ON AIR visible from three sides. Inside lettering is visible only when light is on. Uses any standard bulb  $7\frac{1}{2}$  to 100 watts (not supplied).

Model 3-001 124-3015-220 ON AIR Light 19.4 cm ( $7\frac{5}{8}$ "H) x 15.9 cm ( $6\frac{1}{4}$ "W) x 10.5 cm ( $4\frac{1}{8}$ "D).

# Audio

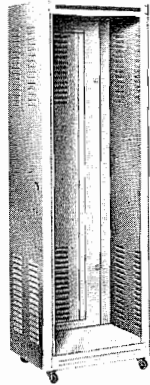

*Bud Rack CR-1780GY*

## Bud Rack Cabinets

These heavy duty rack cabinets are custom-made for Collins. Finished in light gray, with sturdy steel construction, this cabinet has a door on the back. The CR-1780GY provides 177.8 cm (70 in.) of panel space. Shipped knocked down.

CR-1780GY	124-3015-105	192.87 cm (75 <sup>5</sup> / <sub>16</sub> "H)
		55.88 cm (22"W)
		43.49 cm (17 <sup>1</sup> / <sub>8</sub> "D)

## Shielded Wire and Microphone Cable

- 8451 — Belden, 2-conductor, #22 twisted pair, copper stranded ground wire, spiral wrapped shield, vinyl overall insulation. CPN 424 0843 010
- 8422 — Belden, 2-conductor, #22, shielded microphone cable, vinyl overall covering. CPN 425 0212 000
- 8412 — Belden, 2-conductor, #20, shielded microphone cable, rubber overall covering. CPN 425 0250 000
- 8719 — Belden, 2-conductor, #16 stranded shielded wire with stranded copper ground wire, Beld-foil shielded, overall vinyl covering. CPN 124 3015 240

## Rack Cabinet Blank Panels

These blank panels of 0.4762-cm (<sup>3</sup>/<sub>16</sub>-in.) aluminum are finished in light gray to match the Bud CR-1780GY Rack Cabinet.

Size: 48.2 cm (19") W and in heights as listed.

	Cm	Inches
502-8389-123	4.45	(1 <sup>3</sup> / <sub>4</sub> "
502-8393-113	8.89	(3 <sup>1</sup> / <sub>2</sub> "
502-8397-123	13.34	(5 <sup>1</sup> / <sub>4</sub> "
502-8401-113	17.78	(7")

502-8405-113	22.23	(8 <sup>3</sup> / <sub>4</sub> "
502-8409-123	26.67	(10 <sup>1</sup> / <sub>2</sub> "
502-8413-113	31.12	(12 <sup>1</sup> / <sub>4</sub> "
502-8417-113	35.56	(14")

## EMCOR Rack Cabinet

This heavy duty, deluxe rack cabinet is designed to match the Collins line of AM and FM transmitters. The frame is painted black, whereas the doors and side panels are of a light gray finish to match the Collins transmitters. The frame and accessories are sold separately so that the customer can make up any type of rack desired.

- SFR26A 021-0511-010 Rack Cabinet frame for 48-cm (19 in.) panels. Supplied with perforated top and leveling feet, less back door and sidepanels. 175.26 cm (69")H x 53.34 cm (21") W x 55.88 cm (22") D. 155.9 cm (61.38") panel space
- NTN 021-0511-040 Back Door for SFR26A frame
- NTN 021-0511-060 Side Panel for SFR26A frame (2 required for free-standing rack)
- NTN 021-0511-050 Name Plate Trimm Strips for top of SFR26A frame

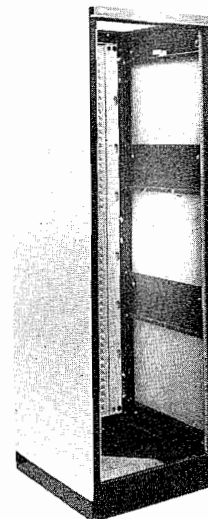

*EMCOR Rack*

## Cannon Connectors

Collins is an authorized distributor of the full line of Cannon Connectors. The following is a listing of those connectors most often required in audio applications. All are 3-contact plugs unless otherwise indicated.

P3-CG-11S, Cannon female cable plug.  
370-2180-000  
P3-CG-12S, Cannon male cable plug.  
370-2190-000  
P3-13, Cannon female plug receptacle.  
370-2060-000  
P3-14, Cannon male panel receptacle.  
370-2090-000  
P3-35, Cannon single gang female wall receptacle.  
370-2150-000  
P3-35-2G, Cannon 2-gang female wall receptacle.  
370-2170-000  
XLR-3-11C, Cannon female cable plug.  
097-5372-000  
XLR-3-11SC, Cannon female cable plug with latch-lock cable clamp.  
097-5371-000  
XLR-3-12C, Cannon male cable plug.  
097-5370-000  
XLR-3-12SC, Cannon male cable plug with latch-lock cable clamp.  
097-5369-000  
XLR-3-13, Cannon female panel receptacle, flush mount.  
097-5368-000  
XLR-3-13N, Cannon female panel receptacle with locknut.  
097-5367-000  
XLR-3-14, Cannon male panel receptacle, flush mount.  
097-5366-000  
XLR-3-14N, Cannon male panel receptacle with locknut.  
097-5365-000  
XLR-3-35, Cannon single gang female wall receptacle.  
097-5364-000  
XLR-3-35-2G, Cannon 2-gang female wall receptacle.  
097-5363-000  
XLR-3-36, Cannon single gang male wall receptacle.  
097-5362-000  
XLR-3-36-2G, Cannon 2-gang male wall receptacle.  
097-5361-000  
UA-3-11, Cannon female cable plug.  
370-2082-000  
UA-3-12, Cannon male cable plug.  
370-2081-000  
UA-3-13, Cannon female panel receptacle, flush mount.  
370-2079-000

UA-3-14, Cannon male panel receptacle, flush mount.  
370-2083-000  
UA-3-31, Cannon female wall mount receptacle.  
099-0463-000  
UA-3-32, Cannon male wall mount receptacle.  
090-0464-000

# Audio





# **STL and Remote Equipment**



# STL and Remote Equipment

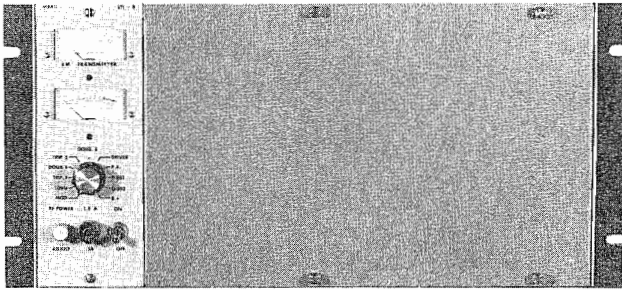

STL-8F Transmitter

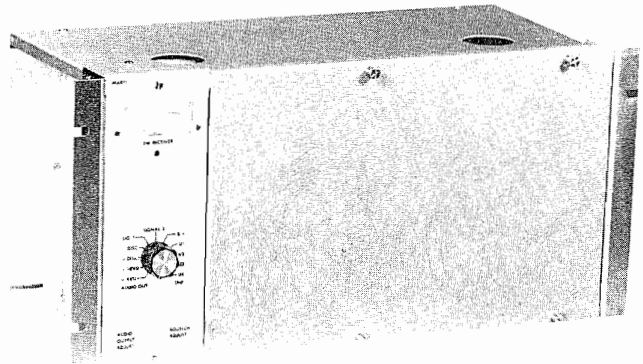

R-200/950 Receiver

## STL Equipment

### Marti STL-8F Transmitter

The Marti STL-8F, one of a series of two models designed to meet the exacting requirements of aural links, is ideal for the FM broadcaster requiring either mono or stereo operation. All solid-state, the unit has a direct FM modulator, a field-proven varactor final, solid-state ovens and high-accuracy crystals providing a frequency stability of  $\pm 0.0005\%$ . The 8-watt system operates in the 942- to 960-MHz range. Automatic switchover circuits are provided for a standby transmitter and RF sensing is built in for "out of status" alarm indication. Two of these units may easily be strapped together for stereo operation. The transmitter is available in either vertical ( $\frac{1}{2}$ -rack width) or horizontal (full rack width) configurations.

Size:	(vertical)	17.8 cm (7") H 21.6 cm (8½") W 38 cm (15") D
	(horizontal)	22.2 cm (8¾") H 48.2 cm (19") W 20.9 cm (8¼") D
Weight:	(vertical)	7 kg (15.5 lb) less rack adapter
	(horizontal)	9 kg (20 lb)
STL-8F/V	NPN	Vertical Mount Transmitter, 8-Watt, FM Applications
STL-8F/H	NPN	Horizontal Mount Transmitter, 8-Watt, FM Applications

### Marti R200/950F Receiver

The Marti R200/950 series of receivers is the companion line for the STL-8 transmitters. The R200/950F model, designed for FM reception, is all solid-state with plug-in modular construction. A solid-state oven and high accuracy crystal provides frequency stability of  $\pm 0.0005\%$ . Automatic switchover circuitry for a standby receiver is provided. Audio output is 600 ohms balanced with a maximum level of 18 dB mW. Multiplex output provides for subcarrier and/or remote control signals. Like the transmitters, both vertical and horizontal configurations are available.

Size:	(vertical)	17.8 cm (7") H 21.6 cm (8½") W 38 cm (15") D
	(horizontal)	22.2 cm (8¾") H 48.2 cm (19") W 20.9 cm (8¼") D
Weight:	(vertical)	4 kg (9 lb) less rack adapter
	(horizontal)	7.3 kg (16 lb)
R200/950F/V	NPN	Vertical Mount Receiver, FM Applications
R200/950F/H	NPN	Horizontal Mount Receiver, FM Applications
MTS-1	NPN	Matching "T" Section for combining two receivers

# STL and Remote Equipment

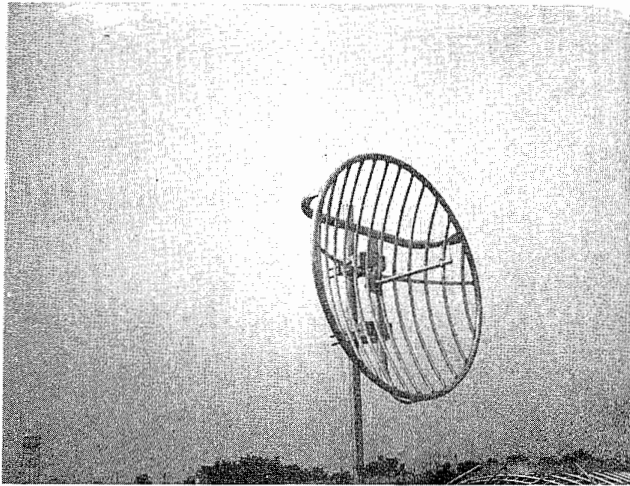

P-948G Antenna

## Mark Products P-948G Parabolic

The Mark P-948G Parabolic Antenna is of multigrad construction and has extremely high strength and rigidity specifications. It will withstand wind thrusts up to 161 km/h (100 miles-per-hour). Operating in the 890- to 960-MHz range, the P-948G has a front-to-back ratio of 28 dB and gain of 18.9 dB.

Size: 1.2 m (4') Diameter  
 Weight: 11.3 kg (25 lb)  
 P-948G NPN 1.2 m (4') Parabolic Antenna

## Mark Products MG-944GN Parabolic

The Mark Products MG-944GN is a cylindrical parabolic antenna operating in the 940- to 960-MHz range. Gain is 13.5 dB; front-to-back ratio is 20 dB. Strength and rigidity is achieved through welded grid construction.

Size: 29.2 cm (13½") H  
 111.8 cm (44") W  
 43.2 cm (17") D  
 Weight: 3.2 kg (7 lb)  
 MG-944GN NPN Cylindrical Parabolic Antenna

## Decibel Products DB-496 Parabolic

For heavy-duty, high-gain applications, Decibel Products DB-496 Cylindrical Parabolic Antenna offers a double-dipole directional radiator enclosed in a weatherproof radome. Grid construction of the reflector provides survival in winds up to 201 km/h (125 miles-per-hour). Forward gain is 13.5 dB; front-to-back ratio is 20 dB.

Size: 29.2 cm (13½") H  
 104.7 cm (42") W  
 43.2 cm (17") D  
 Weight: 4.1 kg (9 lb)  
 DB-496 NPN Cylindrical Parabolic Antenna

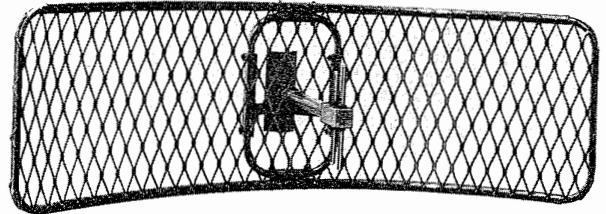

DB-496 Parabolic Antenna

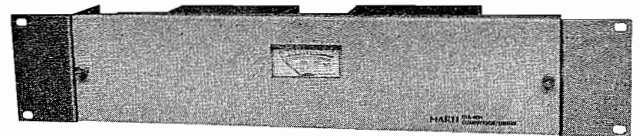

CLA-40/A Compressor/Limiter

## Marti CLA-40/A Compressor/Limiter

The Marti CLA-40/A is recommended for use between the audio control console and the STL transmitter to prevent link overmodulation. It combines the functions of limiting, compression, expansion, and automatic gain control. It is both AM and FM compatible and two may be strapped together for FM stereo applications.

Size: 8.9 cm (3½") H  
 48.2 cm (19") W  
 14cm (5½") D  
 Weight: 2.7 kg (6 lb)  
 CLA-40/A NPN Compressor/Limiter

## Marti SCG-8H Subcarrier Generator

Intended for use in conjunction with an aural STL system, the Marti SCG-8H Subcarrier Generator will transmit any type of auxiliary program material from the studio to the transmitter location, via a link subchannel in the 39- or 67-kHz band. Frequency stability is ±500 Hz; modulation is direct FM; modulation distortion is less than 1.5%.

Size: 8.9 cm (3½") H  
 48.2 cm (19") W  
 14 cm (5½") D  
 Weight: 3.4 kg (7.5 lb)  
 SCG-8H NPN Subcarrier Generator

# STL and Remote Equipment

## Marti SCR-8H Subcarrier Receiver

A companion to the SCG-8H generator already described, the SCR-8H Subcarrier Receiver accepts signals in the 39- to 67-kHz range. Audio output level is +18 dB mW; output impedance is 600 ohms, balanced. As in the generator, an extremely sharp 6-kHz low-pass filter prevents subchannel to main channel crosstalk.

Size: 8.9 cm (3½") H  
48.2 cm (19") W  
14 cm (5½") D

Weight: 3.4 kg (7.5 lb)

SCR-8H NPN Subcarrier Receiver



PLC-101 Receiver

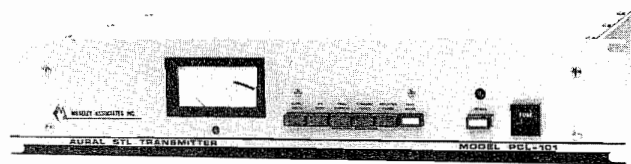

PLC-101 Transmitter

## Moseley PCL-101 System

This transmitter and companion receiver are designed to meet requirements of international AM broadcasting. The transmitter employs direct FM and maximum power output is 15 watts. It is available in 150, 220, 300, 450 or 950 MHz. Other frequencies in the 148- to 470-MHz spectrum are available on special order. For use in the United States, the PCL-101 is available for operation in the 950-MHz band only.

Size: Transmitter 8.9 cm (3½") H  
48.2 cm (19") W  
35.6 cm (14") D

Size: Receiver 4.4 cm (1¾") H  
48.2 cm (19") W  
27.9 cm (11") D

PCL-101 NPN Transmitter, International AM Applications

PCL-101 NPN Receiver, International AM Applications

## Moseley PCL-505 and PCL-505/C Aural Studio-Transmitter Links

This STL provides a high-quality audio channel between a broadcast studio and a remote transmitter site. Alternatively, it provides for studio-to-studio, intercity, network, and similar program audio feeds. Design is for continuous service in accordance with FCC requirements and licensing in most other countries. True direct FM offers most superior sound possible; flat frequency response over a wider range with low distortion. Frequency range is 148 to 174 MHz, 215 to 240 MHz, 300 to 330 MHz, 450 to 470 MHz, and 890 to 960 MHz. Modulation capability is one program and two subcarrier channels.

Size: Transmitter 8.9 cm (3.5") H  
48.2 cm (19") W  
40.6 cm (16") D

Size: Receiver 4.5 cm (1¾") H  
48.2 cm (19") W  
34.9 cm (13¾") D

PCL-505 NPN Transmitter, STL

PCL-505/C NPN Receiver, STL

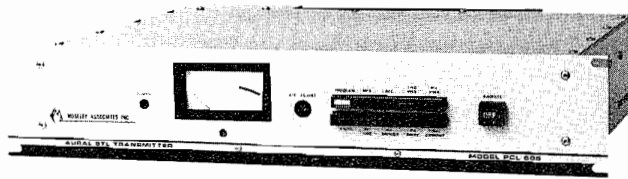

PCL-505 Transmitter



PCL-505 Receiver

## Moseley SCG-8 Subcarrier Generator

The SCG-8 develops a direct FM subcarrier for multiplexing FM transmitters with an additional sound channel. It is available with a center frequency (must be specified) in the 26- to 185-kHz range. A front panel meter indicates peak deviation directly in kilohertz. All-electronic muting is employed, with adjustable time delay and manual override.

Size: 4.5 cm (1¾") H  
48.2 cm (19") W  
25.4 cm (10") D

Weight: 3.6 kg (8 lb)

SCG-8 NPN Subcarrier Generator

# STL and Remote Equipment

## Moseley SCG-9 Stereo Generator

Intended primarily as a companion to the Moseley PCL-505/C Single Link Stereo STL, the SCG-9 can be used for both stereo and monaural broadcasts. It will operate with most direct FM exciters. Left and right channel separation is 35 dB, minimum; frequency response is  $\pm 1$  dB, 30 Hz to 15 kHz.

Size: 4.5 cm (1 $\frac{3}{4}$ " H  
48.2 cm (19" W  
27.9 cm (11" D  
Weight: 4.1 kg (9 lb)  
SCG-9 NPN Stereo Generator

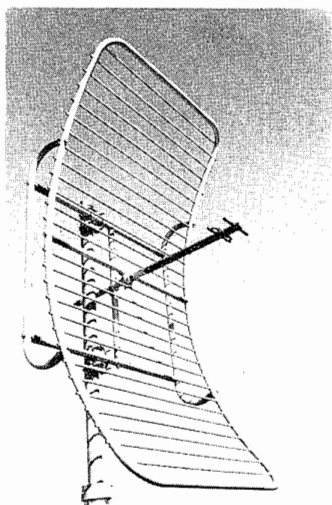

PR-450U Antenna

## Scala PR-450U STL Antenna

Small and lightweight, the PR-450U is an ideal antenna for aural STL applications. Gain is 15 dB; front-to-back ratio is 20 dB, and polarization can be either horizontal or vertical. Net weight is only 11.3 kg (25 pounds). The reinforced aluminum tube construction can withstand 161 km/h (100 mi/h) winds. Frequency range is 350 MHz to 1 GHz; impedance is either 52 or 72 ohms.

Size: 170.2 cm (67" H  
91.4 cm (36" W  
48.2 cm (19" D  
Weight: 11.3 kg (25 lb)

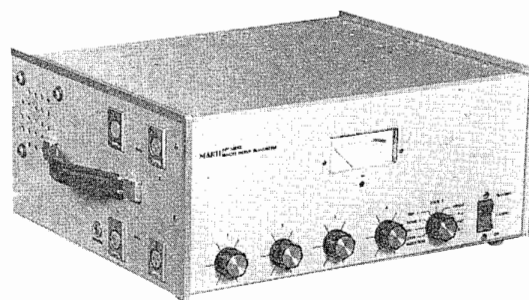

RPT-25/40 Transmitter

## Remote Pickup Equipment

### Marti RPT-40 Transmitter

The Marti RPT-40 Remote Pickup Transmitter is designed for continuous duty in the field. Its all solid-state construction features a direct FM modulator, four audio mixing channels with individual level controls, built-in compressor/limiter for modulation control, and taut band circuit meter. Designed to operate in the 150- to 172-MHz range, the RPT-40 has a maximum output of 40 watts, frequency stability of  $\pm 0.0005\%$ , and capability to operate from either 115/230 volts ac or 13.6 volts dc. A selectable dual frequency operation is an optional feature.

Size: 15.9 cm (6 $\frac{1}{4}$ " H  
38.1 cm (15" W  
30.5 cm (12" D  
Weight: 9 kg (20 lb)  
RPT-40 NPN Transmitter, 40 Watts

# STL and Remote Equipment

## Marti RPT-25 Transmitter

The RPT-25 is similar in appearance to, and has many of the features of, the RPT-40. The RPT-25 is designed to operate in the 450- to 470-MHz spectrum. Output power is 25 watts, maximum. The unit is compatible with unattended automatic relay devices.

Size: 15.9 cm (6½") H (6¼")  
38.1 cm (15") W  
30.5 cm (12") D  
Weight: 9 kg (20 lb)  
RPT-25 NPN Transmitter, 25 Watts

## Marti RPT-1/150

The R-30, a 1-watt remote pickup transmitter, operates in the 152- to 172-MHz range with an impedance of 150 to 500 ohms. The unit has 2 mic input: push-to-talk, and indicator level controls.

Size: 25 cm (10) H  
6.9 cm (2¾") W  
20 cm (8") D  
Weight: 3.3 kg (7½ lb)

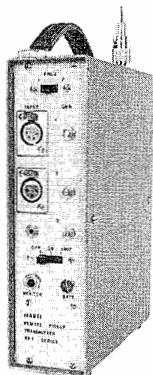

Marti RPT-1/150

## Marti R-30/150 Receiver

The rack-mounted R-30/150 Receiver mates with the RPT-40 Transmitter. An if crystal filter provides maximum selectivity: 6 dB at ±17.5 kHz with a 10.7/F30 filter module (optional filters are available). Audio output is 600 ohms at a +10-dB mW level. Provisions for dual frequency operation are standard; the second crystal and switching assembly are extra cost items.

Size: 22.2 cm (8¾") H  
48.2 cm (19") W  
20.9 cm (8¼") D  
Weight: 7.3 kg (16 lb)  
R-30/150 NPN Receiver

## Marti R-50/450 Receiver

Also a rack-mounted unit, the R-50/450 is designed to mate with the RPT-25 Transmitter. Other than its frequency range (450 to 470 MHz), it is electrically and mechanically similar to the R-30/150.

Size: 22.2 cm (8¾") H  
48.2 cm (19") W  
20.9 cm (8¼") D  
Weight: 7.3 kg (16 lb)  
R-50/450 NPN Receiver

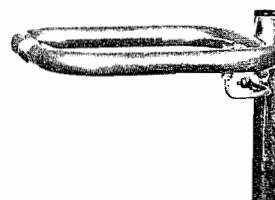

PA-1 Antenna

## Marti PA-1 Portable Antenna

The PA-1 is a single ring, portable antenna operating in the 150- to 170-MHz range. It is horizontally polarized and has unity gain. The PA-1 will mount directly on a 1.6-cm (5/8-inch) -27 mike stand. As a mobile antenna (type MA-1), it can be mounted on a vehicle bumper.

PA-1 NPN Portable Antenna

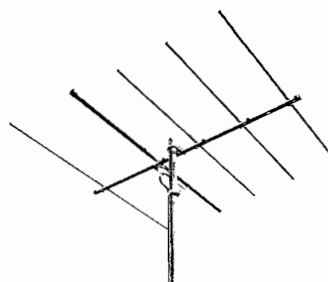

YC Antenna

## Marti YC Antennas

The YC series of antennas is ideal for mobile, portable, or base installations. Capable of handling 100 watts input power, the antennas have an average gain of 9 dB, rear signal rejection of 25 dB, and may be either horizontally or vertically polarized. Six different models are available (depending on frequency range selected).

# STL and Remote Equipment

YC-153	NPN	Antenna (152.80 - 153.40 MHz)
YC-161	NPN	Antenna (161.40 - 162.00 MHz)
YC-166	NPN	Antenna (165.95 - 166.55 MHz)
YC-170	NPN	Antenna (169.85 - 170.45 MHz)
YC-450	NPN	Antenna (450.05 - 450.95 MHz)
YC-455	NPN	Antenna (455.05 - 455.95 MHz)

## Marti ASPR-177 Antenna

Designed for rooftop mounting and operating in the 130- to 174-MHz range, the ASPR-177 is vertically polarized and has 3-dB gain. The unit includes a sealed, tamperproof transformer, cable, and connector.

ASPR-177 NPN Antenna, Rooftop Mount

## Marti ASPC-660 Antenna

The ASPC-660 is a whip, mobile rooftop antenna for any frequency in the 450- to 470-MHz range. The unit has a 4-dB gain.

ASPC-660 NPN Antenna, Whip, Rooftop Mount



RPL-3/4 Transmitter



RPL-3/4 Receiver

## Moseley RPL-3/4 Remote Pickup Links

Compactness and portability characterize the Moseley Associates RPL Series of remote pickup links. The RPL-3 is designed for 148- to 174-MHz operation; the RPL-4, 450- to 470-MHz. Each consists of a transmitter and receiver. The transmitters feature all solid-state circuitry, 3-channel audio mixer, built-in power supplies

(either 120/240 volts ac or 13.5 dc), built-in peak audio limiter, 15 watts maximum output, and full metering functions of all important parameters. The companion receivers occupy only 4.4 cm (1¾ in.) of standard 48.2-cm (19-in.) rack space. System specifications are: audio response — ± 1.5 dB, 30 Hz to 10 kHz; distortion — less than 1.3%; signal-to-noise ratio — 55 dB below 100%.

Size:	Transmitter	10.2 cm (4") H 36.8 cm (14½") W 27.9 cm (11") D
Weight:		7.2 kg (16 lb)
Size:	Receiver	4.5 cm (1¾") H 48.2 cm (19") W 25.4 cm (10") D
Weight:		4.5 kg (10 lb)
RPL-3	NPN	Remote Pickup Link, 148-174 MHz
RPL-4	NPN	Remote Pickup Link, 450-470 MHz

## Moseley AMP Power Amplifier

This RF power amplifier is designed for use with Moseley remote pickup links when operated from a 13.5-volt dc power source. Gain is 6 dB.

AMP-3	NPN	Power Amplifier, 150- to 170-MHz Range
AMP-4	NPN	Power Amplifier, 450- to 470-MHz Range
Size:		10.2 cm (4") H x 14 cm (5.5") W x 11.4 cm (4.5") D
Weight:		1.4 kg (31 lb)



KD20-B Portable Audio Console

## Keldon KD20-B Portable Audio Console

Ideal for a complete facility remote broadcast operation, or as standby studio equipment, the KD20-B Con-



# STL and Remote Equipment

sole provides the broadcaster with complete capabilities: two RIAA-equalized phono inputs, two low-level mike inputs, a high-level (600-ohm) input, and a tape input. The turntables feature synchronous motors and 3-speed operation. There are two outputs: a program line and a public address line that may be used to drive an external power amplifier. The unit uses standard 117-volt ac power, fed into a temperature-compensated and regulated power supply.

Size: 25.4 cm (10") H  
111.8 cm (44") W  
42.1 cm (16½") D  
Standing height is 78.7 cm (31")

Weight: 30.8 kg (68 lb)

KD20-B 124-3015-071 Portable Audio Console



Micro-Trak System D Audio Control Center. Chair is not included.

## Micro-Trak System D Audio Control Center

The Micro-Trak System D Compact Audio Control Center is the ideal unit for the DJ on the go or the producer who wants the flexibility of operating at different locations. For remotes or discotheque the D Compact can be readily handled by two people; you can move in and have your remote or disco running in minutes. With legs that easily fold, the unit can be broken down into a package measuring only 144.6cm (55¾"W) x 63.5cm (25"D) x 40.64cm (16"H). The standard D Compact comes with a model 6440DT console, two model 740 turntables, two model 303 tonearms and a formica covered high strength plywood cabinet. Stan-

ton model 500-AL magnetic cartridges are installed in the model 303 pickup arms, a close talking dynamic microphone is supplied with the unit.

Size: Set up for operation 141.6cm (55¾"W) x 63.5cm (25"D) x 96.5cm (38"H).

Weight: 63.5 Kg (138 lbs)

Finish: Pecan wood grain Formica.

6444-BT Stereo with screw terminals on rear

6444-BX Stereo with XL connectors on rear

6454-BT Monaural with screw terminals on rear

6454-BX Monaural with XL connectors on rear

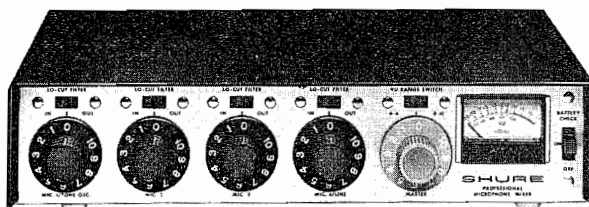

M67 Microphone Mixer

## Shure M67 Mixer

Compact and lightweight, the Shure M67 Microphone Mixer is ideal for both studio and remote applications where several mikes are to be used. The unit accepts four low-level mikes, with one input convertible to line input. It has both 600-ohm line output and low-impedance mike output. There is noiseless switchover to battery operation (battery pack is an option) in case of ac line failure.

Size: 7 cm (2¾") H  
28.9 cm (11¾") W  
18.6 cm (7⅝") D

Weight: 2.2 kg (4.8 lb)

M67 NPN Microphone Mixer, 120 Volts DC

M67-2E NPN Microphone Mixer, 240 Volts AC (w/3-conductor cable)

A67B NPN Battery Power Supply (less batteries)

## Shure SE30 Compressor/Mixer

The Shure SE30 combines the functions of a microphone mixer and a gain riding compressor that is automatic when set for a desired level. Compression range is 40 dB. A graded memory circuit eliminates "pumping" normally associated with audio compressors by sensing signal absence and placing a "hold" on the compression level at that point. The SE30 has four microphone inputs, self-contained battery and ac

# STL and Remote Equipment

power supply with automatic switchover in case of ac failure and feedback gain controls.

Size: 10 cm (3<sup>15</sup>/<sub>16</sub>" H)  
 38.1 cm (15" W)  
 25.4 cm (10" D)  
 Weight: 4.4 kg (9.8 lb)  
 SE30 NPN Compressor/Mixer

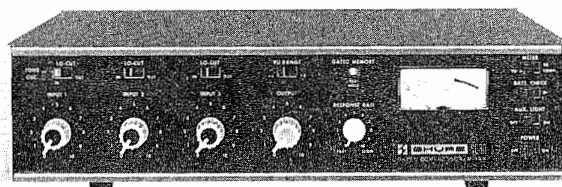

SE30 Compressor/Mixer

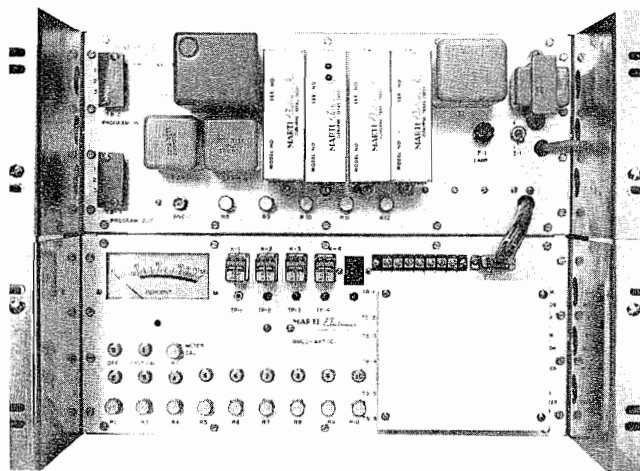

RMC-2AX Remote Control System

## Shure M62V Level-Loc<sup>®</sup> Audio Level Controller

The Shure M62V reduces an overly strong input signal by as much as 100 times — automatically and instantly — to keep actual sound output at a predetermined level. It can operate from a self-contained battery or be powered from the Shure M67 Mixer.

Size: 6.3 cm (2<sup>1</sup>/<sub>2</sub>" H)  
 29.8 cm (11<sup>3</sup>/<sub>4</sub>" W)  
 13.3 cm (5<sup>1</sup>/<sub>4</sub>" D)  
 Weight: 1 kg (2.2 lb)  
 M62V NPN Audio Level Controller

## Remote Control

### Marti RMC-2AX System (10 or 24 Channel)

Designed and approved for both AM and FM subaudible telemetry, the RMC-2AX system requires no interface equipment to meet FCC requirements; such circuits and components are built in. Of all solid-state design and modular construction, the system is available in a 22-function model with 10 metering positions, or for more complex installations, in a 50-function model with 24 metering positions. Subaudible telemetry is accomplished through use of a voltage-controlled oscillator, with a frequency shift of 22 to 28 Hz at a low percentage of modulation. A high-pass filter prevents program audio from modulating the metering channel. Automatic compensation is provided to limit modulation to 100 percent while telemetering. Optional accessories are available to provide smoke, fire, and unauthorized entry detection.

Size:	(Studio Unit)	12.7 cm (5" H) 48.2 cm (19" W) 15.9 cm (6 <sup>1</sup> / <sub>4</sub> " D)
Weight:		6.3 kg (14 lb)
Size:	Transmitter Unit (10)	17.8 cm (7" H) 48.2 cm (19" W) 22.9 cm (9" D)
Weight:		11.8 kg (26 lb)
Size:	Transmitter Unit (24)	44.5 cm (17 <sup>1</sup> / <sub>2</sub> " H) 48.2 cm (19" W) 22.9 cm (9" D)
Weight:		13.6 kg (30 lb)
RMC-2AX(10)	NPN	Remote Control System, 10 Channels
RMC-2AX(24)	NPN	Remote Control System, 24 Channels

# STL and Remote Equipment

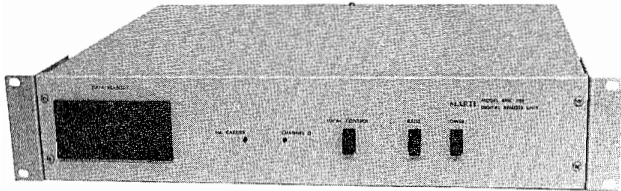

RMC-20S Remote Unit, front view

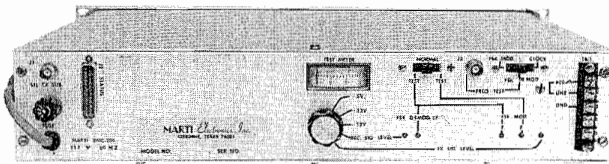

RMC-20S Remote Unit, rear view

## Marti RMC-20 Digital Remote Control

The Marti RMC-20 Digital Remote Control system consists of the RMC-20S studio unit, RMC-20T remote unit and the RY-5T relay control unit. This digital remote control telemetry and status (optional)/limit alarm system provides the ultimate in accuracy, simplicity, and speed of operation. Channel selection is accomplished simply by pressing a single button. The data for the selected channel is then read from the large digital panel display. Raise/lower commands can be given for the selected channel by pressing the raise or lower button.

Advanced digital concepts are applied throughout the system to achieve the greatest accuracy and reliability. Channel selection and commands are switched with high-current 220-volt ac rated relays, which greatly reduces the time and material necessary in remote control installations. Both local control and remote units have built-in test meters for checking all power supplies and communication signal levels. A test jack and switch are provided for checking the digital clock frequency, the FSK demodulator center frequency, and the FSK modulator mark-and-space frequencies.

The system channel capacity can be 5, 10, 15, or 20 channels by plugging in one, two, three, or four Marti R-5 selector units.

## Specifications

Type	Digital command and telemetry using internal FSK modems
Channel Capacity	Basic 5-channel system expandable to 10, 15, or 20 channels. Each channel provides one data readout and two commands.

Command Freq	Wire line 925-975 Hz and 2350-2450 Hz duplex. STL 21-22 kHz
Telemetry Freq	Simplex wire line 2350-2450 Hz SCA 2350-2450 Hz SCA 925-975 Hz SCA subaudible 23-27 Hz AM subaudible 23-27 Hz
Line Requirements	600-ohm voice grade 2-wire bidirectional circuit. Max loss 30 dB each direction
Command Output	Relay closure with all contacts isolated and floating. Contact ratings are 220 V ac, 5 A or 120 V ac, 10 A
Telemetry Accuracy	0.1 percent or one digit.
Temperature Range	-10° to +40°C
Power	115 V ac, 50/60 Hz, single phase
Size & Weight	RMC-20S 8.89 cm H (3½"), 48.3 cm W (19"), 35.56 cm D (14"), 8.16 kg (18 lb) RMC-20T 8.89 cm H (3½"), 48.3 cm W (19"), 35.56 cm D (14"), 9.53 kg (21 lb) R-ST 8.89 cm H (3½"), 48.3 cm W (19"), 17.78 cm D (7"), 1.58 kg (3½ lb)

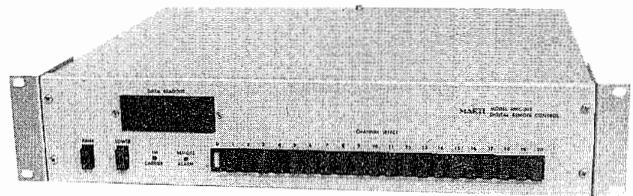

RMC-20S Remote Control

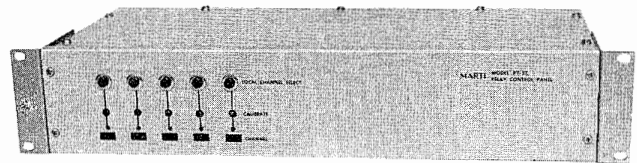

RY-5T Relay Control Panel

## Marti DA-1 DC Operational Amplifier

Complete with its own ac power supply, the DA-1 is used to increase meter sampling voltages to the remote control system.

DA-1      NPN      DC Operational Amplifier

# STL and Remote Equipment

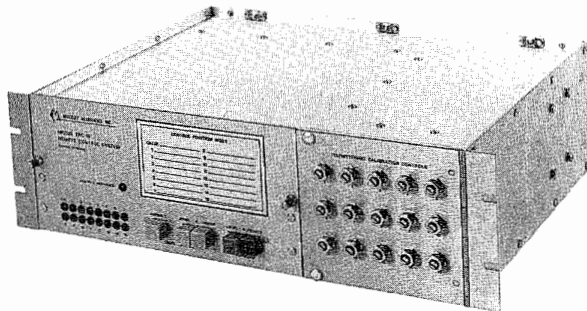

TRC-15A Remote Control System, Transmitter Unit

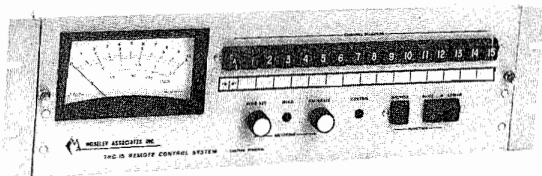

TRC-15A Remote Control System, Studio Unit

## Moseley TRC-15A Remote Control Systems

Designed for both wire and wireless remote control, the TRC-15A system has 15 metering channels and 30 individual control functions. The TRC-15AW requires only a duplex, voice-grade circuit interconnection: the TRC-15AR is the wireless model. Field conversion from one configuration to the other is accomplished by simply exchanging the appropriate modules. Fail-safe provisions in the TRC-15A meet all existing FCC requirements. They will function with the loss of primary power, interconnecting circuit failure, or an actual malfunction of the equipment itself. An interruption of the audio control tone carrier of approximately 15 seconds will trigger the fail-safe circuitry.

Size:	Studio Unit	13.3 cm (5¼") H 48.2 cm (19") W 34.6 cm (13⅝") D
	Transmitter Unit	13.3 cm (5¼") H 48.2 cm (19") W 34.6 cm (13⅝") D
TRC-15AW	NPN	Transmitter/Studio System, Wireline Interconnect
TRC-15AR	NPN	Transmitter/Studio System, Wireless

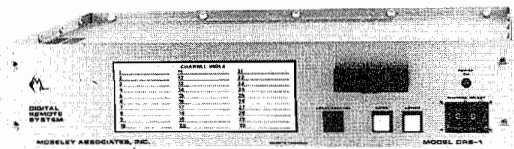

Moseley DRS-1 Remote Terminal

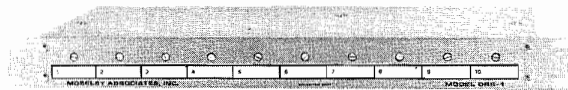

Moseley DRS-1 Selector Unit

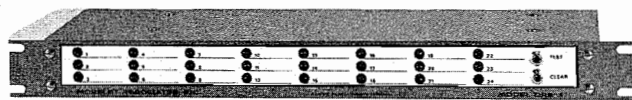

Moseley DRS-1 Status Panel - Remote Terminal

## Moseley DRS-1A Digital Remote Systems

The basic DRS-1A Digital Remote System is divided into three units — Control Terminal, Remote Terminal and Selector Units (s). The Control Terminal is located at the remote control point, normally the studio location in broadcast transmitter remote control. The Remote Terminal and Selector Units are situated at the transmitter site, or location of equipment being controlled. Each Selector Unit provides 10 telemetry/command channels, which allows for field expansion or tailoring of the DRS-1A to fulfill specific channel requirements. A maximum of 30 channels (3 selector units) may be used.

Each telemetry/command channel provides a single telemetry function and two command functions. These command or control functions are individual Form A, isolated dry contact closures and are typically identified as Raise and Lower. The Raise and Lower command outputs can switch external loads of up to 50 watts, non-inductive at potentials of 120V AC or DC. Telemetry inputs accept a DC sample voltage representing the desired analog parameter. This DC voltage is typically in the 1 VDC to 10 VDC range.

DRS-1AW DIGITAL REMOTE SYSTEM — for operation over single voice-grade telephone line or equivalent interconnecting circuits, to provide 10 telemetry/command channels. DRS-1A can be expanded to a total of 20 or 30 telemetry/command channels by the addition of Selector Units. System includes one each Control Terminal, Remote Terminal and Selector Unit.

# STL and Remote Equipment

DRS-1AR DIGITAL REMOTE SYSTEM — for wireless operation, with audible telemetry, to provide 10 telemetry/command channels. Subaudible telemetry is optionally available. Specify subaudible telemetry if desired. DRS-1A can be expanded to a total of 20 or 30 telemetry channels by the addition of Selector Units. System includes one each of Control Terminal with command subcarrier generator (frequency to be specified), Remote Terminal with command subcarrier demodulator (frequency to be specified) and Selector Unit.

Power: 30 channel configuration  
Control Terminal 120/240 VAC,  
50-60 Hz, 30W  
Remote Terminal 120/240 VAC,  
50-60 Hz, 35W

Control Terminal: 8.9cm H (3½") x 48.4cm W (19") x  
30.5cm D (12")

Remote Terminal: 8.9cm H (3½") x 48.4cm W (19") x  
25.4cm D (10")

Selector Unit: 4.4cm H (1¾") x 48.4cm W (19") x  
24.1cm D (9½")

The 7600 series can be interconnected by a telephone line or radio links including STL, SCA and sub-audible telemetry. The system uses Pulse Code Modulation for data transmission including built-in data modems. This technique employs a method of sending each control command twice and checking for a match of each redundant data before updating the control relays. The TFT model 7600 series meets both the FCC control and telemetry failsafe requirements. Options for the 7610 system include a sub-carrier detector, sub-carrier generator and a sub-audible Modem.

The model 7615 Status and Direct Control System, when used in conjunction with the model 7610, provides fifteen toggle switches to provide direct ON/OFF control for up to 15 different functions such as: filament voltage, plate voltage, main power, overload reset, tower lights and program source selection.

When the model 7630 Channel Expander is used in conjunction with the model 7610, it expands the RAISE/LOWER and Telemetry functions from 10 to 30 channels. Up to two model 7630's can be added to the model 7610 to accommodate a total of 50 RAISE/LOWER and Telemetry functions.

When the 7640 Multi-Channel Data Display is used with the 7610 control unit, up to 40 channels of simultaneous data displays, limit alarm and automatic logging can be added to the remote control system.

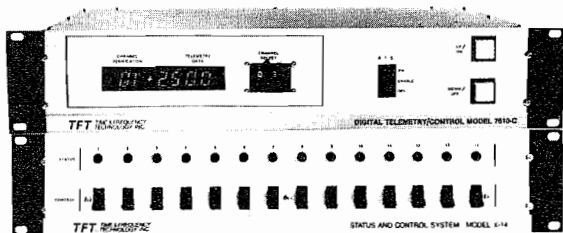

TFT 7610-C Digital Telemetry/Control

## TFT Model 7610, Digital Telemetry Remote Control System

TFT's 7600 series of digital transmitter remote control equipment is designed to meet the needs of both small and large broadcast facilities. It is a modular system starting with a low cost basic 10 channel system (models 7610-C and 7610-R). This provides 10 channels of telemetry and raise/lower functions and is expandable to 50 channels. Expansion includes 30 channels of direct ON/OFF control functions and 30 channels of STATUS/ALARM. Automatic logging is optionally available. Furthermore, tolerance alarm and multi-channel data display can be added on as accessory equipment.

# STL and Remote Equipment



# Monitoring and Test Equipment





# Monitoring and Test Equipment



*FMS-1 Stereo Frequency/Modulation Monitor*

## Belar FMS-1 FM Stereo Frequency/Modulation Monitor

When added to the FMM-1 FM Monitor, the FMS-1 provides complete monitoring and test functions for daily operations and provides additional facilities for weekly and monthly tests and maintenance checks. FM noise, AM noise, pilot frequency, separation, crosstalk, pilot amplitude, and subcarrier suppression all are read on the front panel. It may be used as an intermodulation analyzer to directly measure stereo distortion.

Size: 13.3 cm (5¼") H  
48.2 cm (19") W  
26.7 cm (10½") D

Weight: 5.4 kg (12 lb)

FMS-1 NPN FM Stereo Frequency/Modulation Monitor

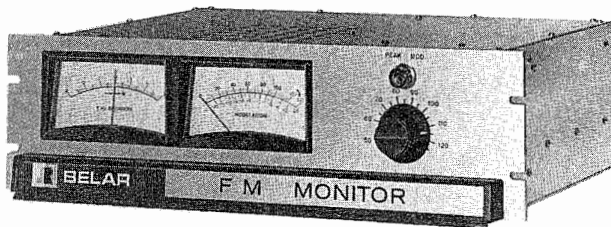

*FMM-1 FM Frequency/Modulation Monitor*

## Monitors

### Belar FMM-1 FM/Frequency/Modulation Monitor

This wideband, all solid-state monitor fulfills requirements of monaural FM monitoring and provides a pure demodulated signal to drive a stereo and an SCA monitor in multiplex operations. The peak flasher operates independently of modulation polarity in that it samples both positive and negative peaks simultaneously and automatically selects and registers the greater amplitude if preset level is exceeded. The unit is type approved for remote monitoring.

Size: 13.3 cm (5¼") H  
48.2 cm (19") W  
26.7 cm (10½") D

Weight: 6.3 kg (14 lb)

FMM-1 NPN FM Frequency/Modulation Monitor

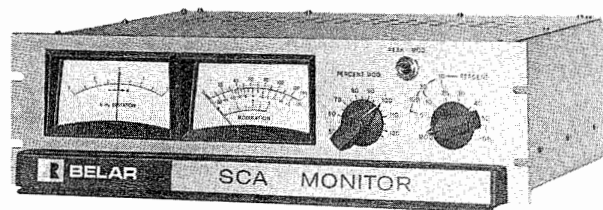

*SCM-1 SCA Frequency/Modulation Monitor*

### Belar SCM-1 SCA Frequency/Modulation Monitor

The SCM-1, added to the FMM-1 Monitor, provides complete monitoring and test functions for SCA store-casting and remote telemetering applications. Up to four crystal switch positions allow four channels to be operated and tested. Interchangeable channel crystals permit unlimited SCA frequency selection.

Size: 13.3 cm (5¼") H  
48.2 cm (19") W  
26.7 cm (10½") D

Weight: 6.3 kg (14 lb)

SCM-1 NPN SCA Frequency/Modulation Monitor

# Monitoring and Test Equipment

## Belar RFA-1 FM RF Amplifier

This unit is a solid-state FM RF amplifier for use in remote FM monitoring. It has 100 dB gain with a 70-dB dynamic range and 1-watt output. The 600-kHz phase linear bandwidth will not degrade a stereo multiplex transmission. The zero axis limiters and good selectivity characteristics (50 dB down at 800 kHz) ensure that adjacent channel interferences are suppressed. Output impedance is 50 ohms.

Size: 7.6 cm (3") H  
 48.2 cm (19") W  
 30.2 cm (11<sup>7</sup>/<sub>8</sub>") D  
 Weight: 3.2 kg (7 lb)  
 RFA-1 NPN FM RF Amplifier

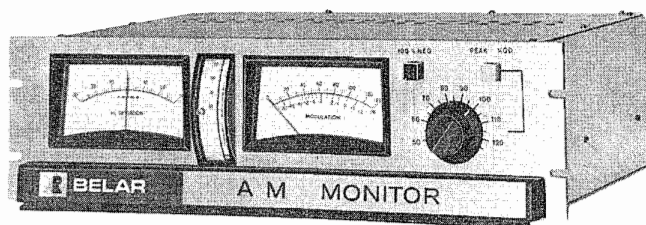

AMM-1 AM Frequency/Modulation Monitor

## Belar AMM-1 AM Frequency/Modulation Monitor

The unique AMM-1 features a separate 100 percent negative peak indicator, detecting absence of carrier and independent of any calibration procedures. The normal peak indicator lamp may be set to 125 percent. The true peak reading modulation meter is switchable to read either positive or negative peaks. A built-in off-frequency alarm driver permits unattended measurement of frequency. The  $\pm 20$  Hz frequency calibrator allows check of external equipment, such as automatic loggers.

Size: 13.3 cm (5<sup>1</sup>/<sub>4</sub>") H  
 48.2 cm (19") W  
 26.7 cm (10<sup>1</sup>/<sub>2</sub>") D  
 Weight: 6.3 kg (14 lb)  
 AMM-1 NPN AM Frequency/Modulation Monitor

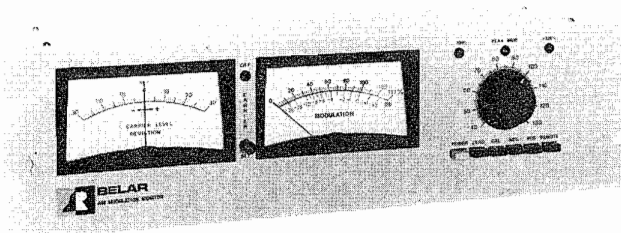

AMM-2 AM Modulation Monitor

## Belar AMM-2/-3 AM Modulation Monitor

Both the AMM-2 and AMM-3 modulation monitors incorporate true ratio-type peak indicators and a unique modulation cancellation scheme to recover unmodulated carrier with which to reference the modulation peaks. The AMM-2, with one modulation meter, and the AMM-3, with two modulation meters, respond accurately to the shortest duration program peaks. The AMM-2 has a single adjustable peak modulation indicator: 40 to 130 percent in less than 1-percent increments. Model AMM-3 has two adjustable peak modulation indicators: positive 1 to 199 percent; negative 1 to 99 percent. Both indicators are independent of carrier level. Both models are equipped with separate negative and positive indicator lamps (AMM-2) or LED; (AMM-3). Model AMM-3 has outputs for listening as well as test functions.

Size:	AMM-2	13.3 cm (5 <sup>1</sup> / <sub>4</sub> ") H 48.26 cm (19") W 15.24 cm (6") D	AMM-3	13.3 cm (5 <sup>1</sup> / <sub>4</sub> ") H 48.26 cm (19") W 21.59 cm (8 <sup>1</sup> / <sub>2</sub> ") D
Weight:		3.62 kg (8 lb)		5.44 kg (8 lb)
	AMM-2	NPN		AM Modulation monitor
	AMM-3	NPN		AM Modulation Monitor

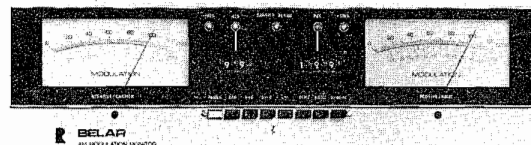

AMM-3 AM Modulation Monitor

# Monitoring and Test Equipment

## Belar RFA-2 AM RF Amplifier

Companion to the AMM-1 Monitor, the RFA-2 allows remote monitoring of carrier frequency deviation and modulation characteristics. Built-in automatic gain control eliminates problems associated with changes in transmitter power level, antenna patterns, and signal fading. Automatic gain control provides a range of more than 30 dB. The RF sensitivity is 100  $\mu$ V across 50 ohms.

Size: 8.9 cm (3½") H  
48.2 cm (19") W  
29.2 cm (11½") D  
Weight: 3.6 kg (8 lb)  
RFA-2 NPN AM RF Amplifier



AS-1 Audio Sentry

## Belar AS-1 Audio Sentry

The AS-1 alarm aurally and visually alerts station personnel of any modulation or carrier absence. The audio sentry reacts instantly on loss of carrier. In modulation loss, the AS-1 can be programmed to sound off between 3 and 60 seconds. The AS-1 has an input sensitivity adjustable from 140 microvolts to 20 volts, an input impedance of 1000 ohms, and a frequency range of 30 to 15,000 Hz. Power requirements are 115/230 volts, 50/60 Hz.

Size: 8.89 cm (3½") H  
48.26 cm (19") W  
12 cm (4¾") D  
Weight: 2.7 kg (6 lb)  
AS-1 NPN Audio Sentry

## Sequerra 1-BR FM Monitor/Tuner

The Sequerra model 1-BR FM monitor/tuner has the unique ability to present a wide range of signal analysis to determine the quality and signal strength of both your FM signal and that of your competitor. An instrument-grade oscilloscope presents a picture of the received signal for analysis as to quality and strength presenting a panoramic view of any 2-MHz-wide spectrum of the FM band. The scope will also present patterns to measure selective response, trace pattern, rejection of AM due to multipath reception, overmodulation due to overcompression of audio signals to sound louder, SCA subcarrier signal level, low signal level, multipath, vector analysis of left-right-center channel, out-of-phase stereo, quadrasonic mode information etc. These functions are all in addition to the straight high quality FM tuner function.

### Tuner Specifications

Frequency Range	87.7 to 108.3 MHz
Quieting Mono	30 dB 1.6 $\mu$ V 60 dB 8 $\mu$ V 70 dB 8 $\mu$ V
Quieting Stereo	30 dB 3 $\mu$ V 60 dB 125 $\mu$ V 70 dB 500 $\mu$ V
Capture Ratio	1 dB
Selectivity	400 kHz 120 dB 200 kHz 20 dB
Total Harmonic Distortion	Mono 400 Hz 0.06% 15 kHz 0.25% Stereo 400 Hz 0.1% 10 kHz 0.2%
Stereo Separation	30 Hz 48 dB 400 Hz 55 dB 10 kHz 40 dB 15 kHz 36 dB
Frequency Response	$\pm$ 0.2 dB 20 Hz to 15 kHz
Output Level	1 V rms
Power Source	120/240 V, 50 to 60 Hz
Size	48.3 cm (19") W, 17.8 cm (7") H, 36.2 cm (14½") D
Weight	20.8 kg (46 lb)

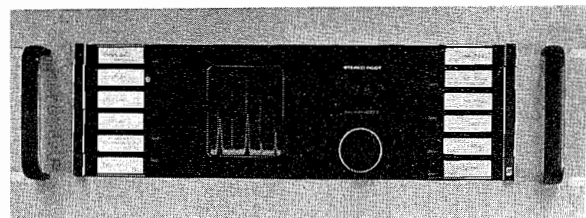

Sequerra 1-BR Broadcast Monitor, Rack Mounted

# Monitoring and Test Equipment

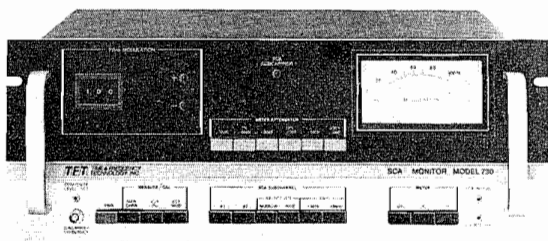

TFT 730 SCA Monitor

## TFT 730 SCA Monitor

When used with Model 723 FM Monitor, Model 730 monitors all characteristics of SCA transmission. Front panel pushbutton switches select SCA injection level, modulation, SCA FM signal-to-noise ratio and cross-talk. In addition to a peak reading modulation meter two peak flashers measure and display plus and minus peak modulation, adjustable from 50 to 29 percent.

Size: 17.9 cm (7") H  
 48.2 cm (19") W  
 40.6 cm (16") D

Weight: 6.8 kg (15 lb)

TFT 730 NPN SCA Monitor

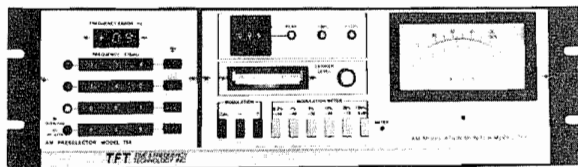

TFT 753/754

## TFT 753 AM Modulation Monitor

The Model 753 ultra-accurate broadband AM Modulation Monitor is designed for direct connection to the RF transmission line at the transmitter site. It is designed with linear-phase filter to eliminate transient overshoot in the filter due to the heavy amplitude clipping in today's audio limiters. A built-in 50-dB meter attenuator in 10-dB steps is provided for proof-of-performance measurements. Both Modulation Meter and peak flashers are self-calibrated to maintain their accuracy over a  $\pm 40\%$  carrier level change. In addition to the fixed +125% and -100% peak modulation lights, a variable peak indicator light settable by a front panel thumbwheel switch is provided to measure peak modulation up to 150% in 1% increments. The ambiguities in peak light settings are eliminated because of the use of the digital thumbwheel switch. Two separate peak modulation calibration points, +125% and -100%, are provided by generating an internal RF signal modulated with asymmetrical peaks for calibrating the en-

tire instrument directly from the input. The Model 753 is competitively priced and it allows you to achieve maximum transmitter modulation to the outer limits.

Optional features include Carrier Power Level Alarm, Absence of Modulation Alarm, Balance Audio Output, 10-kHz whistle filter, 35-Hz low-pass filter for sub-audio telemetry. The Model 753 is fully adaptable for Automatic Broadcast Transmission System (ATS) applications.

## TFT 754 AM RF Preselector With Frequency Readout

By adding the Model 754 Preselector to the 753 Monitor, broadcast stations, consultants, and regulatory agencies can pretune any AM stations via thumbwheel switches and monitor any one of four stations' modulation and carrier frequency off-the-air by pushbutton switch selection. A temperature-compensated crystal oscillator (TCXO) time base is used in the frequency synthesized local oscillator circuit to achieve a  $\pm 2$  Hz per year aging accuracy. Additionally, a patent-pending design is used in the IF amplifier which offers sharp selectivity as well as negligible overshoot in off-the-air monitoring application when it responds to clipped audio signals.

## TFT 755 AM RF Preselector (Modulation Only)

The Model 755 is essentially the same as Model 754 without the frequency measurement capability. By selecting the TCXO time base option, the model 755 IF output jack at the rear panel can be used to monitor carrier frequency with an external frequency counter having an accurate time base. There is only one set of thumbwheel switches on the Model 755 front panel instead of four.

## TFT 763 FM Modulation Monitor

The TFT model 763 FM Modulation Monitor is designed for direct connection to the transmitter, has a full complement of quality TFT features, for maximum transmitter modulation to the outer limits of coverage and for proof-of-performance measurements. In addition to the quasi-peak-reading modulation meter, the model 763 is equipped with a digitally-settable peak flasher which displays plus and minus modulation peaks simultaneously. Flasher limits are adjustable from 50% to 150% in 1% increments, and are set by front panel thumbwheel switches. Calibration of the meter and peak flashers may be checked at any time with a pushbutton activated modulation calibrator.

A built-in meter attenuator and calibrated AM detector allow making AM and FM signal to noise measure-

# Monitoring and Test Equipment

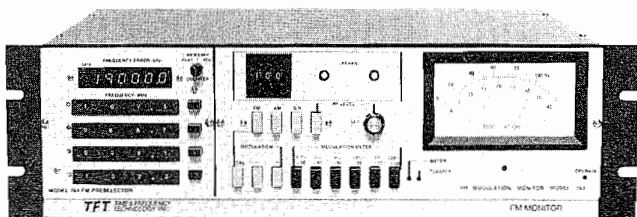

TFT 763/764 Stereo Frequency/Modulation Monitor

ments. The Carrier-Fail Alarm detector circuit is built-in. Carrier Power Level Alarm, Absence-of-Modulation Alarm and Balanced Audio Output are available options.

## Specifications

Frequency Range ..... 88 to 108 MHz  
 RF Input Voltage ..... 1 to 10 volts rms  
 Input impedance ..... 50 ohms.  
 Deviation for  
 100% indication ..... 75 KHz  
 Meter Range ..... 0 to 133%  
 Attenuator Range ..... 0 to -50 dB in 10-dB steps.  
 Power ..... 117/230 VAC ± 10% 50 to 400 Hz  
 Size ..... 48.26cm (19")W x 13.97cm  
 (5½")H x 35.56cm (14")D  
 Weight ..... 10.88kg (14 lbs.)

## TFT 764/765 Preselector

By adding the model 764 Preselector to the 763 Modulation Monitor, broadcast stations can pre-program any four FM stations via thumbwheel switches. They then can precisely monitor off-the-air anyone of the four stations including their own modulation and carrier frequency errors. The model 764 has one set of thumbwheel switches instead of four and has no carrier frequency readout. Otherwise it performs the same functions as the model 764.

## Specifications 764/765

Frequency Range ..... 88 to 108 MHz  
 Input Sensitivity ..... 50 µV for 56 dB S/N  
 250 µV for 66 dB S/N  
 Audio Frequency Response .... ±0.5 dB, 50 Hz to 7.5 KHz  
 Input Impedance ..... 75 ohm nominal

## Specifications 764 Only

Frequency Readout ..... 6 Digits  
 Main Carrier  
 Freq. Error ..... Range 199.999 KHz  
 Resolution 1 Hz  
 Accuracy 100 Hz/year  
 SCA Subcarrier  
 Frequency ..... 23-100 kHz  
 Resolution 1Hz

Accuracy ± 1 Hz  
 Stereo Pilot Frequency ..... 19.0000 kHz  
 Resolution 0.1 Hz  
 Accuracy 0.1 Hz 5/yrs.

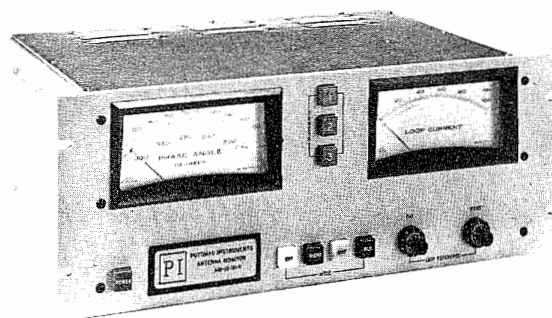

## Potomac Instruments AM-19 Antenna Monitor

The versatile AM-19 provides accurate measurement of phase angle and loop current in directional AM antenna systems. Phase measurement accuracy is ±1.0 degree with a 0.5-degree resolution. Loop current indications are accurate to within ±1.5 percent with a resolution of 0.5 percent. Meters are individually calibrated. Tower selection is accomplished by push-button switches, offering the distinct advantage of switching from one tower to any other tower in the array without sequencing. The AM-19 is designed to accommodate DA-1, DA-2, and DA-3 patterns. Arrays from 2 to 12 towers may be monitored. Outputs are available for automatic logging. For extended frequency range, the AM-19D is available.

Size: 17.9 cm (7") H  
 48.2 cm (19") W  
 32.4 cm (12¾") D  
 Weight: 9 kg (20 lb)  
 AM-19 NPN Antenna Monitor

## Potomac Instruments AM-19D Antenna Monitor

The AM-19D is identical to the AM-19 except for the digital panel meters and associated circuitry. The 4-digit LED numeric displays provide resolution of 1/10 of 1 degree (phase angle), and 1/10 of 1 percent (current ratio). The digital readout feature virtually eliminates operator error in meter interpretation. Remote switching and readout are accomplished like the AM-19.

# Monitoring and Test Equipment

Size: 17.9 cm (7") H  
 48.2 cm (19") W  
 32.4 cm (12<sup>3</sup>/<sub>4</sub>") D  
 Weight: 9 kg (20 lb)  
 AM-19D NPN Antenna Monitor

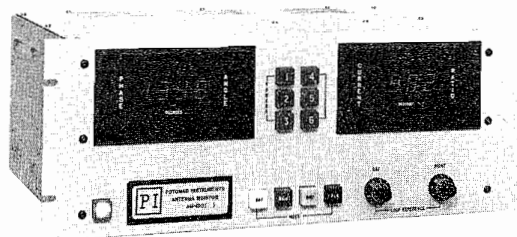

Built-in standard "D" cells will provide approximately 1,000 readings, dependent on use of meter lights and volume setting of the integral loudspeaker. Calibration accuracy is 1 percent, referenced to 220 millivolts per meter.

Size: 22.2 cm (8<sup>3</sup>/<sub>4</sub>") H  
 29.2 cm (11<sup>1</sup>/<sub>2</sub>") W  
 13.0 cm (5<sup>1</sup>/<sub>8</sub>") D  
 (cover closed)  
 Weight: 5.2 kg (11.5 lb)  
 FIM-21 NPN Field Intensity Meter

## RMP-19 (204) Remote Metering Panel

This panel contains meters that duplicate those of the AM-19 (204) for direct display of phase angle and current ratio. A switching relay conserves the required number of remote control channels.

RMP-19 (204) NPN Remote Metering Panel

## RMP-19D (210) Digital Remote Metering Panel

This instrument, with remote LED numeric readout of phase and current ratio, may be used in conjunction with any type 19 monitor. A third auxiliary input is available (on special order) to provide numeric display of any normalized parameter. Display input is selected by front panel pushbuttons or remote contact closure.

RMP-19D (210) NPN Digital Remote Metering Panel

## Potomac Instruments FIM-21 Field Intensity Meter

Lightweight and highly stable, the FIM-21 provides precise electromagnetic field measurements in the 535- to 1605-kHz range. Field intensities between 10 microvolts/m and 10 volts/m are directly indicated on the front panel meter. The printed circuit loop antenna is an integral part of the cover and is coupled to the instrument automatically when the cover is opened.

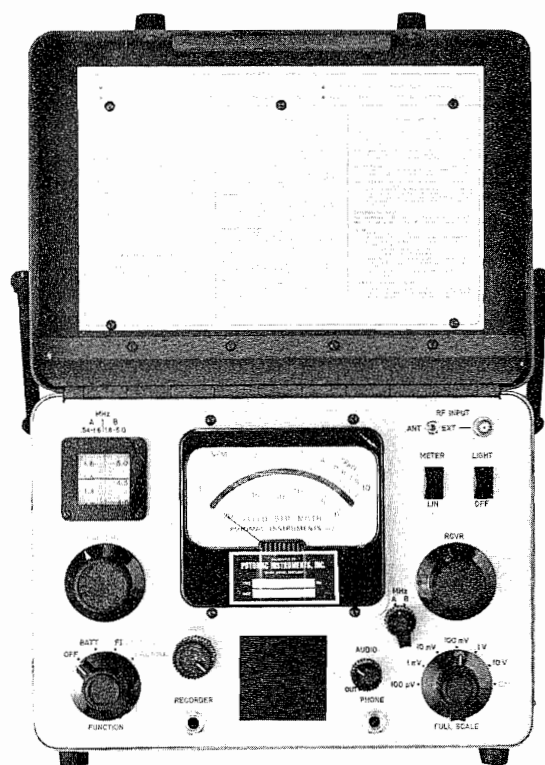

FIM-21 Field Intensity Meter

## Potomac Instruments FIM-41 Field Intensity Meter

This unit is physically similar to the FIM-21 except that it operates in the frequency range of 540 kHz to 5 MHz.

Size: 22.2 cm (8<sup>3</sup>/<sub>4</sub>") H  
 29.2 cm (11<sup>1</sup>/<sub>2</sub>") W  
 13 cm (5<sup>1</sup>/<sub>8</sub>") D  
 (cover closed)  
 Weight: 5.2 kg (11.5 lb)  
 FIM-41 NPN Field Intensity Meter

# Monitoring and Test Equipment

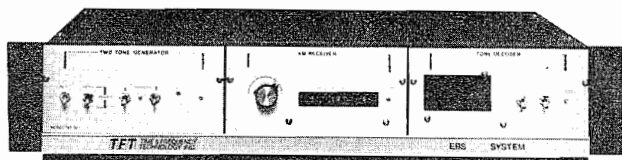

760 EBS System

## EBS Equipment — TFT

The Model 760 EBS System is designed to meet *both* the new FCC Two-Tone EBS interstation alert signaling requirements which became effective April 16, 1976; and the 1000-Hz signaling scheme previously in use. Conversion to the new standard is simple and straightforward, requiring only the removal of a single component.

The modular construction of the system provides for maximum versatility and consists of the following modular elements:

### Model 760 Cabinet Assembly

The Model 760 Cabinet Assembly is designed to accept up to three of the EBS modules described below. Standalone units may be constructed by ordering the Model 760 cabinet and any particular module. A fully loaded cabinet would consist of the Two-Tone Generator on the left, either AM or FM Receiver in the center, and the Two-Tone Decoder on the right. Blank panels are used as fillers where modules are not installed.

### Model 760-02 Dual-Channel FM Receiver

The FM Receiver, Model 760-02, is a high performance dual-channel, fixed frequency FM broadcast receiver. Channel selection is accomplished by a pushbutton switch. Both channels are fixed tuned and the crystals are factory installed. A one-channel version is also available. The CARRIER light will come on only when the desired station is received. A rear panel terminal is provided for activating external carrier-off alarm circuitry. Specify number of channels and frequency with order.

### Model 760-01 Tunable, Frequency Synthesized Receiver

The AM receiver, Model 760-01, is a continuously tunable AM broadcast receiver using a frequency synthesized local oscillator which is phase locked to a 5-MHz crystal oscillator. The local oscillator is tuned by means of a 3-digit front panel thumbwheel switch in 10-kHz steps. The stability of the receiver is that of the crystal oscillator regardless of which AM channel is being re-

ceived. Positive tuning to any desired station is accomplished by dialing the frequency of the selected station and peaking the RF amplifier tuning. The CARRIER light will come on only when the desired station is received. A rear panel terminal is provided for activating external carrier-off alarm circuitry.

In addition to broadcast station use, the AM Receiver provides a low cost monitor for all emergency service agencies, such as police, fire, Civil Defense, hospitals, etc. These services can listen to key EBS participating stations in the local area during any emergency.

### Model 760-03 Two-Tone EBS Decoder

The TFT Two-Tone Decoder, Model 760-03, decodes the 853-Hz and 960-Hz EBS signaling tones from the demodulated output of a receiver. It may be used in conjunction with TFT's Model 760-01 AM Receiver, Model 760-02 FM Receiver, or any audio source which has the EBS Two-Tone signal at 100 mV rms or greater. Stable piezoelectric tuning fork filters are used to achieve  $\pm 5$ -Hz bandwidth from the center frequency of each tone. The timing circuit for the 10-second delay is a signal averaging integrator which eliminates false turn-on by noise. An amplifier and loudspeaker are built-in for audio monitoring. Volume control is internally preset.

### Model 760-05 Dual-Purpose Decoder

The Model 760-05 Dual-Purpose Decoder can be used with either AM or FM receivers to respond to the present carrier break and 1000-Hz tone signaling scheme or, by removing a component, decode the new EBS 853- and 960-Hz dual-signaling tones. The circuit design and electrical characteristics are similar to the Model 760-03 module.

### Model 760-04 Two-Tone Generator

The Two-Tone EBS Generator, Model 760-04, generates the 853-Hz and 960-Hz tones simultaneously with an accuracy of  $\pm 0.25$  Hz. The frequency and stability of the tones are accomplished by synthesizing the tones from a single crystal oscillator.

Model 760-04 should be installed in the program audio line before the audio limiter. A single channel of audio can be routed through the generator. When the generator is activated, program audio is automatically interrupted, the EBS tones inserted, and The Emergency Program Audio is connected to the output. Program audio is restored by the RESET switch.

The generator is activated by two front panel COMMAND switches which need to be simultaneously

# Monitoring and Test Equipment

operated to prevent accidental activation. COMMAND and RESET functions can be remotely controlled through rear panel wiring. The amplitude of each tone can be checked and adjusted individually.

System Size: 8.9 cm (3.5") H  
 48.3 cm (19") W  
 30.5 cm (12") D  
 System Weight: Approx 4.5 kg (10 lb)

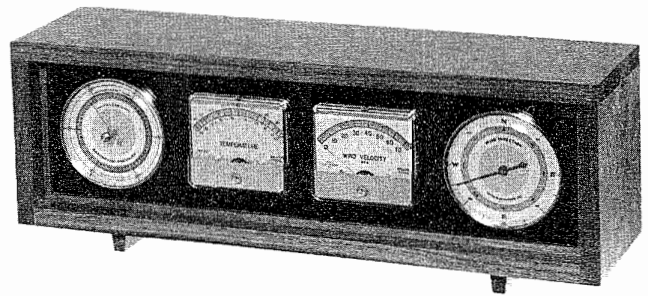

Mark IV-T Weatherminder Console

## Texas-Electronics Meteorological Instruments

Texas-Electronics engineers a complete line of precision meteorological instruments for the broadcaster. The Mark IV-T Weatherminder indicator console gives an accurate, continuous record of area temperature, wind direction and velocity, and barometric pressure. The Series 800 exposed roof sensor, a corrosion-resistant gold anodized aluminum unit, is connected to the indicator console with 30 m (100 ft) of lead-in multiconductor polyvinyl cable. Model 309, an all electronic remote reading thermometer, indicates air temperature from -40° to +49° C (-40° to +120° F) on a large, easily read digital display. Remote thermal sensing elements may be located up to 305 m (1000 ft) from the indicator. The Series 800 digital readout console indicates windspeed and direction, barometric pressure, and humidity.

Mark IV	NPN	Weatherminder Indicator Console
Size:		17.78 cm (7") H 48.26 cm (19") W 12.7 cm (5") D
Weight:		4.5 kg (10 lb)
Series 800	NPN	Roof Sensor
Size:		55.88 cm (22") H 45.72 cm (18") W 76.2 cm (30") L
Total Shipping Weight, Console and Sensor		17.6 kg (39 lb)

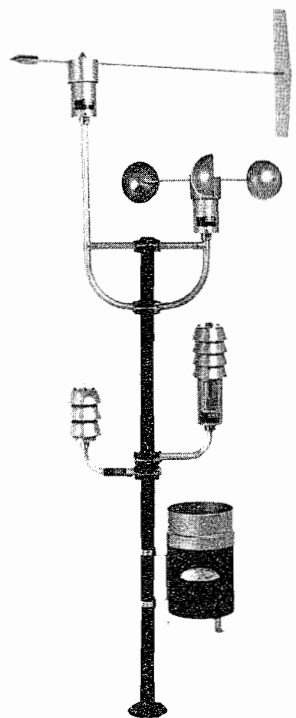

Series 800 Exposed Roof Console

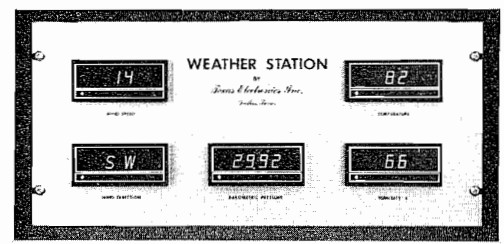

Series 800 Digital Readout Console



# Monitoring and Test Equipment

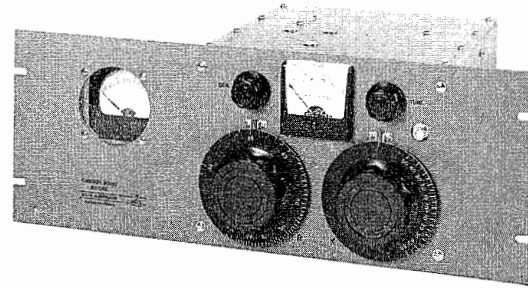

CPB-1 Common Point Impedance Bridge

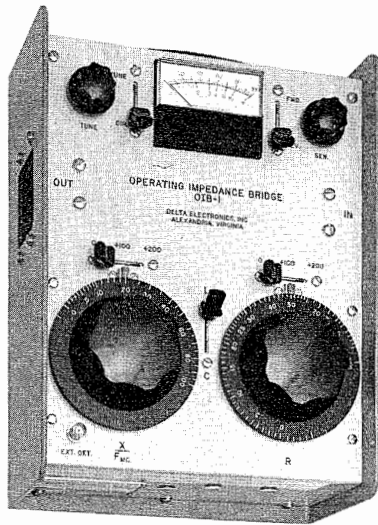

OIB-1 Operating Impedance Bridge

## Delta CPB-1/1A Common Point Impedance Bridge

These two bridges are similar in operation to the OIB-1 model, but are designed for permanent installation in the phasing equipment at the antenna common point. The CPB-1 will handle common point powers up to 5 kW with 100% amplitude modulation on a continuous basis. The CPB-1A is designed for transmitter powers up to 50 kW.

Size:	(without panel)	17.8 cm (7") H 22.8 cm (9") W 23.5 cm (9¼") D
	(panel size)	17.8 cm (7") H 48.2 cm (19") W
Weight:		5.4 kg (12 lb)
CPB-1	NPN	Common Point Impedance Bridge, 5 kW
CPB-1A	NPN	Common Point Impedance Bridge, 50 kW

## Test Equipment

### Delta OIB-1 Operating Impedance Bridge

Operating in the 500-kHz to 5-MHz range, the OIB-1 measures operating impedance of radiators, networks, transmission line sections, and common point of directional antenna systems while they are functioning normally and under full power. The unit is inserted directly in series with the equipment to be measured. Transmitter power is applied and a bridge balance obtained by manipulation of the two dials. Resistance and reactance can then be read directly. The vswr can be read from a meter scale. Through-power rating of the unit is 5 kW modulated; 10 kW carrier only. Accuracy is  $\pm 2$  percent,  $\pm 1.0$  ohm.

Size:	13.3 cm (5¼") H 24 cm (9½") W 31.7 cm (12½") D
Weight:	4.54 kg (10 lb)
OIB-1	NPN Operating Impedance Bridge

### Delta FSM-1 Field Strength Meter

The FSM-1 simply and economically facilitates monitor point measurements, skeleton proof-of-performance measurements, and coverage survey measurements. The FSM-1 is a compact, lightweight field strength meter, crystal controlled calibrated on station frequency. The circuit uses a diode protected dual-gate FET RF amplifier, a dual-gate FET mixer, FET local and calibrate oscillators, and transistor if amplifiers. A ceramic lattice bandpass filter gives flat bandpass and sharp skirt response. The FSM-1 gives excellent adjacent channel rejection and spurious response characteristics.

# Monitoring and Test Equipment

Size: 13.9 cm (5½") H  
 20.3 cm (8") W  
 12.7 cm (5") D  
 Weight: 2 kg (4½ lb)  
 FSM-1 NPN Field Strength Meter

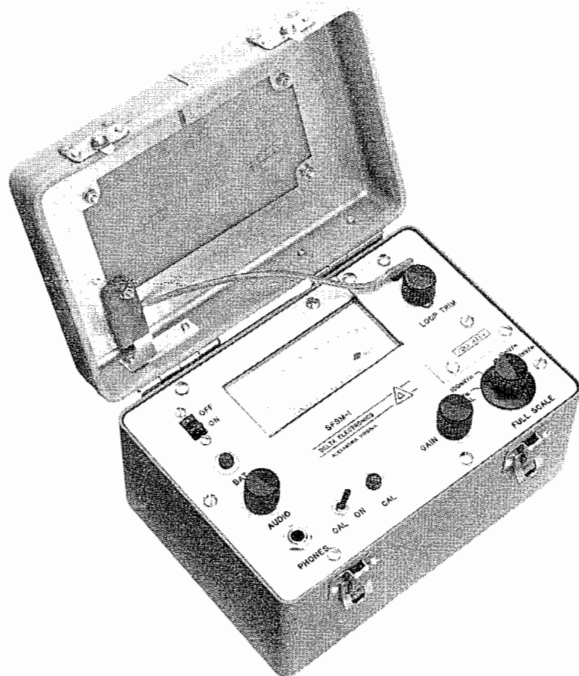

Delta FSM-1 Field Strength Meter

## Potomac Instruments FIM-71 Field Strength Meter

The FIM-71, a portable test instrument of laboratory quality, accurately measures commercial TV and FM broadcast signals and harmonics. The unit, with a 47-MHz to 225-MHz frequency range, contains an accurate internal calibration oscillator and may be used as a tuned voltmeter. When used with the associated antenna assembly, it is a highly accurate field strength meter. A front panel speaker and phone jack are provided for signal identification. The FIM-71 has a highly selective and sensitive RF tuner that provides a high degree of immunity to the effects of undesired signals and allows radiated transmitter harmonics without the use of additional fundamental-frequency filtering.

Size: 22.8 cm (9") H  
 30.4 cm (12") W (excluding antenna)  
 17.7 cm (7") D  
 FIM-71 NPN Portable Field Strength Meter

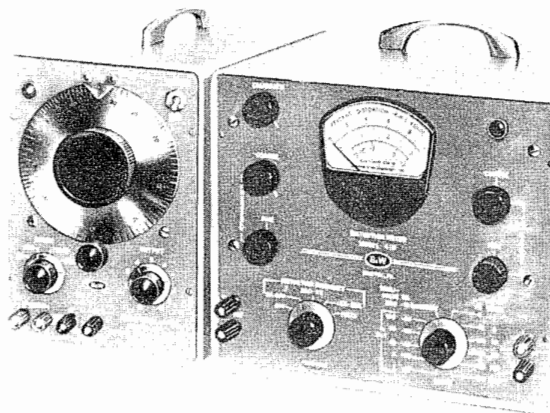

B&W 210 Oscillator

B & W 410 Oscillator

## B&W 210 Audio Oscillator

This unit provides low distortion signals from 10 Hz to 100 kHz. An RC audio circuit is followed by an amplifier with extremely low distortion characteristics. It is ideal for testing broadcast station response, high fidelity equipment, filter characteristics, and any equipment requiring a signal of a known frequency.

Size: 22.8 cm (9") H  
 15.2 cm (6") W  
 30.5 cm (12") D  
 Weight: 5 kg (11 lb)  
 210 NPN Audio Oscillator

## B&W 410 Distortion Meter

Designed as a companion instrument for the Model 210 Audio Oscillator, this distortion meter measures audio distortion, noise level, audio gain or loss in decibels, and ac voltages. Measurements are read directly on the front panel meter. It is a useful device for measurements for FCC proof-of-performance tests.

Size: 22.8 cm (9") H  
 27.6 cm (11¼") W  
 30.5 cm (12") D  
 Weight: 5 kg (11 lb)  
 410 NPN Distortion Meter

# Monitoring and Test Equipment

Size: 8700 Series 8.89 cm (3½") H  
 21.50 cm (8½") W  
 33.66 cm (13¼") D  
 Weight: 3.63 kg (8 lb)  
 8720 NPN Frequency Counter, 150 MHz  
 8730 NPN Frequency Counter, 550 MHz  
 8740 NPN Frequency Counter, 1 GHz

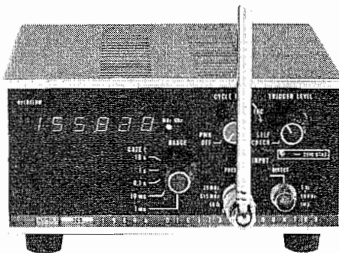

1980A Frequency Counter

## Fluke 1980A Frequency Counter

The 1980A VHF/UHF Frequency Counter may be operated from standard line voltage, or from an optional 12-volt dc battery pack. Its range is from 5 Hz to 50 MHz (direct input) and from 25 MHz to 515 MHz (prescaled input). A variable trigger level control on the direct input helps eliminate erroneous readings due to sine waves with noise spikes or ringing square waves. Readout is automatically displayed on a 6-digit LED display. The 1980A is an invaluable tool for accurate frequency determination of all types of laboratory devices, transmitters, excitors, oscillators, and any type of communication equipment.

Size: 7.62 cm (3") H  
 16.5 cm (6½") W  
 20.3 cm (8") D  
 Weight: 2.2 kg (4.75 lb)  
 1980A NPN VHF/UHF Frequency Counter

## Digitec 8700 Series Frequency/Counters

The 8700 Series consists of three separate models designed specifically for field service, test bench, or lab applications. The models 8720, 8730, and 8740 have frequency measurements of 150 MHz, 550 MHz, or 1 GHz respectively. All three models have opti-ranging for optimum display resolution and standard full 9-digit amber LED display. The 8700 series have standard 10-mV rms input sensitivity with AGC and selectable 50-ohm or 1-megohm input impedance. A front panel slide switch selects X1 or x100 input attenuation. All the models have a designer-style all-aluminum enclosure and are easily rack-mounted. Easy access to all plug-in IC's, circuit boards, and displays facilitates maintenance and calibration.



Digitec 8700 Series Frequency/Counters



Digitec 2180 Multimeter

## Digitec 2180 Multimeter

Model 2180, top of the 2100 series, measures ac/dc volts, ac/dc current, resistance plus ±60 dB in both the bridging and terminated modes. The 2180 enables simple and direct gain and loss measurements of transmission lines or cascade amplifiers. This multimeter has 2 dB references as standard and offers preci-

# Monitoring and Test Equipment

sion leadings of 0.1 dB at an accuracy of  $\pm 0.5$  dB. The 2180 also has a 1200-volt overload protection. Extensive use of large scale integrated circuits ensures reliability, while plug-in IC's, boards, and displays permit quick and easy repair if maintenance is required. As standard, the 2180 also has a built-in battery charger.

Model 2120 delivers the five standard functions: ac/dc volts, ac/dc current and resistance, plus the 1200-volt overload protection.

Model 2110 is specifically designed for general lab, field service or maintenance use, where current and decibel measurements are not a requirement.

Size: 6.3 cm (2.43") H  
18.4 cm (7.25") W  
20.1 cm (7.93") D  
Weight: 0.9 kg (2 lb) less batteries  
2180 NPN Multimeter  
2120 NPN Multimeter  
2110 NPN Multimeter

Size: 6 cm (2½") H  
22 cm (8½") W  
25 cm (10") D  
Weight: 1.2 kg (2.75 lb)  
less batteries  
8000A NPN Digital Multimeter



*Fluke 8000A Digital Multimeter*

## Fluke 8000A Digital Multimeter

Pushbutton control practically eliminates operational error with the 8000A. There are 26 different ranges, including five ranges of ac and dc voltage, five ranges of ac and dc current, and six ranges of resistance. Ranges include: ac voltage — 19.9 mV to 1199 V; dc voltage —  $\pm 199.9$  mV to  $\pm 1199$  V; ac current — 199.9  $\mu$ A to 1999 mA; dc current —  $\pm 199.9$   $\mu$ A to  $\pm$ A to  $\pm 1999$  mA; resistance — 199.9 ohms to 19.99 megohms. Values are read directly on an LED display.

# Monitoring and Test Equipment

## Receivers

### Pioneer Model SX-650 AM-FM Stereo Receiver

The Pioneer high-performance stereo receiver features 35 watts per channel, minimum rms at 8 ohms from 20 Hz to 20,000 Hz with no more than 0.3% total harmonic distortion. The FM tuner employs a low-noise FET and a frequency-linear 3-gang variable capacitor in the front end. The SX-650 has two stereo pairs of tape terminals (deck 1 to deck 2 tape duplication is possible), a function switch to handle FM, AM PHONO, MIC, and AUX.

FM Tuner Section:  
 Usable Sensitivity (IHF) 1.9  $\mu$ V  
 Capture Ratio 1.0 dB  
 Selectivity (IHF) 60 dB  
 Signal-to-Noise Ratio 70 dB  
 Stereo Separation More than 40 dB (1 kHz) More than 30 dB (50 Hz to 19 kHz)

AM Tuner Section:  
 Sensitivity 300  $\mu$ V/m (IHF ferrite antenna)  
 15  $\mu$ V (IHF external antenna)  
 Selectivity 35 dB  
 Signal-to-Noise Ratio 50 dB  
 Total Harmonic Distortion Less than 0.5%

Size: 14.9 cm (5<sup>7</sup>/<sub>8</sub>" H)  
 48 cm (18<sup>29</sup>/<sub>32</sub>" W)  
 37.1 cm (14<sup>19</sup>/<sub>32</sub>" D)  
 Weight: 13.1 kg (28 lb 14 oz)  
 SX-650 NPN Receiver, AM/FM Stereo, 25 Watts

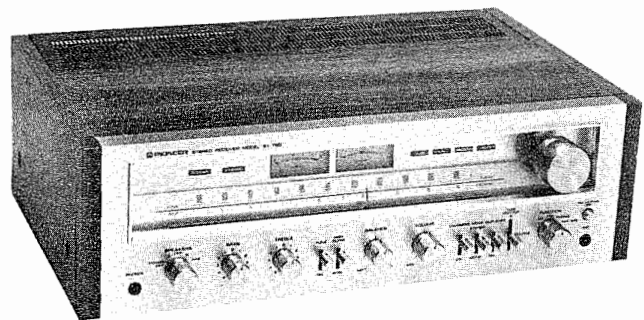

SX-750 AM/FM Receiver

### Pioneer SX-750 AM/FM Receiver

The Pioneer SX-750 AM/FM Receiver is an advanced-design receiver employing features such as dual gate MOS type FET in the FM front end, 4-gang variable capacitor for high sensitivity and selectivity, up-to-the minute circuits and differential amplifier ICs for high noise ratio and low distortion, phase-locked loop circuit in the MPX section, FM muting circuit, two tape inputs for recording and playback, signal strength and center tuning meters, 50 watts audio per channel rms at 8 ohms, and numerous other features that make it the leader in its price class. The receiver is housed in an attractively styled walnut-finished cabinet.

Size: 47.2 cm (18<sup>29</sup>/<sub>32</sub>" W)  
 14.9 cm (5<sup>7</sup>/<sub>8</sub>" H)  
 37 cm (14<sup>19</sup>/<sub>32</sub>" D)  
 Weight: 13.7 kg (30 lb 3 oz)

SX-1250 AM/FM Receiver, 160 W/ch  
 SX-1050 AM/FM Receiver, 120 W/ch  
 SX- 950 AM/FM Receiver, 85 W/ch  
 SX- 850 AM/FM Receiver, 50 W/ch  
 SX- 650 AM/FM Receiver, 35 W/ch  
 SX- 550 AM/FM Receiver, 20 W/ch  
 SX- 450 AM/FM Receiver, 15 W/ch

# Monitoring and Test Equipment

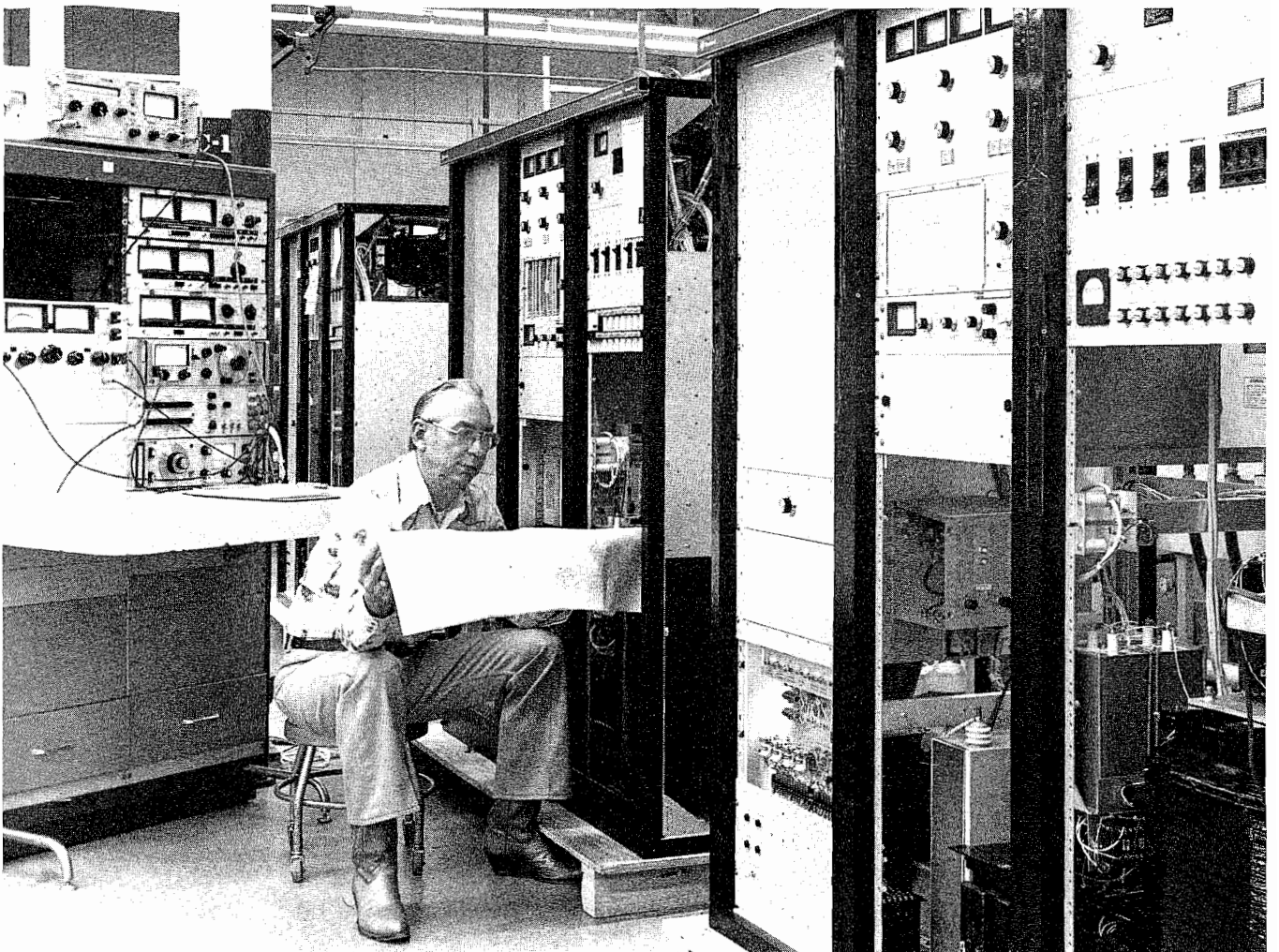

# Services





## Services

The total list of services that Collins offers its customers is too extensive to list, but the following general description of several areas offers a broad overview of Collins services.

**Financial Services.** Rather than having one hard-fast policy concerning payment for equipment and services at Collins, we have chosen to stay flexible to allow you, the customer, to determine how your account is handled. The following list explains the most commonly used plans.

- a. 30-Day Open Account. A normal net-30 charge account with varying credit limits determined by your needs. This account carries no interest.
- b. 30-60-90-Day Charge. An account set up for specific purchases, allowing the total balance to be paid out in 3 equal installments, carrying no interest.
- c. Long-Term Financing. Established to finance major capital expenditures on audio systems, transmitters, towers, automation, and other associated equipment. Normal pay-out can be from 1 to 5 years, depending on total dollar amount. A down payment of 20-25% is usually required, but can vary with individual needs.
- d. Leasing. Both lease-purchase and operating leases can be written on all Collins-supplied equipment. These can be arranged through our own leasing company, or through a leasing agency of your choice. Terms are not fixed and are totally flexible to fit your exact requirements.
- e. Master Charge. For small purchases of equipment and parts, this troublefree service is unique to the broadcast industry. If you don't have a charge card, we will be happy to arrange for an application to be sent to you.

**Technical Services.** Technical services at Collins are wide-ranging in description and depth of involvement. The following five areas are the most commonly used, but should not be limiting if you are considering Collins for your job.

- a. Engineering. A staff of registered professional engineers is available to work out any problems that may arise when installing a system. If a transmitter/phasor combination needs a special interlock system, Collins can provide both the design and hardware to accomplish the end result. If your consultant is involved, we will work

with him at his direction to give you the exact system engineering required.

- b. Field Service. A full time staff of field engineers is available 24 hours a day, 365 days a year, to provide technical assistance over the phone or in the field. Full data is maintained on all Collins equipment built and supplied since 1926, and our engineers know it by heart! If you have questions during installation of new or used equipment, one call to Collins Field Service can usually solve your problem.
- c. Service Parts. Closely related to Field Service, our Service Parts operation functions a full 24 hours a day, 365 days a year. We maintain a complete parts stock on all Collins equipment for 10 years after production closeout on any model. In some cases, we still stock parts on equipment that is 20 years old. Because of Collins proximity to the nation's largest airport, we can provide air shipment to any airport on a moment's notice.
- d. System Concept. If you're building a new station and it's your first, this free service can be a gold mine for you. If you're an old hand, we can free you for more important matters by suggesting a total system approach to fit your general guidelines and budget. Both our local staff of system experts and our district engineers can provide suggestions to streamline and improve your new or existing plant.
- e. Training. If your staff needs technical training on transmitters, Collins can provide this instruction on *your* transmitter. If we provide a checkout on your new transmitter, our field engineer will automatically familiarize your chief engineer with the system. If we install a program automation system for you, we will train your staff to program it for your format.
- f. Installation. For those stations buying a complete turnkey job, Collins will install each and every item in the system and be responsible for its operation. "Total System Responsibility" is the key phrase to remember when considering Collins for your installation.

**Logistics.** In any installation involving more than a few pieces of equipment, logistics may become an important factor. To make the entire job flow as smoothly as possible, Collins attacks the project from three points.

- a. System Coordination. Before shipping any equipment, we will ensure that proper frequency

# Services

information, mounting information, etc., is available to us and to our suppliers to avoid any delays.

- b. Shipping. We will ship according to your instructions — to the letter. If you do not specify shipping information, Collins will select the best method to fit the existing schedule, and will select a carrier to give best handling for each item.
- c. Delivery Followup. We always confirm delivery of our shipments. If an item is lost, we know about it in time to track it down or send in an immediate replacement. This extensive followup avoids unnecessary delays, extension of CP's, and worry about small details.

In general, Collins tries to eliminate problems that can cause you concern and time. We always provide excellent cooperation in terms of understanding and willingness to bend to your requirements. Hand-holding is very important — both for you and for us. Our future depends on you and your evaluation of our performance.

# Engineering Data



## Footage Table for Broadcast Tower Heights

550 KHZ TO 1070 KHZ					1080 KHZ TO 1600 KHZ				
KHZ	METERS	1 WAVE	1/2 WAVE	1/4 WAVE	KHZ	METERS	1 WAVE	1/2 WAVE	1/4 WAVE
550	545	1787.6	893.8	446.8	1080	277.8	911.1	455.5	227.7
560	536	1758.0	879.0	439.5	1090	275.2	902.6	451.3	225.6
570	526	1725.3	862.6	431.3					
580	517	1695.7	847.8	423.9	1100	272.7	894.4	447.2	223.6
590	509	1669.5	834.7	417.3	1110	270.3	886.5	443.2	221.6
					1120	267.9	879.0	439.5	219.7
600	500	1640.0	820.0	410.0	1130	265.5	870.8	435.4	217.7
610	492	1612.7	806.3	403.1	1140	263.2	862.6	431.3	215.6
620	484	1587.5	799.7	396.8	1150	260.9	855.7	427.8	213.9
630	476	1561.2	780.6	390.3	1160	258.6	847.8	423.9	211.9
640	469	1546.3	773.1	386.5	1170	256.4	840.9	420.4	210.2
650	462	1515.3	757.6	378.8	1180	254.2	834.7	417.3	208.6
660	455	1492.4	746.2	373.1	1190	252.1	826.8	413.4	206.7
670	448	1469.4	734.7	367.3					
680	441	1446.4	723.2	361.1	1200	250.0	820.0	410.0	205.0
690	435	1426.8	713.4	356.2	1210	247.9	813.1	406.5	203.2
					1220	245.9	806.3	403.1	201.5
700	429	1407.1	703.5	351.2	1230	243.9	799.1	399.5	199.7
710	423	1387.4	693.7	346.8	1240	241.9	793.7	396.8	198.4
720	417	1367.7	683.8	341.9	1250	240.0	787.2	393.6	196.8
730	411	1348.0	674.0	337.0	1260	238.1	780.9	390.4	195.2
740	405	1328.4	664.2	332.1	1270	236.2	774.7	387.3	193.6
750	400	1312.0	656.0	328.0	1280	234.4	768.8	384.4	192.2
760	395	1295.6	647.8	323.4	1290	232.6	762.9	381.4	190.7
770	390	1279.2	639.6	319.8					
780	385	1262.8	631.4	315.7	1300	230.8	757.0	378.5	189.2
790	380	1246.4	623.2	311.6	1310	229.0	751.1	375.5	187.7
					1320	227.3	746.2	373.1	186.5
800	375	1230.0	615.0	307.5	1330	225.6	739.9	369.9	184.9
810	370	1213.6	606.8	303.4	1340	223.9	734.7	367.3	183.6
820	366	1200.4	600.2	300.1	1350	222.2	728.8	364.4	182.2
830	361	1184.0	592.0	296.0	1360	220.6	723.2	361.1	180.5
840	357	1170.9	585.4	292.7	1370	219.0	718.3	359.1	179.5
850	353	1157.8	578.9	289.4	1380	217.4	713.4	356.2	178.1
860	349	1144.7	572.3	286.1	1390	215.8	707.8	353.1	176.5
870	345	1131.6	565.8	282.9					
880	341	1118.4	559.2	279.6	1400	214.3	703.5	351.2	175.6
890	337	1105.3	552.6	276.3	1410	212.8	696.9	348.4	174.2
					1420	211.3	693.7	346.8	173.4
900	333	1092.2	546.1	273.0	1430	209.8	688.1	344.0	172.0
910	330	1082.4	541.2	270.6	1440	208.3	683.8	341.9	170.9
920	326	1069.2	534.6	267.3	1450	206.9	678.6	339.3	169.6
930	323	1059.4	529.7	264.8	1460	205.5	674.0	337.0	168.5
940	319	1046.3	523.1	261.5	1470	204.1	669.4	334.7	167.3
950	316	1036.4	518.2	259.1	1480	202.7	664.2	332.1	166.5
960	313	1026.6	513.3	256.6	1490	201.3	660.2	330.1	165.0
970	309	1013.5	506.7	253.3					
980	306	1003.6	501.8	250.9	1500	200.0	656.0	328.0	164.0
990	303	993.8	496.9	248.4	1510	198.7	651.7	325.8	162.9
					1520	197.4	647.8	323.4	161.7
1000	300	984.0	492.0	246.0	1530	196.1	643.2	321.6	160.8
1010	297	974.1	487.5	243.7	1540	194.8	639.6	319.8	159.9
1020	294.1	964.6	482.3	241.1	1550	193.5	634.6	317.3	158.6
1030	291.3	955.3	477.6	238.8	1560	192.3	631.4	315.7	157.8
1040	288.5	946.2	473.1	236.5	1570	191.1	626.8	313.4	156.7
1050	285.7	937.1	468.5	234.2	1580	189.9	623.2	311.6	155.8
1060	283.0	928.2	464.1	232.0	1590	188.7	618.9	309.4	154.7
1070	280.4	919.7	459.8	229.9	1600	187.5	615.0	307.5	153.7

# Estimated Ground Conductivity

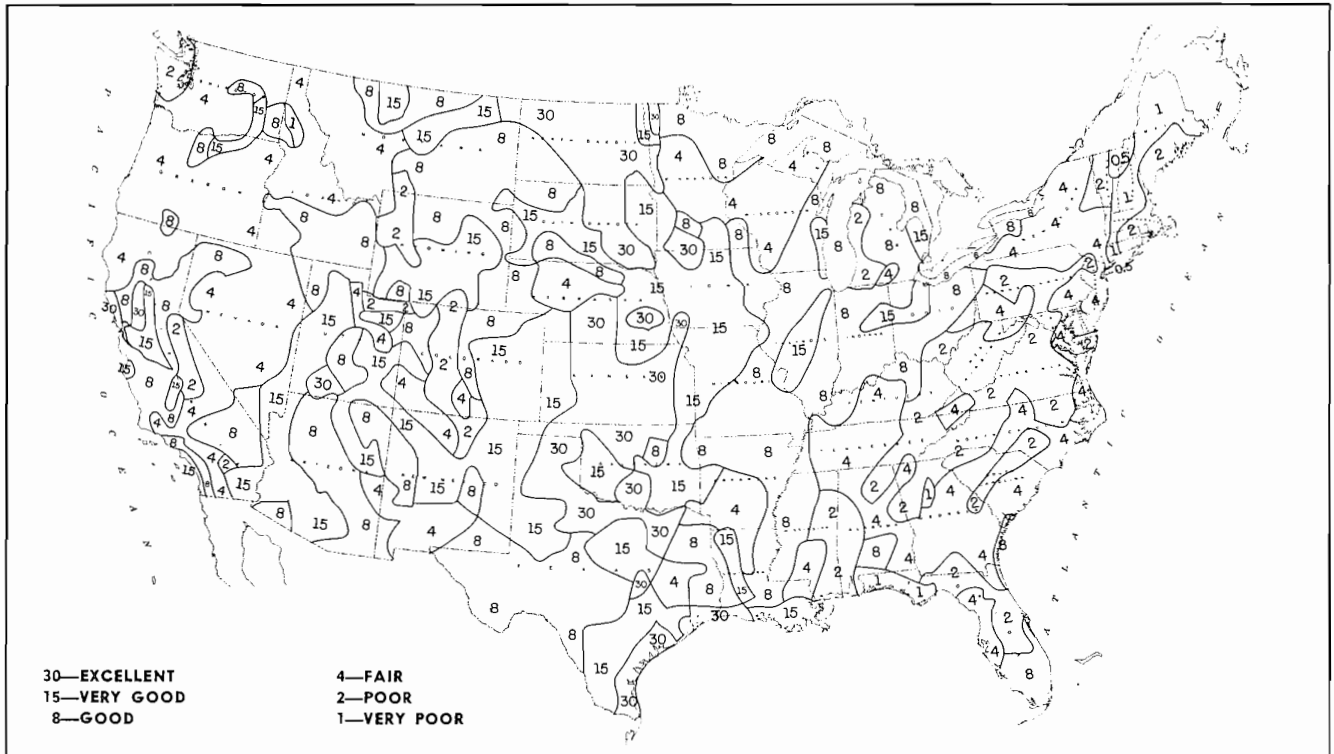

## Conversion Table

MULTIPLY NUMBER OF BY	ANGSTROMS	MICRONS	MILS	INCHES	FEET	MILES	MILLIMETERS	CENTIMETERS	KILOMETERS
ANGSTROMS	1	$10^4$	$2.540 \times 10^5$	$2.540 \times 10^8$	$3.048 \times 10^9$	$1.609 \times 10^{13}$	$10^7$	$10^8$	$10^{11}$
MICRONS	$10^{-4}$	1	$2.540 \times 10$	$2.540 \times 10^4$	$3.048 \times 10^5$	$1.609 \times 10^9$	$10^3$	$10^4$	$10^6$
MILS	$3.937 \times 10^{-6}$	$3.937 \times 10^{-2}$	1	$10^3$	$1.2 \times 10^4$	$6.336 \times 10^7$	$3.937 \times 10$	$3.937 \times 10^2$	$3.937 \times 10^7$
INCHES	$3.937 \times 10^{-9}$	$3.937 \times 10^{-5}$	$10^{-3}$	1	12	$6.336 \times 10^4$	$3.937 \times 10^{-2}$	$3.937 \times 10^{-1}$	$3.937 \times 10^2$
FEET	$3.281 \times 10^{-10}$	$3.281 \times 10^{-6}$	$8.333 \times 10^{-5}$	$8.333 \times 10^{-2}$	1	$5.280 \times 10^3$	$3.281 \times 10^{-3}$	$3.281 \times 10^{-2}$	$3.281 \times 10^3$
MILES	$6.214 \times 10^{-14}$	$6.214 \times 10^{-10}$	$1.578 \times 10^{-8}$	$1.578 \times 10^{-5}$	$1.894 \times 10^{-4}$	1	$6.214 \times 10^{-7}$	$6.214 \times 10^{-6}$	$6.214 \times 10^{-11}$
MILLIMETERS	$10^{-7}$	$10^{-3}$	$2.540 \times 10^{-2}$	$2.540 \times 10$	$3.048 \times 10^2$	$1.609 \times 10^6$	1	10	$10^4$
CENTIMETERS	$10^{-8}$	$10^{-4}$	$2.540 \times 10^{-3}$	2.540	$3.048 \times 10$	$1.609 \times 10^5$	0.1	1	$10^5$
KILOMETERS	$10^{-13}$	$10^{-9}$	$2.540 \times 10^{-8}$	$2.540 \times 10^{-5}$	$3.048 \times 10^{-4}$	1.609	$10^{-6}$	$10^{-5}$	1
° CENTIGRADE	$C = 5/9 (F - 32)$								
° FAHRENHEIT	$F = 9/5 C + 32$								

# Forward VS Reflected Power

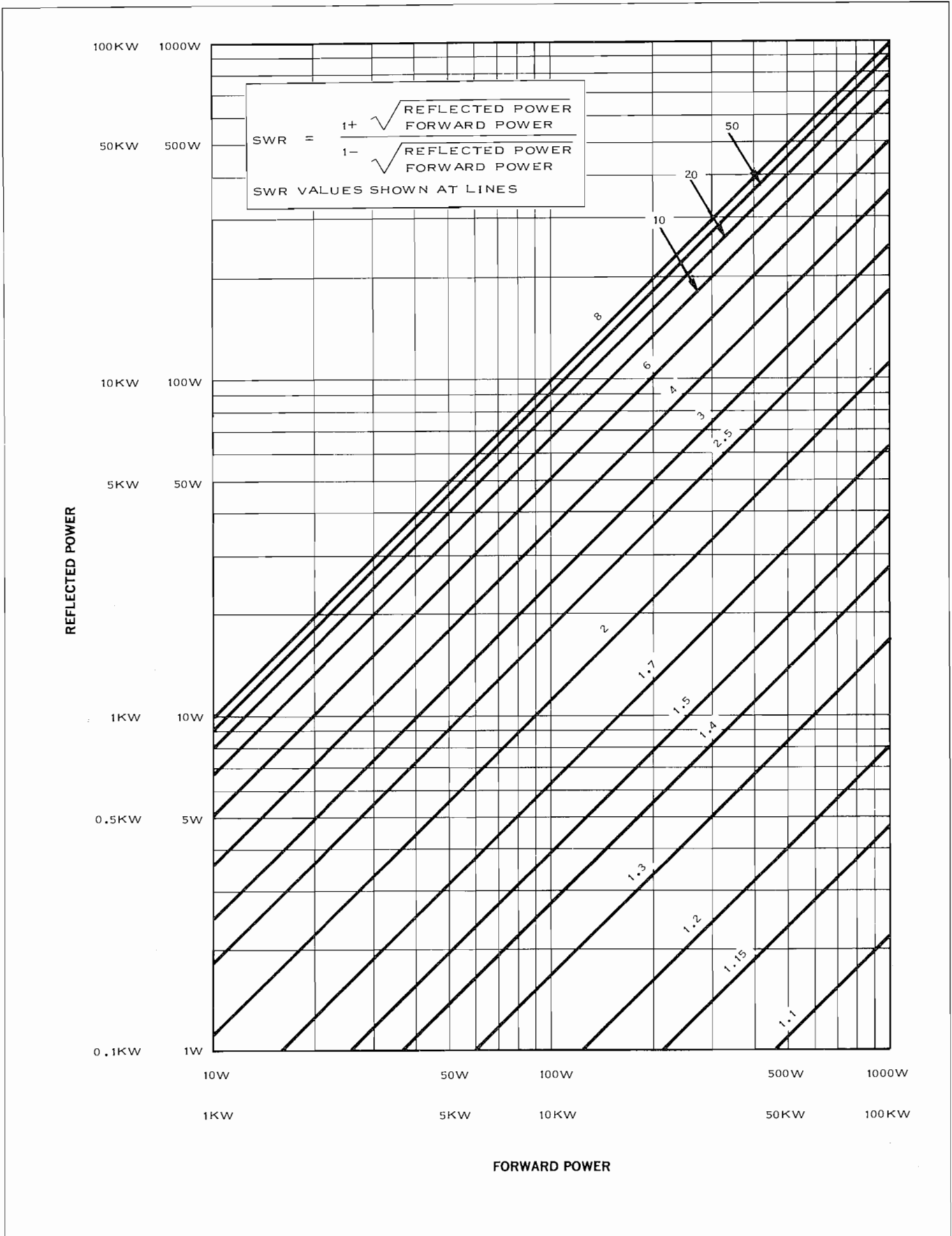

## DECIBELS ABOVE AND BELOW REFERENCE LEVEL 1mw INTO 600 OHMS

Voltage applies to 600 ohm circuits only. Power applies to any impedance.

dB DOWN		LEVEL	dB UP	
VOLTS	MILLIWATTS		dB mW	VOLTS
0.774 6	1.000	0+	0.774 6	1.000
0.690 5	0.794 3	1	0.869 1	1.259
0.616 7	0.631 0	2	0.975 2	1.585
0.548 4	0.501 2	3	1.094	1.995
0.488 7	0.398 1	4	1.228	2.512
0.435 6	0.316 2	5	1.377	3.162
0.388 2	0.251 2	6	1.546	3.981
0.346 0	0.199 5	7	1.734	5.012
0.308 4	0.158 5	8	1.946	6.310
0.274 8	0.125 9	9	2.183	7.943
0.244 9	0.100 0	10	2.449	10.000
0.218 3	0.079 43	11	2.748	12.59
0.194 6	0.063 10	12	3.084	15.85
0.173 4	0.050 12	13	3.460	19.95
0.154 6	0.039 81	14	3.882	25.12
0.137 7	0.031 62	15	4.356	31.62
0.122 8	0.025 12	16	4.887	39.81
0.109 4	0.019 95	17	5.484	50.12
0.097 52	0.015 85	18	6.153	63.10
0.086 91	0.012 59	19	6.905	79.43
0.077 46	0.010 00	20	7.746	100.00
0.043 56	0.003 16	25	13.77	316.2
0.024 49	0.001 00	30	24.49	1.000 Watt
0.013 77	0.000 316	35	43.56	3.162 Watts
0.007 746	0.000 100	40	77.46	10.00 Watts
0.004 356	3.16 X 10 <sup>-5</sup>	45	137.7	31.62 Watts
0.002 449	1.00 X 10 <sup>-5</sup>	50	244.9	100 Watts
0.001 377	3.16 X 10 <sup>-6</sup>	55	435.6	316.2 Watts
0.000 774 6	1.00 X 10 <sup>-6</sup>	60	774.6	1 000 Watts
0.000 435 6	3.16 X 10 <sup>-7</sup>	65	1 377	3 162 Watts
0.000 244 9	1.00 X 10 <sup>-7</sup>	70	2 449	10 000 Watts
0.000 137 7	3.16 X 10 <sup>-8</sup>	75	4 356	31 620 Watts
0.111 077 46	1.00 X 10 <sup>-8</sup>	80+	7 746	100 000 Watts

### USE OF TABLE

Table is tabulated in 1-dB steps from 0 dB mW to ±20 dB mW; thereafter in 5-dB steps to ±80 dB mW. However, the table may be used in 1-dB steps to ±80 dB mW by noting that, except for decimal locations, the power levels repeat themselves every ±10 dB and the voltage levels repeat every ±20 dB.

**Example 1.** What is the voltage produced by a level of -56 dB mW on 600 ohms? Subtract 40 from 56, giving 16. Enter table at 16 dB mW, read volts column on left as 0.1228 volt. Now enter table at 55 and 60 dB mW; -56 dB mW is between these two levels, so table shows correct answer as 0.001228 volt.

**Example 3.** What is the voltage produced by a level of +33 dB mW on 600 ohms? Subtract 20 from 33, giving 13. Enter the table at 13 dB mW, read volts column at right as 3.460 volts. Now enter table at 30 and 35 dB mW; +33 dB mW is between these two levels, so the table shows the correct answer as 34.6 volts.

**Example 2.** What is the voltage produced by a level of -68 dB mW on 600 ohms? Subtract 60 from 68, giving 8. Enter table at 7 dB mW, read volts column on left as 0.3084 volt. Now enter table at 65 and 70 dB mW; -68 dB mW is between these two levels, so the table shows correct answer as 0.0003084 volt.



## Attenuation Expressed as Efficiency

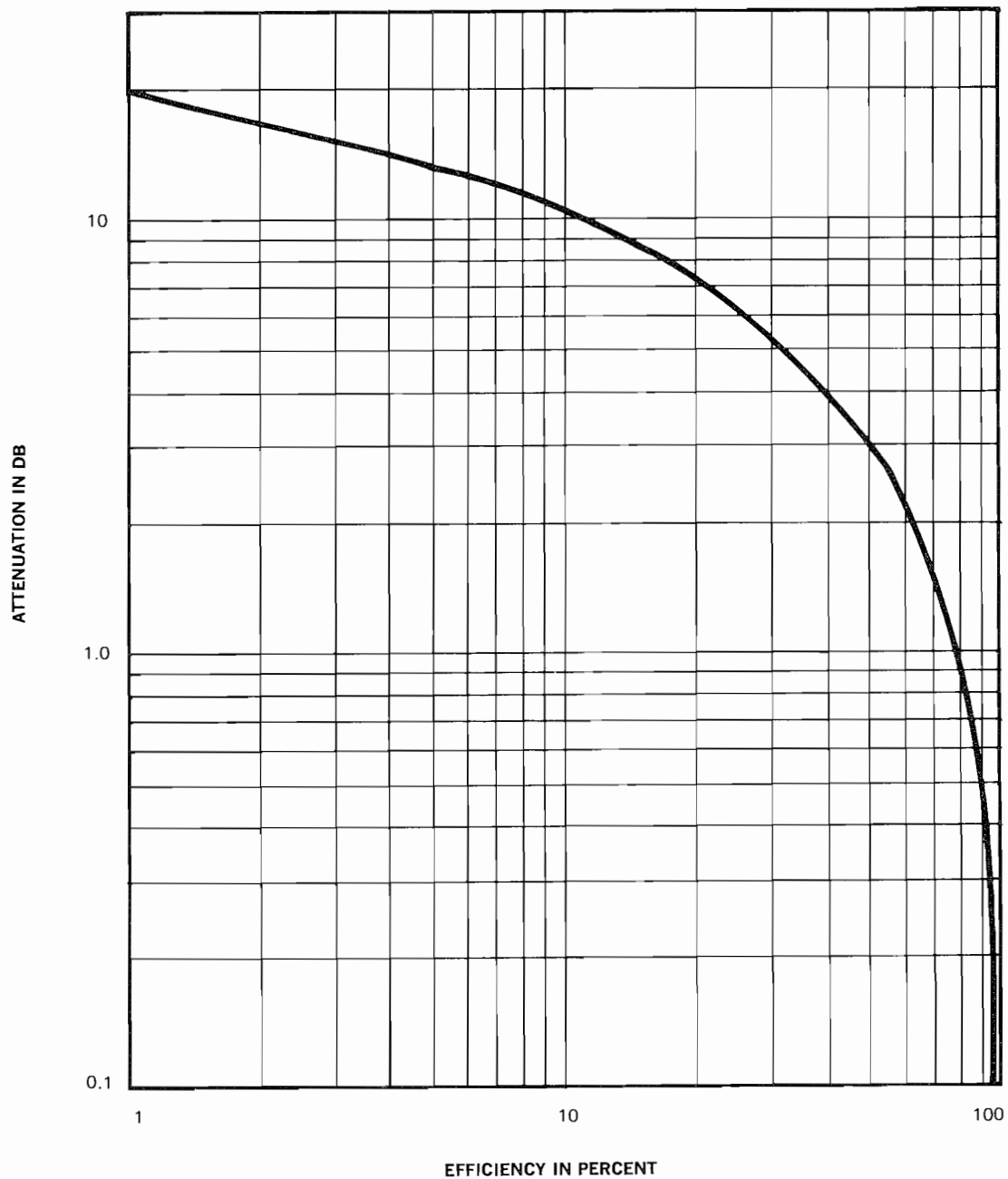

To obtain total loss in a given transmission line, multiply the attenuation in dB per 30 m (100 ft) by the number of 3 m (100 ft) lengths of line to be used. By referring to the curve on this page, the overall transmission efficiency may be determined.

# Audio Dividing Pads

PART NO	CIRCUIT	NO OUTPUTS	DB LOSS	INPUT	OUTPUT	RESISTOR EACH
1	BAL	2	5.0			100Ω
2	BAL	3	0.5			150Ω
3	BAL	4	12.0			180Ω
4	BAL	5	14.0			200Ω
5	BAL	6	15.6			214Ω
6	BAL	8	13.1			235Ω
7	UNBAL	2	6.0			200Ω
8	UNBAL	3	9.5			300Ω
9	UNBAL	4	12.0			360Ω
10	UNBAL	5	14.0			400Ω
11	UNBAL	6	15.6			428Ω
12	UNBAL	8	18.1			466Ω
13	BAL	10	20.0			245Ω

# Attenuator Network

Loss, dB	600 Ohms		600 Ohms		600 Ohms		600 Ohms		600 Ohms		600 Ohms	
	R <sub>1</sub> Ohms	R <sub>2</sub> Ohms	R <sub>1</sub> Ohms	R <sub>2</sub> Ohms	R <sub>1</sub> Ohms	R <sub>2</sub> Ohms	R <sub>1</sub> Ohms	R <sub>2</sub> Ohms	R <sub>1</sub> Ohms	R <sub>2</sub> Ohms	R <sub>1</sub> Ohms	R <sub>2</sub> Ohms
0	∞	∞	∞	∞	∞	∞	∞	∞	∞	∞	∞	∞
0.1	3.58	50204	1.79	50204	7.20	100500	3.60	100500	3.58	100500	7.2	50000
0.2	6.82	26280	3.41	26280	13.70	57380	6.82	57380	6.82	57380	13.8	26086
0.3	10.32	17460	5.16	17460	20.55	34900	10.28	34900	10.32	34900	21.0	17143
0.4	13.79	13068	6.90	13068	27.50	26100	13.80	26100	13.79	26100	28.2	12766
0.5	17.20	10464	8.60	10464	34.40	20920	17.20	20920	17.20	20920	35.4	10169
0.6	20.9	8640	10.45	8640	41.7	17230	20.85	17230	20.9	17230	43.2	8333
0.7	24.2	7428	12.1	7428	48.5	14880	24.25	14880	24.2	14880	50.4	7143
0.8	27.5	6540	13.75	6540	55.05	13100	27.53	13100	27.5	13100	57.6	6250
0.9	31.02	5787	15.51	5787	62.3	11600	31.2	11600	31.02	11000	65.4	5504
1.0	34.5	5208	17.25	5208	68.6	10440	34.3	10440	34.5	10440	73.2	4918
1.5	51.8	3452	25.9	3452	104.3	6950	52.1	6950	51.8	6950	113.4	3174
2.0	68.8	2582	34.4	2582	139.4	5232	69.7	5232	68.8	5232	155.4	2310
2.5	85.9	2053	42.9	2053	175.4	4195	87.7	4195	85.9	4195	200.4	1796
3.0	102.7	1703	51.3	1703	212.5	3505	106.2	3505	102.7	3505	247.8	1452
3.5	119.2	1448	59.6	1448	258.0	3021	120.0	3021	119.2	3021	297.6	1209
4.0	135.8	1249	67.9	1249	287.5	2651	143.8	2651	135.8	2651	351.0	1025
4.5	152.2	1109	76.1	1109	324.6	2365	162.3	2365	152.2	2365	407.4	883.7
5.0	168.1	987.6	84.1	987.6	364.5	2141	182.3	2141	168.1	2141	466.8	771.2
5.5	184.0	886.8	92.0	886.8	405.9	1956	203.0	1956	184.0	1956	530.4	678.7
6.0	199.3	803.4	99.7	803.4	447.5	1807	223.8	1807	199.3	1807	597.0	598.0
6.5	214.6	730.8	107.3	730.8	492.6	1679	246.3	1679	214.6	1679	667.8	539.8
7.0	229.7	685.2	114.8	685.2	537.0	1569	268.5	1569	229.7	1569	743.4	484.3
7.5	244.2	615.6	122.1	615.6	584.7	1475	292.4	1475	244.2	1475	822.0	437.0
8.0	258.4	567.6	129.2	567.6	634.2	1393	317.1	1393	258.4	1393	907.2	396.8
8.5	272.3	525.0	136.1	525.0	685.5	1322	342.8	1322	272.3	1322	996.6	361.2
9.0	285.8	487.2	142.9	487.2	738.9	1260	369.4	1260	285.8	1260	1091	329.9
9.5	298.9	453.0	149.5	453.0	794.4	1204	397.2	1204	298.9	1204	1191	302.2
10.0	312.0	421.6	156.0	421.6	854.1	1154	427.0	1154	312.0	1154	1297	277.5
11.0	336.1	367.4	168.1	367.4	979.8	1071	489.9	1071	336.1	1071	1529	235.5
12.0	359.1	321.7	179.5	321.7	1119	1002	550.5	1002	359.1	1002	1788	201.3
13.0	380.5	282.8	190.3	282.8	1273	946.1	636.3	946.1	380.5	946.1	2080	173.1
14.0	400.4	249.4	200.2	249.4	1443	899.1	721.5	899.1	400.4	899.1	2407	149.6
15.0	418.8	220.4	209.4	220.4	1632	859.6	816.0	859.6	418.8	859.6	2773	129.8
16.0	435.8	195.1	217.9	195.1	1847	826.0	923.2	826.0	435.8	826.0	3186	113.0
17.0	451.5	172.9	225.7	172.9	2083	797.3	1042	797.3	451.5	797.3	3648	98.68
18.0	465.8	152.5	232.9	152.5	2344	772.8	1172	772.8	465.8	772.8	4166	86.4
19.0	479.0	136.4	239.5	136.4	2670	751.7	1335	751.7	479.0	751.7	4748	75.8
20.0	490.4	121.2	245.2	121.2	2970	733.3	1485	733.3	490.4	733.3	5400	66.66
22.0	511.7	95.9	255.9	95.9	3753	703.6	1877	703.6	511.7	703.6	6954	51.72
24.0	528.8	76.0	264.4	76.0	4737	680.8	2369	680.8	528.8	680.8	8910	40.4
26.0	542.7	60.3	271.4	60.3	5985	663.4	2992	663.4	542.7	663.4	11370	34.66
28.0	554.1	47.8	277.0	47.8	7550	649.7	3775	649.7	554.1	649.7	14472	24.87
30.0	563.0	37.99	281.0	37.99	9500	639.2	4750	639.2	563.0	639.2	18372	19.58
32.0	570.6	30.16	285.3	30.16	11930	630.9	5967	630.9	570.6	630.9	23286	15.46
34.0	576.5	23.95	288.3	23.95	15000	624.4	7500	624.4	576.5	624.4	29472	12.21
36.0	581.1	18.98	290.6	18.98	18960	619.3	9480	619.3	581.1	619.3	37200	9.66
38.0	585.1	15.11	292.5	15.11	23820	615.3	11910	615.3	585.1	615.3	47058	7.65
40.0	588.1	12.00	294.1	12.00	30000	612.1	15000	612.1	588.1	612.1	59400	6.06

# Reactance Chart

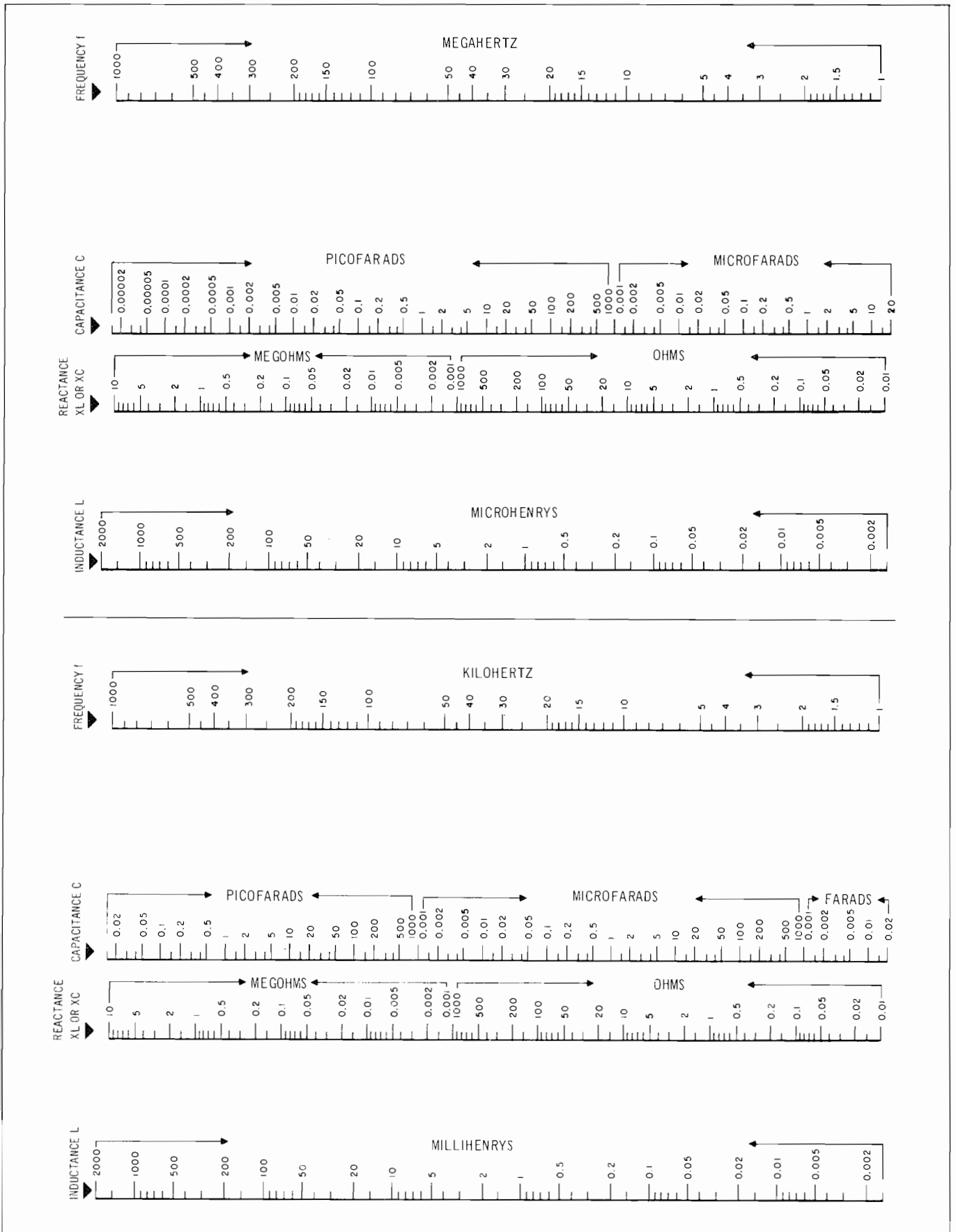

## Volume Level to Power and Voltage Conversion

REFERENCE LEVEL: 0 DBM = 1 MW, 600 OHMS					
MILLIWATTS	VOLTS	DBM	WATTS	VOLTS	DBM
0.000001	0.0007746	- 60	0.001000	0.7746	0
0.000010	0.002449	- 50	0.002512	1.228	+ 4
0.000100	0.007746	- 40	0.006310	1.946	+ 8
0.001	0.02449	- 30	0.01000	2.449	+ 10
0.010	0.07746	- 20	0.1000	7.746	+ 20
0.100	0.2449	- 10	1.000	24.49	+ 30
1.000	0.7746	0	10.00	77.46	+ 40

## Decibels Vs Ratio

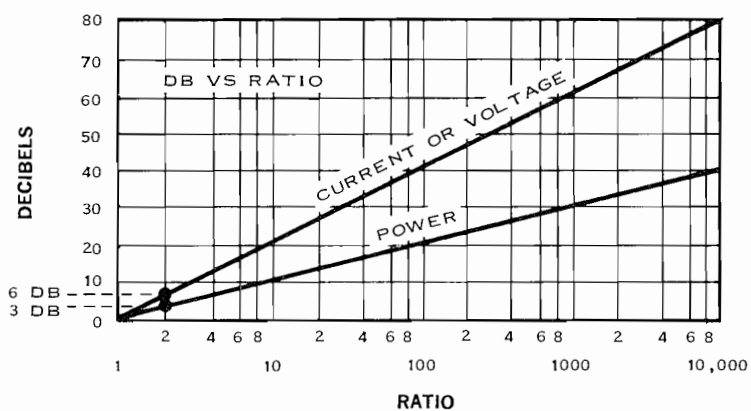

## Increase in Attenuation in Line Due to VSWR on Line

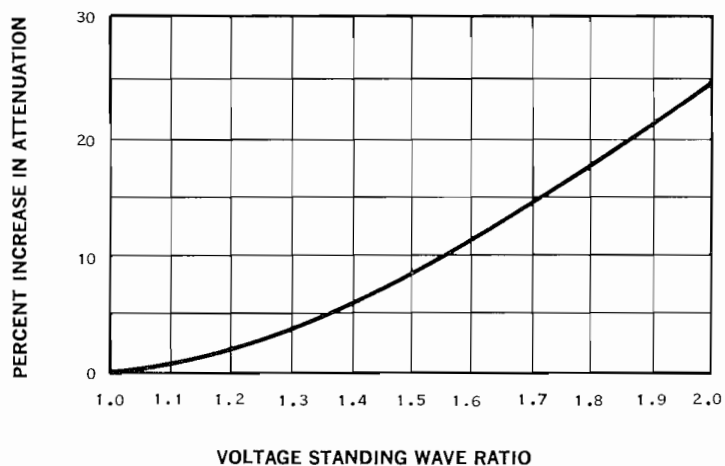

# Standard Color Codes — Resistors and Capacitors

INSULATED UNINSULATED COLOR	FIRST RING BODY COLOR FIRST FIGURE	SECOND RING END COLOR SECOND FIGURE	THIRD RING DOT COLOR MULTIPLIER
BLACK	0	0	NONE
BROWN	1	1	0
RED	2	2	00
ORANGE	3	3	,000
YELLOW	4	4	0,000
GREEN	5	5	00,000
BLUE	6	6	,000,000
VIOLET	7	7	0,000,000
GRAY	8	8	00,000,000
WHITE	9	9	000,000,000

JAN 8,  
1948  
RMA  
CODE

## MOLDED MICA TYPE CAPACITORS

### CURRENT STANDARD CODE

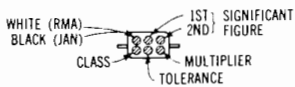

### RMA 3-DOT (OBSOLETE) RATED 500 WVDC ±20% TOL.



### BUTTON SILVER MICA CAPACITOR



### RMA (5-DOT OBSOLETE CODE)

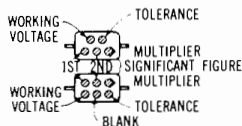
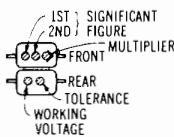

### RMA 4-DOT (OBSOLETE)

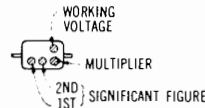

### RMA 6-DOT (OBSOLETE)

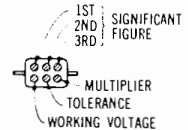

## MOLDED PAPER TYPE CAPACITORS

### TUBULAR CAPACITOR

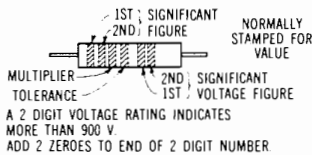

### MOLDED FLAT CAPACITOR COMMERCIAL CODE

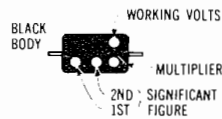

### JAN. CODE CAPACITOR

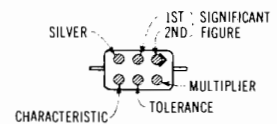

## CERAMIC CAPACITORS

### 5-DOT RADIAL LEAD CERAMIC CAPACITOR

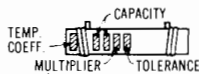

### EXTENDED RANGE TC CERAMIC HICAP

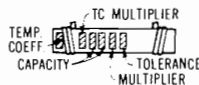

### AXIAL LEAD CERAMIC CAPACITOR

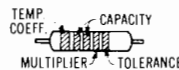

### DISC CERAMIC RMA CODE

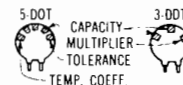

### BY-PASS COUPLING CERAMIC CAPACITOR

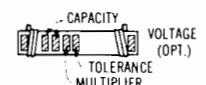

## RESISTORS

### RADIAL LEAD DOT RESISTOR

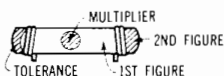

### RADIAL LEAD (BAND) RESISTOR

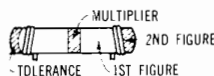

### AXIAL LEAD RESISTOR

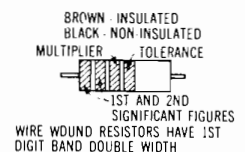

# Conditions of Sale





# Conditions of Sale

## General Conditions of Sale

1. **PRICES.** Buyer agrees to pay Collins Broadcast Products of Rockwell International Corporation (hereinafter called Collins), at its office in Dallas, Texas, for the articles described herein, the prices as specified on the face hereof, provided, however, that if articles are included herein which are manufactured by others than Collins, Collins reserves the right to increase the price thereof to Collins list price for such articles in effect at time of delivery. If all articles are not delivered at one time, Buyer agrees to pay on the terms stated for the unit prices applicable to the articles so delivered.

2. **TAXES.** Except as otherwise specified, the prices stated herein do not include any state, federal, or local sales, use or excise taxes applicable to the sale, delivery, or use of said equipment, and the Buyer expressly agrees to pay to Collins, in addition to the prices herein specified, the amount of any such taxes which may be imposed upon or payable by Collins. Any such tax imposed by a taxing authority in a state in which Collins is not registered will be received and remitted by Collins as agent for Buyer.

3. **TERMS OF PAYMENT AND SECURITY INTEREST.** Notwithstanding any statements of terms appearing on the face of this order, Collins reserves the right to require payment in advance of shipment or to ship C.O.D. Buyer hereby grants to Collins a Purchase Money Security Interest in any articles ordered hereunder which are not fully paid for at the time of their delivery to secure payment of the full purchase price thereof. The Purchase Money Security Interest shall attach to the articles at the time and place of their delivery and Buyer hereby appoints and authorizes Collins, its officers, agents and employees as Buyer's agents for the purpose of signing and recording Financing Statements to perfect the Purchase Money Security Interest. If the purchase price is to be paid on an installment basis, Buyer will, at or before the time of delivery, execute a Note and an additional Purchase Money Security Agreement as Collins shall specify upon forms customarily used by Collins in similar transactions. All sales shall be final and merchandise shall not be returned without the advance approval of Collins. Contact Collins Broadcast Products for approval instructions. If return of new or unused equipment for the Buyer's convenience is allowed, a 15% restocking charge shall be made.

4. **CONTINGENT CONTRACTS.** In the event Buyer is in the process of applying for a Construction Permit from the FCC, this contract shall be contingent upon Buyer's Receipt of same, provided this contract is indicated as contingent on the face hereof. If this is a contingent contract according to the preceding sentence, Seller shall delay delivery of equipment until

receipt of notice from Buyer that Buyer has received a Construction Permit from the FCC. In the event Buyer withdraws his application, or the FCC denies the application, either party may cancel this contract by serving written notice to that effect on the other party within thirty (30) days after the said withdrawal or denial. If this contract is cancelled pursuant to the terms of this paragraph, Collins shall promptly refund in full any downpayment made hereunder by Buyer. Upon the receipt of an FCC Construction Permit, Buyer shall promptly notify Collins and this contract shall be automatically converted from contingent to firm. Prices on Collins-manufactured equipments only shall be firm during the contingent period of this contract, provided such period does not exceed six (6) months. In the event the Construction Permit is delayed longer than six months from the date of this contract, Collins shall have the right to either cancel this contract or amend prices stated herein.

5. **DELIVERY.** Unless otherwise specified on the face hereof, delivery of each article ordered hereunder will take place at the plant of the manufacturer of such article when the manufacturer unconditionally appropriates to this order articles of equipment hereby ordered by packing the same for shipment to Buyer and notifying Buyer that the same has been done. Freight charges from the place of delivery shall be the responsibility of Buyer and all claims against the carrier for equipment damage or loss in transit shall be made by the Buyer. The delivery schedule specified herein is approximate and subject to delays due to causes beyond Collins control including, but not limited to, inability to obtain material, labor, or manufacturing facilities, acts of God, or of the public enemy, any preference, priority or allocation order issued by the Government or any other act of Government, fires, floods, epidemics, quarantine restrictions, strikes, freight embargoes, or delays of Collins suppliers. In the event of such delay, delivery dates shall be extended accordingly for a period equal to the time lost by reason of such delay. In no event shall Collins be liable for consequential damages.

6. **TRADE-IN EQUIPMENT.** Any trade-in allowance herein stated will be granted at the time the trade-in equipment is released to Collins. The full trade-in allowance quoted will be granted provided that the trade-in equipment is released to Collins within ninety (90) days of shipment of the new transmitter. Full allowance quoted shall be subject to personal inspection by a Collins representative, as to its condition at time of release. Failure of the Buyer to deliver the trade-in equipment to Seller within 90 days of shipment of the new transmitter shall, at the option of Seller, entitle Seller to cancel the agreement to accept the trade-in equipment and to collect from Buyer the cash value

# Conditions of Sale

assigned to the trade-in equipment, or in the alternative, decrease the trade-in allowance by 1.5% per month or fractional month of delay.

7. SHIPMENT. In the absence of specific instructions Collins will select the carrier for shipment to Buyer. Except for its obligations under the sections hereof entitled "Guarantee" and "Patents," all responsibility of Collins for said shipment ceases upon delivery to carrier.

8. GUARANTEE AND LIMITED WARRANTY. (a) Collins warrants that each equipment of Collins manufacture or Collins design sold hereunder will, at the date of its delivery, meet its published specification and will be free from defects in design, workmanship and material.

(b) Collins agrees to repair or replace any equipment of its manufacture or of its design which fails to meet the warranty set forth in subparagraph (a) above, or, at Collins option, to refund the purchase price of such equipment, provided:

(1) Notice of a claimed defect in the design, materials or workmanship of transmitters manufactured by Collins is given to Collins within two (2) years from date of delivery, with the exception of rotating machinery such as blowers, motors and fans, for which notice must be given by Buyer to Collins within one (1) year from date of delivery. Notice of a claimed defect in the design, workmanship or materials in any other item of Collins equipment, including but not limited to antennas, consoles and program automation systems, must be given to Collins within one (1) year after the delivery of such item of equipment; and

(2) The equipment is returned to Collins factory, transportation prepaid, in accordance with Collins instructions; and

(3) The failure of the equipment to meet its warranted condition is not caused by abuse or improper use, exposure to environmental conditions more severe than specified by Collins in equipment manuals, improper maintenance, repair or alteration by any person or organization other than Collins or Collins Service Center.

(c) Any equipment or goods sold hereunder which is not of Collins manufacture or of Collins design is sold subject only to the warranty or guaranty of the suppliers thereof and the buyer shall receive such adjustments as Collins may obtain from the suppliers thereof.

(d) The agreement of this paragraph does not extend to tubes, lamps, fuses and other expendable items which are normally replaced upon their failure as a part

of routine maintenance.

(e) Collins further guarantees that any radio transmitter described herein will deliver full radio frequency power output at the antenna lead when connected to a suitable load and operated from a conventional power source of required frequency as stated in the Collins advertised specifications and instruction manuals. Failure of a transmitter due to operation on a power source above or below recommended voltage shall not be a breach of this warranty. If the transmitter requires a 3-phase power source, operation from a simulated 3-phase power source is not recommended and failure of the transmitter to properly operate shall not be a breach of this warranty.

(f) The Buyer acknowledges that he has read and is familiar with the published specifications for the equipment and goods sold hereunder and, relying upon his own judgment or the judgment of a consultant hired by him, has satisfied himself that the equipment is fit for buyer's intended purpose.

(g) In the event a warranty implied by law is, or becomes applicable to the equipment sold hereunder, Buyer's sole right and remedy against Collins for breach of that implied warranty shall be limited to the refund of the purchase price, repair, or replacement of the equipment provided the breach of such implied warranty and notice thereof occurs within one (1) year from the date of delivery of such equipment.

(h) The remedies set forth in this paragraph are exclusive and constitute buyer's sole right and remedy under this agreement. In no event shall Collins have any liability for consequential damages or for loss, damage or expense directly or indirectly arising from the use of the equipment sold hereunder, or any inability to use them separately or in combination with other equipment or material, or from any other cause.

(i) The guarantees of this section and limitations thereon will also accrue to the benefit of any purchaser of Buyer's FCC license, provided:

(1) Notice of the sale of the FCC license is given by Buyer to Collins in writing within thirty (30) days after the consummation of said sale; and

(2) No greater rights are granted to the purchaser of Buyer's FCC license than are granted herein to Buyer.

The foregoing is not applicable to amateur equipment which equipment is sold under the guarantee printed in the instruction book accompanying such equipment.

9. PATENTS. Collins agrees that it will defend, at its

# Conditions of Sale

own expense, all suits against Buyer for infringement of any United States patent or patents covering, or alleged to cover, either said apparatus itself in the form sold by Collins, or the normal operation thereof, where the only issue in such infringement suits involves the Buyer's use of said apparatus, as so sold, for the purpose and in the manner contemplated by this agreement, and Collins agrees that it will pay all sums which, by final judgment or decree in any such suits, may be assessed against the Buyer on account of such infringement, provided that Collins shall be given (i) immediate written notice of all claims of any such infringement and of any suits brought or threatened against Buyer, and (ii) authority to assume the sole defense thereof through its own counsel and to compromise or settle any suit so far as this may be done without prejudice to the right of the Buyer to continue the use, as contemplated, of the apparatus so purchased. If in any such suit so defended the apparatus is held to constitute an infringement and its use is enjoined, or if in the light of any claim of infringement Collins deems it advisable to do so, Collins may either procure the right to continue the use of the same for the Buyer, or replace the same with non-infringing apparatus, or modify said equipment so as to be non-infringing, or take back the infringing apparatus and refund the purchase price less a reasonable allowance for use, damage or obsolescence. Any indirect, remote or consequential damages which may occur as a result of any such infringement are expressly negated, and the complete liability of Collins for any such infringement, or claim of infringement, shall be limited to its agreements herein contained.

10. SUBSTITUTIONS AND MODIFICATIONS. Collins reserves the right to modify the design and specifications of equipment designed by Collins provided that the modification does not adversely affect the performance.

# Price, and the Collins Sound

Just what is “the Collins sound?” Some of our customers describe it as another dimension, something you can **feel**. They call it “**the Collins presence.**” This unique extrasensory sound quality and the established track record of long-life operation have given Collins transmitters a pretigious reputation over the past 40 years. If you’ve always wished for a Collins transmitter but felt you couldn’t afford it, take a closer look at Collins prices today.

Collins transmitters are priced competitively for initial purchase considerations, and cost less to own and operate in the long run. It pays to own Collins. Your audience can hear the difference—just ask them.

Business demands that you look beyond the initial price. Over 100 years ago a prominent philosopher once expressed this concept: “**It’s unwise to pay too much, but it’s worse to pay too little. When you pay too much, you lose a little money—that is all. When you pay too little you sometimes lose everything, because the thing you bought was incapable of doing the thing it was bought to do. The common law of business balance prohibits paying a little and getting a lot—it can’t be done. If you deal with the lowest bidder it is well to add something for the risk you run, and if you do that you will have enough to pay for something better.**”

Wouldn’t you really rather have your listeners hear the superior sound of a Collins transmitter?

# Indexes



# Index of Manufacturers

## Manufacturer (Vendor) Index

	page		page
Abco	81	Otari	84
Ampex	82, 83	Orban	71
Andrew	49		
Argos	94	Panasonic/Technics	67, 68
Aristocart	79	Phelps-Dodge	41, 49
Atlas	92	Pioneer	96, 125
Audiolab	80	Pi-Rod	47
Audio Pak	79	Potomac Instruments	117, 118, 122
		Primo	90, 91
B&W	122	Prodelin	49
Belar	113, 114		
Belden	98	Rank Industries	62
Broadcast Electronics (Spotmaster)	78, 79	Revox	84
Broadcast Sound Associates	97	Robins	80
Bud	98	Russco	64, 66, 70
Cablewave	49	Sansui	76
Cannon	99	Scala	104
Crown	75	Scully/Metrotech	85, 86, 87
		Sennheiser	96
Dale	53	Sequerra	115
Davis	94	Shure	68, 69, 92, 107, 108
Decibel Products	102	SMC	78
Delta	121	Spotmaster	78, 79
Dictaphone/Scully	87	Stanton	69
Digitec (Monsanto)	123	States	52
Dolby	75		
Dorrrough	71	TEAC	64, 87
		Telechron	97
Electro Impulse	52	Telex	88, 96
Electronic Research	54	Texas Electronics	120
Electro-Voice	90, 94, 95	TFT	111, 116, 117, 119
EMCOR	98	Thomson-CSF	72, 73
		Trimm	97
Fidelipac	79, 80, 81		
Fisher-Pierce	52	Union Metal	48
Flexo	93	UREI	65, 66, 74, 75, 76
Fluke	123, 124	Utility Tower	48
Frazier	95		
		Westclox	97
Hughey and Phillips	51		
International Tapetronics (ITC)	76, 77, 83		
Keldon	106		
Kintronics	53		
Luxo	93		
3M	88		
Magneraser	80		
Mark Products	102		
Marti Electronics	101, 102, 103, 104, 105, 108, 109		
Micro-Trak	54, 63, 68, 69, 70, 82, 107		
Monsanto/Digitec	123		
Moseley	73, 103, 104, 106, 110		

# Product Index

	page		
Alignment Tape, Cartridge	80	Impedance Bridges	121
Amplifier, Compressor/Mixer	71	Insulator, Bowl Feed-Through	54
Amplifier, DC Operational	109	Jack Panels	97
Amplifier, Power	106	Lightning Arresters	53
Amplifiers, AM RF	115	Logger, Tape	87
Amplifiers, Audio	75	Meter Panel, Extended, AM & FM	31
Amplifiers, Distribution	73	Microphones	89-92
Amplifiers, FM RF	114	Microphone Arms	93
Amplifiers, Limiter	71, 102, 108	Microphone Mixer	107
Antenna, Accessories	51	Microphone Stands	92
Antenna, Directional FM	42	Mixer, Audio	64
Antenna, FM, Circularly Polarized	35	Monitors, AM Frequency & Modulation	114, 116
Antenna, FM, Educational	41	Monitors, Antenna	117
Antenna, FM, Horizontally Polarized	45	Monitors, FM Frequency & Modulation	113, 116
Antenna, FM, Vertically Polarized	46	Monitors, FM Stereo	113
Antenna, Heater Control System	54	Monitors, Off-Air	115, 125
Antenna, Mobile/Portable/Base	105	Monitors, SCA	113, 116
Antenna, Parabolic	102, 104	Multimeters	123
Antenna, Portable, Single Ring	105	On-Air Lights	97
Antenna, Rooftop Mounted, Vertical	106	Oscillator, Audio	122
Antenna Tuning Unit	54	Panels, Blank, Rack Cabinet	98
Antenna, Yagi	105	Patchcords and Panels	97
Audio Accessories	97	Phasing Equipment	33
Audio Console, Portable	106, 107	Phono Preamplifier/Equalizer	69
Beacon Lights	51	Pressure Pads, Replacement	80
Cartridges, Phono	69	Pole, Antenna Mounting	48
Cartridges, Tape	79	Quad Encoder/Mixer	76
Choke, Tower Lighting Filter	53	Rack, Cabinets	98
Clocks	97	Rack, Storage, Tape Cartridge	81
Connectors, Cannon	99	Receiver, AM-FM	125
Consoles, Audio, Stereo & Mono	57-65	Receiver, Remote Pickup	105
Contactors, RF	53	Remote Control Systems	108-111
Control Panel, Extended, AM & FM	32	Remote Pickup Link	106
Copper Ground Wire and Strap	51	Sampling Loop	54
Disco Audio Mixer	63, 107	Speakers	94
Distortion Meter	122	SCA Generator	19
Dolby Processor	75	Stereo Generator, FM	19
Dummy Loads	52	STL/Baseband Interface	20
Dynamic Presence Equalizer	73	STL Systems and Accessories	101
EBS Systems	119	Subcarrier Generator, STL	103, 104
Erasers, Tape	80	Subcarrier Receiver, STL	103
Exciter, FM	17	Tape, Accessories	80
Field Intensity Meter	118	Tape, Bulk	80, 88
Field Strength Meter	121, 122	Tape Recorders & Reproducers, Cartridge	76
Filter, Variable Bandpass	66	Tape Recorders & Reproducers, Reel-to-Reel	82
Frequency Counters	123	Tone Arms	68
Furniture, Studio	70	Towers, AM & FM	47
Graphic Equalizer	76	Transformer, Antenna Current	53
Ground Screen	51		
Headsets	96		



# Product Index

Transformer, Isolation .....	55
Transformer, Ring .....	51
Transmission Line and Accessories .....	49
Transmitter, AM 10 kW .....	27
Transmitter, AM 5 kW .....	25, 27
Transmitter, AM 1 kW .....	21
Transmitter, FM 50 kW .....	1
Transmitter, FM 40 kW .....	1
Transmitter, FM 25 kW .....	7
Transmitter, FM 20 kW .....	7
Transmitter, FM 10 kW .....	9
Transmitter, FM 5 kW .....	11
Transmitter, FM 2.5 kW .....	13
Transmitter, FM 1 kW .....	13
Transmitter, FM, 10 Watt Educational .....	15
Transmitter, Remote Pickup .....	104
Transmitter Switching Equipment, Automatic Combiner Control .....	5
Transmitter Switching Equipment, Automatic Exciter Control .....	5
Turntable Furniture .....	70
Turntables .....	66
Weather Instruments .....	120
Wire and Cable .....	98





for further information contact:

Collins Radio Group  
Rockwell International  
Broadcast Products  
Dallas, Texas 75207

(214) 690-5574



**Rockwell International**