



INSTRUCTION BOOK

FOR

300G

AM BROADCAST TRANSMITTER

COLLINS RADIO COMPANY
CEDAR RAPIDS, IOWA

WARNING

OPERATION OF THIS EQUIPMENT INVOLVES THE USE OF HIGH VOLTAGES WHICH ARE DANGEROUS TO LIFE. OPERATING PERSONNEL SHOULD AT ALL TIMES OBSERVE ALL THE SAFETY RULES LISTED BELOW. DO NOT CHANGE TUBES OR MAKE ADJUSTMENTS INSIDE EQUIPMENT WITH HIGH VOLTAGE SUPPLY ON. DO NOT DEPEND UPON DOOR SWITCHES FOR PROTECTION BUT ALWAYS SHUT DOWN POWER EQUIPMENT AND OPEN MAIN SWITCH IN POWER SUPPLY CIRCUIT. ALWAYS DISCHARGE AND GROUND CIRCUITS PRIOR TO TOUCHING THEM.

Since the use of high voltages which are dangerous to human life is necessary to the successful operation of the radio transmitting equipment covered by these instructions, certain precautionary measures must be carefully observed by the operating personnel during the adjustment and operation of the equipment.

The major portions of the equipment are within metal cabinet enclosures, provided with access doors which are generally fitted with safety interlock switches which remove dangerous voltages within the cabinets when access doors are open.

Interlocks are also provided on certain removable panels within the cabinets. Other panels, if removed, will not cause interlocks to function and will thereby

allow access to circuits carrying voltages dangerous to human life.

KEEP AWAY FROM LIVE CIRCUITS

Under no circumstances should any person reach within a cabinet with interlocked gates while power supply line switches to the equipment are closed; or handle any portion of exposed equipment which is supplied with power; or to connect any apparatus external to the cabinets to circuits within the cabinets; or to apply high voltages to the equipment even for testing purposes while any non-interlocked portion of the cabinet is removed. Whenever feasible in testing circuits, make continuity and resistance checks rather than directly checking voltage at various points when any high voltage is applied to the transmitter circuits.

DON'T SERVICE OR ADJUST ALONE

Under no circumstances should any person reach within a cabinet for the purpose of servicing or adjusting the equipment without the presence or assistance of another person capable of rendering aid.

DON'T TAMPER WITH INTERLOCKS

Door or safety interlock switches should not be removed or short circuited, nor should reliance be placed upon the interlock switches for removing voltages from the equipment.

5-12-45
CORRECTING

ADDENDA

The following notes have been compiled to correct discrepancies that appear in this instruction book and to add information that has been omitted.

1. The audio input circuit of the 300G transmitter is intended to be used with audio equipment having output impedances of 600 ohms rather than 500 ohms as stated in several instances in this instruction book. All references to 500 ohm input impedance should be 600 ohms.

2. Page 2-4. - The output circuit, as shown in figure 2-4, is in error. Refer to figure 9-5, page 9-7/9-8 for the connections as included in your transmitter. The lead from the loading inductor to the "T" section should be shown connected to the center of the loading inductor.

3. Page 2-1. Paragraph b. - TUNING MOTORS. The statement - "The power for application to the tuning motors is supplied by a 115 volt transformer, Item 25.", may be somewhat misleading. The primary voltage is 115 volts but the secondary voltage, the voltage applied to the motors, is actually 24 volts.

4. Throughout this book you will find references to and illustrations showing the push type of start and stop filament and plate switches. This type of switch has become difficult to procure and a new type of switch, the pull-to-start and push-to-stop type, is being used in 300G transmitters now being built.

5. Figure 2-6 and paragraph b., page 2-5, indicate only one oscillator filament circuit as being energized. It will be noted, referring to figure 9-5, that filament voltage is applied to both oscill-

ator tubes whenever the filament relay is operated.

6. Figure 2-9, page 2-6, indicates that 115 volts is applied to the oscillator crystal heater circuit. This is an error. The voltage that is applied to the crystal heater is 12 volts.

7. Figure 2-12, page 2-9. The capacity of the feedback capacitors, Items 45, in this illustration is an error. The value of these capacitors is actually 5600 mmf instead of the 2000 mmf shown on the schematic.

8. Not included in the list of tubes on page 3-8 are the six 866-866A rectifier tubes. The correct filament voltage for these tubes is 2.5 volts.

9. Page 3-9. Step 4 under OSCILLATOR ADJUSTMENT. It has been found that the normal operating current of the oscillator varies between 10 and 27 ma, depending upon frequency, instead of the 20 to 25 ma that is stated under this adjustment procedure. In addition, experience has proven that a preferable method of starting the oscillator is to change the coupling between the oscillator output circuit and the grid of the following stage by varying the coupling capacitor, Item 59. If the oscillator cannot be started by varying the coupling it is recommended that a new crystal be procured.

10. It might be well to point out that the modulator current meter indicates total modulator current when the TUNE-METER SELECTOR switch is in the 807 PLATE, FINAL AMPLIFIER PLATE or MODULATOR PLATES LOADING position.

(300G) (3-28-47)

Handwritten notes:
...
...
...
...
...

TABLE OF CONTENTS

<u>Paragraph</u>	<u>Page</u>
SECTION 1. GENERAL DESCRIPTION	
1. General	1-1
a. Purpose of Equipment	1-1
b. Mechanical Description	1-1
c. Electrical Description	1-1
2. Reference Data	1-2
a. Frequency Range	1-2
b. Character of Emission	1-2
c. Power Output	1-2
d. Power Source and Input Requirements	1-2
3. Vacuum Tube Complement	1-2
SECTION 2. THEORY OF OPERATION	
1. Mechanical Theory	2-1
a. General	2-1
b. Tuning Motors	2-1
2. Electrical Theory	2-1
a. AC Primary Circuits	2-1
b. Filament Circuits	2-5
c. Low Voltage Supply	2-6
d. High Voltage Supply	2-6
e. RF Circuits	2-7
f. Audio Circuits	2-8
g. Metering Circuits	2-9
SECTION 3. INSTALLATION AND INITIAL ADJUSTMENTS	
1. Installation	3-1
a. Preliminary	3-1
b. Installation Procedure	3-1
2. Initial Adjustments	3-5
a. General	3-5
b. Function of Controls	3-5
c. Outline of Adjustments	3-6
d. Energizing the Equipment	3-6
e. Power Circuit Check	3-7
f. Filament Circuit Adjustment	3-8
g. Tuning Adjustments	3-8
SECTION 4. OPERATION	
1. General	4-0
2. Initial Operation	4-0
a. Starting Equipment	4-0
b. Stopping Equipment	4-2
3. Routine Operation	4-2
a. Starting Equipment	4-2
b. Stopping Equipment	4-2
SECTION 5. OPERATORS MAINTENANCE	
1. General	5-1
2. Routine Checks	5-1
3. Voltage and Current Checks	5-1
4. Fuse Replacement	5-1

<u>Paragraph</u>	<u>Page</u>
5. Circuit Breakers -----	5-1
6. Tube Replacement -----	5-1
7. Room Temperature -----	5-3

SECTION 6. PREVENTATIVE MAINTENANCE

1. Cleaning -----	6-0
a. Transmitter General -----	6-0
b. Air Filter -----	6-0
2. Lubrication -----	6-0
a. Ventilating Blower -----	6-0
b. Tuning Motors and Assemblies -----	6-0
3. Routine Checks -----	6-0
a. Tube Check -----	6-0
b. Mechanical Inspection -----	6-0

SECTION 7. CORRECTIVE MAINTENANCE

1. General -----	7-1
2. Trouble Shooting -----	7-1
a. Tube Failure -----	7-1
b. Isolating the Trouble -----	7-1
c. Power Supply Troubles -----	7-1
d. Distortion -----	7-2
e. Parasitic Oscillations -----	7-2
f. Power Amplifier Stage not Neutralized -----	7-2
g. Failure of Oscillator Unit -----	7-2
h. Ventilating Blower -----	7-2
i. Tuning Motors -----	7-2
3. Servicing the Equipment -----	7-3

SECTION 8. TABLE OF REPLACEABLE PARTS

Color Code -----	8-10
------------------	------

SECTION 9. MISCELLANEOUS PHOTOGRAPHS AND DRAWINGS

GUARANTEE

This equipment is guaranteed against defects in material, workmanship or manufacture, for a period of one year from the date of delivery. Our obligation under this guarantee is limited to repairing or replacing any item which shall prove, by our examination, to be thus defective, provided the item is returned to the factory for inspection with all transportation charges paid. Before returning any item believed to be of defective material, workmanship or manufacture, a detailed report must be submitted to the company giving exact information as to the nature of the defect. The information shall include, in as much detail as possible, all subject material listed under instructions for replacement of parts. Upon receipt of the report by the company, a returned equipment tag will be forwarded to the shipper without delay. **THE RETURNED EQUIPMENT TAG MUST ACCOMPANY ALL SHIPMENTS OF DEFECTIVE PARTS. NO ACTION WILL BE TAKEN ON ANY EQUIPMENT RETURNED TO THE COMPANY UNLESS THE SHIPMENT INCLUDES THE RETURN TAG.**

COLLINS RADIO COMPANY

LIST OF ILLUSTRATIONS

<u>Figure</u>	<u>Title</u>	<u>Page</u>
1-1	300G Radio Broadcast Transmitter (510 0320 00)	1-0
1-2	40F Frequency Control Unit (6978)	1-1
1-3	Functional Block Diagram (Inst 800X)	1-1
2-1	Tuning Motor Assembly (503 2269 002)	2-1
2-2	300G Transmitter—Rear Open View (9758)	2-2
2-3	300G Transmitter—Front Open View (9757)	2-3
2-4	Motor Driven Circuits (503 2270 003)	2-4
2-5	Power Control Circuits (503 2259 001)	2-4
2-6	Filament Circuits (503 2268 002)	2-5
2-7	Low Voltage Rectifier Circuit (503 2265 001)	2-5
2-8	High Voltage Rectifier Circuit (503 2264 001)	2-6
2-9	Oscillator Circuit Schematic (503 2263 001)	2-6
2-10	40F Frequency Control Unit—Open View (6779)	2-7
2-11	297 Crystal Oven (503 2267 002)	2-8
2-12	Audio Driver and Modulator Schematic (503 2271 003)	2-9
2-13	Metering Circuits (503 2272 003)	2-9
3-1	Floor Plan for Installation (508 0899 20)	3-1
3-2	300G Transmitter—Top Rear View (9761)	3-2
3-3	300G Transmitter—Bottom Rear View (9762)	3-4
3-4	Power Level Switch (503 2262 001)	3-5
3-5	Test Meter Switch (503 2258 001)	3-5
3-6	Tune Meter Selector Switch (503 2261 001)	3-5
3-7	Tuning Control Switch (503 2260 001)	3-6
3-8	Block Diagram of Adjustments	3-6
3-9	Block Diagram of Power Circuit Checks	3-7
3-10	Block Diagram of Panel Control Functions	3-9
3-11	300G Transmitter—Front Open View (9757)	3-10
3-12	RF Tuning Curves (503 2266 002)	3-12
4-1	300G Transmitter—Front View Closed (510 0320 00)	4-1
5-1	300G Transmitter—Front View Open (6973)	5-2
7-1	Door Panel—Inside View (9764)	7-4
7-2	300G Transmitter—Rear View Open (9758)	7-5
8-1	Audio Frequency Response and Distortion Curves for 100 Watt Operation	8-11
8-2	Audio Frequency Response and Distortion Curves for 250 Watt Operation	8-12
9-1	300G Transmitter—Bottom Front View (9760)	9-1
9-2	300G Transmitter—Top Front View (9763)	9-2
9-3	Transformer Winding Data (503 2273 004)	9-3 9-4
9-4	65Q-30 Cable Schematic (508 0597 10)	9-5
9-5	1100N Vertical Chassis Cabling Schematic (508 0143 50)	9-7 9-8
9-6	38N-1 Control and Meter Door Schematic (508 0194 30)	9-9
9-7	300G Complete Schematic (508 0145 40)	9-11 9-12
9-8	300G Simplified Schematic (508 0206 30)	9-13 9-14

REPLACEMENT OF PARTS

In case a replacement under the guarantee is desired, a full report must be submitted to the company. This report shall cover all details of the failure and must include the following information:

- (A) Date of delivery of equipment.
- (B) Date placed in service.
- (C) Number of hours in service.
- (D) Part number of item.
- (E) Item number (obtain from Parts List or Schematic Diagram).
- (F) Type number of unit from which part is removed.
- (G) Serial number of unit.
- (H) Serial number of the complete equipment.
- (I) Nature of failure.
- (J) Cause of failure.
- (K) Remarks.

When requisitioning replacement parts, the following information must be furnished:

- (A) Quantity required.
- (B) Part number of item.
- (C) Item number (obtain from Parts List or Schematic Diagram).
- (D) Type number of unit.
- (E) Serial number of unit.
- (F) Serial number of equipment.

NOTE: Blank Service Report forms will be found in the appendix of this instruction book.

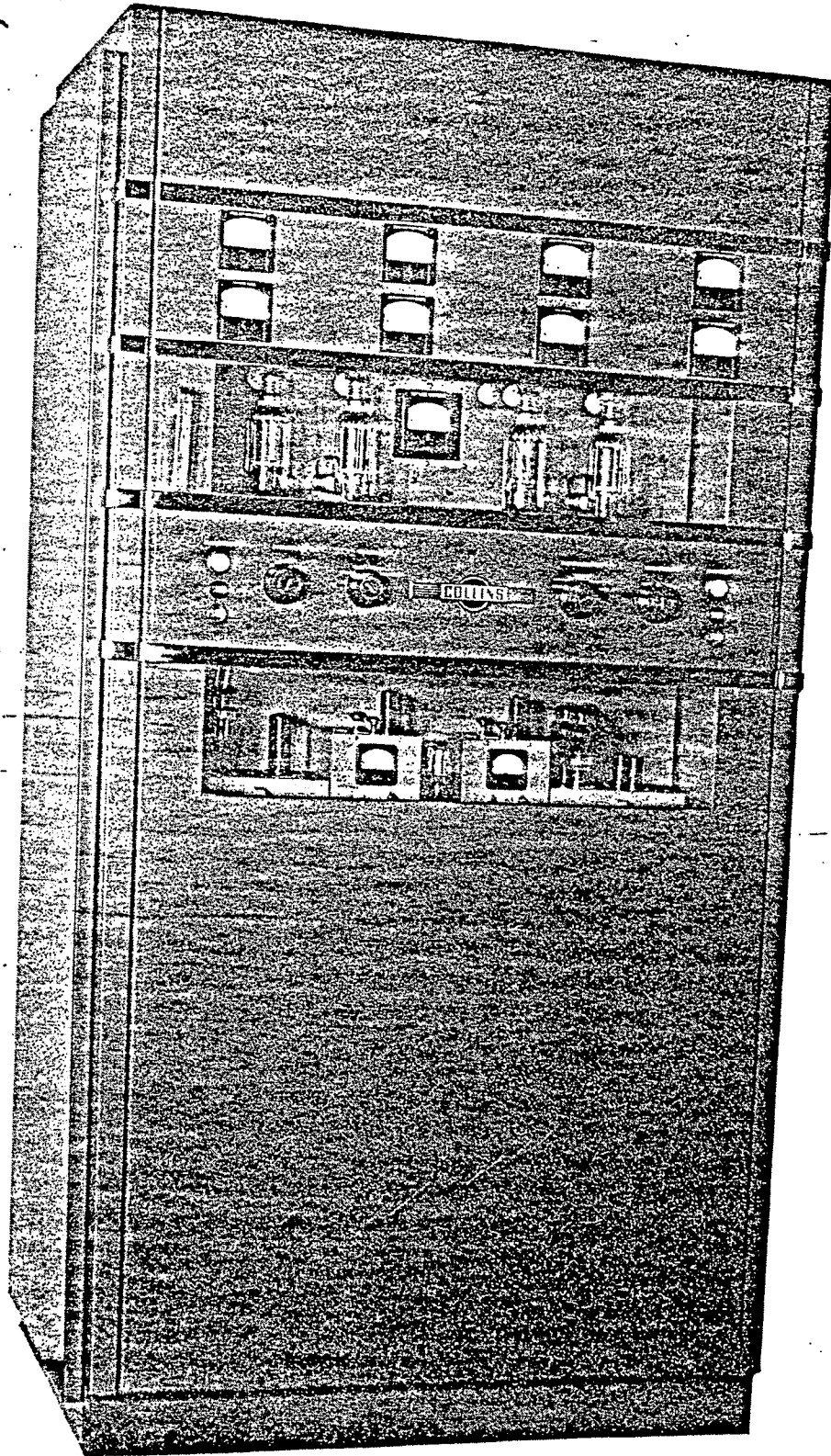

Figure 1-1. 300G Radio Broadcast Transmitter

SECTION 1

Serial #109

GENERAL DESCRIPTION

1. GENERAL.

The purpose of these instructions is to serve as a guide to the installation, adjustment, operation and maintenance of the Collins type 300G Radio Broadcast Transmitter.

a. PURPOSE OF EQUIPMENT. — The Collins 300G Transmitter has been designed particularly for high fidelity broadcast service. This transmitter is high level modulated with a Class B modulator system. The audio frequency system, employing a feedback circuit is designed to give exceptionally high fidelity.

b. MECHANICAL DESCRIPTION.—The transmitter is housed in a single cabinet of neatly styled appearance. The complete equipment occupies a space 29 3/4" deep by 41" wide by 78" high and weighs approximately 1,370 lb. The arrangement of the transmitter is such that all tubes are accessible from the front. Full vision of the power amplifier and modulator tubes is provided by means of glass windows in the access door. For service and maintenance purposes, full length hinged doors are provided on both the front and rear of the cabinet. This feature provides quick and convenient access to the working part of the transmitter. The doors are provided with high voltage interlocking switches for the protection of maintenance personnel.

The frequency control unit³ is of the "plug-in" type of construction. Two complete units are supplied with each equipment. A switch located on the front panel of the 33Q unit allows selection of either oscillator. The oscillator³ not in operation may be removed for repair or adjustment. A ventilating blower is located in the rear of the cabinet. The air is forced through ducts to the front of the upright chassis and circulated to cool the transmitter components. The air is drawn in through spun glass filters located in the rear doors of the cabinet. Three tuned circuits are motor driven, each circuit having a separate tuning motor. Two of these motors drive a flexible steel ribbon that varies the position of a slug in the network coil of their respective circuit. The third motor drives the rotor of a tuning capacitor in the intermediate amplifier stage.

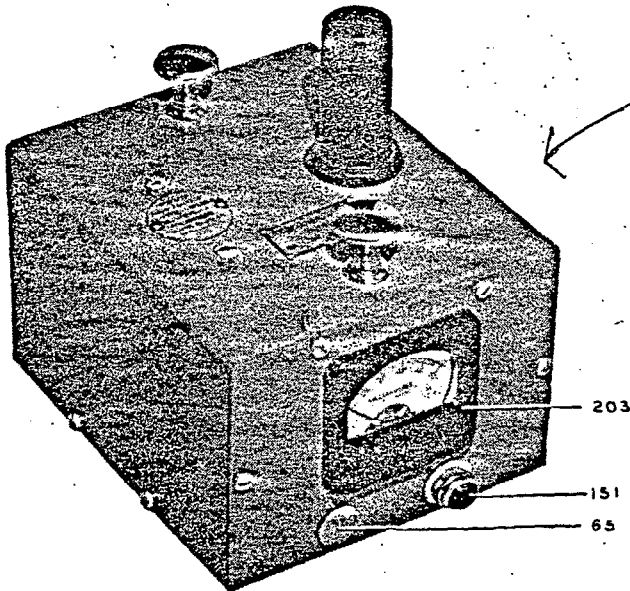

Figure 1-2. 40F Frequency Control Unit

c. ELECTRICAL DESCRIPTION.

(1) VOLTAGE SUPPLY.—Two rectifier sys-

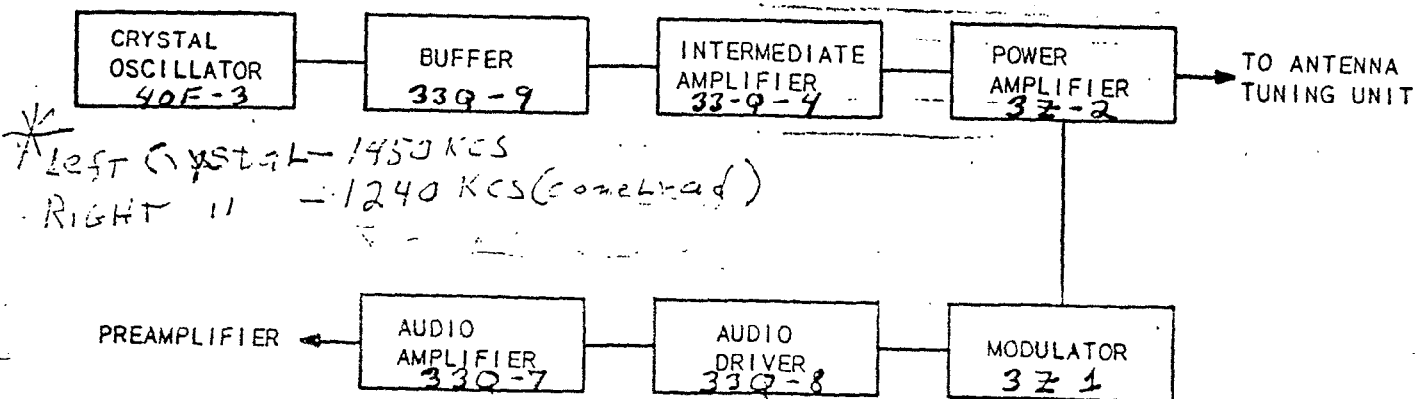

Figure 1-3. Functional Block Diagram

tems are employed in this transmitter to supply the necessary direct current voltage for application to the plates and screens of the transmitting tubes. One system employing two rectifier tubes supplies low voltage to the audio and exciter stages and bias for the modulators. The high voltage supply employs four rectifier tubes.

(2) AUDIO SYSTEM.—A single stage of audio amplification utilizes a pair of 6J5 tubes in a push-pull amplifier circuit. The audio driver employs a pair of 6A5G tubes operating Class A. The modulator circuit utilizes a pair of type 810 tubes operating Class B.

(3) RF CIRCUITS.—The equipment employs four r-f stages; an oscillator, a buffer, an intermediate amplifier and a power amplifier. The oscillator stage is controlled by a low temperature coefficient "AT" cut quartz plate crystal, providing an oscillator with a high degree of frequency stability. A Type 6L6 is employed as a buffer or isolation amplifier. The intermediate amplifier utilizes two Type 807 beam pentode tubes in a parallel connected circuit. The intermediate amplifier plate tank circuit is also used as the grid circuit of the power amplifier tubes. The power amplifier employs two Type 810 tubes in a parallel connected circuit. The plate tank and output network is a combination pi-network and "T" section filter. The variables in the tank and loading networks are inductors; one for tuning the tank circuit and the other for loading. A pickup coil is connected from the antenna terminal to ground to provide a means of coupling the monitoring equipment to the output of the transmitter. No monitoring equipment is provided as a standard accessory. The 300G transmitter is intended for use with an external antenna tuning unit to which it is connected by means of a concentric transmission line. The transmitter is designed for operation with an external program amplifier such as the Collins' Type 6M or 26W.

2. REFERENCE DATA.

a. FREQUENCY RANGE.—This transmitter is designed for use in the broadcast band only and will operate on any one frequency in the range 540 to 1600 kc. After the frequency of operation has once been set, any substantial change in frequency may require modification of the output tank cir-

cuit capacities as well as changes in the neutralizing system.

The oscillator unit is a crystal controlled heat compensated unit. The crystal frequency being the same as the output frequency desired.

b. CHARACTER OF EMISSION.—The modulation system of the 300G transmitter is designed to provide full 100% modulation of the carrier at modulating frequencies between 30 and 10,000 cps. The carrier frequency deviation is held to within 10 cps of the assigned value.

c. POWER OUTPUT.—The transmitter will deliver 250 watts of radio frequency power, on any frequency within the range of 540 to 1600 kc, into a resistive transmission line load having an impedance value of 70 to 200 ohms. Provision is made for instantaneous reduction of power to 100 watts by reducing the plate voltage on the power amplifier tubes.

d. POWER SOURCE AND INPUT REQUIREMENTS.—This equipment has been designed to operate from a 115 volt 1 phase 60 cps or 208/230 v neutral power system. The maximum power demand at 100% modulation with a modulating frequency of 400 cps is approximately 1.7 kw. When modulated at average program level, the power requirement is approximately 1.5 kw at a power factor of 85%.

An audio input level of approximately +19 dbm* is required for full 100% tone modulation. The audio input impedance is 500 ohms.

* 1 milliwatt reference level — 600 ohm base.

3. VACUUM TUBE COMPLEMENT.

The vacuum tubes employed in the 300G equipment are listed below:

Quantity	Tube Type	Function	Unit
2	6F6	R-F oscillator	40F -3
1	6L6	Buffer	33Q -9
2	807	Int. amplifier	33Q -4
2	6J5	Audio amplifier	33Q -7
2	6A5G	Audio driver	33Q -8
2	866/866A	L.V. rectifier	401W -5
4	866/866A	H.V. rectifier	401W -6
2	810	Modulator	3Z -1
2	810	Power amplifier	3Z -2

SECTION 2
THEORY OF OPERATION

See Page 1-1

1. MECHANICAL THEORY.

a. GENERAL.—The 300G Radio Transmitter is housed in a single cabinet. Most of the components are mounted on a vertical chassis inside the cabinet. Components mounted on this chassis have mounting holes that are tapped in the vertical chassis to hold the securing bolts in place while the nut is removed or replaced. All operating controls in the 300G Transmitter are located conveniently on the front of the cabinet. They consist of a filament power control, a plate power control, a power level switch, a meter selector switch, and a single tuning control which serves to control all the tuning adjustments in the transmitter. Full control of all the motor driven variable tuning elements is provided by the selective tuning selector switch and the tuning control knob. Both sides of the vertical chassis are utilized. The following units are mounted on the vertical chassis:

- Unit A 11M Output Network
- Unit B 3Z Final & Modulator ²⁺¹
- Unit C 33Q R-F & Audio Driver ³⁺⁸
- Unit D 401W ⁵⁺⁶ Rectifier & Relay Unit
- Unit E is mounted on the cabinet base.

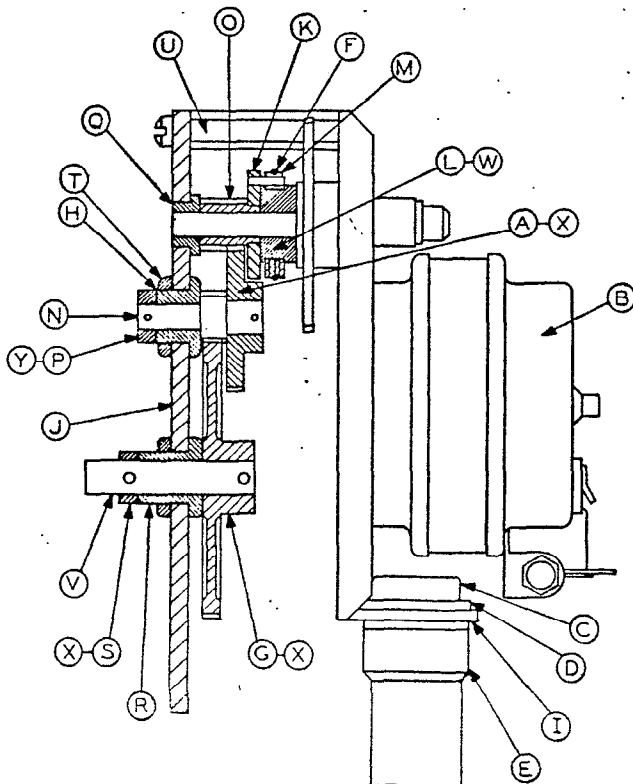

Figure 2-1. Tuning Motor Assembly

The two frequency control units (40F) are of the plug-in type. Two receptacles are provided on the 33Q front panel for these control units. The units are identical so that there is no possibility of damaging the equipment by plugging a unit into the wrong receptacle.

b. TUNING MOTORS.—Three tuning motors are used to tune the 300G. The three motor driven circuits are (refer to figure 2-4) the 807 plate circuit, power amplifier plate tuning, and the antenna loading network. The power for application to the tuning motors is supplied by a 115 volt transformer, Item 25. Operation of the tuning motors is controlled by the tuning control switch, Item 17, and the tuning selector switch, Item 116.

2. ELECTRICAL THEORY.

a. AC PRIMARY CIRCUITS. (Refer to figure 2-5.)—All power contactors in the equipment are of the 115 volt ac type. All power circuits are controlled by opening or closing the transformer primary circuits. The 300G transmitter uses a constant voltage transformer to supply power to the

	COLLINS PART NO.	ITEM
A	990 2120 00	48P 48T 1" P.D. Spur Gear
B	230 7000 00	24 v Tuning Motor
C	369 1001 00	Plug
D	369 2000 00	Retainer
E	369 3000 00	Receptacle
F	340 7040 00	Ring Spring
G	507 3878 00	Spur Gear
H	502 0468 001	Bushing
I	507 3869 00	Bracket
J	507 3868 00	Bearing Plate
K	507 3867 00	Clutch Pin Plate
L	507 3866 00	Clutch Drum
M	507 3865 00	Clutch Ring
N	507 3864 00	Pinion
O	507 3863 00	Pinion
P	502 0466 001	Collar
Q	507 2828 50	Oilite Bearing
R	500 2684 00A	Bushing
S	500 6537 00A	Collar
T	507 0054 00	Nut
U	500 5952 00A	Standoff
V	502 0370 001	1/4" Shaft
W	311 7010 00	7/0 Taper Pin 1/2"
X	311 6000 00	6/0 Taper Pin 3/8"
Y	311 5010 00	5/0 Taper Pin 1/2"
Z	311 7000 00	7/0 Taper Pin 3/8"

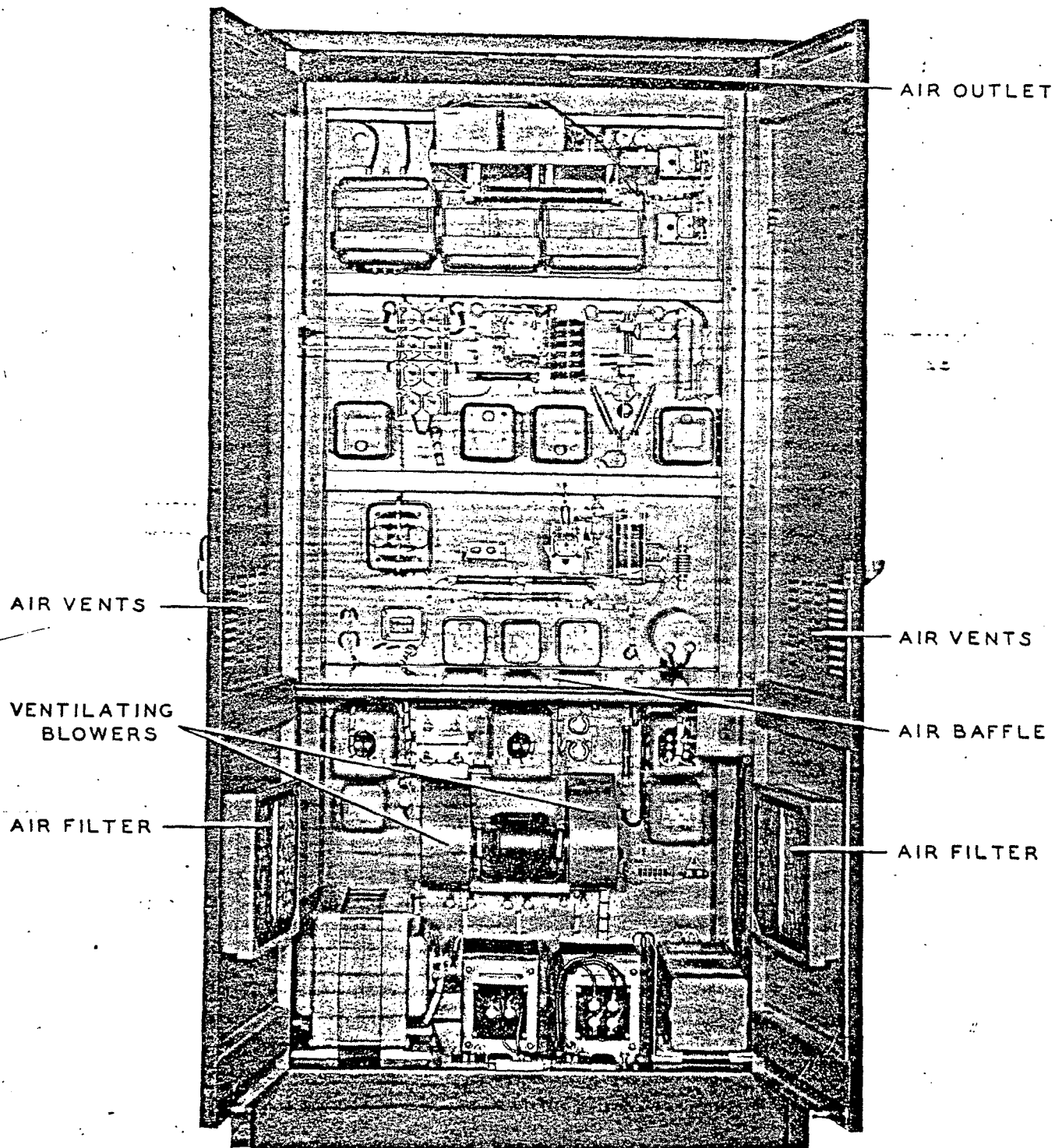

Figure 2-2. 300G Transmitter — Rear Open View

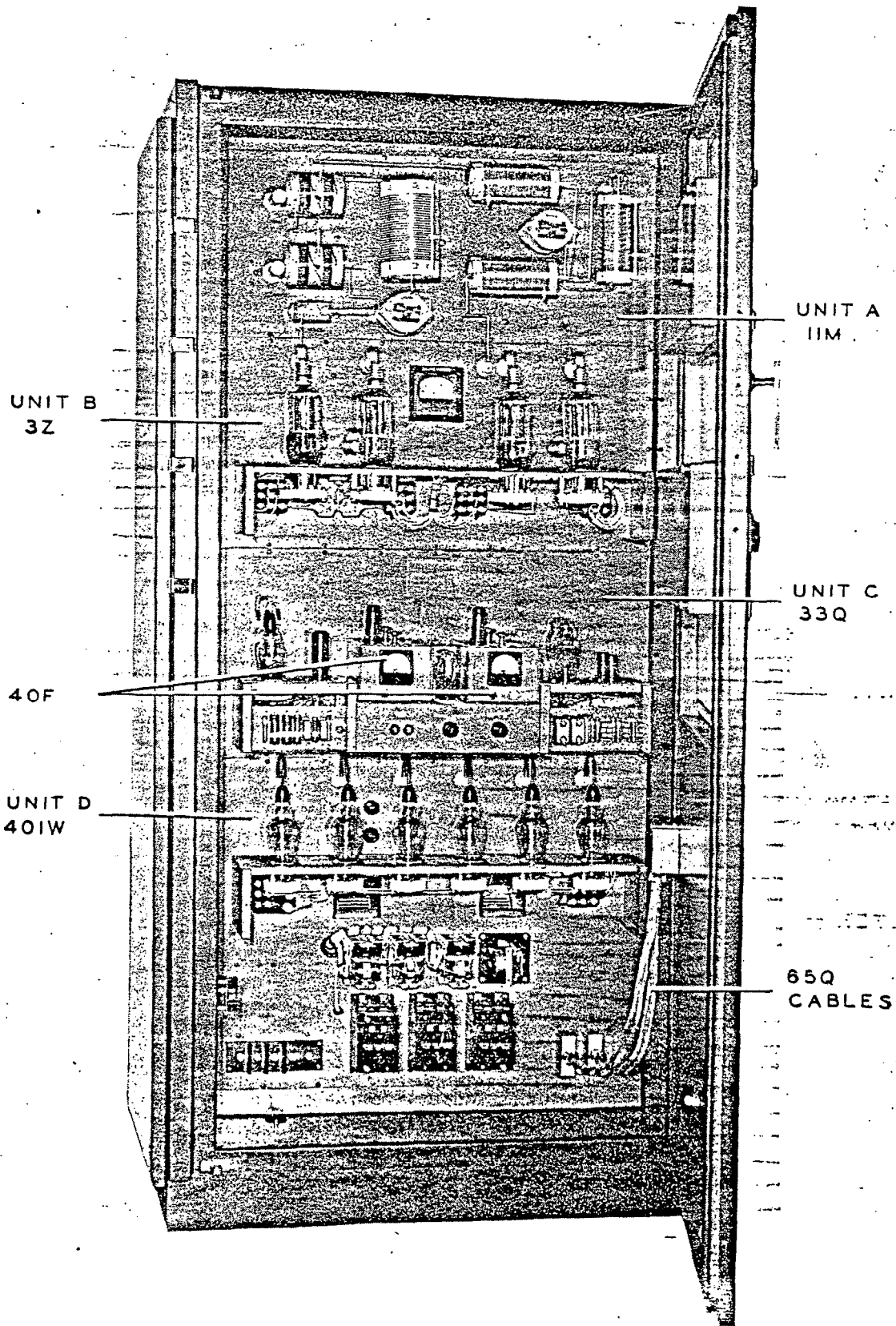

Figure 2-3. 300G Transmitter — Front Open View

the time delay relay will close the contacts required for the operation of the low voltage plate relay which when energized will complete the circuit up to the low voltage circuit breaker, Item 7.

However, before the low voltage supply will be energized, it will be necessary to close the LOW VOLTAGE SUPPLY circuit breaker, Item 7. Before high voltage can be applied to the modulator and power amplifier tubes it will be necessary to

close the HIGH VOLTAGE SUPPLY circuit breaker, Item 6. When the circuit breaker has been closed, the relay, Item 2, may be operated by pressing the PLATE POWER START button, Item 18. The relay, Item 2, will be held operated through the FILAMENT POWER STOP button, Item 13, the PLATE POWER STOP button, Item 18, the door interlock switches, Item 19, the normally open contacts 2-2 and the circuit breaker, Item 5. The operation of the relay, Item 2, will energize the plate transformer, Item 22, and the PLATE POWER pilot lamp, Item 153.

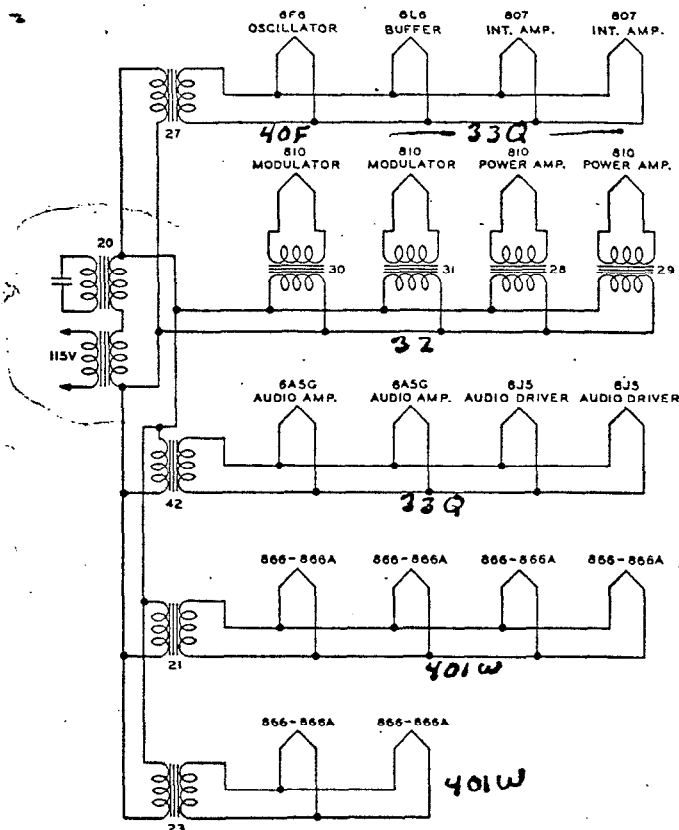

Figure 2-6. Filament Circuits

b. FILAMENT CIRCUITS. (Refer to figure 2-6.)

Filament power for all tubes in the transmitter is supplied by stepdown transformers that are located in the same unit as the tubes that are being supplied. All filament transformers are energized by power from the constant voltage transformer which is energized when the contacts of Item 1 are closed. The constant voltage transformer is employed to provide the best possible filament voltage regulation. However, all filament transformers are provided with taps on the primary windings to facilitate raising or lowering the secondary voltage. Transformer, Item 27, furnishes filament voltage for the 6F6 oscillator, the 6L6 buffer and the two 807 intermediate amplifier tubes. Transformer, Item 42, furnishes voltage to the two 6A5G audio amplifier tubes and the two 6J5 audio driver tubes.

Separate filament transformers are provided for each rectifier system, the modulator and the power amplifier tubes. Transformer, Item 21, furnishes voltage for application to the filaments of the high voltage rectifiers (four 866/866A). Transformer, Item 23, furnishes voltage for application to the filaments of the low voltage rectifiers (two 866/866A). Transformers, Items 30 and 31, furnish filament voltage for the two modulators (810's). Transformers, Items 28 and 29, furnish voltage for application to the filament of the two power amplifier tubes (810's).

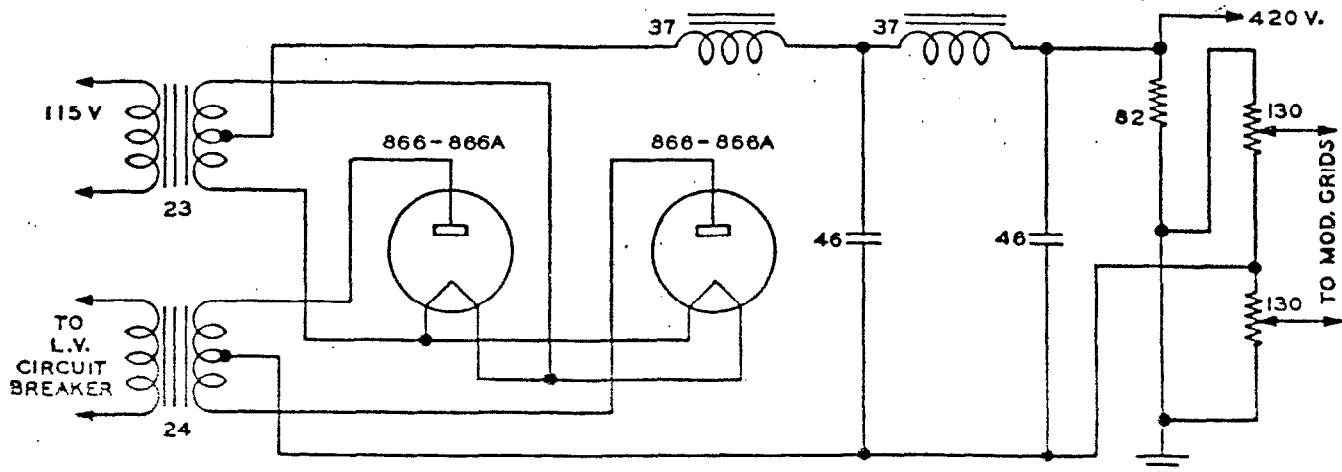

Figure 2-7. Low Voltage Supply

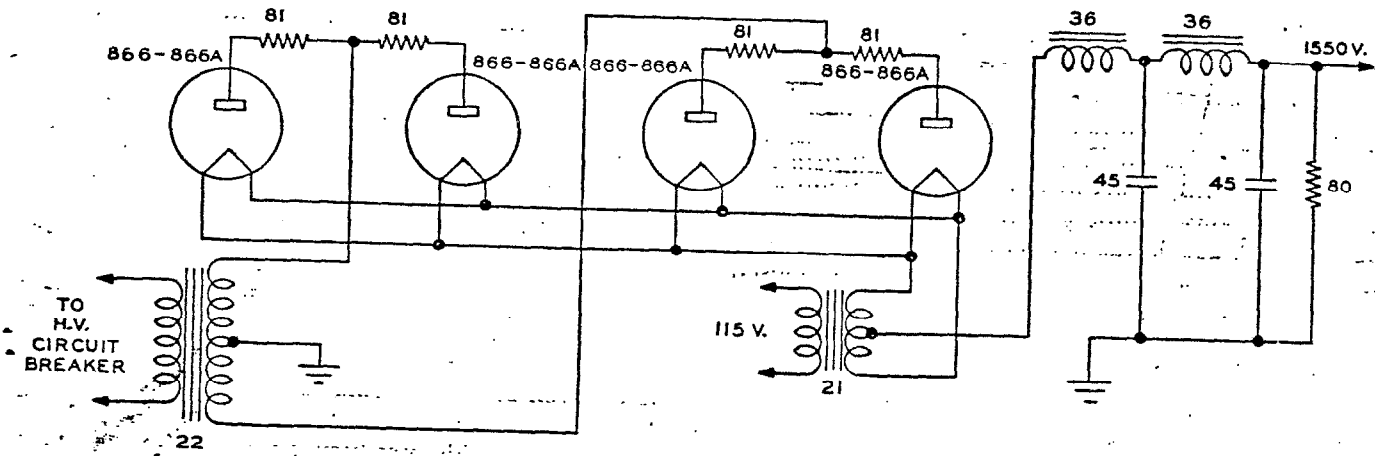

Figure 2-8. High Voltage Supply

401w-5
 c. **LOW VOLTAGE SUPPLY.** (Refer to figure 2-7.)—Two Type 866/866A half wave mercury vapor rectifier tubes are connected in a full wave rectifier system. Plate voltage is applied to the low voltage rectifiers by the operation of the time delay relay, Item 4, and the closing of the low voltage circuit breaker after approximately 30 seconds have elapsed. The output of the rectifiers is filtered by a two section choke input filter. The negative side is above ground potential. The voltage from this supply is reduced through a voltage dividing system for application to the plates and screens of the oscillator.

339 9
 buffer, audio amplifier and audio driver tubes. The full output voltage is applied to the plate of the intermediate amplifier tubes. In addition to supplying low voltage to the stages mentioned above, this supply furnishes bias for the modulator tubes. The rheostats, Item 130, provide a means of varying this bias.

401w-6
 d. **HIGH VOLTAGE SUPPLY.** (Refer to figure 2-8.)—The high voltage supply employs four half wave rectifiers in a full wave rectifier system. Plate voltage is applied to the high voltage rectifiers after

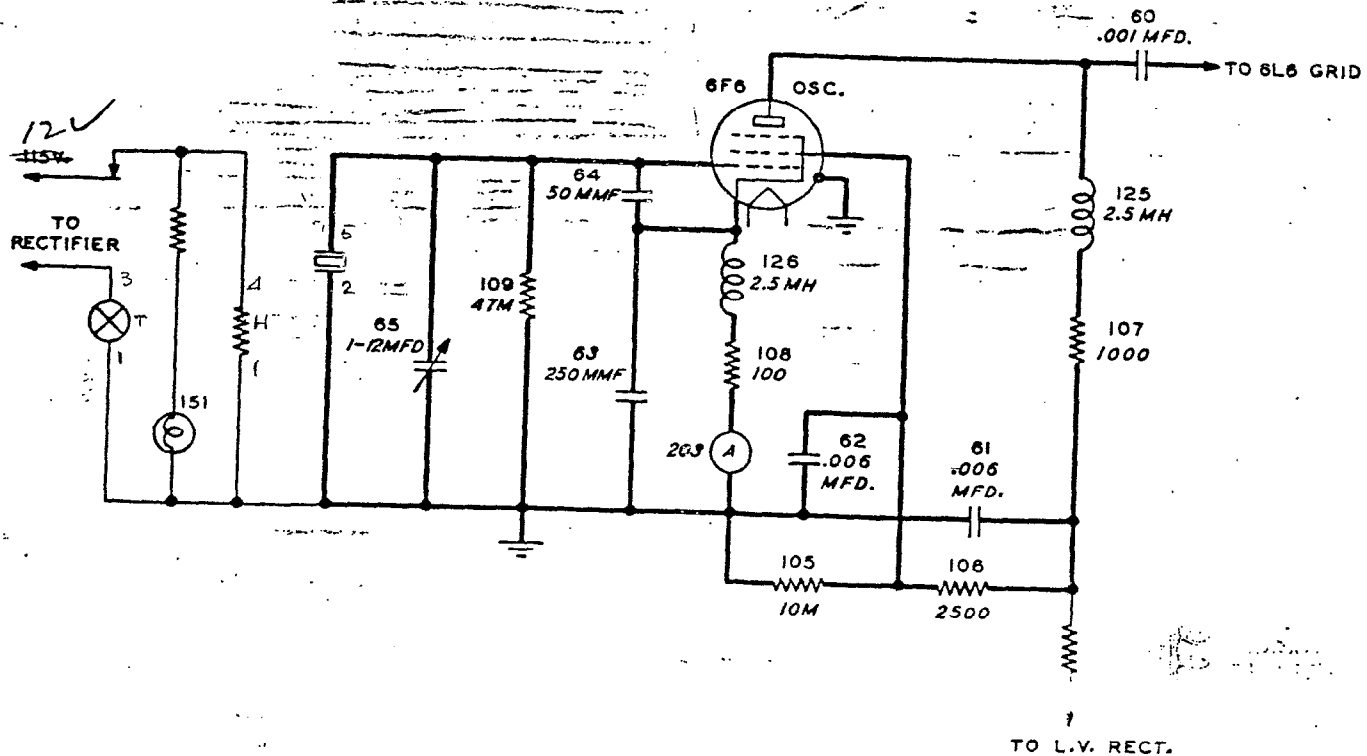

Figure 2-9. Oscillator Schematic

the time delay relay has operated by closing the high voltage supply circuit breaker and pressing the plate power start button, Item 18. Plate voltage for the power amplifier and modulator tubes are furnished by this supply. Two parallel connected resistors in series with the power amplifier plate lead drop the voltage from 1550 volts to 1150 volts; the plate voltage of the power amplifiers being 1550 volts when operating at 250 watts, and 1150 volts when operating at 100 watts output level. The normally closed contact of the relay, Item 8, "short out" the dropping resistors when the power level switch is in the "Hi" position. No reduction is made in the voltage that is applied to the modulator tubes for low power operation. The power level adjustment may be made from the control panel.

e. RF CIRCUITS. ^{40F-3} (Refer to figure 2-9.)—Two 40F oscillator units are furnished with the 300G

transmitter. Each oscillator is complete except for power supply. The crystal oscillator employs a Type 6F6 power amplifier pentode. Filament power is obtained from the transformer, Item 27, located in the 33Q unit. Plate and screen power is obtained from the low voltage supply located in the 401W Unit. The oscillator circuit employed has high inherent frequency stability against variation in dc supply voltage or variation in tube characteristics. Grids #1 and #2 of the 6F6 pentode constitute the control grid and anode of the primary oscillator circuit, and the plate supplies the load. The plate is electronically coupled to the oscillator circuit by the electron stream flowing to the plate. This electron stream is varied by the oscillator potentials on the first two grids, producing a current in the load of the same frequency. The third grid acts as a screen to practically eliminate any capacity between

* see page 1

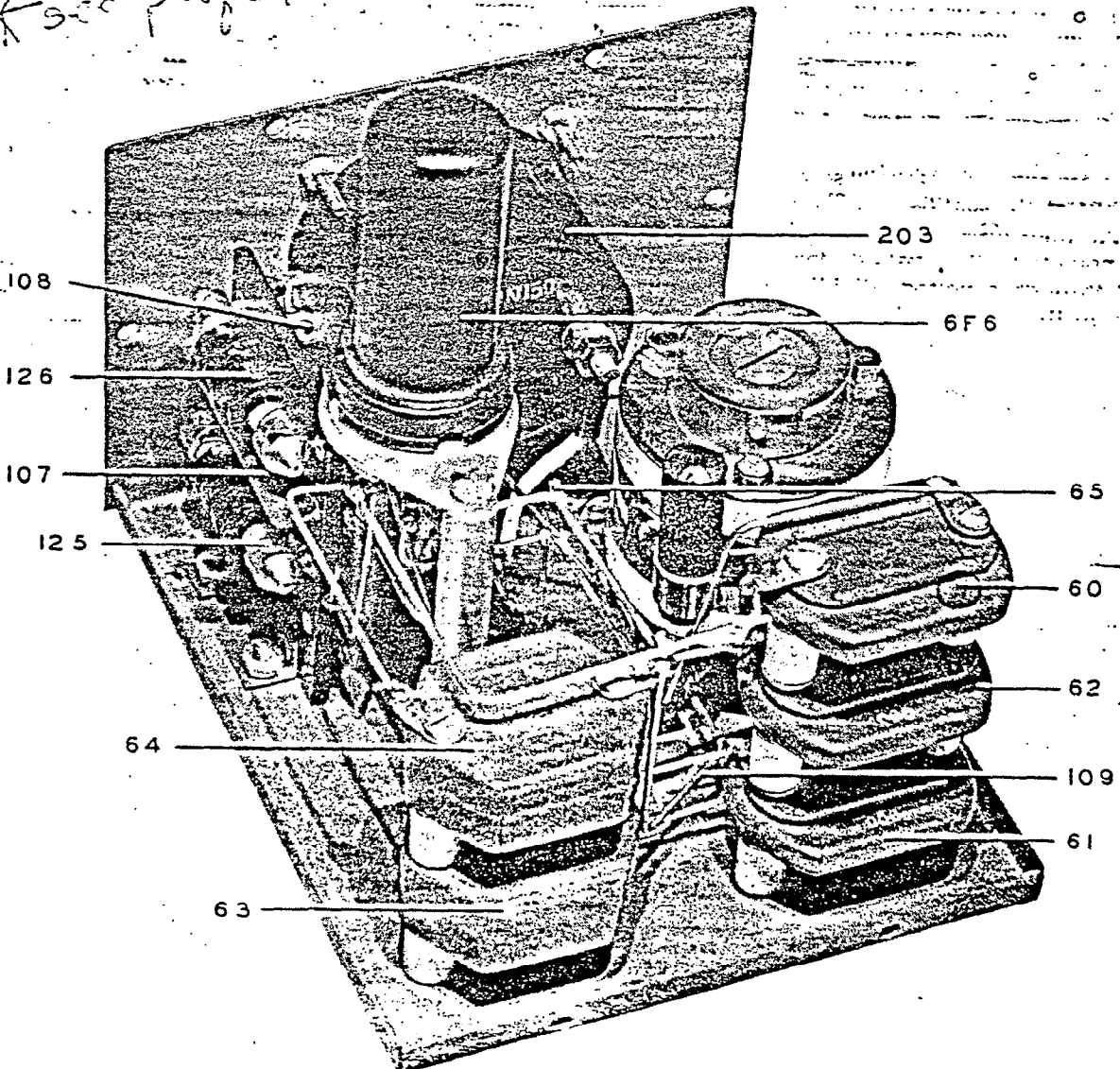

Figure 2-10. 40F Frequency Control Unit - Open View

the plate and the first two grids of the oscillator. The small variable capacitor, Item 65, is connected across the crystal so that the frequency of operation may be varied in a range ± 10 to 20 cps by varying the capacity in parallel with the crystal. If it is found necessary, the frequency may be varied over a range of 200 to 300 cps by adjusting the air gap between the connecting plate and the quartz crystal. (Refer to figure 2-11.)

The oscillators are supplied with selected low temperature coefficient "AT" cut quartz plate crystals with less than three parts in a million drift per degree centigrade. Each crystal is mounted in a Type 297 crystal oven. The crystals are maintained at 50 degrees centigrade by means of a mercury thermostat having a 0.2 degree sensitivity. Either 40F Unit may be selected using the switch, Item 12. In this way the removal of one oscillator unit does not effect the operation of the transmitter.

The output of the oscillator is capacitively coupled to the buffer or isolation amplifier. A Type 6L6 beam power amplifier is employed in the buffer stage. The coupling between the output of the oscillator and the grid of the buffer is varied by the variable capacitor, Item 59.

The intermediate amplifier utilizes two Type 807 beam pentode tubes in a parallel connected circuit. The intermediate amplifier plate tank circuit is also used as the grid circuit for the power amplifier tubes. The tuning capacitor is motor driven and may be controlled from the front panel of the transmitter. The inductor is provided with a movable tap so that the value of inductance may easily be varied.

The power amplifier employs two Type 810 triode tubes in a parallel connected circuit. The output of the intermediate amplifier is capacitively coupled to the grids of the 810's. The parasitic suppressors, Items 118, completely suppress all parasitic oscillations in the power amplifier circuit. The neutralization circuit is a combination of inductance and capacitance. The capacitance is variable. The

power amplifier plate tank and output network a combination pi-network and "T" section filter. This combination reduces harmonics to a negligible value. The variables in the tank and loading networks are inductors. Two motor tuned inductors are employed; one for tuning the tank circuit and the other for loading. All values of capacitance are fixed. The arms of the "T" section are variable inductors. A pickup coil to provide a means of coupling the monitoring equipment to the output of the transmitter is connected from the antenna terminal to ground. This inductor is also variable. An antenna ammeter is connected in series with the antenna lead and is mounted on the 1100N vertical chassis and may be read from the front of the transmitter when the cabinet door is closed.

f. AUDIO CIRCUITS. (Refer to figure 2-12.)- The audio frequency system, employing a feedback circuit, is designed to give exceptionally high fidelity. An audio input level of approximately +1 DBM is required for full 100% tone modulation. The audio input impedance is 500 ohms. The system is designed for operation with an external program amplifier such as the Collins' Type 6M or 26W. The audio input voltage is applied across the terminals of a resistance network inserted between the input terminals and the audio input transformer, Item 32. The secondary of Item 32 is shunted by two loading resistors across each winding for better regulation. The single stage of audio amplification utilizes a pair of 6J5 tubes in a push-pull amplifier circuit. The output of the 6J5's is resistance coupled to the grids of the audio driver tubes. The audio driver employs a pair of 6A5G tubes in a Class A amplifier circuit. The output of the audio driver is transformer coupled to the grids of the modulator.

Two Type 810 tubes operating Class B are used as modulators, with 1500 volts on their plates and operating with fixed bias. The bias supply is regulated by a variable resistor, Item 130. The feedback network from the output of the modulators is coupled back to the secondary windings of the input

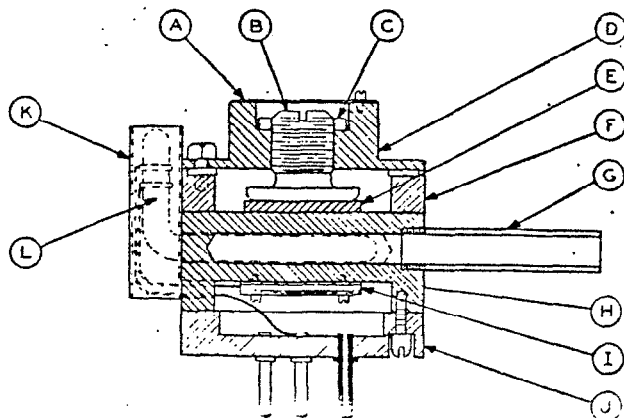

	COLLINS PART NO.	ITEM
A		Nameplate
B	500 1357 00	Air Gap Regulator
C	500 1356 00	Locking Ring
D	500 1358 00	Tap Plate
E		A-T Cut Crystal
F	190 9310 00	Isolantite Ring
G	500 1672 00	Thermometer Guide
H	500 1670 00	Anvil
I		Heater Element
J	190 7233 00	Isolantite Base
K	500 1671 00	Thermostat Cover
L	292 0013 00	Angle Thermostat

Figure 2-11. 297 Crystal Oven

4350

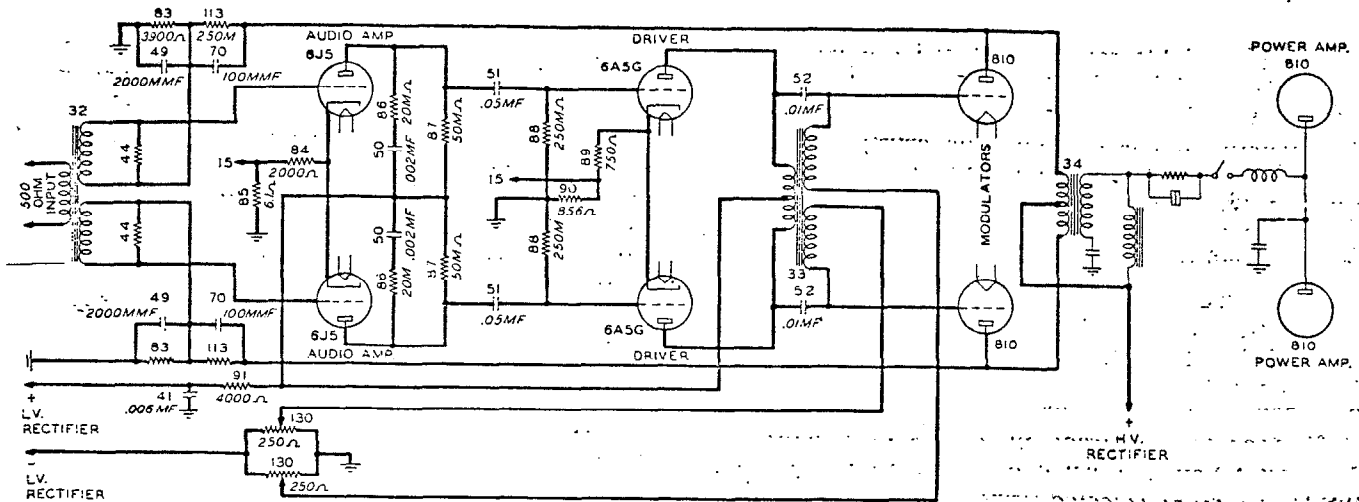

Figure 2-12. Audio Driver and Modulator Schematic

transformer of the audio amplifier tubes. The audio output of the modulator circuit is capable of modulating the r-f output of the final amplifier tubes 100% within the frequency range of 30 to 10,000 cps.

g. METERING CIRCUITS. (Refer to figure 2-13.)
 —All filament voltages except those applied to the rectifiers and audio tubes can be measured utilizing the filament volts meter and the tune-meter selector

switch. When the tune-meter selector switch is in the "807 plate" position the filament volts meter will indicate the voltage on the oscillator, buffer and intermediate amplifier stages. With the tune-meter selector switch in the "Final Amp. Plate" position the filament volts meter will indicate the voltage of one of the power amplifier tubes. When the tune-meter selector switch is in the "Mod. Plates Loading"

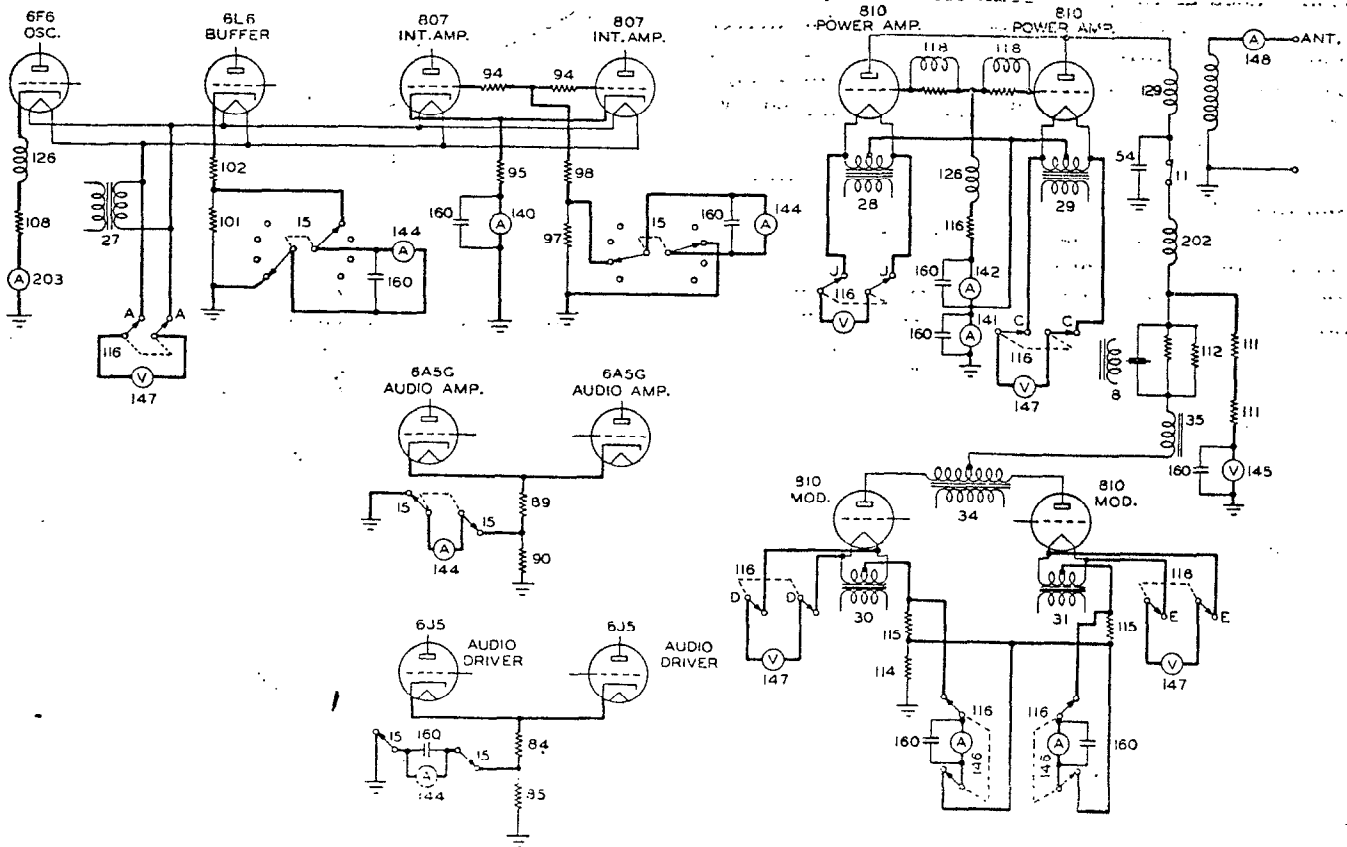

Figure 2-13. Metering Circuits

position the filament volts meter will read the voltage on the remaining power amplifier tube. In the "Mod. Plate 1" position the filament voltmeter reads the voltage across the modulator filament transformer, Item 31. To check the voltage on the other modulator tube place the tune-meter selector switch in the "Mod. Plate 2" position. The cathode current of the oscillator can be read by the meter, Item 203, mounted in the 40F Unit. The cathode current of the 6L6 buffer can be read with the test meter switch, Item 15, in the 6L6 cathode position. The cathode current of the 807 intermediate amplifier tubes can be read at all times, without switching, on meter Item 140. The intermediate amplifier grid circuit can be read with the test meter switch in the "807 grid" position. The 6A5G audio amplifier and 6J5 audio driver tubes cathode current is read

with the test meter switch in the "6J5 and 6A5G cathode" positions respectively. The grid current of the power amplifier is metered at all times with meter, Item 142. The cathode current of the power amplifier is metered at all times with meter, Item 141. The plate voltage of the power amplifier and modulator is read with meter, Item 145. Two 100,000 ohm resistors are in series with this plate voltage meter. The modulator cathode current is read with the tune-meter selector switch in the "Mod. Plate 1" and "Mod. Plate 2" positions. The r-f line current is read with meter, Item 148. The remote antenna current is read with meter, Item 143. All meters with the exception of those measuring the oscillator cathode current and the r-f line current are mounted on the meter panel on the front door of the cabinet.

SECTION 3
INSTALLATION AND INITIAL ADJUSTMENTS

I. INSTALLATION.

a. PRELIMINARY.

(1) UNCRATING. — Caution should be used when uncrating to avoid damage to the equipment. A nail puller should be used to remove the nails instead of a hammer or bar. All units should be inspected carefully. Inspect cables and wiring and make sure that all cable connections are tight. Inspect each unit for loose screws and bolts. Check all controls such as switches, dials, etc., for proper operation as far as can be determined without the application of power. All claims for damage should be filed promptly with the transportation company.

b. INSTALLATION PROCEDURE.

(1) LOCATION OF TRANSMITTER. — The location of the transmitter should be such that there is a minimum clearance of 30 inches at the rear of the transmitter to permit free circulation of air. A minimum clearance of 36 inches is required in front of the transmitter to allow the door to open.

(2) SETTING UP TRANSMITTER. — The transmitter is shipped with the heavier iron core units as well as some of the more fragile parts removed from the cabinet. It is recommended that no attempt be made to place these components in

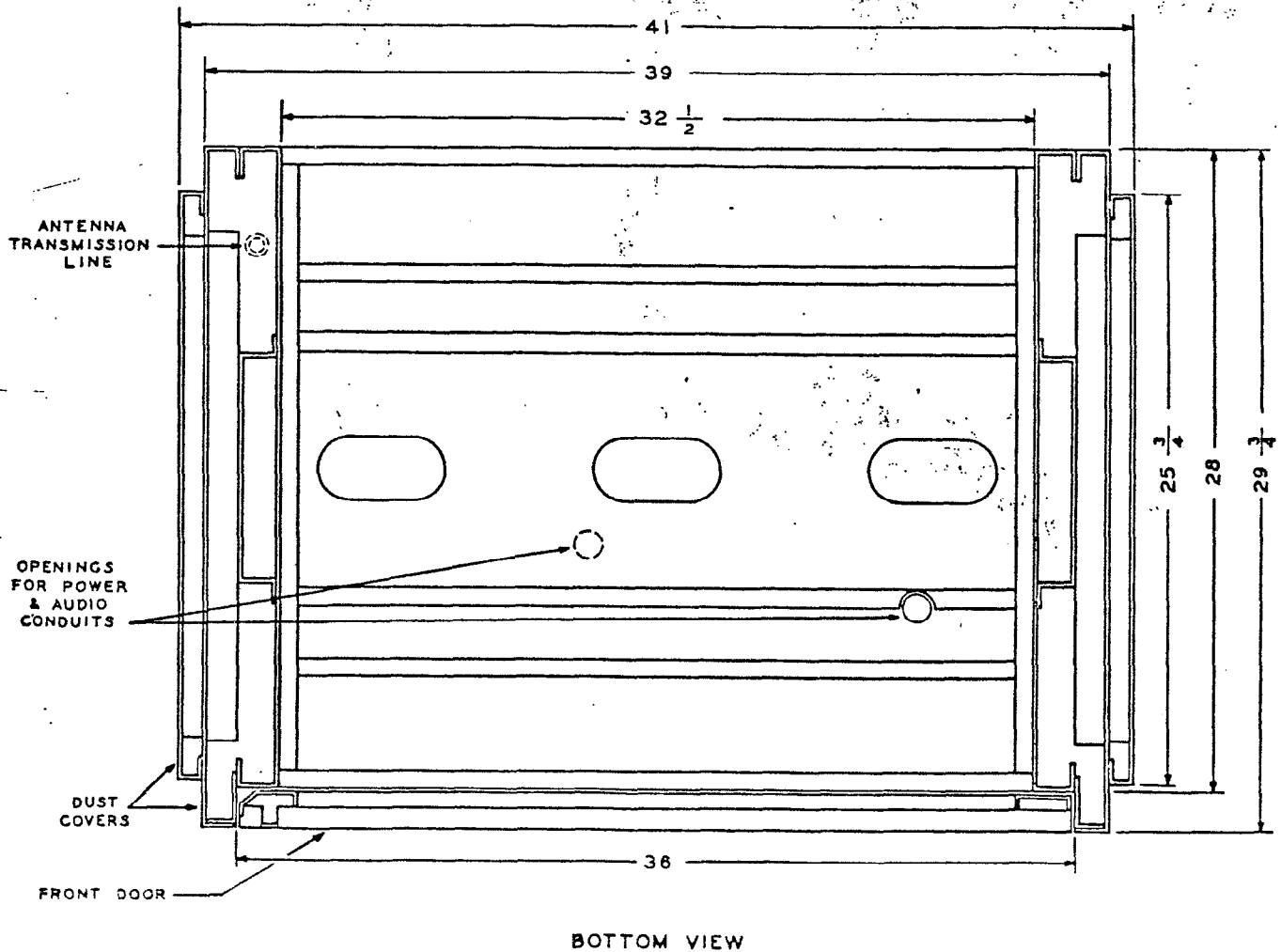

Figure 3-1. Floor Plan for Installation

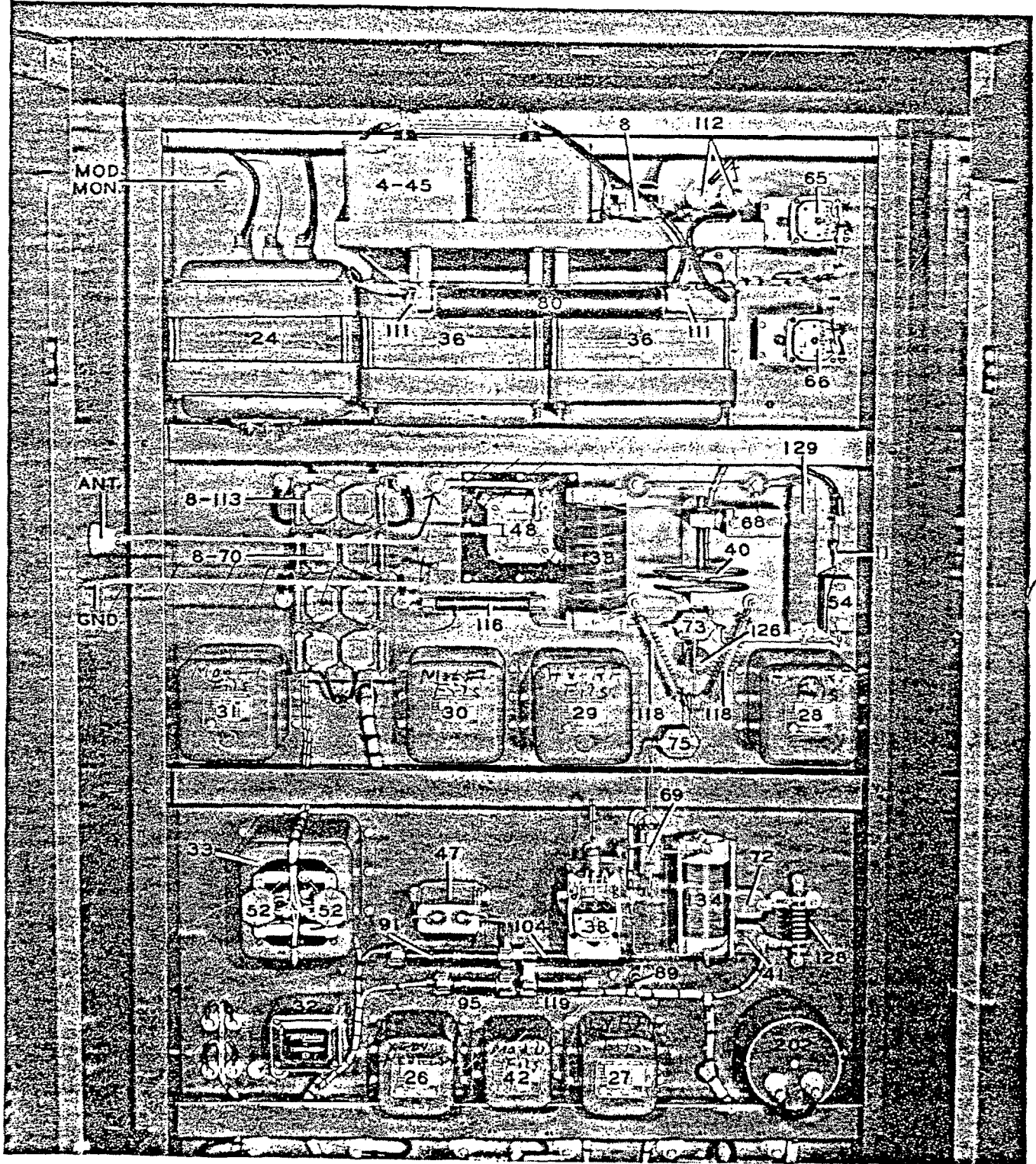

Figure 3-2. 300G Transmitter — Top Rear View

position until the cabinet has been permanently placed on the transmitting room floor.

The comparatively simple arrangement to accommodate the wiring at the base of the transmitter is outlined in Figure 3-1. This drawing requires the installation of the necessary conduit in a concrete floor or the installation of a conduit trench of sufficient depth and width. Another alternative would be to install a false floor under which the necessary wiring may be placed.

Refer to Figures 3-2, 3-3 to simplify placement of components that were removed when the equipment was prepared for shipment. The vertical chassis has been securely braced for shipment and before the braces are removed the bolts provided for securing the chassis in the cabinet should be inserted and tightened. When the vertical chassis has been secured in place, the high voltage transformer should be placed over the locating pins provided in the bottom of the transmitter cabinet. The modulation transformer and the modulation choke should be placed and fastened securely with the stud bolts provided for the purpose. All leads have been properly marked with tags and little difficulty should be had in making the proper connections.

Two receptacles are provided on the 33Q front panel for the two 40F frequency control units. These units are the plug-in type and their installation requires no wire connections.

The tubes have been packed separately and reference to the photographs will aid in the placement of the tubes in the proper sockets.

The two 65Q-30 cables should be connected between the vertical chassis and the front door.

(3) INTER-UNIT WIRING.—For the purpose of identification on the cabling diagram (figure 9-5), each unit has been assigned an arbitrary letter designation. These unit letters are used as a prefix when referring to terminals on any unit. Inter-unit wiring on the cabling schematic (figure 9-5) is indicated by showing at any terminal the type of wire and the terminal and unit to which each wire routes.

The following tabulation lists the type numbers of the various units in the transmitter.

Unit Letter Designation	Unit Type Number	Unit Description
A	11M	Output Network
B	3Z	Final & Modulators
C	33Q	R-F & Audio Driver
D	401W	Rectifier & Relay Unit
E	None	Cabinet Base
F	38N	Door Assembly

The order of designation of inter-unit cabling is as follows: When a wire terminates on a single numbered terminal on a unit, the wire route is from

the source to the terminal on the specified unit and is indicated by the unit letter designation followed by the terminal number. Thus, if we refer to the cabling schematic diagram of the 1100N Vertical Chassis Schematic, we will note that there is a wire starting from terminal number 10 on Unit C which terminates on terminal number 7 of Unit D. Therefore, an arrow at terminal number 10 on Unit C indicates that the wire routes to terminal D7, and the arrow is designated D7. An arrow from terminal number 7 on Unit D indicates that the particular wire in question is terminated on terminal number 10, Unit C. The designation at the end of the arrow is C10.

(4) POWER CONNECTIONS.—The transmitter may be operated from either a 115 volt or a 230 volt 60 cycle single phase power source. The power input cable may be brought up the side of the cabinet channel through the grommet hole to terminals 1, 2 and 3 on the terminal strip. When the transmitter is to be operated from a 115 volt power source, a line capable of carrying at least 20 amperes should be installed. When a 230 volt power source is to be used, a line capable of carrying at least 10 amperes should be installed. It is recommended that a main station switch be installed in the power line to the equipment at some location convenient to the transmitter, so that the power line may be completely disconnected before any attempt is made to service the equipment. Refer to figures 9-1 and 9-5.

(5) SPEECH INPUT CONNECTIONS. — The audio input connections to the transmitter should be made to terminals 4 and 5 on the terminal strip in the lower left-hand corner of the vertical chassis. These connections should be made by means of a twisted pair shielded cable. Refer to figure 9-1.

(6) ANTENNA TERMINATION. — The 300G Transmitter is intended for use with an external antenna tuning unit to which it is connected by means of a concentric transmission line. The transmission line may be carried up the cabinet channel and the outer conductor or ground connection fastened securely to the transmitter ground terminal. The inner conductor of the line should be connected to the 1¼" ceramic bushing terminal located near the top of the cabinet.

(7) MONITORING CONNECTIONS. — The monitoring connection should be made to the Isolantite feedthru located near top of 1100N Vertical Chassis. (Refer to figure 3-2 for exact location of terminal.) A twisted pair should be used connecting one wire to terminal and the other to any convenient chassis ground.

The frequency monitoring connection has not been brought out to a terminal. To obtain pick-up for operation of frequency monitoring equipment it is necessary to make a tap connection to intermediate amplifier plate tank inductor, Item 134.

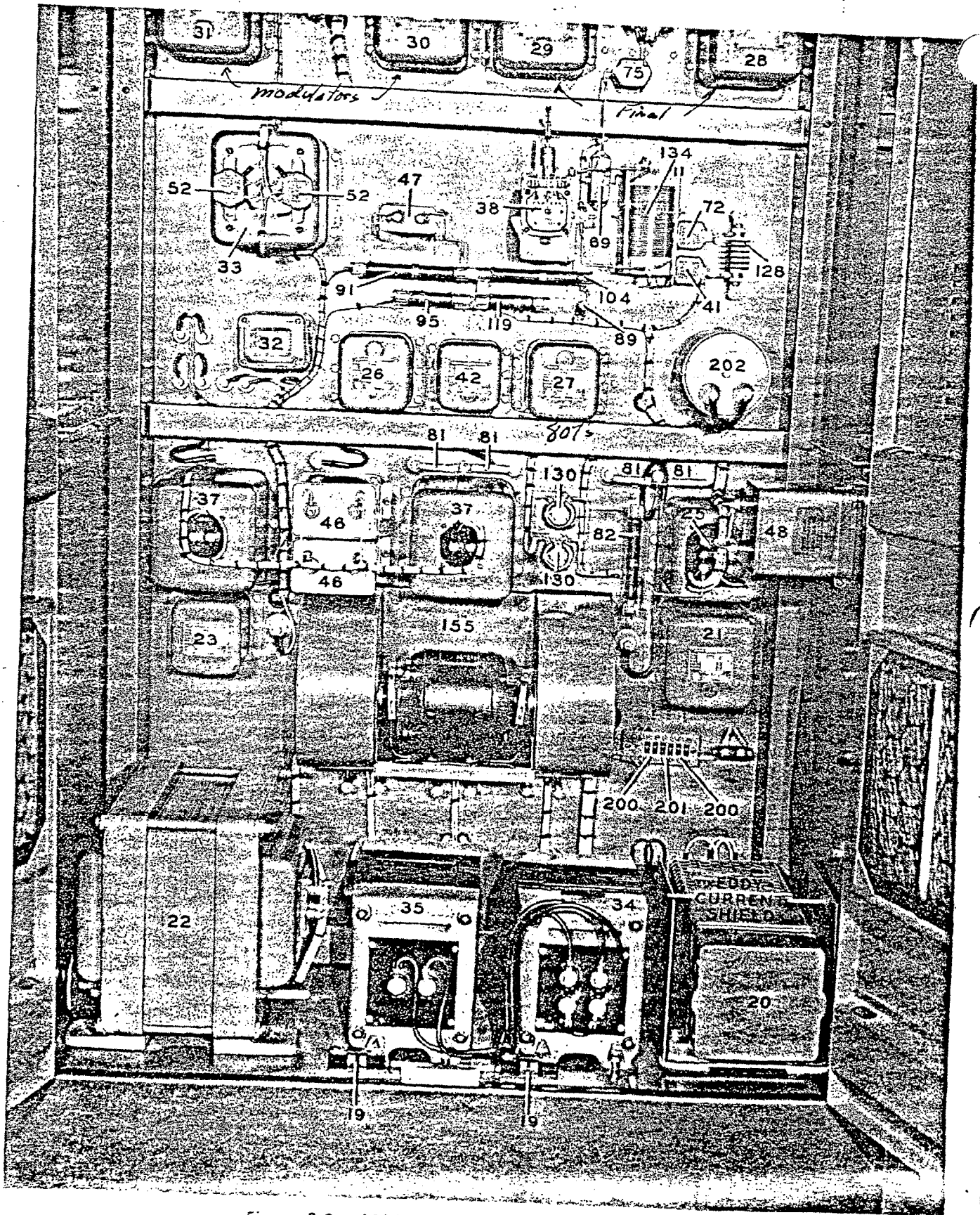

Figure 3-3. 300G Transmitter - Bottom Rear View

(8) ASSEMBLY OF TRANSMITTER TRIM.

—After all the necessary wiring has been installed, the dust covers may be bolted in place. The bolts which hold the retaining strip on the front edge of the cabinet should be loosened so that the front edge of the dust cover assembly can be slid under the strip. Holes in the cabinet walls are provided so that the bolts may be inserted in both front and rear edges of the dust covers.

2. INITIAL ADJUSTMENTS.

a. GENERAL. — The 300G transmitter is operated from controls located conveniently on the front of the transmitter. (Refer to figure 4-1.) The control panel is mounted on the front door and consist of the following:

- Filament Power Control
- Plate Power Control
- Power Level Switch
- Test Meter Switch
- Tune-Meter Selector Switch
- Tuning Control

Three magnetic circuit breakers, Items 5, 6 and 7, located in the 401W Unit, control the major power circuits of the transmitter.

b. FUNCTION OF CONTROLS.

(1) FILAMENT POWER SUPPLY CIRCUIT BREAKER.—This circuit breaker acts as a disconnect switch and must be closed before either filament or plate power can be applied to the transmitter.

(2) FILAMENT START BUTTON. — When Item 5 is closed the filament voltage may be applied

by pressing the filament start button. Pressing this button completes the circuit for the operation of the filament relay, Item 1.

(3) FILAMENT STOP BUTTON. — Pressing the filament stop button opens the circuit that operates the filament relay, Item 1.

(4) POWER LEVEL SWITCH. — This switch controls the output level of the transmitter. This control operates relay, Item 8. The normally closed contacts of this relay “short out” the dropping resistors in the power plate lead when in the HI position.

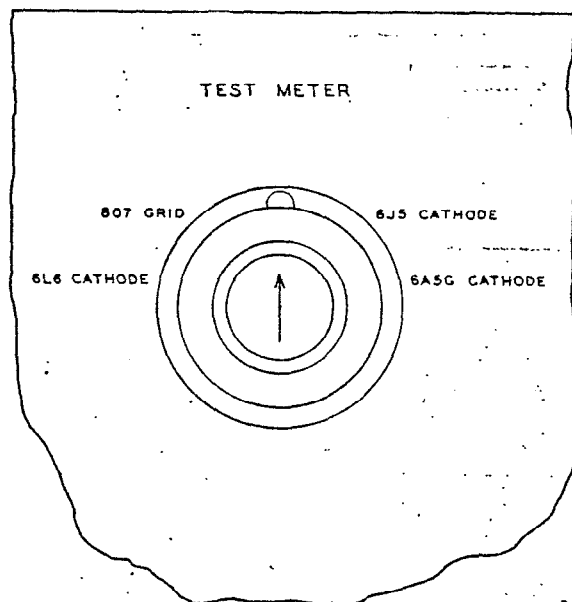

Figure 3-5. Test Meter Switch

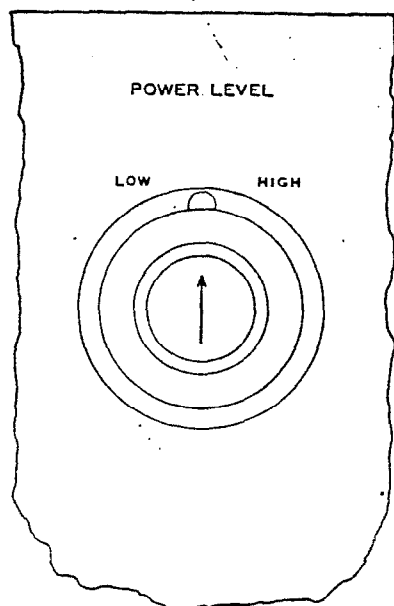

Figure 3-4. Power Level Switch

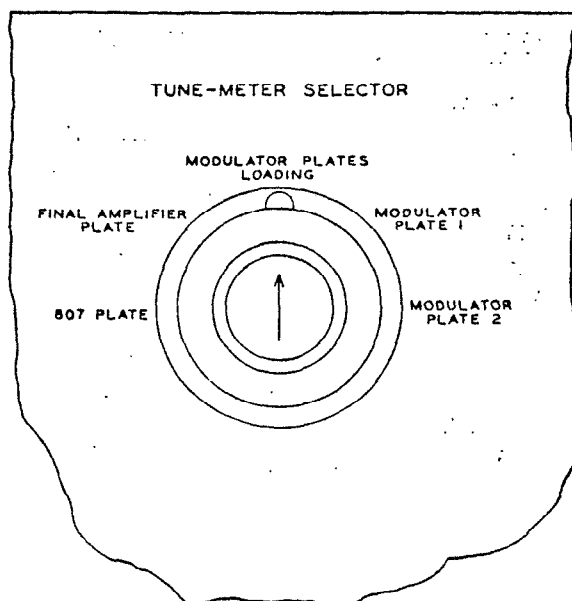

Figure 3-6. Tune-Meter Selector Switch

(5) **TEST METER SWITCH.**—The test meter switch has four positions. When used in conjunction with the test meter it enables the operator to read the cathode current of the 6L6, 6J5 and 6A5G tubes. The grid current of the 807 tubes can also be read utilizing the test meter and the test meter switch.

(6) **TUNE-METER SELECTOR SWITCH.** — The tune-meter selector switch has five positions. The voltage applied to the filaments of all tubes in the transmitter, with the exception of the rectifiers and audio tubes, can be read utilizing the tune-meter switch and the filaments voltmeter. This switch is also used to select different circuits to be metered for the proper tuning and loading of the transmitter.

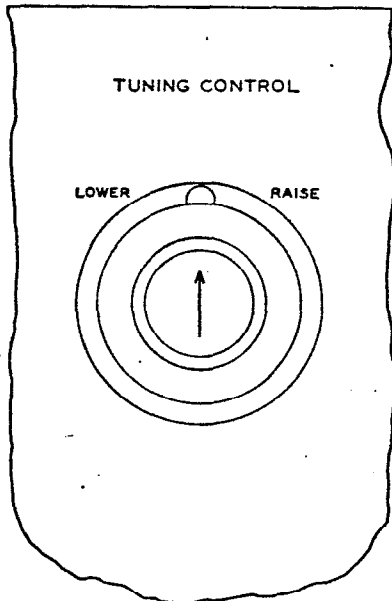

Figure 3-7. Tuning Control

(7) **TUNING CONTROL SWITCH.** — This switch controls the operation of the tuning motors.

(8) **LOW VOLTAGE SUPPLY CIRCUIT**

BREAKER.—Before the low voltage plate supply can be energized, it will be necessary to close this circuit breaker.

(9) **HIGH VOLTAGE SUPPLY CIRCUIT BREAKER.**—Before high voltage can be applied to the modulators and power amplifier tubes, it will be necessary to close this circuit breaker.

(10) **PLATE POWER START BUTTON.**—After the high voltage circuit breaker has been closed, the relay, Item 2, may be operated by pressing the plate power start button. Operation of this relay applies plate voltage to the modulators and power amplifier tubes.

(11) **PLATE POWER STOP BUTTON.**—Operation of this switch de-energizes the relay, Item 2, and opens the high voltage circuit.

c. **OUTLINE OF ADJUSTMENTS.**—A brief outline of adjustment procedure is given in the block diagram (figure 3-8). The adjustment procedure is treated in a step-by-step manner in a later paragraph following this brief outline.

- (1) Power Circuit Check
- (2) Filament Circuit Adjustment
- (3) Oscillator Adjustments
- (4) Intermediate Amplifier Grid Adjustment
- (5) Intermediate Amplifier Plate Tuning
- (6) Power Amplifier Grid Adjustment
- (7) Modulator Bias Adjustment
- (8) Power Amplifier Plate Tuning
- (9) Neutralization
- (10) Antenna Loading Adjustments
- (11) Output Network Adjustments

d. **ENERGIZING THE EQUIPMENT.** — Before energizing the equipment, a thorough inspection of all connections and terminals should be made to assure freedom from faulty operation. The rectifier

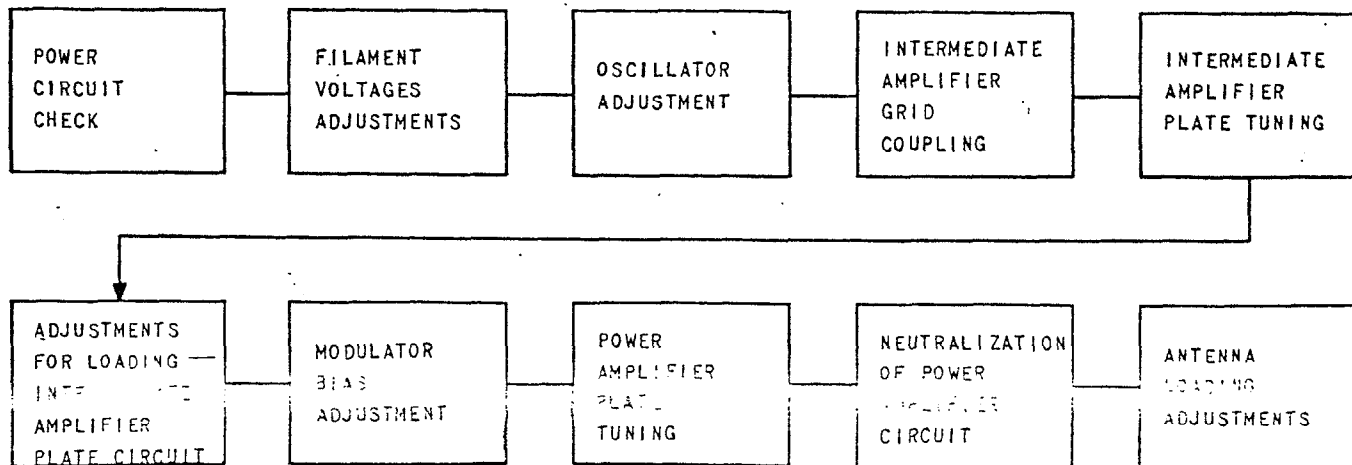

Figure 3-8. Block Diagram of Adjustments

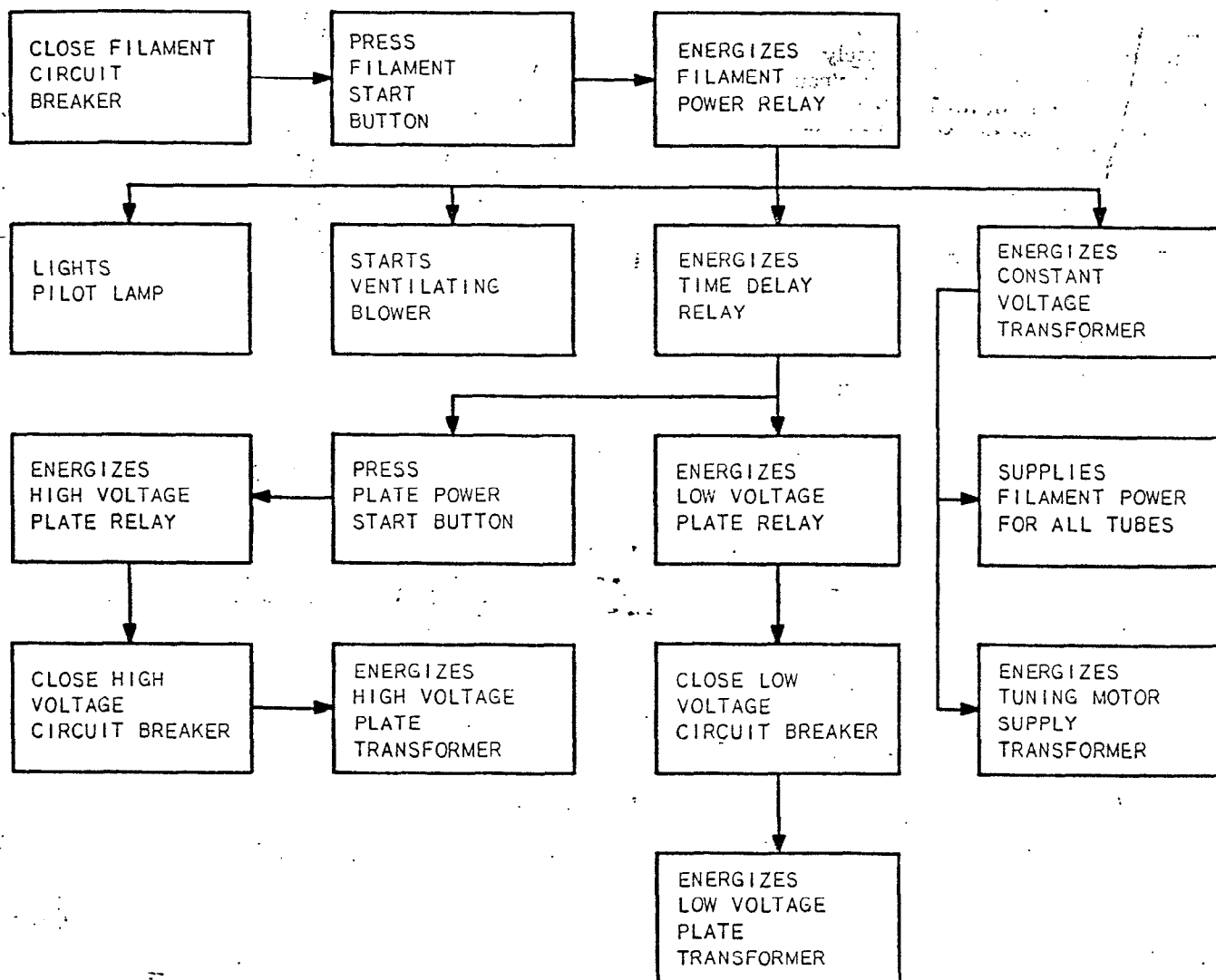

Figure 3-9. Block Diagram of Power Circuit Check

tube plate leads and caps should be checked for clearance to any metal object and tied to some convenient support to prevent accidental short circuits when checking operation of the plate voltage control circuits. Inspect all door interlocks making certain that the male member is free by pressing on the contact block until the spring is completely compressed and then releasing the pressure. If the contact block does not spring out to its initial position, check the two wires comprising the arm for parallelism, bending the wire arms until they are free of the stop pin located between the two wires. Before applying power to the transmitter input, be certain that all circuit breakers are in the OFF position. Do not insert the tubes in the transmitter. These precautions having been taken, the circuit to the transmitter can be energized.

e. POWER CIRCUIT CHECK.

- (1) Energize the circuit to the transmitter.

(2) Close the circuit breaker marked Filament—Fans, Item 5, in the 401W Unit. Closing the filament circuit breaker makes possible the operation of the filament power relay, Item 1.

(3) Press the Filament Start Button, Item 13. The filament relay will be held in the operate position by the circuit through the holding contacts. The closing of the relay, Item 1, will light the pilot lamp, Item 152, start the Ventilating Blower, energize the time delay relay and will energize the constant voltage transformer, Item 20. Energizing, Item 20, applies power to the filament transformer primaries.

(4) Rotate the Tune-Meter Selector switch, Item 116, and check the voltage on the Filament Volts meter. When the tubes are not in the sockets the voltage readings will be only approximately correct because no power is being drawn from the transformer secondaries. If voltage readings are obtained

in all positions of the Tune-Meter Selector switch and the readings are approximately correct for the circuit being metered the power circuit check may be continued. *Vs readings correct for all stages, refer to the notes.*

(5) Press the Filament Power Stop button.

(6) Close the Low Voltage Supply circuit breaker, Item 7.

(7) Press the Filament Power Start button. When approximately 30 seconds have elapsed the time delay relay, Item 4, should operate. If the time necessary for the operation of this relay is not within 10% of the 30 second limit the time of operation should be adjusted. The relay, Item 4, is located on the lower front panel of the 401W Unit. (Refer to the photograph, figure 3-11, for exact location of the relay.) When operated the normally open contacts of relay, Item 4, complete the circuit necessary for the operation of the low voltage relay, Item 3. The low voltage transformer, Item 24, should now be energized.

(8) Close the High Voltage Supply Circuit Breaker, Item 6.

(9) Close the cabinet doors. Press the Plate Power Start button. The high voltage plate relay, Item 2, will operate and be held in the operated position through the door switches, the Plate Power Stop switch, the Filament Power Stop switch and the circuit breaker, Item 5. The high voltage plate transformer, Item 22, should now be energized.

When the above preliminary tests have been completed the 3 circuit breakers should be opened and the tubes inserted in the sockets, (refer to figure 5-1 for the tube locations).

f. FILAMENT CIRCUIT ADJUSTMENT.

(1) GENERAL.—All filament transformers are provided with tapped primary windings to facilitate raising or lowering the secondary voltage. Filament voltages should be adjusted to within 5% of the value recommended for the type of tube used. The following table gives the tube type, function and correct filament voltage.

Tube Type	Function	Correct Voltage
6F6	R-F oscillator	6.3
6L6	Buffer	6.3
807	Intermediate amplifier	6.3
6J5	Audio amplifier	6.3
6A5G	Audio driver	6.3
810	Modulator	10.0
810	Power amplifier	10.0

All filament voltages except those applied to the filaments of the rectifiers and audio amplifier and driver tubes can be measured utilizing the

Filament Volts meter and the Tune-Meter Selector switch.

(2) When the Tune-Meter Selector switch is in the 807 Plate position the Filament Volts meter will indicate the voltage on the three low-power r-f stages, namely, the oscillator, buffer and intermediate amplifier. If some voltage change is required the primary taps on the transformer, Item 27, should be moved to give a secondary voltage within 5% of the recommended 6.3 volts.

(3) If the Tune-Meter Selector switch is placed in the Final Amp Plate position the Filament Volts meter will indicate the voltage on one of the power amplifier tubes. If any change is found necessary move the taps on the transformer, Item 28, until the voltage is within 5% of the 10 volts recommended for the Type 810 tube.

(4) If the Test Meter Selector switch is rotated to the Mod Plates Loading position the Filament Volts meter will indicate the voltage on the remaining power amplifier tube. Voltage adjustment on this filament may be made by adjusting the taps on the transformer, Item 29.

(5) Placing the Test Meter Selector switch in the Mod Plate 1 position connects the Filament Volts meter across the modulator filament transformer, Item 31.

(6) To check the voltage on the other modulator tube place the Test Meter Selector switch in the Mod Plate 2 position. To change the voltage on this tube adjust the taps of the transformer, Item 30.

(7) Filaments of all tubes in the transmitter should now be excited. Permit the equipment to operate in this manner for a period of twenty minutes before the application of any plate power in order to permit proper aging of mercury vapor rectifier tubes. This aging procedure is required only in the case of new tubes. In subsequent operating procedure, the time delay relay will automatically provide the proper time interval.

g. TUNING ADJUSTMENTS.

OPERATION OF THIS EQUIPMENT INVOLVES THE USE OF HIGH VOLTAGES WHICH ARE DANGEROUS TO LIFE. OPERATING PERSONNEL SHOULD AT ALL TIMES OBSERVE ALL SAFETY PRECAUTIONS. DO NOT CHANGE TUBES OR MAKE ADJUSTMENTS INSIDE EQUIPMENT WITH HIGH VOLTAGE SUPPLY ON. DO NOT DEPEND UPON DOOR SWITCHES OR INTERLOCKS FOR PROTECTION, BUT ALWAYS SHUT DOWN POWER EQUIPMENT AND OPEN THE MAIN SWITCH IN SUPPLY LINE TO EQUIPMENT.

(1) R-F CIRCUIT ADJUSTMENT.

(a) OSCILLATOR ADJUSTMENT.—Either

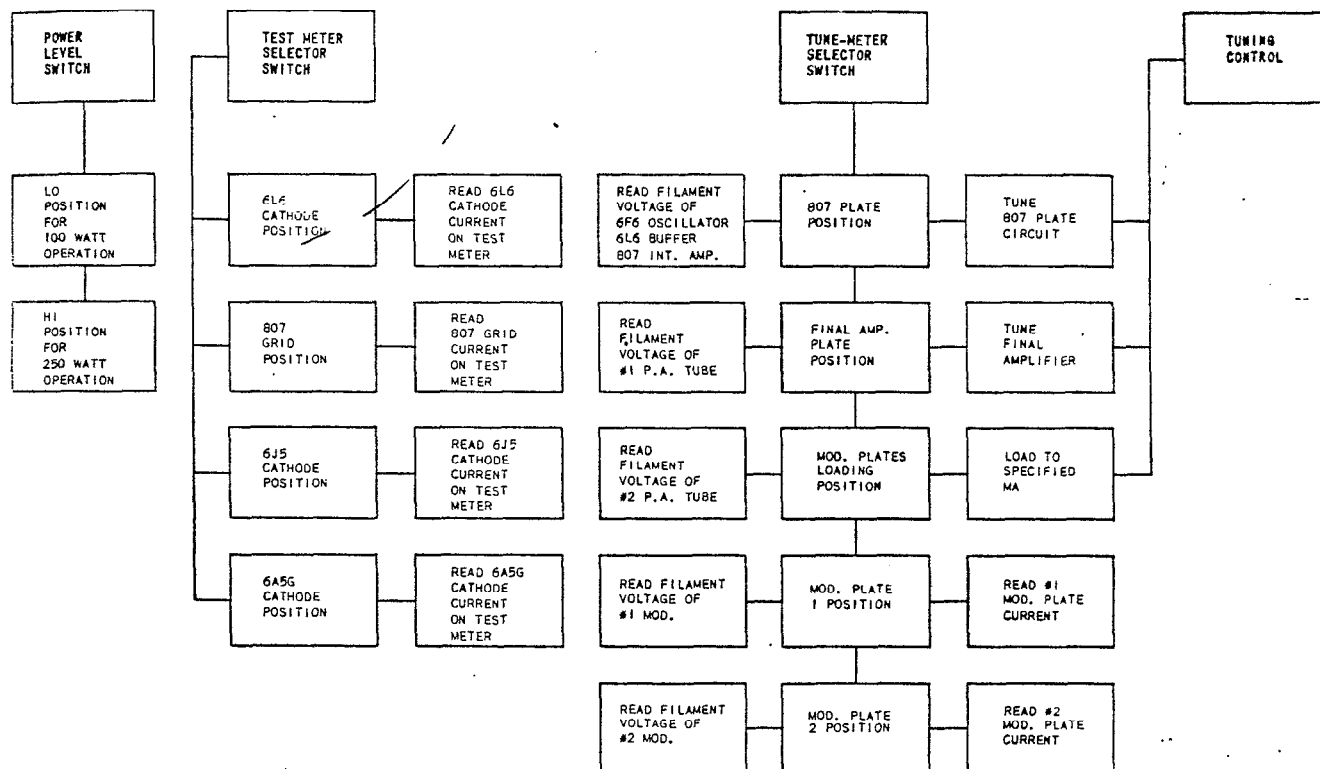

Figure 3-10. Block Diagram of Panel Control Functions

40F Oscillator Unit may be selected for adjustment. Rotating the switch, Item 12, selects the oscillator unit.

1. Place the Crystal Heat switch, Item 10, in the ON position.
2. Place the Filament-Fans circuit breaker, Item 5, and the Low Voltage Supply circuit breaker, Item 7, in the ON position.
3. Close the front and rear doors.
4. Press the Filament Start button, Item 13. The plate and screen voltages will be applied to the oscillator, buffer and intermediate amplifier stages as soon as the time delay relay operates. The oscillator is of the untuned type and no adjustment is available except a trimmer capacitor in the grid circuit. The normal operating current of the 6F6 oscillator tube is between 20 ma and 25 ma. If the meter, Item 203, indicates a cathode current much above 25 ma some adjustment of grid trimmers or crystal air gap may be necessary to start the oscillator. Check the frequency after adjusting the trimmers or air gap. You may have changed your frequency.

(b) INTERMEDIATE AMPLIFIER GRID ADJUSTMENT. — When proper operation of the oscillator has been secured:

1. Rotate the test meter selector switch to the 807 grid position.
2. Adjust buffer grid coupling capacitor,

Item 59, until the test meter indicates approximately 5 ma of grid current. Refer to figure 3-11.

(c) INTERMEDIATE AMPLIFIER PLATE TUNING.—The intermediate amplifier plate tank circuit is also utilized as the power amplifier grid circuit. The tank inductor, Item 134, is provided with a sliding connector to vary the degree of loading of the intermediate amplifier plate circuit and the coupling to the grids of the power amplifier tubes. The tank circuit capacitor is motor driven and controlled from the front panel.

1. Place the Tune-Meter Selector switch in the 807 Plate position and operate the Tuning Control. The cathode current will dip sharply when the point of resonance is reached. If the point of resonance cannot be found it will be necessary to change the tap on the inductor, Item 134, (refer to figure 3-3 for location of the inductor).

2. Before attempting to change the tap place the Low Voltage Supply circuit breaker in the OFF position.

3. Change the tap not more than 2 turns at a time.

4. Place the Low Voltage Supply circuit breaker in the ON position and close the transmitter cabinet door.

5. Press the Filament Power Start button and when the time delay relay has operated, make another attempt to establish resonance in the inter-

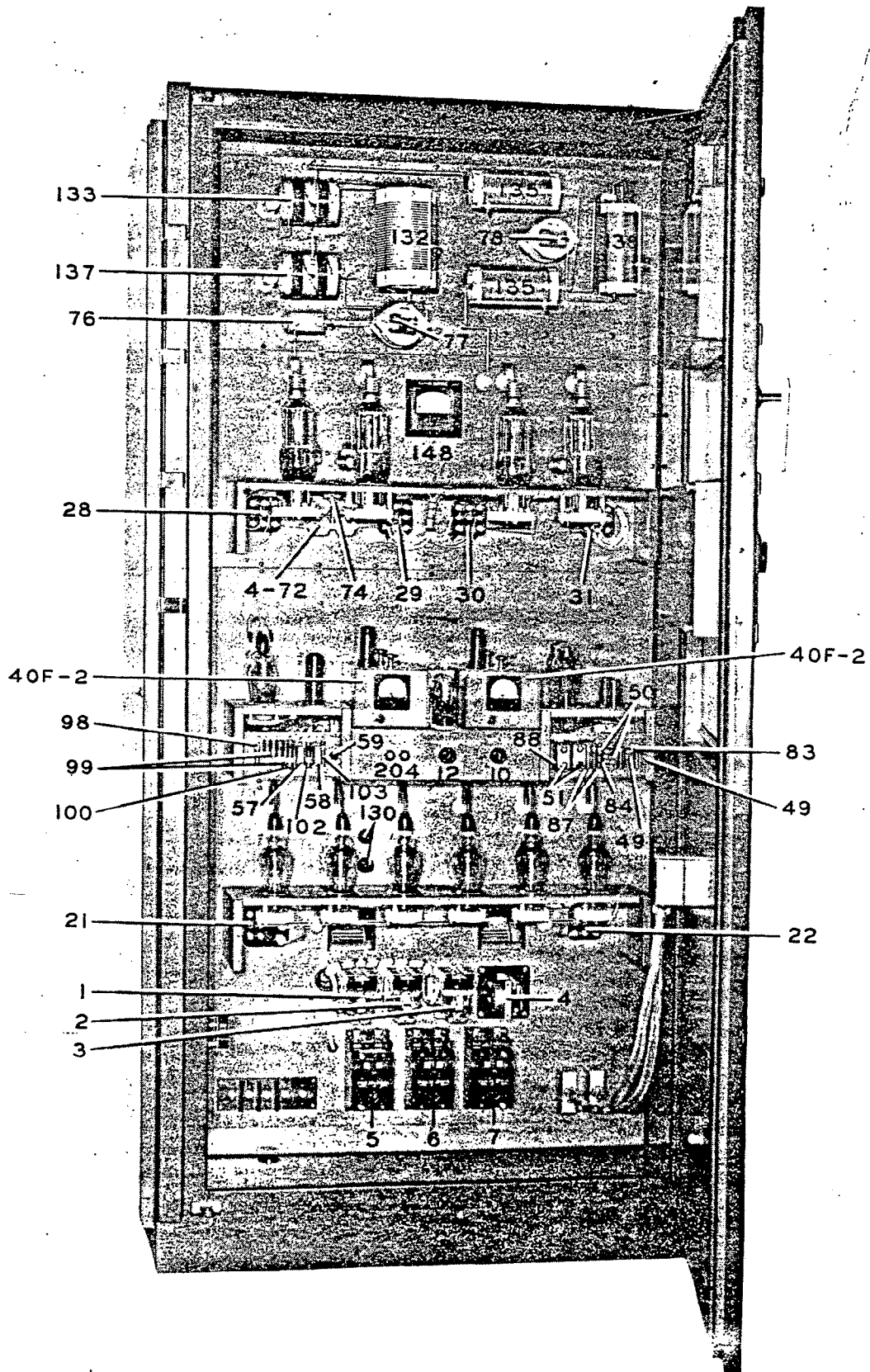

Figure 3-11. 300G Transmitter – Front Open View

mediate amplifier plate tank circuit. Repeat the procedure outlined above until resonance is established with the tuning capacitor at approximately one-half capacity.

(d) POWER AMPLIFIER GRID ADJUSTMENTS.—The degree of loading of the intermediate amplifier plate circuit determines the amount of grid drive to the power amplifier grids.

1. Throw the low voltage supply circuit breaker to the OFF position.
2. Move the rider on, Item 134, toward the end of the inductor, in steps of 2 turns at a time.
3. Check the PA Grid current after each tap change.
4. Retune Int. Amp. plate circuit to establish resonance after each tap change.
5. The tap should be adjusted so that at resonance the power amplifier grid current is somewhat above the recommended 110 ma for the type 810 tubes.

(e) MODULATOR BIAS ADJUSTMENT.—Before attempting to tune the power amplifier circuits, the bias on the modulators should be checked.

1. Open high voltage circuit with switch, Item 11.
2. Place Tune-Meter Selector switch in the Mod Plate 1 position.
3. Close High Voltage Supply Circuit Breaker.
4. Press the Plate Power Start button.
5. Adjust the bias on the modulator tubes to give a static plate current of approximately 15 ma. This adjustment is quite critical and it may be necessary to deviate from the 15 ma value somewhat to minimize audio distortion.
6. Throw the low voltage supply circuit breaker to the OFF position. Refer to figure 3-11.
7. Rotate the rheostat, Item 130. Rotate in a clockwise direction to raise the bias, counterclockwise direction to lower the bias.
8. Throw the low voltage supply circuit breaker to the ON position and close the cabinet door.
9. Press plate power start button and check modulator current.
10. Repeat the above procedure for the second modulator bias adjustment, with the Tune-Meter Selector switch in the Mod Plate 2 position, using the lower rheostat to decrease or increase the bias.

(f) POWER AMPLIFIER PLATE TUNING.

1. Place the Tune-Meter switch in the Mod Plates loading position.

2. Place Power Level control in the LO position.

3. Operate the Tuning Control so that the tuning slug in the variable inductor, Item 33, is in the position farthest to the left on the transmitter as viewed from the front.

4. Rotate the Tune-Meter selector switch to the Final Amp Plate position.

5. Place all circuit breakers in the ON position and close the cabinet doors.

6. Press the Filament power start button.

7. Press the Plate power start button.

8. Rotate the tuning control toward the lower position. Resonance of the power amplifier plate circuit will be indicated by a sharp dip in plate current. It may be necessary to rotate the tuning control in the opposite direction to establish resonance.

(g) NEUTRALIZATION. — The neutralization of the power amplifier circuit has been made and locked at the factory and no further adjustment should be required. However, due to slight difference in interelectrode capacity of various Type 810 tubes, some slight adjustment of the neutralization capacitor, Item 40, may be necessary.

Either the modulation monitor or an oscilloscope may be used to indicate complete neutralization of the power amplifier circuit. In either case the high voltage lead to the plates of the power amplifier tubes should be broken by opening the switch, Item 137. As an additional safety precaution it is also advisable to place the High Voltage Supply circuit breaker in the OFF position before attempting to make any neutralization adjustments. When the modulation monitor or oscilloscope has been connected across the output circuit, the filament and low voltage plate power should be applied to the transmitter. Energizing the low voltage supply applies plate voltage to the three low power r-f stages of the transmitter. Some indication of r-f feedthru may now be observed on the modulation meter or the oscilloscope screen. If the pick-up is not enough to give a good indication of r-f feedthru some adjustment of the tap on the modulation monitor pick-up coil, Item 136, may be necessary. To increase the pick-up slide the tap away from the ground end of the coil. Neutralization adjustments may now be made. The neutralizing capacitor, Item 40, is located on the rear of the 1100N Vertical Chassis and is only accessible when the rear cabinet doors are opened. The plates of the capacitor, Item 40, should be adjusted to give a minimum r-f indication on the monitor or oscilloscope.

IF THE TAP ON THE PICK-UP INDUCTOR, ITEM 136, HAS BEEN MOVED TOWARD THE "HOT END" TO PROVIDE MORE PICK-UP, THE TAP SHOULD BE RETURNED TO THE

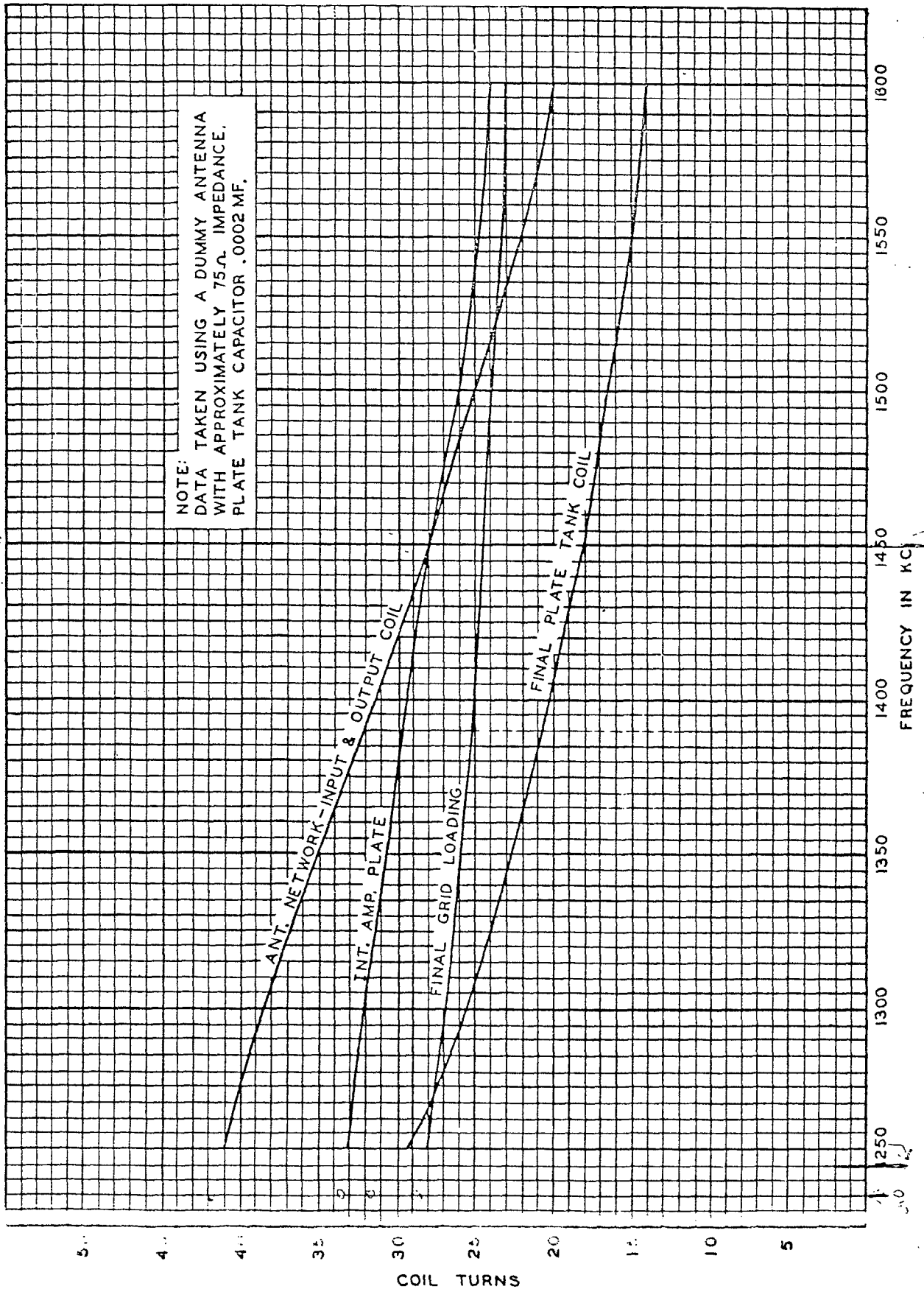
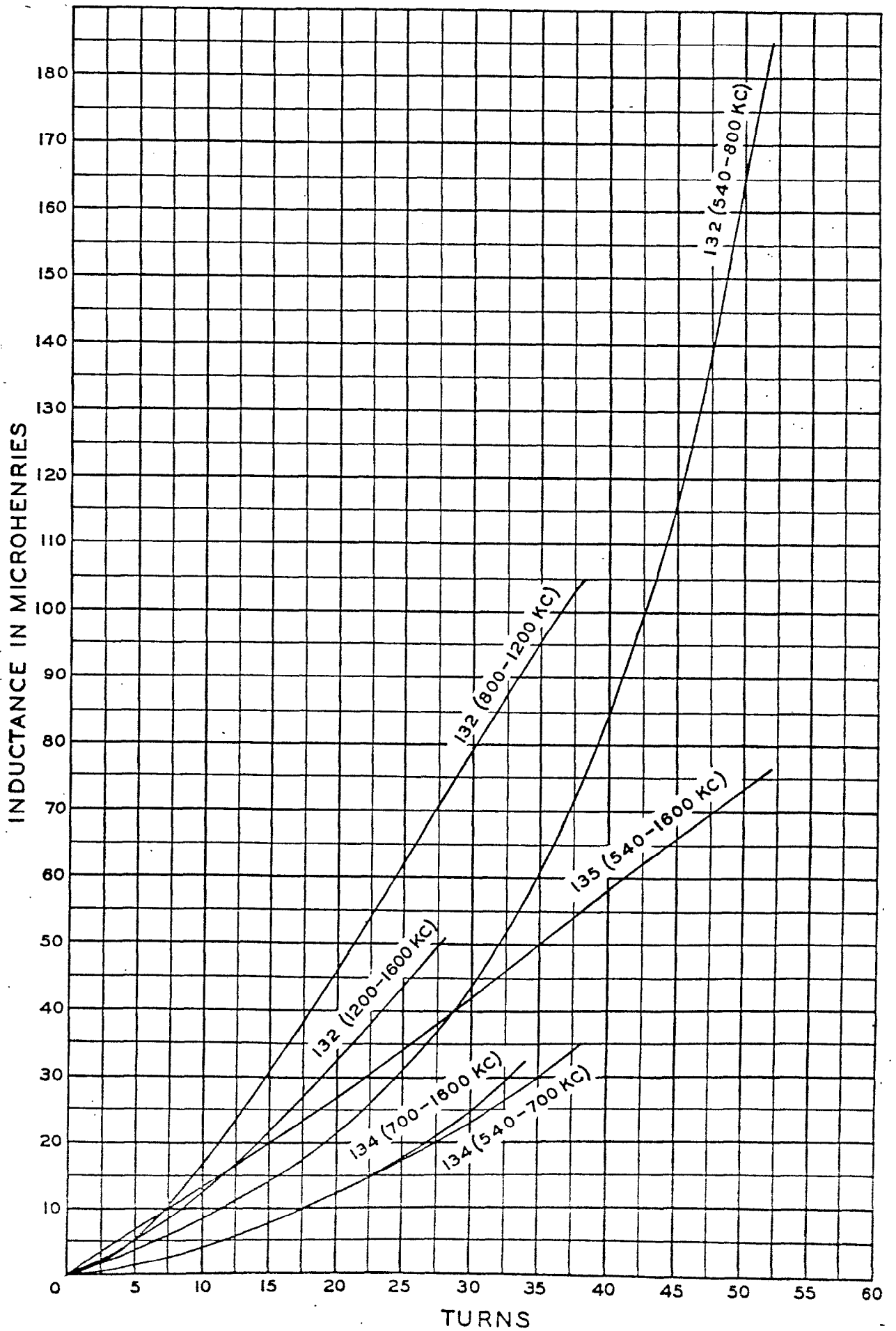
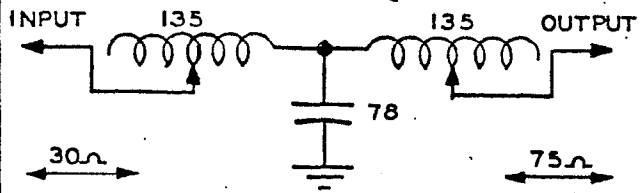

Figure 3-12. RF Tuning Curves

FINAL AMPLIFIER GRID AND OUTPUT INDUCTORS



APPROXIMATE NUMBER OF TURNS REQUIRED
IN T-SECTION COILS TO MATCH 75Ω LINE.



TURN S

55
50
45
40
35
30
25
20
15
10
5
0

500 600 700 800 900 1000 1100 1200 1300 1400 1500 1600

FREQUENCY - KC

S
P
T
b
u
p
o
f
p
e
r
t
e
r
s
a
n
d
p
u
b
l
i
c
a
t
o
r
s
o
f
t
h
e
A
E
E
E

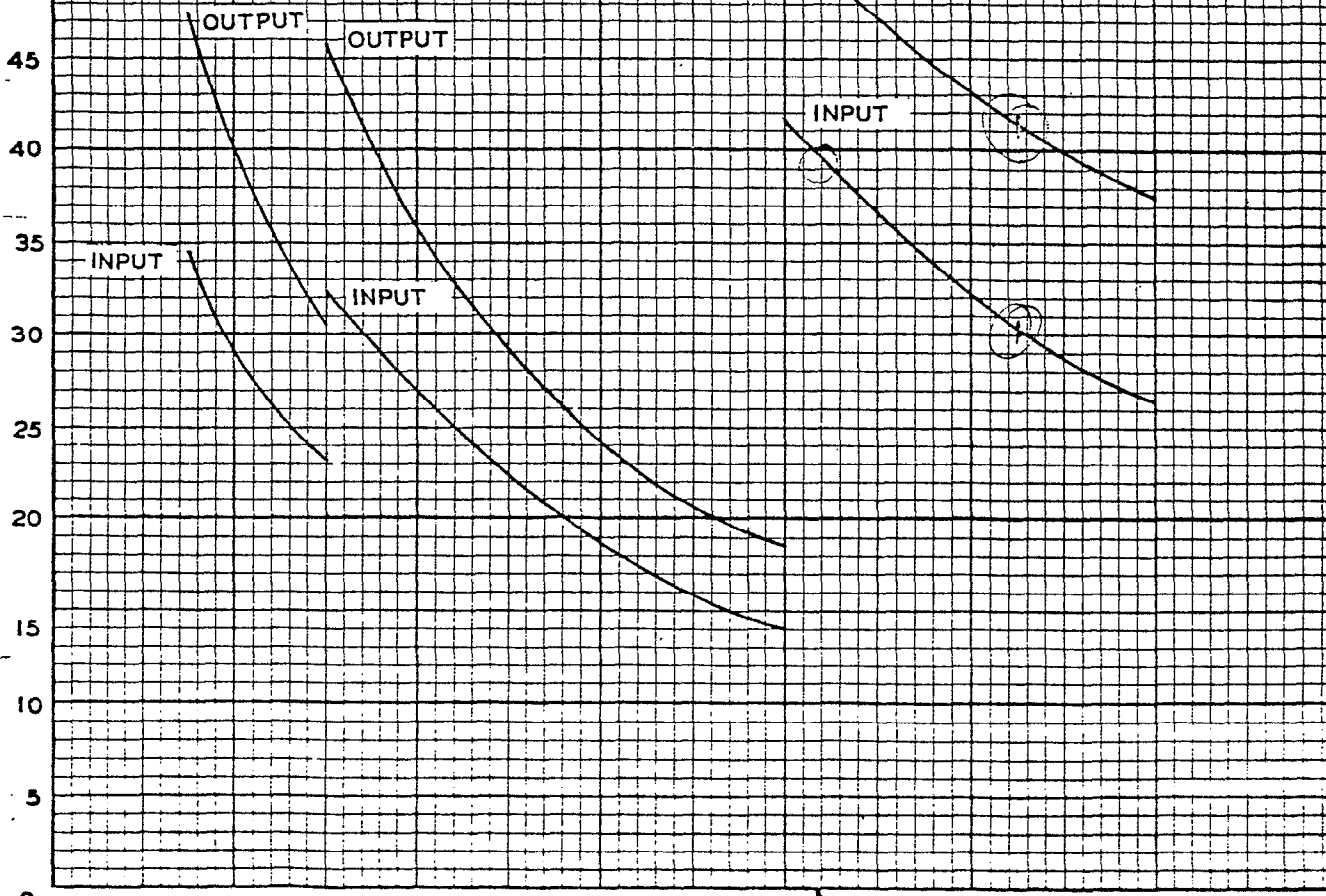

NORMAL POSITION BEFORE APPLYING PLATE VOLTAGE TO THE POWER AMPLIFIER TUBES.

The sliding tap on the pick-up coil should be placed near the "cold" or ground end of the pick-up coil. Placing the tap 8 or 10 turns from the "cold" end of the coil should give enough pick-up for operation of the monitoring equipment.

(h) **LOADING ADJUSTMENTS.**—The output network of the 300G is made up of a pi-network followed by a "T" matching section. All inductor tap adjustments have been made at the factory for the frequency upon which the transmitter is to operate so that only slight adjustments of inductor taps should be necessary. Refer to figure 3-12.

When operated in the 100 Watt position the normal operating power amplifier plate current is approximately 110 ma. Place the Tune-Meter Selector switch in the Mod Plates Loading position. With all circuit breakers in the ON position and high voltage applied to the plates of the power amplifier tubes, attempt to load the power amplifier to rated plate current. Loading is accomplished by operating the Tuning Control. The Tuning Control should be adjusted until the Final Amp Plate meter indicates that the amplifier is loaded to rated plate current. When the above conditions have been obtained, the adjustment of the "T" section may be attempted. The adjustment of the "T" section must follow the "cut and try" method unless the impedance of the transmission line is known. If the impedance of the transmission line is known, the inductance necessary for proper matching of the network to this line may be calculated. Refer to the curves showing the approximate settings of the taps on the inductors, Items 135, matching the network to a 75 ohm line. If the "cut and try" method is to be used, the tap on the input section of the branch of the "T" section

should be adjusted until some indication of antenna current is noticeable on the r-f ammeter, Item 148. To complete the adjustment of the "T" section, set the tap on the output branch to give a maximum antenna line current. When the above conditions have been obtained, some slight adjustment of the power amplifier plate tank circuit may be necessary. To make this adjustment, place the Tune-Meter Selector switch in the Final Amp Plate position and adjust the Tuning Control until the tank circuit is set at exact resonance. The Tune-Meter Selector switch should be returned to the Mod Plates Loading position and the Tuning Control adjusted to give rated output.

When the preliminary adjustments at the 100 watts level have been completed the Power Level switch should be placed in the HI position. When the Power Level switch is in the HI position the relay, Item 8, is released and the normally closed contacts of this relay "short-out" the tuning resistors, Items 112. "Shorting-out" these resistors places the full voltage of the high voltage supply on the plates of the power amplifier tubes. Slight adjustments of the output circuit may be necessary to give the required output.

(2) **AUDIO CIRCUIT ADJUSTMENTS.**—The only audio system adjustment available is that of the grid bias on the Class B modulator tubes. A ⁵⁰⁰700 ohm input circuit is provided to couple the external audio equipment to the grids of the 6J5 audio amplifier tubes. The cathode currents of the audio amplifier and audio driver stages may be metered using the Test Meter switch and the Test Meter. The desired circuit may be selected by rotating the Test Meter switch to the position indicated on the control panel. To check the operation of these two audio stages reference should be made to measurements recorded in the Data Section of the Instruction Book.

SECTION 4 OPERATION

1. GENERAL.

After all adjustments have been made in accordance with the procedure outlined in Section 3, the equipment is ready for operation. This section contains the procedure for actual operation of the equipment only. Refer to figure 4-1 for location of panel controls and meters.

2. INITIAL OPERATION.

a. STARTING EQUIPMENT.

(1) Energize the circuit to the transmitter.

(2) Close all circuit breakers.

(3) Place heater switch, Item 10, in the ON position.

(4) Press the Filament Start Button.

(5) After approximately 30 seconds have elapsed, press the Plate Power Start Button.

The transmitter is now in operation and all meters should be checked to make sure that each circuit is functioning properly. The following tables list the approximate values of meter readings for typical operating conditions:

<u>Circuit Function</u>		<u>100 Watt Operation</u>	<u>250 Watt Operation</u>
CRYSTAL OSCILLATOR Type 6F6 (1)	Filament voltage	6.4	6.4
	Plate voltage	180	180
	Cathode voltage	3.0	3.0
	Cathode current	24 ma	24 ma
	Screen voltage	162	162
BUFFER Type 6L6 (1)	Filament voltage	6.4	6.4
	Plate voltage	235	235
	Screen voltage	253	253
	Grid voltage	0	0
	Cathode voltage	21.5	21.5
	Cathode current	61.1 ma	61.2 ma
INTERMEDIATE AMPLIFIER Type 807 (2)	Filament voltage	6.4	6.4
	Plate voltage	477	477
	Screen voltage	305	305
	Grid voltage	-75	-75
	Cathode voltage	31	31
	Cathode current	164 ma	160 ma
	Grid current	5.0	5.0
POWER AMPLIFIER Type 810 (2)	Filament voltage	10.2	10.2
	Plate voltage	1000	1460
	Plate current	980 at 95% mod.	1410 at 95% mod.
	Grid voltage	170 ma	265 ma
	Grid current	-241	-227
	Grid current	116 ma	110 ma
	Cathode voltage	0	0
	Cathode current	295 ma	420 ma

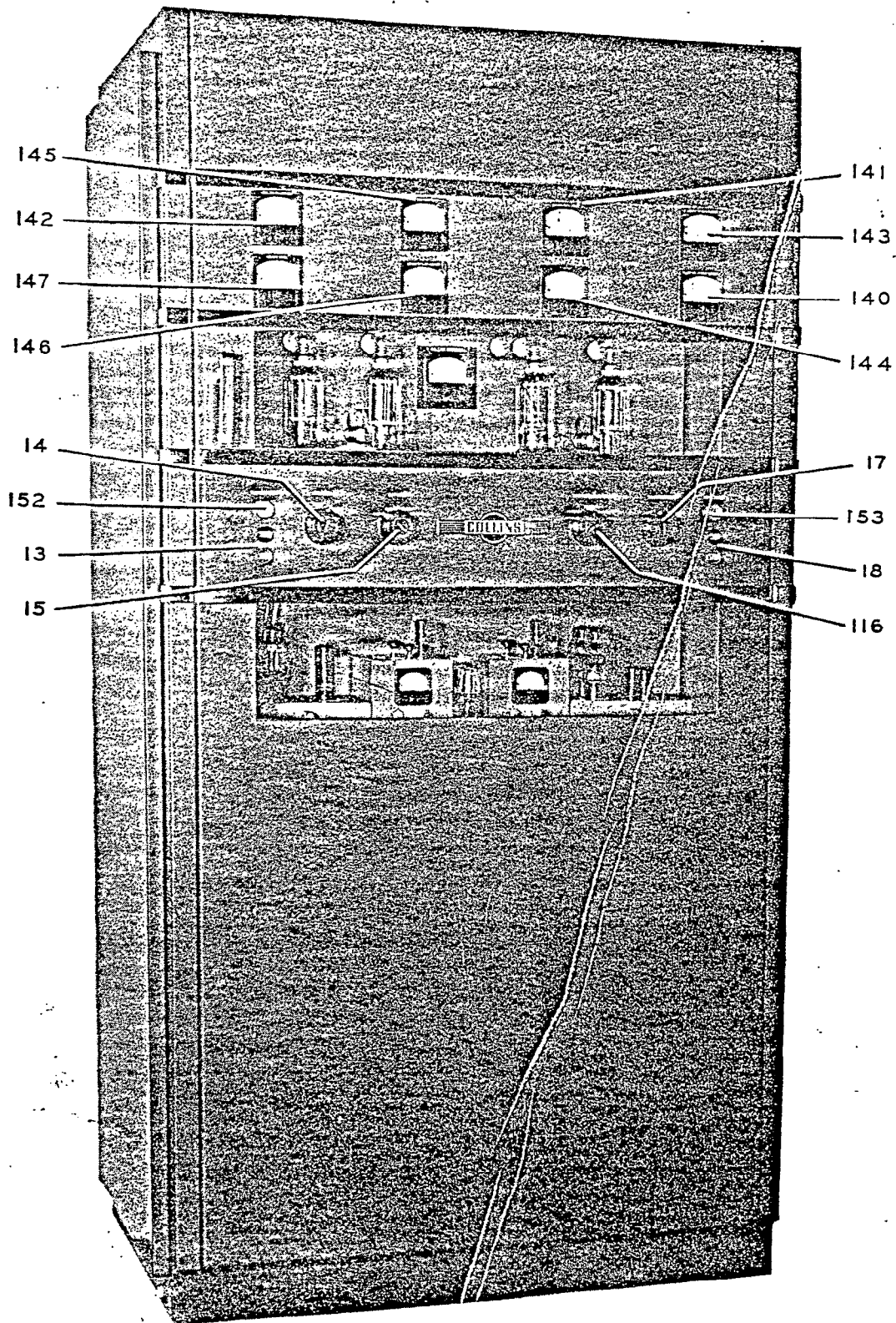

Figure 4-1. 300G Transmitter - Front View Closed

<u>Circuit Function</u>		<u>100 Watt Operation</u>	<u>250 Watt Operation</u>
MODULATOR Type 810 (2)	Filament voltage	10.2	10.2
	Plate voltage	1500	1460
	Grid voltage	-34.5	-34
	Grid current	0	0
	Cathode voltage	0	0
	Cathode current	15 ma static condition 160 ma at 95% modulation	14 ma static condition 260 ma at 95% modulation
AUDIO AMPLIFIER Type 6J5 (2)	Filament voltage	6.3	6.3
	Plate voltage	98.5	98.5
	Plate current	5.0 ma	5.0 ma
	Grid voltage	+3.8	+3.7
	Cathode voltage	+9.5	+9.5
Cathode current	5.0 ma	5.0 ma	
AUDIO DRIVER Type 6A5G (2)	Filament voltage	6.3	6.3
	Plate voltage	242	242
	Plate current	53 ma	53 ma
	Cathode voltage	40	40
	Cathode current	53 ma	53 ma
RECTIFIERS Type 866-866A (4)	High voltage plate	1500	1460
	High voltage fil	2.4	2.4
	Low voltage plate	510	509
	Low voltage fil	2.4	2.4

Power level is controlled by operating the power level switch to HI position for 250 watt operation and to LO position for 100 watt operation.

b. STOPPING EQUIPMENT.

- (1) Press the Filament Stop Button.

3. ROUTINE OPERATION.

a. STARTING EQUIPMENT.

- (1) Press the Plate Start Button.

b. STOPPING EQUIPMENT.

- (1) Press the Filament Stop Button.

Pressing the Plate Start Button will automatically start the operation sequence that applies

filament voltage to the tubes, operates the time delay relay, and applies both the low and high voltages without any further effort on the part of the operator. Pressing the Filament Stop Button will automatically open the high and low voltage circuits and de-energize the filament transformers. This operation shuts off the equipment completely with the exception of the oscillator heaters which are left on at all times.

Final tuning and loading is accomplished by rotating the Tune-Meter Selector switch to the desired circuit to be tuned and operating the tuning control dial.

It is suggested that the equipment be operated in conjunction with a satisfactory program amplifier such as the Collins Type 6M or 26W.

SECTION 5 OPERATORS MAINTENANCE

1. GENERAL.

This radio equipment has been constructed of materials considered to be the best obtainable for the purpose, and has been carefully inspected and adjusted at the factory to reduce maintenance to a minimum. However, for best operation, routine checks of the equipment should be made and existing faults corrected immediately.

2. ROUTINE CHECKS.

a. Examine all mechanical parts such as motor driven assemblies and manual operated switches for excessive wear.

b. Examine electrical system for excessive heating of transformers, resistors, chokes, etc. The constant voltage transformer, Item 20, heats somewhat above average, but, this is not abnormal for transformers of this type.

c. A check on the emission of all vacuum tubes should be made at least every 1000 hours of service. Examine the prongs on all tubes to make certain that they are free from corrosion and that they make a good electrical contact when in the socket.

d. Check all relays for proper operation and inspect relay contacts to make certain they are clean and free from pits.

e. Check all contacts of cable receptacles and plugs to assure a clean and firm mechanical connection between one another.

f. Inspect all component parts for dust accumulation.

g. Check the operation of the equipment in regard to noise and distortion.

It is important that this routine inspection be made as frequently as possible, and it should be thorough enough to include all major electrical circuits of the equipment and the mechanical portion as well.

3. VOLTAGE AND CURRENT CHECKS.

During actual operation meter indications should be under frequent observation to verify the proper operating currents and voltages. A table showing the approximate meter indications under typical operating conditions is shown in Section 4 of this Instruction Book. Some variations in the current

and voltages may occur, but most satisfactory results are obtained from operation at rated values. The filament voltages should be within 5% of the recommended values for the type of tube used. Low voltages result in low emission which affects the tubes operation and reduces tube life. Too high a voltage causes rapid evaporation of cathode material, resulting in a short life. The following table lists the tube type, function and correct filament voltage:

Tube Type	Function	Correct Voltage
6F6	R-F Oscillator	6.3
6L6	Buffer	6.3
807	Intermediate Amplifier	6.3
6J5	Audio Amplifier	6.3
6A5G	Audio Driver	6.3
810	Modulator	10.0
810	Power Amplifier	10.0
866-866A	Rectifier	2.5

4. FUSE REPLACEMENT.

The only fuses employed in the equipment are located in the 40F Frequency Control Unit. Any fuse failures would be a result of trouble in the crystal heater circuit of either of the two Oscillator Units. "Blown" fuses should be replaced with spares only after the circuit in question has been carefully examined to make certain that no permanent fault exists. Always replace a fuse with a new fuse of the proper rating.

5. CIRCUIT BREAKERS.

A check of all circuit breakers should be made immediately if the equipment becomes inoperative. This will assist in the isolation of the power circuits affected by the failures. Check all meter readings for assistance in isolating the difficulty.

6. TUBE REPLACEMENT.

When replacing tubes, make sure that they are seated correctly and fully in their sockets. If the tube has a plate or grid cap lead, be sure this is in place and not lying against a metal chassis. Before removing tubes from their sockets, make certain that all high voltage circuits are shut off. It is a good idea before removing high voltage tubes, to "short" the plate cap to ground with a screwdriver. This will eliminate any danger of an electrical shock.

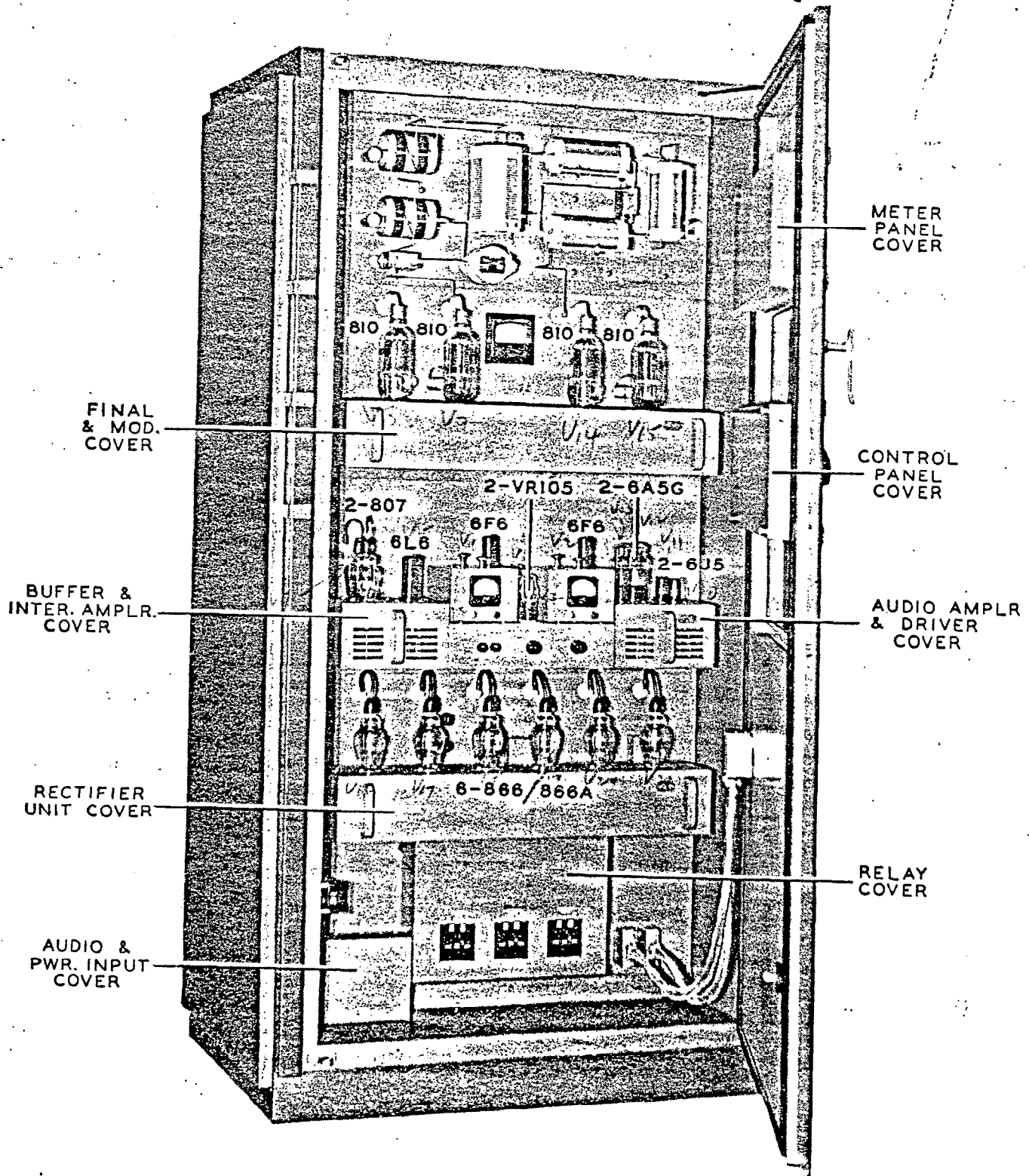

Figure 5-1. 300G Transmitter—Front View Open

caused by the discharge of high voltage filter condensers, where enough time has not elapsed for the charge to fully leak off through the bleeder resistor. Tubes should be sufficiently cooled before removing to prevent the operator from being burnt while handling them. When 866, 866A rectifiers are placed in service for the first time, the filaments should be operated at normal temperature for at least 20 minutes before plate voltage is applied. Always have

a good supply of spare tubes on hand for replacement in case of tube failure. Refer to figure 5-1 for tube location.

7. ROOM TEMPERATURE.

a. Before turning on the equipment, the room temperature should be at least 15° centigrade or higher to protect the 866, 866A rectifiers.

- V₁ - 9cc 6F5 40F unit #1
- V₂ - 9cc 6F5 #2
- V₃ - VR205 in front
- V₄ - VR105 - back
- V₅ - 6L6
- V₆ - 817 front
- V₇ - 817 back
- V₈ - 810 filament left
- V₉ - 810 filament right
- V₁₀ - 6J5 front
- V₁₁ - 6J5 back
- V₁₂ - 6AG5 front
- V₁₃ - 6AG5 back
- V₁₄ - 810 filament left
- V₁₅ - 810 filament right
- V₁₆ - 866A rectifier
- V₁₇ - 733
- V₁₈ -

SECTION 6

PREVENTATIVE MAINTENANCE

To insure peak performance and prevent failure or the impairment of the operation of the equipment, a definite schedule of periodic checks and maintenance procedures should be adhered to.

1. CLEANING.

It is suggested that a cleaning schedule be set up to include only a limited amount of cleaning and dusting to be done at one time. In this way it will require only a few minutes each night after shut-down and a more thorough job will be accomplished. Assign a different section of the transmitter to be covered each night. Arrange the schedule so that a complete coverage of the transmitter is obtained in a weeks time.

a. TRANSMITTER GENERAL.

The greatest enemy to uninterrupted service in equipment of this type is corrosion and dirt. Corrosion is accelerated by the presence of dust and moisture on the component parts in the assembly. It is impossible to keep moisture out of the equipment in certain localities, but foreign particles and dust can be periodically removed by means of a soft brush and a dry oil-free jet of air. Although the cabinet is equipped with a dust filter which will remove most of the dust particles, there is always a slight accumulation of dust in the vicinity of circuits at a high potential above ground. Remove the dust by the above method as often as a perceptible quantity accumulates at any place in the equipment. It is very important that rotating equipment such as the variable capacitors, tap switches, etc., be kept free from dust to prevent undue wear. Corrosion resulting from salt spray or salt laden atmosphere may cause failure of the equipment for no apparent reason. In general, it will be found that contacts such as the tap switches, tube prongs, and cable plug connectors are most affected by corrosion. When it is necessary to operate the equipment in localities subject to such corrosive atmosphere, inspection of wiping contacts, cable plugs, relays, etc., should be made more frequently in order to keep the equipment in good condition.

b. AIR FILTER.

The spun glass filter elements at the rear of the transmitter cabinet will give more satisfactory life if the elements are cleaned about once every two weeks. A small vacuum cleaner is a satisfactory

means of removing surface dirt. The elements should be replaced whenever the spun glass appears to be appreciably clogged by dust and grease.

2. LUBRICATION.

a. VENTILATING BLOWER.

(1) Lubricate the bearings of the ventilating blower motor with spindle oil with a viscosity of 190-220 Saybolt Universal Seconds at 100°F, such as Cities Service Pacemaker #2 or equal.

(2) Use a small amount at one time.

(3) Lubricate frequently.

b. TUNING MOTORS AND ASSEMBLIES.

(1) Lubricate with the same type spindle oil as used on the ventilating blower motors.

(2) Use a small amount at one time.

(3) Lubricate frequently.

3. ROUTINE CHECKS.

a. TUBE CHECK.

(1) A check on the emission of all vacuum tubes should be made at least every 1000 hours of service.

(2) Keep a record of the length of time the tubes are in use.

(3) Operate tubes as near their rated values of voltages and currents as possible.

(4) Replace tubes that have been in service a long time with new ones.

(5) Visually inspect the elements inside of the tubes. Elements may have become warped, increasing the probability of short-circuiting.

(6) When 866/866A mercury vapor rectifiers are put into service for the first time, the filaments should be operated at normal temperature for at least 20 minutes before plate voltage is applied.

b. MECHANICAL INSPECTION.

(1) Check all connections at least once a month. Resolder loose contacts. Tighten all nuts, bolts and screws if any loose ones are found.

(2) Check all contacts of cable receptacles and plugs to assure a clean firm mechanical connection between one another.

(3) Inspect interlock switches in the front and rear doors for proper operation.

(4) Examine all mechanical parts of motor driven assemblies for excessive wear.

SECTION 7 CORRECTIVE MAINTENANCE

I. GENERAL.

If routine maintenance checks and inspection schedules, as outlined in Sections 5 and 6, are performed regularly, very little trouble is likely to occur with this equipment. However, if trouble is encountered, an experienced operator should have little difficulty in locating and correcting the fault. A systematic procedure of testing should be followed to quickly isolate the circuit at fault. Although it is impossible to foresee every case of trouble that may develop, very little should occur, without being evident by abnormal readings of the meters in the transmitter.

2. TROUBLE SHOOTING.

a. TUBE FAILURE.—The most frequent cause of trouble in transmitting equipment is tube failure. If a fault occurs in the equipment, isolation of the circuit at fault is helpful in determining the location of the defective tube. Defective tubes causing an overload in power circuits may usually be located by inspection. It will be found that excessive heating or sputtering within vacuum tubes is a good indication of fault in the tube circuit. Low emission tubes may be the cause of erratic or poor performance of the equipment. If there is any doubt concerning the emission of any tube, it should be checked immediately and replaced if defective. A burnt out filament, obviously, would give no light with voltage applied. Tubes with electrical noises cause excessive distortion or hum. This fault may be more difficult to isolate to a particular tube, but by replacing each tube with a tube known to be in good condition the defective tube can usually be located. It will be noticed that there may be one or two 866/866A mercury vapor rectifier tubes that "fire" intermittently. This does not necessarily indicate trouble or a defective tube. The demand on the power supply caused by a varying load will bring about this condition. If a set of 866/866A tubes can be found that are equally balanced, they may "fire" simultaneously.

b. ISOLATING THE TROUBLE.

(1) Before starting on any extensive set of tests, check the position of all switches and controls and make sure that they are in the correct positions.

(2) A check of all circuit breakers should be made to ascertain the power circuit affected by the trouble.

(3) Check the circuits in the order they are made operative in the process of starting the transmitter.

(4) Compare the readings on all meters with those shown in the table in Section 4. This table lists the typical operating voltages and currents of the various circuits of the transmitter.

(5) Make a visual inspection of all tubes, resistors and chokes. Tubes may be sputtering indicating shorts, or their plates may show color, indicating a heavy current drain. Resistors and chokes may be discolored caused by a short located in their circuit.

c. POWER SUPPLY TROUBLES.

(1) FAILURE OF FILAMENT VOLTAGE SUPPLY.

(a) SYMPTOMS.

1. No filament voltage applied to any tube in the equipment.

2. No filament voltage applied to one certain tube in the equipment.

3. Ventilating blower not operating.

4. Filament pilot light not lit.

(b) PROBABLE CAUSES.

1. Constant voltage transformer defective.

2. Filament transformers applying filament voltage to individual tubes defective.

3. Filament relay contactor, Item 1, defective.

(c) CORRECTION.

1. In case the constant voltage transformer has burnt out, the equipment can be operated temporarily by disconnecting the constant voltage transformer and connecting the leads, that originally ran to the primary, to the secondary leads. The filament voltages may vary somewhat, but this arrangement will be satisfactory until the constant voltage transformer can be replaced with a new one.

2. Replace individual filament transformers that are burnt out.

3. If the Filament Relay Contactor, Item 1, has become defective, it is best to replace it with a new one. Adjustments are very critical on this type of relay and should not be attempted by the operator.

(2) FAILURE OF PLATE VOLTAGE SUPPLY.

(a) HIGH VOLTAGE DOES NOT
COME ON WHEN PLATE START
BUTTON IS PRESSED.

1. SYMPTOMS.

a. Plate pilot lamp does not light and there is no indication of plate voltage on the modulators and power amplifiers.

b. Plate pilot lamp lights but there is no indication of plate voltage on the modulators or power amplifiers.

c. Power output cannot be increased from 100 watts to 250 watts.

2. PROBABLE CAUSES.

a. Defective microswitch in time delay relay.

b. Time delay relay has not operated.

c. High voltage transformer, Item 22, burnt out.

d. Defective High Voltage Rectifier plate contactor.

e. Interlocks on cabinet doors are not closed.

f. Contacts of Power Change Relay, Item 8, dirty, preventing the application of the full plate voltage to the power amplifiers.

3. CORRECTION.

a. Replace defective microswitch in time delay relay.

b. Replace defective High Voltage Transformer with a new one.

c. Replace defective High Voltage Rectifier Plate Contactor with a new one.

d. Inspect door interlock and repair if defective.

(b) LOW VOLTAGE PLATE SUPPLY
VOLTAGE FAILURE.

1. SYMPTOMS.

a. No indication of plate or screen voltages on the low voltage tubes.

b. No bias on the modulators.

2. PROBABLE CAUSES.

a. Time delay relay has not operated.

b. Microswitch in time delay relay defective.

c. Defective low voltage plate contactor, Item 3.

d. Low voltage plate transformer burnt out.

3. CORRECTION.

a. Replace all parts listed above, with new ones, in the event defective ones are found.

d. DISTORTION.

(1) Very little distortion is likely to occur with

this equipment, however, if distortion is at all noticeable, the following checks should be made to locate and correct it.

(a) Check the Static Cathode Current of the modulators. This current should be approximately 15 ma for best operation. This can be obtained by adjusting the bias on the modulators.

(b) Check the components in the feedback network.

(c) Replace 6J5 tubes with tubes known to be good.

Distortion may sometimes be difficult to locate. It may require a step-by-step method of testing with the oscilloscope until the point is reached where the distortion originates.

e. PARASITIC OSCILLATIONS.—Parasitics are guarded against in the design of this equipment. The use of parasitic suppressors dampen parasitics that may develop in the rf driver or power amplifier stages. Should parasitics develop in the buffer stage where a glass Type 6L6 tube is being used, replace the glass tube with a metal one. This will eliminate the intercoupling caused by the unshielded tube.

f. POWER AMPLIFIER STAGE
NOT NEUTRALIZED.

(1) SYMPTOMS.

(a) Grid current varies when tuning the plate circuit of the power amplifier.

(b) Maximum grid current is not obtained when plate circuit is at resonance.

(c) Transmitter can not be modulated 100%.

(2) PROBABLE CAUSE.

(a) Grid to plate capacity of power amplifier tubes has changed with aging tubes.

(b) New tubes have been installed and the grid to plate capacity of these new tubes is different than the grid to plate capacity of the old tubes.

(c) The neutralizing capacitor is out of adjustment.

(3) CORRECTION.—Refer to the paragraph on how to neutralize in Section 3 of this book and re-neutralize.

g. FAILURE OF OSCILLATOR UNIT.—In case of failure of the 40F oscillator unit, the remaining oscillator unit can be selected by operating the switch, Item 12. In this way, the defective unit can be removed for repairs, without affecting the operation of the transmitter.

h. VENTILATING BLOWER.—It is important that the ventilating blower motor be lubricated often. This motor is operating continuously and is subject to more wear, consequently, it should be kept well oiled.

i. TUNING MOTORS.—To minimize the wear in

these motors and their assemblies, they should be lubricated frequently with a light oil. They should be observed often for excessive wear and replaced if necessary.

3. SERVICING THE EQUIPMENT.

When service work or replacement of parts is necessary, it is an easy matter to obtain access to all components of the transmitter. All wiring and components on the front side of the vertical chassis

can be exposed by removing six covers. (Refer to figure 5-1.) All wiring and components on the rear side of the vertical chassis are exposed by removing the two side wire channel covers, the three horizontal wire channel covers and the air baffle. When servicing components in the front door panel, remove the two dust covers, shown in figure 5-1. An eddy current shield has been placed around the constant voltage transformer to prevent the eddy currents, created by this type of transformer, from setting up vibrations within the transmitter cabinet.

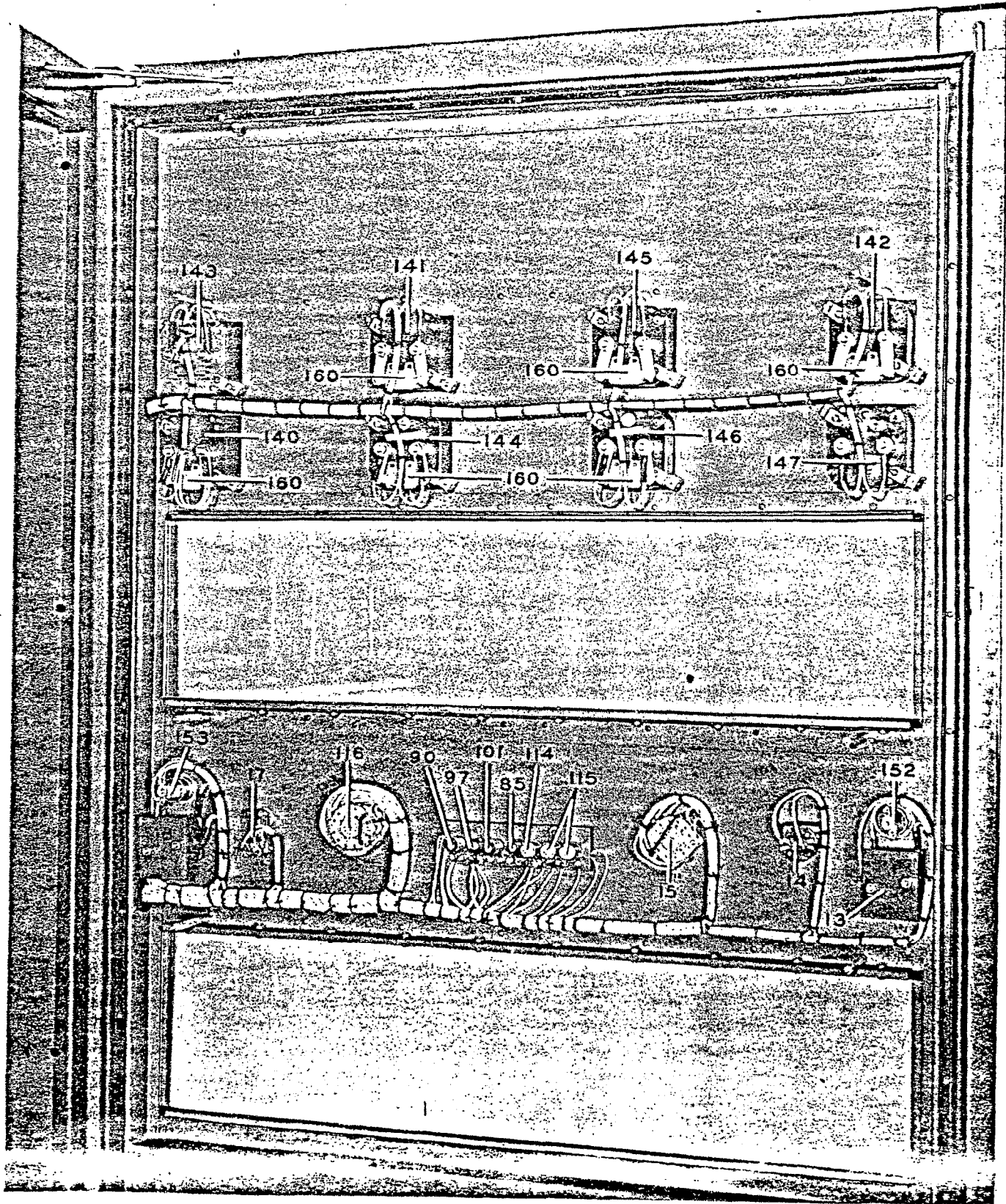

Figure 7-1. Door Panel — Inside View

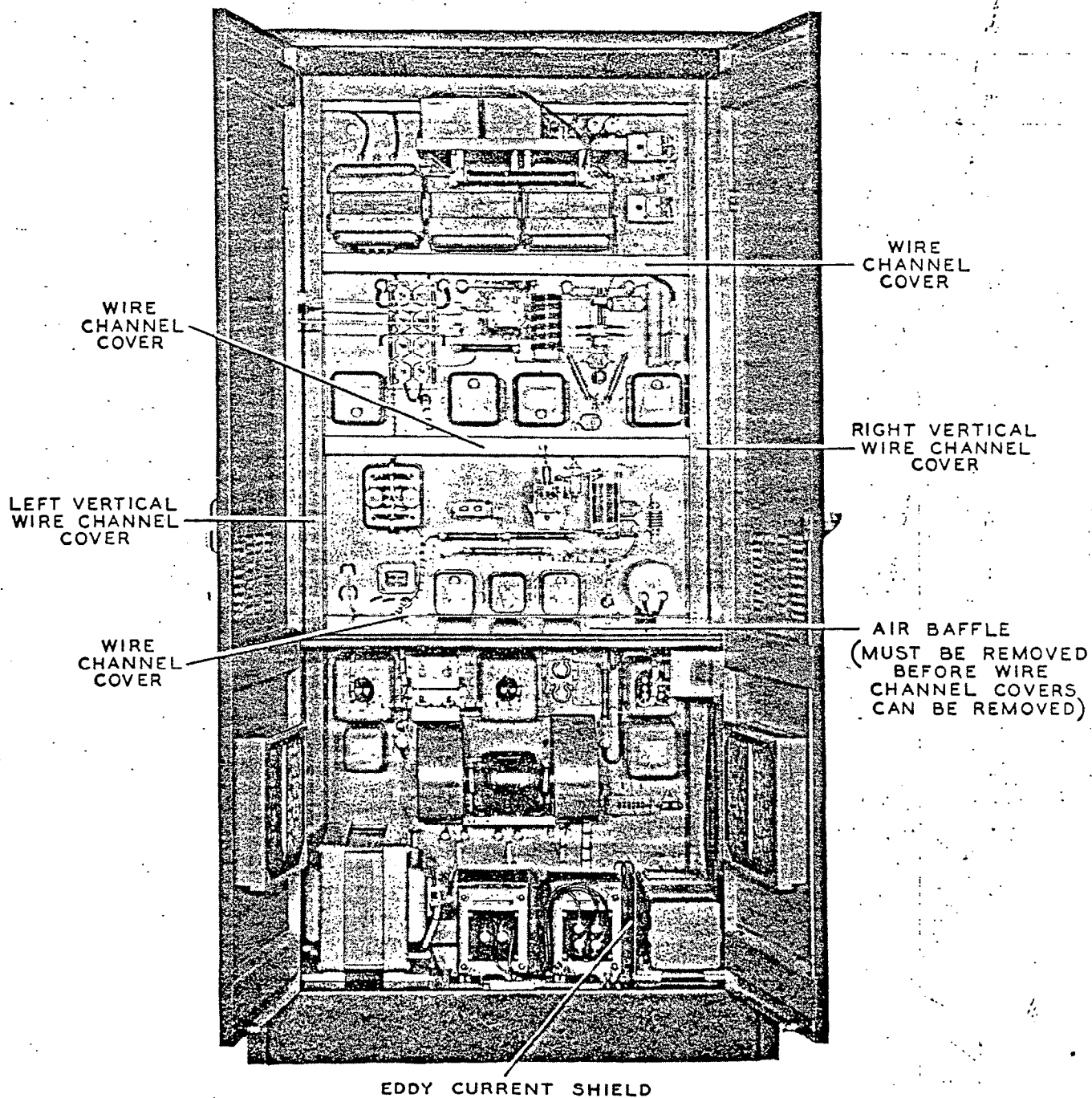

Figure 7-2. 300G Transmitter — Rear View Open

SECTION 8
TABLE OF REPLACEABLE PARTS

SYMBOL DESIGNATION	FUNCTION	DESCRIPTION	MFR. and MFR'S TYPE or CAT. NO.	COLLINS PART NUMBER
40F OSCILLATOR UNIT				
60	Osc plate coupling capacitor	CAPACITOR: Mica; .001 mf $\pm 10\%$; 2500 tv; 1200 wv; .5" x 1.3" x 1.8".	9110 Cat. 9L-22010	925 2101 20
61	Osc plate supply bypass	CAPACITOR: Mica; .006 mf $\pm 10\%$; 2500 tv; 1200 wv; 0.5" x 1.3" x 1.8".	9110 Cat. 9L-22060	925 2601 20
62	Osc screen bypass	CAPACITOR: Mica; .006 mf $\pm 10\%$; 2500 tv; 1200 wv; 0.5" x 1.3" x 1.8".	9110 Cat. 9L-22060	925 2601 20
63	Osc cathode bypass	CAPACITOR: Mica; 270 mmf $\pm 2\%$; dc; 2500 wv dc; 15/16" x 1-11/32" x 1-25/32".		937 0064 00
64	Osc feedback capacitor	CAPACITOR: 51 mmf $\pm 2\%$; 2500 wv dc; 15/16" x 1-11/32" x 1-25/32".		937 0018 00
65	Trimmer capacitor	CAPACITOR: Variable; midget; 1-12 mmf; coaxial cylindrical plates; 9/16" x 1-1/8".	30900 Cat. 22-5230	922 3100 00
107	Osc plate resistor	RESISTOR: Fixed; 1000 ohms $\pm 10\%$; .2 watts; 11/32" diam; 1-3/4" long.	23600 Type BT2	706 1420 00
108	Osc cathode resistor	RESISTOR: Fixed; 100 ohms $\pm 10\%$; 10 watts; wire wound; 13/32" diam; 1-3/4" long.	34500 Type Brown Devil	710 1100 20
109	Osc grid resistor	RESISTOR: Fixed; 47,000 ohms $\pm 10\%$; 1 watt; 217 v max; 4.6 ma max; 7/32" diam; 19/32" long.	900 Cat. GB4731	703 4742 00
125	Osc plate RF	COIL, CHOKER: 2.5 mh; 0.125 amp; 35 to 50 ohms $\pm 20\%$; 1/2" diam; 2" long.	32200	240 2000 00
126	Osc cathode RF choke	COIL, CHOKER: 2.5 mh; 0.125 amp; 35 to 50 ohms $\pm 20\%$; 1/2" diam; 2" long.	32200	240 2000 00
151	Osc pilot light	LAMP, PILOT: 6.3v; 0.15 amps; 7/16" x 1-1/8".	38460 Cat. R40A	262 3240 00
203	Osc cathode milliammeter	METER: 50 ma dc; 50 scale divisions 1.0 ma per division; 2 ohms $\pm 20\%$.	41970 Type 127S	450 0013 00
	Crystal oven	CRYSTAL OVEN: Crystal holder; thermostat and heating element.	8300 Type 297.	
UNIT A-11M OUTPUT NETWORK				
8	Power change relay	RELAY: 110 v; .06A; 540 ohm coil; 1/4" silver contacts; 115 v; 5 amps; mycalex insulation.	28600 Type 1507-MX	407 1000 00
24	LV plate transformer	TRANSFORMER: Pri: 105, 110, 115, 120, 125; 50/60 cps; 240 va Sec: 600-0-600 v; 0.283 amp; 340 va; 215 watts; 6-3/8" x 7-1/2" x 7-1/2".	7800	672 1360 00
36	HV filter reactor (2)	COIL, REACTOR: 6 hy; 0.7 amp; 40 ohm $\pm 20\%$; 120 cps; 10,000 tv; 6-3/4" x 7-1/8" x 7-1/2".	7800	673 1160 00
45	HV filter capacitor (4)	CAPACITOR: Fixed; paper dielectric; 4.0 mf $\pm 10\%$; 5000 tv; 2500 wv; 3-3/4" x 4-9/16" x 5-1/4".	9110 Cat. T-25040	930 0033 00

TABLE OF REPLACEABLE PARTS

Section 8

SYMBOL DESIGNATION	FUNCTION	DESCRIPTION	MFR. and MFR'S TYPE or CAT. NO.	COLLINS PART NUMBER
UNIT A-11M OUTPUT NETWORK (Cont.)				
65	Tuning motor	MOTOR: 24 v; split-phase reversible; 3.4 rpm; 36 watts; 60 cps; 2.4 amps; 2" x 2-1/8" x 3-11/16".	1040 Type 12	230 7000 00
66	Tuning motor	MOTOR: 24 v; split-phase reversible; 3.4 rpm; 36 watts; 60 cps; 2.4 amps; 2" x 2-1/8" x 3-11/16".	1040 Type 12	230 7000 00
76	PA plate blocking capacitor	CAPACITOR: Mica; .0005 mf ±5%; 5000 tv; 60 cps; 1-1/4" x 2-1/4" x 3-1/8".	9110 Type 6L	906 3501 00
77	PA plate capacitor	CAPACITOR: For information on this item refer to page 8-13.		
78	Output network capacitor	CAPACITOR: For information on this item refer to page 8-13.		
80	HV Bleeder resistor	RESISTOR: Fixed; 50,000 ohms ±10%; 92 watts; 2150 v max; 43 ma max; wire wound; 1-1/4" x 9-3/4".	34500	710 0153 00
111	Voltmeter multiplier (2)	RESISTOR: Fixed; 100,000 ohms ±1%; 50 watts; 1200 v max; 12 ma max; wire wound; 3/8" x 5".	34500	728 1004 60
112	HV Dropping resistor	RESISTOR: Fixed; 6000 ohms ±10%; 100 watts; 765 v max; 129 ma max; wire wound; 1" x 7-5/8".	34500	710 0175 00
132	PA plate tank coil assembly	COIL ASSEMBLY: For information on this item refer to page 8-13.		
133	Output network coil	COIL: For information on this item refer to page 8-13.		
135	Output network coil (2)	COIL: Adjustable coil rider; space wound; 52 turns; #14 bus; 3-3/8" x 5-31/32".	8300	508 2140 20
136	Monitor coil assembly	COIL ASSEMBLY: Space wound; adjustable coil rider; 52 turns; #14 bus; 3-3/8" x 5-31/32".	8300	508 2140 20
137	Output network coil	COIL: For information on this item refer to page 8-13.		
UNIT B-3Z RF MODULATOR UNIT				
11	PA high voltage plate power switch	SWITCH: SPST; knife switch; copper blade and clips; 25 amps; bakelite handle; 11/16" x 2".	44970 Cat. 707	260 4010 00
28	Power amplifier filament transformer	TRANSFORMER: Pri: 105, 110, 115, 120, 125 v; 50/60 cps; 65 va Sec: 10 v; 6.5 amp; 65 va; 4-1/2" x 5-1/4" x 5-5/16".	7800	672 1280 00
29	Power amplifier filament transformer	TRANSFORMER: Pri: 105, 110, 115, 120, 125 v; 50/60 cps; 65 va Sec: 10 v; 6.5 amp; 65 va; 4-1/2" x 5-1/4" x 5-5/16".	7800	672 1280 00
30	Modulator filament transformer	TRANSFORMER: Pri: 105, 110, 115, 120, 125 v; 50/60 cps; 65 va Sec: 10 v; 6.5 amp; 4-1/2" x 5-1/4" x 5-5/16".	7800	672 1280 00
31	Modulator filament transformer	TRANSFORMER: Pri: 105, 110, 115, 120, 125 v; 50/60 cps; 65 va Sec: 10 v; 6.5 amp; 4-1/2" x 5-1/4" x 5-5/16".	7800	672 1280 00

TABLE OF REPLACEABLE PARTS

SYMBOL DESIGNATION	FUNCTION	DESCRIPTION	MFR. and MFR'S. TYPE or CAT. NO.	COLLINS PART NUMBER
40	Neutralizing capacitor	UNIT B-3Z RF MODULATOR UNIT (Cont.) CAPACITOR: Variable; 4-14 mmf; 2 plates, adjustable air gap; 4" diameter; 4-13/16" long.	21400 Cat. N-20	923 1200 00
54	PA plate supply filter capacitor	CAPACITOR: Mica; .0001 mf $\pm 10\%$; 5000 tv; 60 cps; 1-1/4" x 2-1/4" x 3-1/8".	9110 Type 6L	906 3102 00
68	Neutralizing capacitor	CAPACITOR: For information on this item refer to page 8-13.		
70	Feedback coupling capacitor (8)	CAPACITOR: Mica; .0001 mf $\pm 10\%$; 2500 tv; 1200 wv; 0.5" x 1.3" x 1.8".	9110 Type 9L	925 3101 20
72	PA filament bypass (4)	CAPACITOR: Mica; 0.01 mf $\pm 10\%$; 2500 tv; 1200 wv; 0.5" x 1.3" x 1.8".	9110 Type 9L	925 1101 20
73	PA grid bypass	CAPACITOR: Mica; .006 mf $\pm 10\%$; 2500 tv; 1200 wv; 0.5" x 1.3" x 1.8".	9110 Cat. 9L-22060	925 2601 20
74	PA filament C.T. bypass	CAPACITOR: Mica; .006 mf $\pm 10\%$; 2500 tv; 1200 wv; 0.5" x 1.3" x 1.8".	9110 Cat. 9L-22060	925 2601 20
113	Feedback network resistor (8)	RESISTOR: Fixed; 250,000 ohms $\pm 10\%$; 1 watt; 500 v max; 2 ma max; 5/16" diam; 1-3/4" long.	23600 Type BT2	706 2504 20
75	PA grid coupling capacitor	CAPACITOR: For information on this item refer to page 8-13.		
116	PA grid resistor	RESISTOR: Fixed; 2000 ohms $\pm 10\%$; 50 watts; 316 v max; 158 ma max; 19/32" diam; 5" long; wire wound.	34500 Type 9, 16 x 4	710 4246 20
118	Grid parasitic suppressor (2)	PARASITIC SUPPRESSOR RESISTOR ASSEMBLY: 50 ohms; 7 watt; 10 turns; #12 bus; 1-5/16" x 3-15/32".	8300	502 4720 002
126	PA grid choke	COIL CHOKE: 2.5 mh $\pm 10\%$; 0.5 amps; multiple-section duo-lateral wound; ceramic form; 1-1/8" diam; 3-7/16" long; 8 ohms.	21400 Cat. CH-500	240 2500 00
129	PA plate feed	COIL CHOKE: Winding 5-1/2" of quadruple bank #24 DSC wire.	8300	571 0460 10
138	Neutralizing coil	COIL NEUTRALIZING: For information on this item refer to page 8-13.		
148	Line RF ammeter or	METER: 200 ohm line; 0-1.5 amp; 60 scaled divisions; 0.025 amps per divisions; 2%; 2-15/16" x 3".	49100 Type 733-Special	451 0002 00
148	Line RF ammeter	METER: 70 ohm line; 0-3 amp; 60 scale divisions 0.05 amp per division; 1 watt; .06 ohms 2%; 2-15/16" x 3".	49100 Type 733	451 0003 00
	Power amplifier (2)	TUBE: Type 810; transmitting triode; 8-1/2" long; 2-9/16" diam.	38110	256 0051 00
	Modulator (2)	TUBE: Type 810; transmitting triode; 8-1/2" long; 2-9/16" diam.	38110	256 0051 00
9	UNIT Crystal heater relay	C-33Q EXCITER AND SPEECH AMPLIFIER RELAY: Single wound; quick acting; single point; 2500 ohms; 6 to 12 v; 1-15/64" x 1-23/32" x 4".	UNIT 8160 Type C	970 1002 00

TABLE OF REPLACEABLE PARTS

SYMBOL DESIGNATION	FUNCTION	DESCRIPTION	MFR. and MFR'S. TYPE or CAT. NO.	COLLINS PART NUMBER
	UNIT	C-33Q EXCITER AND SPEECH AMPLIFIER	UNIT (Cont.)	
10	Crystal heater supply switch	SWITCH: 2 pole; 2 position; one enclosed section non-shorting; 3-3/16" long; 1-3/16" diam.	30300 Cat. 3222J	259 1100 00
12	Oscillator selector switch	SWITCH: 4 pole; 2 position; 2 section shorting type; 1-9/16" diameter; 6-1/4" long.	7000	259 1280 00
21	Int amp plate parasitic suppressor	RESISTOR: Fixed; 47 ohm $\pm 10\%$; 1 w; 6.8 v max; 145 ma max; 7/32" diam; 19/32" long.	900 Cat. GB4701	703 4740 00
26	Crystal heater supply transformer	TRANSFORMER: Pri: 105, 110, 115, 120, 125 v; 50/60 cps; 25 va Sec: 12 v; 2.0 amp; 25 va; 3-5/16" x 4-5/16" x 4-7/16".	7800	674 1240 00
27	Int amp and buffer heater supply transformer	TRANSFORMER: Pri: 105, 110, 115, 120, 125 v; 50/60 cps; 2500 tv; 31.5 va. Sec: 6.3 v 5.0 amps; 2500 tv; 31.5 va; 3-9/16" x 4-7/16" x 4-5/16".	7800	672 1380 00
32	Audio input transformer	TRANSFORMER: Pri: 500 ohm C.T. Sec: 15,000 ohm C.T. ± 1 db; from 30 to 15,000 cps; 2-5/8" x 3-1/8" x 3-5/8".	44500 Type T-44212	667 6760 00
33	Audio driver transformer	TRANSFORMER: Pri: 6000 ohm C.T.; 30 10,000 cps \pm db; 80 ma; 3000 tv; Sec: 6000 ohm C. T.; 50 ma; 3000 tv; 5-5/16" x 5-7/8" x 6".	7800	677 0048 00
38	PA grid tuning capacitor assembly	CAPACITOR: Variable; 18 to 475 mmf; single gang; mycalex insulation; 1-15/16" x 2-13/16" x 4-1/8".	6500 Type X	921 1300 00
39	RF driver grid supply filter capacitor	CAPACITOR: Mica; 0.01 mf $\pm 10\%$; 2500 tv; 1200 wv; 0.5" x 1.3" x 1.8".	9110 Type 9L	925 1101 20
41	Int amp plate supply bypass	CAPACITOR: Mica; .006 mf $\pm 10\%$; 2500 tv; 1200 wv; 0.5" x 1.3" x 1.8".	9110 Cat. 9L-22060	925 2601 20
42	Speech amp filament transformer	TRANSFORMER: Pri: 105, 110, 115, 120, 125 v; 50/60 cps; 19 va Sec: 6.3 v; 3.0 amp; 19 va; 3-3/16" x 3-7/8" x 4".	7800	672 1460 00
44	Audio Input transformer loading resistor (2)	RESISTOR: Fixed; 7500 ohms; $\pm 5\%$ tolerance; insulated composition; 122 wv; 2 watts; .405" diam; 1.78" long.	42300	745 6123 00
47	Oscillator HV suppressor filter capacitor	CAPACITOR: Paper; oil filled; soldering lugs; 4 mf $\pm 10\%$; 1600 tv; 800 wv; 1-3/16" x 3-7/16" x 4-5/8".	9110 Type KG	930 1720 00
49	Audio amp grid decoupling capacitor (2)	CAPACITOR: Mica; .0056 mf $\pm 5\%$; molded case; 1200 wv; 29/64" x 1-1/8" x 1-5/8".	40300	936 1109 00
50	Audio amp plate decoupling capacitor (2)	CAPACITOR: Mica; .002 mf $\pm 10\%$; 2500 tv; 1200 wv; soldering lugs; 11/32" x 1-1/32" x 2-9/32".	40300 Type BE-15	925 2205 20
51	Audio driver grid coupling capacitor (2)	CAPACITOR: Foil-paper; 0.5 mf $\pm 20\%$; 1200 tv; 600 wv; 15/16" x 1" x 2-9/16".	9110 DYRT	956 2086 40
52	Audio driver plate coupling capacitor (2)	CAPACITOR: Mica; 0.01 mf $\pm 10\%$; 2500 tv; 1200 wv; 0.5" x 1.3" x 1.8".	9110 Type 9L	925 1101 20

TABLE OF REPLACEABLE PARTS

SYMBOL DESIGNATION	FUNCTION	DESCRIPTION	MFR. and MFR'S. TYPE or CAT. NO.	COLLINS PART NUMBER
	UNIT	C-33Q EXCITER AND SPEECH AMPLIFIER	UNIT (Cont.)	
53	Int. amp cathode bypass	CAPACITOR: Mica; 0.006 mf $\pm 10\%$; 2500 tv; 1200 wv; 0.5" x 1.3" x 1.8".	9110 Cat. 9L-22060	925 2601 20
55	Int. amp screen bypass	CAPACITOR: Mica; 0.006 mf $\pm 10\%$; 2500 tv; 1200 wv; 0.5" x 1.3" x 1.8".	9110 Cat. 9L-22060	925 2601 20
56	Buffer plate coupling	CAPACITOR: Mica; .002 mf $\pm 10\%$; 2500 tv; 1200 wv; 0.5" x 1.3" x 1.8".	9110 Type 9L	925 2201 20
57	Buffer screen bypass	CAPACITOR: Mica; 0.01 mf $\pm 10\%$; 2500 tv; 1200 wv; 7/16" x 1-1/8" x 1-5/8".	9110 Type 4L	925 1107 20
58	Buffer cathode bypass	CAPACITOR: Mica; 0.01 mf $\pm 10\%$; 2500 tv; 1200 wv; 7/16" x 1-1/8" x 1-5/8".	9110 Type 4L	925 1107 20
59	Buffer grid coupling capacitor	CAPACITOR: Variable; midget; 5.6-100 mmf; one section; soldering lugs; 1-3/16" x 1-5/16" x 2-3/16".	21400 HF-Micro	922 0005 00
69	PA grid capacitor	CAPACITOR: For information on this item refer to page 8-13.		
72	Int amp plate blocking capacitor	CAPACITOR: Mica; 0.01 mf $\pm 10\%$; 5000 tv; 2000 wv; 0.8" x 1.3" x 1.8".	9110 Type 9L	950 1101 20
83	Audio amplifier grid decoupling resistor (2)	RESISTOR: Fixed; 3900 ohms $\pm 10\%$; 2 watts; 89 v max; 22.8 ma max; 5/16" diam; 1-3/4" long.	23600 Type BT-2	706 3900 20
84	Audio amp cathode resistor	RESISTOR: Fixed; 2000 ohms; $\pm 10\%$; 2 watts; 63.2 v max; 31.6 ma max; 5/16" diam; 1-3/4" long.	23600 Type BT2	706 2420 00
86	Audio amp plate decoupling resistor	RESISTOR: Fixed; 20,000 ohms $\pm 10\%$; 200 v max; 10 ma; 5/16" diam; 2 watts; 1-3/4" long.	23600 Type BT2	706 2042 00
87	Audio amp plate resistor (2)	RESISTOR: Fixed; 50,000 ohm $\pm 10\%$; 2 watts; 316 v max; 6.3 ma max; 5/16" diam; 1-3/4" long.	23600 Type BT2	706 5042 00
88	Audio driver grid resistor	RESISTOR: Fixed; 250,000 ohm $\pm 10\%$; 1 watt; 500 v max; 2 ma max; 5/16" diam; 1-3/4" long.	23600 Type BT2	706 2504 20
89	Audio driver cathode resistor	RESISTOR: Fixed; 750 ohm $\pm 10\%$; 10 watts; 86 v max; 115 ma max; 13/32" diam; 1-3/4" long; wire wound.	34500 Type Brown Devil	710 1750 20
91	Audio driver plate resistor	RESISTOR: Fixed; 4000 ohm $\pm 10\%$; 50 watts; 447 v max; 111 ma max; wire wound; 19/32" diam; 5" long.	34500 Type 9/16 x 4	710 4446 20
93	Int. amp and buffer screen parasitic suppressor (3)	RESISTOR: Fixed; 47 ohm $\pm 10\%$; 1 watt; 6.88 v max; 145 ma max; 7/32" diam; 19/32" long.	900 Cat. GB4701	703 4720 00
94	Int. amp and buffer grid parasitic suppressor (3)	RESISTOR: Fixed; 47 ohm $\pm 10\%$; 1 watt; 6.88 v max; 145 ma max; 7/32" diam; 19/32" long.	900 Cat. GB4701	703 4720 00
95	Int. amp cathode resistor	RESISTOR: Fixed; 200 ohm $\pm 10\%$; 25 watts; 70 v max; 353 ma max; 19/32" diam; 3" long.	34500 Type 9/16 x 2	710 0054 00

TABLE OF REPLACEABLE PARTS

SYMBOL DESIGNATION	FUNCTION	DESCRIPTION	MFR. and MFR'S. TYPE or CAT. NO.	COLLINS PART NUMBER
98	UNIT Int. amp grid resistor	C-33Q EXCITER AND SPEECH AMPLIFIER RESISTOR: Fixed; 15,000 ohm $\pm 10\%$; 2 watts; 172 v max; 11.5 ma max; 5/16" diam; 1-3/4" long.	UNIT (Cont.) 23600 Type BT2	706 1542 00
99	Buffer plate resistor	RESISTOR: Fixed; 2000 ohm $\pm 10\%$; 25 watts; wire wound; 224 v max; 112 ma max; 23/32" diam; 2" long.	34500 Cat. 0207	710 3242 00
100	Buffer screen resistor	RESISTOR: Fixed; 50,000 ohms $\pm 10\%$; 7.2 watts; wire wound; 600 v max; 12 ma max; 1/2" diam; 2" long.	34500 Type 20 watt BD	710 2504 20
102	Buffer cathode resistor	RESISTOR: Fixed; 350 ohms $\pm 10\%$; 10 watts; 59 v max; 169 ma max; wire wound; 13/32" diam; 1-3/4" long.	34500 Cat. Ohmite Special #1757	710 1350 20
103	Buffer grid resistor	RESISTOR: For information on this item refer to page 8-13.		
104	Osc HV dropping resistor	RESISTOR: Fixed; 5000 ohms $\pm 10\%$; 50 watts; wire wound; 500 v max; 100 ma max; 19/32" diam; 5" long.	34500 Cat. 140-9	710 4546 20
105	Osc screen dropping resistor	RESISTOR: Fixed; 10,000 ohms $\pm 10\%$; 5 watts; wire wound; 245 v max; 24 ma max; 13/32" diam; 1-3/4" long.	34500 Type Brown Devil	710 1104 20
106	Osc screen voltage dividing resistor	RESISTOR: Fixed; 2500 ohms $\pm 10\%$; 154 v max; 61 ma max; wire wound; 9 watts; 13/32" diam; 1-3/4" long.	34500 Type Brown Devil	710 0030 00
110	Osc pilot light voltage dropping resistor	RESISTOR: Fixed; 75 ohms $\pm 10\%$; 10 watts; 27 v max; 365 ma max; 13/32" diam; 1-3/4" long; wire wound.	34500 Type Brown Devil	710 1752 00
119	Int amp screen resistor	RESISTOR: Fixed; 15,000 ohms $\pm 10\%$; 17 watts; 510 v max; 34 ma max; wire wound; 9/16" diam; 3" long.	34500	710 0075 00
127	Buffer plate choke	COIL, CHOKE: 2.5 mh; 0.125 amps max; 35 to 50 ohms $\pm 20\%$; multiple-section dual-lateral wound; 1/2" diam; 2" long.	32200 Cat. R-100	240 2000 00
128	Int. amp plate choke	COIL, CHOKE: 2.5 mh; 0.5 amps max; 8 ohms $\pm 10\%$; multiple-pi-duo-lateral wound; ceramic form; 1-3/8" diam; 2-15/16" long.	21400 Cat. CH-500	240 2500 00
134	Int. amp plate tank coil	COIL TANK: For information on this item refer to page 8-13.		
150	Crystal comp thermostat supply (2)	RECTIFIER, COPPER OXIDE: 20 v ac; 100 ohms; 11.82 v dc; 118.2 ma dc; 1/2" diam; 1-1/16" long.	8460	353 3000 00
202	PA plate feed choke	COIL, CHOKE: Aircore. 46.5 mh; 350 T #22; 3 1/4" diam; 3 1/2" long.	8300	508 0680 20
204	Crystal heater fuse (2)	FUSE: 2 amp; 250 v; glass enclosed cartridge; 1/4" diam; 1-3/4" long.	29200	264 4070 00
	Intermediate amplifier (2)	TUBE: Type 807; transmitting beam power amplifier; 5-3/4" long; 2-1/16" diam.	38110 Cat. 1042	256 0033 00
	Buffer	TUBE: Type 6L6; beam power amplifier; 4-5/16" long; 1-3/8" diam.	38110	255 0086 00

SYMBOL DESIGNATION	FUNCTION	DESCRIPTION	MFR. and MFR'S. TYPE or CAT. NO.	COLLINS PART NUMBER
	UNIT	C-33Q EXCITER AND SPEECH AMPLIFIER	UNIT (Cont.)	
	Audio driver (2)	TUBE: Type 6AG5; R. F. amplifier pentode; 2- $\frac{1}{8}$ " long; $\frac{3}{4}$ " diam.	38110	255 0048 00
	Audio amplifier (2)	TUBE: Type 6J5; detector amplifier triode; 2- $\frac{3}{8}$ " long; 1- $\frac{5}{16}$ " diam.	38110	255 0044 00
	UNIT	D-401W RECTIFIER AND RELAY UNIT		
1	Filament relay	RELAY: Power contactor; 4 pole N.O.; 10 amp contacts; 110 v; 60 cps; coil; 2- $\frac{3}{4}$ " x 3- $\frac{5}{16}$ " x 5".	900 Cat. B-400	401 9000 00
2	HV rectifier pl contactor	RELAY: Power contactor; 4 pole N. O.; 10 amp contacts; 110 v; 60 cps; coil; 2- $\frac{3}{4}$ " x 3- $\frac{5}{16}$ " x 5".	900 Cat. B-400	401 9000 00
3	LV rectifier pl contactor	RELAY: Power contactor; 4 pole N. O.; 10 amp contacts; 110 v; 60 cps; coil; 2- $\frac{3}{4}$ " x 3- $\frac{5}{16}$ " x 5".	900 Cat. B-400	401 9000 00
4	Time delay relay	RELAY: 1 contact N. O.; motor driven; 10 amp; 115 v; 60 cps; .8 sec max reset time; 30 sec max delay; 3- $\frac{5}{8}$ " x 3- $\frac{5}{8}$ " x 3- $\frac{7}{16}$ ".	9600 Cat. TD2-30S	402 0006 00
5	Filament circuit breaker	RELAY: Time delay; 15 amp 230 v ac; 2 pole; 2 coils; 2- $\frac{15}{16}$ " x 5- $\frac{3}{8}$ " x 6- $\frac{3}{8}$ ".	22100 Cat. 0322-15	260 4463 00
6	HV circuit breaker	RELAY: DPST; 15 amp; 230 v ac; 2 coils; 3" x 5- $\frac{1}{2}$ " x 5- $\frac{3}{8}$ ".	22100 Cat. 0322-15	260 4473 30
7	LV circuit breaker	RELAY: Circuit breaker; time delay; 2 poles; 10 amps; 230 v ac; 2- $\frac{1}{16}$ " x 5- $\frac{5}{8}$ " x 6- $\frac{3}{8}$ ".	22100 Cat. 0322-10	260 4283 30
21	HV rect. filament transformer	TRANSFORMER: Pri: 105, 110, 115, 120, 125 v; 50/60 cps; 62.5 va; Sec: 2.5 v; 25 amps; 62.5 va; 4- $\frac{1}{2}$ " x 5- $\frac{1}{4}$ " x 5- $\frac{5}{16}$ ".	7800	672 1790 00
23	LV rect. filament transformer	TRANSFORMER: Pri: 105, 110, 115, 120, 125 v; 50/60 cps; 37.5 va Sec: 2.5 v 15 amp; 37.5 va; 9- $\frac{3}{4}$ " x 10- $\frac{1}{2}$ " x 11- $\frac{1}{2}$ ".	7800	672 1770 00
25	Tuning motor supply transformer	TRANSFORMER: Pri: 105, 110, 115, 120, 125 v; 50/60 cps; 60 va; Sec: 24 v; 2.5 amp; 60 va; 4- $\frac{1}{2}$ " x 5- $\frac{1}{4}$ " x 5- $\frac{3}{8}$ ".	7800	674 1800 00
37	LV supply filter reactor (2)	COIL: Reactor; 4 hy; 0.5 amp; 40 ohms; soldering lugs; 120 cps; 2500 tv; 5- $\frac{5}{16}$ " x 5- $\frac{1}{8}$ " x 6".	7800 Type 6315E	678 0049 00
46	LV supply filter capacitor (2)	CAPACITOR: Fixed; paper dielectric; 15 mf $\pm 10\%$; 2000 tv; 1000 wv; 2- $\frac{1}{2}$ " x 3- $\frac{3}{4}$ " x 4- $\frac{3}{4}$ ".	9110 Cat. T10150	930 0050 00
81	Rectifier balancing resistor (4)	RESISTOR: Fixed; 50 ohms $\pm 10\%$; 10 watts; 22 v max; 447 ma max; wire wound; 13/32" diam; 1- $\frac{3}{4}$ " long.	34500 Type Brown Devil	710 1502 00
82	LV supply bleeder resistor	RESISTOR: Fixed; 25,000 ohms $\pm 10\%$; 45 watts; 1070 v max; 43 ma max; wire wound; 19/32" diam; 5" long.	34500 Type 9/16 x 4	710 0111 00
130	Modulator bias supply bleeder resistor (2)	RESISTOR: Rheostat; 250 ohms $\pm 10\%$; 25 watts; 3 terminal; 315 ma max; 1- $\frac{9}{16}$ " diam; 2- $\frac{1}{16}$ " long.	34500 Cat. 0154	735 2502 00
155	Ventilating blower assembly	MOTOR: 1/20 hp; 110 v; 60 cps; single phase; 1.4 amps primary current; 1750 rpm; 4- $\frac{3}{4}$ " x 5" x 8".	7280 Cat. Spec. 4937	230 6000 00

TABLE OF REPLACEABLE PARTS

SYMBOL DESIGNATION	FUNCTION	DESCRIPTION	MFR. and MFR'S. TYPE or CAT. NO.	COLLINS PART NUMBER
200	UNIT Audio matching pad resistor (4)	D-401W RECTIFIER AND RELAY UNIT RESISTOR: Fixed; 150 ohms; $\pm 10\%$ 1 watt; 12.3 v max; 82 ma max; 7/32" diam; 19/32" long.	(Cont.) 900 Cat. GB-1511	703 1502 00
201	Audio matching pad resistor	RESISTOR: Fixed; 220 ohms $\pm 10\%$; 1 watt; 14.8 v max; 67 ma max; 7/32" diam; 19/32" long.	900 Cat. GB2211	703 2202 00
	HV Rectifier (4)	TUBE: Type 866-866A; Half-Wave mercury-vapor rectifier; 6-3/8" long; 2-7/16" diam.	38110	256 0049 00
	LV rectifier (2)	TUBE: Type 866-866A; Half-Wave mercury-vapor rectifier; 6-3/8" long; 2-7/16" diam.	38110	256 0049 00
19	Door switch (3)	UNIT E-29W CABINET ASSEMBLY SWITCH: Male section: 11/16" x 1-5/16" x 1-7/8" Female section: 15/16" x 2-5/16".	18860 18860 Cat. 7460330G4	260 4040 00 260 4050 00
20	Constant voltage transformer	TRANSFORMER: Pri: 95 to 125 v; 60 cps; 500 va. Sec: 115 v; 500 va 5-3/8" x 7" x 13-1/4".	42090 Cat. 3004	664 6720 00
22	HV transformer	TRANSFORMER: Pri: 110, 115, 120, v; 50/60 cps; 1050 va. Sec: 1750-0-1750 v; 0.425 amp; 1490 va; 9-3/4" x 10-1/2" x 11-1/2".	7800	672 1780 00
34	Mod transformer	TRANSFORMER: Pri: 0.350 amp max; 4 terminals; 8200 ohm C. T. Sec: 5000 ohms and 6300 ohms; 3 terminals; 5-3/8" x 6-7/8" x 12-7/8".	44500	667 6880 00
35	Mod choke	COIL, CHOKE: 100 hy; 200 ohms; 5000 tv; 3000 v rms; 40 cps; 5-3/8" x 7" x 13-1/2".	44500	668 7150 00
48	Audio coupling	CAPACITOR: 4 mf $\pm 10\%$; 5000 tv; 2500 wv dc; 3-3/4" x 4" x 4-9/16".	9110 Cat. T-25040	930 0033 00
13	Filament start-stop station	UNIT F-38N DOOR ASSEMBLY SWITCH: 1 N. O.; 1 N. C.; Push-button type; 1-15/16" x 2-3/16" x 2-9/16".	900 Cat. N-1010	260 0028 00
14	Power change switch	SWITCH: DPDT; one enclosed section; non-shortening type 3-3/16" long; 1-3/16" diam.	30300 Cat. 3222J	259 1100 00
15	Test meter switch	SWITCH: 2 pole; 4 position; 1 section non-shortening rotor sector; Isolantite insulation; 1-9/16" diam.	7000	259 2500 00
17	Tune-operate switch	SWITCH: DPDT; off normal; Junior Jack switch; 1-1/2" x 1-13/16" x 2-3/16".	30300 Cat. Y-18914	260 3080 00
18	Plate start-stop station	SWITCH: 1 N. O.; 1 N. C.; push-button type; 1-15/16" x 2-3/16" x 2-9/16".	900 Cat. N-1010	260 0028 00
85	Audio amp cathode metering resistor	RESISTOR: Fixed; 6.1 ohm $\pm 1\%$; wire wound 1 watt; 9/16" diam; 9/16" long; 2.470 v max; 405 ma max.	23600 Type WW3	721 6106 00
90	Audio driver cathode metering resistor	RESISTOR: Fixed; 0.560 ohms $\pm 1\%$; 0.749 v max; 1336 ma max; wire wound; 9/16" diam; 1" long.	23600 Type WW4	722 0566 00
97	RF driver grid metering resistor	RESISTOR: Fixed; 6.1 ohms $\pm 1\%$; 2.470 v max; 405 ma max; wire wound; 9/16" diam; 9/16" long.	13600 Type WW3	721 6106 00

TABLE OF REPLACEABLE PARTS

SYMBOL DESIGNATION	FUNCTION	DESCRIPTION	MFR. and MFR'S. TYPE or CAT. NO.	COLLINS PART NUMBER
101	Buffer cathode metering resistor	UNIT F-38N DOOR ASSEMBLY (Cont.) RESISTOR: Fixed; 0.56 ohms $\pm 1\%$; 0.749 v max; 1336 ma max; wire wound; 9/16" diam; 1" long.	13600 Type WW4	722 0566 00
114	Mod cathode metering resistor	RESISTOR: Fixed; 0.20 ohms $\pm 1\%$; 0.447 v max; 2235 ma max; 1 watt; wire wound; 9/16" diam; 1" long.	13600 Cat. 725-9002-7	722 0206 00
115	Mod cathode metering resistor (2)	RESISTOR: Fixed; 0.41 ohm $\pm 1\%$; 1 watt; 0.640 v max; 1561 ma max; 9/16" diam; 1" long.	13600 Type WW4	722 0416 00
116	Meter selector switch	SWITCH: 6 pole; 5 position; 3 section; non-shorting rotor contact; adjustable stop; 1-9/16" diam.	7000	259 8800 00
140	Int amp cathode current meter	METER: 0-300 ma dc; 60 scale divisions 5.0 ma per division; 0.33 ohm 2%; 3" x 3-1/8".	8300	502 4212 002
141	Final amp plate current meter	METER: 0-500 ma dc; 50 scale divisions 10 ma per division; 0.22 ohm 2%; 3" x 3-1/8".	8300	502 4214 002
142	Final amp grid current meter	METER: 0-300 ma dc; 60 scale divisions 5 ma per division; 0.33 ohms 2%; 3" x 3-1/8".	8300	502 4213 002
143	Remote antenna current meter	METER: 0-5 amperes rf; 0.4 watt; 6 ohms 2%; 3" x 3-1/8".	8300	502 4218 002
144	Testmeter	METER: 0-100 ma dc; 50 scale divisions 2 ma per division and 0-10 ma dc; 50 scale divisions .2 ma per division; 55 ohms $\pm 2\%$; 3" x 3-1/8".	8300	502 4219 002
145	Plate voltmeter	METER: 0-2 kv; 40 scale divisions 50 v per division; 1.5 ohms 2%; multiplier to be used 200,000 ohms; 20 watts; 3" x 3-1/8".	8300	502 4215 002
146	Mod plate meter	METER: 0-250 ma dc and 0-500 ma dc; 20 ohms $\pm 2\%$; 50 scale divisions 5 ma per division; 50 scale divisions 10 ma per division; 3" x 3-1/8".	8300	502 4220 002
147	Filament voltmeter	METER: 0-15 volts; 30 scale divisions 0.5 volts per division; 210 ohms 2%; 1.25 watts; 3" x 3-1/8".	8300	502 4216 002
152	Filament pilot light assembly	MOUNTING, PILOT LIGHT: Mtg for candelabra base; 1-5/16" x 2-3/4".	12000 Type 75	262 1360 00
153	Pl pilot light assembly	MOUNTING, PILOT LIGHT: Mtg for candelabra base; 1-5/16" x 2-3/4".	12000 Type 75	262 1360 00
160	Meter bypass (6)	CAPACITOR: Mica; .006 mf $\pm 20\%$; 1000 tv; 500 wv; 11/32" x 1-1/32" x 1-15/32".	40300 Type BE-10	910 2605 40

LIST OF MANUFACTURERS

Mfr. Code	Name Address	Mfr. Code	Name Address
900	Allen Bradley Co. 1336 West Greenfield Ave. Milwaukee 4, Wisconsin	28600	Leach Relay Co. Inc. 5915 5927 Avalon Blvd. Los Angeles 3, California
1040	Alliance Mfg. Co. Alliance, Ohio	29200	Littelfuse Laboratories 4757 Ravenswood Ave. Chicago 40, Illinois
6500	Allen D. Cardwell Mfg. Corp. Plainville, Connecticut	30300	P. R. Mallory Co. Inc. 3029 East Washington St. Indianapolis 6, Indiana
7000	Centralab 900 E. Keefe Ave. Milwaukee 1, Wisconsin	30900	Meissner Mfg. Co. Div of Maguire Inc. Mt. Carmel, Illinois
7280	Century Elec. Co. 1806 Pine Street St. Louis, Missouri	32200	National Co. Inc. 61 Sherman Street Malden 48, Mass.
7800	Chicago Transformer Essex Wire Corp. 3501 Addison St. Chicago 18, Illinois	34500	Ohmite Mfg. Co. 4835 West Flournoy Street Chicago 44, Illinois
8160	C. P. Clare & Co. 4719 West Sunny Side Ave. Chicago 3, Illinois	38110	RCA RCA Victor Division Harrison, N. J.
8300	Collins Radio Co. 855 35th St. N.E. Cedar Rapids, Iowa	38460	Raytheon Prod. Corp. Power Tube Div. Acctg. Office 674 Commonwealth Ave. Boston 15, Mass.
8460	Conant Elec. Lab. 6500 O Street Lincoln 5, Nebraska	40300	Sangamo Electric Co. 1935 Funk Street Springfield, Illinois
9110	Cornell-Dubilier 333 Hamilton Blvd South Plainfield 6, N. J.	41970	Simpson Elec. Co. 5200 18 W. Kinzie St. Chicago 44, Illinois
9600	R. W. Cramer Co. Inc. Centerbrook, Connecticut	42090	Sola Elec. Co. 2525 Clybourn Ave. Chicago 14, Illinois
12000	Drake Mfg. Co. 1713 West Hubbard Street Chicago 22, Illinois	42300	Speer Resistor Corp. St. Marys, Pennsylvania
18860	General Electric Review Schenectady, N. Y.	44500	Thordarson Elec. Mfg. Div. of Maguire Industries Inc. 500 W. Huron St. Chicago 10, Ill.
21400	Hammarlund Mfg. Co. Inc. 460 West 34th Street New York 1, N. Y.	44970	Trumbull Elec. Mfg. Co. 1936 Woodford Ave. Plainville, Connecticut
22100	Heinemann Circuit Breaker Co. 939 Plum Street Trenton, New Jersey	49100	Weston Elec. Instrument Newark 5, New Jersey
23600	International Resistance Co. 401 North Broad St. Philadelphia 8, Penna.		

TABLE OF REPLACEABLE PARTS

DATA

COLOR CODE FOR FIXED RESISTORS—Values in Ohms

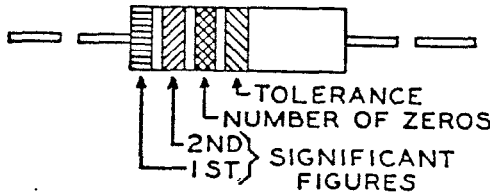

Resistor with axial wire leads.

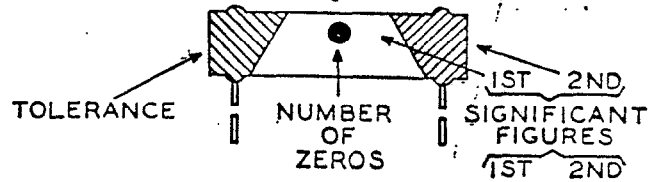

Resistor with radial wire leads.

BODY		END		DOT OR BAND		END	
1st Band		2nd Band		3rd Band		End Band	
Color	Value	Color	Value	Color	Value	Color	Tolerance
Black	0	Black	0	Gold	0.1	Gold	(J) ± 5%
Brown	1	Brown	1	Silver	0.01	Silver	(K) ± 10%
Red	2	Red	2	Black	None	None	(M) ± 20%
Orange	3	Orange	3	Brown	0		
Yellow	4	Yellow	4	Red	0.00		
Green	5	Green	5	Orange	0.000		
Blue	6	Blue	6	Yellow	0.0000		
Violet	7	Violet	7	Green	0.00000		
Grey	8	Grey	8	Blue	0.000000		
White	9	White	9	Violet	0.0000000		
				Grey	0.00000000		
				White	0.000000000		

EXAMPLE FOR AXIAL-LEAD RESISTOR

Band	Color	Significant Figures		Number of Zeros	Tolerance
		1st	2nd		
1	red	2
2	orange	..	3
3	yellow	0000
4	gold	±5%

The resistance of this resistor is 230,000 ohms ±5%

EXAMPLE FOR RADIAL-LEAD RESISTOR

Position	Color	Significant Figures		Number of Zeros	Tolerance
		1st	2nd		
body	orange	3
end	blue	..	6
dot	green	00000
end	silver	±10%

The resistance of this resistor is 3,600,000 ohms ±10%

COLOR CODE FOR FIXED MICA CAPACITORS

Color	CAPACITANCE*		Tolerance	Characteristic
	Significant Figure	Decimal Multiplier		
Black	0	1	20% (M)	A
Brown	1	10	1%	B
Red	2	100	2% (G)	C
Orange	3	1000	3%	D
Yellow	4	4%	E
Green	5	5%	F
Blue	6	6%	G
Violet	7	7%	..
Gray	8	8%	..
White	9	9%	..
Gold	..	0.1	5% (J)	..
Silver	..	0.01	10% (K)	..

* Capacitance in micromicrofarads.

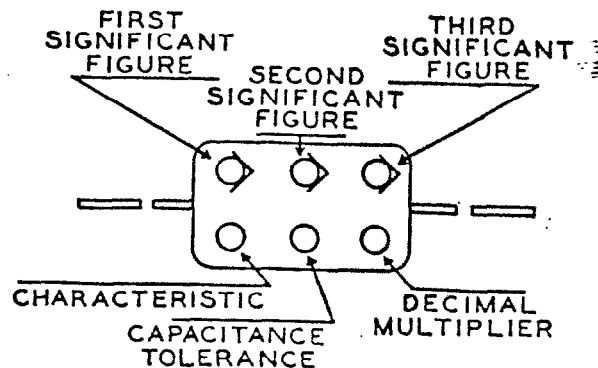

Color code scheme for JAN standard fixed mica capacitors. The significance of the letters denoting "characteristic" will be found in the Joint Army-Navy Specification JAN-C-5.

01000

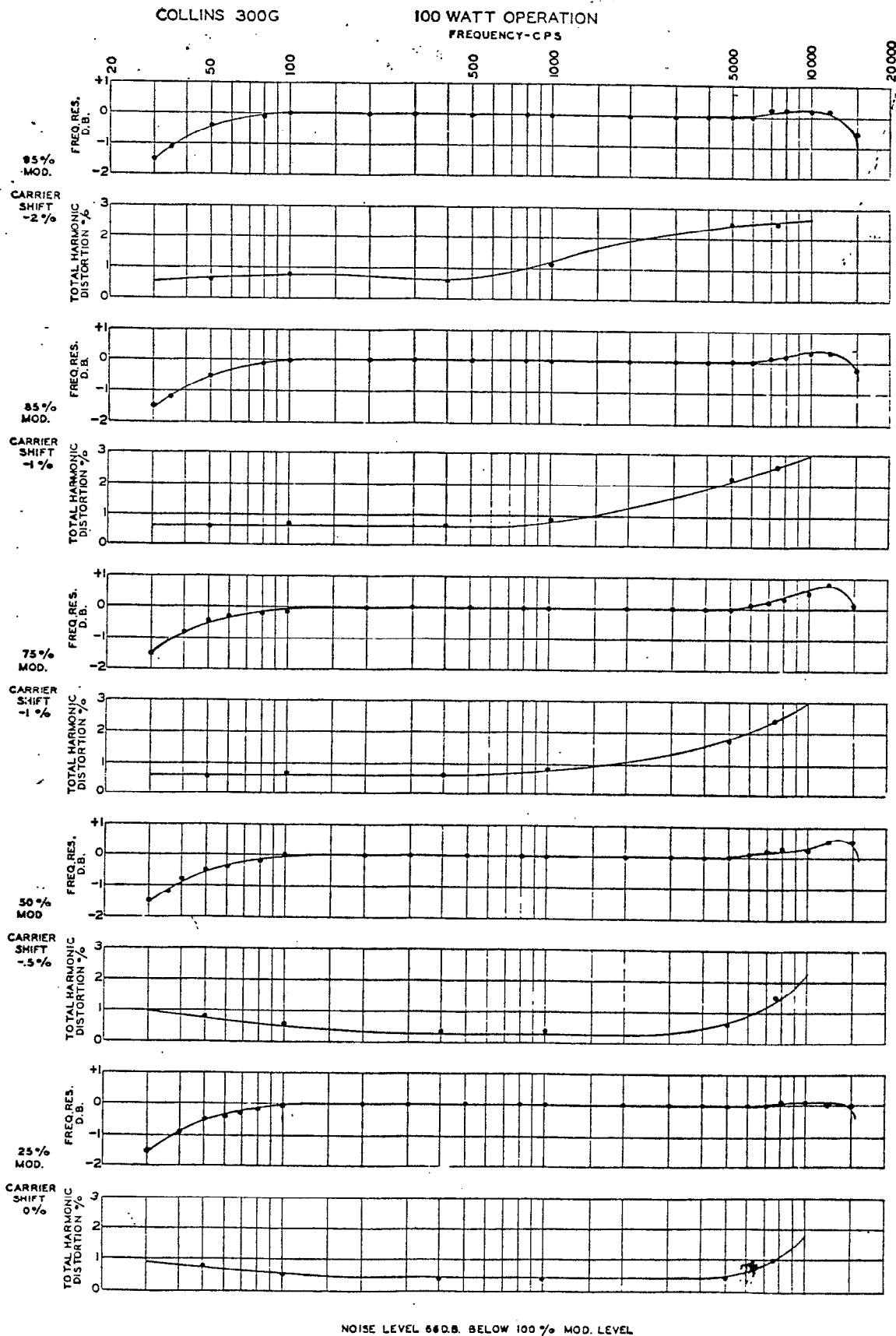
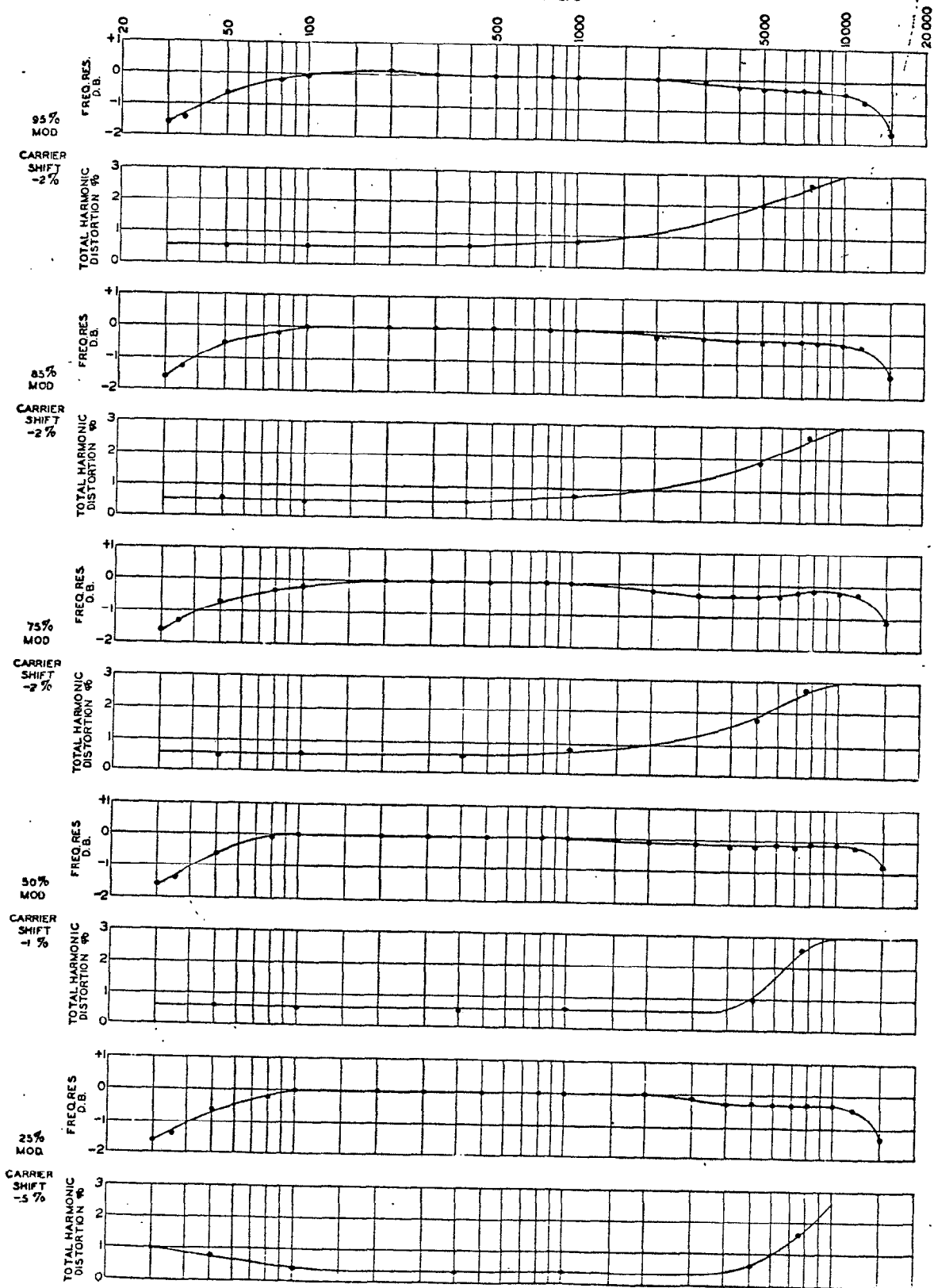

Figure 8-1. Audio Frequency Response and Distortion Curves for 100 Watt Operation

TABLE OF REPLACEABLE PARTS

COLLINS 300G

250 WATT OPERATION
FREQUENCY-CPS



NOISE LEVEL 64DB BELOW 100% MOD LEVEL

Figure 8-2. Audio Frequency Response and Distortion Curves for 250 Watt Operation

OUTPUT CIRCUIT COMPONENTS

IMPORTANT

The antenna coupling and the power amplifier plate tank and neutralizing circuit components of this transmitter vary somewhat with frequency. The following tables have been compiled to aid in the selecting of the proper replacement parts for these circuits. The heading above each table indicates the range of frequencies covered by the particular components.

SYMBOL DESIGNATION	FUNCTION	DESCRIPTION	MFR. and MFR'S. TYPE or CAT. NO.	COLLINS PART NUMBER
FREQUENCY RANGE 540 - 700 KC.				
68	Neutralizing Capacitor	CAPACITOR: Mica; .0001 mfd $\pm 5\%$; 5000 TV; 60 cps; 1- $\frac{1}{4}$ " x 2- $\frac{1}{4}$ " x 3- $\frac{1}{8}$ ".	9110 Type 6L	906 3101 00
69	P. A. Grid Capacitor	CAPACITOR: Mica; .0024 mfd $\pm 5\%$; 3000 TV.	40300	938 0084 00
75	P. A. Grid Coupling Capacitor	CAPACITOR: Mica; .01 mfd $\pm 10\%$; 5000 TV; 2000 W.V.	9110 Type 9L	950 1101 00
77	P. A. Plate Capacitor	CAPACITOR: Mica; .0005 mfd $\pm 5\%$; 6000 TV.	9110 Type 59	904 3501 00
78	Output Network capacitor	CAPACITOR: Mica; .002 mfd $\pm 5\%$; 6000 TV.	40300	939 0044 00
103	Buffer Grid Resistor	RESISTOR; Fixed; 2700 ohm $\pm 10\%$ 2 watt; insulated composition.	23600	745 6104 00
132	P. A. Plate Tank Coil Assembly	COIL ASSEMBLY: Close wound; adjustable coil rider.	8300	503 2254 003
133	Output Network Coil	COIL: Center-tapped; 2- $\frac{1}{2}$ " O.D.; #14 bus; 3- $\frac{3}{4}$ " x 5- $\frac{3}{8}$ ".	8300	503 2244 002
134	Int. Amp. Plate Tank Coil	COIL: Tank; adj. tapped inductor.	8300	503 2252 002
137	Output Network Coil	COIL: Center-tapped; 2- $\frac{1}{2}$ " O.D.; #14 bus; 3- $\frac{3}{4}$ " x 5- $\frac{3}{8}$ ".	8300	503 2244 002
138	Neutralizing Coil	COIL NEUTRALIZING: Close wound; adjustable tap.	8300	503 2248 003
FREQUENCY RANGE 700 - 800 KC.				
68	Neutralizing Capacitor	CAPACITOR: Mica; .0025 mfd $\pm 5\%$; 5000 TV; 60 cps; 1- $\frac{1}{4}$ " x 2- $\frac{1}{4}$ " x 3- $\frac{1}{8}$ ".	9110 Type 6L	906 3251 00
69	P. A. Grid Capacitor	CAPACITOR: Mica; .0016 mfd $\pm 5\%$; 3000 TV.	40300	938 0076 00
75	P. A. Grid Coupling Capacitor	CAPACITOR: Mica; .006 mfd $\pm 10\%$; 5000 TV; 2500 W. V.	9110 Type 9	950 2601 20

SYMBOL DESIGNATION	FUNCTION	DESCRIPTION	MFR. and MFR'S. TYPE or CAT. NO.	COLLINS PART NUMBER
		FREQUENCY RANGE 700-800 KC.	(Cont.)	
77	P. A. Plate Capacitor	CAPACITOR: Mica; .0005 mfd $\pm 5\%$; 6000 TV.	9110 Type 59	904 3501 00
78	Output Network Capacitor	CAPACITOR: Mica; .002 mfd $\pm 5\%$; 6000 TV.	40300	939 0040 00
103	Buffer Grid Resistor	RESISTOR: Fixed; 3600 ohm $\pm 10\%$; 2 watt; ins. metalized.	23600	745 6109 00
132	P. A. Plate Tank Coil Assembly	COIL ASSEMBLY: Close wound; adjustable coil rider.	8300	503 2254 003
133	Output Network Coil	COIL: Center-tapped; 2- $\frac{1}{2}$ " O. D.; #14 bus; 3- $\frac{3}{4}$ " x 5- $\frac{3}{8}$ ".	8300	503 2244 002
134	Int. Amp. Plate Tank Coil	COIL, TANK: Adj. tapped inductor; #12 tinned copper wire.	8300	508 0307 20
137	Output Network Coil	COIL: Center-tapped; 2- $\frac{1}{2}$ " O. D.; #14 bus; 3- $\frac{3}{4}$ " x 5- $\frac{3}{8}$ ".	8300	503 2244 002
138	Neutralizing Coil	COIL: Neutralizing; close wound; adjustable tap.	8300	503 2249 003
		FREQUENCY RANGE 800-900 KC.		
68	Neutralizing Capacitor	CAPACITOR: Mica; .00025 mfd $\pm 5\%$; 5000 TV; 60 cps; 1- $\frac{1}{4}$ " x 2- $\frac{1}{4}$ " x 3- $\frac{1}{8}$ ".	9110 Type 6L	906 3251 00
69	P. A. Grid Capacitor	CAPACITOR: Mica; .0016 mfd $\pm 5\%$; 3000 TV.	40300	938 0076 00
75	P. A. Grid Coupling Capacitor	CAPACITOR: Mica; .006 mfd $\pm 10\%$; 5000 TV; 2500 WV	9110 Type 9	950 2601 20
77	P. A. Plate Capacitor	CAPACITOR: Mica; 390 mmfd $\pm 5\%$; 6000 TV	40300	939 0023 00
78	Output Network Capacitor	CAPACITOR: Mica; .002 mfd $\pm 5\%$; 6000 TV	40300	939 0040 00
103	Buffer Grid Resistor	RESISTOR: Fixed; 3600 ohm $\pm 10\%$; 2 watt; ins. metalized.	23600	745 6109 00
132	P. A. Plate Tank Coil Assembly	COIL ASSEMBLY: Close wound; adjustable coil rider.	8300	503 2253 003
133	Output Network Coil	COIL: Center-tapped; 2- $\frac{1}{2}$ " O. D.; #14 bus; 3- $\frac{3}{4}$ " x 5- $\frac{3}{8}$ ".	8300	502 4793 002
134	Int. Amp. Plate Tank Coil	COIL, TANK: Adj. tapped inductor; #12 tinned copper wire.	8300	508 0307 20

TABLE OF REPLACEABLE PARTS

SYMBOL DESIGNATION	FUNCTION	DESCRIPTION	MFR and MFR'S TYPE or CAT. NO.	COLLINS PART NUMBER
FREQUENCY RANGE 800-900 KC.				
137	Output Network Coil	COIL: Center-tapped; 2-1/2" O.D.; #12 bus; 3-3/4" x 5-3/8".	(Cont.) 8300	502 4794 002
133	Neutralizing Coil	COIL, NEUTRALIZING: Close wound; adjustable tap.	8300	503 2249 003
FREQUENCY RANGE 900-1000 KC.				
68	Neutralizing Capacitor	CAPACITOR: Mica; .00025 mfd ±5%; 5000 TV; 60 cps; 1-1/4" x 2-1/4" x 3-1/8".	9110 Type 6L	906 3251 00
69	P. A. Grid Capacitor	CAPACITOR: Mica; .001 mfd ±5%; 3000 WV	40300	938 0065 00
75	P. A. Grid Coupling Capacitor	CAPACITOR: Mica; .006 mfd ±10%; 5000 TV; 2500 W.V. DC; 0.8" x 1.3" x 1.8"	9110 Type 9	950 2601 20
77	P. A. Plate Capacitor	CAPACITOR: Mica; 390 mmfd ±5%; 6000 TV.	40300	939 0023 00
78	Output Network Capacitor	CAPACITOR: Mica; .002 mfd ±5%; 6000 TV.	40300	939 0040 00
103	Buffer Grid Resistor	RESISTOR: Fixed; 50,000 ohm ±10%; 2 watt; 316 V max; 63 ma max.	34500 Cat. No. 140-9	706 5042 00
132	P. A. Plate Tank Coil Assembly	COIL ASSEMBLY: Close wound; adjustable coil rider.	8300	503 2253 003
133	Output Network Coil	COIL: Center-tapped; 2-1/2" O.D.; #14 bus; 3-3/4" x 5-3/8".	8300	502 4793 002
134	Int. Amp. Plate Tank Coil	COIL, TANK: Adj. tapped inductor; ±12 tinned copper wire.	8300	508 0307 20
137	Output Network Coil	COIL: Center-tapped; 2-1/2" O.D.; #12 bus; 3-3/4" x 5-3/8".	8300	502 4794 092
138	Neutralizing Coil	COIL, NEUTRALIZING: Close wound; adjustable tap.	8300	503 2250 003
FREQUENCY RANGE 1000-1200 KC.				
68	Neutralizing Capacitor	CAPACITOR: Mica; .00025 mfd ±5%; 5000 TV; 60 cps; 1-1/4" x 2-1/4" x 3-1/8".	9110 Type 6L	906 3251 00
69	P. A. Grid Capacitor	CAPACITOR: Mica; .001 mfd ±5%; 3000 W.V.	40300	938 0066 00
75	P. A. Grid Coupling Capacitor	CAPACITOR: Mica; .006 mfd ±10%; 5000 TV; 2500 W.V. DC; 0.8" x 1.3" x 1.8"	9110 Type 9	950 2601 20
77	P. A. Plate Capacitor	CAPACITOR: Mica; .0003 mfd ±5%; 6000 TV.	40300	939 0020 00

SYMBOL DESIGNATION	FUNCTION	DESCRIPTION	MFR. and MFR'S. TYPE or CAT. NO.	COLLINS PART NUMBER
		FREQUENCY RANGE 1000 - 1200 KC.	(Cont.)	
78	Output Network Capacitor	CAPACITOR: Mica; .002 mfd $\pm 5\%$; 6000 TV.	40300	939 0040 00
103	Buffer Grid Resistor	RESISTOR: Fixed; 50,000 ohms $\pm 10\%$; 2 watts; 316 V max; 6.3 ma. max.	34500 Cat. No. 140-9	706 5042 00
132	P. A. Plate Tank Coil Assembly	COIL ASSEMBLY: Close wound; adjustable coil rider.	8300	503 2253 003
133	Output Network Coil	COIL: Center-tapped; 2- $\frac{1}{2}$ " O.D.; # 14 bus; 3- $\frac{3}{4}$ " x 5- $\frac{3}{8}$ ".	8300	502 4793 002
134	Int. Amp. Plate Tank Coil	COIL, TANK: Adj. tapped inductor; # 12 tinned copper wire.	8300	508 0307 20
137	Output Network Coil	COIL: Center-tapped; 2- $\frac{1}{2}$ " O.D.; # 12 bus; 3- $\frac{3}{4}$ " x 5- $\frac{3}{8}$ ".	8300	502 4794 002
138	Neutralizing Coil	COIL, NEUTRALIZING: Close wound; adjustable tap.	8300	503 2250 003
		FREQUENCY RANGE 1200 - 1600 KC.		
63	Neutralizing Capacitor	CAPACITOR: Mica; .00025 mfd $\pm 5\%$; 5000 TV; 60 cps; 1- $\frac{1}{4}$ " x 2- $\frac{1}{4}$ " x 3- $\frac{1}{8}$ ".	9110 Type 6L	906 3251 00
69	P. A. Grid Capacitor	CAPACITOR: Mica; .0002 mfd $\pm 5\%$; 3000 TV; 15/16" x 1-15/16" x 2-13/16".	9110 Type 15L	907 3201 00
75	P. A. Grid Coupling Capacitor	CAPACITOR: Mica; .006 mfd $\pm 10\%$; 5000 TV; 2500 WV d.c.; 0.8" x 1.3" x 1.3".	9110 Type 9	950 2601 20
77	P. A. Plate Capacitor	CAPACITOR: Mica; .0002 mfd $\pm 5\%$; 6000 TV; ceramic case; 2-13/16" x 2- $\frac{1}{2}$ " x 3-13/16".	9110 Type 59	904 3201 00
78	Output Network Capacitor	CAPACITOR: Mica; .0005 mfd $\pm 5\%$; 6000 TV; 3000 WV; 2-13/16" x 3-13/16" x 2- $\frac{1}{2}$ ".	9110 Type 59	904 3501 00
103	Buffer Grid Resistor	RESISTOR: Fixed; 50,000 ohms $\pm 10\%$; 2 watts; 316 V max; 6.3 ma. max.	34500 Cat. 140-9	706 5042 00
132	P. A. Plate Tank Coil Assembly	COIL ASSEMBLY: Close-wound; adjustable coil rider; 28 turns; # 10 bus; 3- $\frac{1}{4}$ " x 3- $\frac{1}{2}$ ".	8300	508 0310 20
133	Output Network Coil	COIL: Center-tapped; 2- $\frac{1}{2}$ " O.D.; # 14 bus; 3- $\frac{3}{4}$ " x 5- $\frac{3}{8}$ ".	8300	502 4793 002
134	Int. Amp. Plate Tank Coil	COIL, TANK: Adj. tapped inductor; # 12 tinned copper wire.	8300	508 0307 20
137	Output Network Coil	COIL: Center-tapped; 2- $\frac{1}{2}$ " O.D.; # 12 bus; 3- $\frac{3}{4}$ " x 5- $\frac{3}{8}$ ".	8300	502 4794 002
138	Neutralizing Coil	COIL, NEUTRALIZING: Close wound; adjustable tap; # 22 bus; 4-1/16" x 4- $\frac{1}{8}$ ".	8300	508 0306 20

SECTION 9
MISCELLANEOUS PHOTOGRAPHS AND DRAWINGS

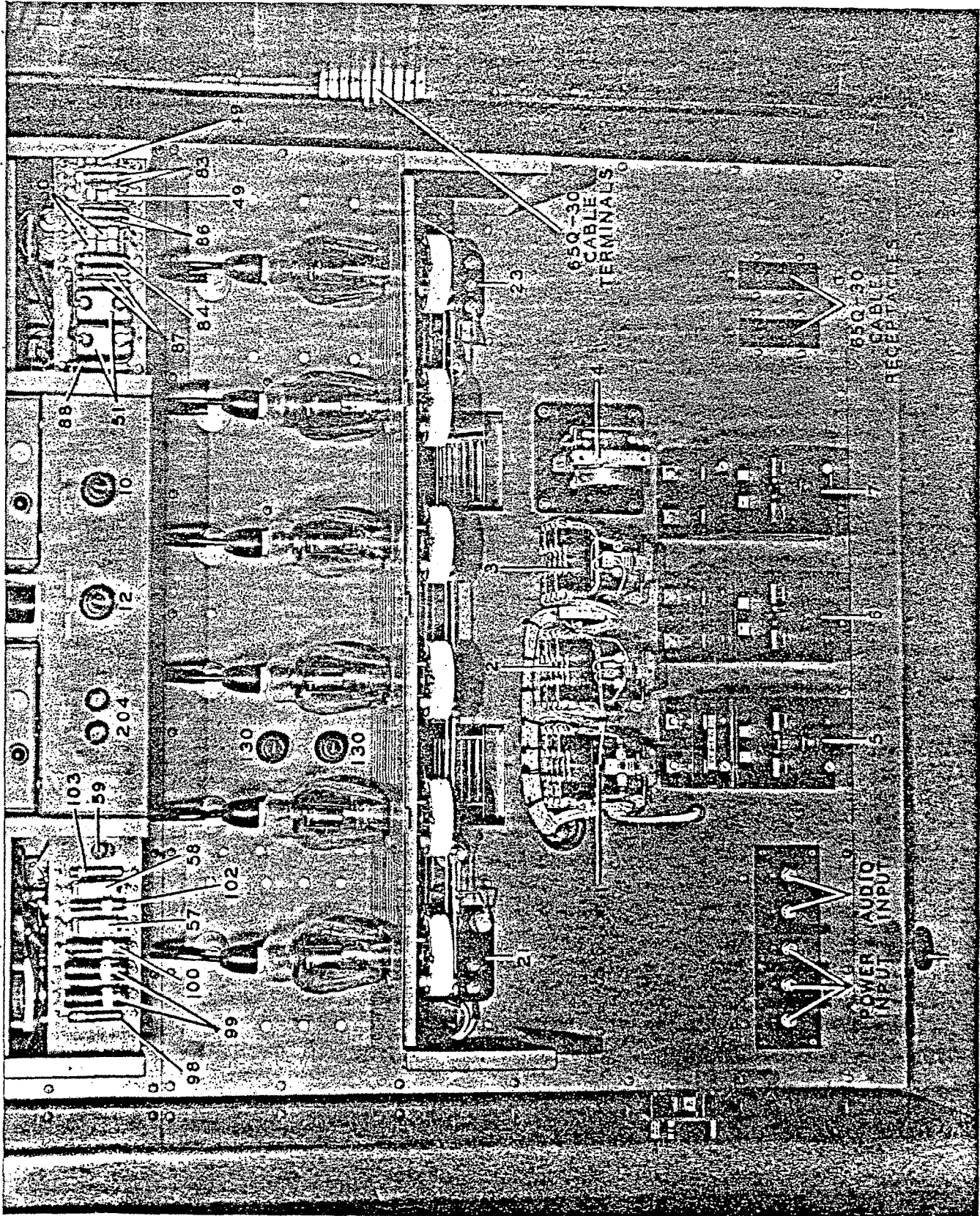
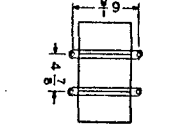
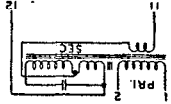

Figure 9-1. 300G Transmitter — Bottom Front View

MISCELLANEOUS PHOTOGRAPHS AND DRAWINGS

ITEM NO. 20 COLLINS PART NO. 664 6720 00



ITEM NO. 26 COLLINS PART NO. 674 1240 00

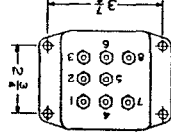
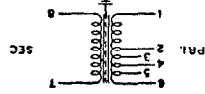

ITEM NO. 42 COLLINS PART NO. 672 1460 00

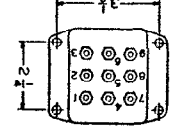
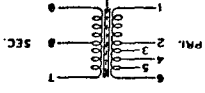

ITEM NO. 21 COLLINS PART NO. 672 1790 00

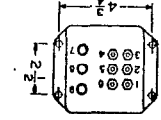
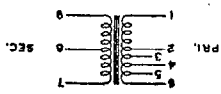

ITEM NO. 27 COLLINS PART NO. 672 1390 00

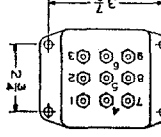
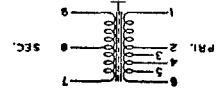

ITEM NO. 23 COLLINS PART NO. 672 1280 00

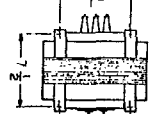
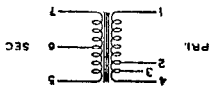

ITEM NO. 24 COLLINS PART NO. 672 1360 00

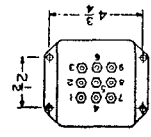
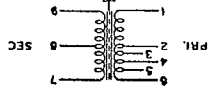

ITEM NO. 22 COLLINS PART NO. 672 1780 00

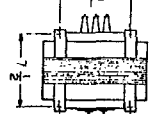
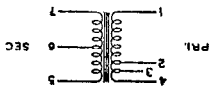

ITEM NO. 25 COLLINS PART NO. 674 1800 00

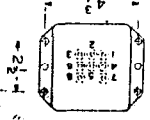
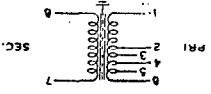

ITEM NO. 24 COLLINS PART NO. 672 1360 00

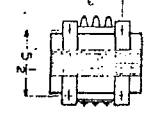
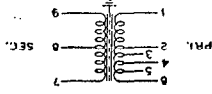

ITEM NO. 33 COLLINS PART NO. 677 0048 00

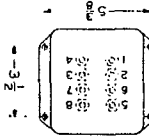
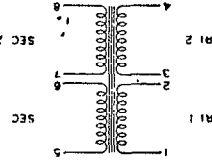

ITEM NO. 34 COLLINS PART NO. 667 6680 00

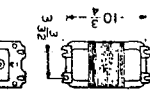
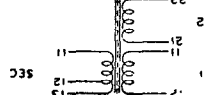

ITEM NO. 23 COLLINS PART NO. 672 1770 00

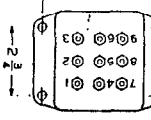
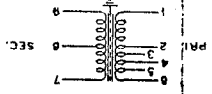

ITEM NO. 32 COLLINS PART NO. 687 6760 00

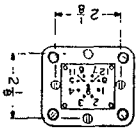
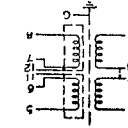

ITEM NO. 24 COLLINS PART NO. 672 1360 00

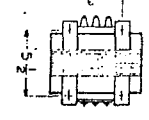
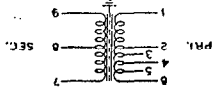

ITEM NO. 33 COLLINS PART NO. 677 0048 00

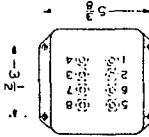
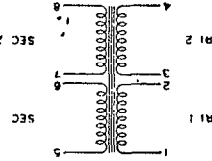

ITEM NO. 42 COLLINS PART NO. 667 6680 00

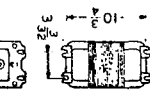
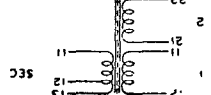

ITEM NO. 21 TERM. VOLTS DC RESISTANCE

1-2 105 PRI=2.8 OHMS
1-3 110 SEC=.008 OHM
1-4 115 TURNS RATIO-
1-5 120 PRI TERMINALS 1 TO 4
1-6 125 TO SEC=46 TO 1
1-8 2.5

ITEM NO. 24 TERM. VOLTS DC RESISTANCE

1-2 105 PRI=1.0 OHM
1-3 110 SEC=.42 OHMS
1-4 115 TURNS RATIO-
1-5 120 PRI TERMINALS 1 TO 4
1-6 125 TO SEC=1 TO 10.43
1-8 600

ITEM NO. 27 TERM. VOLTS DC RESISTANCE

1-2 105 PRI=2.8 OHMS
1-3 110 SEC=.008 OHM
1-4 115 TURNS RATIO-
1-5 120 PRI TERMINALS 1 TO 4
1-6 125 TO SEC=1 TO 30.4
1-8 1750

ITEM NO. 28, 29, 30, 31 TERM. VOLTS DC RESISTANCE

1-2 105 PRI=4.1 OHMS
1-3 110 SEC=.04 OHM
1-4 115 TURNS RATIO-
1-5 120 PRI TERMINALS 1 TO 4
1-6 125 TO SEC=4.8 TO 1
1-8 24

ITEM NO. 27 TERM. VOLTS DC RESISTANCE

1-2 105 PRI=2.0 OHMS
1-3 110 SEC=.03 OHM
1-4 115 TURNS RATIO-
1-5 120 PRI TERMINALS 1 TO 4
1-6 125 TO SEC=18.25 TO 1
1-8 600

ITEM NO. 33 TERM. VOLTS DC RESISTANCE

1-2 105 PRI=4.1 OHMS
1-3 110 SEC=.04 OHM
1-4 115 TURNS RATIO-
1-5 120 PRI TERMINALS 1 TO 4
1-6 125 TO SEC=11.5 TO 1
1-8 24

Figure 9-3. Transformer Winding Data

425 0030 00 SHIELDING, CUT TO LENGTH SUCH THAT ENDS, WITH SHIELDING PULLED TIGHT AND WRAPPED WITH BUS, WILL FIT INSIDE CABLE CLAMPS ON PLUGS.

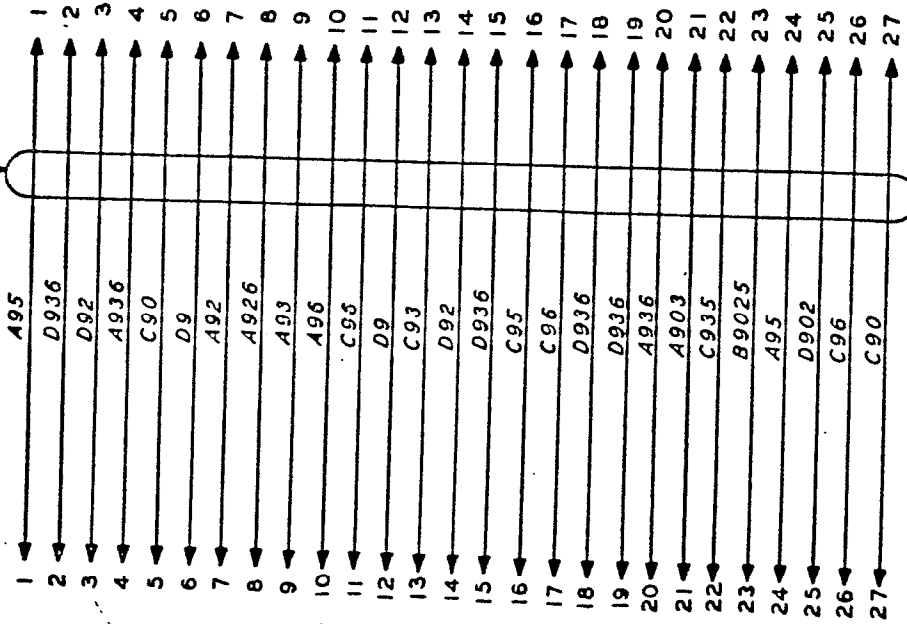

LENGTH OF CABLE BETWEEN PLUGS 27 INCHES TO BE SUCH THAT DOOR WILL OPEN WIDE WITHOUT PUTTING STRAIN ON CABLE.

366 9273 00

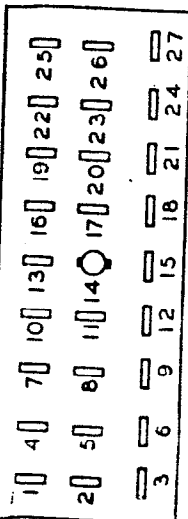

365 8273 00

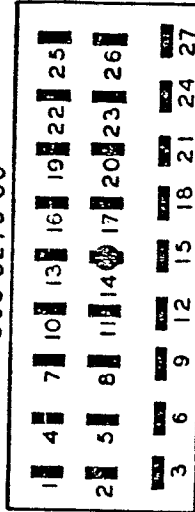

Figure 9-4. 65Q-30 Cable Schematic

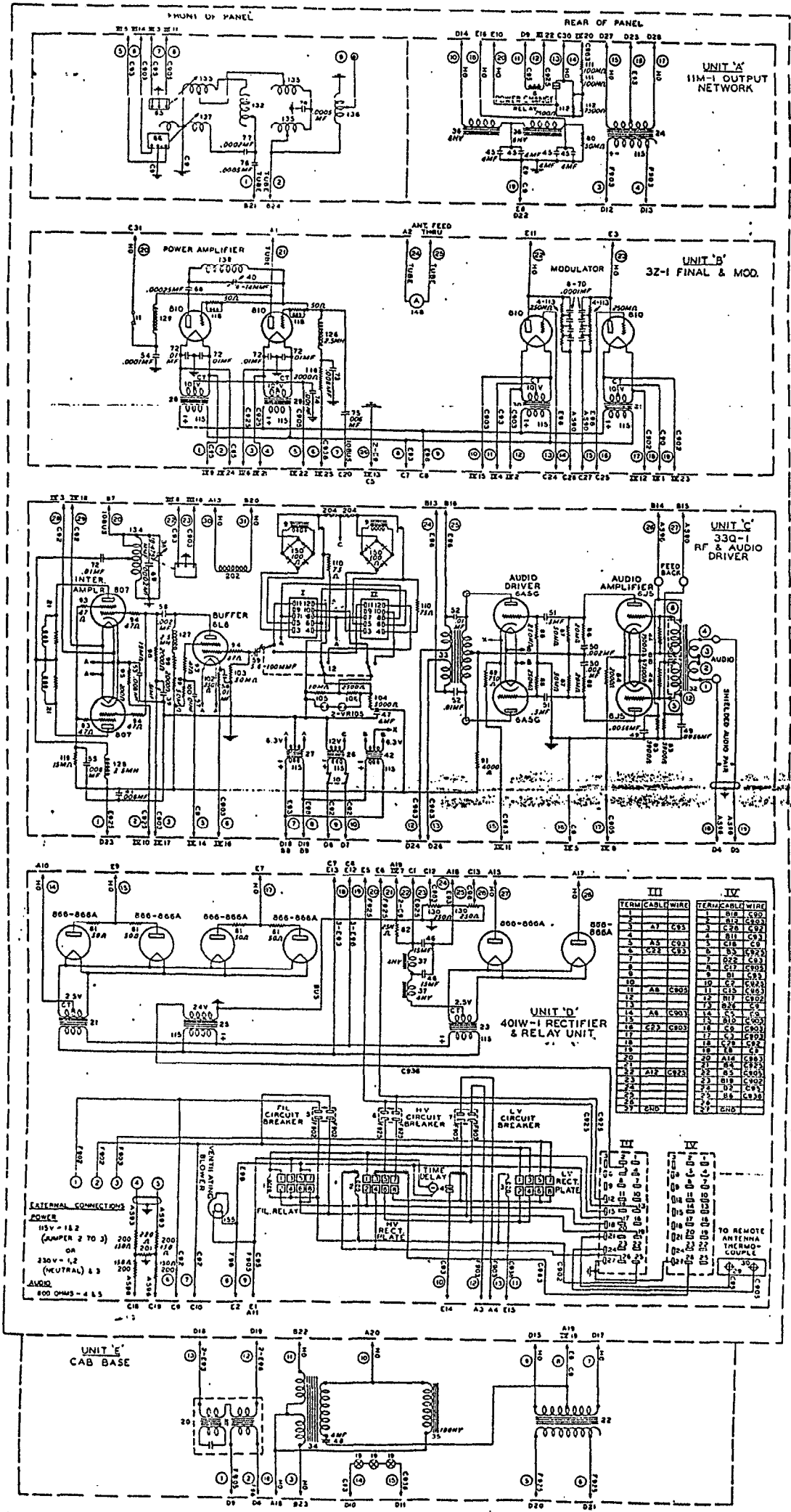

Figure 9-5. 1100W Vertical Chassis Cabling Schematic

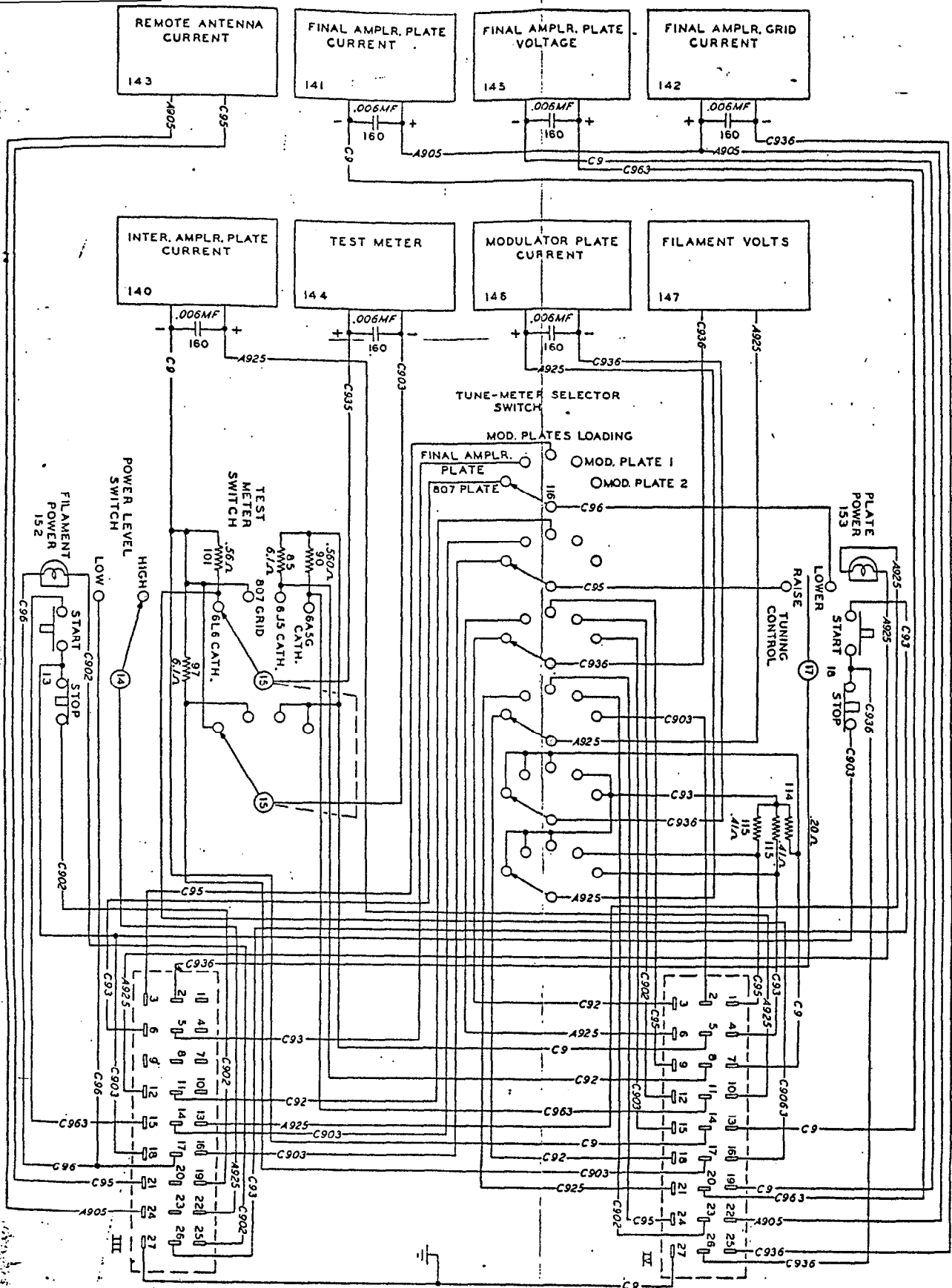
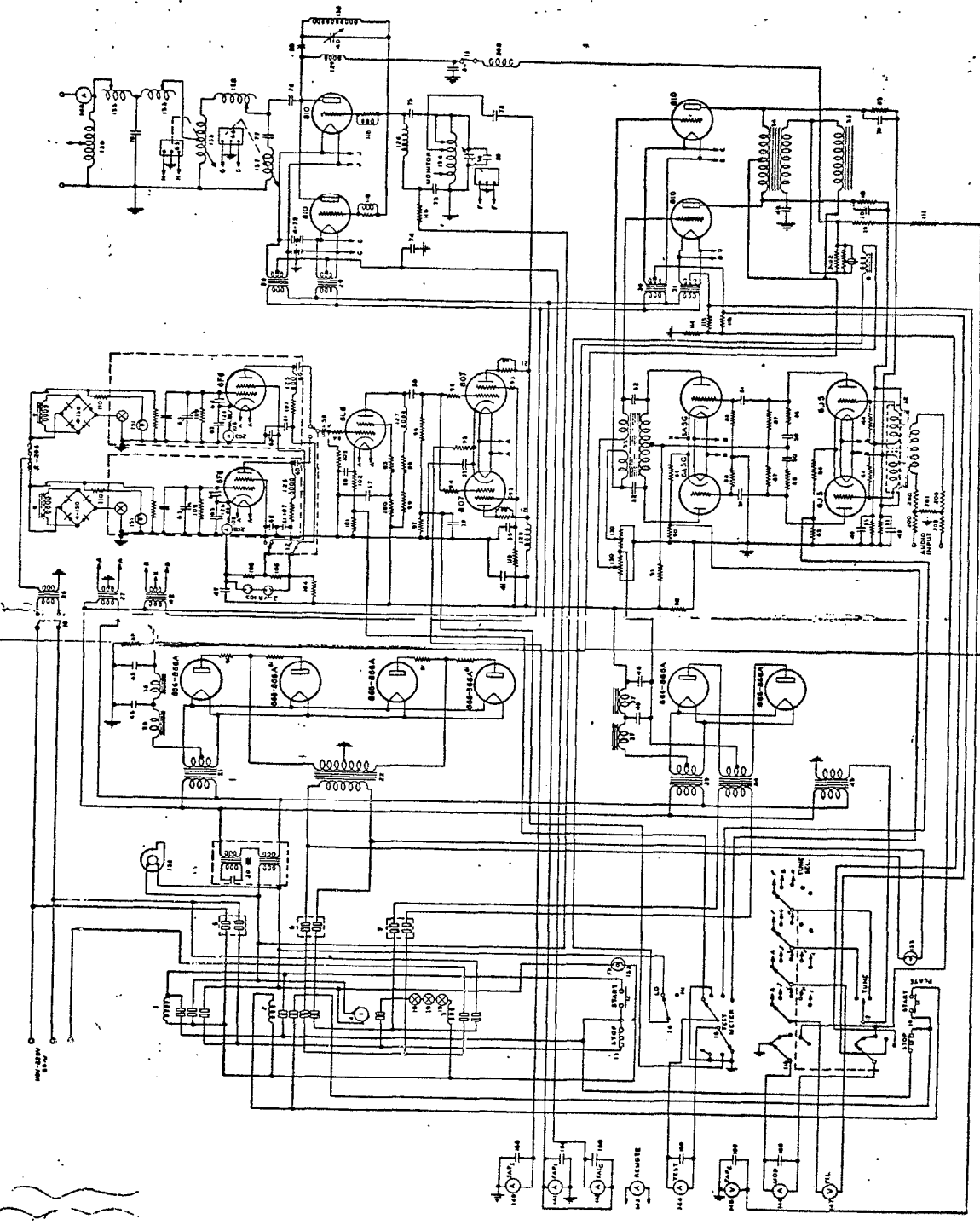

Figure 9-6. 38N Control and Meter Door Schematic



Note
 Transmitter may be operated from either 115 volt or a 230 volt single phase power source. If 115 volt source is to be used connect terminals #2 and #3 together and connect the power line to terminals #1 and #3. If a 230 volt power source is to be used connect the neutral wire of power line to terminal #2.

Figure 9-7. 300G Complete Schematic

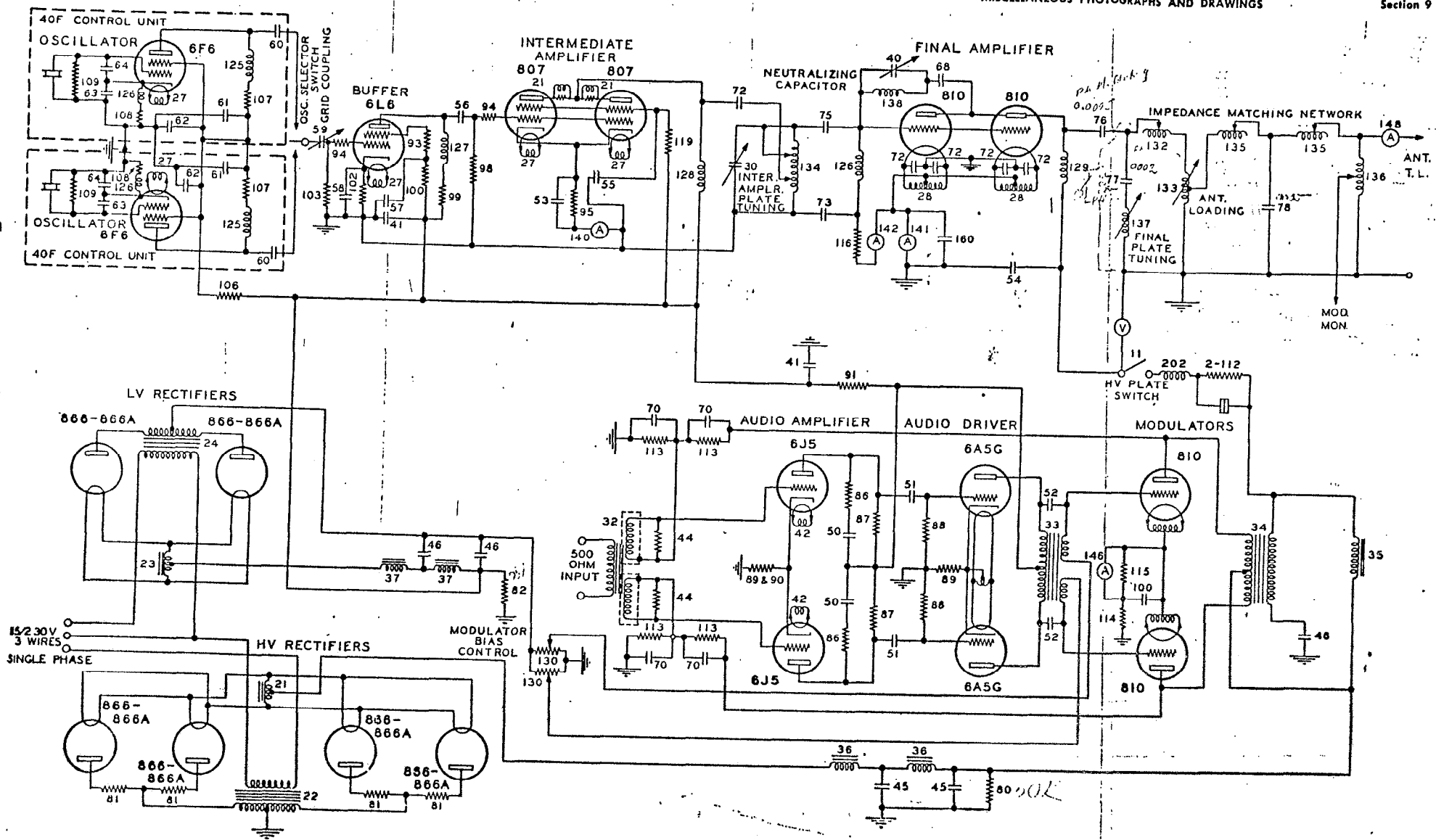
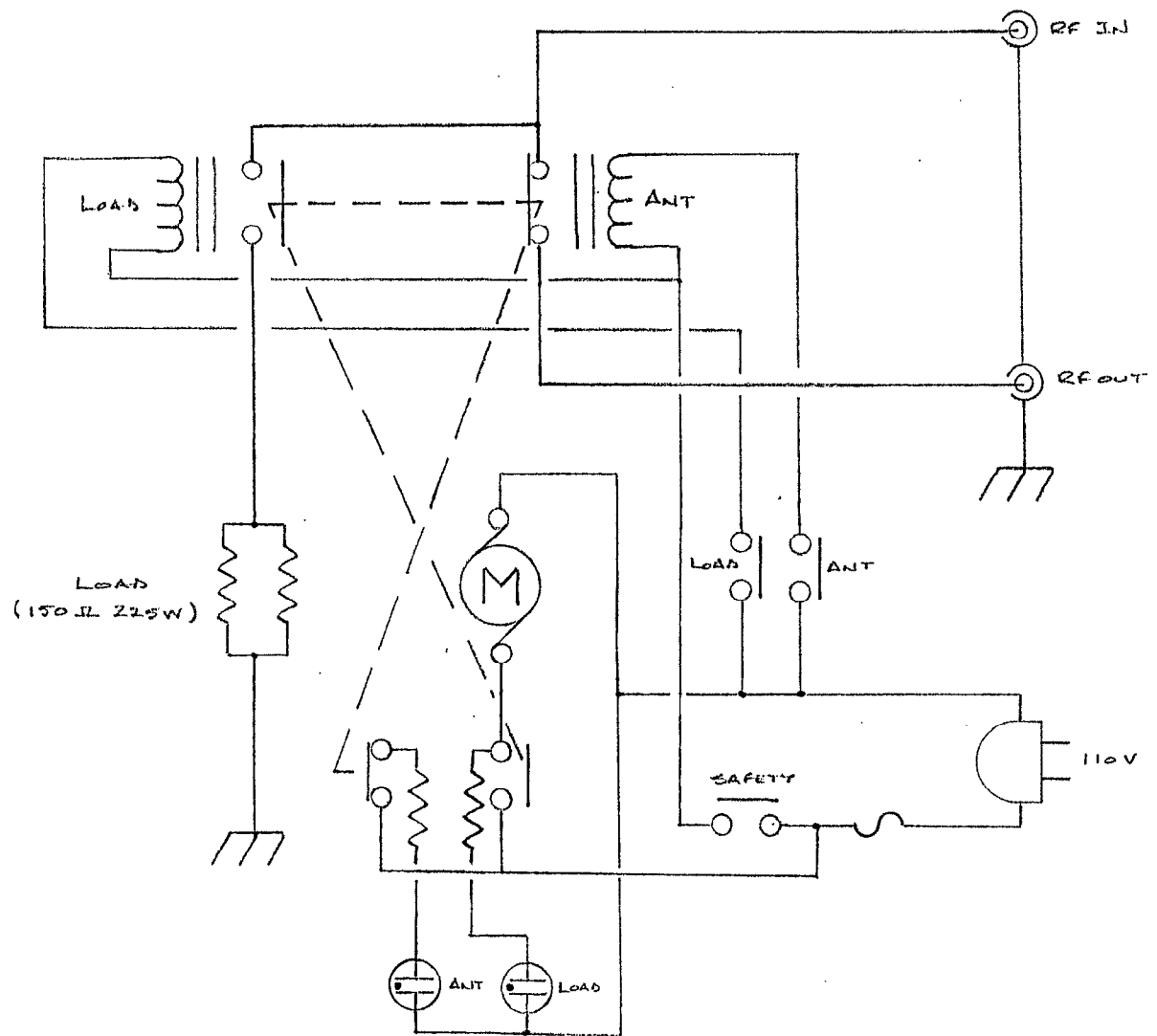

Figure 9-8. 300G Simplified Schematic



250 WATT DUMMY LOAD for COLLINS 300 G

TRANSMITTER CONTROL UNIT
MODEL WRC-10 T

CHG DWN FXY 4-66 5-76 91B6146 E

A	REVISIONS
B	117V LINE FUSE WAS 1A
C	ADD R609, R610 & AMPLITUDE LIMITED CONTROL TONES
D	ADD PINS 5, 6 & 7
E	REVISIONS

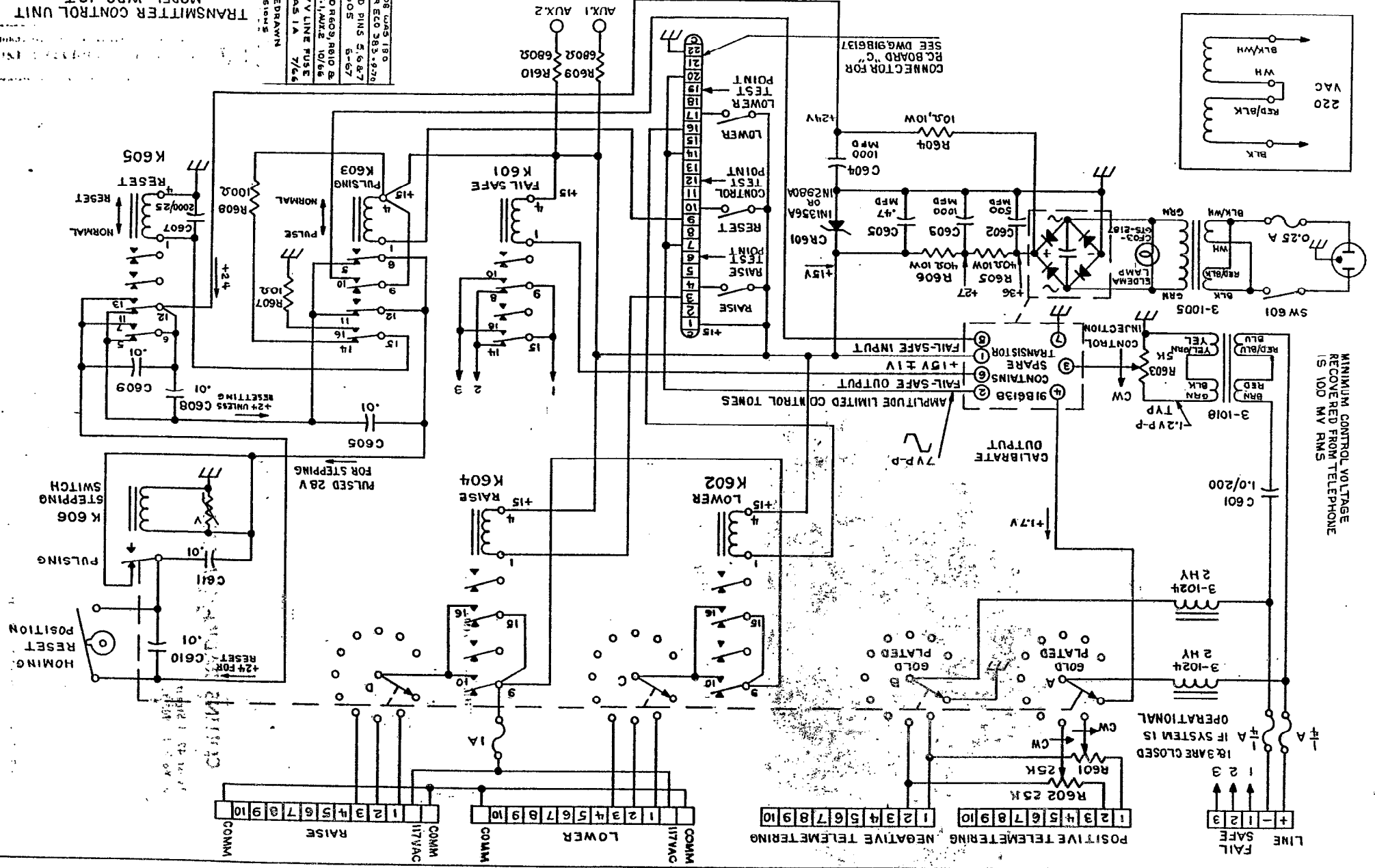

MINIMUM CONTROL VOLTAGE
RECOVERED FROM TELEPHONE
IS 100 MV RMS

CONNECTOR FOR
PC BOARD "C"
SEE DWG 91B6137