

AEL Total RF Transmission Systems

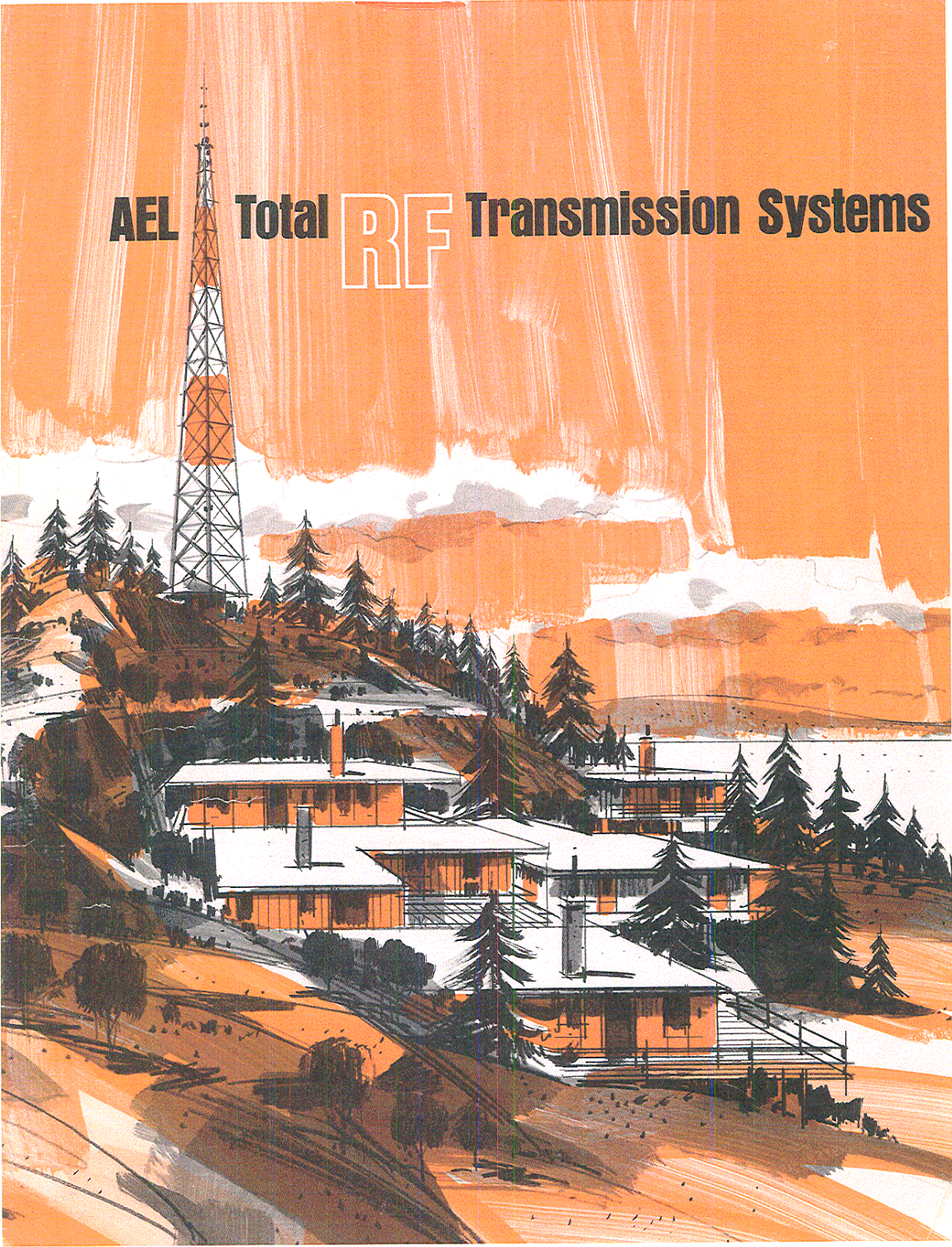

TABLE OF CONTENTS

	Page No.
Model AM-5KD • 5,000W	6
Model AM-10KD • 10,000W	10
Model AM-50KD • 50,000W	14
Model FM-2.5KE • 2,500W	22
Model FM-5KE • 5,000W	24
Model FM-10KE • 10,000W	24
Model FM-15KE • 15,000W	26
Model FM-25KE • 25,000W	28
Model FM-25/25KE • 40,000W-50,000W	30
Model FM-20E Exciter	36
Model FM-20E/SG Stereo Generator	37
Model FM-20E/SC SCA Generator	37
Model FM-15QE Exciter	38
Model FM-15QE/SG Stereo Generator	39

AMERICAN ELECTRONIC LABORATORIES, Inc.



A QUARTER CENTURY OF TECHNOLOGICAL GROWTH

American Electronic Laboratories, Inc. was founded in 1950 by two engineers on the staff of the Moore School of Electrical Engineering at the University of Pennsylvania . . . Dr. Leon Reibman and Conrad J. Fowler.

The modern plant, with the state-of-the-art equipment and facilities, is located on a 55-acre tract in historic Montgomery County, Pennsylvania

The AEL Broadcast Division is part of a responsive and efficient organization, geared to meet the challenges of scientific research, design, development, manufacturing and service.

Throughout the free world numerous customers have benefited from the success of AEL's innovative endeavors: the Department of Defense, the National Aeronautics & Space Administration, many industrial organizations . . . and especially commercial broadcasters.

The requirements of the broadcaster are served throughout the United States, as well as internationally, with marketing representatives dedicated to serve management and the broadcast engineer.

For additional information, contact the Broadcast Marketing Manager at our headquarters in Colmar, PA.

American Electronic Laboratories, Inc.
P.O. Box 552, Lansdale, PA 19446
(215) 822-2929 TWX: 510-661-4976

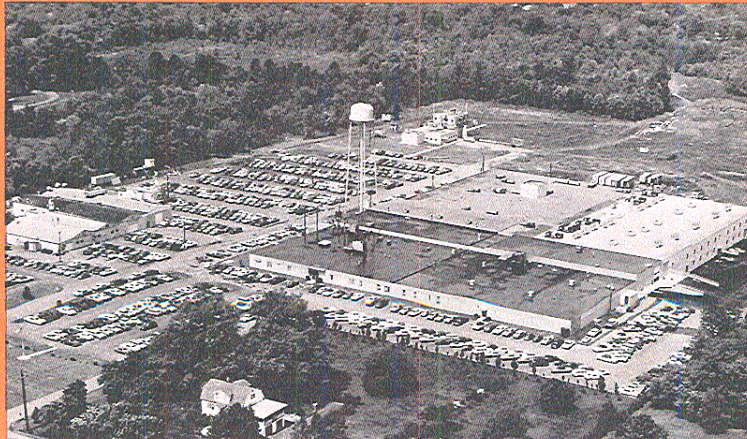

Lee DeForest (1873-1961), an American inventor, pioneered in wireless telegraphy and radio broadcasting. He obtained patents on more than 300 inventions. He patented a vacuum tube called a triode, or audion, in 1907. It often is described as an invention as great as radio itself. The tube, which amplifies weak sounds, is basic to long-distance radio and television communication.

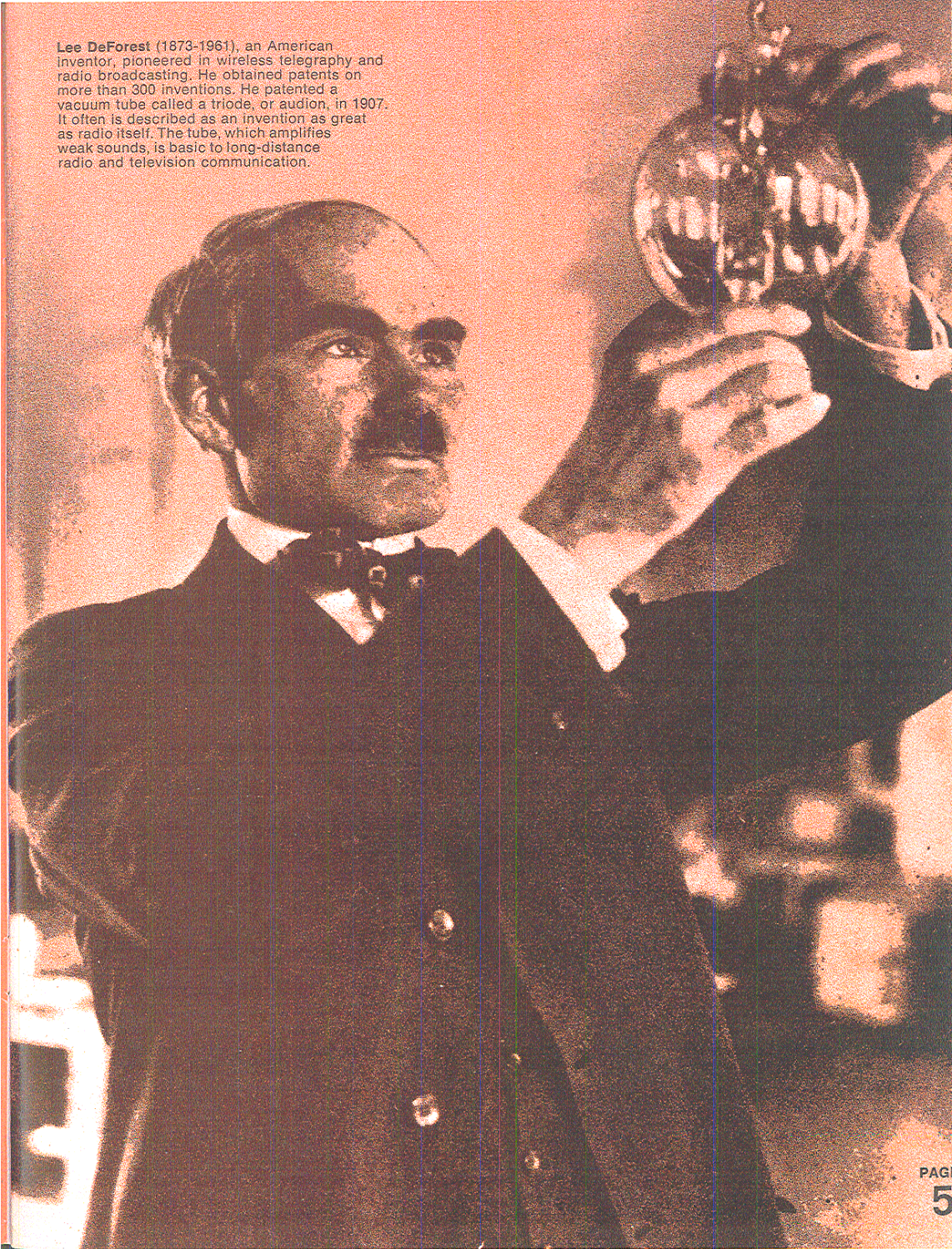

5,000W



FEATURES

- Excellent Fidelity
- Easy Maintenance
- Semi-Automatic Operation
- High Level Modulation
- Solid State Control Circuitry
- 125% Modulation Capability
- Central Control Panel

The Model AM-5KD is a completely self-contained 5,000 Watt AM transmitter. It is FCC Type Accepted for service in the 535 to 1605 kHz broadcast band.

This transmitter was designed for the professional AM broadcaster and features all solid state control circuits, excellent audio fidelity, and semi-automatic start-up features.

FIDELITY

The low level audio section of the AM-5KD is completely solid state. The program input line drives a dual 100 Watt solid state preamplifier whose output provides grid drive to a pair of low distortion 4CX3000A class AB-1 modulators. Negative feedback is used around the complete audio section to reduce distortion and assure high fidelity performance. The overall performance of this transmitter that is of particular interest to the broadcast engineer includes:

- Frequency Response 50 — 7500 Hz (± 1.5 dB)
- Low Distortion 1.5% (typical)
- Low Noise -55dB (unweighted)

Model AM-5KD Broadcast Transmitter

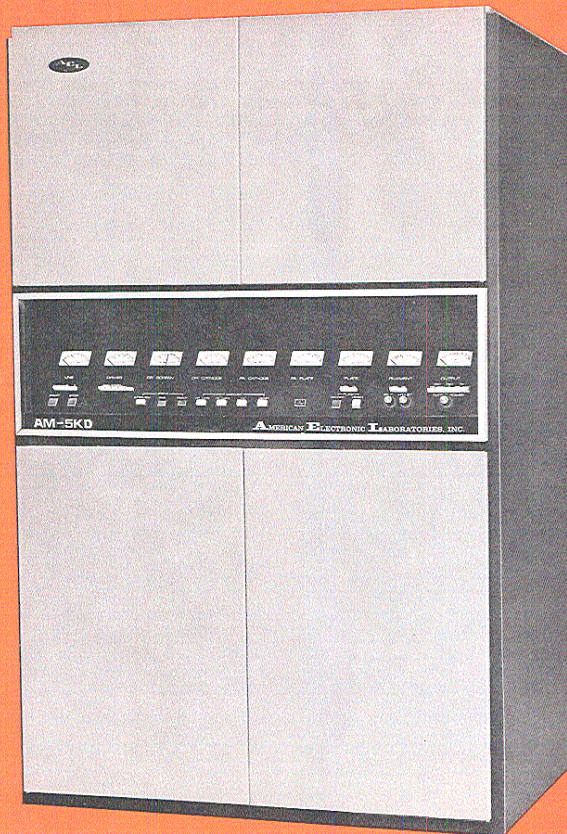

RF OUTPUT CIRCUITRY (Front View)

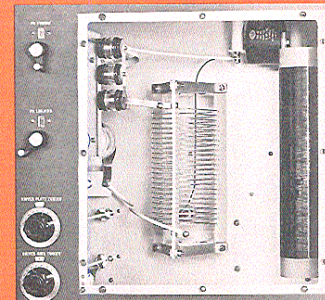

RF choke and plate tank coil. Notice the convenient PA and driver tuning controls.

AMERICAN ELECTRONIC LABORATORIES, Inc.



EASY MAINTENANCE

The transmitter is housed in a single self-contained modern cabinet including the AEL Center Line Control Panel concept. This places all metering, control, and indicator functions at the normal reading level position for easy operation while making tuning or operation adjustments.

The meter panel is front-end hinged for easy access to all control and logic circuits.

All High Power circuits and components are located in the rear of the cabinets.

The entire chassis maintains a positive cabinet air pressure which prevents intrusion of dust and dirt; this feature significantly increases the life of the high-voltage components and reduces the need for maintenance.

TUBES

The RF output stage uses one (1) high gain, high reliability 4CX3000A Tetrode; the RF driver stage utilizes a single 8121 high performance Tetrode which operates at one third of maximum output capabilities; the modulator stage uses two (2) 4CX3000A's operating class AB1.

There are only two tube types (4 tubes total in this 5,000W transmitter).

SEMI-AUTOMATIC OPERATION

This transmitter has several semi-automatic controls that are of interest to the broadcaster. These include automatic re-start, automatic re-cycle, and power cut-back; all control functions are accomplished by solid state logic circuits; each operates from a 24 Vdc regulated power supply. The interlock and sequence relays are also operated from this low voltage source for safety and convenience. Push button start/stop operation is used. Operating and fault status lights are placed in the center-mounted control panel.

AUTOMATIC RE-CYCLING—Overload Protection

Any abnormal condition that might cause an overload condition in the Driver Tube, the Power Amplifier Tube, or the high voltage section of the amplifier immediately initiates a 1 second shut down. The plate voltage is removed automatically from these tubes to protect them from permanent damage. It is automatically returned after this one second interval; after three consecutive shut downs the plate voltage can be restored only by a manual re-set.

(Continued on page 8)

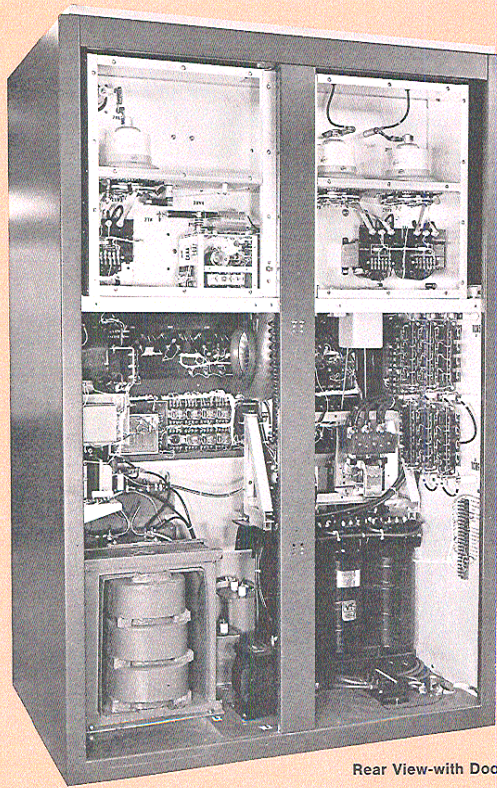

Rear View-with Doors and Air Filters removed.

**RF OUTPUT CIRCUITRY
(Rear View)**

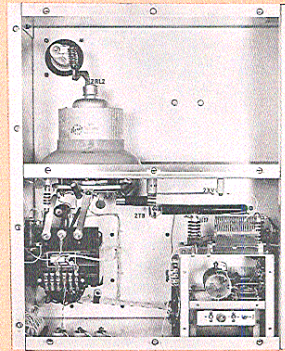

At the top of this RF section is the RF power amplifier and below is the solid state exciter.

5,000W

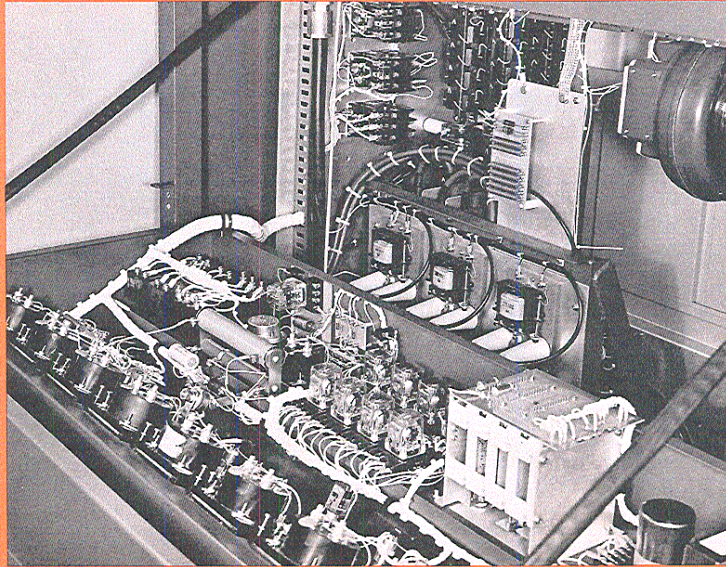

AEL Design Meter Panel Hinged For Quick Access



Model AM-5KD Broadcast Transmitter

AUTO RESTART—Power Interrupt

If the primary power to the transmitter is interrupted for less than 5 seconds the transmitter automatically shuts down; this protects sensitive tubes and circuits. It is automatically returned to full power immediately upon return of primary power. As long as the interrupt is less than 5 seconds this sequence will continue indefinitely. If primary power to the transmitter is interrupted for more than 5 seconds the transmitter is automatically shut down. When full power is restored, a 3 minute restart cycle is automatically instituted after which normal operation of the transmitter resumes. This 3 minute delay is required to protect the sensitive high power tubes.

SELF-CHECK CIRCUITS

In order to assist the broadcast engineer in routine maintenance procedures, and overload Status Board is incorporated in this transmitter. This provides a visual indication whenever one of the following circuits become overloaded:

- High Voltage Supply
- Final Amplifier Driver
- Modulator
- Low Voltage Supply

REMOTE CONTROL

Terminals for connecting remote control and remote metering functions are built into the transmitter, permitting interface with any conventional remote control system.

POWER CUT-BACK

A single button control with automatic built-in sequencing controls the cut-back from 5,000 Watts to 1,000 or 500 Watts.

MECHANICAL/ENVIRONMENTAL

SIZE: 77-1/4"H x 48"W x 36"D (overall)
77-1/4"H x 48"W x 33"D (trim and doors removed)

WEIGHT: 2360 lbs. (approx.)

FLOOR LOADING: 215 lbs./sq. ft. (approx.)

CABINET STYLE: Enclosed single steel cabinet; access through front doors and quickly removable panels, swing-down centrally located meter and control panel, rear doors.

OPERATING AMBIENT TEMPERATURE RANGE: 20°F to 113°F.

STORAGE TEMPERATURE RANGE: —20°F to 120°F.

PROTECTIVE FUNCTIONS

Extra circuit protection is provided by both multiple circuit breakers and fuses. All access doors and hatches are provided with interlocks for protection of personnel. A high voltage shorting stick is provided with each transmitter.

AMERICAN ELECTRONIC LABORATORIES, Inc.

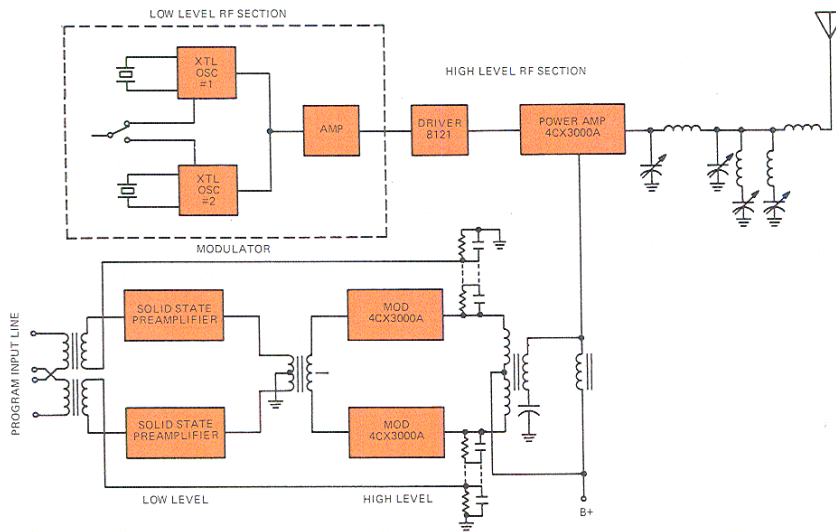

Simplified Block Diagram, AEL AM-5KD Transmitter

SPECIFICATIONS

ELECTRICAL CHARACTERISTICS

Frequency Range:	535 to 1605 kHz.
Frequency Stability:	±5 Hz.
Audio Frequency Input Impedance:	150/600 ohms balanced.
Audio Frequency Input Level:	+10 dBm ±2 dB for 100% modulation.
Audio Frequency Response:	± 1 dB 50 Hz to 8 kHz.
Audio Frequency Distortion:	Less than 2.5% 50 Hz to 8 kHz at 95% modulation.
Noise Unweighted	(referenced 100% modulation at 400 Hz): -55 dB.
Power Output Capability:	5.5 kW.
Modulation:	High level plate modulation.
Type of Emission:	A3
Output Impedance:	50 ohms unbalanced standard; other impedances available on special order.
Carrier Shift	(100% modulation): Less than 3%.
Monitor Output:	5 V to RMS into 50/75 ohms.
Line Voltage:	208 to 240 Vac 60 Hz, 3 phase, 4 wire (others available on special order).
Power Consumption:	0% modulation — 11 kW. 30% modulation — 12 kW. 100% modulation — 14 kW.
Power Factor:	90%
Voltage Variation and Regulation:	±5%.
Spurious RF Emission	(2nd harmonic & higher): -80 dB.

Prices and specifications subject to change without notice

10,000W



FEATURES

- Excellent Fidelity
- Easy Maintenance
- Semi-Automatic Operation
- High Level Modulation
- Solid State Control Circuitry
- 125% Modulation Capability
- Central Control Panel

The Model AM-10KD is a completely self-contained 10,000 Watt AM transmitter. It is FCC Type Accepted for service in the 535 to 1605 kHz broadcast band.

This transmitter was designed for the professional AM broadcaster and features all solid state control circuits, excellent audio fidelity, and semi-automatic start-up features.

FIDELITY

The low level audio section of the AM-10KD is completely solid state. The program input line drives a dual 100 Watt solid state preamplifier whose output provides grid drive to a pair of low distortion 4CX3000A class AB-1 modulators. Negative feedback is used around the complete audio section to reduce distortion and assure high fidelity performance. The overall performance of this transmitter that is of particular interest to the broadcast engineer includes:

- Frequency Response 50 — 7500 Hz (± 1.5 dB)
- Low Distortion 1.5% (typical)
- Low Noise -55 dB (unweighted)

Model AM-10KD Broadcast Transmitter

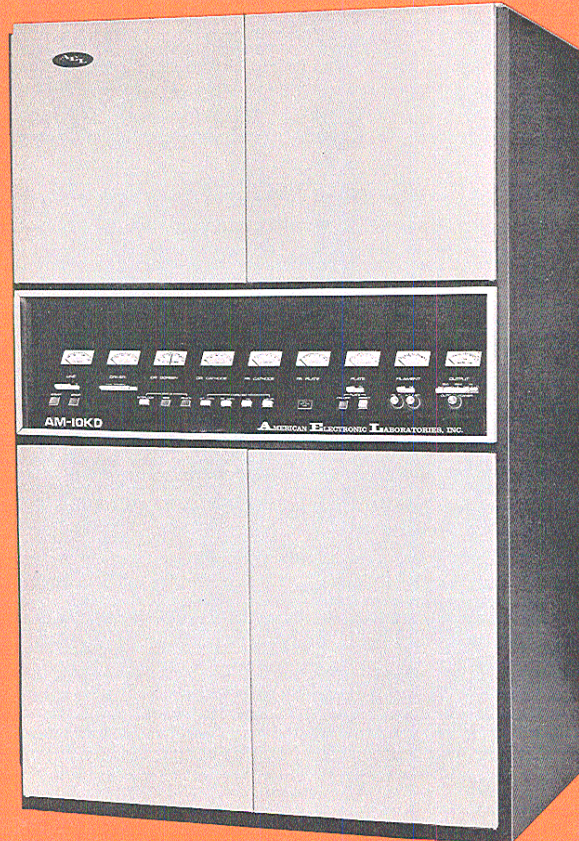

RF OUTPUT CIRCUITRY
(Front View)

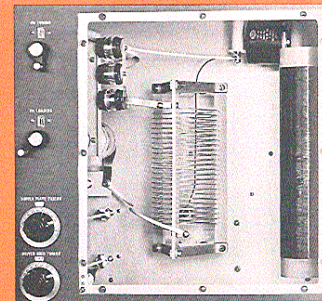

RF choke and plate tank coil. Notice the convenient PA and driver tuning controls.

AMERICAN ELECTRONIC LABORATORIES, Inc.



EASY MAINTENANCE

The transmitter is housed in a single self-contained modern cabinet including the AEL Center Line Control Panel concept. This places all metering, control, and indicator functions at the normal reading level position for easy operation while making tuning or operation adjustments.

The meter panel is front-end hinged for easy access to all control and logic circuits.

All High Power circuits and components are located in the rear of the cabinets.

The entire chassis maintains a positive cabinet air pressure which prevents intrusion of dust and dirt; this feature significantly increases the life of the high-voltage components and reduces the need for maintenance.

TUBES

The RF output stage uses two (2) high gain, high reliability 4CX3000A Tetrodes; the RF driver stage utilizes a single 8121 high performance Tetrode which operates at one half of maximum output capabilities; the modulator stage uses two (2) 4CX3000A's operating class AB1.

There are only two-tube types (5 tubes total) in this 10,000 W transmitter.

SEMI-AUTOMATIC OPERATION

This transmitter has several semi-automatic controls that are of interest to the broadcaster. These include automatic re-start, automatic re-cycle, and power cut-back; all control functions are accomplished by solid state logic circuits; each operates from a 24 Vdc regulated power supply. The interlock and sequence relays are also operated from this low voltage source for safety and convenience. Push button start/stop operation is used. Operating and fault status lights are placed in the center-mounted control panel.

AUTOMATIC RECYCLING—Overload Protection

Any abnormal condition that might cause an overload condition in the Driver Tube, the Power Amplifier Tube, or the high voltage section of the amplifier immediately initiates a 1 second shut down. The plate voltage is removed automatically from these tubes to protect them from permanent damage. It is automatically returned after this one second interval; after three consecutive shut downs the plate voltage can be restored only by a manual re-set.

(Continued on page 12)

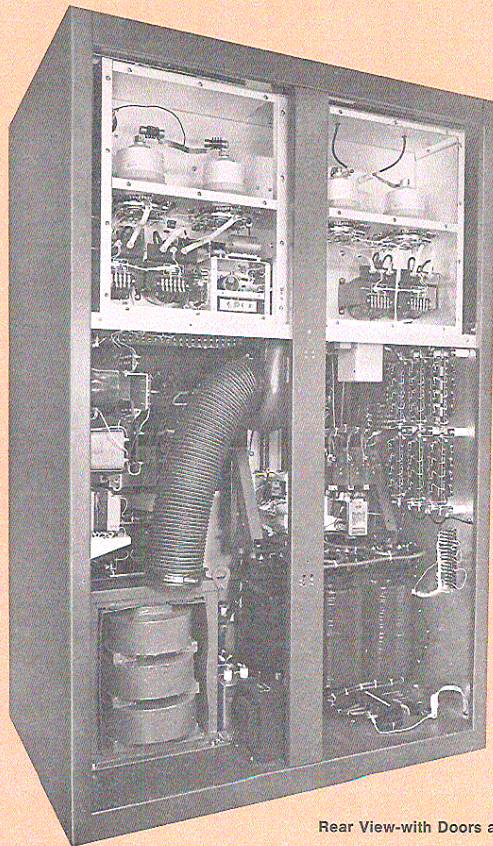

Rear View-with Doors and Air Filters removed.

**RF OUTPUT CIRCUITRY
(Rear View)**

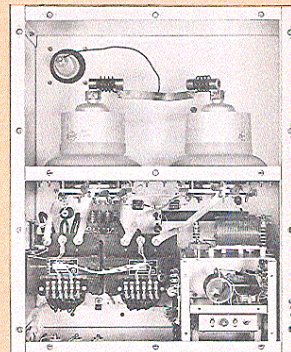

At the top of this RF section is the RF power amplifier and below is the solid state exciter.

10,000W

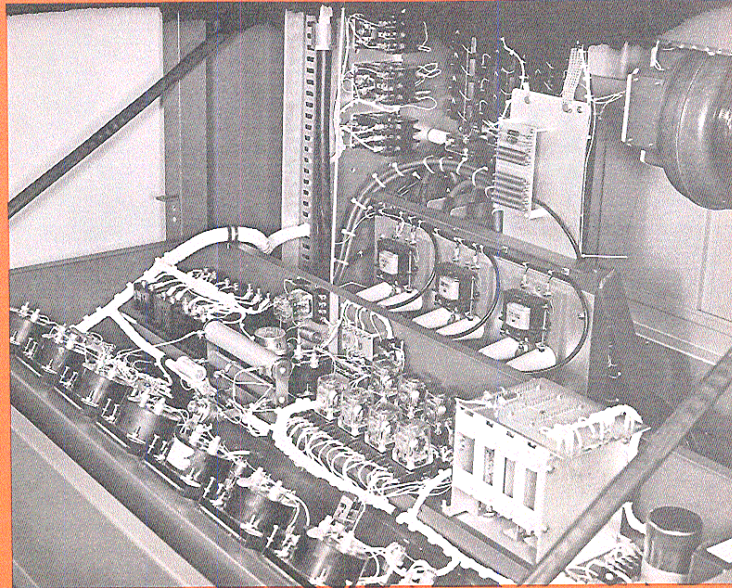

AEL Design Meter Panel Hinged For Quick Access

Model AM-10KD Broadcast Transmitter

AUTO RESTART—Power Interrupt

If the primary power to the transmitter is interrupted for less than 5 seconds the transmitter automatically shuts down; this protects sensitive tubes and circuits. It is automatically returned to full power immediately upon return of primary power. As long as the interrupt is less than 5 seconds this sequence will continue indefinitely. If primary power to the transmitter is interrupted for more than 5 seconds the transmitter is automatically shut down. When full power is restored, a 3 minute restart cycle is automatically instituted after which normal operation of the transmitter resumes. This 3 minute delay is required to protect the sensitive high power tubes.

SELF CHECK CIRCUITS

In order to assist the broadcast engineer in routine maintenance procedures, an overload Status Board is incorporated in this transmitter. This provides a visual indication whenever one of the following circuits become overloaded:

- High Voltage Supply
- Final Amplifier Driver
- Modulator
- Low Voltage Supply

REMOTE CONTROL

Terminals for connecting remote control and remote metering functions are built into the transmitter, permitting interface with any conventional remote control system.

POWER CUT-BACK

A single button control with automatic built-in sequencing controls the cut-back from 10,000 Watts to 5,000 or 1,000 Watts.

MECHANICAL/ENVIRONMENTAL

SIZE: 77-1/4"H x 48"W x 36"D (overall)
77-1/4"H x 48"W x 33"D (trim and doors removed)

WEIGHT: 2360 lbs. (approx.)

FLOOR LOADING: 215 lbs./sq. ft. (approx.)

CABINET STYLE: Enclosed single steel cabinet; access through front doors and quickly removable panels, swing-down centrally located meter and control panel, rear doors.

OPERATING AMBIENT TEMPERATURE RANGE: 20°F to 113°F.

STORAGE TEMPERATURE RANGE: —20°F to 120°F.

PROTECTIVE FUNCTIONS

Extra circuit protection is provided by both multiple circuit breakers and fuses. All access doors and hatches are provided with interlocks for protection of personnel. A high voltage shorting stick is provided with each transmitter.

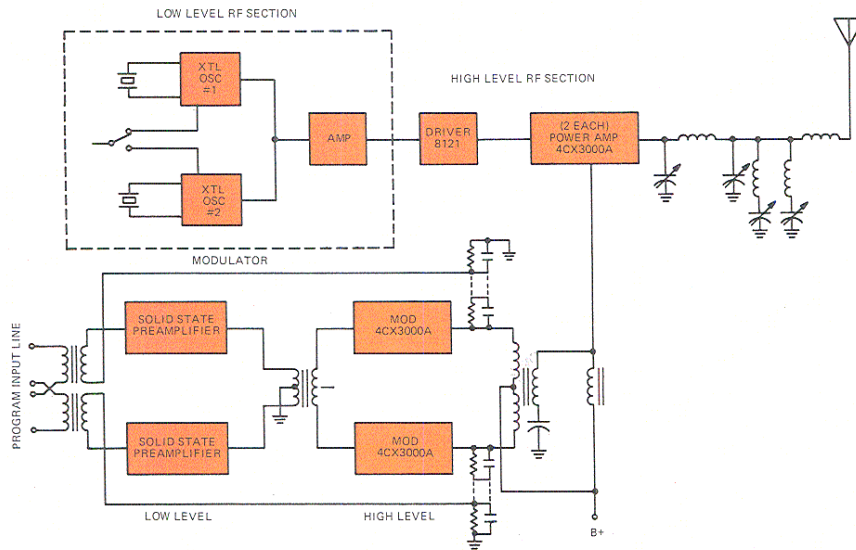

Simplified Block Diagram AEL AM-10KD Transmitter

SPECIFICATIONS

ELECTRICAL CHARACTERISTICS

Frequency Range:	535 to 1605 kHz.
Frequency Stability:	± 5 Hz.
Audio Frequency Input Impedance:	150/600 ohms balanced.
Audio Frequency Input Level:	+ 10 dBm ± 2 dB for 100% modulation.
Audio Frequency Response:	± 1 dB 50 Hz to 8 kHz.
Audio Frequency Distortion:	Less than 2.5% 50 Hz to 8 kHz at 95% modulation.
Noise Unweighted	(referenced 100% modulation at 400 Hz): -55 dB.
Power Output Capability:	11.5 kW.
Modulation:	High level plate modulation.
Type of Emission:	A3
Output Impedance:	50 ohms unbalanced standard; other impedances available on special order.
Carrier Shift	(100% modulation): Less than 3%.
Monitor Output:	5-10 V RMS into 50/75 ohms.
Line Voltage:	208 to 240 Vac 60 Hz, 3 phase, 4 wire (others available on special order).
Power Consumption:	0% modulation — 10 kW. 30% modulation — 22 kW. 100% modulation — 31 kW.
Power Factor:	90%
Voltage Variation and Regulation:	± 5%.
Spurious RF Emission	(2nd harmonic & higher): - 80 dB.

Prices and specifications subject to change without notice

50,000W

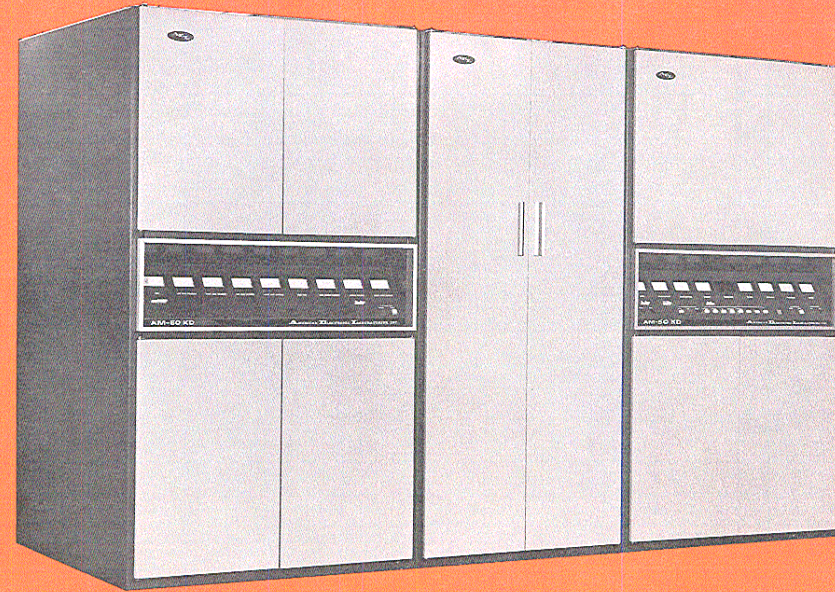

Model AM-50KD Broadcast Transmitter

FEATURES

- Excellent Fidelity
- Easy Maintenance
- Semi-Automatic Operation
- High Level Modulation
- Solid State Control Circuitry
- 125% Modulation Capability
- Central Control Panels

The Model AM-50KD is a high level modulated 50,000 Watt AM transmitter. It is FCC Type Accepted for service in the 535 to 1605 kHz broadcast band.

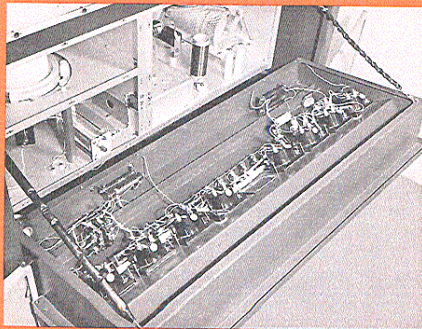

Easy Access Drop-Down Meter and Control Panel

This transmitter was designed for the professional AM broadcaster and features all solid state control circuits, excellent audio fidelity, and semi-automatic start-up features.

FIDELITY

The low level audio section of the AM-50KD is completely solid state. The program input line drives a dual 100 Watt solid state preamplifier whose output provides grid drive to a pair of low distortion 4CX15000A class AB-1 modulators. Negative feedback is used around the complete audio section to reduce distortion and assure high fidelity performance. The overall performance of this transmitter that is of particular interest to the audio engineer includes:

- Frequency Response 50 — 7500 Hz (± 2 dB)
- Low Distortion 1.5% (typical)
- Low Noise -55 dB (unweighted)

EASY MAINTENANCE

This air cooled transmitter is housed in a three section modern cabinet with a separate Power Vault and includes the AEL Center Line Control Panel concept. This places all metering, control, and indicator functions at the normal reading level position for easy operation while making tuning or operation adjustments.

The meter panels are front-end hinged for easy access to all control and logic circuits.

All High Power circuits and components are located in the rear of the cabinets.

All necessary chassis sections maintain a positive cabinet air pressure which prevents intrusion of dust and dirt; this feature significantly increases the life of the high-voltage components and reduces the need for maintenance.

AMERICAN ELECTRONIC LABORATORIES, Inc.

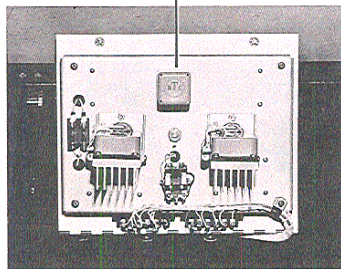
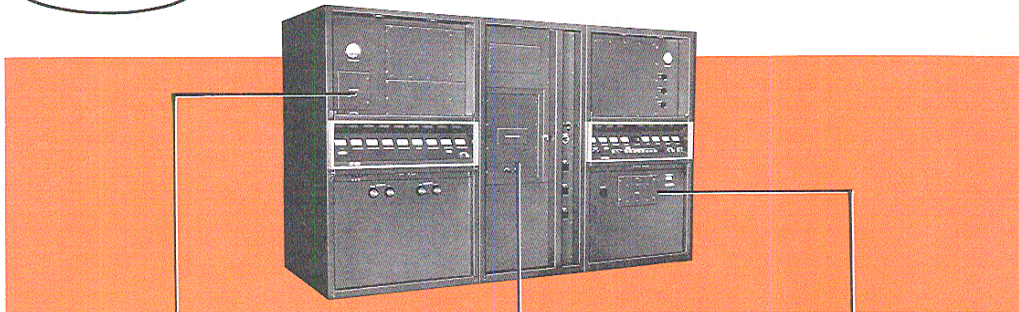

Solid State Audio Amplifier

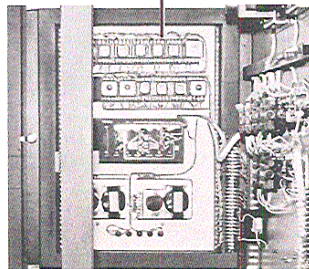

Solid State Control Circuitry

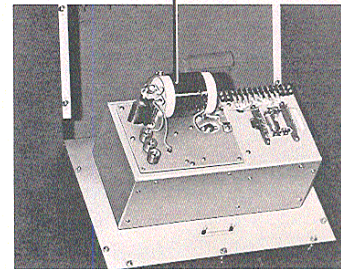

Exciter

TUBES

The RF output stage uses one (1) high gain, high reliability 4CX35000C Tetrode; the RF driver stage utilizes a single 4-400A high performance Tetrode which operates at one half of maximum output capabilities; the modulator stage uses two (2) 4CX15000A's operating class AB1.

SEMI-AUTOMATIC OPERATION

This transmitter has several semi-automatic controls that are of interest to the broadcaster. These include automatic re-start, automatic re-cycle, and power cut-back features; all are accomplished by solid state logic circuits. All operate from 24 Vdc regulated power supplies. The interlock and sequence relays are also operated from this low voltage source for safety and convenience. Push button start/stop operation is used. Operating and fault status lights are placed in the center-mounted control panels. Solid state VSWR protection is a standard feature.

AUTOMATIC RECYCLING—Overload Protection

Any abnormal condition that might cause an overload condition in the Driver Tube, the Power Amplifier Tube, or the high voltage section of the amplifier immediately initiates a 1 second shut down. The plate voltage is removed automatically from these tubes to protect them from permanent damage. It is automatically returned after this one second interval; after three consecutive shut downs the plate voltage can be restored only by a manual re-set.

AUTO RESTART—Power Interrupt

If the primary power to the transmitter is interrupted for less than 5 seconds the transmitter automatically shuts down; this protects sensitive tubes and circuits. It is automatically returned to full power immediately upon return of primary power. As long as the interrupt is less than 5 seconds this sequence will continue indefinitely. If primary power to the transmitter is interrupted for more than 5 seconds the transmitter is automatically shut down. When full power is restored, a 3 minute restart cycle is automatically instituted after which normal operation of the transmitter resumes. This 3 minute delay is required to protect the sensitive high power tubes.

SELF-CHECK CIRCUITS

In order to assist the broadcast engineer in routine maintenance procedures, we have incorporated an overload Status Board in this transmitter. This provides a visual indication whenever one of the following circuits become overloaded:

- High Voltage Supply
- Final Amplifier Driver
- Modulator
- Low Voltage Supply

REMOTE CONTROL

Terminals for connecting remote control and remote metering functions are built into the transmitter, permitting interface with any conventional remote control system.

POWER CUT-BACK

A single button control with automatic built-in sequencing controls the cut-back from 50,000 Watts to 25,000 or 10,000 Watts.

(Continued on page 16)

AEL AM-50KD
Rear View — Driver and PA Cabinet
(Doors Removed)

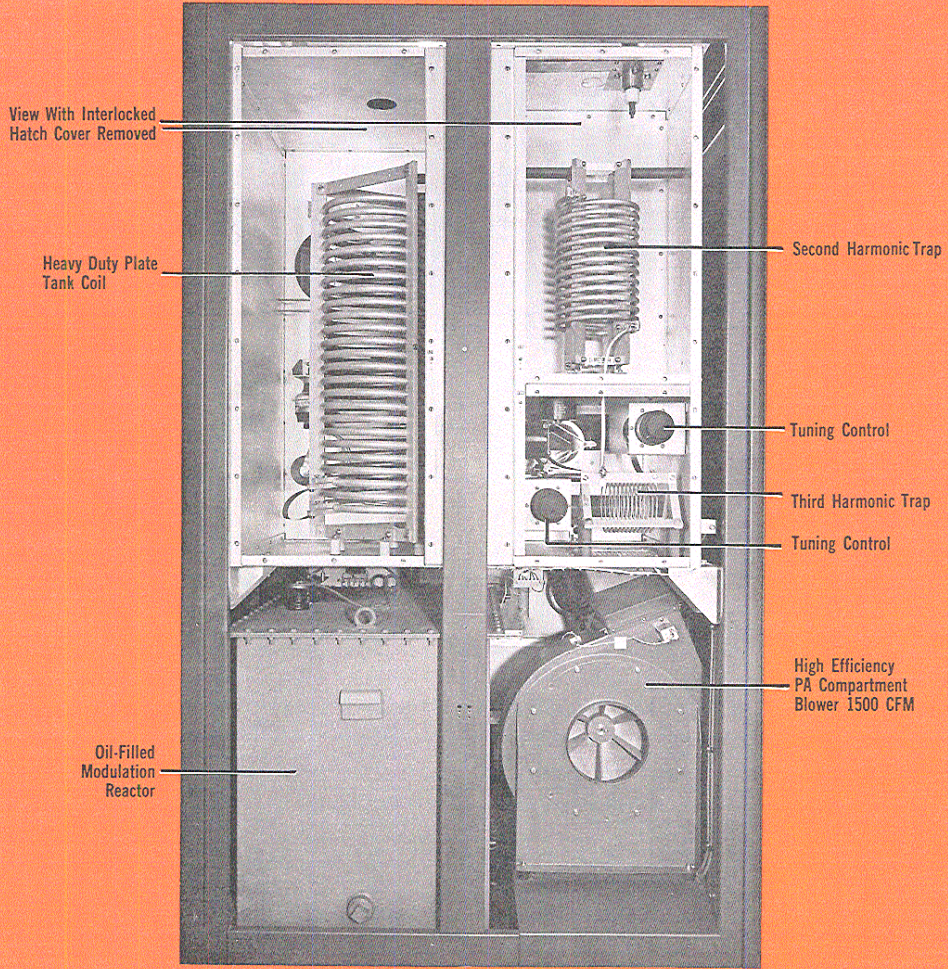



AEL AM-50KD
Rear View — Modulator Cabinet
(Doors Removed)

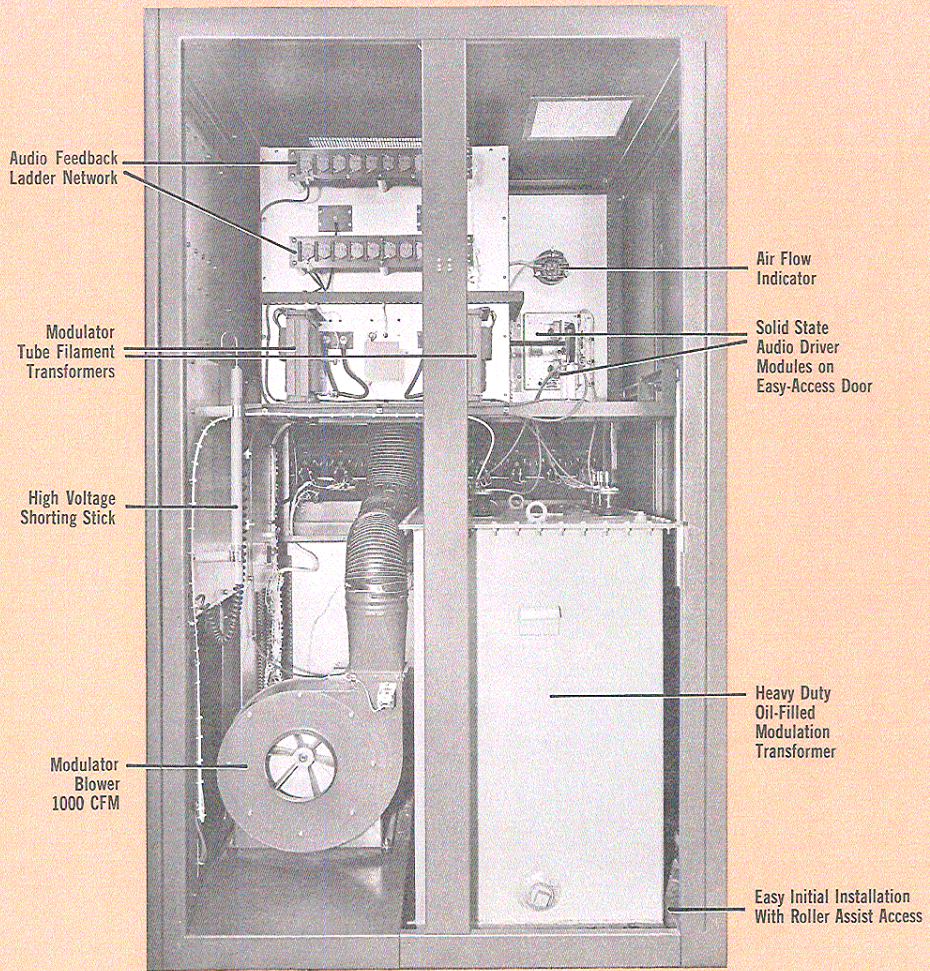

AEL AM-50KD
Front View — High Voltage Power Vault
(Door Removed)

Main Circuit Breaker
High Voltage Step-Start Control
High Voltage Three-Phase
Bridge Rectifier Stacks
Low Voltage Circuit Breaker
High Voltage Shorting Stick

Positive Pressure
Cabinet Fans
1000 CFM Each

High Voltage
Plate Transformer
High Voltage
Power Supply
Filter Choke

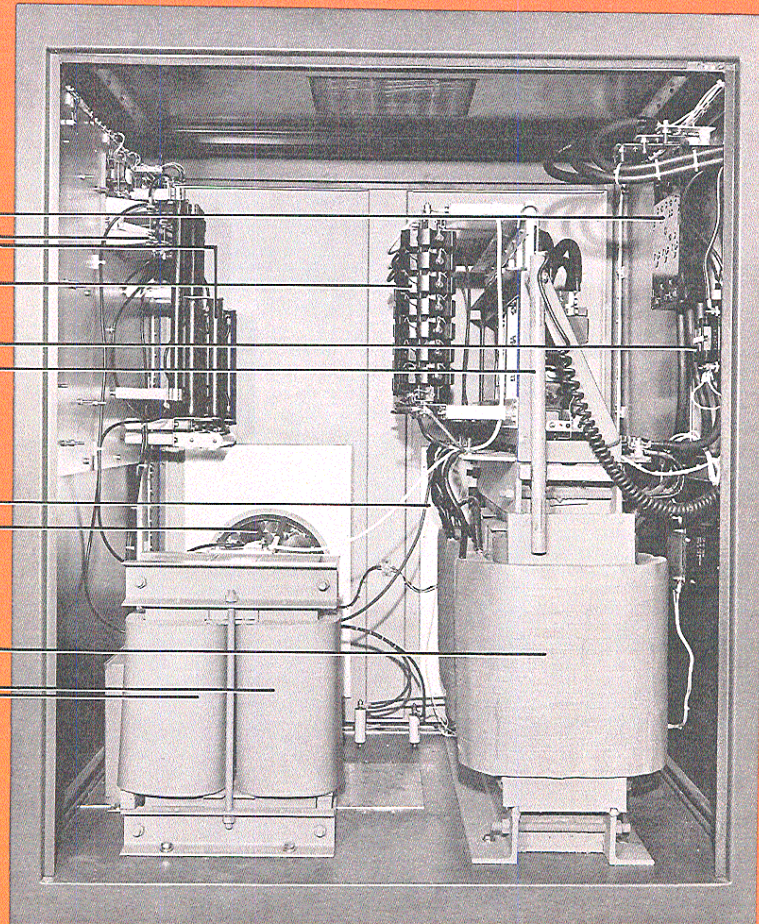



AEL AM-50KD
Rear View — Control Cabinet

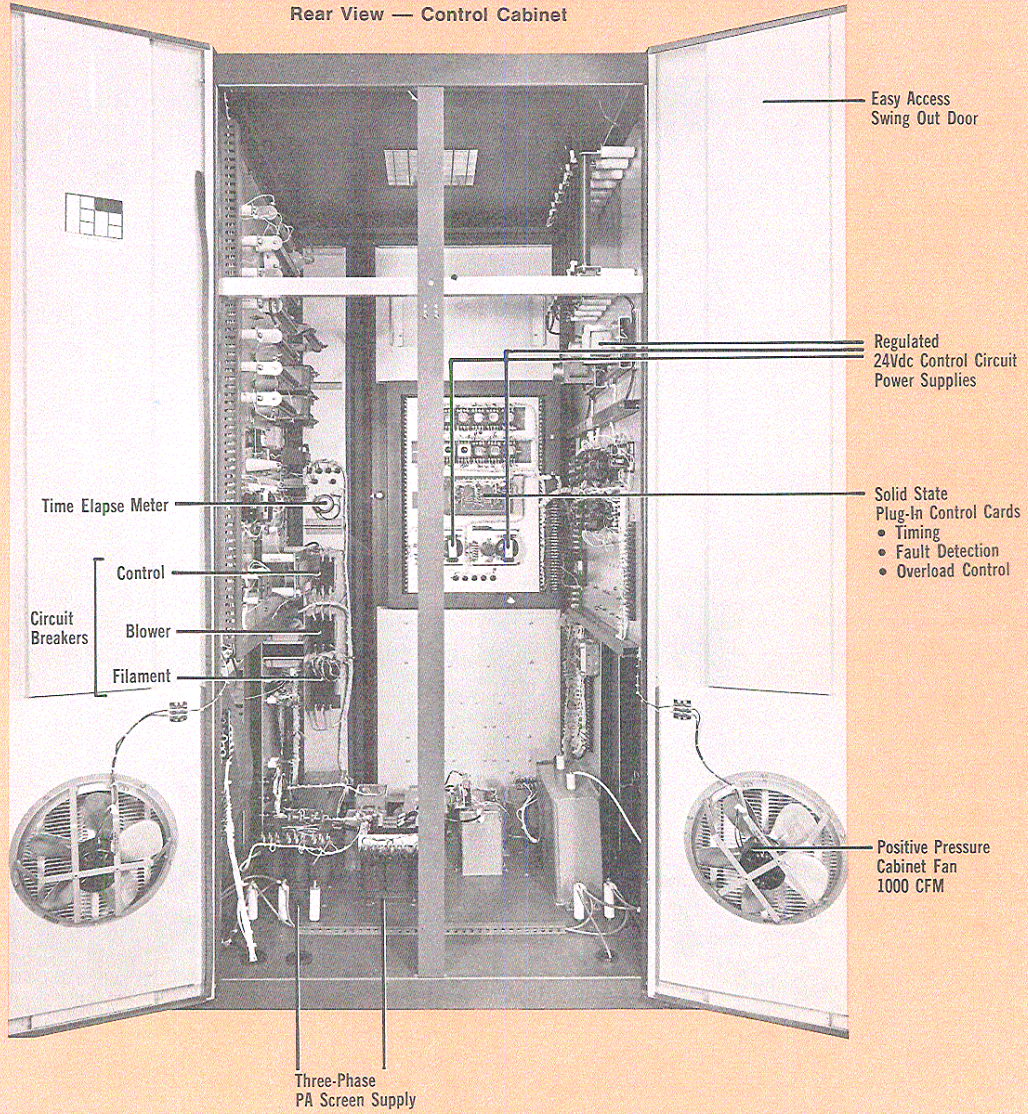

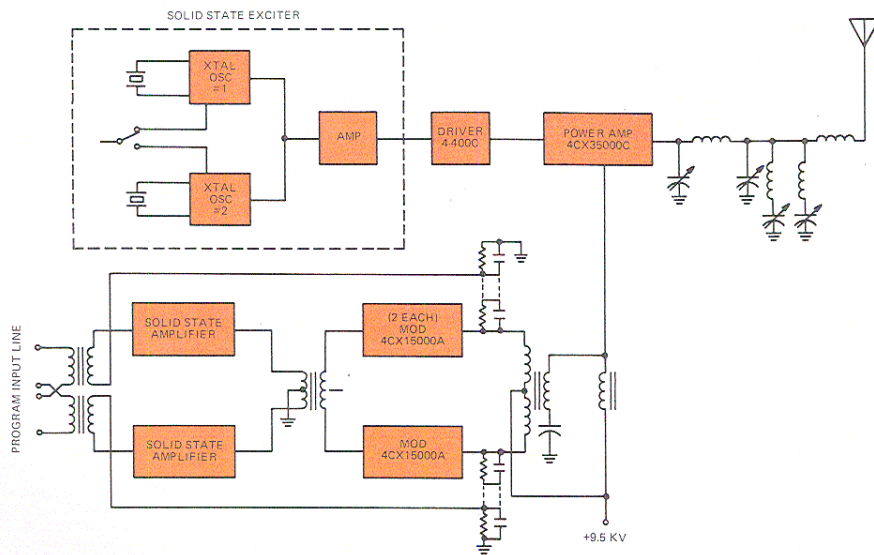

Simplified Block Diagram, AEL AM-50KD Transmitter

SPECIFICATIONS

ELECTRICAL

Power Output55 kW max
Frequency Range530-1640 kHz
Emission	A3
Modulation	High level Class AB ₁
Frequency Stability	±5 Hz
Carrier Shift at 100% Mod3% max
Output Impedance50-230 ohms
Audio Response50-10,000 Hz; ±2dB
Audio Distortion50-7500 Hz, 3% max
Noise (ref 100% mod)	-55 dB max
Spurious Outputs	-80 dB max
Power Line Requirement	380/460 Vac, 3 phase, 60 Hz
Power Consumption (approx)		
0% Modulation99 kW
30% Modulation112 kW
100% Modulation150 kW
Power Factor0.9

MECHANICAL

Main Cabinet Size84" H x 136" W x 48" D
Transformer Vault48" H x 48" W-x 48" D
Weight (approx)13,000 lbs
Operating Temperature0 to 45°C
Operating Altitude6,000 ft. max

TUBE COMPLEMENT

- 1 ea 8121
- 1 ea 4-400C
- 1 ea 4CX35000C
- 2 ea 4CX15000A

Prices and specifications subject to change without notice.

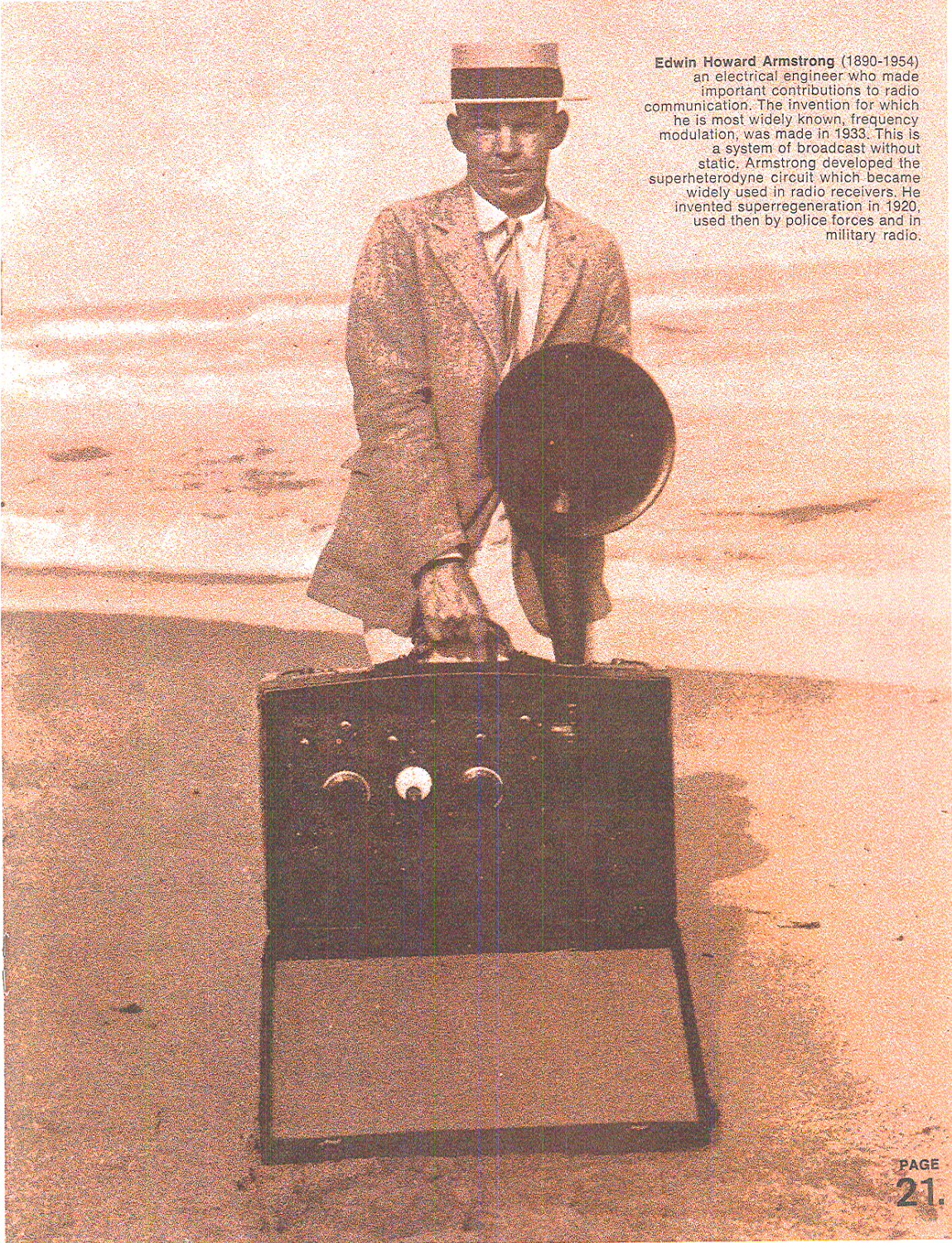

Edwin Howard Armstrong (1890-1954) an electrical engineer who made important contributions to radio communication. The invention for which he is most widely known, frequency modulation, was made in 1933. This is a system of broadcast without static. Armstrong developed the superheterodyne circuit which became widely used in radio receivers. He invented superregeneration in 1920, used then by police forces and in military radio.

2,500W

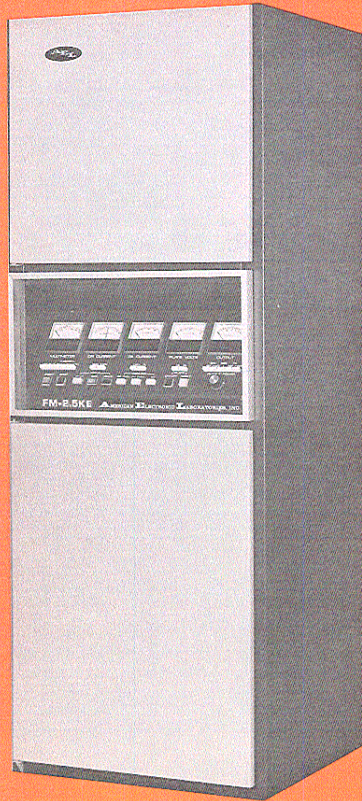

Model FM-2.5KE Broadcast Transmitter

FEATURES

- Superior Performance
- Reliability
- Ease of Maintenance
- Automatic Re-Cycling
 - Overload Protection
 - Power Interrupt
 - Auto Restart (Option)
- Mid-Panel Metering
- Remote Control Interface
- VSWR Protection (Option)
- Elapsed Time Indicator (Option)
- Remote Control Power Adjust (Option)

The FM-2.5KE is a completely self-contained 2500W FM Broadcast Transmitter. It operates at any fixed frequency between 88 and 108 MHz in monaural or stereo, and SCA mode.

It is supplied with a complete set of operating tubes and harmonic filter and is factory pre-tuned and tested to the individual customer's frequency.

SUPERIOR PERFORMANCE

The overall frequency stability of the FM-2.5KE is typically maximum ± 300 Hz (See Exciter, page 38). Excellent linearity, 0.5% total harmonic distortion (THD), and ± 1.0 dB frequency response result in the faithful reproduction of all natural sound.

This outstanding performance is obtained principally by four factors:

- 0.35% IM distortion
- FM noise of -70 dB
- Bandwidth of 250 kHz
- Less than 4° phase shift

RELIABILITY

AEL is a major supplier of militarized RF systems. The same technology and reliability used in these sophisticated systems is designed into our commercial transmitters.

All critical components are operated at 50% below their manufacturer's suggested ratings. The grounded grid final amplifier stage eliminates the need for the usual screen voltage supply, the bias voltage supply, and all tuned input circuits. The conservatively rated IPA uses a 4X150A tube input which operates at only half of the rated power of 250 watts.

The pressurized cabinet reduces dirt and dust intrusion. This significantly increases the operating life of all major high voltage components.

All transmitters are operated at Station TPO and frequencies for a minimum of 100 hours at AEL before shipment to the customer.

EASE OF MAINTENANCE

The estimated mean-time-to-repair of the FM-2.5KE is less than 30 minutes.

All doors and panels are easily removed to give immediate access to all major sub-assemblies. Standard components are used wherever possible and most are mounted in easily reached plug-in modules.

Twenty-four hour parts and technical assistance is available from AEL.

AUTOMATIC RE-CYCLING—Overload Protection

Any abnormal condition that might cause an overload condition in the Driver Tube, the Power Amplifier Tube, or the high voltage section of the amplifier immediately initiates a 1 second shut down. The plate voltage is removed automatically from these tubes to protect them from permanent damage. It is automatically returned after this one second interval; after three consecutive shut downs the plate voltage can be restored only by a manual re-set.

AUTO RESTART—Power Interrupt

If the primary power to the transmitter is interrupted for less than 5 seconds the transmitter automatically shuts down; this protects sensitive tubes and circuits. It is automatically returned to full power immediately upon return of primary power. As long as the interrupt is less than 5 seconds this sequence will continue indefinitely. If primary power to the transmitter is interrupted for more than 5 seconds the transmitter is automatically shut down. When full power is restored, a 3 minute restart cycle is automatically instituted after which normal operation of the transmitter resumes. This 3 minute delay is required to protect the sensitive high power tubes.

MISCELLANEOUS

The Model FM-2.5KE contains many other features of interest to the professional broadcast engineer and technicians. These include a mid-panel metering system for easy viewing. Remote control interface connections are standard. Optional features include VSWR protection, an elapsed time indicator, Automatic level controls, and a remote control power adjust system.

AMERICAN ELECTRONIC LABORATORIES, Inc.



FM-15QE Exciter

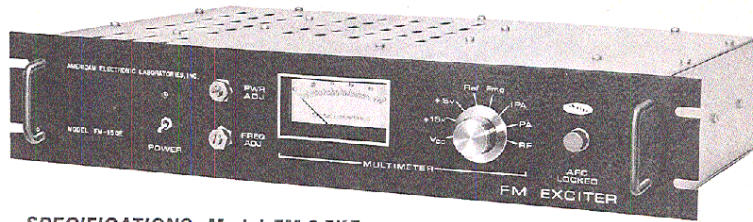

SPECIFICATIONS Model FM-2.5KE

GENERAL

Frequency Range 88 to 108 MHz
 Rated Power Output 500 to 2500 watts
 Type of Emission F3, F9
 RF Load Impedance 50 ohms
 Output Termination 1/2" EIA flange
 Frequency Stability ± 300 Hz
 Modulation Capability ± 100 kHz
 Temperature Range -10 to 55°C
 Altitude Above Sea Level 10,000 ft. max.
 Power Line Requirements
 Voltage 200/240 Vac
 Frequency 60 Hz
 Phase single
 Consumption at 250CW 6 kW
 Power Factor (Max) 0.9
 Overall Dimensions 76" H x 28" W x 26" D
 Net Weight 800 lbs. (approx.)

MONAURAL

Audio Input Impedance 600 ohms balanced
 Audio Input Level
 400 Hz at 100% Modulation +10 ± 2 dBm
 Audio Harmonic Distortion
 50 to 15,000 Hz 0.5% maximum
 Audio Frequency Response ± 1 dB
 Standard 75 microsecond pre-emphasis
 50 to 15,000 Hz
 FM Noise (Ref 400 Hz at 100% Mod) -70 dB
 AM Noise (Reference Carrier AM
 Modulation 100%) -55 dB

STEREO

Audio Input Impedance 600 ohms balanced
 (right and left)
 Audio Input Level (right and left)
 400 Hz at 100% Modulation +10 ± 2 dBm
 Audio Frequency Response ± 1 dB
 (right and left)
 Standard 75 Microsecond
 Pre-Emphasis, 50 to 15,000 Hz
 FM Noise -63 dB
 (Reference 400 Hz at 100% Mod)
 AM Noise -55 dB
 (Reference Carrier AM Mod. 100%)
 Stereo Separation
 50 to 15,000 Hz 40 dB min.
 Stereo Pilot Stability 19 kHz ± 1 Hz
 Cross-talk
 (L+R to L-R, L-R to L+R) -46 dB max.

SCA

Frequency Range 30 to 75 kHz
 Frequency Stability ± 400 Hz
 Audio Input Impedance 600 ohms
 Audio Input Level -15 dBm to 10 dBm
 adjustable
 Muting Delay 0.5 to 5 second adjustable
 FM Noise -63 dB
 AM Noise -55 dB
 Pre-Emphasis 75 microsecond*

*Standard; otherwise specify

Prices and specifications subject to change without notice.

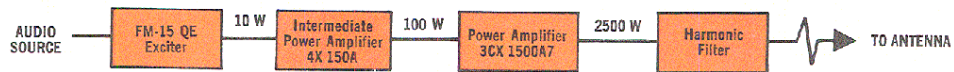

Simplified Block Diagram AEL FM-2.5KE Transmitter

5,000W

10,000W

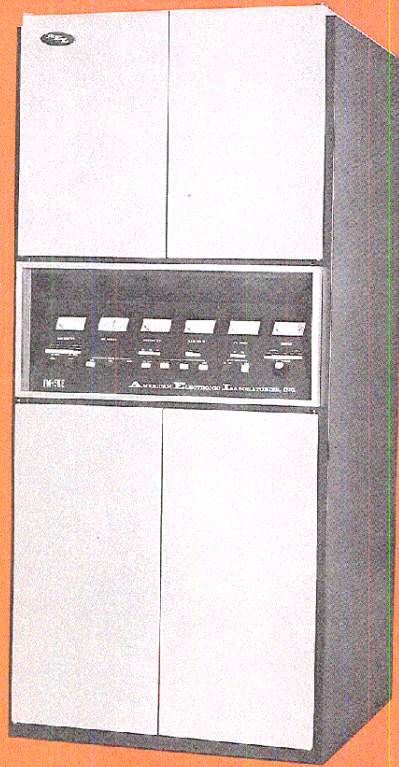

The FM-5KE and FM-10KE are completely self-contained Broadcast Transmitters that operate at 5000W and 10000W respectively. They operate at any fixed frequency between 88 and 108 MHz in monaural or stereo, and SCA mode.

They are supplied with an AEL FM-15QE Exciter, a complete set of operating tubes and harmonic filter and are factory pretuned and tested to the individual customer's frequency.

SUPERIOR PERFORMANCE

The overall frequency stability of these transmitters are typically ± 300 Hz (See Exciter page 38). Excellent linearity, maximum 0.5% total harmonic distortion (THD), and ± 1.0 dB frequency response result in the faithful reproduction of all natural sound.

This outstanding performance is obtained principally by four factors:

- 0.35% IM distortion
- FM noise of -70 dB
- Bandwidth of 250 kHz
- Less than 4° phase shift

RELIABILITY

AEL is a major supplier of militarized RF systems. The same technology and reliability used in these sophisticated systems is designed into our commercial transmitters.

All critical components are operated at 50% below their manufacturer's suggested ratings. The grounded grid final amplifier stage eliminates the need for the usual screen voltage supply, the bias voltage supply and all tuned input circuits.

The pressurized cabinet reduces dirt and dust intrusion. This significantly increases the operating life of all major high voltage components.

All transmitters are operated at Station TPO and frequencies for a minimum of 100 hours at AEL before shipment to the customer.

Model FM-5KE & FM-10KE Broadcast Transmitters

FEATURES

- Superior Performance
- Reliability
- Ease of Maintenance
- Automatic Re-Cycling
 - Overload Protection
 - Power Interrupt
 - Auto Restart
- Mid-Panel Metering
- Remote Control Interface
- VSWR Protection (Option)
- Elapsed Time Indicator
- Remote Control Power Adjust

EASE OF MAINTENANCE

The estimated mean-time-to-repair of these transmitters is less than one hour.

All doors and panels are easily removed to give immediate access to all major sub-assemblies. Standard components are used wherever possible and most are mounted in easily reached plug-in modules.

Twenty-four hour parts and technical assistance is available from AEL.

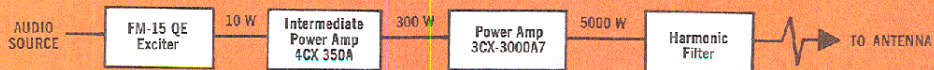

Simplified Block Diagram AEL FM-5KE Transmitter

AMERICAN ELECTRONIC LABORATORIES, Inc.



AUTOMATIC RE-CYCLING—Overload Protection

Any abnormal condition that might cause an overload condition in the Driver Tube, the Power Amplifier Tube, or the high voltage section of the amplifier immediately initiates a 1 second shut down. The plate voltage is removed automatically from these tubes to protect them from permanent damage. It is automatically returned after this one second interval; after three consecutive shut downs the plate voltage can be restored only by a manual re-set.

AUTO RESTART—Power Interrupt

If the primary power to the transmitter is interrupted for less than 5 seconds the transmitter automatically shuts down; this protects sensitive tubes and circuits. It is automatically returned to full power immediately upon return of primary power. As long as the interrupt is less than 5 seconds this sequence will continue indefinitely. If primary power to the transmitter is interrupted for more than 5 seconds the transmitter is automatically shut down. When full power is restored a 3-minute restart cycle is automatically instituted after which normal operation of the transmitter resumes. This three-minute delay is required to protect the sensitive high power tubes.

MISCELLANEOUS

These transmitters contain many other features of interest to the professional broadcast engineer and technicians. These include a mid-panel metering system for easy viewing. Remote control interface connections are standard. Optional features include VSWR protection.

SPECIFICATIONS

FM-5KE and FM-10KE with FM-15QE Exciter

GENERAL

Frequency Range	88 to 108 MHz
Rated power output	FM-5 3000 to 6000 watts FM-10 6000 to 11,000 watts
Type of emission	F3, F9
RF load impedance	50 ohms
Output termination	FM-5 1 1/2" FM-10 3 1/8"
Temperature range	-10 to 55°C
Altitude above sea level	10,000 ft max
Power line requirements:	
Voltage	180/280 Vac
Frequency	50-60 Hz
Phase	3
Power connection	4-wire, Star with grounded neutral
Power consumption	FM-5 9kW FM-10 18kW
Power factor	0.9
Overall dimensions	76" H x 34" W x 35" D
Net weight	FM-5 Approx. 1100 Lbs. FM-10 Approx. 1500 Lbs.

MONAURAL

Audio input impedance	600 ohms balanced
Audio input level	+10 ± 2 dBm (400 Hz @ 100% modulation)
Audio harmonic distortion	0.5% max. (50-15,000 Hz)
Audio frequency response	± 1 dB (75 microsecond pre-emphasis, 50-15,000 Hz)
FM Noise	-70 dB (Ref. 400 Hz @ 100% modulation)
AM Noise	-55 dB (Ref. carrier AM modulation 100%)
Frequency stability	± 500 Hz
Intermodulation distortion	Typical 0.25% (S.M.P.T.E.)

STEREOPHONIC

Audio input impedance	600 ohms balanced (Right and left channels identical)
Audio input level	+10 ± 2 dBm (Right and left channels identical)— (400 Hz @ 100% modulation)
Audio frequency response	± 0.5 dB (Right and left channels identical)— 75 microsecond pre-emphasis, 50-15,000 Hz)
FM noise	-63 dB (Ref. 400 Hz @ 100% modulation)
Stereo separation	-40 dB 50-15,000 Hz
Stereo pilot stability	19 kHz ± 1 Hz
Cross talk	(L+R) into (L-R) -45 dB (L-R) into (L+R) -46 dB
Composite input level for 100% modulation	4 Vpp

SCA

Sub-carrier frequency range	30-75 kHz
Sub-carrier frequency stability	± 400 Hz
Audio input impedance	600 ohms balanced
Audio input level	-15 dBm to -10 dBm (adjustable)
Muting delay	0.5 to 5 seconds (adjustable)
S/N ratio	-63 dB
Pre-emphasis	75 microsecond standard (otherwise specify)

Prices and specifications subject to change without notice

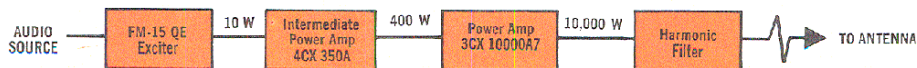

Simplified Block Diagram AEL FM-10KE Transmitter

15,000W



FEATURES

- Superior Performance
- Reliability
- Ease of Maintenance
- Automatic Re-Cycling
 - Overload Protection
 - Power Interrupt
 - Auto Restart
- Mid-Panel Metering
- Remote Control Interface
- VSWR Protection (Option)
- Elapsed Time Indicator
- Remote Control Power Adjust

The FM-15KE is a completely self-contained 15,000W FM Broadcast Transmitter. It operates at any fixed frequency between 88 and 108 MHz in monaural or stereo, and SCA mode.

It is supplied with an AEL FM-15QE Exciter, a complete set of operating tubes and harmonic filter and is factory pre-tuned and tested to the individual customer's frequency.

Model FM-15KE Broadcast Transmitter

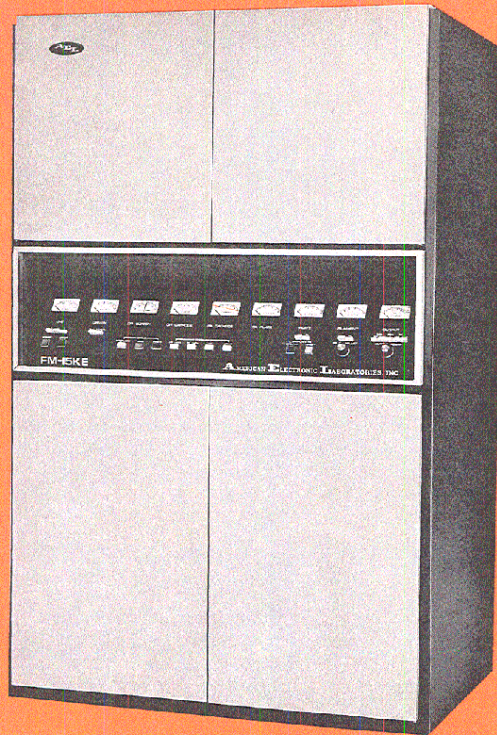

SUPERIOR PERFORMANCE

The overall frequency stability of the FM-15KE is typically ± 300 Hz (See Exciter, page 38). Excellent linearity, 0.5% total harmonic distortion (THD), and ± 1.0 dB frequency response result in the faithful reproduction of all natural sound.

This outstanding performance is obtained principally by four factors:

- 0.35% IM distortion
- FM noise of -70 dB
- Bandwidth of 250 kHz
- Less than 4° phase shift

RELIABILITY

AEL is a major supplier of militarized RF systems. The same technology and reliability used in these sophisticated systems is designed into our commercial transmitters.

All critical components are operated at 50% below their manufacturer's suggested ratings. The grounded grid final amplifier stage eliminates the need for the usual screen voltage supply, the bias voltage supply and all tuned input circuits. The conservatively rated IPA uses a 4CX1000A tube input which operates at only half of the rated power of 1800 watts.

The pressurized cabinet reduces dirt and dust intrusion. This significantly increases the operating life of all major high voltage components.

All transmitters are operated at Station TPO and frequencies for a minimum of 100 hours at AEL before shipment to the customer.

EASE OF MAINTENANCE

The estimated mean-time-to-repair of the FM-15KE is less than 1 hour.

All doors and panels are easily removed to give immediate access to all major sub-assemblies. Standard components are used wherever possible and most are mounted in easily reached plug-in modules.

Twenty-four hour parts and technical assistance is available from AEL.

AUTOMATIC RE-CYCLING— Overload Protection

Any abnormal condition that might cause an overload condition in the Driver Tube, the Power Amplifier Tube, or the high voltage section of the amplifier immediately initiates a 1 second shut down. The plate voltage is removed automatically from these tubes to protect them from permanent damage. It is automatically returned after this one second interval; after three consecutive shut downs the plate voltage can be restored only by a manual re-set.

AMERICAN ELECTRONIC LABORATORIES, Inc.



FM-15QE Exciter

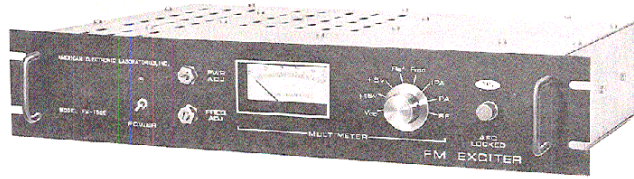

AUTO RESTART—Power Interrupt

If the primary power to the transmitter is interrupted for less than 5 seconds the transmitter automatically shuts down; this protects sensitive tubes and circuits. It is automatically returned to full power immediately upon return of primary power. As long as the interrupt is less than 5 seconds this sequence will continue indefinitely. If primary power to the transmitter is interrupted for more than 5 seconds the transmitter is automatically shut down. When full power is restored a 3-minute restart cycle is automatically instituted after which normal operation of the transmitter resumes. This 3-minute delay is required to protect the sensitive high power tubes.

MISCELLANEOUS

The Model FM-15KE contains many other features of interest to the professional broadcast engineer and technicians. These include a mid-panel metering system for easy viewing. Remote control interface connections are standard. Optional features include VSWR protection.

SPECIFICATIONS FM-15KE with FM-15QE Exciter

GENERAL

Frequency Range 88 to 108 MHz
 Rated Power Output 5,000 to 15,000 watts
 Type of Emission F3, F9
 RF Load Impedance 50 ohms
 Output Termination 3/4" EIA flange
 Frequency Stability ± 300 Hz
 Modulation Capability ± 100 kHz
 Temperature Range -10 to 55°C
 Altitude Above Sea Level 10,000 ft. max.
 Power Line Requirements
 Voltage 208/240 Vac
 Frequency 60 Hz
 Phase 3
 Consumption at 15 kW 25 kW
 Power Factor 0.9
 Overall Dimensions (less filter) 76"Hx48"Wx35"D"
 Net Weight 1800 lbs. (approx.)

STEREO

Audio Input Impedance 600 ohms balanced (right and left)
 Audio Input Level (right and left)
 400 Hz at 100% Modulation +10 \pm 2 dBm
 Audio Frequency Response ± 1 dB (right and left)
 Standard 75 Microsecond
 Pre Emphasis, 50 to 15,000 Hz
 FM Noise -63 dB (Reference 400 Hz at 100% Mod.)
 AM Noise -55 dB (Reference Carrier AM Mod. 100%)
 Stereo Separation
 50 to 15,000 Hz 40 dB min.
 Stereo Pilot Stability 19 kHz \pm 1 Hz
 Cross-talk (L + R to L-R, L-R to L + R) -46 dB max.

MONAURAL

Audio Input Impedance 600 ohms balanced
 Audio Input Level
 400 Hz at 100% Modulation +10 \pm 2 dBm
 Audio Harmonic Distortion
 50 to 15,000 Hz 0.5% maximum
 Audio Frequency Response ± 1 dB
 Standard 75 microsecond pre-emphasis
 50 to 15,000 Hz
 FM Noise (Ref 400 Hz at 100% Mod) -70 dB
 AM Noise (Reference Carrier AM Modulation 100%) -55 dB

SCA

Frequency Range 30 to 75 kHz
 Frequency Stability ± 400 Hz
 Audio Input Impedance 600 ohms
 Audio Input Level -15 dBm to +10 dBm adjustable
 Muting Delay 0.5 to 5 second adjustable
 FM Noise -63 dB
 AM Noise -55 dB
 Pre Emphasis 75 microsecond**
 *33"D without trim **Standard; otherwise specify

Prices and specifications subject to change without notice.

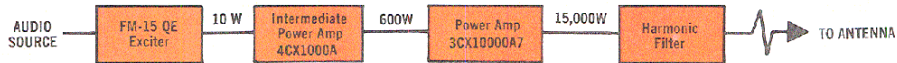

Simplified Block Diagram AEL FM-15KE Transmitter

25,000W



FEATURES

- Superior Performance
- Reliability
- Ease of Maintenance
- Automatic Re-Cycling
 - Overload Protection
 - Power Interrupt
 - Auto Restart
- Mid-Panel Metering
- Remote Control Interface
- VSWR Protection
- Elapsed Time Indicator
- Remote Control Power Adjust

The FM-25KE is a completely self-contained 25,000W FM Broadcast Transmitter. It operates at any fixed frequency between 88 and 108 MHz in monaural or stereo, and SCA mode.

It is supplied with a complete set of operating tubes, FM-20E Exciter, and harmonic filter and is factory pre-tuned and tested to the individual customer's frequency.

Model FM-25KE Broadcast Transmitter

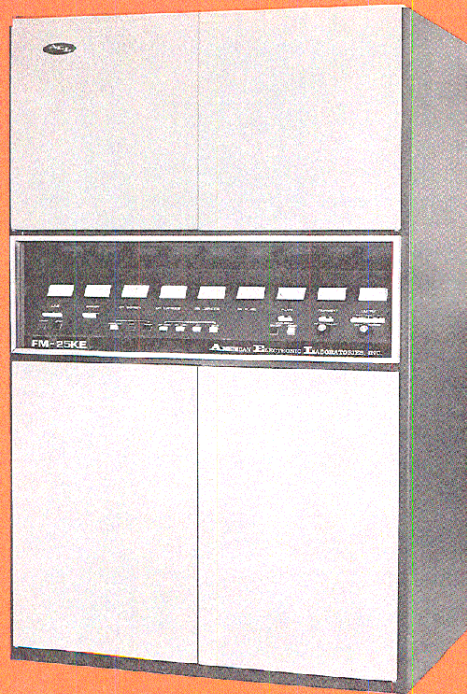

SUPERIOR PERFORMANCE

The overall frequency stability of the FM-25KE is typically ± 200 Hz (See Exciter, page 36). Excellent linearity, 0.5% total harmonic distortion (THD), and ± 1.0 dB frequency response result in the faithful reproduction of all natural sound.

This outstanding performance is obtained principally by four factors:

- 0.35% IM distortion
- FM noise of -70 dB
- Bandwidth of 250 kHz
- Less than 1° phase shift

RELIABILITY

AEL is a major supplier of militarized RF systems. The same technology and reliability used in these sophisticated systems is designed into our commercial transmitters.

All critical components are operated at 50% below their manufacturer's suggested ratings. The grounded grid final amplifier stage eliminates the need for the usual screen voltage supply, the bias voltage supply and all tuned input circuits.

The pressurized cabinet reduces dirt and dust intrusion. This significantly increases the operating life of all major high voltage components.

All transmitters are operated at Station TPO and frequencies for a minimum of 100 hours at AEL before shipment to the customer.

EASE OF MAINTENANCE

The estimated mean-time-to-repair of the FM-25KE is less than 1 hour.

All doors and panels are easily removed to give immediate access to all major sub-assemblies. Standard components are used wherever possible and most are mounted in easily reached plug-in modules.

Twenty-four hour parts and technical assistance is available from AEL.

AUTOMATIC RE-CYCLING— Overload Protection

Any abnormal condition that might cause an overload condition in the Driver Tube, the Power Amplifier Tube, or the high voltage section of the amplifier immediately initiates a 1 second shut down. The plate voltage is removed automatically from these tubes to protect them from permanent damage. It is automatically returned after this one second interval; after three consecutive shut downs the plate voltage can be restored only by a manual re-set.

AMERICAN ELECTRONIC LABORATORIES, Inc.

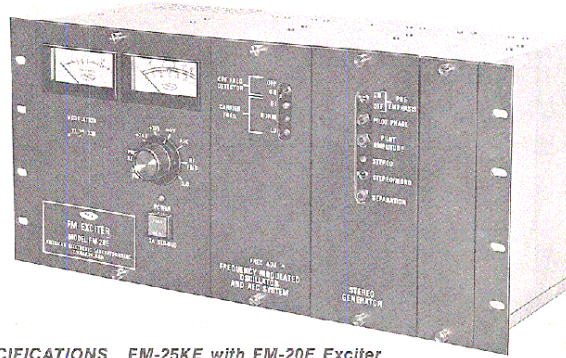

FM-20E Exciter

AUTO RESTART—Power Interrupt

If the primary power to the transmitter is interrupted for less than 5 seconds the transmitter automatically shuts down; this protects sensitive tubes and circuits. It is automatically returned to full power immediately upon return of primary power. As long as the interrupt is less than 5 seconds this sequence will continue indefinitely. If primary power to the transmitter is interrupted for more than 5 seconds the transmitter is automatically shut down. When power is returned a 3 minute re-start cycle is automatically instituted after which normal operation of the transmitter resumes. This delay is required to protect the sensitive high power tubes.

MISCELLANEOUS

The Model FM-25KE contains many other features of interest to the professional broadcast engineer and technicians. These include a mid-panel metering system for easy viewing. Remote control interface connections, VSWR protection, an elapsed time indicator, automatic level controls, and a remote control power adjust system are standard items.

SPECIFICATIONS FM-25KE with FM-20E Exciter

GENERAL

Frequency Range 88 to 108 MHz
 Rated Power Output 3,000 to 25,000 watts
 Type of Emission F3, F9
 RF Load Impedance 50 ohms
 Output Termination 3/4" FIA flange
 Frequency Stability ±300 Hz
 Modulation Capability ±100 kHz
 Temperature Range -10 to 55°C
 Altitude Above Sea Level 10,000 ft. max.
 Power Line Requirements
 Voltage 208/240 Vac
 Frequency 60 Hz
 Phase 3
 Consumption at 25 kW 39 kW
 Power Factor 0.9
 Overall Dimensions (less filter) 75"Hx48"Wx35"D"
 Net Weight 2200 lbs. (approx.)

STEREO

Audio Input Impedance 600 ohms balanced (right and left)
 Audio Input Level (right and left) 400 Hz at 100% Modulation +10 ±2 dBm
 Audio Frequency Response ±1 dB (right and left)
 Standard 75 Microsecond
 Pre-Emphasis, 50 to 15,000 Hz -63 db
 FM Noise (Reference 400 Hz at 100% Mod.) -55 dB
 AM Noise (Reference Carrier AM Mod. 100%)
 Stereo Separation
 50 to 15,000 Hz 40 dB min.
 Stereo Pilot Stability 19 kHz ± 1 Hz
 Cross talk (L+R to L-R, L-R to L+R) -46dB max.

MONAURAL

Audio Input Impedance 600 ohms balanced
 Audio Input Level
 400 Hz at 100% Modulation -10 ±2 dBm
 Audio Harmonic Distortion
 50 to 15,000 Hz 0.5% maximum
 Audio Frequency Response ±1 dB
 Standard 75 microsecond pre-emphasis
 50 to 15,000 Hz
 FM Noise (Ref. 400 Hz at 100% Mod) -70 dB
 AM Noise (Reference Carrier AM Modulation 100%) -55 dB

SCA

Frequency Range 30 to 75 kHz
 Frequency Stability ±400 Hz
 Audio Input Impedance 600 ohms
 Audio Input Level -15 dBm to +10 dBm adjustable
 Muting Delay 0.5 to 5 second adjustable
 FM Noise -63 dB
 AM Noise -55 dB
 Pre-Emphasis 75 microsecond**
 **3rd without trim **Standard; otherwise specify

Prices and specifications subject to change without notice.



Simplified Block Diagram AEL FM-25KE Transmitter

40,000W/50,000W



The FM25/25KE is a completely self-contained 40,000 or 50,000W FM Broadcast Transmitter. It operates at any fixed frequency between 88 and 108 MHz in monaural or stereo, and SCA mode.

It is supplied with a complete set of operating tubes and harmonic filter and is factory pre-tuned and tested to the individual customer's frequency.

The AEL FM-25/25KE is designed for very high power broadcasting service and provides a high degree of redundancy and reliability. This transmitter consists basically of two AEL FM-25KE 25kW FM transmitters whose outputs are connected through a hybrid combiner for a total output capability of up to 50 kW.

The basic configuration comprises two standard FM-25KE transmitters and a control and interface cabinet placed between the two transmitter units. A standard 40 kW 3-1/8" hybrid combiner is normally supplied for external mounting depending on individual station layouts. A larger combiner for use with 6-1/8" line is also available for power level requirements over 40 kW. Additionally, various patching and switching functions can be provided to suit individual station requirements.

A true 90° hybrid combiner accepts the output of both transmitters, adds the two outputs together and delivers the combined output to the antenna. In the event one of the transmitter units shuts down, the remaining transmitter continues to deliver power through the combiner to the antenna. In this case, however, the combiner operates as a power divider with half the power going to the antenna and half being dissipated in a

reject load connected to the combiner. A high degree of isolation is maintained between the transmitters so that service may be performed on the off unit.

A single width matching rack cabinet between the two transmitter units provides metering and control functions for the system as well as a common interface for connection to remote control and monitoring requirements. The exciter, buffer and phasing controls are also in the control cabinet. Meters for all important combiner functions and individual transmitter start, stop and plate voltage control are provided.

A single FM-20E Exciter provides drive to a solid state dual buffer amplifier, the outputs of which provide excitation to the individual 25 kW amplifiers. (See page 36).

Each 25 kW amplifier is connected through its individual harmonic filter to the inputs of the hybrid combiner.

The standard 40 kW output level requires that each 25 kW amplifier operate at only 20 kW, thus providing sufficient reserve and conservative operation.

Each 25 kW amplifier retains all of its individual metering and remote control functions. In addition, in the control cabinet, meters are provided for reading total forward power and reflected power in the antenna system, power in the reject load, power in a dummy load (optional) if used, and power from each transmitter. Also provided are parallel control functions for turning each amplifier on and off and control of plate voltage.

Model FM-25/25KE Broadcast Transmitter

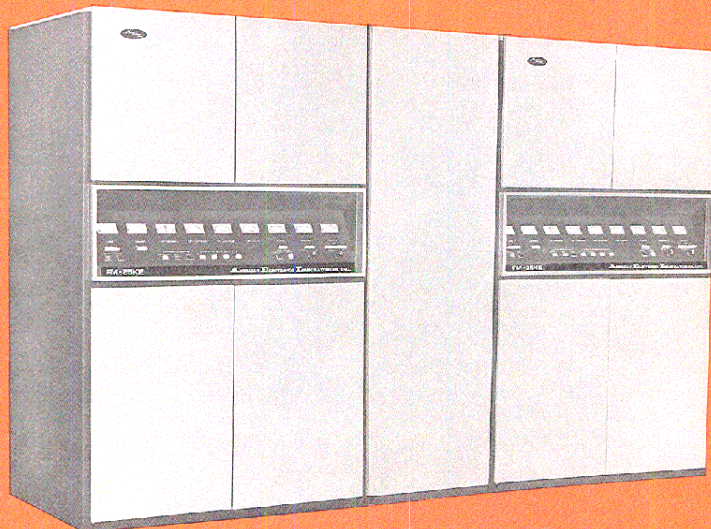



FEATURES

- Superior Performance
- Reliability
- Ease of Maintenance
- Automatic Re-Cycling
 - Overload Protection
 - Power Interrupt
 - Auto Restart
- Mid-Panel Metering
- Remote Control Interface
- VSWR Protection
- Elapsed Time Indicator
- Remote Control Power Adjust

SUPERIOR PERFORMANCE

The overall frequency stability of the Model FM-25/25KE is typically ± 200 Hz (See FM-20E Exciter, page 36). Excellent linearity, 0.5% total harmonic distortion (THD), and ± 1.0 dB frequency response result in the faithful reproduction of all natural sound.

This outstanding performance is obtained principally by four factors:

- 0.35% IM distortion
- FM noise of -70 dB
- Bandwidth of 250 kHz
- Less than 1° phase shift

RELIABILITY

AEL is a major supplier of militarized RF systems. The same technology and reliability used in these sophisticated systems is designed into our commercial transmitters.

All critical components are operated at 50% below their manufacturer's suggested ratings. The grounded grid final amplifier stage eliminates the need for the usual screen voltage supply, the bias voltage supply and all tuned input circuits.

The pressurized cabinet reduces dirt and dust intrusion. This significantly increases the operating life of all major high voltage components.

All transmitters are operated at Station TPO and frequencies for a minimum of 100 hours at AEL before shipment to the customer.

EASE OF MAINTENANCE

The estimated mean-time-to repair of the Model FM-25/25KE is less than 1 hour.

All doors and panels are easily removed to give immediate access to all major sub-assemblies. Standard components are used wherever possible and most are mounted in easily reached plug-in modules.

Twenty-four hour parts and technical assistance is available from AEL.

AUTOMATIC RE-CYCLING—Overload Protection

Any abnormal condition that might cause an overload condition in the Driver Tube, the Power Amplifier Tube, or the high voltage section of the amplifier immediately initiates a 1 second shut down. The plate voltage is removed automatically from these tubes to protect them from permanent damage. It is automatically returned after this one second interval; after three consecutive shut downs the plate voltage can be restored only by a manual re-set.

AUTO RESTART—Power Interrupt

If the primary power to the transmitter is interrupted for less than 5 seconds the transmitter automatically shuts down; this protects sensitive tubes and circuits. It is automatically returned to full power immediately upon return of primary power. As long as the interrupt is less than 5 seconds this sequence will continue indefinitely. If primary power to the transmitter is interrupted for more than 5 seconds the transmitter is automatically shut down. When power is returned a 3 minute restart cycle is automatically instituted after which normal operation of the transmitter resumes. This delay is required to protect the sensitive high power tubes.

MISCELLANEOUS

The Model FM-25/25KE contains many other features of interest to the professional broadcast engineer and technicians. These include a mid-panel metering system for easy viewing. Remote control interface connections, VSWR protection, an elapsed time indicator, automatic level controls, and remote control power adjust system are standard items.



AEL FM-25/25KE Custom Control Cabinet

Front View—Door Removed

Rear View—Door Removed

Individual Power and Total Power Output Meters

Controls and Status Indication of Coax Switching

Control System Transmitters "A" and "B"

Dual Buffer Amplifier for Transmitters "A" and "B"

AEL FM-20E Exciter

AEL FM-20E /SG Stereo Generator

Rear View Individual Power and Total Power Output Meters

Remote Control Function Connection Panel

Rear View Coax Switching Control Relays

Rear View Dual Buffer Amplifier Assembly

Regulated 24Vdc Control Circuit Power Supply

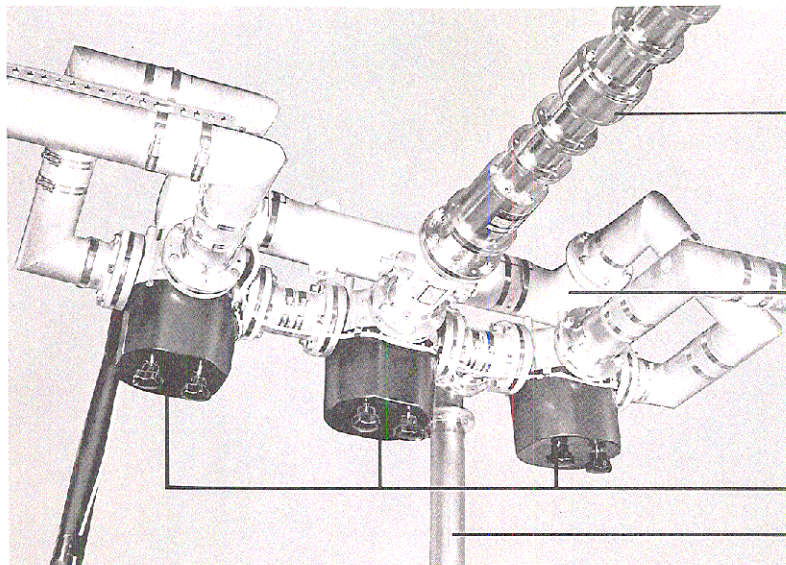

80kW Dummy Load
(Phantom Antenna)

90° 40kW Hybrid
Combiner

3 1/8" Motor-Driven
Coaxial Switches

3 1/8" Coax to
Reject Load

FM-25/25KE 40KW Combiner with Remote Control Coax Switching

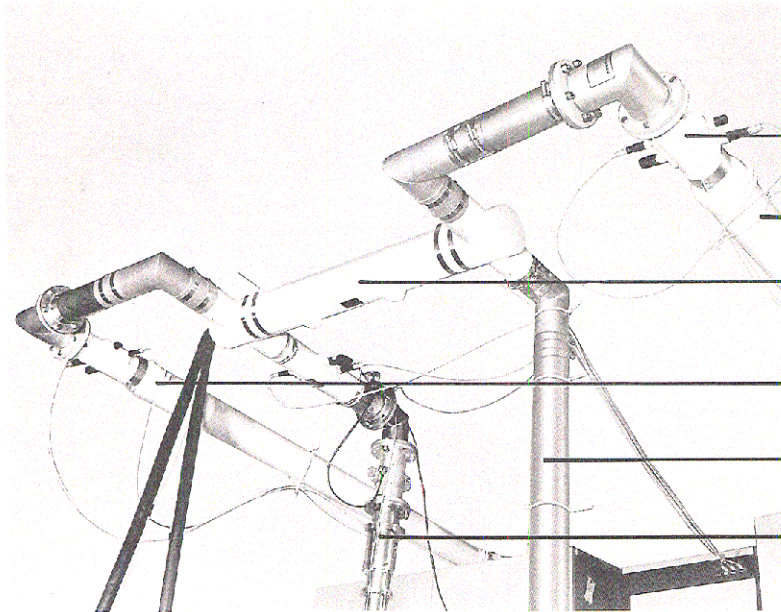

Forward and Reflected
Power Directional
Coupler For
Transmitter "A"

25kW Harmonic Filter
to Transmitter "A"

90° 40kW Hybrid
Combiner

25kW Harmonic Filter
to Transmitter "B"

3 1/8" Coax to
Reject Load

80kW Dummy Load
(Phantom Antenna)

FM-25/25KE 40KW Combiner

(Continued on page 34)

AMERICAN ELECTRONIC LABORATORIES, Inc.



SPECIFICATIONS FM-25/25KE

ELECTRICAL

Power Output 40 kW max with 3 1/4" line
 50 kW max with 6 1/4" line
 Frequency Range 88 to 108 MHz
 Emission F3, F9
 Load Impedance 50 ohms; VSWR 1.5: 1 max
 Output Termination 3 1/4" or 6 1/4" EIA flange
 Frequency Stability ± 200 Hz
 Modulation Capability ± 100 kHz
 Audio Input Impedance 600 ohms balanced
 Audio Input Level 10 ± 2 dBm for 100% mod at 400 Hz
 Audio Response ± 1 dB, 50-15000 Hz
 Audio Distortion 0.5% max, 50-15000 Hz
 FM Noise -70 dB max
 AM Noise -55 dB max
 Power Line 208/240 Vac, 3 phase; 60 Hz
 Power Factor 0.9

MECHANICAL

Overall Dimensions (main cabinets) 76"H x 120"W x 34"D
 (less filters and combiner)
 Net Weight 4600 lbs (approx)
 Operating Altitude 10,000 ft max
 Operating Temperature 0° to 45° C

TUBE COMPLEMENT

2 ea 4CX1000A
 2 ea 3CX15000A7

Prices and specifications subject to change without notice.

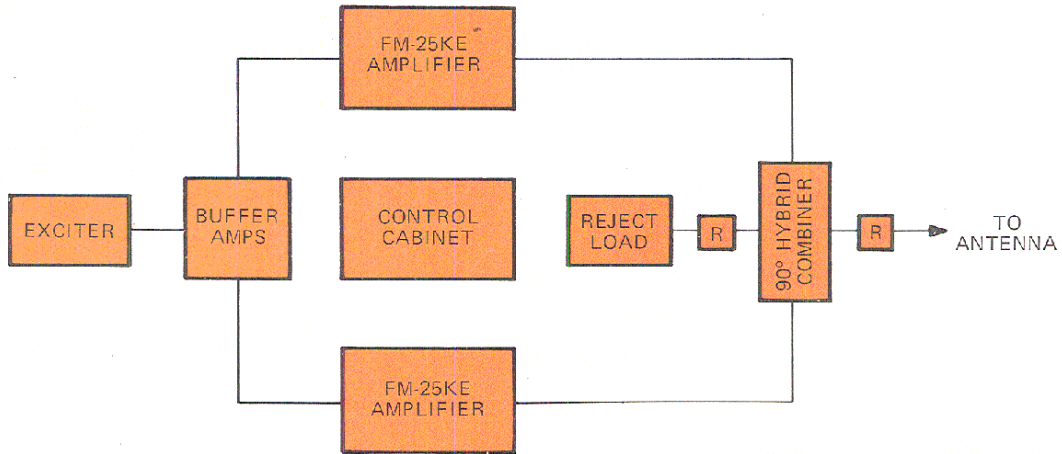

Basic System Block Diagram AEL FM-25/25KE



Guglielmo Marconi (1874-1937) Marquis, an Italian inventor and electrical engineer won recognition for his work in developing wireless telegraphy, or radio. This led to present-day radio broadcasting. He produced a practical wireless telegraph system in 1895 from basic discoveries that had previously been made in wireless telegraphy. He produced the first transatlantic wireless signal in history on Dec. 12, 1901, and patented the horizontal directional aerial in 1905. Marconi invented the beam system of wireless for long-distance communication.

FM-20E EXCITER



The AEL Model FM-20E FM Exciter, nucleus of the AEL FM-25KE Transmitter, is a totally solid state unit employing Direct Carrier Frequency Modulation. The exciter's capabilities allows exceptional performance over a wide frequency range with negligible phase shift and provides good stereo separation, extremely low distortion and noise.

The AFC and FMO circuitry provides long term frequency stability. The modular construction of the AEL FM-20E permits the integration in a single rack mounted unit the Power Supply and Metering Module, the Frequency Modulated Oscillator, the Monaural Module, the Stereo Generator, and the SCA Generator.

FEATURES

- 25 Watt RF output
- 88 — 108 MHz without tuning
- Superior Audio Performance
- Ease of Maintenance
- Military type construction
- Minimum alignment adjustments

SUPERIOR AUDIO PERFORMANCE

This exciter offers superior performance for the professional FM broadcaster. The 25W output provides sufficient reserve power for most installations. Other outstanding performance specifications include:

- Low Intermodulation Distortion
0.35% (typical)
- Frequency Stability
 ± 200 Hz
- Phase Linearity
 $\pm 3^\circ$ at 75kHz deviation

EASE OF MAINTENANCE

All critical circuits are mounted on three readily accessible and replaceable modules. All sensitive circuits located on these boards are measured and displayed on front panel meters. Replacing any one of these plug-in modules will correct most failures that might occur in this exciter. This feature reduces potential down-time to an absolute minimum.

MINIMUM ALIGNMENT ADJUSTMENTS

Most modern exciter designs require from 7 to 14 separate adjustments to maintain frequency stability, distortion, and RF output power. The AEL Model FM-20E exciter requires only 3 alignment adjustments to control these functions. In normal operation, these adjustments will never have to be made unless a component failure occurs.

MILITARY TYPE CONSTRUCTION

These exciters have been designed, manufactured, and tested in conformance to the most rigorous electrical and mechanical requirements. This results in years of trouble-free operation. Only AEL offers these outstanding construction features:

- MIL Spec IC's
- Double-Rail mechanical mountings
- Short circuit-proof power supply
- Heavy gauge steel construction
- PC boards electrically shielded

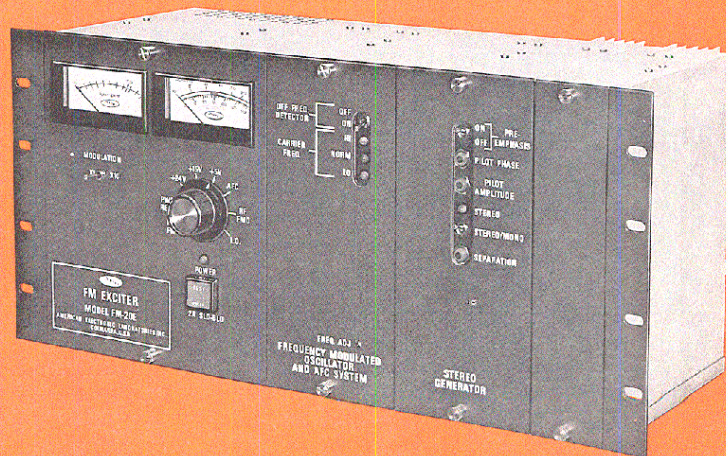



STEREO GENERATOR

The AEL FM-20E/SG stereo generator exceeds its published specifications by a considerable margin. These specifications are by far more exacting than the minimum FCC requirements.

The AEL FM-20E/SG utilizes an all silicon monolithic design which offers unprecedented reliability and performance. A special digital chain for the sub-channel carrier offers extreme stability of frequency and phase. A similar modulation technique assures a separation in excess of 40 dB at any frequency from 50 Hz to 15,000 Hz.

SCA GENERATOR

The AEL FM-20E/SC Generator provides an SCA carrier for the exciter. A digital monolithic circuitry provides excellent stability, performance and reliability. The standard AEL FM-20E/SC provides a 67 kHz sub-carrier (10% modulation, ± 6.7 kHz); a 41 kHz version is also available upon request.

MONAURAL MODULE

The Monaural Module of the FM-20E exciter provides the necessary circuitry for driving the FMO with a 30-15000 Hz $\pm .5$ dB signal. It has an isolation transformer and pre-emphasis and has provision for altering it to any value that may be desired.

SPECIFICATIONS

GENERAL

Frequency Range	88 to 108 MHz
Power Output	5-20 watts (cont. variable)
Load Impedance	50 ohms
AFC	Phase Locked Loop
Type of Modulation	Direct FM
Modulation Capability	± 100 kHz minimum
Altitude	10,000 feet
Temperature Range	-10 to 55°C
Overall Dimensions	8 1/2" x 19" x 8 1/2" deep
Net Weight	19" rack—FMO—P.S.—20 lbs. Monaural module —2.5 lbs. Stereo module —7.0 lbs. SCA module —5.0 lbs.
VSWR	Will withstand an open or a short circuited output indefinitely

MONAURAL OPERATION

Input Impedance	150/600 ohms balanced
Input Level	0 dBm to +20 dBm for 100% modulation
Frequency Response	30-15,000 Hz ± 0.5 dB
Pre-Emphasis	Standard 75 μ sec with provision to change
FM Noise	better than -70 dB
AM Noise	-55 dB
Distortion	0.5% max. (I.M.D. & T.H.D.)

STEREO OPERATION

Input Impedance	600 ohms balanced
Input Level	+10dBm ± 2 dB for 100% modulation
Stereo Response	50-15,000 ± 1 dB
Stereo Pre-Emphasis	75 μ sec standard with provision to change
Distortion	0.5% max. (I.M.D. & T.H.D.)
FM Noise	-63 dB
Stereo Pilot Stability	± 1 Hz
Stereo Separation	40 dB 50-15,000 Hz

SCA SUB-CHANNEL

Frequency Range	30-100 kHz
Frequency Stability	± 400 Hz
Input Impedance	600 ohms balanced
Input Level	-15 to +10 dBm adjustable
Muting Delay	0.5 to 5 seconds adjustable
FM Noise	-63 dB
Cross-Talk	-45 dB

Prices and specifications subject to change without notice.

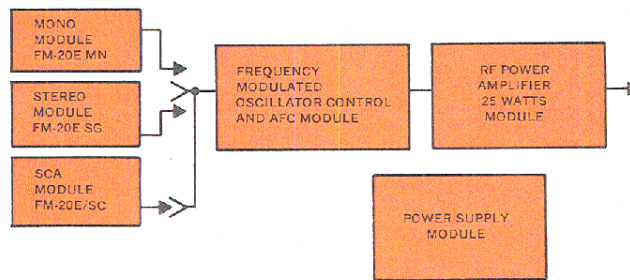

FM-20E Exciter

Printed in U.S.A.



AMERICAN ELECTRONIC LABORATORIES, Inc.

P.O. Box 552, Lansdale, PA 19446 • (215) 822-2929 TWX: 510 661-4976

Copyright © 1976 by American Electronic Laboratories, Inc. All rights reserved.

