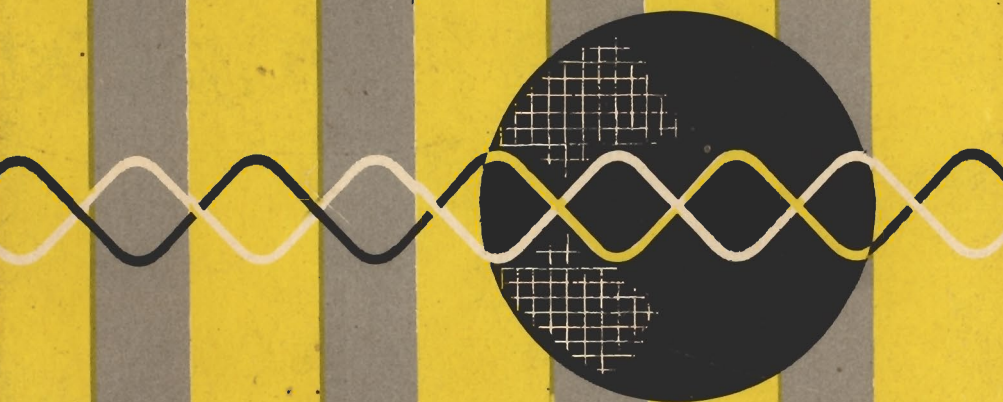


A *Kenneth W. Sams*® PHOTOFAC T PUBLICATION

know your  
**OSCILLOSCOPE**



by PAUL C. SMITH

\$2.00

Cat. No. KOS-1

---

# KNOW YOUR OSCILLOSCOPE

---

by PAUL C. SMITH



HOWARD W. SAMS & CO., INC.  
THE BOBBS-MERRILL COMPANY, INC.  
Indianapolis • New York

FIRST EDITION

FIRST PRINTING — NOVEMBER, 1958  
SECOND PRINTING — APRIL, 1959  
THIRD PRINTING — NOVEMBER, 1960  
FOURTH PRINTING — FEBRUARY, 1962  
FIFTH PRINTING — JANUARY, 1963

KNOW YOUR OSCILLOSCOPE

Copyright © 1958 by Howard W. Sams & Co., Inc.,  
Indianapolis 6, Indiana. Printed in the United States  
of America.

Reproduction or use, without express permission, of  
editorial or pictorial content, in any manner, is pro-  
hibited. No patent liability is assumed with respect to  
the use of the information contained herein.

Library of Congress Catalog Card Number: 58-59729

## PREFACE

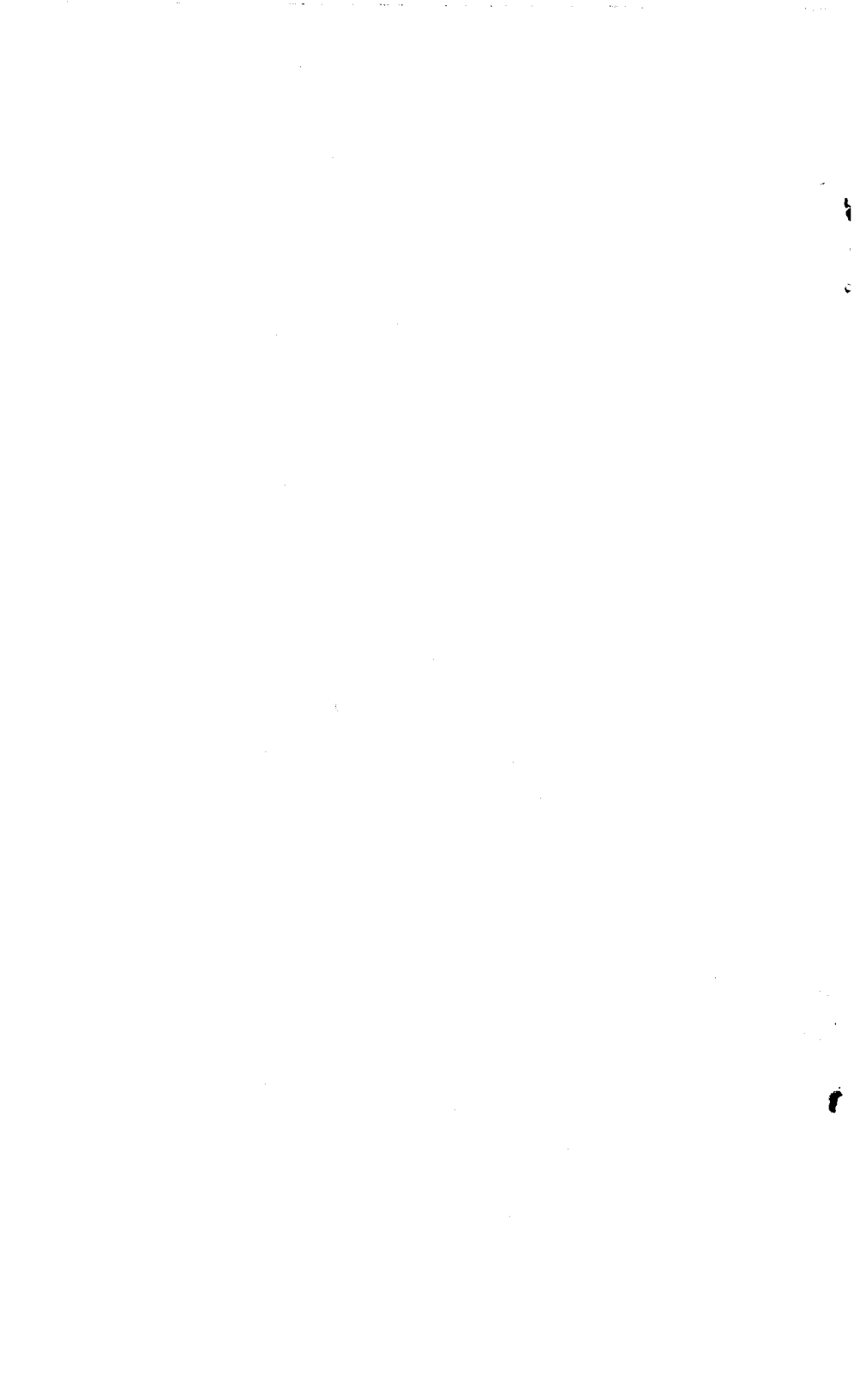
This book has been prepared for all users of oscilloscopes. The approach is from a technical viewpoint, but the subject matter does not require an engineering background on the part of the reader in order to be understood.

As the title suggests, the reader is first introduced to the principal circuits in an oscilloscope and the function of each. The various accessories available for use with oscilloscopes are then described, along with their special functions. One chapter is devoted to the maintenance and proper adjustment of the oscilloscope, since a defective scope, sitting unused on a shelf and gathering dust, is certainly no asset. The last four chapters in the book describe many of the countless applications of oscilloscopes in the field of electronics.

A few applications have, of necessity, been merely touched upon, but they were introduced with the intention of stimulating the curiosity of the reader and possibly leading him into further investigation. Two examples of this type of coverage are the cyclograms presented in Chapter 3 and the tube characteristic curves in Chapter 12.

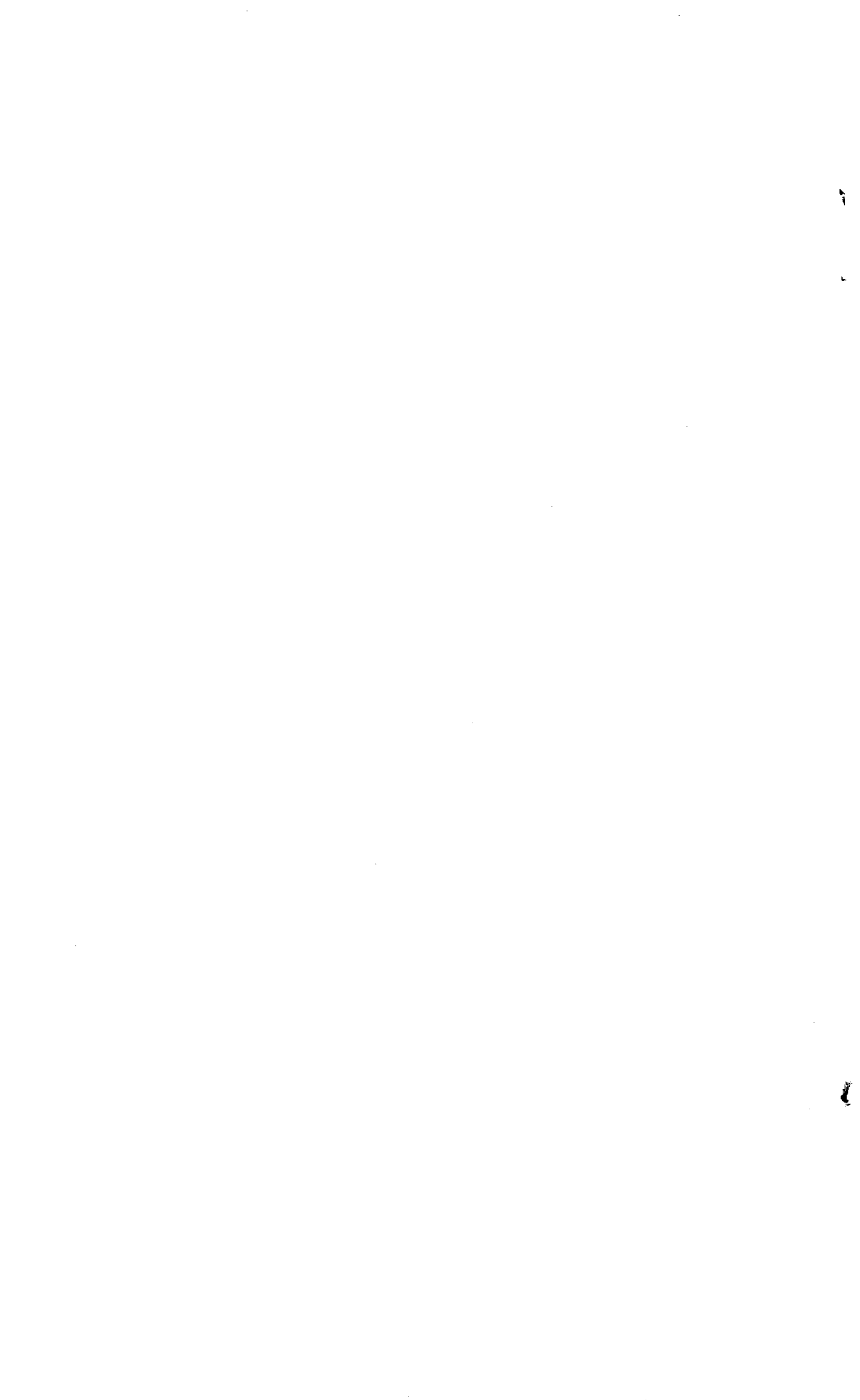
Finally, the author wishes to express his indebtedness to members of the engineering and technical staffs of Howard W. Sams & Co., Inc. for their assistance in preparing this book for publication.

Paul C. Smith



## TABLE OF CONTENTS

CHAPTER 1.	General Information . . . . .	1
CHAPTER 2.	Power Supplies . . . . .	9
CHAPTER 3.	Sweep Systems . . . . .	16
CHAPTER 4.	Synchronization . . . . .	31
CHAPTER 5.	Amplifiers . . . . .	39
CHAPTER 6.	Special Features . . . . .	51
CHAPTER 7.	Accessories . . . . .	61
CHAPTER 8.	Adjusting and Servicing the Oscilloscope . . . . .	79
CHAPTER 9.	Frequency and Phase Measurements . .	95
CHAPTER 10.	Amplifier Testing with Square Waves and Sweep Signals . . . . .	106
CHAPTER 11.	Radio and TV Alignment . . . . .	118
CHAPTER 12.	Signal Tracing and Other Applications . . . . .	136
INDEX . . . . .		149



## CHAPTER 1

### General Information

Man depends on his senses to tell him what is going on in the world about him, and he probably depends most on his sense of sight. This accounts, in part, for the popularity and usefulness of the oscilloscope. The oscilloscope provides the service technician with a "third eye" enabling him to see what is happening in the many electronic circuits with which he works.

At one time the oscilloscope was less common, found mainly in experimental or developmental laboratories. Its use has spread now and some form of the oscilloscope can be found in practically every radio and TV service shop or in any industry concerned with electronics.

The word "oscilloscope" can be separated into two parts, "oscillo" and "scope"; the first is short for "oscillations", and the second means "to view or see". Thus, if we take the word literally, it describes an instrument for viewing oscillations. The term oscillation should be extended to include any vibration or change in amplitude. This applies not only to electrical changes but to mechanical changes, pressure changes, temperature changes, and so on. Any phenomena that are not electrical must first be converted to an electrical signal by means of a transducer and this signal can then be applied to the oscilloscope.

Some examples of usable transducers are crystal, ceramic, and magnetic pickups; and photocells. In most radio and TV applications, an electrical signal is already present or is supplied by accessory equipment. Transducers are not required in such cases — the oscilloscope can be connected directly to the circuits under observation.

When the oscilloscope is properly connected and adjusted, it gives the technician a visible indication of the amplitude, frequency, phase, and waveform of the signal at any particular point in a circuit. An instrument providing as much information as this is a powerful tool indeed. There is probably no phase of electronics where it has not proved useful for designing, testing, or servicing.

#### EARLY DEVELOPMENTS

The forerunner or ancestor of the oscilloscope was an instrument known as the oscillograph. This was a mechanical de-



vice for recording oscillations or other natural phenomena of a variable nature. Recordings were made by a pen that left a trace on a moving ribbon of paper, or by the action of a moving light beam upon photosensitive material, or by some other recording means. An example of a mechanical oscillograph is the barograph, which records barometric pressure changes.

The recording arm of a barograph or other mechanical oscillograph possesses an appreciable mass, thus limiting the response to frequencies below about 10,000 cycles. The response can be made quite good, however, down to very low frequencies, and in this one respect the mechanical oscillograph excels the general-purpose oscilloscope.

The mechanical oscillograph would be of little use in radio and television applications, which deal with frequencies in megacycles rather than kilocycles. The modern oscilloscope, however, can be used for such applications. It was made possible by the development of the cathode-ray tube, which will respond to these higher frequencies.

The oscilloscope is really a voltmeter — but it is a voltmeter with special properties. The voltage applied to its terminals determines the position of the electron beam in the cathode-ray tube. The electron beam produces a spot of light wherever it strikes the fluorescent surface of the tube. As the beam moves across the face of the tube in response to the voltages on the deflection plates, the spot of light also moves; if the movement is fast enough, the spot appears as a continuous trace or line of light.

### **PERSISTENCE**

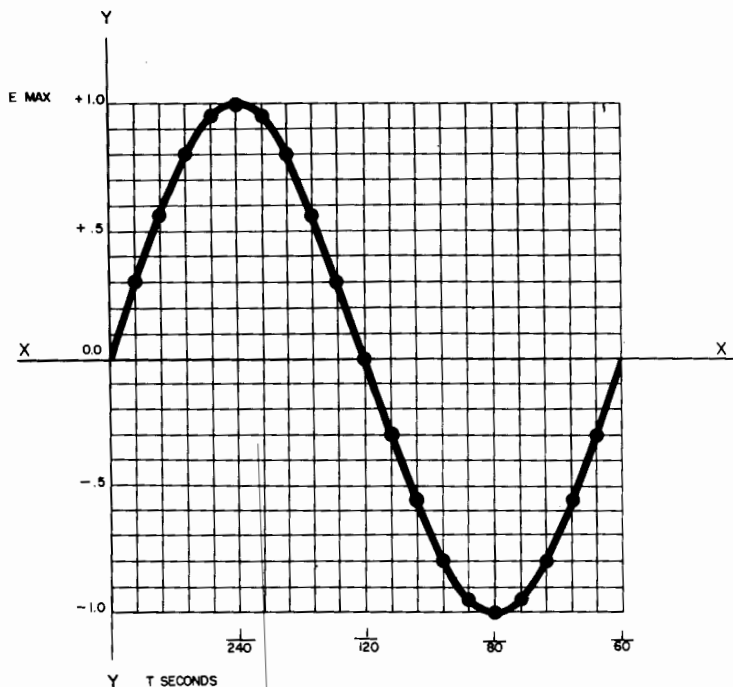
This blending of successive positions of the spot into an apparently continuous trace is due to two factors, (1) the persistence of the phosphor of the tube, and (2) the persistence of vision (the property of the human eye that sees any object or spot of light at its original position for a fraction of a second after it has moved). The persistence of a phosphor is its brief glow after the electron beam has left that spot. In general-purpose oscilloscopes, the blending of the spot into a line is due almost entirely to the persistence of vision. In special-purpose oscilloscopes, a tube with a phosphor of long persistence may be used, and electrical phenomena of short duration and nonrepeating nature can be viewed.

The phosphor most commonly used in oscilloscopes is P1, rated at medium persistence. P5 is a phosphor of short persistence, and P7, one of long persistence. Other phosphors are P4, commonly found in TV picture tubes, and P11, which gives an easily photographed blue trace.

### **GRAPH PATTERNS**

To use a simple analogy, the electron beam can be considered as a pencil writing upon the screen of the cathode-ray tube accord-

ing to the voltage on the deflection plates. When a horizontal-deflection system is used (and practically no oscilloscope is built without one), the trace on the screen is really a graph. Graphs are now so commonplace that hardly a person has not seen one.



**Fig. 1-1. Graph of one cycle of power-line voltage. Frequency is 60 cycles per second.**

Some examples are the temperature graphs and electrocardiographs used in hospitals, or the sales graphs of a business office,

The reader probably has drawn graphs in school; he will remember that they show two sets of data, the values of one set varying in some fashion as the other set varies. One set of values is plotted along the horizontal or X-axis on the graph paper, and the other set is plotted along the vertical or Y-axis. The located points are then connected to form a continuous graph. The action of the oscilloscope in tracing a response curve is so similar to this that some oscilloscopes even have inputs marked "X-amplifier" and "Y-amplifier".

We believe this comparison is a good point to remember. When confusing indications are seen on the oscilloscope screen, it may help if the operator remembers that the oscilloscope is plotting time horizontally and voltage vertically to produce a

graphical account of the operating conditions of the circuit. Usually it is unnecessary to know exactly how much time is represented by the horizontal travel of the trace, as long as the beam is uniform in its rate of travel; but if necessary, this time can be determined accurately and for very short intervals.

Fig. 1-1 shows a graph of one cycle of voltage having a frequency of 60 cycles per second. Instantaneous voltage is plotted above or below the "X" horizontal axis; elapsed time is plotted to the right of the vertical axis "Y" and measured in fractions of a second. The peak voltage is taken as 1 to simplify plotting the graph. This curve is called a sine curve because the amplitude or Y value at any point on the curve equals the maximum value of E (in this case, 1) times the sine of the X value at that point. (X must be converted to degrees, with one complete cycle equalling 360 degrees.)

The sine curve of Fig. 1-1, made by computing and plotting a few points, is the same curve that can be seen if the power line voltage is applied to the oscilloscope input and synchronized with a 60-cycle sawtooth sweep.

### WRITING SPEED

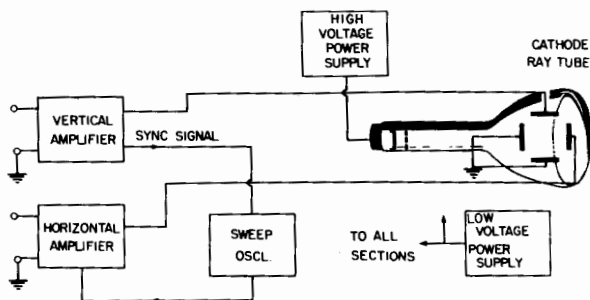
Before discussing the oscilloscope section by section, an important characteristic of all oscilloscopes should be mentioned — the reaction speed of the electron beam to any applied voltage. The beam possesses very little inertia. For all practical purposes, it can be said to have no inertia; consequently, it responds almost instantaneously to the impulse of the deflection voltages. This is the property that enables the trace to follow every variation of the applied signal, no matter how suddenly the signal may change direction or amplitude.

How readily the beam changes direction while moving at high speed can be shown by the following example. Assume an oscilloscope with a sweep frequency of 30 kc and having horizontal amplification capable of expanding the trace to four times the screen width. (Many oscilloscopes will exceed both specifications.) For a 5-inch oscilloscope, this means the trace is equivalent to 20 inches in length although only 5 inches of the center can be seen. The beam sweeps these 20 inches in  $1/30,000$  second — actually, in even less time since some time is lost in retrace. Thus, the beam is sweeping the tube at a "writing speed" of 600,000 inches per second, a little faster than 34,000 miles per hour. The retrace time usually is less than trace time; accordingly, the retrace speed would be much greater. However, the retrace is seldom used for viewing and, therefore, not considered when discussing writing speed.

### INPUT IMPEDANCE

Another important characteristic of the oscilloscope is its high input impedance. This is desirable in any voltage measuring

instrument, for it means the instrument will have a minimum loading or disturbing effect upon any circuit to which it is connected. The vertical amplifier input impedance of a conventional oscilloscope may have any value from 1 to 5 megohms shunted by



**Fig. 1-2. Simplified block diagram of general-purpose oscilloscope.**

25 to 50 mmf. If connected directly to the deflection plates, the impedance may be as high as 10 megohms shunted by 15 mmf. The input impedance at the vertical amplifier can be increased by the use of high-impedance probes.

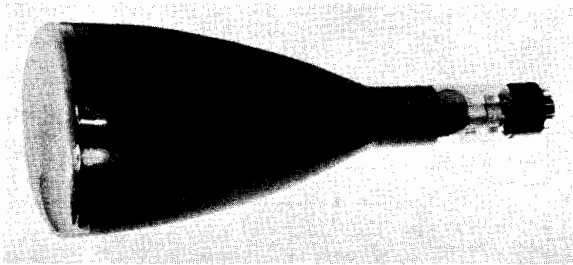
A block diagram of a general-purpose oscilloscope is shown in Fig. 1-2. This is a greatly simplified diagram, with several features combined in each block. The focus, intensity, and positioning circuits are not shown, but have been considered as part of the low-voltage power supply. The step and vernier attenuators usually are associated with the vertical and horizontal amplifiers. Triggering and synchronizing of the sweep oscillator are considered part of the sweep oscillator.

An oscilloscope could be made of a cathode-ray tube and a power supply only. Such an oscilloscope would be extremely limited in the ways it could be used. The signal input would have to be made directly to the deflection plates, and a comparatively strong signal would be necessary to deflect the electron beam a usable amount. After adding vertical and horizontal amplifiers and a horizontal-deflection system to provide a time base, the oscilloscope may be used for an increased number of applications. The oscilloscope can respond to very weak input signals, and general-purpose oscilloscopes sometimes have a vertical-deflection sensitivity of 15 millivolts rms per inch or less.

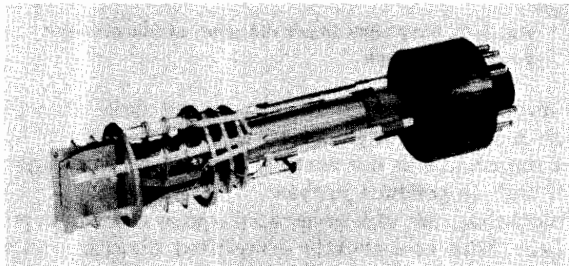
### THE CATHODE-RAY TUBE

A modern 5-inch cathode-ray tube is shown in Fig. 1-3. Externally, it has four parts; the base, the neck, the bulb, and the face or screen. Inside the neck, a portion of the gun structure can be seen. Fig. 1-4 shows this gun structure removed from the

tube. The gun contains all the electrodes for forming, shaping, and directing the electron beam which strikes the fluorescent screen of the tube.

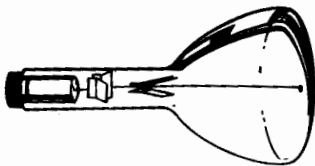


**Fig. 1-3. Modern 5-inch cathode-ray tube.**



**Fig. 1-4. Electron gun of cathode-ray tube.**

Applying the proper voltages to the various electrodes of the gun produces a beam that is brought to a focus in a small spot on the tube screen. The beam intensity is controlled by the voltage on the control grid. The theory pertaining to the focusing action of the gun is probably less interesting to the service technician than the theory pertaining to the action of the deflection plates; consequently, more space will be devoted to the latter. This book will not deal with electromagnetic deflection systems since they are found almost exclusively in television receivers rather than in oscilloscopes.



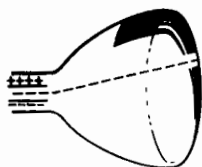
**Fig. 1-5. Path of electron beam through deflection-plate assembly.**

Fig. 1-5 is a perspective drawing showing how the electron beam passes through the space between the deflection plates on its path to the screen. With all deflection plates at the same elec-

trical potential, the beam will pass along the axis of the deflection-plate assembly and strike the center of the screen.

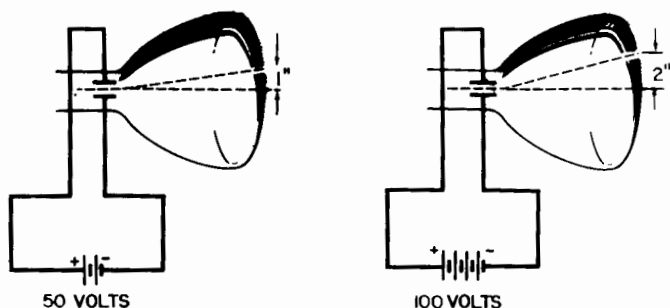
If one plate of a pair of deflection plates is made more positive or negative than the other, the electron beam is attracted

**Fig. 1-6. The electron beam, being negative, is always attracted by the positively charged deflection plate and repelled by the negatively charged deflection plate.**



toward the positive plate and repelled from the negative plate (Fig. 1-6) because unlike electron charges attract and like charges repel each other. The electron beam is always negative and, therefore, is always attracted to the positive plate.

The amount of deflection varies directly with the magnitude of the voltage on the deflection plates. For example, if a potential difference of 50 volts between a pair of plates moves the beam one inch at the screen, 100 volts will move it two inches, and so on. This is shown in Fig. 1-7.



**Fig. 1-7. The amount of deflection is directly proportional to the voltage applied to the plates.**

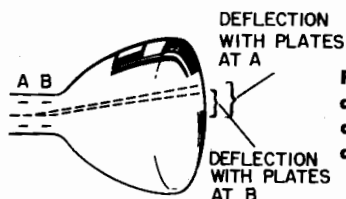
Applying an alternating voltage to the vertical plates moves the beam and produces a vertical line from top to bottom of the screen. Similarly, the proper voltage applied to the horizontal plates produces a horizontal line across the screen. With proper voltages for both sets of plates, the beam can be made to move anywhere on the oscilloscope screen.

## DEFLECTION SENSITIVITY

Deflection sensitivity of a cathode-ray tube, and of the entire oscilloscope, determines the weakest signal that can be viewed successfully with the instrument. Anyone who has consulted a tube

manual about cathode-ray tubes may have noticed that deflection sensitivities can cover a wide range, depending upon the voltages used. The sensitivities also differ for the two pairs of deflection plates, one sensitivity being greater than the other. For example, one tube manual lists the following sensitivities for a 5CP1-A cathode-ray tube. When the voltage of anode No. 3 is twice that of anode No. 2, the sensitivity is 39 to 53 volts DC per inch for every thousand volts supplied to anode No. 2. This range applies to one set of deflection plates. For the other set under the same voltage conditions, the sensitivity is 33 to 45 volts DC per inch per thousand volts supplied to anode No. 2. A different set of sensitivity figures is listed for the tube when anodes No. 2 and No. 3 have equal voltages.

The pair of deflection plates having the greater sensitivity (that is, requiring the smaller number of volts per inch of deflection) is always the pair nearer the base of the tube. The reason can be readily seen by examining Fig. 1-8. In this figure



**Fig. 1-8. Given equal deflection voltages, deflection plates nearer the base of the cathode-ray tube will have the greater deflection sensitivity.**

a pair of deflection plates is shown in two different positions, one (position A) being nearer the tube base than the other. If the applied voltage is the same for both positions, the electron beam will be deflected through an equal angle each time. With equal deflection angles, the deflection plates at position A swing a longer beam, thus giving a longer trace on the screen for the same deflection voltage.

Either pair of plates can be used for the vertical system; the rotational position of the tube about its long axis determines which pair. To obtain the highest possible deflection sensitivity for the vertical system, the cathode-ray tube normally is so positioned that the pair of plates closer to the base produce vertical deflection. The horizontal-deflection plates usually are driven by a stronger signal and are farther from the base than the vertical-deflection plates.

## CHAPTER 2

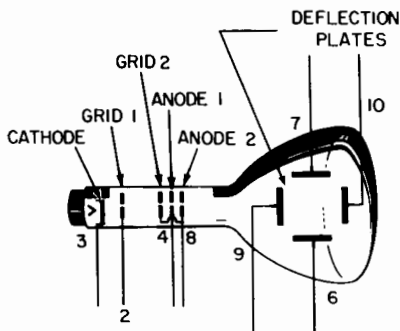
### Power Supplies

The power requirements of a modern oscilloscope are usually met with a power supply having two sections — one of low voltage (about 300 volts DC) and medium current capabilities, the other of comparatively high voltage (1,000 volts DC or higher) and low current capabilities. The low-voltage section operates the amplifiers and deflection generator. The high-voltage section furnishes the potentials for the various elements of the cathode-ray tube.

The power supply also may deliver signals for certain types of synchronization, retrace blanking, and calibration. To gain a better picture of some of the demands upon the power supply, let us first discuss certain aspects of the cathode-ray tube.

#### ELECTRON PATH THROUGH A CATHODE-RAY TUBE

Fig. 2-1 shows a 5UP1 cathode-ray tube as it commonly appears in the schematic diagrams of oscilloscope instruction books. The order indicated for the elements, starting from the base of the tube, is the same in the diagram as for the actual tube,



**Fig. 2-1. Control elements in a 5UP1 cathode-ray tube.**

except possibly anode No. 2. Anode No. 2 is connected internally to grid No. 2. It is also connected to the coated interior of the bulb of the tube, although this is not shown in the diagram. The coating extends almost to the face of the screen and accelerates



the electron beam on its way to the screen, also collecting the electrons of the beam after they have struck the screen.

The path of the electrons through the cathode-ray tube is as follows. The electrons are emitted from the heated cathode and, being negative, are attracted toward the nearest positive element, grid No. 2. They pass on through apertures in grid No. 2 and anodes No. 1 and No. 2 and are subjected to the action of the deflection plates. Finally, they strike the screen of the tube, causing a spot or trace of light, and they then are collected by the interior coating which forms a part of anode No. 2. Thus, the electron path through the tube originates at the cathode and terminates at anode No. 2.

### **Polarities of the Tube Elements**

Proper operation of the cathode-ray tube requires anode No. 1 to be more positive than the cathode and anode No. 2 to be more positive than anode No. 1. Grid No. 1 is the control grid and operates at a voltage equal to or more negative than that of the cathode. Its action is similar to that of the control grid of a receiving tube — it controls the number of electrons flowing between cathode and anode. Being negative, it repels the negative electrons, and if it becomes negative enough, the electron beam is cut off entirely.

The intensity control of the oscilloscope is usually connected to grid No. 1 of the cathode-ray tube, although it may be connected to the cathode instead. A variable intensity depends upon a variable potential difference between the cathode and grid, and this variable potential difference can be obtained if the potential of one element is varied while the potential of the other is held constant. The technician is familiar with this aspect of the operation of the cathode-ray tube through his association with TV. In some receivers, the picture-tube element to which the brightness control is connected is the control grid; in others, it is the cathode.

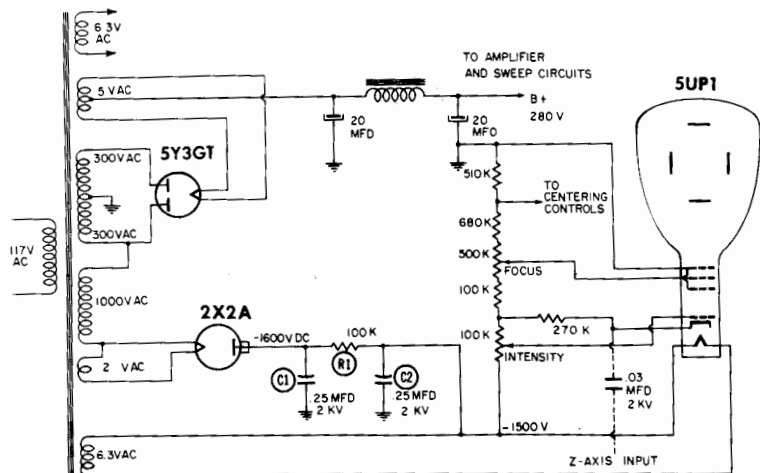
### **Range of Voltage for Normal Operation**

As was stated previously, the necessary potentials for operation of the cathode-ray tube are furnished by the high-voltage section of the power supply. These potentials can vary over a wide range, and satisfactory operation will still be obtained. For example, the voltage at anode No. 2 of a 5UP1 tube can be from 1,000 to 2,500 volts with respect to the cathode. Operation below 1,000 volts is not recommended. No matter which voltage is chosen, there are some advantages and disadvantages. The lower voltages can be attained more easily and economically and make possible a higher deflection sensitivity. These advantages are offset by less brilliance of the spot and poorer focusing qualities.

## RECTIFIER AND FILTERS

A partial schematic diagram of the power supply for the Triplet Model 3441 oscilloscope is shown in Fig. 2-2.

The low-voltage section of the power supply consists of a full-wave rectifier with capacitor and choke filtering. The high-



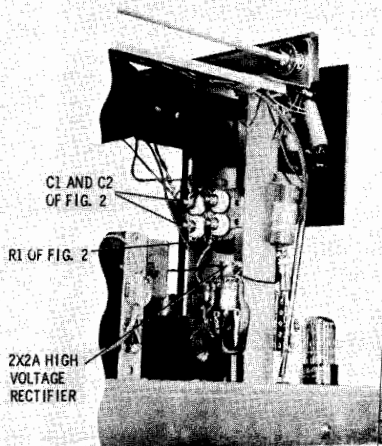
**Fig. 2-2. Partial schematic diagram of the power supply of the Triplet Model 3441 oscilloscope.**

voltage section employs half-wave rectification. Filtering is obtained by a simple resistor-capacitor network, which is adequate because little current is drawn from the high-voltage section. A 1,000-volt winding is in series with one-half the low-voltage winding, and therefore a total of 1,300 volts AC is applied to the high-voltage rectifier. This voltage is high enough to make necessary a high-voltage rectifier tube such as the 2X2A. After a slight voltage drop across the filter network, a potential of approximately 1,500 volts DC is left to operate the 5UP1 cathode-ray tube.

A photograph showing the high-voltage filter network appears in Fig. 2-3. Because little current is required from the supply, the filter network can be of fairly high impedance. It can be a simple RC network with a high value of resistance and a low value of capacitance to help reduce the physical size of the capacitors. Size is important when dealing with high-voltage capacitors. Each capacitor shown has a capacity of .25 microfarad and is rated at 2,000 working volts DC.

The power transformer differs from those used in many other types of test equipment. More windings are required, and the insulation must be better in order to provide the required safety margin for the higher voltages. The transformer diagrammed in

Fig. 2-2 has four filament windings instead of the two commonly found in other equipment. One of the extra windings is for the 2X2A high-voltage rectifier, and the other supplies the 5U1 cathode-ray tube. The filament winding for the cathode-ray tube is sometimes electrostatically shielded from the other transformer windings.



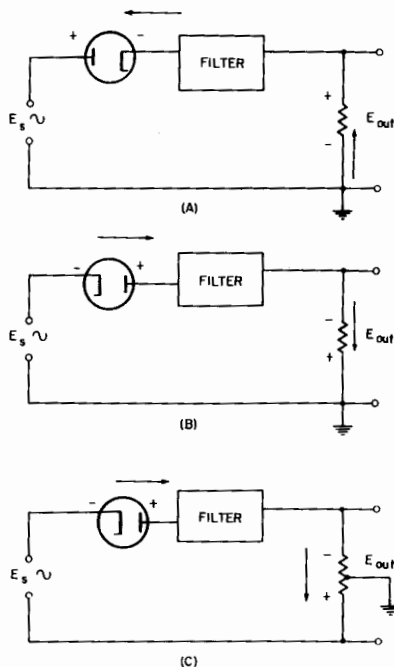
**Fig. 2-3. The high-voltage filter network in the Triplet Model 3441 oscilloscope.**

### NEGATIVE HIGH-VOLTAGE SUPPLY

A noticeable feature of the power supply in Fig. 2-2 may seem strange to the person accustomed to the usual power supplies in radios, amplifiers, and many test instruments. The output of the high-voltage section is negative with respect to ground. The circuits shown in Fig. 2-4 are diagrams of simple half-wave rectifiers and illustrate several possible arrangements. Part A shows a rectifier system with a DC output voltage positive with respect to ground.  $E_s$  represents the AC voltage impressed upon the system, and the resulting electron flow is indicated by the arrows. The rectifier conducts only when its plate or anode is positive with respect to its cathode. In part B of Fig. 2-4 the rectifier has been reversed, and the DC output voltage is therefore negative with respect to ground. The ground connection could be made as in Fig. 2-4C, thus giving DC supply points of both negative and positive polarity with respect to ground.

Most oscilloscopes use the arrangement shown in Fig. 2-4B for the high-voltage supply, often with minor variations. For example, in Fig. 2-5, the circuit of Fig. 2-2 has been redrawn. The rectifiers and filter sections have been omitted; the final stages

and the positioning controls for one of the amplifier channels are shown. R1 and R2 form the ground return for one pair of deflection plates, and the AC output from V2 and V3 is developed across these two resistors. This is a push-pull deflection system in which a negative-going signal is applied to one deflection plate



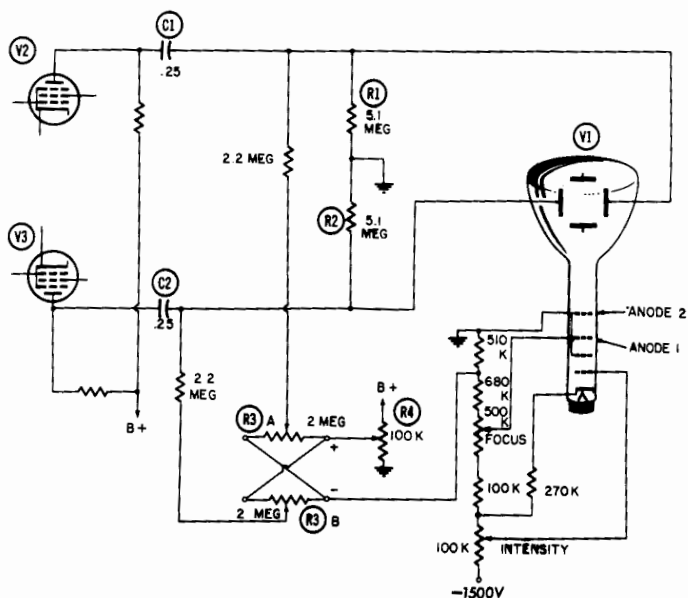
**Fig. 2-4. Several variations of half-wave rectifier circuits.**

of a pair at the same time that a positive-going signal is applied to the other plate.

With the circuit arrangement shown in Fig. 2-5, the DC potential of either deflection plate will not vary greatly from ground potential. Any variation will be due to the action of positioning controls R3A and R3B. These controls are ganged together and so wired that any rotation of the common shaft shifts the slider of one control toward a more positive potential and, at the same time, shifts the slider of the other control toward a more negative potential. As a result, the deflection plates have push-pull action for the DC positioning voltage as well as for the AC signal.

The following advantages result from a negative high-voltage supply: (1) The deflection plates can be operated at a DC potential close to that of anode No. 2, thus eliminating the defocusing effect obtained when the two potentials differ greatly. (2) Capacitors C1 and C2 can be of a fairly low voltage rating. (3) The circuit can be

more easily adapted to DC connection between deflection plates and amplifiers. (4) Less insulation is needed between the positioning controls and the chassis or the front panel.



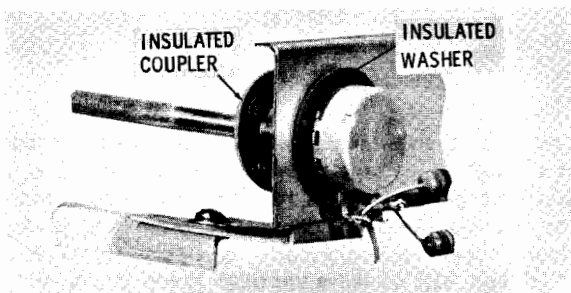
**Fig. 2-5. Partial schematic diagram showing the positioning control and high-voltage divider network of an oscilloscope (Triplet Model 3441).**

Contrast the preceding conditions with those obtained if the polarity of the high-voltage supply were reversed: (1) Anode No. 2 would be at a high positive potential to ground, resulting in an extreme difference in potential between the deflection plates and anode No. 2 if DC connections are made from the amplifier to the deflection plates. (This condition is undesirable.) (2) If blocking capacitors C1 and C2 are used, the deflection plates and anode No. 2 would be at nearly the same potential, but the voltage rating of the capacitors would have to be high. Capacitors of that value and rating would be bulky and expensive. (3) The horizontal- and vertical-positioning controls would have to be highly insulated from the chassis and the front panel to protect against the high voltage.

Regardless of the polarity of the high-voltage supply, the voltage rating of filter capacitors C1 and C2 in Fig. 2-2 must be high. In summary, the advantages seem to lie mainly with the high-voltage supply of negative polarity, and most oscilloscopes employ this system.

## INSULATION OF FRONT-PANEL CONTROLS

As can be seen in Fig. 2-5, the focus and intensity controls are at points of fairly high potential at the negative end of the dividing network; consequently, the manufacturers take precautions



**Fig. 2-6. One method of insulating between a control and the chassis.**

to insulate these controls from the chassis and the front panel. The method used in the Triplet Model 3441 oscilloscope is shown in Fig. 2-6. Insulating washers are used between each control and the mounting bracket, with an insulating coupler between the control shaft and the long metal shaft running to the front panel.

## BEAM INTENSIFICATION

Because it is popular with oscilloscope manufacturers, the 5UP1 cathode-ray tube has been used as an example. However, other cathode-ray tubes are also found in oscilloscopes, and some require a power supply slightly different from those discussed so far. An intensifier anode (called anode No. 3) in the 5ABP1 tube and 5CP1A tube may sometimes be operated at a potential as much as 2,000 volts positive with respect to ground; and at the same time, the control grid may be as much as 2,000 volts negative with respect to ground. The intensifier anode greatly accelerates the electrons in the beam after they have passed between the deflection plates. A brighter spot results, yet the deflection sensitivity is not seriously affected. The increased velocity of the electrons in the beam permits a higher scanning rate. In order to obtain the positive high voltage for the intensifier anode, another half-wave rectifier system can be added.

With all these high-voltage sources present within the case, the operator should be extremely careful when examining the interior of oscilloscopes. The instruction manuals caution against operating the oscilloscope with the chassis outside its case. Before touching any part of the interior of an oscilloscope, the operator should make sure the filter capacitors are not charged.

## CHAPTER 3

# Sweep Systems

In Chapter 1 it was mentioned that the oscilloscope will actually plot a graph of voltage with respect to time. The operator of an oscilloscope can see on its screen an indication of the way a voltage changes in amplitude from one moment to the next. The signal to be observed is normally applied to the vertical deflection system and will cause a vertical trace to appear on the screen, provided the signal is of sufficient amplitude and there is no AC voltage applied to the horizontal-deflection plates.

Under these conditions, a change of amplitude of the signal will result in a change of the height of the vertical trace. In order that these changes in amplitude may be viewed with respect to changes in time, some type of sweep system is incorporated in the oscilloscope. The signal from the sweep system is used to drive the horizontal-deflection plates of the cathode-ray tube. This provides a horizontal trace as a time reference for the signal at the vertical-deflection plates. Because of this, sweep systems are sometimes called time bases. In addition to the sweep signals provided internally in the general-purpose oscilloscope, other sweep signals can usually be applied from an external source.

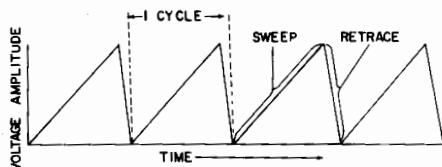
Oscilloscope sweeps may be classed as linear or nonlinear, and as single or repetitive. Single sweeps are seldom found except in laboratory oscilloscopes. Their greatest usefulness is for viewing signals of a nonrecurring nature. They are designed to sweep the beam once across the screen of the oscilloscope and must be timed accurately so that the signal to be viewed will occur at the exact instant of the sweep. A sweep of such short duration would result in a trace that would fade very quickly on a screen of normal persistence; consequently, a screen of long persistence is used to increase the viewing time.

The majority of the signals the service technician will encounter are of a recurring nature. They normally go through a complete cycle of variations a number of times a second. Some examples of this type of signal are: (1) the voltage supplied by the power line, (2) the AC voltages at tube filaments in a receiver, and (3) the voltages generated by the sweep circuits in a television receiver. The ideal sweep for viewing these signals is one in which the beam starts at the left-hand edge of the oscilloscope screen and moves at a uniform rate of speed in a horizontal di-

rection to the right-hand edge of the screen. Upon reaching the right-hand edge, it should reverse direction and return to the starting position at the left of the screen. This return sweep (called retrace) should be made in the least time possible.

### LINEAR SAWTOOTH SWEEP

The waveform of the voltage necessary to produce such a sweep as we have just mentioned is shown in Fig. 3-1. Several cycles of the sawtooth waveform are shown in this figure. The voltage applied to the horizontal deflection plates is plotted in a vertical direction, and time is plotted in a horizontal direction. The sweep produced by such a waveform is called a linear sweep because the useful portion of it moves at a constant rate of speed and can be represented by a straight line on a graph. In many oscilloscopes the retrace is blanked out and does not appear on the screen.



**Fig. 3-1. Voltage waveform used to produce a linear sweep on an oscilloscope screen.**

Retrace blanking can help prevent some of the confusing indications that might be seen without blanking. This is especially true where some of the higher sweep frequencies are used. Usually, raising the sweep rate higher and higher will result in sweep voltage cycles containing a larger percentage of retrace time.

If the retrace is permitted to appear on the screen, together with any vertical deflection caused by signal at that time, it may obscure some more important detail occurring during the forward portion of the sweep.

Blanking can be accomplished by applying the retrace signal from the sweep generator circuits to either the cathode or grid of the cathode-ray tube for intensity modulation. Circuits may be inserted between generator and cathode-ray tube to provide any wave shaping, phase shifting, or amplification that may be necessary.

For some applications retrace blanking may not be desirable, and some oscilloscopes are provided with a switch so that the blanking feature may be turned on or off as desired.

There are three common circuits for producing the sawtooth voltage indicated in Fig. 3-1. One of these, the blocking oscillator, is used more in TV receivers than in oscilloscopes and will not



be discussed here. The other two circuits require the use of a multivibrator or a thyatron oscillator. Let us first consider the circuit using the thyatron oscillator.

### THYRATRON AS A SWEEP OSCILLATOR

The waveform of Fig. 3-1 can be approximated very closely by the voltage across a capacitor being charged and discharged in

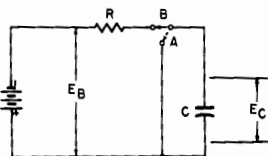


Fig. 3-2. A simple arrangement for charging and discharging a capacitor.

a certain manner. Fig. 3-2 shows a simple arrangement for doing this. When the switch is in position A, capacitor C will be shorted, and no voltage will appear across its terminals. When the switch is moved from point A to point B, the battery will immediately start to charge the capacitor and will continue to charge capacitor C until the voltage across the capacitor equals that across the battery. Theoretically, it would take an infinite length of time for  $E_C$  to reach the voltage  $E_B$ . For most practical purposes,  $E_C$  can be considered to equal  $E_B$  after a time equal to  $5RC$  has elapsed.  $RC$  is measured in seconds and is equal to the product of the resistance in megohms times the capacitance in microfarads.

Fig. 3-3 is a graph showing the ratio between the voltage  $E_C$  and the voltage  $E_B$  obtained with the circuit of Fig. 3-2. It can be seen that the voltage  $E_C$  increases rapidly at first, then more

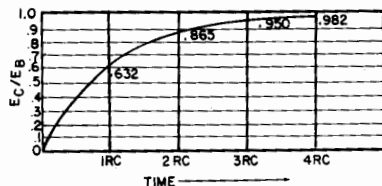


Fig. 3-3. Graph showing the rise in voltage as a capacitor is charged through a resistance.

slowly as  $E_C$  approaches  $E_B$ . Considered as a whole, the curve of Fig. 3-3 appears to have a large amount of curvature, but if only a small portion of the curve is considered at one time, it appears to be nearly straight, especially between points 0 and  $1RC$ . It would therefore be logical to use this latter portion of the curve, or a part of it, to develop the sawtooth curve diagrammed in Fig. 3-1. The manner in which this is done can be explained through the use of Fig. 3-4 illustrating a simple sawtooth oscillator using an 884 thyatron tube.

The  $R$  and  $C$  of Fig. 3-4 correspond to the  $R$  and  $C$  of Fig. 3-2. The 884 tube  $V1$  functions as a switch across capacitor  $C$  in

Fig. 3-4. This capacitor charges through resistor R from the B+ supply. The voltage across this capacitor also serves as the plate-to-cathode voltage for tube V1, and when this voltage reaches a certain value, the gas in the tube ionizes and V1 conducts heavily.

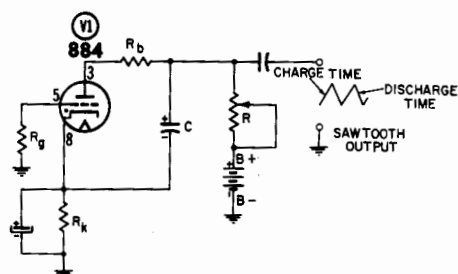


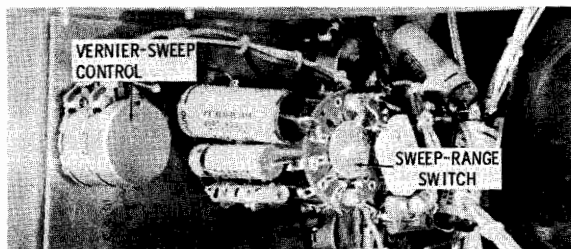
Fig. 3-4. Basic Thyatron sawtooth oscillator.

As V1 conducts, it rapidly discharges capacitor C until the voltage across this capacitor drops to a certain value, called the deionization potential of V1. Tube V1 ceases to conduct at this potential, and capacitor C immediately starts recharging through resistor R. This cycle of charging and discharging is repeated over and over, and in this manner, the sawtooth waveform of Fig. 3-1 is developed. The amplitude of this signal is usually too small for direct application to the horizontal-deflection plates; so, most oscilloscopes will have one stage or more of horizontal amplification between the oscillator and the deflection plates.

The frequency of operation of the sawtooth oscillator of Fig. 3-4 depends upon several factors: (1) the value of resistor R, (2) the value of capacitor C, (3) the B+ supply voltage, and (4) the bias on tube V1. Referring to Fig. 3-3, it can be seen that C will charge to .632 times the applied voltage in a time equal to  $1RC$ . This is true no matter what the individual values of R and C may be. For example, if the product of R in megohms and C in microfarads equals 2, then C will charge to 63 per cent of the applied voltage in two seconds. If R times C equals 1 second, then 63 per cent of the applied voltage will be reached in one second.

It can be seen, therefore, that for any individual value of voltage required to fire tube V1 of Fig. 3-4, this voltage will be reached in less time if RC is reduced and in more time if RC is increased. In the first case the frequency of the sawtooth signal will increase, and in the second case it will decrease. The change in the RC product can be made by varying either R or C, or both. Most oscilloscopes are designed with R variable for fine or vernier control of frequency and with several different capacitors that can be connected individually by means of a switching arrangement. The switch then serves as a coarse control of the frequency. Sawtooth-frequency controls of this type are easily spotted on an

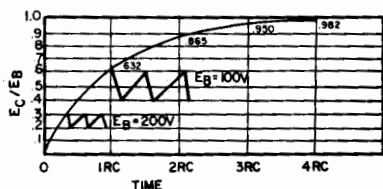
oscilloscope chassis because of their characteristic appearance. They usually consist of a rotary switch on which are mounted several capacitors ranging in regular order from smaller to larger size. Fig. 3-5 shows the sweep-frequency controls of the Hickok



**Fig. 3-5.** The sweep-frequency controls of the Hickok Model 665 oscilloscope.

Model 665 oscilloscope. A five-position rotary switch is used to select the desired sweep range, and a dual potentiometer is used for fine adjustment of each range.

The effect of supplying different values of B+ voltage to the sawtooth-oscillator stage can be illustrated by the following example. Assume the bias of the thyatron tube of Fig. 3-4 has been so set that the tube fires when its anode reaches a potential of 63 volts and deionizes or stops conducting when the charge on capacitor C has fallen to 40 volts. These values are not necessarily characteristic of the 884 thyatron, but are chosen arbitrarily for the purpose of illustration. Fig. 3-3 may be redrawn and the



**Fig. 3-6.** Graph showing the effect of different values of  $E_B$  applied to a thyatron sawtooth oscillator.

sawtooth output from tube V1 superimposed upon it to make Fig. 3-6. Two conditions are pictured: one with a supply of  $E_B = 100$  volts, the other with  $E_B = 200$  volts. In each case the firing potential is 63 volts, and the deionization potential is 40 volts. Two effects of the higher value of  $E_B$  can be noted: (1) a more linear sawtooth waveform, and (2) an increased frequency of the sawtooth signal. If  $E_B$  were only slightly higher than the firing potential of 63 volts, the sawtooth would shift to a position near the top of the curve, the frequency would be lowered, and the waveform would become very nonlinear.

This relationship between linearity and supply voltage is a good point for the technician to keep in mind. If the sweep on his

oscilloscope screen appears to be very nonlinear, it would be well to check the sawtooth oscillator to see if the supply voltage has not changed from its normal value. In most oscilloscopes, this voltage cannot be adjusted.

The other major factor affecting the frequency of the sawtooth signal is the bias on the thyratron tube. The bias governs the firing potential of the tube. If the bias is made more negative, the tube will not fire until a higher anode potential is reached; if it is made less negative, the tube will fire at a lower anode potential. Synchronization of the sawtooth signal with the waveform being viewed can be obtained easily if the sync signal is allowed to control the bias on the grid of the thyratron. The bias for the tube shown in Fig. 3-4 is obtained from the cathode resistor  $R_K$ . In some cases  $R_K$  is made a part of a bleeder network in the B+ supply, and it may also be made adjustable if the oscilloscope designer sees fit. In the latter case it is not adjustable from the front panel, but is preset at the factory for best results.

The effect of the bias voltage on the sawtooth frequency may be summed up as follows: The higher the bias, the higher the firing potential of the tube, and this means more time will be required for capacitor C to charge to the firing potential. The frequency of repetition will therefore be lowered. If the bias is lowered, the reverse effect is true.

### MULTIVIBRATOR SWEEP CIRCUITS

The thyratron sawtooth oscillator is still used in some present-day oscilloscopes, but some form of multivibrator sweep circuit is becoming much more common. At the frequencies at which it operates, the thyratron will give a more rapid retrace, but the multivibrator can generate higher sweep rates. A number of general-purpose oscilloscopes have been designed with sweep rates of several hundred kilocycles per second. The multivibrator is also widely used as a sweep oscillator in TV receivers, and its design differs very little for the two applications, except for the greater frequency range required in the oscilloscope.

The nature of a multivibrator sweep oscillator is such that it can be easily designed to give either a single sweep, triggered sweeps, or free-running sweeps. A free-running sweep is one operating at its own natural frequency in the absence of a synchronizing signal. A triggered sweep has a natural frequency determined by its circuit components, but each cycle of sweep must be initiated or triggered by a synchronizing signal. In the absence of such a signal, no trace will be obtained with the latter type of sweep.

A basic multivibrator circuit is shown in Fig. 3-7. This is a free-running type and operates continuously without the necessity for a triggering signal. If both tubes have similar characteristics and the corresponding resistors and capacitors for each

tube are identical, the output signal at the plate of tube V2 will be a close approximation to a symmetrical square wave. Values of the different components can be chosen so that a nonsymmetrical square wave will be obtained. One tube will conduct for a much

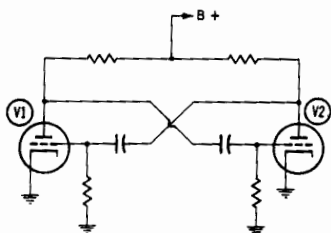


Fig. 3-7. Basic multivibrator circuit.

longer time than the other. This signal can then be used to trigger a discharge tube connected across a capacitor, and thus a sawtooth curve will be obtained.

By further modifications of the circuit, it is possible to eliminate the discharge tube. That function would be performed by the second tube V2 in addition to its function as part of the multivibrator. Twin-triode tubes are particularly adaptable to multivibrator circuits because they contain in one envelope two triodes of identical characteristics. Common choices for this type of operation are 6J6, 12AT7, and 12AV7 tubes.

### SOME REFINEMENTS OF SWEEP CIRCUITS

The examples given and illustrated have been kept rather basic in order to simplify the discussion. It was shown that the use of a small portion of the charging curve of a capacitor results in a fairly linear sawtooth sweep. Some oscilloscopes incorporate means for further linearization of the trace. With a thyratron sweep oscillator, this can be done by placing a pentode tube in the charging circuit of the capacitor. The pentode functions as a constant-current device and allows the capacitor to charge at a constant rate. RC networks are sometimes added to a multivibrator sweep oscillator to improve the shape of the sawtooth wave.

### NONLINEAR SWEEPS

Occasionally it is desirable to use sweeps other than a sawtooth sweep, and usually these are of a nonlinear nature. This means the sweep does not travel at a constant rate in the horizontal direction. The majority of present-day oscilloscopes have provision for using a sine-wave sweep. This is usually obtained internally from the oscilloscope itself and can be taken from a winding on the power transformer. The 60-cycle sine wave obtained in this manner is applied to the horizontal amplifiers of

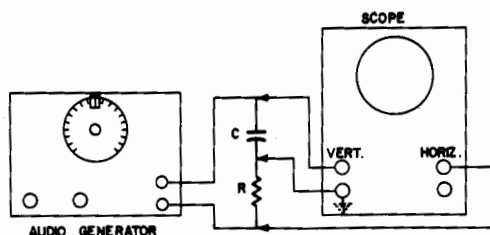
the oscilloscope, and the amplified signal drives the horizontal-deflection plates.

This 60-cycle, sine-wave sweep can be used with a sweep generator to develop the response curve of an amplifier. Most sweep generators use a signal at the power line frequency to drive the sweep-generating circuits. The internal 60-cycle sweep of the oscilloscope is also derived from the power line, usually directly from a transformer winding, so that the two sweeps will automatically be in step. The phasing control on the oscilloscope will be the one to use in this case to adjust the double response curve for coincidence. If the oscilloscope horizontal sweep is obtained by applying the horizontal output of the sweep generator to the horizontal input of the oscilloscope, then the phasing control on the generator is the one to use.

Sine-wave sweeps at other frequencies can be obtained by feeding the output from an audio sine-wave generator to the horizontal-input terminals. These sweeps have their greatest usefulness in frequency measurements (see Chapter 9). They have several disadvantages when used in the manner of a sawtooth sweep; (1) they are nonlinear, (2) retrace time is the same as sweep time, and (3) they cannot be synchronized.

### CIRCULAR AND SPIRAL SWEEPS

Other types of sweeps that find use for special applications are circular and spiral sweeps. The general-purpose oscilloscope as used by radio and TV service technicians will not have these sweeps as built-in features, although they can be made to produce such sweeps by using auxiliary circuits. Among the advantages these sweeps offer are: (1) longer trace for the same size of cathode-ray tube, and (2) no loss of time during retrace.



**Fig. 3-8. Circuit for producing a circular trace, using one sine wave audio generator.**

If a sinusoidal signal is applied to the vertical input of an oscilloscope and another signal of the same frequency but of 90-degree phase difference is applied to the horizontal input, a circular trace will result. This is true only if the signal voltages reaching the deflection plates are of equal amplitude (neglecting the slight difference in deflection sensitivity between horizontal

and vertical plates). If the voltages are unequal, the trace will be an ellipse that can be made a circle by proper adjustment of either the input gain controls or the amplitudes of the applied signals.

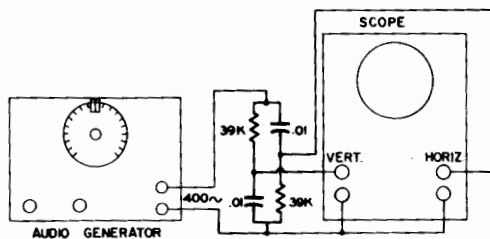
A circular trace can be obtained using only one generator or signal source if some means is used to shift the signal phase 90 degrees before it is applied to the other input of the oscilloscope.

This can be done by applying the signal voltage across a series combination of a resistor and a capacitor, or a resistor and an inductor. If the capacitor or inductor is a purely reactive component (it won't be), the voltage developed across it will be 90 degrees out of phase with the voltage across the resistor.

Fig. 3-8 shows a circuit for developing a circular trace using one generator and a series combination of a resistor and a capacitor. The vertical and horizontal inputs of the oscilloscope have a common ground; so, in order to connect one input across R and the other across C, the ground must be connected to the junction of R and C. This places the ground and case of the signal generator above the the oscilloscope ground, and as a result, hum appears in the trace.

Hum is avoided by the bridge circuit of Fig. 3-9. Values of R and C are not critical. The values shown result in a nearly circular trace.

A signal can be displayed on the circular or elliptical trace by applying it to either the vertical or horizontal input of the oscilloscope. There it will be superimposed upon the signal from the phase-splitting network. The resultant trace may be difficult to understand if the applied signal does not have some simple waveform such as a square wave or a sine wave would present. Either the signal driving the circular sweep or the displayed signal must first be adjusted in frequency so that the two signal fre-

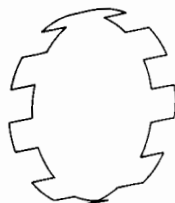


**Fig. 3-9. Circuit which produces an elliptical trace and develops less hum than circuit of Fig. 3-8.**

quencies bear some integral ratio to each other, as when the frequency of the displayed signal is 4, 5, or 6 times the sweep frequency. Otherwise, the waveform will appear to rotate. As the frequencies approach an integral ratio, the rotation appears to slow down, finally stopping when the exact ratio is reached. An interesting feature about the rotation is that it appears to take

place in three dimensions, although it is actually confined to the two-dimensional plane of the cathode-ray tube screen. This three-dimensional effect can be an aid in interpreting the waveform.

**Fig. 3-10. Waveform produced by superimposing a square wave signal on an elliptical trace. Signal is applied to the horizontal input.**



If a square-wave signal is applied to the horizontal input of the oscilloscope shown in Fig. 3-9, the resulting waveform appears as in Fig. 3-10. In this example the frequency of the square wave is eight times that of the signal used to develop the elliptical sweep.

It is evident from Fig. 3-10 that this method of displaying a signal is more complex than a square wave or a sine wave. It would be less confusing if the signal were displayed radially, and this can be done if the signal is used to modulate the second anode voltage of the cathode-ray tube and, in effect, modulate the deflection sensitivity of the oscilloscope. This is not easily done — it requires getting inside the oscilloscope to the cathode-ray tube connections. In most oscilloscopes the second anode of the CRT will be operated at very nearly ground potential, and the modulation must be applied to the cathode. The blocking capacitor used for applying the signal must have a voltage rating high enough to withstand the voltage from the high-voltage supply. A much

**Fig. 3-11. A train of damped sine waves applied to the RC network of Fig. 3-9 will produce a spiral trace.**



higher value of signal voltage is required for this method as compared with the method of Fig. 3-10. A square-wave signal displayed in this manner results in a "cog wheel" pattern rather than the pattern of Fig. 3-10.

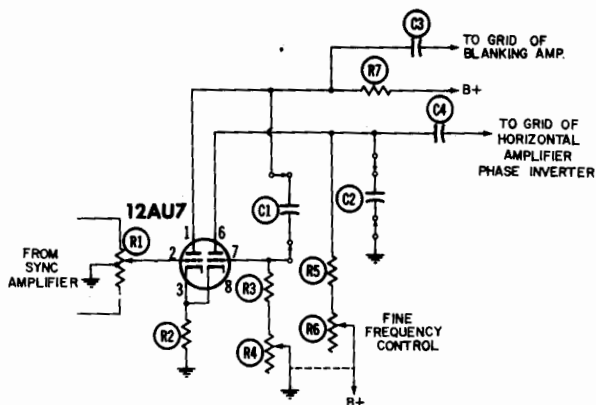
A spiral sweep can be derived from a circular sweep if the amplitude of signal applied to the deflection plates is made to vary in sawtooth fashion. This could be done by varying the gain of the oscilloscope amplifiers in a sawtooth manner or by varying the input signal itself in the same manner. A train of damped sine waves such as shown in Fig. 3-11 would produce a spiral trace if it were substituted for the generator signal used in the setup of Fig. 3-9.



If frequency comparison is the sole consideration, without any attempt to display the waveform of the signal, the simplest and easiest way to use a circular or spiral sweep is to intensity-modulate the sweep with the signal. Many oscilloscopes have an input jack for Z-axis or intensity modulation, and the signal can be applied directly to this jack. When the signal is applied, the signal peaks will produce lighter or darker marks on the trace, depending upon the polarity of the peaks.

### CYCLOGRAMS

The author first ran across this term in a book titled Time Bases written by O. S. Puckle and published by John Wiley & Sons, Inc. A cyclogram is produced by monitoring with an oscilloscope two voltages having a direct cyclic relation to each other — for example, the grid and plate voltages of an oscillator tube. One voltage is applied to the vertical input of the oscilloscope and the other is applied to the horizontal input. In this manner there is no longer a sweep varying linearly with time, as is true with



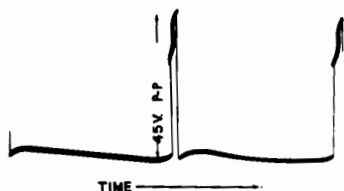
**Fig. 3-12. Multivibrator sweep generator used in Simpson Model 466 HANDISCOPE.**

the sawtooth sweep (unless one of the signals just happens to have a sawtooth waveform). Instead, the position of the beam at any instant represents relative amplitude of signal as compared to the position at some other instant. Vertical position indicates amplitude of vertical signal, and horizontal position indicates amplitude of horizontal signal. A number of cyclograms are shown and discussed in the following paragraphs. It might be well to point out a characteristic of all traces seen on the screen of general-purpose oscilloscopes that can be an aid to interpretation of the waveform. The intensity of the trace is directly affected by the speed of the trace — i.e., the faster the trace, the weaker its intensity. Therefore, it is possible to look at the trace and get an

indication of the relative speed of the beam as it passes through various points on the trace.

The following cyclograms and related waveforms were obtained with an oscilloscope having these deflection polarities:

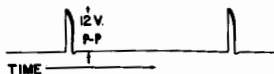
**Fig. 3-13. Waveform at pin 1 (first plate) of the multivibrator of Fig. 3-12.**



vertical deflection — trace moves up with positive voltage increase; horizontal deflection — trace moves to the right with positive voltage increase.

The multivibrator sweep oscillator circuit of the Simpson Model 466 Handiscope is shown in Fig. 3-12. Figs. 3-13 through 3-16 show conventional waveforms viewed at various pins of the multivibrator tube. The viewing oscilloscope was set for internal sawtooth sweep, synchronized with the sweep signal developed by the multivibrator circuit. Therefore, the horizontal displacement in the waveforms can be considered to represent time, and the

**Fig. 3-14. Waveform at pins 3 and 8 (cathodes) of multivibrator of Fig. 3-12.**



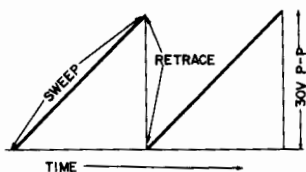
vertical displacement represents signal voltage at the point of observation.

Figs. 3-17, 3-18, and 3-19 show cyclograms obtained by using these signals, two at a time. A person who has always used an oscilloscope in the customary manner may find this use novel and a little difficult to interpret at first. One of the main things to remember is that equal distances along the trace do not necessarily represent equal time duration.

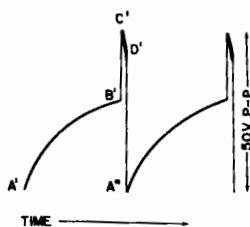
The cyclogram of Fig. 3-17 was obtained by connecting pin 8 of the multivibrator in Fig. 3-12 to the vertical input of the oscilloscope, and pin 6 to the horizontal input. Examination of the figure itself does not reveal which way the beam moves around the closed loop (the directional arrow was added after this direction had been determined). Direction of beam movement can be deduced by examination of Figs. 3-14 and 3-15. Fig. 3-15 shows that the plate voltage rises linearly to a maximum positive value and then drops suddenly back to a minimum. The voltage drop is much faster than the rise. Therefore, the brighter portion from A to B in Fig. 3-17 must correspond to the rising plate voltage, and the dimmer portion from C to D must correspond to the falling plate

voltage as the beam moves around the trace in the direction of the arrow.

The cyclogram of Fig. 3-17 shows then that the voltage on pin 6 rises to a maximum while the voltage on pin 8 remains

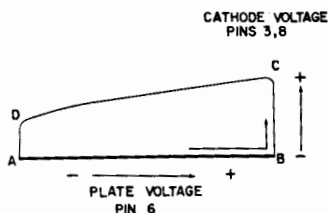


**Fig. 3-15.** Waveform at pin 6 (second plate) of multivibrator of Fig. 3-12.



**Fig. 3-16.** Waveform at pin 7 (second grid) of multivibrator of Fig. 3-12.

constant at a minimum; the voltage on pin 8 jumps suddenly to a positive maximum (B to C) while that on pin 6 changes little or none at all; the voltage on pin 6 drops from C to D while the voltage on pin 8 also drops; and finally, the voltage on pin 8 drops back to a minimum from D to A.



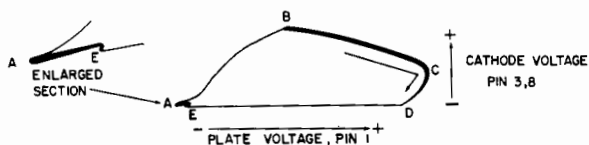
**Fig. 3-17.** Cyclogram comparing plate voltage variations on pin 6 with cathode voltage variations for circuit of Fig. 3-12.

If pin 8 is connected to the vertical input and pin 1 is connected to the horizontal input, the cyclogram of Fig. 3-18 is obtained. This shows the relationship between cathode voltage variation and plate 1 voltage variation. The brightest part of the trace is at A, indicating slowest movement. Between B and C a somewhat faster movement takes place, and all other parts of the curve are traced at high speed. A portion of the curve at A and E is expanded to show detail. This shows a minor reversal of direction of horizontal movement at E, corresponding to the portion of the curve in Fig. 3-13 just to the right of the voltage spike.

Analysis of Fig. 3-18 is as follows: plate voltage and cathode voltage rise together at a rapid rate from A to B; at B, cathode voltage reverses direction, but plate voltage continues to rise, both changing value at a slower rate than at first; at C, plate voltage begins to fall; at D, cathode voltage is almost at minimum, and plate voltage falls rapidly to E where a momentary reversal in di-

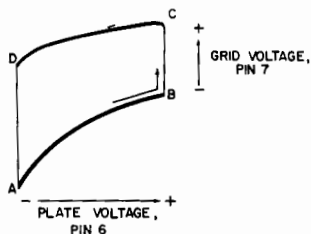
rection occurs; from E to A, plate voltage falls more slowly, and cathode voltage reaches its lowest point.

Fig. 3-19 is the result of connecting the vertical input to pin 7 and the horizontal input to pin 6. Since the signal at pin 6 is a

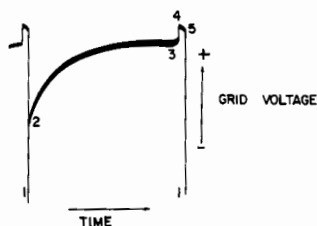


**Fig. 3-18. Cyclogram comparing plate voltage variations on pin 1 with cathode voltage variations for circuit of Fig. 3-12.**

sawtooth wave (in fact, it is the same signal used to drive the horizontal amplifier when an oscilloscope is operated in conventional manner), the result is almost the same as if the waveform at pin 7 were viewed conventionally. There are these differences: the waveform is automatically limited to one cycle; AB and BC occupy the same position in Fig. 3-19 as A'B' and B'C' in Fig. 3-16; CD occurs during the retrace time of the sawtooth waveform; and D'A' of Fig. 3-16 becomes DA of Fig. 3-19.



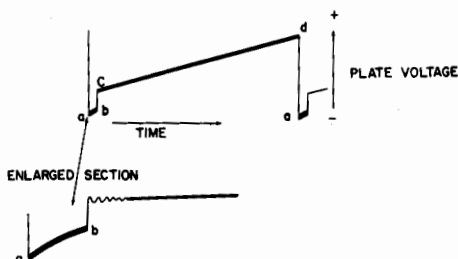
**Fig. 3-19. Cyclogram comparing plate voltage variations on pin 6 with grid voltage variations on pin 7 for circuit of Fig. 3-12.**



**Fig. 3-20. Waveform at grid of vertical blocking oscillator in a TV receiver.**

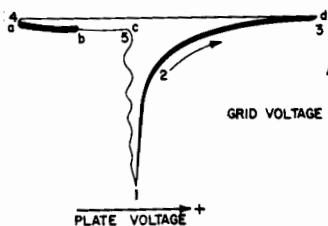
Figs. 3-20 and 3-21 are voltage waveforms obtained at the grid and plate of the vertical oscillator of a TV receiver. The oscilloscope was set for internal sawtooth sweep for these waveforms. The cyclogram of Fig. 3-22 resulted when the grid signal was applied to the vertical input and the plate signal was applied to the horizontal input of the oscilloscope. The numerals and letters indicate identical signal points on the waveforms. The cyclogram shows that the plate voltage rises at a medium rate from a to b, then at a very fast rate from b to c; meanwhile, the grid voltage is declining slowly from 4 to 5. At 5 the grid voltage drops suddenly to a minimum at 1, then rises rapidly to 2 and at

a gradually decreasing rate to 3. The plate voltage from c to d is almost identical to the rising portion of a sawtooth sweep; therefore, the grid voltage between 5 and 3 is displayed as a conventional waveform, with this exception: The wavy line portion of the cyclo-



**Fig. 3-21. Waveform at plate of vertical blocking oscillator in a TV receiver.**

gram between points 5 and 1 results from an irregularity in the plate voltage at c. This irregularity is shown in the enlarged portion of Fig. 3-21 and is in the form of transient oscillations that persist for a few cycles. At d the plate voltage reverses in direction and drops rapidly to the minimum value, while at the same time grid voltage is rising from 3 to 4.



**Fig. 3-22. Cyclogram comparing plate voltage variations with grid voltage variations at the vertical oscillator of a TV receiver.**

These few examples indicate that there are some applications where cyclograms might be particularly suitable and valuable and others where they would be less valuable. The same signals could be compared by means of an electronic switch and an oscilloscope, but the matching of details in two signals might not be as exact with regards to time relationship as when they are viewed in a cyclogram. A cyclogram would probably be of great help to a design engineer in judging the performance of new circuits and the effects of design changes.

## CHAPTER 4

### Synchronization

Synchronization can be defined as the timing of two or more events so that they will occur simultaneously or in step with each other. As applied to oscilloscopes, such timing would be between the signal to be viewed and the sweep system of the oscilloscope. In the majority of cases, the technician will be observing signal that has some regularly recurring peak or dip in its amplitude. In other words, it is made up of cycles that repeat regularly and can therefore be synchronized with the trace of the oscilloscope as the trace sweeps across the oscilloscope screen.

When an oscilloscope has been properly synchronized with a signal, this signal will appear to be stationary on the screen, and one or more cycles of the signal can be seen. If the oscilloscope is slightly out of synchronization, the waveform will appear to move slowly across the screen, either to the right or to the left.

The waveform can be made to "stand still" even without a sync signal if the operator carefully adjusts the fine frequency control. It will not remain stationary very long, though, because of the tendency of the sweep oscillator to wander in frequency. The situation is quite similar to that of a TV receiver which has lost the sync signal: The receiver operator varies the frequency of the sweep oscillator by adjusting the hold control, and when the oscillator frequency agrees with the sweep frequency of the TV signal, the picture is held stationary on the screen, but only as long as the operator is willing to keep adjusting the hold control.

Certain types of signal will be more difficult to synchronize than others. These include signals having little information of a recurring or repeating nature and signals having few pronounced peaks or dips. As the frequencies of both the signal being viewed and the oscilloscope sweep are increased, synchronization also becomes more difficult. The reason for these difficulties will become more apparent later when we consider the process of synchronization.

If a signal does not cycle or repeat at regular intervals, it can still be viewed on certain laboratory-type oscilloscopes. These oscilloscopes use a system whereby the signal is made to initiate or trigger the sweep, which is a "one-shot" or nonrepeating sweep. A cathode-ray tube of long persistence is used so that the waveform developed by the single sweep will not fade immediately, but will persist long enough to be useful to the operator.

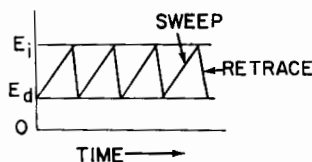
As was just mentioned, this type of sweep will normally be found on oscilloscopes of special or laboratory design only, but a modification of this sweep may be found in some general-purpose oscilloscopes and is called a "driven sweep".

The Hickok Model 640 is one oscilloscope providing a driven sweep. When this model is adjusted for the use of this feature, the beam will be at rest at the right-hand side of the screen until a signal is applied to the oscilloscope input. The applied signal triggers the sweep into operation. The retrace or movement of the beam from right to left occurs first, followed by the sweep of the beam from left to right at a constant rate determined by the settings of the sweep frequency controls.

### SYNCHRONIZATION OF THYRATRON SWEEPS

The preceding chapter mentioned the two types of sweep oscillator circuits most often used in present-day oscilloscopes, the thyatron and the multivibrator types. The thyatron sweep oscillator circuit will be used as the basis for an explanation of the way synchronization can be accomplished, and then comparisons can be made between the two systems.

Fig. 4-1 shows the sawtooth waveform developed by the thyatron oscillator. This is a graph of the voltage developed between the plate and the cathode of the thyatron tube, or between the plate and ground. The zero DC reference level is shown. The



**Fig. 4-1. Free-running operation of a thyatron sweep oscillator.**

$E_i$  = Ionization Potential.

$E_d$  = Deionization Potential.

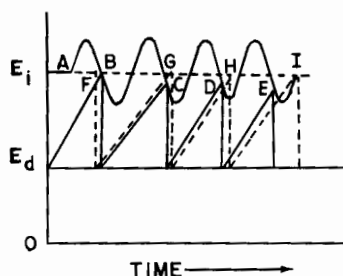
sweep oscillator in this case is shown as free running -- that is, no sync voltage is applied, and the sweep operates at a frequency determined by the time constants and the voltages present in the sweep circuits. It is also assumed that the oscillator has been operating for a short period so that the first cycle of operation does not appear in Fig. 4-1.

One cycle of operation consists of one sweep and one retrace. The plate potential of the thyatron rises from the deionization potential  $E_d$  until it reaches the ionization potential  $E_i$ . This rise in potential sweeps the beam across the screen of the cathode-ray tube. When the plate potential reaches the potential of  $E_i$ , the thyatron fires and discharges the capacitor in its plate circuit. The discharge is very abrupt and continues until the

deionization potential  $E_d$  is reached, at which point another cycle is started. The discharge period corresponds to the retrace period of the beam.

The ionization potential of the thyratron is governed by the voltage between its cathode and grid at any particular instant. If this voltage is constant (as it will be if there is no signal at the grid), the ionization potential will remain constant, as in Fig. 4-1. A change in grid bias (DC voltage between cathode and grid) will result in a new level of ionization potential for the thyratron. If the grid becomes more negative with respect to the cathode, the thyratron requires a higher plate potential in order to fire or conduct. A lower value of grid bias allows the thyratron to fire at a lower plate potential. If an AC signal is applied to the grid, it is superimposed on the DC grid bias and causes the ionization potential to vary in an AC manner at the same frequency as the signal. The variation will be of greater amplitude, and the phase will be reversed by 180 degrees as compared to the grid signal. This means that as the grid becomes more negative, the ionization potential becomes more positive.

To synchronize a sweep oscillator of this type, a sync signal is applied to the thyratron grid. The signal can be taken from some point in the vertical amplifiers of the oscilloscope, from a 60-cycle or 120-cycle source within the oscilloscope, or from some external source of the operator's choice.



**Fig. 4-2. Synchronization of a thyratron sweep generator by means of a sine-wave signal.**

In Fig. 4-2 we have used a sine-wave signal in order to simplify the explanation. The signal is assumed to be taken from a point in the vertical amplifiers and therefore is exactly like the signal to be viewed on the oscilloscope screen, except for amplitude.

Fig. 4-2 is not an actual waveform that could be obtained by connecting another oscilloscope at a certain point in the thyratron sweep generator, but a graphical representation of the action taking place when a sine-wave signal is applied to the thyratron grid. This AC signal at the grid results in a similar, but greater, variation of the ionization potential of the thyratron. This variation is shown as starting at A in Fig. 4-2 and has a 180-degree phase shift from the grid signal. It is of greater amplitude than the grid signal because of the grid-control characteristics of the thyratron.

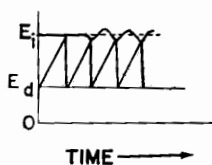


The dotted portion of the  $E_i$  line represents the ionization potential that would result if no sync signal were present, and the dotted sawtooth waveform represents the sweep signal that would be obtained under the same circumstances. In this case, the sweep oscillator would operate at its free-running or natural frequency, and the firing points for the thyatron would be at F, G, H, and I. For simplification the retrace is pictured as occurring instantaneously.

The progress of the synchronized sweep is shown by the continuous sawtooth line representing both the varying plate potential of the thyatron and the sweep voltage applied to the horizontal deflection system of the oscilloscope. The plate potential rises from  $E_d$  to point F, at which point the thyatron would normally fire if the sweep oscillator were free running; but the firing potential has been changed by application of a sync signal, and so the plate potential continues rising to point B. The thyatron fires at point B, retrace occurs, and the sweep repeats. This time the sweep reaches a firing point at C, and thereafter the sweep repeats at regular intervals, with firing points at D, E, and so on. The sweep and the incoming signal are in synchronization from point C on.

Several interesting observations can be made on the basis of the action shown in Fig. 4-2. The sawtooth waveform has been changed from the free-running frequency to the frequency of the applied sync signal. Its amplitude has also been changed somewhat. The free-running frequency was lower than the sync frequency. Synchronization is shown as taking place on the negative slope of the ionization curve.

Fig. 4-3 shows that it is possible to have synchronization take place on the positive slope of the ionization curve. Such



**Fig. 4-3. Synchronization on the positive slope of the ionization curve.**

synchronization would be very unstable and easily disturbed by a slight drift of frequency of either the sawtooth signal or the sync signal. It can easily be seen that, if the amplitude of the applied sync signal is increased much above that shown in Fig. 4-3, the sawtooth waveform will not strike the positive slope of the ionization curve at any point because it will then strike the negative slope first.

In Fig. 4-2, one cycle of sawtooth sweep has been synchronized with each cycle of the applied signal. Under these circumstances, one cycle of the applied signal will be displayed on the oscilloscope screen. If the sweep frequency controls are properly

adjusted to sweep frequencies lower than the input signal, the oscilloscope can be so synchronized that two or more cycles of signal can be viewed. As was previously mentioned, if the frequency ratio between signal and sweep becomes very high, synchronization becomes more difficult.

A number of diagrams could be drawn to show the effects of varying the amplitude and frequency of both waveforms shown in Fig. 4-2, but we will suggest only some of the possibilities, and the reader can verify them by either drawing diagrams or actually experimenting with an oscilloscope, if he is so inclined.

A few possibilities are:

1. With proper choice of the sweep frequency and amplitude of the sync signal, synchronization can be made to occur at any point on the negative slope of the deionization curve. This can be considered the useful range of synchronization.

2. The synchronization range is decreased as the amplitude of the sync signal is increased.

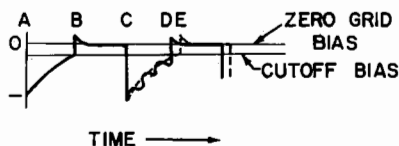
3. It is possible to have too much sync signal. This will be illustrated in a later paragraph.

4. Stable synchronization will not be easily obtained with this type of sweep oscillator if the natural sweep frequency is greater than the frequency of the applied signal.

### SYNCHRONIZATION OF MULTIVIBRATORS

Synchronization of multivibrator sweeps is similar in many respects to that of the thyratron sweep. A typical multivibrator circuit uses both sections of a twin triode with the signal from each plate coupled to the grid of the other section. Each section is alternately cut off while the other conducts. By proper choice

Fig. 4-4. Synchronization of a multivibrator sweep circuit.



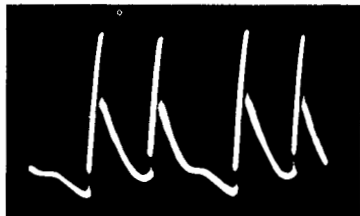
of circuit constants, an unbalanced multivibrator is obtained with one section remaining cut off for a much greater time than its conduction period. The nonconduction period is used as the charging time for a capacitor, thus developing a sweep voltage, and the short conduction period is used to discharge the capacitor, thus developing the retrace. A synchronizing signal can be used to influence the time at which the sweep section changes to a conductive or nonconductive state. Such a signal is usually introduced at the grid of one of the sections.

The waveforms obtained at various points in a typical multivibrator circuit can be found in many textbooks. Fig. 4-4 shows

one such waveform, the waveform developed at the grid of one section of a balanced multivibrator. That is, it is one in which the conduction and nonconduction periods of the sections are equal. At time A the tube section is cut off by a comparatively large negative bias on its grid. Between times A and B the RC networks affecting the section gradually lose their negative charge, and the grid bias rises in a positive direction until it reaches the cutoff value at B, where the tube section suddenly changes to a conductive state and remains so until time C. At time C we have shown how a sync signal introduced at the grid will affect the conduction point on the next cycle. Synchronization is therefore obtained in a manner somewhat similar to that in the example of the thyatron sweep oscillator.

### OVERSYNCHRONIZATION

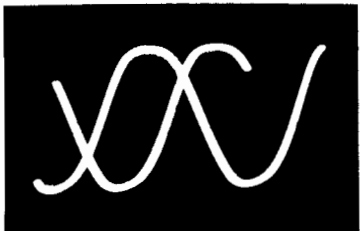
Both types of sweep oscillators are subject to oversynchronization if too much sync signal is applied, and the effects on the resulting waveforms are similar. Fig. 4-5A and B show actual



(A) Signal at the plate of first section.



(B) Sawtooth signal developed at second section.



(C) Waveform seen on oscilloscope screen.

**Fig. 4-5. Oversynchronization of a multivibrator sweep circuit.**

waveforms photographed at points in a multivibrator sweep circuit of an oscilloscope. Fig. 4-5A shows the signal obtained at the plate of the first section, and Fig. 4-5B, the signal at the output of the discharge section. Fig. 4-5C illustrates the waveform actually displayed on the screen of the oscilloscope. Fig. 4-5A shows that one cycle of sweep contains parts of three cycles of sine-wave signal and that the other cycle of sweep contains parts of two cycles of signal. Fig. 4-5B depicts that the sweeps travel

at a constant rate, but that alternate cycles are of different lengths. Each cycle of sweep and retrace can be seen to correspond to certain portions of the waveform of Fig. 4-5C.

If oversynchronization is carried to extremes, the sawtooth waveform of Fig. 4-5B may even degenerate into one large cycle followed by two or three very small ones. In such a case the waveform on the screen would also be greatly distorted. Some manufacturers have designed circuits to lessen or eliminate the possibility of oversynchronization. One method is to use a limiter stage ahead of the point of injection of the sync signal. An oscilloscope using this method is the Precision Model ES 550. In oscilloscopes that do not have provision for limiting oversynchronization effects, it is sometimes found that a change in the vertical amplitude setting will affect the sweep operation, causing the waveform to fall either into or out of sync. These are usually cases where the sync take-off point follows the vertical amplitude control. Therefore, when the vertical amplitude is changed, the amplitude of the sync signal changes with it, with the result that synchronization may be affected.

For simplicity the sync signals shown in the preceding examples have been sine-wave signals. In cases where the sync signal is taken as a part of the signal in the vertical amplifiers of the oscilloscope, it can take on any form, depending upon the waveform being viewed. Generally, stable synchronization will be more easily attained with signals of a peaked or sharply pulsed nature rather than with those of a more even nature. Sometimes a signal may have more peaks at its negative extreme than at its positive extreme or vice versa. A sync polarity-reversal switch on the oscilloscope may help the operator obtain stable synchronization in these cases. If such a switch is not included, the same effect can sometimes be obtained if the signal to be observed is taken from a point having a signal 180 degrees out of phase with respect to the signal at the first point. The signals between two successive stages in an amplifier usually have this phase reversal.

#### HINTS FOR SYNCHRONIZATION

Synchronization is an important step in the operation of an oscilloscope and is one of the steps likely to give the technician some trouble. Let us summarize some of the points brought up in the preceding paragraphs by offering the following hints for synchronization:

1. Set the sync amplitude control to zero or nearly zero.
2. Adjust the sweep frequency controls so that the free-running frequency of the sweep is a little lower than the frequency of the incoming signal or a little lower than some submultiple of this frequency, if more than one cycle is to be viewed.
3. Advance the sync amplitude control until the waveform is steady on the screen. Do not use more sync signal than is necessary.

4. Use the correct sync polarity. If stable synchronization is still difficult to obtain, the following step may help.

5. Use the external sync feature of the oscilloscope and apply a sync signal taken from a point in the circuit where a stronger signal can be found. This method works especially well when weak horizontal sweep signals are being viewed in a TV receiver. A lead placed close to the horizontal section of the deflection yoke will pick up enough sync signal for good synchronization.

## CHAPTER 5

# Amplifiers

Practically all modern oscilloscopes contain amplifiers to increase the signal amplitude before they are applied to the vertical or horizontal deflection plates of the cathode-ray tube. These same oscilloscopes will usually have provision for making direct connection to the deflection plates without benefit of the amplifiers; however, a signal of comparatively high amplitude is required to obtain a useful deflection when making a direct connection to the deflection plates. Amplifiers must therefore be used if low-amplitude signals are to be observed.

For example, one model of oscilloscope is quoted as having a deflection sensitivity of 15 volts rms per inch at the vertical deflection plates. This means a 15-volt rms signal applied to the plates will produce a waveform one inch high. Another model is quoted as having deflection sensitivities of 13 and 17 volts rms per inch, respectively, for the vertical and horizontal deflection plates. The service technician will, in most cases, be dealing with signals having amplitudes much lower than these values. A 15-millivolt signal in the first example would produce a deflection of 1/1,000 inch, certainly of no use to the technician. An amplifier with a voltage gain of 1,000 will bring the deflection up to 1 inch — a usable deflection, though perhaps not ideal.

A direct connection to the deflection plates may prove advantageous in certain cases even though a comparatively large signal is required. When the oscilloscope is used to make exacting phase comparisons, direct connection to both sets of deflection plates will avoid phase distortion that might otherwise be caused by phase differences between the horizontal and vertical amplifiers. The frequency response will also be improved by direct connections if the response of the oscilloscope amplifiers extends a few hundred kilocycles only.

The foregoing paragraphs naturally lead to a consideration of two important characteristics of an oscilloscope, the sensitivity and the frequency response of its amplifiers. The service technician is concerned with these two characteristics because they define to a great extent the limits of the usefulness of an oscilloscope. The sensitivity determines the minimum amount of signal and the frequency response determines the range of frequencies that can be viewed on the oscilloscope. Using a detector probe

will indirectly extend the useful range of the oscilloscope to higher frequencies.

At present, general-purpose oscilloscopes having vertical sensitivities of 10, 15, or 20 millivolts rms per inch are on the market. A number of such oscilloscopes also have a frequency response usable up to 4.5 megacycles and beyond. The sensitivity of an amplifier can be increased by adding a number of stages, but when this increase in sensitivity must also be accompanied by a wide-band response, the design of such an amplifier becomes more difficult. Most oscilloscopes presently incorporate wide-band, push-pull amplifiers.

The wide-band response for these amplifiers is accomplished in much the same manner as that of the video amplifier in a TV receiver — by means of series and shunt peaking, plate loads of low value, and (in some cases) feedback circuits. Often, portions of these circuits are controlled by a switch on the front or rear panel so that the operator can choose between operation at narrow bandwidth with high sensitivity and operation at wide bandwidth with medium sensitivity.

### HIGH-FREQUENCY RESPONSE

Fig. 5-1 shows an example of the use of series and shunt peaking circuits to extend the high-frequency response of the vertical amplifier of an oscilloscope. A small portion of the circuit diagram of the Jackson Model CRO-2 oscilloscope is shown. V2 and V3 with their associated components form two push-pull stages of the vertical amplifier. L2 through L9 are peaking coils. L3 and L4 are shunted by resistors R10 and R11 in order to lower their Q factor and broaden their response characteristics. The switch sections labeled S1-B and S1-C are part of the vertical input control of the oscilloscope. With the switch in any of the first three positions, starting at the extreme counterclockwise position, the amplifier is set for wideband operation. The other three positions are for narrow-band operation.

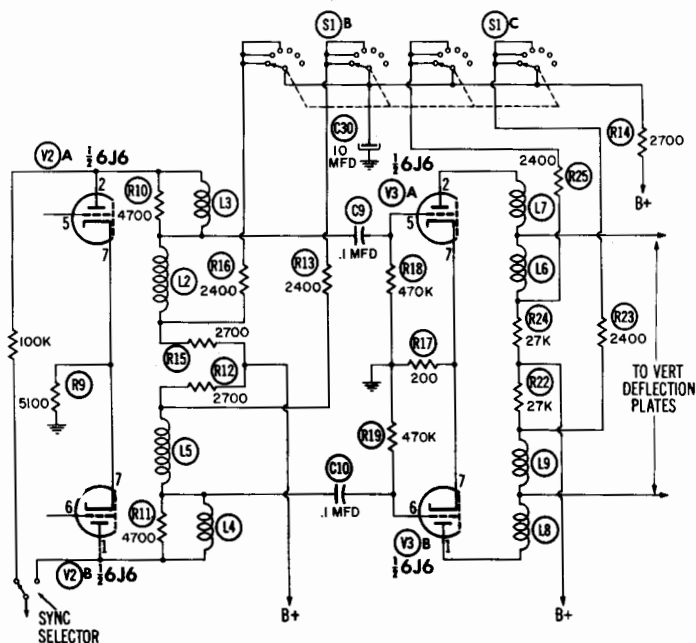
A different method of extending the high-frequency response is shown in Fig. 5-2, a partial schematic of the Hickok Model 770 oscilloscope. A portion of the vertical amplifier is shown. Trimmers C149, C150, C151, and C152 are used as neutralizers. They reduce the effective input capacitances of V110 and V112, and since these input capacitances shunt the higher frequencies to ground, any reduction in their value helps to increase the amplification at higher frequencies.

Further emphasis of the higher frequencies is achieved in the cathode circuits of V110 and V112. With the vertical bandwidth switch in the position shown in Fig. 5-2, C153 and C155 are shorted, and a degenerative signal is developed across the cathode resistors at all frequencies. With the switch open, the higher frequencies are bypassed more than the lower frequencies; therefore,

less degeneration takes place at the higher frequencies. The result is an extension of the amplifier response at the high end.

### LOW-FREQUENCY RESPONSE

Good response to low frequencies is equally important if accurate representation of waveforms is to be obtained. The low-



**Fig. 5-1. Partial schematic diagram of the vertical amplifier of the Jackson Model CRO-2 oscilloscope.**

frequency response of an amplifier depends largely on the size of the filter, bypass, and coupling capacitors. Generally, the larger the value of these capacitors, the better the response to low frequencies. The response can be extended to zero frequency (DC) by using direct-coupled amplifiers like the ones shown in Fig. 5-2.

The usual practice is to design the vertical amplifier to have as wide a frequency range and as great a sensitivity as economically feasible; however, most of the time the horizontal amplifier will be used to amplify the sawtooth signal from the sweep generator of the oscilloscope. Normally, this signal is larger than the signal applied to the vertical amplifier, and its frequency range is usually less; therefore, the horizontal amplifier of an oscilloscope will commonly be designed to have less sensitivity and a narrower frequency response than the vertical amplifier, although in some models they may be identical.



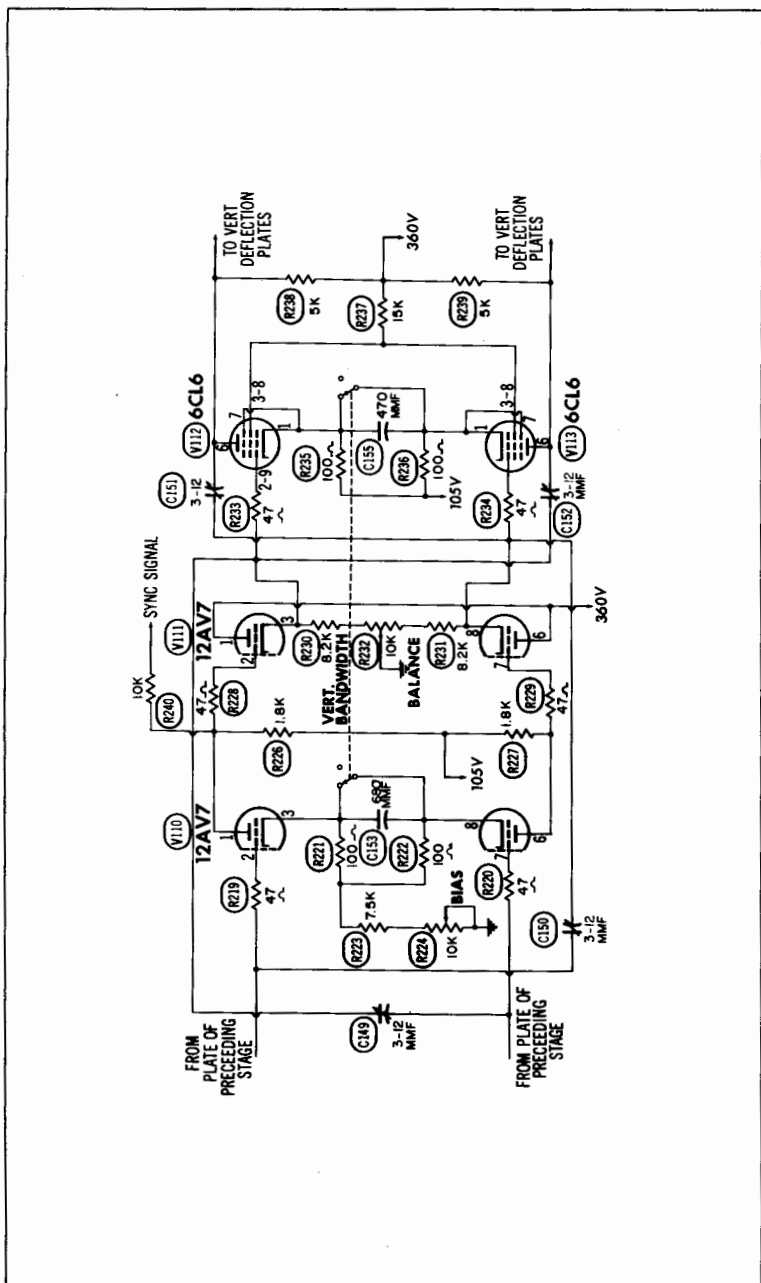


Fig. 5-2. Partial schematic diagram of the vertical amplifier of the Hickok Model 770 oscilloscope.

## DC AMPLIFIERS

An increasing number of oscilloscope designs include DC amplification for one or both deflection amplifiers. If only one amplifier is DC, it will usually be the vertical since this choice will benefit the user more.

Among the advantages offered by DC amplification are minimum phase shift and the extension of the low-frequency response to zero frequency (DC). A few examples will be given of uses of DC oscilloscopes in servicing TV receivers.

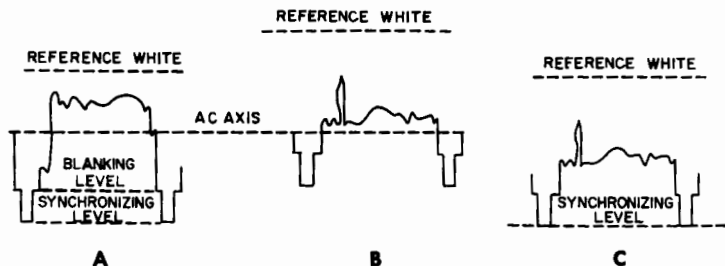


Fig. 5-3. Video signals at the picture tube; viewed on oscilloscope having DC amplifiers.

Generally, the DC amplifier will be useful when viewing an AC waveform superimposed upon a DC component. DC voltages alone can also be indicated, but these are usually more conveniently measured with the conventional voltmeter. TV circuits where the technician might find the DC amplifier particularly useful for spotting improper operation are the AGC returns, direct-coupled video amplifiers, sync circuits, and DC restorers.

As an example, assume that a service technician wishes to check the operation of a DC restorer. The DC-amplifier input of the scope is connected to the restorer output, and the video signal being applied to the picture tube is observed. This signal might appear as in Fig. 5-3A. The scope is synchronized to show two horizontal sync pulses with video information appearing between them. When such a varying signal is passed through an amplifier that is AC coupled only, the signal tends to align itself about the AC axis, and equal areas of the waveform appear above and below the axis.

Fig. 5-3A represents a signal containing information of a predominantly high brightness level; when the transmitted signal shifts to representing darker objects or lower brightness levels, it appears as in Figs. 5-3B and 5-3C. Fig. 5-3B shows that with an AC-coupled amplifier the signal averages itself about the AC axis, and the picture information assumes a position representing a brightness higher than the true level of the scene. A properly functioning DC restorer would restore the sync tips to the level

shown in Fig. 5-3A, and along with them the picture information would assume its true level. See Fig. 5-3C. Therefore, to check for proper operation of the DC restorer, it is only necessary to connect the DC amplifier of the scope to the modulated element of the picture tube and observe the level of the sync tips as the transmitted scene changes from light to dark. For proper operation, the sync level should remain unchanged. A large percentage of present-day monochrome TV receivers do not employ the DC restorer, but the technician will find it in some of the earlier color TV receivers; consequently, the aforementioned application of the DC amplifier in an oscilloscope may prove useful.

Another point of application for the DC amplifier might be at the video detector of a receiver. A great many receivers have the video detector coupled directly to the grid of the first video-amplifier stage, and the instantaneous grid voltage produced by the video signal with respect to the cathode of the video amplifier is important when troubleshooting such stages for overloading or improper operation. A DC scope applied to these stages will aid in localizing such troubles.

For proper operation, sync-separator circuits are also critical with respect to the magnitude of signal. Too large a signal can easily result in unwanted video information being passed along with the desired sync signals. The DC scope will again prove useful in determining the instantaneous voltages of a signal at various points.

The excellent low-frequency response of the DC amplifier is valuable in audio applications such as checking audio-amplifier response or the quality of the square-wave signal so often used in audio testing. Lack of phase shift at low frequencies allows the audio technician to determine that any square-wave tilt observed is due to the audio amplifier rather than to the square-wave source or scope amplifiers.

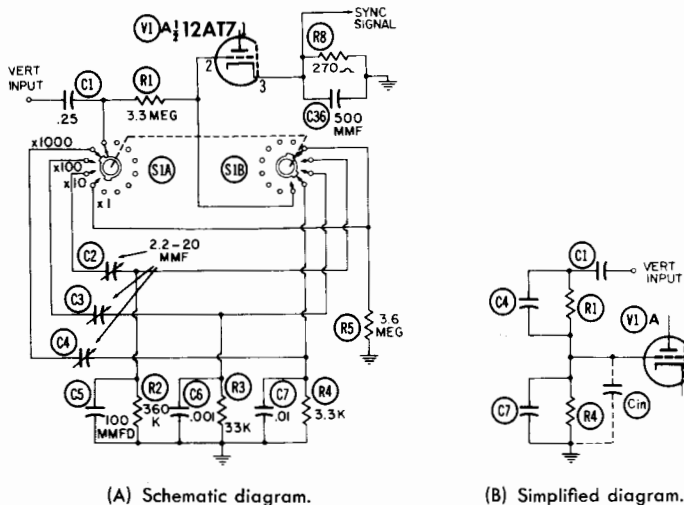
### **PUSH-PULL AMPLIFIERS**

As was mentioned, most present-day oscilloscopes incorporate push-pull amplifiers. If the amplifiers do not have push-pull operation for all stages, at least the stages driving the deflection plates will have such operation. The advantages of this type of operation in oscilloscopes are similar to those obtained from push-pull operation in other applications: better hum cancellation, reduction of second harmonic distortion, and greater signal drive for the same supply voltage. In addition, the number of defocusing and trapezoidal effects are reduced because one plate of each pair of deflection plates is at ground potential, as it is with single-ended operation.

### **ATTENUATORS**

Since voltage amplifications as high as 1,000 times are applied to the weakest signal being viewed, some means must be

provided to prevent overloading when stronger signals are being viewed. In most cases, two attenuators will be used for this purpose — one a continuously-variable signal control and the other a switching arrangement attenuating the signal in units of ten. The switch is placed at the amplifier input, and the variable control is



**Fig. 5-4. The frequency-compensated vertical attenuator of the Simpson Model 458 Colorscope.**

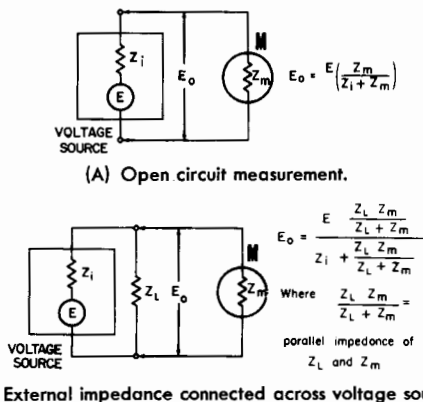
usually separated from it by at least one amplifier stage. The operator should keep in mind that, with this arrangement, it is possible to overload the first amplifier stage and thus get a distorted response curve even though the vernier control is set for minimum response; consequently, a strong signal should be reduced by the attenuator at the amplifier input, and minor adjustments should then be made with this control.

The step attenuator for the vertical amplifier of the Simpson Model 458 Colorscope is shown schematically in Fig. 5-4A. In Fig. 5-4B the switch has been eliminated and only the active components for a single switch position are shown. R1 and R4 in series form a voltage divider, and only about 1/1,000 of the vertical-input signal is applied to the grid of V1A. C4 is a trimmer providing frequency compensation for the applied signals. If a simple divider consisting only of R1 and R4 were used, the input capacitance  $C_{in}$  of V1A would bypass the higher frequencies more than it would the lower frequencies; consequently, the signal amplification applied to the vertical input would be reduced at the higher frequencies. To compensate for this effect, C4 is added. When the product of  $R1 \times C4$  equals the product of  $R4 \times C_{in}$ , the voltage division is independent of frequency.

Note that the values of R2, R3, and R4 in Fig. 5-4A have been chosen to give an attenuation of 10 to 1, 100 to 1, and 1000 to 1 when used with R1. Note also that as R2, R3, and R4 decrease by a factor of 10, C5, C6, and C7 increase by the same factor to maintain a constant RC product. Theoretically, it should be possible to design an attenuator circuit without the use of C5, C6, and C7, with  $C_{in}$  serving in their stead. Then, since  $C_{in}$  does not change, there would be a different time constant for each attenuator position, R2  $C_{in}$  being 10 times R3  $C_{in}$  and 100 times R4  $C_{in}$ . To match these time constants, C2 would be adjusted to 1/10  $C_{in}$ , C3 to 1/100  $C_{in}$ , and C4 to 1/1,000  $C_{in}$ . Now, if we assume a value of 10 mmf for  $C_{in}$  (2.2 mmf for a 12AT7 tube plus stray capacities) the values of the adjusted trimmers would be 1 mmf, .1 mmf, and .01 mmf, respectively. These values are perfectly all right in theory, but not very practical. When C5, C6, and C7 are added, the adjusted trimmers for the circuit of Fig. 5-4A should have a calculated value of about 10 mmf each, a value within practical limits.

### INPUT IMPEDANCE

We have mentioned that the oscilloscope has a relatively high input impedance and that this property is desirable in a volt-



**Fig. 5-5. Diagram illustrating importance of using high impedance equipment when measuring across high-impedance circuits.**

age measuring instrument. Fig. 5-5 shows how more accurate results are obtained if high-impedance equipment is used to measure high-impedance circuits. An open-circuit voltage measurement is one of the simplest to make and is pictured at A of Fig. 5-5. The voltage source is represented by a voltage, E, in series with the internal impedance,  $Z_i$ . The measuring device, M, can be either a voltmeter or an oscilloscope. Now, a peculiar situation arises; once M has been connected to the voltage source, there

is no longer an open circuit. How then can the open-circuit voltage be measured in this manner? The answer is that as the impedance,  $Z_m$ , of the measuring device approaches infinity, the closed circuit comes closer and closer to open circuit conditions, and the measured voltage approaches the exact value of the source voltage,  $E$ . The voltage,  $E_o$ , across  $Z_m$  can be found by the following formula:

$$E_o = E \left( \frac{Z_m}{Z_i + Z_m} \right)$$

This formula shows that as  $Z_m$  becomes greater and greater,  $E_o$  approaches  $E$  in value. Of course, if  $Z_i$  is a very small value,  $Z_m$  does not have to be very large in absolute value to be relatively large compared to  $Z_i$ . In other words, when low-impedance circuits are to be measured, a very high impedance instrument is not necessary, although it can do no harm to use one if available.

If conditions are reversed and  $Z_i$  is large compared to  $Z_m$ , more voltage will be dropped across  $Z_i$ , and the voltage reading  $E_o$  will be lower than the actual open-circuit voltage.

In most cases there will be some external impedance connected to the voltage source, as at B of Fig. 5-5, and the voltage across this impedance is the one to be measured.  $Z_m$  should be large compared to  $Z_L$  to avoid any change in voltage across  $Z_L$  as M is connected. The two impedances  $Z_L$  and  $Z_m$  will be in parallel, and their total value will be less than the smaller of the two. Therefore, more voltage will be dropped across  $Z_i$ , causing an error in the voltage measured across  $Z_L$ .

The ideal input circuit for an oscilloscope would exhibit infinite resistance and no capacitance across the input terminals. In actual practice, of course, this condition can only be approached. Most general-purpose scopes have impedance ratings ranging from 1 to 5 megohms, with 25- to 50-mmF capacitance across the input. These ratings show that the impedance term usually found in a manufacturer's specifications will be expressed in series resistance and parallel capacitance. The AC input of an oscilloscope will usually have a large value DC-blocking capacitor in series with the circuit; however, this component can be ignored because of its relatively low reactance, even at the lowest frequencies observed.

#### OTHER FEATURES OF AMPLIFIERS

We should give some attention to the take-off point for the sync signal. If this signal is to be obtained from within the vertical amplifier circuit, several points could be used. The one shown in Fig. 5-4A will give a minimum amount of loading on the vertical amplifiers because it is a point of low impedance. This point is

also ahead of the vernier control, and adjustment of the vernier control to obtain a larger or smaller response will not upset the synchronization. Since the take-off point is at the front end of the amplifier, no amplification is obtained. Some oscilloscopes might require amplification of the sync signal before the signal is applied to the sweep generator.

When a choice of polarity of the sync signal is offered, the desired polarity is sometimes obtained by means of a double-throw switch. A potentiometer of a suitable value is often bridged across two points having opposite polarities, and the position of the slider will control both the polarity and the amplitude of the sync signal.

Some oscilloscopes have provision for an inversion of the response curve on the screen. This is useful to those operators who like to compare a response curve directly with that pictured in a manual or service chart. Such inversion can be easily accomplished with push-pull amplifiers if double-pole, double-throw switches are used in the output to the vertical deflection plates. If the operator is interested in whether a positive signal will give an upward or a downward deflection of the trace, he can check this by touching the input cable first to a ground point and then to a point of known polarity. If the oscilloscope has DC amplifiers, the trace will move in one direction and will stay there. If an AC amplifier is being used, the trace will jump momentarily in the direction of deflection for that polarity and then return to its original position.

### **EXPANDED SWEEPS**

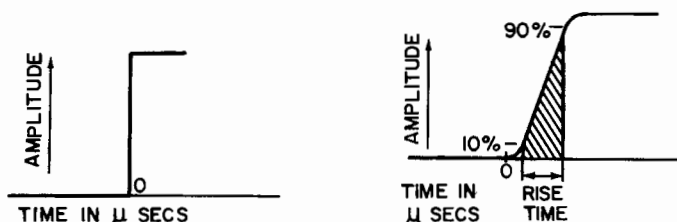
The gain of the horizontal amplifier and the amplitude of the sawtooth signal in most modern oscilloscopes are such that the horizontal sweep can be expanded considerably. By merely adjusting the horizontal gain control, the operator can obtain a sweep 10 times or more the width of the oscilloscope screen. In this manner, small portions of a response curve can be examined in detail.

Some oscilloscopes incorporate a special circuit for obtaining a greater expansion than the horizontal amplifier affords in normal operation. The Jackson Model CRO-2 is an example. If this model is operated in the expanded sweep position, a greater portion of the sawtooth signal developed by the sweep oscillator is fed to the horizontal amplifier. The horizontal amplifier is overdriven by this signal, but the middle portion of the sweep is linear and is greatly expanded. The linear portion of the sweep can be shifted by means of a control that varies the bias on the horizontal amplifier stage to which the sawtooth signal is applied.

### **RISE TIME—WRITING SPEED**

Manufacturers use a number of terms to describe the performance of their oscilloscopes; some of these are well known

because of common usage, while others are lesser known and might need some explanation. Rise time is a term that has been used sparingly in the past, but seen more frequently now. It refers to the time it takes the oscilloscope amplifiers to respond to a signal that changes instantaneously from zero to its final value. At one instant no signal is applied to the amplifier, and, of course, no output is obtained. At the next instant the full amplitude of signal is applied, but it takes a definite interval of time for the amplifier output to rise to a final value. This interval, minus 10% at the beginning and 10% at the end, is the rise time of the amplifier. A diagram illustrating rise time is shown in Fig. 5-6.



**Fig. 5-6. Diagram illustrating rise time.**

Rise time is usually quoted in microseconds, and as a figure of merit the smaller values of rise time will generally indicate better performance in an oscilloscope. Short rise time shows up in the scope's ability to reproduce faithfully a waveform having steep leading edges. This requires a good response to high frequencies.

One manufacturer gives the following formula for calculating the high-frequency response necessary to reproduce satisfactorily a wavefront of given rise time.

$$f = \frac{.36}{t}$$

where,

$f$  = frequency,

$t$  = rise time in microseconds.

Suppose the rise time of an oscilloscope's vertical amplifier is one microsecond. Substituting this value for  $t$  in the formula gives a high-frequency response value of 360 kilocycles.

Writing speed can be subdivided into three classifications: beam writing speed, photographic writing speed, and sweep writing speed. Beam writing speed refers to the linear speed of the beam as it travels across the face of the cathode-ray tube, regardless



of direction. Thus, the beam writing speed would be greater with a vertical signal applied than without because, in addition to horizontal movement due to sweep-circuit voltage, vertical movement has been added by the signal, but with no increase in time for a sweep cycle. For the same reason, beam writing speed would be increased if the sweep amplitude were increased by means of the horizontal gain control. Any increase in beam speed is usually accompanied by a decrease in the trace intensity unless some attempt to counteract this effect is made.

Photographic writing speed is of interest mainly to determine the limits for making photographs of waveforms. These limits depend upon a number of factors such as film emulsion speed, lens aperture, tube phosphor, and accelerating voltage. The term photographic writing speed is seldom encountered in service literature and will not be given further mention here.

Sweep writing speed refers to the speed of the beam in a horizontal direction due to sweep voltage applied to the horizontal amplifier. This speed increases with increased sweep frequency and horizontal gain. Therefore, maximum sweep writing speed will be obtained when the sweep frequency and the horizontal gain controls are at their highest setting.

Writing speeds are usually stated in inches per microsecond or sometimes in reverse order, microseconds per inch. For example, one manufacturer states that his oscilloscope has a maximum usable writing rate of 0.03 second per inch to 0.3 microsecond per inch, and another quotes a maximum speed of 1 inch per microsecond for the triggered sweep of his oscilloscope. This information can be useful to evaluate possible scope performance in the following manner. Suppose you consider buying an oscilloscope with a maximum writing speed of 4 inches per microsecond. This tells you that if you can synchronize a 1-mc signal at the maximum sweep rate, one cycle of this signal will be spread across 4 inches of screen. At the same rate, one cycle of the 3.58-mc color burst would cover a little more than 1 inch of screen; a horizontal sync pulse of 5-microsecond duration would be expanded to an equivalent of 20 inches of screen, and so on. In many cases it is desirable to expand a response curve as much as possible in order that fine detail on the curve can be seen. This is especially true when the operator must view a large number of cycles of a particular signal having a frequency much higher than that of the sweep.

## CHAPTER 6

### Special Features

At various points throughout this book, we use the concept of the basic general-purpose oscilloscope. Such an oscilloscope would include the cathode-ray tube; high- and low-voltage supplies; intensity, focus, and positioning controls; a horizontal sweep system with frequency controls; provision for synchronization; horizontal and vertical amplifiers; and some provision for controlling the amplitude of the horizontal and vertical signals.

An oscilloscope limited to these features is seldom seen. Usually, a number of other features are added to increase the usefulness and efficiency of the instrument. Some of these have already been discussed but are included in the following list, along with others that may not have been mentioned before. Some oscilloscopes may contain a majority of the features listed, although it is probable that no single oscilloscope will contain them all.

1. Expanded sweep.
2. Driven sweep.
3. Slow-speed sweep.
4. Line-frequency sweep.
5. Fixed-frequency sweeps for viewing signals with 60-cycle and 15, 750-cycle rates.
6. Sync at line frequency and at two times line frequency.
7. Input for external sync signals.
8. Automatic sync-level control.
9. Voltage-calibration circuit.
10. RF detector circuit.
11. Polarity reversal of vertical deflection.
12. Positive or negative sync signal.
13. Intensity modulation.
14. Sawtooth output signal.
15. Retrace blanking.
16. Phasing control of line-frequency sweeps.

Expanded sweeps and driven sweeps have been discussed in preceding chapters. Slow-speed sweep is provided on some oscilloscopes by a front-panel jack connected to the frequency-determining network inside the scope. To use this feature, the operator sets the sweep frequency switch to the proper position

and connects a large value of capacitance from the front-panel jack to ground, thus lowering the frequency of the sweep oscillator. A good quality capacitor should be used because any leakage would tend to raise the sweep frequency. This is contrary to the effect of the capacitance, and if the leakage is sufficiently great, the net result may be a sweep rate actually higher than before the capacitor was added.

### FIXED AND LINE FREQUENCY SWEEPS

Sweeps at line frequency and at the horizontal and vertical rates of a TV receiver are commonly used by the technician. The line-frequency sweep is obtained by feeding a signal to the horizontal amplifier, taken from some winding on the power transformer. Therefore, it is not a sawtooth but a sine-wave sweep. It can be used with an RF sweep generator to develop a response curve of a receiver, provided the oscilloscope also has a phasing control (item 16 in preceding list). If this latter feature is omitted from the oscilloscope, the operator should use the synchronized sweep signal from the RF generator to develop the oscilloscope sweep or else be prepared to accept a double response curve and some probable waveform distortion.

Item 5 refers to features obtained by special positions of the sweep frequency switch. These positions are usually marked V and H TV, or in some similar manner, and sweep rates of 30 and 7,875 cycles per second, respectively, are produced when these positions are used. A display of two cycles of signal at the TV vertical or horizontal sweep rate is obtained in this manner, with minimum adjustment of the sweep frequency controls.

### SYNCHRONIZATION REFINEMENTS

Items 6, 7, and 8 are useful in obtaining stable synchronization under trying circumstances. As an example of how these features can be used, let us suppose the technician wishes to view the video signal in a TV receiver as it occurs between two vertical sync pulses, but some fault in the receiver has attenuated the vertical sync pulses at the point where the oscilloscope is connected. If the sync control of the oscilloscope is set to INT (internal) position, synchronization may be difficult to obtain because the sync signal is taken from the signal being viewed, and the necessary vertical sync pulses have been attenuated or are missing from the signal at this point in the receiver circuit. If the sync control is set at the LINE position, sync signals of the proper amplitude and frequency are automatically provided from a point within the oscilloscope.

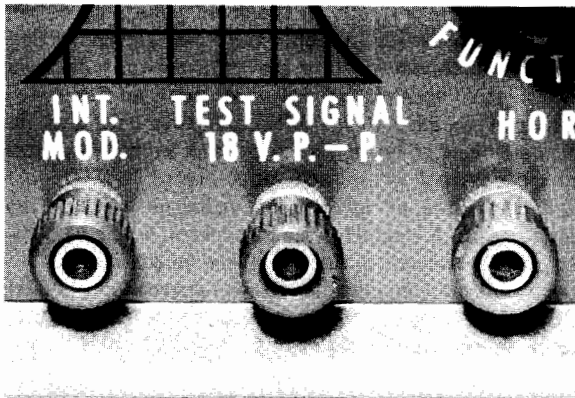
If trouble is encountered with a signal that does not recur at line frequency or some multiple thereof, the sync control can be set to EXT (external) position and the sync signal can be taken

from some point in the receiver circuit where a more definite pulse is obtained.

With regard to item 8, it was mentioned earlier that either too strong or too weak a sync signal results in poor synchronization; therefore, a feature automatically providing the correct level of sync signal will do much toward simplifying the synchronization problem. A limiting stage somewhere in the sync circuit will give a constant-level sync signal, although the vertical signal level may vary considerably at the same time. This feature is provided in some oscilloscopes by the manufacturer.

### VOLTAGE CALIBRATION

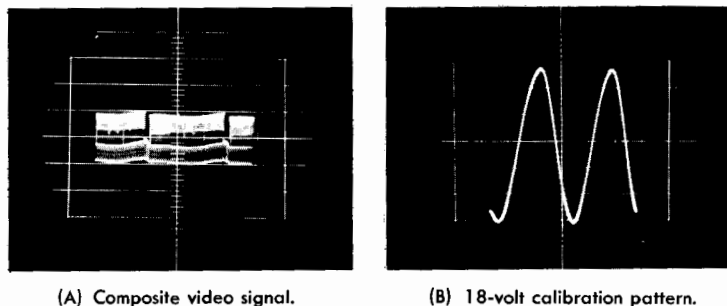
Voltage-calibration circuits (item 9) enable the operator to measure the amplitude of the signals shown on the oscilloscope screen. This is one of the more important features the instrument can have, since it is primarily a voltage-measuring device. Not only the over-all or peak-to-peak voltage of a waveform can be measured, but any detail on the waveform can be compared to other details or to the maximum voltage. This is done by first noting the amount of deflection obtained for a known voltage and comparing it with the deflection obtained for an unknown voltage. One of the simplest provisions for measuring voltages with a scope



**Fig. 6-1. Source of calibration voltage located on front panel of oscilloscope.**

is to connect a jack on the front panel to some point of known voltage inside the scope case. A 6.3-VAC filament winding will provide a sine-wave signal of approximately 18 volts peak to peak. If this voltage is connected to the front panel jack, it is then available for connection to the vertical input for comparison to some

voltage to be measured. This is the type of calibration provision shown in Fig. 6-1. Fig. 6-2 shows how it can be used to measure the peak-to-peak amplitude of a composite video signal. The 18-volt calibration signal occupies a vertical span of six horizontal lines, whereas the composite video signal occupies two lines or



**Fig. 6-2. Photographs taken directly from the screen of a typical service scope.**

1/3 of 18 volts. Therefore, the peak-to-peak voltage of the video signal is 6 volts. If necessary, finer divisions of the calibration grid can be used for more accurate results. Rather than have the calibration voltage terminate on the front panel, some scopes use a switching arrangement to apply the test signal to the vertical system. The switch controlling the calibration voltage will often be found as part of another adjustment, such as the sync selector switch pictured in Fig. 6-3. With the switch of Fig. 6-3 in the calibrate position, a 10-volt, peak-to-peak signal is automatically applied to the vertical attenuator input circuit.

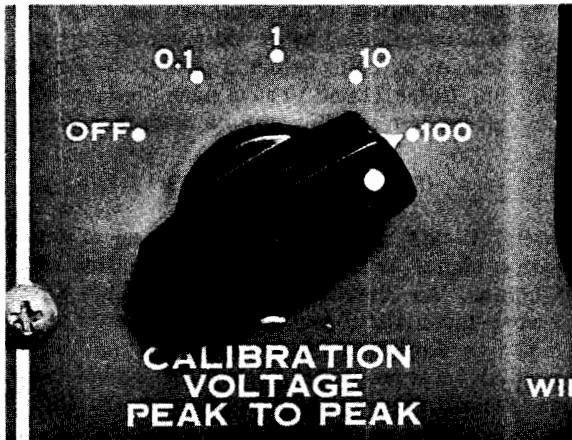
When a number of calibrating voltages are available, they are usually allotted a separate panel control, as in Fig. 6-4, where a choice of four voltages in decade steps is provided.

An example of a somewhat more elaborate method of internal scope calibration is where the instrument incorporates a peak-to-peak reading voltmeter. A front panel view of such an instrument is shown in Fig. 6-5. The vertical attenuator in this example has two calibration positions, 3 and 10 volts, corresponding to two scales on the meter. With the vertical attenuator in either of these two positions, the calibrating voltage knob selects any voltage from 0 to 3, or 0 to 10 volts, and the selected voltage is indicated by the meter pointer. At the same time, a sinusoidal waveform is shown on the screen with an amplitude corresponding to the selected voltage. The final amplitude of the waveform also depends upon the setting of the vertical gain control. When the calibration waveform is compared with a waveform to be measured, the position of the vertical attenuator must be considered. Thus, if a 3-volt calibrating waveform is adjusted with the vertical gain con-

trol for a vertical deflection of two inches and the deflection from an unknown voltage is also two inches when the vertical attenuator is set at position 10, the unknown voltage would be  $10 \times 5$ , or 50 volts. Thus it can be seen that this particular instrument offers a calibration range from 0 to 1000 peak-to-peak volts.



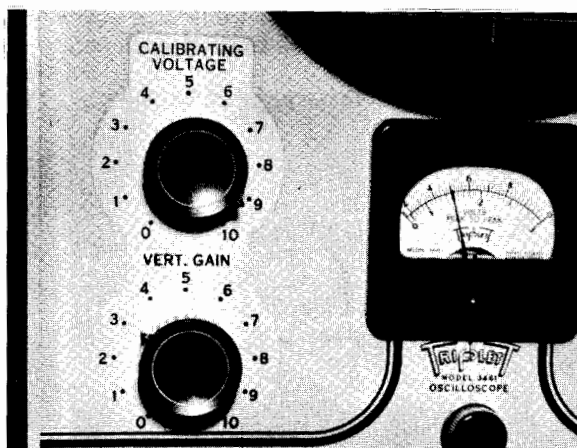
**Fig. 6-3.** Sync selector includes CAL position for internal calibrating voltage.



**Fig. 6-4.** This scope permits the use of four different calibrating voltages.

The technician should keep in mind then that any accessory probe used with a scope may introduce a certain amount of signal

attenuation, and this must be considered if accurate peak-to-peak measurements are to be realized.



**Fig. 6-5. Internal calibration features which include peak-to-peak reading voltmeter.**

### **RF DETECTORS**

The oscilloscope is limited in direct viewing to signals within the frequency range of its amplifiers, but modulated RF signals can also be viewed with the oscilloscope if these signals are detected before being applied to the oscilloscope amplifiers. This detection can be accomplished by circuits within the oscilloscope, as in some models, or by using external probes. The latter method is more common. Items 11 and 12 have been discussed in previous chapters, and no further mention will be made here.

### **INTENSITY MODULATION**

Intensity (Z axis) modulation can be used to determine the frequency of a signal or to measure the deviation of a trace or portion of a trace. An alternating signal of proper amplitude fed to the intensity-modulation jack will increase or decrease the trace intensity in step with the alternations and thus mark the trace at regular intervals. An alternating signal consisting of sharp pulses works best because it produces more distinct markings than an alternating signal of a smoother nature.

### **SAWTOOTH OUTPUT SIGNAL**

Item 14 describes a signal taken from the sweep generating system of the oscilloscope and therefore having the frequency

determined by the setting of the oscilloscope sweep controls. Such a signal can be used for signal substitution in the vertical and horizontal systems of a TV receiver. Although the sawtooth signal does not match the normal signal found in these systems, it can be used for troubleshooting purposes.

### **RETRACE BLANKING**

Retrace blanking (item 15) is usually included as a feature of most oscilloscopes. In some examples the blanking operates continuously, and in others, it may be turned on or off by means of a switch. Usually the retrace period is an extremely small fraction of one sweep cycle and does not interest the oscilloscope operator. In such cases, retrace blanking eliminates any confusion or distraction that might result if the retrace were visible. When the retrace period occupies a greater portion of the cycle, it may be desirable to turn off the retrace blanking so that no part of the signal will be lost during retrace. The waveform visible during retrace may be more difficult to interpret than that shown on the normal portion of the sweep because the retrace is usually non-linear in nature, but it is usually possible to determine facts of a quantitative nature, such as the number of cycles of signal lost during retrace.

### **PHASING CONTROL**

The phasing control (item 16) is useful when a line sweep is used. At this position of the sweep controls, a sine-wave signal is taken from some point of the oscilloscope circuits (usually a winding on the power transformer) and used to drive the horizontal deflection system. The phasing control is used to vary the particular point on the sine-wave signal at which the sweep begins.

### **SPECIAL TYPES OF OSCILLOSCOPES**

The general-purpose oscilloscope is sometimes modified or redesigned with some special purpose or application in mind. One such type of oscilloscope is shown in Fig. 6-6. This oscilloscope, the Probescope Model PO-1, is smaller in size and more convenient to use, with a minimum of connections to be made to circuits under observation. The probe can be hand-held, and consists of a 1CP1 cathode-ray tube mounted in a mu-metal shield. The probe tip is applied directly to the point in the circuit where the test lead of a general-purpose scope would normally be connected. A number of controls are provided on the front panel of the instrument, and their function is the same as those used on a normal instrument. These controls include vertical gain, horizontal gain, vertical positioning, horizontal positioning, intensity, sync amplitude, vernier frequency, and sweep rate. The sweep-

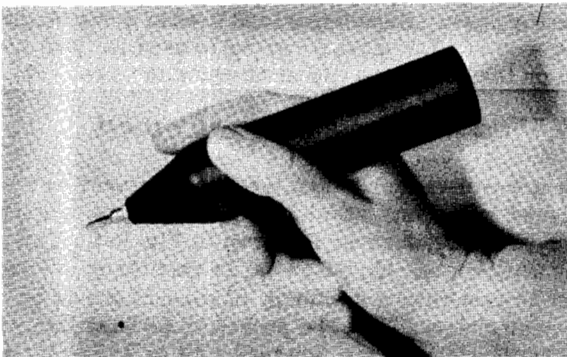


rate control is a five-position switch calibrated for ranges between 20 cycles and 30 kilocycles per second.

Because the focus is sharp for all positions of the intensity control, no focus adjustment is provided. The trace is brilliant



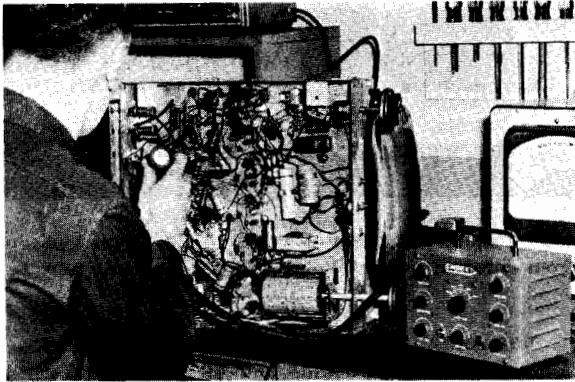
**Fig. 6-6. Probescope Model PO-1 oscilloscope.**



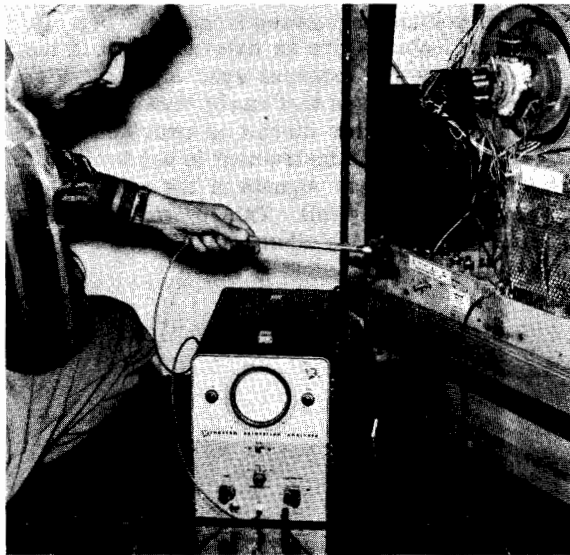
**Fig. 6-7. Probe assembly of the Probescope Model PO-1.**

and can easily be seen under normal viewing conditions. An idea of the size of the instrument can be had from the illustrations. Figs. 6-7 and 6-8 show the probe being hand-held and used on a receiver.

A highly specialized form of oscilloscope is shown in Fig. 6-9. This instrument, the Kingston Absorption Analyzer, is designed for ease and speed in signal tracing electronic circuits, especially TV receivers. Signal pickup is by means of capacitive



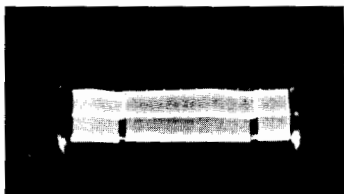
**Fig. 6-8. Probescope Model PO-1 being used to view waveforms in a TV receiver.**



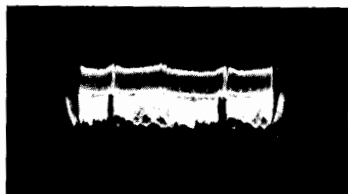
**Fig. 6-9. Kingston absorption analyzer has a unique pickup device.**

pickup rings or crescents that can be slipped over tubes or held next to the circuit components. In addition to the vertical amplifier system normally found in oscilloscopes, a Standard Coil TV tuner is used for tuned amplification of a number of frequencies. Fre-

quencies covered are all commercial VHF channels plus 20, 40, 3.58 and 4.5 megacycles. Signals can be fed to this tuner or directly to the vertical amplifier. The frequency response of the vertical amplifier extends to 300 kc.



**Fig. 6-10. TV signal picked up directly from antenna transmission line.**



**Fig. 6-11. Signal observed with ring probe over tube in video IF strip.**

The horizontal sweep system covers the frequencies from 20 to 120 cps for vertical fields and 4000 to 40,000 cps for horizontal scanning signals. The controls this instrument has in common with general-purpose scopes are the intensity, focus, vertical and horizontal centering, vertical amplitude, sweep amplitude, sync amplitude, and sweep frequency controls.

Two other features are an external input to the horizontal amplifier and a jack for external sync signals. Figs. 6-10 and 6-11 show typical waveforms that can be obtained with this instrument. An internal detector circuit is provided for detection of modulated RF signals. The instrument is not limited to RF signal frequencies, however, since signals in the audio frequency spectrum can be picked up as well. This permits signal tracing of a receiver from one end to the other.

## CHAPTER 7

### Accessories

The modern oscilloscope, with all its versatility, would seem to be complete in itself, needing no accessory equipment to increase its usefulness. Such, of course, is not true; a number of accessories are available and do extend the usefulness of any scope with which they are used. They range from small objects, like probes, to objects sometimes larger than the oscilloscope itself, like the electronic switch.

#### PROBES

The simplest type of probe (one that can hardly be called a probe, or an accessory either, for that matter) is the test lead. Test leads are simply convenient lengths of wire for connecting the oscilloscope input to the observation point. At the oscilloscope end they usually terminate with spade lugs, banana tips, or other tips to fit the input jacks of the scope, and at the other end there will be alligator clips or other convenient means for connecting to electronic circuitry. Since the oscilloscope input has high impedance and high sensitivity, the test leads should be shielded to avoid hum pickup, unless the scope is connected to a low-impedance, high-level circuit.

Although the input impedance of most scopes is considered relatively high compared to the circuits where they may be con-

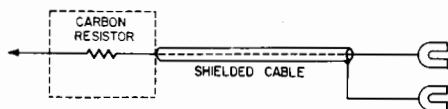
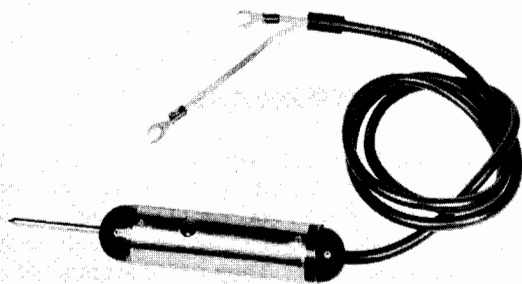


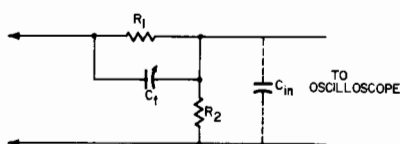
Fig. 7-1. A simple isolation probe.

nected, it is often desirable to increase this impedance in order to avoid loading the circuits or causing unstable effects. The input capacitance of the scope, plus stray capacitance of the test leads, may be just enough to cause a sensitive circuit to break into oscillation when the scope is connected. This effect can often be prevented by an isolation probe made by placing a carbon resistor in series with the test lead, as shown in Fig. 7-1. Values of 10,000 to 47,000 ohms work well in many cases. A slight re-

duction in the amplitude of the waveform must be accepted with this system. The waveshape of a signal may also be changed by this probe. To avoid this possibility, a high-impedance, compensated probe can be used. This probe, often called a low-capacitance



(A) Physical appearance.



(B) Schematic diagram.

**Fig. 7-2. A high-impedance, frequency-compensated probe. (Courtesy of Hickok Electrical Instrument Co.)**

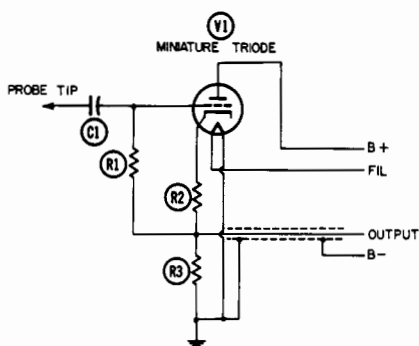
probe, is illustrated in Fig. 7-2. The probe itself is shown at A, and its circuit diagram, at B. The theory of this probe is exactly the same as that for the compensated attenuator mentioned in Chapter 5. The probe will give minimum waveform distortion when adjusted so that the product  $R_1 C_t$  equals  $R_2 C_{in}$ , where  $C_{in}$  is the total input capacitance of the oscilloscope. Typical values for  $R_1$ ,  $R_2$ , and  $C_t$  are:  $R_1$  - 1 megohm,  $R_2$  - 110K, and  $C_t$  - 5 to 20 mmf. These values will give about a 10-to-1 signal reduction.

The cathode-follower probe pictured in Fig. 7-3 offers the advantages of high impedance and low capacitance with a minimum amount of attenuation. A miniature tube and the necessary circuit components are mounted inside the body of the probe, and the connecting cable contains enough leads to supply the current requirements of the tube. The proper voltages are obtained from the oscilloscope circuits and are brought out to a jack on the front panel. A triode is the simplest tube choice for this application because it requires a minimum number of leads to operate it. Counting the two heater connections, there are five pins or leads to the tube: the grid connects to the probe tip through a blocking capacitor; one heater can be connected to the shield

(ground return for the entire assembly); the other heater connection and the plate must each have a separate cable lead; and a fourth cable lead is necessary for the output of the cathode follower. Thus, the number of cable leads is held to four.



(A) Physical appearance.



(B) Schematic diagram.

**Fig. 7-3. Cathode-follower probe for use with oscilloscope at high impedance points. (Courtesy of the Jackson Electrical Instrument Co.)**

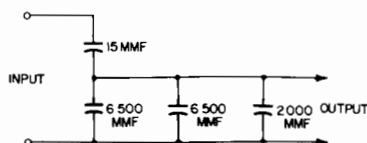
A circuit diagram for the cathode-follower probe is shown in Fig. 7-3B. Proper values for the resistors can be determined from formulas in receiving tube manuals. The effective input impedance of a tube connected in this manner is much greater than the nominal value of  $R_1$  and, at the same time, the effective input capacity is much less than the grid-to-cathode capacity given in the tube manual. This type of probe has the least loading effect of any of the probes shown. The gain of such a stage is always less than one, even though high  $\mu$  tubes are used; however, the gain approaches one as the values of  $\mu$  and  $R_2 + R_3$  are increased. Therefore, this type of probe will give less signal attenuation than the other high-impedance probes mentioned.

The highest voltage that can be safely connected to an oscilloscope input is determined by the voltage rating of the input blocking capacitor. This rating is usually 600 volts or less. Some locations in TV receivers have voltages exceeding this figure. The entire high-voltage section from the plate of the horizontal output tube onward is an example. Waveforms in this section can

be viewed through the use of a capacitive voltage-divider probe like that of Fig. 7-4A. This particular probe measures voltages up to 25 kilovolts rms. The probe illustrated is used primarily for laboratory applications, but indicates the wide variety of probes available.



(A) Physical appearance.



(B) Schematic diagram.

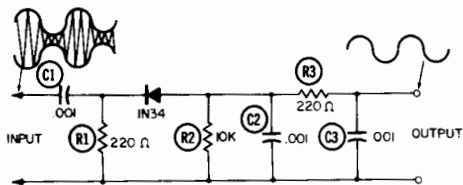
**Fig. 7-4. The capacitive voltage divider for use with high voltage waveforms.**

The schematic of Fig. 7-4B shows that the voltage divider consists of a 15-mmf capacitor in series with three capacitors totaling 15,000 mmf. This gives a voltage division of 1,000 to 1.

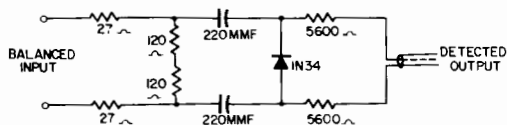
It is interesting to note the mechanical construction of this probe. The 15-mmf capacitor is a vacuum capacitor with a very high voltage rating. One terminal of this capacitor furnishes the connection for the high voltage. A spark gap is provided to prevent damage to the divider from excessively high voltage. Such an elaborate probe is seldom required in the ordinary shop, but capacitive voltage-dividers could be constructed for circuits containing much lower voltages. If such a project is contemplated, high quality components should be used. Presence of resistance in the probe could cause integration or differentiation of the waveform.

The vertical amplifiers of the average general-purpose oscilloscope suffer a drop-off in response to frequencies above a

few megacycles. Consequently, the oscilloscopes cannot be used to view directly any RF signal exceeding this upper limit. The standard broadcast frequencies, extending as they do from about 500 kc to 1600 kc, are well within the direct range of the scope amplifiers, but the IF and RF sections of FM and TV receivers



**Fig. 7-5. A crystal diode probe for demodulating RF signals.**



**Fig. 7-6. A balanced input demodulator.**

pass signals much above this range. The detector probe extends the useful range of the scope to cover these frequencies, and the scope can be used to signal trace these sections of the receivers.

Detector probes, or demodulator probes as they are also called, may be divided into two general classifications: (1) those employing crystal diodes, and (2) those using vacuum tubes. The vacuum tube type has been largely superseded by the crystal diode type because the vacuum tube type is larger and requires heater and plate voltages for operation. The vacuum tube type does have the advantages of being able to amplify and to handle higher voltages than the crystal diode. However, high scope sensitivity and the small signal voltages found in the RF and IF sections of the receivers tend to nullify these advantages.

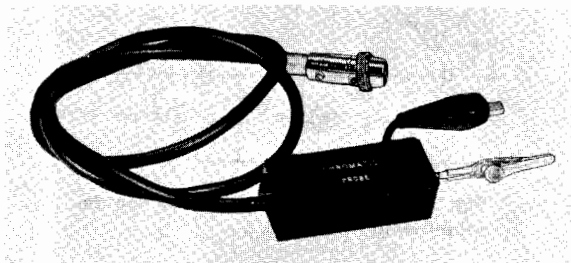
Fig. 7-5 is the schematic for a demodulator probe using a crystal diode. C1 is a blocking capacitor that keeps any DC signal component from being applied to the crystal diode. R1 and R2 form a complete DC path for the crystal diode. R3, C2, and C3 together make a one-section filter to reduce the RF signal amplitude after it has been rectified by the diode. A modulated RF signal applied to the input of the demodulator probe reaches the output of the probe demodulated and filtered as shown in Fig. 7-5. Only the modulating signal remains. The probe can be simplified by omitting R3, C2, and C3, and it will still function satisfactorily at frequencies above the response limit of the scope.

A balanced demodulator probe is pictured in Fig. 7-6. This probe is useful when it is desired to measure the RF and also



maintain a proper impedance termination at the point of application. The input circuit offers a balanced input of 300 ohms, while the output is an unbalanced one to match the oscilloscope.

The probe shown in Fig. 7-7 differs from those just mentioned in that it is not intended for direct connection to an oscilloscope



**Fig. 7-7. The Simpson chromatic probe.**

as a link between the scope and circuits to be tested. Instead, it is designed for use with two generator signals to develop a video sweep signal. This signal can then be used with the oscilloscope to examine any circuit whose response is in the range of TV video frequencies. The unit is called the Simpson Chromatic Probe.

Basically, the chromatic probe is a crystal-diode modulator in which two signal frequencies can be heterodyned and from which the resulting difference frequency can be obtained as an output signal. If one of the two applied signals is an FM signal and the other is an unmodulated RF signal, the output will be another sweep signal of a frequency dependent upon the applied frequencies.

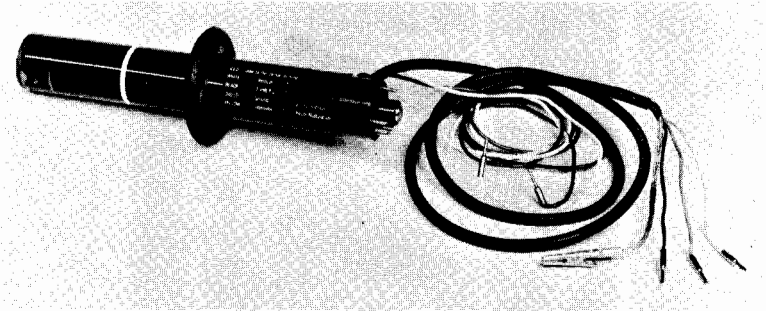
For example, when the FM and RF generator dials are both set to the same frequency — say, 60 megacycles or any other frequency within the range of both generators — a new FM signal will be obtained at the output of the probe. The difference frequency between the two signals when both are at 60 megacycles will be zero, and the difference frequency will vary on both sides of zero as the modulated input signal varies. The sweep width of the new FM signal will be the same as that of the modulated input signal.

The video sweep signal obtained from the probe is centered about zero frequency, but will not go as low as zero in a smooth, continuous manner because of the tendency of two associated oscillators to lock together as they approach the same frequency.

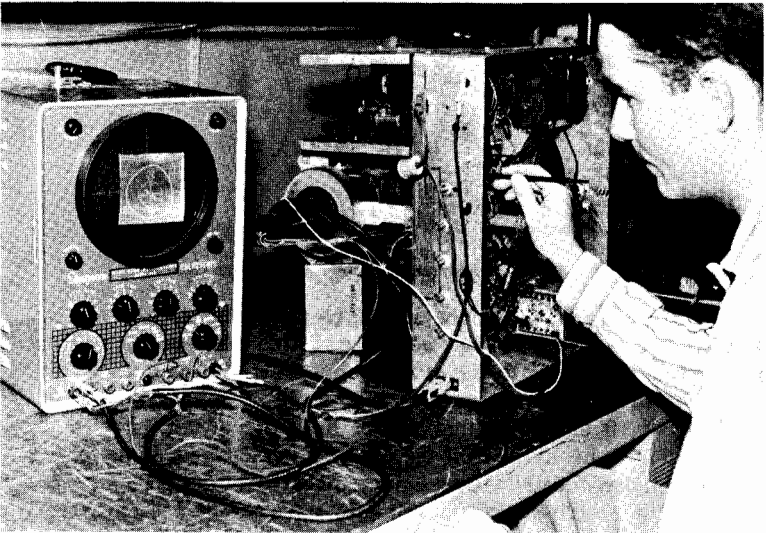
The unusual-looking device of Fig. 7-8 is called a Pic-Probe. Although the instrument has no similarity to a picture tube, it is actually used with an oscilloscope to substitute for one. When the proper connections are made to an oscilloscope and the Pic-Probe inserted into the deflection yoke of an operating TV receiver, the picture normally seen on the picture tube can be reproduced on the

screen of the scope. The instrument is thus a means for checking receiver operation without the need of its picture tube.

The Pic-Probe is shown in use in Fig. 7-9. The oscilloscope to be used must provide for Z-axis or intensity modulation. The scope pictured has this provision on its front panel.



**Fig. 7-8. Radlionic "Pic-Probe."**



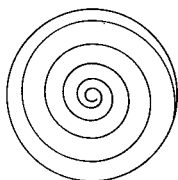
**Fig. 7-9. "Pic-Probe" and scope together substitute for picture tube.**

The probe consists of two specially wound coils and two series of integrating networks. Through inductive coupling, the coils pick up energy from the vertical and horizontal windings of the yoke. The signals are then integrated, and the resulting sawtooth waveforms are applied to the vertical and horizontal inputs of the scope. The amplitude controls of the oscilloscope are adjusted to a raster of proper proportions.

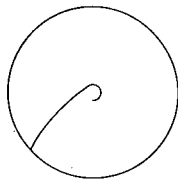
Picture information from the receiver is applied to the intensity-modulation jack of the scope. This information can be taken from either the cathode or grid circuit of the picture tube, depending upon which is the modulated element.



**Fig. 7-10. Doss sweep analyzer, Model D-100, for use with an oscilloscope.**



(A) Normal inductor.



(B) Inductor with shorted turns.

**Fig. 7-11. Test waveforms obtained with Doss probe.**

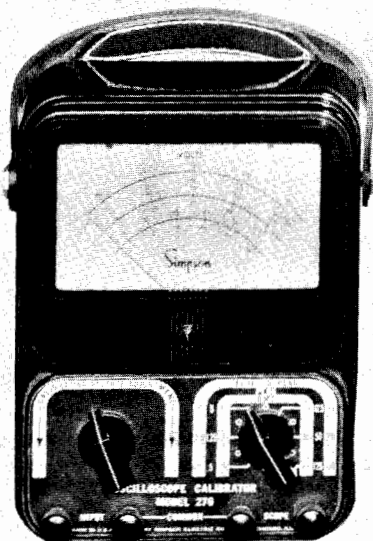
One lead from the probe should be connected to a 1-volt AC source. In the absence of a sweep signal from the receiver, this 1-volt signal is used to develop a small-size sweep, thus preventing burning of the scope screen by an intense spot.

Fig. 7-10 shows an instrument built in conventional probe shape that can be used with an oscilloscope to test inductances for defects, especially those inductances found in TV receiver sweep circuits, such as flyback transformers and deflection yokes. The unit is known as a Doss sweep analyzer, Model D-100. The instrument develops a sharp voltage pulse whenever the slide switch is activated, and this pulse is applied to the component being tested. At the same time, a portion of the pulse is also applied to the horizontal input of the oscilloscope. The resulting trace indicates the condition of the inductive component. For example, an inductor of normal, good quality — i.e., no shorted or open turns — will produce a spiral waveform similar to that shown in Fig. 7-11A. A shorted turn will greatly reduce the Q of the inductor. As a result, the spiral waveform is highly damped and will show only a

few turns, as in Fig. 7-10B, or perhaps less than a single turn of spiral. Other waveforms indicate a completely shorted or open component.

### VOLTAGE CALIBRATORS

Built-in calibration circuits are mentioned in Chapter 6 and range from fairly simple to more complex examples. Several



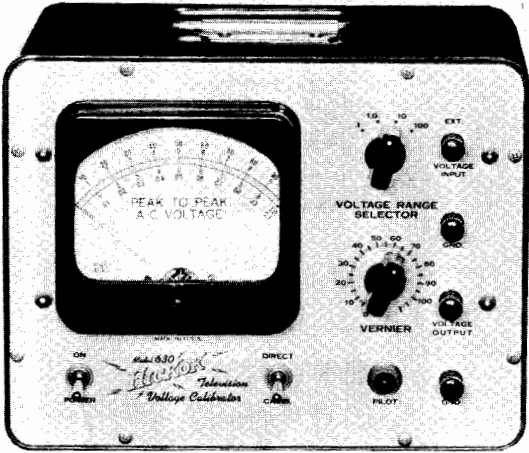
**Fig. 7-12A. Simpson Model 276 Oscilloscope Calibrator.**  
(Courtesy of Simpson Electric Co.)

manufacturers supply separate self-contained units that can be used to calibrate any oscilloscope. A few of these units are pictured in Fig. 7-12A to C. All derive their operating power from the power line source.

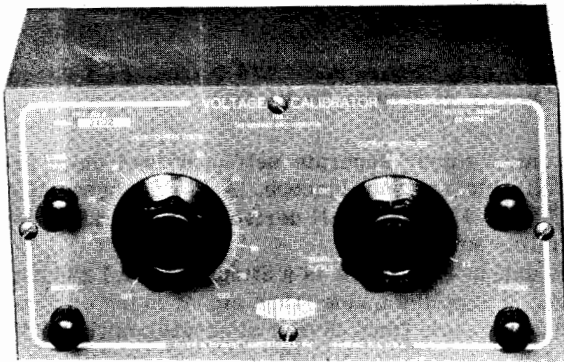
The unit in Fig. 7-12A is a Simpson Model 276 oscilloscope calibrator. It supplies a sine-wave signal to the oscilloscope and meters it at the same time. Every alternate position of the voltage selector switch is a "feedthrough" position, permitting any signal applied to the input terminals to feed directly through the calibrator to the scope input terminals. The other switch positions select voltage ranges from 1 to 250 volts peak-to-peak. Peak and rms values are also marked on the scale for each position. A calibrating voltage adjustment control allows the operator to vary the applied voltage from 0 to full scale for any voltage setting of the switch. Since this calibrator meters the output voltage directly,

the accuracy of the unit is as good as the meter itself, regardless of line voltage variations.

The Hickok Model 630 television voltage calibrator is shown in Fig. 7-12B. In this unit, the square-wave output signal from a



**Fig. 7-12B. Hickok Model 630 television voltage calibrator.**  
(Courtesy of Hickok Electrical Instrument Co.)

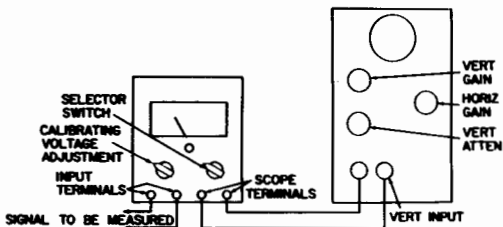


**Fig. 7-12C. Dumont Type 264-B voltage calibrator.**

multivibrator stage is attenuated to the desired level as indicated by the meter and then applied to the output terminals of the calibrator. Stability of level is obtained by using a regulated power

supply. Four voltage ranges with maximum output values of .1, 1, 10, and 100 volts peak-to-peak are provided.

The Dumont Model 264-B oscilloscope calibrator, shown in Fig. 7-12C, has an interesting circuit design. A square-wave



- STEP 1 Connect scope, scope calibrator, and signal source as shown.
- STEP 2 Adjust HORIZ GAIN to zero.
- STEP 3 Turn SELECTOR SWITCH for direct signal feed through.
- STEP 4 Adjust scope VERT GAIN and VERT ATTEN for convenient deflection of unknown signal.
- STEP 5 Turn calibrator selector switch to appropriate position, and adjust CALIBRATING VOLTAGE ADJUSTMENT to obtain same deflection as in Step 4.
- STEP 6 Read voltage of applied signal on meter scale which corresponds to selector-switch position.

**Fig. 7-13. Procedure for measuring amplitude of waveform with scope and external calibrator.**

output is obtained through the use of clipped sine waves. This is accomplished in the following manner: The secondary winding of the power transformer is connected to a rectifier tube for full-wave rectification. The rectified output is smoothed with a 2-section RC filter and regulated at 150 volts with a voltage-regulator tube. The output load resistance is not grounded at one end, but at midpoint, so that output voltages of +75 and -75 are obtained with respect to ground. These voltages are used to bias the sections of a dual diode to which a 325-volt AC signal is applied from the transformer secondary. The dual diode clips this signal at +75 and -75 volts, thus giving essentially a square-wave signal of 150 volts. This signal is dropped to 100 volts peak-to-peak by a series divider, and the 100-volt signal is applied to the decade attenuator of the calibrator. A continuously variable control adjusts the attenuator output from 0 to maximum as indicated by a calibrated dial. The dial scale from 0 to 10 is not subdivided in order to avoid inaccuracies that might arise at this end of the scale.

Since the operation of any one of these units is similar to that of the others, an outline of operating procedure is given for only one, the Simpson Model 276. This outline is shown in Fig. 7-13.

The following hints may help in obtaining the best results with voltage calibrators. It is well to remember that when a signal is fed through the calibrator to the oscilloscope input, the result is not quite the same as when direct connection is made to the

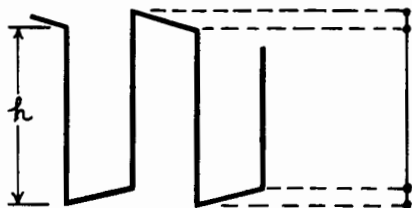


Fig. 7-14. Correct reference height of calibrating voltage.

scope itself, because a small amount of distributed capacity is present in the wiring of the calibrator and is placed in shunt across the oscilloscope input. The capacitance will not be high — one calibrator is listed at 20 mmf, and another, at 70 mmf — but this might affect some complex waveforms in high-impedance circuits. The operator can avoid this possibility, in special cases, if he will dispense with the handy feature of direct feedthrough for the moment and connect the scope directly to the signal take-off point. Then, after the operator has set the oscilloscope controls for a certain size of waveform, he can reconnect to the calibrator for voltage measurement. If necessary, a low-capacitance probe could be used for minimum loading and distortion.

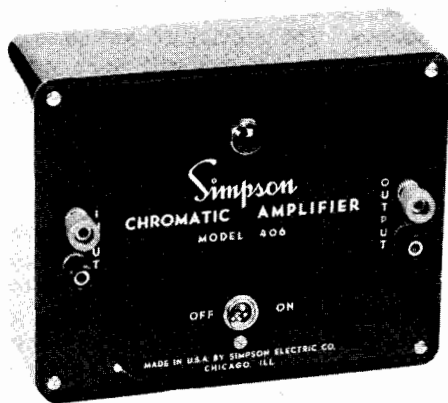
Another precaution to observe is that the scope amplifiers are not overloaded at any time during the calibration. The operator can easily identify the point of overload; it is the point at which the waveshape changes while the controls are adjusted for size.

If the calibrator output is a square wave or clipped sine wave of low frequency, there may be a slight tilting of waveshape with some scopes because of phase shift. This can be checked by expanding the trace horizontally. Such a tilted waveform might appear as in Fig. 7-14. In this figure, the distance  $h$  is the true measure of the height of the calibrating waveform and is the portion that should be used for reference. If the horizontal deflection is reduced to zero, the waveform appears as a vertical line, shown at the right of the figure. Using the entire length of this vertical trace for calibration reference would result in a voltage indication slightly less than the true value. Therefore, this check should be made for possible tilt before setting the vertical reference trace.

## AMPLIFIERS

There are several general-purpose oscilloscopes having excellent deflection sensitivities of 10 millivolts rms per inch. A number of others closely approach this sensitivity. Nevertheless, there are bound to be times when the service technician may

wish for a little more amplification of the signal to be viewed. For example, he may want to make a response check of a chrominance channel in a color TV receiver, using a video sweep signal of limited strength. If the technician makes a stage-by-



**Fig. 7-15. Simpson Model 406 chromatic amplifier.**  
(Courtesy of Simpson Electric Co.)

stage check, he may have a very weak signal at the scope input. This signal can be strengthened by using a suitable auxiliary amplifier. One such amplifier, the Simpson Model 406 chromatic amplifier, is shown in Fig. 7-15. It provides amplification of video frequencies whenever such amplification would be useful in servicing color or monochrome TV receivers.

A voltage amplification of 30 times is claimed for this amplifier over a band of 4 megacycles, with the output flat within  $\pm 0.5$  decibel from 8 kilocycles to 4 megacycles.

In addition to its function as an amplifier, the unit also serves as a filter to attenuate frequencies above 4.5 megacycles. This feature is useful when the amplifier is used with a sweep generator having an output signal that might contain beat frequencies outside the desired range. These undesired beat frequencies could cause confusing indications on the scope screen.

### ELECTRONIC SWITCHES

The electronic switch makes it possible to display two waveforms simultaneously on a single oscilloscope screen. Certain observations can thus be made more easily or conveniently than would be possible without its use. Comparisons can be made between signals at different circuit points to determine the effect



of the intervening circuits with respect to phase, frequency, or amplitude differences. Distortion occurring between two points can be observed. The electronic switch is especially effective when one wishes to determine the results of circuit changes or adjustments while the adjustments are actually being performed. Another means for obtaining dual traces is through the use of a double-beam, cathode-ray tube. This method is not commonly encountered, usually being limited to laboratory or special-purpose oscilloscopes. The electronic switch does not require any special provisions for use and will work with any general-purpose scope. As with other types of equipment, models may differ in the number of features offered.

### Theory of Operation

The basic principle of operation of most electronic switches consists of applying the two signals to be observed to two separate amplifier channels in the switching unit and at the same time applying a square-wave signal to the amplifiers, so that each is alternately driven to cutoff. The output of each channel is developed across a common load (which can be either in the plate or cathode circuit) so that first one and then the other signal appears at the output terminals. The frequency of the applied square-wave signal is called the switching frequency and can be varied to a greater

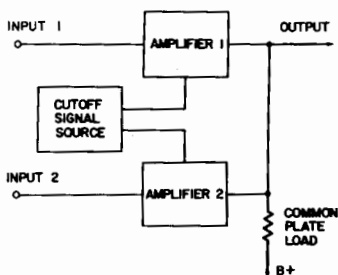


Fig. 7-16. Block diagram of an electronic-switch circuit.

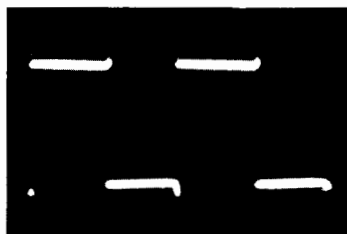
or lesser extent, depending upon the complexity of the instrument.

A simplified block diagram of an electronic switch is shown in Fig. 7-16. The separate channels for inputs 1 and 2 may consist of a single stage for each, or they may have such added refinements as additional stages of amplification preceding the output. Some electronic switches may have cathode-follower inputs for minimum loading effects when connected to circuits.

The cutoff signal for the two amplifier channels is usually obtained from some form of multivibrator circuit. Operating frequencies may vary from 20 cycles per second to 100 kilocycles or greater; both step and vernier adjustments are provided for changing the frequency of the cutoff signal. Some models have provision for applying an external sync signal to the multivibrator

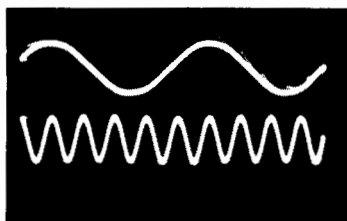
circuit to lock it to some multiple or submultiple of the sync-signal frequency. If the switching rate is synchronized in this manner to a frequency one-half that of the oscilloscope sweep, the two input signals will appear on alternate traces of the beam

**Fig. 7-17. Output signal from the electronic switch with both amplifiers set for zero gain.**

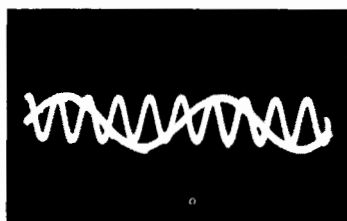


across the scope. In this instance, switching is accomplished during beam retrace and is less noticeable than it would be otherwise.

Another method of synchronization is used in most applications. The synchronizing signal is applied to the oscilloscope rather than to the switching unit. This signal can be obtained from one or the other of the input signals, and the switching frequency is then adjusted to give the least confusion when viewing the two traces. The synchronizing signal is applied to the EXT



(A) Axes separated.



(B) Axes merged.

**Fig. 7-18. Effect of axis shift.**

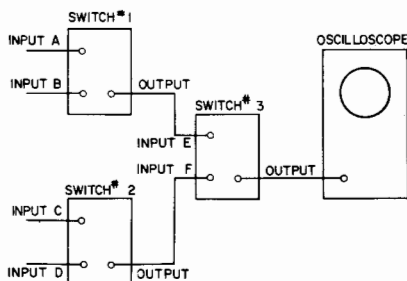
SYNC jack of the oscilloscope; it is generally undesirable to use internal sync for two reasons. If internal sync is used, the oscilloscope attempts to synchronize with both input signals to the switch and with the switching waveform itself. This makes synchronization uncertain, and a distorted pattern usually results. The second reason is that true phase relationship between input signals will not be maintained.

High switching rates have the disadvantage of requiring an oscilloscope of wide response in order to secure the best waveform, because the input signals are superimposed upon a signal that is essentially a square wave. It is commonly known that a square wave of high frequency requires a wide-band amplifier for accurate reproduction.

If the gains of amplifiers 1 and 2 are reduced to zero, the output of the electronic switch will be a square wave (as shown in Fig. 7-17). As the gains of the amplifiers are increased, the two input signals will appear superimposed on the upper and lower portions of the square wave. Proper selection of the switching frequency will cause both traces to appear continuous, one above the other. A control, variously called BALANCE, AXIS SHIFT, POSITIONING, or the like, provides for separation or merging of the two traces on base lines. This is illustrated in Figs. 7-18A and B. Thus, two waveforms can be displayed, one directly above the other, or they can be caused to merge into one trace for more exact comparison.

### Multiple Signals

By using as many switching units as necessary, the technician can display a greater number of waveforms, until practical limits are reached. Fig. 7-19 is a block diagram showing a setup for viewing four signals simultaneously on a single oscilloscope screen. Other combinations can be easily visualized.



**Fig. 7-19. Electronic switch arrangement for viewing 4 signals simultaneously on an oscilloscope.**

The waveform shown in Fig. 7-17 indicates that the electronic switch can also be used as a square-wave generator, and this is verified by the operating manual for the unit. Compared to the capabilities of a normal square-wave generator, its use in this capacity may be somewhat limited, but a worthwhile range of frequencies and amplitude variations are usually covered. The use of square waves for amplifier testing will be discussed in Chapter 10. Practical applications for the electronic switch will also be described in subsequent chapters.

An electronic switch of laboratory caliber is pictured in Fig. 7-20. This unit has two amplifier channels, A and B. Each channel can be used in either an AC or DC manner and is supplied with nine attenuation ratios. The frequency response of either

channel has the following characteristics:

Direct coupling — Flat to DC. With 60 mmf external load, response down not more than 1 db at 10 mc or 3 db at 15 mc. With 100 mmf external load, response down no more than 1 db at 6 mc or 3 db at 11 mc.

Capacitive coupling — Down no more than 30% at 5 cycles. High-frequency response identical to direct coupling.

Coarse and fine separation controls are provided.

The switching rate control is a 4-position switch. In one position a triggering signal can be applied from an external source to trigger the switching circuits at rates of 0 to 100 kc. At the other three positions the switching circuits are free-running at rates of either 1 kc, 10 kc, or 100 kc. During triggered operation, a choice of either positive or negative trigger polarity can be had. Sensitivity to the triggering signal is adjustable by a control.

The circuit design provides for direct coupling to the DC input of an oscilloscope.



**Fig. 7-20. The DuMont Model 330 electronic switch.**  
(Courtesy of Allen B. DuMont Laboratories, Inc.)

## GENERATORS

Generators are associated so often with oscilloscopes that they are mentioned here even though they may not be considered accessories. The square-wave generator has already received

some mention, and in addition there are audio, RF, and sweep generators to be considered.

The audio generator furnishes a sinusoidal signal covering the audio frequency band. The lower frequency limit may be around 10 to 30 cycles per second, while the upper limit may be as high as 100 or 200 kc, although the upper frequency limit of hearing for the human ear may be anywhere from 12,000 to 20,000 cps. The audio generator signal is useful when checking amplifiers for response, amplification, distortion, output power, phase shift, and so on.

The RF or radio frequency generator supplies a signal covering the band of radio frequencies, although a single generator will not cover the entire band, including as it does RF, VHF, and UHF. These generators are useful for alignment, signal tracing, frequency measurement, response curve marking, and other applications.

A sweep generator is merely an RF generator (or in rare cases, an audio generator) whose frequency is made to vary back and forth above and below a center frequency determined by the dial setting.

The rate the frequency varies is usually 60 times per second, but at one time 400 cycles was a popular rate in FM sweep generators (some people called them wobblers at that time, too). A common way of generating the sweep signal is to feed a variable control voltage to some reactance element of the RF oscillator stage. This voltage causes the oscillator frequency to vary above and below center.

At one time, mechanical means for sweep generating were popular. These usually took the form of a motor-driven capacitor. The capacitor was a part of the tuned oscillator circuit, and as it was made to vary in capacity by the motor, the oscillator frequency varied with it.

Another mechanical system is used in some present-day generators. A metal disc is mounted near an inductor that is part of the tuned oscillator circuit. The disc is driven by an attached coil in much the same manner as a speaker diaphragm is driven by its voice coil. The vibrations of the disc cause the inductance to vary, and the oscillator frequency varies in like manner.

Sweep generators, together with an oscilloscope, furnish a convenient means for developing a response curve of tuned circuits or other frequency-discriminating circuits. The response characteristic of an entire video IF strip of a TV receiver can be developed, and the effects of any alignment adjustments can be seen immediately.

## CHAPTER 8

# Adjusting and Servicing the Oscilloscope

A number of oscilloscope control adjustments cannot be considered part of the normal operating procedure. A few of these controls are accessible from the outside of the case — front panel, sides, or rear panel — and the rest are located internally. If a control cannot be reached without removing the oscilloscope from its case, then it probably is fairly stable in adjustment and will rarely need attention, if at all. Adjustment may be made necessary by aging or replacement of tubes and components.

When making adjustments with the instrument outside its case, the technician should use reasonable caution to avoid contact with high voltage sections of the instrument. Potentials as high as 3,000 volts are used to operate the cathode-ray tube in some oscilloscopes.

The operator's manual for the instrument will usually contain instructions for any adjustment the manufacturer considers advisable for the service technician to make. Some of the adjustments to be found in a number of these manuals are mentioned in the following paragraphs.

### DC BALANCE CONTROLS

Oscilloscopes having DC inputs or amplifiers DC-coupled from the vernier gain control onward to the deflection plates will usually have a DC balance control. The reason such a control may be needed can be seen by examining Fig. 8-1, which is a simplified version of the first stages of the horizontal amplifier of an oscilloscope.

The cathode (pin 3) of V101A is directly connected to the grid (pin 6) of V102A through R111 and R119. R111 is the horizontal gain control. As this control is varied from one extreme to the other, any AC signal across R111 will be applied to pin 6 of V102A in either increasing or decreasing strength. At the same time, if there is any DC potential across R111, the DC voltage applied to pin 6 of V102A will also change, causing a shift of position in the trace on the screen. The following test will determine whether a DC balance adjustment is necessary. Rotate the gain control from one extreme to the other. If the trace shifts its position, a balance adjustment is needed.

Fig. 8-1 shows the DC balance control, R110, in series with the cathode resistor, R109. As R110 is varied, the DC potential of pin 3, V101A, also varies. When pins 3 and 8, V101, are at the same potential, there will be, of course, no voltage drop across

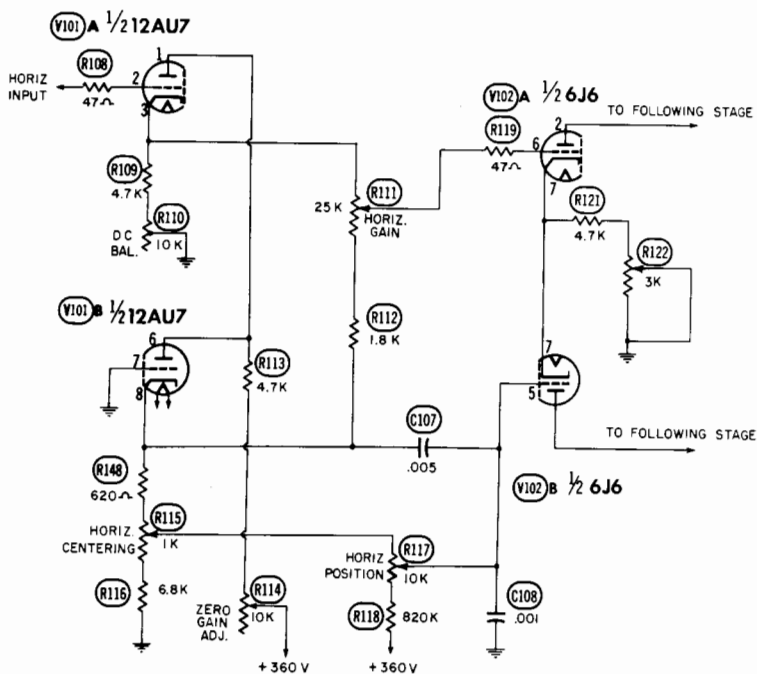


Fig. 8-1. Input stage of an oscilloscope having DC balance adjustment.

the horizontal gain control, R111, and rotation of this control will not affect the position of the trace.

Adjustment of R110 is easily done, then, by the trial method: R110 is rotated, a little at a time, until rotation of the horizontal gain control has no effect on beam positioning. DC balancing of the vertical amplifier is similarly made.

Other controls, sometimes called DC balance controls, are used to insure balanced operating conditions between symmetrical halves of push-pull circuits.

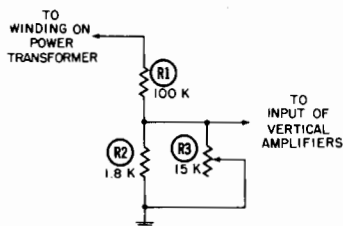
Another adjustment that can be explained using the diagram of Fig. 8-1 is that of the horizontal centering control (R115 in the figure). The purpose of this adjustment is to insure that the beam will be centered horizontally when the horizontal positioning control is turned to the midpoint of its range. For the adjustment, R117 is first set to the midpoint of its range; then R115 is adjusted so that the beam strikes the screen at the horizontal center.

The beam is vertically centered by a similar adjustment in the vertical amplifier of the oscilloscope.

### VOLTAGE CALIBRATION ADJUSTMENT

Most present-day oscilloscopes are equipped with some type of built-in voltage calibration circuit, even if it provides only a single voltage brought out to a front-panel terminal. Those having more elaborate systems will sometimes provide for adjusting the voltage applied to the calibration circuits. A simple voltage dividing network like that of Fig. 8-2, connected across a winding of the power transformer, can be used.

Fig. 8-2. Network for adjusting calibrating voltage.



In this example, R3, the 15K-ohm control, is adjusted to provide .1-volt peak-to-peak for calibration of the vertical amplifier. In another example, the network was connected to one of the low voltage rectifier plate windings of the power transformer and adjusted to give a basic calibration voltage system, using a regulator tube to stabilize the calibration voltage.

When adjustments of this sort are made, the power line voltage to the oscilloscope should preferably be applied through a voltage adjusting transformer so that the oscilloscope can be operated at the voltage for which it was designed.

### VERTICAL AND HORIZONTAL TV SWEEPS

These sweeps are provided at separate positions of the coarse frequency control so that the operator may select them with a minimum of trouble. They are set up to operate at 30 cps and 7,875 cps so that two cycles each of the vertical and horizontal waveforms are displayed. Since they may wander in frequency slightly over a period of time, adjustments are provided for resetting them to their original frequency.

The operator's manual for a certain oscilloscope recommends the following calibration procedure:

1. Set the coarse frequency control to H (TV).
2. Connect an audio generator to the vertical input binding post and set to a frequency of 7,875 cps.
3. Set the locking or sync amplitude control to zero.
4. The sync selector switch should be at the Internal position.
5. Adjust the proper calibration control until the pattern locks in for a one-cycle waveform.



The same procedure would be used for the V (30 cycle) position of the coarse frequency control, except that the generator would be set to 30 cps and the proper calibration control would be adjusted for a one-cycle pattern.

If the technician wishes, he may set the 30-cycle sweep by means of a 60-cycle, line-frequency signal, using Lissajous figures (see Chapter 9 for Lissajous figures). This method might be more accurate than the other if there is any reason to doubt the accuracy of the audio generator setting at 30 cycles. The line-frequency signal can be obtained from some point inside the scope, say a filament winding of the transformer, and should be connected to the vertical amplifier input. If connected internally, it might be wise to insert a blocking capacitor, since some filament windings are connected to DC voltage points. The adjustment then proceeds as in the first instance, except that a two-cycle pattern must be obtained. The 60-cycle vertical signal will make two vertical excursions while the sweep is making one horizontal excursion. The waveform will look like a mathematician's infinity symbol.

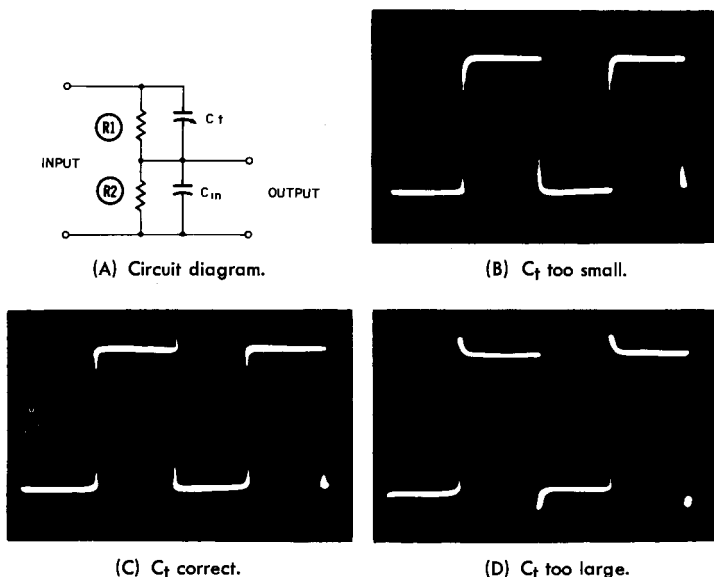
Note that these adjustment procedures recommend setting the sweep frequencies at 30 and 7,875 cps, or exactly half the vertical and horizontal sweep rates of a TV receiver. Other manufacturers may recommend rates a little lower; for example, one operator's manual gives a figure of 25 cps for the vertical and 6,500 cps for the horizontal sweep rates. Chapter 4 (Synchronization) mentioned that the application of a synchronization signal tends to increase the sweep frequency of the scope slightly above its natural free-running frequency, so this latter practice may widen the range of stable synchronization for the TV sweep feature. However, by actual test on an oscilloscope, a signal slightly below the free-running frequency of the oscilloscope sweep can be synchronized. Note also that in this discussion of sync stability we compare signal and sweep frequencies having a 1 to 1 ratio, but the same principle holds true where the signal is twice, three times, or some other whole multiple of the sweep frequency.

These two positions of the sweep frequency control (H and V, TV) can also be calibrated by using a video signal from a TV receiver. The 7,875-cycle sweep is set for two horizontal lines of video pattern, and the 30-cycle sweep is set for two fields.

## COMPENSATED ATTENUATORS

The circuit construction and theory of compensated input attenuators were shown in Chapter 5. The adjustment procedure will be discussed here. It applied equally well to the adjustment of the low-capacity probe to be used with the oscilloscope. There are two major requirements for performing the adjustment — a suitable input signal and some indicating device to show the effects of adjustment. The oscilloscope screen can be used as the indicating device, and a square-wave generator will provide the signal.

The trimmer for each attenuator position is adjusted for the best square-wave pattern on the oscilloscope screen. There should be no rounding or peaking of the leading edge of the square wave. Fig. 8-3 shows the response for different degrees of adjustment of the trimmers. At B, the trimmer capacity is too small; at C, just right, and at D, too large.



**Fig. 8-3. A frequency compensated attenuator and the effect of various degrees of adjustment on a square wave signal.**

The frequency selected for the square-wave signal is important. Usually, a frequency of about 10 kc per second is satisfactory. Since the attenuator network and the amplifiers are in series, one of them will be a limiting factor in the total response of the combination. Theoretically, the attenuator network will attenuate equally all the frequencies applied to it if it is properly adjusted, whereas the amplifier response of many general-purpose scopes will start to fall off around 3 or 4 megacycles or before. The amplifier, then, is the weak link in the response chain, and it should be adjusted first if adjustment is required.

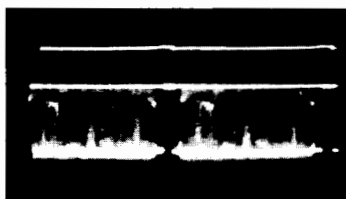
Since the amplifier is the limiting factor in the response of the vertical system, the square-wave frequency should be chosen to suit its requirements. That is, there would be no logic in trying to adjust the attenuator with a signal that would not be passed by the amplifiers. There is a rule of thumb stating that good response to a square-wave signal indicates good response to a sine-wave signal of frequencies ranging from 1/10 to 10 times the square-wave frequency. Following this rule, a 100-kc square wave is

suitable for testing an amplifier to frequencies of 1 megacycle. Actually, whether a 10, or a 100-kc signal is used will make little difference in the final adjustment of the attenuator.

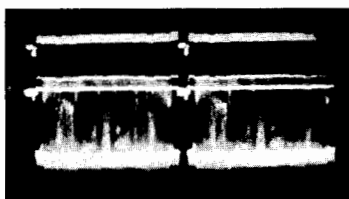
Attenuators in the horizontal amplifier circuit can be adjusted in much the same manner as the vertical attenuators, but there is one complication — an external sweep signal must be provided to drive the vertical amplifiers while the square-wave signal is applied to the horizontal input of the scope. This should be a sawtooth sweep signal in order to present the square wave in undistorted form, but it cannot be obtained internally from the sweep system of the scope itself because this system is normally deactivated when the horizontal selector switch is set for external signals. With sawtooth and square-wave signals applied in this manner, the square wave will be displayed vertically, rather than horizontally, on the oscilloscope screen. The attenuator control is set to the various positions, and the associated trimmer capacitors are then adjusted for best square-wave response. Although there is no provision for synchronizing the sawtooth sweep and the square-wave signal, they can be kept almost in step by hand adjustment of one generator or the other. A slow rate of travel of the waveform across the scope face will not interfere with the adjustment procedure.

#### LOW-CAPACITY PROBES

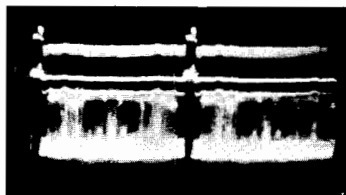
These probes can be adjusted for frequency compensation in the manner just described for vertical attenuators. A square-wave



(A) Correct adjustment.



(B)  $C_c$  too large.



(C)  $C_c$  too small.

Fig. 8-4. Video signal used in adjusting a low-capacitance probe.

frequency of 10 kc should be satisfactory in most cases. If the vertical input attenuator of the oscilloscope is set to the X1 posi-

tion, the signal will feed straight through the attenuator, thus avoiding any effect the attenuator might have.

In the absence of a square-wave generator, the technician can adjust his probe by using the video signal obtained at some point in a TV receiver. The horizontal and vertical sync pulses of this signal have the characteristics of square waves and, because they do differ widely in frequency, are suitable for this method. The video signal should be fed through the probe to the vertical input of the oscilloscope. The oscilloscope is synchronized to the vertical sync pulses, and the waveform will appear as in Figs. 8-4A, B, or C. As the trimmer is adjusted, the level of the horizontal sync pulses will shift with respect to the vertical sync pulse level. The correct adjustment is obtained when both the horizontal and vertical sync pulses are on the same level, as in Fig. 8-4A. This method may not be as accurate as the first one, but is practical when the technician does not have access to a square-wave generator.

### FREQUENCY RESPONSE OF THE AMPLIFIERS

The frequency response of wide-band oscilloscopes is obtained through careful design directed at bringing up the response at the extreme high- and low-frequency ends of the band. Because of natural factors, the response normally falls off at these extremes. Filter and coupling capacitors tend to limit the response at the low end, while shunt capacities limit the response at the high end. Several methods of extending the frequency response of oscilloscope amplifiers are described in Chapter 5. These methods include the use of series and shunt peaking coils, and feedback circuits. Some of these components are adjustable in some oscilloscopes. The manufacturer's instructions for adjusting these components should be faithfully observed if adjustment becomes necessary, and haphazard methods should not be tried. For this reason, no specific adjustment procedure is given here. A complete adjustment of a vertical amplifier system with compensated attenuators, as described by one oscilloscope manufacturer, requires the use of another oscilloscope, an RF demodulator probe, a video sweep generator, a video marker source, and a square-wave generator.

### ASTIGMATISM

Astigmatism in oscilloscopes is a defect in focusing similar to the same defect in the human eye. Astigmatism is manifested by an unequal degree of focus between different portions of the trace. That is, vertical excursions of the beam may give a sharper trace than horizontal excursions, or vice versa. Or, one end of the trace may be sharper than the other. Fig. 8-5 shows this effect in a trace focused at the right extreme but not at the left.

When a corrective adjustment is provided, its use is fairly simple. First, the oscilloscope controls are set to obtain a trace across the cathode-ray tube face (a simple waveform serves admirably), and the astigmatism control is adjusted for the best compromise



**Fig. 8-5. Oscilloscope trace which exhibits the effect of astigmatism.**

focus throughout the trace. A circular waveform is one of the best for this purpose since it makes every possible change in direction of the trace.

### OTHER ADJUSTMENTS

A number of bias adjustments are provided in some oscilloscopes. These adjustments are made to obtain optimum operation of some of the more important or more critical stages. Linearity of sweep is important in obtaining an accurate waveform, and controls are sometimes provided so that the sweep may be made as linear as possible. Another oscilloscope is the best device for checking sweep linearity. The sawtooth waveform should have the straight sides indicated in Fig. 3-1, Chapter 3. Probably the next best test for sweep linearity, if a second oscilloscope is not available, is to synchronize a number of sine waves on the scope screen and note whether the waveform appears compressed or expanded at either end. Sweep linearity is difficult to judge by observing a single cycle of a sinusoidal waveform, but if a number of cycles are viewed at once, crowding or expansion at one end of the sweep is easier to see.

If an oscilloscope has a driven sweep, an adjustment for controlling the operation of this feature is usually provided.

### SERVICING THE OSCILLOSCOPE

The oscilloscope is built with the same type of electronic components and circuit design that the service technician sees daily in his work with receivers and amplifiers. Its circuits function in agreement with the well-known AC and DC laws. Consequently, the same servicing procedures should work equally well with oscilloscopes as with the other electronic equipment that he services. One of the best assets the technician can have is a good knowledge of the construction and function of the different parts of the oscilloscope. His work is made a lot easier, too, if he has another oscilloscope he can use to check the defective oscilloscope. A meter and a tube tester should also be added to the list of necessary test equipment. A schematic diagram of the oscilloscope, with proper voltages and resistances indicated at important points, will be a great help.

Oscilloscope troubles might be grouped roughly under two classifications: (1) those that appear suddenly, and (2) those that suggest gradual deterioration over a period of time. The latter class of troubles may even escape notice unless the performance of the oscilloscope is checked. Performance checks will be discussed in subsequent paragraphs.

The technician can sometimes obtain an idea of the location and cause of the trouble by noting the effect when the controls are operated. Any abnormal effect may be the clue to start him on the correct line of reasoning.

If no direct clue is obtained by working the controls, the technician might start by testing the tubes. If the cathode-ray tube produces a spot or trace that responds to positioning, focus, and intensity controls, it would probably be passed by a tube tester. Gas triode sweep oscillator tubes like the 884 may test all right in a tube tester and yet not perform satisfactorily in actual service; so the final test here should be direct substitution.

The nature of the complaint will often suggest which section of the oscilloscope to examine for the defect. Thus, poor synchronization will most likely result from a fault somewhere between the sync take-off point and the sweep oscillator; poor focusing, positioning, or intensity suggests either the controls themselves or the voltage network supplying the controls; reduced sweep suggests trouble in either the sweep oscillator or the horizontal amplifier; and so on.

In any servicing procedure, the technician should use the same precautions against shock that were recommended earlier in the chapter.

The chart on pages 88 and 89 appears in the operator's manual for the Hickok Model 685 oscilloscope and is designed specifically for troubleshooting that instrument, but could apply in almost all details to other general-purpose oscilloscopes.

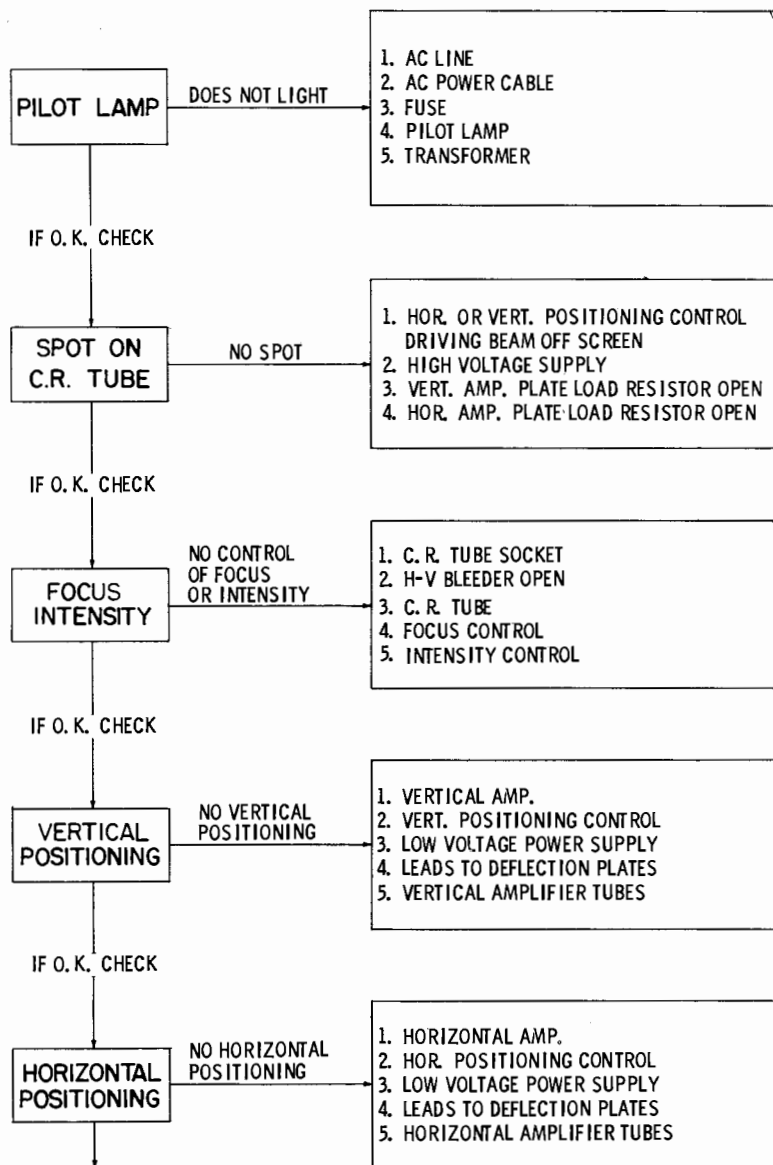
Once a trouble has been localized to a certain point or stage, the defective component can probably be found by visual inspection — as in the case of a burnt resistor — or by voltage and resistance checks. Signal tracing methods, using an audio generator and another oscilloscope, can be resorted to in stubborn cases.

## CHECKING PERFORMANCE

Performance checks might well start with a test of all tubes to make sure that the substandard performance is not due to a weak tube or two.

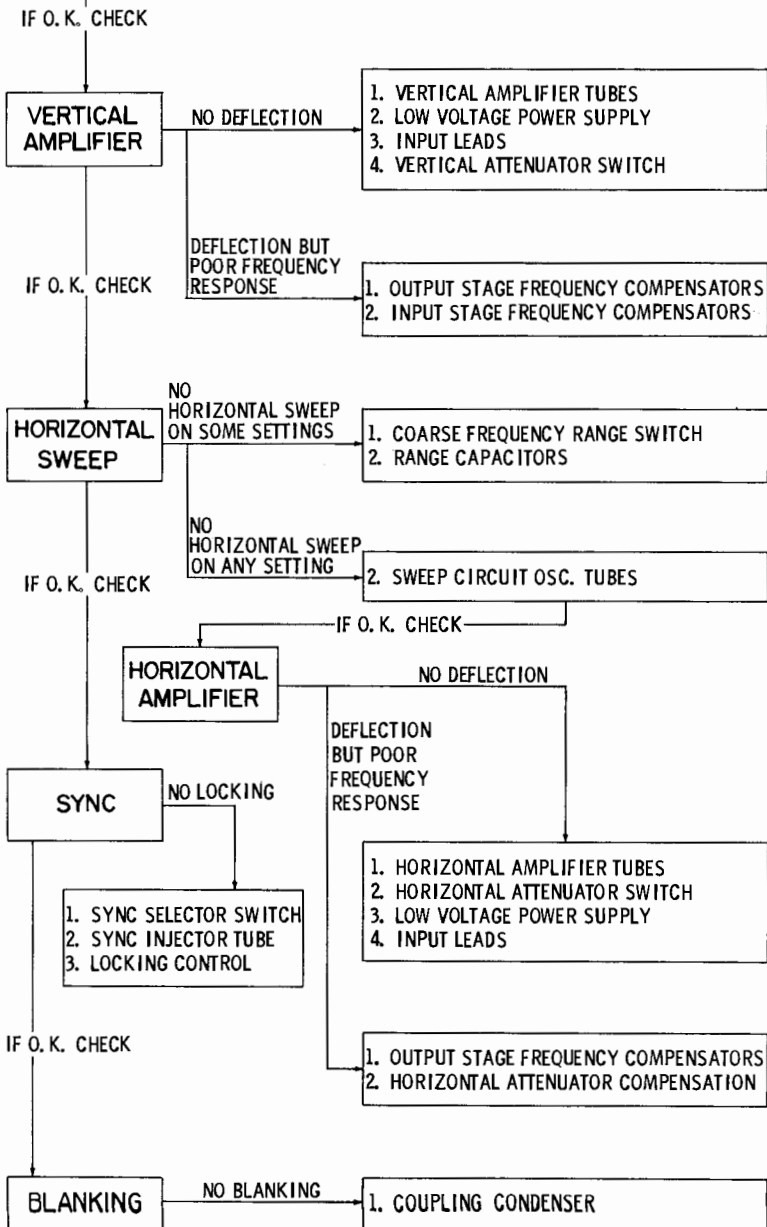
Here are some tests the scope owner can apply to check the condition of his instrument. A source of AC sine-wave signal is needed for some of the tests. This source can be an audio generator, or where a 60-cycle signal is satisfactory, the test-signal source supplied at a binding post on some scopes may be used.

## Troubleshooting Chart for Hickok Model 685 Oscilloscope



(Continued on next page)

(Continued)





### Sensitivity of the Vertical Amplifier

Two methods for checking the sensitivity of the vertical amplifier can be used. The easier and more accurate method — the use of a scope calibrator — will be discussed first.

Connect the calibrator to the vertical-input terminals and set the vertical amplifier control and input attenuator for maximum sensitivity. Adjust the calibrator for a vertical deflection of one or two inches on the scope. Read the input signal from the scope calibrator. Since this reading is in peak-to-peak volts and most scope manuals give the amplifier sensitivity in rms volts per inch, it will be necessary to convert to rms volts. This conversion can be done by dividing peak-to-peak volts by 2.8. This value is then divided by the scope deflection in inches to obtain the sensitivity. For example, assume that a deflection of two inches on the scope is obtained by a 140-millivolt signal from the calibrator. Then:

$$\begin{aligned}\text{Sensitivity} &= \frac{140}{2.8 \times 2} \\ &= 25 \text{ rms millivolts} \\ &\quad \text{per inch}\end{aligned}$$

The second method entails the use of an audio sine-wave generator and a meter for reading AC rms volts. Since the modern oscilloscope has a high sensitivity, the generator output must be attenuated by means of a simple divider network. A 4,700- and 510-ohm resistor across the generator output terminals would allow approximately one-tenth of the generator output to be applied to the scope from across the 510-ohm resistor. Connect an AC VTVM across the divider network. This meter must operate as a VTVM on the AC positions in order to obtain reasonable accuracy. Adjust the generator output for a convenient vertical deflection on the scope, as in the first method. Then read the rms voltage applied to the divider network. As an example, it might be 500 rms millivolts for a two-inch deflection. Only one-tenth of the voltage appearing across the network is applied to the scope. The voltage applied here is 50 millivolts. Since the measurement is already in rms volts, no conversion is needed; we merely make the following calculation:

$$\begin{aligned}\text{Sensitivity} &= \frac{50}{2} \\ &= 25 \text{ rms millivolts} \\ &\quad \text{per inch}\end{aligned}$$

### Sensitivity of the Horizontal Amplifier

Horizontal sensitivity is obtained in much the same manner as the vertical sensitivity, except that the signal must be applied

to the horizontal amplifier. The horizontal amplifier sensitivity is usually much less than the vertical sensitivity (that is, it requires a greater input for one-inch horizontal deflection). The signal most commonly applied to the horizontal amplifier is taken internally from the horizontal-sweep circuit and is of such magnitude that less amplification is necessary.

#### Frequency Response of the Vertical Amplifier

One of the fastest methods for checking amplifier response is through the use of square waves. This method requires some source of square-wave signal, such as a square-wave generator. If such a generator is not available, the horizontal sync pulses in a TV video signal provide a good check. It is an accepted rule that good square-wave response indicates good response of the amplifier to frequencies from one-tenth to ten times the fundamental frequency of the square wave. Thus, if an oscilloscope showed acceptable square-wave response as the square-wave frequency was varied from 250 cycles per second, good scope response would be indicated for the frequency range of from 25 cycles to 2.5 megacycles.



Fig. 8-6. Oscilloscope response using amplifier of 4-megacycle bandwidth.

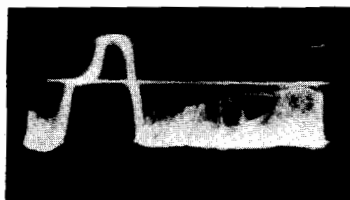
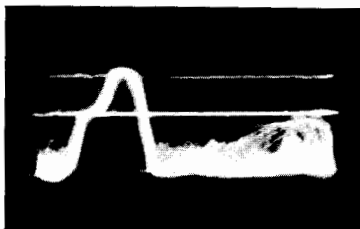


Fig. 8-7. Oscilloscope response using amplifier of 2-megacycle bandwidth.

Another method for determining the frequency response of an amplifier, such as the vertical amplifier in a scope, is to take a number of output readings over the frequency range while maintaining a constant input. These readings can then be plotted as a graph to indicate the response. This method is more time consuming than the other one.

Fig. 8-6 shows the response of an oscilloscope to the video-output signal of a monoscope. The oscilloscope was synchronized to show the horizontal sync pulses. The vertical amplifier was set to the 4-mc bandwidth position. Fig. 8-7 shows the response of the scope to the same signal, but the bandwidth switch was set at the 2-mc position. The square-wave response is poorer, as indicated by the rounded corners. Fig. 8-8 shows the effect of too much input capacity. The scope was left at the 2-mc position, and an additional capacity of .006 mfd was placed in parallel with

the scope input capacity by bridging across the input terminals. As a result, the front porch of the horizontal sync pulse almost disappeared.



**Fig. 8-8. Response showing effect of added input capacitance.**

### Synchronization

Turn the sync amplitude or locking control to zero. Set the sync selector to Internal and apply a moderate signal to the vertical input. Using only the coarse- and the fine-frequency controls, synchronize the signal as nearly as possible. Then advance the sync-amplitude control to lock the signal. If the circuit is operating properly, only a slight adjustment of this control should be necessary.

### Frequency Coverage of Sweep

The fine-frequency control or sweep vernier gives a continuous range of sweep frequencies for each setting of the coarse-frequency control. The top frequency of each range should equal or overlap the bottom frequency of the next higher range. The frequency limits of each range can be checked with an audio-signal generator.

Connect the generator output to the vertical input of the scope. Set the sync-locking control to zero. With the fine-frequency control at each extreme of its range, vary the signal-generator frequency to obtain a stationary pattern of two or three cycles on the scope. Divide the generator frequency by the number of cycles on the scope pattern to obtain the sweep frequency.

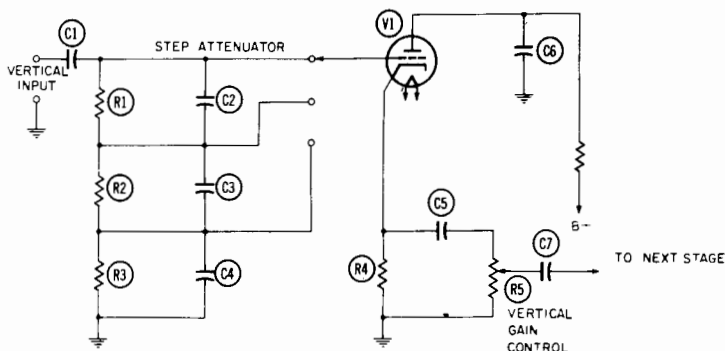
### Sweep Linearity

Connect an audio generator to the vertical-input terminals or use the 60-cps test signal if one is included on the scope. Synchronize the signal with the frequency and locking controls of the scope. Choose a frequency in which several cycles are visible on the screen. Using the horizontal-amplifier control, expand the trace to fill the screen horizontally. The pattern should be evenly spaced throughout its length; if it is crowded or stretched at any portion, nonlinearity of sweep is indicated. If this nonlinearity condition does not disappear as the sweep width is reduced by means of the horizontal-amplifier control, the sweep signal being

applied to the horizontal amplifier may be nonlinear, and the cause should be sought in the sweep-generating circuit. On the other hand, if this nonlinearity disappears as the sweep width is reduced, the nonlinearity was not caused by a defect in the sweep circuit, but by some defect in the horizontal amplifier. When some trouble exists in the horizontal amplifier, the amplifier may possibly be overdriven when the sweep width is adjusted to maximum. Maximum sweep width on most scopes extends past the borders of the screen; therefore, the sweep must be moved to either side with the horizontal-positioning control in order to view the ends of the sweep.

### Vertical Linearity

Apply a weak signal to the vertical input. Adjust the vertical gain to minimum and position the resulting spot on the screen to the center of the ruled grid. Advance the vertical-gain control



**Fig. 8-9. Simplified partial schematic of an oscilloscope showing step attenuator and gain control in vertical amplifier.**

slowly and note whether the signal expands at an equal rate above and below the middle horizontal line of the grid. The DC balance adjustment should be checked, if there is one, to avoid movement of the trace because of misadjustment. Decrease the signal input and increase the scope sensitivity in order to check the extremes of the vertical-amplifier range. Most oscilloscopes incorporate both a variable gain and a step attenuator for the vertical amplifier. These controls are usually placed in the circuit in the order shown in Fig. 8-9. The attenuator appears first, followed by an amplifier stage and the vertical-gain control. Under these circumstances, the first stage can be overloaded by applying an input signal too large for the attenuator position. Then the pattern on the screen would be distorted, no matter how much it might be reduced with the vertical-gain control. Some scopes have the at-

tenuator positions marked with the maximum signal value they are designed to handle. This marking helps the operator avoid possible distortion by overloading.

The foregoing paragraphs cover most of the operating controls encountered in the average general-purpose scope. Laboratory scopes and scopes for special applications would, of course, have additional controls.

## CHAPTER 9

### Frequency and Phase Measurements

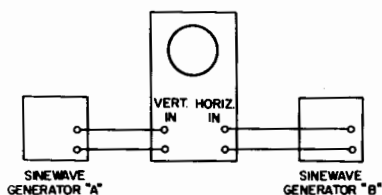
The oscilloscope is well suited for frequency and phase measurements because it responds instantly and faithfully to input signals applied to it. Frequency measurements will be limited to those frequencies within the response range of the oscilloscope amplifiers. If the signals are applied directly to the deflection plates of the cathode-ray tube, the distributed capacity of the related circuits may be a limiting factor. In either case, the frequency range will extend from low audio frequencies up into the radio frequencies.

One of the simplest (also the least accurate) methods of frequency measurement is with the oscilloscope sweep oscillator. The unknown signal is fed to the vertical input of the scope, and the sweep controls are adjusted for a stationary pattern of one cycle, if possible, or for a pattern of several cycles if the scope sweep rate does not go high enough for a 1 to 1 ratio. The frequency of the unknown signal can then be estimated from this information. This method gives approximate results only because the sweep range switches and vernier controls of most oscilloscopes are not calibrated to any degree of precision. The range switch is usually marked at each position with the frequency limits (low and high) to be covered by a complete rotation of the vernier control. The vernier control is usually indexed by a scale that is evenly divided, but that bears no direct relation to the sweep frequencies obtained. However, if the operator wished to take the time, he could make up a calibration chart for each sweep range position and thus obtain a greater degree of precision. For most accurate results, the sync amplitude control should be set to minimum.

#### LISSAJOUS FIGURES

More accurate frequency measurements can be obtained with Lissajous figures. Fig. 9-1 shows how these waveforms can be developed. The internal sweep system of the oscilloscope is turned off, and two different sinusoidal signals are fed to the inputs, one to the vertical and the other to the horizontal. The result is a closed loop waveform named after the French scientist Lissajous, who first showed how such figures could be developed, both optically and geometrically.

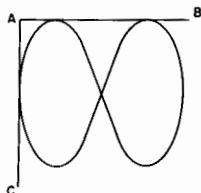
If the frequency of one of the generators is known, the other, or unknown, frequency can be determined by proper interpretation of the Lissajous figure they generate. The known frequency signal is usually connected to the horizontal input of the scope, and the unknown signal is connected to the vertical input. Simple fre-



**Fig. 9-1. Method for generating Lissajous figures.**

quency ratios result in waveforms that are easy to interpret. Therefore, the known frequency generator should be adjusted to obtain such a waveform, if possible. When the two signals have a ratio that can be expressed by whole numbers, such as  $2/3$ ,  $3/4$ ,  $4/1$ , etc., the waveform will appear to be stationary on the scope screen. If one generator is adjusted to give a signal ratio not quite expressible by two whole numbers, the pattern will seem to rotate slowly in one direction or the other. This rotation appears to take place in three dimensions, a fact that can sometimes be used to advantage in counting the loops of the pattern.

Fig. 9-2 shows the pattern resulting from a 2 to 1 frequency ratio and illustrates the method used for calculating the frequency ratios of other patterns. Note that a horizontal line AB is drawn, touching the pattern at two points, and a vertical line AC is drawn, touching the pattern at one point. The points of contact on line AB are caused by vertical excursions of the oscilloscope beam and are therefore related to the frequency of the signal applied to the vertical input of the scope. The points of contact on line AC (only one in this instance) are caused by horizontal excursions of the beam and are therefore related to the frequency of the signal applied to the horizontal input. From the pattern shown in Fig.

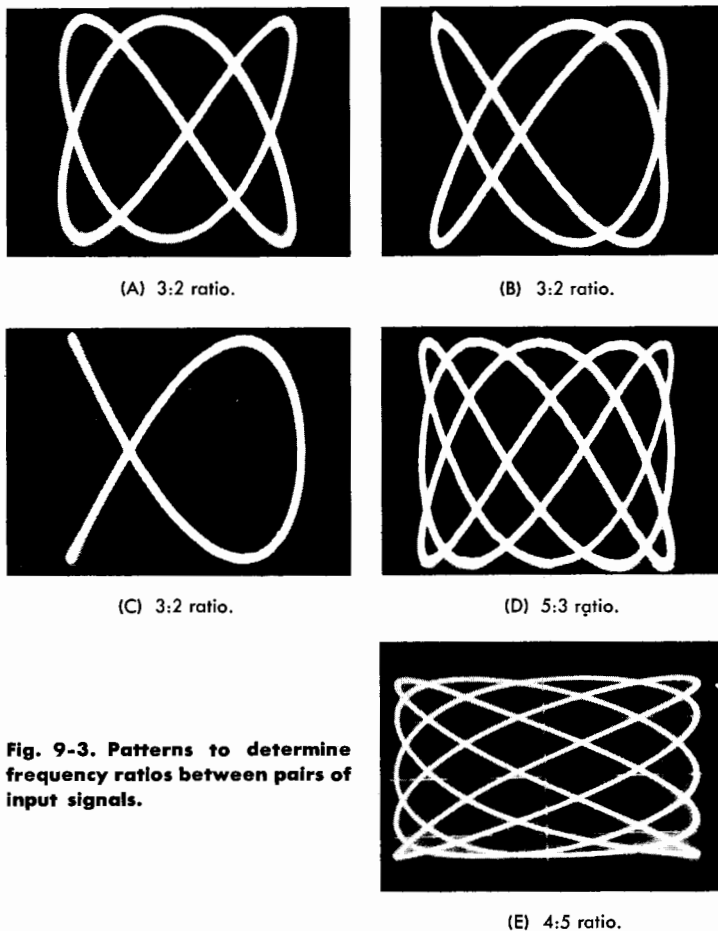


**Fig. 9-2. A method for calculating the frequency ratio indicated by a Lissajous figure.**

9-2, the oscilloscope beam makes two vertical excursions while making one horizontal excursion; therefore, the vertical input signal has twice the frequency of the horizontal input signal. Three points of contact to line AB and one to line AC would indicate that the vertical input signal frequency was three times that of the

horizontal input signal; three points of contact on line AB and two on line AC would indicate that the vertical input signal frequency was  $3/2$  that of the horizontal input signal, and so on.

Once the frequency ratio indicated by the Lissajous figure has been determined, the unknown frequency can be found by



**Fig. 9-3. Patterns to determine frequency ratios between pairs of input signals.**

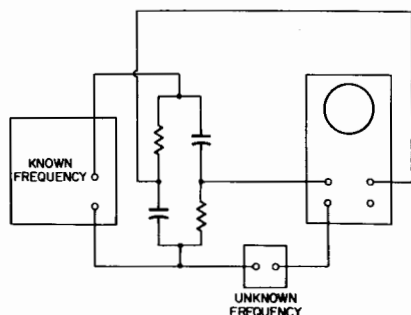
multiplying the known frequency by this ratio. A few of the simpler ratios are shown in Fig. 9-3. At "A", a 3 to 2 ratio is shown. If this pattern is permitted to rotate, it will appear as shown at B or C. The pattern at C could lead to some error in interpretation. The point to remember is that the pattern should consist of closed loops rather than abruptly terminated single lines as it seems to do in Fig. 9-3C. The pattern of Fig. 9-3D indicates a 5 to 3 frequency ratio, while that of Fig. 9-3E indicates a 4 to 5 ratio.



A continually shifting Lissajous pattern results when the phase relationship between the two input signals is constantly changing. The more complex the pattern (resulting from a frequency ratio having large numbers; for example, 17/13) the harder it is to interpret. The task is made even harder by a shifting pattern. It is better, then, to simplify the ratio, if possible, by changing the known frequency. If this is not practical, other methods of frequency determination may work better.

### FREQUENCY DETERMINATION WITH CIRCULAR SWEEPS

Circular sweeps can be used in frequency measurements by superimposing the unknown frequency signal upon the circular waveform and interpreting the resultant waveform. The circular sweep can be developed as discussed in Chapter 3, and the unknown signal is then impressed upon the sweep by placing it either



**Fig. 9-4. Unknown frequency superimposed on circular trace resulting in crown wheel pattern.**

in series or in parallel with the phase-shifting network. A series arrangement is shown in Fig. 9-4. This circuit arrangement results in a pattern resembling a crown wheel in perspective. The crown wheel appears to rotate unless the known signal is adjusted in frequency to obtain a whole number ratio with the unknown signal.

When the known frequency has been adjusted to obtain a stationary pattern, the "cogs" or "teeth" on one side of the crown wheel can be counted and used to calculate the unknown frequency. Fig. 9-5 shows a circular pattern with six teeth. This means the unknown frequency is six times the known frequency. A simple 6 to 1 ratio is indicated by this pattern; the pattern seems to be made up of a single line tracing around the wheel circumference once and outlining six teeth on one edge of the wheel as it does so.

The pattern shown in Fig. 9-6 is a little more involved. Here the pattern appears to be made up of a line going twice around the

circumference, outlining nine teeth as it goes. This represents a 9 to 2 ratio. In other words, the unknown frequency is  $9/2$  the known frequency (the known frequency signal is used to develop the circular trace).

With this method, as with other methods of frequency measurement, it is best to adjust the known frequency so that simple ratios are obtained, such as 1:1, 2:1, 3:2, etc. Thus, any confusion introduced by more complex patterns will be avoided.

Less confusing patterns can be obtained if the unknown signal is used to modulate the circular trace radially as described in Chapter 3.

Lissajous patterns are at their best for frequency and phase measurements when the input signals are sinusoidal or nearly so. Fig. 9-7 shows the resultant pattern when a square-wave signal is applied to the vertical input and a sine-wave signal is applied to

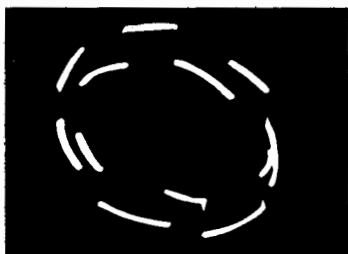


Fig. 9-5. 6 to 1 crown wheel pattern.

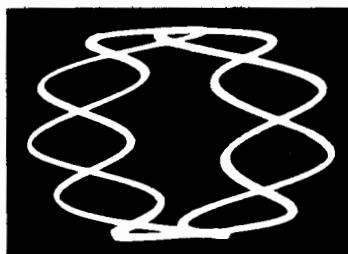


Fig. 9-6. 9 to 2 crown wheel.

Fig. 9-7. Pattern that results when a square-wave signal is applied to the vertical input and a sine-wave signal is applied to the horizontal input of an oscilloscope.

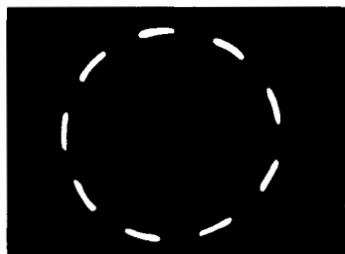


the horizontal input of an oscilloscope. The frequency ratio is 1 to 1; any other ratio results in a pattern that is practically unintelligible.

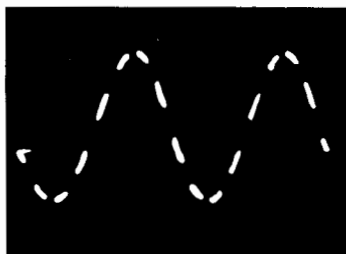
### MEASURING FREQUENCY BY INTENSITY MARKERS

Unknown frequencies can sometimes be determined by using intensity markers. The unknown frequency is applied to the intensity modulation jack of the oscilloscope to mark the pattern developed on the scope screen by the known frequency signal. The pattern can either be a circular trace developed in the manner we have described, or it can be a normal representation of the signal displayed by a sawtooth sweep. Examples of each method are shown in Figs. 9-8 and 9-9 respectively.

In the example in Fig. 9-8, the unknown frequency is determined by counting either the light or the dark dashes of the circle (but not both) and multiplying this number by the known frequency used to develop the circular trace. Fig. 9-9 shows a sine waveform marked by the unknown signal. The number of light (or dark)



**Fig. 9-8. Circular trace with intensity markers for frequency determination.**



**Fig. 9-9. Conventional waveform with intensity markers for frequency determination.**

dashes in one cycle of sine waveform multiplied by the known frequency of this waveform will give the unknown frequency. Both these methods work for simple ratios only, that is, ratios where one term is the numeral 1, as in 2 to 1, 5 to 1, 10 to 1, etc. For a ratio like 2 to 7, for example, light spaces will be superimposed upon dark spaces and cannot be interpreted.

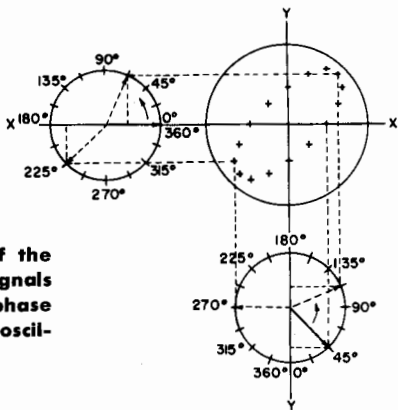
### **ELECTRONIC SWITCH**

Two signals can be compared directly on the oscilloscope by first passing them through an electronic switch, as described in Chapter 7. When the two waveforms are superimposed as in Fig. 7-18B, a direct frequency comparison can be made. For example, it can be seen in Fig. 7-18B that five complete cycles of one signal are completed in the time it takes to complete one cycle of the other signal. Therefore, the frequency ratio is 5 to 1. If one frequency is not some exact multiple of the other, one of the waveforms will appear to travel. A slight adjustment of the known frequency will usually correct this effect and allow an easier comparison to be made.

### **PHASE COMPARISON AND MEASUREMENT**

The oscilloscope can be used to make phase comparisons between two signals of the same frequency. The two signals are fed to the vertical and horizontal inputs in the customary manner to develop a Lissajous pattern. The phase relationship between the two signals can be determined by proper interpretation of this pattern.

The following discussion and waveforms are based on these arbitrarily chosen phase relationships: (1) the horizontal signal is considered to be leading the vertical signal by the specified amounts, (2) the same number of phase reversals take place in the vertical as in the horizontal amplifiers of the oscilloscope, if



**Fig. 9-10. Graphical illustration of the manner in which two sine-wave signals of identical frequency but different phase develop a phase indication on an oscilloscope.**

amplifiers are used, and (3) a positive-going signal applied to the vertical input causes an upward deflection, and a positive-going signal applied to the horizontal input causes deflection to the right.

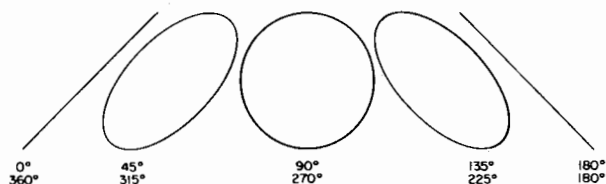
Fig. 9-10 illustrates how two sine-wave signals applied to the vertical and horizontal deflection plates develop a pattern indicative of the phase relationship between the two signals. The large circle represents the face of the scope with X and Y axes drawn through its center. Voltages applied to the horizontal-deflection plates will move the beam along the X-axis to the right or left of center, depending upon the polarity of the voltage. Voltages applied to the vertical-deflection plates produce beam movement along the Y-axis.

The two smaller circles represent sine-wave generators for the vertical and horizontal signals and are divided from zero to 360 degrees in steps of 22.5 degrees. The radial arrows are vector representations of the maximum signal voltage of each generator and are made equal to each other for simpler illustration. The deflection factors of the vertical and horizontal plates of the scope are assumed to be equal for the same reason.

In the left-hand circle, a perpendicular to the X-axis from the point of the radial arrow will represent the instantaneous magnitude of the sine-wave voltage applied to the vertical-deflection plates. This value can be transferred graphically to the scope diagram to locate the vertical position of the beam trace at that instant. Other times during the cycle are indicated by dotted arrows. In like manner, the perpendicular to the Y-axis

from the arrow point in the lower circle represents the horizontal-deflection voltage at any particular instant. This value is transferred graphically to the scope diagram to locate the horizontal position of the beam trace at that instant.

For this illustration, the two sine-wave vectors have been chosen so that the horizontal vector is 45 degrees ahead of the vertical vector. Since the frequencies of both signals are the same, this 45-degree difference is maintained throughout the complete cycle. The beam position on the scope is plotted for every 22.5-degree interval of the cycle, and the resultant graph gives a very good indication of the scope waveform obtained for a phase difference of 45 degrees between signals. The waveform is an ellipse and is the same as that obtained for a phase difference of 360 degrees minus 45 degrees (315 degrees), as will be seen if we consider the horizontal vector as zero reference, with the vertical vector lagging the horizontal.



**Fig. 9-11. Phase indications from 0° to 360° at intervals of 45°.**

Any phase difference can be plotted in this manner, and a complete series would show that the pattern is either a straight line, a circle, or an ellipse. Straight lines occur at zero and 180 degrees phase difference; circles occur at 90 and 270 degrees. All other values of phase difference are shown by ellipses. These ellipses become narrow and approach a straight line at zero or 180 degrees or become broader and approach a circle at 90 and 270 degrees. A number of these patterns are shown in Fig. 9-11. Phase differences are indicated for intervals of 45 degrees, from zero to 360 degrees.

Fig. 9-10 shows how the technician can plot any phase difference he desires and get an accurate waveform like that obtained with the oscilloscope. In practical cases, he may be interested in somewhat the reverse effect. That is, he may have a Lissajous pattern and desire to know the phase difference it represents. Fig. 9-12 shows how an unknown phase angle can be calculated from such a pattern.

It is convenient to consider all the phase angles from 0 to 90 degrees as basic and to calculate all the others through them. Thus, referring to Fig. 9-11 again, at 0 we start with a straight line (a closed loop seen on edge) and go through an infinite series of ellipses, finally arriving at a circle for 90 degrees. The same

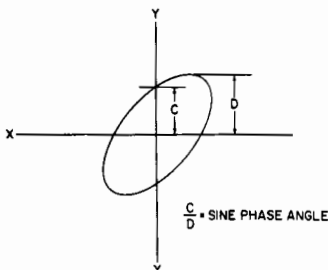
series of ellipses, but slanting in the opposite direction, covers the range from 90 to 180 degrees. The range from 180 to 360 degrees duplicates both series, but in reverse order.

Before making the measurements of Fig. 9-12, the vertical and horizontal gains should be adjusted to be as nearly equal as possible; otherwise, a perfect circle will not be obtained at 90 degrees. The accuracy of this method will not be impaired, however, if the two gains are not exactly equal.

The ellipse should be positioned so that its center coincides with the intersection of the graph lines of the scope calibration screen as shown in Fig. 9-12. If the distances C and D are measured and substituted in the formula given, we obtain the sine of the phase angle. The phase angle can then be found by locating this value in a table of sines.

Phase angles between 90 and 180 degrees (their ellipses slant from lower right to upper left) are found in the following

**Fig. 9-12. A method for calculating the phase angle represented by a 1 to 1 Lissajous figure.**

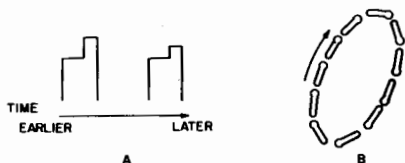


manner: Find the value of the sine by the preceding method. Locate this value and corresponding angle in the sine table. An angle between 0 and 90 degrees will be given, which should then be subtracted from 180 degrees for the final correct value.

Notice in Fig. 9-11 that each waveform is labeled with two values of phase angle. When the technician views the waveform, there is no indication to the eye which phase angle is the correct one. However, there is a difference in how the waveform is developed; in one instance, the beam is traveling clockwise around the waveform and in the other, the beam is traveling counterclockwise. Under the conditions stated in the second paragraph of this discussion of phase comparisons, the beam travels counterclockwise for the 45-, 90-, and 135-degree waveforms of Fig. 9-11 and clockwise for the 315-, 270-, and 225-degree waveforms.

The direction of beam travel can be determined by at least two methods: (1) by changing the phase of one signal in a known direction, and (2) by intensity modulation of the beam with a suitable marker. As an example of the first method, suppose we desire to know whether an ellipse like the first, shown in Fig. 9-11, represents a 45- or 315-degree phase difference. We know the horizontal signal is leading the vertical signal by one or the

other of these amounts. Suppose we increase the lead of the horizontal signal. If the waveform changes in the direction of the circle, it originally was a 45-degree waveform, but if the waveform changes toward a straight line, it was the 315-degree waveform.



**Fig. 9-13. Intensity marker signal at A produces markers as at B. Beam rotation is as indicated by arrow.**

Fig. 9-13 is one example of the type of signal that can be used to mark a pattern so that the direction of beam travel can be determined. This figure shows just the positive peaks of the signal since they are responsible for the visible indication on the waveform. This type of signal is effective for this purpose because, as it is made more and more positive, the beam trace gets brighter and has a tendency to enlarge. The signal at Fig. 9-13A will then result in a marked trace like the one at B. Thus, a trace resembling a series of arrows pointing in the direction of beam travel is obtained. The frequency of the marking signal is unimportant except it should be greater than the vertical input signal and a whole number multiple of this frequency. The intensity adjustment of the oscilloscope should be reduced to nearly minimum intensity for a more effective marker. If a marking signal of the type shown at Fig. 9-13A is not available, others may be used. A sawtooth signal like the one developed by the scope sweep generator will produce a narrow wedge-shaped marker. The peak of the sawtooth will correspond to the wide end of the wedge. Which portion of the sawtooth signal occurs later in time must be known to determine the direction of beam travel.

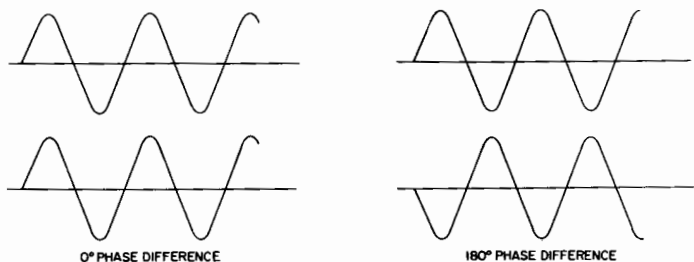
### PHASE COMPARISON WITH AN ELECTRONIC SWITCH

Two signals can be displayed together by means of the electronic switch for phase comparisons. They can either be displaced or superimposed for easiest interpretation. Fig. 9-14 shows two examples that are easy to interpret, the 0- and 180-degree phase differences. These figures might be obtained when comparing waveforms at various points in a conventional amplifier. The phase difference between the input and output signals of a single stage of audio amplification usually is 180 degrees.

When viewing small phase differences, the operator may wish to superimpose the two signals as closely as possible. With

signals viewed in this manner, the slight phase shift caused by operation of a tone control is large enough to be seen.

Both the aforementioned methods of evaluating phase differences, Lissajous patterns and an electronic switch, depend for their accuracy upon the skill and care of the operator. At best,



**Fig. 9-14. Phase comparisons using an electronic switch.**

the results will be only approximate; the operator will probably do well to measure within 10 degrees of the exact value. However, he can get a good idea of what is happening within a circuit and determine whether or not phase relationships are normal.

Special equipment has been designed to give accurate direct indications of phase angles. Some of this equipment involves the use of an oscilloscope, and some does not. Other than this brief mention, however, such equipment will not be discussed here.



## CHAPTER 10

# Amplifier Testing with Square Waves and Sweep Signals

### ADVANTAGES

A number of amplifier characteristics may interest the technician: frequency response, phase shift, tone control action, stability, equalization pattern, distortion, intermodulation percentage, power output, and others. The first five of these characteristics are particularly suited to exploration by means of square waves and sweep signals. The main advantages of testing with these types of signals are the ease and speed with which it can be done. These testing methods can be applied to audio amplifiers and video amplifiers of monochrome and color TV receivers. In fact, they should apply to any amplifier whose frequency response falls within the frequency range of the generator and oscilloscope used.

### SQUARE-WAVE FREQUENCY RESPONSE TEST

The merit of the square-wave test to indicate an amplifier's frequency response is based upon the fact that a square wave represents a great many frequencies other than its own fundamental frequency. Fourier analysis has shown that a square wave can be built up from many sine waves of different amplitudes and frequencies. The fundamental frequency will have the greatest amplitude, and it is combined with odd-numbered harmonics that decrease in amplitude as the order of the harmonics increases.

Thus, a square-wave signal of a certain fundamental frequency applied to an amplifier is a more extensive test of the amplifier response than is a sine-wave signal of the same frequency. The square-wave test for frequency response consists of applying square-wave signals of various fundamental frequencies to the amplifier and observing the output on an oscilloscope. Any change in the shape of the square wave can then be interpreted in terms of frequency response of the amplifier.

This test is not the type that will furnish information for plotting a response curve. That is, the exact ratio between the amplification factors at various frequencies will not be determined.

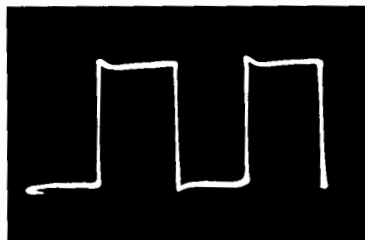
Rather, a quick over-all picture of the frequency response will be gained.

Before a test, the quality of square-wave signal put out by the square-wave generator should be checked. The signal should be fed directly to the oscilloscope input and checked for flatness and sharp corners. A slight imperfection can be tolerated and allowed for when the amplifier response is interpreted. The oscilloscope amplifiers should have response characteristics as good as, or better than, the amplifier being tested; otherwise, they become a limiting factor in the test. If the output waveform from the square-wave generator appears good for some settings of the scope attenuator switch and peaked or rounded at another setting, the attenuator adjustment for that switch position should be checked and readjusted if necessary.

It is customary to assume that a well-reproduced square wave of any particular frequency indicates good response for all frequencies from one-tenth to ten times that frequency. Since this frequency range of 100 to 1 is far short of the range of most present-day amplifiers, the square-wave generator must be reset several times to make a complete test. Usually the extreme low and high ends of the amplifier response will interest the technician more than the midrange. They determine the width of the response range and present more design difficulties to the manufacturer.



**Fig. 10-1.** A 1-kc square wave applied directly to the oscilloscope input.

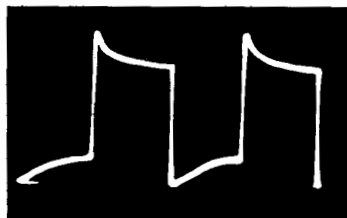


**Fig. 10-2.** Preamplifier Response to the 1 kc square wave. Tone controls were adjusted for flat response.

An acceptable test is to run the square-wave frequency low enough and high enough until the response falls off at these extremes and then tune the generator through the entire range between, meanwhile watching for any peculiarities.

The technician can acquaint himself with some of the square-wave response curves obtainable if he checks the action of the bass and treble controls during a test. Some of the following waveforms were obtained in this manner. Fig. 10-1 resulted from applying a 1-kc signal directly to the vertical input of the oscilloscope. The tops and bottoms of the square wave are straight and level, with no evidence of overshoot or ringing. Fig. 10-2 shows

the same signal applied to the tuner input of a preamplifier of the type used between tuner or phonograph pickup and amplifier. The bass and treble controls were adjusted for a response approaching Fig. 10-1 as nearly as possible. A slight peak remains at the leading edge of the square wave, and this tendency can be noticed



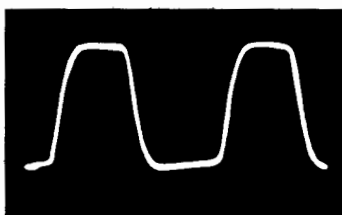
**Fig. 10-3.** Treble emphasis applied to a square wave signal.



**Fig. 10-4.** Effect of bass boost on square wave signal.



**Fig. 10-5.** 50-cycle square wave shows low frequency attenuation and phase shift.



**Fig. 10-6.** High frequency attenuation is shown by rounded corners of square wave.

in some of the illustrations which follow. A sine-wave frequency check shows the amplifier to be flat over the audio range. The most likely explanation of the peak is that it is due to some overshoot in the preamplifier circuits.

When the treble control is advanced, the leading edge of each cycle becomes even more peaked, as in Fig. 10-3. The peak appears for both positive and negative halves of the cycle. A logical conclusion from Fig. 10-3 is that excessive highs in an amplifier are indicated by peaked leading edges of the square-wave response, sloping back to the trailing edge. Conversely, the leading edges should be depressed below normal if the highs are attenuated, and this is exactly what happens.

When the treble control is kept normal and the bass control advanced, the waveform of Fig. 10-4 results. Trailing edges of each half-cycle of the square wave are peaked, sloping gradually from the leading edges. When the bass control is set for attenuation, the waveform slopes in the opposite direction. It then resembles the waveform for treble emphasis. This is about what

you might expect. After all, it is a relative matter — reduce the bass or increase the treble — the results are similar.

Fig. 10-5 is the result of applying a 50-cycle square wave to the preamplifier with the tone controls set for flat response at 1 kc. Leading edges are elevated and trailing edges are depressed — the marks of low frequency attenuation and phase shift. The severity of a square-wave test over a sine-wave test is borne out by the fact that the preamplifier showed practically no attenuation to a 50-cycle, sine-wave signal when compared to its 1000-cycle response, yet the 1000-cycle square wave of Fig. 10-1 was changed to that of Fig. 10-5 at 50 cycles.

When the square-wave generator is adjusted toward the high-frequency extreme, a point is reached where the preamplifier response begins to fall. This is evidenced by a gradual rounding of all corners of the square wave, as in Fig. 10-6, which shows the response to a 10-kc signal. As the square-wave frequency is adjusted higher and higher the corners are rounded more and more, and the square wave takes on the appearance of a sine wave.

### THE SQUARE WAVE AS AN INSTABILITY CHECK

We have seen how the square-wave signal provides a quick check for the frequency response range of an amplifier; it can also discover any tendency to instability. The steep wavefront of the square wave can shock borderline cases into ringing or oscillation, as shown by Figs. 10-7 and 10-8. Ringing is just a form of oscillation that dies away quickly. In Fig. 10-7, about 3 cycles of oscillation are visible in each half-cycle of square wave. Fig. 10-8 indicates a more unstable condition; the oscillations persist throughout the entire cycle, although they may not show in all parts of the reproduction.

When this type of oscillation occurs in audio amplifiers, it is usually above the audio frequency range and, therefore, will not be heard in itself, but it may react with the audible signal to cause distortion. It is almost certain to cause a lowering of the maximum power output.

Although an amplifier may be shock excited to the point of oscillation with a square-wave signal, it might not do so when a sine-wave signal is applied. The results of the square-wave test indicate, however, that some trouble might be expected on large audio signals of complex waveforms.

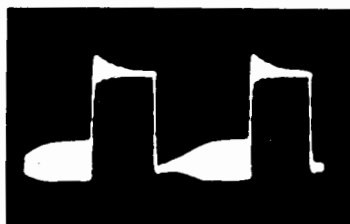
Video amplifiers in TV receivers can be tested with a square-wave signal in much the same manner as audio amplifiers. Interpretation of the resultant waveforms is similar to the examples just given. The range of frequencies is a little different with the TV receiver; it is shifted toward the higher frequencies. That is, it is usually not expected to go as low, but does extend up to several megacycles. Here again, the operator must be certain that the oscilloscope amplifiers do not become the limiting factor

in response at these higher frequencies, or a misleading waveform will be obtained.

Phase shift and ringing are more evident in the TV picture than in an audio signal and cause smearing and repeated outlines during reception of a regular broadcast signal. Incidentally, the



**Fig. 10-7. Moderate ringing induced by application of square waves.**



**Fig. 10-8. Instability shown by continuous oscillation when square wave is applied.**

picture tube can serve as a fair substitute for the scope in the square-wave test since the signal applied to the video amplifiers is fed directly to it. By turning the brightness up and down, the operator can get a good idea of the condition of the square-wave signal at the picture tube. For example, sharp corners on the waveform will result in sharp divisional edges between the light and dark bars on the screen; round corners will result in blended edges to the bars.

### TESTING WITH SWEEP SIGNALS

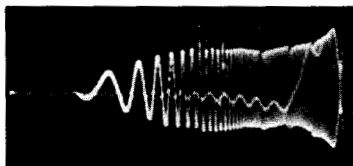
The sweep method of testing results in waveforms that approach the conventional plotted response curve of an amplifier, at least in content if not in actual appearance. The test works for both audio and video frequency amplifiers, if a suitable sweep signal is available. Radio frequency sweep generators have been common for many years now, but video and audio sweep generators are somewhat less common. One method of designing sweep generators, beating a steady signal against a sweeping signal, is difficult to use at low sweep frequencies. The reason is that two oscillators tend to lock together when they approach each other in frequency. Thus, sweeps at comparatively low frequencies, such as the audio and video frequencies, are a little more difficult to attain.

One method of obtaining an audio sweep signal is with a sweep recording. The recording is in the conventional disc form and must be played on a record player to obtain the signal. When the playback system has the proper equalization characteristics, corresponding to the recording characteristics originally used in making the recording, a flat output signal is obtained. The operator can check pickup characteristics, preamplifier equalization,

and tone control action. To make the signal more useful, markers are included during the original recording process. These markers identify the frequencies at various points on the response curve.

Fig. 10-9 shows a response curve obtained by playing an audio sweep recording with a variable reluctance cartridge. No

**Fig. 10-9. Sweep signal obtained directly from disc recording with variable reluctance pickup.**



equalization or amplification was used between the cartridge and the oscilloscope. The recording was cut to a modified NARTB curve, with markers at 70, 1,000, 3,000, 5,000, 7,000, and 10,000 cycles.

Since the cartridge was not equalized, the response waveform is not flat, but shows a reduced response at the low end and a peaked response at the high end. The cartridge is velocity responsive, and would produce a flat waveform if the recording had been made at constant velocity. However, the recording has a constant-amplitude section at the low end and a section of pre-emphasis at the high end, and these sections account for the deviations in response.

The oscilloscope was set for internal sawtooth sweep of 20 cps, with internal synchronization. The 70-cycle marker does not appear in the waveform and has probably been lost at the beginning or end of the oscilloscope sweep. This type of waveform is a little difficult to synchronize so that the whole waveform appears in order from low to high frequencies, as it does in this figure. More often than not, the scope sweep will start somewhere near the middle of the response, and all of the waveform which should appear to the left of this point will be displaced to the right-hand side of the waveform. This is just a minor inconvenience, since the waveform can still be interpreted without much trouble.

The audio sweep record provides a quick and convenient method of checking the effectiveness of equalization networks and tone controls. One thing should be remembered — the playback cartridge is necessary to develop the signal, and since its effect on the signal has a bearing on the final waveform, it must always be considered as one link in the amplifier chain. Other methods of sweep generation do not require a playback cartridge, and so this factor is eliminated in the final consideration of the waveform.

#### **CHECKING VIDEO RESPONSE**

A complaint frequently encountered by service technicians is that a television receiver produces a picture lacking in fine

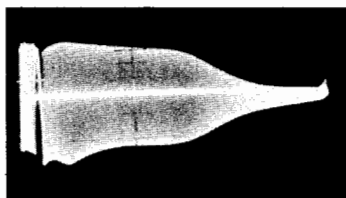
detail. Since the finely detailed portions of the picture are produced by the higher video frequencies, this lack of fine detail indicates that these high frequencies are not being presented to the picture tube. If the RF amplifier, mixer, and IF stages have been checked, and are operating satisfactorily, the trouble must lie in the video amplifier. The video amplifier can be checked with a voltmeter, but this will not prove conclusively that the operation is normal.

The requirements imposed on a video amplifier are quite strict. It must amplify equally all frequencies from 30 cycles to over 4 mc and still maintain an average gain of 20 to 30. That is, the amplifier must have a flat frequency response and sufficient gain. It is difficult to produce both, for if one is increased, the other will decrease, and vice versa.

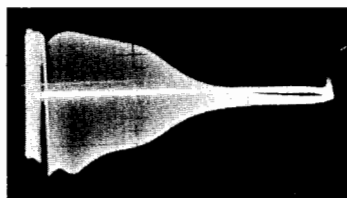
Any variation in component values may change the frequency response of the amplifier, and to detect this change, the frequency response must be known. A graphic curve can be constructed from values obtained by measuring the amplification at various fixed frequencies, but this can become a laborious and time-consuming process. A much simpler and easier method of determining the video-amplifier response is to employ an oscilloscope and sweep generator, in much the same manner as is done in video IF alignment.

The output of an FM signal generator is a frequency-modulated signal that varies between upper and lower frequency limits determined by the setting of the controls. The setting of the Center-Frequency control determines the frequency around which the signal deviation occurs. The Sweep-Width control is used to set the amount of desired deviation above and below the center frequency. For instance, a setting of 25 mc on the Center-Frequency dial and a 10-mc Sweep-Width setting provide a frequency-modulated signal between 20 and 30 mc. When used to align a tuned amplifier, such as the video IF stages, the center frequency of the generator is adjusted to the center of the amplifier passband, and the sweep limits are adjusted to cover the upper and lower limits of the passband. The amplifier output can then be displayed on an oscilloscope screen in the form of a curve. The synchronized sweep voltage from the generator must be connected to the horizontal-input terminals of the oscilloscope. The complete horizontal trace then represents the frequency band covered by the sweep generator. Any point on the horizontal trace represents a definite frequency; therefore, the height of the curve at any given point represents the amplifier output at that frequency. Thus, a curve representative of the amplifier gain at all frequencies within the passband can be displayed. This method can also be used for testing video amplifiers by adjusting the generator to sweep from zero cycles up to the maximum frequency to be checked. A description of this method follows.

Many combinations of generator and oscilloscope will provide a usable pattern, and others will not. At this point, the equipment on hand should be checked to be sure the generator has enough output and the oscilloscope has a sufficiently wide response. The generator and oscilloscope are connected and the controls adjusted as if an amplifier were to be tested, except that the gener-



**Fig. 10-10A.** Response curve with generator connected directly to wide-band oscilloscope.



**Fig. 10-10B.** Response curve with generator connected directly to narrow band oscilloscope.

ator output is connected directly to the oscilloscope input. This gives a response check of both units and should produce a pattern similar to that of Fig. 10-10A. This photo shows the response curve produced by the generator and oscilloscope, which were used to procure all the included photographs. Fig. 10-10B shows a curve obtained with an oscilloscope having insufficient high-frequency response. If a check of the equipment on hand produces a similar pattern, the oscilloscope is not suitable for checking video-amplifier response in this manner.

Connect the sweep generator to the amplifier input and adjust the controls to provide an output of a 4.5-mc center frequency with a sweep width of 9 mc. This setup was used to obtain the accompanying photographs. A wide-band oscilloscope is connected to the amplifier output, and the synchronized sweep output of the generator is connected to the horizontal-input terminals of the oscilloscope. The oscilloscope controls are adjusted so that the sweep voltage from the generator provides the horizontal trace. With this setup, the oscilloscope screen presents a response curve of the amplifier at all frequencies, from a few kilocycles to a little better than 4.5 megacycles (the generator sweep is actually wider than the nominal 9 mc), and any deficiency in the frequency response of the amplifier will appear as a droop or sag in the curve. A separate marker generator may be coupled to the amplifier input, and the marker pip will then identify the frequency at which the amplification loss begins or ends.

The diode detector normally used for video detection is a low-impedance device, and its load impedance is of a very low value. To prevent this low impedance from loading the generator output, the detector load must be removed from the video-amplifier input, and a substitute high-impedance circuit must be added. A



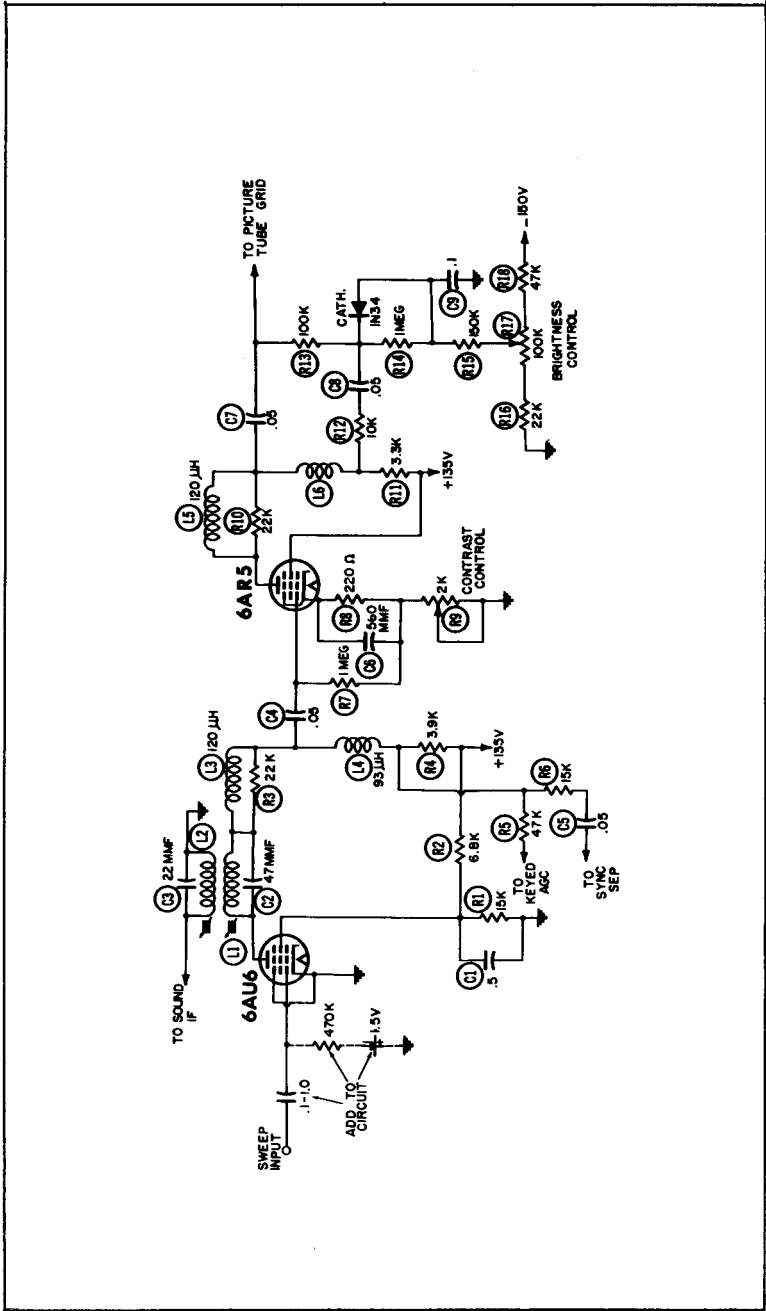
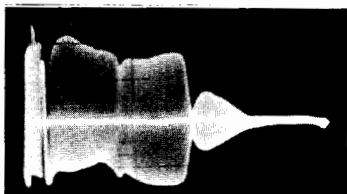
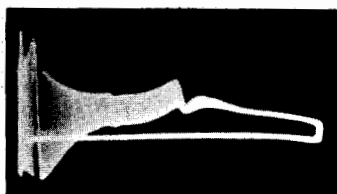


Fig. 10-11. Schematic diagram of video amplifier used in test.

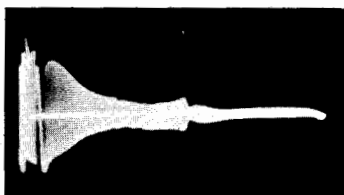
470K-ohm resistor and a 1.5-volt battery are connected in series from the video-amplifier grid to ground. The coupling capacitor should be as large a value as possible (.1 to 1.0 mfd). In circuits where fixed bias is applied to the video-amplifier grid and capacitive coupling is used, only the detector-load circuit need be disconnected.



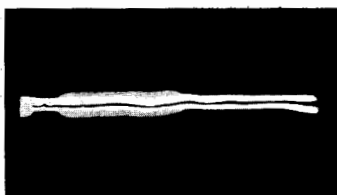
**Fig. 10-12. Normal response of video amplifier.**



**Fig. 10-13. Response curve showing distortion introduced by input capacity of oscilloscope.**



**Fig. 10-14. Response curve produced by open in series peaking coil in 6AU6 plate circuit.**

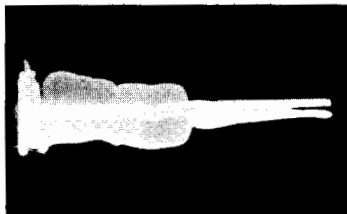


**Fig. 10-15. Response curve produced by open in series peaking coil in 6AR5 plate circuit.**

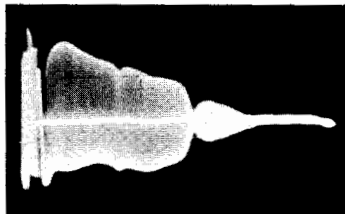
The video amplifier shown schematically in Fig. 10-11 is representative of most video amplifiers in that it is compensated to have a fairly flat response up to 4.5 mc and actually has a small amount of gain up to 6 mc. Fig. 10-12 is a photograph of the normal response curve of this amplifier, showing the extreme dip at 4.5 mc due to the trap formed by L1 and C2. (NOTE: The small gap in the curve at the extreme left does not result from a defect in the video amplifier. The sweep generator used in making these photographs was the beat-frequency type, and the output diminished to zero when the swept oscillator locked in with the fixed oscillator.) The amplifier has some gain above 4.5 mc, but this is of no consequence since only the frequencies below 4 mc are used to modulate the picture tube. A high-impedance probe was used on the input lead of the oscilloscope for all photographs except Fig. 10-13. Fig. 10-13 shows the distortion of the response curve due to the input capacity of the oscilloscope.

One of the troubles often found in a video amplifier is an open peaking coil. When the coil has no shunt resistor, such as

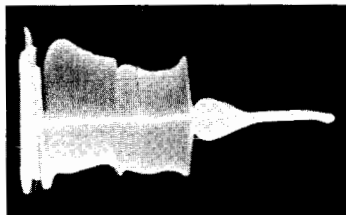
L4 and L6 in Fig. 10-11, the result of an open will be definite. The plate voltage is removed from the tube, and the amplification ceases. The result of an open in L3 or L5 of Fig. 10-11 will be less definite. The shunt resistor is still in the plate circuit; the tube retains plate voltage, although at a low value, and some ampli-



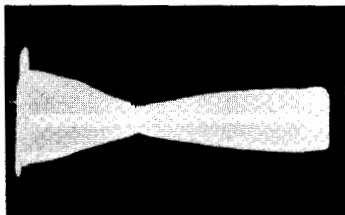
**Fig. 10-16. Response curve with cathode bypass capacitor shorted.**



**Fig. 10-17. Response curve showing effect of added capacity.**



**Fig. 10-18. Effect of stray capacity on high-frequency response.**



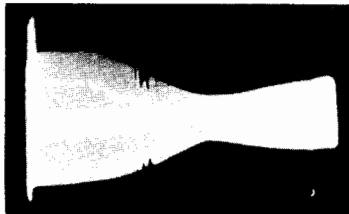
**Fig. 10-19. Response curve obtained with correct adjustment of 4.5 megacycle trap.**

fication remains. Fig. 10-14 shows the result of an open in L3, and Fig. 10-15 shows the result of one in L5. The capacitor C6 in the cathode circuit of the 6AR5 video-output stage was included in the amplifier design to improve the high-frequency response. If an open should occur in this capacitor, the oscilloscope pattern would be similar to Fig. 10-12, but would have a lower amplitude. However, should this capacitor develop an internal short, it would remove the normal bias from the 6AR5, in addition to lowering the response. Fig. 10-16 illustrates the result of this condition, showing the distortion caused by operating the 6AR5 at approximately zero bias.

While a receiver is being serviced, leads and components may have to be rearranged. A lead or component might be moved so close to the video amplifier circuits that an appreciable capacity to ground would be introduced into the circuit. The plate circuits of the video amplifier would be most affected by this added stray capacity. To simulate this condition, a 5-mmf capacitor was shunted to ground from two separate points in the video amplifier, and the resulting waveforms appear in Figs. 10-17 and 10-18.

Fig. 10-17 was obtained with the capacitor connected to the plate (pin 5) of the 6AU6, whereas in Fig. 10-18, the capacitor was connected to the junction of L1 and L3. The added capacity distinctly affects the high-frequency response of the amplifier. This condition could have previously been injected into a receiver by

**Fig. 10-20. Response curve showing misadjustment of 4.5 megacycle trap.**



a service technician who had thoughtlessly moved a lead or component.

This method of checking video response also provides a fast and accurate way of adjusting or checking the 4.5-mc trap during the response check. Reduce the Sweep-Width control setting to approximately 1 mc; adjust the Center-Frequency control to center the response curve on the oscilloscope screen, and inject a calibrated 4.5-mc signal into the video amplifier input. Fig. 10-19 shows the pattern obtained when the trap is correctly adjusted, and Fig. 10-20 shows an incorrect adjustment.

Although this procedure may seem complicated at first, with repeated usage the complications should disappear. It will be easier to set up the equipment and obtain an over-all indication of amplifier performance at once than to make numerous readings with an ohmmeter or voltmeter. For the service technician who demands the best performance from the receivers he has serviced, this method should prove valuable.

## CHAPTER 11

# Radio and TV Alignment

There are a number of tunable circuits in the average radio or TV receiver. Their purposes vary, but usually they are designed to accept or reject certain frequencies so they can be amplified or eliminated entirely, or otherwise controlled. The adjustment of these circuits for proper functioning is called alignment. Several choices may be open to the technician for methods of alignment, but the choice of indicating equipment will usually be between meter and oscilloscope. Sometimes a combination of both may work better. Since this book deals primarily with the oscilloscope and its uses, alignment discussion will be restricted mainly to this type.

### ADVANTAGES OF OSCILLOSCOPE ALIGNMENT

Although a simple AM radio receiver can usually be satisfactorily aligned with a meter, the advantages provided by an oscilloscope are readily apparent when more complex and exacting alignments are attempted. Examples include wide-band IF amplifiers of both AM and FM radios, FM detectors, stagger-tuned or overcoupled video IF amplifiers, and Synchronuide circuits. Alignment of a wide-band IF amplifier with a meter would involve many individual settings of an RF generator and checks of the effect after each alignment adjustment. With a scope and sweep generator, a complete response curve is seen, and the effect of any adjustment upon the entire response is noticed immediately.

Overloaded circuits result in distortion, which cannot be seen on a meter but can be seen on a scope.

Meters are more susceptible than oscilloscopes to damage from overloads.

### PRELIMINARY STEPS

It is good practice to use an isolation transformer between the power line and any AC-DC receiver being aligned to protect both operator and test equipment. The ground lead of much test equipment is connected directly to the case. If the ground lead is connected to any live point on an AC-DC chassis, the results may be unpleasant, to say the least, since it is difficult to avoid touching the case during alignment.



PRE-ALIGNMENT INSTRUCTIONS

The high-voltage lead should be securely taped and kept away from the chassis. Allow a 20-minute warm-up period for the receiver and test equipment.

VIDEO IF ALIGNMENT

Connect the negative lead of a 1.5-volt bias supply to point  $\diamond$ . Positive to chassis. Connect the negative lead of a 3-volt bias supply to point  $\diamond$ . Positive to chassis. Connect the synchronized sweep voltage from the sweep generator to the horizontal input of the oscilloscope for horizontal deflection. The sweep generator output lead should be terminated with its characteristic impedance, usually 50 ohms. Use only enough sweep-generator output to provide a usable pattern on scope. Use 10-mc sweep unless otherwise stated. De-tune mixer plate coil by turning core fully counterclockwise.

DUMMY ANTENNA	SWEEP GENERATOR COUPLING	SWEEP GENERATOR FREQUENCY	MARKER GENERATOR FREQUENCY	CHANNEL	CONNECT SCOPE	ADJUST	REMARKS
1. .001mf	High side to pin 1 (grid) of 6B28 (V1). Low side to chassis.	43.5mc	47.25mc	Any non-interfering channel	Vert. Amp. thru 10K to point $\diamond$ . Low side to chassis. (Across Video Det. load)	A1, A2	Adjust to place marker in trap notch. If two points are found to do this, use the one with slug farthest counterclockwise.
2. "	"	"	42.25mc	"	"	A3, A4, A5	Adjust for maximum gain and symmetry of response similar to Fig. 11-2B with markers as shown. Adjust A3 for maximum gain. A4 to position 45.75-mc marker and A5 to place 42.25-mc marker. Recheck step 1.
3. Direct	Place a thin insulated metal strip between the Mixer-Osc. tube (V202) and tube shield. Connect the high side of sweep generator to the metal strip. Low side to chassis.	"	41.25mc	"	"	A6	Adjust to place marker in trap notch. If two points are found to do this, use one with slug farthest counterclockwise.
4. "	"	"	41.25mc 42.25mc 45.0mc 46.75mc	"	"	A7 & Mixer Plate Coil	Adjust for maximum gain and symmetry of response similar to Fig. 11-2B with markers as shown. Adjust mixer plate coil for maximum gain with 45.74-mc marker at 50%. Adjust A7 for maximum gain and proper tilt. Due to interaction, it may be necessary to repeat adjustment. Recheck step 3.

Fig. 11-2A. Alignment instructions for receiver circuit of Fig. 11-1.

If the receiver being aligned has an AVC or AGC circuit, the alignment instructions will usually recommend disabling or controlling this circuit during alignment. One reason for this is that the AVC or AGC action will partly nullify the effect of an alignment adjustment. Adjustments are usually made for a maximum or a minimum output indication at the scope, but the AGC tries to hold the output constant. Therefore, the AGC should either be disabled or should be held at a constant value.

When a circuit is fairly simple and has no bandwidth considerations, one of the most satisfactory procedures is to maintain the input signal from the alignment generator as low in level as possible and thus avoid any action from the AVC circuit. This system can also be followed where a bandpass effect, together with maximum sensitivity, is desired, for example, when a TV receiver is aligned for fringe area reception.

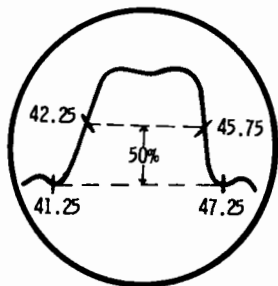


Fig. 11-2B. Video IF response curve.

When the receiver is aligned for reception of normal strength TV signals, RF and video IF stages should be maintained at the same bias level that would be obtained with signals of this strength. In some amplifiers, the over-all response may change as the operating bias is changed. Therefore, to insure best response during actual reception, the receiver is aligned with normal operating bias. This also helps avoid adjustment of any stage to an overload condition.

The alignment bias is usually applied to some convenient point on the AGC line and can be a small battery or other bias supply. Some supplies are made to be adjustable so that a range of values can be had. The correct value and point of application are usually suggested by the receiver manufacturer. Sometimes the value is not considered critical and is specified as "that value of bias which results in an undistorted waveform."

Fig. 11-1 shows part of a TV receiver schematic that can serve as the basis for discussion in the following paragraphs. The section which carries the signal from the antenna straight through to the video output stage is shown and includes the tuner and video IF amplifiers. The alignment instructions for the video IF section appear in Fig. 11-2. The recommended bias for the tuner is 1.5



volts, applied to point  $\diamond A$ . The first and second video IF stages are biased at 3 volts, applied to point  $\diamond B$ . Resistors R29, R30, and R31 isolate these bias supplies from each other and from the 275-volt source.

Another preliminary step often recommended before performing a video IF alignment or response check is to disable the local oscillator in the tuner section. Converter action is not needed for the alignment or response check, and the oscillator, if allowed to operate, may beat with the video IF signal supplied by the generator. The result can be a number of extra curves that resemble the desired response curve and add to the general confusion.

A recommended method of disabling the local oscillator is to substitute a mixer tube of the same type, but with the oscillator grid or plate pin clipped. This method is a practical one for the technician who handles a large number of alignments. A small number of tubes so treated will serve for a large percentage of receivers aligned. If, for any reason, disabling the local oscillator does not seem practical, it can be left operating and the channel setting and fine tuning can be adjusted for minimum effect on the response curve. Avoid channels occupied by local television stations.

### CONNECTION POINTS AND METHODS

Preparation for an oscilloscope alignment includes the connection of sweep generator and oscilloscope to the circuits. Fig. 11-3 shows the minimum equipment necessary to obtain the re-

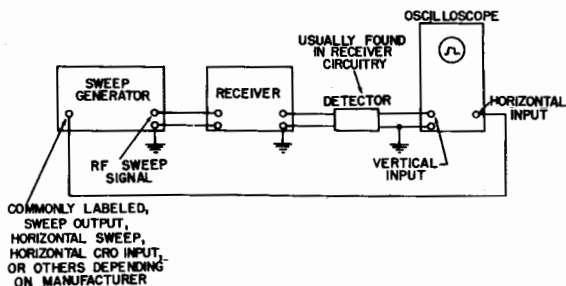
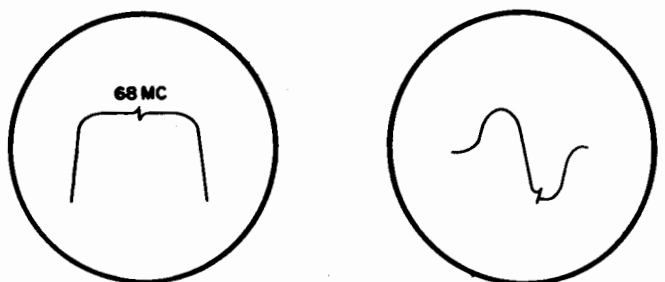


Fig. 11-3. Minimum equipment necessary to obtain a response curve.

sponse curve of any circuit in a receiver. The RF sweep signal is applied to some point of the receiver ahead of the circuit to be analyzed, and the oscilloscope vertical input is connected to some point following it. The resultant waveform indicates the response to the applied sweep frequencies of all circuitry between these two points. A detector is shown between receiver and oscilloscope in Fig. 11-3. This detector is necessary when the sweep frequencies are higher than the response characteristics of the scope ampli-

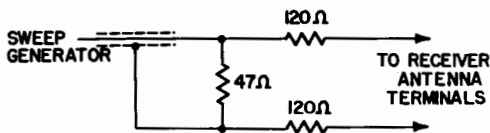
fiers. Such a detector can often be found at some point in the receiver. Typical receiver points that give detection are the mixer grid of the tuner, the video detector, the sound IF limiter grids, and the ratio detector or discriminator.

The sweep generator should be connected so that an undistorted signal is applied. This becomes more important as higher sweep frequencies are used because the connecting cable has transmission line characteristics and must be correctly terminated to avoid reflections. This point is illustrated in Fig. 11-4A, which shows the response of the RF stage of a television tuner. The signal input was made to the receiver antenna terminals through the output cable supplied with the sweep generator. This cable had a built-in terminating network, which is diagrammed in Fig. 11-4C. The generator sweep was set for Channel 4, with a 12-mc sweep and a 68-mc marker. The network shown matched the characteristic impedance of the output cable to the 300-ohm impedance of the antenna input terminals. When a shielded output cable with no terminating network was substituted for the regular cable, the distorted response shown in Fig. 11-4B was obtained.



(A) Tuner response with terminating network.

(B) Tuner response without terminating network.



(C) Schematic diagram of terminating network.

**Fig. 11-4. Matching network and response.**

Examples of a few sweep attenuator pads recommended for use during alignment are shown in Fig. 11-5. They are designed to match three different generator-cable impedances to the 300-ohm balanced input of TV receivers.

Sweep generator connection to the receiver for tuner alignment is usually made directly to the antenna terminals through a

matching network like those shown in Fig. 11-5. Connection points and methods can be somewhat different for video IF alignment. A common point at which to introduce the video IF signal is at the mixer tube. The signal then passes through any tuned circuit in the plate circuit of this tube, and the response of the entire video IF section can be viewed at the video detector. There are several

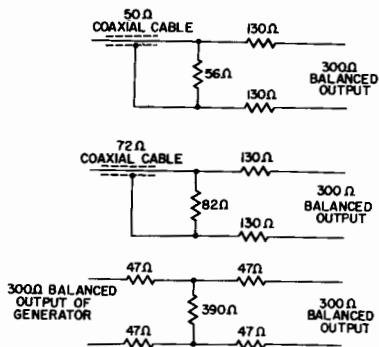


Fig. 11-5. Sweep generator attenuator pads.

ways to inject the sweep signal into the mixer tube circuit; the sweep generator lead can be clipped directly to the mixer grid terminal (not to the oscillator grid), to an ungrounded tube shield over the mixer tube, or to an insulated metal strip inserted between tube shield and tube. The third method has the advantage of the tube not being left unshielded. The metal strip can be moved about to find the most sensitive position. Some TV tuners have a lead brought out to the top surface of the tuner from the mixer grid as an alignment convenience. This point is commonly called a "looker" point and can be used either to view the RF response curve or to inject the IF sweep signal.

The matching networks of Fig. 11-5 are not used when the video IF signal is injected at the mixer stage or succeeding stages. The sweep generator cable should be terminated with a resistance equal to its characteristic impedance, usually 50 or 75 ohms, to avoid cable reflections.

Sometimes a video IF alignment is performed one stage or more at a time, instead of as a group. For example, if the sweep signal is applied to the grid of one IF stage and the scope is connected to the grid of the next stage, the response curve of the first stage can be obtained. A detector circuit is used between the scope input and the video IF stage. Tuned circuits in preceding and succeeding stages may affect the response curve; therefore, some manufacturers recommend shunting these tuned circuits with a low-value resistor to reduce any effect on adjacent circuits during alignment. Values of 180 to 330 ohms are commonly recommended.

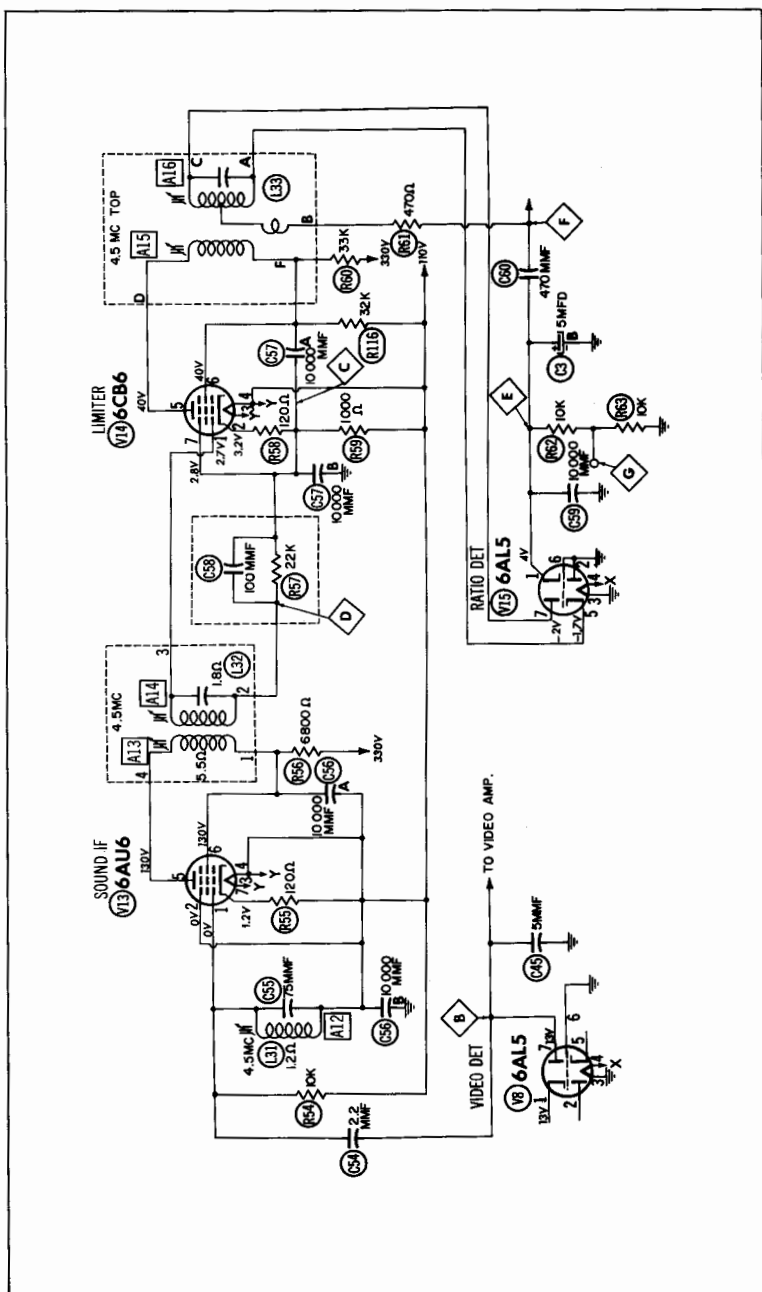


Fig. 11-6. FM sound IF channel and ratio detector.

## FM SOUND IF's AND DETECTORS

A scope alignment of the FM sound IF amplifiers and detector usually separates the two stepwise. The detector is usually aligned first, and then the IF's are aligned; however, the order can be reversed if some of the IF stages have limiting action. A limiter stage can be used as a viewing point for the IF response curve.

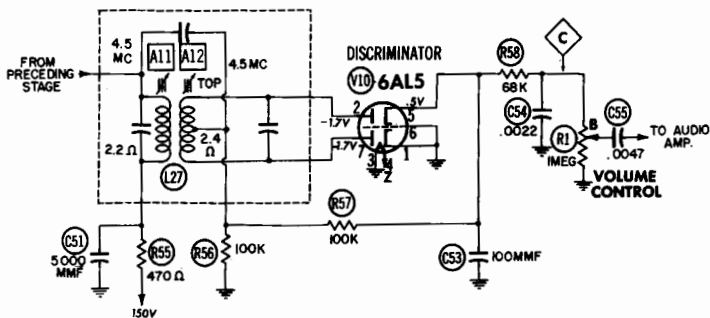


Fig. 11-7. Typical FM discriminator circuit.

The scope connection point for an FM detector alignment depends upon what type of detector it is — that is, whether it is a ratio detector or a discriminator. Fig. 11-6 shows the sound IF circuit for a TV receiver and includes a typical ratio detector circuit. The scope is connected at point  $\diamond E$  while the primary of the ratio detector transformer is being adjusted, and at point  $\diamond F$  while the secondary is being adjusted. Stabilizing capacitor C3 is 5 mfd, a value large enough to bypass some of the response curve (the generator sweep rate is usually 60 cps). Therefore, it must be disconnected while the scope is at point  $\diamond E$ . For this particular circuit, it is convenient to adjust A12, A13, and A14 at the same time as A15, although separate adjustment could be made by placing the scope across R57 (limiter grid resistor).

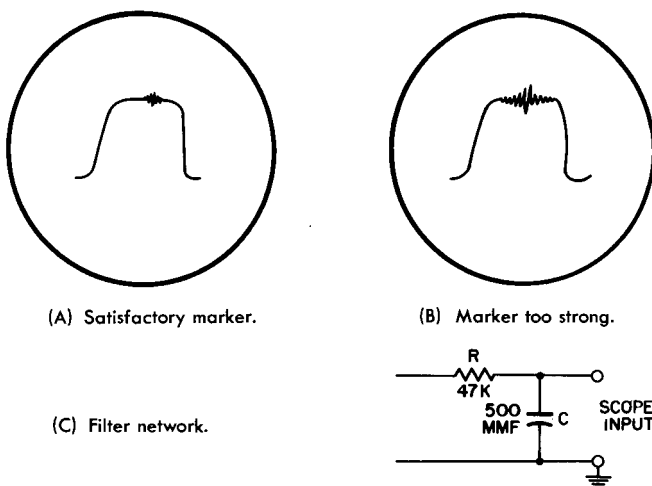
The sweep generator can be connected to point  $\diamond B$  in Fig. 11-6 if it is desired to feed the signal through the sound IF stages, or it can be connected to point  $\diamond D$  if the ratio detector is to be aligned separately.

A discriminator circuit is shown in Fig. 11-7. Oscilloscope alignment of this FM detector can be accomplished with the scope connected to one point,  $\diamond C$ , while slugs A11 and A12 are adjusted.

## MARKERS

An amplifier response curve displayed on an oscilloscope screen may cover a wide range of frequencies. For maximum

usefulness, important points on the response curve should be identified in frequency with markers. Two types of markers, the beat marker and the absorption marker, are common. The beat marker results when an RF signal is applied to the amplifier at the same time as the sweep signal. The marker will appear at the point on the response curve where the instantaneous sweep frequency is identical with the RF signal frequency.



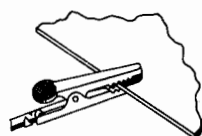
**Fig. 11-8. Marker amplitude variations.**

A beat marker that is satisfactory in appearance is shown in Fig. 11-8A. The marker is definite enough and yet does not distort the curve or occupy too large a portion of it. A marker like that of Fig. 11-8B is undesirably large and can distort the response curve. It is usually the result of a strong marker signal, and its effect can be reduced by either reducing marker signal strength or increasing sweep signal strength. However, the sweep signal should not be increased to the overload point. Sometimes both of these measures do not reduce the relative size of the marker because of extremely sensitive amplifier circuits, signal leakage from the marker generator, or other reasons. The marker width can be decreased by the filter network shown in Fig. 11-8C if connected across the scope input terminals. With this network in place, the higher frequencies of the marker beat are bypassed; since the higher frequencies appear at the extremes of the marker, the marker width is reduced. Values of R and C are not critical, but the time constant RC should not be too large, or the response curve will be distorted.

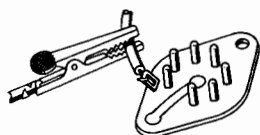
The absorption marker system produces a dip, or indentation, in the response curve. Its action is similar to that of the traps usually found in video IF strips of TV receivers; a high-Q

resonant circuit absorbs energy at its resonant frequency from those circuits to which it is coupled. This loss of energy results in a dip in response at the marker frequency. Some technicians feel that this method causes less disturbance and less distortion of the response curve than the beat marker method. However, it does not seem so well suited to marking trap points on a response curve, since the amplifier gain at these points has already been greatly attenuated by the receiver traps.

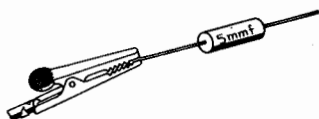
Either marker system can be designed for tunable or fixed operation. For fixed operation, some more commonly used fre-



Clip "hot" lead of RF generator to chassis at appropriate point.



Clip to insulated grid lead in sensitive part of circuit.



Connect to grid circuit or unbypassed cathode circuit through a very small capacitance.

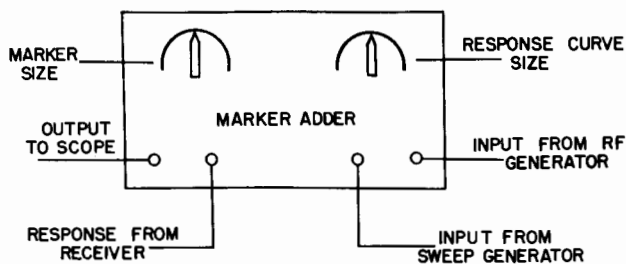
**Fig. 11-9. RF (or marker) generator signal may be injected by being loosely coupled to receiver circuits.**

quencies are chosen, and the instrument is designed to supply markers at those frequencies.

The marker system can either be built into the sweep generator unit or designed as a separate unit. If it is a built-in unit, the marker signal is applied to the receiver at the same point as the sweep signal; a separate marker unit poses the problem of marker injection methods. When an RF generator is used to develop a beat marker like the one shown in Fig. 11-8A, its signal strength is usually so strong that very little coupling is needed. Sometimes, just placing the output lead near a sensitive point in the receiver will inject enough signal to produce a marker. Other marker injection methods are shown in Fig. 11-9.

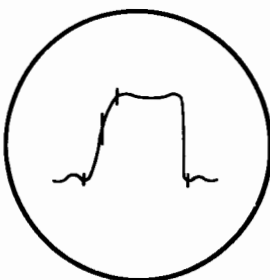
We have mentioned that beat markers may often distort the response curve. Other problems with this type of marker are the difficulty in seeing the exact marker location on the steep side of a response curve, and attenuation at trap frequencies. All these problems are largely overcome by the marker adder system. The marker adder can either be a separate unit or a part of the sweep-marker units. Marker adder operation is as follows: a sweep

signal from the generator is applied to the receiver circuits to develop a response curve in the conventional manner; a portion of the sweep signal is applied separately to the marker adder unit, where it is beat with the marker signal and fed to a detector stage; the detected beat then receives any necessary amplification before being combined in the final stages of the adder with the response curve taken from the receiver and passed on to the oscilloscope for viewing.



**Fig. 11-10A.** Block diagram showing connections when using marker adder unit.

**Fig. 11-10B.** Markers as they appear on response curve using a marker adder.



Since the sweep signals for the receiver response curve and marker adder are both taken from the same sweep generator, the marker will appear at its proper location when combined with the response curve. The marker signal does not pass through the receiver circuits and, therefore, is not attenuated by the trap circuits or amplified at peak response frequencies. The marker remains at the same amplitude on the oscilloscope screen as it is tuned across the entire response curve.

The block diagram of Fig. 11-10A shows the connections necessary to use a certain marker adder unit. The receiver response signal (Fig. 11-10B) is taken from the same point as though the marker adder were not used.

### RESPONSE CURVES

Fig. 11-3 shows the equipment setup for obtaining a receiver response curve. The sweep generator supplies a signal



that is continuously changing or sweeping through a range of frequencies. The extent of this range is governed by the sweep width control setting, and the center frequency of the sweep is governed by the main tuning control of the sweep generator. The output of a well-designed sweep generator should be flat over the entire sweep width, and thus, a signal constantly changing in frequency but not in amplitude is applied to the receiver circuits. The response curve seen on the oscilloscope is a graph showing receiver amplification as vertical deflection and frequency variation as horizontal deflection.

Some oscilloscope operators are not entirely certain of the oscilloscope response needed to view a response curve of, for example, a video IF strip. It seems to them that if a frequency of 25 mc is represented in the response curve, the oscilloscope response should extend to 25 mc. Although the response curve does represent 25 mc, this frequency is absent in the signal applied to the oscilloscope. The response curve frequency is the same as the repetition rate of the generator sweep signal, usually 60 cps. Thus, the signal applied to the scope during a video IF response check resembles a 60-cycle, square-wave signal and can be viewed

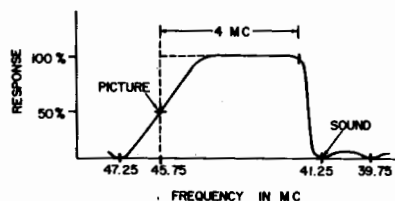


Fig. 11-11. Idealized IF response curve.

with a scope having a response of a few cycles per second to a few thousand cycles per second. If a sweep signal is viewed without a detector, the scope response should extend to the sweep signal frequencies.

An idealized video IF response curve is shown in Fig. 11-11. This response curve will give a flat output from the standard TV video signal. The standard TV signal uses vestigial sideband transmission for the video signal. In other words, part of one sideband (the lower) is not transmitted at full strength. Video frequencies between 1.25 and 4 mc are more or less completely attenuated, and frequencies from 0.75 to 1.25 mc are partly attenuated in this sideband. This gives a transmitted bandwidth of approximately 5 mc (4-mc upper sideband plus 1-mc lower sideband). If the receiver response curve is a rectangle covering these same 5 mc, the frequencies from 0 to 1 mc make a double contribution to the over-all response (one for the upper and one for the lower sideband), and these frequencies are overemphasized. The response curve of Fig. 11-11 gives the same amplification as a rectangular response curve 4 mc wide and is much easier to attain. The total contribution of the upper and lower sidebands at

frequencies from 0 to 1 mc equals that of the upper sideband above these frequencies; the total over-all response is practically flat from 0 to 4 mc.

The response is kept low at 39.75 mc, 41.25 mc, and 47.25 mc to prevent these frequencies from reaching the picture tube, where they would interfere with the desired picture. These intermediate frequencies correspond to adjacent picture, associated sound, and adjacent sound frequencies and are the most likely points for interference to develop. The response at these points is attenuated by traps in the receiver circuit. The sound IF trap at 41.25 mc not only keeps sound frequencies out of the picture, but also helps

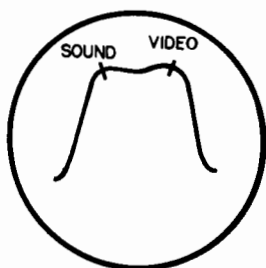


Fig. 11-12. Idealized tuner response curve.

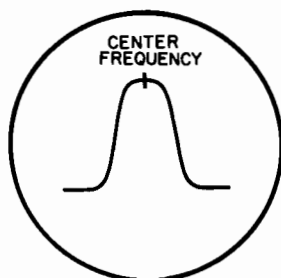


Fig. 11-13. FM sound IF response curve.

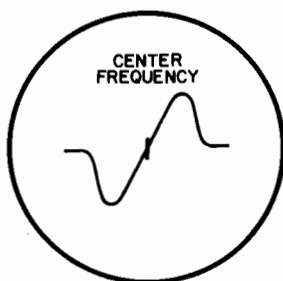


Fig. 11-14. FM discriminator or ratio detector response curve.

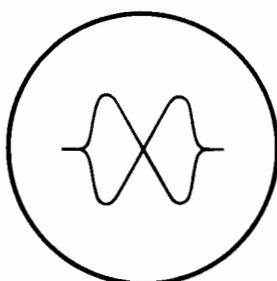


Fig. 11-15. Double response curve of FM detector.

shape the response curve at the upper video frequencies. The response at undesired carrier frequencies generally should be 30 db down from peak response. This response corresponds to 3 per cent of maximum gain. Since adjacent channels are not assigned to the same locality, adjacent channel traps are not always included in receiver design, but may be beneficial for fringe area reception.

The idealized response curve of Fig. 11-11 is seldom encountered in commercial TV receivers. Usually, the peak response will not be as wide or as flat. The alignment technician may get

more gain from video IF amplifiers by aligning for more gain and less bandwidth. Also, running the video carrier higher up the slope of the response curve will give more gain to the lower video frequencies. Some of the higher video frequencies will be lost, of course, which means less fine detail in the picture, but the additional video gain may be just what is needed in a weak signal area.

An idealized tuner response curve is shown in Fig. 11-12. The peak response is wide and flat, and video- and sound-carrier positions are near the top of the response curve. This gives considerable latitude for local oscillator drift or for variations in the setting of the fine tuning control. The actual tuner response curve usually differs from the ideal, which is logical when you consider that the tuner is designed to receive many channels. Usually, the response will dip between the two carrier positions, and the carriers may be below peak response. At different channel settings, the top of the response may slope at different degrees. The manufacturer's alignment instructions will usually state the degree of slant, amount of dip, and lowest permissible position on the response curve for the video and sound carriers.

Actual and theoretical response curves for FM sound IF amplifiers correspond quite closely. Fig. 11-13 shows the response desired when adjusting the sound take-off and sound IF transformers. Fig. 11-14 shows what response curve to obtain at the detector output. This curve applies to both ratio detector and discriminator circuits. The marker indicates the center of the IF band, 4.5 mc for TV receivers and 10.7 mc for most FM broadcast receivers. Recommended bandwidth of the curve of Fig. 11-13 and the straight-line portion of Fig. 11-14 is 100 kc for TV receivers and 200 kc for FM receivers. This bandwidth is necessary for distortionless reception at maximum modulation.

During alignment of the detector transformer, the primary adjustment controls the amplitude of the response curve (Fig. 11-14), and the secondary adjustment controls the straightness of the middle portion. The secondary adjustment also controls the centering of the marker on this curve. These two adjustments are interactive; that is, one adjustment affects the other, and their adjustment should be repeated several times, ending with adjustment of the secondary.

The S curve of Fig. 11-14 is obtained when the oscilloscope horizontal deflection amplifier is driven by a signal from the sweep generator. The butterfly curve of Fig. 11-15 is obtained by using the internal sweep system of the scope, set for a saw-tooth sweep twice the frequency of the generator sweep. This type of curve is preferred by some as an aid in judging marker centering.

### REVERSED AND INVERTED CURVES

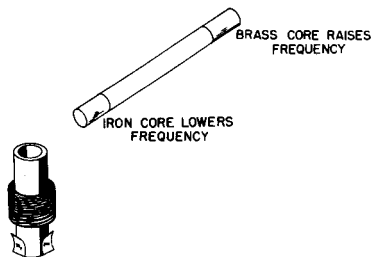
The alignment technician may be disturbed at times by a response curve that does not agree with the curve pictured in the

alignment literature. This may be caused by reversal or inversion of nonsymmetrical curves. Thus, whereas the video marker may appear on the left-hand slope of the response curve in the literature, it appears on the right-hand slope on the scope. This is no cause for concern; it merely indicates that the final horizontal sweep voltage applied to the oscilloscope deflection plates is of opposite polarity to the one used for the alignment example. It can be the result of a different number of stages in the two oscilloscopes or a difference in the two sweep generators. As long as the different points on the response curve can be identified, the direction of sweep should not affect the final results of the alignment.

### SOME ASPECTS OF ALIGNMENT ADJUSTMENTS

When a number of adjustments are to be made, say, during alignment of a complete video IF strip, the technician may find

**Fig. 11-16. Tuning wand placed next to coil simulates alignment adjustment.**



that as the alignment progresses, the receiver breaks into oscillations, preventing further adjustment of that particular slug or trimmer. A common cause for this behavior is the peaking of successive stages to nearly the same frequency. Some alignment instructions forestall this possibility by recommending prealignment adjustments; for example, "turn slug A all the way in, then backout 3 turns". This adjustment will place the slugs somewhere near their proper positions so that little adjustment is necessary.

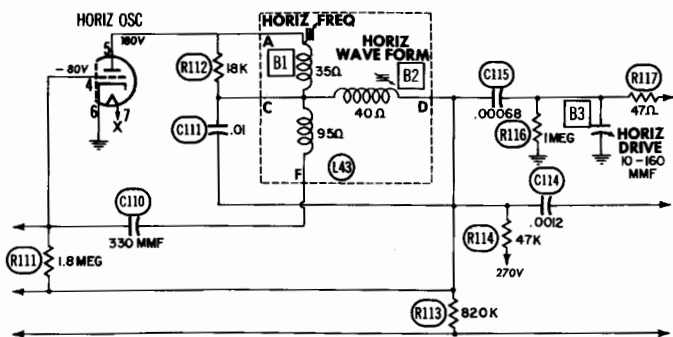
Sometimes a desired response can be obtained at two different positions of a tuning slug. If there are another coil and slug on the same form, the recommended position will place the two slugs farthest apart. This position results in minimum reaction between the two alignment adjustments.

A tuning wand (Fig. 11-16) is a very useful tool for alignment purposes. Two slugs are mounted on opposite ends of a rod of a material which will not affect circuit operation when placed next to circuit components. One slug is brass and the other is of iron composition, similar to the tuning slugs. When the iron end of the wand is brought next to a coil, the inductance of the coil is increased, lowering the resonant frequency. Conversely, when the brass slug is placed next to the coil, the inductance of the coil decreases, raising the resonant frequency. The response curve is

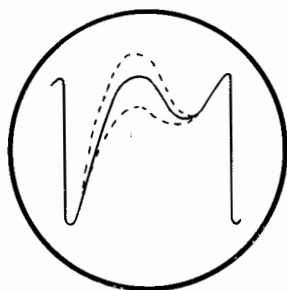
observed, meanwhile, so that the effect of an alignment adjustment can be determined in this manner before the adjustment is made.

### TRAP ALIGNMENT

Trap alignment is usually made to reduce the response as much as possible at a certain frequency, although sometimes it may be primarily a waveshaping operation. As the response is attenuated at the trap frequency, the technician will find that the marker is also attenuated (unless a marker adder system is used) and may disappear unless special precautions are taken. This makes it difficult to tell when the trap circuit is tuned exactly to the marker frequency. The situation can be improved in several ways: the sweep signal strength can be reduced and the scope vertical gain increased, or the marker strength can be increased; the sweep width can be decreased by the sweep generator control.



(A) Schematic diagram.



(B) Waveform observed at terminal C of L43.

**Fig. 11-17. Synchroglide horizontal oscillator circuit and waveforms obtained during adjustment of the horizontal-oscillator transformer.**

This latter step will expand the trap region of the response curve on the scope. The curve can also be expanded by the horizontal

gain control of the scope. All these measures help make the trap marker more visible.

### SYNCHROGUIDE WAVEFORM

The schematic for a Synchroguide horizontal sweep generator is shown in Fig. 11-17A. This circuit can be adjusted with the help of an oscilloscope. The oscilloscope is connected to the terminal of the horizontal frequency transformer marked "C". The important point to remember is that a low-capacity probe should be used with the scope. Otherwise, distortion of the waveform and detuning of the circuits may occur. The waveform to be obtained is shown in Fig. 11-17B. The sharp and smooth peaks should be of equal height, as indicated by the continuous line. Dotted lines indicate waveforms obtained by improper adjustment of waveform slug B2.

## CHAPTER 12

# Signal Tracing and Other Applications

### VISUAL SIGNAL TRACING — RADIO AND TV RECEIVERS

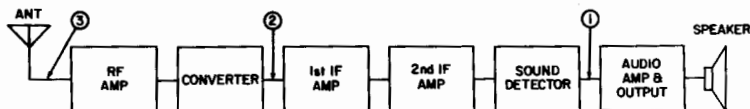
Signal tracing is one of several methods that may be used to service electronic equipment. Certain defects may be just as easily discovered by voltage and resistance measurements and by tube substitution, whereas others will be found with more ease and certainty by signal-tracing methods. The latter defects are more likely to be of the halfway type — that is, the circuit functions, but not perfectly. Some circuits in a receiver may check within the normal tolerance limits of specified resistances and voltages and yet not perform their intended duty. (For example, an oscillator circuit may be off frequency or have a poor waveshape.) Other circuits are passive except for their effect on a signal, as for example, sync clippers and separators in a TV receiver. The oscilloscope makes a fine instrument for locating defects in such circuits because it can show amplitude and waveshape at the same time.

To use the oscilloscope for signal tracing, a signal of proper characteristics is applied to the circuits under question, and the oscilloscope gives a point-by-point indication of any change in the appearance of the signal. In some instances, the circuit itself furnishes a signal that can be traced. If the signal is absent where it should be present, present where it should be absent, or abnormal in amplitude or waveshape, it indicates that some defect exists between signal generator and oscilloscope. By decreasing the gap between generator and scope, the defective stage can be located. Further checks with a voltmeter or ohmmeter will usually locate the defective component.

For signal-tracing purposes, it is convenient to divide a radio, either AM or FM, into about four sections. They are (1) the RF and converter section, (2) the IF amplifier, (3) the sound detector or second detector, and (4) the audio amplifier. It will be noticed that this division groups the circuits according to the type of signal passing through them. For example, consider a standard broadcast AM receiver tuned to receive a 1000-kc carrier with audio modulation. The signal is unchanged (except for possible changes in amplitude) until it reaches the converter stage. There, it is converted to the intermediate frequency,

usually 455 kc, with audio modulation still present. The 455-kc signal is amplified by the IF stages and then applied to the detector stage. From that stage on, it is an audio signal.

We see, then, that at least three different types of signal can be used for signal-tracing the AM radio. The one chosen will de-



**Fig. 12-1. Block diagram of a radio receiver showing points where different types of signal are injected for signal tracing.**

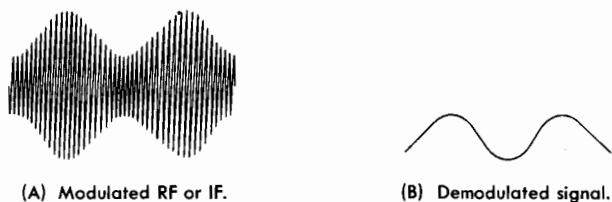
pend upon the point of application. To trace through the entire audio section, an audio signal is applied at the output of the sound detector; to trace through the IF and audio stages, an audio-modulated IF signal is applied at the output of the converter stage; and to trace through the entire receiver, an audio-modulated RF signal is applied to the antenna terminals. These signal application points are indicated on the block diagram of Fig. 12-1 as points 1, 2, and 3, respectively. It is possible to apply an audio-modulated IF signal at the input stage of many receivers and force a signal through the receiver, but this requires a stronger signal because the RF stages are not designed to amplify these frequencies. Receivers with very selective RF stages would be difficult to trace in this manner.

Points 1, 2, and 3 of Fig. 12-1 are not the only points where a signal can be injected for tracing purposes. They are merely the points where the type of signal should be changed. A signal can be injected anywhere that it is convenient or desirable to do so. Likewise, the scope can be connected to any point for viewing, depending upon the number of stages to be included between signal generator and scope. With standard broadcast AM receivers, it is not necessary to insert a detector between scope input and receiver since most present-day scopes have a vertical-amplifier response covering all the receiver frequencies.

Fig. 12-2 shows the two types of patterns to expect under normal conditions with a modulated RF signal applied. The nature of the signal ahead of the sound detector is shown at A, and the signal following the sound detector is shown at B. The first example is similar to the input signal — that is, it is one sine-wave signal modulated by another. The second example shows the modulating signal alone — the carrier signal has been removed by the demodulation circuits. As was stated, these are normal patterns. Under abnormal conditions, they will probably be quite different. In circumstances where there is very little gain between generator and oscilloscope, the maximum oscilloscope gain may be necessary to obtain a usable pattern. This will bring up the hum and noise level in the pattern.



The block diagram of Fig. 12-1 will illustrate an FM receiver as well as an AM receiver. Frequencies involved will be different; the sound detector operates by a different principle, but otherwise, the function of each block is quite similar in either receiver. It is not necessary to use an FM signal to signal-trace the receiver. An amplitude-modulated RF signal will be converted, amplified, and will even pass the FM detector section. It is best



**Fig. 12-2. Response patterns obtained in signal tracing an AM radio receiver.**

to detune the RF generator slightly off the center frequency since discriminator circuits are not sensitive to amplitude changes at this frequency. The RF and IF signals used to signal-trace an FM receiver will be above the frequency range of most oscilloscopes; so, a demodulator probe must be used when the scope is connected ahead of the FM detector. The applied signals should be kept low in amplitude to avoid driving any stage to limiting action.

If the technician wishes, he can use an FM signal generator instead of the AM generator. This will result in response curves similar to those obtained during an alignment procedure.

The TV receiver can be divided into sections in much the same manner as the AM or FM receiver: RF amplifier, converter, video and sound IF amplifiers, and video and audio amplifiers. In addition, there are the circuits pertaining to vertical- and horizontal-sweep generation and synchronization. Fig. 12-3 shows these various sections in a block diagram. The number of video IF and sound IF amplifier stages will vary with different makes and models of receivers and, therefore, will not necessarily agree with the number shown here.

One of the simplest ways of tracing the RF and video IF stages is to use a TV broadcast station as a signal source, if one can be received strongly. A demodulator probe should be used with the oscilloscope. The detected video signal normally appears as in Fig. 12-4 and, of course, should get smaller in amplitude as one proceeds toward the RF section of the receiver. The oscilloscope sweep can be set to synchronize with either the vertical or horizontal sync pulses, but it is usually easier to use the vertical sync rate. The sweep rate for Fig. 12-4 was 30 cps. The waveform of Fig. 12-4 should also be visible through the video

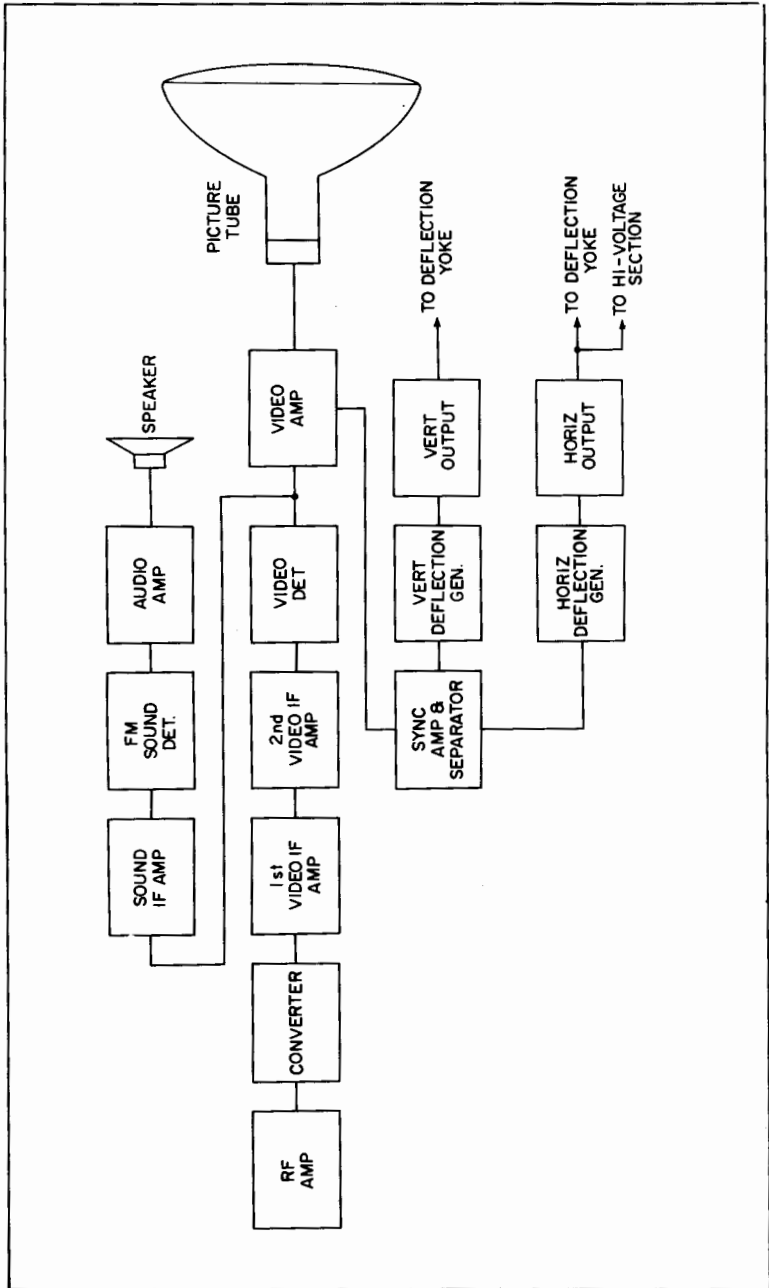
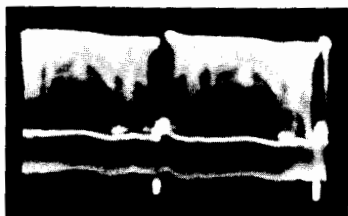


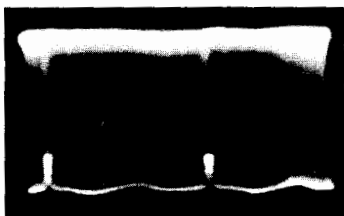
Fig. 12-3. Block diagram of typical TV receiver.

amplifier, up to the picture tube. It is unnecessary to use the demodulator probe in the stages following the video detector.

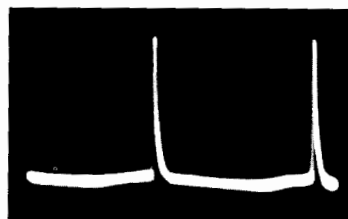
A portion of the video signal is applied to the sync amplifier and separator stages, where the video information is removed



**Fig. 12-4.** Normal video signal at video detector.



**Fig. 12-5.** Video signal after one stage of sync separation. Most of the video information has been removed.



**Fig. 12-6.** Vertical pulses from the output of the vertical integrator network.



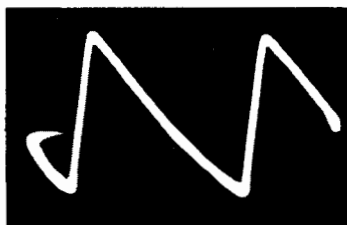
**Fig. 12-7.** Vertical deflection waveform from vertical output stage.

from the signal, leaving the vertical and horizontal sync signals. Fig. 12-5 shows the video signal after one stage of sync separation. Most of the video information has been removed, and will be removed completely in the next stage. The vertical sync signal is passed to the integrator network, and the horizontal pulses are passed to the horizontal-oscillator section. The output of the integrator network appears at Fig. 12-6. The vertical blocking oscillator was temporarily disabled to obtain this picture. The synchronized waveform at the vertical-output stage is shown in Fig. 12-7.

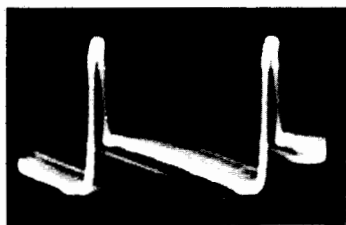
Figs. 12-8A, B, and C show the waveforms obtained at the horizontal phase detector when the receiver is synchronized. The signal fed back from the horizontal-output stage is shown at A, and the outputs from the two halves of the phase detector are shown at B and C.

One of the waveforms from the horizontal multivibrator stage is shown in Fig. 12-9. This waveform was taken at the second grid of the multivibrator tube.

Signal-tracing procedure for the sound system of a TV receiver is practically the same as for an FM broadcast receiver. The principal difference between the two systems is in the sound intermediate frequency — 4.5 mc for TV and 10.7 mc for FM.



(A) Input signal to phase detector.



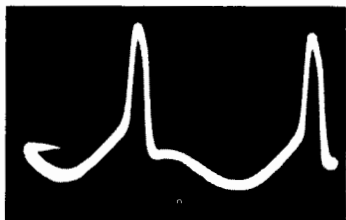
(B) Output from one half of detector.

**Fig. 12-8. Waveforms obtained at the horizontal phase detector.**



(C) Output from other half of detector.

**Fig. 12-9. Waveform obtained at the second grid of the horizontal multivibrator stage.**



### CHECKING DISTORTION OF AMPLIFIERS

The oscilloscope can be used for certain types of distortion checks in amplifiers. (We refer principally to audio amplifiers.) Distortion in an amplifier can be described as a condition that causes the output waveform to be different from the input waveform, neglecting differences in over-all size. If the difference is great enough, it can be observed on the oscilloscope. Several types of distortion will affect amplifiers: amplitude, harmonic, intermodulation, transient, phase, and frequency distortion.

Amplitude distortion is caused by some nonlinear condition in the amplifier and results in a difference in gain for signals of different amplitudes. Harmonic distortion and intermodulation distortion are a direct result of amplitude distortion. Harmonic

distortion causes harmonics to appear in the output when a pure sine-wave input voltage is amplified. Intermodulation distortion causes two input signals to interact so that one modulates the other.

Transient distortion results in improper reproduction of sudden changes in input signal. Phase distortion alters the phase angle between a fundamental and some harmonic or between any two frequencies in a complex waveform. Frequency distortion is the unequal amplification of different frequencies. If we refer to a response curve of an amplifier, frequency distortion will occur at those frequencies indicated by dips or peaks in the curve.

It would be difficult to determine the type or percentage of distortion in an amplifier by inspection of the output waveform. Small percentages of certain types of distortion will not change the appearance of a sine wave too much, but if the peaks are rounded or clipped by overload conditions in an amplifier, the distortion is evident. The value of a scope distortion check is that changes in distortion are readily seen. Thus, the scope probe can be moved from point to point in an effort to locate the source of distortion. If the distortion is localized in this manner to a certain stage, the circuit components in that stage can be checked for such defects as opens, shorts, or changes in value.

As previously pointed out, an electronic switch can be used advantageously when two different stages in an amplifier are compared.

Multiple feedback paths in an amplifier make it more difficult to perform oscilloscope checks because the feedback action may be upset by the added capacitance of the scope input circuit.

The oscilloscope can be used as an aid to amplifier checking with an intermodulation meter. Connected across the output load of the amplifier, the scope will show when the clipping or overload point is reached. At the same time, the scope can be used as a power output indicator if reference is made to a chart listing peak-to-peak voltages for watts output. The chart must have a column for the rated output impedance of the amplifier (usually 8 or 16 ohms).

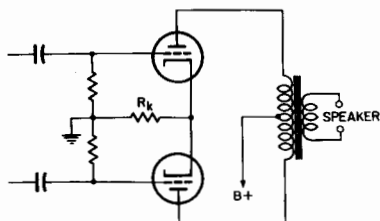
### **BALANCE OF PUSH-PULL AMPLIFIER STAGES**

Some amplifiers provide for balancing the push-pull stages. AC balance can be checked with the oscilloscope. If the push-pull output stage has a common cathode resistor as shown in Fig. 12-10, this is a convenient point to connect the scope. A signal of normal amplitude is applied to the amplifier, and the balance adjustment is made for minimum indication on the scope. This adjustment can be quite sensitive if the oscilloscope gain is set at maximum. If the adjustment does not reach a null or minimum point, it can be helped sometimes by trading the output tubes in their sockets.

Another method of checking AC balance is to connect the oscilloscope, first to one output plate and then to the other, and

compare the signal amplitude at each plate. Here again, the electronic switch can be used advantageously because the signals are compared simultaneously instead of alternately.

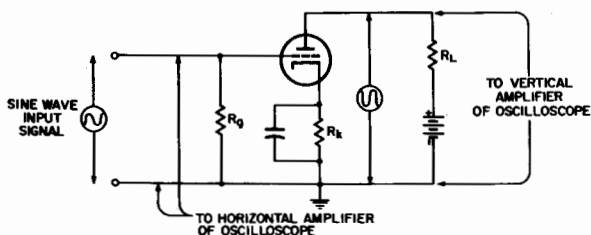
**Fig. 12-10. Oscilloscope can be connected across common cathode resistor  $R_k$  for AC balance adjustment.**



Certain unconventional output circuits may not be suited to either of the balance check methods just mentioned. The technician should follow the manufacturer's recommendations, if any are offered, for AC balancing of these circuits.

### TUBE CHARACTERISTIC CURVES

Fig. 12-11 shows the connection methods that will enable the oscilloscope operator to view one type of electron tube characteristic curve. The curve developed is an operating characteristic

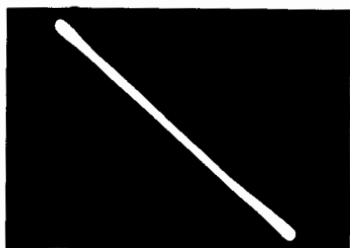


**Fig. 12-11. Method of connecting oscilloscope to an amplifier stage to view the operating characteristic curve.**

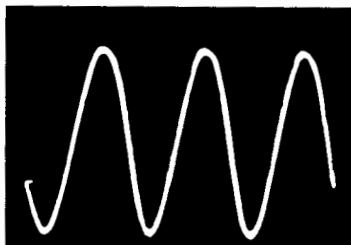
of the tube under the load conditions shown by the circuit.

A number of response curves obtained from a setup like that of Fig. 12-11 are shown in Figs. 12-12 through 12-15. The electron tube used was a medium- $\mu$  triode. The plate voltage supply  $E_b$  was 285 volts.  $R_g$  was 470K ohms,  $R_1$  was 100K ohms, and  $R_k$  was 3300 ohms. Vertical- and horizontal-gain controls were adjusted to maintain the response curve at a convenient size. Notice that the characteristic curves slant upward toward the left, rather than toward the right as do many curves found in tube manuals. The following explanation will show why this is true: (1) For a positive-going signal, vertical deflection of the oscilloscope beam was upward, and horizontal deflection was to the right. (2) The vertical input of the oscilloscope was connected to the plate, and vertical deflection, therefore, corresponds to instantaneous plate

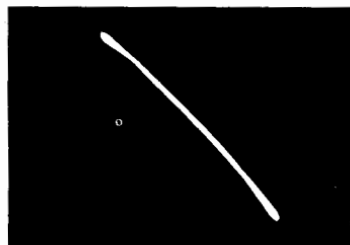
voltage. Because of voltage drop across plate load resistor  $r_{k1}$ , the plate voltage decreases (becomes more negative) as the grid signal increases. Curves shown in tube manuals usually show plate current rather than plate voltage, and plate current increases as grid voltage increases.



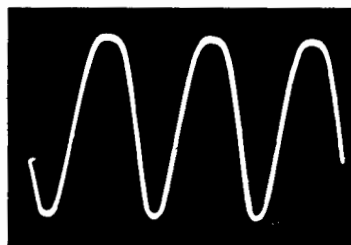
**Fig. 12-12A.** Operating characteristic of a triode with small signal input.



**Fig. 12-12B.** Sine-wave output of triode.



**Fig. 12-13A.** Triode operating characteristic with small overload.

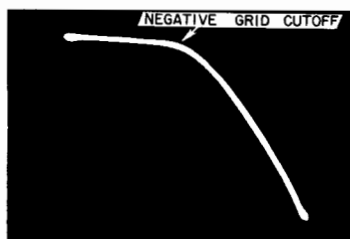


**Fig. 12-13B.** Sine-wave output showing slight amount of distortion.

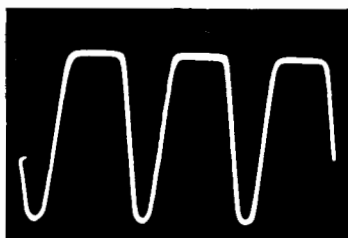
The straight line response of Fig. 12-12A was obtained with a small signal input. The straight line, of course, indicates linear operation. Fig. 12-12B bears this out by showing how the sine-wave input signal is reproduced undistorted at the plate of the amplifier stage. To obtain this response curve, the oscilloscope controls were merely changed from external to internal sweep operation; input signal and connection points were not changed.

When the input signal strength was greatly increased, the operating characteristic of Fig. 12-13A was obtained. The response curve was also increased in size by a proportionate amount, and it was necessary to readjust the vertical and horizontal controls to return the curve to its original size. As shown by this curve, linear operating conditions have been exceeded, and the distorted output waveform of Fig. 12-13B results.

A still greater increase in signal strength produced the greatly distorted waveforms of Figs. 12-14A and B. The arrow in Fig. 12-14A indicates the point of negative grid cutoff. The plate current has been reduced to zero by a highly negative excursion of the grid signal and the plate voltage reaches its highest

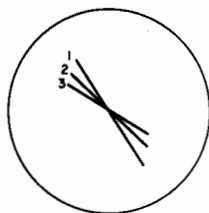


**Fig. 12-14A.** Triode operating characteristic with large signal overload.



**Fig. 12-14B.** Greatly distorted output.

**Fig. 12-15.** Changes in operating characteristic obtained by varying the grid bias of an amplifier stage.



value under these conditions. Making the grid still more negative has no further effect on the plate voltage, and therefore, the curve remains flat for the remainder of the cycle.

Response curves similar to those just mentioned can be obtained by holding the input signal constant and varying other circuit parameters, like grid bias or plate voltage. Fig. 12-15 is a diagram of the results obtained by applying separate values of grid bias to the circuit of Fig. 12-11. The grid return was opened at the grounded end of  $R_g$ , and a bias supply was inserted between  $R_g$  and ground. Curves 1, 2, and 3 correspond to negative bias voltages of 3, 9, and 13 volts, respectively. The degree of slant for each curve indicates the relative amplification obtained for each bias value. Curve 1 indicates the highest amplification factor. If the gain of both horizontal and vertical amplifiers of the oscilloscope were known, the absolute value of the amplification factor could be calculated.

These examples show only a few of the possibilities for analysis of tube characteristics with an oscilloscope. Such analysis might be used as a practical approach to the design of amplifier stages, where it is desirable to select the best circuit values by



the "cut and try" procedure. The exact effect of each selection can be seen and evaluated.

### MEASUREMENT OF SMALL AC SIGNALS

Oscilloscopes are being designed with higher sensitivities and wider frequency-response characteristics than earlier models. These properties, coupled with the fact that the signal waveshape is shown and can be measured even though of complex form, make the oscilloscope a superior instrument for measuring small AC voltages. For example, one manufacturer states that a recent model has a sensitivity of 5 millivolts for full-scale deflection. This permits direct measurements from low-output transducers without the use of a preamplifier.

### CURRENT MEASUREMENT

Beam deflection in an oscilloscope is a direct result of voltages applied to the deflection plates. The oscilloscope is, therefore, a voltage-indicating device. However, it can be used to measure current under certain conditions. The current must first be made to provide a voltage indication, and this can be done by passing the current through a resistance. The value of R must be known, and E can be measured with the oscilloscope; then I can be obtained from Ohm's law:  $I = E/R$ .

A few precautions should be observed: the value of R should be kept small, compared to the impedance of the circuit to which it is connected. If R is too large, it will tend to reduce the total current, and the scope indication will not be the true value for the original circuit. The resistor should be as free from reactance as possible — that is, it should have a minimum of inductance or capacitance to avoid phase shift complications.

### SOME DO'S AND DON'T'S FOR SCOPE OPERATORS

DON'T connect scope to point of high voltage unless a high-voltage probe is used. Signal input plus any DC voltage present should not exceed rated voltage of AC input blocking capacitor.

DON'T leave a bright stationary spot on screen. It may burn the screen phosphor.

DON'T overload the scope amplifiers with too large a signal. Reduce amplitude by first using attenuator switch, then by using vernier gain control. If gain control must be operated at its minimum position, watch out — amplifiers may be overloaded!

DON'T overload circuits under test with a large signal. Check by running generator output up and down. If shape of response curve

changes, circuit may be overloaded. Sometimes a flat response curve may be the result of overload, not of good alignment.

DO be sure the marker you see comes from the marker generator and not from the receiver local oscillator. Check by turning the receiver fine-tuning control. If marker moves across scope screen, it is not from marker generator.

DO use plenty of grounding straps, if necessary. Check by touching receiver chassis with the hand. If the response curve changes, shift the ground strap or add more straps until response does not change when chassis is touched. Terminate the generator cable with the proper impedance, if necessary. Check by sliding the hand along the length of the cable. If the response changes shape, standing waves may be present, which can be reduced by proper termination.

DON'T use too much sync amplitude. It makes synchronization more difficult and changes response curve shape.

DO use the proper probes. Although input impedance is high and capacitance is low in the modern scope, many circuit applications require high-impedance or low-capacitance probes. Almost any oscillator or tuned circuit presents a high impedance at some certain frequency. Use a detector probe ahead of the video IF detector. Be sure that bandwidth of detector probe is adequate.



## INDEX

### A

- Alignment, using oscilloscope, 118-135
  - Advantages of, 118
  - Connection points and methods, 122-124
  - FM sound IF's and detectors, 126
  - Markers, 126-129
  - Preliminary steps, 118-122
  - Response curves, 129-134
    - Reversed and inverted, 132, 133
  - Synchroguide waveform, 135
  - Trap alignment, 134
  - Tuning wand, 133
- Amplifier testing, 106-117
  - Checking video response, 111-117
  - Square-wave frequency response test, 106-109
  - Square-wave instability check, 109-110
  - With sweep signals, 110-117
- Amplifiers, oscilloscope, 39-50
  - DC amplifiers, 43, 44
  - Deflection sensitivity, 39, 40
  - Expanded sweeps, 48
  - Frequency response, 40-44
  - High-frequency response, 40
  - Input impedance, 46, 47
  - Low-frequency response, 41
  - Push-pull, advantages of, 44
  - Rise time, 48, 49
  - Writing speed, 49, 50
- Astigmatism, adjustment, 85, 86
- Attenuators, 44-46
  - Compensated, adjusting of, 82-84
- Auxiliary amplifiers, 72, 73

### B

- Barograph, 2
- Blanking, retrace, 17, 57

### C

- Capacitive voltage-divider probe, 63, 64
- Capacitor, charge time of, 18, 19
- Cathode-follower probe, 62, 63
- Cathode-ray tube, 2, 5-7
  - Electron path, 9, 10
  - Element polarity, 10
  - Operating voltages, 10

- Charge time, capacitor, 18, 19
- Circular sweeps, 23-26
  - Frequency measurement, 98, 99
- Compensated attenuators, adjusting of, 82-84
- Cyclograms, 26-30

### D

- DC amplifiers, 43, 44
- DC balance controls, adjusting of, 79, 80
- Deflection sensitivity, 7, 8, 39, 40
- Deionization potential, thyratron, 19, 32, 33
- Detector probes, 65, 68
- Detectors, RF, 56
- Driven sweep, 31, 32

### E

- Early developments of oscilloscope, 1, 2
- Electrocardiograph, 3
- Electron beam, 2, 6, 7
  - Formation of, 10
  - Inertia of, 4
  - Intensification of, 15
- Electronic switch, 73-77
  - Measuring frequency with, 100
  - Phase comparison with, 104, 105
- Expanded sweeps, 48

### F

- Fixed sweeps, 52
  - Adjusting of, 81, 82
- Frequency controls, in sweep systems, 19, 20
- Frequency measurements, 95-100
  - Circular sweeps, 98, 99
  - Electronic switch, 100
  - Intensity markers, 99, 100
  - Lissajous figures, 95-98
- Frequency response, oscilloscope amplifiers, 40-44
- Front panel controls, insulation of, 15

### G

- Generators used with oscilloscopes, 77, 78
- Graph patterns, 2-4

## H

- High-impedance probe, 62
- Horizontal amplifier, checking sensitivity of, 90, 91

## I

- Input impedance, 4, 5
  - Oscilloscope amplifiers, 46, 47
  - Vertical amplifiers, 5
- Intensity markers, measuring frequency with, 99, 100
- Intensity modulation, 56
- Ionization potential, thyratron, 19, 32, 33
- Isolation probe, 61, 62

## L

- Limiting of sync signal, 37
- Line frequency sweep, 52
- Linear sweep systems, 17-22
- Lissajous figures, measuring frequency with, 95-98
- Low-capacitance probe, 62
  - Adjusting of, 84, 85

## M

- Multivibrator sweep circuits, 21, 22

## N

- Negative high-voltage power supply, 12-14
- Nonlinear sweep systems, 22-26

## O

- Oscillograph, 1, 2
- Oscilloscope accessories, 61-78
  - Amplifiers, 72, 73
  - Electronic switches, 73-77
  - Generators, 77, 78
  - Probes, 61-69
  - Voltage calibrators, 69-72
- Oscilloscope adjustments, 79-86
  - Astigmatism, 85, 86
  - Compensated attenuators, 82-84
  - DC balance controls, 79, 80
  - Low-capacitance probes, 84, 85
  - Vertical and horizontal TV sweeps, 81, 82
  - Voltage calibration, 81
- Oscilloscope probes, 61-69
  - Capacitive voltage-divider, 63, 64

- Cathode-follower, 62, 63
- Detector, 65, 68
- High-impedance, 62
- Isolation, 61, 62
- Low-capacitance, 62
- Sweep analyzer, 68, 69

## Oscilloscope uses

- Alignment, 118-135
  - Amplifier testing, 106-117
  - Balancing push-pull amplifiers, 142, 143
  - Checking amplifier distortion, 141, 142
  - Current measurement, 146
  - Do's and don'ts for scope operators, 146, 147
  - Frequency measurements, 95-100
  - Measurement of small AC signals, 146
  - Signal tracing, 136-141
  - Viewing tube characteristic curves, 143-146
- Oversynchronization, 36, 37

## P

- Performance checks on oscilloscopes, 87-94
  - Horizontal amplifier sensitivity, 90, 91
  - Sweep frequency coverage, 92
  - Sweep linearity, 92, 93
  - Synchronization, 92
  - Vertical amplifier frequency response, 91, 92
  - Vertical amplifier sensitivity, 90
  - Vertical linearity, 93, 94
- Persistence of phosphors, 2
- Phase comparison and measurement, 100-105
  - With electronic switch, 104, 105
- Phasing control, 57
- Phosphor, persistence types, 2
- Power supplies, 9-15
  - Negative high-voltage supply, 12-14
  - Rectifiers and filters, 11, 12
- Probes, 61-69
  - Capacitive voltage-divider, 63, 64
  - Cathode-follower, 62, 63
  - Detector, 65, 68
  - High-impedance, 62
  - Isolation, 61, 62
  - Low-capacitance, 62
  - Sweep analyzer, 68, 69
- Push-pull amplifiers, advantages of, 44

## R

- RC factor, 18, 19
- Rectifiers and filters for power supplies, 11, 12
- Retrace, 4
- Retrace blanking, 17, 57
- RF detectors, 56
- Rise time, amplifiers, 48, 49

## S

- Sawtooth output signal, 56, 57
- Sawtooth sweep systems, 17-22
- Servicing the oscilloscope, 86-94
- Signal-tracing with oscilloscope
  - Advantages of, 136
  - Methods of, 136-141
- Sine curve, 3, 4
- Sine-wave sweep, 22, 23
- Slow-speed sweep, 51, 52
- Special features, 51-60
  - Fixed sweeps, 52
  - Intensity modulation, 56
  - Line frequency sweeps, 52
  - Phasing control, 57
  - Retrace blanking, 17, 57
  - RF detectors, 56
  - Sawtooth output signal, 56, 57
  - Slow-speed sweep, 51, 52
  - Sync limiting, 37, 53
  - Sync refinements, 52, 53
  - Voltage calibration, 53-56
- Special types of oscilloscopes, 57-60
- Spiral sweep, 23-26
- Square waves
  - For checking amplifier instability, 109, 110
  - For testing amplifier frequency response, 106-109
- Sweep analyzer probe, 68, 69
- Sweep frequency control, checking coverage of, 92
- Sweep signals for testing amplifier response, 110-117
- Sweep systems, 16-30
  - Checking linearity of, 92, 93
  - Circular, 23-26
  - Cyclograms, 26-30
  - Driven, 31, 32
  - Expanded, 48
  - Fixed, 52
    - Adjusting of, 81, 82

- Frequency controls, 19, 20
- Line frequency, 51, 52
- Linear, 17-22
- Multivibrator circuits, 21, 22
- Nonlinear, 22-26
- Retrace blanking, 17
- Sawtooth, 17-22
- Sine-wave, 22, 23
- Slow speed, 51, 52
- Spiral, 23-26
- Thyratron oscillator, 18-21
- Synchronization, 31-38, 92
  - Checking sync control, 92
  - Driven sweeps, 31, 32
  - Hints for, 37-38
  - Limiting, 37, 53
  - Multivibrators, 35, 36
  - Refinements, 52, 53
  - Thyratron sweeps, 32-35

## T

- Thyratron sweep oscillator, 18-21
  - Deionization potential, 19, 32, 33
  - Ionization potential, 19, 32, 33
  - Synchronization of, 32-35
- Time constant, 18, 19
- Transducer, types of, 1

## V

- Vertical amplifier
  - Checking frequency response of, 91, 92
  - Checking linearity of, 93, 94
  - Checking sensitivity of, 90
  - Input impedance, 5
  - Video response, checking, 111-117
- Voltage calibration, 53-56
  - Adjustment, 81
- Voltage calibrators, 69-72

## W

- Writing speed, 4, 49, 50

## X

- X and Y axis, 3, 4

## Z

- Z-axis modulation, 56



## OTHER HOWARD W. SAMS BOOKS ON RELATED SUBJECTS



### Famous "101" Ways Series on Test Equipment

by Robert G. Middleton. These 8 books are a veritable library on test equipment. They'll help you get more out of the equipment you own, and enable you to put it to maximum use. Each volume contains data on the hookup connections required, equipment needed, proper test procedures, and evaluations of results. Supplementary notes add background information to the profusely illustrated text. Invaluable for technicians, junior engineers, lab technicians, students, experimenters, etc.

#### **101 Ways To Use Your Sweep Generator**

Just about every practical use for a sweep generator is categorized and cross-referenced for easier location. Over 250 illustrations and waveforms.

**CHAPTER CONTENTS:** 1. Equipment Checks 2. Antenna Tests 3. RF Tests 4. IF Tests 5. Video Tests 6. Sound Tests 7. Color-TV Tests.

144 pp.; 5½" x 8½". No. TEM-1 \$2.00

#### **101 Ways To Use Your Oscilloscope**

Teaches you how to use your oscilloscope for faster, more proficient servicing. With 109 special notes, and 400 illustrations of waveforms and test setups.

**CHAPTER CONTENTS:** 1. Equipment Checks 2. Antenna Tests 3. RF and IF Tests 4. Video-Amplifier Tests 5. Sync Circuit Tests 6. Chroma-Circuit Tests 7. Convergence-Circuit Tests 8. Intercarrier-Sound Tests 9. Audio-Amplifier Tests 10. Miscellaneous Tests

180 pp.; 5½" x 8½". No. TEM-2 \$2.50

#### **101 Ways To Use Your VOM and VTVM**

All the common and many uncommon uses of the VOM and VTVM, beyond simple measurement of DC voltages and resistances.

**CHAPTER CONTENTS:** 1. Equipment Checks 2. DC Voltage Tests 3. Ohmmeter Tests 4. Signal-Tracing Tests 5. AC Voltage Tests 6. DC Current Tests 7. Alignment Applications

116 pp.; 5½" x 8½". No. TEM-3 \$2.00

#### **101 Ways To Use Your Signal Generator**

A handy reference for users of RF-IF signal generators.

**CHAPTER CONTENTS:** 1. Equipment Checks 2. Antenna Tests 3. AM-FM Receiver Tests 4. TV Receiver Tests 5. Component Tests 6. Miscellaneous

128 pp.; 5½" x 8½". No. TEM-4 \$2.00

#### **101 Ways To Use Your Audio Test Equipment**

For the audio technician and enthusiast who wants to know how to use harmonic-distortion meters,

square-wave generators, intermodulation analyzers, and other test instruments in audio work.

**CHAPTER CONTENTS:** 1. Equipment Checks 2. Amplifier Tests 3. Component Tests 4. System Checks

136 pp.; 5½" x 8½". No. TEM-5 \$2.00

#### **101 Ways To Use Your Ham Test Equipment**

For the ham and the technician who services ham gear.

**CHAPTER CONTENTS:** 1. Introduction 2. Grid-dip Meters 3. Antenna-Impedance Meters 4. VOM and VTVM Tests 5. Oscilloscope Tests 6. Reflected-Power and SWR Meters 7. Bridge Tests 8. Miscellaneous Tests

168 pp.; 5½" x 8½". No. TEM-6 \$2.50

#### **101 More Ways To Use Your Scope in TV**

A sequel to the second volume in this series; no uses duplicated in the previous book. Stresses the proper interpretation of observed waveforms. Over 400 illustrations.

**CHAPTER CONTENTS:** 1. Equipment Checks 2. RF Tests 3. IF-Amplifier Tests 4. Video-Amplifier Tests 5. AGC Tests 6. Intercarrier Sound Tests 7. Sync-Separation Tests 8. Vertical-Sweep Circuit Tests 9. Horizontal-AFC and -Oscillator Tests 10. Horizontal-Sweep Circuit Tests 11. Miscellaneous Tests

160 pp.; 5½" x 8½". No. TEM-7 \$2.50

#### **101 More Ways To Use Your VOM-VTVM**

Sequel to early volume on VOM-VTVM. ALL NEW uses. Shows how to check out and troubleshoot door openers, all types of appliances, fluorescent lamps, time controls, electric motors, power supplies, industrial devices, etc. Tells how to use units as S-meter, cavity-wave meter, tachometer, field-strength meter, etc.

**CHAPTER CONTENTS:** 1. Testing Household Devices 2. Special Uses 3. Test Equipment Checks 4. Circuit Tests 5. Component Tests 6. Miscellaneous Tests

128 pp.; 5½" x 8½". No. TEM-8 \$2.50

### **Handbook of Electronic Tables and Formulas (2nd Edition)**

Completely revised, updated and expanded to contain nearly 50% more material than the popular first edition. Truly a one-stop reference for all charts, tables, formulas, laws, symbols and standards used throughout the electronics industry. 6 FULL-COLOR foldout pages show assignments for the entire frequency spectrum, based on the latest FCC allocations. Nothing else like it!

192 pp.; 5½" x 8½". No. HTF-2 \$3.95

### **Electronics Math Simplified**

by Alan Andrews. For the engineer, student, or technician who requires a knowledge of mathematics as it pertains to electronics. Covers the subject in a logical, clear, and concise manner, using dozens of examples related specifically to electronics. Particularly suited for use as a textbook in any school or other training program involving the study of electronics, the book has been especially prepared to coincide with studies leading to 2nd-and 1st-class FCC Radiotelephone licenses.

224 pp.; 5½" x 8½". No. MAT-1 \$4.95

### **Using the Oscilloscope in Industrial Electronics**

by Robert G. Middleton and L. Donald Payne. Provides much-needed specialized information on the use of the oscilloscope in testing and maintaining various industrial electronic devices, showing how to make accurate tests and measurements utilizing this versatile test instrument. Discusses specific applications of the scope in testing and maintaining such devices as thyatron and ignitron controls, saturable reactors and magnetic amplifiers, radar equipment, automotive ignition systems, and transistorized controls. Specific equipment is used to show the reader how to more fully utilize his scope. Particularly useful features are the charts of scope specifications, and the numerous waveforms — with interpretations — depicting normal and abnormal operations.

256 pp.; 5½" x 8½". No. OSM-1 \$4.95

### **Modern Dictionary of Electronics**

by Rudolf F. Graf. BRAND-NEW! Includes definitions of over 10,000 electronics words and terms in current use. Provides the definitions to all the elec-

tronics terms needed by anyone who works in the electronics field. Concentrates specifically on electronics, including all the newest branches of the art. The most up-to-date electronics dictionary available. All important words and terms are cross-referenced to enable you to find the necessary definition with no loss of time. Includes an exclusive Pronunciation Guide showing syllabic division and pronunciations, as determined by industry usage, of over 900 selected words. Its 384 pages and more than 350 supporting illustrations make it a volume you'll find indispensable. Handsomely bound in a durable, wear-resistant hard cover, with rich gold stampings on the front and backbone.

• 384 pp.; 6" x 9". No. DIC-1 \$6.95

### **Troubleshooting With the Oscilloscope**

by Robert G. Middleton. Because it permits you to actually view and analyze instantaneous electronic circuit actions, applications of the oscilloscope in troubleshooting are virtually unlimited. This new volume has been especially written to enable technicians to more effectively use the scope. Written in practical language, the reading of this book will well repay anyone who uses or works with scopes.

128 pp.; 5½" x 8½". No. TOS-1 \$2.50

### **Using and Understanding Probes**

by Rudolf Graf. Describes where and how to use probes to accurately test all types of electronic equipment. In addition to practical data on the probes used in radio and TV servicing, the book also covers special-purpose probes used in industry, agriculture, medicine, etc., for observing, testing, exploring, and measuring. Will save technicians and engineers countless hours of exasperation in trying to find the right probe for the right job.

192 pp.; 5½" x 8½". No. PRG-1 \$3.95

---

*These books are available from electronic parts distributors and leading bookstores. If you cannot obtain them locally, write to Howard W. Sams & Co., Inc., Indianapolis*





# KNOW YOUR OSCILLOSCOPE

by PAUL C. SMITH

The oscilloscope provides you with a "third eye" which lets you see what is actually happening in electronic circuits. But you must know something of the nature of this valuable instrument, and how to use it, before it will serve you. This book presents complete information on the circuitry, functions, and applications of the oscilloscope in easy-to-understand language. Worth-while reading for anyone who uses an oscilloscope . . . a "must" for service technicians and students.



HOWARD W. SAMS & CO., INC.  
THE BOBBS-MERRILL COMPANY, INC.

\$2.00

KOS-1