

# Public-Address Guide



By GUY S. CORNISH

Gernsback Library

No. 41

75 Cents



2. 4

# PUBLIC - ADDRESS GUIDE

*by*  
GUY S. CORNISH



Gernsback Library No. 41

PUBLISHED BY  
RADCRAFT PUBLICATIONS, INC.  
25 West Broadway,  
New York 7, N. Y.

COPYRIGHT, 1950  
BY HUGO GERNSBACK  
All Rights Reserved  
First Printing—June 1950

# Public - Address Guide

INTRODUCTION .....	5
CHAPTER 1...PLANNING THE SYSTEM .....	7
Uses of public address systems. Sound amplifications and sound reinforcement. Types of public address systems. Fixed equipment. Custom built sound systems. Personnel paging. Commercial installations. Portable equipment. Electric megaphone. Mobile equipment. Special equipment. Detectophones. The applause meter. Outlay vs. income. Acoustics, Program, Audience.	
CHAPTER 2...PUBLIC ADDRESS EQUIPMENT .....	16
Microphones. Crystal microphones. Bimorph unit. Ribbon or velocity microphones. Dynamic microphones. Microphone chart of characteristics. Phonographs. Pickups. Scratch filters. Variable-reluctance reproducer. Preamplifier-equalizer. Remote induction pickup. Amplifiers. Resistance coupling. Transformer coupling. Four-channel preamplifier. Class-A amplifiers. Class-B amplifiers. Class AB. Amplifier ratings. Decibels. Loudspeakers. Horns. Trumpets. Re-entrant or reflex horns. Direct-radiator speakers. Speaker baffles. Limited baffle. Infinite baffle. Speaker phasing.	
CHAPTER 3...INSTALLATION .....	34
Acoustics. Generation of sound waves. Speed of sound waves. Frequency, velocity, wavelength. Reflection of sound waves. Sound wave travel time. Reverberation time. Effect of volume and absorption on reverberation time. Sabine formula. Absorption of seats and audience. Absorption coefficients of building materials. Absorption coefficients of commercial acoustic materials. Computation of absorption and reverberation time. Determining amplifier size and number and types of speakers for the job. Choice of speakers. Size of amplifier and number of speakers. Choice of microphones. Microphone guide. Installations requiring a number of microphones. Sizes and types of sound equipment for common installations indoors and outdoors. Microphone and loudspeaker placement. Lapel microphone. Lamp microphone. Speaker tripod. Projectors. Spreaders. Impedance matching and cable size. Output transformers. Multiple speaker connections. High-impedance lines. Low-impedance lines. Determining line loss. Microphone impedance matching. Microphone transformers. Outdoor, portable installations. Setting up the equipment.	

CHAPTER 4...MAINTENANCE AND SERVICING ..... 65

Preventive maintenance. Hanging cables. Power supply protection. Records. Servicing own equipment. Trouble shooting. Hum. Distortion. Intermittent operation. No signals. Audio signal tracer. Public address trouble chart. Hum tracer. Background noise. Tube overheating. Transformer overheating. Weak signals. Motorboating. Howling.

CHAPTER 5...CONSTRUCTION OF THE PA SYSTEM ..... 73

Gain. Fidelity. Power. Requirements for public address systems. Ventilation. Vibrators. Building a portable public address system. Adding a phonograph to the portable public address system. Power cables. Testing the system.

# Introduction

**I**N preparing this book on the selection, operation, maintenance, and construction of public address systems, we have tried to present the subject in a manner that will offer some help to the established radio service technician and also interest the man who has had little practical experience, but desires to enter this branch of the electronics field. Since most radiomen are not graduate electrical engineers and since many are not particularly fond of the use of mathematics, the function of each of the units that make up a public address system is given in plain, everyday language, and the mathematics used is confined to simple formulas. As a guide to their use, several problems are given and solved.

A careful reading of these pages should give a general understanding of the installation and operation of P.A. equipment. Radio technicians who now operate radio repair shops should consider adding sound services to their lines, as their knowledge of circuits and their possession of tools and test equipment make them the logical men in their locality for this work.

The public address field can be divided into two categories: SALES AND INSTALLATION and RENTALS AND SERVICE. To enter the sales field, approach several distributors for prices and sales information and become familiar with their systems. Then you will be able to give the prospective purchaser a complete description of each unit and answer all questions. If the locality is large enough to justify an investment sufficient to purchase and display several complete systems, it will aid greatly in making sales. However, if capital is limited, you may arrange to sell on a commission basis. The building by the radioman of sound equipment for sale is not recommended, as the market offers many good systems at moderate cost. These commercial units are attractive in appearance and generally more suitable for permanent installations.

For those entering the second (rental service) category, with some radio experience and tools to work with, much satisfaction can be had

by constructing one or more amplifiers and by adding many features not found in commercial units . . . features that will facilitate handling in rental service. Such innovations are included in a public address system described in Chapter 5. The amplifier can readily be constructed by the radioman. In addition to having a number of unusual features, the amplifier can be built at reasonable cost and be used to handle better than 90% of all the services the radioman may be called upon to supply. If the use of sound equipment is relatively new in your town, it is advisable to set up and demonstrate the system a few times without charge in order to educate people in its use. Rental service does *not* mean renting the equipment to some inexperienced person and permitting him to operate it. Such practice results in rapid depreciation of the equipment. The meaning of rental service is contracting for sound *service*, hooking-up and operating the equipment, and removing it. The demand for such a service is rapidly growing and it is hoped that the information given in this book will help those of you who want to make public address business your business.

The publishers acknowledge with thanks the cooperation of the following manufacturers in supplying material for this book; Fig. 101—Stromberg-Carlson Co.; Fig. 102—Radio Corporation of America; Fig. 103—Botany Mills; Fig. 104—Langevin Mfg. Corp. Fig. 206—General Electric Co.; Fig. 214—Atlas Sound Corp.; Fig. 316, associated text and Table 3-9—Jensen Radio Mfg. Co.



# Chapter 1

## Planning the System

### Uses of Public Address Systems

WHEN public address equipment was first introduced, it was crude, bulky, very expensive, and its use was limited generally to large athletic fields and convention halls. The carbon microphones used were not suitable for good reproduction of music, and for this reason the equipment was used mostly for speeches and announcements. As microphones were improved and the size and weight of the equipment was reduced, the field for sound broadened, and succeeding years have seen a growing demand for public address service. A few years ago only the largest groups ever thought of using sound equipment, but today it is demanded for gatherings of two or three hundred people.

Most large auditoriums, theaters, and stadiums are now equipped with PA systems, permanently installed. However, there are still many places where PA systems are used only when temporarily installed for each occasion, on a rental basis. In a year's time this generally costs less than owning and maintaining permanent equipment.

It would be impossible to list all the uses of public address systems, because the field is so large, but uses can be separated into two general classes: (1) *sound amplification* and (2) *sound re-enforcement*. As an example of sound amplification, take the case of an announcer at a large athletic field covering a sports event attended by thousands. The announcer speaks close to the microphone and therefore his voice is amplified to such a volume that it overrides the ground noise and is heard by all. There is little concern about quality of voice or any slight distortion in the amplified signal. The sole purpose is to be heard and understood. If the announcer is seated, a desk or table mike stand can be used, but if he is turning from side to side or leaning over to watch plays, an announcer's hand mike will be more satisfactory.

The use of systems for sound re-enforcement is becoming more popular each year, especially where crowds are small and noise level low,

as in the case of a lecturer speaking before two or three hundred people. If there were no other noise of any kind, the speaker could be heard and understood by everyone, but moving of feet, coughing, and outside noise create a noise level that makes hearing difficult in the rear of the room. Often, when people have difficulty hearing what the speaker is saying they converse among themselves. This further increases the existing noise level. As the interference increases and still more listeners are unable to hear, they too start whispering and in a very short time the noise level has risen to such proportions that only those seated in the very front rows can hear at all. Now, if in this same room, with the same crowd of people, a public address system is used for sound re-enforcement, and the microphone is placed 8 or 10 inches from the lecturer and several inches below mouth level, the overall gain of the amplifier may be set so that those in the rear rows will have no difficulty in hearing every word, regardless of the noise level. As long as those seated in the rear can hear, they will remain quiet and the speaker can deliver his lecture without interference.

There are two advantages in using public address for sound re-enforcement: the voice is more natural; and, the speaker can control the volume by varying his distance from the microphone. In this way certain portions of a speech can be emphasized without actually shouting into the microphone.

### **Types of Public Address Systems**

There are three general classes of public address equipment: fixed, portable and mobile.

**FIXED EQUIPMENT.** This class embraces sound systems installed so that they cannot be readily removed. In some cases the amplifier is of the panel type, mounted on the wall; in others it is of the conventional box type, kept in a wooden or metal cabinet large enough to accommodate not only the amplifier but also the microphone and cables when they are not in use. The cabinet should be designed for proper ventilation and should be provided with a lock and key to prevent unauthorized persons from tampering with the equipment.

Smaller public address systems are rapidly becoming popular in churches to re-enforce the minister's voice and reach overflow crowds in Sunday school and other rooms. Some of these systems are wired so that several pews are equipped with headphones for the benefit of those with defective hearing. Electric chimes, another type of fixed public address equipment, are becoming popular in some of the smaller churches. These chimes are metallic reeds, vibrating at their tonal frequencies in a strong magnetic field. These vibrations cause an alternating voltage of like frequency to be generated in the pickup portion of the circuit, and these are fed into the audio amplifier. The amplified output is carried by cable to the loudspeakers high up in the church tower. Some smaller churches, however, make use of a much simpler

installation consisting of a record player connected to the public address amplifier and arranged so that the output can be switched from the church to loudspeakers in the tower. Special chimes records can be played on the record player and the amplified signals switched to the church tower.

Sound equipment for large auditoriums and convention halls is rather large and complicated and often requires the services of a professional public-address control operator. Fig. 101 shows a custom-built sound system, with numerous output channels and microphone, radio, and record inputs.

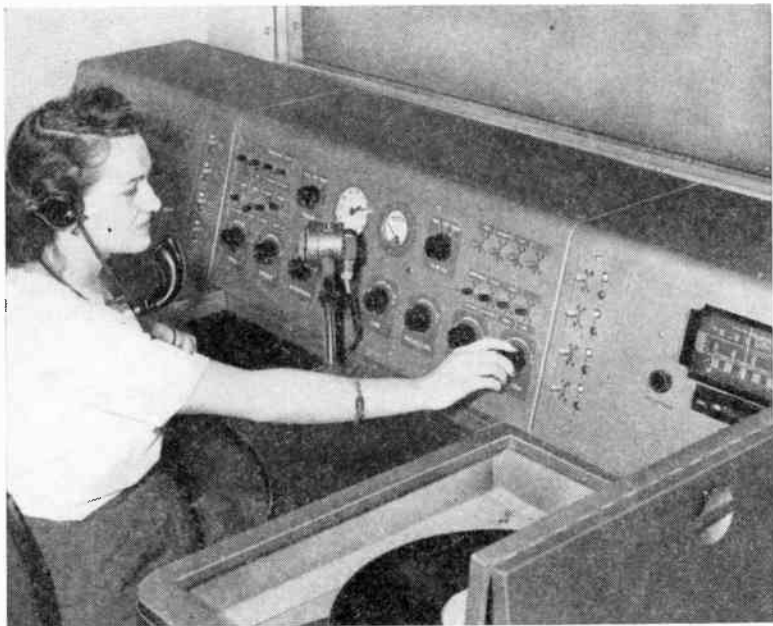

*Fig. 101—Custom-built public address system, completely equipped.*

There is another type of fixed public address service frequently installed in offices, stores, and factories where rapid communication is desired between different departments. Formerly telephones were used. These required the act of ringing, taking off the receiver, and then telephoning the message, necessitating the use of both hands, resulting in a loss of time. Today, modern offices are equipped with a miniature public address system known as an intercommunicator or teletalk. All the user does is press the lever and deliver his message, which can be distinctly heard at the distant end. These systems usually have a selector switch, permitting a number of stations to be selected. This small outfit can be placed on the back of the desk in such position that

the user can reach the selector lever, but he does not have to lean over to talk, as the small speaker acts as a very sensitive microphone.

Commercial "intercoms" come supplied with a connecting cable to carry the sound between the two units of the intercommunicator.



*Fig. 102—Public address system used for special announcements.*

Large department stores are finding it highly advantageous to use fixed public address for special sales announcements, and also for personnel paging with a resultant saving of time and elimination of messenger service. Fig. 102 shows a young woman using the equipment for this purpose.

Besides the very obvious commercial advantages in making public announcements about special sales in various departments of the store, or the time-saving convenience in use as a paging system, many department stores make use of public address equipment for playing records or transcriptions. Much of the music sent out over the public address equipment is seasonal, as, for example, the type of music used during the Easter or Christmas holidays.

Many offices, stores, and factories are using public address equipment for the entertainment and information of their employees. Music, news, and radio programs can be broadcast throughout a building at reg-

ular intervals, and announcements of employee activities can be included. This service fosters a better feeling between employees and management. Fig. 103 shows such an installation at Botany's burling and mending department, where music from a PA system makes the employees' work far more pleasant. Placement of loudspeakers in a permanent installation of this type is simplified by having the loudspeakers



*Fig. 103—Public address used for entertainment of employees.*

suspended by wires or cables from some convenient open steel girder. Sufficient speakers must be supplied so that the volume of music is fairly evenly distributed throughout the entire room. This is rather important, since the use of too few speakers will mean that those working directly below the speakers will be subjected to considerable sound volume in order that those persons located further away may hear in comfort. Fig. 103 shows how judicious placement of loudspeakers results in everyone hearing the music at approximately the same sound level.

Where the installation of a public address system is to be permanent, some experimentation may be necessary in order to properly determine the number of speakers required, their power rating, and their proper placement. Particular speakers may be cut in or out, and

the volume to various speakers controlled through the use of a master control console. The master control console used at United Nations meetings is shown in Fig. 104.

**PORTABLE EQUIPMENT.** Portable public address equipment is designed to be transported from place to place and set up and taken down in a minimum amount of time. It is reasonably light in weight. All cables are equipped with plugs and receptacles for making quick and accurate connections. Each loudspeaker should have at least 50 feet of cable, and the microphone should have about 25 feet. Always carry extra extension cable, with proper plugs for both the speakers and microphone, so the distance between the units can be increased, if necessary, to avoid feedback.

Portable sound equipment varies in size from the small suitcase type used by orchestra leaders and entertainers to large outfits in sound cars. Because thousands of people can be served by sound cars at picnics, athletic events, and outdoor gatherings of all kinds, such portable equipment is popular. Employing this type of service, the operator drives the car to some suitable location on the field where he can extend a power cable to a 110-volt a.c. power socket.

The electric megaphone is another example of portable PA equipment. This device consists of a horn with a microphone built in, which can be carried in the hand, and a small battery-powered amplifier strapped on the operator's back or hung at the side by a shoulder strap. It operates instantly when a push-to-talk button is pressed, and under normal conditions can extend the range of the human voice to about  $\frac{1}{2}$  mile. Its chief uses are in reporting the results of sporting events from the scene of action or where other on-the-spot announcements are desired. It is also used by fire-department officials to give fire orders, and by police when directing highway traffic.

**MOBILE EQUIPMENT.** Mobile public address equipment means a system mounted in a car or truck and designed so that it can be operated while the car is in motion. Some of these mobile units receive power from a separate gasoline motor driving an electric generator. This is the method used for equipment designed for very high outputs. For less powerful units, the generator can be driven by the fan belt on the automobile motor. This arrangement gives satisfactory results except that the motor must be run at uniform speed as long as the equipment is operated. The most popular method today, however, uses a large 6-volt storage battery, operates vacuum tube filaments direct from the battery, and has a vibrator pack or dynamotor to supply the tube plate and screen voltages. In this way the sound equipment can be worked without running the car's motor. Such mobile systems can be used in parades to provide music from records, and also to advertise store openings, special sales, and theater attractions. In some localities where

sound service is desired and no power is available, the mobile unit can solve the problem.

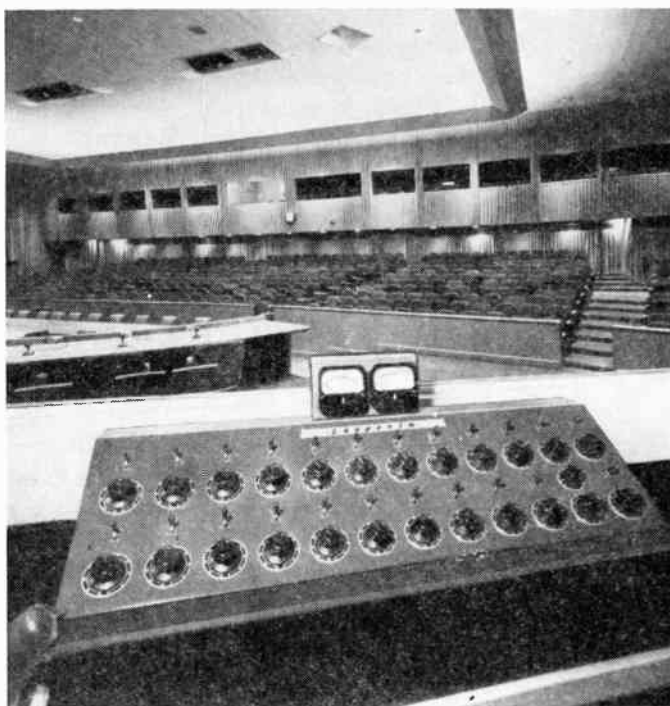

*Fig. 104—Master control console used at United Nations meetings.*

**SPECIAL EQUIPMENT.** Detectophones and hearing aids also are types of portable sound systems; and, while they are small in size and designed for special purposes, they have circuits resembling the larger and more powerful units.

The applause meter, while not considered a public address system, operates in a similar manner. The sound of the applause is picked up by the microphone and amplified by an audio amplifier; but instead of feeding the output into a loudspeaker, the system is wired to a meter designed to measure sound intensity. The meter dial is marked off in 100 or 1,000 divisions, depending on the length of its scale.

Before a contest starts, the master of ceremonies asks everyone present to applaud vigorously. The gain control on the amplifier is then adjusted to a point where the meter pointer registers full scale and is locked at this setting. As each contestant is applauded, the result is read from the meter and recorded by the judges. It is often difficult to judge the amount of applause by ear, hence arguments sometimes begin

when decisions are thus made. However, if each burst of applause is "measured" on the meter, the results are accepted without question.

When a single microphone is used, it should be suspended overhead near the center of the room and the cable brought over to the amplifier. It is the intensity of the applause and not the length of it that registers on the meter. The radioman who is considering the addition of a public address rental service to his radio business should seriously consider obtaining some sort of applause measuring device, since many of his calls for sound service will come from church groups, lodges, and schools where contests are given and winners are chosen by popular acclaim.

Many of the applause meters on the market are elaborate and expensive, and their limited use would not justify purchase. However, by using his amplifier and microphone and a small meter with the proper decibel scale, the versatile radioman can equip himself with the necessary apparatus to handle many contests.

### **Outlay vs. Income**

The amount that your client will pay for installation of a PA system must be carefully considered in relation to actual needs. You must check all requirements and arrange to give no more equipment than is actually needed. Consider the size of the installation and the quality required. If the system is to be used for speaking only, it will be a waste of money to furnish high-fidelity equipment, and if the gathering will consist of only two or three hundred people, it would be wasteful to put in a large, high-powered outfit. It is important that you do not use a system so elaborate and expensive that you lose money every time you use it on a job where a smaller outfit would suffice. After checking over all needs carefully, make an estimate on the installation and decide just what you can furnish for the money paid. However, don't skimp on the size of the equipment if a large outfit is needed, because inadequate coverage will result in customer dissatisfaction. If your customer needs a larger system than he can pay for, it would be better for you to pass up the business than to lose money.

### **Acoustics, Program, Audience**

First, consider the requirements of the public address system. Determine the size of crowd, the noise level if any, the type of program, and the acoustics of the auditorium. In Chapter 3, under the section "Determining Amplifier Size and Number of Speakers," we have presented tables that should assist the operator in choosing proper equipment for the average hookup. If planning the system for sale or permanent hookup, do not recommend an amplifier larger than actually needed. The larger amplifier will increase the cost and you may have difficulty in keeping the total down to a price that will interest the purchaser.



The acoustics of the room are a foremost consideration. Some rooms with smooth walls and low ceilings are a tough problem for the PA man. A clap of the hand can be heard many times as the sound is reflected back and forth in the room. For such locations it is almost impossible to give a definite set of rules to follow in equipment placement. The radioman should arrange to get into the hall some time before the meeting to do some experimenting. After the best location for the microphone and speakers is determined, make a sketch in a small book and keep it for future hookups at this particular location.

The public address man must always keep in mind the nature of the audience and program. As a rule, a group of men in a club or lodge are not as critical of the fidelity of a public address system as members of a musical organization would be. For this reason, a moderately priced outfit would satisfy the former group. Dance bands and small orchestras are not ordinarily interested in expensive sound equipment. On the other hand, if you are installing public address equipment in a school auditorium where music classes and organizations hold rehearsals, or if a professional singer or orchestra is giving a musical program, the equipment should be selected with especial care. These organizations usually require and are willing to pay for high-grade installations.

# Chapter 2

## Public Address Equipment

### Microphones

**T**HE function of the microphone is to change sound waves into equivalent electrical impulses. Sound waves striking the diaphragm (mounted in the microphone) cause it to vibrate in accordance with the frequencies of the sound. The diaphragm is connected to some form of device arranged to transform, modulate, or otherwise change the mechanical motion into electrical energy. The resultant electrical product is fed by cable into an amplifier. All diaphragms have a natural period of vibration, and if this falls within the audio range, the signals at this frequency will be amplified much more than others, resulting in distortion. To eliminate this possibility, the diaphragm is usually stretched so that its natural period is higher than the audio range, giving a more even response for all frequencies. A stretched diaphragm does not respond as readily to weak sound waves because more energy is required to make it vibrate.

Some microphones are better adapted to one class of service than another and for this reason at least two microphones are required for a satisfactory rental service. One microphone should be the close-talking type for outdoor announcements and the other a general-use type for both speech and music. We should get acquainted with the several different types of microphones.

**CRYSTAL MICROPHONES.** The crystal microphone in general use consists of a diaphragm, arranged in such manner as to impart its vibrations to a crystal of Rochelle salt. The vibrations travel from the diaphragm to the crystal through a mechanical link. The crystal, when subjected to such slight mechanical pressure, generates a voltage which is fed by shielded cable to the control grid of the input tube without the use of a transformer. The voltage is very low in value, and a rather high-gain amplifier is required to bring the signal up to suitable levels.

The signals are sharp and clear, and the microphone will work in any position. It is also free from hiss and other background noises. Keep cable length reasonably short, approximately 25 or 30 feet, since longer cables may introduce losses and increase the hum level. Crystal microphones are usually affected by extremes in temperatures and should be handled accordingly. A crystal microphone circuit is shown in Fig. 201.

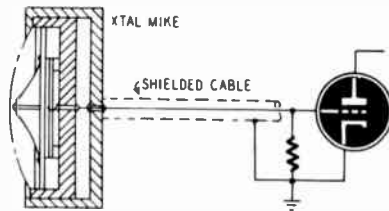

Fig. 201—Crystal microphone circuit.

Another type of crystal microphone, known as the cell or grille type, is composed of several small crystal units, connected in either series or series-parallel. The cell unit is an assembly of two Rochelle-salt crystal elements (called a bimorph unit) in a Bakelite frame. The bimorph elements are made of two crystal plates with electrodes attached, cemented together in such a fashion that an applied sound will cause a bending of the assembly and produce a voltage. Mechanical shocks have little effect on the unit. No diaphragm is used and the sound waves strike the crystals directly. This type has lower output and flatter response than the diaphragm type. It is used only in wide-range systems.

In either the diaphragm type of crystal microphone or the cell type, the principle of operation depends upon the piezo-electric effect (a voltage produced on crystals when subjected to some form of mechanical stress).

**RIBBON OR VELOCITY MICROPHONES.** Ribbon or velocity microphones take their name from a crimped metallic ribbon, suspended between the poles of a powerful permanent magnet. See Fig 202.

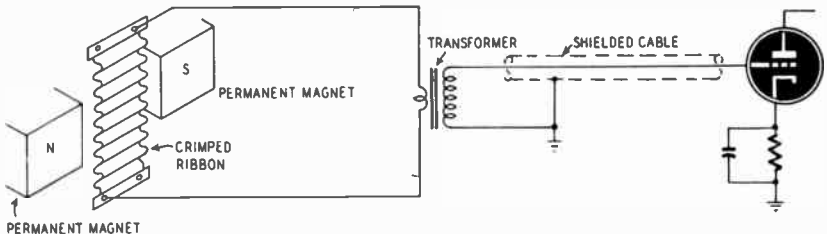

Fig. 202—Ribbon microphone and microphone input transformer.

The freely suspended, crimped ribbon, made of duralumin is insulated from the pole pieces and microphone case, and the ends are directly connected to the primary of a special transformer. The velocity

microphone, a low-impedance device, always has a coupling transformer mounted right in the case. By matching the line impedance to that of this coupling transformer, the amplifier may be located some distance from the microphone, provided the connecting cable is properly shielded. Sound waves striking against the ribbon will cause it to vibrate. These vibrations or movement of the ribbon in a strong magnetic field cause a weak alternating voltage to appear at the ends of the ribbon. The ribbon ends, being connected to the primary of the transformer, induce a secondary voltage which is conveyed to the amplifier. Although the ribbon microphone is an excellent pickup for music and is a studio favorite, it is not good for close talking, as it overemphasizes the lower frequencies, causing an unnatural boomy sound. It is not recommended for outdoor use because strong air currents cause the ribbon to vibrate, generating a rumbling sound and in some cases damaging the ribbon. Owing to the low output level in this type of microphone, there is a tendency to pick up hum from other electrical equipment. It has a lower level output than the crystal-cell type.

**DYNAMIC MICROPHONES.** The dynamic microphone is one of the most popular types in use today for public address service. It operates on the moving coil principle and is constructed somewhat like a miniature dynamic loudspeaker. Attached to the diaphragm is a small coil moving in a strong magnetic field. The low voltage induced in this coil is transformed to suitable levels by a small transformer, similar to the one used with the ribbon microphone. The matching transformer is generally built into the microphone case. This microphone is well adapted to outdoor use because of its ruggedness. Output level is about equal to that of a high-grade crystal microphone, but somewhat lower than that of the general-purpose crystal type.

Neither the carbon microphone nor the condenser microphone find application in public address systems used today. The behavior of these microphones and the others that have been described is listed in the Microphone Characteristics chart, Table 2-1.

## Phonographs

Any sound system to be complete requires a good record player to furnish music at picnics, festivals, fairs, etc. At athletic contests where the participants have no musical organizations of their own, usually several records are played during the program.

As a rule, the turntable mechanism seldom gives trouble if it is kept properly lubricated. Be careful in handling and transporting the record player, to avoid bending the turntable shaft. A slightly bent shaft will cause the record to wobble as it rotates and it may cause the needle to jump a groove. The record player should have a sturdy motor and be designed to play both standard and long-playing discs. The pickup arms should be long enough to handle 16-inch recordings. For public address service, where the records are not played continuously, a single-

Table 2-1 — MICROPHONE CHARACTERISTICS

Types	Price	Ruggedness	Output	Available Impedance	Uses	Remarks
Carbon	Low	Excellent	Very high	Single-button 100 ~ Double-button 200 ~	Ballyhoo systems, police cars, portable transmitters.  Freq. range — Poor.	Very bad hiss and background noise. Must be used in vertical position.
Condenser	High	Low	Very low (without preamp)	Depends on preamp	Broadcasting and recording.  Freq. range — Excellent.	No hiss or background noise. Not popular for P.A. Requires built-in preamplifier.
Velocity	Medium	Medium	Medium	Depends on transformer	Excellent for studio work. Not good for close talking or on windy days.  Freq. range — Excellent.	Works best in vertical position. No hiss or background noise.
Dynamic	Medium	Excellent	Medium	Depends on transformer	General all-around use both outdoors and inside.  Freq. range — Good-Excellent.	Works in any position. No hiss or background noise.
Crystal with diaphragm	Low	Good	Medium to high	High	Most popular for P.A.  Freq. range — Good.	Works in any position. No hiss or background noise. Sensitive to heat.
Crystal cellular	Medium	Medium	Medium	High	High-class PA work. Excellent for music and speech.  Freq. range — Good.	Works in any position. No hiss or background noise. Sensitive to heat.

record machine will prove satisfactory, particularly when using long-playing records. If, however, continuous music is required, use an automatic record player.

If the phonograph is to be used in mobile work, very good service can be had from one having a spring motor, wound by hand. The motor and pickup in all phonographs should be well grounded.

## Pickups

Just as there are many types of microphones to change sound waves into electrical waves, any one of several types of pickups can be employed to change into electrical energy the vibrations recorded in the groove of the record. The earlier electrical reproducers made use of a small armature inside a coil of very fine wire. Soft-iron pole pieces located above and below the coil were kept magnetized by a permanent magnet. When the soft-iron armature vibrated between the magnetized pole pieces, the magnetic flux in the armature changed accordingly and a voltage was induced in the coil. This voltage represented the signal and was fed by cable to the amplifier input. This type of pickup gave good results as long as the armature was centered; but when the rubber or other damping material deteriorated, the armature would strike the pole pieces and the reproduction became unsatisfactory.

The majority of pickups in use today operate in a manner similar to the crystal microphone. The active element is a crystal of Rochelle salt (sodium potassium tartrate), so arranged in the pickup that the vibration of the needle will cause a slightly twisting motion in the crystal. Whenever such crystals are subjected to mechanical strain, voltages are set up on their surfaces. This is the same piezo-electric action that appears in the crystal microphone. The voltage is fed by cable to an amplifier. Electrically speaking, the crystal acts as a capacitor having a capacitance somewhat greater than .001 microfarad, and therefore it offers a much higher impedance to the lower frequencies than it does to the higher, and for this reason the bass response is usually less than that desired by the average listener. Reduced bass response gives music a thin tone. The radioman can make some improvement in the quality by using the circuit arrangement shown in Fig. 203.  $R$  should have a value of between 1 and 5 megohms. The higher the value, the better the bass response. Some experimenting may be necessary, as loudspeak-

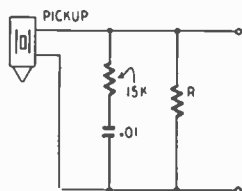

*Fig. 203—The tone response can be controlled by inserting this filter between the pickup and the control grid of the input tube. Increasing the value of  $R$  will have the effect of boosting the bass response. If the value of  $R$  is made much higher than 5 megohms, speaker rattling may occur.*

ers differ and some are not well adapted to low-frequency radiation. Any attempt to increase the bass may result in a rattle.

Another important addition to the record player is a scratch filter. Two tested circuits are shown. In Fig. 204 we have a simple filter that can be used to reduce the scratch. The operator has a choice of two switch positions. In Fig. 205 a similar type of filter is shown, with the addition of a variable resistance. These filters can be successfully used to reduce the high tinny sound of some records and to reduce the scratch from long-used records. Crystal pickups have a tendency to amplify high frequencies more than the lower ones, manifesting itself in the amplification of needle scratch.

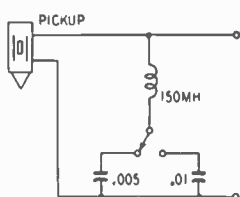

Fig. 204—Two position filter.

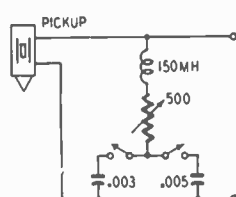

Fig. 205—Variable resistance filter.

Several precautions must be taken in handling crystal pickups in order to ensure satisfactory reproduction. Be careful in placing the pickup on the record, as dropping or a sudden jar may crack the crystal, rendering it unfit for further use. At temperatures above 120° F. the crystal will be permanently damaged and for this reason the pickup should never be left uncovered in the sun on hot summer days. If crystal cartridges are replaced by the operator, great care should be used in soldering the connections, as excessive heat will result in damage to the unit. Most new cartridges have plug-in terminals. Solder before plugging into the cartridge.

While Rochelle salt crystal is used in practically all crystal pickups and microphones, it is by no means the only crystal that offers the piezoelectric effect. Several other chemical compounds are used, such as ammonium phosphate, yielding crystals that can tolerate temperatures much higher than Rochelle. Barium titanate, a ceramic, is also used.

Another type of pickup, operating on the same principle as the dynamic microphone, is used in some special installations and gives excellent response. While it offers some advantages over other types, the use of a permanent magnet adds weight to the unit and requires a counterbalance on the arm extension. There are several additional methods of changing needle vibration into signal voltage, some of which are still in the experimental stage. One of these is the use of a glass-hard steel wire instead of a crystal. Any strain on this wire will produce a weak potential that can be used as signal voltage. Another pickup uses a pair of dissimilar metal strips, their surfaces cleaned and the strips

squeezed together under extreme pressure. Sometimes, heat is applied with the pressure. This dual metal strip when properly made is very sensitive to strain, generating a voltage slightly higher than that of a good crystal. In still other experiments now being conducted, several thin metal leaves are combined by pressure, giving promise of a new unit that can be used in both pickups and microphones.

The experimentation necessary in the development of the strain-wire reproducer resulted in certain techniques in mechanical design that have been incorporated in the *variable-reluctance reproducer*. For years, engineers tried to reduce the weight of the moving parts in magnetic pickups. It is obvious that any weight the stylus or needle has to swing as it traces the record groove is sure to cause record wear, frequency discrimination, and distortion. The variable-reluctance pickup differs from the older magnetic type in the following respect: Instead of the armature passing through the coil and between the pole pieces above and below the coil, it is reduced to a small cantilever spring, with a stylus at one end and the other end attached to a permanent magnet (Fig. 206). The end of the spring carrying the stylus moves back and forth,

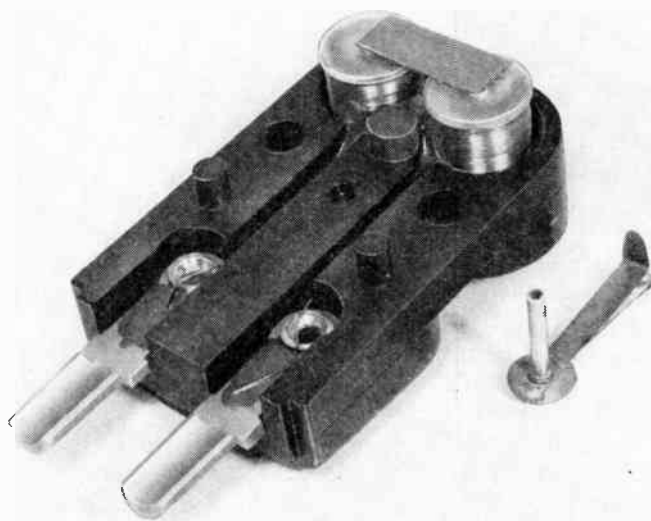

Fig. 206—Exposed view of the *variable-reluctance reproducer*.

laterally, as it traces the wave in the record groove. This lateral movement of the spring, between the small pole pieces of the coil sets up a voltage in the coil which is connected to the pickup leads.

This type of pickup gives very good fidelity and low record wear because of its light needle pressure. A serious disadvantage in some PA applications is its low output (about .02 to .08 volt). This makes



a preamplifier a necessity, unless it can be fed to a microphone input stage. In either case equalization is necessary to bring up bass. A suitable preamplifier-equalizer circuit is shown in Fig. 207.

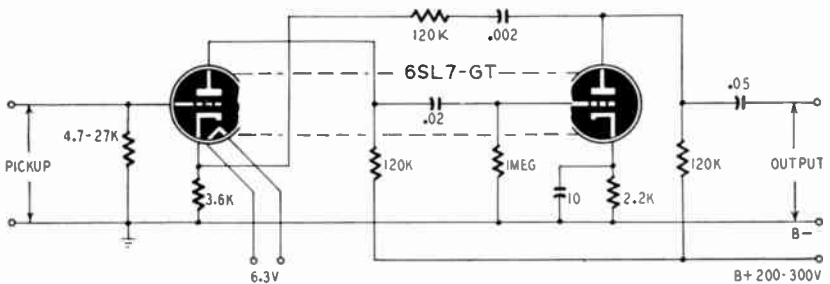

Fig. 207—Preamplifier-equalizer circuit using a high gain duo-triode.

The PA system operator may be called upon to amplify a telephoned talk delivered by someone unable to be present at a meeting. This can be accomplished by the use of an induction pickup. Telephone companies will not permit any connections to their lines or equipment. The induction pickup, which is very satisfactory if properly handled, can be easily constructed. It consists of a good telephone receiver of rather high impedance, or one of the units used on the early horn speakers. The unit is really an oversize telephone receiver. The cover and diaphragm are removed and the unit mounted on a board, face up. As a protection to the fine wire of the coils, fill the unit with sealing wax. Attach a shielded microphone cable about 6 feet long to the two terminals on the back and equip the cable with a phone plug to fit the input jack on the amplifier (Fig. 208).

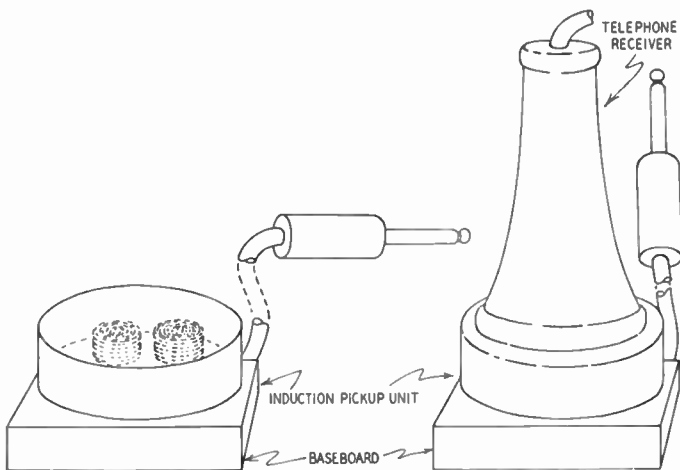

Fig. 208—Exposed view of telephone induction pickup.

The pickup is used in the following manner: Before the meeting starts, the speaker is called on the telephone and asked to count while the PA system operator places the telephone receiver on the pickup unit and rotates the receiver to the best position for pickup. The telephone receiver is now left in this position and a weight is hung on the receiver hook. With cradle-type phones, a snap-on clamp is needed to hold the pickup in place. Commercially made units are also available which pick up from the induction coil located in the base of the telephone stand. When it is time for the telephone speech, the weight is removed, the person is called and given the signal to start. The controls on the amplifier are manipulated in the same manner as if the person were present. In an ordinary telephone circuit, the frequency range is narrow, and the voice when amplified will not equal broadcast quality. However, it will be clear enough to be easily understood. The unit should be kept several feet from the amplifier, to avoid induction pickup from the power transformer.

## Amplifiers

The function of a public address system is to build up weak audio signals to levels high enough to operate loudspeakers. Such a progressive increase in audio power is known as amplification and is attained by the use of vacuum tubes. Each tube, with its associated circuit, is known as a stage of amplification. There is a limit to how much a signal can be increased in one stage, and in order to get the required increase from the input to the output, it is necessary to connect several stages in series. Public address amplifiers ordinarily have three or four stages, depending on the type of microphone used. One of the oldest methods used in coupling two tubes is shown in the drawing, Fig. 209. The plate current from

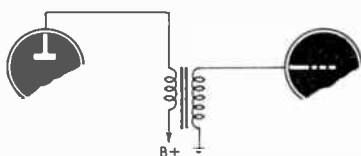

Fig. 209—Transformer coupling.

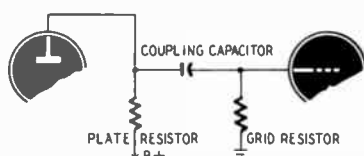

Fig. 210—Resistance coupling.

the first tube flows through the primary of the audio transformer to the positive plate battery. One side of the secondary winding of the transformer is connected to the grid of the next tube, and the other side is usually grounded. If the number of turns in the secondary winding is three times the number in the primary, then the signal voltage on the grid of the second tube will be three times the signal voltage in the primary.

While the transformer offers a simple and efficient method of coupling, it has been replaced almost entirely by resistance coupling except to drive the output stage of high-power amplifiers (Fig. 210).

In the early days when the carbon microphone was our only means of voice pickup, little attention was paid to the form of coupling, because the distortion in the microphones and speakers was such that little could be accomplished by attempting to improve the amplifier. But as new types of tubes made their appearance on the market and microphone and speaker response were improved, transformer coupling began to lose its popularity because of the high cost of high-quality transformers.

Resistance coupling offers four advantages: First, it costs less; second, when properly used, it does not discriminate between frequencies as cheap transformers do; third, it does not create harmonic distortion as cheap transformers will; and fourth, it occupies much less space and adds less weight.

One advantage an operator has in building his own amplifier is that he can add certain sockets, switches, and accessories that will make his system more adaptable to the different types of service he may desire to furnish. One addition that will prove very useful is a power pickoff socket. This is an ordinary 4-hole socket, the contacts in the large holes connecting to the 6-volt filament circuit and in the smaller holes to the plate voltage and ground. Such a socket provides power for a radio tuner, a preamplifier, or other special equipment. The amplifier chassis also should be equipped with a couple of 110-volt receptacles, into which a radio, record player, or work light may be plugged. There are times when the operator will be called upon to place his amplifier in a location where he cannot hear the loudspeakers; this will prove a handicap if he must follow a program and listen for cues. The addition of a small speaker in the amplifier, controlled by a knob on the panel, will enable him to keep abreast of the program. There is a growing demand for public address at forums and meetings where several people are seated at a long table with the moderator in the center. A microphone is placed in front of each participant. As most amplifiers have

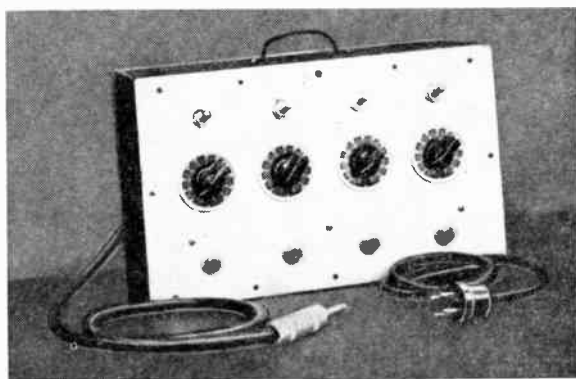

*Fig. 211—Portable four-channel preamplifier and connecting cables.*

but two microphone inputs, a special 4-channel preamplifier can be constructed with a separate switch and volume control for each channel, to enable the operator to set the volume for each microphone (Fig. 211). This preamplifier is equipped with a 4-prong plug that connects to the power pickoff socket and a microphone cable and plug that fits the preamplifier jack. Fig. 212 is a schematic of the unit. For larger forums, a second 4-channel unit can be constructed.

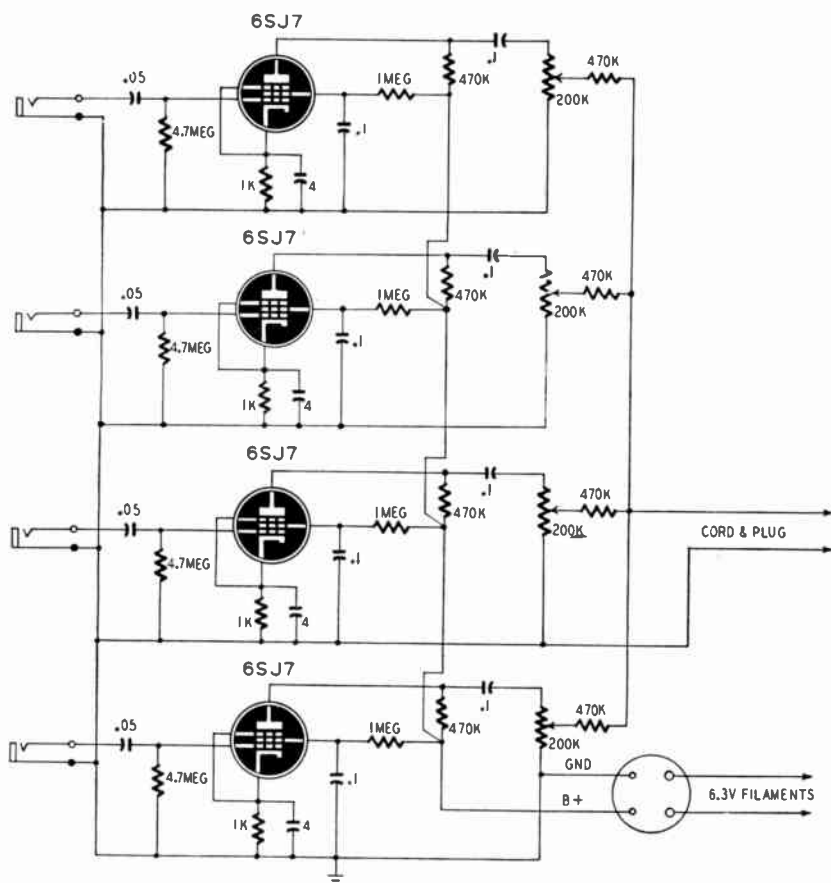

Fig. 212—Circuit diagram of four-channel preamplifier. Additional stages may be added whenever necessary.

Two basic types of power amplification are used in public address amplifiers; class A and class B. In class A, the operating point of the output tube is at the center of the linear portion of the characteristic curve and the entire swing of the grid signal is reproduced in the plate current of that tube. Plate current flows at all times; and if the operating

point is kept in the proper position, the variation in the plate current will be an exact replica of the voltage swing on the grid. The grid potential never swings to a point where it is positive with respect to the cathode; therefore no current flows in the grid circuit. Class-A operation generally is used only in systems of 30 watts or less output.

In class-B amplification the operating point is set at the lower end of the characteristic curve, at a point near cutoff, where practically no current flows at zero grid signal. The grid is driven harder than in class A, and the entire linear portion of the curve is utilized as the grid swings toward the positive side; during a portion of this swing, current flows in the grid circuit. As each tube can only amplify one-half the signal, two tubes must be used in push-pull, for reproduction of the complete signal. With properly designed transformers and chokes, a satisfactory signal for high-power public address systems is obtainable. The main advantage is high power output without excessive plate current drain. However, power supply regulation must be very good. Special output tubes are required for class B.

Many medium-power amplifiers use class-AB power amplification. The operating point is in between class A and class B. Efficiency is greater than class A and less than class B. Many tubes designed for class-A operation will give much higher power output in class AB for a moderate increase in power drain.

## Amplifier Ratings

The two main ratings of audio amplifiers are gain and power output, usually stated in decibels or watts above a given reference point. Some manufacturers also furnish a curve showing the response at various frequencies.

The decibel is a logarithmic unit which is an expression of a ratio. The gain of an amplifier builds up a signal from an extremely low input to a usable output. An amplifier that has twice as much power as another is not twice as loud. The difference between power levels and sound intensity is logarithmic, and as the uniform scale by which sound intensities can be expressed is more desirable than the logarithmic scale of power ratios, sound engineers in 1928 adopted the unit called the decibel to express sound levels. This unit represents the amount of change in sound intensity just discernible to the average ear.

In order to give meaning to the decibel scale, a starting or reference point is needed, and it was decided to place 0 at the threshold of hearing (at which the faintest sounds just become audible). This 0 on the decibel scale represents 6 milliwatts (.006 watts) in electrical power, and with this convenient uniform scale any sound that can be heard can be expressed in so many decibels, preceded by a plus sign. Any sound too faint to be heard, can also be expressed in decibels, preceded by a minus sign. If the sound level at the output of an amplifier is +40 db, this means 40 decibels above 0; and if a microphone is rated at -60 db,

this means that its output in sound intensity is 60 decibels below 0. In order to bring this —60 db up to 0 db a *gain* of 60 db will be required, and to raise this to the above amplifier rating of 40 db an additional gain of 40 decibels will be required. In other words, to bring minus 60-db level up to plus 40-db level, the amplifier will require an over-all gain of 100 db.

The power output rating of an amplifier means the electrical power delivered at the output terminals, and is measured in watts or db above a specified reference level. It is always calculated for a given amount of harmonic distortion (usually 5%). The power output of an audio amplifier determines the sound level that can be obtained from the speakers. *Peak* power output is the maximum output possible regardless of distortion. It is considerably higher than the undistorted output rating. If undistorted output is not known, peak power rating will give some indication of an amplifier's rating. Peak power output can be easily determined by a very simple method: Connect a 500-ohm resistor to the 500-ohm output terminals of the amplifier. The resistor should be noninductive and of sufficient size to dissipate the expected peak power of the amplifier. Across this resistor connect a voltmeter calibrated to read peak a.c. volts. Feed in a signal of approximately 800 cycles per second and measure the maximum voltage. The following voltages will indicate the peak power of the amplifier:

<i>Max. Voltage Across 500 Ohms</i>	<i>Peak Power Output in Watts</i>
173	60
158	50
141	40
123	30
100	20
71	10
50	5

Other values can be determined by the use of the following formula:

$$W = \frac{E^2}{R}$$

W is the output in watts, E is the voltage appearing across the non-inductive resistor, and R is the value in ohms of the noninductive resistor. You can use this method for measuring the power output that will appear across any voice coil. The above problem was calculated for an amplifier with a 500 ohm output. If your amplifier has an 8 ohm output, for example, simply follow the same procedure and use the same formula. The only change you need make in this case would be to substitute 8 in place of 500. Note that the voltage you measure must be squared (multiplied by itself).

A cathode ray 'scope can also be used to measure peak volts, provided you have some means for calibrating the 'scope. Commercial calibrators are available, or you can use a step-down transformer, pro-

vided the voltage appearing across the secondary of the step-down transformer is accurately known. You must also have available a plastic graph, consisting of evenly-spaced squares, which should be placed across the screen of the cathode ray tube in the 'scope. Connect the source of calibration voltage to the vertical input terminals of the 'scope and adjust the vertical gain, until the sine wave appearing on the face of the cathode ray tube covers twenty squares on the graph. If the voltage you are feeding into the vertical input is 10 volts peak to peak, then each square on your graph will represent  $\frac{1}{2}$  volt. You can now feed in your unknown voltage and measure its peak value simply by counting the squares it occupies on the graph. Just one word of caution. Once the 'scope is calibrated, the vertical gain control must not be touched, since this will necessitate your going through the calibration procedure once again. The 'scope can thus be used to read peak volts directly. It has the additional advantage of letting you observe the presence of distortion.

Amplifier power output can also be expressed in decibels. However, since we are dealing with absolute values rather than ratios, the decibel rating must refer to a particular zero reference level. For example, if we rate the power of a 10-watt amplifier in decibels, we must say that it has a power rating of so many decibels above the given zero level. Unfortunately, several different zero levels are in common use. The older one, still used by many PA manufacturers, is a zero level of 6 milliwatts. The newer one, used in broadcasting and by an increasing number of manufacturers is 1 milliwatt (0.001 watt). For power levels in decibels to have any meaning, it is essential to know which zero level is being used. When using a zero level of 1 milliwatt the term volume unit (abbreviated VU) is often used instead of db. Another term used is dbm (m for milliwatt). Thus, a 10-watt amplifier has a power level of +32.2 db referred to 6 milliwatts and +40 VU (or +40 dbm) referred to 1 milliwatt.

## Loudspeakers

A loudspeaker generates sounds by causing some part of the reproducing unit to vibrate at frequencies corresponding to those in the microphone diaphragm. This vibration in the speaker unit can be imparted to the surrounding air in two ways, thus separating loudspeakers into two general classes depending on the method used.

The first and oldest is the horn type, in which a driver unit equipped with a diaphragm capable of reproducing sound at high intensity is coupled to the surrounding air through a speaker horn or trumpet. This horn, to be efficient, must be designed so that the sound waves expand uniformly as they pass through the horn, without reflections or compressions. The design of such horns or trumpets is beyond the ability of the public address operator, as they are not of a uniform straight taper, but follow an exponential law. This type of speaker offers

a sound conversion efficiency of 15 to 25% and is an excellent reproducer for large outdoor gatherings. The radioman should have at least two of these for his outside service. At first these trumpets were used chiefly for outside permanent installations on account of their ability to cover large areas. Because of their length of 5 to 6 feet, they were not well adapted to portable hookups. Later folded or reflex trumpets are much shorter in length, but offer about the same air column (Fig. 213 and 214). The air waves travel out from the reproducer unit about one-third the way and are then returned by an inside reflecting chamber back to the reproducer end of the horn and then out through the bell. This gives about the same result as the long horns, with about one-third the length.

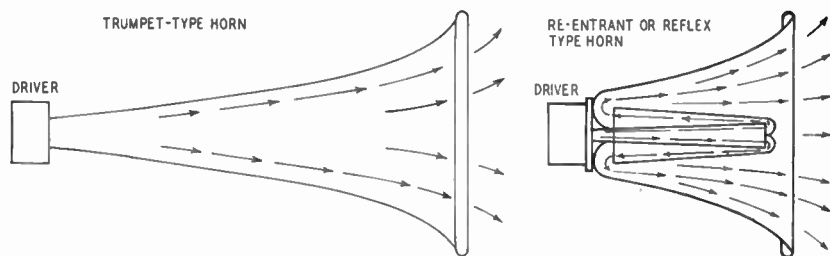

Fig. 213—A trumpet type horn and a re-entrant or reflex type horn.

The second general class of speakers consists of those in which sound waves are produced by a large vibrating cone known as a direct radiator, instead of by a small diaphragm. This type is most generally used today where the sound demands are not too great. It is much less efficient than the horn-type radiator (5-15%), depending on cone and magnet size and type of baffling. It has become a favorite for indoor installations.

As both the horn and direct-radiator speakers operate on the dynamic principle, a strong magnet field is required in their design. Formerly, this field was obtained by a field coil through which direct current was passed, either from the amplifier or a separate power supply. However with the advent of new alloys capable of being magnetized to a much higher degree than steel, the electromagnetic dynamic speaker is fast giving way to the permanent-magnet type. The PM dynamic speaker offers the following advantages: It requires less space, needs electrical energy source, is free from field hum and requires but 2-conductor cable to connect it to the amplifier.

Loudspeaker efficiency has an important bearing on over-all system performance, particularly in large auditorium or outdoor areas. For example, to cover an auditorium of a given size may require a certain sound intensity at a distance of 25 feet from each speaker. To deliver this sound level, a speaker with an efficiency of 30% might require an



electrical input of 30 watts. But a speaker with an efficiency of 15% would require 60 watts input to produce the same sound output!

High-efficiency speakers make it possible to use smaller amplifiers for the same amount of sound output. But since high-efficiency speakers are more expensive, their added cost must be balanced against the added cost of larger amplifiers. In general, the high-efficiency speaker shows maximum economy only in large auditoriums, very noisy locations, and outdoor installations where 50-watt amplifiers or larger are necessary.

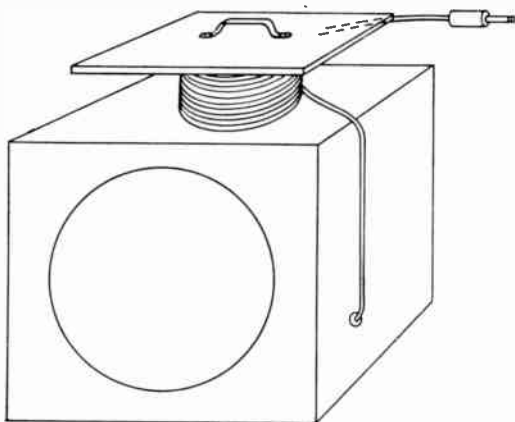

*Fig. 214—A commercial model of a re-entrant type horn.*

PM direct-radiator speakers are moderate in cost and can be housed in a wooden box that any radioman can easily construct. To minimize case vibration, these boxes should be made of  $\frac{7}{8}$ -inch white pine, be of ample proportions to house the speaker completely, and include a back. Four 2-inch holes should be bored in the back, one in each corner, and covered with a piece of thin cloth to keep out dust and dirt. The inside of the box should be lined with one or two thicknesses of an acoustic material. The back should be put on with wood screws, so that it can be removed if necessary. To protect the speaker cone, a piece of  $\frac{1}{2}$ -inch mesh wire should be tacked inside the circular speaker opening of the box. Grille cloth should be placed behind the wire. Some manufacturers furnish speaker boxes without a back, but this exposes the speaker to dust, dirt, and possible damage in transporting from one location to another.

Four rubber feet should be screwed to the bottom of the box to prevent creeping on smooth surfaces.

Each speaker box should have some means of controlling the volume of its speaker. As voice coil impedances differ in various speakers, some experimenting may be necessary to arrive at the proper values; a 100-ohm, 5-watt rheostat has been successfully used in series with the secondary winding of the matching transformer and the voice coil. Each box has one of these matching transformers, and their primaries are connected in parallel to a 500-ohm line. Each box should be equipped with 50 feet of speaker cable. Any cable not needed when hooked up for rental service can be wound around the cable spool on top of the box (Fig. 215).



*Fig. 215—Speaker box showing convenient placement of cable.*

Another addition to the box that will prove helpful to the operator is a receptacle arranged so that one speaker can be connected to another, thus saving much cable. Where several speakers are hung on one side of a long room, the first speaker can be connected to the amplifier, the second speaker connected to the first, and so on. Such box speakers are not well adapted to outdoor service, because they are not weather-proof. A sudden storm can do much damage to the cone and rust metal parts of the speaker. However, if the operator does not have outdoor speakers, he can have made cellophane or thin rubber covers that can be slipped down over the boxes, giving some protection against rain. There are several reasons why a cone speaker must be housed in a box. The cone must be protected, and it gives improved performance in a box that acts as a baffle. Fig. 216 illustrates the action of a baffle on the sound waves. At the instant the cone is driven forward to produce a sound wave, the air immediately in front is momentarily compressed, while the air in the rear is momentarily rarefied. If this cone speaker

were not in a box (Fig. 216-a) these different air pressures would cause some of the air waves to travel back and forth around the edge of the cone, thus distorting the output and lowering the efficiency of the speaker. If the speaker is now placed in a box, without a back (Fig. 216-b), more of the sound waves will be projected outward, but there will be some back-loss, as the drawings show. If a back is placed on the box (Fig. 216-c), there will be little back radiation.

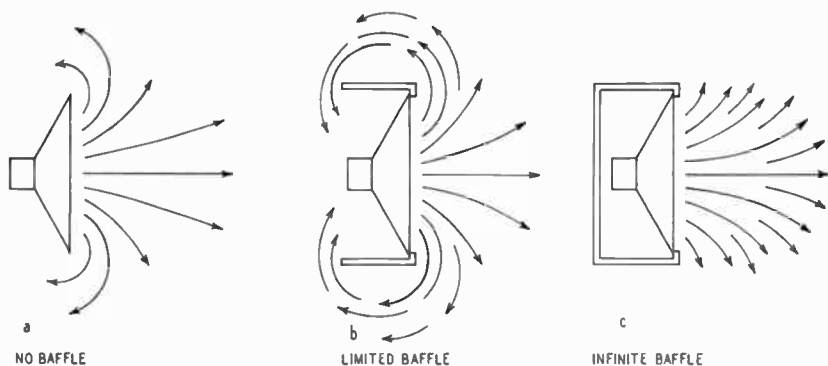

Fig. 216—The effect of having no baffle, a limited baffle, and an infinite baffle.

When two or more speakers are operating in one room, they must be properly phased, that is, they must be connected so that all cones move out and in at the same time; otherwise serious distortion and dead spots may be present in certain parts of the room. To assure proper phasing, use polarized plugs and receptacles on all cables and amplifier outputs. Speakers mounted face to face should be connected out of phase.

To check speaker phasing, connect the two speakers to the amplifier in their normal manner and feed in a standard audio tone of from 400 to 2,000 cycles. Place the speakers side by side so that their fronts are in a line and facing the listener. Observe the relative loudness of the tone. Now reverse the voice coil leads to one speaker and note if volume rises or falls. The proper connection is the one giving greatest volume. If electrodynamic speakers are used, reversing leads to a field coil will have the same phase shifting effect.

# Chapter 3

## Installation

### Acoustics\*

**A** DISCUSSION of the generation, propagation, reflection, and absorption of sound waves is important in order to acquaint the sound man with some of the problems confronting him and measures to remedy them.

### Generation of Sound Waves

While there are several ways of generating sound waves in the air, we are concerned only with the practical aspects of the moving diaphragm or cone of a loudspeaker. When a body vibrates in air, it imparts a portion of its energy to the surrounding air; it generates sound waves. When the diaphragm or cone moves in one direction, the air immediately in front is compressed and this momentarily raises the air pressure at this point above normal. As the diaphragm moves back, the air is momentarily rarefied and the pressure drops below normal. The to and fro movement of the vibrating body causes a rise and fall in the air pressure, resulting in a sound wave moving out at the rate of approximately 1,120 feet per second. In the generation of sound waves, rapidity of diaphragm movement governs the frequency; amplitude of movement controls the volume.

**PROPAGATION OF SOUND WAVES.** Although sound waves travel at a uniform rate, their speed is subject to change as temperature varies. At 32° F. the speed is 1,099 feet per second and at 70° it increases to 1,130 feet per second. As the speaker diaphragm or cone starts from rest and swings out, then swings back and again comes to rest, we say it has completed one cycle. The number of these complete excursions in a second is known as the frequency in cycles per second, and

\* Extracted from "Theory and Use of Architectural Acoustical Materials," published by Acoustical Materials Association, Chicago, Ill.

the distance that the wave travels in the air while making one complete cycle is called the wavelength. The relation between velocity, frequency, and wavelength can be easily understood from the following three formulas.

$$\text{Velocity} = \text{Wavelength} \times \text{Frequency};$$

$$\text{Wavelength} = \frac{\text{Velocity}}{\text{Frequency}};$$

$$\text{Frequency} = \frac{\text{Velocity}}{\text{Wavelength}}.$$

Although three formulas are shown, inspection will show that what we really have is simply the same formula expressed in three different ways. No illustrative problems are given in the use of the formula since the Public Address operator, from a practical viewpoint, is normally not concerned with such theoretical considerations. However, the formula is included to show that a definite relationship does exist between the frequency, velocity, and wavelength of sound waves. It is important to know that sound travels at approximately 1,120 feet per second, since this information enters into the calculation of many practical problems.

### Reflection of Sound Waves

When sound waves come in contact with a wall or other barrier, a portion of the energy is reflected back and the balance is either absorbed or passed on through the barrier. The energy absorbed or passed is of little concern to the sound man, but as a rule the sound waves reflected back present quite a problem. Let us consider a man speaking out-of-doors to a small group in a quiet location where there is no barrier for the sound waves to strike after they leave his mouth and pass out through the group. These waves will continue out into the open spaces and their energy will be dissipated in the distance. There should be no difficulty in understanding him in such a location, as long as the listeners are within range of his voice. If the crowd is large and some of the listeners are beyond voice range, a public address system can be used to amplify the speech and with proper loudspeaker placement the amplified signals will pass out as before, without reflections. Any slight reflection from the chairs or the people can be considered negligible.

If the same speaker and group were inside a building, the ceiling and walls would present a solid barrier to the sound waves, and after passing through the crowd a portion of the sound energy would be reflected back to the ears of the listeners. As these reflections will be

at various angles and slightly different times, the words spoken will be received by the listeners with a slight blur or fringe effect, and, if the distance between the speaker and barrier is great, a distinct echo will result.

Fig. 301 showing a small hall with two listeners A and B seated in different positions in the hall illustrates the effect of sound reflection from smooth walls.

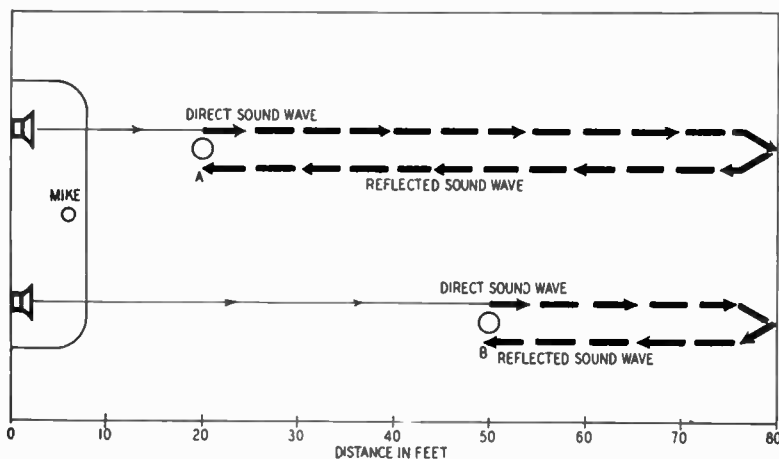

Fig. 301—The reception of a direct sound wave followed by a reflected sound wave produces an echo effect.

Listener A hears the sound when the direct wave reaches his ear. After it travels 60 feet to the rear wall and back 60 feet, or a total of 120 feet, he again hears a faint echo of the original sound. This echo will follow the original sound by about  $\frac{1}{10}$ th second.

Listener B also hears the sound, first as the direct wave reaches his ear, and again after the sound waves travel 30 feet to the wall and back. The echo will be heard about  $\frac{1}{20}$ th second after the direct sound. This "double take" will be true for every listener, although the time lag will vary according to the distance.

In addition to the single reflection illustrated, each listener hears many other components of the original sound which have been reflected back and forth many times from all the room surfaces. For these reasons reflections should be minimized by the application to smooth walls and ceilings of acoustic materials designed to absorb a large part of the energy represented in the sound waves.

The effect of an echo in a large hall is particularly noticeable where there are large areas of reflecting surface, such as the rear and side walls of an auditorium, which are not normally covered with sound absorbing material such as cloth or drapes. Tests should be run prior to the use

of the equipment to determine whether or not an echo will exist. The annoying effect of an echo can result in a loss of business, even tho the installation may be perfect in every other respect. Table 3-1 is a convenient listing of the time required for the sound wave to travel to a reflecting surface and back to the listener.

Table 3-1 — Time Required for the Sound Wave to Travel to the Reflecting Surface and Back to the Listeners at Various Distances.

Total Distance Traveled (feet)	Distance from Ear to Barrier (feet)	Approximate Time Required (seconds)
11.2	5.6	0.01
22.4	11.2	0.02
33.6	16.8	0.03
44.8	22.4	0.04
56.0	28.0	0.05
63.2	31.6	0.06
78.4	39.2	0.07
89.6	44.8	0.08
100.8	50.4	0.09
112.0	56.0	0.1
224.0	112.0	0.2
336.0	168.0	0.3
448.0	224.0	0.4
560.0	280.0	0.5
632.0	316.0	0.6
784.0	392.0	0.7
896.0	448.0	0.8
1008.0	504.0	0.9
1120.0	560.0	1.0

### Effect of Volume and Absorption on Reverberation Time Sabine Formula

*Reverberation time* of a room is the time (in seconds) needed for the average intensity of the reverberant sound of a specified frequency to drop 60 db (to 1/1,000,000 of its initial intensity). Reverberation time is affected by the volume of the room and the sound-absorbing properties of the bounding surfaces and of whatever objects are in the room. The greater the volume the greater the distance the sound will have to travel between reflections from the bounding surface, and hence the greater the time required for a given decrease in intensity. Conversely, increasing the area of the surfaces at which reflection occurs

and the absorption at these surfaces will increase the rate of decay of the reverberant sound. Every type of reflecting surface absorbs a different amount of sound. Standard sound absorption coefficients have been set up for most reflecting surfaces, as the result of a long series of experimental measurements. Table 3-2 shows the sound absorption by seats and audience at a test frequency of 512 cycles per second.

Table 3-2 — Absorption of Seats and Audience  
(at 512 cycles per second)

	Equivalent Absorption (in sabins)
Audience, seated, units per person, depending on character of seats, etc.	3.0-4.3
Chairs, metal or wood	0.17
Pew cushions	1.45-1.90
Theater and auditorium chairs	
Wood veneer seat and back	0.25
Upholstered in leatherette	1.6
Heavily upholstered in plush or mohair	2.6-3.0
Wood pews	0.4

ABSORPTION COEFFICIENTS OF GENERAL BUILDING MATERIALS.\*

Table 3-3 may prove helpful in making simple calculations of the reverberation in rooms. The coefficients given are for a frequency of 512 cycles per second.

Table 3-3.

Material	Coefficient	Material	Coefficient
Brick wall		Openings, stage, depending	
painted	.017	on furnishings	0.25—0.75
unpainted	.03	Deep balcony, upholstered	
Carpet		seats	0.50—1.00
unlined	0.20	Grills, ventilating	0.15—0.50
felt lined	0.37	Plaster	
Fabrics, hung straight		on brick	.025
light, 10 oz. per sq. yd.	0.11	on lath	.03
medium, 14 oz. per sq. yd.	0.13	rough finish	.06
heavy, 18 oz. per sq. yd.	0.50	Wood paneling	.06
Floors			
concrete or terrazzo	.015		
wood	.03		
linoleum, on concrete	.03—.08		
Glass	.027		
Marble	.01		

\*Tables courtesy Acoustical Materials Association.



ABSORPTION COEFFICIENTS (at 512 cycles per second) of several commercial acoustic materials is shown below in table 3-4.

Table 3-4.

Armstrong Cork Co.		National Gypsum Co.	
<i>Cushiontone A</i> (cemented directly to plaster)		<i>Acoustifibre</i> (cemented to plaster)	
1/2 in. thick	0.56	5/8 in. thick	0.62
5/8 in. "	0.60	<i>Econacoustic</i>	
3/4 in. "	0.66	1/2 in. thick	0.62
7/8 in. "	0.74	Owens-Corning Fiberglas Corp.	
<i>Travertone</i>		<i>Fiberglas Acoustical Tile Type A</i>	
3/4 in. thick	0.72	3/4 in. thick	0.75
<i>Corkoustic</i>		1 in. thick	0.79
1 1/2 in. thick	0.44	Simpson Industries	
Celotex Corp.		<i>Acoustical Tile</i>	
<i>Acousti-Celotex</i> (cemented directly to plaster)		(S-1) 1/2 in. thick	0.67
(C-S-1) 1/2 in. thick	0.61	(S-2) 5/8 in. "	0.74
(C-2) 5/8 in. thick	0.69	(S-5) 1 in. "	0.98
(C-4) 1 1/4 in. thick	0.99	United States Gypsum Co.	
Johns-Manville Corp.		<i>Acoustone F</i>	
<i>Fibretone</i> (cemented directly to plaster)		1 1/8 in. thick	0.76
1 1/8 in. thick	0.69	<i>Auditone C and B</i>	
<i>Fibraacoustic</i>		3/4 in. thick	0.68
1 in. thick	0.81	1 in. "	0.79

For a more accurate and fuller description of these materials, contact the manufacturer.

The reverberation time in a room of given volume and surface absorption are summed up in the formula first given and experimentally proven by the pioneer work in this field of W. C. Sabine:

$$T = \frac{0.05V}{a}$$

T is the reverberation time as just described for a 512-cycle tone, V is the total volume of the room in cubic feet, and *a* is the total *equivalent absorption* of the boundaries and of the contents of the room. The equivalent absorption of a surface, expressed in *sabins*, is the product of the area of the surface and its sound absorption coefficient. Thus the absorption of 50 square feet of a material whose coefficient is 0.70 is

$$50 \times 0.70 = 35 \text{ sabins}$$

To compute *a* for any room, multiply the area of each surface by its absorption coefficient. The sum of these plus absorption due to objects in the room, gives the *a* of the formula.

For example: the dimensions of a certain hall are  $112 \times 56 \times 28$  feet and the volume is roughly 175,000 cubic feet. After checking the tables for absorption coefficients we collect the following data shown in Table 3-5 below.

The final result gives the total absorbing power of the hall.

Table 3-5 — Calculation of Absorption.

Material	Dimensions (feet)	Area (sq. feet)	Absorption Coefficient	Equivalent Absorption (sabins)
Floor, cement	$56 \times 112$	6,272	.015	94
Walls, wood panel	$8 \times 336$	2,688	.05	161
plaster	$20 \times 336$	6,720	.025	168
Ceiling, plaster	$56 \times 112$	6,272	.03	188
Curtain, velour	$39 \times 20$	780	0.5	390
Total absorbing power, bare room				1,001
Plus 800 upholstered seats at 0.25 sabin				200
Total absorbing power, no one present				1,201

Assuming that each person entering increases the absorption 4.05 sabins, we can compute the absorption and reverberation time for any size crowd. Table 3-6 shows these computations for the above hall when empty and with up to 800 people. It is interesting to note that the absorption increases with the size of the audience. As a result, the reverberation time decreases. Note, however, that doubling the size of the audience does *not* mean doubling the absorption power, nor is the reverberation time cut in half.

Table 3-6.

Audience (number present)	Absorption (sabins)	Reverberation Time (seconds)
0	1,201	7.3
200	2,011	4.3
400	2,821	3.1
600	3,631	2.4
800	4,441	2.0

Fig. 302 is a simple graph which gives the optimum reverberation time (in seconds) for rooms of different volumes. From the tables of acceptable reverberation time, note that the reverberation will be excessive for this hall and the audience will have difficulty in understanding

what is said. The only remedy is to increase the absorption by applying absorbent acoustic materials to the walls and ceiling. For examples of commercial materials which are readily available for increasing the total absorbing power of a room or hall, refer to Table 3-3 and Table 3-4.

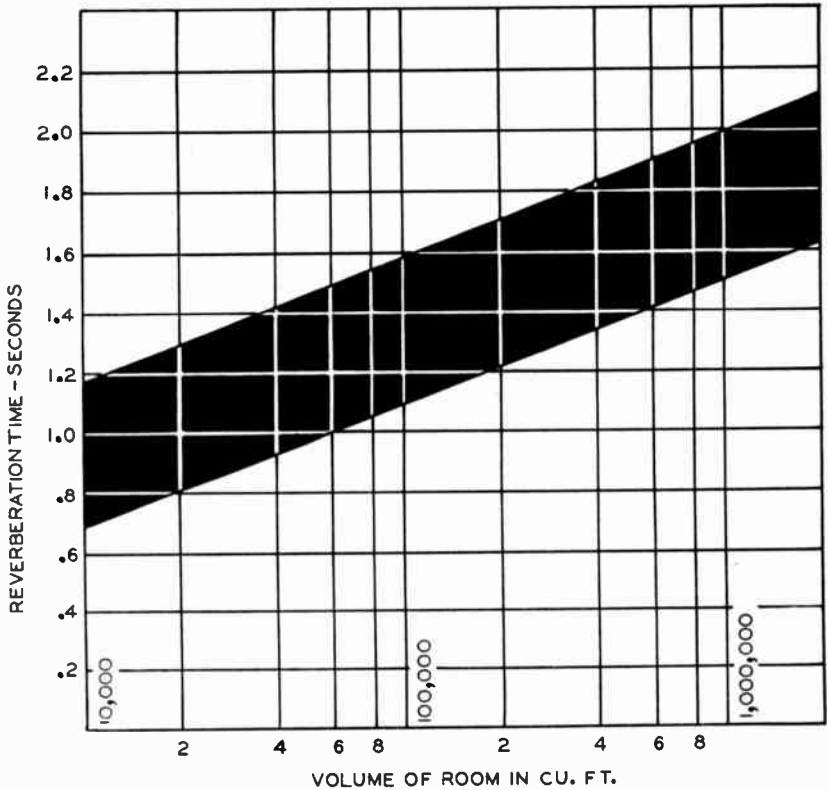

Fig. 302—Graph of acceptable reverberation time.

In order for us to bring this hall down to an acceptable reverberation time several things must be considered. From Fig. 302 we find the acceptable reverberation time for our hall of 175,000 cubic feet to be from 1.2 to 1.7. For our example we will choose 1.5 and assume that the average audience will be 400. The total absorption after correction should be

$$a_{400} = \frac{.05V}{1.5} = \frac{.05 \times 175,000}{1.5} = 5,833 \text{ sabins.}$$

This figure is rounded off to 5,830 for convenience. Referring to the value for an audience of 400 in the untreated room, we find the necessary

increase in absorption is

5,830—2,821=3,009 sabins (3,010 sabins in round figures).

The area of treatment, in square feet, can be found by dividing the necessary added absorption, in sabins, by the coefficient of the material used. The areas required to give the added absorption of 3,010 sabins, using coefficients 0.40, 0.60 and 0.80 are as follows:

<i>Coefficient</i>	<i>Area Required</i> ( <i>sq. ft.</i> )
0.40	7,525
0.60	5,017
0.80	3,762

The location of the absorbing material is governed somewhat by the size and shape of the room, but as a rule the ceiling and the rear wall are used. Side walls are used when the ceiling is low.

The desirable reverberation time for any hall depends on the size of room, average number of people in the audience, and the particular type of program rendered.

For auditoriums using a public address system to amplify sound, it is better to use the lower values and for concert work the higher values.

### **Determining Amplifier Size, Number and Types of Speakers for the Job**

When the sound technician receives a call for public address service, he should look the location over, get an estimate of the number of persons expected to attend, acquaint himself with the type of program to be amplified, and determine if there will be any interfering noises to override. He must realize he will encounter varied problems that will tax his skill and ingenuity. While a discussion of the various units used in sound systems will be found under appropriate headings in this book, a further discussion of the assembly of these units into a system for a particular job may assist the technician in overcoming some of his problems. It is impossible, mathematically, to determine definitely the exact size of amplifier or number of speakers required for any installation, due to the many uncertain factors entering into the problem. However, a few simple formulas can give an approximate solution to these requirements. The experience gained by repeated installations will cumulatively do much to ease difficulties. Keeping records will save considerable time when you are called upon to repeat a particular installation.

While outside and inside installations may appear to use similar equipment, there are several points in which they differ. The amplifiers used in outside systems are heavier and more powerful in order to override high noise levels. The speakers are generally of the trumpet type, projecting sound over long distances. If cone-type speakers are used, they

are 12 or 15 inches in diameter and housed in a weatherproof case to prevent damage from rain and wind. Inside cone speakers, when used outside, can be mounted in a metal case, but unless the cone is waterproof, dampness may cause it to swell out of shape and become worthless.

**LARGE OUTSIDE GATHERINGS.** *Size of amplifier.* Assume that the radioman receives a call for sound service at a festival, picnic, political rally, or sporting event where the number of people ranges from five hundred to several thousand. Suppose in this particular installation he is informed that one thousand persons will be present for the speeches, and they will be seated in chairs on a level plot of ground under trees. He must estimate the distance from the loudspeaker to the person farthest away. This can be done quickly by the step-off method. Suppose this distance is 300 feet and a trumpet speaker is used. To determine roughly the power output of the required amplifier, in watts, the following formula can be used:

$$W=4\times\sqrt[3]{D}$$

where  $W$ =amplifier output in watts,  $D$ =distance in feet.

*Example:*

In the above problem the distance is 300 feet; therefore  $D=300$ .

$$W=4\times\sqrt[3]{300}=4\times 6.7=26.8 \text{ watts.}$$

This does not mean that a 20-watt amplifier could not be used, or that a 30-watt unit would be unsatisfactory. However *with an efficient speaker*, properly connected to avoid a mismatch, the output given by the formula will give excellent coverage.

## Choice of Speakers

It is just as important to choose the proper type and size speaker for large outside gatherings as it is to choose the proper amplifier. For this type of service where the sound waves must be projected over several hundred feet, the straight or folded trumpet gives best results. If more than one horn is used, they should be kept close together. If they are separated any considerable distance, the sound waves projected by one speaker will reach the ears of the listener at a different time than the sound from the other speaker, giving rise to the impression of an echo. If the installation is made at a fair or horse show, where the speakers must be wired up at great distances from the announcer and at different locations, power loss at all frequencies due to line resistance and attenuation from line capacitance must be considered. (See p. 55)

**INSIDE GATHERINGS.** *Size of Amplifier and Number of Speakers.* The radioman should have little difficulty in selecting an amplifier for inside installations. Most commercial units offered for sale range from 8 to 60 watts, and from these a size can be selected for practically any sound job. As a rule only two or three such units are required. Have a 60-watt amplifier for large outdoor work and one or two 20-watt units for indoor use. Table 3-7 shows the more common activities and the

proper size of amplifier for each. In addition to the amplifier size we have shown the size and number of cone speakers used in our installations over many years of service.

Table 3-7 — How to Choose the Right Size and Number of Speakers.

Building	Number Persons	Purpose of Meeting	Number Speakers	Cone Size (inches)	Amplifier Size (watts)
Lodge hall	100–200	Small Banquet	1	8	5–8
Small Church	150–250	Service	2	8	8–10
Gymnasium	150–250	School play	2	10	10–15
Town hall	250–400	Civic meeting	2	12	10–15
Theater	300–600	Play	2	12	20–25
Auditorium	1,000–2,500	Small convention	4	12	40
Large auditorium	2,500–5,000	Large convention	6	12	60

*Choice of Speakers.* For all average inside installations, the cone-type speaker is by far the most popular. Small horn-type speakers are used in such places as bus terminals, railroad stations, and auction rooms, where the system is used for announcing, but never for music reproduction, because of narrow frequency range.

For musical programs where the frequency range requirements are greater, the box-type cone speaker is always used. For the more expensive high-fidelity installations, the speaker box usually houses two speakers, one with a large heavy cone and the other with a lightweight cone. A special filter circuit is sometimes included in the box to separate the high audio frequencies from the low, thus permitting each speaker to reproduce the frequencies best suited for its cone. In this way good reproduction of all musical frequencies are assured. Some radiomen make the mistake of setting speakers on chairs, or down on the stage floor, but such placement cannot give satisfactory coverage. Experience has proven that the speakers should be higher than the heads of the audience and placed so they are on an unobstructed line of sight to those in the rear seats. Speakers should never be placed in the rear of the hall. In some installations, such as churches, funeral homes, etc., it may be desirable to conceal the speakers entirely by covering them with a thin material such as muslin or cheesecloth or by placing them behind potted ferns or palms.

*Choice of microphones.* If the program consists of speech, such as a discussion, debate, forum, or lecture, use a microphone having a clear,

crisp response (good high-frequency response, attenuated low-frequency response). The average crystal or dynamic types are excellent for this purpose. For musical programs, a microphone having a wider frequency range should be used; it can be one of the more expensive dynamic or velocity types. For group singing or orchestra use, the velocity or ribbon microphone is a favorite. The velocity mike is not recommended for close talking, and owing to its low output requires an amplifier of considerable gain. The velocity and dynamic microphones both have transformers in their cases and cannot be used close to electrical equipment, as induction pickup may cause a decided hum. Table 3-8, shown below, can be used as a practical guide in the choice of microphones for various services.

Table 3-8 — Microphone Guide.

Microphone	Police and Other Mobile Uses	Announcer	Lecturer	Soloist	Instrumental Soloist	Orchestra	Broadcast	Organ or Accordion
Carbon	✓							
Average crystal		✓						
Average dynamic		✓						
High-grade crystal			✓	✓				
High-grade dynamic			✓	✓	✓	✓	✓	
High-grade velocity					✓	✓	✓	✓

### Installations Requiring a Number of Microphones

As a general rule, the fewer the microphones used, the better the results. Where more than one microphone is used to pick up sound from the same source, as for group singing and large orchestras, proper microphone phasing is imperative. This means that the microphones must be connected to the amplifier in such manner that their outputs aid, not buck, each other. In other words, when the sound waves cause the diaphragms to move back in all the microphones, the potential on the center conductor of all the cables to the amplifier must be of the same polarity at that instant. If some of the microphones are so connected that sound voltages of opposite polarity are fed in at the same time, there will be a partial voltage cancellation, causing a loss in input. Check this with two microphones, using one as a standard. Reverse leads to one to determine which connection gives greatest output. If more than two microphones are to be tested, check the phase of each at a time, against

a standard. Once properly phased, use polarized plugs and connectors to avoid further difficulty.

When using several microphones in any installation, it is preferable to have all of them of the same make and type. Never use a crystal or dynamic with a velocity mike, as the difference in tension between diaphragms and the floating ribbon causes a wide difference in frequency response. Thus one person's voice will sound entirely different from another's and may spoil an otherwise good job. In a forum hookup where six or eight microphones are placed on a table in front of the participants, it is best to have a switch on each mike, so that each can be turned off when not in use. If this is not done, the pickup from so many open mikes will invariably cause feedback.

## **Suggested Sizes and Types of Sound Equipment for Several Common Installations**

### **Indoors**

#### **LARGE BANQUETS (For announcements and after-dinner speaking)**

Two 10-inch cone speakers,  
10- to 15-watt amplifier,  
Crystal or dynamic microphone.

#### **CHURCHES: (For church services) Medium Size**

Two 12-inch cone speakers,  
10- to 15-watt amplifier,  
Crystal or dynamic microphone.

#### **SCHOOLS (For games, school plays, etc.)**

Two 10-inch cone speakers,  
10- to 15-watt amplifier,  
Crystal or dynamic microphone for speaking,  
High-grade dynamic or velocity microphone for music.

#### **DANCE HALLS**

Two 12-inch cone speakers,  
20- to 25-watt amplifier,  
Crystal or dynamic microphone.

#### **THEATERS**

Two 12-inch cone speakers,  
20- to 25-watt amplifier,  
Crystal or dynamic microphone for speaking,  
High-grade dynamic or velocity microphone for music.

#### **AUDITORIUMS**

Two 12-inch speakers,  
30- to 40-watt amplifier,  
Crystal or dynamic microphones.



## Outdoors

### PICNICS

Two 15-inch, heavy-duty cone speakers, or two medium trumpets,  
40-watt amplifier,  
Crystal or dynamic microphones.

### BALL GROUND

Two or three large-size straight or folded trumpet speakers,  
40- to 60-watt amplifier,  
Close-talking announcer's microphone.

### HORSE SHOWS

Four large-size trumpet speakers,  
60-watt amplifier,  
Close-talking announcer's microphone.

The above installations will require, of course, the necessary cables to connect properly the various units.

*Microphone and Loudspeaker Placement.* For auditoriums, concert halls, churches, theaters, and other inside installations, the radioman will experience difficulties not found in outside work. These will be due to feedback, reflections, and reverberation. If the room is properly treated with acoustic materials and the seats are properly cushioned, little or no trouble should be had. The trouble from reflection and reverberation will be reduced almost to the vanishing point by the treated walls and ceiling, but the radioman will have to use care in placing his microphone and speakers so as to prevent feedback. This is caused by the sound waves from the speaker feeding back into the microphone, causing a very annoying howl. This can be remedied by increasing the distance between the loudspeakers and the microphone. If the microphone is placed in the center of the stage or platform and the loudspeakers are hung on the wall on each side of the room and pointed toward the rear, no trouble should be experienced with this installation. However, in some gatherings where a banquet is followed by a floor show and the microphone is carried out to the middle of the floor during the entertainment, feedback may result if the sound waves are directed toward the microphone. By using a close-talking mike and properly directing the speakers, this trouble can be avoided. When sound equipment is used in halls and gymnasiums with plain walls, reflections will cause considerable trouble and users will have to be instructed to speak close to the mike. Gain will have to be kept low.

In many cases, the PA operator has no choice as to microphone placement. This position is usually fixed in churches, halls, and auditoriums, where pulpits, platforms, and stages are a part of the building. However, the PA operator must choose the proper position for the loudspeakers with respect to the microphone.

The equipment should be set up and tested out before the people arrive. The operator should carry at least three microphone stands: a floor stand for soloists and speakers, a table stand for secretarial reports and after dinner speakers, and a desk stand for ministers' pulpits. Find out before the program starts just how the microphone is to be used so that the proper stand can be chosen. The microphone stand should be adjusted to such height that the microphone never hides the speaker's face. As a rule, the best position is several inches below mouth level. Distance from the microphone depends entirely on the speaker; if he has a forceful voice, the distance can be much greater than for the man with a weak voice. If possible, a short rehearsal or voice test before the meeting should be arranged. See Fig. 303.



*Fig. 303—Correct placement of microphone.*

In placing a microphone floor stand beside a table or desk where the speaker can look down on his notes, one precaution should be taken. Arrange the stand so it cannot strike the table and cause a very decided thump every time the speaker moves. The stand should be kept clear of any object.

Another type of voice pickup favored by some speakers is the lapel mike, a small microphone attached to the lapel of the speaker's coat. While it has some advantages, the necessary trailing cable has limited its use.

In those instances in which it is essential to use a floor type microphone (microphone mounted on a long metal stem or stand) be particularly careful. If there are to be a number of speakers, each talking from a standing position, the proper microphone height will have to be adjusted for each speaker. Floor stand microphones come equipped with an adjusting screw so that microphone height can be readily adjusted. The screw must be sufficiently firm so that the microphone will not slide down while in use. If the adjusting screw is made too tight, the speak-

ers will have difficulty in setting the microphone height properly. The Public Address operator should make these adjustments himself, whenever possible. If this is not always practical, a few words of instruction to the various speakers may save considerable embarrassment later. It is also advisable to caution the speakers against jarring or otherwise striking the microphone, and also to keep clear of all microphone cables.

Some lecturers and some ministers have a strong preference for the microphone hidden from the view of the audience; this can be done by concealing the microphone in a desk lamp used by the speaker to illuminate his notes. Such a lamp can be devised by the operator and should be a part of his equipment (See Fig. 304.) The lamp should be D.C. excited to prevent hum pickup if dynamic or velocity microphones are used.

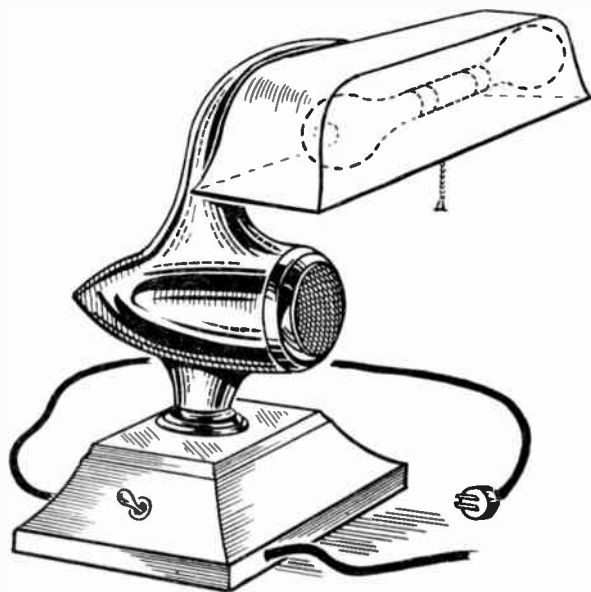

*Fig. 304—A microphone can be concealed in a desk lamp.*

When setting up public address equipment for use in large auditoriums as well as outdoor stadiums, speaker placement becomes one of the sound man's most important problems. Remember that sound travels approximately 1,100 feet per second; for this reason the speakers must be placed relatively close together.

Haphazard placement of speakers, whether in an indoor auditorium or an outdoor stadium or field, will rarely result in satisfactory service. If the installation is to be outdoors (a County Fair, for example) it is advisable to obtain a plan or layout of the exhibits, so that the speakers

may be placed in an intelligent and practical manner. The sound, of course, must always be directed so that it can be heard by an audience which is in constant motion. At the same time the amplitude of sound must be sufficiently great to override the high noise level which is usually present at outdoor events. Avoid any set-up which will result in echos.

In order to better understand the problem let us consider a stadium 600 feet long (Fig. 305). If speakers are placed at each end, say a distance of 550 feet apart, it would take the sound  $\frac{1}{2}$  second to travel this distance. When the announcer speaks into the microphone, his voice is heard by people at one end of the stadium at almost the instant he speaks, and again  $\frac{1}{2}$  second later when the sound arrives from the distant speakers. This gives the impression of an echo, and is very annoying to the listeners. With such a speaker placement, satisfactory service cannot be given.

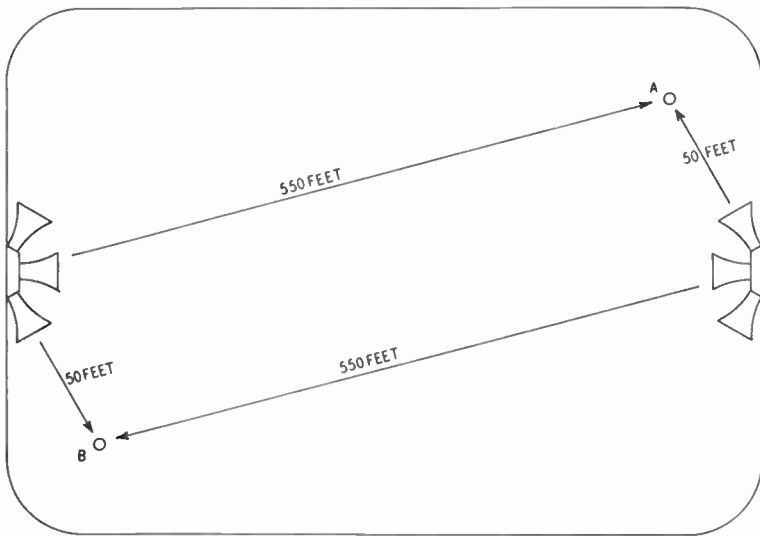

*Fig. 305—Improper placement of loudspeakers in a stadium. This will result in an echo.*

If all the speakers were clustered at one end, then people at that end would hear the announcer the instant he speaks, and those at the far end would hear him  $\frac{1}{2}$  second later, but they would not be aware of the fact. With such a placement there would be no impression of an echo anywhere in the stadium. If the speech were directed toward a smooth wall, the sound might reflect back to some extent. But the reflected waves would be somewhat weaker than those from the speakers and would not cause serious interference. Directing the horns downward about 20 degrees will help eliminate reflected sounds.

It is always more convenient for the Public Address operator to cluster the speakers in one location, in outdoor installations, since this immediately eliminates the possibility of echo effect and avoids the necessity for stringing cables over a considerable distance. The disadvantage, is, of course, that those located on the fringe areas of the outdoor gathering may not hear the sound above the existing noise level.

Fig. 306 shows a typical outdoor installation. Loudspeakers in inside installations should never be placed behind the microphone, as feedback is almost sure to result if the amplifier gain is advanced to any degree. Speakers placed well to one side or ahead of the microphone give the best results.

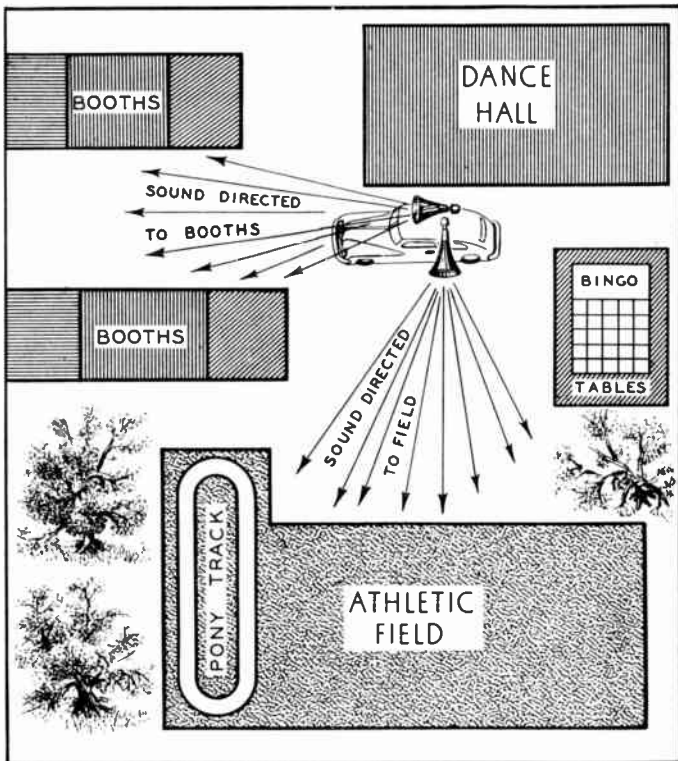

Fig. 306—Correct placement of loudspeakers in a typical outdoor installation.

If the loudspeakers are placed behind the microphones, the amplifier has a tendency to become very unstable, the amount of instability depending upon how close the speakers are to the microphones and whether or not they face them directly. Any tendency on the part of the public address system to behave in a "critical" fashion, resulting in

a whistle or howl, can often be traced to feedback from the output circuit (loudspeakers) to the input circuit (microphones). It is always good practice to keep the speakers and microphones well away from each other.

Fig. 307 shows the right and wrong way to place speakers and microphones.

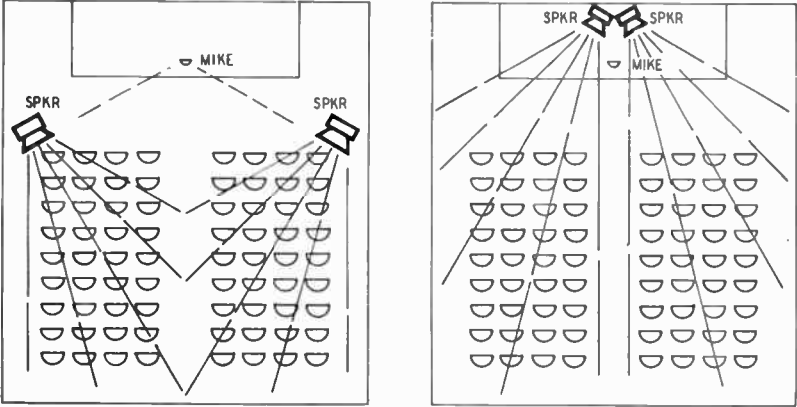

Fig. 307—The microphone and speakers are correctly placed in the illustration at the left. The set-up at the right is incorrect.

Fig. 308 shown below gives a suggested placement for speakers and microphone in a restaurant or night club having a floor show.

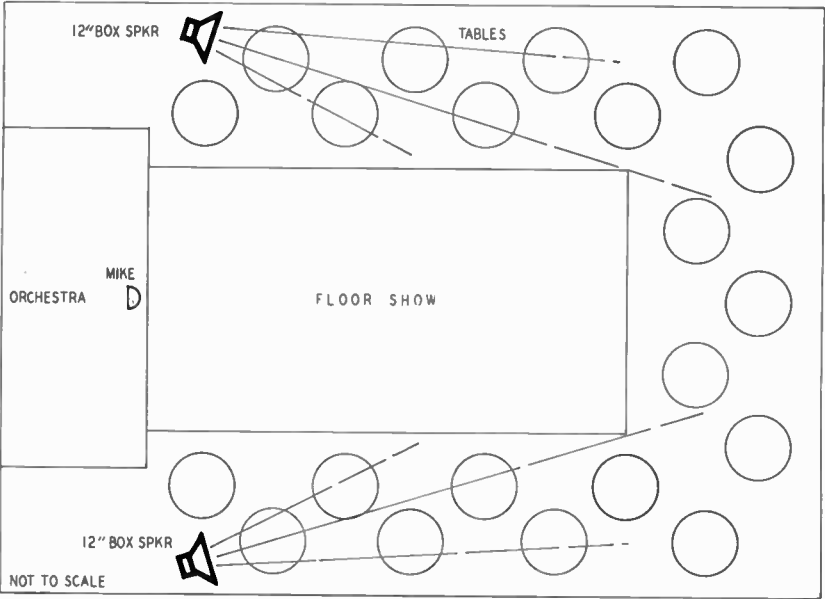
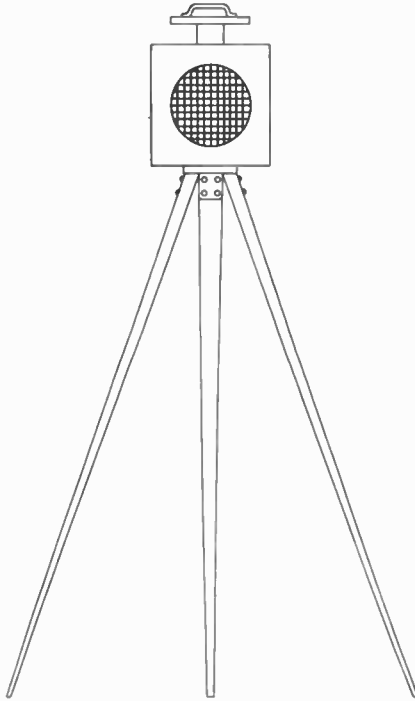

Fig. 308—Possible placement for microphone and multiple speakers for night club.

As previously pointed out, loudspeakers can be hidden with thin green or other dark cloth, with flowers or palms placed in front.

The loudspeakers should be placed in front and somewhat above the audience, for best results. Where it is impossible to hang loudspeakers, the most satisfactory alternative is to use tripods. The tripods can be placed anywhere and the speakers can be rotated to project the sound in any desired direction. The tripod legs are hinged to the top and fold together for convenience when being transported (Fig. 309).



*Fig. 309—Loudspeaker mounted on a tripod.*

Two additions can be made to the box-type speaker that will adapt it to special services. One is a horn-type baffle, made of plywood, and the other is a spreader to cover 180 degrees. Both these baffles are designed to hang on the front of the regular box-type speaker. In some installations, the operator may desire to project sound in one direction, in which case the horn-type baffle is hung on the speaker box. By using the spreader baffle, full high-frequency coverage can be had in small rooms with one speaker.

If the spreaders and projectors are so made that they can be easily attached and detached from the speakers, the direction in which the

sound is to be projected can readily be controlled. The projector is shown in Fig. 310 while the spreader is illustrated in Fig. 311. A reel can be added to the top of the speaker box in order to have on hand an ample supply of cable and yet keep any unused lengths of cable from getting under foot.

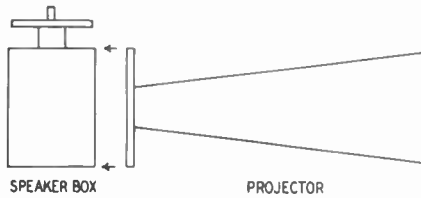

Fig. 310—Projector for directing sound.

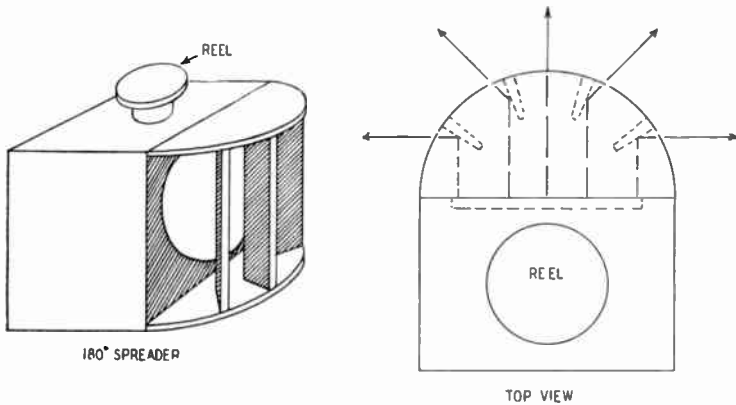

Fig. 311—A 180-degree spreader. The illustration at the right shows how the sound is spread in all directions.

It is impossible to offer a fixed set of rules for speaker placement, because of the difference in equipment, locations, and types of programs, but for the average auditorium, the placements shown in Figs. 306, 307, 308, have proven satisfactory.

### Impedance Matching and Cable Size

To get the best sound quality and the smallest loss of power from a public address system, all the elements—microphones, amplifiers, and speakers—must be interconnected properly. This means selecting the optimum impedances for microphone and speaker lines, matching the impedances of all connecting units, and using cable of correct size.

The output transformer of an audio amplifier usually has several taps on the secondary. These are generally marked 4, 8, 15, 250 and 500 ohms. These taps may be connected to a switching device or terminal strip. The purpose of these different impedances is to enable the oper-



ator to match the amplifier to his speaker load, for only when these two are equal will the greatest power be transferred.

If the distance between the amplifier and speakers is 50 feet or less, the output from the 4- or 8-ohm taps can be fed directly into the voice coils. If two speakers are used, each having a 4-ohm voice coil, they should be connected in series to the 8-ohm tap. Fig. 312 shows the

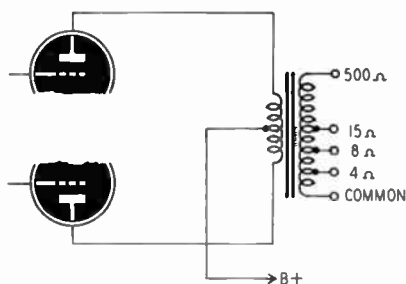

Fig. 312—Multiple-tap output transformer.

wiring diagram of an output transformer having several taps. The tap marked C is the common tap and must always be used for one lead, the other lead connecting to the tap giving desired impedance. If two speakers are used, each having 8-ohm voice coils, they should be connected in parallel and the leads connected to the common and 4-ohm taps. Fig. 313 shows several hookups for matching voice loads. Table 3-9 gives maximum lengths of line for different wire sizes to limit losses to 15% (0.7 db) at line impedances of from 2 to 50 ohms.

Table 3-9 — Maximum Length of Line for 15% Line Power Loss in Range of Common Voice Coil Impedances. Length is Distance, Measured Along the Line, from Amplifier to Load.

Wire Size A.W.G. (B&S)	Load Impedance, Ohms							
	2	4	6	8	10	16	32	50
No. 12	95'	190'	285'	380'	475'	760'	1520'	2360'
14	60'	120'	180'	240'	300'	475'	950'	1500'
16	38'	75'	113'	150'	190'	300'	600'	950'
18	23'	47'	70'	95'	118'	190'	380'	590'
20	15'	30'	45'	60'	75'	118'	236'	375'
22	9'	18'	28'	37'	47'	75'	150'	230'

When the distance between the amplifier and speakers is more than 50 feet, it is customary to use a high-impedance line to avoid signal loss.

The higher impedance circuit means a smaller current flow and lower I<sup>2</sup>R loss in the line. Smaller wire sizes can be used for a given power loss in the line. Power loss can be important in PA applications. There's no sense in using a 25-watt amplifier and wasting 10

watts in the speaker line. Although high-impedance lines are desirable for long runs they have one disadvantage. The self-capacitance of the line causes loss of higher audio frequencies if the line is too long. The higher the impedance the greater this loss becomes.

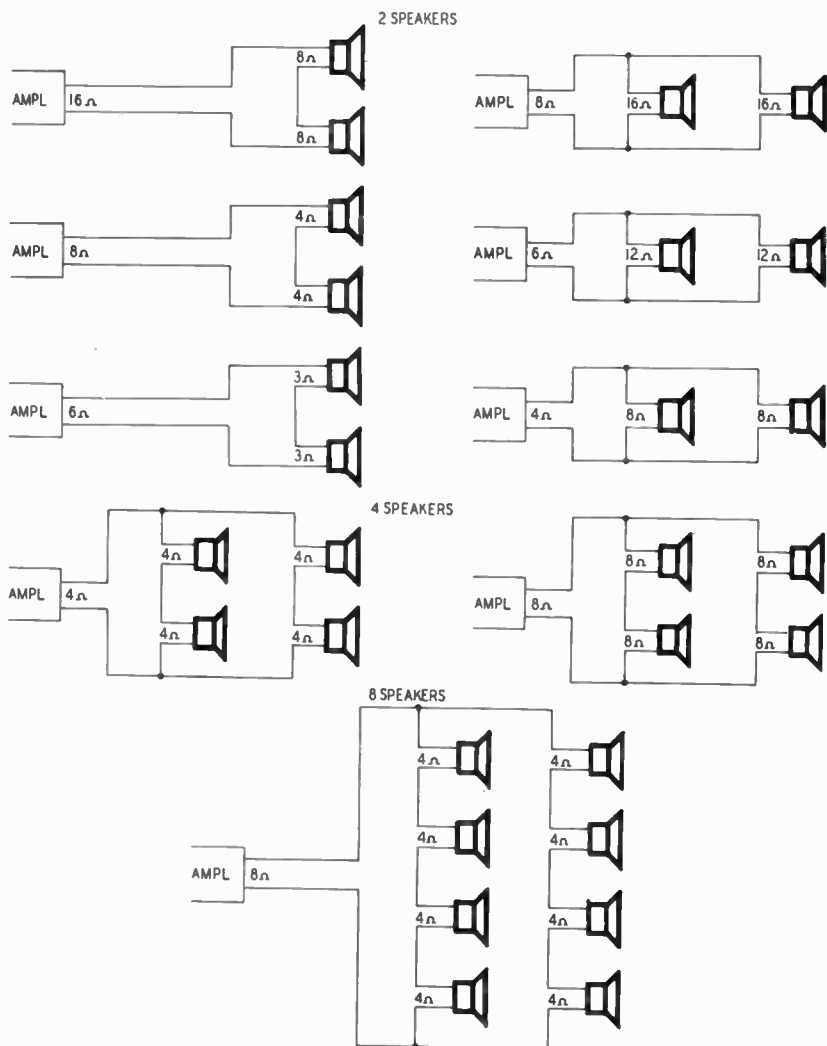

Fig. 313. Speakers can be connected in various series or parallel combinations. Loss of audio power can be avoided by proper impedance matching.

If high impedance lines are used, one side of the line is connected to the common and the other to the high-impedance tap on the amplifier. The low-impedance speaker voice coils cannot be connected to high-

impedance lines, so matching transformers must be used at each speaker. These transformers usually have a 250-, 500-, and a 1,000-ohm tapped primary and a secondary to match the voice coils. See Fig. 314. Fig. 315 shows several examples of speakers in series and series-parallel

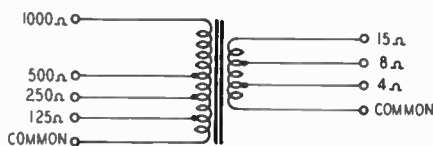

Fig. 314—Speaker matching transformer with tapped primary and secondary.

combinations, connected to high-impedance lines.

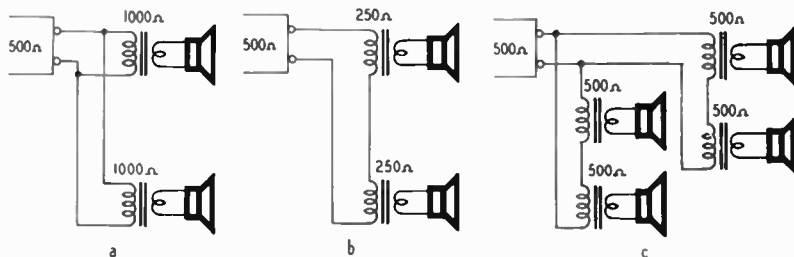

Fig. 315—*a, b, c.*—Possible combinations of speakers connected to high-impedance lines.

To design a high-impedance speaker line which will have the least high-frequency and power loss for a given length means juggling line impedance and wire size. Fig. 316 was devised by the Jensen Radio Manufacturing Co. to make the juggling painless and provide quick answers for the sound technician. When using the figure keep these points in mind: Line capacitance is assumed to be  $50 \mu\text{mf}/\text{foot}$ ; loud-speaker is assumed to have a rising impedance-versus-frequency response typical of moving-coil speakers. In addition the figure is plotted on the basis of a 5% power loss (0.2 db) and a 3-db loss at the highest frequency to be transmitted.

## How to Use the Chart

**MOST ECONOMICAL LINE.** The most economical line is the one which requires the least copper (smallest wire size). For example, what is the most economical 1,500-foot line with transmission to 7,500 cycles? From 1,500 feet on the chart, move horizontally to the right to the 7,500-cycle curve. The nearest standard impedance value (dropping vertically) is 250 ohms and the closest wire size is No. 16 (point A).

**FIXED LINE IMPEDANCE.** If in the above example, the amplifier out-

put impedance is 200 ohms, what would be the effect of working the line at 200 ohms? The intersection of 1,500 feet and 200 ohms falls on the 10,000-cycle curve (point B), so the line would be more than adequate for 7,500-cycle transmission. Point B, however, indicates a wire

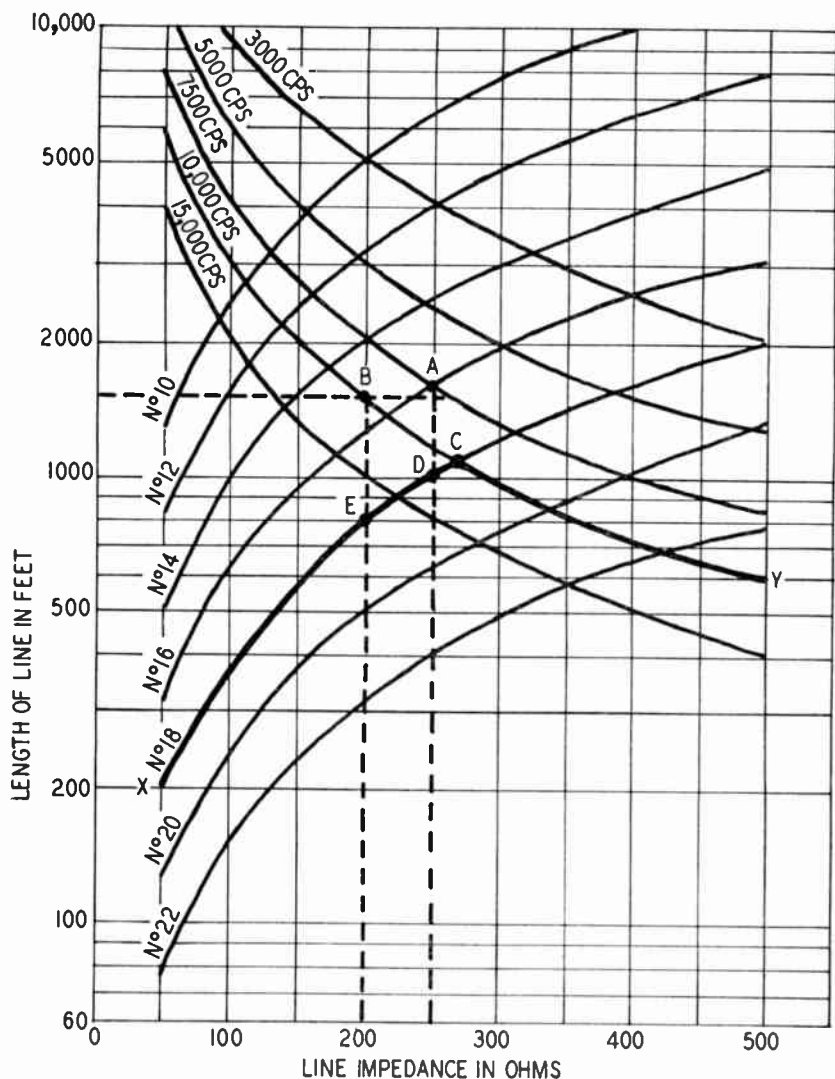

Fig. 316—Transmission line design chart, based on 5% power loss in line and 3 db loss at upper limiting frequency due to line capacity of  $50 \mu\mu\text{f}$  per foot, across typical moving-coil speaker load.

size of about No. 15 (between No. 14 and No. 16) for 5% line loss,

which is more expensive than the No. 16 required for the most economical line (point A, 250 ohms). If the common No. 14 is used, the cost will be greater, while the line loss will be reduced to 3.9%. No. 16 will cost less, but the line loss will be 6.3%, which may be tolerable only if the amplifier has sufficient power margin.

**MAXIMUM LINE LENGTH.** What is the maximum desirable length for a No. 18 line to transmit to 10,000 cycles? Follow the No. 18 curve to the intersection with the 10,000-cycle curve. This gives 1,050 feet at 270 ohms (point C). For 250 ohms (point D), the maximum length is 970 feet. For any other impedance, the permissible maximum length is given by the curve XCY; thus

100 ohms	390 feet (transmits to +15,000 cycles)
200 ohms	790 feet (transmits to +15,000 cycles)
500 ohms	600 feet, etc. (No. 20 or 22 wire may be used)

Of course any length *less* than the indicated maximum can always be used with improved high-frequency response and less power loss.

**DETERMINING LINE LOSS.** A 200-ohm line of No. 18 wire is 1,200 feet long. What is the line loss? For a 200-ohm line, the length for 5% line loss is 790 feet (point E). For a 1,200-foot line, the loss will be proportionately greater, or

$$\frac{1,200}{790} \times 5\% = 7.6\%.$$

## Microphone Impedance Matching

What has been said regarding impedance matching for speakers is also true for microphones and phono pickups except that here we are concerned with loss in *gain* rather than loss in *power*. The greatest transfer of energy takes place when the microphone output and amplifier input impedances are equal. Most PA amplifiers have input impedances of 100,000 ohms or more. The single-button carbon microphone has an impedance of 100 ohms. This impedance being much too low to connect to the high-impedance input of the amplifier, we use a transformer, the primary of which matches the low impedance of the carbon microphone and the secondary matches the high impedance of the amplifier input.

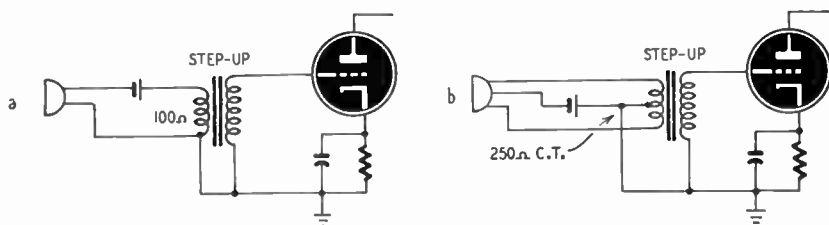

Fig. 317—*a, b*—Connections for single — and double-button carbon microphones.

Single and double button carbon microphone connections are shown in Fig. 317-a and b. Dynamic and velocity units have a matching transformer built in the case. The crystal types have a natural high impedance. A high-impedance microphone may operate satisfactorily (with a good shielded cable) a distance of a hundred feet or so without appreciable loss. However, distances beyond this will usually cause distortion from capacitance effects and loss of signal strength. Long cables, when connected to high-impedance inputs have a tendency to pick up hum. If the input is an inductive device, such as a dynamic microphone, high-frequency loss may occur. If the microphone must be used several hundred feet from the amplifier, the best matching method is to use a step-down transformer near the microphone and a step-up transformer near the amplifier.

Fig. 318 shows a long line when used with a low-impedance single

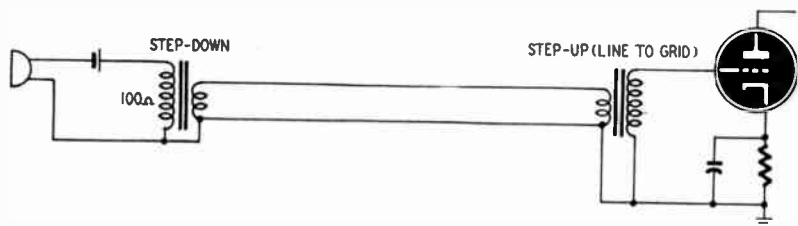

Fig. 318—Circuit for carbon microphone working into a long transmission line.

button carbon microphone. In those instances in which the line is short a high-impedance microphone can be connected to a grid through the use of a 1:1 transformer, or directly connected, as shown in Fig. 319.

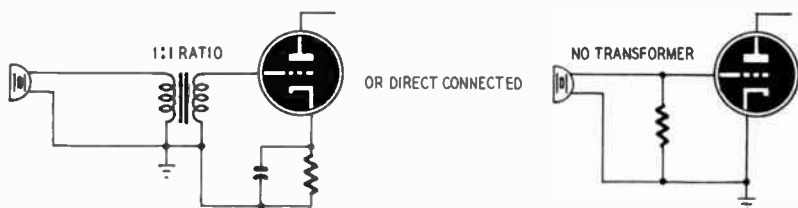

Fig. 319—High impedance microphones when working into short lines can be directly connected or through a 1:1 ratio microphone transformer.

The primary of the transformer near the microphone must match the high impedance of the microphone, and the secondary, of low impedance (usually 30-50, 250, or 500 ohms, depending on transformers), is connected to the cable. The other end of the cable is connected to the low-impedance primary of the second transformer, the secondary of which matches the input on the amplifier. It is important that the wire size of the cable be such as to keep the ohmic resistance low. Fig. 320 illustrates the connections for a long line crystal microphone circuit.

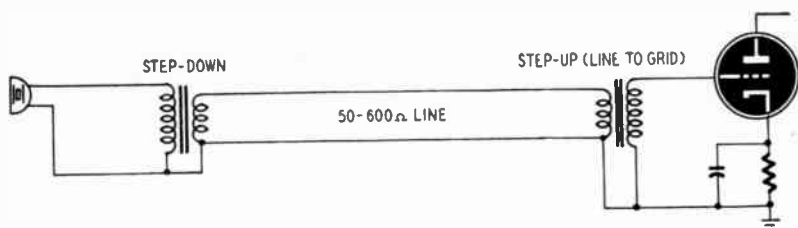

Fig. 320—Circuit connections for a crystal microphone connected to a long low-impedance line.

For short lines, the dynamic and velocity microphones, having a built-in matching transformer, may be connected as indicated in Fig. 321.

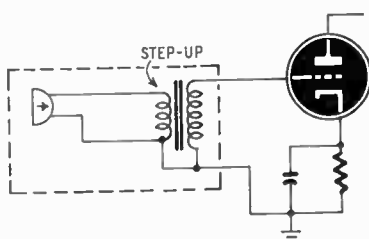

Fig. 321—Velocity microphone with built-in transformer for short line operation.

The impedance match between the microphone and the control grid of the first amplifier tube may be accomplished in several steps as shown in Fig. 322. Here the microphone is transformer coupled to match the impedance of the transmission line. The line impedance is then matched to the control grid through a step-up transformer.

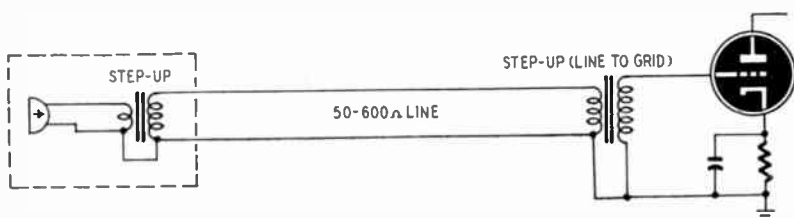

Fig. 322—Impedance matching accomplished through the use of two transformers.

The maximum amount of power transfer between the amplifier output and the loudspeaker load takes place only when the two impedances are equal. Any difference in impedance between the source and load

will be a mismatch, and a loss will result. This loss can be calculated by the use of the following formula:

$$\% \text{ Max. power transfer} = \frac{400 R R_1}{(R + R_1)^2},$$

Where  $R$  = source,  $R_1$  = load.

*Example:* if a load of 250 ohms is connected to a source of 500 ohms, what percentage of maximum power will be transferred?

$$\% \text{ P.T.} = \frac{400 R R_1}{(R + R_1)^2} = \frac{400 \times 500 \times 250}{(500 + 250)^2} = 88.8\% \text{ Max. power transferred,}$$

$$100 - 88.8 = 11.2\% \text{ loss.}$$

*Another example:* if a load of 100 ohms is connected to a source of 500 ohms, what percentage of maximum power will be transferred?

$$\% \text{ P.T.} = \frac{400 R R_1}{(R + R_1)^2} = \frac{400 \times 500 \times 100}{(500 + 100)^2} = 55.5\% \text{ Max. power transferred,}$$

$$100 - 55.5 = 44.5\% \text{ loss.}$$

*Final example:* if an 8-ohm voice coil is connected to an 8-ohm source, what percentage of maximum power will be transferred?

$$\% \text{ P.T.} = \frac{400 R R_1}{(R + R_1)^2} = \frac{400 \times 8 \times 8}{(8 + 8)^2} = \frac{25,600}{256} = 100\% \text{ Max. power.}$$

## Outdoor, Portable Installations

As events and fields differ, it is not feasible to give here any definite hookup procedure, but for satisfactory service several factors must be considered. The announcer should be placed in a position where he can see what is going on, and if he is in a field where there is no elevated stand, probably the best plan is to announce from the rear of a truck. A major problem that confronts the operator in this class of service is the laying of cables. He cannot be too cautious in this matter, for an injury to someone tripping over a cable on the ground may result in a lawsuit. If the cables must be placed on the ground, see that they are run among bushes or along a fence, where few people can step on them. If trees and buildings are nearby, it is much safer to suspend the cables overhead. To do this quickly and without a ladder, we have made use of the following method for over twenty years. Make up a few hooks of rather strong, heavy galvanized iron wire. The upper or the curved portion fits over the limb of a tree and the lower small hook holds the cable. The lower straight portion fits into a hole bored into the end of a 1-inch wooden dowel. Several such dowels are equipped with brass ferrules so they can be put together like a jointed fishing pole. In this way the operator can stand on the ground and put up and take down



his cables. These sticks, upon being disjointed, occupy a very small space in the car. This is illustrated in Fig. 323.

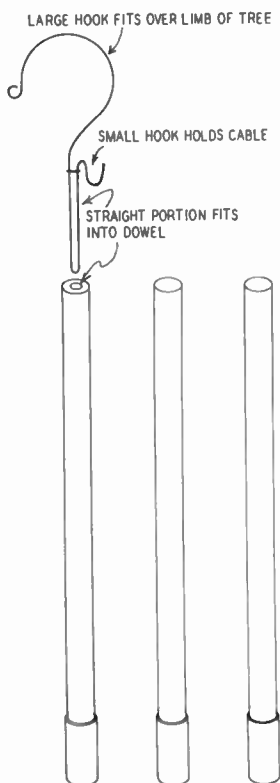

Fig. 323—Curved hooks for holding cable.

## Setting Up the Equipment

The general procedure usually followed by most experienced sound men is as follows:

The equipment should be unloaded and placed in one location, not scattered. It should not be placed where inexperienced persons can handle it. This is especially necessary with the amplifier, many people having a natural urge to throw switches and twist knobs. If the operator is not familiar with the location, he should make inquiry as to the location of 110-volt a.c. outlets. This helps to determine amplifier placement. As a rule there is not much choice in placing the microphone, stages and platforms being building fixtures.

If the PA operator has microphone cable of different lengths, he should choose a single length that will reach from the microphone to the amplifier. Always avoid connecting two cables together, if pos-

sible. The cable should be placed in such position that no one will walk on it. There should be a place to set or hang the speaker (or speakers). If an audience of more than two hundred people is anticipated, the second speaker should be put up. The speaker cables should also be placed in a position where no one can trip over them.

After all units of the system are properly connected, turn on the power. Be sure the gain control is in low position while the tubes are warming up. After a minute or two, advance the gain slowly while someone speaks into the microphone. When a point is reached where the voice is amplified to proper level for the room, note the position of the gain control. As the room fills up, the gain may have to be advanced slightly above this point. The system is now ready for use. After the meeting is over, pull out the power cable first and then proceed to disconnect the various units. All equipment should again be placed together, before loading into the car. Check equipment to see that nothing is left behind.

# Chapter 4

## Maintenance and Servicing

### Preventive Maintenance

ONE of the most embarrassing moments in the life of a public address operator is when trouble develops in the middle of a speech or play, and he is unable to make immediate repairs. If the program is interrupted for any length of time, he may have some difficulty in collecting his rental fee and he may also lose future business. For these reasons he should make every effort to prevent trouble *before* it happens. A careful checkup of the amplifier and all cables should be made periodically, and the tubes should be checked occasionally to see if the emission is normal. Keep a record of each emission test; any tube showing marked changes should be replaced. A similar record of amplifier voltages is a good idea, too.

One trouble that may happen during a program is the opening or shorting of a filter capacitor. An open capacitor will result in a decided hum and may cause reduced power output. A shorted capacitor can cause rectifier tube failure, an overheated or damaged power transformer. Trouble from shorted filter capacitors can be minimized by placing a 6-volt pilot lamp in series with the ground lead of each. See Fig. 401.

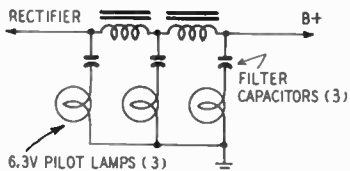

*Fig. 401—The use of pilot lights in series with each filter capacitor will give warning of the approach of the end of useful capacitor life.*

Excessive leak or short will cause the lamp to burn dimly or flash, usually giving advance information of approaching trouble. Some capacitors are terminated with plugs which are plugged into sockets and can be

readily changed if trouble develops. Another common trouble is an open circuit in microphone or speaker cables, often caused by people walking on them. If possible, try to place them where no one will step. Continual stepping on the cable eventually results in trouble. If a cable must be laid across an aisle or doorway, place a heavy rug over it for protection. In hanging cables (especially microphone cable) overhead, as is frequently done at picnics, sport contests, etc., never stretch the cable. Stretch stout rope and hang the cable from it by short pieces of rope or wire hooks spaced about 5 or 6 feet apart, thus removing the strain from the cable (Fig. 402). If cables are hung from light fixtures or placed

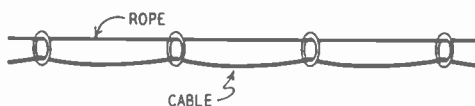

Fig. 402—Rope can be used to support cables.

in the footlight trough of a stage, be sure they do not come in contact with the hot light globes. A cable can thus be permanently damaged. Don't place cables parallel to a power line, for hum from a.c. induction may result.

Never leave an amplifier where it may become damp, for this will eventually cause trouble. If a crystal microphone is used outdoors, never leave it in bright sunlight on hot days when not in use, as this may permanently damage the crystal or temporarily reduce its output. When through using the microphone, cover it with a cloth sack for its protection. If a dynamic or velocity microphone is used, set it up in a location where there are no nearby power lines or transformers which invariably cause a background hum. Be careful in handling all units of public address equipment. Sudden jolts can cause trouble in tubes and circuit wiring that may not show up until the outfit has been in use for a while.

When furnishing sound service on a rental basis, be sure the voltage and type of current are correct for your equipment. All public address systems except special d.c. equipment are designed for 60-cycle, 110-120-volt power.

Watch volume controls. If they begin to get noisy or fail to give a smooth rise in volume when advanced, they are beginning to fail and should be changed. If the operator builds his own amplifier, it is advisable to use porcelain sockets for the output tubes and rectifier, because of high voltages. Ordinary sockets may cause noise or actually short, and once charred are no longer safe to use. Occasionally clean all tube prongs and cable connectors with crocus cloth. Clean switch points with a small brush. Examine cables for signs of wear and corrosion. Repair cables "before" the job, *not* "on the job."

Be sure that any cable passing through a doorway cannot be crushed when the door is closed. Tie doors open with a piece of rope;

if they must be partially closed, the best protection for the cable is to place it in an iron pipe which has been cut in two lengthwise. Place the two halves around the cable and bind together with friction tape.

To summarize preventive maintenance: Inspect and clean equipment regularly, paying particular attention to cables and plugs for signs of wear. Test tubes and measure voltages periodically. Keep a written record of each set of readings; gradual changes will thus be shown up. See that equipment is handled carefully. Remember that cables and connectors probably cause more program failures than any other item.

## **Servicing Own Equipment**

The information given here on how to locate and clear the more common troubles that may arise in public address systems is intended primarily for the technician who owns and operates his own sound equipment. But it should also help those interested in servicing for others. The man who operates a 100% radio service shop can readily add to his line the repair of public address equipment. The same circuit testing equipment and tube checkers can be used, and a very few additional repair parts need be carried in stock. Circuit drawings of all PA amplifiers should be obtained from the manufacturers or one of the PA service manuals purchased and kept in a special binder.

The many stores, theaters, churches, schools, orchestras, and others using sound equipment afford an opportunity for the service technician to enlarge his field of operation. As a rule, the owners of PA equipment prefer to have it serviced by experienced radio repairmen. For this reason the man with a well-equipped service shop should have no difficulty in increasing his revenue by undertaking the repair of such apparatus. The rapidly increasing number of intercom units in offices also affords an opportunity to increase income.

Another type of service the radio technician may want to try is inspection service for offices and factories having permanently installed sound equipment. Contract for periodic inspection of the units, testing and replacing tubes, and cleaning and checking over the equipment generally. Such service is briefly covered in the section "Preventive Maintenance."

## **Trouble Shooting**

No matter how good the parts or how well the equipment is constructed, trouble can always develop. This happens in all electrical devices. However, the operator's understanding of the circuit generally enables him to guess what causes the trouble. Constantly moved from one place to another, portable equipment develops trouble oftener than stationary equipment. For this reason the operator should use care in handling it and avoid excessive jarring in transportation. If the equipment is factory-built, a copy of the circuit should be kept within easy

reach. Generally it is pasted inside the bottom plate of the amplifier chassis. No amount of reading can provide an operator with the equivalent of a few months of experience. Here are a few suggestions on the more common troubles and their possible causes. The usual troubles encountered can be divided into four general classes. These are *hum*, *distortion*, *intermittent operation*, and *no signals*. In a public address system, there are five possible sources of these troubles: microphone, microphone cable, amplifier, speaker cable, and loudspeaker. A trouble chart, Table 4-1, combining the four classes of troubles with the five possible sources is shown on page 69.

**HUM.** There are four causes of hum in a public address system: microphone (and its cable), induction, tubes, and power supply. The microphones which pick up hum are those having small transformers in their cases, such as ribbon and dynamic types. When used near power transformers, generators, motors, etc., they are affected by the a.c. fields set up by these units and a very annoying hum results. The only remedy is to move the microphones. Keep the cables as far as possible from power lines. If the hum is picked up by the microphone or its cable, it will cease when disconnected from the amplifier. If the hum persists after disconnecting the cable, an ordinary pair of headphones is recommended for tracing the signal through the amplifier. In addition to hum, the phones will locate such troubles as distortion, background noise, and loss of signal. Fig. 403 shows the phones, with a .01- $\mu\text{f}$  capacitor in

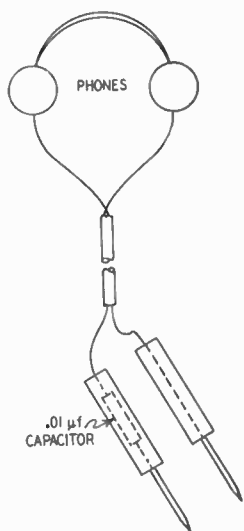

*Fig. 403—This is one of the simplest test instruments that a public address operator can have. The value of capacitance in series with one lead of the headphones is shown as .01  $\mu\text{f}$ . This is not critical. Any value from .01 to .1  $\mu\text{f}$  can be used. The use of earphones having an impedance of 2,000 ohms or more is recommended. An alligator clip, or clips, used in place of the needlepoints will free the hands for circuit adjustments. The capacitor blocks the passage of d.c., protecting the "phones", yet permitting the signal to pass through.*

series with one prod to prevent passage of d.c. The signal can be traced through the amplifier in the following manner: Turn on the amplifier, and when heated clip one side of phone cord to chassis and touch the

Table 4-1. -- PUBLIC ADDRESS TROUBLE CHART

	Hum	Distortion	Intermittent or Noisy Operation	No Signals
Microphone	If dynamic or velocity type, too close to transformer or power wires.	Loose or bent diaphragm. Impedance not matched to input. Too close to sound source.	Loose connection inside case. Defective transformer.	Bad mike, broken or shorted wire in case. Transformer winding open.
Microphone cable	Too long. Shielding not grounded. Too close to power wires or transformer.	Distortion due to capacitance, cable too long.	Broken wire inside cable. Bad terminal or plug connection.	Wire open or shorted in cable. Bad terminals.
Amplifier	Tube } Filament and } cathode leak. Chassis not grounded. Power supply needs more capacitance. Input stages need more shielding. Defective decoupling or bypass capacitor in low-level stage.	Tubes not properly biased. Tubes weak. Low B-Supply voltage.	Tube with loose elements. Loose connection in circuit.	Fuse blown. Tube burned out. Shorted capacitors. Transformer primary open.
Speaker cable	Not likely.	Not likely.	Wire broken in cable or bad terminals.	Wire in cable open or shorted. Bad terminals.
Loudspeakers	If P.M. type, hum not likely from speaker. If electromagnetic field, power supply needs more filtering.	Impedance mismatch. Wires loose on voice coil. Voice coil rubbing. Cone loose around edge. If electromagnetic field, field supply may be defective.	Flex. lead to voice coil loose. Bad output transformer. If electromagnetic type, intermittent in field supply or field coil.	Voice coil lead broken. Bad output transformer.

prod to the plates of the output tubes. The signal, including any hum, can be heard at this point. Next, touch prod to grids of output tubes where same signal will be heard, but at much lower volume. Continue back through the circuit until the trouble is located. With microphone cable disconnected, if hum increases as the gain control is advanced, the trouble may be caused by insufficient shielding of certain parts of the circuit within the amplifier or by defective bypass capacitors in the input stages. The circuits associated with the first two voltage amplifier tubes, the input jacks, and the gain controls must be well shielded from the fields set up by the power supply. Examine all shielding and make sure it is well grounded to the chassis. For checking induction hum in audio amplifiers, make an exploring coil by attaching a 1,000-turn honeycomb coil to the end of a wooden or plastic rod, as shown in Fig. 404.

1000 TURN HONEYCOMB COIL

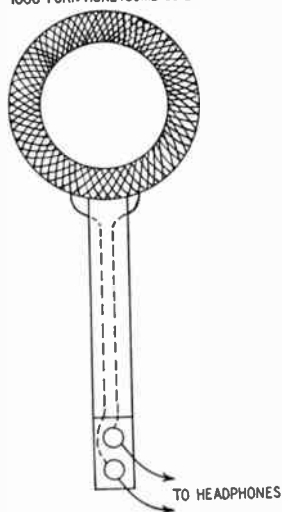

*Fig. 404—Hum in an amplifier may be due to any one or more of a number of causes. Very often hum can be extremely elusive and its elimination requires considerable patience on the part of the operator of public address systems. The test instrument shown here, while very simple, is extremely practical. It will NOT tell you what particular radio component is causing hum, but it WILL localize the hum area for you and enable you to concentrate your attention in those sections of the amplifier giving hum trouble. The honeycomb coil can be protected by encasing it in any suitable non-conducting material.*

Two wires from the coil run down the sides of the rod to two binding posts at the other end, to which a pair of headphones are connected. Using the rod for a handle, the coil can be moved around in the amplifier and the source of hum easily found. Tube hum is generally the result of a cross between the heater and cathode of one of the tubes, and can be cleared by replacing the tubes. Occasionally a breakdown between plate and grid of a beam power tube will occur, causing bad hum and distortion. Hum caused by insufficient filtering in the power unit can be due to either poor engineering or loss of capacitance in the electrolytic capacitors. These capacitors must not be mounted too close to power transformers or rectifier tubes, as excessive heat will shorten their life. Practically all factory-built systems are designed and tested for low hum level before they leave the factory, but as electrolytic capacitors age,



their capacitance becomes lower. The only remedy is replacement. In replacing them, be sure to observe polarity.

**BACKGROUND NOISE.** Background noise can start in several places in an amplifier. Checking through with the headphones, as already mentioned, will lead to its origin. Some of the more common causes are a loose or poorly soldered connection; noisy resistors; leaky coupling capacitors; worn volume controls; dirty contacts in switches and tube sockets; or a faulty tube. The headphones used in checking for hum can also be used for locating background noise.

**DISTORTION.** When one of the tubes is not working on the proper operating point of its characteristic curve, distortion is sure to result. If the tube is worked too far off-center of the linear portion, the signals may not be intelligible. A common cause of this trouble is the coupling capacitor between the plate of one tube and the grid of the next. If this capacitor leaks, some of the positive direct current from the plate reaches the grid, biasing it positive. Its operating point may then be driven near or past the saturation point. Good coupling capacitors should have a d.c. resistance of at least 300 megohms. Carefully check all of them if distortion is present.

**TUBE OVERHEATING.** If the heat of any tube becomes excessive, it is probably caused by a leaky coupling capacitor or a shorted cathode bypass capacitor. When the operating point is driven up on the characteristic curve, excessive plate current will flow. As this plate current must pass through the cathode resistor, it will also overheat and probably be damaged (unless the cathode bypass capacitor is shorted). In case of an overheated tube, carefully check the coupling capacitor feeding the grid of that tube and the cathode bypass capacitor (if one is used).

**POWER TRANSFORMER OVERHEATING.** Overheating of the power transformer is usually caused by a shorted filter capacitor or rectifier tube. Any short circuit in the chassis wiring that causes an excessive flow of plate current will also overheat the power transformer.

**RESISTOR OVERHEATING.** An overheated resistor usually indicates a shorted bypass capacitor. Check any capacitor between the resistor and ground. Improper biasing of a tube causing excessive tube current will have the same effect on plate resistors.

**FILTER CAPACITOR OVERHEATING.** Practically all filter capacitors now used in radio sets and amplifiers are of the electrolytic type and give excellent service. However, after some months of use, their current leakage becomes large enough to cause a temperature rise. This can be noted by placing the hand on the capacitor. If this rise is greater in one unit than any other, it should be changed at once.

**WEAK SIGNALS.** After a rectifier tube has been in service for some months, it may become gassy, resulting in excessive tube current flow due to ionization. In this condition the tube cannot function as an efficient rectifier and signals will drop off in volume. An indication of a gassy or "soft" tube is a glow visible within the plates; replace such a tube at once.

**MOTORBOATING.** This is an oscillation falling within the audio range, possibly caused by insufficient capacitance in a filter or decoupling capacitor. If the capacitors check O.K., a lowering of some resistance values may eliminate the trouble. Grid leaks in the resistance-coupled stages may be too high and ones of lower value should be tried. Don't carry this far enough to cause a drop in low-frequency response.

**HOWLING.** This trouble seldom appears in factory-built equipment, but is sometimes present in home-built amplifiers when used for the first time. If an input transformer is used to drive the output tubes, be sure it is placed in a position not too close to the output transformer, thus eliminating any coupling between them. Try reversing transformer leads to grids of output tubes. A 50,000- to 100,000-ohm resistor shunted across the primary will help in some cases.

# Chapter 5

## Construction of a PA System

**S**INCE the heart of any public address system is the audio amplifier, great care should go into its construction. Nothing but the best material should be used, and the power transformer and choke should be heavy enough to tolerate long periods of operation without overheating. The voltage ratings of the filter capacitors should be higher than any peak voltage across them. Three principal considerations in building an amplifier are gain, fidelity, and power.

**GAIN.** Gain means the ability of the amplifier to raise the input signal energy to levels suitable to drive the output tubes. This gain in signal is accomplished by several vacuum tubes and their associated circuits and should be ample for low output microphones.

**FIDELITY.** The fidelity of an amplifier is its ability to reproduce, without distortion, signals fed into the input of the amplifier. By the use of good material and proper biasing, the radioman should experience no difficulty in constructing a high-fidelity unit.

**POWER.** The power of an amplifier determines the size and number of speakers that can be driven properly.

The amplifier described in this chapter can handle better than 90% of all the services the radioman may be called upon to furnish. The amplifier is so designed that it can be used for mobile sound car operation with the car battery as the prime source of power, or in any location where 117 volts, 60 cycles, is available. The amplifier was designed by Paul W. Streeter and first appeared in the June, 1949, issue of *Radio-Electronics*.

In designing public address equipment for use in a sound car, a number of important factors must be considered.

1. The equipment must be as dependable as possible.
2. It should be compact and easily portable.
3. Reasonably small drain on the car battery is essential.

4. Since 117 volts a.c. is available for long periods of operation, the amplifier should be capable of operating on that power source, to save the battery.

5. The amplifier should have sufficient output to drive two speaker units.

The amplifier shown in Fig. 501 has all of these features. In addition, it can be built at reasonable cost.

By careful arrangement of parts it was found possible to build the amplifier on a chassis which, with cover, turntable, and pickup, measures only 10 x 12 x 11½ inches. Complete with tubes and power cords, it weighs 35 pounds. Sturdy handles placed on either side of the chassis represent a decided convenience in carrying the amplifier from one location to another.

Adequate underchassis ventilation must be provided; and if built-in louvres are not incorporated in the chassis, a series of holes  $\frac{3}{8}$  to 1 inch in diameter should be provided. These should be placed preferably along the lower edge of each end and in the top of the chassis. The holes can be covered with pieces of  $\frac{1}{4}$ -inch hardware cloth soldered to the inside edges.

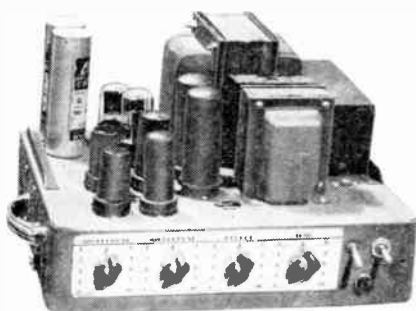

*Fig. 501—The public address amplifier.*

Sockets should be of good quality (Steatite sockets are ideal), since the contacts are necessarily close together and audio currents and d.c. voltages in the amplifier can cause flashover if cheap sockets are used.

Either of two types of 6-volt, 60-cycle vibrators can be used. The can dimensions of both are the same, although they differ in the internal connections and the arrangement of the terminal prongs. The heavier-duty type comes equipped with two complete sets of socket prongs and requires two six-prong sockets mounted on 3-inch centers. It is really the best vibrator to use, since all contacts are paralleled. However, there are large quantities of surplus vibrators on the market, readily obtainable, that have a single six-prong socket mounting. We have had

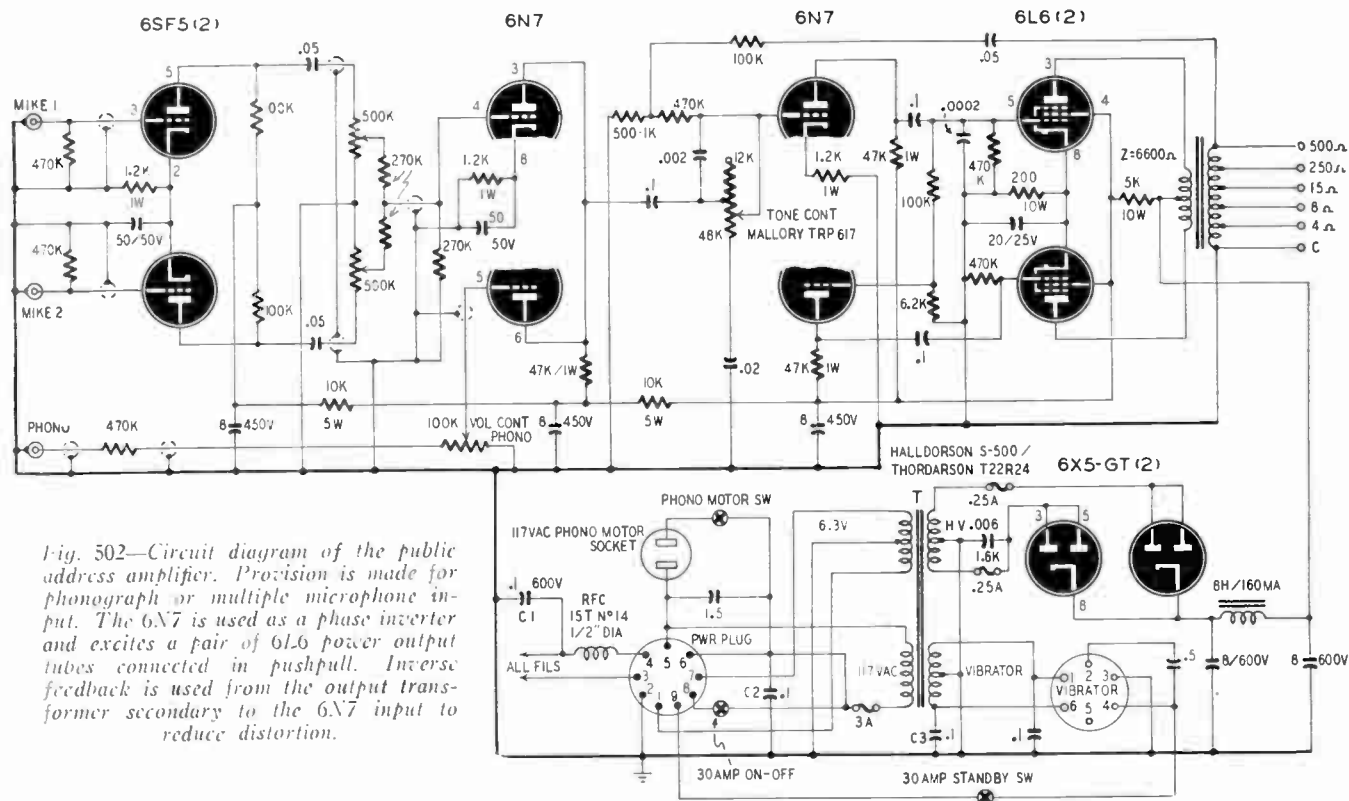

Fig. 502—Circuit diagram of the public address amplifier. Provision is made for phonograph or multiple microphone input. The 6N7 is used as a phase inverter and excites a pair of 6L6 power output tubes connected in pushpull. Inverse feedback is used from the output transformer secondary to the 6N7 input to reduce distortion.

very good service from these vibrators also. The circuit of this amplifier shown in Fig. 502 includes a single-socket vibrator, while Fig. 503 shows the changes necessary to accommodate the two-socket type.

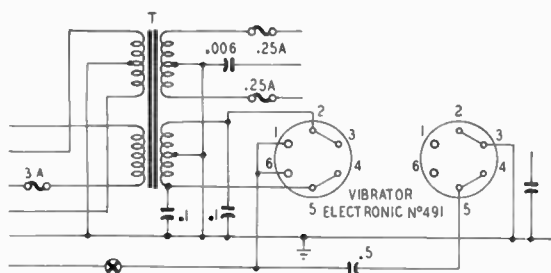

Fig. 2

Fig. 503—Vibrator socket connections.

The power plug on the rear of the chassis is a nine-prong male. This socket should be wired first, as far as possible, since four terminals require heavy conductors—at least No. 10 and preferably No. 8 flexible, stranded, rubber-covered wire. It was found that automobile low-tension wire, obtainable at auto-parts supply houses, was adequate.

First terminal 2 on the plug is wired to the chassis, using a short piece of heavy wire. Paint must be well cleaned from the chassis before soldering, to ensure good connection. A heavy wire connects terminal 3 on the vibrator socket to this same ground point. Also, capacitors C1, C2, C3, and C4 have their outside foils connected to this ground. Later, after the power transformer is installed, three additional heavy leads from it will have to be fastened to this same chassis point.

A heavy wire is connected to terminal 6 of the power plug, to one side of the on-off switch, and from the other side of that switch to terminal 8 of the power plug. A heavy wire from the standby switch to terminal 9 of the plug and from the other side of that switch to terminal 4 of the vibrator socket completes the heavy wiring.

The No. 1 terminals of all tube sockets are next connected directly to the chassis, using short pieces of bare hookup wire soldered directly to the chassis after paint is scraped off. Be very sure that good solid connections are obtained; poor connections here will cause hum. The amplifier will be subject to considerable vibration and rough handling, so make all connections mechanically secure.

The filament r.f. choke is made of No. 14 solid, insulated, hookup wire and fastened between the rear 6X5-GT socket and the power plug. The choke is made by winding 15 turns of this wire on a piece of 1/2-inch wood dowel, after which the coil is slipped off the dowel and bound with string or heavy thread to retain its shape. It is supported by the leads.

After the amplifier has been completely wired, check all connections to be sure that there are no loose joints. A drop of colored paint should be applied to each connection after testing. It will be an aid later if inspection is necessary, for the paint will flake or peel off if the connection is loose.

If a phonograph motor (Fig. 504) is to be installed in the top of the amplifier housing, it should be mounted together with the pickup arm and cartridge assembly. The phonograph on-off switch can be installed on the top front left corner of the housing. Wires from the motor and switch should be twisted and firmly clamped in such a manner that they will not be caught in the motor mechanism. They should terminate in a plug to match a socket on the amplifier chassis. The pickup lead should be shielded and terminate in a plug also. The plugs make it easy to remove the housing for service.



*Fig. 504—Adding a phonograph increases the usefulness of the system.*

If desired, a separate a.c. outlet can be installed on the chassis to furnish 117 volts for an automatic record changer. Power drain up to about 25 watts can be obtained from this amplifier when used with a 6-volt battery, which is sufficient for most changers. The driver of one of our sound cars runs his electric razor from that power source, shaving while he drives—a practice which we do not recommend!

Automatic changers, if used, should be so constructed that jars or vibration will not cause records to jam or to drop at the wrong time. Pickup cartridges must be rugged and capable of taking considerable abuse. Needle protection (an arm rest) must be provided.

Two power cables are required, one for 6-volt d.c. operation and one which is to be used when the amplifier is connected to 117 volts a.c.

Terminals 6 and 9 of the 6-volt connector plug are connected with a piece of No. 10 wire, since considerable current to the vibrator is carried through these pins. Bare wire can be used, covering it with a short piece of spaghetti tubing where exposed. Terminals 2 and 3 are connected with a piece of No. 14 wire, as are terminals 4 and 6. Leads are soldered to terminal 8 and to the junction of terminals 2 and 3. These leads should be long enough to reach the hot starter-switch terminal on the car and an accessible ground terminal on the car frame. The leads may be identified by different-colored insulation, paint, or Scotch-tape tags. The power cable plugs are illustrated in Fig. 505.

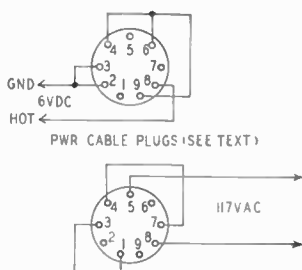

Fig. 505—The power cable plugs are wired as shown in the illustration. Wire these carefully, and do a good soldering job. Poor cable connections can cause noise, intermittent operation, or complete failure.

If a permanent installation is intended, solder lugs should be used for power connections. Terminal nuts should be clean and tight. If the amplifier is to be used only occasionally, good husky battery clips can be used. This practice is not recommended, however, as battery-clip connections are a source of annoyance and create a voltage drop due to poor contact or corrosion.

It will probably be most convenient to test the completed amplifier on 117-volt power first. Connect the power cord to the plug on the rear of the chassis. Connect a microphone (any good crystal or dynamic) to microphone input No. 1. Connect a speaker *large enough to carry the load* to the terminal strip on the rear of the chassis. Turn all controls off before plugging into the outlet.

Turn the on-off switch on and let the tubes warm up for a minute. Turn the microphone gain up slightly, and talk into the microphone. If audio feedback occurs, turn the gain down until it disappears. In use, the microphone should be placed as far as possible from, and behind, the speakers to eliminate feedback. Normal operation should give good volume with the microphone gain turned up one-quarter to one-third of maximum. Next, try the other microphone input. Similar results should be obtained.

The phonograph should now be tested. Normal operation with an average popular-music recording will probably require that the phonograph gain be turned up halfway. Unused gain controls should always be



turned off. The amplifier gain controls can be used to fade or mix any input combination.

When using the amplifier on 6 volts d.c., the on-off switch should be turned on first to allow the tubes to warm up for a minute before the standby switch is turned on to start the vibrator. The standby switch can be turned off to save battery current when the amplifier is used intermittently. If only the filaments are on, the battery drain is 5.35 amperes; the total battery current with the amplifier operating a full output and the phonograph motor on is 21 amperes.

The amplifier should never be turned on with the speaker load disconnected, since a.c. voltages in the output section may rise to dangerous values.

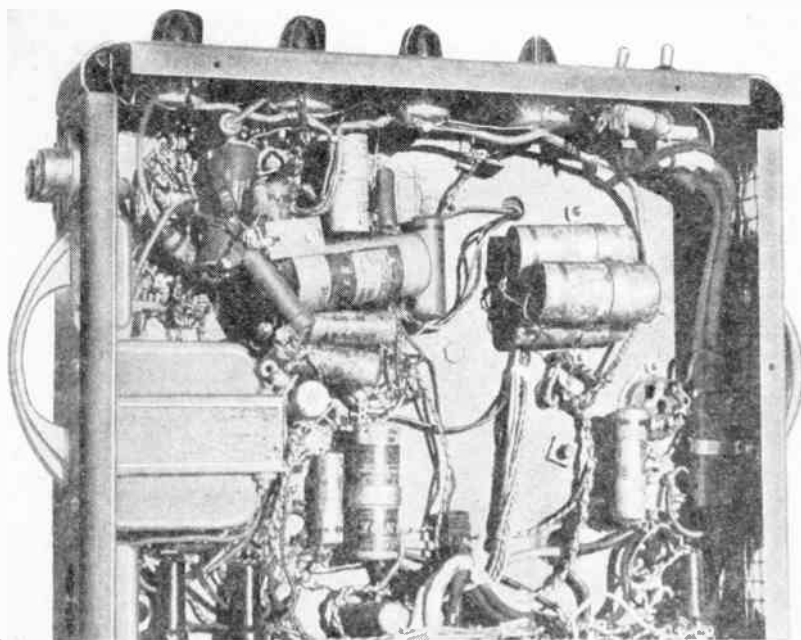

*Fig. 506—Underchassis view of the amplifier. All parts are securely mounted.*

An underchassis view of the amplifier is shown in Fig. 506 above. Since the amplifier is not a piece of fixed equipment but is subjected to considerable handling and transportation, it is essential that particular attention be paid to wiring and mounting of parts. Tie points should be used to secure all components. Wires should be laced to form a sturdy cable. Do not depend on soldering for mechanical strength. Wire connections should be wrapped around terminals and thoroughly secured before soldering. Lockwashers should be used under all screw heads to

keep vibration from loosening screws. All potentiometers should be secured with an inside star washer (or equivalent) under the hexagonal nut.

When more than one speaker is used, the speakers must be properly phased or they will have very little volume and poor tone. On most 25-watt driver units obtainable, terminals are marked, and proper phasing can be accomplished by wiring all the No. 1 terminals together. However, if different-make drivers are used or if the terminals are not marked, it is imperative to check speaker phasing. After speakers have been placed, it is a good plan to make speaker cables with polarized plugs or mark connections to maintain correct phasing.

#### MATERIALS FOR AMPLIFIER

*Resistors:* 1—6,200, 4—100,000, 3—270,000, 4—470,000 ohms,  $\frac{1}{2}$  watt; 3—1,200, 3—47,000 ohms, 1 watt; 2—10,000 ohms, 5 watts; 1—200, 1—5,000 ohms, 10 watts; 1—100,000, 2—500,000 ohms, potentiometers: 1—60,000 ohms, potentiometer, tapped at 12,000 ohms.

*Capacitors:* 1—20 $\mu$ f, 25 volts, electrolytic; 1—50  $\mu$ f, 50 volts, electrolytic; 3—8 $\mu$ f, 450 volts, electrolytic; 1—.0002, 1—.002, 1—.02, 3—.05, 6—0.1, 1—0.5, 1—1.5  $\mu$ f, 600 volts, paper; 2—8  $\mu$ f, 600 volts, electrolytic; 1—.006  $\mu$ f, 1,600 volts, vibrator buffer.

*Transformers and choke:* 1—power transformer; Prim. 6—8 V. or 117 volts, Sec. 650 volts c.t. at 135 ma., 6.3 volts c.t. at 4.75 amp.; 1—output transformer, 6,600 ohms to multitap secondary; 1—8-h, 160-ma filter choke.

*Tubes:* 2—6L6, 2—6X7, 2—6SF5, 2—6X5-GT.

*Miscellaneous:* 1—3-ampere, 2— $\frac{1}{4}$ -ampere fuse assemblies; 2—s.p.s.t. toggle switches, at least one with 30-ampere contacts; 8—octal tube sockets; 1—6.3-volt pilot-lamp assembly; 1—9-prong, male, chassis-mounting plug; 2—9-pin, female, cable-end receptacles; chassis; case; necessary connectors and hardware.



# *The Constantly expanding* **GERNSBACK LIBRARY**

29—**HANDY KINKS AND SHORT CUTS.** A compilation of practical methods of overcoming difficulties encountered by every radio man. Here are kinks on antennas, servicing, the shop, power supplies, etc. — arranged by sections for easy reference, and illustrated. **50c each.**

31—**RADIO QUESTIONS AND ANSWERS.** Here are the answers to the questions most frequently asked the editors by radiomen. The material selected is well diversified and chosen for practical application to workaday problems. Many diagrams. **50c each.**

32—**ADVANCED SERVICE TECHNIQUE.** An up-to-date collection of information on specialized phases of servicing, appealing to the advanced serviceman. The book is a diversified library of ideas, methods, and procedures not found in other books for professional servicemen. **50c each.**

33—**AMPLIFIER BUILDER'S GUIDE.** A valuable book for the designer and constructor of sound equipment. Theory and construction of audio amplifiers are treated. It contains a wide range of technical data on amplifier design, followed by constructional details for a variety of amplifiers. **50c each.**

34—**RADIO-ELECTRONIC CIRCUITS.** Here is an extensive collection of circuit diagrams with a brief description of each, to serve as a source of inspiration to the experimenter bent on developing new circuits. Constructional data is purposely limited to allow space for a maximum number of circuits. **50c each.**

35—**AMATEUR RADIO BUILDER'S GUIDE.** Here is a book for the "ham" who builds his own. Practical and down-to-earth, it is divided into sections on receivers, transmitters, and accessories (antennas, converters, and other equipment). The book is packed with information. **50c each.**

36—**RADIO TEST INSTRUMENTS.** Every radio man can use this book on building test equipment. Among the instruments described are signal tracers, capacity meters, portable and bench multicheckers, signal generators, tube checkers, and electronic voltmeters. **50c each.**

37—**ELEMENTARY RADIO SERVICING.** How to get started and keep going. A wide range of essentials is covered: Planning and Equipping the Shop, Systematic Circuit Checks, Signal Tracing Methods, Servicing Midget Receivers, and other fundamental servicing topics. **50c each.**

38—**HOW TO BUILD RADIO RECEIVERS.** Here is a book for the set builder. 18 modern sets are described including shortwave, broadcast, v.h.f., portable, a.c.-operated, a.c.-d.c., and miniature types — a sufficient variety to appeal to practically every radio fan. **50c each.**

39—**PRACTICAL DISC RECORDING.** This invaluable book is the last word on making good recordings. Technique as well as underlying principles are fully covered. Each important recording component is given a full chapter, explaining its purpose and what features to look for when buying. 96 pages. **75c each.**

40—**THE CATHODE-RAY OSCILLOSCOPE.** This up-to-the-minute book explains how the scope works and its use for servicing and amateur operation. Television, FM and AM receiver alignment is described in progressive stages; also checking modulation percentage, a.c. hum, and general trouble shooting. 112 pages. **75c each.**

42—**HIGH-FIDELITY TECHNIQUES.** Brand New! A common-sense guide to high-fidelity audio design by James R. Langham, **RADIO-ELECTRONICS'** popular audio writer. Not a slide-rule and laboratory treatise, but a down-to-earth handbook that will help every hi-fi man get top performance from his equipment. 112 pages. **\$1.00 each.**

**RADCRAFT PUBLICATIONS, INC., 25 West Broadway, New York 7, N.Y.**

*WATCH FOR NEW TITLES NOT LISTED HERE*