

Billboard®

INTERNATIONAL BUYER'S GUIDE



\$35.00

RECOTON VIDEO LEADS!

Now
over 100
products!

Profit from our VCR and Video Disc bestsellers:

Gold Connection™ Cables

(exclusive low loss engineering)

Installation Accessories

Video Maintenance Products

Video Home Storage Cabinets

Video "Director"

Picture Improvement Products

Dust Covers

Dubbing and Recording Kits

Head Cleaners

Camera Accessories

Storage Boxes



Recoton leads again with a new full line Video Accessoryware program. Packaged to sell, each eye-catching package has complete usage details.

Our best seller display assortments of Video maintenance and individual accessory items will complement your company's hardware sales effort.

Profit from experience! In Video as in Audio, Recoton means Accessoryware. "The Only Accessory Source Your Company Ever Needs".

For full catalog information call (212) 392-6442
or write (on business letterhead, please):

Recoton Corporation, Department BG
46-23 Crane St., Long Island City, N.Y. 11101

Please send your new, expanded 2nd edition Video catalog to:

NAME _____

ADDRESS _____

CITY _____

STATE _____

ZIP _____

Billboard®

INTERNATIONAL BUYERS GUIDE

Billboard Publications, Inc.
9107 Wilshire Blvd., Beverly Hills, Calif. 90210
(213) 273-7040. N.Y. Telex: 710581-6279.

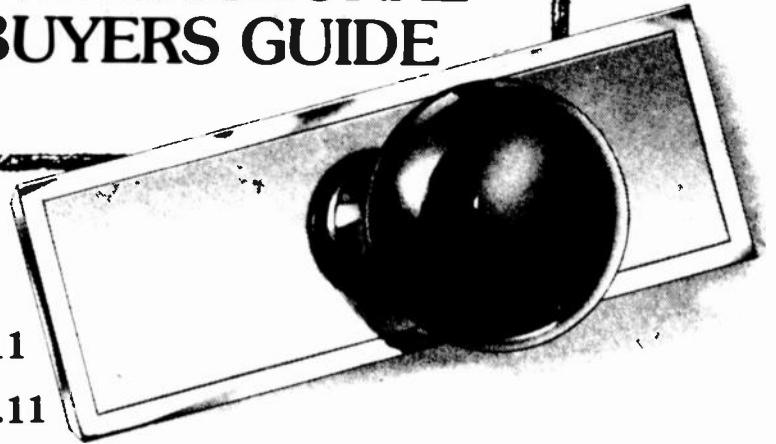

CONTENTS

U.S. LISTINGS.....	11
RECORD COMPANIES.....	11
MUSIC PUBLISHERS.....	37
SHEET MUSIC	59
WHOLESALEERS.....	61
Distributors One-Stops Rackjobbers Importers & Exporters	
SERVICES	104
Associations & Professional Organizations	104
Catalog Services.....	105
Design & Artwork, Printing & Lithographing	105
Licensing Organizations, Music	109
Licensors, Record & Tape	109
Plating, Processing & Pressing Plants	110
Record Promotion	115
Tape Custom Duplicators/Tape Packaging & Labeling	120
Tape Duplicator/Marketers	126
Entertainment Lawyers.....	126
SUPPLIES	130
Cartridge & Cassette Parts Manufacturers	130
Empty Cartridge, Cassette & Reel Manufacturers..	131
Envelopes & Mailers	138
Jackets & Sleeves	139
Labels, Disk	141
Polyethylene Bags & Shrinkwrap	142
Raw Materials Manufacturers/Importers	143
Record Processing Equipment Manufacturers/Importers.....	143
Tape, Blank Loaded, Manufacturers.....	144
Tape, Bulk Raw, Manufacturers.....	152
Tape Duplicating & Processing Equipment Manufacturers/Importers..	154
Tape Packaging & Labeling Equipment Suppliers & Manufacturers	158
Tape, Professional Supplies, Manufacturers.....	160
ACCESSORIES	166
PROMOTIONAL MERCHANDISING AIDS.....	173
JUKEBOX	174
STORE FIXTURES	175
INTERNATIONAL	176



The Radio Programming, Music/
Record International
Newsweekly
Billboard Publications Inc.
1515 Broadway, New York, N.Y. 10036
(212) 764-7300. Telex: 710581-6279.
Cable: Billboy NY. 9107 Wilshire Blvd.,
Beverly Hills, Calif. 90210. (213) 273-
7040.

Publisher: Lee Zhitto (L.A.)
Editor-In-Chief: Gerry Wood (N.Y.)

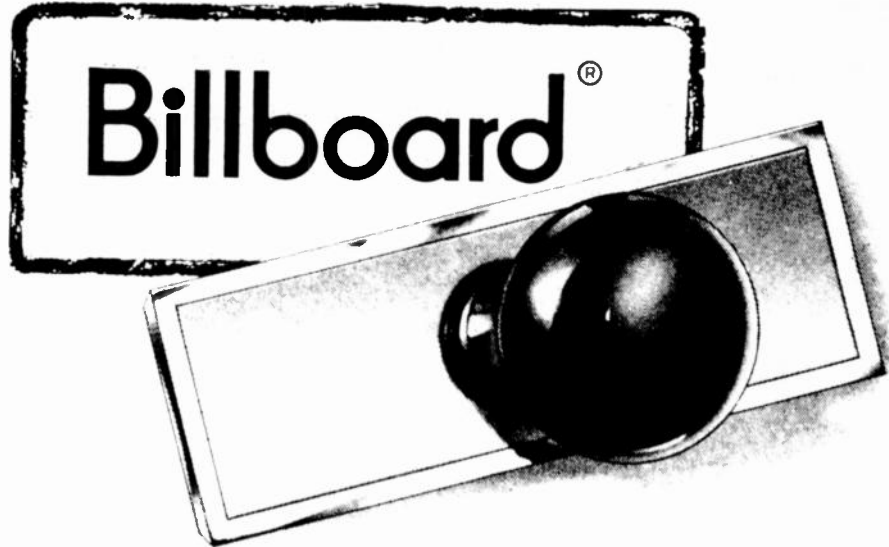

Directory Staff:

Editor: Earl Paige (LA); Assistant Editor: Ed Ochs (LA); Manager of Directory Services: Bob Hudoba (Cinti.). Assistant Manager of Directory Services: Jon Braude. Directory Associates: Roy Crosthwaite, Joan Elsener, Rand Ruggeberg, Kathy Schnurr. European Listings: Mike Hennessey, Vera Madan, Assistant. Art: Salvatore Scorza.

Weekly Editorial Staff:

Managing Editor: Adam White (N.Y.) L.A. Bureau Chief: Sam Sutherland
Executive Editor: Is Horowitz (N.Y.) News Editor: Irv Lichtman (N.Y.)

Offices: Chicago—150 N. Wacker Dr., Ill. 60606. 312 236-9818. Editorial Staff: Alan Penchansky, Bureau Chief & Classical Editor. Cincinnati—2160 Patterson St., 45214 Ohio, 513 381-6450. Los Angeles—9107 Wilshire Blvd., Beverly Hills, Calif. 90210, 213 273-7040. Editorial Staff: Ed Harrison, Record Reviews & Assistant Radio Editor; Jim McCullough, Video/Sound Business Editor; John Sippel, Marketing Editor; Sam Sutherland, Jazz Editor; Jean Williams, Talent Editor; Paul Grein, Reporter. London—7 Carnaby St., W1V 1PG, 01 439-9411. Editorial Staff: Mike Hennessey, Managing Director; Peter Jones, European News Editor. Milan—Piazzale Loreto 9, Italy. 28-29-158. Nashville—14 Music Circle E., Tenn. 37203. 615 748-8100. Editorial Staff: Kip Kirby, Country Editor; Ed Morris, Gospel Editor; Robyn Wells, Reporter. New York—1515 Broadway, New York 10036, 212 764-7300. Editorial Staff: Is Horowitz, Commentary Editor; Douglas E. Hall, Radio Programming Editor; Radcliffe Joe, Disco Editor; Vicki Spitz, Copy Editor; Roman Kozak, Rock Editor; Irv Lichtman, Music Publishing Editor; Richard M. Nusser, International Editor; Pat Nelson, Editorial Assistant. Tokyo—Utsunomiya Bldg., 19-16 Jingumae 6-Chome, Shibuya-ku, Tokyo 150. 03 498-4641. Editorial: Shig Fujita. Washington—733 15th St. N.W., D.C. 20005, 202 783-3282.

Intl Correspondents: Austria—Manfred Schreiber, 1180 Wien, XVIII, Kreuzgasse 27. 222 43-30-974; Australia—Glenn Baker, P.O. Box 261, Baulkham Hills, 2153 New South Wales; Belgium—Michel Verstrepen, Hoogstraat 358, 2570 Duffel. 015-312188. Juul Anthonissen, 27A Oude Godstraat, 3100 Heist op den Berg. 015 241953; Canada—David Farrell, Box 201, Station M, Toronto M6S 4T3. 519 925 2982; Czechoslovakia—Dr. Lubomir Dourzka, 14 Zeleny Pruh, 147 00 Praha 4 Branik. 26-16-08; Denmark—Knud Orsted, 22 Tjoernevej, DK-3070 Snekkersten. 02-22-26-72; Finland—Kari Helopaltio, SF-01860 Perttula. 27-18-36; France—Michael Way (Chief Correspondent), 12 Rue du Faubourg Poissonniere, 75010 Paris. 01-246 8749. Henry Kahn, 16 Rue Clauzel, 75009 Paris. 878-4290; Greece—John Carr, Kaisarias 26-28, Athens 610; Holland—Willem Hoos, Bilderdijhlaan 28, Hilversum. 035-43137; Hong Kong—Keith Anderson, P.O. Box 40, Tai Po, N.T.; Hungary—Paul Gyongy, Orlooutca 3/b, 1026 Budapest 11. Tel: 167-456; Ireland—Ken Stewart, 56 Rathgar Road, Dublin 6, Ireland. 97-14-72; Italy—Daniele Caroli, Viale Marche 21, 20125 Milano. 6083412; Kenya—Ron Andrews, P.O. Box 41152, Nairobi. 24725. Malaysia—Christie Leo, 31 Jalan Riong, Kuala Lumpur. 204.049; Mexico—Marv Fisher, Apartado Postal 11-766, Mexico 11, D.F. 905 531-3907; New Zealand—Phil Gifford, 156 Upper Harbor Dr., Greenhithe, Auckland. 413 9260. Philippines—Ces Rodriguez, 11 Tomas Benitez, Quezon City 3008. Poland—Roman Waschko, Magiera 9m 37, 01-873 Warszawa. 34-36-04; Portugal—Fernando Tenete, R Sta Helena 122 R/c, Oporto; Rumania—Octavian Ursulescu, Str. Radu de la La Afumati nr, 57-B Sector 2, Bucharest O.P.9.13-46-10. 16-20-80; Singapore—Peter Ong, 390 Kim Seng Road. 374488; South Africa—Don Albert, 21 5th Ave., Highlands N. 2192, Johannesburg; Esmond Frank, P.O. Box 87729, Houghton 2041, Transvaal. 011-40-6963; Spain—Ed Owen, Plaza de las Cortes 3, Madrid 14. 429 9812. Sweden—Leif Schulman, Brantingsgatan 49, 4 tr. 115 35 Stockholm. 08-629-873; Switzerland—Pierre Haesler, Hasenweld 8, CH-4600 Olten. 062-215909; U.S.S.R.—Vadim D. Yurchenkov, 14 Rubinstein St., Ap. 15 Leningrad, 191025 15-33-41; West Germany—Wolfgang Spahr (Chief Correspondent), 236 Bad Segeberg, An der Trave 67 b, Postfach 1150. 04551-81428, Jim Sampson (News Editor), Liebherrstr. 19, 8000 Munchen 22. 089-227746. Yugoslavia—Mitja Volcic, Glise Jankovica 2, 71 000, Sarajevo. 071 662-184.

SALES: Associate Publisher & Director of Sales: Tom Noonan (L.A.); Director of Sales, Video/Sound Business: Ron Willman (N.Y.); Sales Administrator: John Halloran (L.A.)

U.S. Sales Staff: Los Angeles—Joe Fleischman, Roni Wald, Mort Weiner. Nashville—John McCartney; New York—Mickey Addy, Jim Bender, Ron Carpenter.

Intl Sales: Australia—Geoff Waller & Associates, 64 Victoria St., North Sydney 2060, Sydney 4362033; Canada—Jim Bender, New York Office; Austria, Benelux, Germany, Greece, Portugal, Scandinavia, So. Africa, Switzerland—contact U.K. office. France—Pierre de Chocqueuse, 13 Rue DeLa Comete, Paris 75007. 555-6024; Great Britain—Peter Mockler, Philip Graham, 7 Carnaby St., London W1V 1PG. 439-9411; Italy—Germano Ruscitto, Piazzale Loreto 9, Milan. 28-29-158; Japan—Hugh Nishikawa, Utsunomiya Bldg., 19-16 Jingumae 6-Chome, Shibuya-ku, Tokyo 150. 03-498-4641; Mexico—Marv Fisher, Apartado Postal 11-766, Mexico 11, D.F. 905 531-3907; New Zealand—Mike Bailey, F.J. Associates, P.O. Box 1367, Wellington. 723475; Spain—David Safewright, Poste Restante, Madrid. 429-9812.

Associate Publisher & Director of Charts & Research: Bill Wardlow (L.A.); Division Controller: Don O'Dell (Cincinnati); Business Affairs Director: Gary J. Rosenberg (L.A.); Circulation Director: Ann Haire (N.Y.); Chart Manager: Jim Muccione (L.A.); Vice President/International Operations: Miles T. Killoch (London); License & Permissions Manager: Georgina Ellen Challis (N.Y.); Production Manager: John Wallace (N.Y.); Production Coordinators: Ron Frank, Tom Quilligan (Cincinnati).

BILLBOARD PUBLICATIONS, INC.

Chairman And President: W. D. Littleford. Executive Vice Presidents: Gerald S. Hobbs, Jules Perel. Senior Vice President: Patrick Keleher, Art & Design Group. Vice Presidents: William H. Evans Jr., Treasurer; Lee Zhitto, Billboard Operations; John B. Babcock, Product Development; Mary C. McGoldrick, Personnel; Ann Haire, Circulation. Secretary: Ernest Lorch. Corporate Manager: Charles Rueger, General Manager of Publishers Graphics.

© Copyright 1981 Billboard Publications, Inc. All rights reserved. This work may not be copied or reproduced in any form (including but not limited to microfiche or microfilm), stored in a retrieval system or transmitted, in any form or by any means, electronic, mechanical, photocopying, recording, or otherwise, without the prior permission of the publisher.

BILLBOARD PUBLICATIONS, INC.

1515 Broadway
New York, N.Y. 10036
(212) 764-7300 Telex: 710581-6279

9107 Wilshire Blvd.
Beverly Hills, Calif. 90210
(213) 273-7040

2160 Patterson St.
Cincinnati, Ohio 45214
(513) 381-6450

14 Music Circle E.
Nashville, Tenn. 37203
(615) 748-8100

SUBSCRIBER SERVICE
Billboard
P.O. Box 13808
Philadelphia, Pa. 19101
(609) 786-1669





Due to its dominance, United States shipments of recordings continue to earn the majority of analysis space in this 22nd edition of the International Buyer's Guide. The U.S. is as well a dominant market for consumer electronics and pro audio equipment. Thus certain charts refer to the now huge \$10.62 billion consumer electronics factory sales volume for 1980.

Factory shipments of recordings in the U.S. during 1980 were near \$3.682 billion at suggested list, just up over the 1979 figure of \$3.676. Units dropped 5% to 649 million after net returns. LPs rose to 308 million units in 1980 after two straight years of declines while singles dropped 26% and for the first year cassettes

beat out 8-tracks.

Among the various U.S. shipment figures supplied by RIAA, the combined tape shipments for 1980 totalled 184 million for a gain of 2% over 1979 but retail list value was down 2.6% at \$1.232 billion. NARM retail activity data reported here is for 1979.

World shipments shown elsewhere reflect few dramatic changes for 1980. However, the international section of the Buyer's Guide continues to show increasing global activity. There are 73 countries reported on. Moreover, steady improvements in statistical data are presented with many countries introduced by brief descriptions of market characteristics.

U.S. SHIPMENT REVIEW			
Dollar Volume	% Change from '79	Unit Sales	% Change from '79
LPs 2.2 Billion	+ 7%	308	+ 6%
Singles ¹ 250	-29%	157	-26%
8-tr. 527	-23%	85	-17%
Cassettes 705	+21%	99	+26%

¹Includes 12-inch singles
Source: RIAA (all figures in millions except where indicated)

TYPES OF RECORDED PRODUCT SOLD FOR 1979	
TYPE OF PRODUCT	% OF DOLLAR VOLUME
Rock, Pop	48.7%
Country	11.9%
Disco	9.2%
Soul	10.2%
Middle of the Road	5.1%
Jazz	4.1%
Classical	4.1%
Children's	5.3%
Comedy	1.4%

SOURCE: NARM

U.S. RECORDING SHIPMENTS		
Year	Sales \$ Millions	% Change
1980	\$3682	-5%
1979	3676	-11%
1978	4131	18.00%
1977	3500	27.9%
1976	2737	16.0%
1975	2360	7.3%
1974	2200	9.1%
1973	1436	4.0%
1972	1383	10.6%
1971	1251	5.8%

Source: Record Industry Association of America. Excludes tax payments, estimates from other data.

TYPES OF OUTLETS SERVICED BY NARM RACK JOBBERS	
TYPES OF RETAIL OUTLET	% OF DOLLAR VOLUME 1979
Department Stores (e.g., Bambergers, Broadway, Macy's)	4.6%
Discount Department Stores (e.g., K-Mart, Sears, Woolco)	74.1%
Variety Stores (e.g., Woolworths, Kresge, Ben Franklin)	7.4%
Convenience Stores (e.g., 7-11, Little General, Stop 'N Go)	1.0%
Retail Record Stores	1.9%
Drug Stores	5.2%
Supermarkets	0.4%
Service PX's	1.6%
Catalog Showrooms (e.g., Basco, Best, Service Merchandise)	3.5%
Miscellaneous	0.3%

SOURCE: NARM

SHIPMENTS BY CONFIGURATION

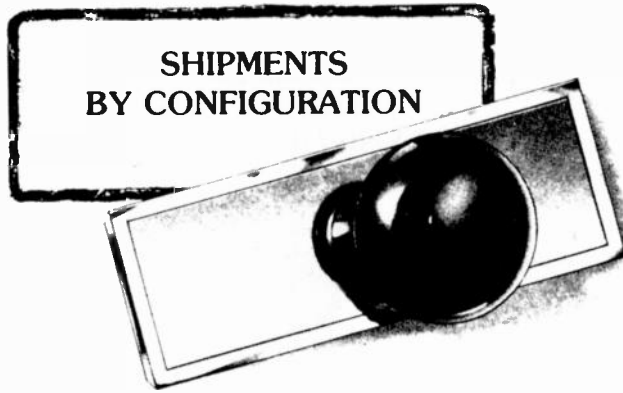

U.S. LP AND SINGLES SHIPMENTS

	1971			1972			1973			1974			1975		
	\$	%	%	\$	%	%	\$	%	%	\$	%	%	\$	%	%
	Change Dist.			Change Dist.			Change Dist.			Change Dist.			Change Dist.		
LPs	1,086	6.8	86.8	1,203	10.8	87.0	1,246	3.6	87.8	1,356	8.8	87.5	1,485	0.5	89.0
Singles	165	0	13.2	180	9.1	13.0	190	5.6	13.2	194	2.1	12.5	183	-5.7	11.0
Total Sales	1,251	5.8	100.0	1,383	10.6	100.0	1,436	3.8	100.0	1,550	7.9	100.0	1,668	7.6	100.0
	1976			1977			1978			1979			1980		
	\$	%	%	\$	%	%	\$	%	%	\$	%	%	\$	%	%
	Change Dist.			Change Dist.			Change Dist.			Change Dist.			Change Dist.		
LPs	1,663	11.9	87.2	2,195.1	32	90	2,473.3	13.0	91	2,057.6	-15.0	85	2,200b	+7	90
Singles	245	16.0	12.8	245.1	0	10	260.3	6.2	9	353.6	+36.0	15	250	-29	10
Total Sales	1,908	14.4	100.0	2,440.2	27.9	100	2,733.6	12.0	100	2,411.2	-12.0	100	2,450b	+2	100

All figures in millions except (b) billions.

SOURCE: NMA

PRERECORDED MUSIC SHIPMENTS

	1971			1972			1973			1974			1975		
	\$	%	%	\$	%	%	\$	%	%	\$	%	%	\$	%	%
	Change Dist.			Change Dist.			Change Dist.			Change Dist.			Change Dist.		
Records	1,251	5.8	71.7	1,383	10.6	71.9	1,436	3.8	71.2	1,550	7.9	70.5	1,668	7.6	70.7
Tapes	493	3.1	28.3	541	9.7	28.1	581	7.4	28.8	650	11.9	29.5	692	6.5	29.9
Total Sales	1,744	5.1	100.0	1,924	10.3	100.0	2,017	4.8	100.0	2,200	9.1	100.0	2,360	7.3	100.0
	1976			1977			1978			1979			1980		
	\$	%	%	\$	%	%	\$	%	%	\$	%	%	\$	%	%
	Change Dist.			Change Dist.			Change Dist.			Change Dist.			Change Dist.		
Records	1,908	14.4	69.7	2,440.2	27.9	69.7	2,733.6	12.0	66	2,411.2	-12.0	66	2,450b	+2	67
Tapes	829	19.8	30.3	1,060.6	15	30.0	1,397.8	32.0	34	1,264.9	-10	34	1,232b	-3	33
Total Sales	2,737	15.9	100.0	3,500.8	27.9	100	4,131.4	18.0	100	3,676.1	-11	100	3,682b	+2	100

All figures in millions except (b) billions.

SOURCE: NMA

TAPE BY CONFIGURATION

	1971			1972			1973			1974			1975		
	\$	%	%	\$	%	%	\$	%	%	\$	%	%	\$	%	%
	Change Dist.			Change Dist.			Change Dist.			Change Dist.			Change Dist.		
8-Track	385	1.8	78.4	425	10.4	78.6	489	15.1	84.1	549.2	12.3	84.5	583.0	6.2	84.2
Cassettes	96	24.7	19.5	102	6.3	18.9	76	25.5	13.1	87.2	14.7	13.4	98.8	13.3	14.3
Reel to Reel	12	-33.3	2.4	8	-33.3	1.5	4	-50.0	.7	2.6	-35.0	.4	2.0	23.4	.3
4-tr. & Others	-	-	-	-	-	-	-	-	-	-	-	-	-	-	-
Quad 8T & Reel	-	-	-	6	-	1.0	12	100.0	2.1	11.3	-5.8	1.7	8.2	-27.4	1.2
Total Sales	493	9.7	100.0	541	9.7	100.0	581	7.4	100.0	650.3	11.9	100.0	692.0	6.4	100.0
	1976			1977			1978			1979			1980		
	\$	%	%	\$	%	%	\$	%	%	\$	%	%	\$	%	%
	Change Dist.			Change Dist.			Change Dist.			Change Dist.			Change Dist.		
8-Track	678.0	16.3	81.8	811	19.6	76.5	948.0	17.0	68	684.3	-28.0	54	527	-23	43
Cassettes	145.7	47.5	17.6	249.6	71.3	23.5	449.8	80.0	32	580.6	+29.0	46	705	+21	57
Reel to Reel	-	-	-	-	-	-	-	-	-	-	-	-	-	-	-
4-tr. & Others	-	-	-	-	-	-	-	-	-	-	-	-	-	-	-
Quad 8T & Reel	5.1	-37.8	.6	-	-	-	-	-	-	-	-	-	-	-	-
Total Sales	828.8	19.8	100.0	1,060.6	15.9	100	1,397.8	32.0	100	1,264.9	-10.0	100	1,232b	-2.5	100

All figures in millions except (b) billions.

SOURCE: NMA

HISTORICAL REVIEW 1981-1877

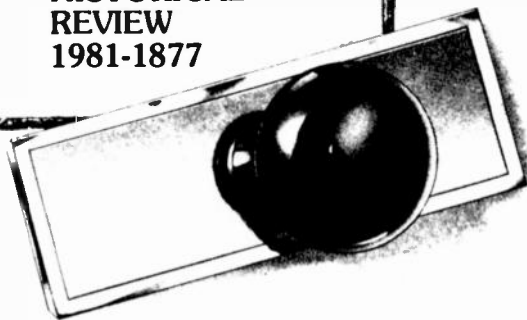

1981	RCA launches SelectaVision videodisk in one of the biggest introductory campaigns in consumer electronics history. CBS debuts CX decoder noise reduction system for compatible encoded disks. Sony unveils 24-track digital professional studio recorder. Personal, portable stereo/headphones establish popularity worldwide as virtually every major manufacturer issued a version of the Sony Walkman. CBS Records answers spiraling inflation and narrow price margins by abolishing list pricing in all product categories as wholesale prices increase.	LP sales surge ("Flower Drum Song," "Peter Gunn," "Kingston Trio At Large").	1959
1980	MCA debuts DiscoVision videodisk in several U.S. markets while RCA and JVC announce forthcoming non-compatible videodisk systems. Many record labels gear up for video. Home-taping controversy heats up in year of sluggish record sales. List price for superstar LPs hits \$8.98.	First stereo LPs and phonographs introduced.	1958 1956
1979	Label mergers and the energy/economy crunch rock industry just coming off an all-time 1978 sales surge that saw U.S. prerecorded volume shoot past \$4 billion. Metal particle audio tape moves to market.	First appearance of high quality stereophonic tape recordings. Elvis craze booms. Videotape recording introduced for TV stations.	1955
1978	\$7.98 becomes the standard U.S. list price, as sales leap past \$3.5 billion in a recording boom that taxes the nation's pressing facilities. Movie soundtracks enjoy renewed popularity, and combined with the disco rage, boost "Saturday Night Fever" to record-breaking sales levels. Digital recording enters the scene and video gains wider acceptance despite format confusion.	Columbia starts record club, while other companies cut LP prices.	1954
1977	New Revised Copyright Law passes, the first since 1909. Direct-to-disk recording is revived. Death of Elvis Presley rocks industry. Video cassette recorded sales boom as many manufacturers enter market. Computers become significant consumer items. Car audio/tape players replace CBs as top new automobile product.	"Sh-Boom" by Crew-Cuts heralds dawn of rock n' roll, "Rock Around The Clock" is out, but sleeps a year. First transistor pocket radio mass-marketed at \$49.95.	1952 1950
1976	Disco breaks as potent promotion and sales source; New Wave knocks, few majors answer. CBS hints of higher-priced superstar releases.	RIAA founded.	1949
1975	Inflation raises singles prices from \$1 to \$1.29, LPs and tapes jump \$1. Budget lines disappear from majors, replaced by \$4.98 lines of steady catalog sellers. Record/tape retail chains proliferate.	78 r.p.m. sales dwindle as RCA announces intention to produce LPs.	1948
1974	Continuing material shortages elevate production costs by 35% for singles and 60% for LPs.	45 r.p.m. introduced by RCA sets off battle of speeds. Three-speed phonograph introduced.	1947
1973	Surge of state antipiracy statutes cuts illicit tape flow.	Columbia issues 33 1/2 r.p.m. LP, with 23 minutes per side.	1946 1945
1972	RCA, Japan Victor Co. and Panasonic debut 4-channel discrete disk system. Sound recordings afforded greater federal protection against piracy. Developmental home video disk system demonstrated.	Limited use of magnetic tape recording in America and Europe. MGM Records bows. Transistor demonstrated.	1942
1971	CBS/Sony preview the "SQ" disk, a compatible 4-channel disk system. First international conference on video recording (VIDCA).	First magnetic wire recorders reach consumers.	1940
1970	Compatible 4-channel 8-track cartridge system, Quad-8, introduced by RCA and Motorola.	Mercury Record Corp. is born. World War II ends. Nine commercial TV stations, 46 FM stations and 943 AM radio stations are on the air as unlimited output of radios is permitted.	1939
1969	Trend toward bigness on all levels of the music business with all areas involved in the merger game.	Nationwide recording ban by AFM, lasting until Nov. 11, 1944. High fidelity technique used by English Decca. Formation of Capitol Records.	1936
1967	Manufacturers raise monaural prices to stereo level as major step in creation of all-stereo industry.	Record industry charts bow in Billboard. Superior magnetic tape recorders are produced in Germany.	1934
1966	Breakthrough of tape cartridge. First major marketing of cassette tape recorders.	First experimental FM goes on air. First tv sets offered for sale in U.S.	1930
1965	U.S. excise tax on records rescinded.	Popularity of jukeboxes boosts industry. First regular television program service started in Britain.	1929
1964	U.S. record sales hit all-time high with Beatles invasion and great gains in LP sales. Automobile stereo tape cartridge players popularized in California.	American Decca is launched. A record player-radio combination is marketed inexpensively by RCA Victor. Federal Communications Commission established.	1927
1962	Summer season one of best in history for singles. Racks register 24% gain over 1961.	EMI forms through Gramophone Co. and Columbia Graphophone merger. First 33 1/2 long-playing record demonstrated by RCA.	1926
1961	FM stereo gets FCC okay; racks show gains.	Depression adds to record industry decline but radio turns more and more to recordings.	1925
1960	Stereo booms to offset singles dip. ("Persuasive Percussion" scores big.)	Victor purchased by RCA. Warner Bros. buys Brunswick Radio Corp.	1924
		Automobile radios introduced. First coast-to-coast radio hookup.	1923
		Introduction of AC radio receivers designed to plug into wall outlet.	1920
		Brunswick's all-electric Panatone bows. Columbia and Victor issue electrical recordings.	1917
		Records boom due to radio. Electrical recording perfected by Bell Laboratories. The loudspeaker replaces earphones.	1915
		First transatlantic broadcast. Dr. Vladimir K. Zworykin applies for patent on tv camera tube and demonstrates complete tv system including picture tube.	1912 1910
		First commercial radio broadcast over WEA, N.Y. First radio receivers advertised for sale.	1909
		Victor releases first jazz record by Original Dixieland Jass Band, and the first Leopold Stokowski/Philadelphia Orchestra recording.	
		David Sarnoff proposes "radio music box" to Marconi Wireless Telegraph Co.	
		Cylinder abandoned, many new labels formed.	
		Enrico Caruso broadcasts by radiophone from backstage at the Metropolitan Opera.	
		Odeon issues first large-scale orchestral recordings.	

WORLD SHIPMENTS

The following is a country-by-country estimate
of 1980 shipments of records and tapes
in U.S. dollars (at retail)
and in units.

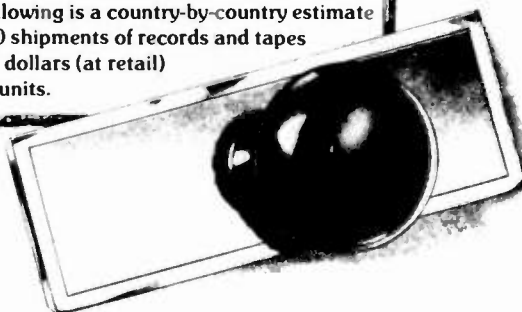

	Units: LP's	Singles	Tape	EP's
ARGENTINA¹ \$120,000,000	7,000,000	6,500,000	6,700,000	
AUSTRALIA \$200,000,000	35,455,000 ²	10,928,000		
AUSTRIA \$80,240,000	6,900,000	3,500,000	2,716,000	
BELGIUM³ \$67,200,000	9,056,000	11,000,000 ⁴	2,154,000	
BRAZIL	NO FIGURES AVAILABLE	NO FIGURES AVAILABLE	NO FIGURES AVAILABLE	
CANADA \$230,000,000	52,395,682	16,750,448	15,430,400	
CZECHOSLOVAKIA \$90,221,876	8,370,483	3,700,000 ⁴	610,280	
DENMARK \$66,110,800	4,367,000	1,992,000	2,548,000	
FINLAND⁵ \$43,250,000	2,334,443	436,793	2,051,388	34,492
FRANCE \$750,000,000	65,000,000	55,000,000	21,005,000	2,350,000
GERMAN FEDERAL REPUBLIC (WEST) \$1,200,000,000	109,700,000	45,000,000	44,400,000	
GREECE \$37,375,000	6,300,000	200,000	2,450,000	
HUNGARY \$31,145,615	5,868,000	1,243,000 ⁴	553,000	
ITALY¹ \$242,970,000	20,000,000	26,500,000	9,000,000	
JAPAN \$1,435,530,000	194,900,000 ⁴		79,970,000	
KENYA \$5,610,000	150,000	2,500,000	80,000	
MEXICO \$330,000,000	NO FIGURES AVAILABLE	NO FIGURES AVAILABLE	NO FIGURES AVAILABLE	
NETHERLANDS \$281,104,000	27,000,000	14,000,000	4,500,000	
NORWAY⁵ \$66,400,000	3,730,000	588,000	3,230,000	
POLAND \$30,266,000	5,500,000	2,506,800	1,131,463	224,763
PORTUGAL \$40,311,093	4,000,000	3,500,000	1,000,000	
SOUTH AFRICA \$87,510,365	5,438,200	6,818,000	3,569,700	
SPAIN \$226,000,000	12,000,000	7,200,000	30,000,000	
SWEDEN \$172,250,000	15,700,000	2,100,000	3,473,000	
SWITZERLAND \$119,000,000	9,167,000	5,000,000	3,371,000	
USSR¹ \$800,000,000	204,000,000			
UNITED KINGDOM \$810,000,000	67,400,000	77,800,000	25,200,000	
UNITED STATES \$3,682,000,000	308,000,000	157,000,000	184,000,000	
URUGUAY \$5,387,087	326,504	35,429 ⁴	295,204	
YUGOSLAVIA \$31,750,000	11,000,000 ²	4,500,000		

¹1979 figures

²LP's & tape combined

³SIBESA members only

⁴Singles & EP's combined

⁵IFPI members only

⁶LP's & singles combined

Sources: Industry associations, Billboard correspondents & estimates

SALES OF CONSUMER ELECTRONICS

FACTORY SALES OF PHONOGRAPHS 1970-1980¹

(ADD 000 UNITS)

Year	Portable and Table	Compact Component	Console Combinations	Total
1980	—	3,197	459	3,656
1979	—	3,811	568	4,379
1978	—	3,751	683	4,434
1977	—	3,653	734	4,387
1976	697	2,452	682	3,831
1975	656	2,472	574	3,702
1974	1,814	2,531	850	5,195
1973	3,777	2,241	944	6,962
1972	2,980	1,364	950	5,294
1971	3,390	—	1,046	4,436
1970	2,943	—	1,048	3,991

¹Prior to 1973, data reflects domestic label which includes products produced or purchased by U.S. manufacturers for sale with their brand names, and excludes those products imported directly by distributors or dealers for resale.

1973-1978 data reflects products produced or purchased by U.S. manufacturers plus those products imported directly by distributors or dealers for resale.

Included in Portable and Table thru 1971.

FACTORY PRODUCTION OF PHONOGRAPHS 1970-80

(ADD 000 UNITS/DOLLARS)

YEAR	PORTABLE AND TABLE (Includes Compact and Component Systems)		CONSOLE		TOTAL	
	UNITS	DOLLARS	UNITS	DOLLARS	UNITS	DOLLARS
1980	3,157	557,000	466	113,000	3,623	670,000
1979	3,689	594,000	553	131,000	4,242	725,000
1978	4,116	650,000	682	160,000	4,798	810,000
1977	3,027	418,000	735	184,000	4,362	602,000
1976	3,021	145,000	654	172,000	3,855	491,000
1975	2,641	133,000	523	132,000	3,164	400,000
1974	3,942	212,000	865	186,000	4,807	554,000
1973	5,234	314,000	901	188,000	6,135	614,000
1972	6,279	392,000	928	185,000	7,207	649,000
1971 ²	4,972	216,000	1,062	209,000	6,034	425,000
1970 ¹	4,572	160,000	1,048	216,000	5,620	376,000

¹Prior to 1971, data reflects factory sales by U.S. manufacturers plus those products imported directly by distributors or dealers for resale.

²1971 and years following data reflect products produced or purchased by U.S. manufacturers plus those products imported directly by distributors or dealers for resale.

SOURCE: Consumer Electronics 1981 Annual Review.

SALES TO DEALERS OF PHONOGRAPHS 1970-1980¹

(ADD 000 UNITS)

Year	Portable and Table	Compact Component	Console Combinations	Total
1980	—	3,225	473	3,698
1979	—	3,761	552	4,313
1978	—	3,741	677	4,418
1977	—	3,614	735	4,349
1976	698	2,470	688	3,856
1975	779	2,642	580	4,001
1974	1,945	2,483	837	5,265
1973	3,437	2,236	923	6,596
1972	3,743	2,227	949	6,919
1971	3,416	—	1,023	4,439
1970	3,019	—	1,087	4,106

¹1972-1979 reflect Total U.S. Market statistics for all phonographs produced and/or sold in U.S. regardless of the brand name or country of origin. Years prior to 1972 based on domestic label only, including products produced or purchased by U.S. manufacturers for sale with their brand name and excluding those products imported directly by distributors and dealers for resale.

ANNUAL FACTORY SALES OF CONSUMER ELECTRONIC PRODUCTS 1974-1980

(Estimated in Millions of Dollars)

Category	1974	1975	1976	1977	1978	1979	1980
Monochrome TV Receivers	500	416	495	530	549	561	588
Color TV Receivers	2,533	2,268	2,755	3,289	3,674	3,685	3,944
Radios	557	372	367	523	449	437	468
Car Audio	370 ¹	355 ¹	497 ¹	534 ¹	582 ¹	623 ¹	1,056
Audio Systems	510	474	489	606	748	748	801
Separate Audio Components	704	652	1,027	1,275	1,143	1,178	1,424
Tape Recorders & Players	886	687	1,120	1,388	1,975	2,128	2,336
TOTAL	6,060	5,224	6,750	8,145	9,120	9,360	10,617

¹Prior to 1980, data reflects factory-installed automobile sound products only.
Source: EIA

HISTORICAL REVIEW 1981-1877 (Cont'd.)

1906	Victrola, first enclosed-horn phonograph, appears.	1889
1904	First double-sided records issued by Odeon. Caruso becomes exclusive Victor artist.	
1903	First royalty system for compensation of recording artists. In Berlin, formation of International Talking Machine Co. (Odeon).	1888
1902	Columbia and Victor share patent on disk recordings, and cylinder drops from favor. Enrico Caruso records opera for the Gramophone Co..	
1901	Marketing of disk recordings moves ahead with formation of Victor Talking Machine Co.	1887
1900	Columbia Phonograph Co. opens London office.	
1899	Deutsche Grammophon Gesellschaft, oldest record manufacturing company, established in Hanover.	1885
1897	International expansion starts with American Graphophone's London office.	1881
1895	National Phonograph Co. formed by Edison, manufacturing and distributing spring-driven phonographs for homes.	1878
1894	Berliner manufactures gramophones and disks in Washington, D.C. while Pathe brothers in France manufacture phonographs and cylinders.	1877
	Columbia Phonograph Co. founded to market American Graphophone products. In Germany, first commercial gramophones and records are manufactured.	
	Edison improves phonograph, using wax, forms Edison Phonograph Works. First celebrity recordings made in Edison's laboratory. North American Phonograph Co. formed.	
	Flat phonograph disk patent application by Emile Berliner and formation of American Graphophone Co. launch recording industry.	
	Bell & Tainter patent "graphophone," replacing tinfoil cylinder with wax-coated cardboard.	
	Chichester A. Bell and Charles Sumner Tainter work on phonograph improvements.	
	Edison Speaking Phonograph Co. and London Stereoscope Co. formed. Phonograph interest in limbo.	
	First reproduction of sound by Edison on tinfoil cylinders and device called "phonograph." Microphone invented by Emile Berliner. France's Charles Cros writes paper describing process of recording and reproducing sound.	

CONSUMER ELECTRONICS U.S. IMPORTS/ EXPORTS

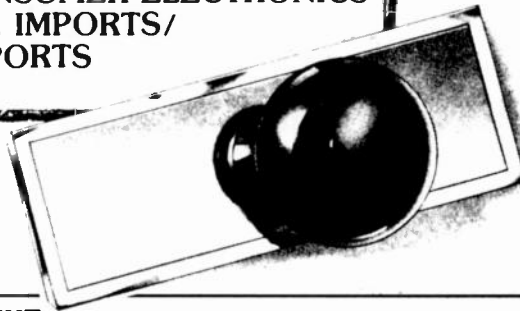

IMPORTS OF AUDIO TAPE EQUIPMENT

Year	Audio Recorders And Players (Cassettes)		Audio Players (Cartridges)		Automotive Players		Total Audio Recorders And Players	
	Units	\$	Units	\$	Units	\$	Units	\$
1980	19,532	845,080	2,334	74,284	9,362	423,280	31,228	1,342,644
1979	16,184	759,723	2,902	71,854	10,491	480,002	29,577	1,311,579
1978	15,996	706,523	3,305	83,835	10,507	471,595	29,808	1,261,953
1977	13,473	519,893	4,199	106,941	8,249	316,746	25,291	943,580
1976	12,664	437,218	4,143	98,766	9,136	286,472	25,943	822,456
1975	7,653	272,669	3,100	78,316	4,903	150,168	15,656	501,153
1974	9,087	310,653	4,488	133,001	4,983	146,655	18,558	590,309
1973	10,470	318,691	7,181	235,522	4,687	102,327	22,338	656,540
1972	9,873	266,698	8,263	244,257	3,641	69,615	21,777	580,570

(Add 000 to all figures)

IMPORTS OF CONSUMER ELECTRONIC PRODUCTS

Year	Home Radios		Automobile Radios		Phonographs		Home Tape Recorders & Players		Auto Tape Players		Video Tape Recorders	
	Units	\$*	Units	\$*	Units	\$*	Units	\$*	Units	\$*	Units	\$
1980	29,874	486,304	3,394	118,985	2,932	153,312	21,866	919,364	9,362	423,280	940	498,333
1979	28,998	491,519	4,431	165,658	3,801	203,229	19,086	831,576	10,491	480,002	681	361,624
1978	37,935	627,749	5,439	184,471	4,312	231,883	19,301	790,358	10,507	471,595	509	279,629
1977	37,782	579,456	5,423	175,686	3,309	173,176	17,672	626,834	8,249	316,746	250	140,947
1976	35,394	498,010	5,970	148,643	2,455	103,726	16,807	535,984	9,136	286,472	70	50,413
1975	27,945	374,561	3,996	102,786	1,299	47,750	10,753	350,985	4,903	105,168	40	26,532
1974	34,433	474,716	4,848	110,994	1,934	92,657	13,575	443,654	4,983	146,654	34	20,388
1973	40,907	448,736	4,459	91,271	2,423	95,690	17,651	554,213	4,687	102,327	76	23,960
1972	40,159	404,499	2,924	53,358	2,451	92,997	18,136	510,955	3,641	69,615	42	16,351
1971	30,988	306,825	3,150	51,263	1,926	61,951	13,548	358,218	2,739	51,136	29	8,138
1970	31,150	305,227	2,232	38,535	2,040	52,456	11,733	315,463	2,779	60,351	24	8,779

(Add 000 to all figures)

*Dollar value is defined generally as the market value in the foreign country (FOB) and excludes U.S. import duties, freight, charges from the foreign country to the U.S. and insurance.

EXPORTS OF CONSUMER ELECTRONIC PRODUCTS

Year	Home Radios		Automobile Radios		Phonographs		Recorders ¹		Video Tape Recorders	
	Units	\$*	Units	\$*	Units	\$*	Units	\$*	Units	\$*
1980	594	20,718	509	47,316	219	57,118	467	65,172	8	76,087
1979	687	26,075	506	39,142	298	50,705	438	54,053	6	65,137
1978	836	21,891	795	55,827	336	55,049	278	36,962	4	51,693
1977	421	7,065	452	28,408	450	31,623	198	41,391	8	46,140
1976	328	4,607	472	24,648	333	28,863	171	33,183	15	51,513
1975	351	4,877	303	16,498	221	19,251	182	34,496	3	44,735
1974	405	5,516	333	14,742	196	17,353	209	31,711	3	49,510
1973	307	3,812	447	16,138	134	10,803	152	22,599	13	32,203
1972	248	3,644	566	15,644	112	7,966	92	16,343	2	27,083
1971	224	3,081	495	13,090	75	6,327	66	16,919	1	18,447
1970	245	4,007	432	9,399	55	4,926	98	22,679	3	16,651

(Add 000 to all figures)

*Dollar value shown is defined generally as the value at the U.S. port of export, based on selling price, including inland freight, insurance, and other charges to the U.S. port of export.

Source: U.S. Department of Commerce and EIA. ¹Exclusive office-type.

VIDEO TAPE EQUIPMENT IMPORTS

Year	Video Recorders/Players		Video Tape Recorders		Total U.S. Market Video Cassette Recorders		
	Units	\$*	Units	\$*	Factory Production	Factory Sales	Sales To Dealers
1980	940	498,333	8	76,087	763,941	801,912	804,663
1979	681	361,624	6	65,137	459,743	414,951	401,930
1978	586	299,051	4	51,693	507,686	487,832	475,396
1977	408	158,822	8	46,140			
1976	291	64,522	15	51,513			
1975	162	34,931	3	44,735			
1974	138	25,277	3	49,510			
1973	272	35,401	13	32,203			
1972	42	16,351	2	27,083			
1971	29	8,138	1	18,447			
1970	24	8,779	3	16,651			

*Dollar value is defined generally as the market value in the foreign country (FOB) and excludes U.S. import duties, freight charges from the foreign country to the U.S. and insurance.

*Dollar value shown is defined generally as the value at the U.S. port of export, based on selling price, including inland freight, insurance, and other charges to the U.S. port of export.

SOURCE: U.S. Department of Commerce.

Annual Sales to Dealers of Video Cameras by Type (Units);
United States, 1979-1980

	1979	1980
Color Video Cameras	60,538	114,465
Monochrome Video Cameras	14,265	8,218

SOURCE: EIA Marketing Services Department.

RECORD COMPANIES

OF THE UNITED STATES

A

A T, see American Album & Tape.
 A B C, see MCA.
 A B F Prod'n's, 8947 Alton St., Philadelphia, Pa. 19115. Tel: (215) 671-1590. Pres.: Larry Feldman.
 A B P Recs., 240 Central Park S., New York, N.Y. 10019. Tel: (212) 582-7379. Pres. & A&R: Allen Abel; VP/Promo: Stan Stankus.
 A B (Street Level), see Sunrise.
 A C I, see Daytwo.
 A D & A Recs., PO Box 1412, Hollywood, Calif. 90028. Tel: (213) 462-3745. Pres.: Ardie Bryant; VP: Anne Bryant; A&R: David P. Bryant.
 A E I, see American Entertainment Int'l.
 A J, see Ala Ents.
 A K O, see Donr.
 A & M Recs. Inc., 1416 N. La Brea Ave., Hollywood, Calif. 90028. Tel: (213) 469-2411. Cable: ALPERMOS. Chm.: Jerry Moss; Vice-Chm.: Herb Alpert; Pres.: Gil Friesen; Sr. VP Promo. & Sales: Harold Childs; VP & Exec. Dir. Promo.: Charlie Minor; VP A&R: David Kershenbaum; VP Creative Servs. & Prod. Mgmt.: Jeff A. Eroff; VP Financial Affairs: Michael Parkinson; VP Bus. Affairs: Ken Powell; VP Sales: David Steffen; VP Quality Control/Quality Control Dir.: Marv Bornstein; VP Artist Development: Martin Kirkup; VP Adv. & Mktg.: Bob Reitman; VP Int'l: Jack Losmann; VP Communications & Ass'ts: Mike Gormley. (Distributed by RCA & A&M & Assoc'd Labels)
 Branches: New York, N.Y., 595 Madison Ave. Zip: 10022. Tel: (212) 826-0477. VP East Coast: Michael Leon; East Coast Artist Development Dir.: Gail Davis; Nat'l Pub. Dir.: Kathy Schenker.
 Int'l branches: Canada, England, France.
 Labels: (Owned) A&M; (distributed) IRS.
 Int'l rep.: Argentina (CBS), Australia (Festival), Austria (CBS), Belgium (CBS), Bolivia (CBS), Brazil (CBS), Central America (Dedeca in Guatemala), Chile (CBS), Colombia (CBS), Costa Rica (CBS), Denmark (CBS), Ecuador (CBS), El Salvador (Ideca), Finland (CBS), France (CBS), Germany (CBS), Greece (CBS), Hong Kong (PolyGram), India (EMI), Israel (CBS), Italy (CBS), Japan (Jfa), Korea (PolyGram), Malaysia (PolyGram), Mexico (CBS), Netherlands (CBS), New Zealand (Festival), Norway (CBS), Panama (Dedeca), Paraguay (EMI in Argentina), Peru (CBS), Philippines (Dyna Prods.), Portugal (Valentim de Carvalho), Singapore (PolyGram), South Africa (RFW), Spain (CBS), Sweden (CBS), Switzerland (CBS), Taiwan (PolyGram), Uruguay (CBS), Venezuela (CBS), West Indies (West Indies Recs.), Yugoslavia (Radio Television Belgrade).
 A M C (Brazil), see Brasilia.
 A M J Int'l Recs., 9000 Sunset Blvd., West Hollywood, Calif. 90069. Tel: (213) 550-0397. Pres.: Alice A. Jackson; VP: K.H. Smith; Gen. Mgr.: Eddie Hersher.
 A P, see Any Prod'n.
 A P A, see TK.
 A R C, see American Rec'g Co. & CBS.
 A R V Int'l, see House of Falco.
 A/S, see Alshire.
 A S A I Rec. Corp., Box 308, Vans Int., Va. 24656. Chm.: R. Fuller; Pres.: Terry Arrington; VP: A. Fuller; Gen. Mgr.: S. Collins; A&R: G.S. Potter; Dirs.: T. Day, J. Hill; Prod'r: Joe Dear.
 Branches: Oakwood, Va., Box 87. Zip: 24631.
 Labels: (Owned) ASAI, ASI, SII, Modoc, Penny Pinchers.
 A S I Recs., 711 W. Broadway, Minneapolis, Minn. 55411. Tel: (612) 521-7631.
 A S I, Va., see ASAI.
 A S I I, see ASAI.
 A S R, see Grapevine Opry.
 A T V Music Corp., 6255 Sunset Blvd., Hollywood, Calif. 90028. Tel: (213) 462-6933.
 Branches: New York, N.Y., 8 B Seventh Ave. Zip: 10106. Tel: (212) 977-5680—Rushville, Tenn., 1217 16 Ave. S. Zip: 37122. Tel: (615) 327-2753.
 Int'l branches: Australia, Canada, England, France, Italy.
 A V I Recs. Inc., 7060 Hollywood Blvd., Suite 1212, Los Angeles, Calif. 90028. Tel: (213) 462-7155. Bd. Chm.: Seymour N. Heller; Pres. & Treas.: Raymond Harris; VP & Sec'y: Ed Cobb; Gen. Mgr.: John Jossey.
 Labels: (Owned) AVI, Nashville; (distributed) in Town, Master 5, Out of Town.
 Abel, see Nashboro.
 Abkco Recs. Inc., 1700 Broadway, New York, N.Y. 10019. Tel: (212) 399-0300. Pres.: Allen Klein; VP: Joel Siller.
 Int'l rep.: UK (Decca).
 Above All, see Rainbow Room.
 Accent Recs., 71906 Hwy. 111, Rancho Mirage, Calif. 92270. Tel: (714) 346-0075. Owner & A&R Dir.: Scott B. Seely; A&R/VP: Buddy Merrill; Promo. & Opts. Dir.: Dolores Guldner; Eng. & Prod'r: Nick Mandola.
 Labels: (Owned) Accent (distributed by GNP Crescendo), Coachella, New Sound.
 Int'l rep.: Australia (Festival), Canada (CTI, MCA), France (Vogue), Germany (DG), Italy (CGD), Ja an (King).
 Accion, see Safari.
 Acme Rec'g Studios, 3821 N. Southport, Chicago, Ill. 60613. Tel: (312) 477-7333. Owner: Mike Rasfeld; Prod'n Mgr.: Jerry Buttitta; Pub.: Bradley Parker Sparrow; Eng.: Glen Odagawa; Ass't Eng.: Henry Candelaria.
 Acorn, see Freddie.

AcoustoGraphic Recs., 1 Simpson's Ln., Edgartown, Mass. 02539. Tel: (617) 627-4639. Owner: Benjamin L. Hall.
 Labels: (Owned) AcoustoGraphic, AcoustoQuad, Beau-Brian, Benjamin Lambert, Newzophone.
 AcoustoQuad, see AcoustoGraphic.
 Acropole Corp. of America, 1410 York Ave., Suite 2D, New York, N.Y. 10021. Tel: (212) 628-6315. Pres. & Gen. Dir.: Bruno George Rontly.
 Labels: (Owned) Bruno, Colosseum.
 Action Recs., 1616 Park Place Ave., Fort Worth, Tex. 76110. Tel: (817) 923-1111. Owner: Marvin Moore; Prod'r: Lew Gillis, Bob Davis.
 Action, Wash., D.C., see Warren.
 Adam Prod'n's Inc., 2501 S. Ocean Dr., Hollywood, Fla. 33022. Tel: (305) 925-1799. Pres.: Robert S. Taran; A&R: Mike Lewis.
 Adelphi Recs. Inc., Box 288, Silver Spring, Md. 20907. Wash., D.C. Tel: (202) 723-6958. Pres.: Gene Rosenthal; VP: Jack Heyman; Promo.: Hap Passman, Tom Sittler.
 Labels: (Owned) Adelphi; (distributed) Clean Cuts.
 Int'l rep.: Canada (Phonodisc), Denmark (CSA), Germany (Moers Music, Taxis), Italy (IRD), Netherlands (Dutch Blues & Boogie), UK (Projection, Swift).
 Ades (France), see Playette.
 Advent Prod'n's, PO Box 772, El Cerrito, Calif. 94530. Tel: (415) 525-1494. Pres. & Gen. Mgr.: Frank Scott.
 Labels: (Owned) Advent, Bullfrog; (distributed) Muskadine.
 Int'l rep.: Canada (Trend), France (Blue Sound), Germany (Taxis), Italy (IRD), Sweden (Amigo), UK (Swift).
 Aesthetic Artist Recs., PO Box 144, Mid City Sta., Dayton, Ohio 45402. Tel: (513) 252-9426. Owner: Paul Wayne Beach.
 Aferton Recs., PO Box 891, Hendersonville, Tenn. 37075. Tel: (615) 865-1641. Pres.: David A. Hoffman; Exec. VP/A&R Dir.: Kenneth A. White.
 Afro Request, see Request.
 Agon, see Dragon.
 Aic, see ECI.
 Aic/Artistic, see ECI.
 Air, see Chrystalis.
 Airborne, see Express.
 Airplay, see Wheel/Home Cooking.
 Airstrip Recs., 110 Gough St., Suite 202, San Francisco, Calif. 94012. Tel: (415) 552-6895. Pres.: Stuart Jacob Glasser; Promo. Co-ord.: Kathleen Delehanty; Pub. & Dist'n. Co-ord.: Cathy Civalo; Exec. Ass't: Gail M. Barrell.
 Ak Ba, see Moustic.
 Alabam, see McKinnon.
 Ala Ents. Inc., 4218 W. Jefferson Blvd., Los Angeles, Calif. 90016. Tel: (213) 737-1000. Pres.: Louis Drozen; VP: David Drozen; Exec. Admin'r: Shelby Meadows Ashford.
 Labels: (Owned) AJ, Ala, Blues Spectrum, Dingo, Hawk Sound, Laff.
 Alamo, see Capital Star Artist.
 Albatross Recs. Inc., PO Box 66558, Seattle, Wash. 98166. Tel: (206) 241-2320. Pres.: Ken Kinnear.
 Albert Prod'n's, c/o Edward B. Marks Music Corp., 1790 Broadway, New York, N.Y. 10019. Tel: (212) 247-7277. Cable: MARKBRO. Telex: 620960.
 Albradella, see Gwen.
 Album Globe Dist'n Co. Inc. (formerly IRDA/International Rec. Dist'g Assocs.), City Square, Suite 107, Hendersonville, Tenn. 37075. Tel: (615) 824-9100. Cable: ALBUMGLOBE. Pres.: Mike Shepherd; Prod'n Co-ord.: Patsy Webb; Sales & Promo. Dwr.: Keith Stewart.
 Labels: (Owned) Invitation, Super Prod'n; (represented) Ambassador, Amoret, Amoura, Berry Hill, Big Boss, Boyd, Buck, Calico, Castle, Cinnamon Int'l, Cowboy Country, Crystal Bridge, Filly-Colt, Gervasi, Gold Sound, Palmetto, Taurus-Astro, Wagner.
 Alear, see Sounds of Winchester.
 Alegre, see Musica Latina.
 Alfa Recs. Inc., 1015 N. Fairfax Ave., Los Angeles, Calif. 90046. Tel: (213) 654-1100.
 Home office: Japan.
 Alhambra Recs. Inc., 4380 NW 128 St., Opa Locka, Fla. 33054. Tel: (305) 685-8396. Telex: 522178. Pres.: Enrique Inurieta Sr.; Exec. VP: Enrique Inurieta Jr.
 Branches: Los Angeles, Calif., 2720 W. Pico Blvd. Zip: 90006. Tel: (213) 733-0137—San Juan, P.R., Alhambra Recs., GPO Box 2702. Zip: 00936. Tel: (809) 724-0465.
 Home office: Spain, Columbia (Discos).
 Labels: (Owned) Al Mex, Al Records, Alhambra, Carnaval, Libra, Odeon.
 Aljean Recs., 7 Colonial Ave., Myerstown, Pa. 17067. Tel: (717) 866-5067. Owner & Pres.: Jean Shade. Sales & Mktg. & Country Mgr.: Al Shade.
 Aljo, see Page.
 All Cars Recs., 7033 Sunset Blvd., No. 309, Hollywood, Calif. 90028. Tel: (213) 465-3990. TWX: (910) 493-2079. Pres.: Antony Harrington; VP: Rene Sonne; VP A&R: Gordon Skene.
 Int'l rep.: Canada (Trend), Germany (Ariola-Eurodisc, Phonogram), Japan (Canyon), Netherlands (FSV).
 Allegheny, see East Allegheny.
 Allen-Martin Prod'n's Inc., 9701 Taylorsville Rd., Louisville, Ky. 40299. Tel: (502) 267-9658.
 Alligator Recs., Box 60234, Chicago, Ill. 60660. Tel: (312) 973-7736. Pres.: Bruce Iglauer; Mktg. Dir.: Melinda Gies; Nat'l Promo. Dir.: Otis Taylor; Controller & Opts. Mgr.: Andrew Gerking.
 Int'l rep.: Australia (Larrikin), Europe & UK (Sonet in Sweden), Japan (Trio), Sweden (Smokestack, Sonet).

Allstar, see National Music.
 Almanac, N.Y., see American Themes.
 Almanac Rec. Co., PO Box 13661, Houston, Tex. 77019. Dir.: Mack McCormick; Prod'r: J.D. Horn.
 Al Mex, see Alhambra.
 Alpha Recs., PO Box 18287, Memphis, Tenn. 38118. Tel: (901) 452-0673. Pres.: Evelyn Graves.
 Al Recs., see Alhambra.
 Alsaman, see Dragon Int'l.
 Alshire Int'l, PO Box 7107, Zip: 91510; 1015 Isabel St., Burbank, Calif. 91502. Tel: (213) 849-4671. Cable: BUDSOUND. TWX: (910) 498-2759. Pres.: Al Sherman; Gen. Mgr.: Dick Ceja.
 Labels: (Owned) A/S, Alshire, Aria Senza Voce, Audio Spectrum, Oscar, Peter Rabbit, Somerset, Stereo Fidelity; (distributed) Azteca, Grit.
 Int'l rep.: Argentina (Microfon), Australia (Astor), Brazil (Fermata), Canada (Total), Colombia (Colombiana de Discos), Germany (Metronome), Greece (CBS), Israel (Hatahit), Japan (Trio-Kenwood), Mexico (Musart), New Zealand (Viking Sevenses), Philippines (Victor), Portugal (Movieplay), Singapore (Alshire), Spain (Movieplay), UK (Pye), Venezuela (Promus).
 Alston, see TK.
 Alternatives in American Music, PO Box 6127, Albany, Calif. 94706. Tel: (415) 527-3606.
 Int'l rep.: Italy (Horo).
 Altone, see American Tape.
 Aiva Recs., 3929 Kentucky Dr., Los Angeles, Calif. 90068. Tel: (213) 760-3670. Owner: Eddie Gurren; R&B Dir.: Barnett Williams; Promo. Dir.: Jan Telfeld.
 Alvorada, see Penco.
 A Major, see Parr-X.
 A Major Label, see Castalia.
 Amalisa Ltd., 3929 46 St., Sunnyside, N.Y. 11104. Tel: (212) 361-2582. 753-4267. Chief Execs.: Charles Lucy, Robert Martin.
 Int'l branch: England.
 Int'l rep.: UK (Pinnacle).
 Amazing Recs., PO Box 26265, Fort Worth, Tex. 76116. Tel: (817) 735-9768. Owner & Mgr.: Jim Yanaway.
 Int'l rep.: Belgium (Parsifal), Canada (Almada), Denmark (Happy New Ear), Germany (Bellaphon), Italy (IRO), UK (Mike's Country Music Room, Richard Wootton).
 Amazon, see TK.
 Ambassador, see Album Globe.
 Amberjack, see Audiofidelity.
 Ambience, see Suniko.
 Ambiente Prod'n's, PO Box 91120, Worldway Postal Center, Los Angeles, Calif. 91120. Tel: (213) 641-0178. Owner: Philip Sonnichsen.
 Ameraba, see West End.
 Americana, see Sine Qua Non.
 American Album & Tape Inc., 315 W. 57 St., New York, N.Y. 10019. Tel: (212) 247-3188.
 Labels: (Owned) AAT, American Album & Tape, American Entertainment, American Nostalgia, Hall of Fame Jazz.
 American Cowboy Songs Inc., The Homeplace, Mount Juliet, Tenn. 37122. Tel: (615) 444-8431. Pres.: Alfred H. LeDoux; Sec'y-Treas.: Bonnie J. LeDoux.
 Int'l rep.: Germany (Siegel), UK (Emerald).
 American Creative Entertainment Ltd., Professional Arts Bldg., 536 E. St. Louis Ave., Las Vegas, Nev. 89401. Tel: (702) 731-2322. Pres.: Frank Moore; VP: Greg Purcott; Sales Mgr.: Jim La Monica.
 Branches: Farmington Hills, Mich., 27650 Farmington Rd., Suite 210. Zip: 48018. Tel: (313) 553-2929—Atlantic City, N.J., Professional Arts Bldg., 1616 Pacific Ave., Suite 817. Zip: 08401. Tel: (609) 348-1809. VP's: Tony Angelo, Danny Luciano.
 American Entertainment Int'l Inc., PO Box 3324, Hollywood, Calif. 90028. Tel: (213) 781-6681. Pres.: David R. Gooch; Sec'y: Walter L. Shuster.
 Labels: (Owned) AEI, London's Pride, MusicCards, Songmaster.
 American Entertainment, N.Y., see American Album & Tape.
 American Jazz, see Happy Jazz.
 American Nostalgia, see American Album & Tape.
 American Pie Inc., 50 Southmont Dr., Tuscaloosa, Ala. 35405. Tel: (205) 345-2162. Pres.: Jim Salem.
 American Playboy, see Music Ents.
 The American Rec'g Co., 2323 Cornish Ave., Los Angeles, Calif. 90064. Tel: (213) 479-8522. Bd. Chm.: Robert Cavallo; Pres.: Maurice White; VP Mktg.: Ronald Ellison; Nat'l R&B Dir.: Maurice Watkins; Nat'l Pop Promos. Dir.: Dee Murray; Market Research Analyst: Georgetown Banks. (Distributed by CBS).
 Label: (Owned) ARC.
 American Rhythm Music, see Rollin' Rock.
 American-Sound-Studio, see Glotite.
 American Tape Corp., 1116 Edgewater Ave., Ridgefield, N.J. 07657. Tel: (201) 943-7860. Cable: RECCONTIN. Pres.: Stephen Flaks; VP Sales: Gerald Gottlieb; VP Admin.: Kathelyn Maran-Mendenhall; Plant Mgr.: Frank Dermody.
 Labels: (Owned) Altone, Radiant, Remington.
 American Theme, see American Themes.
 American Themes & Tapes Inc., 240 W. 55 St., New York, N.Y. 10019. Tel: (212) 246-3000. Cable: BENANTIMUS. Pres.: Jack Benanty; VP: Charles Benanty.

Labels: (Owned) Almanac, American Theme, Arta, Fairyland, Jazz Kings, Parliament, Urania Classics, Urania Jazz
 American Way, see Glolite
 Amherst Recs. 355 Harlem Rd., Buffalo, N.Y. 14224. Tel: (716) 826-9560; WATS (800) 828 7041. Pres. Leonard Silver, A&R: David Parker; Promo. John Penney
 Amoret, see Album Globe
 Amoura, see Album Globe
 Ampro Prod's Inc., 150 Fifth Ave., New York, N.Y. 10011 Tel: (212) 243 7726 Telex: 425233 Pres: Manuel E. Kopeiman, VP Mktg. Susanne Tarter
 Labels: (Owned) Ampro, Ava, Omega
 Am Rec of America, Box 62263, Virginia Beach, Va 23462. Tel: (804) 340-3366. Pres. Alex Spencer, VP. George Crowley; Pub: Nancy Strong.
 Label: (Owned) Dimension
 Anahuac (Discos), 6331 Santa Monica Blvd., Hollywood, Calif. 90019. Tel: (213) 462-0088.
 Int'l rep.: Mexico (Festival)
 Anamaze Recs., 1802 Ocean Pkwy., Suite 2A, Brooklyn, N.Y. 11223 Tel: (212) 627-8499. Pres., Prod' & A&R Dir.: Cosmo Dhms; VP Mktg. & Promo.: Dosa Tooner; Graphic Arts Supervisor: Fae Ellen; Exec. Prod': Michael Tubin
 Int'l rep.: UK (Rough Trade)
 Lee Anderson Ents., PO Box 4141, North Hollywood, Calif. 91607. Tel: (213) 782 6915 Owner & Pres.: Lee Anderson, VP's: Betty & Bruce Dale Anderson.
 Labels: (Owned) Belltone, Country Capers, Greenbush, Sports
 Angel, see Capitol
 Angelco Recs. Inc., 410 S. Michigan Ave., Chicago, Ill. 60605. Tel: (312) 663-9014. Pres.: Mary Angeline Sanford; VP: Robert E. Sanford; Sec'y-Treas.: Paul S. Renard; Mktg. Dir.: Barbara B. Renard. (Distributed by Audiofidelity)
 Branch: Elkhart, Ind., 1121 Marguerite St. Zip: 46514. Tel: (219) 264-5237.
 Annuity Coeptis Music Recs. Tapes Ltd., 2933 River Rd., Croydon, Pa. 19020. Tel: (215) 785-1541.
 Anomoly, see Jersey Coast.
 Ansonia Recs. Inc., 802 Columbus Ave. New York, N.Y. 10025 Tel: (212) 865 2121 Cable ANSORECORD. Pres. Mercedes Glass, Exec. VP: Her man Glass
 Labels: (Owned) Ansonia, Superior
 Chuck Anthony Music Inc., Box 879, Altamonte Springs, Fla. 32701 Tel: (305) 869-7300 Pres. Chuck Anthony; A&R Dir.: Randy Irwin.
 Labels: (Owned) CVR, Rocky
 Antilles, see Island
 Antique Recs., PO Box 192, Pittsburg, Kan. 66762 Tel: (316) 231-6443
 Any Prod'n Inc./Oak Rec'g, 2118 W. 12 St., Santa Ana, Calif. 92703. Tel: (714) 836 1760 Pres.: Craig A. Kitchens; Sec'y-Treas.: Patti Kitchens; Sec'y: Wendy Gayewski, Musical Dir.: Tom Ringlund
 Label: (Owned) AP
 Apexon Recs. Inc., 44-27 Purves St., Long Island City, N.Y. 11101 Tel: (212) 937-4038 Mgr. Darek Ropiak
 Apollo, see Hiding America
 Apon Rec. Co. Inc., PO Box 3082, Steinyard Sta., 44-16 Broadway, Long Island City, N.Y. 11103 Tel: (212) 721-5599. Pres.: Andrew M. Poncic; Prod' & Mktg. Mgr. Don N. Zemann; PR Mgr.: Dorian Michaels.
 Labels: (Owned) Apon, Discapon; (licensed) Amadeo (Austria), Harmonia Mundi (Germany), Hungaroton (Hungary), Supraphon (Czechoslovakia) (tape masters only)
 Appalseed, see June Appal
 Applause Recs., 258 S. Beverly Dr., Beverly Hills, Calif. 90212 Tel: (213) 274 9301 Pres. Artie Mogull; Chief Financial Officer: Jerry Rubenstein; VP & Prod'n Mgr. Path Dennis; Sales Mgr.: Dan Alvino
 Applegate, see Fraternity
 April, see Dragon Int'l
 April Entertainment Ents., PO Box 55340, Indianapolis, Ind. 46205. Tel: (317) 259 4979 Contacts Sid Johnson, Kenny Edmonds.
 Arabesque, see Caedmon/Arabesque
 Arc, see Spina
 Arcade Rec. Co./Arzee Rec. Co., 3010 N. Front St., Philadelphia, Pa. 19133. Tel: (215) 426-5682 Pres.: Rex Zano; Gen. Mgr.: Dave Wilson.
 Labels: (Owned) Arcade, Arzee, Clymax
 Int'l rep.: UK (Rollercoaster)
 Arcano, see Caytronics
 Arch, see Dragon Int'l
 Archive of Folk & Jazz Music, see Everest
 Archive of Piano Music, see Everest
 Archiv Produktion, see PolyGram Classics
 Arctic, see Jame/Guyden
 Arctic (Norway), see SWS
 Argo, see PolyGram Classics
 Argus Rec. Prod'n (div. of Record World), PO Box 58, Glendora, N.J. 08029 Tel: (609) 939 0034. Gen. Mgr.: Lem Harris, A&R Dir.: Eddie Jay Harris, Promo. Patricia Cox.
 Labels: (Owned) Argus, Merry Elf, Never Ending Music, Record Room; (distributed) Black & Blue, Now
 Argyle, see Spina
 Arhoolie Prod'n Inc., 10341 San Pablo Ave., El Cerrito, Calif. 94530 Tel: (415) 525-7471/4996 Pres. Chris Strachwitz.
 Labels: (Owned) Arhoolie; (distributed) Blues Classics, Folklyric, Old Timey
 Int'l reps.: Canada (Almada), Finland (Quality), France (Musidisc-Europe), Germany (Bellaphon), Italy (IRD), Netherlands (Agram/Nuis), Sweden (Sonet), UK (Swift)
 Aria Senza Voce, see Alshire.
 Ariel, see Benson
 Ariola, see Arista
 Ariola America, see Arista
 Arion, see Peters Int'l
 Aris, see Peters Int'l
 Arista Recs. Inc., 6 W. 57 St., New York, N.Y. 10019. Tel: (212) 489-7400 Cable ARISREC Telex: 666282 Pres.: Clive Davis; Exec. VP & Gen. Mgr. Elliot Goldman; Sr. VP Finance: Aaron Levy; Sr. VP Artist Development: Rick Dobbin; Sr. VP Promo. Richard Palmese; VP A&R: Bob Feiden; VP Pub. & Press Servs.: Dennis Fine; VP Nat'l R&B Promo.: Richard Smith; VP Sales: Gordon Bossin; VP ADR Promo.: Michael Bone; VP Admin.: Mort Drosnes; VP A&R Admin.: Paul Sloman; VP & Gen. Counsel: Michael Polack; VP Finance: Pat Mellillo Sr.; VP Int'l: Harry Aron.
 Branch: Los Angeles, Calif., 1888 Century Park E., Suite 1510. Zip: 90067. Tel: (213) 553 1777
 Int'l branch: England
 Labels: Ariola, Ariola America, Arista, Buddha, GRP, Project 3, Savoy.
 Int'l reps.: Argentina (Microfon), Australia (Festival), Austria (Ariola), Belgium (Ariola), Brazil (Ariola), Canada (Capitol), Chile (Discos

Quatros), Denmark (CBS), Ecuador (IFPI), Finland (Finndisc), France (Ariola), Germany (Ariola), Greece (Phonogram), Guatemala (Centroamerica), Hong Kong (EMI), Iceland (Falkinn), India (Gramophone), Israel (Her Azur), Italy (CGD), Japan (Nippon Phonogram), Malaysia (EMI), Mexico (Ariola), Netherlands (Ariola), New Zealand (EMI), Norway (CBS), Philippines (Vicar), Singapore (EMI), South Africa (RPM), Spain (Ariola), Sweden (CBS), Switzerland (Ariola), Venezuela (Velvet), West Indies (West Indies Recs.)
 Ariste, see Hollant
 Ark Recs., PO Box 230073, Tigard, Ore. 97223 Tel: (503) 620-5680 Owner/ Mgr. Jeff Johnson
 Arlo Recs., 7635 Telephone Rd., LeRoy, N.Y. 14482. Tel: (716) 584-3040 Co-Owners: Kenneth V. & James L. Bearce; Prof. Mgr.: Jill D. Welzel; VP Little Studio Music: Jack Bearce.
 Branch: Rochester, N.Y., BHR Recs., 12 Asbury Rd. Zip: 14620. Tel: (716) 442-9112. VP: Chess Carges
 Labels: (Owned) Arlo, Little Studio; (distributed) LP Music.
 Armageddon Recs. Ltd., 432 Moreland Ave., Atlanta, Ga. 30307. Tel: (404) 525-1679. Contacts: Alison Moore, Danny Beard
 Int'l branch: England
 Labels: (Owned) Vermageddon, Hedonics; (distributed) DB
 Arriba Recs., 1305 S. Armatage, Los Angeles, Calif. 90006. Tel: (213) 388-2263. Pres. & Gen. Mgr. Isaac Baly.
 Arrival, see Moonstone
 Arrowhead, see Oakridge
 Arrow Recs. (div. of DRB Ents.), 36427 Sibley Rd., New Boston, Mich. 48164. Tel: (313) 753 4050.
 Ari Attack Recs. Inc., 964 W. Grant Rd., Tucson, Ariz. 85705. Tel: (602) 884-9060. Pres.: William Cashman
 Artemis Recs. Ltd., PO Box 110, 157-52 9c St., Howard Beach, N.Y. 11414 Tel: (212) 738-4806. Pres.: John Giamundo; VP: Rocco Giamundo.
 Int'l reps.: Benelux (Supreme in Belgium), Japan (Polydor).
 Arth, see TK.
 Arta, see American Themes & Tapes.
 Artist America, see Hiding America.
 Artistic, see ECI.
 Artists House Inc., 40 W. 37 St., New York, N.Y. 10018. Tel: (212) 594-9435. Pres.: John Snyder; Prod'n Mgr.: Jim Gicking. (Distributed by MCA)
 Int'l rep.: Japan (King)
 Artistville, see ECI.
 Art Recs. Mfg. Co., PO Box 15032, Fort Lauderdale, Fla. 33318. Tel: (305) 584-1904. Pres.: Harold E. Doane; Exec. St. VP: Vivian P. Doane; Pub. Dir.: David W. Dunn
 Labels: (Owned) Art, Citadelle, Cruise, Souvenir, Unity.
 Arzee, see Everest.
 Arzee, see Arcade.
 Ascension, see Excelsior
 Asch, see Folkways.
 Ashley Rec. Co., 249 Bluegrass Dr., Hendersonville, Tenn. 37075. Tel: (615) 824-3573 Co-Pres.: Leon Ashley, L. S. Walton; VP: F. Case Walton; Pub., Adv. & Promo.: Linda Denny.
 Aslan, see Consolidated Gospel
 Aspro, see Holy Spirit.
 Associated Rec'g Cos. (div. of Associated Inds.), 2250 Bryn Mawr Ave., Philadelphia, Pa. 19131. Tel: (215) 477-7122. Pres.: George Guess; Exec. VP: Marcus Levy, VP Opts.: Ted Brown; VP Nat'l Sales & Promo.: Alonzo Brooks; VP Reg'l Sales: Leonard Spralley; Gen. Mgr.: Sales & Mktg.: Os car Biolack; Promo. Mgr.: Ronald Williams; Promo.: Tom Goodman, James Boulding, James Wise.
 Labels: (Owned) Jaguar, Jenges, Pearl Harbor
 Asylum, see Elektra/Asylum/Nonesuch
 Atco, see Atlantic
 Atlanta, see Trend Recs. in Ga
 Atlanta Int'l Rec. Co. Inc., 1872 Marietta Blvd. NW, Atlanta, Ga. 30318. Tel: (404) 351-4344
 Atlantic Rec'g Corp., 75 Rockefeller Plaza, New York, N.Y. 10019 Tel: (212) 484-6000 Cable: ATCDMUSIC, TWX: (710) 581-6537. Bd. Chm.: Ahmet Ertegun, Vice-Chm.: Sheldon Vogel. Pres. Atlantic Recs.: Doug Morris, Exec. VP & Gen. Mgr.: Dave Glew; Sr. VP Atlantic & Pres. Cotillion Recs. Henry Allen; Sr. VP/Controllor: Mel Lewinter; VP Sales: Sal Uterano, VP's Nat'l Promo.: Tunc Erim, Vince Faraci; VP Promo, Atlantic/Cotillion: Everett Smith; VP Mktg.: George Salowich; VP Ad: Mark Schulman; VP Int'l Mgr.: Cheryl Mitchell; VP & Exec. Ass't to Bd. Chm.: Noreen Woods; Nat'l Pub. Dir.: Stu Ginsburg; Artist Relations & Development Dir.: Perry Cooper; Art Dir.: Bob Deffin; Packaging & Pre-Production Dir.: Arline Brier, Creative Servs. Dir.: Paul Cooper; VP A&R Recs. & Custom Labels: Reen Nall
 Branch: Los Angeles, Calif., 9229 Sunset Blvd. Zip: 90069. Tel: (213) 278-9230 Gen. Mgr.: Les Garland.
 Distribution branches: See Record & Tape Wholesalers section for listings for Warner/Elektra/Atlantic Corp.
 Int'l branches: See WEA Int'l.
 Labels: (Owned) Atco, Atlantic, Cotillion. (distributed) Emerald City, Fin-nadar, Mirage, Modern, Pacific, RFC, Radio, Real World, Rolling Stones, Swan Song.
 Int'l reps.: See WEA Int'l.
 Atlantis, see Star Song in Ga.
 Atlas, see Velvet de Puerto Rico.
 Atterram Rec. Co., PO Box 606, 212 Roswell St., Marietta, Ga. 30061 Tel: (404) 428-5336. Pres. Carl Queen; VP: Arden Williams.
 Labels: (Owned) Atterram, Lanta, Mars La Tour.
 Attlixeras (Sweden), see Zim.
 Atumpen, see Black Fire.
 Audax, see Discopop.
 Audible Images, 822 Stendhal Ln., Cupertino, Calif. 95014. Tel: (408) 446-0808. (Cassettes)
 Audio Accessories Co., 38 W. 515 Deerpark Rd., Batavia, Ill. 60510. Tel: (312) 879 5998 Sales Mgr.: John S. Maloney. (Tape product)
 Audio Arts Inc., 5617 Melrose Ave., Los Angeles, Calif. 90038. Tel: (213) 461 3507.
 Labels: (Owned) Audio Arts, Audio Gospel.
 Audio Fidelity, see Audiofidelity Ents.
 Audiofidelity Ents. Inc., 221 W. 57 St., New York, N.Y. 10019. Tel: (212) 757-7111. TWX: (710) 581-2331. Bd. Chm.: Gaente Pugliese; Pres.: Sam Goff; VP/Gen. Mgr.: Carmen LaRosa; Exec. VP Bus. Affairs: Carl Shaw; Controller: Margaret Johnson; Sales Mgr.: Ivy Cherne.
 Int'l branch: England.
 Labels: (Owned) Amberjack, Audio Fidelity, Chiaroscuro, Coco, First Component Series, Jazz Bird, Knockout, Nutmeg, Charlie Parker, Phoenix; (distributed) Angelco, Gryphon, Strata-East.
 Audio Gospel, see Audio Arts
 Audio Guild, see Record Guild
 Audiophile, Tex., see Happy Jazz

Audiophile, Ga., see Jazzology GHB.
 Auditorama Recs. Corp., 658 10 Ave., New York, N.Y. 10036 Tel: (212) 246-9858. Pres.: Rafael Diaz Gutierrez; Gen. Mgr.: Hilda Diaz Gutierrez.
 Labels: (Owned) Auditorama, Palante, Sono-Max, Taurus.
 Audio Research (Sessions), 1973 Ohio St., Lisle, Ill. 60532. Tel: (312) 960-5100. (TV merchandiser)
 Audio Specialties Inc., 1427 Fernandez Juncos Ave., Santurce, P.R. 00909. Label: (Represented) Direct Disk.
 Audio Spectrum, see Alshire.
 Audio-Technica US Inc., 1221 Commerce Dr., Stow, Ohio 44224 Tel: (216) 686-2600. Pres. Jon R. Kelly, Sr. VP: Fred W. Nichols; VP Sales: Paul A. McGuire; Mktg. Communications Dir.: Don H. Kirkendall; PR Dir.: Shane O'Neil.
 Labels: (Distributed) RCA/RVC (Japan), Telarc, Toshiba-EMI (Japan).
 Aural Explorer, see MMO
 Aurora Borealis, see Crimson Dynasty.
 Aurum Recs. (div. of RBR Communications Inc.), 43 W. 61 St., New York, N.Y. 10023. Tel: (212) 757-8805. Co-Pres.: Bill Radics, Richard Bradley, VP: Ron Beigel.
 Auspex Recs., 12188 Laurel Terrace Dr., Studio City, Calif. 91604. Tel: (213) 877-1078 Owner: Jules Chaikin.
 Aus-Tex, see Colonel Buster Doss.
 Authentic, see Sonic Arts.
 Autograph, see Sonic Arts
 Autumn, Calif., see R. Dean Taylor.
 Autumn Int'l Recs., 202 Heather Dr., Garland, Tex. 75042 Tel: (214) 272-9272 Pres.: Philip S. Otten Jr.
 Ava, see Ampro.
 Avalanche, see Crimson Dynasty
 Avant, see Crystal.
 Avant Garde Recs. Inc., 250 W. 57 St., New York, N.Y. 10019. Tel: (212) 246-1343. Pres.: Frank Siegfried; Gen. Mgr.: Bobby McFarland.
 Int'l rep.: Australia (Move).
 Avanti, see Reflection Sound.
 Avoca Recs. & Tapes, 1404 Sun Flower Ln., New Port Richey, Fla. 33553. Tel: (813) 868-5196. Owner: Francis X. Cashin; Prod'n Mgr.: Anna M. Cashin. Branches: Rowley, Mass., 47 Glen St. Zip: 01969. Tel: (617) 948-2062. Shipping Mgr.: Kevin O'Neill; Sales Mgr.: Ann O'Neill—Deer Park, N.Y., 194 Cleland St. Zip: 11729. Tel: (516) 242-3539. Sales Mgr.: Nora M. O'Neill.
 Labels: (Owned) Avoca, Biarney Castle, IMI
 Int'l rep.: Ireland (Dolphin).
 Award Recs. PO Box 213, Brentwood, Tenn. 37027 Tel: (615) 373-3448. Pres. & A&R Dir.: Briff Collier; VP: Barbara Collier; Special Projects Consultant: Jeff Walker.
 Aztec, see Don.
 Azteca Rec. Inc., 1015 Isabel St., Burbank, Calif. 91502. Tel: (213) 849-4671. Cable: BUDSOUND, TWX: (910) 498-2759 Pres.: Al Sherman; VP: Richard Ceja. (Distributed by Alshire Int'l)
 Azure, see Gold Guitar

B

B-Atlas, see Jody
 B & B, see Barking Dog
 B B B, see Music Adventures.
 B B C, see Gemcom
 B B Recs., PO Box 929, Sikeston, Mo. 63801. Tel: (314) 471-5428. Pres.: Kenneth Bridger.
 Branch: Nashville, Tenn., 34 Music Square E. Zip 37203 Tel: (615) 242-7434
 B C A, see ECI.
 B C Recs., 207 Dahill Rd., Brooklyn, N.Y. 11218. Tel: (212) 851-8338.
 B C O Recs. Inc., 3297 Northcrest Rd., Suite 203, Doraville, Ga. 30340. Tel: (404) 491-0950. Pres.: Arnie Geller; VP: Buddy Bure; VP/Bus. Affairs: Gloria Bure.
 B H R, see Arlo.
 B I D, see Rim 10 & CBS
 B I R C Recs., 601 E. Blackidge Dr., Tucson, Ariz. 85705. Tel: (602) 882-9016. Pres. & A&R: Joe Bidwell; Artist Relations: Erin Brooks; Adv. Joseph Ostrom; Sales & Mktg.: Bob Rollins.
 B L T Recs., PO Box 9830, 3507 W. Vickery, Fort Worth, Tex. 76107 Tel: (817) 737-9911. Pres.: J. P. Kimzey
 B M A, see Jersey Coast & World Int'l.
 B R C, see Brunswick
 B R S Recs. (div. of Soundex Inc.), 1521 Seventh Ave., Beaver Falls, Pa. 15010. Tel: (412) 846-1174. Pres.: Dave Breit; A&R Dir.: Ralph Robb.
 B S O Recs. Inc., 2595 Carrell Ln., Willow Grove, Pa. 19090. Tel: (215) 443-0935 Cable BSOMUSIC Pres. & Gen. Mgr. Sal Barbieri; VP: Cro Schiano; Int'l A&R Mgr.: Ralph Barbieri.
 Int'l branch: Italy
 Int'l reps.: Argentina (Phonogram), Canada (Unidisc), Italy (CGD), Mexico (Zorba), South Africa (Teal).
 Baby Boy, see Old Dominion
 Baby Girl, see Old Dominion
 Baby Grand, see Bowman.
 Bach Guild, see Vanguard.
 Backlash, see Bomp.
 Backstreet, see MCA.
 Bainbridge Entertainment Co. Inc., 2507 Roscomare Rd., Los Angeles, Calif. 90024. Tel: (213) 476-0631. Pres.: Stanley R. Marshall; VP: Harlene Marshall.
 Int'l reps.: Canada (Almada), Hong Kong (Shun Cheong), Italy (Ducale), Philippines (Dyna), Venezuela (Palacio de la Musica).
 Balboa Rec. Co., 16027 Sunburst St., Sepulveda, Calif. 91343. Tel: (213) 892-0044. Owner: Larry Fofine. (Also see Spiral)
 Balkan Hi-Fi, see Balkan Music.
 Balkan Int'l, see Balkan Music.
 Balkan Music Co., 6917 W. Cermak Rd., Berwyn, Ill. 60402. Tel: (312) 484-6436.
 Labels: (Owned) Balkan Hi-Fi, Balkan Int'l
 Balkanton (Bulgaria), see Worldtone.
 Balloon, see Castalia.
 Bal Recs., 511 Berkshire Ave., Los Angeles, Calif. 90032. Tel: (213) 790-1242.
 Bambuco, see Discolando.
 Banana, see Stacy-Leo.
 Bandolier, see Suncountry
 Bang Recs., 2107 Faulkner Rd. NE, Atlanta, Ga. 30324. Tel: (404) 329-9535. Pres.: Ilene Berns; Controller: Lynn Carroll. (Distributed by CBS)
 Labels: Bang, Bullet, Shout, Solid Gold.
 Banjar Recs. Inc., Box 32164, 7440 University Ave. NE, Minneapolis, Minn. 55432 Tel: (612) 755-9829. Pres.: LeRoy Larson; VP: Bert Woolfrey.

- Barbaro, see Musica Latina.
 Barking Dog Publ'ns, PO Box 836 Enterprise, Ala. 36331. Tel: (205) 588-2540. Pres.: Danny Bryan; VP: Michael Bryan.
 Label: (Owned) B&B.
 Barking Pumpkin, see Pumpko & CBS.
 Barnaby Recs., 816 N. La Cienega Blvd., Los Angeles, Calif. 90069. Tel: (213) 657-6150.
 Bass, see Warren.
 Bat, see Dawn Prod'ns.
 Batchwork, see Lesser-Int'l-USA.
 Batish Rec'g Ent's., 1310 Mission St., Santa Cruz, Calif. 95060. Tel: (408) 423-1699. Pres.: S.D. Batish; VP: Mktg. & Sales: Ashwin Batish; VP Dist'n & Promo.: Shania Batish; Gen. Mgr.: Ravi Batish.
 Bayou Blue, see Great Southern.
 Bay Recs., 1516 Oak St., Suite 37, Alameda, Calif. 94501. Tel: (415) 865-2040. Owner: Michael Cogen.
 Label: (Owned) Bay; (distributed) Cabbage, Oink.
 Int'l rep.: Australia (Folkways), Canada (Almada), Germany (Tasim, Troubadour), Japan (BDM), Netherlands (Carol Bloom), Sweden (SAM), UK (Swift).
 Beatdown Recs., 2011 N. 15 Ave., Pensacola, Fla. 32503. Tel: (904) 438-2763. Pres., Gen. Mgr. & A&R: Earl Lett; Exec. Sec'y: Mattie Swain.
 Bearsville Recs. Inc., 3300 Warner Blvd., Burbank, Calif. 91505. Tel: (213) 846-9090 x 195. VP & Gen. Mgr.: Howard Rosen; Nat'l Promo. Dir.: Paul Pieretti. (Distributed by Warner Bros.)
 Branch: Bearsville, N.Y., PO Box 135, Wittenberg Rd. Zip: 12409. Tel: (914) 679-7303. A&R/Artist Development Dir.: Ian Kimmel.
 Beau-Brian, see AcoustoGraphic.
 Beau-Jim Recs. Inc., 10201 Harwin Dr., Suite 2206, Houston, Tex. 77036. Tel: (713) 771-6256. Pres.: James E. "Buddy" Hooper.
 Bee Hive Jazz Recs., 1130 Colfax St., Evanston, Ill. 60201. Tel: (312) 328-5593. Owners: Susan L. & James R. Neumann.
 Int'l rep.: Canada (Coda, Tr nd), Denmark (SteepleChase), Germany (Discomf), Italy (IRD), Japan (King), Sweden (Amigo), UK (Cadillac, Wellard).
 Bee Jay Rec'g Studios, 5000 Eggleston Ave., Orlando, Fla. 32810. Tel: (305) 293-1781. Pres.: Eric T. Schaecker; Gen. Mgr.: Jim Katt; A&R/Prod'r: Bill Vermilion; Prod'r/Arran'g: George Atwell; Technical Supervisor: Andy de Ganahl.
 Label: (Owned) Hype, Immunity, Tener.
 Tom Bee Prod'ns, PO Box 8207, Albuquerque, N.M. 87198. Tel: (505) 268-6110. Gen. Mgr.: J. Thomas E. Ass't Mgr./Sales & Mktg.: Peter Hummel; Pub.: Vicki Bee; Adv.: Thomas Krull; Tape: Dan D. Davis.
 Branch: Woodland Hills, Calif. 21806 Ybarra Rd. Zip: 91364. Tel: (213) 883-0159. Gen. Mgr.: Isaura Gutierrez.
 Label: (Owned) Rocked Out, ouled Out, Native Roots, Numex, Tribal.
 Behold, see P. Suriano.
 Believe in a Dream, see Rm. 10 & CBS.
 Belkin Prod'ns Inc., 28001 Chagrin Blvd., Cleveland, Ohio 44122. Tel: (216) 464-5990. (Distributed by MCA)
 Label: (Owned) Sweet City.
 Belle, see La Louisianne.
 Belltone, see Lee Anderson.
 Belmont Recs. (div. of John Perry Ent's. Inc.), 259A Beech St., Belmont, Mass. 02178. Tel: (617) 924-6222. Pres.: John Penny; Promo.: Jackie Lee Williams.
 Int'l rep.: Germany (Raw), Norway (Rocade).
 The Benson Co. Inc., 365 Great Circle Rd., Nashville, Tenn. 37228. Tel: (615) 259-9111; WATS (800) 251-8984. Pres.: Robert R. MacKenzie; Exec. VP: Wayne Erickson; SR/VP/Mktg. & Sales: Eddy Messack; Mktg. Dir.: Mike Blines; Nat'l Sales Dir.: Larry Gittinson; Radio Promos. Dir.: Bill Taylor; Press & Pub. Dir.: Don Klein.
 Label: (Owned) Benson, Gro enter, HeartWarming, Impact, NewPax, Paragon; (distributed) Ariel, Home Sweet Home, Jim, Lamb & Lion, Milk & Honey, New Dawn, Pilgrim America, Refuge, Scripture in Song, Star Song, Triangle.
 Int'l rep.: Australia (Rhema), Belgium (Universal Songs in Netherlands), Canada (Lawson-Falle), Luxembourg (Universal Songs in Netherlands), Netherlands (Universal Songs), UK (Kingsway).
 Bente Recs., 382 Central Park V., New York, N.Y. 10025. Tel: (212) 749-2267. Co-Pres.: Karin Mann, ohn Blount; Disco Mgr.: John Blount.
 Berlitz Publ'ns Inc., 866 Third Ave., New York, N.Y. 10022. Tel: (212) 935-2000.
 Berry Hill, see Buzz Cason & Al um Globe.
 Berserker Recs., 2054 Universi Ave., Berkeley, Calif. 94704. Tel: (415) 848-6701. Reigning Looney: Matthew Kaufman; Ass't Reigning Looney: Steve Levine; VP A&R: Gary P. Phillips; VP Int'l Affairs: John Doukas; Pub. & Adv. Dir.: Ken Baker.
 Label: (Owned) Berserker, Home of the Hits, Organ
 Int'l rep.: Australia (Festival Austria (Teldec), Germany (Teldec), Sweden (Sonet), Switzerland (Te dec).
 Best Buy Series, see RCA.
 Best-Car, see Rounder.
 Bethlehem Recs., International Jazz Emporium, 401 Fifth Ave., New York, N.Y. 10016. Tel: (212) 889-740. Telex: 236464. TWX: (710) 581-6058. Chm.: Joe Cayre; Pres.: Dick Carter; Int'l Mgr.: Glenn La Russo. (Also see Catsoul)
 Beverly (Brazil), see Brasilia.
 Bicycle Music Co., 8756 Holloway Dr., Los Angeles, Calif. 90069. Tel: (213) 659-6361. Pres.: David Ross r.
 Big Boss, see Album Globe.
 Big Daddy Recs., Box 268, Yonkers, N.Y. 10710. Tel: (914) 779-4684. Co-Owners/Prod'ns: Guy & Pipp Gillette.
 Big El, see Rob-Lee.
 Big Mike, see Right On.
 Big Sky, see SCP.
 Big Sound, see Trod Nossel.
 Big Wheels, see Entertainment Ventures.
 Big Willie, see Forrest Green.
 Biograph Recs. Inc., PO Box 109 Canaan 12029; 16 River St., Chatham, N.Y. 12037. Tel: (518) 392-3400. Cable: BIOGRAPH. Pres.: Arnold S. Caplin; VP: Barbara Caplin.
 Label: (Owned) Biograph, Enter, Dawn, Melodone, Waterfall.
 Int'l rep.: Australia (Mem ry Lane), Canada (Almada), France (Edwards), Netherlands (Nuis edrijven, Cor De Pater), UK (Brian Eagles, Vintage Jazz).
 Birch Recs., Box 92, Wilmette, Ill. 60091. Tel: (312) 251-7037, 583-0129. Pres.: Dave Wylie; VP: June Wylie; VP Promo.: Terry L. Walker; VP Pub.: Ellen Ginden; VP PR: Barbara Allgaier.
 Birdwing, see Sparrow.
 Birthright Recs., 3101 S. West 1st Ave., Los Angeles, Calif. 90018. Tel: (213) 731-0907. Pres.: Byron Speers Jr.; Gen. Mgr.: Leroy Lovett.
 Biscuit City Ent's. Inc., 3974 Venterhouse Rd., Oakland, Calif. 94602. Tel: (415) 530-4563. Pres.: Law Sunday.
 Int'l rep.: Italy (Hi-Fi), Japan (Black Hawk, Disc Center).
 Bivens Brothers, see General Broadcasting.
 Blackbird, see Lakco.
 Black & Blue, see Argus.
 Black Country, see McKinnon.
 Blackdisc, see Blackjack.
 Black Fire Recs., PO Box 38054, Washington, D.C. 20020. Tel: (202) 396-0154. Pres.: James B. Gray; Exec. VP: Plunky Nkabinde; Sales Mgr.: Jerome Gray; Bus. Mgr.: Sylvia Potts; Promo.: Jimmy Gray; Adv. & Graphics: Muzi Nkabinde; Layout & Graphics: Mary Greer.
 Label: (Owned) Black Fire, Cosmic Fire; (distributed) Atumpan.
 Blackjack Recs., PO Box 3367, Hollywood, Calif. 90028. Tel: (213) 761-9679. Mng. Dir.: Jeff Oxman, Dir.: Carl Todd.
 Label: (Owned) Blackjack; (distributed) Blackdisc.
 Int'l rep.: UK (Contempo, Sun-Pacific).
 Black Label, see HSE.
 Black Sant (Italy), see Rounder.
 Black Treasure, see McKinnon.
 Eubie Blake Music Rec'g, 284 A Stuyvesant Ave., Brooklyn, N.Y. 11221. Tel: (212) 574-8511.
 Int'l rep.: Canada (Coda), Japan (Shinsee).
 Blarney Castle, see Avoca.
 Blind Pig Recs., 208 S. First St., Ann Arbor, Mich. 48103. Tel: (313) 428-7216. Prod'n: Jerry Del Giudice. (Distributed by Flying Fish)
 Branches: El Cerrito, Calif., 3409 Santa Clara. Zip: 94530. Tel: (415) 526-0373. Promo. Dir.: Edward Chmielewski—Chicago, Ill., 1713 N. Austin. Zip: 60639. Tel: (312) 745-0760. Sales Rep.: Michael Del Giudice.
 Bloodleaf, see Olivia.
 Blue Ash, see Kare.
 Bluebird, see RCA.
 Blue Candle, see TK.
 Blue Canyon Recs., 701 Fawn Dr., San Anselmo, Calif. 94960. Tel: (415) 457-1199. Pres.: Jim Terr.
 Blue Diamond Co., Box 102C, Chubbuck Rd., Canonsburg, Pa. 15317. Tel: (412) 746-2540. Pres.: Joe Diamond; VP: Cheryl Diamond; Gen. Mgr.: Jerry Walker.
 Blue Dove Recs., 11526 Burbank Blvd., North Hollywood, Calif. 91601. Tel: (213) 761-8888. Pres.: Phillip Mora; Exec. VP: Jill Mather; VP: Oland Joseph Dupuis; Promo. Dir.: Cecelia Gamboa; Promo.: Joe Welch; A&R: J.A. Gamboa.
 Blue Flame, see CJ.
 Blue Goose, see Yellow Bee.
 Blue Horizon, see Sire.
 Blue Island Recs., 1446 N. Martel, Suite 3, Los Angeles, Calif. 90046. Tel: (213) 851-3161. Pres.: Bob Gilbert; VP: Bob Fleming.
 Label: (Owned) Blue Island, Bob, Rock Island.
 Blue Mark, see QCA.
 Blue Note, see EMI America/Liberty & Capitol.
 Blue River Recs., 1741 N. Ivar, Suite 210, Hollywood, Calif. 90028. Tel: (213) 463-7661.
 Label: (Owned) Musi-Que, Musi-Que Contemporary, Solo Plus.
 Blues Classics, see Arhoolie.
 Blue Sky Recs. Inc., 745 Fifth Ave., Suite 1803, New York, N.Y. 10022. Tel: (212) 751-3400. (Distributed by CBS).
 Blues Spectrum, see Ala Ent's.
 Blues Unlimited, see Master-Talk.
 Blue Thumb, see MCA.
 The Boardwalk Entertainment Co., 9884 Santa Monica Blvd., Beverly Hills, Calif. 90212. Tel: (213) 550-6363. Cable: BOARDWALK. Pres.: Neil Borgart; VP Bus. Affairs & Finance: David Shein; VP Promo.: Scott Kranzberg; VP A&R/Publ'g & Int'l: Gary Le Me; VP Pub. & Artist Development: Roberta Shopp; VP Creative Serv's: Ellen Wolff; Controller: Tony D'Anna; Adm. Dir. & Int'l Servs. Co-ord.: Stan Lenarsky.
 Branch: New York, N.Y., 200 W. 58 St. Zip: 10019. Tel: (212) 765-5103. Cable: BOARDWALK. Exec. VP: Irv Biegel; VP East Coast Promo.: Ruben Rodriguez.
 Int'l rep.: France (Vogue), Germany (Bellaphon), Italy (Durium), Netherlands (VIP), Scandinavia (Polar in Sweden), South Africa (Gallo); rest of world (CBS Recs. Int'l in USA).
 Boat Recs., PO Box 3362, Madison, Wis. 53704. Tel: (608) 255-7621. Pres.: Bob Bartel.
 Bob, see Blue Island & Pop Record Research.
 Boddie Rec. Mfg. & Rec'g Inc., 12202 Union Ave., Cleveland, Ohio 44105. Tel: (216) 752-3440. Pres.: Thomas Boddie; VP: Louise Boddie; A&R: Gerald Baxter; Sales Mgr.: Dennis Boddie.
 Label: (Owned) Bounty, Carib, Luau, Soul Mine.
 Bold, see TK.
 Bolivia Recs., PO Box 1304, 1219 Kerlin Ave., Brewton, Ala. 36426. Tel: (205) 867-2228. Pres.: Roy Edwards; VP: Mike Tracy; A&R/Promo.: Gus Grice; Sales Mgr.: Bobbie Roberson.
 Label: (Owned) Known Artist.
 Bollman Int'l Recs., PO Box 28553, Dallas, Tex. 75228. Tel: (214) 263-8798. Contact: B.L. Bollman.
 Label: (Owned) BI, Gospel City.
 Bomba Roja, see Record Guild.
 Bomb Recs. Inc., 2702 San Fernando Rd., Los Angeles, Calif. 90065. Tel: (213) 227-4141. Pres.: Greg Shaw; Sales Dir.: Bo Clifford; Pub. Dir.: Paul Grant; Promo. Dir.: Rich Schmidt.
 Label: (Owned) Bomb, Quark; (distributed) Backlash, Mao, Martian
 Int'l rep.: Australia (Phantom, Rocking Horse), Canada (Almada, Bomb), Finland (Poko), France (Mogher), Hong Kong (Musc Week), Mexico (Mursart), Norway (Sonet), Sweden (Sonet), UK (Stage One).
 Bonanza, see General Music in Tex.
 Bonfire, see Jay Jay.
 Bonnel, see Country Stream.
 Booths, see Katie the Great.
 Boot Master Concert, see Boot Recs.
 Boot Recs. Inc., PO Box 120478, Nashville, Tenn. 37212. Pres.: Jury Krytiuk; VP: Tom C. Connors; Sales: Peter Krytiuk; Promo.: Sharon Kolbuch. (Distributed by Shanachie)
 Home office: Canada.
 Label: (Owned) Boot, Boot Master Concert, Cynda, Generation, (distributed) JMI.
 Boppin' Belle, see Rollin' Rock.
 Borinquen (Disco) Inc., GPO Box 4785, San Juan, P.R. 00936. Pres.: Dano Gonzalez; VP: Benito Valdes; Promo. Mgr.: Ana Santos Gonzalez; Sales Mgr.: Jorge L. Matias.
 Borrowed, see Column Dne.
 Both Sides Rec. Inc., 1730 E. 24 St., Cleveland, Ohio 44114. Pres.: Richard Little.
 Bounty, see Boddie.
 Bouquet-Drchid Ent's., PO Box 4220, Shreveport, La. 71104. Tel: (318) 686-7362. Pres.: Bill Bohannon.
 Bourne Co., 1212 Ave. of the Americas, New York, N.Y. 10036. Tel: (212) 575-1800. Cable: BOURNEMUS. Pres.: Bonnie Bourne.
 Label: (Owned) Murbo.
 Bowman Rec'g & Prod'n Co., 1530 Dunwoody Village Pkwy., Suite 201, Atlanta, Ga. 30338. Tel: (404) 394-7122. Pres.: Hugh E. Bowman II; Dns Mgr. & Disco Contact: Hugh E. Bowman III.
 Label: Baby Grand.
 Boyd Recs., 2609 NW 36 St., Oklahoma City, Okla. 73112. Tel: (405) 942-0462. Pres.: Bobby Boyd. (Also see Album Globe)
 Label: (Owned) Boyd, Saguro.
 Boyfriends, see Frank Evans.
 Branch Int'l Recs., PO Box 31819, Dallas, Tex. 75231. Tel: (214) 750-0720. Owner: Bart Barton; A&R: Mike Anthony. (Also see Sunshine Country & Yatahey)
 Brand X, see Soundwaves.
 Brand-X, see Svallt.
 Brandywine Recs., PO Box 413, Durham, N.H. 03824. Tel: (603) 749-2811. VP's: Richard R. & Ronald B. Shaw
 Brasilia Recs. & Tapes Corp., 29 W. 38 St., New York, N.Y. 10018. Tel: (212) 354-5613. Telex: 666794. Pres.: Herbert Csasznik; Nat'l Sales Mgr.: Chns Scott.
 Label: (Owned) Brasilia, Brass; (distributed) AMC, Beverly, Building, Copacabana, EMI/Odeon, Fontana, Discos Marcus Pereira, Philips, Phonogram, Polydor, PolyGram, RCA, RGE/Fernata, Sabia, Som, Vision, WEA (all Brazil); Chaz Ro. Emergency, Roy B.
 Brass, see Brasilia.
 Bread 'n Honey, PO Box 3391, Ventura, Calif. 93006. Tel: (805) 644-7618. Exec. Prod'r: Mark Craig.
 Breeze, see Hartsong.
 Briar, see Sierra.
 Briarhead, see Sea Cruise.
 Bridge, see Chapel/Bridge.
 Bright Orange, see Cadet Recs.
 Bristol, see Moonstone.
 Broadside, see Folkways.
 Broadway Baby, see Take Home Tunes!
 Broadway/Hollywood, see Take Home Tunes!
 Broadway Intermision, see Old Homestead.
 Broken, see Clay Pigeon.
 Bronjo, see Met Richmond.
 Bronjo Saurus, see Grimson Dynasty.
 Bronze, see Chrysalis.
 Brooklyn Country Recs., 150 E. 39 St., Suite 1705, New York, N.Y. 10016. Tel: (212) 889-3754. Pres.: Valerie Jay; VP: Robert M. Frank; Gen. Mgr. & Promo.: Regina Kay.
 Brotherhood, see SIPRA.
 Brother Recs. Inc., 10880 Wilshire Blvd., Suite 306, Los Angeles, Calif. 90024. Tel: (213) 475-0361. Exec. VP: Jerry Schilling.
 Bruboon, see Gwen.
 Bruno, see Acropole.
 Bruno-Dean Ent's., 46 Cummings Point Rd., Stamford, Conn. 06929. Tel: (203) 348-1312. (TV merchandiser)
 Brunswick Rec. Corp., 1995 Broadway, New York, N.Y. 10023. Tel: (212) 496-0700. Bd. Chm.: Nat' Tarнопol; Pres.: Jerry Kenney; Exec. VP: Raymond Daniels.
 Branch: Chicago, Ill., 1449 S. Michigan Ave. Zip: 60605. Tel: (312) 427-0828.
 Label: (Owned) BRC, Brunswick, Dakar.
 Bryant Recs., 1 E. 42 St., New York, N.Y. 10017. Tel: (212) 682-2539.
 Buck, see Album Globe.
 Buckshot, see Jere.
 Buddha Recs. Inc., 1790 Broadway, New York, N.Y. 10019. Tel: (212) 582-6900. Pres.: Arthur Kass; VP: Chuck Walz.
 Label: Buddha; (dist. by Arista), Suflra.
 Int'l rep.: Argentina (Interdisc), Australia (RCA), Belgium (Vogue), Canada (Quality), Colombia (Sonolux), Denmark (Hede Nielsen), Finland (Discophon), France (Vogue), Germany (Teldec), Greece (Minos Matsas), Hong Kong (Pacific), Italy (Carosello), Luxembourg (Vogue in Belgium), Netherlands (Inelco, K-Itel), New Zealand (RCA), Norway (Disco), Peru (FTA), Portugal (Nova), Spain (RCA), Sweden (Electra), Switzerland (Teldec in Germany), UK (Pye), Venezuela (Palacio de la Musica).
 Building (Brazil), see Brasilia.
 Bulldog Recs. Ltd., 50 E. 42 St., Suite 401, New York, N.Y. 10017. Tel: (212) 687-2299. Pres.: Jeffrey S. Kruger; VP's: Louis Zimman, Howard Kruger; VP Int'l Affairs: Leslie Lewis. (Also see Quicksilver)
 Home office: England.
 Label: (Owned) Bulldog, Ember, Ember Int'l, Great Voices of the Century.
 Int'l rep.: Argentina (Sicamericana), Belgium (Vogue), Brazil (Som), Canada (Almada), Costa Rica (Lyra), Czechoslovakia (Opus), Denmark (EMI), Finland (EMI), Germany (Teldec), Israel (CBS), Italy (Durium), Kenya (AIT), Netherlands (Inelco), New Zealand (Music World), Nigeria (Phonogram), Norway (EMI), Philippines (Disco Corp.), South Africa (David Gresham), Spain (Discophon), Sweden (EMI), Uruguay (Palacio de la Musica), Venezuela (Palacio de la Musica).
 Bullet, see Bang.
 Bullfrog, see Advent.
 Burdette, see First American.
 Burlap, see Sea Cruise.
 Busch Country Prod'ns Co., 1002 W. Busch Blvd., Tampa, Fla. 33612. Tel: (813) 935-6289. Owner: Randall Bethencourt; Promo. & Pub.: Ruth Dozier; A&R: Joe Bethencourt, Cheryl Peacock.
 Buttermilk Recs., 1310 Tulane, Houston, Tex. 77008. Tel: (713) 864-0705. Owner: Charles Bickley; Promo. Mgr.: Brenda Ray; A&R: Trent Burns.
 Label: (Owned) Buttermilk, Flatrock; (distributed) Fair Retail, Hamilton St., Krayola, Rinconada.
 Int'l rep.: Germany (Bear Family), Japan (Tambourne), UK (Making Waves).
 C B O Recs. Inc., 2029 Century Park E., Suite 3720, Los Angeles, Calif. 90067. Tel: (213) 557-1160. TWX: (910) 490-1662. Pres.: Thomas A. White.
 Int'l branch: Italy.
 Int'l rep.: Asia, Japan & the Pacific (RYC in Japan); Austria, Germany & Switzerland (Telefunken-Decca in Germany); Central & South America (CBS in Argentina); Italy (EMI); Scandinavia (Sonet in Sweden); Spain (CBS); Canada, USA & Puerto Rico—Latin Market only (CBS Int'l in Coral Gables, Fla.).
 C B S Masterworks, see CBS Recs.
 C B S Recs., 51 W. 52 St., New York, N.Y. 10019. Tel: (212) 975-4321. Cable: COLRECORD. CBS Recs. Group. Pres.: Walter R. Yetnikoff; Deputy Pres. & Chief Operating Officer: M. Richard Asher; Sr. VP Finance & Ad-

C

min.: Seymour Gartenberg; VP Press & Public Affairs: Robert Altschuler; VP Admin. & Personnel: Frank Calamita; VP Admin.: Caroline Moore; VP Finance: William Fox; VP Mktg. Creative Opns.: Bob Jamieson; VP/Gen. Mgr. Masterworks: Joe Dash; CBS Recs. Div.: Pres.: M. Richard Asher; Exec. VP: Walter L. Dean, Sr. VP & Gen. Mktg.: Paul Smith; Sr. VP Opns. Mfg.: Samuel Burger; Sr. VP Opns. Mktg.: Calvin Roberts; VP Adv. Planning: Linda Barton; VP Pkg. Art & Design: John Berg; VP Bus. Affairs: Marvin Cohn; VP Mktg./Southwest: Jack Chase; VP Customer Financial Relations: Eugene P. Friedman; VP Finance & Admin.: William Fox; VP Mktg. Planning: Joan Griewank; VP Planning & Diversification: Stanley J. Kavan; VP Opns. Admin.: Floyd Kershaw; VP Nat'l Accounts Mktg.: John Kotke; VP Adv. & Creative Servs.: Arnold Levine; VP Mktg.: Mike Martonovich; VP Mktg./Northeastern Region: Ron Piccolo; VP Mktg. Admin.: John F. Ryan; VP Mktg. Servs.: Howard Schwartz; VP & Gen. Mgr. Div. Affairs: LeBaron Taylor; VP Mktg./Midwestern Region: Don Van Gorp; VP Press & Public Information: Wm Wilford; Columbia Recs.: Sr. VP & Gen. Mgr.: Al Teller; VP Columbia Promo: Stan Monteiro; VP Prod. Development: Arma Andon; VP Press & Public Information: Hope Antman; VP Progressive & Jazz Music A&R: George Butler; VP Black Music & Jazz Promo: Vernon Slaughter; VP Talent Acquisition/East Coast: Don DeVito; VP A&R: Michael H. Eichner; VP Contemporary Music A&R/East Coast: Gregg Geller; VP Nat'l Promo.: Ed Hynes; VP Mktg.: Joe Mansfield; VP Columbia Rec. Prod'n's: Thomas Van Gessel; VP Columbia Special Prods.: Albert E. Shulman; Epic/Portrait/Associated Labels: Sr. VP & Gen. Mgr.: Don Dempsey; VP Black Music & Jazz Promo.: Paris Eley; VP Press & Public Information: Susan Blond; VP Artist Development: Al DeMarino; VP Promo.: Al Gurewitz; VP Mktg.: Ron McCarrel; VP Epic A&R: Lennie Petze; VP/Gen. Mgr. CBS Assoc'd Labels: Tony Martell; CBS Video Ent's. Div.: Pres.: Cy Leslie; VP Bus. Admin.: Mickey Hyman; VP Finance: Ted Sullivan; VP Programming: Ned Kandel.

C Y S, see Don D. Sheets
Cabbage, see Bay Recs.
Cable Car, see Grassroots.
Cactus, see Jim Hall.
Cadence Blues, see Cadence Jazz.
Cadence Jazz Recs., Cadence Bldg., Redwood, N.Y. 13679. Tel: (315) 287-2852. Pres.: Robert D. Rusch; Promo.: Dave Bernstein; Sales: Larry Raye; Bus. Mgr.: Susan Miller. Labels: (Owned) Cadence Blues, Cadence Jazz.
Cadet Polka Recs., Box 36, Burnett, Wis. 53922. Tel: (414) 689-2211/2215/2320. Pres.: Don Peachey.
Cadet Recs. Inc., 5810 S. Normandie Ave., Los Angeles, Calif. 90044. Tel: (213) 753-5121. Pres.: Jules Bihari; Opns. Dir.: Donald Macmillan. Labels: (Owned) Bright Orange, Crown, Kent, Modern, Mother Goose, Robin Hood, United.
Caedmon/Arabesque, 1995 Broadway, New York, N.Y. 10023. Tel: (212) 580-3400. Telex: 668478. Pres.: Carol Haubert; Mktg. Dir.: Robert Knox; Exec. Prod'r: Ward Botsford; Prod'n Mgr.: Robert Gavin. Labels: (Owned) Arabesque, Caedmon, Soundbook, Spoken Word Classics; (distributed) Jazz Vault. Int'l repa.: Australia (Discurso, L&S), Canada (D.C. Heath), South Africa (Trutone), UK (Teakfield).
Caex, see Triangle.
Cafe Joli, see Daytwo.
Cajun Classics, see Master-Trak.
Calgar Recs., 853 N. 23 St., Milwaukee, Wis. 53233. Tel: (414) 344-7259. Promo./Pub. Dir.: Calvin Monegar; A&R, Prod'n & Artist Mgmt. Dir.: Gerald Armstead.
Caico, see Walkner Ent's. & Album Globe.
Caliente, see Caytronics.
California Int'l Rec. & Video Works, c/o Nicoletti Music Co. Inc., PO Box 2818, Newport Beach, Calif. 92661. Tel: (714) 497-3758. Pres.: Joseph Nicoletti; VP & Gen. Mgr.: Cheryl Lee Gammon.
California Mud Slide, see Crimson Dynasty.
California Rockability, see Rolin' Rock.
Caliope, see Festival.
Calumet, see San-Lyn.
Calvary Recs. Inc., 142 Eighth Ave. N., Nashville, Tenn. 37203. Tel: (615) 244-8800. Pres.: N.S. Parkerson Jr.; Mgr.: Phyllis Bradhurst. Labels: (Owned) Calvary, Clarion, Life Stream, Premier.
Cambridge Recs. Inc., 125 Irving St., Framingham, Mass. 01701. Tel: (617) 879-2282.
Camden Soul, see Rob-Lee.
Camera Tokyo (Japan), see Outstanding.
Camerica Recs., 489 Fifth Ave., New York, N.Y. 10017. Tel: (212) 682-8400. Telex: 236920. Pres.: Vittorio Benedetto.
Cammeron, see Star Fox.
Ray Campi, see Rolin' Rock.
Campus Grads, see Disc Disk.
Canaan, see Word.
Canadian American, see Dawn.
Canary-Yellow Bird Recs. Co., 1704 Wagner Heights Rd., Stockton, Calif. 95209. Owner: Earl Miles.
Candide, see Moss.
Candy Apple, see World Sound.
Candy Recs., 2716 Springlake Court, Irving, Tex. 75060. Tel: (214) 259-4032. Owner & Gen. Mgr.: Kenny Wayne Hagler. Labels: (Owned) Candy, Holli, Lil' Possum, Sweet Tooth.
Candy, Pa., see Jeree.
Can Scor, see R&R.
Canyon Recs. Inc., 4143 N. 16 St., Phoenix, Ariz. 85016. Tel: (602) 266-4823/7835. Pres.: Raymond A. Boley.
Canyon Recs., 2029 Century Park E., Suite 3930, Los Angeles, Calif. 90067. Tel: (213) 553-5828. Gen. Mgr.: Dan H. Yoshida. Home office: Japan.
Cap, see Cha-Cha.
Capetown Recs., 772 S. Kings Hwy., Cape Girardeau, Mo. 63701. Tel: (314) 335-0100.
Capital Star Artist Ent's. Inc., 1159 Jay St., Rochester, N.Y. 14611. Tel: (716) 328-5565. Pres.: Don Bailes; VP & Sales: Tony Powlowski; Mgr.: Don Redanz. Branch: Williamsport, Pa., 836 Franklin St. Zip: 17702. Tel: (717) 323-6951. Mgr.: Pat Craven. Labels: (Owned) Alamo, Capital Star Artist.
Capitol Recs. Inc., 1750 N. Vine St., Hollywood, Calif. 90028. Tel: (213) 462-6252. Labels: CAPRECORDS. Telex: 674051. Bd. Chm. & Chief Exec. Officer: Bhaskar Menon; Pres.: Don Zimmermann; VP Mktg.: Dennis White; VP A&R: Rupert Perry; VP Creative Servs.: Dan Davis; VP Promo.: Bruce Wendell; VP Int'l: Helmut Feist; VP Bus. Affairs: Robert Young; Div. VP: Black Music A&R: Varnell Johnson; Mktg. & Adv. Dir.: Randall Davis; Talent Acquisition Dir.: Bruce E. Garfield. Branches: New York, N.Y., 1370 Ave. of the Americas. Zip: 10019. Tel: (212) 757-7470. Exec.: Ira Derfer; East Coast Talent Acquisition Dir.: Mitchell Schoenbaum; East Coast Press & Artist Relations Mgr.: Maureen O'Connor; A&R: Robert Currie, Theodore Currier-Nashville, Tenn., 29 Music Square E. Zip: 37203. Tel: (615) 244-7770. Div. VP: Lynn Shults; Nat'l Country Promo. Dir.: Garri McDowell. Int'l branch: Canada. Distribution centers & district sales offices: See Record & Tape Wholesalers section. Labels: Angel, Blue Note, Capitol, EMI, EMI America, Gold Coast, Harvest, M&S, SRI (Spector Recs. Int'l), Seraphim, Sunbird. Int'l repa.: Argentina (EMI), Australia (EMI), Austria (EMI), Barbados (West Indies Recs.), Belgium (EMI), Bolivia (Discolandia), Brazil (Capitol), Chile (EMI), Colombia (CBS), Czechoslovakia (Aria), Denmark (EMI), Dominican Republic (Jublo Tonos), East Germany (Deutsche Schallplatten), Ecuador (IFESA), Egypt (Sono Cairo), Finland (EMI), France (Pathe Marconi-EMI, Sonopresse), Germany (EMI Electrola), Greece (Columbia-EMI), Guatemala (Dideca), Hong Kong (EMI), Hungary (Kultura), India (Gramophone), Ireland (EMI), Italy (EMI), Japan (Toshiba-EMI; Liberty only-King); Korea (Oasis), Malaysia (EMI), Mexico (EMI-Capitol), Netherlands (EMI), New Zealand (EMI), Nigeria (EMI), Norway (EMI), Pakistan (EMI), Peru (IEMPSA), Philippines (Dyna), Portugal (Valentim de Carvalho), Singapore (EMI), South Africa (EMI), Spain (EMI-Odeon), Sweden (EMI), Switzerland (EMI), Taiwan (Four Seas), Thailand (EMI), Turkey (Grunberg Tricaret), UK (EMI), Uruguay (Ricardo & Rodolfo Gioscia), Venezuela (Sonograica; Liberty only-Palacio de la Musica), Yugoslav (Jugoton), Zambia (Teal). Cap-Drion, see Cartoon. Caprice Recs. Inc., 907 Main St., Nashville, Tenn. 37206. Tel: (615) 226-0724. Labels: (Owned) Caprice, Charic, Checkmate, Palace, Relco, Sound-mate.

Capricorn Recs. Inc., 561 Cotton Ave., Macon, Ga. 31201. Tel: (912) 745-8511.
Captain, see Sonic Arts.
Cardinal, N.Y., see Vanguard.
Cardinal, Va., see Rictown.
Carib Recs., 303 W. 42 St., Suite 1000, New York, N.Y. 10036. Tel: (212) 581-3766. Pres.: John Bernard. Labels: Carib, Cookhill, Isle of Spice.
Caribi, see Boddie.
Caribou, see CBS.
Carino, see Caytronics.
Carnaval, see Alambra.
Carolina Recs., 1605 Park Dr., Raleigh, N.C. 27605. Tel: (919) 833-6694. Owner: Ethel L. Casey; Mgr.: Walker L. Casey.
Carol Rec. Co., 1076 River Rd., Hinckley, Ohio 44233. Tel: (216) 278-4440. (Distributed by Glenn Prod'n's)
Carousel Recs. Inc., 12734 N. Crescent Heights Blvd., Los Angeles, Calif. 90046. Tel: (213) 650-6500. Pres. & A&R: Stuart Lanis; VP Finance: Adam Bank; VP Creative Servs.: Colman Bank; VP Sales & Mktg.: Nathan Bank; VP Pub. Mkt. Canyon; VP Adv.: James Scott; VP Promo.: Diann Joy.
Carne, see James Hendrix.
Cartoon Recs., c/o Enchanted Door Inc., PO Box 1235, New Rochelle, N.Y. 10802. Tel: (914) 834-5676. Pres.: Joe Messina; VP A&R: Dan Molino; Special Projects: Chuck McEvily; VP Int'l Mktg.: David Saperstein. Labels: (Owned) Cap-Orion, Cartoon.
Carwar, see Warren.
Carwin Country Recs. & Tapes, 13357 Lorain Ave., Cleveland, Ohio 44111. Tel: (216) 476-2695.
Casablanca, see PolyGram.
Casa Frago Inc., PO Box 2774, San Juan, P.R. 00903. Tel: (809) 725-8842. Labels: (Owned) Frago.
Casa Grande Recs./Don-Mar Recs./Shawmut Recs., PO Box 113, Woburn, Mass. 01801. Tel: (617) 933-1474. Gen. Mgr.: Frank P. Pappalardo; A&R & Prod'n Mgr.: Frank Paul; PR: Joe Paul. Labels: (Owned) Casa Grande.
Cascade Mountain Recs., 18039 Crenshaw Blvd., Suite 300, Torrance, Calif. 90504. Tel: (213) 538-5476. Pres.: William J. Wickline. Branch: Fox Island, Wash., 588 North Shore Blvd. Zip: 98333. Tel: (206) 549-2468. VP A&R: Robert Wickline; VP Promo.: Richard Wickline.
Buzz Cason Prod'n's, 2804 Azalea Pl., Nashville, Tenn. 37204. Tel: (615) 383-8682. Pres. & Prod'r: Buzz Cason. (Also see Album Globe) Labels: (Owned) Berry Hill.
Cassandra Recs., 2027 Parker St., Berkeley, Calif. 94704. Tel: (415) 843-2365. Pres.: Nancy Schimmel; Mgr.: Ruth Burnstein.
Casset Major, see Steady.
Castalia Recs., PO Box 11516, Milwaukee, Wis. 53211. Tel: (414) 272-0963. Pres. & A&R: Jim Spencer; Promo. & PR: Carol Prosser; Project Co-ord. & Art Direction: E.T. Caldwell. Labels: (Owned) A Major Label, Balloon, Castalia, Fair Wind, Thoth.
Castle Music Inc., Box 7574, Tulsa 74105; 141 & Hwy. 75, Glenpool, Okla. 74033. Tel: (918) 299-1224. Pres./Prod'n Mgr.: Benjamin P. Ferrell; VP: Doyle Harrison; Sec'y-Treas.: Nick Kangles; Studio Mgr.: J.E. Everitt; Comp/roller/Sec'y: Dina Kangles. Labels: (Owned) Castle, House of Kings.
Castle, N.J., see Rob-Lee.
Castle, Tenn., see Album Globe.
Cat, see TK.
Catalyst, see Vee Jay.
Catyon Ent's., Box 367, Mayfield Rd., Orwell, Ohio 44076. Tel: (216) 437-8422.
Caytronics Rec. Corp., 401 Fifth Ave., New York, N.Y. 10016. Tel: (212) 889-0044. Pres.: Joe Cayre; VP: Stan Cayre; VP Latin Opns. & Sales Mgr.: Lee Schapiro; Nat'l Pub. & Promo. Dir.: Cesar Ortiz. Distribution branches: See Record & Tape Wholesalers section. Labels: Arcano, Caliente, Carino, Caytronics, Pronto, RCA (Mexico), RCA/Camden (Mexico).
Celestial Harmonies (div. of Mayflower Music Corp.), 605 Ridgefield Rd., Wilton, Conn. 06897. Tel: (203) 762-0558. Telex: 220883. Pres.: Eckart Rahn; VP: Ruby McFarland. Labels: (Owned) Celestial Harmonies, Kuckuck; (distributed) Loft, Wergo, Wind.
Celestial Recs. Releasing Corp. 229 Las Vegas Blvd. S., Las Vegas, Nev. 89101. Pres. & Treas.: Arthur H. Benson; Sec'y: Leslie Sandhofer; A&R: William "Hy" Seaman; Jimmy Haskell, John Kraus, Dalton Priddy; Promo.: Howard Wormser.
Nat'l sales office: HOLLYWOOD, CALIF., 1560 N. La Brea. Zip: 90028. Tel: (213) 467-7644. Labels: (Owned) Celestial, Creative. Int'l repa.: Denmark, Finland, Netherlands, Norway, Sweden & Switzerland (all Nordisk Copyright Bureau), France (Michel Meyers).
Cenpro, see Century Prod'n's.
Centaur Recs., 82 Aldine St., Rochester, N.Y. 14619. Tel: (716) 328-4649. Pres.: Martha B. Pitoni; A&R/Prod'r: Vm Pitoni; Nat'l Sales Mgr.: Marvin Steffy; Adv. & Promos.: Dennis Majzak. Labels: (Owned) Centaur, Jingles, Sea-King. Int'l repa.: Canada (Quality), New Zealand (Peak).
Center, see Biograph.
Center City, see McKinnon.
Century Artist, see Frank Evans.
Century Prod'n's Inc., 171 Washington Rd., Sayreville, N.J. 08872. Tel: (201) 238-5630. Owners: Mickey Yannich, Bob Ligotino. Labels: (Owned) Cenpro.
Century Recs., 6550 Sunset Blvd., Hollywood, Calif. 90028. Tel: (213) 464-3250. Telex: 67-7239.
Century Recs. Inc., 1429 Hawthorne St., Pittsburgh, Pa. 15201. Tel: (412) 781-4557. Pres.: Edward J. Moschetti; A&R: Gail P. Gray.
Century 21, see Solid Brass & Random Ent's.
Cetra (Italy), see Playette.
Cha-Cha Recs., 15041 Wabash Ave., South Holland, Ill. 60473. Tel: (312) 339-0307. Pres.: Donald L. DeLucia; VP's: Don & Bob DeLucia. Labels: (Owned) Cap, Cha-Cha.
Chain Recs., PO Box 121091, Nashville, Tenn. 37212. VP & A&R Dir.: Beverly Jackson.
Chalet Recs./Frederick's Prod'n's, 1375 Beverly Estate Dr., Beerly Hills, Calif. 90210. Tel: (213) 550-7455. Telex: 194642. Pres. & Mktg. Mgr.: Jean-Claude Friederich. Int'l branch: Switzerland. Int'l repa.: Benelus (Trema in France), France (Trema), Greece (CBS), Hong Kong (Victor in Japan), Italy (Carosello), Japan (Victory), Malaysia (Victor in Japan), Philippines (Victor in Japan), Scandinavia (RCA/Electra in Sweden), Singapore (Victor in Japan), South Africa (Gramophone), South America (RCA in USA), Spain (CBS), Switzerland (Trema in France), Taiwan (Victor in Japan).
Chaffont Recs. Inc., 2427 Hawthorne Dr., Montgomery, Ala. 36111. Tel:

(213) 652-7280. Pres.: Stan Kenton; Mktg. Dir.: Earl Horwitz; Prod'n Mgr.: Bill Stiffeld; Pub. & Adv. Dir.: Audrey Coke.
 Credence, see PPL.
 Credo, see Pathways of Sound.
 Creed, see Nashboro.
 Crescendo Rec. Co., 21-31 29 Ave., Astoria, N.Y. 11012. Tel: (212) 278-7832. Pres.: Guido Scgambellone; Prof. Mgr.: Louis Cerruti; Sales Mgr.: William Neal; Promo. Mgr.: Guy Simonnet.
 Crescent Recs. Inc., 324 S. Crescent Dr., Beverly Hills, Calif. 90212. Tel: (213) 553-8024. Pres.: James R. Halper; Gen. Mgr./Country Promo.: Ed die Teichmann.
 Crescent, Tenn., see International Mktg. & Mgmt.
 Crest, see Golden Crest.
 Cricket, see Sunny Day.
 Crimson Dynasty Rec. Corp., PO Box 271, Cedar & West Ave., Jenkintown, Pa. 19046. Tel: (215) 757-8022. Pres.: Stan Peahota; Exec. VP: Alan Meier; VP: Frank Mulvenna; Sec'y-Treas.: Kathy Peahota; A&R Dir.: Destiny Knight.
 Labels: (Owned) Aurora Borealis, Avalanche, Bronto Sauras, California Mud Slide, Crimson Dynasty, Crystal Blue Flame, Debtors Prison, Dragon, Dungeon, Dynasty, Earth Quake, Earth Tremmor, Enchanted Knight, Flame, Golden Hawk, Hologram, Hurricane, Knight, Lightning, Misty Blue, Operation Golden Hawk, Pottergeist, Sinbad, Thunder Lizzard, Tornado, Typhoon, Volcano, Volcanus, Zansabar.
 Criollo, see Latin Percussion.
 Crissy, see Quinto.
 Criterion Music Corp., 6124 Selma, Hollywood, Calif. 90028. Tel: (213) 469-2296. Pres.: M.H. Golden; A&R Mgr.: Bo Golden.
 Labels: (Owned) Granite Music Corp., Palm, Ro Tahiti.
 Int'l rep.: Tahiti (ETS).
 Croaker Recs. Inc., 8238 Apricot St., New Orleans, La. 70118. Tel: (504) 865-9210.
 Eddie Crook Co., PO Box 213, Hendersonville, Tenn. 37075. Tel: (615) 822-1360. Owner: Eddie Crook.
 Labels: (Owned) ECP, Harvest, Morning Star.
 Crossfire, see Dakridge.
 Cross-Over Ents. Inc., 880 NE 71 St., Miami, Fla. 33138. Tel: (305) 759-1405. Pres.: Carlos Oliva; Treas.: Jeanne Giordano; Ass't Prod'r: Georgina Vidal; Promo. Mgr.: Tony Parodi.
 Label: (Owned) Common Cause.
 Crossroad Recs. Inc., PO Box 5422, University Sta., Zip: 98105; 3727 Seattle First Nat'l Bank Bldg., Seattle, Wash. 98154. Tel: (206) 623-0110, 632-3021. Pres.: Vivian T. Williams; VP A&R: Paul Speer; VP Sales: Edward Schacher; VP: Philip L. Williams.
 Crown, see Cadet Recs.
 Crown Point Recs., 7934 Mission Center Court, Suite B, San Diego, Calif. 92108. Tel: (714) 296-9641. Pres.: Robert Racouillat.
 Crow Prod'n, 522 Shore Rd., L.I.K., Long Beach, N.Y. 11561. Tel: (516) 889-0244. Pres./A&R: Gary Leider.
 Cruise, see Art.
 Crusader, see MCA.
 Crystal Blue Flame, see Crimson Dynasty.
 Crystal Bridge, see Album Globe.
 Crystal Clear Recs. Inc., PO Box 3864, San Francisco, Calif. 94119. Tel: (415) 824-0225. Cable: CRYSTAL. Telex: 278020. Pres. & A&R: Edward S. Wolenjak; Mktg. & Sales: Dich Bonaiuto, Larry Marcus.
 Labels: (Owned) Crystal Clear, Ultragroove.
 Crystal Rec. Co., 2235 Willida Ave., Sedro Woolley, Wash. 98284. Tel: (206) 856-4779. Pres. & A&R: Peter Christ; Exec. Ass't: Carol Canning; Dist'n Mgr.: George Fowler; Adv. Mgr.: Sam Mundy.
 Labels: (Owned) Avant, Crystal; (distributed) WIM.
 Int'l rep.: Canada (Trend), Netherlands (Benson).
 Cub, see Mother Cleo.
 Cummings, see Dragon Int'l.
 Cumpari Recs., Box 3731, Hollywood, Calif. 90028. Tel: (213) 876-1097. Pres. & A&R: Tom Bonetti.
 Cupid, see Sound Inc.
 Curb, see CBS, Elektra & Warner Bros.
 Curricane Recs. Co., 1520 Briggs, Suite 3C, Daly City, Calif. 94015. Tel: (415) 756-6510. Pres.: Curry J. Johnson Jr.; VP: Mary Ann Johnson; A&R: Anthony Gayfield; Promos.: Dale Kennedy, John Malone.
 Curtom Recs. Inc., 8910 Ridgeman NW, Dunwoody, Ga. 30338. Tel: (404) 992-6906. Pres.: Curtis Mayfield. (Distributed by Capitol)
 Custom Recs., PO Box 231, Tyler, Tex. 75710. Tel: (214) 597-2961. Mgr.: Curtis Kirk.
 Cynda, see Boot.
 Czech, see MJ.

D

d b a Recs., 875 Ave. of the Americas, Suite 1001, New York, N.Y. 10001. Tel: (212) 279-9326. Pres.: Alex Alexander; Sales Mgr.: John Holanaka; Promos. Dir.: Steve Stoff; Prod. Co-ord.: Sonia Buser.
 Int'l rep.: Argentina (RCA), Austria (TTR), Benelux (TTR), Brazil (RCA), Canada (Quantum), France (Atohl), Germany (TTR), Mexico (RCA), Switzerland (TTR), UK (Carrere), Venezuela (Lover).
 D B, see Armageddon.
 D b Recs., PO Box 1773, Decatur, Ga. 30031. Tel: (404) 289-9273. Owner: T.M. Brady.
 D C, see Velvet de Puerto Rico.
 D C Sound Ents., 6505 Sheridan Rd., Fort Worth, Tex. 76134. Tel: (817) 293-5561, 738-1951. Co-Owner & Promo.: Dorwood Rowell; Co-Owner & A&R: Stan Knowles; Gen. Mgr.: Daphne Knowles; Sales Mgr.: Carolyn Rowell.
 Labels: (Owned) DC Sound, DC Sound Country.
 D D Recs., 50 Music Square W., Nashville, Tenn. 37203. Tel: (615) 327-0571. Contacts: Dee Mullins, Frank Boggs. (Also see Professional Mktg.)
 D G (Deutsche Grammophon), see PolyGram Classics.
 D G Green Label (Germany), see Playette Corp.
 D G J Recs. Inc., PO Box 010772, Miami, Fla. 33101. Tel: (305) 576-6978. Cable: DONJDMUS. Pres. & Sales & Mktg.: Donald G. Johnson; VP: Ronald C. Johnson; VP A&R: Donn Johnson; Pub. & Adv. & Promo. Dir.: Pamela Johnson; Int'l Dir.: Armand Seva.
 Labels: (Owned) DGI, Doro, Sami; (distributed) Fonodisco, Guitarra, Oro.
 Int'l rep.: Mexico (Discos de Guitarra), Venezuela (Fonodisco).
 D G Recs., 301 Midland Ave., Port Chester, N.Y. 10573. Tel: (914) 967-4219, 937-2086.
 D J M Recs. (Dick James Music Inc.), 119 W. 57 St., Suite 400, New York, N.Y. 10019. Tel: (212) 581-3420. Cable: DICKJAMES. TWX: (710) 581-4216. Gen. Mgr.: Arthur Braun.
 D M C, see Dimitri.
 D R C I, see Discostar.
 D R G Archive, see DRG Recs.

D R G Concorde, see DRG Recs.
 D R G Recs. Inc., 200 W. 57 St., New York, N.Y. 10019. Tel: (212) 582-3040. Cable: STETRECS. TWX: (710) 581-4825. Pres.: Hugh Fordin; VP World-wide Mktg.: Rick Winter; Group Head Art. Dir.: Sibbi Chalawick; Comp-troller: Celeste O'Neill; Ass't to VP: Richard Kaminsky; Nat'l Sales Dir.: Ted Wolff; Int'l Licensing: Beth Greenberg.
 Int'l branch: England.
 Labels: (Owned) Choice Cuts, Corner Cuts, DRG, DRG Archive, DRG Concorde, Stet.
 Int'l rep.: Belgium (Flemish import), Canada (London, Trend), Finland (Polarvox), France (DAM, Lido), Italy (Ri-Fi), Japan (Sumiya, Victor), Netherlands (Agram, Oldway, Only Yesterday), Spain (Auvi, Zartos), Switzerland (Disc-imports), UK (Stage One, That's Entertainment), Venezuela (Disc-imports).
 D-Town, see Platinum Sound.
 Daisy, see Waltnr.
 Dakar, see Brunswick.
 Dallas Recs. & Tapes/Triple-J Recs./Trinity Recs. (div. of Trinity Music Inc.), PO Box 10467, Dallas, Tex. 75207. Tel: (214) 631-8828. Pres.: Jim Hilliard; VP A&R Dir.: Jim Pat Mills; VP/Promo. Dir.: Gary Young; VP/Prod'n Dir.: James Neel. (Distributed by Nationwide Sound)
 Dallas Star Recs., 9646 Ryde Rd., Dallas, Tex. 75217. Tel: (214) 286-1711. Owner/Opns. Mgr.: David A. Coffey; New Talent Dir.: David Gage.
 Branch: Nashville, Tenn., 38 Music Square E., No. 115. Zip: 37203. Tel: (615) 244-4224. Branch Mgr.: Harrison Tyner.
 Labels: (Owned) Dallas Gospel, Dallas Star.
 Dana Publ'g Co., 824 83 St., Miami Beach, Fla. 33141. Tel: (305) 865-8960. Pres.: Walter Dana; VP: Gus Dana.
 Label: (Owned) Echo.
 Dance-A-Thon Recs., 1957 Kilburn Dr., Atlanta, Ga. 30324. Tel: (404) 872-6000. Pres.: Aleck Janouiss; VP Pop A&R: Oliver Cooper; VP Classical A&R: Jean Lemonds; VP Artist Relations: Sam Stewart.
 Labels: (Owned) Dance-A-Thon, Hollanta, Hottrax, Revolver. (distributed) Glamour & Grease, Stereo Spectrum.
 Int'l rep.: Argentina (Calmes), Australia (Electric-Dance-A-Thon), Canada (Boot-Dance-A-Thon), Germany (Prom-Dance-A-Thon), UK (Emerald-Dance-A-Thon).
 dancercise, see Music Mktg.
 Dane, see Philly Jazz.
 Dani Recs. (div. of Hilton House Inc.), PO Box 315, Cleveland, Ohio 44127. Tel: (216) 429-1559. Pres.: Donald B. Catalano; VP & Gen. Mgr.: Danielle Catalano; Pop A&R Dir.: Samuel Magee; Classical A&R Dir.: Herbert Jugt; Sales & Mktg. Mgr.: Saul Telgitz; Pub. Dir.: Marian Driscoll; Adv. Dir.: Dan Kelly; Promo. Dir.: David Levy.
 Dansk-Disk, see Lmberg.
 Dark Horse, see Warner Bros.
 Dark Silver Recs., 1921 Beech St., Amarillo, Tex. 79106. Tel: (806) 352-6073. Pres.: Michael Thomas; VP A&R: Dean Taylor; Promo. Dir.: Jack Randall.
 Darva Recs. (div. of MBA Prod'n), 8914 Georgian Dr., Austin, Tex. 78753. Tel: (512) 836-3201/3194. Pres.: Roy J. Montgomery; Gen. Mgr.: Shirley Montgomery; A&R: Joe Montgomery; Promo. & Mktg.: Dick Culp.
 Dash, see TK.
 Date Line Int'l Recs., 400 W. 43 St., Suite 5C, New York, N.Y. 10036. Tel: (212) 244-8148. Pres.: C. Roger Bartlett; A&R: Jane A. Eaton; Promo.: Nancy Belle Brass.
 Datone, see Mel Richmond.
 Dauphne, see Delwood in N.J.
 Dawn Prod'n, Cloud 300, Mt. Gretna, Pa. 17064. Tel: (717) 964-2222. Pres. & A&R Dir.: Joey Weiz; VP Eng.: Dave C. Smith; Exec. Prod'r: Jimmy Velvet; Assoc. Prod'r: Roy Smith.
 Labels: (Owned) Bat, Canadian American, Disc-Go, LeFevre; (distributed) Music City, Palmer, Stable.
 Dawn, N.Y., see Biograph.
 DaySpring, see World Inc.
 Daytwo Recs. Society Inc., 416 E. Hugh, Suite 4A, Tampa, Fla. 33603. Tel: (813) 244-0002. Pres.: Trenton Lewis; Co-VP & A&R: R.R. Metro; Co-VP: A.H. Smart; Pub. Co-ord. & Sales Mgr.: Ulmer Jose Avary; Sec'y: R. Roberts; Project Dir.: G. Russell Smith; Dance Music Promo. Dir.: Heider Gardner.
 Labels: (Owned) Daytwo, Metro, Providence, Russell Street, Sasal Society, VanBees, (distributed) ACI, Cafe Jul.
 Deadwood, see Jim Hall.
 Death Recs., 125 Worth St., New York, N.Y. 10013. Tel: (212) 247-0130.
 Debtors Prison, see Crimson Dynasty.
 Decco Recs. Inc., 207 Seventh St., Pittsburgh, Pa. 15222. Tel: (412) 281-3700. Pres.: Nick Cenco.
 Dee-Bee Rec'g Serv., 704 Ninth Ave. S., Myrtle Beach, S.C. 29577. Tel: (803) 448-8091. Partners: Stan Deppen Jr., Patricia M. Deppen.
 Labels: (Owned) Dee-Bee. (distributed) Eventide.
 Dee Jay, see Nationwide Sound.
 Deejay Musical Works, 1153 S. Highland Ave., Los Angeles, Calif. 90019. Tel: (213) 930-0930. Pres.: Frank Fouli.
 Deep River, see Olvin & Redwood.
 Deep Roots, see Koala & Sonrise Mercantile.
 Deep Water Recs., 12506 Edgewater Dr., Cleveland, Ohio 44107. Tel: (216) 228-2968. Pres.: Sal Scarpa.
 Dejay "Gold & Platinum" Rec. Plaques, 3010 W. Burbank Blvd., Burbank, Calif. 91505. Tel: (213) 845-0744, 849-5347. Owners: Dave & Jackie Goldstein.
 Deka, see W.C. Staley.
 Deli Platters, 445 Park Ave., 6th fl., New York, N.Y. 10022. Tel: (212) 759-7500. Teltelex: 423647. Pres.: Michael J. Lembo Jr.; Prod'n Co-ord.: Fae Horowitz; Promo.: Steve Leeds, Roger Lifeset; PR: Janis Schacht.
 De-Lite Recs., 1733 Broadway, New York, N.Y. 10019. Tel: (212) 757-6770. (Distributed by PolyGram)
 Delwood Music Co. Inc., 160 S. Leswing Ave., Saddle Brook, N.J. 07662. Tel: (201) 843-3239. Pres.: Woodrow C. Gardella; VP: Robert Gardella; Treas.: Sophie Gardella.
 Labels: (Owned) Dauphne, Delwood.
 Int'l rep.: Canada (Quality), UK (EMI).
 Delmark Recs., 4243 N. Lincoln, Chicago, Ill. 60618. Tel: (312) 528-8834. Pres.: Robert G. Koester; VP: Susan Koester; Adv. & Promo. Dir.: Steve Tomaszewski.
 Labels: (Owned) Delmark, Pearl.
 Int'l rep.: Canada (Trend), Finland (Quality), France (Black & Blue), Germany (Taxim), Italy (IRD), Japan (Tno, P-Vine Special), Sweden (Amigo), Switzerland (IRC), UK (Swift).
 Delmar, see Don D. Sheets.
 Del-Mar-Va, see Old Dominion.
 Delos Recs. Inc., 2210 Wilshire Blvd., Suite 664, Santa Monica, Calif. 90403. Tel: (213) 454-0524. Cable: DELOSDISCS. Pres.: Amelia S. Haygood; VP: Diane Gibson; Admn. Ass't: Jessica Madow; Sales Mgr./Dr.: Michael McClain.

Int'l rep.: Argentina (Arteria), Australia (PC Stereo), Canada (Trend), Germany (Bellaphon), Hong Kong (Excel), Mexico (Lubata), Netherlands (Sound Prods.), New Zealand (RTC), Norway (Mayco Agentur), Spain (Vieta), Taiwan (KHS in USA), UK (Unicom).
 Del Rio, see Marsal.
 Delta Int'l Recs. Inc., 1584 E. 31 St., Cleveland, Ohio 44114. Tel: (216) 861-7286. Pres.-Treas.: John R. Gaver; VP: Charles M. Gayer; Sec'y: Theresa Gayer.
 Delta Recs., Box 225, Nacogdoches, Tex. 75961. Tel: (713) 564-2509.
 Deluxe, see Gusto & Muse.
 Richard Delvy Ent's. Inc., 8127 Eirita Dr., Los Angeles, Calif. 90046. Tel: (213) 650-4761. Pres.: Richard Delvy; VP & Gen. Mgr.: Ingrid Geyer; VP: Ed Fournier.
 Branch: San Francisco, Calif., 480 Melrose Ave. Zip: 94127. Tel: (415) 584-0996. Branch Mgr.: Dennis Geyer.
 Demand, Fla., see Request.
 Demand, Tex., see Don Schafer.
 Demon Recs., PO Box 90698, 301 Wells Fargo, No. 28, Houston, Tex. 77090. Tel: (713) 537-9292. Pres. & Treas.: Steve King; VP & Sec'y: Steve Douglas; Promo. & Sales: Cookie Kelly; Promo.: Judy Walker, Marsha King.
 Labels: (Owned) Demon, K&S.
 Denbigh, see East Allegheny.
 Denco, see Rock-A-Nash-A-Billy.
 Denon PCM Rec'gs, see Discwasher.
 Denrich, see Wham Bam.
 Desert Morning Recs., c/o Robert B. Knox Ent's., 4148 50 St. W., Quartz Hill, Calif. 93534. Tel: (805) 943-4183. Owner, Prod'r & A&R: Robert B. Knox; Adv., Publ. & Sales: Jennie Knox.
 Desmar Music Inc., 155 Ave. of the Americas, New York, N.Y. 10013. Tel: (212) 741-1430. Pres.: Marcos Klorman; Gen. Mgr.: Frank Burton.
 Labels: (Owned) Desmar; (distributed) JPA.
 Destiny Recs., PO Box 2094, Sheffield Lake, Ohio 44054. Tel: (216) 949-6397. Owner: Robert Sellers.
 Desto, see CMS.
 Deutsche Grammophon, see PolyGram Classics.
 Deutsche Klassische, see Michele.
 Deutschmark, see Michele & Record Guild.
 Dewdrop Recs., 1324 DId Yatesville Rd., Thomaston, Ga. 30286. Tel: (404) 674-8435, 647-7995. Owner: Don Buchanan.
 Dharmas Recs. (div. of Saturn Inds.), PO Box 615, 117 W. Rockland Rd., Libertyville, Ill. 60048. Tel: (312) 362-4060. Telex: 281051.
 Diablo Rec. Co., 3518 Champlain Ave., Youngstown, Ohio 44502. Tel: (216) 755-7794. Owner, Pres. & A&R: Bill Schaffert.
 Dual Recs. Inc., PO Box 1273, Zip: 37202; 8 Music Square W., Nashville, Tenn. 37203. Tel: (615) 327-3162.
 Dial-Tone, see Eat Recs.
 Digitech, see Sine Qua Non.
 Dimension, see Am Rec.
 Dimension Six, see Sonic Arts.
 Dimitri Music Co., 7859 Bastille Pl., Mill, Md. 21144. Tel: (301) 551-7761. Owner/Pres.: Robert H. Williams; Dpns. Mgr.: Chico Palomina; A&R Dir.: R. Jose Williams.
 Labels: (Owned) DMC, Evergreen, New Directions.
 Dimsa, see Orfeon.
 Dina, see Joey.
 Dingo, see Ala Ent's.
 Dinsa, see Otao.
 Dion, see Jamie/Guyden.
 Direct Disk Labs, 16 Music Circle S., Nashville, Tenn. 37203. Tel: (615) 256-1680. Pres.: Joseph I. Overholt; Controller: James Callahan.
 Int'l rep.: Australia (PC Stereo), Brazil (Peter Comerica), Canada (Sonic Masters), France (Harmonique Diffusion), Germany (Audiodata), Hong Kong (Lee's Sound), Netherlands (AVC), Puerto Rico (Audio Specialties), Singapore (HWE), Two Plus, Sweden (Tonola), Switzerland (Panorama Int'l), Venezuela (Allum's Maracaibo).
 Direct Mktg. Group, 1266 Lincoln Ave., Suite 109, San Jose, Calif. 95125. Tel: (408) 297-9800. (TV merchandiser)
 Direkt to Disk, see Sonic Arts.
 Discapan, see Apon.
 Disc Disk/Joint Int'l Rec. Co., 176-11 Jamaica Ave., Queens, N.Y. 11432. Tel: (212) 523-0780, 526-8373. Owner/Dir.: Keith Hudson; Sales: Junior Walker; A&R: Jean Hudson; Promo.: Trevor Dyke.
 Labels: (Owned) Camp Records, Disc Disk, Joint Int'l, Oops.
 Int'l rep.: UK (Daddy Kool, Greensleeves, Jetstar).
 Disc-Go, see Dawn.
 Disco, see Discostar.
 Discocorp, PO Box 771, Berkeley 94701; 523 Coventry Rd., Kensington, Calif. 94707. Tel: (415) 524-8079. Pres.: Frederick Maroth; VP: George Marton; Sec'y-Treas.: Eric Maisel.
 Labels: (Distributed) Audax, I Grandi Interpreti, Recital, Bruno Walter Society, Western Sound Archive.
 Int'l rep.: Austria (Presser), France (Dave-Music), Germany (Helmut Marcuse), Italy (Stradivarius Club), Japan (Shinsei Serv.), UK (Music Disc-count).
 Discolando Recs. & Tapes Corp., 718 10 Ave., New York, N.Y. 10019. Tel: (212) 581-0650. Pres.: Orlando Bru; Sales & Promo Mgr.: Louis Gargallo.
 Branches: Los Angeles, Calif., 1307 S. Vermont. Zip: 90006. Tel: (213) 381-5580-Santurca, P.R., 626 Calle Cerra. Zip: 00920. Tel: (809) 725-9130. Contact: Sara Garcia.
 Labels: (Owned) Discolando; (distributed) Bambuco, OB Prod'n, Sono-lux, Tikal, Zeida.
 Discolor, see Hubaney.
 Discos Latin Int'l Inc., 1646 S. Vermont Ave., Los Angeles, Calif. 90006. Tel: (213) 734-1527. Cable: DISLATIN. Pres.: Jose A. Garcia; Sec'y: Yanet Garcia; Promo./Sales: Fernando Vian.
 Labels: (Owned) Fono-Rex, Latin Int'l, No. 1, Pega; (distributed) Micro-fon.
 Discos Marcus Pereira (Brazil), see Brasilia.
 Discos Monica, see Peer-Southern.
 Discos Premier (Brazil), see Fermata.
 Discostar Inc., 10245 Collins Ave., Bal Harbour, Fla. 33154. Tel: (305) 861-6947. Pres.: Joseph C. Martin; VP: Jay Martin.
 Labels: (Owned) DRCI, Disco, Jayson, Marton.
 Discos Tropical, see Tropical Music.
 Disco Sur, see Velvet de Puerto Rico.
 Discovery, see Trend in Calif.
 Discus, see Stanyan.
 Discwasher Inc., 1407 N. Providence Rd., Columbia, Mo. 65201. Tel: (314) 449-0941. Pres.: Bruce Maier; Mktg. Dir.: Dale Berlau; Nat'l Sales Mgr.: Jim Hall; A&R: Jeff Weber.
 Labels: (Owned) Discwasher Rec'gs; (distributed) Chalfont (digital), Denon (digital), Varese Sarabande (digital).
 Disko, see Hitwood-Disko.

Disneyland/Vista Recs., 350 S. Bu. on Vista St., Burbank, Calif. 91521 Tel. (213) 840-1000. Cable: DISNE. VP & Gen. Mgr.: Gary R. Kinsel; Nat'l Sales Mgr.: Bob Pavlaciak; Bus. Affairs Mgr.: Steve DeWendt; Prod'n Development Mgr.: Jymn Magon; Prod'n Mgr.: John Wood
Int'l branch: Canada, Walt Disney.
Labels: (Owned) Disneyland, V. (distributed) Charlie Brown.
Int'l reps: Argentina (Phonogra.), Australia (Summit), Belgium (Ades in France), Brazil (Abril), Chile (MI Odeon), Colombia (CBS), Denmark (Starbo), Dominican Republic (Distribuidores Musicales del Caribe), Ecuador (Fediscos), El Salvador (Discosa), Finland (Finnlevy), France (Ades), Germany (Ades in France), Greece (PolyGram), Israel (CBS), Italy (CGD), Japan (Nippon Columbia), Korea (Oass), Mexico (CBS/Columbia), Netherlands (Vido de Beer, Dberon), New Zealand (EMI), Norway (Hjemmet), Peru (El Virre), Philippines (Victor), Portugal (Radio Trunfo), Puerto Rico (Mena), Singapore (EMI), South Africa (Gallo), Spain (Hispanovox), Sweden (H. mmets Journal), Switzerland (Ades in France), Taiwan (Tang), UK (K. el, Pickwick, Polydor), Uruguay (Edisa), Venezuela (Love).
Dixieland Jubilee, see GNP Cresco, ndo.
Doc Ron Prod's Inc., 301 NW Sec 2nd Ave., Boynton Beach, Fla. 33435. Tel. (305) 732-1145. Pres.: Dr. R. n. Stander; VP Sales & Dist.: Maurice Stander; VP Prod'n Chuck How. rd Jr.; Sec'y Treas.: Marianne Stander.
Branch: Nashville, Tenn., 44 Music Square E Zip 37203 Tel. (615) 256 6453
Label: (Owned) Soaring.
Documentary Rec's, Box 24605, 10217 Scenario Ln., Los Angeles, Calif. 90024 Tel. (213) 474-8281 F. es. George V. Casey
Dotejo, see Kare
Johnny Dollar Recs., 42-D Music Square W., Nashville, Tenn. 37203 Tel. (615) 244-4898.
Dolphin Recs. (sub. of Record Bar), PO Box 8744, Durham, N.C. 27707. Tel. (919) 493-4511. Pres.: Barrie Jergman; Gen. Mgr. Tom Roos.
Domestic Recs., 850 Seventh Ave., New York, N.Y. 10019. Tel. (212) 582-7807. Gen. Mgr.: James Alexis J.
Domino Recs. Ltd., 222 Tulane St., Garland, Tex. 75043 Co-Owner, A&R Dir. & Int'l Co-ord.: Gene Summers Co-Owner Deanna Summers; Prod'r/PR Mgr.: Steve Summers
Labels: (Owned) Domino. Fron. Row. (distributed) Lake County (Switzerland)
Domino Recs., 37 Ddell Ave., Yonkers, N.Y. 10701 Tel. (914) 969 5673 VP & Gen. Mgr.: Joe Bollon.
Don-Mar Recs., see Casa Grande
Door Knob, see Gene Kennedy & World Int'l Group.
Dore Recs. Ltd., 1608 Argyle, Holl wood, Calif. 90028. Tel. (213) 462-6608. Pres.: Lew Bedell.
Doric Rec'g Group Inc., PO Box 87, Vacaville, Calif. 95696. Tel. (707) 448-7835. Pres.: Frank R. Killinger; Gen. Mgr.: Dick Penberthy
Dorn Recs., 20531 Plummer St., Shatswilt, Calif. 91311. Tel. (213) 998-0443. Pres.: A. E. Sullivan; A&I Paul Martin; Sales & Mktg. D. Sullivan; Pub. & Adv. Carol Ruskin
Labels: (Owned) AKO, Artz. orn.
Doro, see DGJ
Doss, see Colonel Buster Doss.
Colonel Buster Doss Presents, F. J. Box 927, Manchaca Sta., Austin, Tex. 78652. Pres.: Col. Buster Doss; VP: Barbara Doss, Sec'y: Kim Doss, Treas.: Bo Doss
Labels: (Owned) Aus-Tex., Col. nel Redneck, Doss, Kimbo, Range Buster, 3n Shooter, Stardust, Wizard
Dot, see MCA.
Double A, see Sarg.
Double Feature, see Talpro
Double "L" Recs., 2311 15 St. Troy, N.Y. 12180. Tel. (518) 274-3249 Pres.: Larry Quinn.
Down Home Recs., Box 10, Edna, Kan. 67342. Tel. (316) 922-3322. Pres. Rodney Lay; VP: Vernon Sanc zsky.
Doyle Recs., 3610 Park Ave., Memphis, Tenn. 38111 Tel. (901) 324-7147
Dragon, Pa., see Crimson Dynas y
Dragon Int'l Inc. of New Jersey, PO Box 8263, Haledon, N.J. 07508 Tel. (201) 942-6810. Pres.: Samel el Cummings; VP Gauntlett Cummings; A&R: Jaseth Cummings.
Labels: (Owned) Alsanman, Ap. d, Arch, Cummings, Kela
Int'l reps: Caribbean (West Indies Recs.), Japan (Vivid Sound)
Dragon Recs., 872 Morris Park W., Bronx, N.Y. 10462. Tel. (212) 792-2218. Pres.: Vincent Gaglian
Labels: (Owned) Agon, Drago i.
Dragon (Sweden), see Zim.
Dream, see Salsoul.
Dreamland, see RSD.
Dream Machine, see Diviva.
Dreamstreet Recs., PO Box 193, Iohokus, N.J. 07423. Tel. (201) 825-1383 Pres.: Howard Kenyon; Assoc. Prod'r: Len Leone Jr. (Also see Shanachie)
Int'l reps: Canada (Trend), Italy (IRD), Sweden (Ad Lib), UK (Swift)
Driftwood Recs., PO Box 22988, Nashville, Tenn. 37202. Tel. (702) 385 1297. Pres.: Margaret Yedna n; A&R Dir.: Sundown Pete; Promo.: Howard Vokes; Sales: John Valley.
Branch: Las Vegas, Nev., 160 E. Charleston Zip 89104 Tel. (702) 385 1297. VP: Peter Kobal.
Drive, see TK.
Drup Ent's., see Shtup City.
Drum Recs. Inc., 909 Eighth Ave., N., Suite B, Fargo, N.D. 58102. Tel. (701) 235-8551. Pres.: Thomas J.F. Conoboy; VP & Treas. G.R. Conoboy, VP West Coast: Nathaniel Johns n, Sec'y Warren B. Anderson
Duel, see Lee Dunne.
Duke, see MCA.
Dungeon, see Crimson Dynasty
Dunhill, see MCA
Lee Dunne Ent's., PO Box 2271, Hollywood, Calif. 90028. Tel. (213) 465 5003. Pres.: Lee Dunne, VP Peter Crawford; Sec'y: L. Lane; A&R Dir.: Chris Dunne; Promo.: Jim Sanders; Pub.: Danny Gayot, Randy Fricke, Stuart Deal.
Labels: (Owned) Duel, LDE
Dupuy Recs., 10960 Ventura Blvd., Suite 200, Studio City, Calif. 91604 Tel. (213) 980-6412. Pres.: Pedit Dupuy
Dusk & Dawn Recs., 1810 Eito Rd., Adelphi, Md. 20783 Tel. (301) 776-1669. Contact: Andre Roma
Dyer-Bennet Recs., 792 Colum us Ave., New York, N.Y. 10025 Tel. (212) 866-3675. Mgr.: Harvey Cor
Dynamite, see Jim Hall.
Dynamo Inc., Box 122E, Rt. 1, Iapid City, S.D. 57701 Tel. (605) 342-3040 Pres.: Dale J. Gage; VP Chrs: opher D. Gage, Sec'y Treas. Gwen B. Gage.
Label: (Owned) Lost.
Dynamo, N.Y., see Talpro.
Dynasty Recs. & Video Tapes, 9 29 Sunset Blvd., Los Angeles, Calif. 90069.

Tel. (213) 550-1216. Bd. Chm.: Lance Ong; Pres. Bamby Byrens. VP Bery Byrens
Dynasty, see Crimson Dynasty. Vee Jay & West Recs.
Dyno, see Gemcom
E, see West.
E B C, see NMI
E C I Recs. (div. of Entertainment Communications Int'l), 320 W. Third St., Davenport, Iowa 52801. Nat'l Promo. Mgr.: Gary Unger.
Labels: Aic, Aic/Artistic, Artistic, Artistville, BCA, ECI, Groove Sound, Groove Two, LoveLight, Sugarvine.
E C M, see Warner Bros.
E C P, see Eddie Crook.
E C R, see Las Vegas Rec'g.
E C Y Street Recs./Films, Box 101, College Point, N.Y. 11356. Tel. (212) 961-3327. Pres.: Ed Chapero; VP Sales. Keith Sluchansky, Jack Weinstein; VP Research: Steve Kolanjan.
E G, see PolyGram.
E G C, see Rico.
E G Recs., 161 W. 54 St., New York, N.Y. 10019. Tel. (212) 246-8400.
Home office: England.
E K X, see Seven Hills.
E L I Recs., PO Box 2218, Newburgh, N.Y. 12550. Tel. (914) 564-2742 Contact: Chuck Murphy.
E L J Rec. Co., 1344 Waldron Ave., St. Louis, Mo. 63130. Tel. (314) 863 3605. Pres.: Edwin L. Johnson, Ass't VP: W. Johnson; Sales Mgr.: C Primm.
E & M, see Passion.
E M I America/Liberty Recs. (divs. of Capitol Recs. Inc.), 6920 Sunset Blvd., Los Angeles, Calif. 90028. Tel. (213) 461-9141. Telex: 673271. Chm.: Don Zimmermann; Pres. & Chief Operating Officer: Jim Mazza; VP A&R: Don Grierson; VP Promo.: Dick Williams; VP Bus. Affairs: Mark Levinson; VP Mktg.: Joe Petrone; Mds. Dir.: Frency Gauthier; Talent Acquisition Mgr.: Gary Gersh; Pub. Mgr.: David Budge; Art Dir.: Bill Burks; Artist Development Dir.: Clay Baxter; Sr. Attorney: Estelle Radin. (Distributed by Capitol)
Branches: New York, N.Y., 1370 Ave. of the Americas. Zip: 10019. Tel. (212) 757-7470. East Coast Talent Acquisition Mgr.: John Robert Currie, East Coast Pub. & Artist Relations Dir.: Caroline Prutzman-Mashville, Tenn., 29 Music Square E. Zip: 37203. Tel. (615) 244-9596. Div. VP Nashville: Lynn Shults; Nat'l Country Promo. Dir.: Gerri McDowell.
Int'l branch: England, EMI Recs.
Labels: (Owned) Blue Note, EMI America, Liberty, United Artists.
E M I/Odeon (Brazil), see Brasilia.
E R H Sales, 221 W. 57 St., New York, N.Y. 10019. Tel. (212) 582-4200. (TV merchandiser)
E S I, see Entertainment Systems.
E S P Disk' Ltd., Acorn Hill Rd., Krumville, N.Y. 12447. Pres.: Bernard Stollman.
Branch: New York, N.Y., 5 Riverside Dr. Zip: 10023.
E T C III, see Katie the Great.
E T S Rec. Co., PO Box 932, Honolulu, Hawaii 96808. Tel. (808) 623-9958 Owner: Richard R. Riccio.
Eagle Int'l Recs., PO Box 22312, Nashville, Tenn. 37202. Tel. (615) 876-1729.
Eagle Rec. Co., PO Box 1102, Burbank, Calif. 91507. Tel. (213) 874 7656. Pres. & Gen. Mgr.: Peter Tevis; A&R Dir.: Scott Tevis.
Int'l reps: Colombia (Sonolux), Germany (EMI Electrola), Japan (EMI-Toshiba), Mexico (RCA), Netherlands (EMI-Bovema), South Africa (EMI-Brigadiers), Spain (EMI-Odeon), UK (WEA).
Eagle Rock Music, PO Box 728, Sunland, Calif. 91040. Tel. (213) 243-4109
Earth Int'l, see Lesser-Int'l-USA.
Earth Quake, see Crimson Dynasty.
Earlthone Rec'g Co. Inc., 6120 Sunbury Rd., Westerville, Ohio 43081. Tel. (614) 882-2388. Pres.: Sonny Flaharty; VP: Tom Amann; Promo.: Kim Martinez, Mark Evar; Controller: Al Steigerwalt.
Earth Tremor, see Crimson Dynasty.
The East Allegheny Recs. Group, 335 Hidenwood Dr., Newport News, Va. 23606. Tel. (804) 595-9000. Cable: ALLEGDRUP. Chm. & Pres.: Elwood Evans; Exec. VP: Mark Rosenberg; VP & Gen. Mgr.: Darell Brookson; VP A&R: Eric Shepperd; VP Artist Relations: Eddie Rowe; Artist Relations: Paul Payne, Steve Dwnes; Sec'y: Carole Swensson; PR: Chuck Myerson; Dist'n: Bruce Shehan.
Branches: North Hollywood, Calif., 6104 Cahuenga Blvd. Zip: 90039. Tel. (213) 762-1001. West Coast Sales Dir.: Craig Finch; PR: Tony Rosen-Cherry Chase, Md., 8815 Connecticut Ave. Zip: 20015. Tel. (301) 657-0100. Mid-Atlantic Sales Dir.: Marty Silver; PR: Kevin Cole.
Labels: (Owned) Allegheny, Denbigh, Marquee, Second Chance, Soul City, Southern Bell, Warwick.
East Wind, see JVC.
Eat Recs. (div. of The Phone Co. Inc.), 400 Essex St., Salem, Mass. 01970. Tel. (617) 744-7678. Pres. & A&R: Don Rose; VP/Field Rep.: David H. Simonds; Logistics Co-ord.: J. George Perry.
Branch: New York, N.Y., 540 La Guardia Pl. Zip: 10012. Tel. (212) 533-8441. Prod'r: John Doelp.
Labels: (Owned) Dual-Tone, Eat; (distributed) Neat, Ragun.
Ed Sh Prod'n, 17264 Sherman Ave., Evanston, Ill. 60201. Tel. (312) 491-9155. Pres.: Helen-Kay Eberley; Dist'n/Nat'l Sales: Vincent P. Skowronski.
Echo, see Dana.
Echo Park Recs., 7985 Santa Monica Blvd., Nos. 109-68, Los Angeles, Calif. 90046. Tel. (213) 413-2188. Pres.: Marshall Heaney
Eclipse, Mich., see Renaissance.
Eclipse, N.C., see Galaxie III.
Eden Recs., 15266 Russell, Allen Park, Mich. 48101. Tel. (313) 383-5768.
Dir.: Michael Glenn Kuzma.
Labels: (Owned) Eden, Trinity Sound.
Eden, Calif., see Consolidated Gospel.
Edge Entertainment Inc./Edge Recs., 13045 Ventura Blvd., Studio City, Calif. 91604. Tel. (213) 990-5388. Pres.: Eugene Bambic; VP & Country Contact: Logan Clarke; Sec'y/Treas.: Faun Mills.
Educational Media Assocs. of America Inc., PO Box 921, Berkeley, Calif. 94701. Tel. (415) 525-4583. (Distributed by Discocorp)
Labels: (Owned) I Grandi Interpreti, Recital, Bruno Walter Society, Western Sound Archive.
Int'l reps: Austria (Preiser), France (Dave-Music), Germany (Helmut Marcuse), Italy (Stradivarius Club), Japan (Nippon Columbia, Shinsei Serv.), UK (Music Disc).

Educator Recs. Inc., PO Box 490, Wayne, Pa. 19087. Tel. (215) 423-5960. Pres.: Bari Antz.
Eggplant, see SpinIt.
Electrocard (Romania), see Worldtone.
Elektra/Asylum/Nonesuch Recs., 962 N. La Cienega, Los Angeles, Calif. 90069. Tel. (213) 655-8280. Bd. Chm.: Joe Smith; Vice Chm.: Mel Posner; Exec. VP Mktg.: Vic Faraco; Sr. VP Creative Servs. Jerry Sharell; Sr. VP Finance: Jack Reinstein; Sr. VP A&R: Ken Butts; Sr. VP Prod'n. Keith Holzman; VP PR: Bryn Brndenthal; VP Special Markets. Oscar Fields, VP Bus. Affairs: Debbie Renberg; VP Int'l: George Steele.
Branches: New York, N.Y., 665 Fifth Ave. Zip: 10022. Tel. (212) 355-7610. Sr. VP: East Coast A&R/Pres. Elektra/Metropolitan Recs.: Bruce Lundvall; East Coast Mgr.: Mel Fuhman-Nashville, Tenn., 1216 17 Ave S. Zip: 37212. Tel. (615) 320-7525. VP: Jimmy Bowen, Gen. Mgr.: Ewell Roussel; Mktg. Dir.: Nick Hunter; Nat'l Country Promo. Co-ord.: Bruce Adelman.
Distribution branches: See Record & Tape Wholesalers section for Warner/Elektra/Atlantic Corp.
Int'l branches: See WEA Int'l.
Labels: (Owned) Asylum, Elektra, Elektra/Metropolitan, Nonesuch, (distributed) Elektra/Curb, Planet, Solar.
Int'l reps: See WEA Int'l.
Elektra/Curb, see Elektra/Asylum/Nonesuch.
Elektra/Everest Legacy Series, see Everest.
Elektra/Metropolitan, see Elektra/Asylum/Nonesuch
Elmar Prod'n & Rec. Co., PO Box 18320, Cleveland Heights, Ohio 44118 Tel. (216) 932-9033. Exec. Pres.: Ebony Wright; VP: Diane Wright; Gen. Mgr.: Randy J. Wright; Promos.: Janet Rice; A&R Dir.: Roosevelt Taylor Jr.
Elite Entertainment Ent's., PO Box 25664, Chicago, Ill. 60625 Tel. (312) 883-8660. Pres.: Tom Seymour; Promo.: Ed Kammer; Sales: Stu Sava, Carl Voelker.
Label: (Owned) Force.
Elite, Fla., see Sociedad Int'l de Sonido.
Elm Recs. (div. of Edd L. McNeely Prod'ns), PO Box 1100, 14621 Aden Westminster, Calif. 92683. Tel. (714) 898-7317. Pres. & A&R: Edd L. McNeely; VP: John E. Robinson; Sec'y: Patricia J. McNeely; Nat'l Promo. Dir.: Dennis R. Richard; Sales: Edd L. McNeely Jr.
Labels: (Owned) Elm, (distributed) Faber, Granada.
Int'l reps: Australia (W&G), Belgium (Supreme), Canada (Quality).
Ember, see Bulldog.
Ember Int'l, see Bulldog
Emcee Recs., 9115 Bridgeport Way, Tacoma, Wash. 98499. Tel. (206) 584 1534.
Emerald City Recs., 75 Rockefeller Plaza, New York, N.Y. 10019. Tel. (212) 484-6090. Owners: Charles Greene, Brian Stone. (Distributed by Atlantic)
Emergency Recs. & Filmworks Inc., 29 W. 38 St., New York, N.Y. 10018 Tel. (212) 921-9760. Telex: 666794. Pres.: Sergio Cossa; Nat'l Promo. Dir.: Curtis Urbina. (Distributed by Brasilia)
Emkay, see Hartsong.
Emko, see Kool Kat.
The Empire Project Inc., 420 E. 80 St., New York, N.Y. 10021. Tel. (212) 628-1381. Pres.: Michael Friedman, Exec. VP: Don Silver.
Empire Recs. & Tapes, PO Box 265, Deerfield Beach, Fla. 33441. Tel. (305) 428-2644. Pres.: Josh Noland; VP: Jess Stansbury; Nat'l Promo.: Ritchie Johnson.
Empress, see Express.
Enchanted Knight, see Crimson Dynasty.
Encore Recs., PO Box 343, Santa Monica, Calif. 90406. Tel. (213) 394-5110. Pres.: Irvin A. Brock.
Encore Series, see Columbia Special Prods.
Encounter, see Philly Jazz.
Energy Recs., 50 E. 42 St., Suite 401, New York, N.Y. 10017 Tel. (212) 687 2299. Pres.: Howard Kruger; VP: Jeffrey Kruger; Treas.: Louis Zimman; Promo.: Bernie Cochrane; PR: Roger St. Pierre.
Enrica Recs. Inc., see Rae-Cox.
Enterprze, see Umpire
Entertainment Capital Recs., see Las Vegas Rec'g
Entertainment Systems Int'l Inc., 1628 W. 218 St., Torrance, Calif. 90501. Tel. (213) 328-5590. Pres.: Geoffrey Emery; Exec. VP: Tony Flynn. VP Promo.: Chris Stevens; A&R Dir.: Bob Tenson.
Label: (Owned) ESI.
Entertainment Ventures Inc., PO Box 2388, Zip: 86302; 122 N. Cortez, Suite 211, Prescott, Ariz. 86301. Tel. (602) 445-5801. Chief Exec. Officer: Michael D. Morgan; VP/Artist Relations & Development: Gay Ellen Foreman; Prod'n Mgr.: Garry Greer, Prod. Development Dir.: Sammy Lee Lewis; Dist'n.: Christopher G. Morgan.
Labels: (Owned) Big Wheels, Quarter Moon
Int'l rep: Germany (Intercord).
Entr'acte Recs. Inc., 845 California St., No. 604, San Francisco, Calif. 94108. Tel. (415) 956-0426. Pres.: John Steiner Lasher.
Labels: (Owned) Entr'acte, Label "X."
Int'l reps: Australia (Ava & Susan's, Hollywood House), Canada (Trend), France (Disco Shop), Germany (Helmut Marcuse), Japan (Sumiya), Swit zerland (Disc-Import), UK (Stage Danc).
Epac, see CBS.
Epiphany Recs. Inc., 1324 Portola Dr., San Francisco, Calif. 94127. Tel. (415) 664-0820, 661-6614. A&R & Licensing: Warren Smith; Mfg. & Promo.: Martin Pezzaglia; Promo.: Moe Armstrong; Dist'n & Pub.: Michael Pincus.
Branch: Miami, N.Y., 19 Bryant Ave. Zip: 11576. Tel. (516) 621-8454, (212) 895-5575. Telex: 423566. Contacts: Michael Epstein, David Bar-ram.
Label: (Owned) Public Secrets.
Epitaph, see Vee Jay.
Epoch, see North American Liturgy.
Equa Recs., 1800 Mowry Ave., 43334 Bryant St., Fremont, Calif. 94538. Tel. (415) 794-6637, 651-1015. Pres.: Warren M. Johnson; Exec. VP: Sandra Clark; Promo. Dir.: Bob Jackson.
Eric Recs. (div. of American Rec. Sales Inc.), 1120 Crown Point Rd., West ville, N.J. 08093. Tel. (609) 848-1900. Pres.: Bill Buster; VP: Antony W. Colombet.
Esar, see Bill Rouse.
Esca, see Rounder.
David Eskin Inc., 400 Riverside Dr., New York, N.Y. 10025. Tel. (212) 749-4257. Telex: 237460. Pres.: David Eskin; VP: Rina Eskin; Mgr.: Joseph Bechar; Ass't Mgr.: Howard Smith.
Esoteric, Calif., see Everest.
Eterna, see Lynchrod.
Eterna (East Germany), see Worldtone.
Etowah Recs., 414 Fourth St., Attala, Ala. 35954. Tel. (205) 538-7788.
ephony Recs., 4351 Salfitto St., Woodland Hills, Calif. 91364. Tel. (213) 346-4505. Bd. Chm.: James C. Smith; Pres.: John Bossmann.

Euphoria Recs. Inc., 90 Shirley Ave., Revere, Mass. 02151. Tel: (617) 284-9707. Mng. Dir.: Howard A. Cook, Curtis Naitheeray.
Euphoria, Fla., see Request.

Europa Recs. & Tapes Inc., PO Box 20513, 1302 Heron Dr., Orlando, Fla. 32814. Tel: (305) 896-1371. Cable: COMMARS. Telex: 564436. Pres./A&R: Jean-Pierre Weiller; Sales Mgr.: Sheri Weiller.

Frank Evans Recs. Group, 335 Hidenwood Dr., Newport News, Va. 23606. Tel: (804) 595-9000. Cable: FRANKART. Pres. & Chief Exec. Officer: Frank Evans; Exec. VP: Tom Gregory; VP & Gen. Mgr.: Jon Michael Ivey; Boyfriends Recs. A&R: Chris Newport; Continent Artist Recs. A&R: Greg Cole; Continental Artist Recs. A&R: Ken Wheaton; GayArtist Recs.: Craig London; Premiere Artist Recs. A&R: Marc Shevlin; PR Dir.: Wayne Hampton; Dist'N Dir.: Avery Kincaid

Branches: Hollywood, Calif., 9155 Sunset Blvd. Zip: 90069. Tel: (213) 278-0400. Cable: FRANKART. West Coast PR Dir.: Timothy Norton; Dist./Sales Dir.: Mark Hamilton—New York, N.Y., 919 Third Ave. Zip: 10022. Tel: (212) 371-7100. N.Y. PR Dir.: Bruce Shapiro; Int'l Sales Dir.: Randy Coleman.

Labels: (Owned) Boyfriends, Century Artist, Continental Artist, GayArtist, Premier Artist.

Event, N.Y., see Spring.

Eventide, see Dee-Bee.

Everest Rec. Group, 2020 Ave. of the Stars, Century City, Calif. 90067. Tel: (213) 557-0309. TWX: (910) 490-3807. Pres.: Bernard C. Solomon; A&R/Sales: Lee Palmer; Prod'n: Joseph Behar.

Branches: New York, N.Y., Olympic Recs., 211 W. 56 St., Suite 21-D. Zip 10019. Tel: (212) 541-9360. Pres.: Joseph Abend.

Labels: (Owned) Archive of Folk & Jazz Music, Archive of Piano Music, Arvee, La Comedie Francaise, Concert-Disc, Counterpoint, Elektra/Everest Legacy Series, Esotenc, Everest, Hi Fi, HiFi/Lite, Olympic, Period, Renaissance, Scala, Stradivari, Tradition.

Int'l rep.: Argentina (Microphon, Trova), Australia (Astor, Message), Brazil (Fermata), Canada (Almada), Chile (Goluboff), Denmark (Dansk), France (Barclay, Vogue), Germany (Baerenreiter, Bellaphon, Teldec), Israel (Hatakit), Italy (Fonti-Cetra, Ricordi, Saar, Vedette), Japan (Nippon Columbia), Mexico (Gamma), Netherlands (Philips, Supertone), Spain (Belter, Discophon, Hispavox, Movieplay, Vergara), Sweden (Sonet), UK (Casson).

Evergreen, see Dimitri.

Everyman Classics, see Vanguard

Excello, see Nashboro.

Excelsior Recs. (div. of Pickwick Int'l Inc.), 7500 Excelsior Blvd., Minneapolis, Minn. 55426. Tel: (612) 932-7869. VP & Gen. Mgr.: Don Johnson; Mktg. & Sales Dir.: Michael Mathewson; Opns. Dir.: Jim Tuller.

Branches: North Hollywood, Calif., 7100 Tunjuna. Zip: 91605. Tel: (213) 764-5050. Reg'l Sales Mgr.: Wayne Novak—Atlanta, Ga., 365 Patton Dr. SW. Zip: 30336. Tel: (404) 696-1850. Reg'l Sales Mgr.: Alan Jones—Brentwood, N.Y., 50 Emjay Blvd. Zip: 11717. Tel: (516) 231-8324. Reg'l Sales Mgr.: Frank Bisbano; Classical Sales Mgr.: Martin Basart—Washville, Tenn., PO Box 323. Zip: 37221. Tel: (615) 646-0049. A&R Dir.: Steve Vining—Arlington, Tex., 2200 Randal Mill Rd. Zip: 76011. Tel: (817) 261-4281. Reg'l Sales Mgr.: Tom Colley.

Int'l branch: Canada.

Labels: (Owned) Ascension, Excelsior, Pickwick, Pro Arte, Quintessence; (distributed) Sunbird.

Experience Anonymes, see Lyricord.

Express Recs., PO Box 3367, Hollywood, Calif. 90028. Tel: (213) 894-9487. Mng. Dir.: Jeff Orman; Dir.: Kerry Zurn.

Labels: (Owned) Airborne, Empress, Express, Sweet Stuff.

Int'l rep.: UK (Gull, Sun-Pacific).

F

F E L Publ'ns Ltd., 1925 S. Pontus Ave., Los Angeles, Calif. 90025. Tel: (213) 478-0053. Pres.: Dennis J. Fitzpatrick; Sec'y/Treas.: Mary Fitzpatrick.

F F D Communications Inc., Box 313, Kingsbridge Sta., Bronx, N.Y. 10463. Tel: (212) 543-7770. Pres.: Bruce Hest; VP Recs.: Neil Fredman; Mktg. Dir.: Steve LeBow; Pub. Dir.: Barry Stevens.

F & L, see Fischer & Lucus.

F R O Recs. (div. of Frank Russell Music & Recs. Group Inc.), 170 Linwood Ave., Paterson N.J. 07502. Tel: (201) 595-7557. Pres. & A&R Chief: Frank Russell; VP: Margaret Ruggiero; Nat'l Promo.: Tommy Russell; Gospel Div. A&R: Frank Galardi.

F S R, see Fidelity Sound.

F W P, see Fred Weinberg.

F X L, see Nationwide Sound.

Fabor, see Elm.

Faces, see Cord.

Factory, see Rough Trade.

Factory Beat, see RBR.

Faderkat, see Hiding America.

Fairmont Recs., PO Box 3392, Santa Monica, Calif. 90403. Tel: (213) 391-7833. Partners: Dave Caughen, Cecil Spiller.

Int'l rep.: Denmark (CSA), UK (Great Jazz).

Fair Retail, see Buttermik.

Fair Wind, see Castalia.

Fairyland, see American Themes.

Farth, see Country Stream.

Falcon, see House of Falcon.

Falconer Recs., PO Box 2217, Inglewood, Calif. 90205. Tel: (213) 644-8182. Pres.: L.S. Falconer.

Family Media Int'l, 888 N. Main St., Suite 1000, Santa Ana, Calif. 92701. Tel: (714) 835-8039. Gen. Mgr., Mktg. & Sales: Michael S. Yates; Gen. Mgr., Bus. Admin.: Richard L. Schulz.

Label: (Distributed) Heaven & Earth.

Famous Door Recs., PO Box 92, Sta. A, Flushing, N.Y. 11358. Tel: (212) 463-6281. Owner: Harry Lim.

Int'l rep.: Japan (Toshiba-EMI).

Fantare Recs., PO Box 2501, 5311 SW Ninth, Des Moines, Iowa 50315. Tel: (515) 285-6564. Pres.: Art Stenstrom.

Fania, see Musica Latina.

Fantasy/Honey, see Fantasy/Prestige/Milestone/Stax.

Fantasy/Prestige/Milestone/Stax, 10 & Parker Sts., Berkeley, Calif. 94710. Tel: (415) 549-2500. TWX: (910) 366-7246. Bd. Chm.: Saul Zaentz; Pres.: Ralph Kaffel; VP Bus. Affairs: Al Bendich; VP Finance: Frank Noonan; VP Mktg.: Phil Jones; Sales Mgr.: Kirk Roberts; Nat'l Promo. Dir.: Quincy McCoy; Art Dir.: Phil Carroll; Press & Public Information Dir.: Terri Hinte.

Int'l rep.: Argentina (RCA), Australia (Festival), Austria (Amadeo), Belgium (EMI), Bolivia (Lauro), Brazil (Top Tape), Canada (Phonodisc), Colombia (Godiscos), Denmark (EMI), Ecuador (IFESA), Finland (EMI), France (Musidisc-Europe), Germany (Metronome), Greece (Music-Box),

Guatemala (Discos de Centroamerica), Hong Kong (HK), Israel (Hatakit), Italy (Font-Cetra), Jamaica (G&G), Japan (Victor), Mexico (Gamma), Netherlands (EMI), New Zealand (Festival), Norway (EMI), Peru (El Virrey), Philippines (Disc), Portugal (Radio Trunfo), South Africa (Teal), Spain (Hispavox), Sweden (EMI), Switzerland (Metronome), UK (RCA), Venezuela (Allstar), West Indies (Record Specialists in Jamaica), Yugoslavia (Jugoton).

Labels: (Owned) Fantasy, Galaxy, Milestone, Prestige, Riverside, Stax; (distributed) Fantasy/Honey.

Far East Recs./Fusion Recs., 4810 SW 69 Ave., Miami, Fla. 33155. Tel: (305) 665-5701. Pres.: Rich Piccolo; VP-Promo.: Teri Owens.

Faceback, see GRS.

Farr Recs. (Farr Music Inc.), Box 1098, 350 Grove St., Somerville, N.J. 08876. Tel: (201) 725-3850. Bd. Chm.: Asa Farr.

Farview Recs., PO Box 783, Madison, Tenn. 37115. Tel: (615) 865-5559. Pres.: Tony Farr; Sec'y: Mary Farr.

Fayette, see Parr-X.

Federal, see Gusto.

Fee Bee Rec. Co., 4517 Wainwright Ave., Pittsburgh, Pa. 15227. Tel: (412) 884-4727. Pres.: Joe Averbach; A&R & Arranger: Butch Martin; Promo: Carl Horce.

Labels: (Owned) Fee Bee, Sceptre.

Felco, see Jamala.

Felicity Recs. Inc., PO Box 5754, Austin, Tex. 78763. Tel: (512) 472-1004. Bd. Chm.: William W. McNeal; Pres.: Craig D. Hillis; Exec. VP: Steven Fromholz; VP Mktg.: Shelly Hart.

Fenix, see Ototo.

Maynard Ferguson Music USA Inc., PO Box 716, Ojai, Calif. 93023. Tel: (805) 646-7242. Pres.: Maynard Ferguson; Opns. Mgr.: Janet Lee.

Label: (Owned) MFMI.

Fermata Int'l Melodies Inc., Sunset-Vine Tower Bldg., Suite 916, 6290 Sunset Blvd., Hollywood, Calif. 90028. Tel: (213) 462-7473. Cable: FERMATACAL. TWX: (910) 321-4063. Mgr.: Debora Frenkiel.

Home office: Brazil.

Labels: (Owned) Discos Premier, Fermata, Importa/Som, Peralta, Pick, RGE, Som/Maio, Young (all imported from Brazil).

Festival/Callope Recs., 17711 Margate, Encino, Calif. 91436. Tel: (213) 344-4552.

Festivo, see PolyGram Classics.

Fetish America Inc., 611 Broadway, Suite 214, New York, N.Y. 10012. Tel: (212) 473-1821. Gen. Mgr.: Bob Singerman.

Int'l branch: England.

Fiddler, see Rounder.

Fidelity Sound Recs., 23 Don Court, Redwood City, Calif. 94062. Tel: (415) 366-3173. Owner & Mng. Dir.: Reginald McGovern; Promo. & Pub.: Jim Gallagher.

Int'l branch: New Zealand.

Labels: (Owned) FSR, Five Star.

Fiesta Recs. Co. Inc., 78 Randall Ave., Rockville Centre, N.Y. 11570. Tel: (516) 536-7880. Pres.: Jose Morand; Mgr.: Anne Adams.

Int'l branch: Canada.

Int'l rep.: (Owned) Fiesta, Grecophon.

50/50 Recs. Inc., 11 E. 26 St., 21st fl., New York, N.Y. 10010. Tel: (212) 686-7706. Pres.: Steve Martin; VP: Michael Goldberg; Opns. Dir.: Debra Calandriello; Ass't Opns. Dir.: Ralph Bortone; Prod'n Co-ord.: Marina Casanova.

51 West, see Columbia Special Prods.

50%, see Cord.

50 States Recs. (div. of Accusound Music), PO Box 314, Hendersonville, Tenn. 37075. Tel: (615) 822-5511. Pres.: Donald L. Riss; A&R Dir.: Johnny Howard; Pub. & Adv. Dir.: Georgia Rayson; Promo. Dir.: Richard Colanzi.

Labels: (Owned) Starship; (distributed) Hoedown USA.

Filly-Colt, see Album Globe.

Film Score, see Take Home Tunes!

Filmworld, see McKinnon.

Finer Arts Recs./Transworld Recs., 2122 D.S. Victor St., Aurora, Colo. 80014. Tel: (303) 755-0093. Contacts: Morris, Allan, Barry, Neil & Richard Bernstein.

Finesse, see CBS.

Fink-Pinewood Recs., PO Box 5241, Chesapeake, Va. 23324. Tel: (804) 627-0957. Pres.: Bill Johnson.

Finnadar, see Atlantic.

Finnlevy (Finland), see Worldtone.

Fireball, see Nationwide Sound.

Firecreek Recs. (div. of WM Recs.), 3659 Glen Haven, Houston, Tex. 77025. Tel: (713) 660-7965. Prod.: Mike Miola.

Fire Sign Recs. Ltd., 1650 Broadway, New York, N.Y. 10019. Tel: (212) 765-4495. Telex: 237224. Pres.: Billy Arnett; VP: Steve Loeb; Ass't VP: Ezra Cook; VP Finance: Jerold Kanuk.

Labels: (Owned) Northern Light, Rock City.

Firma, see CJ.

First American Recs. Inc., 73 Marion St., Seattle, Wash. 98104. Tel: (206) 625-9992. Bd. Chm.: Lou Lavinthal; Vice-Chm.: Stan Jaffe; Pres.: Jerry Dennon; Sec'y-Prod'n Mgr.: Tanya Campana; Bus Affairs Mgr.: Bill Angle; Nat'l Sales Mgr.: Bill Metz; Nat'l Promo. Dir.: Tom Mazzetta; Adm. Ass't: Kim Longacre.

Labels: (Owned) First American, Great Northwest, Music Is Medicine, Piccadilly, (distributed) Burdette, Potato, Stony Plain.

First Component Series, see Audiofilecity.

First Edition, see Louisville Orchestra.

First Generation Recs., 809 18 Ave. S., Nashville, Tenn. 37203. Tel: (615) 327-3211. Pres.: Pete Drake; PM: Rick Sanjek; Nat'l Sales Co-ord.: Rachel Brooks.

Firstline Recs., 7715 Sunset Blvd., Suite 300, Los Angeles, Calif. 90046. Tel: (213) 851-6800. TWX: (910) 321-2458. Pres.: Charles Underwood; Ass't to Pres./Int'l Mktg. Dir.: Taffy Rogers; Nat'l Promo. Dir.: Julio Auello.

Fischer & Lucus Inc., United Artists Tower, Penthouse Suite 902, Nashville, Tenn. 37202. Tel: (615) 329-2278. VP/Nat'l Promo. Dir.: Bobby Fischer.

Label: (Owned) F&L.

Fish-Head Recs., PO Box 399, Bay City, Mich. 48707. Tel: (517) 893-8321. Contact: Margo Prosser.

Fist-O-Funk Recs., 293 Richard Court, Pomona, N.Y. 10970. Tel: (914) 634-2446, 354-7157. Pres.: Kevin Misesiv; Prod. Mgr.: Ulla Misesiv; A&R: T.C. James; Promo.: Lewis Calabro.

Branch: New York, N.Y., 90 Collyer Ave. Zip 10956. Tel: (914) 634-2446.

Studio Mgr.: Gary Hill.

Int'l rep.: Canada (Quality), Italy (EMI), UK (EMI).

Five Star, see Fidelity Sound.

Flame, see Gas.

Flame, N.C., see General Broadcasting.

Flame, Pa., see Crimson Dynasty.

Flashlight, see Symposium.

Flatrock, see Buttermik.

Flat Town Music Co., Floyd's Bldg., 434 E. Main, Ville Platte, La. 70586. Tel: (318) 363-2139. Owner: J. Floyd Soileau; Pub. & Promo.: Benny Graeff.

Labels: (Owned) Jean, Maison de Soul, Swallow.

Int'l rep.: France (Le Chant du Monde), UK (Oval, Sonet, Swift).

Fleurette Recs., PO Box 34, Claymont, Del. 19703. Pres.: Alex Czarenko.

Fin-Fin Country, Box 103, Mullen, Neb. 69152. Tel: (308) 546-2293. Gen. Mgr.: L. E. Walker.

Labels: (Owned) Fin-Fin, Garden of Eden.

Flowers Rec'g Studio, Box 120A, Rt. 1, Swoope, Va. 24479. Tel: (703) 885-3309. Owner: Charles A. Flowers; Sec'y/Treas.: Barbara R. Flowers.

Label: (Owned) Flowers.

Flying Disc, see JVC.

Flying Fish Recs. Inc., 1304 W. Schubert, Chicago, Ill. 60614. Tel: (312) 528-5455. Pres.: Bruce Kaplan; VP Prod'n & Mktg.: Jim Netter; VP Promo.: Jon Fox; Ass't VP's: Promo.: Rick Swenson, Chris Heim; VP Opns.: Don Goldman.

Labels: (Owned) Flying Fish; (distributed) Blind Fig, Greenhays, Kaleidoscope.

Int'l rep.: Australia (Larrikin), Canada (Trend), Italy (IRD), Japan (Trio), Spain (Guimbarda), UK (Projection).

Flying High, see Richey.

Flyright (UK), see Shanachie.

Folk-Legacy Recs. Inc., Sharon Mountain Rd., Sharon, Conn. 06069. Tel: (203) 364-5661.

Int'l rep.: Germany (Folk Freak).

Folklyric, see Arhoolie.

Folkraft Publ'g Co. Inc., 10 Fenwick St., Newark, N.J. 07114. Tel: (201) 243-8700.

Folkways Recs. & Serv. Corp., 43 W. 61 St., New York, N.Y. 10023. Tel: (212) 586-7260.

Labels: (Owned) Asch, Broadside, Folkways, RBF.

Int'l rep.: Australia (Carina), Belgium (Schott Freres), Canada (Almada), Denmark (Dansk), France (Chant du Monde), Germany (EMI-Electrola, Plena), Norway (St. Olav), Sweden (Omega).

Fonodisco, see DGJ.

Fono-Rex, see Discos Latin.

Fontana (Brazil), see Brasilia.

Force, see Elite Entertainment.

Forever, see ReGeneration.

For Singers Only, PO Box 10, North Hollywood, Calif. 91603. Tel: (213) 274-5863. Pres.: Phil Moore; VP: Jack Tracy.

Fortuna, see Safari.

Fortune & Hi-Q Recs., 3942 Third Ave., Detroit, Mich. 48201. Tel: (313) 833-5383.

Labels: (Owned) Fortune, Hi-Q, Strate-8.

Four Leaf Clover, see Ozark Opry.

Fragoso, see Casa Fragoso.

Frammus Recs., Box 6164, Minneapolis, Minn. 55406. Tel: (612) 291-8605. Pres.: Steve Tibbetts.

Frannie Recs., PO Box 8135, Chicago, Ill. 60680. Tel: (312) 787-8220. Pres.: Frank Howard Jr.; Exec. VP: R. C. Hillman; Nat'l Promo. Mgr.: Howard Pittman; Int'l Mktg. Mgr.: Clayton Moore.

Fraternity Rec'g Corp., 3744 Applegate Ave., Cincinnati, Ohio 45211. Tel: (513) 661-5451. Cable: FRATREC.

Labels: (Owned) Applegate, Counterpart, Fraternity.

Freckle Recs., PO Box 4005, Pioneer Square Branch, Seattle, Wash. 98104. Tel: (206) 682-3200.

Freddie Recs., 6118 S. Padre Island Dr., Corpus Christi, Tex. 78412. Tel: (512) 992-8411. Owner: Freddie Martinez; Gen. Mgr.: Lee Martinez; Sales & Promo.: Jessie Saucedo; Sales: Laura Guerra; Engs.: Hector Gutierrez, Gary Beck, Rick Longoria.

Labels: (Owned) Acorn, Freddie, Johnny, Rosita.

Freedom Recs. Ltd., PO Box 888, Eastley, S.C. 29640. Tel: (803) 269-7012.

Free Style, see Vanguard.

Frejo, see Fred Weinberg.

Freko Recs., PO Box 11967, Houston, Tex. 77016. Tel: (713) 987-2273. Pres.: Freddie Kober; Sec'y-Treas.: Claudia Kober.

Freeless, see Philo.

Freton Recs. Inc., 3114 Radford Rd., Memphis, Tenn. 38111. Tel: (901) 327-8187.

Friederich's Prod'ns, see Chalef.

Friends & Co., 108 Sherman Ave., New York, N.Y. 10034. Tel: (212) 567-5110.

Frisco Prod'ns, 1218 Hollister Ave., San Francisco, Calif. 94124. Tel: (415) 467-5157. Owners: James B. & William C. Taylor.

From the Jazz Vault, see Made in USA/Marty Wilson Prod'ns.

Front Hall Ent's Inc., RD 1, Wormer Rd., Voorheesville, N.Y. 12186. Tel: (518) 765-4193. Pres.: Kay L. Spence; VP: William J. Spence.

Front Row, see Domino Recs. Ltd. in Tex.

Full Circle Prod'ns Inc., 80 E. San Francisco St., Santa Fe, N.M. 87501. Tel: (505) 982-2900. Contacts: Mark Myerson, Tom Law, Gene McGeorge, Baird Banner.

Labels: (Owned) Full Circle, Helios; (distributed) Turnrow.

Full Moon, see CBS.

Fun City, see Rawls Bros.

Funnybone, see Horizon Publ'g.

Fusion, see Far East.

Future Gold Recs. Inc., 1834 W. Cheltenham Ave., Philadelphia, Pa. 19126. Tel: (215) 424-0800.

G

G B S, see General Broadcasting.

G H E, see Moonlight.

G J P Prod'ns Inc., 511 Newell, Walla Walla, Wash. 99362. Tel: (509) 525-0913. Pres. & A&R Dir.: Gilbert J. Piger; VP: Steven P. Martonick; Sec'y-Treas.: Maria R. Piger; Mgr.: Daniel S. Mallery.

G M C, see General Music in Tex.

G M I, see General Music Inc.

G M S Disc, see Playette.

G M T Recs. Inc., 1550 Poycroft St., Suite 113, Honolulu, Hawaii 96814. Tel: (808) 955-4773/7509. Pres.: Gil M. Tanaka; VP: I. Frank Feary.

G N P Crescendo Recs., 8400 Sunset Blvd., Los Angeles, Calif. 90069. Tel: (213) 656-2614. Cable: CRESREC. Pres. & Int'l: Gene Norman.

Labels: (Owned) Dixieland Jubilee, GNP Crescendo, Largo; (distributed) Accent.

Int'l rep.: Argentina (American Recs.), Australia (Festival), Benelux (Vogue), Brazil (Fif, Fermata), Canada (Almada), France (Vogue), Greece (Music Box), Italy (Fonti-Cetra), Japan (King), Mexico (Musart), Scandinavia (Sonet), Spain (Discophon), Switzerland (Vogue), UK (PRT).

G O, see Grapevine Opry.

G P, see Glenn.

- G & P Recs. Inc., 539 W. 25 St., N.Y. 10001. Tel: (212) 675-6060. Bd. Chm.: Peter Cosmas; Prs.: Nicholas Cosmas, VP A&R/Promo.: George Hornfeck; Treas.: Emm. Hornfeck; Nat'l Sales Mgr.: Enrico Olla; Southwest Dist. Mgr.: Jeff Aro off.
- G R I, see Gospel Recs.
- G R P, see Arista.
- G R S Music & Rec. Group Communication Co., 416 E. Hugh, Suite 22, Tampa, Fla. 33603. Tel: (813) 971-0011. Pres.: G.R. Smith; VP: E.M. Cochco; Special Promo.: Anto io Smith; Co-ord. & Project Dir.: Davie Summer; Sec'y: Lynn Williams
Labels: (Owned) Fareback, GR; Headphone, Smithnight; (distributed) Country Boy, Latin Waters, Ocean & Sea.
- G T P, see Pop Record Research.
- Gael-Linn (Ireland), see Shanach.
- Gala Bail, see Jamie/Guyden.
- Galaxie III Studios, 118 Fifth St., Taylorsville, N.C. 28681. Tel: (704) 632-4735. Owner & Pres.: Harry D. al.
Label: (Owned) Eclipse.
- Galaxy, see Fantasy/Prestige/Wilstone/Star.
- Gallup Recs., PO Box 56055, Los Angeles, Calif. 90008. Tel: (213) 776-1073.
- Garmon Recs., PO Box 14243, San Francisco, Calif. 94114. Tel: (415) 824-3676. Contact: Robert Hanrah n.
Garden of Eden, see Flin-Flin.
- Martin Gary Prod'n's, Box 104, Rt. 2, Hanover, Va. 23069. Tel: (804) 288-7288. Pres.: Martin Gary; VP: Sec'y: Kathleen Gary.
- Gaspardo Recs., PO Box 120069, Nashville, Tenn. 37212. Tel: (615) 383-3168. Owner: Roy Christensen
- Gas Recs., 2716 W. Pico Blvd., Los Angeles, Calif. 90006. Tel: (213) 731-7323.
Home office: Mexico, Discos Cas SA.
Labels: (Owned) Flama, Gas.
- Gatemouth Rec'g Co., 90 Madison Ave., Island Park, N.Y. 11558. Tel: (516) 431-4906. Owner: David Feint an.
Int'l rep.: Canada (Trend), Germany (International Music Serv.), Italy (IRO), Sweden (Musikdistribut rien).
- Gateway, see Rite Rec. & Gemcom.
- GayArtist, see Frank Evans
- Gay 90's Village Inc., PO Box 513, Siheston, Mo. 63801. Tel: (314) 471-1347.
- Geffen Recs., 9126 Sunset Blvd., Los Angeles, Calif. 90069. Tel: (213) 278-9010. Bd. Chm.: David Geffe y; Pres.: Ed Rosenblatt. (Distributed by Warner Bros.)
- Gemcom Inc. (Gillette-Madison Communications Co.), 5488 Griffin Rd., Fort Lauderdale, Fla. 33314. Cable: GILMADCO. Pres.: Robert W. Schachner; Sales Rep.: Bert Maslow.
Branches: Los Angeles, Calif. 769 W. Pico Blvd. Zip: 90006. Tel: (213) 734-3650. Sales Rep.: Bruce dajeska-New York, N.Y., PO Box 5087, FDR Sta. Zip: 10022. Tel: (212) 688-2818. Cable: GEMCORD.
Labels: (Owned) Dyno, Gates ay, Personal Choice; (distributed) BBC, Thunderbird, Who's Who in Ja z.
- General Broadcasting Serv. (GBS) PO Box 1628, Elizabeth City, N.C. 27909. Tel: (919) 232-2703. Pres. & A&R: Ernie Bivens; VP, Promos. & Eng.: Vince Chory; 2nd VP: Wayne C sper; Promo. & Sales Dir.: Beverly Taylor; Sec'y-Treas.: Claudia Bivens; Asheville American Label Dir.: Ernie Bivens III.
Labels: (Owned) Bivens Brothers, Chory Int'l, GBS, Jukebox, Nashville American, Voice; (distributed) Flame, Golden Boots II, Homerun, Kitty Hawk, Moody.
- General Music Corp., 3012 N. Main St., Houston, Tex. 77009. Tel: (713) 225-0450. Pres.: Jay Collier, lps./Gen. Mgr.: Bettey Collier; Sales & Mktg.: Betty Aldis; Nat'l Prom. Dir.: Alan Young.
Labels: (Owned) Bonanza, Co nial, GMC, IRS, Volunteer.
- General Music Inc., 3007 E. Eight Mile Rd., Warren, Mich. 48091. Tel: (313) 756-8890. Pres.: R. Gordon P ince; VP: John Pavlik.
Label: (Owned) GMI.
- Generation, see Boot & Shanach e.
- Genesis Recs., PO Box 27, Nan icoke, Pa. 18634. Tel: (717) 823-9372. Pres.: Jim Watkins
- Genesis Recs., 1300 E. Seven Mile Rd., Suite 101, Detroit, Mich. 48203. Tel: (313) 893-4395.
- Genesis Recs. Inc., 710 Wilshire Blvd., Santa Monica, Calif. 90401. Tel: (213) 393-9293.
- Geo-Disc, see Mobile Fidelity.
- Gervasi, see Album Globe.
- Gestation, see International Mox Recs.
- Ghost Recs., 1905 Pesos Pl., Kala nazoo, Mich. 49008. Tel: (616) 375-2641. Pres.: Don Jobe; VP: Bill Groy r.
Labels: (Owned) Ghost, Jobie
- Gillette-Madison Communication Co., see Gemcom Inc.
- Glad, see TK.
- Glad Hamp Recs. Inc., 1995 Broadway, New York, N.Y. 10023. Tel: (212) 787-1222. VP: Bill Titone; Co. Mgr.: Charlie Mack; PR: Chuck Jones.
- Glamour & Grasse, see Oance-A thon.
- Glenn Prod'n's & Promos., 157 W. 57 St., New York, N.Y. 10010. Tel: (212) 265-6585. Pres.: Ben J. Arrig.
Labels: (Owned) GP, (distributed) Carol, Juno, Rebecca.
- Glo, see Jody.
- Gloite Recs., 827 Thomas, Memphis, Tenn. 38107. Tel: (901) 525-0540.
Labels: (Owned) American-So nd-Studio, American Way, Gloite, Lunix, Memphis & It's Music, Proph cy, Tennessee Country, UFO.
- Glori Recs. Inc., 246 Richmond Ave., Staten Island, N.Y. 10302. Tel: (212) 720-6700. Pres.: Jerry Jacobs n.; VP: Steven Herman; Gen. Mgr.: Arnold McCloud; A&R Dir.: Bill Green.
Labels: (Owned) Glori, Rebel.
- Int'l rep.: Europe & Africa (International Artist in Switzerland).
- Glory Express, see Gold Street.
- God's World, see Holy Spirit.
- Goldband Rec'g Studio, 313 Church St., Lake Charles, La. 70601. Tel: (318) 439-8839. Owner: Eddie Shul r.
- Gold Coast Entertainment, 5915 N. Lincoln Ave., Chicago, Ill. 60659. Tel: (312) 769-4676. Chief Execs.: Cecil Holmes, Mary Stuart. (Distributed by Capitol)
- Gold Dust Recs., 2204 Elliston P., Nashville, Tenn. 37203. Tel: (615) 320-7035. Pres.: Patrick Scharfus Sales Mgr.: Ron Erickson.
Branch: Strasstown, Pa., Box 34. Zip: 19559. Tel: (215) 488-1782. Mgr.: Mark Rake.
- Golden Boots II, see General Broadcasting.
- Golden Crest Recs. Inc., 220 Broa lway, Huntington Station, N.Y. 11746. Tel: (516) 423-7090.
Labels: (Owned) Crest, Golde y Crest.
- Golden Cross, see Gusman.
- Golden Hawk, see Crimson Dym: dy.
- Golden Moon Recs., 136 Maple L., Mooresville, Ind. 46158. Tel: (317) 831-5207. Pres.: William Haskett.
- Golden Shield, see Rite Rec.
- Golden Soul, see Sonic Arts
- Gold Guitar Recs., 1450 Terrell, Beaumont, Tex. 77701. Tel: (713) 832-0748. Owner: Don Gilbert.
Labels: (Owned) Azure, Gold Guitar.
- Goldisc, see Timeless.
- Gold Mind, see Salsoul.
- Gold Recs., 304 N. Point Dr., Stevens Point, Wis. 54481. Tel: (715) 344-8156. Pres.: Norm Dombrowski; VP: Lucille Dombrowski.
- Gold Seal, see RCA.
- Gold Sound, see Album Globe.
- Gold Street Inc., PO Box 124, Kirbyville, Tex. 75956. Tel: (713) 423-5516. Pres. & Gen. Mgr.: James L. Gibson; Promos. & Sales Dir.: Robbie Gibson.
Labels: (Owned) Glory Express, Gold Street.
- Goldust Recs. Co., 115 E. Idaho Ave., Las Cruces, N.M. 88001. Tel: (505) 524-1889. Owner & Gen. Mgr.: Emmit H. Brooks.
- Good News, see Word.
- Good Shepherd Recs., 1228 Reed St., Philadelphia, Pa. 19147. Owner & Chief Operating Officer: Grace Marchesan.
- The Good Sound Factory, 7575 Golden Valley Rd., Golden Valley, Minn. 55427. Tel: (612) 546-4343. Pres.: Edwin L. Brody. Nat'l Sales Mgr.: Norman Tahler; A&R: Ted Campbell.
Labels: (Owned) Good Sound; (distributed) Hansen.
- Good Sounds Recs. Inc., (sub. of Criteria Rec'g Studios), 1755 NE 149 St., Miami, Fla. 33181. Tel: (305) 947-5611. Co-Pres.: Howard R. & Ronald H. Albert; VP: Mack Emerman; Sec'y: Alice Platt.
- Good Time Jazz, see Contemporary.
- Marc Gordon Prod'n's Inc., 1022 N. Palm Ave., Los Angeles, Calif. 90069. Tel: (213) 659-6034. Cable: ROCKYREC.
Labels: (Owned) Colon-United, Rocky Road.
- Gordy, see Motown.
- Gospel America, see Hiding America.
- Gospel City, see Boltman.
- Gospel Heritage Foundation, see Heritage Singers.
- Gospel Media, see Consolidated Gospel.
- Gospel Recs. Inc., PO Box 90, Rugby Sta., 279 Buffalo Ave., Brooklyn, N.Y. 11213. Tel: (212) 773-5910. Pres.: John R. Lockley; Treas.: Connie M. Lockley; Mgr.: Julius R. Lockley Jr.; Promo. Mgr.: Bernice Reid.
Label: (Owned) GR!
- Gospel Roots, see TK.
- Gospel Time, see Ralph's Radio.
- Gothic Recs. Inc., PO Box 533, Murray Hill Sta., New York, N.Y. 10016.
- Graduation-Agreement, see Graduation Recs.
- Graduation Recs. Inc., 212 N. Kingshighway, St. Louis, Mo. 63108. Tel: (314) 361-4400. Pres.: Julian H. Miller II, VP: Lynn Schweizer.
Labels: (Owned) Graduation, Graduation-Agreement.
- Graf Recs. Int'l Ltd., see SWS.
- Graffiti, see Maria.
- Gramavision Inc., PO Box 2772, Grand Central Sta., New York, N.Y. 10163. Tel: (212) 674-1562. Pres.: Jonathan F.P. Rose. Opls. Dir.: Felicia Berkovitz.
Labels: (Owned) Gramavision; (distributed) Living Music.
- Gramercy 5, see Grenadilla.
- Gramophone Recs. (div. of Audio Int'l Inc.), Box 921, Beverly Hills, Calif. 90213. Tel: (213) 276-2726. Pres.: Oliver Berliner; VP & Sec'y: V.A. Dorsey; Pop A&R Dir.: Bill Mundy.
Labels: (Owned) Gramophone, Tropicana.
- Granada Recs., 6461 Wall St., Westminster, Calif. 92683. Tel: (714) 893-3637. Pres.: John E. Robinson. (Distributed by Elm)
- Grandallion, see Jersey Coast.
- Grandi Interpreti, see Educational Media & Discocorp.
- Grand Orgue, see Teleson-America.
- Grand Prix Recs., 2087 Union Ave., Memphis, Tenn. 38104. Tel: (901) 278-4900. Contacts: Ed Dubay, Herb O'Mell, Marty Lacker.
- Grand Prix, Pa., see Sunshine Group.
- Grandville Recs. Inc., 1 E. Scott, No. 408, Chicago, Ill. 60610. Tel: (312) 266-0040. Pres./Exec. Prod'r: Clifford Rubin; VP: Helen Rubin; Sales Mgr.: Cynthia Winston; Treas./Exec. Admin. Dir.: Nancy Rubin; Promo./PR: Shari Mills.
- Granite Music Corp., see Criterion.
- Grape Rec. Co., PO Box 2466, Jackson, Miss. 39205. Tel: (601) 362-0522.
- Grapevine, see Grenadilla.
- Grapevine Opry, 308 Main St., Grapevine, Tex. 76051. Tel: (817) 481-3505.
Labels: (Owned) ASR, GO.
- Graph Recs. Inc., see SWS.
- Grass, see Nationwide Sound.
- Grass Mountain, see Richey.
- Grassound, see Revonah.
- Grassroots Project Unlimited, PO Box 4689, San Francisco, Calif. 94101. Tel: (415) 922-3227. Owner: James Heisterkamp.
Label: (Owned) Cable Car, Ragtime.
- Great Northwest, see First America.
- Great Southern Rec. Co. Inc., PO Box 13977, New Orleans, La. 70185. Tel: (504) 482-4211. Pres. John Berthelot.
Labels: (Owned) Bayou Blue, Great Southern, New Orleans Sound.
- Great Voices of the Century, see Bulldog.
- Grecophon, see Fiesta.
- Greenbush, see Lee Anderson.
- Green Dolphin, see Jeree.
- Forrest Green Ents. Inc., 5004 W. Francis Rd., Clio, Mich. 48420. Tel: (313) 686-0189. Pres. & Disco Contact: Forrest Green; VP & Pub. Mgr.: David O. Norris; A&R: Forrest Green, Rob Carter; Sales, Mktg. & Adv. Mgr.: Don F. Norris.
Labels: (Owned) Big Willie, Forrest Green, Ranger.
- Greenhays, see Flying Fish.
- Green Linnet Recs. Inc., 70 Turner Hill Rd., New Canaan, Conn. 06840. Tel: (203) 966-0864. Pres.: Wendy Newton.
Labels: (Owned) Green Linnet, Leviathan; (distributed) Mulligan (UK).
- Int'l rep.: Australia (Larrikin), Canada (Almada), Ireland (Ireland), UK (Projection).
- Green Menu Recs. (div. of Green Menu Music Factory Inc.), 50 W. 57 St., New York, N.Y. 10019. Tel: (212) 397-3060, 489-0806. Pres. & A&R: Henry Jerome; VP/Mktg. & Promo.: Don Castaldi.
Labels: (Owned) Australia (Festival), France (Barclay), Italy (Sugar), UK (London).
- Greensleeves (UK), see Shanach e.
- Green Tree, see Rounder.
- Greentree, see Benson.
- Grenadilla Ents. Inc., c/o Gilbert & Assocs., 1035 Second Ave., New York, N.Y. 10022. Tel: (212) 526-0546. Pres. & A&R Dir.: Richard Gilbert.
Labels: (Owned) Gramercy 5, Grapevine, Grenadilla, Rocking Horse.
- David Gresham Prod'n's (USA) Inc., 13006 Satcoy, Unit 2, North Hollywood, Calif. 91605. Tel: (213) 875-3944, 982-6597. Pres.: David Gresham; Exec. VP & Mng. Dir.: Patrick Boyle; VP: Allan Goldswain.
- Int'l branch: South Africa.
Label: (Distributed) Nitty Gritty (South Africa).
- Grinder's Switch, see Professional Mktg.
- Grit, see Alshire.
- Groove Sound, see Talpro & ECI.
- Groove Soup, see Cookhouse.
- Groove Time Recs. & Ents., 643 W. Baseline, San Bernardino, Calif. 92410. Tel: (714) 884-3567. Pres./Gen. Mgr.: Grover C. Wimberly III; Ass't Mgr.: James Ford.
Labels: (Owned) Groove Time, One Love.
- Groove Two, see ECI.
- Groundhog, see Styletione.
- Grunt, see RCA.
- Gryphon, see Audiofidelity.
- Guitarra, see DGJ.
- Guitar World, see MMO.
- Guile Recs., 7046 Hollywood Blvd., Hollywood, Calif. 90028. Tel: (213) 462-0502.
- Gusman Co., PO Box 8144, Savannah, Ga. 31412. Tel: (912) 236-6333. Pres.: Waymon A Jones; VP Hattie J. Graham
Labels: (Owned) Golden Cross, Gusman, Patch, Specs.
- Gusto Recs. Inc., 1900 Elm Hill Pike, Nashville, Tenn. 37210. Tel: (615) 889-8000. Pres.: Moe Lytle, Gen. Mgr. Steve Koutzman; A&R/Studio Div.: Tommy Hill, Purchase & Prod'n Mgr.: Chuck Duncan.
Labels: (Owned) Deluxe, Federal, Gusto, Hollywood, King, Power Pak, Starday.
- Guyden, see Jame/Guyden.
- Gwen Rec. Serv., PO Box 3388, 319 Highland Ave., Albany, Ga. 31701. Tel: (912) 436-6508. Pres.: Jesse Boone; VP: Bruce Jones; VP Promo.: Jesse Boone Jr.; Gen. Mgr.: Eric Boone, Sales, Mktg. & Pub.: Regina Boone
Labels: (Owned) Albradella, Bruboon, Cozette, Keith, Soul-Po-Tion.

H

- H C P, see January.
- H M R Prod'n's Inc., 574 W. Court, Scotch Plains, N.J. 07076. Tel: (201) 889-1767. Owner: Harry M. Randle; Pres.: Lillian M. Randle.
- H S E Recs. Inc., 113 17 Ave. S., Nashville, Tenn. 37203. Tel: (615) 256-1604.
Labels: (Owned) Black Label, HSE, JSJ, Ken-Tone, Sav-Al, SuAnn.
- H S O Recs., 920 Market St., Philadelphia, Pa. 19107. Tel: (215) 923-9473.
Contacts: Bill Harper, Nicholas Stovos.
- Jim Hall & Gidget Starr Prod'n's, 5 Aldom Circle, West Caldwell, N.J. 07006. Tel: (201) 226-0035. Owners: Jim Hall, Gidget Starr.
Branches: Fort Smith, Ark., 40 Phoenix Village, Zip: 72901. Tel: (501) 646-1021, (918) 962-3664. Branch Mgr.: Bonnie Saulsberry-Mount Morris, Mich., PO Box 207, Zip: 48458. Branch Mgr.: Howard Olenk-Tutwiler, Miss., Box 333, Rt. 1, Zip: 38963. Tel: (601) 375-8526. Branch Mgr.: Walter Shields-Excelsior Springs, Mo., 646 S. Marnetta St. Zip 64024. Branch Mgr.: Col Rod Morris.
Labels: (Owned) Cactus, Deadwood, Dynamite, Peek, Tar Heel, True Love.
- John Hall Recs. Inc., PO Box 18344, 5009 Davis Blvd., Fort Worth, Tex. 76118. Tel: (817) 281-6605. Pres./Owner: John Hall; Mktg. Mgr.: Troy E. Bradley.
- Hall of Fame Jazz, see American Album & Tape.
- Halo, see Mark Five.
- Halpern Sounds Recs & Tapes, 620 Taylor Way, No. 14, Belmont, Calif. 94002. Tel: (415) 592-4900. Pres.: Steven Halpern; Bus. Mgr.: Carl Trondhem; Admin. Ass't: Victoria Gindele.
- Hamilton St., see Buttermilk.
- Hammer, see Sonar.
- Hammond Music, see CBS.
- Ham Sem Recs. Inc., 314 W. Sixth St., Suite 305, Los Angeles, Calif. 90014. Tel: (213) 627-0557. Cable: HAM-SEM. Pres.: William Campbell; VP A&R: John L. Murphy; Sec'y: Dianna Young. Financial Officer: Huey R. Harris; Adv. & Promo.: Joe B. Campbell, Arthur Elijah Jr.
Branches: Sacramento, Calif., PO Box 20623, Zip: 95820. Tel: (916) 383-1250. Mgr.: Haneef Ahmed-Seattle, Wash., 2703 S. Judkins, Zip: 98144. Tel: (206) 329-4645. Mgr.: Khary Burks.
Labels: (Owned) Ham Sem, (distributed) CSC.
- Handshake Recs., 25 W. 56 St., Penthouse, New York, N.Y. 10019. Tel: (212) 245-3600. Pres.: Ron Alexenburg; VP: Peter Gidion; East Coast Promo. Co-ord.: Marje Meyer-Tannen. (Distributed by CBS)
- Branches: Los Angeles, Calif., 8304 Beverly Blvd. Zip: 90048. Tel: (213) 655-8635. West Coast & Southwest Opls. Dir.: Joel Newman. West Coast Label Co-ord.: Romaine Forsythe-Chicago, Ill., 50 E. Bellevue Pl., No. 702, Zip: 60611. Midwest & Southeast Opls. Dir.: Larry Green.
- Hanna Barbera, see Promotions West.
- Hannibal, see Island.
- Hanover Music Corp., PO Box 6296, Beverly Hills, Calif. 90212. Pres.: Paul Weston.
Label: (Owned) Corinthian.
- Hansen, see Good Sound Factory.
- Happy Beat Recs., 14045 S. Main, Suite 303, Houston, Tex. 77035. Tel: (713) 641-0793. Pres.: Roger Cummings; VP/A&R: Black Music; Steve Cummings; Exec. Sec'y: Betty Cummings; Nat'l A&R: Robert Jackson; Int. Pub. Cornell Blahney; Sales Mgr.: Linda Harris.
Branch: Memphis, Tenn., 5019 Boeingshure, Zip: 38116. Tel: (901) 398-7976.
Labels: (Owned) Happy Beat, (distributed) MSB, Venus.
- Happy Day Recs. Inc., 800 N. Ridgeland Ave., Oak Park, Ill. 60302. Tel: (312) 848-3322. Pres.: Vincent Ippolito; VP: Roger Pauly.
- Happy Jazz Recs. Inc., PO Box 66, Zip: 78291; 522 River Walk, San Antonio, Tex. 78205. Tel: (512) 225-6841.
Labels: (Owned) American Jazz, Audiophile, Happy Jazz.
- Hard Boiled Recs., PO Box 6, 484 Lake Park Ave., Oakland, Calif. 94610. Tel: (415) 482-4854. Pres., Promo., A&R & Sales Mgr.: Dan Orth.
- Hard Times, see Pharaoh.
- Hartson Corp., 5006 Vineland Ave., North Hollywood, Calif. 91601. Tel: (213) 766-5281. Pres.: Tony Hart; VP/Gen. Mgr./A&R: Kent Washburn; Treas.: Joseph Hart; Mktg. Dir.: Dan Jewell, Promo. & Pub. Dir.: Chuck Cime, Creative Servs.: Bill Bichelhaupt; Artist Relations: Linda Reksten.
Labels: (Owned) Breeze, Hartson, Spirit, (distributed) Emkay, Holy Kiss.
Int'l rep.: Australia (Spotlight), Canada (Word), UK (Chapel Lane).
- Harvest, Calif., see Capitol.
- Harvest, Tenn., see Eddie Crook.
- Have, see Tuneworks.
- Hawk Sound, see Ala Ents.
- Headfirst Recs. Inc., 9000 Sunset Blvd., Suite 611, Los Angeles, Calif. 90069. Tel: (213) 550-1010. Bd. Chm.: Bill Traut; Pres.: Dave Pell; VP: Ron Moss, John Van Horn; Chief Financial Officer: Jim Golden; Promo.

Co-ord. & Sales Mgr.: Shopan Entesart; Art Dir.: Sylvester Brown. (Distributed by MCA)
 Headliner Stars, see Robbins.
 Headphone, see GRS.
 HeartWarming, see Benson.
 Heaven & Earth, see Family Media.
 Hedonics, see Armageddon.
 Helicon, see Spoken Arts.
 Helidon (Yugoslavia), see Worldtone.
 Helios, see Full Circle.
 Hello, see Stark.
 Hen Cackle, see Sonyatone.
 James Hendrix Ents., PO Box 90639, 902 42 Ave. N., Nashville, Tenn. 37209. Tel: (615) 297-4174. Pres. & Dir.: James Hendrix; VP: Michael L. Waters; PR: Joseph Taylor; Sec'y-Treas.: Milton Hendrix.
 Label: (Owned) Carve.
 The Herald Ass'n Inc., Box 218, Wellman Heights, Johnsonville, S.C. 29555. Tel: (803) 386-2600. Pres. & Treas.: Erv Lewis; VP & Sec'y: Frances B. Lewis.
 Labels: (Owned) Herald, Klesis, Mark Five; (distributed) Sunshine.
 Int'l rep.: UK (New Music).
 Lawrence Herbst Investment Trust Fund, PO Box 1659, Beverly Hills, Calif. 90213.
 Labels: (Owned) Lawrence Herbst, Total Sound.
 Heritage, see MJ.
 Heritage Recs & Music Corp., PO Box 937, Southampton, Pa. 18966. Tel: (715) 947-0460. Pres./A&R Dir.: Jerry Ross.
 Heritage Singers (Gospel Heritage Foundation), PO Box 1358, Placerville, Calif. 95667. Tel: (916) 622-9369. Pres./Dir.: Max Macce. (Distributed by Starlight)
 Herwin, see Shanachie.
 Hi, see Cream.
 Hickory Recs. Inc., 2510 Franklin Rd., Nashville, Tenn. 37204. Tel: (615) 385-3031. T. Tele: 55-4366. Pres.: Wesley H. Rose; VP/Gen. Mgr.: John R. Brown; VP/Dir.: Mel Foree; A&R/Prof. Dept. Dir.: Ronnie Gant; Pop Div. Prof. Dept.: David Kastle; Nat'l Promo. Dir.: Roy Acuff Jr.; Nat'l Promo.: Peggy Lamb, Jimmy Holland.
 Hi Fi, see Everest.
 HiFi/Life, see Everest.
 Hi-Five Audio-Video Prod'ns, 237 W. 54 St., New York, N.Y. 10019. Tel: (212) 582-6414. Pres.: Mark Klingman; VP: G. Parker; Video Eng. & Technician: Abbie Herrick; Audio-Video Eng.: Barbara Kertesz; Video Dir. & Consultant: Ariel Lucas.
 High Frequency, see Star People.
 Highland, see Hi Dides.
 High Water Rec'g Co., Memphis State Univ., Meeman Journalism Bldg., Rm. 302, Memphis, Tenn. 38152. Tel: (901) 454-2350/2892. Pres.: Dr. Thomas Carpenter; Exec. Prod'r & Dean of College of Communication & Fine Arts: Dr. Richard Ranta; Prod'r/A&R/Sales/Promo.: Dr. David Evans.
 Int'l repa.: France (CLAR) Soul Bag, Vogue, Netherlands (Swingmaster, Martin van Olderen), Sweden (Smokestack).
 Hiding America Inc., Box 1800, Nashville, Tenn. 37202. Pres.: Eric R. Hiding.
 Branch: Tulsa, Okla., Box 7300. Zip: 74105.
 Labels: (Owned) Apollo, Artist America, FaderKat, Gospel America, Hiding America, Hiding Int'l, Music America, Tulsa Int'l.
 Hiding Int'l, see Hiding America.
 Hilside Recs., 948 Stuber Ave., Columbus, Ohio 43206. Tel: (614) 252-7116. Owner: Larry McKenzie.
 Hindsight Recs. Inc., PO Box 7114, Burbank, Calif. 91510. Tel: (213) 982-9563. Pres.: Thomas Gramuglia.
 Hi Oldies Music, 4914 Lankershim Blvd., Suite 5, North Hollywood, Calif. 91601. Tel: (213) 766-5239. Co-Owners: Malcolm Talmadge, Lenny Cummings.
 Labels: (Owned) Highland, Hi Oldies.
 Hi-Q, see Fortune.
 Hisong Recs. (div. of Musedco Publ'g), Box 5916, Richardson, Tex. 75080. Tel: (214) 783-9925. Owner: Richard A. Shuff; Promo.: Royce D. Baker; Prod'r: Eddie Fargason.
 Historical Anthology of Music, see Vanguard.
 Historical Recs. Inc., PO Box 109, Canaan 12029; 16 River St., Chatham, N.Y. 12037. Tel: (518) 392-3400. Pres.: Arnold Caplin.
 Int'l repa.: Australia (Memory Lane), Canada (Almada), France (Edwards), Netherlands (Nuis Bedrijven, Cor De Pater), UK (Vintage Jazz).
 Hit Machine Recs. (div. of Diversified Mgmt Group), PO Box 20692, San Diego, Calif. 92120. Tel: (714) 277-3141. Pres. & Prod'r: Marty Kuritz; Prod'r: David Sanchez, Clark Gault.
 Hit Recs. Inc., 576-B Goldsboro Rd. NE, Atlanta, Ga. 30307. Tel: (404) 688-0799. Exec. Dir.: Harold Bishop; Pres.: Blane Gauss.
 Hitson-Disko Rec. Corp., 327 Upshur St. NW, Washington, D.C. 20011. Tel: (202) 882-7339. Pres.: Clifton Thomas; VP & Exec. Sec'y: Charles Farmer.
 Labels: (Owned) Disko, Hitstown.
 Hob Recs. Inc., 425 E. 58 St., New York, N.Y. 10022. Tel: (212) 751-7078. Pres.: Fred Frank.
 Hoedown USA, see 50 States.
 Holi, see Candy.
 Hollywood Recs., 9502 Harrell, Pico Rivera, Calif. 90660. Tel: (213) 695-7627. Pres.: Dave Paton.
 Hollywood, see Gusto.
 Hologram, see Crimson Dynasty.
 Holy Cross, see McKinnon.
 Holy Kiss, see Hartson.
 Holy Spirit Corp., 27335 Penn St., Inkster, Mich. 48141. Tel: (313) 562-8975. Chm.: Elder Otis G. Johnson; Pres.: Craig T. Erquhart; VP: Willie Jones Jr.; Sec'y: Fionne R. Erquhart; Treas.: Reginald Gay; Ass't Treas.: Robert Miller.
 Branch: Pittsburgh, Pa., 7203 Monticello. Zip: 15208. Tel: (412) 242-5692. Gen. Mgr.: Ardell McNeal.
 Labels: (Owned) Aspro, God's World, Holy Spirit, Jesus Only, Ware.
 Homa, see Seeds.
 Home of the Hits, see Beserley.
 Homerun, see General Broadcasting.
 Homestead, Va., see County.
 Homestead Recs., 4926 W. Gunnison, Chicago, Ill. 60630. Tel: (312) 545-0861. Pres.: Gary Cross; VP: Ray Peccic.
 Home Sweet Home, see Benson.
 Honey, see Fantasy/Prestige/Milestone/Stax.
 Honeydew Recs. Inc., 880 Third Ave., New York, N.Y. 10022. Tel: (212) 752-3380. Cable: HOPRESSAM. (Distributed by Zum)
 Hooks, see Styletone.
 Hooks Bros., see Styletone.

Horizon Publ'g Co., 13615 Victory Blvd., Suite 216, Van Nuys, Calif. 91401. Tel: (213) 997-9100.
 Labels: (Owned) Funnybone, Pedigree.
 Horizon, Wash., see Praise.
 Robert Horwitz Org., PO Box 33073, Granada Hills, Calif. 91344. Tel: (213) 363-5800. Pres.: Bob Horwitz; Exec. VP: Brad Koeppenick; Pub.: Richard Thordike; A&R: Patrick Winningham; Sales Mgr.: Babs Simpson; Creative Services: Ray Rayner.
 Hot, see Right Note.
 Hotlanta Recs., 2459 Roosevelt Hwy., College Park, Ga. 30337. Tel: (404) 762-1490. (Also see Dance-A-Thon)
 Labels: Arstone, Hotlanta.
 Hot Music (div. of Hot Talent Corp.), 420 Lexington Ave., Suite 2920, New York, N.Y. 10017. Tel: (212) 557-1183. Pres.: John Kaye; VP: Lon Berlin; PR Dir.: Paul Amalfitano.
 Hot Politics, see Professional Mktg.
 Hotrax, see Platinum Sound.
 Hottrax, see Dance-A-Thon.
 House of Falcon Inc., 821 N. 23, McAllen, Tex. 78501. Tel: (512) 687-7121.
 Cable: FALCON. Pres.: A. Ramirez Sr.; Sec'y & Gen. Mgr.: A. Ramirez Jr.; Rec'g Dir.: Mark A. Ramirez; Gen. Sales Mgr.: Ramiro Perez.
 Branch: Los Angeles, Calif., 2722 W. Pico Blvd. Zip: 90006. Tel: (213) 731-7247. Mgr.: Sara Segovia.
 Labels: (Owned) ARV Int'l, Falcon, RIC.
 Int'l repa.: Colombia (Corporacion Musical), Guatemala (Dideca), Mexico (Discos & Sonofonolas), Venezuela (Fonodisco).
 House of Guitars, see Mirror.
 House of Kings, see Castle in Dixie.
 Houston Recs. Ltd., 3300 Jensen Dr., Houston, Tex. 77026. Tel: (713) 223-5971/2285. Contact: Gasper P. Puccio.
 Hula Recs. Inc., 2290 Alahao Pl., Bldg. C, Honolulu, Hawaii 96819. Tel: (808) 847-4608.
 Labels: (Owned) Hula, Hurlside.
 Hungaria Recs. Inc., PO Box 2073, Teaneck, N.J. 07666. Tel: (201) 343-5240. Exec. Dir.: Kalman Magyar; Prod. Mgr.: Samuel Jackendoff.
 Labels: (Owned) Hungaria; (distributed) Magyar, Qualiton.
 Hurricane, Pa., see Crimson Dynasty.
 Hurricane Ents., PO Box 3547, 1927 San Mateo NE, Albuquerque, N.M. 87110. Tel: (505) 265-3049/4039, 255-8039. Pres.: Al Hurricane; VP: Tiny Morse; Sec'y-Treas.: Bennie L. Sanchez.
 Hurry Recs., 136 Ninth St., Silvis, Ill. 61282. Tel: (309) 755-9770. Owner & A&R: Wanda Hurry.
 Hype, see Bee Jay.

I

I B C Recs. Inc., United Artists Tower, Suite 307, 50 Music Square W., Nashville, Tenn. 37203. Tel: (615) 329-0714. Bd. Chm.: William Sorenson; Gen. Mgr.: Jerry Hansen; Exec. Sec'y/Finance: Sally Isaacson. (Distributed by PAID)
 Int'l repa.: Australia (RCA), Canada (Carrousel/RCA), Germany (Carrera/Polydor), Sweden (SOS), UK (RCA).
 I C M C, see Promotions West.
 i e inc., 736 S. Eddy St., South Bend, Ind. 46615. Tel: (219) 282-2551.
 I G L, see Iowa Great Lakes.
 I L S Institute, see Institute for Language Study.
 I M I, see Avoca.
 I M M C O, see International Mktg. & Mgmt.
 I P A, see Desmar.
 I P I, see International Phonogram Inc.
 I P C, see International Rec'g Co.
 I R D A (International Rec. Dist'g Assocs.), see Album Globe.
 I R M, see Sound Inc.
 I R S, Calif., see International Rec. Syndicate & A&M.
 I R S, see General Music in Tex.
 Ibs Recs. Inc., see LA 5.
 Image 7, see Word.
 Immunity, see Bee Jay.
 Impact, see Benson.
 Importa/Som (Brazil), see Fermata.
 Importe/IZ Recs., 600 Third Ave., New York, N.Y. 10016. Tel: (212) 687-2318. Tel: 421231. Pres.: Mike Wilkinson; Mktg. Dir.: Laurie Ingber; Controller: Betty Lions; Promo.: Dennis O'Connor.
 Improving Artists Inc., 26 Jane St., New York, N.Y. 10014. Tel: (212) 243-2018. Cable: IMPROVART. Tel: 420001. Pres. & Int'l: Carol Goss; VP & A&R: Paul Bley; Sales & Mktg.: David Good; Artist Tour Dir.: Jim Silverman.
 Int'l repa.: Canada (Trend), Italy (Hi-Fi), Sweden (Amigo), UK (Projection).
 Impulse, see MCA.
 Inca, see Musica Latina.
 Incentive Prod'ns (div. of Jvert Music), 639 Bulen Ave., Columbus, Ohio 43205. Tel: (614) 258-7112. Pres.: Jeffrey V. Smith.
 Index Inc., Box 944, Los Angeles, Calif. 90028. Tel: (213) 469-0045. Telex: 5720103. Mng. Dir.: Philip Culp; Dirs.: William Hein, Steve Boudreau, Wesley Hein, Mark Wesley.
 India Navigation Co., 60 Hudson St., Rm. 205, New York, N.Y. 10013. Tel: (212) 962-3570. Cable: INDNAV. Owner: Bob Cummings.
 Int'l repa.: Austria (Bellaphon), Canada (Trend), Finland (Audiovis), France (DAM), Germany (Bellaphon), Italy (IRD), Japan (King), Netherlands (Agram), Sweden (Forsyte), Switzerland (Bellaphon).
 Indian House, Box 472, Taos, N.M. 87571. Tel: (505) 776-2953. Mgr.: Tony Isaacs; Customer Serv.: Billie Concha.
 Int'l repa.: Canada (Prairie Crafts), Europe (Diffusion Artistique in France).
 Ineri Recs., 1300 Texas Ave., Houston, Tex. 77002. Tel: (713) 222-8561.
 Inner Circle, see Stacy-Lee.
 Inner City, see MMO.
 Innovations Inter., see Right Note.
 Implosion, see TK.
 Insight, see Project 3.
 Institute for Language Study, 136 W. 52 St., New York, N.Y. 10019. Tel: (212) 582-3845.
 Labels: ILS Institute, Nutshell, Recordtime.
 In Sync Labs. Inc., 2211 Broadway, New York, N.Y. 10024. Tel: (212) 873-6174. Pres.: Stephen E. Silver. (Cassettes only)
 Int'l repa.: Canada (Trend), UK (Ucorn).
 Inter-Continental Music Corp., 816 Seventh Ave., Huntington, W. Va. 25701. Tel: (304) 523-3951.
 International Artists, see CBS.
 International Folklore, see Sound Inc.
 International Mktg. & Mgmt. Corp., 3310 Lebanon Rd., Hermitage, Tenn. 37076. Tel: (615) 833-7701.

Labels: (Owned) CIE, Corey; (distributed) Crescent, IMMCO, Monkey Joe. International Mod Recs., 2510 Tarrytown Mall, Houston, Tex. 77057. Tel: (713) 695-3648. Contact: Jim D. Johnson.
 Labels: (Owned) Gestation, International Mod.
 International Phonogram Inc., 17 Lincoln St., Hamden, Conn. 06518. Tel: (203) 288-5552. Pres.: Dean Roumanis.
 Branch: Clearwater, Fla., 210 S. Fort Harrison. Zip: 33516. Tel: (813) 447-1487. Contact: Jonathan Horwich.
 Label: (Owned) IPi.
 International Rec. Dist'g Assocs., see Album Globe.
 International Rec. Syndicate (IRS), 1416 N. La Brea Ave., Hollywood, Calif. 90028. Tel: (213) 469-2411. (Distributed by A&M/RCA)
 International Rec'g Co. Inc., 1649 W. Evergreen Ave., Chicago, Ill. 60622. Tel: (312) 227-2000. Pres.: Leonard March.
 Label: (Owned) IRC.
 In Town, see AVI.
 Intrepid Recs. & Filmworks Inc., PO Box 8033, Kansas City, Mo. 64129. Tel: (816) 924-3441. Pres. & Chief Operating Officer: Ronald L. Gillum; Exec. VP Sales & Gen. Mgr.: Milton Clark; Sr. VP Promos: Anita Brown; VP Artist Relations: E.A. Bentley; VP Nat'l Sales & Singles: Sanford Wynn; VP Creative: Tyrone Gillum; Special Servs. Dir.: W. Slaughter; Nat'l LP & Tape Sales Mgr.: Rita Adams; Bus. Affairs Dir.: G.G. Gillum; Overseas Opns. Dir.: Nathan Rogers.
 Invitation, see Album Globe.
 Inwood, see Consolidated Gospel.
 Iowa Great Lakes Rec'g Co. Inc., PO Box 100, Shore Acres, Spirit Lake, Iowa 51360. Tel: (712) 336-2859. Pres.: John Senn.
 Labels: (Owned) IGL, Sonic.
 Island Recs. Inc., 444 Madison Ave., New York, N.Y. 10022. Tel: (212) 355-6550. TWX: (710) 581-5293. Owner: Christopher Blackwell; Pres. US & Canada Opns.: Ron Goldstein; Financial Dir./Controller: Mel Klein; Pub. Dir.: Ellen Smith.
 Home office: England.
 Labels: (Owned) Island (distributed by Warner Bros.), Antilles, Mango; (distributed) Hannibal.
 Int'l rep.: Canada (WEA).
 Isle City Recs., 411 Kemper, Galveston, Tex. 77550. Tel: (713) 763-8344.
 Isle of Spice, see Carib.
 Ivory, see Hal Southern.

J

J B Recs. Int'l Inc., PO Box 7221, Mobile, Ala. 36607. Tel: (205) 342-6202. Pres.: John N. Blackburn; VP: Sara B. Smith; Sales & Mktg.: Lamar Walker; Promo. Mgr.: Mona Gill.
 J C O A, see Jazz Composer's Orchestra.
 J D C Recs., 2737 S. Pacific Ave., San Pedro, Calif. 90731. Tel: (213) 519-7393. Gen. Mgr.: Jim Callon; Co-Admin: Dale Callon.
 Int'l repa.: Australia (K-tel), Benelus (Dureco, Ronnex), Brazil (K-tel, Som), Canada (Attic), France (WEA), Germany (Jupiter), Japan (Nippon Phonogram), Mexico (Gamma), Portugal (Radio Producoes), Spain (Zahro), Sweden (K-tel), UK (Gull).
 J D E, see PM.
 J & J, see Styletone.
 J M H Recs., 610 W. Due West Ave., Suite G-103, Madison, Tenn. 37115. Tel: (615) 868-1158. Owner & A&R Dir.: James M. Hudgins; Pres. & Sales & Promo. Dir.: Jeff Hudgins; Communications Co-ord.: Amanda Hudgins. Branch: Hendersonville, Tenn., 596 Indian Lake Rd. Zip: 37075. Tel: (615) 824-2627.
 J M I, see Boot.
 J P Music, 741 N. Cahuena Blvd., Hollywood, Calif. 90038. Tel: (213) 465-4476. Pres.: Jimmy Pratt; Gen. Mgr.: Pat Britt.
 Int'l branch: Germany, Juicy People.
 Label: (Owned) Jax Pax.
 J S J, see HSE.
 J Y C Cutting Center Inc., 6363 Sunset Blvd., Suite 500, Hollywood, Calif. 90028. Tel: (213) 467-1166. (Also see Nautilus Rec'gs)
 Labels: (Owned) JVC; (distributed) East Wind, Flying Disc.
 Jade, see Rob-Lee.
 Jaguar, see Associated Rec'g Cos.
 Jahrock, see PA.
 Jam A-Ditty Recs., PO Box 21931, Greensboro, N.C. 27420. Tel: (919) 272-7336/6392. Contacts: Edward Earl Gill, J. Cirt Gill III.
 Jamaka & Felco Rec. Co., 3621 Health Ln., Mesquite, Tex. 75150. Tel: (214) 279-5858. Owners: Jimmy Fields, George McCoy.
 Dick James Music, see DJM.
 Jamestone, see MDS.
 Jamie, see Jamie/Guyden.
 Jamie/Guyden Dist'g Corp., 919 N. Broad St., Philadelphia, Pa. 19123. Tel: (215) 232-8383. Pres.: Harold B. Lipsius; Sales & Mktg.: Paul Fien.
 Labels: (Owned) Arctic, Guyden, Jamie, Phil-L.A. of Soul; (distributed) Dion, Gala Ball, LA Recs., Top & Bottom. (SEE ADVERTISEMENT)
 Jane, see R. Dean Taylor.
 Jansco Recs., PO Box 807, Northridge, Calif. 91328. Tel: (213) 363-6000. Pres.: Jan Scooby; VP Promo.: Gene Paleno.
 Branch: Writer Springs, Calif., 10755 Bachelor Valley Rd. Zip: 95493. Tel: (707) 275-2766.
 January Recs., 5137 West Blvd., Los Angeles, Calif. 90043. Tel: (213) 296-4206. Pres.: Sean Wilbourn Carbo.
 Labels: (Owned) HCP, January.
 Janus Recs. Inc., Box 5188, Incline Village, Nev. 89450. Tel: (702) 831-1582. Pres. & A&R: Tom Bonetti.
 Jarrett, see PPL.
 Jax Pax, see JP Music.
 Jay Jay Rec. & Tape Co., 35 NE 62 St., Miami, Fla. 33138. Tel: (305) 758-0000. Owner, Pres. & Chief Eng.: Walter Jaggiello; Sec'y-Treas.: Jeanette Jaggiello; Sales & Promo.: Walter Jay.
 Labels: (Owned) Bonfire, Jay Jay, Polka Tone.
 Int'l rep.: Canada (Almada).
 Jayson, see Discostar.
 Jazz Bird, see Audiofidelity.
 Jazz Composer's Orchestra Ass'n Inc. (JCOA), 500 Broadway, New York, N.Y. 10012. Tel: (212) 925-2121. Pres.: Timothy Marquand; VP: Jack Jeffers; Exec. Dir.: Michael Mantler; A&R Dir.: Carla Bley; Sales & Mktg. Dir.: Dave Hunt; Sales: A. Richards, Russel Musto; Mgr.: Taylor Storer; Promo. Dir.: Yale Evelev; Accounting: Beth Cummings. (Also see listing for New Music Dist'n Serv. in Wholesalers section.)
 Label: (Owned) JCOA.
 Int'l repa.: Canada (Trend), Europe (ECM in Germany).
 Jazz Connoisseur (Italy), see Zum.
 Jazz Hounds Recs., 10581 Ashton Ave., Los Angeles, Calif. 90024. Tel: (213) 470-3355. Pres.: Jack Harcourt.

Branch: Los Gallos, Calif., 120 Court Ave., No. 48. Zip: 95030. Tel: (408) 358-1175. Contact: Thais Harcourt.
Jazz Kings, see American Theme
Jazzology-GHB Recs., 3008 Wadsworth Mill Pl., Decatur, Ga. 30032. Tel: (404) 288-1480.
Labels: (Owned) Audiophile, Circle, Southland.
Int'l reps: Australia (Ron Gray), France (DAM), Japan (Phoenix Trading), Netherlands (H. Vomborg), Sweden (Ad Lib), Switzerland (Record Serv.), UK (Swift).
Jazz Vault, see Caedmon/Arabesque.
Jeanie Recs., 18 W. Seventh St., Cincinnati, Ohio 45202. Tel: (513) 421-5256.
Jenero Rec. Co., PO Box 121, 300 Court St., Soda Springs, Idaho 83276. Tel: (208) 547-3715. Pres.: Ronald Watts.
Jenges, see Associated Rec'g Cos
Jenny, see Rayner Street.
Jeree Recs., 1469 Third St., New Brighton, Pa. 15066. Tel: (412) 847-0111.
Labels: (Owned) Buckshot, Candy, Green Dolphin, Jeree.
Jeremiah Recs., PO Box 1077, Hebronville, Tenn. 37075. Tel: (615) 824-9412.
JermA Recs. Co., 1410 E. 72 St., Chicago, Ill. 60619. Tel: (312) 752-2755.
Pres.: U. S. Warren.
Labels: (Owned) Chytowns, Je mA.
Jersey Coast Agents Ltd., 72 Thorne Pl., West Keansburg, N.J. 07734. Tel: (201) 787-3891. Cable: JERSE COAST. Chief Exec. Officer: Joe McHugh; VP & Gen. Mgr.: Joshua Ericson; VP Contemporary A&R: D.W. Griffiths; Bluegrass A&R Dir.: John Conlon; Video Prod'n Dir.: Paul Savonen.
Labels: (Owned) Anomaly, Out, Not Recommended Viewing; (distributed) BMA, Grandalloon, Karass, St. nehedge.
Jessup, see Michele.
Jesus Only, see Holy Spirit.
Jet Recs. Inc., 9959 Beverly Grove Dr., Beverly Hills, Calif. 90210. Tel: (213) 553-6801. Pres.: Don Arden; VP: Sharon Arden, VP Creative Servs.: Pat Sciolano; A&R: Larry Ross. (Also see CBS)
Int'l branch: England.
Jet Stream, see Music Ents.
Jewel Tone, see Pickin' Post.
Jewel Rec'g Co., 1594 Kinney Ave., Cincinnati, Ohio 45231. Tel: (513) 522-9336. Owner: Rusty York; Gen. Mgr.: Linda York; Studio Mgr.: Jr. Bennett.
Labels: (Owned) Jewel, Log Cabin, Rye.
Jewel Rec. Corp., PO Box 1125, 721 Texas, Shreveport, La. 71163. Tel: (318) 222-0673/0195. Pres.: Stanle J. Lewis; Exec. VP: F.R. Lewis; Sales & Mktg.: Ms. Dennis Lewis; A&R: Joe Wyatt; Promos.: Herman Finley.
Labels: (Owned) Jewel, Paula Ronn.
Int'l reps: Japan (P-Vine), UK (Charly, Flyright).
Jezreel Inc., 1034 Centerfield Court, Highland Park, Ill. 60035. Tel: (312) 831-5810.
Labels: (Owned) Cool Duck, Midway Prod'ns.
Jim, see Benson.
Jimmie Gee, see Rippaw.
Jim, see Flat Town.
Jingles, see Centaur in N.Y.
Jobie, see Ghost.
Jody, Pa., see Vantage.
Jody Recs. Inc., 2226 McDonald Fre., Brooklyn, N.Y. 11223. Tel: (212) 946-4405.
Labels: (Owned) B-Atlas, Gio, Jody, Romona.
Joey Recs. Inc., 6703 W. Commerce, San Antonio, Tex. 78227. Tel: (512) 432-7893.
Labels: (Owned) Dina, Joey, 'A S.
Johnny, see Freddie.
Johnprod Recs., 540 La Guardia Pl., New York, N.Y. 10012. Tel: (212) 533-8441. Pres.: John Doelp.
Little Richie Johnson Agency, Box 3, 913 S. Main, Belen, N.M. 87002. Tel: (505) 864-7441. Pres.: Little Richie Johnson.
Labels: (Owned) Chuckle, LR, Little Richie.
Paul Johnson Music Prod'ns Inc., PO Box 552, Woodland Hills, Calif. 91365. Tel: (213) 703-6707. Pres.: P. Johnson; Prod'n Ass't: Cheryl Wilks.
Label: (Owned) Petra.
Johnson Rec. Co., 41 Algonquin Dr., Yonkers, N.Y. 10710. Tel: (914) 779-2080. Pres.: Jim McCarthy; Mgr.: Gil Miller, Prod'n Dir.: Henry Boye. Prod'n Consultant: Walter Coen; Special Prods. Dir.: Al Thomas.
Labels: (Owned) Johnson, Jol., (distributed) Conn, Virginia.
Johnston, see CBS.
Joint Int'l, see Disc Disk.
Joher, see Lifetime.
Johe, see Johnson Rec. Co.
Joy, see Stacy-Lee.
Joyce Recs., PO Box 66455, 122-2 Venice Blvd., Los Angeles, Calif. 90066. Tel: (213) 391-4088. Pres.: Vayne Volat.
Joyce III, see Rooster Blues.
Joyous Garde, see Star Song Records in Tex.
Juggalar Recs., 830 Dawn Court, De Kalb, Ill. 60115. Tel: (815) 758-1623.
Partner/Sales & Promo. Dir.: Richard C. Lapka, Partner/Sales Dir.: Richard J. Trelease; Partner/A&R Dir.: David L. Farley, Partner/Pub. Dir.: David J. Lenef; Partner/Sales & Promo. L. Kim McDaniel, Partners: David J. Gessner, David M. Polk, Per. anal Rep./A&R/Promo. John Naughton.
Jukebox, see General Broadcast Ig.
Junction Rec., 93 Morris Ave., Garfield, N.J. 07026. Tel: (201) 478-0601.
Pres.: Jerome Myketyjn; VP: J. Myketyjn, Gen. Mgr.: Perry Stram.
June Appal Rec'gs., Box 743, Whitesburg, Ky. 41858. Tel: (606) 633-9958.
Labels: (Owned) Appalaseed, June Appal, Sourdwood Mountain.
June, see Glenn.
Jupiter Recs., PO Box 3316, Nap., Calif. 94558. Tel: (707) 253-2395. Pres.: W. Faye Faus; VP/Sales & Promo.: Dennis Channing.

K

K. L., see Nu-Sound.
K M C Recs. Corp., 95-26 92 St., Ozone Park, N.Y. 11416. Tel: (212) 845-4236. Pres.: Kacey Casyk; Tre s.: Iwanna Casyk.
Branch: Ridgely, Conn., 76 Nuttman Rd. Zip 06877. Tel: (203) 438-0001. VP: Bruce Merley.
K & R Music Inc., 112 E. Main St., Trumansburg, N.Y. 14886. Tel: (607) 387-5325. Pres.: William M. Kelly; VP: Ray Repp; Finance Dir.: Ann E. Wakeley.
Int'l reps: Canada (B. Broug, Tony).
K & S, see Demon.
K&tel Int'l Inc., 11311 K-tel Dr., Innetonka, Minn. 55343. Tel: (612) 932-4000. Bd. Chm. & Pres.: Phleg Kives, Exec. VP: Raymond Kives, Mickey Effenberg; VP & Gen. Mgr.: David Catlin; VP A&R: David Milner.
Kacha, see Lesser-Int'l-USA.
Kadia, see Old Dominion.

Kajac, see Ozark Opry.
Kajun, see Master-Trak.
Kaledoscope Recs., PO Box O, El Cerrito, Calif. 94530. Tel: (415) 527-6242.
Pres.: Jeff Alexson; A&R Dir.: Tom Diamant. (Distributed by Flying Fish).
Karass, see Jersey Coast.
Karen, see Musica Latina.
Kare Recs. Inc., 1391 Oakland Park Ave., Columbus, Ohio 43224. Tel: (614) 263-4344.
Labels: (Owned) Dolejo, Kare; (distributed) Blue Ash.
Kari Recs. Inc., PO Box 9246, Austin, Tex. 78766. Tel: (512) 345-5796.
Pres.: Doug Pendergrass; VP: Jerry Foster; Sec'y Treas.: Don Bedell; Opns. Mgr.: Johnny Morris; Sales: Johnny Elgin.
Labels: (Owned) Kari, Kik.
Kashmir, see Moonstone.
Kat Family Recs., 2215 Perimeter Park, Suite 21, Atlanta, Ga. 30341. Tel: (404) 252-5800. Pres.: Joel Katz. (Distributed by CBS).
Katie the Great, PO Box 19215A, Los Angeles, Calif. 90019. Tel: (213) 737-6196. Pres.: Tommy Colbert; Creative Mgr.: Yeshayah Tishbach.
Labels: (Owned) Booths, ETC III, Kether Elyon, Malache Elyon.
Kayvette, see TK.
Keene, see Sea Cruise.
Keepsake, see Sound Inc.
Keeta, see Sea Cruise.
Keith, see Gwen.
Kela, see Dragon Int'l.
Gene Kennedy Ents., 2125 Eighth Ave. S., Nashville, Tenn. 37204. Tel: (615) 383-6002. Pres.: Gene Kennedy; VP: Karen Jeglum, Nat'l Promo. Dir. Bobby Young.
Label: (Owned) Door Knob.
Kent, see Cadet Recs.
Ken-Tone, see HSE.
Kenwood, see Nashboro.
Keygma Recs., 5553 Oakville Center, St. Louis, Mo. 63129. Tel: (314) 846-1080. Owner & Sales Mgr.: Emmett P. Taylor III; A&R/Prod'n: Carl Goodin.
Kess Recs., PO Box 140316, Nashville, Tenn. 37214. Tel: (615) 889-6675.
Contact: Jimmy Kish.
Kether Elyon, see Katie the Great.
Keynote Recs., PO Box 4185, Youngstown, Ohio 44515. Tel: (216) 793-7295. Pres. & A&R Dir.: Richard M. Hahn.
Kheba, see Tria.
Kuamichi, see Richey.
Kicking Mule Recs. Inc., PO Box 158, Alderpoint, Calif. 95411. Tel: (707) 926-5312. Head North American Opns.: E.D. Denson; Head European Opns.: Stefan Grossman; VP Admin. Opns.: Mary Alice Beebe.
Labels: (Owned) Kicking Mule, Sierra Wave, Sonet USA, Transatlantic USA, (distributed) Larrikin Folkways (Australia).
Kid Cuz'n Rec. Co., PO Box 182, Midwood Sta., Brooklyn, N.Y. 11230. Tel: (212) 339-3536. Mgr.: Jim Pelton; Sales: Dick Alexander; Promo.: John Upton.
Kidd, see OK.
Kidman Rec. Prods., 4926 W. Gunnison, Chicago, Ill. 60630. Tel: (312) 545-0861. Pres.: Raymond Peck; VP: George Peck.
Kik, see Kari.
Killer, see Little Giant in N.Y.
Kimbo, see Colonel Buster Doss.
King, see Gusto.
King of Kings Rec. Co., 38603 Sage Tree St., Palmdale, Calif. 93550. Tel: (805) 947-4657. Pres. & Gen. Mgr.: LeRoy Pritchett.
Branches: Daytona Beach, Fla., 171 Pine Haven. Zip 32014. Tel: (904) 252-4849. Exec. VP/Promos.: Charles Vickers-Far Rockaway, N.Y., 423 Beach 47 St. Zip 11691. Tel: (212) 471-4319. Exec. Mgr./VP: Gladys Funches.
King & Moore Prod'ns Inc., PO Box 10273, Chicago, Ill. 60610. Tel: (312) 944-1125. Bd. Chm. & Pres.: Xavier King Roy III; VP Mktg.: Ernest L. Miller, Sec'y: Audrey B. Roy; A&R: Carlene Worthy.
Label: (Owned) XKR III.
Kingsway Music, see Star Song in Tex.
Don Kirshner Entertainment Corp., 1370 Sixth Ave., New York, N.Y. 10019. Tel: (212) 489-0440. Chm. Don Kirshner; Pres. Herb Moelis; Talent Development Dir.: Felix Di Palma. (Distributed by CBS).
Kitty Hawk, see General Broadcasting.
Klauer Rec. Co., 10520 Burbank Blvd., North Hollywood, Calif. 91601. Tel: (213) 980-8254. (Also see Varese Sarabande).
Int'l reps: Canada (Almada), China (Hong Kong Recs.), France (Dave Music), Germany (Phonogram), UK (EMI).
Sid Kleiner Music Ents., 3701 25 Ave. SW, Naples, Fla. 33999. Tel: (813) 455-2696. Mng. Dir.: Sid Kleiner; VP-Treas.: Trudy Kleiner. Sec'y: Sara Kleiner; Gen. Mgr.: Mark A. Kleiner.
Labels: (Owned) Country-King, Musi-Poe, Top Star; (distributed) This is It.
Klessis, see Herald Ass'n.
Klub, see Mark Five.
Kneptune Int'l Recs. Inc., 10850 Riverside Dr., No. 302, North Hollywood, Calif. 91602. Tel: (213) 763-5000. Pres.: Kenny Harris. VP & Gen. Mgr.: Dennis F. Rose.
Int'l branch: Canada.
Knight, Calif., see Cobra.
Knight, Pa., see Crimson Dynasty.
Knockout, see Audiofidelity.
Known Artist, see Boliva.
Koala Rec. Co., 108 Lavern Circle, Hendersonville, Tenn. 37075. Tel: (615) 824-8601. Pres.: Welsey E. Sanborn.
Koala Recs. Inc., 6253 Hollywood Blvd., Los Angeles, Calif. 90028. Tel: (213) 467-3203. Pres.: Irving Kessler; VP: Mary Kessler.
Labels: (Owned) Deep Roots, Koala, Lamb & Lion (selected titles), Lamb & Lion Country.
Koko Recs., 888 Seventh Ave., New York, N.Y. 10019. Tel: (212) 541-6880.
Kool Kat Prod'ns Inc., PO Box 176, Monsey, N.Y. 10952. Tel: (914) 425-6040.
Labels: (Owned) Emko, Kool Kat, RRC, Recordland.
Kory, see Countrywide.
Kroyola, see Buttermilk.
Krys, see SIPRA.
Kronos, see Peters Int'l.
Kubanay Publ'g Corp., 4728 NW 167 St., Miami Lakes, Fla. 33014. Tel: (305) 620-0545. Pres.: Rosta A. Don; Dir.: Mateo San Martin; Sales Mgr.: Tony San Martin; Prod'n Mgr.: Leo Suarez; A&R/Promo. Mgr.: Jorge Cabrera; Ass't Mgr.: Vivian Hernandez.
Labels: (Owned) Discolor, Kubaney, Mate.
Int'l reps: Colombia (Grabarco), Dominican Republic (Distribuidora Dominicana de Discos), Ecuador (Studio 2), France (Sonodisc), Mexico (Discos & Cintas Helix), Panama (Continental de Discos), Peru (Galvano), Spain (CBS), Venezuela (Discorona).

Kuchuck, see Celestial Harmones.
Kudu, see Creed Taylor.
L
L A 5 Inc./lbs Recs. Inc., 9701 Walshe Blvd., Suite 1000, Beverly Hills, Calif. 90212. Tel: (213) 550-8115. Pres.: Alec Costandinos. VP: Laurie E. Hirsch.
Int'l reps: Canada (RCA), China (Shun Cheong), France (Barclay, Disc'AZ, RCA), Italy (CGD), Japan (Nippon Phonogram), Mexico (Musart), South Africa (Teal), UK (DJM, Pye), Venezuela (Velvet).
L A Recs., Tapes & Films, 1352 W. Girard Ave., 2nd fl., Philadelphia, Pa. 19123. Tel: (215) 236-2150. Pres.: Dave Crawford, Admin. Dir.: Pamela F. Jackson. A&R Deryll Inman (Distributed by Jame/Guyden).
Branch: Los Angeles, Calif., PO Box 54021. Zip: 90054.
L A X, see CBS.
L C, see Linda Cooper.
L D E, see Lee Dunne.
L I R S Classics, 72 Orange St., Brooklyn, N.Y. 11201. Tel: (212) 875-6193. Owner: Ernest W. Ucko.
L M I, see Lee Magid.
L P Music, see Arlo.
L P G, see Lopyrquan.
L R J, see Little Richie Johnson.
L S Recs., 120 Hickory St., Madison, Tenn. 37115. Tel: (615) 868-7172. Pres., Adv., Tape & Int'l Mgr.: Lee Stoller; Promo. Mgr.: Jack Andrews; Country Dir.: Harold Hodges.
Label "X", see Enfracte.
Laboratory Series, see Sonic Arts.
Lad, see TH.
Laff, see Ala Ents.
Lakoc Rec. Co., 3235 W. Fullerton Ave., Chicago, Ill. 60647. Tel: (312) 772-9444. Owner: Leon A. Kelert.
Labels: (Owned) Blackbird; (distributed) Claremont, Philips-Dutch Swing College Band.
Lake Country Music, PO Box 88, Decatur, Tex. 76234. Tel: (817) 627-2128. Pres.: Danny B. Wood; Partners: Larry Quinlan, Woodbridge, Mark George. Lake Country (Switzerland), see Domino Recs. Ltd. in Tex.
La Louisianne Recs. Inc., 711 Stevenson St., Lafayette, La. 70501. Tel: (318) 234-5577. Pres. & Gen. Mgr.: Carol J. Rachou Sr.; Opns. Mgr.: Carol J. Rachou Jr.
Labels: (Owned) Belle, La Louisianne, Music Mart, Tamm.
Int'l reps: Canada (K-tel, PolyGram), France (Le Chant du Monde, Vogue), UK (Swift).
Benjamin Lambert, see AcoustoGraphic.
Lamb & Lion, see Benson, Koala & Sonrise.
Lamb & Lion Country, see Koala.
Landers-Roberts Ents., 9255 Sunset Blvd., No. 915, Los Angeles, Calif. 90069. Tel: (213) 550-8819. Co-Pres.: Hal Landers, Bobby Roberts; VP Artist Development: Barry Jay Josephson; VP A&R: Jay Landers, A&R: Barry Josephson.
Land of Lincoln, see Chi-Town.
Land O' Jazz Recs., PO Box 26393, New Orleans, La. 70126. Tel: (504) 241-4246. Chief Exec.: Plato Smith.
Landside Recs., Michael Roth, 723151, Atlanta, Ga. 30339. Tel: (404) 432-3877. Pres.: Michael Rothschild.
Lane, see West.
Lanor Recs., 329 N. Main, Church Point, La. 70525. Tel: (318) 684-2176. Owner & Mgr.: Lee Laverne; Ass't: Linda Ballard.
Int'l rep.: UK (Swift).
Lanta, see Atterram.
Largo, see GNP Crescendo.
Lar-Jo Recs. Inc., 1911 Whinton St., Middletown, Ohio 45042. Tel: (513) 425-6716/0996. Pres.: Larry A. Rothermel; Sec'y-Treas.: Barbara Falcone; Promo./Talent Co-ord.: Sascha Baraya.
Lark, see Major Rec'g Co.
Larkspur Recs., PO Box 1001, Soquel, Calif. 95073. Tel: (408) 462-6537. Gen. Mgr.: Jon Hutchings; Sec'y-Treas.: Debbie McNutt; A&R: Tony Hill; Promo./Sales: Kenneth Burton.
Larrikin Folkways (Australia), see Kicking Mule.
Laserdisc, see Lasergram.
Lasergram Co., 1000 W. Oak St., Burbank, Calif. 91506. Tel: (213) 843-6052. Owners: Barry Keate, David L. Von Suerdick, Jeffrey Night.
Label: (Owned) Laserdisc.
Las Vegas Rec'g Studio Inc., 3977 Vegas Valley Dr., Las Vegas, Nev. 89121. Tel: (702) 457-4365. Pres./Chief Eng.: Chips Davis; VP/Studio Mgr.: Hanka Castro; Sec'y-Treas.: Sheila Godfrey; Eng./Prod'n: Ed Bannon, Rick Pond, Rick Cozad, Jim Lanham.
Labels: (Owned) Entertainment Capital Recs. (ECR), Marquee.
Latin Int'l, see Discos Latin.
Latin Percussion Ventures Inc., 160 Belmont Ave., Garfield, N.J. 07026. Tel: (201) 478-6903. Tel: 642805. Pres.: Martin Cohen; VP: Marilyn Cohen; Sales & Promo.: Ricardo Marrero.
Labels: (Owned) Crollo, Latin Percussion Ventures, Turnstyle.
Int'l reps: Australia (Billy Hyde), France (J. Capelle), Netherlands (World), Switzerland (Core).
Latin Waters, see GRS.
Laurel-Protone, see Protone.
Lavere Recs. Inc., 20 F. Robert Pitt Dr., Monsey, N.Y. 10952. Tel: (914) 425-7000. Pres./Treas./Sales & Admin.: Robert Schwartz; VP/A&R/Promo.: Gene Schwartz; Sec'y/A&R/Promo.: Eliot Greenberg; Sales: Ernie Marresca.
Labels: (Owned) Laurie, Rust.
Int'l reps: Argentina (RCA), Australia (RCA), Austria (Musica Schallplatten), Bolivia (Inbonton), Brazil (RCA), Canada (RCA), Chile (Sochem), Colombia (Sonolux), Czechoslovakia (Opus), Denmark (Hedde Nielsen), Dominican Republic (Distribuidores Musicales), Ecuador (Eco. Roberto Recalde), El Salvador (Dicesa), Fiji Islands (Procera), Finland (Discophon), France (RCA), Germany (RCA), Greece (Minos Matsas), Hong Kong (Cosdel), India (Gramophone), Israel (Eastonics), Italy (RCA), Jamaica (Federal), Japan (RCA/RVC), Kenya (AIT), Korea (Jigo), Mexico (RCA), Netherlands (RCA), New Guinea (Walter Bay), New Zealand (RCA), Norway (Disco A/S), Pakistan (EMI), Panama (Discos de Panama), Peru (FTA), Philippines (Victor), Portugal (Telectra), Singapore (Cosdel), South Africa (Teal), Spain (RCA), Sweden (Electra), Switzerland (Musikvertrieb), Thailand (Central Trading), Turkey (Melodi), UK (RCA), Uruguay (APSA), Venezuela (Cordica), Yugoslavia (Jugoton).
La Val Rec. Co., 1327 Cobb St., Kalamazoo, Mich. 49007. Tel: (616) 342-5328. Pres.: Vic La Val; Disco A&R: Tito Taylor; Nat'l Sales Mgr.: Vincent Taylor; Promo.: V. Taylor, Harry Whitco.
Branch: San Francisco, Calif., 1218 Hollister St. Zip: 94124. Tel: (415) 467-5157.

- Labels: (Owned) La Val, Smile, Vic; (distributed) Soul Set.
Lazer Recs., PO Box 77, Center Square, Pa. 19422. Tel: (212) 438-8228.
Contacts: A.A. Gravati, Curtis Rock.
Leaf Recs., PO Box 1297, 815 Trailwood, Hurst, Tex. 76053. Tel: (817) 268-3276.
Le Cam, see Christ.
Lefevre, see Dawn.
Legrand Recs. Int'l, 317 Granby St., Norfolk, Va. 23510. Tel: (804) 623-5565. Cable: ROCKMASTAS. Pres.: Frank Guida; VP's: Millie & Joseph F. Guida; Sec'y-Treas.: Pearl Frank.
Labels: (Owned) Legrand, Norfolk Int'l, Peanut Country, SPQR.
Lexus, see Surfside Hawaii.
LeMans Rec. Co., 331 Triangle Rd., Somerville, N.J. 08876. Tel: (201) 359-5520. Pres.: Chrestelle Goydsh; VP: Bernard Goydsh.
Lemon, see National Recs.
Lemon Square, see Yatahey.
Leonarda Prod'ns, PO Box 124, Radio City Sta., New York, N.Y. 10101. Tel: (212) 666-7697. Pres.: Marnie Hall, VP & Treas.: William J. Scribner; VP & Sec'y: Jane M. Bowers.
Lessor-Int'l-USA, 6443 SW Beaverton Hwy., Portland, Ore. 97221. Tel: (503) 297-5812. TWX: (910) 464-4792. VP: Fred Fiore; Gen. Mgr.: Charlotte Vaughn.
Int'l branch: Germany.
Labels: (Owned) Batchwork, Conquest, Kacha, Limo; (distributed) Earth Int'l.
Levathan, see Green Linnet.
Mark Levinson Acoustic Rec'gs Ltd., 131 Leeder Hill Dr., Hamden, Conn 06517. Tel: (203) 281-6333. Tel: 96-6405.
Int'l rep.: Japan (Nippon Phonogram).
Liberty, see EMI America/Liberty.
Lido, see Old Dominion.
Libra, see Alhambra.
Library of Congress, Motion Picture, Broadcasting & Recorded Sound Div., Washington, D.C. 20540. Tel: (202) 287-5509. Chief: Erik Barnow; Public Servs. Co-ord.: Dorothy Zeisel.
Lifesong/Goldiggers, see Lifesong Recs.
Lifesong Recs. Inc., 488 Madison Ave., New York, N.Y. 10022. Tel: (212) 752-3033. Pres.: Philip S. Kurmit; VP's: Tommy West, Terry Cashman, Gen. Mgr.: Stanley Nowak.
Labels: (Owned) Lifesong, Lifesong/Goldiggers.
Int'l rep.: Australia (RCA).
Life Stream, see Calvary.
Lifetime Rec'gs, 314 S. Goodman St., Rochester, N.Y. 14607. Tel: (716) 244-7526. Owner: Lester W. Osband.
Labels: (Owned) Joker, Lifetime, Lyndell.
Light, see Word.
Lighthouse Prod'ns, 65 Lovell Ave., San Rafael, Calif. 94901. Tel: (415) 454-2898.
Lightning, see Crimson Dynasty.
Lit' Possum, see Candy.
Limo, see Lessor-Int'l-USA.
Lindberg Recs., 1445 Sunset Ridge Rd., Glenview, Ill. 60025. Tel: (312) 729-2047. Pres.: Sven Lindberg; VP: Bjorg Larsen; Pop A&R: Elizabeth Lisa; Sales Mgr.: Frank Three.
Labels: (Owned) Dansk-Disk, Lindberg, Norsk-Disk, Scandinavian, Svensk-Disk.
Lions Den, see Stacy-Lee.
Lisboa, see Penco.
Listening Library Inc., 1 Park Ave., Old Greenwich, Conn. 06870. Tel: (203) 637-3616. VP: Timothy P. Dittow; Mktg. Dir.: Forest Miner.
Labels: (Owned) Listening Library; (distributed) Argo, Caedmon, Columbia, Everest, Folkways, London, RCA, Spoken Arts (all educational product).
Little David Recs. Inc., 8033 Sunset Blvd., Suite 1037, Los Angeles, Calif 90046. Tel: (213) 876-9602. Pres.: Monte Kay.
Little Giant Recs., Box 205, White Lake, N.Y. 12786. Tel: (914) 583-4471. Pres.: Mickey Barnett.
Labels: (Owned) Killer, Little Giant.
Little Giant Rec. Co., 1014 16 Ave. S., Nashville, Tenn. 37212. Tel: (615) 244-4360. Pres.: Roy Sinkovitch; VP & Gen. Mgr.: Mick Lloyd; Promo. Dir.: Dee Ygama.
Int'l reps.: Australia (Janda), Canada (Carousel), Germany (Intercord).
Little Nashville, see Don D. Sheets.
Little Nashville Opry, see Don D. Sheets.
Little People, see Praise.
Little Richie, see Little Richie Johnson.
Little Silver Recs., PO Box 743, Red Bank, N.J. 07701. Tel: (201) 741-5821. Owner, Pres., Prod'r & A&R: John DeCesare; Mgr./Sales: Bert DeCesare.
Little Star Recs. (div. of Barnum Entertainment), 723 N. Seward, Los Angeles, Calif. 90038. Tel: (213) 462-0723.
Little Studio, see Arlo.
Little Things, see Windy Hill.
Living Music, see Gramavision.
Loadstone & Open Rec. Co., 163 Drizaba Ave., San Francisco, Calif. 94132. Tel: (415) 334-2247. Pres. & Gen. Mgr.: Walter C. Stone; Sales & Promos.: Charlie Hines; Sales & Promos. Ass't: John E. Harris; Sec'y-Treas.: B.M. Stone.
Labels: (Owned) Loadstone, Open.
Loft, see Celestial Harmonies.
Log Cabin, see Jewel Rec'g in Dho.
London, see PolyGram Classics.
London's Pride, see American Entertainment.
Long Distance Recs., Box 507, Millwood, N.Y. 10546. NYC Tel: (212) 220-3900.
Longhorn Ballroom Inc., 216 Cornth, Dallas, Tex. 75207. Tel: (214) 428-3128.
Long View Farm, see SE Music.
Lorimar, see CBS.
Lost, see Dynamo.
Lost Lake Arts, see Windham Hill.
Lotus Music Corp., PO Box 2446, Toluca Lake, Calif. 91602. Tel: (213) 902-0202. Pres.: H. Lyman.
Lotus, N.J., see Stacy-Lee.
Louisiana Hayride Recs. Inc., 1708 Grand Ave., Nashville, Tenn. 37212. Tel: (615) 327-4744. Pres.: David Kent.
Louisville Orchestra First Edition Recs., 333 W. Broadway, Louisville, Ky 40202. Tel: (502) 587-8681. Gen. Mgr.: Jack M. Firestone; Mktg. & PR Dir.: Douglas W. Kinzey; Opns.: Greg Copenhaver; PR: Jerry Dotler, Accountant & First Edition Recs. Contact: Mona Lee Griffin. (Distributed by Composers Rec'g)
Label: (Owned) First Edition.
Love, see Random.
Love (Finland), see SWS.
LoveLight, see ECI.
Loyal, see OK.
Loypranq Ltd., 39 W. 55 St., New York, N.Y. 10019. Tel: (212) 586-3350.
Cable: LLOYDPRIICE. Telex: 126655. Pres.: Lloyd Price; A&R Dir.: Nathaniel Adams; Promo. Dir.: Rudy Lucas; Controller: Debra Martinez.
Labels: (Owned) LPG, TPM; (distributed) Marna.
Luau, see Boddie.
Lucifer Recs. Inc., PO Box 263, 37 Woodside Ave., Hasbrouck Heights, N.J. 07604. Tel: (201) 288-8935. Pres.: Ron Luciano; VP: Ed Capone; A&R: Pete Fragale; Sales & Mktg.: Ron Michaels; Pub.: Tom Samuels; Adv.: Arlene Patrino; Promo.: Joe Merlino.
Lummar/Lexcon, see Word.
Luna, see Glotie.
Lybra, see Stacy-Lee.
Lyndell, see Lifetime.
Lynx, see CBS.
Lyrichord Discs Inc., 141 Perry St., New York, N.Y. 10014. Tel: (212) 929-8234. Pres.: Peter Fritsch.
Labels: (Owned) Eterna, Experience Anonymes, Lyrichord.
M
M C A Recs. Inc., 70 Universal City Plaza, Universal City, Calif. 91608. Tel: (213) 508-4000. Cable: MUSICOR. TWX: (910) 499-2679. Telex: 67-7053. Pres.: Bob Siner; VP Adm'n.: Arnold Stone; VP Bus. Affairs & Pres. MCA Recs. Int'l: Lou Cook; VP A&R: Denny Rosecrantz; VP Promo.: Pat Pipolo; VP Creative Affairs: George Osaki; VP Mktg.: Santo Russo; VP Prod'n: Vince Duffy; VP Pub. & Artist Development: Joan Bullard; Exec. Dir. Black Prod.: Jerry Boulding. Backstreet Recs. - Pres.: Danny Bramson. Songbird Recs. - Mktg. Dir.: Charlie Shaw.
Branches: New York, N.Y., 10 E. 53 St. Zip: 10022. Tel: (212) 888-9700. VP/East Coast Gen. Mgr.: Ray D'Aranno; East Coast Press & Artist Development Dir.: Lynn Kellerman-Nashville, Tenn., 27 Music Square E. Zip: 37203. Tel: (615) 244-8944. Pres.: Jim Foglesong; VP Sales & Mktg.: Chic Doherty; VP A&R: Ron Chancey; Promo. Dir.: Erv Woolsey; Pub. Dir.: Jerry Bailey.
Int'l branches: Canada, England.
Distribution branches: See Record & Tape Wholesalers section.
Labels: (Owned) ABC, Backstreet, Blue Thumb, Coral, Dot, Duke, Dunhill, Impulse, MCA, Paramount, Peacock, Songbird; (associated/distributed) Artists House, Crusader, Headfirst, Magnet, Regency, South Coast, Sparrow, Sweet City, Unicorn.
Int'l reps.: Argentina (Microfon), Australia (Astor), Austria (Ariola), Belgium (Ariola), Bolivia (Discolandia), Brazil (Ariola, RGE/Fermata), Caribbean excluding Santo Domingo & Haiti (recs.-GG in Jamaica; tapes-Record Specialists in West Indies), Chile (Philips), Colombia (Orbe), Denmark (Polydor), Dominican Republic (Julio Tenos), Ecuador (Fediscos), El Salvador (Leo), Finland (Finnlevy), France (Arabella), Germany (Ariola-Eurodisc), Greece (Emial), Israel (CBS), Italy (Ricordi), Japan (Victor), Mexico (Bertelsmann), Netherlands (Ariola-Eurodisc), New Zealand (PolyGram), Norway (PolyGram), Paraguay (Microfon in Argentina), Peru (El Virey), Philippines (Home), Portugal (PolyGram), Singapore (Chiang Hual), South Africa (Gallo), Spain (Ariola-Eurodisc), Sweden (PolyGram), Switzerland (Ariola-Eurodisc), Uruguay (Microfon in Argentina), Venezuela (Velvet).
M D J Recs., Preston Tower, Suite C148, Dallas, Tex. 75225. Tel: (214) 691-7319.
M D S Ent's, 813 Heritage Ln., Waterville, Ohio 43566. Tel: (419) 878-8387/8397. Pres.: Michael Drew Shaw; Sales & Promo. Dir.: Park James Shaw. Branch: Grand Rapids, Mich., 2557 Knapp NE. Zip: 49505. Tel: (616) 364-0022. A&R Dir.: Ronald J. Markai.
Labels: (Owned) Jamestone, Northcoast.
M & E, 161 W. 54 St., Suite 602, New York, N.Y. 10019. Tel: (212) 582-7854. US Rep.: Marisa De Luca.
Home office: Italy, Panarecord.
M F M I, see Maynard Ferguson.
M G M, see PolyGram.
M H S, see Musical Heritage Society.
M J Rec'g Inc., Dodge, Neb. 68633. Tel: (402) 693-2379. Pres.: Joe G. Spellerberg Jr.; Mgr. & Buyer: Jo Ann Ruskamp.
Labels: (Owned) Czech, Heritage.
M J Recs. Inc., PO Box 902, Provo, Utah 84601. Tel: (801) 225-4674. Pres.: Richard D. Rees.
Labels: (Owned) ML, Mainline.
M M C, see Mutual Music.
M M G, see Moss.
M M O Music Group Inc., 423 W. 55 St., New York, N.Y. 10019. Tel: (212) 245-4861. Pres.: Irving Kratka; Prod'n Mgr.: Kevin Yatarola; Promo. Dir.: Stephen Hayland; Prof. Mgr.: Victor Horowitz. Branch: North Hollywood, Calif., 13012 Satcoy St. Zip: 91605. Tel: (213) 765-6600. Mgr.: David Kratka.
Labels: (Owned) Aural Explorer, City Sounds, Classic Jazz, Gutar World, Inner City, Music Minus One.
Int'l rep.: Canada (Almada).
M R C, see Major Rec'g Co.
M S B, see Happy Beat.
M S K Prod'ns Inc., 8880 Hubbell Ave., Detroit, Mich. 48228. Tel: (313) 837-1633. Pres.: Chet Kadeski; Sec'y-Treas.: Jerry Snyder; A&R: Johnnie Griffin; Nat'l Promo.: Tom Gelardi; Sales: Joe Ginter.
M S S Recs. Inc., PO Box 429, Sheffield, Ala. 35660. Tel: (205) 381-9200. Pres./Co-Owner: Michael Barnett; Co-Owners: Barry Beckett, Roger Hawkins, David Hood, Jimmy Johnson; Artist Development Dir.: Sharon Weisz; Prod. Co-ord.: Bunny Wright. (Also see Capitol).
M S U Inc., 221 W. 57 St., 5th fl., New York, N.Y. 10019. Tel: (212) 582-5030. Pres.: Steven Grossman; VP: Jimmy Johnson; VP's Prod'n: Peter Alvord, Barry Beckett, Roger Hawkins, David Hood.
Int'l branch: Canada, Unison Recs. Inc.
Int'l rep.: UK (EMI).
M V P, see PolyGram.
Made in USA Recs. & Tapes Inc./Marty Wilson Prod'ns Inc., 185 West End Ave., New York, N.Y. 10023. Tel: (212) 580-0255. Cable: OAMSOUND NY. Pres.: Marty Wilson; Ass't to Pres.: Janet J. Eddy.
Label: (Licensed) From the Jazz Vault.
Magda, see Marsal.
Lee Magid Inc., PO Box 532, Malibu, Calif. 90265. Tel: (213) 858-7282. Cable: LEEEMAG. Pres.: Lee Magid.
Label: (Owned) LMI.
Magnet, see MCA.
Magnetic Video Corp., Consumer Prods. Div., 23434 Industrial Park Court, Farmington Hills, Mich. 48024. Tel: (313) 476-2250. VP & Gen. Mgr.: Jack K. Dreyer; Commercial Prods. Div. - 23705 Industrial Park Dr. Zip: 48024. Tel: 477-6066. VP: Al Echer.
Magyar, see Hungaria.
Mahalo, see Surfside Hawaii.
Maiden Music, 333 Park St., Upper Montclair, N.J. 07043. Tel: (201) 746-6573. Pres.: Mickey Moore; VP: Becki Moore.
Maiden Voyage Recs., 216 Chatsworth Dr., San Fernando, Calif. 91340. Tel: (213) 365-9371. Pres.: Marcia Day; VP: Ron Barron; VP Bus Affairs: Joyce McCord; Mng. Dir.: Garnie Day.
Mainline, see ML.
Mainroads Recs., PO Box 8000, Pittsburgh, Pa. 15216. Tel: (412) 854-2442. Int'l branch: Canada.
Mainstream, see Roulette.
Maison de Soul, see Flat Town.
Majea Recs., 240 E. Radcliffe Dr., Claremont, Calif. 91711. Tel: (714) 624-0677. Pres. & A&R Dir.: Gary K. Buckley.
Major Label Rec. Co., 6876 Alloway E., Worthington, Ohio 43085. Tel: (614) 846-2026. Pres.: Richard Detch.
Major Rec'g Co., PO Box 2072, Waynesboro, Va. 22980. Tel: (703) 942-0106. Owners: John H. & Margie F. Major.
Labels: (Owned) Lark, MRC.
Major, N.Y., see Thomas J. Valentino.
Malache Elyon, see Katie the Great.
Malaco Recs., 3023 W. Northside Dr., Jackson, Miss. 39213. Tel: (601) 982-4522. Pres.: Tommy Couch; VP: Wolf Stephenson; Sales/Bus. Affairs Dir.: Stewart Madison; Nat'l Promo./Pub. Dir.: Dave Clark; A&R: James Griffin.
Labels: (Owned) Chimneyville, Malaco, Southern Biscuit.
Mango, see Island.
Mankind, see Nashboro.
Manna Music & Recs., 2111 Kenmere Ave., Burbank, Calif. 91504. Tel: (213) 843-8100. Pres.: Hal Spencer; Sales Mgr.: Carl Farrer; A&R: Phil Barfoot.
Manson, see Sweetson.
Manton, see SIPRA.
Mao, see Bomp.
Maranatha Music Inc., PO Box 1396, Costa Mesa 92626; 2902 W. Garry Ave., Santa Ana, Calif. 92704. Tel: (714) 979-8536. Cable: MARANATHA. Pres.: Charles Fromm; A&R Dir.: Tom Coomes; Sales & Admin. Dir.: Ted Bleymaier; Comptroller: Rick Latendresse. (Distributed by Word).
Int'l reps.: Australia (Rhema), Canada (Word), Denmark (Teovision), France (Sephora), Germany (Pila), Hong Kong (Green House), Iceland (Blada-Gof), Netherlands (GMI), New Zealand (Osborn), Nigeria (Exambag), Norway (Filadelfiaforlaget), Philippines (Praise), Singapore (Alby), South Africa (Invisible Church), Sweden (Prim), Switzerland (Kings Rock), UK (Word).
Maria Recs., PO Box 3770, Grand Central Sta., New York, N.Y. 10017. Tel: (212) 549-0502. Owner & Pres.: John Clark.
Label: (Owned) Graffiti.
Marcao Recs. (div. of C&P Music Co.), 519 N. Halifax Ave., Daytona Beach, Fla. 32018. Tel: (904) 252-0381. Contact: Bobby Lee Cude.
Marina, see Lopyrquan.
Marjon Int'l Recs., 159 Easton Rd., Hermitage, Pa. 16146. Tel: (412) 347-4726. Pres.: John T. Krizanc; Mgr.: Martha Krizanc.
Mark Five Studio/The Room, 10 Michael Dr., Greenville, S.C. 29610. Tel: (803) 269-3961. (Distributed by Herald Ass'n)
Labels: (Owned) Halo, Klub, Mark Five, Mastertone.
Marlin, see TK.
Marlo Rec. Co., Box 49, RD 1, Utica, N.Y. 13502. Tel: (315) 724-0895. Owner & Pres.: Mario Ketchum; Music Co-ord.: Siim Pikins; VP & Mgr.: Floyd Ketchum.
Marquee see East Allegheny & Las Vegas Rec'g
Marsal Prod'ns Inc., 17353 Castroville Rd., San Antonio, Tex. 78237. Tel: (512) 433-9351. Pres.: Antonio J. Menendez; VP: Felix Elizondo; Sec'y-Treas.: Pat Alvarado.
Branch: Los Angeles, Calif., 2846 W. Pico Blvd. Zip: 90006. Tel: (213) 737-3771. Mgr.: Celia Camacho.
Labels: (Owned) Del Rio, Magda, Sondo Int'l.
Mars Hill Recs., 352 E. 18 St., Erie, Pa. 16503. Tel: (814) 455-8124. A&R Dir.: Angelo Natalie; Promo. Dir.: Craig Firment; Radio Promo.: Mike Watson.
Mars La Tour, see Atteiram.
Marian, see Bomp.
Marton, see Discostar.
Marullo Prod'ns Inc., 1121 Market St., Galveston, Tex. 77550. Tel: (713) 762-4590. Pres.: A.W. Marullo Sr.; VP: A.W. Marullo Jr.; Pop & Country A&R: Mark Allen; Gen. Lee; Sales & Promo. Mgr.: Russ Reeder.
Labels: Red Dot, Ro Tab.
Marycords, Box 48, Powers Lake, N.D. 58773. Pres.: Rev. F.J. Nelson; Sec'y-Treas.: Mrs. James Smith.
Master, see Sounds of Winchester.
Master Disc Recs. & Tapes, 711 E. Walnut St., Suite 209, Pasadena, Calif. 91101. Tel: (213) 796-1600. Pres.: Calvin M. Taylor.
Master 5, see AVI.
Master Linguist, see R.D. Cortina.
Masterpiece, see Sine Qua Non.
Mastertone, see Mark Five.
Master-Trak Sound Recs. (formerly Modern Sound Studio Prod'ns), 413 N. Parkersway Ave., Crowley, La. 70526. Tel: (318) 783-1601. Owner: Jay Miller; Gen. Mgr./Chief Eng.: Mark Miller; Ass't Mgr.: Bill Miller; Eng.: Leslie Hill.
Labels: (Owned) Blues Unlimited, Cajun Classics, Kajun, Master-Trak, Par T, Ringo, Rocko, Showtime, Tribute, Zynn.
Int'l rep.: UK (Flyright, Sonet, Swif).
Masterworks, see CBS.
Mate, see Kubaney.
Max Promos., PO Box 7386, Beaumont, Tex. 77706. Tel: (713) 866-6276. Pres.: Richard T. Bianco; A&R/Sales Promo.: Tim Meehan; Sales Mgr.: Alicia Belaire.
Max's Kansas City Recs., 213 Park Ave. S., New York, N.Y. 10003. Tel: (212) 777-7870. Bd. Chm.: Tommy Oean; Music Dir.: Peter Crowley; VP A&R: John Delgado; VP Pub.: Philip Locaso; VP Sales: Mark Luch.
Maycon Recs. Co., 5306 W. Columbia Ave., Philadelphia, Pa. 19131. Tel: (215) 877-8760. Pres.: Mae Connelly, A&R & Promo.: E.B. Connelly; Sec'y-Treas. & Gen. Mgr.: Charmelle Connelly.
Mayhams Collegiate Recs., PO Box 46, Morningside Sta., New York, N.Y. 10026. Tel: (212) 876-4683. Pres. & Gen. Mgr.: N.B. Mayhams Sr.; VP & Ass't Mgr.: Patricia C. Mayhams; Pub. Adv. & Promo.: Bronson Mayhams.
Dale McBride Ent's., Dale Road 580 E., Lampasas, Tex. 76550. Tel: (512) 556-6276. Pres.: Farn McBride.
Label: (Owned) WMI.
McKinnon Pictures/Rec. Co., PO Box 691, Reading, Pa. 19603. Tel: (215) 372-7361. Pres.: Leonard McKinnon.
Labels: (Owned) Alabam, Allanna, Black Country, Black Treasure, Center City, Corina, Firmworld, Holy Cross, McKinnon, Middletown, Moveland, Onophone, Ottsville, Reading, Slide, Tarheel, Tridelta; (distributed) Yarbbee.
Int'l reps: Argentina (Microfon), Australia (Electric), Austria (Bellaphon),

Bahamas (International House of Music), Belgium (Frankie), Bermuda (Music City), Bolivia (Discolan-ia Duen), Brazil (Odeon), Bulgaria (Balkan), Canada (Musimart), C. ile (IRT), Colombia (Incofite), Costa Rica (Indica), Denmark (Somet/Dan k), Egypt (Somo Cairo), El Salvador (Dicesa), Finland (Finnevly), Fra ce (Musidisc, Disc' AZ), Germany (DG), Greece (Music Box), Hong Kor (Cosco), India (Gramophone), Ireland (Irish Recs.), Israel (Israel Recs.), Italy (Ri-Fi), Jamaica (Dynamic Sounds), Japan (King), Kenya (Sapra), Malaysia (Musico), Mexico (Guitarra), Netherlands (Dutch Rec. Co.), New Zealand (Highton Hughes), Nigeria (Senn-Sound), Norway Arne Bendiksen), Philippines (Vic), Portugal (Radio Triunfo), Singapo (Kwang Sia), Spain (Movioplay), Sweden (Dollars), Switzerland (M tromone), Turkey (Melodi), UK (Black Wax).

McLain Family Band, CPO 1322, Berea, Ky. 40404. Tel: (606) 986-8111. Pres: Raymond McLain.
 Label: (Owned) Country Life.
 Mean Mountain Music, 926 W. Ok thoma Ave., Milwaukee, Wis. 53215. Tel: (414) 483-6500. Owner: M.J. Iushovitz.

Mecca, see W.C. Staley.
 Meet the Classics, see Sine Qua Ion.
 Mega, see Rico.
 Melodeon, see Biograph.
 Melodia, see Polish Rec. Center.
 Melodya/Columbia, see CBS.
 Melody Mexico (Mexico), see Ca; tronic.
 Melway, see Music of Polynesia.

Memorial, see Cord.
 Memphis & It's Music, see Glot.
 Memphis Mgmt. Inc., Box 17272 Memphis, Tenn. 38117. Tel: (901) 323-9682, 685-8533. Pres: Ron B. ckwood.
 Mena Ent's. Inc., 606 Hipodromo A e., Santurce, P.R. 00909. Tel: (809) 723-1764/2300. Pres: Ignacio Mer r; Sales Mgr.: Daniel Mena; Promo. Mgr.: Luis Mojica.

Labels: (Owned) Chemo; (licensed) Disneyland, Promus; (distributed) Discuba, Fuentes, Musart, Per less.
 Mercantile Recs., PO Box 2271, P. Im Springs, Calif. 92263. Tel: (714) 320-4848. Pres: Kent Fox.
 Mercurio, see Velvel de Puerto F co.
 Mercury, see PolyGram.

Mercury Golden Imports, see Pol Gram Classics.
 Mericana Melody, see Mericana ec. Corp.
 Mericana Rec. Corp., 401 Fifth Av., New York, N.Y. 10016. Tel: (212) 889-0044. Pres: Joe Cayre.
 Labels: (Owned) Mericana, Mericana Melody, Salsoul (Salsa).

Meridian Recs., 1921 Buckingham Rd., Los Angeles, Calif. 90016. Tel: (213) 938-8498. Pres: Bill Buchma .
 Merry EH, see Argus.
 Mersey, see Country Star.

Message, see Superior Sound.
 Messenger Recs. (div. of Full Ho e Inc.), 421 S. Main St., Memphis, Tenn. 38103. Pres: William E. Taylor VP Sales & Promo.: Kenneth G. Smith; VP Mdg.: J. W. Crudgington.
 Branch: Nashville, Tenn., PO Box 25066. Zip: 37202. Tel: (615) 885-0475.

Met Richmond Latin Rec. Sales, 137 Utica Ave., Brooklyn, N.Y. 11234. Tel: (212) 253-4600. Cable: SEEC DISC N.Y. Telex: 668550. Pres. & Int'l: David Last; Sec'y: Bea Last; P. Mgr.: S. Press; Promo. Mgr.: D. Erlichman; Tape Supervisor: B. Coh n.
 Labels: (Owned) Bronjo, Dato e, Parnaso, Seeco. Tropical.

Metro, see Daytwo.
 Metropolitan, see Elektra/Asylum /Nonesuch.
 Miami Recs. Dist'g Corp., 2819 I W Seventh Ave., Miami, Fla. 33127. Tel: (305) 635-7925. Cable: MIARI C. Pres.: Caridad Mooya; VP: A.R. Sedenoo; Sec'y-Treas.: Carlos Diaz-Gran doo.

Michele Audio Corp., Andrews St et Rd., Massena, N.Y. 13662. Tel: (315) 769-2448. Pres: GINETTE CORR ER.
 Int'l branch: Canada.
 Labels: (Owned) Deutsche B assische, Michele, Produktion Deutschmar- k, Windmill; (distributed) lessup.
 Mickey Recs., 26 Mountain Ave., Dover, N.J. 07801. Tel: (201) 361-2084. Pres: Michael F. Matushin S.

Microton, see Discos Latin.
 Middletown, see McKinnon.
 Midway Prod'ns, see Jazzrel.
 Mighty Wind, see Sonrise Merca tile.
 Milestone, see Fantasy/Prestige Milestone/Stax.
 Milk & Honey, see Benson.

Milk 'n' Honey, see Zondervan.
 Mill City Recs., PO Box 3759, W neapolis, Minn. 55403. Tel: (612) 452-2105. Rec'g Head: Alan L. Ht gl.
 Millennium Recs., 65 E. 55 St., New York, N.Y. 10022. Tel: (212) 759-3901. Pres: Jimmy Jenner; VP/Nat'l Promo. Dir.: Don Jenner; Mktg. & Artist Development Dir.: Andrew Fr. nces. (Also see RCA)

Miller-Body Prod'ns, see Rando House.
 Miller & Kreisel Sound Corp., 3391 Jefferson Blvd., Culver City, Calif. 90230. Tel: (213) 204-2854. Int'l. DISC: Ken Kreisel; VP: Jonas Miller; Mktg. Mgr.: Scott Simon; Pub. Dir.: Chuck Back.
 Labels: (Owned) RealTime.

Int'l rep.: Europe (Audio Int'l in Germany).
 Mini Recs. Inc. (div. of Prospa Recs.), 745 Franklin Ave., Brooklyn, N.Y. 11238. Tel: (212) 857-2324.
 Minstrel, see Collegium.
 Miracle, see Trod Nossel.

Mirage Recs. Inc., 48 Signal Rd. Stamford, Conn. 06902. Tel: (203) 325-1395. Cable: MIRAMUSIC. Pre .: Jerry Greenberg. (Distributed by Atlantic)
 Branches: Los Angeles, Calif., 9229 Sunset Blvd. Zip: 90069. Tel: (213) 278-6350. Exec. VP: Bob Gr enberg—New York, N.Y., 75 Rockefeller Plaza. Zip: 10019. Tel: (212) 484-8148. A&R Dir.: Jim Delehant.

Mirror Ball Recs., 958 W. Edgem nt Dr., San Bernardino, Calif. 92405. Tel: (714) 882-6796. Gen. Mgr. & A&R Dir.: Bill Bellman; Admin.: Myral Bellman.
 Mirror Recs. Inc., 645 Titus Ave Rochester, N.Y. 14617. Tel: (716) 544-3500. Pres. & Sec'y: Bruce Schaubroek; VP & Treas.: Armand Schaubroek; Promo. & Sales: Jim Deignan; Promo.: Brian Ormon.
 Labels: (Owned) House of Gars, Mirror.

Int'l rep.: Australia (Aieida), Canada (Opus 69, Record Peddler, Tracks on Wax), France (Free Rad, Music Box), Germany (Patten Muehl).
 Misty Blue, see Crimson Dynast.

Mobile Facility Sound Lab, 218-D Northhoff St., Chatsworth, Calif. 91311. Tel: (213) 709-8440. TWX: (913) 494-1936. Bd. Chm.: Brad Miller; Pres.: Herb Belkin; VP Prod. Develop. ment: Gary Giorgi; Int'l Sales & Mktg. Dir.: Michael Dion; Finance Dir.: Roberta Margolis; A&R & Special Projects

Dir.: Jackie Krost; Mktg. Dir.: Pete Senoff; Pub. Dir.: Leslie Rosen; Nat'l Sales Dir.: Mark Westler.

Branches: Atlanta, Ga., 3230 Clairemont N. Zip: 30329. Tel: (404) 541-0815. Southeast Reg'l Sales Mgr.: John Ledford—Chicago, Ill., 1370 W. Greenleaf, No. 3. Zip: 60626. Tel: (312) 274-7686. Midwest Reg'l Sales Mgr.: Jim Benz—Garden City, N.Y., 29 Meadow St. Zip: 11530. Tel: (516) 741-4949. East Reg'l Sales Mgr.: Joe Moshy.

Labels: Geo-Disc, Original Master Rec'g.
 Moby Dick Recs., 231 Hartford St., San Francisco, Calif. 94114. Tel: (415) 861-0476. Chm.: Victor J. Swedesh; Pres.: William L. Molley; VP: Stan J. Morris; Promo.: Michael Bailey.

Branch: Los Angeles, Calif., 640 N. Beachwood Dr., Suite 105. Zip: 90004. Tel: (213) 462-4200.
 Mod-Art Recs. (div. of Mod-Art Prod'g Co. Inc.), 10358 S. Forest Ave., Chicago, Ill. 60628. Tel: (312) 264-2463.

Modern, Calif., see Cadet Recs.
 Modern Method Recs., 268 Newbury St., Boston, Mass. 02116. Tel: (617) 247-7590.

Labels: (Licensed) Tribal Jargon/Sluds Recs.
 Modern Recs., 10 E. 49 St., New York, N.Y. 10017. Tel: (212) 355-3905. Co-Founders/Chief Operating Officers: Danny Goldberg, Paul E. Fishkin; Gen. Mgr./A&R: Chris Evans; Promo. Co-ord.: Christopher Nicks; Creative Servs. Dir.: Linner S. VaSolli. (Distributed by Atco/Atlantic)

Modern Sound Studio Prod'ns, see Master-Trak.
 Modoc, see ASA.
 Monica (Discos), see Peer-Southern.

Monitor Recs. Inc., 156 Fifth Ave., New York, N.Y. 10010. Tel: (212) 989-2323. Cable: MONRECOIN.
 Int'l reps.: Argentina (Madrigal), Australia (Carinia), Belgium (Schott Freres), Canada (Almada), France (Chant du Monde), Germany (Electro- laria), Netherlands (Pastor), Portugal (Mundusong), Switzerland (Music Consort).

Monkey Joe, see International Mktg. & Mgmt.
 Monmouth/Evergreen, see Monmouth Recs.
 Monmouth Recs., 1697 Broadway, Suite 1201, New York, N.Y. 10019. Tel: (212) 757-5105. Pres.: William H. Borden; Sales Mgr.: Claire R. Olivier.

Labels: (Owned) Monmouth/Evergreen.
 Monta, see Warren.
 Montclair Recs., 13755 Bayliss Rd., West Los Angeles, Calif. 90049. Pres: Wallace Todd; A&R Dir.: Miriam Todd.

Monterey Recs., PO Box 8497, Universal City, Calif. 91608. Tel: (213) 243-3456. Owner: Jack Daugherty.
 Montuno Recs. Inc., 1470 Broadway, BMT Mezzanine, Times Square, New York, N.Y. 10036. Tel: (212) 840-0580. Pres: Jesse Moskowitz; VP A&R: Rene Lopez.

Monument Rec. Corp., 21 Music Square E., Nashville, Tenn. 37203. Tel: (615) 244-6565. Cable: MONUWORLD. Pres. & A&R: Fred L. Foster; Treas.: John Dorris; Nat'l Promo. Dir.: Tex Davis; Int'l & Prod'n: Mary Brewer.

Labels: (Owned) Monument, Sound Stage 7.
 Int'l rep.: Worldwide (CBS Int'l).
 Moody, see General Broadcasting.

Moonlight Recs., PO Box 184, Chapel Hill, N.C. 27514. Tel: (919) 967-6666. Pres.: David L. Robert; VP: Anna S. Tuttle; Prod'r/A&R: Don Dixon.
 Labels: (Owned) Moonlight; (distributed) GHE, Windom Hill.

Moon Recs., 1546 Palisades Dr., Pacific Palisades, Calif. 90272. Tel: (213) 454-2142. Pres.: Robert Meyer; Gen. Mgr.: Jeffrey Northover.
 Moon Recs. of Memphis, Tennessee, 3333 Scenic Hwy., Memphis, Tenn. 38128. Tel: (901) 386-8102. Pres.: Cordell Jackson.

Labels: (Owned) Moon Recs. Phase II.
 Moonridge (div. of Moonridge Prod'ns Inc.), PO Box 24, Plainfield, Ill. 60544. Tel: (815) 436-2280. Pres./Gen. Mgr.: Cris Mooney Selfridge; Sec'y-Treas.: Richard J. Selfridge Jr.

Moonridge, Calif., see Pacific Challenger.
 Moonstone Int'l Recs., PO Box 946, Hollywood, Calif. 90028. Tel: (213) 761-9679. Dirs.: Jeff Ozman, Marko Perko; Mktg. Mgr.: K. Dossat; Promo. Mgr.: Arthur Spivak; Int'l Mgr.: J. Billingsley.

Labels: (Owned) Arrival, Moonstone Int'l; (distributed) Bristol, Kashmir.
 Int'l rep.: Greece (Seagull), UK (Contempo, Gull, Sun-Pac).
 Mopres Recs. Inc., 31203 Grando Dr., Rancho Palos Verdes, Calif. 90274. Tel: (213) 541-6710. Pres.: Dean Chambers; VP Promo.: Chris Clay; VP A&R: Gloria Love.

Morning Star, N.J., see Shanachie.
 Morning Star, Tenn., see Eddie Crook.
 Morrhythm, see Outstanding.

The Moss Music Group Inc., 48 W. 38 St., New York, N.Y. 10018. Tel: (212) 944-9560. Cable: VOXPRODUCT. TWX: (710) 581-5948. Pres.: Ira Moss; Exec. VP: Marvin Saines; VP/Special Sales: S. Gordon Strenger; VP Sales: Thomas DeVita; A&R/Creative Servs.: Carol Marunas; A&R/Eng'g: Siso Gandara; Pub/Promo: Patricia Willard.

Branch: Paramount, Calif., 155-14 Garfield Ave. Zip: 90723. Tel: (213) 633-1994. Reg'l Mgr./Sales & Mktg.: Chip Heath.
 Int'l branch: Canada.
 Labels: (Owned) Candide, MMG, MMG (Digital), THS (Turnabout Historical Series), TVC (Turnabout Chamber Series), Turnabout, Turn-On, Vox Box, Vox Cam Laude, Vox Singles; (distributed) Storyville.

Int'l reps.: Argentina (WN), Australia (Argus), Belgium (Schott Freres), Brazil (WEA), Chile (Sonidos), Costa Rica (Reuben), Denmark (Fona Rada), Finland (Musiki Lahti), France (SPI), Germany (Fono), Hong Kong (Pacific), Italy (IRD), Japan (Warner-Pioneer), Mexico (Peerless), Netherlands (Rec Track), New Zealand (Viking Senseless), Peru (Rempeur Orbe), Spain (Ferysa), Sweden (Seelg), Switzerland (Arts Managers, Musica AG), UK (Parnote), Venezuela (Palacio de la Musica).

Motette-Ursina (Germany), see Teleson-America.
 Mother Cleo Prod'ns, PO Box 521, Sunset Blvd., Newberry, S.C. 29108. Tel: (803) 276-0639. Studio Mgr.: Polly Davis; Prod'r/Dir.: Hayne Davis; Int'l: O.T. Hudson; Field Rep.: Willard Brown.

Labels: (Owned) Cleo, Cub, Mother Cleo.
 Mother Goose, see Cadet Recs.
 Motown Rec. Corp., 6255 Sunset Blvd., Los Angeles, Calif. 90028. Tel: (213) 468-3500. Chm.: Berry Gordy; Pres.: Jay Lasker; Exec. VP Mktg. & Dist'n: Dick Sherman; VP Sales: Miller London Jr.; VP Promo.: A. Skip Miller; VP Creative: Lee Young Sr.; VP Artist Relations: Shelly Berger; Int'l Mgr.: Peter Pasternak; Nat'l Press & Pub. Dir.: Bob Jones.

Int'l branches: Canada, England.
 Labels: (Owned) Gordy, Motown, Natural Resources, Prodigal, Rare Earth, Soul, Tamla.
 Int'l reps.: Argentina (Microfon), Australia (Astor), Austria (Bellaphon), Belgium (Vogue), Bolivia (Discolan-ia Duen), Brazil (Top Tape), Canada (Quality), Central America (Dilecia in Guatemala), Chile (Quatro), Colombia (Incofite), Denmark (Electra), Ecuador (IFESA), Finland (Disco-phonia), France (Vogue), Germany (Bellaphon), Greece (Columbia-EMI, Emai), Hong Kong (EMI), India (Gramophone), Ireland (EMI), Israel (Eastronics), Italy (EMI), Japan (Victor), Malaysia (EMI), Mexico (RCA),

Netherlands (VIP), New Zealand (EMI), Norway (Talent Music Org.), Peru (El Virey), Philippines (Octoarts), Portugal (Imavox), Singapore (EMI), South Africa (RPM), Spain (Belter), Sweden (Electra), Switzerland (Bellaphon, CP&A), Thailand (Audiovision), Turkey (Melodi), UK (EMI), Venezuela (Palacio de la Musica), West Indies (GG in Jamaica).

Mount, see Outlet.
 Mountain Railroad Recs. Inc., 3602 Atwood Ave., Madison, Wis. 53714. Tel: (608) 241-2001. Pres.: Stephen Powers; Bus. Mgr./Sales: Bob Postel; Promo.: Jerry DeJong; Artist Tour Co-ord.: Dave McCleary.

Int'l rep.: Canada (Armadillo), Germany (Taxim), UK (Evolution).
 Mountain Recs., 15510 NE 15 Court, North Miami Beach, Fla. 33162. Tel: (305) 944-9949. Pres. & Prod'r: Aaron L. Broomfield; VP: Wynell Broomfield; Sales Mgr.: Ted Williams; Sales: Ben Broomfield; A&R: Dianne Williams, Ron Broomfield; Promo.: Al Broomfield, Carolyn Rodriguez.

Movelead, see McKinnon.
 Mudflap, see Star Jazz.
 Mudist (Sweden), see SWS.
 Mulligan (Ireland), see Green Linnet.
 Multi-Media, see Nationwide Sound.

Murbo, see Bourne.
 Muscle Shoals Sounds Recs., see MSS.
 Muse Recs. (div. of Blanchrs Inc.), 160 W. 71 St., New York, N.Y. 10023. Tel: (212) 873-2020. Pres.: Joe Fields.

Labels: (Owned) Deluxe, Muse; (distributed) Timeless-Muse.
 Music Adventures Recs. Inc., 8033 Sunset Blvd., Suite 101, Hollywood, Calif. 90046. Tel: (213) 650-0060. Int'l Rep.: Jhon Baruth; USA Pres.: Daniel Baruth; USA VP: David Baruth; VP Nat'l A&R: Jain Baruth; VP Nat'l Promo.: Denny Corder; VP Finance: Terry Stovering; VP Europe: Raymond Baruth Jr.; West A&R Mgr.: Shelley Hedes; East A&R Mgr.: Denny Conrad; Artist Development Mgr.: Jeff Reding.

Branch: Cleveland, Ohio, 12501 Madison Ave. Zip: 44107. Tel: (216) 228-8241. Mgr.: Tom Halloran; Eastern Promo.: Marilyn Doerfler.
 Int'l branch: Italy.
 Labels: (Owned) Ohio; (distributed) BBB.

Musica Latina Int'l Inc., 888 Seventh Ave., New York, N.Y. 10019. Tel: (212) 397-6730. Pres.: Gerald Masucco; VP: Victor Gallo; Int'l: Jose Florez.
 Labels: Alegre, Barbara, Cotique, Fania, Inca, Karen, Nuestra, Tico, Yaya.
 Musical Cocktail Recs. Inc., 408 N. Palm Dr., Beverly Hills, Calif. 90210. Tel: (213) 858-1622/1234.

Musical Heritage Society Inc., 14 Park Rd., Tinton Falls, N.J. 07724. Tel: (201) 544-8446. Pres.: Albert Nissim; Gen. Mgr.: Robert Nissim; A&R Dir.: Jeffrey Nissim.
 Label: (Owned) MHS.

Musical Recs. Co., 780 W. 27 St., Hialeah, Fla. 33010. Tel: (305) 887-2638.
 Pres.: Eliseo C. Valdes; Gen. Mgr.: Lazaro Fernandez.
 Music America, see Hiding America.
 Muscanza Corp., 2878 Bayview Ave., Wantagh, N.Y. 11793. Tel: (516) 826-2735. Pres.: Al Rubin.

MusiCards, see American Entertainment.
 Music City, see Dawn.
 Music Ents. Inc., 5626 Brock, Houston, Tex. 77023. Tel: (713) 926-4431.

Pres.: Huey P. Meaux; Treas.: Aaron Schechter; Sec'y: Mary E. Thornton.
 Studio Mgr.: Lonnie Wright.
 Labels: American Playboy, Crazy Cajun, Jet Stream, Pacemaker, Star File.

Music Factory Inc., 567 NW 27 St., Miami, Fla. 33127. Tel: (305) 576-2600.
 Pres.: Robert Archibald.
 Label: (Owned) Platinum.

Music Inn, 169 W. Fourth St., New York, N.Y. 10014. Tel: (212) 243-5715.
 Music Is Medicine, see First America.
 Music Mktg. Corp. (dancercise), IEI Bldg., Airport Plaza Hwy. 36, Hazlet, N.J. 07730. Tel: (201) 264-0700, 739-3232. (SEE ADVERTISEMENT)

Music Mart, see La Louisiane.
 Muscmasters, 14 Park Rd., Tinton Falls, N.J. 07724. Tel: (212) 964-0646.
 Pres.: Jeffrey Nissim, VP: Robert Nissim.

Musci Minus One, see MMO.
 Music of Many Lands, see Request.
 Music of Polynesia Inc., Ala Moana Bldg., Suite 919, 1441 Kapiolani Blvd., Honolulu, Hawaii 96814. Tel: (808) 946-1677. Pres.: Jack de Mello; VP: Ilse de Mello.

Labels: (Owned) Melway, Music of Polynesia.
 Muscraft, see Trend Rec. Corp. in Calif.
 Musi-Poe, see Sid Kleiner.

Musi-Que, see Blue River.
 Musique Circle Recs., PO Box 7991, Long Beach, Calif. 90807. Owners: Mike & Judith Vaccaro, Jack Reiding.
 Musi-Que Contemporary, see Blue River.

Musique Recs., 1141 Liberty Ave., Brooklyn, N.Y. 11208. Tel: (212) 827-5434. Owner: Benny Patti.
 Muskadine, see Advent.

Mustard Seed, see ReGeneration.
 Mustewc Sound Recs. Inc., 193-18 120 Ave., St. Albans, N.Y. 11412. Tel: (212) 527-1586. Pres.: Brenda Reid, Dir.: Steve Reid; Sales/Promo. Mgr.: Ayanna Kai.

Labels: (Owned) Mustewc Sound; (distributed) Ak Ba.
 Int'l reps.: Africa (Bianc Munro in Ghana), France (Musica, Record Shop), Germany (Ring, Jazz Aktuell), Iceland (R. Gudmundsson), Italy (IRD, La Bella Bella), Japan (Record Shop OM), Netherlands (Agram), UK (Jazz Servs. Projection).

Mutual Music Corp., 254 Scott St., San Francisco, Calif. 94117. Tel: (415) 431-3047, 621-4131. Chm./Mktg.: Norman E. Pierce; Pres.: George L. Clark; VP A&R: Jeffrey Richardson; VP Prod'n: Reynold D. Brown.
 Labels: (Owned) MMC, Rambler, Western.

Int'l rep.: Netherlands (Golden Age), UK (Independent Rec. Sales).
 Muza, see Polish Rec. Center.
 Myrrh, see Word.

Mystic Recs. Inc./Clock Recs., 6277 Selma Ave., Hollywood, Calif. 90028. Tel: (213) 644-9667. Pres.: Doug Moody; VP Promo./Sales: Tim Lane; Co-ord.: Nancy Faith.
 Labels: (Owned) Clock, Mystic, Mystic Sound, Solar.

N A L R, see North American Liturgy.
 N A P Recs. Inc., 3941 Don Juan, Abilene, Tex. 79605. Tel: (915) 673-4843, 677-8601. Pres.: Charles D. Grissom.
 N B C Music Recs., PO Box 392, Brentwood, Tenn. 37027. Tel: (615) 793-7085.

N L D C (National Label Dist'g Co.), 1529 Walnut St., Philadelphia, Pa. 19102. Tel: (215) 568-0500. Pres., Promo. & Sales: Steve Schulman; Ass't to Pres., Pres. & PR: Eric Carter.
 N M I Prod'ns Corp., 5500 Troost, Kansas City, Mo. 64110. Tel: (816) 361-8455. Pres.: Eugene Gold; VP: Gilbert Roland; Exec. Dir.: Sales & Mktg.

Roy Boykins; A&R: Mike Green; Country A&R: Harold Stark; Promo. Dir.: C. King; Promo.: Charles Smith. (Also see 3 G's Inds.)
 Labels: (Owned) Cory, EBC, NMI.
 N S D, see Nationwide Sound.
 Nasco, see Nashboro.
 Nashboro Rec. Co., 1011 Woodland St., Nashville, Tenn. 37206. Tel: (615) 227-5081. (Also see AVI)
 Labels: (Owned) Abel, Creed, Excello, Mankind, Nasco, Nashboro; (distributed) Kenwood.
 Nashville American, see General Broadcasting.
 Nashville Int'l Corp., 20 Music Square W., Nashville, Tenn. 37203. Tel: (615) 373-2575. Cable: NICORP. Pres.: Reggie M. Churchwell; VP: Ken Little; Sec'y-Treas. & Sales & Mktg.: Peggy J. Churchwell; Controller: Donna Ancelet; Adv. & Pub.: James E. Gray
 Labels: (Owned) Nashville Int'l, Phoenix.
 Nashville Jazz Prod'n's Inc., 908 Noelton Ln., Nashville, Tenn. 37204. Tel: (615) 383-7658.
 Nashville North Recs., 101 E. Irving Pike Rd., Bensenville, Ill. 60106. Tel: (312) 595-7878. Owner: Archie Drury Sr.
 National Label Dist'g Co., see NLD.
 National Music Ent's., PO Box 35855, Houston, Tex. 77035. Tel: (713) 499-5943. Mgr.: Dan Mechura Sr.; Country A&R: Danny James.
 Labels: (Owned) Alistar, Star.
 National Recs., 3410 Ave. R, Lubbock, Tex. 79412. Tel: (806) 744-5590. Pres.: Bud Andrews.
 Labels: (Owned) Lemon, National.
 Nationwide Sound Dists., PO Box 23262, Nashville, Tenn. 37202. Tel: (615) 385-2704. Pres.: Joe Gibson; VP: David Noel Gibson; Nat'l Promo. Dir. & Sales Mgr.: Betty Gibson; Ass't Promo. Dir.: Debbie Gibson; Nat'l Secondary Promo.: Jerry Duncan.
 Labels: Charta, Cole Cash, Dallas, Dee Jay, FXL, Fireball, Grass, Multi-Media, NSD, New Colony, Phono, Soundwaves, 3-J, Triple-J. (SEE AD)
 Native Roots, see Tom Bee.
 Natural Resources, see Motown.
 Nautilus Rec's (div. of Triton Inds. Inc.), 761 Shell Beach Rd., Shell Beach, Calif. 93449. Tel: (805) 773-1848. Pres.: Steve Krauss; VP: Bob Jonte; Mktg. Dir.: Bexter Boyington; Nat'l Sales Mgr.: Steve Caldero; Finance Dir.: Bill Marre; A&R & Licensing Dir.: J. Luby
 Labels: (Owned) Nautilus; (distributed) Coherent Sound, JVC, Romar.
 Nav, see OR.
 Neat, see Eat.
 Neiz, see Rico.
 Nelwin Recs. Inc., 254 W. 54 St., New York, N.Y. 10019. Tel: (212) 582-9310. Pres.: Winston Negron.
 Nempor, see CBS.
 Neostal Music Co., 425 Bryn Mawr, Birmingham, Mich. 48009. Tel: (313) 647-1662, 538-4444. Pres.: Harvey Yates.
 Nessa Recs., 5404 N. Kimball Ave., Chicago, Ill. 60625. Tel: (312) 588-1204. Owner: Charles Nessa.
 Int'l rep.: Denmark (SteepleChase).
 Never Ending Music, see Argus.
 Newbery Award, see Random House.
 New Born, see Praise.
 New Colony Recs. & Tapes, PO Box 12155, Nashville, Tenn. 37212. Tel: (615) 269-5296. Pres.: Joe Waters; VP: Jim Conley. (Distributed by Nationwide Sound)
 New Dawn, see Zondervan & Benson.
 New Day, see QCA.
 New Dimension, see Wildwood.
 New Directions, see Dimitri.
 New England Rec. Co., Drawer 520, Stafford, Tex. 77477. Contact: Daniel Andrade.
 Int'l rep.: France (Crypto).
 New Leaf Press Inc., PO Box 1045, Harrison, Ark. 72601. Tel: (501) 741-2514. Pres.: Clifford Dudley; VP: John Boneck.
 Label: PTL Club.
 Int'l rep.: Canada (Evangel).
 New Life Recs. (div. of National Music Serv. Inc.), PO Box 5378, Spokane, Wash. 99205. Tel: (509) 328-4207, WATS (800) 541-1565. Pres.: Merrill P. Womach; Exec. VP: Dan Womach; Sales Co-ord.: Dayle K. Maloney; Adv. & Promos. Dir.: Bill Hutchins.
 Neworld Media, No. 1, Neworld Square, South Blue Hill, Me. 04615. Tel: (207) 374-5539. Owner & Pres.: Noel Paul Stookey; Studio Mgr./Eng.: Stu Davis; Eng.: Reg Bennett; Treas.: Joyce Hall; Sec'y: Elaine Sutherland; Shipping & Mktg.: Karen Frangoulis.
 Int'l rep.: Australia (Rhema, Spotlight), UK (Word).
 New Orleans Sound, see Great Southern.
 NewPax, see Benson.
 Newport, see Old Dominion.
 New Song Recs., 2913 95 St., Lubbock, Tex. 79423. Tel: (806) 745-5992. Pres.: Bill Gammill; VP & A&R: Russ Murphy.
 New Sound, see Accent.
 Newtrot Recs., 12842 Fenkel Ave., Detroit, Mich. 48227. Tel: (313) 345-7007. Pres.: Tito Lewis.
 New Wine Prod'n's, PO Box 544, Lomita, Calif. 90717. Tel: (213) 454-1528. Owner & Pres.: G. Nelson Stringer.
 New World, see Recorded Anthology & Peters Int'l.
 Newzophone, see AcoustoGraphic.
 Nighthawk Recs., PO Box 15856, St. Louis, Mo. 63114. Pres.: Robert Schoenfeld; A&R: Leroy Pierson.
 Int'l rep.: Canada (Trend), Germany (Taxim), Italy (IRO), Japan (G&G), UK (Swift).
 Nine, see Westbound.
 Nirvana Recs., 1145 Green St., Manville, N.J. 08835. Pres. & Gen. Mgr.: Marc Zydac; VP & A&R: Mary Ellen Clark.
 Nitfol Recs., PO Box 7723, Tulsa, Okla. 74105. Tel: (918) 747-4118. Pres.: Dick Loftin.
 Nitzy Gritty (South Africa), see David Gresham.
 No Gap, see Zim.
 No Holds Barred, see Request.
 Nomad, see Vanguard.
 Nonesuch, see Elektra/Asylum/Nonesuch.
 Noodle Recs. Corp., 39 W. 55 St., New York, N.Y. 10019. Tel: (212) 246-0385. Cable: VERSATILE.
 Labels: (Represented) Disco Int'l, Greedy, Gull (UK), MCP, Playboy (all for Latin America); Springboard Int'l (for Argentina, Bolivia, Central America, Colombia, Dominican Republic, Mexico, Panama, Peru, Uruguay, Venezuela).
 Norfolk Int'l, see Legrand Recs.
 Norska-Disk, see Lindberg.
 North American Liturgy Resources, 10802 N. 23 Ave., Phoenix, Ariz. 85029. Tel: (602) 864-1980. Pres.: Ray Bruno; VP: David Servey; A&R: Paul Quinlan; Sales Mgr.: Sy Berkowitz; Comptroller: Art Meehan.
 Labels: (Owned) Epoch, NALR.

Int'l rep.: Australia (World of Life Centre), Canada (B. Broughton), UK (Anchor).
 Northcoast, see MDS.
 Northern Light, see Fire Sign.
 Nostalgia, see Sonic Arts.
 Nostalgia Lane Inc., 200 W. 57 St., New York, N.Y. 10019. Tel: (212) 582-5390. Co-Owners: Lee Halpern, Nina Mattikow; Comptroller: Harry Ringler.
 Now, N.J., see Argus.
 Now, Calif., see Original Sound.
 Nucleus Recs., PO Box 111, Seaside, N.J. 07760. Pres.: Robert N. Bowden; Sec'y: Jean Schweitzer.
 Nuestra, see Musica Latina.
 No. 1, see Discos Latin.
 Numex, see Tom Bee.
 Nu-Sound Recs., 4701 Trousdale Dr., Nashville, Tenn. 37220. Tel: (615) 385-3726. Pres.: R. Hayes.
 Label: (Owned) KL.
 Nutmeg, see Audiofidelity.
 NuTop Rec. Inc., 2439 S. Dorsey, Tempe, Ariz. 85282. Tel: (602) 966-7764.
 Nu-Tray Rec. Co., 10015 W. Eight Mile Rd., Franksville, Wis. 53126. Tel: (414) 835-4622. Owner: Mary Hribar; Pres. & Gen. Mgr.: Tommy O'Day.
 Labels: (Owned) Nashville, Tenn., 17 Music Square W. Zip: 37203. Tel: (615) 754-4982. Prof'r: Mike Borchetta.
 Nutshell, see Institute for Language Study.
 Nu-World Rec'g Inc., 2309 N. 36 St., Milwaukee, Wis. 53210. Tel: (414) 445-4872. Bd. Chm. & Pres.: Marvell Love.

O

O B Prod'n, see Discolando.
 O R Recs., 2200 E. Seventh St., Austin, Tex. 78702. Tel: (512) 476-5888.
 Labels: (Owned) Kidd, Loyal, Nav.
 O R C, see Otao.
 Oak Rec's, see Any Prod'n.
 Oakridge Music Rec'g Serv., 2001 Elton Rd., Fort Worth, Tex. 76117. Tel: (817) 838-8001/7623. Pres.: Homer Lee Sewell.
 Labels: (Owned) Arrowhead, Crossfire, Oakridge.
 Oasis, Fla., see Request.
 O'Brien Recs., PO Box 111145, Nashville, Tenn. 37211. Tel: (615) 331-9686.
 Ocean & Sea, see GRS.
 Odeon, see Alhambra.
 Odyssey, see CBS.
 Official Recs., 156 Darkes Ln., Sunnertown, Tenn. 38483. Tel: (615) 964-3571. Cable: BDDPUBCD. Pres.: Paul Mandelstein; VP: Michael Tassone; VP A&R: Philip Schweitzer; VP Sales & Promo.: Gary Rhine; Promo. Dir.: Matthew McClure.
 Int'l branch: Ireland.
 Int'l rep.: UK (Kona).
 Ofir, see Penco.
 Ohio, Cleveland, Ohio, see Music Adventures.
 Ohiophone, see McKinnon.
 Ohio Recs., PO Box 655, Hudson, Ohio 44236. Tel: (216) 653-8295. Pres.: Ethel P. Delaney; A&R: R.T. Delaney; Country Mgr.: Russ Delaney; Pub., Adv. & Promo.: Sandy Lambert.
 Dink, see Bay Recs.
 Oiseau-Lyre, see PolyGram Classics.
 Okart, see Seeds.
 Old Boston, see Rin Theory.
 Old Dominion Recs. Group, PO Box 6025, Newport News, Va. 23606. Tel: (804) 595-9000. Cable: DDMIREC. Chm. & Pres.: E.F. Evans; Exec. VP: Michael Collins; Gen. Mgr.: Bruce Radar; Classical A&R Mgr.: Sunnie Wilcox; Pop A&R Mgr.: Damaire Sinclair; Country A&R Mgr.: Brendon Hale; Artist Relations: Olivia Rowe, Bronn K. Hitton, Roxanna Cohen; PR: Gwynne Markwood.
 Branches: Wheeling, Md., 11250 Georgia Ave. Tel: 20902. Tel: (301) 949-6900. Dist'n: Keith Landsburg; PR: Bronnell Wynkovich—Nashville, Tenn., 649 16 Ave. S. Zip: 37203. Tel: (615) 244-4400. Dist'n: Carlton Wainwright; PR: Kent Bishop.
 Labels: (Owned) Baby Boy, Baby Girl, Del-Mar-Va, Kadia, Libido, Newport, Old Dominion, Parquette, Peninsula, Renora, Stud Guy.
 Old Hat Recs., PO Box 946, Springfield, Tex. 76082. Tel: (817) 433-5720. Pres.: James Michael Taylor; Exec. Dir.: Charles P. Bowley; Sales Mgr.: Anna Golden; Promo. Dir.: Peggy Sioux; A&R: Rick Babb.
 Branch: Portland, Ore., 626 NE 109 Court. Zip: 97220. Tel: (503) 254-5828. VP: James Lloyd Taylor.
 Labels: (Owned) Old Hat, 72 Toppie.
 Old Homestead Recs. Inc., Box 100, Brighton, Mich. 48116. Tel: (313) 227-1997. Pres.: John Morris; VP: Norma Morris.
 Labels: (Owned) Broadway Intermission, Old Homestead, Rutabaga.
 Oldies 45, see Vee Jay.
 Old Timey, see Arhoolie.
 Olenk Recs., G-10282 N. Saginaw Rd., Clo, Mich. 48420. Tel: (313) 686-9644. Owner: Nicholas H. Olejnik.
 Label: (Owned) Song Request Magazine.
 Olivia Recs. Inc., 4400 Market, Oakland, Calif., 94608. Tel: (415) 655-0364.
 Labels: (Owned) Olivia, (distributed) Bloodleaf, Deep River, Dream Machine, Thunderbird, Trish Nugent.
 Ollie, see Rollin' Rock.
 Olympic, see Everest.
 Omaha Recs., PO Box 1491, Omaha, Neb. 68101. Tel: (605) 267-2859. Owner: Douglas Sharples; Promo.: Paul Dunlap.
 Omega, N.Y., see Ampro.
 Ommsound Inc. (div. of Waring Ent's. Inc.), Delaware Water Gap, Pa. 18327. Tel: (717) 476-0550. Chief Exec. Officer: Fred Waring Jr.; Exec. Dir.: Yoshio Inomata; Ass't Dir.: Linda Hay; Prof'r: Bill Goodwin.
 One Love, see Groove Time.
 Onix, see Otao.
 Oops, see Disc Disk.
 Open, see Loadstone & Open.
 Open Sky Recs., 10735 Vernon, Huntington Woods, Mich. 48070. Tel: (313) 544-7558. Pres./A&R: Martin Scot Kosins; Mng. Dir.: Peg DuBois; Chief Technical Eng.: Danny Dallas.
 Operation Golden Hawk, see Crimson Dynasty.
 Orfeon Recs. Inc., 2837 W. Pico Blvd., Los Angeles, Calif. 90006. Tel: (213) 737-1223. Pres.: Rogelio Madero; VP's: Jose Mauricio Perez, Martin Romero.
 Home office: Mexico, Discos Mexicanos SA.
 Branches: New York, N.Y., 680 10 Ave. Zip: 10036. Tel: (212) 581-4639—Sanburco, P.R., 613 Calle Cerra, PDA 15. Zip: 00907.
 Labels: (Owned) Dimsa, Orfeon.
 Orfeu, see Penco.

Organ, see Beserkley.
 Orient, see Rashid.
 Original Cast, see Take Home Tunes!
 Original Master, see Mobile Fidelity.
 Original Sound Recs., 7120 Sunset Blvd., Hollywood, Calif. 90046. Tel: (213) 851-2500. Pres.: Art Laboe; Opns. Mgr.: Joe Daigle.
 Labels: (Owned) Now, Original Sound.
 Orion Master Rec's Inc., PO Box 4087, 5840 Busch Dr., Malibu, Calif. 90265. Tel: (213) 457-3370. Pres.: Giveton Cornfield; Sec'y-Treas.: Marion Cornfield.
 Labels: (Owned) Orion; (distributed) CCC/Orion.
 Int'l rep.: Germany (Disco-Center), Italy (Sciaccia), Spain (Dial), UK (Ember).
 Orlando Rec. Corp., 7513 Lake Dr., Orlando, Fla. 32809. Tel: (305) 855-8920. Telex: 803838. Contact: Carroll Fulmer. (Also see Professional Mktg.)
 Oro, see DGI.
 Oscar, see Alshire.
 Otisville, see McKinnon.
 Otao Recs. Co. Int'l Ltd., 214 W. 96 St., New York, N.Y. 10025. Tel: (212) 866-2469. Cable: OTOARECO. Pres.: L.R. Bernard; VP & Gen. Mgr.: Dolores Vera; VP's: C. & M. Bernard.
 Labels: (Owned) Colony, R.C. Sugar Soul, Taino; (distributed) Dinsa, Fenix, Onix, Teen.
 Our Gang Entertainment Inc., 26111 Brush Ave., Cleveland, Ohio 44132. Tel: (216) 261-8700. Pres.: Joey Porrello; VP & Gen. Mgr.: Bob Porrello; Financial Dir.: Jim De Geronimo; Midwest Artist Development: Ken De Geronimo; A&R Dir.: Roger Hatfield.
 Branch: Marton Grove, Ill., 7901 N. Caldwell Ave. Zip: 60053. Tel: (312) 967-0998. VP Artist Development: Leo Graziano; Midwest Promo.: Jim Stella; Pub.: Nick Schmitz.
 Duter Galaxie, see Star People.
 Outlet Recs., Box 594, 118 Main St., Rocky Mount, Va. 24151. Tel: (703) 483-0689/1538. Owner & Pres.: W. Rod Shively.
 Labels: (Owned) Mount, Outlet.
 Out of Print, see VHF.
 Out of Town, see AVI.
 Output, see Jersey Coast.
 Outstanding Recs., PO Box 2111, Huntington Beach, Calif. 92647. Tel: (714) 842-8635. Owner: Carl S. Beecher.
 Labels: (Owned) Morhythm, Outstanding; (distributed) Camerata Tokyo (Japan).
 Int'l rep.: Germany (Discofon), Japan (Camerata Tokyo), Sweden (Disc Music).
 Ovation Inc., 1249 Waukegan Rd., Glenview, Ill. 60025. Tel: (312) 729-7300. TWX (910) 651-4856.
 Branch: Nashville, Tenn., 803 18 Ave. Zip: 37203. Tel: (615) 327-4871.
 Int'l rep.: Australia (RCA), Canada (RCA), UK (Polydor).
 Overseas Wax, 1650 Broadway, New York, N.Y. 10019. Tel: (212) 541-9198. Pres., Sales & Adv. Mgr.: David Franklin.
 Ozark Opry Inc., PO Box 242, Osage Beach, Mo. 65065. Tel: (314) 348-3383/2270. Owner & Pres.: Lee Mace.
 Labels: Kajak, Ozark Opry, Vision; (distributed) Four Leaf Clover, Z.J.

P

P A Ent's. Inc., John Hancock Center, Suite 5404, 875 N. Michigan, Chicago, Ill. 60611. Tel: (312) 337-5643. Pres.: Andy Pappas; VP Mktg.: Bill Demis; Nat'l Promo.: Les Davis; Int'l Promo.: Mario Contreras.
 Labels: (Owned) Jahrock, Pa. Pyrry.
 P A I D Recs., 3409 Brinkman St., Houston, Tex. 77018. Tel: (713) 880-1175. Pres.: Don Daily; VP: Don Daily.
 Labels: (Owned) Daily; (distributed) IBC.
 P A U S A Recs., PO Box 10069, Glendale, Calif. 91209. Tel: (213) 244-7276.
 VP Sales & Mktg.: Earl D. Horwitz; Prod'n & Promo.: Bill Stiffheld.
 P B R, see Varese Sarabande.
 P C A Recs., c/o PC Assocs., PO Box 175, Fort Wayne, Ind. 46801. Tel: (219) 489-5565.
 P M Recs. Inc., 20 Martha St., Woodcliff Lake, N.J. 07675. Tel: (201) 391-2486. Pres.: Gene A. Perla; VP: Mary Perla.
 Int'l branch: Canada, Post Meridim Prod'n.
 Labels: (Owned) PM; (distributed) JDE, Shih, Silverbirch.
 Int'l rep.: Canada (Phonodisc), Denmark (SteepleChase), Germany (Membran), Italy (IRD), Japan (Sunkyo), UK (Cadillac).
 P M S, see Professional Mktg.
 P P L Recs. Corp., 6331 Hollywood Blvd., Suite 423, Hollywood, Calif. 90028. Tel: (213) 464-0401. Pres.: J. James Jarrett; Exec. VP: Remedios Kelly; Sr. VP Ops.: Gene Boykins; Sr. VP Technical Serv.: Dave Dyer; VP Promos.: Ricardo Starks; VP Sales: Denise Gauthier; VP A&R: Ray Moore; Exec. VP/Credence Recs.: Mike Cruz; Special Serv. Dir.: Ralph Bland; College Co-ord.: Kalani Childs.
 Labels: (Owned) Credence, Jarrett, PPL.
 P * P Recs., 64 Queensberry, No. 122, Boston, Mass. 02215. Tel: (617) 536-4136. Pres.: Steven Pulcher; Exec. VP: Curt Naiterher; VP Sales: Ken Scales; VP A&R: Rick Martin; Key Opns. Head: Ron Marinick; Base Opns. Head: Brad Hallen.
 P T L Club, see New Leaf.
 P V C Recs., c/o Jem Recs., 3619 Kennedy Rd., South Plainfield, N.J. 07080. Tel: (201) 753-6100. Telex: 833438. Pres.: Marty Scott.
 Pablo Live, see Pablo Recs. & RCA.
 Pablo Recs. Inc., 451 N. Canon Dr., Beverly Hills, Calif. 90210. Tel: (213) 274-9831. Cable: JAZPHIL. Pres.: Norman Granz; Admin. VP: Pamela Campbell. (Distributed by RCA).
 Labels: (Owned) Pablo, Pablo Live, Pablo Today.
 Pablo Today, see Pablo Recs. & RCA.
 Pacemaker, see Music Ent's.
 Pacific, see Atlantic.
 The Pacific Arts Corp., PO Box 22770, Carmel, Calif. 93922. Tel: (408) 624-4704. Telex: 351455. Bd. Chm.: Michael Nesmith; Pres.: David Bean; Network Liaison: Dick Broder; Mfg. Dir.: Ann Schwarz; Promo. Dir.: Jeff Green.
 Int'l rep.: Brazil (SOM), Germany (Metronome), Netherlands (Benelus Music Inds.).
 Pacific Challenger Recs. Inc., 2940 E. Miraloma Ave., Anaheim, Calif. 92806. Tel: (714) 992-6820/6827. Telex: 685553. Pres. & Gen. Mgr.: C.E. Whittington; VP Promo.: Dottie McIlroy; Sec'y-Treas.: Virginia Whittington.
 Labels: Moonridge, Pacific Challenger.
 Pacific Recs., c/o Warner Bros. Music, 9200 Sunset Blvd., Hollywood, Calif. 90069. Tel: (213) 273-3323. Chm. & Ed. Silvers; Pres.: Mel Bly. (Distributed by Atlantic).
 Page Rec'g Co., 604 Broad St., Johnstown, Pa. 15906. Tel: (814) 539-8117. Owner & Pres.: Al Page; Promos.: Anthony Page.
 Labels: (Owned) Aijo, Page, Ponderosa.

Painted Smiles Recs. (sub. of Batt'y Recs. Inc.), 116 Nassau St., New York, N.Y. 10038. Tel: (212) 964-31 0.

Palace, see Caprice.

Palante, see Auditorama.

Palladium Recs., 1650 Broadway, New York, N.Y. 10019. Tel: (212) 581 6162.

Palm, see Criterion.

Palmer, see Dawn.

Palmetto, see Album Globe.

Pamlyn Recs., PO Box 6211, Cleveland, Ohio 44101. Pres. Robert Wright. Gen. Mgr. & Promo. Becky Struss. Musical Dir. Ditto Mann. Labels: (Owned) Pamlyn, Tall Tan.

Pan Americana, see Pan American.

Pan American Recs. Inc., 3751 W. 73rd St., Chicago, Ill. 60623. Tel: (312) 521 1100. Pres.: Gustavo Silva; Sec'y: Isabel C. Silva, Treas. J. Manuel Calvo. Buyer: Frances N. Flores. Labels: (Owned) Pan American.

Panart Int'l Inc., 477 W. 27 St., Hialeah, Fla. 33010. Tel: (305) 887 1391. Cable: PANARTREC.

Pandora Music, PO Box 2281, Westover, W. Va. 26505. Tel: (304) 292-6447. Owner: Gilbert Frythall. Labels: (Owned) Pandora, Pandora/Synthe.

Pandora/Synthe, see Pandora Music.

Panini Recs./Panini Prod'n Inc., PO Box 15808, Honolulu, Hawaii 96815. Tel: (808) 947-4985. Pres.: Steven D. Siegfried, VP. Witt H.P. Shingle, Sec'y-Treas.: Lawrence N. Brown.

Pantego Sound Studios, 2210 Rap Blvd., Pantego, Tex. 76013. Tel: (817) 461-8481. A&R: Charles Stewart. Labels: (Owned) Pantego, Upstart.

Pantheon Desert Recs., 6325 N. Ivergordon Rd., Scottsdale, Ariz. 85253. Tel: (602) 948-5883.

Papagayo, see Sociedad Int'l de Sónido.

Paradise Recs. Inc., 4720 W. Magnolia Blvd., Burbank, Calif. 91505. Tel: (213) 980-5644. Pres.: Leon Russell; Mgr.: Diane Sullivan. (Distributed by Warner Bros.)

Paragon, see Benson.

Parallel Recs. & Tapes, 1414 Summit Ridge Dr., Beverly Hills, Calif. 90210. Tel: (213) 477-3651, 858-591. Exec. Pres. Rocky di Giallenico, VP. Robert M. Harrison; Staff: Alexander Prodrick, Larry Weir, Staff Eng./Prod'n: Tom Weir, Pub. Chm. Theresa Weir.

Paramount, see MCA.

Paramount-West Ent's., PO Box 6, Lira Loma, Calif. 91725. Tel: (714) 735-5845. Labels: (Owned) Constitution, Para-West, Podium, Rodeo, Soul Merchant.

Parasound Inc., 680 Beach St., San Francisco, Calif. 94109. Tel: (415) 673 4544. Cable: DOOBYDOO. Pres. Bernard Krause. VP. Admin'r: Pamela South; VP. Planning: Richard Stram.

Para-West, see Paramount-West.

Paredon Recs., 33 W. 17 St., New York, N.Y. 10011. Tel: (212) 242-6001. Charlie Parker, see Audiofidelity.

Park Lane, see CBS.

Park Place Recs., PO Box 564, Tucker, Ga. 30084. Tel: (404) 939 8064. Pres.: Charles E. Park, VP: Joe Castanuela.

Park Place Recs. Ltd., 159 E. 92 St., New York, N.Y. 10028. Tel: (212) 860 0026. Pres.: Jack Levy; Exec. Div.: John Golden; Promo.: Brad LeBeau.

Parliament, see American Themes & Tapes.

Parnaso, see Met Richmond.

Parquette, see Old Dominion.

Parr-X Corp., 8809-11 Rising Sun Ave., Philadelphia, Pa. 19115. Tel: (215) 676-8992. Pres.: Frank Virtue; Sec'y-Treas.: Mary Bozzi, A&R Dir.: Mary Ann Virtue; R&B/Soul A&R: Johny Stiles; Promos.: Linda Virtue, Melvin Wells. Labels: (Owned) A Major, Fayette, Rising Star, Virtue.

Par T, see Master-Trak.

Pasha, see CBS.

Passion Inc./E & M Recs., PO Box 16205, Zip: 92116; 1010 Second Ave., Suite 2222, San Diego, Calif. 9 101. Tel: (714) 265-2123. Pres. Chris Sullivan; Pres. Recs. Div.: Paul Anthony Sansone; VP: Gary Heffern; VP Recs. Div.: Christopher Aiken Davies; Sec'y: Daniel Monte McClain, Treas. & Chief Financial Officer: James Taylor Call; Artist Development: Steve Powell; Tour Development: Gar Insko; Artist Support: Jay Abrams. Branch: Scarsdale, N.Y., 24 E. Parkway, Zip: 10583. Tel: (914) 723-8236. East Coast Opns. Dir.: Anthony P. Sansone. Label: (Owned) E&M.

Passport Recs. Inc., c/o Jem Recs., 1619 Kennedy Rd., South Plainfield, N.J. 07080. Tel: (201) 753-6100. Te. ex: 833438. Pres.: Marty Scott; VP. Ed Gross; Mktg. Dir.: Andy Miele; Promo. Dir.: John Costa, A&R Mgr.: Glenn Fidelity; Int'l Prod. Coord.: Phyllis Pannone Craig. Int'l rep.: Benelux (WEA in Netherlands), France (Barclay), Germany (Metronome), Greece (PolyGram), New Zealand (Record & Tape Co.), Portugal (VOC), Spain (Zaluro).

Pastorale Music Co., 235 Sharon Pl., San Antonio, Tex. 78216. Tel: (512) 822-3593. Pres.: Carolyn Cunningham; Mgr.: W. Patrick Cunningham.

Patelonas, see Clay Pigeon.

Pathe Marconi-EMI (France), see onnosseur Society.

Pathways of Sound Inc., 102 Mt. Auburn St., Cambridge, Mass. 02138. Tel: (617) 354-6190. Pres.: Joe Ber; Mktg. Dir.: D. C. Littlefield. Labels: (Owned) Credo, Pathways of Sound.

Paula, see Jewel m La.

Pavillion, see CBS.

Payback Recs., 508 Penn Square Bldg., Philadelphia, Pa. 19380. Tel: (215) 567-2050.

Peaceable Music, 3525 Encinal Car on Rd., Malibu, Calif. 90265. Tel: (213) 457-4405. Pres.: C. Randolph Luert; Mktg. & Art: Kathy Morphesis. Promo.: R. Nauert; Country A&R: Larry Groce.

Peacock, see MCA.

Peanut Country, see Legrand Recs.

Pearl, see Delmark.

Pearl Harbor, see Associated Rec's Cos.

Pedegree, see Horizon Publ'g.

Peck, see Jim Hall.

Peer Southern Org., 1740 Broadway, New York, N.Y. 10019. Tel: (212) 265 3910. Cable: SOUTHMUSIC. Tel: 424361. Pres. Monique I. Peer, VP's: Ralph Peer II, Mario Conti. Branches: Los Angeles, Calif., 1777 Hollywood Blvd. Zip: 90028. Tel: (213) 469-1667. Mgr.: Roy Koh -Miami, Fla., Northeast Airlines Bldg., Rm. 1409, 150 SE Second St. Zip: 33131. Tel: (305) 358-1488. Mgr.: Omar Merchant -Nashville, Tenn., 7 Music Circle N. Zip: 37203. Tel: (615) 244-6200. Int'l branches: Canada, England, Italy, Sweden. Labels: (Owned) Discos Monica, Pcsound, Spark; (distributed) Southern Library of Rec'd Music.

Pega, see Discos Latin.

Pelican/Silver Pelican Recs., Box 195A, Rt. 1, Maxland, Fla. 32751. Tel: (305) 677-0611. Pres.: Glenn Hamman Sr.

Penco Recs. Inc., 428 Wood St., New Bedford, Mass. 02745. Tel: (617) 995 0595. Cable: PENRECO. Pres. Francisco M. Penha, VP: Francisco A. Penha. Int'l branch: Canada. Labels: (Owned) Coimbra; (distributed) Alvorada, Clave, Lisboa, Ofir, Orfeu, Rapsodia, Roda, Telectra, Vadeca.

Peninsula, see Old Dominion.

Penny Pinchers, see ASAI.

Pepp Recs., 11800 Mayfield Ave., Los Angeles, Calif. 90049. Tel: (213) 820 5061, 857-5982. Co-Owners: Richard J. Rothstein, Aaron Weiner.

Peraia (Brazil), see Fermata.

Marcus Pereira (Discos) (Brazil), see Brasilia.

Perfect, see Timeless.

Period, see Everest.

Periscope Rec. Co., 129 Bishop St., Brockton, Mass. 02402. Tel: (617) 588 6348. Pres.: Edward M. Murvitz; Rec'g Dir.: Ed Michaels; Mktg. Mgr.: Linda Berman. Labels: (Owned) Periscope, Strobe.

Personal Choice, see Gemcom.

Perspective, see Sine Qua Non.

Pesante Rec. Co., 744 W. 28, Norfolk, Va. 23508. Tel: (804) 623-5710.

Petco Int'l Inc., 88-20 Corona Ave., Elmhurst, N.Y. 11373. Tel: (212) 699 5258. Pres.: Robert Petrone. Int'l rep.: Colombia (Fonobosa), Costa Rica (Indica), Ecuador (IFESA), Mexico (Musart), Peru (Petco), Puerto Rico (Rio Piedras).

Peter Pan Inds., 145 Komorn St., Newark, N.J. 07105. Tel: (201) 344-4214. Pres.: Martin Kasen, Sr. VP: Donald Kasen; VP: Abe Rosenblatt; Nat'l Sales Mgr.: James F. Monaghan, Southeastern Reg'l Sales Mgr.: Perry Saffler, Mid-Western Reg'l Sales Mgr.: David Wulfsohn; Western Reg'l Sales Mgr.: Robert Rice, Northeastern Reg'l Sales Mgr.: Sy Spriegelman; Southwestern Reg'l Sales Mgr.: Martyn Markowitz. Branch: Paramount, Calif., 15714 Garfield Ave. Zip: 90723. Tel: (213) 633-1994.

Peter Rabbit, see Alshre.

Peters Int'l Inc., 619 W. 54 St., New York, N.Y. 10019. Tel: (212) 246-2400. Cable: PETERSRECS. Telex: 666262. Int'l branch: Canada. Labels: (Owned) Arns, Cosmos, Kronos, Peters Int'l, West 54; (distributed) Aron, New World (SEE ADVERTISEMENT).

Petra, see Paul Johnson.

Pet Recs./Tapes, PO Box 1102, Burbank, Calif. 91507. Tel: (213) 874-7656.

Peyton Recs. Inc. (div. of JPM Inds.), 3750 Bordeaux Dr., Northbrook, Ill. 60062. Tel: (312) 498-2750.

Phantom, see Windfall.

Pharoah Recs. Ltd., 1260 E. Main St., Meriden, Conn. 06450. Tel: (203) 728-5639. Cable: BELHOP. Labels: (Owned) Hard Times, Pharoah. Phase II, see CBS.

Philadelphia Int'l Recs., 309 S. Broad St., Philadelphia, Pa. 19107. Tel: (215) 985-0900. Bd. Chm.: Kenneth Gamble; Vice Chm.: Leon Huff; Exec. VP: Harry J. Coombs; Legal & Bus. Affairs Dir.: Philip Asbury; Comptroller: William Coger; Adv. & Mdsq. Co-ord.: Becki Butler; A&R Dir.: Dexter



The Only 14kHz Digital Reverb Under \$10,000!

Less than half the price of an EMT 251. About the same as the Lexicon 224. Compare System 5 with either of them. You'll see it's the most advanced digital electronic reverb system available, with a dynamic range of 103 dB; a signal-to-noise of 83 dB; total THD of less than 0.02%; and a real frequency response in excess of 14kHz.

System 5 has four individual reverb programs, four presets, 16 equalization settings and the microprocessor control which combine to give you infinitely more settings than you'll

ever need. The compact remote control can be patched up to 200 feet through a normal audio trunk line. System 5 is the only one that gives you the option of automated reverb addressable from a tape or disk for reverb changes on cue.

And, if System 5 is too much system for your needs, Quad-Eight, the pioneer in digital reverb, has other reverb systems to meet your needs and budget, with prices as low as \$1000. Call us direct, now, to audition System 5 or any Quad-Eight reverb (213) 764-1516

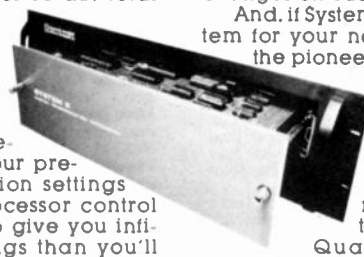

Quad-Eight Electronics
11929 Vose Street, North Hollywood, CA 91605

© 1981 Quad-Eight Electronics

Wansel, Royalties Accountant; Shirley Collins. (Distributed by CBS)
 Labels: (Owned) Philadelphia Int'l, TSDP.
 Philips, see PolyGram Classics.
 Philips (Brazil), see Brasilia.
 Philips-Dutch Swing College Band, see Lakco.
 Phil-L.A. of Soul, see Jamie/Guyden.
 Philly Jazz Inc., PO Box 8167, Philadelphia, Pa. 19101. Pres.: Thomas Buchler.
 Branch: West Hurley, N.Y., PO Box 232. Zip: 12491. Tel: (914) 338-7640.
 Mng. Officer: Rick Barry.
 Labels: (Owned) Philly Jazz; (represented) Dane, Encounter, Survival.
 Int'l reps.: Canada (Trend), Denmark (SteepleChase), UK (Jazz Music).
 Philo Recs. Inc., The Barn, North Ferrisburg, Vt. 05473. Tel: (802) 425-2111.
 Cable: PHILDDISC. TWX: (510) 299-0029. Pres.: Michael Couture; VP A&R: William Schubart; Finance: Robert Crenshaw; Prod'n: Carol Ford; Promo.: Carolyn Brewer; Eng'g Servs. Dr.: Charles Eller.
 Labels: (Owned) Fretless, Philo.
 Int'l reps.: Australia (Larrikin, Musicland), Belgium (Parsifal), Canada (Almada), Denmark (Alpha), France (DAM), Germany (Plaene, Taxim, Teldec), Italy (IRD), Japan (Pooch Yokochi), Netherlands (Munich Recs.), New Zealand (Kiwi), Sweden (Amigo), UK (Making Waves, Projection).
 Phoenix, N.Y., see Audiofidelity.
 Phoenix, Tenn., see Nashville Int'l.
 Phoenix Jazz Recs. Inc., PO Box 3, Kingston, N.J. 08528. Pres.: Tom Curry; Sec'y-Treas.: Russ Chase.
 Phono, see Nationwide Sound.
 Phonogram (Brazil), see Brasilia.
 Phonosonic, see Steady.
 Piccadilly, see First American.
 Pick (Brazil), see Fermata.
 Pick-A-Hit, see SIPRA.
 Pickin' Post Ent's., PO Box 51, Watertown Hwy., Lebanon, Tenn. 37087. Tel: (615) 449-1770, 444-3253. Owner & Pres.: Jewell W. Nave; VP: Joe W. Nave; Promo.: Zay Nave.
 Labels: (Owned) Jewell Tonic, Pickin' Post.
 Pickwick, see Excelsior.
 PicSound, see Peer-Southern.
 Pic-Vue, see Vantage.
 Pilgrim, see Spiral.
 Pilgrim/America, see Benson.
 Pilot, see Stark.
 Pinup, see Second Sun.
 Pioneer Rec. Co., PO Box 231, 1317 S. Peach, Tyler, Tex. 75710. Tel: (214) 597-2961. Mgr.: Curtis Kirk.
 Pioneer, S.C., see Srvatt.
 Pipe, see Trend Recs. in Ga.
 Pitch, see Gusman.
 Planet Recs., 9130 Sunset Blvd., Los Angeles, Calif. 90069. Tel: (213) 775-4710. Pres.: Richard Perry; Ass't to Pres.: Susan Epstein; VP: David Urso. (Distributed by Elektra/Asylum)
 Planet, Ill., see Rooster Blues.
 Plantation, see Shelby Singleton.
 Plastic Recs., 24548 Pierce, Southfield, Mich. 48075. Tel: (313) 559-7630.
 Pres.: Bruce Lorfe; Int'l Dps.: Tom Conner; A&R Dir.: Dennis Forbes; Nat'l Pub. Dir.: Pamela Bates; Nat'l Promo. Dir.: Mitch Stanley; Mktg. Dir.: Peggy De Marco.
 Labels: (Owned) Chaos, Plastic.
 Plateau Recs. Inc., 200 W. 57 St., New York, N.Y. 10019. Tel: (212) 541-7640. Co-Pres.: Lou De Biase, Ed D'Loughlin.
 Platinum, see Music Factory.
 Platinum Sound Prod'ns, 538 N. San Vicente Blvd., Suite 210, West Hollywood, Calif. 90048. Tel: (213) 851-9418. Pres.: Kenneth Howard Smith; VP/Exec.: Lee Rogers; VP Special Projects: Debra Robb; VP PR: Alice M. Jackson; VP Nat'l Promo.: Prentiss Anderson; VP Mktg.: Cervus T. McNeill; VP Concert Promos.: Theodore A. Smith; Area Promos. Dir.: Steve Scott; Graphics & Arts Dir.: John C. Clark Jr.; A&R: R.G. Ingersoll; Jay Setar; Field Dps. Dir.: Clyde E. Smith; Video Dps. Dir.: Charles Truman.
 Labels: (Owned) D-Town, Platinum Sound; (distributed) Hotrax.
 Playette Corp., 301 E. Shore Rd., Great Neck, N.Y. 11023. Tel: (516) 487-3064. Pres.: Sidney A. Evans.
 Labels: (Owned) GMS-Disc, Wilmac; (distributed) Ades (France), Cetra (Italy), DGG-Green Label (Germany), Pleiade (France).
 Playground Recs., PO Box 133, Ojai, Calif. 93023. Pres.: Jim Pewter.
 Int'l reps.: France (Pathe Marconi EMI), UK (Hot Rock).
 Play-Her, see Right Note.
 Pleasone Recs., 1727 Roanoke Ave., Sacramento, Calif. 95838. Tel: (916) 925-4886. Owner: Jerry Parker.
 Pleiade (France), see Playette.
 Plexus Trading Corp., 200 Hudson St., New York, N.Y. 10013. Tel: (212) 431-3482. Telex: 236941. Contact: William Medeot.
 Pliant, see Vantage.
 Plugga Recs., PO Box 3081, Bridge St. Sta., Paducah, Ky. 42001. Tel: (502) 898-7206. Owner/Mgr./Promo.: Mark Collier; Sec'y/Ass't: Dixie Brooks.
 Podium, see Paramount-West.
 Poki, see Tropical Music.
 Polish, see SWS.
 Polish Rec. Center of America, 3069 Milwaukee Ave., Chicago, Ill. 60618. Tel: (312) 539-9898.
 Labels: (Owned) Melodia; (distributed) Muza.
 Polka Tone, see Jay Jay.
 Polka Tune Music (div. of Polka Music Corp.), 211 Post Ave., Westbury, N.Y. 11590. Tel: (516) 334-6228.
 Potlengerst, see Crimson Dynasty.
 Polydor, see PolyGram.
 Polydor (Brazil), see Brasilia.
 PolyGram Classics Inc., 137 W. 55 St., New York, N.Y. 10019. Tel: (212) 399-7000. Telex: 661036. Pres.: Gianfranco Rebutta; Mktg. Dir.: John Harper; Controller: Henning Jorgensen; Deutsche Grammophon: VP: Alison Ames; Pub./Promo.: Grace Patti; Philips Recs.: VP: Nancy Zannini; Pub./Promo.: Peter Clancy; London Recs.: VP: Richard Rolfe; Pub.: Robert Ripp; Promo.: David Town.
 Labels: Archiv Produktion, Argo, DG (Deutsche Grammophon), Festivo, London, Mercury Golden Imports, l'Oiseau Lyre, Philips, Privilege, Telefunken, Verve.
 PolyGram Corp., 450 Park Ave., New York, N.Y. 10022. Tel: (212) 888-9800. Pres. & Chief Exec. Officer: Harvey L. Schein; Sr. VP & Chief Financial Officer: A.A. Bianco; VP Financial Ops. & Reporting: Michael Kolesar; Treas.: Marvin Wolfberg; VP Tax: Peter Dordal; VP Int'l Audit: Henry Osman; VP Law: Arnold Rich; VP Personnel: Barbara McHiam; VP MIS: Marty Cullen.
 PolyGram Direct Mktg. Inc., 810 Seventh Ave., New York, N.Y. 10019. Tel: (212) 399-7341. Pres.: Abe Wiesel.
 PolyGram (Portugal), see Brasilia.

PolyGram Recs. Inc., 810 Seventh Ave., New York, N.Y. 10019. Tel: (212) 399-7100. Pres.: David A. Braun; Exec. VP & Gen. Mgr.: Robert M. Sherwood; Exec. VP Dps.: Guenter Hensler; Sr. VP Mktg.: Harry Lusk; VP Black Music Mktg.: Bill Haywood; VP Legal & Bus. Affairs: Eileen M. Garish; VP A&R: Chip Taylor; VP Nat'l Promo.: Don Colberg; VP Pop Promo.: Bill Cataldo; VP/Rock Dept.: Jerry Jaffe; VP Press & Artist Relations: Len Epan; VP Mktg./Special Projects: Jim Lewis; VP Creative Servs.: Bill Levy.
 Branches: Los Angeles, Calif., 1930 Century Park W. Zip: 90067. Tel: (213) 277-1412. VP & Gen. Mgr. West Coast: Russ Regan; VP Mktg. West Coast: Emiel Petrone; VP A&R West Coast: John Stainze; Press & Artist Relations Dir.: Janet Richman-Nashville, Tenn., 10 Music Circle S. Zip: 37203. Tel: (615) 244-3776. VP/Country A&R: Jerry Kennedy.
 Distribution branches: See listings in Record & Tape Wholesalers section.
 Labels: (Owned) Casablanca, MGM, Mercury, Polydor, Verve; (distributed) Chocolate City, De-Lite, EG, MVP, RSO, Rva, Spring.
 Int'l reps.: Argentina (Phonogram), Australia (PolyGram), Austria (Phonogram, Polydor), Belgium (PolyGram), Bolivia (Discolandia Dueri), Brazil (PolyGram), Canada (PolyGram), Colombia (Philips), Denmark (PolyGram), Ecuador (Fediscom), Finland (Finlay), France (Phonogram, Polydor), Germany (Deutsche Grammophon, Phonogram, Polydor), Ghana (PolyGram), Greece (PolyGram), Guatemala (Dedca), Hong Kong (Polydor), Ireland (PolyGram), Israel (Litratone), Italy (PolyGram), Japan (Nippon Phonogram, Polydor), Kenya (Phonogram), Mexico (PolyGram), Netherlands (Import Music Serv., Phonogram, Polydor), New Zealand (PolyGram), Nigeria (PolyGram), Norway (PolyGram), Panama (Sonomundi), Peru (El Virrey), Philippines (Dyna), Portugal (Phonogram, PolyGram), Singapore (PolyGram), South Africa (Trutone), Spain (Fonogram, Polydor), Sweden (Polydor, PolyGram), Switzerland (PolyGram), UK (Phonogram, Polydor), Uruguay (Discografica), Venezuela (Polydor).
 Ponderosa, see Page.
 Pop Record Research, PO Box 14, Hollywood, Calif. 90028. Tel: (213) 349-9099.
 Labels: (Owned) GTP, Surf City; (distributed) Bob.
 Poptop, see Clay Pigeon.
 Portland, see Ripcord.
 Portrait, see CBS.
 Pose, see Cord.
 Poshboy Recs. & Tapes, PO Box 38861, Los Angeles, Calif. 90038. Tel: (213) 466-7755. Telex: 691304. Pres. & A&R: Robbie Fields; Mktg./Promo.: Kenny Ryback.
 Int'l reps.: Finland (Polarvox), Netherlands (Bertus), Spain (Auv), Sweden (Sound of Scandinavia), UK (Caroline).
 Posse Recs. Inc., 161 W. 54 St., New York, N.Y. 10019. Tel: (212) 581-5398. Pres.: Bill Spitzalky; VP: Jules Rifkind; Sec'y-Treas.: Roy Rifkind. (Also see Spring)
 Potato, see First American.
 Power Pak, see Gusto.
 Prairie Dust Recs., PO Box 40364, Nashville, Tenn. 37204. Tel: (615) 297-8076. Pres. & A&R Prod'r: Larry Morton; Promo. Mgr.: Ann J. Morton.
 Prairie Wind Recs., 104 N. Third, Norfolk, Neb. 68701. Tel: (402) 371-7658.
 Praise Inds. Corp., 1308 Meador St., Unit C5, Bellingham, Wash. 98225. Tel: (206) 671-9562.
 Name office: Canada.
 Labels: (Owned) Country Oak, Horizon, Little People, New Born, Praise, Tunesmith.
 Praise Jesus, see Shekinah.
 Precision, see CBS.
 Prelude Recs. Inc., 200 W. 57 St., New York, N.Y. 10019. Tel: (212) 974-0360. Pres.: Marvin Schlachter; Exec. VP: Stan Hoffman; Mktg. Dir.: Joe Kolsky; A&R: Francois Kevorkian.
 Premier, see Steady.
 Premier Artist, see Frank Evans.
 Premier (Brazil), see Fermata.
 Premiere, see Calvary.
 Prescription Co., 70 Murray Ave., Port Washington, N.Y. 11050. Tel: (516) 767-1929. Owner & Pres.: David F. Gasman; Ass't: Kirk Nordstrom; Tour Co-ord.: Bill Fear.
 Prestige, see Fantasy/Prestige/Milestone/Stax.
 Prime Cuts Recs., 439 Tute Hill, Lyndonville, Vt. 05851. Tel: (802) 626-3317. Pres.: Bruce James; VP A&R: Wayne Malhot.
 Prime Time Recs., 118 Main St., Rocky Mount, Va. 24151. Tel: (703) 483-1538/0689. Pres. & Gen. Mgr.: W. Rod Shively; Sales Mgr.: Judy Shively.
 Prism Recs. Inc., 636 11 Ave., New York, N.Y. 10036. Tel: (212) 247-5900.
 Pres.: Len Fichtelberg; VP: Dee Joseph.
 Privilege, see PolyGram Classics.
 Pro-Arte, see Excelsior.
 Pro-Arte, see Spanish Music Center.
 Process, see Country Star.
 Prod'ral, see Motown.
 Produktion Deutchmark, see Michele.
 Professional Mktg. Serv. Inc. (PMS), United Artist Tower, Suite 907, 50 Music Square W., Nashville, Tenn. 37203. Tel: (615) 327-0571. Pres. & Nat'l Mktg. Dir.: Dee Mullins; Nat'l Promo. Dir.: Carleen Anderson.
 Labels: (Owned) Grunder's Switch; (represented) Crackers, Crane, DDF, Hot Politics, Oriando, True.
 Profile Recs. Inc., 250 W. 57 St., New York, N.Y. 10107. Tel: (212) 582-3555. Cable: PROFILE. Pres.: Cory Robbins; VP: Steven Plotnicki.
 Progressive Recs. Inc., PO Box 500, 601 Virginia Ave., Tifton, Ga. 31794. Tel: (912) 382-8192. Pres.: Gus P. Stairias; VP: James E. Newton.
 Int'l reps.: France (Diffusion Artistique), Japan (Sunjiko), Sweden (Ad Lib), UK (Jazz Horizons).
 Project 3 Recs. (div. of Seagull Ent. Corp.), 200 W. 57 St., New York, N.Y. 10019. Tel: (212) 247-4422. Pres.: Herbert A. Linsky. (Distributed by Arista)
 Labels: (Owned) Insight, Project 3.
 Promotions West Inc., PO Box 10287, Eugene, Ore. 97440. Tel: (503) 484-5812.
 Labels: (Distributed) Hanna Barbera, ICMC.
 Pronto, see Castronics.
 Prophecy, see Glotite.
 Protone Recs., 970 Bel Air Rd., Los Angeles, Calif. 90024. Tel: (213) 472-5344. Dir.: Jane Courtland Welton; Exec. Assoc.: Laila Padorr Nunes.
 Labels: (Owned) Protone; (distributed) Laurel-Protone.
 Proud Earth Recs., PO Box 162, 3697 N. 600 East, Provo, Utah 84601. Tel: (801) 224-1775. Pres.: Stan Bronson; VP: Steve Bronson; Sales Mgr.: Mitt Fletcher.
 Labels: (Owned) Proud Earth, Salt City.
 Providence, see Daytwo.
 Public Secrets, see Epiphany.
 Pulstrak, see Scenerville.
 Pumehana, see Tropical Music.

Pumpko Inds. Ltd., 7720 Sunset Blvd., Los Angeles, Calif. 90046. Tel: (213) 851-9275. Pres.: Frank Zappa; VP/Gen. Mgr.: Marty Goldrod. (Distributed by CBS)
 Label: (Owned) Barking Pumpkin.
 Pure Gold, Calif. see SIPRA.
 Pure Gold, N.Y., see RCA.
 Pygmy, see PA.
 Pyramid Recs., 26177 Kinyon Dr., Taylor, Mich. 48180. Tel: (313) 292-5281.
 Pres.: Peggy LaSorda.
 Pyramid, Int'l. see Roulette.
 Pyramid, N.J., see Rob-Lee.

Q

Q C A Recs. Inc., 2832 Spring Grove Ave., Cincinnati, Ohio 45225. Tel: (513) 681-8400. Pres.: Edward R. Bosken; VP & Gen. Mgr.: Keith Myers; Plant Mgr.: Ken Martin.
 Labels: (Owned) Blue Mark, New Day, QCA, Red Mark, Rejoice, Wildwood.
 Quadraphonic Talent Inc., PO Box 630175, Miami, Fla. 33163. Tel: (305) 472-7757. Pres.: Jack P. Bluestein; VP: Ethel Kanter; Sec'y: Dorothy Leonard.
 Labels: (Owned) Twister.
 Int'l rep.: Brazil (Pirate).
 Qualiton, see Hungaria.
 Quality, see RFC.
 Quark, see Bomp.
 Quarter Moon, see Entertainment Ventures.
 Quicksilver Recs., 9000 Sunset Blvd., Suite 1015, Los Angeles, Calif. 90069. Tel: (213) 278-0415. Pres.: Howard Silvers.
 Labels: (Owned) Quicksilver; (licensed) Bulldog (UK).
 Quichway, see Revonah.
 Quintessence, see Excelsior.
 Quinto Recs., 4423 Ledge Ave., Toluca Lake, Calif. 91602. Tel: (213) 985-8284. Owner: Quint Benedetti.
 Labels: (Owned) Quinto; (distributed) Crissy.
 Qwest Recs., 7250 Beverly Blvd., Suite 207, Los Angeles, Calif. 90036. Tel: (213) 934-4711. (Distributed by Warner Bros.)

R

R B F, see Folkways.
 R C A (Brazil), see Brasilia.
 R C A /Canada (Mexico), see Castronics.
 R C A (Mexico), see Castronics.
 R C A Recs., 1133 Ave. of the Americas, New York, N.Y. 10036. Tel: (212) 930-4000. Pres.: Robert D. Sumner; Div. VP RCA Recs.-USA & Canada: Jack R. Craig; VP RCA Recs.-Europe: Giuseppe Ornato; VP Recs. RCA-Latin America & Pacific: Adolfo Pino; Div. VP Music Serv.: Robert Gordon; Div. VP Bus. Affairs & Int'l Admin.: Ekke Schnabel; Div. VP Finance: Bradford Campbell; Div. VP Int'l Relations: Daniel Sassi; Div. VP Mktg.: Richard Thorward; Div. VP Opgs. Servs.: John Mangini; Div. VP Black Music: Ray Harris; Div. VP Red Seal: Thomas Z. Sheppard; Div. VP Nat'l Sales: Larry Gallagher; Div. VP Promo.: John Belancourt; Staff VP & Sr. Counsel: Jonathan Walton; Div. VP Public Affairs: Herb Helman; Div. VP Mktg. & Talent Acquisition: RCA Recs. Int'l Don Burkheimer; Div. VP Mdsq.: Jack Chudnow; Div. VP Black Music: Promo. Bill Stalon.
 Branches: Hollywood, Calif., 6363 Sunset Blvd. Zip: 90028. Tel: (213) 468-4000. Div. VP Contemporary Music A&R-West Coast: Barry Oslander-Nashville, Tenn., 30 Music Square W. Zip: (615) 244-9880. Div. VP Nashville Opgs.: Jerry Bradley; Div. VP Country Music: Chet Atkins; Div. VP Mktg.: Joe Galante.
 Distribution branches: See Record & Tape Wholesalers section for RCA & A&M & Assoc'd Labels.
 Int'l affiliates: Argentina, Australia, Brazil, Canada, England, France, Germany, Italy, Japan, Mexico, Netherlands, New Zealand, Spain.
 Labels: (Owned) Best Buy Series-budget, Bluebird, Gold Seal, Pure Gold, RCA Victor, Red Seal, Victrola; (associated) A&M group, Chi-Sound, Grunt, Millennium, Pablo, Pablo Live, Pablo Today, Salsoul group, 20th Century-Fox.
 Int'l repa.: Austria (Musica), Bolivia (Inbofon), Chile (Sochem), Colombia (Sonolux), Czechoslovakia (Opus), Denmark (Grammofon), Dominican Republic (Distribuidores Musicales del Caribe), Ecuador (Fadisa), El Salvador (Dicesa), Fiji Islands (Procera), Finland (Discophon), Greece (Minos Matsas), Hong Kong (Cosdel), India (Gramophone), Israel (East-ronics), Kenya (AIT), Korea (Jigu), Norway (Disco), Pakistan (EMI), Panama (Padisco), Peru (FTA), Philippines (Victor), Portugal (Teletra), Singapore (Cosdel), South Africa (Teal), Sweden (Electric), Switzerland (Musikvertrieb), Thailand (Central Trading), Turkey (Melodi), Uruguay (APSA), Venezuela (Cordica), Yugoslavia (Jugoton). (SEE AD)
 R C A/R V C (Japan), see Audio-Technica.
 R C A Victor, see RCA Recs.
 R C I Recs., PO Box 126, Elmsford, N.Y. 10523. Tel: (914) 592-7983. VP: Ray Roberts.
 Labels: (Owned) RCI, Thomas.
 R C S, see Record Company of the South.
 R D S Prod'n, PO Box 3028, Fairview Heights, Ill. 62208. Tel: (618) 397-3701. Pres.: Robert D. Schirmer.
 R F C Recs. Inc., 101 W. 55 St., New York, N.Y. 10019. Tel: (212) 246-4352. Pres.: Ray Caviano; VP & Gen. Mgr.: Bob Siegel.
 Labels: RFC/Atlantic (dist. by Atlantic), RFC/Quality.
 Int'l rep.: Canada (Quality).
 R G E (Brazil), see Fermata.
 R G E/Fermata, see Brasilia.
 R I C, see House of Falcon.
 R I M, see Starborne.
 R M S Triad Prod'ns, 30125 John R., Madison Heights, Mich. 48071. Tel: (313) 585-8887. Owner: Bob Szajner; Prod'r: Laura Holiday; Promo.: Harvey Yates. Local branch: 6267 Potomac Circle, West Bloomfield 48033. Tel: 661-5167.
 Labels: (Owned) RMS, Triad.
 R P I, see Rambler.
 R R C, see Koolha.
 R R P, see Rite Rec.
 R & R Recs. Inc./Ren Rome, 663 Fifth Ave., New York, N.Y. 10022. Tel: (212) 757-3638. Pres.: Rena L. Feeney.
 Labels: (Owned) Can Scor, Factory Beat, Ren Rome.
 R S D Recs., 8335 Sunset Blvd., Los Angeles, Calif. 90069. Tel: (213) 650-1234. Telex: 69-8130. Pres.: Al Coury; Comptroller: Peter Fassler; Nat'l Pub. Dir.: Ronnie Lippin; Admin. Ass't: Laraine Ward; Prod'n: Ellen Nettlich. (Distributed by PolyGram)

Branch: New York, N.Y., 1775 Broadway, Zip: 10019. Tel: (212) 975-0700. Telex: 125779. Sr. VP & Gen. Mgr.: Bob Edson.
 Int'l branch: England.
 Labels: (Owned) RSO; (distributed) Dreamland.
 rti, see Recorded Treasures.
 R T P Int'l, see Rik Tinory.
 Radiant, see American Tape.
 Radio, see Atlantic.
 The Radiola Co., Box C, Sandy Hook, Conn. 06482. Tel: (203) 426-2574; WATS (from outside Conn.) (800) 243-0987. Pres.: J. David Goldin; Gen. Mgr.: Craig Gallichotte; Sales Mgr.: Larry Sockell.
 Radio & Television Commission of the Southern Baptist Convention, 6350 W. Freeway, Fort Worth, Tex. 76150. Tel: (817) 737-4011. Cable: BAPTCOM.
 Rae-Cox Recs. Inc./Enrica Recs. Inc., 1697 Broadway, Suite 1105, New York, N.Y. 10019. Tel: (212) 586-9406. Pres.: Theodore McRae; VP: Fredia Stanton; A&R: William Gray; Pub. Dir.: Tina Whitehead.
 Labels: (Owned) Enrica, Rae-Cox.
 Ragamuffin, see R. Dean Taylor.
 Ragdoll Ent's., 205A Television Circle, Savannah, Ga. 31406. Tel: (912) 927-1761. Pres.: David M. Evans; VP: Janice L. Evans.
 Labels: (Owned) Ragdoll, Rocma.
 Ragin' Rockabilly, see Rollin' Rock.
 Ragtime, see Grassroots.
 Ragun Recs., 400 Essex St., Salem, Mass. 01970. Tel: (617) 744-7678. Gen. Mgr.: Don Rose; Exec. Prod'r: And. Engendorf. (Distributed by Eat Recs.)
 Railroad Center, see Chi-Town.
 Rainbo Rec. Mfg. Corp., 1738 Berkeley St., Santa Monica, Calif. 90404. Tel: (213) 829-3476. Pres.: Jack G. Brown; Sales Mgr.: James Doyle; Prod'n Supervisor: Steve Sheldon; Prod'l Co-ord.: Jodine Setter.
 Rainbow Recs. (div. of Arrow Music Industries Inc.), 506 Cottonwood St., Woodland, Calif. 95695. Tel: (916) 662-0386. Pres.: Leilani Guido; VP: Dennis Litchfield; Sec'y: Tom Rooney.
 Rainbow Room, 30 Rockefeller Plaza, New York, N.Y. 10020. Tel: (212) 757-9090.
 Label: (Owned) Above All.
 Rainbow Sound Inc., 2737 Irving Blvd., Dallas, Tex. 75207. Tel: (214) 631-4277. Pres.: Bob Cline; Exec. VP: Jack Whitt; VP: Phil Kalan; Mktg. & Promo.: Daniel Albritton.
 Rally, see Ralph's Radio.
 Ralph Recs. (div. of The Cryptic Corp.), 444 Grove St., San Francisco, Calif. 94102. Tel: (415) 431-7480. Clm.: John E. Kennedy; Mng. Dir.: Jay Clem; VP/A&R: Hardy Fox; VP/Creative Servs.: Homer Flynn; Sales Dir.: Tom Timony; Adv. & Promo. Dir.: Doug Kroll; Art Dir.: Helen Purdum; Film/Video Dir.: Graeme Whifler.
 Int'l reps.: Australia (Missing Link), Austria (Ithuluh), France (Celluloid), Germany (Killidus, Phonogram), Japan (Sound Trading), Sweden (SAM), UK (Charisma, Do It, Recorded, Rough Trade, Stage One).
 Ralph's Radio Music, Demorest, Ga. 30535. Tel: (404) 778-9117.
 Labels: (Owned) Gospel Time, R. Ily, Zipcode.
 Rambler, Calif., see Mutual Music.
 Rambler Prod'n Inc., 8119 WCR 4E 4, Johnstown, Colo. 80534. Tel: (303) 587-2933. Gen. Mgr.: Keith Stoner.
 Label: (Owned) RPI.
 Ramblin' Prod'n Ltd., 430 S. Glenstone, Suite C, Springfield, Mo. 65802. Tel: (417) 864-4404. Pres.: Keith O'Neil; Dir.: William Dailey; Sec'y: Treas.: Bill Hood; Media Relations: Olivia Ferrell.

Ramex Recs. Inc., 202 S. Milby St., Houston, Tex. 77003. Tel: (713) 223-3591. Pres.: Emilio V. Garza.
 Rampart Recs. (div. of Gordo Ent's.), 255 N. New Hampshire, Los Angeles, Calif. 90004. Tel: (213) 384-9586. Owner & Nat'l Sales Mgr.: Edward L. Davis.
 Int'l reps.: Mexico (Cronos), UK (Creole).
 Ram Recs., 4307 Saundersville Rd., Old Hickory, Tenn. 37138. Tel: (615) 847-3895. Pres.: Mira Ann Smith; VP's: Margaret Lewis.
 Int'l rep.: Canada (Mark-Lin).
 Randall Recs., 29 Elaine Rd., Milford, Conn. 06460. Tel: (203) 878-7383. Pres.: Gerald Randall; VP: Howard Randall; A&R: Bill Blossom.
 Branches: Middletown, N.Y., 15 Randall Heights, Zip: 10940. Tel: (914) 343-6918. A&R: Samuel Randall—Syracuse, N.Y., 1900 W. Genesee St. Zip: 13204. Tel: (315) 468-0161.
 Random Ent's., 12 Merrimac St., Concord, N.H. 03301. Tel: (212) 734-4000. Pres. & Chief Operating Officer: Alan Hartwell; VP & Gen. Mgr.: S.J. Hartwell; A&R/Prod'r: M.J. Nerlino; Promo. Servs.: P.J. Hanse, Barry Nelson.
 Branches: New York, N.Y., 825 Madison Ave. & 134 E. 70 St. Zip: 10021. Tel: (212) 734-4000, 288-6000.
 Labels: (Owned) Love, Random, Rave, Sylvania, Zenith; (distributed) Century 21, Solid Brass.
 Random House School Div., 201 E. 50 St., New York, N.Y. 10022. Tel: (212) 572-2568.
 Labels: Miller-Brody Prod'n's, Newbery Award, Random House.
 Range Buster, see Colonel Buster Doss.
 Ranger, see Forrest Green.
 Ranwood Recs. Inc., 1299 Ocean Ave., Suite 800, Santa Monica, Calif. 90401. Tel: (213) 870-2989, 393-2767. Pres.: Larry Welk; VP: Christine Hamilton; Nat'l Sales Mgr.: Morry Goldman.
 Rapsodia, see Penco.
 Rare Earth, see Motown.
 Raretone (Italy), see Zim.
 Bill Rase Prod'n Inc., 955 Venture Court, Sacramento, Calif. 95825. Tel: (916) 929-9181. Owner & Pres.: Bill Rase; VP: Lori Rase; Sec'y: Shirley Rase.
 Label: (Owned) Esar.
 Rashid Sales Co., 191 Atlantic Ave., Brooklyn, N.Y. 11201. Tel: (212) 852-3295. Cable: ALRASHID. Pres.: Albert Rashid; VP's: Raymond & Stanley Rashid.
 Label: (Owned) Orient.
 Int'l rep.: Greece (EMI).
 Rat Recs., 528 Commonwealth Ave., Boston, Mass. 02215. Tel: (617) 267-4156. Pres.: James G. Harold; Exec. Ass't: Judith A. Mintz; Staff Prod'r: John Kalishes.
 Rattler, see Sarg.
 Rave, see Random.
 Rawls Bros. Prod'n's, 281 W. Sixth, Mansfield, Ohio 44906. Tel: (419) 524-4366, 522-5754. Pres.: Larry Rawls; VP: Box Rawls; PR Dir.: Benjamin O. Jernison.
 Label: (Owned) Fun City.
 Rayner Street Corp., 904 Rayner St., Memphis, Tenn. 38114. Tel: (901) 278-1100. Pres.: Ken Visokay; VP Creative: Paul Zaleski; Exec. VP: Joe Porter; A&R Dir.: Errol Thomas; Promo. Dir.: Gene Lucchesi.
 Labels: (Owned) Jenny, XL.
 Razor Recs., 2648 Magnolia St., Chicago, Ill. 60614. Tel: (312) 549-3227. Owner: Mark LeFars; VP: Mike Landers.

Reachout Int'l Recs. Inc., 611 Broadway, Suite 214, New York, N.Y. 10012. Tel: (212) 477-0563. Pres.: Neil Cooper.
 Reader's Digest Ass'n Inc., Music Dept., 750 Third Ave., New York, N.Y. 10021. Tel: (212) 972-4000. Cable: READIGEST. Prod. Development Mgr./Recorded Music Div.: Simone Bedient.
 Reading, see McKinnon.
 Real, see Sire.
 Reality Recs./Prod'n's, PO Box 824, Elizabeth, N.J. 07207. Tel: (201) 353-3485. Pres. & Prod'r: Hank Strasser; Admin. & Graphics: Aida Maria Batista.
 Real Recs. Inc., 434 Ave. U, Bogalusa, La. 70427. Tel: (504) 732-2942. Pres. & Dir./A&R: James R. Baleman Jr.; Sec'y: R. Ray Orrill Jr.
 Branch: Ross, Calif., PO Box 344, Zip: 94957. Tel: (415) 461-2942. VP & Treas.: Robert A. Braghella.
 Int'l reps.: Canada (Stony Plain), Germany (Teldec).
 RealTime, see Miller & Kreisel.
 Real World Recs., 1438 N. Gower, Hollywood, Calif. 90028. Tel: (213) 469-4100. Cable: PINK LADY. Pres.: Paul Drew; VP: Ann Drew; Exec. Ass't: Susan Lemieux. (Distributed by Alco/Atlantic).
 Rebecca, see Glenn.
 Rebel Recs. of Va., PO Box 191, Floyd, Va. 24091. Tel: (703) 745-2001. Pres.: David Freeman; Promo.: Chet Rhodes.
 Int'l reps.: Italy (IRO), Japan (BOM), Sweden (Sarec), UK (Mike Craig).
 Reborn, see Glori.
 Recital Recs., 4640 E. Lewis, Phoenix, Ariz. 85008. Tel: (602) 959-2076. Owner: L. John Twiford.
 Recital, Calif., see Educational Media & Discocorp.
 Reco-Flex, see Vantage.
 Recommended Viewing, see Jersey Coast.
 Record Company of the South (RCS), 5220 Essen Ln., Baton Rouge, La. 70808. Tel: (504) 766-3233. Pres.: Cyril E. Vetter; VP/Gen. Mgr.: John Fred; Promo. & Sales: Ronnie Shaab.
 Recorded Anthology of American Music Inc., (New World Recs.), 231 E. 51 St., New York, N.Y. 10022. Tel: (212) 753-9820. Cable: RECANTH. Pres.: Herman E. Krawitz; Gen. Mgr.: Mary DeCamp Carlson; A&R Dir.: Elizabeth Ostrow; Prod'n & Dist'n Dir.: Barry Adler. (Distributed by Peters Int'l).
 Label: (Owned) New World.
 Recorded Treasures Inc., PO Box 1278, North Hollywood, Calif. 91604. Tel: (213) 763-3173, 766-4693. Pres.: Walter S. Heebner.
 Label: (Owned) rti, Wette Legacy of Piano Treasures.
 Record Guild of America, 144 Milbar Blvd., Farmingdale, N.Y. 11735. Tel: (516) 293-5858. Pres.: David Shichman.
 Labels: (Owned) Audio Guild, Bomba Roja, Deutschmark, Scrapbook, Simon Says.
 Record Haven Int'l, 636 11 Ave., New York, N.Y. 10036. Tel: (212) 247-5900. Telex: 666754. VP: Len Fichtelberg; Opns. Dir.: Paul Freund. (Importer/Exporter).
 Recordland, see Knol Kat.
 Record & Music People Inc., 635 Elm St., Birmingham, Mich. 48011. Tel: (313) 645-0750. Pres.: Jim Elsmann; Exec. VP: Andre Williams.
 Label: (Owned) Underground.
 Record Recs., 229 San Vicente, Suite D, Santa Monica, Calif. 90402. Tel: (213) 393-1343. Pres.: Peter Kaye; A&R/Prod'n: Richard Haston, Dirk Etienne.
 Record Rendezvous Inc., 134 S. 20 St., Philadelphia, Pa. 19103. Tel: (215) 561-7340. Pres.: Edward R. Marcus; VP: Frances Marcus.

Jon Devlin's

dancercise

Total Exercise System

records & tapes

complete with photo-illustrated instruction books



MUSIC MARKETING CORP.
 IEI Bldg., Airport Plaza Hwy. 36
 Hazlet, NJ 07730 • (201) 264-0700
 Foreign Licenses Available.

- Label: (Owned) Rendezvous.
Record Room, see Argus
Recordtime, see Institute for Language Study
Red (Italy), see Rounder
Red Clay, see Sonyatone
Red Dot, see Marullo
Red Lightnin' (UK), see Shanachie
Red Mark, see QCA
Red Onion Recs., PO Box 366, Dayton, Ohio 45401 Tel (513) 222 2413
Owner & Pres: Sharon Rethman
Red Seal, see RCA
Redwood Recs., PO Box 996, 565 Doolan Canyon, Ukiah, Calif 95482 Tel (707) 462-3589. Tel (707) 462-3589 Pres Jo-Lynne Worley, VP Joanne Shoemaker; Sec'y Holly Near, Dist'n/Mktg. Dir. Betsy York; A&R Eve Lynn Barnes
Labels: (Owned) Redwood, (distributed) Deep River
Int'l repts.: Denmark (Face The Music), Germany (Toubadisc), Netherlands (Carol Bloom), Sweden (Lilith Orngrojd), UK (Women's Rev.)
Reference, see Sumiko
Reflection Sound Prod'n Inc., 1018 Central Ave., Charlotte, N.C. 28204. Tel (704) 377 4596. Pres: Wayne Jennings; A&R Don Dixon, Duke Hall
Labels: (Owned) Avant!, Reflection, Sugarbush.
Refuge Recs. (div of Paradise Group), PO Box 110570, Nashville, Tenn 37211 Tel (615) 776-5051. Pres, Roy Nenow, Ass't to Pres: Brenda Dickson, VP Special Projects. Jack Hafer, Contemporary Artists Dir. Harlan Hunter; A&R Prod'r Greg Nelson, Tour Pub Co-ord. Mike DeMonico. (Distributed by Benson Co.)
Regency Recs. Inc., 1116 N. Cory Ave., Los Angeles, Calif 90069. Tel (213) 278-5131 Cable SAGALAW TWX (910) 499-2178. Pres. Lloyd Segal, Nat'l Promo. Dir Ron Farber, Nat'l Mktg & Sales: Richard Perlmutter, Nat'l Press & Media. Sally Stevens, A&R. Dan Wright: Prod'n Co-ord. John Delgado. (Distributed by MCA)
Int'l repts.: Australia (Astor), Austria (Metronome in Germany), Belgium (WEA), Canada (MCA), France (Carriere) Germany (Metronome), Italy (Ricordi), Japan (Trio), Mexico (Gamma), Netherlands (WEA), New Zealand (PolyGram), Portugal (Hispanav in Spain), South Africa (RPM), Spain (Hispanav), UK (MCA).
ReGeneration Inc., 2199 Nolensville Rd., Nashville, Tenn. 37211 Tel (615) 256-2242 Pres Derric Johnson; VP Ron Coker; Sales Mgr. Eric Wyse
Labels: (Owned) Chenamah, Forever, Mustard Seed, (distributed) SOG.
Rego Insh Recs. & Tapes Inc., 64 New Hyde Park Rd., Garden City, N.Y. 11530 Tel (516) 328 7800 Pres. Paddy Noonan
Reid's World, see TK.
Rejoice, see QCA
Reico, see Caprice
Release Recs., PO Box 234, St. Louis, Mo. 63166 Tel (314) 296-9526 Pres & A&R Dir. B J Baz
Relia Recs., 1004 Clifton, Park Ridge, Ill 60068 Tel (312) 692-6227.
Remington, see American Tape
Renaissance, Calif., see Everest & Trend.
Renaissance Films & Recs., PO Box 3501, Zip. 48502, 614 W. Mott, Flint, Mich. 48505. Tel. (313) 787-2962. Bd. Chm.: Morris O. Ruffin, Pres Margarett Ruffin; VP: VerDel Ruffin, VP/Dist'n: Henry Dawson; Sec'y: Marret Scott; Treas. Darryl Ruffin.
Labels: (Owned) Eclipse, Renaissance.
Rendezvous, see Record Rendezvous.
Renegade, see Chuck Chellman.
Renore, see Old Dominion.
Ren Rome, see R&R.
Reo Tahiti, see Criterion.
Repertoire, see Sonic Arts.
Reprise, see Warner Bros.
Request Recs., 5937 Ravenswood Rd., Fort Lauderdale, Fla. 33312. Tel. (305) 966-0680.
Labels: (Owned) Afro Request, Classical Excellence, Demand, Euphoria, Music of Many Lands, No Holds Barred, Oasis, Request, Sounds of the Caribbean.
Int'l repts.: Australia (Avan-Guard), Belgium (Sonobel), Canada (Almada), Germany (Phonogram), Switzerland (Evason)
Resco Recs., 2039 Antone, Houston, Tex 77055. Tel: (713) 683 7171 Mgr. Russ Reeder; A&R Gene Watson.
Respond Recs. Inc., 1190 Miraloma Way, Suite Y, Sunnyvale, Calif. 94086. Tel (408) 245-1351. Cable: RESPOND SUVL. TWX: (910) 339-9317. Pres: Ronald L. Akin, VP Opns.: Priscilla A. Akin, VP Finance & Admin.: Thomas I. Russell.
Labels: (Licensed) Asahi, Canyon, Disco, King, Tokuma. URC (all Japan), Blackgold, Jem, Mico, Octoarts, Vicor, Wonderland (all Philippines).
Reuben Recs., 8537 Sunset Blvd., No. 2, Los Angeles, Calif. 90069 Tel (213) 657-8852. Owner. Travis Lehman.
Revolution Recs. (div of Graveline Ents Inc.), 1975 NE 149 St., Miami, Fla. 33181. Tel: (305) 940-6999. Pres: Dave Graveline; Exec. VP Jim Rudd; Chief Eng. Ted Stein, Ass't Chief Eng. Jeff Oean.
Revolver, see Dance-A-Thon.
Revonah Recs., Box 217, Ferndale, N.Y. 12734. Tel: (914) 292-5965. Owner & Chief Eng.: Paul Gerry; Studio Mgr. & Promo.: Patricia James.
Labels: (Owned) Quickway, Revonah, Studio 17, Tel-E-Vue; (distributed) Grassound.
Int'l repts.: Canada (Almada), Japan (BOM, Pooch Yokochi), Netherlands (Only Yesterday), UK (String, Mike's Country Music).
Rhythms Prod'n, Box 34485, Whitney Bldg., Los Angeles, Calif. 90034. Tel: (213) 836-4678. Pres., R.S. White; Exec. Prod': David O. White.
Labels: (Owned) Rhythms Prod'n, Tom Thumb.
Rialto Recs., c/o Ron Ross Mgmt., 11257 Blix St., North Hollywood, Calif. 91602. Tel: (213) 508-9865. US Label Mgr. Ron Moss.
Int'l branch: England.
Int'l repts.: Argentina (Sicamericana), Australia (Astor), Denmark (Hede Nielsen), Finland (Discophon), France (Vogue), Germany (Ankola Eurodisc), Greece (Music Box), Ireland (PolyGram), Italy (Dischi), Japan (Victor), Mexico (Gamma), Netherlands (Dureco), New Zealand (PolyGram), Norway (Disco A/S), Peru (FTA), South Africa (Teal), Spain (Zafiro), Sweden (Electra), Venezuela (El Orsco de Moda).
Rice Recs. Inc., 11 Music Circle S., Nashville, Tenn. 37203 Tel: (615) 242 2461. Pres: E. Jimmy Key; VP: Jack J. Key.
Richardson Recs., 1938 Baltimore Annapolis Blvd., Annapolis, Md. 21401. Tel: (301) 757-3733. Owner, Pres. & Chief Eng. Charles A. Richardson. VP. Mary A. Richardson.
Int'l repts.: Australia (MR Acoustics), Canada (Andre Perrault), Netherlands (Benson).
Richey Recs., PO Box 12937, Fort Worth, Tex. 76116. Tel: (817) 731-7375. Owner: Slim Richey, Sales: Bob Jones, Adv. & Promo. Jim Colegrove.
Labels: (Owned) Flying High, Grass Mountain, Ridge Runner; (distributed) Kiamchi.
Int'l repts.: Japan (Trio)
Richtown/Gospel Truth Recs. & Tapes & Film Works Inc., PO Box 7552, Richmond, Va. 23231 Tel. (804) 226 0424 Bd. Chm. Reginald A. Charity Sr., Musical Minister Joseph N. Sire.
Labels: (Owned) Cardinal, Charity, Richtown/Sire.
Richtown/Sire, see Richtown.
Ricochet Recs. Ltd., 8 Pasture Ln., Roslyn Heights, N.Y. 11577 Tel (516) 621-4307 Pres Andy Marvel; VP: David Hirsch, A&R Eliot Goldstein.
Branch: Brooklyn, N.Y., 546 Ninth St., Suite 3 Zip: 11215. Tel: (212) 788 4007
Rico Recs Dist'r Inc., 889 10 Ave., New York, N.Y. 10019 Tel: (212) 247-6330. Pres.: Ralph Cartagena, Sales Mgr. Alma I. Colon.
Labels: (Owned) Comba, Neiz, Rico, Solo, (distributed) EGC, Mega.
Ridge Runner, see Richey
Ridgetop Recs. Inc., 1300 Division St., Suite 204, Nashville, Tenn 37203 Tel (615) 242-2591. Pres: Alice F. Raheigh; Sec'y-Treas.: L. C. Anderson, Promo., Regina Gale.
Right Note Recs. (div. of Jmerson Ents.), 433 N. Cleveland, Memphis, Tenn. 38104 Tel. (901) 278-4401, 345-6731 Bd. Chm.: B.O. Jmerson, Ass't Bd. Chm. David F. Delicisco; Pres. Benjamin O. Jmerson; VP's: Lee & Orman Phillips, Mktg. Dir. Eleazor Stenberg, New Talent Co-ord. Roger S. Howard; A&R Dir. Matthew Williams; Assoc. Prod'r: Lloyd E. Smith
Branch: Mansfield, Ohio, 281 W. Sixth, Suite 216. Zip. 44906. Ass't A&R Dir.: Jonas Pearson
Int'l branch: England
Labels: (Owned) Hot, Innovations Inter., Play-Her, Right Note, Screw U. Sounds, Tight Fil, Zombae.
Right On Recs USA, 408 W 115 St Suite 2 W, New York, N.Y. 10025 Tel (212) 222 8715 Cable RIGHTON Pres Bill Downs, Mgr Dolly Gilmore, A&R G G Turner, Pub & Promo Carl Smith
Labels: (Owned) Big Mike, Right On, (distributed) Contrast (France)
Int'l repts.: France (Contrast)
Rinconada, see Buttermkist
Ringo, see Master Trak.
Riot, see Stacy-Lee
Ripcord Rec'g Servs., PO Box 2098, Vancouver, Wash 98668 Tel (206) 695 2112 Owner Blaine H Allen
Labels: (Owned) Charter, Portland, Ripcord, Vanco
Ripsaw Recs., 121 N Fourth St. Easton, Pa 18042 Tel (215) 258 5990 Pres. Jim Kurk
Branch: New York, N.Y., 320 W 30 St. 5 J Zip 10001 Tel (212) 564 3246 VP Jon Strong
Labels: (Owned) Jimmie Gee, Ripsaw
Int'l repts.: Canada (B Sharp), Germany (Peter Schuster), Norway (Oscar), UK (Stiff)
Rising Star, see Parr X
Rising Sun, see Scene Prod'n
Rite Rec Prod'n Inc., 9745 Lockland Rd., Cincinnati, Ohio 45215 Tel (513) 733-5533 Pres. Philip Burkhardt, VP Prod'n Lan Ackley, VP Graphics Ken Keith Jr.
Labels: (Owned) Gateway, Golden Shield, RRP
Riva Recs Inc. 232 E 61 St. New York, N.Y. 10021 Tel (212) 750 9494 Chm. W A Galf, Pres. R.B. Davis, VP R M Shaw, Exec. VP's O T Horowitz, D P Collopy, Treas. R J Farington (Distributed by PolyGram)
Int'l branch: England.
Int'l repts.: Canada (PolyGram), rest of world (WEA Int'l)
Rivendell Recs., see Star Song in Tex.
River Recs Inc. 5050 Poplar Ave., Memphis, Tenn 38157 Tel (901) 767-0640. Pres Bill Harper
River, Calif., see SDL
Riverside, see Fantasy/Prestige/Milestone/Stax
Roadshow Recs. Corp., 425 E. 58 St., New York, N.Y. 10022 Tel (212) 751 7078. Pres. Fred Frank
Robbins Recs., Box 58, Rt. 3, Leesville, La 71446 Pres. Sherree Scott.
Nat'l Repts: Virginia Angel, Virgins, Darrell & David Scott; Int'l Promo Leonard Scott
Labels: (Owned) Headliner Stars, Robbins.
Robin Hood, see Cadet Recs.
Rob-Lee Music, PO Box 1385, Merchantville, N.J. 08109 Tel (609) 665 8933 Pres Rob Russen; Exec. VP Bob Russen, VP A&R Rodney Russen, Sales Mgr. Bob Harris, Pub Mgr. Eric Russen, Adv Mgr: Jeff Quig, Promo Mgr. Mark Porter, Tape Mgr.: Gary Marlin, Country Mgr John Gison, Accounts Mgr Barbara Russen
Labels: (Owned) Big El, Camden Soul, Castle, Jade, Pyramid, Rock Island, Silverbird, TCB.
Robox Recs., Equity Rec'g Co., 2215 Perimeter Park, Atlanta, Ga 30341 Tel (404) 451-5997.
Rochester Osc Reviewer, see VHF.
Rockability Rebellion, see Rollin' Rock.
Rockability Uprising, see Rollin' Rock.
Rock-A-Nash A Billy Recs., PO Box 4740, Nashville, Tenn 37216 Tel (615) 859-0355. Pres: Wade Curtiss; Mgr S O Neal, A&R O Derwald
Labels: (Owned) Denco, Susano, Terock, Toronto
Rock City, see Fire Sign
Rocked Out, see Tom Bee
Rockers, see Shanachie
Rocket Rec. Co. Inc., 1416 N. Kings Rd., Los Angeles, Calif. 90069 Tel (213) 656-2223 Chm: John Reed; Gen Mgr. Charlie Murdock
Rocking Horse, see Grenadilla.
Rockin'Horse Recs., 13 E. 17 St., New York, N.Y. 10003. Tel (212) 255 7674. Pres. Richard Berger, Sales & Promo. Dir. Steve Marks, A&R Dir Steve Rosenthal. Pub. Dir.: Jenny Abrams.
Rockin' Recs., PO Box 92, Brooklyn, N.Y. 11229. Tel. (212) 645 6131 Pres Phil Saunders
Rockin' Ronny, see Rollin' Rock.
Rockin' Weiser, see Rollin' Rock.
Rock Island, see Rob-Lee & Blue Island
Rockland Road, see Superior Sound.
Rockmasters Inc., 317 Granby St., Norfolk, Va 23510 Tel (804) 623 5565 Cable. ROCKMASTAS. Pres. & Gen. Mgr: Frank J Guida, VP's Millie T & Joseph F Guida (Also see Legrand Recs.)
Rocko, see Master-Trak.
Rocky, see Chuck Anthony.
Rocky Road, see Marc Gordon.
Rocmar, see Ragdoll.
Roda, see Penco
Rodeo, see Paramount West
Rogue Recs., PO Box 568, Woodland Hills, Calif. 91365 Tel (213) 992 4922
Roi Recs., 4712 Elmwood Ave., Los Angeles, Calif 90004 Tel (213) 467 1524.
Rolling Fork Recs., 165 Marguerite, Mill Valley, Calif 94941 Tel (415) 388 8985. Pres: Terry Abrahamson.
Rolling Stones Recs., 75 Rockefeller Plaza, New York, N.Y. 10019 Tel (212) 484 6411. VP Arthur Collins (Distributed by Atlantic)
Rollin' Rock Recs., 6918 Peach Ave., Van Nuys, Calif 91406 Tel (213) 781 4805, 994-5644. Pres.: Ronny Weiser: VP: Patricia Weiser.
Labels: (Owned) American Rhythm Music, Boppin' Belle, California Rockability, Ray Camp, Ollie, Ragn' Rockability, Rockability Rebellion, Rockability Uprising, Rockin' Ronny, Rockin' Weiser, Rollin' Rock, Tubby.
Int'l repts.: Belgium (Barclay/PolyGram), Denmark (K-tel), Finland (K-tel), Rockability Rebel, France (Barclay/PolyGram), Iceland (K-tel), Italy (Carosello/Recordi), Luxembourg (K-tel), Netherlands (K-tel), Sweden (K-tel), Switzerland (Barclay/PolyGram), UK (Rondelet/Spartan).
Roll Top Rec. Co., 1798 Maplewood NE, Warren, Ohio 44483. Tel: (216) 372-2510 Pres.: Richard Michael Obertots; Exec. Mktg. Dir.: Emilia Obertots; VP A&R: Dale Schmidt; Graphic Designs: Mike Verina; Artistic Editor: Nick Verina; Sr. Musical Consultant: Jim Garber; Sales & Finance Pres.: Richard A. Obertots; Jazz Development Sr. Dir.: Bill Warner; Promo. & Planning: K. Manna.
Romar, see Nautilus.
Romona, see Jody
Ronco Teleproducts, 1200 Arthur Ave., Elk Grove Village, Ill. 60007. Tel: (312) 640-0700 (TV merchandiser)
Ronin, see Jewel in It.
Rm 10 Rec'g Studios Inc., 1420 K St NW, Suite 400, Washington, D.C. 20005. Tel: (202) 347-1420. Pres.: Russell Timmons Jr.; Studio Mgr./Admin. Dir.: Gail Evans; Chief Eng.: Tom McCarthy. (Also see CBS)
Label: (Owned) BID (Believe in a Dream)
Rooster Blues Recs., 2615 N. Wilton Ave., Chicago, Ill. 60614. Tel: (312) 281 3385. Partner/A&R/Prod'n: Jim O'Neal; Partner/Creative Servs.: Amy O'Neal; Partner/Album Compilation, Cilla Huggins; Partner/Creative Servs./Foreign Dist'n: Mick Huggins; Sales Ass't: Felix Wolstein; Promo. Ass't: Randy Weinstein; Artist Rep.: Jerry DeWitt.
Int'l branch: England.
Labels: Joyce, Planet, Rooster Blues, Royal American, Tune Town, Ultra-sonic, Yvette's.
Int'l repts.: Canada (Trend).
Roots, see TK.
Roper Recs Inc., PO Box 4386, Long Island City, N.Y. 11104. Tel: (212) 786-2401, 426-1190 Pres. Franc Peri.
Int'l repts.: Canada (Trend), Germany (W. Gielow).
Rose, see W.C. Staley
The Rose Hill Group Inc., 3929 New Seneca Tnph., Marcellus, N.Y. 13108. Tel: (315) 673 1117. Pres. & A&R Dir.: Vincent Taft.
Label: (Owned) Star City.
Rosemary Melody Line Rec'g Co., 732 Montrose St., Vineland, N.J. 08360. Tel: (609) 696 3085.
Rose Recs. Co. Inc., 922 Canterbury Rd. NE, Atlanta, Ga. 30324. Tel: (404) 237-1162 Pres. & A&R Mario W. Peralta; VP & Int'l Mgr.: Frank P. Lappas. Controller Paul Mortensen
Rosita, see Freddie
Ro Tab, see Marullo.
Rough Diamond, see Survivor.
Rough Trade Inc., 1042 Murray St., Berkeley, Calif. 94710. Tel: (415) 548 9212. Pres. & Prod'n Allan Sturdy; A&R: Steve Montgomery; Promo.: Joe Slee
Home office: England
Labels: (Owned) Rough Trade; (distributed) Cross, Factory, Smash Trade, Twinkle.
Roulette Recs. Inc., 1790 Broadway, New York, N.Y. 10019. Tel: (212) 757-9880. Pres.: Morris Levy.
Labels: (Owned) Mainstream, Pyramid, Roulette, Virgo; (distributed) Tiger Lily.
Rounder Recs. Corp., 186 Willow Ave., Somerville, Mass. 02144. Tel: (617) 354-0700. Telax: 921724. Pres. & Promo. Dir.: Marian Leighton; A&R Ken Irwin, Sales Mgr.: Bill Nowlin.
Labels: (Owned) Green Tree, Rounder; (distributed) Bel-Car, Black Saint (Italy), Esca, Fiddler, Red (Italy), Solid Smoke, Soul Note (Italy), String (UK), Tara (Ireland), Topic (UK).
Int'l repts.: Australia (Larrikin), Belgium (Parsifal), Canada (Almada), Denmark (CSA), France (OAM), Germany (Teldec), Hong Kong (Peak Light), Ireland (Mulligan), Italy (IRD), Japan (BOM, Disc Center, KYOA, Pooch Yokochi, Shinsei), Netherlands (Pastor), Norway (Sinar), Spain (Compania Fonografica), Sweden (Sonek), Switzerland (Record Serv.), UK (Mike's Country Music; Record Making Waves, Swift).
Royal American, see Rooster Blues.
Roy B, see Brasilia
Ruboca Recs., 264 Old Hickory Blvd., Madison, Tenn. 37115. Tel: (615) 865-6543. Pres.: Johnny R. Wright, Mgr. John Sturdivant; Sec'y/Sales/Promo: Jean Stromatt.
Ruby, see Slash.
Rumble Recs., PO Box 84, Peoria, Ill. 61650. Tel: (309) 674-5685 Contacts: Todd Waddell, Craig Moore.
Branch: Urbana, Ill., 122 W. Main. Zip: 61801. Tel. (217) 384-8258. Contact. Jeff Hess.
Int'l repts.: UK (Red Lightnin').
Frank Russell Music & Recs. Group Inc, see FRD.
Russell Recs. Inc., 1403 Callens Rd., Ventura, Calif. 93003. Tel (805) 642-3555.
Russell Street, see Daytwo.
Rust, see Laurie.
Rutabaga, see Old Homestead.
Rye, see Jewel Rec'g in Ohio

S

- S A C P C M Digital, see Sonic Arts.
S A M, see Utopia.
S A S, see Joey.
S C M Recs., PO Box 2096, Clearwater, Fla. 33517. Tel: (813) 446-2914. Pres. Donald M. Rolander
S C P Recs., 46 E. Herbert Ave., Salt Lake City, Utah 84111. Tel: (801) 355 5327. Pres: Ron W. Simpson.
Labels: (Owned) Big Sky, SCP
S C R, see Sunshine Country
S O G, see ReGeneration.
S E Music Inc., Airport Dr. Worcester, Mass 01602 Tel: (617) 757-6369. Telex 920328. Pres. Gil Markle, Mgr.: Wendy Thurston.
Branch: North Brookfield, Mass., Long View Farm, Stoddard Rd. Zip: 01535 Tel (617) 867 7662. Mgr: Kathleen Holden.
Label: (Owned) Long View Farm
S F M (Society for Forgotten Music), see Contemporary.
S & H, see Sun-Glo.
S I P R A (Small Independent Prod'n & Rec. Assocs.), 247 N. Western Ave., Suite 6, Los Angeles, Calif. 90004. Tel: (213) 462 9355.
Labels: (Owned) Brotherhood, Community, Pick-A-Hit, Pure Gold, Soul-town, (distributed) Kris, Manton, Silver Sword, US. Velvet, Visconjon.



**The Professional's Choice
in Wireless Microphones**

- Wide frequency response
- Low noise and distortion
- Latest companded technology
- Built-in level indicator
- VHF high band for less interference
- Attractive, non reflective finish

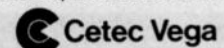

Division of Cetec Corporation
 P.O. Box 5348 • El Monte, CA 91731
 (213) 442-0782 • TWX: 910-587-3539

S I S, see Sociedad Int'l de Sonido
 S M C, see Spanish Music Center.
 S & M Recs., 1806 N. Normandie, Los Angeles, Calif. 90027. Tel: (213) 669-1404. Pres.: John Condon.
 S O L Int'l Recs./River Recs., PO Box 622, Orangevale, Calif. 95662. Tel: (916) 726-4816. Pres.: John Roberts; VP: James Chalmers; Mgmt. Opns.: Larry Crawley.
 S P E B S Q S A (Society for the Preservation & Encouragement of Barber Shop Quartet Singing in America Inc.), PO Box 575, Kenosha, Wis. 53141. Tel: (414) 654-9111.
 S P Q R, see Legrand Recs
 S R I (Spector Recs. Int'l), see Phil Spector & Capitol.
 S R O, see Smudge.
 S R T, see Street Recs.
 S S S Int'l, see Shelby Singleton.
 SWS Org. Inc., 1370 Ave. of the Americas, New York, N.Y. 10019. Tel: (212) 586-1451, 288-9005. Telex: 2375-6, 224600. Pres.: Sverre O. Sundman; Treas.: H.S. Blum; Sec'y: Gerald F. Edelstein; VP: European Opns.: Christy O. Gardsby.
 Int'l branches: Canada (Graf-Fuchs Int'l Ltd.), Germany (SWS Org. GmbH), Netherlands (SWS Org. I.V.), Sweden (Bastun Studio AB, Musik Ultra), Scandinavian SWS Music AB, Switzerland (SWS Org. SA), UK (SWS Org. Ltd.).
 Labels: (Owned) Graf, Graph, SM; (distributed) Arctic (Norway), Love (Finland), Mudst (Sweden), Pohl h. YTF (Sweden).
 Int'l rep.: Argentina (RCA), Australia (RCA), Austria (CBS), Belgium (CBS), Brazil (RCA), Canada (Quintum), Colombia (Tropical), Denmark (EMI), Finland (EMI), France (CIS), Germany (CBS, Eton), Italy (Dunium), Japan (CBS, Epic, Shinko), Mexico (RCA), Netherlands (CBS), New Zealand (RCA), Nigeria (Shanu-lu), Norway (EMI), Portugal (Rossil), Spain (Columbia), Sweden (EMI, Mudst), Switzerland (CBS, Poptlight), Venezuela (Cordica, Discoteca).
 Sabia (Brazil), see Brasilia.
 Safari Recs. Co., 1642 S. Vermont Ave., Los Angeles, Calif. 90006. Tel: (213) 732-0127. Owner: Federico Rioja; Gen. Mgr.: Carlos A. Rodriguez.
 Labels: (Owned) Accion, Cortio, oro, Fortuna, Safari.
 Saguro, see Boyd.
 Salsoul Rec. Corp., 401 Fifth Ave., New York, N.Y. 10016. Tel: (212) 889-7340. TWX: (710) 581-6058. Telex: 236464. Chm.: Joe Cayre; Pres./A&R: Ken Cayre; Exec. VP: Stan Cayre; Int'l Mgr./A&R: Glenn La Russo; Nat'l Promo. Dir.: Connie Johnson. (Distributed by RCA)
 Labels: Bethlehem, Dream, Gold Wind, Salsoul.
 Int'l rep.: Argentina (RCA), Australia (RCA), Austria (Musica Schallplatten), Benelux (RCA), Brazil (RCA), Canada (RCA), Caribbean (Disc Pressers in Jamaica), Colombia (FM), Denmark (SOS), Dominican Republic (Dominica de Discos), Ecuador (EMI USA), Finland (SOS), France (Milan), Germany (RCA), Greece (CBS), India (EMI), Israel (CBS), Italy (Pana), Jamaica (Disc Pressers), Japan (J&RVC), Mexico (RCA), Netherlands (RCA), Norway (SOS), Peru (Sica Fruana), Philippines (Dyna), South Africa (CCP/EMI), Spain (Belter), Sweden (SOS), UK (Excaliber), Uruguay (AFSA), Venezuela (Love).
 Salsoul (Salsa), see Mericana.
 Salt City, see Proud Earth.
 Salt of the Earth Recs., 3282 Catalin Ave., Santa Clara, Calif. 95051. Tel: (408) 998-0140. Pres.: Chris Aaron; VP: Joe Newbert; A&R: Debra Aaron; Studio Mgr.: Jane Newbert.
 Salvation, see Creed Taylor.
 Sami, see DGI.
 Sam Rec. Inc., 45-50 38 St., Long Island City, N.Y. 11101. Tel: (212) 786-7667. Telex: 235976.
 Sandcastle Recs., 157 W. 57 St., New York, N.Y. 10019. Tel: (212) 582-6135. Owners: Mark Cosmedy, Jo n Show; VP: Tom Morgan.
 Branches: Studio City, Calif., 4044 W. Radford Ave. Zip: 91604. Tel: (213) 985-7933 - New Orleans, La., 337 Rue Chartres. Zip: 70130. Tel: (504) 561-0531.
 Sandhill Foxtire Recs., 107 N. Hull, Ainden, Neb. 68959. Tel: (308) 832-0941/1380. Owner: Bob Ayres
 M. R. Sand & Co., PO Box 2255, 205 W. Water St., Sandusky, Ohio 44870. Tel: (419) 625-0028. Owner/Pres.: Joseph F. Yost III.
 Sangre Prod'n's, 9844 Business Park Dr., Sacramento, Calif. 95827. Tel: (916) 361-3652. Pres./VP: Mary Leahy; Exec. Co-ord.: Jan Eric Volz.
 San Juan Music Group, 1637 Ultra Ave., Brooklyn, N.Y. 11234. Tel: (212) 253-4600. Cable: MUSICLEASE. Telex: 668550. Pres.: David Last; Sec'y-Treas.: Bea Cohen; Sales Mgr.: Jerry Chernow.
 San-Lyn Group, Box 46, 414 Cortland Ave., Syracuse, N.Y. 13205. Tel: (315) 476-2779. Gen. Mgr.: Jack Swans on.
 Labels: (Owned) Calumet, San-Lyn.
 Sanskrit Recs., 4120 Excelsior Blvd., Minneapolis, Minn. 55416. Tel: (612) 920-9590.
 Sarg (Rec'g Co.), 311 E. Davis St., Lu ing, Tex. 78648. Tel: (512) 875-3350.
 Owner: Charles Fitch; Sales Mgr.: Sharon Mann; Promo.: Denise Fitch; A&R: Ben W. Fitch; Ass't Mgr.: C. Ieste Fitch.
 Labels: (Owned) Double A, Rattle, Sarg.
 Sasal Society, see Daytwo.
 Sav-All, see HSE.
 Savoy Recs. Inc., 342 Westminster Ave., Elizabeth, N.J. 07208. Tel: (201) 351-6800; NYC (212) 962-3354. VP & Gen. Mgr.: Fred Mendelsohn; Prod'r: Milton Biggiam; Ass't Pres.: James Perry; Promo. Dir.: Arnold McCloud; Exec. Ass't: Helen Gott smann. (Distributed by Arista)
 Scala, see Everest.
 Scandinavian, see Lindberg.
 Scaramouche' Recs., PO Drawer 1967, Warner Robins, Ga. 31099. Tel: (912) 922-1955. Pres./Dir.: Robert R. Kovach; Sec'y: Judi L. Kovach.
 Scene Prod'n's, PO Box 1243, Beckle, W. Va. 25801. Tel: (304) 252-4836.
 Pres.: Richard L. Petry; Gen. Mgr.: William Gent.
 Labels: (Owned) Country Road, Fung Sun.
 Int'l rep.: France (Michel Meyer) Philippines (Empire), Spain (Belter), Switzerland (Metronome).
 Sceneville Inds., 78-08 88 Ave., Woodhaven, N.Y. 11421. Tel: (212) 296-1877. Pres. & Mng. Dir.: A. J. Kleinfeld; VP & A&R: R. L. Knudsen; A&R Dir.: Jim Knudsen.
 Label: (Owned) Pulstrak.
 Sceptre, see Fee Bee.
 Don Schaler Promos., PO Box 5729, Dallas, Tex. 75207. Tel: (214) 339-5891/6166. Pres.: Don Schaler; P: Becky Schaler.
 Labels: (Owned) Demand, Texas.
 Scolarion Recs., PO Box 441, Northrix ge, Calif. 91324. Tel: (213) 780-2288.
 Owner: David Seiden; Mgr.: Ronal Seiden; Sales: Lawrence & Scott Seiden.
 Scotti Bros. Recs., 2114 Pico Blvd., Santa Monica, Calif. 90404. Tel: (310) 450-3193. (Also see CBS)
 Scrapbook, see Record Guild.
 Scratched Recs., 5904 Laird, Austin Tex. 78757.
 Screw U, see Right Note.

Scrimshaw Recs., 6943 Valjean Ave., Van Nuys, Calif. 91406. Tel: (213) 988-6742.
 Scripture in Song, see Benson.
 Sea Cruise Prod'n's, PO Box 110830, Nashville, Tenn. 37211. Tel: (615) 834-1856. Pres. & A&R Dir.: Ken Keene; Exec. VP: Frankie Ford; Adv. Mgr.: Gene Miller.
 Labels: (Owned) Briarmeade, Burlap, Keene, Keeta, Sea Cruise, Sonor (Sound of New Orleans).
 Sea-King, see Centaur in N.Y.
 Sealsong, see Wormwood.
 Seaside, see Southern Sound.
 Second Chance, see East Allegheny.
 Second Sun Prod'n's, Box 133, Rt. 2, Burton, Vashon Island, Wash. 98013. Tel: (206) 463-2850, 625-9548. Pres.: Robert Knnsky; Promo.: Robert Koch.
 Labels: (Owned) Pinup, Second Sun, Triple Disc.
 Seeco, see Met Richmond.
 Seed, see Word.
 Seeds Recs., 2108 NW 115, Oklahoma City, Okla. 73120. Tel: (405) 751-8954. Pres.: Mickey Sherman; Sales Mgr.: Tracy Fulton.
 Labels: Homa, Okart, Seeds.
 Ralph L. Seltzer, c/o Great Oak Vineyard, 1751 Draper Valley Rd., Selma, Ore. 97538. Tel: (503) 597-2161. Cables: MUSICWORLD, SELMA. Owner: Ralph L. Seltzer; Gen. Mgr.: Carla Bartoleffi.
 Int'l branches: Australia, Germany, Spain, UK.
 USA labels represented: Rollin' Rock, Venture.
 Int'l firms represented: Dial (Portugal, Spain), Ondisc (UK), OctoArts (Philippines), Orleon (Mexico), Record Market (Nigeria, West Africa), Regents Park (UK), Reveille (South Africa), Mal Sondock (Austria, Germany, Switzerland), Tapezar (Brazil), Victor (Japan), Virgin (UK).
 Semaphore, see Vantage.
 Sequel, see Rak Timory.
 Seraphim, see Capitol.
 Serenus Corp., 145 Palisade St., Dobbs Ferry, N.Y. 10522. Tel: (914) 693-9321. Pres. & A&R: Paul Kapp.
 Sesame Street Recs. (div. of Distinguished Prod'n's Inc.), 1 Lincoln Plaza, New York, N.Y. 10023. Tel: (212) 874-2700. Pres.: Shy Raiken; Mktg. Dir.: Arthur Denish; Gen. Mgr.: Gerard Esposito. (SEE ADVERTISEMENT)
 Sessions Recs. Inc., 1973 Ohio St., Lisle, Ill. 60532. Tel: (312) 960-5100. Pres.: John R. Wering; VP: Carl M. Fink; Controller: Ken Jakupcak; A&R: P.J. Sproat.
 Seven Hills Publ'g & Rec'g Co. Inc., 905 N. Main St., Evansville, Ind. 47711. Tel: (812) 423-1861. Pres.: Edward W. Krietemeier; VP: M. Lottes; Sec'y-Treas.: Dorothy Pearce; Mgr.: P. J. Hayden.
 Labels: (Owned) EKK, Seven Hills.
 7 Star, see World Int'l.
 1750 Arch Inc., 1750 Arch St., Berkeley, Calif. 94709. Tel: (415) 841-0216.
 Pres.: Tom Buckner; Exec. Dir.: Phil Sawyer; Concert Mgr.: Diane Stone; Rec'g Eng.: Bob Shumaker.
 Int'l rep.: Canada (Almada).
 Shadow Recs., 1517 W. Lake St., Minneapolis, Minn. 55408. Tel: (612) 827-6111. Pres.: Charles F. Campbell.
 Shaffer Recs., 13412 Gladstone Ave., Sylmar, Calif. 91342. Tel: (213) 367-0214. Co-Owner & Chm.: Frank J. Jacobs; Co-Owner & Pres.: Mrs. F.J. Jacobs; Sales & Promo.: Deloris Ann.
 Shake It! Recs., 2530 Luna Ave., Cincinnati, Ohio 45219. Tel: (513) 721-0257.
 Shanachie Recs. Corp., Dalebrook Park, Ho Ho Kus, N.J. 07423. Tel: (201) 445-5561. Pres.: Richard Nevins; Sec'y/Treas.: Daniel Michael Collins.
 Labels: (Owned) Herwin, Morning Star, Rockers, Shanachie; (distributed) Boot (Canada), Dreamstreet, Flyright (UK), Gael-Linn (Ireland), Generation (Canada), Greensleeves (UK), Red Lightnin' (UK), Tara (Ireland), Topic (UK), Trojan (UK).
 Int'l rep.: Australia (Larrikin), Canada (Almada), France (DAM), Germany (Eulenspiegel), Ireland (Tara), Italy (IRD), Netherlands (Munch), UK (Topic).
 Shawmut Recs., see Casa Grande.
 Don D. Sheets Prod'n's, Box 212, Rt. 3, Nashville, Ind. 47448. Tel: (812) 988-2000. Co-Owners/Prod'rs: Don D. & Marti Mae Sheets.
 Labels: (Owned) CVS, Delmarti, Little Nashville, Little Nashville Opry.
 Sheffield Lab Inc., PO Box 5332, Santa Barbara, Calif. 93108. Tel: (805) 969-4744; WATS (800) 235-5737. Pres.: Doug Sax; VP & Treas.: Lincoln Mayorga; Mktg. & Sales Dir.: Andrew Teton; Mgr.: Patricia Meredith; Controller: James Duller.
 Int'l rep.: Australia (Acoustic Monitor), Belgium (Blomhof), Canada (Gray), Denmark (Mayco Agentur in Norway), France (Delta), Germany (Audio Int'l), Italy (Audio SMC), Japan (Mace), Netherlands (Durob), Nigeria (Quintessence in UK), Norway (Mayco Agentur), Singapore (Singapore Audio), South Africa (Symphonia), Sweden (Sven Eriksson), UK (Unicorn).
 Shekinah Music, 52 Werah Pl., Oceanport, N.J. 07757. Tel: (201) 222-4460.
 Owners: Russell N. Chalzo Jr., James W. Bova; A&R: Joe Saint.
 Labels: (Owned) Shekinah; (distributed) Praise Jesus.
 Shelter Rec'g Co. Inc., 1106 N. La Cienega Blvd., Los Angeles, Calif. 90069. Tel: (213) 657-5887.
 Int'l rep.: Australia (Festival), Austria (Ariola-Eurodisc in Germany), France (Arabella), Germany (Ariola-Eurodisc), Greece (CBS), Italy (Ariston), Japan (Nippon Phonogram), Netherlands (Ariola-Eurodisc), Scandinavia (Ariola-Eurodisc in Germany), South Africa (Gallo), South America (Phonogram in Netherlands), Spain (Ariola-Eurodisc), Switzerland (Ariola-Eurodisc in Germany), UK (Island).
 Shih, see PM.
 Shih Shih Wu Ai Recs. Inc., 8120 Oakland Ave. S., Bloomington, Minn. 55420. Pres.: Milo Fine.
 Shire, see Wormwood.
 Shoestring Recs., 1907 Central, Alton, Ill. 62002. Tel: (618) 465-5619.
 Pres.: Howard Neal; VP: David Banks.
 Troy Shondell Prod'n's (div. of Telesonic Recs.), Box 828, Huntington, Ind. 46750. Tel: (219) 356-3964.
 Shout, see Bang.
 Showtime, PO Box 40074, Washington, D.C. 20016. Tel: (202) 397-6952.
 Exec. Pres.: C. Ables; Gen. Mgr.: B. Salles.
 Showtime, La., see Master-Trak.
 Shtup City Recs./Dru Ents., 16 Reef, Suite 1, Marina Del Rey, Calif. 90291.
 Tel: (213) 392-2497. Pres.: Rebecca Dru; VP: Randy Wilson; VP Development: Joe Andrews.
 Shur-Tinga, see Styletone.
 Sierra Recs., PO Box 5853, Pasadena, Calif. 91107. Tel: (213) 355-0181.
 Labels: (Owned) Briar, Sierra.
 Int'l rep.: Austria (Ariola), Belgium (Ariola), France (Arabella Eurodisc), Germany (Ariola-Eurodisc), Italy (IRD), Japan (BOM, Pooch Yokocho, Shinsei Serv.), Netherlands (Ariola-Eurodisc), Norway (Dag Waerner), Spain (Ariola-Eurodisc), Switzerland (Ariola-Eurodisc), UK (Mike's Country Music in Scotland, Projection).

Sierra Wave, see Kicking Mule.
Signature Gramophone Co. Ltd., 1841 Broadway, New York, N.Y. 10023. Tel: (212) 246-3280. Pres.: Bob Thiele.
Silverbird, see Rob-Lee.
Silver Birch, see PM.
Silver Pelican, see Pelican.
Silver Sword, see SIPRA.
Simon Says, see Record Guild.
Simple, see Trod Nossel.
Sinbad, see Crimson Dynasty.
Sine Qua Non Prod's Ltd., 1 Charles St., Providence, R.I. 02904. Tel: (401) 521-2010. Pres.: Joan Grow.
Branch: Los Angeles, Calif., 1362 Lucile Ave. Zip: 90026. Tel: (213) 666-6082. Nat'l Sales Mgr.: Gene Weiss.
Labels: (Owned) Americana, DigiTech, Masterpiece, Meet the Classics, Perspective, Sine Qua Non, Superba.
Sing, see Skyliite Sing.
Shelby Singleton Corp., 3106 Belmont Blvd., Nashville, Tenn. 37212. Tel: (615) 385-1960. Cable: SHELREC. Telex: 3711222. Pres.: Shelby S. Singleton Jr.; VP: John A. Singleton; VP Sales: Jim Wilson; Mktg. Mgrs.: Sharon Kay, Craig Wilson.
Labels: Plantation, SSS Int'l.
Int'l repps.: Australia (Festival), Austria (Bellaphon), Canada (Quality), Denmark (Sonet), Germany (Bellaphon), Japan (Charly/RVC), Netherlands (Charly/CNR), Spain (Charly/Auvi), Switzerland (Bellaphon), UK (Charly Music).
Sire Recs. Co., 3 E. 54 St., 9th fl., New York, N.Y. 10022. Tel: (212) 832-0950. Cable: BLUHORIZON. Telex: 62622. Pres. Sire/VP Warner Bros.: Seymour Stein; Ass't to Pres.: Michael Rosenblatt; VP Artist Development: Ken Kushnick; Pub. Dir.: Audrey Strahl. (Distributed by Warner Bros.)
Branch: Burbank, Calif., 3300 Warner Blvd. Zip: 91510. Tel: (213) 846-9090. Telex: 698512. VP: Promo: Daniel Kelley.
Labels: (Owned) Blue Horizon, Real, Sire.
Int'l repps.: Australia (WEA), Benelux (WEA), Brazil (WEA), Denmark (Metromex), France (Pathe Marconi), Germany (Ariola-Eurodisc), Greece (WEA), Hong Kong (WEA), Israel (CBS), Italy (RCA), Japan (Nippon Phonogram), New Zealand (WEA), Scandinavia (Phonogram), South Africa (WEA), Spain (Hispanox), UK (WEA).
Sivalt Music Co. Inc., PO Box 7172, 10 Michael Dr., Greenville, S.C. 29610. Tel: (803) 295-3177. Pres.: Jesse B. Ewalt; Nat'l Sales Mgr.: Jere Davis.
Labels: (Owned) Brand-X, Pioneer, Tribute.
Six Shooter, see Colonel Buster Doss.
Skids Recs., see Tribal Jargon.
Skill Recs., 268 Alhambra Circle, Coral Gables, Fla. 33134. Tel: (305) 441-1784. Pres.: Laurence H. Shiller.
Branch: New York, N.Y., 100 W. 57 St. Zip: 10019.
Skyliite, see Skyliite Sing.
Skyliite Country, see Skyliite Sing.
Skyliite Sing. Inc., 1008 17 Ave. S., Nashville, Tenn. 37212. Tel: (615) 327-4557.
Labels: (Owned) Christian Faith, Christian Folk, Sing, Skyliite, Skyliite Country, Stateswood, Temple.

Slade Rec. Co., Box 536, Crookston, Minn. 56716. Tel: (218) 281-6450.
Owner: Gary Emerson.
Slash Recs. (J. Ruby Prod's Inc.), 7381 Beverly Blvd., Los Angeles, Calif. 90036. Tel: (213) 937-4660. Pres.: Robert Biggs; VP Bus. Affairs: Mark Trilling; VP A&R/Promo. Dir.: Mark Williams; Mktg. Dir.: Robyn Weiss.
Labels: (Owned) Ruby, Slash.
Slide, see McKinnon.
Small Independent Prod'n & Rec. Assocs., see SIPRA
Smash Trade, see Rough Trade.
Smile, see La Val.
Smithnight, see GRS.
Smithsonian Collection, see Smithsonian Institution.
Smithsonian Institution, Performing Arts Div., Washington, D.C. 20560. Tel: (202) 357-1300.
Label: (Owned) Smithsonian Collection.
Smooch Recs. Inc., 1530 Dunwoody Village Pkwy., Suite 201, Atlanta, Ga. 30338. Tel: (404) 394-7122. Pres.: Hugh E. Bowman II; Opns. Mgr.: Hugh E. Bowman III.
Smudge Recs., PO Box 29342, Dallas, Tex. 75229. Tel: (214) 243-2933.
Pres.: Terry Rose.
Int'l branch: England.
Labels: (Owned) SRO, Smudge.
Snail Recs., 6106 N. Kenmore, Chicago, Ill. 60660. Tel: (312) 262-8500.
Soap Opera Recs., 9 E. 46 St., New York, N.Y. 10017. Tel: (212) 661-2106.
Pres.: Larry Levinson; Sec'y-Treas.: Neil Warner; VP A&R: Phyllis Levinson.
Soaring, see Doc Ron.
Sociedad Int'l de Sonido, 430 Minorca, Coral Gables, Fla. 33134. Tel: (305) 446-0298.
Labels: (Owned) Elite, Papagayo SIS.
Int'l repps.: Ecuador (Famoso), Mexico (Ariola), Peru (IEMPSA), Venezuela (Palacio de la Musica).
Society for Forgotten Music, see Contemporary.
Society for the Preservation & Encouragement of Barber Shop Quartet Singing in America Inc., see SPEBSQSA.
Solar Recs. (Sound of Los Angeles Recs.), 9044 Melrose Ave., Suite 200, Los Angeles, Calif. 90069. Tel: (213) 859-1717. Chief Exec.: Dick Griffey. (Distributed by Elektra/Asylum)
Solar, Hollywood, Calif., see Mystic.
Solar Sound Prod's, Box 98, Aldie, Va. 22001. Tel: (703) 471-5359.
Solid Brass Rec. Prod's Inc., 11 Dellwood Rd., Staten Island, N.Y. 10304. Tel: (212) 979-5945. Pres. & Gen. Mgr.: Pamela Merino; VP & A&R: Michael J. Merino; Treas.-Finance Officer: V.M. Nerlino. (Distributed by Random Entls.)
Labels: (Owned) Century 21, Solid Brass.
Solid Gold, see Bang.
Solid Rock, see Word.
Solid Smoke Recs., PO Box 22372, San Francisco, Calif. 94122. Tel: (415) 731-0500. Contacts: Rico Tee, Marty Arnbunch.
Label: (Owned) War Bride.
Solid Smoke, Mass., see Rounder.
Solist (Germany), see Teleson-America.
Solo, see Rico.
Solo Plus, see Blue River.
Som (Brazil), see Brasilia.
Som (Brazil), see Brasilia.
Soma Recs., 5105 Golden Ln., Las Vegas, Nev. 89119. Tel: (702) 739-9606.
Pres.: Phil Gitelman; VP Joel Cammeron; PR: Chris Andrew; Financial Dir.: Robert van Lydegraf.
Some Recs. Co., 917 Silvermine Rd., New Canaan, Conn. 06840. Tel: (203) 966-7078. Pres.: Sture A. Linden; A&R Dir.: Mike D'Emidio.
Somerset, see Alshire.
Som/Maior (Brazil), see Fermata.
Sonar Recs. Corp., PO Box 455, Bronx, N.Y. 10463. Tel: (212) 549-1770.
Pres.: Norman E. Mendenhall; VP: K. Marani.
Labels: (Owned) Sonar; (distributed) Hammer.
Sonata Recs., 4304 Del Monte Ave., San Diego, Calif. 92107. Tel: (714) 222-3346. Pres. A&R: Paul DiLella; VP: Joseph DiLella; Sales Mgr.: Melbae Newberry; Promo: & Dist'n: Helen DiLella.
Sonet USA, see Kicking Mule.
Songbird, see MCA & Sparrow.
Songmaster, see American Entertainment.
Song Request Magazine, see Olenik.
Songs by Sommers, PO Box 322, Silver Spring, Md. 20907. Tel: (301) 946-9039. Owner: Henry J. Sommers.
Songwriters Recs., PO Box 1253, Santa Cruz, Calif. 95061. Tel: (408) 425-3730. Pres.: Lawrence W. Abrams; VP: James A. Abrams; A&R Dir.: Farah Yala.
Sonic, see Iowa Great Lakes.
Sonicarts, see Sonic Arts.
Sonic Arts Corp., 665 Harrison St., San Francisco, Calif. 94107. Tel: (415) 781-6306. Pres.: Leo de Gar Kulkka; Exec. VP: Herbert P. Haas; Creative Servs.: Leontine L. Kulkka; Graphics: Wayne Pope.
Int'l branch: Germany.
Labels: (Owned) Authentic, Autograph, Captain, Dimension Six, Direkt to Disk, Golden Soul, Laboratory Series, Nostalgia, Repertoire, SAC-PCM Digital, Sonicarts, Super Dimension Six, Washboard; (distributed) Star (Switzerland).
Sonic Wave Recs., c/o Kiderian Recs., 4926 W. Gunnison, Chicago, Ill. 60630.
Sonido Int'l, see Marsal.
Sonolux, see Discolando.
Sono-Max, see Auditorama.
Sonor Prod's Inc. (Sound of New Orleans Recs.), PO Box 110830, Nashville, Tenn. 37211. Tel: (615) 834-1856. Chm.: B.J. Joy; Pres./Exec. Prod'r: Ken Keene. (Also see Sea Cruise).
Sonrise Mercantile Corp., PO Box 607, Malibu, Calif. 90265. Tel: (213) 991-8469. Pres.: Bob Cotterell; Gen. Mgr.: Dave Foster.
Labels: (Owned) Creative Sound, Sonrise; (distributed) AB (Street Level), Deep Roots, Lamb & Lion (selected), Mighty Wind.
Soyatone Recs., PO Box 567, Santa Barbara, Calif. 93102. Tel: (805) 682-8624. Pres.: Peter F. Feldman; VP: Toni Young.
Labels: (Owned) Hen Cackle, Soyatone; (distributed) Red Clay.
Int'l repps.: Australia (Folkways), Germany (Bear), Japan (BOM).
Soul, see Motown.
Soul City, Va., see East Allegheny.
Soul City Recs., 10609 Budlong, Los Angeles, Calif. 90044. Tel: (213) 777-9393.
Souled Out, see Tom Bee.
Soulin', see Warren.
Soul Merchant, see Paramount-West.

Soul Mine, see Boddie.
Soul Note (Italy), see Rounder.
Soul-Po-Tion, see Gwen.
Soul Set, see La Val.
Soul Sounds Unlimited Rec'g Co., PO Box 24240, Cincinnati, Ohio 45224. Tel: (513) 681-1403. Co-Owner: Alvin Don Chico Pettijohn.
Soutdown, see SIPRA.
Soundbook, see Caedmon/Arabesque.
Sound 80 Inc., 2709 E. 25 St., Minneapolis, Minn. 55406. Tel: (612) 721-6341.
Sound Environment Rec'g Series (Sound Environment Rec'g Corp.), Butler Square, Suite 114, 100 M. Sixth St., Minneapolis, Minn. 55403. Tel: (612) 339-4641. Pres.: Bob Bailey.
Branch: St. Paul, Minn., 1236 Lincoln Ave. Zip: 55105. Tel: (612) 690-2707. Prod'n/Eng'g: Russ Borud.
Sound Inc., 56880 North Ave., New Haven, Mich. 48048. Tel: (313) 749-5182.
Labels: (Owned) Cupid, IRM, International Folklore, Keepsake, Trash, Universal Sound.
Soundmate, see Caprice.
Sound of Money, see Vantage.
Sound of New Orleans, see Sonor & Sea Cruise.
Sound of New York Recs. (div. of Phenix Entertainment Corp.), 231 W. 58 St., New York, N.Y. 10019. Tel: (212) 265-3350. Pres. & Chief Operating Officer: Eugene Griffin; VP Admin.: Clarence Eugene Swanson; VP Promos./Mktg./Sales: William Scarborough; Press Information/Development Dir.: Jeanne Frances McPerson; Sec'y: Joyce Harding.
Sounds, see Right Tone.
Sounds of the Caribbean, see Request.
Sounds of Winchester, 314 Lanny Dr., Winchester, Va. 22601. Tel: (703) 667-9379. Pres.: Jim McCoy; VP: R.J. Alford Jr.; Sec'y: Bertha McCoy.
Labels: (Owned) Alear, Macster, Winchester.
Sounds South Recs., 203 Culver Ave., Charleston, S.C. 29407. Tel: (803) 766-2500. Pres.: Harold Thomas; VP/A&R: Michael Thomas.
Labels: (Owned) Sounds South, Wahr.
Int'l rep.: Belgium (Supreme).
Sound Stage 7, see Monument.
Soundwaves Recs., 1204 Elmwood, Nashville, Tenn. 37212. Tel: (615) 385-0900. (Distributed by Nationwide Sound)
Labels: (Owned) Brand K, Soundwaves.
Sountrax, see Sunbeam.
Source Recs. Inc., 1902 Fifth St., Los Angeles, Calif. 90018. Tel: (213) 731-0693. Pres.: Logan H. Westbrook.
Int'l repps.: Brazil (K-tel), UK (Liberty/UA).
Sourwood Mountain, see June Appal.
South Coast, see MCA.
Southern Bell, see East Allegheny.
Southern Biscuit, see Malaco.
Hal Southern Prod's, Box 4234, Panorama City, Calif. 91412. Tel: (213) 786-6957.
Labels: (Owned) Country Gold, Ivory.
Southern Library of Rec'd Music, see Peer-Southern.
Southern Sound Prod's, 100 Labon St., Tabor City, N.C. 28463. Tel: (919) 653-2546. Pres.: Elson H. Stevens; Sales Mgr.: Ferrell L. Jones; Promos.: Retha C. Stevens; A&R: Leonard C. Stephens; Sales & Dist'n: Diane R. Jones.
Label: (Owned) Seaside.
Southern Star Rec'g, 6105 A Youree Dr., Shreveport, La. 71105. Tel: (318) 861-0569. Co-Owners: George W. Clinton, Joe Spivey; Bus. Mgr.: Ted Hardan.
Southern Wing, see Wildwood Studio.
Southland Recs. Inc., PO Box 1547, Arlington, Tex. 76010. Tel: (817) 461-3280. Chief Exec. Officer: Steve Reed.
Southland, Ga., see Jazzology-GHB.
Souvenir, see Art.
Sovereign Rec. Corp., 1619 Broadway, Suite 602, New York, N.Y. 10019.
Pres.: Reuben Fisher.
Space Recs., 2037 Aharado Dr. NE, Albuquerque, N.M. 87110. Tel: (505) 268-8405. Pres. & Gen. Mgr.: A. Medley.
Spanish Music Center Inc., Belvedere Hotel, 319 W. 48 St., New York, N.Y. 10036. Tel: (212) 582-4280. Owner: Gabriel Oller.
Labels: (Owned) Coda, Pro-Arte, SMC.
Spark, see Peer-Southern.
Sparrow Recs. Inc., 8025 Deering Ave., Canoga Park, Calif. 91304. Tel: (213) 703-6599. Pres.: Billy Ray Hearn; VP Admin.: Rick Horne; VP Sales: Bill Conine; Mktg. Servs. Dir.: Bill Hearn; A&R Dir.: Dan Collins. (Also see MCA)
Labels: (Owned) Birdwing, Sparrow; (distributed) MCA/Songbird.
Specialty Recs. Inc., 8300 Santa Monica Blvd., Los Angeles, Calif. 90069.
Tel: (213) 656-7711. Sales & Mktg. Mgr.: Pam Hauer.
Specs, see Gusman.
Phil Spector Int'l, PO Box 69529, Los Angeles, Calif. 90069. Tel: (213) 846-9900. Pres.: Phil Spector; Admin. Dir.: Donna Sekulidis; Bus. Admin. & Legal Counsel: Martin Machat; Int'l Dir.: Tony Bramwell; Int'l Pub. Dir.: Avril Giacobb.
Label: (Owned) Spector Recs. Int'l (SRI).
Spector Recs. Int'l, see Phil Spector & Capitol.
Spectrum Recs., PO Box 757, San Carlos, Calif. 94070. Tel: (415) 593-9554.
Pres.: Paul Weaver.
Spigot, see Spiral.
Spina Music, 2232 Vista Del Mar Pl., Hollywood, Calif. 90068. Tel: (213) 467-6018. Pres.: Harold Spina; Sec'y-Treas.: Edith Spina.
Labels: (Owned) Arc, Argyle.
Spindrift Recs., Box 125, Rt. 1, Corinth, Miss. 38834. Tel: (601) 287-4282.
Pres.: Bill Stottlemyer.
Spint/Eggplant Recs., 3008 Beiden Dr., Los Angeles, Calif. 90068. Tel: (213) 469-2719. Pres.: Nick Thery; VP: Bud Mathis.
Spinn Recs., Box 100-N, RFD 3, Stuart, Va. 24171. Tel: (703) 694-6128.
Dwners: Frank W. Singleton, John F. Williams.
Spiral Recs. & Pub'g, 17 W. 60 St., Rm. 423, New York, N.Y. 10023. Tel: (212) 581-6985. Pres.: Harry Finler.
Labels: (Owned) Pilgrim, Spigot, Spiral; (distributed) Balboa, Collectibles.
Spire, see West End.
Spirit Recs., 38 Stonepoint Ln., Charlotte, N.C. 28210. Tel: (704) 554-8505. Pres.: William R. Bradford III; VP: Alexander Bell.
Spirit Recs., 38 Sherman St., Cambridge, Mass. 02138. Tel: (617) 492-1615.
Pres.: Jonathan S. Goldman; VP: Karen Anderson; Sales Mgr.: J. Barone; Ass't Sales Mgr.: David DeBear; A&R: Jonathan Shade; Artist Development: Joy Silver; Promos.: Tinnie Komar; Mktg.: Joseph Viglione; Talent Co-ord.: J. Bruce Scott; Ass't Talent Co-ord.: Rudy Buck.
Spirit, Calif., see Hartson.
Spoken Arts Inc., 310 North Ave., New Rochelle, N.Y. 10801. Tel: (914) 636-5482. Pres.: Dr. Arthur Luce Klein; VP: Dr. Luce A. Klein; VP Admin.:



Jamie/Guyden
DISTRIBUTING CORP.

JAMIE RECORDS

PHIL-LA. of SOUL RECORDS

WRITE FOR OUR GROWING LIST OF
SUPER OLDIES

... "where there's
always a hit"

919 N. BROAD ST., PHILA., PA. 19123
(215) CE 2-8383

Harold Kaplowitz; Mktg. Dir.: D. ryl O'Rourke; Art Dir.: Barbara Flynn; A&R: Christopher King.
Labels: (Owned) Helicon, Spoke Arts.
Spoken Word Classics, see Caedmon/Arabesque.
Spoonfed Recs., PO Box 744, Malibu, Calif. 90265.
Sports, see Lee Anderson.
Spring Recs. Inc., 161 W. 54 St., New York, N.Y. 10019. Tel: (212) 581-5398.
Pres.: Jules Rifkind; VP: Bill Spiatsky; Sec'y-Treas.: Roy Rifkind.
Labels: (Owned) Spring (distributed by PolyGram), Event, Posse.
Stable, see Dawn.
Stache Recs. Inc., 4050 Buckingham Rd., Suite 208, Los Angeles, Calif. 90008. Tel: (213) 290-2262. P es.: James Earl Jackson; VP: John E. White; Sec'y-Treas.: Renee White. Promos. & Pub. Dir.: E.J. Smith; A&R Dir.: James Earl Jackson.
The Stacy-Lee Label, Box 711, Ha kensack, N.J. 07601. Tel: (201) 488-5211. Pres.: Johnny Miracle; VP: Frank Joy; Treas.: Warren Payne; Sec'y: Sam Diamond; A&R: Kenny Luv
Labels: (Owned) Banana, Inner r, cker, Joy, Lions Den, Lotus, Lybra, Riot, Stacy-Lee, Vanishing Point.
W. C. Staley & Assocs., PO Box 57 2, High Point, N.C. 27262. Tel: (919) 885-0263.
Labels: DeKa, Mecca, Rose.
Standy Recs. Inc., 760 Blandina St., Jtica, N.Y. 13501. Tel: (315) 735-6187.
Pres.: Stanley Markowski; VP: Ar jy Cittadino; Sales & Mktg.: Joyce Markowski.
Stanyan Rec. Co., 8440 Santa Mor ca Blvd., Hollywood, Calif. 90069. Tel: (213) 656-7311. Owner: Rod Mc Guen; Pres. & Gen. Mgr.: Wade Alexander; VP Promo.: Pamela Burns.
Labels: (Owned) Discus, Stanya i.
Star, see National Music.
Starborne Prod'n Corp., 4627 Van luy's Blvd., Sherman Oaks, Calif. 91403. Tel: (213) 995-7832. TWX (91C) 495-2019. Pres.: James P. Schlichting; VP: Linda C. Schlichting; Sales r.: Diane Simmons; Promo. Dir.: Dean Whitney.
Labels: (Owned) Starborne; (dit ributed) RIM.
Star City, see Rose Hill.
Starday, see Gusto.
Stardust, see Colonel Buster Doss
Star Fires, see Star Fox.
Star Flute, see Music Ents.
Star Fox Recs., 4602 Newaygo Rd., ort Wayne, Ind. 46808. Tel: (219) 483-9564.
Labels: (Owned) Cammeron, Str Fires, Star Fox.
Stargem Recs. Inc., 20 Music Squa: W., Suite 200, Nashville, Tenn. 37203. Tel: (615) 244-1025. Pres. & A&R Dir.: Wayne Hodge; Nat'l Promo. Dir.: Chuck Dixon; Video Prod'n Dir.: Dan Hodge.
Starglo Music, PO Box 2180, Placer, Calif. 95667. Tel: (916) 626-4512.
Owners/Gen. Mgrs.: Gil & Sandi Labrucherie; Sales Mgr./Promos.: Jim McDonald.
Label: (Distributed) Heritage Singers.
Star Jazz Recs. Inc., 5220 SW Eighth St., Fort Lauderdale, Fla. 33317. Tel: (305) 581-4310. Pres.: Will Connelly; Exec. VP: Tom Justice; VP Promo: Jim Farrell; A&R Dir.: S.M.T. Ne son.
Labels: (Owned) Mudflap, Star jazz.
Stark Recs. & Tape Co., 628 South St., Mount Airy, N.C. 27030. Tel: (919) 786-2865. Owner & Pres.: Paul E. Johnson.
Labels: (Owned) Hello, Pilot, Str rk, Sugarbear.
Starlog, see Varese Sarabande.
Starman Recs., PO Box 20604, Zip 95820; 2351 Fourth Ave., Sacramento, Calif. 95818. Tel: (916) 454-4521. Pres.: Almeritt V. Covington; VP: Marsha Ann Covington; Treas.: Viol i A. Covington.
Star People Recs., PO Box 553, C sselberry, Fla. 32707. Tel: (305) 331-4453. Pres.: Terry R. Brooks.
Labels: (Owned) High Frequency, Outer Galaxie, Star People.
Starr Rec. Co., Box 1, Florida, N.Y. 10921. Tel: (914) 651-4266. Pres.: Jimmy Sturr; VP: Edward Kosio; Sec'y: Joe Dembeck.
Starship, see 50 States.
Star Song of California, see Conso dated Gospel.
Star Song Recs., 2460 Spring Lake r., Marietta, Ga. 30062. Tel: (404) 973-1170. Pres.: Tim McCabe.
Labels: (Owned) Atlantis, Star ong.
Star Song Recs., 2223 Strawberry, Pasadena, Tex. 77502. Tel: (713) 472-5563. Exec. Pres.: Wayne Dono rho; Pres./A&R: Darrell A. Harris; Sales Mgr.: Philip Dorfingler; Promo. Toni Thigpen; Prod'n: Joan Tankerley. (Also see Benson)
Labels: Joyous Garde, Kingsw y Music, Rvrendell, Star Song.
Int'l reps.: Australia (Rhema), anada (Praise), New Zealand (Sacred), UK (Kingsway).
Star (Switzerland), see Sonic Arts
Starstream Recs., 4801 Woodway Houston, Tex. 77056. Tel: (713) 961-1975. Pres.: Ken Kramer; VP i Gen. Mgr.: Gary Firth
Starwest Recs., PO Box 21, Longv ew, Wash. 98632. Tel: (206) 423-9085.
Gen. Mgr.: Mike Poe.
Stateswood, see Skylite-Sing.
Stax, see Fantasy/Prestige/Milestone/Stax.
Steady Recs., 846 Seventh Ave., ew York, N.Y. 10019. Tel: (212) 757-3800. Pres.: Art Trefleron.
Labels: (Owned) Casset Maior, Phonosonic, Premier, Steady.
Steamboat Recs. Inc., 3500 N. Cal :eway, Suite 1500, Metairie, La. 70002. Tel: (504) 831-9474. Pres.: Re Pearce; Exec. VP: Norris Songe; VP & A&R Dir.: Dale Murray.
SteepleChase Prod'ns Inc., 3943 W Lawrence Ave., Chicago, Ill. 60625. Tel: (312) 463-6146. Pres.: Nils W ther; VP/Gen. Mgr.: Charles Nessa.
Home offic.: Denmark.
Int'l rep.: Canada (Trend).
Stepping Stone, see Trend Recs. i i Ga.
Stereo Fidelity, see Alshire.
Stereo Spectrum, see Dance-A-Th-n.
Stet, see DRG Recs.
Stiff-America, 157 W. 57 St., New York, N.Y. 10019. Tel: (212) 765-3977.
Pres.: Bruce Kirkland; Ass't to res.: Nancy Harrison; Mdsq.: Steve Bonano; Promo.: Roy Rosenberg.
Stiff/Columbia, see CBS.
Stiff/Epic, see CBS.
Stinson Recs., PO Box 3415, Grai ada Hills, Calif. 91344. Tel: (213) 368-1612. Pres.: Jack M. Kall.
Int'l rep.: Colombia (Ramirez).
Stonedog Recs., 208 Lone Oak R ., Paducah, Ky. 42001. Tel: (502) 444-7658. Pres.: Ed Hannan. (Dist ibuted by Nationwide Sound)
Branch: Chicago, Ill., 1819 W. Thome Ave. Zip: 60660. Tel: (312) 869-6468. VP: Stoney Phillips.
Stonehedge, see Jersey Coast.
Stone Post Rec. Co., PO Box 2611 San Bernardino, Calif. 92406. Tel: (714)

886-9016. Pres. & A&R Dir.: Richard Bisterfeldt; VP/Dir.: Jacki Bisterfeldt; Sec'y-Mgr.: Jann Joy.
Branch: Emporia, Kan., PO Box 954. Zip: 66801.
Stoneway Recs. Inc., 2817 Laura Koppe, Houston, Tex. 77093. Tel: (713) 697-7867.
Labels: (Owned) Stoneway, Wide-World.
Stony Plain, see First American.
Storyville, see Moss.
Stradivari, see Everest.
Straight-Face Inc., Box 324, Newark, Del. 19711. Tel: (302) 368-1211.
Pres.: Nick Norris; VP: Mike Fisher; A&R: Jim Tassell, J. Julian.
Strala-East Recs. Inc., 156 Fifth Ave., Suite 413, New York, N.Y. 10010. Tel: (212) 691-9294. Cable: SEFONIC. Telex: 234104. Chief Officers: Charles Tolliver, Stanley Cowell. (Distributed by Audiofidelity)
Strate-8, see Fortune.
Straw Hat Recs., 422 S. Calle Encilia, No. 901, Palm Springs, Calif. 92262. Tel: (714) 325-4735. Pres.: Charlie Beal; Pub./Promo.: D. Van Horn.
Labels: (Owned) Straw Hat, Top Hat.
Street Corner Recs., 2801 Middletown Rd., Bronx, N.Y. 10460. Tel: (212) 733-8813. Owner: Thomas Laura; Mgr.: Ron Blair.
Labels: Chapel Tone, Street Corner.
Street Level, see Consolidated Gospel.
Street Recs. & Tapes Inc., 345 Fullerton Pkwy., Chicago, Ill. 60614. Tel: (312) 784-1583.
Label: (Owned) SRT.
Streke, see Periscope.
String (UK), see Rounder.
Stud Guy, see Old Dominion.
Studio 7, see Vee Jay.
Studio 17, see Reonah.
Stylotone Recs., 254 E. 29 St., Suite 7, Los Angeles, Calif. 90011. Tel: (213) 746-6499. Owner & Pres.: Jerry Hooks; Dir./Mgr.: Duffy Hooks III.
Labels: (Owned) Groundhog, Hooks, Hooks Bros., J&J, Shur-Tinga, Styletone.
SuAnn, see HSE.
Suffolk Mktg., 115 E. Main St., Smithtown, N.Y. 11787. Tel: (516) 979-0100.
(TV merchandiser)
Sugarbear, see Stark.
Sugarbush, see Reflection Sound.
Sugar Hill Recs. Inc., PO Box 4040, Duke Sta., Durham, N.C. 27706. Tel: (919) 489-4349. Pres.: Barry Poss; Promo.: Penny Parsons.
Branch: Roanoke, Va., PO Box 3057. Zip: 24015. Tel: (703) 343-5355.
Mktg.: David Freeman, Chet Rhodes.
Int'l reps.: Australia (Larrikin), Canada (Trend), Italy (IRD), Japan (BOM), Netherlands (American Music), Sweden (Sarec), UK (Making Waves), Mike's Country).
Sugar Hill Recs. Ltd., 96 West St., Englewood, N.J. 07631. Tel: (201) 569-5170. Chairwoman: Sylvia Robinson; Pres.: Joseph Robinson; Exec. VP: Milton Malden; VP: Joey Robinson Jr.; Promo.: Diane Moore; Prod'n: Agnes Pellas; Eng.: Steve Jerome.
Sugarcloaf Recs., 750 Las Gallinas Ave., San Rafael, Calif. 94903. Tel: (415) 479-8211. Owner: Bill Hooks.
Sugar Recs. Inc., PO Box 1181, Florissant, Mo. 63031. Tel: (314) 837-4095.
Pres.: Glen D. Kirkland; VP: Marv E. Kirkland; A&R Dir.: Russ Kirkland; Promo. Dir.: Dale Kirkland.
Int'l rep.: Canada (Praise).

Sugar-Soul, see Dtoao.
Sugartree Recs., 701 Ninth St. NE, Winter Haven, Fla. 33880. Tel: (813) 293-0846. Pres.: D. Rick Mitchell.
Surgavine, see ECI.
Sumiko Inc., PO Box 5046, Berkeley, Calif. 94705. Tel: (415) 843-4500.
Pres.: Blair Boyd; VP: Sumiko Okamoto; Sec'y-Treas.: Clyde Eagleton; Sales/Technical Dir.: David Fletcher; Chief Eng.: Randy Bailley; Sales Mgr.: Roxanne Schwartz; Prod. Dist'n: Peter Schwartz; Controller: Mark Kelly; Quality Control: Patrick Lim; A&R: Tam Henderson.
Labels: (Distributed) Ambience, Reference.
Summer, see Cord.
Summit, see CMS.
Sunbeam Recs. Inc., 13821 Calvert St., Van Nuys, Calif. 91401. Tel: (213) 994-7791.
Labels: (Owned) Sountrak, Sunbeam.
SunBell Recs. Inc., 12231 Snow White, Dallas, Tex. 75234. Tel: (214) 243-5792. Pres.: Ralph Hollis; VP: Greg Hollis.
Sunbird, see Capitol & Excelsior.
Sunburst, see Sunset.
Suncoast Recs., PO Box 5208, Clearwater, Fla. 33518. Tel: (813) 446-2914.
Suncountry Prod'ns Inc., 14 E. Second St., Tucson, Ariz. 85705. Tel: (602) 792-3194. Pres.: Fred Knipe; VP: Jim Bastin; A&R Dir.: Steve Chandler.
Label: (Owned) Bandler.
Sundown Recs., Box 258, Rt. 1, Carriere, Miss. 39426. Tel: (601) 798-7099.
Owner: Vern Pullens; Pub. Ed.: Bruce Dixon.
Branch: Nashville, Tenn., 1204 Elmwood Ave. Zip: 37202. Tel: (615) 385-2704. Owner: Joe Gibson.
Sun Dyl Recs., 312 Sharon Ave., Marshalltown, Iowa 50158. Tel: (515) 752-3198. Dir.: Alan Lund.
Sun-Glo Recs. Inc., 12911 SW 82 Terr., Miami, Fla. 33183. Tel: (305) 279-2523. Pres.: Samuel Solomon Jr.; Exec. VP: Willie V. Harvey Jr.; VP/PR: Frank Solomon; Promo. & Sales Dir.: Darnell Johnson.
Labels: (Owned) S&H, Sun-Glo, Tempus.
Sunny Day Prod'ns, 1931 SE Morrison, Portland, Ore. 97214. Tel: (503) 238-4525. Pres.: Russell E. Gorsline.
Label: (Owned) Cricket.
Sun-Ray Recs., 1662 Wyatt Pkwy., Lexington, Ky. 40505. Tel: (606) 254-7474. Pres.: James T. Price; VP: Harry Price.
Sun Rize, see Charta.
Sunset Recs. Inc., 1577 Redwood Dr., Harvey, La. 70058. Tel: (504) 367-8501. Pres.: George Leber; Sec'y: Julie Foret; Promos. Dir.: Christi Klein.
Labels: (Owned) Sunset, Sunset.
Sunshine, S.C., see Herald Ass'n.
Sunshine Country Recs., PO Box 31351, Dallas, Tex. 75231. Tel: (214) 690-4155. Pres.: Bart Barton; VP: B. C. Bramlett; Nat'l Sales: Rusti James.
Labels: (Owned) SCR, (distributed) Branch Int'l, Vertex, Yatahey.
The Sunshine Group Ltd., 800 S. Fourth St., Philadelphia, Pa. 19147. Tel: (215) 755-7000. Pres.: Walter B. Kahn; Ass't to Pres./Pub.: Lisa Sable; Controller: Dee O'Brien; Promo. Dir./A&R: Rick Garson.
Labels: (Owned) Grand Prix, Sunshine.
Sunshine Sound, see TK.
Superba, see Sine Qua Non.
Super Dimension Six, see Sonic Arts.
Superior, see Ansonia.

We create sound packages...



For those of you who may not be familiar with what we do, we have been designing ads, album covers, labels, catalogs, tape graphics, etc. for over 20 years. We also set the type, do color separations, do the printing, make the jackets. Part of the reason we are still around and growing is that our clients know they can count on us — we're honest, tell it like it is and de-

liver a commendable job, usually on time. Since most of our work (layout, art, typography, camera, printing, etc.) is done internally by our own people and our own equipment we can maintain control of all work and at the same time be very competitive.

Small run and/or low budget: see our full color "Instant Album Covers" free catalog available.

Lee-Myles Associates, Inc.

160 East 56th Street, N.Y., N.Y. 10022 Tel: 758-3232
Cable: LEEMYLES • Plant: 645 West 44 Street
Serving the graphic needs of the record industry since 1952.

Superior Sound Studio, Rockland Rd., Hendersonville, Tenn. 37075. Tel: (615) 824 5141.
 Labels: (Owned) Message, Rockland Road, Superior.
 Super Prod'n, see Album Globe.
 Superstar Recs., 726 Coronet, San Antonio, Tex. 78216. Tel: (512) 344-5979. Pres.: Tom R. Parr.
 Superstructure Recs Ltd., 546 W. Seventh St., San Pedro, Calif. 90731. Tel: (213) 833-9229. Gen. Mgr.: Louis Martinez.
 Supreme Rec. Co., 110 21 Ave. S., Nashville, Tenn. 37203. Tel: (615) 327-1050. Owner: Thomas H. Walls; Promo. Mgr.: Allen M. Henson.
 Labels: (Owned) Supreme, Timberhill.
 Sure Music & Rec. Co. Inc., PO Box 94, 39 N. Sproul Rd., Broomall, Pa. 19008. Tel: (215) 356-2996.
 Surf City, see Pop Record Research.
 Surfside, see Hula.
 Surfside Hawaii Inc., 1365 Colburn St., Honolulu, Hawaii 96817. Tel: (808) 847-0855. Pres.: C.R. Clarke; Controller: Carl Crosier.
 Labels: (Owned) Lohua, Mahalo.
 P. Suriano Ents., 39 Ledgewood Dr., Smithtown, N.Y. 11787. Tel: (516) 543-3913.
 Label: (Owned) Behold.
 Survival, see Philly Jazz.
 Survivor Recs. Inc., 5934 Buffalo Ave., Suite 105, Van Nuys, Calif. 91401. Tel: (213) 997-8819. Pres.: Jason Schwartz; VP A&R: Sandra Schwartz; VP Pub.: William McCormick; Gen. Mgr.: Richard Schulenberg.
 Labels: Rough Diamond, Survivor.
 Susan, see Rock-A-Nash-A-Billy.
 Sutra, see Buddha.
 Svensk Disk, see Lindberg.
 Swallow, see Flat Town.
 Swallowtail Recs., Box 843, Ithaca, N.Y. 14850. Tel: (607) 844-4535. Owner & Pres.: Phil Shapiro.
 Swan Song, see Atlantic.
 Swedish Discophile (Sweden), see Worldtone.
 Sweet City, see Belkin & MCA.
 Sweetong Recs., PO Box 2041, Parkersburg, W. Va. 26101. Tel: (304) 489-2911. Owner: Roger L. Hoover; Eng.: Dave Fore; Promo. Dir.: Judy Crites.
 Labels: (Owned) Mansion, Sweetong.
 Sweet Stuff, see Express.
 Sweet Tooth, see Candy.
 Sword Recs., PO Box 8374, Sta. A. Greenville, S.C. 29604. Tel: (803) 271-1104. Pres.: Richard M. Sandidge; VP: Bill Barnes; Secy-Treas.: Fran Sandidge.
 Sylvania, see Random.
 Symposium Recs., 204 Fifth Ave. SE, Minneapolis, Minn. 55414. Tel: (612) 331-5750. Pres.: George Hanson.
 Labels: (Owned) Flashlight, Symposium.
 Syntonic Research Inc., 175 Fifth Ave., New York, N.Y. 10010. Tel: (212) 243-5434. Pres.: Irv S. Teibel; VP: Michael Kron; Sales Mgr.: R. Patterson; Prod. Mgr.: Kip Kaplan; Research & Development Mgr.: Russ Aarons; Adv. Mgr.: M. Berman.
 Int'l rep.: Australia (Laser), Canada (Treble Clef), Japan (Nippon Phonogram), Netherlands (Munich).

T

T B S, see CDE.
 T C B, see Rob-Lee.
 T Electric Recs. Co. Inc., 450 W. 54 St., New York, N.Y. 10019. Tel: (212) 977-4500. Pres.: Jim Tyrrell; VP/Creative Dir.: Cheryl Tyrrell.
 T H Rec. & Tapes Inc., 10124 NW 80 Ave., Hialeah Gardens, Fla. 33016. Tel: (305) 558-2722.
 Labels: (Owned) Color, Lad, TH.
 T H S (Turnabout Historical Series), see Moss.
 T J Assocs. Inc., 363 Melville Ave., Palo Alto, Calif. 94301. Tel: (415) 327-9094. Pres.: Tom Boyd.
 T K Prod'ns, 495 SE 10 Court, Hialeah, Fla. 33010. Tel: (305) 888-1685.
 Labels: (Owned) Alston, Amazon, Arth, Blue Candle, Bold, Cat, Clouds, Dash, Drive, Glades, Gospel Roots, Marlin, Reid's World, Roots, TK, Weird World, Wolf, (distributed) APA, Inphasion, Kayvette, Sunshine Sound.
 T-Neck, see CBS.
 T P M, see Loypriguan.
 T R C Recs. (div. of TRC Corp.), TRC Mid-America Rec'g Center, 1330 N. Illinois St., Indianapolis, Ind. 46202. Tel: (317) 638-1491.
 T S O P, see Philadelphia Int'l & CBS.
 T S R, see Third Story.
 T 2 Tople, see Did Hat.
 T V C (Turnabout Chamber Series), see Moss.
 T V I Rec. Corp., 211 W. 56 St., Suite 8M, New York, N.Y. 10019. Tel: (212) 246-6400. Pres.: Tony Valor; VP PR: Peter Mallon; VP A&R: Karol Quinn; Ass't Dir. A&R: Joe E. Rome; VP Int'l Mktg.: Joe Mantredi.

T W C Entertainment Corp., GPO Box 2021, New York, N.Y. 10001. Tel: (212) 691-4565. Pres.: Thomas Schroeder; Sec'y & Rock Pop Promo. Mgr.: Jerome Haggart; Treas. & Country Div. Mgr.: Walter Balderson.
 Tabu, see CBS.
 Tadarab, see Charade.
 Taino, see Ototo.
 Take Home Tunes! Rec. Co., Box 496, Georgetown, Conn. 068269. Tel: (203) 544-8288; NYC (212) 580-9345. Exec. Prod'rs: Bruce D. & Doris Chu Yeko; Assoc. Prod'r: Robert Sher.
 Branch: Englewood Cliffs, N.J., Box 1314. Zip: 07632. Tel: (201) 224-5811, 567-5524.
 Labels: (Owned) Broadway Baby, Broadway/Hollywood, Film Score, Driginal Cast, Take Home Tunes!
 Takoma Recs. Corp., 9255 Sunset Blvd., Los Angeles, Calif. 90069. Tel: (213) 550-0171. Pres.: Denny Bruce; Gen. Mgr.: Jon Monday; A&R: John Fahey (Distributed by Chrysalis)
 Talentia Recs. & Tapes, PO Box 371, Mid City Sta., Dayton, Ohio 45402. Tel: (513) 276-2844. Contact: Ken Shapiro.
 Tall Man, see Pamilyn.
 Talpro Prod'ns Inc., 870 Seventh Ave., Suite 348, New York, N.Y. 10019. Tel: (212) 581-4680. Cable: ARTALMADGE. Pres.: Art Talmadge; Promo. & Sales & Disco Contact: Irwin Rawitz.
 Labels: (Owned) Double Feature, Dynamo, Groove Sound, Talpro.
 Tama, see Motown.
 Tamm, see La Louisianne.
 Tangent Rec. Prod'ns, PO Box 231, Derby, Conn. 06418. Tel: (203) 735-8665. Pres./Dir.: Gene St. Jean.
 Tao Recs., PO Box 504, 4290 Acacia Ave., Bonita, Calif. 92002. Tel: (714) 421-0865. Pres. & Gen. Mgr.: Virginia Anderson; Exec. VP: Robert Anderson Sr.
 Tara (Ireland), see Rounder & Shanachie.
 Tar Heel, see Jim Hall.
 Tarheel, see McKinnon.
 Taurus, see Auditorama.
 Taurus-Astro, see Album Globe.
 Tawes Recs., 7511 Farrand Rd., Clio, Mich. 48420. Tel: (313) 639-7685. Pres.: Harry F. Chestler; VP: Kenneth B. Chestler; Sales Mgr.: Cindy Braun; Promo: Mies Braun; A&R: Michael K. Chestler.
 Branch: Fairbanks, Alaska, Star Rt. 80262. Zip: 99701. Tel: (907) 488-9013.
 Taxi Recs. (USA), 5325 Sheridan Dr., No. 801, Williamsville, N.Y. 14221. Tel: (416) 485-1157. Mgr.: Brian Ayres.
 Home office: Canada.
 Taxi Recs., PO Box 10593, Chicago, Ill. 60610. Tel: (312) 673-4949. Pres.: Alan Kroczyk.
 Creed Taylor Inc., PO Box 705, Old Chelsea Sta., New York, N.Y. 10113. Tel: (212) 674-1111. Bd. Chm.: Creed Taylor.
 Labels: (Owned) CTI, Kudu, Salvation.
 R. Dean Taylor Prod'ns, c/o RDT Prod'ns Inc., 1574 Crossroads of the World, Los Angeles, Calif. 90028. Tel: (213) 464-8609.
 Labels: (Owned) Autumn, Jane, Ragamuffin.
 Teen, see Ototo.
 Teena Joy Recs., PO Box 302, Wilmington, N.C. 28402. Pres., Mgr. & Co-Owner: Bobby Ray Stanley; Co-Owners: Teena Joy & Virginia D. Stanley.
 Telarc Recs., 23307 Commerce Park Rd., Cleveland, Ohio 44122. Tel: (216) 464-2313. Pres. & Chief Eng.: Jack Renner; Prod'r: Robert Woods; Mktg. & Promo. Dir.: Michael Kellman. (Distributed by Audio-Technica)
 Teleclra, see Penco.
 Telefunken, see PolyGram Classics.
 Telemark Dance Recs., 6845 Elm St., Suite 502, McLean, Va. 22101. Tel: (703) 356-9113. Pres.: Richard S. Mason.
 Int'l branch: England.
 Labels: (Owned) Telemark; (distributed) Dansan, Hoctor, Philips (UK), Al Pierson, Pye, Rediffusion, Roper, TM, Tema, Sydney Thompson (dance records only).
 Teleson-America, 333 Beacon St., Boston, Mass. 02116. Tel: (617) 353-1664. Dir.: Kenneth Starr.
 Labels: Grand Orgue (France), Motette-Ursina (Germany), Solist (Germany).
 Telesonic Recs., see Troy Shondell.
 Telestar (Sweden), see Worldtone.
 Tel-E-Vue, see Revonah.
 Tell Int'l Rec'g Co., Box 368-A, Rt. 5, Yakima, Wash. 98903. Tel: (509) 966-6334. Pres.: Jerry Merritt; VP's: Hiram White, Lloyd Jones; Eng.: Larry Merritt.
 Temple, see Skyline-Sing.
 Tempus, see Sun-Glo.
 Tener, see Bee Jay.
 Tennessee Country, see Gloitte.
 Terock, see Rock-A-Nash-A-Billy.
 Texas, see Don Schafer.
 Texas Re-Cord Co. (div. of Western Head Music Co.), Box 19, Bulverde, Tex. 78163. Tel: (512) 438-2465. Pres.: Augie Meyers.

Labels: (Owned) Texas Re-Cord, Texas Roc Co.; (distributed) Crazy Meskin.
 Texas Roc Co., see Texas Re-Cord.
 The Record Co., 6362 Hollywood Blvd., Suite 320, Los Angeles, Calif. 90028. Tel: (213) 462-2038. Pres.: Steve Angelica.
 Theresa Recs., PO Box 1267, El Cerrito 94530; 800 The Arlington, Berkeley, Calif. 94707. Tel: (415) 524-4908. Co-Owners: Allen G. Pittman, B. Kazuko Ishida; Raio Promos./Sales: Paul Arscanian.
 Branch: New York, N.Y., 100 Charlton St., No. 7. Zip: 10014. Tel: (212) 620-0856. East Coast Rep.: Dale Fitzgerald.
 Int'l rep.: Belgium (Flemish Import), Canada (Trend), Hong Kong (Progressive Workshop), Italy (IRD), Sweden (Forsyte).
 Third Coast Recs., 1911 Ridge Ave., Evanston, Ill. 60201. Tel: (312) 869-6290. Pres.: Frank Seater; Exec. VP: Sam Lynn; VP Sales/Mktg.: David E. Webb; VP Promo: Lee Arnold; Nat'l Promo. Mgr.: Rich Piombino; Nat'l Sales Mgr.: Dennis Price; Press Relations Dir.: Cary Baker; Nat'l Mktg. Co-ord.: Chris Lynde; Gen. Mgr.: Larry Savoie; Comptroller: Brian Halonen.
 Third Story Recs., 3436 Sansom St., Philadelphia, Pa. 19104. Tel: (215) 386-5998/5987. Pres.: John O. Wicks III, VP: Scott M. Herzog; Promo.: Rod Burton.
 Label: (Owned) TSR.
 Third Street Recs., 10 M. Third St., Philadelphia, Pa. 19106. Tel: (215) 627-3366. Pres.: Jerry Gordon.
 This is It, see Sid Kleiner.
 Thomas, see RCI.
 Thoroughbred Recs., 6503 Wolfcreek Pass, Austin, Tex. 78749. Tel: (512) 288-3370. Owner: Rex T. Sherry.
 Thoth, see Castalia.
 3 G's Inds. Inc., 5500 Troost, Kansas City, Mo. 64110. Tel: (816) 361-8455. Pres.: Eugene Gold; Secy-Treas.: Chris King; Chief Eng.: Mike Green; Promo. Dir.: Ken Searcy; A&R Dir.: Dell Rice; Gospel A&R Dir.: Robert Taylor; Nat'l Sales/Gospe: Gary Malbia; Nat'l Sales R&B: Charles Smith; Special Projects: Elmer Overton; A&R/Special Projects: B. Hofmann.
 Labels: (Owned) Chris C's, Cory, NMI, 3 G's.
 3 J Recs. (div. of Mende Music), PO Box 2776, Long Beach 90801; 9039 E. Los Angeles St., Bellflower, Calif. 90706. Tel: (213) 867-9964. Contact: J.D. Mendenhall. (Also see Nationwide Sound)
 Thunderbird, see Olivia & Gemcom.
 Thunder Lizzard, see Crimson Dynasty.
 Tico, see Musica Latina.
 Tiger Lily, see Roulette.
 Tight Fit, see Right Note.
 Tikal, see Discoland.
 Timberhill, see Supreme.
 Timeless Entertainment Corp., 160 E. 56 St., New York, N.Y. 10022. Tel: (212) 233-5949. Pres.: Fred Bailin.
 Labels: (Owned) Goldac, Perfect.
 Int'l rep.: Austria, Germany & Switzerland (Ariola-Eurodisc).
 Timeless-Muse, see Muse.
 Times Mgmt. Corp., 1216 Granby St., Norfolk, Va. 23510. Tel: (804) 625-0534. Pres.: D.H. Burlage; VP: Guy A. Burlage; Secy-Treas.: Denis J. Burlage. Local Branch: 107 E. 13 St. Zip: 23510. Tel: 625-0534.
 Label: (Owned) Wayton.
 Tin Drum Recs., PO Box 2513, Brooklyn, N.Y. 11201. Tel: (212) 855-5540. Owner: Pavio Vacatatis; Mgr.: Mary E. Zissel.
 Rik Tinory Prod'ns, 180 Pond St., Cohasset, Mass. 02025. Tel: (617) 383-9494. VP: Richard Tinory Jr.; PR: Claire Cohasset, Tinory.
 Labels: (Owned) Old Boston, RTP Int'l, Sequel, Venture.
 Toll Free Recs. & Tapes, see CDE.
 Tomato Music Co. Ltd., GPO 874, Brooklyn, N.Y. 11201. Tel: (212) 875-1313.
 Int'l rep.: Japan (Victor).
 Tommy Boy Music Inc., 1641 Third Ave., Suite 10-H, New York, N.Y. 10028. Tel: (212) 860-4895. Pres.: Thomas Silverman.
 Tom Thumb, see Rhythms Prod'ns.
 Top & Bottom, see Jamie/Guyden.
 Top Hat, see Straw Hat.
 Topic (UK), see Rounder & Shanachie.
 Top of the World Recs., 290 Main St., Suite 900, Buffalo, N.Y. 14202. Tel: (716) 856-4162. Partner: Dean Brownout.
 Top Ranking Sounds, 2109 Opa Locka Blvd., Opa Locka, Fla. 33054. Tel: (305) 685-9605.
 Top-Star, see Sid Kleiner.
 Tornado, see Crimson Dynasty.
 Toronto, see Rock-A-Nash-A-Billy.
 Toshiba-EMI (Japan), see Audio-Technica.
 Total Sound, Calif., see Lawrence Herbst.
 Touche Recs., PO Box 96, El Cerrito, Calif. 94530. Contact: Teresa Yuko Doane.
 Towerhill Recs. (div. of Towerhill Corp.), 6000 Sunset Blvd., Hollywood, Calif. 90028. Tel: (213) 467-8849. Pres. & A&R Dir.: Michael Nemo; Mktg. Dir.: Philip Truckenbrod.
 TownHall Recs., PO Box 5332, 1253 Coast Village Rd., Santa Barbara, Calif. 93108. Tel: (805) 969-4744. Pres.: Lincoln Mayorga; Mgr.: Linda Jones.
 Toy Recs., PO Box 219, Radio City Sta., Zip: 10101, 400 W. 43 St., Suite 19H, New York, N.Y. 10036. Tel: (212) 695-6995. Pres.: N.L. King; VP: Lawrence Lucie.
 Tradition, see Everest.
 Transatlantic USA, see Kicking Mule.
 Transworld Recs., see Finer Arts.
 Trash, see Sound Inc.
 Trend Rec. Corp., 117 N. Las Palmas Ave., Los Angeles, Calif. 90004. Tel: (213) 938-5482. Pres.: Albert Marx; Promo.: Pat Nickerson.
 Labels: (Owned) Discovery, Musicaif, Renaissance, Trend, Verydisco.
 Trend Recs., PO Box 201, Smyrna, Ga. 30081. Tel: (404) 432-2454. Owner & Pres.: Thomas E. Hodges; VP: Frank D. Brannon; Assoc. VP: Jerry Burke.
 Labels: (Owned) Allanta, Stepping Stone, Trend, Trendsetter, Trendside; (distributed) Pipe.
 Trendsetter, see Trend Recs. in Ga.
 Trendside, see Trend Recs. in Ga.
 Triad, see RMS Triad.
 Triangle Recs. Inc., 824 19 Ave. S., Nashville, Tenn. 37203. Tel: (615) 329-1429. Exec. VP & Gen. Mgr.: Elwyn Raymer; Prod Co-ord.: Lynn Phillips; Promo.: Lisa Keelings. (Distributed by Benson Co.)
 Labels: (Owned) Caelix, Triangle, Trigon.
 Int'l rep.: UK (Marshall, Morgan & Scott).
 Tribal, see Tom Bee.
 Tribal Jargon/Skids Recs., 129 Grasmere St., Newton, Mass. 02158. Tel: (617) 244-6803. Dir.: Tristram Lozaw. (Licensed to Modern Method)
 Tribute, see Master Trak & Sivatt.
 Tridelta, see McKinnon.
 Trigon, see Triangle.
 Trinity, see Dallas Recs.

We have combined ingenuity, integrity, and a "helluva" lot of hard work and personal involvement to provide 10 years of service to the country music recording industry as national sales, marketing, and promotion agents for some of the nation's leading independent country labels.

*Results—
over 300 nationally charted records
"nuf sed"*



NATIONWIDE SOUND DISTRIBUTORS

P.O. Box 23262, 1204 Elmwood Ave.
 Nashville, TN. 37202 • (615) 385-2704

Trinity Sound, Calif., see Consolidated Gospel.
 Trinity Sound, Mich., see Eden.
 Triple Disc, see Second Sun.
 Triple-J, see Dallas Recs. & Nationwide Sound.
 Trish Nugent, see Olivia.
 Trix Recs. Inc., Drawer AB, Rosenale, N.Y. 12472. Tel: (914) 687-9573.
 Pres.: Pete Lowry.
 Labels: (Owned) Trix; (distributed) Kheba.
 Int'l rep.: Canada (Almada), Sweden (Smokestack), UK (Swift).
 Trod Nossel Artists, Box 9, 10 George St., Wallingford, Conn. 06492. Tel: (203) 269-4465. Pres.: Thomas Avalier; Nat'l Promo. Dir.: Benjamin Gaet; A&R: Douglas Snyer; Chief Eng.: Richard Robinson.
 Labels: (Owned) Big Sound, M.acle, Simple, Trod Nossel.
 Int'l rep.: Australia (EMI), Germany (Kuckuck), Japan (Decca), Netherlands (Phonogram), UK (Phonogram/London).
 Trojan (UK), see Shanachie.
 Tropical Music Inc., PO Box 1494, Honolulu, Hawaii 96806. Tel: (808) 521-6256. Pres.: Bill Murata.
 Labels: (Owned) Discos Tropica, Poki, Pumehana.
 Tropical, N.Y., see Met Richmond.
 Tropicana, see Gramophone.
 True, see World Wide Music Inc. Professional Mktg.
 True Love, see Jim Hall.
 Trutone Recs., 163 Terrace St., Hawthorn, N.J. 07641. Tel: (201) 385-0940.
 Pres.: Louis Rowatti; Sec'y-Treas.: Chief Eng. & Studio Mgr.: Carl Rowatti; Bus. Mgr. & Adv. Dir.: Adrienne Rowatti; Disk Mastering Engs.: Phil Austin, Steve Robb.
 Tubby, see Rollin' Rock.
 Tulsa Int'l, see Hilding America.
 Tunemsmith, see Praise.
 Tune Town, see Rooster Blues.
 Tune Wizard Recs. Inc., 1525 Bath Ave., Brooklyn, N.Y. 11204. Tel: (212) 236-7131. Pres.: John Frisone; P: Celia Montiglio; Sec'y-Treas.: Ronald Annunziata; A&R: Anthony M. elGatto.
 Tunenetworks Recs. Co., 15625 Vanciel Pl., Encino, Calif. 91436. Tel: (213) 278-8970, TWX: (910) 490-2501. Pres.: Dennis Lambert; VP A&R: Paul Palmer; VP Admin.: Marsha Ingtham; Artist Relations Dir.: Deena Frank; R&B Dir.: Muff Schauer; Int'l Dir.: Maggie Trejo; Creative Servs.: Jode Alyn; Promo.: G.P. Bird.
 Labels: (Owned) Haven.
 Int'l rep.: Netherlands (Phonogram).
 Turnabout, see Moss.
 Turn-On, On, see Moss.
 Turnrow, see Full Circle.
 Turnstyle, see Latin Percussion.
 Turtle Pact, see Turtle Recs.
 Turtle Recs. Inc., 225 N. Taylor Av., Oak Park, Ill. 60302. Tel: (312) 383-8595. Pres.: Ronald L. Kirschner; Sec'y-Treas.: Steve Pastorius.
 Labels: (Owned) Turtle, Turtle act.
 20th Century-Fox Rec. Corp., 8544 Sunset Blvd., Los Angeles, Calif. 90069. Tel: (213) 657-8210. Cable: 20XENREC. Bd. Chm.: Herb Eisenman; Pres.: Neil Portnow; VP Finance & Adm. n.: Monty Houdeshell; Nat'l Promo. Dir.: Donny Brooks; Nat'l Secondary Promo. Co-ord.: Wendy Grasberg; A&R Admin. Dir.: Bill Burdals; A&R Admin. Co-ord.: Sharon Beringer; Accounting Dir.: Dianne Leedy; Royalty Mgr.: Curtis Yew. (Distributed by RCA).
 Labels: (Owned) 20th Century Fox; (distributed) Chi-Sound.
 Twinkle, see Rough Trade.
 Twister, see Quadrasonic.
 2-J, see Ozark Opry.
 2-Mac Recs., 2097 Vestadale Court, Tucker, Ga. 30084. Tel: (404) 938-1210.
 Owners: Phil McDaniel, Joe McAnney.
 Two-Tone, see Chrysalis.
 Typnone, see Crimson Dynasty.

U

U F O, see Glorite.
 U G R, see Unlimited Gold.
 U K Recs. Inc., 315 W. 57 St., Suite 3H, New York, N.Y. 10019. Tel: (212) 581-7577.
 Home office: England.
 U S, see SIPRA.
 U U S, see Utopia.
 Ultragroove, see Crystal Clear.
 Ultrasonic, see Rooster Blues.
 Umpire Enterprises, 1824 Laney Dr., Longview, Tex. 75601. Tel: (214) 758-4063. Owner-Pres.: Jerry Haym; Sec'y: Sandy Wilson; A&R Mgr.: Jeff Johnson.
 Branch: Tucson, Ariz., PO Box 364, Zip: 85717.
 Labels: (Owned) Enterprize.
 Uncle Jam, see CBS.
 Underground, see Record & Music.
 Unicorn Recs., 8615 Santa Monica Blvd., Los Angeles, Calif. 90069. Tel: (213) 652-2070. Pres.: Daphna Edwards; VP/Mktg.: J.J. Jordan; Bus. Affairs Dir.: Michelle Roth; Nat'l Promo.: Debbie Sievert. (Distributed by MCA).
 Unidisc (France), see Worldtone.
 Unique Jazz (Italy), see Zim.
 United, see Cadet Recs.
 United Artists, see EMI America/I berty.
 Unity, Fla., see Art.
 Universal-Alhena Recs., PO Box 3115, Peoria, Ill. 61614. Tel: (309) 673-5755. Owner: Jerry Hanlon.
 Universal Sound, see Sound Inc.
 Unlimited Gold Recs. Inc. (UGR), 2403 Ventura Court, Studio City, Calif. 91604. Tel: (213) 760-1665, 8 7-0535. Cable: UNLIMGOLD. Bd. Chm.: Barry White; Pres.: Rod McGrew; Ass't to Pres.: Jean Johnson; Controller: Laurie Fernandez; Mktg.: Roy Norman. (Distributed by CBS).
 Uno Melodic Recs., 390 Riverside Dr., No. 1C, New York, N.Y. 10025. Tel: (212) 662-8454. Bd. Chm.: Roy Ayers; Sr. VP/East Coast Promo.: Roy Ayers III; Mktg. Dir./East Coast Promo.: Vesta Maxey; Nat'l Promo. Dir.: Weldon A. McDougal III; PR: L. n Thompson, Judy Wright; West Coast Promo.: Cory Lovitt; Art Dir./Artist Development: Dennis Armstead.
 Unregulated Rec. Co. Inc., Box 8 485, College, Alaska 99708. Tel: (907) 456-3419. Pres.: Michael A. Stites; VP: Richard J. Pasillas; Bus. Mgr.: James I. Quinn.
 Up-Date Recs., 1902 Marcella Dr., Nashville, Tenn. 37217. Tel: (615) 367-4432. Pres.: Jim W. Rice.
 Upstart, Tex., see Pantego.
 Up With People, 3103 N. Campbell Ave., Tucson, Ariz. 85719. Tel: (602) 327-7351.
 Urania Classics, see American Themes & Tapes.

Urania Jazz, see American Themes & Tapes.
 Utopian Recs., PO Box 5314, Macon, Ga. 31208. Tel: (912) 477-0415. Pres. & Gen. Mgr.: Randy L. Howard.
 Utopia Ultra-Sound, PO Box 718, Newark, Ohio 43055. Tel: (614) 345-9426. Pres.: Robert H. Kirk Jr.
 Labels: (Owned) SAM, UUS, Utopia.

V

V A P Recs. Inc., 621 N. Broadway, Amityville, N.Y. 11701. Tel: (516) 598-3970. Pres.: Jonathan L. Floyd; VP/A&R: Stafford M. Floyd; Prod. Development: Michael C. Derrick; Promo.: T. Venlo Odum.
 V H F Ent's., PO Box 7513, Rochester, N.Y. 14615. Tel: (716) 467-1592. Pres.: Lawrence P. Fritsch; VP's: Stephen A. Fritsch, John Perovich; Sales Dir.: Charles B. Sawyer; Sales: Michael Gidon; A&R Dir.: Ann E. Fritsch; Prod'n: John M. Fritsch.
 Labels: (Owned) Rochester Disc Reviewer, VHF; (distributed) Out of Print.
 Vadeca, see Penco.
 Thomas J. Valentino Inc., 151 W. 46 St., New York, N.Y. 10036. Tel: (212) 246-4675. Pres.: Thomas J. Valentino Jr.; Exec. VP: Francis T. Valentino; VP: Joanne F. Valentino.
 Labels: (Owned) Major.
 Vamp, see Vample.
 Vample Recs. Inc., PO Box 23152, Kansas City, Mo. 64141. Pres.: Jerry Vample; VP: Freddie Bell; Secretariat & Agent: Jeffrey Zimmerman; A&R: Beneta Payne.
 Labels: (Owned) Vamp Rec'g Co.
 VanBees, see Daytwo.
 Vanco, see Ripcord.
 Vandalia Recs., Box 32, Rt. 2, Quaker St., Vandalia, Mich. 49095. Tel: (616) 476-2110.
 Vanguard Rec's Society Inc., 71 W. 23 St., New York, N.Y. 10010. Tel: (212) 255-7732. Cable: VANMUSICA. Pres. & Classical A&R: Seymour Solomon; Sec'y-Treas.: Maynard Solomon; Pop & Jazz A&R: Danny Weiss; Nat'l Sales Mgr.: Amanda Schuster; Nat'l Promo. & Pub. Dir.: John Boulos; Foreign & Licensing Opns. Dir.: Jo Inguanti; Musicologist: Daniel Nemetz; Chief Eng.: Jeff Zaraya.
 Labels: (Owned) Bach Guild, Cardinal, Everyman Classics, Free Style, Historical Anthology of Music, Nomad, Vanguard.
 Int'l rep.: Argentina (Microfon), Australia (Astor), Austria (EMI), Belgium (Musidisc in France), Brazil (Som), Burma (King in Japan), Canada (Quality), Central America (Dicesa in El Salvador), Colombia (Fuentes), Denmark (Sonet/Dansk), Ecuador (IFESA), Finland (Sonet in Sweden), France (Musidisc), Germany (EMI), Greece (CBS), Hong Kong (Shun Cheong), Israel (Eastronics), Italy (Ricordi), Japan (King), Korea-South (King in Japan), Luxembourg (Musidisc in France), Mexico (Discos & Cintas), Netherlands (Pop-Precision, Classical-Musidisc), New Zealand (Ode), Nigeria (P.N. Onyekwelu), Norway (Arne Bendiksen), Philippines (A&W), Portugal (Radio Triunfo), Spain (Hispanvox), Sweden (Sonet), Switzerland (Phonag), Taiwan (King in Japan), UK (Precision), Venezuela (El Palacio de la Musica).
 Vanishing Point, see Stacy-Lee.
 Vantage Rec'g Co., PO Box 212, Pottstown, Pa. 19464. Tel: (215) 323-3336.
 Labels: (Owned) Jody, Pic-Vue, Piant, Reco-Flex, Semaphore, Sound of Money, Vantage, Zouvenr.
 Varbee, see McKinnon.
 Varese Int'l, see Varese Sarabande.
 Varese Sarabande Recs. Inc., 13006 Satcoy St., North Hollywood, Calif. 91605. Tel: (213) 764-1172. Cable: VARSAR. Telex: 194449. Pres.: Chris Kuchler; Exec. VP: Tom Null; VP: John Sievers; A&R/Special Projects: Scot Holton. (Also see Discwasher).
 Labels: (Owned) Citadel, Varese Sarabande; (distributed) Chalfont, Klavier, PBR, Starlog, Varese Int'l.
 Varulven Recs. & Dist'n, PO Box 2392, Woburn, Mass. 01888. Tel: (617) 935-3560. Pres.: Joseph Allen Count Vigione; VP: Joan McNulty; A&R: Paul B. Lovell, Joe Tortelli; Promo.: Edward J. Sojka, Ray Gianchetti; Mktg.: Jon Goldman, John Visnaskas; Video Dept. Chief: George J. Roewe III; Video: Carolyn Sharp.
 Int'l rep.: France (New Rose).
 Vaya, see Musica Latina.
 Vee Jay Int'l Music, 131 E. Magnolia Blvd., Burbank, Calif. 91502. Tel: (213) 849-2469. Pres.: Betty L. Chiappetta; A&R Dir.: Patrick X. Britt.
 Labels: (Owned) Dynasty, Epitaph, Oldies 45, Vee Jay, A World of Jazz; (distributed) Catalyst, Studio 7.
 Veevo Rec. Co., 54 W. 74 St., Suite 402, New York, N.Y. 10023. Tel: (212) 362-2259. Pres.: Fredric Vonn.
 Vegas Recs., PO Box 80032, Smithfield, Tex. 76180. Tel: (817) 498-3447. Owner-Pres.: D.M. "Doc" Holiday; Sales Mgr. & Promo.: Sandy Sexton.
 Velvet, Calif., see SIPRA.
 Velvet de Puerto Rico Inc., Calle Cerra 627, Santurce, P.R. 00907. Tel: (809) 722-3191, 723-4640.
 Branches: Los Angeles, Calif., 2120 W. Eighth St., Suite 308. Zip: 90057.

Tel: (213) 487-3596—Mishnah Gardens, Fla., 10128 NW 80 Ave. Zip: 33016. Tel: (305) 823-0812.
 Labels: (Owned) Velvet; (distributed) Atlas, DC, Disco Sur, Mercurio.
 Int'l rep.: Germany (Polydor), Netherlands (Phonogram).
 Venture, see Rih Tinory.
 Venus, see Happy Beat.
 Versatile Recs Ltd., 141 E. 63 St., New York, N.Y. 10021. Tel: (212) 838-6565.
 Int'l rep.: Brazil (EMI-Odeon), France (DiscAZ), Venezuela (Velvet).
 Vertex, see Sunshine Country.
 Verve, see PolyGram & PolyGram Classics.
 Verrydisco, see Trend in Calif.
 Vetco Recs., 5825 Vine St., Cincinnati, Ohio 45216. Tel: (513) 242-8000.
 Pres.: Lou Ukleston.
 Vette Recs., 6262 Hollywood, Hollywood, Calif. 90028. Tel: (213) 462-5466.
 Vic, see La Val.
 Victor, see RCA.
 Victor Musical Inds., 9000 Sunset Blvd., Suite 702, Los Angeles, Calif. 90069. Tel: (213) 274-6219. US Rep.: Takashi Misu.
 Victrola, see RCA.
 Village Recs. Inc., 6325 Guilford Ave., Suite 4, Indianapolis, Ind. 46220. Tel: (317) 255-3116.
 Vintage One Recs., Box 576, Libertyville, Ill. 60048. Tel: (312) 367-9390.
 Vintage Rec. Co. Inc., 7901 N. Caldwell Ave., Morton Grove, Ill. 60053. Tel: (312) 967-8775.
 Virgin, see CBS.
 Virginia Rec'g Co., 209 Main St., Fort Lee, N.J. 07024. Tel: (201) 947-3900.
 Owner: Al Thomas; A&R: Tom Argiro; Pub. & Promo.: Jim McCarty. (Distributed by Johnson Rec. Co.).
 Virgo, see Roulette.
 Virtue, see Parr-X.
 Visconjon, see SIPRA.
 Vision, see Ozark Opry.
 Vision (Brazil), see Brasilia.
 Vista, see Disneyland/Vista.
 Vista Int'l Recs., PO Box 120223, Nashville, Tenn. 37212. Tel: (615) 361-3756.
 Viva Recs., 6255 Sunset Blvd., Suite 1019, Los Angeles, Calif. 90028. Tel: (213) 467-2181. Gen. Mgr.: Don Blocker.
 Vocab Inc., 3071 S. Broad St., Chicago, Ill. 60608. Tel: (312) 254-8047.
 Labels: (Owned) Vocab, Wordcraft.
 Voice, see General Broadcasting.
 Voice Box Recs., 3935 Summer Ave., Memphis, Tenn. 38122. Tel: (901) 458-2371. Pres. & A&R Dir.: Mark Blackwood; VP: Cecil Blackwood; Promo Dir.: Barbara Blackwood; Sales & Dist'n Dir.: Caroline Pearson; Shipping & Mng'g: Willie Jackson.
 Vokes Rec. Co., PO Box 12, New Kensington, Pa. 15068. Tel: (412) 335-2775. Pres.: Howard Vokes.
 Labels: (Owned) Country Boy, Vokes.
 Volare Recs. Inc., PO Box 325, Englewood, N.J. 07631. Tel: (201) 567-7538.
 Pres.: Clyde Otis; Prod': David Wofford.
 Volcano, see Crimson Dynasty.
 Volcanus, see Crimson Dynasty.
 Volunteer, see General Music in Tex.
 Vox Box, see Moss.
 Vox Cum Laude, see Moss.
 Vox Singles, see Moss.
 Voyager Recs., 3727 Seattle-First Nat'l Bank Bldg., Zip: 98154, 424 35 Ave., Seattle, Wash. 98122. Tel: (206) 623-0110, 323-1112. Owners: Philip L. & Vivian T. Williams; Sales & Mktg.: Vivian T. Williams.

W

W A E, see Fred Weinberg.
 W A T T Works Inc., Willow, N.Y. 12495. Tel: (914) 688-5373. Owners: Michael Mantler, Carla Bley.
 Int'l rep.: Europe (EMI).
 W B E Recs., 4344 Promenade Way, Suite 300, Marina Del Rey, Calif. 90291. Tel: (213) 823-8311. TWX: (910) 343-7403.
 Home office: Australia.
 W E A (Brazil), see Brasilia.
 W E A Int'l Inc., 75 Rockefeller Plaza, New York, N.Y. 10019. Tel: (212) 484-7100. Cable: ATCOMUSIC. Telex: 424602. Pres.: Nesuhi Ertegun; Sr. VP: Fred Haayen; VP Ops.: Jim Caradine; VP Prod. Admin.: Manfred Bornmann; East Coast A&R Dir.: Ruby Merjan; Press & Pub. Dir.: Tracy Nicholas Bledsoe; Int'l Prod. Mgr.: Jennifer S. Cohen; Bus. Affairs: Virginia Brown; Order Processing Co-ord.: Greta Schickersinsky.
 Admin. office: Burbank, Calif., 111 N. Hollywood Way. Zip: 91505. Tel: (213) 843-6311. Cable: WEALINT. Telex: 181242. Exec. VP: Phil Rose; VP & Treas.: Ken Cooper; VP Videogram Div.: Lee Mendell; Comptroller: Craig Cox; EOP Dir.: Bob McCormack; Royalties Dir.: Don Phillips; West Coast A&R Dir.: Julie Sayres.
 Labels: (see listings for Warner Bros., Elektra & Atlantic).

Sesame Street Records

1 Lincoln Plaza
New York, N.Y. 10023

Phone: 212 874-2700

Art Denish

Shy Raiken
President

Int'l branches: Australia, Austria, Belgium (WEA Recs. & European Coordinating Office), Brazil, Canada, England, France (WEA Filipacchi), Germany, Greece, Hong Kong, Ireland, Italy, Japan (Warner-Pioneer), Malaysia, Mexico, Netherlands, New Zealand, Philippines, Singapore, South Africa, Sweden (WEA Metronome), Switzerland (Int'l European Artists Relations Office).

Int'l reps: Argentina (EMI-Deone), Barbados (Dynamic Sounds in Jamaica), Central America (Dideca in Guatemala), China (Four-Seas), Colombia (Sonolux), Czechoslovakia (Supraphon), Denmark (Metronome), Ecuador (Fediscos), Finland (Scandia), Hungary (Singles only—Kultura), India (Gramophone), Israel (Hed Arzi), Kenya (CBS), Korea (Dasis), Lebanon (Les Fils de Georges Haddad), Nigeria (PolyGram), Norway (Polydor), Peru (El Virrey), Portugal (Radio Triunfo), Spain (Hispano), Switzerland (Musikvertrieb), Thailand (Nite), Turkey (Melodi), Uruguay (Clave), Venezuela (Grabaciones Mundiales), West Indies (Dynamic Sounds in Jamaica), Yugoslavia (Suzy), Zambia (Teal), Zimbabwe (Teal).

W E B C Recs., 8705 Deanna Dr., Gaithersburg, Md. 20760. Tel: (301) 253-5962. Owner-Pres.: Wayne E. Busbice; VP A&R: John W. Busbice; Sec'y Treas.: Martha F. Busbice.

W I M, see Crystal.

W M I, see Dale McBride.

W M O T Ent. Inc., 1228 Spruce St., Philadelphia, Pa. 19107. Tel: (215) 985-0606. Telex: 834784. Pres.: Alan Rubens; VP: Steve Bernstein; A&R: Nick Martinelli; Promo: Reggie Barnes (Distributed by CBS).
Branch: Los Angeles, Calif., 8961 Sunset Blvd. Zip: 90069. Tel: (213) 276-9330. Tel: 698557. VP Int'l Opns. & Gen. Mgr.: Lennie Hodes; Asst. VP Prod. Development & Pub.: Doreen Ringer.

Int'l reps: Benelux (Vogue), France (Vogue), Germany (Metronome), Italy (Ricordi), Mexico (Peerless), Scandinavia (K-tel), UK (PRT).

W W A, see Fred Weinberg.

Wagner, see Album Globe.

Wagon Wheel Recs., Box 85, Rt. 1, Georgetown, S.C. 29440. Tel: (803) 546-7139. Pres. & Owner: Jack Redick.

Wahr, see Sounds South.

Bruno Walter Society, see Educational Media & Discocorp.

Walter Ents., 14702 Canterbury, Tustin, Calif. 92680. Tel: (714) 731-2981. Pres. & A&R Dir.: Steve Waltner; Sales & Mktg.: Sharon Waltner.
Labels: (Owned) Calico, Dasy.

War Brde, see Solid Smoke.

Ware, see Holy Spirit.

Warner Bros. Recs. Inc., 3300 Warner Blvd., Burbank, Calif. 91510. Tel: (213) 846-9090. Bd. Chm. & Pres.: Mo Ostin; Exec. VP: Stan Cornyn; Sr. VP A&R: Lenny Waronker; Sr. VP/Treas.: Murray Giffin; VP Artist Development/Pub.: Bob Regehr; VP Artist Relations: Carl Scott; VP Bus. Affairs: David Berman; VP Nat'l Sales: Lou Dennis; VP Int'l: Tom Ruffino; VP & Exec. Prod'r: Ted Templeman; VP Black Music Mktg.: Tom Draper; VP/Promo. Dir.: Russ Thyret; VP/Prod. Mgmt.: Clyde Bakkiemo; VP/A&R-Progressive: Tommy LiPuma; VP/Creative Dir.: Pete Johnson; VP/Creative Servs. & Opns. Dir.: Adam Somers; Pub. Dir.: Bob Merlis; Progressive Music Dir.: Charlie Lourie; Prod. Mgrs.: Robin Rothman, Benita Brazner, Tim Devine, Veronica Brice; Nat'l Promo. Dir.: Charlie Lake, Pat McCoy, Robert Richards; Nat'l LP Promo. Dir.: George Gerrity, Bonnie Simmons.
Branches: New York, N.Y., 3 E. 54 St. Zip: 10022. Tel: (212) 832-0600 (N.Y.); 832-0950 (Admin.). Sr. VP: Jerry Wexler; VP/Talent: Bob Krasnow; N.Y. Pub. Opns. Dir.: Liz Beth Rosenberg—Nashville, Tenn., PO Box 121196, 1706 Grand Ave. Zip: 37212. Tel: (615) 327-4503. VP/Country Music Dir.: Andy Wickham; Country Div. Gen. Mgr.: Bob Kirsch; Nashville Opns. Dir.: Frank Jones; Promo. Dir.: Stan Byrd; Artist Relations & Pub. Dir.: Bonnie Rasmussen.
Distribution branches: See Record & Tape Wholesalers section for listings for Warner/Elektra/Atlantic Corp.

Int'l branches: see WEA Int'l.

Labels: (Owned) Reprise, Sire, Warner Bros.; (distributed) Bearsville, Dark Horse, ECM, Geffen, Island, Paradise, Quest, Warner/Curb, Warner/Viva, Whitfield.

Int'l reps: See WEA Int'l.

Warner/Curb, see Warner Bros.

Warner/Viva, see Warner Bros.

Warren Rec. Co., 1527 14 St. NW, Washington, D.C. 20005. Tel: (202) 265-2407. Pres.: Dr. C.A. Warren; Exec. VP: Charles H. Montague; VP Sales: Angie M. Bell; Prod'n Mgr.: Rodney Mason; Special Projects Dir.: Betty Wilson, Mae Jackson; A&R: Angus Warren. Promo.: Bertha Rae, M.L. Ruffin; Disco Prod'n: James Davis; Gospel Prod'n: Robert Appletree.
Labels: (Owned) Action, Carwar, Soulin', Warren; (distributed) Bass, Monta, Wet.

Warwick, see East Allegheny.

Washboard, see Sonic Arts.

Waterfall, see Biograph.

Waterhouse Recs., 100 N. Seventh St., Suite 415, Minneapolis, Minn. 55403. Tel: (612) 332-6575. Opns. Dir.: Gary Marx; Nat'l Pub. Dir.: Wayne Isaak; Nat'l Promos. Dir.: Kevin St. John.

Int'l branch: England.

Int'l reps: Canada (Attic), Germany (Line, Teldec), Japan (Polydor), UK (BB).

Waylon, see Times Mgmt.

Fred Weinberg Prod'n Inc., 16 Dundee Rd., Stamford, Conn. 06903. Tel: (203) 322-5778. Pres. & Chief A&R: Fred Weinberg; VP: J. R. Weinberg; Classical A&R: David Crey Lehman; Bus. Affairs: M. Moller.
Labels: (Owned) FWP, Frejo, WAE, WWA.

Weird World, see TK.

Welle Legacy of Piano Treasures, see Recorded Treasures.

Wenra Rec. Co., 5729 Bayview Ave., Richmond, Calif. 94804. Tel: (415) 529-1610.

Wergo, see Celestial Harmonies.

Westbound Recs. Inc., 19631 W. Eight Mile Rd., Detroit, Mich. 48219. Tel: (313) 255-7640. Pres.: Armen Boladian; Admin. Ass't to Pres.: Carole Luedeman; A&R: Bernard Mendelson.
Labels: (Owned) Nine, Westbound.

West End Music Inds. Inc., 250 W. 57 St., Suite 1924, New York, N.Y. 10019. Tel: (212) 757-0695. Pres.: Mel Cheren; VP: Edward L. Kushins.
Labels: (Owned) Ameraba, Spire, West End.

Western, see Mutual Music.

Western News Recs., 595-C Buck, Vacaville, Calif. 95688. Tel: (707) 446-1316.

Western Sound Archive, see Educational Media & Discocorp.

West 54, see Peters Int'l.

West Recs., PO Box 8875, Universal City, Calif. 91608. Tel: (213) 985-2539. Pres.: George E. Clements; VP: Boots Clements.
Labels: (Owned) Dynasty, E. Lane, West.

Wet, see Warren.

Wham Bam Recs. (Music Expo Inc.), PO Box 333, Narberth, Pa. 19004. Tel: (215) 667-5118. Pres.: Denny Somach; VP: Richard Somach.
Labels: (Owned) Denrich, Wham Bam.

Wheel/Home Cooking Recs., PO Box 66595, 3520 Montrose Blvd., Suite 227, Houston, Tex. 77006. Tel: (713) 785-6670. Contact: Roy C. Ames.
Labels: Airplay, Wheel.

Whiplash Recs. Ltd., 150 Gorman St., Naugatuck, Conn. 06770. Tel: (203) 729-2508. Pres.: George Fedorick; Treas./Sec'y: Andrew C. Doback.

White Fox/TR Studios, PO Box 1591, Sarasota, Fla. 33578. Tel: (813) 957-0882. Pres.: Anthony R. Rasmus III; A&R: Tarvin D. Rhodes; Sales/Promo. Mgr.: Laura New.

White Rock Recs. Inc., 401 Wintermantle Ave., Scranton, Pa. 18505. Tel: (717) 343-6718. Pres.: Phil Ladd.

Whitfield Recs. Inc., 901 Westbourne Dr., Los Angeles, Calif. 90069. Tel: (213) 652-5850. (Distributed by Warner Bros.)

Whizeagle Recs., 308 SW Washington, Portland, Ore. 97204. Tel: (503) 226-0088. Owner/Sales Mgr.: Frederick L. Cole; Sec'y: Kathleen A. Cole.

Who's Who in Jazz, see Gemcom.

Wide-World, see Stoneway.

Widebeet Recs., PO Box 311, Rt. 19 N., Wexford, Pa. 15090. Tel: (412) 935-1330. Owner: C.W. Abbott.

Wildwood Entertainment, 114 W. Maiden Ln., Monroe, Conn. 06468. Tel: (203) 261-2979. Pres.: Vincent E. Meyer II; VP: Erich C. Borden.
Branch: Chatham, N.Y., 61 Center St. Zip: 12037. Tel: (518) 434-2014. A&R Dir.: Chuck Wilkins.

Wildwood Studio & Prod'n Inc., Box 157, Rt. 1, Pineville, N.C. 28134. Tel: (704) 588-2324. Pres. & Mgr.: John Roger Branch; VP & Ass't Mgr.: Pat Carpenter.
Labels: (Owned) New Dimension, Southern Wing.

Wildwood, see QCA & Wildwood Entertainment.

Wilamac, see Playette.

Marty Wilson Prod'n Inc., see Made in USA.

Wilwin Recs., PO Box 1669, Carlsbad, Calif. 92008. Tel: (714) 729-8406. Owner: Denny Tymer.

Winchester, see Sounds of Winchester.

Wind, see Celestial Harmonies.

Windfalls Recs., 1790 Broadway, New York, N.Y. 10019. Tel: (212) 765-8450.
Labels: (Owned) Phantom, Windfall.

Windham Hill Recs., PO Box 9388, Stamford, Calif. 94305. Tel: (415) 329-0647. Pres.: William Ackerman.
Labels: Lost Lake Arts, Windham Hill.

Windmill, N.Y., see Michele.

Windom Hill, see Moonlight.

Wind Over the Earth Recs. Inc., 1135 Pearl St., Suite 7, Boulder, Colo. 80302. Tel: (303) 443-9822. Pres.: Mickey Houlihan.

Windy Hill Recs., 119 E. Court Square, Suite 207, Decatur, Ga. 30030. Tel: (404) 296-0967. Pres. & Owner: Jim Diver.
Labels: (Owned) Little Things, Windy Hill.

Winterwood Recs., 33 Highland Ln., Wheeling, W. Va. 26003. Tel: (304) 233-1723. Owner: Don Teachout.

Wizard Prod'n Inc., 2501 S. Ocean Dr., Hollywood, Fla. 33019. Tel: (305) 925-1799. Pres.: Robert S. Taran; Nat'l Sales Mgr.: Evelyn Geldon; Promo.: Burt Compton; A&R: Mike Lewis.

Wizard Recs., 8913 Sunset Blvd., Hollywood, Calif. 90069. Tel: (213) 271-0383. Exec. Dir.: Robert Porter.
Int'l branch: Australia.
Int'l rep.: Australia (EMI).

Wizard, Tex., see Colonel Buster Doss.

Wolf, Fla., see TK.

Wooden Nickel Recs. Inc., c/o Cooper, Epstein & Hurewitz, 9465 Wilshire Blvd., Suite 800, Beverly Hills, Calif. 90212. Tel: (213) 550-1010. Chm.: Jerry Weintraub; Co-Pres.: William Trout; Co-Pres./Sec'y: James Golden.
Wordcraft, see Vocab.

Word Inc., 4800 W. Waco Dr., Waco, Tex. 76710. Tel: (817) 772-7650. Pres.: Jarrell McCracken; Sr. VP Recs. & Music: Stan Moser; VP Sales: Roland Lundy; VP A&R: Buddy Huey; VP Mktg. & Promo.: Dan Johnson; Mdsq. Dr.: Rob Dean; PR Dir.: Walt Quinn.

Branches: North Hollywood, Calif., 10000 Riverside Dr., Suite 1, Toluca Lake, Zip: 91602. Tel: (213) 760-0395. A&R Dir.: Gary Whitlock—Nashville, Tenn., 2300 21 Ave. S. Zip: 37203. Tel: (615) 327-1874. A&R Dir.: Ken Harding.

Int'l branches: Australia (Sacred), Canada (Word), England (Word), New Zealand (Sacred).
Labels: (Owned) Canaan, DaySpring, Myrrh, Word; (distributed) Good News, Image 7, Light, Lumina/Leuxon, Maranatha!, Seed, Solid Rock.

World Int'l Group Inc., 2125 Eighth Ave. S., Nashville, Tenn. 37204. Tel: (615) 383-6540. Pres.: Gene Kennedy; Nat'l Promo. Dir.: Bobby Young.
Labels: (Distributed) BMA, Door Knob, 7 Star.

A World of Jazz, see Vee Jay.

World Sound Rec'g Inc., PO Box 37358, Detroit, Mich. 48235. Tel: (313) 478-3048. Pres.: Dennis A. Gannage.
Labels: (Owned) Candy Apple, World Sound.

Worldstar Recs., PO Box 2609, 119 1/2 E. Main St., Lafayette, La. 70502. Tel: (318) 235-3587. Owner/Mgr.: J. Michael Fernandez.

Worldtone Music Inc., 230 Seventh Ave., New York, N.Y. 10011. Tel: (212) 691-1934.
Labels: (Owned) Worldtone; (distributed) Balkanton (Bulgaria), Electrocord (Romania), Eterna (East Germany), Finleyne (Finland), Heidon (Yugoslavia), Swedish Discophile (Sweden), Telestar (Sweden), Umidisc (France).

World Wide Music Inc., 1300 Drivon St., Nashville, Tenn. 37203. Tel: (615) 256-7543. Pres.: Calvin H. Everhart.
Label: (Owned) Trun.

Worldwide Music Servs., PO Box 995, Ansonia, Sta., New York, N.Y. 10023.

Wormwood Projects, 1540 Lehigh St., Boulder, Colo. 80303. Tel: (303) 499-1108. Pres.: Michael D. Aisner.
Labels: (Owned) Sealsong, Shire, Wormwood.

Wright Recs., 4123 N. 44 St., Milwaukee, Wis. 53216. Tel: (414) 873-4287. Pres.: Ken Wright; VP: Kurt Jensen.

X

X K R III, see King & Moore Prod'n.

X L, see Rayner Street.

Xanadu Recs. Ltd., 3242 Irwin Ave., Kingsbridge, N.Y. 10463. Tel: (212) 549-3655. Cable: XANADU. Pres.: Don Schitten; VP Promo.: Nina Louise Reid Schitten.
Int'l reps: Brazil (Musisom), Canada (Almada), Italy (IRD), Japan (Nippon Columbia).

Y

Y T F (Sweden), see SWS.

Yatahey Recs., PO Box 31819, Dallas, Tex. 75231. Tel: (214) 750-0720. Owner: Pat McKool; A&R: Bart Barton; Promo.: Rusti James. (Also see Sunshine Country).
Labels: (Owned) Yatahey; (distributed) Branch Int'l, Lemon Square.

Yazoo Recs. Inc., 245 Waverly Pl., New York, N.Y. 10014. Tel: (212) 255-3698. Pres., Sales & Pub.: Nick Peris; Pop A&R: Steve Calt; Adv.: James Pohl; Promo. Dir.: Felix Fernandez; Tape: Bob Hicks; Int'l Rep.: James Soli.

Int'l reps: Australia (Larrikin), Canada (Almada), Finland (J. Santavouri), France (DRA), Italy (IRD), Japan (Shinsei), Sweden (Amigo), UK (Swift).

Yellow Bee Prod'n Inc., 245 Waverly Pl., New York, N.Y. 10014. Tel: (212) 255-3698. Pres., A&R & Disco Relations: Nick Peris; VP Int'l Sales: Ben Covington; Pub., Adv. & Promo.: Chris Nelson; Sales & Mktg.: Roosevelt Graves; Adv.: Steve Calt; Tape: Lemon Jefferson.
Label: (Owned) Blue Goose.

Int'l reps: Australia (Larrikin), Finland (J. Santavouri), France (DRA), Italy (IRD), Japan (Shinsei), Netherlands (Sound Prods.), Sweden (Amigo), UK (Projection, Swift).

Yellow Bird, see Canary.

Young (Brazil), see Fermata.

Young Heartz Music Education Serv., PO Box 27784, 2409 Hyperion Ave., Los Angeles, Calif. 90027. Tel: (213) 663-3223.

Yvette's, see Rooster Blues.

Z

Zansabar, see Crimson Dynasty.

Zeida, see Discolando.

Zenth, see Random.

Ze Recs., 154 W. 57 St., New York, N.Y. 10019. Tel: (212) 245-7233. Pres.: Michael Zilkha; Opns. Dir.: Eileen Roaman; Nat'l Promo. Mgr.: Debbie Caponetta.

Zim Recs., PO Box 158, 18 Ivy Dr., Jericho, N.Y. 11753. Tel: (516) 681-7102, 822-7952. Owner: Arthur Zimmerman.
Labels: (Owned) Zim; (distributed) Attalaxers (Sweden), Dragon (Sweden), Honeydew (USA), Jazz Connoisseur (Italy), No Gap (USA), Raretone (Italy), Unique Jazz (Italy).

Int'l reps: Germany (International Music Serv.), Italy (Raretone), Switzerland (Plainsphere), UK (Jazz Horizons).

Zipcode, see Ralph's Radio.

Zipp Zapp Recs. Corp., 1425 Key Hwy., Baltimore, Md. 21230. Tel: (301) 727-5544. Pres. & Promo. Mgr.: Charles P. Guerriero; Treas. & Bus. Mgr.: Ernest W. Cash; Sec'y & Sales Mgr.: John C. Guerriero.

Zv Int'l Inc., 600 N. Sepulveda Blvd., Bel Air, Calif. 90049. Tel: (213) 476-7345. Cable: ZWINC. Telex: 698619. Bd. Chm.: Max Ruderian; Pres.: Irv Holender; Projects Dir.: Alan Letz; Prod'n Mgr.: Matt Steinbuch.

Zombie, see Right Note.

Zondervan Recs. (div. of Zondervan Corp.), 1415 Lake Dr. SE, Grand Rapids, Mich. 49506. Tel: (616) 459-6900. Recs. Dir.: Phil Brower.
Labels: (Owned) Milk 'n' Honey, New Dawn.

Zouvenir, see Vantage.

Zynn, see Master-Trak.

Zyzz Recs., PO Box 23, Sun Valley, Calif. 91352. Tel: (213) 982-2174. Owner & Pres.: James Freedner; Promo.: Lawrence Treadwell.

To save you time and money we've just spent over 546 hours training your next employee!

When money and time are tight, you can't afford to train an employee from scratch. Our graduates have spent a full year in an intensive study of Audio Engineering, Music Production, Studio Electronics, Music Business and Finance, Copyright Laws and Entertainment Contracts. They're young, knowledgeable, and—because they're well trained—effective from the start. Graduates and referrals among the Majors!

If you are in need of someone already possessing the basic knowledge and skills of the industry, we might just have the person to fit your situation.

So call or write us at: **College for Recording Arts**
665 Harrison Street, San Francisco, California 94107
Phone: (415) 781-6306

P.S. If you know a promising and talented person that you'd like to help along, why not let us train them for you!



The school is accredited by the Accrediting Commission of the National Association of Trade and Technical Schools (NATTS), approved by the Calif. Superintendent of Public Instruction, approved for Veteran training, and is authorized under Federal law to enroll non-immigrant alien students. It is also endorsed by the National Academy for Recording Arts and Sciences Training Institute.

MUSIC PUBLISHERS

OF THE UNITED STATES



A

A A O Music (ASCAP), 7231 Franklin Ave., Suite 19, Hollywood, Calif. 90046. Tel: (213) 876-3588. Pres: Spike Janson; VP: O.K. Turner.

A B I/Alexander Brode Inc., 225 W. 57 St., New York, N.Y. 10019. Tel: (212) 586-1674. Cable: ALBROS. Pres: Robert J. Bregman; VP: Dean Streit, Sec'y-Treas.: Michael Lefferts.

Int'l firms represented: Breitkopf & Haertel, J&W Chester (choral works), Composers Library Eds., Continuum Music Press, J.B. Cramer & Co. Ltd., Deutscher Verlag für Musik, Fenette Music, Fontone Music, Glochen Verlag Ltd. (Lehar works), Friedrich Hofmeister, Leonard, Gould & Boffler, MSM, Mount Tahoma Music (Covhanes works), Neue Musik Verlag, Pro Musica, Basil Ramsey, Tetra Music Corp., Transcontinental Music Publ'ns (Jewish music catalog).

A B P Publ'g (ASCAP), 240 Central Park S., New York, N.Y. 10019. Tel: (212) 582-7379. Pres: Allen Abdulezer.

A. K. A. Music (ASCAP)—Contact: Ace K. Adler-Rudd—see Snoopy.

A M Gems (BMI), see Bug Music Group.

A/S Prod'ns (ASCAP), 1825 S. Michigan, Chicago, Ill. 60616. Tel: (312) 644-2044. Pres.: Sylvester Ames Jr.; VP: Colette Skinner; VP & A&R Dir.: Jerome Metcalf.

A S C Music Co. Inc. (ASCAP), 168 W. 10th St., Binghamton, N.Y. 13901. Tel: (607) 722-7259. Pres. & Gen. Mgr.: David J. Lebus. Branch: New York, N.Y., 7 E. 14 St. Zip: 10003.

A T V Music Corp. (BMI), 6255 Sunnyside Blvd., Hollywood, Calif. 90028. Tel: (213) 462-6933. Branches: New York, N.Y., 888 Seventh Ave. Zip: 10019. Tel: (212) 977-5680—Nashville, Tenn., 16 Ave. S. Zip: 37203. Tel: (615) 327-2753. Int'l branches: England, France.

Int'l firms represented: ATV Ltd. (UK), McCauley Music Ltd. (Canada).

Chris Aaron Music (BMI), 3282 Catalina Ave., Santa Clara, Calif. 95051. Tel: (408) 998-0140. Pres.: Chris Aar; VP: Joe Newbert; Prof. Mgr.: Debora Aaron.

Abduction Music (BMI), see Bug Music Group.

Abingdon Press, 201 Eighth Ave. S., Nashville, Tenn. 37202. Tel: (615) 749-6459/6396. Gen. Mgr.: Harold L. Fair; Music Ed.: Robert D. Hoffelt.

Abkco Music Inc. (BMI), 1700 Broadway, New York, N.Y. 10019. Tel: (212) 399-0300. Pres.: Allen Klein; VP: Joel Silver. Int'l rep.: UK (Essex).

Able Music Inc. (BMI), PO Box 387, Oakwood, Va. 24631. Tel: (703) 498-3337. Pres.: Roy John Fuller; Gen. Mgr.: Terry Arrington; Prof. Mgr.: David Stevenson. Branch: Vassant, Va., PO Box 308 Zip: 24656. Tel: (703) 498-3570. Gen. Mgr.: J. Brown.

Abnak Music Ents. Inc. (BMI), 825 Olive at Ross, Dallas, Tex. 75201. Tel: (214) 742-6111.

Accabonac Music (ASCAP), see Chrysalis Lane.

Accadia Music Co. (ASCAP), 996 1/2 Hurant Dr., Beverly Hills, Calif. 90212. Tel: (213) 277-8383. Pres. & Gen. Mgr.: Mary Herscher; VP & Gen. Mgr.: Selma Herscher. (Affiliated with Eddie Weldon Music.) Int'l rep.: Japan (Toshiba), UK: Cyril Shane, Campbell Connelly).

Accredit Music (BMI), see Annexa.

Accreative Copyright Co. (ASCAP), see: Solar Recs.

Accumulative Copyrights Co. (BMI), see Solar Recs.

Acoustic Music Inc. (BMI), PO Box 146, Nashville, Tenn. 37202. Tel: (615) 242-9198. Pres.: Danny Davis. A minor: Nancy Dunne.

Across the Miles Music Publ'g Co. (BMI), c/o David J. Steinberg, 818 Widener Bldg., 1339 Chestnut St., Philadelphia, Pa. 19107. Tel: (215) 564-3880. Pres.: William P. Neale; P. Mgr.: Diane Bernstein.

Acuff-Rose Publ'ns Inc. (BMI), 251C Franklin Rd., Nashville, Tenn. 37204. Tel: (615) 385-3031. Cable: ACUF ROSE. Pres.: Wesley H. Rose; VP & Gen. Mgr.: John R. Brown; VP's: L. De N. May, Mel Foree; Prof. Mgr.: Ronnie Gant.

Int'l branches: Australia, Belgium, Denmark, France, Germany, Italy, Japan, South Africa, Switzerland, L.S.

Int'l rep.: British Honduras (EMI/ASA), Colombia (EMLASA), Costa Rica (EMLASA), Dominican Republic (EMLASA), Israel (Subar), Japan (Shinko), Mexico (EMLASA), Nicaragua (EMLASA), San Salvador (EMLASA), Venezuela (EMLASA).

Adamo Music Corp. (ASCAP), see Larry Spier.

Adams-Ethridge Publ'g Co. (BMI), K. M. Kniper St., Galveston, Tex. 77550. Tel: (713) 763-8344. Int'l rep.: Australia (J. Albert), UK (Francis Day & Hunter).

Adamsongs (ASCAP), see Pazz.

Adaptor Music (BMI), see Bug Music Group.

Addison Street (ASCAP), c/o Sterling Music Co., 8907 Wilshire Blvd., Suite 102, Beverly Hills, Calif. 90211. Tel: (213) 652-5131.

A Dish-A-Tunes Ltd. (BMI), 1605 Broadway, No. 1107, New York, N.Y. 10019. Tel: (212) 245-9612. Pres.: Ken Williams; Gen. Mgr.: Mattie Simpkins.

Admiral Music Publ'g (BMI), see Brunswick.

Adonikam Music (BMI), PO Box 834, Sta. A., Greenville, S.C. 29604. Tel: (803) 271-1104. Pres.: Richard H. Sandigde.

Adventure Music Co. (ASCAP), 1201 6 Ave. S., Nashville, Tenn. 37212. Tel: (615) 320-7287. Pres.: Charles Chiffman; Gen. Mgr.: Georgia Chiffman.

Aesthetic Artist Recs. (ASCAP), PO Box 144, Mid City Sta., Dayton, Ohio 45402. Tel: (513) 252-9426. Ow. er: Paul Wayne Beach.

Agepe (ASCAP), see Hope.

Agent Orange Music (ASCAP), see Rokblok.

Ahab Music Co. Inc. (BMI), 1707 Grand Ave., Nashville, Tenn. 37212. Tel: (615) 327-4629. Pres.: Ray Stevens.

Fred Ahlert Music Corp. (ASCAP), 8907 Wilshire Blvd., Suite 102, Beverly Hills, Calif. 90211. Tel: (213) 652-5131. Pres: Fred E. Ahlert Jr.

Air Raid Music (ASCAP), see 20th Century.

Ala Jamal Music (BMI)—Pres: John Ford Coley—see Silver Nightingale.

Alamo Village Music (BMI), 50 Music Square W., Suite 401, Nashville, Tenn. 37203. Tel: (615) 242-8774.

Al-Bo Music Co. (ASCAP), 37 Odell Ave., Yonkers, N.Y. 10701. Tel: (914) 969-5673. VP & Gen. Mgr.: Joe Bolon.

Alaetha Jane Music (ASCAP), PO Box 4740, Nashville, Tenn. 37216. Pres: Wade Curtiss.

Alexandria House Inc. (ASCAP), PO Box 300, Alexandria, Ind. 46001. Tel: (317) 724-4438. Pres. & Gen. Mgr.: William J. Gaitner; Mtg. Mgr.: Jerry W. Weimer; Sales Mgr.: Robert G. Rist.

Alexis Music Inc. (ASCAP), see Lee Magid.

Alex Music (ASCAP), see Beldeck Levine & Hoffman.

Alfie Recs. (ASCAP, BMI), 7769 Melrose Ave., Los Angeles, Calif. 90046. Tel: (213) 653-4818. Pres.: Al Durand; Gen. Mgr.: Donna Lee; Prof. Mgr.: Dick Gordon.

Alfred Publ'g Co. Inc. (ASCAP), 15335 Morrison St., Sherman Oaks, Calif. 91403. Tel: (213) 995-8811. Pres.: Morton Manus; Exec. VP: Sandy Feldstein.

Algee Music Corp. (BMI), see Al Gallico.

Aliben Music (BMI), see Skinny Zach.

Alima Music Publ'g, 9937 Rainier Ave. S., Seattle, Wash. 98118. Tel: (206) 447-1696. Pres.: Paul Speer.

Aljoni Music Co. (BMI), PO Box 18918, Los Angeles, Calif. 90018. Tel: (213) 934-9955. Owner: Al Hall Jr.

Alkatraz Corner Music Co. (BMI), PO Box 3316, San Francisco, Calif. 94119. Mng. Dir.: Bill Belmont; Dir.: Joe McDonald.

Int'l reps: Australia (Festival), Austria (Rolf Budde), Benelux (Co of the 2 P's/eters), Brazil (ELAM), Central America (CBS), France (Bagatelle), Germany (Rolf Budde), Greece (EMI), Ireland (Chrysalis), Italy (Usignolo), Japan (Hary Fox), Mexico (CBS), New Zealand (Festival), Scandinavia (Sonet), South America (CBS), Spain (EGO), Switzerland (Rolf Budde), UK & Commonwealth (Chrysalis).

Al-Krus Music (BMI), PO Box 4185, Youngstown, Ohio. 44515. Tel: (216) 793-7295. Owner: Richard M. Hahn.

Allied Artists Music Co. Inc. (ASCAP), 15 Columbus Circle, New York, N.Y. 10023. Tel: (212) 541-9200. Cable: ALLARTINT.

All Night (BMI), c/o Odyssey Prod'ns Inc., PO Box 120384, Achlen Sta., Nashville, Tenn. 37212. Tel: (615) 327-9301. Pres.: C.E. Jackson.

All Sunrays Publ'g Co. (ASCAP), see 20th Century.

Allysonne Publ'g Inc. (ASCAP), see 20th Century.

Al-Mc Music (BMI), see Skinny Zach.

Alpha Music Inc. (BMI), 40 E. 49 St., New York, N.Y. 10017. Tel: (212) 753-3234. Pres.: Michael Nurko; VP: A. Vander Molen.

Int'l firms represented: Bosworth & Co. Ltd. (UK); Caramba (Ed.), Jump Ed. Musicali (Italy).

Int'l rep.: UK (Bosworth).

Alpha-Robinson (ASCAP), 19176 Mitchell, Detroit, Mich. 48234. Tel: (313) 893-9370. Pres.: Juanita Robinson.

AlRuby Music Inc. (ASCAP), 8515 Hollywood Blvd., Hollywood, Calif. 90069. Tel: (213) 654-3760.

Alshire Publ'g Cos., PO Box 7107, Zip: 91505; 1015 Isabel St., Burbank, Calif. 91502. Tel: (213) 849-4671. TWX: (910) 498-2759. Cable: BUD-SOUND. Pres.: A. Sherman; Gen. Mgr.: Freda Gross.

Al's Written Music Publ'ns (BMI), 1313 Washington, Parsons, Kan. 67357. Tel: (316) 421-1666. Pres.: C.H. Monday; Gen. & Prof. Mgr.: Albert H. Monday.

Int'l rep.: France (Michel Meyer).

Altam Music Corp. (BMI), see Al Gallico.

Alternatives in American Music (ASCAP), PO Box 6127, Albany, Calif. 94706. Tel: (415) 527-3606. Gen. Mgr.: George M. Lely.

Altez Music (ASCAP), 119 Altez NE, Albuquerque, N.M. 87123. Tel: (505) 296-5578. Owner: J.C. West.

Altman & Greenberg, 1650 Broadway, Rm. 701, New York, N.Y. 10019. Tel: (212) 586-0240. Co-Pres.: Al Altman, Stu Greenberg.

Alvera Publ'g Co. (BMI), PO Box 9304, Tulsa, Okla. 74107. Tel: (918) 242-3303. Pres. & Gen. Mgr.: Al Clauser; Prof. Mgr.: Vera Clauser.

Amachrst Music (ASCAP), see Funky but.

Amadeo-Brio Music (ASCAP, BMI), see Funky but.

Amadeus Music Co. (ASCAP), c/o Franklin Weinrib, Rudell & Vassallo, 950 Third Ave., New York, N.Y. 10022. Tel: (212) 222-2225. Pres.: Earl Rose.

Amalgamated Tulip Corp. (BMI) (div. of Saturn Inds. Inc.), 117 W. Rockland Rd., Libertyville, Ill. 60048. Tel: (312) 362-4060. Pres.: Perry H. Johnson; Prof. Mgr.: Messy Heron.

Amalasia (ASCAP), 3929 46 St., Sunnyside, N.Y. 11104. Tel: (212) 361-2582. Pres.: Charles Lucy; Prof. Mgr.: Robert Lee Martin.

Amber Ways Music (ASCAP), see Americus Music.

Ameb Music Co. (BMI)—Pres.: Carl Maduri; Prof. Mgr.: Gary Doberstyn—see Stone-Rap.

American Broadcasting Music Inc. (ASCAP), 1330 Ave. of the Americas, New York, N.Y. 10019. Tel: (212) 887-7777. Dir.: Ronald Schubert.

Int'l reps: Australia (Chappell), Austria (Schmolzi & Slezak), Belgium (Marouani), Brazil (Intersong), Central America (Edmusa), Czechoslovakia (Schmolzi & Slezak), France (Marouani), Germany (Schmolzi & Slezak), Greece (CBS), Hong Kong (Pathe), Hungary (Schmolzi & Slezak), Israel (CBS), Italy (Ricordi), Japan (Victor), Malaysia (Pathe), Mexico (Edmusa), Netherlands (Basart), New Zealand (Chappell), Scandinavia (April), South America (Intersong), Spain (Quiroga), Switzerland (Schmolzi & Slezak), UK (Cavalcade), Yugoslavia (Schmolzi & Slezak).

American Composers Alliance (BMI), 170 W. 74 St., New York, N.Y. 10023. Tel: (212) 362-8900. Pres.: Nicolas Roussakis; Gen. Mgr.: Rosalie Calabrese.

American Composers Ed. (BMI), see American Composers Alliance.

American Cowboy Music Co. (BMI), 14 Music Circle E., Nashville, Tenn. 37203. Tel: (615) 256-8812. Gen. & Prof. Mgr.: William G. Hall. (Administered worldwide excluding US & Canada by Cherry Lane).

American Dream (ASCAP), 1407 Broadway, New York, N.Y. 10018. Tel: (212) 354-1990.

American Heritage Music Corp. (BMI), 1208 Everett St., Caldwell, Idaho 83605. Tel: (208) 459-7382. Pres., Gen. & Prof. Mgr.: Loyd J. Wanzer.

American Pie Music (BMI), 50 Southmont Dr., Tuscaloosa, Ala. 35405. Tel: (205) 345-2162. Pres.: Jim Salem.

American Rainbird Music (ASCAP), c/o Morning Music USA, PO Box 120478, Nashville, Tenn. 37212.

Home office: Australia.

Int'l firms represented: Barrelhouse, Image, July, Rainbird (all Australia).

Americus Music (ASCAP), PO Box 314, Hendersonville, Tenn. 37075. Tel: (615) 822-5511. Pres.: Donald L. Risa.

Amerosa Music Inc. (ASCAP), see President.

Ametoy Music (BMI), 117 N. Las Palmas Ave., Los Angeles, Calif. 90004. Tel: (213) 938-5482. Pres.: Albert Marx.

Amigo Music Publ'g Co. (ASCAP), 6137 N. Sixth St., Philadelphia, Pa. 19120. Tel: (215) 548-4038. Pres.: Ray Karol.

A-Minor Music (ASCAP), see Universe Communications.

Amron Music (ASCAP), 20531 Plummer St., Chatsworth, Calif. 91311. Tel: (213) 998-0443. Pres. & Gen. Mgr.: A.E. Sullivan; Prof. Mgr.: Dale Sullivan.

Amore Music (BMI), see Alan Hartwell Music.

Amphora Music Corp. (BMI), 1727 Division St., Davenport, Iowa 52804. Pres.: Frank L. Engel.

Ancora Publ'g, 2439 S. Dorsey, Tempe, Ariz. 85282. Tel: (602) 966-7764. Owner & Mgr.: V. Val Michael.

Andgold Music Publ'g, see OAS Music Publ'g.

Andrade Publ'g Co. (BMI), PO Drawer 520, Stafford, Tex. 77085. Tel: (713) 723-3918. Mgr.: Daniel Andrade.

Andrea Music Co. (SESAC), 925 N. Third St., Philadelphia, Pa. 19123. Tel: (215) 627-2277.

Androd Music (BMI), see Bug Music Group.

Andustin Music (ASCAP), PO Box 669, Woodstock, N.Y. 12498. Tel: (914) 679-6069. Pres.: Harris Goldberg; Dir.: Tim Moore, Johanan Yigoda; Prof. Mgr.: Lionel Conroy. (Administered in US & Canada by Ackee/Island Music.)

Int'l reps: Australia (Essex), Germany (Seigel), France (Aiko), Italy (Intersong), UK (Sunbury-Dunbar), Sweden (Aur).

Mike Angelo Music (ASCAP), see Iffi Fitz.

Angelstream Music (ASCAP), see Duell Hart Publ'g.

Johnny Angle Publ'g (BMI), 1772 Hamilton Blvd., Jackson, Miss. 39213. Tel: (601) 362-9172. Owner & Pres.: Johnny Angle.

Anitya Publ'g (ASCAP), 4810 SW 69 Ave., Miami, Fla. 33155. Tel: (305) 665-5701. Cable: MJS/MS/US. Tel: 519739.

Anlon Music Co. (ASCAP)—Owner: Andy Badale—see Puvanne.

Annabelle Music (BMI), see Loring.

AnnBen Music (BMI), see Quint Benedetti.

Annextra Music (BMI), PO Box 40364, Nashville, Tenn. 37204. Tel: (615) 327-0845. Pres.: Ann J. Morton; Gen. Mgr.: Larry Morton; Prof. Mgr.: Aubrey Kelly.

Annie Over Music (ASCAP), see Bobby Fischer.

Annut Music Ltd. (ASCAP), 2933 River Rd., Croydon, Pa. 19020. Tel: (215) 785-1541.

Anode Music Publ'g (BMI), PO Box 11967, Houston, Tex. 77016. Tel: (713) 987-2273. Pres.: Freddie Kober; Gen. Mgr.: Claudia Kober.

Anteresgeo Music (BMI), see Jame.

Chuck Anthony Music Inc. (BMI), PO Box 879, Altamonte Springs, Fla. 32701. Tel: (305) 869-7300. Pres.: Chuck Anthony; Prof. Mgr.: Randy Irwin.

Antsra Music Inc. (ASCAP), 1650 Broadway, Suite 1001, New York, N.Y. 10019. Tel: (212) 489-7555. Telex: 654781. Pres.: Ralph MacDonald; VP: William Salter; Gen. Mgr.: Kirk Fancher; Prof. Mgr.: William Eaton.

Any Production Inc. (ASCAP), 2118 W. 12 St., Santa Ana, Calif. 92703. Tel: (714) 836-1760. Pres.: Craig A. Kitchens.

Apache's Rhythm Music Publ'g (ASCAP), PO Box 34032, Bartlett, Tenn. 38134. Pres.: Paul Zaleski.

Ape's Hit (BMI), see Monkey Music.

Apex Music Publ'ns (BMI), 19146 Teng Ln., Cupertino, Calif. 95014. Tel: (408) 252-1580. Pres. & Gen. Mgr.: E.F. Moss; Prof. Mgr.: R. Richards. Branch: Melbourne, Fla., 4290 Sherwood Blvd. Zip: 32935. Tel: (305) 254-9286. Chief Exec.: Harvey P. Moss.

A-Pus Music Inc., see Arista Intersong.

Apon Publ'g Co. (ASCAP), PO Box 3082, Steynway Sta., Long Island City, N.Y. 11103. Tel: (212) 721-5599. Cable: APONRECS. Pres.: Andrew M. Poncic; Gen. & Prof. Mgr.: Dana I. Mychajiw.

Int'l firm represented: Supraphon Publ'g House (Czechoslovakia).

Appalshop Inc. (BMI), PO Box 743, 118 Main St., Whitesburg, Ky. 41858

Billboard 1981-1982 International at Buyer's Guide

Tel (606) 633-9958. Pres. Dee Davis; Gen. Mgr.: Dudley Coker; Prof. Mgr. Dudley Wilson; Promo Dir.: Rick Bell.
Mike Appel Prod's, 75 E. 55 St., New York, N.Y. 10022. Tel: (212) 759-1610. Pres.: Mike Appel; Opns. Dir.: Robert L. Martin; Admin. Affairs Dir.: Mona Tobin.
Int'l repa.: Australia (Pieglu), Belgium (Hans Kusters), France (Inter-song-Tutti), Germany (Siegel), Italy (Curci), Midwest (Intersong), Japan (April), Netherlands (New Dayglow), South Africa (Intersong), Sweden (Intersong), UK (Intersong).
Apple Butter Music (ASCAP)—Owner: Danny Morgan—see Sunnyslope.
Apple-Glass Music (BMI), PO Box 168, Madison, Wis. 53701. Tel: (608) 251-2000. Pres.: Daniel W. Miller.
Appropos Music (BMI), see Alan Hartwell Music.
April/Blackwood Music Inc., 1350 Ave. of the Americas, 23rd fl., New York, N.Y. 10019. Tel: (212) 975-4886.
Branches: **Canby City, Calif.**, 1801 Century Park W. Zip: 90067. Tel: (213) 556-4780—**Nashville, Tenn.**, 31 Music Square W. Zip: 37203. Tel: (615) 329-2374.
Int'l branches: Argentina, Australia, Belgium, Brazil, Canada, Costa Rica, France, Germany, Greece, Israel, Italy, Japan, Mexico, Netherlands, South Africa, Spain, Sweden, UK, Venezuela.
Aquarius Music Ltd. (ASCAP), 1501 Broadway, New York, N.Y. 10036. Tel: (212) 221-1940. Pres. & Prof. Mgr.: Arnold H. Goldstein.
Arcade Music Co. (ASCAP), see Rex Zarzo.
Archway Publ'g (BMI), see Mariena Music.
Arc Music Corp. (BMI), see Goodman Group.
Ardavan Music (ASCAP), PO Box 2512, Hollywood, Calif. 90028. Tel: (213) 462-3745. Pres.: Ardie Bryant; Gen. Mgr.: Anne Bryant; Prof. Mgr.: David P. Bryant.
Arenar Tracks Music Co. (ASCAP), see Juru.
Argiro Music (BMI), see Virginia Music.
Argonaut Music (BMI), see Hiding.
Argyle Music (ASCAP), see Spina.
Arian Publ'ns (ASCAP), see OAS Music Group.
Arista Music (ASCAP), see Arista-Interworld.
Arista-Interworld Music Group, 8304 Beverly Blvd., Los Angeles, Calif. 90048. Tel: (213) 852-0771. Cable: INMUSIC. Telex: 67499. Pres.: Billy Meshe; Bus. Affairs Dir.: Jeff Brabec; Gen. Prof. Mgr.: Linda Blum; Copy-right Mgrs.: Judy Hicks, Theresa Powers.
Branch: New York, N.Y., 6 W. 57 St. Zip: 10019. Tel: (212) 489-7400. Prof. Mgr.: Steve Sussman.
Aristos Music (BMI), PO Box 184, Chapel Hill, N.C. 27514. Tel: (919) 967-6666. Pres.: David L. Robert.
Arkadelphia Music (ASCAP), see Bregar Music.
Ark of Glenns Music (ASCAP), PO Box 19215A, Los Angeles, Calif. 90019. Tel: (213) 737-6196. Pres.: Tommy Colbert.
Arlo Publ'g/Bearce Publ'g (ASCAP), 7635 Telephone Rd., LeRoy, N.Y. 14482. Tel: (716) 584-3040. Pres.: Kenneth Bearce; Gen. Mgr.: James Bearce; Prof. Mgr.: Jill D. Welzel.
Branch: **Buchser, N.Y.**, 52 Belmont St. Zip: 14620. Tel: (716) 442-9112. Chief Exec.: Jack Bearce.
Armadillo Music (BMI), see Bug Music Group.
Arm Band Music (BMI), see Bug Music Group.
Arnakata Music Inc. (ASCAP), see Cherry Lane.
Arpell/Pinnellas Music Publ'g (ASCAP, BMI) (a Rogue Entertainment Co.), PO Box 568, Woodland Hills, Calif. 91365. Tel: (213) 992-4922. Pres.: Ron Hitchcock; Prof. Mgr.: Ben Rodgers.
Art Audio Publ'g Co. (BMI), 9706 Cameron St., Detroit, Mich. 48211. Tel: (313) 893-3406. Pres.: Albert M. Leigh; Gen. & Prof. Mgr.: Dolores M. Leigh. **Local Branch:** 12080 Moenart St. Zip: 48212.
Douglas Arthur Music (BMI), see Larry Spier.
Artrex Corp., 229 Las Vegas Blvd. S., Las Vegas, Nev. 89101. Pres.: Arthur H. Benson.
Branch: **Hollywood, Calif.**, 1560 N. La Brea, Suite M. Zip: 90028. Tel: (213) 467-7644.
Int'l repa.: France (Michel Meyer).
Artsons Publ'g (ASCAP), PO Box 15032, Fort Lauderdale, Fla. 33318. Tel: (305) 584-1904. Pres.: Harold E. Doane; Exec. VP: Vivian P. Doane.
Ashley Publ'ns Inc. (BMI), 263 Veterans Blvd., Carlstadt, N.J. 07072. Tel: (201) 935-1113.
Int'l repa.: UK (Ashley, Fields).
Ash Valley Music Inc. (ASCAP), 1609 Hawkins St., Nashville, Tenn. 37203. Tel: (615) 244-1060. Pres.: Owen Bradley; Gen. Mgr.: Harold Bradley; Prof. Mgr.: Cecile Light.
Asiomar Music (ASCAP) (div. of RBR Communications Inc.), 43 W. 61 St., New York, N.Y. 10023. Tel: (212) 757-8805. Co-Pres.: Richard Bradley, Bill Radics; Prof. & Creative Mgr.: Ron Beigel. (Distributed by Bradley Publ'ns)
Asleep At The Wheel Music (BMI), see Bug Music Group.
Associated Music Publ'ns Inc. (sub. of G. Schirmer Inc.) (BMI), 866 Third Ave., New York, N.Y. 10022. Tel: (212) 935-5100. Mgr.: B. O'Neal.
Int'l firms represented: Anton J. Benjamin, Bote & Bock (Germany), Breitkopf & Haertel (Germany), Ludwig Doblinger (Austria), Enoch & Cie. (France), Max Eschig (France), F.E.C. Leuckart (Germany), Nagels Verlag (Germany), D. Rahter (Germany), Richard Schauer, N. Simrock (Germany), Union Musical Española (Spain), VAAP (USSR).
Int'l repa.: Australia (Allen), Austria (Ludwig Doblinger), Denmark (Wilhelm Hansen), France (Max Eschig), Germany (Bote & Bock), Italy (G. Ricordi), Spain (Union Musical Española), UK (G. Schirmer).
Astral 7 Publ'g (BMI) (div. of Herbe Smith Music Inc.), 1582-A W. Dorothy Ln., Dayton, Ohio 45409. Tel: (513) 298-8640. Pres., Gen. & Prof. Mgr.: Herbert J. Smith.
Astronette Publ'g Co. (BMI), 2037 Alvarado Dr. NE, Albuquerque, N.M. 87110. Tel: (505) 268-8405. Pres., Gen. & Prof. Mgr.: A. Medley.
Athon Music Co. (BMI), RR 1, Carney, Mich. 49812. Owner: Conrad Haidu.
Ajaj Music (BMI), 4050 Buckingham Rd., Suite 208, Los Angeles, Calif. 90008. Tel: (213) 290-2262. Pres.: James Earl Jackson.
Atlantic Music Corp. (BMI), see Criterion.
Atomic Passion Music (BMI), see Bug Music Group.
Aucouin Mgmt. Inc. (BMI, ASCAP), 645 Madison Ave., New York, N.Y. 10022. Tel: (212) 828-8800. Telex: 236139. Pres.: William Aucouin.
Audible Music Publ'g Co. (ASCAP), 1802 Ocean Pkwy., Suite 2-A, Brooklyn, N.Y. 11223. Tel: (212) 627-8499. Pres. & Gen. Mgr.: Cosmo Dhms; VP & Prof. Mgr.: Dosa Tooner.
Audigram Music (BMI) (div. of Audigram Inc.), 3501 Belmont Blvd., Nashville, Tenn. 37215. Tel: (615) 269-4083.
Audio Arts Publ'g Co. (ASCAP), 5617 Meisroe Ave., Los Angeles, Calif. 90038. Tel: (213) 461-3507. Owner, Pres., Gen. & Prof. Mgr.: Madelon Baker.
Int'l repa.: Australia (Essex), Germany (Global/Altus), Japan (Toshiba), South America (Dodeon in Argentina), UK (Carlin).
Audios Amigos Music (BMI), see Bug Music Group.
Augsburg Publ'g House (SESAC), Box 1209. Zip: 55440; 426 S. Fifth St., Minneapolis, Minn. 55415. Tel: (612) 330-3300. Pres. & Gen. Mgr.: Al-

bert E. Anderson; Music Sales Mgr.: William O. Bliss.
Branches: **Los Angeles, Calif.**, 3224 Beverly Blvd. Zip: 90057. Tel: (213) 386-3722—**Columbus, Ohio**, 57 E. Main St. Zip: 43215. Tel: (614) 224-7411—**Seattle, Wash.**, 2001 Third Ave. Zip: 98121. Tel: (206) 624-0244.
Int'l repa.: Australia & New Zealand (Lutheran Publ'g House).
Aulos Music Publ'rs, PO Box 54, Montgomery, N.Y. 12549. Tel: (914) 692-6270. Ed.: Robert A. Carabia; Music Dir.: Howard M. Feldsher.
Aunt Polly's Publ'g Co. (BMI), PO Box 120657, Nashville, Tenn. 37212. Tel: (615) 385-2555. Owner: Allen Reynolds; Gen. Mgr.: John Donegan.
Int'l repa.: Worldwide (Morning Music).
Aura Love Publ'g (BMI), PO Box 553, Casselberry, Fla. 32707. Tel: (305) 331-4453. Pres.: Terry R. Brooks.
Auspex Music (ASCAP), 1218 Laurel Terrace Dr., Studio City, Calif. 91604. Tel: (213) 877-1078. Owner & Pres.: Jules Chaikin.
Autograph Music (BMI), 601 E. Blackledge Dr., Tucson, Ariz. 85705. Tel: (602) 882-9016. Pres.: Joe Bidwell; Prof. Mgr.: Erin Brooks.
Autumn Leaves Music (ASCAP), 3216 Myra, Farmer's Branch, Tex. 75234. Tel: (214) 241-5105. Pres., Gen. & Prof. Mgr.: Philip Otten. (Administered by United Artists Music).
Avalon Ltd. (BMI), see Cherry Lane.
Robert Allan Ayres (ASCAP), 107 N. Hull, Minden, N.C. 68959. Tel: (608) 832-0941/1380. Owner: Bob Ayres.
Azinda Publ'ns (BMI) (div. of Star Song Recs.), 2460 Spring Lake Dr., Marietta, Ga. 30062. Tel: (404) 973-1170. Pres.: Tim McCabe.

B

B A S Music Publ'g (ASCAP), 5925 Kirby Dr., Suite 226, Houston, Tex. 77005. Tel: (713) 522-2713. Pres., Gen. & Prof. Mgr.: Shelton Bissell.
B C Ent's of Memphis Inc. (BMI), 726 E. McLemore, Memphis, Tenn. 38106. Tel: (901) 947-2553. Pres.: Bob Catron Jr.; VP & Admin. Ass't: Byron Catron; VP: Claudette Catron; Gen. Mgr.: Mary Ann Royston.
B. L. & H. Music Corp. (ASCAP), see H.B. Webman.
B D Cull Songs Inc. (ASCAP), 688 Seventh Ave., New York, N.Y. 10019. Tel: (212) 586-1422. Pres.: Samuel Pearlman; Gen. Mgr.: Bruce Slayton.
Int'l repa.: UK (Carlin).
Baby Tate Music Corp. (BMI), Drawer AB, Rosendale, N.Y. 12472. Tel: (914) 687-9573. Pres.: Peter B. Lowry.
Backbone Publ'g (BMI), see MizMo.
Back to Mono Music Inc. (BMI), see Mother Bertha.
Bad Bird Music Inc. (ASCAP), PO Box 5488, Santa Monica, Calif. 90405. Tel: (213) 871-0538. Pres. & Gen. Mgr.: David R. Norris; Prof. Mgr.: Joe L. Norris Jr.
Baier-Garris Publ'g Co. (BMI), 209 Hickory Hill Dr., Spruce Pine, N.C. 28777. Tel: (704) 765-4834. Pres.: W.W. Garris; Gen. Mgr.: Eugene Baker.
Branch: **Coral Gables, Fla.**, 220 Miracle Mile, Suite 204. Zip: 33134. Tel: (305) 448-5305.
Bakertown Music (BMI), see 20th Century.
Bal & Bal Music Publ'g Co. (ASCAP), 511 Berkshire Ave., La Canada, Calif. 91011. Tel: (213) 790-1242.
Baldursoun Music Corp. (ASCAP), see Larry Spier.
Balmac Music (ASCAP), see Bug Music Group.
Band of Angels Inc. (BMI), 1420 K St. NW, Suite 400, Washington, D.C. 20005. Tel: (202) 347-1420. Pres.: Russell Timmons Jr.; Publ'g Admin. Dir.: Yolanda McFarlane.
Int'l repa.: Worldwide excluding USA & Canada (April Music in USA)
Banham Music Inc. (ASCAP), see Reno/Metz.
Banjar Publ'ns Inc. (ASCAP), Box 32164, 7440 University Ave. NE, Minneapolis, Minn. 55433. Tel: (612) 755-9829. Pres.: LeRoy Larson; VP: Bert Woolfery.
Banjoe Music Inc. (BMI), see Reno/Metz.
Baradat Music (BMI), 1310 E. Kern St., Tulare, Calif. 93274. Tel: (209) 686-2533. Owner & Pres.: Raymond A. Baradat; Gen. Mgr.: Pamela R. Baradat.
Baray Music Inc. (BMI), 49 Music Square E., Nashville, Tenn. 37203. Tel: (615) 329-1323. Pres. & Gen. Mgr.: Ray Baker; VP & Prof. Mgr.: Barbara D. Baker.
Barcam Music (BMI), see Camillo-Barker.
Bar-Cee Music (BMI), see Garrett.
Barchris Music (BMI), see Xanadu.
Barclay Music Corp. (ASCAP), see Shapiro Bernstein.
Barney Music (BMI), see Blanchris.
C. L. Barnhouse Co. (SESAC), 110 B Ave., Oskaloosa, Iowa 52577. Tel: (515) 673-8397. Pres.: C.L. Barnhouse III; Gen. Mgr.: Robert Barnhouse.
Int'l repa.: Austria, Germany & Switzerland (Emil Ruh in Switzerland); France (Henry May), Norway (Schlagerforlaget), Sweden (Trusa).
Barnwood Music (BMI), see Music Publ'g Corp.
Baron Co. Inc., PO Box 149, Oyster Bay, N.Y. 11771. Pres.: Virginia Baron.
Denise Barry Music (ASCAP), see Buddy Music & Bug Music Group.
Jack Bartley Music (ASCAP), see Don Williams.
Earl Barton Music Inc. (BMI), 1121 S. Glenstone, Springfield, Mo. 65804. Tel: (417) 869-6379. Pres. & Gen. Mgr.: E.E. Simon Jr.; Prof. Mgr.: Scott F. Simon. (Licensed through Publishers' Licensing Corp.).
Barton Music Corp. (ASCAP), 9220 Sunset Blvd., Los Angeles, Calif. 90069. Tel: (213) 273-3590. Pres.: Paula Saniocola; Gen. & Prof. Mgr.: Eddie Shaw.
Int'l firm represented: Barton Music Co. Ltd. (UK).
Int'l repa.: UK (Barton).
Baruth Music (ASCAP) (div. of Baruth Prod'ns Inc.), 8033 Sunset Blvd., Suite 101, Hollywood, Calif. 90046. Tel: (213) 650-0060. Pres.: Ihon Baruth; Gen. Mgr.: Dan Baruth; Prof. Mgr.: Jain Baruth.
Branch: **Cleveland, Ohio**, 12501 Madison Ave. Zip: 44107. Tel: (216) 228-8240. Chief Exec.: Sed McCarrett.
Basione Music Inc. (SESAC), see Reno/Metz.
Abdul Basit Music Co., 152 Roseville Ave., Newark, N.J. 07107. Tel: (215) 236-2510. Pres.: Abdul Basit.
Bass-Goldstein Inc. (BMI), PO Box 497, Yonkers, N.Y. 10702. Pres.: Bruce Bass; VP & Gen. Mgr.: Jay Goldstein; Prof. Mgr.: Sara Dakis. (Administered by Dreana Music).
Batish Rac'g Enterprises, 1310 Mission St., Santa Cruz, Calif. 95060. Tel: (408) 423-1699. VP Mktg.: Ashwin Batish.
David Batteau Music (ASCAP), see MizMo.
Baugh Music (BMI), see Bug Music Group.
Mel Bay Publ'ns, 4 Industrial Dr., Pacific, Mo. 63069. Tel: (314) 257-3970. Pres.: Mel Bay.
Int'l repa.: Australia (Castle), Canada (Gordon V. Thompson), Europe (Betwin/Mills).
Beach Bum Music (BMI), see Brother.
Beachcomber Music (BMI)—Pres.: Dave Smith—see Dawn Prod'ns.
Beachtime Music (BMI), see Hiding.

Beagle Publ'g Co. (ASCAP), 3486 E. Lake Rd., Canandaigua, N.Y. 14424. Tel: (716) 394-8919. Contact: Craig Dayton.
Bearce Publ'g, see Arlo.
Beautiful Day Music (BMI), 15 Glenby Ln., Brookville, N.Y. 11545; 22240 Schoenborn St., Canoga Park, Calif. 91304. Tel: (N.Y.) (516) 626-9504; (Calif.) (213) 883-4865. Co-Pres.: Thomas R. Ingegnio (N.Y.), Michael H. Frenchk (Calif.). (Administered by Great People Music).
Beautiful Things Unlimited (BMI), see 20th Century.
Beaver Music Publ'g Corp. (ASCAP), see H.B. Webman.
Beckenhorst Press Inc. (ASCAP), PO Box 14273, Columbus, Ohio 43214. Tel: (614) 268-3010. Pres.: John Ness Beck; Exec. Sec.: John H. Muschick.
Beckie (BMI), 904 Rayner St., Memphis, Tenn. 38114. Tel: (901) 278-1100. Pres.: Ken Vsokey.
Bee/Alexander Prod'ns, 1100 Glendon Ave., Los Angeles, Calif. 90024. Tel: (213) 478-9871. Partners: Jimmy Bee, Morey Alexander.
Bee Cool Music Co. (BMI)—Pres.: Gilda Woods—see Delev.
Beechmont Music Publ'g Corp. (BMI), see H.B. Webman.
Beechwood Music Corp. (BMI), 6255 Sunset Blvd., Hollywood, Calif. 90028. Tel: (213) 469-8371. Pres.: Lester Sill; VP & Prof. Activities Dr.: Paul Tannen.
Branches: **New York, N.Y.**, 1370 Ave. of the Americas. Zip: 10019. Tel: (212) 489-6740—**Nashville, Tenn.**, 1207 16 Ave. S. Zip: 37212. Tel: (615) 320-7700. Gen. Mgr.: Charlie Feldman.
Int'l branches: Canada, Beechwood Music of Canada
Bee Cool Publ'g Co. (BMI), see Jamie.
Beekman Music Inc. (ASCAP), see Theodore Presser.
Beez Weez Music (BMI), c/o Jones, Michael & Cherot, 888 Seventh Ave., New York, N.Y. 10019. Tel: (212) 541-6900. Pres.: Ben Adkins; Gen. & Prof. Mgr.: Louise West.
Beldock Levine & Hoffman, 565 Fifth Ave., New York, N.Y. 10017. Tel: (212) 490-0400. Cable: TELHOFFLAW. Telex: 422046. Gen. Mgr.: Elliot L. Hoffman; Prof. Mgr.: Peter S. Motorin.
Int'l firm represented: William Tell Music (UK).
Belfast Music (BMI), see Reno/Metz.
Belkin Music (BMI), see Stone-Rap.
Bell Holding Music (ASCAP), Box 143, East Glastonbury, Conn. 06025. Tel: (203) 659-2216. Cable: BELHOP. Pres.: Bruce Lloyd; Gen. Mgr.: Marsha Stone; Prof. Mgr.: Sue Astman.
Rocky Bell Music (BMI), see White Cat.
Belmont Music (BMI), see M.M. Cole.
Belmont Music Publ'rs (ASCAP), PO Box 49961, Los Angeles, Calif. 90049. Tel: (213) 472-2557. Cable: BELMUSIC. Pres.: Lawrence A. Schoenberg; Dir.: Reiko Bissey.
Int'l firms represented: B. Schott Sohne (Germany), Universal (Austria).
Int'l repa.: Austria (Universal).
Belwin-Mills Publ'g Corp. (ASCAP), 1776 Broadway, New York, N.Y. 10019. Tel: (212) 245-1100. Cable: BELMILPUB. Telex: 423665. Pres.: Martin Winkler; VP & Gen. Mgr.: Burton L. Litwin.
Branch: **White Plains, N.Y.**, Printed Product Sales Div., 25 Deshon Dr. Zip: 11747. Tel: (516) 293-3400. Telex: 423665.
Int'l branches: Australia, Brazil, Canada, England, France, Germany, Italy, Mexico, Netherlands, New Zealand, Spain, Sweden.
Bema Music (ASCAP)—Pres.: Carl Maduri; Prof. Mgr.: Gary Doberstyn—see Stone-Rap.
Bendig Music Corp. (BMI), see Fermata Int'l.
Quint Benedetti Music (ASCAP), PO Box 2388, Toluca Lake, Calif. 91602. Tel: (213) 985-8284. Pres. & Prof. Mgr.: Quint Benedetti.
Benfel Music (BMI), 10th & Parker Sts., Berkeley, Calif. 94710. Tel: (415) 549-2500. Mgr.: Paul Zaentz.
Phil Bennett Music Co. (ASCAP), I E. 42 St., New York, N.Y. 10017. Tel: (212) 682-2539.
John T. Benson Publ'g Co. Inc. (ASCAP), Metro Center, 1 Vantage Way, Nashville, Tenn. 37228. Tel: (615) 259-9111.
Int'l repa.: Australia (Rhema), Benelux (Universal Songs in Netherlands), Canada (Lawson-Falle).
Berdo Music (BMI), PO Box 8875, Universal City, Calif. 91608. Tel: (213) 985-2539. Pres.: George Clements; Prof. Mgr.: Jim McGuckin.
Berkeley Cooperative Publ'rs, PO Box 158, Alderpoint, Calif. 95411. Tel: (707) 926-5312. Gen. Mgr.: E.D. Denon.
Int'l repa.: Scandinavia (Sonet), UK (Sonet).
Hal Bernard Ent's. Inc., see listing under "H."
John Bernard Music (BMI), 303 W. 42 St., New York, N.Y. 10036. Tel: (212) 581-3766. Pres. & Prof. Mgr.: John Bernard; Gen. Mgr.: A. Baly.
Berry Lou Music (ASCAP), 7046 Hollywood Blvd., No. 410, Hollywood, Calif. 90028. Tel: (213) 462-0502. Owner, Pres. & Prof. Mgr.: Harry Gordon; Gen. Mgr.: Linda Gordon.
John Berthelot & Assocs. (ASCAP), PO Box 13977, New Orleans, La. 70185. Tel: (504) 842-4211. Pres.: John Berthelot.
Beserley, 2054 University Ave., Suite 400, Berkeley, Calif. 94704. Tel: (415) 848-6701. Chief Execs.: Matthew King Kaufman, Steve Beserley.
Beth-Ann Music Co. (ASCAP), 615 Baldwin Ln., Wilmington, Del. 19803. Tel: (302) 762-2410. Pres.: Albert G. Teoli; Prof. Mgr.: Beth Teoli.
Better-Half Music Co. (ASCAP), 1894 N. Stanley Ave., Hollywood, Calif. 90046. Tel: (213) 874-1707.
Beverly Hills Music (BMI), c/o Lawrence Herbst Investment Trust Fund, PO Box 1659, Beverly Hills, Calif. 90213. Pres. & Admin'r: Lawrence Herbst.
Bexley Publ'g Co. (BMI), 3333 Scenic Hwy., Memphis, Tenn. 38128. Tel: (901) 386-8102. Pres.: Cordell Jackson.
Bibo Music Publ'rs Inc. (ASCAP), see Welch Music Group.
The Bicycle Music Co., 8756 Holloway Dr., Los Angeles, Calif. 90069. Tel: (213) 659-6361. Cable: BICYCLE. Pres.: David Rosner.
Johnny Bienstock Music (BMI), 1619 Broadway, New York, N.Y. 10019. Tel: (212) 489-8170.
Bienstock Music Publ'g (BMI), 3361 S. Blue Ridge Court, Westlake Village, Calif. 91361. Tel: (805) 495-8765. Owner: Bill Doane.
Big Apple Music Co. (BMI), see The Entertainment Co.
Big C Music (ASCAP), see 20th Century.
Big Diamond Publ'g (BMI), PO Box 15018, Tulsa, Okla. 74112. Tel: (918) 939-0641, 324-5553. Owner: Ken Holiday Garton.
Big Gun Music (ASCAP), see Robbko.
Big Heart Music Inc. (BMI), 9454 Wishire Blvd., Beverly Hills, Calif. 90212. Tel: (213) 273-7020. Gen. & Prof. Mgr.: Randy Bash.
Big Hurry Music Co. Inc. (ASCAP), 321 Commercial Ave., Palisades Park, N.J. 07650. Tel: (201) 224-8000. Telex: 135384.
Big Kahuna Music (BMI), 663 Watson, Memphis, Tenn. 38111. Tel: (901) 454-9760. Pres.: Philip Rauts.
Big Mike Music (BMI), 408 W. 115 St., Suite 2W, New York, N.Y. 10025. Tel: (212) 222-8715. Cable: RIGHOTN. Pres.: William H. Downs; Gen. Mgr.: Dolly Gilmore.
Int'l firm represented: Michel Meyer (France).
Int'l repa.: UK (Martin Coulter).

BMI BENDS OVER BACKWARDS

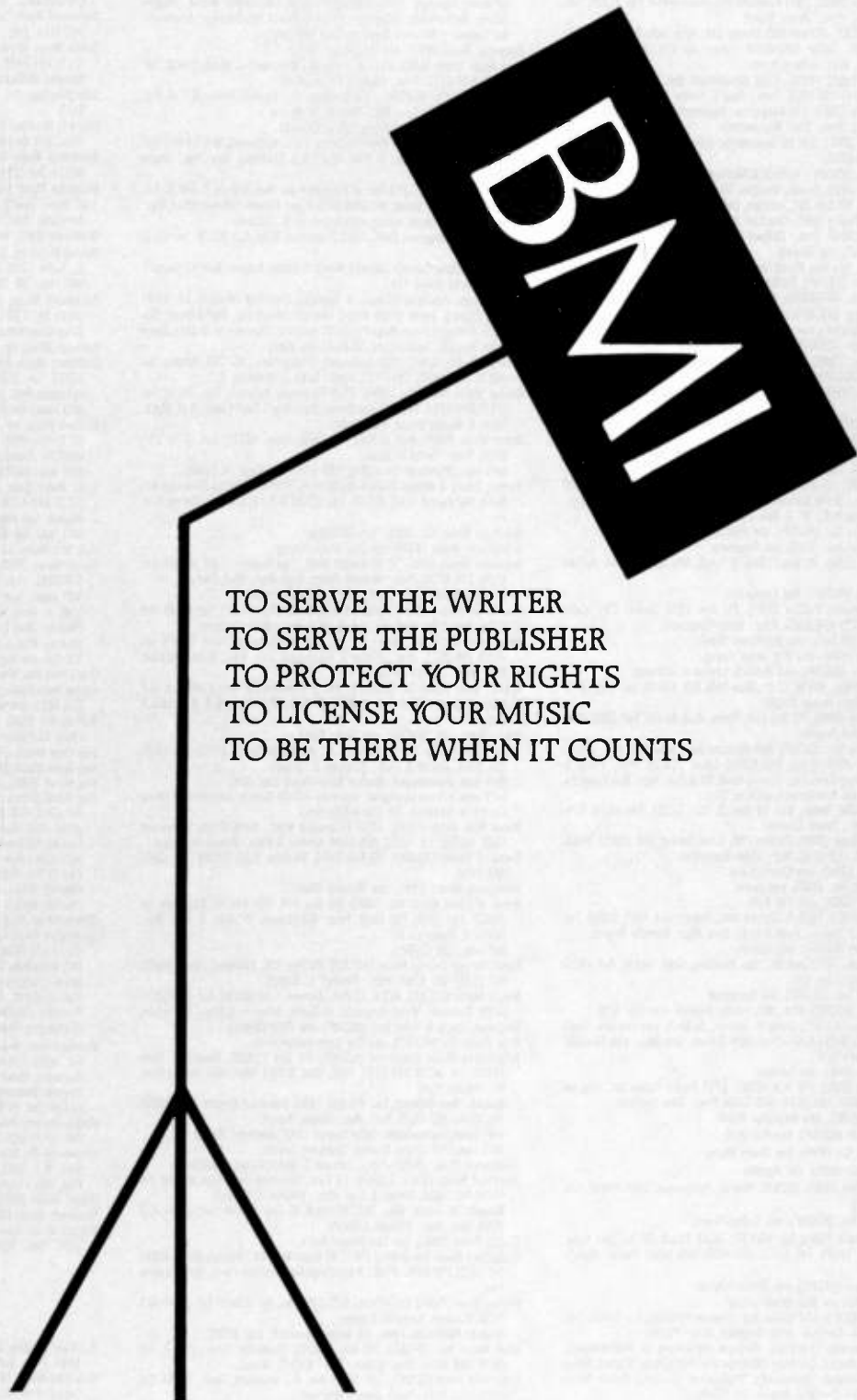

TO SERVE THE WRITER
TO SERVE THE PUBLISHER
TO PROTECT YOUR RIGHTS
TO LICENSE YOUR MUSIC
TO BE THERE WHEN IT COUNTS

BMI STANDS FOR THE BEST

- Big Music (BMI), PO Box 57, 10 George St., Wallingford, Conn. 06492. Tel: (203) 269-4465. Pres.: Thomas Cavalieri; Gen. & Publ'g Mgr.: Edyth L. Mercier.
Int'l rep.: Worldwide excluding USA & Canada (Celestial Harmonies in USA).
- Big Seven Music Corp. (BMI), 1790 Broadway, New York, N.Y. 10019. Tel: (212) 582-4267. Cable: ROULREX. Telex: 422573. Pres.: Morris Levy; VP, Gen. & Prof. Mgr.: Phil Kahl.
Int'l branches: Australia (Planetary-Nom), Belgium (Caradam Eds.), France (Caradam Eds.), Germany (Musikverlag Planetary), Netherlands (Caradam Eds.), South Africa (Planetary-Nom), Switzerland (Caradam Eds.), UK (Planetary-Nom).
Int'l rep.: Brazil (Victor), Denmark (Intersong), Finland (Intersong), Greece (Blackwood), Italy (Star), Japan (High Note), Mexico (EMLASA), Norway (Intersong), Portugal (Canciones del Mundo), Spain (Canciones del Mundo), Sweden (Intersong).
- Big Shoe Publ'g Co. (BMI), 1011 Fountain Rd., Jacksonville, Fla. 32205. Tel: (904) 781-4311. Pres.: Bruce Beard.
- Big Sky Music (ASCAP), PO Box 860, Cooper Sta., New York, N.Y. 10276. Tel: (212) 473-5900. Cable: RAMHORN. Telex: 661139. Admin'r: Naomi Saltzman; Prof. Mgr.: Jeffrey Rosen.
- Big State Music Publ'g (BMI), 1311 Candlelight Ave., Duncanville, Tex. 75137. Tel: (214) 298-9576. Pres.: Paul S. Ketter.
- Big Swan Publ'g Co. (BMI), 156 Darius Ln., Summertown, Tenn. 38483. Tel: (615) 964-3571. Pres.: Paul Wendeinstein.
- Big Swing Publ'g (BMI), 230 W. Commerce, Oklahoma City, Okla. 73109. Tel: (405) 235-3500.
- Bijou Ridge Music, PO Box 476, First & Montana Sts., Wakonda, S.D. 57073. Tel: (605) 267-2859. Owner: Douglas Sharpe.
- Blidion Publ'g Co., PO Box 333, Sunland, Calif. 91040. Tel: (213) 899-6062.
- Blithedoux Music Publ'g (BMI), One East Scott, No. 408, Chicago, Ill. 60610. Tel: (312) 266-0040. Pres.: Clifford Rubin.
- Bitly Music (ASCAP), see Garrett.
- Bit Publ'g (BMI), see Bug Music Group.
- Biograph Recs. Inc. (ASCAP), 16 River St., Chatham, N.Y. 12037. Tel: (518) 392-3400. Cable: BIOGRAPH. Pres.: Arnold S. Caplin.
- Birds Music Corp. (ASCAP), see Cream.
- Birdwing Music (ASCAP), see Sparrow Recs. & Cherry Lane.
- Birthday Boy Music (ASCAP), see Bug Music Group.
- Birthday Music Inc. (BMI), see Music Music Music.
- Birthright Music (ASCAP), 3101 S. Western Ave., Los Angeles, Calif. 90018. Tel: (213) 731-2460, 258-8011. Pres.: Byron Spears; Prof. Mgr.: Le Roy C. Lovett Jr.
- Bisair Music Publ'g (BMI), PO Box 23261, Nashville, Tenn. 37202. Tel: (615) 361-7058. Pres.: Ed Bisair III.
Branch: El Sabramo, Calif., 3449 San Pablo Dam Rd. Zip: 94803. Tel: (415) 222-0385. Gen. Mgr.: Dennis DeSilva.
- Bivens Music (BMI), PO Box 1628, Elizabeth City, N.C. 27909. Tel: (919) 232-2703. Pres.: Ernie Bivens; Prof. Mgr.: Ernie Bivens, Vince Chory.
Branch: Maysack, N.C., Rt. 2, Box 236, Zip: 27958.
- Biva Music Publ'g Inc. (ASCAP), see President.
- Black Coffee Music Inc. (BMI), see Prophecy.
- Blackheart Music (BMI), PO Box 15856, St. Louis, Mo. 63114. Pres.: Robert Schoenfeld.
- Black Note Music (ASCAP), see Funky but.
- Black Stallion Country Publ'rs (BMI), PO Box 2250, Culver City, Calif. 90230. Tel: (213) 674-9280. Pres.: Kenn Kingsbury.
- Black Sun Music (SESAC), see Mayflower Music.
- Black Tent Music (BMI), see Bug Music Group.
- Eubie Blake Music (ASCAP), see Beldock Levine & Hoffman.
- Blanchris Music (BMI), 160 W. 71 St., New York, N.Y. 10023. Tel: (212) 873-2020. Office Mgr.: Renee Steale.
- Blandin Publ'g Co. (BMI), PO Box 162, Provo, Utah 84601. Tel: (801) 224-1775. Pres.: Stan Bronson.
- Bleedingwell Music Inc. (ASCAP), 488 Madison Ave., New York, N.Y. 10022. Tel: (212) 752-3033. Cable: PHILKURN. Telex: 234128. Pres.: Philip S. Kurnit; VP's: Terry Cashman, Tommy West; VP & Gen. Mgr.: Bob Esposito. (Administered by Publishers Licensing Corp.)
Branch: Nashville, Tenn., 812 19 Ave. S. Zip: 37203. Tel: (615) 329-9282. Prof. Mgr.: Karen Condon.
- Blind Basement Music (BMI), PO Box 288, Silver Spring, Md. 20907. Wash. D.C. Tel: (202) 723-6958. Mgr.: Gene Rosenthal.
- Blind Date Music (BMI), see Cherry Lane.
- Blockbuster Music Inc. (BMI), see Jamie.
- Blue Band Music (BMI), see Ray Griff.
- Blue Book Music (BMI), 1225 N. Chester Ave., Bakersfield, Calif. 93308. Tel: (805) 393-1011. Owner: Buck Owens; Gen. Mgr.: Dorothy Owens.
- Blue Candle Music (ASCAP), see Gordon.
- Blue Canyon Music, 701 Fawn Dr., San Anselmo, Calif. 94960. Tel: (415) 457-1199. Owner: Jim Terr.
- Blue Coast Music Inc. (ASCAP), see Fairlyland.
- Blue Echo Music (ASCAP)—Prof. Mgr.: Jerry Newton—see Ray Griff.
- Blue Island Music (ASCAP), 1446 N. Martel, Suite 3, Los Angeles, Calif. 90046. Tel: (213) 851-3161. Pres.: Bob Gilbert; Gen. Mgr.: Bob Fleming; Prof. Mgr.: Linda Dial.
- Blue Lake Music (BMI), see Terrace.
- Blue Mace Music (BMI), PO Box 62263, 2716 Sandy Valley Rd., Virginia Beach, Va. 23462. Tel: (804) 340-3366. Pres.: Alex Spencer.
- Blue Max Music (BMI), see Americus Music.
- Blue Melody Music (ASCAP), see Ray Griff.
- Blue Menu Music Co. (BMI), see Green Menu.
- Blue Monday Music (BMI), see Garrett.
- Blue River Music Inc. (BMI), 1626 N. Vine St., Hollywood, Calif. 90028. Tel: (213) 463-7661.
- Blue Seas Music Inc. (ASCAP), see Geffen/Kaye.
- Blue Umbrella Music Publ'g Co. (ASCAP), 3011 Beach 40 St., Sea Gate, Brooklyn, N.Y. 11224. Tel: (212) 372-6436, 449-5265. Owner: Kadish Millet.
- Bobby's Beat Music (SESAC), see Bobby Fischer.
- Bobok Music (BMI), see Bug Music Group.
- Boca Music Co. (ASCAP), 532 Sylvan Ave., Englewood Cliffs, N.J. 07632. Tel: (201) 567-8100. Co-Pres.: Luigi Creatore, Hugo Peretti.
Int'l rep.: Australia (Festival), Belgium (Intersong in Netherlands), France (Radio Music), Germany (Melodie der Welt), Italy (Sugar), Japan (Victor), Netherlands (Intersong), Philippines (Lustre), South Africa (Leeds), Sweden (Sweden Music), UK (Carlin).
- Bocephus Music Co. (BMI), see Music Publ'g Corp.
- Fred Book Music Co. (ASCAP), Box 333, Tarzana, Calif. 91356. Tel: (213) 996-6181. Pres.: Fred Book. (Distributed by Alexandria House).
- Bo-Gal Music (BMI), PO Box 6687, Wheeling, W. Va. 26003. Ohio Tel: (614) 758-5812. Pres. & Gen. Mgr.: Robert H. Gallion.
- Bohemia Music (BMI), see Bug Music Group.
- Bojan Music Corp. (BMI), 38 Music Square E., No. 300, Nashville, Tenn. 37203. Tel: (615) 244-4336. Pres.: Buddy Lee; Gen. Mgr.: Johnny Paycheck.
- Gary Bonds Music (BMI), see Extra Music.
- Boogie Man Music (ASCAP), see Harrick.
- Boosey & Hawkes Inc. (ASCAP), 24 W. 57 St., New York, N.Y. 10019. Tel: (212) 757-3332. Cable: SONOROUS. Pres. & Mng. Dir.: W. Stuart Pope; Copyright & Royalty Dept. Mgr.: Sylvia Goldstein.
Home office: England.
Int'l branches: Australia, Canada, France, Germany, South Africa, Sweden.
Int'l firms represented: Amberson Ents., Artia (Czechoslovakia), Edwin Ashdown Ltd. (UK), Barry (Argentina), Carisch (Italy), Gehrman (Sweden), IMI-Israel Music Institute (Israel), Kultura (Hungary), New Wind Music (UK), Norman Richardson Ltd. (UK), Savini Zerboni (Italy), Josef Weinberger Ltd. (UK).
- Int'l rep.: Argentina (Barry), Austria (Theater-Verlag Eirich), Denmark (Wilhelm Hansen), Italy (Carisch), Japan (Academia Music, Nippon Gakki), Netherlands (Aldersen), Norway (Norsk Musikforlag), Spain (Vidal Limona y Boceta), Sweden (Carl Gehrman).
- Bopalea Music (BMI), see Bug Music Group.
- Boss Apple Tunes (BMI), 1517 W. Lake St., Minneapolis, Minn. 55408. Tel: (612) 827-6111. Pres.: Charles F. Campbell.
- Boston Music Co. (ASCAP), 116 Boylston St., Boston, Mass. 02116. Tel: (617) 426-5100. Gen. Mgr.: Warren W. Morris.
Int'l rep.: Australia (Aliens), UK (Chappell).
- Boudin Music Publ'g Co. (BMI), PO Box 1375, Baltimore, Md. 21203. Tel: (301) 327-8236. Pres. & Prof. Mgr.: Ray Donahoe; Gen. Mgr.: Henry Donahoe.
- Bourne Co. (ASCAP), 1212 Ave. of the Americas, New York, N.Y. 10036. Tel: (212) 575-1800. Cable: BOURNEMUS. Pres.: Bonnie Bourne; Office Mgr.: Al Tuckman. (Sheet music distributed by G. Schirmer)
Branch: Los Angeles, Calif., 6381 Hollywood Blvd. Zip: 90028. Tel: (213) 469-5101.
Int'l branches: Canada (Bourne Music Canada), France (Bourne-France), UK (Bourne Music Ltd.).
Int'l rep.: Australia (Boosey & Hawkes), Germany (Melodie der Welt), Italy (Curci), Japan (High Note), Mexico (Brambila), Netherlands (Basart), Portugal (Ivan Mogull), South America (Fermata in Brazil), Spain (Ivan Mogull), Switzerland (Melodie der Welt).
- Bowman Publ'g (BMI), 1530 Dunwoody Village Pkwy., No. 201, Atlanta, Ga. 30338. Tel: (404) 394-7122. Pres.: Hugh E. Bowman II.
- Boxcar Music Publ'g Co. (BMI), 6316 Portway, Houston, Tex. 77084. Tel: (713) 859-0332. Pres.: Peter Braz; Gen. Mgr.: Paul Eakin; Prof. Mgrs.: Peter & Marcia Breaz, Paul Eakin.
- Boxer Music (BMI), Box 120501, Nashville, Tenn. 37212. Tel: (615) 254-9798. Pres.: Curtis L. Allen.
Int'l rep.: Worldwide excluding USA (Morning Music in Canada).
- Tommy Boyce & Melvin Powers Music Ents. (ASCAP), 12015 Sherman Rd., North Hollywood, Calif. 91605. Tel: (213) 875-1711. Pres.: Melvin Powers.
- Braeburn Music Co. (BMI), see Stoneway.
- Brainstorm Music (BMI), see Bug Music Group.
- Braintree Music (BMI), 9130 Sunset Blvd., Los Angeles, Calif. 90069. Tel: (213) 275-4710. Pres.: Richard Perry; Prof. Mgr.: Fred Perry.
- Bramsden Music Corp. (BMI), see Campbell Connelly.
- Brant Int'l Music (BMI), PO Box 31819, Dallas, Tex. 75231. Tel: (214) 750-0720. Pres.: Pat McKool; Gen. & Prof. Mgr.: Mike Anthony.
- Brandwood Music Inc. (BMI), PO Box 24214, Nashville, Tenn. 37202. Tel: (615) 298-2523. Pres.: Ansley R. Fleetwood; Gen. Mgr.: Robbie Gordon; Prof. Mgr.: Charlie Lamb.
- Brandy River Music Co. (ASCAP) (div. of Brandywine Recs.), PO Box 413, Durham, N.H. 03824. Tel: (603) 479-2811. VP's: Richard R. & Ronald B. Shaw.
- Brass Music Ltd. (ASCAP), see Brass Press.
- Brass Press (BMI), 136 Eighth Ave. N., Nashville, Tenn. 37203. Tel: (615) 254-8969. Owner & Pres.: Stephen L. Glover.
Int'l firm represented: Musica Rara—Brass Eds. (UK).
Int'l rep.: France (Arpegges), Germany (Ulrich Koeb), Scandinavia (Brass Center in Sweden), UK (June Emerson).
- Brave New Music (BMI), 6253 Hollywood Blvd., Suite 1116, Hollywood, Calif. 90028. Tel: (213) 466-3534. Owner & Pres.: Daniel Friedman.
- Bread 'n' Honey (ASCAP), PO Box 3391, Ventura, Calif. 93006. Tel: (805) 644-7618.
- Breakaway Music (BMI), see Mirsong Music.
- Break of Dawn Music Inc. (BMI), PO Box 958, 434 Ave. U, Bogalusa, La. 70427. Tel: (504) 732-2942. Pres.: R.S. Evans; VP, Gen. & Prof. Mgr.: James R. Bateman Jr.
Int'l rep.: UK (Carlin).
- Breakthrough Quality Music (ASCAP), PO Box 456, Brantford, Conn. 06405. Tel: (203) 488-6166. Pres.: Randall K. Coates.
- Bregar Music (ASCAP), 428 E. 11 Ave., Denver, Colo. 80203. Tel: (303) 839-5789. Partners: Marel Bregante, Al Garth; Admin'r: Edward P. Pierson.
- Bregman, Vocco & Conn Inc. (ASCAP), see 20th Century.
- Brial Music Co. (ASCAP), see The Entertainment Co.
- Briarshade Music Unlimited (ASCAP), PO Box 110830, Nashville, Tenn. 37202. Tel: (615) 242-1037. Pres., Gen. & Prof. Mgr.: Ken Keene; Exec. VP: Frankie Ford.
Branch: New Orleans, La., PO Box 1830, Oakwood Branch. Zip: 70053. Tel: (504) 392-4615. Prof. Mgr.: Wayne Keene.
Int'l firms represented: Baby Snaker (UK), Southern Sound (UK).
Int'l rep.: UK (Baby Snaker, Southern Sound).
- Briarpatch Music (BMI)—Pres.: Edward T. Rabbit—see DebDave.
- Bricbratt Music (BMI), 6801 W. 76 Terr., Overland Park, Kan. 66204. Tel: (913) 642-9600. Owner & Gen. Mgr.: William E. Gilbert.
Branch: St. Louis, Mo., 1843 Kennett Pl. Zip: 63104. Tel: (314) 772-2894. Gen. Mgr.: William J. Keyes.
- Bridge Music (BMI), see The Herald Ass'n.
- Bridgeport Music Inc. (BMI), 19631 W. Eight Mile Rd., Detroit, Mich. 48219. Tel: (313) 255-6740. Pres.: Armen Boladian; Ass't to Pres.: Carole Luede-man.
- Bridger Music Publ'g Co., PO Box 929, Sikeston, Mo. 63801. Tel: (314) 471-5428. Contact: Kenneth Bridger.
Branch: Nashville, Tenn., 34 Music Square E. Zip: 37203.
- Brim Music Inc. (SESAC), PO Box 120591, Nashville, Tenn. 37212. Tel: (615) 269-4410. Pres. & Gen. Mgr.: Gary S. Musick.
- Broadman Press (SESAC), 127 Ninth Ave. N., Nashville, Tenn. 37234. Tel: (615) 251-2533. Pres.: Dessel Aderholt.
- Broad River Publ'g Co. (BMI), Dyer Rt., Cowen, W. Va. 26206. Tel: (304) 226-3424. Pres.: Ernest H. Spearman; Music Ed.: Gladys Spearman.
- Broadway/Hollywood Int'l Music Publ'rs (ASCAP), see Take Home Tunes!
- Bro-Bill (ASCAP), see Lowery.
- Broad Music Co. (ASCAP), PO Box 9345. Zip: 28299; 1409 E. Independence Blvd., Charlotte, N.C. 28205. Tel: (704) 332-2177. Owner: Gladys F. Brodt.
- Int'l firms represented: Ashdown (UK), Banks (UK), Forsyth (UK), Henle (Germany), Leslie (Canada).
Int'l rep.: Canada (Leslie).
- Bronjo Music Publ'g, 1637 Utica Ave., Brooklyn, N.Y. 11234. Tel: (212) 253-4600. Cable: MUSICLEASE. Telex: 668550. Pres.: David Last; Gen. Mgr.: Bea Cohen.
- Int'l firm represented: Sparta-Florida (UK).
- Brooks Bros. Publ'rs (BMI), 311 Margo Ln., Nashville, Tenn. 37211. Tel: (615) 834-4124. Gen. Mgr.: Jake C. Brooks. (Affiliated with Enchantment Music).
- Brookside Music Corp. (ASCAP), 159 W. 53 St., New York, N.Y. 10019. Tel: (212) 541-7761. Pres.: Reid Whitelaw.
- Brother Bear Music (BMI)—Pres.: Dean Whitney—see Buchhorn.
- Brother Publ'g Co. (BMI), 2910 Lincoln Blvd., Santa Monica, Calif. 90405. Tel: (213) 392-3084. Gen. Mgr.: S.C. Gamble.
- Broude Bros. Ltd. (ASCAP), 56 W. 45 St., New York, N.Y. 10036. Cable: BROUDEBRO. Tel: (212) 687-4735.
- Brownleaf Music Co. (BMI), PO Box 7221, Mobile, Ala. 36607. Tel: (205) 342-1177. Pres.: John N. Blackburn; VP: Sara Ann Smith.
- Brown Moon Music (ASCAP), PO Box 19274, Houston, Tex. 77024. Tel: (713) 661-2498. Pres.: Rusty Holster.
Branch: Midland, Tex., PO Box 2661. Zip: 79701.
- John Brumage Co., 514 W. 57 St., New York, N.Y. 10019. Tel: (212) 245-6119.
- Albert E. Brumley & Sons (SESAC), Powell, Mo. 65730. Tel: (417) 435-2225.
- Pres.: Bill Brumley; Gen. Mgr.: Bob Brumley.
- Brunswick Music Publ'g Co. (BMI), 136 S. Swall Dr., Beverly Hills, Calif. 90211. Tel: (213) 657-4895. Owner, Pres., Gen. & Prof. Mgr.: Lee Silver.
- Brushape Music Inc. (BMI)—VP: Gary S. Paxton—see Window.
- Brut Music Publ'g (ASCAP) (div. of Brut Prof'ns Inc.), 1345 Ave. of the Americas, New York, N.Y. 10019. Tel: (212) 581-3114.
- Brutones (BMI), see Bug Music Group.
- Bubbly Music Inc. (USA), 1 Century Plaza, North Tower, 2029 Century Park E., Suite 1730, Los Angeles, Calif. 90067.
Int'l rep.: UK (Black Sheep).
- Buckboard Music (BMI), 1909 Hood Circle, Carrollton, Tex. 75006. Tel: (214) 242-1762. Pres.: Larry Fargo; Gen. Mgr.: Ann Jones; Prof. Mgr.: Steve Chambliss.
- Buckeye Music Inc. (ASCAP), see Carlson.
- Buckhorn Music Publ'g Co. Inc. (BMI), 1007 17 Ave. S., Nashville, Tenn. 37212. Tel: (615) 327-4590. Pres.: Marjorie Wilkin; Gen. Mgr.: Ann Schuster; Prof. Mgr.: Neil Patton Rogers.
Int'l rep.: Australia (Castle), South Africa (Reveille), UK (Valentine).
- Buddah Music Inc. (ASCAP), 1790 Broadway, New York, N.Y. 10019. Tel: (212) 582-6900. Pres.: Art Kass; VP & Gen. Mgr.: Chuck Walz. (Administered by United Artists).
- Int'l rep.: Worldwide (United Artists).
- Budd Music Corp. (ASCAP), 18531 Wells Dr., Tarzana, Calif. 91356. Tel: (213) 345-4204. Pres.: Buddy Kaye.
Branch: Las Vegas, Nev., 850 Tam O'Shanter. Zip: 89109.
Int'l rep.: UK (Budd/Campbell Connelly).
- Bud Don Music Co. (ASCAP), see Glad Music.
- Buddy Music (BMI), 1046 Carol Dr., Los Angeles, Calif. 90069. Tel: (213) 278-2981. (Administered internationally by Bug Music Group)
Int'l rep.: Australia (Warner Bros.), Benelux (EMI Holland), Far East (EMI in Hong Kong), France (Warner Bros.), Germany (Global), Italy (Warner Bros.), Japan (Pacific), Mexico (Beechwood), South Africa (Warner Bros.), South America (Artemis in Netherlands), Sweden (Air), UK (Warner Bros.).
- Bud's Red Hot Music (BMI), see Garrett.
- Buena Vista Publ'g Co. (BMI), PO Box 28553, Dallas, Tex. 75228. Tel: (214) 270-4887. Owner: B.L. Bollman.
- Buffalo Bill Music (BMI), 2501 S. Ocean Dr., Hollywood, Fla. 33019. Tel: (305) 921-6550. Pres.: Robert S. Tarzan; Nat'l Sales: Evelyn Jordan.
- Bug Eyes Music (BMI), see Bug Music Group.
- Bug Juice Music (ASCAP), see Bug Music Group.
- Bug Music (BMI), see Bug Music Group.
- Bug Music Group, 6777 Hollywood Blvd., 9th fl., Hollywood, Calif. 90028. Tel: (213) 466-4352. Pres.: Daniel Bourgoise; VP & Gen. Mgr.: Fred Bourgoise; Prof. Mgrs.: Jim Farnold, Ger Eilers; Copyright Admin'r: Lydia Frazier, Barbara Kirchner.
Int'l rep.: Australia (Matthews), Belgium (Ardmore & Beechwood), Far East (EMI), France (Warner Bros.), Germany (Roba), Israel (April), Italy (Warner Bros.), Japan (Pacific), Netherlands (EMI-Holland), South Africa (Warner Bros.), Sweden (Air), UK (Warner Bros.).
- Bumbershoot Music Inc. (BMI), see Sunnyslope.
- Burlington Music Corp. (ASCAP), 539 W. 25 St., New York, N.Y. 10001. Tel: (212) 675-6060. Cable: FULLRANGE.
Int'l branches: Australia (Palace), Canada (Burlington), France & French Union (Palace), Germany (Burlington), Hong Kong (Burlington-Palace), Italy (Palace), Netherlands (Palace), South Africa (Burlington), Spain & Portugal (Burlington), Sweden (Palace), Switzerland (Burlington), UK (Burlington-Palace).
- Burriesci Bros. Music Prod'ns (ASCAP), 400 W. 27 St., Richmond, Va. 23225. Tel: (804) 230-0225. Studio Dir.: Richard C. Burriesci; Adv. Dir.: John F. Burriesci; Music Dir.: C.J. Alonzo Leger.
Branch: Baltimore, N.Y., Palminteri Music Prod'ns, 73 Huron Rd. Zip: 11426. Tel: (516) 775-4656. Studio Dir.: William L. Palminteri.
- Busch Country Publ'g (SESAC), 1002 W. Busch Blvd., Tampa, Fla. 33612. Tel: (813) 935-6289. Owner: Randall Benthicourt.
- Buttermilk Sky Music Publ'g Corp. (BMI), 515 Madison Ave., Suite 808, New York, N.Y. 10022. Tel: (212) 759-2275. Pres.: Murray Deutch; Gen. & Prof. Mgr.: Stuart Cantor; Admin. Ass't: Fran Barber.
- Butter Music (BMI), see Cream.
- Buzzerb Music (BMI), see Scott Tut.
- Bygonesh Music Corp. (ASCAP), RD 1, Brookfield, Vt. 05036. Tel: (802) 276-3393. Pres.: Bobby Gosh.

- Caligula Inc. (ASCAP), 60 Pearl St., New York, N.Y. 10004. Tel: (212) 483-1939. Pres.: David Forman; VP & Gen. Mgr.: Charles Barter. Int'l rep.: Asia, Europe & UK (Mory Lane in USA).
- Calumet Music (BMI), see M.M. Co.
- Calwest Songs (BMI), c/o Lee Anderson Ent's, PO Box 4141, North Hollywood, Calif. 91607. Tel: (213) 761-6915. Owner & Pres.: Lee Anderson; VP: Bruce Anderson; Pub. Dir.: Eth Anderson. Branch: Bellingham, Wash., 1509 Broadway. Zip: 98225. Tel: (206) 676-9961. Gen. Mgr.: Bob Wood.
- Camelback Mountain Music Corp. (ASCAP), see Shapiro Bernstein.
- Camercia Music (ASCAP), 489 Fifth Ave., New York, N.Y. 10017. Tel: (212) 682-8400. Telex: 236920. Pres.: Vittorio Benedetto.
- Cameron Org. Inc., 320 S. Waiola Ave., La Grange, Ill. 60525. Tel: (312) 352-2026. Prof. Mgr.: Scott A. Cameo.
- Cameo Music Inc. (BMI), see Cameo.
- Camillo-Barker Ent's., 121 Meadowbrook Dr., Sommerville, N.J. 08876. Tel: (201) 359-5110. Co-Pres.: Cecile Barker, Tony Camillo; Gen. Mgr.: Alison Ottman; Prof. Mgr.: Carol Lawrie. Branch: Los Angeles, Calif., 643 Sunset Blvd., Suite 816. Zip: 90028. Tel: (213) 462-3162.
- Camino Real Music (ASCAP), see G. rrett.
- Campshe Music (BMI), see MizMo.
- Campbell Connelly & Co. Inc. (ASCAP), 271 North Ave., New Rochelle, N.Y. 10802. Treas.: Nathaniel Miller. Home office: England.
- Glen Campbell Music Inc. (BMI), 100 Susan Blvd., Los Angeles, Calif. 90069. Tel: (213) 271-1162.
- Canal Publ'g Inc. (BMI), 6325 Guilft Dr., Indianapolis, Ind. 46220. Tel: (317) 255-3116. VP & Gen. Mgr.: Terry Barnes.
- Candlestick Seven (SESAC), see Jir W. Rice.
- Candue Music Inc. (ASCAP), 19 S. B roadway, White Plains, N.Y. 10601. Tel: (914) 682-8069. Pres.: Ron Caran; VP: Bill Heller. (Administered by Copyright Serv. Bureau)
- Can't Stop Music (BMI), 65 E. 55 St., Suite 302, New York, N.Y. 10022. Tel: (212) 751-6177. Telex: 427317. Pres.: Maximilian Dahan-Lavelle; Prof. Mgr.: Roberta Crownover. Int'l firm represented: Scorpio/Jack Scorpio (France).
- Canyon Press Inc., PO Box 1235, Cincinnati, Ohio 45201. Tel: (513) 852-7850. Pres.: G.W. Fahrer Jr.; VP: Alison Fahrer.
- Can You Hear Me Music (BMI), PO Box 14243, San Francisco, Calif. 94114. Tel: (415) 824-3676. Contact: F. bert Hanrahan.
- Capano Music (div. of Britone Inc.) (ASCAP), 237 Chestnut St., Westville, N.J. 08093. Tel: (609) 456-4400. Pres.: Anthony J. Capano; Gen. Mgr.: Patrick Capano; Prof. Mgr.: Bria J. A. Capano.
- Capin Music (BMI), see Biography.
- Capri Music Co. (ASCAP), see Chery Lane.
- Captain Memo Music (ASCAP), 1100 Mayfield Ave., Los Angeles, Calif. 90049. Tel: (213) 820-5061. Pr. s.: Richard Joel Rothstein.
- Captain Slick (ASCAP), see Jim W. Rice.
- Capri Music Corp. (BMI), see Alfie I.
- Cara Publ'ns (ASCAP), 2000 W. D-venor Rd., Columbus, Ohio 43212. Tel: (614) 486-3334. Owner: John T. Igenhorst. (Administered by C.L. Barnhouse)
- Cardio Music (BMI) (div. of Art Alta & Recs. Inc.), 964 W. Grant Rd., Tucson, Ariz. 85705. Tel: (602) 884-9011. Pres.: William Cashman.
- Careers Music Inc. (BMI), see Aris-a-Interworld.
- Carleen Galetana Music (ASCAP), E. Chestnut, Chicago, Ill. 60611. Tel: (312) 943-0305.
- Carlson Music Co. (BMI), 4625 NW 14 St., Fort Lauderdale, Fla. 33319. Tel: (305) 731-4669. Owner: Harry Aron.
- Carlyle Music Publ'g Corp. (ASCAP), see H.B. Webman.
- Carolights Music (ASCAP), see Peaseable Kingdom.
- Carolina Cowboy Music (BMI), see Mylicy.
- Carreau Music (BMI), see Funky T.
- Carroll Music Inc. (BMI), 809 W. norwill Dr., Port Orange, Fla. 32019. Tel: (904) 761-9685. Owners: Pete & Jo Ann Carr.
- Alan Carter Music (BMI), 22 Music Square E., Nashville, Tenn. 37203. Tel: (615) 257-7404. Pres.: Alan Carter; Gen. Mgr.: Brent Carter; Prof. Mgr.: Don Carter; Publ'g Dir.: Ame A. It.
- Carter 3 Music (ASCAP)—Pres.: B. ent Carter—see Alan Carter Music.
- Carwin Country Int'l., 13357 Lorain Ave., Cleveland, Ohio 44111. Tel: (216) 476-2695.
- Cary & Mr. Wilson Music Inc. (BMI) PO Box 500. Zip: 37202; 417 Broadway, Nashville, Tenn. 37203. Tel: (615) 242-5400. Pres.: Ernest Tubb; Gen. & Prof. Mgr.: Justin Tubb (Administered by Window Music).
- Casa David, see JAC.
- Casa Latina Inc. (ASCAP), see Mexican Music.
- Don Casale Music (BMI), 377 Pi infield St., Westbury, N.Y. 11590. Tel: (516) 333-7898. Pres. & Gen. Mgr.: Don Casale.
- Cascade Mountain Music (ASCAP), 18039 S. Crenshaw Blvd., Suite 300, Torrance, Calif. 90504. Tel: (213) 338-5476. Pres.: William J. Wickline. Branch: Fox Island, Wash., 588 North Shore Blvd. Zip: 98333. Tel: (206) 549-2468.
- Casseroles Music Inc. (BMI), see F. 30.
- Castalia Music (BMI), PO Box 1116, Milwaukee, Wis. 53211. Pres.: Jim Spencer; Sales & Promo.: Davv Luhrsenn.
- Castle Hill Publ'g Ltd. (ASCAP), 92 Fifth Ave., Duplex Suite, New York, N.Y. 10021. Tel: (212) 772-9335. Pres.: Peter Casperson.
- Castle Music Inc., PO Box 7574, Tulsa, Okla. 74105. Tel: (918) 299-1224.
- Catspa Publ'g Co. (BMI), 2609 NY 36 St., Oklahoma City, Okla. 73112. Tel: (405) 942-0462. Gen. & Prof. Mgr.: Bobby Boyd.
- Catchup Music (BMI), PO Box 9-30, 3507 W. Vickery, Fort Worth, Tex. 76107. Tel: (817) 737-9911. F. es.: J.P. Kimzey.
- Cat Clothes Music (BMI), see Bu Music Group.
- Cayton Publ'g, PO Box 367, W. Ma. St., Orwell, Ohio 44076. Tel: (216) 437-8422.
- Ceberg Music Corp. (ASCAP)—Pre.: Norman Bergen; Chief Operating Officer: Reid Whitelaw—see Brook ide.
- Cedarwood Publ'g Co. Inc. (BMI) 39 Music Square E., Nashville, Tenn. 37203. Tel: (615) 255-6535. P. es. & Gen. Mgr.: J. William Denny; Prof. Mgr.: John E. Denny. Int'l rep.: Worldwide (Peer-Sol them in USA).
- Celestia Music (BMI), see MizMo Ent's.
- Celesteville Music (ASCAP), see Iokklok.
- Celestial Harmonies (BMI), see A yfflower Music.
- Celta Music Inc. (ASCAP), see Ru Imus.
- Celtone Music (ASCAP), see Cam lo-Barker.
- Centipede Songs (BMI), see Bu Music Group.
- Ce Rock Music, PO Box 77, Centes Square, Pa. 19422. Tel: (212) 438-8228. Owners: A.A. Gravatt, Curtis R. Ch.
- Cetra Music (ASCAP), see Quacki tush.
- C'est Music Corp. (BMI), 582 S. University Ave., Chicago, Ill. 60637. Tel: (312) 493-9781. Pres.: Morton A. Kaplan.
- Chain Gang Music (BMI), see 20 t Century.
- Chalk Farm Music (BMI), 9570 Wishire Blvd., No. 290, Beverly Hills, Calif. 90212. Tel: (213) 276-7663. Pres.: Rick Neigher; Gen. Mgr.: Chris Cote; Prof. Mgr.: Peter Ross.
- Chalove Music (BMI), see Brother Music & MizMo Ent's.
- Chameleon Music (ASCAP), see Reno/Weltz.
- Champion Music Corp. (ASCAP), see We Music Group.
- Champion Music Corp., see MCA.
- Chandler Music Co. Inc. (ASCAP), see Loring.
- Chanson (Eds.) Co., see Stanton.
- Chantem Music Inc. (BMI), see Beldock Levine & Hoffman.
- Chantry Music Press Inc. (SESAC), PO Box 1101, 32-34 N. Center St., Springfield, Ohio 45501. Tel: (513) 325-9992. Pres. & Prof. Mgr.: Frederick M. Otto.
- Chappell Music Co., 810 Seventh Ave., New York, N.Y. 10019. Tel: (212) 399-7373. Cable: SYMPHONY. (Sheet music distributed by Theodore Presser Co.) Branches: Hollywood, Calif., 6255 Sunset Blvd. Zip: 90028. Tel: (213) 469-5141—Nashville, Tenn., 11 Music Circle S. Zip: 37203. Tel: (615) 244-3382. Int'l branches: Australia, Belgium, Canada, England, France, Germany, Italy, Japan, Netherlands, New Zealand, South Africa, Spain, Sweden, Switzerland. Int'l firm represented: Snowblind Music (Canada).
- Chaps Music (ASCAP), see Americus Music.
- Char Barb Music (BMI), Rt. 1, Box 120F, Swoope, Va. 24479. Tel: (703) 885-3309. Pres. & Gen. Mgr.: Barbara R. Flowers; Prof. Mgr.: Charles A. Flowers.
- Charing Cross Music Inc. (BMI), 36 E. 61 St., New York, N.Y. 10021. Tel: (212) 751-6590. Gen. Mgr.: Ian E. Hoblyn. Int'l firm represented: Pattern (UK). Int'l rep.: UK (Pattern).
- Char-Liz Music Inc. (BMI), PO Box 705, Old Chelsea Sta., New York, N.Y. 10113. Tel: (212) 674-1111. Chm.: Creed Taylor; Gen. Mgr.: Vic Chirumbolo. Int'l rep.: Australia (Matthews), Austria (Schmolzi & Slezak), Benelux (Kluger), Germany (Ivan Mogul), France (Sugarmusic), Germany (Schmolzi & Slezak), Italy (Sugarmusic), Japan (Seven Seas), Mexico (Gamma), Scandinavia (Multitone), South Africa (Galio), Spain (Hisparov), Switzerland (Schmolzi & Slezak), UK (Heathside).
- Charter Publ'ns Inc. (ASCAP) (div. of J.W. Pepper & Son), PO Box 850, Valley Forge, Pa. 19482. Tel: (215) 666-0363.
- Stanley Chase Music (BMI), see MizMo.
- Chatawa Music (ASCAP), see Malaco.
- Chatham Music Corp. (ASCAP), see 20th Century.
- Chattanooga Music Publ'g Co. (BMI), 1521 Seventh Ave., Beaver Falls, Pa. 15010. Tel: (412) 846-2225. Pres.: M. David Breit; Gen. Mgr.: Ralph F. Robb.
- Cheavoria Music Publ'g Co. (BMI), PO Box 1304, Brewton, Ala. 36426. Tel: (205) 867-2228. Pres.: Roy Edwards; Gen. Mgr.: Bobbie Roberson; Prof. Mgr.: Mike Tracy.
- Chenanih Music (SESAC), 2199 Nolensville Rd., Nashville, Tenn. 37211. Tel: (615) 256-2242. Pres.: Derric Johnson.
- Cherie Music (BMI), 3621 Health Ln., Mesquite, Tex. 75150. Tel: (214) 279-5858. Owners: Jimmy Fields, George McCoy.
- Cherio (BMI), c/o Lee Eastman, 39 W. 54 St., New York, N.Y. 10019. Prof. Dept.: Robert Jones.
- Cherry Blossom Music Co. (SESAC), see Cherry Lane.
- Cherrydale Music (SESAC), see Dale McBride.
- Cherry Lane Music Publ'g Co. Inc. (ASCAP), 50 Holy Hill Ln., Greenwich, Conn. 06830. Tel: (203) 661-0707. Telex: 643420. Contact: Jean Dinegar. Branches: Beverly Hills, Calif., 9744 Wishire Blvd. Zip: 90212. Tel: (213) 550-7100. Contact: Milton Okun. Int'l branches: Australia, Japan. Int'l rep.: Austria (Schmolzi & Slezak in Germany), Belgium (Interworld in Netherlands), Canada (Weibech), Germany (Schmolzi & Slezak), Greece (Interfong Hella), Ireland (Winter Hill/Interworld in UK), Italy (Franto), Mexico (EMLASA), Netherlands (Interworld), Portugal (Clipper's Eds.), Scandinavia (Air in Sweden), South Africa (Music Publ'g Co.), South & Central America (Fermata), Spain (Clipper's Eds.), Switzerland (Schmolzi & Slezak in Germany), UK (Winter Hill/Interworld).
- Cherry River Music Co. (BMI), see Cherry Lane.
- Cherry Wood Music Co. (ASCAP), see Cherry Lane.
- Chesley Music Corp. (BMI), see Musicprint.
- Jerry Chesnut Music Inc. (BMI), 40 Music Square E., Nashville, Tenn. 37203. Tel: (615) 244-0270. Pres. & Prof. Mgr.: Jerry Chesnut.
- Chess Music Inc. (ASCAP), see Pi-Gem.
- Chestler Publ'g Co. (BMI), 7511 Farrand Rd., Clio, Mich. 48420. Tel: (313) 639-7685. Pres.: Harry F. Chester.
- Chestnut Mound Music (BMI), (div. of the Eddie Crook Co.), PO Box 213, Hendersonville, Tenn. 37075. Tel: (615) 822-1360. Owner: Eddie Crook; Office Mgr.: Janice Crook.
- Chicago Music Publ'g, c/o Greene & Reynolds, 1900 Ave. Of The Stars, Suite 1424, Los Angeles, Calif. 90067. Tel: (213) 553-5434.
- Chicken Key Music (BMI), see Cherry Lane.
- Chiconel Music Corp. Inc. (ASCAP, BMI), 4447 N. Oakland Ave., Milwaukee, Wis. 53211. Tel: (414) 964-4888.
- Children's Musical Plays (ASCAP), see Popular Music.
- Chillywinds Music, 425 Park Ave., New York, N.Y. 10022.
- Chinnichap Publ'g Inc. (BMI), 8919 Sunset Blvd., Los Angeles, Calif. 90069. Tel: (213) 657-8585. Cable: DREAMLAND. Pres.: Mike Chapman; Asst't to Pres.: Dianne O'Brien; Admin.: Billy Meshel. (Administered by Arista Music).
- Chip 'N' Dale Music Publ'g Inc. (ASCAP), see Gene Kennedy.
- Choral Press (SESAC), see Shawnee Press.
- Chorea Noise (BMI), see Bug Music Group.
- Chris Music Publ'g Co. (BMI), PO Box 268, 211 Oak St., Manistique, Mich. 49854. Pres.: Reg B. Christensen.
- J. Christopher Music Co. (ASCAP), see Hope.
- Chrysalis Music Corp. (ASCAP), see Chrysalis Music Group.
- Chrysalis Music Group, 9255 Sunset Blvd., Los Angeles, Calif. 90069. Tel: (213) 550-0171. Pres.: Terry Ellis; VP & Gen. Mgr.: Ann Munday; Prof. Mgr.: (east) Frank D'Amico, (west) Steve Mair.
- John Church Co. (ASCAP), see Theodore Presser.
- Churn Music (ASCAP), see Cream.
- Chu Yeko Musical Foundation (ASCAP), see Take Home Tunes!
- Ciano Publ'g Co. (BMI), PO Box 263, 37 Woodside Ave., Hasbrouck Heights, N.J. 07604. Tel: (201) 288-8935. Pres.: Ron Luciano.
- Int'l firm represented: Michel Meyer & Cie. (France).
- Cible Music (ASCAP), see Garrett.
- Cifi Publ'g Co. (BMI), 3966 Standish Ave., Cincinnati, Ohio 45213.
- Cincinnati Music Co. (BMI), Scheraga Bldg., Suite 405, 906 Main St., Cincinnati, Ohio 45202. Tel: (513) 241-3447. Pres.: Michael S. Schwartz; Gen. Mgr.: Robert L. Schwartz.
- Clara Music Publ'g Corp. (ASCAP), 157 W. 57 St., New York, N.Y. 10019. Tel: (212) 757-9660.
- Claridge Music (ASCAP) (div. of MPL Communications), 39 W. 54 St., New York, N.Y. 10019. Tel: (212) 581-1330. Prof. Dept.: Robert Jones.
- Clarkee Music (BMI) (div. of Contemporary Artist Ent's. Inc.), 8817 Rangely Ave., Los Angeles, Calif. 90048. Tel: (213) 273-5687. Pres.: Stanley Clarke; Exec. Dir.: Carolyn Clarke. Int'l rep.: Europe (InterSong), Japan (Taiyo).
- Clark Musical Prods (BMI), PO Box 299, Watsela, Ill. 60970. Tel: (815) 432-4518. Pres.: Dr. Paul E. Clark; Gen. Mgr.: Michael K. Spitter; Prof. Mgr.: Mark Peterson.
- Clarus Music Ltd. (ASCAP), 340 Bellevue Ave., Yonkers, N.Y. 10703. Tel: (914) 375-0864. Pres.: Selma Fass; Gen. Mgr.: Bernie Fass.
- Clayton-Davis & Assocs. Inc. (BMI), 8229 Maryland St., Louis, Mo. 63105. Tel: (314) 862-7800. Pres.: Irvin Davis; Gen. & Prof. Mgr.: Adele K. Solit.
- Clear Light Inc. (ASCAP), 1500 Gateway Dr., Fort Lauderdale, Fla. 33309. Tel: (305) 973-4900.
- Clevertown Music, 6151 Orange St., No. 318, Los Angeles, Calif. 90048. Tel: (213) 931-2662.
- Cliff Dveller Music (BMI), see Bug Music Group.
- Cling Music Publ'g (ASCAP), see Soprano.
- Clock Music (BMI), see Solar Rocs.
- Clockus Music Co. (BMI), Star Rt., Milford, Calif. 96121. Tel: (916) 253-3689. Owner: Ed Marmor.
- Clotho Music Inc. (BMI), see Beldock Levine & Hoffman.
- Coal Dust Music Inc. (SESAC), see Coal Miners.
- Coal Miners Music Inc. (BMI), 7 Music Circle N., Nashville, Tenn. 37203. Tel: (615) 259-9449. Pres.: O.V. Lynn Jr.; Gen. Mgr.: Meredith Stewart; Prof. Mgr.: Mitch Johnson. Int'l rep.: Australia (Alians Music), Canada (RCA), France (Frances Day), Germany (Siegel), Netherlands (EMI).
- Coast Highway Music (ASCAP), see Open End.
- Coast Music (BMI), see Amestoy.
- Cochise Publ'g Co. (BMI), PO Box 1415, Athens, Tex. 75751. Tel: (214) 675-5192.
- Cockpit Music (ASCAP), see Bug Music Group.
- Cogent Music (BMI)—Owner & Pres.: Ron Davies—see Caledonia Music & MizMo Ent's.
- Martin Cohen (Law Offices of), 6430 Sunset Blvd., Suite 1500, Los Angeles, Calif. 90028. Tel: (213) 463-1151. TWX: (910) 321-3738. Cable: COBOL-LEX. Admin'r: Martin Cohen; Publ'g Admin.: Brenda Theveny.
- Bruce Cohn Music, PO Box 359, Sonoma, Calif. 95476. Tel: (707) 938-4060. Admin. Ass't: Kathleen Nelson.
- Cold Weather Music (BMI), see Four Aces.
- Coleman Music (BMI), see Bug Music Group.
- Coleman, Kestin & Smith Ltd. (BMI)—Gen. Mgr.: Linda Lou Kestin—see Keristene.
- M. M. Cole Publ'g Co. (BMI), 919 N. Michigan Ave., Suite 1602, Chicago, Ill. 60611. Tel: (312) 787-0804. Cable: MMCOLE. Pres.: Shepard Stern.
- Column One Music (ASCAP), PO Box 4086, Springfield, Mo. 65808. Tel: (417) 881-5015. Pres.: James M. Martin. Int'l rep.: Worldwide excluding US & Canada (Acuff Rose in USA).
- Column Two Music (BMI), see Column One.
- Combine Music Corp. (BMI) (div. of Monument Rec. Corp.), 35 Music Square E., Nashville, Tenn. 37203. Tel: (615) 255-0624. Pres.: Robert J. Beckham; VP: Johnny MacRae; Gen. Mgr.: Al Cooley; Prof. Mgr.: Alan Rush. Branch: Hollywood, Calif., 1800 N. Highland Ave. Zip: 90028. Tel: (213) 463-1652. Prof. Mgr.: Bill Anthony. Int'l rep.: Australia (Festival), France (Rideau Rouge), Germany (Rolf Budde), Italy (G. Ricordi), Japan (Taiyo), Mexico (Latino Americana), Netherlands (Basart), South Africa (Reville), Sweden (Air Scandinavia), UK (Keith Prowse).
- Commodore Entertainment Publ'g Corp. (ASCAP), c/o Benjamin Ashburn Assocs., 39 W. 55 St., New York, N.Y. 10019. Tel: (212) 246-0385. Telex: 429420. Pres.: Benjamin Ashburn; Gen. Mgr.: Marilyn Williams. (Administered by Jobete Music).
- Commodore Thompson Music Inc. (BMI), see JMT.
- Company of the Two P(eters) Inc. (BMI), see Jamie.
- Comruco Music Inc. (ASCAP), 3 Kensington Oval, New Rochelle, N.Y. 10805. Tel: (914) 235-1229. Pres.: Mitt Gabler; Gen. Mgr.: David Chase.
- Con Brio Music (BMI), PO Box 196, Nashville, Tenn. 37202. Tel: (615) 329-1944. Pres.: Bill Walker; Gen. Mgr.: Jeanine Walker; Prof. Mgr.: Kendal Franceschi. Int'l rep.: Worldwide excluding USA & Canada (Burlington in UK).
- Concert Music Publ'g Co. (ASCAP), see Studio P/R.
- Concorde Publ'g Co. (SESAC), see Con Brio.
- Concordia Publ'g House (SESAC), 3558 S. Jefferson Ave., St. Louis, Mo. 63118. Tel: (314) 664-7000. Cable: CONPUBCO.
- Concord Music Publ'g Co. Inc. (ASCAP), see Henri Elkan.
- Conductive Music Inc. (BMI), c/o Shapiro & Steinberg, 315 S. Beverly Dr., No. 210, Beverly Hills, Calif. 90212. Tel: (213) 553-1601.
- Cone Music Co. (BMI), see Joe Keene.
- Connections Unlimited Inc., 2817 Parker Court, Wheaton, Md. 20902. Tel: (301) 942-6281. Contact: Margaret Cafarelli.
- Mike Conner Music Corp. (BMI), see Loring.
- Conrad Music (BMI), see Goodman Group.
- Consort Press, see Mark Foster.
- Contemporary Music (BMI) (div. of Contemporary Recs. Inc.), PO Box 2628, Los Angeles, Calif. 90028. Tel: (213) 466-1633. Cable: GOODREC. Pres.: John Koenig; VP: Victoria Koenig.
- Contention Music (SESAC), PO Box 824, Nashville, Tenn. 37202. Tel: (615) 244-8839. Pres. & Gen. Mgr.: Ted Harris; Prof. Mgr.: Jackie Harris.
- Controlled Sheet Music Serv. Inc., 112 Hudson St., Copiague, N.Y. 11726. Tel: (516) 842-8080. Pres.: Ronald Ravitz; Gen. Mgr.: Linda Press.
- Convertible Music (BMI), see Bug Music Group.
- Conynop Music Inc. (BMI) (div. of BSD Recs.), 2595 Carrel Ln., Willow Grove, Pa. 19090. Tel: (215) 443-0935. Cable: BSOMUSIC. Pres. & Gen. Mgr.: Sal Barbieri; Prof. Mgr.: Ciro Schiano. Int'l branch: Italy. Int'l rep.: Canada (Rebera), Italy (Suvini/Zerboni).
- Martin Cooper Music (ASCAP), PO Box 3331, Beverly Hills, Calif. 90212. Tel: (213) 275-4508. Owner: Marty Cooper.
- Int'l rep.: Australia (Jonathan), Germany (Francis Day & Hunter), Scandinavia (Warner Bros.), South Africa (Warner Bros.).
- Copper Basin Publ'ns (BMI), see Coal Miners.
- Copyright Serv. Bureau Ltd., 221 W. 57 St., New York, N.Y. 10019. Tel: (212) 582-5030/1188. Cable: COPYSEB. Chm.: Walter Hofer; Pres.: Gitta A. Hofer; VP Admin.: Jeri R. Spencer; VP & Gen. Counsel: Alan Skiena; Int'l Dir.: Lucille Santarelli. Int'l branches: Argentina (CSB), Australia (Leosong), Belgium (CSB), Brazil (CSB), Denmark (Nordisk), England (Leosong), France (CSB), Germany (CSB Kaminsky), Greece (CSB), Japan (CSB/Mara Int'l), Mexico (CSB), Netherlands (CSB), South Africa (CSB).

Coryell Publ'ns (BMI), see Mayflower Music.
 Don Costa Prod'ns Inc. (BMI), 4215 Coldwater Canyon, Studio City, Calif. 91604. Tel: (213) 980-0400. Pres.: Don Costa; VP & Prof. Mgr.: Leo G. Costa.
 Cotabla Music Inc. (BMI)—Pres.: David Foster—see Nero Ent.
 Cotillion Music Inc. (BMI), 75 Rockefeller Plaza, New York, N.Y. 10019. Tel: (212) 484-8208. Cable: ATCOMUSIC. VP & Gen. Mgr.: Linda Workman; Prof. Mgr.: Barry Dffitzer.
 Int'l repps.: Argentina (Argentine Music), Australia (Warner Bros.), Brazil (Warner Bros.), France (PECF), Germany (Warner Bros.), Italy (Warner Bros.), Jamaica (Sheila), Japan (Taro), Mexico (Beethoven), Netherlands (Warner Bros.), South Africa (Warner Bros.), Spain (Armonco-Clippers), Sweden (Warner Bros.), UK (Warner Bros.).
 Cottonblossom Music, Star Rt. 2, Besmarck, N.D. 58501. Tel: (701) 223-7316.
 Cotton Pickin' Songs (ASCAP), see Garrett.
 Counterpart Music (BMI), 3744 Applegate Ave., Cincinnati, Ohio 45211. Tel: (513) 661-8810. Pres.: Howard Lovdal.
 Country Classics Music Publ'g Co. (BMI), 105 Burk Dr., Oklahoma City, Okla. 73115. Tel: (405) 677-6448. Pres. & Prof. Mgr.: Yvonne DeVaney; Gen. Mgr.: Sonny Lane.
 Branch: Nashville, Tenn., 38 Music Square E., Suite 219. Zip: 37203.
 Country Legs Music (ASCAP), 1577 Redwood Dr., Harvey, La. 70058. Tel: (504) 367-8501. Pres.: George Ledger.
 Country Moon Publ'g, 324 S. Crescent Dr., Beverly Hills, Calif. 90212. Tel: (213) 553-8024. Pres.: James R. Halper.
 Country Road Music Inc. (BMI), c/o Gelfand, Breslauger, Rennert & Feldman, PO Box 2202, 431 S. Palm Canyon Dr., Palm Springs, Calif. 92262. Tel: (714) 325-5095. Publ'g Admin.: Stephen D. Chambers.
 Country Star Music (ASCAP), 439 Wiley Ave., Franklin, Pa. 16323. Tel: (814) 432-4633. Pres.: Norman Kelly.
 Int'l repps.: Canada (Morning Music), France (Michel Meyer), UK (B. Feldman).
 Country Stream Music (BMI), 5053 Tholozan Ave., St. Louis, Mo. 63109. Tel: (314) 481-3916. Pres.: Tony Mazzola; Gen. Mgr.: Sam Mazzola.
 Country Sun Publ'g Co. (BMI), 401 Magnolia, Auburndale, Fla. 33823. Tel: (813) 967-3088. Pres.: Leo Gillman; Gen. Mgr.: Len Walls.
 County Line Music (ASCAP), see Skinny Zach.
 Cousins Music Inc. (BMI), 211 Birchwood Ave., Upper Nyack, N.Y. 10960. Tel: (914) 358-0861. Pres.: Louis E. Cacchetti. (Administered by Copyright Serv. Bureau).
 Covina High Music (BMI), see Bug Music Group.
 Cowboy Junction Publ'g Co. (BMI), Box 1, Star Rt. 1, Lecanto, Fla. 32661. Tel: (904) 746-2394. Pres.: Boris Pastuch.
 Cowboy Kazoo Music (BMI), 5926 El Prado NW, Albuquerque, N.M. 87107. Tel: (505) 345-4835. Pres.: Jeff Burrows.
 Coyote Prod'ns Inc., 14002 Palawan Way, Marina del Rey, Calif. 90291. Tel: (213) 823-0171. Pres.: Leonard Sachs.
 Int'l repps.: Worldwide excluding US, Canada & Germany (April/Blackwood), Germany (Melodie der Welt).
 Crabshaw Music (ASCAP), 5028 Geary Blvd., San Francisco, Calif. 94118. Tel: (415) 221-8550. Pres.: Elvin Bishop. (Administered by Gelfand, Breslauger, Rennert & Feldman).
 Craig-Ellis & Co. Music Publ'rs (ASCAP), see Athon Music.
 Crash Course Music (BMI), see Bug Music Group.
 Crater Face Music (BMI), see Bug Music Group.
 Crazy Cajun Music (BMI), 5626 Brock, Houston, Tex. 77023. Tel: (713) 926-4431. Pres.: Huey P. Meaux; Gen. Mgr.: Beth Thornton.
 Crazy Jena's Music Publ'g (BMI)—Owner: Jena T. Johnson—see Kerstene.
 Cream Publ'g Group, 8025 Melrose Ave., Los Angeles, Calif. 90046. Tel: (213) 655-0944. Cable: BENNCO HOLLYWOOD. Tel: (916) 9812. Pres.: Al Bennett; VP & Publ'g Dir.: Bob Todd; VP & Int'l Dir.: Bobby Weiss; Prof. Mgr.: Marty Sadler.
 Branch: Memphis, Tenn., 1320 S. Lauderdale. Zip: 38106. Tel: (901) 775-3790—Nashville, Tenn., Music Publ'g Corp., 815 18 Ave. S. Zip: 37203. Tel: (615) 327-0518. (see separate listing)
 Int'l repps.: Australia (Leeds), Austria (J. Wemberger), Barbados & Caribbean (West Indies), Benelux (Mondio), France (Mondio), Germany (Melodie der Welt), Hong Kong (EMI), Israel (Muscor), Italy (Curci), Japan (Victor), Malaysia (EMI), New Zealand (Leeds), Philippines (World), Scandinavia (Kleinert), Singapore (EMI), South Africa (Reville), South Korea (EMI), Switzerland (Libu Eds.), Thailand (EMI), UK (Martin-Coulter); Mexico, Costa Rica, Honduras, Nicaragua & Panama (EMILASA); Argentina, Bolivia, Uruguay, Chile, Ecuador, Peru, Paraguay, British Guiana, India, Turkey, Yugoslavia, Portugal, Africa excluding South Africa, Pakistan, Bangladesh, Brunei, Sri Lanka, United Arab Emirates, Cyprus, Gibraltar, Grenada, Bermuda, Bahamas & Belize (Chappell Int'l).
 Creative Concepts Publ'g Corp., 967 E. Djan Ave., Djan, Calif. 93023. Tel: (805) 646-4811. Pres.: John L. Haag.
 Creative Corps., 6607 W. Sunset, Suite E, Hollywood, Calif. 90028. Tel: (213) 462-6164. Pres.: Kurt Hunter; Prof. Mgr.: Tom Barger.
 Creative Light Music (BMI), PO Box 2767, Philadelphia, Pa. 19120. Tel: (215) 745-9616. Exec. Dir.: Richard T. Towley, Sr.
 Creative Music Group, 6430 Sunset Blvd., Suite 1502, Hollywood, Calif. 90028. Tel: (213) 467-1135.
 CreekSide Music Publ'g Co. (BMI), 100 Labon St., Tabor City, N.C. 28463. Tel: (919) 653-2546. Pres.: Elson H. Stevens; Gen. Mgr.: Ferrell L. Jones; Prof. Mgr.: Retha C. Stevens.
 Crescent Moon Music (BMI), see Bug Music Group.
 Crimston Dynasty (ASCAP), PO Box 271, Cedar & West Ave., Jenkintown, Pa. 19046. Tel: (215) 757-8022. Pres.: Stan Peahota; Exec. VP: Frank Mulvenna; VP: Alan Meier; Sec'y-Treas.: Kathy Peahota.
 Cristeval Music (BMI), 5079 Calatrama Dr., Tarzana, Calif. 91356. Tel: (213) 996-1771.
 Criterion Music Corp. (ASCAP), 6124 Selma Ave., Hollywood, Calif. 90028. Tel: (213) 469-2296. Pres.: Michael H. Goldsen; VP & Prof. Mgr.: Bernard Goldsen. (Sheet music distributed by Joseph Goldfeder).
 Int'l repp.: France (Jacques Enoch).
 Critique Music Publ'g Co. Inc. (BMI), 100 Main St., Reading, Mass. 01867. Tel: (617) 944-0423. Pres.: Carl Strube.
 Cromia Music Co. (ASCAP), 37 W. 57 St., New York, N.Y. 10019. Tel: (212) 759-8730.
 Int'l branches: England, France, Germany, Italy.
 Crook and Flail (BMI), see Bug Music Group.
 Crown Jale Alley Music (BMI), see Bug Music Group.
 Crown Music Press—Pres.: Charles Stine; Gen. Mgr.: Stephen L. Glover—see Brass Press.
 Crusin' Music (BMI), see Bug Music Group.
 The Crystal Jukebox (BMI), c/o CBS Studio Center, 4024 Radford Ave., North Hollywood, Calif. 91604. Tel: (213) 760-5000.
 Cubic Music (BMI), see Bug Music Group.
 Cude & Pickins Publ'g (BMI), 519 N. Halifax Ave., Daytona Beach, Fla. 32018. Tel: (904) 252-0381. Pres. & Gen. Mgr.: Bobby Lee Cude; Prof. Mgr.: Watie Riley Pickens.

V & M Cutler Music Co. (ASCAP), PO Box 43, Chatsworth, Calif. 91311. Tel: (213) 886-7746. Pres. & Prof. Mgr.: Victoria-Diane Cutler; Gen. Mgr.: Max Cutler.

D

d b Recs. (ASCAP), PO Box 1773, Decatur, Ga. 30031. Tel: (404) 289-9273.
 Owner: T.M. Brady.
 D E W (BMI), see Don White.
 D R G Music Inc. (ASCAP), 200 W. 57 St., New York, N.Y. 10019. Tel: (212) 582-3040. Cable: STETRECS. TWX: (710) 581-4825. Pres.: Hugh Fordin.
 D R Music (ASCAP), see Lee Magid.
 D'abo Songs Inc./Smith Tunes, see Mayflower Music.
 Dadoico Music (BMI), see Bug Music Group.
 Dahlhouse Publ'g (ASCAP), see Blue Island.
 Dain & DeJoy (BMI), 6363 Sunset Blvd., Los Angeles, Calif. 90028. Tel: (213) 465-1108. Contact: Bud Dain, Ed DeJoy.
 Daksel/Seldak Music Corp. (BMI, ASCAP), 65 W. 55 St., New York, N.Y. 10019. Tel: (212) 765-2600. Tel: 428161. VP & Mng. Dir.: David Wilkes; Admin.: Pat O'Toole.
 Daltonos (BMI), see Bug Music Group.
 Damean Music (ASCAP), see Epoch Universal.
 Dana Publ'g Co. (BMI), 824 83 St., Miami Beach, Fla. 33141. Tel: (305) 865-8960. Pres.: Walter Dana; VP Promo: Gus Dana.
 Danf Music Co. (BMI), see Fisher Music Corp.
 Dandelion Music Co. (BMI), see Jame.
 Danelle Music Co. (ASCAP) (div. of Hilton House Inc.), PO Box 315, Cleveland, Ohio 44127. Tel: (216) 429-1159. Pres.: Donald B. Catalano; Gen. Mgr.: Danelle Catalano; Prof. Mgr.: Marian Driscoll.
 Darak Music (BMI), see Beldeck Levine & Hoffman.
 Daremoly Music (BMI), see Gelfen/Kaye.
 Dar-Jen Music Inc. (BMI), see 20th Century.
 Daria Music (ASCAP), see 20th Century.
 David Music (BMI), 1650 Broadway, New York, N.Y. 10019. Tel: (212) 247-2159.
 Davkie Music Co. (ASCAP), PO Box 8842, Los Angeles, Calif. 90008. Tel: (213) 292-5138. Owner: Isagh Jones. (Administered by Creative Music Group).
 Dawnbreaker Music Co. (BMI), 216 Chatsworth Dr., San Fernando, Calif. 91340. Tel: (213) 365-9375. (Administered by Manatt, Phelps, Rothenberg & Tunney).
 Dawn Prod'ns, Box 300, Mt. Gretna, Pa. 17064. Tel: (717) 964-2222. Cable: URSWEL. Pres.: Joey Weiz; Gen. Mgr.: Randy Boykin; Prof. Mgr.: Prof. Mgr.: Roy Smith.
 Branch: Belair, Md., Box 535, Main St. Zip: 21014.
 Dawn Trader Music (SESAC) (div. of Star Song Recs.), 2223 Strawberry, Pasadena, Tex. 77502. Tel: (713) 472-5563. Exec. Pres.: Wayne Donowho.
 Int'l firm represented: Kingsway Music (UK).
 Int'l repp.: UK (Kingsway).
 Daydan Music Corp. (ASCAP), see Acoustic Music.
 Days Of Old Publ'g Co. (BMI), 3116 Metairie Rd., Metairie, La. 70001. Tel: (504) 834-5711. Pres.: Traci Borges; Gen. & Prof. Mgr.: Philip A. Borges.
 Int'l repp.: Europe (Carlin in UK).
 D'Azure Music Inc. (ASCAP), see Music Music Music.
 Dead Boys Music (ASCAP), see Larry Spher.
 Deaf Monkey Music (ASCAP), see Monkey Music.
 DebbDavis Music (BMI, ASCAP), PO Box 140110, Nashville, Tenn. 37214. Tel: (615) 320-7227. Pres.: James Edward Malloy; Gen. Mgr.: Ken Wehrman.
 Debonair Music (BMI), 721 Colman St., Altadena, Calif. 91001. Tel: (213) 794-2673. Pres. & Gen. Mgr.: Tremain Trenar.
 Dedication Publ'g (BMI, ASCAP), 629 S. Dale, Anaheim, Calif. 92804. Tel: (714) 527-4319. Pres.: Mike Jacobs; Gen. Mgr.: Dak Van Tatenhove.
 Deepay Music Co. (BMI), 3008 Belden Dr., Los Angeles, Calif. 90068. Tel: (213) 469-2719/8204. Owner: Nick Terry; Gen. Mgr.: Bud Mathis.
 Deejay Musical Works Publ'g Co. (BMI), 1153 S. Highland Ave., Los Angeles, Calif. 90019. Tel: (213) 930-0930. Pres.: Frank Foulk.
 Deerwood Music (BMI), see Cream.
 De Gar Music (ASCAP), 665 Harrison, San Francisco, Calif. 94107. Tel: (415) 781-6306. Pres.: Leo de Gar Kulka; Exec. VP: Herbert Haas.
 Int'l firm represented: Star (Switzerland).
 Pietro Devo Publ'ns (SESAC), 133 Seventh Ave. S., New York, N.Y. 10014. Tel: (212) 675-5460.
 Delev Music Co. (BMI), 7231 Mansfield Ave., Philadelphia, Pa. 19138. Tel: (215) 276-8861. Pres.: William L. Lucas; Gen. Mgr.: Adele J. Lucas.
 Int'l repp.: UK (Chappell).
 Delhi Publ'ns Inc. (SESAC), see Willis.
 Lou DeLese Prod'ns (BMI), 1230 E. Mermind Ln., Wyndmoor, Pa. 19118. Tel: (215) 248-1683. Pres.: Lou DeLese; Gen. Mgr.: John R. Tschorn.
 Delmore Music Co. (ASCAP), PO Box 2324, Menlo Park, Calif. 94025. Tel: (415) 322-2947. Pres.: Cy Cohen; Gen. Mgr.: Myrl Nagel.
 Del Norte Music (BMI), see Altaz.
 Deluxe Music (BMI), see M.M. Cole.
 Richard Delvy Ent. Inc. (ASCAP), 8127 Elrta Dr., Los Angeles, Calif. 90046. Tel: (213) 650-4761. Pres.: Richard Delvy; Gen. Mgr.: Ingrid Geyer; Prof. Mgr.: Richard Canada.
 Branch: San Francisco, Calif., 480 Melrose. Zip: 94127. Tel: (415) 584-0996. VP: Dennis Geyer.
 Aldous Deman Publ'g Ltd., PO Box 1348, New York, N.Y. 10101. Tel: (212) 375-2639. VP: Harold Weber.
 Branches: Santa Monica, Calif., 3250 Ocean Park Blvd., Suite 100. Zip: 90405. Contact: James Taylor—Cleveland, Ohio, 2255 E. 89 St. Zip: 44106. Tel: (216) 861-2092.
 Denny Music Inc. (ASCAP), see Cedarwood.
 Denton & Haskins Corp. (ASCAP), PO Box 340, Radio City Sta., New York, N.Y. 10101. Tel: (212) 227-4714. Pres.: Chesley Y. Young; VP & Gen. Mgr.: Morris N. Young (Administered by Musicprint Corp.).
 Derby Music (SESAC), 3977 Vegas Valley Dr., Las Vegas, Nev. 89121. Tel: (702) 457-4365.
 Derry Music Co. (BMI), 601 Montgomery St., Suite 800, San Francisco, Calif. 94111. Tel: (415) 433-1800. Mgr.: Richard Singer.
 Desert Door Music (ASCAP), 7614 Fay Ave., Mesa, Ariz. 85208. Tel: (602) 986-4237. Owner: Raymond Cerimel.
 Desert Moon Songs Ltd. (BMI), see Roadshow.
 Desert Rain Music Ltd. (ASCAP), see Roadshow.
 Destructive World (BMI), see Maynard Ferguson.
 Deuel-Hart Publ'g (BMI) (div. of Hartson Corp.), 5006 Vineland, North Hollywood, Calif. 91601. Tel: (213) 766-5281. Pres. Tony Hart; Exec. VP. Gen. & Prof. Mgr. Kent Washburn.
 De Whit Music (ASCAP), 4627 Van Nuys Blvd., Sherman Oaks, Calif. 91403. Tel: (213) 995-7832. TWX. (910) 495-2019. Pres.: James P. Schlichting.
 Dex Music (BMI), see Mayflower Music.
 Desox Music (BMI), see Band of Angels.

Diagonal Music Inc. (BMI), see Reno/Metz.
 Diamondback Music Co. (BMI), see Great Pyramid.
 Dijon Music Publ'ns (BMI), 9033 Walshe Blvd., Beverly Hills, Calif. 90211. Tel: (213) 278-8118. Cable: AMERPIX. Pres. Terri Fricon; Gen. Mgr.: Gay Jones; Prof. Mgr.: Richard Clements. (Administered by April/Blackwood).
 Ding Dong Music Corp. (BMI), see Barton Music.
 Discmakers Publ'g (ASCAP), see Alan Hartwell Music.
 Walt Disney Music Co. (ASCAP), 350 S. Buena Vista St., Burbank, Calif. 91521. Tel: (213) 840-1000. Cable: DISNEY VP & Gen. Mgr.: Gary Kruel.
 Music Publ'g Mgr. Thomas Bocci, Prod. Development Mgr.: Jymn Magon; Bus. Affairs Mgr.: Steve DeWindt.
 Int'l branches: Canada, France.
 Int'l repps.: Argentina (Korn), Australia (Castle), Brazil (Fermata), Germany (Ufaton), Greece (Intersong), Hong Kong (EMI), Israel (Ilanot), Italy (Savini Zerboni), Japan (Shinko), Mexico (Gamma), Netherlands (EMI), Scandinavia (Intersong), South Africa (Music Publ'g Co.), Spain (Hispanic), UK (Music Sales, Carlin).
 Ditch Road Music Inc. (BMI), see 20th Century.
 Divler Ditson Co. (ASCAP), see Theodore Presser.
 Dixcotech Music (BMI), see Bug Music Group.
 Dixie Melody (ASCAP), see NBC.
 Dobro Publ'g Co. (BMI), Box 49, Rt. 1, Utica, N.Y. 13502. Tel: (315) 724-0895. Pres.: Mario Ketchum; Gen. & Prof. Mgr.: Floyd Ketchum.
 Doc Dick Ent's. (BMI), 16 E. Broad St., Mount Vernon, N.Y. 10552. Tel: (914) 668-4488. Pres.: Richard Rashbaum; Gen. Mgr.: Elizabeth Rashbaum; Prof. Mgr.: Howard Strauss, Jack Uram.
 Doc Ron Publ'g (ASCAP), 301 NW Second Ave., Boynton Beach, Fla. 33435. Tel: (305) 732-1145. Pres.: Dr. Ron Stander; VP Prod'ns: Chuck Howard Jr.; VP Sales: Maurice Stander; Sec'y-Treas.: Marianne Stander.
 Dr. Elizabeth Music (BMI), see Bug Music Group.
 Doheny Music (BMI), 8571 Holloway Dr., No. 2, Los Angeles, Calif. 90069. Tel: (213) 659-5479. Pres.: J.W. Alexander.
 Dolly Bee Music (BMI), 515 E. Racquet Club Rd., Palm Springs, Calif. 92262. Tel: (714) 327-9216. Owner & Pres.: George R. Brown.
 Domestic Music Co. (ASCAP), 850 Seventh Ave., Suite 2003, New York, N.Y. 10019. Tel: (212) 582-7807. Gen. Mgr.: James Alexiou.
 Donna-Marie Music Publ'g (ASCAP), c/o American Creative Entertainment, 1616 Pacific Ave., Suite 817, Atlantic City, N.J. 08401. Tel: (609) 348-1809. Pres.: Danny Luciano.
 Donna Music Publ'g Co. (BMI), PO Box 113, Woburn, Mass. 01801. Tel: (617) 933-1474/7651. Pres.: Frank P. Pappalardo. Gen. Mgr.: Frank Paul. Prof. Mgr.: Joseph Pappalardo.
 Donna-Tara Music (ASCAP), see Len-Lon.
 Don't You Know Music (ASCAP), see Skinny Zach.
 Doooms Publ'g Co. (BMI), PO Box 2072, Waynesboro, Va. 22980. Tel: (703) 942-0106. Owners: John H. Major, Margie F. Major.
 Door Knob Music Publ'g (BMI), see Gene Kennedy.
 Doors Music Co. (ASCAP), c/o Greene & Reynolds, 1900 Ave. of the Stars, Suite 1424, Los Angeles, Calif. 90067. Tel: (213) 553-5434.
 Int'l repps.: Africa (Music Publ'g Co. of Africa), Australia (Rondor), Austria (Altus), Brazil (Mundo Music), Central America (CBS Int'l), Denmark (Sweden Music in Sweden), Finland (Sweden Music in Sweden), Germany (Altus), Hong Kong (Pathe Far East), Iceland (Sweden Music in Sweden), Ireland (Rondor), Japan (Taro), Malaysia (Pathe Far East), Mexico (CBS Int'l), Norway (Sweden Music in Sweden), Singapore (Pathe Far East), South America (CBS Int'l), Spain (Penta/Quiroga), Sweden (Sweden Music), Switzerland (Altus), UK (Rondor).
 Doppler Effect Music (ASCAP), 1798 Maplewood NE, Warren, Ohio 44483. Tel: (216) 372-2510. Pres.: Richard Michael Oberotts.
 Dorstan Music (ASCAP), see MizMo.
 Double Diamond Music (BMI), see 20th Century.
 Double Jack Publ'g (BMI), see Powahatan.
 Doubletree Music (SESAC), see Music Publ'g Corp.
 Doulos Publ'g (BMI), see Maranatha !.
 Downtown Music Co. (ASCAP), see The Entertainment Co.
 Dragon Int'l Inc. (BMI), PO Box 8263, Haledon, N.J. 07508. Tel: (201) 942-6810. Pres.: Samuel Cummings; Gen. Mgr.: Patrick Simpson.
 Kelvin Drake Music (BMI), see 20th Century.
 Drayenn Music Publ'g Co. (BMI), PO Box 934, Edgartown, Mass. 02539. Tel: (617) 627-4639. Owner: Benjamin L. Hall.
 Dream Date Music (BMI), see Bug Music Group.
 Dreenna Music (BMI), see Asilomar.
 Drew Mark Music Inc. (BMI), 3500 N. Causeway, Suite 1500, Metairie, La. 70002. Tel: (504) 831-9474. Pres.: Dale Murray; Gen. & Prof. Mgr.: Rex Pearce.
 Drifter Music (BMI), see Bug Music Group.
 Driftwood Publ'g Co. Inc. (BMI), see Cedarwood.
 Drive-In Music Co. Inc. (BMI), 7120 Sunset Blvd., Hollywood, Calif. 90046. Tel: (213) 851-2500.
 Driving Music (ASCAP), see Creative Corps.
 Drop Dead Music (BMI), see Bug Music Group.
 Dropkick Music (BMI), see Combine.
 Drop Top Music (BMI), 2615 N. Wilton Ave., Chicago, Ill. 60614. Tel: (312) 281-3385. Partners: Jim & Amy O'Neal, Mick & Cilla Huggins.
 Int'l branches: England.
 Drummer Boy Music Corp. (ASCAP), see The Goodman Group.
 Dry Clam Music (BMI), see Bug Music Group.
 Duane Music Inc. (BMI), 382 Clarence Ave., Sunnysvale, Calif. 94086. Tel: (408) 739-6133. Pres.: Garne E. Thompson; Gen. Mgr.: Duane N. Thompson.
 Branch: Albany, Calif., PO Box 6174. Zip: 94706. Tel: (415) 524-4939.
 Duce (ASCAP), c/o TAT Communications Co., 1901 Ave. of the Stars, Los Angeles, Calif. 90067. (Administered by Reno/Metz Music).
 Duchess Music Corp. (BMI), see MCA Music.
 Dum Ditty Music (BMI), see Bug Music Group.
 Dunamis Music (ASCAP), see Rubicon.
 Dunta Music (BMI), see Xanadu.
 Dupuy Publ'g Inc. (ASCAP), 10960 Ventura Blvd., Suite 200, Studio City, Calif. 91604. Tel: (213) 980-6412. Pres. & Prof. Mgr.: Pedro Dupuy; Gen. Mgr.: Gerd S. Aschendorf.
 Dusksongs Music (BMI) (div. of Dusk Rec'g Studios), 2217-A The Alameda, Santa Clara, Calif. 95050. Tel: (408) 248-3875.
 Dusty Roads Music Corp. (BMI), see Al Gallico.
 Dwarf Music (ASCAP), see Big Sky.
 Dy-Cor Inc. (BMI), 792 Columbus Ave., Apt. 10A, New York, N.Y. 10025. VP Harvey Cort.
 Dynamo Publ'g Co. (BMI), PO Box 6, 484 Lake Park Ave., Oakland, Calif. 94610. Tel: (415) 482-4854. Contact: Dan Orth.

E

E D M Music Publ'rs (ASCAP), see Clochus.
 E M P Co. (BMI), see The Entertainment Co.

E & M Publ'g Co (BMI), 2674 St. ele, Memphis, Tenn 38127 Tel (901) 357 0064 Owner, Pres. & Gen Mgr Marshall E Ellis
 E S P Disk Ltd, Acorn Hill Rd, Kri nville, N.Y 12447 Pres. Bernard Stoll man
 Branch: New York, N.Y., 5 Rive side Dr Zip 10023
 E V Music Publ'g Co (ASCAP), 49 0 N Calle Bendita, Tucson, Ariz 85718 Tel (602) 299 4031 Pres: Ev Smith, Gen & Prof Mgr Bill Smith
 Eagle Rock Music Co. (ASCAP), 141 N Belmont, No 308 Glendale, Calif 91206 Tel (213) 243 4109 Pre.: Mort Katz, Gen Mgr Melody A Katz, Prof Mgr Mali Broyles
 Earl Music Co (ASCAP), see Neve land
 Early Bird Music (BMI), 14702 Carterbury, Tustin, Calif 92680 Tel (714) 731 2981 Owner & Pres Steve Waltnr, Sales, Mktg. & Promo Sharon Waltnr
 Earthbound Publ'g Co (BMI) 842 Kate St., No 226 Dallas, Tex 75225 Tel (214) 368 1305 Pres. Sam obello III, Gen Mgr Michael Kubiak
 Earthing Music (ASCAP), 110 W 5 St., New York, N.Y 10024 Tel (212) 799 4181. Pres: Bob Sakayam., Prof Mgr Lynne Raymond
 Mundo Earwood Music (ASCAP), see Music West of the Pecos
 East Coast Recs. Inc., 6012 Lindbergh Blvd., Philadelphia, Pa 19142 Tel (215) 726-6049 Pres.: A Messr a, Gen Mgr. Steve Levy; Prof Mgr: T Rocca
 Eastex Music (BMI) 8537 Sunset Blvd., No 2, Los Angeles, Calif 90069 Tel (213) 657 8852 Owner Tivus Lehman
 East Memphis Music Corp (BMI), see Cream
 East West Music Inc (ASCAP), see The Goodman Group
 Easy Listening Music Corp (ASCA), see Al Gallico
 Edanmor Songs (ASCAP), see Cr noble Songs
 Eden Music Corp /iza Music Co., (BMI), PO Box 325, Englewood, N J 07631 Tel (201) 567 7538 P. s. Clyde Ots, Gen Mgr Janie Wash ington
 Int'l branch: England
 Int'l rep.: Australia (Essex), U (Essex)
 Don Edgar Music Co (BMI), 2312 J sper, Fort Worth, Tex 76106 Tel (817) 626 3448 Pres & Gen Mgr. Jon D Edgar
 Edmark Prod's (BMI), 20802 Cecir Ln., Tomball, Tex 77375 Tel (713) 351 1807. Pres. Edmond A Ev y
 Branch: Aransas Pass, Tex., PO Box 1147 Zip 78336 Tel (512) 758 3271 VP: William L Ellis
 Edson Publ'g Co (ASCAP), see Mi: Mo
 Efen Publ'g Co (BMI), see Reno/ Metz
 El Bandido Music (ASCAP), see G: rrett
 El Chicano Music (ASCAP), 20531 Plummer St., Chatsworth, Calif 91311 Tel: (213) 998-0443. Pres.: M. espron, Gen Mgr. A E Sullivan
 Elizabeth Music Publ'g (BMI), 515 E Racquet Club Rd., Palm Springs, Calif 92262. Tel: (714) 327 9216. Owner George R Brown
 Henri Elkan Music Inc. (ASCAP), 1 16 Walnut St., Philadelphia, Pa. 19107. Tel (215) 735-1900. Pres S V n Gobes, Gen Mgr. L Nasta, Prof Mgr. L Nivard
 Int'l firms represented: Ed And I-Gervan (Belgium), Ed Musicales Brogneaux (Belgium), CeBeDeM (Brigium), Ed A Cranz (Belgium), Islandia Ed. (Iceland), Lindsay Music UK, Ed. Metropolis (Belgium), Arthur Meulmans Fonds (Belgium), P oenaar (Netherlands), Noga (Israel), Scherzando (Belgium), Tierolol -Rosendaal (Netherlands), J.A.H. Wage naar (Netherlands), Ed. Ysaye Belgium
 Elkan-Vogel Inc (ASCAP), see Thodore Presser

Ellebie Music Publ'g Co (BMI), 410 Union St., Farrell, Pa 16121 Tel: (412) 342 9330. Pres & Prof Mgr Willie James Ellebie, Gen. Mgr Margaret Herrington.
 Ellipsis Music Corp (ASCAP), see Jamie
 Ellis & Co. Music Publ'rs (ASCAP), see Athon Music
 Herb Ellis Music (ASCAP), see MizMo
 Elm Publ'g Co (BMI), PO Box 1100, 14621 Allen St., Westminster, Calif 92683. Tel (714) 898-7317. Pres Edd L McNeely; Gen Mgr. Edd L McNeely Jr Local branch: John Robinson Music, 6461 Walt St. Zip 92683. Tel 893 3637. Chief Exec: John E Robinson.
 Int'l rep.: Australia & New Zealand (Woomera Music In Australia), Belgium (Frankie Music/Intermission Music), France (Michel Meyer), Scandinavia (Nordisk Copyright Bureau), Rest of World (London Recs. in USA)
 Elvis Music Inc (BMI), 1619 Broadway, New York, N.Y 10019 Tel (212) 489-8170 Contact Lester Boles
 Emily's Music Co (ASCAP)—Owner Paul Bromwell—see Sunnyslope
 Emit Music (BMI), see Solar Recs
 Emko Music Corp (BMI) (div. of Emko Talent Assocs Corp.), PO Box 176, Monsey, N.Y. 10952. Tel: (914) 425-6040.
 Emmanuel Music (ASCAP), see Ben Speer
 Emperor Music Inc (BMI), see H B Webman
 Empire Tunes Inc., 420 E. 80 St., New York, N.Y. 10021 Tel. (212) 628 1381 Pres: Michael Friedman, Exec. VP Don Silver Local branch: 1 Union Square Zip 10003 Tel: 741-1059
 Enchantment Music Co (BMI), PO Box 998, Mesilla Park 88047; 115 E Idaho, Las Cruces, N.M. 88001. Tel: (505) 524-1889. Owner Emmitt H. Brooks. (Affiliated with Brooks Bros.)
 Enrica Music Inc (BMI), see Rae-Cox & Cooke
 The Entertainment Co. Music Group, 40 W. 57 St., Suite 1510, New York, N.Y. 10019. Tel: (212) 265-2600, 586-3600 Telex: 666140 Principals. Charles Koppelman, Martin Bandier, Publ'g Dir. Joanne Boris, East Coast Prof. Mgr., Larry Osterman
 Epoch Universal Publ'ns (BMI), 10802 N. 23 Ave., Phoenix, Ariz 85029 Tel (602) 864 1980. Pres: Ray Bruno.
 Epp's Music Co. (BMI) (div. of Epstein Ents.), PO Box 28123, 735 N. Gen McMullen Dr., San Antonio, Tex. 78228. Tel: (512) 434-7006 Pres A. Epstein
 Equa Music (ASCAP), 1800 Mowry Ave., Fremont, Calif 94538 Tel (415) 794 6637. Pres Warren M Johnson, Gen Mgr Sandra Clark, Prof Mgr Robert Jackson Local branch: 43334 Bryant St Zip 94538. Tel: 651 1015
 Ere Music, see MCA
 Eric Dynamic Co (BMI), 921 William Howard Taft Rd., Cincinnati, Ohio 45214. Tel: (513) 281-8645.
 Erkhouse Music (BMI)/House of Erik Music (ASCAP), see MizMo.
 Ernel Music Co. (BMI) (div. of Ernest Kelley Inc.), 18329 W. McNichols Rd., Detroit, Mich. 48219 Tel. (313) 533 1550. Pres: Ernest Kelley; Gen Mgr Irving R Kelley; Prof. Mgr. Jerome Cunningham.
 Espionage Lovesongs (BMI), see Bug Music Group.
 European American Music Distrs. Corp (ASCAP), 11 West End Rd., Totowa, N.J. 07512. Tel: (201) 256-7100. Telex. 252311 Pres. Ronald L. Freed.
 Int'l firms represented: Barenreiter—partial catalog (Germany), Ernst Eulenburg Ltd (UK), Moeck—partial catalog (Germany), Schott (Germany, Japan, UK), Universal (Australia, Austria, Switzerland, UK).

Evansongs (ASCAP), c/o E.S.P. Mgmt, 1790 Broadway, New York, N.Y. 10019 Tel. (212) 765-8450 Pres. E S Prager.
 Evanton Music (BMI), PO Box 2217, Inglewood, Calif 90205. Tel: (213) 644 8182. Pres. Leonard S Falconer; Treas. M.P. Falconer.
 Evelyn Music Co. Ltd., 1305 North Highland Ave., Hollywood, Calif 90028. Tel. (213) 463-5888.
 Even Safer Music (ASCAP), see Bug Music Group.
 Exbrook Publ'g Co (BMI), 9110 Sunset Blvd., Suite 120, Los Angeles, Calif. 90069 Tel: (213) 271 1103. Owner. Melville A Shauer
 Excellorec Music Co. Inc (BMI), 1011 Woodland St., Nashville, Tenn. 37206. Tel. (615) 226-5660.
 Int'l rep: UK (Campbell Connolly)
 Existential Music (BMI), 118 Fifth St., Taylorsville, N.C. 28681 Tel: (704) 632 4735 Pres & Owner Harry Deal, Office Mgr., Shirley Robinette.
 Expression Music Co /CCM, 652 Hilary Dr., Tiburon, Calif 94920 Tel: (415) 435 5223. Contact: Laurie Roberts.
 Extra Money Music (ASCAP) (div. of Lambert Apostol Co. Inc.), 1290 Ave of the Americas, Suite 264, New York, N.Y. 10019. Tel (212) 399-0090 Pres Lanny Lambert
 Extra Foxx Publ'g Co (BMI), PO Box 5430, Vallejo, Calif. 94590. Tel: (707) 644-0971 Contacts: Linda & Louis McCall
 Eyeball Music (BMI), PO Box 60234, Chicago, Ill. 60660. Tel: (312) 973 7736. Pres. & Gen Mgr Bruce Iglauer.
 Int'l rep.: Europe (Sonet), Japan (Plumpkin)

F

F Publ'g Inc. (BMI), 888 Seventh Ave., New York, N.Y. 10019. Tel: (212) 397-6730.
 F E L Publ'ns Ltd. (ASCAP), 1925 S. Pontius Ave., Los Angeles, Calif. 90025. Tel: (213) 478-0053.
 F Y O A Q Music (BMI), 240 E. Radcliffe Dr., Claremont, Calif. 91711. Tel: (714) 624-0677 Pres., Gary K. Buckley; Publ'g Rep.: Bob Sheldon.
 Faax Music Publ'g (ASCAP)—Gen. Mgr.: Linda Lou Kestin—see Keristene.
 Factor-Newland Publ'g (ASCAP), see Reno/Metz.
 Factory Fresh Music (ASCAP), see Bug Music Group.
 Fairchild Music Publ'g Corp. (BMI), PO Box 6495, Buena Park, Calif. 90620 Tel (714) 554 0851 Owner & Gen Mgr.: Jerry Wood
 Fairlyland Music Corp (ASCAP), 240 W. 55 St., New York, N.Y. 10019. Tel: (212) 246 3000 Cable: BENANTIMUS Pres. Jack Benanty
 Fairystone Publ'g Co. (BMI), PO Box 594, Rocky Mount, Va. 24151. Tel: (703) 483-0689. Pres. & Gen Mgr.: W. Rod Shively
 Fallen Angel Publ'g (BMI), Canon Dr., Beverly Hills, Calif. 90211. Tel: (213) 271 1186
 Falls City Music (BMI), 9701 Taylorsville Rd., Louisville, Ky 40299. Tel: (502) 267 5466
 Fame Publ'g Co. Inc. (BMI), 603 E. Avalon Ave., Muscle Shoals, Ala. 35660. Tel: (205) 381-0801 Gen. Mgr.: Tom Brasfield.
 Family Affair Music Co. (ASCAP), see Respect.
 Famosonda Music (BMI)—Pres.: Art Stewart—see Baradat.
 Famous Music Corp. (ASCAP) (div. of Gulf + Western Inds. Inc.), 1 Gulf + Western Plaza, New York, N.Y. 10023. Tel: (212) 333-3433. Cable: FAM-USIC. Chief Operating Officer: Marvin Cane; VP Admin.: Sidney Herman; Creative Dir.s. (R&B) Basil Nias, (Pop) Randy Irwin; Standards Dept.: Dick Milfred

LAWRENCE WELK MUSIC GROUP

LAWRENCE WELK • PRESIDENT DEAN KAY • EXECUTIVE VICE PRESIDENT-GENERAL MANAGER

is pleased to announce the relocation of their headquarters to

**LAWRENCE WELK'S
 WILSHIRE PALISADES BUILDING
 1299 Ocean Avenue, Suite 800
 SANTA MONICA, CALIFORNIA 90401
 Telephone (213) 451-5727 or (213) 870-1582**

BRANCH OFFICES
 NASHVILLE • 14 MUSIC CIRCLE EAST • NASHVILLE, TENNESSEE 37203 • TELEPHONE (615) 256-7648
 HOLLYWOOD • 6255 SUNSET BOULEVARD • SUITE 615 • HOLLYWOOD, CALIFORNIA 90028 • TELEPHONE (213) 467-3197
 NEW YORK • 211 WEST 56th STREET • SUITE 21 D • NEW YORK, NEW YORK 10019 • TELEPHONE (212) 581-3197

T.B. HARMS COMPANY (ASCAP) VOGUE MUSIC (BMI) CHAMPAGNE MUSIC CORPORATION (ASCAP)
 BIBO MUSIC PUBLISHERS (ASCAP) HALL-CLEMENT PUBLICATIONS (BMI) JACK AND BILL MUSIC COMPANY (ASCAP)
 HARRY VON TILZER MUSIC PUBLISHING COMPANY (ASCAP) SOMEBODY'S MUSIC (SESAC)

Branches: Hollywood, Calif., 6430 Sunset Blvd. Zip: 90028. Tel: (213) 461-3091. VP: Julie Chester; Creative Dir.: Allan McDougall—Nashville, Tenn., 2 Music Circle S. Zip: 37203. Tel: (615) 242-3531. Creative Dir.: Chuck Neese, Dpns. Dir.: Judi Gottler.

Int'l rep.s: Austria (Melodie der Welt), Canada (Famous-Chappell), Europe excluding Austria & Germany (Famous-Chappell), Germany (Me lodie der Welt), Japan (Nichion), Mexico (Intersong); Philippines (Lustre). (SEE ADVERTISEMENT)

Force Music (ASCAP), see Terrace.

Fargo House Inc. (ASCAP), see Prima-Donna & Al Gallico.

Fargo Publ'g (BMI), 11257 Blair St., North Hollywood, Calif. 91602. Tel: (213) 508-9865. Pres. Joe Farrell; Gen. & Prof. Mgr.: Ron Moss.

Farmer & Thomas Music (BMI), 327 Upshur St. NW, Washington, D.C. 20011. Tel: (202) 882-7339. Pres.: Clifton Thomas; VP & Exec. Sec'y: Charles Farmer.

Faro Music Publ'g (BMI), 255 N. New Hampshire Ave., Los Angeles, Calif. 90004. Tel: (213) 384-9586. Owner: Edward L. Davis.

Fate Music (ASCAP), see Buddy Music.

Father Music Group, 7647 Woodrow Wilson Dr., Hollywood, Calif. 90046. Tel: (213) 462-1922. Exec. VP: Barry Richards.

Int'l rep.: Worldwide (Zebra Discorde in USA).

Fechless (BMI), c/o Jess S. Morgan & Co., 6420 Wilshire Blvd., Los Angeles, Calif. 90048. Tel: (213) 651-1601.

Fee Bee Music Co. (BMI), 4517 Wainwright Ave., Pittsburgh, Pa. 15227. Tel: (412) 884-4727. Cable: FEBE. Pres.: J.M. Averbach; Gen. Mgr.: G. Phillips; Prof. Mgr.: Al Olivieri.

Felicity Music Inc., PO Box 5754, Austin, Tex. 78763. Tel: (512) 472-1004 Pres.: Craig D. Hillis.

Fema Music Publ'ns (ASCAP), PO Box 395, 8 Bunting Ln., Naperville, Ill. 60566. Tel: (312) 357-0207. Pres. & Gen. Mgr.: Frances Adams; Prof. Mgr.: Ed Adams.

Waynard Ferguson Music USA Inc., PO Box 716, Ojai, Calif. 93023. Tel: (805) 646-7242. Pres.: Maynard Ferguson.

Fermata Int'l Melodies Inc. (ASCAP), Sunset-Vine Tower Bldg., Suite 916, 6290 Sunset Blvd., Hollywood, Calif. 90028. Tel: (213) 462-7473. TWX (910) 321-4063. Cable: FERMATACAL. Pres.: Enrique Lebendiger; Mgr. & Sec'y: Debora Frenkel.

Home office: Brazil.

Ferndale Music (BMI), see Leson Int'l.

Ferndock Music (ASCAP) (div. of Wormwood Projects), 1540 Lehigh St., Boulder, Colo. 80303. Tel: (303) 499-1108. Gen. Mgr.: Michael D. Aisner.

Ferry Boat Music (ASCAP), 927 United Pacific Bldg., Seattle, Wash. 98104. Tel: (206) 625-9548. Gen. Mgr.: Robert Krnic.

Festive Music (BMI), 15394 Warwick Blvd., Newport News, Va. 23602. Tel: (804) 877-6877. Pres. W.H. Smith.

Fiddleback Music Publ'g Co. Inc. (BMI), see Tommy Valando.

Fiddy Finding Music Co. (ASCAP), see Gordon.

Fifty One Publ'g Co. (BMI), PO Box 90698, Zip: 77090, 301 Wells Fargo, Suite 28, Houston, Tex. 77090. Pres.: Stephen F. King; Prof. Mgr.: Steven W. Douglas.

Filmways Music Publ'g Inc. (ASCAP), see Musicways.

Fi Music Inc. (ASCAP), see Cream.

Finchley Music Corp. (ASCAP), c/o Arrow, Edelstein & Gross, 1370 Ave. of the Americas, New York, N.Y. 10019. Tel: (212) 586-1451.

Finch Rec'g Co., 2430 Spring Grove Ave., Cincinnati, Ohio 45214. Tel: (513) 421-0850.

Firecreek Recs. (div. of MM Recs.), 3659 GlenHaven, Houston, Tex. 77025. Tel: (713) 660-7965.

Firedrum Music Publ'rs (ASCAP), PO Box 8207, Albuquerque, N.M. 87198. Tel: (505) 268-6110. Pres. & Gen. Mgr.: J. Thomas Bee; Prof. Mgr.: Isauro Gutierrez.

Branches: Woodland Hills, Calif., 21806 Ybarra Rd. Zip 91364. Tel: (213) 883-0159. Telex: 181149.

Int'l rep.s: Australia & New Zealand (Associated in Australia), France (Francis Day), Japan (Seven Seas), Netherlands (Ariola).

Firelight Publ'g (ASCAP), 12824 Lorne St., North Hollywood, Calif. 91605. Tel: (213) 764-3980. Pres.: Douglas Thiele; Gen. & Prof. Mgr.: Jeni Mitchell.

First Artists Music Co. (ASCAP), c/o Management III Music, 9744 Wilshire Blvd., Beverly Hills, Calif. 90212. Tel: (213) 550-7100.

First Generation Music Co. (BMI), see Combine.

First Kiss (ASCAP), see Bug Music Group.

Carl Fischer Inc. (ASCAP), 62 Cooper Square, New York, N.Y. 10003. Tel: (212) 777-0900. Cable: CARFISCHER. Pres.: Walter F. Connor; VP: Warren G. Mackenzie; Sales Mgr.: Stephen H. Marlatt.

Branches: Los Angeles, Calif., 1101 S. Hope St. Zip: 90015. Tel: (213) 749-5227. Mgr.: Morton Baumgart—Chicago, Ill., 312 S. Wabash Ave. Zip 60604. Tel: (312) 427-6652. Mgr.: Gary Sigurdson—Boston, Mass., 156 Boylston St. Zip: 02116. Tel: (617) 426-0740. Mgr.: Warren Patterson

Int'l firm represented: Paterson's Publ'ns Ltd. (UK)

Int'l rep.: UK (Boosey & Hawkes). (SEE ADVERTISEMENT)

Bobby Fischer Music (ASCAP), Box 23333, Nashville, Tenn. 37202. Tel: (615) 329-2278. Pres. Gen. & Prof. Mgr.: Bobby Fischer

Doris Fischer Music Corp. (ASCAP), see Fisher Music Corp.

Fisher Music Corp. (ASCAP), 1619 Broadway, New York, N.Y. 10019. Tel: (212) 586-1504. Pres.: Dan Fisher.

Branch: Van Nuys, Calif., 13850 Victory Blvd. Zip: 91408. Tel: (213) 781-3200. Prof. Mgr.: Frederic Fisher.

Charlie Fitch Music Co. (BMI), 311 E. Davis, Luling, Tex. 78648. Tel: (512) 875-3350. Pres. & Gen. Mgr.: Charlie Fitch; Prof. Mgr.: Celeste Fitch.

Fitness Music (BMI), see Scotti Bros.

H. T. FitzSimons Co. Inc. (SESAC), 357 W. Erie St., Chicago, Ill. 60610. Tel: (312) 944-1841. Cable: FITZCO. Pres. & Gen. Mgr.: Ruth E. FitzSimons.

Harold Flammer Inc. (ASCAP), see Shawnee Press.

Flat Town Music (BMI), PO Drawer 10, 434 E. Main, Ville Platte, La. 70586. Tel: (318) 363-2139. Pres.: Floyd Soileau

Fleetwood Mac Music (BMI), c/o Shapiro & Steinberg, 315 S. Beverly Dr., Suite 210, Beverly Hills, Calif. 90212. Tel: (213) 553-1601. (Administered by Warner Bros. Music)

Int'l rep.: Worldwide excluding U.S., U.K. & Canada (Intersong in UK).

Fleetwood/McMillan Music (ASCAP)—Mgr.: Terry McMillan—see Brandwood.

Fleming Music (BMI), see Blue Island

Flin-Flon Music (BMI), PO Box 103, Main St., Mullen, Neb. 69152. Tel: (308) 546-2294. Gen. Mgr.: L. Earl Walker; Sales Mgr.: David L. Walker

Fling Music Inc. (BMI), see Don Costa.

Florentine Music (BMI)—Pres.: Ray Vernon—see Dawn Prod'ns.

Flowering Stone Music (ASCAP), see Scotti Bros.

Fluffo Tunes (BMI), see Cedarwood.

Fly-By-Night Music Publ'g (BMI), see Hilding.

Flying Fish Music (BMI), 1304 W. Schubert, Chicago, Ill. 60614. Tel: (312) 528-5455. Pres.: Bruce Kaplan; Dir.: William Kubezko; Prof. Mgr.: Chris Heim.

Int'l rep.s: Europe (Sonet), Japan (Pumpkin).

Flynt Music (BMI), see Bug Music Group.

Focal Point Music (BMI), 922 McArthur Blvd., Warner Robins, Ga. 31093. Tel: (912) 923-6533. Pres.: Ray H. Melton; Gen. Mgr.: Jeanette C. Melton; Prof. Mgr.: Eugene Hatfield.

Galar-Music Corp. (BMI), Sharon Mountain Rd., Sharon, Conn. 06069. Tel: (203) 364-5661. Pres. Lee B. Haggerty; Gen. Mgr.: John P. Holland.

Folklore Prod'ns Inc., 1671 Appian Way, Santa Monica, Calif. 90401. Tel: (213) 451-0767. Pres. & Gen. Mgr.: Manuel Greenhill; Prof. Mgr.: Carol Kindt.

Int'l rep.s: Argentina (Melograf), Australia (Essex/Cromwell), Austria (Gloria, Rolf Budde in Germany), Benelus (Rolf Budde in Germany), Brazil (Mundo Musical), Central America (Mundo Musical in Costa Rica), Czechoslovakia (Supraphon), Finland (Sweden Music in Sweden), France (Claude Pascal), Germany (Rolf Budde), Greece (CBS), Iceland (Sweden Music in Sweden), Israel (CBS), Italy (G. Ricordi/Fama), Japan (Sunkyo), Mexico (Mundo Musical), Portugal (RCA in Spain), Scandinavia (Sweden Music in Sweden), Spain (RCA), Switzerland (Flora; Rolf Budde in Germany), UK (Carlin).

Folkstone Music Publ'g Co. (BMI), PO Box 638, Franklin, W. Va. 26807. Tel: (304) 358-2504. Pres. L. Lynn Beckman; Gen. & Prof. Mgr.: Mary Virginia Beckman

Fontaine Music Corp., see MCA.

Foolish Child Music (ASCAP), see 20th Century.

Footh Foot Music (ASCAP), see Bug Music Group.

Formula Music Inc. (ASCAP), see Music Shoals.

Forrest Hills Music Inc. (BMI), see Ash Valley.

Clinton H. Forsman Publ'g Co. (BMI), 210 E. Main, Robstown, Tex. 78380. Tel: (512) 387-1615. Pres.: Clinton H. Forsman.

Fort Knox Music Co. (BMI), 1619 Broadway, New York, N.Y. 10019. Tel: (212) 489-8170. Partners: Jerry Leiber, Mike Stoller, Freddy Block.

Fortress Press (ASCAP), 2900 Queen Ln., Philadelphia, Pa. 19129. Tel: (215) 848-6800.

Fort Wayne Music (ASCAP), 4602 Newway Rd., Fort Wayne, Ind. 46808. Tel: (219) 483-9564. Pres.: Robert A. Foster; Gen. Mgr.: R.L. Cammeron; Prof. Mgr.: Kevin Ferguson.

Fostco Music Press (ASCAP), see Mark Foster

Mark Foster Music Co., 1402 E. Colorado, Urbana, Ill. 61801. Tel: (217) 367-9932. Pres. Dr. James Mckelvey; Gen. Mgr.: Jane Menkhaus; Prof. Mgr.: Hal Simmons. Local branch: 710 S. Goodwin. Zip: 61801. Tel: 367-3939. Chief Exec.: Ira Feldman.

Int'l rep.: France (Bureau de Musique).

Fountain Of Life Music, 5535 25 St. W., Bradenton, Fla. 33507. Tel: (813) 756-7781.

Four Aces Music Inc. (BMI), PO Box 860, Cooper Sta., New York, N.Y. 10276. Tel: (212) 473-5900. Cable: RAMHORN. Telex: 661139 Admin'r & Gen. Mgr.: Naomi Saltzman; Gen. Mgr.: Jeffrey Rosen.

Four Buddies (ASCAP) (div. of Ham-Sem Recs. Inc.), 314 W. Sixth St., Suite 305, Los Angeles, Calif. 90014. Tel: (213) 627-0557. Cable: HAMSEM. Pres.: William Campbell.

Four Knights Music (BMI), 6000 Sunset Blvd., Hollywood, Calif. 90028. Tel: (213) 461-3484.

Four Moons Music Publ'g Group (ASCAP), 279 E. 44 St., New York, N.Y. 10017. Tel: (212) 288-2446. Pres.: Norman Dolph; Prof. Mgr.: Sharon Swanson.

Four Seasons Music (ASCAP), see Nashville Int'l.

Four Star Int'l Inc., 19770 Bahama St., Northridge, Calif. 91324. Tel: (213) 709-1122. Pres.: David B. Charnay; VP: Bus. Affairs & Treas.: Hervey Shaw, VP & Sec'y: Martha Arnold; VP Joseph J. Doyle

X I V Music Inc. (SESAC), see Japalana.

14th Floor Music (BMI), see 20th Century.

Fourth Corner Music (SESAC), see Heartstone.

Fourth Floor Music Inc. (ASCAP), PO Box 135, Bearsville, N.Y. 12409. Tel: (914) 679-7303. TWX: (510) 247-0848. Pres.: Albert Grossman; Gen. Mgr.: Don Schmitzler.

Four Twenty Music (BMI), see Empire Tunes.

Fox Fanfare Music Inc. (BMI), see 20th Century

Sam Fox Publ'g Co. Inc. (ASCAP), 73-941 Hwy. 111, Suite 11, Palm Desert, Calif. 92260. Tel: (714) 568-4144. Pres.: Frederick Fox; VP & Gen. Mgr.: Harry Fox Jr.

Branch: Ft. Lauderdale, Fla., 170 NE 33 St. Zip: 33334. Tel: (305) 563-1844.

Int'l branch: England.

Int'l rep.: Worldwide (United Artists).

Frando Music Inc. (BMI), 8 Heather Dr., St. Louis, Mo. 63123. Tel: (314) 843-9142. Pres.: Frank Daniels; Prof. Mgr.: Shawn Daniels.

Frank & Nancy Music Inc. (BMI), 1619 Broadway, New York, N.Y. 10019. Tel: (212) 489-8170.

Frebar Music Co. (BMI), 5514 Kelly Rd., Brentwood, Tenn. 37027. Tel: (615) 373-4086. Pres. & Gen. Mgr.: Fred Kelly; Prof. Mgr.: Barbara Kelly.

Fredola Music Publ'g Co. (BMI), 7-11 E. Genesee St., Auburn, N.Y. 13021. Tel: (315) 253-5380. Owner: Frank Mucedola.

French Market Music (BMI), 915 Louisa St., New Orleans, La. 70117. Tel: (504) 949-2911. Partners: Clive Wilson, Paige Van Vorst.

Fresh Memory Music (ASCAP), see Songs for Today.

Fox Music Publ'g Co. (BMI), 404 Bluegrass Ave., Madison, Tenn. 37115. Tel: (615) 865-6380. Pres. & Gen. Mgr.: Robert E. Frick; Prof. Mgr.: Ruth Frick.

Fred Kreplach Music (BMI), see Bug Music Group

Fruit Music (BMI), see Boxer.

Fuente Music Co. (BMI), PO Box 1233, Santa Monica, Calif. 90406. Tel: (213) 822-9022. Owner: Bobby Mannque.

Full Cycle Music (BMI), 80 E. San Francisco St., Santa Fe, N.M. 87501. Tel: (505) 982-2900.

Full House Music (BMI), PO Box 25066, Nashville, Tenn. 37202. Tel: (615) 269-0593. Pres.: William Edward Taylor.

Funky Acres Music Co. (ASCAP), 145 W. 55 St., New York, N.Y. 10019. Tel: (212) 245-7179. Pres.: Warren Baker; Gen. Mgr.: Bob Krinsky; Prof. Mgr.: Peter Gorin.

Branch: Seattle, Wash., United Pacific Bldg., Suite 927. Zip: 98104. Tel: (206) 625-9548.

Fun and Profit Music Inc. (ASCAP), see Bug Music Group.

Funky but Music Inc., PO Box 1770, 155 Saunders Ferry Rd., Hendersonville, Tenn. 37075. Tel: (615) 824-9439. Pres.: Kyle Lehning; Sec'y-Treas.: Tony Gottlieb.

Int'l branch: Canada.

Branch: San Juan, P.R., PO Box 2771. Zip: 00903. Tel: (809) 722-4373. Prof. Mgr.: Bill Marantz.

Gil Gad Music Publ'g Group Inc. (BMI), see Eugene Gold.

Galamar Music Corp. (BMI), see Al Gallico.

Galanco Music (BMI), 726 Egin Rd., Newtown Square, Pa. 19073. Tel: (215) 356-0245. Pres.: Ed E. Colletta; VP: Ed Lewis.

Galaxy Music Corp. (ASCAP), 2121 Broadway, New York, N.Y. 10023. Tel: (212) 874-2100.

Represented companies: American Musological Society, Columbia University Press, SUNY Binghamton Eds., University of Washington Press.

Int'l firms represented: Augener Ed., Galliard, London Pro Musica, Stauner & Bell, Joseph Williams Ed., Yorke Ed. (UK); Delreux, Les Eds. Ouvreres (France).

Galleon Music Inc. (ASCAP), see Al Gallico.

Al Gallico Music Corp. (BMI), 120 E. 56 St., New York, N.Y. 10022. Tel: (212) 355-5980. Pres.: Al Gallico; VP Admin. Linda Landi.

Branches: Los Angeles, Calif., 9255 Sunset Blvd. Zip: 90069. Tel: (213) 462-2251—Nashville, Tenn., 50 Music Square W. Zip: 37203. Tel: (615) 327-2773.

Int'l branch: England.

Sammy Gallop Music Co. (ASCAP), see 20th Century.

Don Gant Entis., PO Box 121076, 1225 16 Ave. S., Nashville, Tenn. 37212. Tel: (615) 329-0490.

Garage Music (BMI), 179 Brooklyn, No. 2, San Jose, Calif. 95128. Tel: (408) 289-1897.

Garamoni Music Publ'g Co. (BMI), 676 N. La Salle St., Chicago, Ill. 60610. Tel: (312) 236 3632. Pres.: John Garamoni.

Garden Rake Music Inc. (BMI)—Pres.: Jay Graydon—see Nero Ent's.

Garrett Music Ents., 6255 Sunset Blvd., Suite 1019, Hollywood, Calif. 90028. Tel: (213) 467-2181. Pres.: Snuff Garrett; Exec. VP: Don Blocker, VP: Stephen H. Dorff.

Int'l rep.s: Australia (Jonathan), France (Pathe Marconi), Italy (Curci), Netherlands (EMI), UK (Campbell Connelly).

Gar-To Music (BMI), 5137 West Blvd., Los Angeles, Calif. 90043. Tel: (213) 296-4206. Pres.: Hank Carbo.

Leslie Ann Gary Music Publ'g Co. (ASCAP), see Silver Nightingale.

Gates Music Inc. (BMI), 1 Marine Midland Plaza, Suite 1635, Rochester, N.Y. 14604. Tel: (716) 232-2490. Contact: Tom Iannaccone. (Administered by Beldock Levine & Hoffman)

Larry Gatlin Music (BMI), see Combine.

Gator Music (SESAC)—Pres.: Glen Ray—see Hallnote.

Gaucha Music (BMI), 161 W. 54 St., New York, N.Y. 10019. Tel: (212) 581-5398. Pres.: Roy Rifkind; VP: Bill Spitalny. Gen. Mgr.: Julie Rifkind

Gloria Gaynor Music, 405 Park Ave., New York, N.Y. 10022. Tel: (212) 355-3270. Pres. Gen. & Prof. Mgr.: Lunwood Simon.

Geada Music (BMI), see Mayflower Music.

Gear Publ'g (ASCAP) (div. of Hideout Prod'ns), 567 Purdy, Birmingham, Mich. 48009. Tel: (313) 642-0910.

Geffen/Kaye Music (ASCAP), 9348 Santa Monica Blvd., Suite 304, Los Angeles, Calif. 90210. Tel: (213) 271-9014. Pres.: Chuck Kaye; Prof. Mgr.: Ronny Vance.

Gele Music Publ'g (BMI), see Brunswick.

Genelle Music Co. (BMI), 1304 Fletcher Rd., Tifton, Ga. 31794. Tel: (912) 382-6257. Pres.: Gus Statras; Gen. Mgr.: Genelle Statras; Prof. Mgr.: Perry Statras.

Int'l rep.: Japan (Sunkyo).

General Music Publ'g Co. Inc. (ASCAP), 145 Palisade St., Dobbs Ferry, N.Y. 10522. Tel: (914) 693-9321. Pres. Gen. & Prof. Mgr.: Paul Kapp.

Int'l rep.s: UK (Campbell Connelly, Chappell, Southern, Leeds).

General Words & Music Co. (ASCAP), see Neil A. Kjos.

Gentle Wind Publ'g Co. (BMI), 1030 48 St., Sacramento, Calif. 95819. Tel: (916) 451-3400. Owner, Pres. & Prof. Mgr.: Charles M. Brandt, Gen. Mgr.: Edna A. Brandt.

Geza Music (BMI), see Bug Music Group.

Ghana Music Corp. (BMI), see The Goodman Group

Don Gilbert Music (BMI), 1450 Terrell, Beaumont, Tex. 77701. Tel: (713) 832-0748. Owner: Don Gilbert.

Gil Gilday Publ'g Co. (ASCAP), PO Box 600516, North Miami Beach, Fla. 33160. Tel: (305) 945-3738. Owner, Gen. & Prof. Mgr.: J. Gilday.

Int'l firm represented: Laurel (Canada).

Gil Music Corp. (BMI), see George Prncus & Sons.

Ginger Ale Music Co. (ASCAP), see Nashville Int'l.

Gingham Music Co. (ASCAP), see Sugarplum.

Giordano Music (SESAC), see Zaza.

Give Me A Break Music Co. (ASCAP), see The Entertainment Co.

Glad Hamp Music Inc. (ASCAP), 1995 Broadway, New York, N.Y. 10023. Tel: (212) 787-1222. Pres.: Lionel Hampton; Gen. Mgr.: Bill Titone.

Glad Music Co. (BMI), 3409 Brinkman, Houston, Tex. 77018. Tel: (713) 861-3630. Pres.: H.W. Daily.

Branch: New York, N.Y., 110 E. 59 St. Zip 10022

Int'l branch: UK

Globe Five Music (BMI), see Bug Music Group

Gloibe Publ'g Co. (BMI), 827 Thomas, Memphis, Tenn. 38107. Tel: (901) 525-0540.

Glori Gospel Music (BMI), 2546 Navy Pl., Belmore, N.Y. 11710. Pres.: Steven Herman.

Glory Alleluia Music (BMI), PO Box 9245, Little Rock, Ark. 72219. Tel: (501) 224-3264. Pres.: LeMar Boschman.

Glory Be Music (BMI), see Jevy Music.

GlorySound (ASCAP), see Shawnee Press

God's World (SESAC), see Holy Spirit.

Gold Coast Entertainment Inc., 5915 Lincoln Ave., Chicago, Ill. 60659. Tel: (312) 769-4676. Pres.: Marv Stuart; Mgr.: Sara Melendez.

Frannie Goldie Music (BMI), see MtzMo.

Golden Avatar Music (BMI), see Cherry Lane.

Golden Bridge Music, see Don Gant.

Golden Dawn Music (BMI), 26177 Kynon Dr., Taylor, Mich. 48180. Tel: (313) 292-5281. Pres.: Peggy LaSora.

Golden Fleece Music Publ'g Co. (BMI), c/o David J. Steinberg, 818 Widener Bldg., 1339 Chestnut St., Philadelphia, Pa. 19107. Tel: (215) 564-3880. Pres.: Norman Harris; Gen. Mgr.: Barbara Bell; Prof. Mgr.: Norman Harris, Ron Baker, Earl Young. (Administered by Famous Music—Ensign Music)

Golden Guitar Music Publ'g (BMI), PO Box 40602, Tucson, Ariz. 85717. Pres.: Jeff Johnson.

Golden Sunburst Music (BMI), see Country Legs.

Golden Torch Music Corp. (ASCAP), see Gold Horizon & Screen Gems-EMI

Golden West Melodies Inc. (BMI), 110 E. 59 St., New York, N.Y. 10022. Pres.: Gene Austry; Prof. Mgr.: Carl Cotner.

Eugene Gold Music (BMI) (div. of 'G' Inds.), 5500 Troost, Kansas City, Mo. 64110. Tel: (816) 361-8455. Pres.: Eugene Gold; Gen. Mgr.: Chris King; Prof. Mgr.: Mike Green.

G

Goldfresh Music (BMI), 13006 Sycoby Unit 2, North Hollywood, Calif. 91605. Tel: (213) 875-3944, 912-6597. Pres.: David Gresham
Int'l firms represented: Little Tonster, Yackamo (both South Africa).
Gold Hill Music Inc. (ASCAP), 5x12 Lankershim Blvd., North Hollywood, Calif. 91601. Tel: (213) 766-7112. Pres.: Stephen Stills; Mng. Dir. Ken Weiss.
Int'l reps: Australia (April), Caribbean (Ivan Mogull), Central America (Ivan Mogull), France (Warner Bros.), Germany (Siegel), Israel (Ivan Mogull), Italy (Warner Bros.), Japa (Chappell), Mexico (Ivan Mogull), Netherlands (Basart-Intersong), N.W. Zealand (April), Spain (Armonico), South Africa (EMI Brigadiers), South America (Ivan Mogull), UK (Warner Bros.).
Gold Horizon Music Corp. (BMI), Columbia Plaza East, Suite 215, Burbank, Calif. 91505. Tel: (213) 954-2617. VP: Robert E. Holmes. (Administered by Screen Gems-EMI)
Goldline Music Inc. (ASCAP), see Silverline
Manny Gold Music Publ'r (ASCA), 895 McDonald Ave., Brooklyn, N.Y. 11218. Tel: (212) 435-1910. Fes., Gen. & Prof. Mgr.: Manny Gold.
Gold Street Music Co. (BMI), PO Box 124, Kirbyville, Tex. 75956 Tel: (713) 423-5516 Pres. & Gen. Mgr.: James L. Gibson, Sales & Promo Dir.: Robbie Gibson
Gomba Music (BMI), see Bug Music Group
Go Mental Music (BMI), see Bug Music Group
Good Flavor Songs Inc. (ASCAP), see Buttermilk Sky
Good Groove Music (BMI), see Doc Levine & Hoffman
Good High Music (ASCAP), c/o Helfand, Breslauer, Rennert & Feldman, 1880 Century Park E., Suite 900, Los Angeles, Calif. 90067.
The Goodman Group, 110 E. 59 St., New York, N.Y. 10022 Tel: (212) 751-7300. Cable: ARCMUSIC. Gen. Mgr.: Eugene Goodman, Prof. Mgr.: Buddy Robbins, Copyright Admin'r: Yranda Blum.
Int'l reps: Argentina (Korn), Australia & New Zealand (Jewel Music in Australia), Austria (Hans Gerig in Germany), Belgium (Crete/Medoc in France), Brazil (Intersong), France & SACEM Territories (Crete/Medoc), Germany (Hans Gerig), Greece (IEPI), Israel (Acum), Italy (Radio Recs.), Japan (Toshiba), Mexico & Central America (Beechwood in Mexico), Netherlands (Chappell), Scandinavia (American Songs in Sweden), South Africa & SAMRO Territories (La-trec), Spain & Portugal (Canciones del Mundo), Switzerland (Hans Gerig in Germany), United Kingdom & Ireland (Blue Ribbon/Tristan Music in England).
Good Product Music (ASCAP), 531 W. 25 St., New York, N.Y. 10001 Tel: (212) 675-6060. Bd. Chm.: Peter Cosmas, Pres. Nicholas Cosmas.
Good Tokin' Music (ASCAP), see Scott Tutt.
Goosebump Music (BMI) (div. of the Record Co.), 6362 Hollywood Blvd., Suite 320, Los Angeles, Calif. 90028 Tel: (213) 462-2038
Goosepimple Music (BMI), 7 Colonial Ave., Myerstown, Pa. 17067 Tel: (717) 866-5067. Owner: Jean Hader; Mgr.: Al Shade.
Gopam Ents. Inc. (BMI), 11 Riverside Dr., No. 13C-W, New York, N.Y. 10023 Tel: (212) 724-6120. Pres.: Joffe Levy, Mng. Dir. Laurie Goldstein.
Int'l reps: Australia (Jewel), Austria (Melodie der Welt in Germany), Bulgaria (Melodie der Welt in Germany), Czechoslovakia (Melodie der Welt in Germany), France & Monaco (Jaravelle), Germany (Melodie der Welt), Hungary (Melodie der Welt in Germany), Italy (Suvini Zerboni), Japan (Shinko), Poland (Melodie der Welt in Germany), Portugal (Quiroga in Spain), South Africa (Laetrec), Spain (Quiroga), Switzerland (Melodie der Welt in Germany), UK (Keith Prowse), USSR (Melodie der Welt in Germany), Yugoslavia (Melodie der Welt in Germany).
Gordon Music Co. Inc., 12111 Stratford St., No. 108, North Hollywood, Calif. 91605. Tel: (213) 787-7597. Pres.: Jeffrey E. Gordon
Int'l reps: Australia, France, Germany, Netherlands (all TRO), Italy (Curci, TRO), UK (EMI, TRO).
Gospel Birds Inc. (BMI), c/o Weiss & Meibach, 888 Seventh Ave., New York, N.Y. 10019 Tel: (212) 765-0541. Pres.: Vicki Wickham; Gen. Mgr.: Ina Meibach
Gospel Clef Publ'g Co. (BMI), 279 Buffalo Ave., Brooklyn, N.Y. 11213. Tel: (212) 773-5910.
Gospel Int'l Publ'ns (BMI), see Ellbie
Gospel Message Music Co. (SESAC), see Full House
Goydish Music & Publ'g Co. (BMI), 31 Triangle Rd., Somerville, N.J. 08876. Tel: (201) 359-5520. Owner: Bernard L. Goydish
Graduation Music Inc. (ASCAP), 211 N. Kingshighway, St. Louis, Mo. 63108 Tel: (314) 361-4400. Pres.: Juli H. Miller II, Gen. Mgr.: Lynn Schweizer
Roger Graham Music Publ'r (ASCA), see Athon Music.
Grajonca (BMI), c/o Bill Graham Presents, 201 11 St., San Francisco, Calif. 94103. Tel: (415) 864-0815. Pres.: Bill Graham, Gen. Mgr.: Nick Cianos, Prof. Mgr.: Steve Welkom.
Gramavision Music Co. (BMI), PO Box 2772, Grand Central Sta., New York, N.Y. 10163 Tel: (212) 674-1567. Pres.: Jonathan Rose, Gen. Mgr.: Felicia Berkovitz.
Grand Artists Music (BMI) (div. of Paul Stevens Assocs. Inc.), 8325 SW 132 St., Miami, Fla. 33156. Tel: (305) 238-1088. Pres. & Prof. Mgr.: Paul Stevens, Gen. Mgr.: Jeannine Stevens
Grand Prix Publ'g Co., 2087 Union Ave., Memphis, Tenn. 38104. Tel: (901) 278-4900. Partners: Ed Dubay, Herb O'Mell, Marty Lacker.
Granite Music Corp. (ASCAP), see Interion.
Granite Rock Music (BMI), PO Box 1206, Studio City, Calif. 91604 Tel: (213) 877-1351. Pres.: Dan Max.
Grapes of Rath Music Publ'g Co. (BMI), PO Box 472, Jeffersonville, Ind. 47130. Tel: (812) 282-6427. Pres.: Nelson Rath; Exec. VP. Opns. & Gen. Mgr.: John Paine; Prof. Mgr.: Sonny Lemaire. Local branch: 700 Riverside Dr. Zip: 47130. Tel: 282-6267.
Graph Music (ASCAP), PO Box 669, Woodstock, N.Y. 12498. Tel: (914) 679-6069/2458. Dir.: Pat Sebastian; Harris Goldberg, Artie Traum, George James, Roly Saley; Prof. Mgr.: Fiat Sebastian.
Branch: New York, N.Y., 49 W. 15 St., Suite 5 C. Zip: 10025. Tel: (212) 665-0214.
Grass Mountain Publ'g (BMI), PO Box 12937, Fort Worth, Tex. 76116. Tel: (817) 731-7375. Owner: Slim Richey.
Grassroots Projects Unlimited (BMI), PO Box 4689, San Francisco, Calif. 94101. Tel: (415) 922-3227. Owner: James Hesterkamp.
Gravenhurst Music (BMI), 105 Park Ln., Beaver Falls, Pa. 15010. Tel: (412) 843-2431. Pres.: Jerry Reed; Prof. Mgr.: Roz Miller.
Branch: New Brighton, Pa., 146 1/2 Third Ave. Zip: 15066. Tel: (412) 847-0111.
Gravy Publ'g Co. (BMI) (div. of Cox House Prod'ns), 2541 Nicollet Ave. S., Minneapolis, Minn. 55404. Tel: (612) 872-0646.
Grawick Music Publ'g (BMI), see James Hendrix Ents.
Great Beek Prod'ns (ASCAP), 2999 Smith Springs Rd., No. C-47, Nashville, Tenn. 37217 Tel: (615) 366-6610. Pres.: E.B. Leach; Gen. Mgr.: John Adair Arther; Prof. Mgr.: Peggy Aest.
Greasy Shift Music (BMI), see Bug Music Group
Great Alps Publ'g (BMI), 15510 NE 15 Ct., North Miami Beach, Fla. 33162. Tel: (305) 944-9945. Pres.: Aaron L. Broomfield.

Great American Publ'g Co. (BMI), 576-B Goldsboro Rd. NE, Atlanta, Ga. 30307. Tel: (404) 688-0799. Exec. Dir.: Hal Bishop
Great Honesty Music Inc. (BMI), Box 547, Larkspur, Calif. 94939 Tel: (415) 924-8778. Pres.: Erik Jacobsen.
Great People Music (BMI), see Good Product
Great Pyramid Music (BMI), 10 Waterville St., San Francisco, Calif. 94124 Tel: (415) 468-4288. Pres.: Martyr Buchwald, Gen. & Prof. Mgr.: Joseph Buchwald.
AI Green (BMI), 3208 Winchester Rd., Memphis, Tenn. 38118 Tel: (901) 794-6220.
Greenbar Music Corp. (ASCAP), 7235 Hollywood Blvd., Los Angeles, Calif. 90046 Tel: (213) 874-4275. Pres.: Ben Barton
Green Door Music (BMI), 1616 Park Place Ave., Fort Worth, Tex. 76110 Tel: (817) 923-1111. Pres. & Gen. Mgr.: Marvin Moore.
Greengels Music (BMI), PO Box 21931, Greensboro, N.C. 27420 Tel: (919) 272-3336/6392.
Greenline Music (BMI), see Bug Music Group
Green Menu Music Co. (ASCAP) (div. of Green Menu Music Factory Inc.), 50 W. 57 St., New York, N.Y. 10019 Tel: (212) 397-3060, 489-0806. Pres. Henry Jerome; VP & Gen. Mgr.: Donald Castaldi
Green Mountain Music Corp. (BMI), 806 Oaklawn Ave., Cranston, R.I. 02920. Tel: (401) 944-9005. Co-Pres.: Stuart Wiener, Mike Lewis
Green Up Music (BMI), see Bo-Gal.
Grenoble Songs (BMI), Box 222, Groveport, Ohio 43125 Tel: (614) 837-7506. Gen. Mgr.: Ed Graham.
Ray Griff Ents. (ASCAP), PO Box 23245, Nashville, Tenn. 37202 Tel: (615)

242 1816 Pres. Ray Griff. (Administered by Total Entertainment Com-plex).
Branch: Reno, Nev., 1855 Sierra Sage Ln. Zip 89509 Tel: (702) 826-5899. Chief Exec.: Tommy Amato.
Grimes Creek Music (ASCAP)—Admin'r: William H. Schubart—see Other.
Groovesville Music (BMI), 15855 Wyoming Ave., Detroit, Mich. 48238. Tel: (313) 861-2363. Publ'g Dir.: Brian A. Spears
Groundhog Publ'g (ASCAP), 254 E. 29 St., Los Angeles, Calif. 90011. Tel: (213) 746-6499. Pres.: Jerry Hooks; Gen. Mgr.: Duffy Hooks III; Prof. Mgr.: Mikel Hooks
Int'l rep: UK (Flyright)
Group 88 Music (ASCAP), PO Box 8190, Universal City, Calif. 91608. Tel: (213) 787-3344. Pres.: Carlos Saenz; Gen. Mgr.: Beverly Lowe
Int'l rep: Germany (Rolf Budde)
Group 7 Music (BMI), see Cherry Lane
Gudi Music (BMI), 157 W. 57 St., New York, N.Y. 10019 Tel: (212) 582-6135. Pres.: John Shoup; Gen. Mgr.: Mark Cosmedy (Administered by Music Music Music)
Branch: Chicago, Ill., 205 W. Wacker Dr. Zip 60606 Tel: (312) 368-0032.
Frank Guida Publ'g Co. (BMI), see Rockmasters.
Randy Gundry Music (BMI), see Funky but
E. J. Gurren Music (ASCAP), 3929 Kentucky Dr., Los Angeles, Calif. 90068 Tel: (213) 760-3670. Pres.: Eddie Gurren, Gen. Mgr.: Barnett Williams, Prof. Mgr.: Jan Teifeld.
Gusman Co. (BMI), PO Box 8144, 1216 E. Broad St., Savannah, Ga. 31412 Tel: (912) 236-6733. Pres.: Waymon A. Jones.

A Perfect 10

Carl Fischer Music Jobbers

- 1 Super-Fill receive more—sell more
- 2 One Stop Music Jobbing from rock to Bach
- 3 WATS Program
- 4 Foreign Publications in stock
- 5 Full line of Music by All Publishers from Durand to the Belwin Band
- 6 Best Discounts
- 7 Accessories
- 8 Fast & Accurate
- 9 Export Department in any language, we mean business
- 10 Coast to Coast, contact the nearest:

<p>Carl Fischer of Chicago 312 South Wabash Ave. Chicago, Illinois 60604 (312) 427-6652</p>	<p>Walter Kane & Son (Carl Fischer of New York) 54 Cooper Square New York, NY 10003 (212) 777-2550 Telex: 226000 (ETLX UR)</p>	<p>Carl Fischer of Los Angeles 1101 South Hope Street Los Angeles, CA 90015 (213) 749-5227</p>
---	--	--

'Music Jobbers to the World's Dealers'

H

Haizman Music (BMI), see Bug Music Group
Hall-Clement Publ'ns (BMI), see Weik Music Group
John Hall Music (SESAC), PO Box 18344, Fort Worth, Tex 76118 Tel (817) 281-6605
Hallmarque Musical Works (ASCAP), see Aljon
Hallmote Music Co (BMI), PO Box 40209, Nashville, Tenn 37204 Tel (615) 373-5221. Pres: Tom T. Hall. Gen Opns Mgr: Judi Simmons; Prof. Mgr: Clarence Selman.
Int'l rep.: Worldwide excluding US & Canada (Valentine in UK)
Hall of Fame Music Co (BMI), PO Box 921, Beverly Hills, Calif 90213 Tel (213) 829-3864
Int'l firms represented: Brambla (Mexico), Hnos Marquez (Mexico), Musicabana (Cuba)
Rick Hall Music (ASCAP), see Fame
Hal-Nat Music Publ'g Co (ASCAP), PO Box 37156, Cincinnati, Ohio 45222 Tel: (513) 531-7605 Pres.: Saul Halper, VP Steve Halper, Gen. Mgr Fred A. Halper.
Branch: Los Angeles, Calif., Watts City Prod'ns, 11211 Wilmington Ave Zip: 90059 Tel (213) 564 8932
Int'l reps: Australia (J Albert & Sons), Brazil (Harpu), France (Cara velle), Japan (Toshiba-EMI), UK (EMI)
Halwill Music (ASCAP), see Harlem
Hamman Publ'g Inc (BMI), Rt 1, Box 195 A, Dean Rd., Matland, Fla 32751 Tel (305) 677 0611 Pres Glenn Hamman Sr
Hammermill Pop (ASCAP), see Bug Music Group
Hamptstead Heath Music Publ'ns (ASCAP), 7505 Jerer Ct., Carlsbad, Calif 92008 Pres Jay Senter.
Hand in Glove Music (BMI), see Bug Music Group
Hankey Chip Music (ASCAP), see Derby
Hannan/Phillips (BMI), 1819 W. Thome Ave., Chicago, Ill 60660 Tel (312) 465-3894. Owners: Ed Hannan, Stoney Phillips.
Hanover Music Corp. (ASCAP), PO Box 6296, Beverly Hills, Calif. 90212 Pres. & Treas.: Paul Weston; VP: Jo Stafford; Sec'y: Gary Kleinman.
Hanter Prod'ns Inc. (ASCAP), 800 Bloomfield Ave., Clifton, N.J 07012 Tel. (201) 666 9515, 778-4311. Pres: Hans A. Engel.
Happy Day Music Co (BMI), see Joe Keene
Happy Trails Music (BMI), see Garrett
Happy Tuesday Music (ASCAP), see Garrett
Happy Valley Music (BMI), 186 Willow Ave., Somerville, Mass 02144 Tel. (617) 354-0700 Telex 921724. Partners Ken Irwin, Marian Leighton, Bill Nowlin.
Int'l firm represented: Cezame Eds. (France).
Harbot Music (SESAC), 2 Music Circle S., Nashville Tenn 37203 Owner: Joe Talbot
Margail Music Press (ASCAP), 51 E 12 St., New York, N.Y 10003 Tel (212) 245 7246
Harken Music (BMI), see Music Publ'g Corp
Harlem Music (BMI), 355 Harlem Rd., Buffalo, N.Y 14224 Tel (716) 826 9560. WATS: (800) 828 7041. TWX: (710) 522 1249 Pres Leonard Silver, Gen. Mgr.: David Parker, Publ'g Admin Mgr Lynn Bnehringer
Harlene Music Publ'ns (ASCAP), see Dijon
T. B. Harms Co (ASCAP), see Weik Music Group
Harrai Music (ASCAP), see Amestoy
Harrick Music Inc (BMI), 7764 NW 71 St., Miami, Fla 33166 Tel (305) 592-1014 Pres. Harry Wayne Casey, VP & Gen Mgr Sherry Smith, Prof Mgr. Richard Finch
Int'l rep.: Benelux (Intersong Basart)
Charles K. Harris Music Publ'g Co Inc (ASCAP), see Peer Southern
Harrison Music Corp (ASCAP), 6381 Hollywood Blvd., Suite 601, Hollywood, Calif. 90028 Tel (213) 466 3834 Pres Hannah Russell. Gen Mgr Molly Hyman, Prof. Mgr. Tad Maloney
Int'l rep.: Japan (EMI Toshiba)
Hartford Music Co (SESAC), see Albert E. Brumley
Alan Hartwell Music (BMI), 12 Merrimac St., Concord, N.H 03301 Tel (212) 734-4000 Pres. Alan Hartwell
Harvard Music Inc (BMI), see Ivan Mogull
Hayseed Publ'g (BMI), PO Box 1528, Shreveport, La 71165 Tel (318) 742 7803. Pres. & Prof Mgr David Kent. (Administered by Weilbeck)
Heartstone Music Publ'g Co (BMI), 2140 St. Clair St., Bellingham, Wash 98225 Tel (206) 733 3807 Prof. Mgr.: Rennie Peterson
Heaven's Gate Music (ASCAP), see Band of Angels
Heaven 17 Music (BMI), 1010 Second Ave., Suite 2222, San Diego, Calif 92101 Tel (714) 265-2123 Pres Chris Sullivan.
Heavy Jam'n' Music (ASCAP), PO Box 4740, Nashville, Tenn 37216 Tel (615) 859-0355 Pres Wade Curtiss
Helenback Music (BMI), see Bug Music Group
Helios (Ed.) (BMI), see Mark Foster
Helios Music Corp (BMI), 1619 Broadway, Suite 603a, New York, N.Y 10019 Tel: (212) 581 0280 Pres Claus Dgerman (Mechanical rights administered by Copyright Serv Bureau Ltd)

Int'l firm represented: Ebony (Germany)
Int'l rep.: Germany (Ebony)
Hemlane Music Co. (ASCAP), see Cherry Lane.
Hen-Al Music (BMI), see 20th Century
James Hendrix Ents (BMI), PO Box 90639, 902 42 Ave N., Nashville, Tenn 37209. Tel: (615) 297 4174. Pres & Dir James Hendrix
The Herald Ass'n Inc., Box 218, Wellman Heights, Johnsonville, S.C 29555 Tel (803) 386 2600 Pres & Gen Mgr Erv Lewis, Prof Mgr. Frances B Lewis
Int'l rep.: UK & Ireland (New Music Ents)
Heraldic Music (ASCAP), see Herald Ass'n
Herald Square Music Co. (ASCAP), see Hudson Bay.
Herford Music (ASCAP), see Brim.
Hi-Cue Prod'ns (ASCAP), see Lynnstorm
Highball Music (BMI), PO Box 40484, Nashville, Tenn 37204 Tel: (615) 383-6564. Pres. Jack D. Johnson
Hightree (BMI), c/o Renaissance Mgmt., 433 N. Camden Dr., Suite 950, Beverly Hills, Calif. 90210. Tel (213) 550 1276
High Wave Music Inc (ASCAP)—Pres Gary Wright—see Beldock Levine & Ioffman
Hilaria Music Inc. (ASCAP), 315 W Gorham St., Madison, Wis 53703 Tel (608) 251-2644 Pres Ken Adamany, Gen & Prof Mgr Jeffrey Messen ger
Hilding Music Group, Box 1800, Nashville, Tenn 37202 Pres Eric R Hilding
Hillbrow Music Inc (ASCAP), see Songs for Today
Hi Morning Music Inc (BMI), see Al Gallico
Hip Notic Music (BMI), see Funky Acres
Hipolit Music Co (ASCAP), see Memnon
His Eye Music (SESAC), see Sparrow Recs & Cherry Lane
HitKit Music (BMI), PO Box 22325, Nashville, Tenn 37202 Tel (615) 385 0900 Pres. David N. Gib
The Hit Machine Music Co (BMI) (div of Diversified Mgmt. Group), PO Box 20692, San Diego, Calif. 92120 Tel (714) 277 3141. Pres: Marty Kurtz; VP: David Sanchez
Hitman Music (BMI), see Don Williams
Hobbitron Ents. Inc. (ASCAP), see 20th Century
Hobby Horse Music (BMI), see Garrett
Hob & Nob Music Publ'ns (BMI), 158 W 15 St., Suite 2D, New York, N.Y 10011 Tel: (212) 255 7214 Gen Mgr LeRoy De Gregory
Ivan Hoffman, 2040 Ave of the Stars, Los Angeles, Calif 90067 Tel (213) 556 2804.
Hollytree Music (BMI), 48 Music Square E., Nashville, Tenn. 37203 Tel (615) 244-7300. Pres Sherry Sanders
Holy Moley Music (BMI), see Scotti Bros.
Holy Spirit Music (BMI), PO Box 31, Edmonton, Ky 42129 Tel (502) 628-3573. Pres & Prof Mgr Rev W Junior Lawson, Gen Mgr Charles W Witty.
Holy Spirit Music (ASCAP) (div of Holy Spirit Recs.), 27335 Penn. Inkster, Mich 48141 Tel (313) 562 8975 Pres Otis G Johnson, VP John Washington, Gen Mgr Willie Jones Jr., Prof Mgrs.: Marion L Lang, John Washington.
Branch: Pittsburgh, Pa., 7203 Monticello Zip 15208 Tel (412) 242 5692 Chief Exec. Ardell McNeal
Hometown Music Co. (ASCAP), 80-08 35 Ave., Jackson Heights, N.Y 11372 Tel (212) 651 8213 Pres., Gen. & Prof Mgr Sidney Prosen
Homewood House Music (BMI), 9465 Wilshire Blvd., Suite 800, Beverly Hills, Calif. 90012 Tel (213) 550-1010 Partners Peter Burke, Susan Pomerantz, James Golden.
Honiton Music (BMI), see Arnakata & Cherry Lane
Hoochie Coochie Music (BMI), see Cameron.
Jerry Hooks (ASCAP), see Groundhog
Hoosier Hills Publ'g (BMI), 1309 Celesta Way, Sellersburg, Ind 47172 Tel (812) 246 2959/2865. Owner & Mgr Buddy Powell
Hope Publ'g Co. (ASCAP), 380 S Main Pl., Carol Stream, Ill 60187 Tel (312) 665 3200. Pres George Shorney
Hornsby Music Co. (BMI), PO Box 13661, Houston, Tex 77019 A&R Rep Ezzard Topps; Promo J D Horn
Horsehoe Canyon Music (ASCAP), see Don Williams
Hortor Music Co. (BMI), 313 El Tejon Ave., Oldale, Bakersfield, Calif 93308 Tel (805) 399 9028 Owner Robert L Hirtlor
Hot Bear Music (BMI), see Sugar Creek
Hot Curl Music (BMI), see Bug Music Group
Hot Transistor Tunes Inc (ASCAP), see Iguauna
House of Bryant Publ'ns (BMI), PO Box 120608, Nashville Tenn 37212 Tel: (615) 385 3245 Gen. Mgr: Nona Thomas
Int'l reps: Australia (Chappell), UK (Showcase)
House of Cash Inc (BMI), Gallatin Rd., Hendersonville, Tenn 37075 Tel (615) 824 5110 Pres. J R Cash; Gen Mgr Reba Hancock Prof Mgrs Harlan Sanders, Kathy Cash Brimm
House of Diamonds (BMI), PO Box 449, Cleburne Tex 76031 Owner Jan Diamond
House of Gold Music Inc (BMI), 1614 16 Ave S., Nashville, Tenn 37212 Tel (615) 383-4667
House of Hi Ho (BMI), PO Box 8135, Chicago Ill. 60680 Tel (312) 254 5612, 787 8220 Exec VP: R C Hillsman
House Of Knox (ASCAP), 41418 50 St W, Quartz Hill, Calif 93534 Tel (805) 943-4183 Owner & Gen Mgr Robert B. Knox
House of Longhorn Music (BMI)—Pres Neil Patton Rogers—see Buckhorn
House of Rock Music (BMI), 958 W Edgemont Dr., San Bernardino, Calif 92405 Tel (714) 882 6796 Owners Bill & Myral Bellman. Gen & Prof Mgr: Bill Bellman
House of Weiss Music Co (ASCAP), see 20th Century
Jack Howard Publ'g (BMI), see Rex Zaro
James M. Hudgins Publ'g Co (ASCAP), 610 W Due West Ave., Suite G-103, Madison, Tenn 37115 Tel (615) 868 1158 Owner James M Hudgins. Pres.: Jeffrey M Hudgins.
Hudson Bay Music Co (BMI), 1619 Broadway, New York, N.Y 10019 Tel (212) 489 8170 Partners Freddy Bienstock, Jerry Leiber, Mike Stoller
Huffman Publ'g Co (BMI)—Pres Joe Huffman Gen Mgr Erv Lewis, Prof Mgr Frances B Lewis—see Herald Assn & Township Group
Human Music (BMI), see Bug Music Group
R L Huntzinger Inc (SESAC), see Willis
Hustlers Inc (BMI), 602 Southern Trust Bldg., Macon, Ga 31201 Tel (912) 745 5391

Ichabod Music Co (BMI), see Worthy
Iffin Music Publ'g Co (BMI), 38 Music Square E., Nashville, Tenn 37203 Tel (615) 254-0825
Iffit Fliz Music (BMI), PO Box 6475, Jacksonville, Fla 32236 Tel (904) 786 1741 Pres & Prof Mgr Michael R. Fitzgerald, Gen Mgr Valerie Silva.
Iguauna Music (ASCAP), 225 West End Ave., New York, N.Y 10023 Tel (212) 580-0723. Pres. Toby Byron; Prof Mgr: Nina Levine
India Music Ink (ASCAP), c/o Greene & Reynolds, 1900 Ave of the Stars, Suite 1424, Los Angeles, Calif. 90067. Tel (213) 553-5434
Int'l reps: Asia (Pathe Far East), Australia (Rondor), France (Marouani), Japan (Tayo), New Zealand (Rondor), UK (Rondor)
Indian Summer Music (ASCAP), 11324+ Ventura Blvd., Studio City, Calif. 91604. Tel (213) 761-0759 Pres & Prof Mgr Stephen M. Singer, VP & Gen Mgr Heyward Collins
Int'l rep.: France (Dick James)
Insanly's Music (BMI), 24548 Pierce, Southfield, Mich 48075 Tel (313) 559-7630. Pres. Bruce Lorfel
Inspirational Sounds Inc., PO Box 1363, Union, N.J 07083 Tel (201) 376-3955. Pres. David Casey, Gen. Mgr Ralph Schechtman, Prof. Mgr. D C Johnson
Inspiration Music Co (ASCAP), see ASC.
Insurance Music (BMI), 11616 S Lafayette Ave., Chicago, Ill 60628 Tel (312) 264-2166. Pres. William C. Tyson
Integrity Music Corp (ASCAP), 1050 Fifth Ave., New York, N.Y 10028 Tel (212) 348 6700 Cable INTEG Pres & Gen Mgr. Jack Wolf
Intermountain Music (BMI), PO Box 1067, Hollywood, Calif 90028 Owner & Pres. Reta Chandler
International Doorway Music (ASCAP), 3410 Ave R, Lubbock, Tex 79412 Tel (806) 744 5590 Pres & Prof Mgr Bud Andrews
International Music Publ'ns Co. (BMI)—Pres Cal Freedman—see Tangled Web
Interworld Music Group Inc., see Arista-Interworld.
Invador Music (BMI), 270 Hunters Point Dr., Thousand Oaks, Calif. 91360 Tel: (805) 497-4738. Pres & Gen. Mgr., Don Perry.
The Ironside Cos Inc., PO Box 40923, Nashville, Tenn 37204. Pres. Bob Millsap; Sec'y-Treas Sherry Millsap
Irwin Publ'g Co (BMI), PO Box 3883, Portland, Me 04104 Pres Jeffrey Weinstein
Iska Music (BMI), see MizMo
Island Music/UF0 Music Inc (BMI), 6525 Sunset Blvd., 2nd fl., Hollywood, Calif 90028 Tel (213) 469 1285 Cable ACKEE. Pres. Lionel Conway, VP Pat Shannahan, Gen. & Prof Mgr Gary Heaton.
Home office: England

J

J A C Music Co Inc., 6430 Sunset Blvd., Suite 912, Hollywood, Calif 90028 Tel (213) 469 8234 Pres Hal David, Gen Mgr James David.
J C Music Co., see JAC
J C M (Japan Central Music), 7060 Hollywood Blvd., Suite 510, Hollywood, Calif 90028 Tel (213) 463 9929 Contact (Ms) Akiko Agushi
Home office: Japan
J E D O Music (ASCAP), 5062 Calatrana Dr., Woodland Hills, Calif 91364 Tel (213) 703 0083. Pres John Devran, Gen Mgr Prof Mgrs Jon Devran, S Kay Lacey Branch: 10100 Santa Monica Blvd., Suite 205, Hollywood 90067 Tel 552 3147
J L T Christian Agape Music Co (ASCAP), 104 Eighth St., Salem, N.J 08079 Tel (609) 935 1908 Owner & Pres John L Tussey Jr
J M R Ents., 1014 16 Ave S., Nashville, Tenn 37217 Tel (615) 244-1630 Pres. Roy Sinkovch, Gen Mgr: Mick Lloyd, Prof Mgr Robn Eichel
J S H Music (ASCAP), see Big Heart
JWT Music Inc (ASCAP) (sub of J Walter Thompson USA Inc.), 466 Lexington Ave., New York, N.Y 10017 Tel (212) 867 1000. Pres. Burton J Manning, VP Marion Preston, Treas Neville Sargeant
Jackaroe Music Publ'ns (div of Vanguard Rec'g Society Inc.), 71 W 23 St., New York, N.Y 10010 Tel (212) 255 7732 Cable VANMUSIC Pres Maynard Solomon; Foreign & Lic Opns Dir Jo Inguanti.
Int'l reps: Australia (J. Albert & Son), Benelux (Nada Music in Netherlands), France & SACEM territories (Bagatelle), Germany (Rudolf Stezak), Japan (Victor), Scandinavia (Air in Sweden), Spain (Bocaccio), UK & PRS territories (Panache)
Jack & Bill Music Co (ASCAP), see Weik Music Group
Jack Music Inc. (BMI), PO Box 120477, Nashville, Tenn 37212 Tel (615) 383 0330 VP: Bob Webster
Int'l rep.: Worldwide except USA (Morning).
Alice M Jackson Music (ASCAP), 9000 Sunset Blvd., West Hollywood, Calif 90069 Tel (213) 550 0397 Pres Alice M Jackson Gen Mgr K H Smith
Jackson Jodejuan Music (BMI), see Alice M Jackson
Jacktone Music Corp., see MCA
Ja Clell Music (ASCAP), see Trinity
Jaclyn Music (BMI), 467 Millwood Dr Nashville, Tenn 37217 Tel (615) 366 6906 Pres Col Jack Lynch
Jacon Music/Darnoc Music (BMI), 2958 N Beachwood Dr., Hollywood, Calif. 90068 Tel (213) 465 1261 Owner, Pres & Prof Mgr Jack Conrad (Administered by MizMo Ents)
Jake Carl Publ'ns (BMI), 732 N Main St., Opelousas, La 70570 Tel (318) 942 7092
James Boy Publ'g Co (BMI), PO Box 128, Worcester 19490, 1834 W Cheltenham Ave., Philadelphia, Pa 19126 Tel (215) 424-0800 Pres & Gen Mgr: Jesse James, Prof. Mgr Lenne Hawkins
Deviny James Music (ASCAP), see Pewter Pl.
Dick James Music Inc. (BMI), 119 W. 57 St., New York, N.Y 10019 Tel (212) 581 3420. TWX (710) 581 4216 Pres Dick James, Gen Mgr Arthur Braun.
Int'l rep.: Japan (Yamaha)
James S Ents (BMI), 7120 261 Carlson Circle, Canoga Park, Calif 91303 Pres James Leach
Tommy James Music Inc (BMI), c/o Magna Artists Inc., 595 Madison Ave., New York, N.Y 10022
Jamie Music Publ'g Co (BMI), 919 N Broad St., Philadelphia, Pa 19123 Tel (215) 232 8383 Pres Harold B Lipsius
Jamil Music (BMI), 413 N Parkerson Ave., Crowley, La 70526 Tel (318) 783 1601
Janell Music (BMI), see Tiki Ents
Japan Music—Pres Ned Shankman—see Nero Ents
Jarak Music (ASCAP), see Buttermik Sky
Jardine Music (BMI), see Brother
Jason Sean Music (ASCAP), see 20th Century
Jaspar Music Publ'g Co Ltd (BMI), 852 Elm St., Manchester, N.H 03101 Tel (603) 623 9749, 624 1990 Cable W&G Mng Dir James Parks
Home office: Australia (Woomera)



World-wide Publishing Record Representation

IVAN MOGULL MUSIC ASSOCIATES
 625 Madison Avenue
 New York, N.Y. 10022
 (212) 355-5636
 Telex 236973 Cable: IMOULL

I

I A M Music (ASCAP), 17422 Murphy Ave., Irvine, Calif 92714 Tel (714) 751 2015 Pres Skip Konte
Ice Nine Publ'g Co Inc (ASCAP), PO Box 1073, San Rafael, Calif 94915 Tel (415) 457 2322 Pres Robert Hunter, Gen Mgr Alan Trist
Int'l rep.: Worldwide except USA & Canada (Warner Bros)

Int'l firms represented: Angel (Germany), Banff (Canada), Mersel (Germany), Jaspur (UK), Melb (Canada), Rodeo (Canada), Woomera (Australia).

Int'l reps: Europe, Japan, South Africa, South America, (Copyright Serv Bureau), UK (Chappell, Leeds), Western Hemisphere (Chappell).

Jascurr Music (BMI), see Bug Music Group.

Javors Music Co. (ASCAP), see 20th Century.

Jawbones Music Co., 77 W. 15 St., New York, N.Y. 10011. Tel: (212) 675-3783. Pres.: Joseph Aniello.

Jay & Cee Music Corp. (BMI), see Fort Knox.

Jay Jay Publ'g Co. (BMI), PO Box 4155, Normandy Branch, Miami Beach, Fla. 33141 Tel: (305) 758-0001 Owner: W. Jagello.

Jaymore Music (BMI), Box 100, Brighton, Mich. 48116. Tel: (313) 227-1997. Pres.: John Morris.

Jay Music (ASCAP), 6654 Allott Ave., Van Nuys, Calif. 91401. Tel: (213) 873-2699. Pres.: Johnny Rotella.

R.C. Jay Publ'g Co. (ASCAP), see Fisher Music Corp.

Jay Six Publ'g Co. (BMI), 26 North River, Harwich Port, Mass. 02646. Tel: (617) 432-9070. Pres.: Jack Safer.

Jec Publ'g Co. (BMI), see Cream.

Jemiah Publ'g (BMI), PO Box 250, Columbia, S.C. 29202 Tel: (803) 754-5554. Pres.: Myron Alford; Pro Mgr.: Theodore Hampton Jr.

Jenniejohn Music (BMI), 4123 N. 4 St., Milwaukee, Wis. 53216. Tel: (414) 873-4287. Pres.: Ken Wright.

Jenson Publ'ns Inc. (ASCAP), 288 S. 171 St., New Berlin, Wis. 53151. Tel: (414) 784-4620. Pres.: Art Jensen; VP Prod. Development: John Higgin; VP Sales: Bill Altice; Gen. Mgr.: Ad Wegmann; Prod. Mgr.: Larry Norred.

Jepalana Music (BMI), 723 Seventh Ave., New York, N.Y. 10019. Tel: (212) 245-7640. Pres.: Nathan Schmpf; VP: Jerry Samuels; Prof. Mgr.: Paul Friedberger. (Also see WPN Music)

Jerden, PO Box 3925, Bellevue, Wash. 98009. Tel: (206) 622-0470. Pres.: Gerald B. Dennon.

Jerjoy Music (BMI) (div. of Unwired-Athena Recs.), PO Box 3615, Peoria, Ill. 61614. Tel: (309) 673-5755. Owner: Jerry Hanlon.

Jero Ltd. Publ'g (BMI), 2309 N. 5 St., Milwaukee, Wis. 53210. Tel: (414) 445-4872. Pres.: Marvell Love.

Jerrin Mick Music (BMI), see JMR Ent's.

Jerwin Music (BMI), 6120 Sunbur, Rd., Westerville, Ohio. 43081. Tel: (614) 882-2388. Pres.: Sonny Flahar.

Jevent Music (BMI), 639 Bulew Ave., Columbus, Ohio 43205. Tel: (614) 258-7112. Pres.: Jeffrey V. Smith.

Jevy Music (ASCAP), PO Box 1828, Memphis, Tenn. 38118. Tel: (901) 452-0673. Pres.: Evelyn Graves.

Jewel Music Publ'g Co. Inc. (ASCAP), see Goodman Group.

Jibaro Music Co. Inc. (BMI), PO Box 424, Mount Clemens, Mich. 48043 Tel: (313) 791-2678. Pres. & Prof. Mgr.: James B. Roach; Gen. Mgr.: Ann Roach.

Jimpire Music Inc. (BMI), 110 E. 9 St., New York, N.Y. 10022. Tel: (212) 371-4387.

Jimsnack Music (BMI), see Bug Music Group.

Jru Music Inc. (ASCAP), 201 W. 77 St., Suite 3-C, New York, N.Y. 10024. Tel: (212) 799-0228. Pres.: Richard Gotthehrer; VP: Judy Gotthehrer; Gen. Mgr.: Ron Ross.

Int'l rep: UK (Intersong).

J-Kays Music (ASCAP), see Newark ys.

Jobete Music Co. Inc. (ASCAP), 62 S Sunset Blvd., Hollywood, Calif. 90028.

Tel: (213) 468-3400. Exec. VP: Robert L. Gordy, VP & Gen. Mgr.: Jay S. Lowy, Prof. Mgrs.: Rodney & Tommy Gordy, Dale Kawashima.

Int'l branch: England.

Int'l reps: Argentina (Edison), Australia (Allans), Austria (Discoton), Belgium (Ardmore & Beechwood), Brazil (Top Tape), Denmark (Air), Finland (Air), France (Pathe-Marconi), Germany (Discoton), Iceland (Air), Italy (Festival), Japan (Taiyo), Mexico (Beechwood), Netherlands (EMI), New Zealand (Allans), Norway (Air), South Africa (Laetrec), Spain (EGO), Sweden (Air), Switzerland (Discoton).

JoCee Publ'g Co. (SESAC), see Su-Ma.

JoCher Music Co. (BMI), Box 102C, RD 1, Chubbick Rd., Canonsburg, Pa. 15317. Tel: (412) 746-2540. Pres.: Joe Diamond; VP: Cheryl Diamond.

Joelle Music (ASCAP), see Mighty Matthew.

Little Richie Johnson Music Co. (BMI), 913 S. Main, Belen, N.M. 87002. Tel: (505) 864-7441. Pres.: Little Richie Johnson; Gen. Mgr.: Mary Lukes; Prof. Mgr.: Sue Smrt.

Joiner Music (ASCAP), see Music Publ'g Corp.

Joli Music Inc. (BMI), 41 Algonquin Rd., Yonkers, N.Y. 10710. Tel: (914) 779-2080. Pres.: Jim McCarthy; Gen. & Prof. Mgr.: Gil Miller; Prod'n Dir: Henry Boye.

Int'l rep: UK (Campbell Connelly).

Jolly Rogers Publ'g Co. (ASCAP), see Cherry Lane.

Jomark Music US (ASCAP), 6430 Sunset Blvd., Suite 502, Los Angeles, Calif. 90028. Tel: (213) 469-7125. Pres.: Joel Wertman; Gen. Mgr.: Mark Wertman; Prof. Mgr.: Jack Goga.

Int'l branch: Canada.

Jondora Music (BMI), 10th & Parker Sts., Berkeley, Calif. 94710. Tel: (415) 549-2500. Mgr.: Paul Zaentz.

Jo-Nick Line of Music (BMI)—Pres.: Karen A. Padykula; Gen. Mgr.: JoAnn Nichols—see Pady.

Jon Music (BMI), 329 N. Main, Church Point, La. 70525. Tel: (318) 684-2176. Pres. & Mgr.: Lee Lavergne.

Jonvis Music Co. (BMI), 2233 W. 25 St., Los Angeles, Calif. 90018. Tel: (213) 731-1320. Pres.: J. W. Spriggs; Gen. Mgr.: D. W. Brown.

Int'l rep: France (Tremplin).

Jorob Music (ASCAP), see Bug Music Group.

JoRo Music Corp. (ASCAP), see Larry Spier.

Journeymen Music (BMI), 135-46 Grand Central Pkwy., Kew Gardens, N.Y. 11435. Tel: (212) 974-3043. Gen. Mgr.: Ernest C. Pelito Jr.

Jowli Music (BMI), see Amestoy.

Joyful Wisdom Music Co. (BMI), see Alkatraz Corner.

Juan Songs Ltd. (ASCAP), see Cherry Lane.

JuBop Music (ASCAP), see Xanadu.

Jude Mude Music Corp. (ASCAP), see Larry Spier.

Judy Johnny Music (BMI), see Bug Music Group.

Jugumba Music (ASCAP), c/o Jay Cooper, 9465 Wilshire Blvd., Suite 820, Beverly Hills, Calif. 90212. Tel: (213) 278-1111. Cable: TRADEMARKS. Pres.: Jim Golden.

Juju Raja Music (BMI), see Shekere.

Juldane Music Co. (BMI), 8037 13 St., Silver Spring, Md. 20910. Tel: (301) 585-2776. Owner: Jules M. Damian.

Julep Publ'g Co. (BMI) (div. of Julep Inc.), PO Box 15551, Nashville, Tenn. 37215. Tel: (615) 383-5698.

July Child Music (ASCAP), see Little Things.

Jump Tunes (BMI), c/o Jess S. Morgan & Co., 6420 Wilshire Blvd., Los Angeles, Calif. 90048. Tel: (213) 651-1601.

Ralph Jusko Publ'ns Inc. (SESAC), see Willis.

Just Over The Bridge Music Co. (BMI), see The Entertainment Co.

K

K B L Assocs. (BMI), see The Entertainment Co.

K I R Music (BMI), see Roads of Music.

K & R Music, Inc. (ASCAP), 112 E. Main St., Trumansburg, N.Y. 14886. Tel: (607) 387-5325. Pres.: William M. Kelly.

K R P C O Music (BMI), (div. of Kiderian Recs. Prod'ns), 4926 W. Gunnison, Chicago, Ill. 60630. Tel: (312) 545-0861. Pres.: Ray Peck; VP: George Peck.

Kack Klick Inc. (BMI), House of Guitar Bldg., 645 Titus Ave., Rochester, N.Y. 14617. Tel: (716) 544-3500. Pres.: Armand Schaubroeck; VP: Jim Degman; Prof. Mgr.: Kim Simons.

Gus Kahn Music Co. (ASCAP), 6223 Selma Ave., Hollywood, Calif. 90028. Tel: (213) 462-6088. Owner: Donald Kahn.

Edwin F. Kalmus & Co. Inc. (ASCAP), 13125 NW 47 Ave., Opa Locka, Fla. 33054. Tel: (305) 681-4683. Owner & VP: Lawrence Galison; Pres.: Thea Kalmus; Gen. Mgr.: Leon Galison.

Int'l rep: Argentina (Establecimientos Tow), Europe & England (Belwin-Mills).

Kama Rippa Music (ASCAP), see Buddha.

Kama Sutra Music Inc. (BMI), see Buddha.

Bob Karcy Music (ASCAP, BMI), 437 W. 16 St., New York, N.Y. 10011. Tel: (212) 989-1989. Cable: ROKINTAL. Pres.: Bob Karcy.

Int'l branch: France, Pygmalion.

Karjan Music Publ'g Co. (SESAC) (div. of Little Giant Ent's.), Box 205, White Lake, N.Y. 12786. Tel: (914) 583-4471. Pres.: Mickey Barnett.

Katch Nazam Music (ASCAP) (div. of Rose Hill Group), 3929 New Seneca Tnpl., Marcellus, N.Y. 13108. Tel: (315) 673-1117. Prof. Mgr.: Vincent Taft.

Richard Kaye Publ'ns, 1901 Ave. of the Stars, Beverly Hills, Calif. 90067. Tel: (213) 277-3540.

Int'l firm represented: Steve Hackett Music Ltd. (UK).

Kaye-Smith Music (ASCAP), see Kaye-Smith Prod'ns.

Kaye-Smith Prod'ns, 2212 Fourth Ave., Seattle, Wash. 98121. Tel: (206) 624-8651. Chief Exec. Officer: Lester M. Smith.

Joe Keene Music Co. (BMI), PO Box 602, Kennett, Mo. 63857. Tel: (314) 888-2995. Pres. & Gen. Mgr.: Joe Keene.

Int'l rep: UK (Anchor).

Keep Right (SESAC), see Jim W. Rice.

Keeta Music Co. (BMI), see Briarmead.

Kejoc Music (BMI)—Pres.: Sister Sledge—see Nero Ent's.

Kejra Music, see Stone-Rap.

Kelly & Lloyd Music (ASCAP), see JMR Ent's.

Kelly Music Publ'ns (BMI), see Country Star.

Kendor Music Inc. (SESAC), Main & Grove Sts., Delevan, N.Y. 14042. Tel: (716) 492-1254. VP & Gen. Mgr.: Lester P. Chappell.

Kengorus Music (ASCAP), c/o Perry Potkin & Co., 9200 Sunset Blvd., Suite 607, Los Angeles, Calif. 90069. Tel: (213) 273-6167. Pres.: Brenda Russell; Bus. Mgr.: Perry Potkin.

Gene Kennedy Ent's., 2125 Eighth Ave. S., Nashville, Tenn. 37204. Tel: (615) 383-6002. Pres., Gen. & Prof. Mgr.: Gene Kennedy.

HAL LEONARD PUBLISHING

The Company that has generated high print royalty income by delivering the "extra" educational market, can now generate even higher print royalty income. Hal Leonard Publishing Corporation proudly announces its entrance into the popular music print market.

Our unique marketing and merchandising methods, coupled with our unmatched distribution system and in-house printing facilities, make us the clear choice for your print rights. It's natural to want the highest royalty income possible. It's natural to consider Hal Leonard.

Now Exclusively Representing: Chappell Music, Elsmere Music, The Entertainment Company, Hallnote Music, House of Cash, Intersong (including Hill & Range), RSO, Songpainter Music and Williamson.

**CONTACT: KEITH MARDAK • 8112 W. BLUEMOUND ROAD
MILWAUKEE, WI 53213 (414) 774-3630 • TELEX: 26668**

HL HAL LEONARD PUBLISHING CORPORATION

70050475

Kensington Music Serv., Box 471, Tenafly, N.J. 07670. Tel: (201) 567-4791. Owner: Lynne Hartman Richter.

Arthur Kent Music Co. (ASCAP), 940 Villa Dr., North Myrtle Beach, S.C. 29582. Owner: Arthur Kent.

Kentucky Colonel Music (BMI), PO Box 5853, Pasadena, Calif. 91107. Pres.: John M. Delgatto.

Int'l rep.: Italy (G. Ricordi)

Kenwad Music Inc. (ASCAP), PO Box 2331, Orlando, Fla. 32802. Tel: (305) 896-5601. Pres., Gen. & Prof. Mgr.: Kenneth W. Davies.

Kenwood Music Inc. (BMI), see Songs for Today.

Kenya Music Inc. (ASCAP)—Pres.: Eumir Deodato—see Beldock Levine & Hoffman.

Keristone Music Ltd., (BMI), 538 N. San Vicente Blvd., Suite 210, West Hollywood, Calif. 90048. Tel: (213) 851-9418. Pres.: Kristine J. Smith; Gen. Mgr.: K.H. Smith; Prof. Mgr.: Dee Robb.

Kevrick Music (ASCAP), see San-Lyn.

Gilbert Keyes Music Co. (ASCAP), see Gus Kahn.

K-4 Music, 1405 Locust St., Philadelphia, Pa. 19102. Tel: (215) 735-6695.

Kick-A-Rock (ASCAP), c/o Aucuin Mgmt. Corp., 645 Madison Ave., New York, N.Y. 10022. Tel: (212) 826-8800.

Kicking Mule Publ'g Inc. (BMI), PO Box 158, Alderpoint, Calif. 95411. Tel: (707) 926-5312. Pres.: Ed. Denson.

Int'l rep.: Australia (Larrikin), Europe (Sonet), Japan (Toshiba-EMI).

Kidada Music Inc. (BMI), c/o A&M Recs., 1416 N. La Brea Ave., Hollywood, Calif. 90028. Tel: (213) 469-2411. Cable: ALPERMOSS.

Int'l firm represented: RCA Int'l.

Kimberly Music (BMI), see Maynard Ferguson.

KimKris Music (BMI), see 20th Century.

Kim-Pat Publ'g (SESAC), Box 654, Hillwood Dr., Fayetteville, Tenn. 37334. Tel: (615) 433-2323.

Ki Music (ASCAP), see Daksel/Seidak & MCA.

Kindness Df Strangers Music Co. (BMI), c/o Paramount Pictures, 5415 Marathon St., Los Angeles, Calif. 90038. Tel: (213) 468-5000. Contact: Roger Birnbaum.

Kiner Music Co., PO Box 724, Redmond, Wash. 98052. Tel: (206) 882-1124. Owner: L.F. Kiner.

King Coal Music Inc. (ASCAP), see Coal Miners

King Kong Music (BMI), see Extra Money.

King & Moore Music (BMI), PO Box 10273, Chicago, Ill. 60610. Tel: (312) 944-1125. Bd. Chm. & Pres.: Xavier King Roy III.

Kingsland Publ'g Co. (ASCAP), see Briarmead.

Kings Road Music (BMI), see 20th Century.

Kinky Blu Publ'g (ASCAP), 10 W. Main St., Richmond, Va. 23219. Tel: (804) 643-0281, x. 111. Pres. & Gen. Mgr.: Max Monroe.

Kipahu Music Co. (ASCAP), c/o Colgems-EMI Music Inc., 1370 Sixth Ave., New York, N.Y. 10019. Tel: (212) 489-6740.

Charles Kipps Music Inc. (BMI), 1 Lincoln Plaza, New York, N.Y. 10023. Tel: (212) 580-0154. Pres.: Charles H. Kipps Jr.

Int'l rep.: Australia (Castle), Italy (Ariston), UK (EMI).

Kips Bay Music (ASCAP), see Raybird.

Kirshner/CBS Music Publ'g, 1370 Ave. of the Americas, New York, N.Y. 10019. Tel: (212) 489-0440.

Branch: Los Angeles, Calif., 9000 Sunset Blvd. Zip: 90069. Tel: (213) 278-4160.

Int'l rep.: Argentina (Melograf), Australia (April), Belgium (April), Brazil (ELAM), Central America (Mundo Musical), France (April), Germany (April), Greece (Blackwood), Israel (April), Italy (April), Japan (April), Mexico (Mundo Musical), Netherlands (April), South Africa (April), Spain (April), Sweden (April), UK (April).

Jimmy Kish Music Publ'g Co. (BMI), PO Box 140316, Nashville, Tenn. 37214. Tel: (615) 889-6675. Pres., Gen. & Prof. Mgr.: Jimmy Kish.

Kitlyhawk Music (ASCAP), see 20th Century.

Neil A. Kjos Music Co. (SESAC), 4382 Jutland Dr., San Diego, Calif. 92117. Tel: (714) 270-9800. Pres.: Neil A. Kjos Jr.

Branch: Park Ridge, Ill., 525 Busse Hwy. Zip: 60068. Tel: (312) 825-2168.

Kjos West (SESAC), see Neil A. Kjos.

Klickitat Music (BMI), 1931 SE Morrison St., Portland, Ore. 97214. Tel: (503) 238-4525. Pres.: Russell E. Gorsline.

Know Music (ASCAP), 6300 Southcenter Blvd., Suite 200, Seattle, Wash. 98188. Tel: (206) 241-2320. Pres.: Nancy Wilson; Prof. Mgr.: Ken Kinear.

Knud-Feldt Music Co. (BMI), c/o Scenerville Inds., 78-08 88 Ave., Woodhaven, N.Y. 11421. Tel: (212) 296-1877. Pres.: Robert L. Knudsen; VP: Arthur J. Kleinfeldt; Nat'l Publ'g Dir.: James Knudsen.

Koala Recs. Inc., 6253 Hollywood Blvd., Los Angeles, Calif. 90028. Tel: (213) 467-3203.

Kobal Music Publ'g Co. (BMI), 1605 E. Charleston, Las Vegas, Nev. 89104. Tel: (702) 385-1297. Pres.: Peter Kobal; Gen. Mgr.: Margaret Yednak.

Branch: Nashville, Tenn., PO Box 22988. Zip: 37202.

Kocky Music (BMI), see Cherry Lane.

Koko Music (ASCAP), see Boxer.

Kolber Publ'g Co. (BMI), 332 W. 14 St., Upland, Calif. 91786. Tel: (714) 985-0073.

Kool Kat Music (BMI) (div. of Kool Kat Prod'n's Inc.), 60 Carlton Rd., Monsey, N.Y. 10952. Tel: (914) 425-6040.

Koppelman-Bandier Music Corp. (BMI), see The Entertainment Co.

Kosciusko Music (SESAC), see Malaco.

Jonah Kosten Music, see Stone-Rap.

Krishane Music Co. (ASCAP) (div. of Kris Stevens Ent's. Inc.), 14241 Ventura Blvd., Suite 204, Sherman Oaks, Calif. 91423. Tel: (213) 981-8255. Pres. & Gen. Mgr.: Kris Erik Stevens.

Kropotkin Music (BMI), PO Box 130, Huntington, N.Y. 11743. Tel: (516) 261-1162. Pres.: Tom Pomposello; Mgr.: Robert D. Witter.

Kyodo Tokyo Inc., c/o Henry Miller Assoc., 9454 Wilshire Blvd., Beverly Hills, Calif. 90028. Tel: (213) 278-9454. Telex: 230691529. Home office: Japan.

L

L A Boppers Music, see Marlin Cohen.

L A M (Latin-American Music Co.) (BMI)—Gen. Mgr.: Dolita Vera—see TIM.

L B C Music (ASCAP), see Reno/Metz.

L F Music Group, c/o Famous Music, 1 Gulf & Western Plaza, New York, N.Y. 10023. Tel: (212) 333-3433. Pres.: Lewis Fetterman.

Int'l firm represented: Andover (UK).

Int'l rep.: France (Societe d'Editions Musicales), Germany (J. Michel), Italy (RCA), Sweden (Sweden Music), UK (Andover).

La Bell Music Publ'g (ASCAP), see Brunswick.

Ladd Music Co. (BMI), 401 Wintermatt Ave., Scranton, Pa. 18505. Tel: (717) 343-6718. Owner: Phil Ladd.

Ladera Music Publ'g (BMI), PO Box 91120, Worldway Postal Center, Los Angeles, Calif. 90009. Tel: (213) 641-0178. Owner: Philip Sonnichsen.

Lady Jane Music (BMI), PO Box 614, Tahoe City, Calif. 95730. Tel: (916) 583-6587. Owner & Pres.: Hoyt Anton; Gen. Mgr.: Marlene Prins; Admin. Asst.: Mark Anton.

Branch: Hendersonville, Tenn., PO Box 1077. Zip: 37075. Tel: (615) 824-9412. VP: Mae B. Axton.

Int'l rep.: Australia (Rondor), France (Marouani), Germany (Global), Ireland (Dlofong in UK), Japan (Pacific), Netherlands (Universal), South Africa (Music Publ'g Co. of Africa), Sweden (Sweden Music), UK (Dlofong).

La Jolla Music Publ'g Co. (BMI), see Neil A. Kjos.

Lake Victoria Music (ASCAP), see Narrow Gate.

La Lou Music (BMI), 711 Stevenson St., Lafayette, La. 70501. Tel: (318) 234-5577.

Lambert & Potter Music Co. (BMI), see Tuneworks.

Cristy Lane Music, c/o LS Rec. Co., 120 Hickory St., Madison, Tenn. 37115. Tel: (615) 868-7171.

Stuart Lanis Music Inc. (BMI), 1273 1/2 N. Crescent Heights Blvd., Los Angeles, Calif. 90046. Tel: (213) 650-6500. Pres.: Stuart Lanis; VP's: Adam, Jason & Nathan Bank.

Lantana Music Inc. (BMI), PO Box 630175, Miami, Fla. 33103. Tel: (305) 472-7757. Pres. & Gen. Mgr.: Jack P. Bluestein; VP: Ethel Kanter; Prof. Mgr.: Kevin McManus.

Int'l rep.: Brazil (Pirate), Canada (CMRRA).

Larball Music, c/o Arrow, Edelstein & Gross, 1370 Ave. of the Americas, New York, N.Y. 10019. Tel: (212) 586-1451.

Large Music (ASCAP), see Buddy Music.

Lariat Music (ASCAP), see Music Publ'g Corp.

Larkspur Music Publ'g Co. (BMI), PO Box 1001, Soquel, Calif. 95073. Tel: (408) 462-6537. Gen. Mgr.: Jon Hutchings.

La Salle Music Publ'rs Inc. (ASCAP), see Peer-Southern.

David Lasley Music (ASCAP), Taylor Rd., Branch, Mich. 49402. Tel: (616) 245-8097. Pres., Gen. & Prof. Mgr.: David Lasley.

Las Palmas Music (ASCAP), see Amestoy.

Lassen Music (BMI), see Bug Music Group.

Last Colony Music (BMI) (div. of Last Colony Presentations Inc.), PO Box 3253, Washington, D.C. 20010. Tel: (202) 667-2995. Pres.: M. Nicholas Mann Jr. (Administered by Band of Angels).

Latigo Music (ASCAP), see Music Publ'g Corp.

Laughing Bird Songs Publ'g Co. (ASCAP), see Angelo Roman.

Laurel Canyon Music Ltd. (ASCAP), see Mike Appel.

Lauren Kim Music (ASCAP), 16 Dundee Rd., Stamford, Conn. 06903. Tel: (203) 322-5778, 329-9646. Pres.: Joan R. Weinberg; Gen. Mgr.: Fred Weinberg.

Laurie Publ'g Group (ASCAP, BMI), 20-F Robert Pitt Dr., Monsey, N.Y. 10952. Tel: (914) 425-7000. Pres.: Gene Schwartz; Gen. Mgr. & Treas.: Robert Schwartz; Prof. Mgr.: Eddie Maresca.

Lawday Music Corp. (BMI), see Acoustic Music.

Law Publ'g Co. (BMI), PO Box 699, Satsuma, Ala. 36571. Tel: (205) 675-4431/0701. Pres.: Lois Anne Whiting; Gen. Mgr.: James A. Whiting; Prof. Mgr.: Jamey Whiting.

Layback Music Inc. (BMI), 887 Hedgewood Dr., Baton Rouge, La. 70815. Tel: (504) 766-3233. Pres.: John Fred; Gen. Mgr.: Sandra Bloodworth; Prof. Mgr.: Kevin Gourrier.

Leacom Music (BMI), see Lea Publ'g.

Leaco Music (SESAC), see Lea Publ'g.

Lea Pocket Scores, PO Box 138, Audubon Sta., New York, N.Y. 10025. Tel: (212) 866-4026. Pres.: F. Steinhardt. (Distributed by European-American).

Int'l rep.: Austria & UK (Universal).

Lea Publ'g Co. (ASCAP), 1300 Division St., Suite 204, Nashville, Tenn. 37203. Tel: (615) 254-0572. Pres.: L. C. Anderson.

Lear Music Inc. (ASCAP), 314 Huntley Dr., Los Angeles, Calif. 90048. Tel: (213) 652-2222. Pres.: Jack Raef; Gen. Mgr.: Jude Calkins.

The Bill Music Inc. (BMI), PO Box 11152, Fort Worth, Tex. 76110. Tel: (817) 738-8843. Pres.: Major Bill Smith.

Int'l branch: UK.

Leeds Music Corp., see MCA.

Legshot Publ'g (BMI), see Bug Music Group.

Legs Music Inc. (ASCAP), see Albco.

Lehua Music Co. (ASCAP), 1365 Colburn St., Honolulu, Hawaii 96817. Tel: (808) 847-0855. Pres. & Prof. Mgr.: C. Robert Clarke.

Leigh Group Inc., 1650 Dak St., Lakewood, N.J. 08701. Tel: (201) 367-0080. Pres.: Milton Herson; Gen. Mgr.: David Muldowney; Prof. Mgr.: Mitch Leigh.

Lemco Music Publ'g Co. (BMI), PO Box 8013, 2518 Southview Dr., Lexington, Ky. 40503. Tel: (606) 277-1184.

Ley Lemley Music (ASCAP), see Tymena.

Lemon Square (ASCAP)—Owner: Bart Garton—see Branch Int'l.

Len-Lon Music Publ'g Co. (BMI), c/o Sandra R. Newman, 1326 N. Flores St., Los Angeles, Calif. 90069. Tel: (213) 654-4601. Pres.: Leonard C. Williams; Gen. & Prof. Mgr.: Sandra R. Newman.

Int'l rep.: UK (Anchor).

Lenny Publ'g Co. Inc. (ASCAP), see Su-Ma.

Leono Music (BMI), see Geffen/Kaye.

Lenroy Music (BMI), see Tridex.

Hal Leonard Publ'g Corp. (ASCAP, BMI), 8112 W. Blummond Rd., Milwaukee, Wis. 53213. Tel: (414) 774-3630. Exec. VP & Gen. Mgr.: Keith Mardak.

Admin. & prof'n branch: Winoona, Minn., 960 E. Mark St. Zip: 55987. Tel: (507) 454-2920. Dpns. Mgr.: Robert Gilbertson.

Int'l branches: England, Spain. (SEE ADVERTISEMENT)

Leonard Prod'n's Inc. (BMI), PO Box 222, Gainesville, Tex. 76240. Tel: (817) 466-4076. Pres.: Joe M. Leonard Jr.

Leshell Music (SESAC), see Brunswick.

Leson Int'l Inc. (ASCAP), 1006 17 Ave. S., Nashville, Tenn. 37212. Tel: (615) 327-4565. Pres.: Kathleen Pynor; Gen. Mgr.: Steve Messer.

Less is More Music (BMI), see Bug Music Group.

Let's Go Music (BMI), see Bug Music Group.

Levan Publ'g (ASCAP), see Inspirational Sounds.

Levine & Brown Music, c/o Arrow, Edelstein & Gross, 1370 Ave. of the Americas, New York, N.Y. 10019. Tel: (212) 586-1451.

Irwin Levine Music, c/o Arrow, Edelstein & Gross, 1370 Ave. of the Americas, New York, N.Y. 10019. Tel: (212) 586-1451.

Lexicon Music Inc. (ASCAP), PO Box 296, Woodland Hills, Calif. 91365. Tel: (213) 884-0333. Pres.: Ralph Carmichael; Exec. VP & Gen. Mgr.: Larry Jordan; VP & Prof. Mgr.: Carl Seal.

Int'l rep.: UK (Word UK).

Licette Music Corp. (BMI), see Fairyland.

Lichelle Music Co. Inc. (ASCAP), 4215 Hood Ave., Burbank, Calif. 91505. Tel: (213) 849-7409. VP: Michelle Kay.

Lido (BMI), c/o Padell, Nadell, Fine, Weinberger & Co., 1775 Broadway, N.Y. 10019.

Life Music Inc. (ASCAP), see Musicprint.

Like A Movie Music (ASCAP), see 20th Century.

Lilenas Publ'g Co. (SESAC), PO Box 527, Kansas City, Mo. 64141. Tel: (816) 931-1900.

Sonny Limbo Music (BMI), PO Box 9869, Atlanta, Ga. 30319. Tel: (404) 633-4659. Pres., Gen. & Prof. Mgr.: Sonny Limbo.

Int'l branch: Denmark.

Lincoln Road Music Co. (BMI), see Joe Keene.

Lineage Publ'g Co. (BMI), PO Box 211, East Prairie, Mo. 63845. Tel: (314) 649-2211. Pres.: Tommy Loomas; Prof. Mgr.: Archie Corlew.

Linesider Prod'n's Ltd. (BMI), see Rohm.

Roger Linn Music (BMI), see Don Williams.

Lion's Gate Films Inc., 1861 S. Bundy Dr., Los Angeles, Calif. 90025. Tel: (213) 820-7751.

Lion's Share (ASCAP), see NBC.

Lipservices (ASCAP, BMI) (a div. of T.S.E.C. Inc.), 263 West End Ave., New York, N.Y. 10023. Tel: (212) 580-3030. Cable: HDTLIPS. Telex: 177857. Pres.: Julie Lipsius.

Lisa Sue Music (ASCAP)—Pres.: Jeff Hest—see Merry Sounds.

Mosie Lister Publ'n's Inc. (BMI), PO Box 270182, Tampa, Fla. 33688. Tel: (813) 935-2988.

Lito Music (BMI), c/o Recorded Treasures Inc., PO Box 1278, North Hollywood, Calif. 91604. Tel: (213) 766-4693, 763-3173. Contact: Walt Heebner.

Little Bird Music (ASCAP), see Bug Music Group.

Little D Music (BMI), see 20th Century.

Little Dove Publ'g Co. (BMI), 1228 Reed St., Philadelphia, Pa. 19147. Owner & Chief Operating Officer: Grace Marchesani.

Little Joe Music (BMI), 604 Broad St., Johnstown, Pa. 15906. Tel: (814) 539-8117. Pres. & Gen. Mgr.: Al Page; Prof. Mgr.: Anthony Page.

Little Otis Music (BMI), 101 Westchester Ave., Port Chester, N.Y. 10573. Tel: (914) 939-1066. Pres.: Carlmine Riale.

Little Roger Music (BMI), see Little Things.

Little Things Music (BMI), 119 E. Court Square, Suite 207, Decatur, Ga. 30030. Publ'r: Jim Diver.

Live Music Publ'g Group, 793 Bingham Rd., Ridgewood, N.J. 07450. Tel: (201) 447-4700.

Mick Lloyd Music (SESAC), see JMR.

Lodestar Music Publ'g (SESAC), see Gene Kennedy.

Loena Music Publ'g Co. (ASCAP), 239 W. 18 St., New York, N.Y. 10011. Tel: (212) 989-7200.

Lollipop Music Corp. (BMI), 132 E. 45 St., Penthouse C, New York, N.Y. 10017. Tel: (212) 557-9109, 288-8728. Pres.: Eddie Miller; VP: Trade Martin.

Lombardo Music Inc. (ASCAP), see 20th Century.

Londontown Music (ASCAP), see Garrett.

Lone Lake Songs Inc. (ASCAP), PO Box 126, Elmstord, N.Y. 10523. Tel: (914) 592-7983. Pres.: Ron Carpenter.

Loney Tunes Music/Solid Smoke Songs (ASCAP), see Solid Smoke.

Lookalike Music (BMI), see Bug Music Group.

Look Hear Music (BMI), see Insanity's Music.

Loop Music Publ'g Co. (ASCAP), see Neil A. Kjos.

Lorenz Corp. (ASCAP), 501 E. Third St., Dayton, Ohio 45401. Tel: (513) 228-6118.

Lorezo Music (BMI), see Bug Music Group.

Loretta Music (BMI), 1116 N. Cory Ave., Los Angeles, Calif. 90069. Tel: (213) 278-5131. Cable: SEGALAW. TWX: (910) 499-2178. Pres.: Lloyd Segal.

Lori-Joy Music (BMI), 39 W. 55 St., New York, N.Y. 10019. Tel: (212) 586-3350. Cable: LLDYDPRICE. Telex: 126655. Gen. Mgr.: Debra Martinez; Prof. Mgr.: Nathaniel Adams Jr.

Loring Music Co. (BMI), 1048 N. Carol Dr., Los Angeles, Calif. 90069. Tel: (213) 276-7103. Pres.: Mike Conner.

Lorville Music (SESAC), see Terrace.

Love-Lee Music Co. (BMI), see Lee Magid.

Love Blast Music (BMI), see 20th Century.

Love Boat Music (BMI), see Reno/Metz.

Lovelight Music Publ'g, see Sugarvine.

Love Music (ASCAP), see Alan Hartwell Music.

Love's Music (ASCAP), see Trinity Sound.

Love Street Publ'g (BMI), PO Box 2501, Des Moines, Iowa 50315. Tel: (515) 285-6564. Pres.: Art Stenstrom.

Love That Music (BMI), see Bug Music Group.

Lowersy Music Co. Inc. (BMI), 3051 Clairmont Rd. NE, Atlanta, Ga. 30329. Tel: (404) 325-0832. Pres.: Bill Lowery.

Lowlands Music (BMI), see Bug Music Group.

Low-Sal Music Inc. (BMI), see Lowery.

Low-Twi Music Inc. (BMI), see Lowery.

Lucky Bull Music, 3645 Midvale Ave., Los Angeles, Calif. 90034. Tel: (213) 204-1954. Partners: James & Nancy Bullock.

Lucky's Kum-Ba-Ya Publ'g Co. (ASCAP), PO Box 6, Broham, Mich. 49312. Tel: (616) 689-6886. Owner: Ross Fulton.

Luckyu (BMI), c/o Jess S. Morgan & Co., 6420 Wilshire Blvd., Los Angeles, Calif. 90048. Tel: (213) 651-1610.

Lu-Cor Music (ASCAP), 7357 S. Euclid Ave., Chicago, Ill. 60649. Tel: (312) 643-4308.

Lucey's Store Music (BMI), Box 268, Yonkers, N.Y. 10710. Tel: (914) 779-4684. Co-Owners: Guy & Pipp Gillette.

LuduKay Music Publ'rs (BMI), see Sapphire.

Lyn-Low Music Inc. (BMI), 1518 Chelsea Ave., Memphis, Tenn. 38108. Tel: (901) 725-1400. Gen. Mgr.: Larry Rogers.

Lynal Music (BMI), see Buttermill Sky.

Lynnsford Publ'g Co. (ASCAP), 408 N. Palm Dr., Beverly Hills, Calif. 90210. Tel: (213) 858-1234. Pres. & Prof. Mgr.: Irving Mills; Gen. Mgr.: Paul Mills.

Lynsey Music Ltd., see MAM.

Lyra Music Co. (ASCAP), 133 W. 69 St., New York, N.Y. 10023. Tel: (212) 874-3360.

Lyresong Inc. (BMI), 1227 Spring St. NW, Atlanta, Ga. 30309. Tel: (404) 873-6425. Pres.: Harry Karras; VP: Robert B. Richardson; Sec'y-Treas.: Babs Richardson.

M

M A M Music Publ'g Corp. (ASCAP), 10100 Santa Monica Blvd., Suite 205, Los Angeles, Calif. 90067. Tel: (213) 552-3025. VP: Gordon Mills; VP & Gen. Mgr.: Jon Devian; Prof. Mgr.: S. Ball.

Int'l branches: Australia, Belgium, Canada, England, France, Germany, Italy, Netherlands, Sweden.

Int'l rep.: Argentina & Brazil (MCA), Japan (Nichion), South Africa (Leeds), Spain (Southern).

M C A Music (ASCAP) (div. of MCA Inc.), 445 Park Ave., New York, N.Y. 10022. Tel: (212) 759-7500. Cable: MUSICOR. Pres.: Salvatore T. Chiantia; Contacts: Mark Koren, John McKellen, Leeds Levy.

Branches: Universal City, Calif., '0 Universal City Plaza, Zip: 91608. Tel: (213) 508-4550. Nashville, Tenn., 1106 17 Ave. S. Zip: 37212. Tel: (615) 327-4622. Contact: Jerry Crutcliff.

Int'l branches: Australia (Leeds: MCA), Brazil (MCA), Canada (Leeds), France (MCA), Germany (MCA), Italy (MCA), Japan (MCA), Netherlands (MCA), UK (Leeds).

Int'l firms represented: Le Chai du Monde (France), Hans Gerig/Arno Volk (Germany), Sugar Music (Italy), Savini Zerbone (Italy).

Int'l rpts: Argentina (Korn), Mexico (EMUSA), Spain (Southern Music Espanola), Sweden (Sweden Music).

M C I Music (BMI), 20 E. First St. Yonkers, N.Y. 10550. Tel: (914) 699-4003. Pres.: Frank Rigo; Gen. & Prof. Mgr.: Michael Berman. (Administered by Sugar N' Soul Music)

M-E Music Co. (ASCAP), 1697 Broadway, Suite 1201, New York, N.Y. 10019. Tel: (212) 757-5105. Co-Owner: William H. Borden, Claire R. Olivier.

M F M I (ASCAP), see Maynard Ferguson.

M J Q Music Inc. (BMI), 200 W. 5 St., New York, N.Y. 10019. Tel: (212) 582-6667. Pres.: John Lewis; G. n. Mgr.: Paul Schwartz.

M M O Music Group Inc., 423 W. 5 St., New York, N.Y. 10019. Tel: (212) 245-4861. Telex: 427997. Pres.: Irving Krulik; Prof. Mgrs.: Kevin Yatarola, Victor Horowitz.

Branch: North Hollywood, Calif., 13012 Satcoy St. Zip: 91605. Tel: (213) 765-6600. Gen. Mgr.: David Kr. Ika.

M P I Communications Inc. (ASCA '), c/o Lee Eastman, 39 W. 54 St., New York, N.Y. 10019. Prof. Dept.: Robert Jones.

M R I Music (ASCAP) (div. of Mus. Resources Int'l Corp.), W. 34 St., New York, N.Y. 10019. Tel: (212) 9-7-2066.

Int'l rpts: Australia, Brazil, England, France, Germany, Japan (all Copyright Serv. Bureau in USA).

M T M Prod's (ASCAP), see René Metz.

Mabrah Music (BMI), see Bug Music Group.

MacArthur Music (BMI), PO Box 21, 1659 Sweetbrier St., Palmdale, Calif. 93550. Tel: (805) 947-1232. P. as. & Gen. Mgr.: Glen MacArthur.

MacHarmony Music (ASCAP) (div. of Date Line Int'l Recs.), 400 W. 43 St., Suite 5-C, New York, N.Y. 10015. Tel: (212) 244-8148. Pres.: C. Roger Bartlett.

Madder Music (BMI), see Bug Music Group.

Madelon Music (BMI), see Audio Arts.

Madrid Music Co. (ASCAP), PO Box 504, 4290 Acacia Ave., Bonita, Calif. 92002. Tel: (714) 421-0865. P. as. & Gen. Mgr.: Virginia B. Anderson; Exec. VP & Prof. Mgr.: Robert E. Anderson Sr.

Mad Scientist Music (BMI)—Cont.: Lance Ong—see Street City.

Magic Fleet Music Inc. (BMI), see Brookslee.

Magic Muffin Music (BMI), see 21st Century.

Lee Magid Inc., PO Box 532, Ma bu, Calif. 90265. Tel: (213) 858-7282. Cable: LEE-MAG. Pres.: Lee Magid.

Int'l firms represented: Alexis Musikverlag (Germany).

Magnum Music (SESAC), 150 Goran St., Naugatuck, Conn. 06770. Tel: (203) 729-2508. Pres.: George Fedorick; Gen. Mgr.: Andrew C. Doback; Prof. Mgr.: George Szanku Jr.

Maiden Music (SESAC), 333 Park St., Upper Montclair, N.J. 07043. Tel: (201) 746-6573.

Mainspring Music Corp. (ASCAP), see Al Gallico.

Mainspring Watchworks Music (AS AP), PO Box 40133, San Francisco, Calif. 94140. Tel: (415) 626-4467. G. n. Mgr.: H.S. Carr.

Main Steve Music (ASCAP), PO Box 3763, Hollywood, Calif. 90028. Tel: (213) 894-9487. Pres.: Jeff Oxnan; VP: Kerry Zirin; Copyright Mgr.: J. Garber; Prof. & Royalty Mgr.: K. Dossat. (Affiliated with Mirsong Music)

Int'l rep.: UK (Sun-Pacific).

Mainstay Music Inc. (BMI), see Al Gallico.

Malaco Music Co. (BMI), 3023 W. Northside Dr., Jackson, Miss. 39213. Tel: (601) 982-4522. Pres.: Tom Cox Jr.; VP & Prof. Mgr.: Wolf Stephenson.

Mal-Bren Music Inc. (ASCAP), see 20th Century.

Malcolm Music Ltd. (BMI), see S Amnee Press.

Malson Music (ASCAP), see Garr tt.

Malylye Music (BMI), see Garrett.

Maltone Music (BMI), see Bug Music Group.

Management Agency & Music Publ'g Inc. (BMI), see MAM.

Management III Music (BMI), 544 Wilshire Blvd., Los Angeles, Calif. 90012. Tel: (213) 550-7100. Music Ops. Dir.: Sandi Beach.

Manatt, Phelps, Rothenberg & Tur rey, 1888 Century Park E., No. 2100, Los Angeles, Calif. 90067. Tel: (213) 556-5555.

Mandy Music (ASCAP), see Frank & Nancy.

Manfield Music (BMI), see Holy & Pirit.

Manikin Music Co. (ASCAP)—Res.: Carl Maduri; Prof. Mgr.: Gary Doberstyn—see Stone-Rap & 2 Hh Century.

Man-Ken Music Ltd. (BMI), 34 Pleasant Run, Old Westbury, N.Y. 11568. Tel: (212) 752-1330. Telex: 621400. (Administered by Stevens H. Weiss).

Int'l rep.: UK (St. Annes).

Manna Music Inc., 2111 Kenner Ave., Burbank, Calif. 91504. Tel: (213) 843-8100.

Mantra Music (BMI), 222 E. Garv y Ave., Monterey Park, Calif. 91754. Tel: (213) 280-8783. Owner & Pre.: Johnny Thompson.

Manwin Music (BMI), c/o Chapr an Dist'g Co., 1212 Albany St., Los Angeles, Calif. 90015. Tel: (213) 749-9484. Owner: Al Chapman.

Maple Leaf Music Publ'g (BMI), see H.B. Webman.

Maranatha! Music Inc. (ASCAP), 2902 W. Garry Ave., Santa Ana, Calif. 92704. Tel: (714) 979-8536. Publ'g Dir.: Tom Coomes.

Maraville Music Corp. (ASCAP), see Barton Music.

Marble Music Publ'g (ASCAP), see Brunswick.

Marcella Music (BMI), see Bug Music Group.

Marcia Music Co. (BMI), see Iva Mogull.

Marcus Music (BMI), see Bug Music Group.

Marcy Music, see Manna Music.

Marfre Music Publ'g Co. (BMI), 118 S. Padre Island Dr., Corpus Christi, Tex. 78412.

Marguerita Music Inc. (ASCAP), see H.B. Webman.

Marielle Music Publ'g Corp. (BMI), PO Box 842, Radio City Sta., New York, N.Y. 10019. Tel: (212) 580-9723. Pres. & Gen. Mgr.: Don Seat; Prof. Mgr.: Amy Cole.

Branch: Chicago, Ill., PO Box 1 012. Zip: 60611. Tel: (312) 266-9616.

Mar-Ken Music Co. (BMI), see C herry Lane.

Jon Mark Music (BMI), see May over Music.

Marko Press (BMI), see Mark Fc ster.

Edward B. Marks Music Corp. (BMI), 1790 Broadway, New York, N.Y. 10019. Tel: (212) 247-7277. Cable: MARKBRO. Telex: 620960. Pres.: Joseph Auslander; VP & Publ'ns Dir.: Bernard Kalban.

Martena Music (ASCAP), 101 E. Irving Park Rd., Bensenville, Ill. 60166. Tel: (312) 595-7878. Owner: Arch e Drury, Sr.

Marten Music Co. (ASCAP), see Jordan.

Marmor Music Inc. (BMI), see C ockus.

Marsaint Music Inc. (BMI), 380 Clematis Ave., New Orleans, La. 70122. Tel: (504) 949-8386. Pres.: Al en Toussaint; Gen. & Prof. Mgr.: Marshall E. Sehorn. (Administered by Farmer Bros. Inc.)

Marshall Songs Music (BMI) (div. of Echo Park Recs.), 7985 Santa Monica Blvd., No. 109-68, Los Angeles, Calif. 90046. Tel: (213) 413-2188, 656 0256. Pres.: Marshall Heaney.

Marsmith Music (BMI), see Amestoy.

Marson Inc. (BMI), 817 18 Ave. S., Nashville, Tenn. 37203. Tel: (615) 329-0212.

A. W. Marullo Music (BMI), 1121 Market St., Galveston, Tex. 77550. Tel: (713) 762-4590. Pres.: A.W. Marullo Sr.; Gen. Mgr.: A.W. Marullo Jr.

Marvelle Music Co. (BMI), see Lee Magid.

Marvin Gardens (ASCAP), 9884 Santa Monica Blvd., Beverly Hills, Calif. 90212. Tel: (213) 550-6363. Pres.: Neil Bogart.

Marvin Music Co. (ASCAP), see Fisher Music Corp.

Josef Marx Music Co. (ASCAP), see McGinnis & Marx.

Marycords (ASCAP), Box 48, Powers Lake, N.D. 58773.

Marzique Music (BMI), 5752 Bowcroft St., Los Angeles, Calif. 90016. Tel: (213) 295-0058. Pres.: Harold R. Battiste Jr.; Gen. Mgr.: Alviette M. Battiste.

Masterlease Music Publ'ns (BMI), PO Box 234, St. Louis, Mo. 63166. Tel: (314) 296-9526. Pres.: Bob J. Box.

Masterview Music Publ'g Corp. (BMI), PO Box 52, Ridge Rd. & Butler Ln., Parkside, Pa. 18944. Tel: (215) 257-9616. Pres.: John Wolf; Gen. Mgr.: Tom Fausto; Prof. Mgr.: Ann Fausto.

Mathematical Music (ASCAP), see Blue Canyon.

The Mathes Co., PO Box 22653, Nashville, Tenn. 37202. Tel: (615) 868-4835. Pres.: Dave Mathes.

Matrix Publ'g Co. (ASCAP), PO Box 12246, Memphis, Tenn. 38112. Tel: (901) 274-7788. Contacts: Dane & Gail Sullivan.

Int'l rep.: Worldwide except USA & Canada (Ivan Mogull).

Mayflower Music Corp. (ASCAP), 605 Ridgfield Rd., Wilton, Conn. 06897. Tel: (203) 762-0558. Telex: 220883. Pres.: Eckert Rahn.

U.S. firms administered worldwide: Coryell Publ'ns, Dex Music, Geada Music, Jon Mark Music, Phrase Text Music, Shemesh Music, Solar Plexus Music, Tarik Music, Unit Core Corp., Wonderbuns Inc.; U.S. firms administered outside the U.S.: Alrac Music, Avid Music, Futures Passed Music, Lauralee Music, Mouzon Music Co., Ondine Music, Real To Real Music, Timboto Music Ltd., Watt Works Inc.

Int'l rpts: Australasia (Matthews in Australia), Benelux (Ariola in Netherlands), Brazil (ELAM, Gismonit in Switzerland), France (Panache), Italy (Franton), Ireland (Panache), Japan (Sunkyo), Portugal & Spain (Bocaccio), Switzerland (ERP in Germany, Gismonit), UK (Panache).

May 12th Music Inc. (BMI) (div. of Whitefield Recs. Inc.), 901 Westbourne Dr., Los Angeles, Calif. 90069. Tel: (213) 652-5850.

Dale McBride Publ'g Co. (BMI), Farm Road 580 E., Lampasas, Tex. 76550. Tel: (512) 556-6276. Pres.: Dale McBride.

Jim McCoy Music (BMI), PO Box 574, Winchester, Va. 22601. Tel: (703) 667-9379. Pres. & Prof. Mgr.: Jim McCoy; Gen. Mgr.: Bertha McCoy.

McDonald Music Co. (BMI), see Alkatraz Corner.

McGinnis & Marx Music Publ'ns (BMI), PO Box 229, Planetarium Sta., New York, N.Y. 10024. Tel: (212) 799-5214. Owner: Mrs. Josef Marx, Mng. Ed.: Margaret Gresh.

Int'l rpts: Europe excluding UK (Baerenreiter in Germany), UK (Peters).

MChoma Music Inc. (BMI), see Iguana.

Jimmy McHugh Music Inc. (ASCAP), 9301 Wishire Blvd., Suite 400, Beverly Hills, Calif. 90210. Tel: (213) 271-1967, 272-4871. Pres. & Prof. Mgr.: Lucille Meyers.

McRon Music Co. (ASCAP), 521 Fifth Ave., New York, N.Y. 10017. Tel: (212) 682-5844. Pres.: Tsipora Miron; VP & Prod'n Dir.: Steve Monroe; VP & Int'l Mgr.: Thelma Moore; Pub.: Jon Arthur; Promo: Marie M. Gaudreau.

Meadow Music (BMI), 1727 Roanoke Ave., Sacramento, Calif. 95838. Tel: (916) 925-4886. Owner: Jerry Parker.

Medbery Music (ASCAP), 8611 Pershing Dr., Playa del Rey, Calif. 90291. Tel: (213) 822-3813. Pres.: Michael L. Sandomeno; Prof. Mgr.: Bev Sandomeno.

Media Interstellar Music (BMI), (div. of Clay Pigeon Int'l), PO Box 20346, Chicago, Ill. 60620. Tel: (312) 778-8760. Pres. & Prof. Mgr.: Vytautas Beleska; Sales: Rudy Markus.

Mega-Star Music (BMI) (div. of Norby Walters Assoc.), 200 W. 51 St., New York, N.Y. 10019. Tel: (212) 245-3939. Gen. Mgr.: Barry Yearwood.

Melanie Music Ltd., see MAM.

Robert Mellin Music Publ'g Corp. (BMI), 1841 Broadway, New York, N.Y. 10023. Tel: (212) 757-3287. Cable: MELLINMUS. Pres.: Robert Mellin; VP: Sanford Green.

Int'l branch: England.

Mellyric Music (ASCAP), PO Box 1077, Cleveland, Tenn. 37311. Tel: (615) 479-1415. Pres.: Donald B. Gibson.

Melody Lane Publ'ns Inc. (BMI), see Peer-Southern.

Melomusic Publ'ns (ASCAP), see Alton Music.

Melstep Music (BMI)—Contact: Syble C. Richardson—see Woodrich.

Melway Music Inc. (ASCAP), Ala Moana Bldg., Suite 1500, Honolulu, Hawaii 96814. Tel: (808) 946-3244. (Administered by Music of Polynesia Inc.)

Mennon Ltd. (ASCAP), PO Box 98, Forrest Hills, N.Y. 11375. Tel: (212) 261-1111. Cable: MEMNON. Pres.: Krzysztof Z. Purzycki.

Branch: Glen Cove, N.Y., PO Box 98. Zip: 11542. Tel: (516) 676-3960. Gen. Mgr.: Katherine Swier.

Memory Lane Music Corp. (BMI), see Larry Spier.

Memphis Mgmt. Inc. (ASCAP, BMI), Box 17272, Memphis, Tenn. 38117. Tel: (901) 323-9682, 685-8533. Pres.: Ron Blackwood.

Mende Music Publ'g (BMI), PO Box 2776, Long Beach, Calif. 90801. Tel: (213) 867-9964. Pres. & Gen. Mgr.: J.D. Mendenhall.

Mention Music Inc. (BMI), see Music Music Music.

Mentor Music Inc., 18 Broadview Dr., Brookfield, Conn. 06804. Tel: (203) 775-1358. Pres.: Robert Nagel.

Mepro Music (BMI), see Equa.

Mercantile Music (BMI), PO Box 2271, Palm Springs, Calif. 92263. Tel: (714) 320-4848. Owner: Kent Fox.

Mercury Music Corp. (SESAC), see Theodore Presser.

Mercury Shoes Music (BMI), see Great Pyramid.

Meredith Music Inc. (ASCAP)—Pres.: Ron Peterson—see Buchhorn.

Merion Music Inc. (BMI), see Theodore Presser.

Mernee Music (ASCAP), see Woodrich.

Merrimac Music Corp. (BMI), see The Goodman Group.

Merrymount Music Inc. (BMI), see Theodore Presser.

Merry Sounds (ASCAP) (div. of Lisa Sue Music), PO Box 313, Kingsbridge Sta., Bronx, N.Y. 10463. Tel: (212) 543-7770. Pres.: Bruce Hest; Gen. Mgr.: Merry Salos; Prof. Mgr.: Neil Friedman.

Mesa Lane Music (ASCAP), 315 Washington St., Suite 2, Marina del Rey, Calif. 90291. Tel: (213) 306-0100. Pres.: Ron Altbach. (Administered by MizMo Ent's.)

Meshugah Music (BMI), see Xanadu.

Meteconk Music Corp. (BMI), see Marielle.

Printing Music For Music Makers



Columbia Pictures Publications
A division of Columbia Pictures Industries, Inc.
16333 NW 54th Ave., PO Box 4340, Hialeah, FL 33014
Frank J. Hackinson, President

Toll Free (800) 327-7643

The Most Comprehensive Catalog Available In The Music Industry!

Top Chart Personalities & Movie Themes!

Widest Variety Of Mixed Folios!

Extensive Sheet Music Selections!

Best Arrangers!

Educational Programs!

New Book Club Program!

Best Discount Policy!

Worldwide Sales & Shipping!

Convenient Toll Free Number!

Exclusive Distributor of Almo, Centerstream & Peer Publications

Metronome Music Corp. (ASCAP), 210 Fifth Ave., New York, N.Y. 10010. Tel: (212) 679-9312.
Home offices: Switzerland.
Int'l rep.: Denmark (Multitone).
 Metrolina Publ'g Co. Inc. (BMI), Rt. 1, Box 157, Pineville, N.C. 28134. Tel: (704) 588-3998. Pres.: John Roger Branch. Gen. Mgr.: Mike Branch.
 Metronome Music Publ'g Co., Collins & Willard Sts., Philadelphia, Pa. 19134. Tel: (215) 426-5925. Pres.: Albert Schick.
 Metropolitan Music Co. (BMI), 4225 University Blvd., Houston, Tex. 77005. Tel: (713) 668-3279. Mgr.: J.R. Lee.
 Mexican Music Centre Inc. (ASCAP), 345 W. 58 St., Suite 2 P., New York, N.Y. 10019. Tel: (212) 582-5705. Cable: COPYRIGHT. Mng Dir.: Gerard de La Chapelle.
 Michavin Music (BMI), 1260 N. F. St., Pensacola, Fla. 32501. Owner & Mgr.: Vincent L. Smith III.
 Mid-American Music Publ'g (ASCAP) (div. of Ozark Opry Inc.), PO Box 242, Osage Beach, Mo. 65065. Tel: (314) 348-3383. Gen. Mgr.: Lee Mace.
 Midnight Gold Publ'g Co. (BMI), PO Box 287, Bemch, La. 70342. Tel: (504) 384-0546, 385-1842. WATS: (800) 535-5990. Pres.: Vincent A. Guzzetta Jr.; Gen. Mgr.: Cindy Reed; Prof. Mgr.: Chet Guzzetta.
 Mid States Music Publ'g Inc. (BMI), 7710 N. May, Oklahoma City, Okla. 73116. Tel: (405) 848-8346. Pres.: Jim Ross. Gen. Mgr.: Ken Hurst.
 Midstream Music Publ'g (BMI), Box 225A, Mountain Falls, Rt. 1, Winchester, Va. 22601. Tel: (703) 877-1820. Pres.: Max Mandel; VP: Pete Hand.
 Midwest Music Corp. (BMI), see Barton Music.
 Mielus Copyright Mgmt., 527 Madison Ave., Suite 317, New York, N.Y. 10022. Tel: (212) 371-7950.
Branch: Union, N.J., 2351 Laurana Rd. Zip: 07083. Tel: (201) 686-0716.
 Mighty Mathieson Music (BMI)—Pres. Greg Mathieson—see Nero Ents.
 Mighty Matthew Music (ASCAP), 26111 Brush Ave., Cleveland, Ohio. 44132. Tel: (216) 261-8700. Pres.: Joel Porrello.
 Mighty Max Music (ASCAP), c/o Max's Kansas City, 213 Park Ave. S., New York, N.Y. 10003. Tel: (212) 777-7870.
 Mighty Music (BMI), PO Box 27160, Phoenix, Ariz. 85061. Tel: (602) 276-7116. Pres.: Mike Lenaburg; Gen. Mgr.: Leila Freeman; Prof. Mgr.: Eric Lenaburg.
 Mighty Three Music Group, 309 S. Broad St., Philadelphia, Pa. 19107. Tel: (215) 546-3510. TWX: (710) 670-0860. Pres.: Earl Shelton; VP & Gen. Mgr.: Constance Heigler; Prof. Mgr.: William Lacy.
 Mighty Twins Music (BMI), 9134 S. Indiana Ave., Chicago, Ill. 60619. Tel: (312) 264-5452. Pres. & Prof. Mgr.: Ronald Scott.
Branch: Harvey, Ill., 15646 S. Ashland. Zip: 60426. Gen. Mgr.: Lorin C. Bates.
 Tiffany Miko Music, 9646 Ryle Rd., Dallas, Tex. 75217. Tel: (214) 286-1711. Owner: David A. Coffey.
 Mildoba Publ'g Co. Inc. (ASCAP), 1525 Bath Ave., Brooklyn, N.Y. 11204. Tel: (212) 236-7131. Pres.: John Frisone.
 Earl Miles Publ'g Co. (BMI), 1704 Wagner Heights Rd., Stockton, Calif. 95209. Owner: Earl Miles.
Int'l rep.: South Africa (RCA-Teal).
 Minion Ubbem Music (BMI), see Bug Music Group.
 Arnold Mills & Assocs., 8721 Sunset Blvd., Suite 201, Los Angeles, Calif. 90069. Tel: (213) 657-2024. Pres.: Arnold Mills.
 Mirmic Music (BMI), PO Box 201, Smyrna, Ga. 30081. Tel: (404) 432-2454. Pres. & Prof. Mgr.: Tom Hodges; Gen. Mgr.: Jerry Burke.
 Minniepaal Music Publ'g Co. (BMI), Rt. 1, Box 199-C, Somerset, Wis. 54025. Tel: (715) 247-5192. Pres.: David Anthony; Gen. Mgr.: Patricia Wachter; Prof. Mgr.: Dennis Johnson.
Branch: Minneapolis, Minn., 6724 Camden Ave. N. Zip: 55430. Tel: (612) 566-7729.
 Minstrel Music (SESAC), see Zaza.
 Miracle-Joy Publ'ns (BMI), Box 771, Hackensack, N.J. 07601. Tel: (201) 488-5211. Pres.: Johnny Miracle; VP: Frank Joy; Gen. Mgr.: Kenny Luv. Prof. Mgr.: Sam Diamond.
Branch: Knoxville, Tenn., Rt. 2, Ogg Ln. Zip: 37918. Tel: (615) 689-5219. Gen. Mgr.: William Daise.
 Jennifer Miro Music (BMI), see Bug Music Group.
 Mirsong Music USA (BMI) (div. of Moonstone Int'l Recs.), PO Box 946, Hollywood, Calif. 90028. Tel: (213) 721-1637, 894-9487. Pres.: Marko Perko. Gen. Mgr.: Jeff Oxman; Prof. Mgr.: Arthur Spivak.
 Mirlou Music Inc. (BMI), see Ivan Mogull.
 Miss Alate Music (ASCAP), see Garrett.
 Mississippi River Music Publ'g Co. (ASCAP), see Music River.
 Mister Moose Music (BMI), see Funky but.
 Mr. Mort Music (ASCAP), 44 Music Square E., Nashville, Tenn. 37203. Tel: (615) 255-2175. Pres.: Charles Fields; Gen. Mgr.: Bernice Fields.
 Mr. Music Co. (BMI), see Barton Music.
 Mr. Par Music (BMI), 5143 Goodland Ave., North Hollywood, Calif. 91607. Tel: (213) 763-1616. Owner: Paul Robin; Prof. Mgr.: Larry Brunswick.
 Miyako Music (BMI), see MizMo.
 MizMo Ents., 2512 Chandler Blvd., Burbank, Calif. 91505. Tel: (213) 954-9946. Owner & Pres.: Maureen Woods.
 Mobilized Music (BMI), see Bug Music Group.
 Modern Music Publ'g Inc. (BMI), 5810 S. Normandie Ave., Los Angeles, Calif. 90044. Tel: (213) 753-5121.
 Ivan Mogull Music Corp. (ASCAP), 625 Madison Ave., New York, N.Y. 10022. Tel: (212) 355-5636. Cable: IMOGULL. Tel: 236973. Pres: Ivan Mogull. Prof. Mgrs.: Lori Guber, Gloria Gottschalk.
Int'l branches: Argentina, Australia, Belgium, Brazil, Canada, Colombia, Czechoslovakia, France, Germany, Greece, Israel, Italy, Jamaica, Japan, Mexico, Netherlands, Singapore, South Africa, Spain, Sweden, Switzerland, UK, Venezuela.
Int'l firms represented: Worldwide excluding US & Canada—Athens Music Co. (BMI), Bucrenis Music Co. (BMI), Buckley Music Co. (ASCAP), Rolls Royce Music (ASCAP), Ninandy Music Co. (BMI), Southern Pines Music Publ'g Co. (ASCAP), NFL Films Inc. (BMI), Hargrove Music (BMI), Roswell Music Co. (BMI), Mulligan Publ'g Co. Inc. (ASCAP), Chicken Fried Music (BMI), Dr. Livingston I. Presume Music (BMI), Groper Music (BMI), Neath Music (BMI), Nunn Publ'g (BMI), Ray Willie Hubbard Music (BMI), Serendipity Publ'g Corp. (BMI), 16th Avenue Music Inc. (BMI), Big Ten Music Co. (BMI), Peach Music (BMI), See Miri Music (ASCAP), Tomeja Music Inc. (ASCAP), Ozone Music (BMI), Busybudy Music (BMI), Gaucho Music (BMI), Possie Music (BMI), Sandbox Music (ASCAP), Elbomo Music Inc. (BMI), Worldwide excluding US, Canada, UK & Australasia—Django Music Inc. (ASCAP), Lark Music Inc. (BMI), Lonport Music Corp. (BMI), MEWEG Music Inc. (BMI), Nevo Music Corp. (BMI), Skyforest Music Co. Inc. (BMI), Tiplot Music Co. Inc. (ASCAP), WEMG Music Inc. (ASCAP), Windbreeze Music Ltd. (ASCAP), Glen Campbell Music Inc. (BMI), Latin America—Belwin Mills Publ'g Corp. (ASCAP), Mills Music Inc. (ASCAP), American Academy of Music Inc. (BMI), Multitone Music Inc. (BMI), Ramsel Publ'g Co. (BMI), Pamoja Music (ASCAP), Daksel Music Corp. (BMI); Central America, Spain & Portugal—Bourne Co.; Latin America, Spain & Portugal—Ganga Publ'g BV, Harrison's Ltd., Lady Casey Music Inc. (BMI), Maternal World Charitable Foundation Ltd., Latin Amer-

ica, Spain, Portugal, Israel & Rep. of South Africa—Far Fetched Music; Latin America & Caribbean—Velvet Apple Music (BMI), Song Yard Music (ASCAP), Shapiro Bernstein & Co. Inc., Columbia Pictures Music Corp.; Parts of Africa—Shapiro Bernstein & Co. Ltd., Latin America, Israel & Caribbean—Gold Hill Music Inc. (ASCAP), Stephen Stills Music (BMI); Latin America, Spain, Rep. of South Africa, Japan, Australia & New Zealand—Round World Sounds Inc. (BMI), Overdrive Music (ASCAP); Latin America, Japan & Parts of the Orient—Ben Peters Music (BMI); Japan—Mongu Music Inc., Australasia & Japan—Salsoul Music Publ'g Corp. (ASCAP), Lucky Three Music Co. (ASCAP), Earl Barton Music, Rose Bridge (BMI), Strawberry Hill Music (ASCAP), Spain & Portugal—Kamakazi Music (BMI), Manlow Music (BMI).
Int'l reps: Argentina (RCA), Belgium (Radio Tele-Music), Brazil (RCA), Canada (Attic), Czechoslovakia (Supraphon), France (Bagatelle), Germany (Rolf Budde), Greece (AEP), Israel (ACUM), Italy (RCA), Jamaica (Norman E. Wright), Mexico (Edimusa), Netherlands (Universal Songs), Singapore (Burlington Palace), Sweden (Sweden Music), Switzerland (Musikvertrieb). (SEE ADVERTISEMENT).
 Mole Hole Music (BMI), see Bug Music Group.
 Mollie Music Publ'g Co. (BMI), PO Box 3081, Bridge St. Sta., Pudacah, Ky. 42001. Tel: (502) 898-7206. Owner: Mark Collier.
 Mom Bell Music Publ'g Co. (BMI), c/o David J. Steinberg Esq., 818 Widener Bldg., 1339 Chestnut St., Philadelphia, Pa. 19107. Tel: (215) 564-3880. Pres.: Tony Bell; Attorney: David J. Steinberg.
 Mom & Dad Music (BMI), see Funky but.
 Monkey Music, Box 288, Nashville, Tenn. 37221. Tel: (615) 646-3335. Pres.: Robert A. May; Gen. Mgr.: Neil A. Signer.
 Monkhous Music (BMI), 5009 Ashby Dr., Brentwood, Tenn. 37027. Tel: (615) 255-3500. Pres.: Ann Sluckey.
 Monona Music Co. (BMI), see Cameron.
 Monroe-Ames Music (BMI), Box 871, 2700 Ford St., Ames, Iowa 50010. Tel: (515) 232-2991. Pres. & Gen. Mgr.: Steve Monroe.
 Myrtle Monroe Music (ASCAP), 10th & Parker Sts., Berkeley, Calif. 94710. Tel: (415) 549-2500. Mgr.: Paul Zaentz.
 Monsterous Music (ASCAP), 5105 Varna Ave., Sherman Oaks, Calif. 91423. Tel: (213) 467-1135. Pres.: John Davis; Admin'r.: Jay Warner. (Administered by Over the Rainbow Music).
Int'l rep.: UK (Creative Music).
 Montana Mule (BMI), see Bug Music Group.
 Moutauk Music Inc. (BMI), see H.B. Webman.
 Montello Music (BMI), 5709 Hempstead Rd., Madison, Wis. 53711. Tel: (608) 271-5924. Pres. & Gen. Mgr.: Jon W. Whirry.
 Montgomery Publ'g Co. (BMI), 8914 Georgian Dr., Austin, Tex. 78753. Tel: (512) 836-3201/3194. Pres.: Roy J. Montgomery Sr.; Gen. Mgr.: Shirley A. Montgomery; Prof. Mgr.: Eimer J. Montgomery.
Branch: Fort Wayne, Ind., 3408 McKinnis Ave. Zip: 46808. Tel: (219) 743-7561. Gen. Mgr.: Charles L. Montgomery.
 Montroy Music Co. (BMI), 7210 Roos, Houston, Tex. 77074. Tel: (713) 774-0075/3075. Pres.: Dr. John D. Montroy.
 Mood Music Co. Inc. (ASCAP), see Shapiro Bernstein.
 Moogy Music (BMI), 237 W. 54 St., New York, N.Y. 10019. Tel: (212) 582-6414. Pres.: Mark Klingman; VP: G. Parker.
 Moo Moo Music Corp. (BMI), see Marielle.
 Moonbow Music Inc. (BMI)—Pres.: Charles M. Newell; Gen. Mgr.: Pat Martin—see Appalshop.
 Moon-June Music (BMI), 4233 SW Mangold, Portland, Ore. 97219. Tel: (503) 777-4622. Pres. & Gen. Mgr.: Bob Stoutenburg. Local branch: 5821 SE Powell Blvd. Zip 97206.
 Moon Meadow Publ'g Co. (ASCAP), see 20th Century.
 Moonridge Music (ASCAP), see Pacific Challenger.
 Moore Melodic Music (BMI), see Cherry Lane.
 Moorpark Music Corp. (ASCAP), see Marielle.
 Mogres (BMI), see Multi. Mill.
 Morley Music Co. (ASCAP), c/o Eastman & Eastman, 39 W. 54 St., New York, N.Y. 10019. Tel: (212) 581-1330. Prof. Dept.: Robert Jones.
 Morning Music (USA) Inc. (ASCAP), PO Box 120478, Nashville, Tenn. 37212. Toronto Tel: (416) 625-2676. Telex: (06) 960250. Pres.: Jury Krytiuk, Mgr.: Mark Altman; Ass't Mgr.: Anne Fuller; Prof. Mgr.: Avi Altman, Promo.: Peter Krytiuk.
Home Office: Canada.
Int'l affiliates: England.
U.S. firms administered worldwide: Joe Allier Music, Aunt Polly's Music, Blue Band Music, Blue Candle Music, Blue Echo Music, Blue Melody Music, Boxer Music, Cornbread Music, Dean's List, Evening Publ'ns, Family of Man, Fruit, Good Music Co., Lloyd Green, House of Cash, Jack Music Inc., Jando Music Inc., Koko, Mountainwood Music, Myownah Music, Owlufus Music, Poet's Publ'g, Pulleybone Music, Shanache, Sidewalk Publ'ns, Silver Dollar, Song of Cash, Stonehill Music, Don Wayne Music.
Int'l firms represented: Cabot Trav. Canadian Brass, Crown-Vetch, Fogo, Alex Groschak, Ital Roots, Izzetta, J. Mid-continental, Morning, Skinner Pond, Speckled Bird, Time Being, V Music (all Canada); Weltmusik, Wiener Musikproduktion, Wien Melodie (all Austria), Hans Kusters (Belgium); Opus (Czechoslovakia), Rolf Budde, Cyclus, Radio-Tele, Ring Musik, Tantris (all Germany); Blue Tulip, Pascale, Universal (all Netherlands), Author's Agency (Poland); Land of Song, Octava, Squirrel, Josef Wenberger (all UK).
Int'l reps: Australia (Image), Austria (Melodie der Welt), Belgium (Hans Kusters), Colombia (Cosidos), Finland (Fazer), Germany (Melodie der Welt), Greece (Grecophon), Israel (April), Italy (RCA, Curcio), Japan (Yamaha), Mexico (Edimusa), Netherlands (Universal), New Zealand (Image), Philippines (Bayanihan), South Africa (Laetec, Reveille, Contagious), Southeast Asia (EMI), Spain (Montserrat), Sweden (Sweden Music, Sonet), Switzerland (Melodie der Welt), Venezuela (Unimusic), West Indies (Gorgon).
 Edwinn H. Morris & Co. (ASCAP) (div. of MPL Communications Inc.), 39 W. 54 St., New York, N.Y. 10019. Tel: (212) 581-1330. Cable: EASTMANAID. Prof. Mgr.: Robert Jones.
Int'l branches: Argentina, Australia, Canada, England, France, Germany, Italy, South Africa, Sweden.
Int'l reps: Brazil (Intersong), Japan (Intersong), Mexico (Intersong), Netherlands (Chappell), Spain (Chappell), Switzerland (Chappell).
 Morris Music Inc. (BMI), 6255 Sunset Blvd., Suite 1904, Hollywood, Calif. 90028. Tel: (213) 463-5102. Pres.: Steve Morris. (Administered by Chap pell).
 Rick Moses Music Co. (BMI), see 20th Century.
 Mo-Su Music (BMI), see Bug Music Group.
 Mother Bertha Music Inc. (BMI), PO Box 69529, Los Angeles, Calif. 90069. Tel: (213) 846-9900. Pres.: Phil Spector; Admin. Dir. & Gen. Mgr.: Donna Sekulidis.
 Mother Martha Music (BMI)—Pres.: David Dakil—see Buchhorn.
 Mother's Cup Music (ASCAP), see Band of Angels.
 Moth Music Ltd. (BMI), see Chrysalis Music Group.
 Moulton Music Corp. (ASCAP), see Larry Spier.

Mountain Glory Music (BMI), 52 Werah Pl., Oceanport, N.J. 07757. Tel: (201) 222-4460. Owners: Russell N. Scalzo, Jr., James W. Bova.
 Mountain Green Music (BMI), see Romare.
 Mountain Railroad Music (ASCAP), 3602 Atwood Ave., Madison, Wis. 53714. Tel: (608) 241-2001. Pres.: Stephen Powers.
 Mount Laurel Music (BMI), see 20th Century.
 Moving World Music (ASCAP), see Soulful Music.
 Mozart Eds. Inc. (ASCAP), see President.
 M-3 Music Co. (ASCAP), see Cherry Lane.
 Mulatto Music (BMI), see MizMo.
 Mull-Ti Hit Music Co. (BMI), 50 Music Square W., Nashville, Tenn. 37203. Tel: (615) 329-4487. Pres.: Frank Mull.
 Multi. Mill. (ASCAP), 31203 Ganado Dr., Rancho Palos Verdes, Calif. 90274. Tel: (213) 541-6710. Pres.: Dean Chambers.
 Munchkin Music (ASCAP), see Open End.
 Munka Music (BMI), 9315 Carmichael Dr., La Mesa, Calif. 92041. Tel: (714) 464-0910. Pres.: Stephen C. LaVere; Gen. Mgr.: Glona Askew; Prof. Mgr.: Mimosa LaVere.
 Muppet Music Inc. (ASCAP), see Cherry Lane.
 Murrly-Gage Music (ASCAP), see Brother.
 Music Shoals Rhythm Section Music Inc. (SESAC), see Music Shoals Sound.
 Music Shoals Sound Publ'g Co. Inc. (BMI), PO Box 915, 1000 Alabama Ave., Sheffield, Ala. 35660. Tel: (205) 381-2060. Pres.: Jimmy R. Johnson; VPs: Roger G. Hawkins, Barry C. Beckett; Sec'y-Treas.: David Hood; Publ'g Admin'r.: Diane Butler.
 Musedco Publ'g Co. (BMI) (div. of Hisong Recs.), PO Box 5916, Richardson, Tex. 75067. Tel: (214) 783-9925. Owner: Richard A. Shuff; Prom'l Mgr.: R.D. Baker.
 Musetta Music Co. Inc. (ASCAP), see Loring.
 Music Anno Domini/No Violence Music (SESAC), Box 7452, Grand Rapids, Mich. 49510. Tel: (616) 241-3787. Pres. & Prof. Mgr.: Hans Altana.
 Muscancza Corp. (ASCAP), 2878 Bayview Ave., Wantagh, N.Y. 11793. Tel: (516) 826-2735. Pres.: Al Rubin.
 Music City Music Inc. (ASCAP), see Combine.
 Music Crusaders (BMI), see H.B. Webman.
 Music for Percussion (BMI), 170 NE 33 St., Fort Lauderdale, Fla. 33334. Tel: (305) 563-1844. Pres.: F.C. O'Keefe; Gen. Mgr.: Bernard Fisher.
 The Music Group, 7278 Hollywood Blvd., Suite 22, Hollywood, Calif. 90046. Tel: (213) 876-2393. Contacts: Danny Sheridan, Richard E. Goss.
 Music Management, PO Box 174, Pleasantville, N.Y. 10570. Tel: (914) 769-5580.
 Musicmaster Publ'ns Inc. (ASCAP), 1650 Broadway, New York, N.Y. 10019. Tel: (212) 246-3869. Contact: Frank Meits.
 Music Music Inc. (ASCAP), 157 W. 57 St., New York, N.Y. 10019. Tel: (212) 582-6135. Pres.: Chet Gerlach.
 Music of Polynesia Inc., 1441 Kapolani Blvd., Suite 919, Honolulu, Hawaii 96814. Tel: (808) 946-1677.
 Music Press (ASCAP), see Theodore Presser.
 Musicprint Corp., Box 767, Radio City Sta., New York, N.Y. 10101. Tel: (212) 582-2642. Pres.: Robert O'Brien; Gen. Mgr.: Barbara Carney.
 Music Publ'ns of Hawaii (BMI), PO Box 25141, Honolulu, Hawaii 96825. Tel: (808) 955-4773/7509. Pres.: Gil M. Tanaka.
 Music Publishing Corp., 815 18th Ave. S., Nashville, Tenn. 37203. Tel: (615) 327-0518. Pres.: Bob Todd; VP & Gen. Mgr.: Dave Burgess; Prof. Mgr.: Chuck Burgess; Publ'g Admin'r.: Lori Todd.
Branch: Los Angeles, Calif., 8025 Melrose Ave. Zip: 90046. Tel: (213) 655-0944.
 Music River Publ'g Co. (BMI), Meeman Journalism Bldg., Rm. 302, Memphis State University, Memphis, Tenn. 38152. Tel: (901) 454-2350/2892. Pres.: Dr. Thomas Carpenter.
 Music Sales Corp. (ASCAP), 33 W. 60 St., New York, N.Y. 10023. Tel: (212) 246-0325. Telex: 236113.
Int'l branches: Japan, UK.
Int'l reps: France (Caravelle), Germany (Rolf Budde), Japan (Toshiba), Sweden (Reuter & Reuter), UK (Dorset Bros., Essex).
 Musicstone Music (BMI), PO Box 343, Santa Monica, Calif. 90406. Tel: (213) 394-5110. Pres.: Irvin A. Brock.
 Musicways Inc. (BMI), 9033 Wilshire Blvd., Suite 310-A, Beverly Hills, Calif. 90211. Tel: (213) 278-8118. Pres.: Terri Fricon, Prof. Mgr.: Gay Jones.
Int'l rep.: Australia (Jonathan), Canada (Morning, Skinner's Pond), Germany (Meridian), Netherlands (Step 1), South Africa (Jonathan).
 Music West of the Pecos (BMI), PO Box 8545, 3012 N. Main St., Houston, Tex. 77009. Tel: (713) 225-0450. Pres.: Jay Collier; Gen. Mgr.: Betty Collier; Prof. Mgr.: Mundo Earwood.
 Musique de Soleil (ASCAP), 6 Melrose Dr., Livingston, N.J. 07039. Tel: (201) 533-0448. Pres.: Marc Katz; Gen. Mgr.: Michael Asher; Prof. Mgr.: Roy Hodes.
 Musrad Publ'g Inc. (BMI), see Radmus.
 Mutevic Sound Inc. (BMI), 193-18 120 Ave., New York, N.Y. 11412. Tel: (212) 527-1586. Pres.: Brenda Reid; Gen. Mgr.: Jamaal Kwame; Prof. Mgr.: Steve Reid.
 Muiheco Music (BMI), see Bug Music Group.
 My Bess Music (BMI), see Bug Music Group.
 My Father's Music (BMI), see Ben Speer.
 My High's Music (ASCAP)—Pres.: Neil Patton Rogers—see Buchhorn.
 Mylnkewicz Music (BMI), see Bug Music Group.
 Myriad Music Publ'g Corp. (ASCAP), see H.B. Webman.
 Mystery Music Inc. (BMI), 2520 Cedar Elm Ln., Plano, Tex. 75075. Tel: (214) 867-6656. VP: Pnhk L. Murphey.
 Mystic Music (BMI), see Solar Recs.

N

N A L R Music Publ'g (BMI), 10802 N. 23 Ave., Phoenix, Ariz. 85023. Tel: (602) 943-7229. Pres.: Ray Bruno; VP: David Serey.
 N B C Music Inc. (ASCAP), PO Box 392, Brentwood, Tenn. 37027. Tel: (615) 793-7085. Prof. Mgr.: Linda Adams.
 N M S Publ'g Co. (ASCAP), PO Box 5378, Spokane, Wash. 99205. Tel: (509) 328-4207. WATS: (800) 541-1565.
 N R P Music Group, 160 E. 56 St., 11th Fl., New York, N.Y. 10022. Tel: (212) 233-5949. Contact: Fred Bavin.
 Norman Nardim Music (BMI), see Roads of Music.
 Narrow Gate Music Inc. (ASCAP), PO Box 860, Cooper Sta., New York, N.Y. 10076. Tel: (212) 473-5900. Cable: RAMHORN. Telex: 661139 Admnyr. & Gen. Mgr.: Naomi Saltzman; Prof. Mgr.: Jeffrey Rosen.
 Narwhal Music Inc. (BMI), see Skyhill.
 Nasetan Publ'g Co. (BMI), PO Box 1485, Lake Charles, La. 70602. Pres.: Eddie Shuler.
 Nashal Music (BMI), see Bobby Fischer.
 Nashville Int'l Music Group, 20 Music Square W., Suite 202, Nashville, Tenn. 37203. Tel: (615) 373-2575. Pres.: Reggie M. Churchwell; VP & Gen. Mgr.: Ken Little. Prof. Mgr.: Neil Signer.

Natural Songs Inc. (ASCAP), see uneworks
 Nearysong Publ'g (BMI), see 20th Century
 Nearytunes Publ'g Co. (ASCAP), see 20th Century
 Needahit Publ'g Co. Inc. (BMI), 264 Old Hickory Blvd., Madison, Tenn 37115 Tel: (615) 865-6543 Fes. Johnnie R Wright; Gen. Mgr. John Sturdivant.
 Neil Music Inc (BMI), 8400 Sunset Blvd., Suite 4A, Los Angeles, Calif. 90060. Tel: (213) 656-2614. Cable: CRESREC. Pres.: Gene Norman.
 Int'l rep.: Australia (Festival), Benelux (Vogue), Brazil (Gravacoes Electricas), France (Vogue), Germany (Belmont), Italy (Fonti Cetra), Japan (Seven Seas), Switzerland (Vogue), UK (Sonet).
 Nelms Music (BMI), PO Box 12, Focky Mount, N.C. 27801 Tel (919) 459-4691 Pres., Gen. & Prof. Mgr. John Nelms
 Neostat Music Co. (BMI), 425 Br N Mawr, Birmingham, Mich. 48009. Tel: (313) 647 1662, 538-4444. Pr. s. Aldine M. Yates.
 Neptune Music Publ'rs (BMI), 8 Aldine St., Rochester, N.Y. 14619. Tel: (716) 328-4649 Pres. Martha Pitoni, Gen. Mgr. Ven Pitoni; Prof. Mgr.: Marvin Steffey.
 Nero Ents., Inc., 185 Pier Ave., Santa Monica, Calif. 90405 Tel: (213) 396-3185 Prof. Mgrs.: Ned Shank van, Mary Koetting.
 Net Casting Ministries, 550 Evar. Rd., Springfield, Pa 19064 Tel (215) 543-4490.
 Neuron Music (ASCAP), PO Box 594, Hollywood, Calif. 90028. Tel (213) 662-8588.
 Neurotic Music (BMI), see 20th century
 Neurrp Songs (BMI), see Bug Music Group
 Never Ending Music (BMI), PO Box 58, Glendora, N.J. 08029 Tel (609) 227 7562. Pres. Eddie J. Harri s, Gen. Mgr.: Lem Harris
 Neverland Music Co. (BMI), 83 F verside Or., New York, N.Y. 10024. Tel: (212) 877-0400 Pres. & Prof. Mgr.: Earl S. Shuman.
 Int'l rep.: Worldwide (April Music in U.S.)
 Newbag Music Co. (BMI), Box 114, Rt. 2, Hanover, Va. 23069. Tel: (804) 746-9309. Pres.: Martin Gary; VP: Kathleen Gary.
 New Chatham Music (ASCAP), PO Box 111, Pittsburgh, Pa. 15230. Tel: (412) 371-0697. Pres.: Thomas E. Morgan.
 New Child Music Publ'g (ASCAP), PO Box 524, Kailua-Kona, Hawaii 96740. Cable: NAKA. Pres.: Jeanne N. Kashima.
 Int'l rep.: Japan (Watanabe) Malaysia (Pathe), Philippines (Bayanhan), Singapore (Pathe)
 Newcreature Music (BMI), 108 erkeley Dr., Madison, Tenn 37115. Tel (615) 868-3407 Pres. Bill Ar lerson Jr., Gen. Mgr. Donald O. Morris. Prof. Mgrs.: Bill Anderson Jr., Jonald O. Morris
 New Executive Music (BMI), see 3rother
 New Fairfield Music Co. (ASCAP), see Cherry Lane.
 New Hidden Valley Music (ASCAP), see Geffen/Kaye
 Newkeys Music Inc (BMI) 11 Mt. Cicrte S., Nashville, Tenn 37203. Tel: (615) 242-2461 Bd. Chm. E. Jimmy Key, Pres.: Jack J. Key
 New Music Edition (BMI), see T. Idore Presser
 New Outlook Music Inc (BMI), c/o David J. Steinberg, 818 Widener Bldg., 1339 Chestnut St., Philadelphia, Pa. 19107. Tel: (215) 564-3880. Pres.: Wilbert Hart
 Newport Beach Music (BMI), see IAM
 Newport Music Co (ASCAP), 11 5 Little Bldg., 80 Boylston St., Boston, Mass. 02116 Tel: (617) 482-678 Owner Harry Paul
 New Soul Music (ASCAP), see 20th Century
 New Tandem Music (ASCAP), see Reno/Metz
 Newtux Music (ASCAP), see East x
 New Times Music (BMI), see Op n End
 New Valley Music Press, Sage Fall, Smith College, Northampton, Mass 01063 Tel: (413) 584 2700 x 2261 Chm.: Ronald Perera.
 New Wine Prod'ns (ASCAP), PO Box 544, Lomita, Calif. 90717 Tel: (213) 454 1528. Pres.: G. Nelson Stinger
 Newworld Media Music Publ'rs (ASCAP), 1 Newworld Square, South Blue Hill, Me. 04615 Tel: (207) 374-55-9. Owner Noel Paul Stookey
 Nice Noise Inc (BMI), see Chen Lane
 Nick-O Val Music, 332 W 71 St., New York, N.Y. 10023 Tel: (212) 873 2179 Pres. Nickolas Ashford Prof. Mgr. Valerie Simpson
 Joseph Nicoletti Music Co (ASCAP), PO Box 2818, Newport Beach, Calif 92663 Tel: (714) 497 3758 res. Joseph Nicoletti, Gen. Mgr. Cheryl Lee Gammon, Prof. Mgrs.: Joseph Nicoletti, Cheryl Lee Gammon
 Nida Music Publ'g Co (ASCAP), 014 Murietta Ave., Sherman Oaks, Calif 91423 Tel: (213) 981-5331 res. & Gen. Mgr.: Nicholas S. Carras
 Nukeda Music Co (BMI), 1907 Central, Alton, Ill. 62002 Tel: (618) 465 5619 Pres. Howard E. Neal, P. Robert Thomas
 Nikka Dee Music (ASCAP), see Con Costa
 Ben Nisbet Music Inc (ASCAP), see Narrow Gate
 Nise Prod'ns Inc (BMI), 413 Cooper St., Camden, N.J. 08102 Phila Tel: (215) 276-0100 Bd. Chm. Frank Nise, Pres. Michael Nise.
 Nitfol Music (BMI) (div of Nitfol :nts), PO Box 7723, Tulsa, Okla 74105 Tel: (918) 747 4118 Pres., G n & Prof. Mgr. Dick Lottin
 Int'l rep.: France (Michel Meyer)
 Noctur Music (BMI), see 20th century
 No Exit Music Co. Inc (BMI), 535 Cotton Ave., Macon, Ga 31201 Tel: (912) 745-8511.
 Int'l rep.: Austria (RGS), Benelux (New Dayglow), Denmark (Multitone), Finland (Multitone), Germany (RGS), Greenland (Multitone), Iceland (Multitone), Ireland (Carlin), Japan (Tanyo), New Zealand (Coburn in Australia), Norway (Multitone), Southern Africa—including South Africa, S W Africa, Rhodesia, Lesotho Swaziland, Botswana & Transkei (Gallo), Spain (Hispanox), Sweden (Multitone), Switzerland (RGS), UK (Carlin)
 No Grease Music, see Prophecy
 Kenny Nolan Publ'g Co (ASCAP), c/o Peter C. Bennett, 9060 Santa Monica Blvd., Suite 300, Los Angeles, Calif 90069. Tel: (213) 278 7344. Cable: LEGIBUS Pres. Kenny Nolan Gen. Mgr.: Peter C. Bennett
 Norbud Music (BMI), see Reno/ Metz
 Northern Music Co., see MCA
 North 40+3 Music (BMI), see Carrett
 North Mountain Music (BMI)—Pr. s Norman Bergen, Chief Operating Officer: Reid Whitelaw—see Brool side
 Northshore Publ'g Inc., (ASCAP) see 20th Century.
 North & Son Music Inc (ASCAP) see Shapiro Bernstein
 Northspur Music (BMI), see Bug Music Group
 Northwest (BMI), 911 E Fourth Ave., Olympia, Wash 98506 Tel: (206) 352-9097 Pres. Allen P. Giles
 Norvik/Hauge Music Publ'g Co., 897 Walker Ave., Oakland, Calif 94610 Tel: (415) 763-5182. Pres. Norman Hauge
 No Strings Music Co (BMI), see Cherry Lane
 Notable Music Co Inc (ASCAP) Jiv. of Cy Coleman Ents), 161 W 54 St., New York, N.Y. 10019 Tel: (212) 757-9547 Pres. Cy Coleman, Gen. Mgr.: Eric Colodne.
 Int'l firm represented: Camp: il Connelly (UK)
 Note Filler Music (BMI), see Janie.
 Notes Unlimited Inc (ASCAP), see President

Novello Publ'ns Inc. (ASCAP), 145 Palisade St., Dobbs Ferry, N.Y. 10522 Tel: (914) 693-5445.
 Home office: England
 No Violence Music Publ'g (SESAC), see Music Anno Domini.
 Nujac Publ'g Co. Inc. (BMI), see Jame.
 No. 11 Music (BMI), see Skyhill.
 Numbers Music (ASCAP), see Management III.
 Numb Skull Music (BMI), see Bug Music Group.
 Nyssa Publ'g (ASCAP), 676 N. La Salle, Suite 601, Chicago, Ill. 60610 Tel: (312) 266-8844. Contact: Dick Lux.

O

O A S Music Group Inc., 805 18 Ave. S., Nashville, Tenn. 37203. Tel: (615) 327 3900. Prof. Mgrs.: Dane B. Bryant, Stephen S. Singleton
 O A S Music Publ'g (ASCAP), 3140 E. Shadowlawn Ave. NE, Atlanta, Ga. 30305. Tel: (404) 231-9888. Pres.: Keith C. Andrews. Gen. Mgr.: Kathy M. Heiser.
 O S Y Music, 200 Noll Plaza, Huntington, Ind. 46750. Tel: (219) 346-8400.
 Oakridge Music Publ'g Co. (BMI), 2001 Elton Rd., Haltom City, Tex. 76117. Tel: (817) 838-8001. Owner: Homer Lee Sewell.
 Oakshire Music (BMI), see Skyhill.
 Obsessive Songs (BMI), see Rohm.
 Ocean Drive Music (BMI), see Brookside.
 Michael O'Connor Music (BMI), PO Box 1869, Studio City, Calif. 91604 Tel: (213) 762-7551. Pres.: Michael O'Connor.
 O'Connor Songs (ASCAP), see Michael O'Connor
 Octave Higher Music (BMI), 11208 N 38 Pl., Phoenix, Ariz 85028. Tel: (602) 953-1671. Pres. & Gen. Mgr.: Phillip Kelly.
 Mary Frances Odle Publ'g (BMI), 8431 Howard Dr., Studio 2, Houston, Tex. 77017. Tel: (713) 477-9432. Pres. & Prof. Mgr.: Mary Frances Odle; Gen. Mgr.: T.A. Seberger. Local branch: Frances Rollins Music, PO Box 4335, Pasadena 77502. Tel: (713) 477-9432.
 Offs Music (BMI), see Bug Music Group.
 Oh Boy Music Co. (ASCAP), see Great Honesty.
 Oho Music (BMI), see Bug Music Group.
 Oily Maniac Music (BMI), see Bug Music Group.
 Onkshir Publ'g Co. (BMI), PO Box 20814, 2108 W. 115, Oklahoma City, Okla. 73156 Tel: (405) 757-8954. Pres.: Mickey Sherman.
 Milton Okun Publ'g Co. (BMI), see Cherry Lane.
 Old Boston Publ'g Co. (BMI), 180 Pond St., Cohasset, Mass. 02025. Tel: (617) 383-9494. Pres.: Richard Tinory, Artist Relations: Claire L. Tinory.
 Old Fox Publ'g Co. (BMI), 2018 E. Center St., Kingsport, Tenn. 37664. Tel: (615) 246-8651. Pres.: Basil J. Palmer; Gen. Mgr.: Edith Isom.
 Old Friends Music, see Don Gant.
 Old Home Place Music (BMI), 8705 Odanna Dr., Gaithersburg, Md 20760. Tel: (301) 253-5962. Pres.: Wayne Busbuck.
 Old Soul Music (BMI), see 20th Century
 Olenik Recs. (ASCAP), G-10282 N. Saginaw Rd., Clio, Mich 48420. Tel: (313) 686-9644. Owner, Pres. & Prof. Mgr.: Nicholas H. Olejnik.
 Oteo Music (BMI), 228 S. Helberta, Redondo Beach, Calif 90277 Tel: (213) 372-9317. Owner: Jim Turnage
 Ota Music (BMI), see Management III.
 Otiva Music (SESAC), see Zaza.
 Otsongs (BMI), see Bug Music Group

O'Lyrcal Music (ASCAP), see O'Lyric
 O'Lyric Music (BMI), 11833 Laurelwood Dr., Suite 8, Studio City, Calif. 91604 Tel: (213) 506-5473 Pres.: Jim O'Loughlin; Gen. Mgr.: Tom Shapiro. Prof. Mgr.: Kathryn Haddock.
 One Eye Soul Publ'g Co. (BMI), see Jame.
 Oneida Music Publ'g Co. (BMI), 760 Blandina St., Utica, N.Y. 13501. Tel: (315) 735-6187. Owner: Stanley Markowski; Gen. Mgr.: Joyce Markowski; Prof. Mgr.: Andrew Cittadino.
 One More Music (ASCAP), see Annetra.
 One Note Beyond Music (ASCAP), 819 18 Ave. S., Nashville, Tenn. 37203. Tel: (615) 329-0532. Gen. Mgr.: John Weaver.
 Onesimus Music, PO Box 235, Pitman, N.J. 08701. Tel: (609) 881-6743.
 One Three Nine Music (ASCAP), see Hayseed.
 Onhisown Music (BMI), see OAS Music Group.
 Onnysay Publ'g Co. (BMI), PO Box 9154, Wells Rd. SW, Knoxville, Tenn. 37920. Tel: (615) 970-2327. Pres.: H.S. Watson.
 On The Boardwalk Music (BMI), see Marvin Gardens.
 Oozlefinch Music (ASCAP), see Oozle.
 Oozle Music (BMI), PO Box 669, Woodstock, N.Y. 12498 Tel: (914) 679-6069/2458. Pres.: Harris Goldberg.
 Open End Music Inc. (BMI), 7720 Sunset Blvd., Los Angeles, Calif 90046. Tel: (213) 851-9115. Cable: NEWTIMES. Telex: 194738. Pres.: Bennett H. Goltzer; Gen. Mgr.: Eloise Peacock.
 Open Sky Music Publ'rs (ASCAP), 10735 Vernon, Huntington Woods, Mich. 48070. Tel: (313) 546-7558. Pres.: Martin Scot Kosins; Gen. & Prof. Mgr.: Peg Oubois.
 Orange Bear Music (BMI), see Scully Music.
 Orange Blossom Music (SESAC), United Artists Tower, Penthouse Suite 902, 50 Music Square W., Nashville, Tenn. 37203. Tel: (615) 329 0714.
 Orchid Publ'g (BMI), PO Box 4220, Shreveport, La. 71104. Tel: (318) 686-7362. Pres.: Bill Bohannon; Gen. Mgr.: Coy Bohannon; Prof. Mgr.: Dick Neeley.
 Origtunes Publ'g Co. (BMI), Box 1143, Bellflower, Calif. 90706. Tel: (213) 866-4146. Owner: Weari Ehlison.
 Osito Music Publ'g (BMI), see Group 88.
 O Songs Inc. (ASCAP), see Roadshow.
 James Osterberg Music (BMI), see Bug Music Group.
 Other Music Inc. (ASCAP), The Barn, North Ferrisburg, Vt. 05473. Tel: (802) 425-2111. TWX: (510) 299-0029. Pres.: Michael Couture; VP & Gen. Mgr.: William H. Schubart. (Administered by Music Management).
 Int'l rep.: Australia (Castle Music), Benelux (Intersong in UK), France (Bagatelle), Germany (Rudolf Slezak), Japan (Tanyo), Sweden (Ar Music), UK (Panache)
 Ottumwa Music (BMI), see Garrett
 Our Children's Music Corp. (BMI), see Goodman Group.
 Outer Galaxie Publ'rs Inc. (BMI), see Aura Love.
 Over Easy Music (BMI), see Bug Music Group.
 Over the Rainbow Music, 6430 Sunset Blvd., No. 716, Los Angeles, Calif 90069. Tel: (213) 467-1135.
 Oxford Univ. Press Inc. (ASCAP), 200 Madison Ave., New York, N.Y. 10016. Tel: (212) 679-7300. Cable: FROWOE. Music Dept. Mgr.: Susan Brailove.
 Home office: England.
 Ozark Ramblin' Music (BMI), 430 S. Glenstone, Suite C, Springfield, Mo. 65802. Tel: (417) 864-4404. Or.: William Oailey; Pres.: Keith O'Neil.
 Ozone Music (BMI), see Bug Music Group

Famous Music Publishing Companies

WE'VE GOT THE MUSIC!

THANKS FOR THE MEMORY • ALFIE • RAIDERS OF THE LOST ARK
 STELLA BY STARLIGHT • MONA LISA • MISSION: IMPOSSIBLE
 GENTLE ON MY MIND THE GODFATHER
 ROMEO AND JULIET LOVE STORY
 LOVE LETTERS MOON RIVER
 SILVER BELLS TANGERINE



**Marvin Cane
 Sidney Herman**

<p>LOS ANGELES 6430 Sunset Boulevard 90028</p> <p>Julie Chester Allan McDougall</p>	<p>NEW YORK 1 Gulf + Western Plaza 10023</p> <p>Dick Milfred Randy Irwin Basil Nias</p>	<p>NASHVILLE 2 Music Circle South 37203</p> <p>Judy Gotter</p>	<p>LONDON 50 New Bond Street, England</p> <p>Mark Rowles Diana Graham</p>
--	---	--	---

P

P A Ents. Inc., John Hancock Center, Suite 5404, 875 N. Michigan Ave., Chicago, Ill. 60611. Tel: (312) 337-5643. Pres.: Andy Pappas.

P E M Assocs. (ASCAP), see The Entertainment Co.

P P L Music, 6331 Hollywood Blvd., Suite 407, Hollywood, Calif. 90028. Tel: (213) 469-0401.

P P X Publ's (BMI), 300 W. 55 St., New York, N.Y. 10019. Tel: (212) 247-6010. Cable: CHALPRISES. Telex: 236287.

Pachuko Music (BMI), see Bug Music Group.

Pacific Challenger Music (BMI), 2940 E. Miraloma Ave., Anaheim, Calif. 92806. Tel: (714) 992-6827. Pres.: C.E. Whittington; Gen. Mgr.: Dottie McIlroy, Prof. Mgr.: Don Rohrs.

Pacific View Music (ASCAP), see Don Williams.

Package Good Music (BMI), 1145 Green St., Manville, N.J. 08835. Pres. & Gen. Mgr.: Marc Zydiac; A&R: Mary Ellen Clark.

Pasca Music Publ'g (ASCAP), see Lynnstorm.

Padaua Music Co. (BMI), see Faro.

Pady Music Publ'g Co. (ASCAP), 431 Willow St., Woonsocket, R.I. 02895. Tel: (401) 765-2234. Pres., Gen. & Prof. Mgr.: Karen A. Padyuka.

Paganiniana Publ's Inc., 211 W. Sylvania Ave., Neptune, N.J. 07753. Tel: (201) 988-8400. Cable: TFHBOOKS, ASBURY PARK. Pres.: Dr. Herbert Aelrod; Exec. VP: Paul L. Paradise.

Int'l rep.: UK (Forsyth).

O. Pagan & Bro. Inc. (SESAC), 289 Bleecker St., New York, N.Y. 10014. Tel: (212) 242-6744. Pres.: Frank Gavani; VP: Theresa Costello.

Painted Desert Music Corp. (BMI), see Shapiro Bernstein.

Paint It Green Music (BMI), see Band of Angels.

Palmat Music Publ's (BMI), 726 Carlson Dr., Orlando, Fla. 32804. Tel: (305) 644-3853. Pres.: Will Campbell.

Pale Pachyderm Publ'g (BMI), 444 Grove St., San Francisco, Calif. 94102. Tel: (415) 431-7480. Chm.: John E. Kennedy.

Palmerston Music—Pres.: John Kaplan—see Dawn Prod'n's.

Pal Publ'g, 10755 Bachelor Valley Rd., Witter Springs, Calif. 95493. Tel: (707) 275-2766. Pres.: Jan Scobey.

Pamly Music Co. (BMI), PO Box 6211, Cleveland, Ohio 44101. Pres.: Robert L. Wright; Gen. Mgr. Beck Strauss; Prof. Mgr.: Otto Mann.

Pam Music (BMI), see Ralph's Radio Music.

Panini Music (BMI), PO Box 15808, Honolulu, Hawaii 96815. Tel: (808) 947-4985. Pres.: Steven D. Siegfried; VP: Witt H.P. Shingle.

Pantego Sound, 2210 Rapier Blvd., Pantego, Tex. 76013. Tel: (817) 461-8481. Pres.: Charles Stewart.

Pantheon Desert Publ'g (BMI), 6325 N. Invergordon Rd., Scottsdale, Ariz. 85253. Tel: (602) 948-5883. Gen. Mgr.: Brent Burns.

Panther Music Corp. (ASCAP), see Peer-Southern.

Paradallon Music (BMI), see Bug Music Group.

Parsons Music Publ'g (ASCAP)—VP: Conrad States—see Mirsong Music.

Paragon/Benson Publ'g Group, 19 Ave. N. & Hayes, Nashville, Tenn. 37203. Tel: (615) 327-2836. Pres.: Robert R. MacKenzie; Gen. Mgr. Wayne Erickson; Prof. Mgrs.: Bubba Smith, Mike Smith, Marlice Kraemer.

Int'l reps.: Australia (Rhema), Austria, Germany & Switzerland (Hansler); Benelux (Universal Songs in Netherlands); England (Coronation).

Park J Tunes (ASCAP) (div of Northcoast Entertainment), 813 Heritage Ln., Waterville, Ohio 43566. Tel: (419) 878-8387. Pres.: Michael Drew; Asst. to Pres.: Judy Russell; Gen. Mgr.: Robert Drew; Prof. Mgr.: Raye Lenardson.

Parasound Inc. (ASCAP), 680 Beach St., San Francisco, Calif. 94109. Tel: (415) 673-4544. Cable: 000BYD00. Pres.: Bernard Krause.

Parks Music Corp. (SESAC), see Ned A. Kjos.

Participation Music Inc. (ASCAP), 330 W. 58 St., New York, N.Y. 10019. Tel: (212) 265-2520. Tel: 237316. Dirs.: Clive Calder, Dave Robinson, Prof. Mgr.: Rachelle Greenblatt.

Int'l firm represented: Street Music Ltd. (UK).

Partner Music (BMI), 1518 Chelsea Ave., Memphis, Tenn. 38108. Tel: (901) 725-1400. Gen. Mgr.: Larry Rogers.

Party-Time Music (BMI), 525 SW 42, Oklahoma City, Okla. 73109. Tel: (405) 632-3958. Pres.: Tom Jackson; Gen. Mgr.: Wendell Goodman, Prof. Mgr.: Wanda Jackson.

Pasha Music Org. (BMI), 5615 Melrose Ave., Hollywood, Calif. 90038. Tel: (213) 466-3507. Telex: (910) 3214537. Pres.: Spencer D. Proffer; Gen. Mgr.: Ann Summer-Davis; Prof. Mgr.: Coral Browning. (Administered by April/Blackwood).

Int'l reps.: Germany, Italy, Scandinavia, UK (April/Blackwood).

Joseph Patelson Music House Ltd. (ASCAP), 160 W. 56 St., New York, N.Y. 10019. Tel: (212) 757-5587. Owner: Joseph Patelson.

Paths of Music (ASCAP), see Roads of Music.

Patlow Publ'n Co. (BMI), 17429 Indian Ave., Detroit, Mich. 48240. Tel: (313) 531-9330. Pres.: M.J. Patlow.

Phaun Music Publ'g Co. (BMI), 3518 Champlain Ave., Youngstown, Ohio 44502. Tel: (216) 755-7794. Owner, Pres. & Gen. Mgr. Bill Schaffert.

Payto Ippolito Music Inc. (BMI), 800 N. Riegeland, Oak Park, Ill. 60302. Tel: (312) 848-3322. Pres. & Prof. Mgr.: Roger Pauly, Gen. & Prof. Mgr. Vincent Ippolito.

Pavanne Music Co. (ASCAP), 2315 Foxhaven Dr., Franklin, Tenn. 37064. Tel: (615) 373-8506. Owners: Frank Stanton, Andy Badale.

Branch: New York, N.Y., 157 W. 57 St. Zip: 10019. Tel: (212) 581-9639. Contact: Andy Badale.

Pay Paw Music (BMI), see Bug Music Group.

Payback Music Publ'g Co., 508 Penn Square Bldg., Philadelphia, Pa. 19107. Tel: (215) 567-2050.

Pay Dirt Music (ASCAP), 1227 Spring St. NW, Atlanta, Ga. 30309. Tel: (404) 873-6425. Pres. Barbara H. Richardson, Prof. Mgr. Robert B. Richardson.

Peaceable Kingdom (ASCAP), 3525 Encinal Canyon Rd., Malibu, Calif. 90265. Tel: (213) 457-4405. Pres.: C. Randolph Nauert; Prof. Mgr. Randy Nauert.

Peaceful Music Co. (BMI) (div of Pacific Arts Corp. Inc.), PO Box 22770. Carmel, Calif. 93922. Tel: (408) 624-4704. Cable: PACARTS. Telex: 351455.

Peacock Music (BMI), see 20th Century.

Peak Publ'g (BMI) (div of Stage 3 Sound Prod'n's), 12 E. 39, Kansas City, Mo. 64111. Tel: (816) 531-1375. Pres. & Gen. Mgr. Don Warnock, Prof. Mgr. Clara Warnock.

Pebble Music Ltd. (BMI), see Cherry Lane.

Pedro Music Corp. (BMI), see Cyril Shane.

Peer Int'l Corp. (BMI), see Peer-Southern.

Peer-Southern Org., 1740 Broadway, New York, N.Y. 10019. Tel: (212) 265-3910. Cable: SOUTHMUSIC. Telex: 424361. Pres. Monique I. Peer, Sr. VP: Ralph Peer II; VP: Mario Conti; Int'l Mgr.: Latin American Div. Prom. Groups.

Branches: Los Angeles, Calif., 6922 Hollywood Blvd. Zip: 90028. Tel: (213) 469-1667. TWX: (910) 321-4098. Mgr.: Roy Kohn—Miami, Fla.,

Northeast Airlines Bldg., Rm. 1409, 150 SE Second St. Zip: 33131. Tel: (305) 358-1488. Mgr.: Omar Marchant—Santurca, P.R., Edificio Banco Ponce, 1250 Ponce de Leon Ave. Zip: 00908. Tel: (809) 725-2380, 723-3918. Gen. Mgr.: Paquito Fontarras—Nashville, Tenn., 7 Music Circle N. Zip: 37203. Tel: (615) 244-6200.

Int'l branches: Argentina (EDAMI), Australia (Southern), Austria (Southern), Belgium (Southern), Brazil (EMBI), Canada (Peer-Southern), Chile (Southern), Colombia (Peer), England (Southern), France (SEMI-Meridial), Germany (Peer), Italy (Southern), Japan (Southern), Mexico (EMMI, Muxa, PHAM), Netherlands (Holland Music), New Zealand (Southern), South Africa (Southern), Spain (Southern), Sweden (Southern), Switzerland (Southern), Venezuela (Peer).

Int'l firms represented: Ed. A. Cranz—partial catalog (Belgium), Ediciones Mexicanas de Musica (Mexico), Editorial Argentina de Musica (Argentina), Editorial Cooperativa Interamericana de Compositores (Uruguay), Enoch & Cie—partial catalog (France), Liber-Southern (UK), Pan American Union, Wagner & Leven (Mexico). (SEE ADVERTISEMENT)

Pag Music Co. (BMI), see Neverland.

Peluperus Music Co. (ASCAP), 4142 Benton Blvd., Kansas City, Mo. 64130. Tel: (816) 861-0582. Pres.: Robert Motley; Gen. Mgr.: Byron Motley.

Pelton Publ'g Co. (BMI), PO Box 182, Midwood Sta., Brooklyn, N.Y. 11230. Tel: (212) 339-3536. Pres.: Jim Pelton; Gen. Mgr.: Dick Alexander; Prof. Mgr.: Nat. Courtney; Promo: John Upton.

Pending Publ'g Co. (BMI), see Beldock Levine & Hoffman.

Penny Pinchers Publ'g Corp. (sub. of Able Music Inc.), PO Box 387, Oakwood, Va. 24631. Tel: (703) 498-3337. Chm.: R. Fuller; Pres.: Gayle Collins, Gen. Mgr. S.G. Potter; Prof. Mgr.: Adam Fuller.

Penny Thoughts Music (BMI) (div. of John Penny Ents. Inc.), 259A Beech St., Belmont, Mass. 02178. Tel: (717) 924-6722. Pres.: John Penny.

Pentagon Music Co. (BMI), see Jame.

People Pleaser Music (BMI), 1018 Central Ave., Charlotte, N.C. 28204. Tel: (704) 377-4596. Owner & Mgr.: Wayne Jernigan.

Pera Music Corp. (BMI), see Peer-Southern.

Perennial Music (BMI), 3099 Diablo View Rd., Lafayette, Calif. 94549. Tel: (415) 930-7573. Gen. & Prof. Mgr.: Hillel Resner.

Perfection Music Publ'g (BMI), see Regal.

Perfect Union Music (ASCAP), see Brum.

Periscope Music (BMI), 129 Bishop St., Brockton, Mass. 02402. Tel: (617) 588-6348. Pres. & Prof. Mgr.: Edward M. Hurvitz.

Peritra Music (BMI), PO Box 4386, Long Island City, N.Y. 11104. Tel: (212) 786-2401, 426-1190. Pres.: Franc Perla.

Perla Music (ASCAP), 20 Martha St., Woodcliff Lake, N.J. 07675. Tel: (201) 391-2486. Pres.: Gene A. Perla, Gen. Mgr.: Marie Perla.

Int'l rep.: Japan (Sunkyo).

Perpetual Music (BMI), 744 W. 28 St., Norfolk, Va. 23508. Tel: (804) 623-5710. Pres. Lucille Seals.

Personified Music Co. (BMI), Rt. 1, Tennyson, Ind. 47637. Tel: (812) 567-4354. Pres.: R.E. Willis Sr.; Prof. Mgr.: Bob Willis.

Peso Music (BMI), see Garrett.

Petco Int'l Inc. (ASCAP), 88-20 Corona Ave., Elmhurst, N.Y. 11373. Tel: (212) 699-5258. Pres.: Robert Petrone.

Int'l branch: Peru.

Int'l rep.: Worldwide (Mundo Musical).

Peter David Music Co. Inc. (SESAC), see Ivan Mogull.

Peter Jan Publ'g (BMI), 2313 S. 49 Ave., Omaha, Neb. 68106. Tel: (402) 556-5675. Pres.: Charles Canuso.

Peter Piper Publ'g (ASCAP), see Stuart Lans.

Ben Peters Music (BMI), 900 Old Hickory Blvd., Rt. 6, Brentwood, Tenn. 37027. Tel: (615) 373-5530.

C. F. Peters Corp. (BMI), 373 Park Ave. S., New York, N.Y. 10016. Tel: (212) 686-4147. Chm.: Mrs. Walter Hinrichsen, Pres. Henry Hans Hinrichsen, VP: Walter Bendix.

Home office: Germany.

Int'l firms represented: Alsbach (Netherlands), Beliaeff (Germany), Broekmans (Netherlands), Choudens (France), Oessam (Belgium), Donemus (Netherlands), Engstrom (Denmark), Dan Fog (Denmark), Forberg (Germany), Grah (Germany), Harmonia (Netherlands), Henrichshofen (Germany), Hug (Switzerland), Kneusslin (Switzerland), Lienau (Germany), Lyche (Norway), Merseburger (Germany), Mitteldeutscher (Germany), Witty Mueller (Germany), Musikh-Huset (Norway), Musikwissenschaftlicher Verlag (rental music), Austriak, Noetzel (Germany), Pegasus (Germany), Reinhardt (Switzerland), Ries & Erler (Germany), Samfundet (Denmark), Schwann (Germany), Sueddeutscher Musikverlag (Germany), Taurus (Germany), Tonger (Germany), Vieweg (Germany), Westend (Germany), Zambon (Italy).

Petoskey Music Inc. (BMI), 3007 E. Eight Mile Rd., Warren, Mich. 48091. Tel: (313) 756-8890. Pres.: John Pavlik; VP: R. Gordon Price.

Pewter Pal Music (BMI), PO Box 133, Ojai, Calif. 93023. Pres.: Jim Pewter.

Philella Music (BMI), see Pewter Pal.

Phaun Int'l Ents. (ASCAP), see Gefen/Kaye.

Phoenkongs (ASCAP), PO Box 622, Northbrook, Ill. 60062. Tel: (312) 564-2484. Owner: James Durst.

Phonotones (ASCAP), 400 Essex St., Salem, Mass. 01970. Tel: (617) 744-7678. Pres.: Don Roze.

Phrase Text Music (ASCAP), see Mayflower Music.

Picasso Publ'g Co. (ASCAP), 5032 Lanherkim Blvd., North Hollywood, Calif. 91601. Tel: (213) 766-7142. Dir.: Ken Weiss.

Pickering Music Publ's (BMI), see Lynnstorm.

Pick'n Post (BMI), PO Box 51, Lebanon, Tenn. 37087. Tel: (615) 449-1770.

Pick Trunk Music, see Stone Rap.

Picture This Music (BMI), see Bug Music Group.

Pi-Gem Music Inc. (BMI), PO Box 40984, Nashville, Tenn. 37204. Tel: (615) 244-8950. Pres. Tom Collins; Gen. Mgr.: David Conrad; Prof. Mgr. Gary Harrison.

Pigfoot Music (ASCAP), PO Box 130, Point Reyes Station, Calif. 94956. Tel: (415) 663-1096.

George Pincus & Sons Music Corp. (ASCAP), 1650 Broadway, New York, N.Y. 10019. Tel: (212) 245-0110. Cable: PINCUSGIL. Pres.: George Pincus; Prof. Mgr. & Ass't to Pres.: Amy Javors.

Int'l branches: Australia, Pincus-Gil Music Ltd.; England, Ambassador Music Ltd.

Pinebrook Music Corp. (BMI), see H.B. Webman.

Pine Island Music (BMI), PO Box 630175, Miami, Fla. 33163. Tel: (305) 472-7757. Pres. & Prof. Mgr.: Jack P. Bluestein, VP: Ethel Kanter.

Int'l reps.: Brazil (Prate), Canada (CMRRA).

Pinelias Music (BMI), see Arpell/Pinelias.

Pinpoint Music Publ'g (BMI), c/o Little Nashville Recs., Box 212, Rt. 3, Nashville, Ind. 47448. Tel: (812) 988-2000. Owners: Don D. & Marti Mae Sheets.

Pipe Music (BMI), see Mirmic.

Plain Great Music Corp. (ASCAP), 6525 Sunset Blvd., 8th fl., Hollywood, Calif. 90028. Tel: (213) 469-3936. TWX: (910) 321-4450. VP & Gen. Mgr.: Ronald S. Henry.

Platinum Music Publ'g (ASCAP) (div. of The Music Factory Inc.), 567 NW 27 St., Miami, Fla. 33127. Tel: (305) 576-2600. Pres.: Bob Archibald; Gen. Mgr.: Florian Raymond.

Platinum Pen Music Publ'g Co. (BMI) (sub. of Cloud Born Prod'n's), 18000 Mack Ave., Grosse Pointe, Mich. 48224. Tel: (313) 882-0566. Pres.: Gary Praeg; Gen. Mgr.: Ken Sands; Prof. Mgr.: Mary Ann Matiello.

Playground Music (BMI), see Pewter Pal.

Pleasures Music Inc. (BMI)—Pres. & Gen. Mgr.: William H. Schubarth—see Other.

Plibby Music (BMI), see Four Moons.

Plum Creek Music (BMI), see Terrace.

Plunge Publ'g Co. (BMI), PO Box 441, Northridge, Calif. 91324. Tel: (213) 780-2288. Pres.: David M. Seiden.

Plus One Music (BMI), see Management III.

Plymouth Music Co. Inc. (ASCAP), see Music for Percussion.

Pocket-Money Music (BMI) (div. of Smudge Recs.), PO Box 29342, Dallas, Tex. 75229. Tel: (214) 243-2933. Pres.: Terry Rose.

Int'l branch: England, Whitsett-Churchill Music.

Poco Loco Music Co. (BMI), see Furo.

Poema Publ'g, 8996 Fruitridge Rd., Sacramento, Calif. 95826. Tel: (916) 383-4387.

Pointless Music (BMI), see JEDO.

Polka Towne Music (BMI) (div. of Polka Music Corp.), 211 Post Ave., Westbury, N.Y. 11590. Tel: (516) 334-6228. Pres.: Teresa Zapolska.

Pollyday Publ'g Co. Inc. (BMI), see Su-Ma.

Pommar (BMI), c/o Dick K. Withers, Box 53, Nashville, Tenn. 37221. Tel: (615) 352-5684.

Pomona Music Corp. (BMI), see Shapiro Bernstein.

Ponderosa Music Co. Inc. (BMI), see Shapiro Bernstein.

Pondfield Music Inc. (ASCAP), see Reno/Metro.

Popular Music Co. (ASCAP), 49 W. 45 St., New York, N.Y. 10036. Tel: (212) 840-8833. Pres.: Morton Browne; Prof. Mgr.: Addy Browne.

Porpete Music Publ'g Co. (BMI), PO Box 777, Hollywood, Calif. 90028. Tel: (213) 882-1558. Pres. & Gen. Mgr.: Anita Poree.

Porsche Music (SESAC), see Judane.

Portage Publ'g Co. (BMI), 16634 Gannon W., Rosemount, Minn. 55068. Tel: (612) 432-5737. Pres.: Larry LaPole.

Porter Music Co. (BMI), 811 18 Ave. S., Nashville, Tenn. 37203. Tel: (615) 329-2122. Owner: Porter Wagoner; Gen. Mgr.: Carla Scarborough.

Int'l reps.: France (Francis Day), Germany (Siegel), Japan (Taiyo), Netherlands (Intersong-Basart), Scandinavia (April in Sweden), South Africa (EMI-Brigandiers), UK (Carlin).

Positive Prod'n's (BMI), PO Box 1405, Highland Park, N.J. 08904. Tel: (201) 463-8147. Pres.: J.J. Vincenzo.

Pov Music (ASCAP), see Judane.

Powhatan Music Publ'g (BMI), PO Box 993, 211 E. Fourth St., Salem, Va. 24153. Tel: (703) 389-4829. Pres.: Jack Mullins; Gen. Mgr.: Jim Eanes; Prof. Mgr.: J.R. Mullins.

Powdermill Publ's Inc. (BMI), see Window.

Power Play Music (BMI) (div. of Gusto Recs. Inc.), 1900 Elm Hill Pike, Nashville, Tenn. 37210. Tel: (615) 889-8000.

Prairie Wind Music (BMI), PO Box 273, 1011 S. Third, Norfolk, Neb. 68701. Tel: (402) 371-7658. Pres.: Jim Casey; Gen. Mgr.: Beth Holloway; Prof. Mgr.: Bob James.

The Prescription Co. (BMI), 70 Murray Ave., Port Washington, N.Y. 11050. Tel: (516) 767-1929. Owner & Pres.: David F. Gasman.

President Music Corp. (ASCAP), 1785 E. Sahara Ave., Suite 380, Las Vegas, Nev. 89104. Tel: (702) 732-0812. Pres., Gen. & Prof. Mgr.: Joseph E. Zerga.

Int'l branch: Austria.

Int'l firms represented: MMS Musikverlag (Austria); Bronco & Merco Musik, Domo Musikverlag, Selected Sound GmbH, Top Star Musik Prod'n's (all Germany).

Theodore Presser Co. (ASCAP), Presser Pl., Bryn Mawr, Pa. 19010. Tel: (215) 525-3636. Cable: RESSERP. Pres.: Arnold Brody; Educational Dir. & Sales Mgr.: George D. Hottel; Editorial Dir.: Vincent Perschett; Prod'n Mgr.: Tom McDonough; Performance Dept.: Eugene Moon; Adv. Mgr.: Larry Sandberg; Publ's Mgr.: Larry Brody.

Sale selling agent for the following US publishers: Robert Fairfax Birch Publ's, Cambium Publ's, Cavata Music Publ's, Coburn Press, Columbia Music Co., Excelsior Music Publ'g Co., Mowray Music Publ's, Multi-Key Publ's, Adolph Sandole Music Publ'g, Soursalinda Music Corp., Tenuto Publ's, Tritone Press, Union Publ's.

Int'l firms represented: Theodore Presser Co.—Berben (Ed.) (Italy), Billaudot (Eds.) (France), Bizet (Eds.) (Belgium), Boccacini & Spada Editori (Italy), Editio Musica Budapest (Hungary), Francaises de Musique (France), Heugel & Cie (France), Heuwelmeijer (Ed.) (Netherlands), Impero-Verlag (Germany), Jobert & Cie (Eds.) (France), Alphonse Leduc & Cie. (France), Musicales Transatlantiques (France), Music Box Dancer Publ's (Canada), Ongaku-No-Tomo-Sha (Japan), Reimers (Eds.) (Sweden), Robertson Publ's (UK), United Music Publ's (UK); Elikan-Magal Inc.—Ars Nova (Netherlands), Choudens (Eds.) (France), Consortium Musical (France), Durand & Cie. (France), Hamelle & Cie. (France), Henry Lemoine & Cie. (France), Rideau Rouge (Eds.) (France).

Int'l sales rep.: Continental Europe, South Africa, Burma, Israel, Hong Kong, Singapore, Malaysia (Kalmus); Japan & South Korea (Ongaku-No-Tomo-Sha), UK & Ireland (Kalmus, United), Scandinavia (Reimers).

Janie Price Music (ASCAP), PO Box 30384, Dallas, Tex. 75230. Tel: (214) 750-9993. Pres., Gen. & Prof. Mgr.: Janie Price.

Jimmy Price Music Publ'g (BMI), 1662 Wyatt Plwy., Lexington, Ky. 40505. Tel: (606) 254-7474. Owner & Pres.: James T. Price; Gen. Mgr.: Harry P. Price; Prof. Mgrs.: Charles Stephens, Kathleen Parin; Prof.: Andy Anderson.

Prima-Donna Music Co. (BMI) (div. of Prima-Donna Ent. Corp.), PO Box 15385, Nashville, Tenn. 37215. Tel: (615) 373-2390. (Administered by Al Gallico).

Primitive West Publ'g (ASCAP), see American Heritage.

Princess Music Publ'g Corp. (ASCAP), see H.B. Webman.

Pringle Music Publ's (BMI), 7021 Hatillo Ave., Canoga Park, Calif. 91306. Tel: (213) 347-3902.

Print Music Co. Inc. (ASCAP), see Japalana.

Pritchett Publ's (BMI), 38603 Sage Tree St., Palmdale, Calif. 93550. Tel: (805) 947-4657. Pres.: L.R. Pritchett.

Branch: Daytona Beach, Fla., 171 Pine Haven, Zip: 32014. Tel: (904) 252-4849. Gen. & Prof. Mgr.: Charles Vickers.

Process Music Inc. (BMI), see Country Star.

Proclamation Prod'n's Inc. (ASCAP), Orange Square, Port Jervis, N.Y. 12771. Tel: (914) 856-6686.

Professional Music Prods. Inc. (ASCAP), 14731-E Franklin Ave., Tustin, Calif. 92680. Tel: (714) 838-8421. Pres.: Leon White; VP & Gen. Mgr.: Jeffrey Brown.

Professor Pork Publ'g (ASCAP), see Beldock Levine & Hoffman.

Pronto Music Inc. (BMI), see Cotillon.

Prophecy Publ'g Inc. (ASCAP), 31 1/2 Guadalupe, Austin, Tex. 78705. Tel: (512) 452-9412. Pres.: Tommy White.
Int'l rep.: Australasia (Festival Austria (ERP), Belgium (New Dayglow), Germany (ERP), Netherlands (New Dayglow), Scandinavia (Air in Sweden), Switzerland (ERP).
 Prop Publ'g (BMI), see Inspiration al Sounds.
 Proton Music (ASCAP) (div. of Pro One Recs.), 970 Bel Air Rd., Los Angeles, Calif. 90024. Tel: (213) 472-5. 44. Dir.: Jane Courtland Welton.
 Jeanne Pruett Music Inc. (BMI), 7318 Ave. S., Nashville, Tenn. 37203. Tel: (615) 327-2165.
 Pubicare Publ'g (ASCAP), 2510 T rrytown Mall, Houston, Tex. 77057. Tel: (713) 780-4506. Pres. Jim D J hson. (Administered by Copyright Serv. Bureau)
 Publishers' Licensing Corp., 488 J adison Ave., New York, N.Y. 10022. Tel (212) 753-1110. Cable: PHIL J RN. Telex 234128. Contact: Philip S. Kurnit; Copyright Mgr.: Joan C hetti.
 Pullen Pucker Music, PO Box 121223, Nashville, Tenn. 37202. Tel: (615) 361-3756.
 Punaluu Music (ASCAP), PO Box 31186, Honolulu, Hawaii 96820. Tel: (808) 293-1800. Contact: Rick Asher Keeler.
 Gerard W. Purcell Assocs. Ltd. (A.C.A.P.), 964 Second Ave., New York, N.Y. 10022. Tel: (212) 421-2670. Cable: PURCELLAS.
 Purple Lady Publ'g (BMI), PO B x 757, Tiburon, Calif. 94920. Tel: (415) 435-0720. Pres.: Barbara Mes in.
 Pzazz Music (BMI)/Adamsongs (A.C.A.P.) (divs. of Music Concepts Int'l), 257 Ashdale Pl., Los Angeles, Calif. 10049. Tel: (213) 476-2286. Pres. & Prof. Mgr.: Stephen L. Bedell.

Q

Q C A Music Inc. (ASCAP), 2832 S ring Grove Ave., Cincinnati, Ohio 45225. Tel: (513) 681-8400.
 Quackenbush Music Ltd. (ASCAP) PO Box 2202, Palm Springs, Calif. 92263. Tel: (714) 325-5095. Pres.: Carly Simon; Gen. Mgr.: Arlyne Rothberg. (Administered by Gelfand, Bri Jauer, Rennett & Feldman)
 Quartet Music Inc. (ASCAP), see Trio.
 Queen of Hearts Music, 6105A Yo re Dr., Shreveport, La. 71105. Tel: (318) 861-0569. Owners: George Clinton, Joe Spivey.
 Quickmix Music Inc. (BMI), see Iro.
 Quinones Music Co. (BMI), 1344 Waldron St. Louis, Mo. 63130. Tel: (314) 863-3605. Pres.: Eddie L. Johnson; Gen. Mgr.: Ora Lovings. Prof. Mgr.: Clinton Primm.
 Quintet Music Inc. (ASCAP), see Trio.

R

R C S Music Publ'g Inc. (ASCAP), 5220 Essen Ln., Baton Rouge, La. 70808. Tel: (504) 766-3233. TWX: (510) 993-3493. Pres.: Cyril E. Vetter; VP, Gen. & Prof. Mgr.: John Fred.
 R E M Music Publ'rs, 2118 S. 71 St., Philadelphia, Pa. 19142. Tel: (215) 729-4423. Partners: Russell E. & Patricia A. Moore.
 R F D Music Publ'g Co. Inc. (A.S.A.P.), see Peer-Southern.
 R M S Trad Publ'g (ASCAP), 626 P otomac Circle, West Bloomfield, Mich. 48033. Tel: (313) 585-8887, 61-5167. Owner: Bob Szajner.
 Branch: Madison Heights, Mich., 30125 John R. Zip: 48071.
 R S O (The Robert Stogwood Org.), 1775 Broadway, New York, N.Y. 10019. Tel: (212) 975-0700. Telex: 125779. Pres.: Fredric B. Gershon; VP Publ'g: Eileen Rothschild. (Administered by Chappell Music).
 Branch: Los Angeles, Calif., 1335 Sunset Blvd. Zip: 90069. Tel: (213) 650-1234.
 Int'l branch: England.
 Int'l firm represented: Numa Music (UK).
 Rac Racouillat Music Mgmt. Ent's (BMI), 7934 Mission Center Court, Suite B, San Diego, Calif. 92108. Tel: (714) 296-9641. Pres.: Robert Racouillat; Prof. Mgr.: Roger Doyle.
 Radmus Publ'g Inc. (ASCAP), 15 48 St., New York, N.Y. 10017. Tel: (212) 838-8660. Pres.: Hubert Terh-ssen; Gen. Mgr.: Martin R. Feely.
 Rae-Cox & Cooke Music Corp. (ASCAP), 1697 Broadway, Suite 1105, New York, N.Y. 10019. Tel: (212) 586-9406. Pres.: Theodore McRae; VP: Fredia Staton.
 Ragged Island Music (BMI), 4317 Saundersville Rd., Old Hickory, Tenn. 37138. Tel: (615) 847-3895. Pres.: Margaret Lewis; Gen. & Prof. Mgr.: Myra Smith.
 Int'l rep.: Worldwide (EMI in UK).
 Rainbow Road Publ'g, 1212 Bell irmes, Nashville, Tenn. 37207. Tel: (615) 865-0653. Chm.: Glenn Summers.
 Rainlight Music, see MCA.
 Rainy Now Music (ASCAP), see Jerry Lane.
 Rally Music (BMI), see Ralph's Radio Music.
 Ralph's Radio Music (BMI), Hwy 441-23, Demorest, Ga. 30535. Tel: (404) 754-6249.
 Ramms Music (BMI) (div. of Falcon Inc.), 821 N. 23, McAllen, Tex. 78501. Tel: (512) 687-7121. Cable: FALCON. Pres.: A. Ramirez Jr.
 Int'l rep.: Mexico & Latin America (Leo Musical in Mexico).
 Ram's Horn Music (ASCAP), see Big Sky.
 H. & G. Randall Inc. (ASCAP), 9 Elaine Rd., Milford, Conn. 06460. Tel: (203) 878-7383. Pres.: Gerald Randall; VP: Howard Randall; A&R: Bill Bloxson.
 Branches: Middletown, N.Y., 5 Randall Heights. Zip: 10940. Tel: (914) 343-6918--Syracuse, N.Y., 100 W. Genesee St. Zip: 13204. Tel: (315) 468-0161.
 Teddy Randazzo Music Inc. (BMI), 51 W. 86 St., New York, N.Y. 10024. Tel: (212) 873-1800. Pres.: Teddy Randazzo; Gen. & Prof. Mgr.: Hermi Hanlin.
 Ranjack Music (BMI), see 20th Century.
 Fred Raphael Music Inc. (ASCAP), 319 Via Don Benito, Cathedral City, Calif. 92234. Tel: (714) 328-0170. Pres.: Hermione Greene.
 Rare Blue Music Inc. (ASCAP), see Chrysalis Music Group.
 Bill Rase Prod'ns Inc., 955 Ven ure Court, Sacramento, Calif. 95825. Tel: (916) 929-9181. Pres., Gen. & Prof. Mgr.: Bill Rase.
 Rashone Music (BMI), 455 W. f snover St., Trenton, N.J. 08618. Tel: (609) 989-9202. Pres.: Eddie Tone. (Administered by CBS Inc.)
 Rathsmo Music Co. (BMI), see Jameron.
 Raton Songs Inc. (BMI), see Bica.
 Rat Trap Music Publ'g Co. (BM), see 20th Century.
 Raven Music (BMI), 4107 Woodl ind Park Ave. N., Seattle, Wash. 98103. Tel: (206) 632-0887. Pres.: Ronald W. Ellis.
 Rawhide Music Co. (BMI), see Ausic Publ'g Corp.
 Raybird Music Inc. (BMI), 457 f. 57 St., New York, N.Y. 10019. Tel: (212) 245-2299. Pres.: Ray Passman.
 Raydee Music Co. (SESAC), see Glad Music.
 Raydiola Music (ASCAP), PO E xx 5270, Beverly Hills, Calif. 90210. Tel: (213) 857-5517. Prof. Mgr.: Fred S. Moultrie.

Razze Dazzle Music Inc. (BMI), 51 W. 86 St., New York, N.Y. 10024. Tel: (212) 873-1800. Pres.: Hermi Hanlin.
 Real Fine Songs (BMI), see Musicways & 20th Century.
 Rear Window Music (BMI), see Solid Smoke.
 Rebecca Angelina Music (ASCAP)--Pres. Don Cartee--see Alan Cartee.
 Rebel Music (BMI), see Bug Music Group.
 Reborn Music (SESAC), see Glori Gospel.
 Record Junkie (BMI), 9000 Cynthia St., Suite 205, Los Angeles, Calif. 90069. Tel: (213) 275-4790. Co-Pres.: Robert Adels, Topper Schroeder.
 Red Admiral Music Inc. (BMI), see Chrysalis Music Group.
 Red Barn Music Publ'g Co. (BMI), PO Box 84, Strausstown, Pa. 19559. Tel: (215) 488-1782. Pres. Patrick Siczakus; Gen. Mgr.: Mark Rake.
 Branch: Nashville, Tenn., 2204 Elliston Pl. Zip: 37203. Tel: (615) 320-7035.
 Red Cow Music Inc. (ASCAP), see RSO.
 Red Dwarf Music (BMI), 13006 Satucoy St., North Hollywood, Calif. 91605. Tel: (213) 764-1172. Cable: VARSAR. Telex 194449. Pres. Chris Kuch ler.
 Redhead Music (ASCAP), see MizMo.
 Jack Redick Music Publ'g Co. (BMI), Box 85, Rt. 1, Georgetown, S.C. 29440. Tel: (803) 546-7139. Owner: Jack Redick.
 Red River Songs Inc. (BMI), 1001 N. Lincoln St., Burbank, Calif. 91506. Tel: (213) 557-2553. Pres. Dorothy L. Bond; Gen. Mgr.: Sherry Bond; Prof. Mgr.: Ken Rose.
 Red Robn Music Corp. (BMI), see Al Gallico.
 Red Rock Music Co. (BMI), PO Box 2671, Denver, Colo 80201. Tel: (303) 572-9099. Pres. James C. Scott Sr., Gen. Mgr.: Beatrice James; Prof. Mgr.: Sherman Johnson.
 Red Stripe Music (BMI), see Don Williams.
 Red Tennes Music Co. (BMI), 816 N. LaCienna Blvd., Los Angeles, Calif. 90069. Tel: (213) 657-4521. Contacts: Dale Gonyea, Lynette Cimmi.
 Rees Publ'g Group (ASCAP, BMI), PO Box 902, Provo, Utah 84601. Tel: (801) 225-4674. Pres. R. Rees.
 Jim Reeves Ent's Inc., PO Drawer 1, 200 Madison St., Madison, Tenn. 37115. Tel: (615) 868 1150.
 Int'l rep.: Worldwide excluding USA & Canada (Intersong).
 Regal Music Inc. (ASCAP) (div. of Century Recs.), 1429 Hawthorne St., Pittsburgh, Pa. 15201. Tel: (412) 781-4557. Pres.: Edward J. Moschetti, Prof. Mgr.: Gail P. Gray.
 Re-generation Publ'ns (ASCAP), see Chenannah Music.
 Regent Music Corp. (BMI), see Goodman Group.
 Herb Res Music Corp. (BMI), see Summit Music.
 Remembrance Music (ASCAP), see Tiki Ent's.
 Lloyd Zane Remick, 1529 Walnut St., 6th fl., Philadelphia, Pa. 19102. Tel: (215) 568-0509. Pres.: Lloyd Zane Remick; Admin. Asst. Elyce Carter.
 Renda Music Inc. (BMI), 3830 N. Seventh St., Phoenix, Ariz. 85014. Tel: (602) 277-1336. Pres. Floyd M. Ramsey.
 Leon Rene Publ'ns (ASCAP), 2124 W. 24 St., Los Angeles, Calif. 90018. Tel: (213) 737-5125.
 Renleigh Music Inc. (BMI), see Leigh Group.
 Reno/Metz Music Inc. (ASCAP), 9000 Sunset Blvd., Los Angeles, Calif. 90210. Tel: (213) 278-7222. Telex 4720023. Pres. Bob Reno, Gen. Mgr.: Paul Brown, Prof. Mgr.: Paul di Franco.
 Int'l firm represented: RMO Music Ltd (UK).
 Int'l rep.: Worldwide (Artemis in Netherlands).
 Republic Music Corp. (BMI), see World Music.

Resaca Music Publ'g Co. (BMI), see Combine.
 Respect Music Co. (BMI), 1159 S. La Jolla Ave., Los Angeles, Calif. 90035. Tel: (213) 938-3531. Pres.: Miles Grayson, Gen. Mgr.: Peggy Grayson; Prof. Mgr.: Leron Horton.
 Revelation Music Publ'g Corp. (ASCAP), see Tommy Valando.
 Revere Beach Music, see Martin Cohen.
 Revolver Music (ASCAP), PO Box 11321, St. Petersburg, Fla. 33733. Tel: (813) 576-9118. Gen. Mgr.: Charles R. Klump.
 William Rezey Music Co. (BMI), 815 Central Ave., Albany, N.Y. 12206. Tel: (518) 438-3333.
 Rhythm Valley Music (ASCAP), 1304 Blewett St., Graham, Tex. 76046. Tel: (817) 549-1641. Pres. & Prof. Mgr.: Orville Clarda; Gen. Mgr.: Doris Clarda.
 Fred Rice Prod'ns Inc., PO Box 643, 48-780 Eisenhower Dr., LaQuinta, Calif. 92253. Tel: (714) 564-4823. Pres.: Fred Rice, Gen. Mgr.: Robert Rice.
 Jim W. Rice Ent's., 1902 Marcella, Nashville, Tenn. 37217. Tel: (615) 367-4432. Pres. Jim W. Rice.
 Charles Rich Music Inc. (BMI), 8229 Rockcreek Pkwy., Cordova, Tenn. 38018. Tel: (901) 382-2100.
 Ricochet Recs., 8 Pasture Ln., Roslyn Heights, N.Y. 11577. Tel: (516) 621-4307, NYC. Tel: (212) 788-4007. Partners: Andy Marvel, David Hirsch.
 Ridge Runner Publ'g (ASCAP), see Grass Mountain.
 Tim Riley Music (BMI), 5324 Trimmer, Memphis, Tenn. 38119. Tel: (901) 767-6098. Pres.: Tim P. Riley.
 Ripcord Music (BMI), PO Box 2098, Vancouver, Wash. 98668. Tel: (206) 695-2112. Owner & Gen. Mgr.: Blaine H. Allen.
 Rising Sons Music Inc. (BMI), see Combine.
 Rite Music (BMI), 9745 Lockland Rd., Cincinnati, Ohio 45215. Tel: (513) 733-5533. Pres.: Carl J. Burkhardt; VP: Philip Burkhardt.
 Tex Ritter Music Publ'g (ASCAP), see Criterion.
 Riva Music Inc. (ASCAP), 232 E. 61 St., New York, N.Y. 10021.
 Int'l branch: England.
 Int'l firms represented: BRM Publ'g Pty. Ltd. (Australia), Crezent Music Ltd (UK), Dorsimo Music Ltd., GM Music Ltd. (UK), Tartan Music Ltd. (UK), Y-Not Music Ltd. (UK).
 Roadmaster Music Corp. (BMI), see Al Gallico.
 Roadshow Music Group, 425 E. 58 St., New York, N.Y. 10022. Tel: (212) 751-7078. Prof. Mgr.: Nancy Ruchs.
 Roads of Music Publ'g Corp. (BMI), 850 Seventh Ave., New York, N.Y. 10019. Tel: (212) 582-1250. Telex: 428131. Pres.: Niko Joel Anducic; Gen. Mgr.: Aliza Anducic; Prof. Mgr.: Tom Bush.
 Domestic firms represented outside USA: Accabonac Music (BMI), Stormy Forest Prod'ns (ASCAP) (both Austria, Germany, Switzerland).
 Int'l firms represented: Filmkunst Musikverlag GmbH/Intervox Musikverlag GmbH (Germany), Ketchup Music (France).
 Robadon Music (BMI), PO Box 2094, Sheffield Lake, Ohio 44054. Tel: (216) 949-2078. Owner: Robert W. Sellers.
 Marty Robbins Ent's., 713 18th Ave. S., Nashville, Tenn. 37203. Tel: (615) 327-4940/3752. Pres.: Marty Robbins; Gen. Mgr.: James E. Farmer.
 Don Robertson Music Corp. (ASCAP), PO Box 414, Thousand Oaks, Calif. 91359. Tel: (213) 889-0876. Pres.: Don Robertson.
 Int'l rep.: Worldwide except USA & Canada (Chappell-Morris).
 Robin Hood Music Co. (BMI), 5531 Tuxedo Terr., Hollywood, Calif. 90028. Tel: (213) 465-9758. Pres.: John Marascalco; Office Mgr.: Bill Taylor.
 Rob Roy Music Inc. (ASCAP), see President.

Our 50th Year

1931 1981

SESAC

The Sound Of The Future

Rocket Publ'g. 3459 Cahuenga, Los Angeles, Calif 90068. Tel (213) 851 9845.
Int'l branch: England
 Rockmasters Inc (BMI), 317 Granby St., Norfolk, Va. 23510 Tel: (804) 625 3470. 623-5565 Cable: ROCKMASTAS Pres. Frank Guida, Prof. Mgr. R Burns.
Int'l branch: Italy, Gargano/Rockmasters.
 Rockmore Music (BMI), 1733 Carmona Ave., Los Angeles, Calif 90019 Tel (213) 933-6521. Owner & Gen. & Prof. Mgr.: Willie H. Rocquemore; Pres Perry Rocquemore; Sales Mgr.: Jennifer Jayson.
 Rockslam Music (BMI), see Bug Music Group
 Rocky's Ragdoll Publ'g Co. (BMI), 205-A Television Circle, Savannah, Ga. 31406. Tel. (912) 927-1761 Pres: David M. Evans.
 Rodeheaver Co. (ASCAP) (div. of World Inc.), 100 Publishers Dr., Winona Lake, Ind. 46590. Tel (219) 267-5116. Pres: J.W. McCracken; VP: N. Bruce Howe Jr.
 Roger Music Inc. (ASCAP), 449 S. Beverly Dr., Beverly Hills, Calif. 90212. Tel (213) 553 8787. Pres. Joseph S. Shrimman
 Lelan Rogers Music Inc. (ASCAP), see MizMo
 Rohm Music (BMI) (div. of Tro Nossel Artists Inc.), Box 57, 10 George St., Wallingford, Conn. 06492 Tel (203) 265 0010. Pres. Thomas Cavalier; Gen. & Publ'g Mgr.: Edyth L. Mercier.
Int'l rep.: Worldwide excluding US & Canada (Celestial Harmonies)
 Robbiok, 203 Louse Ave., Nashville, Tenn. 37203 Tel: (615) 329-9988 Co Pres. Steve Gibson, Bill Martin, Prof. Mgr. Mark Scott
Int'l reps: Australia (Jonathan), Benelus (Co of the Two P)eters in Netherlands), France (Francis Day), Germany (Hans Gerg), South Africa (Jonathan), Sweden (Sweden Music), UK (EMI)
 Angelo Roman Ent's., Box 813, Valinda, Calif. 91744. Tel (213) 464-1112 Pres. Angelo Roman Jr.
 Romarey Publ'g Co. (BMI), PO Box 6582, Fort Worth, Tex. 76115. Tel: (817) 924-3413. Pres. Cecil Lopez, Gen. & Prof. Mgr.: Stanley George.
 Romona Music (ASCAP), 702 S. 15 St., Newark, N.J. 07013. Pres.: Gloria Black; Gen. Mgr.: Tom Bosco; Prof. Mgr.: Vincent Vallis. (Affiliated with Vado Music).
 Ronarte Publ'ns (ASCAP), 46 E. Herbert Ave., Salt Lake City, Utah, 84111 Tel: (801) 355-5327 Pres. & Gen. Mgr.: Ron W. Simpson.
 Roncom Music Co. (ASCAP), 305 Northern Blvd., Great Neck, N.Y. 11021 Tel: (516) 466-5810.
Int'l branch: England
 Rondor Music Inc., 1358 N. La Brea Ave., Hollywood, Calif. 90028. Tel: (213) 469-2411. Cable: ALPERMOSS. Telex: 691282 TWX. (910) 321-3593
Int'l branches: Australia, Canada, England.
US firms represented outside US & Canada: in Australia—Alchemical Music (ASCAP), Assorted Music (BMI), Bellboy Music (BMI), Big Hill Music (ASCAP), Brantree Music (BMI), Charleville Music (BMI), Concourse Music (BMI), Doors Music (ASCAP), Fifth Floor Music (ASCAP), Four Knights Music (BMI), Fourth Floor Music (ASCAP), Gypsy Boy Music (BMI), Hibiscus Music (BMI), Hollenbeck Music (BMI), Hollywood Allstar Music (BMI), Hummit Music (BMI), India Music (ASCAP), Jasperrilla Music (BMI), Lady Jane Music (BMI), Mburu Music (ASCAP), Medicine Hat Music (ASCAP), Mighty Three Music (BMI), Miles Ahead Music (ASCAP), Modern American Music (ASCAP), Ninth Music (BMI), Pal Dog Music (ASCAP), Pamjoeken Music (ASCAP), Porchester Music (ASCAP), Saggi fire Music (BMI), Boz Scaggs Music (ASCAP), John Sebastian Music (BMI), Shillelagh Music (ASCAP), Three Knights Music (ASCAP), Weather Report Music (BMI), World War Three Music (BMI), in UK—Arnas Music Corp. (ASCAP), David Bateau Music (ASCAP), Brantree Music (BMI), Charleville Music (BMI), Clean Sheets Music (BMI), Doors Music Co. (ASCAP), Dovan Music (ASCAP), Frettsongs, Hollenbeck Music (BMI), India Ink Music (ASCAP), Jasperrilla Music (BMI), Magic Land Music (ASCAP), Miles Ahead Music (ASCAP), Modern American Music (ASCAP), Rosy Publ'g Inc., Saggi fire Music (BMI), Tangerine Music (BMI), Walkin' Fish Music, Weather Report (BMI), X-Ray Music (BMI), in Hong Kong, Malaysia, Singapore & South Africa—Magdalen Music, Others—Bitchin' Guy Music (ASCAP), Catpatch Music (BMI), Crazy Horse Music (BMI), Joycol Music (BMI), Lost Cabin Music (BMI), Red Setter Music (ASCAP), Sacred Heart Music (BMI).
Int'l firms represented in USA: Bluebeard Music, Budgie Music, Creek Publ'g Ltd., Depiford Songs, Dormant Music Ltd., Enismore Music, En voy Music, Fair Music Ltd., Geronimo Music Ltd., Headquarters Artist, Katho Ltd., Macaulay Music, Management Ltd., Manthula Music Ltd., Oval Music, Roker Music Ltd., Secret Songs, Signalgrade Ltd., Silver Star Publ'g, Smudge Music, Straitjacket Songs, Tin Lind Music (all UK).
 Romg Music Co. (ASCAP)—Owner: Adrian Belew—see Sunnyslope.
 Ron-Ken Music (ASCAP), see Petoskey.
 Rontrom Music Co. (ASCAP), 110 21 Ave S., Nashville, Tenn. 37203 Tel (615) 327-1050. Owner Tom Walls.
 Room 7 Music (BMI) (div. of Seven Arts Press), PO Box 649, Hollywood, Calif. 90028 Pres. Walter E. Hurst.
 Roots Music (BMI), PO Box 111, Seabright, N.J. 07760. Pres. Jean Schweitzer; VP: Robert N. Bowden.
 Brian Ross Music (BMI), 3884 Franklin Ave., Los Angeles, Calif. 90027 Tel (213) 662-3121. Pres.: Brian Ross.
 Rothstem Music Ltd., 40 Sutton Pl., New York, N.Y. 10022 Tel: (212) 751 8619. Partners: Elynn & Sharol Rothstem.
 Rotten Music (BMI), see Bug Music Group
 Rough Rider Music (SESAC), see Annextra.
 Rough Trade Inc. (ASCAP), 1412 Grant Ave., San Francisco, Calif. 94133 Tel: (415) 986-3675. Pres.: Alan Strady; Gen. Mgrs.: Ray Farrell, Sharon Martinez; Prof. Mgrs.: Steve Montgomery, Ann Lehman Local branch: 1042 Murray St., Berkeley 94710. Tel: 548-9212
Home office: England.
 Rough Trade Music Ltd. (BMI), see Rough Trade Inc.
 Round Sound Music (BMI), 1918 Wise Dr., Dothan, Ala. 36303 Tel: (205) 794-9067. Pres. Jerry Wise.
 Roundtree Music Publ'g (ASCAP), 5945 Irving St., Philadelphia, Pa. 19139. Tel: (215) 476-8416. Pres.: Allen L. Davis; Gen. Mgr.: Victor Sokoya; Prof. Mgr.: Vince Adams.
 Rout Music (BMI), PO Box 246, Seabright, N.J. 07760. Pres. Robert N. Bowden.
 RowChar Music (ASCAP), 716 W 33 St., San Pedro, Calif. 90731 Tel: (213) 833-1233. Pres.: John Rowin; Gen. Mgr. Charlotte Politte
 Royal K Music, see Musique de Soleil.
 Royal Spin Music Inc. (BMI), 26 Cass Pl., Brooklyn, N.Y. 11235 Tel (212) 743-3709. Pres.: Nat Margolis, VP: William Rizzo.
 Royal T Music (ASCAP), PO Box 946, Springtown, Tex. 76082 Tel (817) 433-5720. Pres. James Michael Taylor; Gen. Mgr.: Barbranne Taylor; Prof. Mgr.: Peggy Souix.
Branch: Portland, Ore., 626 NE 109 Ct Zip 97220 Tel (503) 254-5828 VP: James L. Taylor.
 Rubank Inc. (ASCAP), 16215 NW 15 Ave., Miami, Fla 33169 Tel: (305) 625 5323.
 Rubicon Music (BMI), 8319 Lankershim Blvd., North Hollywood, Calif

91605 Tel: (213) 875 1775 Pres. Freddie Piro, VP & Gen. Mgr. Ms. Teri Piro, Prof. Mgr. Dan Howell.
 David Rubinson & Friends Inc., 827 Folsom St., San Francisco, Calif 94107 Tel (415) 777 2930 Telex: 340116 Pres. David Rubinson, Prof. Mgr. Kathi Horton
 Ru-Dot To Music (BMI), see Derby
 Rumbin' Songs (BMI), PO Box 84, Peoria, Ill. 61650. Tel (309) 674-5685 Contact: Todd Waddell.
 Runaway Inflation Music (BMI), see 20th Century
 Frank Russell Music (ASCAP), 170 Linwood Ave., Paterson, N.J. 07502. Tel (201) 595-7557 Pres. & Gen. Mgr.: Frank Russell, VP Margaret Rug gero; Prof. Mgr.: Tommy Russell.
 Rustron Music Prod'ns (BMI), 200 Westmoreland Ave., White Plains N Y 10606. Tel: (914) 946-1689. Pres. Rusty Gordon. Gen Mgr.: Ron Caruso, Prof. Mgrs.: Rusty Gordon, Ron Caruso.
Branch: Arcadia, Calif., Rustron Music West, 2804 S. Baldwin Ave Zip 91006. Tel: (213) 446-5855 Gen. & Prof. Mgr.: Mike Cohen.
Int'l firm represented: Sono Ent Rec Co. (Columbia)
Int'l reps.: Central & South America, Mexico, Spain (Alhambra Int'l in USA).
 Charles Ryckman Music Publ'g & Sales Co. (ASCAP, BMI), 7966 SW Seventh Court, North Lauderdale, Fla 33068 Tel (305) 721 7907 Pres. Charles G. Ryckman.
S
S & R Music Publ'g Co. (ASCAP), 39 Belmont, Rancho Mirage, Calif. 92270 Tel (714) 346 0075 Owner Scott B Seely, Promo & Opts. Mgr. Dolores Gulden
S U K I Music (BMI), see JEDO
S V O Music (ASCAP), see Reno/Metz
 Sabal (ASCAP), 1722 West End Ave., Nashville, Tenn. 37203. Tel: (615) 327 4104 Pres.: Mel Tillis; Prof. Mgr.: Jimmy Darrell.
 Saber Tooth Music (BMI), see Scotti Bros.
 Saddlebag Music (BMI), see Indian Summer.
 Salfmar Publ'g Co. (BMI), PO Box 978, Mooresville, N.C. 28115. Tel (704) 663-4892. Pres. Gen. & Prof. Mgr.: Jack Safrit.
 Sage & Sand Music (SESAC), see Music Publ'g Corp.
 St. Cecilia Music (BMI) (div. of Parallel Recs. & Tapes), 1414 Summit Ridge Dr., Beverly Hills, Calif. 90210 Tel (213) 858-5913, 477-3651 Pres. Larry A Weir; Gen. Mgr. Robert M. Harrison, Prof. Mgr. Tom W. Weir.
St. Francis Music Co. (BMI), see Derry
St. Nicholas Music Inc. (ASCAP), 1619 Broadway, New York, N.Y. 10019 Tel: (212) 582-0970. Pres.: Johnny Marks
 Saka Music Co. (BMI), 5937 Ravenswood Rd., Bldg. H-11, Fort Lauderdale, Fla 33312. Tel: (305) 456-0847 TWX (510) 954-9798 Pres. Eugene Seltzer; Gen. Mgr.: Ruth Gamba
 Salsoul Music Publ'g Corp. (ASCAP), 401 Fifth Ave., New York, N.Y. 10016 Tel (212) 889 7340 Telex: 236464 Pres. Joseph Cayre, Admin'r Larry Spier
Int'l reps: Argentina (Relay), Australia & New Zealand (Ivan Mogull), Belgium (Roba), Canada (Sunbury/Dunbar), France (Belwin Mills), Italy (Pana), Japan (Ivan Mogull), Mexico (EDIM), Netherlands (Roba), Portugal (RCA), Scandinavia (Aur), South Africa (Musicprece), Spain (RCA), UK (ATV)
Same Old Music Publ'g (BMI), PO Box 622, Orangevale, Calif. 95662 Tel: (916) 726-4816. Pres. John Roberts; VP: James Chalmers
Sam Vox Music Inc. (ASCAP), see President
Sand Island Music Co. (BMI), PO Box 688, Eugene, Ore. 97440 Tel: (503) 686-0779. Pres.: Kathy L. Wasanen; Gen. & Prof. Mgr.: Joel King.
Sandman Music Publ'g Co. (ASCAP), 6 Morris Ave., Montville, N.J. 07045 Tel (201) 334-0863. Prof. Mgr. Sandy Nelson.
Sands Music Corp. (ASCAP), see Barton Music.
Sandy Springs Music (ASCAP), see Bowman.
Sanga Music Inc. (BMI), 250 W 57 St., Suite 2017, New York, N.Y. 10019 Tel: (212) 586-6553. Cable: LEMANAG. Pres.: Harold Leventhal; Gen. Mgr.: Joy Graeme
Sangre Prod'ns Inc. (ASCAP), 9844 Business Park Dr., Sacramento, Calif 95827. Tel: (916) 361-3652. VP: Mary Neely; Exec. Coord.: Jan Eric Volz. San Juan Avenue Music, 8909 W Olympic Blvd., Beverly Hills, Calif. 90211 Tel: (213) 657 8795
San-Lyn Music (BMI), Box 46, Colvyn Sta., Syracuse, N.Y. 13205. Gen. Prof. Mgr.: Jack Swanson
Sanskrit Publ'g Co. (ASCAP), 4120 Excelsior Blvd., Minneapolis, Minn 55416. Tel: (612) 920-9590
Santa Gertrudis Music (BMI), see Trinity.
Sapphire Music Publ'g, 2815 Octavia St., New Orleans, La. 70115. Tel: (504) 866 3478, 340-4068. Pres. Lou Welsch Jr.; Prof. Mgr. Sandy Terry.
Sara Lee Music Publ'g Co. (BMI), see Chris
Saran Music Co. (BMI), PO Box 17667, Dallas, Tex. 75217 Tel: (214) 428-3128. Pres.: Dewey Groom
Sashay Music Inc. (ASCAP), see Morris Music & Chappell
Satchitananda Publ'g (BMI), PO Box 891, Hendersonville, Tenn. 37075. Tel (615) 865 1641. Pres.: David A. Hoffman
Satrycon Music (BMI), PO Box 75692, Los Angeles, Calif. 90075 Tel: (213) 656-0982. Owner: David Austin.
Satsong Music (ASCAP), PO Box 720636, Atlanta, Ga. 30328 Tel: (404) 393-4640. Contact: Steve Ray.
Satsuma Music (BMI), see Big Heart.
Saul Avenue Publ'g Co. Inc. (BMI), see Hal-Nat.
Savoy Music (BMI), 342 Westminster Ave., Elizabeth, N.J. 07208. Tel: (201) 351-6800. VP & Gen. Mgr.: Fred Mendelsohn; Office Mgr.: Helen Gottesmann.
Sawgrass Music Publ'ns Inc. (BMI), 1722 West End Ave., Nashville, Tenn. 37203. Tel: (615) 327 4104 Pres. & Gen. Mgr.: Lonnie M Tillis, Prof. Mgr.: Jimmy Darrell
Scales of Justice Music Inc. (BMI), PO Box 2609, 119 1/2 E Main St., Lafayette, La 70502 Tel: (318) 235 3587 Pres. J. Michael Fernandez
Scarlett Stallion Music (BMI), see Rees
Schabraf Music (BMI) (div. of Bee Jay Booking Agency & Rec'g Studios Inc.), 5000 Eggleston Ave., Orlando, Fla. 32810 Tel (305) 293 1781. Pres Eric T. Schabacker; VP & Gen. Mgr. James A. Katt
Schaum Publ'ns Inc. (ASCAP), 2018 E. North Ave., Milwaukee, Wis 53202 Tel (414) 276 9984 Pres. John W. Schaum; VP & Gen. Mgr.: Wesley Schaum.
Int'l rep.: England & Germany (Bosworth).
Schiffman Music Co. (BMI), 9200 Sunset Blvd. No. 620, Los Angeles, Calif 90069 Tel: (213) 550-0200.
Int'l reps: France (Marouani), Germany (Messel), Japan (Taiyo), Spain (Hisparov)
David Schine & Co Inc., 626 S. Hudson Ave., Los Angeles, Calif. 90005. Tel (213) 937 5000 Pres. G. David Schine; Gen. Mgr.: Berndt Schine.
E C Schirmer Music Co. (ASCAP)/Ione Press Inc. (BMI), 112 South St., Bos

ton, Mass 02111 Tel (617) 426 3137 Cable: SCHIRMUOCO Pres. Rob ert Mac Williams, Gen. Mgr. Pauline Delaney
Sole selling agent for: American Muscological Society Eds. American Recorder Society Eds. Columbia Univ Music Press, Galaxy Music Corp., Highgate Press (all USA), Camera Music, London Pro Musica Eds., Nova Music, Stainer & Bell, Yorke Ed (all UK), Edition Delreux (France), Les Eds. Ouvrieres (France), Edition Feuchling (Switzerland)
Int'l rep.: British Commonwealth excluding Australia, Canada & New Zealand; Europe & South Africa (Richard Schauer in UK)
G Schirmer Inc. (ASCAP), 866 Third Ave., New York, N.Y. 10022 Tel (212) 935 5100 Pres. Edward Murphy; Prof. Mgr. Howard Scott; Adv. Mgr. K Handel.
Subsidiary Co.: Associated Music Publ'ns Inc
Int'l firms represented: Anton Benjamin (UK), Bote & Bock (Germany), Breitkopf & Haertel (Germany), J. Curwen & Sons (UK), Ludwig Doblinger (Austria), Enoch & Cie. (France), Eds Max Eschig (France), F.E.C. Leuckart (Germany), Faber Music Ltd (UK), Mezhunarodnaja Kniga (USSR), Musikverlag Zimmermann (Germany), Adolph Nagel (Germany), D. Rahter (UK), G. Ricordi (France, Germany, Italy, South America), Eds Salabert (France), R. Schauer (UK), Hans Sikorski (Germany), N. Simrock (UK), Union Musical Espanola (Spain), VAAP (USSR)
Schroder Music Co. (ASCAP), 2027 Parker St., Berkeley, Calif. 94704 Tel (415) 843-2365 Owner, Nancy Schimmel, Mgr. Ruth Burnstein.
A Schroeder Int'l Ltd., 200 W 51 St., New York, N.Y. 10019 Tel (212) 582-8995 VP & Gen. Mgr. Beldeon Fortunato
Andrew Scott Inc. (ASCAP), see Leigh Group
G Scott Music Publ'g Co. (ASCAP), 345 S Citrus Ave., Los Angeles, Calif 90036 Tel (213) 939 3630 Owner James I Lester
Scotti Bros Music Publ'g, 2114 Pico Blvd. Santa Monica, Calif. 90405 Tel (213) 450-3193 TWX (910) 490 2638 Pres. Tony Scott, VP & Gen. Mgr. Kim Espy, Admin. Dir. Carole Standford
Scott Music Publ'ns (ASCAP), PO Box 148, Hollywood, Calif. 90028 Tel (714) 992-1522. Pres.: Scott Fredrickson, Gen. Mgr. Debra Kuehn (Dis tributed by Alfred Publ'g)
Screen Gems-EMI Music Inc. (BMI), 6255 Sunset Blvd., Hollywood, Calif 90028. Tel (213) 469-8371. Pres. Lester Silf, VP Admin: Jack Rosner, VP & Prof. Activities Dir. Paul Tannen
Branches: New York, N.Y., 1370 Ave of the Americas, Zip: 10019 Tel (212) 489-6740—Nashville, Tenn., 1207 16 Ave S Zip 37212 Tel (615) 320 7700.
Int'l branches: England, Germany, Italy, Sweden
Int'l reps: France (Eco), Japan (Toshiba-EMI)
Screen Test Music Publ'g Co. (ASCAP), see Slide
Scribble Music (BMI), see Bug Music Group
Scrunge Music (BMI), 8947 Alton St., Philadelphia, Pa. 19115 Tel (215) 671-1590 Pres. & Gen. Mgr. Larry Feldman
Scully Music (ASCAP)/Orange Bear Music (BMI), 800 S Fourth St., Phila delphia, Pa. 19147 Tel (215) 755 7000 Pres. Walter B. Kahn, VP Lisa Sable
Seabreeze Music Co. (BMI), see Rex Zario
Seacoast Music Publ'g Co Inc. (BMI), 1440 79th St. Causeway, Suite 301, Miami Beach, Fla. 33141 Tel (305) 861 2181 Co Pres. Hal Fen, Robert Uhlmann, Prof. Mgr. Linda Sperber
Int'l rep.: Worldwide (Intersong Int'l)
Seaford Music (BMI), PO Box 42338, San Francisco, Calif. 94101 Tel (415) 821-7311 Dir. Barry Melton
Int'l reps: Austria (Rolf Budde), France & SACEM territories (Robinsong), Germany (Rolf Budde), Italy (Suono), Japan (Harry Fox), Netherlands (Anagon), Scandinavia (Sonet), Switzerland (Rolf Budde), UK & Com monwealth (Chrysalis)
Seasun Experience Music Prod'ns (ASCAP), PO Box 1725, Daytona Beach, Fla. 32015 Tel: (904) 255 4891/1401:354 Owner & Prof. Mgr. Thomas P. Brown.
John Sebastian Music (BMI), c/o Mitchell, Silberberg & Knupp, 1800 Cen tury Park E., Los Angeles, Calif. 90067 Tel (213) 553 5000. Cable: SIL MITCH. Telex: 691347.
Frank Sechm Music (BMI), see Bug Music Group
Second Wind Music (BMI), see Bug Music Group
Seet Music (BMI), see Bug Music Group
Sei Sedaka Music Publ'g, 1370 Ave of the Americas, New York, N.Y. 10019 Tel (212) 586 5712
See Johnny Run Songs (BMI), see Bug Music Group
Seesaw Music Corp. (ASCAP), 2067 Broadway, New York, N.Y. 10023. Tel (212) 874-1200 Pres. & Prof. Mgr. Raoul R. Ronson, Gen. Mgr. S.B. Kohn.
Int'l firm represented: Tonos (Germany)
Segel & Goldman Inc., 9348 Santa Monica Blvd., 2nd fl., Beverly Hills, Calif 90210 Tel (213) 278 9200 Pres. Ralph Goldman, Gen. Mgr. Paul Gi gery
Sidney A. Seidenberg Music Ltd., 1414 Ave. of the Americas, New York, N.Y. 10019 Tel (212) 421 2021 Cable: SAS TALENTS Telex: 128285 Pres. Sidney A. Seidenberg, Gen. Mgr. Floyd Lieberman
Int'l rep.: Worldwide excluding Australasia, Canada, UK & USA (Ivan Mo gull).
Ralph L. Seltzer Inc., c/o Oak Great Vineyard, 1751 Draper Valley Rd., Selma, Ore. 97538. Tel: (503) 597-2161 Cable: MUSICWORLD. Pres. Ralph L. Seltzer, Gen. Mgr. Carla Batoletti
Int'l branches: Australia, England, Germany, Spain
US firms represented: Barcam, Paddle, Rollin' Rock, Ron Wesser
Int'l firms represented: Budding (UK), Dinsong (UK), Franton (Italy), Matthews Music (Australia & New Zealand), OctoArts (Philippines), Pa cifico (Mexico), Quiroga (Spain & Portugal), Regents Park (UK), Reveille (South Africa), STS Music Int'l (Germany, Austria, Switzerland), Sha fer (UK), TC Music (Brazil), Victor (Japan), Virgin (UK)
Semerak Publ'g Co. (BMI), 4327 S Sacramento Ave., Chicago, Ill. 60632 Tel (312) 523 3914 Pres. R.M. Semerak
Senor Music (ASCAP), see Garrett
Seph Music (BMI), see 20th Century
September Music Corp. (ASCAP), 250 W 57 St., Suite 1916, New York, N.Y. 10019 Tel (212) 581 1338 Cable: MILLSTAN Pres. Stanley Mills
Int'l firms represented: Groyenoco Music (UK), Hush Music Ltd (UK), Robert Kingston (UK)
Serveca Music (BMI)—Owner Crest T. McNeill, see Keristene
Sesco Music (BMI), 1572 Park Ceres Court, San Jose, Calif. 95118. Tel (408) 265-2008 Gen. Mgr. David Sesanak.
Sesco Songs (ASCAP), see SESCO Music
Seven Figure Music Corp. (ASCAP), see Al Gallico
Seven Hills Publ'g Co Inc. (BMI), 905 N Main St., Evansville, Ind. 4771 Tel (812) 423-1861. Pres. Ed Kretemeyer, Gen. Mgr. P.J. Hayden.
Seven Of Us Music (BMI), 26 Mountain Ave., Dover, N.J. 07801. Tel: (201) 361-2084 Pres. Michael F. Matlusow Sr.
Seyah Music (BMI), 1227 Spring St., NW, Atlanta, Ga. 30309. Tel: (404) 873 6425. Pres.: Barbara H. Richardson.
Shade Tree Music Inc. (BMI), PO Box 500, Bella Vista, Calif. 96008. Tel

(916) 241-9020. Pres. & Prof. Mgr.: Merle Haggard; VP: Bob Whitson.
Int'l rep.: Worldwide excluding USA & Canada (Southern).
 Shadow Fax Music (BMI), see DJ Music Group.
 Shaftsbury Music Ltd., see MAM.
 Shamba Publ'g Co. (BMI), 254 E. 9 St., Suite 7, Los Angeles, Calif. 90011.
 Tel: (213) 746-6499. Pres.: D. H. Hookey III.
 Cyril Shane Music Inc. (ASCAP), 2922 Killion, Woodland Hills, Calif. 91367.
 Tel: (213) 340-8016. Pres.: Cyril Shane.
Int'l branch: England.
Int'l firms represented: Kings & Sons Ltd., Pedro Music Ltd., Super-songs Ltd. (all U.K.).
Int'l rep.: Australasia (Allans Music in Australia), Germany, Austria & Switzerland (Melodie der Welt), South Africa (Gallo).
 Shapiro Bernstein & Co. Inc. (ASI AP), 10 E. 53 St., New York, N.Y. 10022.
 Tel: (212) 751-3395. Cable: BIRNSTEIN. Pres.: Richard M. Voltter, Exec. VP: Leon J. Brettler, Prof. Mgr.: Casey Del Casino.
Int'l branch: England.
Int'l rep.: Australia (Wallaby).
 Eddie Shaw Music Corp. (ASCAP) see Barton Music.
 Shawnee Press Inc. (ASCAP) (div. of Waring Enters. Inc.), Delaware Water Gap, Pa. 18327. Tel: (717) 476-0530. Chief Exec. Officer: Fred Waring Jr.; Pres.: Fred Waring; Sales Mgr.: Sam DeRenzi; Licenses Dir.: Steve Kan ych.
 Sheffield Music Corp. (BMI), see Shapiro Bernstein.
 Shekere Music (BMI), 2218 Rowwood Ave., Richmond, Va. 23220. Tel: (804) 355-3586. Pres.: Plunk' Nkabinde; VP & Gen. Mgr.: James Gray; Prof. Mgr.: Sylvia Potts.
 She-La-La (SESAC), see Derby.
 Sheli Music Publ'g Corp. (BMI). Pres.: James Castor—see Jimpre.
 Sheljac Music (BMI), see Bug Music Group.
 Shelton Assocs. (BMI), 2250 Bryl Mawr Ave., Philadelphia, Pa. 19131. Tel: (215) 477-7122. Pres.: George Guess; Gen. Mgr.: Ted Brown; Prof. Mgr.: Richard Jackson.
 Sheview Publ'ns Co. (BMI), 4145 S. King Dr., Chicago, Ill. 60653. Tel: (312) 624-8060. Pres.: James W. Shelton Jr.
 Shemesh Music (SESAC), see M ylfower Music.
 Shenandoah Music (ASCAP), see Terrace.
 Shepherd's Fold Music (BMI)—see: Darrell Harris—see Dawn Treader.
 Sheri Glen Publ'ns Inc. (BMI), 1116 Alford Ave., Birmingham, Ala. 35226.
 Tel: (205) 823-5602. Pres.: B.cky Davis; Gen. & Prof. Mgr.: William Fowler.
 Sherylly Publ'g Co. (BMI), 495 S. 10 Court, Hialeah, Fla. 33010. Tel: (305) 888-1685.
Admin. branch: New York, N.Y., 65 E. 55 St., Suite 604. Zip: 10022. Tel: (212) 752-0160.
Int'l rep.: Worldwide (CBS Int'l in USA).
 Sherman Oaks Music (BMI), see Combine.
 Shidel Music (BMI), see Bug Music Group.
 Shindler & Assocs. Inc. (ASCAP) see Shindler Music.
 Shindler Music Co. Inc. (BMI), P. Box 381585, Memphis, Tenn. 38138. Tel: (901) 685-2321. Pres.: Robert Shindler; Gen. Mgr.: Tom Jones III; Prof. Mgr.: Laura Shindler.
 Shoals Music Mill Publ'g Co. (ASCAP), see Alan Cartee.
 Shoesongs (ASCAP), see Bug Music Group.
 Shoetunes (BMI), see Bug Music Group.
 Troy Shondell Music (SESAC), P. Box 292, 450 Jefferson Park Mall, Huntington, Ind. 46750. Tel: (219) 356-3964. Pres.: Troy Shondell; Gen. Mgr.: Carol Schelton; Prof. Mgr.: James E. Chovanec.
 Short Pump Assocs. (BMI), PO Box 11292, 1901-E N. Hamilton St., Richmond, Va. 23230. Tel: (804) 355-4117. Contact: Dennis Huber.
 Short Rose (ASCAP), see Songs of the Southland.
 Shotgun Music Co. (BMI), 22 Pitt St., Freeport, N.Y. 11520. Tel: (516) 546-8008. Pres.: Anthony Ferran; Prof. Mgr.: Bill Seabrook.
Int'l rep.: Worldwide excluding USA & Canada (Burlington in UK).
 Show Biz Music Group, 110 21 Ave. S., Nashville, Tenn. 37215. Tel: (615) 327-0514. Pres.: Reg Dunlap.
 Shownote Music Co., see Show note.
 Showoff Publ'g Co., see Showpiece.
 Showpiece Profl'ns (BMI), PO Box 19, Main St., Yonkers, N.Y. 10702. Tel: (914) 965-0801, 968-5949. Pres.: Robert B. Schoen.
 Showtime Publ'g Co. (BMI), PO Box 40074, Washington, D.C. 20016. Tel: (202) 397-6952. Pres.: Charles A. Ables; Gen. Mgr.: Berch L. Salles.
 Shtup City Publ'g (ASCAP), 16 eel, Suite 1, Marina Del Rey, Calif. 90291. Tel: (213) 392-2497. Pres.: Rebecca Dru.
 Sidmal Publ'g (ASCAP), see Til al Publ'g.
 Siggy Music (BMI), see 20th Century.
 Sight & Sound Int'l Inc., PO Box 27, 3200 S. 166 St., New Berlin, Wis. 53151. Tel: (414) 784-5850.
Int'l branch: Netherlands.
 Jerry Sikorski Music (BMI), see Bug Music Group.
 Silhouette Music Corp. (ASCAP), see The Herald Ass'n.
 Silicon Music Inc. (BMI), 222 T. lane St., Garland, Tex. 75043. Pres. & Gen. Mgr.: Gene & Dea Summer.
Int'l rep.: France (Big Beat Netherlands (Collector Recs.)), Switzerland (Lake County), UK (Red Ho /Blue Cat).
 Silk Purple Music (BMI), 1516 Oak St., Alameda, Calif. 94501. Tel: (415) 865-2040. Owner: Michael Logan.
 Silver Blue Music Ltd. (ASCAP) 220 Central Park S., New York, N.Y. 10019. Tel: (212) 586-3535.
 Silverhill Music (BMI), PO Box 19439, Los Angeles, Calif. 90039. Tel: (213) 663-8073. Exec. Ass't: Paul F. Wells.
 Silver House Music Co. (ASCAP), see 20th Century.
 Silverline Music Inc. (BMI), 321 Rockland Rd., Hendersonville, Tenn. 37075. Tel: (615) 824-7273. Pres.: Duane Allen; Gen. & Prof. Mgr.: Noel Fox. Local branch: 1019 17 Ave. S. Zip: 37212. Tel: 327-4815.
 Silver Music (ASCAP), see Bla chrs.
 Silver Nightingale Music (ASCAP), 2165 Benecia Ave., Los Angeles, Calif. 90025. Tel: (213) 556-1721 (714) 436-1051. Pres.: Joan Nemour; Gen. Mgr.: Virginia Healy; Prof. Mgr.: Sidney Bulkin.
Int'l firm represented: Petr'rbill Music (Canada).
Int'l rep.: Australia & New ealand (Matthews in Australia), Benelux (Intersong Basart), Germany (STDS), Mexico (Latino Americana), Scandinavia (Air Music in Sweden).
 Silver Soul Music (BMI), see ombine.
 Silverstone Music (ASCAP), see Heartstone.
 George Simon Inc. (ASCAP), 2147 Sunshine Circle, Palm Springs, Calif. 92262. Tel: (714) 327-446. Pres.: George Simon.
 Paul Simon (BMI), 36 E. 61 St., New York, N.Y. 10021. Tel: (212) 751-6590. Gen. Mgr.: Ian Hoblyn.
 Simply Great Music (BMI), see Plain Great.
 Singing River Publ'g Co. Inc. (MI), 205 Acacia St., Biloxi, Miss. 39530. Tel: (601) 436-3927. Pres.: Mar on Carpenter; Gen. Mgr.: Winona Carpenter; Prof. Mgr.: Lee Carpenter.
 Singin' Suite Music (SESAC)—see Palton Rogers—see Buchhorn.

Shelby Singleton Music Inc. (BMI), 3106 Belmont Blvd., Nashville, Tenn. 37212. Tel: (615) 385-1960. Cable: SHELREC. Pres.: Shelby S. Singleton Jr.; VP & Gen. Mgr.: John A. Singleton; Prof. Mgr.: Sid Singleton.
Int'l rep.: Australia (Festival), Austria (Belver), Belgium (Basart), France (Pathe-Marconi), Germany (Belver), Japan (Pacific), Netherlands (Basart), Portugal (Canciones del Mundo), South Africa (Clan), South America (Odeon), Spain (Canciones del Mundo), Sweden (Sweden Music), Switzerland (Belver), UK (Sonet).
 Singletree Music Co. (BMI), see Music Publ'g Corp.
 Sing Me Music Inc. (ASCAP), 501 Chesterfield Ave., Nashville, Tenn. 37212. Tel: (615) 297-0024. Pres.: Jean Zimmerman; Prof. Mgr.: Mary Louise Smith.
 SingSpration Inc. (ASCAP) (div. of The Zondervan Corp.), 1415 Lake Dr. SE, Grand Rapids, Mich. 49506. Tel: (616) 459-6900. Pres.: Peter Kladder Jr.; Exec. VP: John S. Helder.
Branch: Dallas, Tex., Stamps Baxter Music Co., 201 S. Tyler, Zip: 75208. Tel: (214) 943-1155. Gen. Mgr.: Wilford Roach.
 Sing Sweeter Music (BMI), see The Matthes Co.
 Siren Songs (BMI), c/o Loeb & Loeb, 10100 Santa Monica Blvd., 22nd Fl., Los Angeles, Calif. 90067. Tel: (213) 552-7783.
 Sirloin Music Publ'g (BMI), 14045 S. Main, Suite 303, Houston, Tex. 77035. Tel: (713) 641-0793. Pres.: Roger L. Cummings; Gen. Mgr.: Steve Cummings; Prof. Mgr.: Robert Jackson.
 Sir Winston Music (BMI), see Nashville Int'l.
 Sivatt Music (BMI), PO Box 7172, Greenville, S.C. 29610. Tel: (803) 269-3961. Pres.: Jesse Eavate.
 Six Continents Music Publ'g Inc. (BMI), see Arista-Interworld.
 Skafish Music (BMI), see Cameron.
 Ski-Cat Music (BMI), see Garrett.
 Skidmore Music Co. Inc. (ASCAP), see Shapiro Bernstein.
 Jimmie Skinner Music Publ'g (BMI), 5825 Vine St., Cincinnati, Ohio 45216. Tel: (513) 242-8000. Pres.: Lou Ukelson.
 Skinny Zach Music Inc. (ASCAP), 6430 Sunset Blvd., Suite 1104, Los Angeles, Calif. 90028. Tel: (213) 461-2988. Pres.: Zach Glickman.
Int'l rep.: France (Criterion), Germany (Toledo), UK (Cyril Shane).
 Skip Jack Music (BMI), see Mimic.
 Skyhill Publ'g Co. Inc. (BMI), 6525 Sunset Blvd., Hollywood, Calif. 90028. Tel: (213) 469-1285. TWX: (910) 321-4342. Pres.: Denny Corfield; Gen. Mgr.: Gary Heaton; Dir.: Lionel Conway; Admin.: Pat Shannahan.
Int'l rep.: Australia (Phil Matthews), Austria (ERP), Belgium (Hans Kusters), Brazil (Fermata), France (Warner Bros.), Germany (ERP), Greece (Blackwood), Italy (Franton), Japan (Shinko), Mexico, Central & South America (EMILAS), Netherlands (New Daylong), South Africa (Gallo), Sweden (Sonet), Switzerland (ERP), UK (Virgin).
 Skyway Music Publ'g (BMI), PO Box 133, Hollywood, Calif. 90028. Owner: Everett L. Whenham.
 Slambeat Music (BMI), see Trinity.
 Slap Shot Music (BMI), see Don Williams.
 Slash Music, 7381 Beverly Blvd., Los Angeles, Calif. 90036. Tel: (213) 937-4660. Pres.: Robert Buggs.
 Sleepy Hollow Music Co. (ASCAP), PO Box 7, Swannanoa, N.C. 28778. Tel: (704) 686-3235. Pres.: Billy Edd Wheeler.
Branch: Los Angeles, Calif., c/o Magic Touch Music, 9134 Sunset Blvd. Zip: 90069. Tel: (213) 273-6580—Nashville, Tenn., 508 Whispering Hills. Zip: 37211. Tel: (615) 883-3170. Prof. Mgr.: Linda S. Dotson.
 Slide Music Publ'g Co. (ASCAP) (div. of McKinnon Recs. Co.), PO Box 691, Reading, Pa. 19601. Tel: (215) 372-7361. Pres.: Leonard McKinnon.
Int'l rep.: Argentina (Julio Korn), Australia (Allans), Austria (Ludmilla), Belgium (Disco), Brazil (Copacabana), Canada (Jendate), Chile (Fermata), Denmark (Winkler), Finland (Coda), Germany (Paul C. Arends), Greece (Anon), Ireland (Segway), Israel (Israeli Music Publ'ns), Japan (Crown), Switzerland (Belmont), Sweden (Globe), UK (Cyril Shane, Soul-sational Sounds).
 Skmbull Music (BMI), see Brum.
 Slingshot Music (BMI) (div. of TRC Corp.) c/o TRC Mid-America Rec'g Center, 1330 N. Illinois St., Indianapolis, Ind. 46202. Tel: (317) 638-1491.
 Slippery Jack Song Co. (ASCAP), see Skip Taylor & Bug Music Group.
 Slow Dancing Music Inc. (BMI), see Buttermilk Sky.
 M. Lynwood Smith Publ'ns (SESAC), Rt. 1, Box 151, Wesson, Miss. 39191. Tel: (601) 833-2560. Owner & Mgr.: M. Lynwood Smith.
 Smokin' Joe Music (BMI), see Bug Music Group.
 Smooth Sailing Music (ASCAP), see NBC.
 Smorgaschord Music Co. (ASCAP)—Owners: Rob Fetters, Bob Nyswonger—see Hal Bernard.
 Snake Dance Music (BMI), see Bug Music Group.
 Snarky Fred Music (BMI), see Bug Music Group.
 Snoopy Music (BMI) (div. of Graveline Ent's. Inc.), 1975 NE 149 St., North Miami, Fla. 33181. Tel: (305) 940-6999. Pres.: Dave Graveline; Exec. VP: Jim Rudd.
Branch: Coconut Grove, Fla., 3156 Grifford Ln. Zip: 33133. Tel: (305) 448-2735.
 Snow Music (BMI), c/o Jess S. Morgan & Co., 6420 Wilshire Blvd., Los Angeles, Calif. 90048.
 Society for the Publ'n of American Music (ASCAP), see Theodore Presser.
 Sakit Music (BMI), 455 N. Snyder Rd., Dayton, Ohio 45427. Tel: (513) 854-2797. Pres.: Al Freeders.
 Solar Plexus Music (BMI), see Mayflower Music.
 Solar Recs. Inc. (div. of Mystic Recs.), 6277 Selma Ave., Hollywood, Calif. 90028. Tel: (213) 464-9667. Pres.: Doug Moody.
 Solar Systems Music (ASCAP), 441 E. 20 St., New York, N.Y. 10010. Tel: (212) 674-1143. Pres.: Sheila Davis; Prof. Mgr.: Hal Zachary.
 Sola Scriptura Songs (BMI) (div. of Ark Recs.), PO Box 230073, Tigard, Ore. 97223. Tel: (503) 620-5680.
 Solid Smoke Songs (ASCAP), PO Box 22372, San Francisco, Calif. 94122. Tel: (415) 731-0500. Contact: Marty Arbunich.
 Solo Music Inc. (ASCAP), 4708 Van Noord Ave., Sherman Oaks, Calif. 91423. Tel: (213) 762-2219. Pres. & Gen. Mgr.: Paul Mills.
 Some Other Music (ASCAP), see Bug Music Group.
 Somerset Press (ASCAP), see Hope.
 Somerset Songs Publ'g Inc. (ASCAP), see Evansongs.
 Something Else Music Co., 917 Silvermine Rd., New Canaan, Conn. 06840. Tel: (203) 966-7078. Pres.: Sture A. Linds.
 Henry J. Sommers (ASCAP), PO Box 322, Silver Spring, Md. 20907. Tel: (301) 946-9039. Owner: Henry J. Sommers (SEE ADVERTISEMENT).
 Somor Music (BMI), see Bug Music Group.
 Son Deane Publ'ns (ASCAP), Hartsdale, N.Y. 10530. Tel: (914) 693-1590. Pres.: Howard Deanto; Gen. Mgr.: Craig Deanto; Prof. Mgr.: Sondra Deanto.
 S'one Songs (BMI), 10101 Woodlake Dr., No. M., Cockeysville, Md. 21030. Tel: (301) 628-7357. Gen. & Prof. Mgr.: George Irlman.
 Song America, see Hiding.
 Song Farm Music (BMI), PO Box 24561, Nashville, Tenn. 37202. Tel: (615) 242-1037. Pres.: Tom Pallardy; Gen. Mgr.: Jo Pallardy.
 Songfest Music Inc. (ASCAP), see George Pincus & Sons.

Songmine Music (BMI), see Bug Music Group.
 Songmaster Music (BMI)—VP: Arthur Spivak—see Mirsong Music.
 Songsellers Co. (ASCAP) (div. of Sovereign Rec. Corp.), 1619 Broadway, New York, N.Y. 10019. Tel: (212) 247-2904. Pres.: Ruby Fisher.
 Songs for Real (BMI)—Pres.: James R. Bateman Jr.—see Break of Dawn.
 Songs for Today Inc., 50 E. 42 St., Suite 401, New York, N.Y. 10017. Tel: (212) 687-2299. Ed. Chm.: Jeffrey S. Kruger. Pres.: Howard Kruger; Creative Affairs Leslie Lewis; VP Copyright & Licensing: Margaret Brace.
Int'l branch: England.
Int'l firms represented: Ed. Muscales Catalogue (France), Florida (UK), Gloucester (UK), Henney (UK), International Music of Italy—IMI (Italy), Mark Music (UK), Metropole (UK), Mood Music (UK), Sharon (UK), Sleeping Bunny (UK), Soul Music (UK), York (UK).
 Songs From The Box (BMI), 3935 Summer Ave., Memphis, Tenn. 38122. Tel: (901) 458-2371. Pres.: Mark Blackwood.
 Songs of Bandier-Koppelman Inc. (ASCAP), see The Entertainment Co.
 Songs of Manhattan Island Music Co. (BMI), see The Entertainment Co.
 Songs of Mexico Inc. (ASCAP), see Mexican Music.
 Songs of the Southland (BMI), PO Box 120536, Nashville, Tenn. 37212. Tel: (615) 320-5151. Pres.: James Petrie; Prof. Mgr.: David C. Gilton.
Branch: Mayfield Heights, Ohio, 6668 Mayfield Rd. Zip: 44124. Tel: (216) 442-3464. Chief Exec.: R. Gregory Boudon.
 Song Songs (ASCAP), 229 San Vicente, Suite D, Santa Monica, Calif. 90402. Tel: (213) 393-1343. Pres.: Peter Kaye.
 Sonlife Music Co. (ASCAP) (div. of Paul Johnson Music Prod'n Inc.), PO Box 552, Woodland Hills, Calif. 91365. Tel: (213) 703-6707. Pres.: Paul A. Johnson; Adm'n. Ass't Cheryl Wilks.
 Son-Lo Publ'g Co. (BMI), see Fort Knox.
 Sonquest Music, 7046 Hollywood Blvd., No. 707, Los Angeles, Calif. 90028. Tel: (213) 463-5181.
 Sophisticate Music Inc. (BMI), 41 Algonquin Rd., Yonkers, N.Y. 10710. Tel: (914) 779-2080. Pres.: Josse Nelson Johnson; Gen. & Prof. Mgr.: Gil Miller; Pub. & Promo. Dir.: Jim McCarthy.
Int'l rep.: Europe (Campbell Connolly).
 Soprano Music Co. (BMI), 4118 W. 106 St., Lennox, Calif. 90304. Tel: (213) 673-3562. Pres. & Prof. Mgr.: Tina L. Thompson; VP & Gen. Mgr.: Joe Chryar Jr.
Int'l rep.: France (Michael Meyer).
 Soro (SESAC), 2737 Irving Blvd., Dallas, Tex. 75207. Tel: (214) 631-4277. Pres.: Bob Cline.
 Soufuss Music (ASCAP), see Beldock Levine & Hoffman.
 Soufful Music Inc. (BMI), 450 W. 54 St., New York, N.Y. 10019. Tel: (212) 977-4500. Pres.: Jim Tyrrell.
 Soul Syndicate Music (BMI), see Bug Music Group.
 Sound Approach, 31 Penny Dr., Huntington Station, N.Y. 11746. Tel: (516) 421-3824. Pres.: Elaine M. Schoppe; Gen. Mgr.: William R. Schoppe Jr.
 Sound Attack Music (BMI), see Bug Music Group.
 Sound Corp. Music (ASCAP), 907 Main St., Nashville, Tenn. 37206. Tel: (615) 226-0724.
 Sound Inc. Music (BMI), 56880 North Ave., New Haven, Mich. 48048. Tel: (313) 749-5184.
 Sound of Nolan Music (BMI), see Kenny Nolan.
 Sounds Music Co. (ASCAP), PO Box 40-2947, Miami Beach, Fla. 33140. Tel: (305) 861-9396. Owner: Stanley Cooper.
 Sounds of Memphis, 904 Rayner, Memphis, Tenn. 38114. Tel: (901) 274-9814.

"OLE COUNTRY MUSIC"

**Vocal: Rex Klingensmith
 Country Star Record #1037
 (New Release)**

★

For quick copy, contact: Mr. Norman Kelly, Country Star Records, P. O. Box 536, Franklin, Pennsylvania 16323, Phone: (814) 432-4633. Published by Country Star Music, Inc./Henry J. Sommers, ASCAP.

★

**Composer:
 Henry J. Sommers, ASCAP
 P. O. Box 322, Silver Spring,
 Maryland 20907**

Soundstage Studios Inc., 10 Music Circle S., Nashville, Tenn. 37203. Tel: (615) 256-2676.
 Sound Syndicate, see *Alfie Recs.*
 Southern Crescent Publ'g (BMI), 121 N. Fourth St., Easton, Pa. 18042. Tel: (215) 258-5990. Pres.: Jim Kirk; Gen. Mgr.: Jonathan Strong.
 Branch: New York, N.Y., 320 W. 30 St., No. 5-J. Zip: 10001. Tel: (212) 564-3246.
 Int'l rep.: Canada (Warhorse), UK (Street Music).
 Southern Melody Publ'g Co. (BMI), 122 W. Woodridge Dr., Durham, N.C. 27707. Tel: (919) 489-4349. Pres.: Barry Potts.
 Southern Music Co. (ASCAP), 1100 Broadway, San Antonio, Tex. 78292. Tel: (512) 226-8167. Pres. & Gen. Mgr.: Arthur Gurwitz; Publ'ns Dir.: Arthur Ephross.
 Int'l rep.: UK (Behwin-Mills).
 Southern Music Publ'g Co. Inc. (ASCAP), see *Peer-Southern*.
 Southern Nights Music (ASCAP), see *Combine*.
 Southern Writers Group, Box 40764, 2804 Azalea Pl., Nashville, Tenn. 37204. Tel: (615) 383-8682. Pres.: Buzz Cason.
 Southwest Words & Music (BMI) (div. of Suncoyunter Ents.), 14 E. Second St., Tucson, Ariz. 85705. Tel: (602) 792-3194. Pres.: Fred Kniper; Country Music Div. Mgr.: Tom Chandler; Prod. Mgr.: Steve Chandler.
 Spacetrack Ents. (ASCAP), PO Box 4523, North Hollywood, Calif. 91607. Tel: (213) 761-0664. Pres.: Troy B. Raglin; Gen. Mgr.: J. McAllister; Prof. Mgr.: T. Dodds.
 Spaghettum Music Co. (ASCAP), see *Low Delise*.
 Sparrow Recs. Inc., 8025 Deering Ave., Canoga Park, Calif. 91304. Tel: (213) 703-6599. Pres.: Billy Ray Mear; Publ'g Dir.: Phil Perkins; Mktg. Dir.: Bill Conine. (Publishing Administered by Cherry Lane).
 Sparrow Song (BMI), see *Sparrow Recs. & Cherry Lane*.
 Speak Music Inc. (BMI), see *Window*.
 Special Rider Music (ASCAP), see *Big Sky*.
 Specific Gravity Music (BMI), see *Bug Music Group & Martin Cohen*.
 Spectrum Publ'ns (SESAC), PO Box 757, San Carlos, Calif. 94070. Tel: (415) 593-9554. Dir.: Dr. Paul L. Weaver.
 Ben Speer Music (SESAC), 54 Music Square W., Nashville, Tenn. 37203. Tel: (615) 329-9999. Pres.: Ben L. Speer; Gen. Mgr.: Stephen Speer.
 Spellgold Music Inc. (BMI), see *Reno/Metz*.
 Aaron Spelling Music (ASCAP), see *Reno/Metz*.
 Aaron Spelling Prods (BMI), see *Reno/Metz*.
 Spelling/Goldberg Music (ASCAP), see *Reno/Metz*.
 Spelling Ventures Music (BMI), see *Reno/Metz*.
 Spencer Music Co. (ASCAP), 736 West End Ave., New York, N.Y. 10025. Tel: (212) 697-5895. Pres.: J.C. Alliger; Gen. Mgr.: Bruce Spencer; Prof. Mgr.: Alan Abel.
 Larry Spier Inc. (ASCAP), 401 Fifth Ave., New York, N.Y. 10016. Tel: (212) 686-1777. Telex: 236464. Pres.: Larry Spier; VP: Dorothy Spier.
 Int'l firms represented: Black Sun, Brunetti, Giacomo, Rebera, Vasula (all Canada).
 Int'l rep.: Worldwide (Memory Lane in UK).
 Spina Music (ASCAP), 2232 Vista Del Mar Pl., Hollywood, Calif. 90068. Tel: (213) 467-6018. Pres. & Prof. Mgr.: Harold Spina; Gen. Mgr.: Edith Spina.
 Int'l rep.: UK (Wilson).
 Spiral Rec. Corp. Publ'ns (ASCAP), 17 W. 60 St., New York, N.Y. 10023. Tel: (212) 581-6985.
 Spirit & Soul Publ'g Co. (ASCAP), 141 & Hwy. 75, Glenpool, Okla. 74033. Tel: (918) 299-1224. Pres.: Benjamin P. Farrell.
 Spring Hill Publ'g Group (BMI), see *Chenamah Music*.
 Squirtface Music (ASCAP), see *Loretta Music*.
 Stable Music Co. (BMI), 6503 Wolfcreek Pass, Austin, Tex. 78749. Tel: (512) 288-3370. Owner: Rex T. Sherry.
 Staircase Publ'g Co. (BMI) (div. of Fretone Recs. Inc.), 3114 Radford Rd., Memphis, Tenn. 38111. Tel: (901) 327-8187.
 Wade C. Staley Music Publ'ns, PO Box 5712, High Point, N.C. 27622. Tel: (919) 885-0263.
 Stallion Music Inc., see *OAS Music Group*.
 Stallman Recs. Inc. (BMI), 1697 Broadway, New York, N.Y. 10019. Tel: (212) 582-6928. Pres.: Lou Stallman.
 Standard-Colonial Music Publ'g Co. (BMI), Bldg. 8, 6 Gill St., Woburn, Mass. 01801. Tel: (617) 935-7500. Pres.: Robert D. Levinson.
 Sta-New Music Co. (BMI), see *Genelle*.
 Michael Stanley Music, see *Stone-Rap*.
 Stanyan Music Co. (ASCAP), 8440 Santa Monica Blvd., Hollywood, Calif. 90069. Tel: (213) 656-7311. Pres.: Rod McKuen; Gen. Mgr.: Wade Alexander; Prof. Mgr.: Pamela Burns.
 Starcountry Music Co. (BMI), see *Stargold Publ'ns*.
 Starcraft Music (ASCAP), PO Box 3415, Granada Hills, Calif. 91344. Tel: (213) 368-1612. Pres.: Jack M. Kall.
 Star Data Music (BMI) (div. of Spindrift Recs.), Rt. 1, Box 125, Corinth, Miss. 38834. Tel: (601) 287-4282. Pres.: Bill Stottlemeyer.
 Starfox Publ'g (BMI), PO Box 13584, 1957 Kilburn Dr., Atlanta, Ga. 30324. Tel: (404) 872-6000. Owner & Prof. Mgr.: Aleck Janoulis.
 Stargem Recs. Inc. (ASCAP, BMI), 20 Music Square W., Nashville, Tenn. 37203. Tel: (615) 244-1025. Pres.: Wayne Hodge.
 Stargold Music Co. (ASCAP), see *Stargold Publ'ns*.
 Stargold Publ'ns Inc. (ASCAP), PO Box 140542, 211 Cumberland Circle, Nashville, Tenn. 37214. Tel: (615) 889-2320. Pres.: Roy G. Edwards Jr.; Gen. Mgr.: John L. Weaver III; Prof. Mgr.: Fay Benson.
 Star Prod'ns Inc., 1624 W. 103 St., Beverly Hills, Ill. 60643. Tel: (312) 233-1622. Pres.: James A. Gibbons.
 Starrite Publ'g Co. (BMI), see *Glad Music*.
 Starsound Music (BMI), 2844 Stout Rd., Cincinnati, Ohio 45239. Tel: (513) 742-0316. Pres.: David Chastain.
 Stars & Stripes Music (BMI), see *Americus Music*.
 Startime Music (ASCAP), see *Fred Rice Prod'ns*.
 Starwest Music (BMI), 1048 14 St., Longview, Wash. 98632. Tel: (206) 423-9085.
 Stasny Music (ASCAP), see *Bug Music Group*.
 Startras Music Co. (ASCAP), see *Genelle*.
 Stax Music (ASCAP), 10th & Parker Sts., Berkeley, Calif. 94710. Tel: (415) 549-2500. Mgr.: Paul Zantze.
 Steektech Music (ASCAP), see *Skinny Zach*.
 Stepping Stone Music (BMI), see *Mimic*.
 Stigwood Music Inc. (BMI), see *RSD*.
 Robert Stigwood Drg., see *RSD*.
 Stonebase Music Co. (BMI), 1613 Orizaba Ave., San Francisco, Calif. 94132. Tel: (415) 334-2247. Pres. & Gen. Mgr.: Walter C. Stone.
 Int'l rep.: Brazil (Shark), France (Michel Meyer).
 Stone Gold Music (ASCAP), see *20th Century*.
 Stonehill Music Co. (BMI), 51 Music Square E., Nashville, Tenn. 37203. Pres. & Gen. Mgr.: Bill Gatzimos; VP: Crystal Gayle.
 Int'l rep.: Canada (Morning).
 Stone-Rap Music Co. Inc. (BMI), 28001 Chagrin Blvd., No. 205, Cleveland, Ohio 44122. Tel: (216) 464-5990.

Stone Row Music Co. (BMI), 2022 Vardon Ln., Flossmoor, Ill. 60422. Tel: (312) 799-7194. Pres.: Joanne Swanson.
 Stonewall Publ'g Co. (BMI), see *Cedarwood*.
 Stoneway Publ'g Co. (BMI), 2817 Laura Koppe, Houston, Tex. 77093. Tel: (713) 697-7867. Pres.: Roy M. Stone; Gen. Mgr.: Mary Gobert.
 Stony Point Music (BMI), 38 Stony Point Ln., Charlotte, N.C. 28210. Tel: (704) 554-8505. Contacts: Bill Bradford, Sandy Bell.
 Stooze Staffel (BMI), see *Bug Music Group*.
 Storeville Publ'g Co. (BMI), see *John Berthelot*.
 Straight-Face Music (ASCAP)—A&R: James Tassel, J. Julian—see *White Clay*.
 StraightWay Music (ASCAP)—Pres.: Darrell Harris—see *Dawn Treader*.
 Strait James Music (BMI), see *Bug Music Group*.
 Strawberry Patch (ASCAP), PO Box 7417, Marietta, Ga. 30065. Pres.: Diane Pfeifer.
 Streamsong Music (BMI), see *Radmus*.
 Street City Music (BMI), 9229 Sunset Blvd., No. 414, Los Angeles, Calif. 90069. Tel: (213) 550-1216. Pres.: Bambi Byrens.
 Street Kids Music (BMI), see *Don Williams*.
 Stuckey Publ'g Co. (BMI), PO Box 102, Brentwood, Tenn. 37027. Tel: (615) 255-3500. Pres.: Nat Stuckey; Gen. Mgr.: Ann Stuckey.
 Studio P/R Inc. (BMI), 224 S. Lebanon St., Lebanon, Ind. 46052. Tel: (317) 482-4440. Pres.: James G. Houston; Exec. VP & Sales Mgr.: John F. Welch; VP Editing & Opns.: Tom Johns; Sec'y-Treas.: Ann Houston.
 Studio 224 (ASCAP), see *Studio P/R*.
 Sublime Music (BMI), see *Songs for Today*.
 Sudden Rush Music Inc. (BMI), 750 Kappock St., Riverdale, N.Y. 10463. Tel: (212) 884-6014. Pres.: Alan Krotin.
 Sueno Publ'g Co. (BMI), Rt. 2, Troutman, N.C. 28166. Tel: (704) 528-4843. Pres. & Prof. Mgr.: Don E. Moose.
 Sufi Pipkin Music (BMI), PO Box 3991, Hollywood, Calif. 90028. Tel: (213) 276-2063. Owner: Linda R. Moxley; Prof. Mgr.: John Destine.
 Sugar Creek Co. (ASCAP), 2828 Arroyo, Suite 241, Dallas, Tex. 75219. Tel: (214) 526-1413. Pres.: Bob C. Greer; Gen. & Prof. Mgr.: Bear Holderness.
 Sugar Free Music (BMI), see *Sugar N' Soul*.
 Sugar Melodi Inc., see *MCA*.
 Sugar N' Soul Music Inc. (ASCAP), 109-23 71 Rd., Forest Hills, N.Y. 11375. Tel: (212) 268-8060. Pres. & Gen. Mgr.: Don Levy; VP & Prof. Mgr.: Mark Sameth; Prof. Mgr.: Michael Berman.
 Sugarplum Prod'ns Co. (BMI), 1022 16 Ave. S., Nashville, Tenn. 37212. Tel: (615) 255-5711. Pres.: Patsy Bruce.
 Sugar Song Publ'ns Inc., see *MCA*.
 Sugarvine Music Publ'g (BMI), PO Box 3013, Davenport, Iowa. 52808. Prof. Mgr.: Gary Unger.
 SuLyn Publ'g Inc. (BMI), PO Box 28835, Memphis, Tenn. 38128. Tel: (901) 386-7360. Pres.: Louis Chiozza; Sec'y-Treas.: Reba Walker.
 Sumac Music Inc. (BMI), 1697 Broadway, Suite 1209, New York, N.Y. 10019. Tel: (212) 246-0575. Pres.: Susan McCusker; VP: Jerry Love; Gen. & Prof. Mgr.: Deirdre O'Hara; Int'l Mgr.: Sandy Jones.
 Int'l rep.: Australia (April), Austria (Butterfly in Germany), Brazil (Fermata), Canada (April), Central America (Chappell in UK), France (Marouline), Germany (Butterfly), Italy (Sugar), Japan (Watanabe), Mexico (Chappell in UK), Scandinavia (Sweden Music in Sweden), Spain (Ego), UK (Carlin).
 Su-Ma Publ'g Co. Inc. (BMI), PO Box 1125, 728 Texas St., Shreveport, La. 71163. Tel: (318) 222-7182. Pres.: Stanley J. Lewis; Gen. Mgr.: Donna Lewis.
 Sumari Prod'ns, PO Box 130, Brooklyn, N.Y. 11223. Chief Exec: Richard Kendall.
 Summer Duck Publ'g Corp. (BMI), 1216 Granby St., Norfolk, Va. 23510. Tel: (804) 625-0534. Pres.: D.H. Burlage.
 Sunburst Music Co. (BMI), see *Mike Appel*.
 Summit Songs Corp. (ASCAP), 250 W. 57 St., New York, N.Y. 10019. Tel: (212) 957-9330. Pres.: Margot Reis; Gen. Mgr.: Patricia Bente.
 Sunny-Birchard Music (ASCAP), Box CN-27, Princeton, N.J. 08540. Tel: (609) 896-1411. Pres.: David K. Senstack.
 Int'l firm represented: Zen-Dn (Japan).
 Int'l rep.: Japan (Zen-Dn), UK (Boosey & Hawkes, Keith Prowse, EMI).
 Sunball Music (BMI), see *Bug Music Group*.
 Sun-Bear Corp., 1650 Broadway, New York, N.Y. 10019. Tel: (212) 765-4495. Telex: 237224.
 Int'l rep.: Australia (Castle), France (Pascal, Allo), Germany (Siegel), Japan (Shinko, Toshiba-EMI, Watanabe), Netherlands (Anagon, Inter-song-Basart, Universal), Scandinavia (Sweden Music), UK (ATV, EMI, Health Levy).
 Suncountry Song Co. (ASCAP), see *Southwest Words & Music*.
 Sunday Visitor Music, see *O S V Music*.
 Sun Disc Music (BMI), see *Rokblok*.
 Sunflower Music Corp. (ASCAP), see *The Goodman Group*.
 Sun Island Music Publ'g Co. (BMI), GPO Box 27, Bronx, N.Y. 10451. Tel: (212) 582-3240. Pres.: Murray Fuller.
 Sunnybrook Music Co. (BMI), 2200 Sunnybrook, Tyler, Tex. 75710. Tel: (214) 592-7677.
 Int'l rep.: Worldwide (Mietus in USA).
 Sunnyslope Music (ASCAP) (div. of Hal Bernard Ents.), PO Box 6507, 2181 Victory Pkwy, Cincinnati, Ohio 45206. Tel: (513) 861-1500. Pres.: Stanley B. Hertzman.
 Sunshine Country Ents. Inc. (BMI), PO Box 31351, Dallas, Tex. 75231. Tel: (214) 690-8875. Cable: SUNSHINE. Pres. & Gen. Mgr.: Bart Barton; Prof. Mgr.: Pat McKool; Nat'l Sales Mgr.: Rusti James.
 Sunshine Music Co. (BMI), see *Gordon*.
 Sun-Shower Songs (BMI), PO Box 55340, Indianapolis, Ind. 46205. Tel: (317) 259-4979.
 Sunstorm Mgmt. Consulting (div. of Sunstorm Entertainment Servs.), 8230 Beverly Blvd., Los Angeles, Calif. 90048. Tel: (213) 852-1108. Pres.: Ed Conway.
 Superhype Publ'g (ASCAP), see *Cotillion*.
 Supersound Music (BMI)—Owner: Lee Rogers—see *Keristene*.
 Supreme Music Corp. (ASCAP), see *20th Century*.
 Sure-Fire Music Co. Inc. (BMI), 60 Music Square W., Nashville, Tenn. 37203. Tel: (615) 244-1401. Pres.: Doyle Wilburn; VP: Leslie Wilburn.
 Sure Music & Rec. Co., PO Box 94, 39 N. Sproul Rd., Broomall, Pa. 19008. Tel: (215) 356-2996. Pres.: Leonard Rosen; Gen. Mgr.: Stewart Harmon; Prof. Mgr.: Beth Merle.
 Surfside Hawaii Inc., see *Lehua*.
 Surf & Turf Tunes (BMI), see *Bug Music Group*.
 Surias Music Inc., see *Peer-Southern*.
 Surrey Music Co. (ASCAP)—Pres.: Frank Stanton; Prof. Mgr.: Anne Stokes—see *Pavanne*.
 Susaper Music (ASCAP), see *Invador Music*.
 Sus-Den Music (ASCAP), see *Heavy Jamin*.
 Sweet Baby Music (BMI), see *Combine*.
 Sweet n' Low Music (BMI), see *Madrid*.
 Sweet Polly Music (BMI), PO Box 521, Hwy. 76, Newberry, S.C. 29108. Tel:

(803) 276-0639. Dir.: Hayne Davis; Mgr.: Polly Davis; Relations: D.T. Hudson; Field Rep.: Willard Brown.
 Sweet Singer Music (ASCAP), see *The Mathes Co.*
 Sweet Swamp Music (BMI), The Gables, Halcott Rd., Fleischmanns, N.Y. 12430. Tel: (914) 254-4565. Pres. & Prof. Mgr.: Barry Drake; Gen. Mgr.: Patricia Padla.
 Sweet Tooth Publ'g (BMI), 2716 Springlake Court, Irving, Tex. 75060. Tel: (214) 259-4032. Owner & Gen. Mgr.: Kenny Wayne Hagler.
 Swing Bee Publ'g (BMI), 1130 Coffa St., Evanston, Ill. 60201. Tel: (312) 328-5593. Owners: Susan L. & James R. Neumann.
 Swing & Tempo Music Inc. (BMI), see *Glad Hamp*.
 Glenn Symmonds Music (ASCAP), see *MizMo*.
 Symposium Music Publ'g Inc. (BMI), 204 Fifth Ave. SE, Minneapolis, Minn. 55414. Tel: (612) 331-5750. Prof. Mgr.: George Hanson.

T

T I M (The International Music Co.) (ASCAP), 214 W. 96 St., New York, N.Y. 10025. Tel: (212) 866-3112. Cable: OTOARECO. Pres.: L. Paul Bernard; Gen. Mgr.: Raul M. Bernard.
 T R F Music Inc., see *Alpha Music*.
 T R O (The Richmond Org.), 10 Columbus Circle, New York, N.Y. 10019. Tel: (212) 765-9889.
 Int'l rep.: Australia (Essex), Canada (Essex), France (Essex), Germany (Essex), Italy (Mario Aromando), Japan (Essex), Mexico (Essex), Netherlands (Essex), Scandinavia (Essex in Sweden), South Africa (Essex), Spain (Essex), UK (Essex).
 T W C Music (SESAC), GPO Box 2021, New York, N.Y. 10001. Tel: (212) 691-4565. Pres.: Tommy Blue; Gen. Mgr.: Jerome Haggart; Prof. Mgr.: Walter Balderson.
 Taepier Music (ASCAP) (div. of Barcus-Berry Inc.), 5381 Production Dr., Huntington Beach, Calif. 92649. Tel: (714) 898-9211. Pres.: L.M. Barcus; Prof. Mgr.: John F. Berry.
 Tajah Music (BMI), see *Raybird*.
 Take Home Tunes Rec. Co., PO Box 1314, Englewood Cliffs, N.J. 07632. Tel: (201) 224-5811; (messages) (201) 567-5524. Pres. & Prof. Mgr.: Doris Chu Yeh.
 Branch: Georgetown, Conn., PO Box 496. Zip: 06829. Tel: (203) 544-8288. Chief Exec.: Bruce Yeh.
 Takya Music Inc. (ASCAP), 265 W. 20 St., New York, N.Y. 10011. Tel: (212) 989-8048. Pres.: Stuart Scharf.
 Int'l rep.: Worldwide (DeShufflin).
 Tatesin Music (BMI), PO Box 772, El Cerrito, Calif. 94530. Tel: (415) 525-1494. Pres. & Gen. Mgr.: Frank Scott.
 Tam-Jet Music Publ'g (BMI), see *20th Century*.
 Tancy Music Co. (ASCAP), see *Don Costa*.
 Tandem/TAT Music (ASCAP), see *Reno/Metz*.
 Tangled Web Music Co. (ASCAP), see *Cherry Lane*.
 Tangled Web Music Co. (BMI), 7050 Shoup Ave., No. 222, Canoga Park, Calif. 91504. Tel: (213) 884-4495. Pres. & Gen. Mgr.: Michael Hart; Prof. Mgr.: Dan Aaronson. (Administered by World Artists Music Co.)
 Tannen Music Inc. (BMI), 38 Laurel Lodge Court, Stamford, Conn. 06903. NYC Tel: (212) 489-6740. Pres.: Paul Tannen.
 Tarpier Music (BMI), see *MizMo*.
 Tark Music Co. (BMI), see *Mayflower Music*.
 Tarka Music (ASCAP), see *Skyhill*.
 Taurus Music Co. (BMI), see *Sounds Music*.
 Teardrop Music (ASCAP), PO Box 40001, 4701 Trousdale Dr., Nashville, Tenn. 37220. Tel: (615) 385-3726. Pres.: Ronnie Hayes.
 Teaspoon (ASCAP), 1438 S. Gower, Hollywood, Calif. 90028. Tel: (213) 469-4100. TWX: (910) 321-3824. Pres.: Paul Drevor.
 Tektra Publ'g (BMI), 711 W. Broadway, Minneapolis, Minn. 55411. Tel: (612) 521-7631. Pres.: Dan R. Holmes; Gen. Mgr.: Sandra Milani.
 Tempi Music Co. (BMI), 133 W. 87 St., New York, N.Y. 10024. Tel: (212) 799-5557. Cable: TEMPID.
 Templeton Publ'g Co. Inc. (ASCAP), see *Shawnee Press*.
 Tender Tunes, see *Buddha*.
 Tennessee Swamp Fox Music Co. (ASCAP), see *Combine*.
 Tennessee Valley Music (SESAC), see *Woodrich*.
 Ten of Diamonds Music (BMI), 5934 Buffalo Ave., Suite 105, Van Nuys, Calif. 91401. Tel: (213) 997-8819. Chm. & Pres.: Jason Schwartz; Gen. Mgr.: Richard Schulenberg; Prof. Mgr.: Sandra Schwartz, Anita Kagan, Bill McCormick; (Bon Chance Music Div.) Bonnie Frederics.
 Tequila Music (BMI), see *Garrett*.
 Terryra Music Publ'g Co. (BMI), 909 Keil Rd., Toledo, Ohio 43607. Tel: (419) 531-2271. Pres.: Porter Roberts.
 Terrace Music Corp. (ASCAP), 803 18 Ave. S., Nashville, Tenn. 37203. Tel: (615) 327-4871. Prof. Mgr.: Robert John Jones.
 Terrana/Binder Music (ASCAP), 666 N. Robertson Blvd., Los Angeles, Calif. 90066. Tel: (213) 652-4422. Contact: Russ Terrana.
 Tessalon Music (ASCAP), 62 Music Square W., Nashville, Tenn. 37203. Tel: (615) 327-4538. Owners: Cliff Ayers & Connie Lynne Ostermeyer.
 Peter Tevis Music (BMI), PO Box 1102, Burbank, Calif. 91507. Tel: (213) 874-7656. Pres.: Peter Tevis; Prof. Mgr.: Scott Tevis.
 Thea Music (BMI), see *Ferry Boat*.
 Third San Music (ASCAP), see *Cherry Lane*.
 Third Story Recs. (ASCAP), 3436 Sansom St., Philadelphia, Pa. 19104. Tel: (215) 386-5998/5987. Pres.: John D. Wicks III.
 Third World Music Inc. (BMI), see *Cherry Lane*.
 Thirty Four Music (ASCAP), 4329 Coffa Ave., Studio City, Calif. 91604. Tel: (213) 766-6411. Pres.: Russell Shaw; VP: Emmitt Rhoades; Prof. Mgr. & Sec'y-Treas.: Eddie Shaw.
 Harold Thomas Music Co. (BMI), 203 Culver Ave., Charleston, S.C. 29407. Tel: (803) 766-2500. Pres.: Harold Thomas.
 Thoruk Publ'g Co. (BMI), see *Don Williams*.
 Three Brothers Music Inc. (ASCAP), see *Char-Liz*.
 Three Cousins Music (BMI), see *Little Things*.
 3-Deal Music (BMI), 2123 N. Seminary Ave., Chicago, Ill. 60614. Tel: (312) 348-3730. Pres.: Carl Bonafede; VP: Frank Pizzi.
 3 G's Music (ASCAP), see *Eugene Gold*.
 3 H's Music (ASCAP), 1103 Neff Ave. S., West Covina, Calif. 91790. Tel: (213) 919-5055. Pres.: Henry Dakes; Gen. Mgr.: Loretta Dakes.
 Int'l firms represented: Acetatos (Mexico), J. Albert & Sons (Australia).
 Int'l rep.: Europe & UK (Cyril Shane in UK), Italy (Sidet).
 Three W Music (BMI), see *Bug Music Group*.
 Three Willows Music (BMI), 515 W. 62 St., Chicago, Ill. 60621. Tel: (312) 987-3081. Pres. & Prof. Mgr.: Frances Willoughby; Gen. Mgr.: John Davis.
 Thrush Music Publ'g (BMI), see *Brian Ross*.
 Thunder Music, 451 S. Rexford Dr., Beverly Hills, Calif. 90212. Tel: (213) 556-0061. TWX: (910) 490-5749. Exec. Dir.: Robin Loggie.
 Home office: Japan.
 Tidewater Music Co., PO Box 4192, Huntsville, Ala. 35802. Tel: (205) 881-7976. Owner: George Wells.

Sell
Your Sound
With Soundsheets

PLACE COIN HERE IF
33 1/3 RPM
STEREO
SOUNDSHEET SLIP

LISTEN!

Music produced, arranged & recorded at:

BeeJay

RECORDING STUDIOS
Orlando, Florida

MFD. IN U.S.A. BY **EVATONE** 70¢
SOUNDSHEETS CLEARWATER, FL.

▲ LISTEN TO THIS SOUNDSHEET, THEN MAIL US THIS CARD ▼

Hear how Soundsheets can help sell your album, act, instrument or arrangement.

Nobody heard one word of your latest brochure. Nobody heard your latest print ad, either. Printed material just can't sell sound the way sound can.

But how do you include sound in a brochure or magazine? Simple. On Eva-Tone Soundsheets. Listen to the way Soundsheets have been used already — and to some new ideas, too. Then mail us this card.

A Soundsheet specialist will get back to you in a hurry, to help you decide the best way to use Eva-Tone Soundsheets in your next promotion.

Then people will HEAR what you're talking about.

Soundsheets sound great to me. Tell me more and tell me quick.

I'd like to hear more about BeeJay Recording Studios, too.

Name _____

Title _____

Organization _____

Address _____

City/State/Zip _____

Phone _____

EVATONE 4801 Ulmerton Road
SOUNDSHEETS Clearwater, Florida 33520
Phone (813) 577-7000 — TWX 810-863-0394

Billboard Buyer's Guide - Sept. 1981 708

Billboard
Buyer's Guide
Sept. 1981 708



Billboard Buyer's Guide - Sept. 1981 708

BUSINESS REPLY CARD

FIRST CLASS PERMIT NO. 1364 CLEARWATER, FLORIDA

POSTAGE WILL BE PAID BY ADDRESSEE

EVA-TONE

SOUNDSHEETS

4801 ULMERTON ROAD
CLEARWATER, FLORIDA 33520

NO POSTAGE
NECESSARY
IF MAILED
IN THE
UNITED STATES



Tiki Ents. Inc., 792 E. Julian, San Jose, Calif. 95112. Tel: (408) 286-9840. Pres. & Gen. Mgr.: Grade O'Neal.

Floyd Tillman Music Co. (BMI), 430 San Jacinto St., Houston, Tex. 77002. Tel: (713) 225-6654. Pres.: Byron Benton; Gen. Mgr.: Charles Benton; Prof. Mgr.: Floyd Tillman.

Tital Publ'g (BMI), 4914 Lankers im Blvd., Suite 5, North Hollywood, Calif. 91601. Tel: (213) 766-5239. Owners: Malcolm Talmadge, Lenny Cummings.

Timberland Publ'g Co. (BMI), Forest City, Iowa 50436. Tel: (515) 582-2992. Pres.: Arlo C. Johnson.

Times Square Music Publ'ns Co. (BMI), see Hudson Bay

Tithonus Music Ltd. (BMI), see Illemon.

Together Music (SESAC), see Brin

Tomake Music Co. Inc. (ASCAP), see Window

Tomcat Music Publ'g Co. (BMI), see Window

Tompon Music (BMI), see 20th Century

Tomiew Publ'g (BMI), 12202 Umcn Ave., Cleveland, Ohio 44105. Tel: (216) 752-3440. Pres. & Gen. Mgr.: Thomas R. Boddie

Tompalland Music (BMI), 916 E. Ave. S., Nashville, Tenn. 37212. Tel: (615) 327-0005. Partner: Jon Glaser.

Tompaul Music Co. (BMI), 628 So 10th St., Mount Airy, N.C. 27030. Tel: (919) 786-2865. Owner: Paul E. Johnson.

Tom Thumb Music (ASCAP) (div. of Rhythms Prod'ns), Box 34485, Whitney Bldg., Los Angeles, Calif. 90031. Tel: (213) 836-4678. Pres. & Prof. Mgr.: R.S. White; Gen. Mgr.: M.W. (Andelman)

Tooter Scooter Music (BMI)—Pres.: Jeanne Osborne; Gen. Mgr.: Grade O'Neal—see Tiki Ents.

Top Drawer Music (BMI), PO Box 8011, Mobile, Ala. 36608. Tel: (205) 343-3124. Pres.: M. Brown.

Top of the Town Music Co. (ASCAP), see The Entertainment Co.

Topographic Music Inc. (ASCAP)—Pres.: Elliot L. Hoffman—see Beldock Levine & Hoffman.

Total Entertainment Complex, W. 51st Dr., Tullahoma, Tenn. 37388. Tel: (615) 455-2607.

Touchable Music (BMI), see Fun by You.

Touchdown Music Co. (BMI), see Adventure.

Touch Of Gold Music Inc. (BMI), see Tuneworks

Toulouse Music Publ'ns (BMI), 40 Box 96, El Cerrito, Calif. 94530. Tel: (415) 526-3491. Pres.: Jacques Dussault; Gen. Mgr.: James Bronson Jr. (Administered by Copyright Serv. Bureau)

Toupat Music Publ'g Co. Inc. (BMI), 402 Shotwell Ave., Monroe, La. 71202. Tel: (318) 322-2537. Pres.: Tjussaint L. McCall; Gen. Mgr.: Patrick H. Robinson.

Track Music Inc. (BMI), 200 W. 57 St., New York, N.Y. 10019. Tel: (212) 582-6667. Pres.: Kit Lambert; Gen. Mgr.: Paul Schwartz.

Int'l firm represented: Fabulux (UK)

Jim Tract Music (ASCAP), see M 20.

Tradition Music Co. (BMI), 10341 San Pablo Ave., El Cerrito, Calif. 94530. Tel: (415) 525-7471. Pres.: C. Strachwitz. (Administered in USA, Canada, & Japan by Harry Fox Agency).

Int'l reg.: France (Fantasia), Central & Sweden America (CBS Int'l), Germany (April), Netherlands (S net), Sweden (Sonet), UK (April)

Trajames Music Co. (ASCAP), 11 Harrison Court, South Orange, N.J. 07079. Tel: (201) 762-2504. Pres.: Jimmy Wisner; Gen. Mgr.: Jane Berson

Transaction Music Ltd., 225 E. 57 St., New York, N.Y. 10022. Tel: (212) 838-2590. Cable: TRANSMUSIC. Telex: 421943. Pres.: Mildred Fields.

Int'l firms represented: Australasia (Festival), Benelux (Universal), Japan (Victor), Scandinavia (Sv eden Music), UK (Bocu).

Trebron Music Inc. (BMI), 134 Fourth Ave. N., Franklin, Tenn. 37064. Tel: (615) 790-8696. Pres.: Norbit Putnam; Prof. Mgr.: Ann J. Keener.

Treeshouse Music, PO Box 195, Dayton, Ohio. 45459. Tel: (513) 429-0833.

Tree Publ'g Co. Inc. (BMI), PO Box 1273, 8 Music Square W., Nashville, Tenn. 37202. Tel: (615) 327-162. Pres.: Buddy Killen; VP: Donna Hilley, Prof. Mgrs.: Dan Wilson, Chr. Dodson, Terry Choate, David Womack.

Int'l reg.: Argentina (Musica Argentina), Australia (Essex), Belgium (Ardmore & Beechwood), Brazil (Itaipu), Chile (Sochem), Denmark (EMI), France (Francis Day), Germany (Melodie der Welt), Greece (EMI), Hong Kong (EMI), Italy (La Voce del Padrone), Japan (Toshiba-EMI), Mexico (Beechwood), Nether lands (EMI), South Africa (EMI-Brigadiers), Spain (Ego), Sweden (EMI), JK (EMI).

Treetop Music (BMI), see Brow leaf.

Trides Music Co. (BMI), PO Box 1646, Burbank, Calif. 91507. Tel: (213) 849-5774. Owners: Robert L. Bogle, Donald L. Wilson; Gen. Mgr.: S. Rivera.

Tri-Muscript Co. (SESAC), see Muscript.

Trina Jill Music Corp. (ASCAP), 101 Fifth Ave., New York, N.Y. 10016. Tel: (212) 889-7340. Pres.: Joseph Cayre; Admin'r: Larry Spier

Trinity Music Inc., PO Box 1045, Dallas, Tex. 75207. Tel: (214) 631-8828. Pres.: Jim Hilliard; VP & Pub'l'g Dir.: Lynn Dee Frye.

Trinity Sound (ASCAP) (div. of Ence Recs.), 15266 Russell, Allen Park, Mich. 48101. Tel: (313) 383-5768. Dir.: Michael Glenn Kuzma

Tno Music Co. Inc. (BMI), 1619 Broadway, New York, N.Y. 10019. Tel: (212) 489-8170. Co-Pres.: Jerry Leber, Mike Stoller

Triple O Songs Inc. (BMI), see Roadshow.

Tripoli Music (BMI) (div. of Elit Entertainment Ents), PO Box 25664, Chicago, Ill. 60625. Tel: (312) -83-8660. Pres: Tom Seymour

Tri-State Music Publ'g Co. (BMI), PO Box 121, 300 Court St., Soda Springs, Idaho 83276. Tel: (208) 547-3715. Pres.: Ronald Watts.

Trueme Music Inc. (ASCAP), 82-19 Ave. S., Nashville, Tenn. 37203. Tel: (615) 329-1429. Pres.: Bury Red; Exec. VP: Elywn Raymer.

Branch: Dayton, Ohio, 501 E. Third St. Zip: 45401. Tel: (513) 228-6118.

Truxie Tunes (BMI), see Bug M Music Group.

Tromba Publ'ns—Pres.: Gerald ndsley; Gen. Mgr. Stephen L. Glover—see Brass Press.

Trouble Boys Music (BMI), c/o Ed Danky, 4926 W. Gunnison, Chicago, Ill. 60630. Tel: (312) 545-0861

Troycato Music (ASCAP), see 20th Century

True Blue Music Publ'g Co. (ASCAP), 16027 Sunburst St., Sepulveda, Calif. 91343. Tel: (213) 892-0044. Pres.: Larry Foline

Trust Music Mgmt. Inc., 6255 Sunset Blvd., Los Angeles, Calif. 90028. Tel: (213) 462-6933. Telex: 69-4356. Pres. & Gen. Mgr.: Samuel S. Tryst.

Trusty Publ'ns (BMI), Rt. 1, Box 100, Nebo, Ky. 42441. Tel: (502) 249-3194. Pres.: Elsie Childers.

Ernest Tubb Music Inc. (BMI), see Cary & Mr. Wilson & Window Music.

Tuff Enuff Music Publ'g (BMI), see BAS

Tuff Turky Toons Inc., c/o Craig Wilson, 160555 Ventura Blvd., Suite 721, Encino, Calif. 91436. Pres.: Tony Jacks

Int'l firm represented: Strike Music (UK)

Int'l reg.: UK (Strike Music)

Tumbleweed Music, 4344 Prom-nade Way, Suite 300, Marina del Rey, Calif. 90291. Tel: (213) 823-8311. TWX: (910) 343-7403

Home office: Australia.

Tune-Kel Publ'g Co. Inc. (BMI), PO Box 50650, New Orleans, La. 70150. Tel: (504) 392-1525. Pres.: Joseph Banashak

The Tune Room Inc. (ASCAP), 200 W. 57 St., New York, N.Y. 10019. Tel: (212) 265-0741. Pres.: Jerry Rogovoy

Tuneworks Co. (BMI), 15625 Vondorf Pl., Encino, Calif. 91436. Tel: (213) 278-8970. TWX: (910) 490-2507. Pres.: Dennis Lambert; Gen. Mgr.: Diane Frank; Prof. Mgr.: Paul Palmer.

Int'l reg.: Australia & New Zealand (Festival in Australia), Austria (Siegel in Germany), Benelux (Nada Music in Netherlands), France (ART), Germany (Siegel), Greece (Blackwood), Italy (G. Ricordi), Japan (Toshiba-EMI), Latin America (Intersong Int'l in Spain), Scandinavia (Air Music in Sweden), South Africa (Laetrec, UK) & Portugal (Canciones del Mundo/Chappel Iberica in Spain), Switzerland (Siegel)

Scott Tuff Music, PO Box 121213, Nashville, Tenn. 37212. Tel: (615) 329-0856. Pres.: R. Scott Tuff.

Twelve Tribes Music Co. Inc. (BMI), PO Box 18785, Denver, Colo. 80218. Tel: (303) 832-3999. Pres. & Gen. Mgr.: Jim Ransom; Prof. Mgr.: Marie M. Mendoza.

20th Century Fox Music Corp. (ASCAP), 8544 Sunset Blvd., Los Angeles, Calif. 90069. Tel: (213) 657-8210. Telex: 696221. Pres.: Herbert N. Eisenman; VP Creative: Eddie Lambert; VP Contracts & Copyright Admin.: Barbara Brunow; Catalog Promo Mgr.: Steve Nelson.

Int'l reg.: Argentina (Korn-Intersong), Australia (Chappell), Austria (Francis Day & Hunter, Global), Belgium (Kluger), Brazil (Intersong), Canada (Chappell), Colombia (Intersong), France (Intersong, Francis Day), Germany (Francis Day & Hunter, Global), Greece (Blackwood), Israel (Litratone), Italy (Curci), Japan (Chappell, Taiyo), Luxembourg (Kluger), Mexico (Intersong), Netherlands (Universal), New Zealand (Chappell in Australia), Philippines (Chappell in Australia), Portugal (Canciones del Mundo), Scandinavia (Chappell), South Africa (Music Publ'g Co.), Spain (Canciones del Mundo), Switzerland (Francis Day & Hunter, Global), UK (Chappell, Francis Day & Hunter, Boosey & Hawkes, Keith Prowse), Venezuela (Intersong).

Twiford Music (BMI), 4640 E. Lewis, Phoenix, Ariz. 85008. Tel: (602) 959-2076. Owner: L. John Twiford.

Twilight City Music Publ'g (BMI), see Songsellers

Twin Duck Music (BMI), see Ron Weiser & Bug Music Group.

Twin Tail Music (BMI), 8809-11 Rising Sun Ave., Philadelphia, Pa. 19115. Tel: (215) 676-8992. Pres.: Frank Virtue

Twitty Bird Music Publ'g Co. (BMI), 8 Music Square W., Nashville, Tenn. 37203. Tel: (615) 327-3162.

Two Beat Music, see MCA

212 Music Co. (BMI), see The Entertainment Co

Tyler Publ'g Co. (BMI), PO Box 231, Tyler, Tex. 75710. Tel: (214) 597-2961. Mgr. Curtis Kirk

Tymena Music (BMI), 430 Pearce Rd., Pittsburgh, Pa. 15234. Tel: (412) 341-0991. Pres.: Ty Lemley; VP & Treas. Tolmena Lemley; Gen. Mgr.: Bud Lemley

Tymer Music (BMI), PO Box 1669, Carlsbad, Calif. 92008. Tel: (714) 729-8406

Harrison Tyner Int'l Inc., 38 Music Square E., No. 115, Nashville, Tenn. 37203. Tel: (615) 244-4224. Pres.: Harrison Tyner; Gen. Mgr.: Dallas Laird; Prof. Mgr.: Kevin McMaster.

Branches: Dallas, Tex., Box 30221. Zip: 75230. Tel: (214) 387-9808—Houston, Tex., Box 27152. Zip: 77027. Tel: (713) 626-2171.

Tyrantosaur Sounds (BMI), see Rees

U

U S Songs Inc. (ASCAP), see Trio

Ultimate Recs Music Publ'g (ASCAP, SESAC), 7087 Bark Ln., San Jose, Calif. 95129. Tel: (408) 996-1868

Ultima Thule Music Publ'g Co. (BMI), PO Box 20604, 2351 Fourth Ave., Sacramento, Calif. 95820. Tel: (916) 454-4525. Pres.: Almeritt V. Covington.

Ultra Sounds Unlimited Publ'g (BMI), PO Box 3501, Flint, Mich. 48502. Tel: (313) 787-2962. Bd. Chm.: Morris D. Ruffin.

Underwood Music (BMI), 7715 Sunset Blvd., Suite 300, Los Angeles, Calif. 90046. Tel: (213) 851-6800. TWX: (910) 321-2458. Pres.: Charles Underwood.

Union Square Music (ASCAP), see Empire Tunes

Unroyce Music (BMI), c/o Harrison & Hearn, Crocker Plaza, Suite 600, 84 W. Santa Clara St., San Jose, Calif. 95113. Tel: (408) 298-7565. Pres.: Charles Privitera.

Unit Core Corp. (BMI), see Mayflower Music.

United Artists Music, 6753 Hollywood Blvd., Los Angeles, Calif. 90028. Tel: (213) 469-3600. Cable: UNARTMUSIC. TWX: (910) 321-4052. Pres.: Harold Seider; VP Int'l: Frank Banyai; Copyright Dir.: Silvia Blach; VP Prof.: Vic Guder; Prof. Dir.: Danny Strick.

Branch: New York, N.Y., 729 Seventh Ave. Zip: 10019. Tel: (212) 575-3000. Cable: UNARTMUSIC. Telex: 62946. Legal Counsel: Sidney Shemel. VP & Prof. Mgr.: Barry Bergman. (Print Div.: Bug 3 Music Corp. VP & Gen. Mgr.: Steve Colter)—Washington, Tenn., 1013 16th Ave. S. Zip: 37212. Tel: (615) 327-4594. Cable: UNARTMUSIC. VP: Jimmy Gilmer

Int'l branches: Australia, Belgium, Canada, France, Germany, Italy, Japan, Netherlands, Sweden, UK.

Int'l reg.: Argentina (Korn), Austria (Indra), Brazil (Meridional), Hong Kong (EMI), Israel (Subar), Mexico (EMLASA), South Africa (Cian), Spain (Hispaviva), Switzerland (Melodie).

United Mexican Music Publ'ns Inc. (BMI), see Mexican Music

United Steel Music Co. Inc. (BMI), see Window.

Universal Entertainment Corp., 120 Hickory St., Madison, Tenn. 37115. Tel: (615) 868-1172.

Universal Stars Music Inc. (BMI), Box 5-8, Rt. 3, Leesville, La. 71446. Pres.: Sherree Stephens.

Unverse Communications (SESAC), 8033 Sunset Blvd., No. 1025, Los Angeles, Calif. 90046. Tel: (213) 851-0695. Pres.: Nate Fortner

Upper Hand Music (SESAC), see Con Bro

Upstart Music, see Pantego Sound

Upstream Music (BMI), see Bug Music Group

Up-Trend Music (BMI), see Jim W. Rice.

Upward Bound Music Co. (BMI), 12911 SW 82 Terr., Miami, Fla. 33183. Tel: (305) 279-2523. Pres.: Samuel Solomon Jr.

Up With People (ASCAP), 3103 N. Campbell Ave., Tucson, Ariz. 85719. Tel: (602) 327-7351. Pres.: J.B. Belk

Utopia Music (ASCAP), PO Box 5314, Zip: 31208, 380 Riverdale Rd., Macon, Ga. 31204. Tel: (912) 477-0415. Pres. & Gen. Mgr.: Randy L. Howard

V

V M Music Publ'g (ASCAP), see Jomark

Vaam Music (BMI), 3740 Evans Ave., Suite C-114, Los Angeles, Calif. 90027. Tel: (213) 664-7765. Pres.: Pete Martin

Vabrintr Music (BMI), see 20th Century.

Vado Music Co. (ASCAP), 2226 McDonald Ave., Brooklyn, N.Y. 11223. Tel: (212) 946-4405. Pres.: Vincent A. Velardi; Gen. Mgr.: Gloria Black.

Tommy Valando Publ'g Group Inc., 1270 Ave. of the Americas, Suite 2110, New York, N.Y. 10020. Tel: (212) 489-9696. Pres.: Tommy Valando; Gen. Mgr.: Arthur Valando.

Rocky Valdez Music, 4640 W. 118 St., Hawthorne, Calif. 90250. Tel: (213) 676-8882. Pres.: Rocky Valdez.

Thomas J. Valentino Inc. (ASCAP), 151 W. 46 St., New York, N.Y. 10036. Tel: (212) 246-4675. Pres.: T.J. Valentino.

Valleybrook Music Corp. (ASCAP), see Rex Zaro.

Jerry Vample Publ'g Co. (BMI), PO Box 23152, Kansas City, Mo. 64141. Pres. & Gen. Mgr.: Jerry Vample; Prof. Mgr.: Michael L. Charles.

Paul Vance Publ'g Co. (ASCAP), 159 W. 53 St., New York, N.Y. 10019. Tel: (212) 581-0030. Pres.: Paul Vance.

Vanguard Music Corp. (ASCAP), 250 W. 57 St., New York, N.Y. 10019. Tel: (212) 246-1343. Pres.: Frank Siegfried; Gen. Mgr.: Bobby McFarland.

James R. Vanleer Music Inc. (BMI), see 20th Century.

Vaudell Music Publ'ns (ASCAP)—Mgr.: Ellsworth F. Moss; Dir.: Vaudell E. Moss—see Apex.

Vector Music (BMI), 1107 18 Ave. S., Nashville, Tenn. 37212. Tel: (615) 327-4161.

Velvet Apple Music (BMI), 4301 Hillsboro Rd., Suite 224, Nashville, Tenn. 37215. Tel: (615) 327-2338. Owner: Dolly Parton; Gen. Mgr.: Robert F. Hunka.

Int'l reg.: France (Francis Day), Germany (Siegel), Japan (Taiyo), Netherlands (Intersong-Basart), Scandinavia (April in Sweden), South Africa (EMI-Brigadiers), UK (Carlin).

Velvet Recs. Inc. (BMI), 10128 NW 80 Ave., Hialeah Gardens, Fla. 33016. Tel: (305) 823-0812.

Verde Vista Music (ASCAP), 2383 Union St., No. 4, San Francisco, Calif. 94123. Tel: (415) 567-6935. Pres.: S. White.

Vernon Music Corp. (ASCAP), see 20th Century.

Very Own Music Co. (BMI), see 20th Century.

Very Safe Music (BMI), see Bug Music Group.

Vette Music Co. (ASCAP), 6290 Sunset Blvd., Suite 1809, Hollywood, Calif. 90028. Tel: (213) 462-5466.

Int'l reg.: Austria (Compass), France (Francis O'Neil), Germany (Compass), Ireland (Larry Shayne), Iron Curtain Countries (Compass in Germany), Italy (Compass in Germany), Japan (Tone), Netherlands (Larry Shayne), Scandinavia (Compass in Germany), UK (Larry Shayne).

Vicki Music (BMI), see Bug Music Group.

Vicky Music (BMI), see Bug Music Group.

Victoria Falls Music (BMI), see Four Aces.

Video Music (BMIV), see Bug Music Group.

Vidor Publ'ns Inc. (BMI)—Prof. Mgr.: Tom Ritter—see Red River.

Norm Vincent Publ'g (BMI), 2110 The Woods Or., Jacksonville, Fla. 32216. Tel: (904) 246-3216. Pres.: Norman F. Vincent; Gen. Mgr.: Karen W. Vincent

Vintage Music Inc. (BMI), see Combine.

Viper Music (BMI), see Bug Music Group.

Virginia Music Co. (BMI), 209 Main St., Fort Lee, N.J. 07024. Tel: (201) 947-3900. Pres.: Al Thomas; Gen. Mgr. Tom Agriro; Prof. Mgr.: Jim McCarthy

Visual Songs (BMI), see Creative Corps.

Vitak-Elsnc Co. (SESAC), 6400A S. Woodward Ave., Downers Grove, Ill. 60515. Tel: (312) 963-0200. Pres. Lawrence Musielak.

Jerry Vogel Music Co. Inc. (ASCAP), 58 W. 45 St., New York, N.Y. 10036. Tel: (212) 730-0478. Cable: TINPANALLY. Gen. Mgr.: Mabel Cram.

Vogue Music Inc. (BMI), see Welk Music Group.

Vokes Music Publ'g Co. (BMI), PO Box 12, New Kensington, Pa. 15068. Tel: (412) 335-2775. Pres. & Mgr.: Howard Vokes.

Volkwein Bros. Inc. (ASCAP), 117 Sandusky St., Pittsburgh, Pa. 15212. Tel: (412) 322-5100

Harry Von Tizer Music Publ'g Co. (ASCAP), see Welk Music Group.

Wron Eye Music (ASCAP), see Roads of Music.

W

W B Music Corp. (ASCAP), see Warner Bros.

W P N Music Co. Inc. (ASCAP), 10 Swirl Ln., Levittown, N.Y. 11756. Tel: (516) 796-3698. Pres.: Paul Friedberger. VP & Prof. Mgr.: Warren Schatz; Sec'y-Treas.: Nat Schnapp

Branch: New York, N.Y., Japalana Music, 723 Seventh Ave. Z.p. 10019. Tel: (212) 245-7640

Int'l rap.: UK (Cyril Shane).

Walden Music Inc. (ASCAP), see Cotillon.

Wallet Music (BMI), see Garrett.

Wanessa Music Inc. (BMI), PO Box 387, Radio City Sta., New York, N.Y. 10019. Tel: (212) 582-0543.

Warner Bros. Music (ASCAP) (div. of Warner Bros. Inc.), 9200 Sunset Blvd., Los Angeles, Calif. 90069. Tel: (213) 273-3323. Cable: WANG. Chm.: Chuck Kaye. Pres.: Mel Bly; Gen. Mgr.: Bob Stabile; Prof. Mgr.: Michael Sandoval; Copyright Dir.: Al Kohn.

Branches: New York, N.Y., 75 Rockefeller Plaza. Zip: 10019. Tel: (212) 484-8000. Prof. Mgr.: Henry Marks—Nashville, Tenn., 44 Music Square W. Zip: 37203. Tel: (615) 254-8777. Gen. Mgr. Tim Wipperman.

Int'l branches: Australia, Brazil, England, France, Germany, Italy, Netherlands, Scandinavia, South Africa.

Int'l firms represented: Bright, Bron Group, Moggie, Pendulum, Pentangle, Skylark, Slim Chance, Sweet, Topographic, Winterfold.

Warner/Levenson Publ'g Co. (ASCAP), 9 E. 46 St., New York, N.Y. 10017. Tel: (212) 661-2106

Warner Tamerlane Publ'g Corp. (BMI), see Warner Bros.

Warus Music (BMI), 1410 E. 72 St., Chicago, Ill. 60619. Tel: (312) 752-2755. Pres. U.S. Warren

Lord William Washington Music (BMI), see Bug Music Group.

Watchpocket Music (BMI), see Bug Music Group

Waterhouse Music (BMI), 100 N. Seventh St., Minneapolis, Minn. 55403. Tel: (612) 332-6575. Pres. & Gen. Mgr. Gary Marx.

Watertoons Music (BMI), see Cameron

Watt Works Inc. (BMI), Willow, N.Y. 12495. Tel: (914) 688-5373. Pres.: Michael Mantler.

Wazuru Music Inc. (BMI), see Gloria Gaynor

Waysta Music, see Wade C. Staley.

Weaner-Levant (ASCAP), see Theodore Presser

Web IV Music Publ'g (BMI), 2107 Faulkner Rd. NE, Atlanta, Ga. 30324. Tel: (404) 329-9535. Pres.: Ilene Berns.

H. B. Webman & Co., 1650 Broadway, Suite 701, New York, N.Y. 10019. Tel: (212) 586-0240. Cable: WEBMANMUS. Owners & Mgrs.: Hal & Belle Webman.

Int'l reg.: Australia (J. Albert), Austria, Germany & Switzerland (J. Michel), Italy (Curci), Norway, Denmark & Sweden (Reuter & Reuter).

Webo Music (BMI), see 20th Century.

Wedge Music Inc. (BMI), see Skinny Zach.

Jerry Weintraub Music Co. (BMI), see Cherry Lane
 Weintraub/Dhun Music (ASCAP), see Management III
 Ron Weiser Publ'g (BMI), 6918 Peach Ave., Van Nuys, Calif. 91406 Tel. (213) 781-4805, 994 5644 Pres. Ron Weiser Gen. Mgr. Patricia Weiser. (Administered by Bug Music Group)
 Int'l repps.: Australia (Matthews), France (WEA), Germany (Roba), Italy (WEA), Japan (Pacific), Netherlands (EMI), Scandinavia (Arr Music), UK (WEA)
 Stevens H. Weiss, 444 Madison Ave., New York, N.Y. 10022 Tel. (212) 752 1330 Cable SDNGBIRD Admin'r. Stevens H. Weiss, Ass't Admin'r. Shelley Kaye
 Weik Music Group, 1299 Ocean Ave., Suite 800, Santa Monica, Calif. 90401 Tel. (213) 451-5727 Exec. VP & Gen. Mgr. Dean Kay (SEE ADVERTISE MENT)
 Wellesley Music Co. (BMI), see Integrity
 Welton Music (BMI), see Protone
 Weiz Music Co. (ASCAP), see Dawn Prod'ns
 Wesjac Music (BMI), 129 W. Main St., Lake City, S.C. 29560 Tel. (803) 394 3712 Owner William R. Bragdon Jr.
 Western Hemisphere Music Co. (BMI), 252 Robby Ln., New Hyde Park, N.Y. 11040 Tel. (516) 627-8861 Pres. Harvey Fachlin, Gen. Mgr. Steve Rachlin, Prof. Mgr. Craig Rachlin
 We Three Music Inc. (BMI), see H.B. Webman
 Wet Song Music (BMI), see Bug Music Group
 Weyman Music (ASCAP), see Amestoy
 Norm Whaler Music (ASCAP), see NBC
 Wheen Music (ASCAP), see Four Moons
 Whiskey Drinkin' Music (BMI), see Bug Music Group
 Ian Whitcomb Songs (BMI), see Bug Music Group
 White Cat Music (ASCAP), Box 3247, Shawnee, Kan. 66203 Tel. (913) 631 6060 Contact Frank Fara
 White Clay Prod'ns Inc. (BMI), Box 324, Newark, Del. 19711 Tel. (302) 368 1211 Pres. E. Michael Fisher, VP & Prof. Mgr. Nicholas C. Norris, Gen. Mgr. Melissa A. Williams
 Don White Publ'g (ASCAP), 2020 Ridge Ave., Philadelphia, Pa. 19121 Tel. (215) 765-4889 Pres. P. Donald White
 White Dwarf Music (ASCAP), c/o dba Recs., 875 Ave. of the Americas, Suite 1001, New York, N.Y. 10001 Tel. (212) 279-9126 Telex 237155 Gen. Mgr. Alex Alexander
 Int'l repps.: France (Atoll), Germany (Schacht), Italy (Durium), Japan (Shinko), Mexico (EDIM), Portugal (Notas Magica), Scandinavia (Arr), Spain (Notas Magica), UK (Louigny)
 White Line Music Inc. (BMI), see Coal Miners
 Whitesque Music (BMI), see Bug Music Group
 White Tiger Music (USA) (BMI), see Mirsong Music
 White Way Music Co. Inc. (ASCAP), 65 W. 55 St., Suite 11G, New York, N.Y. 10019 Tel. (212) 245-1958 Cable WHITPRODIN Pres. & Prof. Mgr. Edward R. White, Gen. Mgr. Peter White
 Wicked Good Music (BMI), see Bug Music Group
 Widget Publ'g (BMI) (div of Widget Rec'g. Inc.), PD Box 2446, Muscle Shoals, Ala. 35660 Tel. (205) 381-1300 Pres. & Prof. Mgr. Ron Ballew
 Shane Wilder Music (BMI), PD Box 3503, Hollywood, Calif. 90028 Tel. (213) 467-1958 Pres. Shane Wilder
 Int'l branches: Germany, Ireland, UK
 Wild Goose Music (BMI), see Sleepy Hollow
 Wild Sanctuary Music (BMI), see Parasound

Wiljex Publ'g Co. (ASCAP), see Con Brio
 Will Du Music Publ'g Co. (BMI), 833 N. Orange Grove Ave., Los Angeles, Calif. 90046 Tel. (213) 653-8358 Pres. L.L. Dulfon, Gen. Mgr. M. Wer show, Prof. Mgr. Lou Dulfon
 Don Williams Music Group, 1888 Century Park E., No. 1106, Los Angeles, Calif. 90067 Tel. (213) 556-2458 Owner & Gen. Mgr. Don Williams, Prof. Mgr. Trav Livingston
 Dootsie Williams Publ'ns (BMI), 121 S. Hope St., Suite 334, Los Angeles, Calif. 90012 Tel. (213) 628-7768 Pres. & Prof. Mgr. Dootsie Williams, Gen. Mgr. Jo Williams
 Willis Music Co. (SESAC), 7380 Industrial Rd., Florence, Ky. 41042 Tel. (606) 283-2050 Pres. Edward R. Cranley, Controller Frank Scordato
 Wilojarston Music (ASCAP), see Brother
 WilSing Music Publ'rs (BMI), Box 100 N. RFD 3, Stuart, Va. 24171 Tel. (703) 694-6128 Pres. & Gen. Mgr. John F. Williams, Prof. Mgr. Frank W. Singleton
 Wilson Brothers Music (ASCAP), see Funky but
 Wilsonian Music (ASCAP), see Brother
 Wilson/Zario (BMI), see Rex Zario
 Wit Too Music (ASCAP), PD Box 4563, Nashville, Tenn. 37216 Tel. (615) 883-2855 Pres. Tom Wilkerson
 Wimot Music, 8961 Sunset Blvd., Los Angeles, Calif. 90069 Tel. (213) 276 9330 VP. Leonard Hodges
 Windham Hill Music, PD Box 9388, Stanford, Calif. 94305 Tel. (415) 329 0647 Pres. William Ackerman
 Window Music Publ'g Co. Inc. (BMI), 809 18 Ave. S., Nashville, Tenn. 37203 Tel. (615) 327-3211 Pres. Pete Drake, Gen. & Prof. Mgr. Rose Trimble
 Windsea Music (BMI), see Cherry Lane
 Windstar Music (ASCAP), see Cherry Lane
 Windstorm Music (BMI), see Bug Music Group
 Windy Jenny Music (BMI), see Cherry Lane
 Mike Wing Music Publ'g (BMI), PD Box 171, Bellevue, Wash. 98009 Tel. (206) 828-3642 Owner Mike Wing
 Winner Music (BMI), c/o International Rec'g. Co., 1649 W. Evergreen, Chicago, Ill. 60622 Tel. (312) 227-2000 Pres. Leonard March
 Winsor Music (BMI), see Bug Music Group & Ron Weiser
 Wishbone Music (ASCAP), see Don Williams
 Wits End Music (BMI), see Bug Music Group
 Wizard Music Co. (ASCAP), 11 Harrison Court, South Orange, N.J. 07079 Tel. (201) 762-2504 Pres. Jimmy Wisner, Gen. Mgr. Jane Berson.
 Womach Publ'g Co. (SESAC), see NMS
 Wonderbuns Inc. (BMI), see Mayflower Music
 Wonderland Music Co. Inc. (BMI), see Walt Disney
 Curtis Wood Music (ASCAP), PO Box 22312, Nashville, Tenn. 37202 Tel. (615) 876-1729 Pres. Curtis Wood
 Wooden Bear Music (ASCAP), see Big Heart
 Wooden Nickel Music Inc. (ASCAP), c/o Cooper, Epstein & Hurewitz, 9465 Wilshire Blvd., Suite 800, Beverly Hills, Calif. 90212 Tel. (213) 550 1010 Pres. James Golden, VP. Bill Traut
 Woodglen Publ'ns (BMI), PD Box 35855, Houston, Tex. 77035 Tel. (713) 499-5943 Owner & Gen. Mgr. Dan Mechura Sr.
 Woodrich Publ'g Co. (BMI), George Wallace Park Dr., Lexington, Ala. 35648 Tel. (205) 247-3983 Pres., Gen. & Prof. Mgr. W.P. Richardson.
 Int'l repps.: UK (Dick James)
 Curtis L. Woods Publ'g Co. (BMI), PD Box 701, North Wilkesboro, N.C. 28659 Tel. (919) 667-6662 Gen. & Prof. Mgr. Curtis L. Woods

Woolfson Inc. (BMI), see 20th Century
 Word Music (ASCAP), 4800 W. Waco Dr., Waco, Tex. 76796 Tel. (817) 772 7650
 Branch: North Hollywood, Calif., 10000 Riverside Dr., Suite 1 Zip 91602 Tel. (213) 760-0395—Nashville, Tenn., 2300 Hillsboro Rd., Suite 302 Zip 37212 Tel. (615) 383-8964
 Workin' Country Music (BMI), 12231 Snow White Dr., Dallas, Tex. 75234 Tel. (214) 243-5792 Pres. Ralph Hollis
 World Artist Music Co. Inc. (BMI), see Cherry Lane
 World Music Inc. (ASCAP), 18 E. 48 St., New York, N.Y. 10017 Tel. (212) 688-6230 Pres. Sammy Kaye, Prof. Mgr. Marie Garbarine
 World's Finest Music (BMI), 1109 Brooks Ln., Indianapolis, Ind. 46202 Tel. (317) 542-7460 Pres. Karriem Musher, Prof. Mgr. Michael Whitaker
 World Songs Publ'g Inc. (ASCAP), see Arista Interworld
 WorldWide Music Inc., 1300 Division St., Nashville, Tenn. 37203 Tel. (615) 256-7543 Pres. & Gen. Mgr. Calvin H. Everhart
 Worldwide Music Publ'rs & Dist's., PD Box 995, Ansonia, Sta., New York, N.Y. 10023 Pres. Eric Fletcher
 Int'l firms represented: Musica Rara, Antico, Mapa Mundt, Emerson
 Worthless Music (ASCAP), see JEDD
 Worthy Music Co., 1909 Ave. K, Brooklyn, N.Y. 11230 Tel. (212) 377-4321 Owner Gil Snapper
 Writing Table Music Co. (ASCAP), see Spaceark Ent's
 Wynwood Music Co. Inc. (BMI), Box 101, Broad Run Va. 22014 Tel. (703) 361-1040 Pres. Peter V. Kuykendall

X

X C Music Publ'g (ASCAP), 425 Sycamore St., Columbus, Ohio 43206
 Xanadu Recs. Ltd., 3242 Irwin Ave., Kingsbridge, Bronx, N.Y. 10463 Tel. (212) 549-3655 Cable XANADU Pres. Don Schlitten, Gen. Mgr. Nina Reid Schlitten
 Int'l repps.: France (Vogue), Japan (Pumpkin)

Y

Yankee Hillbilly Music (BMI), see Bug Music Group
 Yarmouth Publ'g (BMI), see Bug Music Group
 Ybarra Music (ASCAP), PD Box 665, Lemon Grove, Calif. 92045 Tel. (714) 462-6538 Owner Richard Braun, Gen. Mgr. R. Williams
 Year Round Music Co. (BMI), see 20th Century
 Yellow Bee Music (BMI) (div of Yellow Bee Prod'ns Inc.), 245 Waverly Pl., New York, N.Y. 10014 Tel. (212) 255-3698 Pres. Nick Perls
 Yellow Dog Music Inc. (ASCAP), see Hudson Bay
 Young Ideas Music (ASCAP), see 20th Century
 Youngun' Publ'g Co. (BMI), see Combine
 Yo Yo Music (BMI), see Fred Rice Prod'ns
 Yuggoth Music Co. (BMI), 9465 Wilshire Blvd., Suite 820, Beverly Hills, Calif. 90212 Tel. (213) 550-1010 Partners Bill Traut, Jim Golden, Bob Monaco
 Yuma Music Corp. (ASCAP), see Shapiro Berstein

Z

Zane Music Inc. (BMI), see Lloyd Zane Remick
 Frank Zappa Music Inc. (BMI), see Open End
 Zappo Music (ASCAP), see 20th Century
 Rex Zario Music (BMI), 3010 N. Front St., Philadelphia, Pa. 19133 Tel. (215) 426-5682 Pres. Rex Zario, Gen. Mgr. Betty Lelav
 Int'l repps.: Australasia (Festival), Benelus (Charles Bens), Germany (Charles Bens), UK (Campbell Connelly, Chappell)
 Zaza Music (BMI), 880 NE 71 St., Miami, Fla. 33138 Tel. (305) 759-1405 Pres. Carlos Oliva, Gen. Mgr. Georgina Vidal, Carlos Salzarite (Administered by Chillywinds Music)
 Zebra Discorde Music Group, 6255 Sunset Blvd., Suite 1911 Hollywood, Calif. 90046 Contact Christian De Walden
 Zeldgamojs Music (ASCAP), see Radmus
 Zeus Bolts Publ'g Co. (ASCAP), 532 Ninth St., Brooklyn, N.Y. 11215 Tel. (212) 788-5514 Pres. Harold O. Sessa
 Zomba Ent's Inc. (BMI), 330 W. 58 St., New York, N.Y. 10019 Tel. (212) 265-2520 Telex 237316 Pres. Clive Calder, VP. Ralph Simon, Prof. Mgr. Rachelle Greenblatt
 Int'l branch: England
 Zound Publ'g, 19 Bridge St., Glen Cove, N.Y. 11590 Tel. (516) 676-3366 Pres. & Prof. Mgr. Gary Leder, Gen. Mgr. David Loewenstem

INTRODUCING

THE MUSICTIME DISPLAY CENTER

**ADDED SERVICE FOR
 YOUR CUSTOMERS. . .
 ADDED PROFIT FOR YOU!**



The Dumont MusicTime Display Center, a \$75 value, is yours free with your order.

Until now, there hasn't been a music folio display rack which combined attractiveness, profitability and high volume.

- * You can display 12 of the top-selling folios. We'll make sure they're the hot-sellers. And we'll also keep you re-supplied so there's no selling "downtime."
- * For those who have been specializing in records and tapes, this is the easy, profitable way to reach new customers, or expand sales to present customers. (And, you can sell at list price.)
- * The Center is compact, designed to attract and sell, and destined to be a great profit center for you.

Be among the first to offer the new look in music folio marketing.

MUSICTIME

P.O. BOX 2810
 CHERRY HILL, N.J. 08034



Give the gift of music.

1941



40th Anniversary

1981

SHEET MUSIC

JOBBERS & SUPPLIERS OF THE UNITED STATES



CALIFORNIA

● GAROEN GROVE (Area Code 714)

Largo Music Corp., 7421 Anaconda Ave. Zip 92641 Tel. 898-0507 VP Western Div. Jack Griffith, Opns. Mgr. Mike Scharwath, Sales Mgr. Tom Smelser
Home office: Columbia, Md.

● LOS ANGELES METROPOLITAN AREA (Area Code 213)

Alfred Publ'g Co. Inc., 15335 Morrison St., Sherman Oaks 91403 Tel. 995-8811 Pres. Morton Manus, Sales Mgr. Mark L. Hill
Almo Publ'ns, 1358 N. La Brea, Hollywood 90028 Tel. 469-2411 Mgr. Linda Chelgren
Chappel Music Co., 6255 Sunset Blvd., Suite 1904 Zip 90028 Tel. 469-5141
Home office: New York, N.Y.

Chebro Music Co., 17421 B.E. Geary Ave., City of Industry 91744 Tel. 964-1153 Gen. Mgr. Terry Orme
Home office: Idaho Falls, Idaho

Criterion Music Corp., 6124 Selma Ave., Hollywood 90028 Tel. 469-2296
Carl Fischer of Los Angeles Inc., 1101 S. Hope St. Zip 90015 Tel. 749-5227
Gen. Mgr. Marty Baumgart
Home office: New York, N.Y.

Inspirational Music, P.O. Drawer 1, Northridge 91378 Tel. 987-2911 Pres. Gen. & Sales Mgr. Hugh H. Edwards
M.C.A. Music (div. of MCA Inc.), 70 Universal City Plaza, Universal City 91608 Tel. 508-4550 VP. Leids Levy
Home office: New York, N.Y.

Peer Southern Org., 6777 Hollywood Blvd., Hollywood 90028 Tel. 469-1667 Cable: SOUTHMUSIC LOS ANGELES TWX (910) 321-4098 Pres. Mrs. Monique I. Peer, Branch Mgr. Roy Kahn
Home office: New York, N.Y.

Morse M. Freeman Inc., 733 S. Spring St. Zip 90055 Tel. 623-7211 Pres. & Gen. Mgr. Harold L. Freeman, Ass't Gen. Mgr. Terrence M. Stevens
Warner Bros. Music Inc., 9200 Sunset Blvd. Zip 90069 Tel. 273-3323 Pres. Mel Bly, Gen. Mgr. James Cornelius, Sales Mgr. Ray Kennedy
Branch: New York, N.Y.

Watts City Prods., 11211 Wilmsington Ave. Zip 90059 Gen. Mgr. Joe Foran
Affiliate: Cincinnati, Ohio, Devitt & Hanser Music Co. Inc.
Western Int'l Music Inc., 2859 Hill Ave. Zip 90034 Tel. 870-9381 Pres. William Schmidt

● OJAI (Area Code 805)

Creative Concepts Publ'g Corp., 67 E. Ojai Ave. Zip 93023 Tel. 646-4811 Pres. John L. Haag

● SAN FRANCISCO & BA' AREA (Area Code 415)

Byron Hoyt Sheet Music Serv., 90 Tenth St. Zip 94103 Tel. 431-8055 Pres. Arthur B. Gurwitz, Sales Mgr. Donald M. Schmeer Jr.
Pacific Coast Music Inc., P.O. Box 42069, 141 Kearny Zip 94108 Tel. 996-2385 Gen. Mgr. Stan Halvean
Affiliate: Las Vegas, Nev., Hansen House

● TUSTIN (Area Code 714)

Professional Music Prods. Inc., 11731 E. Franklin Ave. Zip 92680 Tel. 838-8421 Pres. Leon White, VP & Gen. Mgr. Jeffrey Brown

COLORADO

● AURORA (Area Code 303)

Son Key Inc., P.O. Box 31757, Zip 80041 Tel. 366-1413

● DENVER METROPOLITAN AREA (Area Code 303)

Linear Music Publ'ns, 1790 Welster St., Lakewood 80215 Tel. 238-0186 Pres. & Gen. Mgr. Rick Chm. Sci., Sales Mgr. Georgia Chivisco

CONNECTICUT

● GREENWICH (Area Code 203)

Cherry Lane Music Co. Inc., 50 Holly Hill Ln. Zip 06830 Tel. 661-0707 NYC (212) 824-7711 Telex 643420 Pres. Lauren Keiser, VP. Lorain Levy, Mktg. Mgr. Veronica Pope
Branch: Atlanta, Ga.

FLORIDA

● DAYTONA BEACH (Area Code 904)

Cude & Pickens Dist'g., 519 N. Fairfax Ave. Zip 32018 Tel. 257-0381 Pres. & Sales Mgr. Bobby Lee Cude

● FORT LAUDERDALE (Area Code 305)

Plymouth Music Co. Inc., 170 W. 33 St. Zip 33334 Tel. 563-1844 Gen. Mgr. Bernard Fisher

● MIAMI METROPOLITAN AREA (Area Code 305)

Columbia Pictures Publ'ns (div. of Columbia Pictures Inds. Inc.), P.O. Box 4340, 16333 NW 54 Ave., Hialeah 33014 Tel. 620-1500 WATS

(800) 327-7643 Pres. Frank J. Hackinson, Sales Mgr. Bill Price, Jobber & Foreign Sales Mgr. Raul Artiles

Hansen House, 1860 West Ave., Miami Beach 33139 Tel. 532-5461 Gen. Mgr. Manolo Garcia, Sales Mgr. Charles H. Hansen II

Home office: Las Vegas, Nev.
Peer Int'l Org., Northeast Airlines Bldg., Rm. 1409, 150 SE Second Ave. Zip 33131 Tel. 358-1488

Home office: New York, N.Y.

● TAMPA (Area Code 813)

J. W. Pepper of Florida, 5201 Harney Rd. Zip 33610 Tel. 621-3444 Gen. Mgr. Melvyn Schlegel

Home office: Valley Forge, Pa.

GEORGIA

● ATLANTA (Area Code 404)

Cherry Lane Music Co. Inc., 9401 Robert Dr., Apt. 12 F, Zip 30338 Tel. 997-2800 Sales Rep. Susan Pettijohn

Home office: Greenwich, Conn.
Georgia Music Supply Inc., P.O. Box 490331, Zip 30349 Tel. 996-3385 Pres. Richard F. DeCourcy, Gen. Mgr. Linda Galgano

J. W. Pepper of Atlanta, 4773 Wendell Dr., SW Zip 30336 Tel. 691-6500

Home office: Valley Forge, Pa.

● CLARKESVILLE (Area Code 404)

Clarkesville Rec. Sales Co. Inc., P.O. Box 198, 608 N. Washington St. Zip 30573 Tel. 754-2152

IDAHO

● IDAHO FALLS (Area Code 208)

Chebro Music Co., Box 2009, 327 Broadway Zip 83401 Tel. 522-8691 TWX (910) 978-5905 Pres. Ioan Chesbro, Sales Mgr. Doug Gnales

Branch: City of Industry (Los Angeles Metropolitan Area), Calif.

ILLINOIS

● CHICAGO METROPOLITAN AREA (Area Code 312)

Carl Fischer of Chicago Inc., 312 S. Wabash Ave. Zip 60604 Tel. 427-6652

Gen. Mgr. Gary Sigurdson

Home office: New York, N.Y.

Harris Teller Inc., 7400 S. Mason Ave. Zip 60638 Tel. 496-2100 Pres. Edward Harris, Gen. Mgr. Mike Harris, Sales Mgrs. F. Salvador, W. Cavens

Martin & Morris, 4312 S. Indiana Zip 60653 Tel. 268-6676

Vitak Electric Co., 6400A S. Woodward Ave., Downers Grove 60515 Tel. 963-0700 Pres. Lawrence G. Musielak

● PEORIA (Area Code 309)

St. Louis Peoria Music Co., 272 SW Adams St. Zip 61602 Tel. 676-3141

WATS (800) 447-0958

Affiliate: Las Vegas, Nev., Hansen House

● ROCKFORD (Area Code 815)

Festival of Song Music Co., 1519 Windsor Rd. Zip 61111 Tel. 654-1260

INDIANA

● ALEXANDRIA (Area Code 317)

Alexandria House Inc., P.O. Box 300, S.R. 9 S. Zip 46001 Tel. 724-4438

Pres. William J. Gaither, Mktg. Mgr. Jerry Weimer, Sales Mgr. Robert G. Rist

● LEBANON (Area Code 317)

Studio P. R. Inc., 224 S. Lebanon St. Zip 46052 Tel. 487-4440 Pres. James G. Houston, Exec. VP & Sales Mgr. John F. Welch

KENTUCKY

● FLORENCE (Area Code 606)

Willis Music Co., 7390 Industrial Rd. Zip 41047 Tel. 283-2050 Pres. F.R. Cranley

LOUISIANA

● ALEXANDRIA (Area Code 318)

Gospel Music Inc., P.O. Box 1706, 1212 Main St. Zip 71301 Tel. 443-2549

Pres. Gen. & Sales Mgr. J.D. Davis

MARYLAND

● BALTIMORE (Area Code 301)

Marshall/Mangold Dist'g. Co. Inc., 4805 Nelson Ave. Zip 21215 Tel. 542-7214 Pres. & Sales Mgr. Manny Goldberg

● COLUMBIA (Area Code 301)

Largo Music Corp., 9195 Red Branch Rd. Zip 21045 Tel. 995-1776

Branch: Garden Grove, Calif.

● ROCKVILLE (Area Code 301)

Harris Music Co., 12260 Wilkins Ave. Zip 20852 Tel. 770-1950 Owner

Marshall I. Harris

MASSACHUSETTS

● BOSTON METROPOLITAN AREA (Area Code 617)

Boston Music Co., 116-122 Boylston St. Zip 02116 Tel. 426-5100 Gen. Mgr. Warren W. Morris, Sales Mgr. Charles A. Constantine
Local branches: Boston Music Co. at Berkeley, 146 Massachusetts Ave. Zip 02215 Tel. 267-8223 Branch Mgr. Jeff Lucas
Boston Music Co. at Harvard Square, 57 Boylston St. Cambridge 02138 Tel. 492-2000 Branch Mgr. Bonnie Summerfield

Albert Najarian Wholesale Music Inc., 295 Huntington Ave. Zip 02115 Tel. 536-5007 Pres. & Sales Mgr. Albert Najarian

MICHIGAN

● DETROIT METROPOLITAN AREA (Area Code 313)

J. W. Pepper of Detroit, 552 Robbins Dr., Troy 48064 Tel. 588-1000

Home office: Valley Forge, Pa.

Thomas Music Supply Co., 3715 N. Woodward Ave., Royal Oak 48072 Tel. (313) 549-4422 Pres. Beatrice Brown, Sales Mgr. Martha Janke

MINNESOTA

● MINNEAPOLIS-ST. PAUL METROPOLITAN AREA (Area Code 612)

Grason, Tel. 338-0775 see World Wide Publ'ns

World Wide Publ'ns, 1303 Hennepin Ave., Minneapolis 55403 Tel. 338-0940

● WINONA (Area Code 507)

Hal Leonard Publ'g Corp., 960 E. Mark St. Zip 55987 Tel. 454-2920

Branch: Milwaukee, Wis.

MISSOURI

● SPRINGFIELD (Area Code 417)

Gospel Publ'g House, 1445 Boonville Ave. Zip 65802 Tel. 862-2781

NEVADA

● LAS VEGAS (Area Code 702)

Hansen House, 955 E. Sahara Zip 89104 Tel. 735-4947 Pres. Charles Hansen, Sales Mgr. John Brimhall

Branch: Miami Beach (Miami Metropolitan Area), Fla.

Affiliates: San Francisco, Calif., Pacific Coast Music Inc., Peoria, Ill., St. Louis Peoria Music Co., Seattle, Wash., Capitol Music Co. Inc.

NEW JERSEY

● CHERRY HILL (Area Code 609)

Charles Dumont & Son Inc., P.O. Box 2810, 22 Springdale Rd. Zip 08034 Tel. 424-5813, WATS (800) 257-8283 Pres. Charles J. Dumont, Gen. Mgr. George Biello Jr., Sales Mgr. Dorothy Kavros

Musictime (div. of Charles Dumont & Son), P.O. Box 2810, 22 Springdale Rd. Zip 08034 WATS Tel. (800) 257-8283 Pres. Charles J. Dumont, Mktg. Dir. George Biello Jr. (Photos only) (SEE ADVERTISEMENT)

● FAIRFIELD (Area Code 201)

Publisher Sales Inc., 16 Passaic Ave. Zip 07006 Tel. 575-1804 WATS (800) 631-1044 Pres. Leo Artiles, Gen. Mgr. Tom Massarella, Sales Mgr. Angela Biel

NEW YORK

● COPIAGUE (Area Code 516)

Controlled Sheet Music Serv. Inc., 112 Hudson St. Zip 11726 Tel. 842-8080 Pres. Ronald Ravitz, Gen. & Sales Mgr. Linda Press

Music of the Month, see Controlled Sheet Music

● MELVILLE (Area Code 516)

Belwin Mills Publ'g Corp., 25 Deshon Dr. Zip 11747 Tel. 293-3400 Pres. Martin Winkler

● NEW YORK METROPOLITAN AREA (Area Code 212)

April Blackwood Publ'ns, 1350 Ave. of the Americas 23rd fl. Zip 10019

Tel. 975-7045 Dir. Al Kugler, Admin. Ass't Marsha Tannenbaum (Distributed by Bradley Publ'ns)

Big 3 Music Corp., 729 Seventh Ave. Zip 10019 Tel. 575-2978 Pres. Harold Seider, VP & Gen. Mgr. Stephen L. Cotter, Sales Mgr. Margaret Carman

Bradley Publ'ns (div. of RBR Communications Inc.), 43 W. 61 St. Zip 10023

Tel. 757-8805 Co. Pres. Richard Bradley, Bill Radics, VP. Mark Dunham

Cambridge Publ'ns, 489 Fifth Ave. Zip 10017 Tel. 682-8400 Telex 236920

Pres. Vittorio Benedetto, Publ'ns Dir. Johnny Dentato

Chain Dist. Inc., 476 E. Fordham Rd., Bronx 10458 Tel. 298-3350 Pres. Morris Bronen, Gen. Mgr. Sid Bronen

Chappel Music Co., 810 Seventh Ave. Zip 10019 Tel. 399-7373

Branches: Los Angeles, Calif., Nashville, Tenn.

Cherry Lane Music Co. Inc., see listing under Greenwich, Conn.

Pietro Deiro Music Headquarters, 133 Seventh Ave. S. Zip 10014 Tel. 675-5460 Pres. Pietro Deiro

ONE WORLD

GREENWORLD

ROCK, NEW WAVE & JAZZ
IMPORTED and EXPORTED
from & to

SCANDINAVIA • JAPAN • AUSTRALASIA
UNITED KINGDOM • CONTINENTAL EUROPE

PRINCIPAL DISTRIBUTORS

for the
INDEX LABEL

Write, Call or Telex for Catalogue

**GREENWORLD
DISTRIBUTION**

20445 GRAMERCY PLACE TORRANCE, CALIFORNIA 90501 USA
TELEPHONE (213) 533-8075, (800) 421-2095 TELEX (4) 5720103

Carl Fischer Music Jobbers, 54 Cooper Square Zip 10003 Tel: 777 2550.
Branch Opns. Dir. Stephen Einhorn
Branches: Los Angeles, Calif., Chicago, Ill. (SEE ADVERTISEMENT)
Oons Fisher Music Corp., 1619 Broadway Zip 10019 Tel: 586 1545
Lee/Art Graphics Inc., 157 Chambers St. Zip 10007 Tel: 267-4140 Pres
Lucie Koppelman; Gen. Mgr. Charles Koppelman
M C A Music (div of MCA Inc.), 445 Park Ave Zip 10022 Tel: 759 7500
Telex: 423647 Pres. Salvatore T. Chiantia.
Branches: Universal City (Los Angeles Metropolitan Area), Calif., Nash-
ville, Tenn.
Edward B. Marks Music Corp., 1790 Broadway Zip 10019 Tel: 247-7277
Cable: MARKBRO Telex: 620960 Pres. Joseph Auslander, VP & Pub'l'n
Dir. Bernard Kalban
Edwin H. Morris & Co. Inc. (div of MPL Communications Inc.), 39 W. 54 St
Zip 10019 Tel: 581 1330
Music Sales Corp., 33 W. 60 St. Zip 10023 Tel: 246 0325 Pres. Herbert
Wise, Sales Mgr. Joseph Lyons
Int'l branches: Australia, Music Sales Australia Pty Ltd., England, Music
Sales Ltd., Germany, Music Sales GmbH
Peer Southern Org., 1740 Broadway Zip 10019 Tel: 265-3910 Pres. Mo-
nique I. Peer Sr. VP. Ralph Peer II, VP. Mario Conti (SEE ADVERTISE-
MENT)
Rashid Sales Co., 191 Atlantic Ave., Brooklyn 11201 Tel: 852 3295/3298
Cable: ALRASHID Pres. Albert Rashid Sales Mgr. Raymond Rashid
Local branch: 155 Court St. Zip 11201 Tel: 852 3298 Gen. Mgr.
Stanley Rashid
R. I. Silver Assocs. Inc., 527 Madison Ave. Zip 10022 Tel: 752 3180
Tempo Music Inc., 750 Park Ave. Zip 10021 Tel: 249 7500
Terminal Musical Supply Inc., 166 W. 48 St. Zip 10036 Tel: 245 5270
Pres. Arthur Nitka, Gen. Mgr. George Rizzo
Warner Bros. Music, 75 Rockefeller Plaza, 14th Fl. Zip 10022 Tel: 484-
8000 VP. Herman Steiger, Sales Mgr. Steve Spooner
Home office: Los Angeles, Calif.

• **WEST BABYLON (Area Code 516)**

Mark Music Serv. Ltd., 95 Eads St. Zip 11704 Tel: 420-8310 Pres. Harold
Goydel, Gen. Mgr. David Weiss, Sales Mgr. Steven Goydel

NORTH CAROLINA

• **CHARLOTTE (Area Code 704)**

Brod't Music Co., PO Box 9345, Zip 28299, 1409 E. Independence Blvd. Zip
28205, Tel: 332 2177 Owner Gladys F. Brod't, Gen. Mgr. Frank G. Pot-
ter, Sales Mgr. Edwin M. Belch Jr.

OHIO

• **CINCINNATI (Area Code 513)**

Davitt & Hanser Music Co. Inc., 415 Greenwell Ave. Zip 45238 Tel: 451-
5000, Pres. Bob Hanser, Sales Mgr. Jack Hanser
Hal Nat. Music Publ'g Co., PO Box 37156, Zip 45222 Tel: 531 7605, 891-
2300 Pres. Saul Halper, Gen. Mgr. Steven D. Halper
Branch: Los Angeles, Calif., Walts City Prod'n

• **CLEVELAND (Area Code 216)**

Grossman Music Corp., 1278 W. Ninth St. Zip 44113 Tel: 696-1234 Cable
GROMUSIC

• **COLUMBUS (Area Code 614)**

Stanton Sheet Music, 118 E. Main St. Zip 43215 Tel: 224 4257

PENNSYLVANIA

• **PITTSBURGH (Area Code 412)**

Volkwein Bros. Inc., 117 Sandusky St. Zip 15212 Tel: 322-5100 Pres. Carl
W. Volkwein, Gen. & Sales Mgr.: Walter E. Volkwein.

• **VALLEY FORGE (Area Code 215)**

J. W. Pepper & Son Inc., Box 850, Eisenhower Rd. Zip 19482 Tel: 666 9600
Branches: Tampa, Fla.; Atlanta, Ga.; Detroit, Mich.

RHODE ISLAND

• **PROVIDENCE (Area Code 401)**

Axelrod Music Inc., 251 Weybosset St. Zip 02903 Tel: 421 4833.

TENNESSEE

• **CLEVELAND (Area Code 615)**

Pathway Press, 1080 Montgomery Ave. Zip 37311 Tel: 476-5197

• **NASHVILLE (Area Code 615)**

Acuff-Rose Sales Inc., 2510 Franklin Rd. Zip: 37204, Tel: 385 3031, Pres.
Wesley H. Rose, Sheet Music Sales Mgr. John R. Brown.
The Benson Co., 365 Great Circle Rd. Zip 37228 Tel: 259-9111 Telex:
555131 Pres. Robert MacKenzie, Sr. VP. Mktg. Eddy Messick
Chappell Music Co., 11 Music Circle S. Zip: 37203 Tel: 244 3382, Mgr.
Henry Hurt

Home office: New York, N.Y.

MCA Music (div of MCA Inc.), 1106 17 Ave. S. Zip 37212 Tel: 327-4622
VP & Gen. Mgr. Jerry Crutchfield.

Home office: New York, N.Y.

Peer-Southern Org., 7 Music Circle N. Zip 37203 Tel: 244-6200

Home office: New York, N.Y.

TEXAS

• **FORT WORTH (Area Code 817)**

Don Edgar Music, 2312 Jasper. Zip: 76106 Tel: 626-3448. Owner & Gen.
Mgr. O.D. Edgar

• **SAN ANTONIO (Area Code 512)**

Southern Music Co., 1100 Broadway, Zip 78215 Tel: 226-8167, Pres. &
Gen. Mgr. Arthur Gurwitz.

WASHINGTON

• **SEATTLE (Area Code 206)**

Capitol Music Co. Inc., PO Box 21906, 1530 Third Ave. Zip 98111, Tel: 622-
4013, Gen. Mgr. Paul C. Leaf.
Affiliate: Las Vegas, Nev., Hansen House

WISCONSIN

• **MILWAUKEE (Area Code 414)**

Hal Leonard Publ'g Corp., 8112 W. Bluemound Rd. Zip: 53213 Tel: 774-
3630, Telex: 26668, Exec. VP & Gen. Mgr.: Keith Mardak.
Home office: Winona, Minn. (SEE ADVERTISEMENT)

dance-it[®]
Distributors

" THE SINGLE MOST IMPORTANT DISTRIBUTOR " TM

" ALL THE HITZ - ALL THE TIME " TM

DANCE * R & B * SOUL * 12" DISCS

LOS ANGELES
(213) 854-0700

SAN JOSE
(408) 294-4082

1822 WEST SAN CARLOS, SAN JOSE, CA 95128



WHOLESALE

RECORDS & TAPES/UNITED STATES

The wholesale function(s) of all companies is set in bold face and parenthesis after each listing. The following abbreviations identify these functions: (D) Distributor; (OS) One Stop; (RJ) Rack Jobber; (I) Importer; (E) Exporter. The function of a branch or home office is indicated only when it differs from that of the listing.

ALABAMA

● ATTALLA (Area Code 205)

Reliable Rec. & Tape Co. Box 6, 113 Zip 35954 Tel 538 6043 Owner. Singles, Albums & Tape Buyer C. R. O'Neal (Rec. & Tape RJ).

● BIRMINGHAM (Area Code 205)

Music Center Rec. Dist. Inc. 1401 Second Ave. N. Zip 35203 Tel 251 8252 Owner Virgil C. Lugar Sr. Mgr. Albums, Singles & Tape Buyer Virgil C. Lugar Jr. (Rec. & Tape OS)

● BREWTON (Area Code 205)

Known Artist Dist., PO Box 1304 Zip 36426 Tel 867 2228 Owner Bobbie Roberson Mgr. Singles & Albums Buyer Roy Edwards (Rec. OS) Branch: New York, N.Y.

ARIZONA

● PHOENIX (Area Code 602)

All Label West Inc. 3304 N. 27 Ave. Zip 85017 Tel 258 1542 Pres. Cary Budin VP Mktg. Jim Robinson VP & Gen. Mgr. Bill Glaseman Buyer Cubby Falls (Rec. & Tape RJ) Accessories: Memorex

Alta Dist. Co. (div. of Aldisco Corp.) Southwest Div., 2950 W. Catalina Dr. Zip 85017 Tel 269 1411 Ge. & RJ Mgr. Lee Weimar, D. & OS Mgr. Rita Powell, Buyers D. Singles, Albums & Tape Rita Powell, RJ Singles Jim Brunner, RJ Albums Dwayne Witten, RJ Tape Ken Hayes (Rec. & Tape D & RJ), (Rec. & Tape OS as: Alta One Stop)

Labels: Abkco, Ala, CMH, Caerleon, Chalfont, Chrysalis, Denon, Discwasher, Disney, Excelsior, GNF, Crescendo, Lafl. Living Language, Original Sounds, Pickwick, Pro Arte, Quilnessence, Ranwood, Sesame Street, Sunbird, Takoma, Varese Sarabande

Accessories: Ampex, Audio Magnetics, Certron, Discwasher, Dynasound, Fidelitone, Le Bo, Maxell, Memorex, Recoton, Savoy, Scotch, TDH, Tracs

Alta One Stop (Rec. & Tape OS) Mgr. Rita Powell, Buyers, Singles, Jim Brunner, Albums, Dwayne Witten, Tape, Ken Hayes—see Alta Dist. Co. Associated Dists. Inc. 3803 N. 3rd Ave. Zip 85019 Tel 278 5584 Principal Leonard M. Singer, Sales Mgr. Gus Figueroa, OS Mgr. Angela C. Singer, Buyers D. & OS Single, Cory Sloman, D. Albums & Tape, Kevin Weir, OS Albums & Tape, Tom Weber, Sandy Gentry (Rec. & Tape D & OS)

Labels: Abet, Adelphi, Alta, Alligator, Alston, Amberjack, Antilles, Ariola, Arista, Audio Fidelity, Becket, Blind Pig, Boardwalk, Bomb, Brunswick, Buddha, Cat, Chalet, Chimneyville, Citadel, Clean Cuts, Clouds, Concord, Jazz, Contemporary, Creed, DL, DRG, Dakar, Dash, Delmark, Deluxe, Devaki, Discovery, Drive, Earw. Entr. Acte, Epiphany, Ernie's, Eccello, Fantasy, 51 West, First American, Flying Fish, Folkways, Fretilless, GRP, Galaxy, Glades, Gordy, Gospel Roots, Gospel Truth, Grand, Great North, west, Greenhays, Hannibal, Hi Dia, Navigation, Insight, Jazz à la Carte, Jewel, Juana, Kaleidoscope, Kewwood, Kicking Mule, Mavler, Laurie, Leg, Malaco, Mango, Mankind, Mar'n, Milestone, Monitor, Motown, Mountain, Railroad, Muse, Music Is Me, music, Muscraft, Nashboro, Natural, Re sources, Ode, Olivia, Our Canyon, Ovalton, Paid, Passport, Paula, Pausa, Philo, Piccadilly, Posse, Prelude, Prestige, Project 3, R.F.C., Rare Earth, Rebel, Request, Ronn, Rounder, Savoy, Seeds & Stems, Sierra, Briar, Sonet, Soul, Starlog, Star, Stet, Str. (America), Sugar Hill, Sunshine, Sound, Souza, TK, Tama, Taxi, Theres, Timeless, Tomato, Trend, Vanguard, Varese Sarabande, Vintage, Visa, Waterhouse, Weird World, Wheeler, Wind, Jam Hill

Accessories: BASF, Discwasher, Le Bo, TDH
Pickwick Dist. N. Cos. Rack Servs. Div., 3118 W. Thomas Rd., Suite 710 Zip 85017 Tel 272 9343 Sales Mgr. Tom Catchings (Rec. & Tape RJ)
Home office: Minneapolis, Minn.

Smash Rec. Dists., 2909 W. Fairmount Zip 85017 Tel 264 5659 Owners Jackie & Clarence Elgas, Mgr. Jackie Elgas, Singles, Buyers Jackie Elgas, Charlotte Harrington (Rec. OS)

● TEMPE (Area Code 602)

Pro One Stop, 901 S. Hohokam Dr. Zip 85281 Owner & Mgr. Jim Johnson, Tape Export Mgr. Francisco Cervantes, Buyers, Singles, Susan Holder, Albums, Dutch Cramblitt, Tape, Carter Frey (Rec. & Tape OS, RJ & E)

● TUCSON (Area Code 602)

Cash Sales Co., 2901 E. Broadway Blvd. Zip 85716 Tel 326 6588 Mgr. S. R. See (Rec. D) Distributes close outs, job lots, overstocks
Disk Rec. Jobbers Empire Inds., 7611 E. La Cienega Dr. Zip 85715 Owner & Mgr. S.L. Simon (Rec. OS & RJ)

ARKANSAS

● LITTLE ROCK (Area Code 501)

Discount Recs. Inc., 3400 S. University Zip 72204 Tel 565 0304 Owner Jack Garner, Mgr. & Buyer Mike Baugh (Rec. & Tape OS & RJ, also Rec. & Tape OS as Soul City Recs.)

Handeman Co., 6301 Forbing Rd. Zip 72209 Tel 562 8800 (Rec. & Tape RJ) Home office: Clawson (Detroit Metropolitan Area) Mich
Soul City Recs. (Rec. & Tape OS)—Mgr. Tom Ed Hockersmith Tel 371 0464—see Discount Recs. Inc.

● WEST MEMPHIS (Area Code 501)

Boss Ugly Bob Recs. & Tapes, 2314 E. Broadway St. Zip 72301 Tel 735 6420 Mgr. Brandon Catron (Rec. & Tape OS)
Home office: Memphis, Tenn.

CALIFORNIA

● BUENA PARK (Area Code 714)

Brown Rec. Dists. Inc., 7342 Melrose St. Zip 90621 Tel 522 8351 Telex 685663 Mgr. John Olson, Buyers, Singles, Karl Galledge, Albums & Tape, Andy Tenner, Craig Doucette, Mike McClintock, Accessories, Dave Guccione (Rec. OS & E, Tape OS)

Videocassette lines: CBS, MCA, Magnetic Video, VCA, Warner, Bemo
Accessories: Ampex, Discwasher, Glory, Le Bo, Marsand, Maxwell, Memorex, Planstehl, Sound Guard, TDH, Walts

● FULLERTON (Area Code 714)

Music Operators Serv. Inc., 536 W. Commonwealth Zip 92632 Tel 879 1771 Owner & Mgr. Buddy Robinson, Buyers, Singles, Trudy Crawford, Albums, David Crawford (Rec. OS)

● GARDEN GROVE (Area Code 714)

Largo Music Corp., 7421 Anaconda Ave. Zip 92641 Tel 898 0507 Western Div. VP Jack Griffith, Opns. Mgr. Michael Schwarzwath, Sales Mgr. Tom Smelser (Rec. & Tape OS & RJ)

Home office: Columbia (Baltimore Metropolitan Area), Md
Videocassette lines: CBS, Columbia Pictures, Disney, MCA, Magnetic Video, Paramount, WEA
Videodisk lines: CBS, MCA, Paramount, WEA

● HEALDSBURG (Area Code 707)

Luna Recs. Corp., 434 Center St. Zip 95448 Tel 433 4138 Owner, Mgr. & Buyer Abel de Luna (Rec. & Tape OS, RJ, I & E)
Branch: San Jose, Calif.

● LOS ANGELES METROPOLITAN AREA (Area Code 213)

Aldisc Int'l (Rec. & Tape E), see Record Sales Co. Inc.
Alhambra Dist. g. Inc., 2720 W. Pico Blvd. Zip 90006 Tel 733 0137 Telex 686444 Mgr. Antonio Estevez (Rec. & Tape D & I)

Home office: Opa Locka (Miami Metropolitan Area), Fla. (See for prod. distributed)

Alternative Music Dists. Inc., 2702 San Fernando Rd. Zip 90065 Tel 227 4141 Pres. Greg Shaw, Gen. Mgr. Bo Clifford, Promo. Rich Schmidt (Rec. D, OS, I & E)

Labels: BOMP, BFD, Baron, Bomb, Clone, Eat, Frontier, Gohog, Green Line, Isabelle, Martan, Mohawk, Moxie, Mystery, 9 1/2 x 16, Ostrich, Phan tom, Posh Boy, Quark, Richmond, Rollin' Rock, Sounds Interesting, Stiff, Trash, Vox, What, World

American Music Inc./Luv Music, 1932 Hyperion Ave. Zip 90027 Tel 668 1800 Co. Owner Len Chapman, Co. Owner, Albums & Tape Buyer, Lanny Lee, Sales Mgr. Bill Sterling, Warehouse Supervisor, Dan Devine, OH Mgr. Cindy Allen (Rec. & Tape D—cutouts, overstocks, TV packages)

Ameria Mex Dist. Co. (American Mex. Rec. Co.), 2534 W. Pico Blvd. Zip 90006 Tel 487 4100 Owner Leonard Silver, Mexican Albums & Tape Buyer Elliot Mellman (Rec. & Tape RJ)

American Music Mktg., 2952 W. Pico Blvd. Zip 90006 Tel 734 1996 Pres. & Buyer Chel Coplen, VP Rack Servs. Joe D'Amore (Rec. & Tape D, RJ, I & E—budget lines, cutouts) (SEE ADVERTISEMENT)

American Universal, PO Box 8915, 4029 Lankershim, Universal City 91608 Pres. Martin Lancaster, Mgr. Jerry Lang, Buyers, OS, Singles, Albums & Tape, Arthur Berchan, RJ Singles & Tape, Arthur Berchan, RJ Albums, Doc Bowie (Rec. & Tape OS & RJ)

Videocassette & videodisk lines: All major lines
Amex Recs. Inc., 267 N. Lake Ave., Pasadena 91101 Tel 681 0271 Pres. Horacio Von Sydow, Mgr. Guillermo Von Sydow (Rec. & Tape RJ)

Amigo Recs. Dist., 2858 W. Pico Blvd. Zip 90006 Tel 735 1358 Owner Edmundo Perez, Mgr. Eduardo Perez, Buyers, Singles, Rayda Lizarcano, Albums, Yolanda Cisneros, Local branch Top Hits Recs., 2854 W. Pico Blvd. Zip 90006 Tel 731 9650 Mgr. Pedro Mares, Buyers, Singles, Nelly Rodriguez, Albums, Henry Corrales (Rec. & Tape D, OS, I & E)

Labels: ALH, ARV, Accon, Arcano, Arriba, Atlas, Audiomec, Auditoria, Avon, Bonanza, CBS, Caliente, Cara, Carrino, Caytronics, Color, Cronos, DLV, Dicesa, Dimsa, Disco America, Discoland, Disney, Duro, E.G., Eco, Epsilont, Falcon, Fama, Fama, Fiesta, Flama, Fonorex, Fuentes, Gas, Gema, Hit, LM, Lad, Latin, Llamarada, Lorena, Luna, Mar, Melody, Mercurio, Microlon, Musart, OB, Olimpico, Orfeon, Otra, Peerless, Profono

Many Services For The One Stops — Operators Rack Jobbers — Retail Record Stores

- Juke Box Title Strips, Printed and Blank
- Colored Acetates (Used As Program Indicators)
- Self-Adhesive Price Labels
- Self-Adhesive Artist/Category/Header Strips (SAVE MONEY! Use This Item On Your Old LP Divider Boards)
- Hot Stamped and Blank White Plastic (.040 Gauge) LP And 45 RPM Divider Boards
- Printed And Blank 4-Ply Yellow Bin Divider Boards For 45 RPM Records

Tailor Made For Your Needs — Send For Brochure

STAR TITLE STRIP CO., INC.

842 Western Avenue, Pittsburgh, PA 15233

Area Code 412 231-4314

Pronto Raff Raiz Ramez Reyna Rio Bravo Str Art Sonomez Sound
 mex TH TNT Taurus, Texas, Vaya Velvet, West Side
 Bob Andrews Recs PO Box 7000 115 Redondo Beach 90277 Tel 378
 9674 Owner & Albums Buyer Bob Andrews (Rec. D)
 Labels: Henri Interplay Jazz Chronicles Nortac Outstanding Sea
 Breeze, Straight Ahead Jazz
 Rick Ballard Imports 3634 Tuller Zip 90034 Te 390 6888 Sales Lee
 Kaplan (Rec. D, I & E)
 Home office: Berkeley (San Francisco & Bay Area) Calif (See for prod
 distributed)
 Baly Rec & Tape Dists 2525 W Pico Blvd Zip 90006 Tel 487 2155
 Owner: Mgr & Buyer Isaac Baly (Rec. D, DS, RJ & I; Tape D & DS Latin
 & Spanish prod only)
 Labels: Alhambra, Alto Arcano Atriba Atlas Autiomes, Borinquen CBS
 Caytronics, Discolando Disneyland fama hurricane Melody Mer
 curio Americana, Musart, Nova Vox Odeon Orfeon Peerless Pronto
 Ramez Rio Bravo Romeo SB, Sonart Soundmex Viza
 Berklay Air Servs., PO Box 91156 World Way Zip 90009 Tel 674 6690
 (Overseas transportation servs)
 Home office: Jamaica (New York Metropolitan Area) N.Y.
 Brillory Corp 155 N San Vicente Blvd Beverly Hills 90211 Tel 568 5304
 Pres Laurence Villes Nat'l Sales Dir G Paul Lethner (Rec. I)
 Branches: Oakland (San Francisco & Bay Area) Calif New York N.Y.
 Labels: Calliope (France) Camerata (Japan), Chandos (UK) Claves
 (Switzerland) Dynamic (Italy), Harmonia Mundi (France) Hong Kong
 (Hong Kong), Hyperion (UK) Interdisc (Germany) Merlion (UK) Nimbus
 (UK) Ricordi (Italy)
 C B S Recs 17337 Ventura Blvd Encino 91316 Tel 501 2350 VP Western
 Div Frank Mooney Reg'l Co ord Mickey Forester Branch Mgr Dennis
 Hannon (Rec. & Tape D - see New York N.Y. office for prod distributed)
 California Music Co. 2933 W Pico Blvd Zip 90006 Tel 733 1181 Pres
 Sam Ricklin, VP & Gen Mgr Ronald E Ricklin Buyers Albums Nash
 Lazzalde Singles & Tape, Ron Vermette (Rec. & Tape DS & E)
 California Rec. Distis Inc PO Box 6367, Glendale 91204 1242 Los Angeles
 Tel 245 6464 246 8228 Owner George Hucuti
 Sales Mgr Don Davis, Promo Mgr Ted Higashinaka Sales Tony Jacobs
 (Rec. D)
 Branches: San Francisco Calif Seattle Wash
 Labels: APM, APM Aeco Archchec, Alligator Amazing Amberjack Angel
 arc Antilles Arabesque, Arholite Aries Audio Fidelity Audio Rari
 ties, Bet Car, Big Band Int'l Bix Lives, Blues Classics Boogie Woogie
 CMH Caedmon, Cetra Opera, Charocrozo Clappers Columbia Special
 Procs Concert Disc Concord Jazz Contemporary, Cook Counterpoint
 County Creative World, Critteron Delmark Duveland Jubilee Ecker
 works Everest Fantasy, Fifty One West First American Flying Fish Fly
 ing High Folklyric, Fretless GNP Galaxy, Giants of jazz Glendale
 Golden Age, Golden Era Good Time Jazz Gospel Truth Granite Grass
 Mountain Great Northwest Green Hays Greentree Gryphon HDS Han
 nibal Happy Face, History in Sound Improv Jain Jazz a la Carte Jazz
 Archives, Jazz Bird Jazz Treasury Jazzworks Kaleidoscope Kicking
 Mule Knockout, Laurie Legacy Los Angeles Mango Mark 56 Mile
 stone Music Is Medicine Natural Organic North Country, Nut
 meg Old Timey, Olympic Original Sound, Paid Pausa Pearl Period
 Philo Phoenix 10 & 20, Picadilly Polaris Potato Prestige Radiola Ran
 wood Rattlesnake Razor Rebel Regency Ridge Runner Riverside
 Rounder Salk, Sandy Hook, Shadow Shamrock Shiloh Solid Smoke
 Sounds Spokane, Standing Room Only Six Sixty Platin Strata East
 Sugar Hill, Synchronic Research, Tandem Thunderbird Timeless Total
 Sound Tolem Tradition Transatlantic Trema Vantage Varese War
 Bride Waterhouse Xanadu
 Accessories: Memorex
 Cal Mex Int'l One Stop, 5849 E. Whittier Blvd Zip 90022 Tel 261 6723
 (Rec. D, DS, I & E; Tape D & DS)
 Labels: ARV, Alhambra Alshire Arcano Badboys Billionaire Cronos
 Doubleshot, East Side Story, Eco, Falcon Fama Fama, Freddie Fuego
 Gas, Good Old Gold Hi Oldies Latin Int'l Luna Mares Musart Orfeon
 Peerless Profono Pronto, Raff, Ramez TH, TR Whiz
 Imports Mexican prod
 Accessories: AVM BASF, Le Bo Planton Scotch, Watts Wei Mac
 Canterbury Recs Inc 805 E Colorado Blvd Pasadena 91101 Tel 681
 4922 Gen Mgr Charles Gordon Sec'y Treas L Leonard Gordon, Buyers
 Singles Jessi Bruno, Ellen Madison Albums Charles Gordon Tape Jen
 nifer Freedman (Rec. & Tape DS, RJ & E)
 Capitol Recs 3117 San Fernando Rd Zip 90065 Tel 254 9111 258 3275
 (Rec. & Tape D)
 Other branches: San Francisco, Calif., Littleton (Denver Area) Colo
 Miami Fla, Atlanta Ga, Niles (Chicago Metropolitan Area) Ill German
 town Md., Westwood (Boston Metropolitan Area), Mass Madison
 Heights (Detroit Metropolitan Area), Mich South Bloomington (Min
 neapolis St Paul Area) Minn, New York N.Y. Cleveland Ohio Bethle
 hem, Pa, Nashville, Tenn, Dallas Tex
 Labels: Accord, Angel, Capitol EMI America Harvest, Liberty, MSS Cap
 tel Melodiya/Angel, Seraphim Spector, Townhouse
 Cayre Inds of California Inc, Bonnie Brae Bldg Suite 205 1830 W Olym

pic Blvd Zip 90006 Tel 383 1386 (Rec. & Tape D)
 Home office: New York N.Y. Caytronics Corp (Rec. & Tape D, DS, RJ, I &
 E/D - see for prod distributed)
 Celebrity Concert Corp 12225 San Vicente Blvd Zip 90049 Tel 476 2557
 Cable CELEBRIA Bd Chm Sidney Justin Pres Bernard Luber Branch
 206 Emerald Ave Balboa Island 92662 Tel (714) 675 9382 (Rec. &
 Tape D & I)
 Label: Melodiya (USSR)
 Chapman Dist'g Co Inc 1212 S Albany St Zip 90015 Tel 749 9484
 Owner Al Chapman Mgr & Albums Buyer Herb Chapman Singles
 Buyer Louis Cortez (Rec. & Tape D)
 Labels: Alshire Alwin Audio Arts, Birthright Cabot Cada (Amden) Ca
 naan Capitol Columbia Conversa Phone Cricket Crystal Dictation
 Disc Disneyland, Disneylandia, 49th State Gateaway Glori Good News
 Heart Warming, Jim Swaggert, Lamb Lamb & Lion Light Living Lan
 guage, MCA, Malaco Manna, Maranatha Master Rogers Monitor Motiva
 tion, Myrrh New Birth Outstanding RCA Ranwood Sacred Sauny Spe
 cially TCB, Tempo Waikiki World World Young Peoples Recs
 (SEE ADVERTISEMENT)
 City Hall Recs 6208 Colfax Ave North Hollywood 91606 Tel 506 4404
 District Sales Mgr Tamar Cohn (Rec. & Tape D, I & E)
 Home office: San Francisco Calif (See for prod distributed)
 City One Stop 2551 S Alameda St Zip 90058 Tel 737 7759 Owners Da
 vid Berkowitz Pat Moreland, Lou Fogelman Mgr Godfrey Kerr Buyers
 Singles Richard Diamond, Albums & Tape Sam Ginsburg (Rec. & Tape
 DS & E)
 Dance D Dists 256 S Robertson Beverly Hills 90211 (Rec. & Tape D, I &
 E)
 Home office: San Jose, Calif (See for prod distributed)
 Discos Latin Int'l Inc 1646 S Vermont Ave Zip 90006 Tel 734 1527
 Owner Jose A Garcia, VP Yanel Garcia (Rec. & Tape D)
 Branch: Chicago Ill Fernando Yvan
 Labels: Fono Rex, Latin Int'l Microton Pega
 Distribution By Dave 7220 Owensmouth Ave Suite 103 Canoga Park
 91303 Tel 887 7930 Mgr & Buyer Dave Peters (Rec. & Tape D reli
 gious prod only)
 Labels: Ala Benson Birdwing Bread N Honey Calvary Capitol Chalice
 Chico Holiday Columbia Continental Singers Cream Cross Country Day
 Spring Dynamic Galilee Good News Greentree Heart Warming Hi
 Hobbs Horizon Impact Jesus People Jimmy Swaggart John Hall Ken
 Copeland Kushner, Koala Lamb & Lion Light Lightship MCA Manna
 Maranatha Mercury Messianic Mighty Wind Millennium Myrrh New
 Life New Pax New Song New World Paragon Paul Johnson Peaceable
 Peter Pan Rainbow Ranwood Seed Shalom, Singcord Skyline Solid
 Rock Sonrise Sparrow Spirit Star Song Sword Takonia Tempo
 Triangle Timesmith United Artists Vesper Warner World World
 Donsep Trading Co Inc 8525 Teller Ave Sun Valley 91352 Tel 767 4645
 Owner Fred Sepanlou (Rec. & Tape E)
 Eastern Pacific Sounds Inc 11012 Ventura Blvd Suite G Studio City
 91604 Tel 760 7900 Telex 6831109 Pres Doug Lusa Audophile &
 Import Dir Jim Snowden Export & Video Dir Craig Chasen (Rec. &
 Tape I & E)
 Imports from Japan (SEE ADVERTISEMENT)
 Fermata Int'l Melodies Inc 6290 Sunset Blvd Suite 916 Hollywood
 90028 Tel 462 7473 TWX (910) 321 4063 Cable FIRMATA CAL
 Owner Enrique Lebendiger Mgr Debora Frenkel (Rec. I)
 Labels imported: Discos Premier Fermata, Importa Som Peralta Pick
 RGI Som Mamar Young (all Brazil)
 Global Rec. Ents PO Box 49345 Zip 90049 Tel 995 8627 Pres Randy
 Hoffman (Rec. & Tape D)
 Distributes cutouts close outs, deletions videotape accessories & im
 ports
 Greenwood Dist n 20445 Gramercy Pl Torrance 90501 Tel 533 8075
 Telex 5720103 Mng Diris Steve Boudreau William Hein Mark
 Wesley Wesley Hein Overseas Purchasing Kathy Boudreau Do
 mestic Purchasing Wesley Hein Sales Mgr Gary Gonsowski Ex
 port David Stollenberg, Adv Mgr Peter Heur (Rec. & Tape D,
 I & E)
 Labels: Bomp 415, Frontier Interzone Ut Or Music Pacific of
 Lights Posh Boy Ralph Random Radar Red Rough Trade, SST Siren
 Windspeil
 Labels imported: Affinity (UK) Albert (Australia) Ambient (UK) Ateni
 (France), Ballon Noir (France) Barclay (France), Bead (UK) Bocaccio
 (Spain) Bouquet (France) Bozi Mlyn (Canada) Carriere (France), Cham
 pagne (Australia) Chapa (Spain) Charisma (UK), Charly (UK) Cinevox
 (Italy), Clearlight of Jupiter (Australia), Cramps (Italy) Crypto (France)
 Cube (UK) Decca (Netherlands), Demos (Denmark), Digit (Finland)
 Dindisc (UK) Decca Ricordi (Italy) Divergio (Italy), Drom (UK) EG
 (UK) EMI (Australia) Finland, Netherlands New Zealand, Sweden UK)
 Egg (France) Electric (UK) Energy Discs (Canada) Ensign (UK), Feeri
 (France) Felish (UK) Fontana (France Italy) Gull (UK), Hi Hat (Fin
 land) IC (Germany), II (France) Industrial (UK) Infinity (Australia) In
 tercord (Germany), Invisible (France) LTM (France) Love (Finland)

MNW (Sweden) Manifest (Sweden) Mercury (Australia Netherlands
 UK) Mistler (Sweden) Movieplay (Spain) Mushroom (Australia) Ne
 gri (Netherlands) Neutron Star (Australia) Numero Uno (Italy) Ob
 scure (UK) PDU (Italy) Pathe Marconi (France) Philips (France Italy
 Netherlands New Zealand UK) Polydon (Canada France Italy Nether
 lands New Zealand UK) Pye (UK) RCA (France Italy New Zealand)
 RSD (UK) Ramnes (France) Red (UK) Red (UK) Regular (Australia) Roll
 ing Stones (Netherlands) SFP (France) Schneeball (Germany) Scopa
 (France) Silence (Sweden) Sky (Germany) Sonet (Sweden) Sonpresse
 (France) Sordide Sentimental (France) Spiregels (Germany) Svenska
 Love (Sweden) Tapica (France) Track (UK) Ultima Spiaggia (Italy)
 Valentin de Carvalho (Portugal) Vertigo (France Netherlands New Zea
 land UK) Virgin (UK) WEA (Germany New Zealand) WWA (UK) Wizard
 (Australia) (SEE ADVERTISEMENT)
 Handiman Co 1544 N Knowles Ave Zip 90063 Tel 261 0268 (Rec. &
 Tape RJ)
 Home office: Clawson (Detroit Metropolitan Area) Mich
 House Dists 1362 Lucile Ave No 1 Zip 90026 Tel 666 6082 Mgr John
 lerardi (Rec. & Tape D)
 Home office: Kansas City Mo (See for prod distributed)
 House of Falcon Inc ARV Rec Sales 2722 W Pico Blvd Zip 90006 Tel
 731 7247 Mgr Sara Segovia Promo Rafael Vasquez (Rec. & Tape D)
 Home office: McAllen Tex (Rec. & Tape D, DS & RJ)
 Labels: ARV Int'l Falcon Ric
 Inspirational Music 18108 Parthenia St Northridge 91328 Tel 987 2911
 Owner Mgr & Buyer Hugh H Edwards (Rec. & Tape D)
 Distributes major religious labels
 J D C 2737 S Pacific Ave San Pedro 90731 Tel 519 7393 Reg Mgr Jim
 Calton Co Admin Dale Galton (Rec. D & I)
 Labels: JDC Launch Moby Dick Unwave
 JEM Recs West Inc 18629 Topham Reseda 91335 Tel 996 6754 VP
 Mark Ferjahan Gen Mgr Bob Say (Rec. & Tape D & I)
 Home office: South Plainfield, N.J. JEM Recs Inc (See for prod distrib
 uted)
 John's Music 11020 S Main St Zip 90061 Tel 755 1165 Owner John L
 Jackson Mgr Marie Jackson Buyers Singles Marie Jackson Albums &
 Tape John L Jackson (Rec. & Tape DS)
 Kandomerica Inc 5134 Walnut Grove Ave San Gabriel 91776 Tel 286
 6611 Telex 675337 Pres Toshi Fujimoto VP Birgitta Landmark Mgr
 Y Ujue (Rec. & Tape I & E)
 La Cite 2306 Westwood Blvd Zip 90064 Tel 475 0658 0095 Telex
 181210 Owner Lou Plazulotis (Rec. & Tape I)
 Labels imported: Barclay CBS Carriere Deesse EMI Pathe Marconi
 Fontana Philips Polydor RCA Vogue (all France)
 Luv Music, see Amcan
 M C A Dist'g Corp 11312 Penrose St Sun Valley 91352 Tel 768 3200
 Reg'l Dir Leroy Sather Branch Mgr John Jump (Rec. & Tape D)
 Other branches: Denver Colo, Miami Fla Norcross (Atlanta Metropoli
 tan Area), Ga Rosemont (Chicago Metropolitan Area) Ill Columbia
 (Baltimore Metropolitan Area), Md Woburn (Boston Metropolitan Area),
 Mass Edina (Minneapolis St Paul Area) Minn St Louis, Mo Collings
 wood N.Y. New York, N.Y. Cincinnati Cleveland, Ohio Nashville, Tenn,
 Dallas, Tex, Seattle, Wash
 Labels: Artists House Backstreet, Coral Headfirst MCA Regency Song
 bird, Sparrow, Unicorn Vocalion
 Videocassette & Videodisc Ines: MCA
 Musica Latina Inc (GGG Rec Dists) 2360 W Pico Blvd Zip 90006 Tel
 385 7151 (Rec. D, DS & RJ; Tape D)
 Labels: Ansonia, Arcano Beller Caytronics Columbia, Discolando
 Fuentes, Kubaney Latin Int'l Miami Modiner Orion Pantano, Parnaso,
 Regal Remo, Rico Rico Vox, Son Art Sono Lux Sono Mex Sono Radio
 Top Hits UA Latino Velvet, El Zarape
 Musical Recs Co Musical Tapes Inc 2958 W Pico Blvd Zip 90006 Tel
 737 0937 Gen Mgr Valentin Velasco (Rec. & Tape D, DS & RJ)
 Home office: Miami Fla (See for prod distributed)
 Musical Tapes Inc, see Musical Recs Co/Musical Tapes Inc
 Music Brokers (div of Rainbow Inds Inc) 2651 W Pico Blvd Zip 90006
 Tel 386 4937 Owner Webber & Assocs Inc Mgr Hugh M Behr Al
 bums & Tape Buyer Helen Flower (Rec. & Tape D, DS & E)
 Distributes cut out & overstock albums & tape
 Accessories: AVM Gopher Memorex Paramount TDK (SEE AD
 VERTISEMENT)
 Pickwick Dist n Cos Independent Dist n Div 9420 Teller Ave Sun Valley
 91352 Tel 875 3960 Branch Mgr Bill Shaler Ops Mgr Dennis Gar
 vey, Sales Mgr Bear Racoff, Buyers Singles, Bob Lampkin Albums,
 Rich Lockwood (Rec. & Tape D) (Rec. & Tape RJ as Pickwick Dist n Cos
 Rack Servs Div)
 Home office: Minneapolis Minn
 Labels: APA, AVI Abkco Ala, Albatros Alfa Alston Ariola, Arista, Arista
 Novus, Boardwalk Bold Bomb, Buddha, Cab Chaleit, Chrysalis, Cloud
 Credence Dash Devaki, Drive Excelsior Fabulous Flashback Freckle
 G&P, GRP, Glade, Gordy Gram, Juana Kudu, Laff Lifesong, Marden Vay
 age, Malaco, Marlin Motown Muscle, Natural Resources Our Gang, Dva
 tion PPL, Penthouse, Pickwick Plantation, Posse, Prelude, Pro Arte,
 Project III Quintessence Rare Earth, Robox Savoy, Seeds & Stems, Soul,
 Stiff Sun Sunbird Sunshine Sound, Suiza, TK Takoma Tamla, Tapestry,
 Trolley, Vanguard Vintage, Weird World Wheel, Windham Hill
 Accessories: Shape
 Pickwick Dist n Cos Rack Servs Div 7100 Tujunga Ave North Hollywood
 91605 Tel 764 5050 Branch Mgr Ken Redemski, Prod Mgr Paul
 Buetell Sales Mgr Ray Reed (Rec. & Tape RJ) (Rec. & Tape D as Pick
 wick Dist n Cos, Independent Dist n Div)
 Home office: Minneapolis Minn
 Pico Boulevard Rec Sales, 2820 W Pico Blvd Zip 90006 Tel 731 0778
 Mgr James Harris Singles, Albums & Tape Buyer A Hinz (Rec. & Tape
 DS, I & E)
 PulyGram Dist n Inc 1930 Century Park West 2d Fl Zip 90067 Tel 556
 3126 Reg'l VP Emiel Petrone Branch Mgr Kenny Hamlin (Rec. & Tape
 D)
 Home office: New York, N.Y. (See for prod distributed)
 Pyramid Dists 527 Hill St Santa Monica 90405 Tel 399 2222 Owner
 Mike Anderson (Rec. D)
 Labels: Antilles, Celestial Harmonies Cheops Golden Voyage, Halpern
 Sound, Heavenly Music, Laurel Pacific Arts, Synchronic Research, Unity
 Varese Sarabande, Windham Hill, Wind Song Sounds
 R C A & A&M & Assoc'd Labels, 6363 Sunset Blvd, Hollywood 90028 Tel
 468 4066 Reg'l Sales Dir Bill Graham, Branch Sales Mgr Jim Bego,
 Sales Mgr Bill Meehan (Rec. & Tape D - see New York N.Y. office for
 prod distributed)
 B Rae Trading Co Ltd 341 N Oak St, Inglewood 90302 Tel 673 7053
 Pres Harold Goldman (Rec. E)
 Record Sales Co Inc 1015 Isabel St, Burbank 91502 Tel 849 4671
 WAIS (800) 423 2936 TWX (910) 498 2759 Owner Al Sherman, Mgr
 Dick Ceja (Rec. D), (Rec. & Tape E as Aldisc Int'l)

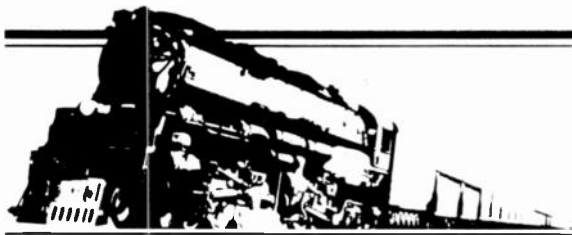

EASTERN PACIFIC SOUNDS INC.

PURVEYORS OF RECORDINGS FROM THE U.S.A., AUDIO & VISUAL, AND IMPORTERS OF FINE JAPANESE PRESSINGS.

(213) 760-7900 • TLX 683-1109 BXCAR • FAX (213) 508-5410

11012 Ventura Boulevard • Suite G • Studio City, California • 91604 U.S.A.

Labels: A/S, Alishre, Aria Sen a Voce, Audio Spectrum, Azteca, Exact, Grit, Oscar, Peter Rabbit, Somerset, Stereo Fidelity
 Record Shack of Los Angeles, 300 W. Carob Ave., Compton 90220 Tel 537
 7000 Branch Mgr Al Miklow (Rec. & Tape OS, I & E)
 Home office: Woodside (New York Metropolitan Area), N.Y. Record
 Shack of New York City Inc
 Records Ltd., 2818 W Pico Blvd Zip 90006 Tel 737 2611 Owner J
 Thomas Arambasin, Mgr & Albums Buyer David Schulman (Rec. D, OS,
 I & E)

Labels: AEI, Aries, Big Band I, L, Broadway Baby, Cerberus, Chalfont
 Citadel, Corinthian, Entr' Acte, Golden Era, Klavier, Laureate, Medallion
 Original Cast Drion, PBR, Painted Smiles, Pelican, Soundtrak, Starlog,
 Sunbeam, Take Home Tunes, Take Tandem
 Salas Sales, 11219 Randall St., Sun Valley 91352 Tel 767 6803 Owner
 John Sales, Admin Ass't Judy Bied (Rec. & Tape D - cutouts)
 Saturn Ent's., 2698 W Pico Blvd Zip 90006 Tel 737-0616 Pres Gale
 Phelps, Mgr Ken Richmond, Buyer Jack Frost (Rec. OS, I & E)
 Howard L Silvers, 9000 Sunset Blvd., Suite 1015 Zip 90069 Tel 278
 0415/7222 Pres Howard L Silvers Local branch 18100 Burbank
 Blvd., Suite 10, Zip 91356 T: 1 708 0630 (Rec. & Tape D - cutouts)
 Sound Music Sales, 2546 W Pico Blvd Zip 90006 Tel 381 6054 Owner
 M Pinto Gen Mgr Tom Iayashy (Rec. & Tape OS & E)
 Sound Video Unlimited Inc., 6912 N Tunjanga Blvd., North Hollywood
 91605 Tel 985 7602 Mgr Bruce Reiman
 Home office: Skokie (Chicago Metropolitan Area), Ill

Videocassette & Videodisk lines: All lines
 Accessories: Alltop, Amaray, Atari, Mattel, Maxell, Memorex, Nortronics,
 RMS, Scotch, Sony, TDK, Tota Video, Video Organizer
 M Stewart & Co., 10289 W Pico Blvd Zip 90064 Tel 879 0644 Pres
 Mendel Stewart, Export Mgr ouise King (Rec. & Tape E)
 Sun State Music Dist's Inc., 2654 W Pico Blvd Zip 90006 Tel 383 4137
 Mgr George Morie, Buyers George Morie, Ted Ray (Rec. & Tape OS)
 Surco Ent's., 16632 1/2 Marquee Ave., Pacific Palisades 90272 Tel 454 3915,
 459 1437 Telex 182052 Mny. Dir Eduardo Ostrogovich, Mgr Frank
 Loffarelli (Rec., Tape & Video apc I & E)
 Symphonette Music Dist's, 4520 Valerio St., Burbank 91505 Tel 846 2707
 Gen Mgr Herb Dale (Rec. & Tape D - overruns, deletions, cutouts)
 (SEE ADVERTISEMENT)

Transcontinent Rec. Sales West, 11818 Vose St., North Hollywood 91605
 Tel 982 2821 (Rec. & Tape R)

Home office: Buffalo, N.Y.
 Viking Recs & Accessories Inc., 4750 Valerio St., Burbank 91505 Tel 843
 2105 Owners Jim McGraw, C. Anderson, Albums & Tape Buyer Jim
 McGraw (Rec. & Tape RJ)

Branch: Belmont (San Francisco & Bay Area), Calif
 Warner Elektra/Atlantic Corp., 11 N Hollywood Way, Burbank 91505 Tel
 843 6311 Pres Henry Droz Local branch: 21701 Prairie St. Chatsworth
 91311 Tel 709 4190 Mgr Trent Gordon, Sales Mgr Dave Mount
 (Rec. & Tape D)

Branches: San Francisco, Calif Denver, Colo., Windsor (Hartford Area),
 Conn., Virginia Gardens (Miami Metropolitan Area), Fla., Atlanta, Ga.
 Bensenville (Chicago Metropolitan Area), Ill. Greenbelt, Md., Woburn
 (Boston Metropolitan Area), Mass., Southfield (Detroit Metropolitan
 Area), Mich., Minneapolis, Minn., Kansas City, Mo., Marlton, N.J., New
 York, N.Y., Charlotte, N.C., Cin. innati, Cleveland, Ohio, Houston, Irving
 (Dallas Area), Tex., Tukwila (Seattle Area), Wash
 Labels: Asylum, Atco/Curtom, Atlantic, Bearsivie, Beserkley, Big Tree,
 Cotillion, Dark Horse, ECM, Elektra, Elektra/Curb, Emerald City, Finna
 dar, Getten, Island, Mirage, Modern, Nonesuch Pacific, Paradise, Planet
 Quest, Real World, Reprise, Rolling Stones, Scotti Bros., She, Sire, Solar,
 Swan Song, Virgin, Warner Bros., Warner/Curb, Warner Spector,
 Whitehead

Videocassette lines: Warner Home Video
 Women's Music Dist'n Co., 506 S Verdugo Rd., No. 1, Glendale 91205 Tel
 956 6624 Owner, Singles, Albums & Tape Buyer Betsy York (Rec. &
 Tape OS)

Branch: Cambridge (Boston Metropolitan Area), Mass
 Y S L Recs., PO Box 8330, Van Nuys 91409, 18308 Rayen St., Northridge
 91325 Tel 886-4432 Pres. Brian Ashley (Rec. D & I - Japanese prod
 only)

● POMONA (Area Code 714)

Corsair Continental Corp., 1433 E Mission Blvd, Zip 91766 Tel 629 0814
 VP & Gen Mgr Larry W Berter (Rec. D & E)
 Distributes all square & round dance labels

● ROSEVILLE (Area Code 916)

Le Jo Recs (River City Rec. Dist's. Inc.), 212-F Harding Blvd Zip 95678 Tel
 782 7348 Pres., Mgr. Singles Albums & Tape Buyer John Radakowitz
 (Rec. & Tape OS, RJ & E)
 Accessories: Ampex, Maxell, Memorex, TDK

● SAN DIEGO (Area Code 714)

EURPAC West Inc. (div of EURPAC Serv Inc.), 9360-62 Cabot Dr Zip
 92126 Tel 566 7661 Pres William C Bethune, VP Finance James Bur
 gio, Buyers, Singles, Sheila Smith, Albums & Tape, Stewart Trusk (Rec. &
 Tape OS, RJ & E - civilian & military sales)
 Folk Arts Rare Recs., 3611 Adam Ave Zip 92116 Tel 282 7833 Owners
 Lou & Virginia Curtiss, Mgr Lou Curtiss, Buyers Singles, Lowe Stokes,
 Albums, Crockett Ward: Tape, Goebell Reeves (Rec. & Tape D)
 Labels: ARC, Advent, Banner, Bell, Black Path, Black Swan, Blues Clas
 sics, Challenge, Champion, Cl: inola, Cleartone, Conqueror, Continental,
 Crazy Water, Dial, Dillpickle, Civa, Domino, Gennett, Gillikin, Globe, Grey
 Gull, Herwin, Homestead, Hyline, Jelly Roll, Jewel, Khrome Kazoo, Little
 Wonder, Lyric, Madison, Melotone, Meteor, Milestone, Moxie, Munchkin,
 Muse, Muskadine, New Comfert, Norel, Norel Music, Noble Turkey, Dkeh, Di
 ympia, Droite, Paramount, Perfect, Phonolamp, Phonotopia, Pickle,
 Poik, Puritan, Pyrzogki, Qu: dling, Radex, Regal, Romeo, SDFOTM,
 Scoodler, Silvertone, Supertone, E. Timely Tunes, Triangle, Van Dyke, Vin
 tage, Vocalion, Vulkan, Yehudi, Zonophone

● SAN FRANCISCO & BAY AREA (Area Code 415)

All Rec Serv., 425 Alice St., Oakland 94607 Tel 465 4783 Owners Mi
 chael S Pankos, Robert Sareipa, VP. Singles, Albums & Tape Buyer
 Sandy Shee, Mgr Michael Hillman (Rec. & Tape OS & E)
 AudioSound, 1185 Chess Dr., Foster City 94404 Tel 574 7585 Owner Nor
 man Dison, Mgr Laurence Lurie (Rec. I & E)
 Labels: Accent (Belgium), As Rec (France), Audio Lab (Japan), Audio

Source (USA), East Wind (Japan), JVC (Japan), Mark Levinson (USA), Lyr
 icon (Sweden), Philips (Japan), Polyhymna (Norway), Proprius (Swe
 den), Reference (USA), Sound Storage (USA), Three Blind Mice (Japan)
 Back Room Rec Dist'g Co (div of Arhoolie Inc.), 10341 San Pablo Ave. El
 Cerrito 94530 Tel 525 4996 Pres Chris Strachwitz, Mgr. Singles, Al
 bums & Tape Buyer Robin Wise, Sales Vernon McNemar, Lee Hilde
 brand, LA Sales: Bob Marin, Seattle Sales Judy Werle, Promo Cathy
 Nelson Keyes (Rec. D & I, Tape D)

Labels: Advent, Alligator, Arhoolie, Azteca, BRI, Back in the Saddle,
 Baker, Bandy, Baron, Bay, Behemoth, Berkeley Rhythm, Biscuit City,
 Blue Goose, Blues Classics, Boogie Woogie, Broadway, Brown Door, Bull
 frog, Cabbage, Candy Apple, Collectors Classics, County, Crazy Cajun,
 Creole, Croaker, D. D., Delmark, Demo, Earwig, Fama, Flying High, Folk
 Legacy, Folklyric, Folkways, Freckle, Fretless, GHE, GHP, Goldband,
 Golden Country, Grass Mountain, Hacienda, Hen Cackle, Iron Horse,
 JEMF, Jack Rabbit, Jazzman Tea, Jazz Treasury, Jim, Joey, Kaleidophone,
 Kaleidoscope, Kanaaha, Kicking Mule, Lanor, Lion & Lamb, Lo Ball, Long
 Sleeve, Lost Dog, Mason de Soul, Mamish, Maraire, Mardi Gras, Mi
 chelle, Monte!, Muskadine, Norteno, North Country, Oblique, Dink, Did
 Homestead, Did Time Classics, Did Timey, Dmac, Pearl, Philo, Police,
 Puritan, RCS, Ramlight, Rebel, Rebellion, Red Clay, Rib, Ridge Runner,
 Rounder, Sail Scholastic, Sierra Brar, So, Solid Smoke, Sombreno, Son
 yatone, Sounds, Specialty, Spivey, Storm, String, Sugar Hill, Sugar Loaf,
 Swallow, Top Soil, Tradewinds, Troika, Veejay, Voyager, War Bride, West
 wind, Windham Hill, Windswept, Yazoo.

Labels imported: America (France), Black Cat (Netherlands), Cat
 (France), Festival (France), Jazz Anthology (France), Musidisc (France),
 Dcora (France), RCA (France), Roots (Austria), SDNM (Greece), Seventy
 Seven (UK), Sonet (UK), Swaggle (Australia), Temple (UK)

Rick Ballard Music, PD Box 5063, Berkeley 94705 Tel 849-3852 Owner
 Rick Ballard (Rec. D, I & E)

Branches: Los Angeles, Calif., Seattle, Wash
 Labels: ACC, About Time, Adelphi, Aeco, Airborne, Akba, Alacra, Alterna
 tives in American Music, Ambi, American Cave, Andrew's Music, Angelus,
 Anima, Aten, Auricle, Au Roar, Avocado, Baobab, Bee Hive, Bellows, Bet
 Car, Bija, Bisharra, Black Fire, Bola Press, CCL, CJR, CP Squared, Ca
 dance Jazz, Carousel, Chatham Square, Choice, Clean Cuts, Composers
 Collective, Contemporary, Dane, Discovery, Doria, Dym, Ekapa, Empire
 Esoteric, Essene, Europa, Evidence, Evidence Artistic, FKT, Flow Chart,
 Focus Fourth Stream, Frammis, Feelance, Gatemouth, Gramercy 5,
 Grapevine, Grits, Hat Hut, Hidden Meaning, Hindsight, Hugo's Music,
 Hummingbird, IBMS, IPS, I Am Shee, Ibu, Improvising Artists, Independ
 ent, India Navigation, Insight, JCD4, JDE, Jazz, Jazz a la Carte, Jewel
 Jewish Malador, Jim Lowe, KZB2, Kabell, Kromel, Labor, Laissez Faire,
 Laughing Angel, Leo, Los Angeles Phonograph, Lovely/Vital, MG, Matra,
 Metalanguage, Mozon, Musicworks, Mustewc, Nessa, New Jazz, New
 Pulse, Numbus, Ninewinds, Di the Cosmos, Dimmsound, 110, Organic
 Dboe, Dsmosis, Dtic, PM, PZ Parachute, Passin' Thru, Philly Jazz, Polar
 Bear, Productions of Kharma, Progressive, Pyramid, Quark, RE, RPM,
 Record, Re-Entry, RRT, SRP, Sahara, Segue, 1750 Arch, Shah, Shih, Silver
 Sphinx, Spring, Steeplechase, Storyville, Survival, Sweet Earth, Theatre
 for Your Mother, Theresa, Third Street, 360 Music, Tiwa, Tomorrow Int'l,
 Trans Musea, Trident, Uplown, Vineyard, Visible, WATT, Wenna, Wizard,
 World Artists, Xanadu, Zoar

Labels imported: Ad Lib (France), All Life (France), Audio Daddio (Neth
 erlands), Circle (Germany), Daybreak (Netherlands), Discos Yoko (Mex
 ico), ECM (Germany), ENJA (Germany), FMP (Germany), Falcon (Scot
 land), Fluid (France), Ictus (Italy), Japo (Germany), Marge (France),
 Matrix (Denmark), Moers (Germany), Moods (Germany), Musica
 (France), Dnari (Canada), SAJ (Germany), Sackville (Canada), Sandra
 (Germany), Sonet (UK), Spoltite (UK), Timeless (Netherlands), Water
 land (Netherlands), Wave (UK)

Brilly Corp., 93 Monte Cresta Ave., Oakland 94611 Tel 654 3888 North
 western Rep Grant Reed (Rec. I)

Home office: Beverly Hills (Los Angeles Metropolitan Area), Calif (See
 for prod imported)

C B S Recs., 120 Howard St., Suite 450, Zip 94105 Tel 495-6910 Branch
 Mgr Jerry Pitti (Rec. & Tape D - see New York, N.Y. office for prod
 distributed)

California Rec. Dist's Inc., 436 Duncan St. Zip 94131 Tel 821 3206 Sales
 Donn Sanders (Rec. D)
 Home office: Glendale (Los Angeles Metropolitan Area), Calif.
 Labels: AFM, Ace, Amazing, Ambergack, Angelaco, Arabesque, Aries, Au
 dio Fidelity, Audio Rarities, Big Band Int'l, Big Lives, Boogie Woogie,
 Caedmon, Celra Opera, Chiaroscuro, Clappers, Clearing House, Columbia
 Special Prods., Concert Disc, Counterpoint, Creative World, Criterion, Ev
 erest, Fifty One West, First American, Giants of Jazz, Glendale, Golden
 Age, Golden Era, Granite, Gryphon, Happy Face, History in Sound, Im
 prov, Jazz Archives, Jazz Bird, Jazz Treasury, Laurie, Legacy, Los Angeles,
 Mark 56, Music Is Medicine, Natural Organic, Nutmeg, Olympic, Period,
 Phoenix ID & D, Picadilly, Polaris, Potlato, Radiola, Razor, Ridge Runner,
 Shamrock, Shiloh, Sounds, Standing Room Only, Strata East, Sugar Hill,
 Syntonic Research, Tahiti, Tandem, Thunderbird, Total Sound, Tradition,
 Tremya, Varese

Accessories: Memorex
 Capitol Recs., 185 Berry St., Suite 4805, Zip 94107 Tel 771 3210 (Rec. &
 Tape D - see office in Los Angeles, Calif., for prod distributed)

City Hall Recs., 15 Tiburon St., San Rafael 94901 Tel 457-9080 Owner
 & Buyer Robin Cohn (Rec. & Tape D, I & E)

Branches: North Hollywood (Los Angeles Metropolitan Area), Calif.,
 Seattle, Wash
 Labels: AEI, AFF, APE, Ace of Spades, Adelphi, Advent, Aircheck, Ajax,
 Ajaz, Alpha, Amazing, Ambition, Ambrosia, Arcadia, Aries, Art Attack, Au
 diophile, Audio Encores, Audio Precision, Aviva, BFD, BDB, Bald Ego, Bal
 lad, Bandstand, Bandy, Barrelhouse, Beet, Bent, Big Band Int'l, Big Star,
 Bio-Centennial, Biography, Big Lives, Blackbird, Blue Angel Jazz Club,
 Blue Koala, Blue Lantern, Blue Night, Bomp, Bountiful, Broadway,
 Broadway Baby, Bullfrog, CFH, CFF, CSP, Cachalot, Cassandra, Celestial
 Harmonies, Center, Cerberus, Chalfont, Charly, Chicago Slide, Circle,
 Citadel, Clarsreach, Clanco, Clanka Lanka, Clappers, Clean Cuts, Club of
 Spade, Columbia Special Prod., Column One, Cook, Corinthian, Country
 Turtle, Cowboy Carl, Crescent City Cue, Curtan Calls, DRG, Daffodil,
 Destiny, Dirty Shame, Discwasher, Dreamstreet, Eclectic, Ekapa, Ekotse,
 El Camino, Emonon, Emily Enigma, Entr' Acte, Eghiphany, Escape, Eubie
 Blake, Euphonic, Factory, Fairmont, Famous Door, Fanfare, Fat Cat, Fi
 delity Sound, Filmstore, Fit, Flat, Flying Crow, Folk Legacy, Front Hall,
 GHB, GP, Gammon, Gary Wilson, Gas, Giants of Jazz, Golden Age, Golden
 Era, Golden Legends, Good Time, Good Time Jazz, Grassroots, Green Lin
 net, Grey Forest, Halcyon, Hamilton, Harrison, Herwin, Hidden Meaning,
 Historical, Hollywood Soundstage, Homespun, Honeydew, Houndstooth,
 IARC, Instant Joy, Interplay, Interzone, Jamey Abernold, Jazz Archives,
 Jazz Guild, Jazzology, Jewel, Jim Taylor Presents, Joliet, Joyce, Juice Joint,
 Jump, June Appal, Kally-Dpe, Kaydee, Key, King, Landside, Laureate.

CUT-OUTS

Your complete source for
 high-quality major label
 over-runs and deletions...
 LP's, Cassettes, and 8-tracks.

Courteous, expedient
 service

FREE CATALOGUE ON REQUEST

(Dealer & Jobber inquiries only)

symphonette

MUSIC DISTRIBUTORS

4520 VALERIO ST.
 BURBANK, CA 91505
 213-846-2707



Give the gift of music.

... dramatically increase your BOTTOM
 LINE PROFITS by offering the "best
 traffic builders" available at a price that
 attracts ...

**PERSONALIZED RACK OPERATION
 FOR YOUR STORE FEATURING HOT
 NUMBERS IN SOUL, JAZZ, BLUES
 (albums, cassettes & 8-tracks).**

We are specialists in cut-outs and have
 developed a unique rack operation de
 signed for individual stores/chains.

**Send for our catalogue now and ask
 about our personalized rack program.
 High profit product aimed at your bot
 tom line. Name artist's that'll build
 traffic.**

Contact (call or write)

**Martina Freedman
 (213) 734-1996**



AMERICAN MUSIC MARKETING

2952 West Pico Blvd.
 Los Angeles, CA 90006
 (213) 734-1996

**Chet Coplen, President
 Joe D'Amore, V.P. Rack Services Div.**

Lee, Legends, Leviathan, Library of Congress, Loughorn, Longview, Lost Nite, Lumere, Lunar, MAO, MF, MFC, Magi, Makossa, Mamlish, Man made, Master Jazz, Matra, Melodeon, Merry-makers, Messaround, Michigan Archives, Miljac, Mineburg, Mr. Blues, Mr. Brown, Modern, Mon mouth, Evergreen, More, Morningsstar, Muscraft, Muskadine, Mystery Toast, Newworld, New Orleans, New Pulse, New World, Nighthawk, Official, One Ten, Optional, Original Cast, Origin Jazz Library, Otis, Outline, PMP, Painted Smiles, Palo Alto, Paragon, Pathfinder, Pelican, Perkoft, Philomet, Phoenix Jazz, Pop Up, Progressive Pumpkin, Quark, RA, RCS, Radio Archives, Radiola, Rambler, Rasta Movement, Razor, Rebecca, Red, Release, Robos, Rollin' Rock, Rooster, Rosetta Rough Trade, Ruba, Rumble, SRI, San Diego Jazz Club, Sandy Hook, Seabereeze, Shadow, Shamrock, Shanachie, Shoestring, Silhouette, Smcky Mary, Solid Smoke, Sonora, Sountrak, Southland, Spitball, Spokane, Standing Room Only, Stardust, Starfire, Starlog, Stash, Steel, Straight Ahead Jazz, Suburban Industrial, Sunbeam, Sunburn, TBA, Take Home Tunes, Take Two, Tandem, The Sirens, Tiwa, Totem, Tradition, Trash, Traveler's, Trix, Trout, Twin/Tone, Uptown, Uptown Lowdown Jazz, VGM, Vanlage, Varese, Violet, Virgin Vinyl, Wagon Tracks, War Bride, Western, Westwood, Whid Isle, Wild, Wild Eye, Wins, World Jazz, Zeus, Zim

Labels imported: AB (Australia), Affinity (UK), Agram (Netherlands), Alternative Energy (Ireland), Amigo (Sweden), Artistic (UK), Atlantic (Japan, UK), Attack (UK), B Lee (UK), Banff (Canada), Bear Family (Germany), Bingow (France), Black Cat (Denmark), Black Saint (Italy), Blue Horizon (UK), Blue Parrot (UK), Blue Rhythm (Germany), Blues Boy (Sweden), Boot (Canada), Breakwater (Canada), Burning Sounds (UK), Burning Vibrations (UK), CBS (UK), Cadillac (UK), Caete (Switzerland), Capitol (UK), Carib Gems (UK), Celluloid (France), Celtic (Canada), Cha Cha (UK), Chess (UK), Chiswick (UK), Chyme, Claddagh (Ireland), Clock Tower, Collectors, Comhaltas (Ireland), Conflict (Canada), Congo, Crest (UK), Cynda (Canada), DEB (Canada), DJM, Daddy Kool (UK), Dawn Club (Germany), Decca (UK), Denon (Japan), Discpresser (Canada), Douglas (UK), Dragon (UK), EMI (UK), Eagran (Ireland), Edizione dell'Isola (Italy), Embassy (UK), First Heard (UK), Flyright (UK), Form (Ireland), Fountain Retrieval (UK), Gael Linn (Ireland), Garrett (Sweden), Generation (Canada), Gold (Switzerland), Grapenhauer, Grassroots (Australia), Greensteves (UK), Hammer (UK), Hawk (Ireland), Hefty Jazz (Denmark), Hep (Scotland), Highway (Ireland), Hit Run (UK), ID (Ireland), Inchechronn (Ireland), Iri (France), Itai, JMS (France), JSP (UK), Jazz Circle (Switzerland), Jazz Connoisseur (Italy), Jazz Craft (Denmark), Jazz Groove (UK), Jefferson (Sweden), Joke (Germany), KC (UK), Kaya, Kuckuck (Germany), Le Ron du Blues (Canada), Loft, Lyric (Australia), MCA (UK), MGM (Japan, UK), MNW (Sweden), Majic (UK), Magpie (UK), Meteor (UK), Micron (Canada), Mr. R&B (Sweden), Monument (UK), Mulligan (Ireland), Munich (Netherlands), Oats (Ireland), Odeon (UK), Dgham (Ireland), Oldie Blues (Netherlands), Onari (Canada), Owl (France), Daford (Italy), Philips (UK), Pioneer Int'l (Canada), Pizza (UK), Polydor (Ireland), Pye (UK), RCA (UK), Rarities (Denmark), Red Light ning (UK), Red/Vedette (Italy), Redwood (UK), Rock & Country (Netherlands), Roller Coaster (UK), Route 66 (Sweden), Sackville (Canada), Sarge (UK), Senta (Canada), Shaskeen (Ireland) Sir (Sweden), Soma, Soul Note (Italy), Stockholm (Sweden), String (UK), Sun (UK), Swing House (UK), Swing World (UK), Syndicate Chapter (UK), Tania Motown (UK), Tara (Ireland), Topic (UK), Trailer/Leader (UK), Transatlantic (UK), Triskel (Ireland), Trojan (UK), Union Pacific (UK), Unique Jazz

(Italy), United Artists (UK), Uniteledis (Italy), Virgin Front Line (UK), Vo calon (UK), WF, White (Netherlands), World (UK), Xtra (UK)

La Val Dists of California, 1218 Hoister Ave Zip 94124 Tel 467 5157
Owner & Buyer Brad Taylor (Rec. & Tape D)
 Labels: Bay Tone Comedians Inc., La Val Seaside, Soul Set, Sun Dance, Vic

Major Dists., 4191 First St., Space 108, Livermore 94550 Tel 455 6868
Mgr Don Thurman (Rec. & Tape RJ)
Home office: Tukwila (Seattle Area), Wash

Mighty Fine Dist'g, 99 Park Ln., Brisbane 94005 Tel 468 4000 Pres Ster Ing Laner, Mgr Ferd Skribeleit, Buyers Singles, Mike Evans, Albums, Ron Sampiere (Rec. DS)

Music People Inc., 1025 W MacArthur Blvd., Oakland 94608 Tel 653 5811
 Pres Elliot Blaine, Exec VP & Gen Mgr Jason Blaine, Buyers Singles, Albums & Tape, Elliot & Jason Blaine (Rec. & Tape DS)

Music Town Rec. Dists & Promo, Co., 55 Pacific Ave., No 150, Pittsburg 94565 Tel 458 5316 (Rec. D)
Home office: Nashville, Tenn (See for prod distributed)

Pacific Rec. & Tape Dists Inc., 7305 Edgewater Dr., Suite E, Oakland 94621 Tel 639 7661 Owners Robert Sarenpa, Michael S Pankos, Sandy Skeie, Mgr Michael S Pankos, Buyer Tom Larson. (Rec. & Tape D).
Branch: Seattle, Wash
 Labels: Abkco, Accent, Ala, Alligator, Alston, Antilles, Becket, Blind Pig, C11, Chalet, Chrysalis, Clouds, Concord Jazz, Contemporary, Dore, Fan tasy, Firstline, Flying Fish, 415, GNP/Crescendo, Galax, Gordy, Gramavision, Hannibal, Home Grown, Horn, House of Cash, IBC, Jam, Jazz Works, Jeremiah, Laff, Light, Mainstream, Malaco, Mango, Milestone, Mojo, Mo town, Mountain Railroad, Muse, Myrrh, Ode, Original Sound, Paid, Pass port, Ranwood, Rare Earth, Rhino, Riverside, Roulette, Seeds & Stems, Specialty, Stax, Stiff, Sugarhill, Sutra, TK, Takoma, Tama, Tapestry, Theresa, Trojan, Venture, Vintage, Visa, Waterhouse, Weird World, Wheel, Word

Parallax Corp., PO Box 838, Orinda 94563 Tel 254-6300 Pres Michael R Phillips, Mgr & Buyer C Bennett (Rec. D)
Label: Orinda

Pickwick Dist'n Cos., Independent Dist'n Div., 375 Sutter St Zip 94108 Tel 981 8787 Field Sales Mgr Jack Campbell (Rec. & Tape D—sales only, see Los Angeles office for prod distributed). (Rec. & Tape RJ as Pickwick Dist'n Cos. Rack Servs. Div.)
Home office: Minneapolis, Minn

Pickwick Dist'n Cos., Rack Servs Div., 11 Guttard Rd., Burlingame 94010 Tel 697 6800 Div VP Bill Hall, Sales Mgr Ted Lambeth (Rec. & Tape RJ), (Rec. & Tape D as Pickwick Int'l Inc., Distribution Div.)
Home office: Minneapolis, Minn

PolyGram Dist'n Inc., 5725 Paradise Dr., Suite 740, Corte Madera 94925 Tel 927 0720 Mgr Bill Follett (Rec. & Tape D)
Home office: New York, N.Y. (See for prod distributed)

RCA & A&M & Assoc'd Labels, 1 Executive Park Plaza, No 5, Thomas Mel lon Circle, Suite 130 Zip 94134 Tel 468-5550 Mgr. Charles Rice (Rec. & Tape D—see New York, N.Y. office for prod distributed)

Rivera Ents., 1908 Mission St Zip 94103 Tel 626 1212 Pres & Gen Mgr M Castillo Rivera, Mgr L Vargas Rivera, Buyers Singles, Fatma Esco bar, Albums, M Castillo Rivera (Rec. & Tape D, I & E)
Labels: Discos America, Melodias, RGM

Systematic Rec. Dist., 729 Heinz Ave., No 1, Berkeley 94710 Tel 845 3352 Owner & Mgr Peter Handel (Rec. D, I & E)
Labels: Frontier, Lust/Unlust, Optional, Poshboy, SST
Imports from Australia, Germany, UK

Viking Recs. & Accessories Inc., 25 Karen Rd., Belmont 94002 Tel 593 1058 Mgr: Albums & Tape Buyer Rick Galdon. (Rec. & Tape RJ)
Home office: Burbank (Los Angeles Metropolitan Area), Calif
 Warner/Elektra/Atlantic Corp., 6800 Beach St., No 460 Zip 94109 Tel 441 6111 Sales Mgr Bill Perasso. (Rec. & Tape D—see office in Los Angeles, Calif., for prod distributed)

Western Rec Sales, 5021 Seaport Ave., Richmond 94804 Tel 235-8840
Owner & Mgr Vern Cupples (Rec. & Tape D & RJ)
Distributes: Excelcior, Kids Stuff, Peter Pan, ProArte, Quintessence, Sesame Street
Accessories: Alltop, Discwasher, Glory, Le Bo, Marsand, Memorex, Savoy, Shape, Sony, Sound Guard, TDK, Tempo

• SAN JOSE (Area Code 408)

Dance It Oists., 1822 W San Carlos, Zip 95128 Tel 294 4082 Owner & Albums Buyer Terry M. Brown, Mgr Nick Lygatos, Singles Buyer Mike Homby (Rec. & Tape D, I & E)
Branch: Beverly Hills (Los Angeles Metropolitan Area), Calif
 Labels: Airwave, B&C, Brass, Emergency, Fusion, Groove Time, Moby Dick, Musique, Profile, Roy B, Scorpio, Tone Wizard, YAP, Westend
Labels imported: Uno Wave, Uno Disk (both Canada)
Accessories: Memorex (SEE ADVERTISEMENT)

Luna Recs Corp., 82 S First St Zip 95113 Tel 295 3203 Mgr & Buyer Maria Perez (Rec. & Tape DS, RJ, I & E)
Branch: Healdsburg, Calif

• SAN LUIS OBISPO (Area Code 805)

Square Deal Rec. Co., 169 Prado Rd Zip 93401, Tel 543-3636 D & DS
 Mgr Richard W Ferris, E Mgr Colleen Fitzsimmons, Buyers Albums, Gordy Hall, Tape, Lisa Newbold (Rec. & Tape D, OS & E)
Labels: AMBI, Adelphi, Arpe, Arjan, Ajax, Azax, Alcazar, Alligator, Amazing, American Album & Tape, American Gramophone, April, BFD, Babylon, Baron, Bay, Bee Hive, Behemoth, Blackbird, Blind Pig, Blotto, Bluebeat, Bomp, Bnar, CMH, CP, Chalfont, Citadel, Clone, Club of Spade, Columbia, Company Texas, Cowboy King, Crystal Clear, Curtain Calls, Dangerhouse, Delta, Drome, Empire, Emus, Endangered Species, Epiphany, Equly, Es cape, Esoteric, Exact, Faulty, First American, 415, Framms, Freckle, Free less, Frontier, Galemouth, Gazebo, Giants of Jazz, Giorno Poetry, Glen dale, Green Linnet, Gulcher, Haiku, Harbor, Hearsay, Helios, Honeydew, Hyrax, Infidelity, International Artists, JDC, Jazz Archives, Jazz Connors seur, Jazz Treasury, Joyce, June Appal, Kicking Mule, Kory, Lamb & Lion, Lamon, Lee, Longhorn, Lost Nite, MAO, Manmade, Mark, Mountain Rail road, Mr. Brown, Music Is Medicine, Nautilus, New Clear, Nighthawk, Nine Winds, Oblique, Official, Old Homestead, Optional, Orange, Orinda, PBR Int'l, Peaceable, Pelican, P10, Piccadilly, Pickwick, Poca River, Polish, Poshboy, Quintessence, Ragtime, Rainbow, Rainight, Ralph, Ram ber, Random Radar, Rebel, Rhino, Richmond, Ridge Runner, Rollin' Rock, Rooster, Rough Trade, Rumble, SST, Shasta, Shiloh, Shoestring, Solid Smoke, Sonet, Sonatone, Stash, Stiff, Subterranean, Sugar Hill, Texas Re Cord, Titan, Trix, Twin Tone, United, VGM, Varese Sarabande, Wagon Tracks, Wheeler, Windham Hill, Zim
Accessories: BASF, Maxell, Scotch, TDK, Transcriber (SEE ADVER TISEMENT)

• SANTA ANA (Area Code 714)

Abbey Road Rec. Dists., 1516 Edinger St. Bldg A&B Zip 92705 Tel 541 4132 (Rec. & Tape OS)

• SUNNYVALE (Area Code 408)

Respond Int'l Recs Inc., PO Box 62015 Zip 94088, Miraloma Business Park, 1190 Suite Y, Miraloma Way Zip 94086 Tel 245-1351 Pres Ronald L Akin, VP Opns P.A. dela Cruz (Rec. & Tape D, I & E)
Labels: Blackgold, Jem, Mico, Octoarts, Vicor, Wonderland (all Philip pines), Asahi, Canyon, Discso, King, TV, Tokuma, URC (all Japan)

COLORADO

• DENVER AREA (Area Code 303)

A & N One Stop, PO Box 2671 Zip 80201 Tel 572 9099 Owner James C Scott Sr., Mgr L Dean, Buyers Singles, James C Scott Jr., Albums, M.A. Scott (Rec. OS), (Rec. RJ as James Sales Co.)

Alpha & Omega Dists Inc., 7100 Broadway, Bldg 6, Unit H Zip 80221 Tel 429 4046 (Rec. D, OS & RJ)
Labels: AB, Alexandria House, Birdwing, Bread 'n Honey, Canaan, Cherry Lane, Chrism, Dayspring, Daystar, Daadem, Fisherfolk, Good Life, Good News, Greentree, Hart Song, Heart Warming, Heritage, Hope, Image VII, Impact, JIM, Jubilation, KCP, Lamb & Lion, Light, Maranatha, Messianic, Mighty Milk, Milk & Honey, Myrrh, New Life, New Paa, New Song, New World, Paragon, Peaceable, Peltra, Praise, Rivendell, Sec, Singcord, Singsoption, Solid Rock, Sonrise, Sparrow, Spirit, Starson, Tempo, Triangle, Tunemsmith, Word

Big State Denver, 2186 S Holly, Suite 104 Zip 80222 Tel 759 8500
 Sales Roger Christian, Promo Debebye Shell (Rec. & Tape D)
Home office: Dallas, Tex., Big State Rec. Dist'g (See for prod. distrib uted)

C B S Recs., 5680 S Syracuse Circle, Suite 418, Englewood 80111 Tel 770 4613 Branch Mgr Mike Waggoner (Rec. & Tape D—See New York, N.Y. office for prod distributed)

C M D Sales Co., 4085 E Mississippi Ave., Suite E Zip 80224 Tel 692 9565 Owner, Mgr & Singles Buyer Ronald J Staggs. (Rec. & Tape DS & RJ)
Photographs: BSR, Marantz, Sanyo
Playback equip.: Marantz, Sanyo, US Pioneer
Accessories: Maxell, Sanyo, Soundsaver, TDK, Tracs, Transcriber
 Capitol Recs., 10812 W Powers Pl., Littleton 80123 Tel 979 8607 (Rec. & Tape D—see office in Los Angeles, Calif., for prod distributed)

Christy's Rec Sales, PO Box 367, Westminster 80030 Tel 429 2429
 Owner, Singles, Albums & Tape Buyer Christina Marquez. (Rec. & Tape OS)

D L M Music Dists., 4990 Nome, No 3D Zip 80239 Tel 371 3260 VP Larry Gentry, Mgr Mel Nimon, Albums & Tape Buyer Tom Satriano. (Rec. & Tape OS)
Accessories: Discwasher, Le Bo, Maxell, Memorex, TDK

CHAPMAN DISTRIBUTING CO., INC.

LA's Finest Distributor

Manufacturer's Inquiries Most Welcome.
 Your Product Deserves Personal Attention.
 ALSO
 Complete Lines of Religious, Gospel and Sacred.

Contact:

CHAPMAN DISTRIBUTING CO., INC.

1212 South Albany
 Los Angeles, Calif. 90015
 Phone: (213) 749-9484

Al Chapman, President
 Herb Chapman, Sales Mgr.

SQUARE DEAL
Record Company



P.O. Box 1002,
 169 Prado Road
 805/543-3636 San Luis Obispo,
 TWX 910/351-6700 California 93406 1002

UNIQUE INDEPENDENT LABEL DISTRIBUTION for the INDEPENDENT RETAILER

over 300 fine "INDIE" labels covered in 250 pages of catalog

"MOST COMPLETE SINGLE SOURCE of Cutouts, Overpressings and Budget Labels Anywhere."

over 350 page catalog sent on request

BLANK TAPE, VINYL SLEEVES, BUTTONS, PATCHES, JEWELRY, GRAPHICS AND BOOKS

LP's, 8-Tracks, Cassettes Export Service Competitive Prices

BONAPARTE



**BRITAINS
FOREMOST
EXPORTER**

ENGLISH &
EUROPEAN
RECORDS

Phone us now on
(212) 420-0580

118 West 3rd St.,
New York, NY 10012

Danjay Music Inc., 10625 E. 47 Ave Zip 80239 Tel. 373-1760 Owner Phil Lasky; Pres. Evan Lasky, Opn; Mgr. George Hill, Buyers Len Rokosz, Ric Gourtay (Rec. & Tape OS)
Branch: Tukwila (Seattle Area) Wash
Handeman Co., 4860 Nome St. Zip 80239 Tel. 373 1420 (Rec. & Tape RJ)
Home office: Clawson (Detroit Metropolitan Area), Mich
House Dist's., 5046 W. 36 Ave Zip 80212 Tel. 477-3044 Mgr. Tom Eaton (Rec. & Tape D)
Home office: Kansas City, Mo (See for prod. distributed)
Infal Recs. Inc., 2217 Champa St. Zip 80205 Tel. 892 7141 Owner & Buyer: Victor M. Hernandez (Rec. & Tape OS, RJ & I)
James Sales Co., 2327 E. 28 Ave Zip 80205 Tel. 572 9099 Owner C.W. James; Mgr. James C. Scott Sr. Buyers: Singles, Jim Scott, Albums, M.A. Scott (Rec. RJ), (Rec. OS as & N One Stop)
Lieberman Ent's Denver, 11000 E. 51 Ave Zip 80239 Tel. 371 2190 Mgr. Jack Goodman, Opns Mgr. Bruce Voigt, OS Mgr. Mike Smith, Buyers: Singles, Cheryl Brungardt, Albums & Tape, Diana Anderson (Rec. & Tape OS & RJ)
Home office: Minneapolis, Minn
Little House Recs. Ltd., 602 S. Errierson Zip 80209 Tel. 778 7258 Pres. Tony Knobel, Opns, Mgr. & A-i-ums Buyer: Nancy Flanagan (Rec. D) Labels: American Gramophone Delos, Direct Disk Labs, Nautilus, Real Time
M C A Dist'g Corp., 288 Clayton St., No. 305 Zip 80206 Tel. 320-1919, 333 0059 Branch Mgr.: John Frie (Rec. & Tape D—see office in Los Angeles, Calif., for prod. distrib. ed)
Mile Hi One Stop Inc., 150 Rio Virande Blvd. Zip 80223 Tel. 629-1960 Mgr. Bob Jacobs (Rec. & Tape OS, RJ & I), (Rec. & Tape D as Pan American Rec. Supply)
Home office: Skokie (Chicago Metropolitan Area), Ill. Sound Unlimited Inc.
Videocassette & Videodisk lines. All lines.
Accessories: Alltop, Amaray, Atari, BASF, Discwasher, Duracell, Fuji, Hagerstown, Le-Bo, Marsand, Ma Tel, Maxell, Memorex, Pfanstiel, Savoy, Sony, Sound Guard, TOK, Tota Video, Video Organizer, Vid-Lid
Mountain Coin Machine Dist's., 3CJ W. 53 Pl. Unit B Zip 80216 Tel. 629 6804 Mgr.: Marty Cerin; Single's & Albums Buyers: Clem Diederich (Rec. OS)
Pan American Rec. Supply, 150 Rr Grande Blvd. Zip 80223 Tel. 629 1960 Mgr. Bob Jacobs (Rec. & Tape D), (Rec. & Tape OS, RJ & I as Mile Hi One Stop)
Home office: Skokie (Chicago Metropolitan Area), Ill., Sound/Video Unlimited Inc. (Rec. & Tape OS, RJ & I)
Labels: CTI, Caedmon, Concord Jazz, GNP Crescendo, Impact, Light, Living Language, Mainstream, Monitor, Muse, Pyramid, Roulette, Savoy, Syntonic Research, TK group
Pickwick Dist'n Cos., Rack Servs Div., 11720 E. 49 Ave Zip: 80239 Tel. 371-0900 Mgr. Al Wosk, Buy r Lydia Monchak (Rec. & Tape RJ)
Home office: Minneapolis, Minn
R C A & A&M & Assoc'd Labels, 6100 E. Evans Ave., Bldg. No. 1, Suite 120, Zip: 80222 Tel. 759-8181 Mgr. Mike Ketchum (Rec. & Tape D—see New York, N.Y., office for prod. distributed)
Ron's Dist's of Denver, 5201 N. Federal Blvd. Zip. 80221 Tel. 477 3611 (Rec. & Tape D & RJ)
Distributes cutouts, promotional material
W M Dist'g, 4105 Holly St. Zip. 80216 Tel. 320-4660 Mgr. Bob Krug, D Buyer: Marlon Ericson. (Rec. & Tape D), (Rec. & Tape OS & RJ as Western Mdrsr. Inc.)
Home office: Amarillo, Tex., Western Mdrsr. Inc.
Labels: ASI, AVI, Abkco, Alfa, Arerama, Arista, Cachet, Chrysalis, Church, Cream, Disneyland, Fantasy, First American, IRDA, Jeremiah, Laif, Mushroom, Nashboro, October, Ovalton, PA USA, PBR, Pacific Arts, Plantation, Prelude, Prism, Ranwood I, Romero Brothers, Scorpion, Shelby Singleton, Soul City, TMS, Vangu, rd
Warner/Elektra/Atlantic Corp., 1482 S. Parker Rd., No. 204 Zip 80231, Tel: 750-4850 Sales Mgr. Randy Patrick (Rec. & Tape D—see office in Los Angeles, Calif., for prod. distributed)
Western Mdrsr. Inc. (Rec. & Tape OS & RJ), see WM Dist'g

Society, Improv, JRC, Jazz, Kay, Living Language, MMG, Mark 56, Monitor, Muse, Musicraft, Orion, Peter Pan, Peters Int'l, Rego, Request, 1750 Arch, Sheba, Sound Effects, Stan Kenton, Stanyon, Starr, Storyville, TMI, TRC, Thumble, Trifon, Trend, Turn On, Varese, Vox, World Jazz
Accessories: Alltop, Continental, Memorex, Sony, Sound Guard, TOK, 3M
Tin Pan Recs Inc., 157 Charter Oak Ave, Zip 06106 Tel. 278 5222 Owner & Mgr. Thomas Markoski (Rec. & Tape D, OS & RJ)
Labels: BBC, Brasilia, Cada, Oazz, Dyno, Enjoy, G.P. Gateway, Gilette Madison, Juno, Peerless Classics, Peter Pan, Plantation, Rebecca, Release, SoCon, Sun, VAP, Who's Who in Jazz
Accessories: Irish, Memorex, Peerless, Recoton, Shape
Warner/Elektra/Atlantic Corp., 851 Marshall Phelps Rd., Windsor 06095, Tel. 688 7581 Sales Mgr. Mike Fontecchio (Rec. & Tape D—see office in Los Angeles, Calif., for prod. distributed)

● **NEW CANAAN (Area Code 203)**
The Musicsmith, 103 Main St Zip 06840 Tel: 972 0002 (Rec. OS, RJ & E; Tape OS & RJ)

● **NDANK (Area Code 203)**
Dean Wallace Rec. Dist. Ltd., PO Box 162 Zip 06340 Tel. 536-4963 WATS (800) 243 0330 Warehouse 48 Main St. Pres. Oean Wallace Jr., Mgr. Jack Hoyle (Rec. D & I)
Labels: Adelphi, Alligator, Amazing, Amb, Arhoolie, Audiophile, Bay, Bert & I, Bee Hive, Biograph, Black Eagle, Blind Pig, Blue Goose, Blues Classics, CMH, Cardinal, Celeste, Clean Cuts, Clearwater, Collegum, County, Delmark, Oobre, Earwig, Everest, Flying Fish, Flying High, Folk Legacy, Folk Lyric, Folkways, Fretless, Front Hall, GHB, Gatemouth, Grass Mountain, Greenhays, Green Linnet, Green Mountain, Herwin, Historical, Improvising Artists, Iron Horse, JCOA, Jay Round, Jazz Archives, Jazz Guild, Jazzology, June Appal, Kaleidoscope, Kicking Mule, Living Folk, Major Michigan Archives, Mineral River, Minstrel, Muscle, Nessa, Newworld, Old Timey, Olymp c, PM, Pearl, Philly Jazz, Philo, Programme Audio, RE/SE, Rebel, Regency, Release, Revonah, Rex, Ridge Runner, Rooster, Rounder, 1750 Arch, Shanachie, Shilon, Singlebrook, Sierra/Binar, Sonet (USA), Stash, Steeplechase (USA), Stinson, Sugar Hill, Swallowtail, Sweet Earth, Symposium, Syntonic Research, Tifton, Titanic, Tradition, Trax, Troubadour, WATT, Waterhouse, Windham Hill, Yazoo, Yodel-ah-hee
Labels imported: Affinity, BBC, Boot, Dolphin, Dragon, Flyright, Fogerty's Cove, Gael Linn, Generation, Greensteves, Greenwich Village, Horselips, Inchecronin, Maggie, Micron Mulligan, Oldie Blues, Outlet, Red Lightning, Sky/Attack, Sweet Folk, Tara, Topic, Transatlantic, Trishell, Trojan, Virgin/Front Line, Xtra

DISTRICT OF COLUMBIA

● **WASHINGTON (Area Code 202)**
African Rec. Centre Dist's Ltd. (ARC Rec. Dist's), 1316 U St NW Zip 20009 Tel. 462-0659; Mgr. Mark Jackson (Rec. D & OS)
Home office: New York, N.Y. (See for prod. distributed)

CONNECTICUT

● **BRIDGEPORT AREA (Area Code 303)**
Nu Music Dist'g, PO Box 1534, Sempmorton Sta., Fairfield 06430. NYC Tel (212) 289-7824. Pres. Scott W Anderson, VP. Amy L. Anderson (Rec. D) Labels: Ambition, DBA, Factor, Firesgn, Flow'n' 5, Importe'12, JDC, Launch, D, Park Place, Polyes er, Ralph, Rhino, Rough Trade, Select.

● **GEORGETOWN (Area Code 203)**
Take Home Tunes, PO Box 496, Zip 06829 Tel. 544 8288 Mgr. Bruce Yeko (Rec. D)
Home office: Englewood Cliffs, N.J. (See for prod. distributed)

● **HAMDEN (Area Code 203)**
Roger Brouso Phonograph Recs. 24 Scott St Zip 06514 Tel. 288-3838 Owner & Buyer Roger Broussr (Rec. OS)

● **HARTFORD AREA (Area Code 203)**
Aquarius Dist's of New England Inc., 479 Park Ave., East Hartford 06108 Tel: 278-4061 Pres., Mgr., Singles & Albums Buyer: Marvin Ginsburg, Promo. Tracy Garneau (Rec. & Tape D)
Labels: Ariola, Arista, Becket, Brunswick, Buddah, Dakar, Disneyland, Europa, GRP, Gusto, K Tel, Mushroom, Nostalgia Lane, Novus, Power Pac, Prism, RFC, Ranwood, Savoy, Starday, Sugar Hill, Superscope, Sutra, Vista, West End
Accessories: Discwasher, Maxell, Memorex
C B S Recs 60 Washington St., Suite 1004 Zip 06106 Tel. 522 7151 Branch Mgr. Phil Balsam (Rev. & Tape D—see New York, N.Y., office for prod. distributed)
Central Rec. & Tape Dist's Inc., 115 S. Satellite Rd., South Windsor 06704 Tel. 528-2171 Owner Edward E. Stein, Mgr. Robert L. Hoyt, Buyers: Singles, Amy Holstein, Albums, Robert L. Hoyt (Rec. & Tape OS & RJ)
One-Stop Music Serv. Inc., PO Box 321, 24 26 Clark St., East Hartford 06108 Tel. 528-4126 Owner Richard J. Godlewski, Singles & Albums Buyer: Dot Maurice (Rec. D)
Labels: Advent, Aishire, Audio Identity, Bert & I, CMH, Chiaroscuro, Childrens Recs. of America, Clari: Children, Columbia Special Prods., Contemporary, ConversaPhone, Creative World, Crystal Clear, DRG, Delmark, Denon, Discovery, Dyno, Education Media, Electric Lemon, Environment, Everest, Fiesta, Glendale, Golden Age of Radio, Haydn



LPS - TAPE - DISCO
CURRENT • CUTOUT

Write For
Catalog

MUSIC BROKERS

2651 W. PICO BLVD.
LOS ANGELES, CALIF. 90006
(213) 386-4937

EXPORT
EXPERTS

Black Fire Dist. PD Box 38054 Zip 20020 Tel 357 3572 Dwner & Pres James B Gray, VP & Gen Mgr Plunky Nkabinde. Albums Buyer Jimmy Gray (Rec. D)
Labels: AKBA, Alupman, Black Fire, Cosmic Fire, Divine, Freelance, IPS SRP, Strata, Third World, Tribe, Trident, Triumph, Ujamaa
Warner/Elektra/Atlantic Corp.—Tel 475 6505—also see listing in Green bell, Md

FLORIDA

• **FORT LAUDEROALE AREA (Area Code 305)**

K & S Assocs. Inc., Rack Div., 6412 N. University Dr., Tamarac 33321 Tel 721 6310 Pres. & Albums Buyer George Kurtz, VP & Albums Buyer Bob Shengold (Rec. RJ)
Sid's Recs. & Tapes Inc., 2900 E. Sunrise Blvd Zip 33304 Tel 563 9278, 565 5855 Dwner Sidney Debin, Mgr. & Buyer Skip Asbury (Rec. DS)

• **GAINESVILLE (Area Code 904)**

Raven's Recs., 13 208 Jennings, Zip 32612 Tel 392 9531 Pres Daryl Toor (Rec. D—rare & discontinued titles)

• **JACKSONVILLE (Area Code 904)**

Dabill Rec. & Tape Serv., 1988 San Marco Blvd. Zip 32207 Tel 398 2297 Pres Marjorie C Livert, Mgr., Singles, Albums & Tape Buyer William E Binkley Jr (Rec. & Tape OS & RJ)
Lieberman Ent's, Southeast, 9603 N. Main St Zip 32218, Tel 751 2600 Dpns. Mgr Jerry Drner (Warehouse only, also see listing in Atlanta, Ga.)

• **MIAMI METROPOLITAN AREA (Area Code 305)**

Alhambra Dist'g Inc., 4380 NW 128 St., Dpa Locka 33054 Tel 885 4298, 685 8396, Telex 522178 Pres. Enrique Inurriet Jr., Exec VP Enrique Inurriet Jr., Gen Mgr. Miguel Estivil, Sales Mgr Rich Corrooso, Promos Mgr Betty Diaz (Rec. & Tape D & I)
Branches: Los Angeles, Calif., San Juan, P.R.
Labels: Al, Al Mex, Alhambra, Carnaval, Libra
Labels imported: Belter (Spain), Columbia (Spain), Dila (Guatemala), EMI Int'l (Spain), Gamma (Mexico), Grabaciones Mundiales (Venezuela), Kangaroo (Italy), Moveplay (Spain), RCA Int'l., Sonolux (Colombia), Sonoradio (Peru)
B B Recs., 7317 NW 79 Terr Zip 33166 Tel 887 4259 Pres Bernard Bin nick, (Rec. E—closeout singles & albums)
C B S Recs., Lincoln Square Office Center, South Tower, Suite 100, 18425 NW Second Ave Zip 33169 Tel 653 5760 Branch Mgr Larry Golinski (Rec. & Tape D—see New York, N.Y., office for prod distributed)
Capitol Recs., Pan American Bldg., 7220 NW 36 St., Suite 245 Zip 33166 Tel 592 3810 (Rec. & Tape D—see office in Los Angeles, Calif., for prod distributed)

Cayre Dist's of Florida Inc., 7290 W. Second Way, Hialeah Gardens 33014 Tel 558 4934 (Rec. & Tape D)

Home office: New York, N.Y., Caytronics Corp (Rec. & Tape D, OS, RJ, I & E—see for prod distributed)

Handleman Co., 2346 NW 147 St., Dpa Locka 33054 Tel 681 4618 (Rec. & Tape RJ)

Home office: Clawson (Detroit Metropolitan Area), Mich
International Music Recs. & Tapes, 7806 NW Seventh Ave Zip 33150 Tel 691 3493 Dwner L L Dean, Mgr B Bryant, Buyer C Simmons (Rec. & Tape RJ), (Rec. D—cutouts)

M C A Dist'g Corp., 7370 NW 36 St., Suite 133 Zip 33166 Tel 592 5140 Branch Mgr Larry Glaser (Rec. & Tape D—see office in Los Angeles, Calif. for prod distributed)

M J S Entertainment of Florida Inc., 8228 NW 56 St Zip 33166 Tel 592 6085 Pres Al Zamora, VP Promc Bob Perry, D Sales Mgr Fred Held, E & DS Sales Mgr Cindy Barr, Buyers Singles, Jeff MacDonald, Albums, Gary Kulla, Dpns Mgr Bill Fradera. (Rec. & Tape D & OS), (Rec. & Tape E as MJS Int'l Inc.)

Branches: Atlanta, Ga., Long Island City (New York Metropolitan Area), N.Y.

Labels: BC, Brunswick, Disneyland, Emergency, Enjoy, 51 West, Groove Time, Importe, Juana, Mango, Prism, Sugar Hill, Top Rankin, Vanguard
Accessories: BASF, Certron, Discwasher, Duotone, Fuji, Le-Bo, Maxell, Memorex, Reclon, Savoy, Sony, TDK. (SEE ADVERTISEMENT)

M & M Recs Dist's Inc., 501 W 28 St., Hialeah 33010 Tel 887 4522 Dwner & Buyer Manuel J. Mato, Mgr Mariano Rodriguez (Rec. & Tape D, OS & RJ)

Labels: Atlas, Lad, TH, Velvet
Morbros Inc./Mr Nostalgia, PD Box 414201, Miami Beach 33141 Tel: 754-9115 Dwner Singles, Albums & Tape Buyer Charles P Morrison (Rec. & Tape D)

Labels: Ajaz, Clif, Conversa Phone, Curtain Calls, Fanfare, Giants o' Jazz, Golden Era, Hollywood Sound Stage, Joyce, Monitor, Monmouth Evergreen, Muscraft, Progressive, Radiola, Request, Sountrak, Stage, Stash, Sunbeam

Musical Recs. Co./Musical Tapes Inc., 780 W. 27 St., Hialeah 33010, Tel 887 2638 Pres Eliseo Valdes, Gen Mgr Lazaro Fernandez. (Rec. & Tape D, OS & RJ), (also Rec. D as Sunshine Rec Dist's.)
Branches: Los Angeles, Calif., San Antonio, Tex.

Labels: Belter, Bueno, Discuba, Eco, Eli, Fuentes, Musart, Peerless.

Musical Tapes Inc., see Musical Recs. Co./Musical Tapes Inc

D P One Stop, 1543 NW 165 St Zip 33169 Tel 625-3122 Zip 33169 Mgr & Singles Buyer Paul Yoss (Rec. DS, I & E)

Pickwick Dist' n Cos., Independent Dist'n Div., 13145 NW 45 Ave., Dpa Locka 33054 Tel 685 7601 Mgr Bob Wilder, Singles & Albums Buyer Jerry Coleman (Rec. & Tape D)

Home office: Minneapolis, Minn

Labels: AVI, Abkco, Arista, Audio Fidelity, Boardwalk, Buddah, Buena Vista, Camden, Chrysalis, Coco, Concord Jazz, Deluxe, Disney, Fiesta, First American, Flying Fish, GNP Crescendo, GRP, Gordy, Gospel, Greenhays, Hi, Hitsville, Import, International Artists, Jam, Kaleidoscope, Kudu, Lifesong, Living Language, Maiden Voyage, Motown, Mountain Railroad, Muse, Natural Resources, Nessa, Ode, Ovalton, Pacific Arts, Passport, Penthouse, Pickwick, Posse, Prodgal, Quintessence, Rare Earth, Regency, Rhino, Robox, Sam, Savoy, Sesame Street, Soul, Spring,

Stiff, Sweet City, Takoma, Tamla, Tapestry, Tomato, UK, Visa, Wheel, Zephyr

Accessories: Shape

PolyGram Dist' n Inc., 8400 NW 52 St., Suite 227, Zip 33166 Tel 592-7970 Mgr Larry Hensley (Rec. & Tape D)

Home office: New York, N.Y. (See for prod distributed)
R C A & AEM & Assoc'd Labels, 7220 NW 36 St., Suite 103 Zip 33166 Tel: 592 4646, Mgr Jerry Sulhan (Rec. & Tape D—see New York, N.Y., office for prod distributed)

Recordland Export Inc., 3401 NW Seventh St Zip 33125 Tel 649 2110 Mgr Reinaldo Liabona (Rec. & Tape E)

Specialty Dist's Inc., PO Box 4155, Normandy Sta., Miami Beach 33141 Tel 758 0000 Pres W Jay (Rec. & Tape D)
Distributes all polka labels

Accessories: Ampep

Sunshine Rec Dist's (Rec. D)—Gen Mgr Carlos Gonzalez—see Musical Recs

Tone Dist's, PD Box 1447, Hialeah 33010; 495 SE 10 Court, Hialeah 33010 Tel 888-1685 Gen Mgr Lynda Stone (SEE ADVERTISEMENT)

United Rec. & Tape Dis, Inc., 9800 NW 77 Ave, Hialeah Gardens 33016 Tel 821 3100 Bd Chm Allan Wolk; Pres. Sydney Silverman, VP David Jackowitz, Singles & Albums Buyer, Brad Harrison. (Rec. & Tape RJ)
Branch: Atlanta, Ga.

Vibrations, 14700 Biscayne Blvd., North Miami 33181, Tel 944-6952 Pres Larry Schaffer (Rec. & Tape OS, RJ, I & E)

Warner/Elektra/Atlantic Corp., 6555 NW 36 St., Virginia Gardens 33166 Tel: 871 2090 Sales Mgr Dave Benjamin. (Rec. & Tape —see office in Los Angeles, Calif., for prod distributed)

• **ORLANDO AREA (Area Code 305)**

Mountaineer Rec Serv Inc., 4109 Barwood Dr Zip 32805, Tel 339-4276, 841-4595, Dwner Howard Holliday Jr. (Rec. OS)

Southern Music, 30 S Orange Ave Zip 32801 Tel 422 8671 Dwner Ron Road, Mgr George Brymer, Buyers Singles, Steve Flesher, Albums, George Brymer. (Rec. & Tape OS)

Sunshine Music, 290 Iris Rd, Casselberry 32707 Tel 830-7410 Dwner & Mgr Richard Stultz, Buyers Singles, Chris Lesisco, Albums & Tape, Jim Boylston. (Rec. & Tape OS & RJ)
Accessories: Sony

• **POMPANO BEACH (Area Code 305)**

Musico-Town Rec. Dist's & Promo Co., 1841 NE 42 St Zip 33064, Tel 943 8039 (Rec. D)
Home office: Nashville, Tenn (See for prod distributed)

• **SARASOTA (Area Code 813)**

Distributors Inc., 210 Ringling Shopping Center Zip 33577 Tel 953-3797 Pres Gary Kuban (Rec. OS & RJ)

• **TALLAHASSEE (Area Code 904)**

Looking Forward Dist's (Community Literature Inc.), 730 W. Gaines St Zip 32304 Tel 224-9490 Mgr: Peter Le Forge; Albums & Tape Buyer Andy Downs. (Rec. & Tape OS)

Accessories: Maxell, Reclon, TDK

Mobile Rec Serv Co., 5505 Debbie Dr Zip 32304 Tel 575-6653 Mgr. John Montgomery (Rec. OS—singles only)
Home office: Pittsburgh, Pa

• **TAMPA (Area Code 813)**

Tampa Recs., 3608 N. Armenia Ave Zip 33607 Tel 876 5314, Owner Al Burns & Tape Buyer S Delgado. (Rec. & Tape OS & RJ)—Latin prod only

GEORGIA

• **ALBANY (Area Code 912)**

Gwen Rec. Serv., 319 Highland Ave Zip 31706 Tel 436 6508 Dwner Mgr & Buyer Jesse Boone (Rec. & Tape DS)

• **ATLANTA METROPOLITAN AREA (Area Code 404)**

C B S Recs., 18 Executive Park Dr. NE Zip 30329 Tel 321-4553 VP South east Region Roger Melting, Reg'l Co-ord Barbara Savage; Branch Mgr Ron Peek (Rec. & Tape D—see New York, N.Y., office for prod distrib uted)

Capitol Recs., 1670 NE Freeway Access Rd Zip 30329 Tel 321 5441, (Rec. & Tape D—see office in Los Angeles, Calif., for prod distributed)

Creative Audio Mktg. Inc., 5725 Buford Hwy., Suite 104 Zip 30340 Tel 455-0214 Dwner, Mgr & Buyer Joe A. Hanson. (Rec. D)
Label: Direct Disk Labs

Duplex Rec. Dist. of Atlanta, 699 McDaniel St. SW Zip 30310, Tel: 524-9174, Pres. Alex Williams. (Rec. D)

Labels: Arno, Dove, Duplex Startown, Esprit, Rocksool, Sidetrack, Soult rack, Spacetown

Photographs: Admral, Magnavox, Masterworks, Morse Electrophonic, Motorola, Panasonic, RCA, Zenith

Accessories: E.V. Peerless, RCA, Watts.

Georgia Music Supply Inc., PD Box 490331 Zip 30349 Tel 996-3385 Dwner & Albums Buyer Richard F DeCourcy, Mgr Linda Galgano. (Rec. D)

Labels: American Heritage, Atriam, Bay, Boot (Canada), Briar, CMH, Columbia Lea, County, Flying Fish, Gusto, June Appal, Kaleidoscope, Kicking Mule, Leather, Did Homestead, Outlet, Puritan, Rebel, Revonah, Ridgerunner, Rounder, Rural Rhythm, Shanachie, Shiloh, Starday-King, Sugar Hill, Thunderhead, Vassari, Velco

Handleman Co., 1578 Litton Dr., Stone Mountain 30083 Tel. 938-9467 (Rec. & Tape RJ)

Home office: Clawson (Detroit Metropolitan Area), Mich.

House Dist's., 1325-A N. Cliff Valley Way Zip 30319 Tel 633 1684, Mgr Rick Dandes. (Rec. & Tape D)

Home office: Kansas City, Mo (See for prod distributed)

Jacyn Sales Inc., 7185 Cane Leaf Dr., Fairburn 30213 Tel 964 3837 Dwner, Mgr & Buyer James H Alexander. (Rec. & Tape D & RJ)

SCHWARTZ BROTHERS, INC.



4901 FORBES BLVD.—LANHAM, MARYLAND 20801 (301) 459-8000

Largest Independent Distributor in the East for:
Records
Pre-recorded Tapes
Gospel Music
Video Cassettes

Video Discs
Video Archives
Blank Tapes
Video Games
Audio Accessories

SERVING: DELAWARE, MARYLAND, NEW JERSEY, NORTH AND SOUTH CAROLINA, PENNSYLVANIA, VIRGINIA, WASHINGTON, D.C. AND WEST VIRGINIA

CAROLINA AREA
5501 EXECUTIVE CENTER DRIVE, SUITE 101
CHARLOTTE, N C 28212
(LOCAL) (704) 536-9390
(ALL OTHERS) (800) 638-0243

BALTIMORE AREA
727-4770

PHILADELPHIA AREA
1101 KINGS HIGHWAY NORTH, SUITE 104
CHERRY HILL, N.J. 08002
PHILA. (215) 923-1271
N.J. (609) 482-2130

WASHINGTON AREA
ORDERS 459-9181
GENERAL 459-8000

ALL OTHER AREAS
ORDERS (800) 638-0538
GENERAL (800) 638-0530



1910 GRANBY STREET — NORFOLK, VIRGINIA 23517
LOCAL (804) 622-8663 VIRGINIA (800) 582-8337 ALL OTHERS (800) 446-8271

Labels: Afteram, Greentree, Gusto, Heart Warming, Impact, JIM, King, Starday.
 Lieberman Ent's Southeast, 2700 Cumberland Pkwy., Suite 260, Zip 30339
 Tel 432-0306 Mgr Dennis Nicollis, Buyers: Singles, G. Black, Albums.
 J. Scaglione (Rec. & Tape RJ) sales & purchasing only, also see listing in Jacksonville, Fla.
Home office: Minneapolis, Minn (Rec. & Tape OS & RJ)
 MCA Dist'g Corp., 6403 Warren Dr., Norcross 30093 Tel 447-6405 Branch
 Mgr Carl Michelakos (Rec. & Tape D—see office in Los Angeles, Calif. for prod distributed)
 M J S Entertainment of Georgia Inc., 2775 E Bankers Industrial Dr Zip 30360
 Tel 448-7772 WATS (800) 241-5389 Telex 700598 Pres Christopher Barr, VP Jim D'Rourke, Inport Mgr Randy Dickson, Buyers Singles, Fred Harris, Albums, John Norwood (Rec. & Tape D, OS & T)
Home office: Miami, Fla
 Labels: Canaan, Creed, 51 West, Importe/12, Jewel, Kenwood, Light, Myrrh, Nashboro, Paula, Ronn, Springboard, Trip, Word
 Accessories: Classic One Le Bo, Maxell, Memorex, Savoy, TDK (SEE ADVERTISEMENT)
 Nova Dist'g Corp., 1873 Enterprise Dr., Norcross 30093 Tel 447-1591
 Pres Steve Libman, Sales Mgr Stan Kaiser, Dpms Mgr Bud Libman, Singles Albums & Tape Buyer Steve Libman (Rec. & Tape OS)
 Accessories: Memorex, Savoy, Iust Buster, Recoton
 One-Stop Rec. House Inc., 1872 Marietta Blvd Zip 30318 Tel 351-9140
(Rec. & Tape OS)
 Accessories: BASF, Capitol Mag, etc., Le Bo, Memorex, Planstiehl
 Pickwick Dist'n Cos., Independent Dist'n Div., 2151 Northwest Pkwy., Marietta 30067 Tel 952-3343 Mgr Jack Mesler, Dpms Mgr Lynn Ward, Sales Mgr Tom Beckwith, Buyers Singles, Charles Johnson, Albums, Juan Buckner (Rec. & Tape D), Rec. & Tape RJ as Pickwick Dist'n Cos., Rack Servs Div)
Home office: Minneapolis, Minn
 Labels: APA, AVI, Abel, Abkco, Arcant, Ala, Alfa, Alston, Amberjack, Angelaco, Ariola, Arista, B&G, Becket, Benson, Bet Car, Birthright, Black Saint, Blind Pig, Boardwalk, Bold, Bon b, Buddah, CMH, Camden, Cat, Charos coro, Chrysalis, Cloudborn, Clouds, Concord Jazz, Contemporary, Creed, Crystal Clear, Dash, Deluxe, De aki, Dixie Jubilee, Drive, Entr' Acte, Ernie's, Excelsior, Fabulous, Fantasy, First American, Flying Fish, GNP Crescendo, GRP, Galaxy, Glades, G rdy, Gospel Roots, Gospel Tone, Gospel Truth, Grand, Great Northwest Greenhays, Gryphon, Heart Warming, Heat, Hob, Jam, Jazz Bird, Jua ia Kaleidoscope, Kenwood, Kudu, Laff, Lamb & Lion, Lifesong, Living Language, Lyons, Maiden Voyage, Malaco, Marlin, Milestone, Milk & Honey, Molown, Muscle, Muse, Music is Medicine, Nashboro, Natural Resources, New Birth, New Dawn, New Moon, New Pax, North Country, Now: Nutmeg, Dur Gang, Davton, Paragon, Pausa, Penthouse, Phoenix 10 & 20, Pickwick, Posse, Prestige, Pro Arte, Prodigal, Project 3, Quintessence, Ranwood, Rare Earth, Refuge, Regency, Rhino, Ridgetop, Robo, Rounder, SMI, Sam, Savoy, Seeds & Stems, Sesame Street, Solid Smoke, Soul Note, Sound Factory, Sounds South, Spiral, Stax, Stiff, Sitali, East, Sunbird, Sunshine Sound, Sutra, Syntonic Research, TK, Takoma Tamla, Tapestry, Thunderbird, Tomato, Trolley Car, Vintage, War Bride, Waterhouse, Wheel, Wicked, Weird World, Windham Hill
 Accessories: Shape
 Pickwick Dist'n Cos., Rack Servs Div., 2151 Northwest Pkwy., Marietta 30067 Tel 952-3343 Mgr Dennis Hoefler, Sales Mgr Bernie Hoen,

Buyer Joe Bucklew (Rec. & Tape RJ), (Rec. & Tape D as Pickwick Dist'n Cos., Independent Dist'n Div.)
Home office: Minneapolis, Minn
 PolyGram Dist'n Inc., 590 Commerce Park Dr., Suite 175, Marietta 30060
 Tel 428-2929 Reg'VP Herb Heidt, Branch Mgr Tim Monnig (Rec. & Tape D)
Home office: New York, N.Y. (See for prod. distributed)
 RCA & A&M & Assoc'd Labels, 3395 Northeast Expwy Zip 30341 Tel 455-3636 Reg'l Sales Dir Charlie Hall, Branch Sales Mgr Harry Clark, Sales Mgr George Jackson (Rec. & Tape D—see New York, N.Y. office for prod distributed)
 Record Dist'n Amalgamated (div of The Group Inc.), 1957 Kilburn Dr Zip 30324 Tel 872-6000 Mgr Ari G. Poulos, Buyer Diver Cooper (Rec. & Tape D & E)
 Labels: Banned, Dance A Thon, Glamour & Grease, Hotlanta, Hottrax, Screaming Grease, Stereo Spectrum, Thevis
 Record Dist's Inc., 6427 Warren Dr., Norcross 30093 Tel 449-6085 Pres & Mgr Norm Botteron; Buyers Singles, Spencer Herzog, Albums & Tape, Al Moore; Controller Marian Runger (Rec. & Tape OS)
 Accessories: Discwasher, Maxell, Savoy
 Tara Rec. & Tape Dist'g Co. Inc., PO Box 13939 582 Armour Circle NE Zip 30324 Tel 875-8272 Nationwide WATS (800) 241-5538 Georgia WATS (800) 282-4060 Pres Gwen M Kesler, Buyers Singles, James Waters, Albums & Tape, Joe Terrebonne, Accessories, George Myers, Promo Jame Miller (Rec. & Tape D & OS)
 Labels: AVI, Adelphi, Airwave, Alligator, Alston, Americo, Antilles, Audio Book, Audio Gospel, Auric, B&C, BSD, Birthright, Brass, Brunswick, Calvary, Camerica, Canaan, Caprice, Cat, Citation, Clean Cuts, Clouds, County, Credence, Creed, DB, DGTL, Dalear, Dash, Dawn, Dayspring, Dazz, Dealer's Choice, Delta, Dictation Disc, Disneyland, Dore, Drive, Emergency, Enjoy, Epiphany, Ernie's, Eternal Gold, Firstline, Footloose, Fountain, Fun City, GHE, G&P, Gateway, Glades, Golden Ear, Gold Sound, Gospel Roots, Groove Time, Gusto, HSE, Hannibal, Heart Warming, Hep Me, IBC, Impact, Import, J&B, Jame, Jazz a la Carte, Jazzworks, Jeremiah, Jewel, Jim Juana, Kari, Kayvette, Kent, Kentone, Kenwood, Kid stuff, King, LA, LMS, Lamb & Lion, Landslide, Lifestream, Light, Limglight, Living Language, Lummar, Malaco, Mango, Maranatha, Marlin, Mass, Merry Messenger, Music, Myrrh, Nashboro, New Birth, New Man, New Pax, New Song, Newtrif, Dde, One Two Three, PAID, PM, PPL, Palo Alto Jazz, Paragon, Passport, Paula, Plantation, Powerhouse, Prelude, Prism, Q, Rebel, Refuge, Roadshow, Ronn, Roulette, Roy B, SLL, SSS, Soul, San Francisco Sound, Savoy, Snow Star, Sound of Brooklyn, Sound of Gospel, Sounds of New York, Soundtrek, Soundwaves, Specialty, Stanson, Starday, SuAnne, Sue Int'l, Sugar Hill, Sugar Plum, Sun, Sunshine Sounds, TK, TR, TSDB, Tangent, Tay-ster, Theresa, Uno Melodic, United, Vanguard, Venture, Visa, Vista, West End, Who's Who in Jazz, Wicked, Wonderland, World, World
 Accessories: Aliso, Ampex, Audio Magnetics, Dustbuster, Esmond, Interco, Le Bo, Planstiehl, Savoy, TDK, Tracs (SEE ADVERTISEMENT)
 Trac Rec. Inc., 2070 G Boston Dr., College Park 30337 Tel 997-2263 Gen Mgr., Albums & Tape Buyer Walt Lumpkin, Singles Buyer Marty Dwens.
(Rec. & Tape OS)
 Playback equip.: JSR, Toshiba
 Videocassette lines: CBS/MGM, MCA, Magnetic Video, Paramount, Warner Bros
 Accessories: Audio Magnetics, BMI, Dustbuster, EV Game, TDK, Tracs

Tara

RECORD & TAPE DISTRIBUTING CO., INC.

The South's Most Aggressive Distributor

"Where service is our policy"

**DISTRIBUTOR OF OVER
150 LABELS**

• Gospel & juke box headquarters •
• Full line one-stop service •

Gwen Kesler
President

Wayne Franklin
Vice President

**582 Armour Circle
Atlanta, GA 30324
(404) 875-8272**

TONE DISTRIBUTORS

FLORIDA'S MOST EXPERIENCED DISTRIBUTOR

Full Line One Stop
One Day Service
Distributor Of Many Specialty Items
Full Line Of Accessories And Blank Tapes
Watch For Advertised Specials
Special Orders Don't Upset Us

TONE DISTRIBUTORS, INC.
495 S.E. 10th Court
P.O. Box 1447
(305) 888-1685 • Hialeah, Fla. 33010 • Lynda Stone

EXPORT DIVISION

TONE DISTRIBUTORS, INC.

New Releases — Fast!!
Same Day Service
One Mile From Miami Int'l Airport
Full Line of Oldies — 45's

TONE DISTRIBUTORS, INC.
495 S.E. 10th Court
Hialeah, Florida 33010
(305) 888-1685 TELEX 519250

OP-One Stop

All Orders Shipped Same Day

Over 15,000 Oldies With Title Strips

One Stop Record Specialists

MIAMI

1543 NW 165 Street
(305) 625-3122

JACKSONVILLE

4606 Shirley Avenue
(904) 384-8742

United Rec. & Tape Inds. Inc., 4300 B Bankers Cir. le NE, Atlanta Ind'l Park Zip: 30360. Tel: 448-1500. Branch Mgr. John Brenner. Singles & Albums Buyer Jack Roberge (Rec. & Tape RJ)
Home office: Hialeah Gardens (Miami Metropolitan Area), Fla
Warner/Elektra/Atlantic Corp., 250 Villanova Dr., Atlanta Gateway Park Zip: 30336. Tel: 344 4933 Branch Mgr. Bill Biggs. Sales Mgr. Bob Wiensstroer. (Rec. & Tape D—see office in Los Angeles. Calif. for prod distributed)

● **AUGUSTA (Area Code 404)**

Pyramid Music & More, 826 Broad St Zip 30902 Tel 724-1508 Owner, Singles, Albums & Tape Buyer Robert Gordon Local branch Flash's Big G Platter Shop, 209 N 11th St Zip 30902 Mgr. Jephrey Gordon (Rec. & Tape OS)

● **CLARKESVILLE (Area Code 404)**

Clarkesville Rec. Sales Co. Inc., PO Box 198 Zip 30523 Tel 754 2152 (Rec. & Tape OS & RJ)
Accessories: Audio Vox, Automatic Radio, Conic, Electro Brand, Tenna

HAWAII

● **HONOLULU (Area Code 808)**

CBS Recs., 1580 Makalao St., Suite 840 Zip 96114 Tel 955 0774 Sales Rep Joseph Victor Crovo Jr (Rec. & Tape D—see New York, N.Y. office for prod. distributed)

Eric of Hawaii Inc., 2071 S. Beretania St. Zip 96826 Tel 946 6522 Owner, Mgr. & Buyer Irving Piminsky (Rec. & Tape B)
Labels: Arista, Asylum, Bearsville, Cream, ECM, Elektra, Island, Mele, Paradise, Sire, TK, Trim, Warner Bros.

Island 1 Stop (Rec. & Tape OS & RJ)—Buyer Lowell Tsuchiyama—see Surfside Dist.

Kona-Kai Dist. Co., PO Box 2135 Zip 96805 Tel :47 4608 Owner, Donald P. McDiarmid Jr., VP, Mgr. & Buyer Donald F. McDiarmid III (Rec. & Tape D, R, I & E)

Rec. labels: Hula, Punalani, Surfside.
Imports from the Philippines

Major Dists. Inc., 1007 Ollingham Blvd. Zip 96817. WATS (800) 845 3884 Mgr. Scott Ferrand (Rec. & Tape RJ)
Home office: Tukwila (Seattle Area), Wash

Microphone Music Co., 2077 S. Beretania St. Zip 96826. Tel 946 1488 Owner & Mgr. Ken Kaizawa. Sales & Promo Paul Fujii (Rec. & Tape D, I & E)

Labels: Atco, Atlantic, Berlitz, Big Tree, Coalition, Disneyland, Fiesta, Golden, Inner City, Little David, Living Language, Prelude, Ranwood, Rolling Stones, Roulette, Scotti Bros., Swan Song, Vista
Labels imported: Viking (New Zealand), all Japanese labels.
Accessories: Le-Bo, Royal.

Music Craft Dists. of Hawaii Ltd., 296 Mokuaea St Zip 96819 Tel 841 6219 Owner & Mgr. Walter Y. Kurokawa (Rec. & Tape D)

Labels: AVI, Ansonia, Antilles, Arcano, Audio Fidelity, Brasilia, Brunswick, CITI, Cadet, Caytronics, Coco, Concord Jazz, Contemporary, Discovery, Everest, Fantasy group, 51 West, Flying Fish, Folkways, 49th State, Hannibal, Hawaii Sons, Kicking Mule, Laff, Laurie, Mango, Mark 56, Meridian, Miami, Monitor, Mouth of Evergreen, Muse, Nashboro, Omnisound, Orleon, Original Sound, Orinda, PBR Int'l, Paradise, Parnaso, Plantation, Poki, Polyneal, Prism, Private Stock, Project 3, Reflection, Request, Roper, Rounder, SSS Int'l, Sam Sparrow, Sun, Sutra, Tradewinds, Vanguard, Waikiki, Word, Xanadu, Yazoo

Pickwick Dist'n Cos., Rack Servs Div., 735 Iwilei Dr Zip 96817 Tel 521 1802 Mgr. Chuck Gilbertson, Buyer Sterling Foster (Rec. & Tape RJ)
Home office: Minneapolis, Minn.

RCA & A&M & Assoc'd Labels, 1221 Kapiolani Blvd., Suite 512 Zip 96814 Tel 524 3030 Mgr. Robert Haas. (Rec. & Tape D—see New York, N.Y. office for prod distributed)

Rack Serv Hawaii Inc., 2073 S. Beretania St Zip 96826 Tel 946 7737 (Rec. & Tape RJ)

Surfside Dists. Inc., 1365 Colburn St Zip 96817 Tel 841-0414 VP & Gen Mgr. Ed Nielsen (Rec. D), (Rec. & Tape OS & RJ as Island 1 Stop)

Labels: Alfa, Banyan, Chrysalis, Coco Palms, Creative World, First American, GNP Crescendo, Gryphon, Ho, Lehua, Mahalo, Motown group, Mushroom, Nakhali, Ovalton, Pausa, Prism, Pumehana, Sesame Street, Syntonic Research, Takoma, Tomato, Turnabout, Varese Sarabande, Vox World Wide Dists. Ltd., 1132 Auahi St Zip 96814 Tel 531 0133 Rec. Div. Mgr. Harvey Roessler (Rec. & Tape D)
Labels: Mountain Apple, Music of Polynesia

IDAHO

● **IDAHO FALLS (Area Code 208)**

Slusser Whsle. Co., 920 Lincoln Rd Zip 83401 Tel 523 0775 (Rec. & Tape RJ)

ILLINOIS

● **CHICAGO METROPOLITAN AREA (Area Code 312)**

Antares Dists., 3235 W Fullerton Ave. Zip 60647 Tel 772-9444 Owner, Singles & Albums Buyer Leon A. Kelert (Rec. D & I)

Labels: Affinity, Ajax, Alshire, Amalgamated, Arcadia, Arcane, Aries, Audiophile, Bandstand, Bent, Birch, Big Lives, Blackbeard, Blackbird, Black Eagle, Blue Flame, Blue Lantern, Boot, Bountiful, Briar, Broadway, CBS (UK), Charly, Claremont, Collector's Classics, Columbia Special Prods., Cook, Curtain Calls, Daffodil, Dirty Shame, Oregon, Dream Street, Epiphany, Eubie Blake Music, Euphonic, Euphonia, Famous Door, First Hand, Flight, GHB, Gatemouth, Generation, Greensleeves, Harrison, Herwin, Homespun, IAIRC, Jazz Archives, Jazz Guild, Jazzology, Jazz Pi-

ano, Jazz Success, Jazz Unlimited, Jim Taylor Presents, Joyce, Kanawha, Kay Dee, MCA (UK), Maggie, Merry Makers, Mod Art, Motherlode, Musicraft, Nessa, New Orleans, No/Gep, Old Homestead, Oldie Blues, Origin, Pa Oa, Palm Tree, Pelican, Peter Pan, Philips, Power, Progressive, Pumpkin, Puritan, Rarities, Red Lightnin', Red Onion, Retrospect, San Diego Jazz Club, Seabreeze, Shanachie, Sidewalk Hot Jazz, Sky, Smoky Mary, Southland, Spitball, Stash, Stomp Off, Takoma, Trans Sam, Triad, Trojan, Uptown Lowdown, Varese Int'l, Virgin, Xtra, Zim

Balkan Music Co., 6917 W. Cermak Rd., Berwyn 60402 Tel: 484-6436. Music Mgr. Louis J. Hlad (Rec. & Tape D)
Branch: Beaver Falls (Pittsburgh Metropolitan Area), Balkan Rec. Dist'l Co

Labels: Balkan Int'l, Czech, Delta Int'l, Greyko, Marjon, Monitor Barney's Recs. Inc., 3400 W. Ogden Ave. Zip: 60623. Tel: 521-6300 Owner Willie J. Barney, Mgr. Raymond Barney, Singles & Albums Buyer: Nita Davis. (Rec. OS)

CBS Recs., The Tower, Suite 301, 2850 E. Golf Rd., Rolling Meadows 60008. Tel: 640-5900 VP Central Div. Don Van Gorp, VP Midwest Region: Jim Scully, Reg'l Co-ord. Kim Brines, Branch Mgr. John Madison. (Rec. & Tape D—see New York, N.Y. office for prod distributed)

CNS Co. Inc., 10614 S. Mackinaw Ave. Zip: 60617 Tel: 375-4052 Owner Charles N. Stephens. (Tape RJ)

Capitol Recs., 6401 Gross Point Rd., Niles 60648 Tel: 647-8338. (Rec. & Tape D—see office in Los Angeles, Calif., for prod distributed)

Casa Pan-Americana, see Pan American Recs.

Chicago One Stop Inc., 444 N. Lake Shore Dr Zip 60611. Tel: 822-9815. Pres. Howard M. Rosen, Mgr.: Ken Ryan, Buyer Ron Fischel (Rec. & Tape OS)

Downtown Recs. Mgmt. Corp (Rec. & Tape OS), see Mid-America Specialty, Fletcher's 1 Stop Recs. & Tapes, 450 E. 75 St. Zip: 60619 Tel 874-4484 Owner, Singles, Albums & Tape Buyer: Ester Fletcher. (Rec. & Tape OS)

Accessories: Capitol Magnetics, Memorex, Scotch, TDK
Galvano Dist'g Corp., 4147 W. Armitage Ave. Zip 60639 Tel: 235-3800. Owner: Anthony Galvano, Mgr. John Galvano, Buyers: Singles, Norma Barazowski, Albums, Joyce Vermilyer, Tape, Gene Gorjeczew. (Rec. & Tape OS)

Playback equip. & phonographs: Hitachi, Pioneer
Videocassette & Videodisc lines: All lines
Accessories: CRT, Le-Bo, Maxell, Memorex, Recoton, Scotch, TDK (SEE ADVERTISEMENT)

Tony Galvano Recs. Inc., 4134 W. Armitage Ave Zip 60639 Tel 278-8300 Pres. Anthony Galvano, Mgr. & Singles Buyer: Frank Scardino. (Rec. & Tape OS—jukebox trade)

Gibson's Town & Country One Stop, 1956 W. 51 St. Zip 60609 Tel 776 0700 Owners: Gregory & Kathie Gibson; Mgr & Buyer G.G. Gibson (Rec. & Tape OS)

H S I Dist'g, 4322 W Fullerton, Zip: 60639. Tel: 486-1171. Owner: William R. Stocking, Mgr. & Album Buyer Christopher Miller. (Rec. D)

Labels: American Gramophone, SCS Mastersound, Chalfont, Crystal Clear, Delos, Denon, Direct Osk Labs, Discwasher, Nautlius, Nippon Phonogram, Real-Time, Sound 80, Toshiba EMI, Varese/Sarabande, WEA Japan
Accessories: Audio Aids, Platter Matter, Sumiko

Handleman Co., 801 Lunt Ave., Elk Grove Village 60007 Tel: 364-0230 (Rec. & Tape RJ)

Home office: Clawson (Detroit Metropolitan Area), Mich.

House Dists., 3410 Lake Shore Or., Suite 7-E. Zip 60657 Tel 248-1834. Mgr. Carole Bernstein (Rec. & Tape D)

Home office: Kansas City, Mo. (See for prod distributed)

J S J Tape Dists. Inc., 6620 W. Belmont, Zip 60634 Tel 286-4444. Owner, Mgr & Buyer Joseph Swatek (Tape OS—cutouts) (SEE ADVERTISEMENT)

K R P C O Kiderian Rec. Dists., 4926 W. Gunnison St. Zip 60630 Tel 545-0861 Owner: Raymond Peck; Mgr.: George Peck; Buyers: Singles, Vince Hartnet, Albums, Ray Peck. (Rec. D)

Labels: Armenian, Black Beauty, Camels Hair, Chicago Sound Factory (CSF), Centaur Talent, Dick/Hike, Ghetto, Gienoaks, Homestead, Illinois Prod'g Corp., Kid, Kiderian, LRM, Middle Eastern, Newbury, Paw Print, Ray Peck Prods., Recordgraph, Ruby, ST Lewis, Sonic Wave, Trinity, Virgin Vinyl, Wind City

Kiderian Rec. Dists., see KRPCO

Kinnara Inc., 4323 N. Elston Ave. Zip: 60641. Tel: 588-7735 Pres. Raeburn Flerlage, Singles, Albums & Tape Buyer: Steven Gusler. (Rec. D & I, Tape D)

Labels: Ace of Spades, Adelphi, Adolescent, Advent, Affinity (UK), Airways, Alligator, Amazing, Arabesque, Archive of Folk & Jazz, Archive of Piano, Arhoolie, Aries, Audio Arts, Auricle, Avant, Aviva, BOB, Baobab, Barrelhouse, Bartok, Bash, Bay, Bee Hive, Bel Car, Black Saint (Italy), Blind Pig, Blue Goose, Blue Night, Blue Ridge, Blues Classics, Bornand, Broadside, Bulltrot, CRI, Caedmon, Cambridge, Candy Apple, Carolsdat, Chalfont, Charly (UK), Chicago Slide, Citadel, Claremont, Clay Pi geon, Clean Cuts, Club of Spade, Column One, Connoisseur Society, Contemporary, Conversa-Phone, Cough Drop, Country Turtle, County, Cowboy Carl, Crazy Cajun, Crystal, ORG, Octation Disc, Discovery, Ear-

**CUT-OUTS
CASSETTE & 8-TRACK
OUR SPECIALTY**

If you are a Distributor,
rack jobber or exporter,
CONTACT J.S.J. TODAY!
Call or Write for FREE catalog

J.S.J. TAPE DISTRIBUTORS INC.
6620 W. Belmont Ave.
Chicago, Ill. 60634
312-286-4444

RUBY SALES COMPANY, INC.
PROMOTION - PREMIUMS
BROKERAGE
45's - LP'S - TAPES
JOB LOT ITEMS



4038 W. ARMITAGE, CHICAGO, ILL. 60639
312-276-5484



PICKWICK DISTRIBUTION COMPANIES

INDEPENDENT
DISTRIBUTION
DIVISION

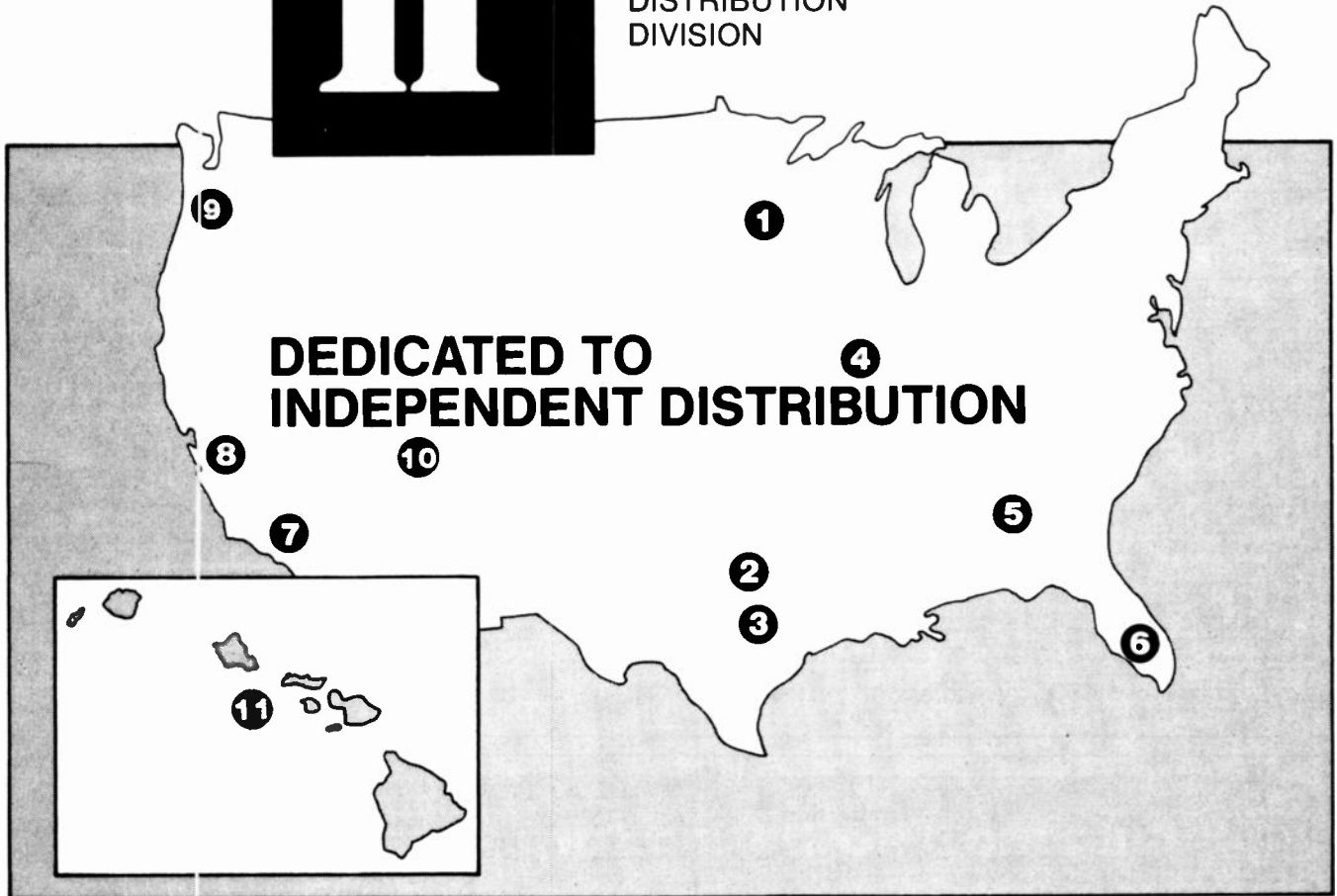

**DEDICATED TO
INDEPENDENT DISTRIBUTION**

- ① **MINNEAPOLIS** 7500 Excelsior Boulevard
Minneapolis, Minnesota 55426 (612) 932-7548
- ② **DALLAS** 2200 East Randol Mill Road
Arlington, Texas 76011 (817) 261-4281
- ③ **HOUSTON** 6400 Westpark, Suite 465
Houston, Texas 77057 (713) 780-7650
- ④ **NASHVILLE** 42 Music Square West, Suite B
Nashville, Tennessee 37203 (615) 256-2647
- ⑤ **ATLANTA** 2151 N.W. Parkway
Marietta, Georgia 30067 (404) 952-3343
- ⑥ **MIAMI** 13145 North West 45th Avenue
Opa Locka, Florida 33054 (305) 685-7601
- ⑦ **LOS ANGELES** 9420 Telfair
Sun Valley, California 91352 (213) 875-3960
- ⑧ **SAN FRANCISCO** 375 Sutter Street
San Francisco, California 94108 (415) 981-8787
- ⑨ **SEATTLE** 573 Industry Dr., Bldg. 5E
Seattle, Washington 98188 (206) 575-0470
- ⑩ **DENVER** 2186 So. Holly Suite 110
Denver, Colorado 80222 (303) 692-0410
- ⑪ **HAWAII** 735 Iwilei Drive
Honolulu, Hawaii 96817 (808) 521-1802

wig, Editions Makossa, Ekapa, Emily, Empire, Epiphany, Everest, FKT, Factory, Flying Fish, Flying High, Folk Legacy, Folk Lyric, Folkways, Freckle, Fretless, Front Hall, GDS, GNP Crescendo, Giorno Poetry, Golden Age, Golden Era, Good Time Blues, Good Time Jazz, Gothic, Grapevine, Grass Mountain, Great Dame, Greenhays, Green L'nnet, Grenadilla, Grits, Homegrown, IAI, IPS, India Navigation, In Sync, Interplay, Jazz Archives, Jin, Juke Joint, June Appal, Kaleidoscope, Key, Kinking Mule, LMS, Land slide, Laughing Angel, Legend, Leonarda, Le Roi du Blues (Canada), Longhorn, Longview, Louisville, Lovely Music, Lynchord, Lyricon, MCR, Maison de Soul, Mamish, Mezumbah, Mill Jac, Mmemosyne, Moers (Ger many), Mojo, Monmouth-Evergreen, Mr. Blues, Muscraft, Muza (Po land), New Orleans, New World, Nimbus, Nine Winds, Nudie Official, Of the Cosmos, Old Homestead, Oldie Blues, Old Timey, Olympic, Optional, Origin Jazz Library, Orion, Outline, Outstanding, PHO, PM, Pandora, Paredon, Pearl, Pelican, Philly Jazz, Philo, Plymouth, Poca River, Pump kin, Puritan, Ra, Rainbow, Rainbow Morning, Rambler, Rambler, Razor Rebel, Red, Red Clay, Re Entry, Regency, Retrac, Revel, Revival, Ridge Runner, Rosetta, Rough Trade, Rounder, S&H, Sail Sam, Scholastic, 1750 Arch, Shanachie, Shasta, Simmons, Siren, Skyline, Snail Solid Smoke, Sonel, Soulnote (Italy), Starlog, Stash, Sugar Hill, Survival, Swallow, Swallowtail, Sweet Earth, Syntonic Research, Take Two, Theresa, Titanic Topic (UK), Tower Hill, Tradition, Transatlantic, Trend, Trident, Tris, Ubu Communex, Varese Int'l, Varese Sarabande, Very Oisco, Vineyard, Vinyl, Wagon Tracks, Wim, Wix, Wizard, Xtra, Yazoo (SEE ADVERTISEMENT) La Voz Hispana, 1824 W. Division St. Zip 60622 Tel. 252 5135 Owner Mgr & Buyer Nelson A Cruz (Rec. & Tape OS—Latin prod only) Lieberman Ent's Inc., 1000 Touhy Ave., Elk Grove Village 60007 Tel. 593

2120 Reg'l OS Mgr. Bruce Lowry, Branch Mgr. Dennis Sinclair, DS Mgr. Tom O'Flynn, Opns Mgr. Jerry Skillicorn, Sales Mgr. Ed Chittim, Reg'l Buyer Wayne Grossman, Singles Buyer Adrian Neuman, Albums Buyer Rob Taylor (Rec. & Tape OS & RJ) Home office: Minneapolis, Minn
Living Blues Mail Order Sales & Dist'n, 2615 N. Wilson Ave. Zip 60614 Tel. 281 3385 Owners Jim & Amy O'Neal, Singles & Albums Buyers Jim O'Neal, Felix Wohrstein (Rec. D, I & E)
Labels: Ace, Advent, Airway, Alley Cat, Alligator, Altee, Ashanti, BOB, Baron, Barrelhouse, Bash, BeBe, Big Boy, Big Sam, Big Star, Big Town, Black Magic, Blind Pig, Blue Flame, Blues Alley, Blues Connoisseur, Blue Soul, Bracob, Bullfrog, CJ, Celestial, Cher Kee, Clearstone, Colt, Cynthia, Darby, Dawn S, Delmark, Earwig, Echo, Enrica, Firma, Flying Fish, 4 Brothers, GAS Goldband, Golden Africa, Good Time, High Water, ICT, JS, Joliet, Kenneth, Kris, Lunar ≈ 2, Mamish, Melancholy, Mimosas, Mirage, Mr. Blues, Mr. Bo Weevil, PM, Pearl, Rae Cox, Razor, Rhodes Way, Rooster, Rooster Blues, Rumble Shama, Simmons, Sirens, Sky Hero, Spivey, Sould Sound, Spoonful, Styletone, TJ, Tomel, WASP, XRT, Yambou. Labels imported: Blue Angel (Germany), Fleetville (UK), JSP (UK), Wolf (Austria)
M & A Rec. Whslers (Rec. RJ & OS), see Surplus Rec. & Tapes
MCA Dist'g Corp., 10700 W. Higgins Rd. Suite 100, Rosemont 60018 Tel. 298 6600 Reg'l Dir. Ron Warren, Branch Mgr. Rod Linnum (Rec. & Tape D—see office in Los Angeles, Calif. for prod. distributed)
M S Dist'g Co., 7901 N. Caldwell Ave. Morton Grove 60053 Tel. 478 1133 Owners John Salstone, Tony Dalesandro, Sales Mgr. Rick Chrzan (Rec. & Tape O)

Branch: Clayton (St. Louis Metropolitan Area), Mo
Labels: APA, AVI, Airwave, Adelphi, Ala, Alfa, Alligator, Alston, Amberjack, Ambush, Angelaco, Ariola, Arista, Audio Fidelity, Becket, Bet Car, Blackbird, Black Label, Black Saint, Blind Pig, Boardwalk, Bold, Bomb, Bomp, Brunswick, Buddha, Burdette, CMH, CRC, CTI, Camden, Canyon, Cal, Chiarosuro, Chimeville, Chrysalis, Church, Door, Clean Cuts, Clouds, Coco, Contemporary, DSA, Dash, Dayspring, Daystar, Dealers Choice, De vaki, Oore, Drive, End, Equad, Erect, Excelsior, Fabulous, Family, Fat City, First American, Flash Back, Flying Fish, Full Circle, GORP, GPE, Gee, Ghe, Glades, Good News, Goodtime Jazz, Gospel Roots, Gospel Tone, Grand, Great Northwest, Greenhays, Gryphon, HOS, Helios, Holiday, Horn, House of America, IAS, IBC, ICA, Import, JEM, Jazzbird, Jazz World, Jeremiah, Jet, Janner, Juana, Jugular, Kaleidoscope, Kayvette, Laif, Leather, Light, MFP, Mainstream, Malaco, Maranatha, Marlin, Master score, Maze, Messenger Gospel, Mirus, Mountain Railroad, Muscle, Mushroom, Music is Medicine, Myrrh, New Birth, Newman, New Song, North Country, Novus, Nutmeg, Ode, Official, Omission, Orlando, Our Gang, Outrageous, Ovalton, PVC, Passport, Pausa, Peter Pan, Phoenix, Plastic, Piccadilly, Pickwick, Posse, Prism, Pyramind, Quark, Quintes sence, RAL, Rat City, Rattlesnake, Regency (Flying Fish), Regency (Ova tion), Rio, Robox, Roulette, Rounder, Sail, Savoy, Seed, Seeds & Stems, Select, Slash, Solid Rock, Solid Music, Songwriter, Soul Note, Star Vi sion, Strata East, Streetwise, Sugar Hill, Sunbird, Sunshine Sound, Super Stereo, Sutra, Sweet Bottom, Syntonic Research, TK, Takoma, Taxi, Terry Gregory, Third Coast, Thunderbird, Tifton, Tiger Lily, Titanium, Trash, Trema, Trolley Car, Universal Jazz, Vintage, Virgin, Virgo, Vesa, Vox, WLUP, WXRT, Wanna, War, Bride, Wheeler, Weird World, Word
Mid America Specialty Dist. Inc., 444 N. Lake Shore Dr. Zip 60611, Tel. 822 0822 Pres. Howard M. Rosen, Gen. Mgr. Maurice Rouso, Purchas ing Dir. Ron Fischel (Rec. & Tape RJ), (Rec. & Tape OS as Downtown Recs. Mgmt. Corp.)
Mr. T's Volume Rec. & Tape Sales, 1728 E. 87 St. Zip 60617 Tel. 375 8445 Owner Max Tannenbaum, Sales Mgr. Johnny Johnson (Rec. & Tape D, OS & RJ)
Distributes cutouts, overstocks, promotional copies
Multinational Dist's. Inc., 3514 W. 26 St. Zip 60623, Tel. 522-1877 Owners Miguel & Magdali Remon, Adelqui Boue, Mgrs. Miguel Remon, Adelqui Boue, Singles, Albums & Tape Buyer Adelqui Boue. Local branches: 1454 N. Milwaukee Ave. Zip 60622, Tel. 235-6900; 8929 S. Commercial Ave. Zip 60617, Tel. 721-6585. (Rec. & Tape OS & RJ)
Pan American Recs. Inc. (Casa Pan Americana), 3751 W. 26 St. Zip 60623 Tel. 521-1100 Pres. Gustavo Silva (Rec. & Tape D, OS & RJ)
Labels: ARV, Alegre, Alhambra, All Art, Ansonia, Antilla, Arcano, Arriba, Atlas, Audio Latino, Audimax, Audiovox, Azteca, Bego, Bernal, Borinquen, Buena Suerte, CBS de Mexico, CR, Caliente, Capri, Carino, Caytronics, Columbia, Costeno, Cotique, Crazy Cajun, Cri Cri, OLV, Oel Rio, Oel Sol, Oel Sur, Oel Top, Del Valle, Dimsa, Oisco Grande, Discolando, Discuba, Disneylandia, Dominante, EGC, East Bend, Eco, Falcon, Fama, Fania Int'l, Flor, Flor Mex, Freddie, Fuentes, GC, Gas, Gema, Good Luck, Gut, Ideal, Impacto, Inca, Keylock, Kubaney, Latin Int'l, Latin Soul, Magda, Marsal, Mate, Mercurio, Mercana, Mexico, Mex Melody, Miami, Mister G, Mon tilla, Musart, Musimes, Neliz, Norteno, Novavox, Nuevo ORO, Odeon, Or feon, Pan Americana, Papalote, Parnaso, El Palo, Peerless, Profono, Pronto, Raff, Ramez, Rovi, Safari, Secco, Sombrero, Son Art, Sonolux, TH, TR, Teardrop, Teca, Tex Mex, Tico, Tikal, Torres, Tropical, UA Latino, Vaya, Velvet, West Side, ZAZ, El Zarape, Zeida
Pickwick Dist'n Cos., Rack Servs. Div., 1350 Kirk St., Elk Grove Village 60007 Tel. 766 3683 Mgr. Mike Neville, Sales Mgr. Bill Siverthorpe; Buyer John Costellanos (Rec. & Tape RJ)
Home office: Minneapolis, Minn
Polish Rec. Center of America, 3069 N. Milwaukee Ave. Zip 60618, Tel. 539-9898 Owner Jan Wojewodka, Mgr. Joseph Zielinski (Rec. & Tape I) Imports from Poland
PolyGram Dist'n Inc., 4825 N. Scott St., Bldg. 2, Suite 206, Schiller Park 60176 Tel. 671 5380 Reg'l VP Harry Losh, Branch Mgr. Bob Colosi (Rec. & Tape D)
Home office: New York, N.Y. (See for prod. distributed)
Progress Rec. Dist'g Inc., 930 Lee St., Elk Grove Village 60007 Tel. 593 5955 Pres. Joe Simone, VP & Gen. Mgr. Harold Davis, Buyer Bob Blay ney (Rec. & Tape D)
Branches: Indianapolis, Ind., Clayton (St. Louis Metropolitan Area), Kan sas City, Mo.—also see listing in Highland Heights (Cleveland Metropol itan Area), Ohio
Labels: Abet, Abico, Alpha Omega, Antilles, Bainbridge, Clone, Concord Jazz, Cream, Creed, DRG, Delmark, Dimension, Disneyland, Earthtone, Fantasy, 51 West, Firstline, Fischer & Lucas, 415, Frontline, G&P, Galaxy Gordy, Gospel Truth, Hannibal, Hi, IRS/Faulty, Jazz America, Kenwood Laurie, Lifesong, Mango, Milestone, Mojo, Motown, Muse, Nutt & Jeff, Nashboro, Natural Resources, PAID, PPL, Penthouse, Plantation, Polish, Prelude, Prestige, Project 3, RFC, Ranwood, Rare Earth, Rhino, Ridgetop, Riverside, Sam, Shelby Singleton, Silverstar, Soul, Sound Factory, Sound of Gospel, Stax, Stiff America, Sun, Tamla, Tapestry, Vanguard, Venture, Vista, Waterhouse, Westbound, Wheel
RCA & A&M & Assoc'd Labels, 2809 Butterfield Rd., Suite 180, East Oak Brook 60521 Tel. 986 8300 Reg'l Sales Dir. John Rucker, Branch Mgr. Tom Potter, Branch Sales Mgr. Richard Wilcoien (Rec. & Tape D—see New York, N.Y. office for prod. distributed)
Rac A Recs., 1801 S. Lumber Zip 60616 Tel. 666-3828 Owner, Albums & Tape Buyer William Knapp, Mgr. Charles Knapp (Rec. & Tape RJ & E) (SEE ADVERTISEMENT)
Re-United Rec. & Tape Dist's Inc., 1829 S. Michigan Ave. Zip 60616 Tel. 376 0020 (Rec. & Tape D)
Labels: Al & the Kid, Cadet, Capaquiarius, Dana, EMT, Echo, Eldee, Foun tain, Golden Ear, Good Luck, J&B, Juana, Kan, Magic Disc, Malaco, Prism, Rhetta, Royal Shield, Starvision, Sandpiper, TSOB, Triplet, Van essa, Yohan
Ruby Sales Co. Inc., 4038 W. Armitage Zip 60639 Tel. 276-5484, Owner Mgr. & Buyer R.W. Lawrence (Rec. & Tape RJ) (SEE ADVERTISEMENT)
Chel Schaffer Prod'n's, 864 N. Ashland Ave. Zip 60622 Tel. 421 4372 Owner & Buyer Chel Schaffer (Rec. & Tape D)
Labels: Archer, Bel Aire, Chicago Polkas, Oyno, Gold, Halo, Mint, Owl, Ram, Sound, Starr, Stetjo
Seebro Prods. Co., 2416 S. Michigan Ave. Zip 60616 Tel. 842-8221, Owner I Siegal, Mgr. Singles & Albums Buyer R Siegal (Rec. D)
Labels: Golden, Peter Pan, Power, Superheroes, Tifton, Tinkerbell
Accessories: Fidelitone, Panasonic, Seebro
Sound/Video Unlimited Inc., 5404 W. Touhy Ave., Skokie 60077 Tel. 674-0850 Pres. Noel Gimbel, Branch Mgr. Stan Meyers (Rec. & Tape OS, RJ & I)
Branches: North Hollywood (Los Angeles Metropolitan Area), Calif., Den ver, Colo.—Mile Hi One Stop (Rec. & Tape OS & RJ), & Pan American Rec Supply (Rec. & Tape D)
Videocassette & Videodisc lines: All Ines.
Playback equip.: Claron, Jensen, Pioneer



SPEEDY ACCESS TO THE BEST MIX IN THE MIDWEST!

Over 200 high-quality independent labels with same-day shipment. Rare classics, authentic blues and jazz, bluegrass and country, rock and reggae, spoken and international and language instruction. Even blank tape! . . . You name it!

Kinnara, Inc. RECORD AND TAPE DISTRIBUTORS
4323 NORTH ELSTON AVENUE, CHICAGO, ILLINOIS 60641 PHONES: (312) 588-7735 • 583-5085



Galgano Distributing Corp.

WE CAN HANDLE ALL YOUR MUSICAL NEEDS

- **Complete Stocking Warehouse of Catalog Product**
All Labels: Albums, Tapes & 45's
- **Special Orders Are Our Specialty**
Hard to Find Albums, 8-Tracks & Cassettes
- **Advertised Specials**
Both Weekly & Monthly
- **All Brands of Blank Tapes**
Scotch Maxell Memorex TDK
- **Selected Imports**
- **Complete Lines of Audio Equipment for Car & Home**
Pioneer Hitachi Fisher De Jay
Toshiba

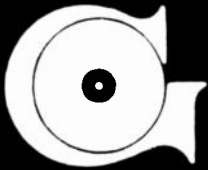

Call or Write:
GALGANO DISTRIBUTING CORPORATION
4147 W. Armitage Ave., Chicago, Ill. 60639
(A-C) 312/235-3800

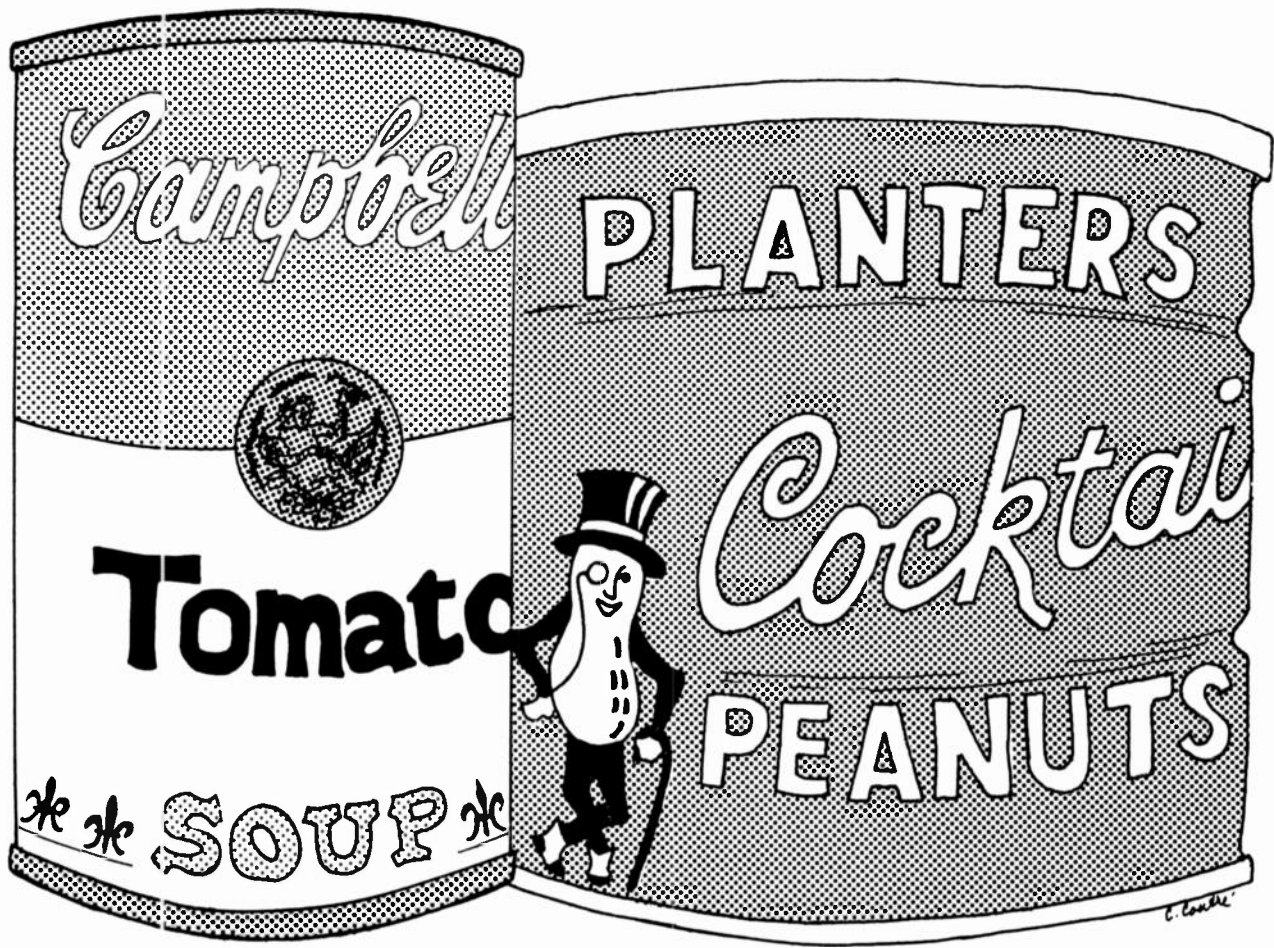

In the “everything from soup to nuts” category, these may be the only things we don’t carry.

At **Sound/Video Unlimited**, **Mile Hi**, and **Southern One Stop** we feel the 80’s will see a great expansion in the consumer’s home entertainment needs. And how can you sell it if you don’t have it?

So we’re prepared to stock your store with everything from Video Movies to Chubops, records and tapes to Duracell batteries, Mattel and Atari to T-Shirts. We’ll give you

the kind of order fill you need to do good business with reliable prompt service.

Our inventory of **video movies** is the largest in the country with over 1500 titles to choose from and our selection of **records** and **tapes** is the most complete you’ll find.

And we’re growing all the time.

Maybe it’s about time you considered growing with us?

Sound/Video Unlimited

SOUND/VIDEO UNLIMITED

5404 W. Touhy Ave. Skokie, Illinois 60077
312/674-0850 312/561-2500 Toll Free 800/323-4243

MILE HI ONE STOP

150 Rio Grande Boulevard, Denver, Colorado
303/629-1960 In CO 800/332-3813
Out of State 800/525-6094

SOUND/VIDEO UNLIMITED

6912 North Tujunga Avenue
North Hollywood, California 91605
213/985-7602

SOUTHERN ONE-STOP

Hollywood Commercial Center
2588 Stirling Ave. Hollywood, Florida
305/925-0407

THE “ONE STOPS” FOR ALL YOUR ENTERTAINMENT NEEDS

Accessories: Ailsop, Amaray, Atari, Calibron, Discwasher, Ouracell, Hagerstown, Le-Bo, Mattel, Maxell, Memorex, Nortronics, Planstiel, RMS, Reclon, Savoy, Scotch, Sony, Sound Guard TOK, Video Organizer, Watts. (SEE ADVERTISEMENT)
 Surplus Recs. & Tapes, 1120 W. Exchange. Zip: 60609. Tel: 376-8432. Pres.: Merrill Rose; Gen. Mgr. & Buyer: Jack Rose. (Rec. D), (Rec. RJ & OS as M&A Rec. Whslers.)
 Branch: Passaic, N.J. (Rec. D & E, Tape E)
 Distributes cut-outs & surplus. (SEE ADVERTISEMENT)
 Fernando Vian, 2151 N. Humboldt Blvd. Zip: 60647. Tel: 278-7613. (Rec. & Tape D)
 Home office: Los Angeles, Calif., Oiscos Latin Int'l.
 Labels: Fono Rex, Latin Int'l, Microfon, Pega.
 Warner/Elektra/Atlantic Corp., 222 W. Sivert Court, Bensenville 60106. Tel: 595-6000. Branch Mgr.: Al Abrams; Sales Mgr.: Rick Cohen. (Rec. & Tape D - see office in Los Angeles, Calif., for prod. distributed)

● PEORIA (Area Code 309)

Sound Investment Inc., 1109 W. Main. Zip: 61606. Tel: 673-3887. Owner: William R. Love; Mgr.: Dave Roger; Buyers: Albums, Dave Roger, Sue Anderson, Tape, Jim Gunn. (Rec. & Tape OS)

● ROCKFORD (Area Code 815)

Festival of Song Music Co., 1519 Windsor Rd. Zip: 61111. Tel: 654-1260. Pres.: E.L. Myers; Albums Buyer: Richard L. Myers (Rec. & Tape D)

Labels: Alshire, Angel, Avant Garde, Benson, Birdwing, Bread & Honey, Bridge, Calvary, Canaan, Capitol, Chapel, Clarion, Columbia, Copeland, Creed, Dynamic, Gather, Good News, Greentree, HSE, Heart Warming, Hope, Impact, Jewel, Lexicon, Light, Lillenas, London, MCA, Manna, Maranatha, Mercury, Message, Messianic, Myrrh, Nashboro, New Life, New Pax, New Song, Paragon, Peacock, Petra, QCA, RCA, Rainbow, Savoy, Seed, Servant, Shalom, Skylite, Sonrise, Sparrow, Star Song, Supreme, Swaggart, TKE, Tempo, Triangle, Ultimate, Word.

INDIANA

● ANGOLA (Area Code 219)

Gospelrama, PO Box 267. Zip: 46703. Tel: 665-9540; WATS: (800) 348-4677; Indiana WATS: (800) 552-1794. Owner: F. Michael Colacurci. (Rec. D & OS - religious prod. only)
 Labels: Birdwing, Calvary, Canaan, Chalice, Creative Sound, Foster, Good Life, Green Tree, Heart Warming, Hope, Housetop, Impact, Jews for Jesus, John Hall, Light, Maiden, Manna, Messianic, Myrrh, New Life, RCA, Rainbow Sound, Skylite, Sonrise, Sparrow, Star Song, Tempo, Word, Zonder van

● ELWOOD (Area Code 317)

New Light Dist. Inc., 521 N. Anderson St. Zip: 46036. Tel: 552-9846. Pres. & Buyer: Jim Cochran. (Rec. D)
 Distributes cut-outs & overstocks. (SEE ADVERTISEMENT)

● EVANSVILLE (Area Code 812)

Mobile Rec. Serv. Co., 2244 E. Virginia St. Zip: 47711. Tel: 477-3927. Mgr. Mark Oate Schweickart. (Rec. OS - singles only)
 Home office: Pittsburgh, Pa.

● FORT WAYNE (Area Code 219)

Midwest Distis., Exec. Office, 2415 Forest Park Blvd. Zip: 46805. Owner & Mgr. Walt Ostermeyer. Local branch: 3535 N. Anthony. Zip: 46805. Tel: 483-8230. Mgr. & Buyer: Deanne May. (Rec. & Tape RJ)
 Mobile Rec. Serv. Co., 5336 Southbrook Rd. Zip: 46815. Tel: 485-9446. Mgr. Jon R. Didier. (Rec. OS - singles only)
 Home office: Pittsburgh, Pa.
 Tallman One Stop, 1023 E. Pontiac St. Zip: 46803. Tel: 456-8422. Owners Robert & Patricia Hatcher, Singles, Albums & Tape Buyer Patricia Hatcher. (Rec. & Tape OS)

● GARY (Area Code 219)

United Nat'l Rec. Sales, 4393-91 Tri-City Plaza. Zip: 46406. Tel: 949-1208, 949-1378. Owners Bobby & Maxine Joiner. Local branches: 1650 Broadway. Zip: 46407. Tel: 885-2705-8038. E. Melton Rd. Zip: 46403. Tel: 938-4820-3815. Broadway. Zip: 46409. Tel: 884-7200-4704. Indianapolis Blvd., East Chicago 46312. Tel: 398-7464. (Rec. OS)

DELETIONS
Records & Tapes
ALL MERCHANDISE IN STOCK
MAJOR LABELS
TOP ARTISTS
 Contact Bill or Charlie Knapp
 for Free Catalog
Rac-A-Records, Inc.
 1801 So. Lumber St.
 Chicago, Illinois 60616
 Tel. 312-666-3828
 TELEX: 724 389 TELESPAN • ATTN: RAR

● INDIANAPOLIS (Area Code 317)

Father's & Sun's Inc., 4100 Industrial Blvd. W. Zip: 46254. Tel: 293-5310. Telex: 272127. Pres. David Crockett; Exec. VP: Marc Freije, Mktg. & Sales: Denise Elert; Albums & Tape Buyer: Don Simpson. (Rec. & Tape OS, I & E)
 Labels: ICOA; also distributes cutouts & overstocks
 Labels imported: ECM (Germany), European rock & jazz labels
 Accessories: Audio Technica, Discwasher, Marsand, Maxell, Memorex, Savoy, Service, Sound Guard, TOK, Watts
 Progress Rec. Dist'g Inc., 6325 Gifford, Suite 3A. Zip: 46208. Tel: 259-4873. (Rec. & Tape D/O)
 Home office: Elk Grove Village (Chicago Metropolitan Area), Ill - see for prod. distributed
 Scott's One-Stop Rec. & Tape Serv. Inc., 1319 N. Capitol Ave. Zip: 46202. Tel: 639-5491. Pres.: Lew Jones, Opns. Mgr.: Oon Gobrecht. (Rec. & Tape OS)

● MOORESVILLE (Area Code 317)

Golden Memories Recs. Inc., PO Box 217, 136 Maple Ln. Zip: 46158. Tel: 831-5207. Pres.: William J. Haskett. (Rec. D & E)
 Distributes oldies.

● RICHMOND (Area Code 317)

U E S Dist'g Corp. (Universal Entertainment), PO Box 938, 814 Promenade. Zip: 47374. Tel: 935-7744. Pres.: Kent J. Henry, VP, Albums & Singles Buyer: Mike Verloop. (Rec. & Tape OS & RJ)

● VALPARAISO (Area Code 219)

Music Mdsrs. Inc., 2904 E. Cascade Dr. Zip: 46383. Tel: 465-1567. Owners: Michael Quick, Mark Duggleby. (Rec. & Tape OS & RJ)

IOWA

● DAVENPORT (Area Code 319)

Music Wave Distis (MWD), PO Box 3013. Zip: 52808. Mgr. Gary Unger. (Rec. D)
 Labels: AIC, Artistic, Artistville, BCA, ECI, Groove Sound, Groove II, Love light, Sugar Vine

● DES MOINES (Area Code 515)

Pickwick Dist'g Cos., Rack Servs. Div., 2400 Sunset Rd. Zip: 50321. Tel: 282-8185. Branch Mgr. Wayne Olson, Sales Mgr. Jerry Parker, Buyer: Ray Munson. (Rec. & Tape RJ)
 Home office: Minneapolis, Minn.

KANSAS

● KANSAS CITY AREA (Area Code 913)

Hoffman Inds. Inc., 8441 Quivira, Lenexa 66215. Tel: 888-4885. Owner, Albums & Tape Buyer: Arnold J. Hoffman. (Rec. & Tape RJ)
 Sources Co., PO Box 6129, Leawood 66206. Tel: 642-5942. Mgr. Arthur Elliott. (Rec. D)
 Home office: Minneapolis, Minn. (See for prod. distributed)
 Total Sound Distis., 5622 Johnson Or., Mission 66202. Tel: 384-0300. Owner & Mgr. Allan Levy. (Rec. & Tape OS)

● LAWRENCE (Area Code 913)

Kiel's Rec. & Stereo Supply Inc., PO Box 2, 2100 A W 25 St. Zip: 66044. Tel: 842-1544. Owner: John J. Kieler, Buyer: Steve Wilson. (Rec. & Tape OS & RJ)

● MANHATTAN (Area Code 913)

Western Mdsrs. Inc., 1562 Hayes Or. Zip: 66502. Tel: 539-0542. Mgr.: Joel Seamen. (Rec. & Tape RJ)
 Home office: Amarillo, Tex. (Rec. & Tape OS & RJ)

KENTUCKY

● CAMPBELLVILLE (Area Code 502)

Central Electronics, PO Box 340, 108 N. Central Ave. Zip: 42718. Tel: 456-5631. Owner & Buyer: Randall B. Herron. (Rec. & Tape D, OS & RJ)
 Labels: Christian Faith, Design, Heart Warming, Hilltop, Little Oarlin', Nashboro, Nashville, Paramount, Pickwick, Plantation, Premier, Radiant, SSS Int'l, Scepter, Sing, Skylite, Songs of Faith, Starday-King, Stateswood, Sun, Temple, Up Front, Word
 Playback equip.: Arthur Fulmer, Stellasonic
 Phonographs: Delmonico, Major, Victor
 Accessories: Amberg, BSR, Electro Voice, Transcriber

● FLORENCE (Area Code 606)

Piks Corp., 225 Merravay Or. Zip: 41042. Tel: 525-9006. (Rec. & Tape D)
 Home office: Cleveland, Ohio. (See for prod. distributed)

● LOUISVILLE (Area Code 502)

Kentuckiana Rec. Sales (div of Vine Recs. Inc.), 560 S. Fourth St. Zip: 40202. Tel: 582-3331. (Rec. & Tape OS)
 Kings Rec. Shop, 240 W. Jefferson St. Zip: 40202. Tel: 584-5535. Owner & Mgr. Gene King, Buyers: Singles, Ann King, Albums & Tape, Gene King. (Rec. & Tape D, OS & I)
 Distributes cutouts, oldies
 Labels imported: RCA (Canada, UK)



CALL TOLL FREE (800) 428-6417

- Service With Personal Attention
- Full Catalogs Monthly
- Same Day Service
- Competitive Prices
- Efficient Export Service

NEW LIGHT DISTRIBUTORS, INC.
521 N. Anderson Street
Elwood, Indiana 46036
(317) 552-9846

Drbit Radio, PD Box 1644, Zip 40211 Tel 584-5535 Dwner & Mgr SA Csler (Rec. & Tape I & E)
Imports recs & pre-recorded tap: from France, Germany, Italy, Japan, Scandinavia, UK, tape playback -quip from Germany & Japan
Exports pre-recorded tape, playback equip
Shively Dne Stop, 4464 Shively Cent-r Zip 40216 Tel 447-4951 Dwner & Mgr AR Brown (Rec. & Tape I & S)

● **OWENSBORO (Area Code 502)**

Wax Works Inc., 325 E Third St, Zip 42301 Tel 926-0008 Dwner Terry Woodward, Buyer Larry Devuonc (Rec. & Tape DS & RJ)
Accessories: Alltop, Ampex, D scwasher, Le-Bo, Maxell, Memorex, Planstiehl, Sound Guard, TDK, Wtts
Webster's Inc., PO Box 1916, 1308 V Ninth St Zip 42301 Tel 926 4441 Owner & Mgr Doug Webster (Rec. & Tape RJ)

LOUISIANA

● **ALEXANDRIA (Area Code 318)**

Gospel Dist Inc., PO Box 1706, 12 2 Main St Zip 71301 Tel 443 2549 Owner & Mgr JD Davis (Rec. D, DS & RJ)
Distributes all gospel labels
Music Racks, 1406 Fourth St Zip 71301 Tel 443 2549 Dwner & Mgr JD Davis (Tape OS & RJ)

● **BATON ROUGE (Area Code 504)**

Centaur Recs Inc, PD Box 23764, Zip 70893 Tel 769 0632 (Rec. I & E)
Labels imported: Meridian (UK), Pavane (Belgium), Saga (UK)
New Generation Inc., 10010 Florida Blvd Zip 70815 Tel 272 1700 Mgr Irwin Shaab, Local branch 3332 I ighland Rd Zip 70808 Tel 383-9700 Mgr Joseph Shaab, Buyer Davi Trivanovich (Rec. & Tape RJ)

● **GONZALES (Area Code 504)**

Gonzales Music Whsie., PD Box 1153, Southland Dr Zip 70737 Tel 644 2801 Owner, Singles & Albums Buyer Roy J Shaw (Rec. & Tape DS)

● **LAFAYETTE (Area Code 318)**

Stagg's Music Shoppe, 503 N. Unive sity Zip 70501 Tel 232 1575 (Rec. OS)

● **LAKE CHARLES (Area Code 318)**

Goldband Rec Dist Corp., PD Box 485, 313 Church St Zip 70602 Tel 439 8839 Pres. Eddie Shuler, Buyer Jeff Le June (Rec. & Tape D, I & E)
Labels: Alshire, Americana, Anla, Big D, Bold, Canaan, Discus, Esquire, Farm, Folk Star, Goldband, Gusto, Heart Warming, Impact, Jador, Jin, La nor, Light, Luftin, Lyric, Myrrh, l'elican, Power Pak, Shannon Soul Un limited, Sparrow, Starday King, S'trobe, Swallow, Tempo, Word

● **NEW ORLEANS AREA (Area Code 504)**

All South Dist'g Corp., 1924 Lafayette St, Zip 70113 Tel 568 0971 Owner Warren K Hildebrand, Mgr Richard Brown, Buyers Singles, Jeff Fontz, Albums, Warren Hildebrand, Jeff Fontz, Gladim Scott (Rec. & Tape D, OS & RJ)

Labels: ASI, Abet, Abkco, Ala, Alston, American Variety, Antilles, Archives of Jazz, Arhoolie, Ariola, Arista, BC, BTM, Bandy, BeeGee, Biograph, Black Forum, Black Gold, Black Jazz, Blue Canyon, Blues Classics, Blue Star, Boardwalk, Bold, Brunswick, Buddha, CMH, CJI, Cadet, Caedmon, Calla, Canaan, Cal, Checker, Chess, Chimneyville, Chrysalis, Cin/Kay, Commercial, Cream, Creative World, Creed, Dakar, Dash, Daybreak, Dictation Disc, Dimension, Disneyland, Dore, Drive, ESP, Emergency, Excello, Excelsior, Fantasy, Flying Fish, 4 Star, GWP, Gec, Glades, Golden, Gordy, Gospel, Gull, Heart Warming, Hi, IRDA, Impress, JB, Jamie, Jewel, Jim, Jin, Juana, Kayvette, Kent, Kik'r, Koko, Kudu, Laff, Light, Living Lan guage, Magic Disc, Mainstream, Malaco, Mango, ManKind, Mardi Gras, Marin, Mericana, Milestone, Motown, Muse, Mushroom, Music Is Medicine, Nashboro, Natural, Natural Resources, Did Timey, Did Town, Dnyx, Original Sounds, Dvation, Passport, Paula, Peter Pan, Phil LA of Soul, Pickwick, Platinum, Poppy, Prestige, Prima, Pro Arte, Project 3, Pyramid, Quintessence, Randy, Ranwood, Rare Earth, Respect, Riverside, Ronn, Roulette, Salvation, Savoy, Scepter, Shelter, Soul, Soul Int'l, Sound Bird, Stang, Stax, Stiff, Stone, Stop, Sugar Hill, Sun, Sunbird, Swallow, TK, Ta koma, Thama, Three Brothers, Tomato, Turbo, Vanguard, Venture, Vibra tron, Viko, Virgo, Visa, Vista, Wand, Weird World, Wet Soul, Wicked, Word
Videocassette lines: CBS/MGM, Magnetic Video
Accessories: Capitol, Le-Bo, Maxell, Memorex, Professional, Recoton, TDK

Is Music Inc., 8700 W Judge Perez Dr., Chalmette 70043 Tel 279 1120 Mgr & Buyer Gary J Edwards (Rec. & Tape D & E)
Labels: Bourbon 641, Crescent Country, Dulai, Fat Tuesday, Nobility, Second Line, Shalon, Sound of New Orleans (SEE ADVERTISEMENT)
Lean Rec Dist'g Co., 2815 Dclavia St Zip 70115 Tel 866 3478 Dwner & Buyer Lou Welsch Jr (Rec. & Tape D)

Labels: ABC, All American group, Arch, Audio Treasury, Backbeat, Bi ograph, Blue Beat, Blue Thumb, Cachet, Can Brio, Coral, Cross Country, Deluxe, Dimension, Dobre, Dot, Duk, Dunhill, Federal, Firecracker First Generation, Folly, GBS, GMC, Golden Moon, Gold Rush, Gusto, Hickory, Hollywood, Hot Pax, Impulse, Infinity, Jam Sesson, Jeremiah, Just Good, Koala, Lab Jazz, Little Gem, Ludu Kay, MCA, MSK, Mitagro, Nationwide Sound group, Ocean City, One Way, Paramount, Peacock, Pilot, Plan tation, Platinum Plus, Power Pak, QCA, Rainbow, Rainbow Sound, Re gency, Rice, Rising Star, Rob Chris, Ruboca, SCR, SSS Int'l, Sapphire, Sec ond Generator, Sounds of Music, South Breeze, Starday/King, Sun Theresa, True, Unicorn, Westminster, Whiskey River, World Int'l group
Lee Rec Dist., 4546 S Park Dr, Metairie 70001 Tel 888-2406 Dwner, Mgr & Buyer Paul V Lee Local branch: 122 Focus St (Rec. D)

Labels: Alligator, Benje, Blue Goose, Delmark, Era, Federal, Fire, Fury, Goldies-45, Riverside, Souffle, Soul Po Tior, Specialty, Springboard, Star day King, Symposium, Takoma, Trip, Trix, Up Front, Yazoo
Dne Stop Rec Shop Inc., 1400 N Broad S; Zip 70119 Tel 949 5781 Dwner & Mgr Joe Assunto, Buyer Lloyd Legendre (Rec. DS)
Record Sales of New Orleans, 1928 Lafayette St Zip 70113 Tel 524 3537 Owner, Warren Hildebrand, Mgr, Singles, Albums & Tape Buyer D Shtrck (Rec. & Tape DS).

Videocassette & Videodisk lines: All lines

Saint Expedite Dist'g Co., PD Box 13977 Zip 70185 Tel 482 4211 Dwner & Buyer John Berthelot (Rec. & Tape D)
Labels: Bandy, Delta, GNP Crescendo, Dixieland Jubilee, Great Southern, New Orleans Sound

● **SHREVEPORT (Area Code 318)**

B & B Sales Inc., PO Box 7038, 1014 Joseph St Zip 71107. Tel 226-0105 (Tape D)

Labels: Adam VIII, Capitol, MCA, Pickwick/Camden, Power Pak, RCA, Starday King, United
Playback equip: Electra Radio, Arthur Fulmer, Pioneer
Stan's Rec Serv., 728 Texas St Zip 71101 Tel 222-7182 Dwner Stanley J Lewis, Mgr Ronnie Lewis, Buyers Singles & Albums, Ronnie Lewis, Jesse Camp, Franke Spano, Tape, George Willis (Rec. & Tape D, DS & RJ)

Label: AVI, Ace, Ala, Alligator, Alston, Amberjack, Amerama, American, Antilles, Ares, Ariola, Arista, Audio Arts, Audio Fidelity, BC, Baby, Baby Ion, Beam Junction, Berlitz, Birth Right, Black Label, Bollau, Bomb, Bro ken Bow, Brunswick, Brut, Bryan, Buddha, Cannon, Celebration, Celes bal, Chalet, Challenge, Chanterelle, Chansma, Charsim, Cherry Red, Chris, Church Door, Churchill, Classic Jazz, Clouds, Cochise, Commercial, Con Brio, Cream, Country, Creed, Crescendo, Cyclone, Dakar, Dana, Dash, Day Spring, Deco, Dharm, Dimension, Disneyland, Door Knob, Drive, Earl Long, Eclipse, Emergency, Enjoy, Erne, Eternal Gold, Evolution, Family,

IS MUSIC INC.

8700 W. Judge Perez Dr.
Chalmette, Louisiana 70043
(504) 279-1120
(504) 277-7060

**AUTHENTIC NEW ORLEANS,
DIXIELAND, JAZZ, BIG
BANDS, AND RHYTHM & BLUES**

Artists:

SWEET EMA
PAPA FRENCH
MIKE VAX
TOMMY RIDGLEY
BAYOU JAZZ BAND
CATALOG AVAILABLE!

Specializing in export

THIRTY
THREE
YEARS



**PROMOTION
SALES & SERVICE
DISTRIBUTING
THE HITS**

**STAN
THE RECORD MAN**

(HITMAKER OF THE SOUTH)

CHECK OUR LOW PRICES

*the BIG one-stop service
in the south!*

- EXPERT SERVICE AND ADVICE
- COMPLETE STOCK OF SINGLES
- LPs
- GOLD STANDARD CATALOGUE
- OLDIES BUT GOODIES
- SPIRITUALS
- R&B—POP—C&W
- JUKE BOX STANDARDS
- TITLE STRIPS ON ALL CURRENT RELEASES
- ONE DAY SERVICE (ORDERS SHIPPED SAME DAY RECEIVED)

STAN'S, 728 Texas Street, Shreveport, Louisiana 71101
(318) 222-7182

Fantasy, First American, First Line, Four Star, Free Spirit, Fretone, GK, GME, GRP, Galaxy, Glades, Glory, Golden Ear, Goldmine, Good News, Gospel, Gospel Roots, Gospel Truth, Govno, Graff, Grand, Greedy, Groove Time, Gyrphon, Gusto, HDM, HSE, Hearfirst, Hi, Highland, Hob, Image, Impress, JB, JWS, Jay Walking, Jed, Jefferson, Jeremiah, Jet Set, Jewel, Jim, Juana, Ju Par, Kent, Kenwood, Kris, Label, Laff, Lamb, Lion, Light, Living Language, Locos, Long Distance, Lummar, Lyons, MRC, Mainstream, Mason de Soul, Malaco, Mango, Mankind, Marlin, Meli, domo, Messenger, Milestone, Motown, Mushroom, Music Is Medicine, Mutt & Jeff, Myrrh, Nashboro, Nashville, Natural Resources, Negram, New Birth, New Day, Newman, New World, Noco, Nutmeg, Ode, Ovation, P&P, Pacific, Paragon, Parker, Passport, Paula, Pax, Penthouse, Pharoah, Phoenix, Phones, Plantation, Posse, Potato, Powerhouse, Praise, Prestige, Prism, Project 3, Pure Silk, RSR, Rage, Randy, Ranwood, Rare Earth, Ronn, Roots, Roulette, Rounder, Ruboca, SCR, SFI, SSS Int'l, Sail, Sam, Savoy, Sesame Street, Skyline, Skylite, Solid Smoke, Soulful Oldies, Soul Country, Soul Power, Sound Scape, Sounds of Gospel, Sound Trek, Spe, cialty, Spire, Standby, Stany, Stax, Steeple Gospel, Stoneway, Strata, East, Sue Ann, Sugar Hill, Sun, Sunshine, Sunshine Sound, Sutra, Swa, low, TK, Talsman, Tania, Tomato, Top Ranking, Track, Trolley Car, Truth, Turbo, USR, Uno Melodic, VJ Int'l, Vanguard, Vap, Vee Jay, Venture, Ves, per, Visa, Vista, We Four, Weird World, West End, West One, Wolf, Word, World Pacific, Jazz, Xanadee, Zaka, Zebra (SEE ADVERTISEMENT)

● **SULPHUR (Area Code 318)**

Keece Cos. Inc., 1625 Arizona St, Zip 70663 Tel 527 8609 (Rec. & Tape OS & RJ)

● **VILLE PLATTE (Area Code 318)**

Floyd's Whistle Dist. Co., PO Drawer 10, 434 E Main St, 70586 Tel 363 2184 Owner: J. Floyd Solaieu, Mgr. Ray Lafleur, Buyer: Terry Lafleur (Rec. D, OS & E, Tape D, OS & RJ)
Labels: American Playboy, Arhoolie, Bayou, Bell-air, Benson, Boo Ray, Cajun Classics, Cajun Jamboree, Calvary, Cannaan, Crazy Cajun, D. Dimenson, Eric, Goldband, Golden Ear, Heart Warming, Hep Me, Jewel, Jim, Jim Joliette, Kom a Day, Lanor, Lyric, Maison de Soul, Mike Adkins, Milk & Honey, Myrrh, NSO, Original Sound, Paula, Rebs'l, Rounder, Showtime Specialty, Starbarn, Starlite, Sugar Hill, Supreme, Swallow, Word
Playback equip.: General Electric, Hitachi, Pana-onic
Accessories: GRT, Le Bo, Planstiehl, Seebro

MAINE

● **PORTLAND (Area Code 207)**

Commercial Dist., 8 Somerset St, Zip 04101 Tel 774 5362. Owners: Jack & Herbert Holmes, Gen. Mgr. Tony Arroda, Mdse. Mgr. Bill Tiffany (Rec. & Tape D, OS & RJ)
Labels: CBS, Capitol, London, MCA, MGM, Motown, RCA, United Artists, WEA group

Accessories: Le Bo, Recolon, Savoy, Sound Guard, Watts
East Coast Oists, 200 Anderson St, Zip 04101 Tel 772 5665 (Rec. & Tape RJ)

Photographs & Playback equip.: Sony

MARYLAND

● **BALTIMORE METROPOLITAN AREA (Area Code 301)**

Action Dist'g Co., 3921 Hollins Ferry Rd., Lansdowne 21227 Tel 242 5055
Owners: Sam & Mark Anoff, Mgr. & Buyer: Sam Anoff, Sales: Mark Anoff (Rec. & Tape D)
Labels: ARC, Album Globe, Alshire, Award, Bobco, Boblo, Bomp, Boyd, Brogan, Bursgency, CIE, CJ, Candle, Charia, Cherry Pie, Copper Mountain, Corona, Crescent, Crusader, Current, Dale, Dallas, Oar, Darko, Dee Jay, Dee Mora, Oenim, Derrick, Dharna, Door Knob, Ooylen, EIO, Eagle, Edge, Emus, Equity, Erin, Exact, F&L, FXL, Fairview, Favorite Song, Fifty States, Fitch, Four Star, Fretone, From the Country, G Bar, GC, Gemini, Genesis, Gervasi, Gil's, Goddess, Gold Dust, Golden Angel, Golden Eagle, Grace Lane, HSE, Heart Warming, Hilltop, Hi Oldies, Impact, Inergy, It's Just Country, Jade, Jim, Kansas City, Kari, Kik, Kings Music City, Koala, LS, Lina, Little Nashville, Little Ritchie, Macho, Maverick, Mercantile, Monitor, Music America, NSO, Nashville, Nu Trayl, Orlando, Ortega, Pantheon Desert, Papa Joe's, Plantation, Pot o' Gold, Prairie Dust, Renegade, Resco, Ridge Top, Roundtable, Royal American, Silver Sword, Soul Town, Sound Factory, Sound Waves, South Breeze, Spirit, Spring River, Star Gem, Stoneway, Su Ann, Sun, Sunshine Country, Superior, Super Prod'n, Tanglewood, Teddy Bear, 31, Tille, Travel, True, Vulcan, Wild, World Independent Group, World Wide Sound, Zemo
Ellis Dist'g Corp., 33 New Plant Court, Owings Mill 21117 Tel 363 1212
Owner: Edgar H. Ellis, Gen. Mgr. & Buyer: Florence Cohen, Warehouse Mgr. George Allen (Rec. & Tape RJ)
Handelman Co., 8320 Sherwood Court, Washington Ind'l Park, Jessup 20794 Tel 953 1771 (Rec. & Tape RJ)
Home office: Clawson (Detroit Metropolitan Area), Mich
Largo Music Corp., 9195 Red Branch Rd., Columbia 21045 Tel 995 1776
Pres. Lawrence M. Goldberg, Sr. VP. Raymond L. Creighton, VP. Mdsgr. Justin Dudley, VP. Mktg. James E. Lara (Rec. & Tape OS & RJ)
Branches: Garden Grove, Calif., Arlington (Fort Worth Area), Tex., Virginia Beach, Va.
Videocassette lines: CBS, Columbia Pictures, Disney, MCA, Magnetic Video, Paramount, WEA
Videodisk lines: CBS, MCA, Paramount, RCA
M. C. A. Dist'g Corp., Standard Courts West, 9160 Red Branch Rd., Columbia 21045 Tel 992 0020 Branch Mgr. Ed Keelan (Rec. & Tape D—see office in Los Angeles, Calif., for prod. distributed)
Mar Matic Sales Co. Inc., 1140 E. Cold Spring Ln, Zip 21239 Tel 435-1477
Owner: Maurice Sykes, Mgr. Joseph S. Barranco, Singles Buyer: Phyllis Farinholt (Rec. OS & E)
Marshall Mangold Dist'g Co. Inc., 4805 Nelson Ave, Zip 21215 Tel 542 7214
Owner: Manny Goldberg, Mgr. Sandy Miller (Rec. D & RJ)
Labels: Archive of Folk & Jazz, Disneyland, Everest, Pickwick.

Musical Sales Mobile Serv (Rec. & Tape RJ—see Musical Sales One Stop Inc.)
Musical Sales One Stop Inc., 40 S. Caroline St, Zip 21231 Tel 675 1400
Pres. Milton Bereson, Gen. Mgr. Mashe Mehlman, Buyers: Singles, Walter Meeneke, Albums: Elliott Berlin, Tape, Joe Stinett (Rec. & Tape OS & E), (Rec. & Tape RJ as Music Sales Mobile Serv.)
Videocassette lines: AVC, Arrow, Blue Video, Cal Vista, Limited Edition, Select/Essex, Swedish Erotica, Turn On TV, VC, VCI Video Gems
Pickwick Dist'n Cos., Rack Servs. Div., Empire Tower Bldg., 7300 Ritchie Hwy., Glen Burnie 21061 Tel 760-6750. Sales Mgr. Dick LeBrun (Rec. & Tape RJ)
Home office: Minneapolis, Minn.
Potomac Music (JEK Ent's Inc.), 1009 Cathedral St, Zip 21201 Tel 837 7726 (Rec. & Tape OS)
Accessories: Batteries, blank tape
Branch: Cheverly, Md.
Schwartz Bros Inc.—Tel 727 4770—see listing under Lanham, Md.
Transcontinent of Maryland, 7405 Liberty Rd, Zip 21207 Tel 944 6911 (Rec. & Tape OS)
Home office: Buffalo, N. Y., Transcontinent Rec. Sales (Rec. & Tape RJ)
Zamoski Co., 1101 Oe Soto Rd, Zip 21223 Tel 644 2900 Pres. Calman J. Zamoski Jr., VP. Sales & RJ Mgr. Irv. Gomprecht, D. Mgr. Joyce L. Heider, D. Buyer: Merle Lucardo, RJ Buyers: Pip Smith, Diane Featon (Rec. & Tape D & RJ)
Labels: AVI, Abko, Amberjack, Antilles, Arch, Audio Fidelity, Audio Rarities, BBC, BC, Baby O, Becket, Blue Heaven, Boardwalk, Bomb, Brazilia, Brunswick, CTI, Chiaroscuro, Choice, Cream, Creative World, Oazz, Dictation Disc, Discovery, Emergency, Enjoy, Epiphany, Etc., Everest, GNP, Crescendo, Gatemouth, Gateway, Gramavision, Grand, Gryphon, Hannibal Image, JEM, Jam, Jazz a la Carte, Jazz Bird, Jazz Works, Kari, LA, L.E.G., Lyric, Majic Disc, Mango, Mutt & Jeff, Neuman, Nutmeg, Pausa, Phoenix, Posse, Ronze, Roulette, San Francisco, Stash, Strata East, Sugar Hill, Synchronic Research, Thunderbird, Trolley Car, Uno Melodic, West End, Who's Who in Jazz
Photographs: Zenith
Accessories: Ampiro, Le Bo, Maxell, Memorex, Pacific, Porpatune, Recoton, Service, TDK

● **CHEVERLY (Area Code 301)**

Potomac Music (JEK Ent's Inc.), 4819 Lydell Rd, Zip 20785 Tel 773 4474 (Rec. & Tape OS)
Home office: Baltimore, Md.
Accessories: Batteries, blank tape

● **CHEVY CHASE (Area Code 301)**

Rounder Dist'n, 5009 Oatton Zip 20015 Tel 656 5876 Mgr. Geoff Edwards (Rec. & Tape D, I & E)
Home office: Somerville (Boston Metropolitan Area), Mass. (See for prod. distributed)

● **GERMANTOWN (Area Code 301)**

Capitol Recs., Century XXI, 20030 Century Blvd, Zip 20767 Tel 428 0790 (Rec. & Tape D—see office in Los Angeles, Calif. for prod. distributed)

● **GREENBELT (Area Code 301)**

PolyGram Dist'n Inc., 9111 Edmonston Rd., Suite 201, Zip 20770 Tel 441 1670 Mgr. Harvey Rosen (Rec. & Tape D)
Home office: New York, N.Y. (See for prod. distributed)
R. C. A. & A&M & Assoc.'d Labels, 911 Edmonston Rd, Zip 20770 Tel 792 7205 Branch Mgr. Jim Grady (Rec. & Tape D—see New York, N.Y. office for prod. distributed)
Warner/Elektra/Atlantic Corp., 9111 Edmonston Rd., Suite 305-306, Zip 20770 Tel 792 7540 Sales Mgr. Van Pieter Wyckoff (Rec. & Tape D—see office in Los Angeles, Calif. for prod. distributed)

● **HAGERSTOWN (Area Code 301)**

Interstate Rec. Oists. Inc., 29 Prospect St, Zip 21740 Tel 733 1378 Owners: Richard M. & Melvin C. Greenwald, Mgr. Carlton Smith (Rec. & Tape OS & RJ)

● **HYATTSVILLE AREA (Area Code 301)**

C & M One Stop (div. of LOS Inc.), 5405 Lafayette Pl, Zip 20781 Tel 699 5888 Owner: Murray A. Berman, Buyers: Singles, Randy Evans, Albums & Tape, Lisa Hunter, Chen Parson (Rec. & Tape OS)
Videocassette lines: CBS, Warner Bros
Orum Major Music Dist., 5611 Landover Rd, Zip 20784 Tel 864-3935
Owner: Michael P. Mackulics, Mgr. Singles, Albums & Tape Buyer: Tom Hodges (Rec. & Tape OS)

● **LANHAM (Area Code 301)**

District Recs. Inc. (Rec. & Tape RJ)—Mgr. James Schwartz—see Schwartz Bros
S B I Video, 4901 Forbes Blvd, Zip 20801 Tel 459 8000 Sales Mgr. Oon Rosenberg, Buyer: Charlie Myers
Videocassette lines: Budget, CBS/MGM, Columbia Pictures, Disney, KVC, KV General, MCA, Magnetic Video, Media, NFL Films, Nostalgia, Merchant, Paramount, VCI, Vid-America, Video Gems, WCI, Warner Bros., Wizard
Videodisk lines: Columbia Pictures, Magnetic Video, Paramount
Schwartz Bros Inc., 4901 Forbes Blvd, Zip 20801 Tel 459 8000 Owners: James, Bertram & Stuart Schwartz, VP. Sales: Jerry Jacobs, Gen. Mdsgr. Mgr. Stephen Schwartz, Sales Mgr. Eugene Horn (Rec. & Tape D), (Rec. & Tape RJ as District Recs. Inc.)
Branches: Cherry Hill, N. J., Charlotte, N. C., Norfolk, Va., Tidewater One Stop (Rec. & Tape OS)
Labels: Aila, Anista, Audio Arts, Audio Gospel, Birth Right, Black Label, Boardwalk, Brothers of Washington, OC, CMH, Chrystal, Church Door, Concord Jazz, Day Star, Disneyland, EGL, Ernie's, Fantasy, 51 West, Flying Fish, Free Spirit, GRP, Gordy, Gospel Roots, Gospel Truth, Greentree, Gusto/Starday/King, HSE, Heart Warming, IBC, Impact, Jeremiah, Jewel/Paula, Jim, Juana, Kenwood, LA, Laff, Laurie, Lifesong, Light, Living Language, Lummar, Malaco, Milestone, Mirus, Motown, Muse, Myrrh, Nashboro, New Birth, Original Sound, Ovation, PAIO, Passport Visa, Pickwick, Praise, Pray, Prelude, Prestige, Pro Arte, Project 3, Quintessence, Rainbow Sound, Ranwood, Rejoice, Sam, Savoy, Sesame Street, Skylite, Sound of Gospel, Specialty, Stiff, Sun, Super Disc, Sutra, TCS, TK, TR, Tania, Telarc, Vanguard, Venture, Vesper, Vista, Waterhouse, Word

ROUNDER RECORDS

DISTRIBUTOR • EXPORTER • IMPORTER

**JAZZ/FOLK/NEW WAVE/NOSTALGIA/BLUES
BLUEGRASS/ROCKABILLY/REGGAE/IRISH . . .**

Ace (import)
Arhoolie
Bee Hive
Bet Car
Black Saint
Bomp
Columbia Special Products
Contemporary
Delmark
El Saturn
Flying Fish

Folkways
Hannibal
Heartbeat
JSP (import)
Library of Congress
Nessa
New World
Philo
RCA (French import)
Solid Smoke
Soul Note (import)

Specialty
Spotlite (import)
Starday
Stash
Steeplechase
Sugar Hill
Timeless (import)
War Bride
Windham Hill
Xanadu
Yazoo

over 300 labels in all

**FAST SERVICE/EXCELLENT FILLS
FOR CATALOGS AND ORDERING INFORMATION**

ROUNDER DISTRIBUTION

186 WILLOW AVE., SOMERVILLE, MA 02144 USA 617-354-0700
611 BROADWAY, RM. 415, NEW YORK, NY 10012 USA 212-477-4600
TELEX: 921724 ROUNDER INT.

Accessories: Allsup, Ampex, Audio Technica, BASF, Duracell, Empire, Maxell, Memorex, Peckering, Rec-Non, Scotch, Shure, Sony, Sound Guard, TDK (SEE ADVERTISEMENT)

● **SILVER SPRING (Area Code 301)**

C B S Recs., 8720 Georgia Ave., Suite 608 Zip 20910 Tel 587-5000
Branch Mgr. Jim Chiodo (Rec. & Tape D—see New York, N.Y. office for prod distributed)
Richman Bros., 13301 Rockview Court, Zip 20906 Tel 933-6006 Mgr Howard Rosenthal (Rec. & Tap. D & OS)
Home office: Pennsauken, NJ See for prod distributed)

MASSACHUSETTS

● **BOSTON METROPOLITAN AREA (Area Code 617)**

Alpha Dist'l Corp., 5 Priscilla Circle Weymouth 02188 Tel 266-0354 Con tact Paul Maged (Rec. & Tape D)
Home office: New York, N.Y. (See for prod distributed)
Boston Rec Dist Inc., 24 Ashmont Rd., Wellesley 02181 Tel 235-7865
Dwner Mgr & Buyer Jerry Flatto (Rec. & Tape OS & RJ)
C B S Recs., 33 Hayden Ave., Lexington 02174 Tel 861-6180 Branch Mgr George Ryan (Rec. & Tape D—see New York, N.Y. office for prod distrib uted)
Capitol Recs., 420 Providence Hwy., Rm 113, Westwood 02090 Tel 329-5770 (Rec. & Tape D—see office in Los Angeles, Calif. for prod distrib uted)
Dick's Rec. Co. Inc., 890 Providence Hwy., Dedham 02026 Tel 326-8790 Dwner Richard Mitchell, Mgr. Richard Peach, Buyers Singles, Richard Peach Albums & Tape, Melvin Tobrish (Rec. & Tape OS)
Disco Inc., 651 Washington St., Brookline 02146 Tel 734-1900 VP & Buyer G. Margolis (Rec. & Tape OS & RJ)
E Z One Stop Rec. Serv. Inc., 92 Sagamore St., North Quincy 02171 Tel 328-7900 Owner & Mgr. Aaron H. Gross, Buyer Robert Levin (Rec. & Tape OS), (Rec. & Tape D & RJ) as Royal Dist's.)
Federated Rec Co. Inc., 24 Munroe St., Newlinville 02160 Tel 969-1773 (Rec. & Tape OS, RJ & E)

Hot Cakes Music Inc., 24 Munroe St. Newtonville 02160 Tel 969-1773 (Rec. & Tape D, OS, RJ&E)
Distributes cutouts, budget labels.

M C A Dist'l Corp., 20 Cumming Park, Woburn 01801 Tel 933-9290
Branch Mgr. Jim LaFrance (Rec. & Tape D—see office in Los Angeles, Calif., for prod distributed)

Malco Inds. (div. of Malden Mop & Brush Co.), 266 Broad St., Lynn 01901 Tel 595-7500 Gen. Mgr. A.J. Goldstein (Rec. RJ)

Malverne Discs. Inc. of Boston, 77 Summer St. Zip 02110 Tel 423-3820
Mgr. Stan Goodman (Rec. & Tape D)
Home office: Long Island City (New York Metropolitan Area), N.Y. Malverne Discs. Inc.

Labels: AVI, Abet, Alfa, Alston, B-ckel, Cat, Chrysalis, Concord Jazz, Con temporary, Creed, Dash, Drive, Fantasy, 51 West, Galaxy, Glade, Gryphon, Jazz American, Juana, Ka vette, Kenwood, LaH, Laurie, Lifesong, Light, Malaco, Martin, Mileston, Mirus, Muse, Myrrh, Nashboro, New Birth, Dvalton, PAUSA, Prelude, Prestige, Project 3, Pyramid, Ranwood, Riverside, Roulette, Savoy, Specialty, Stax, Sunshine Sound, Sutra, TK, Takoma, Waterhouse, Wolf, Wor 1

Music Sales Inc., Bldg 8, 6 Gill St., Woburn 01801 Tel 935-7500 Mgr.: Howard Ring, Buyers, Singles, Jack Marshall, Albums, Rich Marcus (Rec. OS)

Music Suppliers Inc., 77 Wexford St., Needham Heights 02194 Tel 444-9310 Dwner Gordon Dinerstein Mgr. Ed Calmus, Buyers Singles & Albums, Vahan Aghajanian, Tape, Pen Handelman (Rec. & Tape OS & RJ)

Peter's Rec. Dne-Stop Inc. (PRDS), 880 Providence Hwy., Dedham 02026 Tel 329-5210 Owner, Mgr., Singles & Tape Buyer Peter McDermott, Albums Buyer Donald Moscatelli. (Rec. & Tape OS)

PolyGram Dist'n Inc., 200 W Cummings Park, Suite M-50, Woburn 01801 Tel 933-8155 Mgr. Paul Wennk (Rec. & Tape D)
Home office: New York, N.Y. (See for prod distributed)

R C A & A&M & Assoc'd Labels, 38 1/2 Elliot St., Newton Upper Falls 02164 Tel 964-4955 Mgr. Rich Attinson (Rec. & Tape D—see New York, N.Y. office for prod distributed)

Rounder Recs. Corp., 186 Willow Ave., Somerville 02144 Tel 354-0700 Dwners Marian Leighton, Ken Irwin, Bill Nowlin; Mgr. Duncan Browne, Singles & Albums Buyer Glenn K. Jones. (Rec. & Tape D, I & E)
Branches: Chevy Chase, Md. B ooklyn (New York Metropolitan Area), N.Y.

Labels: About Time, Ace of Hearts, Adelphi, Advent, Alcazar, Alligator, Amazing, Ambition, American Heritage, Appuga, Archive of Folk & Jazz, Ahoolee, Armageddon, Artificial Intelligence, Astro Jet, Audiophile, Autobahn, BBC, BFD, Bandy, Baobab, Baron, Barrelhouse, Bay, Beehive, Beet, Bent Reed, Bert & I, Bel Jar, Big Daddy, Biograph, Black Eagle, Blast, Blind Pig, Blue Angel, Blue Goose, Blues Classics, Bomp, Briar, Broadway, Bullfrog, CFH, CMH Cabbage, Cachalot, Caution, Celeste, Chalfont, Chlorinated, Circle, Ci adel, Clanka Lanka, Clappers, Classics Int'l, Clean Cuts, Club of Spade, Collector, Columbia, Columbia Special Prods., Commodore, Contemporary, Colley Light, Country Life, Country Turtle, County, Cowboy Carl, Creative World, Cynda, Delmark, Dirty Shame, Discovery, Domain, Dre, mstreet, ESCA, Earwig, Eat, Elephant's Graveyard, El Saturn, Ember, Em ly, Encounter, Entr' Acte, Essene, Eubie Blake, Euphonic, Everest, Factor, Factus, Fate 1, Fiddlin' Whale, Flying Crow, Flying Fish, Flying High, Fl-right, Folk Legacy, Folk Lyric, Folkways, Fretless, Front Hall, GHB, GNP, Crescendo, Gatemouth, Gateway, Glen dale, Golden Age, Good Time Jazz, Grass Mountain, Greenhays, Green-ime, Green Linnet, Ground Zero HDS, Harbor, Heartbreak Hits, Herald, Herwin, Historical, Hollywood Soundstage, Homestead, Honeydew, Imag-ination, Improvising Artists, Ind a Navigation, Interplay, Interzone, Isa belle, JCOA, JCDA WATT, JEMF, Jazz Archives, Joe-Tel, Jump, June Appal, Kaleidoscope, Kicking Mule, Lan Hall, Legacy, Levathan, Library of Con-gress, Likeable, Lion, Longdivity, Longhorn, Longview, Lovely Music, Lust/Unlust, Lyrichord, Mamlis, Mardi Gras, Mark 56, Matrix, Melo-dion, Michael's Pub, Mineral River, Mr. Blues, Modern Method, Monitor, Monmouth/Evergreen, Mornings ar, Musickraft, Muskadine, NRG, Nessa, Neworld, New World, Nighthaw, North Country, Did Homestead, Old Time, Olympic, Dmac, Omnisound, Onari, Drgin Jazz Library, Outline, Outrageous, PM, P&P, Paredon, Pearl, Philly Jazz, Philo, Philomet, Phoe-nix Jazz, Plantation, Plant Life, Polisar, Progressive, Pumpkin, Pure & Easy, Puritan, Quark, Radiola, Re-iph, Rambler, Ramblin', Random Radar, Rattlesnake, Razor, Rebel, Red, Red Goose, Red Sweater, Regency, Re-

lease, Relic, Revel, Rhino, Ridge Runner, Rollin' Rock, Rooster, Rose, Rosetta, Rough Trade, Rounder, Sackville, Salco, Sail, Sandy Hook, Sea Breeze, 1750 Arch, Shake, Shanachee, Shasta, Shiah, Shiloh, Sierra, Sil ver Sphinx, Singlebrook, Solid Smoke, Sonet, Specialty, Spivey, Spring, Starday/Gusto, Starday/Powerpak, Starday/King, Starlog, Starlog/Va-rese, Star Rhythm, Slash, Steeplechase, Straight Ahead, Streetsong, Sugar Hill, Sun, Swallow, Sweet Earth, Syntonic Research, TRC, Take Two, Theresa, Tolem, Tradition, Traditional, Trash, Trux, Trod Nossel, Trouba-dor, Vandan, Varese Sarabande, Varulven, Vetcu, Vox, Voyager, Vu, Wagon Tracks, War Bride, Waterhouse, Western, Widebeest, Windham Hill, Wins, Word of Mouth, XRT, Xanadu, Yazoo, Zim

Labels imported: Agram, Amigo, Appaloosa, Armageddon, Attack Attic, Azul, Blackbird, Black Saint, Blues Boy, Boa, Boot, Bunny Lee, Burning Sounds, CBS, Carib Gems, Cash & Carry, Celluloid, Cha Cha, Charly, Chrysalis, Chyme, Clock Tower, Collector, Conflict, Crest, Daddy Kool, Deb, Dingle's, Dire, Dischi della Quercia, Dragon, Edizioni, Free Reed, Gael Linn, Generation, Greenleaves, Hammer, Hit Run, Icuts, Id, Invis-ible, Iona, Ital, JSP, Jazz Live, LTM, MCA, Magpie, Meleor, Micron, Dats Moo, Didie Blues, Dval, Pioneer Int'l, Plant Life, Quango, RCA, Red, Red Lightn'r, Red Rag, Rock & Country, Route 66, Rubber, Sarge, Silver Hill, Sky, Sonet, Soul Note, Specialty, Spottite, Springthyme, Star Light, Strng, Tara, Temple, Third World, Topic, Treasure, Trojan, Virgin, WF, Wa-terland (SEE ADVERTISEMENT)

Royal Dist's., 96 Sagamore St., North Quincy 02171 Tel 328-1822 Dwner & Mgr. Aaron H. Gross (Rec. & Tape D & RJ), (Rec. & Tape OS as E Z Dne Stop Rec. Serv. Inc.)
Labels: Contessa, Crown, Custom, Mother Goose, overstock, olde 45's
Accessories: Recoton

Sound Sellers Inc., 80 Independence Ave., Quincy 02169 Tel 472-3660
Owner Brian Lawson, Mgr., Singles & Albums Buyer Arthur Rich, Tape Buyer James Roth (Rec. & Tape OS & RJ)

Warner/Elektra/Atlantic Corp., PD Box 4016, 200 Unicorn Park Dr., Woburn 01888 Tel 935-5170 Branch Mgr. Don Dumont, Sales Mgr. Fran Al-berle (Rec. & Tape D—see office in Los Angeles, Calif., for prod distrib uted)

Women's Music Dist'n Co., 33 Richdale Ave., No. 211, Cambridge 02140 Tel 661-0554 Mgr.: Trish Karlinski (Rec. & Tape OS)
Home office: Glendale (Los Angeles Metropolitan Area), Calif.

● **LAWRENCE (Area Code 617)**

N E R T of New England, PD Box 268, Zip 01842, 641 Haverhill St. Zip 01841 Tel 686-4293 Dwner, Mgr., Singles, Albums & Tape Buyer Jerry P. Marcus (Rec. & Tape OS & E)
Accessories: Ampex, BASF, Black Diamond, Fuji, Le Bo, Maxell, Memo rex, Nortronic, Recoton, Savoy, Scotch, Sound Guard, TDK, Watts

● **NEW BEDFORD (Area Code 617)**

Penco Rec. Co., 428 Wood St. Zip 02745 Tel 995-0595 Dwner Francisco A. Penha (Rec. & Tape I & E)
Labels imported: Alvorada, Belfer, Clave, Coimbra, Estudio, Interdisco, Lisboa, Dfir, Ondá, Drefu, Rapsodia, Roda, Telectra (all Portugal).
Exports pre-recorded tapes.

● **SHREWSBURY (Area Code 617)**

Music Machine, PD Box 262 Zip 01545. Dwner Paul Brough; Mgr & Buyer M. Faddoul. (Rec. & Tape OS)

● **SOMERSET (Area Code 617)**

Pickwick Dist'n Cos., Rack Servs. Div., 185 Riverside Ave. Zip: 02725 Tel: 676-3061 Div VP Herb Dorfman; Branch Mgr Jim Curci; Sales Mgr Richard Berube, Buyer Gerni Chase. (Rec. & Tape RJ)
Home office: Minneapolis, Minn

MICHIGAN

● **ANN ARBOR (Area Code 313)**

Spring Arbor Dist., PD Box 985 Zip 48106 Tel (313) 994-4053 Pres. Jim Carlson, Buyer Gerald Blalock (Rec. & Tape D)
Labels: Alexandria House, Arel, Asian, Avant Garde, Benson, Bread 'n' Honey, CBS, Caedmon, Calvary, Canaan, Country Dak, Dawn, Dayspring, Fisher Folk, Good Life, Good News, Gospel Media, Gospetrama, Gotz, Greentree, Heaven & Earth, Image VII, Impact, Jim, John Hall, K&R, Lamb & Lion, Lexicon, Light, MCA, Maiden, Maranatha, Milk & Honey, Myrrh, NALR, New Born, New Dawn, New Life, Newpax, New Song, Pyramid Peaceable, Pilgrim, Polygram, Praise, RCA, Rainbow, Savoy, Seed, Ser-vant, Singsgiving, Skylite, Solid Rock, Songbird, Sonrise, Sparrow, Spirit, Starsong, Takoma, Triangle, Tunesmith, WEA, Weston Priory, Word

● **AUBURN HEIGHTS (Area Code 313)**

J's Dist'n Serv. Inc., 2163 Avon Industrial Dr. Zip 48057 Tel 852-5707 Dwner Vincent H. Jaeger, Singles, Albums & Tape Buyer: Pat Jaeger (Rec. & Tape OS & RJ)

● **BRIGHTON (Area Code 313)**

Arc Jay-Kay Dist'l Co. (div. of Handieman Co.), 1289 Rickett Rd. Zip 48116 Tel 227-2231 Gen. Mgr. Tom Schlesinger; Sales Mgr.: Mike McKenzie, Sales Admin. Pauline Fran (Rec. & Tape D)
Labels: AVI, Abkco, All Platinum, Alston, Amazon, Apa, Aries II, Ariola, Arista, Arth, At Home, Bach Guild, Big Town, Birthright, Blue Candle, Bold, Bomp, Buddha, Cadet, Cadet Concept, Cardinal, Cat, Checker, Chess, Chrysalis, Churchill, Circa, Clouds, Cream, Creative World, Cre-scendo, Dash, Dial, Dixieland Jubilee, Dore, Drive, Era, Everman, Fa-bulous, Fantasy, Flashback, GNP, GRP, Galaxy, Generation Int'l, Glades, Good Sounds, Gordy, Gospel Roots, Gusto, HDM, Hi, Hollywood, IBC, IRDA, Import, Inphason, JEM, JRC, Jay Jay, Jewel, Juana, Kayette, Kent, King, Konduko, Kudu, LRC, Largo, Laurie, Malaco, Malcolm X, Marlin, Metric, Milestone, Motown, Mountain Railroad, Mushroom, NSD, Natural Resources, Novus, Original Sound, Dvalton, PVC, Passport, Paula, Plan-tation, Platinum, Prestige, Prudigat, Pyramid, Ranwood, Rare Earth, Rat City, Reid's World, Rice, Ronn, Roots, Roulette, Rounder, Royal Flush

Old Fashioned Service For All Your Music Needs

45's
TAPES
RECORDS
RECORDING TAPE

VINYL VENDORS

Full Service • One Stop • Rack Jobber
BOX LOT PRICES • \$5.98 5-SAVER PROGRAM
TRY OUR SPECIAL ORDERS • WEEKLY SPECIALS
Same Day Shipping • Volume Discounts

VINYL VENDORS, INC.
7870 SPRINKLE ROAD • KALAMAZOO, MICH. 49002
PHONE (616) 323-0131
IN MICH. TOLL FREE (800) 632-0870 OUTSIDE MICH. CALL COLLECT
BEST IN THE MIDWEST

Savoy, Seeds & Stems, Seventy-First Street, Shield, Silverblue, Simtone, Sketches in Black, Soul, Soul Power, Stang, Stang, Stax, Stone Dogg, Sugar Hill, Sun, Sunbird, Sunshine Sound, TK, Takoma, Tania, Tiger Lily, Turbo, Vanguard, Versatile, Vesper, Vibration, Vintage, Visa, Wanderick, Weird World, Wolf.

● **CADILLAC (Area Code 616)**

B & R Music, 2400 E. 30 Rd. Zip: 49601. Tel: 775-3145. Owner, Mgr. & Buyer: Roy Newland. (Rec. & Tape RJ)

● **CHARLOTTE (Area Code 517)**

State-Wide Dist'g, 2370 Brookmead Way, Zip: 48812. Tel: 543-0097. Owner: Norman E. Martens, Mgr.: Mark A. Martens. (Rec. & Tape OS & RJ) Accessories: Le-Bo, Memorex, Service, TDK.

● **DETROIT METROPOLITAN AREA (Area Code 313)**

A T C Music Dist'g Inc., 104 W. Fourth St., Royal Oak 48067. Tel: 545-8888. Mgr., Singles & Albums Buyer: Bob Zilli. (Rec. OS)

Ami Dist. Corp., 34411 Industrial Rd., Livonia 48150. Tel: 525-7600. Owners & Buyers: Harry Manoojan, Carl Mooradian, Bernard Schwarz. (Rec. & Tape D)

Labels: Ala, Ariola, Arista, Boardwalk, Brunswick, Buddah, Conversa-Phone, Dana, Fantasy, Fiesta, Golden, Gospel Truth, Laff, Living Language, MSK, Malaco, Milestone, Monitor, Ode, Pristige, Riverside, Savoy, Stax.

Accessories: Audio Magnetics, Ouracell, Fuji, Memorex, Panasonic, Sony, TDK, Toshiba.

Angell Rec. & Tape Sales, 2616 Puritan St. Zip: 48218. Tel: 341-7053. Owners: Ron Rogers, Allen Walker, Rec. Mgr. & Buyer: Ron Rogers. (Rec. & Tape OS & RJ) Accessories: Le-Bo, Maxell, Memorex, TDK.

C B S Recs., 24681 Northwest Hwy., Suite 32, Southfield 48075. Tel: 354-D470. Branch Mgr.: John Farr. (Rec. & Tape D—see New York, N.Y., office for prod. distributed)

Cadet Dist. Co. Inc., 13380 Capitol Ave., Oak Park 48237. Tel: 548-3171. Owners: Harry & Isadore Levin, Buyer: Leo Cheslak. (Rec. & Tape OS), (Rec. & Tape RJ as Cornell Recs. Inc.)

Accessories: Intermagnetics, Memorex, Recoton Capitol Recs., 550 E. Mandoline St., Madison Heights 48071. Tel: 583-9600. (Rec. & Tape D—see office in Los Angeles, Calif., for prod. distributed)

Cornell Recs. Inc. (Rec. & Tape RJ—see Cadet Dis. Co. Inc.) Gospel Int'l Inc., 18945 Livernoss. Zip: 48221. Tel: 345-4915. Pres.: Larry T. Robinson. (Rec. OS)

Gransin Dist., 13731 Woodward Ave., Highland Park 48203. Tel: 867-4500. (Rec. & Tape OS—gospel prod. only)

Handleman Co., 1055 W. Maple Rd., Clawson 48017. Tel: 435-3100. (Corporate Headquarters) (Rec. & Tape RJ)

Dist'g branches: Little Rock, Ark., Los Angeles, Calif., Denver, Colo., Opa Locka (Miami Metropolitan Area), Fla., Stone Mountain (Atlanta Metropolitan Area), Ga., Elk Grove Village (Chicago Metropolitan Area), Ill.; Jessup (Baltimore Metropolitan Area), Md., North Kansas City (Kansas City Area), Mo., Latham (Albany Area), N.Y., Charlotte, N.C., Blue Ash (Cincinnati Area), Ohio, Youngstown, Ohio, Oklahoma City, Okla., Memphis, Tenn., Dallas, Tex., Tukwila (Seattle Area), Wash. Int'l branches: Canada—Calgary, Alta., Moncton, N.B., Toronto, Ont., St. Laurent (Montreal Metropolitan Area), P.Q. Inter/Soul Rec. Dist. (div. of Inter/Soul Ent's Inc.), 18329 W. McNichols. Zip: 48219. Tel: 533-1550. (Rec. D) Labels: Big Hit, Boomam, Capsoul, Geneva, Great Joy, Grill, Inter/Soul, Sunburst, Underground.

Len's One Stop, 3415 Chrysler. Zip: 48201. Tel: 831-5299. (Rec. & Tape OS & E)

M & H Dist'g Inc., 14500 W. Eight Mile Rd., Oak Park 48237. Tel: 968-4560. Opns. Mgr.: Jack Millman, Sales Mgr.: John Hudson. (Rec. D) Labels: Albradella, BCN, Bano, Biljuma, Blue Rose, Groove Rime, Importe/12, Juana, LCA, Marathon, Moby Dick, Nacnudah Int'l, Setting Sun, Sounds of New York, Uno Melodic, VIP Int'l, Watchman

Martin & Snyder One Stop, 8880 Hubbell Ave. Zip: 48228. Tel: 272-7800. (Rec. OS & RJ, Tape OS)

Music Peddlers Inc., 1755 E. Maple, Troy 48084. T-l: 524-2800. Pres.: Carl Thom, Gen. Mgr.: Jerry Adams, Buyers: Singles, Albums & Tape, Linda Powers, Fred De Coopman, Tom Henderson, Roy Burkhardt, Classical Albums, Bill Close, Accessories, John Beers. (Rec. & Tape OS)

Accessories: Alltop, Dishwasher, Fuji, Maxell, Memorex, Pfanstiehl, Savoy, Service, TDK. Paks Corp., Mark Plaza, 21411 Civic Center Dr., Suit# 108, Southfield 48076. Tel: 353-3230. (Rec. & Tape D) Home office: Cleveland, Ohio. (See for prod. distributed)

PolyGram Dist'n Inc., 755 W. Big Beaver, Suite 2213, Troy 48084. Tel: 362-4420. Mgr.: Bill Schulte. (Rec. & Tape D) Home office: New York, N.Y. (See for prod. distributed)

Prime Whse. Ltd., 15018 Grand River. Zip: 48227. Tel: 838-3422. Owner: Gerald L. Morris, Mgr.: Veronica McMillen, Singles, Albums & Tape Buyer: Kenneth Morris. (Rec. & Tape OS)

Progress Rec. Dist'g Inc., 19025 W. Ten Mile Rd., Southfield 48075. Tel: 358-3132. Mgr.: Bill Allen. (Rec. & Tape D) Home office: Highland Heights (Cleveland Metropolitan Area), Ohio. (See for prod. distributed)

R C A & A&M & Assoc'd Labels, 22255 Greenfield, Suite 140, Southfield 48075. Tel: 569-5980. Mgr.: Joe Wallace. (Rec. & Tape D—see New York, N.Y., office for prod. distributed)

Simpson's Whse. Inc., 16540 James Couzens Hwy., Zip: 48221. Tel: 341-1885. Mgr.: Liz Adanandus. Office: 845 Livernoss, Ferndale 48220. Tel: 544-9252. (Rec. & Tape OS) Accessories: BASF, Bib, Le-Bo, Maxell, Memorex, Pfanstiehl, Recoton, Sony, TDK.

Warner/Elektra/Atlantic Corp., 17500 Northland Park Court, No. 2, Southfield 48075. Tel: 569-4822. Sales Mgr.: Gil Roberts. (Rec. & Tape D—see office in Los Angeles, Calif., for prod. distributed)

● **EAST LANSING (Area Code 517)**

Old Fogey Dist'g, PO Box 1795, 541 E. Grand River. Zip: 48823. Tel: 337-7503. Owner & Mgr.: Stanley Werbin, Singles & Albums Buyer: Bob Blackman. (Rec. D)

Labels: Abraham, Ace of Spades, Adelphi, Affinity, Alligator, Amazing, American Heritage, Appaloosa, Arhoolie, Aviva, ERI, Banff, Banshee, Bay, BetCar, Biograph, Blackbird, Black Saint, Blind Pig, Blue Goose, Blue Horizon, Blue Labor, Blue Night, Blue Ridge, Blues Classics, Bookay,

Boot, Briar, Bunny Lee, Burning Sounds, Bushays, CBS imports, CCE, CMH, Cabbage, Carol Gems, Celeste, Celluloid, Celtic, Cha Cha, Charly, Charmers, Chicago Slide, Chyme, Claddagh, Clean Cuts, Clocktower, Conflict, Corridor, Country Turtle, County, Crest, Del Grosso, Dimension, Disc Pressers, Douglas imports, Dreamstreet, Ekapa, Embassy, Epic, Everest, Fiddler, First Head, Flying Crow, Flying Fish, Flying High, Flight, Fogarty's Cove, Folk Legacy, Folklyric, Foldsays, Form, Fretless, Front Hall, Gael-Linn, Gateway, Generation, Golden Age, Golden Classics, Grass Mountain, Greenhays, Green Linnet, Greensleeves, Guitar World, Gusto, Hammer, Hawk, Hen Cackle, Heritage, Herwin, Highway, Historical, Houndstooth, Id, Inchecronin, Interplay, Juke Joint, June Appal, Kaleidoscope, Kanawha, Kicking Mule, King, Leader/Trainer, Leather, Le Roi du Blues, Levathan, Library of Congress, Longview, MCA imports, Magi, Maggie, Mamlsh, Maatra, Melodone, Michigan Archives, Micron, Midwest Coast, Minstrel, Mint Julep, Monument, Morning Star, Mountain, Mulligan, Music Minus One, NM, Nighthawk, Nine Winds, North Country, North Track, Oads, Ogham, Old Homestead, Oldie Blues, Old Timey, Omni Network, Origin Jazz Library, Outlet (Ireland), Outrageous, Ozark, Palm Tree, Park Street, Philo, Poca River, Polydor, Power Pak, Prismatic, Ra, Ram, Rambler, Ramblin', Rebel, Redbud, Red Clay, Red Goose, Red Lightnin', Regency, Ridge Runner, Rosetta, Rossendale, Rounder, Ruba, Rural Rhythm, Sail, Sarge, Scruggs, Shamrock, Shanachie, Shaskeen, Shiloh, Sierra, Sierra Wave, Silver Hill, Snowflake, Solid Smoke, Sonel, Sonytone, Soul Note, Special Rider, Spirit, Starday/King, Starlight, Stash, Stooft, Straight Ahead, Strata, String, Sugar Hill, Sunny Mountain, Swallowtail, Sweet Earth, Syndicate Chapter, Take Two, Tara, Totop, Totem Traditional, Transatlantic, Traveler, Treasure Isle, Trident, Trojan, Troubadour, Union Pacific, Velco, Vineyard, Virgin, WF, War Bird, Watt, Webco, Weiser, Wenh, Western, Westwood, Wheatland, Wildebeest, Xtra, Yazoo.

● **GRAND HAVEN (Area Code 616)**

Tant Ent's Inc., 205 Washington St. Zip: 49417. Tel: 846-6930. Owners: Billie & Ellen Thomas, Mgr. & Albums Buyer: Billie Thomas. (Rec. D, I & E) Labels: Ace of Spades, Adelphi, Advant, Acco, Airborne, Aircheck, Ajax, Alligator, Aragon, Arcadia, Arhoolie, Audiofidelity, Aviva, BOB, Bandstand, Barrelhouse, Bay, Bee Hive, Big Band Archives, Big Band Landmark, Big Star, Bija, Birch, Biscuit City, Bin Lives, Blackbird, Black Fire, Black Saint, Blind Pig, Blue Angel Jazz Club, Blue Canyon, Blues Classics, Blue Goose, Blue Labor, Blue Lantern, Blue Night, Bountiful, Briar, Broadway, Bullfrog, Celeste, Charlie, Charescuro, Chicago Slide, Choice, Cinema, Cine Sound, Clanco, Claremont, Columbia Special Prod., Command Performance, County, Cowboy Carl, Crown, Curtain Calls, DRG, Delmark, Dirty Shame, Discovery, Discovery/Trend, El Camino, Electric Lemon, Emanon, Empire, Enja, Entr' Acte, Esca, Eubie Blake, Euphonic, Eurodisc, Everest, Extreme Rarities, F&W, Fanfare, Fat Cat Jazz, Feathers, Fiddledeedoo, Fiddlers Wynn, Fintie, First Head, Flying Fish, Folk Leg acey, Folkways, Freckle, Fretless, Friends Club, Front Hall, Gatemouth, Genesis, Giants of Jazz, Glendale, Golden Era, Great Dane, Halcyon, Herwin, High Street Station, History, Holy Spirit, Homespun, IAJRC, Improv, Improvising Artists, India Navigation, Inmsiree/Green Linnet, Interplay, JCOA/ Watt, JRC, Jazz Archives, Jazz Classics, Jazz Giants, Jazz Guild, Jazz Showcase, Jazz Studies, Jazz Treasury, Jim Taylor Presents, Joker, Joliet, Joyce, Jump, June Appal, Kaleidoscope, Kicking Mule, Klavier, Kneedeep, Labor, Legends, Log Cabin, Long Neck, Lunar, Mamlsh, Mark 56, Mary, Merry Makers, Michigan Archives, Mill City, Mr. Blues, Motherlode, Mountain Railroad, Mozum, Mzw, Mule, Mulligan, Muskadine, Music Liberate, Music Works, Natural Organic, Nessa, New Orleans, Night hawk, Old Homestead, Oldie Blues, Old Timey, Onari, Origin Jazz Library, PM, Pacho, Pearl, Pelican, Philo, Phidomel, Phoenix, Piedmont, Premier, Progressive, Pumpkin, Puritan, Queen Dst, Radio Archives, Radiola, Rebel, Red Goose, Red Onion, Retrospect, Revelation, Rodgerunner, Rouser, Sackville, Sail, Seabreeze, 1750 Arch, Shanachie, Shih, Shiloh, Sierra, Sierra Wave, Solid Smoke, Sonel, Sounds of Swing, Spittune, Spokane, Spotlight, Standing Room Only, Startone, Stash, Steeplechase, Stiff, Straight Ahead, Sugar Hill, Sunbeam, Swing Era, Symposium, Take Two, Takoma, Tangent, Third Street, Titanic, Totop, Totem, University of Michigan Bands, Votco, Voyager, Wolverine, World Jazz, Yazoo, Yorkshire, Zip.

● **GRAND RAPIDS (Area Code 616)**

Kent One-Stop Inc., 41 S. Division Ave. Zip: 49503. Tel: 459-2670. (Rec. & Tape OS & RJ)

● **KALAMAZOO (Area Code 616)**

La Val Rec. Dist., 1327 Cobb St. Zip: 49007. Tel: 342-5328. Owner: Vic La Val; Mgr. & Buyer: Vincent Taylor; Promo: Harry Whited, Val Taylor. (Rec. D) Labels: Ball, Bay Tone, Boss, Comedian, Dooto, Funday Finger, Luny, La Val, Luck, Paritee, Soul Set, T&L, Trash, Vix, Weird World.

Vinyl Vendors Inc., 7870 Sprinkle Rd. Zip: 49002. Tel: 323-0131. WATS (800) 632-0870. Owner & Sales Mgr.: Jeff Boyd; Owner, Opns. Mgr. & Accessories Buyer: Craig Hedeon, Owner & Mktg. Mgr.: Teri Broerse; Buyer: Don Stuckro, Rack Servs. Allan Witte. (Rec. & Tape OS & RJ) Accessories: Alltop, Boker Merzon, Dishwasher, Ouracell, Maxell, Pfanstiehl, Robins, Service, Sound Guard, Savoy, TDK, Watts (SEE ADVERTISEMENT)

● **OWOSSO (Area Code 313)**

Rock-A-Rolla Recs. Inc., 200 W. Main. Zip: 48867. Tel: 723-5145. Saginaw Tel: (517) 752-8379, Flint Tel: (313) 767-5891. Owners: Thomas E. & Edwin T. Dews, Gen. Mgr.: Thomas E. Dews, Singles, Albums & Tape Buyer: Doug Earp, Accessories Buyer: Sharon Shea. (Rec. & Tape OS & RJ) Phonographs: Craig Accessories: Discwasher, Electro-Voice, Le-Bo, Maxell, Memorex, Savoy, Sony, Sound Guard, TDK.

C B S Recs., 6600 France Ave. S., Suite 160, Minneapolis 55435. Tel: 929-4604. Branch Mgr.: Bob Ewald. (Rec. & Tape D—see New York, N.Y., office for prod. distributed)

Calico, 1733 Selby Ave., St. Paul 55104. Tel: 644-4155. Owner & Albums Buyer: Sherry Longesth. (Rec. D)

Labels: Carolstatter, Cassandra, Galaxia, Lima Bean, Olivia, Open Door, Pleiades, Redwood, Riverbear, Sea Friends, Terrapin, Urama, Windbag, Capitol Recs., 10800 Lyndale Ave., South Bloomington 55420. Tel: 884-0444. (Rec. & Tape D—see office in Los Angeles, Calif., for prod. distributed)

Dart Recs. Inc., 1815 W. River Rd. N., Minneapolis 55411. Tel: 529-9571. Pres.: Dick Daly, Buyers: Singles, Irv Gorse, Albums & Tape, Joel Cor-yell. (Rec. & Tape OS & RJ)

Dominion Music Corp., 7681 Washington Ave. S., Minneapolis 55435. Tel: 941-9600. Sales Dir.: Joe Ceram, Mdsq. Dir.: Steve Prust. (Rec. D) Labels: Arrival, Commonwealth, Dominion Music, Era, K-tel.

Gamco, 858 Decatur Ave. N., Minneapolis 55427. Tel: 545-0129. Owner: Ira Heilicher, Gen. Mgr.: Jan Jordan, Buyer: Melody Sweetin. (Rec. & Tape RJ) (Rec. & Tape OS as Vinyl Solution)

Jim's Rec. Shop, 1724 University Ave., St. Paul 55104. Tel: 646-3357. Owner & Buyer: James Christensen. (Rec. OS)

Lieberman Ent's. Inc., 9549 Penn Ave. S., Minneapolis 55431. Tel: 887-5300. Bd. Chm.: David Lieberman, Pres.: Harold Okinow, VP: Opns. Dick Moerbitz; Nat'l OS Mgr.: Dennis Price, Nat'l Buyers: Singles, Wayne Grossman, Albums & Tape, Sylvester Vanyo. Local branch: Opns. Mgr.: Dianne Rasmussen, Buyers: Singles, Sherry Williams, Albums, Pat Weiser. (Rec. & Tape OS & RJ)

Branches: Denver, Colo. (Rec. & Tape OS & RJ); Jacksonville, Fla./Atlanta, Ga. (Rec. & Tape RJ); Elk Grove Village (Chicago Metropolitan Area), Ill. (Rec. & Tape OS & RJ); Kansas City, Mo. (Rec. & Tape OS & RJ); Mount Laurel, N.J. (Rec. & Tape RJ); Cleveland, Ohio. (Rec. & Tape RJ); Portland, Ore. (Rec. & Tape OS & RJ); Dallas, Tex. (Rec. & Tape OS & RJ) M C A Dist'g Corp., 4530 W. 77 St., Suite 199, Edina 55435. Tel: 835-6020. Branch Mgr.: Bill Pierce. (Rec. & Tape D—see office in Los Angeles, Calif., for prod. distributed)

Pickwick Dist'n Cos., Independent Dist'n Div., 7500 Excelsior Blvd., Minneapolis 55426. Tel: 932-7595. VP & Gen. Mgr.: Jack Bernstein (see Fort Worth, Tex., branch). Local branch: Mgr.: Michael Meyer. (Rec. & Tape D), (Rec. & Tape RJ) as Pickwick Dist'n Cos., Rack Servs. Div.)

Branches: San Francisco, Sun Valley (Los Angeles Metropolitan Area), Calif.; Opa Locka (Miami Metropolitan Area), Fla.; Atlanta, Ga.; Nashville, Tenn.; Arlington (Fort Worth Area), Houston, Tex. Labels: APA, AVI, Abkco, Accent, Ala, Alfa, Alligator, Alston, Amberjack, Angelaco, Anriola, Arista, Audio Fidelity, Bach Guild, Becket, BetCar, Blind Pig, Boardwalk, Bold, Bomb, Brunswick, Buddah, Burdette, CMH, Cat, Chalel, Charescuro, Chrysalis, Clouds, Cognito, Concord Jazz, Contemporary, Dash, Delute, Devaki, Dore, Drive, Entr' Acte, Excelsior, Fabulous, Fantasy, Fat City, First American, Flame, Flying Fish, GMP, G&P, GRP, Galaxy, Glades, Good Sound, Gordy, Gospel Truth, Grand, Great Northwest, Greenhays, Gryphon, Hindsight, IBC, Image, Impahsion, Insight, Jam, Jazz Bird, Jeremiah, Juana, Kaleidoscope, Karate, Kudu, LRC, Laff, Life Song, Living Language, MF, Malaco, Marlin, Milestone, Museum, Muse, Mushroom, Music Is Medicine, Neva, North Country, Ode, Olie, Our Gang, Ovalton, PA-USA, Pacific Arts, Paid, Panaural, Passport, Penthouse, Pro Arne, Piccadilly, Pickwick, Plantation, Prelude, Prestige, Prism, Pro Art, Prodigal, Project 3, Quintessence, Ranwood, Rare Earth, Rattlesnake, Reflection, Regency, Request, Rhino, Riverside, Robox, Roulette, Rouser, Sail, Sapodilla, Savoy, Seeds & Stems, Shadow, Shield, Solid Smoke, Soma, Solo, Spiffola, Stax, Stiff, Stony Plant, Strata East, Sugar Hill, Sun, Sunbird, Sunshine Sound, Sutra, Sweet City, Syntonic Research, TK, Takoma, Tania, Tapestry, Tiger, Lily, Tomato, Twin Tone, Vanguard, Vintage, Virgo, Visa, War Bird, Waterhouse, Weird World, Windham Hill, Wolf. (SEE ADVERTISEMENT)

Pickwick Dist'n Cos., Rack Servs. Div., 7500 Excelsior Blvd., Minneapolis 55426. Tel: 932-7600. Sr. VP: Eric Paulson, Div. VP: Arne Gross. Local Mgr.: Larry Johnson, Sales Mgr.: Duane Wachholz. Prod. Mgr.: Ken Faulkner, Opns. Mgr.: Skip Abel. (Rec. & Tape RJ), (Rec. & Tape D) as Pickwick Dist'n Cos., Independent Dist'n Div.)

Branches: Phoenix, Ariz.; Burlingame (San Francisco & Bay Area), North Hollywood (Los Angeles Metropolitan Area), Calif.; Denver, Colo., Atlanta, Ga., Honolulu, Hawaii, Elmhurst (Chicago Metropolitan Area), Ill.; Des Moines, Iowa; Glen Burnie (Baltimore Metropolitan Area), Md.; Somerset, Mass.; St. Louis, Mo.; Arlington (Fort Worth Area), Houston, Tex.; Seattle, Wash.

Re-Mark Co., 2444 Cavell Ave. S., Minneapolis 55426. Tel: 545-1211. Owner & Mgr.: J.L. Goldstein, Mail Order: Mark Goldstein, Buyer: Joan Y. Dstrin. (Rec. & Tape D, OS, RJ & E)

Distributes & exports cutouts, overstocks & promotional material. Scoot Around Rec. Dist'n, 2448 34 Ave. S., Minneapolis 55406. Tel: 722-7049, 489-8288. Owners: Melissa Miller, Susan Horns, Buyer: Susan Horns. (Rec. D)

Labels: Augsburg, Banjar, Bay, Corbett, Family Owl, Folk Legacy, Fretless, Green Linn, Housedog, Jeffrey David, June Appal, Likeable, Mineral River, Mirth, Mountain Railroad, Panaural, Philo, Port of Dixie, Progressive, Roster, Roster Blues, Rose Alley, Swallowtail, Train on the Island, Traveller, Waterfront, Wheatland, Windham Hill. Sources Co., 254 First Ave. N., Minneapolis 55401. Tel: 374-2832. Owners: Steven Teachout, Arthur Elliott. Mgr.: Singles & Albums Buyer: Steven Teachout. (Rec. D) Branch: Leawood (Kansas City Area), Kan

Labels: ASI, American Gramophone, Audio Directions, Audio Encores, Audio Technica, Chalfont, Clean Cuts, Crystal Clear, Delos, Direct Disc Labs, Discwasher, East Wind, East World, Gale, In Sync, Levinson, LYCA, Miller & Kreisel, Nautilus, Opus, Orinda, Philips/Mercury, Proprius, RCRN (Japan), Sarastro, Sheffield, Sound Environment, Telarc, Three Blind Mice, Toshiba, Umbrella, Varese Sarabande.

Vinyl Solution (Rec. & Tape OS)—Sales Mgr.: Rick Shedd—see Gamco. Warner/Elektra/Atlantic Corp., 4930 W. 77 St., Suite 235, Edina 55435. Tel: 835-7255. Sales Mgr.: Rick Cohen. (Rec. & Tape D—see office in Los Angeles, Calif., for prod. distributed)

MISSISSIPPI

● **JACKSON (Area Code 601)**

Bennett's Rec. Dist's Inc., 3109 Delta Dr. Zip: 39213. Tel: 981-4328. Owner & Mgr.: James Bennett, Buyers: Sheila Bryant, James Bennett. (Rec. & Tape OS) Playback equip.: Craig Accessories: Capitol, Finetone, Pfanstiehl

MINNESOTA

● **MINNEAPOLIS-ST. PAUL AREA (Area Code 612)**

Brown Bros. Inc., 3346 Washington Ave. N., Minneapolis 55412. Tel: 522-6648. Pres.: Raymond W. Brown. (Rec. OS)

MISSOURI

• **JOPLIN (Area Code 417)**

Legg Supply Co., PD Box 2368, 3403 Schifferdecker. Zip: 64801. Tel: 781-3327. Owner: Gene Legg; Mgr: Nona Legg; Buyer: Gary McBride. (Tape RJ)

• **KANSAS CITY AREA (Area Code 816)**

C B S Recs., 2460 Pershing Rd., Suite 200. Zip: 64108. Tel: 842-9898. Branch Mgr: Bryan Martinovic. (Rec. & Tape D—see New York, N.Y., office for prod. distributed)

Davidson's One Stop Phono Recs., 321 Southwest Blvd. Zip: 64108. Tel: 842-5220. Owner: Mildred S. Davidson; Mgr: Velma Gobble; Buyers: Singles, Harold Hassler; Albums, N. S. Davidson; Tape, Velma Gobble. (Rec. & Tape OS)

Eklund Ent's. Inc., 1915 Truman Rr. Zip: 64127. Tel: 474-7628. Owners: Lee & Jean Eklund; Mgr: Lee Eklund; Singles, Albums & Tape Buyer: Clifford Moore. (Rec. & Tape OS & RJ)

Handelman Co., 1137 Saline St., North Kansas City 64116. Tel: 421-0135. (Rec. & Tape RJ)

Home office: Clawson (Detroit Metropolitan Area), Mich. House Dist's, 4128 Broadway, Zip 64111. Tel: 561-2744. Owner: Harold S. Brody; Gen. Mgr.: Kevin Papuga; Buyer: Lane Turner; Dpns Mgr: Dave Conn. (Rec. & Tape D)

Branches: Los Angeles, Calif.; Denver, Colo.; Atlanta, Ga.; Chicago, Ill.; Driftwood, Tex.

Labels: AEI, Abbey, Accent, Advent, Aeco, Airborne, Aircheck, Ajax, Ajaz, Alligator, Alternate Energy, Arrazing, American Gramophone, American Heritage, Arabesque, Archive o Folk & Jazz, Archive of Piano, Arhoolie, Armadillo, Attack, Audio Directions, Aviva, BBC, B&C, Bach Guild, Bandstand, Baobab, Bee Hive, Bet-Car, Biograph, Black Saint, Blind Pig, Blue Goose, Blue Night, Blue Rhythm, Blues Classics, Boa, Bob, Boot, Brandywine, Briar, Bullfrog, Bunny Le.; Burning Sounds, CBS (Imports), CMH, CRI, Caedmon, Candy Apple, Cardinal, Carib, Center, Cerebus, Chalfont, Charmers, Chicago Slide, Chym.; Citadel, Classic Int'l Filmusicals, Clock Tower, Club of Spade, Columbia Special Prod., Concord Jazz, Conflict, Contemporary, Corinthian, Courty, Cowboy Carl, Creative World, Croaker, Curtain Calls, Cynda, Dance Ae obelms, Delmark, Delos, Direct Disc, Dirty Shame, Discovery, Disc Presser, Dolphin, Dragon, Dreamstreet, El Camino, Epiphany, Everest, Everyman, Exact, Fanfare, Fantasy, Flying Fish, Flying High, Flyright, Folk Lega y, Folklyric, Folkways, Fox, Freckle, Fretless, Front Hall, Full Circle, G-IE, GNP Crescendo, Gael Linn, Galaxy, Gatemouth, Gateway, Generat'n, Giants of Jazz, Glendale, Golden Age, Good Time Jazz, Gospel Truitt, Gramavision, Gramercy 5, Grapevine, Grass Mountain, Greenhays, Green Linnet, Greensleeves, Grenadilla, Gusto, Halcyon, Hammer, Hani ah, Helios, High Note, Historical, Hit & Run, Hollywood Soundstage, Hor eyedew, Horselips, Improvising Artists, India Navigation, Interplay, JB, Jazz a la Carte, Jazz Archives, Jazz Classics, Jazz Works, Joyce, June Appal, I aleidoscope, Kaya, Kaycee Jazz, Kaydee, Kicking Mule, King, Klavier, Le: ther, Legacy, Le Roi du Blues, Longhorn, Lost, Lyricbird, MCA (Imports), M&K Real Time, Magi, Maggie, Mamlish, Manmade, Matrix, Medallion, Helodeon, Micron, Milestone, Mr. Blues, Mission Music, Mobile Fidelity, Monitor, Mooncrest, Moonlight, Morning Star, Mountain Railroad, Mulgan (Imports), Muscraft, Musicworks, Muskadine, Natural Organic, N ssa, Newworld, Night Hawk, No Big Deal, Nomad, North Country, Oblique, Official, Didie Blues, Old Timey, Dlympic, Dmnisound, Dnari, Drigon Jazz Library, Dval, Palo Alto, Pandora, Pausa, Payola, Pearl, Philo, Phoenix Jazz, Pioneer, Powerpak, Prestige, Professional Music Prod'ns, Pumpkin, Rabbit, Radiola, Ramblin', Razor, Reality, Rebel, Red Lightning, Regency, Release, Rhino, Ridge Runner, Riverside, Rooster, Rosetta, Founder, Russell, Sackville, Sail, Sandy Hook, Sarge, Senta, 1750 Arc, Shadow, Shanachie, Shasta, Sheffield, Shloh, Shoestring, Simmons, S nglebrook, Sirens, Sky, Solid Smoke, So net, Soulnote, Soundtrack, Sp eey, Spokane, Starday, Starlight, Starlog, Slash, Stax, Steeplechase, St H, Strong, Sugar Hill, Sunbeam, Symphonica, Syndicate Chapter, Sy tonic Research, T-Shirts, TRC, Tara, Taxi, Tee Vee, Telarc, Texas Re-Cord, Theresa, Topic (Imports), Totem, Tradition, Train on the Island, Transatlantic, Treasure Isle, Trend, Trident, Tris, Trojan, Troubadour, Union Pac fic, VGM, Vanguard, Varese Int'l, Violet, Virgin, Voyager, Wagon Tracks, War Bride, Waterhouse, Who's Who, Windham Hill, Windswept, Xanadu, fazoo (SEE ADVERTISEMENT)

Lieberman Ent's. Inc., 6131 Deranus Rd. Zip: 64120. Tel: 231-2470. Mgr: Bob Pockrandt; Dpns Mgr.: Tony Burasco; OS Mgr.: Mike Clark; Buyers: Singles, Carolyn Brooks; Albums: Steve Miller. (Rec. & Tape OS & RJ) Home office: Minneapolis, Minn.

Progress Rec. Dist'g Inc., 4340 Rockhill Rd. Zip: 64110. Tel: 531-1048. (Rec. & Tape D)

Home office: Elk Grove Village (Chicago Metropolitan Area), Ill—see for prod. distributed

Warner/Elektra/Atlantic Corp., Plaza Center Bldg., Suite 323, 800 W. 47 St. Zip: 64112. Tel: 561-5623. Sales Mgr: Dennis Schone. (Rec. & Tape D—see office in Los Angeles, Calif. for prod. distributed)

Windy Dist. Co. Inc., 13624 E. 50 Hwy. Zip: 64138. Tel: 524-8766. (Rec. D)

Labels: Aslan, Birdwing, Breac N Honey, Catvary, Canaan, Dayspring, Good News, Great Circle, Green ree, Heart Warming, Lamb & Lion, Light, Maranatha, Messianic, Milk & Honey, Myrrh, New Leaf, Newpax, New Song, Paragon, Peaceable, Ser d, Singcord, Solid Rock, Sparrow, Star song, Word.

• **ST. LOUIS METROPOLITAN AREA (Area Code 314)**

Great Atlantic & Pacific Music Co. 3310 Lucas Ave. Zip: 63103. Tel: 531-4644. TWX: (910) 761-0487. P.r.s.: Norman Hausfater; Mgr.: Lester Neal. (Rec. & Tapes I & E) (SEE ADVERTISEMENT)

L & R Dist'g Inc., 1901-05 Delma Blvd. Zip: 63103. Tel: 421-3622. Pres: Lewis Ruben, Singles Buyer: Robert Love. (Rec. OS)

M C A Dist'g Corp., 9666 Dive St., Suite 100. Zip: 63132. Tel: 991-3015. Branch Mgr: Mike Smith. (Rec. & Tape D—see office in Los Angeles, Calif. for prod. distributed)

M S Dist'g Co., 200 S. Hanley, Clayton 63105. Tel: 862-7575. Mgr: Terry Pasquale. (Rec. & Tape D)

Home office: Morton Grove (Chicago Metropolitan Area), Ill. (See for prod. distributed)

Middlewest Rec. Dist. Co., 1911 Yashington. Zip: 63103. Tel: 621-8350. (Rec. D)

Labels: BC, Brunswick, Cadet, Century 21, Churchill, DK, Dana, Diversified, Emergency, Enjoy, Gil'sunny, Gold Band, Gusto, ICA, Jewel, K

INDEPENDENT DISTRIBUTOR IN THE MIDWEST



Denver • Austin • Chicago • Kansas City • St. Louis • Atlanta

House Distributors

4128 Broadway
P.O. Box 5935
Kansas City, Mo. 64111
800-821-3324 - (816) 561-2744

CUT-OUTS

and **OVERSTOCK**
LP's — CASSETTES — 8-TRACKS

WE BUY FOR CASH
ANY AND ALL
QUANTITIES OF
SURPLUS, CUT-OUTS,
DELETES &
LP's & TAPES

JAZZ • ROCK • C&W
EASY LISTENING

If You Are In The Business
Of Cut-Outs—WE SHOULD
BE DOING BUSINESS

WE ARE EXPORT PROFESSIONALS

We Service Everyone, Small & Large, Promptly

Write or call for our complete catalog!

GREAT ATLANTIC & PACIFIC MUSIC CO.

3310 Lucas Ave., St. Louis, Missouri 63103
314-531-4644 TWX 910-761-0487 CAPMUSCO-STL

Arik, Kari, Key, LA, MSK, Malaco, Nashboro, Q&A, Savoy, Sound Factory, Sugar Hill, TEC, VR, West End, Wheel
 P B One Stop Rec. Serv. Inc., 1919 21 Washington St Zip 63103 Tel 331-2074 (Rec. & Tape OS & RJ)
Playback equip., & phonographs: Rotel of America
Accessories: Audio Magnetics, Le-Bo, Memorex, Planstehel, Savoy
 Pickwick Dist'n Cos., Rack Servs Div., 1600 Heritage Landing, Suite 212 C, St. Charles 63301 Tel 441 1351 Sales Mgr John Rabe (Rec. & Tape RJ)
Home office: Minneapolis, Minn
 Progress Rec. Dist'g Inc., 200 S Hanley Rd., Suite 517 Clayton 63105 Tel 727 3886 (Rec. & Tape D)
Home office: Elk Grove Village (Chicago Metropolitan Area), Ill --see for prod. distributed
 R C A & A&M & Assoc'd Labels, 2086 Craigshire, Suite Q Zip 63141 Tel 878 5454 Mgr Fred Love, (Rec. & Tape D--see New York, N.Y. office for prod. distributed)
 Record-Wide Dist. Inc., 1755 Chase Dr., Fenton 63026 Tel 343 7100 (Rec. & Tape D & RJ)
Distributes cutouts, surplus, major & budget lines, mid-lines
 Sound Disk Tributors Inc., 8006 Dale Zip 63117 Tel 781 9270 Pres John Mandelker, VP Steve Ferzacca, Video Sales Mgr Dan Thompson, Ware house Mgr Randy Shure, Buyers Singles, Tom Lunt, Albums, Terry Perkins, Tape, Rick Sanford, Accessories, Rick Phlegley, Advertising Co-ord John DeRoy (Rec. & Tape DS)
Videocassette lines: CBS/MGM, Columbia Pictures, MCA, Magnetic Video, Nostalgia Merchant, Paramount, Video Gems, Warner Bros
 Top Notch Rec. Co., 20 Country Fair, Zip 6314 Tel 991 0909 (Rec. & Tape RJ)
 Uptown Music Inc., 4703 McPherson Zip 63108 Tel 367 2602 Dwner & Singles Buyer Betty Dorrin, Mgr. Albums & Tape Buyer Mike Dorrin (Rec. & Tape DS)

• SPRINGFIELD (Area Code 417)

Journeyman Ent's, 1447 E. Kearney Zip 65803 Tel (417) 866-5715. Pres Thurman Aldridge, Mgr. Morene Thomas
Labels: Calvary, Canaan, DIP, Dayspring, Everlasting, Good Life, Good News, Greentree, Heart Warming, Image VII, Impact, Lamb & Lion, Light, Maranatha, Milk & Honey, Myrrh, New Dawn, Yewpax, New Song, Paragon, Rainbow, Seed, Singcord, Singpiration, Skylite, Solid Rock, Su preme, Word

MONTANA

• BUTTE (Area Code 406)

C J Co., 1006 S Montana St Zip 59701 Tel 792-0747 Dwner Craig Foley, Mgr. Albums & Tape Buyer Joe Barger (Rec. & Tape DS & RJ)
Accessories: Le Bo, Majestic, Memorex

• GREAT FALLS (Area Code 406)

Holm-James Dist's Inc., Fourth Ave & Sixth St S Zip 59401 Tel 761 2420

Dwner R E Holm, Buyer J E Holm (Rec. & Tape D & RJ)
Labels: Capitol, Columbia group, Disneyland, London, MCA group, Mercury, RCA, Ranwood, United Artists, WEA
Playback equip.: Akai, Emerson, Hitachi, Motorola
Phonographs: Hitachi
Accessories: Fidelitone, Koss, Le-Bo, Scotch

NEBRASKA

• OMAHA (Area Code 402)

Northwest One Stop, 8461 Lake Zip 68134 Tel 391 4922 (Rec. & Tape DS)
 Records & Tapes Inc., 13533 I Circle Zip: 68137 Tel 344 3344 Mgr Brian Harden; Buyers Curt McKean, Bill Shearer; Accessories, Dave McKee (Rec. & Tape DS & RJ)
Accessories: Audio Technica, Cartron, Dishwasher, Empire, Fuji, Maxell, Memorex, Nortronics, Savoy, Servace, TDK, Thunderfoot
 Research Servs Inc., PO Box 31110 Zip 68131 Tel 393 0265 Dwner C L Wintz; Mgr R P Wintz, Buyer Daniel J Wintz (Rec. & Tape RJ)

NEVADA

• LAS VEGAS (Area Code 702)

International Music Prod'n & Publ'g, 714 E Sahara Ave., Suite 201 Zip 89104, Tel 457 0812/2775 Dwner Joseph E Zerga (Tape I & E)
Imports pre-recorded tape from Austria, Germany, Italy, Switzerland, UK

NEW HAMPSHIRE

• LEBANON (Area Code 603)

World Wide Whistle Dist., 15 Parkhurst, Zip 03766 Tel 298 7953. Dwner, Mgr & Buyer Earl Heath (Rec. & Tape D & RJ)
Labels: American Heritage, Country, Jessup, Melody, Pine Tree, Rebel, Revonah, Rounder, Stoneway
Playback equip.: AITC, AR, Acmiral, Aiko, BSR, Craig, Electroponic, Emerson, JVC, Juliette, Magnus Morse, Panasonic, RCA, Sanyko, Sanyo, Solar, Sony, Sylvania

• NASHUA (Area Code 603)

R M E Inc., Simoneau Plaza, 300 Main St Zip 03060 Tel 883 2454 Dwner Tom Plaut (Rec. & Tape RJ)

NEW JERSEY

• AVENEL (Area Code 201)

Sutton Rec. Co., 22 G Craigwood Rd Zip 07001 Tel 382 7770 Dwners James & David Sutton; Mgr & Buyer Jeff Sturman (Rec. & Tape RJ, I & E)
Imports & exports cutouts, over runs, special prods

• CHERRY HILL (Area Code 609)

R C A & A&M & Assoc'd Labels, 1101 Kings Hwy N., Suite G-102, Zip 08002 Tel 779 0920 Mgr Art Weissman (Rec. & Tape D--see New York, N.Y. office for prod. distributed)
 Schwartz Bros Inc., 1101 Kings Hwy N., Suite 104 Zip 08002 Tel 482 2136, Philadelphia Tel (215) 923-1271 Mgr Richie Salvador (Rec. & Tape D)
Home office: Lanham, Md
Labels: Abel, Airwaves, Alfa, American Gramophone, Ariola, Arista, Audio Arts, Benson, Birthright, Black Label, Buddha, Canaan, Chalel, Chris, Church Door, Concord Jazz, Creed, DRG, Dayspring, Day Star, Dealer's Choice, Devaki, Direct Disc, Dore, EGL, Ernie's, Exact, Exello, Excelsior, GHE, GRP, Good News, Gordy, Greentree, HSE, Heart Warming, Hindsight, Impact, Insight, JAM, Jeremiah, Jewel/Jim, Juana, Judane, Kenwood, Kudu/Motown, Lamb & Lion, Language 30, Lifesong, Light, Locus, Luminar, Malaco, Mirus, Motown, Myrrh, NRG, Nashboro, National Resources, New Birth, New Pax, New Song, Novus, Original Sound, Dur Gang, Dva Iton, PAID, Paragon, Paul, Pickwick, Plantation, Polish, Praise, Pray, Prelude, Prism, Pro Arte, Prodigal, Project 3, Quintessence, Rainbow Sound, Rare Earth, Reflection, Ronn, SSS Int'l, Sam, Savoy, Seed, Seeds & Stems, Sesame Street, Short Pump, Skylite, Solid Rock, Soul, Sound of Gospel, Specialty, Stet, Strff, Sun, Sunbird/Pickwick, Sunshine, Super Disc, Sutra, TK, TR, Tania, Telarc, Tomato, Triangle, Vesper, Vintage, Wheel, Word
Accessories: Allsop, Ampex, Audio Technica, BASF, Duracell, Empire, Maxell, Memorex, Pickering, Recoton, Scotch, Shure, Sony, Sound Guard, TDK

• CINNAMINSON (Area Code 609)

Alex Araco Co Inc., 835 Industrial Hwy Zip 08077 Tel 829 4813 Dwner Alex Araco, VP Vincent Datilio, Sales Mgr Fred Edwards, Dpns Mgr Eddy Garrow (Rec. & Tape D, DS & RJ)
Distributes cutout albums & tapes

• COLLINGSWOOD (Area Code 609)

M C A Dist'g Corp., 900 Haddon Ave., Suite 206 Zip 08108 Tel 854 5810, Philadelphia Tel (215) 922 5659 Reg'l Dir Ron DeMarino, Branch Mgr Bob Speca (Rec. & Tape D--see office in Los Angeles, Calif., for prod. distributed)

• EAST BRUNSWICK (Area Code 201)

P R D B Dist's, Inc., 742 Hwy 18 Zip 08816 Tel 257-3336. Dwners Powell Gary Saks, Joseph P Ingegno; Mgr. Joseph P Ingegno, Buyer Powell Gary Saks (Rec. & Tape D, OS & RJ)
Labels: Arabesque, CMS, Caedmon, Cambridge, Camden, Candide, Chal font, Citadel, Columbia Special Prods., Delos, Desmar, Desto, Disneyland, Educational Activities, Folkways, Gateway, Golden, MMG, Newbery Award, Pathways of Sound, Peter Pan, Pickwick, Quintessence, RCA Educational, RCA/RVC (Japan), Scholastic, Simon Says, Spoken Arts, Telarc, Titanic, Turnabout, Turn Dn, Unicorn (Imports), Varese Sarabande, Viking Press, Vox
Accessories: Maxell, Memorex, Recoton, TDK

• ENGLEWOOD CLIFFS (Area Code 201)

G L P Int'l (div of German Language Pub'ns Inc.), 560 Sylvan Ave. Zip 07632 Tel 871 1010, NYC Tel (212) 736 7455 Pres Peter J Perske, Rec. Div. Mgr C. Victoria Gavalas, Sales & Mktg Dir James C Banthos (Rec. & Tape D, I & E)
Labels imported: Ariola, EMI-Electrola, Eurodisc, Europa, Europa-Klassik, Fontana, Hansa, Jupiter, Maritim, Metronome, Philips, Polydor, RCA, Sonic (all Germany)
Take Home Tunes, PO Box 1314, Zip. 07632 Tel 224 5811 Mgr & Buyer Doris Yeko (Rec. D)
Branch: Georgetown, Conn
Labels: Broadway Baby, Chu-Yeko Musical Foundation, Film Score, Original Cast, Painted Smiles, Take Home Tunes

• FORT LEE (Area Code 201)

Bonded Servs., 2050 Center Ave Zip 07024 Tel 592 7868, NYC (212) 695 2034 (Tape & Film Storage) (SEE ADVERTISEMENT)

• HILLSIDE (Area Code 201)

Apex Martin Rec. Sales Inc., 467 Mundell Pl. Zip 07205 Tel 964-5960. Dwner Sam Weiss; Pres Sol Gleit, Buyers, Singles, Jamie Fortland, Albums & Tape, Joe Martinez (Rec. & Tape DS & RJ)
Accessories: Maxell, Memorex, Walco

• HO HO KUS (Area Code 201)

Shanachie Recs Corp., Dalebrook Park 07423 Tel 445 5561 Pres Richard Nevins (Rec. D & I)
Labels: Harwin, Morning Star, Rockers, Shanachie
Labels imported: Affinity (UK), Bool (Canada), CBS Int'l, Charly, Clad dagh (Ireland), Flyright (UK), Gael Linn (Ireland), Generation (Canada), Greensleeves (UK), MCA (UK), Red Lightnin' (UK), Tara (Ireland), Topic (UK), Trojan (UK), Virgin (UK)

• IRVINGTON (Area Code 201)

Diericks Vending Co. Inc., 1316 Springfield Ave Zip 07111 Tel 371-0777 (Rec. & Tape OS & RJ)
 Elmar Assocs., PO Box 301, 45 Dakland St Zip 07111 Tel 399 0119 Prin cipal: Victor Kapliff (Rec. D)
Labels: Distinct, Dove, Input, Iskra, Ruta

• MARLTON (Area Code 609)

Warner/Elektra/Atlantic Corp., PO Box 966, 500 Lincoln Dr Zip 08053 Tel 596 1200, Philadelphia Tel (215) 923 2700 Branch Mgr. Pete Stocke, Sales Mgr Rich Cervino (Rec. & Tape D--see office in Los Angeles, Calif., for prod. distributed)

RECORDS & TAPES, INC.

CALL TODAY !

Watts line: 1-800-228-9543

Nebraska Calls: 402-330-3013

FULL LINE RECORD AND TAPE ONESTOP

(Contact Brian Harden)

FULL LINE HI-FI, CAR STEREO, BLANK

TAPE AND ACCESSORY ONE-STOP

(Contact Dave McKee)

THE PLACE TO GO FOR THE NAMES YOU KNOW!

Records and Tapes, Inc.

13533 I Circle • Omaha, Nebraska 68137

● **MOUNT LAUREL (Area Code 609)**

Lieberman Ents Inc., 823 Eastgate Dr., Unit 3 Zip 08054 Tel 234 9150
 Mgr Ken Sattler, Opns. Mgr John Holman, Singles, Albums & Tape
 Buyer Mark La Spina (Rec. & Tape RJ)
 Home office: Minneapolis, Minn (Rec. & Tape OS & RJ)

● **NEWARK (Area Code 201)**

Folkraft/Dance Rec. Dist. (div. of Folkraft Publ'g Co. Inc.), 10 Fenwick St
 Zip 07114 Tel 243 8700 (Rec. D, I & E; Tape E)
 Labels: Belco, Blue Star, Boger, Folkraft, Grenn, Hi Hat, Hootor, J Bar K,
 Jewel, Kalox, Kismet, Kolo Festival, MacGregor, Old Timey, Pilgrim,
 Pulse, Scope, Sets in Order, Square L, Tikva, Top, Wagon Wheel, Windsor,
 Xopo, Young People's Recs
 Rec. labels imported: Tanz (Germany) Jugoton RTB (Yugoslavia)
 Exports pre recorded tape & payback equip
 In A Spin Rec. Corp., 204 Vanderpol St Zip 07114 Tel 243-0518 Owner,
 Singles, Albums & Tape Buyer Raymond Springer (Rec. & Tape I & E)

● **NEW BRUNSWICK (Area Code 201)**

Performance Rec & Tape Dist., 332 George St Zip 08901 Tel 545 3004
 (Rec. & Tape I & E—cutouts, overstocks, promos) (SEE ADVERTISEMENT)

● **NORTH BERGEN (Area Code 201)**

West Side Sound Dist. Inc., 1405 2 St Zip 07047 Tel 866 5188 (Rec. &
 Tape D)
 Home office: New York, NY (see for prod distributed)

● **OAK RIDGE (Area Code 201)**

R N S Inc., 7 Manor Dr Zip 07431 Tel 697 2212 Owner & Albums Buyer
 Robert N. Schwartz, Mgr Gar Pranciklas (Rec. D, OS, RJ & E)
 Labels: Century, Crystal Clear, Direct Disk Labs, M&K, Nautilus, Orinda,
 Sound 80
 Accessories: Metrosound

● **PASSAIC (Area Code 201)**

New York Rec & Tape Dist. Inc. (Rec. D & E, Tape E), see Surplus Rec &
 Tape Dist
 Surplus Rec & Tape Dist /New York Rec & Tape Dist. Inc. 84 184 Dayton
 Ave., Bldg 5A Zip 07055 Tel 778 0877, NYC Tel (212) 695 6117
 Owners: Manny G. Wells, Merri I. Rose, Buyers: Jack Rose, Pete Hyman
 (Rec. D & E, Tape E)
 Home office: Chicago, Ill
 Distributes cutouts (SEE ADVERTISEMENT)

● **PATERSON (Area Code 201)**

Promo Rec Dist'g Co Inc., 160 E Fifth St Zip 07524 Tel 279 2010 Con
 tacts: Carl Post, Max Goldstein (Rec. & Tape D)
 Labels: Emus, Ghent, also distributes overstocks, cutouts, TV prod (SEE
 ADVERTISEMENT)

● **PENNSAUKEN (Area Code 609)**

Bandstand Rec. Serv., 9242 Commerce Hwy Zip 08110 Tel 665 8200
 Pres & Gen. Mgr. Ernie Santonio, Sales Mgr. Mario Daulerio (Rec. &
 Tape DS & RJ)
 Richman Bros Recs Inc., 6935 Air ort Hwy Ln Zip 08109 Tel 665 8085
 Philadelphia Tel (215) 477 17-2 Owners: Jerold, Alan & Richard Rich
 man, Gen. Mgr. Jerold Richman, Buyers: Singles, Woody Oyer, Albums,
 Tim Comerford, Ted Neumann, Aike Ferguson, Tape, Sam Cass (Rec. &
 Tape D & DS)
 Branch: Silver Spring, Md
 Labels: Adelphi, Alligator, Amaz ng, Ambition, Archive of Folk & Jazz, Ar
 hoolie, BFD, Back Door, Bay, Behieve, BelCar, Biograph, Blind Pig, Blue
 Goose, Blues Classic, Bomp, Cat h, Clean Cuts, Concert Disc, Conga, Con
 temporary, Counterpoint, County, Courtsane, Creative World, Delmark,
 Discovery, Dreamstreet, Dutch Treat, Encore, Entr' Acte, Everest, F&W,
 Fiesta, Flying Fish, Flying High, Folk Legacy, Folklyric, Folkways, Freckle,
 Fretless, Front Hall, GNP Crescendo, Gatemouth, Grass Mountain, Green
 Dolphin, Greenhays, Green Linn-t, HOS, Hannibal, Herwin, Hindsight, In
 dia Navigation, Interplay, Iron Horse, JCOA, Jazzworks, June Appal, Kalei
 doscope, Kent, Kicking Mule, Leather, Legacy, Likeable, Lynn, Midnight,
 Monitor, Monmouth/Evergreen Mulligan, Music Craft, Nessa, Nine
 Winds, Official, Omni Jazz, PM, I also Alto, Philo, Pot Luck, Radiola, Rebel,
 Rhino, Ridge Runner, Rollin' Fock, Rough Trade, Rounder, Sail, Sha
 nachie, Sierra Briar, Solid Smoke, Slash, Steeplechase, Sugar Hill, Swai
 lowtail, Theresa, Very Disco, Vetro, Watt, Windham Hill, Yazoo, Zim
 Videocassette lines: MCA, Warner Bros
 Accessories: BASF, Bowers, Osi-washer, Dynasound, Fidelitone, Gopher,
 Maxell, Memex, Memorex, Nor-ico, Peerless, Pfanstiehl, Savoy, Sound
 Guard, Stak-It, TOK, Tempo, Venco, Watts
 Shulman Rec. Co. Inc. 7030 Colonial Hwy Zip 08109 Tel 662 8870 Own
 ers: Jerome Shulman, Lee Swed, Mgr. Manny Drucker, Buyers: Singles,
 Gary Shulman, Albums & Tape: Manny Drucker (Rec. & Tape RJ)

● **PRINCETON (Area Code 609)**

Princeton Rec. Exchange, 20 Nass u St Zip 08540 Tel 921 0881 Owner
 Barry Weisfeld (Rec. D—new, used, discontinued prod)

● **RAHWAY (Area Code 201)**

A B A Rec. Dist. Inc., 1467 Pinewood St Zip 07065 Tel 574 0900 Owner &
 Albums Buyer Al Btensky (Rec. & Tape D, I & E)
 Labels: Bethlehem, Bright Orange, Everest, Jazz Bird, Kent, Nutmeg,
 Olympic, Phoenix 10/20, United, also distributes cutouts (SEE
 ADVERTISEMENT)

● **SOMERVILLE (Area Code 201)**

Polka Hits, 331 Triangle Rd Zip 07876 Tel 359 5520 Owner & Buyer B L
 Goydsh, Mgr C Goydsh (Rec. & Tape D, OS & RJ)
 Labels: Ashire, Ampol, Baywa - Bel Aire, Chicago Sound, Oata, Oyno,
 Eastwind, Fantastik, Garden State, Goodwill, Ha Lo, Jay Jay, Jody, Ke
 rebo, L Kay, Le Mans, MGM, Maxim, Rave, Rex, Ridge, Rm, Rola, Starr,
 Stejlo, Stella, Tip, Usana, Wan

CUT-OUTS AND MANUFACTURERS' OVERSTOCKS



- AMERICA'S MOST COMPLETE STOCK OF MAJOR LABEL LONG PLAYING RECORDS, 8-TRACKS AND CASSETTES.
- ROCK, COUNTRY, DISCO, JAZZ, CLASSICAL, TV PRODUCT
- SEND FOR OUR FREE CATALOG
- FASTEST SHIPMENTS, IMMEDIATE DELIVERY

PLUS
EMUS/GHENT

AMERICA'S BEST ECONOMY JAZZ & ROCK LABELS
 TRY US . . . YOU'LL LIKE US!

**PROMO RECORD
DISTRIBUTING COMPANY**
 160 EAST 5TH STREET, PATERSON, NEW JERSEY 07524
 201-279-2010 WORLDWIDE TELEX 130463

PERFORMANCE Record & Tape Distributors



CUT-OUT & OVERSTOCK LPs, Cassettes, Imports 45

Find out why people say that ours . . . is the best cut-out list I've ever seen . . . Specializing in rock, jazz, new wave and hard to find LP's. We Export. Call or write for your catalog today.

382 George Street, New Brunswick, N.J. 08901
 (201) 545-3004 Telex: 642876

Jem RECORDS DISTRIBUTION

*Exclusive national distribution and marketing for PASSPORT, VISA, PVC, EDITIONS E.G., VIRGIN INTERNATIONAL, SLASH, RED STAR, and RATICITY, and ROCKY HORROR.

*National distributor for RALPH, RHINO, 99, 415, DB, POSHBOY, and other fine American "indie" labels.

3619 Kennedy Road, South Plainfield, New Jersey 07080 - (201) 753-6100
 18629 Topham Street, Reseda, California 91335 - (213) 996-6754



• **SOUTH PLAINFIELD (Area Code 201)**

JEM Recs. Inc. PO Box 362, 3619 Kennedy Rd. Zip 07080 Tel 753-6100
 Pres: Martin Scott, VP: Ed Grossi, Treas: Jeff Tenenbaum, Comptroller: Howard Herbitter, Gen. Mgr: Rick Lawler, Sales Mgr: Bob Grossi, Mktg Dir: Andy Miele, Prod'n Mgr: Phyllis Pannovic-Craig, Art Dir: Murray Brennan (Rec. & Tape D & I)
 Branch: Reseda (Los Angeles Metropolitan Area), Calif., JEM Recs. West Inc.
 Int'l branch: England, Pacific Recs
 Labels: Bomp, DB, Clone, EG, Felush, 415, 99 PVC, Passport, Posiboy, Ralph, Rat City, Red Star, Rhino, Slash, Twin Fone, Virgin Int'l, Visa
 Labels imported: A&M (Canada, UK), Aquarius (Canada), Arista (UK), Armageddon (UK), Atlantic (France, Germany, UK), Attic (Canada), Barclay (France), Beggars Banquet, Brain (Germany), CBS (Canada, Denmark, France, Germany, Netherlands, UK), Charisma (UK), Charly (UK), Chiswick (UK), Chrysalis (UK), Contour (UK), Oecca (Germany, UK), Oeram (UK), Ondisc, EMI (France, Germany, UK), Egg (France), Electra (France, UK), Electric (UK), Ember (UK), Epic (UK), F Beat, Factory, 4 AD, (UK), Fresh (UK), Go Feet, Golden Hour (UK), Gull (UK), Harvest (UK), Island (UK), Korova, Laser, MCA (UK), MLP (UK), Metronome (Germany), Nems (UK), Object, Obscure (UK), Phonogram (France, Germany, Italy, UK), Polydor (France, UK), Purple (UK), Pye (UK), RAK (UK), RCA (France, Germany, UK), Real, Rocket (UK), Rough Trade, Sire, Sky (Germany), Sonel (UK), Siff (UK), Sunset (UK), Threshold (UK), Transatlantic (UK), Trojan (UK), 2 Tone, United Artists (Canada, UK), Vertigo (Ger

many, UK), Virgin (UK), Warner Bros (Germany, UK), Zoo (SEE ADVERTISEMENT)

• **SPRINGFIELD (Area Code 201)**

Prime Dist., 155 US 22 E. Zip 07081 Tel 379 9642 Owners: Oave Casey, Ralph Schechtman (Rec. OS)
 Profit Sales Dist. Inc., PO Box 176 Zip 07081 Tel 379 9640 Owners: Ralph Schechtman, Oave Casey (Rec. D & RJ)
 Labels: Audio Arts, Creed, Glori, HSE, Inspirational Sounds, Jam Sessions, Jewel, Kenwood, Nashboro, Paula, Pegasus, Reborn

• **TEANECK (Area Code 201)**

Hungaria Recs. Inc., PO Box 2073, Zip 07666 Tel 343 5240, Exec. Dir: Frank Di Marsico, Treas: Edward Frederick, Opns Mgr: John MacGregor
 Kalman Magyar, Prod Mgr: Samuel Jackendoff (Rec. D, I & E)
 Labels: Hazam, Hungaria, Hungaroton, Magyar, Peprita, Qualiton, Saban, Supraphon

• **UNION (Area Code 201)**

All Service One Stop Inc., 950 Greeley Ave. Zip 07083 Tel 686 3500 Pres: Frank Di Marsico, Treas: Edward Frederick, Opns Mgr: John MacGregor
 One Way of New Jersey, 1080 Garden State Rd. Zip 07083 Tel 964 6222
 VP & Gen Mgr: George Zarembo (Rec. OS & Tape E)
 Branch: Cleveland, Ohio

Transcontinent of New Jersey, PO Box 405, 1080 Garden State Rd. Zip 07083 Tel 964 6222 (Rec. & Tape OS & RJ)
 Home office: Buffalo, N.Y., Transcontinent Rec. Sales

• **WESTVILLE (Area Code 609)**

American Rec. Sales Inc., 1120 Crown Point Rd. Zip 08093 Tel 848 1900
 Pres & Buyer: Bill Buster; VP: Antony W. Colombet, Mgr: Bill Carlin, Singles Buyer: Bill Buster (Rec. OS-45rpm oldies) (SEE ADVERTISEMENT)

NEW MEXICO

• **ALBUQUERQUE (Area Code 505)**

Del Norte Rec. Dists., 1930 Gun Club SW Zip 87105 Tel 877 2070 Dwner & Buyer: Bennie Martinez, Mgr: Margaret Martinez (Rec. & Tape D & OS-Spanish & Indian prod.)
 Labels: Alta Vista, Apache, Apache Spirit, Buena Suerte, DLB, Del Norte, Hacienda, Hermanos, JBO, Navajo Sundowners, Sunrise
 Hurricane Rec. Dists., PO Box 3547, 1927 San Mateo NE Zip 87110 Tel 265 4039/3049 Owners: Al, Morrie, & B Sanchez, Mgr: Al Sanchez, Buyer: Morrie Sanchez (Rec. & Tape D & RJ)
 Labels: Alegre, Arcano, Buena Suerte, Casanova, Caytronics, Columbia, Cristy, DLV, Dmsa, Discuba, Disneylandia, Dominante, Eco, Falcon, Fred die, Gas, Good Luck, Hurricane, Keyloc, Magda, Marsol, Mex Melody, Miami, More, Mother Lode, Musart, Musimex, Orfeon, Papalote, Parnaso, El Palo, Peerless, RIG, Rovi, Sondo Int'l, Sunglow, Teardrop, Tex Mex, Tico, Torres, Tuna, UA Latino, El Zarape, Zaz, Zeida & most labels from Mexico, New Mexico & Texas
 Linden Dists., 7400 Osuna Rd. NE. Zip 87109 Tel 884-8103 Mgr: Singles & Albums Buyer: L. Blaschke (Rec. & Tape OS)
 Tocino Music Ents., 900 Fourth St. SW Zip 87102 Tel 247 8051 (Rec. & Tape D & OS)
 Labels: Casanova, Cristy, Del Norte, Hurricane, Kiva, Mother Lode
 Accessories: Recoton

NEW YORK

• **ALBANY AREA (Area Code 518)**

Albany One Stop, 1241 Broadway Zip 12204 Tel 434-8396 (Rec. & Tape OS)
 Home office: Buffalo, N.Y., Transcontinent Rec. Sales (Rec. & Tape RJ)
 Bee Gee Dist'g Corp., Shaker Park, Latham 12110 Tel 785-1122 Pres: Lawrence Smith, Exec. Gen. Mgr: Richard A. Margolis, Mdsr. Mgr: Joe Yanulavich (Rec. & Tape D & RJ), (Rec. & Tape OS as Leonard Smith Inc.)
 Labels: Aishre, Arabesque, Audio Fidelity, Bert & I, CMS, Cadet, Caedmon, Canaan, Connoisseur Society, Dana, Disney, Dyno, Everest, Fiesta, First Component, Golden, Greene Mountain, Gusto, Jay Jay, K Tel Do minion, Light, Music Minus One, Myrrh, Original Sound, Peter Pan, Pickwick, Plantation, Project 3, Ranwood, Ronco, Starday, Starr, Turnabout, Vox, Word
 Accessories: E V Game, Hartzell, Le Bo, Maxell, Memorex, Peerless, Recoton, Savoy, Scotch
 Handleman Co., 8 Northway Ln., Latham 12110, Tel 783-5436 (Rec. & Tape RJ)
 Home office: Clawson (Detroit Metropolitan Area), Mich.
 Mobile Rec. Serv. Co., 21-27 Leisuresville, Watervliet 12189 Tel 785-7662
 Mgr: Joseph McNally, (Rec. OS-singles only)
 Home office: Pittsburgh, Pa.
 One Way Recs. Inc., 12 Commercial Rd. Zip 12205 Tel 489-3288, Owner & D. Mgr: David Schlang, OS Mgr: Joe Paone; Tape & I & E Mgr.: Gerald McCarthy; Buyers: Cutout & Overstock Albums, David Schlang; OS Albums & Tapes, Joe Paone (Rec. & Tape D, I & E-cutouts, overstocks), (Rec. & Tape OS & E) (SEE ADVERTISEMENT)
 Accessories: Discwasher, Maxwell, Memorex, TDK
 Leonard Smith Inc. (Rec. & Tape OS), see Bee Gee Dist'g Corp.
 Trans World Music Corp., PO Box 11580, Zip 12211, 874 Albany-Shaker Rd., Latham 12110, Tel: 783-5152 Owner & Pres.: Robert J. Higgins, Gen. Mgr: Frank Griffin, Buyers: Singles, David Roy, Albums, Bob Langford, Dennis Centorranchi (Rec. D & RJ), (Rec. OS as Upstate Music)
 Labels: AA, Amberjack, Audio Fidelity, Bert & I, CMS, Caedmon, Chiaro curo, Column One, Dana, Oesto, Disneyland, Oyno, Everest, Fiesta, First Component, Folkways, GNP, Gateway, Golden, Greophon, Inner City, Lyrrichord, MMG, Monitor, Monmouth-Evergreen, Music Minus One, Nautilus, Olympic, Dryx, Peter Pan, Philo, Phoenix 10, Phoenix 20, Qualiton,

IMPORTING/EXPORTING

*America's largest importer and distributor of rock product.

*One of America's leading exporters of independently manufactured labels.



Jem records

3619 Kennedy Road, South Plainfield, New Jersey 07080 - (201) 753-6100
 18629 Topham Street, Reseda, California 91335 - (213) 996-6754

WE'RE

#1

SURPLUS

Records ★ 8 Track Tapes ★ Cassettes

SEND FOR

FREE CATALOG LISTING (FOR THE TRADE ONLY)

Huge Selection of Manufacturers' Deletions, Overruns, Closeouts.

POP ★ SHOWS ★ MOVIES ★ JAZZ
 COUNTRY & WESTERN ★ ROCK ★ VOCALS
 CLASSICS ★ INSTRUMENTALS and much more!

Cash In On The Extra Profits That Surplus Makes Possible.

IMMEDIATE DELIVERY

WE BUY AND SELL SURPLUS

SURPLUS RECORD

and Tape Distributors

84-184 Dayton Avenue
 Building 5A
 P.O. Box 479
 Passaic, N.J. 07055
 (201) 778-0877 (212) 695-6117
 MANNY WELLS - PETE HYMAN

1120 West Exchange Avenue
 Chicago, Illinois 60609
 (312) 376-8432
 MERRILL OR JACK ROSE

WORLD WIDE TELEX 133404 NY RECORD PAS

Cut-Outs

Albums, 8-Tracks & Cassettes

Proven Sellers for High Profits

plus . . . complete line of Bethlehem, Kent, United, Bright Orange, Everest and many more jazz, blues, gospel and rock labels.



Write or call for Catalog.
RECORD DISTRIBUTORS, INC.
 1467 Pinewood St.

Rahway, New Jersey 07065 201-574-0900

**NUMBER 1
IN CANADA for
OVERSTOCKS
DELETIONS
SURPLUS**

**Special Offers on
All Labels**

**RECORDS
TAPES
ACCESSORIES**

**We Import
and Export**

**LISS
INTERNATIONAL**

3495 Thimons Blvd.
Montreal, Quebec H4R 1V5
Telex: 05824667
(answerback: DYNATRONIC)

Rim, Rounder, Sesame Stree, Supraphon, Telarc, Thunderbird, Turnabout, Vox.

Accessories: Classic I, Discwasher, Empire, Intermagnetics, Le-Bo, Maxwell, Memorex, Planstiel, Recoton, Savoy, Sound Guard, TDK, Watts. Upstate Music (Rec. OS)—Mgr., Singles & Albums Buyer: Dennis Centofranchi—see Trans World Music.

• **AMSTERDAM (Area Code 518)**

Almor Playtime Co. Inc., 140 Guy Park Ave. Zip: 12010. Tel: 843-3801. Pres.: Albert A. Hyman; Singles, Albums & Tape Buyer: Linda Austin. (Rec. & Tape D, OS & RJ)
Labels: Disneyland, Pickwick Int'l.
Accessories: Le-Bo, Maxwell, Memorex, Recoton, TDK.

• **BEDFORD HILLS (Area Code 914)**

Polyphon Rec. Co., PO Box 124 Zip: 10507. Tel: 666-5287. Owner: Olga Jirakova; Mgr.: Karel B. Weiss. (Rec. D & I)
Labels: Polyphon, Qualiton, L'Orphon.
Labels imported: Supraphon (Czechoslovakia).

• **BUFFALO AREA (Area Code 716)**

Agepe Dist'n, 1685 Elmwood Ave., No 208-C. Zip: 14207. Tel: 874-6050. WATS: (800) 828-7471. Owner: John Lilley, John Narraway, Sales Mgr.: Mark Sparks; Albums Buyer: John Narraway. (Rec. D & RJ, Tape D—gospel prod. only)
Labels: AB, Airborn, Aslan, Brdwing, Bread & Honey, Canaan, Chris, Dayspring, Fisher Folk, Good News, Goltz, Greentree, Heartsong, Heart Warming, Impact, Jim, John Hall, Lamb & Lion, Maranatha, Mars Hill, Messianic, Mighty Wind, New Life, New Pax, New Song, New World, Paragon, Pax, Petra, Rainbow, Rock, Sangre, Scripture in Song, Seed, Solid Rock, Sunrise, Sparrow, Spirit Starsong, Tempo, Tunesmith, Word, Word of God.

Alices One Stop, 110 McKesson Hwy., Cheektowaga 14225. Tel: 685-2405. (Rec. & Tape OS), (Rec. RJ, I & E as Buffalo Ent's. Inc.)

Best Recs., 355 Harlem Rd. Zip: 14224. Tel: 826-9560. Mgr.: Paul Bapst; Buyers: Singles & Disco LP's, Larry Ver Hagen, Albums & Tape, Jim Primerano. (Rec. & Tape D, also see Transcontinent Rec. Sales)

Labels: Antilles, Ariola, Arista, Audio Sources, Becket, Bell Gold, Blind Pig, Buddah, Dealer's Choice, DRG, DRG Archive, Dyno, Entr'Acte, 51 West, Flashback, Flying Fish, Gateway, Gemcom, Great American Music, GRP, IBC, ICA, Importe, Jeremiah, Kaleidoscope, Laff, Mango, Muse, Ode, Park Lane, Passport, Personal Choice, Posse, Prelude, Project 3, Randolph, Rat City, Reflections, Regency, Rhino, Roulette, Savoy, Stash, Stet, Sugar Hill, Sierra Briar, Sunshine, Sutra, Theresa, Timeless Muse, Versatile, Virgo, Visa, Waterhouse, Who's Who in Jazz.

Buffalo Ent's. Inc. (Rec. RJ, I & E)—Tel: 685-2400—see Alice's One Stop.
Buffalo One Stop, 1790 Main St. Zip: 14208. Tel: 882-0427. Mgr. & Buyer: Larry Ver Hagen. (Rec. & Tape OS), (Rec. & Tape RJ as Transcontinent Rec. Sales)

Piks Corp., 182 Ashland. Zip: 1-222. (Rec. & Tape D)

Home office: Cleveland, Ohio (See for prod. distributed)

Progress Rec. Dist'n Inc., 261 Etacstone Blvd., Tonawanda 14150. Sales Mgr.: Jim McGowan. (Rec. & Tape D)

Home office: Highland Heights (Cleveland Metropolitan Area), Ohio. (See for prod. distributed)

Ruda's Dist'n Co., 915 Broadway. Zip: 14212. Tel: 852-3121. Owner: Don Ruda; Buyers: Singles, Dennis Ruda; Albums, Dave Ruda. (Rec. & Tape OS—polka prod.)

Soul Recs. One Stop Inc., 350 Broadway. Zip: 14204. Tel: 856-3051. Pres.: Del Broward; Mgr. & Buyer: Audrey A. Broward. (Rec. & Tape OS & RJ)

Transcontinent Rec. Sales Inc., 355 Harlem Rd. Zip: 14224. Tel: 826-9560.

Owner: Leonard Silver; VP & Opns. Mgr.: Tom Colson; VP & Nat'l Buyer: David Colson; Singles Buyer: Larry Ver Hagen; Albums & Tape Buyer: Jim Primerano. (Rec. & Tape RJ), (Rec. & Tape OS as Buffalo One Stop), (Rec. & Tape D as Best Recs.)

Branches: North Hollywood (Los Angeles Metropolitan Area), Calif. (Rec. & Tape RJ); Baltimore, Md., Transcontinent of Maryland (Rec. & Tape OS); Union N.J., Transcontinent of New Jersey (Rec. & Tape OS & RJ); Albany, N.Y., Albany One Stop (Rec. & Tape OS); Rochester, N.Y., Rochester One Stop (Rec. & Tape OS & RJ); Syracuse, N.Y., Syracuse One Stop (Rec. & Tape OS & RJ); Cincinnati, Ohio, Ambat Recs. (Rec. & Tape OS & RJ); Cleveland, Ohio, Northern Rec. Sales (Rec. & Tape OS & RJ)

• **CARLE PLACE (Area Code 516)**

Wilmi Sales, 556 Westbury Ave. Zip: 11514. Tel: 333-0275. Pres.: Edward Smith. (Rec. OS & RJ, Tape OS)

• **FARMINGDALE (Area Code 516)**

Record Guild of America, 144 Milbar Blvd. Zip: 11735. Tel: 293-5858.

Owner: David Schichman. (Rec. & Tape D)
Labels: Deutsche Klassische, Deutschmark

Variety Audio (div. of Phoenix Inds. Corp.), 144 Milbar Blvd. Zip: 11735. Tel: 293-5858. Owner: David Schichman; Buyer: Bill Kobrin. (Rec. & Tape RJ)

• **FREEPORT (Area Code 516)**

Candy Stripe Recs., 371 S. Main St. Zip: 11520. Tel: 379-5151/5760; NYC Tel: (212) 895-3930; WATS Outside NY State: (800) 645-3747. Telex: 126851. Owner & Bd. Chm.: Bernard Keil; Pres.: Stan Gecht; VP Int'l Sales: Larry Sonin; Mgr.: Errol Murad; Sales Mgr.: Michael Schlackman; Buyers: Singles, Albums & Tape, Louis Labrecosa; Accessories, Irving Glasser. (Rec. & Tape D, OS, I & E)

Labels: ABC, A&M, AVI, Alston, Angel, Apple, Ariola, Arista, Asylum, Atco, Atlantic, Bearsville, Blue Note, Blue Thumb, Buddah, Butterfly, CTI, Capitol, Capricorn, Casablanca, Columbia, Dash, De-Lite, Deram, Dot, Drive, Dunhill, ECM, EMI, Elektra, Epic, Fantasy, Fiesta, Goldmine, Harvest, Hi, Impulse, Infinity, Island, Janus, LRC, Laff, London, London Int'l, MCA, Mainstream, Mango, Marlin, Mercury, Midsong, Milestone, Monument, Motown, Mushroom, Nashboro, Oasis, Odyssey, Parachute, Parrot, Peacock, Polydor, Prelude, Prestige, Prism, RCA, RSO, Ranwood, Red Greg, Reprise, Rolling Stones, Rounder, Salsoul, Savoy, Seraphim, Sesame Street, Sire, Superscope Tele-Story, Swan Song, TK, Takoma, Tamlia, Threshold, Tomato, 20th Century, United Artists, Vanguard, Victrola, Warner Bros., Westbound.

Playback equip.: Sharp, Sony.
Accessories: Ampeex, Audio Magnetics, BASF, Discwasher, Fuji, Le-Bo,

TIME NEVER RUNS OUT ON OLDIES

AMERICA'S LARGEST OLDIES ONE-STOP!

**SPECIALIZING IN ALL MAJOR AND INDEPENDENT LABELS
MANUFACTURER AND DISTRIBUTOR OF ERIC RECORDS**

- **MOST COMPLETE SELECTION**—Over 20,000 titles in stock on all labels. Many unavailable from any other source.
- **BEST PRICES!**—In one easy-to-use catalog, you'll find all the best-selling back-to-back hits at our low one-stop price PLUS NEARLY 400 OLDIES AT VERY COMPETITIVE CUT-OUT PRICES.

- We ship only the **HIGHEST QUALITY PRESSINGS** available!! All records carefully inspected before shipment.
- Special attention to **EXPORT ORDERS**
- **OUR FILLS AVERAGE OVER 90%**.
- **ERIC RECORDS** is our own high quality Oldies Label. Write for separate catalog and special price on ERIC orders over 300 pieces.

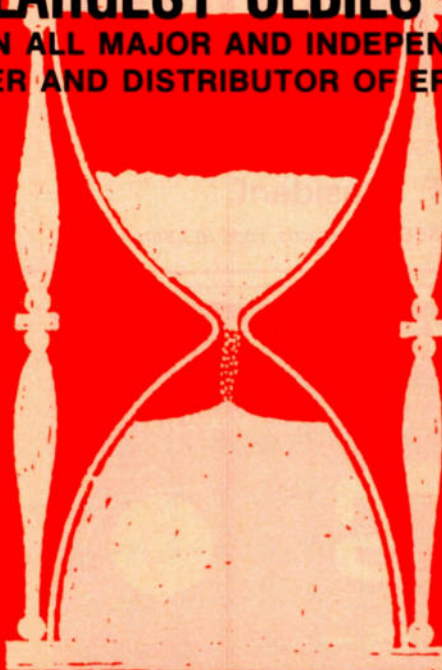

**american
record
sales, inc.**



p.o. box 287, 1120 crown point rd., westville, n.j. 08093 phone: (609) 848-1900

WRITE OR PHONE FOR INFORMATION AND OUR NEW 1981 CATALOG LISTING OVER 2,300 BEST SELLING OLDIES

TAPE KING INC.

220 West 19th St., N.Y., NY 10011

(212) 675-0800 • Telex: 237-891

*America's
Fastest Growing
One Stop Exporting
to all Countries*

TOLL FREE NUMBER
800-221-7938 (Outside New York State)

*Check our monthly specials in Billboard
and come see us
when you are in New York.*

Orders Shipped Same Day
We Catalog All Labels on LP's and Tapes
Minimum Orders are \$50 (CASH, COD or CERTIFIED CHECK only)



MET RICHMOND LATIN RECORD SALES

1637 UTICA AVE., BROOKLYN, N.Y. 11234 • TEL: (212) 253-4600
Cable Address: "SEECODISC-NY" • Telex: 668550

DAVID LAST, President

Thanks to our Licensees for making SEECO Records Tops in Latin Music

CLOSEOUT RECORDS INC.

220 West 19th Street, New York, N.Y. 10011
Phone Toll Free: (800) 221-7340 or (212) 691-8884 • Telex: 237891

CUTOUTS

**We have the titles—
We have the prices**
Send for complete price list

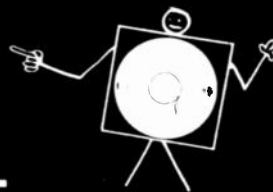

Magnatone, Maxell, Memorex, Recoton/Black Magic, Robins, Savoy, Scotch, Sony, Sound Guard, Stak II, TDK, pre-recorded videotape. (SEE ADVERTISEMENT)
El Roy Ents Inc., 39 St. Mary's Pl. Zip 11520. Tel 223-3910. Pres. Roy Imber; Buyers: Singles, V. Causeman, Albums, M. Lerner, Tape, S. Lerner. (Rec. & Tape R)

● **GARDEN CITY (Area Code 516)**

Rego Irish Recs. & Tapes Inc., 64 New Hyde Park Rd. Zip 11530. Tel: 328-7800 Owner Paddy Noonan (Rec. & Tape DS & I)
Labels: Columbia, Irish Party Series, MCA, Tifton, Irish imports

● **GREAT NECK (Area Code 516)**

Playette Corp., 301 East Shore Rd. Zip 11023 Tel 487-3064 Owner. Sidney A. Evans (Rec. & Tape I)
Labels imported: Ades (France), Cetra (Italy), Chant du Monde (France), DG (Germany), Festival (France), GMS Disc, Hachette, Hispavox (Spain), Lumen (France), Omnivox (France), Pleiade (France), Visaphon (Germany)

● **HAUPPAUGE (Area Code 516)**

Big Red Ents, 40 Oser Ave Zip 11788 Tel 231-7300 Pres Lou Sebok, Sales Mgr. Roger Weinand. (Rec. & Tape D)
Labels: Stereo Gold; also distributes promotional materials.

● **HUNTINGTON (Area Code 516)**

Cut Rite Recs., 310 New York Ave. Zip 11743 Tel 427-7893. Owner B.K. Land; Mgr., Nick Lohri. Buyers: Singles, Rick Ras; Albums, Kim Land (Rec. & Tape OS)

● **HUNTINGTON STATION (Area Code 516)**

R & S Rec. Dists., 129 E 12 St Zip 11746. Tel 271-0416 Owner & Buyer Scott Sheryll (Rec. & Tape D—cutouts, promotional prod.)

● **ISLAND PARK (Area Code 516)**

Scott Dist'g Corp., PO Box 280, 4217 Austin Blvd Zip: 11558 Tel 432-1234. Telex 221508. Owner Sidney Kruglick. (Rec. & Tape D, I & E)
Branch: Norfolk, Va
Distributes promotional recs & tapes

● **ITHACA (Area Code 607)**

Swallowtail Recs., PO Box 843 Zip 14850. Tel 844-4535 Owner, Mgr & Buyer Phillip Shapiro (Rec. D)
Labels: Folk Legacy, Front Hall, Philo, Swallowtail, other folk music prod.

● **JERICHO (Area Code 516)**

Countrywide Tape & Rec Dists Inc., 200 Robbins Ln Zip 11753. Tel: 433-9550 NYC Tel (212) 380-3900. Telex 126316 (Rec. & Tape D, I & E). Distributes cutouts, overstocks, promotions (SEE ADVERTISEMENT)
Intercontinental Recs & Cassettes Inc., 200 Robbins Ln Zip 11753 Tel 938-9610 Telex 126316 (Rec. & Tape DS) (SEE ADVERTISEMENT)

Unique Recs (Rec. E), see Zim Recs

Zim Recs., PO Box 158, 18 Ivy Dr Zip 11753. Tel 681-7102 Owner Arthur Zimmerman. (Rec. I & E) (also Rec. E as Unique Recs.)
Labels imported: AB (Australia), Alpha (Netherlands), Amigo (Sweden), Atlaxeras (Sweden), Blue Parrot (UK), Blue Rhythm (Germany), Caracol (France), Classic Jazz Masters (Sweden), Collectors Classics (Denmark), Dawn Club (Germany), Dragon (Sweden), East West (Sweden), Falcon (UK), Flyright (UK), Fountain (UK), Four Leaf Clover (Sweden), Gannet (Netherlands), Gaps (Netherlands), Gardena (Netherlands), Grandophone (Netherlands), Hep (UK), Hot Oogs (Netherlands), Hurricane (Netherlands), Jackson (Germany), Jazz Connoisseur (Italy), Jazz Document (Sweden), Jazz Piano (Denmark), Jazz Society (Sweden), Jazz Unlimited (Denmark), Lee Lambert (UK), Magpie (UK), Mahogany (France), Munich (Netherlands), On the Loose (Italy), Panachord (Netherlands), Queen Disc (Italy), Raretone (Italy), Retrieval (UK), Right Key hole (Italy), Rilophone (Germany), Stool (Netherlands), Tangent (UK), Tax (Sweden), Texas Blues Piano (UK), Two Flats Disc (Italy, Netherlands), Unique Jazz (Italy), Vinyl (UK)

● **LIBERTY (Area Code 914)**

Harbor Rec. Export Corp., 10 Chestnut St. Zip 12754. Tel 292-3334 Pres. Jerome Horng (Rec. & Tape E) (SEE ADVERTISEMENT)

IMPORTS

**Solid Gold Savings on
PRE-RECORDED CASSETTES
& Records from Europe**

- Contemporary Music
- Soundtracks • Classical
- Nostalgia • Disco • Jazz & Rock

Our thing is service & fill
all the time!

Write or call for free catalog.

MUSICRAMA

164 Driggs Ave., Brooklyn, NY 11222
(212) 389-7818 Telex 225587

Orders received today . . .

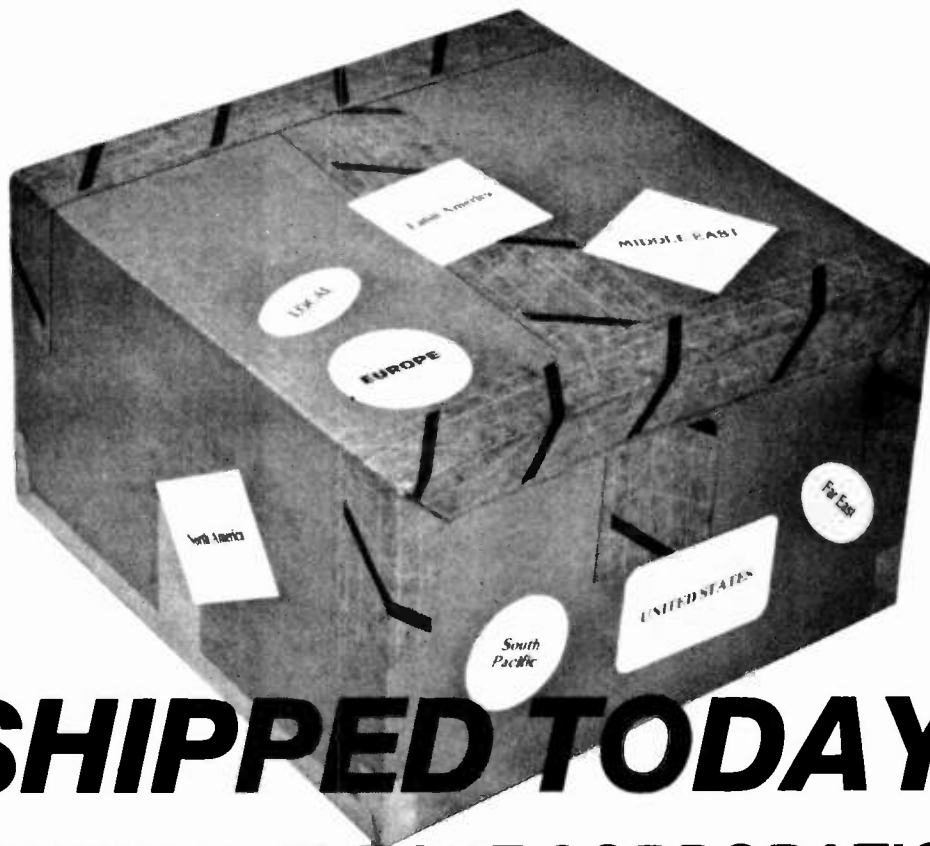

SHIPPED TODAY!

CARDINAL EXPORT CORPORATION
One-Stop/Distributor/Exporter
ships the latest releases Same Day
from New Offices and Warehouse!

We've moved into modern offices and warehousing facilities bulging with a huge inventory of new releases. Top artists! All popular American labels! Virtually the largest selection of records and tapes under one roof—at extremely attractive prices.

Service at Cardinal is designed to meet all your needs! We advise you in advance of new releases and our spectacular close-out deals, and ship the same day as receipt of your order to close-by New York airports and carrier lines.

You get quicker delivery and make more money faster doing business with the oldest and largest export record and tape company in America—Cardinal!

**TELEX OR WRITE FOR PROMPT
AND FAVORABLE QUOTATIONS!**

**THE ONLY SOURCE
YOU'LL EVER NEED FOR—**

- LP's • 12" Discos • 45 Pops
- Oldies • 8 Track Cartridges
& Cassettes
- Video Tapes • Blanks

**NEW YORK'S LARGEST ONE-STOP
DISTRIBUTOR/EXPORTER**

#7009



CARDINAL EXPORT CORPORATION

30-55 Vernon Boulevard, Long Island City, New York 11102 U.S.A.
Tel: (212) 545-6200 • Telex: (Intl) WUI 667830 • (U.S.) WU 645030 • Cable: COCARDINAL

EXPORT ONLY

ARE YOU AN OVERSEAS RECORD & TAPE BUYER LOOKING FOR:

1. CLOSEOUT RECORDS & TAPES?
• Largest Assortment, Low, Low Prices.
2. NEW & CURRENT RELEASES — ALL LABELS?
• Fast Service, Competitive Prices.
3. RECORD & TAPE ACCESSORIES?
• Largest and Most Complete Selection.
4. VIDEOCASSETTES AND VIDEODISCS?
• Blank and Pre-recorded (All Labels)

If so, communicate immediately with a firm that has been serving the overseas record, tape and high fidelity markets FOR 35 YEARS

ALBERT SCHULTZ, INC.

116 West 14th Street, New York, N.Y. 10011 USA
(212) 924-1122/Cable: ALBYREP New York/Telex: 236569 (ALBY UR)

Newest Imports Handled With Old-Fashioned Care

UK • Australia • Japan • Holland • Germany

rock • new wave • heavy metal
beatles • collectors classics
foreign music publications
cassettes

write or call for free catalogue

Dutch East India Trading

3341 Belagh Avenue
Wantagh, NY 11793
516-679-8700

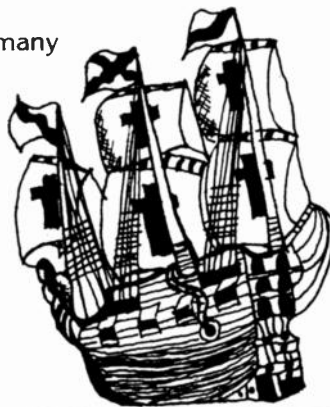

CHERRY PICKED CUT-OUTS

LP's—CASSETTES—8 TR.

SPECIAL DEALS FOR
VOLUME USERS & EXPORT ONLY

✓ JAZZ ✓ ROCK ✓ DISCO
✓ MOR ✓ C'W ✓ SPECIALS

HOPE INTERNAT'L PROD'NS, LTD.
AMERICAN ALBUM & TAPE, CORP.

850 Seventh Ave.
New York, N.Y. 10019
Tel (212) 247-3188 (212) 246-4980
Telex: 226000 TLX UR

Current Records & Tapes
Close-Out Offers

ALL AMERICAN
LABELS COMBINED IN
ONE SHIPMENT

ELTRON
EXPORT
COMPANY

57 Leonard St., New York, N.Y. 10013
(212) 966-4710

Telex: 421234

cabl: ELTRONCOMP

• NEW HYOE PARK (Area Code 516)

Stratford Dis. Inc., 815 Second Ave. Zip: 11040. Tel: 352-4200, NYC Tel: (212) 343-6920. TWX: (510) 223-0823. Pres.: Allan Silverman; Gen Mgr.: Raymond Espinosa (Rec. & Tape OS, I & E) (SEE ADVERTISEMENT)

• NEW YORK METROPOLITAN AREA (Area Code 212)

A A Rec. Hunter Dist'g Co., 507 Fifth Ave. Zip: 10017. Tel: 986-6077. Pres.: Jay Sonn (Rec. & Tape OS & RJ), (Rec. & Tape E as All Brands Rec. & Tape Export Corp., 507 Export Corp.)

A-1 Rec. Sales, 659 10 Ave. Zip: 10036. Tel: 246-1234/3330. (Rec. & Tape OS) (SEE ADVERTISEMENT)

African Rec. Centre Dis. Ltd. (ARC Dis.), 1194 Nostrand Ave., Brooklyn 11225. Tel: 493-4500. Pres.: R. Francis, VP: Roland Francis; Mgr.: Robert Thomas; Buyers: Singles, Tevor Davis; Albums, Ralph Johnson (Rec. D & OS), (Rec. I & E as Egbe Omo Nago African Mkt. & Imports)

Branch: Washington, D.C.
Labels: African Music Explosion, Jumbo Caribbean Disco, Kola, Makossa, Makossa Int'l, Makossa Tropical Disco. (SEE ADVERTISEMENT)

All Brands Rec. & Tape Export Corp. (Rec. & Tape E), see AAA Rec. Hunter Dist'g Co.

Alpha Dist'g Corp., 20 West End Ave. Zip: 10023. Tel: 397-1920. Owner: Harry N. Apostoleris; Mgr. & Buyer: Murray Viscoso; Sales Mgr.: Nick Campanella. (Rec. & Tape D)

Branch: Weymouth (Boston Metropolitan Area), Mass.

Labels: Abiko, Antilles, Ariola, Arista, Arista Freedom, Boardwalk, Bomb, Buddha, Burdette, Charlie Brown, Cream, Disneyland, Excelsior, First American, GNW, G&P, GRP, Gordy, Grand, Great American Music, Hannibal, H, Imp, Koala, Kudu, Living Language, M&R, Mango, Mim, Mr. Pickwick, Motown, Mountain Railroad, Natural Resources, Novus, Ode, Paid, Passport, Penthouse, Piccadilly, Pickwick, Pro Arte, Quintessence, Rat City, Robox, Sam, Sesame Street, Soul, Stiff America, Sun, Sunbird, Superstar, Tamla, Tomato, Vanguard, Venture, Visa. (SEE ADVERTISEMENT)

American Album & Tape Dis. / Hope Int'l, 850 Seventh Ave. Zip: 10019. Tel: 247-3188. Pres.: David King; VP: Hope King; Int'l VP: Warren Ashley; Gen. Mgr.: George Curtis. (Rec. & Tape D, I & E—cutouts, close-outs, overstocks) (SEE ADVERTISEMENT)

Antilla Rec. Dist. Inc., 667 10 Ave. Zip: 10036. Tel: 582-4546. Mgr. Jose Hernandez. (Rec. & Tape D, OS & RJ)

Labels: Antilla, Aro, Bravo, Bronco, CBS Int'l, Funny, Gema, Maype, Modiner, Musicalia, Musicuba, Orsound, Performance, Rumba, Suave, Tone Latino

Apon Rec. Co. Inc., PO Box 3082, Steiway Sta., 44-16 Broadway, Long Island City 11103. Tel: 721-5599. Pres.: Andrej M. Poncic; Sales Mgr.: Donald M. Zemann. (Rec. & Tape I)

Labels imported: Amadeo (Austria), Angelicum (Italy), Christophorus (Germany), Harmonia Mundi (Germany), Jugoton (Yugoslavia), Opus (Czechoslovakia), Panton (Czechoslovakia), Polyphon (Austria)

Archer Int'l, 205 Lexington Ave. Zip: 10016. Tel: 532-2323. VP Sales: Irwin Eisen. (Rec. & Tape I & E)

Argus Rec. Dist. Inc., 160 W. 46 St., Rm. 506. Zip: 10036. Tel: 799-7458. Mgr.: Rose Saggio. (Rec. D)

Labels: Aries, August, Criteron, GP, Indian House, Juno, Mounted, Pa-Dik, Rex, Riccio, Spiral.

Arovax Rec. Corp. (Rec. & Tape RJ), see Olympia Rec. Ind. Inc.

Audio Dist. Inc., 1182 Broadway. Zip: 10001. Tel: 725-4570. Pres.: Al Antebi; VP: Buddy Antebi. (Rec. & Tape D)

Distributes cutouts.

Audiogram Rec. Corp., 658 10 Ave. Zip: 10036. Tel: 246-9858. Owner: Rafael Diaz Gutierrez; Mgr.: Hilda Diaz Gutierrez. (Rec. D)

Labels: Accion, Atlas, Audiogram, CBS Int'l, Color, DC, Disco Sur, Duro, Fabuloso, Lad, Legal, Madely, Mercurio, Palante, Preludio, Sono Max, Taurus, Top-Hit, Velvet, Virtuoso.

Berkeley Air Servs. Mktg., PO Box 665, Cargo Bldg. 80, JFK Airport, Jamaica 11430. Tel: 656-6066. Telex: 425628. TWX (710) 582-4910. Owner: Bernard Klamborg. (Air transportation servs.)

Branch: Los Angeles, Calif. (SEE ADVERTISEMENT)

Bonaparte Recs., 118 W. 3 St. Zip: 10012. Tel: 420-0580. Owner: Guy Melhuish. (Rec. D & I)

Imports from UK (SEE ADVERTISEMENT)

Brasilia Recs. & Tapes Corp., 29 W. 38 St. Zip: 10018. Tel: 354-5613. Telex: WUJ 666794. Pres.: Herbert Csasznik; Nat'l Sales Mgr.: Chris Scott. (Rec. & Tape D, I & E)

Labels: Brasilia, Brass, Emergency, Roy B.

Labels imported: AMC, Beverly, Building, Copacabana, EMI/Odeon, Fontana, Marcus Pereira, Philips, Phonogram, Polydor, Polygram, RCA, RGE/Fermata, Sabia, Som, Vision, WEA (all Brazil), Movie-Play, Polygram (both Portugal)

Brilly Corp., 509 W. 112, Suite 2W. Zip: 10025. Tel: (212) 662-4338. East Coast Rep.: Dennis Miller. (Rec. I)

Home office: Beverly Hills (Los Angeles Metropolitan Area), Calif.—see for prod. imported)

C B S Recs., 95-25 Queens Blvd., Rego Park 11374. Tel: 830-3600. VP Eastern Div.: John Kotecki; Reg'l Co-ord.: Karen Padgett; Branch Mgr.: Jim Urte. (Rec. & Tape D)

Other branches: Encino (Los Angeles Metropolitan Area), San Francisco, Calif., Englewood (Denver Area), Colo., Hartford, Conn., Miami, Fla., Atlanta, Ga., Honolulu, Hawaii, Rolling Meadows (Chicago Metropolitan Area), Ill., Silver Spring, Md., Lexington (Boston Metropolitan Area), Mass., Southfield (Detroit Metropolitan Area), Mich., Minneapolis, Minn., Kansas City, Mo., Cincinnati, Cleveland, Ohio, Baia Olynwyd (Philadelphia Metropolitan Area), Pa., Memphis, Tenn., Dallas, Houston, Tex., Tukwila (Seattle Area), Wash.

Labels: BID, Bang, Barking Pumpkin, Blue Sky, Canbou, Coast to Coast, Columbia, Curb, Gold Coast, Hammond, Handshake, Jet, Johnston, KAT, Krshner, LAX, Lynx, Nemperor, PIR, Pasha, Pavilion, Phase II, Precision, T-Neck, Tabu, Uncle Jam, Unlimited Gold, WMOT

Capitol Recs., 1370 Ave. of the Americas. Zip: 10019. Tel: 757-7470. (Rec. & Tape D—see office in Los Angeles, Calif., for prod. distributed)

Cardinal Export Corp., 30-55 Vernon Blvd., Long Island City 11102. Tel: 545-6200. Owner: Arthur Lerner; VP's: Charles Lerner, Edwin Seligman, James Morton; OS Mgr.: Gary Hall; I & E Mgr.: Bernardo Golden; Buyers: Singles, Marc Eiselman. Albums & Tape, Alan Marker. (Rec. & Tape OS, I & E) (SEE ADVERTISEMENT)

Caytronics Corp., 401 Fifth Ave. Zip: 10016. Tel: 889-7340. (Rec. & Tape D, I & E). Local branch: Cayre Dis. 653 10 Ave. Zip: 10036. Tel: 541-4090. (Rec. & Tape OS & RJ)

Branches: Los Angeles, Calif., Cayre Inds. of California Inc., Hialeah Gardens (Miami Metropolitan Area), Fla., Cayre Dis. of Florida Inc., San Antonio, Tex., Cayre Dis. of Texas Inc. (All Rec. & Tape D)

Labels: Arcano, Bethlehem, Caliente, Carno, Caytronics, Free Spirit, Gold

CALIFORNIA, HERE WE COME.

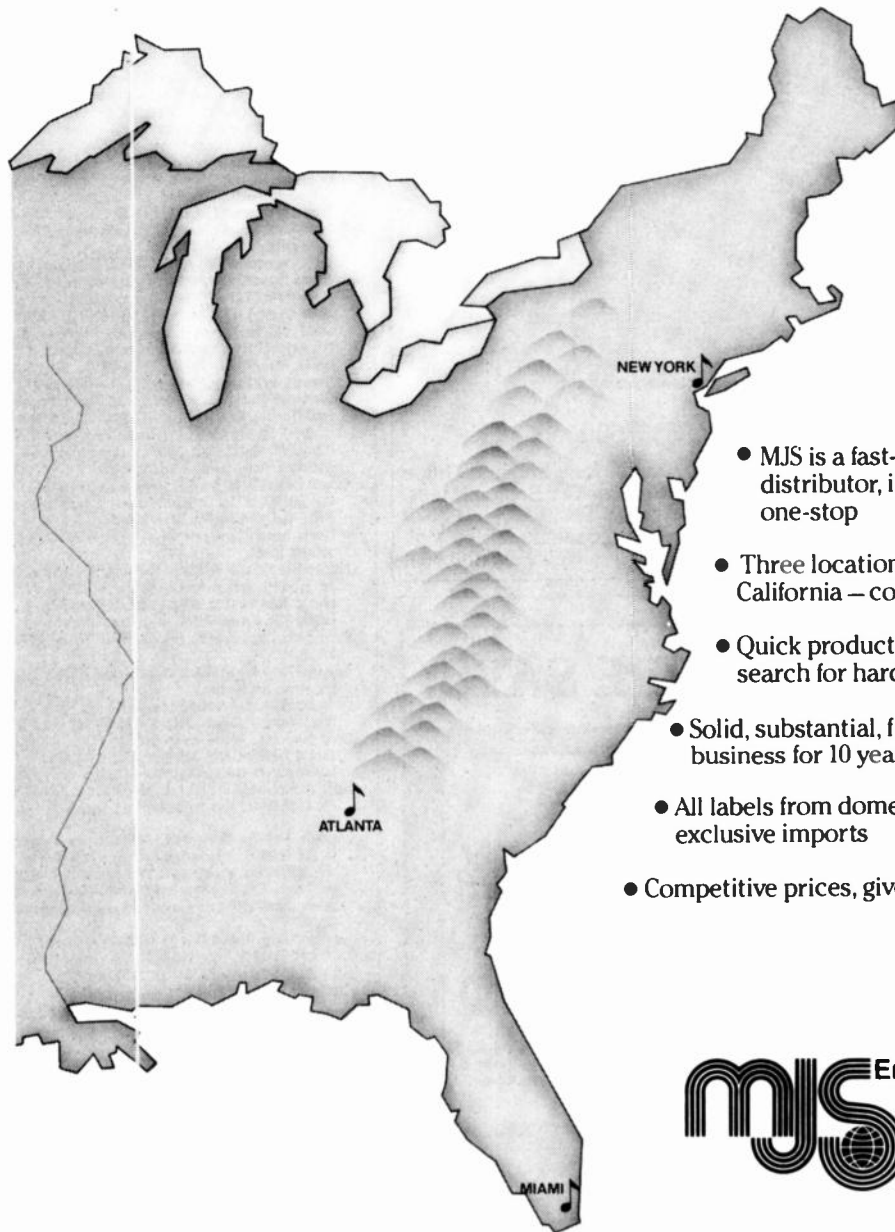

- MJS is a fast-growing record and tape distributor, importer, exporter and one-stop
- Three locations in the East with a fourth – California – coming on stream
- Quick product fill and shipment, will search for hard-to-find items
- Solid, substantial, financially sound, in business for 10 years
- All labels from domestic manufacturers, plus exclusive imports
- Competitive prices, give us a try!



Entertainment Corporation

Michael J. Spector, President

MJS Entertainment of Georgia, Inc.

Jim O'Rourke, President
Rod Gunther, Sales Mgr.
John Norwood, Head Buyer
Randy Dickson, Import Sales
2775-E Bankers Industrial Drive
Atlanta, Georgia 30360
Phone (404) 448-7772
(1) 800-241-3389
Telex: 70-0598 (MJS Music Atl)
One-stop, importer distributor

MJS Entertainment of Florida, Inc.

Al Zamora, President
Jeff McDonald, VP Purchasing
8228 N.W. 56th Street
Miami, Florida 33166
Phone: (305) 592-6085
(1) 800-327-3559
Telex: 51-9739 (MJS Music Mia)
One-stop, distributor

MJS International, Inc.

Al Zamora, President
Gary Kulla, Album Buyer
Jeff McDonald, Single Buyer
Cindy Barr, Domestic Sales
Fred Held, Independent Distribution
8228 N.W. 56th Street
Miami, Florida 33166
Phone (305) 592-6085
(1) 800-327-3559
Telex: 51-9739 (MJS Music Mia)
Exporter

MJS Entertainment of New York, Inc.

Chris Barr, President
Alicia Bravo,
International Sales Mgr.
Morty Schlesinger,
Vice President/Intl Sales
Johnny Espinal, Buyer
47-31 35th Street
Long Island City, New York 11101
Phone: (212) 784-0360
(1) 800-221-1552
Telex: WU 645880 (MJS Music NYK)
ITT 422479
Distributor, one-stop, exporter, importer

No One Handles the North East Better Than

MALVERNE



Malverne Distributors, Inc.

New York and New Jersey Offices and Warehouses:
 35-35 35th St., L.I.C., N.Y. 11106
 Tel: (212) 392-5700—Toll free wats line: 800-221-1406
 Jerry Winston, President
 Joe Grippo, V.P. & Dir. of Marketing:

New England Office
 77 Summer St., Boston, Mass.
 Tel: (617) 423-3820
 Stan Goodman, Sales Mgr.
 —New England Ter.

CAPTAIN CANDY STRIPE SAYS:

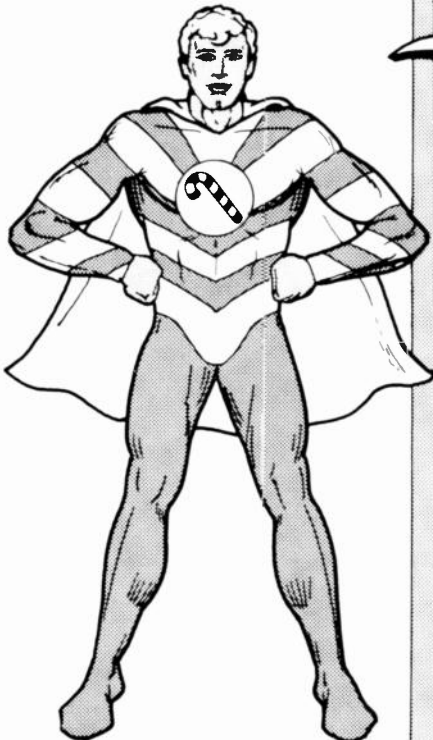

LAST YEAR
 WE FILLED 95%
 OF OUR ORDERS
 FOR HARD TO FIND
 LP'S AND TAPES!

... SEE OUR AD
 ON BACK COVER...



371 SOUTH MAIN STREET, FREEPORT, N.Y., U.S.A. 11520
 (516) 379-5151 (212) 895-3930
 TOLL FREE: 800-645-3747 (OUTSIDE NEW YORK STATE)
 TELEX: 126851 CANSTRIPE FREE

Mind, Mericana, Mericana-Melody, Normex, Pronto, RCA, Salsoul, Sal
 soul-Salsa
 Chapel-Tone Music, PO Box 673, Bowling Green Sta Zip 10004 Tel 464
 3642 Owner & Singles Buyer Ronald Blair, Mgr & Albums Buyer
 Thomas Lauria Local Branch Street Corner Recs, 2801 Middletown Rd
 Bronx 10460 Tel: 733-8813 Owner Thomas Lauria (Rec. & Tape D)
 Labels: Chapel Tone, Graffiti, Mana, Street Corner
 Chin Randy's Recs Inc., 1342 St John's Pl., Brooklyn 11213 Tel 778 9470
 Owner Victor Chin, Mgr Monica Chin (Rec. OS)
 Closeout Recs Inc, 220 W. 19 St. Zip 10011 Tel 691 8884 Telex 237891
 Pres. Joseph Abady, Sec'y Barry Chay. (SEE ADVERTISEMENT)
 d b a Recs., 875 Ave of the Americas, Suite 1001 Zip 10001. Tel 279
 9326. Mgr. Alex Alexander: Singles & Albums Buyer John Holanka (Rec.
 D)
 Labels: Alexander, Atoll (France), dba, Quantum (Canada).
 Daro Exports Ltd., 146B Coney Island Ave., Brooklyn 11230. Tel 252 4355
 Pres. Albert J. Okas, Mgr Y Okas (Rec. & Tape E)
 Exports all rec labels, tapes & video tapes. (SEE ADVERTISEMENT)
 Daybreak Express Recs., PO Box 250, Van Brunt Sta., 169 Seventh Ave.,
 Brooklyn 11215 Tel 499-0487 Owner, Singles & Albums Buyer Jim
 Ego, Mgr Steve Bosky (Rec. D, I & E)
 Labels: ACC, About Time, Agoric, Air Check, Ajax, Ajaz, Ak Ba, Alaca,
 Ambi, American Clave, Anima, Artistry, Atman, Audiophile, Aviva, Band
 stand, Baobab, Bee Hive, Beez, Bellows, Biograph, Bishara, Bittersuite,
 Blue Labor, Bodeswell, Boogie Woogie, Broadway, Cadence Jazz, Carou
 sel, Choice, Circle, Corvo, Dane, Dark Orchid, Ootlo, Dreamstreet, Ekapa,
 Emily, Empire, Encounter, Escape, Esoteric, Famous Door, Fanfare, Fat
 Cat, Flow Chart, GHB, Gatemouth, Giants of Jazz, Glad Hamp, Greyforest,
 Halcyon, Harrison, Herwin, Hindsight, Historical, Hummingbird, IAJRC,
 IPS, Idbib, Jazz a la Carte, Jazz Bird, Jazz Dance, Jazz Mark, Jazz Treas-
 ury, Jazz Works, Joyce, Kaydee, K2B2, Labor, Los Angeles, Milljac,
 Muntu, New Pulse, Nine Winds, Outline, Palo Alto, Parachute, Paragon,
 Philly Jazz, Phlometel, Phoenix, Pumpkin, QEO, Quark, RMS, Ra, Re-Entry,
 Revilition, Rosetta, S&H, SRP, San Diego Jazz Club, Shoestring, Silver
 Tone, Slide, Sonora, Sounds, Spitball, Standing Room Only, Survival,
 Sweet Earth, Theresa, Town Hall, Trans Museq, VGM, Visible, Who's Who,
 World Artists
 Labels imported: A (UK), Affinity (UK), Atmosphere (France), Bead (UK),
 Bingow (France), Blue Parrot (UK), Cadillac (UK), Cecma (Italy), Center
 of the World (France), Circle (Germany), Classic Jazz Masters (Sweden),
 Cobra (France), Ego (Germany), Esquire (UK), FMP (Germany), First
 Heard (UK), Fluid (France), Fore (Italy), Fourth Way (UK), Free Lance
 (France), HEP (UK), Haast (Netherlands), Hefty Jazz (UK), ICP (Nether-
 lands), Ictus, (Italy), Impro (France), Incus (UK), Ingo (Italy), JMS
 (France), Jazz Society (Sweden), Leo (Finland), Marge (France), Moers
 (Germany), Muzq (Poland), Ogun (UK), Onari (Canada), Owl (France),
 Palm (France), Raretone (Italy), Rarities (UK), SIR (Sweden), Sackville
 (Canada), Spottlite (UK), Sun (France), Swing Classics (Sweden), Swing
 House (UK), Swing World (UK), Tax (Sweden), Uptown Jazz (Canada),
 Waterland (Netherlands), Wave (UK)
 Disques Du Monde, PO Box 836, Madison Square Sta Zip 10159, 186 Fifth
 Ave Zip 10010 Tel. 243-4793 Owner Crescenzo Capece Jr., Singles
 Buyer Carl Johnson (Rec. D—mail order)
 Labels: Bomp, 415, Jupiter, Keystone, Pamc, Select, Shake, other inde-
 pendent labels
 Distribuidora Nacional de Discos de New York, 214 W 96 St Zip 10025
 Tel. 866-2469 Pres. L. Raul Bernard, VP & Sec'y Treas. Blanca Bernard
 (Rec. & Tape D), (Rec. & Tape I & E as Otao Recs Co. Int'l Ltd.)
 Labels: Algo, Banny, Colony, Coqui, Onsa, Fenix, Kelsa, ORC, Tamo
 Dolian Prods. Corp., 307 Fifth Ave. Zip 10016. Tel 684 6274. (Rec. & Tape
 E)
 Egbe Omo Nago African Mkt & Imports (Rec. I & E)—Mgr. John Williams—
 see African Rec Centre
 Ettron Export Co, 57 Leonard St. Zip 10013 Tel 966-4710 Telex 421234
 Pres Werner T Glaeser (Rec. & Tape E) (SEE ADVERTISEMENT)
 David Eskin Inc., 400 Riverside Dr Zip: 10025 Tel: 749-4257 Telex
 237460 ESKINUR Pres & Buyer David Eskin. (Rec. & Tape OS & E)
 Exports records, tapes, video cassettes & disks. (SEE ADVERTISEMENT)
 Euroclass Rec Dists Ltd., 155 Ave of the Americas, 11th Fl. Zip 10013 Tel:
 741 1430 Owner Marcos Klorman, Mgr Frank Burton (Rec. & Tape D &
 I)
 Labels: American Gramophone, Audio-Technica, Cambridge, Chalfont,
 Citadel, Delos, Desmar, In Sync Labs, International Piano Archives, Kla
 vier, Mnemosyne, Musicmasters, PRB, Pelican, RCA Japan, Telarc, Tita
 nic, Toshiba EMI, Umbrella, Varese Sarabande, Westwood
 Labels imported: Ensayo (Spain), Rubini (UK), Unicorn (UK), Zambra
 (Spain).
 507 Export Corp. (Rec. & Tape E), see AAA Rec Hunter Dist'g Co
 G L P Int'l—Tel 736 7455—also see listing under Englewood Cliffs, N J
 Galiko Music & Film Prod'n, 241 W 18 St Zip 10011 Tel 989 7200
 (OS & E) (SEE ADVERTISEMENT)
 German News Co Inc., 218 E 86 St Zip 10028 Tel 288 5500 (Rec. &
 Tape D & I)

THANK YOU

OVERSEAS BUYERS AND AMERICAN EXPORTERS

Since 1965 BERKLY is the most reliable transportation specialist serving the music industry.

Shipping daily from N.Y. & L.A. American products at the best cargo rates. Complete documentation, banking, collections, insurance, free marketing.

For personal & confidential attention

Contact: Bernard Klainberg, President

BERKLY AIR SERVICES CORP.

Bldg. 80, PO Box 666, J.F.K. Int'l Airport,
 Jamaica, N.Y. 11430, U.S.A.
 Phone: (212) 656-6066 Telex: 425628 TWX: 710-582-4910
 Cable: BERKLYAIRNEWYORK

Labels: Gemini Hall, Leonarda, WDP, OASI, Past Masters
Labels imported: Acanta (Germany), Baerenreiter (Germany), Brain (Germany), CBS (Germany), Cantate (Germany), Caprice (Sweden), D Sound (Germany), DaCamera (Germany), Discophila (Germany), EMI (UK), EMI Electrola (Germany), Erato (Germany), Finlandia (Finland), Fontana (Germany), Harmonia Mundi (Germany), MPS (Germany), Metronome (Germany), Pape (Germany), Philips (Germany), Polydor (Germany), Preiser (Germany), RCA (Germany), Schwann (Germany), Telefunken (Germany), Vista (UK), Wergo (Germany), Club 99
 Sam Goody Int'l Inc., (Rec. & Tape I & E), see SMG Dist
 Gospel Rec. One Stop, 42-39 Crescent St., Long Island City 11101 Owner Dorothy Mitchell, Mgr., Singles, Albums & Tape Buyer Buddy Franklin (Rec. & Tape OS)
 Gotham Discs, 42-39 Crescent St., Long Island City 11101 Tel 786 5400 Owner Dorothy Mitchell, Mgr., Singles, Albums & Tape Buyer Buddy Franklin (Rec. & Tape OS)
 HitTown, 609 W 125 St Zip 1002 Tel 662 2230 (Rec. & Tape OS)
 Home's One Stop, 217 Bronx Terminal Mkt., Bronx 10451 Tel 292 0267 590-7286 Owner Johnny Honeycutt, Gen. Mgr., Singles, Albums & Tape Buyer, Ralph Vazquez (Rec. & Tape OS) (SEE ADVERTISEMENT)
 Hope Int'l, see American Album & Tape
 House of Menorah Inc., 36 Eldridge St Zip 10002 Tel 925 7573 Gen. Mgr & Buyer Sol Tischler, Nat'l Sales: Mgr Jonathan Tischler (Rec. & Tape D & I—Hebrew & Yiddish prod. or y)
Labels: Aderet, Ampis, Artistic, Banner, CBS, Columbia, Elektra, Em bassy, Emes, Epstein, Famous, LIL, Gal Ton, Hatakit, Hed Arzi, IMF, Isradisc, Isralectra, Israphone, JE', Koliphone, MG, Magnatone, Makolit, Maloh, Marjanil, Menorah, Mon tor, Mor, Musque Int'l, Nachas, Negri nah, Noam, Phonodor, Pirchei, Polydor, RCA, Record Collector's Guild, Request, Roulette, Rozanna, Tikva, Vanguard, YC, Zimran, Zimray
 Important Rec. Dist., 149 03 New York Blvd., Jamaica 11434 Tel 995 9200 Telex 668694 Pres. Bai-y Kobrin (Rec. & Tape D & I)
Labels: Bomp, 415, Ralph, Rouh Trade
Labels imported: Ariola, CBS, EMI, Polygram, RCA, WEA (all Australia, France, Germany, Netherlands, UK), Beggar's Banquet (UK), Factory (UK), Rough Trade (UK), Teldex (Germany) (SEE ADVERTISEMENT)
 International Book Rec. Dist., 40-11 24 St., Long Island City 11101 Tel 786-2966 Owners V. Rudenjak, S. Simunovic, Mgr. Clyde Allen, Buyers Classical, Clyde Allen, Imports, Christina Roden (Rec. & Tape I & E)
Labels imported: Barclay (France), CBS (France, Japan), Chant du Monde (France), Dischi Ricordi (Italy), Durium (Italy), EMI (Denmark, Sweden, UK), EMI Electrola (Germany), EMI Italiana (Italy), EMI Odeon (Spain), EMI Toshiba (Japan), Fcrl Cetra (Italy), Hispavox (Spain), Jugoton (Yugoslavia), Music for Pleasure (France), Pathe Marconi EMI (France), Philips (Norway), Phonogram (Brazil, France, Spain), Polydor (France), RCA (France, Italy), RTB (Yugoslavia), Replica (Italy), R-FI (Italy), Schwann (Germany), Soudisc (France), Sunset France (France), Tangent (UK), Vogue (France) (SEE ADVERTISEMENT)
 J & R Music World, 23 Park Row 2 10038 Tel 732 8600 Owners Joe & Rachelle Friedman, Mgr. Henry Leserowitz, Buyers Marly Singer, Jean Smith (Rec. & Tape OS, I & E) (SEE ADVERTISEMENT)
 King Karol Recs. Inc., 126 W 42 St Zip 10036 Tel 354 7684 Owners Ben Karol, Phil King, Mgr. Morris Weissman, Buyers Singles, Joe Carter, Albums, John Beier, Tape Stuart Tiff (Rec. & Tape OS, I & E)
 Known Artist Dist., 1619 Broadway Zip 10019 Tel 265 1292 Mgr. Krzysztof Z Purzycki (Rec. OS)
 Home office: Brewton, Ala



THE CONTEMPORARY RECORD SPECIALIST

Thank you for your support. SKYDISC is now bigger and better than ever because of you. We feel communication is the ultimate key to running a successful import department. Our phone-sales concept puts you in touch with our knowledgeable sales staff several times a week. We look forward to serving you in the coming year . . .

including

- largest import one-stop in America
- largest catalog of 7" imports in U.S.
- merchandising displays available
- 90% fill from our 10,000-sq.-ft. warehouse
- speedy delivery
- magazines—from U.K.: Melody Maker, Sounds, New Musical Express, Record Mirror, Hot Press, Face, Flexipop, Smash Hits, Zigzag, Kerrang; also from Europe: Vinyl. From U.S.: Take It, Trouser Press, N.Y. Rocker, Boston Rocker, and our exclusive Fanzine Packs from U.K.
- rock buttons

PUBLIC IMAGE LTD. • THE SLITS •
 THE TEARDROP EXPLODES •
 OZZY OSBOURNE •

If you sell imports, you should know us.

KING CRIMSON •
 GENX • JOY DIVISION •
 BLACK UHURU • MAGAZINE • AC/DC

SEND FOR THE NEWLY COMPLETED SKYDISC CATALOG 800-645-7185



101-32 DuPont St., Plainview, N.Y. 11803
 (516) 349-0900 Telex: 645-578

. . . And, for our CUSTOMERS ABROAD, please write or telex us with your address and telex # so we can start sending you, regularly, new release information on America's independently Manufactured Labels.

Exporting Since 1939

M. SLUIS Co., Inc.

Exporters . . .

Of all American labels of phonograph records and pre-recorded tapes . . .

of closeouts and stock lots . . .

of blank cassette and cartridge tapes, and video tape cassettes.

M. SLUIS CO., INC.

15 Park Row
 New York, NY 10038
 Tel: 212/349-0590
 Cable Address: CINAECO
 Telex: 223068 (RCA)

COUNTRYWIDE

RECORD & TAPE DISTRIBUTORS, INC.

Most Exciting Distributor of

- CUT-OUTS and OVERRUNS
- PROMOTIONAL ROCK & R&B LP's
- TAPES AND CASSETTES

We receive letters saying we have the best catalog in the business. *Send for it.*

COUNTRYWIDE

RECORD & TAPE DISTRIBUTORS, INC.

200 ROEBINS LANE, JERICHO, N.Y. 11753
 Telex 126316 Answer Back CWTRI-UI-JERI
 (516) 433-9550 (212) 380-3900

Herbert A Linsky Assocs Inc., 200 W 57 St., Suite 602 Tel 582-2594.
 Pres. Herbert A. Linsky (Cutout rep.)
 M C A Dist'g Corp., 10 E 53 St Zip 10022 Tel 888 9700 Branch Mgr
 George Collier (Rec. & Tape D—see office in Los Angeles, Calif., for prod.
 distributed)
 M J S Entertainment of New York Inc., 47 31 35 St., Long Island City 11101
 Tel 784 0360 WATS (800) 221 1552 Telex 422479 Pres Joe Stan-
 zone, VP Int'l Sales M Schlessinger, Int'l Sales Mgr A Bravo, Buying
 Mgr Johnny Espinal (Rec. & Tape D, DS, J & E)
 Home office: Miami, Fla (SEE ADVERTISEMENT)
 Malverne Dist's Inc., 35 35 35 St., Long Island City 11106 Tel 392 5700
 Pres Jerry Winston, VP, Mgr., Singles & Albums Buyer Joe Grippo. (Rec.
 & Tape D)
 Branch: Boston, Mass., Malverne Dist's Inc of Boston
 Labels: AVI, Abet, Alfa, Alston, Becket, Chrysalis, Concord Jazz, Contem-
 porary, Creed, Dash, Drive, Excello, Fantasy, 51 West, Galaxy, Glade, Gry-
 phon, Jazz American, Juana, Kayvette, Kenwood, Laff, Laurie, Lifesong,
 Light, Malaco, Martin, Milestone, Mirus, Muse, Myrrh, Nashboro, New
 Birth Ovation, PAUSA, Prelude, Prestige, Project 3, Pyramid, Ranwood,
 Riverside, Roulette, Savoy, Specialty, Stax, Sunshine Sound, Sultra, TK,
 Takoma, Waterhouse, Wolf, Word (SEE ADVERTISEMENT)
 Met Richmond Latin Rec Racks, 1637 Ullica Ave., Brooklyn 11234 Tel 253-
 4600 Telex 668550 Cable SEECODISC Owner D Last, Mgr Albito
 Velez, Buyers Singles, B Cohen, Albums, Don Erlichman, Tape, Eoldes
 Corniel (Rec. & Tape RJ), (Rec. & Tape E as Met Richmond Latin Rec
 Sales) (SEE ADVERTISEMENT)
 Met Richmond Latin Rec Sales (Rec. & Tape E)—Mgr Bob Stack—see Met
 Richmond Latin Rec Racks
 Musicrama Recs & Tapes, 164 Driggs Ave., Brooklyn 11222 Tel 389 7818
 Telex 225587 Sales Mgr Charles Jarzabek, Sales Rep Gabriele Bur-
 arowitz (Rec. & Tape I)
 Labels imported: Barclay (France), Muza (Poland), Pathe Marconi
 (France), Phonogram (UK), RCA (Italy) (SEE ADVERTISEMENT)
 Music Town Rec Dist's & Promo Co., 28 11 Murray St., Flushing 11354 Tel
 461-3308 (Rec. D)
 Home office: Nashville, Tenn (See for prod distributed)
 N M C Corp., 1 Penn Plaza, Suite 1706 Zip 10119 Tel 279-5850 Bd
 Chm Jesse Selter, Exec VP Maxwell Friedberg (Rec. & Tape D)
 Distributes overstocks & surplus
 New Music Dist'n Serv (div of Jazz Composer's Orchestra Ass'n), 500
 Broadway, 4th Fl Zip 10012 Tel 925 2121 Mgr Taylor Storer, Sales
 Mgr Dave Hunt, Sales Russ Musto, Singles & Albums Buyer Yale Eve-
 lev, Promo Yale Evelev, Spencer Richards (Rec. D & E)
 Labels: Ardwood, About Time, According Advance, Aesthetic Research,
 Airborne, AK BA, Alacra, Allen Houser, Altsax, American Clave, Ananda,
 Andrew's Music, Ap-Gu-Ga, Arewaa, Arise, Atman, Auricle, Avocado, Avon
 Hill, Badger, Baker Street, Baobab, Beep, Bellows, Bent, Benyo, Beth An-
 derson, Big City, Bija, Birdseye, Birth, Bola Press, Bozi Mlyn, Breeze, CP
 Squared, CRI, CSP, Cafeteria, Capra, Centering, Chatham Square, Cody,
 Concept, Cornpride, Creative Consciousness, Crosswind, DYM, Daagnim,
 Daggett, Dane, Dark Horse, Doria, Dromm, EPI, ERP, Earthquake, Empire,
 Evidence, FKT, Finnadar, Flat, Folkways, Fourth Stream, Frammis, GPS,
 Gorno Poetry, Gibex, Grammavision, Grenadilla, Hat Hut, Hidden Mean-
 ing, HoPo, Hugo's Music, Humming Bird, IPS, Myrax, I Am She, Ibu, Idi-
 bib, Independent, India Navigation, Interzone, Irida, JCOA, JDE, J Jas
 mine, Joe's Smashing, Kabell, Kenya, Kolimama, Kromel, Labor, Land



SPECIALISTS IN:

European, Heavymetal,
 New Wave, Rock and
 Disco LP's, EP's,
 Singles and 12".

We provide the most
 complete and fastest
 service to retailers,
 one-stops and
 distributors.

149-03 New York Blvd.
 JAMAICA, N.Y. 11434
 Tel: (212) 995-92000
 Telex: 668694 MPORT

HARBOR RECORD EXPORT CORP.

The Legendary Exporter
 high in the Catskill Moun-
 tains. Offering lowest ex-
 port prices on . . . Jazz,
 Blues, Surplus, Cut-outs,
 and Budget Brands with
 superb SERVICE.

10 Chestnut Street
 Liberty,
 New York 12754
 (914) 292-3334



When you need to fill a position,
 you'll have a qualified graduate
 that you helped educate.

**GIVE TO THE
 UNITED NEGRO COLLEGE FUND.
 A MIND IS A TERRIBLE THING
 TO WASTE.**

Photographer: Dwight Carter
 A Public Service of This Magazine &
 The Advertising Council
 © 1981 United Negro College Fund, Inc



ATTENTION!!!

INTERCONTINENTAL RECORDS & CASSETTES, INC.

Is Pleased to Announce the Birth of An Exciting New Concept, One Stop Shopping for the Record Retailer. We specialize in current Imports not released in the U.S.A., British New Wave, European Rock, Australian & Japanese pressings, European deletions & Midprice product, and Picture Sleeve 7" & 12" singles from everywhere. ALSO a full One Stop Service on all current American product, AND the best selection of cutouts around.

Call or write to:

INTERCONTINENTAL RECORDS & CASSETTES, INC.

200 Robbins Lane, Jericho, L.I., N.Y. 11753

Phone: 516-938-9610 • Telex: 4758131

STOP PRESS . . . EXPORT CUSTOMERS EVERYWHERE

We Ship Current U.S. Midprice & Full Price Product—Catalogue, New Releases, Special Orders as well as a great selection of Cutouts anywhere in the world—Write or call for Catalogues & Price Lists.

Mammals, Leo, Line, Linear B, Lovely, Lust/Unlust, MG, MU, Meridian, Metalanguage, Microcosmic, Mirn, Mission, Modern Method, Mozown, Muntu, Music Gallery, NYC Artist's Collective, NYC Composer's Collective, Nascent, Nessa, New Frontiers, New Jazz, Nimbus, 99, Nine Winds, Nocturne, Oceanic, Omnisound, One Ten, Open Loop, Opus One, Organic Oboe, Osmosis, Other Media, Outcat, Outline, Ow, Pandora, Parachute, Passin' Thru, People's Music Works, Performance, Polaris, Progressive, Pyramid, Quadrangle, Ralph, RSM, Record Sluts, Red/Rouge, Re-Entry, Revelation, Rift, Robey, Rough Trade, Ruba, Rutledge, SRP, Sahara, Sea side, 1750 Arch, Shih Shih Wu Ari, Silver Sphinx, -onus, Scound Environment, Soundmasters, Sparrow, Spectrum, Spitball, Station Hill, Survival, Sweet Earth, TEA, Tanam Press, Theater for You, Mother, Theoretical, 360 Degrees, Titanic, Tiwa, Trans Museq, Transmic, Trident, Trutone, Universal Justice, Vacuum, Vineyard, Vinyl, Visible, Vrbulo, Watt, Wizard, Zanja, Zero, Zoar

Olympia Rec. Ind. Inc. 239 W 18 St Zip 10011 T-1 989-7200 (Rec. & Tape D), (Rec. & Tape RJ as Arovox Rec Corp.)
Labels: Osneyland, Golden, Kelti-Aurora, Vista

Otoao Recs Co Int'l Ltd. 214 W 96 St Zip 10025 Tel 866 2469 Owner L.R. Bernard, Mgr O Vera (Rec. & Tape I & E), (Rec. & Tape D as Oistri budora Nacional de Discos de New York)

Labels imported: Gransa (Ecuador), Onix (Ecuador)

Peters Int'l Inc. 619 W 54 St Zip 10019 Tel 246 400 Cable PETERS RECS Telex 666262 Pres Chris Peters (Rec. D & I, Tape I)
Labels: Arion, Anis, Berlitz, Kronos, Peters Int'l, West 54
Labels imported: Arion (France), Ariston (Italy), Barclay (France), CBS Int'l, CGD (Italy), EMI Int'l, Fomit Celra (Italy), IPG (France), Minos Mat sas (Greece), Music Box (Greece), Opus (Czechoslovakia), Phonogram Int'l, Polydor Int'l, RCA Int'l, Turcaphon group. (SEE ADVERTISEMENT)

PolyGram Dist'n Inc. 810 Seventh Ave Zip 10019 Tel 399-7100 VP Sales Jack Kiernan; VP Ops. Bert Franzblau, VP Finance Ron König, VP Prod Mgmt Rick Bleiwess, Nat'l Album Dir Harry Palmer, Nat'l Mdsq Dir Rob Singer, Nat'l Singles Mgr Herb Greene, Sales Admin Dir Sterling Devers, Nat'l Sales Admin'r June Silverman (Nat'l office) Local dist'n branch: 15 Columbus Circle, 10th Fl Zip 10023 Tel 399 7467 Reg 1 VP Shelly Rudin; Branch Mgr Jeff Brody (Rec. & Tape D)

Branches: Los Angeles, Corte Madera (San Francisco & Bay Area) Calif., Miami, Fla., Marietta (Atlanta Metropolitan Area), Ga., Schiller Park (Chicago Metropolitan Area), Ill., Greenbelt, Md., Woburn (Boston Metropolitan Area), Mass.; Troy (Detroit Metropolitan Area), Mich., Lakewood (Cleveland Metropolitan Area), Ohio, Dallas, Tex., Seattle Wash
Labels: Archiv, Argo, Casablanca, Charisma, Chocolate City, DJM, De Lite, Oeram, Deutsche Grammophon, Dreamland, Emarcy, Festivo, Head line, H., International, L'Oiseau Lyre, London, MCM, Mercury, Parrot, Phase 4, Philips, Polydor, Privilege, RSO, Riva, Spring, Telefunken, Threshold, Treasury, UK, Vertigo, Verve, Virgin, Zappa

Procanyn's Polka Palace, 40 22 61 St., Woodside 11377 Tel 898 9346 Owner & Buyer Walter Procanyn (Rec. & Tape D)
Labels: Amigo, Bayway, Bel Aire, Chicago, Crystal Tone, Cuca Delta Int'l, Dyno, Eastwind Int'l Artists, Eurotone, Fantastic, Fiesta, Garden State, Goodwill, IRM, International Artists, Jay Jay, Le Mans, Maxim, Monitor, Polka Tone, Rave, Request, Rex, Ridge, Rim, Sound, Stamco, Starr Steljo, Stella, Studio 5, Tifton, Tip, Tric, Usana, V Wam

Qualiton Imports Ltd., 39 28 Crescent St., Long Island City 11101 Tel 937 8515 Owners Otto & Judith Quittner, Pres Otto Muittner, Sales Mgr

**LOOKING FOR A ONE-STOP...
IF YOU'RE INTO DANCE MUSIC TRY US!**

SERVICING THE AREA
SERVICING THE COUNTRY
SERVICING THE WORLD

- IMPORTED 12-INCH DISCO
- EXPORT SALES
- FAST SERVICE
- FULL SELECTION
- VOLUME REBATES

STRATFORD DISTRIBUTORS, Inc.

815 Second Avenue • New Hyde Park • New York 11040
Phone: (212) 343-6920 (516) 352-4200 Telex: 510-223-0823

If you would like to receive Stratford Distributors regular price list, plus a copy of our weekly sales sheet, please fill in the coupon below and return to Stratford

(Dealers Only Please)

STORE NAME: _____
 ADDRESS: _____
 PHONE: _____
 BUYER: _____

Build your profits...check our prices!!!

12" DISCO IMPORTS WHOLESALE & EXPORT

- Are You Looking for 12" Disco U.S. & Imports?
Try us—We have the best selection of Disco wholesale you can find.
- We stock all current & new release Disco material from Canada, France, Germany, Holland, Italy, Mexico and U.S.
- Call, write or telex us for our current Disco flyer.
- We are export professionals & will give you personal service. We also can sell to you catalog LP releases from all foreign countries.
- We have our own Oldies Catalog listing 5000 singles from the '50's to the present.

Send for free catalog

IMPORT-O-DISC RECORDS

40 South Mall, Plainview, N.Y. 11803
(516) 694-4545 TELEX 230 199 SWIFT-UR

George Volckening, Albums & Tape Buyer, Judith Quittner (Rec. & Tape D & I)

Labels imported: BIS (Sweden), CRD (UK), Hungaroton (Hungary), Pan ton (Czechoslovakia), Pearl (UK), Pepita (Hungary), Qualiton (Hungary), Supraphon (Czechoslovakia).

RCA & A&M & Assoc'd Labels, 1133 Ave. of the Americas, Zip 10036 Tel 930 4606 Reg'l Sales Dir. Bob Heatherly, Branch Sales Mgr. Bob Rifici, Sales Mgr. Mary Beth Connors. (Rec. & Tape D)

Other branches: Hollywood (Los Angeles Metropolitan Area), San Francisco Calif., Denver, Colo., Miami, Fla., Atlanta, Ga., Honolulu, Hawaii, East Oak Brook (Chicago Metropolitan Area), Ill., Greenbelt, Md., Newton Upper Falls (Boston Metropolitan Area), Mass., Southfield (Detroit Metropolitan Area), Mich., Edina (Minneapolis St. Paul Area), Minn., St. Louis, Mo., Cherry Hill, N.J., Independence (Cleveland Metropolitan Area), Ohio, Dallas, Tex., Tukwila (Seattle Area), Wash.

Labels: A&M, Bluebird, Gold Seal, Grunt, Millennium, NY Int'l, Pablo, Pablo Live, Pure Gold, RCA, Red Seal, Salsoul, 20th Century, Victrola

R & J Recs. Inc. 108 Sherman Ave. Zip 10034 Tel 942 8185 (Rec. & Tape D & OS)

Labels: Alegre, Coco, Cotique, Exitos, Fania, Inca, TR, Tico, Yaya Random Dist'n Group, 11 Dellwood Rd. Staten Island 10304 Tel 979 5945. (SEE ADVERTISEMENT)

Rashid Sales Co., 191 Atlantic Ave., Brooklyn 11201 Tel 852 3295 Owners: Albert, Raymond & Stanley Rashid, Mgr. & Albums Buyer Stanley Rashid (Rec. & Tape D, OS & I)

Labels imported: Bardaphone, Buzardphone, Carophone, EMI Araby (EMIAR), EMI Parlephone, Sout el Hob, Sout el Phan, Sout Wa Soura (all Arabic), EMI Greece, Odeon, Regency (all Greek).

Videocassette lines: Arabian Video Entertainment, Trytell Record Haven, 636 11 Ave. Zip 10036 Tel 247 5900 Telex 666754. Owners Sam & Len Fichtelberg, Gen. Mgr. Paul Freund, Export Div. Mgr. Jim McCarthy, Sales Jim Kelly, Singles, Albums & Tape Buyer Tom Schlapak (Rec. & Tape OS, RJ, I & E)

Record Shack of New York City Inc., 72-02 51 Ave., Woodside 11377 Tel 899 0200 Telex 62632 Owner & Pres. Edward A. Portnoy, Mgr. Gene Fink (Rec. & Tape OS, I & E)

Branch: Compton (Los Angeles Metropolitan Area), Calif., Record Shack of Los Angeles

Record Warehouse, 171 W. 57 St. Zip 10019 Tel 541 4666 Telex 640748 Pres. Arthur Danziger (Rec. E—cutouts, rare rock)

Release Recs. Inc., 4257 Katonah Ave., Bronx 10470 Tel 325 6808 Pres. Daniel J. Ryan (Rec. & Tape I)

Labels imported: Chart, Chyme, Dolphin, Gael Linn, Hawk, Outlet, Polygram, Release, Tara (all Ireland), Affinity, Charly, Greensteves, Trojan (all UK)

Alex S. Roberts Assocs. Inc., 28 20 41 Ave., Long Island City 11101 Tel 786 8264 Pres. Edward B. Thom. (Rec. & Tape E)

Henry Rosenberg Ltd., New York Sheraton Hotel, 870 Seventh Ave., Suite 348 Zip 10019 Tel 541 5350 Pres. Henry Rosenberg (Rec. & Tape D, I & E)

Videocassette line: Magic of Derek Dingle

Distributes close-outs, surplus tape lines, cutouts, overstock Rounder Dist'n, 169 Seventh Ave., Brooklyn 11215 Tel 965 4746 Mgr. Dave Nives (Rec. & Tape D, I & E)

Home office: Somerville (Boston Metropolitan Area), Mass. (See for prod distributed)

VOIC • "RATED NO.1 IN SERVICE AND RELIABILITY" • PIONEER

AUDIO & VIDEO RETAILERS CALL THE "HOT LINE!"

Lowest Possible Prices! Take Advantage of our Multi-Million Dollar Buying Power.
Every Major Brand! Audio/Video Equipment, Cartridges, Accessories, Blank Tape. The Most Up-To-Date Models in Factory Sealed Cartons.

CALL OUR WHOLESALE "HOT LINE" TODAY!
(212)732-3944 FOR IMMEDIATE SERVICE!

TELEX #:126221 J&R NYK
GENERAL INFORMATION:
(212)732-8600

WHOLESALE DIV., 23 PARK ROW, NEW YORK CITY, 10038



DUAL • JENSEN • FUJI • TECHNICS • SCOTCH • ELECTROVOIC

PIONEER • TDK • PANASONIC • SONY • JVC • DUAL • MAXELL

EXCLUSIVE SPECIALISTS FOR
THE JUKE BOX OPERATORS
The One-Stop with a complete selection of Singles, Disco, Soul, Pop and Rock Oldies, Standards, Latin and Background Music.

TITLE STRIPS WITH ORDERS
Immediate Delivery
Mail Orders Our Specialty

OTTO WILKINSON
General Manager

A-1 RECORD SALES

659 Tenth Ave., N.Y., N.Y. 10036. Phone: (212) 246-1234—246-3330



*34 Years Of
Experience*

ALPHA Distributing Corporation

20 West End Avenue, New York, New York 10023

212-397-1920

Telex: 236581 ALCO

In • New York • New Jersey • Connecticut • Massachusetts

**BEST
PRICES
QUICK
SERVICE**

Customer
Satisfaction
is our
Business.

New
Releases,
Catalogue
Material,
Cut-outs,
Etc. . .

Write or
Call
for Catalogues
and
Special Offers.



**EXPORTERS
PHONOGRAPHIC
RECORDS
AND TAPES**

**WAMID,
INC.**

200 Hudson Street
N.Y.C., N.Y. 10013
U.S.A.
TELEX: 236941
TELEPHONE: 212 • 431-3480

S M G Dists. Inc., 46-50 54 Ave., Maspeth 11378. Tel: 937-7200. (Rec. & Tape D), (Rec. & Tape I & E as Sam Goody Int'l Inc.)
Distributes cutouts, over runs.
Albert Schultz Inc., 116 W. 14 St. Zip: 10011. Tel: 924-1122. Cable: ALBY-REP. Telex: 236569. Pres.: Albert Schultz; Mgr.: Ricardo Leon. (Rec. & Tape E)
Exports all current & cut-out rec. & tape labels, accessories, blank audio cassettes, cartridges & open reel tape, tape supplies for mfrs. of cassettes & cartridges; high fidelity & discotheque equip.; blank & pre-recorded videocassettes. (SEE ADVERTISEMENT)
Sight & Sound Women Inc., 20 W. 22 St. Zip: 10010. Tel: 929-6207. Pres.: Robin Imandt. (Rec. D)
Labels: Alligator, Arch, Arhoolie, Benyo, Blues Classics, Carolsdatter, Even Keel, Folkways, Fr-tless, Halcyon, Inner City, Lima Bean, Lucy, Magnus, Mary, Open Door, Dut & Dut, PM, Paredon, Philo, Riverbear, Rosetta, Sea Friends, Sea Wave, Sound Environment, Spivey, Stash, Storyville, Troubador, Turnabout, Urana, Vox, Waterhouse, Women's Wax Works.
M. Sluis Co. Inc., 15 Park Row. Zip: 10038. Tel: 349-0590. Cable: CINAEC. Telex: 223068 (RCA), 667670 (WU). Pres.: M. Sluis; VP: H. Elion; Mgr.: Ms. M. Zylber. (Rec. & Tape E)
Exports all rec. labels, tape lines, blank audio & video tape, closeouts & stock lots. (SEE ADVERTISEMENT)
Stratford Dists. Inc.—Tel: 341-6920—see listing under New Hyde Park, N.Y.
Sunshine Rec. Dists., 710 12 Ave. Zip: 10019. Tel: 265-3530. (Rec. D).
Labels: Airwave, Ameraba, Aurum, BC, Baby D, Barbara Jean Int'l, Brass, Brunswick, Chiaroscuro, Dakar, Dazz, Double Shot, Emergency, Eric, Et Cetera, Express, GNP Crescendo, Gold Disc, Hi, ICA, JAM, JDC, Jeremiah, Jewel, Kelli Arts, Knockout, Laser, Legge, Magic Disc, NRC, New York City, PBI, Passion, Posse, Prism, RFC, Ramparts, Richburg, Roy B, Silhouette, Snowflake, Spectrum, Sugar Hill, TSDB, Uniwave/Unidisc, Uno Melodic, VAP, We Four, West End, Wheel, Willkerr.
Surplus Rec. & Tape, Dist.—Tel: 695-6117—see Passaic, N.J., listing.
Tape King Inc., 220 W. 19 St. Zip: 10011. Tel: 675-0800. Telex: 237891.
Owner: Joseph Abady; Mgr.: David Abady; Buyers: Singles, David Abady; Albums, Joseph & David Abady, Claudia Druven; Tape, David Abady. (Rec. & Tape OS & E). (SEE ADVERTISEMENT)
Titan United Corp., 25 W. 43 St. Zip: 10036. Tel: 354-5005. Pres.: Martin L. Roemer. (Rec. & Tape D—military sales only)
Top Ten Hits Recs. Dists., 641 10 Ave. Zip: 10036. Tel: 489-9428. Owner & Tape Buyer: Anibal Torres; Mgr. & Albums Buyer: Ana T. Torres. (Rec. D, Tape OS)
Labels: Cesta, Citation, Dino, Fonseca, Hacienda, Kim, La Cole, Lassisi, Mavela, New Generation, Rana, Suave, TR, TTH, US.
Wamid Inc., 200 Hudson St., 12th fl. Zip: 10013. Tel: 431-3480. Telex: 236941. Pres.: William M-deot; Mgr.: Christian Geldreich. (Rec. & Tape I & E) (SEE ADVERTISEMENT)
Warner/Elektra/Atlantic Corp., 1700 Broadway. Zip: 10019. Tel: 757-3939.
Branch Mgr.: Mike Holzman; Sales Mgr.: Paul DeGennaro. (Rec. & Tape D—see office in Los Angeles, Calif., for prod. distributed)
West Side Sound Dist. Inc., 593 10 Ave. Zip: 10036. Tel: 586-2710. Pres.: Arturo J. Saiz. (Rec. & Tape D)
Branch: North Bergen, N.J.
Labels: AS Int'l, Raiz, Se-co, Tropical WS Latino, West Side.

HONE'S ONE STOP RECORDS & TAPES

SOUL • ROCK • GOSPEL • COUNTRY • WESTERN & RAP

SPECIAL LOW DISCOUNT PRICES

IF YOU WANT THE LATEST OF ANY TYPE OF SOUND,
WE HAVE IT. IF NOT, WE'LL GET IT!

We have many other specials which change weekly. Will ship anywhere. For more information:



**HONE'S ONE STOP
RECORD DISTRIBUTORS**

217 BRONX TERMINAL MARKET, BRONX, N.Y. 10451
Ask for Johnny or Chuck (212) 292-0267

Wholesale
Records
Tapes
Accessories

**FOR
EXPORT ONLY
All Labels
Records & Tapes**

- New Releases
- Rock & Pop
- Disco & Jazz
- Afro Cuban
- Nostalgia
- Classical
- Cutouts
- Video Cassettes
(PAL and American Systems)
- Always in Stock
- Lowest Export Prices
- Fastest Delivery

Free Catalogue on Request

**DAVID
ESKIN
INC.**

400 Riverside Drive
New York 10025 USA
Telex 237460 ESKINUR • Tel (212) 749-4257

**NATIONAL DISTRIBUTION
FOR INDEPENDENT RECORD COMPANIES**

THROUGH LOCAL DISTRIBUTORS & ONE-STOPS
AND DIRECT TO RETAILERS AND MAIL ORDER

WE PROVIDE KNOW HOW AND SERVICES FROM
RECORDING SESSION TO FINISHED DISC & SALES

WE OFFER PRESSING, PROMOTION
AND MARKETING GUIDANCE.

RANDOM DISTRIBUTION GROUP

11 DELLWOOD RD. / STATEN ISLAND, N.Y. 10304 / 212-979-5945

OUR
22nd
YEAR



Win Records and Video, Inc.

45-50 38th St. Long Island City, N.Y. 11101

(212) 786-7667

TELEX:666987

Export Professionals

- ★ We have the most extensive Oldie, 45, LP and Tape Inventory in the world.
- ★ Distributor for all Labels, Imports and New Releases — Same Day Service. Over 10,000 hard-to-get titles updated daily.
- ★ Always the Lowest Discount Prices. Call us for our Catalog, FREE with first order.
- ★ Conversant in all Languages.
- ★ We do listen to all Dance Records.



Distributor for all Video Tapes:

- ★ CBS/MGM, Magnetic Video, Media, Paramount, VCX, Warner, MCA, Columbia, Nostalgia Merchants. Blank Tapes and Accessories: Fuji, TDK, Memorex, Ampex, Panasonic & others.

Over 25 Years of Solid Experience.

"Customer consensus rates our service #1 in the world!"

Largest Exporter of Phonograph Records in the World.

DISTRIBUTORS OF HOME ENTERTAINMENT PRODUCTS

AT LAST...A TOTALLY FULL SERVICE

EXPORT ONE-STOP...

GALIKO

GALIKO MUSIC & FILM PRODUCTIONS

has now merged with RECORD HAVEN EXPORT

241 West 18th Street, New York, N.Y. 10011

(212) 989-7200 • TELEX 666754 HAVEN

over 20 years of solid experience Galiko now offers:

- COMPLETE CURRENT CATALOG OF ALL POPULAR MUSIC, LPs & TAPES, 12" & 7" (rock, rhythm & blues, new wave, reggae, jazz, disco, country, etc.)
- 24 HOUR DELIVERY OF NEW RELEASE PRODUCT
- SPECIAL ORDERS (items not stocked) SHIPPED COMPLETE IN 4 WORKING DAYS
- WEEKLY CUT OUT SPECIALS LIST
- CATALOG OF OLDIES AVAILABLE
- VIDEO PRODUCT, SPECIAL ATTENTION GIVEN TO "PAL AND SECAM" SYSTEM
- ANY MARKETABLE PRODUCT, THAT CAN BE SOLD OR DISTRIBUTED IN USA RETAIL MARKET, GALIKO WILL GLADLY BE YOUR SOLE SELLING AGENT.
- ANY USE PRODUCT, BESIDES RECORDS, YOU WISH TO IMPORT, GALIKO WILL GLADLY BE YOUR PURCHASING AGENT.

Ervin Litkei, President

Susan Fichtelberg, Vice President

Larry Lipp, Executive Buyer

AFRICAN RECORD CENTRE DISTRIBUTORS, LTD. IS SERVING YOU BETTER !!

*The Largest Selection of
African Records Available. Plus . . .*
REGGAE • CALYPSO • SOCA

- FULL CATALOG
- RELIABLE SERVICE
- LOWEST PRICES

WE EXPORT WORLDWIDE—ALL INQUIRIES WELCOME



CALL OR WRITE
AFRICAN RECORD CENTRE DISTRIBUTORS, LTD.
Exclusive Worldwide Distributors of Makossa
International Group Labels
1194 NOSTRAND AVENUE, BROOKLYN, NEW YORK 11225 - U.S.A.
(212) 493 4500 CABLE ADDRESS AFRECENTRE. NY



TELEX 220883 TAUR
TWX 7105815380 TPNYK

MAKOSSA means MUSIC!
MAKOSSA GROUP LABELS

CUT CORNERS

**PREMIUM CUT-OUT LP'S & TAPES
PICTURE DISCS, ROCK CLOCKS & MORE!!**

- PROMPT SERVICE
- QUANTITY DISCOUNTS
- DEFECTIVE RETURN POLICY
- MONTHLY CATALOG

SAVE TIME AND MAKE MONEY
CALL OR WRITE FOR FREE CATALOG TODAY



430 FALMOUTH ROAD, NORTH BABYLON, N.Y. 11704
TELEPHONE (516) 587-7722
TELEX: 647021—Ans Back—ALL RECORD WERY

Win Recs. Inc., 45-50 38 St., Long Island City 11101. Tel: 786-7667. Owner & Pres: Sam Weiss; VP & Mgr.: George Weiss; VP Video Div.: Herb Goldfarb; Buyers: Singles, Smokey Smoker, Albums, Jamie Kimeck; Tape, Zeke Lengua. (Rec. & Tape OS, RJ, I & E)
Videocassette lines: All Star, Columbia, MCA, MGM, Mag Video, Media, Nostalgia Merchants, Paramount, VCI, Warner Bros.
Accessories: BASF, BMI, Discwasher, EV Game, Le-Bo, Maxell, Memorex, Peerless, Reclon, Sony, Sound Guard, TDR. (SEE ADVERTISEMENT)
Worldtone Music Inc., 230 Seventh Ave. Zip 10011. Tel: 691-1934. Mgr.: K. Spear (Rec. & Tape D, I & E)
Labels: Hadarim, MIH, Worldtone
Labels imported: Amiga (East Germany), Balkanton (Bulgaria), Chant du Monde (France), Electrecord (Romania), Eterna (East Germany), Finnlevy (Finland), Nova (East Germany), Swedish Society Discofil (Sweden), Telearstar (Sweden)
Worldwide Music Dists., PO Box 995, Zip 10023. Pres: Eric Fletcher. (Rec. & Tape I & E)
Labels imported: Abbey (UK), CRD (UK), GFH (UK), Guild (UK), Meridian (UK), Pye (UK), Viking (UK), Wealden (UK)
Zemeron Trading Inc., 114 E. 25 St. Zip 10010. Tel: 673-2430 (Rec. & Tape I).
Labels: Gal-Ton, Hataklit, Hed Arzi, Isra-disc (all Israel)

- **NORTH BABYLON (Area Code 516)**
Cut Corners Rec. Dist. of New York, 430 Falmouth Rd. Zip 11704. Tel: 587 7722. Pres & Buyer Karl Groeger. (Rec. & Tape D, OS, I & E)
Labels: Rhino; also distributes cutouts & overstocks. (SEE ADVERTISEMENT)
- **NYACK (Area Code 914)**
Harry Warriner, 101 Gedney St. Zip 10960. Tel 358 5086. Owner Harry Warriner. (Rec. & Tape D)
Distributes cutouts, premiums.
- **PLAINVIEW (Area Code 516)**
Import Disc Corp., 40 South Mall. Zip 11803. Tel 694-4545. Owner: Bob Miller. Mgr.: Kenneth Shunkman. (Rec. OS, I & E) (SEE AD)
Imports from Canada, France, Germany, Italy, Mexico, Netherlands, UK.
Paramount Recs. Inc., 81 Sheer Plaza Zip 11803. Tel: 249 1990. Pres: Herb Shenkman. Mgr.: Singles & Albums Buyer: Andrew Shenkman. (Rec. OS, RJ & E)
Skydisc Inc., 101 32 Dupont St. Zip 11803. Tel: 349-0900. Owners: Tim & Kerr Kelly, Neil Smilowitz. Steve Melhush. (Rec. I & E) (SEE ADVERTISEMENT)
- **POUGHKEEPSIE (Area Code 914)**
Toy House of Hudson Valley (div. of Kustas Bros. Inc.), Manchester Rd. Zip 12603. Tel 471 2740. Pres. & Mgr.: Louis J. Kustas. (Rec. & Tape OS & RJ)
Accessories: Hagerstown, Le Bo, Reclon, Savoy.

- **REOWOOD (Area Code 315)**
North Country Dists., Cadence Bldg., 345 Rt. One. Zip 13679. Tel 287 2852. Albums Buyer: Larry Raye. (Rec. D, RJ, I & E)
Labels: Adelphi, Birch, Cadence, Clean Cuts, Daffodil, Dagel, Denon, Fanfare, Halcyon, Hat Hut, India Navigation, JSP, Jazz, Jazz Chronicles, Joyce, Mellalanguage, Nimbus, Ozone, Pumpkin, Revelation, Sahara, Session, Spitball, Spring.
- **ROCHESTER AREA (Area Code 716)**
House of Guitars Inc., 645 Titus Ave. Zip 14617. Tel 544 3500. Owner: Armand Schaubroek; Mgrs.: Jim Degman, John Fritch, Buyers: Singles, Mike Snowcone, Albums, Jim Degman. Local branch: 1 Grange Pl., Irondequoit 14617. Tel 266-9584 (Rec. RJ & E), (Rec. D & OS as Kach Kick Inc.), (Rec. & Tape I & E as Mirror Inc.)
Labels: Blank, CBS/Sony (Japan), Capitol (France), GRT (Canada), House of Guitars, Mirror, Dzark, Polydor (Canada), Ralph, Sky Dog (France), Stiff (UK)
Photographs: Craig, Kenwood, Sony
Accessories: Memorex, RCA, Sony, Sound Guard, TDK
Kach Kick Inc. (Rec. D & OS)—D Mgr.: Bruce Schaubroek. DS Mgr.: Kim Simons, Buyers: D Singles, Greg Prevost, DS Singles, Mike Snowcone, Albums, Kim Simons—see House of Guitars Inc.
Mirror Inc. (Rec. & Tape I & E)—Owner & Mgr.: Bruce Schaubroek—see House of Guitars Inc.
Rochester One Stop, 2527 W. Henrietta Rd. Zip 14623. Tel 424 2002. (Rec. & Tape OS & RJ)
Home office: Buffalo, N.Y., Transcontinent Rec. Sales (Rec. & Tape RJ)

- **SYOSSET (Area Code 516)**
Larry Sockell Inc., 100 Colony Ln. Zip 11791. Tel 921-2821. Owner, Mgr. & Buyer: Larry Sockell. (Rec. sales rep., D, I & E)
Labels: Big Band Era, Brasilia imports, Bruno Walter Soc., Choice, Composer's Recs. Inc., Converse-Phone, Everest, Folkways, GNP Crescendo, Gwelo imports, Hindsight, Klavier, Louisville Symp., Lyrichord, Monitor, Monmouth Evergreen, Olympiac, Radiola, Roper, Simon Says, Town Hall
Videocassette lines: Radiola/Video Yesteryear.
- **SYRACUSE (Area Code 315)**
Mage Serv Mdsq Inc., 112 Ronnell Dr. Zip 13219. Tel 488 2512. Pres.: A. Orlando, Mgr.: Singles. Albums & Tape Buyer: Gerry Orlando. (Rec. & Tape OS & RJ)
Morris Dist'g Co. Inc., 1153 W. Fayette St. Zip 13204. Tel 475 6531. (Rec. & Tape D & OS)
Labels: Pickwick, RCA, Vox.
Accessories: Le-Bo, Memorex, Reclon, Scotch, Walls
Syracuse One Stop, 333 W. Fayette St. Zip 13202. Tel. 476-4019. (Rec. & Tape OS & RJ)
Home office: Buffalo, N.Y., Transcontinent Rec. Sales. (Rec. & Tape RJ)
- **WANTAGH (Area Code 516)**
Dutch East India Trading, 3341 Beltagh Ave. Zip 11793. Tel 679-8700. Telex 4758099. (Rec. I & E)
Muscanza Corp., 2878 Bayview Ave. Zip 11793. Tel 826-2735. Owner, Mgr. & Albums Buyer: Al Rubin. (Rec. & Tape D—children's prod only)
Labels: CMS, Caedmon, Camden, Disneyland, Disneylandia (Spanish)

prod.) Folkways, Peter Pan, Pickwick, Sesame Street, Superscope (Eng. Irish, French, Italian, Portuguese & Spanish prod.), Ultra Sound, Wonderland
 Playback equip.: Superscope (SEE ADVERTISEMENT)

● **WESTBURY (Area Code 516)**

All Rec. Dist. Inc., 44 Bond St. Zip 11590 Tel. 997 7160 Owners: Charles Nero, Michael Cono, Mgr. Stan Schneider, Buyers: Singles, Cliff Fenster, Albums, Michael Mangiacapre, Tape, Jerry Mercorella (Rec. & Tape OS & E)

Accessories: Le Bo, Maxell, TDK
 Polka Towne Music, 211 Post Ave. Zip 11590 Tel. 334 6228 Owner & Buyer: Teresa Zapolska (Rec. & Tape D & OS)
 Labels: Adena, Alshire, Amerpol, Amigo, Ampol, Ardene, Bayway, Bel Air, Chalet, Chicago, Cuca, D. Dana, Data, Dearborn, Delta Int'l, Don Joe, Dyno, Eastwind Int'l, Elgin, Eurotone, Fantastik, Fiesta, Garden State, Gold, Goral, Halo, Happy Times, IRM, Imperial Sound, JBL, Jay Jay, Jody, K&B, Kay, Kerebo, L. Kay, Le Mans, Li Dar Studio, Maxim, Melodia, Micro, Monitor, Muza, Polish Song, Polka Towne, Pronit, Rave, Ray, Request Resound, Rex, Ridge, Ridgemoor, Rim, Rol, Rola S&S, Select, Silverbell, Sound, Spectrum, Spotlite, Stamco, Starr, Steljo, Stella, Studio S, Sure, Tifton, Trash, Usana, Veriton, Vicrom, Vista, Wam, Yar

● **WOODMERE (Area Code 516)**

Leonard Finkel Assocs., PO Box 39, 574 Lehigh Ln. Zip 11598 Tel. 374 3221 Pres. Leonard Finkel (Rec. D)
 Playback equip.: Audiovox, Lloyds, Sanyo, Teletone, Vanity Fair
 Accessories: Allsop, Ampea, Arista, BASF, BMI, Discwasher, Duracell, Empire, Eveready, Fuji, Irish, Koss, Le Bo, Maxell, Memorex, Mura, Planstehtl, Pickering, Pickwick, Recoton, Rembrandt, Scotch, Shure, Sony, Sound Guard, Stah II, Stanton, TAE, TDK, Walco, Watts

NORTH CAROLINA

● **ASHEBORO (Area Code 919)**

Kenway Sales, PO Box 1553 Zip 27203 Tel. 625 6354 Owner: H. Wayne McDowell, Mgr. Laurenda McDowell (Rec. & Tape OS & RJ)
 Accessories: Blank Tape

● **BREVARD (Area Code 704)**

Omega Music Inc., 105 E. Main St. Zip 28712 Tel. 884 2320 Bus. Mgr. & Buyer: Linda B. Zuch (Rec. & Tape D, OS & E)
 Labels: Alexandria House, Benson, Calvary, Christian World, Columbia, Copeland, Creative Sound, Discovery, Edify, Good Life, Hope, Inter-Varsity, Lillenas, MCA, Manna, Maranatha, New Life, North American Liturgy, Rainbow Sound, Savoy, Servant, Singpiration, Sparrow, Spirit Star Song, Supreme, Takoma, Triune Triangle, Weston Priority, Word, Word of God, Zondervan

● **CARRBORO (Area Code 919)**

Disc Trading Co., PO Box 606 Zip 27510 Tel. 942 3142 Pres. Jim Enright VP. Robert O'Reilly Export Mgr. Chris Davis (Rec. I & E)
 Imports from Australia, Europe, Japan, Mexico, Scandinavia, UK, Uruguay (SEE ADVERTISEMENT)

● **CHARLOTTE (Area Code 704)**

Bib Dist'g Co., 101 Yorkmont Rd. Zip 28210 Tel. 527 0440 Pres. & Singles Buyer: Joe Voynow, Mgr. & Albums Buyer: Bill Norman (Rec. & Tape D, OS & RJ)
 Labels: Alarm, Alston, Boardwalk, Canaan, Cat, Chimneyville, Creed, Dash, Drive, Glade, Gordy, Gusto, HSE, Heart Warming, Juana, Light, Malaco, Milestone, Motown, Nashboro, Prodigal, Rare Earth, Su Ann, TK, TMS, Tania, Weird World, Word
 Disc Tape & Rec. Co., 900 Atlando Ave. Zip 28206 Tel. 376 0140 Owners: Othel Brown, Tim Braswell, Mgr., Singles & Albums Buyer: John Towles (Rec. & Tape RJ)
 General Music Corp., 1720 Toal St. Zip 28206 Tel. 377 5623 (Rec. & Tape D—budget prod.)
 Handleman Co., 11626 F. Wilmar Blvd. Zip 28210 Tel. 588 3432 (Rec. & Tape RJ)
 Home office: Clawson (Detroit Metropolitan Area), Mich.
 M D R E Music Inc., 7814 Tyner St. Zip 28213 Tel. 597 1860 Contacts: Charles A. Hartley, H. Grady Brown Jr. (Rec. & Tape RJ)
 Schwartz Bros. Inc., 5501 Executive Center Dr., Suite 101 Zip 28212 Tel. 536 9390 Mgr. Otis Henry (Rec. & Tape D)
 Home office: Lanham, Md.
 Labels: Arista, Benson, Birthright, Buddah, Concord Jazz, Fantasy, 51 West, GRP, Galaxy, Gospel Truth, Jewel/Paula, Laif, Laurie, Milestone, Novus, Praise, Pray, Prestige, Project 3, Rainbow Sound, Riverside, Savoy, Sesame Street, Sound of Gospel, Sta., Stiff, TR
 Warner/Elektra/Atlantic Corp., 5105 Monroe Dr. Zip 28212 Tel. 568 0482 Sales Mgr. Roger Heims (Rec. & Tape D—see office in Los Angeles Calif. for prod. distributed)

● **DURHAM (Area Code 919)**

Ladyshipper Inc., PO Box 3124 Zip 27705 Tel. 596 0717 Mgrs. & Albums Buyers: Laurie Fuchs, Elizabeth Snow (Rec. D)
 Labels: Aeolus, Affinity, Ars Pro Femina, BetCar, Bloodleaf, Carolsdatter, Cassandra, Deep River, Dream Machine, Even Keel, Galaxia, Gemini Hall, Leonarda, Lima Bean, Lucy, Mary, Mother of Pearl, Old Lady Blue Jeans, Olivia, Open Door, Origami, Pleiades, Redwood, Riverbear, Rosetta, Schnarf, Sea Friends, Sea Wave, Sisters Unlimited, Spaniel, Terrapin, Urana, Windbag, Women's Wax Works

● **ELIZABETH CITY (Area Code 919)**

General Broadcasting Serv., PO Box 1628 Zip 27909 Tel. 232 2703 (Rec. D)
 Labels: American Artists, American Voices, Bivens, Chory Int'l, Flame, GBS, Golden Boots II, Homerun, Jukebox, Moody, Nashville, American Pussycat, Reo, Voice

● **FAYETTEVILLE (Area Code 919)**

A A Co. Inc., PO Box 5866, 6232 Bragg Blvd. Zip 28303 Tel. 867 6111 (Rec. & Tape OS & RJ)

SOME OF THE FINEST EUROPEAN RECORDINGS NEVER REACH AMERICAN SHORES.

IBR IS CHANGING THAT

Our Import Service is committed to providing the very best in imported recordings, featuring recent releases, unusual repertoire, and historical reissues of musically significant recordings. Our Labels include extensive selections from the EMI Catalogues of England, France, Germany, Italy, Denmark and Sweden; RCA France, England and Italy; Philips and NKF from Norway; Replica and Bongiovanni from Italy; Carrerre and Vogue from France; and a large selection from Polygram Brasil, and much, much more.

CONTACT US FOR COMPLETE CATALOGUE ORIGINAL SOUNDTRACKS, CLASSICAL, POPULAR, FOLK, NOSTALGIA, JAZZ, DISCO.

INTERNATIONAL BOOK AND RECORD DISTRIBUTORS

40-11 24th Street, Long Island City, New York 11101
 (212) 786-2966 Telex: 235967 IBRD



WHOLESALEERS



FOR THE BEST CUTOUTS ONE WAY RECORDS

12 COMMERCIAL RD.
 ALBANY, N.Y. 12205

518 • 489-3288
 800 • 833-3553
 TELEX: 145499

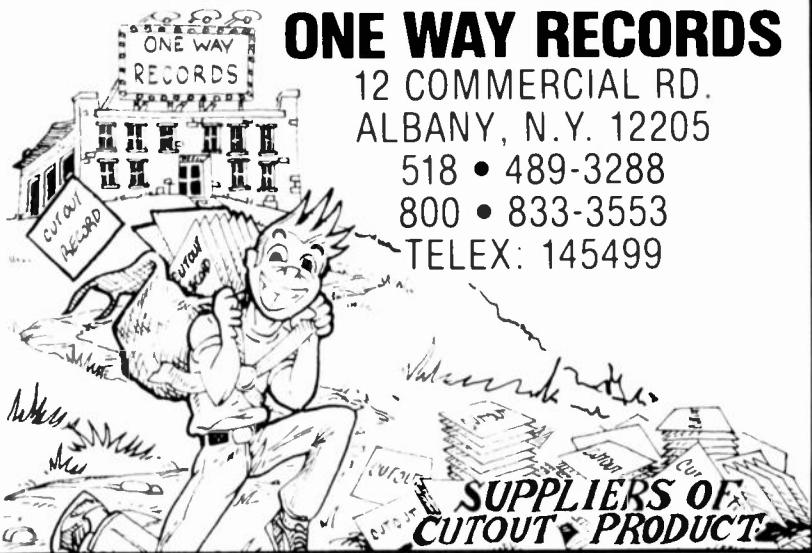

IMPORTS!

DISCOVER NEW PRODUCT
FOR A NEW MARKET

Rock, "New Music", Futurist, Funk, Dance...
Major Labels - UK, European, Japanese,
Australian and U.S. Independent Releases
SPECIALISTS IN: Service and Price.
DO IT NOW! - Call or Write for Updated Catalog

Telephone: 919/942-3142
Telex: 579337 Oisctrade CPEL



POST OFFICE BOX 606BB
CARRBORO, NORTH CAROLINA 27510



Telers International

AMERICA'S LARGEST

• IMPORTER • MANUFACTURER • DISTRIBUTOR

OF INTERNATIONAL PRODUCT

ETHNIC • CLASSICAL • JAZZ • M.O.R.

(212) 246 - 2400

619 WEST 54th STREET, NEW YORK, N.Y. 10019

Telex: 666262

DOLLY DIMPLES HIT PARADE

A New Cable TV Show
for Children

- LP's Available
- MZA 3001—Dolly Dimples
 - MZA 3002—Dolly Dimples Fever
 - MZA 3003—Dolly Dimples Disco
 - *MZA 3004—Dolly Dimples Favorite Songs
 - **MZA 3005—Dolly Dimples Greatest Hits
- Call 516-826-2735
*Available 1/1/82
**Available 4/1/82

RECORDS, 8-TRACKS, CASSETTES

All Labels

Current and closeouts.
Orders consolidated.
Nearly 40 years
experience.

DARO EXPORTS, LTD.

1468 Coney Island Avenue
Brooklyn, N.Y. 11230
Cables: EXPODARO

● **MOUNT AIRY (Area Code 919)**
Stark Recs. 628 South St. Zip 27030 Tel 786 2865 Pres Paul E Johnson (Rec. & Tape DS & RJ)

OHIO

● **AKRON AREA (Area Code 216)**
Audio Technica US Inc., 1221 Commerce Dr. Slow 44224 Tel 686 2600 Pres Jon R Kelly, Sr VP Fred W Nichols (Rec. D, I & E)
Label: Telarc
Labels imported: RCA/RVC (Japan), Toshiba EMI
Twelgrena Ents Inc., 2775 Yellow Creek Rd Zip 44313 Tel 836 5591 Pres J Hugh Macey, Mgr Cem Macey, Buyers: Mrs C Zavodny (Rec. D & E—dance recs only)
Labels: Belco, Blue Ribbon, Blue Star, Bogan, CEM, Chicken Fat, Cross Roads, D & E, D&R, Dance Alone, Dance Ranch, Dancetime, E Z Fun, Elite, FTC, Family Squares, Flutter Wheel, Folkraft, Ghost Town, Gold Star, Greenwood, Grenn, HAT, HMV, Hanf, HiHat, Hoctor, J Bar K, Jewel, Kalox, Kimbo, Lightning S, Lloyd Shaw, Longhorn, Lore, LouMac, Lucky, MacGregor, Magic, Marian, Marko, Mayflower, Mibs, Mustang, National, Did Timer, Parlophone, Pilgrim, Pioneer, Pulse, Rainbow, Red Boot, Rockin' A, Roper, Scope, Sets in Order, Slavjani, Square Dance USA, Square Tunes, Star Dust, Sunny Hills, Swinging Square, TDP, Telemark, Thunderbird, Tikva, Wagon Wheel, Wadd West, Windsor, World of Fun, Worldtone
Photographs: Newcomb
Accessories: Grenn, Newcomb, plastic sleeves for 45 rpm's

● **ATHENS (Area Code 614)**
Audio Buff Co Inc., 315 W Union St Zip 45701 Tel 593 3014 (Rec. & Tape DS)

● **CANTON AREA (Area Code 216)**
Praise Recs, PD Box 8080 Zip 44711 Pres J Maas (Rec. D)
Labels: Canaan, Diadem, Heart Warming, Impact, Joyous Melodies, Pickwick, Praise, Sacred, Singcord, Sword, Teen, Tot, World
Stark Rec & Tape Serv Inc., 8000 Freedom Ave NW, North Canton 44720 Tel 494 2282 Dwner Paul David, VP & Buyer Joe Bressi (Rec. & Tape RJ)

● **CINCINNATI AREA (Area Code 513)**
Ambat Recs., 2350 Gilbert Ave Zip 45206 Tel 751 5071 (Rec. & Tape DS & RJ)
Home office: Buffalo, N.Y., Transcontinent Rec Sales (Rec. & Tape RJ)
C B S Recs., Tri County Office Park, 1313 E Kemper Rd., Suite 302 Zip 45246 Tel 671 0310 Branch Mgr Nate Wolk (Rec. & Tape D—see New York, N.Y. office for prod distributed)
Halper's One Stop, PD Box 37156 Zip 45222 Mgr Saul Halper Handleman Co., 4550 Cornell Rd., Blue Ash 45241 Tel 891 9633 (Rec. & Tape RJ)
Home office: Clawson (Detroit Metropolitan Area), Mich
M C A Dist'g Corp., Bldg 2, 11750 Chesterdale Rd Zip 45246 Tel 771 4870 Branch Mgr Roger Harris (Rec. & Tape D—see office in Los Angeles, Calif., for prod distributed)
Mobile Rec Serv Co., 3623 Edwards Rd., No 2 Zip 45208 Tel 871 8215 Mgr Frederick R Siegel (Rec. DS—singles only)
Home office: Pittsburgh, Pa
P & G Rec Co., 1667 Central Phwy Zip 45214 Tel 381 2233 Dwner & Mgr Paul Smith, Buyers: Singles, Jon Palmer, Albums, Larry Jacobson (Rec. & Tape DS)
Branch: Columbus, Ohio
Progress Rec Dist'g Inc., 230 Northland Blvd., Suite 117 Zip 45246 Tel 771 4190 Sales Mgr Dale Putteet (Rec. & Tape D)
Home office: Highland Heights (Cleveland Metropolitan Area), Ohio (See for prod distributed)
Jimmie Skinner Music, 5825 Vine St Zip 45216 Tel 242 8000 Dwner Lou Ukelson, Buyers: Singles, Laurie Ukelson, Albums & Tape, Lou Ukelson (Rec. & Tape D & E)
Labels: Afteram, Birch, Cook, County, Gateway, IRMA, Jainy, Jewel, Jordan, Kanawha, Log Cabin, Melody, Duthouse, Pine Tree, Puritan Rebel, Revonah, Ridge Runner, Sugar, Sugar Hill, Vetco, Zap
Supreme Dist'g Co. Inc., 1000 Broadway Zip 45202 Tel 421 0747 Dwners Al Klayman, Bob Giglio, Mgr., Singles, Albums & Tape Buyer Al Klayman (Rec. & Tape D)
Labels: Audio Arts, BBC, Blind Pig, Boot, CMH, Candide, County, Creed Discovery, Disneyland, Fantasy, Flying Fish, Fretless, Galaxy, Gateway, Gemcom, Green Hays, Improvising Artists, Kaleidoscope, Kenwood, MMG, Milestone, Muse, Music Craft, NSD, Nashboro, Nessa, Dmni Sound, Original Sound, Philo, Plantation, Prestige, Progressive, Rainbow Sounds, Rebel, Riverside, Rounder, SSS Int'l, Sail, 1750 Arch, Shanachie, Sierra/Briar, Solid Smoke, Stax, Storyville, Sugar Hill, Sun, Sunshine Sound, Sutra, Takoma, Timeless, Trend, Turnabout, Use Vetco, Vista, Vox, Vox Boxes, War Bride, Who's Who, Zoom
Accessories: Ampiro Dustbuster, Fidelityone
Warner/Elektra/Atlantic Corp., 34 Irangular Park Dr., No 3403 Zip 45246 Tel 772 5800 Sales Mgr Terry Cox (Rec. & Tape D—see office in Los Angeles, Calif., for prod distributed)

● **CLEVELAND METROPOLITAN AREA (Area Code 216)**
Action Music Sales Inc., 6541 Eastland Rd., Hayes Industrial Park Zip 44142 Tel 243 0300 VP & Mgr Dennis Baker, Buyer Clay Pasternack (Rec. & Tape D)
Labels: AVI, Abet, Abkco, Accent, Adelphi, Ala, Amberjack, Ameraba, An gelaco, Appaloosa, Archives of Jazz, Ariel, Ashtree, Audio Arts, Audio Fidelity, Audio Int'l, Audio Rarities, B C, Bach Guild, Bambridge, Baron, BetCar, Bethlehem, Big Town, Birthright, Black Label, Black Saint, Blues Spectrum, Bomp Boogie Woogie, Brasilia, Brunswick, CMH, CRA, CRC, Canaan, Cardinal, Chalfont, Chiaroscuro, Church Door, Churchill, Citadel, Clean Cuts, Coby, Concord Jazz, Contemporary, Cook, Cornithian, County, Creative World, Creed, Dakar, Dayspring, Dingo, Disneyland, Dore, Eagle Int'l, Electric Lemon, Emergency, Ernie's, Eternal Gold, Everyman, Ex cello, Fantasy, First Component, First Line, Fona, Fretless, GNP Crescendo, GP, Galaxy, Giants of Jazz, Glendale, Golden, Goldisc, Good

News, Good Time Jazz, Gospel Tone, Gospel Truth, Green Menu, Green Tree, Groove Sound, Gryphon, Gusto, HSE, Haller, Happy Face, Harlequin, Heart Warming, Highland, Hi Oldies, Image, Impact, Improv, Jazz Bird, Jazz Treasury, Jewel, Jim, Juana, Juno, Karate, Kent, Kenwood, King, Klavier, Knock Out, Koala, Laif, Lamb & Lion, Largo, Laurie, Light, Living Language, Locos, Longhorn, Lynn, Malaco, Mankind, Maranatha, Mark 56, Matrix, Milestone, Milk & Honey, Mirror, Mobile Fidelity, Modern, Myrrh, Nasco, Nashboro, Nessa, New Birth, Newman, New Pax, Newsong, North County, Nostalgia Lane, Nutmeg, Old Town, Original Sound, Outrageous, PBR, PM, Pacific Challenger, Paragon, Paula, Pausa, Peter Pan, Philo, Phoenix 10 & 20, Pilgrim America, Plantation, Polka City, Power Pak, Prestige, Progressive, Quark, Radiola, Rainbow Sound, Rambin, Rampart, Rattle snake, Rebecca, Rebel, Reborn, Refuge, Riverside, Ronn, Ross, Rounder, Rumble, SF Sound, SRO, SSS, Sail, Sandcastle, Sandy Hook, Seed, Single brook, Solid Rock, Solid Smoke, Soul Note, Sound Effects, Sound of Gospel, Sounds, Sounds Rare, Spire, Standing Room Only, Starday, Starlog, Star Song, Stax, Steeplechase, Strata East, Sugar Hill, Sun, Syntonic Research, T Bird, Jazz, Taz, Telarc, Testament, Thumble, Trash, Triangle United, YGM, Vanguard, Varese, Vesper, Vista Vox, War Bride West bound, Westend, Wonderland, Word, Xanadu, ZIV

Accessories: Audio Technica, Bib, Maxell, Memorex, Scotch, Sound Guard, TOK, Tracs

Arrow Dist'g Co., 23690 Commerce Park, Beachwood 44122 Tel 464 5095 Pres Don Weiss, Adm Mgr Jim Freeman, Mdsr Mgr Jim Ley, Sales Mgr Ron Smith, Buyer Tony Brenner (Rec. & Tape RJ)

C B S Recs., 23215 Commerce Park Dr., Suite 316, Beachwood 44122 Tel 464 7020 Reg'l VP Rich Kudolla, Branch Mgr Jim Hawn (Rec. & Tape D—see New York, N.Y. office for prod distributed)

Capitol Recs., Commerce Place, 7123 Pearl Rd., Suite 105 Tel 888 8575 (Rec. & Tape D—see office in Los Angeles, Calif., for prod distributed)

Cleveland One Stop Inc., 3822 Prospect Ave Zip 44115 Tel 881 4393 Mgr. Singles, Albums & Tape Buyer Charles Young (Rec. & Tape DS)

Lieberman Ent's Inc., 5613 Cloverleaf Pkwy Zip 44125 Tel 524 9750 Mgr. Darrell Creekmur, Opns Mgr Mike McGowan, Reg'l & Albums Buyer Ousty Bowling, Singles Buyer Hugh Washem (Rec. & Tape RJ)

Home office: Minneapolis, Minn (Rec. & Tape DS & RJ)

Sherman Lieberman, 5923 Cantwell Dr., Mayfield Heights 44124 Tel 461 3342 Owner & Mgr Sherman Lieberman (Rec. D—also represents House Osts., Kansas City, Mo., see for prod distributed)

Labels: Conversa-Phone, Everest, Fiesta, Qualitone imports Accessories: Pianstehl, Savoy, video software

MCA Ost'g Corp., 1721 Superior Ave E Zip 44115 Tel 621 9770, Branch Mgr. Lew Zellman (Rec. & Tape D—see office in Los Angeles, Calif., for prod distributed)

Northern Rec. Sales, 1811 E 40 St, Zip 44103 Tel 361 2650 (Rec. & Tape OS & RJ)

Home office: Buffalo, N.Y. Transcontinent Rec. Sales (Rec. & Tape RJ)

One Way Recs of Ohio, 1801 E 40, Zip 44103 Tel 391 9250 Branch Mgr William O Spaulding (Rec. OS & Tape E)

Branch: Union, N.J. (SEE ADVERTISEMENT)

Piks Corp., 2140 50 Hamilton Ave Zip 44114, Tel 696 3155 Owners Ron Schaler, Harvey Korman, VP & Gen Mgr Harvey Korman, VP Sales John Horn, Singles, Albums & Tape Buyer Ken Antonelli (Rec. & Tape D)

Branches: Florence, Ky., Southfield (Detroit Metropolitan Area), Mich., Buffalo, N.Y., Columbus, Ohio, Pittsburgh, Pa

Labels: APA, Arl Wave, Ala, Ai & the Kidd, Alanna, Alligator, Alfa, Alston, American Gramophone, American, Antilles, Arvola, Arista, Arista Free dom, Arista Novus, Audio Directions, Audio Source, Axe, BBP, BMA, Becket, Blind Pig, Blue Candle, Blue Heaven, Blues Spectrum, Board walk, Bold, Bomb, Breakthrough, Brax, Buddha, CTI, Candy Apple, Chai tagoogie, Chopper, Chrysalis, Chute, Classical Excellence, Clouds, Coherent Sound, Connection, Country Porn, Crystal Clear, Dash, Dawn Life, Dealers Choice, Decco, Dee Jay, Delmark, Delos, Delux, Demand, Oemom, Devaki, Dial, Direct Disc Labs, Disciple, Oream Machine, Orive, Earth, Eastwind, Emus, End Gee, Enjoy, Entr' Acte, Excelsior, Fabulous, Fiddlers Wynd, Fifty States, First American, Fizz, Flying Fish, Foggy Bottom, GHE, GRP, Gee, Glades, Good Sound, Gospel Roots, Gospel Tone, Grand, Green Hays, Great Northwest, Hannibal, Heat, Hindsight, Hob, House of Cash, Import, Impasion, Insight, Jaybird, Jazz a la Carte, Jazz Archives, Jazz Works, Jazz World, Jefferson Boulevard, Jeremiah, Juana, Judah, Jukebox, Kaleidoscope, Kari, Kayvette, Konduko, LA, LRC, Laif, Language 30, Leg, Los Angeles, Mainstream, Mango, Marlin, Maze, Messenger, Gospel, Mo seka, Mountain Railroad, Muscle, Muse, Music America, Nationwide Sound, Nautilus, New Moon/Cloudborn, Nostalgia Lane, Nu Music, Obel isk, Ode, Official, Olivia, Olympia, Our Gang, Ovation, Owl, Passport, Pickwick, Pizzaz, Posse, Prairie Oust, Prine, Prism, Project III, Pyramid, Q, Quintessence, Ranwood, Request, Rhino, Ridgeway, Robox, Rojac & Tayster, Rooster, Roots, Roulette, Royal Flush, Savoy, Seeds & Stems, Shadow, Sheffield Lab, Shield, Silverblue, Slash, Sound Factory, Sound waves, Standing Stone, Stonedog, Sugar Hill, Sunbird, Sunshine, Sun shine Sound, Sutra, Syntaur, TK, Takoma, Tangletwood, Third Coast, Thor oughbred, Timeless, Transport, Trolleycar, VAP, Vee Jay, Vintage, Virgin Int'l, Virgo, Visa, Wanderick, Wanna, Waterhouse, Weird World, Wenh, Western Hemisphere, Wheeler, Wolf, XRT

PolyGram Ost'n Inc., 14600 Detroit Ave., Suite 450, Lakewood 44107 Tel 228 6412, Reg'l VP Frank Peters (Rec. & Tape D)

Home office: New York, N.Y. (See for prod distributed)

Progress Rec. Ost'g Inc., 190 Alpha Park, Highland Heights 44143 Tel 461 7880 Pres Joe Simone, Gen Mgr Brent Marcogussepe, Buyer Noble Clark (Rec. & Tape D)

Branches: Southfield (Detroit Metropolitan Area), Mich., Tonawanda (Buffalo Area), N.Y., Cincinnati, Ohio—also see listing in Elk Grove Village (Chicago Metropolitan Area), Ill

Labels: Chalel, Clone, Cream, DRG, Omension, Earthtone, 51 West, Fountain, 415, GMI, G&P, Gordy, Gramavision, Hi, IRS/Faulty, Jazz America Mktg., Lifesong, Maiden Voyage, Natural Resources, Overture, Paid, Penthouse, Polish, Prelude, Prodigal, RFC, Rare Earth, Sam, Soul, Stiff/America, Sunshine, Taml, Tapestry, Tetrachord, Venture, Venus, Wheel

R C A & A&M & Assoc'd Labels, 5000 Rockside Rd., Independence 44131 Tel 447 1400 Mgr Oom Violini (Rec. & Tape D—see New York, N.Y. office for prod distributed)

S & M Sales, 4353 Cranwood Court, Warrensville Heights 44128 Tel 662 6153 Owner Ernest Furst, Gen Mgr. Mark Abram, Buyers Singles, Mark Abram, Albums & Tape, Ernest Furst (Rec. & Tape OS & RJ)

Superior Recs. Inc., 11202 Superior Ave Zip 44106 Tel 421-6770 (Rec. & Tape OS)

Warner/Elektra/Atlantic Corp., 4560 Willow Pkwy Zip 44125 Tel 271-3900, Branch Mgr. Mike Spence, Sales Mgr Fred Katz (Rec. & Tape D—see office in Los Angeles, Calif., for prod. distributed)

Home office: Cincinnati, Ohio.

Piks Corp., 4314 Astor Ave Zip 43227 Tel 237 7148 (Rec. & Tape D)

Home office: Cleveland, Ohio (See for prod distributed)

Robert & Co., 1910 Lockbourne Rd Zip 43207 Tel 444 9842 Owner & Buyer Robert M. Benjamin (Rec. & Tape OS, including oldies)

● **DAYTON AREA (Area Code 513)**

A & B Rec Co Inc., 40 Heid Ave Zip 45404, Tel: 236 4808 Pres Larry Frisby, VP & Buyer Tom Weiser (Rec. & Tape RJ)

Ohio Rec Rack Dist's., 72 S Main St., Miamisburg 45342, Tel 866-3629 Owner, Mgr & Buyer Chris Mondoff (Rec. & Tape D, OS, RJ, I & E)

Distributes overstocks, auction close-outs, cutouts, pre-packs

● **NEW ALBANY (Area Code 614)**

Mobile Rec. Serv. Co., 7809 Walnut St Zip 43054, Tel 855-7970, Mgr Craig S. Gallagher (Rec. OS—singles only)

Home office: Pittsburgh, Pa.

● **NEWARK (Area Code 614)**

Utopia Ultra-Sound, 38 & 40 S First St, Zip 43055 Tel 345-9426 Pres. & Tape Buyer Robert H. Kirk Jr., Mgr Oon Shannon (Rec. & Tape D & RJ)

Labels: CSP, Capitol SM, Gusto, Jessup, Mack, Pickwick, Promo, SAM, UUS, Warner SP

● **PORTSMOUTH (Area Code 614)**

Dayton Rec. Serv. Inc., 1020 Seventh St, Zip 45662, Tel 353-2115 Pres W.A. Carrington; VP Mgr & Buyer Joe Taylor (Rec. & Tape RJ)

● **SANDUSKY (Area Code 419)**

M. R. Sand & Co., PO Box 2255, 209 W. Water St, Zip 44870, Tel: 625-0028 Owner, Mgr & Buyer Joseph F Yost III (Rec. & Tape OS & RJ).

● **OLON (Area Code 216)**

Allied Rec. Sales, 34240 Aurora Rd Zip 44139 Tel 248 3090 Pres R.A Burke (Rec. OS & RJ)

● **STEUBENVILLE (Area Code 614)**

Honeycomb Recs., 507 Cedar Ave Zip 43952, Tel: 283-1959 Owner, Singles, Albums & Tape Buyer Jeff Johnson (Rec. & Tape RJ)

● **TOLEDO (Area Code 419)**

Northwestern Dist's. Inc., 4318 Monroe St Zip 43606, Tel 474-7114, Pres. Mgr & Buyer George A. LaCourse (Rec. & Tape RJ)

● **YOUNGSTOWN (Area Code 216)**

Discount Recs & Tapes, 545 Market St, Zip 44502, Tel 744 7787 Owner & Buyer Tony March (Rec. OS & RJ; Tape OS)

Handleman Co., 625 Bev Rd Zip 44512, Tel 726-8121 (Rec. & Tape RJ)

Home office: Clawson (Detroit Metropolitan Area), Mich.

OKLAHOMA

● **BROKEN ARROW (Area Code 918)**

Crossroads Dist'g Co., PO Box 283, 1008 N. Hickory Zip 74012 Tel 251 6212, Mgr. & Buyer John R. Lepper (Rec. & Tape D)

Labels: Benson, Calvary, Canaan, Op, Good News, Greentree, Heart Warming, Image VII, Impact, Jim, Jubilation, KCP, Lamb & Lion, Light, MCA, Maranatha, Milk & Honey, Myrrh, New Life, PFI, Paragon/Newpax, Refuge, Sparrow, StarSong, Takoma, Triangle, Word.

● **NORMAN (Area Code 405)**

Oklahoma Tapes & Recs. Inc., PO Box 946 Zip 73070 Tel 364 5034 Owner Bill Bodin (Tape D—Spanish prod. & budget lines)

● **OKLAHOMA CITY (Area Code 405)**

All Recs. Inc., 520 Classen Blvd Zip 73106, Tel 235-3381, Mgr. & Buyer Bill Hill (Rec. & Tape OS)

Bromo Dist's. Inc., PO Box 60709, 2500 N. Walker, Zip 73146 Tel 521-0301 Buyer Buster Bassett (Rec. & Tape OS & RJ)

Videocassette lines: Disney, Magnetic Video, Media, Nostalgia, SportsWorld

Handleman Co., 4118 Will Rogers Pkwy Zip 73108 Tel 946 1410 (Rec. & Tape RJ)

Home office: Clawson (Detroit Metropolitan Area), Mich

Phil's One Stop Recs., PO Box 60349, 1736 Linwood Blvd, Zip 73106, Tel 235-9671 (Rec. OS)

● **TULSA (Area Code 918)**

Bill's T Recs., 19 N Harvard Zip 74145, Tel 939-6305 Owner John Rogers (Rec. OS)

Ooc's One Stop, 820 E 36 St N Zip 74106 Tel 425-2643, Owner, Singles & Albums Buyer Larry Eck, Mgr. Rose Foster (Rec. & Tape OS)

OREGON

● **EUGENE (Area Code 503)**

Middle Man Dist's, 4232 W Seventh Ave Zip 97402 Tel 484-0434 Co owner & Mgr Karl Manseth, Co owner & Buyer John Marshall (Rec. & Tape D)

Distributes cutouts

Precision Sound Mktg Ltd., 1420 Amberland Zip 97401 Tel 686-8439 Mgr Chuck Udothem (Rec. D & E)

Home office: Bothell (Seattle Area), Wash. (See for prod distributed)

● **PORTLAND (Area Code 503)**

Lieberman Ent's Inc., 3014 N. Wygant, Zip 97217 Tel: 283-1293 Mgr: Ron Peterson, Opns. Mgr. Lee Sherry, OS Mgr.: Joe Maita, Singles, Albums & Tape Buyer Bob O'Neil (Rec. & Tape OS & RJ)

Home office: Minneapolis, Minn

Sea-Port Rec. One Stop Inc., 7911 NE 33 Or., Suite 120 Zip 97211 Tel 287 0868 Owner Tom Choate; Buyers Singles, Gina Esmino, Albums, Merge Bond, Vicki Stephenson (Rec. & Tape OS)

Branch: Tukwila (Seattle Area), Wash.

PENNSYLVANIA

● **BETHLEHEM (Area Code 215)**

Capitol Recs., 2980 Ave. B, Lehigh Valley Ind'l Park, No. 1, Zip 18017, Tel 868-1401 (Rec. & Tape D—see office in Los Angeles, Calif., for prod distributed)

Rave, 415 Buchanan St, Zip 18015, Tel 865-1941, Owner & Mgr. Joe Timmer (Rec. & Tape D)

Labels: Crech, Fiesta, Haller, LeMans, Rave, Ray, Rex, Stella & all polka recs

● **ERIE (Area Code 814)**

Mobile Rec. Serv. Co., PO Box 3513, Tel 866-0002, Mgr.: Mayer W. Gold (Rec. OS—singles only)

Home office: Pittsburgh, Pa

● **HARMONY (Area Code 412)**

Jesus Music Osts., Box 218, RR 2 Zip 16037, Tel 452-5556 Owner Louis P. Hancherick (Rec. & Tape D—contemporary Christian prod)

Labels: AB, Airborne, Othama, Good News, Greentree, Lamb & Lion, Loverock, MCA Songbird, Mars Hill, Messianic, Myrrh, New Song, Solid Rock, Sonrise, Sparrow, Spirit, Star Song, White Horse

● **HARRISBURG (Area Code 717)**

A I M Osts. Inc., 4911 Jonestown Rd (Rear) Zip 17109, Tel 652-8097, Owner & Buyer Endo Corsetti (Rec. & Tape RJ)

O & H Ost'g Co., 2525 N. Seventh St, Zip 17105, Tel 236-8001 Mgr Oon Levine; Buyers: Singles, Rick Prayer, Albums & Tape, Ginny Fry (Rec. & Tape OS & RJ)

IN PHILADELPHIA

For Volume Sales of
Records & Tapes!

record distributing
corporation

919 No. Broad St.,
Phila., Pa. 19123
(215) CE 2-3333

LEN RAKLIFF, Gen. Mgr.

● **COLUMBUS (Area Code 614)**

P & G Recs., 1195 N. High St, Zip 43201, Tel 291 3141 Mgr & Buyer Russ Miner (Rec. & Tape OS)

WHY NOT DEAL WITH THE BEST?

BEST SELECTION • BEST SERVICE • BEST FILL

Sony Tape.
Full Color Sound.



Scotch Brand
Videocassettes



TDK

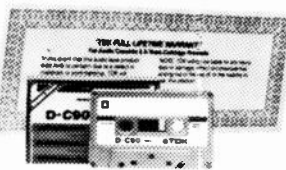

Full Lifetime Warranty

maxell
Epitaxial
Videocassettes



The Tape
of the Stars



FUJI
CASSETTES



24-Hour Freight-Paid Service

A. I. Rosenthal Associates, INC

A Complete Tape and Accessory Service

FOR TOLL-FREE ORDERING CALL (800) 523-2472 (CALL COLLECT)
SEND FOR FREE CATALOG (DEALERS ONLY)

Dept. H, 1035 Louis Drive, Warminster, PA 18974

AMPEX • AUDIO TECHNICA • DISCWASHER • DURACELL • DYNASOUND • EVEREADY •
FUJI • MAXELL • MEMOREX • PICKERING • RECOTON • SAVOY •
SCOTCH • SHAPE • SHURE • SONY • SOUND GUARD • TDK • TRACS • WATTS

• **JOHNSTOWN (Area Code 814)**

Page Rec'g Co., 604 Broad St. Zip: 15906. Tel: 539-8117. Owner & Mgr.: Al Page. (Rec. & Tape D & RJ)
Labels: Bel-Aire, Chicago Polkas, Dyno, Fiesta, Greyko, Hymntone, Jay Jay, Marjon, Nashville, Page, Power-Pak, Rave, Request, Sacred, Silverbell, Sing, Skylite, Sword, Tambura, Word.
Playback equip.: Granada, Sharp.

• **LEHIGHTON (Area Code 717)**

Barnes Rec. Dist., Box 103, RD 2 Zip: 18235. Tel: 645-2321. Owner & Mgr.: William H. Barnes. (Rec. & Tape OS & RJ)

• **LEWISTOWN (Area Code 717)**

Mobile Rec. Serv. Co., 104 Logan St. Zip: 17044. Tel: 248-6442. Mgr.: John Houser. (Rec. OS—singles only)
Home office: Pittsburgh, Pa.

• **MILTON (Area Code 717)**

Music Box, 205 Broadway, Zip: 17847. Tel: 742-7101. Owner: Dale L. Reedy. (Rec. & Tape D)

• **PHILADELPHIA METROPOLITAN AREA (Area Code 215)**

(Also see New Jersey listings)

Almacenes Asturias (Rec. & Tape D), see Villanueva Asturias Corp.
Asturias (Rec. & Tape OS), see Villanueva Asturias Corp.
Bandstand Rec. Serv., see Pennsauken, N.J., listing.
C B S Recs., 2 Bala Cynwyd Plaza, Bala Cynwyd 19004. Tel: 839-0246.
Branch Mgr.: Irv Medway. (Rec. & Tape D—see New York, N.Y., office for prod. distributed)
Coliseum Recs. & Tape Ltd., 134 S. 20 St. Zip: 19103. Tel: 698-7710. Pres.: Robert Morton. (Rec. & Tape E)
Exports cutouts, surplus, deletions.
Norman D. Cooper Inc., Presidential Apts. Complex, 1 Winding Dr. Zip: 19131. Tel: 878-9591. Pres.: Norman D. Cooper; Buyers: Singles, David Brown; Albums & Tape, Joe Altieri. (Rec. & Tape OS, RJ & E)
Videocassette lines: MCA, Magnetic Video, Swedish Erotica, WCI.
Heller's Rec. Buyer-Exporter, 3149 Kensington Zip: 19134. Tel: 634-5663.
Owner: Robert Heller. (Dealer in rec. collections)
Richard Kastner Co. Inc., PO Box 168, 1100 Virginia Dr., Fort Washington 19034. Tel: 628-4111. Pres.: Richard Kastner; Sales Mgr.: Michael Mosko. (Rec. & Tape D & E—cutouts)
M C A Dist'g Corp.—Tel: 922-5659—also see Collingswood, N.J., listing.
National Rec. & Tape Co. Inc., see Serv-Rite.
Record Rendezvous Inc., 134 S. 20 St. Zip: 19103. Tel: 561-7340. (Rec. D, OS, RJ, I & E; Tape OS & RJ)
Labels: Cinwirth, MVH, Oldies But Goodies, Pet-Rat, Psycephonic, Rendezvous, Rockin' Richie, sub-distributes: Montgomerys, Scorpio, Tasty Licks, Times Square.
Richman Bros.—Tel: 477-1742—also see Pennsauken, N.J., listing.

A. I. Rosenthal Assocs. Inc., 1035 Louis Dr., Warminster 18974. Tel: 441-8900. Pres.: Alfred Rosenthal; Sales Mgr.: Hugh Boyle; Dpns. Mgr.: James Eldridge III.

Accessories: Audio (Audio Technica, Recoton), batteries (Duracell, Eveready), blank tape (Ampeg, Audio Magnetics, Fuji, Maxell, Memorex, Recoton, Sony, TDK, 3M), cartridges & styli (Audio Technica, Pickering, Shure), headsets (Audio Technica, Pickering, Power Drive), needles (Recoton), rec. care prods. (Audio Technica, Black Magic, Clean Sound, Discwasher, Memorex, Sound Guard, Watts), tape cases (Amaray, Dynasound, Innovative Concepts, Savoy, Shape). (SEE ADVERTISEMENT)
Schwartz Bros. Inc.—Tel: 923-1271—also see Cherry Hill, N.J., listing.
Scorpio Music Dist. Inc., PO Box 391, Cornwells Heights; 2933 River Rd., Croydon 19020. Tel: 698-7707, 785-1541. Telex: 843366. Pres.: Michael Adler; VP: John T. Gervasoni; Gen. Mgr.: Steve Parelman. (Rec. D, OS, RJ & E)

Distributes overstocks, close-outs, promotional materials. (SEE ADVERTISEMENT)

Serv-Rite Rec. & Tape Co./National Rec. & Tape Co. Inc., 515 Andrews Rd., Trevoise 19047. Tel: 364-1370. Mgr.: Sylvan Gross; Albums & Tape Buyers: Sylvan Gross, Steve Weed. (Rec. & Tape RJ—cutouts)

Slotkin Recs., 111 Forrest Ave., Narberth 19072. Tel: 667-1870. Owner, Singles, Albums & Tape Buyer: Herbert Slotkin. (Rec. & Tape OS)

Smith Rec. Sales Inc., 1904 W. Columbia Ave. Zip: 19121. Tel: 232-1054. Sales Mgr.: Bill Scott. (Rec. & Tape OS—gospel prod.)

Third Street Jazz & Rock, 10 N. Third St. Zip: 19106. Tel: 627-3366. Owner, Singles & Albums Buyer: Jerry Gordon. (Rec. RJ—cutout & overstock)

Universal Rec. Dist'g Corp., 919 N. Broad St. Zip: 19123. Tel: 232-3333.

Owner: Harold Lippus; Mgr.: Len Rakliff; Buyers: Singles, Kathy Walsh; Albums, Len Rakliff. (Rec. & Tape D & OS)

Labels: ABKCO, AVI, Ala, Antilles, Audio Fidelity, Boardwalk, Brunswick, CMH, CTI, Chiaroscuro, Chrysalis, Disneyland, Emergency, End, Fantasy, 51 West, First American, Galaxy, Gone, Grand, Hannibal, IRS, Impact, Import, Jamie, Laff, Laurie, Living Language, Mango, Milestone, Muse, Ode, Passport, Pausa, Posse, Prestige, Ranwood, Riverside, Roulette, Specialty, Stax, Sugar Hill, Sun, Takoma, Tapestry, Tomato, Vanguard, Visa, Vista, Waterhouse.

Accessories: Le-Bo. (SEE ADVERTISEMENT)

V A C Dial (Rec. & Tape E), see Villanueva Asturias Corp.

Villanueva Asturias Corp., 401 W. Girard Ave. Zip: 19123. Tel: 236-4544.

Mgr. & Buyer: Jack Villanueva (Rec. & Tape D), (Rec. & Tape E as VAC Dial). Local branches: Almacenes Asturias, 2331 N. Front St. Zip: 19133.

Tel: 426-9810. Mgr. & Buyer: Maria Villanueva. (Rec. & Tape D)—Asturias, 1200 N. Fourth St. Zip: 19123. Tel: 236-4545. Mgr.: Carlos Villanueva; Buyer: J. Villanueva. (Rec. & Tape OS)

Labels: Alma Hispana, Clubman Dial, VA.

Accessories: EV Game.

Vintage Recs. Inc., PO Box 251, Quarry & Hamilton Sts., Darby 19023. Tel: 586-5200. Pres.: Murray Graber. (Rec. & Tape D & E)

Labels: Arctic, Audicon, Big Town, Bright Orange, Collectables, Columbia Special Prods., Commodore, Cook, Crown, Dionn, Emus, Encore, Ghent, Impact, Jamie/Guyden, Kent, Laurie, Legrand, Lost Nite, MAC, MSL, Modern, Mohawk, Montel, Mother Goose, Palomino, Peter Pan, Phil-LA of Soul, Radiola, Relic, Rust, Sandy Hook, Sundi, Superscope, Teardrop, Top & Bottom, Truckstop, Tru-Gems, United, Wins; cutout singles, albums & tapes.

Accessories: Blank tape & tape accessories (Audio Magnetics, Columbia Magnatone, Memorex); carrying cases (Hartzell, Savoy); catalogs (Record Research); needles (E-V Game, Rvertone); spindles & stereos

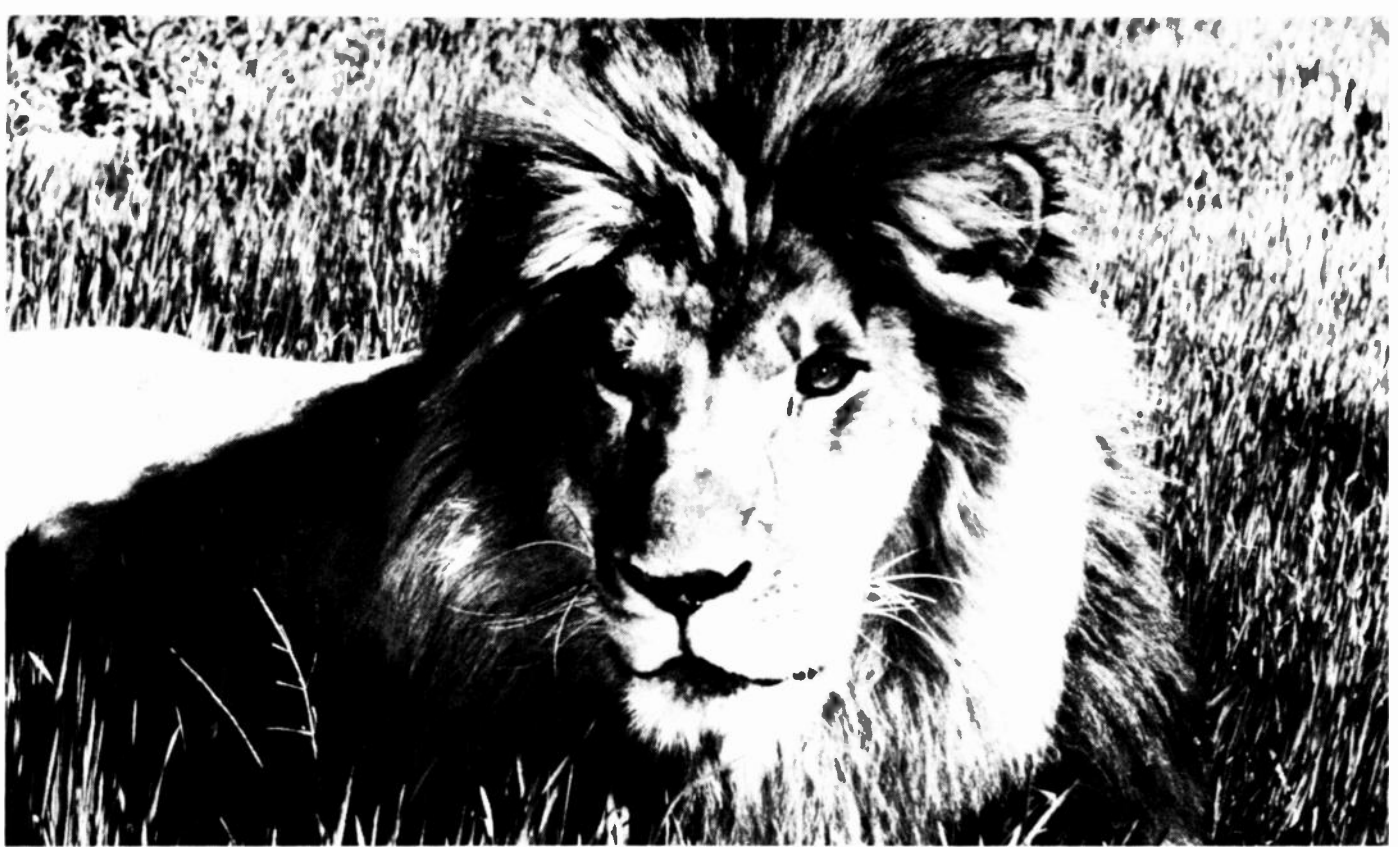

HOW TO SURVIVE IN THE PLASTIC JUNGLE.

Are you being eaten up by the soaring costs of current LP's? Are you being boiled in a pot by the manufacturers? If the answer is yes, you should be trading with SCORPIO MUSIC.

You see, since we were raised in the jungle of the record business, we know the laws of survival. And since we know all the laws, we can provide you with a constant supply of prime cutout and overstock LP's at the lowest prices in the industry.

If you take a Safari through our catalog, you'll discover hundreds of hot selling and hard-to-get albums. You'll even find exclusive items you just can't get from anybody else. And since our prices are so civilized, you can make up to 400% profit and fight the savage effects of inflation all in one breath.

When you place an order with Scorpio, you always get good fills to keep your customers happy and prompt service to keep you happy. And if you live on the other side of the earth, you'll never have to worry. Our professional export department is second to none.

If you're just starting out in the record business or if you're undecided on what to buy, you can depend on us. Like experienced guides, we're always ready to give sound advice when you need help or when you're not sure.

Because our success depends on your success, we'll do whatever it takes to make you King of the Jungle.

So, if you want to survive in the record business, clip the coupon, phone or telex for our latest listing today. After all, the bottom line of your business depends on it.

SPECIALISTS IN
OVERSTOCKS—CUTOUTS—
DELETIONS—BUDGET
PRICED RECORDS



scorpio
music distributors, inc

2933 River Rd. • Croydon, Pa. 19020
Ph. 215-785-1541 • Telex 843366—Recstapes: Crdn

Scorpio Music Distributors
2933 River Rd.
Croydon, Pa. 19020

Dept. BG

Ok Gentlemen, I want to survive. Rush your latest catalogs without delay.

Name _____

Company _____

Address _____

City _____ State _____ Zip _____

(Dorchester, TeleTone), corrugated mailers, paper & plastic sleeves, tape players.
Videocassette lines: Video Yesterday
 Warner/Elektra/Atlantic Corp.—Tel 923-2700—also see Marlton, N.J., listing.
 William's Dne Stop, 817 N. Broad St. Zip 19123 Tel 232-2020. Dwner Sid Williams. (Rec. OS)

● **PITTSBURGH METROPOLITAN AREA (Area Code 412)**

A & C Recs. & Tapes Inc., 1031 Forbes Ave. Zip 15:19. Tel 391 4676. Dwners Eugene T. Jakiel, John R. Hoebler, Buyers Singles, Norm Kirsh, Albums & Tape, Anthony Piotrowski. (Rec. & Tape OS & RJ)
Videocassette lines: MCA, Warner Bros.
 Balkan Rec. Dist'g Co., RD 2, Concord Church Rd., Beaver Falls 15010 Tel. 843-1962. (Rec. & Tape D)
Home office: Berwyn (Chicago Metropolitan Area), Ill.
 Labels: Balkan Int'l, Czech, Delta Int'l, Greyko Marjon, Monitor East Coast Dist's., 633 Liberty Ave. Zip 15222. Tel 281 6344. Dwner & Mgr.: Nick Lomakin. (Rec. D, OS & RJ; Tape OS & RJ)
 Labels: Argos, Audiopole, Borderline, Contemporary, Dial, Dictation Disc, Dooto, Evergreen, GNP Crescendo, G1J, Golden Crest, Humorsonic, K&H, Mardi Gras, Music Minus Dne, Russell Dance, Spolite, Switchcraft Mobile Rec. Serv. Co., PO Box 2879. Zip 15230; 2716 Penn Ave. Zip 15222. Tel: 391-8182. Pres. Maurice F. Dseroff, VP. Harvey Campbell, Sales Specialists: Jim Dseroff, Marianne Smith, Sales Mgr. Ted Howell, Sales Programming Don Bray. (Rec. OS—singles only)
Branches: Tallahassee, Fla., Evansville, Fort Wayne, Ind., Watervliet (Albany Area), N.Y., Cincinnati, New Albany, Dnic, Erie, Lewistown, Pa. Dne Stop Inc., 518 Chartiers Ave., McKees Rock: 15136. Tel 771-0700. Pres. Bill Lawrence, VP. William Blair, Buyer Michael Fortunato, Div Mgr. Chris Lawrence. (Rec. & Tape OS & RJ).
 Pks Corp., 354 Cherrydell Dr. Zip 15220. Tel 341-8081. (Rec. & Tape D)
Home office: Cleveland, Ohio (See for prod. distributed)
 Record World-Dne Stop, 1332 Fifth Ave. Zip 15211. Tel 391-7429. Dwner Barney Stein, Buyers Singles & Tape, Barney Stein, Albums, Evelyn Stein. (Rec. & Tape OS & RJ)
 Sounds Dist'g Corp., 3701 Bigelow Blvd. Zip 15213. Tel 681-7611. Pres. Norton L. Kalinsky, VP. Richard Zimmer, Buyers: George Kalinsky, Rich Thomas. (Rec. & Tape OS & RJ)

● **WEXFORD (Area Code 412)**

North Country Music, PO Box 311, Rt. 19 N. Zip 15090 Tel 935-1330. Dwner, Mgr. & Buyer C. W. Abbott. (Rec. D & RJ)
 Labels: Adelphi, American Heritage, Biscuit City, Blind Pig, CMH, County, Delmark, Flying Fish, Folk Legacy, Folkways, Front Hall, Green Linnet, June Appal, Kaleidoscope, Nessa, Philo, Rebel, Regency, Rounder, Sha nachie, Sierra/Briar, Sugar Hill, Widebeest

● **WILKES-BARRE (Area Code 717)**

Record Town Inc., Wyoming Valley Mall, Zip 18702. Tel 829-3603. Pres & Mgr Joe Nardone. (Rec. & Tape RJ)

PUERTO RICO

● **HATO REY (Area Code 809)**

Carrillo Dist's. (Tape D & I)—Tel: 763-4595—see San Francisco Dist's. Inc. Caytronics of Puerto Rico, 252 F.D. Roosevelt Ave., Esq. Antonin Lin. Zip: 00919. Tel 767-4313. Dwner & Mgr.: Sergio Ballesteros. (Rec. & Tape D)
 Labels: Arcano, Bethlehem, Calente, Carino, Caytronics, Charro, Melody, Mercana, Nor-Mex, Dtra, Pronto, Salsoul, Salsoul Salsa
 San Francisco Dist's Inc., 340 Barbosa St. Zip 00919 Tel 764-3481 Cable SAFRA. (Tape D & I), (also Tape D & I as Carrillo Dist's.)

● **SAN JUAN (Area Code 809)**

Alhambra Dist'g Inc., GPD Box 2702 Zip 00936 Tel 724-0465. Telex 385859 Mgr Ricardo Fabregues. (Rec. & Tape D & I)
Home office: Dpa Locka (Miami Metropolitan Area), Fla. (See for prod. distributed)
 Caribe Audio Dist. Inc. PO Box 5833, Zip 00906, 70 Condado Zip 00907. Tel 725-1650, 722 0219. Pres Fernando Gallardo, Mgr. Francisco Alonso, Buyers Singles & Albums, Francisco Alonso; Tape. Lilliam Alvarez. (Rec. D & I, Tape D)
 Labels: Arista, Audio-Technica, Capitol, Direct to Disk, Sheffield Labs. Labels imported: Crocus (France), Deutsche Grammophon (Germany), Telefunken (Germany)
 Phonographs: Marantz, Technics, Yamaha
 Playback equip.: Bose, JBL, Marantz, Teac, Technics, Yamaha
 Accessories: Audio Technica, Discwasher, Fidelitone, Maxell
 Casa Fragosa Inc., PO Box 2774. Zip 00903 Tel 725-8842, 723-0504 (RJ)
 Distribuidora Nacional de Discos Inc., 606 Calle Cerra, Pda. 15. Zip: 00907. Tel 724-4964. Pres Gilberto Gonzalez Arenas, VP & Sales Mgr. Aida N. Gonzales; Gen. Mgr.: Juan Guzon. (Rec. & Tape OS & RJ)
 Int'l branch: Dominican Republic, Distribuidora Dominicana de Discos.
 Mena Ent's. Inc., 606 Hipodromo Ave., Santurce 00909. Tel 723-1764/2300. Dwner: Ignacio Mena, Mgr., Singles, Albums & Tape Buyer: Daniel Mena. (Rec. & Tape D)
 Labels: Chemo, Discuba, Disneyland Vista, Fuentes, Musart, Peerless, Promus.
 San Francisco Discount Inc., 302 San Francisco St., Did San Juan 00901 Tel 725-4661. (Rec. & Tape OS)
 Top Ten Hits Rec's Dist's, 622 Calle Cerra, Pda. 15. Santurce 00907. Tel: 724-6891. Mgr., Singles & Albums Buyer Pedro Merced. (Rec. D)
 Labels: Cesta, Citation, Dino, Fonseca, Hacienda, Kim, La Cole, Lassisi, Marvela, New Generation, Rana, Suave, TR, TTH, US

RHODE ISLAND

● **PROVIDENCE (Area Code 401)**

Beacon Shops Inc., 821 N Main St Zip 02904 Tel 861 7500. (Rec. & Tape OS)

● **SMITHFIELD (Area Code 401)**

New England Rec. & Tape Dist. Inc., 10 Industrial Dr. Zip 02917 Tel 231-0485. Dwner: Angelo G. De Pardo, Singles, Albums & Tape Buyer: Robert Beneduce. (Rec. & Tape RJ)

● **WARWICK (Area Code 401)**

Rhody Rec & Tape Serv. Inc., 65 Meadow St. Zip: 02886. Tel: 738-8003. Pres. Rubin Zeidman; Mgr.: Arthur Zeidman; Buyer Inez Marovelli. (Rec. & Tape OS)

SOUTH CAROLINA

● **MYRTLE BEACH (Area Code 803)**

Myrtle Beach Stereo Tape Center, 6203 N. Kings Hwy. Zip 29577 Tel 449-3056. (Tape RJ)

● **PIEDMONT (Area Code 803)**

Cooper's Dne Stop, Rt. 1, Hwy. 86. Zip 29673. Tel: 845-6862. Dwner: George Cooper, Mgr. & Buyer: George Cooper III. (Tape RJ)

TENNESSEE

● **COOKEVILLE (Area Code 615)**

Rack Ent's. Inc., PO Box 3066, 1570 Brown Ave. Zip 38501. Tel 526-9709. Dwner & Buyer: Bill Amnette. (Rec. & Tape RJ)

● **KNOXVILLE AREA (Area Code 615)**

A & R Dist'g Co. Inc., 1301 Prosser Rd. Zip 37914. Tel 546-7881. Dwner: Tommy Ayres; Mgr.: Larry Long; Singles, Albums & Tape Buyer: Albert W. Smith. (Rec. & Tape OS & RJ)
 Accessories: Ampex, Audio Magnetics, Le-Bo, Planstehel
 Knox Rec. Rack Co., PO Box 11167, 1539 Amherst Rd. Zip 37919 Tel 584-8531. (Rec. RJ, Tape OS & RJ)
 Accessories: Ampex, Memorex, Recoton, TDK.
 Smoky Mountain Rec. Co., PO Box 208, Concord 37720. Tel: 691-2269. Dwner & Singles Buyer: David M. Mize. (Rec. RJ)
 Tucker's Rec. Shop Inc., 25 Market Square Mall, Zip 37902. Tel 522-9300. Pres., Singles & Albums Buyer: Martin Tucker Robertson. (Rec. & Tape OS)

● **MARYVILLE (Area Code 615)**

Michael Ginsburg Dist'n, 908 Montgomery Ln. Zip: 37801. Dwner: Michael Ginsburg. (Rec. D, OS & I)
 Labels: Adelphia, Blind Pig, County, Flying Fish, Front Hall, Greenhays, Green Linnet, June Appal, Kaleidoscope, Kicking Mule, Rambler, Rebel, Rounder, Shanachie, Sierra/Briar, Sugar Hill, Windham Hill
 Labels imported: Gael-Linn, Tara, Topic

● **MEMPHIS (Area Code 901)**

Audio Rack Serv. Inc., 3305 Fontaine Rd Zip 38116. Tel: 345-5706. Pres.: James Hurley; Mgr.: Singles, Albums & Tape Buyer: Bob Hurley. (Rec. & Tape RJ)
 Boss Ugly Bob Recs. & Tapes (BC Ent's. of Memphis Inc.), 726 E. McLemore. Zip 38106. Tel 947-2553. Pres.: Bob Catron Jr., VP Claudette Catron; Buyers: Singles, Byron Catron, Albums & Tape, Claudette & Bob Catron. Local branches: 2440 Chelsea. Zip 38108. Tel 458-7230—1416 Airways. Zip 38114. Tel 323-7289—4234 S Third. Zip 38109. Tel 785-5151—47 S. Main Zip 38101. Tel 527-8492—167 N. Tullman. Zip: 38114. Tel 327 2740—3206 N Thomas. Zip 38127. Tel 357-1598. (Rec. & Tape OS)
 Branch: West Memphis, Ark.
 Accessories: Duotone, Fidelitone, Arthur Fullmer, Le-Bo, Shure
 C B S Recs., 755 Crossover Ln., Suite 126-128. Zip 38117. Tel: 761-3381.
 Branch Mgr. Barry Mog. (Rec. & Tape D—see New York, N.Y., office for prod. distributed)
 Handleman Co., 3412 Jackson Ave. Zip 38122. Tel: 324-6686. (Rec. & Tape RJ)
Home office: Clawson (Detroit Metropolitan Area), Mich.
 Hot Line Rec. Dist. Inc., PO Box 3351, 421 S. Main St. Zip: 38103. Tel 525-0756. (Rec. & Tape D & OS), (Rec. & Tape RJ as Record Dept. Mdsrs.)
 Labels: AJ, AVI, Abet, Ace, Ala, Alarm, Alston, Antique, BTM, Barnaby, Burtbright, Blue Candle, Blues Spectrum, Bold, Bright Drange, Cadet, Cadet/Concept, Cat, Checker, Chess, Chimneyville, Clouds, Comedian Int'l, Country Soul, Courage, Cream, Creed, DJM, Dash, Dictation Disc, Dingo, Drive, Ernie's, Excello, Fantasy, Fretone, GRT, Galaxy, Generation Int'l, Glades, Gospel Corner, Gospel Truth, Hi, Juana, Kayvette, Kent, Kenwood, Ko Ko, Laff, Laurie, MD, Malaco, Mankind, Marlin, Messenger, Milestone, Montuno, Nashboro, Nationwide Sound, October, Plantation, Prelude, Prestige, Randy's Spiritual, Ranwood, Republic, Roots, SDH, SSS Int'l, Shadybrook, Sound Bird, Specialty, Spire, Star, Stone Dogg, Sun, TK, Tomato, United, Weird World, West End, Wicked, Wolf.
 Accessories: Capitol, Fidelitone, Gemco, Le-Bo, Memorex
 Poplar Tunes Dne Stop, 308 Poplar Ave Zip 38122. Tel 525-6348. Local branches: Pop Tunes-East, 4195 Summer Ave Zip 38122. Tel: 324-3855—Pop Tunes-South, 4622 Faroma. Zip 38116. Tel 346-7172. (Rec. & Tape OS)
 Pop Tunes, see Poplar Tunes.
 Record Dept. Mdsrs. Inc., 511 S. Main St. Zip 38103. Tel 526-0567. (Rec. & Tape RJ), (Rec. & Tape D & OS as Hot Line Rec. Dist. Inc.)
 Select D-Hit Recs., 605 Chelsea Ave. Zip 38107. Tel 523-1190. (Rec. & Tape D & OS)
 Labels: AVI, Audio Arts, Audio Fidelity, Black, Brunswick, Church Door, Creed, DK, GME, Golden Ear, Groove Time, HSE, J&B, Jewel, Kent, Lyon, Modern, Nashboro, Posse, Randy, Sam, Scorpio, Sounds of Gospel, Sparrow, Specialty, Sugar Hill, Tempo, United
 Accessories: Audio Magnetics, BASF, Fidelitone, Recoton, Rivertone, Robins
 Six Sisters Dist., 1899 S. Third. Zip 38109. Tel 774-5689. Dwners: Michal, Bobby & Myrna Cole, Mgr. Dorothy McGowan; Buyers Dorothy

Universal
 RECORD AND TAPE CITY
COMPLETE RECORD AND TAPE SERVICE
 Mr. Bob Perloff
 UNIVERSAL RECORD AND TAPE CITY
 919 No. Broad Street, Philadelphia, Pa. 19123
 (215) CE 5-2726
 Call toll free 1-800-523-0834
 In Penna. call toll free 1-800-822-3919

McGowan, Bobby & Michal Cole. (Rec. & Tape D), (Rec. & Tape OS as Michal's OS Rec.)

Labels: Beantown, CRS, Crossfire, Crusade, D-Vine, Fame, Folkway, Gospel Express, Hub City, Michal, Phila Sounds, Retta's, Sendus, Soul Beat, Soul Town, Tossan
Accessories: Transcriber.

● NASHVILLE (Area Code 615)

Benson Co., 365 Great Circle Rd. Zip 37228 Tel 259-9111 (Rec. D)

Labels: Ariel, Benson, Greentree, Heart Warming, Impact, Jim, Lamb & Lion, Miki & Honey, New Dawn, Newpax, Paragon, Pilgrim America, Refugee, Starsong, Triangle

Capitol Recs., 29 Music Square E. Zip 37203 Tel 244-7770 (Rec. & Tape D—see office in Los Angeles, Calif., for prod. distributed)

Central South Music Sales Inc., 3730 Vulcan Dr. Zip 37211 Tel 833-5960 Owner & Mgr. Randall Davidson, Buyers: Singles, Jack Flippen, Albums, Mark Maynard (Rec. & Tape OS)

Fischer & Lucius Inc., 50 Music Square W. Zip 37203 Tel 329-2278 Owner Joe D. Lucius. (Rec. & Tape D)

Labels: F&L, Ridgtop, Sound Factory, Tanglewood
Jimmy's One Stop, 113 N. Ave. S. Zip 37203 Tel 256-1604 Owner Larry Blackwell Sr., Singles, Albums & Tape Buyer Larry Blackwell Jr. (Rec. & Tape OS)

MCA Dist'g Corp., 50 Music Square W., Suite 205 Zip 37203 Tel 327-3466 Branch Mgr. Barry Yarbrough (Rec. & Tape D—see office in Los Angeles, Calif. for prod. distributed)

Music City Rec. Dist. Inc., 25 Lincoln St. Zip 37202 Tel 255-7315 Pres. Hutch Carlock, Mgr. Ted Adams, Sales Mgr. Mike Wise, Buyers: Singles, Ted Adams, Albums, Ted Adams, Hayes Carlock, Bruce Carlock, Tape, Ted Adams. (Rec. & Tape D, OS, RJ & E)

Labels: Abel, Alarm, Alston, Camden, Cat, Chimneyville, County, Creed, Dore, Drive, Exello, Flying Fish, Glades, Gusto, HSE, Heart Warming, Impact, Jewel, Kayvette, Kenwood, Malaco, Mankind, Nasco, Nashboro, Old Homestead, Paula, Rebel, Ronn, Rounder, Rural Road, Sound City, Specialty, Starday, Su Ann, TK, TMS, Vanguard, Vetco, Vista, Wicked
Accessories: Discwasher, Empire, Hagerstown, Maxell, Memorex, Peerless, Pianstiel, Savoy, Sound Guard, TDK, Tracs, Watts

Music Town Rec. Dist. & Promo Co., 62 Music Square W. Zip 37203 Tel 327-4538 Pres. Cliff Ayers Ostermeyer, VP. Connie L. Wright, Buyers: Singles, Chris Ostermeyer, Albums, Clark Ostermeyer (Rec. D)

Branches: Martinez (San Francisco & Bay Area), Calif., Pompano Beach, Fla., Flushing (New York Metropolitan Area), N.Y.

Labels: Accent, Advance, All Star, Alto, American Sound, Angeltone, Archway, Arrawak, Art, Arvee, Atlas, Audio Arts, Avenue, Ballad, Bandbox, Baton, Bay Uke, Bee, Beltone, Big Mama, Big Sound, Blackbird, Black Gold, Blue Chip, Boliva, Bozer, Breeze, Bronze, Buddy, Bullseye, Buzz, C&M, Campus, Canary, Canyon Country Boys, Capa, CapCity, Cardinal, Carrie, Cavern, Celebrity Circle, Century City, Chante, Chattahoochee, Chroma, Chytown, Cimmaron, Clare, Cloud 9, Collt. Commerce, Conclave, Confedate, Contour, Country World, Creation Sound, Crest, Crossfire, D. J., Dalton, Daran, Dart, Debby, Delden, De Lite, Del Mar, Desert, De Venus, Dome, Domino, Dot-Mar, Double Eagle, E&B, Ebb, Electra, Emerald, Empire, Endeavor, Enterprise, Erol, Evelyn, Event, Fabbri, Fax, Film City, Five D Flick, Flo-Jo, Ford, GCM, GRT, Gass, General American, Genesis, Glenolden, Golden World, Gordy, Gusman, H&L, Hacienda, Hallmark, Harward, High Country, Hit, Hitsville, Hudson, Hugo, Injun, Inscio, Insight, Jalap, Jame, Jazz, Jemal, Jemal Soul, Jeree, Jessup, Jofu, Jule, Julmar, KEF, K.W. Kangaroo, Kanwisk, Kasko, Keen, Kenco, Kid Car'n, Luv, La Salle, Las Vegas, Lincoln, Lmj, Lucky Four, M-Arts, MRC, Mars, Major, Malinda, Las Vegas City, Marvella, Mayhams, Mayland, Meadowlark, Mecca, Median, Mickey, Millage, Miracle, Molly, Moon, Mosrite, Motif, Motown, Mule Kick, Murray-Covert, Music Creek, Music Factory, Music Town, My Goodness, Neptune, New England, Nu Joy, DL, Orbit, Pathe, Peacock, Petal, Pinpoint, Pirouge, Plato, Pony, Prentel, Prudigal, Public, RPR, RSPV, Rae-Cos, Ram, Ranwood, Raydar, Rebel, Red Wing, Rena, Reno Smiley, Rev, Rimrock, Riparia d'Oro, Road, Roadrunner, Ro Ark, Robbins, Rondollet, Rush Street, Sabine, Sable, Sabre, Sage, Sand, Scolorion, Scram, Serand, Shalomar, Shee, Shirley, Silver Pelican, Silver Seal, Sims, Sir, Smog City, Solite Sunshine, Soutrak, Sprint, Starday, Steady, Sur Speed, Sylvana, Tania, Tampa, Tapir, Taylor, Tempo, Three Hills, Tiara, Tidenote, Tip Toe, Trek, Trade, Twilight, Tw-Lite, United, VDC, Valco, Varsity, Varelly, Vesuvius, Vida, Via, Wagner, Wagon Tracks, Way-Out, Wayside, Wedge, Wells-Desert, Westport, Zodiac

Pickwick Dist'n Cos., Independent Dist'n Div., 42 Music Square W., Suite B Zip 37203 Tel 256-2647 (Rec. & Tape D—sales only, see Atlanta, Ga. listing for prod. distributed)

Home office: Minneapolis, Minn.
Ernest Tubbs Dist., 417 Broadway Zip 37203 Tel 255-7503 Owner Ernest Tubbs, Mgr. Singles & Albums Buyer David McCormick (Rec. & Tape D, I & E—country prod.)

TEXAS

● AMARILLO (Area Code 806)

Western Mdsrs. Inc., PO Box 32270, 421 E. 34 St. Zip 79120 Tel 376-6251 Pres. Sam Marmaduke, Sr. VP. R. H. Williamson, Exec. VP. Bob Schneider, Retail VP. John Marmaduke, Buyer Steve Marmaduke (Rec. & Tape OS & RJ)

Branches: Denver, Colo. (Rec. & Tape OS & RJ), (Rec. & Tape D as WM Dist'g); Manhattan, Kan. (Rec. & Tape RJ); Houston (Rec. & Tape OS & RJ), Irving (Dallas Area), Tex. (Rec. & Tape RJ).

● AUSTIN (Area Code 512)

Austin Rec. Dist., PO Box 312, Zip 78767 Tel 321-6271 Owner Susan Jarrett (Rec. & Tape D)

Labels: Amazing, Arhoolie, Armadillo, Bellaire, CBS imports, Charly imports, County, Crazy Cajun, Oelta, Fable, Fate, Folkbiry, Jackalope, Lisa, Longhorn, Longneck, MCA imports, Old Timey, Rainlight, Rat Race, Red Lightnin' imports, Rinconada, Roy, Shasta, Sluff, Texas Re Cord, Texas Soul, WWB

Tom Bishop Co., 6144 Hwy 290 W. Zip 78735 Tel 892-1570 Owner, Mgr. & Buyer Tom Bishop. (Rec. & Tape OS & RJ)

● CONROE (Area Code 713)

Marketing Professionals, 144 Melmont Zip 77032 Tel 273-3356 Owner & Mgr. George B. Reed. (Rec. D)

Labels: Audio Source, Detos, RealTime, Rec. Mktg., Sheffield Lab
Accessories: Aspen

● CORPUS CHRISTI (Area Code 512)

House of Music, 1026 S. Port. Zip 78405 Tel 882-2191. Owner, Mgr. & Buyer John W. Herrera. (Rec. & Tape OS)

● DALLAS AREA (Area Code 214)

(Also see listings under Fort Worth)

Big State Dist'g Corp., 4830 Lakawana, Suite 121 Zip 75247 Tel 631-1100 Owners: H.W. & Don Darley, Billy Emerson, Mgr. Billy Emerson, Buyer Mike Emerson. (Rec. & Tape D), (Rec. & Tape OS as Big State One Stop), (Rec. & Tape RJ as Records of Dallas)

Branch: Denver, Colo., Big State Denver
Labels: AJ, APA, Ala, Abel, Adelphi, Alfa, Alithia, Alligator, Amberjack, Anjelaco, Antilles, Arth, Astro, At Home, Audio Fidelity, BC, Becket, Bellare, Big Town, Blue Canada, Blues Spectrum, Bold, Brighter Day, Brunschw, Cfl, Canaan, Casino, Cat, Chimneyville, Clean Cats, Clouds, Cochise, Columba, Contemporary, Coyote, Creed, D, Dash, Dealers Choice, Delta, Dictation Disc, Dimension, Dooto, Dove, Drive, Emergency, Exello, Fantasy, Galaxy, Glades, Glori, Golden Ear, Good Sounds, Gordy, Gospel Roots, Gospel Truth, Groove Time, Gryphon, Hannibal, Hillside, JEM, Jazz Bird, Jeremiah, Juana, Ju Par, Kayvette, Kent, Kenwood, Kirk-R, Kimbo, King, LRC, Laff, Lamb & Lion, Lifesong, Light, Living Language, Malaco, Mango, Manking, Maranatha, Marlin, Milestone, Mistletoe, Monitor, Motown, Myrrh, Nashboro, Natural Resources, Newpax, New song, Old Town, Paid, Phoenix, Plantation, Prestige, Prodigal, Pyramid, Rare Earth, Riverside, Roots, Roulette, Rounder, Russell, Sam, San Francisco Sounds, Scorpion, Solid Smoke, Soul, Soul Country, Sound Waves, Spire, Starday, Stoneway, Strata East, Sugar Hill, Sun, Sunshine Sound, Sutra, TK, Tania, Thunderbird, Vanguard, Venture, Virgo, War Bride, Weird World, Word, XRT

Bromo Dist. of Dallas Inc., 3373 Garden Brook Zip 75234 Tel 247-7302 (Rec. OS)

C B S Recs., 8700 Stemmons Fwy., Suite 309 Zip 75247 Tel 634-1700 VP Southwest Region Jack Chase, Reg'l. Co. ord. Sherry Turnage, Branch Mgr. Danny Yarbrough. (Rec. & Tape D—see New York, N.Y., office for prod. distributed)

Capitol Recs., 6730 Oakbrook Blvd. Zip 75235 Tel 637-1890 (Rec. & Tape D—see office in Los Angeles, Calif., for prod. distributed)

H & W One Stop Recs. Inc., 3109 Grand Ave. Zip 75215 Tel 421-7396 (Rec. & Tape OS)

Handlemo Co., 2931 Irving Blvd., No. 106 Zip 75247 Tel 631-2943 (Rec. & Tape RJ)

Home office: Clawson (Detroit Metropolitan Area), Mich
Lieberman Ent. Inc., 9801 Chartwell Dr. Zip 75231 Tel 349-2520 Mgr. Jim Sinclair, Dpns Mgr. Robert Smith, OS Mgr. David Nichols, Buyers: Singles, Susan Elder, Albums & Tape, Jim Coffin (Rec. & Tape OS & RJ)
Home office: Minneapolis, Minn

MCA Dist'g Corp., 11212 Gemini St. Zip 75229 Tel 241-8646 Reg'l. Dir. Rod Tremblay, Branch Mgr. Dan Purcell (Rec. & Tape D—see New York, N.Y., office for prod. distributed)

PolyGram Dist'n Inc., 14200 Midway Plaza, Suite 125, Zip 75240 Tel 387-2797 Reg'l. VP Paul Lucks (Rec. & Tape D)
Home office: New York, N.Y. (See for prod. distributed)

RCA & A&M & Assoc.'s Labels, 4232 Spring Valley Rd. Zip 75234 Tel 661-3739 Branch Sales Mgr. Jim Yates (Rec. & Tape D—see New York, N.Y., office for prod. distributed)

Records of Dallas (Rec. & Tape RJ), see Big State
Sondino Int'l Rec. & Tape Dist., 4504 Lake Ave. Zip 75219 Tel 528-3813, 521-3904. (Rec. D)

Labels: Arcano, CBS Int'l, Caliente, Capri, Carino, Caytromcs, Del Valle, El Zarape, Gas, Orfeon, Pronto, Son, Sondo, Star Ship, Vencador, Visa
Accessories: Ampex, RiverTone

Sound City Dist., 4647 Mint Way, Zip 75236 Tel 330-6893/7786 Pres. Thomas P. Sims, Exec. VP. Owane Niemeyer, Dpns Mgr. Walter Hanna (Rec. & Tape OS—cutouts, overruns)

Triple S One Stop Recs., 320 S. Lancaster, Kiest Shopping Center Zip 75216 Tel 375-1111 Buyer Jim Sanders (Rec. & Tape OS)

Warner/Elektra/Atlantic Corp., PO Box 3567, 1909 Hereford Dr., Irving 75061 Tel 255-2141 Branch Mgr. Paul Sheffield, Sales Mgr. Jim McAuliffe (Rec. & Tape D—see office in Los Angeles, Calif., for prod. distributed)

Western Mdsrs. Inc., PO Box 470286, 2200 Regency Dr., Irving 75247 Tel 438-8112 Mgr. P. Pagliara (Rec. & Tape RJ)

Home office: Amarillo, Tex. (Rec. & Tape OS & RJ)
Westex Recs. & Reels, 3151 Commonwealth Zip 75247 Tel 637-1810 Owner Eddie Childres, Buyers, Debbie & Eddie Childres. (Rec. & Tape OS & RJ)

● DRIFTWOOD (Area Code 512)

House Dist., Box 14-W, Rt. 1, Zip 78619 Tel 858-7409 Mgr. Charlie Wrobel (Rec. & Tape D)

Home office: Kansas City, Mo. (See for prod. distributed)

● EL PASO (Area Code 915)

Krupp Dist'g Co., 311 S. Santa Fe St. Zip 79901 Tel 532-4961 (Rec. & Tape OS)

● FORT WORTH AREA (Area Code 817)

Victor Hotho & Co., PO Box 9738, Zip 76107 Tel 335-1833 (Rec. & Tape RJ)

Landmark Dist. Inc., 2020 E. Randol Mill Rd., Arlington 76011 Tel 469-1071 WATS (Texas) (800) 792-1039 (Other states) (800) 433-1624 Mgr. Jay Griffin, Buyer Rusty Matz (Rec. & Tape D, RJ & E—religious prod. only)

Labels: Birdwing, Bread & Honey, Cachet, Calvary, Canaan, Capitol, Cross Country, Crescendo, Dayspring, Good News, Greentree, Heart Warming, Housetop, Image VII, Impact, Jim, Jubilation group, Lamb & Lion, Light, Maranatha, Mercury, Messianic, Myrrh, New Life, New Pax, New World, Paragon, PolyGram, Praise, QCA, RCA, Ranwood, Sacred, Singersation, Skylite Sing, Solid Rock, Sparrow, Starsong, Tempo, Triune, Windchime, Word

Largo Music Corp., 803 Ave. E., Suite 307, Arlington 76011 Tel 640-8991 Contact Henry Moeller (Rec. & Tape OS & RJ)

Home office: Columbia (Baltimore Metropolitan Area), Md
Video cassette lines: CBS, Columbia Pictures, Disney, MCA, Magnetic Video, Paramount, WEA

Videodisc lines: CBS, MCA, Paramount, RCA

Pickwick Dist'n Cos., Independent Dist'n Div., 2200 E. Randol Mill Rd., Ar

lington 76011 Tel 261-4281 Nat'l Dist'n Div. VP & Gen. Mgr. Jack Bernstein, Nat'l Dpns Mgr. Allan Roller, Branch Mgr. Don Gillespie, Buyer Bebe Pulliam. (Rec. & Tape D), (Rec. & Tape RJ as Pickwick Dist'n Cos., Rack Servs. Div.)

Home office: Minneapolis, Minn
Labels: AVI, Abico, Ariola, Arista, Armadillo, Aural Explorer, Boardwalk, Bomb, Buddha, CMM, Camden, Choice, Chrysalis, City Lights, Classic Jazz, Concord Jazz, Devaki, Enlr, Act, Excelsior, First American, Fizz, GNP Crescendo, G&P, GRP, Grand, Great Northwest, Hob, House of Cash, Inner City, Jam, Javel, Marden Voyage, Mirus, Muse, Muscle, Music Is Medicine, New Birth, Doe, Our Gang, Davton, PVC, Passport, Paula, Pausa, Picadilly, Pickwick, Prelude, Prism, Pro Arte, Project 3, Quintessence, Ranwood, Reflection, Regency, Rhino, Rollin' Rock, Ronn, SMI, Savoy, Seeds & Stems, Sesame Street, Sink, Skylite, Slash, Sluff, Stony Plain, Sunbird, Syntonic Research, Takoma, Trolleycar, Vintage, Visa, Waterhouse, Wheel

Pickwick Dist'n Cos., Rack Servs. Div., 2200 E. Randol Mill Rd., Arlington 76011 Tel 261-4281 Mgr. Ray Chambers, Buyer Jim Newhouse. (Rec. & Tape RJ), (Rec. & Tape D as Pickwick Dist'n Cos., Independent Dist'n Div.)

Richey Recs., 7121 W. Vickery, Unit 118, Zip 76116 Tel 731-7375 Owner & Mgr. Slim Richey, Buyers: Singles, Jim Cotegrove, Albums, Bob Jones (Rec. & Tape D), (Rec. I & E as Self 'Dem Recs.)

Labels: Alligator, American Heritage, Broadway Intermision, County, Delmark, Flying Fish, Flying High, Grass Mountain, HDS, Kaleidoscope, Kung, Old Homestead, Dullet, Physical, Plantation, Power Pak, Priority, Puritan, Rambler, Rebel, Reverend, Ridge Runner, Rounder, Rural Rhythm, SSS Int'l, Sonyatone, Stonaway, Sun, Texas Re Cord, Vetco
Sell Dem Recs. (Rec. I & E)—see Richey Recs.

● FRANKSTON (Area Code 214)

Mills Specialty Whse., 4-2 Three Points Ext. Zip 75763 Tel 876-3816

Owner, Mgr. & Buyer E. A. Mills. (Rec. OS & RJ)

● GRAHAM (Area Code 817)

Boase Dist'g Inc., 1317 Edgewood Zip 76046 Owner Jim Boase; Mgr. & Buyer Janice Boase (Tape RJ)

● HOUSTON AREA (Area Code 713)

Acme Dist'g Co., 3743 University Blvd. Zip 77005 Tel 665-0741 Owner, Singles, Albums & Tape Buyer Kenneth Parish (Rec. & Tape RJ)

Alamo Rec. Dist. Inc., PO Box 9627, Zip 77013 Tel 453-7128 (Rec. & Tape RJ—Spanish prod.)

Home office: San Antonio, Tex.

C B S Recs., 2190 North Loop W., Suite 100 Zip 77018 Tel 680-8900 Branch Mgr. Luke Lewis. (Rec. & Tape D—see New York, N.Y., office for prod. distributed)

H W Daily, 3409 Brinkman, Zip 77018, Tel 861-9251 Owners: H.W. & Don Daily, Mgr. Wes Daily, Sales Becky Bransfield, Promo: Mike Hicks, Buyers: Singles, Mary Roberts, Albums & Tape, David Bennett (Rec. & Tape OS)

Accessories: Fuji, Maxell, Memorex, Scotch, TDK

G P Recs. & Tapes Dist., PO Box 21100, 2124 N. Main St. Zip 77026 Tel 223-9293 Owner Gaston C. Ponce. (Rec. D)

Labels: Bonito, Exito Regional, Firmamento, Gapoca, Hit, Novavox, Sabroso

Lotasso, PO Box 10860, 1634 Wakefield Dr. Zip 77018 Tel 686-1155 Owner Maxine Eickenhorst, Albums & Tape Buyer A.H. Eickenhorst (Rec. & Tape D, OS & RJ)

Labels: ADLT, Alshire, Camden, Pickwick Int'l, Stoneway, United; also distributes cutouts & close outs

Merrbach Rec. Serv., 323 W. 14 St. Zip 77008 Tel 862-7077 Owner N.F. Merrbach (Rec. D)

Labels: Bee Shark, Blue Star, Bogan, Dance Ranch, E.Z. Lore, Rockin' (A), Swinging Square (All square dance labels)

Music Serv. Co., 5631 Old Clinton Dr. Zip 77020 Tel 675-7581 Owner & Mgr. Harry Rossmann, Buyer Tom Meyer (Rec. & Tape RJ)

Pickwick Dist'n Cos., Independent Dist'n Div., 6400 W. Park, Suite 465, Zip 77057 Tel 780-7650 (Rec. & Tape D—see Fort Worth listing for prod. distributed)

Home office: Minneapolis, Minn

Record Dist'g Serv. Inc., 2039 Antone Zip 77055 Tel 683-7171 (Rec. D & OS)

Labels: Acetone, Astro, Bandana, Bandolero, Buzz-Bee, Crazy Cajun, Dapros, GMC, Gusto, Hep Me, Hillside, Jin, Mesquite, Music America, Na, Nonwide Sound, Plantation, RDS, Rock N Saddle, Silver Moon, South Breeze, Sun, Sunbird, T

Record Specialty's Co., 14528-A Hempstead Hwy. Zip 77040 Tel 939-1031 Owner, Singles & Albums Buyer: Harvey V. Hood. (Rec. & Tape RJ)
South Texas Whse. Recs. & Tapes Inc., 8566 Katy Fwy., No. 123, Zip 77024 Tel 464-6507 Mgr. & Buyer R. G. Guilleman (Rec. & Tape OS, RJ & E)

Home office: San Antonio, Tex.

United Rec. Dist., 1613 St. Emanuel St. Zip 77003 Tel 228-8151 Owner Jack Kirby, Mgr. Gee Saldana, Buyers: Singles, Terri Lore, Albums & Tape, Jerry Wilkie (Rec. & Tape OS)

Warner/Elektra/Atlantic Corp., 5750 Bentliff, Suite 200 Zip 77036 Tel 789-5920 Sales Mgr. John Quinn. (Rec. & Tape D—see office in Los Angeles, Calif., for prod. distributed)

Western Mdsrs. Inc., PO Box 2384, Zip 77001, 520 W. 38 St. Zip 77018 Tel 688-7783 Mgr. John Sobieski, Buyer Pat C. Deekard (Rec. & Tape OS & RJ)

Home office: Amarillo, Tex.

● LUBBOCK (Area Code 806)

Recordland USA Inc., PO Box 10112, Zip 79408, 3111 34 St. Zip 79410 Tel 792-3277 Owner Allan Rosen, Buyer Carl Keel. (Rec. & Tape OS)

● McALLEN (Area Code 512)

Alamo Rec. Dist. Inc., 1412 Beaumont Zip 78501 Tel 687-4282 (Rec. & Tape RJ—Spanish prod.)

Home office: San Antonio, Tex.

House of Falcon Inc./ARY Rec. Sales, 821 N. 23 Zip 78501 Tel 686-5851 Mgr. & Buyer Ramiro Perez (Rec. & Tape D, OS & RJ)

Branch: Los Angeles, Calif. (Rec. & Tape D)
Labels: ARV Int'l, Falcon, Ric

• **SAN ANTONIO (Area Code 512)**

Alamo Rec. Dist. Inc., 5707 Grey Rock, Zip 78228. Tel: 436-1166. (Rec. & Tape RJ—Spanish prod.)
 Branches: Houston, McAllen, Tex
 Cayre Dist. of Texas Inc., 722 San Pedro, Zip 78212. Tel: 222-0106. (Rec. & Tape D)
 Home office: New York, N.Y. Caytronics Corp. (Rec. & Tape D, OS, RJ, I & E—see for prod. distributed)
 E & R One Stop, 301 S. Main Ave. Zip 78204 Tel: 22 0911 Owner Ethel Schram, Mgr & Buyer Pete Bustamante (Rec. & Tape DS)
 Musical Recs. Co./Musical Tapes Inc., 135 Braniff Cr Zip 78216 Tel: 349 1433 Mgr. Ruben Espinosa (Rec. & Tape D, CS & RJ)
 Home office: Miami, Fla. (See for prod. distributed)
 Musical Tapes Inc., see Musical Recs. Co./Musical Tapes Inc
 Music Merchants Inc., 310 W Nakoma Dr Zip 782 6 Tel: 349 1267 Dwn ers Bill McGehee, John Gonzales, Albums & Tape Buyer Larry Langford (Rec. & Tape OS)
 Rangel Music Co Inc, PO Box 5524, 809 Fredericksburg Rd Zip 78201 Tel: 735 6111 Mgr Manuel E Rangel (Rec. D, OS & RJ; Tape D)
 Labels: ARV, Big Star, Cara, Falcon, Fama, Fireball, Nuevo, Profano, SRP
 South Texas Whistle Recs & Tapes Inc., 724 Levington Zip 78212 Tel: 224 0754 Mgr. & Buyer R.W. Powers (Rec. & Tape OS, RJ & E)
 Branch: Houston, Tex
 Accessories: Le Bo
 U S Sound Dist. Inc., 1924 Fredericksburg Rd Zip 78201 Tel: 733 6377 Pres. Alvaro Fajardo, Mgr. Rey Gonzales (Rec. & Tape RJ & E)

• **SAN BENITO (Area Code 512)**

Rio Grande Music Co., PO Box 861, 119 S. Sam Houston Blvd Zip 78586 Tel: 399 5377 Mgr Manuel E Rangel (Rec. D, OS & RJ; Tape D & DS)
 Labels: ARV, Akron, Alfa, Alhambra, Arcano, BCM, Bego, Bernal, Bronco, Buena Suerte, CBS Latin, CR, CRC, Caliente, Carasta, Capri, Carino, Cay tronics, Chemiro, Chuco, Coast, Cobra, Colonial, Columbia, Corona, Cu Coy, DLB, DLY, De La Rosa, Del Rio, Del Sur, Del Valle, Del West, Discolo, Dominante, Do-Re-Mi, E, Z, East Band, Escorpion, Falcon, Fama, Fireball, Firma, Flecha, Freddie, Fuego, G.C. GCP, Gabe, Gapoca, Gas, Ha cinda, Hino, Hurricane, Ideal, Impacito, JC, Jilgaero, Joey, Jo-in, Keyloc, Latino Int'l, Latin Soul, Lira, Magda, Marsal, Mex Melody, Miami, Mister G, Musart, Musi Mex, Norco, Morteno, Nova Vox, Nuevo, Orfeon, Oro, Par nazo, El Palo, Peerless, Popular, Primer, Pronto, RCA, RN, Raff, Ramez, Real, Relampago, Reloj, Ric, Rocca, Rosina, Rovi, Sombrero, Sonido Int'l, Starlite, Sunglow, Super Mex, Teardrop, Tex Mex, Torres, UA Latino, Un-ico, Valmon, West Mex, ZAAD, El Zarape.
 Playback equip.: Marantz, Pioneer, RCA, Sony, Zenith
 Accessories: BASF, Scotch

UTAH

• **LAYTON (Area Code 801)**

K S G Dist'g, 330 N Main, Zip 84041 Tel: 376-0861 Owner Kevin Garn, Mgr Greg Sanders, Albums & Tape Buyer Kevin Garn (Rec. & Tape RJ)

• **SALT LAKE CITY (Area Code 801)**

Alta Dist'g Co., Intermountain Div., PO Box 26856, 2270 Bridger Rd Zip 84126 Tel: 972 3800, VP & Gen Mgr Joe Sasich, Ass'l Gen Mgr & Sales & Mktg. Mgr Winston G Jones Jr., Retail Div Gen Mgr Nick Sasich, OS Mgr. Gene Stevens, Buyers Singles, Alice Hale, Albums, Layne Kresser, Tape, Ron Nicks, Accessories, Gene Stevens (Rec. & Tape D, OS & RJ)
 Labels: Abkco, Ala, CMH, Caedmon, Chalfont, Chrysalis, Denon, Disc washer, Disney, Excelsior, GNP Crescendo, Laif, Living Language, Original Sounds, Pickwick, Pro Arte, Quintes ence, Ranwood, Sesame Street, Sunbird, Takoma, Varese Sarabande
 Accessories: Ampex, Audio Magnetics, Certon Discwasher, Dynasound, Fidelitone, Le Bo, Mazell, Memorex, Recoton, Savoy, Scotch, TDK, Tracs Cordova's Importers & Dists., PO Box 16065, 543 N 400 North Zip 84116 Tel: 355 1914 Owner & Mgr Carl C Cordova (Rec. & Tape D & I)
 Labels: Alhambra, Arcano, Arriba, Bonanza, CEC, Caliente, Carino, Cay tronics, Comex, Cronos, DLB, De La Rosa, Ec., Falcon, Fama, Freddie

Gas, Hurricane, Joey, Jovi, Keylock, Lorena, Melody, Mericana, Musart, Nova Vox, Orfeon, Peerless, Pronto, RJG, Reyna, Roybal, Sound Mex, Viza
 Western Toy & Hobby Inc., 327 W Second South, Zip 84101 Tel: 364-6593 (Rec. D & RJ)
 Rec. Labels: Disneyland, Gusto-Alto, Pickwick
 Phonographs: LJN

VERMONT

• **BURLINGTON AREA (Area Code 802)**

Altec Dist'g Co. Inc., 36 Church St, Zip, 05401. Tel: 864-5777 Pres.: Martin F. Gold, Treas. Howard Goldberg, Opns. Mgr. Paul Schulman, Buyer Ken Freestone, Sales Mgr.: Billy Northup, Mktg. Co. ord. Bill Perrault. (Rec. & Tape OS, RJ, & E)
 Videocassette & videodisk lines: CBS Video, Columbia Pictures, Karl MCA, Magnetic Video, NFL, Nostalgia Merchant, Paramount, Quality X, VCI, VCC, VCX, VXP, Vid America, Vintage Video, Walt Disney, Warner, Wizard.
 Accessories: Fuji, Memorex, TDK.

• **WATERBURY (Area Code 802)**

Silo Inc., Box 82, RD2, Zip, 05676 Tel: 244-8657 Owner, Mgr. Singles, Albums & Tape Buyer Joan Pelton. (Rec. D, OS & I; Tape D)
 Labels: Adelphi, Arholite, Aron, Avoca, Banjar, Bard, Bay, Bert & I, Biograph, Blackbird, Blind Pig, Blue Goose, Blues Classics, COIC, CDS, CMH, Cabbage, Caedmon, Cassandra, Celeste, Celestial, Claddagh, Clairssearch, Clearwater, County, Crest, Droll Yankee, Everest, F&W, Flying Fish, Flying High, Folk Legacy, Folklyric, Folkways, Freckle, Fretilless, Front Hall, Full Circle, Gael-Linn, Galaxia, Gateway, Gramavision, Grass Mountain, Green Hays, Green Linnet, Green Mountain, Greenwich Village, Harmonies, Helios, Herwin, Jeremiah, June Appal, Kaleidoscope, Kicking Mule, Lima Bean, Lincoln House, Living Folk, Mineral River, Minstrel, Monks of the Weston Priory, Morning Star, Mountain Railroad, Neworld, New World, Ogham, Old Timey, Orngami, PPI, Pacific Cascade, Personal Choice, Peters, Philo, Physical, Pleiades, Rainbow Morning, Rainbow Snake, Rebel, Red Squirrel, Revels, Revonah, Ridge Runner, Riverbear, Rooster, Rosen-shantz, Rosetta, Rounder, S&I, Sea Friends, Shanachie, Sierra Briar, Soap, Sonet, Stash, String, Sugar Hill, Swallowtail, Tangent, Terrapin, Titanic, Topic, Traditional, Troubadour, Voyager, Waylon, Wheatland, Windham Hill, Wise Women, Women's Wax Works, Yazoo
 Labels imported: Ayre (Canada), Big Foot Betty (Canada), Boot (Canada), CCBP (Canada), Celtic (Canada, UK), Dance Craft (Canada), Dingle (UK), Doctor Charlie (Canada), Ducktail (Canada), Elephant (Canada), Fogarty's Cave (Canada), Free Reed (UK), Glencoe (Canada), Highway (UK), Leader/Trailer (UK), Leapfrog (Canada), Lismor (UK), Mariposa (Canada), Mulligan (Ireland), Owen Sound (Canada), Plant Life (UK), Rubber (UK), Temple (UK)

VIRGINIA

• **McLEAN (Area Code 703)**

Telemark Dance Recs., PO Box 55, Zip 22101. Tel: 356-9113. Owners & Mgrs. Dick & Sheila Mason. (Rec. & Tape D, I & E)
 Labels: Dance Along, German, Hi Hat, Hoctor, Al Pierson, Roper, Telemark
 Labels imported: Ariola (Germany), Danson, Europa (Germany), IDTA, Ioy, Mambelle, Philips, Polydor, Redifusion (UK), Sydney Thompson, Telemark (UK), Tema (UK)

• **NORFOLK (Area Code 804)**

Eurpac East, 961 Norfolk Square, Zip 23502 Tel: 857-0131 Music Div Mgr. Jim Ramsey
 Accessories: Ampex.
 Scott Dist'g Corp., 3418 Azalea Garden Rd, Zip: 23513. Tel: 855-0188 Buyer Robert Kruglick. (Rec. & Tape D—military sales, promotional recs & tapes for civilian dist'n)

Home office: Island Park, N.Y.
 Accessories: Blank tape.
 Tidewater One Stop, 1910 Granby St. Zip 23517 Tel: 622-8663. Mgr. Charles Faison (Rec. & Tape OS)
 Home office: Lanham, Md., Schwartz Bros. Inc. (Rec. & Tape D).

• **RICHMOND (Area Code 804)**

Dean's One Stop Ltd., PO Box 26205, Zip: 23260. Tel: 321-7515. Pres. Dean Hogue, VP. Robert Marshall, Buyers: Dean Hogue, Robert Marshall. (Rec. & Tape OS & RJ)

• **ROANOKE (Area Code 703)**

Record Depot Dists., PO Box 3057, Zip: 24015. Tel: 343-5355 Owner David Freeman; Mgr. Chet Rhodes, Buyers: Albums, Barry Poss; Tape, David Freeman. (Rec. & Tape D)
 Labels: Adelphi, Alligator, American Heritage, Atteram, CMH, County, Flying Fish, Front Hall, Grassound, Green Linnet, June Appal, Kicking Mule, Leather, Mountain, Old Homestead, Outlet, Philo, Puritan, Rebel, Revonah, Ridge Runner, Rounder, Shanachie, Shloh, Sierra/Briar, Son-yatone, Starday/King, Sugar Hill, Troubadour, Velco, Wango, Turner Candy Co., 516 Rorer Ave. SW, Zip: 24008. Tel: 342-0500 Owner, Mgr & Buyer A.L. Turner Jr. (Rec. & Tape RJ)

• **ROCKY MOUNT (Area Code 703)**

Outlet Rec. Dists., Box 594, 118 Main St, Zip: 24151 Tel: 483-0689 Owner Rod Shively (Rec. & Tape D)
 Labels: American Heritage, CMH, County, Goldtone, Heritage, Leather, Mount, Mountain, Old Homestead, Outlet, Power Pak, Prime Time, Rebel, Revonah, Ridge Runner, Rounder, Starday/King, Sugar Hill.

• **VIRGINIA BEACH (Area Code 804)**

Largo Music Corp., 3472 Glen Arden Rd, Zip: 23464. Te: 427-7327 Contact Louis Rice (Rec. & Tape OS & RJ)
 Home office: Columbia (Baltimore Metropolitan Area), Md.
 Videocassette lines: CBS, Columbia Pictures, Disney, MCA, Magnetic Video, Paramount, WEA
 Videodisk lines: CBS, MCA, Paramount, RCA.

WASHINGTON

• **BELLINGHAM (Area Code 206)**

Praise Inds. Corp., 1308 Meador St., Unit C5 Zip: 98225 Tel: 671-9562 (Rec. & Tape D)
 Labels: Country Oak, Faith, Fisher Folk, Herald, Horizon, Little People, New Born, Praise, Starsong, Tunesmith.

• **SEATTLE AREA (Area Code 206)**

Rich Ballard Imports, 252 Fulton Zip 98109 Tel: 283-7134. Sales Gary Bannister. (Rec. D, I & E)
 Home office: Berkeley (San Francisco & Bay Area), Calif. (See for prod. distributed)
 C B S Recs., 1051 Andover Park E., Tukwila 98188. Tel: 575-0931. Branch Mgr. Joe Yoppolo (Rec. & Tape D—see New York, N.Y., office for prod. distributed)
 California Rec. Dists. Inc., 6011 S Roxbury Zip 98118 Tel: 723-0900 Sales Mgr. George Bigley, Promo. Mgr. Ted Higashioka (Rec. D)
 Home office: Glendale (Los Angeles Metropolitan Area), Calif.
 Labels: AFM, APM, Aecco, Alligator, Amazing, Amberjack, Angelaco, Ara-besque, Arholite, Arnes, Audio Fidelity, Audio Rarities, Bach Guild, Bet Car, Big Band Int'l, Big Lives, Blues Classics, Boogie Woogie, Broadway, CMH, Caedmon, Cetra Opera, Chiaroscuro, Clappers, Clearing House, Col-umbia Special Prods., Concert Disc, Concord Jazz, Contemporary, Cook, Counterpoint, County, Creative World, Criterion, Delmark, Dixieland Ju-bilee, Eckerwoks, Everest, Fantasy, Fifty-One West, First American, Fly-ing Fish, Flying High, Folklyric, Fretilless, Galaxy, Giants of Jazz, Glendale, Golden Age, Golden Era, Good Time Jazz, Gospel Truth, Granite, Gryphon, Happy Face, History in Sound, Improv, Jazz Archives, Jazz Bird, Jazz Treasury, Kaleidoscope, Kicking Mule, Laurie, Legacy, Los Angeles, Mark 56, Milestone, Muse, Music Is Medicine, Musicworks, Natural Organic, Nutmeg, Old Timey, Olympic, Original Sound, Pausa, Pearl, Period, Philo, Phoenix 10 & 20, Picadilly, Polaris, Potato, Prestige, Radiola, Razor, Re-bel, Regency, Ridge Runner, Riverside, Rounder, S&I, Sandy Hook, Shadow, Shamrock, Shloh, Sounds, Standing Room Only, Stax, Strata-East, Sugar Hill, Syntonic Research, Tahiti, Tandem, Thunderbird, Time less, Total Sound, Tradition, Transatlantic, Trema, Varese, Waterhouse, Xanadu
 Accessories: Memorex
 City Hall Recs., 46 W. Etruria, Apt. D Zip 98119 Tel: 282-4820. Reg'l Sales Mgr. George Romansic (Rec. & Tape D, I & E)
 Home office: San Francisco, Calif. (See for prod. distributed)
 Danjay Music Inc., 1041 Industry Dr., Tukwila 98188. Tel: 575-0675 Mgr. Mike Boyle, Buyer Bill Green (Rec. & Tape OS)
 Home office: Denver, Colo.
 Disc City One Stop (Record Sales & Serv. Inc.), PO Box 24701, Zip 98124, 1540 Fourth Ave. S. Zip: 98134. Tel: 622-4005 Owner: Larry Dolgoff, Singles Buyer: Bill Dolgoff. (Rec. & Tape OS)
 General Rec. Serv. Inc., 6565 Seventh Ave. S Zip 98108 Tel: 767-7444. Pres. & Gen. Mgr.: Paul H. Portteus; Mgr.: Singles, Albums & Tape Buyer Russ Portteus, Sales Mgr. Tom Tomlin. (Rec. & Tape RJ)
 Handlemans Co., 1207 Andover Park W, Tukwila 98188. Tel: 575-0400. (Rec. & Tape RJ)
 Home office: Clawson (Detroit Metropolitan Area), Mich.
 Kiner Dist'g Co., PO Box 724, Redmond 98052 Owner & Buyer: Larry F Kiner. (Rec. I)
 Labels imported: Aircheck, Radio Archives, Spokane, Totem
 M C A Dist'g Corp., 2633 Eastlake Ave. E., No. 301, Zip: 98102. Tel: 322 3100. Branch Mgr. Dan Wedlock. (Rec. & Tape D—see office in Los An-geles, Calif., for prod. distributed)
 Major Dists. Inc., 18292 Andover Park W, Tukwila 98188. Tel: 575-0081. Owner R.G. Anderson, VP Rec. Div. Gary Clark, Buyers Singles, Inge Wood, Albums, Jim Nickle, Monica Moore, Tape, Gary Davis; CE Sales Mgr. Mike Ellis (Rec. & Tape RJ)
 Branches: Livermore (San Francisco & Bay Area), Calif., Honolulu, Hawaii.



DICK CAVETT

for the



Around the world or around the corner can be the loneliest place for a service person. But USO is there to help break the loneliness through family programs, intercultural tours, classes, or just a place to sit and rest.

Support your USO through the United Way, OCF, or local USO campaign

USO WORLD HDQTRS — 1146 19th St., N.W., Wash., D.C. 20036

DON'T LET INFLATION BLOW IT!



Phonographs: BSR.
Playback equip.: Hitachi, Mitsubishi, Panasonic.
Accessories: BASF, Duracell, Le-Bo, Maxell, Memorex, Recoton, Tran scribe.
Pacific Rec. & Tape Dists. Inc., 5612 Sixth Ave. S. Zip: 98108. Tel: 762-1056. (Rec. & Tape D)
Home office: Oakland (San Francisco & Bay Area), Calif. (See for prod distributed)
Pacific Rec. Serv., 678 Industry Dr., Tukwila 98188. Tel: 575-3110. Pres: Jim Huffine. Sales: Denny Vaughn. (Rec. & Tape D)
Labels: Disneyland, Excelsior, Living Language, Peter Pan, Pickwick, Pro Arte, Quintessence, Sesame Street, Telarc, also distributes cutouts.
Accessories: Rec., tape & video.
Pickwick Dist'n Cos., Independent Dist'n Div., 573 Industry Dr., Tukwila 98188. Tel: 575-0470. Field Sales Mgr: Maury King. (Rec. & Tape D—sales only, see Los Angeles, Calif., office for prod. distributed) (Rec. & Tape OS & RJ as Pickwick Dist'n Cos., Rack Servs. Div.)
Home office: Minneapolis, Minn.
Pickwick Dist'n Cos., Rack Servs. Div., 9860 40 Ave. S. Zip: 98118. Tel: 725-2500. Mgr: Al Zangrillo; Buyer: Fred Stewart. (Rec. & Tape RJ)
Home office: Minneapolis, Minn.
PolyGram Dist'n Inc., 1018 Industry Dr. Zip: 98188. Tel: 575-3830. Mgr: Gerry Kopecky. (Rec. & Tape D)
Home office: New York, N.Y. (See for prod. distributed)
Precision Sound Mktg Ltd., 24310 Second Pl. W., Bothell 98011. Tel: 483-1222. Mgr: Singles & Albums Buyer: Frank Klammer. (Rec. D & E)
Branch: Eugene, Ore.
Labels: ASI, Accent (Belgium), American Gramophone, Audio Directions, Audio Encore, Audio Source, Century, Chalfont, Concord Jazz, Delos, Denon (Japan), Direct Disk Lab, Discwasher, Firstline, JVC (Japan), Kiras (Canada), Mark Levinson, Mobile Fidelity, Nautilus, Orinda, Philips (Japan), Proprius (Sweden), RCA (Japan), Realtime, Sound 80, Starlog, Telarc, Trend, Varese Sarabande, Waikiki.
Accessories: BASF, Decca, Jac-it, Permastat
R C A & A&M & Assoc'd Labels, 925 Industry Dr., Tukwila 98188. Tel: 575-1410. Mgr: Bonnie McCassy. (Rec. & Tape D—see New York, N.Y., office for prod. distributed)
Roundup Music Dists., 18300 Midvale Ave. N. Zip: 98133. Tel: 542-7551. (Rec. & Tape RJ)
Sea-Port Rec. One Stop Inc., 582 Industry Dr., Tukwila 98188. Tel: 575-3131. Sales: Bob Hanft, Edie Mitchell. (Rec. & Tape OS)
Home office: Portland, Ore.
Warner/Elektra/Atlantic Corp., 1156 Industry Dr., Tukwila 98188. Tel: 575-0190. Sales Mgr: Jack Shue. (Rec. & Tape D—see office in Los Angeles, Calif., for prod. distributed)

• **VANCOUVER (Area Code 206)**

Crown Prods. Inc., 1405 NE 88 St. Zip: 98665. Tel: 574-5331. Owner, Mgr. & Buyer: Vernon H. Haas. (Rec. & Tape D)
Labels: Avant Garde, Benson, Bread N Honey, Calvary, Columbia, Hope, KCP, Lillenas, Manna, New Life, Pickwick, RCA, Rainbow Sound, Ranwood, Singcord, Skylite, Sparrow, Star Song, Tempo, Word

WEST VIRGINIA

• **CHARLESTON (Area Code 304)**

Elkins Rec. Shop, 1127 Central Ave. Zip: 25302. Tel: 343-7833. (Rec. OS)
3-D Electronics Inc., 1541 W. Washington St. Zip: 25312. Tel: 345-6829.
Pres: Dave Ferrell; **Mgr.:** Roger Fields; **Buyers:** Singles, Tanus McClanahan, Albums & Tape, Richard Fisher. (Rec. & Tape D & RJ)
Labels: A&M, CMH, Capitol, Capricorn, Casablanca, Columbia, Country, GRT, Heart Warming, Jim, King Bluegrass, MCA, Mercury, Pickwick, Polygram, RCA, RSD, Rebel, Salsoul, Sire, 20th Century, WEA, Word
Phonographs: BSR, Garrard, Marantz.
Playback equip.: Emerson, Marantz, Pioneer of America, Superscope.
Accessories: Arista, Le-Bo, Memorex, Philmore.

• **HUNTINGTON AREA (Area Code 304)**

Music Man Inc., 2519 Fourth Ave. Zip: 25703. Tel: 522-7551. (Rec. & Tape OS)

WISCONSIN

• **BURLINGTON (Area Code 414)**

Music Mart, 164 E. Washington. Zip: 53105. Tel: 763-3361. Owner: Rollin J. Ruedebusch; **Mgr.:** Lucille Waardenburg. Singles, Albums & Tape Buyer: Jeanette Brandes. (Rec. & Tape OS)
Videodisk lines: RCA.

• **MAOISON (Area Code 608)**

Rapid Sales Co. Inc., 1019 Jonathan Dr. Zip: 53713. Tel: 271-2551. Pres.: Rolf V. Voegelin. Buyers: Singles, Lowell Grass; Albums & Tape, Donald Smith; Budget Lines & Accessories, Robert Odbink, D Labels, Lois Lawrence. (Rec. & Tape D & RJ)
Labels: Disneyland, GNP Crescendo, Golden, Peter Pan, Ranwood, SQN, Tell, Vox.

• **MILWAUKEE (Area Code 414)**

Audie's One-Stop, 2204 W. North Ave. Zip: 53205. Tel: 342-4636, 931-8015.
Owner & Mgr.: Autacruaga Dotson; Singles, Albums & Tape Buyer: John Reed. **Local branch:** Audie's Recs., 2239 W. Capitol Dr. Zip: 53206. Tel: 445-2420. **Mgr. & Buyer:** George Johnson. (Rec. & Tape OS)
Mean Mountain Music, 926 W. Oklahoma Ave. Zip: 53215. Tel: 483-6500.
Owner: M.J. Muskovitz. (Rec. OS, I & E—50's & 60's prod.)
Northwest Territory, 630 N. Broadway. Zip: 53202. Tel: 271-2805. (Rec. D)
Labels: Adelphi, Philo, Ramblin', Rounder, Tool Room.
Radio Doctors & Recs. Ltd., 240 W. Wells St. Zip: 53203. Tel: 276-6422.
Pres: Stuart Glassman; **Mgr.:** Michael Mowers. Buyers: Singles, Annette & John Jankowski; Albums, Thomas Jacobson, Tape, Randy Hauser. (Rec. & Tape OS)

Use your
"Dollars and Sense"
 Write for this
 free booklet,
 Pueblo, Colorado
 81009.



A public service message of The Advertising Council and The U.S. Departments of Agriculture, Commerce, Labor and Treasury. Presented by this magazine

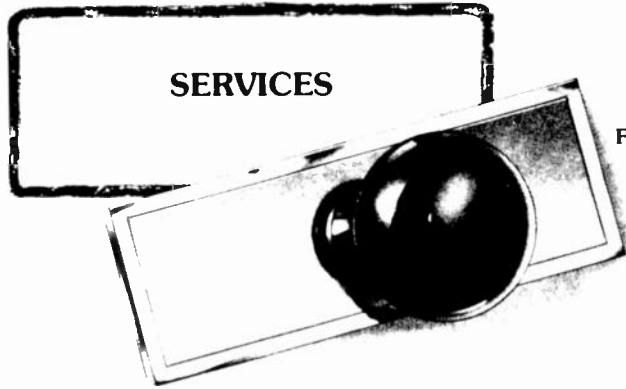

FOR THE U.S. MUSIC-RECORD-TAPE INDUSTRY

ASSOCIATIONS & PROFESSIONAL ORGANIZATIONS

A C A, see American Composers Alliance
 A E S, see Audio Eng'g Society
 A F M, see American Federation of Musicians
 A F T R A, see American Federation of Television & Radio Artists
 A G A C, see American Guild of Authors & Composers
 A G V A, see American Guild of Variety Artists
 A M U, see American Musicians Union
 Academy of Country Music, PO Box 508, 6255 Sunset Blvd., Suite 915 Hollywood, Calif 90028. Tel (213) 462 2351 Exec Sec'y Fran Boyd
 Affiliate Artists Inc 155 W 68 St., Suite 35 F., New York, N.Y. 10023 Tel (212) 580 2000 Pres Richard C. Clark, Communications Dir Janet K Sanders
 Afro American Music Opportunities Ass'n Inc., 2409 Wayzata Blvd. Minneapolis, Minn 55405 Tel (612) 377 7330 Exec Dir C Edward Thomas
 Amateur Chamber Music Players Inc. PO Box 547 Vienna Va 22180 Tel (703) 281 1230 Sec'y Ruth McGregor
 American Academy & Institute of Arts & Letters, E33 W 155 St., New York, N.Y. 10032 Tel (212) 368 5900 Pres Arthur Schlesinger Jr., Asst Lydia Kaim
 American Accordionists' Ass'n Inc., 165 W 10 St. New York, N.Y. 10014 N.Y. Tel (201) 991 5010 Pres Frank J. Busso
 American Ass'n for Music Therapy, New York Univ., Washington Square 35 W Fourth St., Rm 777, New York, N.Y. 10003 Tel (212) 598 3634 Pres Dr. Kenneth Bruscia, Exec Sec'y Evelyn Cisarano
 American Choral Directors' Ass'n, PO Box 5310, Lawton, Okla 73504 Tel (405) 355 8161 Nat'l Exec Sec'y Or Gene Frooks
 American Choral Foundation Inc. 130 W 56 St., New York, N.Y. 10019 Tel (212) 246 3361
 American College of Musicians, PO Box 1807, 806 Rio Grande Austin Tex 78767 Tel (512) 478 5775
 American Composers Alliance (ACA), 170 W 74 St. New York, N.Y. 10023 Tel (212) 362 8900 Exec Dir Francis Thorne, Asst Mgr Lynda Dunn
 American Council for the Arts, 570 Seventh Ave., New York N.Y. 10018 Tel (212) 354 6655 Pres W Grant Brownrigg
 American Dance Therapy Ass'n Inc., 2000 Century Plaza, Columbia Md 21044 Tel (301) 997 4040 Pres Dr Erma Dosamantes Alperston Exec Sec'y Patricia Latten
 American Federation of Musicians (AFM), 1500 Broadway New York N.Y. 10036 Tel (212) 869 1330 Pres Victor W uentelba
 American Federation of Television & Radio Artists (AFTRA), 1350 Ave of the Americas, New York N.Y. 10019 Tel (212) 261 7700 Nat'l Exec Sec'y Sanford I Wolff
 American Guild of Authors & Composers (AGAC) 40 W 57 St. New York, N.Y. 10019 Tel (212) 757 8833 Cable SONGRITE Pres Ervin Drake
 American Guild of Music, PO Box 3, Downers Grove, Ill 60515 Tel (312) 968 0173 Pres Walter Truszkowski Exec Sec'y ED Herrick
 American Guild of Musical Artists (AFM), 1841 Broadway, New York N.Y. 10023 Tel (212) 265-3687 Nat'l Exec Sec'y DeLloyd Tibbs
 American Guild of Organists, 815 Second Ave., New York N.Y. 10017 Tel (212) 687 9188 Exec Dir Daniel N Colburn II

American Guild of Variety Artists (AGVA) 1540 Broadway New York N.Y. 10036 Tel (212) 765 0800
 American Harp Society Inc. 6331 Quebec Dr. Los Angeles Calif 90068 Tel (213) 463 0716 Pres Pearl Chertok, Office Mgr Dorothy Remsen
 American Music Center Inc., 250 W 54 St., Suite 300, New York, N.Y. 10019 Tel (212) 247 3121 Pres Charles Dodge, Exec Dir Margaret F Jory
 American Music Conference 1000 Skokie Blvd., Wilmette, Ill 60091 Tel (312) 251 1200 Pres Gene C Wenner
 American Musicians Union Inc (AMU), 8 Tabin Court Dumont N.J. 07628 Tel (201) 384 5378
 American Recorder Society, 13 E 16 St 7th fl New York N.Y. 10003 Tel (212) 675 9042 Pres Shelley Grushkin, Office Mgr Mary Ann Fleming
 American Society of Univ Composers, 250 W 54 St., Rm 300, New York N.Y. 10019 Tel (212) 247 3121 Exec Committee Chm Richard Brooks, Asst Martin Gonzalez
 American Symphony Orchestra League, PO Box 669, Vienna Va 22180 Tel (703) 281 1230 Chief Exec Officer Catherine French Assoc Dir Lisa Gonzalez
 American Theatre Ass'n 1000 Vermont Ave NW Washington, D.C. 20005 Tel (202) 628 4634
 Americas Boychoir Federation (div of International Federation of Children's Chorus), PO Box 677, 125 S Fourth St., Connettsville, Pa 15425 Tel (412) 628 3939 Pres Rodolfo Torres
 Amusement & Music Operators Ass'n, 35 E Wacker Dr Chicago Ill 60601 Tel (312) 726 2810 Exec VP Lea A Oraste
 Associated Male Chorus of America Inc 106 Maplefield Rd Pleasant Ridge, Mich 48069 Tel (313) 544 1995 Exec Sec'y Russell R Fleharty
 Association for Recorded Sound Collections Inc PO Box 1643, Manassas, Va 22110 Wash D.C. Tel (202) 523 3294 Exec Sec'y Les Wafflen
 Association of College, Univ & Community Arts Admin's Inc, PO Box 2137, Madison Wis 53701 Tel (608) 262 0004, Exec Dir William M Dawson
 Association of Professional Vocal Ensembles 1830 Spruce St., Philadelphia, Pa 19103 Tel (215) 545 4444 Nat'l Exec Sec'y Janice F Kestler
 Audio Engineering Society Inc (AES), Lincoln Bldg., Rm 2520 60 E 42 St New York N.Y. 10017 Tel (212) 661 8528 Telex 620298 Exec Dir Donald J Plunkett
 B M A, see Black Music Ass'n
 Black Music Ass'n (BMA), 1500 Locust St Suite 1905, Philadelphia, Pa 19102 Tel (215) 545 8600 Exec Dir Glenda Gracia, Consultant Jules Malamud
 Bluegrass Club of New York 380 Lexington Ave., Suite 1119 New York, N.Y. 10017 Tel (212) 687 9000 Pres Douglas Tuchman
 Louis Braille Foundation for Blind Musicians 215 Park Ave S New York, N.Y. 10003 Tel (212) 982 7290 Exec Dir Shel Freund
 Broadcasting Foundation of America, 52 Vanderbilt Ave New York N.Y. 10017 Tel (212) 986 6448 Cable BRODFOUNAM Chm George E Probst, Music Dir John Berkly
 Bruckner Society of America Inc PO Box 2570 Iowa City, Iowa 52244 Tel (319) 338 0313 Pres Charles L Eble
 C A M E O (Creative Audio & Music Electronics Org.) 10 Delmar Ave Framingham Mass 01701 Tel (617) 877 6459 Pres Larry Blakely, Admin'r Nancy Maher
 C M A, see Country Music Ass'n
 Central Opera Serv Metropolitan Opera Lincoln Center New York N.Y. 10023 Tel (212) 957 9871 Admin Dir Maria F Rich
 Chamber Music America 1372 Broadway 14th fl., New York N.Y. 10018

Tel (212) 221 0270 Pres Michael Jaffee, Exec Dir Benjamin S Dunham
 Chautauqua Institution, Chautauqua, N.Y. 14722 Tel (716) 357 5635 Pres Dr Robert R Hesse
 College Band Directors Nat'l Ass'n, c/o Baylor Univ Bands, Waco Tex 76798 Tel (817) 755 3571 Pres William Foster, Pres Elect H Robert Reynolds, VP Don Hunsberger, Sec'y Treas Richard L Floyd
 College Music Society Inc., Univ of Colorado, Regent Box 44, Boulder, Colo 80309 Tel (303) 492 5049 Pres Barbara English Maris, Exec Sec'y Craig Short
 Composers & Lyricists Guild of America Inc., 13542 Ventura Blvd Sherman Oaks, Calif 91423 Tel (213) 986 4203 Pres John Cacavas
 Country Music Ass'n Inc (CMA), PO Box 22299 Zip 37202, 7 Music Circle N Nashville, Tenn 37203 Tel (615) 244-2840 Cable CMANAS Telex: 786528 Bd Chm Bruce Lundvall, Pres Tandy Rice, Exec Dir Jo Walker Meador Assoc Exec Dir Ed Benson, Exec VP Tom Collins
 Country Music Foundation Inc., 4 Music Square E, Nashville, Tenn 37203 Tel (615) 256 1639 Exec Dir William Ivey
 Country Music Foundation of Colorado, PO Box 19435 Oenver, Colo 80219 Tel (303) 936 7762 Pres & Exec Dir Gladys Hart
 Creative Audio & Music Electronics Org., see CAMEO
 Dance Films Ass'n Inc 250 W 57 St., New York, N.Y. 10019 Tel (212) 598 9138
 Dance Notation Bureau Inc 505 Eighth Ave., New York, N.Y. 10018 Tel (212) 736 4350 Exec Dir Murrel Topaz
 E I A see Electronic Inds Ass'n
 Electronic Inds Ass'n (EIA), 2001 I St NW, Washington, D.C. 20006 Tel (202) 457 4900 Bd Chm W Bennett Conner, Pres Peter F McCleskey
 F E D A P T see Foundation for the Extension & Development of the American Professional Theatre
 F I C A P, see Federation of Int'l Country Air Personalities
 Federation of Int'l Country Air Personalities (FICAP), 1201 16 Ave S, Nashville, Tenn 37212 Tel (615) 320 0115
 Florida Country Music Foundation & Hall of Fame Inc., 2409 Winona Ave at Indian Oaks, Leesburg, Fla 32748 Tel (904) 787 1051 Chief Exec & Promos Mama Jo Hunt, Sales Mgr Eleanor Huggins
 Foundation for the Extension & Development of the American Professional Theatre (FEDAPT) 165 W 46 St Suite 310, New York, N.Y. 10036 Tel (212) 869 9690 Contact Morey Epstein
 G M A, see Gospel Music Ass'n
 Gospel Heritage Foundation, PO Box 1358, Placerville, Calif 95667 Tel (916) 622 9369 Pres & Music Dir Max J Mace
 Gospel Music Ass'n (GMA), PO Box 23201, 38 Music Square W, Nashville Tenn 37202 Tel (615) 242 0303 Pres WF Myers, Exec Dir Donald W Butler Sr
 The Hymn Society of America Inc., Wittenburg Univ Springfield, Ohio 45501 Tel (513) 327 6308 Exec Dir W Thomas Smith
 I A M A see International Ass'n of Auditorium Managers
 I T A, see International Tape Ass'n
 Institute of Audio Research Inc., 64 University Pl., New York, N.Y. 11566 Tel (212) 677 7580 Or Philip Stein
 International Ass'n of Auditorium Managers (IAAM), 500 N Michigan Ave., Suite 1400, Chicago, Ill 60611 Tel (312) 661 1700 Pres John W Fearey Exec Dir Richard E Kinville
 International Ass'n of Organ Teachers USA, 7938 Bertram Ave., Hammond Ind 46324 Tel (219) 844 3395 Pres & Music Dir Dorothy S Greig, Admin Dir & Sec'y Treas. Jack C Greig
 International Fan Club Org (div of Tri-Son Inc.), PO Box 177, Wild Horse, Colo 80862 Tel (303) 962 3543 Co Pres Loudilla, Loretta & Kay Johnson, Gen Mgr Loudilla Johnson
 International Federation of Children's Chorus, PO Box 677, 125 S Fourth St., Connettsville, Pa 15425 Tel (412) 628-8000 Pres Francis Oelvin, Sec'y Gen Catherine Martin
 International Jazz Federation Inc. 1697 Broadway, Suite 1203, New York, N.Y. 10019 Tel (212) 586-6971
 International Platform Ass'n, 2564 Berkshire Rd., Cleveland Heights, Ohio 44106 Tel (216) 932 0505
 International Rhythm & Blues Ass'n, 11616 S Lafayette Ave., Chicago, Ill 60628 Tel (312) 264 2166 Pres William C Tyson
 International Society of Performing Arts Admin's, c/o Columbia Music Festival Ass'n, 1527 Senate St Columbia, S.C. 29201 Tel (803) 771 6303 Treas Leon Harrelson
 International Tape Ass'n, 10 Columbus Circle, Suite 2270, New York, N.Y. 10019 Tel (212) 956 7110
 J C O A, see Jazz Composer's Orchestra Ass'n Inc
 Jazz Composer's Orchestra Ass'n Inc (JCOA), 500 Broadway, 4th fl., New York, N.Y. 10012 Tel (212) 925-2121 Exec Dir, Michael Mantler, Gen Mgr Taylor Storer
 Kappa Kappa Psi, Nat'l Honorary Band Fraternity, Oklahoma State Univ., 122 Seretean Center, Stillwater, Okla 74078 Tel (405) 372-2333 Exec Sec'y Thomas F Sirdridge
 Masterwork Music & Art Foundation Inc., 300 Mendham Rd., Morristown, N.J. 07960 Tel (201) 538 1860 Development Dir, Arthur E Ravander
 Memphis Rec'g Prod'n Ass'n, Commerce Tower, Suite 1590, 1 Commerce Square, Memphis, Tenn 38103 Tel (901) 523 0533 Cable HAMCAST, Sec'y Treas Harold C Streibich
 Metropolitan Opera Nat'l Council, Lincoln Center, New York, N.Y. 10023 Tel (212) 974 0230

Worldwide PROFESSIONAL STORAGE and MANAGEMENT SERVICES
AUDIO & VIDEO TAPES • FILMS
 50 years of experience
 • ENVIRONMENTALLY CONTROLLED FACILITIES
 • ELECTRONIC SECURITY • FIRE SUPPRESSION
 • COMPUTERIZED INVENTORY CONTROL



BONDED SERVICES 2050 Center Ave., Fort Lee, NJ 07024

- New York—(212) 695-2034
- Ft. Lee, NJ—(201) 592-7868
- Toronto — (416) 363-6414
- Amsterdam — 41 42 00
- Los Angeles—(213) 761-4058
- Montreal — (514) 866-4919
- Mexico City — (905) 588-1922
- Hong Kong 3-6577/71

Modern Music Masters Society, PD Box 347 Park Ridge, Ill 60068 Tel (312) 825 1451 Pres D D Premo, Exec Sec'y Linda Darlington

Moravian Music Foundation Inc, 20 Cascade Ave, Winston-Salem, N C 27107 Tel (919) 725-0651 Dir: James Boeringer

Musepro, 1414 Ave of the Americas, New York, N Y 10019 Tel (212) 489 9245

Music Critics Ass'n Inc, 6201 Tuckerman Ln, Rockville, Md 20852 Tel (301) 530-9527 Exec Sec'y Richard D Freed

Music Educators Nat'l Conference, 1902 Association Dr, Reston, Va 22091 Tel (703) 860-4000 Pres Mary E Hoffman, Exec Dir Dr Donald W Dillon, Exec Asst Marilyn Likens

Music Library Ass'n Inc, 2017 Walnut St, Philadelphia, Pa 19103 Tel (215) 569-3948 Pres D W Krummel, Admin Asst John Shifert

Music Performance Trust Funds of the Rec'g Inds 1501 Broadway, New York, N Y 10036 Tel (212) 391 3950

Music Teachers Nat'l Ass'n Inc, 1133 Carew Tower, Cincinnati, Ohio 45202 Tel (513) 421 1420 Pres Dr Robert Sutton, Exec Dir Marriann H Clinton

N A B, see National Ass'n of Broadcasters

N A C U S A, see National Ass'n of Composers USA

N A R A S, see National Academy of Rec'g Arts & Sciences

N A R M, see National Ass'n of Rec'g Mdsrs Inc

Nashville Ass'n of Talent Dir's, 25 Music Square W, Nashville, Tenn 37203 Tel (615) 254-5721 Pres Don Light, Exec VP Jack D Johnson, VP's Dick Blake, Joe Sullivan, Exec Dir Maggie Cavender

Nashville Songwriters Ass'n Int'l, 25 Music Square W, Nashville, Tenn 37203 Tel (615) 254 8903 Exec Dir Maggie Cavender

National Academy of Popular Music & Songwriters Hall of Fame, 1 Times Square, New York, N Y 10036 Tel (212) 221 1252 Pres Sammy Cahn, Exec Dir Abe Diman, Curator Dscar Brand, Archives Mgr Frankie Mac Cormick

National Academy of Rec'g Arts & Sciences (NARAS), 4444 Riverside Dr, Suite 202, Burbank, Calif 91505 Tel (213) 843 8233 Nat'l Exec Dir Christine M Farnon

National Ass'n for Music Therapy Inc, PD Box 610, Lawrence, Kan 66044 Tel (913) 842 1909 Pres Carol H Bitcon, Exec Dir Margaret Sears

National Ass'n of Broadcasters (NAB), 1771 N St NW, Washington, D C 20036 Tel (202) 293 3500

National Ass'n of Composers USA (NACUSA), PD Box 49652, Barrington Sta., Los Angeles, Calif 90049 Tel (213) 541 8213 Pres Marshall H Balosky

National Ass'n of Jazz Educators, PD Box 724, Manhattan, Kan 66502 Tel (913) 776-8744 Exec Dir Matt Betton, Admin Asst Betty Betton

National Ass'n of Music Merchants Inc, 500 N Michigan Ave., Chicago, Ill 60611 Tel (312) 527 3200 Pres Charles K Hale, Exec VP Larry R Linkin

National Ass'n of Organ Teachers Inc, see Int'l Ass'n of Organ Teachers USA

National Ass'n of Pastoral Musicians, 225 Sheridan St NW Washington, D C 20011 Tel (202) 723-5800 Pres Rev Virgil C Funk

National Ass'n of Rec'g Mdsrs Inc (NARM), 1060 Kings Hwy N., Suite 200 Cherry Hill, N J 08034 Tel (609) 795 5555

National Ass'n of Schools of Music, 11250 Roger Bacon Dr No. 5, Reston, Va 22090 Tel (703) 437 0700 Pres Robert Bays, Exec Dir Samuel Hope

National Ass'n of Teachers of Singing Inc, 250 W 57 St Suite 2129 New York, N Y 10019 Tel (212) 582 4043 Pres Irvin Bushman Pres Elec John Burgin, Exec Sec'y James Browning

National Choral Council, 20 W 40 St, New York, N Y 10018 Tel (212) 869 0970 Exec Dir Martin Josman

National Entertainment & Campus Activities Ass'n, PD Box 11489, Columbia, SC 29211 Tel (803) 799 0768 Exec Dir Gary English

National Federation of Music Clubs, 1336 N Delaware, Indianapolis, Ind 46202 Tel (317) 638 4003 Pres Mrs Jack C Ward Office Mgr Barbara T Bryant

Branch: Greenville, S.C., Rt. 12, Paris Mountain Zip 29609

National Guild of Community Schools of the Arts Inc, 175 Fifth Ave., Suite 516, New York, N Y 10010 Tel (212) 673-0980 Pres Allen Sapp, Exec Dir Marica J Horwitz

National Guild of Piano Teachers Teacher Div of American College of Musicians, PD Box 1807, 808 Rio Grande Austin, Tex 78767 Tel (512) 478 5775

National Music Council, 250 W 54 St, Suite 300, New York, N Y 10019 Tel (212) 265 8132 Pres Gunther Schuller, Exec Sec'y Doris D'Connell

National Music Publ'rs Ass'n Inc, 110 E 59 St, New York, N Y 10022 Tel (212) 751 1930 Cable HAFDX Pres Leonard Feist, Exec Asst Heather D Connor

National Opera Ass'n, Rt 2 Box 93, Commerce, Tex 75428 Tel (214) 886 3830 Pres Natalie Limonick, Acting Sec'y Registrar Mary Elaine Wall ace

National Opera Institute, c/o John F Kennedy Center, Washington D C 20566 Tel (202) 254 3694

National Orchestral Ass'n, 111 W 57 St, New York, N Y 10019 Tel (212) 247 1228 Pres Langdon Van Norden, Exec Dir Lois Schweitzer

National Piano Foundation, 435 N Michigan Ave., Chicago, Ill 60611 Tel (312) 527 5494

National Piano Mfrs Ass'n of America, see National Piano Foundation

National School Orchestra Ass'n, 330 Bellevue Dr, Bowling Green, Ky 42101 Pres James H Godfrey, Treas C Gary Jams

New Orleans Jazz Club of California, PD Box 1225, Kernville, Tex 78028 Tel (512) 896 2285 Pres Bill Bacin

New York Singing Teachers' Ass'n, 12 Engle St, Cresskill, N J 07626 Tel (201) 568 8093 Pres Robert Latherow

Opera America Inc, 1010 Vermont Ave NW Suite 702, Washington, D C 20005 Tel (202) 347 9262 Admin'r Dean K Stein

Opportunity Resources for the Arts, 1501 Broadway, New York, N Y 10036 Tel (212) 575 1688

People To People Music Committee Inc, c/o John F Kennedy Center, Washington, D C 20566 Tel (202) 254 3694 Exec Dir Ruth Sickalus

Phi Beta Fraternity, Univ of Houston, School of Communications Houston, Tex 77004 Tel (713) 749 3521, 747 5305 Nat'l Pres Dr Martha J Haun

Phi Beta Mu Nat'l Music Fraternity, 226 E Alamo Dr., Lakeland, Fla 33803 Tel (813) 646 8101 Nat'l Pres Charles Minelli

Phi Mu Alpha Sinfonia Fraternity, 10600 Old State Rd., Evansville, Ind 47711 Tel (812) 867 2433 Exec Dir Dr Dan Beeman

Piano Technicians Guild Inc, 113 Dexter Ave. N., Seattle, Wash. 98109 Tel (206) 283 7440, 682 9700 Exec Dir Donald Santy

R I A A, see Recording Ind Ass'n of America

R I A A Video, see Recording Ind Ass'n of America

Recording Ind. Ass'n of America (RIAA), 888 Seventh Ave., New York, N Y 10106 Tel (212) 765 4330 Pres Stanley M Gortikov, Exec Dir Stephen Traman

S P A R S (Society of Professional Audio Rec'g Studios), 215 S Broad St., 7th Fl., Philadelphia, Pa 19107 Tel (215) 735 9666

S P E B S Q S A, see Society for the Preservation & Encouragement of Barber Shop Quartet Singing in America.

Society for Ethnomusicology Inc, 201 S Main St., Rm 513, Ann Arbor, Mich 48104 Tel (313) 761 7787 Pres Gerard Behague.

Society for the Preservation & Encouragement of Barber Shop Quartet Singing in America (SPEBSQSA), 6315 Third Ave., Kenosha, Wis 53140 Tel (414) 654 9111 Exec Dir, Hugh A Ingraham

Society of the Classic Guitar, 409 E 50 St, New York, N Y 10022 Tel (212) 688 7586, Contact: Beatriz Giannandrea

Tau Beta Sigma Nat'l Band Sorority, see Kappa Kappa Psi

Theatre Communications Group Inc, 355 Lexington Ave., New York, N Y 10017 Tel (212) 697-5230

United States Institute for Theatre Technology Inc., 330 W 42 St., Rm 1702, New York, N Y 10036 Tel (212) 563-5551 Pres Leland H Watson

Universal Jazz Coalition Inc, 156 Fifth Ave Rm 817 New York, N Y 10010 Tel (212) 924 5026 Exec Dir Nobuko Cobi Naita

Violoncello Society Inc, 101 W 57 St., Suite 2D, New York, N Y 10019 Tel (212) 246 3267

Young Audiences Inc, 115 E 92 St., New York, N Y 10028 Tel (212) 831 8110 Exec Dir Warren H Yost, Bus Mgr Lee Saunders

CATALOG SERVICES, RECORD & TAPE

A B C Schwann Publ'ns Inc, 535 Boylston St., Boston, Mass 02116 Tel (617) 437 1350 Pres & Chief Exec Officer William Schwann, Adv Mgr Seymour Resnick (Record & Tape)

Branch: New York, N.Y., 825 Seventh Ave, Zip 10019

George Alexander Group Inc, 1063 Post Rd, Darien, Conn. 06820 Tel (203) 655 7791 (Record & Tape)

Carter Corp., 1916 11 St., Rockford, Ill 61101 Tel (815) 397 3200 Cable CARTERCDRP Pres Robert L Fleming, VP Sales & Mktg. Sandra L Fleming, Plant Mgr W Skip Kruger (Record & Tape.)

Lion Rec'g Servs. Inc., 1905 Fairview Ave NE, Washington, D C 20002 Tel (202) 832 7883 (Tape only)

Mark Custom Rec'g Inc., 10815 Bodine Rd, Clarence, N.Y 14031 Tel (716) 759 2600 Pres & Sales Mgr Vincent S Morette (Record only)

N E R T (New England Rec' & Tape) (div of PBN Survey), PD Box 268 Zip 01842, 641 Haverhill St., Lawrence, Mass 01841 Tel (617) 686 4293 Pres Jerry P Marcus, VP Int'l Sales; P H Kankey, Gen Mgr Melvin L Marcus, Sales Mgr B J Kankey (Record & tape - PBN Survey)

One Spot Publ'g (div of Trade Serv Publ'ns Inc.), 1000 W Central Rd Mount Prospect, Ill 60056 Tel (312) 392 1720 Pres J A Simpson, VP & Gen Mgr E V Mironko (Record-New Release Reporter, Numerical Index, Popular Guide)

Phonolog, see Trade Service Publ'ns

Pop Record Research, PD Box 14, Hollywood, Calif 90028 Tel (213) 349 9099 Pres Gary M Theroux, Admin Ass't Russell Bidwell, Sales Mgr Mark Charger, Adv Mgr, Peter Roberts (Archive of pop music research information.)

Pro 1 Audio Visual Inc., PD Box 33, Highland Park, Ill 60035 Tel (312) 433 4575 Pres R L Pink, VP J Pink, Sales Mgr M M Pink, Adv Mgr D D Pink (Record & Tape)

Quad Inc. Ents., PD Box 19, Capron, Va 23829 Tel (804) 653 2671 (4 channel record & tape.)

Record Research Inc., PD Box 200, Menomonee Falls, Wis 53051 Tel (414) 251 5408 Pres Joel Whitburn. (Record & tape chart compilation serv ices)

Trade Serv Publ'ns Inc., Phonolog Publ'g Div., PD Box 85007 Zip 92138 10996 Torreyana Rd., San Diego, Calif 92121 Tel (714) 457 5920 Pres J A Simpson, Editor Dia Corelli (Weekly record information serv - Phonolog Reporter, weekly tape information serv - List D Tapes)

DESIGN & ARTWORK, PRINTING & LITHOGRAPHING

The key to the abbreviations used in this category is: "(DES)" for those companies which execute designs or artwork, and "(PRT)" for those which do printing or lithographing.

ALABAMA

• OOTHAN (Area Code 205)

Tri-State Publ'g Co. Inc., 120 S St. Andrews Zip 36301 Tel 792-6808 (DES, PRT)

ARIZONA

• PHOENIX (Area Code 602)

General Cassette Corp., 2311 N. 35 Ave. Jip 85009, Tel. 269-3111 (DES-tape only)

Universal Audio Corp., 6540 E Lafayette Blvd., Scottsdale 85217 Tel 949-7577 (DES)

• TUCSON (Area Code 602)

Antique Print'n Parlor 601 E Sixth St. Zip 85705 Tel 884-7544, Prop. J.W. Shirley, Art Dir., Steve Nelson. (DES, PRT)

CALIFORNIA

• CAMPBELL (Area Code 408)

Westape, 503 B Vandell Way Zip 95008 Tel 379 0871 Sales Mgr Rich Krueger (DES-record & tape, PRT-tape only). (SEE ADVERTISEMENT)

• LA PALMA (Area Code 714)

Matthews Int'l Corp., 5555 Fresca Dr Zip 90623 Tel 523-5511 Mgr J Davis (PRT-film masters, symbol consultation & testing)

Home office: Pittsburgh, Pa

• LOS ANGELES METROPOLITAN AREA (Area Code 213)

A G I (Album Graphics Inc.), 424 N Larchmont Blvd Zip 90004 Tel 462 0821 (Sales office only) (DES, PRT)

Home office: Melrose Park (Chicago Metropolitan Area), Ill

Album Graphics Inc., see AGI

Alshire Int'l Inc., 1015 Isabel St., Burbank 91510 Tel 849-4671, WATS (800) 423 2936, Cable BUDDSUIND TWX (910) 498-2759 Pres. Al Sherman, Gen. Mgr, Dick Ceja. (DES, PRT)

Award Rec. Mfg. Inc., 11016 La Cienega Blvd., Inglewood 90304 Tel 645-2281 (PRT-record only)

Bert Co. Ents. Inc. (div. of the Walter Reed Drg Inc.), 1855 Glendale Blvd Zip 90026, Tel 665 5137, (DES, PRT)

Home office: New York, N.Y.

Cadet Recs Inc., 5810 S Normandie Ave Zip 90044, Tel 753-5121 Pres Jules Bihari, Mgr Don Macmillan. (DES, PRT)

Branch: Park Ridge, N J

Contamer-Kraft Inc., 8321 DeCelis Pl., Sepulveda 91342 Tel 893 9721 (PRT)

Creative Minds Inc., 1560 N La Brea, Suite M, Hollywood 90028, Pres.: Arthur H. Benson, Sales Mgr. Howard Wormser (DES)

Custom Rec Mfg Co., 5810 S Normandie Ave Zip 90044 Tel 753 5121 Pres Jules Bihari, VP Don Macmillan. (DES, PRT)

D A K Inds Inc., 10845 Vanowen St., North Hollywood 91605 Tel 984 1559 WATS (800) 423 2636 Cable DAKENT Tel 651396 Pres Drew Alan Kaplan (PRT-tape only)

Rod Dyer Inc., 5550 Wilshire Blvd., Suite 301 Zip 90036 Tel 937 4100 Pres Rod Dyer, VP Robert Kahn (DES)

Hope Street Studio, 607 N Ave 64 Zip 90042 Tel 258 6741, Pres & Dwner Van Webster, Studio Mgr. Cristy Robertson (DES)

Ivy Hill Graphics & Packaging (div of Ivy Hill Communications Inc.), 4800 S Santa Fe Ave. Zip 90058 Tel 587 3131 Exec. VP Russell Muir, Gen. Mgr Del Eaton, Sales Mgr Arthur Kern (DES, PRT)

Home office: Great Neck, N Y

K M Recs. Inc., 2980 N Dntario St., Burbank 91504 Tel 841-3400 Pres: Glade Merkley, VP Custom Servs. Jim Auchterlome, VP Audiophile Sales Mike Malan, Mktg & Adv Mgr Bruce Leek (PRT-record only)

Kdisc (sub. of Keycor Century Corp.), 6550 Sunset Blvd., Hollywood 90028 Tel 466 1323 Gen & Studio Mgr, Bill Lightner. (DES, PRT-record only)

Plant: Saugus, Calif (SEE ADVERTISEMENT)

Kosh & Co., 1584 Crossroads of the World, Hollywood 90028, Tel 466-9755 (DES)

Lester Music Engraving, 345 S Citrus Ave Zip 90036 Tel 939 3630 Dwner James T Lester (DES)

The Merchandising Guild, 6163 Glen Alder, Zip 90068 Tel 663 1293 (DES)

Modern Album of California Inc 3116 Vanowen St. Burbank 91505, Tel 845 7655 Pres William S. Pine, Gen. Mgr., Raymond Gardocki. (PRT-record only)

Home office: Hauppauge, N.Y., Modern Album & Finishing Co Inc

Monarch Rec Mfg Corp (sub of Electrosound Group Inc), 9545 San Fernando Rd., Sun Valley 91352, Tel 767 8833 Pres Nate DuRoff, VP & Gen Mgr Bob Barone (PRT-record only)

Home office: Holbrook, N.Y., Electrosound Group Inc

Sales office: New York, N.Y., Electrosound Group Inc

Musicsearch, 9000 Cynthia St., Suite 205 Zip 90069 Tel 275 4790 VP

LABELS, JACKETS, & 7" SLEEVES

Call today for fully illustrated brochure and price list.

KEYSTONE PRINTED SPECIALTIES Co. Inc.
321 Pear St., Scranton, Pa. 18505
TWX: (510) 671-4619

Along with complete art, design, and typesetting dept., full film and color separations, 4-color record label backdrops, label imprinting, 4-color (full bleed) 7" sleeves and unique 7" mini jackets, 12" sleeves, cassette labels and insert cards, cartridge labels, custom and stock jackets with bright full color stock record labels available for imprinting. We specialize in serving the recording industry with fast service and quality printing.

Phone: (717) 346-1761

Admin: Robert Greenfield, VP Creative Servs., Tipper Schroeder (DES)
 Myriad Prods'n, 1314 N. Hayworth Ave., Suite 402, Zip 90046, Tel: 851-1400, Pres. Ed Harris (DES)
 Neelson/Anklam Inc., 11908 Ventura Blvd., Stud. o City 91423, Tel: 980-1631, Bd Chm. Ron Neelson; Pres. Barry D. Anklam, VP: Bill Feitz (DES)
 Pacific Eye & Ear, 451 N. La Crenega Blvd, Zip 90048, Tel: 659-2121, (DES)
 Pedersen Label Printing Co., 11152 Fleetwood St., Sun Valley 91352, Tel: 768-3122, Pres. Herman A. Fredrick, Prod. Mgr. S. Kadonaga (PMT)
 Photo/Graphics, 1125 E. Drange Ave., Monrovia 91016, Tel: 359-9414 (DES)

Queens Lithographing Corp., 6290 Sunset Blvd., Suite 304, Hollywood 90028, Tel: 464-7700 (DES, PMT)
 Home office: Long Island City (New York Metropolitan Area) N.Y.
 Plant: Indianapolis, Ind., Rutgers Packaging Corp.

Radio Central, 427 W. Fifth St., Suite 611, Zip 90013, Tel: 626-9891 (DES, PMT—tape only)

Rainco Rec. Mfg. Corp., 1738 Berkeley St., Santa Monica 90404, Tel: 829-3476, TWX (910) 343-7420, Pres. Jack G. Brown, VP & Gen. Mgr.: James Doyle; Prod'n Supervisor: Steve Sheldon (PMT—record only)

Roach Inc., 8430 Tunjunga Ave., Sun Valley 91352, Tel: 767-8300, (DES & PMT—customized tee shirts & hats only)
 Home office: Columbus, Ohio

Shorewood Packaging Corp., 1830 Glendale Blvd., Zip 90026, Tel: 660-3043, (PMT—record only)
 Home office: New York, N.Y.

Stoughton Printing Co., 130 N. Sunset Ave., City of Industry 91744, Tel: 961-3678, LA 686-2753, Pres. & Gen. Mgr.: Jack W. Stoughton, Sales Mgr.: Jack Stoughton Jr. (PMT—record only)

Superior Data/Graphics Corp., 5717 Santa Monica Blvd., Zip 90038, Tel: 467-5133 (PMT)

Superscope Inc., 22459 Paul Revere Dr., Woodland Hills 91364, Tel: 998-9333 & 2090, Pres. Joseph S. Tushinsky, Mktg. & Sales Mgr.: Bill Rosen. (DES, PMT)

Surf City Recs., PO Box 14, Hollywood 90028, Tel: 149-9099, Pres.: Gary M. Theroux; Adm'n Ass't: Russell Bidwell, Sales Mgr.: Mark Charger, Adv. Mgr.: Peter Roberts (DES)

Tape Specialty Inc., 13411 Saltcoy St., North Hollywood 91605, Tel: 786-6111, Pres.: Steve Feldman, Gen. Mgr.: Len Feldman, Chief Eng.: Stu Feldman (DES—tape only)

Wong Design Co., 6255 Sunset Blvd., Zip 90028, Tel: 469-4194, Chief Exec.: Ron Wong, (DES—record only)

● **MISSION VIEJO (Area Code 714)**
 Kerne Erickson Visual Communications, Box 2175, Zip 92690, Tel: 831-2818 (DES)

● **MONTEREY (Area Code 408)**
 Publishers' Art Serv., 455 Pierce St., Zip 93940, Tel: 375-1191 (DES)

● **OCEANSIDE (Area Code 714)**
 Exxel Co., 1907 Apple St., Zip 92054, Tel: 439-3020, Pres. J. Richard Lee, Gen. Mgr.: Bill Kottcamp (DES)

● **SACRAMENTO (Area Code 916)**
 Bill Rase Prods'n Inc., 955 Venture Court, Zip 95825, Tel: 929-9181, Dwner & Pres.: Bill Rase (DES)

● **SAN FRANCISCO & BAY AREA (Area Code 415)**
 Conlan/Golden Inc., 501 Forbes Blvd., Suite 106, South San Francisco 94080, Tel: 871-9672 (DES, PMT)

Fred Fox Music Co., 406 Kehoe Ave., Half Moon Bay 94019, Tel: 726-3725, Pres. F. H. Nesbitt Jr., Sales Mgr.: V.A. Nesbitt (DES)

Cathy Furniss & Assocs., 680 Beach St., Suite 445, Zip: 94109, Tel: 885-2807, Pres. Cathy Furniss, Adv. Mgr.: Isabelle Aggson (DES, PMT)

Luna's Illuminations, 111 Chester St., Fairfax 9493C, Tel: 457-5970 (DES)
 Pacific Int'l Magnetics Inc., 185 Berry St., Zip: 94107, Tel: 495-8830, (Sales office only) (DES, PMT)
 Home office: Richmond, B.C., Canada

Sonic Arts Corp., 665 Harrison St., Zip: 94107, Tel: 781-6307, Pres. Leo de Gar Kalka, Gen. Mgr.: Herbert P. Haas (DES, PMT)

● **SANTA CRUZ (Area Code 408)**
 Suttle Designs, 118 Myrtle St., Zip: 95060, Tel: 426-2819, Dwner & Art Dir.: S. Suttle (DES)

● **SAUGUS (Area Code 805)**
 Kdcsc (sub. of Keycor Century Corp.), 26000 Springbrook Ave., Zip: 91350, Tel: 259-2360, Pres.: Eugene R. Schutz, Gen. Mgr.: Bill Lightner (DES, PMT—record only)
 Office: Hollywood (Los Angeles Metropolitan Area), Calif

● **STANTON (Area Code 714)**
 Photo-Lith Int'l, 11816 Western Ave., Zip: 90680, Tel: 893-5037, WATS (800) 893-5037 (DES & PMT—customized tee-shirts only)

● **STOCKTON (Area Code 209)**
 Liberty Fixture Inc., PD Box 8431, 2467 Mariposa Rd., Zip: 95208, Tel: 948-1176, Pres., Sales & Adv. Mgr.: Leonard Semler; Gen. Mgr.: Wayne Hubner (PMT)

COLORADO
 ● **BOULDER (Area Code 303)**
 Video/Audio Artistry Corp. (Vidac Ltd.), PD Box 4571, 1258 Bear Mountain Court, Zip: 80302, Tel: 499-2001, (DES)

● **DENVER (Area Code 303)**
 Soundmark Corp., 4950 Nome St., Unit C, Zip: 80239, Tel: 371-3076 (PMT)

CONNECTICUT
 ● **DARIEN (Area Code 203)**
 George Alexander Group Inc., 1063 Post Rd., Zip: 06820, Tel: 655-7791, NYC (212) 886-5600, (DES, PMT)

● **SOUTHPORT (Area Code 203)**
 Sound Innovations, 290 Bronson Rd., Zip: 06490, Tel: 259-0467, Dwner & Eng.: John Arcolla, Gen. Mgr.: Frank Baldissero; Sales Mgr.: Steve Kruteme (DES, PMT—tape only)

● **TRUMBULL (Area Code 203)**
 J & D Litho Serv., 9 Sally Ann Dr., Zip: 06611, Tel: 261-3366 (PMT)

● **UNION CITY (Area Code 203)**
 A C Hampson Printing Co. Inc., 168 City Hill St., Zip: 06770, Tel: 729-2294, Pres.: Augustus D. Hampson; Sales Mgr.: John W. Berry, (DES, PMT—tape only)

● **WILMINGTON AREA (Area Code 302)**
 Ken Del Prods'n Inc., 111 Valley Rd., Richardson Park 19804, Tel: 655-7488, (DES, PMT)
 National Tape Dup'rs, see Ken Del

DELAWARE
 ● **BEAR (Area Code 302)**
 Factors Etc. Inc., Geissler Park, Zip: 19701, Tel: 834-1625, Pres.: H. Lee Geisler, Sales Mgr.: Laurence H. Seeny, (DES, PMT—customized tee shirts only)

● **WILMINGTON AREA (Area Code 302)**
 Ken Del Prods'n Inc., 111 Valley Rd., Richardson Park 19804, Tel: 655-7488, (DES, PMT)
 National Tape Dup'rs, see Ken Del

● **WILMINGTON AREA (Area Code 302)**
 Ken Del Prods'n Inc., 111 Valley Rd., Richardson Park 19804, Tel: 655-7488, (DES, PMT)
 National Tape Dup'rs, see Ken Del

FLORIDA
 ● **FORT LAUDERDALE AREA (Area Code 305)**
 Alpha Recs Inc., 1400 NW 65 Ave., Plantation 33313, Tel: 587-6011, (DES, PMT)

● **MIAMI METROPOLITAN AREA (Area Code 305)**
 Allison Alhambra Recs Inc., 4380 NW 128 St., Zip: 33054, Tel: 685-8396, Tele: 522178 (PMT)

Central Lithographers Inc., 1900 W. Fourth Ave., Hialeah 33010, Tel: 888-6728 (PMT)

Image Devices Inc., 1825 NE 149 St., Zip: 33181, Tel: 945-1111, Telex: 519348, TWX (810) 845-4242, Sales Mgr.: Bill Retter (PMT)

Miami Tape Inc., 8180 NW 103 St., Hialeah Gardens 33015, Tel: 558-9211 (PMT)

Musical Tapes Inc., 770 W. 27 St., Hialeah 33010, Tel: 885-9156, Pres.: Eliseo C. Valdes (DES—tape only, PMT—record & tape)

Tropical Paper Box Co., 7000 NW 25 St., Zip: 33122, Tel: 592-5520, (PMT)

● **ORLANDO AREA (Area Code 305)**
 Magnetix Corp., 770 W. Bay St., Winter Garden 32787, Tel: 656-4494, Pres.: John Lory (PMT)

GEORGIA
 ● **ATLANTA METROPOLITAN AREA (Area Code 404)**
 Linear Prods Inc., 4507-K Mills Pl SW, College Park 30366, Tel: 761-5432 (DES, PMT)
 Home office: New York, N.Y.

Matthews Int'l Corp., 1303 Logan Circle NW, Zip: 30318, Tel: 355-3255, Mgr.: D. Barley (PMT—film masters, symbol consultation & testing)
 Home office: Pittsburgh, Pa

Project 70 Audio Servs Inc., 1127 Spring St. NW, Zip: 30309, Tel: 875-7008 (PMT—tape only)

Ryco, 794 Ralph McGill Blvd., Zip: 30301, Tel: 522-9726, Pres.: Herb Haralson (PMT)

The T. Shurtley Inc., 1200 Menlo Dr. NW, Zip: 30377, Tel: 351-9850, WATS (800) 241-1052, Pres.: Jay J. Cohen; VP Sales: Paul I. Katz, (DES, PMT—customized tee-shirts only)

Wonder Graphics Inc., 983 Waverly Way, Zip: 30307, Tel: 524-1200, (DES)

● **COLUMBUS (Area Code 404)**
 Capricorn Sales, 4018 Buena Vista Rd., Zip: 31907, Tel: 563-5353, (DES & PMT—customized tee-shirts only)

● **LA GRANGE (Area Code 404)**
 S P C Co. (div. of Shorewood Packaging Corp.), 1707 Shorewood Dr., Zip: 30240, WATS Tel: (800) 241-0186, Plant Mgr.: Ken McCabe, (DES, PMT)
 Home office: New York, N.Y., Shorewood Packaging Corp.

ILLINOIS
 ● **CHICAGO METROPOLITAN AREA (Area Code 312)**
 A G I (Album Graphics Inc.) 1950 N. Ruby St., Melrose Park 60160, Tel: 344-9100, TWX (910) 226-0417, Pres.: Donald W. Kosterka; Sales Mgr.: Kevin McKenna, (DES, PMT)
 Sales offices: Los Angeles, Calif.; New York, N.Y.

Acrylic Design & Fabrication Co., 1147 W. Ohio, Zip: 60622, Tel: 226-4222 (DES)

Ad-Vertising Unlimited, PO Box 8135, Zip: 60680, Tel: 787-8220, Pres.: R.C. Hillsman; Sales Mgr.: Frank Howard Jr.; Adv. Mgr.: Howard Pittman, (DES)

Album Graphics Inc., see AGI

Armageddon Talent Assocs., 1604 W. Juneway Terr., Zip: 60626, Tel: 465-3373, Mgr.: Fred Trehen, (DES)

Audio Accessories Co., 38 W. 515 Deerpath Rd., Batavia 60510, Tel: 879-5998, Sales Mgr.: John S. Maloney, (DES—tape only)

Audio Artists Ltd., PO Box 7, Wheaton 60187, Tel: 668-6682, (DES)

Bruce Packaging Co., 8025 N. Kenneth Ave., Skokie 60076, Tel: 583-2818, Pres.: Joseph Halpern, (DES)

M. M. Cole Music Publ'g Co., Playboy Bldg., Suite 1602, 919 N. Michigan Ave., Zip: 60611, Tel: 787-0804, Cable: MMCDLE, Pres.: Shepard Stern; Sales Mgr.: J.C. Cole; Adv. Mgr.: Mike Stern, (DES, PMT)

Fort Dearborn Lithograph Co., 6035 W. Gross Point Rd., Niles 60648, Tel: 647-8730 (DES, PMT)

Higgins, Hegner, & Genovese Int'l, 510 N. Dearborn, Zip: 60610, Tel: 644-1882 (DES)

Kiderlin Recs. Prods'n, 4926 W. Gunnison St., Zip: 60630, Tel: 545-0861, Pres.: Raymond Peck, Gen. & Sales Mgr.: George Peck, (DES—record only)

Matthews Int'l Corp., 3435 N. Kimball Ave., Zip: 60618, Tel: 539-7000, Mgr.: J. Bluemling (PMT—film masters, symbol consultation & testing)
 Home office: Pittsburgh, Pa

Media Int'l Inc., 425 N. Michigan, Zip: 60611, Tel: 467-5430, Pres.: Duane Lundeen; VP: Margaret Lundeen, Gen. Mgr.: Al Masters, (DES—record & tape, PMT—tape only)

Planet Communications (div. of Clay Pigeon Int'l), PO Box 20346, Zip: 60620, Tel: 778-8760, Pres. & Gen. Mgr.: Vytautas Beleska, Sales Mgr.: Rudy Markus, Special Projects Mgr.: D. Jaras (DES)

Poly Com Group, 201 E. Ohio St., Zip: 60611, Tel: 222-9480, Gen. Mgr.: Rich ard Jablonski, Sales Mgr.: Dave Bertz; Prod'n Mgr.: Carmen Trombetta, (DES)

Pro I Audio-Visual Inc., PD Box 33, Highland Park 60035, Tel: 433-4575, Pres.: R.L. Pink, VP: J. Pink, Sales Mgr.: M.M. Pink; Adv. Mgr.: D.D. Pink (DES, PMT)

Rainbow Bridge Studios Inc., 117 Rockland Rd., Libertyville 60048, Tel: 362-4060, Studio Mgr.: Ron Schwartz (DES)

Rooster Blues Recs., 2615 N. Wilton Ave., Zip: 60614, Tel: 281-3385, (DES, PMT)

Trackdown Rec. Dist. & Rec. Promo Co., 542 S. Dearborn, Suite 1102, Zip: 60605, Chm.: Hank Williams; Pres.: T.J. Wocker; Adv. Mgr.: J.V. Seldon (DES, PMT)

Vinylweid, 2011 W. Hastings, Zip: 60608, Tel: 243-0606 (PMT—tape only)

● **ROCKFORD (Area Code 815)**
 Carter Corp., 1916 11 St., Zip: 61101, Tel: 397-3200, Cable: CARTERCRP, Pres.: Robert L. Fleming, VP Sales & Mktg.: Sandra L. Fleming, Plant Mgr.: W. Skip Kruger (DES, PMT)

INDIANA
 ● **INDIANAPOLIS (Area Code 317)**
 Bowers Rec. Sleeve Co., 5331 N. Tacoma Ave., Zip: 46220, Tel: 251-3918, Pres.: James E. Bowers; VP Thomas R. Bowers, (DES & PMT)

Intheatre Inc., 4990 Massachusetts, Zip: 46218, Tel: 545-2001, (DES)
 Reco-Sleeve Packaging, 620 S. Belmont, Zip: 46221, Tel: 635-7777, Pres.: Leonard Verebay; Sales & Adv. Mgr.: Leonard Dimond (PMT)

Rutgers Packaging Corp. (div. of Queens Lithographing Corp.), 620 S. Belmont Ave., Zip: 46221, Tel: 635-7777, TWX (810) 341-3457/3400, Pres.: Abe Garde, Record Sales: Len Dimond (DES, PMT)
 Home office: Long Island City (New York Metropolitan Area), N.Y., Queens Lithographing Corp.

● **RICHMOND (Area Code 317)**
 P R C Rec'g Co. (div. of Richmond Rec'g Corp.), 1600 Rich Rd., Zip: 47374, Tel: 962-9511 (PMT)
 Home office: New York, N.Y.

● **TERRE HAUTE (Area Code 812)**
 Ivy Hill Communications Inc., Fort Harrison Ind'l Park, Fruitridge Ave., Zip: 47803, Tel: 466-9851, (PMT)
 Home office: Great Neck, N.Y.

Modern Album of Indiana Inc., 1299 Voorhees St., Zip: 47808, Tel: 235-6001 (PMT)
 Home office: Hauppauge, N.Y., Modern Album & Finishing Co. Inc.

Woodburn Printing Co., 25 S. Sixth St., Zip: 47808, Tel: 466-6822, Pres.: Donald P. Pendergast; Sales Mgr.: Ed Schulz; Adv. Mgr.: John Crippen (PMT)

IOWA
 ● **CARLISLE (Area Code 515)**
 Harold Luick & Assocs., 110 Garfield St., Zip: 50047, Tel: 989-3679, Contact: Harold L. Luick (DES, PMT)

● **CORALVILLE (Area Code 319)**
 Safeguard Co., PD Box 5555, 108 Second Ave., Zip: 52241, Tel: 351-7830, Gen. Mgr.: (Audio-Visual Prods'n): Ben Pfloof (DES—tape only)
 Home office: Brookfield (Milwaukee Metropolitan Area), Wis.

● **DES MOINES (Area Code 515)**
 Stenco Graphics, PO Box 2501, 5311 SW Ninth, Zip: 50315, Tel: 285-6564, (DES & PMT—customized tee-shirts only)

KENTUCKY
 ● **LOUISVILLE (Area Code 502)**
 Allen-Martin Prods'n Inc., 9701 Taylorsville Rd., Zip: 40299, Tel: 267-9658, (DES)

LOUISIANA
 ● **BATON ROUGE (Area Code 504)**
 Record Co. of the South (RCS), 5220 Essen Ln., Zip: 70808, Tel: 766-3233, Pres.: Cyril E. Vetter; Gen. Mgr.: John Fred; Sales Mgr.: Ronnie Schaab, Art Dir.: Ed Lakin, (DES, PMT)

● **VILLE PLATTE (Area Code 318)**
 Ville Platte Rec. Mfg. Co., 120 E. Cypress St., Zip: 70586, Tel: 363-2104, Pres.: J. Floyd Soileau; Sales Mgr.: Ronnie Soileau, (DES & PMT—record only)

MARYLAND
 ● **BALTIMORE AREA (Area Code 301)**
 The Record Factory, 10120 Marble Court, Cockeysville 21030, Tel: 628-2920, (DES)

● **HYATTSVILLE (Area Code 301)**
 The Shirt Xplosion Co. Inc., 5618 Lafayette Pl., Zip: 20781, Tel: 277-4400, (DES & PMT—customized tee-shirts only)

● **KENSINGTON (Area Code 301)**
 Omega Rec'g Servs., 10518 Connecticut Ave., Zip: 20795, Tel: 946-4686, Dwner & Chief Eng.: W. Robert Yesbek, (DES)

**PRINT DIRECT
 ALBUM JACKETS**

* SHORT RUNS

* LOW PRICES

H.R.C. Printing
 P.O. Box 1152-BG
 Mechanicsburg, PA 17055
 (717) 766-0943

• **WHEATON (Area Code 301)**
Big Ed's Unlimited 11141 Georgia Ave., Suite A 1 Silver Springs Zip 20902 Tel 949 9500 (DES & PRT—customized tee shirts only)

MASSACHUSETTS

• **BOSTON METROPOLITAN AREA (Area Code 617)**
Fleetwood Communications Co Inc. 321 Revere St Revere 02151 Tel 289-6800. Pres V P Giarrusso, Gen Mgr Raymond G Samora, Sales Mgr Victor Mancini, Adv Mgr Robin Samora (DES, PRT)
Matthews Int'l Corp. 3 Brooks Dr. Braintree 02184 Tel 848 8220 Mgr R Deals (PRT—film masters, symbol consultation & testing)
Home office: Pittsburgh, Pa
Rik Tinory Prod'ns, 180 Pond St., Cohasset 02025 Tel 383 9494 Pres Richard F Tinory, Artist Relations Claire L Babcock (DES, PRT)

• **CHICOPPEE (Area Code 413)**
Dielectrics Inc., 300 Burnett Rd Zip 01020 Tel 598 8308 (DES, PRT)
Just For the Record, 40 Marion St Zip 01013 Tel 592 0457 Pres Robert S Bator, Adv Mgr Celine St. Laurent Bator (DES)
• **TURNERS FALLS (Area Code 413)**
Silver Screen Design, 88 Third St Zip 01376 Tel. 863 4496 (DES—custo mized silk screened tee shirts only)

MICHIGAN

• **DETROIT METROPOLITAN AREA (Area Code 313)**
Graphic Design Inc., 23800 Amber, Warren 48089 Tel 758 0480 (DES, PRT)
Tape-Tronics Inc., 750 E. Mandoline, Madison Heights 48071 Tel 588 8281 TWX (810) 232-1524. (DES)

MINNESOTA

• **MINNEAPOLIS-ST. PAUL METROPOLITAN AREA (Area Code 612)**
Ark Rec'g Co (div of Fulton Electronics), 4208 Brunswick Ave N Minneapolis 55422 Tel 537 7076 Pres Robert W Fulton, Sales Mgr Robert W Frederer (DES)
Bethany Fellowship Inc., 6820 Auto Club Rd., Minneapolis 55438 Tel 944 2121 Cable BETHANY Pres T A Hegre, Gen Mgr M F Johnson, Sales Mgr Bill Linder (DES—tape only)
Communication Arts Inc., 2526 27 Ave S Minneapolis 55406 Tel 721 5357 (DES)
E M C Corp., 180 E. Sixth St., St Paul 55101 Tel 227 7366 Pres David E Feinberg, VP Richard T. Stevens, Customer Sales Dir C Carter (PRT)
Esco Artist, 2613 NE Garfield St Minneapolis 55418 Tel 789-5650 Owner Jo Esco (DES)

MISSOURI

• **KANSAS CITY (Area Code 816)**
Stage 3 Sound Prod'ns Inc., 12 E 39 St Zip 64111 Tel 531 1375 (DES)
• **ST. LOUIS METROPOLITAN AREA (Area Code 314)**
Matthews Int'l Corp., 10866 Indian Head Ind'l Blvd Zip 63132 Tel 423 9800 Mgr C Gilbert (PRT—film masters, symbol consultation & testing)
Home office: Pittsburgh, Pa
• **SPRINGFIELD (Area Code 417)**
Collette Studios, 200 E Commercial St Zip 65801 Tel 864 7015

MONTANA

• **MISSOULA (Area Code 406)**
Meadowlark Ventures—Graphic Design by Dolack, PO Box 7218 Zip 59807 Tel 728 2180.

NEW JERSEY

• **ASBURY PARK (Area Code 201)**
Sound Arts Co Inc., 5 Cindy Ln Zip 07712, Tel 493-8666 Pres Charles J Gspann, VP Francis M. Gspann (DES)
• **CAMDEN (Area Code 609)**
Recorded Publ'ns Labs (div of Recorded Publ'ns Mfg Co Inc.), 1100 State St Zip 08105 Tel 963 3000, Phila (215) 922 8558 Pres David H Goodman, Sales Mgr Pat Landon, Adv Mgr Edward J Goodman (DES).
Sales office: New York, N.Y.
• **CARLSTADT (Area Code 201)**
Q A I Inc., 640 Del Rd, Zip 07072 Tel 460-0060, NYC (212) 964 1714 Pres. Steve Dauman, Sales Mgr George Ratowsky (PRT).
• **CLIFTON (Area Code 201)**
Matthews Int'l Corp., 1151 Bloomfield Ave Zip 07012 Tel 473 7330 Mgr W Hammond (PRT—film masters, symbol consultation & testing)
Home office: Pittsburgh, Pa
• **COLLINGSWOOD (Area Code 609)**
Pauli Prods, PO Box 29 Zip 08108 Tel 547 8925 Pres Joseph A Pauli; VP Zara May Pauli. (PRT—tape only) (SEE ADVERTISEMENT)
• **FARMINGDALE (Area Code 201)**
Charlie Roberts Advertising & Promos Inc., Vat 69 Zip 07727 Tel 938-4351 Pres. Robert Schumann, Gen Mgr Charlie Roberts, Sales Mgr Linda Charamonte (DES)
• **GLENDORA (Area Code 609)**
Record Room, 308 E Evesham Rd Zip 08029 Tel 939 0034 (DES)
• **HAWORTH (Area Code 201)**
Trutone Recs., 163 Terrace St Zip 07641 Tel 385 0940 (DES, PRT)
• **LYNDHURST (Area Code 201)**
Color Seps Litho Preps Serv., PO Box 151 Zip 07071 Tel 438-6729 Pres J.G. Principato (DES)
• **MONTCLAIR (Area Code 201)**
Linear Sound Rec'g, 211 Glenridge Ave Zip 07042 Tel 744 0686 Pres M Kroll, Sales Mgr T Steinmann (DES)
• **PARK RIDGE (Area Code 201)**

Cadet Recs. Inc., 12 Maple Leaf Dr Zip 07656 Tel 391 3676 VP Sales & Mktg Robert K Herrington (Sales office only) (DES, PRT)
Home office & plant: Los Angeles, Calif
• **PENNSAUKEN (Area Code 609)**
Rand El Advertising, 7249 A Browning Rd Zip 08109 Tel 665-8611 (DES)

NEW YORK

• **BOHEMIA (Area Code 516)**
R H M Inds Ltd., 180 Orville Dr Zip 11716 Tel 567 7222, NYC (212) 895 9344 (PRT)
• **CLARENCE (Area Code 716)**
Mark Custom Rec'g Serv 10815 Bodine Rd Zip 14031 Tel 759 2600 Pres & Sales Mgr Vincent S Morette (DES)
• **FARMINGDALE (Area Code 516)**
Pressure Sensitive Tape & Label Corp., 135 Schmitt Blvd Zip 11735 Tel 293 7300 (DES, PRT—tape only)
Shorewood Packaging Corp., 55 Engineers Ln., Zip 11735 Tel 694 8230 (DES, PRT)
Home office: New York, N.Y.
• **GREAT NECK (Area Code 516)**
Ivy Hill Communications Inc., Community Dr Zip 11022 Tel 487 0200 Pres Ellis Kern. (PRT)
Branches: Los Angeles, Calif., Terre Haute, Ind
• **HAUPPAUGE (Area Code 516)**
Disc Graphics (div of Pickwick Int'l Inc.), 10 Gilpin Ave Zip 11787 Tel 234 1400 (PRT)
Modern Album & Finishing Co Inc., Cardinal Ind'l Park, Gilpin Ave Zip 11787 Tel 234-1100, NYC (212) 291 7600 Pres G D Thomas, Sales Mgr R A Froehlig (PRT)
Branches: Burbank (Los Angeles Metropolitan Area), Calif., Modern Album of California Inc., Terre Haute, Ind., Modern Album of Indiana Inc., Nashville, Tenn., Modern Album of Tennessee Inc
Prestige Label Corp., 255 Oser Ave Zip 11787 Tel 273 0020 (PRT)
• **HOLBROOK (Area Code 516)**
Electrosound Group Inc., 725 Broadway Ave Zip 11741 Tel 567 3700 Corporate Pres. Richard H Burkett, Pres., Rec Pressing Div Dick Meixner, Sales Mgr (east) Ron Roberto Local plant: Goldisc Rec'g Inc., Veterans Hwy & Broadway Zip 11741 Tel 589 0462, NYC (212) 895 6575 Pres Richard Meixner, Sales Mgr John Finnegan, Adv Mgr Rich Renda (PRT—record only)
Plants: Sun Valley (Los Angeles Metropolitan Area), Monarch Rec Mfg Co, Shelbyville, Ind., Allentown, Pa., Allentown Rec Co Inc
• **HUNTINGTON STATION (Area Code 516)**
Shelley Prods Ltd., 220 Broadway Zip 11746 Tel 423 7090 (DES, PRT)
• **LINDENHURST (Area Code 516)**
Coastal Specialty Tapes Inc., 274 Bangor St Zip 11757, Tel 226 5900 Opm Head & Sales Mgr Dan Dobbs (DES, PRT—tape only)
• **MELVILLE (Area Code 516)**
Sound by Blachly, 69 Old East Neck Rd Zip 11747 Tel 673 0330 Contact Bill Blachly (DES)

• **NEW ROCHELLE (Area Code 914)**
Westchester Int'l Prod'ns Inc., 41 Rosedale Ave Zip 10801 Tel 664 3099 NYC (212) 724 2880 Pres Jon H Starke, Gen Mgr William Starke, Sales Mgr Gloria Finigan (DES, PRT)
• **NEW YORK METROPOLITAN AREA (Area Code 212)**
A G I (Album Graphics Inc.), 125 W 55 St Zip 10019 Tel 489 0793 TWX (710) 581 5597 VP Mktg Richard Block (Sales office only) (DES)
Home office: Melrose Park (Chicago Metropolitan Area), Ill
A D Adams Advertising Inc., 145 E 52 St Zip 10022 Tel 755 0845 Pres A D Adams (DES)
Branch: Woodbury, N.Y.
Album Graphics Inc., see AGI
Ampro Prod'ns Inc., 150 Fifth Ave Zip 10011, Tel 243 7726 Cable TA PEXXRON Telex 425233 (DES)
Apon Rec Co Inc., PO Box 3082, Steinway Sta., 44 16 Broadway, Long Island City 11103 Tel 721 5599 Pres Andrew M. Poncic, Sales Mgr Roman Krawciw, Adv Mgr Don Zemann (DES)
Atwater Press Inc., 207 W 25 St Zip 10001 Tel 675 2710 (DES, PRT)
James Bell Graphic Design Inc., 119 W 23 St Zip 10011 Tel 929-8855 Pres James Bell, VP S Campbell, Sales Mgr, Jane Sapiro (DES)
G Benson & Co Printers Inc., 75 Spring St Zip 10012 Tel 925 7100 Contact Gerald J Benson (DES, PRT)
Bert Co Entis Inc (div of the Walter Reade Org Inc.), 241 E 34 St Zip 10016, Tel 683-6300 Cable WALREAD Telex 12227 Pres Sheldon Gunsberg, Exec VP, VP Finance & Treas. Christopher W Preuster (Sales office only) (DES, PRT)
Branch: Los Angeles, Calif
Ely Besalel Ltd., 235 E 49 St Zip 10017 Tel 759 7820 Pres Ely Besalel. (DES)
Leo Bliok Advertising, 24 W 57 St Zip 10019 Tel 245 8938 Owner Leo Bliok (DES—record only)
Creative Media Agency, 227 E 69 St Zip 10021 Tel 472 0100 Pres & Creative Dir Arthur Krieger, Prod'n Mgr. Al Douglas (DES)
D R G Recs Inc., 200 W 57 St Zip 10019 Tel 582 3040 Cable STETRECS TWX (710) 581 4825 Pres. Hugh Fordin, Mng. Dir.: Rick Winter, Nat'l Sales & Mktg Dir Ted Wolff (DES)
Disc Communications Ltd., 743 Fifth Ave Zip 10023 Tel 371 0390. (DES, PRT)
Orate Design, 145 E 52 St, Rm. 403 Zip 10022 Tel 751 2031 Pres & Art Dir Spencer Drake (DES—record only)
E R H Sales Corp., 221 W 57 St, Zip 10019 Tel 582 4200 Pres: Lee Halpern, Gen Mgr Michael Halpern, Sales Mgr Robert Shavelson (DES, PRT) (SEE ADVERTISEMENT)
Electrosound Group Inc., 1290 Ave of the Americas Zip 10019 Tel 581 5641 (PRT—record only)
Home office: Holbrook, N.Y.
Farmlitt & Barsanti, 1123 Broadway Zip, 10010 Tel 691 9398 (DES)
Great American Screen Designs Ltd., 230 Fifth Ave Zip 10001 Tel 683 4077 (DES, PRT)
Guaranteed Printing Serv Co., 119 W 23 St Zip 10011 Tel 929-2410 (DES, PRT)
Stephen P. Haas Advertising Art, 24 W 57 St Zip 10019 Tel 581 8442. Pres Stephen Haas. (DES)
Image Creators Inc., 310 E. 65 St Zip 10021 Tel 535 0257 (DES).
Jewelrite Signs & Letters, 13 E 31 St., New York, N.Y 10016 Tel 473 1169.

QUEENS GROUP

**Specialized Printing
And Packaging For All
Audio & Video Requirements**

**QUEENS LITHO
N.Y. 212 457-7700
RUTGERS PACKAGING
INDIANAPOLIS, IND.
317 635-7777
QUEENS LITHO
CALIF. 213 464-7700**

683-4474. Design & Lettering Dir.: William Bark, Artwork Dir.: F. Frank (DES)

Lee-Myles Assocs. Inc., 160 E. 56 St. Zip: 10022. Tel: 758-3232. Cable LEE-MYLES. Pres. Robert M. Miller, VP. Howard Roseff (DES, PRT). (SEE ADVERTISEMENT)

M B S Love Unlimited, 15-32 127 St., College Point 11356. Tel: 359-8500. WATS: (800) 221-0474. Pres.: Barry Kaminsky; VP: Sally Kaminsky; Gen. Mgr.: Alan Kaminsky; Sales Mgr.: Barbara Masin: (DES, PRT)—customized T-shirts & iron-ons only

Mac Murray Press Inc., 230 W. 17 St. Zip: 10011. Tel: 924-1530. Pres.: Bernard Leman; Sales Mgr.: Arnold Kohn (DES, PRT) (SEE ADVERTISEMENT)

Olympic Litho Corp., 116 Nassau St., Brooklyn 11201. Tel: 522-2400. Pres. Marvin D. Frankel; Gen. Mgr.: Herbert Farber. (PRT—color separations).

P R C Rec'g Co. (div. of Richmond Rec'g Corp.), 1 85 Ave. of the Americas Zip: 10036. Tel: 997-1250. Pres.: Hugh Landy VP & Sales Mgr.: David Grant. (PRT)

Plants: Compton (Los Angeles Metropolitan Area), Calif., Richmond, Ind. Charlie Passantino Inc., 311 W. 43 St., 5th fl. Zip: 10036. Tel: 586-1469. Pilgrim Press Corp., 36-01 43 Ave., Long Island City 11101. Tel: 937-9515. (PRT)

Daniel H. Price Inc., 15 E. 48 St. Zip: 10017. Tel: 755-1982. Acct. Exec.: Mitchell Price (DES, PRT)

Progressive Label & Litho Co., 286 Stanhope St., Erosoklyn 11237. Tel: 497-2320. Pres.: Jerome J. Root; Gen. Mgr.: Bernie Stein (DES, PRT)

Promedeus Arts Inc., 1776 Broadway. Zip: 10019. Tel: 586-3770. Pres. Lew Morris; Sales Mgr.: Jerry Present; Adv. Mgr.: Pon Parisi. (DES)

Queens Lithographing Corp., 52-35 Barnet Ave., Long Island City 11104. Tel: 457-7700. Chief Exec. Officer: Eric Kaitman; Pres.: Leonard Verebay, Sr. VP. Sales: Richard Roth (DES, PRT)

Branch: Hollywood (Los Angeles Metropolitan Area), Calif

Plant: Indianapolis, Ind., Rutgers Packaging Corp. (SEE ADVERTISEMENT)

Randee Int'l Prods Inc., Sheraton Hotel, Suite 3A8, 870 Seventh Ave. Zip: 10019. Tel: 586-0631. (DES, PRT)

Recorded Publ'ns Labs. (div. of Recorded Publ'ns Mfg. Co. Inc.), 2 Penn Plaza, Suite 1500. Zip: 10001. Tel: 868-3115. Eastern Reg'l Sales Mgr.: Lee Kallett. (Sales office only) (DES, PRT)

Home office: Camden, N.J.

Roman & Smith Assocs., 401 E. 89 St. Zip: 10028. Tel: 348-2852. Contacts: Johanna Roman, Roscoe Smith (DES, PRT)

Jasper Samuel Advertising & Recs Inc., 60 E. 42 St., Suite 541. Zip: 10017. Tel: 490-2787. Pres.: Jasper Samuel. (DES)

Shepard Printing Corp., 111 Eighth Ave. Zip: 10011. Tel: 255-1930 (DES, PRT)

Shorewood Packaging Corp., 10 E. 53 St. Zip: 10022. Tel: 371 1500. Pres. Paul Shore; Exec. VP: Floyd S. Glinert, VP. Special Projects: Marc Shore, VP. Nat'l Sales: Ken Rosenblum; VP. West Coast Sales: Jim Palmer. (DES, PRT)

Branches: Los Angeles, Calif., La Grange, Ga., Farmingdale, N.Y.

Silk Stocking Prod'ns Ltd., 216 W. 18 St., 10th fl. Zip: 10024. Tel: 255-4424. Chm.: Lloyd Ribner Jr., Pres. Elliot J. Galdy. (PRT)

Tri-Lon Color Lithographebs Ltd., 54 W. 21 St. Zip: 10010. Tel: 255-6140. Pres.: Morris Struckler, VP: David Struckler. (PRT)

Video Corp. of America, 231 E. 55 St. Zip: 10022. Tel: 355-1600. (DES)

Visual Information Systems, 15 Columbus Circle. Zip: 10023. Tel: 541-8080. Pres. Jay Raeben; VP. Prod'n & Programming: David Barnhizer; Gen. Mgr.: Paul Garsh; Sales Mgr.: Joe Scorzani. (DES)

Warjo Promos., 145 W. 55 St., Suite 2E. Zip: 10019. Tel: 245-7179. (DES, PRT)

Morton D. Wax & Assocs., 1650 Broadway. Zip: 10019. Tel: 247-2159. Pres.: Morton D. Wax. Local branch: 200 W. 51 St. Zip: 10019. (DES) (SEE ADVERTISEMENT)

● **ROCHESTER (Area Code 716)**
Visual Horizons, 208 Westfall Rd. Zip: 14623. Tel: 424-5300. (DES)
Wakeup Promos., 194 Ripplewood Dr. Zip: 14616. Tel: 865-2307. (DES, PRT)

● **RONKONKOMA (Area Code 516)**
Andrews-Nunnery Envelope & Paper Co., 2175 Fifth Ave. Zip: 11779. Tel: 467-2000. TWX: (510) 228-1095. Pres.: Stuart J. Andrews Jr.; Sales Mgr.: John F. Muller Jr.; Ass't Plant Mgr.: Robert J. Andrews. (DES, PRT)
Home office: Holbrook, N.Y., ElectroSound Group Inc.
Sales office: Sun Valley (Los Angeles Metro Area), Calif., Monarch Rec. Mfg. Inc., New York, N.Y., ElectroSound Group Inc.

● **SPRING VALLEY (Area Code 914)**
Pro/Creatives Corp., 25 W. Burda Ln. Zip: 10977. Pres.: Sales & Adv. Mgr.: David Rapp. (DES—record only)

● **TROY (Area Code 518)**
Wildwood Entertainment, 276 Fourth St. Zip: 12180. Tel: 273-7660. VP: Erich Borden. (DES)

● **UTICA (Area Code 315)**
Oneida Video-Audio Tape Cassette Corp., 760 Blandina St. Zip: 13501. Tel: 735-6187. Pres.: Stanley Markowski. (DES & PRT—record only)

NORTH CAROLINA

● **CANTON (Area Code 704)**
Recording Serv. of Western North Carolina Inc., 10 Penland St. Zip: 28716. Tel: 648-6012. Owner: J. Ted Evans Jr.; VP: Kay Evans. (DES, PRT)

● **THOMASVILLE (Area Code 919)**
Adtees Corp., PO Box 608, Stanley Ave. Zip: 27360. Tel: 475-0111. (DES & PRT—customized tee-shirts only)

OHIO

● **AKRON (Area Code 216)**
Yoe-Yoe Studios, 174 Portage Dr. Zip: 44303. Tel: 836-2497. Contacts: Craig & Janet Yoe. (DES)

● **CINCINNATI (Area Code 513)**
Artists Rec'g Co. Inc., 320 Mill St. Zip: 45215. Tel: 761-0011. (DES)
Counterpart Creative Studios Inc., 3744 Applegate Ave. Zip: 45211. Tel: 661-8810. (PRT)
Alex Gellen Design, 405 Executive Bldg. Zip: 45202. Tel: 651-1308. Pres.: Alex Gellen. (DES)
Jewel Rec'g Co., 1594 Kinney Ave. Zip: 45231. Tel: 522-9336. Pres.: Rusty York, Gen. Mgr.: Linda York, Sales Mgr.: Rollin Bennett Jr. (DES—record only)
Q C A Custom Pressing, 2832 Spring Grove Ave. Zip: 45225. Tel: 681-8400. Pres.: Edward R. Bosken, VP & Sales Mgr.: Keith Myers; Plant Mgr.: Ken Martin. (DES & PRT—record only). (SEE ADVERTISEMENT)
Rite Rec. Prod'ns Inc., 9745 Mangham Dr. Zip: 45215. Tel: 733-5533. Owner: Carl J. Burkhardt, Pres.: Philip M. Burkhardt; VP. Prod'n: Lan A. Ackley; VP. Graphics: Kenneth D. Keith Jr.; Sales Mgr.: Dan Burton. (DES, PRT)
Studio Pressing Serv., 320 Mill St. Zip: 45215. Tel: 761-8294. Pres.: B. Hyrne; Sales Mgr.: M. Tye. (DES, PRT)

● **CLEVELAND METROPOLITAN AREA (Area Code 216)**
Storycraft Inc., 18630 Detroit Ave., Lakewood 44107. Tel: 221-4722. (DES)

● **COLUMBUS (Area Code 614)**
Graphics of Columbus Inc., 5211 N. High St. Zip: 43214. Tel: 846-6126. (PRT)
Hillside Recs., 948 Studer Ave. Zip: 43206. Tel: 252-7116. Owner & Pres.: Larry McKenzie. (DES)
Roach Inc., PO Box 16548, 2255 Westbelt Dr. Zip: 43216. Tel: 876-9951. WATS: (800) 848-7970 (outside Ohio). (DES & PRT—customized tee-shirts only)
Branch: Sun Valley (Los Angeles Metropolitan Area), Calif.

● **NEWARK (Area Code 614)**
Utopia Ultra-Sound, 38-40 S. First St. Zip: 43055. Tel: 345-9426. Pres.: Robert H. Kirk Jr.; VP: Don Shannon; Gen. Mgr.: Robert H. Kirk Sr.; Sales Mgr.: Rose Shannon. (DES)

● **YOUNGSTOWN (Area Code 216)**
United Audio Rec'g Studio, 5947 Stillson Pl. Zip: 44512. Tel: 758-5463. Pres.: William Warner, Gen. & Sales Mgr.: Ray Nevel. (DES)

OKLAHOMA

● **TULSA (Area Code 918)**
C E S Rec'g Inc., 2500 N. Hemlock Circle, Broken Arrow 74012. Tel: 627-8474. Pres.: Basil W. Thomas; Gen. Mgr.: Judy McAlister; Mktg. Mgr.: Walter J. McKee Jr. (DES & PRT—tape only)
I T I Studios (International Teaching Tapes), 4235 S. Memorial Dr. Zip: 74145. Tel: 663-7700. Pres.: Meredith R. Gray; Sales Mgr.: Sonny Gray. (DES, PRT)
The Master Sound Inc., 8137 E. 46 St. Zip: 74145. Tel: 663-7186. Pres.: Donald Boshears; Gen. Mgr.: Peter Enns, Sales Mgr.: Louis Threenton. (DES)

OREGON

● **PORTLAND (Area Code 503)**
Northwestern Inc., Motion Pictures & Rec'g, 1224 SW Broadway. Zip: 97205. Tel: 226-0170. Pres.: Robert M. Lindahl, Sales Mgr.: Paul A. Buescher. (PRT)

PENNSYLVANIA

● **ALLENTOWN (Area Code 215)**
Allentown Rec. Co. Inc. (sub. of ElectroSound Group Inc.), 1002-10 Walnut St. Zip: 18102. Tel: 433-7405. (PRT—record only)
Home office: Holbrook, N.Y., ElectroSound Group Inc.
Sales office: New York, N.Y., ElectroSound Group Inc.

● **BETHLEHEM (Area Code 215)**
Mystic Oak Recs., 1 E. Church St. Zip: 18018. Tel: 867-4300. (DES)

● **CARLISLE (Area Code 717)**

Inside Art, 80 York Rd. Zip: 17013. Tel: 243-1082. Chief Exec.: Gail S. Gorden. (DES)

● **MECHANICSBURG (Area Code 717)**
H R C Printing, PO Box 1152, 5252 E. Trindle Rd. Zip: 17055. Tel: 766-0943. Gen. Mgr.: Donald E. Baldwin. (DES, PRT) (SEE ADVERTISEMENT)

● **PHILADELPHIA METROPOLITAN AREA (Area Code 215)**
Community Press, 6047-49 Woodland Ave. Zip: 19142. Tel: 729-4655. (DES & PRT—record only)
Kalstein Graphics, 6128 York Rd. Zip: 19141. Tel: 549-5085. (DES)
Matthews Int'l Corp., 3780 Main St. Zip: 19127. Tel: 483-6200. Mgr.: R. McCann. (PRT—film masters, symbol consultation & testing)
Home office: Pittsburgh, Pa.
UniComm Inc., 414 Swedeland Rd., King of Prussia 19406. Tel: 275-7100. Pres.: J.L.C. Ulrich Jr.; Gen. Mgr.: Robert G. Rowe Jr. (PRT—tape only)

● **PITTSBURGH (Area Code 412)**
George Heid Prod'ns & AV Prods., 701 Washington Rd. Zip: 15228. Tel: 561-3399. (DES)
Matthews Int'l Corp., 1575 McFarland Rd. Zip: 15216. Tel: 341-4464. Chm. & Pres.: T.F. Purner Jr.; Symbol Mgr.: M. Field. Local branch: 1211 W. Liberty Ave. Zip: 15226. Tel: 561-5120. Mgr.: G. Barefoot. (PRT—film masters, symbol consultation & testing)
Branches: La Palma, Calif.; Atlanta, Ga.; Chicago, Ill.; Braintree (Boston Metropolitan Area), Mass.; St. Louis, Mo.; Clifton, N.J.; Philadelphia, Pa.; Dallas, Tex.
Int'l branch: Canada, Bernard Matthews Ltd.

● **SCRANTON (Area Code 717)**
Keystone Printed Specialties Co. Inc., 321 Pearl St. Zip: 18505. Tel: 346-1761. Pres.: M.C. Fischer; Sales & Adv. Mgr.: Martin C. Fischer. (DES, PRT) (SEE ADVERTISEMENT)

● **SHARON (Area Code 412)**
Marjon Recs. Inc., 159 Easton Rd., Hermitage 16146. Tel: 347-4726. Pres.: John T. Krzancic; Sales Mgr.: Martha Krzancic; Adv. Mgr.: Ruth Toth (DES, PRT)

PUERTO RICO

● **CIDRA (Area Code 809)**
Linear Prods. of Puerto Rico, PO Box AB. Zip: 00639. Tel: (809) 739-8435. (DES, PRT)

RHODE ISLAND

● **WARWICK (Area Code 401)**
Great Graphics!, PO Box 3, Zip: 02887. 151 Keeley Ave. Zip: 02886. Tel: 738-8877. Owner & Pres.: Bill Montella Jr. (DES, PRT)

SOUTH CAROLINA

● **COLUMBIA (Area Code 803)**
Howard Knight Entis. Inc., 2424 Pleasant Ridge. Zip: 29209. Tel: 783-0325. (DES, PRT)

TENNESSEE

● **FAYETTEVILLE (Area Code 615)**
Kim-Pat Entis., PO Box 654, Hillwood Dr. Zip: 37334. Tel: 433-2323/5661. (DES)

● **MEMPHIS (Area Code 901)**
T-Shirts Int'l, 239 S. Cooper St. Zip: 38104. Tel: 522-8383. (DES, PRT)

● **NASHVILLE METROPOLITAN AREA (Area Code 615)**
Album Globe Dist'n Co. Inc., City Square, 260 W. Main, Suite 107, Hendersonville 37075. Tel: 824-9100. Pres.: Mike Shepherd; Adv. Mgr.: Keith Stewart. (DES, PRT)
American Sound Recs./Emerald Recs., 62 Music Square W. Zip: 37203. Tel: 327-4538. Pres.: Cliff Ayers Ostermeyer; Sales Mgr.: Chris Ostermeyer; Gen. & Adv. Mgr.: Connie L. Wright; PR: Alma Lee Combs. (DES)
Chumley Prods., PO Box 100823, 2802 Foster Ave. Zip: 37210. Tel: 833-6184. Pres.: P.E. Chumley. (PRT—record only)
Color Graphics Inc., 305 Church St., Goodlettsville 37072. Tel: 859-4001. (DES, PRT)
Creative Concepts, Faron Young Exec. Bldg., 1300 Division St., Suite 106. Zip: 37203. Tel: 259-3790. Partners: Jim Kent, Vernell Hackett. (DES, PRT)
Custom Tape Dupl'r's Inc., 341 Hill Ave. Zip: 37210. Tel: 256-1728. Pres.: L.C. Tant; Sales Mgr.: Mike Tant. (DES, PRT—tape only)
Gusto Recs. & Tapes, 220 Boscobel St. Zip: 37213. Tel: 256-1656. TWX: (810) 371-1055. Pres. & Sales Mgr.: Moe Lytle; Gen. Mgr.: Steve Kountzman. (DES, PRT)
M F P Inc., 453 Chestnut St. Zip: 37203. Tel: 256-6161. (PRT—record only)
Modern Album of Tennessee Inc., 457 Chestnut. Zip: 37203. Tel: 255-7461. (PRT)
Home office: Hauppauge, N.Y., Modern Album & Finishing Co. Inc.
Nashville Album Prod'ns Inc., 1114 Gallatin Rd. N., Madison 37115. Tel: 883-2153. Pres.: Steve Botts; Art Dir.: Gregg Spickard. (DES, PRT) (SEE ADVERTISEMENT)
Pinwheel Art & Photography Studios Inc., 1211 116 Ave. S. Zip: 37212. Tel: 327-9125. (DES)
Professional Mktg. Serv. Inc., 50 Music Square W., Suite 907, Nashville, Tenn. 37203. Pres.: Dee Mullins. (DES)
Sea Cruise Prod'ns, PO Box 110830. Zip: 37211. Tel: 834-1856. Pres. & Adv. Mgr.: Ken Keene, VP & Gen. Mgr.: F.V. Guzzo; VP & Sales Mgr.: Gene Miller. (DES)
Superior Sound Studios, 329 Rockland Rd., Hendersonville 37075. Tel: 824-5141. (DES)
Harrison Tyner Int'l Inc., 38 Music Square E., Suite 115. Zip: 37203. Tel: 244-4224. Owner & Pres.: Harrison Tyner, Sales Mgr.: Dallas Laird; Adv. Mgr.: Kevin McMaster. (DES)
United Rec. Pressing Inc., 453 Chestnut. Zip: 37122. Tel: 259-9396. (DES, PRT—record only)
Williams Printing Co., 417 Commerce St. Zip: 37219. Tel: 256-7125. VP. Sales: Dudley Fortner. (PRT)

TEXAS

● **DALLAS (Area Code 214)**
Electronic Technological Inds. of America Inc., PO Box 1580. Zip: 75221.

Give Your Product the Package It Deserves

MacMurray Press Creates Exciting & Printing For the Recording Industry

- RECORD JACKETS AND LABELS
- CASSETTE INSERTS AND LABELS
- AUDIO VISUAL PRINTED PRODUCTS

MacMurray Press, Inc.

35 Years Service to the Recording Industry
230 W. 17th St., NEW YORK, N.Y. 10011
212-924-1530 800-221-9390

Tel. 827-8002 Bd. Chm.: John Kanter, Gen. Mgr. David Coleman, Sales Mgr.: Larry Pearson (DES, PRT)
 Matthews Int'l Corp., 7715 Sovereign Row Zip 75247 Tel 631-8240 Mgr G. Motley, (PRT)—film masters, symbol consultation & testing)
Home office: Pittsburgh, Pa
 Rainbow Sound Inc., 1322 Inwood Rd Zip 75247 Tel 638-7712 Pres Bob Cline, Exec. VP Jack Whitl (DES—record only)

● **FORT WORTH AREA (Area Code 817)**

Ink Inc., PO Box 946, Springtown 76082 Tel: 433-5720 Pres. James Michael Taylor, Sales Mgr. Charles Bowles, Adv Mgr. Barbara Anne Taylor (DES)

● **HOUSTON (Area Code 713)**

Riverside Albums, 7400 Pinemont Zip 77040 Tel 462-2700 VP Earl Thomas, Sales Mgr. Brenda Cox (DES, PRT)

● **SAN ANTONIO (Area Code 512)**

Joey Recs Mfg., 6703 W Commerce Zip 78227 Tel 432-7893 (DES)
 Texas Rec. Mfg. Inc., 1422 W. Poplar, Zip 78207 Tel 733-6138. Pres. C. Foy Lee, Gen. Mgr. Jimmy Burton; Sales Mgr. Jeannie Hill (DES, PRT)

● **SAN BENITO (Area Code 512)**

Rio Grande Music Co., 119 S. Sam Houston Blvd. Zip 78586 Tel: 399-5377 Sales Mgr. John F. Phillips. (DES—record only)

● **WACO (Area Code 817)**

Creative Communications Inc (sub of SMI), 918 N Valley Mills Zip 76710 Tel 776-6553 (DES)
 Mike's Print Shop, 2507 Grim, Zip 76707 Tel 752-2321 Owner Mike Stanley (PRT)
 Charles Wallis Inc., 4700 W Waco Dr Zip 76710 Tel 776-5113 Pres Charles Wallis, Gen. Mgr. Roger Lindstrom (DES)

UTAH

● **SALT LAKE CITY (Area Code 801)**

Covenant Rec's Inc., PO Box 26817, 1345 Major St Zip 84126 Tel 487-1096 Pres. V. Lewis Kofford; Adv. Mgr. Jeff Lund. (DES)

VIRGINIA

● **ALOIE (Area Code 703)**

Solar Sound Prod'n's (div. of VEE Corp.), Box 98 Zip 22001 Tel 471-5359 Bus Mgr.: Frank Adair. (PRT)

WISCONSIN

● **ELKHART LAKE (Area Code 414)**

Sohn Mfg. Inc., Box X Zip 53020 Tel 876-3361 (DES, PRT)

● **MILWAUKEE METROPOLITAN AREA (Area Code 414)**

Audio Cassette Dupl'r's of Wisconsin, 159 E. Silver Spring Dr Zip 53217 Tel 961-1635. Pres.: J. Shutter, Gen. Mgr. G. Miller, Sales Mgr. J. Stoeker (DES)
 Holoubek Studios Inc., 4712 N. 125 St. Butler 53007 Tel 781-4800. WATS (800) 558-0566 Telex 269472. Nat'l Sales Mgr. David W. Bruns (DES & PRT—iron-on transfers & customized tee-shirts)

WYOMING

● **CHEYENNE (Area Code 307)**

Rocky Mountain Rec'g, 8305 Christensen Rd. Zip 82001 Tel 638-8733 Pres. Ray Alexander; Sales & Adv. Mgr. Georgia Alexander. (DES, PRT)

LICENSING ORGANIZATIONS, MUSIC

A M R A (American Mechanical Rights Ass'n), 250 W. 57 St., Suite 2632, New York, N.Y. 10017. Tel: (212) 246-4077 Exec. Dir.: Rosalie W. Miller (Mechanical rights only)

A S C A P (American Society of Composers, Authors & Publ'rs), ASCAP Bldg., 1 Lincoln Plaza, New York, N.Y. 10023 Tel: (212) 595-3050. Pres. Hal David (Performing rights only)

Membership offices: Hollywood, Calif., 6430 Sunset Blvd., Suite 1002 Zip 90028 Tel: (213) 466-7681—Nashville, Tenn., 2 Music Square W Zip 37203. Tel: (615) 244-3936

Licensing offices: San Francisco, Calif., Equitable Life Bldg., Rm 1020, 120 Montgomery St. Zip 94104 Tel: (415) 781-2141—North Miami, Fla., 1065 NE 125 St. Zip 33161 Tel: (305) 895-6390—Atlanta, Ga., 1 Pezometer Way NW, Suite 415, Zip 30339 Tel: (404) 952-8843—Rosemont, Ill., 10400 W. Higgins Rd., Suite 235, Zip 60618 Tel: (312) 827-6810—New Orleans, La., International Trade Mart Bldg., Suite 1322, Zip 70130 Tel: (504) 524-7701—Framingham, Mass., 10 Speen St Zip 01701 Tel: (617) 873-3515—Troy, Mich., 755 W Big Beaver Rd., Suite 306, Zip 48084 Tel: (313) 362-2444—Minneapolis, Minn., 7850 Metro Pkwy., Suite 106, Zip 55402 Tel: (612) 854-0763—Cleveland, Ohio, 772 Hanna Bldg., Playhouse Square Zip 44115 Tel: (216) 771-6722—Allison Park, Pa., 4084 Mount Royal Blvd Zip 15101 Tel: (412) 486-2625—Jenkintown, Pa., Benjamin Fox Pavilion, Suite 807, Old York Rd. Zip 19046 Tel: (215) 885-2510—Santurce, P.R., SPACEM (Society of Puerto Rican Authors, Composers & Editors of Music), PO Box 9692, Zip 00908 Tel: (809) 722-0495—Houston, Tex., Communications Center, Suite 340, 3901 Westheimer, Zip 77027 Tel: (713) 621-5692—Seattle, Wash., 444 NE Ravenna Blvd., Suite 306 Zip 98115 Tel: (206) 524-8185.

Int'l membership office: England
 B M I (Broadcast Music Inc.), 320 W. 57 St., New York, N.Y. 10019 Tel: (212) 586-2000. Cable: BROADCASTMUSIC Telex: 127823 Pres. Edward M. Cramer, Sr. VP Theodora Zavin, VP PR Russ Sanjek (Performing rights only)

Branches: Hollywood, Calif., 6255 Sunset Blvd Zip 90028 Tel: (213) 465-2111—San Mateo, Calif., 1650 Borel Pl. Zip 94402 Tel: (415) 349-9590—Coral Gables, Fla., 1320 S Dixie Hwy. Zip 33146 Tel: (305) 666-6122—Schmumberg, Ill., 1325 Remington Rd., Suite S Zip 60195 Tel: (312) 843-7771—Boston, Mass., 888 Worcester Rd Zip 02181 Tel: (617) 237-3885—Melville, N.Y., 275 Broadhollow Rd Zip 11747 Tel: (516) 293-6644—Hato Rey, P.R., Pan Am Bldg., Suite 905, 255 Ponce de Leon Ave. Zip 00917 Tel: (809) 754-6490—Nashville, Tenn., 10 Music Square E. Zip 37203 Tel: (615) 259-3625. VP Frances Preston—Hous-

ton, Tex., 8401 Westheimer St., Suite 217, Zip 77063 Tel: (713) 783-8956 (SEE ADVERTISEMENT)

C S C (Copyright Sharing Corp.), PO Box 3738, Olympic Sta., Beverly Hills, Calif 90212 Tel: (213) 477-1064. Pres. Dennis J. Fitzpatrick (Sacred music reprint rights only)

Copyright Serv Bureau Ltd., 221 W. 57 St., New York, N.Y. 10019 Tel: (212) 582-5030 Cable: HOFERESQ Telex: 422062 Chm. Walter Hofer; Pres. Gille A. Hofer; VP & Gen. Counsel Alan N. Skuena, Exec. Dir. Jeri Spencer (Mechanical rights only)

Harry Fox Agency Inc., 110 E. 59 St., New York, N.Y. 10022 Tel: (212) 751-1930 (Mechanical rights only)

Italian Book Corp., 1119 Shore Pkwy., Brooklyn, N.Y. 11214 Tel: 236-5803 Pres. Frank Tudisco, VP & Gen. Mgr. Lyvia DeMartino (Performing & mechanical rights)

L A F C A P (Latin American Federation of Composers, Authors & Publ'rs), 345 W. 58 St., New York, N.Y. 10019. Tel: (212) 582-5705 Pres. Rogelio Brambila, Mng. Dir. Gerard de La Chapelle. (Mechanical rights only)

Int'l branches: Mexico, Peru, Venezuela

Mietus Copyright Mgmt., 527 Madison Ave., New York, N.Y. 10022 Tel: (212) 371-7950. Pres. Leonard S. Mietus. (Mechanical rights only)

S E A C Inc., 10 Columbus Circle, New York, N.Y. 10019 Tel: (212) 586-3450 Chm. Alice H. Prager, VP Adv. & PR Charles Scully, VP & Affiliation Dir. Vincent Candolara. (Mechanical & performing rights)

Branches: Los Angeles, Calif., 9000 Sunset Blvd Zip: 90023. Tel: (213) 274-6814—Nashville, Tenn., SESAC Bldg., 11 Music Circle S Zip 37203 Tel: (615) 244-1992 (SEE ADVERTISEMENT)

S P A C E M (Society of Puerto Rican Authors, Composers & Editors of Music), see ASCAP

LICENSORS, RECORD & TAPE

Alshire Int'l Inc., 1015 Isabel St., Burbank, Calif 91510. Tel: (213) 849-4671 WATS: (800) 423-2936. Cable: BUDDSOUND TWX (910) 498-2759 Pres. Al Sherman; Gen. Mgr. Dick Ceja.

American Sound Recs./Emerald Recs., 62 Music Square W., Nashville, Tenn. 37203. Tel: (615) 327-4538. Pres. Cliff Ayers Ostermeyer, Sales Mgr. Chris Ostermeyer; Gen. & Adv. Mgr. Connie L. Wright. PR Alma Lee Combs.

Ampro Prod'n's Inc., 150 Fifth Ave., New York, N.Y. 10011 Tel: (212) 243-7726. Cable: TAPEXRON Telex 425233.

Apon Rec. Co. Inc., PO Box 3082, Steinway Sta., 44-16 Broadway, Long Island City, N.Y. 11103 Tel: (212) 721-5599. Pres. Andrew M. Poncic, Sales Mgr. Roman Krawicz; Adv. Mgr. Don Zemann (Classical music only)

Apple Juice Prod'n's Inc., 6381 Hollywood Blvd., Hollywood, Calif 90028 Tel: (213) 464-2482

Ario Recs. Inc., 7635 Telephone Rd., Le Roy, N.Y. 14482. Tel: (716) 584-3040 Pres. Kenneth Bearce; Gen. Mgr. James Bearce, Sales Mgr. Jill Weizel

Cadet Recs. Inc., 5810 S Normandie Ave., Los Angeles, Calif 90044 Tel:

(213) 753-5121 Pres. Jules Bihari; Mgr. Don Macmillan
 Branch: Park Ridge, N.J., 12 Maple Leaf Dr Zip 07656 Tel: (201) 391-3676 VP Sales & Mktg. Robert K. Herrington.

Covenant Rec's Inc., PO Box 26817, 1345 Major St., Salt Lake City, Utah 84126. Tel: (801) 487-1096. Pres.: V. Lewis Kofford, Adv. Mgr. Jeff Lund

Curtiss Universal Rec. Master Lease & Sales, PO Box 4740, Nashville, Tenn 37216 Tel: (615) 859-0355. Pres. Wade Curtiss, VP Curt Edwards.

D R G Recs Inc., 200 W 57 St., New York, N.Y. 10019 Tel: (212) 582-3040. Cable: STETRECS TWX (710) 581-4825 Pres. Hugh Fordin, Mng. Dir. Rick Winter, Nat'l Sales & Mktg. Dir., Ted Wolff, Admin. Licensing: Beth Greenberg. Royalties: Richard Kaminsky

Double H Licensing Corp., 221 W. 57 St., New York, N.Y. 10019. Tel: (212) 581-2424. Pres. Lee Halpern, Ass't to Pres.: Harry Rngler; VP Sales: Larry Halpern, VP Int'l Michael Halpern

Emerald Recs., see American Sound Recs

Fleetwood Communications Co. Inc., 321 Revere St., Revere, Mass. 02151. Tel: (617) 289-6800. Pres. Vincent Giarrusso; Gen. Mgr. Raymond G. Samora, Sales Mgr. Victor Mancini, Adv. Mgr. Robin Samora

David Hubert & Assocs., 541 Continental Court Bldg., Suite 541, 201 N. Orange Grove Blvd., Pasadena, Calif 91103. Tel: (213) 796-9693. Cable: CONSULTIME TWX: (910) 588-3792 Contact: David Hubert

Represents: Bearsville, CRI, Century, Delos, Ediga, Everest Group, First American, JVC, Pye Recs Group, RPM/Blue Chip

Indalo Int'l, PO Box 49284, Atlanta, Ga. 30359 Tel: (404) 634-0578 Pres. & Int'l Dir. Richard M. Singer

Jewel Rec'g Co., 1594 Kinney Ave., Cincinnati, Ohio 45231 Tel: (513) 522-9336 Pres. Rusty York, Gen. Mgr. Linda York, Sales Mgr. Rollin Bennett Jr

Michele Audio Corp., Andrew Street Rd., Massena, N.Y. 13662. Tel: 769-2448 Pres.: Gnette Cormier, Sales Mgr. Harold Friedman, Mgr. Jack Daniels.

Music Resources Int'l Corp., 110 W. 34 St., Suite 806, New York, N.Y. 10001 Tel: (212) 947-2066

Nostalga Lane Inc., 200 W. 57 St., New York, N.Y. 10019 Tel: (212) 582-5390

Dne World of Music, 17208 Braxton St., Granada Hills, Calif 91344 Tel: (213) 360-8088 Cable: WEISSWORLD Telex 698370 Pres. Marjorie Weiss

Overseas Music Servs. Inc., 30 Rockefeller Plaza, New York, N.Y. 10112 Tel: (212) 541-8862 Cable: OVERMUSIC. Telex: 235309. Pres. John E. Nathan, Ass't to Pres.: Nancy Weshkoff

Paradiso Inc., PO Box X, Wilton, Conn 06897 Tel: (203) 762-5188 Cable: INTERPARADISO Telex: 965940 Pres. L von Kleydorff, Gen. Mgr. Iris A. Thomas

Peter Pan Inds., 145 Komorn St., Newark, N.J. 07105 Tel: (201) 344-4214 Pres. Martin Kasen, Sr. VP Donald Kasen, Nat'l Sales Mgr. James Monaghan, Sales Admin'r. Dee Stempler. Local branch: 88 St. Francis St. Zip 07105 Tel: 344-4214

Record Masters Inc., PO Box 4740, Nashville, Tenn 37216 Tel: (615) 859-0355 Pres. Wade Curtiss, Sales Mgr. S. Neal

San Juan Music Group, 1637 Utica Ave., Brooklyn, N.Y. 11234 Tel: (212) 253-4600 Cable: MUSICLEASE N.Y. Telex: 668550 Pres. David Last, Sales Mgr. B. Cohen (SEE ADVERTISEMENT)

ESTABLISHED **alco** SINCE 1942

RESEARCH AND ENGINEERING, INC.

CUSTOM AND PRODUCTION

RECORD MFG.

ONE RECORD OR A MILLION

FROM YOUR TAPE WE MAKE:

• STUDIO MASTER • MATRIX • LABELS • ALBUM JACKETS • FINISHED RECORD • PACKAGED AND DROP SHIPPED

WE SPECIALIZE IN VINYL 45'S

FOR INFORMATION CONTACT ELLEN SHANNON OR TABB REX

6201 SANTA MONICA BOULEVARD, HOLLYWOOD, CALIFORNIA 90038

PHONE (213) 466-1101

THE SAN JUAN MUSIC GROUP

A Licensing Organization

Original Artist Masters Available

For All Territories

1637 Utica Ave., Brooklyn, N.Y. 11234
 (212) 253-4600 Cable: MUSICLEASE N.Y.
 Telex: 668550

WEA MANUFACTURING INC.
 P.O. Bcx 321, Olyphant, PA 18447
 (717) 383-2472

**QUALITY RECORD PRESSING
 AND
 TAPE DUPLICATING**

 **Allied Record Company**
 6110 Peachtree St.
 Los Angeles, CA 90040
 (213) 725-6900
 TWX 910 580-4731

 **Specialty Records Corporation**
 1400 E. Lackawanna Ave.
 Olyphant, PA 18447
 (717) 383-2471
 TWX 510 671-4580

YOU MAKE THE MUSIC...

Highest Quality —
We treat all projects with care,
— from the simplest to the most complex

Some of our clients include: Sesame Street
Records, Twisted Sister, Jazz Archives, Ace of Hearts,
The Smithsonian Institution

Let us coordinate
your total record
manufacturing needs

Our services include:
Art & Typesetting, Prep-Work
& Separations, Printing, Jacket
Fabrication, Labels, Mastering
Plating, Pressing, Tape
Duplication, Complete Marketing
Aids and Anything Unusual

...ERH MAKES THE RECORDS

ERH Productions, Inc.
 221 West 57th St., New York City 10019
 Telephone (212) 582-4200, TWX 710-581-5446
 Call Bob or Michael



Ralph L. Seltzer Inc. c/o Great Dak Vineyard. 1751 Draper Valley Rd. Selma, Dre 97538. Tel (503) 597-2161 Cables MUSICWORLD. Dwner Ralph L. Seltzer. Gen Mgr. Carla Bartoletti
 Sonic Arts Corp. 665 Harrison St. San Francisco, Calif 94107 Tel (415) 781 6307 Pres. Leo de Gar Kulkka. Gen Mgr. Herbert P. Haas
 Take Home Tunes Rec. Co. PO Box 1314, Englewood Cliffs, N.J. 07632 Tel (201) 224-5811 (Tues & Fri.). (201) 567 5524 (Messages only) Prod'r Doris Chu Yeko
 Transpac Int'l. 1088 Woodside Rd., Berkeley Calif 94708 Tel (415) 548 7102 TWX (910) 366 7930 Cable BERKEX Dwner: Ian G. Brown

**PLATING, PROCESSING
 & PRESSING PLANTS**

ARIZONA

• **PHOENIX (Area Code 602)**
 Universal Audio Corp. 6540 E. Lafayette Blvd. Scottsdale 85217 Tel 949 7577 (Plating & processing only)
 Wakefield Mfg. Inc. PO Box 6037, 1745 W Linden Zip 85005 Tel 252 5644 TWX (910) 951 1340 Pres. Richard A. Wakefield VP J.A. Monahan. Quality & Research Eng'g Mgr. Kent Smitherger. Mktg & Admin Mgr. Nancy Stringer (SEE ADVERTISEMENT)
 • **TEMPE (Area Code 602)**
 Superior Rec. Pressing Corp. West. 802 W 24 St Zip 85282 Tel 894-1687 Pres. J.H. Dunn

CALIFORNIA

• **ANAHEIM (Area Code 714)**
 Chateau East Mfg. 1040-R N Grove St Zip 92806 Tel 630 0145 Pres. J. Truszaw. VP Sales S. Hager. Gen Mgr. W. Younger (Pressing only)
 • **CAMARILLO (Area Code 805)**
 Record Technology Inc. 486 Dawson Dr Zip 93010 Tel 484 2747 Pres. W.D. Bauer
 • **FULLERTON (Area Code 714)**
 B A M C D Recs. 1106 West Ave Zip 92633 Tel 738 4259 (Pressing only)
 • **LOS ANGELES METROPOLITAN AREA (Area Code 213)**
 Alberts Rec. Mfg. Co. 312 Monterey Pass Rd., Monterey Park 91754 Tel 282 5181. 283 5446 Pres & Adv. Mgr. S.J. Alberts. Sales Mgr. John J. Alberts
 Alco Research & Eng'g Inc. 6201 Santa Monica Blvd., Hollywood 90038 Tel 466 1101 (Pressing only) (SEE ADVERTISEMENT)
 Allied Rec. Co. 6110 Peachtree St Zip 90040 Tel 725 6900 Exec. VP David L. Brown. Sales & Customer Serv. Mgr. Stephen R. Broadhead (Pressing only) (SEE ADVERTISEMENT)
 Aishire Int'l Inc. 1015 Isabel St., Burbank 91510 Tel 849 4671 WATS (800) 423 2936 Cable BUDDUND TWX (910) 498 2759 Pres. Al Sherman. Gen. Mgr. Dick Ceja
 American Metropolitan Communications Inc. 8640 Hillside Ave., Hollywood 90069 Tel 654 9515 Pres. M.R.F. Hanau. Exec. VP T. Randolph (Custom "decorative" record pressing)
Admin. branch: Miami, Fla., 777 Brickell Ave. Suite 702 Zip 33131
Factory: Santa Monica, Calif., Rainbo Recs
Int'l branches: England, France, Netherlands
 Award Rec. Mfg. Inc. 11016 S. La Cienega Blvd., Inglewood 90304 Tel 645 2281 Pres & Sales Mgr. Martin Ansoorian. Gen. Mgr. George Abajian
 Cadet Recs. Inc. 5810 S. Normandie Ave Zip 90044 Tel 753 5121 Pres. Jules Bihari. Mgr. Don Macmillan
Branch: Park Ridge, N.J.
 Columbia Rec. Prod'ns. 1801 Century Park W., Century City 90067 Tel 556 4700 (Sales office only)
 Plants: Santa Maria, Calif., Terre Haute, Ind., Pitman, N.J. CBS Recs. Inc.
 Custom Rec. Mfg. Co. 5810 S. Normandie Ave Zip 90044 Tel 753 5121 Pres. Jules Bihari. VP. Don Macmillan
 Fidelatone Mfg. Co. Inc. 12848 Weber Way, Hawthorne 90250 Tel 678 4346 Pres. Richard L. Artz. Sales Mgr. Rosemary Harrison
 Finebilt Mfg. Co. Inc. 931 N. Citrus Ave., Hollywood 90038 Tel 466 9511 Cable COEXPORT. Telex 698393 Pres. Alwin P. Schmid. VP & Tape Sales Mgr. Joseph Bouzaglou. Sales Mgr. Manuel Munoz (Plating & pressing only)
 J V C Cutting Center Inc. (div. of Victor Co. of Japan). 6363 Sunset Blvd. Suite 500, Hollywood 90028 Tel 467 1166 Studio Mgr. Larry Boden (disk mastering only) (SEE ADVERTISEMENT)
 K M Recs. Inc. 2980 N. Dntario St., Burbank 91504 Tel 841 3400 Pres.

1941

HOME AWAY FROM HOME

USO

40th Anniversary

1981

Ultra High-Performance Quality Records ...they don't grow on trees

They come from talent, hard work, advanced technology, and strict quality controls. The smallest flaw can ruin an otherwise perfect record, so why compromise the finished product just to save few cents in the processing and pressing? With a 50-year track record of making the finest discs, JVC is one manufacturer you can trust.

- JVC developed "Super Vinyl," a highly polymerized synthetic compound with high vinylacetate content. It enables us to press records with lower noise, wider dynamics, and more uniform frequency response. Super Vinyl is so tough it increases the useful life of a record many times.
- JVC's special long-term plating process, done in a cleaned air environment, preserves every groove in your delicate lacquer disc. Slow plating, by reducing the chance of granularity or voids, also improves the quality of the metal parts.
- For the ultimate in uniformity, we created special automatic record presses. Out come perfect records, untouched by human hands so there are no fingerprints, contamination or surface irregularities.

Cross section of a conventional disc

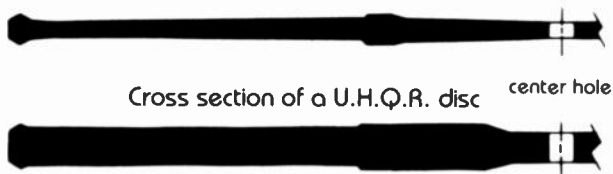

Cross section of a U.H.Q.R. disc

- U.H.Q.R. discs are thicker and heavier than conventional discs so they lay flat and are less likely to warp. Channel separation is significantly improved, and harmonic distortion sharply reduced due to our flat, custom polished stampers and extra long pressing cycle. It's the same process we use for the JVC technical record series, the standard for professional mono, stereo and CD-4 phono equipment calibration.

At JVC, we do more than pressing. We have our own recording studios in Japan, and the largest record label in that quality conscious market. JVC re-pioneered modern half-speed techniques to cut at greater levels with wider frequency response and lower distortion. JVC is committed to advancing the state of recording art and science. With contributions such as a 120 pole quartz lock direct drive lathe motor, the new CH-90 cutter head, and the DAS Series 90 digital audio recording/editing/mastering system, we bring a broader understanding to your record manufacturing needs.



The JVC Cutting Center is the exclusive North American representative for JVC Record Processing and Pressing. For more information, contact us or Victor Company of Japan, Ltd., Record Division, 1-2-5 Motoakasaka, Minato-Ku, Tokyo, Japan.

*U.H.Q.R. is JVC's trademark for our proprietary process of manufacturing "Ultra High-Performance Quality Records."

JVC

JVC Cutting Center, Inc.

6363 Sunset Blvd., Suite 500, Hollywood, CA 90028
(213) 467-1166

(A subsidiary of the Victor Company of Japan, Ltd.)

**What was Nashville's best kept secret?
NASHVILLE RECORD PRODUCTIONS**



Specializing in all your record production needs with state of the art equipment and professional staff.

Featuring

- ... Three disc mastering studios
- ... Artwork and typesetting
- ... Record and Jacket production
- ... Price competitive

Let our creative specialists show you the difference.

Call or write.



Nashville Record Productions, Inc.
469 Chestnut Street Nashville, Tennessee 37203
(615) 259-4200



A Subsidiary of Keysor-Century Corporation

**MASTERING • PLATING
PRESSING • PRINTING**

6550 Sunset Boulevard
Hollywood, California 90028
[213] 466-1323

25000 Springbrook Avenue
Saugus, California 91350
[805] 259-2360
[213] 365-3991

Glade Merkley, VP Custom Servs.; Jim Auchterlome, VP Audiophile Sales; Mike Malan, Mktg. & Adv. Mgr.; Bruce Leek, (Pressing only)
Kdisc (sub. of Keysor Century Corp.), 6550 Sunset Blvd., Hollywood 90028
Tel: 466-1323 Pres: Eugene R. Schutz; Gen Mgr. Bill Lightner.
Plant: Saugus, Calif (SEE ADVERTISEMENT)
Korelich Eng'g & Mfg Co., 6331 Santa Monica Blvd., Hollywood 90038 Tel: 462-2545. (Pressing only)
James G. Lee Rec. Processing Inc., 145 W. 154 St., Gardena 90247 Tel: 321-2187 Pres. James G. Lee, Gen Mgr. Edward Tobin Jr. (Plating & processing only.)
Monarch Rec. Mfg. Corp. (sub. of ElectroSound Group Inc.), 9545 San Fernando Rd., Sun Valley 91352 Tel: 767-8833 Pres. Nate DuRoff, VP & Gen Mgr. Bob Barone
Home office: Holbrook, N.Y., ElectroSound Group Inc.
P R C Rec'g Co. (div. of Richmond Rec'g Corp.), 18700 Laurel Park Rd., Compton 90220 Tel: 979-8545. Plant Mgr. Chic Groves
Home office: New York, N.Y.
R C A Recs., 6363 Sunset Blvd., Hollywood 90028 Tel: 468-4000. (Sales office only)
Home office: New York, N.Y.
Plant: Indianapolis, Ind.

Rainbo Rec. Mfg. Corp., 1738 Berkeley St., Santa Monica 90404 Tel: 829-3476 TWX (910) 343-7420. Pres. Jack G. Brown; VP & Gen. Mgr. Jim Doyle, Prod'n Supervisor Steve Sheldon (SEE ADVERTISEMENT)
Tembo Mfg. Co., 139 Maryland St., El Segundo 90245 Tel: 322-8077 (Pressing only)
Virco Rec'g Inc., 700 S. Date Ave., Alhambra 91803 Tel: 283-1888 Mktg Dir. Nyal R. London

• **SAUGUS (Area Code 805)**

Kdisc (sub. of Keysor Century Corp.), 26000 Springbrook Ave Zip 91350 Tel: 259-2360 Pres. Eugene R. Schutz; Gen Mgr. Bill Lightner.
Office: Hollywood (Los Angeles Metropolitan Area), Calif

CONNECTICUT

• **HAMDEN (Area Code 203)**

Record Prods. of America Inc., 700 Sherman Ave Zip: 06514 Tel: 248-6371. Pres.: Stanley Roczynski; VP & Sales Mgr. Steve Suzanski (Plating & processing only)

• **NORWALK AREA (Area Code 203)**

Cook Labs. Inc., 375 Ely Ave., South Norwalk 06854 Tel: 853-3641 Pres. Emory Cook, Adv Mgr. Frank Stall

FLORIDA

• **CLEARWATER (Area Code 813)**

Eva-Tone Soundsheets Inc., 4801 Ulmerton Rd Zip 33520 Tel: 577-7000 TWX (810) 863-0394. Pres.: R. Evan Evans, Mktg Mgr. Laurance Johnson; Adv Mgr. Mel Ardelean (Flexible disk pressing only) (SEE ADVERTISEMENT)

• **FORT LAUDERDALE AREA (Area Code 305)**

Alpha Recs. Inc., 1400 NW 65 Ave., Plantation 33313 Tel: 587-6011

• **MIAMI METROPOLITAN AREA (Area Code 305)**

Allison-Alhambra Recs. Inc., 4380 NW 128 St., Opa Locka 33054 Tel: 685-8396 Telex: 522178

Caribbean Recs. Mfg. Corp., 3081 NW 24 St Zip 33142 Tel: 633-4322/9963 Telex: 441453 (Pressing only)

Miami Tape Inc., 8180 NW 103 St., Hialeah Gardens 33015 Tel: 558-9211 (Plating & processing only)

• **ORLANDO (Area Code 305)**

Magnetix Disc Corp., 700 W. Bay St., Winter Garden 32787 Tel: 656-4494 Pres.: John Lory

GEORGIA

• **ATLANTA METROPOLITAN AREA (Area Code 404)**

King-Pin Rec. Pressing Co., 212 Roswell St., Marietta 30061 Tel: 428-5336 Pres. David E. Forrester, VP Shirley Queen, Prod Mgr. Michael Floyd

ILLINOIS

• **CHICAGO METROPOLITAN AREA (Area Code 312)**

Columbia Rec. Prod'ns, 630 N. McClurg Court Zip: 60611 Tel: 944-6000 Midwest Reg'l Sales Mgr. Dick Hutter (Sales office only) (Pressing only)
Plants: Santa Maria, Calif.; Terre Haute, Ind.; Pitman, N.J.
The Diskwerks, 1244 Remington Rd., Schaumburg 60195 Tel: 885-1330 WATS (800) 323-6260 Contacts: Michael Freeman, Ron Lewter

• **MASTERING**
• **RECORD PRESSING**
• **JACKET SERVICE**
QUALITY RECORD PRESSING AT REASONABLE COST
KING-PIN RECORD PRESSING CO.
212 ROSWELL STREET, BOX 606
MARIETTA, GEORGIA 30061
PH. 404-428-5336

The new generation of plating systems
for audio and video disks

Audio Matrix Mark II

(remote-controlled rectifiers)

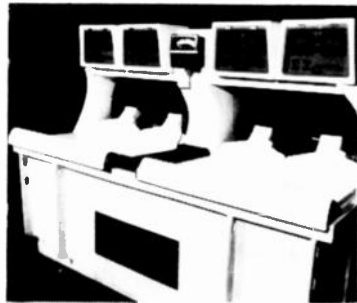

Available with 2, 4 or 8 positions

Audio Matrix AV

(all rectifiers and plating cells in one console)

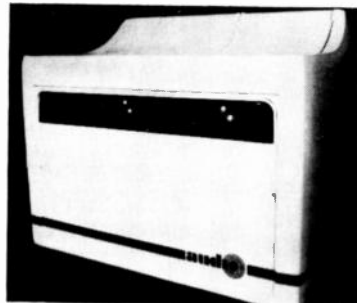

Available with 2, 4 or 6 positions

With these extraordinary features.

Complete automation includes raising and lowering of cathodes and tank covers. Operator puts matrix on, pushes "start," takes matrix off.

Built-to-last construction includes rugged, reliable all-new cathode head and drive mechanism.

Compact, integrated design makes assembly easy, operation trouble-free. System comprises two modules. One is entire filter, pump and heat exchanger mounted on molded fiberglass base. Two simple connections tie it to the plating module.

Excellent matrices have been and are being plated at 375 amperes.

Individual plating positions are separated by fiberglass dividers.

Programmable rectifiers provide sophisticated automatic plating cycle control.

Continuous monitoring of temperature, current and voltage is provided on digital LED displays.

Submicronic filter removes particles down to 0.2 microns.

Self cleaning tank requires no production down-time for plating cell cleaning.



370 Sagamore Avenue
Mineola, New York 11501
Telephone 516-747-4979
Telex 12-6419

**QUALITY
IS
IMPORTANT**



WAKEFIELD MFG. INC.
CUSTOM RECORD PRESSING
 P.O. BOX 6037/1745 W. LINDEN
 PHOENIX, AZ 85005
 (602) 252-5644

Kiderian Recs. Prod'ns, 4926 W. Gunnison St. Zip: 60630. Tel: 545-0861.
 Pres.: Raymond Peck, Gen. & Sales Mgr.: George Peck.
 Musical Prods. Inc., 521 W. 26 St. Zip: 60616. Tel: 225-9117.
 Sound Studios, 230 N. Michigan Ave. Zip: 60601. Tel: 236-4814. Pres.: Jerry
 Markham; VP & Gen. Mgr.: Dan Tynus. (Pressing only)
 Trackdown Rec. Dist. & Promo Co., 542 S. Dearborn, Suite 1102. Zip: 60605
 Nat'l Dir. & Bd. Chm.: Hank Williams; Pres.: T.J. Wocker; Adv. Mgr.: J.V.
 Seldon.

INDIANA

- **INDIANAPOLIS (Area Code 317)**
 R C A Recs, 6550 E. 30 St. Zip: 46219. Tel: 267-5000.
 Home office: New York, N.Y.
- **RICHMOND (Area Code 317)**
 P R C Rec'g Co. (div. of Richmond Rec'g Corp.), 1600 Rich Rd. Zip: 47374.
 Tel: 962-9511.
 Home office: New York, N.Y.

- **TERRE HAUTE (Area Code 812)**

Columbia Rec. Prod'ns, 1400 Fruitridge Ave. Zip: 47805. Tel: 466-8111. VP
 Mfg., Disk & Tape: Ken Lemry. (Pressing only)
 Sales offices: Century City (Los Angeles Metropolitan Area), Calif.; Chi-
 cago, Ill.; New York, N.Y.; Nashville, Tenn.

LOUISIANA

- **VILLE PLATTE (Area Code 318)**
 Ville Platte Rec. Mfg. Co., 120 E. Cypress St. Zip: 70586. Tel: 363-2104.
 Pres.: J. Floyd Soileau; Sales Mgr.: Ronnie Soileau.

MARYLAND

- **BALTIMORE AREA (Area Code 301)**
 The Record Factory, 10120 Marble Court, Cockeysville 21030. Tel: 628-
 2920. (Pressing only)

MICHIGAN

- **DETROIT (Area Code 313)**
 Archer Rec. Pressing Co., 7401 E. Dawson. Zip: 48212. Tel: 365-9545. Pres.:
 R.J. Archer; VP: J.M. Archer; Sec'y-Treas.: M. Archer.

MISSISSIPPI

- **JACKSON (Area Code 601)**
 Malaco Sound Rec'g (div. of Malaco Inc.), 3023 W. Northside Dr. Zip: 39213.
 Tel: 982-4522. (Pressing only)

MISSOURI

- **ST. LOUIS METROPOLITAN AREA
 (Area Code 314)**
 Technisonic Studios Inc., 1201 S. Brentwood Blvd. Zip: 63131. Tel: 727-
 1055. Pres.: Edward H. Canter.

NEW JERSEY

- **ANCORA (Area Code 609)**
 Presswell Recs. Mfg. Co., White Horse Pike & Ehrke Rd. Zip: 08037. Tel: 561-
 5250.
- **CRANBURY (Area Code 609)**
 Hub Servall Rec. Mfg. Corp., Cranbury Rd. Zip: 08512. Tel: 655-2166. Sales
 Mgr.: Barry Ruegg. (Pressing only)
- **ELIZABETH (Area Code 201)**
 Lened Int'l Corp., 489 Henry St. Zip: 07201. Tel: 354-5205. Telex: 138767
 Owners: Leonard Palmer, Joseph Flusteder. (SEE ADVERTISEMENT)
- **HAWORTH (Area Code 201)**
 Trutone Recs., 163 Terrace St. Zip: 07641. Tel: 385-0940.
- **MOUNTAINSIDE (Area Code 201)**
 Bestway Prods. Inc., 1105 Globe Ave. Zip: 07092. Tel: 232-8383. Pres.: How-
 ard Massler; Gen. Mgr.: Benjamin Williams; Prod'n Mgr.: Paul Stevens.
 (Pressing only) (SEE ADVERTISEMENT)
- **NEWARK (Area Code 201)**
 Dynamic LP Stereo Rec. Pressing Co. Inc., see Sun Plastics.
 Peter Pan Inds., 145 Komorn St. Zip: 07105. Tel: 344-4214. Pres.: Martin
 Kasen; Sr. VP: Donald Kasen; Nat'l Sales Mgr.: James Monaghan; Sales
 Admin'r: Dee Stempler. Local branch: 88 St. Francis St. Zip: 07105. Tel:
 344-4214. (Pressing only)
- **PARK RIDGE (Area Code 201)**
 Sun Plastics Co. Inc./Dynamic LP Stereo Rec. Pressing Co. Inc., 900 Passaic
 Ave. East Newark 07029. Tel: 482-6749; NYC (212) 349-0977. Pres.:
 Jerry Salerno; Sales Mgr.: Rocco Salerno. (SEE ADVERTISEMENT)
- **PITMAN (Area Code 609)**
 C B S Recs. Inc., Woodbury-Glassboro Rd. Zip: 08071. Tel: 589-8000. (Press-
 ing only).
 Sales offices: Century City (Los Angeles Metropolitan Area), Calif.; Chi-
 cago, Ill.; New York, N.Y.; Nashville, Tenn.
- **SOMERDALE (Area Code 609)**
 Superior Rec. Pressing Corp., 900 Kennedy Blvd. Zip: 08083. Tel: 784-6600.
 Tracy-Val Corp., Somerdale Ind'l Park, 201 Linden Ave. Zip: 08083. Tel: 627-
 3000. Pres.: James A. Miller. (Plating only) (SEE ADVERTISEMENT)

NEW MEXICO

- **ALBUQUERQUE (Area Code 505)**
 Bill Hunter's Rec'g Serv., 118 Alcazar NE. Zip: 87108. Tel: 268-8442. Gen.
 Mgr.: Bill Hunter. (Pressing only)

NEW YORK

- **CLARENCE (Area Code 716)**



The Nation's Largest "Under One
 Roof" Custom Record Manufacturer.

**So, you're
 looking for a
 record
 pressing
 company....**

(That will check your oil
 and clean your windshield)

When it comes to record
 manufacturing, "the full service"
 facility to consider is QCA Custom
 Pressing. QCA's professional service
 and quality workmanship are backed
 by 30 years of experience in the
 record industry.

Neumann mastering, plating, design
 services, color separations, printing,
 jacket fabrication and pressing.



2832 Spring Grove Ave.
 Cincinnati, Ohio 45225
 513-681-8400

Mark Custom Rec'g Serv., 10815 Bodine Rd. Zip 14031. Tel. 759-2600 Pres. & Sales Mgr. Vincelt S. Morette (Plating & processing only)

● **HAUPPAUGE (Area Code 516)**

Keel Mfg. (div. of Pickwick Int'l Inc.), 15 Gilpin Ave. Zip 11787. Tel. 234-0200. (Pressing only)

● **HOLBROOK (Area Code 516)**

Electrosound Group Inc., 725 Broadway Ave. Zip 11741. Tel. 567-3700 Corporate Pres. Richard H. Burkett; Pres. Rec. Pressing Div. Dick Meixner. Sales Mgr. (east) Ron Roberto. Local plant: Goldisc Rec'g Inc., Veterans Hwy & Broadway. Zip 11741. Tel. 589-0462. NYC (212) 895-6575 Pres. Richard Meixner. Sales Mgr. John Finnegan. Adv. Mgr. Rich Renda. Plants: Sun Valley (Los Angeles Metropolitan Area), Calif., Monarch Rec Mfg. Co., Shelbyville, Ind.; Allentown, Pa.; Allentown Rec. Co. Inc.

● **HOLTSVILLE (Area Code 516)**

Donora Mfg. Co. Inc., 658 Blue Point Rd. Zip 11742. Tel. 654-1110. NYC (212) 895-1955. Pres.: Ray Kessel

● **HUNTINGTON STATION (Area Code 516)**

Shelley Prods. Ltd., 220 Broadway. Zip 11746. Tel. 423-7090

● **NEWBURGH (Area Code 914)**

Larchwood Music Co. Inc., 639 Broadway. Zip 12550. Tel. 561-6888. Contact: Martin Gross. (Pressing only)

● **NEW YORK METROPOLITAN AREA (Area Code 212)**

Apexon Rec. Pressing, 44-27 Purves St., Long Island City 11101. Tel. 937-4038. Mgr. Darek Ropiak

Apon Rec. Co. Inc., PO Box 3082, Steinway Sta., 44-16 Broadway, Long Island City 11103. Tel. 721-5599. Pres. Andrew M. Poncic. Sales Mgr. Roman Krawciw. Adv. Mgr. Don Zemann (Pressing only)

Audio Matrix Inc., 915 Westchester Ave., Bronx 10459. Tel. 589-3500. Local sales office: 1290 Ave. of the Americas, Rm. 3737. Zip 10019. Tel. 247-8289. (Plating & processing only)

Columbia Rec. Prod'n's, 49 E. 52 St. Zip 10022. Tel. 975-4321. (Sales office only)

Plants: Santa Maria, Calif.; Terre Haute, Ind.; Pitman, N.J.; CBS Recs Inc.

Delta Rec'g Corp., 16 W. 46 St. Zip 10036. Tel. 840-1350. (Plating & processing only)

Disc Communications Ltd., 743 Fifth Ave. Zip 10023. Tel. 371-0390

E R H Sales Corp., 221 W. 57 St. Zip 10019. Tel. 582-4200. Pres. Lee Halpern. Gen. Mgr. Michael Halpern. Sales Mgr. Robert Shavelson (SEE ADVERTISEMENT)

Electrosound Group Inc., 1290 Ave. of the Americas. Zip 10019. Tel. 581-5641. (Sales office only)

Home office: Holbrook, N.Y.

Plants: Sun Valley (Los Angeles Metropolitan Area), Calif.; Monarch Rec Mfg. Co., Shelbyville, Ind.; Holbrook, N.Y.; Goldisc Rec'g Inc., Allentown, Pa.; Allentown Rec. Co. Inc.

Europadisk Ltd., 75 Varick St. Zip 10013. Tel. 226-4401. Cable EUROPA-DISK TWX (710) 581-2034. Pres. James P. Shelton VP. Christian S. Lach. Prod'n Mgr. (Ms) Pat Rosiello. (Audiophile Rec. Plating & Pressing)

Mastercraft Rec. Plating Inc., 609 W. 51 St. Zip 10019. Tel. 265-6040. (Plating & processing only)

P R C Rec'g Co. (div. of Richmond Rec'g Corp.), 1185 Ave. of the Americas. Zip 10036. Tel. 997-1250. Pres. Hugh Landy. VP & Sales Mgr. David Grant.

Plants: Compton (Los Angeles Metropolitan Area), Calif.; Richmond, Ind.

R C A Recs., 1133 Ave. of the Americas. Zip 10036. Tel. 930-4000. (Sales office only)

Sales offices: Los Angeles, Calif.; Nashville, Tenn.

Plant: Indianapolis, Ind.

R G H Rec. Mfg. Corp., 750 Eighth Ave. Zip 10036. Tel. 354-4336. (12" Pressing only) (SEE ADVERTISEMENT)

Romaba Rec. Pressing Corp., 33-34 St., Brooklyn 11232. Tel. 499-3060. Pres. Theodore Kolsky. (Standard & Picture Disk Pressing)

Sony Corp. of America, 9 W. 57 St. Zip 10019. Tel. 371-5800. Telex 0147212. 424595. Exec. VP. Ken Tamiya. (Manufacturing of Laser/Optical Videodisks only)

● **TROY (Area Code 518)**

Wildwood Entertainment, 276 Fourth St. Zip 12180. Tel. 273-7660. VP. Erich Borden. (Plating & Processing only)

● **UTICA (Area Code 315)**

Oneida Video Audio Tape Cassette Corp., 760 Blandina St. Zip 13501. Tel. 735-6187. Pres. Stanley Markowski. (Pressing only)

● **WYANDANCH (Area Code 516)**

P R I Rec. Pressing, 410 Long Island Ave. Zip 11798. Tel. 643-3353

OHIO

● **CINCINNATI (Area Code 513)**

Artists Rec'g & Rec. Pressing Co. Inc., 320 Mill St. Zip 45215. Tel. 761-0011

Counterpart Creative Studios Inc., 3744 Applegate Ave. Zip 45211. Tel. 661-8810. (Plating & processing only)

Q C A Custom Pressing, 2832 Spring Grove Ave. Zip 45225. Tel. 681-8400. Pres. Edward R. Bosken. VP & Sales Mgr. Keith Myers. Plant Mgr. Ken Martin. (SEE ADVERTISEMENT)

Rite Rec. Prod'n's Inc., 9745 Mangham Dr. Zip 45215. Tel. 733-5533. Owner Carl J. Burkhardt; Pres. Philip M. Burkhardt, VP. Prod'n. Lan A. Ackley. VP. Graphics. Kenneth D. Keith Jr. Sales Mgr. Dan Burton.

Studio Pressing Serv., 320 Mill St. Zip 45215. Tel. 761-8294. Pres. B. Hyrne. Sales Mgr. M. Tye

● **COLUMBUS (Area Code 614)**

Mus-I-Col Inc., 780 Oakland Park Ave. Zip 43224. Tel. 267-3133. Owners John W. Hull, Boyd P. Niederlander. (Pressing only)

PENNSYLVANIA

● **ALLENTOWN (Area Code 215)**

Allentown Rec. Co. Inc. (sub. of Electrosound Group Inc.), 1002-10 Walnut St. Zip 18102. Tel. 433-7405.

Home office: Holbrook, N.Y.; Electrosound Group Inc. Sales office: New York, N.Y.; Electrosound Group Inc.

● **MECHANICSBURG (Area Code 717)**

Baldwin Sound Prod'n's Inc., 5252 E. Trindle Rd. Zip 17055. Tel. 766-0787. (Pressing only) (SEE ADVERTISEMENT)

Billboard 1981-1982 International Buyer's Guide

● **PHILADELPHIA METROPOLITAN AREA (Area Code 215)**

Diskmakers Inc., 925 N. Third St. Zip 19123. Tel. 627-2277. NYC (212) 966-3185. Pres. Morris Ballen. VP. Larry Ballen. (Pressing only) (SEE ADVERTISEMENT)

Hodge Rec. Mfg. Co., 1314-24 S. Howard St. Zip 19147. Tel. 334-5662. (Pressing only)

Plastic Ent's. Corp., 1360 Industrial Hwy., Southampton 18966. Tel. 355-7555. Pres. Joe Stewart

Valley Exports Int'l Inc., PO Box 8, Merion Sta. Zip 19066. Tel. 473-0108. Contact: Larry Ballen. (Designer & builder of pressing plants)

● **SCRANTON AREA (Area Code 717)**

Specialty Recs. Corp., 210 N. Valley Ave. Olyphant 18447. Tel. 383-2471. TWX: (510) 671-4580. Pres. Richard C. Marquardt. VP. Sales: John R. Williams. (SEE ADVERTISEMENT)

PUERTO RICO

● **SAN JUAN (Area Code 809)**

Rio Piedras Recs. & Discos Borrinquen, GPO Box 4785. Zip 00936. Tel. 790-2188/2186/2142. Pres.: Dario Gonzalez. Gen. & Sales Mgr. Benito Valdes. (Pressing only)

TENNESSEE

● **MEMPHIS (Area Code 901)**

Plastic Prods. Co., 1746 Chelsea Ave. Zip 38108. Tel. 276-7160. (Pressing only)

● **NASHVILLE (Area Code 615)**

Chumley Prod'n's, PO Box 100823, 2802 Foster Ave. Zip 37210. Tel. 833-6184. Pres. P.E. Chumley.

Columbia Rec. Prod'n's, 34 Music Square E. Zip 37203. Tel. 259-4321. (Sales office only) (Pressing only)

Plants: Santa Maria, Calif.; Terre Haute, Ind.; Pitman, N.J.; CBS Recs Inc.

Dixie Rec. Pressing Inc., 631 Hamilton Ave. Zip 37203. Tel. 256-0922. (Pressing only)

M F P Inc., 453 Chestnut. Zip 37203. Tel. 259-9396. (Plating & processing only)

Nashville Album Prod'n's Inc., 1114 Gallatin Rd. N., Madison 37115. Tel. 883-2153. Pres.: Steve Botts. Art. Dir.: Gregg Spickard. (Pressing only) (SEE ADVERTISEMENT)

Nashville Phono Matrix Inc., 310 Chestnut St. Zip 37210. Tel. 244-2405. Pres. Betty J. Kemp. Gen. Mgr. Michael Kemp. Sales Mgr. Thomas E. Kemp. (Plating & processing only)

Nashville Rec. Prod'n's, 469 Chestnut St. Zip 37203. Tel. 259-4200. (SEE ADVERTISEMENT)

Precision Rec. Pressing Inc., 70 Visco Court. Zip 37210. Tel. 256-8978. VP. Ronnie Yearwood. (Pressing only)

R C A Recs., 30 Music Square W. Zip 37203. Tel. 244-9880. VP. Jerry Bradley.

Plant: Indianapolis, Ind.

Home office: New York, N.Y.

Sound of Nashville Inc., 305 11 Ave S. Zip 37203. Tel. 244-1124. Pres. John Ivanits. Sales Mgr. Allen Morel.

Southern American Rec. Pressing Co. Inc.—Tel. 256-2521—see Sound of Nashville.

Joe Talbot & Assocs., 2 Music Circle S. Zip 37203. Tel. 244-7954. (SEE ADVERTISEMENT)

United Rec. Pressing Inc., 453 Chestnut St. Zip 37203. Tel. 259-9396. (Pressing only)

TEXAS

● **AUSTIN (Area Code 512)**

M B A Prod'n's, 8914 Georgian Dr. Zip 78753. Tel. 836-3201/3194. Pres. Roy J. Montgomery Sr. VP. Shirley A. Montgomery

P S G Rec'g Studio, PO Box 1482, 4322A N. Lamar Blvd. Zip 78767. Tel. 454-5653. Pres. Pedro S. Gutierrez. (Pressing only)

● **DALLAS (Area Code 214)**

Rainbow Rec. Pressing, 2721 Irving Blvd. Zip 75207. Tel. 630-6401. VP. Phil Kalan. (Pressing only)

● **HOUSTON (Area Code 713)**

Houston Recs. Ltd., 3300 Jensen Dr. Zip 77026. Tel. 223-5961

● **SAN ANTONIO (Area Code 512)**

Joey Recs., 6703 W. Commerce. Zip 78227. Tel. (512) 432-7893. Texas Rec. Mfg. Inc., 1422 W. Poplar. Zip 78207. Tel. 733-6138. Pres. C. Foy Lee. Gen. Mgr. Jimmy Burton. Sales Mgr. Jeannie Hill.

● **SAN BENITO (Area Code 512)**

Rio Grande Music Co., 119 S. Sam Houston Blvd. Zip 78586. Tel. 399-5377. Sales Mgr. John F. Phillips. (Pressing only)

VIRGINIA

● **ALDIE (Area Code 703)**

Solar Sound Prod'n's (div. of VEE Corp.), Box 98. Zip 22001. Tel. 471-5359. Bus. Mgr. Frank Adair. (Pressing only)

WYOMING

● **CHEYENNE (Area Code 307)**

Rocky Mountain Rec'g, 8305 Christensen Rd. Zip 82001. Tel. 638-8733. Pres.: Ray Alexander. Sales & Adv. Mgr.: Georgia Alexander

RECORD PROMOTION
(including Public Relations & Publicity)

ARKANSAS

● **LITTLE ROCK (Area Code 501)**

Blaze Org. Ltd., Music Mktg. Div., 913 Bedford St. Zip 72202. Tel. 376-9379. Pres.: James E. Handy II. Exec. VP: Gregory L. Hardy. Branch: St. Louis, Mo.

Park on the roof



Since 1939

RAINBO RECORDS

1738 Berkeley Street
Santa Monica, California 90404
(213) 829-3476 TWX 910-343-7420
CUSTOM PRESSING
OUR 42nd YEAR IN THE MUSIC INDUSTRY

DAILY CAPACITY, 50,000 to 75,000—Any size—Any Color—Any Shape—Any Picture.

New quality process on Picture Records pressed on the finest AUDIOPHILE vinyl compound.

ASK ABOUT OUR SENSATIONALLY PRICED 7" PICTURE RECORDS.

RGH
Record Manufacturing Corp.

Audiophile Records Available

QUALITY IS OUR PRIME OBJECTIVE. IF IT'S YOURS, CALL US.

RGH
RECORD MANUFACTURING CORP.
A FULL SERVICE COMPANY

Cutting, Plating, Labels, Jackets...

750 Eighth Ave., New York, N.Y. 10036 • (212) 354-4336

QSP:NAP

Quality, Service, Price...the three reasons to call us first for custom products like:

- | | | |
|-------------|-----------|-----------------------|
| Mastering | Albums | Jackets |
| Pressing | Singles | Printed Sleeves |
| Printing | 8-Tracks | Labels |
| Fabrication | Cassettes | Posters |
| | | In-House Art & Design |

High quality and fast service at reasonable prices—who could ask for more? Many of our customers do... and we deliver!



NASHVILLE ALBUM PRODUCTIONS, INC.

1114 GALLATIN RD. N.
MADISON, TN 37115
(615) 883-2153/2154

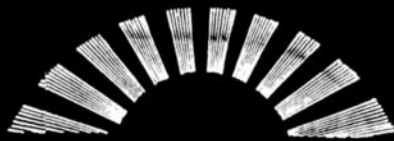

Sun Plastics Company, Inc.
Dynamic L.P. Record Pressing Co., Inc.

900 Passaic Avenue East Newark, N.J. 07029

Phones: N.J. 201-482-6749

N.Y. 212-349-0977

35 YEARS OF SERVICE TO THE RECORD INDUSTRY

Record Pressing

15 YEARS Service & Quality

- * ALBUM JACKETS
- * LABELS
- * INSERT SLEEVES
- * 8 TRACK TAPES
- * CASSETTE TAPES
- * FAST DELIVERY

Baldwin Sound Productions, Inc.
5252 E. Trindle Road
P.O. Box 1152
Mechanicsburg, PA 17055
(717) 766-0787

10,000 SQ. FT.
Manufacturing Space

IT'S FANTASTIC!

You spent a fortune getting the right sound. Make sure it gets on record. You deserve the best quality pressing available and intend to get it. Sounds easy. But it's not. Why? Because all records are "Pressed" or molded from metal stampers. These stampers contain the fortune you just spent getting "The Sound." If these stampers fall short in quality, there can be no quality records pressed. Get the picture! Don't take chances with your product! To get quality records, you've got to get the best stampers available and we think we make the best, but you be the judge.

We think our Record Presses and Extruders are also the best. Ask around.

RECORD PLATING - RECORD PRESSES - HORIZONTAL AND VERTICAL EXTRUDERS

Manufacturing for the Phonograph Record Industry

TRACY-VAL CORPORATION
GENTRY MACHINE CORP. Somerdale Industrial Park
201 Linden Avenue • Somerdale, N.J. 08083 • Code (609) 627-3000

CALIFORNIA

• ANAHEIM (Area Code 714)

50 State Dist'g Co. Inc., 1174 Knollwood Circle Zip 91019 Tel 761-8051
Home office: Las Vegas, Nev.

• LOS ANGELES METROPOLITAN AREA (Area Code 213)

Alite Recs. (div of Sound Syndicate), 7769 Melrose Ave. Zip 90046 Tel 653-4818. Pres. Al Durand, Sales Mgr. Dick Gordon, Adv Mgr. Donna Durand

Aishire Int'l Inc., 1015 Isabel St., Burbank 91510 Tel 849-4671 WATS (800) 423-2936. Cable: BUD SOUND TWX: (910) 498-2759. Pres. Al Sherman, Gen. Mgr.: Dick Ceja

Apple Juice Prod'ns, 6381 Hollywood Blvd., Suite 604, Hollywood 90028 Tel 464-2482

Art Benson Promos /Creative Minds, 1560 N. La Brea, Suite M, Hollywood 90028. Pres. Arthur H. Benson, Sales Mgr. Howard Wormser.

Fred Benson Promo., PO Box 14856, Long Beach 90803 Tel 433-5735, 463-9311. Pres. Fred Benson

Bly/Hakim Org., 12457 Ventura Blvd., Studio City 91604. Tel 760-0280

Contacts Stan Bly, Jack Hakim

Carman Prod'ns, 15456 Cabrito Rd., Van Nuys 91406 Tel 873-7370. Pres. T.R. Skeeter, Mgr. J. Eddy, Sales Mgr. W. Trowbridge

Larry Cohen Mktg. Inc., 6671 Sunset Blvd. Zip 90028 Tel 466-6484. Creative Minds Inc., see Art Benson.

Endless Music Promos, 12854 Landale St., Studio City 91604 Tel (213) 760-1979. Pres. Rusty Garner.

The Entertainment Group, 1626 N. Wilcox, No. 704, Zip 90028 Tel 467-5689. Chief Execs: Thad Anders, Dean Cloud. (Public Relations)

Lu Fields Promos Inc., PO Box 4200, Hollywood 90028. Tel 469-7101

Owner & Pres. Lu Fields; Gen. Mgr. Vicki Rappee

Oon Graham Promos. Ltd., 6255 Sunset Blvd., Suite 1911, Hollywood 90028 Tel 461-3686. Pres. Oon Graham.

Hinton & Svendsen Promos, 6255 Sunset Blvd., Suite 603, Hollywood 90028. Tel 462-6808. Contacts: Bruce Hinton, Peter Svendsen.

Branch: Cleburne, Tex.

Image Mktg & Media, 6525 Sunset Blvd., Suite 8, Hollywood 90028 Tel 464-8341. Co-Pres. Leanne Meyers, Shelly Heber.

Kosh & Co., 1584 Crossroads of the World, Hollywood 90028 Tel 466-9755

Lancelot Promos., 1240 N. Flores, West Hollywood 90048 Tel 650-0017

Ray Lawrence Ltd., PO Box 1987, Studio City 91604. Tel 552-1000

Levinson Assocs Inc., 927 N. La Oenega Blvd. Zip 90069. Tel 657-8800. Pres. Bob Levinson

Branch: New York, N.Y.

Mahoney/Wasserman & Assocs Inc., 117 N. Robertson Blvd. Zip 90025 Tel 550-3922. Pres. Jim Mahoney, VP Paul Wasserman (Public Relations)

Branch: New York, N.Y.

Musicsearch, 9000 Cynthia St., Suite 205 Zip 90069 Tel 275-4790 VP

Admin.: Robert Greenfield, VP Creative Servs. Topper Schroeder

Parallel Promos, 6253 Hollywood Blvd., Suite 612, Hollywood 90028. Tel 463-9500

Tony Richland Promo., 1680 N. Vine St., Hollywood 90028. Tel 467-2151

Pres. Tony Richland, VP Tom Richland; Sales Mgr. Jo-Jo Richland; Adv. Mgr.: Lizzie Richland

Solters/Roshin/Friedman Inc., 9255 Sunset Blvd. Zip 90069. Tel 278-5692

Home office: New York, N.Y.

Stardust Prod'ns, 8033 Sunset Blvd. Zip 90046 Tel 874-2617. Pres. Philip

Cutler

Surf City Recs., PO Box 14, Hollywood 90028 Tel 349-9099. Pres.: Gary M

Theroux. Admin. Ass't Russell Bidwell; Sales Mgr. Mark Charger; Adv

Mgr.: Peter Roberts

Tar Prod'n Co. Inc., 12029 Ventura Blvd., Studio City 91604. Tel: 985-3560

Nick Thery Rec. Promo., 3008 Belden Or. Zip 90068. Tel 469-2719. Pres.

Nick Thery

3 J Recs. (div. of Mende Music), PO Box 2776, Long Beach 90801. Tel 867-9964. Contact: J.O. Mendenhall

Whittlemore Corp., 21608 Arcos Or., Woodland Hills 91364. Tel 657-2327

Pres.: Oon Whittlemore

Norman Winter & Assocs., 6255 Sunset Blvd., Suite 714, Hollywood 90028 Tel: 462-7453. Pres. Norman Winter (Public Relations & Publicity)

• SAN FRANCISCO & BAY AREA (Area Code 415)

Ken Baker Publicity Servs., 4034 20 St. Zip 94114 Tel: 864-2333. (Public Relations)

Augie Blume & Assocs., PO Box 190, San Anselmo 94960. Tel: 457-0215

Pres. August G. Blume. VP Nancy O. Blume, Northern Calif. Promo

Mgr.: John Tobin

Fred Foxx Music Co., 406 Kehoe Ave., Half Moon Bay 94019. Tel 726-3725

Gen. Mgr. F.H. Nesbitt Jr., Sales Mgr.: V.A. Nesbitt

Cathy Furniss & Assocs., 680 Beach St., Suite 445. Zip 94109. Tel: 885-2807. Pres. Cathy Furniss; Adv. Mgr. Isabelle Aggson.

Sylvia White, 2383 Union St., No. 4, Zip 94123 Tel 567-6935.

• SANTA ROSA (Area Code 707)

Making Tracks Promos., 5170 Pressley Rd. Zip 95404 Tel 585-2105. Principals: Eddie Humber, Dede Whiteside (ADR only)

COLORADO

• BOULDER (Area Code 303)

Video/Audio Artistry Corp. (Vidaac Ltd.), PO Box 4571, 1258 Bear Mountain Court, Zip 80302. Tel 499-2001.

CONNECTICUT

• GEORGETOWN (Area Code 203)

Broadway Baby Recs., PO Box 496. Zip: 06829. Tel: 544-8288. Gen. Mgr.: Bruce Yeko; Mgr. Doris Chu Yeko

Affiliated company: Englewood Cliffs, N.J., Broadway/Hollywood Prod'ns

• GREENWICH (Area Code 203)

Hallah Communications (Halcom), 35 Greenwich Hills Dr. Zip 06830. Pres. Gene Hallahan.

• WILTON (Area Code 203)

Paradiso Inc., PO Box X. Zip: 06897. Tel: 762-5188. Cable: INTERPARADISO. Telex: 965940. Pres.: L. von Kleydorff, Gen. Mgr.: Iris A. Thomas

DISTRICT OF COLUMBIA

• WASHINGTON (Area Code 202)

Carwar Rec. Promo. Inc. (sub of Carwar Co. Corp.), 1527 14 St. NW. Zip

2005. Tel: 265-2407. Pres. C.A. Warren; VP: Charles H. Montague. Dir & Gen. Mgr. Angie Bell.
Solar Sound Prod'ns, see listing under Aldie, Virginia.

FLORIDA

• **MIAMI METROPOLITAN AREA (Area Code 305)**

Edkie Lambert, 985 NE 149 St. Zip: 33161. Tel: 947-8140.
MusicBank, PO Box 016722. Zip: 33101. Tel: 445-0382. Promo Mgr. A. Aras.

• **TAMPA-ST. PETERSBURG AREA (Area Code 813)**

Mike Douglas & Assocs., 333-31 St. N., Suite 20, St. Petersburg 33713. Tel: 896-5151. Pres.: Mike Douglas.
Suncoast Promos, 411 Belle Isle Ave., Belleaire Beach 33535. Tel: 596-3603, 595-7144. Contacts: Perry Stevens, Neil McIntyre

GEORGIA

• **ATLANTA (Area Code 404)**

Atterram Prod'ns Inc., 212 Roswell Rd. NE, Marietta 30305. Tel: 428-5336
C D E Promos, PO Box 41551. Zip: 30331. Tel: 231-9290. Pres. Charles Edwards.
Duplex Rec. Dist. & Rec. Promos, 699 McDaniel St. Zip: 30341. Tel: 523-4261.
Stan Green & Assocs., 110 Spring St. Zip: 30303. Tel: 233-1333. Pres. Stan Green, Gen. Mgr.: Keith Winslow; Sales Mgr.: Roger Harris.
Nationwide Music-Rec. Inds., PO Box 41551. Zip: 30331. Pres. Charles Edwards.
Wade Pepper Promos., 1195 Mount Paran Rd. NW. Zip: 30327. Tel: 233-5167.
Pro-Talent Consultants, PO Box 29543. Zip: 30359. Tel: 424-1684. Co-ord.: J. Richard Eckert; Prod. Mgr.: Glen Elliott.
Startown Ent's. of Atlanta, 699 McDaniel St. SW. Zip: 30310. Tel: 523-4261/1113. VP: Alex Williams.
Home office: Columbus, Miss.

HAWAII

• **HONOLULU (Area Code 808)**

Gabco of Hawaii, PO Box 27371. Zip: 96827. Tel: 524-3455. Cable: BEZOLD
Telex: 633103. Chm.: Philip C.M. Seow; Mgr.: Leilani Frank.
Home office: Singapore.

ILLINOIS

• **CHICAGO METROPOLITAN AREA (Area code 312)**

Advertising Unlimited, PO Box 8135. Zip: 60680. Tel: 787-8220. Pres. R.C. Haisman; Sales Mgr.: Frank Howard Jr.; Adv. Mgr.: Howard Pittman.
Howard Bedno & Assocs. Inc., 549 W. Fullerton Pkwy. Zip: 60614. Tel: 883-0100. Pres.: Howard Bedno; Promo: Cy Gold; Adv. Mgr.: Peter Wright.
Chicago Ink, 520 N. Michigan Ave., No. 610. Zip: 60611. Tel: 661-1616

(Rec. Promo & Public Relations)
M. M. Cole Publg Co., Playboy Bldg., Suite 1602, 919 N. Michigan Ave. Zip: 60611. Tel: 787-0804. Cable: MCMCOLE. Pres.: Shepard Stern; Sales Mgr.: J.C. Cole; Adv. Mgr.: Mike Stern.
Paul Gallis, 1801 Cree Ln., Mount Prospect 60056. Tel: 827-6414.
Tony Gideon Promos., PO Box 21413, 7150 S. Yates Blvd. Zip: 60649. Tel: 643-4117.
Kiderian Recs. Prod'ns, 4926 W. Gunnison St. Zip: 60630. Tel: 545-0861.
Pres. Raymond Peck; Gen. & Sales Mgr.: George Peck.
Musical Prods. Inc., 521 W. 26 St. Zip: 60616. Tel: 225-9117.
National Radiophone, PO Box 235, Highland Park 60035. Tel: 432-0116.
Pres.: David J. Dahl.
Planet Communications (div. of Clay Pigeon Int'l), PO Box 20346. Zip: 60620. Tel: 778-8760. Pres. & Sales Mgr.: Vytautas Beleska; Sales Mgr.: Rudy Markus; Special Projects Mgr.: D. Jaras.
Rainbow Bridge Studios Inc., 117 Rockland Rd., Libertyville 60048. Tel: 362-4060. Studio Mgr.: Ron Schwartz.
Trackdown Rec. Dist. & Promo Co., 542 S. Dearborn, Suite 1102. Zip: 60605.
Nat'l Dir. & Bd. Chm.: Hank Williams; Pres.: T.J. Wocker; Adv. Mgr.: J.V. Seldon.
• **COLLINSVILLE (Area Code 618)**
Mar-Kay Rec. Co., 1 Scotch Pine Dr. Zip: 62234. Tel: 344-4443. Pres. Hubert Joyce; VP & Sales Mgr.: Ron Allen; Gen. Mgr.: Phyllis Neely.
• **ROBINSON (Area Code 618)**
Ron Wheeler Ent's., 202 W. Plum. Zip: 62454. Tel: 544-7898. Pres. Ronald E. Wheeler.

INDIANA

• **INDIANAPOLIS (Area Code 317)**

Bowers Rec. Sleeve Co., 5331 N. Tacoma Ave. Zip: 46220. Tel: 251-3918.
Pres.: James E. Bowers; VP: Thomas R. Bowers

• **SOUTH BEND (Area Code 219)**

Disco Party Prod'ns Inc., PO Box 905. Zip: 46624. Tel: 234-9104. Owner & Sales Mgr.: Jim Van Zant; Adv. Mgr.: Drew Leach

IOWA

• **CARLISLE (Area Code 515)**

Iowa Sound Promos. & Advertising (div. of Harold Luch & Assocs.), 110 Garfield St. Zip: 50047. Tel: 989-3679. Contact: Harold L. Luch.

• **DAVENPORT (Area Code 319)**

Top Sound Promos., PO Box 3013. Zip: 52808. Contact: Gary Unger

• **OTTUMWA (Area Code 515)**

Operation Music Ent's., 233 W. Woodland Ave. Zip: 52501. Tel: 682-8283.
Pres.: Nada C. Jones.

KANSAS

• **KANSAS CITY AREA (Area Code 913)**

Dave Krieger Ent's. Ltd., 8813 W. 55 Terr., Merriam 66202. Promoter: Dave Krieger. (Airplay only)

DISKMAKERS

DOES IT ALL!
10" Records/12" Records/45's/Cassettes/8Tracks
Diskmakers since 1946. Send for our free price list
925 N. 3rd St., Philadelphia, Pa. 19123
212-966-3185 and 215-627-2277

The Bestway Group



- BESTWAY PRODUCTS, INC.**
Custom Pressing Division/Custom Injection Molders Division

- RANDEE INTERNATIONAL PRODUCTIONS, INC.**
Peerless Audiophile Record Division

- SERVOR CORP.**
Custom Warehousing

- AA./WONDERLAND & MERRY**
Children's Records & Tapes

- RANDEE CAPITAL CO.**
Quality Industrial Real Estate

1105 Globe Avenue, Mountainside, New Jersey 07092
NJ (201) 232-8383 • NY (212) 349-3668

Mutual Mgmt Assocs. PO Box 3247, Shawnee 66203. Tel 631-6060.

KENTUCKY

- **LEXINGTON (Area Code 606)**
Joe Middleton, 2212 Clays Mill Rd. Zip: 40503. Tel: 278-4194

LOUISIANA

- **BATON ROUGE (Area Code 504)**
Record Co. of the South (RCS), 5220 Essen Ln. Zip: 70808. Tel: 766-3233
Pres. Cyril E. Vetter; Gen. Mgr. John Fred; Sales Mgr. Ronnie Schaab.
Art Dir. Ed Lakin
- **NEW ORLEANS (Area Code 504)**
Sapphire Promos, 2815 Octavia St. Zip: 70115. Tel: 340-4068. Pres. Lou Welsh. Prom'l Dir. Sandy Terry.
- Sunset Rec. Promos, 3512 Purdue Dr., Metairie 70003. Tel: 887-5677. Dir. Christi Klein.
- **SHREVEPORT (Area Code 318)**
Stan's Rec. Dist., 728 Texas St. Zip: 71102. Tel: 222-7182. Pres. Stanley J. Lewis. VP & Sales Mgr. Ronnie Lewis, Adv. Mgr. Ann Mims.

MARYLAND

- **KENSINGTON (Area Code 301)**
Omega Rec'g Servs., 10518 Connecticut Ave. Zip: 20795. Tel: 946-4686
Owner & Chief Eng. W. Robert Yesbek.

MASSACHUSETTS

- **BOSTON METROPOLITAN AREA (Area Code 617)**
Fleetwood Communications, 321 Revere St., Revere 02151. Tel: 289-6800.
Pres. Vincent Giarrusso, Gen. Mgr. & Treas. Faymond G. Samora, Sales Mgr. Victor Mancini; Adv. Mgr. Robn Samora
- Ed Hurwitz Music Promos., 129 Bishop St., Brockton 02402. Tel: 588-6348.
Pres. & Adv. Mgr. Edward M. Hurwitz, Sales Mgr. Linda Berman
- Charles Martignette Mgmt., PO Box 9295, Zip: 02114. Tel: 734-5400. Pres. Charles Martignette Jr., Adv. Mgr. Dudley Wmchester.
- Rik Tinory Prods Inc., 180 Pond St., Cohasset 02025. Tel: 383-9494. Pres. Richard F. Tinory, Artist Relations: Claire L. Eabcock.
- **BROCKTON (Area Code 617)**
Park Ave. Prod'ns, 180 Highland St., Suite 25. Zip: 02401. Tel: 588-2235
Exec. Dir. Richard Perer Jr.
Home office: Eastchester, N.Y.
- **LAWRENCE (Area Code 617)**
N.E.R.T. (New England Rec. & Tape) (div. of PBN Survey), PO Box 268, Zip: 01842. 641 Haverhill St. Zip: 01841. Tel: (617) 686-4293. Pres. Jerry P. Marcus, VP Int'l Sales: P.H. Kankey, Gen. Mgr.: Melvin L. Marcus, Sales Mgr.: B.J. Kankey.

MICHIGAN

- **DETROIT METROPOLITAN AREA (Area Code 313)**
Leo Cheslak, 25315 Lyndon Ave., Redford Township 48239. Tel: 548-3171
Pres. Leo Cheslak
- Graphic Design Inc., 23800 Amber, Warren 48089. Tel: 758-0480.
- R.M.S. Triad Prod'ns, 30125 John R., Madison Heights 48071. Tel: 585-8887.
- Saul Star Promos. Unlimited, 6940 Carriage Hills Dr., Plymouth 48170. Tel: 525-7600. Pres. Saul Star
- Kelvyn Ventour Promos. Inc., 14234 Grandmont, Zip: 48227. Tel: 493-0210
Pres. Kelvyn Ventour

MINNESOTA

- **MINNEAPOLIS METROPOLITAN AREA (Area Code 612)**
A.S.I. (Audiotele Systems Inc.) Recs., 711 W. Broadway, Zip: 55411. Tel: 521-7631. Pres. Dan R. Holmes, Sales Mgr. Wes Hayne, Adv. Mgr. Sandra Milan
- Discover Division Inc., 5198 W. 76 St. Zip: 55435. Tel: 831-5338. Pres. Paul W. Smith, VP. Les Boelter
- Doug Lee Midwest Promo. Inc., 810 First St. S., No. 210, Hopkins 55343. Tel: 938-7020. Owner. Doug Lee.
- Edwin Neuger & Assocs. Inc., 800 Baker Bldg. Zip: 55402. Tel: 335-6621
Pres. Edwin Neuger
- Streetside Mktg. & Promo., 240 Water St., Excelsior 55331. Tel: 474-8415
Pres. Douglas Ackerman

MISSISSIPPI

- **COLUMBUS (Area Code 601)**
Startown Recs., 1130 Airbase Rd. Zip: 39701. Tel: 434-8510. Pres.: Allen

White, Gen. Mgr. Annie Mae White; Sales Mgr. Aldean Clemons.
Branches: Atlanta, Ga., Memphis, Tenn.

MISSOURI

- **ST. LOUIS (Area Code 314)**
Blaze Org. Ltd., Music Mktg. Div. PO Box 5009, Zip: 63115. Tel: 383-8069
Reg'l Mktg. Mgr. Christopher Merrweather.
Home office: Little Rock, Ark.

NEVADA

- **CARSON CITY (Area Code 702)**
Gopher Prods. Corp., PO Box 1812, 2201 Lockheed Way, Zip: 89701. Tel: 882-9333. WATS (800) 648-0958. Pres.: Warren Perkins. (SEE ADVERTISEMENT)

- **LAS VEGAS (Area Code 702)**
50 State Dist'g Co. Inc., 3052 S. Highland, Zip: 89109. Tel: 732-0333
Branch: Dallas, Tex.
Int'l branch: Canada, 7 Province Dist'g

NEW JERSEY

- **CHERRY HILL (Area Code 609)**
Fred DiSipio Assocs., 1101 King's Hwy. N., Suite 107, Zip: 08034. Tel: 482-2183, 424-3633
- **EAST ORANGE (Area Code 201)**
E-MC Rhythm Ltd. Inc., PO Box 369, 56 S. Munn Ave., No. 4-K, Zip: 07018. Tel: 676-1375, 673-5632. Pres.: Eric R. McPherson Jr.
- **ENGLEWOOD CLIFFS (Area Code 201)**
Broadway/Hollywood Prod'ns, Box 1314, Zip: 07632. Tel: 224-5811 (Tues & Fri), 567-5524 (Messages)
Affiliated company: Georgetown, Conn., Broadway Baby Recs.
- **FAIRVIEW (Area Code 201)**
Platinum Promos. Inc., PO Box 276, Zip: 07022. Tel: 943-6438. Pres. Jerry Lembo
- **FARMINGDALE (Area Code 201)**
Charlie Roberts Advertising & Promo. Inc., Vat 69, Zip: 07727. Tel: 938-4351.
Pres. Robert Schumann; Gen. Mgr. Charlie Roberts, Sales Mgr.: Linda Chiaromonte.
- **GLENDORA (Area Code 609)**
Record Room, 308 E. Evesham Rd. Zip: 08029. Tel: 939-0034
- **MONTCLAIR (Area Code 201)**
Linear Sound Rec'g, 211 Glenridge Ave. Zip: 07042. Tel: 744-0686. Pres. M. Kroll, Sales Mgr.: J. Steinmann
- **NEWARK (Area Code 201)**
Sterling Title Strip Co. Inc., 1175 Broad St. Zip: 07114. Tel: 243-0222. Pres. Dick Steinberg, Sales Mgr.: William Thomas
- **NEW MILFORD (Area Code 201)**
Sol Abrams Assocs. Inc., 331 Webster Dr. Zip: 07646. Tel: 262-4111. Pres. Sol Abrams. (Publicity, Public Relations)
- **PENNSAUKEN (Area Code 609)**
Rand El Advertising, 7249-A Browning Rd. Zip: 08109. Tel: 665-8611.

NEW MEXICO

- **ALBUQUERQUE (Area Code 505)**
Bill Hunter's Rec'g Serv., 118 Alcazar NE, Zip: 87108. Tel: 268-8442. Gen. Mgr.: Bill Hunter
- **BELEN (Area Code 505)**
Little Richie Johnson Agency, 610 Oates Ave. Zip: 87002. Tel: 864-7441.
Pres.: Little Richie Johnson.

NEW YORK

- **AROSLEY (Area Code 914)**
Blue Chek Music Inc., PO Box 74, Zip: 10502. Tel: 592-3479.
- **BINGHAMTON (Area Code 607)**
American Renaissance Music Int'l Consultants (ARM), PO Box 1124, Zip: 13902. Tel: 754-5748. Pres.: A.R. Moss
- **BUFFALO (Area Code 716)**
Top of the World Recs., 290 Main St., Suite 900, Zip: 14202. Tel: 856-4162.
Contact: Dean Brownrout. (Rec. Promo, Public Relations)
- **CLARENCE (Area Code 716)**
Mark Custom Rec'g Inc., 10815 Bodine Rd. Zip: 14031. Tel: 759-2600. Pres. & Sales Mgr.: Vincent S. Morette.

- **EASTCHESTER (Area Code 914)**

Park Ave. Prod'ns, 72 Tuckahoe Ave. Zip: 10707
Branch: Brockton, Mass.

- **LARCHMONT (Area Code 914)**

Tea Pot Prod'ns, 1416 Boston Post Rd. Zip: 10538. Tel: 834-2145. Pres. Kal Fagan.

- **LE ROY (Area Code 716)**

Arlo Recs. Inc., 7635 Telephone Rd. Zip: 14482. Tel: 584-3040. Pres.: Kenneth Bearce; Gen. Mgr. James Bearce, Sales Mgr. Jill Welzel

- **MELVILLE (Area Code 516)**

Sound by Blachly, 69 Old East Neck Rd. Zip: 11747. Tel: 673-0330. Contact: Bill Blachly

- **NEW ROCHELLE (Area Code 914)**

Westchester Int'l Prod'ns Inc., 41 Rosedale Ave. Zip: 10801. Tel: 664-3099
NYC (212) 724-2800. Pres. Jon H. Starke; Gen. Mgr.: William Starke; Sales Mgr.: Gloria Finigan.

- **NEW YORK METROPOLITAN AREA (Area Code 212)**

- Sol Abrams Assoc. Inc., see listing under New Milford, N.J.
A. O. Adams Advertising Inc., 145 E. 52 St., Zip: 10022. Tel: 755-0845. Pres.: A.D. Adams
Branch: Woodbury, N.Y.
- Apon Rec. Co. Inc., PO Box 3082, Steinway Sta., 44 16 Broadway, Long Island City 11103. Tel: 721-5599. Pres. Andrew M. Poncic, Sales Mgr.: Roman Krawcow, Adv. Mgr. Don Zemann (Classical music only)
- Atwater Press Litho Corp., 207 W. 25 St., Zip: 10001. Tel: 675-2710
- B.B. Publicity, 3025 Ocean Ave., Brooklyn 11235. Tel: 646-0352. Pres. Bob Bank; Sales Mgr.: Ellen Lerner; Promo Dir. Ron Michaels
Int'l branch: Canada.
- James Bell Graphic Design Inc., 119 W. 23 St., Zip: 10011. Tel: 929-8855.
Pres. James Bell. VP: S. Campbell, Sales Mgr.: Jane Sapiro
- J. Bingo Prod'ns Inc., 1456 Ohm Ave., Bronx 10465. Tel: 829-9117. Pres. Joe Bingo
- Bert Bogash & Assocs., 322 W. 57 St., Zip: 10019. Tel: 397-0989. (Public Relations & Marketing)
- Paul Brown, 36-10 47 Ave., Long Island City 11101. Tel: 392-5100. (College only)
- Budd Prod'ns, 157 W. 57 St., Zip: 10019. Tel: 247-4896. Pres.: Budd Hellawell. (Public Relations & Rec. Promo.)
- Lee Canaan Assoc. Ltd., 51 E. 42 St., Zip: 10017. Tel: 682-4155. Pres. Lee Canaan, Promo Dir. Ruth Schechter. (Public Relations)
- Contact Publicity, 1904 Glenwood Rd., Brooklyn 11230. Tel: 434-6301/8881. Pres. Jo Ann Abrams
- Copy Art Photographers (div. of James J. Kriegsmann Inc.), 165 W. 46 St., Zip: 10036. Tel: 757-0233.
- D.I.S. Co., 1641 Third Ave., Suite 10-H, Zip: 10028. Tel: 860-4895. Pres. Thomas Silverman. (Public Relations & Publicity)
- Disc Communications Ltd., 743 Fifth Ave., Zip: 10023. Tel: 371-0390.
- Morninglight Prod'ns, 145 E. 52 St., Rm. 403, Zip: 10022. Tel: 751-2031.
Pres. & Art Dir. Spencer Orate.
- Juggy Gayles Inc., 67-45 E. 190 Ln., Fresh Meadows 11365. Tel: 454-6593.
Pres. Juggy Gayles
- Richard Gersh Assocs. Inc., 200 W. 57 St., Zip: 10019. Tel: 757-1101. (Public Relations)
- Glenn Prod'ns & Promos., 157 W. 57 St., Zip: 10019. Tel: 265-6585. Pres. Ben Arrigo
- Great American Screen Designs, 230 Fifth Ave., Zip: 10001. Tel: 683-4077
- Ren Grevalt Ltd., 200 W. 57 St., Suite 907, Zip: 10019. Tel: 582-0252. Pres. Ren Grevalt
- Bernie Ilson Inc., 65 W. 55 St., Zip: 10019. Tel: 245-7950
- Image Creators Inc., 310 E. 65 St., Zip: 10021. Tel: 535-0257
- Ketchum MacLeod & Grove Public Relations, 90 Park Ave., Zip: 10016. Tel: 983-8000. Cable: KETCHUMADS. VP & Dir.: Lou Capozzi; Entertainment Div. Acct. Supervisor: Len Saldor. (Public Relations)
- Steven Leeds Promos., 130 W. 57 St., Suite 12B, Zip: 10019. Tel: 765-8553
- Levinson Assocs. Inc., 10 W. 66 St., Suite 126, Zip: 10023. Tel: 595-3336.
Home office: Los Angeles, Calif.
- Mahoney/Masserman & Assocs. Inc., 110 E. 59 St., Zip: 10022. Tel: 751-2060. VP: Larry Eisenberg. (Public Relations)
Home office: Los Angeles, Calif.
- Music Resources Int'l Corp., 110 W. 34 St., Suite 806, Zip: 10001. Tel: 947-2066
- Nostalga Lane Inc., 200 W. 57 St., Zip: 10019. Tel: 582-5390
- Nouveau Monde Promos., see Record Logic
- Myrna Post Assocs., 145 E. 49 St., Zip: 10017. Tel: 935-7122
- Daniel H. Price Inc., 15 E. 48 St., Zip: 10017. Tel: 755-1982. Acct. Exec.: Mitchell Price
- Programming Aids For Progressive Radio, 80 24 25 St., Floral Park 11004. Tel: 347-1208. Pres. Jay Rosen. Adv. Mgr.: Jim Cohn
- Promedeus Arts Inc., 1776 Broadway, Zip: 10019. Tel: 586-3770. Pres. Lew Morris; Sales Mgr.: Jerry Present, Adv. Mgr.: Ron Paris
- Rave, 134 E. 70 St., Zip: 10021. Tel: 734-4000. (Demo Placement) (SEE ADVERTISEMENT)
- Record Logic Corp./Nouveau Monde Promos., 1500 Broadway, Zip: 10036. Tel: 398-0511
- Rockbill Inc., 130 W. 57 St., Zip: 10019. Tel: 977-9680. Pres. Jay I. Coleman; Talent Coord.: Janet Fialkoff
- Richard H. Hoffman Assocs., 697 West End Ave., Zip: 10025. Tel: 749-3647
Bd. Chm. Richard Hoffman; Gen. Mgr. John Bowman, Sales Mgr.: Malvina Cohn, Ass't Sales Mgr.: Louise Sanders
- Roman & Smith Assocs., 401 E. 89 St., Zip: 10028. Tel: 348-2852. Contacts: Johanna Roman, Roscoe Smith
- Jasper Samuel Advertising & Recs. Inc., 60 E. 42 St., Suite 541, Zip: 10017. Tel: 490-2787. Pres. Jasper Samuel
- Janis Schacht Public Relations, Little Theater, 240 W. 44 St., Zip: 10036. Tel: 869-3459. (SEE ADVERTISEMENT)
- Howard Sherman Public Relations, 682 Broadway, Zip: 10012. Tel: 777-4711. Pres. Howard Sherman. (Publicity)
- Billy Smith Public Relations, PO Box 130, Zip: 10024. Tel: 787-8111. Pres. Billy Smith
- Solters/Roskin/Friedman Inc., 45 W. 34 St., Zip: 10001. Tel: 947-0515.
Cable: SHELEE. Telex: 125291.
Branch: Los Angeles, Calif.
- Fred Stuart Assocs., 45 E. 66 St., Zip: 10021. Tel: 988-4619. Pres. Fredric R. Stuart, VP. Nancy Sanderson
- Tomorrow Today Public Relations Agency, 405 E. 54 St., Suite 13-D, Zip: 10022. Tel: 832-3150. Dir.: Candy Leigh, Creative Dir.: Dee Breland. (Publicity & Public Relations)
- Morton Dennis Wax & Assocs., 1650 Broadway, Zip: 10019. Tel: 247-2159.
Cable: MORTWAX. Pres.: Morton Dennis Wax. Local branch: 200 W. 51 St.

JANIS SCHACHT
PUBLIC RELATIONS

THE LITTLE THEATRE BUILDING • 240 WEST 44 STREET
NEW YORK CITY 10036 • 212-869-3459

Zip: 10019. (Rec. Promo & Publicity) (SEE ADVERTISEMENT)
• SPRING VALLEY (Area Code 914)
 Pro/Creatives Corp., 25 W. Burda Ln. Zip: 10977. Pres., Sales & Adv. Mgr. David Rapp.
• TROY (Area Code 518)
 Wildwood Entertainment, 276 Fourth St. Zip: 12180. Tel: 273-7660. VP. Erich Borden.
• UTICA (Area Code 315)
 Oneida Video Audio Tape Cassette Corp., 760 Blandina St. Zip: 13501. Tel: 735-6187. Pres. Stanley Markowski.
• WOODBURY (Area Code 516)
 A. D. Adams Advertising Inc., Chemical Bank Bldg., 8243 Jericho Tpk. Zip: 11797. Tel: 692-5044.
 Home office: New York, N.Y.

NORTH CAROLINA

• MOORESVILLE (Area Code 704)
 Colt Promos, PO Box 978. Zip: 28115. Tel: 663-4892. (Rec. Promo & Rec. Distribution to Radio Stations)
• WILMINGTON (Area Code 919)
 Ehitruve Rec'g Music Pub'g Co. & Music Makers Network of America Prod'ns, PO Box 3022. Zip: 28401. Tel: 762-4001. Pres. John Lewis Jones, VP. Betty F. Scavilla, Sales Mgr. James L. Wheeler, Adv. Mgr. J. D. Johnson

OHIO

• CINCINNATI (Area Code 513)
 Counterpart Creative Studios Inc., 3744 Applegate Ave. Zip: 45211. Tel: 661-8810.
 Julie Godsey Independent Rec. Promo, 265 Jupiter Dr. Zip: 45238. Tel: 451-5793. Pres.: Julie Godsey.
 Jewel Rec'g Co., 1594 Kinney Ave. Zip: 45231. Tel: 522-9336. Pres. Rusty York, Gen. Mgr. Linda York, Sales Mgr. Rollin Bennett Jr.
 Roosevelt Lee Int'l, 3966 Standish Ave. Zip: 45213. Tel: 793-8191. Pres. Roosevelt Lee, Sales Mgr. Robert Williams, Adv. Mgr. Ronald Lee.
 Record Promo Ent's, 1730 Losantiville Rd. Zip: 45237. Tel: 531-4317. Pres. & Sales Mgr. Edward Saphier. (Promo & Dist'n Servs.)
• CLEVELAND (Area Code 216)
 Solid Soul Prod'ns & Promos, 3282 E. 119 St. Zip: 44120. Tel: 752-1904. Pres.: Fred Fluellen, Exec. VP & Adv. Mgr. Tony Luke, Sales Mgr. William Merritt.
 T. N. T. Atmosphere Concert Consultants, see Solid Soul.
• COLUMBUS (Area Code 614)
 Hillside Recs., 948 Studer Ave. Zip: 43206. Tel: 252-7116. Owner & Pres. Larry McKenzie.
 Dave Segel Promos of Ohio, 1304 Cranwood Square S. Zip: 43229. Tel: 885-2789. Owner. Dave Segel.

OKLAHOMA

• OKLAHOMA CITY (Area Code 405)

J.R. Promos, 1911 N. Classen, Suite 1. Zip: 73106. Tel: 528-8346. Contact Jim Ross. (Rec. Promo & Publicity)

OREGON

• PORTLAND (Area Code 503)
 Lesser Int'l USA, 6443 SW Beaverton Hwy. Zip: 97221. Tel: 297-5812. TWX: (910) 464-4792

PENNSYLVANIA

• BETHLEHEM (Area Code 215)
 Mystic Oak Recs., 1 E. Church St. Zip: 18018. Tel: 867-3400. Talent Coord.: W.J. Concevitich.
• PHILADELPHIA (Area Code 215)
 Dick Colanzi, 1302 Sigel St. Zip: 19148. Tel: 334-7133.
 George Guess Ltd., 2250 Bryn Mawr Ave. Zip: 19131. Tel: 477-7122.
• PITTSBURGH (Area Code 412)
 Star Title Strip Co. Inc., 842 Western Ave. Zip: 15233. Tel: 231-4314. Mgr. William P. Miller.
• SCRANTON (Area Code 717)
 White Rock Recs. Inc., 401 Wintermantle Ave. Zip: 18505. Tel: 343-6178. Pres. Phil Ladd.

SOUTH CAROLINA

• COLUMBIA (Area Code 803)
 Howard Knight Ent's Inc., 2424 Pleasant Ridge. Zip: 29209. Tel: 783-0325

TENNESSEE

• LEWISBURG (Area Code 615)
 WeCare Promo & Mktg. Inc., Rt. 4, Box 226A. Zip: 37094. Tel: 364-2247, 356-3549. Pres. B.J. McElwee.
• MEMPHIS (Area Code 901)
 H. O. W. E. Country Inc., PO Box 381466, Germantown Sta., Zip: 38138. Pres. Bucky Wooten, Gen. & Sales Mgr. Jason Wooten.
 Southern Rec. Promo Inc., 5324 Timmons. Zip: 38119. Tel: 767-6098. Pres. Tim Riley.
 Startown Ent's of Memphis, 1037 E. Parkway S. Zip: 38104. Tel: 725-7019. Sales. James Mack, Booking Agent. James Stout.
 Home office: Columbus, Miss.
• NASHVILLE AREA (Area Code 615)
 Album Globe Dist'n Co. Inc., City Square, 260 W. Main, Suite 107, Hendersonville 37075. Tel: 824-9100. Pres. Mike Shepherd, Adv. Mgr. Keith Stewart, Album Coord. Patsy West.
 American Sound Recs./Emerald Recs., 62 Music Square W. Zip: 37203. Tel: 327-4538. Pres. Cliff Ayers Ostermeyer, Sales Mgr. Chris Ostermeyer, Gen. & Adv. Mgr. Connie L. Wright, P.R. Alma Lee Combs.
 Mike Borchetta Rec. Promo., PO Box 23308. Zip: 37202. Tel: 255-6471, 758-2995. Pres. Mike Borchetta, Gen. Mgr. Scott Borchetta, Sales Mgr. Mark Borchetta.
 Chuck Chellman Co. Inc., 1201 16 Ave. S. Zip: 37212. Tel: 320-7287

Cookie Crumbles Promos, PO Box 120891. Zip: 37212. Tel: 244-7443. Contact: Johnny Koval.
 Creative Concepts (div. of Specialized Office Servs.), 1300 Division St., Suite 106. Zip: 37203. Tel: 259-3790. Partners: Jim Kent, Vernell Hackett.
 Disc-Play Promos, PO Box 60443. Zip: 37206. Tel: 226-2991.
 Fischer & Lucus Inc. Rec. Promo & Dist'n, United Artists Tower, Suite 902, 50 Music Square W. Zip: 37202. Tel: 329-2278. Pres. & Mktg. Dir.: Joe D. Lucus. VP & Nat'l Promo Dir.: Bobby Fischer.
 Horseshoe Dis'ts. & Promos, 2937 Harlin Dr. Zip: 37211. Tel: 331-1125. Pres. R.L. Brown, Sales Mgr.: Webb Foley.
 Kathy's Country Promos, PO Box 24407. Zip: 37202. Tel: 834-4789.
 Keeley/Pride Promo & Mktg., 5156 Ashley Dr. Zip: 37211. Tel: 331-1705, 646-9999.
 Mike Kelly Org., 44 Music Square E. Zip: 37203. Tel: 256-6453.
 Gene Kennedy Ent's., 2125 Eighth Ave. S. Zip: 37204. Tel: 383-6002.
 Mull Ti Hit Promos, 50 Music Square W., Suite 604. Zip: 37203. Tel: 329-4487.
 Music City Mktg. Co., PO Box 40483, 2608 Westwood Dr. Zip: 37204. Tel: 292-5555. Owner: W. Lee Trimble.
 Nashville Album Prod'ns Inc., 101 Music City Circle. Zip: 37203. Tel: 883-2153.
 Nationwide Sound Dis'ts., PO Box 23262. Zip: 37202. Tel: 385-2704. Pres. Joe F. Gibson, Sales Mgr. & Nat'l Promo. Dir.: Betty Gibson.
 Professional Mktg. Serv. Inc., 50 Music Square W., Suite 907. Zip: 37203. Tel: 327-0571. Pres. Dee Mullins.
 Pro Motions Plus Inc., PO Box 120691, 3106 Belmont Blvd. Zip: 37212. Tel: 385-1960. Pres. Jonathan E. Fricke.
 Jan Rhees Mktg. PO Box 74. Zip: 37221. Tel: 329-1325. Pres. & Gen. & Sales Mgr. Jan Rhees.
 Bob Saporiti Promos., 260 W. Main St., Suite 107, Hendersonville 37075.
 Sea Cruise Prod'ns, PO Box 110830. Zip: 37211. Tel: 834-1856. Pres. & Adv. Mgr. Ken Keene; VP & Gen. Mgr.: F.V. Guzzo, VP & Sales Mgr. Gene Miller.
 Special Delivery Promos., 210 25 Ave. N., The Sound Seventy Suite Zip: 37203. Tel: 327-1711.
 Stargem Recs. Inc., 20 Music Square W., Suite 200. Zip: 37203. Tel: 244-1025.
 Harrison Tyner Int'l Inc., 38 Music Square E., Suite 115. Zip: 37203. Tel: 244-4224. Owner & Pres. Harrison Tyner, Sales Mgr. Dallas Laird, Adv. Mgr. Kevin McMaster.
 World Int'l Group (WIG), 2125 Eighth Ave. S. Zip: 37204. Tel: 383-6540

TEXAS

• AUSTIN (Area Code 512)
 Joe P. Ethridge Promos, 7106 Scenic Brook Dr. Zip: 78736. Tel: 288-3581.
• CLEBURNE (Area Code 817)
 Hinton & Svendsen Promos., PO Box 297. Zip: 76031. Tel: 641-7875. Contacts: Bruce Hinton, Peter Svendsen.
 Branch: Hollywood (Los Angeles Metro Area), Calif.
• DALLAS (Area Code 214)
 Electronic Technological Inds. of America Inc., PO Box 1580. Zip: 75221. Tel: 827-8002. Bd. Chm. John Kanter; Gen. Mgr.: David Coleman, Sales Mgr. Larry Pearson.

for the most complete coverage in the USA

national record

Promotion/PR

AOR · Top 40 · Dance · R&B · MOR · C&W · Classical · Jazz

Partial Credit List: Don Kirshner, Charles Koppelman and The Entertainment Company, Famous Music, Spring/Posse Records, CBS Int'l Music Group, RSO Records, Paramount Pictures, Paramount TV, Screen Gems/EMI, RCA Records, Columbia Records, MCA Records, Polydor Records, Chappell Music, SATURDAY NIGHT FEVER, A STAR IS BORN (Soundtrack), THE SPY WHO LOVED ME (Soundtrack), Sid Bernstein, Ornette Coleman, Chick Corea, Neil Diamond, Fatback Band, Marvin Hamlisch, Millie Jackson, Robert Kraft, Chuck Mangione, Glenn Miller Orchestra, Joe Simon, Carole Bayer Sager, Barbra Streisand, SOPHISTICATED LADIES, The Roxy & Xenon.

WIDOWAX Introducing a new service:

Specializing in the PRODUCTION and Distribution of Videocassettes for the PRO-MOTION of Recording Artists. PRODUCTION: From concept through shooting and editing. PROMOTION: National distribution for Cable, Satellite and TV exposure.

MORTON DENNIS WAX & ASSOCIATES

200 West 51st Street, New York, New York 10019 212/247-2159 Telex: ATT: MORTWAX: 226000 (ETLX UR) established 1956

- **GAINESVILLE (Area Code 817)**
TanDen Prod'n, PD Box 382, Zip 76240. Tel: 665-6759. Pres.: Bobby Den-nous, Sales Mgr.: Gregg Ballew; Adv. Mgr.: Roger Christian.
- **HOUSTON (Area Code 713)**
Slick Norris Artists & Promos, PD Box 653, Highlards 77562. Tel: 424-4235. Pres.: Slick Norris.
Randall Parr Drg. Ltd., 411 E. Crossttimbers. Zip: 77022. Tel: 691-6151. Dwner: Randall Parr.
- **SAN ANTONIO (Area Code 512)**
Joey Recs., 6703 W. Commerce. Zip: 78227. Tel: 432-7893.
- **SAN BENITO (Area Code 512)**
Rio Grande Music Co., 119 S. Sam Houston Blvd. Zip: 78586. Tel: 399-5377. Sales Mgr.: John F. Phillips.
- **WACO (Area Code 817)**
Charles Wallis Inc., 4708 W. Waco Dr. Zip: 76710. Tel: 776-5113. Pres: Charles Wallis, Gen. Mgr.: Roger Lindstrom.

UTAH

- **SALT LAKE CITY (Area Code 801)**
Covenant Rec'g's Inc., PO Box 26817, 1345 Major St. Zip: 84126. Tel: 487-1096. Pres.: V. Lewis Kofford; Adv. Mgr.: Jeff Lund.

VERMONT

- **SPRINGFIELD (Area Code 802)**
Gregorie Nelson Ficara Ent's., 40 Clinton St. Zip: 05156. Tel: 885-3820. Pres & Gen. Mgr.: G.N. Ficara; Sales Mgr.: Patty de Greena; Adv. Mgr.: Greg Ficara.

VIRGINIA

- **ALDIE (Area Code 703)**
Solar Sound Prod'n, PD Box 98, Zip 22001. Tel: 471-5359. Bus. Mgr.: Frank Adair.
- **SALEM (Area Code 703)**
Amphion Prod'n, 21 S. College Ave., Suite 6. Zip: 24153. Tel: 389-7094. Pres.: Lee Michaels.

WEST VIRGINIA

- **BERKELEY SPRINGS (Area Code 304)**
Ruppenthal Ent's., PD Box 235, Zip: 25411. Tel: 258-2627. Pres. & Music Dir.: Virgil H. Ruppenthal.

**TAPE CUSTOM
DUPLICATORS/TAPE
PACKAGING & LABELING**

Audio and Video lines indicate which configurations the firms duplicate. Companies which offer packaging and labeling of tape product are indicated by "(PKG)" which appears after the main body of their listings.

ALABAMA

- **BIRMINGHAM (Area Code 205)**
Charlie & Co. Inc., 5500-B Crestwood Blvd. Zip: 35212. Tel: 870-0247, 592-3601. Pres.: Charles Colvin; Mgr.: Mark Colvin.
Audio: 8-tr., cassette.
- **MUSCLE SHOALS (Area Code 205)**
Fame Rec'g Studios Inc., 603 E. Avalon Ave. Zip: 5660. Tel: 381-0801.
Audio: Cassette, open reel.

ARIZONA

- **PHOENIX (Area Code 602)**
Audio-Video Rec's of Arizona Inc., 3830 N. Seventh St. Zip: 85014. Tel: 277-4723.
Audio: Cassette, open reel.
Video: 1/2" U-matic cassette, 1/4" Beta & VHS cassette
General Cassette Corp., 2311 N. 35 Ave. Zip: 85009. Tel: 269-3111 (PKG—audio & video)
Audio: 8-tr., cassette.
Universal Audio Corp., 7244 E. Indian School Rd., Scottsdale 85251. Tel: 949-7577.
Audio: 8-tr., cassette, open reel.

**ATTENTION: PRODUCERS,
PUBLISHERS and ARTISTS**

**ESTABLISHED COMPANY
LOOKING FOR
NEW MASTERS**

for early release, or will consider
New Songs for recording, if you submit
GOOD DEMO RECORD
(or 7 1/2 IPS-Tape or cassette and lead sheet)

BY MAIL ONLY, TO **RAVE** DEPT BB
134 E. 70th St., NY, NY 10021

- **TUCSON (Area Code 602)**
Kyrac Corp., 2111 E. 20 St. Zip: 85719. Tel: 624-2408. Pres. & Sales Mgr.: Keyvan Mokhtarian (PKG)
Audio: 8-tr., cassette, open reel.

CALIFORNIA

- **ANAHEIM (Area Code 714)**
Cerron Corp., 1701 S. State College Blvd. Zip: 92806. Tel: 634-4280 TWX (910) 593-1611
Audio: 8-tr., cassette (SEE ADVERTISEMENT)
Harry McCune Sound Serv. Inc., 1773 W. Lincoln Ave. Zip: 92801. Tel: 533-7650, LA (213) 656-0112. Pres.: Harry McCune Jr.; Gen. Mgr.: Herbert Shor. (Sales office only) (PKG)
Home office: San Francisco, Calif.
Audio: Cassette, open reel.
Video: 1/2" U-matic cassette.
- **CAMPBELL (Area Code 408)**
Westape, 503-C Vandell Way. Zip: 95008. Tel: 379-0870. Sales Mgr.: Rich Krueger.
Audio: 8-tr., cassette (SEE ADVERTISEMENT)
- **HUNTINGTON BEACH (Area Code 714)**
Tapette Corp., 15702 Producer Ln. Zip: 92649. Tel: 638-7960. Pres. Jim Neiger II; Video Div. Sales Mgr.: John Miles; Audio Div. Special Accts. Mgr.: Bob Sheehy; Customer Servs. Mgr.: Mary Deery (PKG)
Audio: Cassette, open reel
Video: 1" helical, 1/4" U-matic cassette, 1/2" Beta & VHS cassette
- **LOS ANGELES METROPOLITAN AREA (Area Code 213)**
A G I (Album Graphics Inc.), 424 N. Larchmont Blvd. Zip: 90004. Tel: 462-0821. (Sales office only) (PKG only—audio & video)
Home office: Melrose Park (Chicago Metro Area), Ill.
A S R Rec'g Servs. Inc., 8960 Eton Ave., Canoga Park 91304. Tel: 341-1124. VP Sales: Howard Shapiro; Gen. Mgr.: Robert Goldman (PKG)
Home office: Glen Rock, N.J.
Audio: 8-tr., cassette, open reel
A T & T (Able Turntable & Tape) Rec'g Inc., 725 N. Highland Ave., Hollywood 90038. Tel: 933-5701. Pres. James Carroll; Sales Mgr.: Renny Kelly. (PKG)
Audio: 8-tr., cassette open reel
Abbey Tape Dupl'rs Inc., 5358 Cartwright Ave., North Hollywood 91601. Tel: 985-3136. Pres.: Norman C. Cooke (PKG)
Audio: Cassette, open reel
Able Turntable & Tape, see AT&T
Album Graphics Inc., see AGI
Audio Encounter, 9614 Cozycroft Ave., Unit H, Chatsworth 91311. Tel: 998-7455. Pres.: Elinore Freeland.
Audio: Open reel.
Award Rec. Mfg. Inc., 11016 La Cienega Blvd., Inglewood 90304. Tel: 645-2281. Pres. & Sales Mgr.: Martin Ansoorian; Gen. Mgr.: George Abajian.
Audio: 8-tr., cassette.
Bert-Co Ent's. Inc. (div. of the Walter Reade Drg. Inc.), 1855 Glendale Blvd. Zip: 90026. Tel: 665-5137 (PKG only)
Home office: New York, N.Y.
Cadet Recs. Inc., 5810 S. Normandie Ave. Zip: 90044. Tel: 753-5121. Pres. Jules Bihar; Mgr.: Don Macmillan (PKG)
Branch: Park Ridge, N.J.
Audio: 8-tr., cassette.
Columbia Rec. Prod'n's, 1801 Century Park West, Century City 90067. Tel: 556-4700. (Sales office only)
Plants: Santa Maria, Calif.; Terre Haute, Ind.; Pitman, N.J.
Audio: 8-tr., cassette.
Custom Dupl'n Inc., 6330-36 Arizona Circle. Zip: 90045. Tel: 670-5575. Pres.: Leonard Gross; Sales Mgr.: Bob Hvelty; Prod'n: Jeri Gonzales. (PKG)
Audio: 8-tr., cassette & VHS cassette.
Custom Rec. Mfg. Co., 5810 S. Normandie Ave. Zip: 90044. Tel: 753-5121. Pres.: Jules Bihar; VP: Don Macmillan (PKG)
Audio: 8-tr., cassette, open reel.
D A K Inds. Inc., 10845 Vanowen St., North Hollywood 91605. Tel: 984-1559. WATS: (800) 423-2636. Cable: DAKENT. Telex: 651396. Pres.: Drew Alan Kaplan (PKG)
Audio: Cassette.
E M C Corp., 6855 Santa Monica Blvd., Hollywood 90038. Tel: 463-3282. (Sales office only) (PKG)
Home office: St. Paul (Minneapolis-St. Paul Metro Area), Minn.
Audio: Cassette, open reel.
Excalibur Video Systems Inc., 4015 Wilshire Blvd. Zip: 90010. Tel: 384-5175 (PKG)
Video: 1" type C open reel, 1/4" U-matic cassette, 1/2" VHS cassette.
H I Ent's. Inc., 9537 Telstar Ave., Suite 121, El Monte 91731. Tel: 444-9224. (PKG)
Audio: Cassette, open reel.
Ivy Hill Graphics & Packaging (div. of Ivy Hill Communications Inc.), 4800 S. Santa Fe Ave. Zip: 90058. Tel: 587-3131. Exec. VP: Russell Mur; Gen. Mgr.: Del Eaton; Sales Mgr.: Arthur Kern (PKG only)
J & I Cassette, 23947 Ventura Blvd., Calabasas 91302. Tel: 992-6200. Pres.: John F. Brennan; Sales & Adv. Mgr.: Ivy Brennan (PKG—audio & video)
Audio: Cassette
M C A Whitney Rec'g Studios Inc., 1516 W. Glenoaks Blvd., Glendale 91201. Tel: 245-6801. VP & Gen. Mgr.: Brent Albright; Tape Dupl'g Mgr.: Ted Glover
Audio: Cassette, open reel
M L Tape Dupl'g, 16834 Superior St., Sepulveda 91343. Tel: 988-2737. Co. Dwners: Bill & Carol Ball; Pres.: Bill Ball; VP: Carol Ball; Gen. Mgr.: Mike Hathaway; Sales Mgr.: Susan Castle (PKG)
Audio: 8-tr., cassette.
Video: 1/2" U-matic cassette, 1/4" Beta & VHS cassette
Modern Album of California Inc., 13755 Bayliss Rd., Burbank 91505. Tel: 845-7655. Pres.: William S. Pine; Sales Mgr.: Raymond Gardocki. (PKG only—audio & video)
Home office: Hauppauge, N.Y. Modern Album & Finishing Co. Inc. Montclair Studios, 13755 Bayliss Rd. Zip: 90049. Dwner & Pres.: Wallace Todd; Studio Mgr. & Chief Eng.: Miriam Todd (PKG)
Audio: 8-tr., cassette, open reel.
Video: 1/2" Beta & VHS cassette.
North American Tape Dupl'g Co., 15414 Cabrillo Rd., Van Nuys 91406. Tel: 781-7650. VP & Gen. Mgr.: Norm Teter; Mktg. Dir.: Larry Stagnaro. (PKG)
Audio: 8-tr., cassette.

- Professional Cassette Equip., 2909 Ocean Park Blvd., Santa Monica 90405. Tel: 829-4077. Dwner: G.D. Theodos; Gen. Mgr.: D. Capener. (PKG)
Audio: Cassette
R C A Recs., 6363 Sunset Blvd., Hollywood 90028. Tel: 468-4000. (Sales office only)
Home office: New York, N.Y.
Plant: Indianapolis, Ind.
Audio: 8-tr., cassette
Radio Central, 427 W. Fifth St., Suite 611. Zip: 90013. Tel: 626-9891. (PKG)
Audio: Cassette, open reel.
Martin Roberts & Assocs. Inc., 270 N. Canon Dr., Suite 103, Beverly Hills 90210. Tel: 273-0381. (PKG)
Audio: Cassette
See Hear Inds. (div. of RIA Inc.), 120 W. 155 St., Gardena 90248. Tel: 516-0315. Pres.: Ray Jacobs; Dupl'n Sales Mgr.: Stan Gerstein (PKG—audio only)
Audio: 8-tr., cassette, open reel
Video: 1/4" U-matic cassette, 1/2" Beta & VHS cassette.
Shorewood Packaging Corp., 1830 Glendale Blvd. Zip: 90026. Tel: 660-3043. VP Sales: Jim Palmer (PKG only—audio & video)
Home office: New York, N.Y.
Sound/Pro Inds. Inc., 7529 Trasic Ave., Playa del Rey 90291. Tel: 822-0510. Pres.: Donald K.M. Rothberg; Nat'l Mktg. Dir.: Don Millard; Sales Mgr. Tom Reed; Adv. Mgr.: Linda Newton. (PKG)
Audio: 8-tr., cassette.
Studer Revox America Inc., 14046 Burbank Blvd., Van Nuys 91401. Tel: 780-4234. Contact: Bill Van Doren.
Home office: Nashville, Tenn.
Audio: Open reel
Superscope Inc., 22459 Paul Revere Dr., Woodland Hills 91364. Tel: 998-9333 x 2090. Pres. Joseph Tushinsky; Mktg. & Sales Mgr.: Bill Rosen. (PKG)
Audio: Cassette
Tape-A-Thon Corp./Cavox Stereo Prod'n's, 502 S. Isis Ave., Inglewood 90301. Tel: 776-6933. WATS: (800) 421-1029. Pres.: Lee Tate; Sales Dir.: Robert Mayfield. (PKG)
Audio: Cassette, open reel, NAB cartridge.
Tape Specialty Inc., 13411 Satcoy St., North Hollywood 91605. Tel: 786-6111. Pres.: Steve Feldman; Gen. Mgr.: Len Feldman; Chief Eng.: Stu Feldman.
Audio: 8-tr., cassette
Video: 1/2" Beta cassette
Trans American Video Inc., 1541 N. Vine St., Hollywood 90028. Tel: 466-2141. (PKG)
Video: 2" quad
U S Video, 1136 N. Highland Ave., Hollywood 90038. Tel: 464-7579. Exec. VP: Dave Hancock; VP Sales: Robert Creamer.
Video: 2" quad, 1" type C, open reel, 1/4" U-matic cassette, 1/2" Beta & VHS cassette
Valley Video, 4209 W. Burbank Blvd., Burbank 91505. Tel: 841-2387. Dwner & Chief Eng.: Robert Simonton; Sales Mgr.: Mary Simonton.
Video: 1/4" EIAJ open reel, 1/4" U-matic cassette, 1/2" Beta & VHS cassette
Video Rec. Albums of America/Vine Street Video Centre, 8471 Universal Plaza, Universal City 91608. Tel: 462-1099. Pres.: Troy Cory; Gen. Mgr.: Banes Prescott; PR Sales: Lynn Mann.
Audio: Cassette.
Video: 2" quad, 1" helical, 1/4" U-matic cassette, 1/2" Beta & VHS cassette.
Vidtronic, Video Cassette Div., 855 N. Cahuenga Blvd., Hollywood 90038. Tel: 856-8200.
Video: 1/4" U-matic cassette, 1/2" Beta & VHS cassette, 1/2" Technicolor cassette.
Virco Rec'g Inc., 700 S. Date Ave., Alhambra 91803. Tel: 283-1888. Mktg. Dir.: Nyall R. London.
Audio: Cassette, open reel.
West American Sound, 8120 Webb Ave., North Hollywood 91605. Tel: 768-6100. Pres.: Frank Day; VP: Paul Hayes; VP Mktg.: Paul Adams; Reg'l Sales Mgr.: Robert Sheehy. (PKG)
Home office: Warren (Detroit Metropolitan Area), Mich.; American Sound Corp.
Branches: Atlanta, Ga.; American Sound-Atlanta; Closter, N.J.; American Sound
Audio: 8-tr., cassette, open reel.
- **MONTCLAIR (Area Code 714)**
Phylco Audio, 4709 Brooks St. Zip: 91763. Tel: 621-9561. Dwner: Robert Deates; Gen. Mgr.: Rick Deates.
Audio: Cassette, open reel.
- **OCEANSIDE (Area Code 714)**
Excel Co., 1907 Apple St. Zip: 92054. Tel: 439-3020. Pres.: J. Richard Lee; Gen. Mgr.: Bill Kottcamp (PKG)
Audio: Cassette, open reel.
- **SACRAMENTO (Area Code 916)**
Bill Rase Prod'n's Inc., 955 Venture Court. Zip: 95825. Tel: 929-9181. Dwner & Pres.: Bill Rase. (PKG)
Audio: Cassette, open reel.
Video: 1/4" EIAJ open reel, 1/4" U-matic cassette, 1/2" Beta & VHS cassette.
- **SAN DIEGO (Area Code 714)**
Studio West, 5042 Ruffner St. Zip: 92111. Tel: 277-4714
Audio: Cassette.
- **SAN FRANCISCO & BAY AREA (Area Code 415)**
Kenneth A. Bacon Assocs., 216 Montego Key, Novato 94947. Tel: 883-5041. Dwner: Kenneth A. Bacon; Prod'n Mgr.: Rick Bacon.
Audio: Cassette, open reel.
Coast Rec's, 1340 Mission St. Zip: 94103. Tel: 864-5200. (PKG)
Audio: Cassette, open reel.
Command Prod'n's, PD Box 26348. Zip: 94126. Tel: 332-3161. Pres.: Warren Weagant; VP: Kiti Weagant; Sales Mgr.: John Edwards.
Audio: Cassette, open reel.
Cory Sound Co., 310 Townsend. Zip: 94107. Tel: 543-0440. Contact: Phillip Markinson (PKG)
Audio: Cassette, open reel
Fred Fox Music Co., 406 Kehoe Ave., Half Moon Bay 94019. Tel: 726-3725. Pres.: F.H. Nesbitt; Sales Mgr.: V.A. Nesbitt.
Audio: 8-tr., cassette, open reel.
Video: 1/4" Beta & VHS cassette.
Cathy Furness & Assocs., 680 Beach St., Suite 445. Zip: 94109. Tel: 885-2807. Pres.: Cathy Furness; Adv. Mgr.: Isabelle Aggson.
Audio: Cassette.

The Gate, 351 G St., San Rafael 94901 Tel: 777-2700 Pres. Don Geis; Gen. Mgr.: Mary Geis, Sales Mgr.: Pattie Geis; Chief Eng.: John Geis
Audio: Open reel.

Highland Labs, 840 Battery St. Zip 94111 Tel: 981-5010 (PWG)
Video: 2" quad, 1" helical, 1/4" U-matic cassette, 1/2" Beta & VHS cassette

Mann Endless Cassette Inds. Corp., PO Box 1347 Zip 94101 Tel: 221-2000 Pres. Donald Mann, Sales Mgr.: Robert Wells, Adv. Mgr.: Bob Kline

Audio: Cassette (standard & "endless" types)
Harry McCune Sound Serv. Inc., 951 Howard St. Zip 94103 Tel: 777-2700 (PWG)

Branch: Anaheim, Calif.
Audio: Cassette, open reel
Video: 1" open reel, 1/4" EIAJ open reel, 1/4" U-matic cassette
Pacific Int'l Magnetics Inc., 185 Berry St. Zip: 94107 Tel: 495-8830 (Sales office only) (PWG-audio & video)

Home office: Richmond, B.C., Canada
Audio: Cassette, open reel

Recortec Inc., 475 Ellis St., Mountain View 94043 Tel: 962-0220 TWX (910) 379-5022 Pres. Dr. Lester H. Lee, Sales Mgr.: Ron R. Troxell
Audio: Cassette, open reel

Sonic Arts Corp., 665 Harrison St. Zip: 94107 Tel: 781-6307 Pres. Leo de Gar Kulkka; Gen. Mgr.: Herbert P. Haas (PWG)
Audio: Cassette

Stanford Int'l, PO Box 609, 569 Laurel St., San Carlos 94070 Tel: 592-5958 Pres. Fred Dobbs, Opns. Mgr.: Jan Dillard (PWG)
Audio: Cassette

Mark Starr Corp., 1609 64 St., Emeryville 94608 Tel: 658-0109 Pres. Gary W. Wood (PWG)
Audio: Cassette

Television Assocs. Inc., 2410 Charleston Rd., Mountain View 94043 Tel: 967-6040 Pres. Ed Carlstone (PWG)
Video: 2" quad, 1" type C open reel, 1/4" EIAJ open reel, 1/4" U-matic cassette, 1/2" Beta & VHS cassette

• **SAN JOSE (Area Code 408)**
Audiodyne Co., PO Box 825 Zip 95106 Tel: 287-3520 Pres. Louis R. Charamonte

Audio: 8-tr., cassette, open reel
M.J.S. 2514 Seaboard Ave. Zip 95131 Tel: 262-8793 Owner: Michael Steiner
Audio: Cassette

• **SANTA CLARA (Area Code 408)**
Shur Sound & Sight Inc., 3350 Scott Blvd., Bldg. No. 5 Zip: 95051 Tel: 727-7620 VP & Gen. Mgr.: Glenn Cardon; VP Sales: Lonnie Cory (PWG)
Audio: 8-tr., cassette, open reel

• **SANTA CRUZ (Area Code 408)**
Balish Rec'g Ent's, 1310 Mission St. Zip 95060 Tel: 423-1699 VP Mktg & Sales: Ashwin Balish, Gen. Mgr.: Ravi Balish
Audio: Cassette

• **SUNNYVALE (Area Code 408)**
Respond Int'l Recs Inc., 1190 Miraloma Way, Suite Y Zip: 94086 Tel: 245-1351 Cable RESPOND TWX (910) 339-9317 Pres. Ronald L. Akun
Audio: 8-tr. cassette
Video: 1/2" Beta & VHS cassette

• **SUNNYVALE (Area Code 408)**
Respond Int'l Recs Inc., 1190 Miraloma Way, Suite Y Zip: 94086 Tel: 245-1351 Cable RESPOND TWX (910) 339-9317 Pres. Ronald L. Akun
Audio: 8-tr. cassette
Video: 1/2" Beta & VHS cassette

• **SUNNYVALE (Area Code 408)**
Respond Int'l Recs Inc., 1190 Miraloma Way, Suite Y Zip: 94086 Tel: 245-1351 Cable RESPOND TWX (910) 339-9317 Pres. Ronald L. Akun
Audio: 8-tr. cassette
Video: 1/2" Beta & VHS cassette

• **SUNNYVALE (Area Code 408)**
Respond Int'l Recs Inc., 1190 Miraloma Way, Suite Y Zip: 94086 Tel: 245-1351 Cable RESPOND TWX (910) 339-9317 Pres. Ronald L. Akun
Audio: 8-tr. cassette
Video: 1/2" Beta & VHS cassette

• **SUNNYVALE (Area Code 408)**
Respond Int'l Recs Inc., 1190 Miraloma Way, Suite Y Zip: 94086 Tel: 245-1351 Cable RESPOND TWX (910) 339-9317 Pres. Ronald L. Akun
Audio: 8-tr. cassette
Video: 1/2" Beta & VHS cassette

• **SUNNYVALE (Area Code 408)**
Respond Int'l Recs Inc., 1190 Miraloma Way, Suite Y Zip: 94086 Tel: 245-1351 Cable RESPOND TWX (910) 339-9317 Pres. Ronald L. Akun
Audio: 8-tr. cassette
Video: 1/2" Beta & VHS cassette

• **SUNNYVALE (Area Code 408)**
Respond Int'l Recs Inc., 1190 Miraloma Way, Suite Y Zip: 94086 Tel: 245-1351 Cable RESPOND TWX (910) 339-9317 Pres. Ronald L. Akun
Audio: 8-tr. cassette
Video: 1/2" Beta & VHS cassette

• **SUNNYVALE (Area Code 408)**
Respond Int'l Recs Inc., 1190 Miraloma Way, Suite Y Zip: 94086 Tel: 245-1351 Cable RESPOND TWX (910) 339-9317 Pres. Ronald L. Akun
Audio: 8-tr. cassette
Video: 1/2" Beta & VHS cassette

• **SUNNYVALE (Area Code 408)**
Respond Int'l Recs Inc., 1190 Miraloma Way, Suite Y Zip: 94086 Tel: 245-1351 Cable RESPOND TWX (910) 339-9317 Pres. Ronald L. Akun
Audio: 8-tr. cassette
Video: 1/2" Beta & VHS cassette

• **SUNNYVALE (Area Code 408)**
Respond Int'l Recs Inc., 1190 Miraloma Way, Suite Y Zip: 94086 Tel: 245-1351 Cable RESPOND TWX (910) 339-9317 Pres. Ronald L. Akun
Audio: 8-tr. cassette
Video: 1/2" Beta & VHS cassette

• **SUNNYVALE (Area Code 408)**
Respond Int'l Recs Inc., 1190 Miraloma Way, Suite Y Zip: 94086 Tel: 245-1351 Cable RESPOND TWX (910) 339-9317 Pres. Ronald L. Akun
Audio: 8-tr. cassette
Video: 1/2" Beta & VHS cassette

• **SUNNYVALE (Area Code 408)**
Respond Int'l Recs Inc., 1190 Miraloma Way, Suite Y Zip: 94086 Tel: 245-1351 Cable RESPOND TWX (910) 339-9317 Pres. Ronald L. Akun
Audio: 8-tr. cassette
Video: 1/2" Beta & VHS cassette

• **SUNNYVALE (Area Code 408)**
Respond Int'l Recs Inc., 1190 Miraloma Way, Suite Y Zip: 94086 Tel: 245-1351 Cable RESPOND TWX (910) 339-9317 Pres. Ronald L. Akun
Audio: 8-tr. cassette
Video: 1/2" Beta & VHS cassette

• **SUNNYVALE (Area Code 408)**
Respond Int'l Recs Inc., 1190 Miraloma Way, Suite Y Zip: 94086 Tel: 245-1351 Cable RESPOND TWX (910) 339-9317 Pres. Ronald L. Akun
Audio: 8-tr. cassette
Video: 1/2" Beta & VHS cassette

• **SUNNYVALE (Area Code 408)**
Respond Int'l Recs Inc., 1190 Miraloma Way, Suite Y Zip: 94086 Tel: 245-1351 Cable RESPOND TWX (910) 339-9317 Pres. Ronald L. Akun
Audio: 8-tr. cassette
Video: 1/2" Beta & VHS cassette

• **SUNNYVALE (Area Code 408)**
Respond Int'l Recs Inc., 1190 Miraloma Way, Suite Y Zip: 94086 Tel: 245-1351 Cable RESPOND TWX (910) 339-9317 Pres. Ronald L. Akun
Audio: 8-tr. cassette
Video: 1/2" Beta & VHS cassette

• **SUNNYVALE (Area Code 408)**
Respond Int'l Recs Inc., 1190 Miraloma Way, Suite Y Zip: 94086 Tel: 245-1351 Cable RESPOND TWX (910) 339-9317 Pres. Ronald L. Akun
Audio: 8-tr. cassette
Video: 1/2" Beta & VHS cassette

• **SUNNYVALE (Area Code 408)**
Respond Int'l Recs Inc., 1190 Miraloma Way, Suite Y Zip: 94086 Tel: 245-1351 Cable RESPOND TWX (910) 339-9317 Pres. Ronald L. Akun
Audio: 8-tr. cassette
Video: 1/2" Beta & VHS cassette

• **SUNNYVALE (Area Code 408)**
Respond Int'l Recs Inc., 1190 Miraloma Way, Suite Y Zip: 94086 Tel: 245-1351 Cable RESPOND TWX (910) 339-9317 Pres. Ronald L. Akun
Audio: 8-tr. cassette
Video: 1/2" Beta & VHS cassette

• **SUNNYVALE (Area Code 408)**
Respond Int'l Recs Inc., 1190 Miraloma Way, Suite Y Zip: 94086 Tel: 245-1351 Cable RESPOND TWX (910) 339-9317 Pres. Ronald L. Akun
Audio: 8-tr. cassette
Video: 1/2" Beta & VHS cassette

• **SUNNYVALE (Area Code 408)**
Respond Int'l Recs Inc., 1190 Miraloma Way, Suite Y Zip: 94086 Tel: 245-1351 Cable RESPOND TWX (910) 339-9317 Pres. Ronald L. Akun
Audio: 8-tr. cassette
Video: 1/2" Beta & VHS cassette

• **SUNNYVALE (Area Code 408)**
Respond Int'l Recs Inc., 1190 Miraloma Way, Suite Y Zip: 94086 Tel: 245-1351 Cable RESPOND TWX (910) 339-9317 Pres. Ronald L. Akun
Audio: 8-tr. cassette
Video: 1/2" Beta & VHS cassette

• **SUNNYVALE (Area Code 408)**
Respond Int'l Recs Inc., 1190 Miraloma Way, Suite Y Zip: 94086 Tel: 245-1351 Cable RESPOND TWX (910) 339-9317 Pres. Ronald L. Akun
Audio: 8-tr. cassette
Video: 1/2" Beta & VHS cassette

• **SUNNYVALE (Area Code 408)**
Respond Int'l Recs Inc., 1190 Miraloma Way, Suite Y Zip: 94086 Tel: 245-1351 Cable RESPOND TWX (910) 339-9317 Pres. Ronald L. Akun
Audio: 8-tr. cassette
Video: 1/2" Beta & VHS cassette

Vidcom Corp./Ari-Gem Dupl'ns, 1101 15 Ave. NW Zip 20005 Tel: 223-2986
Video: 1/4" EIAJ open reel, 1/4" U-matic cassette, 1/2" Beta & VHS cassette.

FLORIDA

• **MIAMI METROPOLITAN AREA (Area Code 305)**

Allison Alhambra Recs Inc., 4380 NW 128 St. Zip 33054 Tel: 658-8396 Telex: 522178
Audio: 8-tr. cassette, open reel

Miami Tape Inc., 8180 NW 103 St., Hialeah Gardens 33015 Tel: 558-9211 (PWG)
Audio: 8-tr. cassette

Musical Tapes Inc., 770 W. 27 St., Hialeah 33010 Tel: 885-9156 Pres. Eliseo C. Valdes
Audio: 8-tr., cassette

Tape Dupl'rs of Florida Inc., 785 W. 83 St., Hialeah 33014 Tel: 822-7585 (PWG)
Audio: 8-tr., cassette

• **ORLANDO AREA (Area Code 305)**
Christian Dupl'ns Inc., 1710 Lee Rd. Zip 32810 Tel: 299-7363 (PWG)
Audio: Cassette

Magneta Corp., 770 W. Bay St., Winter Garden 32787 Tel: 656-4494 Pres. John Lory (PWG)
Audio: 8-tr., cassette, open reel

• **POMPANO BEACH (Area Code 305)**
Trackmaster Inc., 1310 S. Dixie Hwy W. Zip 33060 Tel: 943-2334 Pres. Roy Parsons, Sec'y-Treas.: Lupe Parsons
Audio: 8-tr. cassette

• **POMPANO BEACH (Area Code 305)**
Trackmaster Inc., 1310 S. Dixie Hwy W. Zip 33060 Tel: 943-2334 Pres. Roy Parsons, Sec'y-Treas.: Lupe Parsons
Audio: 8-tr. cassette

• **POMPANO BEACH (Area Code 305)**
Trackmaster Inc., 1310 S. Dixie Hwy W. Zip 33060 Tel: 943-2334 Pres. Roy Parsons, Sec'y-Treas.: Lupe Parsons
Audio: 8-tr. cassette

• **POMPANO BEACH (Area Code 305)**
Trackmaster Inc., 1310 S. Dixie Hwy W. Zip 33060 Tel: 943-2334 Pres. Roy Parsons, Sec'y-Treas.: Lupe Parsons
Audio: 8-tr. cassette

• **POMPANO BEACH (Area Code 305)**
Trackmaster Inc., 1310 S. Dixie Hwy W. Zip 33060 Tel: 943-2334 Pres. Roy Parsons, Sec'y-Treas.: Lupe Parsons
Audio: 8-tr. cassette

• **POMPANO BEACH (Area Code 305)**
Trackmaster Inc., 1310 S. Dixie Hwy W. Zip 33060 Tel: 943-2334 Pres. Roy Parsons, Sec'y-Treas.: Lupe Parsons
Audio: 8-tr. cassette

• **POMPANO BEACH (Area Code 305)**
Trackmaster Inc., 1310 S. Dixie Hwy W. Zip 33060 Tel: 943-2334 Pres. Roy Parsons, Sec'y-Treas.: Lupe Parsons
Audio: 8-tr. cassette

• **POMPANO BEACH (Area Code 305)**
Trackmaster Inc., 1310 S. Dixie Hwy W. Zip 33060 Tel: 943-2334 Pres. Roy Parsons, Sec'y-Treas.: Lupe Parsons
Audio: 8-tr. cassette

• **POMPANO BEACH (Area Code 305)**
Trackmaster Inc., 1310 S. Dixie Hwy W. Zip 33060 Tel: 943-2334 Pres. Roy Parsons, Sec'y-Treas.: Lupe Parsons
Audio: 8-tr. cassette

• **POMPANO BEACH (Area Code 305)**
Trackmaster Inc., 1310 S. Dixie Hwy W. Zip 33060 Tel: 943-2334 Pres. Roy Parsons, Sec'y-Treas.: Lupe Parsons
Audio: 8-tr. cassette

• **POMPANO BEACH (Area Code 305)**
Trackmaster Inc., 1310 S. Dixie Hwy W. Zip 33060 Tel: 943-2334 Pres. Roy Parsons, Sec'y-Treas.: Lupe Parsons
Audio: 8-tr. cassette

• **POMPANO BEACH (Area Code 305)**
Trackmaster Inc., 1310 S. Dixie Hwy W. Zip 33060 Tel: 943-2334 Pres. Roy Parsons, Sec'y-Treas.: Lupe Parsons
Audio: 8-tr. cassette

• **POMPANO BEACH (Area Code 305)**
Trackmaster Inc., 1310 S. Dixie Hwy W. Zip 33060 Tel: 943-2334 Pres. Roy Parsons, Sec'y-Treas.: Lupe Parsons
Audio: 8-tr. cassette

• **POMPANO BEACH (Area Code 305)**
Trackmaster Inc., 1310 S. Dixie Hwy W. Zip 33060 Tel: 943-2334 Pres. Roy Parsons, Sec'y-Treas.: Lupe Parsons
Audio: 8-tr. cassette

• **POMPANO BEACH (Area Code 305)**
Trackmaster Inc., 1310 S. Dixie Hwy W. Zip 33060 Tel: 943-2334 Pres. Roy Parsons, Sec'y-Treas.: Lupe Parsons
Audio: 8-tr. cassette

• **POMPANO BEACH (Area Code 305)**
Trackmaster Inc., 1310 S. Dixie Hwy W. Zip 33060 Tel: 943-2334 Pres. Roy Parsons, Sec'y-Treas.: Lupe Parsons
Audio: 8-tr. cassette

• **POMPANO BEACH (Area Code 305)**
Trackmaster Inc., 1310 S. Dixie Hwy W. Zip 33060 Tel: 943-2334 Pres. Roy Parsons, Sec'y-Treas.: Lupe Parsons
Audio: 8-tr. cassette

• **POMPANO BEACH (Area Code 305)**
Trackmaster Inc., 1310 S. Dixie Hwy W. Zip 33060 Tel: 943-2334 Pres. Roy Parsons, Sec'y-Treas.: Lupe Parsons
Audio: 8-tr. cassette

• **POMPANO BEACH (Area Code 305)**
Trackmaster Inc., 1310 S. Dixie Hwy W. Zip 33060 Tel: 943-2334 Pres. Roy Parsons, Sec'y-Treas.: Lupe Parsons
Audio: 8-tr. cassette

• **POMPANO BEACH (Area Code 305)**
Trackmaster Inc., 1310 S. Dixie Hwy W. Zip 33060 Tel: 943-2334 Pres. Roy Parsons, Sec'y-Treas.: Lupe Parsons
Audio: 8-tr. cassette

• **POMPANO BEACH (Area Code 305)**
Trackmaster Inc., 1310 S. Dixie Hwy W. Zip 33060 Tel: 943-2334 Pres. Roy Parsons, Sec'y-Treas.: Lupe Parsons
Audio: 8-tr. cassette

• **POMPANO BEACH (Area Code 305)**
Trackmaster Inc., 1310 S. Dixie Hwy W. Zip 33060 Tel: 943-2334 Pres. Roy Parsons, Sec'y-Treas.: Lupe Parsons
Audio: 8-tr. cassette

• **POMPANO BEACH (Area Code 305)**
Trackmaster Inc., 1310 S. Dixie Hwy W. Zip 33060 Tel: 943-2334 Pres. Roy Parsons, Sec'y-Treas.: Lupe Parsons
Audio: 8-tr. cassette

• **POMPANO BEACH (Area Code 305)**
Trackmaster Inc., 1310 S. Dixie Hwy W. Zip 33060 Tel: 943-2334 Pres. Roy Parsons, Sec'y-Treas.: Lupe Parsons
Audio: 8-tr. cassette

• **POMPANO BEACH (Area Code 305)**
Trackmaster Inc., 1310 S. Dixie Hwy W. Zip 33060 Tel: 943-2334 Pres. Roy Parsons, Sec'y-Treas.: Lupe Parsons
Audio: 8-tr. cassette

• **POMPANO BEACH (Area Code 305)**
Trackmaster Inc., 1310 S. Dixie Hwy W. Zip 33060 Tel: 943-2334 Pres. Roy Parsons, Sec'y-Treas.: Lupe Parsons
Audio: 8-tr. cassette

• **POMPANO BEACH (Area Code 305)**
Trackmaster Inc., 1310 S. Dixie Hwy W. Zip 33060 Tel: 943-2334 Pres. Roy Parsons, Sec'y-Treas.: Lupe Parsons
Audio: 8-tr. cassette

• **POMPANO BEACH (Area Code 305)**
Trackmaster Inc., 1310 S. Dixie Hwy W. Zip 33060 Tel: 943-2334 Pres. Roy Parsons, Sec'y-Treas.: Lupe Parsons
Audio: 8-tr. cassette

• **POMPANO BEACH (Area Code 305)**
Trackmaster Inc., 1310 S. Dixie Hwy W. Zip 33060 Tel: 943-2334 Pres. Roy Parsons, Sec'y-Treas.: Lupe Parsons
Audio: 8-tr. cassette

• **POMPANO BEACH (Area Code 305)**
Trackmaster Inc., 1310 S. Dixie Hwy W. Zip 33060 Tel: 943-2334 Pres. Roy Parsons, Sec'y-Treas.: Lupe Parsons
Audio: 8-tr. cassette

• **POMPANO BEACH (Area Code 305)**
Trackmaster Inc., 1310 S. Dixie Hwy W. Zip 33060 Tel: 943-2334 Pres. Roy Parsons, Sec'y-Treas.: Lupe Parsons
Audio: 8-tr. cassette

HAWAII

• **HONOLULU (Area Code 808)**
Musicassette Dupl'rs of Hawaii, PO Box 22190 Zip: 96822 Tel: 533-4165 (PWG)

Audio: Cassette, open reel
P.S.C. Prod'ns, 985 Waimanu St. Zip: 96814 Tel: 537-5695 Pres. Michael Tanaka (PWG)

Audio: Cassette, open reel

• **CHICAGO METROPOLITAN AREA (Area Code 312)**

A.G.I. (Album Graphics Inc.), 1950 N. Ruby St., Melrose Park 60160 Tel: 344-9100 TWX (910) 226-0417 Pres. Donald W. Kosterka; Sales Mgr.: Kevin McKenna (PWG only)

Sales offices: Los Angeles, Calif.; New York, N.Y.
Album Graphics Inc. see AGI

Audio Accessories Co., 38 W. 515 Deerpath Rd., Batavia 60510 Tel: 879-5998 Sales Mgr.: John S. Maloney (PWG)
Audio: 8-tr., cassette, open reel

Audio Artists Ltd., PO Box 7, Wheaton 60187, 429 St. Charles Rd., Carol Stream 60187 Tel: 668-6682 (PWG)
Audio: Cassette, open reel

Bell & Howell Video Div., 720 Landwehr Rd., Northbrook 60062 Tel: 291-1150 Pres. T.J. Wheeler; Nat'l Sales Mgr.: John Borger (PWG)
Video: 2" quad, 1" open reel, 1/4" U-matic cassette, 1/2" Beta & VHS cassette

Boulevard Rec'g Studios Inc., 641 Madison St., Oak Park 60302 Tel: 386-5388 Pres. Hal Katchuck
Audio: Cassette, open reel

Cassette Servs., 815 N. Douglas St., Arlington Heights 60004 Tel: 398-8403 Owner & Pres.: Willis J. Connor; Sales Mgr.: Michael Connor (PWG)
Audio: Cassette, open reel

Century Audio & Development Inc., 1018 Busse Hwy., Park Ridge, Ill. 60068 Tel: (312) 696-0675 (PWG)
Audio: Cassette

Columbia Pictures Videocassette Servs., 1501 Landmeier Rd., Elk Grove Village 60007 Tel: 640-2350 Telex: 206923 Exec. VP: George M. Ricci; Bus. Mgr.: T. Martin Rennels
Video: 2" quad, 1" helical, 1/4" U-matic cassette, 1/2" Beta & VHS cassette

Columbia Rec. Prod'ns, 630 N. McClurg Court Zip: 60611 Tel: 944-6000 Midwest Reg'l Sales Mgr.: Dick Hulter. (Sales office only)
Plants: Santa Ana, Calif.; Terre Haute, Ind.; Pitman, N.J.

Audio: 8-tr., cassette, open reel
Industrial Audio-Film Servs. Inc., 6228 Oakton St., Morton Grove 60053 Tel: 965-8400 (PWG)

Audio: 8-tr., cassette, open reel
International Audio Inc., 2934 Malmo Dr., Arlington Heights 60005 Tel: 956-6030 (PWG)

Audio: 8-tr., cassette, open reel
International Rec'g Co., 1649 W. Evergreen Ave. Zip: 60622 Tel: 227-2000 Pres.: Leonard March
Audio: Cassette, open reel

Audio: 8-tr., cassette, open reel
International Rec'g Co., 1649 W. Evergreen Ave. Zip: 60622 Tel: 227-2000 Pres.: Leonard March
Audio: Cassette, open reel

Audio: 8-tr., cassette, open reel
International Rec'g Co., 1649 W. Evergreen Ave. Zip: 60622 Tel: 227-2000 Pres.: Leonard March
Audio: Cassette, open reel

Audio: 8-tr., cassette, open reel
International Rec'g Co., 1649 W. Evergreen Ave. Zip: 60622 Tel: 227-2000 Pres.: Leonard March
Audio: Cassette, open reel

Audio: 8-tr., cassette, open reel
International Rec'g Co., 1649 W. Evergreen Ave. Zip: 60622 Tel: 227-2000 Pres.: Leonard March
Audio: Cassette, open reel

Audio: 8-tr., cassette, open reel
International Rec'g Co., 1649 W. Evergreen Ave. Zip: 60622 Tel: 227-2000 Pres.: Leonard March
Audio: Cassette, open reel

Audio: 8-tr., cassette, open reel
International Rec'g Co., 1649 W. Evergreen Ave. Zip: 60622 Tel: 227-2000 Pres.: Leonard March
Audio: Cassette, open reel

Audio: 8-tr., cassette, open reel
International Rec'g Co., 1649 W. Evergreen Ave. Zip: 60622 Tel: 227-2000 Pres.: Leonard March
Audio: Cassette, open reel

Audio: 8-tr., cassette, open reel
International Rec'g Co., 1649 W. Evergreen Ave. Zip: 60622 Tel: 227-2000 Pres.: Leonard March
Audio: Cassette, open reel

Audio: 8-tr., cassette, open reel
International Rec'g Co., 1649 W. Evergreen Ave. Zip: 60622 Tel: 227-2000 Pres.: Leonard March
Audio: Cassette, open reel

Audio: 8-tr., cassette, open reel
International Rec'g Co., 1649 W. Evergreen Ave. Zip: 60622 Tel: 227-2000 Pres.: Leonard March
Audio: Cassette, open reel

Audio: 8-tr., cassette, open reel
International Rec'g Co., 1649 W. Evergreen Ave. Zip: 60622 Tel: 227-2000 Pres.: Leonard March
Audio: Cassette, open reel

Audio: 8-tr., cassette, open reel
International Rec'g Co., 1649 W. Evergreen Ave. Zip: 60622 Tel: 227-2000 Pres.: Leonard March
Audio: Cassette, open reel

Audio: 8-tr., cassette, open reel
International Rec'g Co., 1649 W. Evergreen Ave. Zip: 60622 Tel: 227-2000 Pres.: Leonard March
Audio: Cassette, open reel

Audio: 8-tr., cassette, open reel
International Rec'g Co., 1649 W. Evergreen Ave. Zip: 60622 Tel: 227-2000 Pres.: Leonard March
Audio: Cassette, open reel

Audio: 8-tr., cassette, open reel
International Rec'g Co., 1649 W. Evergreen Ave. Zip: 60622 Tel: 227-2000 Pres.:

Kiderian Recs. Prod'ns, 4926 W Gunnison St Zip 60630 Tel 545-0861
 Pres: Raymond Peck, Gen & Sales Mgr: George Peck.
Audio: 8-tr., cassette.
 M B S Rec'g Studio, 232 E. Ohio, Zip 60611. Tel 828-0225
Audio: 8-tr., cassette, open reel.
 Media Int'l Inc., 425 N. Michigan, Zip 60611. Tel 467-5430 Pres: Duane
 Lundeen, VP: Margaret Lundeen, Gen Mgr.: Al Masters (PWG)
Audio: 8-tr., cassette, open reel.
 Musical Prods. Inc., 521 W. 26 St Zip 60616 Tel 225-9117 (PWG)
Audio: 8-tr., cassette, open reel.
 Poly Com Group, 201 E. Ohio St. Zip 60611. Tel: 222-9480. Gen. Mgr: Rich-
 ard Jablonski; Sales Mgr: Dave Bertz, Prod'n Mgr: Carmen Trombetta
Video: 2" quad., 1" helical, 1/4" U-matic cassette, 1/4" Beta & VHS cas-
 sette
 Programming Technologies Inc. 6666 N. Lincoln Ave., Lincolnwood 60645.
 Tel 676-9400. Sales Mgr.: Steven Sorkin. (PWG)
Audio: Cassette.
 Pro J Audio-Visual Inc., PD Box 33, Highland Park 60035 Tel 433-4575
 Pres. R.L. Pink, VP: J. Pink; Sales Mgr: M.M. Pnk, Adv Mgr: D.D. Pnk
 (PWG)
Audio: Cassette.
Video: 1/2" Beta & VHS cassette.
 Rainbow Bridge Studios Inc., 117 Rockland Rd., Libertyville 60048. Tel
 362-4060. Studio Mgr: Ron Schwartz.
Audio: Cassette, open reel.
 Sound Studios, 230 N. Michigan Ave Zip 60601 Tel 236-4814. Pres Jerry
 Markham, VP & Gen. Mgr.: Dan Tynus. (PWG)
Audio: 8-tr., cassette, open reel.
 Tono-Tapes Inc., 5932 N. Northwest Hwy. Zip 60611 Tel 763-0980 (PWG)
Audio: Cassette, open reel.
 Vinylweid, 2011 W. Hastings. Zip: 60608. Tel 243-1060. (PWG only—audio &
 video)

• KANKAKEE (Area Code 815)

Imperial Int'l Learning Corp., PD Box 548. Zip: 60501 Tel 933-7735 Chief
 Exec: Spencer Barnard; Gen. Mgr.: F.R. Ringfelt.
Audio: Cassette, open reel

• SPRINGFIELD (Area Code 217)

TeleVisual Prod'ns, 1414 S. Fifth. Zip: 62703. Tel 525-1238
Audio: 8-tr., cassette, open reel.
Video: 1" open reel, 1/4" U-matic cassette, 1/4" EIAJ open reel, 1/4" EIAJ
 cartridge, 1/4" Beta & VHS Cassette.

INDIANA

• GOSHEN (Area Code 219)

Precision Audio Inc., 16722 County Rd 40 Zip 46526. Tel: 642-3852 Pres
 Sanford Swartzendruber, Gen. Mgr: Jim Clymer Jr (PWG)
Audio: Cassette, open reel.

• INDIANAPOLIS (Area Code 317)

Commercial Features Inc., 2330 N. Yandes Zip: +6205. Tel: 926-4585
Audio: Cassette, open reel.
 R C A Recs., 6550 E. 30 St. Zip: 46219 Tel 267 5000
Home office: New York, N.Y.
Audio: 8-tr., cassette.

• MICHIGAN CITY (Area Code 219)

Infonics Inc., PO Box 1111, 238 Hwy 212 Zip 46350 Tel: 879-3381 Telex
 233111
Audio: 8-tr., cassette, open reel (SEE ADVERTISEMENT)

• RICHMOND (Area Code 317)

P R C Rec'g Co. (div. of Richmond Rec'g Corp.), 11-00 Rich Rd. Zip: 47374
 Tel: 962-9511 (PWG)
Home office: New York, N.Y.
Audio: 8-tr., cassette.

• TERRE HAUTE (Area Code 812)

Columbia Rec. Prod'ns, 1400 N. Frutridge Ave. Zip: 47805 Tel 466-8111
Sales offices: Century City (Los Angeles Metropolitan Area), Calif., Chi-
 cago, Ill., New York, N.Y.; Nashville, Tenn.
Audio: 8-tr., cassette, open reel.

Modern Album of Indiana Inc., 1299 Voorhees St. Zip: 47808. Tel: 235-6001.
 (PWG only—audio & video)
Home office: Hauppauge, N.Y., Modern Album & Finishing Co. Inc.

IOWA

• CARLISLE (Area Code 515)

Harold Luch & Assoc., 110 Garfield St Zip: 50047 Tel: 989-3679 Contact
 Harold L. Luch.
Audio: 8-tr.

THE FACTS

We are Custom Loaders of
 blank Cassette, 8-Track &
 Reel to Reel Tape.

WE DUPLICATE

AUDIO: Cassettes (Stereo)
 8 Track (Stereo)
 Reel to Reel (Full Track
 Mono)

VIDEO: U-Matic • VHS • Beta

We have available a full line of cassette,
 8-track & reel to reel accessories.

The Little Warehouse, Inc.

4906 Van Epps Rd., Brooklyn Heights, OH 44131
 (216) 398-0022

• CORALVILLE (Area Code 319)

Safeguard Co., PO Box 5555, 108 Second Ave Zip 52241 Tel: 351 7830
 Gen Mgr (Audio Visual Prod'ns): Ben Pflof
Home office: Brookfield (Milwaukee Metropolitan Area), Wis
Audio: 8-tr., cassette, open reel.

• COUNCIL BLUFFS (Area Code 712)

Moss Rec'g Serv., PD Box 417, 708 W Broadway. Zip 51502 Tel 322-4513
 (PWG)

• DES MOINES (Area Code 515)

Studio 2000 Ltd., 515 28 St. Zip: 50312. Tel 282-8306. Studio Dir James
 Shelby, Dupl'n Mgr: Bryan Jolliffe
Audio: Cassette, open reel.
 Triad Prod'ns Inc., 1910 Ingersoll, Zip 50309 Tel: 243-2125 Pres: Richard
 Trump, Sales Eng: William Syrhorst
Audio: Cassette, open reel

KANSAS

• WICHITA (Area Code 316)

High Fidelity Rec'g Inc., 1059 Porter. Zip 67203 Tel 262-6456 Pres.
 James Strattan (PWG)
Audio: 8-tr., cassette, open reel
Video: 1/4" U-matic cassette, 1/4" Beta & VHS cassette

KENTUCKY

• LEXINGTON (Area Code 606)

Lemco Custom Rec'g, 2518 Southview Dr. Zip 40503 Tel 277-1184
Audio: Cassette, open reel.

• LOUISVILLE (Area Code 502)

Allen-Martin Prod'ns Inc. 9701 Taylorsville Rd. Zip: 40299. Tel: 267-9658
Audio: Cassette

MARYLAND

• KENSINGTON (Area Code 301)

Omega Rec'g Servs., 10518 Connecticut Ave. Zip 20795. Tel: 946-4686.
 Owner & Chief Eng: W. Robert Yesbek.
Audio: 8-tr., cassette, open reel.

• TIMONIUM (Area Code 301)

Bradley Ent's Inc., 108 Galewood Rd. Zip 21093 Tel 252-8520 Pres: Joe
 Bradley; Exec Ass't: Stephen J. Rosasco
Audio: Cassette.

MASSACHUSETTS

• BOSTON METROPOLITAN AREA (Area Code 617)

Continental Rec'g's Inc., 210 South St. Zip 02111 Tel 426-3131. Pres: L.
 Daniel Flynn, Mktg. Dir: Stan M. Silverman. (PWG)
Audio: 8-tr., cassette, open reel
 Data Packaging Corp., 205 Broadway, Cambridge 02139. Tel: 868-6200.
 Pres: Otto Morningstar; Exec VP: Greg Mathus; VP Mktg: Jerry R. Hill;
 Sales & Mktg. Mgrs: (audio video) Gene Hull, (consumer) Pegge Har-
 matz. (PWG only—audio)
 Fleetwood Communications Co. Inc., 321 Revere St., Revere 02151. Tel
 289-6800 Pres: V.P. Giarrusso, Sales Mgr: Victor Mancini, Adv Mgr.:
 Robin Samora
Audio: 8-tr., cassette, open reel.
Video: 1/4" U-matic cassette, 1/4" Beta & VHS cassette
 Rik Tinory Prod'ns, 180 Pond Rd., Cohasset 02025. Tel: 383-9494. Pres:
 Richard F. Tinory. Artist Relations: Claire L. Babcock.
Audio: 8-tr., cassette, open reel.

• CHICOPEE (Area Code 413)

Dielectrics Inc., 300 Burnett Rd Zip 01020 Tel: 598-8308 (PWG only)

MICHIGAN

• DETROIT METROPOLITAN AREA (Area Code 313)

American Sound Corp., 3319 E. Ten Mile Rd., Warren 48091 Tel: 539-2900.
 Pres: Frank Day; VP & Gen. Mgr.: Paul M. Hayes; VP & Sales Mgr: Paul
 E. Adams (PWG)
Branches: North Hollywood (Los Angeles Metropolitan Area), Calif., West
 American Sound; Atlanta, Ga., American Sound-Atlanta Corp., Closter,
 N.J., American Sound
Audio: 8-tr., cassette, open reel
 Artie Fields Prod'ns, 9430 Woodward Ave Zip: 48202. Tel 873-8900. (PWG)
Audio: Open reel
 General Television Network, 13225 Capital Ave., Dak Park 48237. Tel 548
 2500. Pres: R. Randolph Hippler. (PWG)
Video: 2" quad. 1" helical, 1/4" U-matic cassette, 1/4" Beta & VHS cas-
 sette
 Magnetic Video Corp., 23434 Industrial Park Court, Farmington Hills 48024
 Tel: 476-2250 Pres: Andre A. Blay, VP & Gen. Mgr., Consumer Prods.
 Jack K. Dreyer, VP Commercial Prods.: Al Eicher, VP Admin.: Robert J.
 Vandegrift, VP Mktg.: Larry E. Bennett. (PWG)
Video: 2" quad, 1" helical, 1/4" U-matic cassette, 1/4" Beta & VHS cas-
 sette
 Sound Patterns DXM, 38180 Grand River, Farmington Hills 48018 Tel: 477-
 6444
Audio: Cassette, open reel
 Tape Tronics Inc., 750 E. Mandoline, Madison Heights 48071. Tel: 588-
 8281. TWX (810) 232-1524
Audio: 8-tr., cassette.

• MOUNT CLEMENS (Area Code 313)

Bazzy Electronics Corp., 39 N. Rose. Zip 48043. Tel: 463-2592. (PWG)
Audio: 8-tr., cassette.

MINNESOTA

• MINNEAPOLIS-ST. PAUL METROPOLITAN AREA (Area Code 612)

A S I (Audio/tek Systems Inc.), 711 W. Broadway. Minneapolis 55411. Tel:
 521-7631. Pres: Dan R. Holmes, Sales Mgr: Wes Hayne, Adv Mgr:
 Sandra Milan
Audio: Cassette, open reel.
 Bethany Fellowship Inc., 6820 Auto Club Rd., Minneapolis 55438. Tel: 944-
 2121. Cable: BETHANY Pres: T.A. Hegre; Gen. Mgr: M.F. Johnson, Sales
 Mgr.: Bill Linder. (PWG)
Audio: Cassette

• MOUNT CLEMENS (Area Code 313)

Bazzy Electronics Corp., 39 N. Rose. Zip 48043. Tel: 463-2592. (PWG)
Audio: 8-tr., cassette.

MINNESOTA

• MINNEAPOLIS-ST. PAUL METROPOLITAN AREA (Area Code 612)

A S I (Audio/tek Systems Inc.), 711 W. Broadway. Minneapolis 55411. Tel:
 521-7631. Pres: Dan R. Holmes, Sales Mgr: Wes Hayne, Adv Mgr:
 Sandra Milan
Audio: Cassette, open reel.
 Bethany Fellowship Inc., 6820 Auto Club Rd., Minneapolis 55438. Tel: 944-
 2121. Cable: BETHANY Pres: T.A. Hegre; Gen. Mgr: M.F. Johnson, Sales
 Mgr.: Bill Linder. (PWG)
Audio: Cassette

Communication Arts Inc., 2526 27 Ave. S., Minneapolis 55406. Tel: 721-
 5357
Audio: Cassette

E M C Corp., 180 E. Sixth St., St. Paul 55101. Tel 227-7366. Pres: David E.
 Feinberg; VP: Richard T. Stevens. Custom Sales Dir: C. Carter. (PWG)
Sales office: Hollywood (Los Angeles Metropolitan Area), Calif.
Audio: Cassette, open reel.

Metacom Inc., 1401-B W. River Rd. N., Minneapolis 55411. Tel 588 2781
 Pres.: James I. McCann; Sales Mgr: Philip T. Levin, Adv. Mgr: Timothy
 Devilbliss. (PWG)
Audio: Cassette, open reel.

MISSISSIPPI

• JACKSON (Area Code 601)

Malaco Sound Rec'g (div. of Malaco Inc.), 3023 W. Northside Dr. Zip 39213
 Tel: 982-4522
Audio: 8-tr., cassette, open reel

MISSOURI

• KANSAS CITY (Area Code 816)

Acme Dist's., PO Box 8123, 5644 Holmes. Zip 64112 Tel: 444-8123 Pres.
 Shirley Black, Sales Mgr: Ward Black
Audio: Cassette.
Video: 1/4" U-matic cassette, 1/4" Beta & VHS cassette

Recording Studios 55 (div. of 3'G Inds.), 5500 Troost Zip 64110 Tel 361-
 8455. Chief Eng: Mike Green, Gen. Mgr: Eugene Gold; Sales Mgr: C.
 King
Audio: 8-tr., cassette, open reel

Stage 3 Sound Prod'ns Inc., 12 E. 39 St Zip: 64111 Tel: 531-1375 (PWG)
Audio: Cassette, open reel.

• ST. LOUIS METROPOLITAN AREA (Area Code 314)

Technisonic Studios Inc., 1201 S. Brentwood Blvd. Zip 63131. Tel: 727
 1055. Pres: Edward H. Canter
Audio: Cassette, open reel.

• SPRINGFIELD (Area Code 417)

Aard-Vark Rec'g Inc., 335 S. Jefferson Zip: 65806 Tel: 866-4104. Pres:
 John Jacobsen
Audio: Cassette

National Audio Co. Inc., Box 3657 GS. Zip 65804 Tel: 883-5377
Audio: Cassette, open reel

MONTANA

• HELENA (Area Code 406)

Valtron Rec'g Studio, 305 Allen St. Zip: 59601. Tel: 442-0734. Pres & Adv
 Mgr.: Lester Liedle, Sales Mgr: Sandy Liedle.
Audio: Cassette, open reel

NEW JERSEY

• ASBURY PARK (Area Code 201)

Sound-Arts Co. Inc., 5 Cindy Ln. Zip 07712 Tel 493-8666. Pres: Charles J.
 Gspann; VP: Francis M. Gspann. (PWG)
Audio: Cassette, open reel.

• CAMDEN (Area Code 609)

Recorded Publ'ns Labs (div. of Recorded Publ'ns Mfg. Co. Inc.), 1100 State
 St Zip: 08105. Tel: 963 3000. Phila (215) 922-8558. Pres: David H.
 Goodman; Sales Mgr.: Pat Landon; Adv Mgr: Edward J. Goodman. (PWG)
Sales office: New York, N.Y.
Audio: 8-tr., cassette, open reel, special cartridges for background music
 & audio/visual

• CHERRY HILL (Area Code 609)

Tape Servs. Inc., 1 Keystone Ave. Zip 08003 Tel 424-9450 Sales Mgr
 Michael T. Mulcahy. (PWG only—audio only)

• CLOSTER (Area Code 201)

American Sound Corp., 317 Harrington Ave. Zip 07624. Tel 767-9033 VP
 Mktg: Paul E. Adams (Sales office only)
Home office: Warren (Detroit Metropolitan Area), Mich.
Audio: 8-tr., cassette, open reel.

• CRESSKILL (Area Code 201)

Unaworld Corp., 210 Knickerbocker Rd. Zip 07626. Tel: 871-0555 Pres:
 Fred Cooper.
Audio: 8-tr., cassette.

• GLEN ROCK (Area Code 201)

A S R Rec'g Servs. Inc., 21 Harristown Rd Zip 07452 Tel: 652-5600 TWX:
 (710) 988-5625 (PWG)
Branches: Canoga Park (Los Angeles Metropolitan Area), Calif., Dallas,
 Tex.
Audio: 8-tr., cassette (SEE ADVERTISEMENT)

• LEONIA (Area Code 201)

S/T Videocassette Dupl'g Corp., 500 Willow Tree Rd. Zip 07605. Tel 947
 6450, NYC (212) 239-4653. Gen Mgr: Stephan J. Ladden; Mktg. & Sales
 Dir: William R. Hitchcock.
Home office: New York, N.Y., Video Corp. of America.
Video: 1/4" U-matic cassette, 1/4" Beta & VHS cassette, 1/4" EIAJ open reel.

• MAPLE SHADE (Area Code 609)

A M P Rec'g's (div. of Intensive Programs Int'l), PD Box 14, 307 W. Main St
 Zip 08052. Tel: 667-1667. Pres: Donald R. Marsh, Gen. Mgr: Gerald
 Tyson
Audio: Cassette, open reel

• MONTCLAIR (Area Code 201)

Linear Sound Rec'g, 211 Glenridge Ave. Zip 07042 Tel: 744 0686 Pres: M.
 Kroll; Sales Mgr: Tom Steinmann (PWG)
Audio: 8-tr., cassette, open reel
Video: Dpen reel, 1/4" U-matic cassette, 1/4" Beta & VHS cassette.

• NORTHVALE (Area Code 201)

Preferred Sounds Inc., 135 Ludlow Ave. Zip 07647 Tel 768-8007 Pres:
 Sal Nastro; VP Opns & Admin: Dave Goldstein; Exec VP Sales: Al San-
 torino, VP Sales, Eastern Div: Bob Schultz; VP Mktg: Baron Lee. (PWG)
Audio: 8-tr., cassette, open reel.
Video: 1/4" U-matic cassette, 1/4" Beta & VHS Cassette.

• PARK RIDGE (Area Code 201)

Cadet Recs., 12 Maple Leaf Dr Zip 07656. Tel: 391-3676 VP Sales & Mktg.

- R.K. Herrington. (Sales office only) (PKG)
Home office & plant: Los Angeles, Calif
Audio: 8-tr. cassette, open reel
- **PITMAN (Area Code 609)**
C B S Recs. Inc., Lambs & Woodbury Rds. Zip: 08071 Tel: 589-8000
Sales offices: Hollywood (Los Angeles Metropolitan Area), Calif., Chicago, Ill., New York, N.Y., Nashville, Tenn
Audio: 8-tr. cassette, open reel
 - **RIOGIEFELD (Area Code 201)**
American Tape Corp. (div. of VideoVision Inc.), 1116 Edgewater Ave Zip 07057 Tel: 943-7860. VP Sales: Gerry Gottlieb; VP Admin: Kathelyn Maran-Mendenhall; Plant Mgr: Francis A. Dermody (PKG)
Audio: 8-tr. cassette.
 - **SCOTCH PLAINS (Area Code 201)**
H M R Prod'ns Inc., 574 W. Court. Zip: 07076 Tel: 889-1767. Owner Harry M. Randel; Pres: Lillian M. Randel.
Audio: Cassette.
 - **UPPER SAOULE RIVER (Area Code 201)**
Cassette Prod'ns Inc., 118 Rt 17 Zip 07458 Tel 327 1707 (PKG)
Audio: Cassette. (SEE ADVERTISEMENT)
 - **WEST CALOWELL (Area Code 201)**
R K O Tape Corp., 3 Fairfield Crescent. Zip: 07006 Tel: 575-8484 VP & Gen Mgr: Hugh Wallace. Sales Mgr: Lee Gray (PKG)
Audio: Cassette, open reel.
 - **WEST ORANGE (Area Code 201)**
House of Music, 1400 Pleasant Valley Way. Zip: 07052 Tel: 736-3062, NYC (212) 964-7444. Pres.: C.E. Conrad
Audio: 8-tr. cassette, open reel

NEW MEXICO

- **ALBUQUERQUE (Area Code 505)**
Bill Hunter's Rec'g Serv., 118 Alcazar NE. Zip: 87108 Tel: 268-8442. Gen Mgr: Bill Hunter.
Audio: 8-tr. cassette, open reel

NEW YORK

- **CLARENCE (Area Code 716)**
Mark Custom Rec'g Serv., 10815 Bodine Rd. Zip: 14031 Tel: 759-2600
Pres. & Sales Mgr: Vincent S. Morette
Audio: Cassette.
- **FARMINGDALE (Area Code 516)**
Pressure Sensitive Tape & Label Corp., 135 Schmitt Blvd Zip 11735 Tel: 293-7300 (PKG only—video)
Shorewood Packaging Corp., 55 Engineers Ln. Zip: 11735. Tel: 694-8230 (PKG only—audio & video)
Home office: New York, N.Y.
- **FRANKLIN SQUARE (Area Code 516)**
Master Sound Prod'ns Inc., 921 Hempstead Tnkp. Zip: 11010 Tel: 354-3374. Owners: Ben Rizzi, Maizne Chreim.
Audio: Cassette
Video: ¼" U-matic cassette, ½" VHS cassette
- **HAUPPAUGE (Area Code 516)**
Allison Audio Prods. Inc., 1290 Motor Pkwy. Zip: 11787 Tel: 234-2010, NYC (212) 953-1124. Bd. Chm: Louis Ligatoy; Pres.: Abraham Chayet
Audio: 8-tr. cassette
- **HOLTSVILLE (Area Code 516)**
Studio Magnetics Co. Inc., 12 Long Island Ave Zip: 11742 Tel: 289-3400
Pres: George Clahane. VP: Craig M. Balaban (PKG only)
- **HUNTINGTON STATION (Area Code 516)**
Shelley Prods. Ltd., 220 Broadway. Zip: 11746. Tel: 423-7090.
Audio: 8-tr. cassette, open reel
- **LE ROY (Area Code 716)**
Arlo Recs. Inc., 7635 Telephone Rd. Zip: 14482 Tel: 584-3040. Pres: Kenneth Bearce; Gen Mgr: James Bearce; Sales Mgr: Jill Weizel.
Audio: Open reel.
- **LINOENHURST (Area Code 516)**
Coastal Specialty Tapes Inc. (formerly Pratt-Spector Corp.), 274 Bangor St. Zip: 11757 Tel: 226-5900. Opns. Head & Sales Mgr: Dan Dobbs (PKG only—audio)
- **MAMARONECK (Area Code 914)**
Cine Magnetics Video, 650 Hatstead Ave. Zip: 10543 Tel: 698-3434; NYC (212) 542-0700. WATS (800) 431-1102. Contacts: Bob Orzack, June Johnston
Video: ¼" U-matic cassette, ½" Beta & VHS cassette
- **MASSENA (Area Code 315)**
Michele Audio Corp., Andrew Street Rd. Zip: 13662 Tel: 769-2448. Pres: Ginette Cormier; Sales Mgr: Harold Friedman; Adv. Mgr: Jack Daniels (PKG)
Audio: 8-tr. cassette
- **MOUNT VERNON (Area Code 914)**
Sentry Inds. Inc., 221 N. MacQuesten Pkwy. Zip: 10550 Tel: 664-2909
Cable SENTIND. Pres: Harold Rosen. VP: Barry Rosen (PKG)
Video: ¼" cassette.

- **NEW YORK METROPOLITAN AREA (Area Code 212)**
A G I (Album Graphics Inc.), 125 W 55 St. Zip: 10019. Tel: 489-0793. TWX (710) 581-5597. VP Mktg: Richard Block. (Sales office only) (PKG only—audio & video)
Adwar Video Corp., 100 Fifth Ave. Zip: 10011. Tel: 691-0976. Telex: 420801. Pres: Samuel Adwar; Sales Mgr: Mike McKenna; Chief Eng: William Claghor
Video: ¼" EIAJ open reel, ¼" U-matic cassette, ½" Beta & VHS cassette
Album Graphics Inc., see AGI.

- Andol Audio Prods. Inc., 4212 14 Ave. Brooklyn 11219. Tel: 435-7322
Pres: Anthony A. Maniere; Sales Mgr: Rocco Salvatore; Adv. Mgr: Domenico Salvatore (PKG)
Audio: 8-tr. cassette
- Audio-Tech Labs., 2819 Newkirk Ave., Brooklyn 11226 Tel: 469-7134
Audio: Cassette.
- Bert-Co Ent's. Inc. (div. of the Walter Reade Drg. Inc.), 241 E. 34 St. Zip: 10016. Tel: 683-6300. Pres: Sheldon Gunsberg; Exec. VP: VP Finance & Treas: Christopher W. Preuster. (Sales office only) (PKG only)
Branch: Los Angeles, Calif.
- Broadcasting Foundation of America, 52 Vanderbilt Ave., Suite 1810 Zip: 10017 Tel: 986-6448. Acting Exec. Dir.: Calvin W. Stillman; Program Dir: Catherine Probst (PKG)
Audio: Open reel
- Cassette Rec'g Corp., see National Rec'g Studios
- Columbia Rec. Prod'ns, 51 W. 52 St. Zip: 10022 Tel: 975-4321 (Sales office only)
Plants: Santa Maria, Calif., Terre Haute, Ind., Pitman, N.J., CBS Recs Inc.
Audio: 8-tr. cassette, open reel
- Cue Rec'gs, 1156 Ave. of the Americas Zip: 10036. Tel: 757-3641.
Audio: 8-tr. cassette, open reel
- Delta Rec'g Corp., 16 W. 46 St. Zip: 10036. Tel: 840-1350
Audio: 8-tr. cassette, open reel.
- Devlin Prod'ns Inc., 150 W 55 St. Zip: 10019 Tel: 582-5572. Pres: Sandra Devlin; VP & Eng'g Dir: Roman Culka; Gen. Mgr: Tom McCormick; Sales Rep: Cecelia Lazarescu.
Video: 2" quad, 1" open reel, ¼" U-matic cassette, ½" Beta & VHS cassette
Note: Video duplication done in all TV modes (NTSC, PAL, SECAM, PAL-M)
- Direct Rec'gs Inc., 18 E. 50 St. Zip: 10022 Tel: 759-7979. (PKG)
Audio: Cassette, open reel.
- Disc Communications Ltd., 743 Fifth Ave. Zip: 10023 Tel: 371-0390 (PKG)
Audio: 8-tr. open reel.
- E R H Sales Corp., 221 W 57 St. Zip: 10019 Tel: 582-4200. Pres: Lee Halpern; Gen. Mgr: Michael Halpern; Sales Mgr: Robert Shavelson. (PKG)
Audio: 8-tr. cassette, open reel
Video: ¼" U-matic cassette, ½" VHS cassette. (SEE ADVERTISEMENT)
- E U E/Screen Gems (div. of Columbia Pictures Inds. Inc.), 222 E. 44 St. Zip: 10019 Tel: 867-4030
Video: 2" quad, ¼" U-matic cassette
- Intercontinental Televideo Corp., 10 W. 66 St., Suite 11-F. Zip: 10023. Tel: 595-9454. Pres: Gerald Citron; VP: Nigel Toovey.
Audio: ¼" U-matic cassette, ½" Beta & VHS cassette.
- M T I, see Modern Telecommunications Inc.
- Marvell Packaging Co., 230 W. 17 St. Zip: 10011 Tel: 929-8435. VP: Barry Berman; Sales Mgr: Scott Teich (PKG only—audio & video)
- Modern Telecommunications Inc. (MTI), 885 Second Ave. Zip: 10017. Tel: 355-0510 (PKG)
Video: All formats
- National Rec'g Studios Inc. & National Video Center, 730 Fifth Ave. Zip: 10019 Tel: 757-6440

- Audio: 8-tr. cassette, open reel.
Video: 2" quad, 1" open reel, ¼" U-matic cassette, ½" Beta & VHS cassette
- National Video Center, see National Rec'g Studios
- Nostalgia Lane Inc., 200 W. 57 St. Zip: 10019. Tel: 582-5390
Audio: 8-tr. cassette.
- P R C Rec'g Co. (div. of Richmond Rec'g Corp.), 1185 Ave. of the Americas Zip: 10036. Tel: 997-1250. Pres.: Hugh Landy; VP & Sales Mgr.: David Grant (PKG)
Plants: Compton (Los Angeles Metropolitan Area), Calif.; Richmond, Ind.
Audio: 8-tr. cassette.
- Queens Lithographing Corp., 52-35 Barnett Ave., Long Island City 11104 Tel: 457-7700. Chief Exec. Officer: Eric Kaitman; Pres.: Leonard Verebay; Sr. VP Sales: Richard Roth (PKG only—audio & video)
Branch: Hollywood (Los Angeles Metropolitan Area), Calif.
Plant: Indianapolis, Ind., Rutgers Packaging Corp. (SEE ADVERTISEMENT)
- R C A Recs., 1133 Ave. of the Americas. Zip: 10036 Tel: 930-4000. (Sales office only)
Sales offices: Los Angeles, Calif., Indianapolis, Ind., Nashville, Tenn.
Plant: Indianapolis, Ind.
Audio: 8-tr. cassette, open reel
- Recorded Publ'ns Labs. (div. of Recorded Publ'ns Mfg. Co. Inc.), 2 Penn Plaza, Suite 1500. Zip: 10001. Tel: 868-3115. Eastern Reg'l Sales Mgr: Lee Kallett. (Sales office only) (PKG)
Home office: Camden, N.J.
Audio: 8-tr. cassette, open reel, special cartridges for background music & audiovisual.
- Reel Dupl'r's Inc., 723 Seventh Ave. Zip: 10019 Tel: 944-8977
Audio: Cassette, open reel
- Regent Sound Studios Inc. 25 W. 56 St. Zip: 10019 Tel: 245-2630. Pres: Robert Lifkin; Gen. Mgr.: Elissa Kline.
Audio: Cassette, open reel.
Video: 2" quad, 1" type C open reel, ¼" U-matic cassette.
- Reliance Audio Visual Corp., 550 W. 43 St. Zip: 10036. Tel: 736-0700. Pres: Gil M. Meyer; Gen. Mgr.: Marilyn Pepsach; Tech. Dir.: John Peiplow.
Audio: Cassette, open reel.
Video: ¼" U-matic cassette, ½" Beta cassette.
- Rombex Prod'ns Corp., 245 W. 55 St. Zip: 10019. Tel: 757-3681. Gen. Mgr: Lucina Hahn; Mktg. Dir.: Joel Willis
Video: 2" quad, 2" helical (IVC), 1" open reel, ¼" U-matic cassette, ½" EIAJ open reel, ¼" EIAJ cartridge, ½" Beta & VHS cassette
- Sadler Rec'g, 118 E. 28 St. Zip: 10016. Tel: 684-0960. Pres: John Sadler
Audio: Cassette, open reel.
Video: ¼" U-matic, ½" Beta & VHS cassette
- Jasper Samuel Advertising & Recs. Inc. 60 E. 42 St., Suite 541 Zip: 10017. Tel: 490-2787. Pres: Jasper Samuel. (PKG only—audio & video)
- ServiSound Inc., 35 W. 45 St. Zip: 10036. Tel: 921-0555. Pres: Nat Levy. Gen. & Sales Mgr: Mike Shaprow. (PKG)
Audio: Cassette, open reel.
- Shorewood Packaging Corp., 10 E. 53 St. Zip: 10022. Tel: 371-1500. Pres: Paul Shore; Exec. VP: Floyd S. Gliner; VP Special Projects: Marc Shore; VP Nat'l Sales: Ken Rosenblum; VP West Coast Sales: Jim Palmer (PKG only)

When you need

CASSETTE DUPLICATION



Benefit from the Quarter-Century of Experience & Expertise of

JULIUS A. KONINS

President of Cassette Productions, Inc.
Creator and inventor of, and holder of patents on, the most advanced cassette duplicating equipment in the world.

STATE OF THE ART duplicating standard and esoteric premium tapes.

Request FREE demo tape on your business letterhead.

Call JULIE KONINS at 201-327-1707
or address him personally at:

CASSETTE PRODUCTIONS, INC.
118 State Highway No. 17, Upper Saddle River, N.J. 07458

Branches: Los Angeles, Calif.; Shorewood Packaging; La Grange, Ga., SPC Co.; Farmingdale, N.Y.; Shorewood Packaging.

T V R Inc., 333 W. 52 St. Zip: 10019. Tel: 541-4050. VP Mktg: Allen Schulman; Dpns. Mgr.: James C. Mahoney
Video: 2" quad, 1" helical, 1/4" U-matic cassette, 1/4" Beta & VHS cassette

United Research Lab Corp., 681 Fifth Ave. Zip: 10022. Tel: 751-4663. TWX: (710) 581-3622. Pres.: George Adams; Gen. Mgr.: Anita Adams; Sales Mgr.: Lee Rand; Chief Eng.: Jim Lee
Video: Cassette, open reel
Audio: 1/4" Beta cassette.

Video Corp of America, 231 E. 55 St. Zip: 10023. Tel: 355-1600
Branch: Leona, N.J., S/T Videocassette Dupl'g Corp.
Video: 1/4" U-matic cassette, 1/4" Beta & VHS cassette, 1/4" EIAJ open reel, 1/4" EIAJ cartridge.

Visual Information Systems, 15 Columbus Circle, Zip: 10023. Tel: 541-8080
 Pres.: Jay Raeben; VP Prod'n & Programming: David Barnhizer; Gen. Mgr.: Paul Gersh; Sales Mgr.: Joe Scozzari. (PWG—audio & video)
Video: 2" quad, 1" helical, 1/4" U-matic cassette, 1/4" Beta & VHS cassette.

Windsor Total Video, 565 Fifth Ave. Zip: 10017. Tel: 725-8080. Bd. Chm.: Bob Henderson; Pres.: Bert Goodman; VP Prod'n & Sales: Bert Sapersstein; Dpns. Mgr.: Nancy Squire
Video: 2" quad, 1" type C, 1/4" U-matic cassette, 1/4" Beta & VHS cassette.

• NORTH BELLMORE (Area Code 516)

Telephone Dynamics Corp., 2473 A Jerusalem Ave. Zip: 11710. Tel: 221-9870.
Audio: Cassette.

• OCEANSIDE (Area Code 516)

Burlington Audio Tapes Inc., 106 Molt St. Zip: 11572. Tel: (516) 678-4414
 Pres.: Ruth Schwartz; VP: Rudy Schwartz
Audio: In-cassette dupl'g. (SEE ADVERTISEMENT)

• PORT CHESTER (Area Code 914)

Associated Audio Servs. Inc., 181 Westchester Ave. Zip: 10573. Tel: 937-5129. Pres.: D. Richard Kraus; VP: Allan Johnson. (PWG)
Audio: 8-tr., cassette, open reel.

• ROCHESTER (Area Code 716)

Visual Horizons, 180 Metro Park. Zip: 14623. Tel: 424-5300.
Audio: Cassette.

• TROY (Area Code 518)

Wildwood Entertainment, 276 Fourth St. Zip: 12180. Tel: 273-7660. VP: Erich Borden
Audio: Cassette

• UTICA (Area Code 315)

Dneida Video-Audio Tape Cassette Corp., 760 Biandina St. Zip: 13501. Tel: 735-6187. Pres.: Stanley Markowski.
Audio: Cassette.

• YONKERS (Area Code 914)

Video Software & Prod'n Center Inc. (VSP), 380 Walnut St. Zip: 10701. Tel: 423-4400. Pres.: Kenneth Wise; Sales Mgr.: John San Pietro. Client Servs. Mgr.: Dee Martin.
Video: 2" quad, 1" types A & C open reel, 1/4" EIAJ open reel, 1/4" U-matic cassette, 1/4" Beta & VHS cassette.

NORTH CAROLINA

• CANTON (Area Code 704)

Recording Servs. of Western North Carolina Inc., 10 Penland St. Zip: 28716. Tel: 648-6012. Dwner: J. Ted Evans Jr.; VP: Kay Evans.
Audio: 8-tr., cassette, open reel.

• CHARLOTTE (Area Code 704)

Arthur Smith Studios, PO Box 220551, 5457 Monroe Rd. Zip: 28222. Tel: 536-0424. Pres.: Arthur Smith; Sales Mgr.: Clay Smith; Sales Mgr.: Wiley Brown. (PWG)
Audio: Open reel.

OHIO

• CINCINNATI (Area Code 513)

Audiocraft Rec'g Co., 915 W. Eighth St. Zip: 45203. Tel: 241-4304. Pres.: Earl T. Herzog Jr. (PWG)
Audio: 8-tr., cassette, open reel.
Video: 1/4" U-matic cassette, 1/4" Beta & VHS cassette.

Counterpart Creative Studios Inc., 3744 Appligate Ave. Zip: 45211. Tel: 661-8810. (PWG)
Audio: 8-tr., cassette, open reel.

Rite Rec. Prod'n Inc., 9745 Mangham Dr. Zip: 45215. Tel: 733-5533
 Dwner: Carl J. Burkhardt; Pres.: VP: Philip M. Burkhardt; VP Prod'n: Lan A. Ackley; VP Graphics: Kenneth D. Keith Jr.; Sales Mgr.: Dan Burton. (PWG)
Audio: 8-tr., cassette, open reel.

• CLEVELAND METROPOLITAN AREA (Area Code 216)

Boddie Rec. Mfg. & Rec'g Inc., 12202 Union Ave. Zip: 44105. Tel: 752-3440
 Pres.: Thomas R. Boddie; Sales Mgr.: Dennis R. Boddie. (PWG)
Audio: 8-tr., cassette, open reel.

The Little Warehouse Inc., 4906 Van Epps Rd. Zip: 44131. Tel: 398-0022. (PWG)
Audio: 8-tr., cassette. (SEE ADVERTISEMENT)

Storcraft Inc., 18630 Detroit Ave., Lakewood 44107. Tel: 221-4722. (PWG)
Audio: Cassette.

• COLUMBUS (Area Code 614)

Magnetic Studios, 4784 N. High St. Zip: 43274. Tel: 262-8607.
Audio: Cassette, open reel.

Mus-I-Col Inc., 780 Dakland Park Ave. Zip: 43224. Tel: 267-3133. Dwners: John W. Hull, Boyd P. Niederlander.
Audio: 8-tr., cassette, open reel.

• NEWARK (Area Code 614)

Utopia Ultra Sound, 38-40 S. First St. Zip: 42055. Tel: 345-9426. Dwner: Robert H. Kirk Jr.; VP: Don Shannon; Gen. Mgr.: Robert H. Kirk Sr.; Sales Mgr.: Rose Shannon. (PWG)
Audio: 8-tr., cassette.

• YOUNGSTOWN (Area Code 216)

United Audio Rec'g Studio, 5947 Stillson Pl. Zip: 44512. Tel: 758-5463
 Pres.: William Warner; Gen. & Sales Mgr.: Ray Nevel.
Audio: 8-tr., cassette, open reel.

OKLAHOMA

• OKLAHOMA CITY (Area Code 405)

Video One Inc., 1216 N. Blackwelder. Zip: 73106. Tel: 524-2111. Pres.: Robert M. Howard; Prod'n Mgr.: Rick A. Lippert
Video: 1/4" U-matic cassette, 1/4" Beta & VHS cassette.

• TULSA (Area Code 918)

C E S Rec'g Inc., 2500 N. Hemlock Circle, Broken Arrow 74012. Tel: 627-8474. Pres.: Basil W. Thomas; Gen. Mgr.: Judy McAlister; Mktg. Mgr.: Walter J. McKee Jr. (PWG—audio only)
Audio: 8-tr., cassette
Video: 1/4" Beta & VHS

I T I Studios (International Teaching Tapes), 4235 S. Memorial Dr. Zip: 74145. Tel: 663-7700. Pres.: Meridith R. Gray; Sales Mgr.: Sonny Gray. (PWG)
Audio: 8-tr., cassette, open reel.

The Master Sound Inc., 8137 E. 46 St. Zip: 74145. Tel: 663-7186. Pres.: Donald Boshears; Gen. Mgr.: Peter Enns; Sales Mgr.: Louis Threton. (PWG)
Audio: Cassette
Video: 1/4" U-matic cassette, 1/4" Beta & VHS cassette.

OREGON

• PORTLAND (Area Code 503)

Northwestern Inc., Motion Pictures & Rec'g, 1224 SW Broadway. Zip: 97205. Tel: 226-0170. Pres.: Robert M. Lindahl; Sales Mgr.: Paul A. Buescher. (PWG)
Audio: Cassette, open reel.

PENNSYLVANIA

• LANCASTER (Area Code 717)

Spectrum Fidelity Magnetics, 49 Glenwood Ave. Zip: 17602. Tel: 295-9275. (PWG)
Audio: Cassette, open reel.

• PHILADELPHIA METROPOLITAN AREA (Area Code 215)

AudioVisual Communications Inc., 435 Crooked Ln., King of Prussia 19406. Tel: 272-8500. Pres.: John Ballantyne; VP Sales: John Butterworth. (PWG)
Audio: Cassette, open reel.

Diskmakers Inc., 925 N. Third St. Zip: 19123. Tel: 627-2277. NYC Tel: (212) 966-3185. Pres.: Morris Ballen; VP: Larry Ballen.
Audio: 8-tr., cassette. (SEE ADVERTISEMENT)

MarketDyne Int'l, 1600 Arch St. Zip: 19101. Tel: 241-2935. (PWG)
Video: 1" open reel, 1/4" U-matic cassette, 1/4" EIAJ open reel, 1/4" EIAJ cartridge.

UniComm Inc., 414 Swedeland Rd., King of Prussia 19406. Tel: 275-7100. Pres.: J.L.C. Ulrich Jr.; Gen. Mgr.: Robert G. Rowe Jr. (PWG)
Audio: Cassette, open reel.

• PITTSBURGH (Area Code 412)

Audio Innovators Inc., 216 Blvd. of the Allies. Zip: 15222. Tel: 471-6220.
 Pres.: Norman J. Cleary; Gen. Mgr.: Martha J. Wilson.
Audio: Cassette, open reel.

George Head Prod'n & AV Prods., 701 Washington Rd. Zip: 15228. Tel: 561-3399. (PWG—audio & video)
Audio: Cassette, open reel.

• PRIMOS (Area Code 215)

E J Stewart Inc., 525 Mildred Ave. Zip: 19018. Tel: 626-6500. Pres.: Eric R. Address; Gen. & Adv. Mgr.: Howard S. Lipman; Sales Mgr.: Andy Kienzie. (PWG)
Video: 2" quad broadcast, 1" type C, 1/4" U-matic cassette.

• SCRANTON (Area Code 717)

Specialty Recs. Corp., 210 N. Valley Ave., Dlyphant 18447. Tel: 383-2471. TWX: (510) 671-4580. Pres.: Richard C. Marquardt; VP Sales: John R. Williams.
Audio: 8-tr., cassette.

• WARREN (Area Code 814)

Loranger Mfg. Corp., Entertainment Prods. Div., 10-48 Clark St. Zip: 16365. Tel: 723-8600. VP: Robert Loranger. (PWG only—audio) (SEE ADVERTISEMENT)

SOUTH CAROLINA

• GREENVILLE (Area Code 803)

Duplication Serv. (div. of Custom Rec'g & Sound Inc.), PO Box 7647, 1225 Pendleton St. Zip: 29611. Tel: 269-5018. Pres.: Robert W. Edwards. (PWG)
Audio: 8-tr., cassette, open reel.

Video: 1/4" U-matic cassette, 1/4" Beta & VHS cassette.

• MYRTLE BEACH (Area Code 803)

Dee-Bee Rec'g Serv., 704 Ninth Ave. S. Zip: 29577. Tel: 448-8091. Pres.: Stan Deppen Jr.; Sales Mgr.: Kenneth Deppen; Adv. Mgr.: Pat Gerrick. (PWG)
Audio: Cassette, open reel.

TENNESSEE

• FAYETTEVILLE (Area Code 615)

Kim-Pat Ent's., PO Box 654, Hillwood Dr. Zip: 37334. Tel: 433-2323/5661. (PWG)
Audio: 8-tr., cassette, open reel.

• MEMPHIS (Area Code 901)

Shoe Prod'n Inc., PO Box 12025, 485 N. Hollywood. Zip: 38112. Tel: 458-4496. Pres.: Warren E. Wagner; VP & Music Dir.: Wayne Crook. (PWG)
Audio: Open reel
Video: 1/4" U-matic cassette, 1/4" VHS cassette.

• NASHVILLE AREA (Area Code 615)

American Sound Recs./Emerald Recs., 62 Music Square W. Zip: 37203. Tel: 327-4538. Pres.: Cliff Ayers Dstermeyer; Gen. Mgr.: Connie Lynne Wright; Sales Mgr.: Chris Dstermeyer; PR: Alma Lee Combs.
Audio: 8-tr.

Columbia Rec. Prod'n's, 34 Music Square E. Zip: 37203. Tel: 259-4321. (Sales office only)
 Plants: Terre Haute, Ind.; Pitman, N.J.; CBS Recs. Inc.
Audio: Cassette, open reel.

Custom Tape Dupl'rs Inc., 341 Hill Ave. Zip: 37210. Tel: 256-1728. Pres.: L.C. Tant; Sales Mgr.: Mike Tant. (PWG)
Audio: 8-tr., cassette.

Fanta Professional Servs., 1213 16 Ave. S. Zip: 37212. Tel: 327-1731. Pres.: Johnny Rosen.
Audio: 8-tr., cassette, open reel.

Video: 2" quad, 1" helical "C" format, 1/4" U-matic cassette, 1/4" Beta & VHS cassette.

Globe Rec'g Studio Inc., 1313 Dickerson Rd. Zip: 37207. Tel: 226-0811. Dwner & Mgr.: Jim Maxwell; Sec'y-Treas.: Glenna Maxwell.
Audio: Cassette, open reel.

Gusto Recs. & Tapes, 22D Boscobel St. Zip: 37213. Tel: 256-1656. TWX: (810) 371-1055. Pres. & Sales Mgr.: Moe Lytle; Gen. Mgr.: Steve Kountzman.
Audio: 8-tr., cassette.

Modern Album of Tennessee Inc., 457 Chestnut. Zip: 37203. Tel: 255-7461. (PWG only—audio & video)

Home office: Hauppauge, N.Y., Modern Album & Finishing Co. Inc.
 Nashville Album Prod'n's Inc., 101 Music City Circle. Zip: 37203. Tel: 883-2153. (PWG)

Audio: 8-tr., cassette
 R C A Recs., 30 Music Square W. Zip: 37203. Tel: 244-9880. VP: Jerry Bradley.
Home office: New York, N.Y.

Plant: Indianapolis, Ind.
Audio: 8-tr., cassette, open reel

Sound of Nashville Inc., 305 11 Ave. S. Zip: 37203. Tel: 244-1124. Pres.: John Iwants; Sales Mgr.: Allen Morel.
Audio: 8-tr., cassette.

Southern American Rec. Pressing—Tel: 256-2521—see Sound of Nashville.
 Stargem Recs. Inc., 20 Music Square W., Suite 200. Zip: 37203. Tel: 244-1025. (PWG only—video)

Studer Revox America Inc., 1425 Elm Hill Pike. Zip: 37210. Tel: 254-5651. Pres.: Bruno Hochstrasser; Gen. Mgr.: Bill R. Muggler; Nat'l Sales Mgr.: Barry D. Evans, Technical Mgrs. (Studer) Doug Beard, (Revox) Renaud Delapraz.

Branches: Van Nuys (Los Angeles Metropolitan Area), Calif.; New York, N.Y.
Audio: Open reel.

TEXAS

• AUSTIN (Area Code 512)

P S G Rec'g Studio, PO Box 1482, 4322-A N. Lamar Blvd. Zip: 78767. Tel: 454-5653. Pres.: Pedro S. Gutierrez
Audio: 8-tr., cassette, open reel.

• DALLAS (Area Code 214)

A S R Rec'g Servs., 13101 Preston Rd., Suite 300. Zip: 75240. Tel: 239-7171. Home office: Glen Rock, N.J.
Audio: 8-tr., cassette.

At The Top Cassette Dupl'rs, 13640 Omega. Zip: 75234. Tel: 980-7671. Gen. Mgr.: Chad Witmeyer
Audio: Cassette.

Electronic Technological Inds of America Inc., PO Box 1580. Zip: 75221. Tel: 827-8002. Bd. Chm.: John Kanter; Gen. Mgr.: David Coleman; Sales Mgr.: Larry Pearson. (PWG)
Audio: 8-tr., cassette, open reel.

Tapemasters Inc., PO Box 38651. Zip: 75238. Tel: 349-0081. (PWG)
Audio: 8-tr., cassette, open reel.

• FORT WORTH AREA (Area Code 817)

Dakridge Music Rec'g Studio, 2001 Elton Rd., Haltom City 76117. Tel: 838-8001. Eng.: Homer Lee Sewell.
Audio: Cassette, open reel.

• SAN ANTONIO (Area Code 512)

A S I (Abadon/Sun Inc.), PO Box 6520, 10330 Kolzevue. Zip: 78209. Tel: 824-8781. Pres.: Galen Carol.
Audio: Cassette.

Marsal Prod'n's Inc., 1735 Castroville Rd. Zip: 78237. Tel: 433-9351. Pres.: Antonio J. Menendez; Gen. Mgr.: Pat Alvarado; Sales Mgr.: Felix Elizondo
Audio: 8-tr., cassette.

Texas Rec. Mfg. Inc., 1422 W. Poplar. Zip: 78207. Tel: 733-6138. Pres.: C. Foy Lee; Gen. Mgr.: Jimmy Burton; Sales Mgr.: Jeannie Hill. (PWG)
Audio: 8-tr.

• SAN BENITO (Area Code 512)

Rio Grande Music Co., 119 S. Sam Houston Blvd. Zip: 78586. Tel: 399-5377. Sales Mgr.: John F. Phillips.
Audio: 8-tr., cassette.

• WACO (Area Code 817)

Creative Communications Inc. (sub of SMI), 920 N. Valley Mills. Zip: 76710. Tel: 776-6553. (PWG)
Audio: Cassette.

UTAH

• PROVO (Area Code 801)

Sound Concepts, PO Box 299, 108 W. Center. Zip: 84601. Tel: 375-7333. Dwner: Michael Jensen. (PWG)
Audio: Cassette

• SALT LAKE CITY (Area Code 801)

Bonneville Prod'n's, 130 Social Hall Ave. Zip: 84111. Tel: 237-2400. TWX: (910) 925-5266.
Audio: Cassette, open reel.

Chase Media Inc., Busch Park, 5284 S. 320 W., Suite C-166. Zip: 84107. Tel: 261-1383. Pres. & Gen. Mgr.: Randal S. Chase; Sales Mgr.: Irel Chase.
Audio: 8-tr., cassette, open reel.

Covenant Rec'g's Inc., PO Box 26817, 1345 Major St. Zip: 84126. Tel: 487-1096. Pres.: V. Lewis Kofford; Adv. Mgr.: Jeff Lund. (PWG)
Audio: Cassette.

VIRGINIA

• MANASSAS (Area Code 703)

Memory Makers, 9202 Amelia Court. Zip: 22110. Tel: 631-9465. Pres.: Jim Corrado; VP: Donna Corrado. (PWG—audio & video)
Audio: 8-tr., cassette, open reel.

WASHINGTON

• OLYMPIA (Area Code 206)

Sound Preservers Co., 911 E. Fourth Ave. Zip: 98506. Tel: 352-9097. Dwner: Allen P. Giles.
Audio: 8-tr., cassette, open reel.

• SEATTLE (Area Code 206)

Cinema Sound Corp., see Investment Technology.

infonics[®]

TAPE DUPLICATORS

Track System

1/2 or 1/4 Track Reel or cassette
to 1/2 or 1/4 track cassette
or reel.

Master Tape Widths

Reel 1/4 or 1/2" (Specify)
Cassette .150

Master Speeds

Reel 40-80 (3 3/4-7 1/2) IPS
80-160 (7 1/2-15) IPS
Cassette 20 (1 7/8) IPS

Reel Size

7 or 10 1/2" low torque
(may be adjusted for 5")

Frequency Response

30 Hz to 16 KHz
within 3 db

Distortion

Less than 0.9% thd
(200 nwb/m) operating level

Flutter and Wow

Less than 0.1% unweighted

Speed Deviation

Less than 0.15%

Equalization and Level Set

NAB Standard playback/record
200 nwb/m record level

Program Separation

Better than 60 db
Stereo pair 40 db

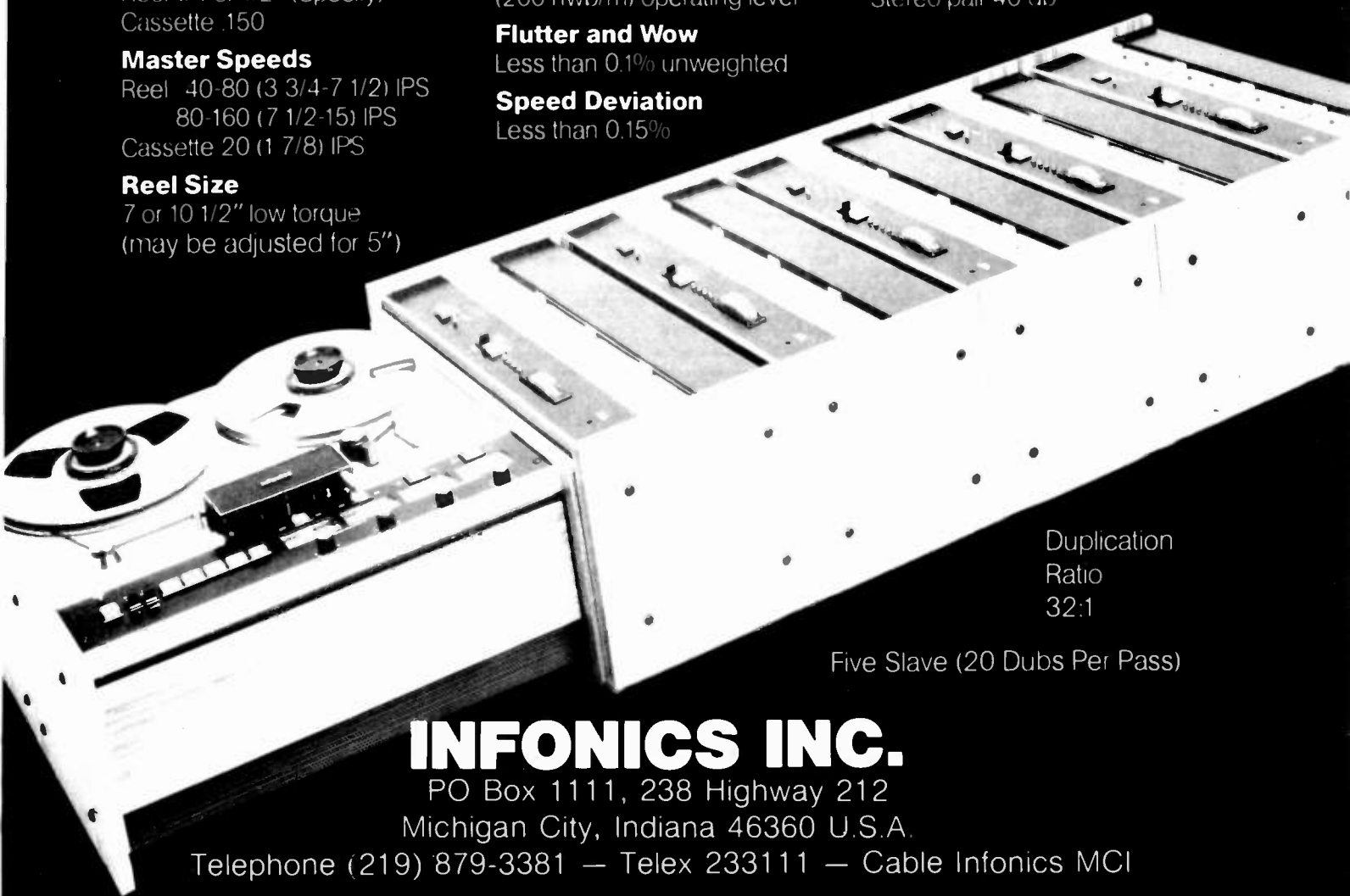

Duplication
Ratio
32:1

Five Slave (20 Dubs Per Pass)

INFONICS INC.

PO Box 1111, 238 Highway 212
Michigan City, Indiana 46360 U.S.A.

Telephone (219) 879-3381 — Telex 233111 — Cable Infonics MCI

PHOENIX AUDIO LTD., HONG KONG

200 Lockhart Rd. 6/F Wanchai, Hong Kong · Tel. 5-747299 Telex 65855 PHNIX HX

**SEE AND HEAR THE 200A SERIES AT THE
NEW YORK AES AND AT MONTREUX, MARCH 1982**

**Bring your best or worst Master and we will provide
measuring and listening equipment for comparison.**

Investment Technology Inc., 1940 124 Ave NE, Bellevue 98005 Tel 454 7720.

Music Farm Inc., 615 E Pike St Zip 98122 Tel 323 6847
Audio: Open reel

WISCONSIN

• **MILWAUKEE (Area Code 414)**

A & B Cassette Dupl'rs of Wisconsin, 1502 S 87, West Allis 53214. Tel 774 7250 Pres. Gen & Sales Mgr Judy Benz
Audio: Cassette

Audio Cassette Dupl'rs of Wisconsin, 159 E Silver Spring Dr. Zip 53217 Tel 961-1635 Pres J Shutter, Gen. Mgr. G. Miller, Sales Mgr J Stoecker (PWG)
Audio: Cassette, open reel

Video: 1/2" U-matic cassette, 1/2" Beta & VHS cassette

Dave Kennedy Rec'g Studios, 231 W Wisconsin Ave Zip 53203 Tel 273 5720. Pres. Dave Kennedy, Chief Eng Larry Drydyk. (PWG)—labeling service only

Audio: 8 tr. cassette, open reel

Orange Prod'n House, 6055 W Fond du Lac Zip 53218 Tel 461 3600 Pres Larry Lee Hansen, Gen Mgr Jack Shaw, Sales Mgr Cindy Gould (PWG)

Audio: 8 tr. cassette, open reel

Video: 1" open reel, 1/2" U-matic cassette, 1/2" Beta & VHS cassette

Safeguard Co., PO Box 33, Brookfield 53005 Tel 782 6430 Pres Richard A Reichcz; Gen Mgr Barbara Pangel

Branch: Coraiville, Iowa
Audio: 8 tr. cassette, open reel, 2 tr cartridge

**TAPE DUPLICATOR/
MARKETERS OF 8-TR.,
CASSETTE & OPEN REEL**

Ampro Prod'ns Inc., 150 Fifth Ave., New York, N.Y. 10011 Tel (212) 243 7726. Cable TAPEXXRON. Telex 425233

Tape lines: Apro, Omega

Barclay Crocker, 11 Broadway, New York, N.Y. 10004 Tel (212) 952 0068 Partner Henry A Barclay Jr.

Open reel: Argo, Desmar, Entr'acte, Halcyon, L'Oiseau-Lyre, Mercury, Musical Heritage Society, Philips, Spectrum, Telefunken, Unicorn, Van guard

Kim Pat Ents., PO Box 654, Hillwood Dr., Fayetteville, Tenn 37334 Tel (615) 433 2323/5661

Tape lines: Blaze, Davis Unlimited HSE JSJ, Jma, Ken Tone, Kim Pat, Sav All, Su-Ann

Utopia Ultra Sound, 38 40 S First St Newark, Ohio 43055 Tel (614) 345 9426 Pres Robert H Kirk Jr, VP Don Shannon, Gen Mgr Robert H Kirk Sr, Sales Mgr Rose Shannon

B-tr.: Jessup, Mac, SAM, Shields, UUS

**ENTERTAINMENT
LAWYERS**

This listing includes attorneys believed to have experience in the music industry based upon professional listings and our subscription information.

CALIFORNIA

• **LOS ANGELES METROPOLITAN AREA (Area Code 213)**

Philip M. Audikoff, 9255 Sunset Blvd., Suite 706 Zip 90069 Tel 273-3180 Albalá & Levine, 2029 Century Park E., Suite 60 Zip 90067 Tel 556-1000 Larry Altman, 1880 Century Park E. Zip 90067 Tel: 552-4993

Fredric W. Ansis, 2029 Century Park E., 25th fl Zip 90067 Tel 553-6666 TWX 698109

Doug Apatow, 1880 Century Park E. Zip: 90067 Tel: 553-0082

Armstrong, Hendler & Barnett, PC, 1888 Century Park E., Suite 1888. Zip: 90067 Tel: 553-0305

Arrow, Edelstein, Gross & Margolis, 9200 Sunset Blvd., Suite 1210. Zip: 90069 Tel 274-6184.

Donald B. Bachrach, see Iglow & Bachrach.

Ball, Hunt, Hart, Brown & Baerivitz, 120 Linden Ave. Long Beach 90802 Tel 435-5631.

Barger & Wolen, Security Pacific Plaza, 333 S. Hope St., 38th fl Zip 90071. Tel 680-2800. Cable. BARWOL. Telex: 181074

Stephan M. Baron, 10100 Santa Monica Blvd., 25th fl. Zip 90067. Tel 553-8200

Barovick, Konecky, Braun, Schwartz & Kay, 9665 Wilshire Blvd., Suite 300, Beverly Hills 90212. Tel 278-2752. Cable HARBAROKG. Telex 69-8656

Beeher, Mockabee, Arant & Jagger, 3435 Wilshire Blvd., Suite 1100. Zip 90010. Tel: 385-7087.

Belcher, Henzie & Biegenzahn, PC, 333 S Hope St., Suite 3650. Zip 90071 Tel 624-8293

Peter Bennett, 211 S. Beverly Dr., Beverly Hills 90211. Tel 278-7344

Berg & Spire, 9100 Wilshire Blvd., 3rd fl., Beverly Hills 90212. Tel 273-8121

Oon Biederman, see Mitchell, Silberberg & Knupp

Edward Blau, see Pacht, Ross, Warne, Bernhard & Sears

Seymour Bricker, see Kaplan, Livingston, Goodwin, Berkowitz & Selvin

Samuel H. Brown, 3701 Wilshire Blvd., Suite 700. Zip 90010 Tel 381-3866

Brown & Brown, PC, 10100 Santa Monica Blvd., Suite 2080. Zip: 90067. Tel 879-0131.

Buchalter, Nemer, Fields & Chrystie, PC, Broadway Plaza, 700 S. Flower St., 7th fl Zip 90017. Tel 626-6700

Bushkin, Kopelson, Gams, Games & Wolf, 2029 Century Park E., 25th fl. Zip 90067 Tel 553-6666 TWX 698109

Caidin, Katman, Sampson & Marget, 9454 Wilshire Blvd., Suite 209, Beverly Hills 90212. Tel 272-9041

William A. Cohen, see Sklar, Cohen & Stashower Inc.

Cohen & Steinhart, 6430 Sunset Blvd., Suite 1500 Zip 90028 Tel 463-1151 TWX (910) 463-1151

Martin Cohen, see Cohen & Steinhart.

Jay L. Cooper, see Cooper, Epstein & Hurewitz.

Cooper, Epstein & Hurewitz, PC, 9465 Wilshire Blvd., Suite 800, Beverly Hills 90212 Tel: 278-1111 Cable TRADEMARKS. Telex: 698217.

Dern, Mason, Swerdlow & Floum, PC, 2049 Century Park E. Zip 90067 Tel 552-0700.

Stan Diamond, see Diamond & Wilson

Diamond, Titem & Colden, 10850 Wilshire Blvd., 12th fl. Zip 90024. Tel: 879-3444. Cable DIALAW. Telex: 67-4758.

Diamond & Wilson, 1 Century Plaza, 25th fl., 2029 Century Park E. Zip 90067. Tel: 557-0844.

Diller & Freedman, 1880 Century Park E. Zip: 90067. Tel: 553-6411

Dolman, Wolfe & Linden, PC, 1888 Century Park E., 6th fl. Zip 90067 Tel: 277-2236.

Dretzin & Kauff, 10100 Santa Monica Blvd., Suite 1040. Zip: 90067. Tel: 879-5404.

Morley Drucker, PC, 9465 Wilshire Blvd., Suite 328, Beverly Hills 90212. Tel: 278-6852. Cable DRUPAT.

Joseph S. Dubin, 1880 Century Park E., Suite 1400 Zip: 90067 Tel 879-4044. Cable MARKRIS

Kenneth B. Dussack, 8447 Wilshire Blvd., Suite 409, Beverly Hills 90211. Tel 653-2123.

Norman Edell, 9171 Wilshire Blvd., Beverly Hills 90212. Tel 273-1850.

Ehrman & Jackson, 9401 Wilshire Blvd., Beverly Hills 90212. Tel 858-6475

Michael Ehrman, see Ehrman & Jackson

Eric Eisner Esq., 9885 Charleville Blvd., Beverly Hills 90212. Tel: 277-8148.

Ervin, Cohen & Jessup, 9401 Wilshire Blvd., 9th fl., Beverly Hills 90212. Tel: 273-6333. Cable JOLIED. TWX (910) 490-5748

Fain, Lavine, Kaufman & Young, PC, 121 S. Beverly Dr., Beverly Hills 90212. Tel: 272-7807

Irving S. Feffer, 8383 Wilshire Blvd., Beverly Hills 90211. Tel: 653-5522.

Fierstein & Sturman Law Corp., 1888 Century Park E., Suite 1500 Zip 90067. Tel: 553-5500

Fine, Armstrong, Perzik & Friedman, 10960 Wilshire Blvd., Suite 1900. Zip 90024. Tel: 879-3300.

Max Fink Law Office, 9777 Wilshire Blvd., Beverly Hills 90212. Tel 273-6760

Bernard J. Fischbach, see Fischbach & Fischbach.

Gregory E. Fischbach, see Fischbach & Fischbach.

Fischbach & Fischbach, PC, 2029 Century Park E., Suite 1370. Zip: 90067. Tel: 556-1956. Telex: 699182.

John T. Frankenheimer, see Loeb & Loeb.

Freshman, Marantz, Comsky & Deutsch Law Corp., 9100 Wilshire Blvd., East Tower, 9th fl., Beverly Hills 90212. Tel: 273-1870

Fredric N. Gaines Esq., see Bushkin, Kopelson, Gams, Games & Wolf

Gang, Tyre & Brown, 6400 Sunset Blvd. Zip 90028. Tel: 463-4863 TWX (910) 321-2382. Cable GANKOT.

Gibson, Dunn & Crutcher, 515 S. Flower St. Zip 90071. Tel: 488-7000

Cable GIBTRASK. Telex 67-4930. Local branch: 2029 Century Park E., Suite 4000. Zip 90067. Tel: 552-8500.

Philip H. Gillen, see Goller, Gillin, Gottesman & Menes

Glass, Karp, Warburg & Prera, 9100 Wilshire Blvd., Suite 411 E. Beverly Hills 90212. Tel 858-1070.

Gold, Herscher, Marks & Pepper, 8500 Wilshire Blvd., Beverly Hills 90211. Tel: 652-0490. 655-5163

Lessing E. Gold, Buckeye Bldg., Suite 614, 8500 Wilshire Blvd., Beverly Hills 90211 Tel 652-0490.

Gold & Robbins, 1605 W Olympic Blvd. Zip 90015 Tel: 738-5102. 506-4078.

Goldberg & Bloom, 16200 Ventura Blvd., Encino 91436. Tel: 788-4161

Goller, Gillin, Gottesman & Menes, 1901 Ave. of the Stars, Suite 1240 Zip 90067. Tel 879-0594.

Greenberg & Glusker, 1900 Ave. of the Stars, 20th fl. Zip 90067. Tel 553-3610. Cable GREENLER.

Griffin, Griffin & Jackson, 301 E. Colorado Blvd., Pasadena 91101

Alan L. Grodin, see Cooper, Epstein & Hurewitz

Stephen J. Gross, see Gross & Malatesta

Gross & Malatesta, 2049 Century Park E. Zip 90067 Tel 552-9244.

Kim Guggenheim, see Schlesinger & Guggenheim.

Brian Gunshor, see Levine, Krom & Unger.

Haberman & Klein Law Corp., 1901 Ave. of the Stars, Suite 1630 Zip 90067. Tel 277-2833. Cable STANLAW.

Harris & Donovan, 615 S. Flower. Zip: 90017. Tel 629-4861

William K. Hayes, 2029 Century Park E., Suite 600. Zip 90067. Tel 557-8433.

Hertzberg & Childs, 9454 Wilshire Blvd., Suite 500, Beverly Hills 90212. Tel: 278-8460. Cable HERCHILD

Hertzberg, Koslow & Franzen, 3550 Wilshire Blvd Zip 90010. Tel. 381-1121

Herzig & Walsh Inc., 9465 Wilshire Blvd., Beverly Hills 90212. Tel 272-8671. Cable HERZIPAT.

Barry L. Hirsch, 9171 Wilshire Blvd., Suite 800, Beverly Hills 90212. Tel 273-1240. Cable LITLAW. Telex: 69-8267

Ivan Hoffman, 2040 Ave. of the Stars. Zip 90067. Tel: 556-2804.

Peter Hoffman, see Irell & Manella

Huebner & Worrel, 900 Wilshire Blvd., Suite 1000. Zip 90017. Tel 626-7766. Cable HUEPAT.

Walter E. Hurst, 6253 Hollywood Blvd. Zip 90028. Tel: 469-7209

Iglow & Bachrach, 8601 Wilshire Blvd., Suite 1001. Beverly Hills 90211. Tel: 855-0088.

Irell & Manella, 1800 Ave. of the Stars, Suite 900. Zip: 90067. Tel: 879-2600. 277-1010. Cable IRELLA. Telex: 181258.

Irwin, Hale & Jacobs, 2029 Century E. Zip: 90067. Tel: 277-3700

John G. Irwin, see Irwin & Rowan.

Irwin & Rowan Law Office, 2029 Century Park E., Suite 1690. Zip: 90067. Tel: 553-2526.

David Jackson, see Ehrman & Jackson.

Jacobs & Baumgarten, Wells Fargo Bank Bldg., 6th fl., 433 N. Camden Dr., Beverly Hills 90210. Tel: 550-8046.

Jessup & Beecher, 15233 Ventura Blvd., Suite 716, Sherman Oaks 91403. Tel: 788-8330.

Neville Johnson, 2029 Century Park E. Zip 90067. Tel: 277-4370.

Jonas & Fern, 10880 Wilshire Blvd., Suite 1115. Zip: 90024. Tel 879-3960. Cable CORPLAW. TWX: (910) 342-7570.

Jones, Day, Reavis & Pogue, 2029 Century Park E., Suite 3600. Zip: 90067. Tel: 553-3939

Jones & Wilson, 11620 Wilshire Blvd., Suite 300 Zip: 90025. Tel: 478-9756

Kadison, Praelzer, Woodard, Quinn & Rossi, 707 Wilshire Blvd., 40th fl. Zip 90017. Tel: 688-9000. Cable GRAYBIN. Telex: 67-3230

Kaplan, Livingston, Goodwin, Berkowitz & Selvin, 450 N. Roxbury Dr., Beverly Hills 90210. Tel: 274-8011. Telex: 67-4858.

Robert Kaplan, see Stein, Kahan & Kaplan

Arnold Kassoy, see Rosenfeld, Kassoy & Kraus.

Maurice H. Katz, PC, 1880 Century Park E., Suite 615. Zip 90067. Tel: 553-4500.

45 JEFFERSON ST., STAMFORD, CT 06902

Tapecom
INC.

**New England's
LARGEST Duplicator!**

**(203) 325-1541
(212) 581-9855**

Keatinge, Pastor & Mintz, PC, Broadway Plaza, 700 S. Flower St., Suite 600. Zip: 90017. Tel: 625-5241. Cable: KEARN. Telex: 69-1208. Telecopier: 489-1683.

Louis J. Khoury, 1880 Century Park E., Suite 1150. Zip: 90067. Tel: 553-6111.

George David Kieffer, see Manatt, Phelps, Rothenberg & Tunney.

Kindel & Anderson, 555 S. Flower St., 26th fl. Zip: 90071. Tel: 680-2222. Cable: KAYANDA. Telex: 67-7497.

Richard D. Kirshberg, 1800 Ave. of the Stars, Suite 90067. Tel: 879-2600.

Kent J. Klavens Esq., 1901 Ave. of the Stars, Suite 1630. Zip: 90067. Tel: 277-2833.

Marvin H. Kleinberg, PC, 9100 Wilshire Blvd., Suite 710. Beverly Hills 90212. Tel: 550-8161. Cable: INTELPROP.

Leonard Korobkin, 1801 Ave. of the Stars, Suite 310. Zip: 90067. Tel: 277-8200.

Kenneth L. Kraus, see Rosenfeld, Kassoy & Kraus.

Charles Krohn, 1680 Vine St. Zip: 90028. Tel: 460-4730.

Howard Krom, see Levine, Krom & Unger.

J. H. Kushnick, 9100 Wilshire Blvd., Beverly Hills 90212. Tel: 274-8805.

Jonathan S. Landau, see Landau & Lerner.

Landau & Lerner, 15760 Ventura Blvd., 9th fl., Encino 91436. Tel: 986-0893, 872-0199.

Richard Leher, see Mitchell, Silberberg & Knupp.

Norton J. Lehman, 404 N. Roxbury Dr., Beverly Hills 90210. Tel: 273-5614. Cable: LEHLAW.

Lenoir & Shaw, 6255 Sunset Blvd., Penthouse Suite 2205. Hollywood 90028. Tel: 464-8424.

Leonard D. Lerner, see Landau & Lerner.

Jerome L. Levine, see Albala & Levine.

Levine, Gorman & Levine, 1900 Ave. of the Stars. Zip: 90067. Tel: 553-2400.

Levine, Krom & Unger, 404 N. Roxbury Dr., Suite 600, Beverly Hills 90210. Tel: 273-3555. Cable: LEVKRO.

Levinson, Rowen, Miller, Jacobs & Kabrins, 2 Century Plaza, 2049 Century Park E. Zip: 90067. Tel: 557-2455, 879-2515.

Levy, Leipziger & Normanton, 433 N. Camden Dr., Beverly Hills 90210. Tel: 550-0345.

Libott, Yassan & Mundy, 1888 Century Park E., Suite 1408. Zip: 90067. Tel: 879-5711.

Robert H. Lieberman Esq., see Berg & Spire.

Lillick, McHose & Charles, 707 Wilshire Blvd. Zip: 90017. Tel: 620-9000. Cable: IRALILICK. Telex: 67-7013.

Ronald A. Litz, PC, 9595 Wilshire Blvd., Suite 710, Beverly Hills 90212. Tel: 273-4330, 878-4330.

Loeb & Loeb, 10100 Santa Monica Blvd., Suite 2200. Zip: 90067. Tel: 552-7700. Telex: 673106.

Lyon & Lyon, 800 Wilshire Blvd., 9th fl. Zip: 90017. Tel: 489-1600.

Maiden, Rosenbloom & Wintroub, 1930 Century Park W., Suite 400. Zip: 90067. Tel: 277-0440, 879-1570.

Manatt, Phelps, Rothenberg & Tunney, 1888 Century Park E., 21st fl. Zip: 90067. Tel: 556-1500. Cable: MANATOP. TWX: (910) 490-5744.

Manning & Roberts, 1900 Ave. of the Stars, Suite 2840. Zip: 90067. Tel: 879-3042.

John E. Mason Jr., see Mason & Sloane.

Mason & Sloane, 9200 Sunset Blvd., Suite 505. Zip: 90069. Tel: 273-8351. TWX: (910) 490-5745.

Maupin, Chaum, Cutler & Tepinsky, 2021 Century Park E. Zip: 90067. Tel: 879-3051.

Memel, Jacobs, Pierno & Gersh, 1801 Century Park E., 25th fl. Zip: 90067. Tel: 556-2000. Cable: L'AVOCAT USA. TWX: (910) 490-5923.

Barry Menes, see Goller, Gillin, Gottesman & Menes.

Mitchell, Silberberg & Knupp, 1800 Century Park E., 9th fl. Zip: 90067. Tel: 553-5000. Cable: SILMITCH. Telex: 69-1347.

Henry T. Moore Jr., 1901 Ave. of the Stars, Suite 1475. Zip: 90067. Tel: 879-0888.

N. Dann Moss, 9220 Sunset Blvd. Zip: 90069. Tel: 278-8090.

Ed Morris, 6430 Sunset Blvd. Zip: 90028. Tel: 467-1431.

Nisson, Robbins, Dalgarn & Beriner, 707 Wilshire Blvd., Suite 4750. Zip: 90017. Tel: 620-0600. Cable: LAPAT.

Milton E. Olin Jr., see Mitchell, Silberberg & Knupp.

O'Melveny & Meyers, Crocker Citizens Nat'l Bank Bldg., 611 W. Sixth St. Zip: 90017. Tel: 620-1120. Cable: MOMS.

Oppenheim, Appel & Dixon, 2029 Century Park E. Zip: 90067. Tel: 277-0400.

Randrew A. Outlaw, 2049 Century Park E., Suite 1800. Zip: 90067. Tel: 552-9337.

Pacht, Ross, Warne, Bernhard & Sears Inc., 1800 Ave. of the Stars, Suite 500. Zip: 90067. Tel: 277-1000. Cable: PAWARB. TWX: (910) 490-2597.

Padel, Kaden & Nadel, 8600 Metrose Ave. Zip: 90069. Tel: 652-8150.

Averil C. Pasarow, 6380 Wilshire Blvd. Zip: 90048. Tel: 653-2321.

Donald Passman, see Gang, Tyre & Brown.

Lee Phillips, see Manatt, Phelps, Rothenberg & Tunney.

Pollock, Bloom & Dekom, 9255 Sunset Blvd., Suite 1011. Zip: 90069. Tel: 278-8622.

Pollock, Pollock & Fay, PC, 1888 Century Park E., Suite 1520. Zip: 90067. Tel: 879-0111.

Poms, Smith, Lande & Rose, PC, 1888 Century Park E., Suite 1000. Zip: 90067. Tel: 277-4181. Cable: POMPAT. Telex: 698271.

Joseph E. Porter III, 9465 Wilshire Blvd., Suite 730, Beverly Hills 90212. Tel: 278-4782. Telex: 696191.

Peter Priamus, 707 Wilshire Blvd. Zip: 90017. Tel: 628-9152.

Reed & Shaw, Broadway Plaza Bldg., 700 S. Flower St. Zip: 90017. Tel: 622-1100.

Regan, Goldfarb, Heller, Wetzler & Quinn, 9601 Wilshire Blvd., Beverly Hills 90210. Tel: 273-3737.

Mitchell N. Reinis, 3550 Wilshire Blvd., Suite 1720. Zip: 90010. Tel: 386-1300.

Irwin Rennett, 1880 Century Park E. Zip: 90067. Tel: 553-1707.

Todd Russell Reinstein, PC, 1880 Century Park E., Suite 615. Zip: 90067. Tel: 553-4500, 879-2335.

Michael L. Robins, 2049 Century Park E., Suite 1800. Zip: 90067. Tel: 879-4407.

Rogers & Harris, 9200 Sunset Blvd., Suite 404. Zip: 90069. Tel: 272-8489.

Romney, Schaap, Golant, Disner & Ashen, 9720 Wilshire Blvd., 6th fl., Beverly Hills 90212. Tel: 550-7121.

Michael Rosenfeld, see Rosenfeld, Kassoy & Kraus.

Rosenfeld, Kassoy & Kraus, 270 N. Canon Dr., Suite 300, Beverly Hills 90210. Tel: 858-7788. TWX: (910) 490-5929.

Rosenfeld, Meyer & Susman, 9601 Wilshire Blvd., 4th fl., Beverly Hills 90210. Tel: 858-7700. Cable: ROMERSU.

Roston & Schwartz, PC, 5900 Wilshire Blvd., Suite 1430. Zip: 90036. Tel: 938-3658. Cable: ROSCHPAT.

Barry K. Rothman, 9200 Sunset Blvd., Suite 509. Zip: 90069. Tel: 350-6166.

Thomas P. Rowan, see Irwin & Rowan.

David Rudich, 9255 Sunset Blvd., Suite 414. Zip: 90069. Tel: 550-8020. Cable: CABLELAW.

Rudin, Perlestein & Chieffo, 9601 Wilshire Blvd., Suite 526, Beverly Hills 90210. Tel: 278-6060. Cable: RUDLAW.

Rutter & Ebbert, 1900 Ave. of the Stars, Suite 2200. Zip: 90067. Tel: 879-9494.

Gunther H. Schiff, 9665 Wilshire Blvd., Suite 800, Beverly Hills 90212. Tel: 278-2752. Cable: LITLAW. Telex: 69-8267.

Alfred W. Schlesinger, see Schlesinger & Guggenheim.

Schlesinger & Guggenheim, 6255 Sunset Blvd., Suite 1214, Hollywood 90028. Tel: 462-6011. Telex: 181398.

James P. Schreiber, 9665 Wilshire Blvd., Suite 800, Beverly Hills 90212. Tel: 550-0678. Cable: LITLAW. Telex: 69-8267.

Schulenberg & Warren, PC, 10100 Santa Monica Blvd., 25th fl. Zip: 90067. Tel: 553-8200.

Schurmer, Drane, Bulls & McCarthy, 10880 Wilshire Blvd., Suite 1000. Zip: 90024. Tel: 879-1428.

K. Schwartz, see Oppenheim, Appel & Dixon.

Ross Schwartz, see Cooper, Epstein & Hurewitz.

Sedgwick, Detert, Moran & Arnold, Travelers Bldg., Suite 1934, 3600 Wilshire Blvd. Zip: 90010. Tel: 386-2833.

Lloyd M. Segal, 1116 Cory, Zip: 90069. Tel: 274-5857.

Sélan & Schaeffer, 2029 Century Park E. Zip: 90067. Tel: 553-5301.

Selvin & Weiner, PC, 1900 Ave. of the Stars, Suite 2400. Zip: 90067. Tel: 277-1555, 879-1555. Cable: SELCOLAW.

Alan M. Shafer, see Fine, Armstrong, Perzik & Friedman.

Shahin & Wawro, A Law Corp., 1801 Century Park E. Zip: 90067. Tel: 879-1500.

Ned Shankman, 185 Pier Ave., Santa Monica 90405. Tel: 396-3185.

Allen Shapiro, see Kaplan, Livingston, Goodwin, Berkowitz & Selvin.

Michael Shapiro, see Shapiro & Steinberg.

Shapiro & Steinberg, PC, 315 S. Beverly Dr., Suite 210, Beverly Hills 90212. Tel: 553-1601.

Shearer, Fields & Shearer, 9255 Sunset Blvd., Suite 616. Zip: 90069. Tel: 272-8252, 274-5434.

Edward M. Sherman, 3410 Club Dr., Suite 14. Zip: 90064. Tel: 553-2188.

Charles Silverberg, see Silverberg, Rosen, Leon & Behr.

Silverberg, Rosen, Leon & Behr, 2029 Century Park E., Suite 1900. Zip: 90067. Tel: 879-2818.

Simon & Sheridan, 2404 Wilshire Blvd., Suite 400. Zip: 90057. Tel: 380-3330.

Sklar, Coben & Stashower Inc., 6399 Wilshire Blvd. Zip: 90048. Tel: 651-2333.

Staff, Mosk & Rudman, 9200 Sunset Blvd., Suite 825. Zip: 90069. Tel: 275-5351. Cable: SEMINAR. Telex: 69-8309.

Stavitt, King & Foonberg, A Law Corp., 2049 Century Park E., Suite 900. Zip: 90067. Tel: 553-1600. Telex: 67-4305.

Owen J. Sloane, PC, 9200 Sunset Blvd. Zip: 90069. Tel: 273-8351.

Smaltz & Needley, 530 W. Sixth St. Zip: 90014. Tel: 625-1666.

Chester Leo Smith, 10889 Wilshire Blvd., Suite 1245. Zip: 90024. Tel: 477-1531.

Abe Somer, see Mitchell, Silberberg & Knupp.

Spensley, Horn, Jubas & Lubitz, 1880 Century Park E., Suite 500. Zip: 90067. Tel: 553-5050. Cable: TECHLAW.

Stein, Kahan & Kaplan, 12301 Wilshire Blvd., No. 616. Zip: 90025. Tel: 820-7555.

Steven Steinberg, see Shapiro & Steinberg.

Stephens, Martin, Berg & Lasater, PC, 555 S. Flower St., Suite 2020. Zip: 90071. Tel: 629-3111.

Andrew J. Stern, 8467 Beverly Blvd. Zip: 90048. Tel: 635-4533.

Stern & Stambul, PC, 11661 San Vicente Blvd., Suite 1010. Zip: 90049. Tel: 272-9216.

Joel Strote, PC, 280 S. Beverly Dr., Suite 402, Beverly Hills 90212. Tel: 858-8816.

Ronald E. Sweeney, see Joseph E. Porter III.

Swerdlow, Glibork & Shimer, United California Bank Bldg., 9601 Wilshire Blvd., Beverly Hills 90210. Tel: 274-8045, 272-9531.

Larry A. Thompson Esq., 1888 Century Park E., Suite 622. Zip: 90067. Tel: 553-1555.

Robert H. Tourtelot, 1880 Century Park E. Zip: 90067. Tel: 277-3135.

Troy, Malin & Pottinger, PC, 1801 Century Park E., 16th fl. Zip: 90067. Tel: 553-4441. Cable: TROMALAW. Telex: 69-1737.

Turner, Gerstenfeld, Wilk & Tigerman, 8383 Wilshire Blvd., Beverly Hills 90211. Tel: 657-3100.

Harry L. Usher, 9595 Wilshire Blvd., Beverly Hills 90212. Tel: 276-6137, 272-4191.

Raymond Wallenstein, 2049 Century Park E., Suite 1550. Zip: 90067. Tel: 553-6002. Cable: WALFED.

Norton Warburg, see Glass, Karp, Warburg & Prera.

Ward & Heyler, 1901 Ave. of the Stars, Suite 1475. Zip: 90067. Tel: 879-0888.

Jerome E. Weinstein Inc., PC, 9401 Wilshire Blvd., Beverly Hills 90212. Tel: 274-7157.

Weisman, Grush & Breckler, PC, 1880 Century Park E., Suite 817. Zip: 90067. Tel: 879-2810. Cable: JUGLAW.

Whann & McManigal, 315 W. Ninth St., Suite 920. Zip: 90015. Tel: 622-7163.

David W. Williams, 9701 Wilshire Blvd., Beverly Hills 90212. Tel: 858-8051.

Jack A. Whitley II, 6331 Hollywood Blvd., Suite 414. Zip: 90028. Tel: 461-8186.

Wills, Green & Muehl Law Corp., 700 S. Flower St., Suite 1120. Zip: 90017. Tel: 688-7407. Cable: WILLPAT.

Craig R. Wilson, 16055 Ventura Blvd., Suite 721, Encino 91436. Tel: 501-6600.

Joseph Wolf, 10960 Wilshire Blvd. Zip: 90024. Tel: 477-7011, 879-1795.

Werner Wolfen, see Irell & Manella.

David E. Wood, 10880 Wilshire Blvd., Suite 912. Zip: 90024. Tel: 879-2656.

Wyman, Bautzer, Rothman & Kutche, 2049 Century Park E., 14th fl. Zip: 90067. Tel: 556-8000. Cable: WYBAROK. Telex: 69-1304.

Youngman, Hungate & Leopold, 2049 Century Park E., 31st fl. Zip: 90067. Tel: 277-3333.

Keith Zajac, see Loeb & Loeb.

Ziffren, Brittenham & Gullen, 2049 Century Park E. Zip: 90067. Tel: 552-3388, 879-2813.

● SAN FRANCISCO & BAY AREA (Area Code 415)

Michael R. Ashburne, 950 Battery St., Suite 300B. Zip: 94111. Tel: 421-8160.

Barger & Wolen, 100 Van Ness Ave., 18th fl. Zip: 94102. Tel: 552-4900.

Buchanan & Wagner, 3320 Bank of America Center. Zip: 94104. Tel: 391-1510.

Cadwalader & Black, 155 Montgomery St., 15th fl. Zip: 94104. Tel: 989-1221.

Canady & Pollack, Hartford Bldg., 650 California. Zip: 94108. Tel: 434-1600.

Ferguson, Hoffman, Henn, Mandel & Heil Inc., 1365 Columbus Ave. Zip: 94133. Tel: 673-8300.

Fitch, Even, Tabin & Luedeka, 605 Market St. Zip: 94105. Tel: 777-4690.

Erwin Fredrich, 3025 Fillmore. Zip: 94123. Tel: 563-8870.

Gordon & Hodge, 544 Pacific Ave. Zip: 94133. Tel: 391-4550.

Robert E. Gordon, see Gordon & Hodge.

Jeff Graubner, Ghirardelli Square, Chocolate Bldg., 4th fl., 900 North Point. Zip: 94109. Tel: 441-1211.

Harrison & Hearn, 425 California St., Suite 2501. Zip: 94104. Tel: 956-6431.

Branch: San Jose, Calif., Crocker Plaza, 84 W. Santa Clara St., Suite 600. Zip: 95113. Tel: (408) 298-7565.

Edward R. Hearn, see Harrison & Hearn.

Richard A. Hodge, see Gordon & Hodge.

Jacobs, Silis & Coblentz, Bank of America Center, 555 California St. Zip: 94104. Tel: 391-4800.

Michael Krassner, see Rohan & Stepanian.

Lillick, McHose & Charles, 2 Embarcadero Center, 26th fl. Tel: 421-4600.

Howard Prim, see Canady & Pollack.

Brian Rohan, see Rohan & Stepanian.

Rohan & Stepanian, 819 Eddy St. Zip: 94109. Tel: 771-6174. Telex: 340224.

Rudy, Rapoport & Holden, Russ Bldg., 22nd fl., 235 Montgomery St. Zip: 94104. Tel: 981-4850.

Sedgwick, Detert, Moran & Arnold, 111 Pine St., 11th fl. Zip: 94111. Tel: 982-0330.

Richard K. Thompson, 860 Corbett Ave. Zip: 94131. Tel: 285-8070.

Winchell & Winchell, 22 Battery St. Zip: 94111. Tel: 956-5700.

DISTRICT OF COLUMBIA

● WASHINGTON (Area Code 202)

Arent, Fox, Kintner, Plotkin & Kahn, 1815 H St. NW. Zip: 20006. Tel: 857-6082.

Berl Bernhard, 1660 L St. NW. Zip: 20036. Tel: 452-7424.

Burns, Jackson, Miller, Summit & Jacoby, 1025 15 St. NW. Zip: 20005. Tel: 659-3300.

Robert Delson, 1900 L St. NW. Zip: 20036. Tel: 833-9540.

Dressler, Goldsmith, Clement, Gordon & Shore Ltd., 609 Crystal Plaza I, Arlington, Va. 22202. Tel: (703) 521-1880.

Michael C. Elmer, see Finnegan, Henderson, Farabow & Garrett.

Finnegan, Henderson, Farabow & Garrett, 1775 K St. NW. Zip: 20006. Tel: 293-6850.

Gibson, Dunn & Crutcher, 1776 G St. NW. Zip: 20006. Tel: 789-8500.

Jones, Day, Reavis & Pogue, 1735 I St. NW. Zip: 20006. Tel: 861-3939. Cable: REPLAW.

Lillick, McHose & Charles, 1333 New Hampshire NW. Zip: 20036. Tel: 785-3288.

Rogers & Wells, 1666 K St. NW. Zip: 20002. Tel: 331-7760. Cable: WALAW. Telex: 248439.

Charles B. Ruttenberg Esq., see Arent, Fox, Kintner, Plotkin & Kahn.

Robert M. Sczier, see J.E. Wingfield Law Offices.

Troy, Malin & Pottinger, 1300 19 St. NW. Zip: 20036. Tel: 828-1900.

William Utz, 1320 19 St., 4th fl. Zip: 20036. Tel: 785-2130.

J.E. Wingfield Law Offices, 4035 Connecticut Ave. NW. Zip: 20008. Tel: 362-8000.

GEORGIA

● ATLANTA (Area Code 404)

Kneller & Sanders, Peachtree Summit, Suite 1948, 401 W. Peachtree St. NW. Zip: 30308. Tel: 523-2322.

Macey & Zussman, 1795 Peachtree Rd. NE. Zip: 30309. Tel: 897-7200.

Scott Sanders, see Kneller & Sanders.

Mark Edward Shephok, Equitable Bldg., 97 Peachtree Park Dr. Zip: 30309. Tel: 522-2260.

Trauner, King & Cohen, 38 Old Ivy Rd. NE. Zip: 30342. Tel: 233-1900.

ILLINOIS

● CHICAGO METROPOLITAN AREA (Area Code 312)

Richard E. Alexander Ltd., 33 N. Dearborn St. Zip: 60602. Tel: 726-7800.

Allegrretti, Newitt, Witcoff & McAndrews, 125 S. Wacker Dr. Zip: 60606. Tel: 372-2160. TWX: (910) 221-5317.

Alter & Weiss, 208 S. LaSalle St., Suite 510. Zip: 60604. Tel: 337-2100. Cable: ALT.

Arvey, Hodcs, Costello & Burman, 180 N. La Salle St. Zip: 60601. Tel: 855-5000.

Marshall Burmeister, see Burmeister, York, Palmatier, Hamby & Jones.

Burmeister, York, Palmatier, Hamby & Jones, 135 S. La Salle St., Suite 1046. Zip: 60603. Tel: 782-6663.

Jerome Butler, 69 W. Washington. Zip: 60602. Tel: 263-4882.

Charles B. Cannon, 135 S. La Salle St., Suite 640. Zip: 60603. Tel: 236-1585. Cable: CANPAT Chicago.

Joel M. Carlins, see Carlins & Marrinson.

Carlins & Marrinsky, 120 S. La Salle St. Zip: 60601. Tel: 368-1666.

Carlins & Marrinson Ltd., 180 N. LaSalle St., Suite 1810. Zip: 60601. Tel: 726-9710.

Cook, Wetzel & Egan Ltd., PC, 135 S. La Salle St. Zip: 60603. Tel: 236-8500.

Joseph M. Crispino, 6914 W. North Ave. Zip: 60635. Tel: 622-4800.

Dressler, Goldsmith, Clement, Gordon & Shore Ltd., 1825 Prudential Plaza. Zip: 60601. Tel: 527-4025. Cable: SCHNEIDRES.

Fitch, Even, Tabin & Luedeka, 135 S. La Salle St. Zip: 60603. Tel: 372-7842. Cable: PATLAW.

Gary, Juetner & Pyle, 33 N. Dearborn St., Suite 2301. Zip: 60602. Tel: 236-8123. Cable: FRANBEL.

John B. Hirsch, 33 N. Dearborn St. Zip: 60602. Tel: 372-3276.

Hosier, Niro & Daleiden Ltd., 135 S. La Salle St. Zip: 60603. Tel: 236-0733.

Hume, Clement, Brinks, William & Olds Ltd., PC, 1 IBM Plaza, Suite 4100. Zip: 60611. Tel: 822-9800. Cable: JUDICATURE CHICAGO. Telex: 25-4300.

Kegan, Kegan & Berkman, 79 W. Monroe St. Zip: 60603. Tel: 782-6495. Cable: JADEF.

Keil & Witherspoon, 135 S. La Salle St., Suite 1260. Zip: 60603. Tel: 236-5030. Cable: COUNSEL-CHICAGO. Telex: 25-3862.

Kinzer, Pfler, Dorn & McEachran, 55 E. Monroe St. Zip: 60603. Tel: 236-1112. Cable: ELECTRIEY.

Robert Knechtel, 20 W. Wacker Dr., Suite 4020. Zip: 60606. Tel: 726-5342.

Laff, Whitesel & Rockman, John Hancock Center, 875 N. Michigan Ave. Zip: 60611. Tel: 649-0200. Cable: LAWHRO.

Tom Leavens, 875 N. Michigan Ave. Zip: 60611. Tel: 664-3620.

Lee & Smith, 10 S. Riverside Plaza, Suite 330. Zip: 60603. Tel: 726-1982.

Letvinn & Geren, 135 S. La Salle St., Suite 1400. Zip: 60603. Tel: 641-3320.

Levenfeld & Kanter, 10 S. La Salle St., 8th fl. Zip: 60603. Tel: 346-8380.

Leydig, Voit, Osann, Mayer & Holt Ltd., 1 IBM Plaza, Suite 4600. Zip: 60611. Tel: 822-9666. Cable: WOLFEHUMB.
 Lockwood, Dewey, Alex & Cummings, 1 First Nat'l Plaza, Suite 3030. Zip: 60670. Tel: 782-4860. Telex: 25-3631.
 Mason, Kolehmainen, Rathburn & Wyss, 20 N. Wacker Dr. Zip: 60606. Tel: 621-1300. Cable: MAKRAW. TWX: (910) 221-5312.
 Lewis F. Matuszewicz & Assocs., 33 N. Dearborn. Zip: 60602. Tel: 726-8787.
 Dennis M. McWilliams, 53 W. Jackson Blvd., Suite 1215. Zip: 60604. Tel: 427-1351. Cable: MANBRO.
 Linda Mensch, see Shelton, Kalcheim & Cotnoir.
 Merriam, Marshall & Bicknell, 2 First Nat'l Plaza, Suite 2100. Zip: 60603. Tel: 346-5750. Telex: 25-3856.
 Neuman, Williams, Anderson & Olson, 77 W. Washington St. Zip: 60602. Tel: 346-1200. Cable: JONAD TW. TWX: (910) 221-5530.
 Olson, Trexler, Wolters, Bushnell & Fosse Ltd., 141 W. Jackson Blvd. Zip: 60604. Tel: 427-8082.
 Claudia Oney, 1 N. La Salle St. Zip: 60602. Tel: 782-1964.
 John L. Parker & Assocs., 39 S. La Salle St. Zip: 60603. Tel: 263-6560.
 Pattishall, McAuliffe & Hofstetter, Prudential Plaza, Zip: 60601. Tel: 642-9518. Cable: ROWOOD. Telex: 254473.
 Piggott & Gerstman Ltd., 2 N. La Salle St. Zip: 60602. Tel: 263-4350.
 Jay B. Ross, 11 S. La Salle St., Suite 930. Zip: 60603. Tel: 372-1575.
 Schulman, Silverman & Kreiter, 180 N. La Salle St. Zip: 60601. Tel: 332-7400.
 Cris Mooney Selfridge, 100 N. La Salle St., Suite 704. Zip: 60602. Tel: 782-9766.
 Shelton, Kalcheim & Cotnoir, 79 W. Monroe St., Suite 1305. Zip: 60603. Tel: 782-8854.
 Richard Shelton, see Shelton, Kalcheim & Cotnoir.
 Silverman, Cass & Singer Ltd., 105 W. Adams St. Zip: 60603. Tel: 726-6006. Cable: SILCAS. Telex: 25-4359.
 William J. Stellman, 20 N. Wacker Dr. Zip: 60606. Tel: 346-1630.
 Titton, Fallon, Lungmus & Chestnut, 209 S. La Salle St. Zip: 60604. Tel: 263-1841. Cable: PATRAC.
 Vogel, Dithmar, Stotland, Stratman & Levy, 189 W. Madison St. Zip: 60602. Tel: 372-2552.
 Wallenstein, Spangenberg, Hattis & Strampel, 135 S. La Salle St., Suite 2106. Zip: 60603. Tel: 263-7831.
 Anthony S. Zummer, 53 W. Jackson Blvd. Zip: 60604. Tel: 427-1351.

MASSACHUSETTS

● BOSTON METROPOLITAN AREA (Area Code 617)

Paul J. Carchidi, 1351 Main St., Brockton 02401. Tel: 586-6908.
 Wendy S. Harrison Esq., 141 Tremont St. Zip: 02111. Tel: 482-6363.
 Robert G. Rosenblatt, 1 Washington Mall. Zip: 02108. Tel: 742-7730.
 Mike Rousseau, 320 Benjamin St., Wincendon C1475. Tel: 297-0451.
 Maurice P. Tonissi II Esq., 104 Charles St., No. 290. Zip: 02114. Tel: 367-1663.
 Jerry J. Weinberg, 65 E. India Row. Zip: 02110. Tel: 367-2660.

NEW YORK

● NEW YORK METROPOLITAN AREA (Area Code 212)

Abeles, Clark & Osterberg, 4 E. 52 St. Zip: 10012. Tel: 755-0812. Cable: LANANLAW.
 Daniel Aharon, 888 Seventh Ave. Zip: 10019. Tel: 586-3490.
 Amster, Rothstein & Engleberg, 90 Park Ave. Zip: 10016. Tel: 697-5995. Cable: AMROTHPAT. TWX: (710) 581-4766.
 Anderson & Goldman, 235 Madison Ave. Zip: 10017. Tel: 679-2400. Cable: ANGOATY. Telex: 296-402.
 Allen H. Arrow, see Arrow, Edelstein, Gross & Margolis.
 Arrow, Edelstein, Gross & Margolis, PC, 1370 A.E. of the Americas. Zip: 10019. Tel: 586-1451. Telex: 224-600.
 Arum, Friedman & Katz, 450 Park Ave. Zip: 10022. Tel: 644-9800.
 Austrian, Lance & Stewart, PC, 630 Fifth Ave. Zip: 10020. Tel: 489-9500. Cable: AUSTRIANCE.
 Gary Baker, see Mayer, Nussbaum, Katz & Baker.
 Barones, Rabbino & Arnold, 18 E. 48 St. Zip: 10017. Tel: 421-7070. Cable: BARRABARN. Telex: 42-8768.
 Barovick, Konecky, Braun, Schwartz & Kay, 1 Dag Hammarskjold Plaza. Zip: 10017. Tel: 940-8200.
 Mortimer Becker, see Becker & London.
 Becker & London, 15 Columbus Circle. Zip: 10023. Tel: 541-7070. Cable: BECLONDON.
 Beldock, Levine & Hoffman, 565 Fifth Ave. Zip: 10017. Tel: 490-0400. Cable: TELHOFFLAW. Telex: 42-2046.
 Myron Beldock, see Beldock, Levine & Hoffman.
 Alan S. Bergman, see Zissu, Stein, Bergman, Couture & Mosher.
 Royal E. Blakeman, see Marshall, Bratter, Cree & Allison & Tucker.
 Bobrow, Greenapple, Burton, Distler & Midler, 919 Third Ave. Zip: 10022. Tel: 752-2604.
 Brooks, Haidt, Haffner & Delahunty, 99 Park Ave. Zip: 10016. Tel: 697-3355. Cable: BROHAD. Telex: 236306.
 Brumbaugh, Graves, Donohue & Raymond, 30 Rockefeller Plaza. Zip: 10020. Tel: 489-3300. Cable: CAMBRUFREE. Telex: 238555.
 Alan Brutton, see Brutton & Brutton.
 Brutton & Brutton, 1290 Ave. of the Americas, Suite 3710. Zip: 10019. Tel: 581-1522.
 Burgoyne, Rose & Bohmatt, 551 Fifth Ave. Zip: 10017. Tel: 986-0060.
 Arnold Burns, see Burns, Jackson, Miller, Summitt & Jacoby.
 Burns, Jackson, Miller, Summitt & Jacoby, 445 Park Ave. Zip: 10022. Tel: 980-3200. Cable: BURNLX. Telex: 74-8376.
 Burns, Lobato & Adams, PC, 71 Broadway. Zip: 10006. Tel: 742-0760. Cable: BURNSLAW. ITT Telex: 421-487; RCA Telex: 235-451.
 Gideon Cashman, see Pryor, Cashman, Sherman & Flynn.
 Robert L. Casper, see Casper & Epstein.
 Casper & Epstein, PC, 1780 Broadway. Zip: 10019. Tel: 765-5038. Telex: 422954.
 James Charne, see Hutzler & Charne.
 Irving Cohen, see Cohen, Grossberg & Zinkin.
 Cohen, Grossberg & Zinkin, 505 Park Ave. Zip: 10022. Tel: 688-6940.
 Cohn, Gluckstein, Lurie, Ostirn & Lublick, 1370 Ave. of the Americas. Zip: 10019. Tel: 757-4000. Cable: COHGLICK.
 Edward E. Colton, see Colton, Weissberg, Hartnick & Yamin.
 Colton, Weissberg, Hartnick & Yamin, 505 Park Ave. Zip: 10022. Tel: 371-4350. Cable: EDCOLT.
 Connor & Chopnick, 9 E. 46 St. Zip: 10017. Tel: 697-8130. Cable: LACONIC.
 Cooper, Dunham, Clark, Griffin & Moran, 30 Rockefeller Plaza. Zip: 10020. Tel: 977-9550. Cable: KERCURTIS. Telex: 422-523.
 Stephen H. Cooper Esq., see Weil, Gotshal & Manges.
 Jerold L. Couture, see Zissu, Stein, Bergman, Couture & Mosher.
 Philip M. Cowan, see Cowan & Cowan.

A. Halsey Cowan, see Cowan & Cowan.
 Cowan & Cowan, 1350 Ave. of the Americas. Zip: 10019. Tel: 246-2060.
 Cowan, Leibowitz & Latman, PC, 200 E. 42 St. Zip: 10017. Tel: 986-6272. Cable: COWLIELAT. Telex: 428143.
 Martin R. Cramer, see Ruden & Cramer.
 Curtis, Morris & Saford, PC, 530 Fifth Ave. Zip: 10036. Tel: 840-3333. Cable: CUMOSAT. Telex: 222571.
 Darby & Darby, PC, 405 Lexington Ave. Zip: 10017. Tel: 697-7660. Cable: YBRAD.
 Davis & Gilbert, 850 Third Ave. Zip: 10022. Tel: 593-0707.
 Davis, Hoxie, Faithfull & Haggood, 45 Rockefeller Plaza. Zip: 10020. Tel: 757-2200. Cable: EXPLICIT. Telex: 12-8162; Int'l Telex: 42-1236.
 Nelson & Gordon, 230 Park Ave. Zip: 10017. Tel: 661-9800. Cable: DELGORG. Telex: 23-6153. TWX: (710) 581-4437.
 Alvin Deutsch, see Linden & Deutsch.
 Dornbush, Mensch & Mandelstam, 747 Third Ave. Zip: 10017. Tel: 935-3900.
 Egon Dumler, 575 Madison Ave. Zip: 10022. Tel: 759-4580.
 Gerald F. Edelstein, see Arrow, Edelstein, Gross & Margolis.
 Owen Epstein, see Levine & Thall.
 Robert Epstein, see Casper & Epstein.
 Eyre, Mann, Lucas & Just, 155 E. 44 St. Zip: 10017. Tel: 682-4980. Cable: ANMANN.
 Seymour Feig, see Feig & Taubman.
 Feig & Taubman, 159 W. 53 St. Zip: 10019. Tel: 586-6380.
 Ronald E. Feiner, see Colton, Weissberg, Hartnick & Yamin.
 Andrew J. Feinman, see Feinman & Kraslowsky.
 Feinman & Kraslowsky, PC, 424 Madison Ave. Zip: 10017. Tel: 421-8787.
 Feit & Ahrens, 488 Madison Ave. Zip: 10022. Tel: 371-6220. Cable: LAWSMAT. Telex: 238527.
 John R. Fernbach, 410 Park Ave. Zip: 10022. Tel: 421-4100.
 Jerome H. Field, 1116 Ave. H., Brooklyn 11230. Tel: 434-0781.
 Robert E. Fischer, see Lowenthal, Landau, Fischer & Singer.
 Fish & Neave, 277 Park Ave. Zip: 10017. Tel: 826-1050. Cable: FISNEAVE. Telex: 12-5806.
 Robert Flax, see Michael F. Sukin.
 Frankfurt, Garbus, Klein & Selz, 485 Madison Ave. Zip: 10022. Tel: 980-0120. Cable: MATMITO.
 Leonard Franklin, see Franklin, Weinrib, Rudell & Vassallo.
 Franklin, Weinrib, Rudell & Vassallo, 950 Third Ave. Zip: 10022. Tel: 935-5500. Telex: 42-7453.
 Barry I. Fredericks, see Goldschmidt, Fredericks, Kurzman & Oshatz.
 Ganer & Ganer, 31 W. 87 St. Zip: 10024. Tel: 873-1472.
 Maxine Ganer, see Ganer & Ganer.
 Gelberg & Kronover, 711 Third Ave. Zip: 10017. Tel: 599-3200.
 Gersten, Scherer & Kaplowitz, 150 E. 58 St. Zip: 10022. Tel: 752-9700.
 Gold, Farrell & Marks, 595 Madison Ave. Zip: 10022. Tel: 935-9200.
 Jerold B. Gold, see Granett & Gold.
 Goldschmidt, Fredericks, Kurzman & Oshatz, 655 Madison Ave. Zip: 10021. Tel: 838-2424.
 Goldstein, Schrank, Seigelstein & Shays, 99 Park Ave. Zip: 10016. Tel: 986-3036. Cable: STANHERBAT.
 Granett & Gold, PC, 1350 Ave. of the Americas. Zip: 10019. Tel: 246-2060. Cable: GRANETGOLD.
 Solomon Granett, see Granett & Gold.
 Greenbaum, Wolf & Ernst, 437 Madison Ave. Zip: 10022. Tel: 758-4010. Cable: GREWOLFERN. ITT Telex: 423007; RCA Telex: 236009.
 Greenwald, Kovner & Goldsmith, 521 Fifth Ave. Zip: 10017. Tel: 687-6600. Cable: HAGREENLAW.
 John B. Griffin, 60 E. 42 St. Zip: 10017. Tel: 687-9099. Cable: GRIFFINLAW.
 John M. Gross, see Arrow, Edelstein, Gross & Margolis.
 David Grossberg, see Cohen, Grossberg & Zinkin.
 Allen Grubman, see Grubman & Indursky.
 Grubman & Indursky, PC, 65 E. 55 St. Zip: 10022. Tel: 888-6600. Telex: 426104.
 Jeremiah S. Gutman, see Levy, Gutman, Goldberg & Kaplan.
 Hall, Dickler, Lawrence, Kent & Howley, 460 Park Ave. Zip: 10022. Tel: 838-4600. Cable: HALCASRO.
 Hall, McNichol, Hamilton & Clark, 330 Madison Ave. Zip: 10017. Tel: 682-3060. Cable: LANDWATER.
 Burton H. Hanft, 105 Madison Ave. Zip: 10016. Tel: 889-1420.
 Jay S. Harris, see Weissberg & Harris.
 Harris & Pienek, 425 Park Ave. Zip: 10022. Tel: 935-5810.
 Peter A. Herbert, see Parcher & Herbert.
 Mark D. Herman, see Herman & Benn.
 Herman & Benn Esqs., 110 E. 59 St. Zip: 10022. Tel: 758-3102.
 Hess, Segall, Popkin, Guterman, Pelz & Steiner, 230 Park Ave. Zip: 10017. Tel: 689-2400. Cable: TIMMY. Telex: 12-7400.
 Paul Hessel, see Gelberg & Kronover.
 Walter Hofer, 221 W. 57 St. Zip: 10019. Tel: 582-5030. Telex: 422062.
 Elliot L. Hoffman, see Beldock, Levine & Hoffman.
 Holland, Armstrong, Wilkie & Previto, Empire State Bldg., 350 Fifth Ave. Zip: 10001. Tel: 736-2080.
 Hubbell, Cohen, Stiebel & Gross, 551 Fifth Ave. Zip: 10017. Tel: 687-1360. Cable: HUPATLAW. Telex: 42-3051.
 Hutzler & Charne, 250 W. 94 St. Zip: 10025. Tel: 864-6169.
 Arthur Indursky, see Grubman & Indursky.
 Javitz & Javitz, 1345 Ave. of the Americas. Zip: 10019. Tel: 586-4050. Cable: BAULITS. RCA Telex: 23-7188.
 Johnson & Tannenbaum, 250 W. 57 St. Zip: 10019. Tel: 265-4072.
 Jones, Michael & Cherot, 888 Seventh Ave. Zip: 10019. Tel: 541-6900.
 Kane, Dalsimer, Kane, Sullivan & Kurucz, 420 Lexington Ave. Zip: 10017. Tel: 687-6000. Cable: DUELSION. ITT Telex: 42-6767.
 N. Dennis Kaplan, 923 Fifth Ave., Duplex Suite. Zip: 10021. Tel: 772-2440.
 Karpatic, Pollet & LeMoult, 1345 Ave. of the Americas. Zip: 10019. Tel: 765-2700.
 Dennis Katz, PC, 110 E. 59 St. Zip: 10022. Tel: 758-1433.
 Marvin Katz, see Mayer, Nussbaum, Katz & Baker.
 Kaye, Scholer, Fierman, Hays & Handler, 425 Park Ave. Zip: 10022. Tel: 759-8400.
 Kazdin & Weinstein, PC, 2 Pennsylvania Plaza. Zip: 10001. Tel: 564-3377.
 Kenyon, Kenyon, Reilly, Carr & Chapin, 59 Maiden Ln. Zip: 10038. Tel: 425-7200. Cable: AMAXIA. Int'l Telex: 42-2141; Domestic Telex: 12-7799.
 Kirschstein, Kirschstein, Ottinger & Corrin, PC, 666 Fifth Ave. Zip: 10019. Tel: 757-2920. Cable: KIRSCHMOR. Telex: 427115.
 Harold S. Klein, 4 W. 56 St. Zip: 10019. Tel: 757-4611.
 M. William Kraslowsky, see Feinman & Kraslowsky.
 Krause, Hirsch & Gross, 41 E. 42 St. Zip: 10017. Tel: 986-1122. Cable: KRAUSCHIRSH.
 Eric Kronfeld, 1501 Broadway, 30th fl. Zip: 10036. Tel: 840-2200.
 Jules Krutz, 161 W. 54 St. Zip: 10019. Tel: 489-7095.
 Peter Lane, 60 E. 42 St. Zip: 10017. Tel: 986-0086.
 Lankenau, Kovner & Bickford, 30 Rockefeller Plaza. Zip: 10020. Tel: 489-

8230. Telex: 237522. Cable: LANKOFORD.
 Lano, Feinberg & Cohen, 555 Madison Ave. Zip: 10022. Tel: 421-0700. TWX: (710) 581-2711. Cable: SIMASH.
 Lawrence S. Levine, see Beldock, Levine & Hoffman.
 Robert F. Levine, see Levine & Thall.
 Levine & Thall, 485 Madison Ave. Zip: 10022. Tel: 980-0120.
 Levy, Gutman, Goldberg & Kaplan, 363 Seventh Ave. Zip: 10001. Tel: 736-2226.
 Harley I. Lewin, 888 Seventh Ave., Suite 2400. Zip: 10019. Tel: 586-3490.
 Liddy, Sullivan, Galway & Vaccaro, 253 Broadway. Zip: 10007. Tel: 267-7400. Cable: LIHADSD.
 Bernard R. Lieberman, 60 W. 42 St. Zip: 10017. Tel: 682-7214.
 Lawrence Lighter, 1350 Ave. of the Americas. Zip: 10019. Tel: 582-5250.
 Bella L. Linden, see Linden & Deutsch.
 Linden & Deutsch, 110 E. 59 St. Zip: 10022. Tel: 758-1100.
 Jack London, see Becker & London.
 Lowenthal, Landau, Fischer & Singer, 250 Park Ave. Zip: 10017. Tel: 986-1116.
 Martin J. Machat, 1501 Broadway. Zip: 10036. Tel: 840-2200.
 Arthur A. March, 60 E. 42 St. Zip: 10017. Tel: 661-3680. Cable: MAILVIES.
 Gerald A. Margolis, see Arrow, Edelstein, Gross & Margolis.
 Paul Marshall, see Marshall, Morris, Powell, Silfen & Cinque.
 Marshall, Bratter, Greene, Allison & Tucker, 430 Park Ave. Zip: 10022. Tel: 421-7200.
 Marshall, Morris, Powell, Silfen & Cinque, 130 W. 57 St. Zip: 10019. Tel: 582-1122. Telex: 421067.
 Mayer, Nussbaum, Katz & Baker, PC, 75 Rockefeller Plaza. Zip: 10019. Tel: 484-6450. Telex: 238038.
 McAulay, Fields, Fisher & Goldstein, 20 Exchange Place. Zip: 10005. Tel: 248-5330. Cable: LAURIAMES.
 Martin Mensch, see Dornbush, Mensch & Mandelstam.
 Migdal, Tenney, Glass & Pollack, 598 Madison Ave. Zip: 10022. Tel: 832-4900. Cable: RAMIGLO. Telex: 66388.
 Milgrm, Thomajan & Jacobs, 25 Broadway. Zip: 10004. Tel: 952-9292. Cable: MILATOM. Telex: 126965.
 Kendall Minter, 888 Seventh Ave. Zip: 10019. Tel: 541-6900.
 Maria P. Monet, see Shearman & Sterling.
 Morgan, Finnegan, Pine, Foley & Lee, 345 Park Ave. Zip: 10022. Tel: 758-4800. Cable: FINDURPINE. ITT Telex: 421792.
 Monte Morris, 130 W. 57 St. Zip: 10019. Tel: 582-1122.
 Moses & Singer, 1271 Ave. of the Americas. Zip: 10021. Tel: 246-3700.
 James W. Mosher, see Zissu, Stein, Bergman, Couture & Mosher.
 Myron R. Nadler, see Roemer & Nadler.
 Harold H. Newman, 8 Turner Dr., New Rochelle 10804. Tel: (914) 632-3187.
 Nims, Howes, Colison & Isner, 60 E. 42 St. Zip: 10017. Tel: 682-4590. Cable: NIMS.
 Harold Orenstein, PC, 110 W. 57 St. Zip: 10019. Tel: 247-6460. Cable: HOMUSLAW. Telex: 237409.
 Ostrolenk, Faber, Gerb & Sofen, 260 Madison Ave. Zip: 10016. Tel: 685-8470. Cable: OSTROFABER. Telex: 2306925.
 O'Sullivan, Wolff, Karabell & Graev, 280 Park Ave. Zip: 10017. Tel: 661-3600. Cable: APPELAW.
 L. Peter Parcher, see Parcher & Herbert.
 Parcher & Herbert, 10 E. 40 St. Zip: 10016. Tel: 689-6325.
 Parker, Duryee, Zunino, Malone & Carter, 1 E. 44 St., Suite 3300. Zip: 10017. Tel: 573-9300. Cable: PAROUR.
 Paskus, Gordon & Hyman, 45 Rockefeller Plaza. Zip: 10020. Tel: 841-0200. Cable: PACOLOGO. Telex: 148325.
 Phillips, Nizer, Benjamin, Krim & Ballou, 40 W. 57 St. Zip: 10019. Tel: 977-9700. Cable: PHILLNIZER. Telex: 126127.
 Tobias Pienek, see Harris & Pienek.
 Barry H. Platnick, 250 W. 57 St. Zip: 10019. Tel: 757-4315.
 Saul P. Pryor, see Pryor, Cashman, Sherman & Flynn.
 Pryor, Cashman, Sherman & Flynn, 410 Park Ave. Zip: 10022. Tel: 421-4100. Cable: PRCYROUT. Telex: 640221.
 Steven R. Rand, 1290 Ave. of the Americas, Suite 3232. Zip: 10019. Tel: 541-4655.
 Regan, Goldfarb, Heller, Wetziar & Quinn, 445 Park Ave. Zip: 10022. Tel: 754-3000. Cable: REGOLAW. Telex: 125843.
 Rembar & Curtis, 19 W. 44 St. Zip: 10036. Tel: 575-8500. Cable: REMBARLAW.
 Richard H. Roemer, see Roemer & Nadler.
 Roemer & Nadler Esqs., 605 Third Ave. Zip: 10016. Tel: 986-1702. Telex: 423747.
 Rogers & Wells, Pan Am Bldg., 200 Park Ave. Zip: 10017. Tel: 972-7000. Cable: YOSKLAW. Telex: 224493.
 Eric Roger, 18 E. 48 St. Zip: 10017. Tel: 421-7070.
 Rosenblum & Freedman, 135 W. 50 St. Zip: 10019. Tel: 586-0916.
 H. Rosenblum, see Rosenblum & Freedman.
 Richard M. Rosenthal, PC, 425 Park Ave., 5th fl. Zip: 10022. Tel: 758-0809.
 Roth & Bucholz, 52 Park Ave. Zip: 10016. Tel: 889-8530. Cable: ROTHBUCH.
 Michael Rudell, see Franklin, Weinrib, Rudell & Vassallo.
 Ruden & Cramer, 405 Seventh Ave. Zip: 10001. Tel: 239-4515.
 Edward A. Sargoy, 105 Madison Ave. Zip: 10016. Tel: 889-1420.
 Richard D. Savitsky, 50 E. 42 St. Zip: 10017. Tel: 697-8689.
 Schimmel, Rochlin & Lipsky, 510 Fifth Ave. Zip: 10036. Tel: 840-6444.
 Paul Schindler, see Grubman & Indursky.
 Conrad Shadlen, 375 Park Ave., Suite 3403. Zip: 10022. Tel: 752-5250. Cable: LAWSHADLEN. Telex: 234869.
 Shaw & Stedina, 350 Madison Ave. Zip: 10017. Tel: 682-2233.
 Shearman & Sterling, 153 E. 53 St. Zip: 10022. Tel: 483-1000.
 Paul J. Sherman, see Pryor, Cashman, Sherman & Flynn.
 Peter S. Shukat, 111 W. 57 St. Zip: 10019. Tel: 245-4580.
 Alan L. Shulman, see Silverman & Shulman.
 Jerry H. Shustrek, 155 E. 55 St. Zip: 10022. Tel: 832-3040.
 Alan Siegel Esq., see Pryor, Cashman, Sherman & Flynn.
 Martin E. Siffen, PC, 545 Fifth Ave. Zip: 10017. Tel: 986-0890.
 Stuart Silfen, see Marshall, Morris, Powell, Silfen & Cinque.
 Noel L. Silverman, see Silverman & Shulman.
 Silverman & Shulman, PC, 136 E. 57 St. Zip: 10022. Tel: 758-2020. Telex: 224600.
 Melvin Simenensky, see Gersten, Scherer & Kaplowitz.
 Alan Skiena, see Walter Hofer.
 Barry M. Smith Esq., 110 E. 59 St., Suite 1407. Zip: 10022. Tel: 838-7790.
 Smith, Steibel, Alexander & Saska, PC, 460 Park Ave. Zip: 10022. Tel: 751-2660. Cable: YORKSMITH. Telex: 424036.
 Solinger & Gordon, 250 Park Ave. Zip: 10017. Tel: 687-1140. Cable: SOLGORLAW.
 Alan J. Stein, see Zissu, Stein, Bergman, Couture & Mosher.
 George N. Stein, see Zissu, Stein, Bergman, Couture & Mosher.
 Stuart & Zavin, 60 E. 42 St., Suite 2340. Zip: 10017. Tel: 661-5380.
 Michael F. Sukin, PC, 919 Third Ave. Zip: 10022. Tel: 838-6044. Telex: 12041.

Ronald S. Taft, 18 W. 55 St. Zip 10019. Tel: 586-8844
 Joseph Taubman, see Feig & Taubman.
 Peter M. Thall, see Levine & Thall
 Michael S. Toorock Esq., 605 Third Ave. Zip 10016 Tel 972 1100
 Townsend, Rabinowitz, Pantaleoni & Valente, 535 Fifth Ave. Zip 10017. Tel: 687-4385. Cable: TOWRAPAN.
 Turchin & Topper, 60 E. 42 St. Zip: 10017 Tel 661-0420
 Robert M. Urband, PC, 641 Lexington Ave. Zip: 10022. Tel: 421-6190.
 John Vassallo, see Franklin, Weinrib, Rudell & Vassallo
 Watson, Leavenworth, Kelton & Taggart, 100 Park Ave. Zip: 10017. Tel 683-4221. Cable: WATSOLAW. Telex: 620866.
 Howard Wattenburg, 130 W. 57 St. Zip: 10019. Tel: 582 1122
 Jon M. Waxman, 111 W. 57 St. Zip: 10019. Tel: 245-4580 Cable: MISTERWIZ Telex: 425289
 Cameron K. Wehringer, 25 W. 43 St. Zip: 10036. Tel 736-9380. 730-1755. Cable: CAMWEHR.
 Weil, Gotshal & Manges, 767 Fifth Ave. Zip: 10022. Tel 758-7800.
 Nathan Weiss, see Weiss & Meibach.
 Weiss, Dawid, Fross & Lehman, 750 Third Ave. Zip 10017 Tel 953-9090. Cable: LEHRMARKS. Telex: 422455.
 Weiss & Meibach, 888 Seventh Ave. Zip: 10023 Tel 765-4936 Telex: 427533.
 Franklin R. Weissberg, see Colton, Weissberg, Hartnick & Yamin
 L. Arnold Weissberger, see Weissberger & Harris.
 Weissberger & Harris, 120 E. 56 St. Zip: 10022. Tel 758-0800 Cable: ARNWEISLAW.
 David Werchen Esq., 150 E. 58 St., Suite 3000 Zip 10155 Tel 486-0535 Telex: 960127 Swift NYK (domestic), 230199 Swift UR (int'l).
 Allan P. White, 233 Broadway. Zip: 10007. Tel: 227-6291.
 Wolder, Gross & Yavner, 41 E. 42 St. Zip: 10017. Tel: 687-3233. Cable: WOLGROSPAT.
 Wyatt, Gerber & Shoup, 261 Madison Ave. Zip: 10016. Tel: 687-0911. Cable: GEDRIGHT ITT Telex: 421733.
 Carl L. Zanger, 500 Fifth Ave. Zip: 10036 Tel: 840-2940
 Zelnick & Bressler, 1 World Trade Center, Suite 1535. Zip: 10048 Tel. 466 1123. Cable: LEGIBUS. Telex: 424848.
 Benjamin Zinkin, see Cohen, Grossberg & Zinkin.
 Leonard Zissu, see Zissu, Stein, Bergman, Couture & Mosher.
 Zissu, Stein, Bergman, Couture & Mosher, 270 Madison Ave. Zip: 10016. Tel: 683-5320 Telex: 428131.
 Joseph E. Zynczak, PC, 65 W. 55 St. Zip 10019 Tel: 977-9340 Telex: 237322.

Malcolm L. Mimms Jr., Third Nat'l Bank Bldg., 13th fl. Zip: 37219. Tel.: 244-0020.
 David Pack, see Pack & Price.
 Pack & Price, Life & Casualty Tower, 18th fl. Zip: 37219. Tel: 244-0626
 Rose Palermo, 43 Music Square W. Zip: 37203. Tel: 244-4270.
 James W. Price Jr., see Pack & Price.
 Stephen K. Rush, Third Nat'l Bank Bldg., 17th fl. Zip: 37219. Tel: 244-5200
 Val Sanford, Home Federal Bldg., 230 Fourth Ave. N. Zip: 37219. Tel: 244-4994.
 Joe Saperstein, 210 25 Ave. N., Suite 1001. Zip: 37203. Tel: 327-4280

Grant W. Smith, Young Exec. Bldg., Suite 300, 1300 Division St. Zip: 37203. Tel: 244-3696.
 James Randolph Smith, 65 Music Square E. Zip: 37203. Tel: 327-0048.
 Robert L. Sullivan, Third Nat'l Bank Bldg., 8th fl. Zip: 37204. Tel: 244-1713.
 W. Robert Thompson, PC, 21 Music Circle E. Zip: 37203. Tel: 259-4167.
 Daniel E. Tyler, 43 Music Square W. Zip: 37203. Tel: 244-4270.
 Larry L. Westbrook, 2002 Richard Jones Rd., Suite C-101. Zip: 37215. Tel: 383-3327.
 Willis & Knight, 215 Second Ave. N. Zip: 37201. Tel: 259-9600.
 Larry Woods, 121 17 Ave. S. Zip: 37203. Tel: 259-4366.

TENNESSEE

• **MEMPHIS (Area Code 901)**

Orville Almon Jr., 1491 Union Ave. Zip: 38104. Tel: 274-7067.
 Maurice McGehee, 100 N. Main, Suite 2504. Zip: 38103. Tel: 525-8871.
 Fred M. Ridolphi Jr., 1 Commerce Square, Suite 1900 Zip: 38103. Tel: 523-8211.
 R. Lee Roberts Jr., see Roberts & Assocs.
 Roberts & Assocs., Exchange Bldg., Suite 816. Zip: 38103. Tel: 526-5848
 Seymour S. Rosenberg, 3681 Summer Ave. Zip: 38122. Tel: 454 1393.
 Harold C. Streibich, 1 Commerce Square, Suite 1590. Zip: 38103. Tel: 523-0533.
 Blanchard E. Tual, Sterick Bldg., Suite 1041. Zip: 38103. Tel: 525-6665.
 Mary Margaret Weddington, 150 E. Court Ave., 2nd fl. Zip: 38103. Tel: 526-0606.
 James G. Zumwalt, 1491 Union Ave. Zip: 38104. Tel: 274-7067

• **NASHVILLE (Area Code 615)**

Richard L. Albers, 3221 Nolensville Rd. Zip: 37211 Tel: 832-0138.
 H. Stanley Allen Jr., Life & Casualty Tower. Zip: 37219. Tel: 244-0847
 Barksdale, Whalley, Gilbert, Frank, Ludwick & Milom, Third Nat'l Bank Bldg., 201 Fourth Ave. N. Zip: 37219. Tel: 244-0020.
 Jean Nelson Beckner, Home Federal Bldg. Zip: 37219. Tel: 244-4994.
 Craig Benson, see Benson & Ellis.
 Benson & Ellis, 112 21 Ave. S., Suite 205. Zip: 37203. Tel: 327-3334.
 William T. Bozeman, First Federal Bldg., 2nd fl. Zip: 37219. Tel: 256-2134
 Gerald Arthur Burkett, Stahlman Bldg., Suite 531. Zip: 37201. Tel: 242-9489.
 Stanley M. Chernau, see Denney, Lackey & Chernau
 William Cleary, First American Center, 28th fl. Zip: 37238. Tel: 256-2422
 W. Ovid Collins Jr., Third Nat'l Bank Bldg., 18th fl. Zip: 37219. Tel: 244-1440.
 Kinian Cosner, First American Center, 14th fl. Zip: 37238. Tel: 259-2179.
 Denney, Lackey & Chernau, 218 Third Ave. N. Zip: 37201. Tel: 244-5480
 Harlan Dodson, Nashville City Bank Bldg., 315 Union St., Suite 900. Zip: 37201. Tel: 244-6840.
 Fred O. Ellis Jr., see Benson & Ellis.
 Farns, Warfield & Kanaday, Third Nat'l Bank Bldg., 17th fl. Zip: 37219. Tel: 244-5200.
 Richard H. Frank Jr. Esq., see Barksdale, Whalley, Gilbert, Frank, Ludwick & Milom.
 Goodpasture, Carpenter & Woods, 1 Commerce Pl., Suite 1911. Zip: 37239. Tel: 244-2042.
 S. Ralph Gordon, Parkway Towers, Suite 1112, 404 James Robertson Pkwy. Zip: 37219. Tel: 244-1568.
 Jack Green, 201 Thompson Ln., Suite 2. Zip: 37211. Tel: 834-0456
 James H. Harris III, see Harris & Leach.
 Harris & Leach, PC, 2 Music Circle S. Zip: 37203. Tel: 259-4507
 Aubrey B. Harwell Jr., Third Nat'l Bank Bldg., 8th fl. Zip: 37219. Tel: 244-1713.
 Jonathan Harwell, 400 Home Federal Bldg. Zip: 37219. Tel: 256-0500.
 Donald D. Hildebrand, 214 Third Ave. N. Zip: 37201. Tel: 244-2070.
 Rodger B. Kesley, United American Bank Bldg., Suite 1110. Zip: 37219. Tel: 244-0267.
 Ronald W. Kilgore, 1300 Division St., Suite 300. Zip: 37203. Tel: 244-3696.
 Harrington A. Lackey, 1033 Stahlmann Bldg. Zip: 37201. Tel: 254-0371.
 Lewis Laska, 901 Church. Zip: 37203. Tel: 255-6288.
 Charles A. Leach, see Harris & Leach
 Jude T. Lenahan, American Trust Bldg. Zip: 37201. Tel: 242-1721.
 John D. Lentz, 226 Third Ave. N. Zip: 37201. Tel: 327-3000.
 Ralph Levy Jr., Third Nat'l Bank Bldg., 13th fl. Zip: 37219. Tel: 244-0020.
 R. David Ludwick, see Barksdale, Whalley, Gilbert, Frank, Ludwick & Milom.
 Richardson R. Lynn, 65 Music Square E. Zip: 37203. Tel: 327-0048 0048.
 H. McKinley Marlow Jr., Parkway Towers, Suite 107, 404 James Robertson Pkwy. Zip: 37219. Tel: 259-9288.
 Martin & Cochran, 226 Third Ave. N. Zip: 37201. Tel: 259-2255.
 Robert G. McDowell, United American Bank Bldg., Suite 1110. Zip: 37219. Tel: 244-0267.
 W. Michael Milom, see Barksdale, Whalley, Gilbert, Frank, Ludwick & Milom.



There are many good ways to make your money work for you. And some not so good. So don't leap into anything without taking a long, hard look. Especially if you have no savings in reserve. And if you don't have enough savings, look into U.S. Savings Bonds. Because Bonds do make sense.

They guarantee the interest. They're guaranteed against loss, fire, and theft. And the Payroll Savings Plan is a sure, easy way to guarantee savings. Federal income tax may be deferred and there's *no* state or local income tax.

A little is set aside each payday for U.S. Savings Bonds. Your savings will grow until you're ready to reap the rewards of regular saving.

Saving is one of the most important financial decisions you'll ever make.



When you put part of your savings into U.S. Savings Bonds you're helping to build a brighter future for your country and for yourself.



SUPPLIES

FOR THE U.S. MUSIC-RECORD-TAPE INDUSTRY

C-60
C-90
CASSETTES

C-O
CASSETTES

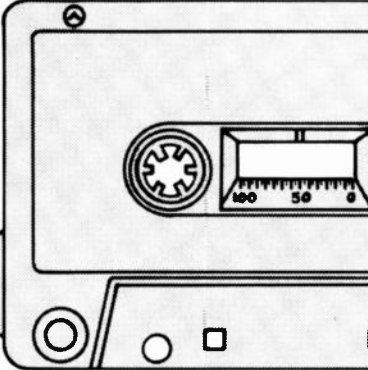
**THINK
JAPAN**

**THINK
FILAM**



(213) 630-2500

13984 S. ORANGE AVE. PARAMOUNT, CA. 90723

CARTRIDGE & CASSETTE PARTS MANUFACTURERS

- Alinabal Inc., 28 Woodmont Rd., Milford, Conn. 06460. Tel. (203) 877-3241. TWX: (710) 462-1178. Pres. V.C. Wachter; VP Dpns.: C.H. Hannan; Gen. Sales Mgr. John M. Robertson.
Audio: Liners, pressure pads & shields.
Analyst, see Pacific Int'l
- J.C. Anglum Co. Inc./Tapeponents Inc., Box 236, 36 Midvale Rd., Mountain Lakes, N.J. 07046. Tel. (201) 263-1442. Pres. J. Clifford Anglum.
Audio: 8-tr. pinch rollers & pressure pads.
- Associated Audio Servs. Inc., 181 Westchester Ave., Port Chester, N.Y. 10573. Tel. (914) 937-5129. Pres.: D. Richard Kraus; VP: Allan Johnson.
- Athena Inds. Inc., 2200 Industrial Way S., Toms River, N.J. 08753. Tel. (201) 244-8500. Pres.: Louis Ligator; Sales Mgr. Mark Chayet.
Corp. office: Hauppauge, N.Y., 1290 Motor Pkwy. Zip: 11787. Tel. (516) 234-2010
Audio: All cassette parts.
- Audio Accessories Co., 38 W. 515 Deerpath Rd., Batavia, Ill. 60510. Tel. (312) 879-5998. Sales Mgr.: John S. Maloney.
Audio: Plastic cassette hub locks, record tab plugs
- Audio Inds. Inc., Broad & Linden Aves., Ridgefield, N.J. 07657. Tel. (201) 945-4545
Audio: 8-tr. & cassette parts (SEE ADVERTISEMENT)
- AudioPak, see Capitol Magnetic Prods.
- Bazzy Electronics Corp., 39 N. Rose, Mount Clemens, Mich. 48043. Tel. (313) 463-2592.
Audio: 8-tr. parts.
- Burlington Audio Tapes Inc., 106 Mott St. Dceanside, N.Y. 11572. Tel. (516) 678-4414. Pres. Ruth Schwartz, VP: Rudy Schwartz (SEE ADVERTISEMENT)
- Cadet Recs. Inc., 5810 S. Normandie Ave., Los Angeles, Calif. 90044. Tel. (213) 753-5121. Pres. Jules Bihari; Mgr. Don Macmillan.
Branch: Park Ridge, N.J., 12 Maple Leaf Dr. Zip: 07656. Tel. (201) 391-3676. VP Sales & Mktg.: Robert K. Herrington.
Audio: 8-tr.
- Capitol Magnetic Prods. (div. of Capitol Recs. Inc.), 6902 Sunset Blvd., Hollywood, Calif. 90028. Tel. (213) 461-2701. Pres.: Edward C. Khoury; VP Mktg. Admn.: John Apsitis; VP Domestic Sales: Larry Hockemeyer; VP Int'l Sales: Bud Jackson; Mktg. Coord. Natalie Goss.
Sales offices: Atlanta, Ga., 1670 NE Freeway Access Rd. Zip: 30329. Tel. (404) 321-5441—Niles, Ill., 6401 Gross Point Rd. Zip: 60648. Tel. (312) 775-7101—New York, N.Y., 1370 Ave. of the Americas. Zip: 10019. Tel. (212) 757-7470.
Int'l branch: Singapore
Audio: 8-tr. parts.
Brand name: Audio Pak.
- Custom Cartridge Inc., 341 Hill Ave., Nashville, Tenn. 37210. Tel. (615) 244-5668. Pres.: Cliff Tant.
Audio: 8-tr.
- D A K Inds. Inc., 10845 Vanowen St., North Hollywood, Calif. 91605. Tel. 984-1559; WATS (800) 423 2636. Cable: DAKENT. Telex: 651396. Pres. Drew Alan Kaplan.
Audio: Cassette liners, hubs, housings, pins, rollers & pressure pads.
- Data Packaging Corp., 205 Broadway, Cambridge, Mass. 02139. Tel. (617) 868-6200. TWX. (710) 320-0885. Pres.: Ditto Morningstar; Exec. VP: Greg Mathus; VP Mktg.: Jere Hill; Sales & Mktg. Mgrs.: (audio-video) Gene Hull, (consumer) Peggy Harmatz.
Audio: 8-tr. & cassette parts. (SEE ADVERTISEMENT)
- Delta Magnetics Corp., 1901 McDonald Ave., Brooklyn, N.Y. 11223. Tel. (212) 627-6556. Telex: 642271.
Branch: Edison, N.J., PO Box 494. Zip: 08817. Tel. (201) 287-8907.
Audio: Graphite coated cassette shims & roll stock.
- Dixon Inds. Corp. (a Bundy Co.), 386 Metacomb Ave., Bristol, R.I. 02809. Tel. (401) 253-2000. Telex: 92-7706. Pres.: Bert Katzane; Sales Mgr.: John F. McCurdy Jr.
Audio: Cassette shims, acetal post rollers, cartridge top rings & teflon thrust washers.
Video: U-matic, Beta & VHS cassette tabs, guides & teflon thrust pads.
- Donnak Inds., PO Box 422, Ridgefield, N.J. 07657. Tel. (201) 945-6820.
Audio: Cassette hubs, flanged rollers, slip sheets, stainless steel pins, spring pads, shields, sonic & screw-type shells & windows. (SEE ADVERTISEMENT)
- Chet Dunn Assocs. Mfg. Rep., 20 Locke Rd., Billerica, Mass. 01821. Tel. (617) 663-2000. Telex: 947429. Pres.: Chet Dunn.
Audio: Staking rods, leader locks. (SEE ADVERTISEMENT)
- Dynz/Day Plastics Inc. (sub. of American Sound), 6270 S. Country Club Rd., Tucson, Ariz. 85706. Tel. (602) 746-1001. Pres.: Frank S. Day; VP & Gen. Mgr.: Larry Rosser; Sales: Leslie Day.
Sales offices: North Hollywood, Calif., 8120 Webb Ave. Zip: 91605. Tel. (213) 768-6100. Sales Dir.: Bill Dawson—Closter, N.J., 317 Harrington Ave. Zip: 07624. Tel. (201) 767-9033. VP Mktg.: Paul Adams.
Audio: Cassette hubs, rollers & shells.
- El Mar Plastics Inc., 821 E. Artesia Blvd., Carson, Calif. 90746. Tel. (213) 327-3180. Cable: ELMAR. TWX: (910) 346-6940. Pres.: Allen Schor.
Audio: 8-tr. & cassette parts. (SEE ADVERTISEMENT)

Filam Nat'l Plastics Inc., 13984 S. Orange Ave., Paramount, Calif. 90723
Tel: (213) 630-2500.
Audio: Hub locks. (SEE ADVERTISEMENT)

Gabriel Mfg. Co. Inc., 125 S. Liberty Dr., Stony Point, N.Y. 10980. Tel: (914) 942-0100. Pres.: Ed Gabriel, VP: Richard Gabriel, Gen. Mgr.: Vin Tullio; Adv. Mgr.: Ellen Gabriel.
Audio: Hubs, pins, rollers, shells.

Hi-Flex Corp., 404 Artillery Rd., Taylors, S.C. 29687 Tel: (803) 268-2363.
Audio: Cassette shims ("punched out" & continuous), pressure pads.

Horian Eng'g Inc., 600 Lake Emma Rd., Lake Mary, Fla. 32746. Tel: (305) 323-2400. TWX: (810) 856-0300. Pres.: Richard C. Horian, Gen. Mgr.: James Horian; Sales Mgr.: Robert L. Horian; Adv. Mgr.: Sue Coleman.
Audio: 8-tr. & cassette shells.

Imco Inc., PO Box 444, Huntington, Ind. 46750. Tel: (219) 356-4810.
Audio: Elastomeric pinch rollers.

Joyce Molding Corp., 501 Division St., Boonton, N.J. 07005. Tel: (201) 334-2020.
Audio: pinch rollers, pressure pads.
Brand name: Max Sound. (SEE ADVERTISEMENT)

Kyrie Corp., 2111 E. 20 St., Tucson, Ariz. 85719. Tel: (602) 624-2408. Pres. & Sales Mgr.: Keyvan Mokhtarian.
Audio: All cassette parts.

L J S Corp., 1225 Broadway, Main Floor, New York, N.Y. 10001. Tel: (212) 725-0290. Pres.: George T. Saddler, Gen. Mgr.: H. Johnson, Sales Mgr.: Elias Smyrnakis.
Audio: All components.

Lenco Co., PO Box 160, 10240 Deerpark Rd., Waverly, Neb. 68462. Tel: (402) 786-7488. Pres.: Don Leonhardt; Mktg. Dir.: Brad Harse; Sales Mgr.: Oaryl Chapelle.
Audio: Cassette hubs, rollers, tab inserts, hub locks. (SEE ADVERTISEMENT)

Loranger Mfg. Corp., Entertainment Prods. Div., 10-48 Clark St., Warren, Pa. 16365. Tel: (814) 723-8600. VP: Robert Loranger.
Audio: 8-tr. & cassette parts. (SEE ADVERTISEMENT)

Mastro Inds. Inc., 3040 Webster Ave., Bronx, N.Y. 10467. Tel: (212) 547-5600. Pres.: Mario Maccaferri.
Audio: Cassette guide rollers, keyhole hubs.

Max Sound, see Joyce Molding.

Minnesota Rubber Co., 363D Wooddale Ave. S., Minneapolis, Minn. 55416. Tel: (612) 927-1400.
Audio: 8-tr. pinch & drive rollers.

Mission Plastics South Inc., 341 Hill Ave., Nashville, Tenn. 37210. Tel: (615) 244-5668.
Factory: Jackson, Tenn., 74 Mission Dr. Zip: 38301. Tel: (901) 423-0810.
Audio: Cassette parts. (SEE ADVERTISEMENT)

Mr. Cassette Video Corp., 234 Fifth Ave., No. 304, New York, N.Y. 10001. Tel: (212) 689-9332. Pres.: George T. Saddler; Gen. Mgr.: H. Johnson; Sales Mgr.: Elias Smyrnakis.
Video: All videocassette parts.

Overland Prods. Co. Inc., PO Box 567, 515 N. Pierce St., Fremont, Neb. 68025. Tel: (402) 721-7270. Pres. & Sales Mgr.: Howard J. Pearson.
Audio: 8-tr. & cassette pressure pads, pins & shields. (SEE ADVERTISEMENT)

Pacific Int'l Magnetics Inc., 185 Berry St., No. 3865, San Francisco, Calif. 94107. Tel: (415) 495-8830.
Home office: Canada.

Audio: Cassette components.
Brand name: Analyt.

Respond Int'l Bcecs Inc., 1190 Miraloma Way, Suite Y, Sunnyvale, Calif. 94086. Tel: (408) 245-1351. Cable: RESPOND. TWX: (910) 339-9317. Pres.: Ronald L. Akn.

Rivertone Corp., Dillon Rd., Morticello, N.Y. 12701. Tel: (914) 794-8888.
Audio & Video: Plastic & rubber injection molding machines for tape parts.

Roller Corp. of America, 3601 S. Clinton Ave., South Plainfield, N.J. 07080. Tel: (201) 757-7330. Pres.: Edward Monett, VP: Jack E. Monett.
Audio: 8-tr. pinch rollers.

Shape Inc., PO Box 366, Biddeford Int'l Park, Biddeford, Me. 04005. Tel: (207) 282-6155. Telex: 944325.
Audio: Cassette hubs, pins, pressure pads, rollers, shells, shields (SEE ADVERTISEMENT)

Specialty Composites Corp., Delaware Int'l Park, Newark, Del. 19713. Tel: (302) 738-6800. Sales Mgr.: R. Prybutok; Adv. Mgr.: J. Welsh.
Audio: Pressure pads.

Tapponents Inc., see J.C. Anglim.

Trans-Am Inds. Inc., 845 Broad Ave., Ridgefield, N.J. 07657. Tel: (201) 945-2000.
Audio: Cassette hubs, double flanged rollers, slip sheets, stainless steel pins, tabs. (SEE ADVERTISEMENT)

Unique Prods. Inc., 2501 W. 237 St., Torrance, Calif. 90505. Tel: (213) 530-7500. TWX: (910) 347-6236. Pres.: George Lusko.
Audio: Cassette pressure pads, pins, shields & windows, screws, digital pressure pads, continuous reels.

Universal Tape Corp. Inc., 821 E. Artesia Blvd., Carson, Calif. 90746. Tel: (213) 327-3203. Pres.: Edward O. Praeger.
Audio: 8-tr.-snap & screw-type halves, bronze & foam type pressure pads, platforms; cassette-sonic, screw & snap type halves, stainless steel pins, pressure pads, mu-metal shields, hubs, double flanged idler rollers, window, teflon, graphite & polyester shield gaskets & liners & stainless steel pins.

EMPTY CARTRIDGE, CASSETTE & REEL MANUFACTURERS

A & E Data Technology Corp., 2945 Airway Ave., Costa Mesa, Calif. 92626. Tel: (714) 549-8353. Pres.: Kenneth L. Smith; Nat'l Sales Mgr.: Sue H. Carpenter; Prod. Mgr.: Walter M. Oavenport.
Video: 1/4" U-matic cassette, 1/4" VHS cassette.

A/V Paragon, see Universal Tape.

Ampex Corp., 401 Broadway, Redwood City, Calif. 94063. Tel: (415) 367-2011. Telex: 348464. TWX: (910) 378-5920.
Sales Offices: Birmingham, Ala. PO Box 845. Zip: 35205. Tel: (205) 823-6132. Glendale, Calif., 500 Rodier Dr. Zip: 91201. Tel: (213) 240-5000. San Diego, Calif., PO Box 99847. Zip: 92109. Tel: (714) 272-8337. Denver, Colo., 2124 S. Birch. Zip: 80222. Tel: (303) 757-1829/6491. Orlando, Fla., PO Box 15008-B. Zip: 32808. Tel: (305) 423-2962. Atlanta,

**CASSETTE-PARTS
STANDARD-SPECIAL
DOUBLED FLANGED ROLLERS
KEYHOLE HUBS
LEADER TAPE WINDOWS
SHIELDS SPRING PADS
STAKING ROD PINS
GRAPHITE COATED LINERS
CASSETTE SHELLS
SONIC - SCREW
RECORD TABS
CASSETTE TAPE
8 TRACK LUBE TAPE**

**DONNAK
INDUSTRIES**
P.O. Box 422
Ridgefield, N.J. 07657
(201) 945-6820
Telex: 133396

Funny Looking

No matter how funny they look, you've loved our quality tape hubs, cassette boxes and locks.

Now, look at our new soft cassette box. Unbreakable, clear plastic is molded with four posts to grip the cassette firmly. The unique double locks are placed to insure no damage to tape or pressure pad when box is opened.

See, also, our efficient bulk cassette locks. Simply inserted into holes in the carton sides, they stop tape rotation, and save labor and money.

Still think they look funny?

FILAM NATIONAL PLASTICS INC.
13984 S. Orange Ave.
Paramount, Ca. 90723
Phone: (213) 630-2500

... they say
we are
the best...

Manufacturer
and supplier of:

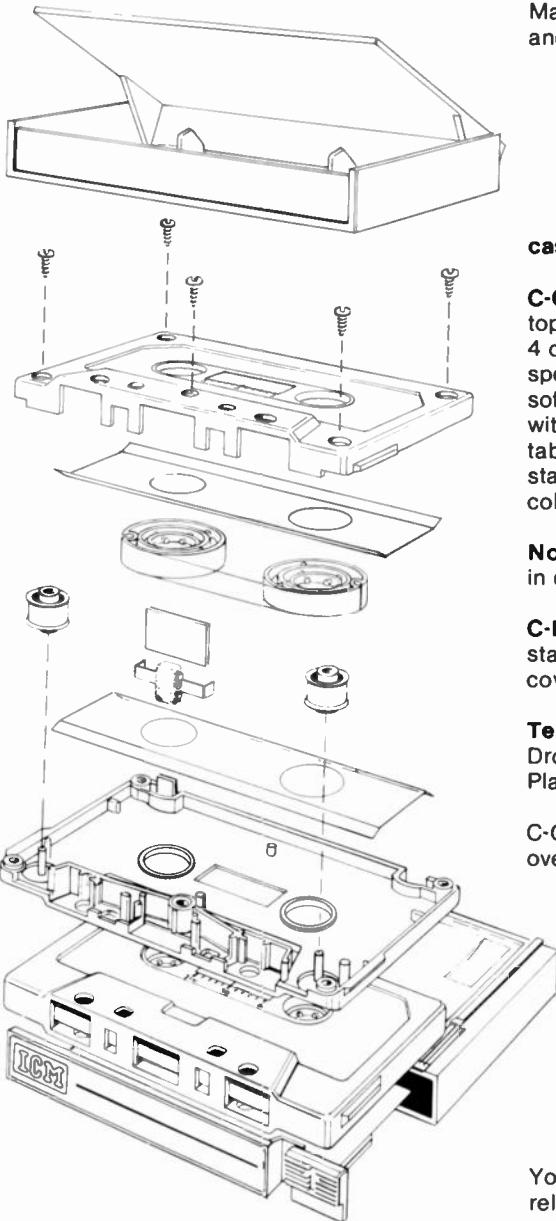

cassette parts

C-O cassettes
top performance
4 or 5 screws or sonic welded
special liner
soft or hard window
with plastic or steel pin
tabs in or out
standard or Cro 2 type
colors

Norelco style box
in different colors

C-Box storage system
standard or with transparent
cover

Testequipment
Drop-Out tester DO 2000
Play + wind tester 7804

C-O Production:
over 60 million per year

Your partner for quality and
reliability

ICM Ltd.
Mühlebachstr. 27
CH-8800 Thalwil
Switzerland
Tel. 01/720 29 42
Telex 53759

ICM
SWITZERLAND

Ga., 3135 Chestnut Dr. Suite 101. Zip: 30340. Tel: (404) 451-7112—
Honolulu, Hawaii, PO Box 25367. Zip: 96825. Tel: (808) 395-7144—
Elk Grove Village, Ill., 2201 Lunt Ave. Zip: 60007. Tel: (312) 593-6000—
Overland Park, Kan., PO Box 7282. Zip: 66207. Tel: (913) 383-1951—
Florence, Ky., Elsedon Bldg. Zip: 41042. Tel: (606) 371-1476—
Baton Rouge, La., PO Box 14238. Zip: 70808. Tel: (504) 766-6270—
Bethesda, Md., 0215 Fernwood Rd. Zip: 20034. Tel: (301) 530-8800—
Framingham, Mass., PO Box 1020. Zip: 01701. Tel: (617) 877-8060—
Minneapolis, Minn., 5200 W. 73 St. Zip: 55435. Tel: (612) 835-5560—
Elk Horn, Neb., PO Box 553. Zip: 68022. Tel: (402) 556-3400—
Hackensack, N.J., 65 Commerce Way. Zip: 07601. Tel: (201) 489-7400—
Williamstown, N.J., PO Box 513. Zip: 08094. Phila Tel: (215) 887-7400—
Buffalo, N.Y., PO Box 4. Zip: 14221. Tel: (716) 586-2580—
Cleveland, Ohio, PO Box 134. Zip: 44212. Tel: (216) 225-1262—
Nashville, Tenn., PO Box 120532. Zip: 37212. Tel: (615) 256-4836—
Dallas, Tex., 1615 Prudential Dr. Zip: 75235. Tel: (214) 637-5100—
Houston, Tex., 5300 Telephone Rd. Zip: 77087. Tel: (713) 928-3741—
Salt Lake City, Utah, 2880 S. Main. Suite 111. Zip: 84115. Tel: (801) 487-8181—
Seattle, Wash., 628 Industry Dr. Bldg. 8. Zip: 98188. Tel: (206) 675-5156.

Audio: 8-tr., cassette, 7, 10½ & 14" reels.
Video: Beta, VHS & U-matic cassette, open reel.
Ampro Prod'ns Inc., 150 Fifth Ave., New York, N.Y. 10011. Tel: (212) 243-7726. Cable: TAPEXKRON. Telex: 425233.
Audio: 8-tr., cassette.
Analyst, see Pacific Int'l
J.C. Anglum Co. Inc./Tapeponents Inc., Box 236, 36 Midvale Rd., Mountain Lakes, N.J. 07046. Tel: (201) 263-1442. Pres.: J. Clifford Anglum.
Audio: 8-tr., cassette.
Athena Inds. Inc., 2200 Industrial Way S., Toms River, N.J. 08753. Tel: (201) 244-8500. Pres.: Louis Ligator. Sales Mgr.: Mark Chayet.
Corp. office: Hauppauge, N.Y., 1290 Motor Pkwy. Zip: 11787. Tel: (516) 234-2010.
Audio: Cassette & sub-assemblies of cassette parts.
Audio Inds. Inc., Broad & Linden Aves., Ridgfield, N.J. 07657. Tel: (201) 945-4545.
Audio: 8-tr., cassette. (SEE ADVERTISEMENT)
Burlington Audio Tapes Inc., 106 Mott St., Oceanside, N.Y. 11572. Tel: (516) 678-4414. Pres.: Ruth Schwartz; VP: Rudy Schwartz.
Audio: Reels.
Brand name: Olympic. (SEE ADVERTISEMENT)
Cadet Recs. Inc., 5810 S. Normandie Ave., Los Angeles, Calif. 90044. Tel: (213) 753-5121. Pres.: Jules Bihari; Mgr.: Don Macmillan.
Branch: Park Ridge, N.Y., 12 Maple Leaf Dr. Zip: 07656. Tel: (201) 391-3676. VP Sales & Mktg.: Robert K. Herrington.
Audio: 8-tr.
Carter Corp., 1916 11 St., Rockford, Ill. 61101. Tel: (815) 397-3200. Cable: CARTERCORP. Pres.: Robert L. Fleming; VP Sales & Mktg.: Sandra L. Fleming. Plant Mgr.: W. Skip Kruger.
Audio: Reels.
Cassette Masters Corp., 2 Bashford St., Yonkers, N.Y. 10701. Tel: (914) 968-1605. Pres.: Leonard Ripley.
Audio: Screw-type cassettes, mm-cassettes.
Cetron Corp., 1701 S. State College Blvd., Anaheim, Calif. 92806. Tel: (714) 634-4280; WATS (800) 854-3943. TWX: (901) 593-1611. Pres.: Edwin Gamson; VP Mktg.: Ray Allen; Adv. Mgr.: Hal Wilde.
Audio: 8-tr., cassette. (SEE ADVERTISEMENT)

IMPORTANT NOTICE

AUDIO INDUSTRIES
Announces

- **NORELCO STYLE BOXES**
40 MILLION PER YEAR
- **C-O CASSETTES**
- **CASSETTE & 8 TRACK TAPE**
- **CASSETTE COMPONENTS**
- **CASSETTE TABS**
- **BLANK CASSETTES**
C-30, C-60, C-90,
HEAD CLEANERS

HIGHEST QUALITY • LOW PRICES
Call or Write

AUDIO INDUSTRIES
Broad & Linden Aves. • Ridgfield, N.J. 07657
Tel: 201-945-4545 • Telex 133396



SHAPE VIDEOBOX



SHAPE CASSETTEBOX



VHS VIDEOCASSETTE



C-O CASSETTE

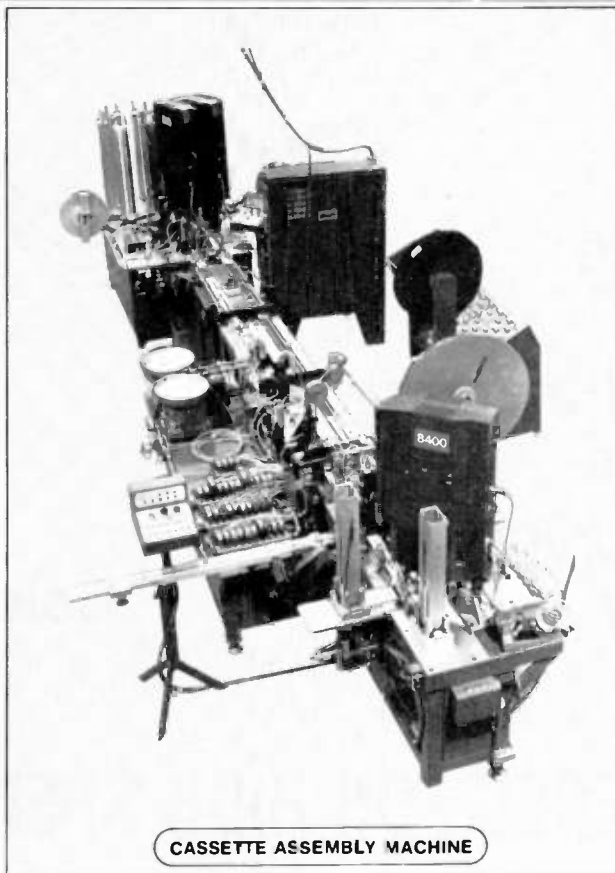

CASSETTE ASSEMBLY MACHINE



AUTOMATIC CASSETTE HUB LOADER

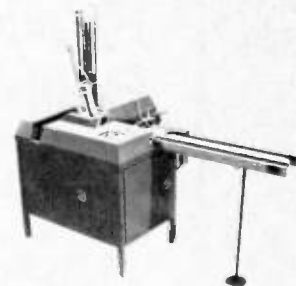

CASSETTE PACKAGING MACHINE

Creativity • Craftsmanship • Quality • That's SHAPE!

Shape Videobox—The expandable component storage system that interlocks to organize, protect and store both VHS and Beta tapes. Stack them vertically or horizontally to organize a video library.

Shape Cassettebox—The expandable component storage system for audio tapes. Each cassettebox interlocks with another to organize, protect and store cassettes at home, in car, van, boat or plane.

Shape Multistand—Multi-purpose to store cassettes, records, or video discs. Unique sleek design stores 30 records or 20 cassettes.

Automatic Cassette Hub Loader—Automatically feeds, orients and places hubs on spindles. All leader feeding, hub staking, leader winding and ejection are automatic.

C-O Cassette—Craftsmanship and quality control is built in every 5 screw, sonic weld or computer grade cassette.

Cassette Assembly Machine—The Shape Cam is fully automatic C-O assembly system.

VHS Videocassette—C-O Cassette or parts will be available to meet the expanding video software marketplace.

C-O Cassette & Packaging Machines—A complete line of machines for automatic and semi-automatic cassette assembly and packaging. Modular design allows all system applications to meet production requirements.

SHAPE®

Biddeford Industrial Park, Biddeford, Maine 04005
207/282-5155 Telex 944325 SHAPE INC. BIFD.

TRANS-AM INDUSTRIES

C-0 CASSETTES

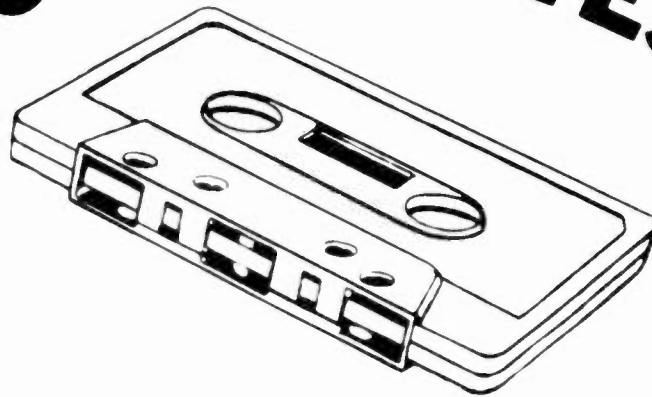

**Immediate
Delivery
Meets All Industry
Standards
Provides High
Reliability**

**Sonic
Sealed
Screw Type
Tabs In
Tabs Out
Colors Available**

**ENGINEERED FOR HIGH SPEED LOADING
CAPACITY 80 MILLION PER YEAR**

Call or Send for Price List and Samples

TRANS-AM INDUSTRIES

845 BROAD AVE., RIDGEFIELD, N.J. 07657
Tel: (201) 945-2000 • Telex: 133396

USE THE LEADER!



What makes Lenco the leader? Precision production and exacting quality control. Our sonic and five screw C \emptyset cassettes are American made. And we're proud of our national reputation and distribution.

Now, with Lenco's new Los Angeles warehouse, your order is delivered even quicker.

Lenco's innovative engineering allows loading at ultra-high speeds without scatter wind or linerburn. Lenco's quality duplicates itself with our accessories, including Soft Poly, Ampex and Norelco style boxes.

Use the leader...

Write or call:

LENCO

10240 Deerpark Road / P.O. Box 160 / Waverly, NE 68462 / (402) 786-7488

LEADER LOCK

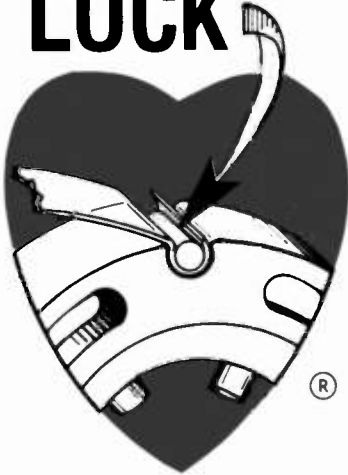

THE HEART OF YOUR CASSETTE

That little piece of staking rod is the big difference in the quality of your cassette.

Our Leader Lock is better because of our unique Double Extrusion process which delivers a rod diameter tolerance of not more than $\pm .0005"$ (.0127mm).

— Sizes from .049" (1.2446mm) to .068" (1.7272mm).
— Extruded in increments of .001" (.0254mm).

— Tolerance not more than $\pm .0005"$ (.0127mm).

— Popular sizes — .052" (1.320mm) and .062" (1.575mm) stocked for immediate shipment.

Designed and engineered for the cassette industry by the Burnhams of New York, our staking rod virtually eliminates cassette failure due to leader tape pull-out.

We also make special extrusions for particular requirements.

Ask us!

Exclusive Agents for the Burnhams:

CHET DUNN ASSOCIATES

Manufacturers' Representatives
20 Locke Road
Billerica, Mass. 01821
(617) 663-2000
TELEX 947429

Custom Cartridge Inc., 341 Hill Ave., Nashville, Tenn. 37210 Tel: (615) 244-5668. Pres.: Cliff Tant.
Audio: 8 tr.
Custom Dupl'n Inc., 6330 36 Arizona Circle, Los Angeles, Calif. 90045 Tel: (213) 670-5575. Pres.: Leonard Gross. Sales Mgr.: Bob Hively. Prod'n: Jeri Gonzales.
Audio: 8 tr., cassette
Video: Beta & VHS cassette.
D A K Inds. Inc., 10845 Vanowen St., North Hollywood, Calif. 91605 Tel: (213) 984 1559. WATS (800) 423 2636. Cable DAKENT. Telex: 651396. Pres.: Drew Alan Kaplan.
Audio: Cassettes, reels.
Daisung America Inc., 51 E. 42 St., New York, N.Y. 10017 Tel: (212) 682 6045.
Home office: Korea
Audio & Video: Cassette
Brand names: Seca, Solfa
Data Packaging Corp., 205 Broadway, Cambridge, Mass. 02139 Tel: (617) 868 6200. TWX (710) 320 0885. Pres.: Otto Morningstar, Exec. VP: Greg Mathus. VP Mktg.: Jere Hill. Sales & Mktg. Mgrs.: (audio-video) Gene Hull. (consumer) Peggy Harmatz.
Audio: 8 tr., cassette. (SEE ADVERTISEMENT)
Dyna/Day Plastics Inc. (sub. of American Sound), 6270 S. Country Club Rd., Tucson, Ariz. 85706 Tel: (602) 746-1001. Pres.: Frank S. Day. VP & Gen. Mgr.: Larry Rossier. Sales: Leslie Day.
Sales offices: North Hollywood, Calif., 8120 Webb Ave. Zip: 91604. Tel: (213) 768-6100. Sales Dir.: Bill Dawson—Closter, N.J., 317 Harrington Ave. Zip: 07624. Tel: (201) 767-9033. VP Mktg.: Paul Adams.
Audio: 8 tr., cassette.
E H C. see Electronic Homes.
Electronic Homes Co., 1225 Broadway, Main Floor, New York, N.Y. 10001 Tel: (212) 725-0290. Bd. Chm.: George T. Saddler. Sales Mgr.: Elias Smyrnakis. Adv. Mgr.: Joe Gary.
Audio: Cassette.
Brand name: EHC.
El Mar Plastics Inc., 821 E. Artesia Blvd., Carson, Calif. 90746 Tel: (213) 327 3180. Cable: ELMAR TWX (910) 346-6940. Pres.: Allen Schor.
Audio: 8 tr., cassette (5-screw & sonic welded). 3", 5" & 7" open reels (SEE ADVERTISEMENT)
Fidelipac Corp., 109 Gaither Dr., Mount Laurel, N.J. 08057 Tel: (609) 235 3511. TWX (710) 897 0254. Pres.: Roger Thanhauser. Sales & Mktg. Mgr.: Arthur Constantine.
Audio: NAB cartridges (A, AA, B & C sizes)
Brand names: Fidelipac, Master Cart.
Filam Nat'l Plastics Inc., 13984 S. Orange Ave., Paramount, Calif. 90723 Tel: (213) 630 2500.
Audio: 8 tr., cassette. (SEE ADVERTISEMENT)
Gabriel Mfg. Co. Inc., 125 S. Liberty Dr., Stony Point, N.Y. 10980 Tel: (914) 942 0100. Pres.: Ed Gabriel. VP: Richard Gabriel. Gen. Mgr.: Vin Tullio. Adv. Mgr.: Ellen Gabriel.
Audio: Cassette
Hi Energy, see Ultra Specialty
I P S, 107 Bridge Rd., Hauppauge, N.Y. 11787 Tel: (516) 234 3322
Audio: Cassette
I T I, see Investment Technology

Investment Technology Inc., 1940 124 Ave. NE, Bellevue, Wash. 98005 Tel: (206) 454-7720.
Audio: Cassette
Brand name: IIT.
Joyce Molding Corp., 501 Division St., Boonton, N.J. 07005 Tel: (201) 334-2020.
Audio: 8 tr., cassette.
Brand name: Max Sound. (SEE ADVERTISEMENT)
Kyrac Corp., 2111 E. 20 St., Tucson, Ariz. 85719 Tel: (602) 624-2408. Pres. & Sales Mgr.: Keyvan Mokhtarian.
Audio: Cassette.
L J S Corp., 1225 Broadway, Main Floor, New York, N.Y. 10001 Tel: (212) 725-0290. Pres.: George T. Saddler. Gen. Mgr.: H. Johnson. Sales Mgr.: H. Johnson. Sales Mgr.: Elias Smyrnakis.
Audio: 8 tr., cassette.
Lenco Co., PO Box 160, 10240 Deerpark Rd., Waverly, Neb. 68462 Tel: (402) 786-7488. Pres.: Don Leonhardt; Mktg. Dir.: Brad Harse; Sales Mgr.: Daryl Chapelle.
Audio: 8 tr., cassette, reels. (SEE ADVERTISEMENT)
Loranger Mfg. Corp., Entertainment Prods. Div., 10 48 Clark St., Warren, Pa. 16365 Tel: (814) 723-8600. VP: Robert Loranger.
Audio: 8 tr., cassette. (SEE ADVERTISEMENT)
M I P, see Molded In! Plastics
M J S, 2514 Seaboard Ave., San Jose, Calif. 95131 Tel: (408) 262-8793.
Owner: Michael Steiner
Audio: 8 tr., cassette, reels.
M M C, see Magnetic Mktg.
Magnetic Mktg. Corp., 29 Valley View Terr., Wayne, N.J. 07470 Tel: (201) 694 3502. Telex: 138558. Pres.: Thomas J. Hofbauer. Sales Mgr.: Brendan F. Browne; Adv. Mgr.: M. Judas.
Audio: 8 tr., cassette.
Brand name: MMC. (SEE ADVERTISEMENT)
Magnetic Media Corp., 500 Eastern Pkwy., Farmingdale, N.Y. 11735 Tel: (516) 293-1010. Cable: MAGMEDIA Telex: 143223. Pres.: Aaron Wasserstrom. Gen. Mgr.: John Cristiano. Sales Mgr.: Paul Mastroianni.
Audio: Cassette. (SEE ADVERTISEMENT)
Marmac, see Mastro.
Master Cart, see Fidelipac.
Mastro Inds. Inc., 3040 Webster Ave., Bronx, N.Y. 10467 Tel: (212) 547-5600. Pres.: Mario Macratelli.
Audio: 8 tr., cassette.
Brand name: Marmac.
Max Sound, see Joyce Molding
Meister Mfg. Co., PO Box 633, Downey, Calif. 90241 Tel: (213) 861-3198.
Audio: 7", 8", 10 1/2" aluminum reels.
Miami Tape Inc., 8180 NW 103 St., Hialeah Gardens, Fla. 33015 Tel: (305) 558-9211.
Audio: 8 tr., cassette.
Mission Plastics South Inc., 341 Hill Ave., Nashville, Tenn. 37210 Tel: (615) 244 5668.
Factory: Jackson, Tenn., 74 Mission Dr. Zip: 38301 Tel: (901) 423-0810.
Audio: 8 tr., cassette. (SEE ADVERTISEMENT)
Mr. Cassette Inds. Inc., 234 Fifth Ave., No. 304, New York, N.Y. 10001 Tel: (212) 689 9332. Bd. Chm.: George T. Saddler. Pres.: Joseph Gary, Gen. Mgr.: H. Johnson. Sales Mgr.: Elias Smyrnakis.
Audio: Cassette

No. 410
Flat Shield

No. 201
Cassette Spring Pad

No. 470M
Cassette Full Shield

No. 510
Flat-Foam Shield

No. 508
8 Track Foam Pad

No. 208
8 Track Cartridge Spring Pad

Special designs on request
Call or Write

OVERLAND PRODUCTS CO.
P.O. Box 567 • 515 North Pierce Street
Fremont, Nebr. (USA) 68025 • 402/721-7270

Mr. Cassette Video Corp., 234 Fifth Ave., No. 304, New York, N.Y. 10001. Tel: (212) 689-9332. Pres. George T. Saddler; Gen. Mgr. H. Johnson; Sales Mgr. Elias Smyrnakis.
Video: Cassette.
 Molded Ind'l Plastics Inc., 151 Wakelee Ave., Ansonia, Conn. 06401. Tel: (203) 735-2331.
Audio & Video: Reels.
Brand name: MIP.
 Olympic, see Burlington.
 P.R.C. Rec'g Co. (div. of Richmond Rec'g Corp.), 1185 Ave. of the Americas, New York, N.Y. 10036. Tel: (212) 997-1250. Pres. Hugh T. Landy, VP Sales, David Grant.
Plants: Compton, Calif., 18700 Laurelpark Rd. Zip: 90220. Tel: (213) 979-8545. Plant Mgr. Dan Huber—Richmond, Ind., 1600 Rich Rd. Zip: 47374. Tel: (317) 962-9511. Plant Mgr. George Douglas.
Audio: Cassette.
 Pacific Int'l Magnetics Inc., 185 Berry St., No. 3865, San Francisco, Calif. 94107. Tel: (415) 495-8830.
Home office: Canada.
Audio: Cassette.
Brand name: Analyst.
 Plastic Reel Corp. of America, 46 Passaic St., Wood Ridge, N.J. 07075. Tel: (201) 933-9125. Pres. F. Giglio, VP & Gen. Mgr. Robert A. Miller, Sales Mgr. Pat Baccarella.
Audio: 2 1/2" 7" reels, hubs.
Video: Reels for 1/2", 1" & 2" tape.
Brand name: Plio Magic.
 Plio Magic, see Plastic Reel.
 Polyline Corp., 1233 Rand Rd., Des Plaines, Ill. 60016. Tel: (312) 298-5300. Pres. John Kaiser.
Audio: Plastic reels. (SEE ADVERTISEMENT)
 Pro 1 Audio-Visual Inc., PO Box 33, Highland Park, Ill. 60035. Tel: (312) 433-4575. Pres. R.L. Pink, VP J. Pink; Sales Mgr. M.M. Pink, Adv. Mgr. D.D. Pink.
Audio: Cassette.
Video: Beta & VHS cassette.
 Raynor Sales Co. Inc., 2698 W. Pico Blvd., Los Angeles, Calif. 90006. Tel: (213) 737-3737. Pres. & Adv. Mgr. Ray Abrams Sr., Sales Mgr. Ray Abrams Jr.
Audio: 8 tr.
 Review Ent's (USA) Inc., 54 W. 39 St., New York, N.Y. 10018. Tel: (212) 840-2780. Contacts: Mike Thaler, Paul Smith.
Audio: Cassette.
Video: Cassette (VHS & Beta). (SEE ADVERTISEMENT)
 Robins Inds. Corp., 75 Austin Blvd., Commack, N.Y. 11725. Tel: (516) 543-5200. Pres. Herman Post, VP Sales: Stu Caine.
Audio: Cassette.
Brand name: Brand 5.
 Scotch, see 3M.
 Seca, see Dalsung.
 See Hear Inds. (div. of RJA Inc.), 120 W. 155 St., Gardena, Calif. 90248. Tel: (213) 516-0315. Pres. Ray Jacobs; Sales Mgr. Bernadette McNulty.
Audio: 8 tr. cassette.
Video: 1/4" U-matic cassette, 1/2" Beta & VHS cassette.
 Sentry Inds. Inc., 221 N. MacQuisten Pkwy., Mount Vernon, N.Y. 10550. Tel: (914) 664-2909. Pres. Harold Rosen, VP. Barry Rosen.

Audio: 8 tr. cassette.
 Shape Inc., PO Box 366, Biddelford Ind'l Park, Biddelford, Me. 04005. Tel: (207) 282-6155.
Audio: 8 tr. cassette.
Video: VHS cassette. (SEE ADVERTISEMENT)
 Soifa, see Dalsung.
 Studio Magnetics Co. Inc., 12 Long Island Ave., Moltsville, N.Y. 11742. Tel: (516) 289-3400. Pres. George Clahane, VP. Craig M. Balaban.
Audio: Screw-type cassette.
 Studio Quality, see Ultra Specialty.
 T D K Electronics Corp., 755 Eastgate Blvd., Garden City, N.Y. 11530. Tel: (516) 746-0880. Telex: 144535. VP & Gen. Mgr. Ken Kohda, Sales Mgr. John Schattin, Video Prod. Mgr. Ed Pessara.
Branches: Irvine, Calif., 2102 E. Allon St. Zip: 92714. Tel: (714) 979-5811. WATS: (800) 854-0123. Div. Mgr. Lee Adams—Marietta, Ga., 4062 Kingston Court, Zip: 30067. Tel: 952-4600. Reg'l Mgr. George Casteel—Des Plaines, Ill., 1011 E. Touhy Ave., Suite 165. Zip: 60018. Tel: 297-1341. WATS: (800) 323-5956. Reg'l Mgr. Jack Pender.
Audio: 7" & 10" metal reels. (SEE ADVERTISEMENT)
 Tape A Thon Corp./CaVox Stereo Prods. 502 S. Isis Ave., Inglewood, Calif. 90301. Tel: (213) 776-7933. WATS: (800) 421-1029. Pres. Lee Tate; Sales Dir. Robert Mayfield.
Audio: Cassette, open reel, NAB cartridge.
 Tapemaker Sales Co., 48 Urban Ave., Westbury, N.Y. 11590. Tel: (516) 333-2700. Pres. Arthur Brandwein, Office Mgr. Karen Sitkoff.
Video: Beta & VHS cassette.
 Tapeponents Inc., see J.C. Anglum.
 Thalco Audio Inc., 2 Dickens Ave., Dix Hills, N.Y. 11746. Tel: (516) 667-1616. Chief Exec. Michael Thaler.
Audio: 8 tr. cassette.
Video: Beta & VHS cassette.
 3 M Co. Audio/Video Prods. Div. 3M Center St. Paul, Minn. 55144. Tel: (612) 733-1466. Corp. VP D.E. Denham; Div. VP J.E. Povolny, Mktg. Dir. W.J. Madden, Nat'l Sales Mgr. J.L. Leon, Mkt. Opns. Mgr. J.B. Hanks, Mkt. Communications Mgr. D.J. Linehan.
Branches: Anchorage, Alaska, 5531 Minnesota Dr. Zip: 99502. Tel: (907) 276-2363—Burbank, Calif., 126 W. Elm Court, Zip: 91502. Tel: (213) 848-5534—Los Angeles, Calif., 6023 S. Garfield Ave. Zip: 90040. Tel: (213) 726-6300—South San Francisco, Calif., 320 Shaw Rd. Zip: 94080. Tel: (415) 589-2663—Washington, D.C., 1101 15 St. NW. Zip: 20005. Tel: (202) 331-6900—Atlanta, Ga., 2860 Bankers Ind'l Dr. Zip: 30360. Tel: (404) 447-7000—Honolulu, Hawaii, PO Box 30048, 4443 Malaas St. Zip: 96818—Argo, Ill., 6850 S. Harlem Ave. Zip: 60501. Tel: (312) 496-6500—Needham Heights, Mass., 155 Fourth Ave. Zip: 02194. Tel: (617) 449-0300—Farmington, Mich., 23923 Research Dr. Zip: 48024. Tel: (313) 477-5000—Eagan, Minn., PO Box 32211, St. Paul 55133. 3130 Lexington Ave. S. Zip: 55121. Tel: (612) 733-3300—St. Louis, Mo., PO Box 510, 10725 Baur Blvd. Zip: 63166. Tel: (314) 997-8500—West Caldwell, N.J., PO Box 76, 15 Henderson Dr. Zip: 07006. Tel: (201) 575-2000—Cincinnati, Ohio, 4835 Para Dr. Zip: 45237. Tel: (513) 242-2313—Cleveland, Ohio, 12200 Brookpark Rd. Zip: 44130. Tel: (216) 267-1800—Philadelphia, Pa., 5698 Rising Sun Ave. Zip: 19120. Tel: (215) 728-5300—Dallas, Tex., 2121 Santa Anna Ave. Zip: 75228. Tel: (214) 324-8100—Seattle, Wash., Andover Ind'l Park, 100 Andover Park W. Zip: 98188. Tel: (206) 244-7200.
Audio: Reels (1/4", 1/2", 1", 2", 5", 7", 10 1/4", 14")

The MONEY-SAVER!



Poly Box
 for audio cassettes
 soft, hinged, see-through

We make it. We ship it from stock. You can rely on the consistently high quality of our cassette boxes.

Call us for prices.
 312/298-5300

Polyline
 Corp.

1233 Rand Road
 Des Plaines, Illinois 60016

19

**IF YOU WANNA BOX...
 AND NOT GET HURT...
 CALL EL MAR PLASTICS!**

— because El Mar has boxes — cassette boxes — at prices that won't leave a bruise! All kinds — Norelco style boxes, hinged poly boxes, Ampex style boxes, and 12-pack cassette storage boxes.



In fact, we've been making more boxes longer than anyone!

We've recently taken some of the sting out of the price fight, by setting up a fully automated line to increase our production of Norelco style boxes by an additional 40 million a year.

And not just any old box! The new El Mar boxes have all rounded corners, molded raised edges

on the lid to reduce scratching and a super strong hinge! Plus, they have been tested and proven on all automatic packaging equipment.

When quality and dependability count, we have a C-O that can't be beaten. Solid 5 screw housing with all the top grade components you've come to expect

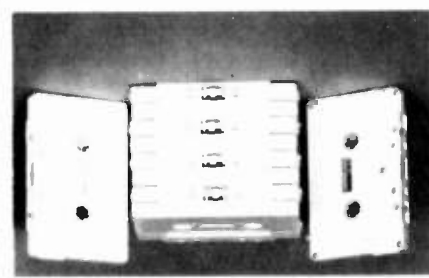

Please call for prompt quotation and samples.

El Mar Plastics, Inc.
 821 E. Artesia Blvd., Carson, CA 90746
 (213) 327-3180

Manufacturer of quality C-O cassettes, cassette boxes, tape accessories and 1/4" tape reels.



Video: Reels (2", 1")
Brand name: Scotch.
 Trans-Am Inds. Inc., 845 Broad Ave., Ridgefield, N.J. 07657. Tel: (201) 945-2000.
Audio: Sonic & Screw-type cassette. (SEE ADVERTISEMENT)
 U T C, see Universal Tape
 Ultra Specialty Inc., 20700 S. Beishaw Ave., Carson, Calif. 90746 Tel: (213) 537-8850. Cable: ULTRASPEC. Telex: 194566. Pres. Don Wong, Pres. Ultraspec Int'l: Gary Lyle
Audio: Cassette
 Video: 1/2" Beta & VHS cassette
Brand names: Hi-Energy, Studio Quality, Ultra
 Universal Tape Corp. Inc., 821 E. Artesia Blvd., Carson, Calif. 90746 Tel: (213) 327-3203. Pres. Edward D. Praeger
Audio: 8-tr., cassette, open reel.
Brand name: A/V Paragon, UTC, Universal.

(800) 423-2936 Cable BUDSCUND. TWX (910) 498-2759 Pres. Al Sherman, Gen. Mgr. Dick Ceja (M)
 Award Rec. Mfg. Inc., 11016 La Cienega Blvd., Inglewood 90304. Tel: 645-2281. Pres. & Sales Mgr. Martin Ansoorian, Gen. Mgr. George Abajian (LP mailers only)
 Bert Co. Ent's. Inc. (div. of the Walter Reade Drg. Inc.), 1855 Glendale Blvd. Zip 90026 Tel: 665-5137 (M)
Home office: New York, N.Y.
 Container Kraft Inc., 8321 De Celis Pl., Sepulveda 91343 Tel: 893-9721 (M)
 Gilmore Envelope Corp., 4540 Worth St. Zip 90063 Tel: 268-3401. (M)
 Ivy Hill Graphics & Packaging (div. of Ivy Hill Communications Inc.), 4800 S. Santa Fe Ave. Zip 90058 Tel: 587-3131. Exec. VP. Russell Muir; Gen. Mgr. Del Eaton, Sales Mgr. Arthur Kern (M)
Home office: Great Neck, N.Y.

• **SAN FRANCISCO (Area Code 415)**
 Pacific Int'l Magnetics Inc., 185 Berry St., No. 3865 Zip 94107 Tel: 495-8830
Home office: Canada

FLORIDA
 • **MIAMI (Area Code 305)**
 Duotone Co. Inc., PD Box 1168 Zip 33143 Tel: 665-1121 Pres. Stephen Nester Sr., Sales & Adv. Mgr. Stephen Gibson Nester (SEE ADVERTISEMENT)

ENVELOPES & MAILERS

The key to the abbreviations following the listing is: (M) Manufacturer, (D) Distributor, (I) Importer.

CALIFORNIA

• **LOS ANGELES METROPOLITAN AREA (Area Code 213)**
 Alshire Int'l Inc., 1015 Isabel St., Burbank 91510 Tel: 849-4671 WATS



Manufacturers
 of
 Quality
 Products
 to the
 Tape
 Industry

**REVIEW
 ENTERPRISES,
 (USA), INC.**

**AUDIO CASSETTES
 C-O CASSETTES**
 BLANK CASSETTES
 CASSETTE DUPLICATING TAPE
 PRIVATE BRANDING AVAILABLE

**VIDEO CASSETTES
 C-O CASSETTES**
 BLANK CASSETTES VHS & BETA
 PRIVATE BRANDING AVAILABLE

**IMMEDIATE DELIVERY AVAILABLE
 FROM OUR REGIONAL WAREHOUSES**



Contact **MIKE THALER**
**REVIEW
 ENTERPRISES, (USA), INC.**
 54 W. 39TH STREET • NEW YORK, NY 10018 • [212] 840-2780

ILLINOIS

• **CHICAGO METROPOLITAN AREA (Area Code 312)**
 Bruce Packaging Co., 8025 N. Kenneth Ave., Skokie 60076 Tel: 583-2818. Pres. Joseph Halperin (M)
 M. M. Cole Publ'g Co., Playboy Bldg., Suite 1602, 919 N. Michigan Ave. Zip 60611 Tel: 787-0804. Cable: MCMCOLE. Pres. Shepherd Stern; Sales Mgr. J.C. Cole, Adv. Mgr. Mike Stern (7" & 12" mailers) (MD)
 Forest Packaging Corp., 542 Factory Rd., Addison 60101. Tel: 543-7035. Pres. John R. Kissock, VP Sales R.H. Napp (Mailers only)
 Pro 1 Audio Visual Inc., PO Box 33, Highland Park 60035 Tel: 433-4575. Pres. R.L. Pink, VP J. Pink, Sales Mgr. M.M. Pink, Adv. Mgr. D.D. Pink (MD)
 Vinylweld, 2011 W. Hastings Zip 60608 Tel: 243-0606
 • **ROCKFORD (Area Code 815)**
 Carter Corp., 1916 11 St., Rockford, Ill. 61101 Tel: (815) 397-3200. Cable: CARTERCORP. Pres. Robert L. Fleming, VP Sales & Mktg. Sandra L. Fleming, Plant Mgr. W. Skip Kruger
Product: "Soft side" plastic mailers

INDIANA

• **INDIANAPOLIS (Area Code 317)**
 Bowers Rec. Sleeve Co., 5331 N. Tacoma Ave. Zip 46220 Tel: 251-3918. Pres. James E. Bowers, VP Thomas R. Bowers (MD)
 • **TERRE HAUTE (Area Code 812)**
 Ivy Hill Communications Inc., Fort Harrison Ind'l Park, Fruitridge Ave. Zip 47803. Tel: 466-9851
Home office: Great Neck, N.Y.

IOWA

• **CARLISLE (Area Code 515)**
 Harold Luck & Assocs., 110 Garfield St. Zip 50047 Tel: 989-3679. Contact Harold Luck

MASSACHUSETTS

• **CHICOPEE (Area Code 413)**
 Dielectrics Inc., 300 Burnett Rd. Zip 01020 Tel: 598-8308

MINNESOTA

• **MINNEAPOLIS (Area Code 612)**
 Discover Division Inc., 5198 W. 76 St. Zip 55435 Tel: 831-5338. Pres. Paul W. Smith, VP Les Boelter

NEVADA

• **CARSON CITY (Area Code 702)**
 Gopher Prods. Corp., Box 1812, 2201 Lockheed Way. Zip 89701 Tel: 882-9333. WATS (800) 648-0958. Pres. Warren Perkins (M) (SEE ADVERTISEMENT)

NEW JERSEY

• **BLOOMFIELD (Area Code 201)**
 Reliance Plastics & Packaging (div. of Reliance Folding Carton Corp.) 225 Belleville Ave. Zip 07003. Tel: 748-2222 (Audio Visual mailers)
 • **ELIZABETH (Area Code 201)**
 Lened Int'l Corp., 489 Henry St. Zip 07201 Tel: 354-5205 Telex: 138767. Owners: Leonard Palmer, Joseph Flusteder (M) (SEE ADVERTISEMENT)

NEW YORK

• **ALBANY (Area Code 518)**
 Pak Wk Corp., 128 Tivoli St. Zip 12207 Tel: 465-4556. Pres. Samuel A. Strasser, Sales Mgr. Myron S. Strasser Jr. (Mailers only)
 • **GREAT NECK (Area Code 516)**
 Ivy Hill Communications Inc., Community Dr. Zip 11022 Tel: 487-0200. Pres. Ellis Kern (M)
 Branches: Los Angeles, Calif., Terre Haute, Ind.
 • **HAUPPAUGE (Area Code 516)**
 Modern Album & Finishing Co. Inc., Cardinal Ind'l Park, Gilpin Ave. Zip 11787. Tel: 234-1100. NYC (212) 291-7600. Pres. G.D. Thomas, Sales Mgr. R.A. Froehlig
 Branches: Burbank (Los Angeles Metropolitan Area), Calif., Modern Album of California Inc., Terre Haute, Ind., Modern Album of Indiana Inc., Nashville, Tenn., Modern Album of Tennessee Inc.
 • **LINDENHURST (Area Code 516)**
 Coastal Specialty Tapes Inc., 274 Bangor St. Zip 11757 Tel: 226-5900. Dpns. Head & Sales Mgr.: Dan Dobbs (M)
 • **NEW YORK METROPOLITAN AREA (Area Code 212)**

A G I (Album Graphics Inc.), 125 W. 55 St. Zip: 10019 Tel: 489-0793 TWX (710) 581-5597. VP Mktg.: Richard Block (Sales office only) (M)
Home office: Melrose Park (Chicago Metropolitan Area), Ill.
 G. Benson & Co. Printers Inc., 75 Spring St. Zip 10012 Tel: 925-7100. Contact Gerald J. Benson (M)
 Bert Co. Ent's. Inc. (div. of Walter Reade Drg. Inc.), 241 E. 34 St. Zip 10016 Tel: 683-6300. Cable: WALREAD. Pres. Sheldon Gunsberg, Exec. VP, VP Finance & Treas. Christopher W. Preuster (M)
Branch: Los Angeles, Calif.
 Brown Paper Co., PO Box 591, Van Brunt Sta., Brooklyn 11215 Tel: 925-8833. (SEE ADVERTISEMENT)
 Canover Inds., 48 St. & Maspeth Ave., Maspeth 11378. Tel: 456-8900
 Disc Communications Ltd., 743 Fifth Ave. Zip 10023 Tel: 371-0390. Telex 666669
 E R H Sales Corp., 221 W. 57 St. Zip: 10019 Tel: 582-4200. Pres. Lee Halperin, Gen. Mgr. Michael Halperin, Sales Mgr. Robert Shavelson (M) (SEE ADVERTISEMENT)
 Gem Built Container Corp., 48-20 50 Ave., Woodside 11377 Tel: 784-8800 (M)
 Guaranteed Printing Serv. Co. Inc., 119 W. 23 St. Zip 10011 Tel: 929-2410 (M)
 Imperial Paper Box Corp., 252 Newport St., Brooklyn 11212 Tel: 346-6100. TWX (710) 584-2386. Pres. L. Sukoff, (Videodisk packaging)
 Branches: Los Angeles, Calif., Imperial Pacific Sales Corp., Indianapolis, Ind., Imperial Packaging Co. Inc.
 Charlie Passantino Inc., 311 W. 43 St. Zip: 10036. Tel: 586-1469

Silk Stocking Prod'ns Ltd., 216 W. 18 St., 10th fl. Zip: 10024. Tel: 255-4424.
Chm.: Lloyd Rubner Jr.; Pres.: Elliot J. Galdy

Edward R. White Inc., 18 E. 41 St. Zip: 10017. Tel: 687-2167. Pres. & Sales
Mgr.: Lawrence Goldstein (7" & 12" record mailers) (MO)

• **RONKONKOMA (Area Code 516)**

Andrews Nunnery Envelope & Paper Co. (sub. of ElectroSound Group Inc.),
2175 Fifth Ave. Zip: 11779. Tel: 467-2000. TWX: (510) 228-1095. Pres.
Stuart M. Andrews Jr.; Sales Mgr.: John F. Muller Jr.; Asst. Plant Mgr.:
Robert J. Andrews (M)

Home office: Holbrook, N.Y.; ElectroSound Group Inc.
Sales offices: Sun Valley (Los Angeles Metro Area), Calif.; Monarch Rec.
Mfg. Inc., New York, N.Y.; ElectroSound Group Inc.

OHIO

• **TOLEDO (Area Code 419)**

Pioneer Inds., PO Box 4653, Old West End Sta. Zip: 43620. Mgr.: Lowell P.
Amos

Chief products: Envelopes, mailers, backer boards, mailer cartons.

TENNESSEE

• **NASHVILLE (Area Code 615)**

Super Prod'ns, PO Box 1569, 31 Industrial Park, Hendersonville 37075. Tel:
822-5080. Pres.: Gordon Cash

TEXAS

• **DALLAS (Area Code 214)**

Electronic Technological Inds. of America Inc., PO Box 1580. Zip: 75221.
Tel: 827-8002. Bd. Chm.: John Kanter; Gen. Mgr.: David Coleman; Sales
Mgr.: Larry Pearson.

WYOMING

• **CHEYENNE (Area Code 307)**

Rocky Mountain Rec'g, 8305 Christensen Rd. Zip: 82001. Tel: 638-8733.
Pres.: Ray Alexander; Sales & Adv. Mgr.: Georgia Alexander (MD)

**JACKETS & SLEEVES
(LP & VIDEODISK)**

The key to the abbreviations following the company listings is: (M) Manu-
facturer, (D) Distributor, (I) Importer.

CALIFORNIA

• **LOS ANGELES METROPOLITAN AREA
(Area Code 213)**

A G I (Album Graphics Inc.), 424 N. Larchmont Blvd. Zip: 90004. Tel: 462
0821. (Sales office only) (M)

Home office: Melrose Park (Chicago Metropolitan Area), Ill.

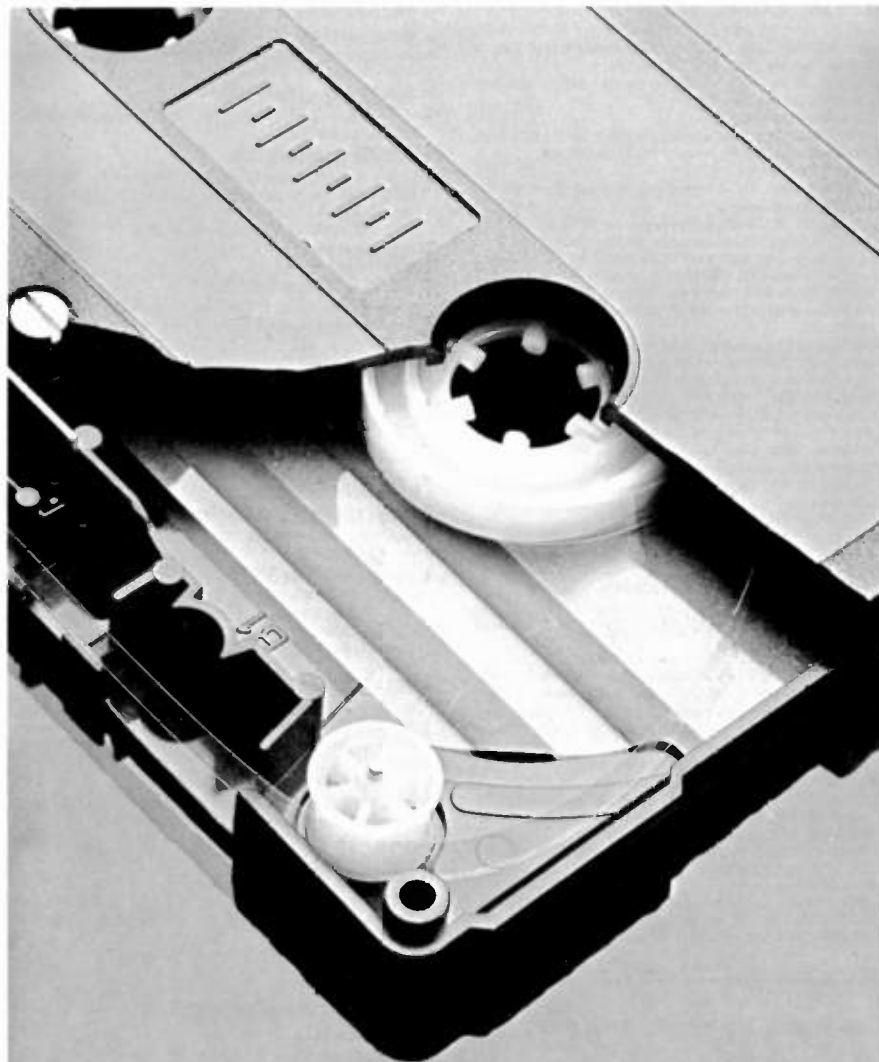

sssssilent
mech-a-nism
(mek-ə-niz-əm)

**L.P. RECORD
& CASSETTE
MAILERS**
WE SHIP ANY QUANTITY
—ANYWHERE!

PACKAGING FOR THE RECORD
INDUSTRY
BROWN PAPER CO., INC.
BOX 591
VAN BRUNT STATION
BROOKLYN, N.Y. 11215
(212) 925-8833



Nuova Siat s.r.l.
Via Dell'Orto, 21
21047 Saronno (VA) - Italia
Tel. 02-9607450 - 9607485
Telex 335884 N SIAT I

Album Graphics Inc. see AGI
 Aishire Int'l Inc., 1015 Isabel St., Burbank 91510 Tel 849-4671 WATS (800) 423-2936. Cable: BUDSOUND TWX (9 0) 498-2759 Pres At Sherman. Gen Mgr Dick Ceja (LP only) (M)
 Bert-Co Ent's Inc. (div. of the Walter Reade Org. Inc.), 1855 Glendale Blvd Zip 90026 Tel 665-5137 (LP only) (M)
Home office: New York, N.Y.
 Cadet Recs Inc., 5810 S. Normandie Ave Zip 90044 Tel 753-5121 Pres Jules Bihari; Mgr Don Macmillan (LP only) (Jackets only)
Branch: Park Ridge, N.J.
 Computer Color Corp., 3711 Cahuenga Blvd W., Studio City 91604. Tel 877-2326. (Jackets only)
 Custom Rec. Mfg. Co., 5810 S. Normandie Ave Zip 90044 Tel 753 5121 Pres. Jules Bihari, VP Don Macmillan (LP only) (Jackets only)
 Gilmore Envelope Corp., 4540 Worth St. Zip 90063 Tel 268 3401 (M) Imperial Pacific Sales Corp., 4528 Brazil St Zip 90639 Tel 245-8583 Gen Mgr. Lincoln Slegman (Jackets only—LP only) (M)
Home office: Brooklyn (New York Metropolitan Area), N.Y., Imperial Paper Box Corp.
 Ivy Hill Graphics & Packaging (div. of Ivy Hill Communications Inc., 4800 S Santa Fe Ave. Zip 90058. Tel 587 3131 Exec VP Russell Muir, Gen Mgr. Del Eaton, Sales Mgr. Arthur Kern (LP only) (M)
Home office: Great Neck, N.Y.
 K M Recs Inc., 2980 N. Ontario St., Burbank 91504 Tel 841-3400 Pres Glade Merkle, VP Custom Servs. Jim Aughterlorie, VP Audiophile Sales Mike Malan, Mktg & Adv Mgr Bruce Leek. (Jackets only)
 Kdisc (sub. of Keyser Century Corp.), 6550 Sunset Blvd., Hollywood 90028 Tel 466-1323 Pres Eugene R. Schutz; Gen. Mgr. Bill Lightner (Jackets only—LP only)
Plant: Saugus, Calif. (SEE ADVERTISEMENT)
 Modern Album of California Inc., 3116 Vanowen St., Burbank 91505 Tel 845-7655 Pres. William S. Pine, Gen Mgr. Raymond Gardocki (Jackets only)
Home office: Hauppauge, N.Y., Modern Album & Finishing Co Inc
 Monarch Rec. Mfg. Inc. (sub. of Electrosound Group Inc.), 9545 San Fernando Rd., Sun Valley 91352 Tel 767-8833 (Sales office only) (Sleeves only) (M)
Home office: Holbrook, N.Y., Electrosound Group Inc
Plant: Hicksville, N.Y., Andrews-Nunnery Envelope & Paper Corp
 Pedersen Label Printing Co., 11152 Fleetwood St., Sun Valley 91352 Tel 768-3122 Pres. Herman A. Fredriks, Prod Mgr S Kadonaga. (M)
 Queens Lithographing Corp., 6290 Sunset Blvd., Suite 304, Hollywood 90028 Tel 464-7700. (M)
Home office: Long Island City (New York Metropolitan Area), N.Y.
Plant: Indianapolis, Ind., Rutgers Packaging Corp
 Raynor Sales Co Inc., 2698 W. Pico Blvd Zip 90005 Tel (213) 737 3737 Pres. & Adv Mgr. Ray Abrams Sr.; Sales Mgr. Ray Abrams Jr (Gift sleeves only)
 Shorewood Packaging Corp., 1830 Glendale Blvd Zip 90026 Tel 660-3043 VP Sales Jim Palmer (M)
Home office: New York, N.Y.
 Stoughton Printing Co., 130 N. Sunset Ave., City of Industry 91744 Tel 961-3678, 686-2753 Pres & Gen Mgr. Jack W. Stoughton, Sales Mgr. Jack Stoughton Jr. (Jackets only—LP only) (M)

• **SAN FRANCISCO & BAY AREA (Area Code 415)**
 Conlan/Golden Inc., 501 Forbes Blvd, Suite 106, South San Francisco 94080 Tel 761 7617 (Jackets only) (M)
 • **SAN JOSE (Area Code 408)**
 M J S, 2514 Seaboard Ave Zip 95131 Tel 262 8793 Dwner Michael Steiner (Jackets only) (M)
 • **SAUGUS (Area Code 805)**
 Kdisc (sub. of Keyser Century Corp.), 26000 Springbrook Ave Zip 91350 Tel 259 2360 Pres: Eugene R. Schutz, Gen Mgr. Bill Lightner. (Jackets only—LP only) (M)
Office: Hollywood (Los Angeles Metropolitan Area), Calif
CONNECTICUT
 • **UNION CITY (Area Code 203)**
 A.C. Hampson Printing Co., 168 City Hill St Zip 06770 Tel 729-2294 Pres. Augustus D. Hampson, Sales Mgr. John W. Berty (Jackets only—LP only)
DELAWARE
 • **WILMINGTON AREA (Area Code 302)**
 Ken Del Prod'n Inc., 111 Valley Rd., Richardson Park 19804 Tel 655 7488. (Jackets only—LP only) (M)
National Tape Dupl'rs, see Ken Del
FLORIDA
 • **FORT LAUDERDALE AREA (Area Code 305)**
 Alpha Recs Inc., 1400 NW 65 Ave., Plantation 33313 Tel 587 6011. (Jackets only—LP only)
 • **MIAMI (Area Code 305)**
 Duotone Co. Inc., PD Box 1168, Zip 33143 Tel 665-1121. Pres. Stephen Nester Sr., Sales & Adv Mgr. Stephen Gibson Nester (Sleeves only—LP only) (SEE ADVERTISEMENT)
 Tropical Paper Box Co., 7000 NW 25 St Zip 33122. Tel 592 5520. (Jackets only)
 • **ORLANDO AREA (Area Code 305)**
 Horian Eng'g Inc., 600 Lake Emma Rd., Lake Mary 32746 Tel 323 2400 TWX (810) 856 0300 Pres. Richard C. Horian, Gen Mgr. James Horian, Sales Mgr. Robert L. Horian, Adv Mgr. Sue Coleman (Sleeves only—LP only)
 • **POMPANO BEACH (Area Code 305)**
 Trackmaster Inc., 1310 S. Dixie Hwy W Zip 33060. Tel 943 2334. Pres. Roy Parsons, Sec'y Treas. Lupe Parsons. (Sleeves only)
GEORGIA
 • **LA GRANGE (Area Code 404)**
 S P C Co. (div. of Shorewood Packaging Corp.), 1707 Shorewood Dr Zip 30240 Tel 884 3036 WATS (800) 241 0186. Plant Mgr. Ken McCabe (Videodisk only)
Home office: New York, N.Y., Shorewood Packaging Corp.
ILLINOIS
 • **CHICAGO METROPOLITAN AREA (Area Code 312)**
 A G I (Album Graphics Inc.), 1950 N. Ruby St., Melrose Park 60160. Tel 344-9100. TWX (910) 226 0417 Pres. Donald W. Kosterka, Sales Mgr. Kevin McKenna (LP only) (M)
Sales offices: Los Angeles, Calif.; New York, N.Y.
 M M Cole Publ'g Co., Playboy Bldg., Suite 1602, 919 N. Michigan Ave Zip 60611 Tel 787 0804. Pres. Sheper Stern, Sales Mgr. J.C. Cole. Adv Mgr. Mike Stern (Standard 7" & 12" sleeves, 7" "color coded" sleeves)
 Fine Design Prods. Inc., 1830 S. Clinton Zip 60616 Tel 939-5420 Pres Harvey Fine, Gen. Mgr.: Dorothy Olson, Sales Mgr. Richard Doherty Musical Prods Inc., 521 W 26 St Zip 60616. Tel 225 9117 (Jackets only) (M)
 Pro I Audio Visual Inc., PD Box 33, Highland Park 60035. Tel 433-4575 Pres R.L. Pink, VP J. Pink, Sales Mgr. M.M. Pink, Adv Mgr. D.D. Pink (LP only)
INDIANA
 • **INDIANAPOLIS (Area Code 317)**
 Bowers Rec. Sleeve Co., 5331 N. Tacoma Ave Zip 46220 Tel 251 3918 Pres. James E. Bowers, VP Thomas R. Bowers (Sleeves only) (MD)
 Imperial Packaging Co Inc., 7800 Records St Zip 46226 Tel 545-7476 (Jackets only)
Home office: Brooklyn (New York Metropolitan Area), N.Y., Imperial Paper Box Corp
 Reco Sleeve Packaging, 620 S Belmont Zip 46221. Tel 635 7777 Pres. Leonard Verebay, Sales & Adv. Mgr. Len Diamond
 Rutgers Packaging Corp. (div. of Queens Lithographing Corp.), 620 S Belmont Ave Zip 46221 Tel 635-7777 TWX (810) 341-3457, 341 3400 Pres. Abe Garde, Sales & Adv. Mgr. Len Diamond (Videodisk only) (M)
Home office: Long Island City (New York Metropolitan Area), N.Y., Queens Lithographing Corp
 • **TERRE HAUTE (Area Code 812)**
 Ivy Hill Communications Inc., Fort Harrison Ind'l Park, Fruitridge Ave. Zip 47803 Tel 466-9851 (M)
Home office: Great Neck, N.Y.
 Modern Album of Indiana Inc., 1299 Voorhees St Zip 47808. Tel 235-6001. TWX (810) 356 2116. (Jackets only)
Home office: Hauppauge, N.Y., Modern Album & Finishing Co. Inc
 Woodburn Printing Co., 25 S. Sixth St Zip 47808. Tel 466 6822. Pres. Donald P. Pendergast, Sales Mgr. Ed Schulz, Adv Mgr. John Crippen (Jackets only) (M)
IOWA
 • **CARLISLE (Area Code 515)**
 Harold Luck & Assocs., 110 Garfield St. Zip 50047 Tel 989-3679 Contact Harold Luck
LOUISIANA
 • **VILLE PLATTE (Area Code 318)**
 Ville Platte Rec Mfg Co., 120 E Cypress St. Zip 60586 Tel 363 2104. Pres.: J. Floyd Soileau, Sales Mgr.: Ronnie Soileau. (LP only) (M)

MASSACHUSETTS
 • **CHICOPPEE (Area Code 413)**
 Dielectrics Inc., 300 Barnett Rd. Zip 01020 Tel 598-8308.
MICHIGAN
 • **DETROIT (Area Code 313)**
 Archer Rec. Pressing Co., 7401 E Davison Zip 48212. Tel 365-9545. Pres. R. J. Archer, VP Jim Archer, Sec'y-Treas. M. Archer (Jackets only—LP only) (M)
NEVADA
 • **CARSON CITY (Area Code 702)**
 Gopher Prods Corp., Box 1812, 2201 Lockheed Way Zip 89701 Tel 882 9333. WATS (800) 648 0958. Pres. Warren Perkins. (Sleeves only—LP only) (M) (SEE ADVERTISEMENT)
NEW JERSEY
 • **ELIZABETH (Area Code 201)**
 Lened Int'l Corp., 489 Henry St Zip 07201 Tel 354-5205 Telex 138767. Owners Leonard Palmer, Joseph Flusfeder (M) (SEE ADVERTISEMENT)
 • **LYNDHURST (Area Code 201)**
 Colorseps Lithopres Serv., PD Box 151 Zip 07071. Tel 438-6729. Pres.: J.G. Principato. (LP only) (M)
 • **MOUNTAINSIDE (Area Code 201)**
 Bestway Prods. Inc., 1105 Globe Ave. Zip 07092 Tel 232-8383 Pres. Howard Massier; Gen. Mgr. Benjamin Williams, Prod'n Mgr. Paul Stevens (SEE ADVERTISEMENT)
 • **PARK RIDGE (Area Code 201)**
 Cadet Recs Inc., 12 Maple Leaf Dr Zip 07656 Tel 391-3676 VP Sales & Mktg. Robert K. Herrington (Sales office only) (Jackets only—LP only)
Home office & plant: Los Angeles, Calif
NEW YORK
 • **BOHEMIA (Area Code 516)**
 R H M Inds. Ltd., 180 Drville Dr. Zip 11716 Tel 567-7222. NYC (212) 895-9344. (Jackets only—LP & Videodisk)
 • **COMMACK (Area Code 516)**
 Robins Inds Corp., 75 Austin Blvd. Zip 11725 Tel 543-5200. Pres.: Herman Post, VP Sales Stu Caine (M)
 • **FARMINGDALE (Area Code 516)**
 Shorewood Packaging Corp., 55 Engineers Ln Zip 11735 Tel 694-8230. (Videodisk only)
Home office: New York, N.Y.
 • **GREAT NECK (Area Code 516)**
 Ivy Hill Communications Inc., Community Dr. Zip 11022 Tel 487 0200. Pres. Ellis Kern (LP only) (M)
Branches: Los Angeles, Calif., Terre Haute, Ind.
 • **HAUPPAUGE (Area Code 516)**
 Disc Graphics (div. of Packwick Int'l Inc.), 10 Gilpin Ave. Zip 11787 Tel 234 1400. (Jackets only—LP only) (M)
 Modern Album & Finishing Co. Inc., Cardinal Ind'l Park, Gilpin Ave. Zip 11787 Tel 234 1100; NYC (212) 291-7600. Pres. G.D. Thomas, Sales Mgr. R.A. Froehlig (LP & Videodisk)
Branches: Burbank (Los Angeles Metropolitan Area), Calif., Modern Album of California Inc., Terre Haute, Ind., Modern Album of Indiana Inc., Nashville, Tenn., Modern Album of Tennessee
 • **HOLBROOK (Area Code 516)**
 Electrosound Group Inc., 725 Broadway Ave. Zip 11741. Tel 567-3700. Corp Sales Mgr. (east) Ron Roberto. **Local plant:** Goldisc Rec'gs Inc., Veterans Hwy & Broadway Zip 11741 Tel 589-0462; NYC (212) 895-6575 Pres.: Richard Meixner, Sales Mgr. John Finnegan; Adv. Mgr. Rich Renda. (Sleeves only—LP only)
Plant: Hicksville, N.Y., Andrews-Nunnery Envelope & Paper Corp.
 • **MOUNT VERNON (Area Code 914)**
 Sentry Inds. Inc., 221 N. MacQueston Pkwy. Zip 10550. Tel 664-2909 Cable SENTIND. Pres.: Harold Rosen, VP. Barry Rosen (Sleeves only)
 • **NEW YORK METROPOLITAN AREA (Area Code 212)**
 A G I (Album Graphics Inc.), 125 W 55 St. Zip 10019 Tel 489-0793 TWX (710) 581-5597. VP Mktg. Richard Block. (Sales office only) (M)
Home office: Melrose Park (Chicago Metropolitan Area), Ill.
 Album Graphics Inc. see AGI
 G Benson & Co. Printers Inc., 75 Spring St. Zip 10012. Tel 925-7100. Contact Gerald J. Benson (LP only) (M)
 Bert Co Ent's Inc. (div. of the Walter Reade Org. Inc.), 241 E. 34 St. Zip 10016 Tel 683-6300. Cable WALREAD. Telex: 12227 Pres. Sheldon Gunsberg, Exec. VP. Finance & Treas. Christopher W. Preuster. (M)
Branch: Los Angeles, Calif
 Brown Paper Co., PO Box 591, Van Brunt Sta., Brooklyn 11215. Tel: 925-8833 (SEE ADVERTISEMENT)
 D R G Recs Inc., 200 W. 57 St. Zip 10019. Tel 265-4050 Cable STETRECS. TWX (710) 581-4825. Pres.: Hugh Fordin, Mng Dir. Rich Winter, Nat'l Sales & Mktg. Dir. Ted Wolff. (LP only)
 Disc Communications Ltd., 743 Fifth Ave. Zip 10023. Tel 371-0390. (M)
 E R H Sales Corp., 221 W. 57 St. Zip 10019. Tel 582-4200. Pres.: Lee Halpern, Gen. Mgr. Michael Halpern, Sales Mgr. Robert Shavelson. (LP only) (M) (SEE ADVERTISEMENT)
 Electrosound Group Inc., 1290 Ave. of the Americas Zip 10019. Tel 581-5641. (Sales office only) (Sleeves only) (M)
Home office: Holbrook, N.Y.
Plant: Hicksville, N.Y., Andrews-Nunnery Envelope & Paper Corp.
 Guaranteed Printing Serv. Co. Inc., 119 W. 23 St. Zip 10011. Tel 929-2410. (M)
 Imperial Paper Box Corp., 252 Newport St., Brooklyn 11212. Tel 346-6100. TWX (710) 584 2386. Pres. L. Sukoff (Jackets only)
Branches: Los Angeles, Calif., Imperial Pacific Sales Corp., Indianapolis, Ind., Imperial Packaging Co. Inc.
 Le Bo Prods. Co. Inc. (div. of Peerless Vid Tronic Corp.), 58-60 Grand Ave. Maspeth 11378 Tel 894-5155 Cable LEBDPRDUX. Telex 424790. Pres. P. Dayton. (Sleeves only) (M) (SEE ADVERTISEMENT)
 Lee Myles Assocs. Inc., 160 E. 56 St. Zip 10022. Tel 758-3232. Cable LEE MYLES. Pres. Robert M. Miller; VP. Howard Roseff. (LP & Videodisk) (M) (SEE ADVERTISEMENT)

NO MORE INVENTORY PROBLEMS

Now you can have runs of 1,000 record jackets

- 6 day delivery from film to pressing plant.
- European style coating

Contact: Peter Kerr or Bren Ellis

(514) 861-2411 Telex 05-267411

Ross Ellis Ltd.
 300 Ann St.
 Montreal, Que.
 H3C 2K2
 Canada



Mac Murray Press Inc., 230 W. 17 St. Zip 10011. Tel: 924-1530 Pres: Bernard Lerman; Sales Mgr.: Arnold Kohn (LP only) (M) (SEE ADVERTISEMENT)

Charlie Passantino Inc., 311 W. 43 St. Zip: 10036 Tel: 586-1469
Pilgrim Press Corp., 36-01 43 Ave., Long Island City 11101 Tel: 937-9515 (Jackets only) (M)

Progressive Label & Litho Co., 286 Stanhope St., Brooklyn 11237 Tel: 497-2320. Pres: Jerome J. Rood; Gen. Mgr.: Bernie Stein. (Jackets only) (M) (SEE ADVERTISEMENT)

Queens Lithographing Corp., 52-35 Barnett Ave., Long Island City 11104 Tel: 457-7700. Chief Exec. Officer: Eric Kaltman; Pres.: Leonard Verebay, Sr. VP Sales: Richard Roth. (Jackets—LP & Videodisk, Sleeves—LP only) (M)

Branch: Hollywood (Los Angeles Metropolitan Area), Calif
Plant: Indianapolis, Ind., Rutgers Packaging Corp (SEE ADVERTISEMENT)

Shepard Printing Corp., 111 Eighth Ave. Zip: 10011 Tel: (212) 255-1930 Pres: Philip M. Rosenbloom (Jackets only) (M)

Shorewood Packaging Corp., 10 E. 53 St. Zip: 10022 Tel: 371-1500. Pres: Paul Shore; Exec. VP: Floyd S. Gilmer; VP Special Projects: Marc Shore, VP Nat'l Sales: Ken Rosenblum. (Videodisk only) (M)

Branches: Los Angeles, Calif., LaGrange, Ga., Farmingdale, N.Y. (SEE ADVERTISEMENT)

Silk Stocking Prod'n's Ltd., 216 W. 18 St., 10th fl. Zip: 10024 Tel: 255-4424 Chm.: Lloyd Ribner Jr.; Pres: Elliot J. Galdy.

● PLAINVIEW (Area Code 516)

Delrama Int'l, 37 Newtown Rd. Zip: 11803. Tel: 293-8740 Telex: 127262. (Sleeves only)

● RONKONKOMA (Area Code 516)

Andrews Nursery Envelope & Paper Co. (sub. of ElectroSound Group Inc.), 2175 Fifth Ave. Zip: 11779 Tel: 467-2000 TWX: (510) 228-1095. Pres: Stuart M. Andrews Jr.; Sales Mgr.: John F. Muller Jr.; Ass't Plant Mgr.: Robert J. Andrews. (Sleeves only—LP only) (M)
Home office: Holbrook, N.Y.; ElectroSound Group, Inc. Sales offices: Sun Valley (Los Angeles Metropolitan Area), Calif.; Monarch Rec. Mfg. Inc., New York, N.Y.; ElectroSound Group Inc.

● UTICA (Area Code 315)

Oneida Video Audio Tape Cassette Corp., 760 Blandina St. Zip: 13501. Tel: 735-6187. Pres.: Stanley Markowski.

NORTH CAROLINA

● CANTON (Area Code 704)

Recording Servs. of Western North Carolina Inc., 10 Penland St. Zip: 28716. Tel: 648-6012. Owner: J. Ted Evans Jr.; VP: Kay Evans. (LP only)

OHIO

● CINCINNATI (Area Code 513)

Artists Rec'g Co. Inc., 320 Mill St. Zip: 45215. Tel: 761-0011. (Jackets only) (M)

Jewel Rec'g Co., 1594 Kinney Ave. Zip: 45231. Tel: 522-9336. Pres: Rusty York; Gen. Mgr.: Linda York; Sales Mgr.: Rollin Bennett Jr. (Jacket fabrication)

Q C A Custom Pressing, 2832 Spring Grove Ave. Zip: 45225 Tel: 681-8400 Pres: Edward R. Bosken, VP & Sales Mgr. Keith Myers; Plant Mgr. Ken Martin (M) (SEE ADVERTISEMENT)

Studio Pressing Serv., 320 Mill St. Zip: 45215. Tel: 761-8294. Pres: B. Hyne. Sales Mgr.: M. Tye. (Jackets only—LP only) (M)

PENNSYLVANIA

● MECHANICSBURG (Area Code 717)

H R C Printing, Box 1152, 5252 E. Trindle Rd. Zip: 17055 Tel: 766-0943 Gen. Mgr.: Donald E. Baldwin (LP only) (M) (SEE ADVERTISEMENT)

● PHILADELPHIA (Area Code 215)

Community Press, 6047-49 Woodland Ave. Zip: 19142. Tel: 729-4655. Hodge Rec. Mfg. Co., 1314-24 S Howard St. Zip: 19147 Tel: 334-5662 (Sleeves only) (MD)

● PITTSBURGH AREA (Area Code 412)

Record Rama, Rt. 8, Hampton Plaza, 4706 William Flynn Hwy, Allison Park 15101. Tel: 486-2100. (Jackets—D, 45 rpm record history sleeves—M)

● SCRANTON (Area Code 717)

Keystone Printed Specialties Co. Inc., 321 Pear St. Zip: 18505 Tel: 346-1761. Pres: M.C. Fischer. Sales Mgr.: Martin C. Fischer. (LP & Videodisk) (M) (SEE ADVERTISEMENT)

● SHARON (Area Code 412)

Marjon Recs. Inc., 159 Easton Rd., Hermitage 16146. Tel: 347-4726. Pres: John T. Krzancic; Sales Mgr.: Martha Krzancic; Adv. Mgr.: Ruth Toth (Jackets only) (M)

PUERTO RICO

● SAN JUAN (Area Code 809)

Rio Piedras Recs. & Discos Borinquen, GPO Box 4785. Zip: 00936 Tel: 790-2188/2186/2142. Pres: Oario Gonzalez. Gen & Sales Mgr.: Benito Valdes.

TENNESSEE

● NASHVILLE (Area Code 615)

Color Graphics Inc., 305 Church St., Goodlettsville 37072. Tel: 859-4001. (M)

Nashville Album Prod'n's Inc., 1114 Gallatin Rd. N., Madison 37115. Tel: 883-2153. Pres: Steve Bolts; Art Dir.: Gregg Spickard (SEE ADVERTISEMENT)

Sea Cruise Prod'n's, PO Box 110830. Zip: 37211. Tel: 834-1856. Pres & Adv. Mgr.: Ken Keene; VP: F.V. Guzzo; VP & Sales Mgr.: Gene Miller

Super Prod'n's, PO Box 1569, 31 Industrial Park, Hendersonville 37075. Tel: 822-5080. Pres: Gordon Cash (LP only)

Williams Printing Co., 417 Commerce St. Zip: 37219. Tel: 256-7125. VP Sales: Dudley Fortner (M)

TEXAS

● DALLAS (Area Code 214)

Electronic Technological Inds. of America Inc., PO Box 1580. Zip: 75221. Tel: 827-8002. Bd. Chm.: John Kanter; Gen. Mgr.: David Coleman. Sales Mgr.: Larry Pearson.

● FORT WORTH METROPOLITAN AREA (Area Code 817)

Wills Printing Co., PO Box 211, Arlington 76010. Tel: 572-1414. Pres: Calvin Wills. (Jackets only—LP only) (M)

● HOUSTON (Area Code 713)

Riverside Albums, 7400 Pinedmont. Zip: 77040. Tel: 462-2700. VP: Earl Thomas, Sales Mgr.: Brenda Cox. (Stock & custom jackets only)

● SAN ANTONIO (Area Code 512)

Texas Rec. Mfg. Inc., 1422 W. Poplar. Zip: 78207. Tel: 733-6138. Pres: C. Foy Lee, Gen. Mgr.: Jimmy Burton, Sales Mgr.: Jeannie Hill (Jackets only) (M)

UTAH

● SALT LAKE CITY (Area Code 801)

Chase Media Inc., Busch Park, 5284 S. 320 W., Suite C-166. Zip: 84107. Tel: 261-1383. Pres & Gen. Mgr.: Randal S. Chase. Sales Mgr.: Irel Chase (MD)

WYOMING

● CHEYENNE (Area Code 307)

Rocky Mountain Rec'g, 8305 Christensen Rd. Zip: 82001. Tel: 638-8733. Pres: Ray Alexander, Sales & Adv. Mgr.: Georgia Alexander. (Jackets only)

LABELS, DISK

The key to the abbreviations following the company listings is: (M) Manufacturer, (D) Distributor, (I) Importer. For tape labels please refer to Professional Tape Supplies.

CALIFORNIA

● LOS ANGELES METROPOLITAN AREA (Area Code 213)

Alshire Int'l Inc., 1015 Isabel St., Burbank 91510. Tel: 849-4671. WATS (800) 423-2936. Cable: BUDSOUND TWX (910) 498-2759. Pres: Al Sherman; Gen. Mgr.: Dick Ceja (M)

Award Rec. Mfg. Inc., 11016 La Cienega Blvd., Inglewood 90304. Tel: 645-2281. Pres & Sales Mgr.: Martin Ansoorian; Gen. Mgr.: George Abajian (45 & LP)

Bert Co. Ints. Inc. (div. of Walter Reade Drg. Inc.), 1855 Glendale Blvd. Zip: 90026. Tel: 665-5137. (M)
Home office: New York, N.Y.

Custom Rec. Mfg. Co., 5810 S. Normandie Ave. Zip: 90044. Tel: 753-5121. Pres: Jules Bihari; VP: Don Macmillan (45 & LP)

Ivy Hill Graphics & Packaging (div. of Ivy Hill Communications Inc.), 4800 S. Santa Fe Ave. Zip: 90058. Tel: 587-3131. Exec. VP: Russell Muir; Gen. Mgr.: Del Eaton; Sales Mgr.: Arthur Kern (M)

Home office: Great Neck, N.Y.
K. M. Recs. Inc., 2980 N. Ontario St., Burbank 91504. Tel: 841-3400. Pres: Glade Merkle; VP: Custom Servs.: Jim Auchterlone; VP: Audiophile Sales: Mike Malan; Mktg. & Adv. Mgr.: Bruce Leek

Kdisc (sub. of Keycor Century Corp.), 6550 Sunset Blvd., Hollywood 90028. Tel: 466-1323. Pres: Eugene R. Schutz; Gen. Mgr.: Bill Lightner (M)
Plant: Saugus, Calif. (SEE ADVERTISEMENT)

Queens Lithographing Corp., 6290 Sunset Blvd., Suite 304, Hollywood 90028. Tel: 464-7700. (M)

Stoughton Printing Co., 130 N. Sunset Ave., City of Industry 91744. Tel: 961-3678, 686-2753. Pres & Gen. Mgr.: Jack W. Stoughton; Sales Mgr.: Jack Stoughton Jr. (45 & LP) (M)

● SAN FRANCISCO & BAY AREA (Area Code 415)

Conlan/Golden Inc., 501 Forbes Blvd., Suite 106, South San Francisco 94080. Tel: 761-7617. (M)

● SAUGUS (Area Code 805)

Kdisc (sub. of Keycor Century Corp.), 26000 Springbrook Ave. Zip: 91350. Tel: 259-2360. Pres: Eugene R. Schutz; Gen. Mgr.: Bill Lightner (45 & LP) (M)
Office: Hollywood (Los Angeles Metropolitan Area), Calif.

DELAWARE

● WILMINGTON AREA (Area Code 302)

Ken Del Prod'n's Inc., 111 Valley Rd., Richardson Park 19804. Tel: 655-7488 (45 & LP) (M)
National Tape Dupl'rs. see Ken Del

FLORIDA

● FORT LAUDERDALE AREA (Area Code 305)

Alpha Recs. Inc., 1400 NW 65 Ave. Plantation 33313. Tel: 587-6011 (LP & 45)

ILLINOIS

● CHICAGO METROPOLITAN AREA (Area Code 312)

A G I (Album Graphics Inc.), 1950 N. Ruby St., Melrose Park 60160. Tel: 344-9100. Pres: Donald W. Kosterka; Sales Mgr.: Kevin McKenna (M)
Sales offices: Los Angeles, Calif., New York, N.Y.

Fort Dearborn Lithograph Co., 6035 W. Gross Point Rd., Niles 60648. Tel: 647-8730

Media Int'l Inc., 425 N. Michigan. Zip: 60611. Tel: 467-5430. Pres: Duane Lundeen; VP: Margaret Lundeen; Gen. Mgr.: Al Masters. (45 & LP)

Musical Prods. Inc., 521 W. 26 St. Zip: 60616. Tel: 225-9117. (M)

● ROCKFORD (Area Code 815)

Carter Corp., 1916 11 St. Zip: 61101. Tel: 397-3200. Cable: CARTERCORP. Pres: Robert L. Fleming; VP Sales & Mktg.: Sandra L. Fleming; Plant Mgr.: W. Skip Kruger.

INDIANA

● TERRE HAUTE (Area Code 812)

Ivy Hill Communications Inc., Fort Harrison Ind'l Park, Fruitridge Ave. Zip: 47803. Tel: 466-9851. (M)
Home office: Great Neck, N.Y.

Woodburn Printing Co., 25 S. Sixth St. Zip: 47808. Tel: 466-6822. Pres: Donald P. Pendergast; Sales Mgr.: Ed Schulz; Adv. Mgr.: John Crippen (M)

IOWA

● CARLISLE (Area Code 515)

Harold Luck & Assocs., 110 Garfield St. Zip: 50047. Tel: 989-3679. Contact: Harold L. Luck. (45 & LP)

LOUISIANA

● VILLE PLATTE (Area Code 318)

Ville Platte Rec. Mfg. Co., 120 E. Cypress St. Zip: 70586. Tel: 363-2104. Pres: J. Floyd Soileau; Sales Mgr.: Ronnie Soileau (45 & LP) (M)

MASSACHUSETTS

● CHICOPEE (Area Code 413)

Dielectrics Inc., 300 Burnett Rd. Zip: 01020. Tel: 598-8308.

MICHIGAN

● DETROIT (Area Code 313)

Archer Rec. Pressing Co., 7401 E. Davison. Zip: 48212. Tel: 365-9545. Pres: R.J. Archer; VP: J.M. Archer; Sec'y Treas.: M. Archer (45 & LP) (M)

NEW JERSEY

● CARLSTADT (Area Code 201)

Q A I Inc., 640 Dell Rd. Zip: 07072. Tel: 460-0060. NYC (212) 964-1714. Pres: Steven Dauman; Sales Mgr.: George Ratowsky. (LP only) (M)

● LYNDHURST (Area Code 201)

Colorseps Lithopress Serv., PO Box 151. Zip: 07071. Tel: 438-6729. Pres: J.G. Principato (M)

NEW YORK

● BOHEMIA (Area Code 516)

R H M Inds. Ltd., 180 Orville Dr. Zip: 11716. Tel: 567-7222. NYC (212) 895-9344. (45 & LP)

● GREAT NECK (Area Code 516)

Ivy Hill Communications Inc., Community Dr. Zip: 11022. Tel: 487-0200. Pres.: Ellis Kern. (M)
Branches: Los Angeles, Calif.; Terre Haute, Ind.

● HAUPPAUGE (Area Code 516)

Disc Graphics (div. of Pckwick Int'l Inc.), 10 Gilpin Ave. Zip: 11787. Tel: 234-1400. (45 & LP) (M)

Modern Album & Finishing Co. Inc., Cardinal Ind'l Park, Gilpin Ave. Zip: 11787. Tel: 234-1100. NYC (212) 291-7600. Pres.: G. D. Thomas; Sales Mgr.: R.A. Froehlig (45 & LP)

Branches: Burbank (Los Angeles Metropolitan Area), Calif.; Modern Album of California Inc., Terre Haute, Ind.; Modern Album of Indiana Inc.; Nashville, Tenn.; Modern Album of Tennessee.

BERNIE STEIN JERRY ROO
TEL. (212) 497-2320

8-TRACK LABELS
RECORD JACKETS
RECORD LABELS
CASSETTE LABELS

PROGRESSIVE LABEL & LITHO CO.
286 STANHOPE ST., BROOKLYN, N.Y. 11237

NEW YORK METROPOLITAN AREA (Area Code 212)

A G I (Album Graphics Inc.) 125 W 55 St Zip 14019 Tel 489 0793 TWX (710) 581 5597 VP Mktg Richard Block (Sales office only) (M)
 Home office: Melrose Park (Chicago Metropolitan Area) Ill
 G Benson & Co Printers Inc, 75 Spring St Zip 10012 Tel 925 7100 Con tact Gerald J Benson (M)
 Bert Co Ents Inc (div of Walter Reade Org Inc) 241 E 34 St Zip 10016 Tel 683 6300 Cable WALREAD Telex 12227 Pres Sheldon Gunsberg Exec VP VP Finance & Treas Christopher W Preuster (M)
 Branch: Los Angeles, Calif
 Brown Paper Co., PO Box 591, Van Brunt Sta., Brooklyn 11215 Tel 925 8833 (SEE ADVERTISEMENT)
 Disc Communications Ltd 743 Fifth Ave Zip 10023 Tel 371 0390 Telex 666669 (M)
 E R H Sales Corp., 221 W 57 St Zip 10019 Tel 582 4200 Pres Lee Halpern, Gen Mgr Michael Halpern, Sales Mgr Robert Shavelson (M) (SEE ADVERTISEMENT)
 Guaranteed Printing Serv Co Inc., 119 W 23 St Zip 10011 Tel 929 2410 (M)
 Lee Myles Assocs Inc, 160 E 56 St Zip 10012 Tel 758 3232 Cable LEEMYLES Pres Robert M Miller VP Howard Roseff (45 & LP) (SEE ADVERTISEMENT)
 Mac Murray Press Inc, 230 W 17 St Zip 10011 Tel 924 1530 Pres Bernard Lerman, Sales Mgr Arnold Kohn (45 & LP) (M) (SEE ADVERTISEMENT)
 Charlie Passantino Inc, 311 W 43 St Zip 10016 Tel 586 1469
 Progressive Label & Litho Co., 286 Stanhope St., Brooklyn 11237 Tel 497 2320 Pres Jerome J Rood, Gen Mgr Bernie Stein (M) (SEE ADVERTISEMENT)
 Silk Stocking Prod's Ltd., 216 W 18 St 10th fl., Zip 10024 Tel 255 4424 Chm Lloyd Ribner Jr., Pres Elliot J Galdy

UTICA (Area Code 315)

Oneida Video Audio Tape Cassette Corp., 760 Blandina St Zip 13501 Tel 735 6187 Pres Stanley Markowski (45 & LP) (M)

NORTH CAROLINA

CANTON (Area Code 704)

Recording Servs of Western North Carolina Inc, 10 Pentland St Zip 28716 Tel 648 6012 Owner J Ted Evans Jr VP Ray Evans (45 & LP)

OHIO

CINCINNATI (Area Code 513)

Artists Rec'g Co Inc., 320 Mill St Zip 45215 Tel 761 0011 (M)
 Q C A Custom Pressing, 2832 Spring Grove Ave Zip 45225 Tel 681 8400 Pres Edward R Bosken, VP & Sales Mgr Keith Myers, Plant Mgr Ken Martin (M) (SEE ADVERTISEMENT)
 Studio Pressing Serv., 320 Mill St Zip 45215 Tel 761 8294 Pres B Hyne, Sales Mgr M Tye (45 & LP)

PENNSYLVANIA

MECHANICSBURG (Area Code 717)

H R C Printing, Box 1152, 5252 E Trindle Rd Zip 17055 Tel 766 0943 Gen Mgr Donald E Baldwin (45 & LP) (M) (SEE ADVERTISEMENT)

PHILADELPHIA (Area Code 215)

Fenton Label Co., Coral & Buckwist Sts Zip 19124 Tel 288 2910

SCRANTON (Area Code 717)

Keystone Printed Specialties Co Inc, 321 Pear St Zip 18505 Tel 346 1761 Pres M C Fischer, Sales Mgr Martin C Fischer (45 & LP) (M) (SEE ADVERTISEMENT)

SHARON (Area Code 412)

Marjon Recs Inc., 159 Easton Rd., Hermitage 16146 Tel 347 4726 Pres John T Krizanec, Sales Mgr Martha Krizanec, Adv Mgr Ruth Toth (M)

PUERTO RICO

CIORA (Area Code 809)

Linear Prods. of Puerto Rico Inc, PO Box AB Zip 00639 Tel 739 8435

SAN JUAN (Area Code 809)

Rio Piedras Recs & Discos Borrinquen GPO Box 4'85 Zip 00936 Tel 790 2188/2186/2142 Pres Dario Gonzalez, Gen & Sales Mgr Benito Val des

TENNESSEE

NASHVILLE (Area Code 615)

Color Graphics Inc., 305 Church St., Goodlettsville 37072 Tel 859 4001

M F P Inc, 453 Chestnut St Zip 37203 Tel 256 6161
 Nashville Album Prods Inc., 1114 Gallatin Rd N., Madison 37115 Tel 883 2153 Pres Steve Botts, Art Dir Gregg Spickard (SEE ADVERTISEMENT)
 Super Prod ns, PO Box 1569 31 Industrial Park, Hendersonville 37075 Tel 822 5080 Pres Gordon Cash (45 & LP)
 United Rec Pressing Inc., 453 Chestnut St Zip 37203 Tel 259 9396 (M)
 Williams Printing Co., 417 Commerce St Zip 37219 Tel 256 7125 VP Sales Dudley Fortner (M)

TEXAS

OALLAS (Area Code 214)

Electronic Technological Inds of America Inc, PO Box 1580 Zip 75221 Tel 827 8002 Bd Chm John Kanter Gen Mgr David Coleman Sales Mgr Larry Pearson

SAN ANTONIO (Area Code 512)

Texas Rec Mfg Inc., 1422 W Poplar Zip 78207 Tel 733 6138 Pres C Foy Lee, Gen Mgr Jimmy Burton, Sales Mgr Jeanne Hill (M)

WACO (Area Code 817)

Mike's Print Shop, 2507 Grim Zip 76707 Tel 752 2321 Owner Mike Stanley

UTAH

SALT LAKE CITY (Area Code 801)

Chase Media Inc, Busch Park, 5284 S 320 W Suite C 166 Zip 84107 Tel 261 1383 Pres & Gen Mgr Randal S Chase, Sales Mgr Irel Chase (MD)

WISCONSIN

ELKHART LAKE (Area Code 414)

Sohn Mfg Inc., Box X Zip 53020 Tel 876 3361

WYOMING

CHEYENNE (Area Code 307)

Rocky Mountain Rec'g, 8305 Christensen Rd Zip 82001 Tel 638 8733 Pres Ray Alexander Sales & Adv Mgr Georgia Alexander (45 & LP) (MD)

POLYETHYLENE BAG & SHRINKWRAP SUPPLIERS

The key to the abbreviations following the company listings is: (M) Manufacturer, (D) Distributor, (I) Importer.

CALIFORNIA

LOS ANGELES METROPOLITAN AREA (Area Code 213)

Aishure Int'l Inc., 1015 Isabel St., Burbank 91510 Tel 849 4671 WATS (800) 423 2936 Cable BUDSOUND TWX (910) 498 2759 Pres Al Sherman, Gen Mgr Dick Ceja (Shrinkwrap only)

Award Rec Mfg Inc., 11016 La Cienega Blvd., Inglewood 90304 Tel 645 2281 Pres & Sales Mgr Martin Ansoorian, Gen Mgr George Abayan (Shrinkwrap only)

Container Kraft Inc., 8321 De Cels Pl Sepuveda 91343 Tel 893 9721 (Polybags only) (M)

M Latter Mfg & Sales, 3208 W Jefferson Blvd Zip 90018 Tel 737 0440 Owner Mel Latter

Queens Lithographing Corp, 6290 Sunset Blvd Suite 304, Hollywood 90028 Tel 464 7700 (Polybags only) (M)
 Plant: Indianapolis, Ind., Rutgers Packaging Corp

OCEANSIDE (Area Code 714)

Exzel Co., 1907 Apple St Zip 92054 Tel 439 3020 Pres J Richard Lee, Gen Mgr Bill Koltcamp (Polybags only)

SAN FRANCISCO (Area Code 415)

Cory Sound Co., 310 Townsend Zip 94107 Tel 543 0440 Contact Phillip Markinson (Shrinkwrap only)

Pacific Int'l Magnetics Inc., 185 Berry St., No 3865 Zip 94107 Tel 495 8830 (Polybags only)
 Home office: Canada

SAN JOSE (Area Code 408)

M J S 2514 Seaboard Ave Zip 95131 Tel 262 8793 Owner Michael Steiner (Polybags only) (M)

FLORIDA

FORT LAUDERDALE AREA (Area Code 305)

Alpha Recs Inc., 1400 NW 65 Ave., Plantation 33313 Tel 587 6011 (Shrinkwrap only)

MIAMI (Area Code 305)

Duotone Co. Inc., PO Box 1168 Zip 33143 Tel 665 1121 Pres Stephen Nester Sr., Sales & Adv Mgr Stephen Gibson Nester (Polybags only) (SEE ADVERTISEMENT)

POMPANO BEACH (Area Code 305)

Trackmaster Inc., 1310 S Dixie Hwy W Zip 33060 Tel 943-2334 Pres Roy Parsons, Sec'y Treas Lupe Parsons (Shrinkwrap only)

HAWAII

HONOLULU (Area Code 808)

Muscassette Duplrs of Hawaii, PO Box 22190 Zip 96822 Tel 533 4165 (Shrinkwrap only)

ILLINOIS

CHICAGO METROPOLITAN AREA (Area Code 312)

Bruce Packaging Co., 8025 N. Kenneth Ave., Skokie 60076 Tel 583-2818 Pres Joseph Halperin (Polybags only) (M)

Industrial Audio Film Servs Inc, 6228 Oakton St., Morton Grove 60053 Tel 965 8400 (Shrinkwrap only)

Media Int'l Inc., 425 N Michigan Zip 60611 Tel 467 5430 Pres Duane Lundeen, VP Margaret Lundeen, Gen Mgr Al Masters (Shrinkwrap only)

ROCKFORD (Area Code 815)

G C Electronics 400 S Wyman St Zip 61101 Tel 968-9661 Cable GCELECT (Polybags only)

INDIANA

INDIANAPOLIS (Area Code 317)

Bowers Rec Sleeve Co, 5331 N Tacoma Ave Zip 46220 Tel 251 3918 Pres James E Bowers, VP Thomas R Bowers (Polybags only) (MD)

Reco Sleeve Packaging, 620 S Belmont Zip 46221 Tel 635 7777, Pres Leonard Verebay, Sales & Adv Mgr Len Dimond (Polybags only)

Rutgers Packaging Corp (div of Queens Lithographing Corp.), 620 S Belmont Ave Zip 46221 Tel 635 7777 TWX (810) 341 3457, 341-3400, Pres Abe Garde, Sales & Adv Mgr Len Dimond (Polybags only) (M)
 Home office: Long Island City (New York Metropolitan Area), N.Y., Queens Lithographing Corp

MICHIGAN

DETROIT METROPOLITAN AREA (Area Code 313)

Archer Rec Pressing Co., 7401 E Davison Zip 48212 Tel 365 9545 Pres R J Archer, VP J M Archer, Sec'y Treas M Archer (Shrinkwrap only)

MINNESOTA

MINNEAPOLIS (Area Code 612)

Discover Division Inc., 5198 W 76 St Zip 55435 Tel 831 5338 Pres. Paul W Smith, VP Les Boelter (Polybags only)

NEW JERSEY

FAIRFIELD (Area Code 201)

Autovend Packaging Systems, PO Box 712, 1275 Bloomfield Ave Zip 07006 Tel 575 1040 (SEE ADVERTISEMENT)

MOUNTAINSIDE (Area Code 201)

Bestway Prods Inc., 1105 Globe Ave Zip 07092 Tel 232 8383 Pres. Howard Massler, Gen Mgr Benjamin Williams, Prod'n Mgr Paul Stevens (Shrinkwrap only) (SEE ADVERTISEMENT)

NEW YORK

COMMACK (Area Code 516)

Robins Inds Corp., 75 Austin Blvd Zip 11725 Tel 543 5200 Pres. Herman Post, VP Sales Stu Carine (M)

HAUAPPAUGE (Area Code 516)

Arista Ents Inc., 35 Hoffman Ave Zip 11787 Tel 234 7000 (Polybags only) (I) (SEE ADVERTISEMENT)

MOUNT VERNON (Area Code 914)

Sentry Inds Inc., 221 N MacQuestion Pkwy Zip 10550 Tel 664 2909, Cable SENTIND Pres. Harold Rosen, VP Barry Rosen (Polybags only)

NEW YORK METROPOLITAN AREA (Area Code 212)

Brown Paper Co., PO Box 591, Van Brunt Sta., Brooklyn 11215 Tel 925-8833 (Polybags only) (SEE ADVERTISEMENT)

Copy Art Photographers (div of James J Kriegsmann Inc.), 165 W 46 St Zip 10036 Tel 757 0190 (Polybags only)

Disc Communications Ltd., 743 Fifth Ave Zip 10023 Tel 371-0390 Telex 666669 (Polybags only)

E R H Sales Corp., 221 W 57 St Zip 10019 Tel 582 4200 Pres Lee Halpern, Gen Mgr Michael Halpern, Sales Mgr Robert Shavelson (M) (SEE ADVERTISEMENT)

Le-Bo Prods Co Inc (div of Peerless Vid Tronics Corp.), 58 60 Grand Ave., Maspeth 11378 Tel 894-5155 Cable LEBOPRODDUX Telex 424790 Pres. P Dayton (M) (SEE ADVERTISEMENT)

Mac Murray Press Inc., 230 W 17 St Zip 10011 Tel: 924 1530 Pres Bernard Lerman, Sales Mgr Arnold Kohn (Shrinkwrap only) (SEE ADVERTISEMENT)

Marvel Packaging Co., 230 W 17 St Zip 10011 Tel 929 8435 VP Barry Berman, Sales Mgr Scott Teich

Charlie Passantino Inc., 311 W 43 St Zip 10036 Tel 586 1469 (Polybags only)
 Poly Plastic Packaging Co Inc., 44 80 11 St., Long Island City 11101, Tel 392-8670. (Polybags only)
 Reclon Corp., 46-23 Crane St., Long Island City 11101 Tel 392-6442, Pres Robert Borchardt, Exec VP Peter Wish, VP Sales George Calvi (Polybags only) (MD) (SEE ADVERTISEMENT)

CASSETTE LABELS

**WHITE AND COLOR PRE-DIECUT PRESSURE SENSITIVE SHEETS
 READY FOR IMPRINTING OR IMPRINTED TO ORDER.**



**PAULI PRODUCTS
 P. O. BOX 29 · DEPT. BD
 COLLINGSWOOD, N. J. 08108
 (609) 547-8925**

• RONKONKOMA (Area Code 516)

Andrews Nursery Envelope & Paper Corp. (sub of ElectroSound Group Inc.), 2175 Fifth Ave. Zip 11779 Tel 467 2000 TWX (510) 228 1095 Pres Stuart M. Andrews Jr. Sales Mgr John F. Muller Jr. Ass't Plant Mgr Robert J. Andrews (M-Polybags)
Home office: Holbrook, N.Y., ElectroSound Group Inc
Sales offices: Sun Valley (Los Angeles Metro Area), Calif. Monarch Rec Mfg. Inc., New York, N.Y., ElectroSound Group Inc

• UTICA (Area Code 315)

Onerda Video Audio Tape Cassette Corp., 760 Blandina St. Zip 13501 Tel 735 6187 Pres Stanley Markowski (Shrinkwrap only)

OHIO

• CINCINNATI (Area Code 513)

Jewel Rec'g Co., 1594 Kinney Ave. Zip 45231 Tel 522 9336 Pres Rusty York Gen Mgr Linda York Sales Mgr Rollin Bennett Jr. (Shrinkwrap only)

• COLUMBUS (Area Code 614)

Mus I Col Inc., 780 Oakland Park Ave. Zip 43224 Tel 267 3133 Owners John W. Hull Boyd P. Niederlander (Shrinkwrap only)

PENNSYLVANIA

• MECHANICSBURG (Area Code 717)

H R C Printing, 5252 E. Trindle Rd. Zip 17055 Tel 766 0943 Gen Mgr Donald E. Baldwin (SEE ADVERTISEMENT)

TENNESSEE

• NASHVILLE (Area Code 615)

Nashville Album Prod'n Inc., 101 Music City Circle. Zip 37203 Tel 256 0121 (M)

WYOMING

• CHEYENNE (Area Code 307)

Rocky Mountain Rec'g, 8305 Christensen Rd. Zip 82001 Tel 638 8733 Pres Ray Alexander, Sales & Adv Mgr Georgia Alexander (Shrinkwrap only)

RAW MATERIALS MANUFACTURERS/ IMPORTERS

Allied Rec'g, 3232 Greenpoint Ave. Long Island City, N.Y. 11101 Tel (212) 784 2318

Product: Blank disks

J. C. Anglum Co. Inc./Tapeponents Inc. Box 236 36 Midvale Rd., Mountain Lakes, N.J. 07046 Tel (201) 263 1442 Pres J. Clifford Anglum
Product: Vinyl resin & compounds styrene resin & compounds, color concentrates

Audiorecords, see Capitol

Cabot Corp., 200 Raritan Center Pkwy., Edison N.J. 08817 Tel (201) 225 1000

Product: Carbon black

Capitol Magnetic Prods (div of Capitol Recs Inc.), 6902 Sunset Blvd., Hollywood, Calif. 90028 Tel (213) 461 2701 Pres Edward C. Khoury VP Mktg. Admin John Apsitis VP Domestic Sales Larry Hockemeyer VP Int'l Sales Bud Jackson, Mktg. Coord. Natalie Goss
Product: Blank lacquer disks for mastering and reference

Brand name: Audiorecords

Celanese Plastics, 26 Main St. Chatham, N.J. 07928 Tel (201) 635 2600

Product: Celanar polyester film

Dixon Inds Corp (a Bundy Co.), 386 Metacom Ave. Bristol R.I. 02809 Tel (401) 253 2000 Telex 927706 Pres Bert Katzanek, Sales Mgr John F. McCurdy Jr.

Product: Polyolefin compound

Finebilt Mfg Co., 931 N. Citrus Ave. Hollywood, Calif. 90038 Tel (213) 466 9511 Cable COEXPORT Telex 698393 Pres Alwin P. Schmid, VP & Tape Sales Mgr Joseph Bouzaglou, Sales Mgr Manuel Munoz

Product: Record compounds coating slurry

G S P Metals & Chemicals Inc. 2535 E. 28 St. Los Angeles Calif. 90058 Tel (213) 582 0685 Pres Shepard Drazin
Product: Plating metals, chemicals & equip

Gotham Audio Corp., 741 Washington St. New York, N.Y. 10014 Tel (212) 741 7411 Pres Stephen F. Temmer Sales Mgr Russell O. Hamm

Product: Blank lacquer disks for mastering
Brand name: Pyral

Hi Flex Corp., 404 Artillery Rd., Taylors, S.C. 29687 Tel (803) 268 2363
Product: Polyolefin, polyester, graphite coated polyester rolls

Lenahan Assocs Inc. PO Box 397, Pitman, N.J. 08071 Tel (609) 589 5755 TWX (510) 686 7519

Product: Custom milling compounds
M P M (div of Pfizer Inc.), 640 N. 13 St., Easton, Pa. 18042 Tel (215) 253 6261

Chief product: Magnetic iron oxide for tape coating
Pyral see Gotham Audio

Rainville Co. Inc., 200 Clay Ave. Middlesex, N.J. 08846 Tel (201) 752 8100

Product: PVC/carbonblack conveying systems size reduction & silos
Randolph Prods Co., Box 67, Carlstadt, N.J. 07072 Tel (201) 438 3700 Pres John H. Randolph

Product: Record lacquer
Richardson Co. Polymeric Systems Div., 15 Meigs Ave., Madison, Conn. 06443 Tel (203) 245 0441

Product: Injection molding, polystyrene compounds—standard black & custom transparent colors
Tenneco Chemical Corp., Turner Pl., Piscataway, N.J. 08854 Tel (201) 981 5000

Product: Record compounds
Tranco Prods Corp. 609 W. Elizabeth Ave., Linden, N.J. 07036 Tel (201) 862 0030

Product: Blank disks (SEE ADVERTISEMENT)

RECORD MANUFACTURING EQUIPMENT MANUFACTURERS/ IMPORTERS

Al Be Inds. Inc. 16633 Minnesota Ave., Paramount, Calif. 90723 Tel (213) 363 2563

Chief product: Matic preplasticizer

Aragon, see Certain Teed Machinery

Audio Matrix Inc., 915 Westchester Ave., Bronx, N.Y. 10459 Tel (212) 589 3500

Local branch: Audiomatic Corp., 1290 Ave. of the Americas, New York 10019 Tel 582 4870

Chief product: Record presses & plating systems

Certain Teed Machinery (div. Certainteed Corp.), 5501 N. 119 St. W., Maize, Kan. 67101 Tel (316) 722 2811

Gen Mgr Ken McKown, Sales Mgr William Hoebner

Chief product: Single screw extruders

Brand name: Aragon

D D W Inc. 533 Hagan St., Nashville, Tenn. 37203 Tel (615) 256 2183

Telex 554302 Pres. Bill Westerman

Chief product: Extruders (Automatic & manual)

Brand name: Sure Shot (SEE ADVERTISEMENT)

Diacoustic Lab., 23958 Craftsman Rd., Calabasas, Calif. 91302 Tel (213) 888 8010 Owner & Pres Ernest Knight, Sales Mgr W.D. Vredenburgh.

Chief product: Disk recording styli, blank disks, stereo disk cutting lathes

E P I, see Extruder Prod'ns

Europadisk Ltd., 75 Varick St., New York, N.Y. 10013 Tel (212) 226 4401

Cable EUROPADISK TWX (710) 581-2034 Pres James P. Shelton, VP:

Christian S. Lach (Manufacturer's Rep.)

Product: Record plating equip

Brand name: Europa Film (Sweden)

Europa Film, see Europadisk

Extruda Prods Inc., 100 S. Washington Ave., Dunellen, N.J. 08812. Tel (201) 753 2144 Cable EXPRO

Chief product: Compounding extruders & preplasticizers.

Brand name: EPI

Finebilt Mfg Co Inc., 931 N. Citrus Ave., Hollywood, Calif. 90038 Tel (213) 466 9511 Cable COEXPORT Telex 698393 Pres Alwin P. Schmid; VP

& Tape Sales Mgr Joseph Bouzaglou, Sales Mgr. Manuel Munoz

Chief product: Presses, molds, extruders

Gentry Machine Corp., Somerdale Ind'l Park, 201 Linden Ave., Somerdale N.J. 08083 Tel (609) 627 3000 Pres. Paul Miller.

Chief products: Presses, extruders

Brand names: Hydramold 150, Miller Compounder (SEE AD)

Manufacturers of MASTER RECORDING BLANKS

Tranco Products Corp.

609 West Elizabeth Ave., Linden, N.J. 07036
Tel: (201) 862-0030-33 Cable: REGNIS

NEW! FOR A FACTORY FRESH APPEARANCE
WRAP OR RE-WRAP . . . With the New
"SUPER BRAIN" SHRINK PACKAGER

VIDEO CASSETTES - VIDEO DISCS - RECORD ALBUMS



• **FAST** - No warm-up time. A sealed package in less than 2 seconds every time.

• **FULL SEAL** - With one motion produce a completely sealed wrap.

• **DURABLE** - Solid State Controls for long life.

• **DEPENDABLE** - Adjusts heat requirements automatically whether sealing one or one-hundred.

• **SIMPLE** - Set control one time and forget it.

• **CAPACITY** - Seals up to a 14" x 14" Package.

For The Special Introductory Offer **Call Toll Free: 800-526-2276.**

APS

AUTOVEND PACKAGING SYSTEMS

1275 BLOOMFIELD AVE. • P.O. BOX 712
FAIRFIELD, N.J. 07006 • (201) 575-1040

Gotham Audio Corp., 741 Washington St., New York, N.Y. 10014 Tel: (212) 741 7411 Pres. Stephen F. Temmer, Sales Mgr. Russell O. Hamm.
Product: Disk cutting systems
Brand name: Neumann

Hamilton Mfg. Co. (div of Gram Inds Inc.), 510 First Ave., West Haven, Conn. 06516 Tel: (203) 933-1625 TWX (710) 465 2982
Chief product: Manual & automatic record presses; 7", 10" & 12" molds, insert molds & frame assemblies, mold accessories & accessory equip

Hydamold 150, see Gentry Machine.
 I C R, see Ransteele.
 I E S, see Industrial Electroforming

Industrial Electroforming Systems Corp., 533 Hagan St., Nashville, Tenn. 37203 Tel: (615) 256 2183 Telex 554302 Fres. Bill Westerman
Chief Product: Matrix plating systems
Brand name: IES (SEE ADVERTISEMENT)

James G. Lee Rec. Processing Inc., 145 W 154 St., Gardena, Calif. 90247 Tel: (213) 321-2187, Pres. James G. Lee, Gen. Mgr. Edward Tobin Jr.
Chief product: Record matrices, masters, mothers, stampers.

Lened Int'l Corp., 489 Henry St., Elizabeth, N.J. 07201 Tel: (201) 354 5205 Telex 138767 Owners: Leonard Palmer, Joseph Flusfeder
Chief products: Record inserting machine, automatic record pressing systems. (SEE ADVERTISEMENT)

Maple Clamp Corp., 1278 Underwood Ave., San Francisco, Calif. 94124, Tel: (415) 822 8855 Pres. Paul Joulsohn
Chief product: Record trimmers

Mastercraft Rec. Plating Inc., 609 W 51 St., New York, N.Y. 10019 Tel: (212) 265 6040
Chief product: Plating equip.

Micro Point Inc., 8 Westchester Plaza, Elmsford, N.Y. 10523 Tel: (914) 592 4014, TWX (710) 567 1223 Pres. Edward Schwartz
Chief product: Disk recording systh

Miller Compounder, see Gentry Machine

Musical Prods Inc., 521 W 26 St., Chicago, Ill. 60616 Tel: (312) 225 9117
Chief product: Plating equip
Brand name: Vans.

Namiki Precision Jewel Co. Ltd., 15 Essex Rd., Paramus, N.J. 07652 Tel: (201) 368 8310 TWX (710) 990 1273
 Home office: Japan
Chief product: Cutting systh

Neumann, see Gotham Audio

Ransteele Audio Inc., 1697 Broadway, New York, N.Y. 10019 Tel: (212) 265 5563 Pres. Thomas S. Steele
Chief product: Disk mastering equip., cutterheads, cutterhead driver pre amplifiers, power amplifiers, cutting lathe control systems, variable pitch & depth control computers, meter monitor switching analyzers, custom control consoles, lathe rebuilding, customizing & updating of equip
Brand names: ICR, Ransteele

Record Prods of America Inc., 700 Sherman Ave. Hamden, Conn. 06514 Tel: (203) 248-6371 Pres. Stanley Roczynski, VP & Sales Mgr. Steve Suzanski
Chief products: 12", 10" & 7" 2 pc. molds, insert molds, frame assemblies, mold accessories, plating equip., label cutting presses

S M T, see Southern Machine

Sontec Electronics, 10120 Marble Court, Cockeysville, Md. 21030. Tel: (301) 628 2920
Product: Mastering lathe control systems
Brand name: Compudisk

Southern Machine & Tool Corp., 533 Hagan St., Nashville, Tenn. 37203. Tel: (615) 256-2183. Telex: 554302 Pres. Bill Westerman
Chief Product: 7" & 12" automatic & manual presses.
Brand name: SMT (SEE ADVERTISEMENT)

Standard Paper Box Machine Co. Inc., 476 Broome St., New York, N.Y. 10013. Tel: (212) 925-9818.
Chief product: Jacket machines

Tranco Prods Int'l, 875 Merrick Ave., Westbury, N.Y. 11590 Tel: (516) 333-2000.
Chief product: Master record blanks (SEE ADVERTISEMENT)

Vans, see Musical Prods.

Wildwood Audio, see Wildwood Entertainment

Wildwood Entertainment, 276 Fourth St., Troy, N.Y. 12180 Tel: (518) 273-7660 VP. Erich Borden.
Product: Mastering systems.
Brand name: Wildwood Audio

Worldex Mfg. Co. Ltd., 1212 N. La Brea Ave., Hollywood, Calif. 90038. Tel: (213) 466 3324, Cable: WORLDEX. Pres. Louis R. Baptista
Chief product: Record presses, electroplating plants, dies, edging machines

Agfa Gevaert Inc., 275 North St., Teterboro, N.J. 07608. Tel: (201) 288 4100.
Sales offices: **Burlingame, Calif.**, 1633 Old Bayshore Hwy. Zip: 94010. Tel: (415) 692-2432—**Los Angeles, Calif.**, 1801 Century Park E. Zip: 90067 Tel: (213) 552-9622—**Atlanta, Ga.**, 380 Interstate N., Suite 200 Zip: 30339. Tel: (404) 955-4326—**Oak Brook, Ill.**, 2803 Butterfield Rd., Suite 200. Zip: 60521. Tel: (312) 242-1915—**Lexington, Mass.**, Lexington Office Center, Hayden Ave. Zip: 02173. Tel: (617) 890-5430—**Sacauscus, N.J.**, 24 Meadowlands Pkwy., Suite 300. Zip: 07094. Tel: (201) 330-1800—**New York, N.Y.**, 1 Penn Plaza, Rm 3527. Zip: 10001. Tel: (212) 279-2560—**Dallas, Tex.**, 3003 LBJ Fwy., Suite 100. Zip: 75234. Tel: (214) 243-7315
Video: 2" quad, ¼" U-matic cassette, ¼" cassette, (SEE ADVERTISEMENT)

Arko Magnetic Corp., 234 Fifth Ave., No. 304, New York, N.Y. 10001. Tel: (212) 689-9332. Pres. Elias Smyrnakis; Gen. Mgr.: George T. Saddler; Sales Mgr. H. Johnson.
Audio: 8-tr., cassette, open reel.
Brand names: Audio VU, Marmac, New Symphony, Olympia.

Awia America Inc., 35 Oxford Dr., Moonachie, N.J. 07074. Tel: (201) 440-5220
Audio: Cassette (60,90,120)

American Sound Corp., 3319 E. Ten Mile Rd., Warren, Mich. 48091. Tel: (313) 539-2900. Pres.: Frank S. Day, VP & Gen. Mgr.: Paul M. Hayes, VP & Sales Mgr. Paul E. Adams.
Branches: **North Hollywood, Calif.**, 8120 Webb Ave. Zip: 91605. Tel: (213) 768-6100. VP. Paul Hayes, VP Mktg.: Paul Adams; Reg'l Sales Mgr. William Dawson—**Atlanta, Ga.**, American Sound-Atlanta, 2091 Faulkner Rd. NE. Zip: 30324. Tel: (404) 633-4577. Gen. Mgr.: Matt Polakoff; Sales Mgr. Peter Thomason—**Closter, N.J.**, 317 Harrington Ave. Zip: 07624. Tel: (201) 767-9033
Audio: 8-tr. & cassette (custom lengths), open reel

American Tape Corp. (div. of VideoVision Inc.), 1116 Edgewater Ave., Ridge field, N.J. 07657. Tel: (201) 943-7860. VP Sales: Gerry Gottlieb; VP Adm. Kathryn Marant-Mendenhall; Plant Mgr. Francis A. Dermody.
Audio: 8-tr. (0.80), cassette (0.90).
Brand name: Remington.

Ampex Corp., 401 Broadway, Redwood City, Calif. 94063. Tel: (415) 367-2011. Telex 348464 TWX (910) 378-5920
Sales Offices: **Birmingham, Ala.** PO Box 845. Zip: 35205. Tel: (205) 823-6132—**Glendale, Calif.**, 500 Rodier Dr. Zip: 91201. Tel: (213) 240-5000—**San Diego, Calif.**, PO Box 99847. Zip: 92109. Tel: (714) 272-8337—**Denver, Colo.**, 2124 S. Birch. Zip: 80222. Tel: (303) 757-1829/6491—**Orlando, Fla.**, PO Box 15008-B. Zip: 32808. Tel: (305) 423-2962—**Atlanta, Ga.**, 3135 Chestnut Dr., Suite 101. Zip: 30340. Tel: (404) 451-7112—**Honolulu, Hawaii**, PO Box 25367. Zip: 96825. Tel: (808) 395-7144—**Elk Grove Village, Ill.**, 2201 Lunt Ave. Zip: 60007. Tel: (312) 593-6000—**Overland Park, Kan.**, PO Box 7282. Tel: 66207. Tel: (312) 383-1951—**Florence, Ky.**, Elsedon Bldg. Zip: 41042. Tel: (606) 371-1476—**Baton Rouge, La.**, PO Box 14238. Zip: 70808. Tel: (504) 766-6270—**Bethesda, Md.**, 10215 Fernwood Rd. Zip: 20034. Tel: (301) 530-8800—**Framingham, Mass.**, PO Box 1020. Zip: 01701. Tel: (617) 877-8060—**Minneapolis, Minn.**, 5200 W 73 St. Zip: 55435. Tel: (612) 935-5560—**Elkhorn, Neb.**, PO Box 553. Zip: 68022. Tel: (402) 556-3400—**Hackensack, N.J.**, 65 Commerce Way. Zip: 07601. Tel: (201) 489-7400—**Williamsstown, N.J.**, PO Box 513. Zip: 08094. Phila. Tel: (215) 887-7650—**Buffalo, N.Y.**,

TAPE, BLANK LOADED, MANUFACTURERS

The numbers in parentheses following the 8-track & cassette configurations show recording time in minutes; those following open reel configurations (2", 1" & ¼") show length of tape in feet.

A A, see Audio Accessories.
 A & B Cassette Dupl'g, 1502 S. 87, West Allis, Wis. 53214 Tel: (414) 774-7250 Pres. Gen. & Sales Mgr. Judy Benz.
Audio: Cassette
Brand name: Audio Max

A T Pro, see Abbey Tape

A/V Paragon, see Universal Tape

Aard-Vark Rec'g Inc., 335 S. Jefferson, Springfield, Mo. 65806 Tel: (417) 866 4104 Pres. John Jacobsen
Audio: 8-tr (4-90 min), cassette (0-130 min)
Brand name: jdt

Abbey Tape Dupl'rs, 5358 Cartwright Ave., North Hollywood, Calif. 91601. Tel: (213) 985-3136 Pres. Norman C. Cooke.
Audio: Cassette (2 120)
Brand name: AT Pro

Able Turntable & Tape, see AT&T

Acme Dist., PO Box 8123, 5644 Holmes, Kansas City, Mo. 64112 Tel: (816) 444 8123 Pres. Shirley Black, Sales Mgr. Ward Black.
Audio: Cassette (custom—1 to 120 min)
Video: ¾" U-matic & ¼" Beta & VHS cassette (custom lengths)

SMT

PRESSES

Sure-Shot

EXTRUDERS

IES

PLATING

**NEW — THE WORLD'S ONLY AUTOMATIC THAT PRESSES BOTH 7" AND 12" RECORDS.
 NEW — NO MORE PAPER LABELS FOR 7" RECORDS.**

OUR EQUIPMENT IS IN OVER 100 PLANTS WORLD WIDE. WE MANUFACTURE THE BROADEST LINE IN THE INDUSTRY: AUTOMATIC AND MANUAL PRESSES — EXTRUDERS — COMPLETE HIGH SPEED PLATING SYSTEMS.

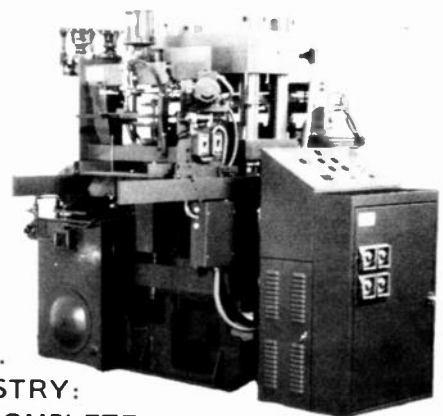

SOUTHERN MACHINE & TOOL CORP.

533 HAGAN STREET
 NASHVILLE, TENNESSEE 37203
 (615) 256-2183, TELEX 554302
 BILL WESTERMANN, PRES. & FOUNDER

**EUROPEAN AGENT:
 KLAUS GRABOWSKI
 ZENTMARKWEG 37
 FRANKFURT, W. GERMANY
 49611-786906**

Lened automated record pressing systems

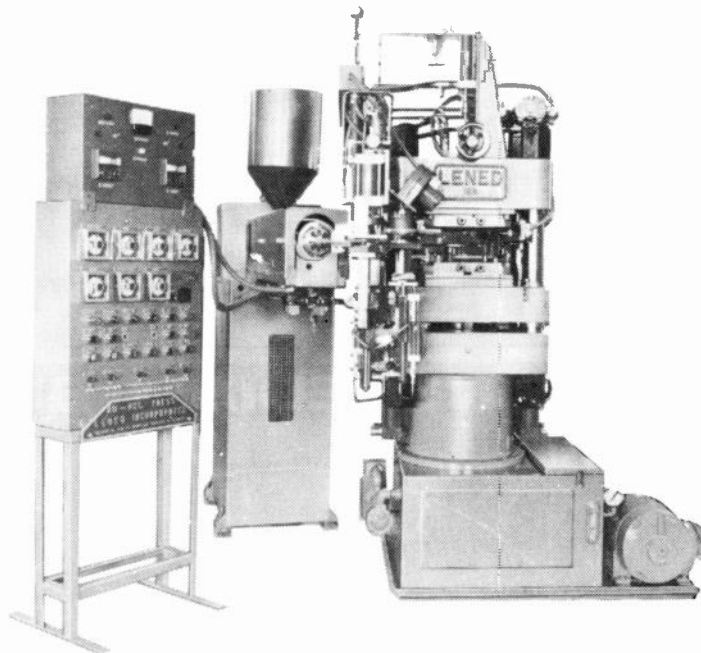

Eliminate hand operations in the production of 7", 10" and 12" phonograph records. A single machine tender can operate a battery of these units, simply by providing stacks of labels and removing stacked and sleeved records at the delivery end. Proven for 18 years. In excess of 1,000 installations in North

and South America, Europe and the Orient.

Write, telex or phone for information regarding Lened systems, or for information about Lened's other equipment for the industry, including packaging, handling, counting and related equipment.



LENE INTERNATIONAL CORP.

489 Henry Street, Elizabeth, New Jersey 07201
Telephone: (201) 354-5205 • Telex: 138767

PO Box 4 Zip 14221 Tel (716) 586-2580 Cleveland, Ohio, PO Box 134 Zip 44212 Tel (216) 225 1262—**Nashville, Tenn.**, PO Box 120532 Zip 37212 Tel (615) 256 4836—**Dallas, Tex.**, 1615 Prudential Dr Zip 75235 Tel (214) 637 5100—**Houston, Tex.**, 5300 Telephone Rd Zip 77087 Tel (713) 928 3741—**Salt Lake City, Utah**, 2880 S Main, Suite 111 Zip 84115 Tel (801) 487 8181—**Seattle, Wash.**, 628 Industry Dr Bldg 8 Zip 98188 Tel (206) 575 0156
Audio: 8 tr (45 90), cassette (45.6(90,120), open reel (1200',1800',2500',3600') broadcast (600',900',2500',3600',5000')
Video: 2" quad 1" open reel 1/2" EIAJ open reel (1250',2400'), 1/4" U matic cassette (10 60), 1/2" Beta cassette (30 60 120)
Ampro Prods Inc., 150 Fifth Ave New York, N Y 10011 Tel (212) 243 7726 Cable TAPEXKRON Telex 425233
Audio: 8 tr (40.60 80), cassette (30.60.90 120)
Analyst see Pacific Int'l
Andol Audio Prodc. Inc., 4212 14 Ave., Brooklyn, N.Y. 11219 Tel (212) 435 7322 Pres. Anthony A. Maniere, Sales Mgr. Rocco Salvatore, Adv. Mgr. Domenick Salvatore
Audio: 8 tr & cassette (1 90)
Apollo, see Greatapes
Arista Ent's Inc., 35 Hoffman Ave Hauppauge, N.Y. 11787 Tel (516) 234 7000
Audio: 8 tr (40.45 80.90) cassette (60.90), (SEE ADVERTISEMENT)
Arrow Trading Co. Inc., 1115 Broadway, New York, N.Y. 10010 Tel (212) 255 7688 (Audio only)
Associated Audio Servs. Inc., 181 Westchester Ave., Port Chester, N.Y. 10573 Tel (914) 937 5129. Pres. D. Richard Kraus, VP. Allan Johnson
Audio: 8 tr, cassette
Brand name: Crusader
Athana Audio Prods (div. of Arber Inds.), PO Box 2696, 1815 Mullin Ave Torrance, Calif 90510 Tel (213) 320 1451
Audio: Cassette (custom lengths)
Audio Accessories Co., 38 W 515 Deerpath Rd., Eatavia, Ill 60510 Tel (312) 879 5998 Sales Mgr. John S. Maloney
Audio: 8 tr, cassette, endless loop cassette (cu. tom lengths), "private label" cassettes, open reel (1200')
Brand name: AA
Audiodyne Co., PO Box 825, San Jose, Calif 95108 Tel (408) 287 3520 Owner & Pres. Louis R. Charamonte
Audio: 8 tr, cassette, open reel & broadcast (custom lengths)
AudioGraphics (div. of Herald Publ'g House), 3225 S. Noland Rd., Independence Mo 64055 Tel (816) 252-5010
Audio: Cassette (standard & custom lengths)
Audio Inds. Inc., Broad & Linden Aves., Ridgefield, N.J. 07657 Tel (201) 945 4545
Audio: 8 tr, cassette (SEE ADVERTISEMENT)
Audio Magnetics Corp., 2602 Michelson Dr., Irvine, Calif 92716 Tel (714) 833 0020 Pres. Isidore Philosophie, VP Ind'l Frnds. Stewart B. Schlosberg, Nat'l Sales Mgr. Charles Trausch
Audio: 8 tr (45 90), cassette (45.60 *0 120), open reel (1200',1800',2400')
Brand names: Tracs, High Performance
Audio Max, see A&B
Audiopak, see Capitol
Audiotrack, see Little Warehouse
Audio VU, see Airko

AudioVisual Communications Inc., 435 Crooked Ln. King of Prussia, Pa 19406 Tel (215) 272 8500 Pres. John Baltantyne, VP. Sales John Butterworth
Audio: Cassette (custom lengths up to 120 minutes) open reel (up to 10 1/2" reels)
Autek, see Northwestern
B A S F Systems Corp., Crosby Dr., Bedford Mass 01730 Tel (617) 271 4000 Nat'l Sales Dir. James S. Walker Video Prod. Mgr. Theodore Van Sickle
Branches: Santa Monica, Calif., 1307 Colorado Ave Zip 90404 Tel (213) 451 8781—Atlanta, Ga., 3300 Buckeye Rd., Suite 403 Zip 30341 Tel (404) 455 4145—Palatine, Ill., 800 E. Northwest Hwy., Suite 220 Zip 60067 Tel (312) 934 4990—Ridgewood, N.J., 579 Franklin Tnph Zip 07450 Tel (201) 447-6904
Audio: cassette (60,90), open reel (7"—1800',2400')
Video: 1/2" Beta cassette (L 500), 1/2" VHS cassette (120)
Kenneth A. Bacon Assocs., 216 Montego Key Novato, Calif 94947 Tel (415) 883 5041 Owner. Kenneth A. Bacon, Prod'n Mgr. Rick Bacon
Audio: Cassette, open reel
Brand name: KABA
Batish Rec'g Ent's., 1310 Mission St., Santa Cruz, Calif 95060 Tel (408) 423 1699 VP Mktg & Sales Ashwin Batish, Gen. Mgr. Ravi Batish
Audio: Cassette
Bazzy Electronics Corp., 39 N. Rose, Mount Clemens, Mich 48043 Tel (313) 463 2592
Audio: 8 tr, cassette (custom lengths)
Betamax, see Sony
Bethany Fellowship Inc., 6820 Auto Club Rd., Minneapolis, Minn 55438 Tel (612) 944 2121 Cable BETHANY Pres. T. A. Hegre, Gen. Mgr. M.F. Johnson, Sales Mgr. Bill Linder
Audio: Cassette (custom lengths)
Bonneville Prods'n., 130 Social Hall Ave., Salt Lake City, Utah 84111 Tel (801) 237 2400 TWX (910) 925 5266
Audio: Cassette (30.45.60.90.120)
Bradley Ent's Inc., 108 Galewood Rd., Timonium Md 21093 Tel (301) 252 8520 Pres. Joe Bradley, Exec. Ass't. Stephen J. Rosasco
Audio: Cassette
Brand S., see Robins
Broadcast Electronics Inc. (a Filmways Co.), 4100 N. 24 St. Quincy Ill 62301 Tel (217) 224 9600 Cable SPOTMASTER Telex: 250142 Pres. Lawrence J. Cervon, VP. Mktg. Curtis I. Kring, Sales Mgr. J. Engle, Adv. Mgr. Thomas R. Humphrey
Broadcast 1, see RKD
Burlington Audio Tapes Inc., 106 Mott St. Oceanside, N.Y. 11572 Tel (516) 678 4414 Pres. Ruth Schwartz, VP. Rudy Schwartz
Audio: Cassette, open reel
Video: 1/2" Beta & VHS cassette (SEE ADVERTISEMENT)
C E S Rec'g Inc., 4960 S. 83 East Ave., Tulsa Okla 74145 Tel (918) 627 8474 Pres. Basil W. Thomas, Gen. Mgr. Judy McAlister
Audio: 8 tr, cassette (custom lengths up to 90 min)
Video: 1/2" Beta & VHS cassette
C L C. see International Audio
C P H Video, 9229 Sunset Blvd., Suite 812, Los Angeles Calif 90069 Tel (213) 274-8113 Telex: 698236
Home office: Australia
Video: 1/2" Beta & VHS cassette

Calibron, see Horan Eng'g
Capitol Magnetic Prods (div. of Capitol Recs. Inc.), 6902 Sunset Blvd. Hollywood, Calif 90028 Tel (213) 461 2701. Pres. Edward C. Khoury, VP. Mktg. Admin. John Apsite, VP. Domestic Sales. Larry Hockemeyer, VP. Int'l Sales. Bud Jackson, Mktg. Coord. Natalie Goss
Sales offices: Atlanta, Ga., 1670 NE Freeway Access Rd. Zip 30329 Tel (404) 321 5441—Biles, Ill., 6401 Gross Point Rd. Zip 60648 Tel (312) 775 7101—New York, N.Y., 1370 Ave. of the Americas Zip 10019 Tel (212) 757 7470
Int'l brand: Singapore
Audio: Broadcast cartridge (custom lengths)
Brand name: Audiopak
Carter Craft, see Carter Corp
Carter Corp., 1916 11 St., Rockford Ill 61101 Tel (815) 397 3200 Cable CARTERCORP Pres. Robert L. Fleming VP. Sales & Mktg. Sandra L. Fleming, Plant Mgr. W. Skip Kruger
Audio: Cassette (10-90)
Brand name: Carter Craft
Cassette Masters Corp., 2 Bashford St. Yorkers, N.Y. 10701 Tel (914) 968 1605 Pres. Leonard Rippl'y, Gen. & Sales Mgr. V.J. DePaul
Audio: Cassette
Video: 1/2" U matic cassette, 1/2" Beta & VHS cassette
Cassette Servs., 815 N. Douglas St., Arlington Heights, Ill 60004 Tel (312) 398 8403 Owner & Pres. Willis J. Conner, Sales Mgr. Michael Connor
Audio: Cassette
Brand name: Hi Q
Century Audio & Development Inc., 1018 Busse Hwy. Park Ridge, Ill 60068 Tel (312) 696 0675
Audio: Cassette (47.62.92.122)
Certron Corp., 1701 S. State College Blvd., Anaheim Calif 92806 Tel (714) 634 4280, WATS (800) 854 3943 TW: (910) 593 1611 Pres. Edwin Gamson, VP. Mktg. Ray Allen, Sales Mgr. Monica Terrill, Adv. Mgr. Hal Wilde
Audio: 8 tr (45.65.90), cassette (30.60.90) (SEE ADVERTISEMENT)
Charlie & Co. Inc., 5500 B. Crestwood Blvd., Birmingham, Ala 35212 Tel (205) 870 0247 592 360) Pres. Charles Colvin, Mgr. Mark Colvin
Audio: 8 tr, cassette
Chase Media Inc., Busch Park, 5284 S. 320 W., Suite C. 166, Salt Lake City Utah 84107 Tel (801) 2e1 1383 Pres. & Gen. Mgr. Randal S. Chase, Sales Mgr. Irel Chase
Audio: 8 tr (standard lengths) cassette, open reel (custom lengths)
Christian Dupl'ns Inc., 1710 Lee Rd., Orlando Fla 32810 Tel (305) 299 7363
Audio: Cassette open reel (custom lengths)
Colorchrome, see RKD
Col Tape, see Columbia Pictures
Columbia Pictures Videocassette Servs., 1501 Landmeier Rd., Elk Grove Village, Ill 60007 Tel (312) 640 2350 Telex: 206923 Exec. VP. George M. Ricci, Bus. Mgr. T. Martin, Rennels
Video: 1/2" cassette
Brand name: Col Tape
Continental Electronics, 408/ Glencoe Ave. Marina del Rey Calif 90291 Tel (213) 822 2045 Sales Mgr. John Adams
Audio: Cassette (45.60.90.120)
Cory Sound Co., 310 Townsend, San Francisco Calif 94107 Tel (415) 543 0440 Contact: Phillip Makinson

THE INCREDIBLE BULK
 C A S S E T T E T A P E

CERTRON offers three tape formulas:

FEREX I—Our new premium tape formulation that can be used for recording studio masters. Imagine how extraordinary your duplicated copies will sound!

HIGH ENERGY—for quality music duplication.

LOW NOISE—For economical duplicating and loading.

FEATURES:

- UNIFORM COATING THICKNESS
- PRECISION SLITTING
- HEAVY DUTY BINDER—Virtually eliminates oxide shed
- CONSISTENT QUALITY
- SAME DAY SHIPMENT OF RUSH ORDERS—All tapes in inventory.

Also available:
 C-O's cassette boxes and cassette labels

certron

CONTACT: Certron Corporation, Industrial Products Division
 1701 S. State College Blvd., Anaheim, Ca. 92806
 (714) 634-4280 Toll Free: outside Calif. (800) 854-3943 TWX 910-5931611/ANS BACK: CERTRON ANH

The Speed-King Model 790 cassette loader,
designed so one attendant operating
three machines can produce up to 9000
high-quality, C-60 cassettes in seven hours . . .

That's fast!

(and that's standard)

The Speed-King Model 790 is the most accurate, reliable cassette loader in the world today.

It is easy to operate, with all operating controls being located in a single front panel. It is easy to keep in service, because the 790 has a computerized quality control system with a digital panel that identifies problems if they occur . . . And usually the operator can solve the problem.

Even the stacker/stamper is unique: it offers you two choices for labeling and packaging. You can have the loaded cassettes stacked one side up, or alternately.

Other King innovations range from the automatic self cleaning vacuum system — to a DC Servo motor braking system that requires no

adjusting — plus the most reliable cue detection system for maximum yield of prerecorded cassettes — and a vacuum counter wheel that counts each second allowing accuracy on blank lengths to \pm two seconds (4 inches).

But what's really innovative about the new Speed-King 790 is its price when measured in low cost per cassette, and savings in labor and floor space.

For further information on the Speed-King 790 cassette loader call or write:

King Instrument Corporation
80 Turnpike Road • Westboro, MA 01581 • USA
Phone: (617) 366-9141
Cable: KINGINST/Telex 94-8485



KING

World Leader in Tape Tailoring Systems[®]



Audio: Cassette, open reel (custom lengths)
 Creative Communications Inc. (sub of SMI), 923 N Valley Mills, Waco, Tex 76710. Tel (817) 776 6553
Audio: Cassette.
 Criterion, see Lafayette
 Crolyn, see E 1 du Pont
 Crusader, see Associated Audio
 Custom Cassette, see Industrial Audio-Film
 Custom Tape Dupl's Inc., 341 Hill Ave., Nashville, Tenn 37210 Tel (615) 256-1728. Pres.: L C Tant. Sales Mgr.: Mik + Tant
Audio: 8-tr (5-90), cassette (5-120)
 D A K Inds. Inc., 10845 Vanowen St., North Hollywood, Calif 91605 Tel (213) 984-1559 WATS: (800) 423-2636. Cable DAKENT Telex 651396
 Pres: Drew Alan Kaplan
Audio: Cassette (30.60.90)
 Dalsung America Inc., 51 E 42 St., New York, N.Y. 10017 Tel (212) 682-6045
Home office: Korea
Audio: 8-tr, cassette (30.60.90.120), open reel.
 Data Packaging Corp., 205 Broadway, Cambridge, Mass 02139 Tel (617) 868-6200 TWX (710) 320 0885. Pres: Otto Morningstar, Exec VP Greg Mathus, VP Mktg Jere Hill, Sales & Mktg Mgrs (audio-video): Gene Hull, (consumer) Peggy Harmatz.
Audio: 8 tr., cassette (standard, mini & micro—custom lengths) (SEE ADVERTISEMENT)
 Delta Magnetics Corp., 1901 McDonald Ave., Brooklyn, NY 11223 Tel (212) 627-6556. Telex 642271.
Branch: Edison, N.J., PO Box 494, Zip 08817 Tel (201) 287-8907
Audio: 8-tr. (40.64.80.100.120), cassette (60.90.120), open reel (7"—1200', 1800', 2400', 3600', 5"—1200', 1800')
 Disco Party Prod'ns, PO Box 905, South Bend, Ind 46624 Tel: (219) 234 9104, Owner & Sales Mgr: Jim Van Zant; Adv. Mgr: Drew Leach
Audio: "Private label" cassettes (90)
 Duotone Co Inc., PO Box 1168, Miami, Fla 33143 Tel (305) 665 1121
 Pres: Stephen Nester Sr., Sales & Adv Mgr: Stephen Gibson Nester.
Audio: 8 tr (35.70.80), cassette (30.60.90.120) (SEE ADVERTISEMENT)
 E 1 du Pont de Nemours & Co Inc., Magnetic Prods Div., Photo Prods Dept., du Pont Airport, Bldg. 1, Wilmington, Del 19898 Tel (302) 774 1000.
Audio: Cassette (60.90.120)
Video: 1/4" U-matic cassette (10 90), 1/2" EIAJ open reel (1250', 1800', 2400', 3600'), 1/2" Beta (60 180 min.) & VHS (60 360 min.) cassette
Brand name: Crolyn.
 Duratape, see Mallory
 E M C Corp., 180 E. Sixth St., St. Paul, Minn 55101 Tel (612) 227 7366
 Pres.: David E. Feinberg, VP Richard T. Stevans, Custom Sales Dir C Carter.
Audio: Cassette
 Electronic Homes Co., 1225 Broadway Main Floor, New York, N.Y. 10001 Tel: (212) 725-0290. Chm: George T. Saddler Sales Mgr: Elias Smyrnakis; Adv. Mgr: Joe Gary.
Audio: 8-tr., cassette, mini cassette, open reel
Brand names: Grandmaster, Mr. Cassette, Toyota

El Mar Plastics Inc., 821 E Artesia Blvd., Carson, Calif 90746 Tel (213) 327 3180 Cable ELMAR, TWX (910) 346 6940. Pres.: Allen Schor.
Audio: 8-tr (1-90) (SEE ADVERTISEMENT)
 Elvtrue Rec'g Music Pub'g Co & Music Makers Network of America Prod'ns, PO Box 3022, Wilmington, N C 28401 Tel: (919) 762-4001. Pres: John Lewis Jones, VP Betty F. Scavilla, Sales Mgr: James L. Wheeler, Adv. Mgr: J D Johnson
Audio: Cassette, open reel.
Brand name: Excellence
 Emerald, see Irish Magnetic
 Exactime, see SSK
 Excellence, see Elvtrue
 Ferrodyn, see Westape
 Fidelipac Corp., 109 Gaither Dr., Mount Laurel, N.J. 08057, Tel (609) 235 3511 TWX (710) 897-0254. Pres: Roger Thanhauser, Sales & Mktg Mgr.: Arthur Constantine.
Audio: Broadcast cartridge (all lengths)
 Finebilt Mfg Co Inc., 931 N. Citrus Ave., Hollywood, Calif. 90038 Tel: (213) 466 9511 Cable CODEXPRT. Telex: 698393 Pres: Alwin P. Schmid, VP & Tape Sales Mgr.: Joseph Bouzoglou; Sales Mgr.: Manuel Munoz.
Audio: 8 tr, cassette, open reel
 Fleetwood Communications Co Inc., 321 Revere St., Revere, Mass 02151 Tel (617) 289-6800. Pres.: V.P. Giarrusso; Gen. Mgr.: Raymond G. Samora; Sales Mgr.: Victor Mancini; Adv. Mgr.: Robin Samora
Audio: 8-tr, cassette, open reel.
Video: 1/4" U-matic cassette, 1/2" cassette
 4 Starr, see Le-Bo
 Fuji Photo Film USA Inc., Magnetic Tape Div., 350 Fifth Ave., 70th Fl., New York, N.Y. 10118 Tel: (212) 736 3335. Cable FUJIFILM, VP & Gen Mgr: John Dale; Nat'l Sales Mgr: John Birmingham, Adv. Mgr: Margaretha Bystrom
Audio: Cassette (46.60.90.120), "metal" tape cassette (46.60.90), broadcast (2200', 3400', 66600', 9600')
Video: 2" & 1" open reel, 1/4" cassette (10,15,20,30,60), 1/2" Beta cassette (15/30, 30/60, 45/90, 60/120, 180/270); 1/2" VHS cassette (30, 60, 90, 120)
 Gabriel Mfg Co Inc., 125 S Liberty Dr., Stony Point, N.Y. 10980, Tel (914) 942 0100 Pres: Ed Gabriel; VP Richard Gabriel, Gen. Mgr.: Vin Tullio; Adv. Mgr: Ellen Gabriel.
Audio: 8 tr (10-60), cassette (1 120)
 General Cassette Corp., 2311 N 35 Ave., Phoenix, Ariz 85009, Del: (602) 269-3111
Audio: Cassette
Video: 1/4" U-matic cassette, 1/2" Beta & VHS cassette
 Grand Master Magnetic Tape Co., 1225 Broadway, Main Floor, New York, N.Y. 10001 Tel: (212) 725-0290. Pres: George T. Saddler, Gen. Mgr.: John J. Zimmerman, Sales Mgr.: Elias Smyrnakis
Audio: 8-tr, cassette, open reel
 Greatapes, 123 S 12 St., Minneapolis, Minn 55403 Tel (612) 339 1651.
 Contacts: Dan Prepho, Diane Woelm
Audio: Cassette (1-120)
Video: 1/4" U-matic cassette (1-60)
Brand name: Apollo
 Heritage, see International Audio
 H 1 Ents. Inc., 9537 Telstar Ave., Suite 121, El Monte, Calif 91731, Tel (213) 444 9224

Audio: Cassette (1-120)
 High Fidelity Rec'g Inc., 1059 Porter, Wichita, Kan 67203. Tel (316) 262-6456.
Audio: Cassette.
 High Performance, see Audio Magnetics.
 Hilo, see Magnetic Mktg
 Hi-Q, see Cassette Servs
 Hitachi Sales Corp. of America, 401 W. Artesia Blvd., Compton, Calif. 90220 Tel: (213) 774-5151
Audio: Cassette (60.90)
 Horian Eng'g Inc., 600 Lake Emma Rd., Lake Mary, Fla. 32746 Tel (305) 323 2400. TWX (810) 856-0300. Pres: Richard C. Horian; Gen. Mgr.: James Horian, Sales Mgr.: Robert L. Horian; Adv. Mgr.: Sue Coleman
Audio: Cassette (60, 90).
Brand name: Calibron
 Infonics Inc., PO Box 1111, 238 Hwy. 212, Michigan City, Ind 46360. Tel (219) 879-3381. Telex: 233111.
Audio: 8-tr., cassette, open reel & broadcast (custom lengths)
Brand name: Phoenix (SEE ADVERTISEMENT)
 Industrial Audio-Film Servs Inc., 6228 Dakton St., Morton Grove, Ill. 60053 Tel (312) 965-8400
Audio: Cassette
Brand name: Custom Cassette
 Instart, see Pacific Int'l
 Intermagnetics Corp., 1311 Colorado Ave., Santa Monica, Calif. 90404, Tel (213) 393-9281 Pres: Terry C. T. Wherlock, VP Sales: Doug Rowlands; VP Communications: Bruce Weber
Audio: Cassette (30, 60, 90, 120)
 International Audio Inc., 2934 Malmo Dr., Arlington Heights, Ill 60005 Tel (312) 956 6030
Audio: 8-tr. (45.64.90), cassette (1-120), broadcast (10 sec -12 min.).
Video: 1/4" cassette (5,10,20,30,60)
Brand names: CLC, Heritage, International Audio, Videospot.
 Irish Magnetic Rec'g Tape (div of Morban Nat'l Sales Co. Inc.), 270-78 Newtown Rd., Plainview, N.Y. 11803 Tel (516) 293-5582 Cable MORHANEX. Telex: 96-7880. Pres: G. Zigman; Sales Mgr: George Krug; Adv Mgr: George Taub.
Audio: 8-tr., cassette, open reel.
Video: 1/4" EIAJ open reel, 1/4" U-matic cassette, 1/2" Beta & VHS cassette.
Brand names: Audio—Emerald, Irish, Video—Irish
 Itera Ltd., 1535 Broad St., North Bellmore, N.Y. 11710. Tel (516) 785-6480.
Audio: 8-tr (35 80), cassette (30-120)
 J d I, see Aard Vark
 J & I Cassette, 23947 Ventura Blvd., Calabasas, Calif 91302 Tel (213) 992 6200 Pres: John F. Brennan; Sales & Adv. Mgr: Ivy Brennan
Audio: Cassette, open reel (custom lengths)
Video: 1/4" U-matic cassette, 1/2" Beta & VHS cassette (custom lengths)
 J V C Inds. Co., 41 Slater Dr., Elmwood Park, N.J. 07407, Tel (201) 794-3900 Pres: M. Sakoda, Sales Mgr: Harry Elias; Adv. Mgr.: Cliff Shearer
Video: 1/4" cassette (15,20,30,60), 1/2" EIAJ open reel, 1/2" VHS cassette
 K A B A, see Kenneth A. Bacon
 Ken Del Prod'ns Inc., 111 Valley Rd., Richardson Park, Del 19804, Tel (302) 655-7488
Audio: Cassette (custom lengths)
 Kim-Pat Ents., PO Box 654, Hillwood Dr., Fayetteville, Tenn. 37334 Tel

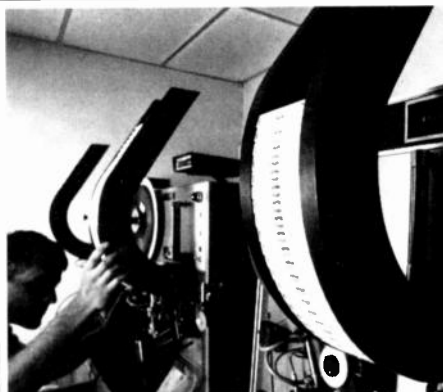

Professional Tape Duplicating Services

As Northern California's largest independent tape duplicator with latest state-of-the-art equipment, experienced service representatives and a convenient South Bay location, we are qualified to handle any cassette production job . . . quickly, accurately, and cost-effectively.

Let Westape help you develop a complete cassette program including recording studio services, graphic-arts production of labels, duplication and final custom packaging. Premium blank-loaded cassettes are available from Westape, too.

Call us at (408) 379-0870 for a brochure and price schedule. You just may find that Westape is precisely the audio cassette duplication service you've been looking for.

Westape

Audio Production / Tape Duplication
 503-C Vandell Way/Campbell, CA 95008
 (408) 379-0870

THE GREAT AMERICAN MANUFACTURER INTRODUCES THE GREAT AMERICAN SOUND.



LORAN. THE MOST ADVANCED AND REVOLUTIONARY AUDIO CASSETTE IN THE WORLD.

Loran™ Audio Cassettes have been selected by the Consumer Electronic Show Design and Engineering Exhibition as "one of the most innovative consumer electronics products of 1981".

Loranger is also supplier for some of the most prestigious companies in the world.

NORELCO BOXES:

- Manufactured and Assembled in U.S.A.
- Over 70 million produced annually
- Logo capability
- Proven on all Packaging Equipment

8 TRACK:

- Platform In or Out
- Custom Color
- Logo Capability
- Proven on all Winding Equipment

C-O CASSETTES:

- Available in Sonic Weld
- Black, White, and Gray Colors
- Automated Assembly
- Proven on all Winding Equipment

LORANGER

Contact John Belleau for more information:

Loranger Manufacturing Corp. 10-48 Clark Street, Warren, PA 16365 (814) 723-8600 Telex 91452

- (615) 433-2323/5661
Audio: 8-tr. (custom lengths).
 Myric Corp., 2111 E. 20 St., Tucson, Ariz. 85719. Tel: (602) 624-2408. Pres. & Sales Mgr.: Keyvan Mokhtarian.
Audio: 8-tr., cassette & open reel (custom lengths).
 L J S Corp., 1225 Broadway, Main Floor, New York, N.Y. 10001. Tel: (212) 725-0290. Pres.: George T. Saddler; Gen. Mgr.: H. Johnson; Sales Mgr.: Elias Smyrnakis.
Audio: 8-tr., cassette.
Brand name: Lear Jet Stereo-High Performancs.
 Lafayette Radio Electronics, 111 Jericho Tpk., Srosset, N.Y. 11791. Tel: (516) 921-7700.
Audio: 8-tr., cassette, open reel
Brand name: Criterion.
 Laser, see Swire Intermagnetics.
 Lear Jet Stereo, see LJS Corp.
 Le-Bo Prods. Co. Inc. (div. of Peerless VidTronics Corp.), 58-60 Grand Ave., Maspeth, N.Y. 11378. Tel: (212) 894-5155. Cable: LEBOPROUX. Telex: 424790. Pres.: P. Oayton
Audio: 8-tr. (40-90), cassette (60,90).
Brand name: A Starr (SEE ADVERTISEMENT)
 Lecture Brand, see Robins.
 Lecturercassette, see Pacific Int'l.
 Leda, see Continental Electronics.
 Lettercassette, see Pacific Int'l.
 Lion Rec'g Servs. Inc., 1905 Franklin Ave. NE, Washington, D.C. 20002. Tel: (202) 832-7883. Pres.: Harold H. Lion; Sales & Adv. Mgr.: Jim Fox.
Audio: Cassette, open reel (custom lengths).
 Little Warehouse Inc., 1820 W. Schaaf Rd., Cleveland, Ohio 44109. Tel: (216) 398-0022
Audio: 8-tr. (1-100), cassette (1-120), open reel.
Brand name: Audiotrack. (SEE ADVERTISEMENT)
 M J S, 2514 Seaboard Ave., San Jose, Calif. 95131. Tel: (408) 262-8793.
 Owner: Michael Steiner.
Audio: 8-tr. (46,60,90,100), cassette (46,62,92, 20), open reel (1800'), broadcast (1-22 min.)
 M M C, see Magnetic Mktg.
 Magnetic Mktg. Corp., 29 Valley View Terr., Wayne, N.J. 07470. Tel: (201) 694-3502. Telex: 138558. Pres.: Thomas J. Hofbauer; Sales Mgr.: Brendan F. Browne; Adv. Mgr.: M. Judge.
Audio: 8-tr., cassette (60,90,120), open reel, broadcast.
Brand name: Hilo, MMC. (SEE ADVERTISEMENT).
 Magnetix Corp., 770 W. Bay St., Winter Garden, Fla. 32787. Tel: (305) 656-4494. Pres.: John Lory.
Audio: 8-tr., cassette, open reel, broadcast.
Video: 1" open reel, 1/2" EIAJ open reel.
 Mallory Dist. Prods. Co., 3029 E. Washington Ave., Indianapolis, Ind. 46201. Tel: (317) 636-5353.
Audio: 8-tr. (45,90), cassette (30,45,60,90,120)
Brand name: Duratape.
 Mann Endless Cassette Inds. Corp., PO Box 1347, San Francisco, Calif. 94101. Tel: (415) 221-2000. Pres.: Donald Mann; Sales Mgr.: Robert Wells; Adv. Mgr.: Bob Kline.
Audio: Standard "Philips-type" endless cassettes. (10 sec. to 20 min. lengths)
 Marmac, see Arko & Mastro.
 Mastro Inds. Inc., 3040 Webster Ave., Bronx, N.Y. 10467. Tel: (212) 547-5600. Pres.: Mario Maccaferri.
Audio: 8-tr. (45,90), cassette (30,45,60,90,120).
Brand name: Marmac.
 Maxwell Corp. of America, 60 Oxford Dr., Moonachie, N.J. 07074. Tel: (201) 440-8020. Pres. T. Okada; Nat'l Sales Mgrs.: (consumer audio) M. Standley, (consumer video) D. Patricia, (professional/industrial prods) J. Ringwood; Adv. Mgr.: Chris Mangapane.
Audio: 8-tr. (46,60,90), cassette (46,60,90,120), open reel (1800').
Video: 1/2" EIAJ open reel (1200', 2400'), 1/4" U-matic cassette (30,60), 1/4" Beta cassette (L-250, L-500, L-750), 1/4" VHS cassette (30,60,90,120 min.)
 Media Int'l Inc., 425 N. Michigan, Chicago, Ill. 60611. Tel: (312) 467-5430. Pres.: Duane Lundeen; VP: Margaret Lundeen; Gen. Mgr.: Al Masters.
Audio: 8-tr., cassette, open reel, broadcast (custom lengths).
 Memorex Corp., Consumer Prods. Group, 1600 Memorex Dr., Santa Clara, Calif. 95052. Tel: (408) 987-1752. Telex: 334492 VP & Gen. Mgr.: John R. Humphreys; Mktg. Mgr.: Albert P. Pepper; Nat'l Sales Mgr.: Jack C. Battaglia.
 Branches: **Grande Grove, Calif.**, 12821 Western Ave., Suite L, Zip: 92641. Tel: (714) 891-2541—**Lombard, Ill.**, 335 Eisenhower Ln. S. Zip: 60148. Tel: (312) 620-3240—**Cincinnati, Ohio**, 8170 Corporate Park Dr. Zip: 45242. Tel: (513) 891-3380—**King of Prussia, Pa.**, 741 Fifth Ave. Zip: 19406. Tel: (215) 337-1050—**McLean, Va.**, 1970 Chain Bridge Rd. Zip: 22101. Tel: (703) 821-3300—**Lynwood, Wash.**, 4208-198 St. SW, Suite 110. Zip: 98036. Tel: (206) 774-6507.
Audio: 8-tr. (45,60,90), cassette (30,45,60,90,120).
Video: 1/4" VHS cassette (30,60,90,120); 1/4" Beta cassette (L-250, L-500, L-750).
 Memory Media Prods., 1417 E. Edinger Ave., Santa Ana, Calif. 92705. Tel: (714) 835-0317. Pres.: Edward A. Conti; Sales & Adv. Mgr.: Murray L. Shackelford.
Audio: Cassette, open reel.
Video: 1" open reel, 1/4" U-matic cassette, 1/4" EIAJ open reel, 1/4" Beta & VHS cassette.
Brand name: Spectrum.
 Metacom Inc., 1401-B W. River Rd. N., Minneapolis, Minn. 55411. Tel: (612) 588-2781. Pres.: James I. McCann; Sales Mgr.: Phillip T. Levin; Adv. Mgr.: Timothy DeWibbiss.
Audio: Cassette (33,60,63,90,93,120,123).
Brand name: Rebound.
 Miami Tape Inc., 8180 NW 103 St., Hialeah Gardens, Fla. 33015. Tel: (305) 558-9211.
Audio: 8-tr. (40,60,90), cassette (40,60,90,120).
 Michele Audio Corp., Box 566, Andrews Street Rd., Massena, N.Y. 13662. Tel: (315) 769-2448. Pres.: Ginette Cormier; Sales Mgr.: Harold Friedman; Mgr.: Jack Daniels.
Audio: 8-tr. (40,60,80,90), cassette (60,90,120).
Brand names: Michele, Michele's.
 Mr. Cassette Inds. Inc., 234 Fifth Ave., No. 304, New York, N.Y. 10001. Tel: (212) 689-9332. Bd. Chm.: George T. Saddler; Pres.: Joseph Gary; Gen. Mgr.: H. Johnson; Sales Mgr.: Elias Smyrnakis.
Audio: 8-tr., cassette.
 Mr. Cassette Video Corp., 234 Fifth Ave., No. 304, New York, N.Y. 10001. Tel: (212) 689-9332. Pres.: George T. Saddler; Gen. Mgr.: H. Johnson; Sales Mgr.: Elias Smyrnakis.
Video: Open reel, 1/4" U-matic cassette, 1/4" Beta & VHS cassette.
 Musical Tapes Inc., 770 W 27 St., Hialeah, Fla. 33010. Tel: (305) 885-9156. Pres.: Euseo C. Valdes.
Audio: 8-tr., cassette.
 Musiccassette Dupl'r's of Hawaii, PO Box 22190, Honolulu, Hawaii 96822. Tel: (808) 533-4165.
Audio: Cassette (30,45,60,90 & custom lengths), open reel (1200', 1800').
 Nagra Magnetic Rec'rs Inc., 19 W. 44 St., New York, N.Y. 10036. Tel: (212) 840-0999.
Audio: Open reel
 Nakamichi USA Corp., 1101 Colorado Ave., Santa Monica, Calif. 90401. Tel: (213) 451-5901. Telex: 652429. Pres.: E. Nakamichi; VP & Nat'l Sales Mgr.: Katsura Izumi.
Audio: Cassette (60,90).
 Nassau, see Telephone Dynamics.
 New Symphony, see Arko.
 North American Tape Dupl'g Co., 15414 Cabrillo Rd., Van Nuys, Calif. 91406. Tel: (213) 781-7650. VP & Gen. Mgr.: Norm Teler; Mktg. Dir.: Larry Stagnaro.
Audio: 8-tr., cassette (45,60,90, 20).
 Northwestern Inc., 1224 SW Broadway, Portland, Ore. 97205. Tel: (503) 262-0170. Pres.: Robert M. Lundahl; Sales Mgr.: Paul A. Buescher.
Audio: Cassette (custom loaded).
Brand names: Autek, Northwestern.
 Olympia, see Arko.
 P S C Prod'ns, 985 Waimanu St., Honolulu, Hawaii 96814. Tel: (808) 537-5695. Pres.: Michael Tanaka.
Audio: Cassette (30,45,60,90 & custom lengths), open reel (1200', 1800').
 Pacific Int'l Magnetics Inc., 185 Berry St., No. 3865, San Francisco, Calif. 94107. Tel: (415) 495-8830.
Home office: Canada.
Audio: Cassette, open reel.
Video: 1/2" Beta & VHS cassette.
Brand names: Audio-Analyst, Instart, Lecturercassette, Lettercassette, & "private" label; Video-Analyst.
 Panasonic Co. (div. of Matsushita Electronic Corp. of America), 1 Panasonic Way, Secaucus, N.J. 07094. Tel: (201) 348-7000.
 Branches: **Duluth, Ga.**, 2 Mecca Way, Zip: 30136. Tel: (404) 448-5683—**Elk Grove Village, Ill.**, 1098 Greenleaf Ave. Zip: 60007. Tel: (312) 593-0710—**Irving, Tex.**, 1825 Walnut Hills Ln. Zip: 75062. Tel: (214) 256-1388.
Audio: Cassette (60,90).
Video: 1/4" cassette, 1/4" VHS cassette, 1/4" EIAJ open reel, 1/4" EIAJ cartridge.
 Park, see Robins.
 Pentagon Inds. Inc., 4751 N. Olcott Ave., Chicago, Ill. 60656. Tel: (312) 867-9200. Pres.: Tom Horton; VP Mktg.: James R. Dow; Sales Mgr.: Joe Holtenkamp.
Audio: Cassette (10-120).
 Phoenix, see Infonics.
 Phylco Audio, 4709 Brooks St., Montclair, Calif. 91763. Tel: (714) 621-9561.
 Owner: Robert Deates; Gen. Mgr.: Rick Deates.
Audio: Cassette, open reel.
 Pro, see Memorex.
 The Pro, see Utopia Ultra-Sound.
 Programming Technologies Inc., 6666 N. Lincoln Ave., Lincolnwood, Ill. 60645. Tel: (312) 676-9400. Sales Mgr.: Steve Sorkin.
Audio: Cassette.
 Pro 1 Audio-Visual Inc., PO Box 33, Highland Park, Ill. 60035. Tel: (312) 433-4574. Pres.: R.L. Pink; VP: J. Pink; Sales Mgr.: M.M. Pink; Adv. Mgr.: D. D. Pink.
Audio: Cassette.
 Project 70 Audio Servs. Inc., 1127 Spring St. NW, Atlanta, Ga. 30309. Tel: (404) 875-7008.
Audio: Cassette (custom lengths for duplicators).
 Quantitape, see Sound Studios.
 R K O Tape Corp., 3 Fairfield Crescent, West Caldwell, N.J. 07006. Tel: (201) 575-8484. VP & Gen. Mgr.: Hugh Wallace.
Audio: Cassette (60,90).
Video: 1/2" Beta cassette (L-250, 500 & 750)
Brand names: Audio—Broadcast 1, Ultrachrome; Video—Colorchrome.
 Radio Shack (div. of Tandy Corp.), 1 Tandy Center, Fort Worth, Tex. 76086. Tel: (817) 390-3272.
Audio: 8-tr. (45,90), cassette (30,45,60,90,120), open reel (900', 1200', 1800', 2400', 3600').
Brand names: Realistic, Supertape.
 Bill Rase Prod'ns Inc., 955 Venture Court, Sacramento, Calif. 95825. Tel: (916) 929-9181. Owner & Pres.: Bill Rase.
Audio: Cassette (custom lengths).
 Raynor Sales Co. Inc., 2698 W. Pico Blvd., Los Angeles, Calif. 90006. Tel: (213) 377-3737. Pres. & Adv. Mgr.: Ray Abrams Sr.; Sales Mgr.: Ray Abrams Jr.
Audio: 8-tr.
 Realistic, see Radio Shack.
 Recorded Publ'ns Labs (div. of Recorded Publ'ns Mfg. Co. Inc.), 1100 State St., Camden, N.J. 08105. Tel: (609) 963-3000; Phila. (215) 922-8558. Pres.: David H. Goodman; Sales Mgr.: Pat Landon; Adv. Mgr.: Edward J. Goodman.
Audio: 8-tr., cassette, open reel (custom lengths).
 Recording Servs. of Western North Carolina Inc., 10 Penland St., Canton, N.C. 28716. Tel: (704) 648-6012. Pres.: J. Ted Evans; VP: Kay Evans.
Audio: 8-tr., cassette, (custom lengths).
 Recording Studios 55 (div. of 3 G Inds.), 5500 Troost, Kansas City, Mo. 64110. Tel: (816) 361-8455. Chief Eng.: Mike Green; Gen. Mgr.: Eugene Gold; Sales Mgr.: C. King.
Audio: 8-tr., cassette.
 Recorte Inc., 475 Ellis St., Mountain View, Calif. 94043. Tel: (415) 962-0220. TWX: (910) 379-5022. Pres.: Dr. Lester H. Lee; Sales Mgr.: Ron R. Troxell.
Audio: Cassette (custom lengths).
Video: 1/4" U-matic cassette (5-60 min.).
 Reclon Corp., 46-23 Crane St., Long Island City, N.Y. 11101. Tel: (212) 392-6442. Pres.: Robert Borhardt; Exec. VP: Peter Wish; VP Sales: George Calv.
Audio: 8-tr. (40,45,80,90,100), cassette (45,60,90,120), open reel (5" reel—600', 900', 1200', 1800', 7" reel—1200', 1800', 2400', 3600') (SEE ADVERTISEMENT)
 Remington, see American Tape.
 Respond Int'l, 1190 Miraloma Way, Suite Y, Sunnyvale, Calif. 94086. Tel: (408) 245-1351. Cable: RESPOND. TWX: (910) 339-9317. Pres.: Ronald L. Akun.
Audio: 8-tr. (45), cassette (45,60,90), open reel.
 Review Ents. (USA) Inc., 54 W. 39 St., New York, N.Y. 10018. Tel: (212) 840-2780. Contacts: Mike Thaler, Paul Smith.
Audio: Cassette.
Video: 1/2" Beta & VHS cassette. (SEE ADVERTISEMENT)
 Rezound, see Meta-Com.
 Rite Rec. Prod'ns Inc., 9745 Mangham Rd., Cincinnati, Ohio 45215. Tel: (513) 733-5533. Owner: Carl J. Burkhardt; Pres.: Philip M. Burkhardt; VP Prod'n: Lan A. Ackley; VP Graphics: Kenneth O. Keith; Sales Mgr.: Dan Burton.
Audio: 8-tr., cassette, open reel (custom lengths).
 Robins Inds. Corp., 75 Austin Blvd., Commack, N.Y. 11725. Tel: (516) 543-5200. Pres.: Herman Post. VP Sales: Stu Caine.
Audio: 8-tr. (40,64,80), cassette (60,90,120), mini-cassette (30).
Brand names: Brand 5, Lecture, Park.
 S S K Ents. Inc., 2488 Townsgate Rd., Westlake Village, Calif. 91361. Tel: (805) 889-1831.
Audio: 8-tr. (1-99).
Video: 1/2" Beta & VHS cassette (custom lengths)
Brand name: Exactime
 Scotch, see 3M.
 See Hear Inds. (div. of RJA Inc.), 120 W. 155 St., Gardena, Calif. 90248. Tel: (213) 516-0315. Pres.: Ray Jacobs; Sales Mgr.: Bernadette McNulty.
Audio: Cassette (30-120), open reel.
Video: 1/2" Beta cassette (L-250, L-500, L-750), 1/4" VHS cassette (120).
 Sentry Inds. Inc., 221 N. MacQuesten Pkwy., Mount Vernon, N.Y. 10550. Tel: (914) 664-2909. Cable: SENTINO. Pres.: Harold Rosen; VP: Barry Rosen.
Audio: 8-tr. (40,80,100), cassette (30,60,90,120), open reel (1200', 1800', 2400').
Video: 1/2" Beta cassette.
 ServSound Inc., 35 W. 45 St., New York, N.Y. 10036. Tel: (212) 921-0555. Pres.: Nat Levy; Gen & Sales Mgr.: Mike Shapiro.
Audio: Cassette.
 Shur Sound & Sight Inc., 3350 Scott Blvd., Bldg. No. 5, Santa Clara, Calif. 95051. Tel: (408) 727-7620. VP & Gen. Mgr.: Glenn Cardon; VP Sales: Lonnie Cory.
Audio: 8-tr., cassette, open reel (custom lengths).
 Sony Corp. of America, 9 W. 57 St., New York, N.Y. 10019. Tel: (212) 371-5800. Local branch: 47-47 Van Dam St., Long Island City 11101. Tel: 361-8600.
Audio: 2" x 1" open reel, 8-tr. (46,90), cassette (46,60,90,120), open reel.
Video: 2" quad, 1" open reel, 1/4" U-matic cassette, 1/4" EIAJ open reel, 1/4" Beta cassette
Brand names: Betamax, U-Matic.
 Soundmark Corp., 4950 Nome St., Unit C, Denver, Colo. 80239. Tel: (303) 371-3076.
Audio: Cassette, open reel (custom lengths).
 Sound/Pro Inds. Inc., 7529 Trasic Ave., Playa del Rey, Calif. 90291. Tel: (213) 822-0510. Pres.: Donald K.M. Rohgery; Nat'l Mktg. Dir.: Don Millard; Sales Mgr.: Tom Reed; Adv. Mgr.: Linda Newton.
Audio: 8-tr., cassette (custom lengths).
Video: 1/2" Beta cassette.
 Sound Studios, 230 N. Michigan Ave., Chicago, Ill. 60601. Tel: (312) 236-4814. Pres.: Jerry Markham; VP & Gen. Mgr.: Dan Tynus.
Audio: Cassette, open reel (custom lengths).
Brand name: Quantitape.
 Spectrum, see Memory Media.
 Spectrum Fidelity Magnetics, 49 Glenwood Ave., Lancaster, Pa. 17602. Tel: (717) 295-9275.
Audio: 8-tr. (1-60), cassette (1-90), open reel.
 Stanford Int'l, PD Box 609, 569 Laurel St., San Carlos, Calif. 94070. Tel: (415) 592-5958. Pres.: Fred Dobbs; Ops. Mgr.: Jan Dillard.
Audio: Cassette.
 Mark Starr Corp., 1609 64 St., Emeryville, Calif. 94608. Tel: (415) 658-0109. Pres.: Gary W. Wood.
Audio: Cassette (custom lengths).
 Studio Magnetics Co. Inc., 12 Long Island Ave., Holtville, N.Y. 11742. Pres.: George Chahane; VP: Craig Balaban.
Audio: Cassette (custom lengths), open reel
Video: 1/4" U-matic cassette (custom lengths).
Brand names: Studio Magnetics, Studio Master, Studio Pro, Studio Standard.
 Studio Master, see Studio Magnetics.
 Studio Pro, see Studio Magnetics.
 Studio Quality, see Ultra Specialty.
 Studio Standard, see Studio Magnetics.
 Super Avilyn, see TDK.
 Superscope Inc., 22459 Paul Revere Dr., Woodland Hills, Calif. 91364. Tel: (213) 998-9333. Pres.: Joseph Tushinsky; Mktg. & Sales Mgr.: Bill Rosen.
Audio: 8-tr. (45,90), cassette (62,92,122).
 Supertape, see Radio Shack.
 Swire Intermagnetics Co., 234 W. 146 St., Gardena, Calif. 90248. Tel: (213) 515-0494. Telex: 698238. Pres.: Irving Kutz; Exec. VP Sales & Mktg.: James W. Lantz; Gen. Mgr.: Leonard A. Heming.
Audio: 8-tr. (45,90), cassette (45,60,90,120).
Brand names: Laser, XL.
 T D K Electronics Corp., 755 Eastgate Blvd., Garden City, N.Y. 11530. Tel: (516) 746-0880. Telex: 144535. VP & Gen. Mgr.: Ken Kohda; Sales Mgr.: John Schattlin; Video Prod. Mgr.: Ed Passara.
 Branches: **Irving, Calif.**, 2102 E. Alton St. Zip: 92714. Tel: (714) 979-5811. WATS: (800) 854-0123. Div. Mgr.: Lee Adams—**Marietta, Ga.**, 4062 Kingston Court, Zip: 30067. Tel: (404) 952-4600. Reg'l Mgr.: George Casel—**Des Plaines, Ill.**, 1011 E. Touhy Ave., Suite 165. Zip: 60018. Tel: (312) 297-1341. WATS: (800) 323-5956. Reg'l Mgr.: Jack Pender.
Audio: 8-tr. (45,90), cassette (30,45,60,90,120,180) (labeled & unlabeled), open reel (1200', 1800', 3600').
Video: 1/4" VHS cassette (labeled & unlabeled).
Brand name: Super Avilyn. (SEE ADVERTISEMENT)
 T S I, see Tape Specialty.
 Tapecom Inc., 45 Jefferson St., Stamford, Conn. 06902. Tel: (203) 325-1541. TWX: (710) 474-3334. Pres.: Gene Tornatore; VP: Fred Luminoso.
Audio: 8-tr., cassette (custom lengths). (SEE ADVERTISEMENT)
 Tape Dupl'r's of Florida Inc., 785 W. 83 St., Hialeah, Fla. 33014. Tel: (305) 822-7585.
Audio: 8-tr., cassette, (private brands)
 Tape Head Co. Inc., 665 S. State St., Salt Lake City, Utah 84111. Tel: (801) 521-3839. Pres.: Stan Schubach; Sales Mgr.: D. Montoya.
Audio: Cassette.
Video: Open reel, 1/4" U-matic cassette, 1/4" Beta & VHS cassette.
Brand name: Teleposys.
 Tapemaker Sales Co. Inc., 48 Urban Ave., Westbury, N.Y. 11590. Tel: (516) 333-2700. Pres.: Arthur Brandwein; Office Mgr.: Karen Sitkoff.

This cassette
sells itself.
A million times a week.



**Top quality cassettes
...in quantity.**

At Data Packaging, we manufacture, assemble and ship over a million cassettes every week. Our high production capabilities here in the U.S. mean fast delivery to you... but we don't just make cassettes fast. We've shown the marketplace that Data Packaging quality is consistent, whether the order is 500 or 500,000. At Data Packaging, more than 35 years of experience in injection-molding technology works to your sales advantage.

Find out for yourself why Data Packaging quality sells over a million cassettes a week. Call the Audio/Video Division of Data Packaging for more information.

**Data Packaging packs
quality in every product**

- CO cassettes
(weld and screw type)
- mini-cassettes
- micro-cassettes
- 8-track cartridges
- custom tape winding
- storage units for cassettes,
8-tracks and records



**DATA PACKAGING
CORPORATION
AUDIO/VIDEO DIVISION**

205 Broadway, Cambridge, MA 02139
Corporate Offices: (617) 868-6200
National Sales Office: (317) 776-0066

Video: 1/2" Beta & VHS cassette
Brand name: Videotime
 Tapemasters Inc., PO Box 38651, Dallas, Tex 75238 Tel: (214) 349 0081
 Audio: 8 tr. (45,60,90), cassette (45,60,90) open reel
 Tape Servs. Inc., Cherry Hill Ind'l Park, I Keystone Ave., Cherry Hill, N.J. 08003, Tel: (609) 424 9450. Sales Mgr Michael T. Mulcahy
 Audio: "Private label" 8 tr. (custom lengths)
 Tape Specialty Inc., 13411 Satcoy St., North Hollywood, Calif 91605 Tel (213) 786-6111 Pres Steve Feldman, Gen Mgr Len Feldman, Chief Eng. Stu Feldman
 Audio: 8 tr., cassette (2-122)
 Video: 1/2" Beta cassette
Brand name: TSI
 Tapette Corp. 7221 Garden Grove Blvd., Sur e K. Garden Grove, Calif 92641 Tel (714) 638 7960.
 Audio: Cassette (1 94)
 Telephone Dynamics Corp. 2473 A Jerusalem Ave., North Bellmore, N.Y. 11710 Tel: (516) 221 9470
 Audio: Cassette, open reel (custom lengths)
Brand name: Nassau
 Telexprosys, see Tape Head
 Texas Rec. Mfg. Inc., 1422 W Poplar, San Antonio, Tex 78207 Tel (512) 733 6138. Pres. C. Foy Lee. Gen Mgr Jimmy Burton. Sales Mgr Jeanne Hill
 Audio: 8 tr.
 Thalco Audio Inc., 2 Dickens Ave. Dix Hills, N.Y. 11746 Tel (516) 667 1616 Chief Exec. Michael Thaler
 Audio: Cassette
 Video: 1/2" Beta & VHS cassette
 3 M Co. Audio/Video Prods Div., 3M Center, St Paul, Minn 55144 Tel (612) 733 1466 Corp VP D.E. Denham Div VP John Povolny, Mktg Dir W.J. Madden, Nat'l Sales Mgr J.L. Leon, Mktg Ops Mgr J.B. Hanks, Mkt. Communications Mgr D.J. Linehan
Branches: Anchorage, Alaska, 5531 Minnesota Dr. Zip 99502 Tel (907) 276 2363—Burbank, Calif., 126 W Elm Court, Zip 91502 Tel (213) 848 5534—Los Angeles, Calif., 6023 S Garfield Ave. Zip 90040 Tel (213) 726 6300—South San Francisco, Calif., 320 Shaw Rd. Zip 94080 Tel (415) 589 2663—Washington, D.C., 1101 15 St NW Zip 20005 Tel (202) 331 6900—Atlanta, Ga., 2860 Bankers Ind'l Dr. Zip 30360 Tel (404) 447 7000—Honolulu, Hawaii, PO Box 30048, 4443 Malaas St Zip 96818—Argo, Ill., 6850 S Harlem Ave Zip 60501 Tel (312) 496 6500—Needham Heights, Mass., 155 Fourth Ave Zip 02194 Tel (617) 449 0300—Farmington, Mich., 23923 Research R. Zip 48024 Tel (313) 477 5000—Eagan, Minn., PO Box 32111, St Paul 55133, 3130 Lexington Ave S Zip 55121 Tel (612) 733 3300—St. Louis, Mo., PO Box 510, 10725 Baur Blvd. Zip 63166 Tel (314) 997 8500—West Caldwell, N.J., PO Box 76, 15 Henderson Dr Zip 07006 Tel (201) 227 9100—Cincinnati, Ohio, 4835 Para Dr Zip 45237 Tel (513) 242 2313—Cleveland, Ohio, 12200 Brookpark Rd. Zip 44130 Tel (216) 267 1800—Philadelphia, Pa., 5698 Rising Sun Ave Zip 19120 Tel (215) 728 5300—Dallas, Tex., 2121 Santa Anna Ave Zip 75228 Tel (214) 324 8100—Seattle, Wash., Andover Ind'l Park, 100 Andover Park W Zip 98188 Tel (206) 244 7200
 Audio: 8 tr. (45,90), cassette (45,61,90,120) open reel (1200',1800',2400',3600'), broadcast
 Video: 2" quad, 1" helical, 1/2" U matic cassette (5,10,15,20,30,40,50,60), 1/2" VHS cassette (60,120 & 120-240 min), 1/2" Beta cassette (30,60 & 60-120 min)
Brand name: Scotch
 Trackmaster Inc., 1310 S Dixie Hwy W., Pompano Beach, Fla 33060 Tel (305) 943 2334 Pres Roy Parsons, Sec'y Trass Lupe Parsons
 Audio: 8 tr. cassette
 Tracs, see Audio Magnetics
 Trad Prods Inc., 1910 Ingersoll, Des Moines Iowa 50309 Tel (515) 243 2125 Pres Richard Trump, Sales Eng. Wilhelm Synhorst
 Audio: Cassette (5-94), open reel
 U T C, see Universal Tape
 Ultrachrome, see RKO
 Ultramagnetics, see Ultra Specialty
 Ultrasound, see Ultra Specialty
 Ultra Specialty Inc., 20700 S. Belshaw Ave., Carson, Calif 90746 Tel (213) 537 8850 Cable ULTRASPEC Telex 194566 Pres Don Wong, Pres UI Iraspec Int'l Gary Lyle
 Audio: Cassette
 Video: 1/2" U matic cassette; 1/2" Beta & VHS cassette
Brand names: Audio—Studio Quality, Ultrasound, Video—Ultramagnetics
 U matic, see Sony
 Universal Tape Corp Inc., 821 E Artesia Blvd., Carson, Calif 90746 Tel (213) 327 3203 Pres Edward D. Praeger
 Audio: 8 tr., cassette & open reel (custom lengths)
 Video: 1" open reel, 1/2" U matic cassette, 1/2" EIAJ open reel 1/2" EIAJ cartridge (custom lengths), 1/2" cassette
Brand name: A/V Paragon, UTC, Universal
 Utopia Ultra-Sound, 38-40 S First St., Newark, Ohio 43055 Tel (614) 345 9426, Pres Robert H. Kirk Jr., VP Con Shannon, Gen. Mgr Robert H. Kirk Sr., Sales Mgr Rose Shannon
 Audio: 8 tr., cassette
Brand name: The Pro
 V T C, see Phylco
 Videospot, see International Audio
 Videotime, see Tapemakers
 Warjo Promos, 145 W 55 St., Suite 2E New York N.Y. 10019 Tel (212) 245 7179
 Audio: Cassette (30,60,90), open reel
 X L, see Swire Intermagnetics
 Zenith Radio Corp., 1900 N Austin Ave., Chicago, Ill 60639 Tel (312) 745 2000
 Audio: 8 tr. (45,90), cassette (30,45,60,90,120)

Office Center, Hayden Ave Zip 02173 Tel (617) 890-5430—Secaucus, N.J., 24 Meadowlands Pkwy., Suite 300, Zip 07094 Tel (201) 330 1800—New York, N.Y., 1 Penn Plaza, Rm. 3527, Zip 10001 Tel (212) 279 2560—Dallas, Tex., 3003 LBJ Fwy., Suite 100, Zip 75234 Tel (214) 243 7315
 Audio: Cassette, broadcast (SEE ADVERTISEMENT)
 American Tape Corp., (div of VideoVision Inc.), 1116 Edgewater Ave., Ridge Top, N.J. 07657 Tel (201) 943 7860 VP Sales Gerry Gotthieb, VP Admin Kathryn Marani-Mendenhall, Plant Mgr F.A. Dermody
 Audio: 8 tr., cassette
Brand name: Remington
 Ampex Corp., 401 Broadway, Redwood City, Calif 94063 Tel (415) 367 2011 Telex: 348464 TWX (910) 378-5920
 Sales Offices: Birmingham, Ala. PO Box 845 Zip 35205 Tel (205) 823 6132—Glendale, Calif., 500 Rodier Dr. Zip 91201 Tel: (213) 240-5000—San Diego, Calif., PO Box 99847, Zip 92109 Tel: (714) 272 8337—Denver, Colo., 2124 S Birch Zip: 80222 Tel (303) 757-1829/6491—Orlando, Fla., PO Box 15008-B Zip 32808 Tel (305) 423-2962—Atlanta, Ga., 3135 Chestnut Dr., Suite 101, Zip 30340 Tel (404) 451 7112—Honolulu, Hawaii, PO Box 25367 Zip 96825 Tel: (808) 395 7144—Elk Grove Village, Ill., 2201 Lunt Ave. Zip 60007 Tel (312) 593 6000—Overland Park, Kan., PO Box 7282 Zip 66207 Tel (313) 383 1951—Florence, Ky., Elsdend Bldg. Zip 41042 Tel: (606) 371-1476—Baton Rouge, La., PO Box 14238 Zip 70808 Tel (504) 766-6270—Bethesda, Md., 10215 Fernwood Rd. Zip: 20034 Tel: (301) 530-8800—Framingham, Mass., PO Box 1020 Zip: 01701 Tel: (617) 877-8060—Minneapolis, Minn., 5200 W 73 St. Zip 55435 Tel: (612) 835-5560—Elkhorn, Neb., PO Box 553 Zip: 68022 Tel: (402) 556-3400—Hackensack, N.J., 65 Commerce Way Zip: 07601 Tel: (201) 489-7400—Williamstown, N.J., PO Box 513 Zip: 08094 Phila Tel: (215) 887 7650—Buffalo, N.Y., PO Box 4 Zip 14221 Tel: (716) 586-2580—Cleveland, Ohio, PO Box 134, Zip 44212 Tel: (216) 225-1262—Nashville, Tenn., PO Box 120532 Zip 37212 Tel: (615) 256-4836—Dallas, Tex., 1615 Prudential Dr. Zip 75235 Tel (214) 637-5100—Houston, Tex., 5300 Telephone R. Zip 77087 Tel (713) 928-3741—Salt Lake City, Utah, 2880 S. Main, Suite 111, Zip 84115 Tel: (801) 487-8181—Seattle, Wash., 628 Industry Dr. Bldg. 8, Zip 98188 Tel: (206) 575-0156
 Video: 2" quad, 1" open reel, 1/2" EIAJ open reel, 1/2" U matic cassette, 1/2" cassette
 Andol Audio Prods Inc., 4212 14 Ave., Brooklyn, N.Y. 11219 Tel (212) 435 7322 Pres. Anthony A. Manere, Sales Mgr Rocco Salvatore, Adv Mgr Domenico Salvatore
 Audio: 8 tr. cassette
 Audio Inds. Inc., Broad & Linden Aves., Ridgfield, N.J. 07657 Tel (201) 945-4545
 Audio: 8 tr. cassette (SEE ADVERTISEMENT)
 Audiotape, see Capitol
 B A S F Systems Corp., Crosby Dr., Bedford, Mass 01730 Tel (617) 271-4000 Professional Prods. Mgr: Robert L. Piselli.
Branches: Santa Monica, Calif., 1307 Colorado Ave. Zip 90404 Tel (213) 451 8781—Atlanta, Ga., 3300 Buckley Rd. Suite 403 Zip: 30341 Tel (404) 455 4145—Palatine, Ill., 800 E Northwest Hwy. Suite 220 Zip 60067 Tel (312) 934-4990—Ridgewood, N.J., 579 Franklin Trpk Zip 07450 Tel (201) 447 6904
 Audio: Cassette
 Burlington Audio Tapes Inc., 106 Mott St., Oceanside, N.Y. 11572 Tel (516) 678 4414 Pres. Ruth Schwartz, VP Rudy Schwartz
 Audio: 8 tr., cassette, open reel, broadcast
 Video: 1" open reel, 1" cartridge, 1/2" cassette, 1/2" EIAJ open reel, 1/2" EIAJ cartridge
Brand name: Olimpic (SEE ADVERTISEMENT)
 Capitol Magnetic Prods. (div of Capitol Recs. Inc.), 6902 Sunset Blvd., Hollywood, Calif 90028 Tel (213) 461 2701 Pres. Edward C. Khoury, VP Mktg Adm. John Apostis, VP Domestic Sales Larry Hockemeyer, VP Int'l Sales Bud Jackson, Mktg Coord. Natalie Goss
 Sales offices: Atlanta, Ga., 1670 NE Freeway Access Rd. Zip 30329 Tel (404) 321-5441—Miles, Ill., 6401 Gross Point Rd Zip 60648 Tel (312) 775 7101—New York, N.Y., 1370 Ave of the Americas Zip 10019 Tel (212) 757 7470
 Int'l branch: Singapore
 Audio: 8 tr. cassette
Brand name: Audiotape
 Certon Corp., 1701 S State College Blvd., Anaheim, Calif 92806 Tel (714) 634 4280, WATS (800) 854 3943 TWX (910) 593 1611 Pres Edwin Gamson, VP Mktg Ray Allen, Adv Mgr Hal Wilde
 Audio: 8 tr., cassette (SEE ADVERTISEMENT)
 Columbia Magnetics (div. of CBS Inc.), 15 Great Pasture Rd., Danbury, Conn. 06810 Tel (203) 744-3555 NYC (212) 226 2120
Branch: Los Angeles, Calif., 1930 Century Park W. Zip 90067 Tel (213) 556 4836
 Audio: 8 tr., cassette, open reel
 Cory Sound Co., 310 Townsend, San Francisco, Calif 94107 Tel (415) 543-0440 Contact Phillip Markinson
 Audio: Cassette, open reel
 Crolyn, see E I du Pont
 Custom Duplin Inc., 6330 36 Arizona Circle, Los Angeles, Calif 90045 Tel (213) 670 5575 Pres Leonard Gross, Sales Mgr Bob Hwely, Prod'n Jeni Gonzales
 Audio: 2" open reel, 1" open reel, 8 tr., cassette, 1/2" open reel
 Video: 1/2" Beta & VHS cassette
 D A K Inds Inc., 10845 Vanowen St., North Hollywood, Calif 91605 Tel (213) 984 1559 WATS (800) 423-2636 Cable DAKENT Telex 651396 Pres Drew Alan Kaplan
 Audio: Cassette
 Delta Magnetics Corp 1901 McDonald Ave., Brooklyn, N.Y. 11223 Tel (212) 627 6556 Telex 642271
Branches: Edison, N.J. PO Box 494 Zip 08817 Tel (201) 287 8907
 Audio: 8 tr., cassette, open reel
 Donnak Inds., PO Box 422, Ridgfield, N.J. 07657 Tel (201) 945 6820
 Audio: Cassette (SEE ADVERTISEMENT)
 E I du Pont de Nemours & Co. Inc., Magnetic Prods Div., Photo Prods Dept., du Pont Airport, Bldg 1, Wilmington, Del 19898 Tel (302) 774 1000
 Audio: Cassette
Brand name: Crolyn
 Electronic Homes Co., 1225 Broadway, Main Floor, New York, N.Y. 10001 Tel (212) 725-0290. Bd Chm George T. Saddler, Sales Mgr Elias Smyrnakis, Adv Mgr Joe Gary
 Audio: 8 tr., cassette, open reel
Brand name: Toyota
 El Mar Plastics Inc., 821 E Artesia Blvd., Carson, Calif 90746 Tel (213) 237 3180 Cable ELMAR TWX (910) 346 6940 Pres Allen Schor
 Audio: 8 tr. (SEE ADVERTISEMENT)

Finebilt Mfg Co Inc., 931 N Citrus Ave., Hollywood, Calif. 90038 Tel (213) 466-9511. Pres., Alwin P. Schmid, VP & Tape Sales Mgr: Joseph Bouzaglou, Sales Mgr: Manuel Munoz
 Audio: Cassette, open reel
 Video: 1/2" U matic cassette, 1/2" EIAJ cartridge
 Gabriel Mfg Co Inc., 125 S Liberty Dr., Stony Point, N.Y. 10980 Tel (914) 942-0100. Pres Ed Gabriel; VP Richard Gabriel, Gen Mgr Vin Tulio, Adv Mgr Ellen Gabriel
 Audio: Cassette
 Greencorp Magnetics Inc., 860 E Walnut, Carson, Calif 90746 Tel (213) 538-3247 Contact Larry Anthony
Home office: Australia
 Audio: Cassette
 H D P, see Magnetic Media
 Hilo, see Magnetic Media
 Infonics Inc., PO Box 1111, 238 Hwy 212, Michigan City, Ind 46360 Tel (219) 879-3381
 Audio: Cassette (SEE ADVERTISEMENT)
 Loranger Mfg Corp., Entertainment Prods Div., 10 48 Clark St., Warren, Pa 16365 Tel (814) 723-8600 VP Robert Loranger.
 Audio: Cassette (SEE ADVERTISEMENT)
 M M C, see Magnetic Mktg
 Magnetic Mktg. Corp., 29 Valley View Terr., Wayne, N.J. 07470 Tel (201) 694-3502 Telex 138558. Pres Thomas J Hofbauer, Sales Mgr Ben dan F. Browne, Adv. Mgr. M. Judge
 Audio: 8 tr., cassette, open reel, broadcast
 Video: 2", 1", 1/2", 1/4" Beta & VHS, 1/2" Technicolor
Brand names: Hilo, MMC (SEE ADVERTISEMENT)
 Magnetic Media Corp., 500 Eastern Pkwy., Farmingdale, N.Y. 11735 Tel (516) 293 1010 Cable MAGMEDIA Telex 143223 Pres Aaron Was serstrom, Gen. Mgr.: John Cristiano, Sales Mgr.: Paul Mastroianni
 Audio: Cassette
Brand names: TM-100, HOP (SEE ADVERTISEMENT)
 Magnetix Corp., 770 W Bay St., Winter Garden, Fla 32787 Tel (305) 656 494 Pres John Lory
 Audio: Cassette
 Media Int'l Inc., 425 N Michigan, Chicago, Ill 60611 Tel (312) 467 5430 Pres Duane Lundeen, VP Margaret Lundeen, Gen Mgr Al Masters
 Audio: 8 tr., cassette, open reel
 Miami Tape Inc., 8180 NW 103 St., Hialeah Gardens, Fla 33015 Tel (305) 558-9211
 Audio: 8 tr., cassette
 Olimpic, see Burlington
 Pacific Int'l Magnetics Inc., 185 Berry St., No. 3865, San Francisco, Calif 94107 Tel (415) 495-8830
Home office: Canada
 Audio: Cassette, open reel
 Video: 1/2" Beta & VHS cassette
 R J A, see See Hear Ellis
 Recortec Inc., 475 Ellis St., Mountain View, Calif. 94043 Tel (415) 962-0220 TWX (910) 379 5022 Pres. Dr Lester H Lee, Sales Mgr Ron R Troxel
 Audio: Cassette
 Remington, see American Tape
 Respond Int'l, 1190 Miraloma Way, Suite Y, Sunnyvale, Calif 94086 Tel (408) 245 1351 Cable RESPOND TWX (910) 339 9317 Pres Ronald L. Akin
 Audio: 8 tr., cassette, open reel
 Review Ent's (USA) Inc., 54 W 39 St., New York, N.Y. 10018 Tel (212) 840-2780 Contacts Mike Thaler, Paul Smith
 Audio: Cassette (SEE ADVERTISEMENT)
 See Hear Inds., 120 W 55 St., Gardena, Calif 90248 Tel (213) 516 0315 Pres Ray Jacobs, Sales Mgr. Ray Johnson
 Audio: Cassette, open reel
Brand name: RJA
 Sentry Inds Inc., 221 N MacQuesten Pkwy., Mount Vernon, N.Y. 10550 Tel (914) 664 2909 Cable SENTIND Pres Harold Rosen, VP Barry Rosen
 Audio: 8 tr., cassette, open reel
 Video: 1/2" Beta cassette
 Soundmark Corp., 4950 Nome St., Unit C, Denver, Colo 80239 Tel (303) 371 3076
 Audio: Cassette, open reel
 Studio Quality, see Ultra Specialty
 Super Avilyn, see IDK
 T O K Electronics Corp., 755 Eastgate Blvd., Garden City, N.Y. 11530 Tel (516) 746-0880 Telex 144535 VP & Gen Mgr Ken Kohda; Sales Mgr John Schattin, Video Prod Mgr Ed Pessara
Branches: Irvine, Calif., 2102 E Alton St Zip 92714 Tel (714) 979 5811 WATS (800) 854 0123 Div Mgr Lee Adams—Marietta, Ga., 4062 Kingston Court Zip: 30067 Tel (404) 952-4600, Reg'l Mgr George Castle—Des Plaines, Ill., 1011 E. Touhy Ave., Suite 165 Zip 60018 Tel (312) 297-1341 WATS (800) 323-5956, Reg'l Mgr Jack Pender.
 Audio: Cassette (pancakes)
 Video: 1/2" VHS cassette
Brand name: Super Avilyn (SEE ADVERTISEMENT)
 T M-100, see Magnetic Media
 Tapemakers Sales Co., 48 Urban Ave., Westbury, N.Y. 11590 Tel (516) 333 2700 Pres Arthur Brandwein, Office Mgr: Karln Sirkoff
 Video: 1/2" U matic cassette, 1/2" Beta & VHS cassette
 3 M Co. Audio/Video Prods. Div., 3M Center, St Paul, Minn 55144 Tel (612) 733-1466 Corp VP D.E. Denham, Div VP J.E. Povolny, Mktg Dir W.J. Madden, Nat'l Sales Mgr J.L. Leon, Mktg Ops Mgr J.B. Hanks, Mkt. Communications Mgr D.J. Linehan
Branches: Anchorage, Alaska, 5531 Minnesota Dr. Zip 99502 Tel (907) 276 2363—Burbank, Calif., 126 W Elm Court, Zip 91502 Tel (213) 848 5534—Los Angeles, Calif., 6023 S Garfield Ave. Zip 90040 Tel (213) 726 6300—South San Francisco, Calif., 320 Shaw Rd. Zip 94080 Tel (415) 589 2663—Washington, D.C., 1101 15 St NW Zip 20005 Tel (202) 331-6900—Atlanta, Ga., 2860 Bankers Ind'l Dr. Zip 30360 Tel (404) 447 7000—Honolulu, Hawaii, PO Box 30048, 4443 Malaas St Zip 96818—Argo, Ill., 6850 S Harlem Ave Zip 60501 Tel (312) 496 6500—Needham Heights, Mass., 155 Fourth Ave Zip 02194 Tel (617) 449 0300—Farmington, Mich., 23923 Research R. Zip 48024 Tel (313) 477 5000—Eagan, Minn., PO Box 32111, St Paul 55133, 3130 Lexington Ave S Zip 55121 Tel (612) 733 3300—St. Louis, Mo., PO Box 510, 10725 Baur Blvd. Zip 63166 Tel (314) 997 8500—West Caldwell, N.J., PO Box 76, 15 Henderson Dr Zip 07006 Tel (201) 227 9100—Cincinnati, Ohio, 4835 Para Dr Zip 45237 Tel (513) 242 2313—Cleveland, Ohio, 12200 Brookpark Rd. Zip 44130 Tel (216) 267 1800—Philadelphia, Pa., 5698 Rising Sun Ave Zip 19120 Tel (215) 728-5300—Dallas, Tex., 2121 Santa Anna Ave Zip 75228 Tel (214) 324 8100—Seattle, Wash., Andover Ind'l Park, 100 Andover Park W Zip 98188 Tel (206) 244 7200

TAPE, BULK RAW, MANUFACTURERS

A/V Paragon, see Universal Tape
 Agfa Gevaert Inc., 275 North St., Teterboro, N.J. 07608 Tel (201) 288 4100
Sales offices: Burlingame, Calif., 1633 Old Bayshore Hwy Zip 94010 Tel (415) 692 2432—Los Angeles, Calif., 1801 Century Park E Zip 90067 Tel (213) 552 9622—Atlanta, Ga., 380 Interstate N. Suite 200 Zip 30339 Tel (404) 955 4326—Oak Brook, Ill., 2803 Butterfield Rd. Suite 200 Zip 60521 Tel (312) 242 1915—Lexington, Mass., Lexington



TDK brings two new standards to open reel.

Raising sound standards is nothing new to TDK. For years, TDK cassettes have set reference standards. Now TDK offers two breakthroughs in open reel—GX and LX. Both are bound to cause quite a stir among your open reel customers. Like all TDK products, they're formulated for the finest audio reproduction and fast turnaround.

TDK GX is perfect for the critical demands of music mastering. Equally impressive LX will please the most discriminating audiophile. The way they sell will certainly please you. Their high visibility packaging lets customers know that GX and LX aren't just another couple of open reel tapes. They're TDK. It means their outstanding

formulations are going to get the most out of open reel. All the full, rich sound. And a smooth, reliable performance.

GX is available in four different lengths, all with a special graphite and carbon backcoating that prevents static and reduces modulation noise while providing stable winding. LX is available in six configurations, four available with backcoating for semi-professional and audiophile use.

If you think open reel has gone as far as it can go, introduce your most demanding customers to TDK GX and LX. You could open up a whole new standard for their recording. And a whole new area of sales.

 **TDK**
MUSIC LIVES ON TDK

Audio: 8-tr., cassette, open reel
Video: 2" & 1" open reel, 1/4" U-matic cassette, 1/4" EIAJ open reel, 1/2" Beta & VHS cassette
Brand name: Scotch
 Toyota, see Electronic Homes
 U T C, see Universal Tape Corp
 Ultramagnetics, see Ultra Specialty
 Ultra Specialty Inc., 20700 S. Belshaw Ave., Carson, Calif. 90746. Tel (213) 537-8850. Cable: ULTRASPEC Telex 194566 Pres Don Wong, Pres UI traspec Int'l. Gary Lyle.
Audio: 8-tr., cassette.
Video: 1/4" U-matic (10,000'), 1/2" Beta & VHS; cassette (5,000')
Brand names: Audio-Studio Quality, Ultrasound, Video-Ultramagnetics
 Universal Tape Corp. Inc., 281 E Artesia Blvd., Carson, Calif. 90746 Tel (213) 327-3203. Pres. Edward O Praeger.

Audio: 8 tr., cassette, open reel
Video: 1" open reel, 1/4" U-matic cassette, 1/4" EIAJ open reel, 1/2" EIAJ cartridge, 1/2" cassette
Brand name: A/V Paragon, UTC, Universal

TAPE DUPLICATING & PROCESSING EQUIPMENT MANUFACTURERS/ IMPORTERS

A V A (Audio Video Automation) 150 D Knickerbocker Ave., Bohemia, NY 11716 Tel (516) 567 5156 Pres R Zofly, Mktg.: A Novotny

MISSION PLASTICS SOUTH, INC.
THE ONLY MANUFACTURER IN THE SOUTHEAST

- C-0 Cassettes
- Cassette Components
- Eight-Track Cartridges
- Norelco Boxes



Call or Write

Sales Office:
 341 Hill Ave.
 Nashville, Tenn. 37210
 (615) 244-5668
 Clif Tant

Mfg. Facility
 74 Mission Dr.
 Jackson, TN 38301
 (901) 423-0810

Audio & Video: Cassette loaders
 Accurate Sound Int'l Inc., 114 Fifth Ave., Redwood City, Calif 94063 Tel (415) 365-2843
Audio: Tape duplicators
Brand name: Asco
 Air Bin, see Investment Technology
 Alpha, see International Audio
 Asco, see Accurate Sound
 Associated Audio Servs. Inc., 181 Westchester Ave., Port Chester, N.Y. 10573 Tel (914) 937-5129. Pres D. Richard Kraus, VP Allan Johnson
Product: 8 tr winding machines
Brand name: Dupliquip Auto 8
 Audio Inc., 219 Crossen Ave., Elk Grove Village, Ill 60007 Tel (312) 640-1030 Pres W R Hinkle, VP Sales Mitt Sherman; VP Mlg Norman De letzke
Audio: Cassette loaders, cassette rewinders & timers, cartridge winders
Video: Loaders & unloaders (1/2", 1/4"), splicers
 Audiodyne Co., PO Box 825, San Jose, Calif 95106 Tel: (408) 287 3520
 Owner & Pres Louis R. Charamonte
Audio: 8 tr., cassette & open reel winders, 8 tr. cartridge splice finder
 AudioGraphics (div of Herald Publ'g House), 3225 S Noland Rd., Independence, Mo 64055 Tel (816) 252 5010
Product: Cassette duplicators & loaders
 Audiomatic Corp., 1290 Ave of the Americas, New York, N.Y. 10019 Tel (212) 582 4870 Telex 126419 Pres Milton B. Gelfand, VP Customer Servs. Marilyn J. Best, Adv Mgr J P Lohman Local branch: Audio Matrix Inc., 915 Westchester Ave., Bronx 10459 Tel 589 3500
Audio: Cassette duplicators
Brand name: Electro Sound (Distributor) (SEE ADVERTISEMENT)
 Audio/Tek Inc., 502 D Vandell Way, Campbell, Calif 95008 Tel (408) 378 5586 Pres Robert W Kratt
Audio: 8 tr., cassette & open reel duplicators, cassette loaders, duplicator master recorders
 Auto Tec, see United Research
 Bazy Electronics Corp., 39 N Rose Mount Clemens, Mich 48043 Tel (313) 463 2592
Audio: Cassette rewinders, in-cartridge duplicators
 Beaucart, see UMC
 Cassettelead, see Shape
 Cetec Gauss (div of Cetec Corp.), 9130 Glenoaks Blvd., Sun Valley, Calif 91352 Tel (213) 875 1900 Pres W Murt Fuji
Audio: High speed tape duplicating systems & quality control reproducers
Brand name: Gauss (SEE ADVERTISEMENT)
 Duplicator II, see Recorderx
 Dupliquip Auto 8, see Associated Audio
 ElectroSound Inc. (sub of ElectroSound Group Inc.), 160 San Gabriel Dr., Sunnyvale, Calif. 94086 Tel (408) 245 6600 Pres Raymond J. Schaaf
Branch: Omaha, Neb., Electro Sound Midwest, 3528 Dodge St. Zip 68131 Tel (402) 344 4114, Mktg. Mgr Jim Cook, (Sales office)
Audio: Duplicators, QC reproducers, automatic 8 tr & cassette winders, loaders, splicers & recorder/reproducers
 Ferroxcube Corp., 5083 Kings Hwy., Saugerties, N.Y. 12477 Tel (914) 246 2811
Audio: 8 tr & cassette duplicating head assemblies
 Finebilt Mfg Co Inc., 931 N Citrus Ave., Hollywood, Calif 90038 Tel (213) 466 9511 Pres Alwin P. Schmid, VP Joseph Bouzaglou, Sales Mgr Manuel Munoz
Audio: Magnetic tape coaters & slitters, test equip
 Gauss, see Cetec
 Gotham Audio Corp., 741 Washington St., New York, N.Y. 10014 Tel (212) 741 7411 Pres. Stephen F. Temmer, Sales Mgr Russell O Hamm
Audio: Duplicators, cassette tape winders
Brand name: Magnetophon, Teletunken
 I E M, see International Electro Magnetics
 I T I, see Investment Technology
 Infonics Inc., PO Box 1111, 238 Hwy 212, Michigan City, Ind 46360 Tel (219) 879 3381 Telex 233111
Audio: Duplicators
Brand names: Infonics, Phoenix (SEE ADVERTISEMENT)
 Intermagnetics Corp., 1311 Colorado Ave., Santa Monica, Calif 90404. Tel (213) 393 9281 Pres Terry C T. Wherlock, VP Sales: Doug Rowlands, VP Communications Bruce Weber
Audio & video: Coaters, slitters, calendars, assembly & test equip

MAGNETIC TAPE PROCESSING EQUIPMENT

Passavant, the quality name in magnetic tape processing equipment for the past 25 years, manufactures a complete line of coating and slitting machinery. Passavant equipment is sold and serviced worldwide and used by many of the worlds leading magnetic tape manufacturers. We provide complete package magnetic tape manufacturing facilities to meet your production needs.

- Unwinds
- Film Conditioners
- Film Cleaners & Washers
- Gravure & Reverse Roll Coaters
- Smoothing & Orientation Equipment
- Floater Dryers
- Cure Ovens
- Calender
- Rewinds
- Slitting Machines

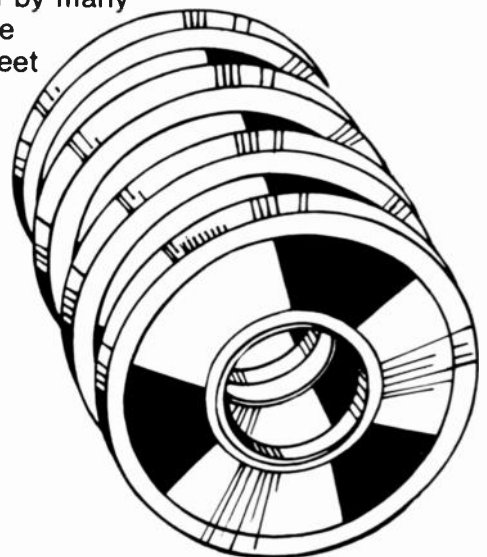

PASSAVANT

PASSAVANT CORPORATION
 P.O. BOX 2503, BIRMINGHAM, ALA. U.S.A. 35201
 (205) 853-6290



Don't take our word... Take our free samples.

And you'll be convinced that Magnetic Media has what you've always wanted in cassette tapes and cassette shells.

- Consistent quality duplicating tapes for music and voice.
- Precision 5-screw cassettes in two designs.
- Servicing all fields: Music, Religion, Education, others.
- Fast delivery from our distribution centers in New York, Dallas, Los Angeles.

You will never know how good Magnetic Media tapes and cassette shells are until you load them on your equipment.

We are so confident that you will be pleased, we will provide you free samples of our tapes and cassette shells.

Request your samples today. On your business letterhead. Or call (516) 293-1010.



MAGNETIC MEDIA

Magnetic Media Corporation, 500 Eastern Parkway, Farmingdale, NY 11735 • (516) 293-1010

International Audio Inc., 2934 Malmo Dr., Arlington Heights, Ill. 60005. Tel. (312) 956-6030
Audio: In-cassette duplicators
Brand name: Alpha
 International Electro-Magnetics Inc., 350 N. Eric Dr., Palatine, Ill. 60067
 Tel. (312) 358-4622. Bd. Chm. John Pretto, Sales Mgr. Tony Pretto
Audio: Heads, tape transports
Brand name: IEM
 Investment Technology Inc., 1940 124 Ave. NE, Bellevue, Wash. 98005. Tel. (206) 454-7720
Audio: Air-driven loop bin
Brand names: Air Bin, ITI
 King Instrument Corp., 80 Turnpike Rd., Westboro, Mass. 01581. Tel. (617) 366-9141. Pres. William H. Anderson, VP Sales. William E. Chne.
Audio: Automatic & semi-automatic cassette loaders
Video: 1/2" (Beta & VHS) cassette loaders (SEE ADVERTISEMENT) M M C, se: Magnetic Mktg.
 M Q C, see Magnetic Mktg.
 M T D, see Magnetic Mktg.
 M T I Corp., 124 Montclair Ave., Montclair, N.J. 07042. Tel. (201) 744-2220
Cable: MTICDRP. Pres. Timothy A. Cole
Audio: High-speed duplicators & loaders
Brand names: System III, Tapematic. (SEE ADVERTISEMENT)
 Magnerecord, see Telex
 Magnifax Int'l Inc., Rt. 1, Rogers, Ark. 72756. Tel. (501) 925-1818. Telex 536433

Product: Tape Duplicating Systems. (SEE ADVERTISEMENT)
 Magnetic Mktg. Corp., 29 Valley View Terr., Wayne, N.J. 07470. Tel. (201) 694-3502. Telex. 138558. Pres.: Thomas J. Hofbauer, Sales Mgr.: Brendan F. Browne, Adv. Mgr.: M. Judge
Audio: In-cassette duplicators & loaders, pancake duplicator, degaussers
Brand names: MMC, MQC, M'D. (SEE ADVERTISEMENT)
 Magnetophon, see Gotham Audio
 Mini Max, see Recordex Corp.
 Diari Corp., 2 Davis Dr., Belmont, Calif. 94002. Tel. (415) 592-8311. Pres. Jack Soma, Mktg. Mgr.: Steven Krampf, Nat'l Sales Mgr.: Michael Bernard, Field Sales Eng. (Industrial Prods.): Michael Pappas
Audio: Open reel mastering, in-cassette mastering/production, pancake & loop bin duplicators
 P C E, see Professional Cassette Equip
 Passavant Corp., PO Box 2503, Birmingham, Ala. 35201. Tel. (205) 853-6290. Telex: 782118. TWX: (810) 733-5547. Adv. Dir.: Tom Roberts III
Audio & Video: Unwinders, conditioning units, coaters, dryers, calendars, rewinders, slitters. (SEE ADVERTISEMENT)
 Pentagon Inds Inc., 4751 N. Olcott Ave., Chicago, Ill. 60656. Tel. (312) 867-9200. Pres. Tom Horton, VP Mktg.: James Dow, Sales Mgr.: Joe Hollenkamp
Audio: In-cassette, reel-to-reel & reel-to-cassette duplicators
 B. F. Perkins (div. of Roehlen Inds.), GPD Box 366, 939 Chicopee St., Chicopee, Mass. 01021. Tel. (413) 536-1311. Telex 955342
Audio & video: Magnetic tape calendars, filled & nylon shell rolls, cooling rolls, unwinds, rewinds, splice jumping & edge guiding

Phoenix, see Infonics
 Pickering Audio-Infonics, 535 N. Alexandria, No. 104, Los Angeles, Calif. 90004. Tel. (213) 669-8243. Owner: Edward F. Pickering. (Exported by Singer Prods. Co. Inc.)
Audio: Tape duplicating system & tape winders for all formats
 Professional Cassette Equip., 2909 Ocean Park Blvd., Santa Monica, Calif. 90405. Tel. (213) 450-4499. Owner: G.D. Theodos, Gen. Mgr.: D. Cape-ner
Audio: Cassette loaders
Brand name: PCE
 Recordex Corp., 1935 Delk Ind'l Blvd., Marietta, Ga. 30067. Tel. (404) 955-7368. Pres. Tom Allen, VP Dgms: Dave Nally; VP Eng'g: Wayne Powers; VP Sales & Mktg.: Wayne Cook
Audio: Cassette & reel to cassette duplicators, in-cassette duplicating systems
Brand names: Duplicator II, Mini Max, Super Pro H
 Recortec Inc., 475 Ellis St., Mountain View, Calif. 94043. Tel. (415) 962-0220. TWX: (910) 379-5022. Pres.: Dr. Lester H. Lee; Sales Mgr.: Ron R. Troxell
Audio: Automated cassette duplicators & loaders
Video: 1/2" & 1/4" automated videocassette loaders. (SEE AD)
 Rockford Automation, 3381 Forest View Rd., Rockford, Ill. 61109. Tel. (815) 398-7601
Audio & Video: Cassette automatic assembly systems
 S S K Ent's Inc., 2488 Townsgate Rd., Westlake Village, Calif. 91361. Tel. (805) 889-1831
Audio: Reel to cassette, reel to hub & continuous loop to pancake for 8-tr. See Hear Inds. (div. of RJA Inc.), 120 W. 155 St., Gardena, Calif. 90248. Tel. (213) 516-0315. Pres.: Ray Jacobs, Sales Mgr.: Bernadette McNulty
Audio: High-speed cassette duplicators
Brand name: Wollensak
 Shape Inc., PD Box 366, Biddeford Ind'l Park, Biddeford, Me. 04005. Tel. (207) 282-6155
Audio: Automatic & semi-automatic cassette & 8-tr assembly equip., automatic 8-tr. splicers & winders, cassette winders
Brand names: CassetteLoad, Shape. (SEE ADVERTISEMENT)
 Singer Prods. Co. Inc., 875 Merrick Ave., Westbury, N.Y. 11590. Tel. (516) 333-2000 (Export only)
Audio: Tape winders & duplicators
Brand name: Recordex
 Studer Revox America Inc., 1425 Elm Hill Pike, Nashville, Tenn. 37210. Tel. (615) 254-5651. Pres.: Bruno Hochstrasser; Gen. Mgr.: Bill R. Muggler; Nat'l Sales Mgr.: Barry D. Evans, Technical Mgrs.: (Studer) Doug Beard, (Revox) Renaud Delapraz
Branches: Los Angeles, Calif., 14046 Burbank Blvd. Zip: 91401. Tel. (213) 780-4234. Contact: Bill Van Doren—New York, N.Y., 155 Ave. of the Americas. Zip: 10013. Tel. (212) 255-4462. Contacts: Fred Layn, Tom Mintner
Audio: Master recorders, quality control recorders/reproducers
 Super Pro H, see Recordex
 System III, see MTI
 Tapemaker Sales Co. Inc., 48 Urban Ave., Westbury, N.Y. 11590. Tel. (516) 333-2700. Pres. Arthur Brandwein; Office Mgr.: Karen Sitkoff
Audio: Programmable cassette testing unit, loop bin
Video: Videocassette loading equip., staking machines
 Tapematic, see MTI

ATTENTION TAPE DUPLICATORS, RADIO STATIONS, RECORDING STUDIOS, AUDIO TAPE DISTRS., TAPE USERS, ETC.

We are Manufacturers & Distributors of 1/4" reel to reel tape (5", 7" & 10 1/2") as well as Panca-~~kes~~, 10 1/2" metal reels, hubs & flanges. Reels & boxes sold separately or together plus hard to get related items.

In Cassette Duplicators!
 We feature excellent quality high speed duplicating cassettes at economical prices—for free sample—write to us on your letterhead!

OUR CUSTOMERS RECOGNIZE LOW PRICES & GOOD QUALITY
 When you're looking for something special in the audio tape line, come to us! We stand behind our merchandise 100%. We specialize in export.

Burlington Audio Tapes, inc.

New Spacious Office & Warehouse
 106 Mott St., Oceanside, NY 11572 (516) 678-4414

1 PERSON OPERATION

~~32 OR 64 TIMES~~
NOW 50 OR 100 TIMES

AUTOMATED CASSETTE DUPLICATOR

COMBINING duplication and loading into one operation is Recortec's contribution to cutting your labor costs. And, the Bi-Directional Master eliminates the master bin loop! With the system pictured, one operator keeps the C-zero hoppers supplied, puts on new pancakes and spot checks the finished product.

QUALITY is built into this professional equipment to provide the best in open reel type duplication systems. The standard 50 times duplication ratio provides the highest fidelity attainable in high speed duplication. Even at 100 times, the bandwidth is sufficient for most recording applications.

PRODUCTIVITY of your operation can be continually expanded from a start-up 1 x 1 system, to a 1 x 8 as pictured and even to larger configurations. Our systems provide highest productivity, and a quality product with fewer operators. Only Recortec offers automated duplication and loading in one operation!

RECORTEC, INC. 475 Ellis St., Mountain View, CA 94043 TEL: (415) 962-0220 TWX: 910-379-5022

With your apex printer you'll print label copy right on your cassette.

Save time, money, trouble, space.

Eliminate inventory problems, costly label overruns,

Save 3¢ or more per cassette



Distributed in the U.S.
and worldwide by



1290 Avenue of the Americas
New York, New York 10019
Telephone 212-582-4870
Telex 12-6419

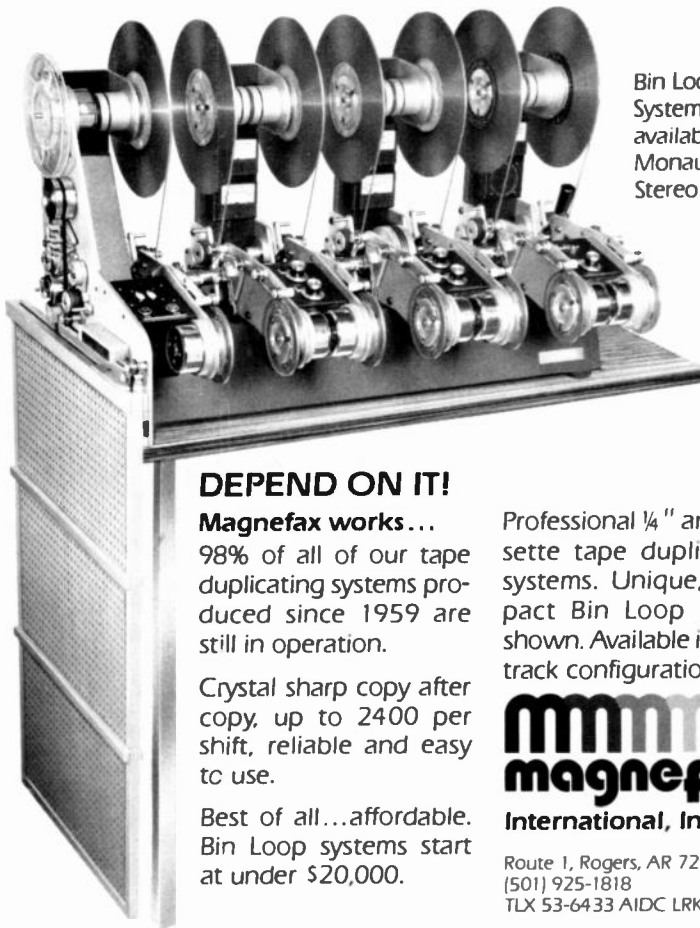

Bin Loop System available in Monaural or Stereo

DEPEND ON IT!

Magnifax works...
98% of all of our tape duplicating systems produced since 1959 are still in operation.

Crystal sharp copy after copy, up to 2400 per shift, reliable and easy to use.

Best of all...affordable. Bin Loop systems start at under \$20,000.

Professional 1/4" and cassette tape duplication systems. Unique, compact Bin Loop model shown. Available in most track configurations.



International, Inc.

Route 1, Rogers, AR 72756
(501) 925-1818
TLX 53-6433 AIDC LRK

Telectro Systems Corp., 96 18 43 Ave., Corona, N.Y. 11368 Tel (212) 651 8900 Pres Harry Sussman
Audio: High speed duplicators
Telefunken, see Gotham Audio
Telex Communications Inc., 9600 Aldrich Ave. S., Minneapolis, Minn 55420 Tel (612) 884 4051 Pres Ansel Kleiman, VP Mktg James S. Arrington, Adv & Sales Promo Dir Peter Schwarz
Audio: Cassette & open reel modular duplicators/copiers, broadcast reel & cartridge recorders/reproducers
Brand name: Magnecord, Telex
Trackmaster Inc., 1310 S Dixie Hwy W Pompano Beach, Fla 33060 Tel (305) 943 2334 Pres Roy Parsons, Sec'y Treas Lupe Parsons
Product: 8 tr & cassette duplicators, verifiers, exercisers

U M C Electronics Co 460 Sackett Point Rd., North Haven, Conn 06473 Tel (203) 288 7731 Telex 963510 Pres James C Leu, Nat'l Sales Mgr Bernard H Ribillard
Audio: Broadcast cartridge tape recorders & reproducers
Brand name: Beaucart
United Research Lab Corp., 681 Fifth Ave., New York, N.Y. 10022 Tel (212) 751 4663 TWX (710) 581 3622 Pres George Adams, Sales Mgr Lee Rand, Gen Mgr Anita Adams, Chief Eng Jim Lee
Audio: Exact duplicate replacement parts for professional recorders
Brand name: Auto Tec
Verbatim Corp., 323 Soquel Way, Sunnyvale Calif 94086 Tel (408) 245 4400
Audio: Cassette tension monitors head & guide gauge, torque tester Wollensak see See Hear

TAPE PACKAGING & LABELING EQUIPMENT MANUFACTURERS & IMPORTERS

A P S see Autovend
Audio Accessories Co. 38 W 515 Deerpath Rd., Batavia, Ill 60510 Tel (312) 879 5998 Sales Mgr John S Maloney
Product: Label application machine
Brand name: Tuck
Audiomatic Corp., 1290 Ave of the Americas, New York, N.Y. 10019 Tel (212) 582 4870 Telex 126419 Pres Milton B Gelland VP Customer Servs Marilyn J Best, Adv Mgr J.P. Lohman Local branch: Audio Matrix, Inc. 915 Westchester Ave., Bronx 10459 Tel 589 3500
Product: "On cassette" printers
Brand name: Apex (Distributor) (SEE ADVERTISEMENT)
Autovend Packaging Systems (APS), PO Box 712 1275 Bloomfield Ave., Fairfield, N.J. 07006 Tel (201) 575 1040
Product: Solid state shrink film packaging systems (SEE ADVERTISEMENT)
Kenneth A Bacon Assocs., 216 Montego Key, Novato, Calif 94947 Tel (415) 883 5041 Owner Kenneth A Bacon, Prod'n Mgr Rick Bacon

THE COMPLETE SOURCE FOR TAPE DUPLICATING EQUIPMENT & SUPPLIES

- HIGH-SPEED DUPLICATORS*
- SIDEWINDERS
- MASTERING EQUIPMENT
- QUALITY CONTROL EQUIPMENT
- DEGAUSSERS
- LOW-COST LABELERS
- SHRINK PACKAGERS
- BLANK-LOADED CASSETTES & C-0's
- BULK TAPE CASSETTE & LUBE

* 8:1, 16:1, 32:1 & 64:1

magnetic marketing CORPORATION

Magnetic Marketing has invented, manufactured, sold and serviced equipment and materials for the tape duplicating industry.

Magnetic Marketing is the one organization that can supply all of your requirements for an entire tape plant, including installation and training. In addition to the equipment that we manufacture and the major lines we represent, we offer great savings on



CASSETTE DUPLICATORS

rebuilt and demo master makers, winders, duplicators, and packaging equipment. Also, Magnetic Marketing offers the best prices on bulk tape, cartridges and cassettes.

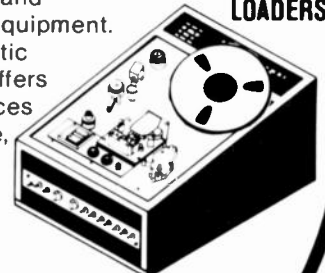

CASSETTE LOADERS

magnetic marketing CORPORATION

Ask about our Lease Plans

Call Today!
(201) 694-3502
Telex # 138558
Neamee Cedr

29 Valley View Terrace
Wayne, New Jersey 07470

Electro Sound tape duplicators with automatic quality control System 8000 at 64:1/32:1 System 5000 at 32:1/16:1

Superlative audio

From frequency response of $\pm 2\%$ from 40Hz to 15kHz through every individual performance specification, the new System 8000 and System 5000 are outstanding: signal-to-noise, crosstalk rejection, WOW and flutter, harmonic distortion, tape speed accuracy. You've never heard such high audio capability.

Microprocessor architecture

Electro Sound's trend-setting microprocessor is an integral part of the systems' design. It controls and monitors the key process functions, shuts the system down if key functions vary beyond acceptable limits and locates any problem with a built-in diagnostic program. It also counts and displays the number of completed selections and pancakes.

The amazing Electro Sound 4300 Quality Control & Assurance System

Automatic, high speed quality control is available with all-new optional accessories. Eight performance parameters are measured and shown on a hard-copy printout with pass-fail readout, all within seconds. The system uses a digitally-encoded quality control tone which is automatically recorded at the end of each pancake - with no attention from the operator. The tone is then read back, the signals are decoded and the results printed. Any out-of-tolerance specifications are flagged on the readout.

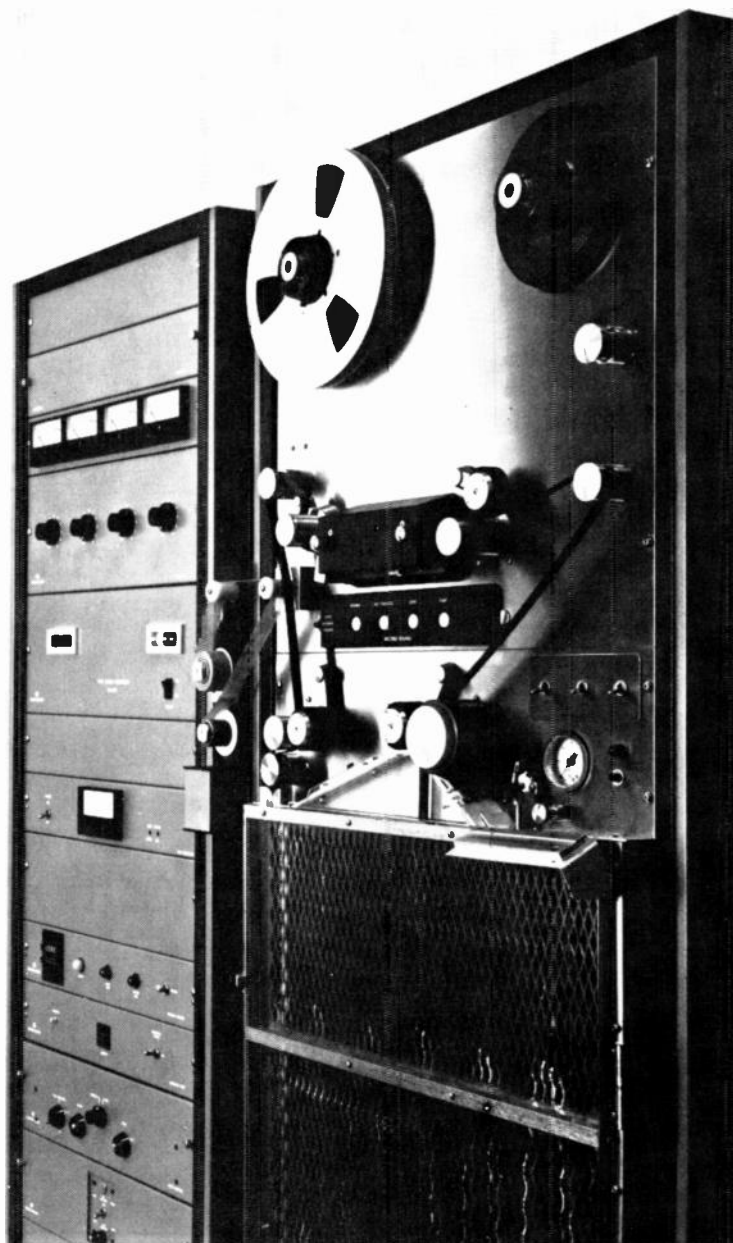
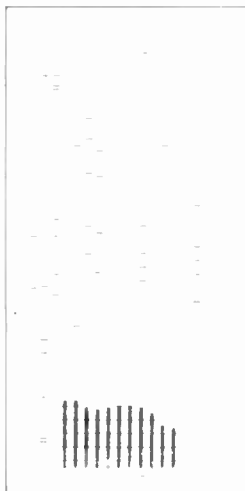

Distributed in the U.S.
and worldwide by

audio
AUDIOMATIC CORPORATION

1290 Avenue of the Americas
New York, NY 10019, USA
Cable: AUDIOMATIC
Telephone: 212-582-4870
Telex: 12 6419

new from **mti**
SYSTEM III
 the cassette
 duplicator
 for the 80's

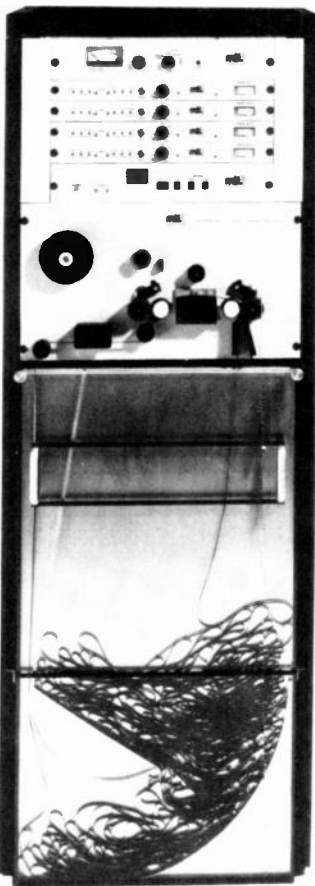

- superior 64:1 and 32:1 performance
- designed for easy operation and maintenance
- realistic price



for complete specifications
 and pricing, contact
 Tim Cole at:

mti **MTI CORPORATION**
 124 Montclair Avenue
 Montclair, N.J. 07042
 Phone 201 744-2220
 Telex 642611 MTI CORP
 Cable MTICORP

Product: Label printing machine
 Bazzy Electronics Corp., 39 N. Rose, Mount Clemens, Mich. 48043 Tel: (313) 463-2592

Product: Shrink wrap sealer
 Cheshire (a Xerox Co.), 408 Washington Blvd., Mundelein, Ill. 60060 Tel: (312) 949 2000

Product: Labeling machines
 Cinema Sound Corp., see Investment Technology
 Coastal Specialty Tapes Inc., 274 Bangor St., Lindenhurst, N.Y. 11757 Tel: (516) 226-5900 Dpns. Head & Sales Mgr. Dan Dobbs

Product: Labeling machines
 Chet Dunn Assocs. Mfg. Rep., 20 Locke Rd., Billerica, Mass. 01821 Tel: (617) 663-2000 Telex 947429 Pres. Chet Dunn

Product: Cassette assembly machinery. (SEE ADVERTISEMENT)

E-System, see Econocorp
 Econocorp Inc., 71 Fourth Ave., Needham Heights, Mass. 02194 Tel: (617) 444-8070

Product: Horizontal loading packaging equip
 Brand name: E System, Econoseal

Econoseal, see Econocorp
 Gopher Prods. Corp., PO Box 1812, 2201 Lockheed Way, Carson City, Nev. 89701 Tel: (702) 882 9333 WATS (800) 648 0958 Pres. Warren Perkins

Product: Labelers
 Brand names: Rotex, Uniline (SEE ADVERTISEMENT)

I T I, see Investment Technology
 Investment Technology Inc., 1940 124 Ave. NE, Bellevue, Wash. 98005 Tel: (206) 454 7720

Product: Cassette labeler, label printing equip
 Brand name: ITI
 M. Letter Mfg. & Sales, 3208 W. Jefferson Blvd., Los Angeles, Calif. 90018 Tel: (213) 737 0440 Dwner Mel Letter

Product: Shrink packaging machinery
 M M C, see Magnetic Mktg
 M T I Corp., 124 Montclair Ave., Montclair, N.J. 07042 Tel: (201) 744 2220

Cable MTICORP Pres. Timothy A Cole

Product: Labeling & inserting machines
 Brand name: Tapematic (SEE ADVERTISEMENT)

Magnetic Mktg. Corp., 29 Valley View Terr., Wayne, N.J. 07470 Tel: (201) 694 3502 TELEX 138558 Pres. Thomas J. Holbauer, Sales Mgr. Brendan F. Browne, Adv. Mgr. M. Judge

Product: Cassette labeler
 Brand name: MMC (SEE ADVERTISEMENT)

Master Rec. Supply, 4000 W. Magnolia Blvd., Burbank, Calif. 91505 Tel: (213) 841 7500

Product: Labeling Machinery (SEE ADVERTISEMENT)

N J M Inc., 6 Commerce Rd., Fairfield, N.J. 07006 Tel: (201) 227 8300
 TWX (710) 734 4353 Pres. A.R. Schaefer, Mktg. & Sales Dir. Malcolm Smith, Nat'l Sales Mgr. H.L. Jepson
 Branches: San Mateo, Calif., 307 S. B St. Zip 94401 Mgr. T.A. Paul-Des Plaines, Ill., 2720 Des Plaines Ave. Zip 60018 Tel: (312) 296 1021 Mgr. E. Kristensen

Product: Pressure sensitive labeling equip
 Brand name: Pony Label DRI, Pony Pacer, Pace Setter

Pace Setter, see NJM
 Pony Label DRI, see NJM
 Pony Pacer, see NJM
 Rotex, see Gopher

Rutgers Packaging Corp., see Queens Lithographing
 Scandia Packaging Machinery Co., 180 Brighton Rd., Clifton, N.J. 07012 Tel: (201) 473 6100, Sales Coord. W.B. Bronander III

Product: Packaging machinery for labeling, cartoning, & shrinkwrapping 8 tr., labeling, Norelco box inserting, shrinkwrapping for audio cassettes, and cartoning & shrinkwrapping for video cassettes. (Complete systems available.) (SEE ADVERTISEMENT)

Shape Inc., PO Box 366, Biddeford Ind'l Park, Biddeford, Me. 04005 Tel: (207) 282 6155

Product: Automatic cassette assembly & packaging machines (SEE ADVERTISEMENT)

Stevenson Inds., 19431 Londeilus St., Northridge, Calif. 91324, Tel: (213) 993 0040

Product: Shrink film packaging equip

Tapematic, see MTI
 Tuck, see Audio Accessories
 Uniline, see Gopher

**TAPE,
 PROFESSIONAL SUPPLIES,
 MANUFACTURERS**

Ace Label Systems, 140 Jackson Ave. N., Hopkins, Minn. 55343 Tel: (612) 933-3105
 Audio: Cassette labels

Amaray Int'l Corp., 2251 Grant Rd., Suite H, Los Altos, Calif. 94022 Tel: (415) 968 2840 VP Sales & Mktg. Ron Garrett
 Audio: Cassette boxes

J C Anglum Co. Inc./Tapeponents Inc., Box 236, 36 Midvale Rd., Mountain Lakes, N.J. 07046 Tel: (201) 263 1442 Pres. J. Clifford Anglum
 Audio: Cassette boxes

Athenia Inds. Inc., 2200 Industrial Way S., Toms River, N.J. 08753 Tel: (201) 244-8500 Pres. Louis Ligator, Sales Mgr. Mark Chayot
 Audio: Norelco style cassette boxes

Audico Inc., 219 Crossen Ave., Elk Grove Village, Ill. 60007 Tel: (312) 640 1030 Pres. W.R. Hinkle, VP Sales. Mill Sherman, VP Mfg. Norman Deletzke
 Audio: Cassette labels

Audio Accessories Co., 38 W. 515 Deerpath Rd., Batavia, Ill. 60510 Tel: (312) 879 5998 Sales Mgr. John S. Maloney
 Audio: Boxes, labels & printed materials in styro block (book) formats
 Brand names: Audiopak, Infopak

Audio Inds. Inc., Broad & Linden Aves., Ridgefield, N.J. 07657 Tel: (201) 945 4545

Audio: Norelco style cassette boxes (SEE ADVERTISEMENT)

Audiolab Electronics, 3725 Esperanza Dr., Sacramento, Calif. 95825 Tel: (916) 485-0500
 Audio: Degaussers

Audiomatic Corp., 1290 Ave. of the Americas, New York, N.Y. 10019, Tel: (212) 582 4870 Telex: 126419 Pres: Milton B. Gelfand, VP Custom Servs. Marilyn J. Best, Adv. Mgr. J.P. Lohman, Local branch: Audio Ma-

FIFTEEN
YEARS OF
tape packaging

**WITH SCANDIA MACHINERY
AND AUTOMATED SYSTEMS**

1960's



Scandia introduced the first fully automatic high-speed 8-track labeling, cartoning, and wrapping system.

1970's



Scandia introduced the first fully integrated high-speed packaging system for labeling, inserting, and wrapping audio cassettes.

1980's



Scandia now introduces the all-new economical, automated cartoning, and wrapping system for video cassettes, again leading the way.



SCANDIA
THE TAPE PACKAGING LEADER

Scandia Packaging Machinery Company
P.O. Box 575 Allwood Station
180 Brighton Rd., Clifton, New Jersey 07012
(201) 473-6100 • Telex No. 133513

Professional Cassette Tape Duplicator Systems



Equipment Shown . . . Model 2000 BL4-C Master with 1200B Slaves

Audio/Tek—for fifteen years the name synonymous with cost-effective production of audio cassettes.

Audio/Tek—versatile systems to meet your specific duplicating needs thru the use of various configurations of standard Audio/Tek components.

Audio/Tek—assures duplicated product of uncompromising quality, because quality is *not* compromised in equipment design and manufacture.

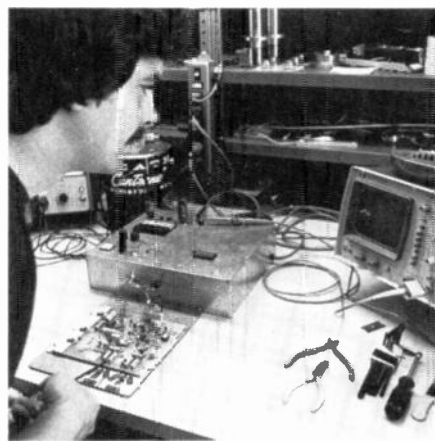
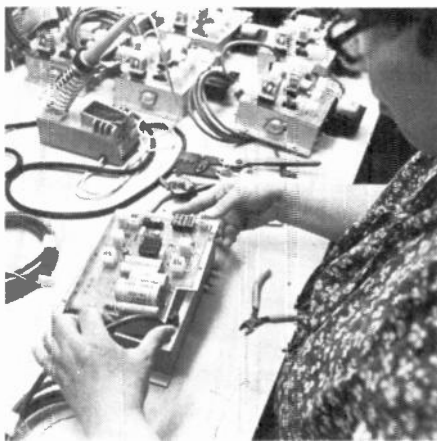

For the assured performance you can depend on . . .

AUDIO/TEK

503-B Vandell Way, Campbell, CA 95008 U.S.A. Telephone: (408) 378-5586 Telex: 172-230

Together for a new beginning...

- fully automatic C-O assembling system
- separated groups to assemble special parts
- engineering service to solve your technical problems

GIMMA

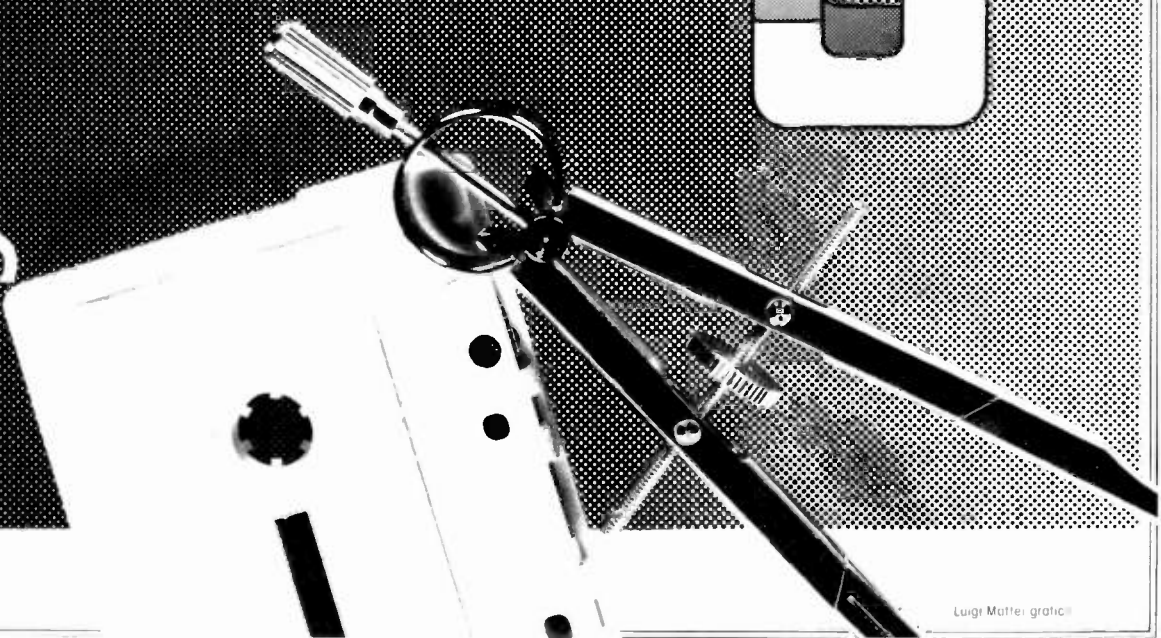

Can You Label 1500 Cassettes on Both Sides in One Hour? Now You Can... With This New ITI Cassette Labeler!

- Also saves you labor. While loading, the same operator can label.
- Saves maintenance costs, too.
- Call 213/841-7500.

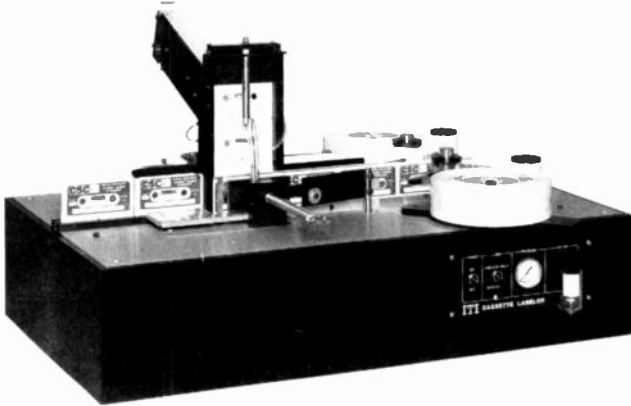

MASTER RECORDING SUPPLY, INC.
4000 West Magnolia Boulevard, Bldg. J
Burbank, California 91505

SERVING THE COMPLETE NEEDS OF THE CASSETTE DUPLICATOR.

Itix Inc. 915 Westchester Ave. Bronx 10459 Tel 589 3500
Audio: Splicing & leader tapes (SEE ADVERTISEMENT)
 Audiopak. see Audio Accessories
 AudioVisual Communications Inc., 435 Crooked Ln., King of Prussia, Pa 19406 Tel (215) 272 8500 Pres John Ballhantyne, VP Sales John Buterworth.
Audio: Cassette labels
 Kenneth A Bacon Assocs., 216 Montego Key, Novato, Calif 94947 Tel (415) 883-5041 Owner, Kenneth A Bacon, Prod'n Mgr Rick Bacon
Audio: Cassette labels & box inserts, cartons
 Beau, see UMC
 G Benson & Co Printers Inc., 75 Spring St., New York, N.Y. 10012 Tel (212) 925 7100 Contact Gerald J. Benson
Audio: 8 tr & cassette pressure sensitive labels
 Bogen, see International Rec'g.
 W H Brady Co Specialty Tape Prods., PO Box 571, 727 W Glendale Ave., Milwaukee, Wis 53201. Tel (414) 332-8100 Cable BRAOYCO Telex 26677 Gen Mgr John Arnold, Mktg Mgr Ken Vaughn
Audio: 8 tr & cassette leader & splicing tape, 8 tr sensing tape, master splicing tape
Video: 1/2" & 3/4" videocassette splicing & sensing tapes, Beta cassette leader tape
 Bruce Packaging Co., 8025 N. Kenneth Ave., Skokie, Ill 60076. Tel (312) 583 2818. Pres.: Joseph Halperin.
Audio: Open reel boxes, cassette packaging & boxes, corrugated packaging
 Burlington Audio Tapes Inc., 106 Mott St., Oceanside, N.Y. 11572 Tel (516) 678-4414 Pres Ruth Schwartz, VP Rudy Schwartz (SEE ADVERTISEMENT)
 Coastal Specialty Tapes Inc., 274 Bangor St., Lindenhurst, N.Y. 11757 Tel (516) 226 5900 Opns. Head & Sales Mgr: Dan Dobbs
Audio: 8-tr & cassette labels, splicing & sensing tape, splicer, paper leader tape
Video: Helical lead-in splicing tape
 Columbia Magnetics (div. of CBS Inc.), 15 Great Pasture Rd., Danbury, Conn 06810 Tel: (203) 744 3555 NYC (212) 226 2120
 Branch: Los Angeles, Calif., 1930 Century Park W Zip 90067 Tel (213) 556 4835
Audio: Splicing & abrasive tape, liquid magnetic pattern detecting kit
 Brand names: Columbia Magnetics, Magna See
 Copy Art Photographers (div. of James J. Kreigsmann), 165 W 46 St., New York, N.Y. 10036 Tel: (212) 757 0190
Audio: 8-tr & cassette labels.
 Cory Sound Co., 310 Townsend, San Francisco, Calif 94107 Tel (415) 543 0440 Contact Phillip Markinson
Audio: Cassette labels
 Custom Rec. Mfg Co., 5810 S Normandie Ave., Los Angeles Calif 90044 Tel (213) 753 5121 Pres Jules Bihari, VP Don Macmillan
Audio: Cassette labels.
Video: Cassette labels.
 D A K Inds. Inc., 10845 Vanowen St., North Hollywood, Calif 91605 Tel (213) 984 1559 WATS (800) 423-2636 Cable DAKENT Telex 651396 Pres. Drew Alan Kaplan
Audio: Cassette labels

(Continued on page 347)



from our "Short-Order" Department...

• Scratch Resistant • High Impact
NORELCO BOXES
 and
SOFT POLY BOXES
 No Minimum Order!

Low ... Low ... Prices ...
 Our Low Prices Will Put Money
 Into Your Pockets!

**SAME DAY
 SHIPMENTS**

Orders in by 10:00 A.M.
 Shipped out by 4:30 P.M.

Buy Direct From Manufacturer!

CALL TODAY... 201-334-2020

MAX-SOUND

A DIVISION OF JOYCE MOLDING

501 DIVISION STREET • BOONTON, NEW JERSEY 07005

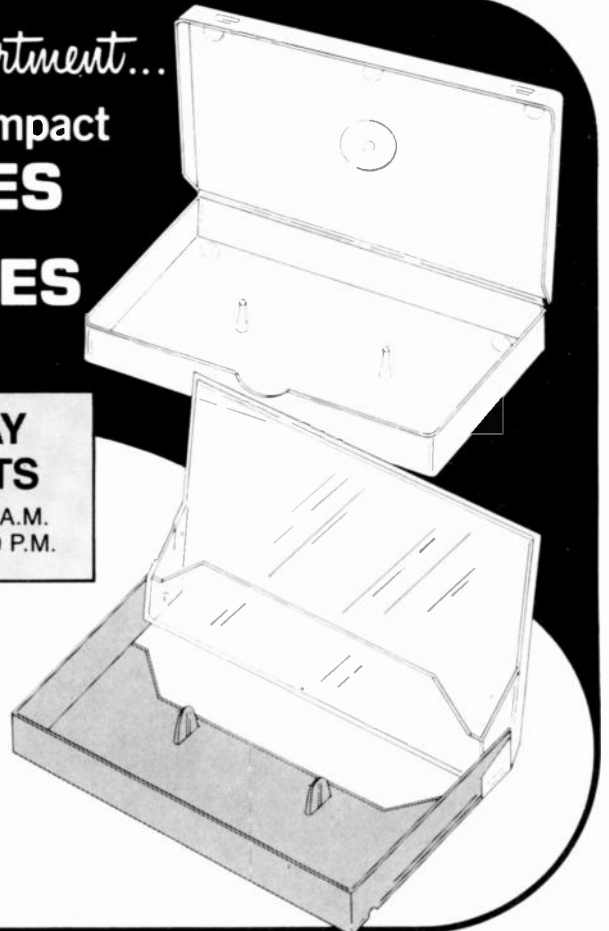

SOLID AS A ROCK!



That's Cetec Gauss. And that's Gauss High Speed Audio Tape Duplicators. Engineered for high productivity, highest quality sound duplication and maximum reliability. A duplicating system that's dependable tape after tape. That's why Gauss systems are known internationally. And that's why Gauss has maintained a quality

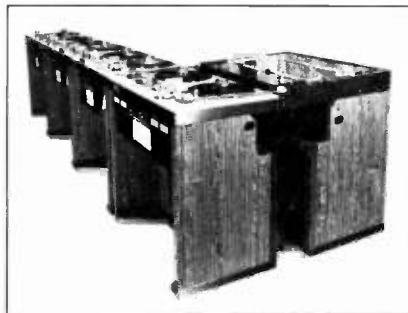

reputation as the forerunner in the tape duplicating industry. Ask anyone who owns Gauss equipment. They know that with Gauss they remain state-of-the-art because Gauss is state-of-the-art. Better duplication quality. Greater reliability. Cetec Gauss. Built to last.

gauss by Cetec.

CETEC GAUSS, 9135 Glenoaks Blvd. Sun Valley, CA 91352 (213) 875-1900 TELEX: 194989

CETEC INTERNATIONAL LTD. Steinisachstrasse 3, 6317 Oberwil/Zug, Switzerland 042-215-332 TELEX: 78806

Unit 2F, 15 Northfield Industrial Estate, Beresford Ave., Wembley, Middlesex HA01YB, England 01-900-0355 TELEX: 935847

Divisions of Cetec Corporation

ACCESSORIES/SUPPLIES



**MANUFACTURERS & IMPORTERS/
FOR THE RECORD & TAPE DEALERS**

The key to the abbreviations following the company listings is: (M) Manufacturer, (D) Distributor, (I) Importer.

A A, see Audio Accessories
A/V Paragon, see Universal Tape
A Bee Syndicate Inc., 230 Fifth Ave., New York, N.Y. 10001 Tel (212) 684 7850
Product: Record & Tape—carrying & storage cases (M)
Acrylic Design & Fabrication Co., 1147 W Ohio, Chicago, Ill 60622 Tel (312) 276 4222
Product: Record & Tape—carrying & storage cases (audio & video)
Advance Prods Co. Inc., PO Box 2178 Zip 67201, 101 E Central, Wichita, Kan 67214 Tel (316) 263 4231 Pres William D DeVore, Sales & Adv Mgr Paul Keck
Product: Storage cabinets (Pxmable) (M)
Akro Mills, 880 W Waterloo Rd., Akron, Ohio 44314 Tel (216) 848 3773
Product: Record & Tape—carrying & storage cases (Record Mate, Tape Mate) (M)
Aldshur Mfg Co Inc, 63 E Sandford Blvd., Mount Vernon, N.Y. 10550 Tel (914) 668 1297 Pres & Adv Mgr Gerald Shidley, Sales Mgr Lindley Nichols
Product: Record—45 rpm adaptors (Televees) (M)
Allsop Inc, PO Box 23, Bellingham, Wash 98227 Tel (206) 734 9090 Telex 152101, VP Jim Allsop, Sales & Adv Dir Ron Morgan
Product: Tape—cassette head cleaners (audio & video)
Amaray Int'l Corp., 2251 Grant Rd., Suite H, Los Altos, Calif 94022 Tel (415) 968 2840 VP Sales & Mktg Ron Garrett
Product: Tape—cassette storage cases (audio & video) (M)
Amberg, see Vernon McMillan
American Lighting Specialties Inc., 1942 W Artes a Blvd Torrance Calif 90504 Tel (213) 532 9262
Product: Record & Tape—carrying & storage cases (M)
American Sound Corp., 3319 E Ten Mile Rd., Warren, Mich 48091 Tel (313) 539 2900 Pres Frank S. Day, VP & Gen Mgr Paul Hayes, VP & Sales Mgr Paul E Adams
Branches: North Hollywood, Calif., 8120 Webb Ave Zip 91605 Tel (213) 768 6100 VP Paul Hayes, VP Mktg Paul Adams, Reg'l Sales Mgr William Dawson—Atlanta, Ga., American Sound Atlanta, 2091 Faulkner Rd NE Zip 30324 Tel (404) 633 4577 Gen Mgr Matt Pola koff, Sales Mgr Peter Thomason—Closter, N.J., 317 Harrington Ave Zip 07624 Tel (201) 767 9033
Product: Tape—head cleaners (M)
Amper Corp, 401 Broadway, Redwood City, Calif 94063 Tel (415) 367 2011 Telex 348464 TWX (910) 378 5920
Sales Offices: Birmingham, Ala., PO Box 845 Zip 35205 Tel (205) 823 6132—Glendale, Calif., 500 Roder Dr Zip 91241 Tel (213) 240 5000—San Diego, Calif., PO Box 99847 Zip 92109 Tel (714) 272 8337—Denver, Colo., 2124 S Birch Zip 80222 Tel (303) 757 1829/6491—Orlando, Fla., PO Box 15008 B Zip 32808 Tel (305) 423 2962—Atlanta, Ga., 3135 Chestnut Dr., Suite 101 Zip 30341 Tel (404) 451 7112—Honolulu, Hawaii, PO Box 25367 Zip 96825 Tel (808) 395 7144—Elk Grove Village, Ill., 2201 Lunt Ave Zip 60007, Tel (312) 593 6000—Overland Park, Kan., PO Box 7282 Zip 66207 Tel (913) 383 1951—Florence, Ky., Elsedon Bldg Zip 41042 Tel (606) 371 1476—Baton Rouge, La., PO Box 14238 Zip 70808 Tel (504) 766 6270—Bethesda, Md., 10215 Fernwood Rd Zip 20834 Tel (301) 530 8800—Framingham, Mass., PO Box 1020 Zip 01701 Tel (617) 877 8060—Minneapolis, Minn., 5200 W 73 St Zip 55435 Tel (612) 835 5560—Elkhorn, Neb., PO Box 553 Zip 68022 Tel (402) 556 3400—Hockensack, N.J., 65 Commerce Way Zip 07601 Tel (201) 489 7400—Williamstown, N.J., PO Box 513 Zip 08094 Phila Tel (215) 887 7650—Buffalo, N.Y., PO Box 4 Zip 14221 Tel (716) 586 2580—Cleveland, Ohio, PO Box 134 Zip 44212 Tel (216) 225 1262—Nashville, Tenn., PO Box 120532 Zip 37212 Tel (615) 256 4836—Dallas, Tex., 1615 Prudential Dr Zip 75235 Tel (214) 637 5100—Houston, Tex., 5300 Telephone Rd Zip 77087 Tel (713) 928 3741—Salt Lake City, Utah, 2880 S Main, Suite 111 Zip 84115 Tel (801) 487 8181—Seattle, Wash., 628 Industry Dr Bldg B Zip 98188 Tel (206) 575 0156
Product: Tape—head cleaners, demagnetizer, leader & splicing tape (M)
Ampro Design Prod'ns Inc, see Distec
R B Annis Co., 1101 N Delaware St., Indianapolis, Ind 46202 Tel (317) 637 9282 Owner R B Annis
Product: Tape—demagnetizers (audio & video) (Han D Mag), pocket magnetometer (Amires) (M)
Apres Audio Ltd 7 Revere Court, Suffern, N.Y. 1C901 Tel (914) 368 0866 Pres Eric Shupack, Sales Mgr Madelyn Shupack Adv Mgr Alan Shu pack
Product: Designer audio & video furniture (Apres), speaker wall brackets (Audio Architects)
Arista Entis Inc 35 Hoffman Ave., Hauppauge N.Y. 11787 Tel (516) 234 7000
Product: Record record care prods, replacement styli, 45 rpm adaptors, Tape—head cleaners demagnetizers leader & splicing tape (SEE ADVERTISEMENT)
Aspen Ltd 77 E Floyd Ave., Englewood, Colo 80110 Tel (303) 789 2239 Pres Sid Laks, Sales Mgr Bill Bystrom, Adv Mgr K Davis
Product: Record—record care prods, anti-static cleaner & scratch remover stylus cleaner, Tape—head head cleaners & demagnetizers, test tape (M)

Audio Accessories Co., 38 W 515 Deerpath Rd., Batavia, Ill 60510 Tel (312) 879 5998 Sales Mgr John S Maloney
Product: Tape—carrying & storage cases (audio & video), head cleaners (audio), cassette hub locks (AA), cassette repair kit (Sav A Tape), plastic splicing blocks
Audio Architects, see Apres
Audio Groom, see Empire
Audio Inds Inc, Broad & Linden Aves, Ridgefield N.J. 07657 Tel (201) 945 4545
Product: Tape—head cleaners, leader tape (M) (SEE ADVERTISEMENT)
Audio Kare (div of Hammond Inds Inc.), 155 Michael Dr Syosset, N.Y. 11791 Tel (516) 364 1900 Pres Colin E. Hammond, VP David C Rich, Sales Mgr Vincent E Finnegan Jr
Product: Record—turntable level, Tape—cleaners (Quietone) head cleaners (TPC)
Audiolab Electronics, 3725 Esperanza Dr., Sacramento, Calif 95825 Tel (916) 485 0500
Product: Tape—demagnetizers (MD)
Audiomatic Corp., 1290 Ave of the Americas, New York, N.Y. 10019 Tel (212) 582 4870 Telex 126419 Pres Milton B Gelland, VP Customer Servs Marilyn J Best Adv Mgr J P Lohman Local branch: Audio Matrix Inc, 915 Westchester Ave., Bronx 10459 Tel 589 3500
Product: Tape—leader & splicing tape (audio) (SEE ADVERTISEMENT)
Audio Technica US Inc., 1221 Commerce Dr., Stow, Ohio 44224 Tel (216) 686 2600 Pres Jon R Kelly, Sr VP Fred Nichols, VP Sales Paul A McGuire, Mktg Communications Dir Don Kirkendall
Product: Record—record care prods, preservatives, record cleaners, stylus cleaners, replacement styli, tonearm lifts, phono cables (M)
Audiotex (div of GC Electronics), 400 S Wyman St., Rockford, Ill 61101 Tel (815) 968 9661 Cable GCELECT
Product: Record—record care prods (Record Basic, Record Plus, Blue Max, Record Purifier), anti static turntable mat, 45 rpm adaptors, Tape—head cleaners, demagnetizers, leader tape, splicing tape & equip
B A S F Systems Corp, Crosby Dr Bedford, Mass 01730 Tel (617) 271 4000 Audio Prod Mgr John P Hiltz
Branches: Santa Monica, Calif., 1307 Colorado Ave Zip 90404 Tel (213) 451 8781—Atlanta, Ga., 3300 Buckeye Rd, Suite 403 Zip 30341 Tel (404) 455 4145—Palatine, Ill., 800 E Northwest Hwy, Suite 220 Zip 60067 Tel (312) 934 4990—Ridgewood, N.J., 579 Franklin Trpk Zip 01730 Tel (201) 447 6904
Product: Tape—Cassette storage units
B M I (Baker Merzon Inc) 4916 Maspeth Ave., Maspeth, N.Y. 11378 Tel (212) 381 1303
Product: Record—carrying cases record care prods, Tape—carrying cases, cassette head cleaners
Kenneth A Bacon Assocs., 216 Montego Key Novato Calif 94947 Tel (415) 883 5041 Owner Kenneth A Bacon, Prod'n Mgr Rick Bacon
Product: Tape—carrying & storage cases, bulk erasers, demagnetizers, leader tape, splicing tape & equip (all audio)
Bazzy Electronics Corp., 39 N Rose, Mount Clemens, Mich 48043 Tel (313) 463 2592
Product: Tape—head cleaners, demagnetizers
Bib, 1751 Jay Ell Dr, Richardson, Tex 75081 Tel (214) 238 1224 Telex 792451 Mng. Dir (USA) Stephen Godfrey Nat'l Sales Mgr Michael Craft, Internal Sales Coord Debi McBride
Home office: England
Product: Record—record care prods, Tape—head cleaners, demagnetizers splicing tape & equip (audio & video)
Blackbourn Inc., 10150 Crossdown Circle, Eden Prairie, Minn 55344 Tel (612) 944 7010 Pres & Adv Mgr, George F Snelgrove, Sales Mgr Thomas F Sabow
Product: Tape—vinyl cassette albums (audio & video) (M)
Black Magic, see Recoton
Blue Max, see Audiotex
Bokor—Merzon, see BMI
Bowers Rec Sleeve Co, 5331 N Tacoma Ave, Indianapolis, Ind 46220 Tel (317) 251 3918 Pres James E Bowers, VP Thomas R Bowers
Product: Record—replacement record sleeves (Lifetime Protectors Protect Your Records), LP & tape gift wraps, polyethylene jacket covers (M)
W H Brady Co, PO Box 571, 727 W Glendale Ave Milwaukee, Wis 53201 Tel (414) 332 8100 Cable BRADYDC Telex 26677 Gen Mgr John Arnold, Mktg Mgr Ken Vaughn
Product: Tape—leader & splicing tape
Broadcast Electronics Inc (a Filmmags Co.) 4100 N 24 St., Quincy, Ill 62301 Tel (217) 224 9600 Cable SPDMASTER Pres Lawrence J Cerven, VP Mktg CI Krng, Sales Mgr J Engle, Adv Mgr Thomas R Humphrey
Product: Tape carrying & storage cases head cleaners demagnetizers, leader & splicing tape
Burlington Audio Tapes Inc., 106 Mott St., Oceanside N.Y. 11572 Tel (516) 678 4414 Pres Ruth Schwartz, VP Rudy Schwartz
Product: Tape—head cleaners leader & splicing tape (M) (SEE ADVERTISEMENT)
C D I see Custom Dupln
C M C see Coastal Specialty

Calibron, see Horan
Camra, see RMS
Carter Corp., 1916 11 St., Rockford, Ill 61101 Tel (815) 397 3200 Cable CARTERCORP Pres Robert L Fleming, VP Sales & Mktg Sandra L Fleming, Plant Mgr W Skip Kruger
Product: Record replacement styli, 45 rpm adaptors, Tape—head cleaners, demagnetizers, splicing tape, connectors cables, adaptors & other video accessory prods
Cetrion Corp., 1701 S. State College Blvd., Anaheim, Calif 92806 Tel (714) 634 4280 TWX (910) 593 1611 Pres Edwin Gamson, VP Mktg Roy Allen, Adv. Mgr Hal Wilde, Sales Mgr Monica Terrill
Product: Tape—head cleaners (SEE ADVERTISEMENT)
Clean Sound, see Recoton
Clean Sweep, see Horan
Clean Track, see Horan
Coastal Specialty Tapes Inc., 274 Bangor St. Lindenhurst, N.Y. 11757 Tel (516) 226 5900 Opns Head & Sales Mgr Dan Dobbs
Product: Tape—leader tape, splicing tape (CMC)
Continental Electronics, 4087 Glencoe Ave., Marina del Rey, Calif 90291 Tel (213) 822 2045 Sales Mgr John Adams
Product: Record—carrying & storage cases, record care prods, turntable mats, 45 rpm adaptors, replacement styli, Tape—carrying & storage cases, head cleaners, bulk erasers, demagnetizers, leader tape, splicing tape & equip
Crestmark Inds., Edison, N.J. 08817 Tel (201) 225 0700
Product: Record & Tape—carrying & storage cases
Custom Case Mfg Co., 6232 Bragg Blvd., Fayetteville, N.C. 28303 Tel (919) 867 4106 Pres Al Metzger, Nat'l Sales Mgr Judy Harris
Product: Record & Tape—carrying & storage cases (M)
Custom Dupln Inc., 6330 36 Arizona Circle, Los Angeles, Calif 90045 Tel (213) 670 5575 Pres Leonard Gross, Sales Mgr Bob Hively, Prod'n Jeri Gonzales
Product: Tape—head cleaners, leader tape, splicing tape & equip (CDI) (M)
D M I see Display Media
D Stat II see Discwasher
Dajim Corp., 1 Park St., Amsterdam, N.Y. 12010 Tel (518) 842 4800
Product: Home audio furniture
Data Packaging Corp, see Dynasound
Delrama Int'l, 37 Newtown Rd., Plainville, N.Y. 11803 Tel (516) 293 8740
Product: Record—record care prods (M)
Dielectrics Inc., 300 Burnett Rd., Chicopee Mass 01020 Tel (413) 598 8308
Product: Record & Tape—carrying & storage cases (custom fabrication) (M)
DISContinued Recs., 444 S Victory Blvd, Burbank Calif. 91502 Tel (213) 849 4791, 846 9192 Owner Les Szarvas
Product: Reference library of out-of-print record material
Oscover Division Inc., 5198 W 76 St, Minneapolis, Minn 55435 Tel (612) 831 5338 Pres Paul W Smith, VP Les Boelter
Product: Record—record care prods
DiscTracker, see Discwasher
Discwasher Inc., 1407 N Providence Rd., Columbia, Mo 65201 Tel (314) 449 0941 Pres Bruce R Maier, Nat'l Sales Mgr James D Hall, Adv Mgr Vickie Williamson
Product: Record—record care prods cleaner (Discwasher System) stylus cleaner (SC 2) piezoelectric anti static gun (Zerostat), audio con nector cables (Gold ens), anti static turntable mat (D Stat II), turntable isolation damping device (DiscFoot), speaker cables (Smog Lifters) Tape head cleaners (audio) (Perfect Path)
Display Media Inc., 120 Laura Dr., Addison, Ill 60101 Tel (312) 543 8330 Pres & Gen Mgr R Gribben
Product: Record & Tape—carrying & storage cases (DMI) (M)
Distec Inc., 42 Barringer Dr., Charlotte, N.C. 28210 Tel (704) 527 6931 VP & Gen Mgr Fred E Martintz
Product: Record—carrying & storage cases record care prods (Dust buster) Tape—head cleaners, demagnetizers
Donna Inds, PO Box 422, Ridgefield, N.J. 07657 Tel (201) 945 6820
Product: Tape—head cleaners, leader tape (SEE ADVERTISEMENT)
Dosis, see Double Sixteen
Double Sixteen Co., 407 Gundersen Ave., Carol Stream Ill 60187 Tel (312) 653 1616
Product: Tape—carrying & storage cases (Dosis) (M)
Duotone Co Inc, PO Box 1168, Miami, Fla 33143 Tel (305) 665 1121 WATS (outside Fla.) (800) 327 5808 Pres Stephen Nester Sr, Sales & Adv Mgr Stephen Gibson Nester
Product: Record record care prods., replacement styli, 45 rpm adaptors, Tape—head cleaners demagnetizers splicing tape. (M) (SEE ADVERTISEMENT)
Dustbuster see Distec
Dynasound (div of Data Packaging Corp.) 205 Broadway Cambridge Mass 02139 Tel (617) 868 6200 TWX (710) 320 0885 Pres Otto Morning star Exec VP Gregory Mathus, VP Mktg Jere Hill Sales & Mktg Mgrs (audio video) Gene Hull (consumer) Peggy Harmatz
Product: Record & Tape carrying & storage cases (M) (SEE ADVERTISEMENT)

THE HITS JUST KEEP ON COMING.



Featured above are just three items in our line of audio and video storage accessories—a uniquely designed storage file to hold 32 cassettes, a sleek portable carrying case for 15 cassettes, and a handsome video storage center for 15 video cassettes. Dynasound® makes life a lot easier for you, because Dynasound® has it all. So now there is just one order. One shipment. One invoice. We've always had contemporary styling, competitive pricing, and hard-working, eye-catching packaging. And now that our expanded line offers something for everyone, we're bound to be the biggest hit in our business. And in yours.

Call Dynasound®, a division of Data Packaging Corporation, 205 Broadway, Cambridge, MA 02139. (617) 868-6200. TWX: 710-320-0885.

WE HAVE MORE IN OUR LINE, SO YOU HAVE LESS TO DO. ®

DYNASOUND

SAVOY

A SAVOY Exclusive

Echelon I Deluxe - The ultimate!



STYLE 4520
Holds 20 Beta Tapes



STYLE 4620
Holds 20 VHS Tapes



STYLE 2760
Holds 60 Cassettes



STYLE 2730
Holds 30 Cassettes

- Featuring Puritan Stitched collars
- Complete corner closure
- Heavy duty locks
- Acrylic rayon tray inserts
- Colors: Black, Brown, Tan, Burgundy

SAVOY LEATHER MFG. CORP.

Factory: Ward Hill Industrial Park, P.O. Box 176
Haverhill, Mass. 01830 • 800-343-8140

- E V G Inc. (formerly EV Game Inc.), 186 Bufo Ave., Freeport, N.Y. 11520. Tel: (516) 378-0440. Pres.: Michael Oamsky; Nat'l Sales Mgr.: Bill Ranshous; Adv. Co-ord.: Charlotte Larson.
Product: Record—45 rpm adaptors, replacement styli (Electro-voice, Pro-Mag). (M)
- Electronic Homes Co., 1225 Broadway, Main Floor, New York, N.Y. 10001. Tel: (212) 725-0290. Bd. Chm.: George T. Saddler; Sales Mgr.: Elias Smyrnakis; Adv. Mgr.: Joe Gary.
Product: Tape—storage cases, head cleaners, demagnetizers (Toyota). (M)
- Electro-Voice, see EVG.
- El Mar Plastics Inc., 821 E. Artesia Blvd., Carson, Calif. 90746. Tel: (213) 327-3180. Cable: ELMAR. TWX: (910) 346-6940. Pres.: Allen Schor.
Product: Tape—cassette storage box, head cleaners, demagnetizers, splicing tape. (M) (SEE ADVERTISEMENT)
- Empire Scientific Corp., 1055 Stewart Ave., Garden City, N.Y. 11530. Tel: (516) 222-1400. Telex: 125472. VP Sales: Andrew D. Segal.
Product: Record—record care prods. (Audio Groome, Watts), replacement styli (for Empire phono cartridges) (M)
- M. Eppy Designer/Manufacturer, 1064 River Rd., Edgewater, N.J. 07070. Tel: (201) 224-2771. Contact: Marvin Eppy.
Product: Record—record file/organizer (Hi-File).
- Erase-Sure, see Magnesonics.
- Esselte Pendaflex Corp., 300 Garden City Plaza, Garden City, N.Y. 11530. Tel: (516) 741-3200.
Product: Record & Tape—carrying & storage cases (Music Library) (M).
Product: Ever-Ready Packaging & Assembly, see Reliance Plastics.
- Fidelipac Corp., 109 Gaither Dr., Mount Laurel, N.J. 08057. Tel: (609) 235-3511. TWX: (710) 897-0254. Pres.: Roger Thanhauser; Sales & Mktg. Mgr.: Arthur Constantine.
Product: Tape—carrying & storage cases, head cleaners, demagnetizers, splicing tape & equip. (M)
- Fidelitone Inc., 3001 Malmo Rd., Arlington Heights, Ill. 60005. Tel: (312) 640-2473. Telex: 281050. Pres.: Charles M. Smith; Sales Mgr.: Gordon Oakes; Adv. Mgr.: Joe Singer.
Product: Tape—video storage chests.
- Filam Nat'l Plastics Inc., 13984 Orange Ave., Paramount, Calif. 90723. Tel: (213) 630-2500.
Product: Tape—storage cases. (SEE ADVERTISEMENT)
- Finebilt Mfg. Co. Inc., 931 N. Citrus Ave., Hollywood, Calif. 90038. Tel: (213) 466-9511. Pres.: Alwin P. Schmid; VP: Joseph Bouzoglou; Sales Mgr.: Manuel Munoz.
Product: Tape—head cleaners, leader tape (Finetape).
- Fine Design Prods. Inc., 1830 S. Clinton, Chicago, Ill. 60616. Tel: (312) 939-5420. Pres.: Harvey Fine; Gen. Mgr.: Dorothy Olson; Sales Mgr.: Richard Doherty.
Product: Record & Tape—carrying & storage cases. (M)
- Finetape, see Finebilt.
- Fuji Photo Film USA Inc., Magnetic Tape Div., 350 Fifth Ave., New York, N.Y. 10118. Tel: (212) 736-3335. VP & Gen. Mgr.: John Oale; Nat'l Sales Mgr.: John Bermingham; Adv. Mgr.: Margaretha Bystrom.
Product: Tape—"4" videocassette head cleaning cassettes.
- G C Electronics, 400 S. Wyman St., Rockford, Ill. 61101. Tel: (815) 968-9661. Cable: GCELECT. VP & Gen. Mgr.: Wayne Timpe; Sales & Special Mkts. Dir.: James E. Heighway; Adv.: Joyce Onanhue
Product: Record—record care prods., 45 RPM adaptors, record handler grip device; Tape—head cleaners, demagnetizers, tape erasers & splicers. (M)
- Gabriel Mfg. Co. Inc., 125 S. Liberty Dr., Stony Point, N.Y. 10980. Tel: (914) 942-0100. Pres.: Ed Gabriel; VP: Richard Gabriel; Gen. Mgr.: Vin Tullio; Adv. Mgr.: Ellen Gabriel.
Product: Tape—head cleaners. (M)
- Gold-ens, see Oiscwasher.
- Gusdorf Corp., 6900 Manchester Ave., St. Louis, Mo. 63143. Tel: (314) 647-1207. Cable: GUSOORSON. Telex: 44821.
Product: Electronics furniture.
- Han D-Mag, see R.B. Annis.
- Hartzell Custom Prods., Turtle Lake, Wis. 54889. Tel: (715) 986-4407.
Product: Record & Tape—carrying & storage cases (The Organizer). (M)
- Herald Electronics (div. of Teletype Inc.), 6611 Lincoln Ave., Lincolnwood, Ill. 60645. Tel: (312) 675-1100. Pres.: Charles F. Kellner; Sales Mgr.: Hank Katz.
Product: Record—45 RPM adaptors; Tape—carrying & storage cases, demagnetizers.
- Hervic Electronics Inc., 18750 Onard St., Tarzana, Calif. 91356. Tel: (213) 343-3441. Gen. Mgr.: Armand Herskovic; Sales & Adv. Mgr.: Warren Harwood.
Product: Record—stylus cleaners, turntable accessories.
- Horian Eng'g Inc., 600 Lake Emma Rd., Lake Mary, Fla. 32746. Tel: (305) 323-2400. Pres.: Richard C. Horian; Gen. Mgr.: James Horian; Sales Mgr.: Robert L. Horian; Adv. Mgr.: Sue Coleman.
Product: Record—carrying & storage cases, record care prods. (Calibron, Clean-Sweep); Tape—carrying & storage cases, head cleaners, demagnetizers (Calibron, Clean-Track). (M)
- I P S, 107 Bridge Rd., Hauppauge, N.Y. 11787. Tel: (516) 234-3322.
Product: Tape—8-tr. & cassette head cleaners.
- Imperial Plastics Inc., PO Box 246, Lakeville, Minn. 55044. Tel: (612) 469-4951. Pres.: John Gambell; Nat'l Sales Mgr.: Daniel P. Mahoney.
Product: Record—carrying & storage cases; Tape—carrying & storage cases, plastic security boxes for cartridges & cassettes.
- International Rec'g Co., 1649 E. Evergreen Ave. Chicago, Ill. 60622. Tel: (312) 227-2000. Pres.: Leonard March.
Product: Record—record care prods., turntable mats, 45 RPM adaptors, replacement styli; Tape—head cleaners, bulk erasers, demagnetizers, leader tape, splicing tape & equip.
- Irish Magnetic Rec'g Tape (div. of Morhan Nat'l Sales Co. Inc.), 270-78 New town Rd., Plainview, N.Y. 11803. Tel: (516) 293-5582. Cable: MORHANEX. Telex: 96-7880. Pres.: G. Zigman; Sales Mgr.: George Krug; Adv. Mgr.: George Taub.
Product: Tape—head cleaners. (M)
- Itera Ltd., 1535 Broad St., North Bellmore, N.Y. 11710. Tel: (516) 785-6480.
Product: Record—replacement styli; Tape—cassette storage library, tape carousels & storage centers, demagnetizers.
- Jacksonville Ginter Box Co. Inc., 2527 Walnut St., Jacksonville, Fla. 32206. Tel: (904) 355-8341.
Product: Record—LP storage rack (Pack Rack); Tape—8-tr. case.
- K.A./Kustom Acoustics Inc., 6628 W. Irving Park Rd., Chicago, Ill. 60634. Tel: (312) 685-6609. Pres.: Ted R. Karson.
Product: Speaker stands, audio cable.
- King Instrument Corp., 80 Turnpike Rd., Westboro, Mass. 01581. Tel: (617) 366-9141. Pres.: William H. Anderson; VP Sales: William E. Cline.
Product: Tape—splicing tape. (SEE ADVERTISEMENT)
- Kustom Kreations Inc., 19316 Londelus St., Northridge, Calif. 91324. Tel: (213) 886-8383.
Product: Tape—carrying & storage cases. (M)
- Lafayette Radio Electronics Corp., 111 Jericho Tpkn., Syosset, N.Y. 11791. Tel: (516) 921-7700.
Product: Tape—demagnetizers. (M)
- Le-Bo Prods. Co. Inc. (div. of Peerless Vid-Tronics Corp.), 58-60 Grand Ave., Masspet, N.Y. 11378. Tel: (212) 894-5155. Cable: LEBOPRODU. Telex: 424790. Pres.: P. Dayton.
Product: Record—carrying & storage cases, record care prods., turntable mats, 45 rpm adaptors, replacement styli; Tape—carrying & storage cases, head cleaners, bulk erasers, demagnetizers. (SEE ADVERTISEMENT)
- Lifetime Protectors, see Bowers.
- Linear Sound Rec'g, 211 Glenridge Ave., Montclair, N.J. 07042. Tel: (201) 744-0686. Pres.: M. Kroll; Sales Mgr.: T. Steinmann.
Product: Tape—carrying & storage cases, head cleaners, demagnetizers, leader & splicing tape.
- M J S, 2514 Seaboard Ave., San Jose, Calif. 95131. Tel: (408) 262-8793. Owner: Michael Steiner.
Product: Tape—head cleaners.
- M M C, see Magnetic Mktg.
- Magnesonics Sales & Mfg. Co., 3740-E Transport, Ventura, Calif. 93003. Tel: (805) 642-3092. Pres.: Donald P. Grosslight.
Product: Tape—bulk erasers (Erase-Sure), cassette rewriter (Rapid-Winder).
- Magnetic Mktg. Corp., 29 Valley View Terr., Wayne, N.J. 07470. Tel: (201) 694-3502. Telex: 138558. Pres.: Thomas J. Hofbauer; Sales Mgr.: Brendan F. Browne; Adv. Mgr.: M. Judge.
Product: Tape—demagnetizers, bulk erasers. (M) (SEE ADVERTISEMENT)
- Magnetic Media Corp., 500 Eastern Pkwy., Farmingdale, N.Y. 11735. Tel: (516) 293-1010. Cable: MAGMEDIA. Telex: 143223. Pres.: Aaron Wasserstrom; Gen. Mgr.: John Christiano; Sales Mgr.: Paul Mastroianni.
Product: Tape—leader tape (audio). (M) (SEE ADVERTISEMENT)
- Malloy Dist'r Prods. Co., 3029 E. Washington Ave., Indianapolis, Ind. 46201. Tel: (317) 636-5353.
Product: Tape—head cleaners. (M)
- Marsand Inds. Inc., 5150 W. Jefferson Blvd., Los Angeles, Calif. 90016. Tel: (213) 938-2755. Exec. VP: Martin A. Waterman, VP Sales: Ron News-wander.
Product: Record—carrying & storage cases; Tape—carrying & storage cases (audio & video). (M)
- Marshall Electronics Inc., PO Box 2027, Culver City, Calif. 90230. Tel: (213) 836-4288. Pres.: H. Shultz; Sales Mgr.: L. Marshall; Adv. Mgr.: W. Rex.
Branch: Tuckahoe, N.Y., LCA Sales Co., 76 Main St. Zip: 10707. Tel: (914) 961-4700. Sales Mgr.: Bob Sherwood.
Product: Tape—microphone phone, video camera cable.
- Mastro Inds. Inc., 3040 Webster Ave., Bronx, N.Y. 10467. Tel: (212) 547-5600. Pres.: Mario Maccalferi.
Product: Tape—head cleaners, 8-tr. dust caps.
- Maxell Corp. of America, 60 Oxford Dr., Moonachie, N.J. 07074. Tel: (201) 440-8020. Pres.: T. Okada; Nat'l Sales Mgrs.: (consumer audio) M. Standley, (consumer video) O. Patricia, (professional/industrial prods.) J. Ringwood; Adv. Mgr.: Chris Mangiapane.
Product: Tape—demagnetizers (audio).
- Vernon McMillan Inc., 801 Newark Ave., Elizabeth, N.J. 07208. Tel: (201) 352-8800.
Product: Record & Tape—carrying & storage cases (Amberg) (M)
- Memorex Corp., Consumer Prods. Group, 1600 Memorex Dr., Santa Clara, Calif. 95052. Tel: (408) 987-1752. Telex: 334492. VP & Gen. Mgr.: John R. Humphreys; Mktg. Mgr.: Albert P. Pepper; Nat'l Sales Mgr.: Jack C. Battaglia.
Branches: Garden Grove, Calif., 12821 Western Ave., Suite L. Zip: 92641. Tel: (714) 891-2541—Lombard, Ill., 335 Eisenhower Ln. S. Zip: 60148. Tel: (312) 620-3240—Cincinnati, Ohio, 8170 Corporate Park Dr. Zip: 45242. Tel: (513) 891-3380—King of Prussia, Pa., 741 Fifth Ave. Zip: 19406. Tel: (215) 337-1050—McLean, Va., 1970 Chain Bridge Rd. Zip: 22101. Tel: (703) 821-3300—Lynnwood, Wash., 4208-198 SW, Suite 110. Zip: 98036. Tel: (206) 774-6507.
Product: Record—record care prods.; Tape—8-tr. head & capstan cleaners, cassette head cleaners, cassette cleaning kit.
- Metacom Inc., 1401-B W. River Rd. N., Minneapolis, Minn. 55411. Tel: (612) 588-2781. Pres.: James I. McCann; Sales Mgr.: Phillip T. Levin; Adv. Mgr.: Timothy Devibellis.
Product: Tape—carrying & storage cases. (MD)
- Metrocar, see RNS.
- Metrosound, see RNS.
- Micro-Trak Corp., 620 Race St., Holyoke, Mass. 01040. Tel: (413) 536-3551. Pres. & Sales Mgr.: William E. Stacy.
Product: Tape—carrying & storage cases (audio). (M)
- Microtran Co. Inc., 145 E. Mineola Ave., Valley Stream, N.Y. 11582. Tel: (516) 561-6050. TWX: (510) 225-8412.
Product: Tape—head cleaners, demagnetizers. (M)
- Mid America Plastics Corp., 6900 Canby, Reseda, Calif. 91335. WATS Tel: (800) 423-5000.
Product: Tape—carrying & storage cases (audio & video)
- Mr. Cassette Inds. Inc., 234 Fifth Ave., No 304, New York, N.Y. 10001. Tel: (212) 689-9332. Bd. Chm.: George T. Saddler; Pres.: Joseph Gary, Gen. Mgr.: H. Johnson; Sales Mgr.: Elias Smyrnakis.
Product: Tape—head cleaners, bulk erasers, demagnetizers (all audio).
- Mr. Cassette Video Corp., 234 Fifth Ave., No. 304, New York, N.Y. 10001. Tel: (212) 689-9332. Pres. George T. Saddler; Gen. Mgr. H. Johnson; Sales Mgr.: Elias Smyrnakis.
Product: Tape—head cleaners, bulk erasers, demagnetizers (all video).
- Monster Cable Co., 101 Townsend St., San Francisco, Calif. 94107. Tel: (415) 777-1355. Telex: 470584. Pres.: Noel Lee; Sales Mgr.: Jan Whitaker; Production: Andy Choy.
Product: Speaker cables & connectors (Monster Cable, Powerline); Record—disk stabilizers, head shells (Orsonic).
- Music Library, see Esselte Pendaflex.
- Nakamichi USA Corp., 1101 Colorado Ave., Santa Monica, Calif. 90403. Tel: (213) 451-5901. Pres.: E. Nakamichi; VP & Nat'l Sales Mgr.: Katsura Izumi.
Product: Tape—demagnetizers.
- Namiki Precision Jewel Co. Ltd., 15 Essex Rd., Paramus, N.J. 07652. Tel: (201) 368-8310. TWX: (710) 990-1273.
Home office: Japan.
Product: Record—replacement styli.
- National Audio Co. Inc., Box 3657 GS, Springfield, Mo. 65804. Tel: (417) 883-5377.
Product: Tape—bulk erasers, splicing tape & equip. (audio & video); leader tape (audio).
- North American Tape Dupl'g Co., 15414 Cabrito Rd., Van Nuys, Calif. 91406. Tel: (213) 781-7650. VP & Gen. Mgr.: Norm Teter; Mktg. Dir.: Larry Stagnaro.
Product: Tape—carrying & storage cases (audio), head cleaners (audio), bulk erasers (audio), demagnetizers (audio).
- Nortronics Co. Inc., 8101 10 Ave. N., Minneapolis, Minn. 55427. Tel: (612) 545-0401. Nat'l Sales Mgr.: Ken Lubitz.
Product: Tape—carrying & storage cases (audio), head cleaners, bulk erasers, demagnetizers, splicing tape. (M)
- Nuclear Prods. Co., PO Box 5178, El Monte, Calif. 91734. Tel: (213) 283-2603. Pres. & Gen. Mgr.: Richard M. Eveith.
Product: Record—record care prods: cleaning brush (Staticmaster). (M)
- The Organizer, see Hartzell.
- Orsonic, see Monster Cable.
- Osawa & Co. Inc., 21 Harbor Park Dr., Port Washington, N.Y. 11050. Tel: (516) 484-5455. Pres.: Y. Okamoto; VP Sales: Jack McMurray; Adv. Mgr.: Vince Wheeler.
Product: Record—record care prods. (Nagako), turntable mats; Tape—head cleaners (audio), splicing tape & equip. (audio).
- Pacific Int'l Magnetics Inc., 185 Berry St., No. 3865, San Francisco, Calif. 94107. Tel: (415) 495-8830.
Home office: Canada.
Product: Tape—carrying & storage cases, head cleaners, bulk erasers (audio & video); demagnetizers, (audio), leader tape (audio), splicing tape & equip. (audio & video).
- Pack Rack, see Jacksonville.
- Paramount Housewares, 1035 Westminster Ave., Athlambra, Calif. 91803. Tel: (213) 570-1601. Pres.: Joseph D. Winston; Sales & Adv. Mgr.: Charles W. Holmes.
Product: Tape—storage cases.
- Peerless Vid-Tronics Corp., 60 West St., Bloomfield, N.J. 07003. Tel: (201) 429-8600. Pres.: Herb Raviv; Sales Mgr.: Andy Oanzico.
Product: Record—carrying & storage cases; Tape—carrying & storage cases, head cleaners, demagnetizers. (M)
- Perfect Path, see Oiscwasher.
- Permostat, see Stanton.
- Planstiehl Chemical Corp., 3300 Washington St., Waukegan, Ill. 60085. Tel: (312) 623-1360. Pres.: Merle R. Nelson; Mkt. Dir.: Bob Wight.
Product: Record—record care prods., 45 rpm adaptors, (all Plantone); replacement styli (Planstiehl); Tape—head cleaners (Plantone).
- Plantone, see Planstiehl.
- Phyclo Audio, 4709 Brooks St., Montclair, Calif. 91763. Tel: (714) 621-9561. Owner: Robert Deates; Gen. Mgr.: Rich Deates.
Product: Tape—head cleaners, leader tape, splicing tape (all audio).
- Pixomobile, see Advance Prods.
- Pixoff, see Sonic Research.
- Plasti Plex Corp., 1209 Chicago Rd., Troy, Mich. 48084. Tel: (313) 589-1771.
Product: Record—storage cases, record care prods.; Tape—storage cases.
- Port-A-Tune (div. of Action Leathercraft Inc.), 5340 E. Harbor, Commerce, Calif. 90040. Tel: (213) 728-1155.
Product: Record & Tape—carrying & storage cases.
- Powerline, see Monster Cable.
- Pro Mag, see EVG.
- Pro 1 Audio-Visual Inc., PO Box 33, Highland Park, Ill. 60035. Tel: (312) 433-4575. Pres.: R.L. Pink; VP: J. Pink; Sales Mgr.: M.M. Pink; Adv. Mgr.: O.O. Pink.
Product: Record & Tape—carrying & storage cases.
- Protect Your Records, see Bowers.
- Protone Inds., 13349 Salford St., North Hollywood, Calif. 91605. Tel: (213) 765-0782. Pres.: Barry Stern.
Product: Tape—cassette carriers.
- Pyramid Mfg. Inc., 13127 Harper Ave., Detroit, Mich. 48213. Tel: (313) 839-2888. Pres.: Russ DiBartolomeo.
Product: Tape—modular storage furniture (Videnza).
- Q-A-I Inc., 640 Oell Rd., Carlstadt, N.J. 07072. Tel: (201) 460-0060; NYC (212) 964-1714. Pres.: Steve Dauman; Sales Mgr.: George Ratowsky.
Product: Tape—splicing & cueing tape.
- Q R K, see Broadcast Electronics.
- Quietone, see Audio-Kare.
- R C 4, see Stanton.
- R M S Electronics Inc., 50 Antin Pl., Bronx, N.Y. 10462. Tel: (212) 892-6700. Pres.: Arthur A. Fink; VP: Albert Goldstein; Sales Mgr.: Seymour Goldberg.
Product: Tape—carrying & storage cases, videocassette recorder accessories, camera cables, video connectors. (M)
- R N S Inc., 7 Manor Dr., Oak Ridge, N.J. 07438. Tel: (201) 697-2212. Pres.: Robert N. Schwartz; Gen. Mgr.: Elizabeth Schwartz; Sales Mgr.: Gary Pranchitas.
Product: Record—record care prods. (Metrocar, Metrosound); Tape—carrying & storage cases, head cleaners (Metrosound); leader & splicing tape. (I)
- Radio Shack (div. of Tandy Corp.), 1 Tandy Center, Fort Worth, Tex. 76086. Tel: (817) 390-3272.
Product: Record—record care prods., turntable mats, 45 RPM adaptors, replacement styli, patch cords; Tape—carrying & storage cases, head cleaners (audio & video), bulk erasers, demagnetizers, leader tape, splicing tape & equip. (all Realistic).
- Rapid-Winder, see Magnesonics.
- Raynor Sales Co. Inc., 2698 W. Pico Blvd., Los Angeles, Calif. 90006. Tel: (213) 737-3737. Pres. & Adv. Mgr.: Ray Abrams Sr.; Sales Mgr.: Ray Abrams Jr.
Product: Record—carrying & storage cases, record care prods., 45 rpm adaptors, replacement styli, record gift sleeves; Tape—head cleaners, demagnetizers, leader & splicing tape.
- Realistic, see Radio Shack.
- Record Basic, see Audiotex.
- Record-Mate, see Akro-Mills.
- Record Plus, see Audiotex.
- Record Purifier, see Audiotex.
- Recoton Corp., 46-23 Crane St., Long Island City, N.Y. 11101. Tel: (212) 392-6442. Pres.: Robert Borchardt; Exec. VP: Peter Wish; VP Sales: George Calvi.
Product: Record—carrying & storage cases, 45 rpm adaptors, replacement styli (all Recoton), record care prods. (Black Magic, Clean Sound). Tape—carrying & storage cases (audio & video), leader & splicing tape (Recoton); head cleaners (audio & video), & demagnetizers (Black Magic & Recoton); video cables & connectors, splitters & switching boxes. (M) (SEE ADVERTISEMENT)
- Reliance Plastics & Packaging Div., Reliance Folding Carton Corp. 225 Bellville Ave., Bloomfield, N.J. 07003. Tel: (201) 748-2222. Pres.: Marshall Weingarden; Sales Mgr.: Marion Bureleigh.
Product: Tape—vinyl storage cases (audio & video), videocassette slip cases. (M)

ACCESSORIES

Riverton Corp., Dillon Rd., Monticello, N.Y. 12701 Tel (914) 794 8888
Product: Record—carrying & storage cases, record care prods., 45 rpm adaptors, replacement styli, Tape—head cleaners
 Robins Inds. Corp., 75 Austin Blvd., Commack, N.Y. 11725 Tel (516) 543 5200 Pres. Herman Post; VP Sales Stu Carne
Product: Record—carrying & storage cases, record care prods. 45 RPM adaptors, stylus pressure gauge (Gramme), ionic static neutralizing gun (Rob-D Stat), stylus microscope, phono pads & cushions, Tape—carrying & storage cases, head cleaners, demagnetizer, leader, splicing & sewing tape, bulk erasers, tape cleaners (Soundtrack Scrubber), splicing & editing equip., cassette & 8 tr. repair kits, cassette tension winders, tape clips
 Rotel of America Inc., 13528 S. Normandie Ave., Gardena, Calif. 90249 Tel (213) 327 0600 Pres. T. Tachikawa, Sales Mgr. Mel Kaplan
Product: Record—record care prods. (M)
 S.C.2, see Discwasher
 S.S.K. Ent's Inc., 2488 Towngate Rd., Westlake Village, Calif. 91361 Tel (805) 889-1831
Product: Tape—head cleaners (audio & video) (M)
 Sav A Tape, see Audio Accessories
 Savoy Leather Mfg. Corp., Ward Hill Ind'l Park, 260 Neck Rd., Haverhill, Mass. 01830 Tel (617) 374 0351 TWX (710) 347 1121
Product: Record & Tape—carrying & storage cases (audio & video) (SEE ADVERTISEMENT)
 Saxton Prods. Inc., 215 N. Rt. 303, Congers, N.Y. 10920 Tel (914) 268 6846
Product: Record—replacement styli, Tape—demagnetizers
 Scotch, see 3M
 Seebro Prods. Co., 2416 S. Michigan Ave., Chicago Ill. 60616 Tel (312) 842 8221 Pres. I. Siegal; Sales Mgr. R. Siegal
Product: Record—carrying & storage cases, wire record racks, pole record racks, record carts, Tape—carrying & storage cases (MD)
 Sentry Inds. Inc., 221 N. MacQuesten Pkwy., Mount Vernon, N.Y. 10550 Tel (914) 664 2909, Cable SENTINO Pres. Harold Rosen, VP Barry Rosen
Product: Record—carrying & storage cases, record care prods., 45 RPM adaptors, replacement styli, Tape—carrying & storage cases, head cleaners, demagnetizers, leader & splicing tape (MDI)
 Service Mfg. Co. Inc., River St., Hastings-on-Hudson, N.Y. 10706 Tel (914) 478 4000 Pres. Joseph L. Berkman; Nat'l Sales Mgr. Stuart Glenwick
Product: Tape—carrying & storage cases, videocassette storage cabinets (M)
 Shape Inc., PO Box 366, Biddeford Ind'l Park, Biddeford, Me. 04005 Tel (207) 282 6155
Product: Tape—audio & video cassette storage cases (Shape) (SEE ADVERTISEMENT)
 Silk Stocking Prods. Ltd., 216 W. 18 St., 10th fl., New York, N.Y. 10024 Tel (212) 255-4424 Chm. Lloyd Ribner Jr. Pres. Elliot J. Galdy
Product: Carrying & storage cases
 Smog Lifters, see Discwasher
 Snap Jack Inc., 805 Clifton Ave., Clifton, N.J. 07013 Tel (201) 779 0225
Product: Record—LP jacket wall frames
 Sonar Radio Corp., 3000 Stirling Rd., Hollywood, Fla. 33021 Tel (305) 981 8800 Chm. Bernard E. Klein
Product: Tape—Video bulk erasers (Videoraser)
 Sonic Research Inc., 27 Sugar Hollow Rd., Danbury Conn. 06810 Tel (203)

792 8822, Pres. Peter E. Pritchard, Nat'l Sales & Mktg. Mgr. Ronald E. Wilcox; Adv. Mgr. Elliot Edrick
Product: Record—record care prods. (PixoM) (I), replacement styli (Sonus) (M)
 Sonrise Audio Systems, 13622 NE 20 St., Bellevue, Wash. 98005 Tel: (206) 641 1900 Pres. Douglas Anderson
Product: Audio & video cabinetry
 Sonus, see Sonic Research
 Sound Guard Corp. (div. of Audio Technica), 348 SW 13 Ave., Pompano Beach, Fla. 33060 Tel (305) 782-1041 WATS (800) 327 1144 Pres. Greg Cornehlis
Product: Record—record care prods., preservatives, cleaners, record care work pad, stylus care kit (SEE ADVERTISEMENT)
 Sound/Pro Inds. Inc., 7529 Trasic Ave., Playa del Rey, Calif. 90291 Tel (213) 822 0510, Pres. Donald K. M. Rothgery, Nat'l Mktg. Dir. Oon Millard, Sales Mgr. Tom Reed, Adv. Mgr. Linda Newton
Product: Tape—carrying & storage cases, head cleaners
 Soundtrack Scrubber, see Robins
 Speaker Uppers, 20946 Carrier Rd., Walnut, Calif. 91789 Tel (714) 598-1906
Product: Speaker stands
 Stak It by Visual Displays Corp., 975 Essex St., Brooklyn, N.Y. 11208 Tel (212) 649 1818 Pres. Samuel Nadrich, Sales Mgr. Michael Nadrich, Plant Mgr. David Nadrich
Product: Record & Tape—cabinets, stereo component & speaker stands, video component cabinets (SEE ADVERTISEMENT)
 Stanford Int'l PO Box 609, 569 Laurel St., San Carlos, Calif. 94070 Tel (415) 592 5958 Pres.: Fred Dobbs, Opns. Mgr. Jan Oillard
Product: Tape—carrying & storage cases, head cleaners, bulk erasers, de magnetizers, leader & splicing tape
 Stanton Magnetics Inc., 200 Terminal Dr., Plainview, N.Y. 11803 Tel: (516) 349 0200 TWX (510) 221-1845 Pres. Walter O. Stanton, VP Prof Prods. Jim Fox, Prof Prods. Nat'l Sales Mgr. Peter Bidwell, Adv. Mgr. Gordon Hurt
Product: Record—record care prods., anti-static record preservative, (Permostat), record care kit (RC4), replacement styli, stylus cleaning kit (Stanton)
 Staticmaster, see Nuclear Prods.
 Sterling Prods. Co. Inc., 1689 Oakdale Ave., West St. Paul, Minn. 55118 Tel (612) 455 6691
Product: Tape—carrying & storage cases
 Studio Magnetics Co. Inc., 12 Long Island Ave., Holtsville, N.Y. 11742 Tel (516) 289-3400, Pres.: George Clahane, VP: Craig M. Balaban
Product: Tape—Non abrasive cassette head cleaners, aerosol head cleaners, cassette storage modules (Add'N'Stac) (M)
 T O K Electronics Corp., 755 Eastgate Blvd., Garden City, N.Y. 11530 Tel (516) 746 0880 Telex 144535 VP & Gen. Mgr. Ken Kohda, Sales Mgr. John Schattin, Video Prod. Mgr. Ed Pessara
 Branches: Irvine, Calif., 2102 E. Alton St. Zip 92714 Tel (714) 979-5811 WATS (800) 854 0123 Div. Mgr. Lee Adams—Marietta, Ga., 4062 Kingston Court Zip 30067 Tel (404) 952-4600 Reg'l Mgr. George Castel—Des Plaines, Ill., 1011 E. Touhy Ave., Suite 165 Zip: 60018 Tel (312) 297 1341 WATS (800) 323 5956 Reg'l Mgr. Jack Pender
Product: Tape—carrying & storage cases, head cleaners, demagnetizers (M) (SEE ADVERTISEMENT)
 T.P.C. see Audio Kare

TUNING IN TO TODAY'S SERVICE FAMILY



The USO is a world of services which helps reduce feelings of homesickness for our servicemen and women.

Michael Landon

The many USO volunteers are around the world listening to a problem, offering assistance, and letting these young people know we care.

Shirley Jones

It could be family programs, involvement in a community project, information on a drug problem, or just a chance to sit and relax at over 125 USOs worldwide.

Gavin MacLeod

Support USO through the United Way, OCF, or local USO campaign

USO World Hqtrs. 1146 19th St. N.W. Wash. D.C. 20036

LEBO / PEERLESS

60 West Street
 Bloomfield, N.J. 07003
 (201) 429-8600

YEAR 'ROUND BEST SELLERS

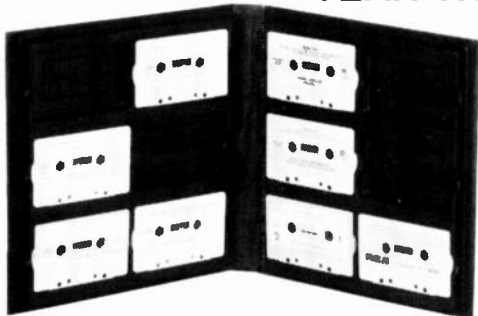

CA-12 Holds 12 cassettes. Compact fold-out easy access cassette holder with press and pop feature.

CA-24D Holds 24 cassettes



VIDEO CASSETTE LIBRARY

Deluxe video cassette library. Beautiful gold stampings on luxurious leather-like material simulating rare book bindings. Designed for shelf, tabletop, etc. Available in 2 formats.
VL-200-B (Betamax)
VL-201-V (VHS)



8 TRACK BLANK TAPE CARTRIDGE
 American made Professional Blank recording tape. Available in 40 and 80 minutes.



4 STARR BLANK CASSETTE
 American made Low noise—high frequency blank cassette. Available in 60 and 90 minute configurations.



DUSTBUSTER

Stop listening to dust. Start listening to great sound. A great new way to keep dust and dirt from accumulating on your records.
DB-1 Counter Display
DB-2 Blister Card



EXECUTIVE CASSETTE ATTACHE CASE

This executive style attache case is designed for the contemporary "mover." Soft Touch crafted excellence is available in 4 configurations for both audio and video.
PSC-18N—holds 18 pre-recorded cassettes
PSC-18A—holds 18 cassettes without box
PSV-3B—holds 3 BETA tapes
PSV-3V—holds 3 VHS tapes

One of the most popular groups in the recording industry.



A full line of record care products.

At Sound Guard we offer the audio and record retailer a money-making line of professional-quality products. Our products clean, preserve, protect and enhance your customers' records. With Sound Guard it's a snap to stimulate those valuable "extra" sales. Because, at today's record prices, consumers want to protect their investments.

It's easy to spot our popular group.

At Sound Guard we've created new colorful eye-catching packaging that's a handsome addition to your store. Our point-of-purchase displays grab the impulse buyer; our literature helps make the sale; our quality gets the repeat sales. And we'll also be winning consumers over with our new national advertising program. In addition to a strong campaign in the audio books we'll be advertising in such magazines as Oui, Rolling Stone, G.Q., Esquire, Popular Electronics and Scientific American.

You'll be seeing more of us soon.

Because, in addition to our quality line of record care products, we're improving and expanding. This year we introduced a vastly superior anti-static preservative, and we'll soon be announcing several new products.

The stage is set for profits.

We have all the top performers: Sound Guard Record Preservative, Cleaner, Work Pad, Stylus Care Kit, and Total Record Care System. All you have to do is stock them, spotlight them, and start ringing up sales.

**sound
guard**
W

Sound Guard Corporation
348 S.W. 13th Avenue
Pompano Beach, Fla. 33060
(800) 327-1144
In Florida: (305) 782-1041

Facilities: Cincinnati, Ohio; Tokyo, Japan; Brussels, Belgium.

INTRODUCING

THE MUSICTIME DISPLAY CENTER

ADDED SERVICE FOR
YOUR CUSTOMERS...
ADDED PROFIT FOR YOU!



Until now, there hasn't been a music folio display rack which combined attractiveness, profitability and high volume.

- * You can display 12 of the top-selling folios. We'll make sure they're the hot-sellers. And we'll also keep you re-supplied so there's no selling "downtime."
- * For those who have been specializing in records and tapes, this is the easy, profitable way to reach new customers, or expand sales to present customers. (And, you can sell at list price.)
- * The Center is compact, designed to attract and sell, and destined to be a great profit center for you.

Be among the first to offer the new look in music folio marketing.

The Dumont MusicTime Display Center, a \$75 value, is yours free with your order.

MUSICTIME

P.O. BOX 2810
CHERRY HILL, N.J. 08034



Give the gift
of music.

WANTED

Discontinued
PHONO NEEDLES

Both Diamond & Sapphire
Worth up to \$1.00 Each
Send for Full Details.

arista

"the accessory specialists"

America's number 1 line of
display packaged merchandise.

- Diamond Needles
- Phono Cartridges
- Record & Tape Care
- Tape Cases
- Video Accessories
- Audio Cables & Connectors
- Headphones
- Microphones
- Intercoms
- Telephone Accessories
- AC & DC Adapters
- Foreign Voltage Converters & Lots, Lots More

arista enterprises inc.
35 Hoffman Ave., Hauppauge, N.Y. 11788
516-234-7000 ● TWX: 510-227-9822

Duotone®

6875 S.W. 81st St., Miami, FL 33143
Tel. (305) 665-1121

Duotone Phonograph Needles Diamond, Sapphire & Steel



We carry an extensive inventory of all makes of needles, including Shure, A.D.C., Tetrad, Pickering, B.S.R. Sony.

Write for FREE catalog with the most complete line of needles, cassettes, record care and tape accessories, blank tapes, audio cables

We Export Around the World

- Taber/eraser, see Taber Mfg
Taber Mfg & Eng'g Co., 2081 Edison Ave., San Leandro, Calif. 94577 Tel (415) 635-3831
Product: Tape-demagnetizers (Taber/eraser) (M)
Tapecom Inc., 45 Jefferson St., Stamford, Conn 06902 Tel (203) 325 1541 TWX (710) 474-3334 Pres. Gene Tornatore, VP Fred Luminoso
Product: Tape-carrying & storage cases (SEE ADVERTISEMENT)
Tape-maker Sales Co. Inc., 48 Urban Ave., Westbury, N.Y. 11590 Tel (516) 333-2700, Pres. Arthur Brandwein, Office Mgr. Karen Sitkoff
Product: Tape-splicing tape (M)
Tape-Mate, see Akro Mills
Tape Servs. Inc., Cherry Hill Ind'l Park, 1 Keystone Ave., Cherry Hill, N.J. 08003 Tel (609) 424-9450 Sales Mgr. Michael T. Mulcahy
Product: Record-record care prods. (private label), Tape-head cleaners, demagnetizers (M)
Teac Corp. of America, 7733 Telegraph Rd., Montebello, Calif. 90640 Tel (213) 726-0303 Pres.: Norio Tamura; VP Mktg. Barry Goldman, Gen Mgr. Gary Beckerman; Adv Mgr.: Tay Hotta
Product: Tape-head cleaners, demagnetizers. (M)
Televox, see Aldshire
Tempo (div. of Hagerstown Leather Goods Co.), 858 Willow Circle, Hagerstown, Md 21740 Tel. (301) 797-6600. Pres. Dr. Harold N. Taylor, VP Mktg.: David L. Handler
Product: Record & Tape-"custom made" carrying & storage cases (audio & video)
3 M Co., Audio/Video Prods. Div., 3M Center, St. Bldg. 2525 N. St. Paul, Minn. 55101 Tel (612) 733-1466, Corp VP D.E. Denham, Div VP J.E. Povoiry, Mktg. Dir. W.J. Madden, Nat'l Sales Mgr. J.L. Leon, Mkt. Oprns. Mgr. J.B. Hanks, Mkt. Communications Mgr. D.J. Linehan
Branches: Anchorage, Alaska, 5531 Minnesota Dr. Zip 99502 Tel (907) 276-2363--Burbank, Calif., 126 W. Elm Court, Zip 91502 Tel (213) 848-5534--Los Angeles, Calif., 6023 S. Garfield Ave. Zip 90040 Tel (213) 726-6300--South San Francisco, Calif., 320 Shaw Rd. Zip 94080 Tel (415) 589-2663--Washington, D.C., 1101 15 St. NW Zip 20005 Tel (202) 331-6900--Atlanta, Ga., 2860 Bankers Ind'l Dr. Zip 30360 Tel (404) 447-7000--Honolulu, Hawaii, PO Box 30048, 4443 Malaas St Zip 96818--Argo, Ill., 6850 S. Harlem Ave Zip 60501 Tel (312) 496-6500--Needham Heights, Mass., 155 Fourth Ave Zip 02194, Tel (617) 449 0300--Farmington, Mich., 23923 Research Dr. Zip 48024, Tel (313) 477-5800--Eagan, Minn., PO Box 33211, St. Paul 55133, 3130 Lexington Ave S. Zip 55121 Tel (612) 733-3300--St. Louis, Mo., PO Box 510, 10725 Baur Blvd Zip 63166 Tel (314) 997-8500--West Caldwell, N.J., PO Box 76, 15 Henderson Dr Zip 07006 Tel (201) 575-2000--Cincinnati, Ohio, 4835 Para Dr Zip 45237 Tel (513) 242-2313--Cleveland, Ohio, 12200 Brookpark Rd Zip 44130 Tel (216) 267-1800--Philadelphia, Pa., 5698 Rising Sun Ave Zip 19120 Tel (215) 728-5300--Dallas, Tex., 2121 Santa Ana Ave Zip 75228 Tel (214) 324-8100--Seattle, Wash., Andover Ind'l Park, 100 Andover Park W Zip 98188 Tel (206) 244-7200
Product: Tape-carrying & storage cases, head cleaners, leader & splicing tape (Scotch) (M)
Toyota, see Electronic Homes
Trackmaster Inc., 1310 S. Dixie Hwy W., Pompano Beach, Fla. 33060 Tel (305) 943-2334 Pres. Roy Parsons, Sec'y Treas.: Lupe Parsons
Product: Tape-bulk erasers, splicing tape & equip
Transcriber Co. Inc., PO Box 478, Attleboro, Mass. 02703 Tel (617) 222 3525, VP John Sheasgreen, Nat'l Sales Mgr. John McDonald
Product: Record-record care prods., record preservative (Sound Saver), turntable mats; Tape-demagnetizers (audio), bulk erasers (audio)
U T C, see Universal Tapeak
Ultra Specially Inc., 20700 S. Belshaw Ave., Carson, Calif. 90746 Tel (213) 537-8850, Cable ULTRASPEC Telex: 194566 Pres. Don Wong, Pres. UI traspec Int'l Gary Lyle
Product: Record-carrying & storage cases; Tape-carrying & storage cases, leader & splicing tape, ultrasonic film splicer
Universal Tape Corp. Inc., 821 E. Artesia Blvd., Carson, Calif. 90746 Tel (213) 327-3203 Pres. Edward O. Praeger
Product: Tape-head cleaners, demagnetizers, leader & splicing tape (A/V Paragon, UTC, Universal) (M)
Utopia Ultra-Sound, 38 40 S. First St., Newark, Ohio 43055 Tel (614) 345-9426 Owner Robert H. Kirk Jr., VP Don Shannon, Gen Mgr. Robert H. Kirk Sr., Sales Mgr. Rose Shannon
Product: Tape-head cleaners (MD)
Videnza, see Pyramid
Videoraser, see Sonar Radio
Vinylweld, 2011 W. Hastings, Chicago, Ill. 60608 Tel (312) 243-0606
Product: Record & Tape-carrying & storage cases
Visual Displays Corp., see Stak-It
Vulcan Binder & Cover (div of EBSCO Inds Inc.), PO Box 29, Vincent, Ala 35178, Tel (205) 672-2241 VP R. Denson Parker, Sales Mgr. John R. Boleslawski, Adv Mgr. B.R. Cummings
Product: Tape-carrying & storage cases (M)
W R E, see Wide Range Electronics
Walco-Linck Corp., 1234 Hwy 46, Clifton, N.J. 07015 Tel (201) 471-1070
Product: Record-replacement styl. (M)
Watts, see Empire
Wide Range Electronics Corp., 2119 Schueltz Rd., St. Louis, Mo. 63141, Tel (314) 567-5366
Product: Tape-bulk erasers, magnetic erasing pencil (WRE)
Xedit Corp., 133 S. Terrace Ave., Mount Vernon, N.Y. 10550 Tel (914) 668 0388, Pres. Claude Karczmer, Sales Mgr. Daniel Briefstein
Product: Tape-splicing & editing equip. (Editall)
Zerostat, see Oiscwasher

1941

HOME AWAY FROM HOME

USO

The USO in the old days was quite a different USO than it is today. Sure there were shows and recreation; there still are. But the USO today offers family services, tours, travel assistance and emergency help for service personnel stationed around the world.

40th Anniversary
Bob Hope

1981

PROMOTIONAL MERCHANDISING AIDS



AdTees Corp., PO Box 608, Stanley Ave., Thomasville, N.C. 27360 Tel (919) 475 0111 Pres. Tim Batten, VP Mktg. Tim Tucker

Product: Customized T shirts

American Metropolitan Communications Inc., 8640 Hillside Ave., Hollywood, Calif. 90069 Tel (213) 654 9515 Pres. MRF Hanau Exec VP T Randolph

Admin. branch: Miami, Fla., 777 Brickell Ave., Suite 702 Zip 33131

Factory: Santa Monica, Calif., AMC Inc./Rainbo Recs. 1738 Berkeley St Zip 90404

Product: Individually 'personalized' records (M)

Brand name: Han O Disc

Artemis Inc., 556 Westport Ave., Norwalk Conn 06851 Tel (203) 846 0828 WATS (800) 243 6102 Telex 965802

Product: Posters (L, D)

Art Phyl Creations, 162 50 NW 48 Ave., North Miami, Fla. 33127 Pres. Art Hochman, Adv. Mgr. Lori Sidlar

Product: Keychains (M)

Art Servs Inc., 8221 Melrose Ave., Los Angeles, Calif. 90046 Tel (213) 653 9033 Contact Melinda Green

Product: "Gold record" commemorative plaques

Big Ed's Unlimited, 11141 Georgia Ave., Suite A 1 Wheaton, Md. 29092 Tel (301) 949 9500

Product: Customized T shirts

Capricorn Sales, 4018 Buena Vista Rd., Columbus, Ga. 31907 Tel (404) 563 5353

Product: Customized T shirts

Chu Bops, 125 W 55 St., New York, N.Y. 10019 Tel (212) 977 3468 Contacts Susan Eisner, Frank Horowitz, Gary Mankoff (Sales office only)

Product: Miniature bubblegum record album novelty featuring actual jacket artwork

Dajm Corp., 1 Park St. Amsterdam, N.Y. 12010 Tel (518) 842 4800

Product: Plastic display aids (M)

Deejay Gold & Platinum Rec. Plaques Co., 3010 W Burbank Blvd., Burbank, Calif. 91505 Tel (213) 845 0744, 849 5347 Pres. Dave Goldstein

Sales Mgr. Jackie Goldstein

Product: "Gold & Platinum" Record Plaques

Factors Etc. Inc., Geissler Park, Bear, Del. 19701 Tel (302) 834 1625 WATS (800) 441 7650 Pres. H. Lee Geissler Sales Mgr. Laurence H. Seeny

Product: Customized T shirts

Gopher Prods. Corp., PO Box 1812, 2201 Lockheed Way, Carson City, Nev. 89701 Tel (702) 882 9333 WATS (800) 648 0958 Pres. Warren Perkins

Product: T shirts, hats/caps, jackets, signs (M) (SEE ADVERTISE MENT)

Product: T shirts, hats/caps, jackets, signs (M)

Han O Disc, see American Metropolitan

Holoubek Studios Inc., 4712 N. 125 St., Butler, Wis. 53007 Tel (414) 781 4800 WATS (800) 558 0566 Telex 269472. Nat'l Sales Mgr. David W. Bruns

Product: T shirts & iron ons (M)

Howard Knight Ents. Inc., 2424 Pleasant Ridge, Columbia, S.C. 29209 Tel (803) 783 0325

Product: Posters, T shirts (M), belt buckles, hats/caps, keychains, patches, jackets (D)

Product: T shirts & iron ons (M)

Harold Luxch & Assocs., 110 Garfield St., Carlisle, Iowa 55047 Tel (515) 989 3679 Contact Harold Luxch

Product: Posters, belt buckles, T shirts, hats/caps, keychains, patches, jackets (D)

Luna's Illuminations, 111 Chester St., Fairfax, Calif. 94930 Tel (415) 457 5970

Product: T shirts

M B S Love Unlimited, 15 32 127 St., College Point, N.Y. 11356 Tel (212)

359 8500 WATS (800) 221 0474 Pres. Barry Kaminsky, VP. Sally Kaminsky, Gen. Mgr. Alan Kaminsky, Sales Mgr. Barbara Masry

Product: T shirts & iron-ons

Mahoney/Wasserman & Assocs., 117 N. Robertson Blvd., Los Angeles, Calif. 90025 Tel (213) 550 3922 Pres. Jim Mahoney, VP. Paul Wasserman

Branch: New York, N.Y., 510 Madison Ave. Zip 10022 Tel (212) 751 2060 VP. Larry Eisenberg

Product: Posters, T shirts, jackets

The Merchandising Guild, 6163 Glen Alder, Los Angeles, Calif. 90068. Tel (213) 663 1293

Product: Posters, belt buckles, T shirts, hats/caps, keychains, patches, embroidered satin jackets (all D)

Motor City Mdsq., 104 W. Fourth St., Suite 309, Royal Oak, Mich. 48067 Tel (313) 398 1637

Product: Posters, buttons, badges, T shirts, greeting cards

Olympic Litho Corp., 116 Nassau St., Brooklyn, N.Y. 11201 Tel (212) 522 2400 Pres. Marvin D. Frankel, Gen. Mgr. Herbert Farber

Product: Posters (M)

One Stop, 1001 Monterey Pass Rd., Monterey Park, Calif. 91754 Tel (213) 263 7361 WATS (800) 421 6341

Product: Button making machines

Photo Lith Int'l, 11816 Western Ave., Stanton, Calif. 90680 Tel (714) 893 5037

Product: Customized T shirts

Promedeus Arts Inc., 1776 Broadway, New York, N.Y. 10019 Tel (212) 586 3770 Pres. Lew Morris, Sales Mgr. Jerry Present, Adv. Mgr. Ron Parisi

Product: Posters, belt buckles, T shirts, hats/caps, keychains, patches, jackets (M)

Q A I Inc., 640 Dell Rd., Carlsbad, N.J. 07072 Tel (201) 460 0060, NYC (212) 964 1714, Pres. Steve Daumen, Sales Mgr. George Ratowsky

Product: Posters (M)

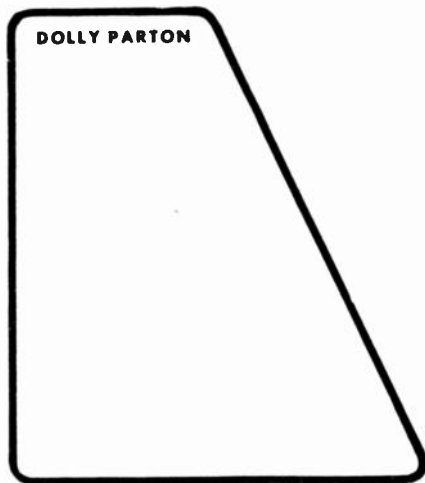

DIVIDER CARDS

By  **GOPHER**

- IN STOCK DIVIDER CARDS
- CUSTOM & PROMOTION DIVIDERS
- 16 YEARS OF QUALITY & SERVICE

TOLL FREE

(800) 648-0958

SILKSCREENED: T-SHIRTS, IN-STORE SIGNS & PROMOTION ITEMS



GOPHER PRODUCTS CORP.

2201 Lockheed Way, Carson City, Nev. 89701

Mfg. Audio • Video
Stereo • Record & Tape

CABINETS

Available in Walnut or Teak

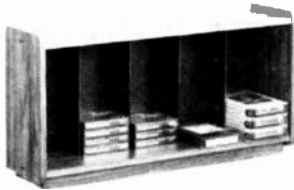

8TC-5065

Holds 50—8 track or 65 cassettes

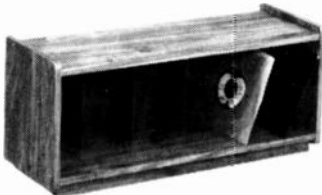

45R-225

Holds 225—45RPM records or 32—7" reel to reel

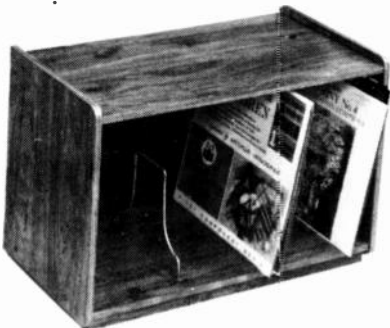

LP-140

Holds 140 LP Records



Model: V-3-D-42

Size—8"H x 15 1/8"D x 26 1/2"W

Universal: 3 Drawers, Holds: 36 VHS Tapes or 42 BETA Tapes, Security Lock



By VISUAL DISPLAYS CORP.

975 ESSEX ST., (212) 649-1818
BROOKLYN, NY 11208

West Coast: RAYNOR SALLES, L.A. CA
(213) 742-0888

Mid Atlantic: SCHWARTZ BROS., Lanham, MD
(301) 459-8000

The Caribbean: CARIBBEAN WHOLESALE SVC
Bayamon, P.R. 00619
(809) 785-8375

Ask for Catalog of Complete Line of Cabinets for
Records, Tapes & Stereo Components

Roach Inc. PO Box 16548, 2255 Westbelt Dr., Columbus, Ohio 43216 Tel (614) 876-9951, WAIS (800) 848 7970 (outside Ohio) Pres John Baird Branch: San Valley, Calif., 8430 Tunjunga Ave. Zip 91352 Tel (213) 767 8300

Product: Customized T shirts & hats

Rockbill Inc., 130 W 57 St., New York, N.Y. 10019 Tel (212) 977-9680 Pres Jay Coleman, Talent Coord Janet Falkoff

Product: Posters (M)

The Shirt X plosion Co. Inc., 5618 Lafayette Pl., Hyattsville, Md 20781 Tel (301) 277-4400

Product: Customized T-shirts (M)

Silk Stocking Prod'ns Ltd., 216 W 18 St., 10th fl., New York, N.Y. 10024 Tel: (212) 255-4424 Chm. Lloyd Ribner Jr., Pres Elliot J Galdy

Product: Posters, belt buckles, T-shirts

Starmakers Poster Corp., 18 E. 41 St., New York, N.Y. 10017 Tel (212) 685 2993, Pres Eileen Miller.

Product: Posters (M)

Stenco Graphics, PO Box 2501, 5311 SW Ninth, Des Moines, Iowa 50315 Tel (515) 285 6564, Pres. Art Stenstrom

Product: Customized T-shirts.

Stiff Tees, 157 W 57 St., New York, N.Y. 10019 Tel (212) 765 3977 Pres Bruce Kirkland, Asst to Pres Nancy Harrison, Mdsge Steve Bonano.

Product: T shirts, posters, buttons.

Summerland Prods Inc. 11842 Vase St., North Hollywood, Calif 91605 Tel (213) 764 2324 WAIS (800) 423 3696/3697 Contact Johnny Devito

Product: Posters, T shirts, hats/caps, jackets, buttons

Totto Pass, 1127 Vine St., Cincinnati, Ohio 45210 Tel (513) 621-9779 Pres Steve Otto

Product: Adhesive cloth tour passes & patches for concert & radio station promotions (M)

The T Shirtery Inc., 1200 Menlo Dr NW, Atlanta, Ga 30377 Tel (404) 351 9850 WAIS (800) 241 1052 Pres Jay J Cohen, VP Sales, Paul I Katz.

Product: T Shirt, hats/caps, jackets. (M)

T-Shirts Int'l Inc., 239 S Cooper St., Memphis, Tenn. 38104, Tel (901) 522 8383

Product: T shirts (M, I, D, R), caps (M, I, D, R), jackets (M, D, R)

The Ultimate Design Group, 730 W Oregon, Milwaukee, Wis 53204 Tel (414) 276 5680

Product: Pewter pins, badges (M)

Warjo Promos, 145 W 55 St., Suite 2E, New York, N.Y. 10019, Tel (212) 245 7179

Product: Posters, T shirts, patches, jackets, buttons (M)

Winterland Prod'ns Rock & Roll Apparel 890 Tennessee, San Francisco, Calif 94107 Tel (415) 648-7700

Zap Ent's., 2833 W Pico Blvd., Los Angeles, Calif 90006 Tel (213) 732 3781

Product: Posters (D)

JUKEBOX MANUFACTURERS

Centuri Inc., 245 W 74 Pl., Hialeah, Fla. 33014 Tel (305) 558 5200 Telex 803694

Rnck Dia Mfg. Corp., 800 N Kedzie Ave., Chicago, Ill 60651 Tel (312) 638 7600, Bd. Chm.: David C. Rockola; Pres. Donald C. Rockola, Exec VP Edward G. Doris, Sr VP Mktg. David R. Rockola; VP & Sales Dir Hugh J Gorman; Sales Mgr., Music Div., John L. Bugenhagen

Rowe Int'l Inc. (sub. of Triangle Inds. Inc.), 75 Troy Hills Rd., Whippany, N.J. 07981, Tel: (201) 887 0400, Cable RDVEND

Int'l branch: Canada.

TITLE STRIP MANUFACTURERS

Don's Title Strip Co. Inc., 1146 W Montrose Ave., Chicago, Ill 60613 Tel (312) 271 7290 Pres Don Chik

Hit Program Serv., see Sterling Title Strip.

Kiderian Recs. Prod'ns, 4926 W Gunnison St., Chicago, Ill 60630 Tel (312) 545-0861 Pres Raymond Peck, Gen & Sales Mgr. George Peck

Star Title Strip Co. Inc., 842 Western Ave., Pittsburgh, Pa 15233 Tel (412) 231 4314 Mgr William P. Miller (SEE ADVERTISEMENT)

Sterling Title Strip Co. Inc., 1175 Broad St., Newark, N.J. 07114 Tel (201) 243 0222 Pres. Dick Steinberg, Sales Mgr. William Thomas

Rik Tinory Prod'ns, 180 Pond St., Cohasset, Mass 02025 Tel (617) 383 9494 Pres. Richard F. Tinory, Artist Relations Claire L Babcock



USO is still surrounding the world with services for our Armed Forces. Entertainment, emergency help, centers and much more.

Barbara Mandrell

40th Anniversary

1981

Remember, only you can prevent forest fires.



A Public Service of This Magazine & The Advertising Council

STORE FIXTURES



The key to the abbreviations following the company listings is: (M) Manufacturer, (D) Distributor, (I) Importer.

A Bee Syndicate Inc., 230 Fifth Ave., New York, N.Y. 10001 Tel: (212) 684-7850.

Product: Record & tape display racks (M)

Acrylic Design & Fabrication Co., 1147 W. Dtho, Chicago, Ill. 60622 Tel: (312) 226 4222.

Product: Record & tape (audio & video) display racks, point of purchase displays.

George Alexander Group Inc., 1063 Post Rd., Darien, Conn. 06820 Tel: (203) 655-7791.

Product: Record & tape browser boxes, record & tape display racks, record & tape divider cards.

Art Phyl Creations, 162-50 NW 48 Ave., North Miami, Fla. 33127. Pres. Art Hochman, Adv. Mgr.: Lon Sidlar

Product: Record & tape (audio) browser boxes, record & tape (audio) display racks (M)

G. Benson & Co. Printers Inc., 75 Spring St., New York, N.Y. 10012 Tel: (212) 925 7100. Contact: Gerald J. Benson.

Product: Record & tape divider cards.

Ted Bushman Signs, 627 Broadway, Massapequa, N.Y. 11758. Tel: (516) 798-8590. Dwner: Ted Bushman.

Product: Record & tape divider cards & signs (M)

Carter Corp., 1916 11 St., Rockford, Ill. 61108. Tel: (815) 397-3200. Pres. Robert L. Fleming, VP Sales & Mktg. Sandra L. Fleming, Plant Mgr. W. Skip Kruger.

Product: Record display racks (Carter-Craft) (M)

Container Kraft Inc., 8321 De Celis Pl., Sepulveda, Calif. 91343. Tel: (213) 893-9721.

Product: Record & tape browser boxes, record & tape display racks.

Continental Forest Inds., Bleached System Dpns, Office Park II, Greenwich, Conn. 06830 Tel: (203) 661-2233. TWX (710) 579-2912. VP John R. Curtin

Product: Security systems (Conversale Orange anti-counterfeiting paperboard product)

Conversale Orange, see Continental Forest Inds.

Creative Store Equip. Inc., PO Box 933, Terrell, Tex. 75160. Tel: (214) 563-5869. Pres. Jerry G. White, Gen. Mgr. John Bowen

Product: Record & tape display racks, tape security systems

Crow Prod'ns, 700 Shore Rd., No. 5-D, Long Beach, N.Y. 11561 Tel: (516) 889-0244. Pres. Gary Leider. (Point of Purchase Displays)

Custom Case Mfg. Co., 6232 Bragg Blvd., Fayetteville, N.C. 28303. Tel: (919) 867-4106. Pres. Al Metzger, Nat'l Sales Mgr. Judy Harris

Product: Record & tape divider cards (M)

Dajim Corp., 1 Park St., Amsterdam, N.Y. 12010 Tel: (518) 842-4800.

Product: Record browser boxes, record & tape display racks (Monark) (M)

Design Fabrications Inc., 1215 Wheaton St., Troy, Mich. 48084 Tel: (313) 689-8206.

Product: Record & tape display racks (custom) (M)

Dielectrics Inc., 300 Burnett Rd., Chicopee, Mass. 01020. Tel: (413) 598-8308

Product: Record & tape divider cards (custom fabrication)

Directree, see Dick Wagner

Discover Division Inc., 5198 W. 76 St., Minneapolis, Minn. 55435 Tel: (612) 831-5538. Pres. Paul W. Smith, VP: Les Boelter.

Product: Record & tape browser boxes, record & tape display racks, record & tape divider cards.

Display Media Inc., 120 Laura Dr., Addison, Ill. 60101. Tel: (312) 543-8330. Pres. & Gen. Mgr.: R. Gribben

Product: Tape display racks & security systems (Securette) (I)

Dstec Inc., 42 Barringer Dr., Charlotte, N.C. 28210. Tel: (704) 527-6931. VP & Gen. Mgr. Fred E. Martintz

Product: Record & tape browser boxes, record & tape display racks, record & tape divider cards.

Electra Display, 122 W. 27 St., New York, N.Y. 10001. Tel: (212) 924-1022. VP: D. Ruderman.

Product: Moving signs, display lighting

Fidelpac Corp., 109 Gaither Dr., Mount Laurel, N.J. 08057. Tel: (609) 235-3511. TWX (710) 897-0254. Pres. Roger Thanhauser; Sales & Mktg. Mgr. Arthur Constantine

Product: Tape display racks (M)

Fixture Concepts Inc., 104 Nelsen Ave., Tukwila, Wash. 98188. Tel: (206) 226-1450. Gen. Mgr.: Jerry Schoeler; Sales Mgr. Peter Scott; Adv. Mgr.: Lynda Hobson.

Product: Record & tape (video) browser boxes, record & tape (video) display racks, tables, counters & related items for display & merchandising, wire LP racks & pegboard accessories.

Forest Packaging Corp., 542 Factory Rd., Addison, Ill. 60101. Tel: 543-7035. Pres. John Kissock; VP: Richard Napp.

Product: Corrugated counter top displays.

Freedman Artcraft Eng'g Corp., PO Box 228, Charlevoix, Mich. 49720. Tel: (616) 547-6501. Gen. Mgr. Ronald Massey; Sales Mgr. L.L. Espich.

Branch: City of Industry, Calif., 14424 Bonellist. Zip. 91744. Tel: (213) 968-9591. Sales & Dpns. Mgr. Ron Lloyd.

Product: Record browser boxes, record & tape display racks.

Gopher Prods. Corp., PO Box 1812, 2201 Lockheed Way, Carson City, Nev. 89701. Tel: (702) 882-9333. WATS (800) 648-0958. Pres.: Warren Perkins.

Product: Record & tape divider cards (M) (SEE ADVERTISEMENT)

Hamilton Fixture Co., 4805 Hamilton-Middletown Rd., Hamilton, Ohio 45012. Tel: (513) 868-2144. Pres. John Schlegel, VP & Sales Mgr. John Overmann.

Product: Record & tape browser boxes, record & tape display racks (MD)

Ivy Hill Graphics & Packaging (div. of Ivy Hill Communications Inc.), 4800 S. Santa Fe Ave., Los Angeles, Calif. 90058. Tel: (213) 587-3131. Exec. VP Russell Mur; Gen. Mgr.: Del Eaton; Sales Mgr. Arthur Kern; Display Div. Dir. Jerry Gottschalk.

Product: Record & tape browser boxes, record & tape display racks, record & tape divider cards.

Kobrin Store Fixture Co., 254 Wallabout St., Brooklyn, N.Y. 11206. Tel: (212) 387-1747. Prod'n Mgr. Benjamin Kobrin, Plant Superintendent Charles Kobrin; Sales Mgr. Samuel Kobrin

Product: Record & tape (audio & video) browser boxes, record & tape (audio & video) display racks (M)

Kustom Krealions Inc., 19316 Londelhus St., Northridge, Calif. 91324. Tel: (213) 886-8383.

Product: Tape browser boxes & display racks

Le-Bo Prods Co Inc. (div. of Peerless Vidronics Corp.), 58-60 Grand Ave., Maspeth, N.Y. 11378. Tel: (212) 894-5155. Cable: LEBDPRDUX Telex 424790. Pres.: P. Dayton

Product: Record & tape (audio) browser boxes, record & tape (audio) divider cards (M) (SEE ADVERTISEMENT)

Liberty Fixture Inc., PO Box 8431, 2467 Mariposa Rd., Stockton, Calif. 95208. Tel: (209) 948-1176. Pres., Sales & Adv. Mgr. Leonard Semler; Gen. Mgr. Wayne Hibner

Product: Record & tape (audio & video) browser boxes, record & tape (audio & video) display racks & related items (SEE ADVERTISEMENT)

Loranger Mfg. Corp., Entertainment Prods. Div., 10 48 Clark St., Warren, Pa. 16365. Tel: (814) 723-8600. VP: Robert Loranger

Product: Record & tape browser boxes (M) (SEE ADVERTISEMENT)

Harold Luck & Assocs., 110 Garfield St., Carlisle, Iowa 50047. Tel: (515) 989-3679. Contact: Harold L. Luck

Product: Record & tape display racks (M)

Mallory Dist' Prods. Co., 3029 E. Washington Ave., Indianapolis, Ind. 46201. Tel: (317) 636-5353

Product: Tape display racks (M)

Modern Album & Finishing Co. Inc., Cardinal Ind'l Park, Gilpin Ave., Hauppauge, N.Y. 11787. Tel: (516) 234-1100. NYC (212) 291-7600. Pres. G.D. Thomas; Sales Mgr. R.A. Froehlig

Branches: Burbank, Calif., Modern Album of California Inc., 3116 Vanowen St. Zip. 91505. Tel: (213) 845-7655. Pres. William S. Pine; Sales Mgr. Raymond Gardocki—Torre Haute, Ind., Modern Album of Indiana, 1299 Voorhees St. Zip. 47808. Tel: (812) 235-6001—Nashville, Tenn., Modern Album of Tennessee Inc., 457 Chestnut. Zip. 37203. Tel: (615) 255-7461.

Product: Record & tape divider cards

Monark, see Dajim.

N E R T (New England Record & Tape) (div. of PBN Survey), PO Box 268, Zip 01842, 641 Matherhill St., Lawrence, Mass. 01841. Tel: (617) 686-4293. Pres. Jerry P. Marcus, VP Int'l Sales P.H. Kankey, Gen. Mgr. Melvin L. Marcus; Sales Mgr. B.J. Kankey.

Product: Record browser boxes, record display racks

Nostalgia Lane Inc., 200 W. 57 St., New York, N.Y. 10019. Tel: (212) 582-5390.

Product: Record browser racks, record & tape display racks, record divider cards.

Pacific Int'l Magnetics Inc., 185 Berry St., No. 3865, San Francisco, Calif. 94107. Tel: (415) 495-8830.

Home office: Canada

Product: Tape display racks (audio)

Pak-Wik Corp., 128 Tivoli St., Albany, N.Y. 12207. Tel: (518) 465-4556. Pres. Samuel A. Strasser; Sales Mgr. Myron S. Strasser Jr.

Product: Tape browser boxes

Paramount Housewares, 1035 Westminster Ave., Alhambra, Calif. 91803. Tel: (213) 570-1601. Pres. Joseph D. Winston; Sales & Adv. Mgr. Charles W. Holmes.

Product: Record browser boxes, record display racks, tape storage cases (M)

Raynor Sales Co. Inc., 2698 W. Pico Blvd., Los Angeles, Calif. 90006. Tel: (213) 737-3737. Pres. & Adv. Mgr. Ray Abrams Sr., Sales Mgr. Ray Abrams Jr.

Product: Record & tape browser boxes, record & tape display racks, record & tape divider cards.

Recoton Corp., 46-23 Crane St., Long Island City, N.Y. 11101. Tel: (212) 392-6442. Pres. Robert Borchardt, Exec. VP Peter Wish, VP Sales George Calvin.

Product: Record & tape browser boxes, record & tape display racks, record & tape divider cards (SEE ADVERTISEMENT)

Ryco, 794 Ralph McGill Blvd., Atlanta, Ga. 30301. Tel: (404) 522-9726. Pres. Herb Haralson; Point of Purchase Div. John Stanton

Product: Point-of-Purchase displays

Scotch, see 3M.

Securette, see Display Media.

Seebro Prods. Co., 2416 S. Michigan Ave., Chicago, Ill. 60616. Tel: (312) 842-8221. Pres.: I. Siegal; Sales Mgr. R. Siegal

Product: Record display racks, wire pegboard baskets

Shape Inc., PO Box 366, Biddelford Ind'l Park, Biddelford, Me. 04005. Tel: (207) 282-6155.

Product: Record & tape display racks (Shape Multistand) (SEE ADVERTISEMENT)

Silk Stocking Prod'ns Ltd., 216 W. 18 St., 10th Fl., New York, N.Y. 10024. Tel: (212) 255-4424. Chm. Lloyd Rubner Jr., Pres. Elliot J. Gaidy

Product: Divider cards.

Starbite Video Advertiser, see Voorhies.

Star Title Strip Co., 842 Western Ave., Pittsburgh, Pa. 15233. Tel: (412) 231-4314, Mgr. William P. Miller.

Product: Record & tape divider cards (MD)

3 M Co. Audio/Video Prods. Div. 3M Center, St. Paul, Minn. 55101. Tel: (612) 733-1466. Corp. VP D.E. Denham, Div. VP J.E. Povolny, Mktg. Dr. W.J. Madden, Nat'l Sales Mgr. J.L. Leon, Mkt. Dpns. Mgr. J.B. Hanks, Mkt. Communications Mgr. D.J. Lunehan

Branches: Anchorage, Alaska, 5531 Minnesota Dr. Zip. 99502. Tel: (907) 276-2363—Burbank, Calif., 126 W. Elm Court. Zip. 91502. Tel: (213) 848-5534—Los Angeles, Calif., 6023 S. Garfield Ave. Zip. 90040. Tel: (213) 726-6300—South San Francisco, Calif., 320 Shaw Rd. Zip. 94080. Tel: (415) 589-2663—Washington, D.C., 1101 15 St. NW. Zip. 20005. Tel: (202) 331-6900—Atlanta, Ga., 2860 Bankers Ind'l Dr. Zip. 30360. Tel: (404) 447-7000—Honolulu, Hawaii, PO Box 30048, 4443 Malaas St. Zip: 96818—Argo, Ill., 6850 S. Harlem Ave. Zip. 60501. Tel: (312) 496-6500—Needham Heights, Mass., 155 Fourth Ave. Zip. 02194. Tel: (617) 449-0300—Farmington, Mich., 23923 Research Dr. Zip. 48024. Tel: (313) 477-5000—Eagan, Minn., PO Box 33211, St. Paul 55133; 3130 Lexington Ave. S. Zip. 55121. Tel: (612) 733-3300—St. Louis, Mo., PO Box 510, 10725 Baur Blvd. Zip. 63166. Tel: (314) 997-8500—West Caldwell, N.J.,

(Continued on page 348)

Rated No. 1



Video Wall Unit

NO 1745 84" H • 48" L • 15 1/2" D

- Holds 256 VHS Tapes 440 beta tapes
- Clear plastic secured doors
- Walnut finish

FREE Write for our brochure showing our complete line of video racks.



Liberty Fixture Inc. • 2467 Mariposa Rd.
P.O. Box 8431, Stockton, Ca. 95208
(209) 948-1176



INTERNATIONAL

Argentina	178	German Democratic Republic (East)	223	Norway	287
Australia.....	180	German Federal Republic (West).....	223	Pakistan	289
Austria.....	185	Greece	240	Panama.....	289
Bahamas.....	187	Guatemala	241	Peru.....	289
Belgium.....	187	Holland		Philippines.....	290
Bermuda	191	see Netherlands		Poland.....	292
Bolivia.....	191	Hong Kong.....	242	Portugal	293
Brazil.....	191	Hungary	243	Romania.....	294
Bulgaria	194	Iceland.....	243	Singapore.....	295
Canada.....	194	India	244	South Africa,	
Chile.....	205	Ireland.....	244	Republic Of.....	296
China, People's Republic of.....	206	Israel	245	Spain.....	298
Colombia.....	206	Italy.....	246	Sudan.....	302
Costa Rica.....	207	Ivory Coast	260	Surinam	302
Cyprus.....	208	Jamaica.....	261	Sweden.....	302
Czechoslovakia	208	Japan	261	Switzerland.....	308
Denmark	208	Kenya	272	Taiwan (Republic of China).....	312
Dominican Republic.....	211	Korea, South	272	Thailand.....	313
Ecuador.....	211	Lebanon	272	Trinidad & Tobago	313
Egypt	212	Malaysia.....	273	Turkey.....	314
El Salvador	212	Mexico.....	274	USSR.....	314
England,		Netherlands.....	279	United Kingdom	315
see United Kingdom		New Zealand.....	286	Uruguay	342
Finland	212	Nicaragua	287	Venezuela	343
France	215	Nigeria	287	Virgin Islands.....	345
				Yugoslavia	345

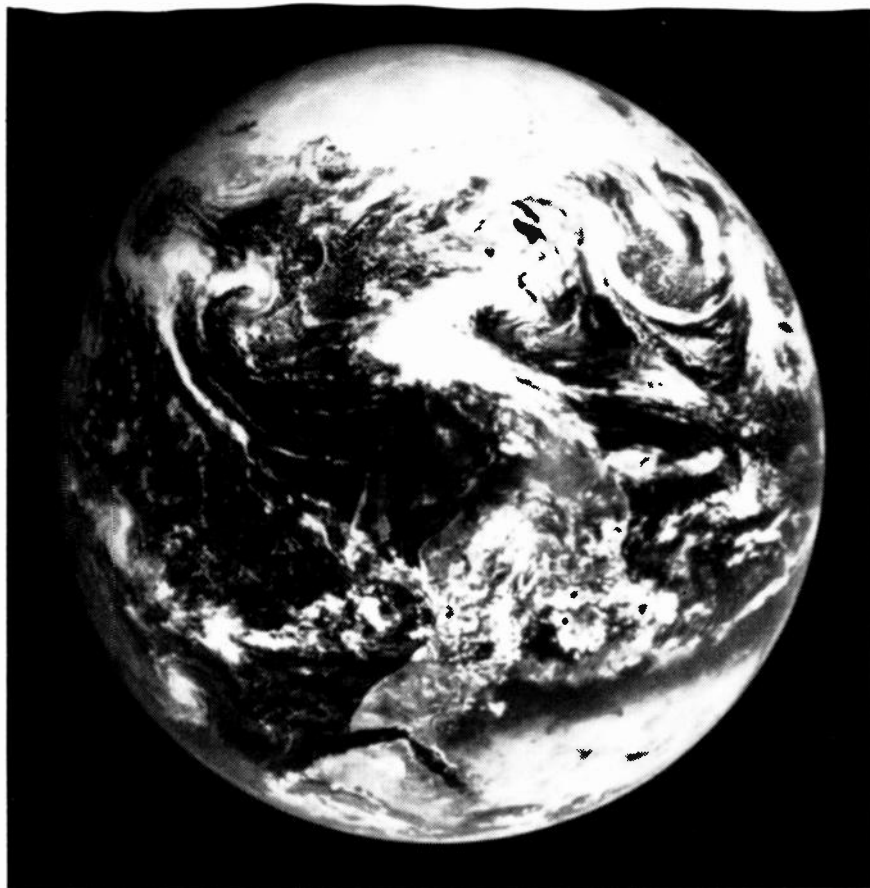

The expanding universe of CBS Records International.

The biggest American international record company
is also the best.

We depend less on others so you can count
on us for more. All over the world.

Look for us in: Argentina, Australia, Austria,
Belgium, Brazil, Canada, Central America, Colombia,
Cyprus, Denmark, Finland, France, West Germany, Greece,
Hong Kong, Ireland, Israel, Italy, Japan, Mexico, Netherlands, New Zealand,
Norway, Spain, South Africa, Sweden, Switzerland, UK and Venezuela.

And discover our new subsidiaries in:
Chile, Kenya and Nigeria.

CBS Records International.
The biggest and the best.
With more companies in more countries.

INTERNATIONAL

MUSIC-RECORD-TAPE SECTION



ARGENTINA

Population: 26,800,000.
Rate of exchange: \$1 (US) = 5000 pesos
Per capita income: \$2,100

Holidays: January 1, Holy Thursday, Good Friday, May 1 (Labor Day), May 25 (Anniversary of the 1810 Revolution), June 23 (Flag Day), July 9 (Independence Day), August 17 (Anniversary of the Death of General San Martin), December 8 (Immaculate Conception), December 25

• record & tape manufacturers / distributors / importers

A R, see American Rec'g
A T C, see Sicaamericana.
Accord, see Musidisc
America, see Musidisc
American Rec'g SAICFIA, Manuela Pedraza 2649/51, 1429 Buenos Aires Tel 701 2159/8954 Cable AUTORRADIO Telex 22687 Pres. Claudio Mario Nadal, Gen. Mgr. Miguel Angel Pettinato, Sales Mgr. Luis Galvez Santana, Int'l Dir. Ramon Villanueva.
Labels: (Owned) AR, Tennessee, (licensed foreign) Accion (Mexico), Continental (Brazil), DJM (UK), Everest (USA), Font Cetra (Italy), GNP Cre scendo (USA), Musidisc (France), Sonet (Sweden), Sweet City (USA)
Angel, see EMI Odeon.
Ariel, see Famous.
Artaria-Kotrona S.R.L., Esmeralda 459, Buenos Aires: 1007 Tel 392-2683 Cable ARIADISC Execs. Ingrid Roehre, Elizabeth Kallay, Bruno Iannice, Marta Alicia Blejer; Gen. Mgr. Bruno Iannice, Sales Mgr. Claudio Davila (Distributor/Importer)
Home office: Germany, Artaria
Labels: (Owned) Artaria, Exclused Cassette, Kontrast, Kotrona Pro pile, Specialty, (licensed) Amerindian (German), Bis (Sweden), Delos (USA), Harmonia Mundi (Germany), Everest group (USA), Schwann (Ger many), Unicorn (UK)
Audiomagnética SAIC, Donado 2362 C, 1430 Buenos Aires Tel: 51-3371 Pres. Carlos Klavins.
Bang Bang, see Jaime Olaszewski Circle Line & Mu-disc
C B S SAICF (Discos), Emilio Mitre 1819, 1474 Buenos Aires Tel 922-4011 Cable COLRECORD Telex 17091 Mng Dir Hecio Cuomo, Finance Mgr. Hector Antuna.
Labels: (Owned) CBS, Columbia, Epic, Odyssey, Orfeo, Portrait, (li censed) A&M (USA), Astarte (Spain), Blue Sky (USA), Boardwalk (USA), Bus (Italy), CGO (Italy), Caribou (USA), Cleveland Int'l (USA), Dan (Mex ico), La Discoteca (Venezuela), Full Moon (USA), GTO (UK), Heriba (Bo livia), Jet Pad (Switzerland), Kirschner (USA), Monument (USA), Nem peror (USA), Ode (USA), PIR (USA), Prophecy (USA), Shakat (USA), Sher bet (Australia), Som (Brazil), Sondor (Uruguay), Sono-Radio (Peru), Spindizzy (USA), Splash (Italy), Sweet City (USA), TK (USA), T Neck (USA), Tabu (USA), Tappan Zee (USA), Unlimited Gold (USA), Virgin (UK), WMDT (USA), Windfall (USA), Zarape (USA)
Calmex S.R.L., Virrey Loreto 2521, 1426 Buenos Aires: Tel 782-3037.
Int'l branch: USA
Labels: (Owned) Calmex, Top, (licensed) Eagle (USA), Insieme (Italy), PPX (USA), Srocco (USA), Yep (Italy)

Camel, see Musictape.
Capitol, see EMI Odeon.
Carmusic SAIC, Mexico 2833, Buenos Aires. Tel 97 7185. Pres. Laura Roma Casella, Gen. Mgr. Alba Casella
Labels: (Owned) Carmusic, (represented) Monica (USA), Europa (Ger many)
Int'l rep.: Uruguay (APSA)
Casablanca, see Phonogram.
Cashbox, see Interdisc.
Cauce, see Trova
Chango, see RCA
Circle Line, see Jaime Olaszewski Circle Line
Colon Recs. S.L. 33 Orientales 955/57, 1236 Buenos Aires Tel 922 5323 Mgr. Rudi B. Szajnuk (Wholesaler/Importer/Exporter)
Columbia, see CBS
D G, see Phonogram
Diapason, see Sicaamericana.
Discolandia Oueri & Cia. Ltda., Ave. Belgrano 3459, 3rd fl., Dept 15, Buenos Aires.
Home office: Bolivia
Discosa, see Interdisc
EMI Odeon SAIC (IFPI), Mendoza 1660, 1428 Buenos Aires. Tel 781 4061/9 Cable TURNTABLE Telex 22796 Mng. Dir. Luis S. Aguado, Finance Dir. Alberto Pandelo, Prod'n Dir. Roberto Altuna, Prod. Dir. Roberto Ruz, Comm'l Dir. Alberto Caldero, Factory Mgr. Jorge Cellerino
Labels: (Owned) Angel, Capitol, EMI, EMI America, Harvest, Liberty, Odeon, Parlophone, (licensed) WEA (USA)
Int'l reps.: Bolivia (Discolandia), Ecuador (IFESA), Guatemala (Dideca), Peru (IEMPSA), Uruguay (A & R Giosia), USA (Discos Alhambra), Vene zuela (Los Ruices)
E P S A (Electrical Prods. SAIC), Mexico 2835, Buenos Aires. Tel 93 8316, 97 4609. Pres. & Gen. Mgr. Laura Roma Casella (Distributor—Tape only)
Epic, see CBS
Exclused Cassette, see Artaria-Kotrona
Famous S.R.L., Anasco 1015, Buenos Aires Tel 59 2918
Labels: (Owned) Ariel, (represented) EMI (UK)
Festival, see Musidisc
Fontana, see Phonogram
Harvest, see EMI Odeon
Impacto, see Tonodisc
Interdisc SA/K Tel, Pedro Goyena 70/72, 1424 Buenos Aires Tel: 923-4926/9209. Pres. Ruben Ciro Aprile; VP Maria Vargas Aprile, Sales Mgr. Jorge Aprile, Accounting: Luis Spadolara, Art & Prod'n Pape Puentes, Promo: Jorge Allegro, Luis Gils, Int'l Maria Aprile
Labels: (Owned) Cashbox, Interdisc, (licensed foreign) AVI (USA), Baby (Italy), Buddha (USA), Carosello (Italy), Continental (Brazil), K tel (USA), Melody (Mexico), Musidisc Europa (France), Prelude (USA); (dis tributed—not licensed) Discosa
Int'l reps.: Bolivia (Laureano Rojas), Brazil (K tel), Mexico (Melody), Spain (K tel), Venezuela (K tel).
Jazz Anthology, see Musidisc.
Karussell, see Phonogram
Kontrast, see Artaria-Kotrona
Kotrona, see Artaria-Kotrona
Liberty, see EMI Odeon
Linea Tres, see RCA
London, see Phonogram
M G M, see Phonogram
Magnetec, see Magnetec
Magnetec SA, Albarino 1540, 1440 Capital Federal Tel 68 6834 Cable MAGNATEC BAIRES. Pres. Alfredo Farhi; Gen. Mgr. Carlos Farhi; Sales Mgr. Ruben Ochoa.
Label: (Distributed—not licensed) Magnetec
Mercury, see Phonogram.
Microton Argentina SA (IFPI), Lavalle 1430, 4th fl., Buenos Aires Tel 49 6128, 40 9728. Cable MICROTON BAIRES Telex 17774 MIFON AR. Pres. Mario Ruben Kaminsky, VP. Norberto Kaminsky
Labels: (Owned) Micsa, (licensed foreign) Alshire (USA), Ariola (world wide), Arista (USA), Audiofidelity (USA), Belter (Spain), Infopesa (Peru), Island (USA), Jupiter (Germany), MCA (USA), Motown (USA), Ricordi (Italy), Ri-Fi (Italy), Velvet (Venezuela)
Int'l reps.: Bolivia (Heriba), Colombia (Codiscos), Ecuador (IFESA), Mex ico (Ariola), Peru (Infopesa), Spain (Ariola), Uruguay (EDISA), Venezuela (Velvet)
Micsa, see Microton
Music Hall, see Sicaamericana
Musictape S.R.L., Gamera 1822, 1431 Buenos Aires. Tel (541) 52-7414/8241, Pres. Jose Carlos Silvestre, Gen. Mgr. Alberto E. Silvestre; Sales Mgr. Daniel Halperin.
Labels: (Owned) Camel, Musictape, (licensed) Anhembi (Brazil), Bendig (Brazil), Camel (Brazil), Coombe (UK), Count Down (Germany), Crazy (Brazil), FIF (Brazil), GIA (Brazil), Infoco (Brazil), Intersom (Brazil), Seta (Brazil), Sigla (Brazil), Take Play (Brazil).
Int'l rep.: Brazil (Tropisong).
Musidisc Europe Sudamericana SAICF, Uruguay 1037, 4th fl., 1016 Buenos Aires. Tel: 41 0464/7091. Cable: MUSIDISC BAIRES. Telex 22197 Pres Jean Fano; Gen. Mgr. Jaime Olaszewski
Home Office: France.
Labels: (Owned) Accord, America, Festival, Jazz Anthology, Musidisc.

Score, Vsadisc, (licensed domestic) Bang Bang, Circle Line Prod'ns; (li censed foreign) Atlas (Italy), Atropa (France), Durium (Italy), Earth (USA), Elver (Belgium), Gull (UK), Lesser Int'l (Germany), Notable (USA), Panarecord (Italy), Rockoko (USA), Saar (Italy), Victoria (Ger many)
Int'l reps.: Colombia (Codiscos), Uruguay (EISA/Phonogram, Sondor/ CBS)
N G, see Tonodisc
Odeon, see EMI Odeon
Odyssey, see CBS
Jaime Olaszewski Circle Line Producciones, Agüero 1920, 8th fl., 18, 1425 Buenos Aires Tel 826 0034. Cable: CIRCLE-LINE BAIRES. Telex 22197 Gen. Dir. J. Olaszewski Fried; Gen. Mgr. A.M. Hernandez.
Labels: (Owned) Bang Bang, Circle Line, (licensed foreign) Albatros (France), Dial (Spain), Elver (Belgium), Ibach (France), MM (France), Multipix (UK), Tommy (Uruguay), Victoria (Germany).
Domestic labels represented: Alos (worldwide), Arfon (worldwide except Uruguay), Argentina Prod'ns (worldwide except UK), Campo (worldwide except Bolivia), Mburucuyá (worldwide), Paraguari (worldwide), TK (Eu rope, Japan), Tonodisc (Europe, Japan)
Int'l reps.: Chile (Quatro), Colombia (Codiscos), Ecuador (Fadisa), France (Elypeyrol), Japan (Muscamigos), Spain (Dial), Uruguay (Maloa, Tommy)
Orfeo, see CBS
Paraiso Recs. S.R.L., Maipu 896, 1006 Buenos Aires. Tel 392-1674. Telex 121625 (Distributor/Importer)
Int'l rep.: USA (Daniel Szylid)
Parlophone, see EMI Odeon
Philips, see Phonogram
Phonogram SAIC (IFPI), Calle Moreno 2038, Buenos Aires. Tel: 48-7709/5524/6728. Telex 17775. Mng. Dir. John Lear, Gen. Mgr. Roberto Lopez, Int'l Mgr. Adrian Berwick.
Labels: (Owned) Casablanca, DG, Fontana, Karussell, London, Mercury, Philips, Polydor, Vertigo, Verve, (licensed foreign) Charisma (UK), Ene slyand Vista (USA), Lollipop, MGM (USA), RSD (USA), Rocket (UK), Za hro (Spain)
Polydor, see Phonogram
Portrait, see CBS
Proarca, see RCA
Prodisco, see Tonodisc
Promusica, see Tonodisc
Propile, see Artaria-Kotrona
RCA Ltd. (Succursal Argentina) (IFPI), Paroissien 3930, 1430 Buenos Aires. Tel 541-4171. Cable: RCAAAR Telex 21239. Pres. Adolfo Pino. Gen. Mgr. Jorge Oscar Schutt, Sales Mgr. Guillermo Glucksman.
Labels: (Owned) Linea Tres, Proarca; (licensed foreign) Barclay (France), Camden (USA), Can't Stop (USA), Erato (France), Fantasy (USA), Hansa (Germany), Mellow (Netherlands), Polar (Sweden), Pure Gold (USA), RCA (USA), Red Seal (USA), Victor (USA), Victrola (USA); (distributed—not licensed) Chango, Radio, Roex.
Radio, see RCA
Record World S.R.L., Pueyrredon 1924, 1119 Buenos Aires. Tel: (01) 771 9908.
Mgr. Luis G. Pisterman (Importer/Exporter)
Rhombus, see Trova
Ritmo, see Sicaamericana
Roex, see RCA
Rondo Musical S.R.L., La Pampa 2586, 1428 Buenos Aires. Tel: 784-0747. Gen. Mgr. Jorge C. Esperon.
Sazam, see Sicaamericana
Score, see Musidisc
Sicaamericana SACIFI (IFPI), Jose E. Uriburu 40-42, 1027 Buenos Aires. Tel: 46-9807. Cable: SICAMERICANA. Pres. Nestor Norberto Sefasco; Gen. Mgr. Carlo Langus, Sales Mgr. Jorge Nicosa.
Labels: (Owned) Music Hall, Ritmo, (licensed) Durium (Italy), Eagles (UK), Hispavox (Spain), Marler (Spain), Musart (Mexico), Orfeon (Mex ico), PRI (UK), Rialto (UK), Satril (UK), Sire (UK); (distributed—not li censed) ATC, Diapason, Sazam
Int'l reps.: Bolivia (Lauro), Colombia (INS), Costa Rica (Indica), Ecuador (Famoso), Mexico (Orfeon), Uruguay (Sondor)
Specialty, see Artaria-Kotrona
Tema, see Trova
Tennessee, see American Rec'g
Tonodisc SA (IFPI), Culpina 375, 1406 Buenos Aires. Tel: 612-4873/5107, 611 4819. Telex: 9191. Pres. Natalio Garber; VP. Francisco Vidal; Sales Mgr. Ricardo Portela; Promo Mgr. Julio Garcia, Prod'n Mgr. Raul Gimenez.
Labels: (Owned) Impacto, NG, Prodisco, Promusica; (licensed foreign) BASF (Venezuela), Boni (Colombia), Ljubljana (Yugoslavia), Musart (Mexico), Victor (Japan).
Int'l reps.: Brazil (Chantecler, Columbia), France (Delphine), Italy (Saar), Mexico (Gas), Spain (Belter), UK (BBC), USA (Project 3).
Top, see Calmex.
Tower Recs., Verbal 457, Local 83, Buenos Aires. Tel: 99 1659. Owners. Ralph Haeck, Eduardo Ostrogovich. (Importer/Exporter)
Int'l branch: USA, Surco Ents.
Trova Inds. Musicales SA (IFPI), Cangallo 4378/80/82, Buenos Aires. Tel: 811 0890/0990/2810. Pres. Felix Horowicz, Gen. Mgr. & A&R Nahun Roberto Rudoff.
Labels: (Owned) Cauce, Rhombus, Tema, Trova, Vernal; (distributed—not licensed) CID (Brazil), Carosello (Italy), Erre TV (Italy), Gravacos Elec-

WE'RE GROWING.
We developed 10 Hit Records
this year.

AMERICAN RECORDING

American Recording wants to represent the most important labels sold in Argentina
American Recording S.A.I.C.F.I.A.

Manuela Pedraza 2649 - c.c. 98 - Suc. 29
CP 1429 Buenos Aires Argentina
Phone: 701-2159/8954
Cable: AUTORRADIO BAIRES
Telex: 22687 BOMER AR

*Join us in celebrating
the international success of
our great artists.*



ncas (Brazil), Phonogram (Brazil), Som Livre (Brazil)
 Int'l reps: Brazil (CID, Continental, Phonogram, RGE/Fermata, Sigla), Chile (Quatro), France (Pathe Marconi EMI), Italy (Carosello), Japan (Victor), Mexico (Gamma), Spain (CBS), Uruguay (Clave), Venezuela (BASF)
 Vernal, see Trova
 Vertigo, see Phonogram
 Verve, see Phonogram
 Visadisc, see Musidisc
 W K Producciones Artísticas, Juan Francisco Segui 1728, Buenos Aires. Contact Enrique Iriberrí.
 Label: (Represented) Moss Music Group (USA)

• music publishers

Acorde (Ed.), see Edamí
 Audiomagnética SAIC, Donado 2362 C, 1430 Buenos Aires. Tel: 51-3371. Pres. Carlos Klavins.
 Calmix S.R.L., Virrey Loreto 2521, 1426 Buenos Aires. Tel: 782-3037
 Int'l firms represented: Intersong (Germany), Sugar Music (Italy)
 Edamí S.R.L. (Ed. Argentina de Música Int'l), Tucumán 994, 1049 Buenos Aires. Tel: 35-2187/4358. Gen. Mgr. Elsa N. Villar
 Int'l firms represented: EMBI (Brazil), ENMI (Mexico), Holland (Netherlands), Peer (Colombia), Germany, Italy, Puerto Rico, Musa (Mexico), PHAM (Mexico), SEMI (France), Southern (Australia), Austria, Belgium, Canada, Chile, Japan, New Zealand, South Africa, Spain, Sweden, Switzerland, UK, Bad Boy, Gold Hill, Gopam, Kamakazy, Mauve, Peer Southern, Purple, Rare Magnetism, Sashay, Sheryl, Surias (all USA)
 Edifon S.R.L., Tucumán 1455, 9th fl., A. Buenos Aires. Tel: 45-7142 Cable: MICROFON BAIREs Telex: 17774 MIFDNI AM. Pres. Mario Ruben Kaminsky, Gen. Mgr. Elena S. de Larrazabal
 Int'l firms represented: Arabella (Mexico, Spain), Arista (USA), Berglen (USA), Bertam (USA), Black Bull (USA), Jobete (USA), Old Branton Road (USA), Ollantay (Peru), Stone Age (USA), Stone Diamond (USA)
 Int'l reps.: Peru (Ollantay), USA (Pampa)
 Korn SAIC (Ed. Musical), Av. Cordoba 1351, 2nd fl., Buenos Aires. Tel: 44-0611/5142/9798. Cable: EDIKDRN. Gen. Mgr. Nelida Lopez French
 Int'l firms represented: United Artists group (USA)
 M A I (Musica Argentina e Internacional) SA Ed. Talcahuano 68, 1391 Buenos Aires. Tel: 37-9441. Cable: EDIMAI Telex: 22796. Pres.: Luis S. Aguado. Gen. Mgr.: Maria Hajdenwurcel.
 Int'l firms represented: Discorama (Spain), EGD (Spain), EMI (UK), Ecomus (Colombia), ITAIPU (Brazil), Sochem (Chile), Unimúsica (Venezuela).
 Int'l reps.: Brazil (ITAIPU), Spain (EGD)
 Melograf S.R.L. (affiliate of CBS Songs Int'l), Suipacha 476, 1008 Buenos Aires. Tel: 49-3551 Dir. Hecio Cuomo. Gen. Mgr.: Beatriz Lupo.
 Int'l firms represented: ATV, Blue Seas/Jac. Clar. Frank, Garrett, Albert Hammond Ent's., Hudmar, Jet, Kirshner, E. B. Marl's, Robert Mellin, Saggi fire, Sheryl, Third Story, Tuna Fish (all USA); alvorada (Brazil).
 Int'l reps.: Worldwide (CBS Songs)
 Mundo Musical S.R.L. (Eds.), see Melograf
 Musica Argentina e Internacional, see MAI
 Music Tape (SADAIC), Gamera 1822, 1431 Buenos Aires. Tel: (541) 52-8241/7414. Pres.: Jose Carlos Silvestre. Gen. Mgr.: Alberto E. Silvestre. Prof. Mgr.: J.C. Silvestre.
 Int'l firms represented: Crazy, Hirmaos Vitale, Tropisong (all Brazil)
 Int'l rep.: Brazil (Tropisong).
 Ddeon (Ed.), see MAI
 Jaime Diszewski, Aguero 1920, 8th fl., 18, 1425 Buenos Aires. Tel: 826-0034. Cable: CIRCLE LINE BAIREs Telex: 22197. Gen. Dir.: J. Diszewski. Fried. Gen. Mgr.: A.M. Hernandez.
 Int'l firms represented: Paul Beuscher (France), Bretagne (France), Claude Carrere (France), Coda (Belgium), Elypeyrot (Europe), Isabelle (France), Melodie der Welt (Germany), Johann Michel (Germany), Storzando (France), Tremplin (France).
 P A M S C O S A C (Pan American Music Serv. Corp.), Jose E. Uruburu 40-42, 3rd fl., Buenos Aires. Tel: 49-0399, 46-9807/00. Cable: PAMESCD
 Int'l firms represented: CAM (Italy, Spain), CD (Belgium), Come Il Vento (Italy), Curci, Durium (Italy), Hispavox (Spain), Marouani (France), Drbemusa (Venezuela), Pema (France), PHAM (Mexico), Pull (Italy), G. Ricordi (Italy), Televis (Italy), You You (France)
 Int'l reps.: Colombia (Exitos), Mexico (PHAM), Uruguay (Tacuara), Venezuela (Orbemusa).
 Peer Southern Org., see Edamí
 Puma (Publicaciones Musicales Americanas) S.R.L., Culpina 375, Buenos Aires. Tel: 612-4873/5107. Pres. Francisco Vidal. Gen. Mgr.: Marta Rizzo.
 Relay (Eds. Musicales) SA, Paraisos 3930, Buenos Aires. Tel: 70-4171/4175. Telex: 21239. VP: Jorge Oscar Schutti; Mgr.: Howard Dean McCluskey
 Int'l firms represented: Acapulco (Mexico), Ariola America (USA), Balair (Brazil), Brinos (Spain), Bron (UK), Bull Pen (USA), CAM (USA), Catevento (Brazil), Cherry Lane (USA), Erasmus (U.A.), Estrella (Mexico), 57th Street Entertainment (USA), Infinity (USA), Jandora (USA), Luciana (Brazil), Lucky Three (USA), Marquez (Mexico), Ivan Mogull (USA), Novo Rumo (Brazil), Page Full of Hits (USA), Perren Vib-s (USA), RCA affiliates (worldwide), Saber Tooth (USA), Salsoul (USA), Scorpio (France), Scott Tone (USA), Scott Wolfe (UK), Unimúsica (Venezuela), Universal (Spain)
 Int'l rep.: RCA (Worldwide)
 S I G E M (Sistema Globo de Ediciones Musicales), 683 Florida, Buenos Aires. Tel: 392-9962.
 Trompos Publ'g. S.R.L., see Edifon
 Ultramoderna (Ed.), see MAI

• services

ASSOCIATIONS & PROFESSIONAL ORGANIZATIONS
 Asociación Wagneriana de Buenos Aires, Santa Fe 1243, 1st fl., Buenos Aires
 Collegium Musicum de Buenos Aires, Libertad 1630 Buenos Aires.
 Mozarteum Argentino, Rodríguez Peña 1882, 1021 Buenos Aires. Tel: 44-4836. Pres. Jeannette Arata de Enza

CATALOG SERVICES

American Rec'g SAICFIA, Manuela Pedraza 2649/51, 1429 Buenos Aires. Tel: 701-2159/8954. Cable: AUTORRADIO Telex: 22687. Pres. Claudio Mario Nadal. Gen. Mgr.: Miguel Angel Pettinato. Sales Mgr.: Luis Galvez Santana.
 C B S Recs SAICF (Discos), Emilio Mitre 1819, 1424 Buenos Aires. Tel: 922-4011. Cable: CDRECORD. Telex: 17091. Mng. Dir. Hecio Cuomo.

DESIGN & ARTWORK

American Rec'g SAICFIA, Manuela Pedraza 2649/51, 1429 Buenos Aires. Tel: 701-2159/8954. Cable: AUTORRADIO Telex: 22687. Pres.: Claudio

Mario Nadal. Gen. Mgr.: Miguel Angel Pettinato; Sales Mgr.: Luis Galvez Santana.
 Artaria-Kotrona S.R.L., Esmeralda 459, 1007 Buenos Aires. Tel: 392-2683. Cable: ARIADISC. Gen. Mgr.: Bruno Iannice; Sales Mgr.: Claudio Davila.
 SoHo S.R.L., Uruguay 806, 5th fl., 1015 Buenos Aires. Tel: (01) 41-6389. Mgr.: Nelson Montes.
LICENSING ORGANIZATION, MUSIC
 S A D A I C (Sociedad Argentina de Autores & Compositores de Musica), Lavalle 1547, Buenos Aires. Tel: 40-4867 (Performing rights only)

LICENSORS, RECORD & TAPE

Artaria-Kotrona S.R.L., Esmeralda 459, 1007 Buenos Aires. Tel: 392-2683. Cable: ARIADISC. Gen. Mgr.: Bruno Iannice; Sales Mgr.: Claudio Davila.
 Musictape S.R.L., Gamera 1822, 1431 Buenos Aires. Tel: (541) 52-7414/8241. Pres.: Jose Carlos Silvestre. Gen. Mgr.: Alberto E. Silvestre. Sales Mgr.: Daniel Halperin.
PLATING, PROCESSING & PRESSING PLANTS
 Artaria-Kotrona S.R.L., Esmeralda 459, 1007 Buenos Aires. Tel: 392-2683. Cable: ARIADISC. Gen. Mgr.: Bruno Iannice; Sales Mgr.: Claudio Davila.
 C B S SAICF (Discos), Emilio Mitre 1819, Buenos Aires. Tel: 922-4041. Cable: CDRECORD. Telex: 17091. Mgr.: Hecio Cuomo.
 Galvads S.R.L., 11 de Septiembre 481, Ramos Mejia, Buenos Aires. Tel: 653-6826. Gen. Mgr.: Raul Iglesias.

PRINTER & LITHOGRAPHER

Artaria-Kotrona S.R.L., Esmeralda 459, 1007 Buenos Aires. Tel: 392-2683. Cable: ARIADISC. Gen. Mgr.: Bruno Iannice; Sales Mgr.: Claudio Davila.

RECORD PROMOTION

Artaria-Kotrona S.R.L., Esmeralda 459, 1007 Buenos Aires. Tel: 392-2683. Cable: ARIADISC. Gen. Mgr.: Bruno Iannice; Sales Mgr.: Claudio Davila.
 Audiomagnética SAIC, Donado 2362 C, 1430 Buenos Aires. Tel: 51-3371. Pres.: Carlos Klavins.
 Musictape S.R.L., Gamera 1822, 1431 Buenos Aires. Tel: (541) 52-7414/8241. Pres.: Jose Carlos Silvestre. Gen. Mgr.: Alberto E. Silvestre. Sales Mgr.: Daniel Halperin

TAPE CUSTOM DUPLICATORS

TAPE PACKAGING & LABELING
 The Audio and Video lines indicate the configurations which the firms duplicate. Companies which offer packaging and labeling of tape product are indicated by "(PKG)" which appears after the main body of their respective listings.

American Rec'g SAICFIA, Manuela Pedraza 2649/51, 1429 Buenos Aires. Tel: 701-2159/8954. Cable: AUTORRADIO Telex: 22687. Pres. Claudio Mario Nadal. Gen. Mgr.: Miguel Angel Pettinato; Sales Mgr.: Luis Galvez Santana. (PKG)
 Audio: Cassette.
 Artaria-Kotrona S.R.L., Esmeralda 459, 1007 Buenos Aires. Tel: 392-2683. Cable: ARIADISC. Gen. Mgr.: Bruno Iannice; Sales Mgr.: Claudio Davila. (PKG)
 Audio: Cassette, open reel
 Video: 1" open reel, 1" cartridge, 1/2" cassette, 1/4" EIAJ open reel, 1/4" EIAJ cartridge.
 Audiomagnética SAIC, Donado 2362 C, 1430 Buenos Aires. Tel: 51-3371. Pres.: Carlos Klavins.
 E M I Dodeon SAIC, Montaneses 2150, 1428 Buenos Aires. Tel: 781-4061/69. Cable: TURNTABLE. Telex: 22796.
 Audio: Cassette.
 E P S A (Electrical Prods. SAIC), Mexico 2835, Buenos Aires. Tel: 93-8316. 97-4609. Pres. & Gen. Mgr.: Laura Roma Casella.
 Audio: 8-tr., cassette, open reel
 Magnatec SA, Albarino 1540, 1440 Capital Federal. Tel: 68-6834. Cable: MAGNATEC BAIREs. Pres. Alfredo Farhi; Gen. Mgr.: Carlos Farhi; Sales Mgr.: Ruben Ochoa.
 Audio: Cassette.
 Musictape S.R.L., Gamera 1822, 1431 Buenos Aires. Tel: (541) 52-7414/8241. Pres.: Jose Carlos Silvestre. Gen. Mgr.: Alberto E. Silvestre. Sales Mgr.: Daniel Halperin.
 Audio: Cassette, open reel.
 Phonogram SAIC, Calle Moreno 2038, Buenos Aires. Tel: 48-7709/5524. Telex: 17775. Mng. Dir.: John Lear.
 SoHo S.R.L., Uruguay 806, 5th fl., 1015 Buenos Aires. Tel: (01) 41-6389. Mgr.: Nelson Montes.
 Audio: Cassette.

• supplies

CARTRIDGE & CASSETTE PARTS
EMPTY CARTRIDGES, CASSETTES & REELS
 American Rec'g SAICFIA, Manuela Pedraza 2649/51, 1429 Buenos Aires. Tel: 701-2159/8954. Cable: AUTORRADIO Telex: 22687. Pres. Claudio Mario Nadal. Gen. Mgr.: Miguel Angel Pettinato; Sales Mgr.: Luis Galvez Santana (Audio only)
 Brand names: AR, Tennessee
 Artaria-Kotrona S.R.L., Esmeralda 459, 1007 Buenos Aires. Tel: 392-2683. Cable: ARIADISC. Gen. Mgr.: Bruno Iannice; Sales Mgr.: Claudio Davila. (Importer)
 Audio: 8-tr., cassette
 Magnatec SA, Albarino 1540, Capital Federal 1440. Tel: 68-6840. Cable: MAGNATEC BAIREs. Pres. Alfredo Farhi; Gen. Mgr.: Carlos Farhi; Sales Mgr.: Ruben Ochoa. (Empty only)
 SoHo S.R.L., Uruguay 806, 5th fl., 1015 Buenos Aires. Tel: (01) 41-6389. Mgr.: Nelson Montes. (Empty only)
 Audio: Cassette.

ENVELOPES & MAILERS

JACKETS & SLEEVES
LABELS, DISK
POLYETHYLENE BAGS & SHRINKWRAP
 Artaria-Kotrona S.R.L., Esmeralda 459, 1007 Buenos Aires. Tel: 392-2683. Cable: ARIADISC. Gen. Mgr.: Bruno Iannice; Sales Mgr.: Claudio Davila. (Importer)

PROFESSIONAL TAPE SUPPLIES

Magnatec SA, Albarino 1540, Capital Federal 1440. Tel: 68-6834. Cable: MAGNATEC BAIREs. Pres. Alfredo Farhi; Gen. Mgr.: Carlos Farhi; Sales Mgr.: Ruben Ochoa.
 Audio: Boxes, hubs
 SoHo S.R.L., Uruguay 806, 5th fl., 1015 Buenos Aires. Tel: (01) 41-6389. Mgr.: Nelson Montes.
 Audio: Cassette labels

RAW MATERIALS
RECORD MANUFACTURING EQUIPMENT

Artaria-Kotrona S.R.L., Esmeralda 459, 1007 Buenos Aires. Tel: 392-2683. Cable: ARIADISC. Gen. Mgr.: Bruno Iannice; Sales Mgr.: Claudio Davila (Importer)
TAPE, BLANK LOADED & BULK RAW
 Agfa-Gevaert Argentina SACI, Bme. Mitre 1902/10, Buenos Aires. Tel: 45-9012/7726/8465. Cable: ARGEVA.
 Audio: Blank-compact cassette, open reel; raw-cassette, broadcast studio.
 Brand names: Agfa Carat, Agfa Stereochrom, Agfa Videochrom
 American Rec'g SAICFIA, Manuela Pedraza 2649/51, 1429 Buenos Aires. Tel: 701-2159/8954. Cable: AUTORRADIO Telex: 22687. Pres. Claudio Mario Nadal. Gen. Mgr.: Miguel Angel Pettinato; Sales Mgr.: Luis Galvez Santana. (Blank only)
 Audio: Cassette.
 Brand names: AR, Perception, Sonoline, Tennessee
 Artaria-Kotrona S.R.L., Esmeralda 459, 1007 Buenos Aires. Tel: 392-2683. Cable: ARIADISC. Gen. Mgr.: Bruno Iannice; Sales Mgr.: Claudio Davila. (Importer)
 Audio: Cassette, open reel
 Video: 1" open reel, 1" cartridge, 1/2" cassette, 1/4" EIAJ open reel, 1/4" EIAJ cartridge.
 Audiomagnética SAIC, Donado 2362 C, 1430 Buenos Aires. Tel: 51-3371. Pres.: Carlos Klavins.
 B A S F (Argentina) SA, PD Box 4800, Av. Corrientes 327, 1000 Buenos Aires. Tel: 32-9491/9496. Telex: 121067.
 Audio & Video: Cassette, open reel
 SoHo S.R.L., Uruguay 806, 5th fl., 1015 Buenos Aires. Tel: (01) 41-6389. Mgr.: Nelson Montes.
 Audio: Cassette

TAPE DUPLICATING & PROCESSING EQUIPMENT
 Artaria-Kotrona S.R.L., Esmeralda 459, 1007 Buenos Aires. Tel: 392-2683. Cable: ARIADISC. Gen. Mgr.: Bruno Iannice; Sales Mgr.: Claudio Davila. (Importer)
 SoHo S.R.L., Uruguay 806, 1015 Buenos Aires. Tel: (01) 41-6389. Mgr.: Nelson Montes
 Product: In-cassette, reel-to-reel, reel-to-cassette duplicators.
 Brand name: Pentagon.

TAPE PACKAGING & LABELING EQUIPMENT

Artaria-Kotrona S.R.L., Esmeralda 459, 1007 Buenos Aires. Tel: 392-2683. Cable: ARIADISC. Gen. Mgr.: Bruno Iannice; Sales Mgr.: Claudio Davila (Importer)

• accessories manufacturers

American Rec'g SAICFIA, Manuela Pedraza 2649/51, 1429 Buenos Aires. Tel: 701-2159/8954. Cable: AUTORRADIO Telex: 22687. Pres. Claudio Mario Nadal. Gen. Mgr.: Miguel Angel Pettinato; Sales Mgr.: Luis Galvez Santana.
 Product: Record-carrying & storage cases, tape-carrying & storage cases, head cleaners, leaders & splicing tape.
 Artaria-Kotrona S.R.L., Esmeralda 459, 1007 Buenos Aires. Tel: 392-2683. Cable: ARIADISC. Gen. Mgr.: Bruno Iannice; Sales Mgr.: Claudio Davila. (Importer)
 Product: Record-carrying & storage cases, record care prods., turntable mats, 45 RPM adaptors, replacement styli. Tape-carrying & storage cases, head cleaners, bulk erasers, demagnetizers, leader tape, splicing tape & equip.
 Brescia Electronica SAIC, Fitz Roy 1929, Buenos Aires. Tel: 771-0863.
 Product: Record-replacement styli
 Holimar S.R.L., Cespedes 2670, Buenos Aires. Tel: 73-8127. (Importer)
 Product: Record-replacement styli (Ortolon).
 Ortolon, see Holimar
 Musictape S.R.L., Gamera 1822, 1431 Buenos Aires. Tel: (541) 52-7414/8241. Pres.: Jose Carlos Silvestre. Gen. Mgr.: Alberto E. Silvestre. Sales Mgr.: Daniel Halperin.
 Product: Record-turntable mats, tape-head cleaners, leader tape, splicing tape & equip.
 SoHo S.R.L., Uruguay 806, 5th fl., 1015 Buenos Aires. Tel: (01) 41-6389. Mgr.: Nelson Montes.
 Product: Tape-head cleaners, bulk erasers.

• store fixtures

Artaria-Kotrona S.R.L., Esmeralda 459, 1007 Buenos Aires. Tel: 392-2683. Cable: ARIADISC. Gen. Mgr.: Bruno Iannice; Sales Mgr.: Claudio Davila. (Importer)
 Product: Record & tape browser boxes, display racks, divider cards, security systems.
 Musictape S.R.L., Gamera 1822, 1431 Buenos Aires. Tel: (541) 52-7414/8241. Pres.: Jose Carlos Silvestre. Gen. Mgr.: Alberto E. Silvestre. Sales Mgr.: Daniel Halperin.
 Product: Tape display racks (audio).

• jukebox importer

• jukebox title strip importer

Artaria-Kotrona S.R.L., Esmeralda 459, 1007 Buenos Aires. Tel: 392-2683. Cable: ARIADISC. Gen. Mgr.: Bruno Iannice; Sales Mgr.: Claudio Davila. (Importer)

• promotional merchandising aids

Artaria-Kotrona S.R.L., Esmeralda 459, 1007 Buenos Aires. Tel: 392-2683. Cable: ARIADISC. Gen. Mgr.: Bruno Iannice; Sales Mgr.: Claudio Davila. (Importer)
 Product: Posters, belt buckles, T-shirts, hats/caps, keychains, patches, jackets

AUSTRALIA

Population: 14,000,000
 Rate of exchange: \$1 (US) = 0.87 Australian dollars
 Per capita income: \$5,540
 Holidays: January 1, January 26 (Australia Day), Good Friday, Easter Mon

day, April 25 (Anzac Day), Queen's Birthday, December 25, December 26 (Boxing Day).

RECORDS & TAPE:

Total records & pre-recorded tape sold: \$200,000,000.
 Record & pre-recorded tape production: LP's & cassette 1980-35,455,000 units; 1979-34,148,000 units. Singles 1980-10,928,000 units; 1979-10,527,000 units.
 Type of distribution: Manufacturer-to-retailer predominates.
 Type of promotion: Radio exposure predominates, but TV film clips have usually been very effective.
 Jubilees: 5,000.

RADIO STATIONS:

No. of commercial 126; No. of government 88.
 Comment: Primarily independent operations, with specialized programming occurring in metropolitan areas. Pop/rock stations are usually dominant in the metropolitan areas, with MDR and country stations dominating elsewhere. Jazz and black music is nonexistent.

TELEVISION STATIONS:

No. of commercial 50; No. of government 87.
 Comment: American and English shows are dominant, with locally produced shows accounting for approximately 20% of programming.

• record & tape manufacturers / distributors / importers

A D, see Crest.
 A T A Recs., 96 Giebe Point Rd., Giebe, Sydney, NSW 2037. Tel: (02) 660-3466. Cable: SHDWBIZ. Telex: 22429. Mng. Dir.: Kevin Jacobsen; Gen. Mgr.: Maxwell Moore; Sales Mgr.: Col Joye. (Distributed by Festival)
 Labels: (Owned) ATA, Southern Star, Wheel.

A T V, see EMI.
 Adhesive, see Missing Link & Musicland.
 Albert Prod's, 139 King St., Sydney, NSW 2000. Tel: (02) 232-2144. Cable: MUSIC. Telex: 27194. Mng. Dir.: E.F. Albert; Int'l Div. Mgr.: Crispin Dye; European Div. Mgr.: Alex Young; A&R Mgr.: Fila Riccobono; Exec. Prod's: Harry Vanda, George Young; Studio Mgr.: Bruce C. Brown.
 Int'l branches: Germany, USA.

Albion, see Liberation.
 Another Rec. Dist'n, GPO Box 236C, Hobart, Tasmania 7001. Tel: (002) 34-8905. Telex: 57059. Dir.: Stefan Markovitch. (Distributor; Exporter as Exports)
 Labels: (Distributed) Amigo, Contemporary, ENJA, East-Wind, Good Time Jazz, Next Wave, Red Lightning, Storyville, Tro, Kanada.

Anthology, see Musicland.
 Archiv, see PolyGram.
 Argus Music Pty. Ltd., 10-16 Dowling St., Woolloomooloo, Sydney, NSW 2000. Contact: Malcolm Reed.
 Labels: (Represented) Moss Music Group (USA).

Arrival Recs., 46 Pyrmont Bridge Rd., Pyrmont, NSW 2009. Tel: (02) 660-0011. Contact: Phil Israel.
 Astor Recs. Pty. Ltd. (IFPI), 1092 Centre Rd., Clayton, Melbourne, Vic. 3168. Tel: (03) 544-2444. Cable: SCHUHV. Telex: 31244. Gen. Mgr.: Rex M. Barry; Sales Mgr.: Arno Rievers.
 Labels: (Owned) Astor, W&G; (Licensed domestic) Fable, Rough Diamond; (Licensed foreign) Alshire (USA), Cream (USA), Europa (Germany), Everest (USA), Lismor (UK), MCA (USA), Miller (Germany), Motown (USA), Ovalton (USA), PRT (UK), Parallax (USA), Redifusion (UK), Rialto (UK), Somerset (Germany), Vanguard (USA).

Int'l rep.: Canada (Boot), New Zealand (Music World).
 Asylum, see WEA.
 Alco, see WEA.
 Atlantic, see WEA.
 Au-Go-Go, see Missing Link & Musicland.

Avan-Guard Music Pty. Ltd. (IFPI), PO Box 182, Brickfield Hill, NSW 2000; 401A Pitt St., Sydney, NSW. Tel: (02) 267-5253. Mng. Dir.: Ali Knoll; Gen. Mgr.: Judith Knoll; Sales Mgr.: Stuart Emanuel.
 Labels: (Owned) Avan-Guard, Pepito, Titon; (Licensed foreign) Muse (USA); (distributed-not licensed) Afro Request (USA), CBS Int'l (worldwide), CMH (USA), De-Luxe (USA), Epic Int'l (worldwide), Five Star (New Zealand), Hed-Arzi (Israel), Hungaroton (Hungary), No Bars Hold (USA), Dde (New Zealand), Pepita (Hungary), Qualiton (Hungary), Request (USA), Timeless/Muse (USA).
 Int'l rep.: Fiji (Morris Headstrom), Hong Kong (Hong Kong Recs.), Hungary (Kultura), New Zealand (Ode).

Avs & Susans Crystal Palace Arcade, George St., Sydney, NSW. Tel: (02) 264-3179.
 Labels: (Represented) Entr'acte (USA).

Avenue, see Image & Festival.
 Axis, see EMI.
 Axle, see Missing Link.
 Basilisk, see Musicland.
 Battoli, see Battlyman.
 Baltgas, see Battlyman.
 Batjazz, see Battlyman.

Battlyman Recs. Australia, PO Box 94, 101 William St., Bathurst, NSW 2795. Tel: (063) 315-708, 312-062. Cable: BATRECORDS. Proprietor: Christopher Battye; A&R: Tony Ansell; Sales Mgr.: Ian Frame; Adv. & Album Cover Design: Marc Battye.
 Labels: (Owned) Battfolk, Baltgas, Batjazz.
 Int'l rep.: USA (Transpac).

Big Girl, see Missing Link.
 Big Mouth, see Laser.
 Bluebird, see RCA.
 Blue Goose, see 7 Recs.
 Board, see Catskill.
 Bootleg, see Fable.
 Brook, see 7 Recs.
 Bullet, see Crest.
 Bungerees, see Dpal.

Bunyip Recs. Pty. Ltd., 2 Seventh St., Warragamba, NSW. Tel: (047) 74-1422. Mng. Dir.: Ian B. MacLeod. (Distributed by 7 Recs.)
 Labels: (Owned) Bunyip, Rockability.
 Int'l rep.: New Zealand (RCA, 7 Recs.).
 C B S Recs. Australia Ltd. (IFPI), 15 Blue St., Sydney, NSW 2060. Tel: (02) 339-0255. Cable: COLRECORD. Telex: 21246. Chm.: William Smith; Mng. Dir.: Paul Russell; Deputy Mng. Dir.: John McCready.
 Labels: (Owned) CBS. Epic. Portrait. (Licensed) ARC, Blue Sky, Boardwalk, Caribou, Carb, GTO, Giant, Illegal, Jet, Kershner, Nempeter, T-Neck, TSOP, Tabu, Tappan Zee, Uncle Jam, Unlimited Gold, Virgin (all USA).

Camden, see RCA.
 Candle, see Larrikin.
 Capitol, see EMI.
 Carina Co. Pty. Ltd., PO Box 126, Carina House, 6 Artarmon Rd., Willoughby (Sydney), NSW 2068. Tel: (02) 95-2005. Cable: CARINIA. Mng. Dir.: Mrs. N. Kulakowski; Gen. Mgr.: C.R. Barlow.
 Labels: (Owned) Carina, Chic, Classics-For-All, Line 99, Dpera-For-All; (represented) Ariola (Germany), Audio Fidelity (USA), Baccarola (Germany), Belter (Spain), Chiaroscuro (USA), Elite Special (Switzerland), Erato (France), Eurodisc (Germany), Fiesta (USA), Folkways (USA), Fonit-Cetra (Italy), Gremphone (USA), Harmonia Mundi (Germany), Jugoton (Yugoslavia), MPS (Germany), Metronome (Germany), Monitor (USA), PWN (Poland), RTB (Yugoslavia), C.N. Rood (Netherlands), Sciascia (Italy), Telefunken (Germany), Viking (New Zealand).
 Int'l rep.: New Zealand (Viking)

Cascade, see Delron.
 Casino, see Delron.
 Catskills Music Pty. Ltd., 18 Oleander St., Brighton, NSW 5048. Tel: (08) 296-9965. Mng. Dir.: T.J. Evans; Gen. Mgr.: R.E. Evans; Music Prod's: R. Robjohns.
 Labels: (Owned) Board.

Chaluz Ent. Pty. Ltd., 74B Trafalgar St., Annandale, NSW 2038. Tel: (02) 660-0385. Mng. Dir.: Charles Fisher; Gen. & Sales Mgr.: Michael McMartin; Ass't Mgr.: Donna Reed.
 Labels: (Owned) Trafalgar.
 Champagne, see Musicland.
 Cherry Pie Recs. PO Box 225, 34 Warne St., Pennant Hills, NSW 2120. Tel: (02) 84-5506, 819-6151. Cable: MATTMUS. Telex: 10101. Mng. Dir.: Graeme Rule. (Distributed by RCA)

Chc, see Carina.
 Claron Recs., 70 King George St., Unit 2, Victoria Park, WA 6100. Tel: 362-1184. Mng. Dir.: Martin Clarke.
 Classics For All, see Carina.
 Classics For Pleasure, see EMI.
 Cleopatra Recs., PO Box 121, Elsternwick, Vic. 3185. Tel: (03) 523-6124. Telex: 34225. Mng. Dir.: Jeremy Fiebigler; Gen. Mgr.: Aister Webb. (Distributed by Musicland)

Labels: (Owned) Cleopatra, Dpton.
 Colossal Recs. of Australia Pty. Ltd., 28 Milton St., West Melbourne, Vic. 3003. Tel: (03) 329-0316. Cable: COLSSAL. Telex: 30333. Mng. Dir.: Mimmo Lo Prete; Gen. Mgr.: Osvaldo Maone; Sales Mgr.: Sam Lo Prete.
 Labels: (Owned) Colossal, DEMA; (licensed) Ala, Alpha, Ariston, Carosello, Durium, Phonogram, Ricordi, Ri-Fi, WEA (all Italy); D'Amato (Malta); Columbia, Marter, Zafiro (all Spain); Galaxy, President (both UK).

Columbia, see EMI.
 Columbia Studio Two, see EMI.
 Concert Rec'g, PO Box 108, 10 Caloola Rd., Wentworthville, NSW 2145. Tel: 631-6189. Gen. Mgr.: John Clancy; Sales Mgr.: Mary Clancy.
 Home office: USA
 Labels: (Owned) Concert, Moonlight.

Copperfield Recs., PO Box 206, 127 Carrington Rd., Waverley, NSW 2024. Tel: (02) 389-3043. Mng. Dir. & Gen. Mgr.: David Gibson; Sales Mgr.: Leif Gibson. (Distributed by Janda)
 Labels: (Owned) Copperfield; (Licensed foreign) Big (Italy), Euro (Italy), Prom (Germany), Symphony Tone (Switzerland).
 Int'l rep.: UK (Spark).

Cotillon, see WEA.
 Crest Rec. Co. Pty. Ltd., PO Box 270, St. Kilda, Vic. 3182. Tel: (03) 531-5148/1588. Mng. Dir.: Marcus Herman; Mktg. Dir.: Don Fraser.
 Labels: (Owned) AO, Bullet, Crest, Crest Int'l.
 Int'l reps.: New Zealand (Music World), UK (Multiple Sound).

D E M A, see Colossal.
 D G, see PolyGram.
 Delron Recs. (div. of Ibane & Co. Pty. Ltd.), PO Box 64, 10-14 W. Parade, West Ryde, NSW 2114. Tel: (02) 80-3193/6334. (Importer/Exporter as World Wide Rec. Imports)

Labels: (Owned) Cascade, Casino, Delron, Solid Gold; (distributed) Dewdrop, Peter Pan, Tiny Tot; (represented) DG, Rickatit, Vee Jay (USA).
 Delux Recs. Pty. Ltd., PO Box 1670, North Sydney, NSW 2060. Tel: (02) 888-5444. Telex: 21654. Mng. Dir.: Michael Browning; Int'l Opts. Dir.: Richard Griffiths. (Licensed to RCA)
 Labels: (Owned) Delux, Luxury.

Dewdrop, see Delron.
 Discuro Pty. Ltd., 20 McKillop St., Melbourne, Vic. 3000. Tel: (03) 67-5391. Gen. Mgr.: Tim Mann. (Distributor/Importer)
 Labels: (Distributed-not licensed) Arion (France), Caedmon (USA), Erato (France), Lyrichord (USA), Melodiya (USSR), Seon (Germany), Topic (UK)

E M I Recs. Australia (IFPI), 301 Castlereagh St., Sydney, NSW 2000. Tel: (02) 2-0912. Cable: EMIRECORD. Telex: 24182. Mng. Dir.: Peter Jamieson; Mktg. Mgr.: Brian Harris; Prod. & Promos. Mgr.: David Gilchrist.
 Branches: Adelaide, SA 5067, 83 Fullerton Rd., Kent Town. Tel: (08) 332-9233. Telex: 88312. Sales Mgr.: Paul Marlborough-Brisbane, Qld. 4066, 24 McDougall St., Milton. Tel: (07) 36-7388. Telex: 41912. Sales Mgr.: Graham Smith-Melbourne, Vic. 3205, Tel: (03) 690-3022. Telex: 33359. Sales Mgr.: Geoff Greensill-Perth, WA 6008, 292 Rokeby Rd., Subiaco. Tel: (09) 381-4055. Telex: 93146. Sales Mgr.: Jeff Reynolds.
 Home office: UK.

Labels: (Owned) Axis, Capitol, Classics For Pleasure, Columbia, Columbia Studio Two, EMI, EMI America, EMI Int'l, Electrola, Harvest, His Master's Voice (HMV), Listen for Pleasure, Odeon, DZ, Parlophone, Pathe, Pathe Marconi, Regal, Regal Zonophone, Stateside, Studio 301, Toshiba; (licensed domestic) ATV, Albert Prod's, Survival, WBE; (licensed foreign) Argo (UK), Blue Note (USA), Carrere (UK), Cheswick (UK), Cube/Fly (UK), Decca (UK), Deram (UK), Liberty (USA), London (USA), Private Stock (USA), Purple (UK), RAK (UK), Rolling Stones (UK), Threshold (UK), United Artists (USA), Waverley (UK).

Int'l reps.: France (Pathe Marconi), Germany (Electrola-EMI), Japan (Toshiba), Netherlands (Bovema-EMI), New Zealand (EMI), Philippines (Dyna), USA (Capitol).
 Earth Media Rec'g Co., 14 Glen St., Milsions Point, NSW. Tel: (02) 929-8669.
 Electrola, see EMI.
 Elektra, see WEA.
 Endeavour, see 7 Recs.
 Enigma, see WEA.
 Environment, see Laser.
 Epic, see CBS.

Eureka Recs., PO Box 113, North Ryde, NSW 2113. Tel: (02) 888-6470. Mng. Dir.: Les Simmonds; Gen. Mgr.: Helen Matthews. (Licensed to RCA)
 Labels: (Owned) Eureka, Stockade.
 Expordisc, 50 A Argyle St., Hobart, Tasmania 7000. Tel: (002) 34-8905. Telex: 57059. Dir.: Stefan Markovitch. (Exporter; Distributor as Another Rec. Dist'n).

Fable Rec. Co. Pty. Ltd., 137 Moray, South Melbourne, Vic. 3205. Tel: (03) 699-9999. Telex: 33609. Mng. Dir.: Ron Tudor. (Distributed by Astor)
 Labels: (Owned) Bootleg, Fable.

Fast Forward, see Musicland.
 Festival Recs. Pty. Ltd. (IFPI), 63-79 Miller St., Pyrmont, NSW 2009. Tel: (02) 660-4022. Cable: FESTIVAL. Telex: 25686. Mng. Dir.: Allan Hely; Gen. Mgr.: Jim White; Sales Mgr.: Noel W. Brown.
 Int'l branches: England, New Zealand, USA.
 Labels: (Owned) Festival, Festival Int'l, Infinity, Interfusion; (distributed) ATA, Avenue, Mushroom, Razzle, Regular; (represented) A&M (USA), Arista (USA), Barclay (France), Bearsville (USA), Berserker (USA), Bronze (UK), Butterfly (USA), Chrysalis (UK), Concord Jazz (USA), Crescendo (USA), DJM (UK), Fantasy (USA), Hispavoc (Spain), Island (UK, USA), Magnet (UK), Monument (USA), Shelter (USA), Shelby Singleton (USA), Stiff (UK).

Fiddling Fool Prod's, 19 Adolphus St., Balmain 2041. Tel: (02) 827-2203.
 Focus, see Spotlight.
 Fontana, see PolyGram.
 Fontana Gold, see PolyGram.
 44, see PolyGram.

Gold Seal, see RCA.
 Grass Roots Recs., PO Box 4, Drummoyne, NSW 2047. Tel: (02) 819-7422. Cable: MATTMUS. Telex: 10101. Owners: Phil & Chris Matthews. (Distributed by PolyGram)
 Ron Gray, 12 Sheffield St., Merryland, NSW 2160.
 Labels: (Represented) Jazzology-GHB (USA).

H M V, see EMI.
 Hadley Recs., Egret Pl., Calala, Tamworth, NSW 2340. Tel: (067) 65-7813. Mng. Dir.: Eric W. Scott; Gen. Mgr.: Hilary B. Scott.
 Labels: (Owned) Hadley; (distributed-not licensed) Koala, Dpal.
 Hamard TV Prod's Pty. Ltd., PO Box 225, 376 Swan St., Richmond, Melbourne, Vic. 3121. Tel: (03) 428-1618. Mng. Dir.: Sino Guzzardi; Office Mgr.: James Laming; Sec'y: Fiona Burke. (Distributed by Hamard & Trac).

Branches: Keswick, SA 5035, 30 Kent Rd. Tel: (08) 223-5333. State Mgr.: Graham Foster-Lane Cove, NSW 2066, 47a Penrose St., Suite 1. Tel: (02) 427-1155. State Mgr.: Alec Smith-Perth, WA 6001, PO Box 1918. Tel: (09) 321-7762.
 Happening Prod's Pty. Ltd., Uniline House, 4th fl., 5-13 Northcliff St., Milsions Point, Sydney, NSW 2061. Tel: (02) 922-4100. Cable: SEMUS. Telex: 26405.

Harbour, see Image & 7 Recs.
 Harvest, see EMI.
 Melodior, see PolyGram.
 His Master's Voice, see EMI.
 Hollywood Music Video, 1100 High St., Armadale, Vic. 3143. Tel: 509-7633.
 Labels: (Represented) Entr'acte (USA).

Horizon Recs., 68 Arther St., North Sydney, NSW 2061. Tel: (02) 922-1277.
 Chief Exec. & Gen. Mgr.: D. Robertson; Sales Mgr.: R. Robertson.
 Hunter, see Larrikin.
 Billy Hyde Music Pty. Lty., 7 Union St., South Melbourne, Vic. 3205. Telex: 35739. Pres.: Gary Hyde; Gen. Mgr.: Ivor McGuffin.
 Labels: (Represented) Latin Percussion Ventures (USA).

Image Recs. Pty. Ltd. (IFPI), 137 Moray St., South Melbourne, Vic. 3205. Tel: (03) 699-9999. Cable: IMAGERECORD. Telex: 33609. Mng. Dir.: John E. McDonald; Gen. Mgr.: Keith Colias; Promo. & Sales Mgr.: Steve Rawlins. (Licensed to 7 Recs.)
 Labels: (Owned) Avenue (dist. by Festival), Harbour, Image, Music Plus; (Licensed) Ace (Canada), Boot (Canada), Coombe (UK), Emerald (UK), Gateway (USA), Jupiter (Germany), Karma (Germany), Midson (USA), Music World (New Zealand), Shiva (Belgium), Specialty (USA), TTR (Netherlands), Sydney Thompson (UK), Who's Who in Jazz (USA).

Int'l rep.: Canada (Atlantic, Boot), Germany (Teldec), New Zealand (Atlantic, Festival, Music World), South Africa (RPM), UK (Atlantic, Emerald), USA (Atlantic).
 Infimly, see Festival.
 Innocent, see Missing Link.
 Interfusion, see Festival.

International, see RCA.
 International Artists Recs. & Music, 86 Chandos St., St. Leonards, NSW 2065. Tel: 438-1255. Telex: AA70639. Mng. Dir.: Ralph Lynch; A&R Mgr.: Jimmy Stewart; Promo. Co-ord: Claudia Chaddourn.

J & B Recs., 30 Whiting St., Artarmon, Sydney, NSW 2064. Tel: (02) 439-4377. Mng. Dir.: Brian Nicholls; Gen. Mgr.: Tony Paris.
 Labels: (Owned) J&B.
 Janda Recs., 47 Wellington St., Rozelle, Sydney, NSW 2039. Tel: (02) 82-0628. Mng. Dir.: Andrew Steele; Sales Mgr.: Stuart Emanuel. (Distributor/Importer)

Labels: (Owned) Janda Jazz; (licensed) Acanta (Germany), Jazzs, MBS (USA), Mick Lloyd (USA); (distributed-not licensed) Audite (Germany), CRD (UK), Claves (Switzerland), Contemporary Jazz (USA), Denon (Japan), ECM (Germany), ENJA (Germany), JAPD (Germany), Unicorn (UK), Walt (Germany).

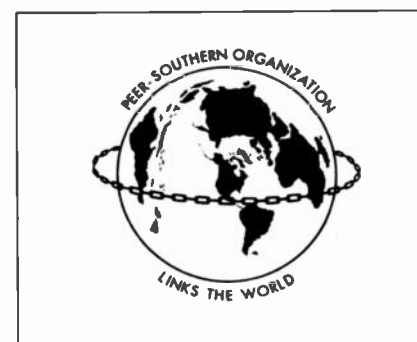

Southern Music Publishing Co. (A/Asia) Pty. Ltd. Sydney, Australia

Jazzis Recs., PO Box 512, Double Day (Sydney) NSW 2028. Tel: (02) 36 3580. Telex: 70041
 Jazz & Jazz, see PolyGram.
 Jazznote, see Larrikin.
 Junction, see 7 Recs.
 K G C Magnetic Tape Pty. Ltd., PO Box 118, 46 Applebee St., St. Peters, Sydney, NSW 2044. Tel: (02) 519 2677. Cable: TOWVEY. Telex: 22809. Gen. Mgr.: W.F. Gordon.
Labels: (Owned) NCC, (licensed foreign) Bartlett Bliss (UK), Federal (USA), Gusto (USA), King (USA), Pinnacle (UK), RK (UK), Starday (USA)
 K-tel Int'l, PO Box 121, 46 Pyrmont Bridge Rd., Pyrmont, NSW 2009. Tel: 660-0011. Telex: (790) 24810.
Home office: USA
 Karussell, see PolyGram.
 Ken A Tone, see Old Tyme.
 Koala, see Hadley.
 L & S Educational Group, 99-101 Argus St., Cheltenham, Vic. Tel: 550-6311. Cable: SCDHLB MELBOURNE. Mng. Dir.: Iar R. Stevenson, Gen. Mgr. Ross Hennessy, Sales Mgr.: Richard Clivaz. Adv. Mgr.: Malcolm MacArthur.
Label: (Represented) Caedmon (USA)
 Larrikin Recs Pty. Ltd. (IFPI), PO Box 162, Paddington, NSW 2021. Tel: (02) 336-567. Chief Exec. & Gen. Mgr.: Warren Fahey, Sales Mgr.: Philip **Labels: (Owned) Candle, Hunter, Jazznote, Larrikin, (licensed foreign) Black Saint (Italy), Erato (UK), Flying Fish (USA), Flyright (UK), Joker (Italy), Kicking Mule (USA), Philo (USA), Red (Italy), Rounder (USA), So-Net (UK), (distributed-not licensed) Au-Go-Go, Missing Link, Wendi.**
 Laser Recs. Pty. Ltd., 55 Grove St., Birchgrove, Sydney, NSW 2041. Tel: (02) 818-2590. Mng. Dir.: G. Pierson, Gen. Mgr.: A. Davidson, Sales Mgr.: W. Thomas. (Distributed by RCA & 7 Recs.)
Labels: Big Mouth, Environment, Laser, Reg Leg, Studio Dne.
 Int'l reps.: Austria (Bellaphon), Germany (Brillaphon), Italy (Cinevox), Scandinavia (Safir), Switzerland (Bellaphon), USA (Dorn).
 Liberation Recs., 9 Dundas Ln., Albert Park, Melbourne, Vic. 3206. Tel: (03) 690-3399. Telex: 31738. Mng. Dir.: Michael Gudinski; Dir.: Glen Wheatley, Gen. Mgr.: Gary Ashley.
Label: (Distributed) Albion
 Line 99, see Carina.
 Listen For Pleasure, see EMI.
 Local, see Missing Link.
 Luxury, see Deluxe.
 Lyonum Trading, PO Box 517, Crows Nest, NSW 2065.
Label: (Represented) Crystal (USA)
 Lyrac, see Old Tyme.
 M G M, see PolyGram.
 M R Acoustics, PO Box 165, Annerley, Brisbane 4103. Tel: 48 7598, 284-6764. Dir.: Colin H. Robertson, Gen. Mgr.: G.A. Robertson, Sales Mgr.: W.L. McAuliffe.
Labels: (Licensed foreign) Audio Lab (Japan), Entr'acte (USA), Gasparo (USA), HFS 75 (UK), Nippon Phonogram (Japan), RCA (Japan), Reference Recs (USA), Richardson (USA), Stereo Review Discs (USA), Umbrella (Canada), (represented) Century, Crystal Clear, First Line, Fresh Aire, Mobile Fidelity, Drinda, Sheffield, 2000 BC (all USA), Propius (Sweden).
 M-Squared, see Musciand.
 Mamba, see Missing Link.
 Mercury, see PolyGram.
 Mercury/Emarcy, see PolyGram.
 Mercury Golden Imports, see PolyGram.
 Metro, see PolyGram.
 Midi, see WEA.
 Midnight Recs., PO Box 144, Milsions Point, NSW 2061, 275 Alfred St., North Sydney, NSW 2060. Tel: (02) 922-6077. Telex: 23551. Owner: Peter Rix, Gen. Mgr.: Gibson Kemp.
 Minstrel Recs. Co. Pty. Ltd., 12 Humphrey St., Rosebery, NSW 2018. Tel: (02) 699-2720. Gen. Mgr.: Peter Cian, Sales Mgr.: Julie Gabriele, Dirs.: P. Zappia, C. Zahar.
Labels: (Represented) CBS, CGD, EMI, RCA, Records, Ri-Fi, Saar, Said (all Italy).
 Mirage, see Trans-Tasman.
 Missing Link Recs., PO Box 5159AA, GPO, 239 Flinders Ln., Melbourne, Vic. 3001. Tel: (03) 63-5507. Telex: 57059. Mng. Dir.: Keith Glass, Gen. Mgr.: Bruce Mine. (Distributed by Missing Link, Musciand & 7 Recs.)
Labels: (Owned) Au Go Go, Missing Link, (licensed foreign) Cherry Red (UK), Ralph (USA), Rough Trade (UK), Virgin (UK); (distributed-not licensed) Adhesive, Innocent, Mamba, Propelle (New Zealand), Reverse, Rough Trade (UK), Unforgettable.
 Int'l reps.: New Zealand (Propeller, RTC), UK (4AD, Pop-Aural, Rough Trade, Stage One), USA (Disc Trading, Green-world, Systematic).
 Moonlight, see Concert.
 Move Recs., 10 Glen Dr., Eaglemont 3084. Tel: (C3) 497 3105. Chief Exec. Martin Wright. (Distributed by Rhema)
Labels: (Owned) Move, (represented) Avant Garde (USA).
 Mushroom Recs. Pty. Ltd., 9 Dundas Ln., Albert Park, Melbourne, Vic. 3206.

Tel: (03) 690-3399. Cable: MUSHREC. Telex: 31738. Mng. Dir.: Michael Gudinski; Dir.: Ray Evans, Gen. Mgr.: Gary Ashley, Bus. Affairs: Simon Young. (Distributed by Festival)
Branch: North Sydney, NSW, 275 Alfred St., 12th Fl. Tel: (02) 436 1411.
Branch Mgr.: Ann Wright.
 Music For Pleasure, see Summit.
 Musciand Export Corp., PO Box 380, Elsternwick, Vic. 3185. Tel: (03) 523 6124/5375. Telex: 34225. Mng. Dir.: Joanne Feibiger, Sales Mgr.: David R. Williams. (Exporter, Distributor as Musciand Rec. Dist.)
 Musciand Rec. Dist., PO Box 121, Elsternwick, Vic. 3185; 26 Oak Grove, Ropponlea, Vic. 3182. Tel: (03) 523 6124/5375. Telex: 34225. Mng. Dir.: Jeremy Feibiger, Nat'l Sales Mgr.: Neal Snodgrass; Financial Mgr.: Ken Waddell, Dist'n Mgr.: William R. Tolson. (Distributor, Exporter as Musciand Export Corp.)
Labels: (Distributed-not licensed domestic) Adhesive, Anthology, Au Go Go, Basilius, Champagne, Cleopatra, Fast Forward, M-Squared, Missing Link, Neutron Star, 1901, Option, Phantom, Pumphanlie, Raven, Unforgettable, (distributed-not licensed foreign) Affinity, Bomb (Canada), Bomp (USA), Brain (Germany), Charly (UK), Cherry Red (UK), Egg (France), 4AD (UK), Greensleeves (UK), Innovative Communication (Germany), Opus (Czechoslovakia), Pulse (UK), Ralph (USA), Sky, Spoon (Germany).
 Music Plus, see Image.
 Music World, see Trans-Tasman.
 Network Publ'g (IFPI), PO Box 68, Milsions Point, Sydney, NSW 2061. Tel: (02) 922-4455. Mng. Dir.: Doug Jansen.
Label: (Owned) Rich
 Neutron Star, see Musciand.
 Nonesuch, see WEA.
 Kenedy, see EMI.
 Old Tyme Imports, 350 Centre Rd., Bentleigh, Vic. 3204. Tel: (03) 557-1050. Owner & Gen. Mgr.: Kenneth M. Henderson.
Labels: (Owned) Lyrac, (licensed domestic) Ken A Tone, Philophone, (licensed foreign) Air Check (USA), Arcadia (UK), Blue Rhythm (Germany), Caprice (Sweden), Dawn Club (Germany), Doric (USA), Fountain (UK), Halcyon (UK), Harrison (USA), Hindsight (USA), IAJRC (USA), Monmouth Evergreen (USA), Music For Collectors (USA), Nostalgie (Sweden), Phantastic (Sweden), Radio Archives (USA), Sountrak (USA), Spokane (USA), Sunbeam (USA), Tolem (USA), VJM (UK), (distributed-not licensed) Ajax, Ajax, Anhoote, Big Band Archives, Biograph, Blues Classics, Broadway Intermision, Cif, Citadel, Emery Cook, County, DRG, Fantare, Glendale, Golden Era, Golden Legends, Historical, Hollywood Soundstage, Jazz Archives, Joyce, Mark 56, Melodeon, Nostalgie Greats, Nostalgie Lane, Did Homestead, Did Time, Daxford, Pelican, Radiola, Sandy Hook, Stee, Take Two (all USA), BBC Radio & TV, Dery, Rare Recorded Eds. (all UK), Grannophone (Netherlands).
 Int'l reps.: Germany (Blue Rhythm), USA (City Hall).
 Omega Recs. Pty. Ltd., Spectrum Bldg., Suite 104, 1st fl., 220 Pacific Hwy., Crows Nest, NSW 2065. Tel: (02) 922-3243/3485. Dir. & Gen. Mgr.: E.A. Standfield, Sec'y: S.R. Matthews. (Distributed by Janda)
Labels: (Owned) Omega, Velvet.
 1901, see Musciand.
 Dpal Recs., 20 Barnes St., West Tamworth, NSW. Tel: (067) 659-290. Chief Exec.: Ross Murphy. (Distributed by Hadley)
Labels: (Owned) Bungaree, Opal, Stoney Broke.
 Dpera-For-All, see Carina.
 Option, see Cleopatra & Musciand.
 Outlet Rec'g Co. Ltd., 1 Jane St., Smithfield, Sydney, NSW
Home office: UK-Northern Ireland
 Dz, see EMI.
 P C Stereo Pty. Ltd., PO Box 272, Mount Gravatt, Brisbane, Qld. 4122. Tel: (07) 343-1612. Telex: 42993. Mng. Dir.: Clive A. Purcell; Sales Mgr.: M. Shepherd.
Labels: (Licensed) Chandos (UK), Delos (USA), Telarc (USA); (distributed-not licensed) Digatech, Sine Qua Non, Sonic Arts, Sound 80, Ultra Fi (all USA)
 Parlophone, see EMI.
 Pathe, see EMI.
 Pathe Marconi, see EMI.
 Pepto, see Avan-Guard.
 Peter Pan, see DeLron.
 Phantom Recs. Pty. Ltd., Box A566, Sydney South, NSW 2000. Tel: (02) 264 8992. Dir.: Dare Jennings, Gen. & Sales Mgr.: Jules R. B. Norrington.
Label: (Owned) Phantom
 Int'l reps.: USA (Bomp).
 Philips, see PolyGram.
 Philips Int'l, see PolyGram.
 Philophone, see Old Tyme.
 Platypus, see Janda.
 Polydor, see PolyGram.
 PolyGram Recs. Pty. Ltd. (IFPI), PO Box 314, Westfield Towers, 2nd fl., 100 William St., Sydney, NSW 2011. Tel: (02) 357-3277. Cable: PHDNRC. Telex: 26856. Mng. Dir.: Ross Barlow, Mktg. Mgr.: Graham Newman, Financial Mgr.: Stephen Wagner.
Labels: (Owned) Archiv, DC, Fontana, Fontana Gold, 44, Heliodor, Karussell, MGM, Mercury, Mercury/Emarcy, Mercury Golden Imports, Metro, Philips, Philips Int'l, Polydor, Polyphon, Polystar, Privilege, RSO, Resonance, Vertigo, Verve, (distributed) Grass Roots, Jazz & Jazz, Warm & Genuine, (licensed) BBC (UK), CTI (USA), Capricorn (USA), Charisma (UK), Chess (USA), Gladly (UK), Kudu (USA), Mercury/Delite (USA), Mercury/Lone Star (USA), Pablo (USA), Pablo Live (USA), Polydor/EG (UK), Polydor/Kolob (USA), Polydor/MVP (USA), Polydor/Oyster (USA), RSO/Curtom (USA), Rocket (UK), Salvation (USA), Phil Spector Int'l (UK), Track (UK), Universe.
 Polyphon, see PolyGram.
 Polystar, see PolyGram.
 Portrait, see CBS.
 Powderworks, see 7 Recs.
 Praise Inds. Corp., 21 Kyabra St., Fortitude Valley, Qld. Tel: 52-4004.
Home office: USA
Labels: (Owned) Praise group
 Privilege, see PolyGram.
 Pumphanlie, see Musciand.
 Pure Gold, see RCA.
 R C A Ltd. (IFPI), 11 Khartoum Rd., North Ryde, NSW 2113. Tel: (02) 888 5444. Cable: RCAAUST. Telex: 21654. Mng. Dir.: Brian Smith.
Home office: USA
Labels: (Owned) Bluebird, Camden, Gold Seal, International, Pure Gold, Rockaway, Victor, Victrola, Vintage, (licensed domestic) Deluxe, Eureka, Laser, Stockade, (licensed foreign) AVI (USA), Ariola (USA), Ariola Eurodisc (Germany), BTM (UK), Buddha (USA), Can't Stop (USA), Celebrity (UK), Criminal (UK), Flying Dutchman (USA), Grunt (USA), Hansa (Germany), Lifesong (USA), Lollipop (Germany), Midsong (USA), Neon (UK), Numero Uno (Italy), Polar (Sweden), Prelude (USA), Pyramid (USA),

RKM (Belgium), Roulette (USA), Salsoul (USA), Signature (USA), Solar (USA), State (UK), Teal (South Africa), Tembo (UK), Bob Thiele Music (USA), Wandong (USA); (distributed) Cherry Pie, Grass Roots, Selection group
 R S D, see PolyGram.
 Ramrod, see Johnny Rebb.
 Raven, see Musciand.
 Reader, see Festival.
 Razzle's Digest Servs. Pty. Ltd., 26-32 Waterloo St., Surry Hills, Sydney, NSW 2010. Tel: (02) 699-0111. Cable: READIGEST. Telex: 20260. Rec. & Tape Dept. Mgr.: Keith N. Anderson.
Home office: USA
 Johnny Rebb Ent's. Pty. Ltd., PO Box 341, 370A Port Hacking Rd., Caringbah, NSW 2229. Tel: (02) 525-7124, 522-7139. Pres.: Johnny Rebb, Gen. Mgr.: Syd McDonagh, Music Co-ord.: Russ Kruger.
Label: (Owned) Ramrod
 Record Dist. (Australia) Pty. Ltd., 32 Railway Parade, Granville, NSW 2142. Tel: (02) 637-3087. Cable: IBNATE. (Distributor)
 Regal, see EMI.
 Regal Zonophone, see EMI.
 Regular Recs. Pty. Ltd., 33 Riley St., East Sydney, NSW 2011. Tel: (02) 33 5073. Telex: 70518. Joint Mng. Dirs.: Cameron Allan, Martin Fabinyi, Gen. Mgr.: Lynn Morrissey. (Distributed by Festival)
 Reg Leg, see Laser.
 Reprise, see WEA.
 Resonance, see PolyGram.
 Reverse, see Missing Link.
 Rhema Recs., 210 Pitt St. 5th Fl., Sydney, NSW 2000. Tel: (02) 267-3466. Mng. Dir.: David Smallbone; Gen. Mgr.: Phil Truscott, Sales Mgr.: Alan Kennedy.
Labels: (Owned) Rhema, (licensed foreign) Benson, Bread & Honey, Maranatha!, Star Song (all USA); (distributed-not licensed) Move, Scripture in Song (New Zealand).
 Rich, see Network.
 Rockability, see Bunyip.
 Rockaway, see RCA.
 Rough Diamond, see Astor.
 Selection, see RCA.
 7 Recs. Pty. Ltd., 28 Cross St., Brookvale, NSW 2100. Tel: (02) 938-2200. Cable: SEVENRECD. Telex: 20270. Chief Exec.: Ken Harding, Sales Mgr.: Phil Israel.
Labels: (Owned) Brook, Endeavour, Junction, Powderworks, 7; (licensed domestic) Blue Goose, Viper, Harbour, Image, Missing Link; (licensed foreign) Avatar (UK), Creole (UK), Ember (UK), Logo (UK), Stunn, (New Zealand), Transatlantic (UK)
 Int'l reps.: New Zealand (Stunn).
 Solid Gold, see DeLron.
 Southern Star, see ATA.
 Spotlight Music Pty. Ltd., 262 Pitt St., Sydney, NSW 2000. Tel: (02) 264 7922. Mng. Dir.: Michael J. O'Neill; Gen. Mgr.: Kevin N. Hooper.
Labels: (Owned) Focus; (licensed) Celebration Servs. (UK), Sparrow/Birdwing (USA), (distributed-not licensed) Worldwide Ventures (Canada)
 Int'l reps.: New Zealand (Dobson Inds.), UK (Kingsway)
 Stateside, see EMI.
 Stockade, see Eureka & RCA.
 Stoney Broke, see Opal.
 Studio One, see Laser.
 Studio 301, see EMI.
 Summit Recs., 176 S. Creek Rd., Dee Why West, NSW 2099. Tel: (02) 982 6577. Mng. Dir.: Clive Gannon, Sales Mgr.: Ross Alexander.
Labels: (Owned) Music for Pleasure, Summit-Fair, (licensed) Disney (USA), Sesame Street (USA), Summit Concorde, Summit De-Luxe, Summit Gold, Summit Universal; (represented) CBS Harmony, RCA Camden, RCA Pure Gold.
 Survival, see EMI.
 Swagge Recs., 21 Renown St., Burwood, Vic. 3125. Tel: (03) 288-6280. Pres.: Nevil L. Sherburn.
 Int'l reps.: USA (Back Room).
 Telmak Teleprods. Pty. Ltd., 28 Montague St., Balmain (Sydney), NSW 2041. Tel: (02) 818-3188. Telex: 71324.
 Tempo, see Avan-Guard.
 Tifton, see Avan-Guard.
 Tiny Tot, see DeLron.
 Toshiba, see EMI.
 Tralafgar, see Chaluz.
 Trans-Tasman Prod'ns Pty. Ltd., 377 Bialand Rd., Ryde, NSW 2112. Tel: (02) 80-4077. Gen. Mgr.: Roger Curry.
Labels: (Owned) Mirage, Music World.
 Int'l reps.: New Zealand (Music World).
 Traq Dist., Chandler House, 2nd fl., 118-120 Edward St., Brisbane, Qld. 4000. Tel: (07) 229-6550. (Distributor)
Label: (Distributed) Hammond.
 Unforgettable, see Missing Link & Musciand.
 Velvet, see Omega.
 Vertigo, see PolyGram.
 Verve, see PolyGram.
 Victor, see RCA.
 Victrola, see RCA.
 Viking Rec. Co. Pty. Ltd., B.O. Smith & Son, ANZ Bank Bldg., 20th fl., 68 Pitt St., Sydney, NSW 2000. Tel: (02) 233-6933. Cable: BABRUC. Telex: 27929. (Sales office only)
Home office: New Zealand. Viking Sevenses Ltd
 Vintage, see RCA.
 W E A Recs. Pty. Ltd. (IFPI), 39/47 Albany St., Crows Nest, NSW 2065. Tel: (02) 438-4511. Cable: WEAERC. Telex: 24653. Mng. Dir.: Paul M. Turner; Mktg. Dir.: Peter Ikm.
Home office: USA. WEA Int'l
Labels: (Owned) Asylum, Alco, Atlantic, Cotillion, Elektra, Enigma, Mid, Nonesuch, Reprise, WEA, Warner Bros. (licensed) Beggars Banquet (UK), Big Tree (USA), Black Lion (UK), Brother (USA), Clean (USA), Damo, (UK), Dark Horse (UK, USA), DiscReet (USA), Fimnadar (USA), Lightning (UK), Little David (USA), Manicore (USA), Pacific (USA), Paradise (USA), Planet (USA), Radar (UK), Real (UK), Riva (UK), Riva (UK, USA), Scotti Bros. (USA), Sire (USA), Swan Song (USA), TDS (UK), Target (UK), Warner Carib (USA), Westbound (USA), Whitfield (USA)
 W B E Recs., 88 Richardson St., Albert Park, Vic. 3206. Tel: (03) 699 5366. Telex: 35906. Contact: David Wyatt. (Licensed to EMI).
 Int'l branch: USA
 W & G, see Astor.
 Warm & Genuine, see PolyGram.
 Warner Bros., see WEA.
 Wendi, see Larrikin.
 Wheel, see ATA.

**JANDA RECORDS
 PTY LTD**
 IMPORTER DISTRIBUTORS
 WHOLESALERS

**JANDA JAZZ
 CONTACT FOR AUST
 DISTRIBUTORSHIP OF YOUR
 CATALOGUE**

**P.O. BOX 180
 CONCORD NSW 2137
 TEL (02) 73 2951**

**JANDA RECORDS YOUR
 AUSTRALIAN CONNCTION**

Wizard Recs. (Australia) Pty Ltd., 301 Castlereagh St. Sydney, NSW Tel (02) 20912 Telex: 24182, Exec Dir Robie Porter, Gen Mgr Alan Blake. (Distributed by EMI)
Int'l reps: USA
Int'l reps: Canada (PolyGram), New Zealand (EMI), South Africa (EMI)
Word Recs. Australia, 18-26 Canterbury Rd., Heathmont, Vic. 3135 Tel (03) 729-3777. Gen. Mgr. Stanley R. Moulton.
Branch: Sydney, NSW 2000, 309 Pat St Tel: (02) 267 3911
Labels: (Licensed) Good News, Light, New Song, Seed, Word (all USA), Image VII (Canada).
Word of Life Centre, 134 Beach St., Frankston, Vic. 3199
Labels: (Represented) Epoch (USA), NALR (USA)
World Wide Rec Imports-Tel (02) 80 6631-see Delron

• **music publishers**

A T V Northern Songs Pty Ltd., Eagle House, Suite 103, 118 Alfred St. Milsons Point, NSW 2061 Tel (02) 929-9826 Cable NDRSDNGS. Mng Dir Christopher John Gilbey, Prof. Mgr. Don Bruner
Int'l firms represented: ATV, Black Sheep, Graduate, Tony Hiller, Hit & Run, Jarrow, Logo, Northern Songs, Numan, Rockslam, Lawrence Wright (all UK), ATV, Bibbo, Champagne, Gene Clark, Dark Cloud, Bruce Donnelly, Easy Money, Golden Mountain, Goody Tunes, Gray Matter, Green Tunes, Hall-Clement, Stevan Hailer, Jack & Bill, Stephen A. Kipner, Mistress, Malaco, Terry Shaddick, Shoe Tunes, Spikes, Sweet Jelly Roll, Venice, Vogue, Welbeck, Welk group (all USA), ATV (Canada), Allo (France), Loli pop (Germany).
Int'l reps: Canada, UK, USA (all ATV), France (Allo), Sweden (Air).
Acuff Rose Publ'ns Pty Ltd., see Allans.
Arborne Publ'g, see Essex.
J. Albert & Son Pty Ltd., 139 King St., Sydney, NSW 2000. Tel (02) 232 2144. Cable MUSIC Telex 27194 Mng Dir E F Albert, Int'l Div Mgr. Crispin Dye, European Div. Mgr. Alex Young, Copyright Mgr. W. Donald son, Royalties Mgr. H. Bosler.
Int'l branch: Germany (Europa Div.)
Int'l reps: Argentina (E.B. Marks), Austria (Francis Day & Hunter), Belgium (J. Albert), Brazil (E.B. Marks), Canada (E.B. Marks), Denmark (Air), Finland (Air), France (Warner Bros), Germany (Francis Day & Hunter), Iceland (Air), Italy (Frantoni), Japan (J. Albert), Mexico (E.B. Marks), Netherlands (J. Albert), Norway (Air), South Africa (Music piece), Spain (EGD), Sweden (Air), Switzerland (Francis Day & Hunter), UK (J. Albert), USA (E.B. Marks).
Allans Music Australia Pty Ltd., PD Box 5131, Melbourne 3001, 276 Collins St., Melbourne, Vic. 3000 Tel (03) 63 0451 Cable PIANDFDRTX Telex 37934. Mng Dir Peter J. Green, Gen. Mgr. Joe Halford, Music Dir Frank I. Baxter.
Branch: Sydney, NSW 2061, 28 Glen St., Milsons Point Tel (02) 922 7357.
Int'l firms represented: Alfred (USA), Associated (USA), Beacon (USA), Belwin Mills (USA), Boston (USA), Box & Cox (UK), Breithof & Haertel (Germany), Canadian Music Sales (Canada), J. & W. Chester (UK), Coal Miners (USA), Copper Basin (USA), J.B. Cramer (UK), Cyril Shane (UK/USA), Eds Durand (France), Edu Tainment (USA), William Elkin (UK), Carl Fisher (USA), Handy Bros. (USA), Hargall (USA), Frederick Harris (UK), Heugel (France), Jobete (USA), Alfred A. Kalmus (UK), King Coal (USA), Kongrude (UK), Le Duc (France), F.E.C. Leuchart (Germany), Nov ello (UK), Pedro (UK/USA), Porter (USA), Robertson (UK), G. Schirmer (USA), Schott Eulenbug (UK), Song Yard (USA), Summi Zervoni (Italy), Texas Red Songs (USA), Gordon V. Thompson (Canada), Velvet Apple (USA), W&N (USA), White Line (USA), Wilis (USA).
Apri Music Pty Ltd., 15 Blue St., North Sydney, NSW 2060 Tel (02) 339 0255 Cable CDLRECDR Telex: 21246 Gen. Mgr. John Anderson.
Int'l firms represented: Blackwood, Bovina, Canopy/White Daks, Country Road, Dickcheid, EMP/KBL Publ'g, Inner Golde, Gold Hill, Gronjaca, Albert Hammond, Hickory Grove, Hudmar, Frane Sanctum, Jet, Jetsoongs, Krsner, Light, Manhatts, Dier, Porcara, Ron Powell, RSPV/Westbrook, Saybrook, Sheefire, Shetyen, Stephen Stills, Sumac, Small Sounds (all USA), Virgin (UK).
Associated Music Pty Ltd., 602/83 Mount St., North Sydney, NSW 2060 Tel: 929-6787 Telex 21474. Mng Dir Brian Smith, Gen Mgr Barry Kimberley.
Int'l firms represented: Apt (USA), Ariola America (USA), Blendingwell (USA), Chicago (USA), Coulgins, Crabshaw, Cycius, Miki Dallon (UK), Don (USA), Dunbar (USA), Erva (USA), 57th Street, Global, Green Mountain (USA), Kidada (USA), Ladysmith (UK), Laetrec (South Africa), Lion (USA), Lynnal (USA), Ronnie Milasap (USA), John Mitchell (USA), Naked Snake (USA), One of a Kind, Dweper (USA), RCA (Argentina, Brazil, Canada, France, Germany, Italy, Mexico, Spain, UK), Rasinda (USA), Sea grape, Bobby Sherman (USA), Silver Dagger (USA), Silver Fiddle/Neil Young (USA), Siren, Al Stewart (USA), Summit (UK), Artie Wayne (USA), Westpar (USA), Young Blood (UK), Zevon.
Int'l reps: Argentina, Brazil, France, Germany, Italy, Mexico, Spain (all RCA), Japan (Global), South Africa (Laetrec), UK (Sunbury), USA (Inter world).
Barton Music Pty Ltd. (APRA), see Chappell.
Batgas & Co. Publ'g, PD Box 94, 101 William St., Bathurst, NSW 2795 Tel (063) 315 708, 312 062. Cable BATERCDRDS Proprietor Christopher Battye, A&R Tony Ansell.
Int'l rep: USA (Transpac)
Belinda Music, see Castle.
Bellbird Music Publ'g Co. Pty. Ltd. (APRA), 28 Cross St., Brookvale, NSW 2100. Tel (02) 938 2200. Cable SEVENRECDX Telex 20270 Chief Exec. Ken Harding. (Administered by Chappell)
Breakfast Music Publ'g (APRA), PD Box 767, Surlers Paradise, Qld 4217 Tel (075) 31 2107.
Int'l rep: USA (TRD).
Castle Music Pty. Ltd. (APRA), 120 Christie St., St. Leonards, Sydney, NSW 2065. Tel (02) 439 6688 Cable BELMUSIC Telex 22872 Mng Dir Frank A. Donley.
Int'l firms represented: Black Bull (USA), Bruton (UK), DeWolfe (UK), Walt Disney (USA), EMI (UK), Al Gallico (USA), Noel Gay (UK), Heath Levy (UK), KPM (UK), Screen Gems (USA).
Int'l reps: UK (EMI), USA (Screen Gems).
Cellar Music Co. (APRA), 19 Adolphus St., Balmain, NSW 2041 Tel (02) 827 2203. Dir.: Gus McNeil, Gen. Mgr. Spider Scholtens.
Int'l firms represented: Josephine & Ephraim Music (New Zealand), Kelly Songs (Canada).
Chappell & Co. (Australia) Pty. Ltd. (APRA), 225 Clarence St., 7th fl., Sydney, NSW 2000. Tel: (02) 290 3500. Cable SYMPHDNY Telex 25799 Mng. Dir.: Colin Cornish, Prof. Mgr. Alex Pivsic.
Int'l firms represented: ABC Dunhill (USA), Aberbach, American Broadcasting (USA), Average (UK), Begonia Melodies (USA), Irving Berlin (USA), Johnny Binstock (USA), Big Sky (USA), Boomtown Rats (UK), Bregman Vocco & Conn (USA), Bulpen (USA), Buxton Hill (USA), CAM

(Italy), Chappell Aznavour (France, UK), Chappell Morris, Chess (USA), Clean Sheets (USA), David Robinson & Friends (USA), Dwart (USA), En sign (USA), Famous (USA), Fleetwood Mac (USA), Fox Fanfare (USA), Frettsongs (USA), Gershwin (USA), Golden Withers (USA), Huppy (Germany), Herald Square (USA), House of Bryant (USA), Kamakazi (USA), Kiss (USA), Lowery Group (USA), Magnet (UK), Manlow (USA), Mayday (USA), Robert Mellin (UK, USA), Moonlight & Magnolias (USA), Music for Unicef (USA), Naked Snake (USA), New Daylow (Netherlands), New World (USA), Painted Desert (USA), Paramount (USA), Perren Vibes (USA), Pi-Gen (USA), Pink Floyd (UK), Rams Horn (USA), Sky Writing (UK), Special Rider (USA), Robert Stigwood Drg (UK, USA), Shapiro Bernstein (UK, USA), Times Square (USA), 20th Century (USA), William son (USA), Wren (USA), Victor Young (USA)
Int'l reps: Worldwide (Chappell/Intersong)
Cherry Pie Music, PD Box 225, 34 Warne St., Pennant Hills, NSW 2120 Tel (02) 819-6151, 84 5506 Telex 10101 Cable MATTIMUS Mng Dir Dawn Rule
Cherry River Music Pty Ltd., 20 Glen St., Suite 304, Milsons Point, NSW 2061
Home office: USA, Cherry Lane
Cleopatra Music, PD Box 121, Elsternwick, Vic. 3185. Tel (03) 523 6124 Telex 34225
Coathanger Music (APRA), 19 Adolphus St., Balmain, NSW 2041 Tel (02) 827 2203. Dirs. Gus McNeil, Ross Ryan, Gen. Mgr. Gus McNeil (Also see Cellar Music)
Coburn Music Ltd (APRA), see Sundowner.
Comet Music (Australia) Pty. Ltd. (APRA), see Chappell
Connors Music (APRA), see Rondor.
Cool Music, see Sparmac
Cowboy Music, see Sparmac
D. Davis & Co. Pty Ltd. (APRA), see Allans.
Deluxe Music, PD Box 1670, North Sydney, NSW 2060 Tel 926 833. Telex 21654 Mng. Dir. Michael Browning.
Int'l rep: UK (Zomba)
Desert Fox Music (APRA), see Network
Walt Disney Prodn's Pty. Ltd., 149 Castlereagh St., Sydney, NSW 2000 Tel (02) 267 8942 Cable MICKMIDUSE Contact Walter Granger
Int'l firm represented: Walt Disney (USA).
Ephraim Music (APRA), see Cellar Music.
Essex of Australia Pty Ltd., Upline House, 4th fl., 5-13 Northcliff St., Milsons Point, Sydney, NSW 2061. Tel (02) 922 4100 Cable SEMUS. Telex 26405 Gen. Mgr. Bruce Powell.
Int'l firms represented: A-Z (UK), Attic (Canada), Bewlay (USA), Blue Gum (UK), Boatful (USA), Duzzy Heights (UK), Dulchy (Netherlands), EG (UK), Early Morning (Canada), Evil Eye (USA), Garrett (USA), House of Gold (USA), Island (UK), Adrian Lighton (USA), Mannan (USA), Neon (UK), DAS (USA), Palm Beach (UK), Paper (UK), Performance (UK), Pure (USA), St. Annes (UK), State (UK), Tickson (USA), Trane (USA), Bruce Welch (UK), Wherefore (USA), Don Williams (USA)
Int'l reps: USA (TRD), rest of world (Essex)
Eureka Music Pty Ltd. (APRA), PD Box 113, North Ryde, NSW 2113 Tel (02) 888-6470 Mng Dir Les Simmonds, Gen. Mgr. Helen Matthews.
Int'l firm represented: Happy Valley (USA)
Festival Music Pty Ltd. (APRA), 63 79 Miller St., Pyrmont, Sydney, NSW 2009. Tel (02) 660-5218 Cable FESTIVAL Telex 25686. Mng Dir Alan Hely, Gen. Mgr. Peter Hebbes.
Int'l branches: England, USA.
Int'l firms represented: Andorra (USA), Antisia (UK), Beserkley group (USA), Boca (USA), British Lion (UK), Brother/Wilqarstn (USA), Carlin (UK), Cherry (UK), Chrysalis (UK), Combine (USA), Dawnbreaker (USA), Decoy (UK), John Farrar (USA), Frank & Nancy (USA), Gold Forever (USA), Lee Hazelwood (USA), Island (UK, USA), Jacan Darnoc (USA), Jos ley (UK), Kaiser (USA), Larball (USA), Levine & Brown (USA), Magictand (USA), Mine (USA), Neighbourhood (USA), Neil (USA), Newkeys (USA), Panache (UK), Playboy (USA), Prophecy/Black Coffee (USA), Proud Par (USA), Purple (UK), Resaca (USA), Safari (UK), Douglas Sahn (USA), Shelby Singleton (USA), Skatt Songs (USA), Song Tailors/I've Got The Music (USA), Story Songs (USA), Tahia (UK), Teddy Jack (USA), Tembo (UK), Terrapin (USA), Tortoise (USA), Touch of Gold (USA), United Artists (UK, USA), Xavier Music (UK)
John J. Francis Music Publ'g Co. (APRA), 36 Barden St., Tempe, NSW 2044 Tel (02) 55-6612 Mng Dir John J. Francis
Gypsy Music Pty Ltd. (APRA), see Rondor
Halfpenny Music, 18 Dleander St., Brighton, NSW 5048. Tel (08) 296 9965. Prof. Mgr. Raelene Evans; Gen. Mgr. John Evans
Haven Music Pty Ltd. (APRA), see Image
Horizon Publ'g, 68 Arther St., North Sydney, NSW 2061. Tel: (02) 922 1277
Chief Exec. & Gen. Mgr.: D. Robertson
Image Music Pty Ltd. (APRA), 137 Moray St., South Melbourne, Vic. 3205 Tel (03) 699-9999 Cable IMAGERECORD Telex 33609 Mng Dir John E. McDonald; Gen. Mgr. Tony Beutell; Prof. Mgr. Terry Dean.
Int'l firms represented: Joe Allen, Angel Wing, Aunt Polly's Music, Blue Echo, Boxer, Brian Cadd, Buzz Casson, Castle Hill, Closed Door, Cumberland, Daria Daryen, First Floor, First Lady, Front Lawn/Back Yard, Good, Lloyd Green, Homewood House, House of Cash, Jack, Jeanome, Keca,

Parquet, Prodigal Son, Pulleybone, September, Silver Dollar, Skippers Pond, Song of Cash, Stonehill, Strong Box, Tapage, Window, Wooden Nickel (all USA); Autobahn Pritsch, Rofle Budde, Butterfly/Michael Kunze, Intro, Magazine, Siegel, Transistor (all Germany), Emerald, Hush, New Acme, Round, Sparta Florida (all UK), Angela (South Africa), Axe (Canada), Budapest (Hungary), Contagious (South Africa), Morning (Canada), Claude Pascal (France), Shiva (Belgium), Transistor (South Africa).
Int'l reps: Canada (Morning), Germany (Siegel), Japan (Pacific), Nether lands (Universal), South Africa (Contagious, Transistor), UK (Angle, Round), USA (American Image, American Rainbird).
Intersong Music Pty. Ltd. (APRA), see Chappell.
Kurt Jacob & Co. Pty. Ltd., PD Box 91, 74 78 Brandling St., Alexandria, NSW 2015 Tel (02) 519 4916
Int'l firms represented: Ed Melodie (Switzerland), Hohner (Germany, UK, USA), Pelikan (Switzerland)
Janda Music Publ'rs, 47 Wellington St., Rozelle, Sydney, NSW 2039 Tel (02) 82 0628. Gen. Mgr. Andrew Steele
Doug Jansen Music (APRA), see Network
Jonathan Music (Australia) Pty Ltd., PD Box 1504, 83 Mount St., North Sydney, NSW 2060. Tel (02) 929-6787, 922 6709 Cable JONATHAN Telex 21474 Dirs. Barry & Vicki Kimberley
Int'l firms represented: Stephen Bishop, Martin Cooper, Diana, Encrip Emanuel, Ghandava Edzactly, Gnosso, Bob James, Roland Kluger, Milk Money, Musicways, Jon Peters, Raydiola, Paul Simon, Special Songs, Bruce Springsteen, Topanga.
Int'l reps: Belgium (Roland Kluger), Japan (Pacific), Luxembourg (Roland Kluger)
Joye Publ'g, 98 Glebe Point Rd., Glebe, Sydney, NSW 2037 Tel (02) 660 3466 Cable SHDWBIZ. Telex 22429 Mng Dirs. Kevin Jacobsen, Col Joye.
Int'l rep: USA (Joye).
July Music (APRA), 137 Moray St., South Melbourne, Vic. 3205 Tel (03) 699 9999 Telex 33609 Mng. Dir. Ron Tudor.
Larrikin Music Ltd., 282 Oxford St., Paddington, NSW 2021 Tel (02) 336 567 Mng. Dir. Warren Fahey
Int'l firms represented: Alligator, Big Ear, Sonet (UK)
Int'l rep: UK (Roberton Brown)
Laser Music Pty. Ltd. (APRA), 55 Grove St., Birchgrove, Sydney, NSW 2041 Tel (02) 818 2590 Telex 29603 Mng. Dir. G. Pierson, Gen. Mgr. A Davidson, Prof. Mgr. Debbie Young
Leeds Music Pty. Ltd., Universal House, 23 Pelican St., Darlinghurst, Sydney, NSW 2010 Tel: (02) 61 6088 Cable LEEDSMUSIC Telex 25687 Mng. Dir. Jack Howard Argent.
Home office: USA, MCA
Int'l firms represented: Churn (USA), Cookhouse (USA), East Memphis (USA), Everblue (UK), Far Out (France), First (UK), First Artists (USA), Goblet (UK), Mother Tongue (USA), Theodore Presser (USA), Satni (UK), Valley (UK), Vector (USA)
Leosong Copyright Serv., 33 Bligh St., Suite 1205, Sydney, NSW 2000 Tel (02) 233-5577 Telex 71155. Mng. Dir. Philip C. Walker, Gen. Mgr. Jennifer L. Walker.
Int'l reps: UK (Leosong), USA (Copyright Serv. Bureau)
M A M Music Publ'g Pty Ltd, GPD Box 4917, Sydney, NSW 2001 Tel (02) 267 6088 Cable LEEDSMUSIC Telex 25687 Mng Dir Jack H Argent
Martins Music, 70 King George St., Unit 2, Victoria Park, WA 6100 Tel 362 1184. Mng. Dir. Martin Clarke
Int'l rep: Worldwide (Festival)
Matrix Music, 20 Barnes St., West Tamworth, NSW Tel (067) 659 290
Chief Exec. Ross Murphy
Matthews Music (APRA), PD Box 4, Drummingue, NSW 2047 Tel (02) 819 7422 Cable MATTIMUS. Telex 10101 Owners Phil & Chris Matthews
Int'l firms represented: Air & Graces (UK), Arcade (USA), Asterisk Music (UK), Big Secret (UK), Bug (USA), Candlewick Music (USA), Char Luz (UK), Crusty (UK), Andrew Heath (UK), Barry Mason Music (UK), May flower (USA), Mielus (USA), Dike Grog (USA), Tom Parker (UK), Pennine (UK), Plangent Vision (UK), Rock (UK), Silver Nightingale (USA), Skyhill group (USA), Street Tunes (UK), Tembo (UK), Three Brothers (USA)
Mush Music, see Sparmac
Mushroom Music Pty Ltd (APRA), 9 Dundas Ln. Albert Park, Melbourne Vic 3206 Tel (03) 690-3399 Cable MUSHREK Telex 31738 Mng Dir Michael Gudinski, Prof. Mgr. Jenny Keath, Bus Affairs Simon Young; Royalties Jan Simon
Int'l firms represented: Albion, Blackhill, City Boy, Forever Endeavour, Gates, Modern Publ'g, Nuneed, Police Songs, Pop 'N' Roll, Street Music
Musical Rights (Australia) Pty Ltd (APRA), see Chappell
Musical Music Pty Ltd. (APRA), see Sundowner
Music Sales Australia Pty Ltd., 27 Clarendon St., Artarmon, Sydney, NSW 2064 Tel: (02) 439 8855. Gen. Mgr. Neville Prentice
Home office: England.
My Quade Melodies (APRA), see Rondor
Network Publ'g (APRA), PD Box 68, Milsons Point, Sydney, NSW 2061 Tel (02) 922 4455. Mng. Dir. Doug Jansen, Gen. Mgr. John Weston, Prof. Mgr. Ken Lang
Int'l firm represented: Angeta (South Africa)

For the most aggressive exploitation and promotion of your catalog, try us!



Harbour RECORDS



Image RECORDS

Records & Publishing Group

Image Music, Rainbird Music, Haven Music

Image Records 137 Moray St., Sth. Melbourne
Vic. 3205 Australia Telex AA33609 (Music)
Cables: Imagemusic Tel. (03) 699 9999

Omega Music Pty. Ltd., 220 Pacific Hwy, Suite 104, 1st fl, Crows Nest, NSW 2065. Tel: (02) 922-3243. Dir.: E.A. Stamford.

Penjane Music (Australia) Pty. Ltd. (Norman Whiteley Holdings Pty. Ltd.) (APRA), PO Box 159, Uniline Bldg., 4th fl., 5-13 Northcliff St., Milsons Point, NSW 2061 Tel: (02) 922-6540/6503 Cable: ABISONG. Telex: 22859 Chm. & Mng. Dir.: Kathleen M. Whiteley; Gen. Mgr.: Penny J. Whiteley.

Pinewood Music (APRA), 2 Seventh St., Warragamba, NSW Tel: (047) 74 1422. Mgr.: Ian B. MacLeod.

Porter Music, see Sparmac.

Rainbird Music (APRA), see Image.

Ready Mister Music (APRA), see Cellar Music.

Johnny Rebb Ent's. Pty. Ltd. Publ'g (APRA), PO Box 341, 370a Port Hacking Rd., Carlingbah, NSW 2229. Tel: (02) 525-7124 522-7139. Gen. Mgr.: Syd McDonagh. Mgr.: Russ Kruger.

Regular Music, 33 Riley St., East Sydney, NSW 2011 Tel: (02) 33-5073 Telex: 70518 Joint Mng. Dir.: Cameron Allan, Martin Fabinyi. Gen. Mgr.: Lynn Morrissey.

Rhema Music, 210 Pitt St., Sydney, NSW 2000 Tel: (02) 267-3466. Dir.: Ian Smallbone.

Int'l firms represented: Benson, Bug & Bear, Home Sweet Home, Paragon Assocs. (all USA)

Int'l rep.: USA (Paragon).

Rondor Music (Australia) Pty. Ltd. (APRA), 104-108 Mount St., 3rd fl., North Sydney, NSW 2060 Tel: (02) 92-0666 Cable: IRVINGALMO. Mng. Dir.: John Bromell, Gen. Mgr.: Jane Moore, Prof. Mgr.: Mark Evans.

Int'l firms represented: Arakata, Beggars Barquet, Dump, GH Grafton, Heathway, Oscar, Quarry, RMD, Rondor, Strange, Whitsett, Churchill (all UK), Alchemical, Almo, Assorted, Barricade, Bellboy, Big Hill, Blue Harb, Blue Street, Buggybug, Brainfree, Caleb, Chappo, Charville, Crazy Horse, Dead Sea, Doors, Fifth Floor, Foghorn, Four Knights, Four Score, Fourth Floor, Gypsy Boy, Hibiscus, Hollenbeck, Hummit, India, Jasperilla, Jewell, Lady Jane, Bob Marley, Mburu, Mccicme Hat, Mighty Three, Modern American, Ninth, Pal Dog, Pamjoke, Porchester, Saggifire, Boz Scaggs, Sea of Tunes, Sweet Summer Night, Tammi, Three Knights, Weather Report, Woolfsongs, World War Three (all USA), Almo, Irving (Canada)

Int'l reps.: Belgium (Universal), Canada (Almo-Irving), Germany (Glo bal), Japan (Pacific), Netherlands (Universal) South Africa (Gallo), UK (Rondor), USA (Almo-Irving)

A Schroeder Music (Australia) Pty. Ltd. (APRA) ADC House, 12th fl., 99 Elizabeth St., Sydney, NSW 2000 Tel: (02) 233-1588

Home office: USA

Int'l firms represented: Aloud, Anm, Arbutus, Arch, Arvens, Bagmin, Bella Godiva, Boscoe, Burlac, Catch Fire, Cui Mother, Dandy Dittys, Dreams & Visions, Emm Jay, Fitness King, Fool Killers, Fourvuv Survival, Kim Fowley, Golden Unlimited, Great Montana, Hedley Songs, Home coming, Humdrum, January, Jem, Joans Bone, Joint, LaLanne, Larbell, Lasse, Last Laugh, Lazy Canary, Magnamoun, Manistee, Mempro, Mile Wide River, Mother Hen, My Baby's, Next Stop, One Stop, Pierhead, Pit field, Rebecca Raccoon, Rel Nel, Roper, La Vette, Sea Lark, Sep, Skin, Stewart-Nims, Summerfree, Super Songs, Tijuca, Va Delta, Van couver, Very Own, Wrather, Yameta, Zekefield Folies

Sevensae Publ'g Pty. Ltd., c/o B.O. Smith & Sons, ANZ Bank Bldg., 20th fl., 68 Pitt St., Sydney, NSW 2000 Tel: (02) 233-6933. Cable: BABRUC

Int'l rep.: UK (Emerald, MCPS).

Shogun Music (APRA), see Network.

Soul Music, 10-14 W. Parade, West Ryde, NSW '14.

Southern Music Publ'g Co. Australasia Pty. Ltd., Carlton House, 38-40 York St., Sydney, NSW 2000 Tel: (02) 29-2547. Cable: SOUTHMUSIC

Home office: USA, Peer Southern Org.

Sparmac Music, 301 Castlereagh St., Sydney, NSW 2061 Tel: (02) 20912 Telex: 24182. Exec. Dir.: Robie Porter; Admir'r John L. Smith

Int'l rep.: USA (Portent).

Speed Limit Music (APRA), see Rondor

Spotlight Music Pty. Ltd. (AMPAL), 262 Pitt St., Sydney, NSW 2000 Tel: (02) 264-7922. Mng. Dir.: Michael J. O'Neill, Gen. Mgr.: Kevin N. Hooper

Int'l firms represented: Birdwing, Candle, Later Rain, Shaundra, Spar row (all USA)

Sprint Music (APRA), see Rondor

Slave Music Publ'g Co., PO Box 270, St. Kilda, vic 3182 Tel: (03) 531 5148. Mng. Dir.: Marcus Herman.

Step Seven Music Pty. Ltd. (APRA), see Image

Stunning Publ'g (APRA), see Rondor

Suchof Pty. Ltd. (APRA), see Network

Sugarmusic Australasia Pty. Ltd., see Atlans

Summertime Music (APRA), see Rondor

Sundowner Music Pty. Ltd. (APRA), 643 Chapel St., Melbourne, Vic 3141 Tel: (03) 240-8577. Cable: SUNOWNER. Telex: 30379. Dir.: Barry M. Coburn, Prof. Mgr.: Peter Ban Hogg.

Int'l firms represented: Garden Court (USA), Spaniel Music (UK)

Swaggle Music (APRA), 21 Renown St., Burwood, Vic 3125 Tel: (03) 288 6280. Exec. Nevill L. Sherburn.

Syrus Publ's (APRA), see Cellar Music

Tafalgar Music (APRA), 748 Trafalgar St., Annanvale, NSW 2038. Tel: (02) 660-0385. Mng. Dir.: Charles Fisher; Gen. Mgr.: Michael McMartin

Int'l firms represented: Bruised Orange/Big Ears (USA)

Int'l rep.: Canada (Blackwood-Ray Burton)

Tumbleweed Music Pty. Ltd. (APRA), 88 Richard on St., Albert Park, Mel bourne 3206 Tel: (03) 699-5366. Cable: OZRECORDS. Telex 35906

Mng. Dir.: Glenn Wheatley, Gen. Mgr.: David Myatt

Int'l branch: USA, Australian Tumbleweed

Int'l firms represented: Arista/Carerees (USA), Gear (USA), Gem (UK)

Int'l reps.: Belgium (Martin-Coultier), France (Pathe Marcon), Germany (Melodie der Welt, Siegel Musikverlage), Japan (Tayou), Luxembourg (Martin-Coultier), Netherlands (Anagon), Scancinavia (Air), South Africa (Gallo), UK (EMI), USA (Screen Gems)

Wallaby Music Pty. Ltd. (APRA), see Chappell

Warner Bros Music (Australia) Pty. Ltd. (APRA), 319b Penshurst St., Will oughby, Sydney, NSW 2068. Tel: (02) 406-5322. Cable: WARNERMUSE Telex: 24111. Mng. Dir.: Bill Flemming, Gen. Prv. Mgr.: Joanne Oolan

Int'l firms represented: Blue Oyster Cult, Brook n Bird, C'est, Chc, Chn mng, Complicated Toozie, Coral Reeler, Core, Catillon, Curtom, Ora mondback, Ovine's, East, Feckless, Flames of Almond, Free Junket, Fry King, Gaffen/Kaye, Givng Room, Goldline, Guerilla, Lightree, Ice Age, Ice Mine, Jump Tunes, On Kirshner, Kiatoons, Kr., Ludo, Mersaint, Mar tin-Coultier, Mews, Pronto, Quackenbush, William Quills, Tony Roberts, Rosy, Staysail, Steinberg, Superhype, Tessa, Trm Ice, Topographic, Viva, Walden, Warner Bros., Wilsons, Wow & Flutter, Zomba

Int'l reps.: Brazil, France, Germany, Italy, Netherlands, Scandinavia, South Africa, UK, USA (all Warner Bros.)

Norman Whiteley Holdings Pty. Ltd., PO Box 159, Uniline Bldg., 4th fl., 5-13 Northcliff St., Milsons Point, NSW 2061 Tel: (02) 922-6540/6503 Cable: ABISONG. Telex: 22859 Chm & Mng. Dir.: Kathleen M. Whiteley.

Gen. Mgr.: Penny Whiteley.

Int'l firms represented: Big Seven (USA), Fame (USA), Gale (UK), Gamba (USA), Jump (Italy), Larball (USA), Laurel Canyon (USA), Lupus (UK), Penjane (UK), Pink Floyd (UK), Rudolf Slezak (Germany), Time (USA), Tree Int'l (USA), Trio/Hudson Bay (USA), Vence (USA), Hans Wewerka (Germany), Wizard (UK)

Int'l reps.: Japan (Intersong), South Africa (Intersong), UK (Penjane), USA (Royalty Control, Vence).

Woomeera Music Co. (APRA), 17-19 Radford Rd., Reservoir, Vic 3073. Tel: 460-4522. Cable: OUALSCALE MELBOURNE. Dir. & Gen. Mgr.: R. J. Gil lespie.

Int'l branch: USA, Jasper.

Int'l firms represented: Banff (Canada), Rodeo (Canada)

Int'l rep.: Worldwide (Jaspar).

Word Books Australia, 18-26 Canterbury Rd., Heathmont, Vic 3135. Tel: (03) 729-3777. Gen. Mgr.: Stanley R. Moulton.

Int'l firms represented: Lexicon (USA), Word (USA)

Yeldah Music (APRA), Egret Pl., Calala, Tamworth, NSW 2340. Tel: (067) 65-7813. Mng. Dir.: Eric W. Scott; Gen. Mgr.: Hilary Scott.

Bob Young Music (APRA), see Rondor.

• **sheet music jobber / supplier**

Music Sales Australia Pty. Ltd., 27 Clarendon St., Artarmon, Sydney, NSW 2064. Tel: (02) 439-8855. Gen. Mgr.: Neville Prentice.

Home office: England.

• **services**

ASSOCIATIONS & PROFESSIONAL ORGANIZATIONS

A R I A (Australian Rec. Ind. Ass'n), 222 Pitt St., Sydney, NSW 2000 Tel: (02) 267-7877. Cable: PHONOCORD. Exec. Dir.: John L. Hayes.

Australian Copyright Council Ltd., 22 Alfred St., Milsons Point, NSW 2061. Tel: (02) 92-1151. Chm. G. O'Donnell.

Australian Music Publ's Ass'n Ltd., 215 Clarence St., Sydney, NSW 2000. Tel: (02) 29-6201. Cable: AZCA. Sec'y: R. Lollback.

Musica Viva Australia, 68-70 Clarence St., Sydney, NSW 2000. Tel: (02) 29-8444. 29-1684. Cable: MUSICAVIVA. Telex: 70239. Gen. Mgr.: Kim Wil liams. Exec. Officer: Derek Minnett.

Tamworth Song Writers Ass'n, PO Box 497, Tamworth, NSW 2340. Tel: (067) 65-7055. Pres.: Eric Watson; Sec'y: R. Krcchner.

DESIGN & ARTWORK

A T A Sound Studios Pty. Ltd., 96 Glebe Point Rd., Glebe, NSW 2037 Tel: (02) 660-3466. Cable: SHOWWB. Telex: 22429. (Rec. only)

Concert Rec'g, PO Box 108, 10 Caloola Rd., Wentworthville, NSW 2145 Tel: 631-6189.

Home office: USA, Los Angeles, Calif

Copperfield Sound Prod'ns, 127 Carrington Rd., Waverley, NSW 2024 Tel: (02) 389-3043. Mng. Dir. & Gen. Mgr.: David Gibson.

E M I (Australia) Ltd., 301 Castlereagh St., Sydney, NSW 2000. Tel: (02) 20912. Cable: EMIRECORD. Telex: 24182. Mng. Dir.: Peter Jameson, Mktg. Mgr.: Brian Harris.

Hadley Recs., Egret Pl., Calala, Tamworth, NSW 2340. Tel: (067) 65-7813. Mng. Dir.: Eric W. Scott, Gen. Mgr.: Hilary Scott.

Klarion Ent's Pty. Ltd., PO Box 379, 63 Kingsway, South Melbourne, Vic 3205. Tel: (03) 61-3801. Telex: 34732. Mng. Dir.: B.K. Horman; Sales Mgr.: R. Welch. (Tape only)

Branches: Artarmon, NSW 2064, 3 Lancelly Pl., Unit 3 Tel: (02) 438-1388—Brisbane, Qld. 4000, 199 Elizabeth St. Tel: (07) 229-2077—Adelaide, SA 5000, 35-37 Halifax St. Tel: (08) 212-2217

Move Recs., PO Box 266, Carlton South 3053. Tel: (03) 497-3105. Partners: Nicholas Alexander, Martin Wright.

Mushroom Art, 9 Dundas Ln., Albert Park, Vic 3206. Tel: (03) 690-3399

Cable: MUSHREC. Telex: 31738. Mng. Dir.: Michael Gudinski; Gen. Mgr.: Alan Scholz.

Gary Pearton, 42 NW Arm Rd., Gympie, NSW Tel: (02) 29-2824, 521 5485.

Rede-Radia Pty. Ltd., PO Box 270, 122 Chapel St., St. Kilda, Vic 3182 Tel: (03) 531-1588. Mng. Dir.: Marcus Herman, Mktg. Mgr.: Don Fraser.

White & Gillespie (Melbourne) Ltd., 17 Radford Rd., Reservoir, Melbourne, Vic 3073. Tel: (03) 460-4522. Cable: OUALSCALE. Dir.: R.J. Gillespie; Gen. Mgr.: A.E. White.

LICENSING ORGANIZATIONS, MUSIC

A P R A (Australasian Performing Right Ass'n) Ltd., 25-27 Albany St., Crows Nest, Sydney, NSW 2065. Tel: (02) 439-8666. Telex: 23939. Mng. Dir.: J.L. Sturman (Performing rights only)

Int'l branch: New Zealand

Australasian Mechanical Copyright Owners Society Ltd., 215 Clarence St., Sydney, NSW 2000. Tel: (02) 29-6201. Cable: AZCA. Mng. Dir.: A.J. Turner (Mechanical rights only)

Phonographic Performance Co. of Australia Ltd., 222 Pitt St., Sydney, NSW 2000. Tel: (02) 267-7877. Gen. Mgr.: John L. Hayes (Performing rights only)

LICENSORS, RECORD & TAPE

E M I (Australia) Ltd., 301 Castlereagh St., Sydney, NSW 2000 Tel: (02) 20912. Cable: EMIRECORD. Telex: 24182. Mng. Dir.: Peter Jameson; Mktg. Mgr.: Brian Harris.

Rede-Radia Pty. Ltd., PO Box 270, 122 Chapel St., St. Kilda, Vic 3182 Tel: (03) 531-1588. Mng. Dir.: Marcus Herman; Mktg. Mgr.: Don Fraser.

PLATING, PROCESSING & PRESSING PLANTS

C B S Recs. Australia Ltd., 15 Blue St., North Sydney, NSW 2060 Tel: (02) 339-0255. Cable: COLRECORD. Telex: 21246. Chm. William Smith; Mfg. Mgr.: Robert Hayden (Pressing only)

E M I (Australia) Ltd., 301 Castlereagh St., Sydney, NSW 2000. Tel: (02) 20912. Cable: EMIRECORD. Telex: 24182. Mng. Dir.: Peter Jameson; Mktg. Mgr.: Brian Harris.

Festival Recs. Pty. Ltd., Festival House, 63-79 Miller St., Pyrmont, Sydney, NSW 2009. Tel: (02) 660-4022. Telex: 25686. Mng. Dir.: Allan Hely, Gen. Mgr.: Jim White, Sales Mgr.: Noel Brown.

RCA Ltd., 11 Khartoum Rd., North Ryde, Sydney NSW 2113 Tel: (02) 888-5444. Cable: RCAAUST. Telex: 21654. Mng. Dir.: Brian Smith.

7 Recs. Pty. Ltd., 28 Cross St., Brookvale, NSW 2100. Tel: (02) 938-2200. Cable: SEVENRECS. Telex: 20270. Chief Exec.: Ken Harding, Factory Mgr.: Arthur Wilson.

PRINTERS & LITHOGRAPHERS

C B S Recs. Australia Ltd., 15 Blue St., North Sydney, NSW 2060 Tel: (02) 339-0255. Cable: COLRECORD. Telex: 21246. Chm. William Smith; Mfg. Mgr.: Robert Hayden.

E M I (Australia) Ltd., 301 Castlereagh St., Sydney, NSW 2000 Tel: (02) 20912. Cable: EMIRECORD. Telex: 24182. Mng. Dir.: Peter Jameson; Mktg. Mgr.: Brian Harris.

Klarion Ent's Pty. Ltd., PO Box 379, 63 Kingsway, South Melbourne, Vic 3205. Tel: (03) 61-3801. Telex: 34732. Mng. Dir.: B.K. Horman; Sales Mgr.: R. Welch. (Tape only)

Branches: Artarmon, NSW 2064, 3 Lancelly Pl., Unit 3 Tel: (02) 438-1388—Brisbane, Qld. 4000, 199 Elizabeth St. Tel: (07) 229-2077—Adelaide, SA 5000, 35-37 Halifax St. Tel: (08) 212-2217

RCA Ltd., 11 Khartoum Rd., North Ryde, Sydney NSW 2113 Tel: (02) 888-5444. Cable: RCAAUST. Telex: 21654. Mng. Dir.: Brian Smith.

RECORD PROMOTION

Copperfield Sound Prod'ns, 127 Carrington Rd., Waverley, NSW 2024 Tel: (02) 389-3043. Mng. Dir. & Gen. Mgr.: David Gibson.

Festival Recs. Pty. Ltd., Festival House, 63-79 Miller St., Pyrmont, Sydney, NSW 2009. Tel: (02) 660-4022. Telex: 25686. Mng. Dir.: Allan Hely, Gen. Mgr.: Jim White, Sales Mgr.: Noel Brown.

Patch Prod'ns Pty. Ltd., 8 Yeo St., Sydney, NSW 2089. Tel: (02) 909-2584.

Rede-Radia Pty. Ltd., PO Box 270, 122 Chapel St., St. Kilda, Vic 3182 Tel: (03) 531-1588. Mng. Dir.: Marcus Herman; Mktg. Mgr.: Don Fraser.

TAPE CUSTOM DUPLICATORS TAPE PACKAGING & LABELING

The Audio and Video lines indicate the configurations which the firms duplicate. Companies which offer packaging and labeling of tape product are indicated by "(PRG)" which appears after the main body of their respective listings.

Ampex Australia Pty. Ltd., 65 Waterloo Rd., North Ryde, NSW 2113. Tel: (02) 887-3333. Cable: VIDEOAPE. Telex: 20608. Mng. Dir.: Greg Nixon, Magnetic Tape Div. Mktg. Mgr.: Richard Blackett. (PRG only—audio & video)

Branch: Blackburn, Vic. 3030, 21 Terra Cotta Dr. Tel: (03) 877-6222

C B S Recs. Australia Ltd., 15 Blue St., North Sydney, NSW 2060. Tel: (02) 339-0255. Cable: COLRECORD. Telex: 21246. Chm.: William Smith; Mfg. Mgr.: Robert Hayden.

Audio: Cassette

C P H Video, PO Box 27, Willoughby, NSW 2068. Tel: (02) 43-0444. Telex 20689. Pres.: David Maxwell.

Video: ¼" Beta & VHS cassette

Caras Emporium Pty. Ltd., 215 Lonsdale St., Melbourne, Vic 3000. Tel: (03) 663-3605. Telex: 31501. (Manufacturers' rep.)

Audio: 8-tr., 8-tr. quadraphonic, cassette, open reel

Brand name: Trakmaster.

Copperfield Sound Prod'ns, 127 Carrington Rd., Waverley, NSW 2024 Tel: (02) 389-3043. Mng. Dir. & Gen. Mgr.: David Gibson.

Audio: 8-tr. cassette, open reel, open reel quadraphonic.

Video: ¼" cassette

E M I (Australia) Ltd., 301 Castlereagh St., Sydney, NSW 2000. Tel: (02) 20912. Cable: EMIRECORD. Telex: 24182. Mng. Dir.: Peter Jameson, Mktg. Mgr.: Brian Harris. (PRG)

Audio: Cassette

Festival Recs. Pty. Ltd., Festival House, 63-79 Miller St., Pyrmont, Sydney, NSW 2009. Tel: (02) 660-4022. Telex: 25686. Mng. Dir.: Allan Hely, Gen. Mgr.: Jim White, Sales Mgr.: Noel Brown.

K G C Magnetic Tape Pty. Ltd., PO Box 118, 40 Applebee St., St. Peters, Sydney, NSW 2044. Tel: (02) 519-2677. Cable: MAGTAP. Telex: 71659. Gen. Mgr.: W. F. Gordon, Sales Mgr.: E. Black; Audio Sales Mgr.: Carlo Ferrante

Audio: Cassette

Video: ¼" cassette, ¼" Beta, VHS & Philips (V-2000) cassette

Klarion Ent's Pty. Ltd., PO Box 379, 63 Kingsway, South Melbourne, Vic 3205. Tel: (03) 61-3801. Mng. Dir.: B.K. Horman; Sales Mgr.: R. Welch.

Branches: Artarmon, NSW 2064, 3 Lancelly Pl., Unit 3 Tel: (02) 438-1388—Brisbane, Qld. 4000, 199 Elizabeth St. Tel: (07) 229-2077—Adelaide, SA 5000, 35-37 Halifax St. Tel: (08) 212-2217

Audio: 8-tr., 8-tr. quadraphonic, cassette, open reel

Video: ¼" cassette

RCA Ltd., 11 Khartoum Rd., North Ryde, Sydney NSW 2113. Tel: (02) 888-5444. Cable: RCAAUST. Telex: 21654. Mng. Dir.: Brian Smith

Audio: Cassette

Tape Duplicators Pty. Ltd., 3 Chard Rd., Brookvale, NSW 2100. Tel: (02) 938-1539. Ours: B.M.T. & L.A. Frost.

Audio: Cassette.

• **supplies**

CARTRIDGE & CASSETTE PARTS

Greencorp Magnetics Pty. Ltd., 80 Perry St., Matraville, NSW 2036. Tel: (02) 661-6511. Telex: 24761. Mng. Dir.: Jack N. Green; Gen. Mgr.: Warren A. Green; Sales Mgr.: Stephen L. Green; Technical Mgr.: W. Dale Humphriss.

Int'l branches: France, Hong Kong, Israel, USA

EMPTY CARTRIDGES, CASSETTES & REELS

Ampex Australia Pty. Ltd., 65 Waterloo Rd., North Ryde, NSW 2113. Tel: (02) 887-3333. Cable: VIDEOAPE. Telex: 20608. Mng. Dir.: Greg Nixon; Magnetic Tape Div. Mktg. Mgr.: Richard Blackett

Branch: Blackburn, Vic. 3030, 21 Terra Cotta Dr., Tel: (03) 877-6222.

Audio: Cassettes, reels

Greencorp Magnetics Pty. Ltd., 80 Perry St., Matraville, NSW 2036. Tel: (02) 661-6511. Telex: 24761. Mng. Dir.: Jack N. Green; Gen. Mgr.: Warren A. Green; Sales Mgr.: Stephen L. Green; Technical Mgr.: W. Dale Humphriss.

Int'l branches: France, Hong Kong, Israel, USA

Audio: 8-tr., cassettes, reels

K G C Magnetic Tape Pty. Ltd., PO Box 118, 40 Applebee St., St. Peters, Sydney, NSW 2044. Tel: (02) 519-2677. Cable: MAGTAP. Telex: 71659. Gen. Mgr.: W. Gordon, Sales Mgr.: E. Black, Audio Sales Mgr.: Carlo Ferrante

Audio: Cassettes, 5" & 7" reels

Klarion Ent's Pty. Ltd., PO Box 379, 63 Kingsway, South Melbourne, Vic 3205. Tel: (03) 61-3801. Telex: 34732. Mng. Dir.: B.K. Horman; Sales Mgr.: R. Welch.

Branches: Artarmon, NSW 2064, 3 Lancelly Pl., Unit 3 Tel: (02) 438-1388—Brisbane, Qld. 4000, 199 Elizabeth St. Tel: (07) 229-2077—Adelaide, SA 5000, 35-37 Halifax St. Tel: (08) 212-2217

Audio: Reels

JACKETS & SLEEVES

E M I (Australia) Ltd., 301 Castlereagh St., Sydney, NSW 2000. Tel: (02) 20912. Cable: EMIRECORD. Telex: 24182. Mng. Dir.: Peter Jameson; Mktg. Mgr.: Brian Harris (LP)

E M I (Australia) Ltd., 301 Castlereagh St., Sydney, NSW 2000. Tel: (02) 20912. Cable: EMIRECORD. Telex: 24182. Mng. Dir.: Peter Jameson; Mktg. Mgr.: Brian Harris. (45, LP)

RAW MATERIALS

Nylax Corp. Ltd., 359 Horsley Rd., Milperra, NSW 2214. Tel: (02) 774-4444. Telex: 20403. Mng. Dir.: Henry Bosch; Gen. Mgr.: Keith J. Anderson; Prod. Mgr.: Malcolm Scott. Product: Vinyl compounds (dry blend, granules or biscuit).

PROFESSIONAL TAPE SUPPLIES

E M I (Australia) Ltd., 301 Castlereagh St., Sydney, NSW 2000. Tel: (02) 20912. Cable: EMIRECORD. Telex: 24182. Mng. Dir.: Peter Jamieson; Mktg. Mgr.: Brian Harris. Audio: Cassette labels.

TAPE, BLANK LOADED & BULK RAW

Agfa Gevaert Ltd., PO Box 48, Whitehorse Rd. 372-380, Nunawading, Vic. 3131. Tel: 878-8000. Cable: AGFAGEVAERT. Telex: 30702 Melbourne. Audio: Blank-compact-cassette, open reel, raw-cassette, broadcast studio. Video: Cassette, open reel.

Amplex Australia Pty. Ltd., 65 Waterloo Rd., North Ryde, NSW 2113. Tel: (02) 887-3333. Cable: VIDEOTAPE. Telex: 20608. Mgr./Dir.: Greg Nixon; Magnetic Tape Div. Mktg. Mgr.: Richard Blackett. Branch: Blackburn, Vic. 3030, 21 Terra Cotta Dr. Tel: (03) 877-6222. Audio: Cassette, open reel. Video: 2" & 1" open reel, 3/4" & 1/2" cassette.

Audiotope, see Klarion. B A S F Australia Ltd., 55 Flemington Rd., North Melbourne, Vic. 3051. Tel: 329-9555. Telex: 30448. Sales Mgr.: N. Price. (Raw only) Audio: Cassette, open reel. Video: 2" & 1" open reel, 3/4" & 1/2" cassette.

C P H Video, PO Box 27, Willoughby, NSW 2068. Tel: (02) 43-0444. Telex: 20689 Pres. David Maxwell. Int'l branches: England, USA. Video: Cassette. Brand name: Trackmaster.

Caras Emporium Pty. Ltd., 215 Lonsdale St., Melbourne, Vic. 3000. Tel: (03) 663-3605. Telex: 31501. (Manufacturers' rep.) Audio: 8-tr., cassette. Brand name: Trackmaster.

G-tape, see Greencorp. Greencorp Magnetics Pty. Ltd., 80 Perry St., Matraville, NSW 2036. Tel: (02) 661-6511. Telex: 24761. Mng. Dir.: Jack N. Green; Gen. Mgr.: Warren A. Green; Sales Mgr.: Stephen L. Green; Technical Mgr.: W. Dale Humphris. Int'l branches: France, Hong Kong, Israel, USA. Audio: 8-tr., cassette, open reel. Video: 1/2" EIAJ open reel, 3/4" cassette.

Klarion Ent's. Pty. Ltd., PO Box 379, 63 Kingsway, South Melbourne, Vic. 3205. Tel: (03) 61-3801. Telex: 34732. Mng. Dir.: B.K. Horman; Sales Mgr.: R. Welch. Branches: Artarmon, NSW 2064, 3 Lanceli Pl. Unit 3. Tel: (02) 438-1388-Brisbane, Qld. 4000, 199 Elizabeth St. Tel: (07) 229-2077-Adelaide, SA 5000, 35-37 Halifax St. Tel: (08) 212-2217. Audio: Blank-cassette, open reel, raw-8-tr. cassette, open reel. Brand names: Audiotope, Klarion.

Opus, see Greencorp. Trackmaster, see Caras. TAPE DUPLICATING & PROCESSING EQUIPMENT

B A S F Australia Ltd., 55 Flemington Rd., North Melbourne, Vic. 3051. Tel: 329-9555. Telex: 30448. Sales Mgr.: N. Price. Audio: Pancakes. Caras Emporium Pty. Ltd., 215 Lonsdale St., Melbourne, Vic. 3000. (Manufacturers' rep.) Audio: Winders, exercisers, 8-tr. duplicators, verniers, 8-tr. & cassette loaders. Brand name: Trackmaster.

Klarion Ent's. Pty. Ltd., PO Box 379, 63 Kingsway, South Melbourne, Vic. 3205. Tel: (03) 61-3801. Telex: 34732. Mng. Dir.: B.K. Horman; Sales Mgr.: R. Welch. Branches: Artarmon, NSW 2064, 3 Lanceli Pl. Unit 3. Tel: (02) 438-1388-Brisbane, Qld. 4000, 199 Elizabeth St. Tel: (07) 229-2077-Adelaide, SA 5000, 35-37 Halifax St. Tel: (08) 212-2217. Audio: Checkers, duplicators, loaders. Brand name: Otari.

Otari, see Klarion. Trackmaster, see Caras. • accessories manufacturers

Amplex Australia Pty. Ltd., 65 Waterloo Rd., North Ryde, NSW 2113. Tel: (02) 887-3333. Cable: VIDEOTAPE. Telex: 20608. Mgr./Dir.: Greg Nixon; Magnetic Tape Div. Mktg. Mgr.: Richard Blackett. Branch: Blackburn, Vic. 3030, 21 Terra Cotta Dr. Tel: (03) 877-6222. Product: Tape-head cleaners & demagnetizers, leader & splicing tape & equip.

B A S F Australia Ltd., 55 Flemington Rd., North Melbourne, Vic. 3051. Tel: 329-9555. Telex: 30448. Sales Mgr.: N. Price. Product: Tape-head cleaners, splicing tape & equip. Colossal Recs. of Australia, 28 Milton St., West Melbourne, Vic. 3003. Tel: (03) 329-0316. Mng. Dir.: Mimmo LoPrete; Sales Mgr.: Sam LoPrete. Product: Record & Tape-carrying & storage cases (audio).

Greencorp Magnetics Pty. Ltd., 80 Perry St., Matraville, NSW 2036. Tel: (02) 661-6511. Telex: 24761. Mng. Dir.: Jack N. Green; Gen. Mgr.: Warren A. Green; Sales Mgr.: Stephen L. Green; Technical Mgr.: W. Dale Humphris. Int'l branches: France, Hong Kong, Israel, USA. Product: Record-carrying & storage cases, record care prods., 45 rpm adaptors. Tape-carrying & storage cases, head cleaners, demagnetizers, leader & splicing tape.

K G C Magnetic Tape Pty. Ltd., PO Box 118, 40 Applebee St. St. Peters, Sydney, NSW 2044. Tel: (02) 519-2677. Cable: MAGTAP. Telex: 71659. Gen. Mgr.: W. Gordon; Sales Mgr.: E. Black; Audio Sales Mgr.: Carlo Ferrante. Product: Tape-head cleaners, demagnetizers, leader & splicing tape & equip.

Klarion Ent's. Pty. Ltd., PO Box 379, 63 Kingsway, South Melbourne, Vic. 3205. Tel: (03) 61-3801. Telex: 34732. Mng. Dir.: B.K. Horman; Sales Mgr.: R. Welch. Branches: Artarmon, NSW 2064, 3 Lanceli Pl. Unit 3. Tel: (02) 438-1388-Brisbane, Qld. 4000, 199 Elizabeth St. Tel: (07) 229-2077-Adelaide, SA 5000, 35-37 Halifax St. Tel: (08) 212-2217. Product: Tape-head cleaners, demagnetizers, leader & splicing tape & equip.

• store fixtures

Amplex Australia Pty. Ltd., 65 Waterloo Rd., North Ryde, NSW 2113. Tel: (02) 887-3333. Cable: VIDEOTAPE. Telex: 20608. Mgr./Dir.: Greg Nixon; Magnetic Tape Div. Mktg. Mgr.: Richard Blackett. Branch: Blackburn, Vic. 3030, 21 Terra Cotta Dr. Tel: (03) 877-6222. Product: Tape-head cleaners, demagnetizers, leader & splicing tape & equip.

B A S F Australia Ltd., 55 Flemington Rd., North Melbourne, Vic. 3051. Tel: 329-9555. Telex: 30448. Sales Mgr.: N. Price. Product: Tape-head cleaners, demagnetizers, leader & splicing tape & equip. Colossal Recs. of Australia, 28 Milton St., West Melbourne, Vic. 3003. Tel: (03) 329-0316. Mng. Dir.: Mimmo LoPrete; Sales Mgr.: Sam LoPrete. Product: Record & Tape-carrying & storage cases (audio).

Greencorp Magnetics Pty. Ltd., 80 Perry St., Matraville, NSW 2036. Tel: (02) 661-6511. Telex: 24761. Mng. Dir.: Jack N. Green; Gen. Mgr.: Warren A. Green; Sales Mgr.: Stephen L. Green; Technical Mgr.: W. Dale Humphris. Int'l branches: France, Hong Kong, Israel, USA. Product: Record-carrying & storage cases, record care prods., 45 rpm adaptors. Tape-carrying & storage cases, head cleaners, demagnetizers, leader & splicing tape.

K G C Magnetic Tape Pty. Ltd., PO Box 118, 40 Applebee St. St. Peters, Sydney, NSW 2044. Tel: (02) 519-2677. Cable: MAGTAP. Telex: 71659. Gen. Mgr.: W. Gordon; Sales Mgr.: E. Black; Audio Sales Mgr.: Carlo Ferrante. Product: Tape-head cleaners, demagnetizers, leader & splicing tape & equip.

Klarion Ent's. Pty. Ltd., PO Box 379, 63 Kingsway, South Melbourne, Vic. 3205. Tel: (03) 61-3801. Telex: 34732. Mng. Dir.: B.K. Horman; Sales Mgr.: R. Welch. Branches: Artarmon, NSW 2064, 3 Lanceli Pl. Unit 3. Tel: (02) 438-1388-Brisbane, Qld. 4000, 199 Elizabeth St. Tel: (07) 229-2077-Adelaide, SA 5000, 35-37 Halifax St. Tel: (08) 212-2217. Product: Tape-head cleaners, demagnetizers, leader & splicing tape & equip.

• store fixtures

Amplex Australia Pty. Ltd., 65 Waterloo Rd., North Ryde, NSW 2113. Tel: (02) 887-3333. Cable: VIDEOTAPE. Telex: 20608. Mgr./Dir.: Greg Nixon; Magnetic Tape Div. Mktg. Mgr.: Richard Blackett. Branch: Blackburn, Vic. 3030, 21 Terra Cotta Dr. Tel: (03) 877-6222. Product: Tape-head cleaners, demagnetizers, leader & splicing tape & equip.

Magnetic Tape Div. Mktg. Mgr.: Richard Blackett. Branch: Blackburn, Vic. 3030, 21 Terra Cotta Dr. Tel: (03) 877-6222. Product: Tape display racks. Colossal Recs. of Australia, 28 Milton St., West Melbourne, Vic. 3003. Tel: (03) 329-0316. Mng. Dir.: Mimmo LoPrete; Sales Mgr.: Sam LoPrete. Product: Display racks. Greencorp Magnetics Pty. Ltd., 80 Perry St., Matraville, NSW 2036. Tel: (02) 661-6511. Telex: 24761. Mng. Dir.: Jack N. Green; Gen. Mgr.: Warren A. Green; Sales Mgr.: Stephen L. Green; Technical Mgr.: W. Dale Humphris. Int'l branches: France, Hong Kong, Israel, USA. Product: Divider cards.

AUSTRIA

Population: 7,499,395. Population by age groups: 0-14-1,537,714; 15-24-1,223,164; 25-49-2,408,356; 50+ -2,330,161. Rate of exchange: \$1 (US) = 16.00 schillings. Per capita income: \$5,940. Holidays: January 1 (New Year's), Easter Monday, May 1 (Labor Day), Ascension Day, Pentecost, Corpus Christi, August 15 (Assumption), October 26 (National Holiday), November 1 (All Saints' Day), December 8 (Immaculate Conception), December 25, 26 (Christmas).

RECORDS
Record sales certification awards: Gold single-50,000 units. Gold LP-25,000 units. Records sold domestically including imports (retail value): LP's 1980-6,900,000 units, \$48,126,000; 1979-6,959,000 units, \$41,293,000. Singles 1980-3,500,000 units, \$9,062,000; 1979-3,737,000 units, \$10,495,000. Records imported from USA (factory value): 1980-\$322,000. 1979-\$312,000. Records exported to USA (factory value): 1980-\$29,000. 1979-\$57,000. Records imported from countries other than USA (factory value): 1980-\$13,845,000. 1979-\$15,332,000. Records exported to countries other than USA (factory value): 1980-\$1,923,000. 1979-\$2,005,000. Average retail price per record: LP's-\$6.97; singles-\$2.59. TV merchandising: 13% of total sales. Record club sales: 15.5% of total. Discounting: Frequent.

Type of distribution: The manufacturer-to-retailer system predominates with a market share of approximately 64%; the manufacturer-to-whole-saler-to-retailer system has 16%; manufacturer-to-record-club-to-retailer has 15.5%; rack jobbing has 4.5%. Type of promotion: Austrian TV and the broadcasting system owned by the government are the main sources, followed by magazines, newspapers, discos and fan clubs. Jukeboxes: 10,000. **TAPE:** Market: The tape market, where the musicassette system prevails, decreased about 20% in 1980 compared to 1979. The main reason for this is attributed to the sales of blank cassettes, of which about 10.5 million were sold in 1980. The market for 8-track cartridge and open reel is virtually nonexistent. VHS dominates the video market, followed by Video 2000 and Beta. Pre-recorded tape sold domestically: Cassette 1980-2,716,000 units, \$23,016,000; 1979-3,026,000 units, \$27,412,000. Pre-recorded tape imported from USA (factory value, CIF): 1980-\$56,300. Pre-recorded tape imported from countries other than USA (factory value, CIF): 1980-\$7,335,000. Pre-recorded tape exported to countries other than USA (factory value, FOB): 1980-\$1,618,000. Average retail price per tape: Cassette-\$8.47. **CONSUMER ELECTRONICS:** Number of homes with: Radios-2,350,000; television sets-2,120,000, color-1,000,000, b&w-1,200,000; phonographs-1x650,000; audio tape recorders-3,400,000; video tape recorders-57,000. **RADIO STATIONS:** No. of government 3 (1 AM, 3 FM). **TELEVISION STATIONS:** No. of channels: 2 government; 85% color (PAL). **IMPORT/EXPORT REGULATIONS:** Record/ships from EFTA (European Free Trade Ass'n) and EG (European Common Market) countries are tax free; those from the USA are taxed 15.5%. Tape imports from EFTA countries and EG countries are tax free; those from the USA are taxed 10%.

MARKET ANALYSIS: The Austrian sound-carrier market is dominated by the members of the Austrian branch of the International Federation of Producers of Phonograms and Videograms. The IFPI represents the biggest companies such as Amadeo, Ariola, Bellaphon, CBS, EMI Columbia, Musica, Phonogram, Polydor and WEA. The record clubs have great importance here, having been able to reach a sales turnover of 15.5% of the entire market. The turnover of the non-IFPI members reached about 21%. 1980 record company sales were down about 1.5% compared to 1979. The most important slump in the record field was registered by low-price albums, which were down 30%, while middle-and-high-price album sales rose about 10%.

While open reel and 8-track cartridges have nearly vanished from the Austrian market, musicassettes dropped 15% in 1980. This was due to the effects of worldwide recession on the sound-carrier market and to sales of blank cassettes. According to a market research institute study, it is estimated that some 10.5 million blank cassettes were sold in Austria in 1980. Market share for type of music is divided into 58% for international pop and entertainment, 20% national pop and entertainment, 13% classical and 9% country. After a Supreme Court decision, parallel imports have long increased. This is also due to the fact that record prices have been rising considerably in the neighboring countries. Video is becoming more important. It is estimated that an additional 50,000 new video units will be bought in 1981, adding to the current 57,000 VHS dominates the pre-recorded video market, followed by Video 2000 and Beta. Video 2000 enjoys much of its success to the Philips video factory in Vienna, which has a capacity of 700,000 recorders per year.

Manfred Schreiber.

• record & tape manufacturers / distributors / importers

A V O Schallplatten GmbH, Kohlgasse 23, A-1050 Vienna, Tel: (0222) 55 13 57. Telex: 77307. Gen. Mgr.: Heinz Juergens. Labels: (Owned) AVO; (distributed-not licensed) Baca (Germany), Compact (Germany), Concord (Germany), Image (Switzerland), Maerchenland (Germany), Opp (Germany), Polyband (Germany), Topsound (Germany).

Accord Schallplatten Produktion GmbH & Co. KG, Herzog Friedrich Str. 8, A-6020 Innsbruck. Tel: (05222) 27 3 64. Gen. Mgr.: Wolfgang Lochbihler. Amadeo Oesterreichische Schallplatten GmbH (IFPI), Mariahilfer Guertel 32, A-1060 Vienna. Tel: (0222) 56 35 60. Cable: AMAEODISC. Telex: 75261. Gen. Mgr.: Victor R. Cordani; Sales Mgr.: Gottfried Urschler. Labels: (Owned) Amadeo, Atom; (distributed-not licensed domestic) WM Produktion; (licensed foreign) Ades (France), BBC (UK), Barclay (France), Big Bear (UK), Black Lion (UK), Butterfly (USA), Brain (Germany), CNR (Netherlands), CTI (USA), Can't Stop (USA), Ceter (France), Chicwick (UK), Christophorus (Germany), Ciao (Italy), Cream (USA), DJM (UK), De-Lite (USA), Disneyland (USA), EGG (France), Elite Special (Switzerland), Erkoeng (Germany), Global (Germany), Gold (Switzerland), Kudu (USA), Jewel (Germany), Intercord (Germany), LA (USA), Lax/Far Out (USA), Logo (UK), Mandragora (Germany), MPS (Germany), Metronome (Germany), Nature (Germany), Nems (UK), Ovalion (USA), Pacific Art (USA), Passport (USA), Ricordi (Italy), Riviera (France), Saphir (Germany), Shark (USA), Spiegelei (Germany), Springboard (USA), Sussex (UK), Suff (Germany), Toledo (Germany), Tudor (Switzerland), Zebra (Germany).

Int'l reps.: Belgium (Polydor), Finland (Finnlevy), France (Phonogram), Germany (Metronome), Italy (Ricordi), Luxembourg (Polydor), Japan (Phonogram), Netherlands (Polydor), Norway (Norsk Phonogram), Portugal (Phonogram), South Africa (EMI), Spain (Hispanavox), Sweden (Sonet), Switzerland (Metronome), UK (Sonet), USA (Apon).

Angel, see EMI. Archiv, see Polydor. Ariola Schallplatten GmbH (IFPI), Hofmohlgasse 1-5, A-1150 Vienna, Tel: (0222) 83 56 05. Mng. Dir.: Stephen von Friedberg; Mktg. Mgr.: Erich Krapfenbacher. Home office: Germany, Ariola-Eurodisc. Labels: (Owned) Ariola, Arista, Baccarola, Eurodisc, Pan, Savoy; (licensed) Albion (UK), Bearsville (USA), Bronze (UK), CMH (USA), Caroline (UK), Clan Celentano (Italy), Front Line (UK), Golden Hour (UK), Hansa (Germany), Island (UK), Jupiter (Germany), MCA (USA), Mantecore (UK), Maritim (Germany), Melodia (USSR), Montana (UK), Musizza (Italy), Oasis (Germany), PBR (USA), President (UK), Pye (UK), Real (UK), Roulette (USA), Shelter (USA), Sire (USA), Supraphon (Czechoslovakia), Tomato (USA), Virgin (UK). (distributed-not licensed) Arcade (Germany), Hit, Lion Baby, Wolf.

Int'l reps.: see Ariola-Eurodisc listing in Germany. Arista, see EMI. Artone, see CBS. Asylum, see WEA. Alco, see WEA. Atlantic, see WEA. Atom, see Amadeo. Autobahn, see Phonogram. Baccarola, see Ariola. Bacillus, see Bellaphon. Back Door, see Phonogram. Bellaphon Recs. (IFPI), Grundstengasse 5-7, A-1160 Vienna. Tel: (0222) 43 61 22. Telex: 75922. Gen. Mgr.: Gerhard David; A&R Mgr.: Rudolf Spreitzer. Home office: Germany. Labels: (Owned) Bacillus, Bellaphon, Bellaphon Classic, Bellaphon Condo Serie, Bellaphon Int'l, Bellaphon Panoptikum, Bellaphon World Serie, Danube Jazz Serie, Heimatland, Pirifikus, Rare Bird; (licensed) Acanta (Germany), Accent, Admiral, Alaska, Appaloosa, Arhoolie (USA), Aristocrate (East Germany), Audio Fidelity, Audio Rarities, Avator (UK), Bang (USA), Biton, Black Bear, Black Saint (USA), Blues Classics, Boardwalk (USA), Bullett, Bunte Illustrierte (Germany), Cain (Germany), Canyon, Chant du Monde (France), Chiaroscuro, Concord Jazz (USA), Cottonball, Dallas Sound, Delos, Direction, ECM (Germany), ENJA (Germany), Eterna, Everest, Evolution, Exhibit, Experiences Anonyms, Fabulous, First Class, First Component Series, Four Leaf Clover, Gordy (USA), Greensleeves (UK), Hallelujah, Hitsville, Hoer Zu/Bellaphon (Germany), Honey Bee, Image, Initial, JAPO (Germany), JVC Direct Disk (Japan), Jackson Sound, Jamaica Sound (UK), Karate, King, Kiswell (UK), L&R (Germany), Lyrichord, Mr. G. Motown (USA), Mowest (USA), Muse, Nagara, Nessa, Old Timey, Panoptikum, Peg (Germany), Peggy (USA), Penny Farthing (UK), Perception, Piccolo, Pick Up, Pinguin, Plantation (USA), Pompey, Pop, Power Rak, Prodigal, Rare Earth, Richey, Ri-Fi (Italy), Roadshow, Roxbury, SSS Int'l, Schluesselloch (Germany), Schwann (Germany), Scotti Bros. (USA), Sesam, Shout, Soul, Soul Note, Spottite, Starday King, Star, SteepleChase, Stereo Dimension, Stern/Bellaphon (Germany), Sun (USA), Swing, Tania Motown (USA), Tapestry, Thumble, Timeless, Tonstudio Biber (Germany), Turtle Creek, Vesuvius, Victory, WAIT (Germany), Woolfe. Das Beste (Verlag) GmbH (Reader's Digest Verlag GmbH), Singerstr. 2, A-1010 Vienna. Label: Das Beste.

Blue Danube, see Musidisc. Bovema, see EMI. A Burkl oHG Schallplatten Gross & Einzelhandel, Reiserstr. 32, A-10220 Vienna. Tel: (0222) 72 14 59. (Distributor). C B S Schallplatten GmbH (IFPI), Hofmohlgasse 1-5, A-1150 Vienna. Tel: (0222) 83 56 08. Cable: COLRECORD. Telex: (8470) 12123. Gen. Mgr.: Jaroslav Sevcik; Mktg. & Sales Mgr.: Rudolf Nikles. Labels: (Owned) Artone, CBS, Embassy, Epic, Harmony, Maestro, Masterworks, Odyssey, Portrait, Robbi; (licensed) A&M (USA), Aladin, BID, Bang (USA), Blue Star, Blue Sky (USA), CGD (Italy), Caribou (USA), Curb (USA), Dreyfus (France), GTO (UK), Horizon (USA), Invictus (USA), Jet (UK), Johnston (USA), Kirshner (USA), M Music, Monument (USA), Nemperor (USA), Philadelphia Int'l (USA), Precision (USA), Startite (USA), TK (USA), T-Neck (USA), Uncle Jam (USA), Unlimited God (USA).

Capitol, see EMI. Casablanca, see Phonogram. Charisma, see Phonogram. Classics for Pleasure, see EMI. Cobra, see EMI. Columbia, see EMI. Columbia-Music, see EMI. Communica, Kleeblattgasse 4, A-1010 Vienna. Tel: (0222) 63 24 45, 63 55

52, 66 34 48.
 Cotillon, see WEA.
 Court Opera Classics, see Ditto G. Preiser.
 Crystal, see EMI.
 D G, see Polydor.
 D R K, see Phonogram.
 Danube Jazz Serie, see Bellaphon.
 Discotrade Gesellschaft mbH, Neulercherfeldstr. 12, A-1160 Vienna. Tel: (0222) 48 25 91. Telex: 135245. Gen. Mgr.: Erich Kahr; Sales Mgr.: Alfred Kretschmer. (Distributor/Importer)
 Labels: (Distributed—not licensed) Amati, Billa Musica, Clear Sound, Delta, Europa, Jet, Multisound, SST, Sonix, Song, Supertone (all Germany).
 DisqueD'Aulriche, see Musidisc.
 Donauton, see Musidisc.
 E M I Columbia Austria GmbH (IFPI), Webgasse 43, A-1060 Vienna. Tel: (0222) 57 36 76. Cable: EMICDL. Telex: 1-13336. Mng. Dir.: Peter Mampell. Sales Mgr.: Roland Beck; Finance & Admin. Dir.: Wilfried Hawlik; A&R Nat'l Mgr.: Joe Artnet; A&R Int'l Mgr.: Christine Hruska. Local Branch: Kaerntnerstr. 30. Tel: (0222) 52 36 75.
 Branch: A-5020 Salzburg, Universitätsplatz 15. Tel: (06222) 43 215.
 Labels: (Owned) Angel, Bovema, Capitol, Classics For Pleasure, Cobra, Columbia, Columbia-Music, Crystal, EMI, EMI America, EMI-Disc, EMI-EAR, Electrola, Eminent, Encore, Gloria, Harvest, His Masters' Voice, Liberty United, Musica Prae Classica, Negram, Ddonson, Dne Up, Parlophone, Pathe, Pathe-Marconi, Regal, Seraphim, Sidewalk, Sonopresse, Stimme Seines Herrn, Talsman, United Artists, Waverley, Welt-Rekord; (Licensed foreign) Abbey Road (UK), Accent (UK), Apple (UK), Artists House (USA), Blue Note (USA), Chandlers (Germany), Colcirt (Germany), Folkways (USA), Harmonia Mundi (Germany), Hitsville (UK), Hoer zu (Germany), Kaleidoskop (Germany), Kling Klang (Germany), MFP (UK), Dz (Australia), Papagayo (Germany), Prisma (Germany), RAK (UK), Rolling Stones (UK), Russel Raekords (Germany), Safa-i (Germany), Soul (USA), Sunburst (UK), Unicorn (UK), Vanguard (USA), Yona (France), Zoom (UK).
 Earl Recs., Industriest. B13, A-2345 Brunn. Tel: (02236) 6188. Telex: 79182. Chief Exec.: Renate A. Herzog.
 Eastwind, see Phonogram.
 Electrola, see EMI.
 Elektra, see WEA.
 Embassy, see CBS.
 Eminent, see EMI.
 Encore, see EMI.
 Epic, see CBS.
 Eurodisc, see Ariola.
 Euroton Austria GmbH, Nobilgasse 40 42, A-1150 Vienna. Tel: (0222) 92 11 02. Telex: 31111. Mng. Dir.: E. Kozak; Sales Mgr.: Gerhard Hoke.
 Labels: (Owned) Optima, Souvenir; (represented) Camden (UK), Documentary Series (Germany), Hallmark (UK), Pikwick (France, USA).
 Fantastik, see Koch.
 Fass, see Phonogram.
 Fontana, see Phonogram.
 Gig Sound Recs., Favoritenstr. 72, A-1040 Vienna. Tel: (0222) 65 91 46. Telex: 133906. Mng. Dir.: Markus Spiegel; Imp. Mgr.: Wolfgang Strobl. (Importer)
 Gloria, see EMI.
 Harmony, see CBS.
 Harvest, see EMI.
 Heimatland, see Bellaphon.
 Heliodor, see Polydor.
 Help Int'l, see Help Recs.
 Help Recs., Johann Schachslweg 9, A-9020 Klagenfurt. Tel: (04222) 31 558. Chief Exec.: Eddy Korschke.
 Labels: (Owned) Help, Help Int'l, Life.
 His Master's Voice, see EMI.
 Hit Rec. Austria Musikproduktion, Dr. Rasperstr. 10A, A-4802 Ebensee. Tel: (06133) 72 90. Dir.: Gisela Feichtinger; Prod.: M. Feichtinger. (Distributed by Ariola).
 Inpart Warenhandel GmbH, Aspenstr. 133, A-1224 Vienna. Tel: (0222) 22 73 78. Telex: 133934. Mng. Dir.: Gabriele Freihammer; Dist'n: Kurt Schweiger.
 Intraton, see Musidisc.
 Itruhuk, Harrachstr. 46, A-4020 Linz. Tel: (0732) 25 72 84.
 Labels: (Represented) Ralph (USA).
 Jenisch, Schallplatten-Produktion, Alberichgasse 8, A-1150 Vienna. Tel: (0222) 92 32 62. Gen. Mgr.: Ervin H. Jenisch.
 K-tel Int'l GmbH, Mariannengasse 32, A-1090 Vienna. Tel: (0222) 43 95 71. Telex: 076923. Mng. Dir.: Wolfgang Simon; Sales Mgr.: W. Tomtschik.
 Kabarett aus Wien, see Otto G. Preiser.
 Karussell, see Polydor.
 Koch Recs., A-6652 Elbigenalp/Tirol. Tel: (05634) 6444, 221. Telex: 05561. Dir.: Franz Koch; Sales Mgr.: Seib Anton.
 Labels: (Owned) Fantastik, Koch, Roko.
 Lebendige Vergangenheit, see Otto G. Preiser.
 Lesborne Osterreich Tontraeger Musik, Kremsergasse 8-10, A-1130 Vienna. Tel: (0222) 82 42 15. Telex: 134391. Gen. Mgr.: Herman Macek; Prod.: Oscar Frenschich.
 Label: (Distributed) Sona Souvenir.
 Liberty United, see EMI.
 Life, see Help.
 Lion Baby Recs., Hietzinger-Hauptstr. 98, A-1130 Vienna. Tel: (222) 82 27 954, 82 68 233. Gen. Mgr.: Peter Lossack. (Distributed by Ariola).
 M C P-Joehcher, Box 47, Industriest. A-6430 Oet. Tel: (05266) 542. Telex: 53991. Gen. Mgr.: Hans Joehcher.
 M G M, see Polydor.
 M S C (Music Serv. Center) GmbH, Hofmohlgasse 1-5, A-1150 Vienna. Tel: (0222) 83 85 44, 85 83 91. Telex: 135249. Mng. Dir.: Walter Schwabl.
 Maestro, see CBS.
 Mandragora, see Amadeo.
 Masterworks, see CBS.
 Mercury, see Phonogram.
 Migo Schallplatten, Fuchsthallergasse 11, A-1090 Vienna. Tel: (0222) 31 54 96. Gen. Mgr.: Rudolf Matiasovics. (Distributor/Importer)
 Labels: All labels from UK & USA.
 Mojam, see Montego.
 Montego Mgmt. (IFPI), Kohlenhofgasse 4/8, A-1150 Vienna. Tel: (0222) 83 05 52. Gen. Mgr.: Lance Lumsden; Promo. Ass't: Alice Gautier.
 Label: (Owned) Mojam.
 Musica Prae Classica, see EMI.
 Musica Schallplatten Vertrieb GmbH (IFPI), Webgasse 43, A-1060 Vienna. Tel: (0222) 57 36 46. Cable: MUSICA. Gen. Mgr.: Franz J. Walner; Sales Mgr.: Franz Brenner. (Distributor)
 Labels: (Distributed—not licensed) Aavalanche, Al, Orion, Aquarius, Arcade, Argo, Arion, Audition, Autobahn, Aves, BBZ, BTM Baby, Beserkley, Big

Mouth, Box, Buddha, CBD, Cantagallo, Cheap skate, Chess, Contempo, Creole, Cube, DRG, Decca, Delphine, Deram, Diamant, EMG, Electric, Erato, First American, Flying Dutchman, Fuer Dich, GEM, Gold Mind, Good Earth, Grunt, Gryphon, H&L, Heimat-Melodie, Ibach, Janus, Jupiter, Kama Sutra, Kayvette, Kick, Kiosk, Line, Lollipop, London, London-Cross-over, MAM, Magnet, Malaco, Midland, Millennium, Nems Spiegele, Nova, Nova-Gooder, Numero Uno, DK, L'Diseau Lyre, Opus, Phantom, Pinball, Pinnacle, Pool, Pro Arte, Produktor Associati, RCA, RPM, Red Bus, Roadshow, Saga, Seon, Soul Train, Spaghetti, Stoff, Stille Musik, Storyville, Strand, Sugar Hill, TTR, Tattoo, Telarc, Telefunken, Threshold, Tomato, Trojan, 20th Century, Ulstein. Vinyl, Vogue, Windsong, Wooden Nickel, Yep, Zerolandia, Zilch.
 musica viva Austria, Trabeng 32, A-9241 Wernberg. Tel: (04252) 21 74, (04242) 2 67 52. Gen. Mgr.: Dr. Eilfriede Drtnr.
 Labels: (Owned) musica viva; (represented) Drpheus, Pape Verlag Ber In.
 Musidisc Schallplatten, Stuwertstr. 35, A-1020 Vienna. Tel: (0222) 24 34 01, 92 25 73.
 Labels: (Owned) Blue Danube, Disque D'Aulriche, Donauton, Intraton, Musidisc, Popcord, Viewtone.
 Negram, see EMI.
 Nonesuch, see WEA.
 Ddeon, see EMI.
 Ddissey, see CBS.
 Dne Up, see EMI.
 Dptima, see Euroton.
 Paltram Prods. Gebr. Lang-G 11/18, A-1150 Vienna. Tel: (0222) 83 89 154. Gen. Mgr.: Evelyn Sperker.
 Labels: Paltram, Roots, Soundbird, Truth.
 Pan, see Ariola.
 Parlophone, see EMI.
 Pathe, see EMI.
 Pathe-Marconi, see EMI.
 Piffikus, see Bellaphon.
 Philips, see Phonogram.
 Phonogram (IFPI), Mariahilfer Guertel 32, A-1060 Vienna 6. Tel: (0222) 56 55 83. Telex: 0112512. Gen. Mgr.: Erhart Pusching; Int'l Prod. Mgr.: Michael Neubauer; Int'l Promo. Mgr.: Horst Bichler; Sales Mgr.: Gottfried Uebler.
 Labels: (Owned) Autobahn, Back Door, Casablanca, Charisma, DRK, Eastwind, Fass, Fontana, Mercury, Philips, Polystar, Star Club, Vertigo; (Licensed foreign) Rocket, Rough Trade; (distributed) Roots.
 Polydor GmbH (IFPI), Mariahilferstr. 127, A-1060 Vienna 6. Tel: (0222) 56 15 71. Mng. Dir.: Erich Turan.
 Labels: (Owned) Archiv, Dg, Heliodor, Karussell, MGM, Polydor, Verve; (represented) Carrere (France), Dreamland, EG (UK), GTD (UK), Harlekin (Netherlands), Hispavox (Spain), Polar (Sweden), RSD (UK), Spring (USA).
 PolyGram Musikunternehmen GmbH, Mariahilfer Guertel 32, A-1061 Vienna 6. Tel: (0222) 57 63 66. Telex: 12512. Pres.: Wolfgang Arming; Procurent: Franz Rauscher.
 PolyGram Rec. Serv. GmbH (IFPI), Kreilplatz 1, A-1195 Vienna. Tel: (222) 37 15 45. Telex: 074577. Gen. Mgr.: Dr. Helmut Hofmann.
 Polyhymna, Industriest. B13, A-2345 Brunn. Tel: (02236) 6188. Telex: 79182. Chief Exec.: Renate A. Herzog.
 Polystar, see Phonogram.
 Popcord, see Musidisc.
 Portrait, see CBS.
 Ditto G. Preiser & Co., Fischerstiege 9, A-1010 Vienna. Tel: (0222) 63 62 28, 63 18 53. Pres.: Ditto G. Preiser.
 Labels: (Owned) Court Opera Classics, Kabarett aus Wien, Lebendige Vergangenheit, Preiser; (Licensed foreign) Turnabout (USA), Vox (USA).
 Int'l repps: France (Dave), Germany (EMI-Electrola), Japan (Nippon Columbia), Switzerland (Jecklin), UK (Parnote Distribution), USA (German News).
 Rare Bid, see Bellaphon.
 Regal, see EMI.
 Reprise, see WEA.
 Robbi, see CBS.
 Roko, see Koch.
 Roots, see Paltram & Phonogram.
 Savoy, see Ariola.
 Seraphim, see EMI.
 Sidewalk, see EMI.
 Sona Souvenir, see Lesborne.
 Sonopresse, see EMI.
 Soundbird, see Paltram.
 Souvenir, see Euroton.
 Star Club, see Phonogram.
 Stimme Seines Herrn, see EMI.
 Talsman, see EMI.
 Teldec/Musica Austria, Webgasse 43, A-1060 Vienna.
 Truth, see Paltram.
 Tyrols (Rasinger Handels GmbH & Co.), Meistr. 36, A-6170 Zirl/Tirol. Tel: (05238) 24 03. Telex: 53947. Mng. Dir.: Elsa Rasinger; Press & PR: Angeliqe Jennerwein.
 United Artists, see EMI.
 V A M O (Verband der Arbeiter Musikvereine Desterreich), Fischerstiege 4, A-1010 Vienna. Tel: (0222) 63 91 65.
 V M Recs. Vertriebs GmbH & Co. KG, Box 47, Industriest. A-6430 Oetztal. Tel: (05266) 8126. Telex: 53991. Gen. Mgrs.: Hans Joehcher, Hubert Pirschner.
 Vertigo, see Phonogram.
 Verve, see Polydor.
 Viewtone, see Musidisc.
 W E A Music Tontraegervertriebsgesellschaft mbH (IFPI), Hofmohlgasse 1-5, A-1150 Vienna. Tel: (0222) 83 75 57. Chief Exec.: Gunther Zitta; Gen. Mgr.: Dr. Harald Neuteufel.
 Labels: (Owned) Asylum, Atco, Atlantic, Cotillon, Elektra, Nonesuch, Reprise, WEA Int'l (USA), Warner Bros.; (Licensed foreign) Automatic (UK), Big Tree (USA), Blue Inc. (UK), Bunny (Germany), Curb (USA), Dark Horse (USA), Discreet (USA), Emerald City (USA), F-Beat (UK), Finnadar (USA), IC catalog prod. (Germany), Korova (UK), Laser (UK), Little David (UK), Planet (USA), RFC (USA), Radar (UK), Riva (USA), Scope (UK), Strike (UK), Swan Song (USA), TDS (USA), Westbound (USA), Whitfield (USA).
 W M Produktion, see Wiener & Amadeo.
 Warner Bros., see WEA.
 Waverley, see EMI.
 Welt-Rekord, see EMI.
 Wiener Musikproduktion (IFPI), Neulercherfeldstr. 3-7, A-1160 Vienna. Tel: (0222) 43 59 91. Cable: WMPRODUKTION. Gen. Mgrs.: Thomas Albrecht, Richard Toeman, Johann Michel; Ass't Mgrs.: Hans Granzer, Peter Jirka. (Distributed by Amadeo).
 Label: (Owned) WM Produktion.
 Wolf, see Ariola.

Label: (Owned) WM Produktion.
 Wolf, see Ariola.

• music publishers

Aberbach (Wien) GmbH/Interzone Musikverlag GmbH, Schellinggasse 7, A-1010 Vienna. Tel: (0222) 52 63 46. Chief Exec.: H. Schneider.
 Admira Musikverlag KG, Postfach 287, Schellinggasse 7/6, A-1010 Vienna. Tel: (0222) 52 63 46. Mng. Dir.: Hermann Schneider.
 Allround Music, see Arends.
 Arena Musikverlag, Gluckgasse 1, A-1010 Vienna. Tel: (0222) 52 63 46.
 Arends Music KG, Industriest. B13, A-2345 Brunn. Tel: (02236) 6188. Gen. Mgr.: Renate A. Herzog.
 Int'l firms represented: Paul C. Arends, Burlington, Hazyland, Shirley, Trumpf (all Germany).
 Astoria Musikverlag, Himmelstr. 69, A-1190 Vienna. Tel: (0222) 32 35 11.
 Atrium Music Verlag GmbH, Sechshausstr. 112/16, A-1150 Vienna. Tel: (0222) 83 20 334. Gen. Mgrs.: Johann Hausner, Thomas Albrecht. (Administered by Josef Weinberger)
 Autobahn Musikverlag GmbH, Industriest. B13, A-2345 Brunn. Tel: (02236) 61 88. Telex: 79182. Mng. Dir.: Renate A. Herzog.
 Beliver Music, Grundsteingasse 5, A-1160 Vienna. Tel: (0222) 43 61 22. Gen. Mgr.: Gerhard David; A&R Mgr.: Rudolf Spreitzer.
 Int'l branch: Germany.
 Belvedere Musikverlag, Graf Starhembergasse 38, A-1040 Vienna. Tel: (0222) 65 23 60, 65 19 50. Dwner: Erich Benedini.
 Bosworth & Co. Ltd. GmbH, Dr. Karl Lueger Platz 2, A-1010 Vienna. Tel: (0222) 52 81 40.
 Int'l branches: England, Germany.
 Franz Christ Wiener Arion Verlags-GmbH, Schoenbrunnerstr. 124, A-1050 Vienna. Tel: (0222) 55 83 92. Gen. Mgrs.: Gottfried Indra, Margaretha Hrubec. (Affiliated with Feuerschwert [Ed.])
 Condor Musikverlag Hannelore Winkler, Durigstr. 20, A-6020 Innsbruck. Cable: CNDDDR. Telex: 054222. Dwner & Mgr.: Hannelore Winkler.
 Contact Music KG Musikverlag, see Autobahn.
 Danubius Musikverlag GmbH, Wurmsergasse 28/18, A-1150 Vienna. Tel: (0222) 95 13 52. Telex: 135811. Gen. Mgr.: Gottfried Indra.
 Int'l firms represented: ABC/Dunhill (USA), Barn (UK), Ben Ghazi (USA), Big Secret (UK), Bruno (UK), Carnbro (UK), Catrine (UK), Char-Liz (USA), Cirrus (Canada), Fennario (USA), Fiddler's (UK), GH (UK), Gambi (USA), Robin Gibb (UK), Grever (Mexico), Heathside (UK), JGK (UK), Joyride (USA), Katzenjammer (Canada), Lambda (Germany), Lollipop (Germany), Ludington House (UK), Macaulay (UK), No Exit (USA), Ornum (Germany), Penjane (Australia), Pippin the Friendly Ranger (UK), RGS (Germany), Rear Exit (USA), Ryerson (USA), Schmolzi & Slezak (Germany), Silver Cloud (UK), Slane (UK), Rudolf Slezak (Germany), Strange (UK), Stratus (Canada), Sunspot (Canada), Tembo (UK), Three Bros. (USA), Trillium (Canada), Vence (USA).
 Ludwig Döbbling (Bernhard Herzmann) KG, Dorotheergasse 10, A-1010 Vienna. Tel: (0222) 52 35 04. Cable: MUSICDDB. Comm'l Mgr.: Helmut Pany.
 Int'l firms represented: Associated (USA), Bote & Bock (Germany), Henle (Germany).
 Int'l repps: France (BMB Mario Bois), Germany (MGS-Zimmerhansl), Italy (Messagerie), South Africa (Criterion), UK (Alfred A. Katmus), USA (Associated).
 Eberle-Verlag, see Edith Hochmuth.
 Eddyton Ed. Johann Schachslweg 9, A-9020 Klagenfurt. Tel: (04222) 31 558.
 Efi-Ton Verlag, Filigradergasse 11, A-1060 Vienna. Tel: (0222) 57 69 423. Dwner: Elisabeth Huber.
 Euro-Music, Neulercherfeldstr. 3-7, A-1160 Vienna. Tel: (0222) 43 59 91. Telex: 113705. Gen. Mgr.: Thomas Albrecht; Ass't Mgrs.: Hans Granzer, Peter Jirka.
 Int'l firms represented: ATY (USA), Abacus (Germany), Accord (Germany), Angela (South Africa), At Home (USA), Baby Run (UK), Bearsongs (UK), Beserkley (USA), Black Bull (USA), Black Neon (UK), Black Sheep (UK), Blue Mountain (UK), Blue Seas (USA), Bourne group (USA), Brand X (USA), Cam-Ai (UK), Cammoran (Germany), Cansel (UK), Center City (USA), Chruswood (USA), Cookhouse (USA), Roger Cook (USA), Donna (USA), Cross Keys (USA), Delme (Germany), Dizzy Heights (UK), Omega (UK), Double R/Green Grass (USA), Ear Responsible (USA), Eau D'Yeah (USA), Eighties (USA), Elmira (Canada), Far Out (USA), B. Feldman (UK), Forever Endeavor (USA), Four Knights (USA), Francis Day & Hunter (UK), Freedom (UK), Garden Court, Gold Sovereign (USA), Grob (USA), Gull (UK), Hard Work (USA), Hello There (USA), Hewo (Germany), Hit & Run (UK), Island group (UK), Jac (USA), Jobete (USA), KI West Coast (USA), Kaiser (USA), Kevin (UK), Kiss (UK), Kongried (UK), LBG Artists (Netherlands), Larball (USA), Lestercourt (UK), Levine & Brown (USA), Liliput (Germany), Lingo (Germany), Makamilion (USA), Manticore (UK), Martin-Coulter (UK), Melodie Der Welt (Germany), Mercy Brothers (Canada), Middle Road (UK), Mighty Three (USA), Milwaukee (USA), Mr. Bones (USA), Modern Love Songs (USA), Morgenrot (Germany), Geoff Morrow (UK), Mother Tongue (USA), Munchin (USA), Murleezons (USA), No Sheet (USA), Olymp (Germany), Peach Cobbler (USA), Queen (UK), RAK (UK), Radar (UK), Related (USA), Roba (Germany), Rye Boy (USA), SSP (UK), St. Annes (UK), Satril (UK), Screen Gems (USA), Shanna (UK), Siebenpunkt (Germany), Slow Dancing (USA), Small Hill (USA), Stablo (Germany), Stallion (USA), Sterling (USA), Third Story (USA), Three Knights (USA), Tree (USA), Tremor (USA), Tumbleweed (Australia), Twitty Bird (USA), Uncanny (USA), Valdene (UK), Vanilla (UK), Vassar (USA), Warhawk (USA), Westwind (Germany), Frank Zappa (USA).
 Feuerschwert (Ed.), Hofmohlgasse 1-5, A-1150 Vienna. Tel: (0222) 83 56 05. Mng. Dir.: Stephen von Friedberg; Gen. Mgr.: Gottfried Indra. (Affiliated with Franz Christ).
 Fortissimo Verlag, Margaretenplatz 4, A-1050 Vienna. Tel: (0222) 55 72 404. Mgr.: Bruno Hauer.
 Glocken-Verlag Musikverlag GmbH, Postfach 111, A-1043 Vienna; Theobaldgasse 16, A-1060 Vienna. Tel: (0222) 56 12 64. Mng. Dir.: Gertrud Eder.
 Helbing KG E. Harm & Co. (Ed.), PO Box 416, A-6021 Innsbruck; Kaplanstr. 9, A-6064 Neu-Rum/Innsbruck. Tel: (05222) 62 333. Cable: HEL-BLINGMUSIK. Chief Exec.: Helmut Winkler.
 Int'l firms represented: Michael Jay (Germany), Hans Sikorski (Germany).
 Edith Hochmuth Verlags GmbH, Seilergasse 12, A-1010 Vienna. Tel: (0222) 52 27 51, 52 21 42, 52 27 14. Cable: WELTMUSIK. Telex: 135049. Gen. Mgr.: Edith Hochmuth.
 Int'l firms represented: Mento, Quint, Valentine (all Germany).
 Gottfried Indra Musik & Buehnenverlag GmbH, Schulstr. 109, A-2103 Langensdorf. Tel: (02244) 2537. Gen. Mgr.: Gottfried Indra.
 Branch: A-1150 Vienna, Wurmsergasse 28/18. Tel: (0222) 95 13 52. Telex: 135811.
 Int'l firms represented: Armo, Big Three Music, Bob Dylan, Dick James,

Global (Germany), Rondor group, Paul Simon, United Artists Int'l. Jensch (Musikverlag), Alberchgasse 8, A-1150 Vienna. Tel: (0222) 92 32 62, 92 56 50. Contact: Erwin H. Jensch.

Jungrunnen (Verlag), PO Box 583, Rauhenteingasse 5, A-1011 Vienna. Tel: (0222) 52 12 99.

Johann Kliment, Kollingasse 15, A-1090 Vienna. Tel: (0222) 34 51 47.

Koch Recs., A-6652 Elbigenalp/Tirol. Tel: (05634) 6444, 221. Telex 05561. Dr. Franz Koch, Sales Mgr.: Selb Anton.

Ludwig Krenn GmbH, Reinoldgasse 42, A-1150 Vienna. Tel: (0222) 834-231.

Lesborne Osterreich Trautraeger GmbH, Kremsergasse 8/10, A-1130 Vienna. Tel: (0222) 82 42 15. Telex: 134391. Gen. Mgr.: Herman Macek M.M.S. Music, Erdbergstr. 25-27, A-1030 Vienna. Tel: (0222) 72 35 64. Chief Exec.: Manuela Zerga.

Int'l firm represented: Arabella (Germany).

Meisel Produktion Musikverlag Winkler & Harm oHG, Box 591, A-6021 Innsbruck, Siemensstr. 4, A-6041 Neu-Rum/Innsbruck. Tel: (05222) 63 45 10. Cable: MUSIKOEMATTE. Telex: (05) 4222. Chief Exec.: Helmut Winkler.

Int'l firm represented: Meisel (Germany).

Metrolon, see Edith Hochmuth.

Montego Mgmt., Kohlenhofgasse 4/8, A-1150 Vienna. Tel: (0222) 83 05 52. Gen. Mgr.: Lance Lumsden.

Oesterreichischer Bundesverlag, Schwarzenbergstr. 5, Vienna 1.

Papageno Buch & Musikalienverlag & Buehnenvertriebs GmbH, see Josef Weinberger.

Peer Southern Org., see Southern Music.

Hans Pero Buhnen & Musikverlag, Baeckerstr. 6, A-1010 Vienna. Tel: (0222) 52 34 67.

Phoebus Musikverlag, Spengergasse 2, A-1050 Vienna. Tel: (0222) 65 19 50. Owner: Erich Benedini.

Profil Promos (Ed.), Hadikgasse 68, A-1140 Vienna. Tel: (0222) 82 41 31, 82 45 23. Telex: 134181. Owners: Herbert Faehter, Karl Scheibmaier, Adolf Robitschek, Postfach 42, Graben 14, A-1011 Vienna. Tel: (0222) 52 32 89.

Int'l branch: Germany.

Rubato, Hollandstr. 18, A-1020 Vienna. Tel: (0222) 33 92 42.

Hermann Schneider Musik, Glück 1, A-1010 Vienna. Tel: (0222) 52 63 46.

Screenmusic Musikverlags GmbH, Penzingerstr. 66, A-1140 Vienna. Tel: (0222) 82 26 84, 82 73 58. Gen. Mgrs.: Gerhard Heinz, Karl Spiehs, Gottfried Indra.

Thomas Sessler Verlag GmbH, Johannessgasse 12, A-1010 Vienna. Tel: (0222) 52 32 84.

Int'l branch: Germany.

Siegel & Hochmuth Verlags GmbH, Seilergasse 12, A-1010 Vienna. Tel: (0222) 52 21 42, 52 27 14, 52 27 51. Cable: WELTMUSIK. Telex: 135049. Gen. Mgr.: Edith Hochmuth.

Int'l firms represented: Johann Hoffmann, Jupiter, Kasperek Meridian, Meteor, Ralph Maria Siegel (all Germany).

Solsten-Verlag, Neulerchenfelderstr. 3-7, A-1160 Vienna. Tel: (0222) 43 59 91. Telex: 113705. Gen. Mgr.: Thomas Albrecht, Ass't Mgrs.: Hans Granzer, Peter Jurka.

Southern Music Wien GmbH, Seilergasse 12, A-1010 Vienna. Tel: 52 27 51, 52 27 14, 52 21 42. Cable: SOUTHMUSIC. Telex: 135049. Gen. Mgr.: Edith Hochmuth.

Home office: USA, Peer Southern.

Int'l firms represented: Almond (UK), Cedarwood (USA), Jloral (USA), Roger Miller (USA), Musa (Mexico), Parchment (USA), Peer Southern (worldwide), Royal Oak (UK), Small Smile (UK), Sunbird (USA), Troika (USA), Vinco (UK).

Int'l rep.: Worldwide (Peer Southern).

Step Two Musikverlag GmbH, Neulerchenfelderstr. 3-7, A-1160 Vienna. Tel: (0222) 43 59 91. Cable: STEPTWO. Telex: 113705. Gen. Mgrs.: Ralph Siegel, Thomas Albrecht, Ass't Mgrs.: Hans Granzer, Peter Jurka, Joachim Neubauer.

Studio Musikverlag, Freytaggasse 21, A-1210 Vienna. Tel: (0222) 30 53 09. Dir.: Dr. Josef Nejer.

Styria, Labkowitzplatz 1, A-1010 Vienna. Tel: (0222) 52 92 23.

Symphonia, Lothringerstr. 20, A-1030 Vienna. Tel: (0222) 72 44 48.

Theaterverlag Erich GmbH, Lothringerstr. 20, A-1030 Vienna. Tel: (0222) 72 45 85.

Topsound (Ed.), see Phoebus.

Universal Ed., Karlsplatz 6, A-1010 Vienna.

V A M O (Verband der Arbeiter Musikvereine Oesterreich), Fischerstege 4, A-1010 Vienna. Tel: (0222) 63 91 65.

Int'l reps.: Germany (Johann Andree), USA (Dr. Fred Schadler).

Josef Weinberger Wien, Neulerchenfelderstr. 3-7, A-1160 Vienna. Tel: (0222) 43 59 91. Telex: 113705. Cable: WEINIOS. Gen. Mgrs.: Thomas Albrecht, Richard Toeman, Johann Michel, Ass't Mgrs.: Hans Granzer, Peter Jurka.

Int'l firms represented: Josef Weinberger - AA (Germany), ATV (USA), AVI (USA), Ackee (UK, USA), After Dark (USA), Fred Ahlert (USA), Alien (USA), Alienecho (USA), Alshre (USA), Aran Prod's (Switzerland), Asco (Australia), BL&H (USA), Backlin (USA), Beaver (USA), Becho mont (USA), Big Secret (UK), Bossa Fataka (USA), Bowling Green (USA), Brilliant (Germany), Butterfly (Germany), Cannon group (USA), Capella (Germany), Carlyle (USA), Charleville (USA), Cinevox (Germany), Clandalee (USA), Go Jac (USA), Coloni (Germany), Colour Me Gone (UK), Compass (Germany), Netherlands, UK, USA, Conduvce (USA), Cosma (Germany), Crusty (UK), Curtis (UK), Cyclis (Germany), Dany (Germany), De Blaech Foeoes (Germany), Diamondback (USA), Dog Soldier (USA), Dump (USA), Dunbar (Canada), Eurocord (Germany), Famous group (USA), Festival Attraction (USA), Fresky (USA), Fish Scent (USA), Fleetwood (UK), Flowering Stone (USA), Frabjous (USA), Gustav Gerdes (Germany), Gerig (Germany), Global (Japan), God Tunes (USA), Goldberg (Germany), Gold Forever (USA), Great Honesty (USA), Halcyon (UK), Holland Dozer (USA), Hollywood Allstar (USA), Holy Moly (USA), Homburg (Germany), Icebag (USA), Inter Musik (Germany), Jana (USA), Jec (USA), Kidada (USA), Knollwood (USA), La Cienega (USA), Lady Casey (USA), Ledacian (USA), Levathan (UK), Libra (UK), Light (USA), Little Dragon (USA), Lucky Three (USA), Lunatunes (USA), MPL Communications (UK, USA), Mandina (USA), Marabu (Germany), Mar Vista (USA), Melodia (Germany), Metal Machine (USA), Micache (USA), J. Michel (Germany), Modern American (USA), Mole (USA), Mondial (Germany), Montauk (USA), Montunes (USA), Musical Crusaders (USA), Myriad (USA), Night wind (USA), Nineteen Eighty Five (USA), Noble (Germany), Oakfield Ave (USA), Onaje (USA), On Time (USA), Orania (Germany), Willi Ostermann (USA), Pal Dog (USA), Pearlized (USA), Pedro (USA), Petra (USA), Pian gen Visions (UK), Playboy (USA), Plurikan Krunde (USA), Pods (USA), Presto (Germany), Princess (USA), Pure Songs (USA), RCA group (Argentina, Brazil, France, Italy, Mexico, Spain, USA), Rhine (Germany), Rialto (Germany), Riccardo-Ton (Germany), Le Rideau Rouge (France), Rock (UK), Rocksmith (USA), Rocky Mountain Nat'l Park (USA), Ronin (USA), Roycolt (UK), Saber Tooth (USA), Leonard Sachs (USA), Salsoul (USA),

Jupp Schmitz (Germany), August Schnorrenberg (Germany), Scott Tone (USA), Cyril Shane (USA), Steakhouse (Germany), Street (UK), Sugar (France, Germany, Italy), Sunbury (Canada, UK), Supertop (Germany), Sure Enough Tunes (Canada), Thursday (USA), Titania (Germany), Victoria (Germany), Warfare (UK), H.B. Webman (USA), We Three (USA), Weed High Nightmare (USA), Wicked Fly (UK), Wildflowers (USA), R.P. Winkelman Tunes (USA), Yellow Brick Road (USA), Wiener Musikproduktion - Cheap Thrills (USA), Cheerio (USA), Chinnchap (UK), Martin Cohen (USA), Covered Wagon (UK), Diamond (UK), Gopam (USA), Hutones (USA), Pic (USA), Ring Musik (Germany), Rytkov (USA), We rock (USA), Wien Melodie - Melodie der Welt (Germany), Ring (Germany), Paul Wotschach (Germany).

Int'l reps.: Papageno - Germany (Heros), UK (Josef Weinberger), Josef Weinberger - Germany (Melodie der Welt, Josef Weinberger), UK (Josef Weinberger), Wiener Musikproduktion - Germany (Melodie der Welt), Wien Melodie - Germany (Melodie der Welt, Josef Weinberger), UK (Josef Weinberger).

Weltmusic, see Edith Hochmuth.

Wiener Arion Verlags GmbH Buch & Musikalienhandlung, Schoenbrunnerstr. 124, A-1050 Vienna. Tel: (0222) 55 83 92. Gen. Mgr.: Thomas Albrecht, Ass't Mgrs.: Hans Granzer, Peter Jurka (Administered by Josef Weinberger).

Wiener Boheme Verlag, Erdbergstr. 25-27, A-1030 Vienna. Tel: (222) 72 35 64. Gen. Mgr.: Manuela Zerga.

Int'l firms represented: Discoton (Germany), Oreiklang-Oreimasken (Germany), Interworld (USA), Ufaton (Germany).

Wiener Musikproduktion, see Josef Weinberger.

Wien Melodie GmbH, see Josef Weinberger.

• services

ASSOCIATIONS & PROFESSIONAL ORGANIZATIONS

Austrian Music Pub'l's Union (Musikverleger Union Oesterreich), Baumannstr. 10, A-1030 Vienna. Tel: (0222) 73 15 55.

Austrian Society for Music (Oesterreichische Gesellschaft fuer Musik), Hanuschgasse 3, A-1010 Vienna. Tel: (0222) 52 42 99.

European Jazz Federation, PO Box 671, A-1011 Vienna; Andreasgasse 10/17, A-1070 Vienna. Tel: (0222) 93 54 29.

I.F.P.I. Landesgruppe Oesterreich, c/o Ariola Schallplatten GmbH, Postfach 98, A-1151 Vienna; Hofmolkigasse 1.5, A-1150 Vienna. Tel: (0222) 83 56 05. Telex: 131862.

I.G.J. - Internationale Gesellschaft fuer Jazzforschung (Int'l Society for Jazz Research), Leonhardstr. 15, A-8010 Graz. Tel: (03122) 32 0 53.

I.M.Z. (International Music Centre Vienna), Lothringerstr. 20, A-1030 Vienna. Tel: (0222) 72 57 95.

Internationale Gesellschaft fuer Alte Musik (International Society for Old Music), Minontenplatz 2, A-1010 Vienna. Tel: (0222) 63 55 31. Chief Execs.: Bernhard Klebel, Hans Radbauer, Gen. Mgr.: Gerold Seidl.

International Gustav Mahler Society, Wiedner Guertel 6/2, A-1040 Vienna. Tel: (0222) 65 08 355, 82 73 75.

International Society for Contemporary Music, Hanuschgasse 3, A-1010 Vienna. Tel: (0222) 52 42 99.

Mediacult (International Institute for Audio Visual Communication & Cultural Development), Meltnerchgasse 12, A-1030 Vienna. Tel: (0222) 72 53 44, 75 12 86. Cable: MEDIAICULT.

Mozart Society of Vienna, Boesendorferstr. 12, A-1010 Vienna.

Mozart Union, Meltnerchgasse 8, A-1030 Vienna 3.

Musikalische Jugend Oesterreichs (Jeunesses Musicales), Boesendorferstr. 12, A-1010 Vienna. Tel: (0222) 65 63 56.

Musikergewerkschaft (Gewerkschaft Kunst, Medien, Freie Berufe), Maria Theresienstr. 11, A-1090 Vienna.

O.R.F. (Oesterreichischer Rundfunk) (Austrian Broadcasting Co.), Wuerzburgergasse 30, A-1136 Vienna. Tel: (0222) 82910. Cable: ORF. Telex: 132347.

Society of the Friends of Music in Vienna (Gesellschaft der Musikfreunde in Wien), Boesendorferstr. 12, A-1010 Vienna. Tel: (0222) 65 86 81.

LICENSING ORGANIZATIONS, MUSIC.

A.K.M. Gen. mbH (Staatlich genehmigte Gesellschaft der Autoren, Komponisten & Musikverleger), Baumannstr. 8/10, A-1030 Vienna. Tel: (0222) 73 15 55. Cable: MUSIKAUTOREN. Pres.: Dr. Marcel Rubin; Gen. Mgr.: Ernst Huemer (Performing rights only).

Austro Mechana GmbH (Gesellschaft zur Verwaltung & Auswertung mechanischer-musikalischer Urheberrechte), Baumannstr. 10, A-1030 Vienna. Tel: (0222) 72 63 62, 72 35 87. Pres.: Hermann Schneider; Gen. Mgr.: Dr. Helmut Steinmetz (Mechanical rights only).

Laterar Mechana GmbH (Wahrnehmungsgesellschaft fuer Urheberrechte), Linke Wienzeile 18, A-1060 Vienna. Tel: (0222) 57 21 61. Dir.: Franz Leo Popp.

PLATING, PROCESSING & PRESSING PLANTS

A.T.G. A-2433 Margarethen am Moos. Tel: (02230) 2454.

Polydor GmbH, Mariahilferstr. 127, A-1060 Vienna. Tel: (0222) 56 15 71. Mng. Dir.: Erich Turan.

PolyGram Rec. Serv. GmbH (IFPI), Kreilplatz 1, A-1195 Vienna. Tel: (0222) 37 15 45. Gen. Mgr.: Dr. Helmut Hofmann.

Otto G. Preiser & Co., Fischersteige 9, A-1010 Vienna. Tel: (0222) 63 62 28, 63 18 53. Pres.: Otto G. Preiser.

PRINTER & LITHOGRAPHER

PolyGram Rec. Serv. GmbH, Kreilplatz 1, A-1195 Vienna. Tel: (222) 37 15 45. Gen. Mgr.: Dr. Helmut Hofmann.

RECORD PROMOTION

Communica, Kleeblattgasse 4, A-1010 Vienna. Tel: (0222) 63 24 45, 63 55 52, 66 34 48.

I.M.Z. (International Music Centre Vienna), Lothringerstr. 20, A-1030 Vienna. Tel: (0222) 72 57 95.

Koch Recs., A-6652 Elbigenalp/Tirol. Tel: (05634) 6444, 221. Telex: 05561. Dr.: Franz Koch, Sales Mgr.: Selb Anton.

Poim Promo Poetsch, Hofmolkigasse 1.5, A-1151 Vienna. Tel: (0222) 83 56 05. Telex: 11862. Gen. Mgr.: Wolfgang Poetsch.

TAPE CUSTOM DUPLICATORS

A.T.G. A-2433 Margarethen am Moos. Tel: (02230) 2454.

Audio: Cassette.

Koch Recs., A-6652 Elbigenalp/Tirol. Tel: (05634) 6444, 221. Telex: 05561. Dr.: Franz Koch, Sales Mgr.: Selb Anton.

Audio: Cassette.

Musidisc Schallplatten, Stuwersstr. 35, A-1020 Vienna. Tel: (0222) 24 34 01, 92 25 73.

Polydor GmbH, Mariahilferstr. 127, A-1060 Vienna. Tel: (0222) 56 15 71. Mng. Dir.: Erich Turan.

Audio: Cassette.

PolyGram Rec. Serv. GmbH, Kreilplatz 1, A-1195 Vienna. Tel: (0222) 37 15 45. Gen. Mgr.: Dr. Helmut Hofmann.

Audio: Cassette

• supplies

EMPTY CARTRIDGES, CASSETTES & REELS

Musidisc Schallplatten, Stuwersstr. 35, A-1020 Vienna. Tel: (0222) 24 34 01, 92 25 73 (Importer).

POLYETHYLENE BAGS

Musidisc Schallplatten, Stuwersstr. 35, A-1020 Vienna. Tel: (0222) 24 34 01, 92 25 73 (Importer).

TAPE, BLANK LOADED & BULK RAW

Agfa-Gevaert GmbH, Mariahilferstr. 198, A-1153 Vienna. Tel: 83 36 41, 85 85 11. Telex: 2715. Mng. Dir.: H. J. Kaminski; Sales Mgr.: A. Pollatschek.

Audio: Blank-compact-cassette, open reel, raw-cassette, broadcast studio.

Video: Cassette, open reel.

Brand names: Agfa Carat, Agfa Stereochrom, Agfa Videochrom.

Audio Magnetics, see Inter Import.

B.A.S.F. Osterreich GmbH, Hietzinger Hauptstr. 119, A-1131 Vienna. Tel: 82 94 31. Telex: 134264. Sales Mgr.: Hans Kemper.

Audio: Blank-cassette, open reel, raw-cassette.

Video: Blank-1" open reel, 1/4" & 1/2" cassette.

Brand name: BASF.

Inter Import oHG, Czerningasse 6, A-1020 Vienna.

Audio: 8 tr., cassette, open reel.

Brand name: Audio Magnetics.

Musidisc Schallplatten, Stuwersstr. 35, A-1020 Vienna. Tel: (0222) 24 34 01, 92 25 73 (Importer) (Blank only).

• accessories

manufacturers / importers

Boyd & Haas, Rupertstplatz 3, A-1170 Vienna. Tel: (0222) 47 27 015.

Product: Record-replacement stylus.

Euroton Austria GmbH, Nobilengasse 40/42, A-1150 Vienna. Tel: (0222) 92 11 02. Telex: 31111. Mng. Dir.: E. Fozak; Sales Mgr.: Gerhard Hoke.

Product: Record-carrying & storage cases, 45 rpm adaptors.

Migo Schallplatten, Fuchshallergasse 11, A-1090 Vienna. Tel: (0222) 31 54 96. Gen. Mgr.: Rudolf Matiasovics.

Product: Record record care products.

Musidisc Schallplatten, Stuwersstr. 35, A-1020 Vienna. Tel: (0222) 24 34 01, 92 25 73 (Importer).

Product: Record-carrying & storage cases, record care products.

• store fixtures

manufacturers / importers

Euroton Austria GmbH, Nobilengasse 40/42, A-1150 Vienna. Tel: (0222) 92 11 02. Telex: 31111. Mng. Dir.: E. Fozak; Sales Mgr.: Gerhard Hoke.

Product: Browser boxes, display racks.

Musidisc Schallplatten, Stuwersstr. 35, A-1020 Vienna. Tel: (0222) 24 34 01, 92 25 73 (Importer).

Product: Display racks.

BAHAMAS

Population: 238,000

Rate of exchange: \$1 (US) = 1.0 Bahamian dollars

Per capita income: \$4,000

Holidays: January 1, Good Friday, Easter Monday, First Friday in June (Labor Day), Whit Monday, July 10 (Independence Day), First Monday in August (Emancipation Day), October 13 (Discovery Day), December 25, 26 (Boxing Day).

• record & tape

manufacturers / distributors / importers

House of Music Ltd, PO Box N9226, Mackey St., Nassau, N.P. Tel: 50331. Cable: MUSIC. Dis.: Hartlyn M. & Bradley B. Roberts. (Distributor/importer).

International Music Recs. & Tapes, PO Box 2041, East St. S., Nassau. Tel: 5 3134. (Rack jobber, cutouts).

Home office: USA, Miami, Fla.

Intertone (Bahamas) Ltd, PO Box F1052, Freeport. Telex: 297 30080. Pres.: Terrence Gape; Gen. Mgr.: Orville Turnquest; Sales Mgr.: Aaron Gardner. (Distributor/importer).

Labels: (Distributed-not licensed) A&M (Canada), Ariola (Belgium), Black & Blue (Germany), CBS (Canada), Chrysalis (France), Dynamic Sound, ECM (Germany), FMI (UK), Frato (France), Island (UK), Jokee (Italy), MCA (Canada), Pablo (France), Phonogram (Netherlands), Polydor (Germany), RCA (Italy), Ricordi (Italy), WEA (Canada).

O.H.B. Recs. Co. USA, 521, Nassau, N.P.

Home office: USA.

BELGIUM

Population: 9,855,110

Population by age groups: 0-14 - 21%, 15-24 - 17%, 25-49 - 28%, 50+ - 34%

Rate of exchange: \$1 (US) = 38.3 Belgian francs

Per capita income: \$5,225

Holidays: January 1, 2nd Easter Day, Whit Monday, Ascension, May 1 (Labor Day), July 21 (Independence Day), August 15 (Assumption), November 1 (All Saints Day), November 11 (Armistice Day), December 25.

RECORDS:

Record sales certification awards: Gold single - 50,000 units (nat'l), 100,000 units (int'l). Gold LP - 15,000 units (nat'l), 25,000 units (int'l). Records sold domestically including imports: LP's 1980 - 9,056,000 units, 1979 - 10,200,000 units; EP's 1979 - 230,000 units, EP's & Singles 1980 - 11,000,000 units, Singles 1979 - 12,000,000 units.

Average retail price per record: LP's: \$4; EP's \$2.50; Singles: \$1.
Record club sales: 5% of total.
Discounting: Frequent.
Type of record distribution: Percentages of total sales for 1979—manufacturer-to-retailer (48.1%), manufacturer-to-wholesaler-to-retailer (51.9%).
Jobsites: 30,000.

TAPE:
Market: Pre-recorded cassette sales are declining gradually, while blank tape sales continue to rise as more and more young buyers use blank tape to copy records. Pre-recorded video tape is just being introduced into the market. Three sales clubs are in operation, and there is one magazine which covers video software.
Pre-recorded tape sold domestically including imports: Cassette 1980—2,154,000 units; 1979—2,200,000 units.
Average retail price per tape: \$4.

RADIO STATIONS:
 No. of government: 3 (AM & FM); No. of independent: 150 (FM).
Comment: One station programs news, public service, and all types of music. Another features cultural shows, such as opera and classical music. A third transmits popular programs, including pop and rock music. All are run by the government, and since air time is not for sale, there are no commercials. The independent radio stations, which are, of course, illegal, all broadcast popular music, mostly of Belgian origin.

TELEVISION STATIONS:
 No. of channels: 12 government, 100% color.
Comment: Television programs include news, sports, talk shows, cultural programs, children's shows, and a lot of movies, but not much popular music (one program per week on RTB and one program every two weeks on BRT).

IMPORT/EXPORT REGULATIONS:
 Belgian regulations are based on the principals of free economy. Agreements with the Common Market are respected.

MARKET ANALYSIS:
 In 1980, the largest independent record company in the nation, Fonior, closed because of bankruptcy. More than 70 people lost their jobs when former Fonior head Pelgrims de Bigard sold his plants in France and Belgium. The international rack jobber Maison B even also went out of business, forcing its Belgian branches to close.

In spite of these setbacks, the general economic crisis was not too hard on the industry. SIBESA, the professional organization for Belgium's record companies, showed a drop of only 5.2 per cent in product turnover, and the outlook at the end of the year was optimistic. 1981 is proving that there was good reason for optimism.

The brightest and most dramatic turn in events, was the emergence of indigenous rock music and the independent radio station boom. There were hardly any Belgian rock artists in the 1970's, but the 80's have seen the debuts of at least 50 rock groups and solo artists, and their records are selling well. As a result, recording studios are pressing plants are enjoying renewed prosperity, and several new record companies have been created. Among the latter are Parsley, Red Zebra, Sandwich, and a Brussels branch of England's DK Records. The most popular of the new rock artists are the Kids, Jo Lemare, Raymond van het Groenewoud, the Kreuners, TC Maic, Rick Tubbaux and the Taxis, the Employees, the Machines, the Bet, Toy, Lvo and Scooter, and Machavel. *Michel Verstrepen*

• record & tape manufacturers / distributors / importers

A R S, see American.
 Aariana, see Unidans.
 Avalanche, see Unidans.
 Accent, see Baltic.
 Alpha, see Leman & Gorle.
 Alpha Recs., 147 Leedsesteenweg, 9410 Erpe-Mere. Tel: (053) 70-43-23. Telex: 12585. Chief Exec.: Roland Uytendaele; Sales: Erna van Eerenbruch. (Exporter)
 American Recs. Sales (ARS Recs PvbA), 32 Hopland, 2000 Antwerp. Tel: (031) 31-33-55. Telex: 71784. Chief Exec.: Patrick Busschots; Gen. Mgr.: Luda Vercammen; Sales Mgr.: Patrick Hantson; Promo. & Retail: Lydia Celis.
Labels: (Owned) BMC, Lonely Dancer.
 Aquarius, see Unidans.
 Arcade, see PMP.
 Archiv, see PolyGram.
 Ariola Benelux NV (IFPI), 3 Bloemendreefllaan, 1810 Wommel. Tel: (02) 269-4058. Telex: 62354. Gen. Mgr.: M.J. Klijnjan; Sales Mgr.: Myriam Wellens; Financial Mgr.: W. Peynboer; Mktg. Mgr.: B. Carbonez.
Labels: (Owned) Ariola, Ariola-Eurodisc, Arista, Baccarola; (Licensed) Ariola America (USA), Ariola-Clan Celentano (Italy), Bearsville (USA), Bronze (UK), Chrysalis (UK), Dreyfus/Motors (France), Fleet (Netherlands), Hansa (Germany), Island (UK), Jupiter (Germany), MCA (USA), M-Recs. (Germany), Shelter (USA), Sierra Brnar (USA), Souplet (France), Tomato (USA), Virgin (UK).
 Ariola-Eurodisc, see Ariola Benelux.
 Arista, see Ariola Benelux.
 Artibano, 55 Rue Delfosse, 6538 Manage. Tel: (064) 55-25-04. Gen. Mgr.: Benedetto Artibano.
 Asselkrem PvbA (ELKA Group), 30 Kerkstraat, 9-60 Hamme. Tel: (052) 47-94-64. Telex: 22417. Gen. Mgr. Louis de Beule; Sales Mgr.: Els Roels.
 Asylum, see WEA.
 Atco, see WEA.
 Atlantic, see WEA.
 B E A M Int'l, 35-37 Italiei, 2000 Antwerp. Tel: (031) 33-45-37. Cable: BEA-MAUIDID. Telex: 71401. Mng. Dir.: Ed Savoir (Distributor/Importer/Exporter)
Labels: Audio Encores (Canada), Chalfont (USA), Dishwasher (USA), Varesse/Sarabande (USA).
 B R M, see Baltic.
 Baccarola, see Ariola Benelux.
 Baltic-Didac, see Baltic.
 Baltic SA/NV (IFPI), 105 bus 20 Carnotstraat, 2100 Antwerp. Tel: (031) 36-38-56, 28-40-84. Telex: 33140. Pres.: M. Wuyts; Dir.: Ben Gyselincx; Sales Mgr.: Ronald Dom.
Labels: (Owned) BRM, Baltic, Baltic-Didac; (Licensed) Carlton (UK), Gold Star (UK), Pantlon (Czechoslovakia), Rdfidiffusion (UK), Soul Vista (USA), Supraphon (Czechoslovakia); (distributed—not licensed domestic) Accent, Musique en Wallonie, Ricercar; (distributed—not licensed foreign) Agram (Netherlands), Anacrouse (France), Arholive (USA), Aureo (UK), Balkanton (Bulgaria), Bee Hive (USA), Bet Car (USA), Biograph

(USA), Bis (Sweden), Black Saint (Italy), CMS/Desto (USA), CRD (UK), Caprice (Sweden), Claves (Switzerland), Concord Jazz (USA), DDF, DRG (USA), Daybreak (Netherlands), ENJA (Germany), Electrecord (Romania), Forlane (France), Four Leaf Clover (Sweden), Gateway (USA), Heritage (UK), Hungaroton (Hungary), Intercord (Germany), Legend (UK), Melodiya (USSR), Moers (Germany), Muse (USA), Muza (Poland), Nimbus (UK), Dpus (Czechoslovakia), Dsmoss Jazz (Netherlands), Pavane, Pepita (Hungary), Prelude (UK), Qualiton (Hungary), Richter Scales, Rim (UK), Royale (UK), Saphir (Germany), Spottite (USA), Steeplechase (Denmark), Summit (USA), Symphonica (UK), Themes (UK), Tudor (Switzerland), Unicorn (UK), Waterland (Netherlands).
 Biram Recs., 86 Av. Moliere B3, 1180 Brussels. Tel: (02) 345-4203. Telex: 26220. Chief Exec.: Jean Kluger.
 Bizet Prod'ns & Pub'n's Ltd. (IFPI), 13 Madeleine St., 1000 Brussels. Tel: (02) 511-5120, 512-1583. Pres. & Gen. Mgr.: Felix R. Faecq; VPs: J.P. & V. Bizet.
Labels: (Owned) Bravo, Expo, IMC, Jazz Club, Sphinx; (Licensed) Garami (Brazil).
 Blomhof SA (Ets.), 172a Rue Brogniez, B-1070 Brussels. Tel: (02) 522-1813.
Labels: BLDMMRAD. Telex: 63086. Gen. Mgr.: C. Janssen, Hi-Fi Team Mgr. W. Menge; Mxell Mgr.: C. van Canneyt.
Labels: (Licensed foreign) Approche (France), Century (USA), Crystal Clear (USA), M&K (USA), Sheffield Lab (USA), Telarc (USA).
 Blue Note, see EMI.
 Boite a Musique, 17 Rue Ravenstein, 1000 Brussels. Tel: (02) 513-0965.
 Dir.: Antoine de Wouters d'Opinter.
Labels: Pavane.
 Bravo, see Bizet.
 C B A Music (Connection Business Artists Inc.), 14 Rue de Turin, B-4020 Liege. Tel: (041) 36-85-24. Gen. Dir. Tomis Chlaren; Gen. Mgr. Alan Desutter; Promo. Dominique Evans.
 C B S Disques/Grammofonplaten SA/NV, Chaussee de Vilvorde, 1180 Brussels. Tel: (02) 241-8730. Telex: 22642. Gen. Mgr.: Alain J.P. Diver.
 Capitol, see EMI.
 Cardinal Recs. Int'l, 13 bis Wouter Haecklaan, B-2100 Deurne. Tel: (031) 21-78-74. Dir.: Rocco Granata.
 Carrere Belgium, 591 Ch. de Jette, Brussels. Tel: (02) 428-8954. Telex: 64137. Gen. Mgr.: E. van der Smissen.
Labels: (Owned) Carrere; (distributed—not licensed) CNR (Netherlands).
 Casablanca Music, 5 Gasthuisstraat, 1000 Brussels. Tel: (02) 512-3687 Mgr.: J. Bauwens.
 Classics for Pleasure, see Music for Pleasure.
 Clown Music NV (IFPI) (div. of Johnny Hoes Benelux Music Inds.), PD Box 24, 93-bus 30 Van Eycklaan, B-3680 Maaseik. Tel: (11) 56-59-13. Dir.: Jacques Hoes; Gen. Mgr.: Joseph Verbest.
Labels: (Owned) Clown, Gnome, Start.
 Cogedep (SA) Music Rack-Jobber, 290 Av. de Schaerbeek, 1800 Vilvoorde. Tel: (02) 251-60-70. Mng. Dir.: Gustave Smeets; Sales Mgr.: Georges Verheyen. (Distributor/Rack Jobber).
 Columbia, see EMI.
 Cotillion, see WEA.
 Grammed Discs, 52 Rue Paul Lauters, 1050 Brussels. Tel: (02) 640-7914. Mgr.: Marc Hollander.
Int'l reps: Austria (Italuloh), France (Celluloid, Standby), Germany (Eigelstein, Recommended, Zensor), Italy (La Centrale, Recommended), Japan (Recommended), Norway (Union), Sweden (Recommended), Switzerland (Recommended), UK (Bonaparte, Fresh, Recommended, Rough Trade), USA (Greenworld, Wayside).
 Debut Music, 15 Europalaan, Industriezone 2, B-9800 Deinze. Tel: (091) 86-48-81. Telex: 12197. Mng. Dir.: Chris R. Van Dost, Jules G. Callebaut Sr.
 Deutsche Grammophon, see PolyGram.
 Diamant, see Vogue.
 Dureco Belgium SA, 1 Av. J.P. Ballings, B-1090 Brussels. Tel: (02) 479-9983. (Sales office only)
Home office: Netherlands.
 E L K A, see Asselkrem.
 E M I-America, see EMI Belgium.
 E M I Belgium SA/NV (IFPI), 49 Rue Emile Clausstraat, 1050 Brussels. Tel: (02) 640-7501. Telex: 22616. Mng. Dir.: C.G.W. Andrews; A&R Mktg. Mgr.: J. Govaerts; Sales Mgr.: H. Hendricks; Label Mgrs.: B. Robert, L. Arys; Classical Label Mgr.: J. Langlois.
Labels: (Owned) Blue Note, Capitol, Columbia, EMI, EMI-America, Electro, HMV, Harvest, IBC, Liberty-United, Odeon, Parlophone, Pathe, Punch, Regal-Zonophone; (licensed domestic) Payola, Scalp; (licensed foreign) Harmonia Mundi (Germany), Magnet (UK), Purple (UK), RAK (UK), Rolling Stones (UK).
 Electro, see EMI.
 Elektra, see WEA.
 Elvers Recs., 97 Rue de la Marliere, 7700 Mouscron. Tel: (056) 33-15-45. Telex: 57744. Gen. Mgr.: Marcel de Keukeleire, Int'l Mgr. Pierre Vandemaete.
 Eurovox, see PMP.
 Explorer, see WEA.
 Expo, see Bizet.
 Flemish Import Whslrs., 138 Zegersdreef, 2130 Brasschatt. Tel: (031) 51-74-37. (Importer—UK, USA)
 Flower, see Jump.
 Fly Music SprL, 133/135 Chaussee de Nivelles, B-6521 Arquennes. Tel: (067) 87-81-43. Pres.: Jean Sablon
Labels: (Owned) Fly, Lucifer
Int'l rep.: Netherlands (Score).
 Fontana, see Phonogram.
 Frankie Music PvbA, 74 Greinstr., Antwerp. Tel: (03) 32-24-85, 31-60-60, 33-65-99. Cable: FRASUPREME.
Labels: (Owned) Frankie, Pims, Supreme; (represented) DJM (UK), Dolphin (UK), Ember (UK), Evolution (UK), Mabel (Switzerland), Music-D (USA), Page One (UK), Pama (UK), Norman Petty Prod'ns (USA), Rediffusion (UK), Republic (USA), Swampfire (USA), W&G (Australia).
Int'l reps: Australia (W&G), Germany (Aniola), Netherlands (Phonogram), UK (Dick James), USA (Norman Petty).
 Fun Recs., 14 Nieuwstraat, 3370 Boutersem. Tel: (016) 73-36-04. Mgr.: Mr. Pitschou.
 Gamma Recs., 78/80 Lange van Bloerstraat, 2000 Antwerp. Tel: (031) 35-21-11. Telex: 33713. Gen. Mgrs.: Leo Feisenstein, Stonne Holmgren. (One Stop/Importer/Exporter)
Labels: (Licensed domestic) JW's, Snow; (licensed foreign) Dgun (UK).
 Gnome, see Clown.
 H M V, see EMI.
 Hans, see Hans Kusters & PolyGram.
 Harvest, see EMI.
 Hebra Recs. SprL (IFPI), 30 Rue St. Christophe, 1000 Brussels. Tel: (02) 512-7361/9375. (Distributed by Phono Office)
Labels: Hebra, Horizon.

Horizon, see Hebra.
 Hurray, see Palette.
 I B C, see EMI.
 I M C, see Bizet.
 Impact, see Phonogram.
 Inelco Belgium SA (IFPI), 94 Av. des Croix de Guerre, 1120 Brussels. Tel: (02) 216-0160. Cable: INELCDBEL. Telex: 22990. Pres.: Pierre-Jean Goemaere; Sales Mgr.: Marc Haelters.
Labels: (Owned) Lark; (licensed foreign) Groove (UK), Metropole (France), Dvalton (USA), Rockhouse (Netherlands), Satril (UK), Strand (Germany); (distributed—not licensed) AZ (France), BAM (France), BTM (UK), Cavalier (France), Coluche (France), Erato (France), Eur, Chiswick (UK), Flying Dutchman (USA), Gem (UK), Grunt (USA), Gryphon (USA), If (UK), Millennium (USA), NY Int'l (USA), Phantom (UK), RCA (USA), RCA Gold Seal (USA), RCA Int'l (USA), RCA Lineatre (Italy), RCA Victor (France), Roadshow (USA), Salsoul (USA), Saravah (France), Temporel (France), 20th Century (USA).
 Inside Recs. NV, 92-94 Berendrechtstraat, 2020 Antwerp. Tel: (031) 16-06-60.
 Interclub Belgium, 34 Kleine Barelstraat, 2800 Mechelen. Tel: (015) 41-13-31; 7 Steenmolendreef, 2580 Sint-Katelijne-Waver. Tel: (015) 20-05-87. Mng. Dir.: G.C.J. Peroux; Gen. Mgr.: Leopold Piroux; Sales Mgr.: C.J. Proux Jr. (Distributor/Importer)
Labels: Atmos-Fear, Both Sides, Cascade, Fonk, Free, Future, Galaxy, Hot Vinyl, Interclub, Mondo Video, Number 1, Plastikh, Poptimistic, Shangri-La, Space, The Label, Three W. WER, Young Sound.
 J W's, see Gamma.
 Jazz Club, see Bizet & Palette.
 Jump Recs., 34 Hertselde, 2nd fl., 8200 Brugge 2. Owner & Mgr. Eddy van Mouffaert.
Labels: (Owned) Flower, Jump; (licensed) Yeah Songs.
Int'l rep.: Netherlands (Telstar).
 Roland Kluger Music (RKM), 8 Rue Fernand Neuray, 1060 Brussels. Tel: (02) 344-4840. Pres.: Roland Kluger; Int'l Mgr.: Ida Halta; Exploitation Mgr.: Herman van Lar. (Distributed by Vogue)
Labels: (Owned) RKM.
Int'l reps: Australia (RCA), France (Vogue), Germany (Hansa), Greece (Music Box), Italy (Durium), Latin America (Phonogram), Mexico (Gamma), Netherlands (WEA), Portugal (Nova), South Africa (RPM), Spain (Hispanavox), UK (Sire), USA (Sire).
 Hans Kusters Music PvbA, 9A Langestraat, B-1700 Assel. Tel: (02) 452-7203/8963. Cable: KUSTERMUSIC. Telex: 62228. Pres. Hans-P. Kusters.
Labels: (Owned) Hans.
 Lark, see Inelco.
 Leman & Gorle SprL, 27 Rue Steppe, Brussels. Tel: (02) 427-3372. Gen. Mgr.: Pierre Gorle.
Labels: (Owned) Alpha, MBM (Moumumenta Belgicae Musicae).
Int'l reps: France (Musidisc).
 Liberty-United, see EMI.
 Lonely Dancer, see American.
 Lucifer, see Fly.
 M B M, see Leman & Gorle.
 M G M, see PolyGram.
 Meeuwens Disques, 2 Av. des Merisiers, 1320 Genval. Tel: (02) 425-4010. Telex: 22922. Promo.: F. van der Smissen.
 Mercury, see Phonogram.
 Midi, see WEA.
 Monopole Recs. (NV Lambrechts), 7 Kwadenplasstraat, 3100 Heist op den Berg. Tel: (015) 24-16-25. Mgr. J. van de Vel; Gen. Mgr.: L. Lambrechts. (Distributed by Phono-Office)
Labels: (Owned) Monopole, Paprika, Passe-Partout.
Int'l rep.: Netherlands (Score).
 Monumenta Belgicae Musicae—MBM, see Leman & Gorle.
 Music for Pleasure (Belgium NV) (IFPI), 25 Dud Strijderstraat, 1600 Sint-Pietersleuw. Tel: (02) 377-8086. Telex: 64505. Mng. Dir.: C. Andrews; Gen. Mgr.: J. Brunel; Prod. Mgr.: H. Heymans.
Labels: (Owned) Classics for Pleasure, Music for Pleasure, Prestige for Pleasure, Sounds Super, Success for Pleasure.
 Music Radio Promos, Benelux, Postbus 31, Luchtbal, B-2030 Antwerp 3. Tel: (031) 64-73-08. Dir.: Lousa Eyckmans; Gen. & Sales Mgr.: Jozef Segers. (Distributor/Importer)
 Musque en Wallone, see Baltic.
 Neovlon, see Stock.
 D K Recs., 31 Rue Montoyer, 1040 Brussels. Tel: (02) 511-7290. Telex: 26146. Dir.: Nigel Griffiths.
 Odeon, see EMI.
 Dnadisk, 21-A Dude Dorpsweg, 8202 Varsenard. Tel: (050) 31-59-10.
 Onyx, see Stock.
 P M P PvbA (IFPI), 82 Rederykersstraat, 2610 Wilryk. Tel: (031) 28-40-84. Telex: 33140. Pres. Louis van Rymenant; Gen. Mgr.: Ben Gyselincx; Sales Mgr.: Ronald Dom.
Labels: (Owned) Arcade, Eurovox, Richter Scale 8, Valentine.
 Palette Recs., 8 Rue Fernand Neuray, B-1060 Brussels. Tel: (02) 344-4840. Telex: 26350. Pres.: Felix Faecq; VP & A&R: Roland Kluger.
Labels: (Owned) Hurray, Jazz Club, Palette, Sphinx.
 Paprika, see Monopole.
 Parlophone, see EMI.
 Parsifal, 67 Guldenveldeaan, 8000 Brugge. Tel: (050) 33-95-16. Telex: 191926. Chief Exec.: G. Behaeghe.
 Passe-Partout, see Monopole.
 Pathe, see EMI.
 Pavane, see Boite a Musique.
 Rayola, see EMI.
 Philips, see Phonogram.
 Phonogram Recs. SA/NV (IFPI), 215 Rue Victor Hugo, 1040 Brussels. Tel: (02) 733-9690. Cable: PDLREC. Telex: 24516. Gen. Mgr.: Charles Licoppe.
Labels: (Owned) Fontana, Impact, Mercury, Philips, Vertigo; (licensed foreign) Argo (UK), Charisma (UK), Decca (UK), Deram (UK), Durium (Italy), London (UK), Discow-Lyre (UK), Threshold (UK); (distributed—not licensed) Adele (France), Albatros (France), Fieche (France), Harlequin (Netherlands), Ibach (France), Telstar (Netherlands), Triema (France).
 Phono-Office, 45 49 Blvd. des Arbaletr., 1400 Nivelles. Tel: (067) 22-71-68. Pms, see Franke.
 Polydor Recs. SA/NV (IFPI), 215 Rue Victor Hugo, 1040 Brussels. Tel: (02) 733-9690. Cable: PDLREC. Telex: 24516. Gen. Mgr.: Maurice Mertens
Labels: (Owned) Archiv, Deutsche Grammophon, MGM, Polydor, Verve. (distributed—not licensed) Ades (France), Barclay, Biram, Capricorn (USA), Cube (UK), Delphine (France), Flarenasch, Hans, Hispanavox (Spain), Mamcha (Netherlands), DK, Pabo (USA), Phil Spector (UK), RSD (USA), Topkapi, Wad Disney (France).
 Polygram Recs. SA/NV (IFPI), 215 Rue Victor Hugo, 1040 Brussels. Tel: (02) 733-9690. Cable: POLREC. Telex: 24516. Mng. Dir.: Charles Licoppe.

(Holding co for Phonogram & Polydor)
 Prestige For Pleasure, see Music For Pleasure
 PUNCH see EMI
 Pyramid Int'l Music, 8 Bosstraat, 9180 Belsele Tel (031) 72 46 15 Gen Mgr Marc De Coen
 R C A NV/SA, Recs Div Belgium, 30 Square Francois Riga, 1030 Brussels Tel (02) 216 9780 Telex 63718 Gen Mgr Carl Vos, Sales Mgr F Struyven
Labels: (Licensed foreign) Bluebird (USA), Camden (USA), Cavalier (France), Colgems (USA), DRG (USA), FY (France), Fiori (Italy) Flying Dutchman (USA), Gold Seal (USA), Grunt (USA), Gryphon (USA), Lineaire (France), New York Int'l (USA), Pure Gold (USA), RCA (USA), RCA Int'l Red Seal (USA), Roadshow (USA), Safari (UK), Saravah (France), Solar (USA), Tabu (USA), Temporel (France), Tortoise (USA), 20th Century (USA), Victrola (USA), Windsong (USA), Wooden Nickel (USA) (distributed-not licensed) AZ (France), BAM (France), Cerame/Argile (France), Coluche (France), Erato (France), Escargot (France), Laurie (USA), Sal sou (USA), Swift (UK), Telelukon (Germany)
Video labels: RCA, Videobox
 R F C, see WEA
 R K M, see Roland Kluger
 Radar, see WEA
 Rainbow Recs & Music Co (Harry's PubA), 100 Bergstraat 3100 Heist op den Berg Tel (015) 24 49 50 Telex 63379 Mng Dir Stan Verbeeck, Prod'r Ricky Druver, PR Mgr Fred Steyn
 Ranch (Fa.), 1 J P Ballingsstr 1090 Brussels Tel (02) 479 9984
 Reader's Digest World Servs SA, 29 Quai du Hainaut, 1080 Brussels Tel (02) 428 0778 Telex 21876 European Repertoire Admin'r Henri Heymans
 Recommended Recs, 4 Chemin D'Homont 7498 Hennuyeres Tel (067) 63 76 71 Contact Eric Faes
 Record Trade Co, 45 Kathelijnestraat, 2800 Mechelen Tel (015) 20 40 80 Telex 63370
 Regal Zonophone, see EMI
 Reprise, see WEA
 Reward, 470 Steenwinkelstr, Schelle, Antwerp Tel (031) 87 58 32/07
 Chief Exec J Clauwers, Gen Mgr J Blanchaert Sales Mgr P Blanchaert
Labels: Gamma, Reward
 Ricercar, see Baltic
 Richter Scale 8, see PMP
 Rippie see Vogue
 Roller Dog Recs, 34 Blvd du Jardin Botanique, 1000 Brussels Tel (02) 217 0844 Mgr Marc Pillory
 Scap, see EMI
 Schott Freres Sprl (IFPI), 30 Rue St Jean, 1000 Brussels Tel (02) 512 3980 Mgr J Junne (Distributor/Importer)
Labels: Astree, Barenreiter Musiphon (Germany), Calliope (France), Candide, Da Camera (Germany), FSM (Germany), Folkways (USA), Har monia Mundi (France), Italia, Monitor (USA), Music Minus One (USA) SFP, Schwann (Germany), Toccata, Turnabout Vox Box, Wergo (Germany), Zephyr (Belgium)
 Selection, see Will
 Shiva Sprl/PubA, 56 Meerodestraat, B 1060 Brussels Tel (02) 538 7547 Telex 63084 Gen Mgr Jack Maurer
 Sinus Music (AFM Group), 77 Rue de Brabant, B-1030 Brussels Tel (02) 217 8986, 218 4774 Telex 62596 Gen Mgrs Alfie Faickenbach, Claude Arnou, Financial Dir Hubert De Clerck
Labels: (Owned) Sinus, Surprise, Surprise Deluxe, (Licensed) Everest (USA), Hammer (UK), Kama Sultra (USA), Key Seven (USA), Laff (USA), Morfy Craft (USA), Peerless (UK, USA), San Juan (USA), Red Bird (USA), Redwood (Canada)
 Int'l reps.: Germany (Bellaphon, OPP) Netherlands (Oldway) Sweden (Marilia), Switzerland (Activo) UK (Jeffrey Collins)
 Snow, see Gamma
 Sonobel, Sonobel Bldg 15 Pl Rouppe B 1000 Brussels Tel (02) 512 0928 Chief Exec Pierre Borzee
Labels: (Owned) Sonobel, (represented) AFA (France), Aba (France) Archive (USA), Discara (France), Everest (USA), Harmony (Italy), Jackman (France), Joker (Italy) National (France), Olympic (USA), Pickwick (USA), Playasound (France), President (France) Rus (France), Scala (USA), Tradition (USA) UP (Italy), VYG (France), Vedette (Italy)
 Sounds Superb, see Music For Pleasure
 Sphinx, see Bizet & Palette
 Start, see Clowin
 Stock Music Int'l 19 Paestebloekstraat 3600 Genk Tel (011) 35 02 21
 Pres Wim Boscheck
Labels: Neveloon, Onyx
 Int'l rep.: Netherlands (Dennis)
 Success For Pleasure, see Music For Pleasure
 Supreme, see Frankie
 Surprise, see Sinus
 Surprise Deluxe, see Sinus
 Topkapi, see PolyGram
 Umidans Sprl, 98 Kortrykstr., 8511 Aalbeke Tel (056) 22 48 92 Chief Exec Jean Yves Vanloo, Sales Mgr Christophe Delbar
Labels: (Owned) Aariana, Aavalanche, Aquarius
 Int'l reps.: Brazil (Aariana, Aquarius) Italy (COD), UK (Aariana), USA (Aariana)
 V King, see Vogue
 Valentine, see PMP
 Variety Music Corp SA, 30 Av de Roodebeek 1040 Brussels Tel (02) 736 0887, 735 9707 Telex 24516 Chief Exec C Derweduwen (Direct marketing)
 Vertigo, see Phonogram
 Verve, see PolyGram
 Vogue PIP SA (IFPI), 35 Blvd Barthelemy 1000 Brussels Tel (02) 511 7991 Cable VOGDIS Telex 22560 Pres Leon Cabat, Mng Dir Roger Meylermans, Gen Mgr Jose Leruth, Promo Gigi Bastin, A&R Philippe Gosez
Home office: France
Labels: (Owned) Diamant, Rippie V King, (licensed domestic) RKM, (licensed foreign) AVI (USA), All Platinum (USA), Blue Print (UK), Board walk (USA), Buddha (USA), Cadet (USA), Calibre (UK), Checker (USA), Chess (USA), Cream (USA), OJM (UK), De Lite (USA), Freedom (USA), GNP Crescendo (USA), Graduate (UK), Hi (USA), Kingdom (UK), Melba (France), Midsong Int'l (USA), Motown (USA), PRT (UK), Precision (UK), Rialto (UK), Roulette (USA), Sonet (UK), Sugarhill (USA), Swing (France), VIP (Netherlands), WNOT (USA), Xanadu (USA)
 Int'l reps.: Netherlands (VIP), Switzerland (Compagnie de Publications Sonores & Audio Visuelles)
 W E A European Coordinating Inc 363 Av Louise, 1050 Brussels Tel (02) 647 9965 Telex 62030 Mng Dir Brigitta Peschko
Home office: USA

W E A Recs SA/NV, (IFPI), 79 Blvd Lambert, B 1030 Brussels Tel: (02) 242 5757 Deputy Mng Dir Ted Sikkink, Sales Mgr Charly DeClerq, Prod Mgr Francois De Kock, Mktg Mgr Jean Marie Sothe
Labels: (Owned) Asylum, Alca, Atlantic, Cotillion, Elektra, Explorer, Mtdi, Nonesuch, RFC, Radar, Reprise, WEA, Warner Bros, (licensed foreign) Big Three (USA), Curb (USA), Lollipop (Germany) Planet (USA), Real (UK), Riva (UK), Sire (USA), Swan Song (UK), Westbound (USA)
 Warner Bros, see WEA
 Will Recs, 42 Av Clays, B 1030 Brussels Tel (02) 241 4186 Dir Gen Pierre Pletinckx
Labels: (Owned) Selection, Will, (represented) Canopo (Italy), Capitol Media (USA), Gemilli (Italy), MP 2000 (France), Moniophone (France), Musique pour l'Image (France), New Times (France), Orly (France), Production Mad Unity, Tele Music (France), A Verchuren (France)
 Yeph Songs, see Jump
 Zephyr, see Schott

• music publishers

A N Z, 30 32 Vriehedstr., Bus 14, 2000 Antwerp Tel (031) 37 93 92 Gen Mgr Porter Valeer, Gen Sec'y Rob Eykens
 Apollo Music Eds Musicales, 11 Av Lloyd Georges, 1050 Brussels Tel (02) 640 0600 Telex 24247 Pres Jacques Verdonck, Gen Mgr M Lienart
 April Music Belgium SA/NV, 68 Chaussee de Vildorde, 1120 Brussels Tel (02) 241 8730 Telex 22642 Professional Mgr Bernard Goffin
Int'l firms represented: Albert Hammond (USA), Alotagood/Kool (USA), April/Blackwood (worldwide), BRM (USA), Backroad (USA), Barnaby (USA), Big Tools (USA), Buster Poindexter (USA), Claudine (USA), Clay (USA), Country Road (USA), Coyote (USA), Dave Mason (USA), Derringer (USA), Dickiebird (USA), Dimeola (USA), Dinsong (UK), Dozier (USA), Fa vorite (Yugoslavia), Fourteenth Hour (USA), Grajona/Davalex (USA), Hariene (USA), Hatband (USA), Herophant (USA), Hudmar (USA), Ian Hunter (USA), Jet (USA), Joelsongs/Impulsive (USA), Kershner (USA), Mi del (USA), Mine (USA), Mr Sun Shine (USA), Mor-Seh (USA), Nattan ham (USA), Notas Magicas (Spain), RSPV (USA), Roundabout (USA), Sherlyn (USA) Sheronda (USA), Silver Steed (USA), Stephen Kipner (USA), Sunnypop (Netherlands), Tuna Fish (USA), Virgin (UK), Winter Blues (USA)
 Int'l reps.: Argentina (Melograf), Brazil (Elam, Melograf, Mundo Musical), Colombia (CBS), Costa Rica (Mundo Musical), Mexico (Mundo Musical), Venezuela (Mundo Musical), Yugoslavia (Favorite), rest of the world (April/Blackwood)
 Ardmore & Beechwood SA, see EMI
 Assekrem PubA (ELKA Group), 30 Kerkstraat, 9160 Hamme Tel (052) 47 94 64 Telex 22417 Gen Mgr Louis de Beule
 Baltic SA/NV, 105 bus 20 Carnostraat, 2000 Antwerp Tel (031) 36 38 56, 31 81 83, 28 04 84 Telex 33140 Pres Ke Riema, Gen Mgr Ben Gij-selincx
Int'l branches: Canada (Brian Millan Corp.), Netherlands
Int'l firms represented: Vincent Chiarelli (USA), Lemmel (UK), Mason (UK), Brian Millan (Canada), Rhythmic (UK), Supraphon (Czechoslovakia) Bens (Eds Musicales), 1 Av. J P Ballings, B 1090 Brussels Tel (02) 479 9984 Cable BENSMSUSIC
 Bizet Prod'n & Publ'n Ltd., (SABAM, SOGEDI), 13 Madeleine St., 1000 Brussels Tel (02) 511 5120 Pres Felix R Faecq, Gen. Mgr. Veronica Bizet, Professional Mgr J P Bizet
Int'l firms represented: Balance (Luxembourg), Mangione (Brazil), Sate l Int'l (Luxembourg), Steinberg (USA)
 Int'l reps.: Austria (Oversea), Brazil (Mangione), France (IMC), Germany (Oversea), Italy (Sweet Melody), Luxembourg (Balance), Switzerland (Oversea), UK (Bizet), USA (Bizet)
 Brauer Ed., 30 Rue St Christophe, B 1000 Brussels Tel (02) 512-7361/9375 Pres Mrs H Brauer, Gen Mgr Jean Darlier
 Raoul Breton Belgique Sprl, 8 Rue Fernand Neuray 1060 Brussels Tel (02) 344 4840
 C B A Music (Connection Business Artists Inc.), 14 Rue de Turin, B 4020 Liege Tel (041) 36 85 24 Mng Dir Tomis Chlaren
 Clowin Music (div of Johnny Hoes Benelux Music Inds), 93 bus 30 Van Eycklaan, B 3680 Maaseik Tel (11) 56-59 13 Dir Jacques Hoes, Gen Mgr Joseph Verbiest
Int'l firm represented: Benelux Music (Netherlands)
 Coda Publ's, 97 Rue de la Marliere, 7700 Mouscron Tel (056) 33 15 39, 33 15 45 Cable ELVERECORDS Telex 57744 Owner Etienne Verhoyen, Exec Pierre Vandemaete
 Decibel Music, 15 Europalaan, Industriezone 2, B 9800 Deinze Tel (091) 86 48 81 Telex 12197 Mng Dirs Chris R Van Oost, Jules G Callebaut Sr
 Digit, 78 80 Lange van Bloerstraat, 2000 Antwerp Tel (031) 35 21 11 Telex 33713 Gen Mgrs Leo Felsenstein, Stonne Holmgren, Luc Ardjns
 E L K A, see Assekrem
 E M I Music Publ'g Belgium SA, 20 Av des Capucines, 1030 Brussels Tel (02) 242 7712, 242 7941 Telex 22922 Mng Dir Charles G W An drens, Gen Mgr Jan d'Haese
Int'l firms represented: Al Gallico (USA), Algee (USA), Beechwood (USA), Big Big (UK), Budd (USA), Bug (USA), Chibell (UK), Colgems (USA), Cross Keys (USA), Dix, Donna, EMI (Scandinavia), ERM Int'l (UK), Easy Listening (USA), Feldman (France), France Melodie (France), Francis Day (France), Francis Day & Hunter, Hearts Delight (USA), Herman Da rewski, Her Music, Hologingfield-Nisbeth & Beck (UK), Hurricane (UK), Jo bels (USA), Kale Bush (UK), Kennedy Street, Kipahula (USA), Manches ter, Marouani (France), Moonwater (UK), Mother Goose (UK), My Songs (UK), New Town Sound (UK), Our Music (UK), Queen, Rebel (UK), Red Bus (UK), Roar, Robbins, Rolling Stones (UK), Screen Gems (USA), Stem & Van Stock (USA), Stone Diamond (USA), Stop Points (UK), Tree (USA)
 Int'l reps.: Argentina (MAI), Australia (Castle), Canada (Beechwood), France (Eco, Pathe Marconi), Germany (Accord), Italy (Voce del Padrone), Mexico (Beechwood) Netherlands (EMI), South Africa (EMI Brigadiers), Spain (Ego), UK (EMI)
 Eurovox Music Group (SABAM), 322 Pierstraat, 2550 Kontich Tel (031) 87-60 20 Pres Louis van Rymenant
 Int'l reps.: USA (Eurovox, Intervox)
 Fleet Publ'g SA, 8-10 Rue Fernand Neuray, B-1060 Brussels, Tel (02) 344-4840 Telex 26350 Mng Dirs Robert A Aardse, Roland Kluger
Int'l firm represented: Gassongs (UK)
 Fly Music, 133/135 Chaussee de Nivelles, B-6521 Arquesnes Tel (067) 87-81 43 Pres Jean Sablon
 Int'l rep.: Canada (Morning)
 Francis-Day SA (Eds), see EMI
 Gold Crown Music (SABAM), Box 10, 11 Blvd Louis Mettewie, 1080 Brus sels Tel (02) 426-2256 Pres & Gen Mgr Roger O Feinberg
 Granata Music Eds., 13 bis Wouter Haecklaan, B 2100 Dourne, Tel (031) 21 55 81, Or. Rocco Granata
 Hebra Recs Sprl, 30 Rue St Christopher, 1000 Brussels, Tel (02) 512

7361
 Intersong-Primavera SA (SABAM), 45 Place de Jambinne de Meux, 1040 Brussels Tel (02) 733 9789 Telex 24516 Mng. Dr. Charles Kuiper, Professional Mgr. Simon Shrimpton Smith
Int'l firms represented: Aurelius, Bron, Chappell (Africa), Chappell (Australia), Chappell (Canada), Chappell (Germany), Chappell (Italy), Chappell (Netherlands), Chappell (Spain), Chappell (Sweden), Chappell (Switzerland), Chappell (USA), French Music, Gorima, Harbot/Sesac/Contention, Intersong Basart, Intersong Music Ltd., Intersong Paris, In tersong USA, Melodie, Melody Nelson, S. Miller, Nouvelles Prod'n Mi chel Legrand, Progressive, St. Annes, Eds & Prod'n Theatrales, Trichappell (USA), Unchappell (USA), J Weinberger, Belinda/Artemis group-Blue Gum, CTA/Carlin, Davray, Elvis/White Heaven, Fast Western, Geta way, Harlene/Dijon, Leon Henry, Hudson Bay, Josley, Kama Sultra, Lark, Jeff Lynne/United Artists/Jet, Marson, Midsong/Diagonal/Midland, Norma/Schelfin Zager, Peterman, Pickwick Int'l, Ramsel, Ryan, Sam, Ten East/Five West, Tone, Trio, Roy Wood, Yellow Dog, Belinda/Carlin group-AMP, Abacus, Alston, Lynch, Big Top/K, Lynch, Carlin, Cathrye & Nomat, Davray, Design, Dukes Lodge, Escort, Fluke/Enquiry, GTO, Geta way, Gloria, Gold Disc, Joaneline, Lynn, Marilyn, Miracle, Oaktree, Peter man, Alan Price, Pulsar, Ryan, Shadows, Slimina, Swansong, Sweet City, Warland Waterloo, Zan, Belinda/ Hill & Range group-Aberbach, Atzal, Beckie, Bennie Benjam, Brenner, Central, Cotillon, Crown, Dottie, Euro pean Plays & TV, Frederick & Katrina, Gladys, Hill & Range, Home Folks, Intersong USA/Gaucho/ Belinda, Kentucky, MEC Milano, Moni-ment, Mother Bertha, Noma, Noma & Marzonna, Noma & Marty's, S. Elvis Presley, Progressive, Quintel, Anne Rachel, Red River, Roosevelt, Rumba lero, SPR, St. Louis, Sita, Hank Snow & Open Road, Southwind, TM, Tee Pee, Ernest Tubb, US, Venice, Vicki, Bob Wilts, Chappell group-AM, A&R, Actual Size, Acuff Rose, Larry Adler, American, Advanced, Albion, Alexcar, Algonquin, Ambassadors, Ameh, Admiral Int'l Pictures, Ample, Andrew, Anhanbar, Antheq, Anton, D. & J. Arion, Ariou, Ascherberg Hopwood & Crew, Astral, Athenaeum, Athenae, Avocat, BAM, BBC, BDM, Bakers Lane/Synnylosse, Barbara Hanna, Barton, Bay, Beautiful, Bed rock, Begonia, Bema, Bennie Benjam, Benon, Irving Berlin, Bug Fuss, Big Sandy, Big Six, Big Wind, Bimmer, Bleu Discus, Blue Guitto, Karl Blore, Boston, Brackenejuce, Bradbury Wood, Bregman Voco & Conn, Britanna, Brown Shoes, Brown Trout, Bundin, Burthen, Butler, John Cam eron, Porgie Campbell, Canadiana, Canad, Capitol, Captain Beaky, Carlyle Alpina, Carmichael, Carnaby, Carolintone, Carlton, Charvold, Celenia, Cepror, Chandler, Chann, Chappell, Chappell-Styne, Chermis, Chatham, Chilly Winds, Clara, Gene Clark, Roy Clark, Claurus, Clear, Aw/Pussy, Clondyke, Cloud Cookoo, Tanta & Susan Collins, Communicated, Coop/ Garden Rake, Coronation, Corston, Cosmic Echoes, Crawford, Crazy, Cyma, DBH, Deane & Deo, Delaware, Delev, Delory, Delstone, Delta Artists, Dena, De Silva Brown & Henderson, Dirk, Dobbins, Dr Music, Orellia, Double R, Douglas, EFD, Earlon, Echoes of the Cosmos, Eggs & Coffee, Elbomo, Eldee, Empire Sound, English Folk Dance & Song, Esches-desche, Era, Erva, Efte, Esco, European, Every Night, Eve, Fairlane, Fame, Featherbed, Fiber, Fiddleback, Finger, Fred Fischer, Florence, Four-Eleven, Frank, Freedom, Furze, G&C, Galaneye, Galoping Films, Garden Rake/Coop, General, Gershwin, Gimcrack, Glorious, Green Dream, Green & Stept, Grob Chappell, Hael, Haicratta, Halmel, Handle, Hanna Barbera, Eddie Hardin, Harms, T.B. Harms, Heritage, Hindsight, Hip Trip/ Spectrum VII, Amanda Jane & Roger Holman, Homemade, Honky Tonk, Hot Cha, House of the Living, Huckleberry Creek, Jay Hugely, Hummit, IG Ice man, In the Black/In the Red, Ipanema, Ironside, Ivanhoe, Ivy, JP, Jabern, Jacmar, Jamarine, J.W. Jenkins, John Jennings, Jubilee, Jubile, Julie, Kalmba, Kalfier, J. Ward, Kander & Ebb, Kandidate, Joldi Karo, Ken-Glen, David Keizer, G. Jonah Kosten, Labrador, Langham, Lauralan, Lee, Leslie, Le Vien, Lou Levy, Louis Linzer, Little Gravel, Little People, Lwng Music, Lombardo, Long, Low, Lowery Chappell, Sal Low, Thom Low, Twi Low, Lujac, M&P, MFC, MRC, Macheita, Mac Hugh & Adamson, Robert MacLeod, Malundi, Magic Mouth, Malden, Manger, Mara Lane, Marus, Martin, Mashy, Massey, Maureen, Maxana, Maxey, Mburu, Me gusta, Melomaga/Phiomela, Merjoda, Merin Assoc's, Meryl, Stephen Metz, Midas, Milene, Milrose, Minstrel, Mio, Ivan Mogull, Mountain & Coyote, Mud Int'l, Muhon, Northwood, Music For UNICEF, Music Machine, Mutual, Namrac, Near, Nurth, Nemson, Newkeys, New Morning, New tonville, Northern, Nurock, Terry Dats, Ohio Players, Ole Colony, Omar, Ondra, Osmond, Oxygen, Pabilo, Pamela, Para Sac, John Paul, George Paxton, Paxwin, Pearl, Pee Wee Valley, Pendulum, Pentagle, Perennial August, Phonogram Int'l, Picasso, Pillow, Pink Floyd, Pink Pelican, Pippin the Friendly Ranger, Planetary, Play One, Please & Thank, Shemer Poe, Polyscope, Cole Porter, Portfolio, Producers, Promco, Pure Noise, Quin tel, R&R, Rah, Fred Raphael, Real, Red Anchor, Red Bullet, Red Coat, Redrock, Redwood, Revelation, Rhinelandier, Ring Pasta, Rinimer, Road, Robinson/Sparkle, Rolando, Romano, David Rose, Fred Rose, Rose- meadow, Rumbalero, Paul Ryan, Rey Bread, Saggiere, Sahara, Douglas Sahn, Salmon, Sarah, G. Schirmer, Skopje, Scotia, Seaciff/Swados, Sel bonn, Sesac, Set to Music, J. & J. Shakespear, Shari, Shemer Poe, Snibo, Sobsons, Songs of Faith, Souci, Southern Love, Spectacular, Larry Spier, Springfield, Stafree, Michael Stanley, Starshine, Steam-

for the Benelux:



UNIVERSAL SONGS
 26, AVENUE PALMERSTON
 1040 BRUSSELS, BELGIUM
 PHONE: 2-230 4159

power. J. Stokkermans & B. Bos. Storybook, Stratford, Subiddu, Sun Flower, Sunne Day, Superical, Super, Super Music, Supreme, Syl verprise, Sylverpride, J.Y. Tahoe, Tangewood, Tashman, Tebo, Tee Kaye, Tee Pee, Tesco, Thiele, Think Big, Three Bridges, Tight Corpora tion, Timco, Tivoli, Tobey, Henry Tobias, Tomeja, Tom Tom, Top Hat, Triangle, Tri-Chappell, Trillium, Tropical Soundtracks, Trumck, Unchappell, Vernon, Victoria, Vogue Choice, WG, Wardo, Warnes, Warp Seven, Sam Weiss, Welzheim, Wembley, Werner Janssen, White Cloud, White Forest, White Lie, White Light, Whiting, Williamson, Marty Wilson, Wind chime, Winneton, Murray Wizzell, Wombat, Wonder, Victor Young, Zargon, Zethus, Znarig. **Chappell Morris Group**—Adams Strouse, Aec Cee, Albums, Amno, Alphaventure, Anvil, Ardmore, Balladeer, Banes, Barwin, Bedack, Beechwood, Beldock & Kushnick, Betaventure, Bibo, Big B, Big H, Big L, Bobwhite, Bradshaw, Breezy Willow, Bresnahan, Buddha, Bullfrog, Burke-Van Heusen, Burning Bush, Carwin, Champagne, Charling, Cherry bell, Cinema, Clover, Country Music, Creative, Crestview, Darian, Joe Davis, Degar, De Vorzan, Educational Music Serv., Fancy Space, Wes Farrell, Fenwood, Jose Ferrer, Joe Frank, Georgia, Simon George, Graphole, Gramophone, Grayfiar, Guard, Hall of Fame, Harwin, Hit, Holly Vine, Hot Damm, Iero, Iron March, JAF, Jerryco, Les John, KF3, Kajanus Killyhawk, Ledgfield, Joe M. Leonard Jr., Leona, Leo, Lion, MRC, Mara, March, Mayfair, Melrose, Mercedes, Mercer & Morris, Meridian, Mesquite, Mo mar, Monopoly, Montecto, Morley, E.H. Morris, Motion Picture, Mount Royal, Muirfield, Music for Albums, New Christy, Oriole, PK, Patricia, Peak, Picturone, Quail, Rallon, Rango, Ravenswood, Reis, Reis Dart, Herb Reis, Rondell, Sashay, Satyrcon, Schlager, Sherbourne, Simon House, Slippery Jack, South Mountain, Space, Sparrow, Spartan, Spina, Stanwood, Streeterville, Suchan, Summit, TC, TPI, Tamerlane, Telekew, Thundербуд, Toluca, Truck, Upario, Valeness, Van Winkle & Orian, Vogue, Warner Tamerlane, Welcome, Whalens, Whiskey Joe, White Smith, Windy City, Winnore, Wren, Zizane. **Famous Chappell Group**—AH, Ac cadia, Addax, Ampco, Beverly, Blue Flame, Boo, Brazmout, Brind, Broug ham, Bruin, Burke-Van Heusen & Assocs., Burvan, Chissica, Crisco, Crowfoot, Oaverdan, Diplomat, Directors Company, Engagement, Ensign, Famerville, Famous, Fat Mama, Forest Hills, Gomalco, Heers, High Sierra, Infinte, Kaiser, Love Lies Bleeding, Maller, Mother Mistro, Para-Andi, Parabat, Para-Ed, Para-Kim, Paramount, Paramount/Roy Rogers, Para-Nowgen, Para-Sac, Para Thal, Para-Thumb, Para-Tracs, Para-Wag, Popular Melodies, Rorbury, Some Old Songs, Scarab, Scrolie of the North, Silbury Hill, Spier & Caslow, Sun Vine, Tinker Street, Tomake, Top Floor, Universal, Vin Sun, Window; **Intersong Int'l Group**—Aay, Arawak, Agus, Audigram, Bear Brown, John Beland & Kings Point, Benj & Me dulla, William Bell & Bell-Kat, Johnny Brienstock, Bud Shorty, Black Bud & Omaha, Blue Oyster Cult, Hamilton Bohannon, Bridge House, Buik, CAM USA, Cale Americana, Cape Ann/Three Cheers/Cape May/John Rich bourg, Carlin, Charlotte/Timboe, Cherry, Cherry Vanilla, Stanley Clarke/Clarke, Mike Curb/Caseyem, Davray, Doctor Snuggles, Dog Soldier, Double Exposure, Doughtboy, Betty Earland, Enz, Fabel, Wes Farrell, Wes Farrell/Wescraft, Fairfield, Father, Father/Claudia, Fifth Floor, Fleetwood Mac, Fleetleede, Four Knights, Fuse, Golden Syrup, Richard Gottelher & Jiru, Harbor, Hardcore, Hensley, Hit & Run, Itoz/Good Morning, Hudson Bay, Intersong/Group UFO/WEA, Irod, Jadar/Golo/Oynatone/Cnted/Tansoul, Jimpire, Jru, Jop & Panted Star, Jossley, Kaskal, Kenya/Eumr Deodato, Klub, Kolob, Kongride, Limey/Every Little Tune, Litha/Thalain, Little Fugitive, Little Lasso/ Moonhill/Kurley/Pinson/Strobe Light, Lucky, Magnet, Martin/Couler, Mayday, Matragun/Hilliard/Nelson, Mews, Mobbeta, David Mook/Damont, Masy Moran & Almitia, Mt. M Mimssey, Mured/Barbro, Music Mgmt., Music Korral Progressive, Nine teen Eighty Five, Normal, Omlug/Shirts, Open End & Oyster, Orange, Pal Dog, Plainview, Pocket Full of Tunes, Pocket, Polypub/Phonopub, Quick Mix, RSO, Rap Metz/Aaron Spelling/Spelling Goldberg, Rick's, Rising Sun, Roaring Rock, Rock, Rockhopper, Rodra & Berna, Ru-Do, Samba, Sea breeze, Simon Sossan/Aliza Thorah, Shepstone & Oibbens, Sky Forest, Sky Writing, Sleepy Dumpling, Solid Gold, Song, Slave & Nickelodeon, Sweet, TH, Taupride/Filz/Lizard/ Skunkster Quark/Windecor McMaybe/Sweet & Noodle, Teenage Heaven/Carlin, Thames Talent, Time/Red wall, Times Square/Herald Square, Toneshree, Watlsons, Wednesday Morning, Winkelman/Parts Down/Brown Sound, Zum, Chappell Azna vor; **Chappell JPM**.

Italmusic Sprl, 8 Rue Fernand Neury, 1060 Brussels Tel: (02) 344-4840.
Jokers AGC Music, 470 Steenwinkelstr., Schelle, Antwerp. Tel: (031) 87 58 07. Chief Exec.: J. Clauwers, Gen. Mgr.: J. Blancart.
Jump Music, 34 Hertsvelde, 2nd fl., 8200 Brugge 2. Owner & Mgr.: Eddy van Moulaert.

Int'l rep.: Netherlands (Benelux Music Inds.)
Kluger Int'l, 8 Rue Fernand Neury, 1060 Brussels Tel: (02) 344-4840
 Telex: 26350. Gen. Mgr.: Roland Kluger, Exploitation Mgr.: Herman van Laar.

Int'l firms represented: ATV, Bob Dylan, Heavy, Le Minotaure, Paul Simon, Prelude, 20th Century, (all USA); Northern, Lawrence Wright (both UK); Sweden Music (Sweden).

Jean Kluger Sprl (Eds.), 86 Av. Mohiere B, B 1180 Brussels Tel: (02) 345 4129/4203. Telex: 26220 Bream B. Mng. Dir.: Jean Kluger, Ass't: Myriam DeKoster.

Int'l firms represented: Bleu Blanc Rouge, Topkapı, Zagora (all France).

Hans Kusters Music PvbA, 9A Langestr., 1700 Asse. Tel: (02) 452-7203/8963. Gen. Mgr.: Hans Kusters.

Int'l firms represented: ATV (UK), Barn (UK), Big Secret (UK), Blackhill (UK), Black Neon (UK), Blueytones (UK), Boomtown Rats (Switzerland), Bron (UK), Cuckoo (UK), Danor (USA), Desert Songs/Breakaway (UK), Feckless/Jump Tunes (USA), Fourth Floor (USA), Freshwater (UK), Robin Gibb (UK), Gold Dust/Morning (Canada), Geoff & Eddie (USA), Guido & Maurizio de Angelis Fests (Germany), Halcyon (UK), Health Levy (UK, USA), Highrise (USA), Tony Hiller (UK), Island (UK, USA), Joe Allen (USA), LadySmith/State (UK), Lynnal & Jarac (USA), Marksmen (UK), McCartney/ATV (UK), Macaulay (UK), Nada (Netherlands), Nada-DK (Netherlands), Nada Winter (Netherlands), Osibusounds (UK), Panache (UK), Pennine Songs (UK), Planting Visions (UK), Ricordi (Italy), Rock Music (UK), Rock Artistes (UK), Bruce Springsteen (USA), Stonebridge (USA), Street (UK), Three Hats Prodn's (Canada), viciglobe (UK), Xavier (UK), Zomba (UK).

L M G (Studio), 268-270 Rue de Lodelinsart, B-5080 Montignies/Sambre. Tel: (071) 41-67-86. Pres. & Dir.: Gen. Liliane Gardin, Artistic Dir.: Raphael Bellhore, PR: Alan Slangen, Press: Patrick Victor.

Lelong (Ed.), 36 Rue du Disque, 1020 Brussels. Tel: (02) 79-22-43.

M A M Music Publ'g, 8 Rue Fernand Neury, 1060 Brussels. Contact: Bernd Radtke.

Mangione (Eds.), see Bizef.

Maxwell Music SA, 61 Av. Legrand, 1050 Brussels. Tel: (02) 640 6850. Mng. Dir.: Serge Barkowski; Gen. Mgr.: Roland Vanbeneden.

Int'l firms represented: Quintberg (Germany), Francis Oreyfus (France), Labrador (France), Albert (Germany), Ram (Germany), Rideau Rouge (France).

Int'l rep.: France (Francis Oreyfus), Germany (Albatross, Quint, Ram)

Metropolis, 5 Van Erftborstraat, B-2000 Antwerp. Tel: (031) 33-11-42. Owner: Albert Rollewagen.

Int'l reps: Brazil (Fermata), Spain (Union), UK (Peters), USA (Henri Elkan).

Moderny Publ'rs, see Coda.

Musical Box (SABAM), 1 Rue d'Hervin, 5436 Resteigne. Tel: (84) 38-82-31. Dir.: Cuvelier Stany.

Nathalie Rey (Eds.), see Bizef.

Olympia Music Publ'g (SABAM), PO Box 1, 99 Av. Marie de Hongrie, B-1080 Brussels. Tel: (02) 425-210.

Peer-Southern, see World Music.

Prestation Music, 42 Av. Clays, B 1030 Brussels. Tel: (02) 241-4186.

Int'l rep.: France (New Times, Orly, St. Germain des Pres).

Radio Tele Music SA, 67 Av. Franklin Roosevelt, 1050 Brussels. Tel: (02) 640-0600, 640-5150. Gen. Mgr.: Robert Terheggen.

Int'l firm represented: Ivan Hugel (USA).

Rainbow Recs & Music Co (Harry's PvbA), 100 Bergstraat, 3100 Heist-op den-Berg. Tel: (015) 24-49-50. Telex: 63379. Mng. Dir.: Stan Verbeeck.

Rakki Music PvbA (SABAM), 74 Grenzstraat, Antwerp. Tel: (03) 32-24-85, 31-60-60, 33-65-99. Cable: FRASUPREME.

Int'l firms represented: Dundee (USA), Hazyland (Switzerland).

Int'l rep.: USA (Dundee).

Reader's Digest World Servs. SA, 29 Quai du Hainaut, 1080 Brussels. Tel: (02) 428-0778. Telex: 21876. European Repertoire Admin'r: Henri Heymans.

Rizko Music, 78/80 Lange van Bloerstraat, 2000 Antwerp. Tel: (031) 35-21 11. Telex: 33713. Gen. Mgrs.: Leo Feinstein, Stonne Holmgren.

Rockarolla Music (AFM Group) (SABAM), 77 Rue de Brabant, B-1030 Brussels. Tel: (02) 217-8986, 218-4774. Telex: 62596. Gen. Mgr.: Althe Falkenbach.

Int'l firms represented: Bruton, ITC Filmscores, KPM, Themes (all UK); Shapiro, Bernstein & Co. (UK & USA).

Roses Music, 16 Rozelaarstr., 9490 Oenderwindeke. Tel: (054) 33-64-46. Owner & Pres.: Rose Windels.

Schott Freres Sprl, 30 Rue St. Jean, Brussels. Tel: (02) 512-3980. Mgr.: J.J. Junne.

Int'l rep.: France (Lemoine), Germany (B. Schott's Soehne, Peters), UK (Peters).

Shiva Sprl/PvbA, 56 Merodestraat, 1060 Brussels. Tel: (02) 538-7547. Telex: 63084. Gen. Mgr.: Orik Bogart.

Stock Music Int'l, 19 Paebeelookstraat, 3600 Genk. Tel: (011) 35-02 21. Pres.: Wim Boscheck.

Int'l rep.: Netherlands (Oennis).

Tristan Recs & Music, 114 Groendendaal, 2060 Merksem Tel: (031) 72-36-74. Chief Exec.: Bob Baelemans.

United Artists Music (Belgium), 8 Rue Fernand Neury, B-1060 Brussels. Tel: (02) 344-4840. Telex: 26350. Gen. Mgr.: Roland Kluger, Exploitation Mgr.: Herman van Laar.

Universal Songs SA (SABAM), 26 Av. Palmerston, B-1040 Brussels. Tel: (02) 230-4159, 230-4175. Cable: UNISON. Telex: 22090. Gen. Mgr.: Wim Landman; Prof. Mgr.: Linda Van Waesberge.

Int'l branch: Netherlands.

Int'l firms represented: J. Albert & Son (Australia), Antisia (USA), Apocalypse (UK), Arnakata (UK), Baby Chick (USA), Beaumont (UK), John T. Benson (USA), Bibo (USA), Champagne (USA), Chinnichap (UK), Clandlee (USA), Cookhouse (USA), Crown-Velch (Canada), Edeclan (USA), 57th Street Entertainment (USA), Hall-Clement (USA), Harry Von Tizer (USA), Healthside (UK), Hope (USA), Interworld (UK, USA), Jack & Bill (USA), Janz (Germany), Koppelman-Bandler (USA), La De Da (USA), Logo (UK), Maranatha (USA), Metal Machine (USA), Morning (Canada), Nimbus 9 (Canada), Oakheld Avenue (USA), Paragon (USA), Angel Parker (UK), Quarry (UK), RAK (UK), Rondor (UK, USA), Scott/Wolfe Songs (UK), Shillelagh (USA), Skinnners Pond (Canada), Spaniel (UK), Strange (UK), Sunbury (UK), Tembo (UK), Universal Songs (Netherlands), Vogue (USA), Woodwater (Jamaica), Wood (UK).

Int'l rep.: Netherlands (Universal Songs) (SEE ADVERTISEMENT)

V A K, 166 Prins Bouwewijnlaan, 2610 Wilrijk. Tel: (031) 49 09-16. Mgr.: Rik Vervecken.

Marcel Vanspele & Bekar (Eds. Musicales), 6 Route de Charleroi, B-7140 Ressaix-lez-Binche, Hainaut. Tel: (064) 33-35 86.

Int'l firm represented: Marth Cayla (France).

Vergucht (Chansons), 40 Rue d'Herres, 1000 Brussels. Tel: (02) 11-41-71. J. M. Verhoeven (SABAM), Rue du Pretore 80 Rechtszaalstr., B-1070 Brussels. Tel: (02) 521-3871.

Int'l firm represented: Pierre Duhautes (France).

Vogue Int'l Sprl, 35 Blvd. Barthelemy, 1000 Brussels. Tel: (02) 511-5417. Cable: VOGDIS. Telex: 22560. Pres.: Leon Cabat, Gen. Mgr.: Roger Meyle-mans.

Home office: France.

Voix du Rhythme, 42 Av. Clays, B-1030 Brussels. Tel: (02) 241-4186.

World Music Group, 8 Rue Fernand Neury, 1060 Brussels. Tel: (02) 344-4840. Telex: 26350. Pres.: Felix R. Faecq, Assoc. Exec. Mgr.: Roland Kluger.

Int'l firms represented: Comufra (France), Format (UK), Sam Fox (USA), IMC (France), Moss Rose (USA), Thames (UK), Ray Ventur (France), Irmaos Vitale (Brazil); **partial catalogs represented:** KPM (UK), Mills (USA).

Int'l reps: Argentina (Europa), Australia (World), Austria (Welt Muzik), Canada (Transcanada, Zodiac), Czechoslovakia (State Publ'g House), France (Vendome), Germany (Ton & Kunst, Trumpf), Greece (Apollon), Italy (World), Japan (Shinko), Luxembourg (Luxemburg Music, Magelan), Mexico (Brambia), Netherlands (IMC), New Zealand (Southern), Scandinavia (Intreco), South Africa (Good), Spain (World), Switzerland (World), UK (Good), USA (Columbus, Compton, Zodiac).

Zoom Music (SABAM), 36 Av. Bel-Air, B-1180 Brussels. Tel: (02) 343-4590. Gen. Mgr.: Michel Hellawell.

• services

ASSOCIATIONS & PROFESSIONAL ORGANIZATIONS

Agentship Associated Press, 1-49 K de Grolen, 1040 Brussels.

B O D (Belgian DJ Org.), 12 Rue du Coqjan, 1391 Lettelingen. Tel: (02) 395-5047.

Belgian Royal Music Publ'rs Ass'n, 13 Rue de la Madeleine, 1000 Brussels. Tel: (02) 511-5120. Pres.: Felix Faecq; Light Music Section Pres.: Roland Kluger, Light Music Section VP: Hans Kusters.

C N U D A (Comite Nat'l des Usagers du Droit d'Auteur), Cite de la RTB, Scherbeek-Linthout.

Centrale Generale des Syndicats Liberaux de Belgique, 2 Rue Brederode, Brussels.

Chambre Syndicale des Editeurs de Musique de Belgique, 13 Rue de la Madeleine, B 1000 Brussels. Tel: (02) 511-5120. Pres. & Int'l PR: F.R. Faecq, VPs: J. Junne (Classical), R. Kluger (Pop), A. Rollewagen (Brass Bands); Gen. Sec'y: Maryse Cappendyck (Publishers' Ass'n)

Chambre Syndicale des Fabricants d'Instruments de Musique, 271 Rue Royale, B-1000 Brussels. (Musical instrument mfrs. ass'n)

E O O (European Osc-Jockeys Ass'n), 13-A Rue du Monument, 4834 Goe Limbourg. Tel: (087) 22-37-37.

European Broadcasting Union (Technical Centre), 32 Av. Albert Lancaster, B-1180 Brussels. Tel: (02) 374-5830. Cable: UNIRADIO. Telex: 21230, 21939.

Federation Int'l Des Jeunesses Musicales, Palais des Beaux Arts, 10 Rue Royale, B-1000 Brussels. Tel: (02) 513-9774. Cable: PALARTES. Telex: 61825. Sec'y Gen.: Hadelin Donnet.

PhiHarmonic Society of Brussels, Palais des Beaux-Arts, 11 Rue Baron Horta, B-1000 Brussels. Tel: (02) 512-1001. Pres.: Count Boel; Ors: Herve Thys, Jan Poot.

S I B E S A (Syndicat Belge de l'Industrie & de l'Edition Phonographiques & Audiovisuelles Asbl), 28 Rue des Colonies, 1000 Brussels. Tel: (02) 513-5383. pres.: A. Olivier; VP: C. Licoppe; Treas.: R. Meylemans; Admin'rs: C. Andrews, P. Goemaere, T. Sikkink; Or.: P. Lebbink.

secteur Activities Culturelles de la Centrale Generale des Services Publiques, 9-11 Pl. Fontaines, B-1000 Brussels. Tel: (02) 11-22-31.

Sonocom Int'l, 18 Rue des Ecoles, 4800 Verviers. Tel: (087) 22-37-37, 22-01-81.

Union of Belgian Composers, 1 Av. du Cor de Chasse, or 1 Jachtvoorlaan, B-1170 Brussels. Tel: (02) 672-7530. Pres.: W. Pelemans.

Union of Professional Osc-Jockeys, 13-A Rue du Monument, 4834 Goe-Limbourg. Tel: (087) 76-29-99, 76-32-99.

DESIGN & ARTWORK

Barlow, 7 Kwadenplasstraat, 3100 Heist op den Berg. Tel: (015) 24-16-25.

Bizet Prodn's & Publ'ns Ltd., 13 Madeleine St., 1000 Brussels. Tel: (02) 511-5120. Pres.: Felix R. Faecq; Gen. Mgr.: Veronica Bizet; Sales Mgr.: J.P. Bizef.

Octus Screenprint, 115 Rijnemansweg, B-2840 Haacht.

Oruco Printing Office, 273 Beertstraat, B-1500 Halle. Tel: (02) 356-3835. Telex: 25832. Sales Mgr.: Jan Neef.

Orukkerij Elga, 14 Nieuwstr., 3370 Boutersem.

Harry's PvbA, 100 Bergstraat, 3100 Heist-op-den-Berg. Tel: (015) 24-49-50. Telex: 63379. Mng. Dir.: Stan Verbeeck.

Monopole Recs, Barlow Printing, 7 Kwadenplasstraat, B-3100 Heist op den Berg. Tel: (015) 24-16-25.

Music Radio Promos, Benelux, Postbus 31, Luchtbal, B-2030 Antwerp 3. Tel: (031) 64-73-08. Dir.: Louisa Eyckmans; Gen. & Sales Mgr.: Jozef Seger.

LICENSING ORGANIZATIONS, MUSIC

S A B A M (Societe Belge des Auteurs, Compositeurs & Editeurs), 75-77 Rue d'Arion, 1040 Brussels. Tel: (02) 230-2660. Chm.: V. Legley; Gen. Mgr.: E. Hoolants.

Int'l affiliates: Austria (Austro-Mechana, Literar Mechana), Czechoslovakia (OSA), France (SORM), Germany—East (AWA), Germany—West (GEMA), Greece (AEPI), Hungary (Artisjus), Israel (ACUM), Italy (SIAE), Japan (Jasrac), Netherlands (STEMRA), Poland (ZAKS), Portugal (SAR), Scandinavia (NCB), Spain (SGAE), Switzerland (Mechanizant), USSR (UAEI), UK (MCPS), USA (Harry Fox), Yugoslavia (SAKOL).

S O G E U A I (Societe de Gestion de Droits Intellectuels Asbl), 13 Rue de la Madeleine, B-1000 Brussels. Tel: (02) 511-5120. Pres.: Felix R. Faecq; VP: Lucienne Bizef; Gen. Sec'y: Maryse Cappendyck.

Int'l affiliates: Austria (Austro-Mechana), Czechoslovakia (OSA), France (SORM), Germany (GEMA), Greece (AEPI), Italy (SEDIRI), Netherlands (STEMRA), Scandinavia (NCB), South Africa (SARRAL), Spain (SGAE), Switzerland (Mechanizant), UK (MCPS), USA (AMRA).

LICENSORS, RECORD & TAPE

Monopole Recs, Barlow Printing, 7 Kwadenplasstraat, 3100 Heist op den Berg. Tel: (015) 24-16-25.

PLATING, PROCESSING & PRESSING PLANTS

C B A Music (Connection Business Artists Inc.), 14 Rue de Turin, B-4020 Liege. Tel: (041) 36-85-24. Mng. Dir.: Tomis Chiaren; Sales Mgr.: Alan Desutter; Promo.: Dominique Elians.

Clown Music NV, PO Box 24, B-3680 Maaseik. Tel: (11) 56-59-13. Dir.: Ojamschidi Scharyar.

Etpeco Ltd. (div. of Druco Printing Office), 273 Beertstraat, B-1500 Halle. Tel: (02) 356-3835. Telex: 25832. Sales Mgr.: Jan Neef.

Fonoprs/Barlow Pressing/Inter Service Press PvbA, 94 Appelweg, 3221 Holsbeek. Tel: (016) 56-83-63, 56-98-82. Telex: 61246.

Fonoplatten Perserij, 1 Houwijkterstraat, 3910 Herk-de-Stad. Tel: (015) 53-31-11.

Harry's PvbA, 100 Bergstraat, 3100 Heist-op-den-Berg. Tel: (015) 24-49-50. Telex: 63379. Mng. Dir.: Stan Verbeeck.

Monopole Recs, Barlow Printing, 7 Kwadenplasstraat, 3100 Heist op den Berg. Tel: (015) 24-16-25. (Pressing only)

Sobelpress SA, 480-482 Av. de Couronne, 1050 Brussels.

PRINTERS & LITHOGRAPHERS

Bizet Prodn's & Publ'ns Ltd., 13 Madeleine St., 1000 Brussels. Tel: (02) 511-5120. Pres.: Felix R. Faecq; Gen. Mgr.: Veronica Bizet; Sales Mgr.: J.P. Bizef.

C B A Music (Connection Business Artists Inc.), 14 Rue de Turin, B-4020 Liege. Tel: (041) 36-85-24. Mng. Dir.: Tomis Chiaren; Sales Mgr.: Alan Desutter; Promo.: Dominique Elians.

Clown Music NV, PO Box 24, B-3680 Maaseik. Tel: (11) 56-59-13. Dir.: Ojamschidi Scharyar.

Octus Screenprint, 115 Rijnemansweg, 2840 Haacht.

Oruco Printing Office, 273 Beertstraat, B-1500 Halle. Tel: (02) 356-3835. Telex: 25832. Sales Mgr.: Jan Neef.

Orukkerij Elga, 14 Nieuwstr., 3370 Boutersem.

Harry's PvbA, 100 Bergstraat, 3100 Heist-op-den-Berg. Tel: (015) 24-49-50. Telex: 63379. Mng. Dir.: Stan Verbeeck.

Monopole Recs, Barlow Printing, 7 Kwadenplasstraat, 3100 Heist op den Berg. Tel: (015) 24-16-25.

RECORD PROMOTION

(Including Public Relations & Publicity)

Agentship Associated Press, 1-49 K de Grolen, 1040 Brussels. Tel: (02) 511-5120. Pres.: Felix R. Faecq; Gen. Mgr.: LuVeronica Bizet; Sales Mgr.: J.P. Bizef.

C B A Music (Connection Business Artists Inc.), 14 Rue de Turin, B-4020 Liege. Tel: (041) 36-85-24. Mng. Dir.: Tomis Chiaren; Sales Mgr.: Alan Desutter; Promo.: Dominique Elians.

Honky Tonk, 6 Genthof, 8000 Brugge. Tel: (050) 33-81-30.

Interclub Belgium, 34 Kleine Barelstraat, 2800 Mechelen. Tel: (015) 41-13-31. 7 Steenmolendreef, 2580 Sint-Katelijne-Waver. Tel: (015) 20-25-87. Mng. Dir.: G.C.J. Piroux; Gen. Mgr.: Leopold Piroux; Sales Mgr.: G.J. Piroux Jr.

Lion Concerts, 7 Koninklijke Laan, 2600 Berchem. Tel: (031) 30-18-94.

Metropolitan Entertainments, 16 Leopoldstr., 2000 Antwerp. Tel: (031) 64-73-08.

Microtone, 5 Dude Graanmarkt, 1000 Brussels. Tel: (02) 358-0942.
Maurice Moreau, 65/8 Blvd. Mettewie, 1080 Brussels. Tel: (02) 466-9972.
Music Radio Promos. Benelus, Postbus 31, Luchtbal, B-2030 Antwerp 3 Tel: (031) 64-73-08. Dir.: Louisa Eychmans; Gen. & Sales Mgr.: Jozef Segers.
Lucy Rozenbaum, 10 Rue Fernand Neuray, 1060 Brussels. Tel: (02) 344-4840.

Zoom Music, 36 Av. Bel-Air, B-1180 Brussels. Tel: (02) 343-4590. Gen. Mgr.: Michel Hellawell.

TAPE CUSTOM DUPLICATORS

Clown Music NV, PD Box 24, B-3680 Maaseik. Tel: (11) 56-59-13. Dir. Diamschidi Scharyar.
Audio: 8-tr., cassette.

Elpeco Ltd (div. of Druco Printing Office), 273 Beertstraat, B-1500 Halle. Tel: (02) 356-3835. Telex: 25832. Sales Mgr.: Jan Neef.

Harry's PvbA, 100 Bergstraat, 3100 Heist-op-den-Berg. Tel: (015) 24-49-50. 24-10-29. Telex: 63379. Mng. Dir.: Stan Verbeeck; Ass't Mr. Relick.
Audio: Cassette.
Video: Cassette.

• supplies

ENVELOPES & MAILERS

Druco Printing Office, 273 Beertstraat, B-1500 Halle. Tel: (02) 356-3835. Telex: 25832. Sales Mgr.: Jan Neef.

Interclub Belgium, 34 Kleine Bareelstraat, 2800 Mechelen. Tel: (015) 41-13-31; 7 Steenmolenstraat, B-2580 Sint-Katelijne-Waver. Tel: (015) 20-25-87. Mng. Dir.: G.C.J. Proux; Gen. Mgr.: Leopold Proux; Sales Mgr.: G.J. Proux Jr.

JACKETS & SLEEVES

Druco Printing Office, 273 Beertstraat, B-1500 Halle. Tel: (02) 356-3835. Telex: 25832. Sales Mgr.: Jan Neef.

Harry's PvbA, 100 Bergstraat, 3100 Heist-op-den-Berg. Tel: (015) 24-49-50. Telex: 63379. Mng. Dir.: Stan Verbeeck.

Interclub Belgium, 34 Kleine Bareelstraat, 2800 Mechelen. Tel: (015) 41-13-31; 7 Steenmolenstraat, 2580 Sint-Katelijne-Waver. Tel: (015) 20-25-87. Mng. Dir.: G.C.J. Proux; Gen. Mgr.: Leopold Proux; Sales Mgr.: G.J. Proux Jr. (LP only)

Monopole Recs. Barlow Printing, 7 Kwadenplasstraat, 3100 Heist op den Berg. Tel: (015) 24-16-25. (LP only)

LABELS, DISK

Druco Printing Office, 273 Beertstraat, B-1500 Halle. Tel: (02) 356-3835. Telex: 25832. Sales Mgr.: Jan Neef.

Monopole Recs. Barlow Printing, 7 Kwadenplasstraat, 3100 Heist op den Berg. Tel: (015) 24-16-25. (45 & LP)

POLYETHYLENE BAG & SHRINKWRAP SUPPLIERS

Interclub Belgium 34 Kleine Bareelstraat, 2800 Mechelen. Tel: (015) 41-13-31; 7 Steenmolenstraat, 2580 Sint-Katelijne-Waver. Tel: (015) 20-25-87. Mng. Dir.: G.C.J. Proux; Gen. Mgr.: Leopold Proux; Sales Mgr.: Leopold Proux. (Polybags only)

Triaco, 25 Rue des Alycons, B-1080 Brussels

PROFESSIONAL TAPE SUPPLIES

Monopole Recs. Barlow Printing, 7 Kwadenplasstraat, 3100 Heist op den Berg. Tel: (015) 24-16-25.
Product: Cassette labels.

TAPE DUPLICATING & PROCESSING EQUIPMENT

B E A M Int'l Sarl, 35-37 Italelei, 2000 Antwerp. Tel: (031) 33-45-37. Cable: BEAMAUDID. Telex: 71401. Mng. Dir.: Ed Savori.

Video: Equalizers.
Brand name: Superex.

TAPE, RAW & BLANK LOADED

Advent, see BEAM.

Agfa-Gevaert NV, Verkooporganisatie Benelus, 27 Septestr. 2510 Mortsel. Tel: (031) 40-59-00. Telex: 31223. Magneetband Dept. Mng. Dir.: D van den Broek.

Audio: Raw-Cassette, blank-2", 1", cassette, open reel

Video: Blank-2", 1", 3/4", 1/2" Beta & VHS.

Amplex SA, 8 Rue de l'Industrie, B-1400 Nivelles. Tel: (067) 22-49-21. Telex: 57432.

Audio: 2", 1", cassette, open reel.

Video: 2", 1", 3/4", Cassette, 1/2" Beta & VHS Cassette

B A S F, Audio-Video Dept., 14 Av. Hamoir, B-1180 Brussels. Tel: (02) 375-2400. Cable: BASBRU. Telex: 22016. Sales Mgr.: Jacky Swaelens (Blank only)

Audio: 2", 1", cassette, open reel

Video: 1", 3/4", 1/2" Beta & VHS, 1/2" VCC.

B E A M Int'l, 35-37 Italelei, 2000 Antwerp. Tel: (031) 33-45-37. Cable: BEAMAUDID. Telex: 71401. Mng. Dir.: Ed Savori (Importer-blank only)

Audio: Cassette.
Brand name: Advent.

Blomhof SA (Ets.), 172a Rue Brogniez, B-1070 Brussels. Tel: (02) 522-1813. Dir.: C. Janssen; Hi-Fi Team Sales Mgr.: W. Menge, Maxell Team Mgr.: C. van Canneyt.

Audio: 8-tr., cassette, open reel.

Brand name: Maxell.

De Greef SprL, 367 Chaussee d'Alsemberg, B-1180 Brussels. Tel: (02) 345-3918. Cable: MATRADID. Telex: 24616. Mng. Dir.: F. Morris; Gen. Mgr.: P. Moulart. (Blank only)

Audio: Cassette, open reel.

Brand name: Pyral

I C M, see Triaco.

Magnex, see Troubadour.

Maxell, see Blomhof.

Pyral, see De Greef.

Triaco, 25 Rue des Alycons, B-1080 Brussels (Raw only)

Audio: 8-tr., cassette, open reel.

Brand name: ICM.

Troubadour SprL, 141 Grande Rue au Bois, B-1030 Brussels. Tel: (02) 736-7831. Telex: 25987. Mng. Dir.: Rene Balanger.

Audio: Cassette.
Brand name: Magnex.

• accessories

Amplex SA, 8 Rue de l'Industrie, B-1400 Nivelles. Tel: (067) 22-49-21. Telex: 57432.

Product: Tape-carrying & storage cases, head cleaners, bulk erasers, demagnetizers, leader tape, splicing tape & equip. (all audio & video).

Aracor SA, 12 Blvd. Sylvain Dupuis, B-1070 Brussels. Tel: (02) 521-2370, 522-9327. Telex: 61450. Mng. Dir.: Werner Huys.
Product: Record-carrying & storage cases, record care prods., turntable

mats, 45 rpm adaptors, replacement styli; Tape-carrying & storage cases, head cleaners, demagnetizers, leader & splicing tape.

Blomhof SA (Ets.), 172a Rue Brogniez, B-1070 Brussels. Tel: (02) 522-1813. Cable: BLOMTRAD. Dir.: C. Janssen, Hi-Fi Team Mgr.: W. Menge, Maxell Team Mgr.: C. van Canneyt.

Product: Record-record care prods., turntable mats, 45 rpm adaptors, replacement styli.

De Greef SprL, 367 Chaussee d'Alsemberg, B-1180 Brussels. Tel: (02) 345-3918. Cable: MATRADID. Telex: 24616. Mng. Dir.: F. Morris; Gen. Mgr.: P. Moulart.

Product: Record-replacement styli.

Brand name: Stanton

Interclub Belgium, 34 Kleine Bareelstraat, 2800 Mechelen. Tel: (015) 41-13-31; 7 Steenmolenstraat, 2580 Sint-Katelijne-Waver. Tel: (015) 20-25-87. Mng. Dir.: G.C.J. Proux; Gen. Mgr.: Leopold Proux; Sales Mgr.: G.J. Proux Jr.

Product: Record-carrying & storage cases.

Triaco, 25 Rue des Alycons, B-1080 Brussels.

Product: Tape-carrying & storage cases, head cleaners

Vogue SA, 35 Blvd. Barthelémy, B-1000 Brussels. Tel: (02) 511-7991. Telex: 22560.

Product: Record-carrying & storage cases, Tape-carrying & storage cases, head cleaners, demagnetizers.

• promotional merchandising aids

The following is a list of companies involved in the manufacturing, importing, distribution & retailing of items promoting the music industry and/or its artists. The key to symbols used is: (M) manufacturer; (I) importer; (D) distributor and (R) retailer.

Monopole Recs. Barlow Printing, 7 Kwadenplasstraat, 3100 Heist op den Berg. Tel: (015) 24-16-25.

Product: Posters (M).

• store fixtures

Blomhof SA (Ets.), 172a Rue Brogniez, B-1070 Brussels. Tel: (02) 522-1813. Dir.: C. Janssen; Hi-Fi Team Mgr.: W. Menge, Maxell Team Mgr.: C. van Canneyt.

Product: Tape display racks (audio & video)

BERMUDA

Population: 62,500

Rate of exchange: \$1 (US) = 1.0 Bermudan dollars

Holidays: January 1, Good Friday, May 24 (Bermuda Day), Cup Match Days, December 25, 26 (Boxing Day)

• record & tape manufacturers / distributors / importers

Duane, see Edmar.

Edmar Recs., PO Box 204, Harrington Hundreds, Hamilton 5. Tel: (809) 295-4839. Pres.: Edward De Mello; Gen. Mgr.: Joseph De Mello.

Labels: (Owned) Duane, Edmar

Int'l rep.: Canada (Holborne).

BOLIVIA

Population: 5,550,000

Rate of exchange: \$1 (US) = 24.75 pesos

Per capita income: \$725

Holidays: January 1, Good Friday, May 1 (Labor Day), May 25 (Chuquisaca Anniversary), Corpus Christi, July 16 (La Paz Day-La Paz only), August 6 (Independence Day), September 14 (Cochabamba Day-Cochabamba only), December 25

• record & tape manufacturers / distributors / importers

Ande, see Jallilla.

Discolandia Dueri & Cia. Ltda. (IFPI), Calle Potosi 920, 1st fl., La Paz. Tel: 3-28513. 3-56656. Cable: DISCOLANDIA. Telex: 5458. Pres.: Miguel A. Dueri; VP: Miriam S. de Dueri; Label Mgr.: Henry Dueri; A&R: Orlando Rojas; Gen. Acct'g: Alberto Espinoza; Promo. & Pub.: Oscar Rivero; Gen. Mgr. Sales: Oscar Prieto

Branches: Cochabamba, Agencia Discolandia, Plaza 14 de Septiembre 6175. Tel: 2-2239-Oruro, Casa Alanes, Ave. 7 de Octubre 1450. Tel: 5-2302-Santa Cruz, Agencia Discolandia, Casilla 2103. Libertad 220 & 224. Tel: 2-8975-Sucre, Calle San Alberto 1. Tel: 1669. Mgr.: Elias Sabag-Tarija, Discofoto Rodriguez, Casilla 134, Sucre 646-652.

Labels: (Owned) Exito, Lyra, (Licensed) Decca (UK), EMI (UK), IEMPSA (Peru), MCA (USA), Polydor (West Germany), Sono-Radio (Peru)

Int'l reps.: Worldwide (EMI in UK) excluding Peru (IEMPSA).

Exito, see Discolandia Dueri

Heriba Ltda. (IFPI), Abdon Saavedra 2190, La Paz. Tel: 351-744, 343-580, 367-831. Cable: HERIBA. Gen. Mgr.: Eduardo Ibanez Wigger, Sales Mgr.: Elba Wigger

Labels: (Owned) Heriba, (Licensed) CBS (worldwide), IFESA (Ecuador), Microfon (Argentina), Sondor (Uruguay), Top Hits (Venezuela).

(Uruguay)

Int'l rep.: Worldwide (CBS)

Inbofon Ltda., see Industria Boliviana del Fonograma

Industria Boliviana del Fonograma (Inbofon Ltda.), Edif. Alameda, 6th fl., Dept. 205, El Prado, Bloque B, La Paz. Tel: 372-228. Telex: 5458. Int'l Dir. & Gen. Mgr.: Johnny Dueri, Sales Mgr.: Mario Luis Flores

Label: (Represented) RCA (USA)

Jallilla (Discos), Figueroa 788, Dept. 1, 2nd fl., La Paz. Tel: 366-514. Cable: JALLALLA. Pres. & Dir. Gen.: Julio Martinez Arteaga, Sales Mgr.: Arminda Gonzales Taibo.

Labels: (Owned) Ande, Jallilla

Lauro & Cia. Ltda., Av. de las Heroinas 0534, Cochabamba. Tel: 2-6632. Cable: LAURO. Telex: Lauro Bx 5907. Owner: Laureano Rojas Alcocer, Sales Mgr.: Orlando Bustamante, Int'l Mgr.: Vickie de Valenzuela. Local branch: Calle Sucre 3509. Tel: 2-1241.

Branches: La Paz, Av. America 115. Tel: 2-5697-Oruro, Galeria del Disco, Calle Potosi 1621. Tel: 51448. Mgr.: Alfredo Zamora-Santa Cruz, Ayacucho 238. Tel: 2-5130. Mgr.: Enrique Duran-Sucre, Calle Nicolas Ortiz 2. Casilla 239. Tel: 2434-Tarija, Calle Sucre 646-652, Casilla 134. Tel: 3101.

Labels: (Owned) Lauro, Lauro Int'l; (Licensed) Ariola (Germany, Mexico, Spain, Brazil), Barclay (France), Beller (Spain), Columbia (Spain), Copacabana (Brazil), El Disco de Moda (Venezuela), Fantasy (USA), Fermata (Brazil), Gamma (Mexico), Hispavox (Spain), Jupiter (Germany), Musart (Mexico), Music Hall (Argentina), Musidisc (Argentina), Peerless (Mexico), Phonogram (Argentina, Brazil, Chile, Colombia, Mexico, Peru, Spain, Uruguay, Venezuela), Seeco (USA), TK (Argentina), Zafiro (Spain).

Lauro Int'l, see Lauro

Lyra, see Discolandia Dueri

• music publishers

Heriba (Ed. Musical), Abdon Saavedra 2190, La Paz. Tel: 351-744. Cable: HERIBA. Gen. Mgr.: Eduardo Ibanez Wigger.

Kollasuyo Eds. Musicales (Sobodaycom), Calle Figueroa 788, Dept. 1, 2nd fl., La Paz. Tel: 366-514. Cable: KDLASUYD. Pres. & Dir. Gen.: Julio Martinez Arteaga. Gen. Mgr.: Arminda Gonzales Taibo; Prof. Mgr.: Sergio Hinojosa M.

Lyra (Ed.), Casilla 422, Calle Potosi 814, 3rd fl., La Paz. Tel: 3-56656. 3-28513. Pres.: Miguel A. Dueri.

• services

DESIGN & ARTWORK

Discolandia Dueri & Cia. Ltda., Calle Potosi 920, 1st fl., La Paz. Tel: 3-56656, 3-28513. Pres.: Miguel A. Dueri; VP: Miriam S. de Dueri; Gen. Sales Mgr.: Oscar Prieto

Heriba Ltda., Abdon Saavedra 2190, La Paz. Tel: 351-744, 343-580, 367-831. Gen. Mgr.: Eduardo Ibanez Wigger, Sales Mgr.: Elba Wigger; Prod'n Mgr.: Dora de Ibanez.

LICENSING ORGANIZATION, MUSIC

Sobodaycom (Sociedad Boliviana de Autores & Compositores de Musica), Figueroa 788, Dept. 1, 2nd fl., La Paz. Tel: 366-514. Cable: SDBDDAY. CDM. Pres. & Dir. Gen.: Julio Martinez Arteaga; Sec'y: Jorge Canedo Michel.

PLATING, PROCESSING & PRESSING PLANTS

PRINTERS & LITHOGRAPHERS

TAPE CUSTOM DUPLICATORS

Discolandia Dueri & Cia. Ltda., Calle Potosi 920, 1st fl., La Paz. Tel: 3-56656, 3-28513. Pres.: Miguel A. Dueri; VP: Miriam S. de Dueri; Gen. Sales Mgr.: Oscar Prieto

Heriba Ltda., Abdon Saavedra 2190, La Paz. Tel: 351-744, 343-580, 367-831. Gen. Mgr.: Eduardo Ibanez Wigger, Sales Mgr.: Elba Wigger; Prod'n Mgr.: Dora de Ibanez.

Labels: (Owned) Dueri, (Licensed) P&G

RECORD PROMOTION

Heriba Ltda., Abdon Saavedra 2190, La Paz. Tel: 351-744, 343-580, 367-831. Gen. Mgr.: Eduardo Ibanez Wigger, Sales Mgr.: Elba Wigger; Prod'n Mgr.: Dora de Ibanez.

• supplies

ENVELOPES & MAILERS

JACKETS & SLEEVES

LABELS, DISK

POLYETHYLENE BAGS

PROFESSIONAL TAPE SUPPLIES

RECORD MANUFACTURING EQUIPMENT

TAPE, BLANK LOADED

TAPE DUPLICATING & PROCESSING EQUIPMENT

Discolandia Dueri & Cia. Ltda., Calle Potosi 920, 1st fl., La Paz. Tel: 3-56656, 3-28513. Pres.: Miguel A. Dueri; VP: Miriam S. de Dueri; Gen. Sales Mgr.: Oscar Prieto

Heriba Ltda., Abdon Saavedra 2190, La Paz. Tel: 351-744, 343-580, 367-831. Gen. Mgr.: Eduardo Ibanez Wigger, Sales Mgr.: Elba Wigger; Prod'n Mgr.: Dora de Ibanez.

• accessories & store fixtures

Discolandia Dueri & Cia. Ltda., Calle Potosi 920, 1st fl., La Paz. Tel: 3-56656, 3-28513. Pres.: Miguel A. Dueri; VP: Miriam S. de Dueri; Gen. Sales Mgr.: Oscar Prieto

Product: Record-record care prods., replacement styli; Tape-head cleaners, demagnetizers, leader & splicing tape; record & tape browser boxes, record & tape display racks, record & tape divider cards.

BRAZIL

Population: 119,000,000

Rate of exchange: \$1 (US) = 90 cruzeiros.

Per capita income: \$1300

Holidays: January 1, Carnival, Holy Thursday, Good Friday, May 1 (Labor Day), September 7 (Independence Day), November 2 (Memorial Day), November 15 (Proclamation of the Republic), December 25.

• record & tape manufacturers / distributors / importers

A E S C R J, see Top Tape.

Air Bus, see Camel.

Alldisc-Consulтора & Comercial Fonografica Ltda., Rua Alagoas 159, cj. 84, 01242 São Paulo. Tel: (011) 257-8424. Telex: 1132128. Pres.: Geraldo L. Loewenberg; Gen. Mgr.: Janine M. U. Loewenberg; Sales Mgr.: Roberto A. Loewenberg.

Labels: (Owned) Alldisc; (Licensed) Arston (Italy), Bainbridge (USA), Black & Blue (France), Coombe (UK), Countdown (Germany), Discos (Italy), Dureco (Netherlands), Elite-Special (Switzerland), Everest (USA), Jo-Jo (USA), Ri-Fi (Italy), Telstar (Netherlands)

Angel, see EMI-Odeon.
 Aquarela, see Top Tape.
 Archiv, see PolyGram.
 Arco-Iris, see Top Tape.
 Ariola Discos Fonográficos & Filas Magnéticas Ltda., Rua General Rabelo 43, 22451 Gavea, Rio de Janeiro, Tel: (021) 274-2545/2697. Cable: ARIOLA DISCOS. Telex: (021) 31575. Gen. Mgr.: Jose Victor Rosa Jr.; Sales Mgr.: Yassuo Ono; Int'l A&R Mgr.: Antonio Duncan; Int'l A&R S&T Mgr.: George Ruopp; Int'l A&R Promo. Co-ord.: Regina Vidal.
 Branch: **Sao Paulo**, Rua Teixeira da Silva 654, 04002 Paraiso. Tel: (011) 283-0932/0949. Cable: ARIOLA DISCOS. Telex: (011) 33039.
 Labels: (Owned) Ariola, Arista; (licensed) Bronze (UK), Center, Handshake (USA), Hansa (Germany), Island (UK), MCA (USA), Ze (USA).
 Int'l reps.: Argentina (Microfon), Australia (RCA), Austria (Ariola), Belgium (Ariola Benelux), Bolivia (Lauro), Canada (Quality), Chile (Quatro), China (Pacific), Colombia (Sonolux), Denmark (CBS), Ecuador (Fadisa), Finland (Finnisc), France (Arabella), Germany (Ariola Eurodisc), Greece (PolyGram), Guatemala (Dideca), Iceland (Falkinn), India (Gramophone), Israel (Hed Arzi), Italy (CGO-Messaggerie Musicali), Japan (King), Mexico (Bertelsmann), Netherlands (Ariola Eurodisc Benelux), Norway (CBS), Peru (FTA), Portugal (PolyGram), South Africa (RPM), Spain (Ariola Eurodisc), Sweden (CBS), Switzerland (Ariola), Turkey (Turkoku), UK (Ariola Eurodisc), USA (Ariola America), Venezuela (Cordica), West Indies (West Indies).
 Arista, see Ariola.
 Asylum, see WEA
 Atco, see WEA.
 Atlantic, see WEA.
 Bandeirantes Discos (IFPI), Av. Brigadeiro Luis Antonio 1404, 1st fl. Sobrelaje, Conj. 11B, Sao Paulo. Tel: (011) 289-4477. Dir.: Roberto de Oliveira; Artistic Mgr.: Sergio Lopes; Int'l Dir.: Claudio Petraglia.
 Labels: (Owned) Clack, Master; (licensed foreign) Band.
 Bemol, see TapeCar.
 Building, see Som Industria & Comercio.
 C B S Industria & Comercio Ltda. (IFPI), Rua Buenos Aires 2, 15th & 16th fl., 20000 Rio de Janeiro. Tel: (021) 231-0516, 22-4469/0285. Cable: COLRECORD. Telex: (11) 25905. Mng. Dir.: Tomaz Munoz; Mktg. Mgr.: Roberto Augusto.
 Labels: (Owned) CBS, Collector Jazz Series, Entre, Epic, Masterworks, Odyssey, Okeh, Tropicana, Urupuru, Ve Leiro; (licensed foreign) A&M (USA), ELO (UK), TK (USA).
 Int'l rep.: USA (CBS).
 C I D, see Companhia Ind'l de Discos.
 Camden, see RCA.
 Camel Recs./Tropisong Gravacoes Musicais Ltda. (IFPI), Rua Oscar Freire 1061, Cerqueira Cesar, 01426 Sao Paulo. Tel: (011) 282-0200. Pres.: Jose Carlos Silvestre; Gen. Mgr.: Monica Liliãna Silvestre; Sales Mgr.: Marco A Assis.
 Labels: (Owned) Air Bus, Camel, Car Wash; (licensed foreign) Cinevox (Italy), Constelation (Argentina), Coombe (UK), Eleven (Italy), Musicstape (Argentina).
 Int'l reps.: Argentina (Camel, Musicstape), Chile (Quatro), Germany (Countdown), Italy (Cinevox), Mexico (Camel), UK (Coombe).
 Campeao Discos, Rua Otavio Correa 202/102, 22291 Urca, Rio de Janeiro. Tel: (021) 246-7214. Pres.: Wilson F. Falcao. Gen. Mgr.: Ilka F. Brito; Sales Mgr.: Gilda C. Falcao.
 Labels: (Owned) Campeao; (represented) Alcere (USA), BPL (Germany), Beat (Italy), Colt (USA), Destiny (USA), Dixie (Germany), Espirit (USA), Firma (USA), Gallo (USA), Genuine (USA), Jody (USA), K-Arc (USA), Mayhams (USA), Miisumi (USA), Mishawaka (USA) Northland (USA), Novelty (USA), Panorama (Germany), R&R (USA), TIB (Germany), Unity (Germany).
 Int'l reps.: Angola (Vadeca), Argentina (Low), Belgium (Vadeca), France (Vadeca), Germany (Vadeca), Mexico (Panamusic), Netherlands (Parade), Portugal (J.C. Donas), South Africa (RPM), Venezuela (Favedica).
 Capitol, see EMI-Odeon.
 Carroussel, see Companhia Ind'l de Discos.
 Car Wash, see Camel.
 Center, see Seta & Ariola.
 Chantecler, see Gravacoes Eletricas.
 Charger, see Som Industria & Comercio.
 Clack, see Bandeirantes & WEA.
 Collector Jazz Series, see CBS.
 Companhia Ind'l de Discos (IFPI), Rua 7 de Marco 331, Bonsucesso, 21040 Rio de Janeiro. Tel: (021) 280-9222. Cable: CIDISCOS. Telex: (021) 30043. Pres.: Hermann Zuckermann; VP Int'l: Harry Zuckermann, Gen Mgr.: Rodolfo Zuckermann.
 Labels: (Owned) CID, Carroussel, Crazy Cat Itamaraty, Magic Music, Square; (licensed) Aquarius (France), Biarri (France), Coombe (UK), Countdown (Germany), Pickwick (USA), Saar (Italy), Secco (USA), Spector Int'l (USA), Toledo/Hansa (Germany).
 Int'l reps.: Colombia (Tropical), France (Sonodisc), Germany (Toledo-Hansa), Greece (Music Box), Italy (CGD), Portugal (Vadeca), Venezuela (BASF).
 Continental, see Gravacoes Eletricas.
 Copacabana, see Som Industria & Comercio.
 Copa Musical, see Top Tape.
 Coronado, see EMI-Odeon.
 Cotillion, see WEA.
 Courto, see Seta.
 Crazy Cat, see Companhia Ind'l de Discos.
 D G, see PolyGram.
 Decca, see PolyGram.
 Disc Test, see Mangione, Filhos & Cia.
 Disquinho, see Gravacoes Eletricas.
 Dragon, see WEA.
 E M I-Odeon Fonografica Industrial & Eletronica SA, Caixa Postal 2752, Zone: 20000; Rua Mena Barreto 151, Botafogo, 22271 Rio de Janeiro. Tel: (021) 286-1212. Cable: TURNABLE. Telex: (021) 23678. Mng. Dir.: Rolf Dillmann; Gen. Mgr.: Yukiharu Eto; Int'l A&R Mgr.: Jorge Davidson.
 Labels: (Owned) Angel, Capitol, Coronado, EMI, Harvest, Imperial, Odeon, Parlophone; (licensed) A&M (USA), Decca (UK), London (UK, USA), Passport (USA), Pathe (France), Pyramid (USA), RAK (UK), United Artists, Versatile (USA).
 Int'l rep.: Worldwide (EMI).
 Eldorado (Estudio) Ltda., Rua Major Queidino 7E, 7th fl., 01050 Sao Paulo. Tel: (011) 256-5411. Telex: 1124005. Pres.: Joao Lara Mesquita; Gen. Mgr.: Luiz Carlos Villas Boas Souza; Sales Mgr.: Dirce H. Sanches; Int'l Mgr.: Geraldo L. Loewenberg.
 Elektra, see WEA.
 Elenco, see PolyGram.
 Emblema, see Padrao.
 Entre, see CBS.

Epic, see CBS.
 Equipe, see Padrao.
 Festa, see PolyGram.
 Fontana, see PolyGram.
 Gold Seal, see RCA.
 Gravacoes Eletricas SA (IFPI), Av. do Estado 4667, 01515 Sao Paulo. Tel: (011) 279-6811. Telex: (11) 22329. Chm.: Alberto Jackson Byington Neto; Mng. Dir.: Hans Hjalmar Paul Beugger; Comm'l Mgr.: Moacyr Minghini Machado.
 Labels: (Owned) Chantecler, Continental, Oiscao, Disquinho, (licensed) Audio Fidelity (USA).
 Groove, see RCA.
 Guarani, see Mangione, Filhos & Cia.
 Hara Internacional Musica & Filmes Ltda., Rua Joaquim Silva 56, 5th fl., Rio de Janeiro. Tel: (021) 252-4256, 222-0972. Or.: Nilo S. Pinto; Gen. Mgr.: Ruth de Castro Savaget.
 Labels: (Owned) Musidisc, Oxala.
 Int'l reps.: Bolivia (Heriba Ltda.), Colombia (Fonogramas), Ecuador (Famoso), El Salvador (Boni), Mexico (Guitarra), Peru (FTA), USA (Musical Recs.), Venezuela (Fonografica del Caribe).
 Harvest, see EMI-Odeon.
 Heliodor, see PolyGram.
 I N A, see WEA.
 Imagem, see Musisom.
 Imperial, see EMI-Odeon.
 Importadora Peter Comercio & Industria Ltda., Rua 24 De Maio 276-7, Andar S/72, 01041 Sao Paulo.
 Label: (Represented) Direct Disk (USA).
 Independente Comercial & Distribuidora Ltda., Av. Brig. Faria Lima 1857, Cj. 114, 01451 Sao Paulo. Tel: (011) 815-1339. Telex: 1125388. Pres.: Luiz Carlos Villas Boas Souza; Gen. Mgr.: Cesare Benvenuti; Sales Mgr.: Dirce H. Sanches; Int'l Mgr.: Geraldo L. Loewenberg.
 Labels: (Owned) Alldisc, Independente.
 International, see RCA.
 Itamaraty, see Companhia Ind'l de Discos.
 Joias Musicais, see Mangione, Filhos & Cia.
 K-tel do Brasil Comercial Ltda., Rua Tobias do Amaral 46, Cosme Velho, Rio de Janeiro RJ. Tel: (021) 205-4545. Gen. Mgr.: Alan Joel Cordover; Sales Dir.: Bernd Peter Vogel; Artistic Dir.: Ricardo Barley.
 Labels: (Owned) K-tel, Kelo; (licensed foreign) Antler (USA), Attic (Canada), Creole (UK), Ibach (France), Ibis (USA), Inphasion (USA), JDC (USA), Key Seven (Canada), Malco (USA), Quality (Canada), Splash (UK), State (UK).
 Kelo, see K-tel.
 M G M, see PolyGram.
 Magic Music, see Companhia Ind'l de Discos.
 Mangione, Filhos & Cia. Ltda., Rua do Ovidor 183, 1st fl., Suites 14-19a, 20000 Rio de Janeiro ZC-00. Tel: (021) 242-3223. Cable: EDMANGIONE. Pres.: Estevam Scianguia Mangione; Sales Mgr.: Ubaldo S. Mangione; Foreign Mgr.: Estevao Salvador S. Mangione.
 Labels: (Owned) Disc Test, Guarani, Joias Musicais, Red Lips.
 Master, see Bandeirantes & WEA.
 Masterworks, see CBS.
 Mercury, see PolyGram.
 Mis, see Som Industria & Comercio.
 Musidisc, see Hara.
 Musisom Empreendimentos, Rua Alfonso Pena 101, CEP 20.270 Rio de Janeiro. Tel: (021) 254-1915. Pres.: Jonas Silva; Gen. Mgr. Ademur William, Sales Mgr.: Sergio Guedes.
 Labels: (Owned) Imagem; (licensed) Everest (USA), Joker (Italy), Xanadu (USA).
 News, see Som Industria & Comercio
 Nonesuch, see WEA.
 Odeon, see EMI-Odeon
 Odyssey, see CBS.
 Okeh, see CBS.
 One Way RBR, see Top Tape
 Oxala, see Hara
 Padrao Distribuciao de Fonogramas Ltda., Rua Sao Francisco Xavier 961, 20000 Rio de Janeiro Tel: (021) 284-1332/1992.
 Labels: (Owned) Emblema, Equipe, Padrao, Spot, (licensed) Alshire Int'l (USA), Arrowtubs (UK), Candide (USA), International Artists (UK), Turnabout (USA), Vox (USA).
 Parlophone, see EMI-Odeon.
 Peralta, see RGE.
 Philips, see PolyGram
 Pick, see RGE.
 Polydor, see PolyGram
 Polyfar, see PolyGram.
 PolyGram Discos Ltda., Av. Rio Branco 311, 4th fl., 20000 Rio de Janeiro. Tel: (021) 220-9698/9998. Cable: POLYGRAM. Telex 2122739. Mng. Dir.: Antonio Coelho Ribeiro; Controller: Cor Van Dijk; A&R Mgr.: Roberto Menescal; Sales Mgr.: Heleno de Oliveira.
 Branch: 01404 Sao Paulo SP, Alameda Campinas 266, Jardim Paulista. Tel: (011) 251-1311.
 Labels: (Owned) Archiv, DG, Decca, Elenco, Festa, Fontana, Heliodor, MGM, Mercury, Philips, Polydor, Polyfar, Polystar, Sinter, Vertigo, Verve; (licensed) CNR, Casablanca (USA), Charisma (UK), Pablo (USA), RSO (UK, USA), Rocket (UK).
 Polystar, see PolyGram
 Premier, see RGE.
 Pure Gold, see RCA.
 R C A Eletronica Ltda. (IFPI), Rua Santa Clara 50, Cobertura 01, 22041 Rio de Janeiro. Tel: (021) 255-7225. Telex: (21) 30965. Pres.: Dswaldo Guronzi, Sales Mgr.: Nilton Correa; Int'l: Jorge Pino.
 Labels: (Owned) Camden, Gold Seal, Groove, International, Pure Gold, RCA Victor, Red Seal, Vic, Victrola; (licensed domestic) Sigla, Som Livre; (licensed foreign) Ariston (Italy), Barclay (France), Can't Stop (USA), Chrysalis (UK), De-Lite (USA), Erato (France), Gem (UK), Grant (USA), Magnet (UK), Millennium (USA), Pickwick (UK), Polar (Sweden), Roulette (USA), Solar (USA), Sugar Hill (USA), 20th Century-Fox (USA), Vanilla (Italy), Welman (France).
 R G E (Comercial Fonografica) Ltda., Pça. Paçoa Martins 138, Sao Paulo. Tel: (011) 825-9377.
 Labels: (Owned) Meraltia, Pck, Premier, RGE, Som/Maior, Young.
 Red Lips, see Mangione, Filhos & Cia.
 Red Seal, see RCA.
 Reprise, see WEA.
 Rural, see TapeCar.
 Sabia, see Som Industria & Comercio
 Saco, see Som Industria & Comercio.
 Seta Fonogramas Ltda., Al. Joaquim Eugenio de Lima 697, 01403 Sao Paulo. Tel: (011) 288-4240. Pres.: Paulo Machado de Carvalho Filho; Comm'l Dir.: Joaquim Carlos S. Clemente; A&R Mgr.: Carlos M. Carvalho (Distrib-

uted by Ariola).
 Labels: (Owned) Courto, Center, Seta.
 Sigla (Sistema Globo de Gravacoes Audio-Visuais) Ltda., Rua Assuncao 443, Rio de Janeiro. Telex: 22251. Gen. Dir.: Joao Araujo; Prod'n Mgr.: G. Mello; Int'l Mgr.: A. Paladino; Technical Mgr.: R. Bittencourt. (Distributed by RCA).
 Labels: (Owned) Soma, Som Livre.
 Sinter, see PolyGram.
 Soma, see Sigla.
 Som Industria & Comercio SA (IFPI), Rua Eugenia S. Vitale 173, R. Ramos Sao Bernardo do Campo-SP. Tel: (011) 457-5344. Cable: SOMDISCOS. Telex: (011) 4240. Pres.: Adiel Macedo de Carvalho; Mng. Dir.: Olavo Antonio Bianco; Gen. Mgr.: Gunter Czaasznik; Sales Mgr.: Rosvaldo Cury; Plant Mgr.: Joao F. Blumenschein.
 Int'l distributor: USA, Brasilia Recs. & Tapes Corp.
 Labels: (Owned) Building, Charger, Copacabana, News, Sabia, Saco, Som, Test Pressing, Underground, Vision; (licensed) Baby (Italy), Columbia (Spain), Fuentes (Colombia), Harmonia Mundi (Germany), Intermusique (Luxembourg), MPS (Germany), PPX (USA), Prelude (USA), Quatro (Chile), Supraphon (Czechoslovakia), Vanguard (USA), West One (USA), West Side Latino (USA), (distributed-not licensed) Mis, Marcus Pereira, Int'l reps.: Argentina (CBS), Australia (RCA), Benelux (Vogue), Canada (Brasilia in USA), Chile (Quatro), Colombia (Fuentes), France (Vogue), Germany (Metronome, Teldec), Greece (CBS), Israel (CBS), Italy (Baby), Japan (Global, RCA), Korea (RCA), New Zealand (RCA), Philippines (Victor), Portugal (Radio Triunfo, Rossini), Spain (Columbia, Hispavox), Switzerland (Vogue), UK (Decca), USA (West Side Latino), Venezuela (Swabaciones Mondiales).
 Som Livre, see Sigla & RCA.
 Som/Maior, see RGE.
 Sosamba, see TapeCar.
 Spot, see Padrao.
 Square, see Companhia Ind'l de Discos.
 Studium Gravacoes Discos & Tapes Ltda., Rua Aurora 983, Cj. 71, 01209 Sao Paulo. Tel: (011) 222-2989. Pres.: Victor Settani; Pres: Aluisio Pontes, Geraldo Loewenberg.
 Label: (Owned) Studium.
 T C, see TapeCar.
 TapeCar Gravacoes SA (IFPI), Rua Aguiar Moreira 639, 20000 Rio de Janeiro. Tel: (021) 280-5582. Pres. & Dir.: Manuel Valls Camero; Gen. Mgr.: Fernando de Araujo Neves; Sales Mgr.: Ary Perdigao; Int'l Mgr.: Paulo Roberto Correa de Araujo.
 Labels: (Owned) Rural, Sosamba, TC, TapeCar; (distributed) Bemol; (represented) Bareback (USA), Basart (Netherlands), Cinevox (Italy), Count Down (Germany), O&M (USA), Damil (UK), Disques Direction (Canada), Everest (USA), Fonior (Belgium), Honeybee (USA), Mainstream (USA), Parachute (USA).
 Test Pressing, see Som Industria & Comercio.
 Top Tape Musica SA, Rua Alice 97, Laranjeiras, 20000 Rio de Janeiro ZC-01. Tel: (021) 205-5552. Cable: MUSITOP. Telex: (21) 23923. VP A&R & Promo.: Joel B. Leibovitz; VP Int'l Opera.: Myrian Sylvia Avanzi; VP Sales: Salomao Sobrinho; VP Prod.: Teresa Brito.
 Branch: **Sao Paulo**, Rua Osorio Duque Estrada 39, Vila Nova Tup, Ibirapuera, 04001 Sao Paulo. Tel: (011) 287-8676. Sales Mgr.: Alberto Bantosti Neto; Promo. Mgr.: Dorival Rosa.
 Labels: (Owned) Aquarela, Arco-Iris, Copa Musical, One Way RBR, Top Tape; (licensed domestic) AESCRU; (licensed foreign) AVI (USA), Carabine (France), Carrere (France), Cinevox (Italy), De-Lite (USA), Dream (USA), Fantasy (USA), Gang (USA), Greedy (USA), Gold Mind (USA), Gordy (USA), Lifesong (USA), Lollipop (Germany), Milestone (USA), Motown (USA), Olde World (USA), Rare Farthing (UK), Playboy (USA), Prestige (USA), Prudigal (USA), Penny Earth (USA), Salsoul (USA), Stamy (Switzerland), Stax (USA), Tamla (USA), Vigor (USA).
 Int'l reps.: Argentina (RCA), Portugal (Imavox).
 Tropicana, see CBS.
 Tropisong, see Camel.
 Urupuru, see CBS.
 Underground, see Som Industria & Comercio.
 Ve Leiro, see CBS.
 Vertigo, see PolyGram.
 Verve, see PolyGram.
 Vic, see RCA.
 Victrola, see RCA
 Vision, see Som Industria & Comercio.
 W E A Discos Ltda. (IFPI), Rua Itaipava 44, Jardim Botânico, 22461 Rio de Janeiro. Tel: (021) 286-3332. Mng. Dir.: Andre Midani; Sr. VP's: Michael Gregory, David Jones; Mktg. Dir.: Leonardo Neto.
 Labels: (Owned) Asylum, Atco, Atlantic, Cotillion, Elektra, Nonesuch, Reprise, WEA, WEA Int'l, Warner Bros.; (licensed domestic) Bandeirantes, Clack, Dragon, INA, Master; (licensed foreign) Dark Horse, Rolling Stones, Swan Song.
 Warner Bros., see WEA
 Young, see RGE.

• music publishers

Alldisc-Consultoria & Comercial Fonografica Ltda., Rua Alagos 159, cj. 84, 01242 Sao Paulo. Tel: (011) 257-8424. Telex: 1132128. Pres.: Geraldo L. Loewenberg; Gen. Mgr.: Janine M.U. Loewenberg.
 Int'l firm represented: Ariston (Italy).
 Int'l rep.: USA (Ivan Mogull).
 Adnana (SICAM), see Fermata
 Alvorada Ltda. (Ed. Musical), see Meridional.
 Amor, see Fermata.
 Arapua (SBACEM), see Fermata
 Arlequim Ltda. (Ed. Musical), Caixa Postal 3264, Vila Biarque, Rua Frederico Stedel 267, 01225 Sao Paulo. Tel: (011) 220-3494/1343.
 Ata (UBC), see Fermata.
 Augusta Ltda. (Ed.) (SICAM), see Fermata.
 Avenida, see Fermata.
 Baliao Ltda. (Ed. Musical) (SICAM), see Sigem.
 Bandeirante (UBC), see Fermata.
 Bela Musi (Ed.), see Top Tape.
 Betina Edicoes & Promocoas Ltda., Rua 7 de Marco 331, Bonsucesso, 21040 Rio de Janeiro. Tel: (021) 280-9222. Cable: CIDISCOS. Telex: (021) 30043. Pres.: Hermann Zuckermann; Gen. Mgr.: Rodolfo Zuckermann; Prof. Mgr.: Harry Zuckermann.
 Beverly Ltda. (Ed. Musical) (UBC), see Meridional.
 Bevorada Music Corp., see Meridional.
 C A M Brazil, see Arlequim.
 C I D Edicoes & Promocoas Ltda., see Betina.
 Campeao (Ed.), see Falcao.
 Carioca Ed. Musical Ltda. (SBACEM), Av. do Estado 4667, 01515 Sao Paulo.

Tel (011) 279-6811 Telex (11) 22329 Chm Alberto Jackson Byington Neto, Mgr Moacyr Minghini Machado, Publ'g Co-ord Antonio Carlos Senefonte

Catavento Ltda. (Ed. Musical) (SBACEM), see Sigem

Copa Musical Ltda. (Ed.), see Top Tape

Cordilheras Ed. Musicais Ltda., see ITAIPI

Curci Brasil (UBC), see Fermata

Drmk (UBC), see Fermata

Duchess Ed. Musical Ltda., see MCA

E L A M - Ed. Latino Americana de Musica Ltda., see Mundo Musical

E M B I, see Editora de Musica

E S I (Sadembra), see Fermata

Editora de Musica Brasileira & Internacional SA (EMBI), Rua Teofilo Dtoni 135, 3rd fl., Rio de Janeiro, G.B. Tel (021) 233-3046/2596 Cable EM BISA Gen Mgr Manoel Nenzinho Pinto

Branch: 01205 Sao Paulo, Av. Rio Branco 233, Rm 91 Tel (011) 221 7325

Home office: USA, Peer Southern Drg

Int'l firms represented: Alrhond, Bad Boy/Rare Magnetism, Cedarwood, Combine, Cotillon, Peer Int'l, Southern (all USA)

Emblema Ed., see Equipe

Equipe Producoes Musicais Ltda. (UBC), Rua Sao Francisco Xavier 961, 20000 Rio de Janeiro Tel (021) 284-1332/1992

Falcao Ed. (UBC), Rua Diavolo Correia 202/102, 22291 Urca, Rio de Janeiro Tel (021) 246-7214 Pres. Wilson F. Falcao, Gen Mgr Ilha F. Brito

Int'l firms represented: R. Barbey (Belgium), Beat (Italy)

Int'l reps.: Italy (Beat), Japan (Nicolme), Mexico (Panamic), Portugal (Valentim de Carvalho), Venezuela (Drbe)

Femina Ed. Musicais Ltda., see ITAIPI

Ferman (Ed. Musical), see TC

Fermata do Brasil Ltda. (UBC), Av. Ipiranga 1123, 6th fl., 01039 Sao Paulo Tel (011) 229-3411 Cable FERMA TA BRASIL Pres. Enrique Lebendiger, Gen Mgr. Juvenal Fernandes, Copyright Dept. Neide Martin Alves Pereira, Royalties Dept. Silvia de Divera Espósito

Int'l firms represented: Arista (USA), Bourne (UK), Sidney Bron group (UK), Butterfly (Germany), Chrysalis (UK), Core (Canada), Curci (Italy), EMP (USA), Essex group (UK), Far Dut (USA), Good Flavor (USA), Heathside (UK), Ted Jack (USA), Dick James group (UK), Klatoons (Canada), Love Zager (USA), MCA group (USA), Manicore (UK), Meridian (Germany), Muscle Shoals (USA), Nickle Shoe (USA), Panache (UK), Sands/Barton (USA), Skyhill (USA), Slow Dancing (USA), Virgin (UK)

Int'l reps.: Chile (Fermata), Mexico (Edmusa), Switzerland (Int'l Melodies Geneve), USA (Bendig, Fermata Int'l), Venezuela (Unimusic)

G G Producoes Ltda., see Intersong

Gapa Ltda., see Intersong

Viava Gurreiro (Ed.) (UBC), see Mangione

Helo Ltda. (Ed. Musicais), see Intersong

ITAIPI Uds. Musicais Ltda. (UBC), Rua Mena Barreto 151, Rio de Janeiro Tel (021) 286-1212 Telex (021) 23678 Gen Mgr Marcos Kilzer

Int'l firms represented: ATV (USA), BBC (UK), Big Ben (UK), Big Pig (UK), Big Sky (UK), Chinnichap (UK), Colgems-EMI (USA), Cross Keys (USA), Dwarf (UK), EMI group (UK), Earl Barton (USA), Eaton (UK), Hal Nat (USA), Lupus (UK), MPL Communications (UK), Macaulay (USA), Northern Songs (USA), Durr (UK), Queen (UK), RAK (UK), Ram's Horn (UK), Red Bus (UK), Rondor (USA), Screen Gems EMI (USA), Special Rider (UK), Tree (USA), Wizard (UK)

Int'l rep.: Worldwide (EMI group)

Indus Ltda. (Ed. de Musica) (SBACEM), see Editora de Musica

Intersong Ltda. (Eds.), Av. Rio Branco 277, Grupo 708/710, 20047 Rio de Janeiro Tel (021) 220-2421 Cable EDISINTER Gen Mgr Jose Loureiro, Intersong Catalogs Prof Mgr Carlos Celles Silva, Chappell Catalog Prof Mgr Cecilia MacDowell

Int'l firms represented: ATV, Acuf Rose, Baarn Bicycle, Big Apple, Bregman, Vocco & Conn, Cafe Americana, Carlin, Chappell, Chicago Group, Famous, Fuse, Gentoo, Hanna Barbera, T B Harms, Health Levy, Hit & Run, Hudson Bay, Island, Kamakazi, Lowery, Magnet, Man Ken, Midsong, Edwin H. Morris, RSD, Ricks, Spellgood, 20th Century

Int'l reps.: Worldwide (Chappell, Intersong)

Irmaso Vitale SA, Rua Franco Pinto 42, Sao Paulo

Japer (Ed. Musical), see TC

Jequibau (SICAM), see Fermata

Latino Americana de Musica Elam (Ed.) Ltda., see Mundo Musical

Latino Ed. Musical Ltda. (SICAM), Av. do Estado 4667, 01515 Sao Paulo Tel (011) 279-6811 Telex (11) 22329 Chm Alberto Jackson Byington Neto, Mgr Moacyr Minghini Machado, Publ'g Co-ord Antonio Carlos Senefonte

Lenda Producoes & Edicoes Ltda., see ITAIPI

Limar (SICAM), see Fermata

Lotus Ltda. (Eds. Musicais), Rua Tobias do Amaral 46, Cosme Velho, Rio de Janeiro RJ Tel (021) 205 4545 Mgr. Robert Liot Backer

Louca Fina Eds. Musicais Ltda., see ITAIPI

Luciana Ltda. (Ed. Musical) (UBC), see Sigem

Lyra Ltda. (Ed. de Musica) (Sadembra), see Editora de Musica

M C A do Brasil Ed. Musical Ltda., Rua Aurora 964, 01209 Sao Paulo Tel (011) 222-0273 Cable EDITAMUS

Home office: USA

Int'l firms represented: Belwin Mills (USA), Big Pig (UK), Groovy (UK), Isaye (Belgium), Joaneline (USA), Kalmus (USA), Leeds (USA), MAM (UK), Melane (UK), Northern (USA), Shaftesbury (UK), Spanka (USA), Threshold (UK), Valley (UK)

Int'l rep.: Worldwide (MCA)

M D K Music Ltd. (SICAM), Caixa Postal 13030, CEP 01000 Sao Paulo SP, Rua Parque da Fonte 194, CEP 02345 Barro Branco, Sao Paulo SP Tel (011) 203 6692, 204-1607 Pres. Malcolm Kiger

Int'l branch: USA

Int'l firms represented: Apanacea, Art in Space, Birthright, Bodi, Chinwah Songs, Dirty Martha, Early Bird, Edwood, Good Lovin, Gudi, House of Talley, Lambourne, Lantana, Marullo, Mid-America, Music Designers, New Chatham, James P. D'Brock & Boot, Provo, Glenn Regan, Shelvew, Spaceark, George W. Strih, Stonebass, Till Cron, Vibration, Whalebone (all USA), Centraum, Montrose (both Canada), BC (UK), Beat (Italy), Bixio (Italy), Hans Geric (Germany), West (Italy)

Int'l reps.: Argentina (BS Producciones), Canada (Unidisc/Univwave), Finland (Gold Disc), Mexico (Edmusa), UK (BC, DeCastro), Venezuela (Interworld)

Mangione, Filhos & Cia. Ltda., Rua do Duvdor 183, 1st fl., Suites 14 19 a, 20000 Rio de Janeiro ZC-00, Tel (021) 242 3223/3698 Cable EDIZMANGIONE Pres. Estevam Scavanga Mangione, Gen Mgr. Maria Lúcia S. Mangione, Prof Mgr. Estevam S. Mangione

Int'l firm represented: Bizet (Belgium)

Int'l reps.: Belgium (Bizet), Japan (Unl), Portugal (Oris)

Marajo, see Fermata

Marajoara Ed. Musicais Ltda., see ITAIPI

Melodias Americanas (UBC), see Fermata

Melograf (Ed. Ltda.), see Mundo Musical

Meridional Ed. Musicais Ltda. (SICAM), Rua Eugenia S Vitale 173, R. Ramos Sao Bernardo do Campo-SP Tel (011) 457 5344 Telex (011) 4240 Dr. Diavolo A Branco, Gen Mgr. Antonio D Santos

Int'l firms represented: Televs (Italy), UA/Big 3 (USA)

Int'l reps.: France (Vogue), Italy (Televs)

Meridional (UDSA) Music Corp., see Meridional

Moleque Ed. Musicais Ltda., see ITAIPI

Morumbi Ltda. (Ed.) (SICAM), see Intersong

Mundo Musical Ltda. (Ed.) (div. of CBS), Rua Buenos Aires 2, 16th fl., 20000 Rio de Janeiro Tel (021) 231-2957 Cable SAMIRE Gen Mgr Roterdam Salomao

Int'l firms represented: Blackwood, Burlington, Chandos, Fourth Floor, Fulness Music/Gabriel Eall, Garrett, Kool, Lowery, Robert Mellin, Miles Ahead, Naccyo, Paul Simon, Strong Arm, Tuna Fish, Venice (all USA)

Int'l rep.: USA (CBS group)

Musica Brasileira Moderna (UBC), see Fermata

Musicolor Ed. Musical Ltda. (SADEMBRA), Av. do Estado 4667, 01515 Sao Paulo Tel (011) 279-6811 Telex (11) 22329 Chm. Alberto Jackson Byington Neto, Mgr Moacyr Minghini Machado, Publ'g Co-ord Antonio Carlos Senefonte

Musrara Ed. Musical Ltda., see MCA

Arthur Napoleao (UBC), see Fermata

Nossa Terra (UBC), see Fermata

Nova Musica Ltda., see Top Tape

Novo Rumo Ltda. (Ed. Musical) (Sadembra), see Sigem

One Way Prod'ns Ed. Ltda. (Sadembra), see Top Tape

Dros Ed. & Producoes Artisticas Ltda., see ITAIPI

Peer-Southern Drg., see EMBI

Pergola Ltda. (Ed. Musicais), see Intersong

Pipoca (Eds) Ltda., see Intersong

Bruno Quano Material Cultural Ltda. (UBC), Rua Joao Afonso 15, Rio de Janeiro Tel (011) 246-7993 Cable QUAINO Pres. Bruno Quano, Gen Mgr. Danilo Rocha, Prof. Mgr. Tania Regina G. De Souza

Int'l firms represented: (Classical catalogs only) Paul Beuschler (France), Chappell (UK), Choudens (France), George Delneuf (France), Durand & Cia. (France), Enoch & Cia. (France), Max Eschig (France), Jobert (France), Heugel & Cie. (France), Alphonse Leduc (France), Rdeau Rouge (France), Tonos (Germany)

R C A Jagure Ltda. (Ed. Musical), see Victor

R C A Leme Ltda. (Ed. Musical), see Victor

R C A Ltda. (Ed. Musical), see Mangione

Red Lips (Ed.) (SICAM), see Mangione

Rio Musical (UBC), see Fermata

Santos Dumont (UBC), see Fermata

Saturno Ltda. (Ed. Musicais), see Intersong

Scorpius Musica Ltda. (Sicam), see Top Tape

Seresta (Sadembra), see Fermata

7 Notas Ltda. (Ed. Musicais), see Meridional

Sidomar (SICAM), see Fermata

Sigem (Sistema Globo de Edicoes Musicais Ltda.) Rua Joao Afonso 15, Botafogo, Rio de Janeiro Tel (011) 286-3846 Cable SIGEM Telex (21) 22795 Pres. Bruno Quano, Gen Mgr. Danilo Rocha, Prof. Mgr. Tania Regina G. De Souza

Branch: Sao Paulo, Av. Angelica 501 Tel. (021) 826 1130, 664336 Mgr. Claudette Aparecida de Faria

Int'l branches: Argentina (Trompos), France, USA

Int'l reps.: Argentina (Relay), France (You You), Germany (Tropical), Italy (Sugar), Japan (Top), Portugal (Valentim de Carvalho), Sweden (Sweden), Spain (Notas Magicas), UK (Belsize)

Sonata (SICAM), see Fermata

Step Five Sul Americana (UBC), see Fermata

Studio Hara Eds. Musicais Ltda. (UBC), Rua Joaquin Silva 56, 5th fl., Rio de Janeiro Tel (021) 222 0972 Dir. Nilo S. Pinto, Gen Mgr. Ruth de Castro Savaget

Sugarmusic do Brasil, Ltd. (Ed.) (UBC), Edif. Avenida Central Sala 627, Av. Rio Branco 156, Rio de Janeiro Tel (021) 262-0968 Cable CDPYGAN Contact H. Gandelman Esq.

Home office: Italy

T C Ltda. (Ed. Musical) (SICAM), Rua Aguilar Moreira 639, 20000 Rio de Janeiro Tel (021) 230-5469 Cable TAPECAR Dir. Manuel Valls Camero, Gen. Mgr. Paulo Roberto C. Araujo

Int'l reps.: Germany (Hanseatic), Mexico (Edmusa), USA (Elbomo & Tomeja)

Talismã Ed. Musical Ltda. (SICAM), Rua Aurora 983, Cj. 72, 01209 Sao Paulo Tel (011) 222 2989 Pres: Victor Seltam, Assessor George Mello Salles

Tapajós Ed. Musicais Ltda., see ITAIPI

Tapacar (Ed. Musical), see TC

Tecla Ltda. (Ed. de Musica) (SICAM), see Editora de Musica

Templo Ed. Musicais Ltda., see ITAIPI

Terra Plana (UBC), see Fermata

Top Tape (Grupo Ed.), Rua Alice 97, Laranjeiras, 20000 Rio de Janeiro ZC 01 Tel (021) 245 3515 Cable MUSITDP Dir. Joel B. Leibovitz, Gen. Mgr. Roterdam Salomao

Int'l firms represented: At Home, Black Bull, Boca, Equinox, Four Knights, Hibiscus, Jobete group, Joyfully Sad, Lowery, Rip Keca, Raton, Wild Flowers (all USA), AA (Belgium), Paris Tour Eiffel (France)

Torres, see Fermata

Tres Pontas Ed. Musicais Ltda., see ITAIPI

Tres Simbolos Ed. Musical Ltda. (UBC), Av. do Estado 4667, 01515 Sao Paulo Tel (011) 279 6811 Telex (11) 22329 Chm Alberto Jackson Byington Neto, Mgr Moacyr Minghini Machado, Publ'g Co-ord Antonio Carlos Senefonte

Tropisong Gravacoes Musicais Ltd., Oscar Freire 1061, 01426 Sao Paulo Tel (011) 282 0200 Pres. & Prof. Mgr. Jose Carlos Silvestre; Gen Mgr. Morris Roice

Int'l firm represented: Musictape (Argentina)

Int'l reps.: Argentina (Musictape, Pub. Sadac), Italy (Bixio, Eleven)

Victor Ltda. (Ed. Musical) (UBC), Rua Barata Ribeiro 181, Loja 1, 20000 Rio de Janeiro Tel (021) 255 1069 Cable BRARCA Telex (021) 22714 Mng. Dir. Adolfo Pino, Gen. Mgr. Dmar Leite Jundi

Int'l firms represented: Acapulco (Mexico), Antisna (USA), Ariola America (USA), Associated (Australia), Big Seven (USA), CAM (USA), Camerica (USA), Cames (USA), Can't Stop (USA), Clandalee (USA), Compass (Netherlands), Cyclus (Germany), Dizzy Heights (UK), Edim (Mexico), Edmusa (Mexico), 57th Street (USA), Gesterne (Netherlands), Global (Japan), Green Mountain (USA), Interworld (USA), Kidada (USA), Kiss Songs (USA), Ledacian (USA), Metal Machine (USA), Ivan Moguli (USA), Naked Snake (USA), Dakfield Avenue (USA), Page Full D Hts (UK), Planetary (USA), Polar (Sweden), RCA (France, Italy, Spain), RCA Int'l (USA), Rashida (USA), Relay (Argentina), Rocket (UK), Saber Tooth (USA), Scorpio/Black Scorpio (France), Scott Tone (USA), Scott-Wolfe

(UK), Six Continents (USA), Street Music (UK), Sunbury (UK), Sunbury/Dunbar (Canada), Thomas Fund (USA), US Arabella (USA), Union Songs (Sweden), Valgroup (USA), World Song (USA)

Int'l reps.: Argentina (Relay), Australia (Associated), Belgium (Universal Songs), Bolivia (Inbolon), Canada (Sunbury/Dunbar), Chile (SIAE), Colombia (Sonulux), Denmark (EMI), Ecuador (Drama), France (RCA), Germany (Cyclus), Italy (RCA), Japan (Global), Mexico (Edim), Netherlands (Universal Songs), Peru (SIAE), Portugal (Teletra), Spain (RCA), Switzerland (Melodie), UK (Sunbury), USA (Interworld), Venezuela (Unimusic)

Warner Bros Ltda. (Eds. Musicais) (UBC), Rua Itapava 44, Jardim Botânico, 20000 Rio de Janeiro Tel (021) 246-2215 Mng. Dir. Andre Midani, Sr VP Michael Gregory

Int'l firms represented: Curtom (USA), T B Harms (USA), Viva (UK), WB (USA), Warner Bros (UK, USA), Warner Tamerlane (USA), M. Witmark (USA)

• services

ASSOCIATIONS & PROFESSIONAL ORGANIZATIONS

Associação Brasileira dos Produtores de Discos, Rua Sao Jose 90, Rms. 1406/10, Rio de Janeiro Tel (021) 263 6377

Museu Villa Lobos, Ministerio da Educacao & Cultura, Palácio da Cultura, Rua da Imprensa 16, Rm 913, 20030 Rio de Janeiro CEP Tel 220 2139/4339 Dir. Arminha Villa Lobos

CATALOG SERVICES

Tropisong Gravacoes Musicais Ltda., Oscar Freire 1061, 01426 Sao Paulo Tel (011) 282-0200 Pres. Jose Carlos Silvestre (Rec. & Tape)

DESIGN & ARTWORK

Lidervideo Comunicacao Audiovisual SA, Rua da Assembleia 58, 12th fl., 20000 Rio de Janeiro Tel (021) 231-0327, 232-9047. Pres. Antonio Luiz Mendes de Almeida, Gen. Mgr. Ricardo Jorge Nick, Sales Mgr. Helio Nogueira, Development Mgr. Gustavo Moraes Rego

PolyGram Discos Ltda., Av. Rio Branco 311, 4th fl., 20000 Rio de Janeiro Tel (021) 220 9222 Mng. Dir.: Antonio Coelho Ribeiro

Tapacar Gravacoes SA, Rua Aguilar Moreira 639, 20000 Rio de Janeiro Tel (021) 280 5282 Pres. Manuel Valls Camero, VP Fernando de Araujo Neves, Plant Dir. & Sales Mgr. Ademir Pereira

LICENSING ORGANIZATIONS, MUSIC

S B A C E M (Sociedade Brasileira de Autores, Compositores & Escritores de Musica), Praca Mahatma Gandhi 2, 709-710 Cinelandia, 20018 Rio de Janeiro CEP Tel (021) 220-5935/3635 Pres. Adelino Moreira de Castro, First Sec'y Tito Da Silva Mendes

S B A T (Sociedade Brasileira de Autores Teatrais), Av. Almirante Barroso 97, 3rd fl., Rio de Janeiro Tel (021) 221-4464/4844 Superintendent Djalma Bittencourt (Represents the interests of BMI & SESAC)

S I A E, Rua Evaristo da Veiga 35, Rio de Janeiro, Tel (021) 222 7219 (Mechanical rights only)

S I C A M (Sociedade Independente de Compositores & Autores Musicais), Largo Passandunú 51, 10th 16th fls., 01034 Sao Paulo, Tel (011) 223 8555 Cable MUSAUDTRES Pres. Adilson Teixeira de Godoy (Mechanical & performing rights)

U B C (Uniao Brasileira de Compositores), Rua Visconde Inhauma 134, 7th fl., Rio de Janeiro Tel 233 0222

Bill Cosby says:
“Red Cross
does those 101
community
jobs nobody
seems to have
time for.”

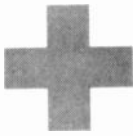
American Red Cross

A Public Service of This Magazine & The Advertising Council

LICENSOR, RECORD & TAPE

Tropisong Gravações Musicais Ltda., Oscar Friere 1061, 01426 Sao Paulo. Tel: (011) 282-0200. Pres.: Jose Carlos Silvestre.

PLATING, PROCESSING & PRESSING PLANTS

Companhia Ind'l de Discos, Rua 7 de Marco 331, Bonsucesso, 21040 Rio de Janeiro. Tel: (021) 280-9222. Cable: CIDISCO5. Telex: (021) 30043. Pres.: Hermann Zuckermann; VP Int'l: Harry Zuckermann; Gen. Mgr.: Rodolfo Zuckermann.

E.M.I. Odeon Fonografica Industrial & Elettronica SA, Caixa Postal 2752, Zone 20000, Rua Mena Barreto 151, Botafogo, 22271 Rio de Janeiro. Tel: (021) 286-1212. Cable: TURNTABLE. Mng. Dir.: Rolf Dihmann; Studio Mgr.: Zoltan Merky; Pressing Plant Mgr.: Flavio P. Magri.

Gravações Eletricas SA, Av. do Estado 4667, 01515 Sao Paulo. Tel: (011) 279-6811. Telex: (11) 22329. Chm.: Alberta Jackson Byington Neto; Mng. Dir.: Hans H. Paul Beugger; Comm'l Mgr.: Moacyr Minghini Machado.

PolyGram Discos Ltda., Av. Rio Branco 311, 4th fl., 20000 Rio de Janeiro. Tel: (021) 220-9222. Mng. Dir.: Antonio Coelho Ribeiro. (Pressing only)

RCA Elettronica Ltda., Av. Engenheiro Billings 2227, Sao Paulo. Tel: (011) 268-2133. Pres.: Adolfo Pino; Ind'l Mgr.: Marco Antonio Altamini.

RGE (Comercial Fonografica) Ltda., Pca. Paqueta Martins 138, Sao Paulo. Tel: (011) 825-9377

Som Industria & Comercio SA, Rua Eugenia S. Vitale 173, R. Ramos Sao Bernardo do Campo-SP. Tel: (011) 457-5344. Cable: SOMDISCOS. Telex: (011) 4240. Pres.: Adiel Macedo de Carvalho; Mng. Dir.: Olavo A. Bianco; Gen. Mgr.: Gunter Csasznik; Plant Mgr.: Joao F. Blumenschein; Sales Mgr.: Rosvaldo Cury.

Tapcar Gravações SA, Rua Aguiar Moreira 639, 20000 Rio de Janeiro. Tel: (021) 280-5282. Pres.: Manuel Valls Camero; VP: Fernando de Araujo Neves; Plant Dir. & Sales Mgr.: Ademir Pereira.

WEA Discos Ltda., INA Diadema, Rua Ruyce Frires Alvim, 975 Sao Paulo. Tel: (011) 456-3866. Plant Mgr.: Ademir Bellardi.

PRINTERS & LITHOGRAPHERS

Companhia Ind'l de Discos, Rua 7 de Marco 331, Bonsucesso, 21040 Rio de Janeiro. Tel: (021) 280-9222. Cable: CIDISCO5. Telex: (021) 30043. Pres.: Herman Zuckermann; VP Int'l: Harry Zuckermann; Gen. Mgr.: Rodolfo Zuckermann.

Lidervideo Comunicacao Audiovisual SA, Rua Assembleia 58, 12th fl., 20000 Rio de Janeiro. Tel: (021) 231-0327, 2-2-9047. Pres.: Antonio Luiz Mendes de Almeida; Gen. Mgr.: Ricardo Jorge Nick; Sales Mgr.: Hedio Nogueira; Development Mgr.: Gustavo Moraes Rego.

Som Industria & Comercio SA, Rua Eugenia S. Vitale 173, R. Ramos; Sao Bernardo do Campo-SP. Tel: (011) 457-5344. Cable: SOMDISCOS. Telex: (011) 4240. Pres.: Adiel Macedo de Carvalho; Mng. Dir.: Olavo A. Bianco; Gen. Mgr.: Gunter Csasznik; Plant Mgr.: Joao F. Blumenschein; Sales Mgr.: Rosvaldo Cury.

Tapcar Gravações SA, Rua Aguiar Moreira 639, 20000 Rio de Janeiro. Tel: (021) 280-5282. Pres.: Manuel Valls Camero; VP: Fernando de Araujo Neves; Plant Dir. & Sales Mgr.: Ademir Pereira.

RECORD PROMOTION

Tapcar Gravações SA, Rua Aguiar Moreira 639, 20000 Rio de Janeiro. Tel: (021) 280-5282. Pres.: Manuel Valls Camero; VP: Fernando de Araujo Neves; Plant Dir. & Sales Mgr.: Ademir Pereira.

Tropisong Gravações Musicais Ltda., Oscar Friere 1061, 01426 Sao Paulo. Tel: (011) 282-0200. Pres.: Jose Carlos Silvestre.

TAPE CUSTOM DUPLICATORS

TAPE PACKAGING & LABELING

The Audio and Video lines indicate the configurations which the firms duplicate. Companies which offer packaging and labeling of tape product are indicated by "(PKG)" which appears after the main body of their respective listings.

A P G Elettronica SA, Rua Funchal 314, 04551 Sao Paulo. Tel: (011) 210-4755, 211-9721, 212-4337. Telex: (011) 24278. Pres.: Sebastiao R. Bastos, Superintendent: William Schaefer Jr., Consumer Sales Mgr.: Richard Banfield; Industrial Sales Mgr.: Maria Antonieta Chalmers. Audio: 8 tr., cassette.

E.M.I. Odeon Fonografica Industrial & Elettronica SA, Caixa Postal 2752, Zone 20000, Rua Mena Barreto 151, Botafogo, 22271 Rio de Janeiro. Tel: (021) 286-1212. Cable: TURNTABLE. Mng. Dir.: Rolf Dihmann; Studio Mgr.: Zoltan Merky. Audio: Cassette.

Lidervideo Comunicacao Audiovisual SA, Rua da Assembleia 58, 12th fl., 20000 Rio de Janeiro. Tel: (021) 231-0327, 232-9047. Pres.: Antonio Luiz Mendes de Almeida; Gen. Mgr.: Ricardo Jorge Nick; Sales Mgr.: Hedio Nogueira; Development Mgr.: Gustavo Moraes Rego. Videos: 2" open reel, 1" open reel, 1/2" cassette, 1/4" EIAJ open reel, 1/4" EIAJ cartridge.

PolyGram Discos Ltda., Av. Rio Branco 311, 4th fl., 20000 Rio de Janeiro. Tel: (021) 220-9222. Mng. Dir.: Antonio Coelho Ribeiro. Audio: Cassette.

RGE (Comercial Fonografica) Ltda., Pca. Paqueta Martins 138, Sao Paulo. Tel: (011) 825-9377

Som Industria & Comercio SA, Rua Eugenia S. Vitale 173, R. Ramos Sao Bernardo do Campo-SP. Tel: (011) 457-5344. Cable: SOMDISCOS. Telex: (011) 4240. Pres.: Adiel Macedo de Carvalho; Mng. Dir.: Olavo A. Bianco; Gen. Mgr.: Gunter Csasznik; Plant Mgr.: Joao F. Blumenschein; Sales Mgr.: Rosvaldo Cury. Audio: Cassette.

Tapcar Gravações SA, Rua Aguiar Moreira 639, 20000 Rio de Janeiro. Tel: (021) 280-5282. Pres.: Manuel Valls Camero; VP: Fernando de Araujo Neves; Plant Dir. & Sales Mgr.: Ademir Pereira (PKG). Audio: Cassette.

Tropisong Gravações Musicais Ltda., Oscar Friere 1061, 01426 Sao Paulo. Tel: (011) 282-0200. Pres.: Jose Carlos Silvestre. Audio: Cassette, open reel.

Tapcar Gravações SA, Rua Aguiar Moreira 639, 20000 Rio de Janeiro. Tel: (021) 280-5282. Pres.: Manuel Valls Camero; VP: Fernando de Araujo Neves; Plant Dir. & Sales Mgr.: Ademir Pereira (PKG). Audio: Cassette.

Tropisong Gravações Musicais Ltda., Oscar Friere 1061, 01426 Sao Paulo. Tel: (011) 282-0200. Pres.: Jose Carlos Silvestre. Audio: Cassette, open reel.

• supplies

CASSETTE PARTS

A P G Elettronica SA, Rua Funchal 314, 04551 Sao Paulo. Tel: (011) 210-4755, 211-9721, 212-4337. Telex: (011) 24278. Pres.: Sebastiao R. Bastos, Superintendent: William Schaefer Jr., Consumer Sales Mgr.: Richard Banfield; Industrial Sales Mgr.: Maria Antonieta Chalmers. Audio: Housings, hubs, pins, press pads, rollers, shields, shims.

Som Industria & Comercio SA, Rua Eugenia S. Vitale 173, R. Ramos Sao Bernardo do Campo-SP. Tel: (011) 457-5344. Cable: SOMDISCOS. Telex: (011) 4240. Pres.: Adiel Macedo de Carvalho; Mng. Dir.: Olavo A. Bianco; Gen. Mgr.: Gunter Csasznik; Plant Mgr.: Joao F. Blumenschein; Sales Mgr.: Rosvaldo Cury.

EMPTY CARTRIDGES, CASSETTES & REELS

A P G Elettronica SA, Rua Funchal 314, 04551 Sao Paulo. Tel: (011) 210-

4755, 211-9721, 212-4337. Telex: (011) 24278. Pres.: Sebastiao R. Bastos, Superintendent: William Schaefer Jr., Consumer Sales Mgr.: Richard Banfield; Industrial Sales Mgr.: Maria Antonieta Chalmers. Audio: Cassette.

Plajet Industria & Comercio de Plasticos Ltda., Av. Rio Branco 156, Gr. 2110, Centro, CEP 20043 Rio de Janeiro. Tel: (021) 262-4595. Telex: (021) 21388. Contact: M. Amir. Audio: Cassette.

Polyethylene Bags Sleeves Som Industria & Comercio SA, Rua Eugenia S. Vitale 173, R. Ramos Sao Bernardo do Campo-SP. Tel: (011) 457-5344. Cable: SOMDISCOS. Telex: (011) 4240. Pres.: Adiel Macedo de Carvalho; Mng. Dir.: Olavo A. Bianco; Gen. Mgr.: Gunter Csasznik; Plant Mgr.: Joao F. Blumenschein; Sales Mgr.: Rosvaldo Cury.

POLYETHYLENE BAGS SLEEVES

Som Industria & Comercio SA, Rua Eugenia S. Vitale 173, R. Ramos Sao Bernardo do Campo-SP. Tel: (011) 457-5344. Cable: SOMDISCOS. Telex: (011) 4240. Pres.: Adiel Macedo de Carvalho; Mng. Dir.: Olavo A. Bianco; Gen. Mgr.: Gunter Csasznik; Plant Mgr.: Joao F. Blumenschein; Sales Mgr.: Rosvaldo Cury.

LABELS, DISK

Tapcar Gravações SA, Rua Aguiar Moreira 639, 20000 Rio de Janeiro. Tel: (021) 280-5282. Pres.: Manuel Valls Camero; VP: Fernando de Araujo Neves; Plant Dir. & Sales Mgr.: Ademir Pereira.

PROFESSIONAL TAPE SUPPLIES

A P G Elettronica SA, Rua Funchal 314, 04551 Sao Paulo. Tel: (011) 210-4755, 211-9721, 212-4337. Telex: (011) 24278. Pres.: Sebastiao R. Bastos, Superintendent: William Schaefer Jr., Consumer Sales Mgr.: Richard Banfield; Industrial Sales Mgr.: Maria Antonieta Chalmers. Product: Duplicating & mastering tape, Philips boxes.

Plajet Industria & Comercio de Plasticos Ltda., Av. Rio Branco 156, Gr. 2110, Centro, CEP 20043 Rio de Janeiro. Tel: (021) 262-4595. Telex: (021) 21388. Contact: M. Amir. Audio: Norelco boxes.

RECORD MANUFACTURING EQUIPMENT

RCA Elettronica Ltda., Av. Engenheiro Billings 2227, Sao Paulo. Tel: (011) 268-2133. Pres.: Adolfo Pino; Ind'l Mgr.: Marco Antonio Altamini. Product: 7" & 12" molds.

TAPE, BLANK LOADED & BULK RAW

A P G Elettronica SA, Rua Funchal 314, 04551 Sao Paulo. Tel: (011) 210-4755, 211-9721, 212-4337. Telex: (011) 24278. Pres.: Sebastiao R. Bastos, Superintendent: William Schaefer Jr., Consumer Sales Mgr.: Richard Banfield; Industrial Sales Mgr.: Maria Antonieta Chalmers. Audio: Cassette, open reel.

Brand names: Blank-Ampex, Hitec, XHF, Raw-Ampex. B A S F Brasileira SA, Av. Sao Luis 86, 01000 Sao Paulo. Tel: (011) 257-0011. Telex: 1122745. Magnetic Prods. Div. Gen. Mgr.: Hector Urbina; Sales Mgr.: Mauricio Parise; Prod. Mgr.: Joao Carlos Gaya. Audio: Cassette & open reel.

Video: 1" open reel & 1/2" cassette. Som Industria & Comercio SA, Rua Eugenia S. Vitale 173, R. Ramos Sao Bernardo do Campo-SP. Tel: (011) 457-5344. Cable: SOMDISCOS. Telex: (011) 4240. Pres.: Adiel Macedo de Carvalho; Mng. Dir.: Olavo A. Bianco; Gen. Mgr.: Gunter Csasznik; Plant Mgr.: Joao F. Blumenschein; Sales Mgr.: Rosvaldo Cury. (Blank only) Audio: Cassette.

Brand names: Audiomasters, Pop Sound, TK7. Tape Duplicating & Processing Equipment Audiopro Ltda. (Ceal) Som & Educacao, Rua Bolivar 54, Rio de Janeiro. Tel: (021) 235-0424.

• accessories

manufacturers

A P G Elettronica SA, Rua Funchal 314, 04551 Sao Paulo. Tel: (011) 210-4755, 211-9721, 212-4337. Telex: (011) 24278. Pres.: Sebastiao R. Bastos, Superintendent: William Schaefer Jr., Consumer Sales Mgr.: Richard Banfield; Industrial Sales Mgr.: Maria Antonieta Chalmers. Product: Tape-head cleaners, demagnetizers, leader tape.

B A S F Brasileira SA, Av. Sao Luis 86, 01000 Sao Paulo. Tel: (011) 257-0011. Telex: 1122745. Magnetic Prods. Div. Gen. Mgr.: Hector Urbina; Sales Mgr.: Mauricio Parise; Prod. Mgr.: Joao Carlos Gaya. Product: Tape-leader & splicing tape.

Som Industria & Comercio SA, Rua Eugenia S. Vitale 173, R. Ramos Sao Bernardo do Campo-SP. Tel: (011) 457-5344. Cable: SOMDISCOS. Telex: (011) 4240. Pres.: Adiel Macedo de Carvalho; Mng. Dir.: Olavo A. Bianco; Gen. Mgr.: Gunter Csasznik; Plant Mgr.: Joao F. Blumenschein; Sales Mgr.: Rosvaldo Cury. Product: Record-carrying & storage cases; Tape-carrying & storage cases, head cleaners.

Tapcar Gravações SA, Rua Aguiar Moreira 639, 20000 Rio de Janeiro. Tel: (021) 280-5282. Pres.: Manuel Valls Camero; VP: Fernando de Araujo Neves; Plant Dir. & Sales Mgr.: Ademir Pereira. Product: Record-record care prods.; Tape-head cleaners, demagnetizers, leader & splicing tape.

Tapcar Gravações SA, Rua Aguiar Moreira 639, 20000 Rio de Janeiro. Tel: (021) 280-5282. Pres.: Manuel Valls Camero; VP: Fernando de Araujo Neves; Plant Dir. & Sales Mgr.: Ademir Pereira. Product: Record-record care prods.; Tape-head cleaners, demagnetizers, leader & splicing tape.

Tapcar Gravações SA, Rua Aguiar Moreira 639, 20000 Rio de Janeiro. Tel: (021) 280-5282. Pres.: Manuel Valls Camero; VP: Fernando de Araujo Neves; Plant Dir. & Sales Mgr.: Ademir Pereira. Product: Record-record care prods.; Tape-head cleaners, demagnetizers, leader & splicing tape.

Tapcar Gravações SA, Rua Aguiar Moreira 639, 20000 Rio de Janeiro. Tel: (021) 280-5282. Pres.: Manuel Valls Camero; VP: Fernando de Araujo Neves; Plant Dir. & Sales Mgr.: Ademir Pereira. Product: Record-record care prods.; Tape-head cleaners, demagnetizers, leader & splicing tape.

Tapcar Gravações SA, Rua Aguiar Moreira 639, 20000 Rio de Janeiro. Tel: (021) 280-5282. Pres.: Manuel Valls Camero; VP: Fernando de Araujo Neves; Plant Dir. & Sales Mgr.: Ademir Pereira. Product: Record-record care prods.; Tape-head cleaners, demagnetizers, leader & splicing tape.

Tapcar Gravações SA, Rua Aguiar Moreira 639, 20000 Rio de Janeiro. Tel: (021) 280-5282. Pres.: Manuel Valls Camero; VP: Fernando de Araujo Neves; Plant Dir. & Sales Mgr.: Ademir Pereira. Product: Record-record care prods.; Tape-head cleaners, demagnetizers, leader & splicing tape.

Tapcar Gravações SA, Rua Aguiar Moreira 639, 20000 Rio de Janeiro. Tel: (021) 280-5282. Pres.: Manuel Valls Camero; VP: Fernando de Araujo Neves; Plant Dir. & Sales Mgr.: Ademir Pereira. Product: Record-record care prods.; Tape-head cleaners, demagnetizers, leader & splicing tape.

Tapcar Gravações SA, Rua Aguiar Moreira 639, 20000 Rio de Janeiro. Tel: (021) 280-5282. Pres.: Manuel Valls Camero; VP: Fernando de Araujo Neves; Plant Dir. & Sales Mgr.: Ademir Pereira. Product: Record-record care prods.; Tape-head cleaners, demagnetizers, leader & splicing tape.

Tapcar Gravações SA, Rua Aguiar Moreira 639, 20000 Rio de Janeiro. Tel: (021) 280-5282. Pres.: Manuel Valls Camero; VP: Fernando de Araujo Neves; Plant Dir. & Sales Mgr.: Ademir Pereira. Product: Record-record care prods.; Tape-head cleaners, demagnetizers, leader & splicing tape.

Tapcar Gravações SA, Rua Aguiar Moreira 639, 20000 Rio de Janeiro. Tel: (021) 280-5282. Pres.: Manuel Valls Camero; VP: Fernando de Araujo Neves; Plant Dir. & Sales Mgr.: Ademir Pereira. Product: Record-record care prods.; Tape-head cleaners, demagnetizers, leader & splicing tape.

Tapcar Gravações SA, Rua Aguiar Moreira 639, 20000 Rio de Janeiro. Tel: (021) 280-5282. Pres.: Manuel Valls Camero; VP: Fernando de Araujo Neves; Plant Dir. & Sales Mgr.: Ademir Pereira. Product: Record-record care prods.; Tape-head cleaners, demagnetizers, leader & splicing tape.

Tapcar Gravações SA, Rua Aguiar Moreira 639, 20000 Rio de Janeiro. Tel: (021) 280-5282. Pres.: Manuel Valls Camero; VP: Fernando de Araujo Neves; Plant Dir. & Sales Mgr.: Ademir Pereira. Product: Record-record care prods.; Tape-head cleaners, demagnetizers, leader & splicing tape.

Tapcar Gravações SA, Rua Aguiar Moreira 639, 20000 Rio de Janeiro. Tel: (021) 280-5282. Pres.: Manuel Valls Camero; VP: Fernando de Araujo Neves; Plant Dir. & Sales Mgr.: Ademir Pereira. Product: Record-record care prods.; Tape-head cleaners, demagnetizers, leader & splicing tape.

Tapcar Gravações SA, Rua Aguiar Moreira 639, 20000 Rio de Janeiro. Tel: (021) 280-5282. Pres.: Manuel Valls Camero; VP: Fernando de Araujo Neves; Plant Dir. & Sales Mgr.: Ademir Pereira. Product: Record-record care prods.; Tape-head cleaners, demagnetizers, leader & splicing tape.

Tapcar Gravações SA, Rua Aguiar Moreira 639, 20000 Rio de Janeiro. Tel: (021) 280-5282. Pres.: Manuel Valls Camero; VP: Fernando de Araujo Neves; Plant Dir. & Sales Mgr.: Ademir Pereira. Product: Record-record care prods.; Tape-head cleaners, demagnetizers, leader & splicing tape.

Tapcar Gravações SA, Rua Aguiar Moreira 639, 20000 Rio de Janeiro. Tel: (021) 280-5282. Pres.: Manuel Valls Camero; VP: Fernando de Araujo Neves; Plant Dir. & Sales Mgr.: Ademir Pereira. Product: Record-record care prods.; Tape-head cleaners, demagnetizers, leader & splicing tape.

Tapcar Gravações SA, Rua Aguiar Moreira 639, 20000 Rio de Janeiro. Tel: (021) 280-5282. Pres.: Manuel Valls Camero; VP: Fernando de Araujo Neves; Plant Dir. & Sales Mgr.: Ademir Pereira. Product: Record-record care prods.; Tape-head cleaners, demagnetizers, leader & splicing tape.

• services

ASSOCIATIONS & PROFESSIONAL ORGANIZATIONS

National Committee of the Int'l Music Council, c/o Bulgarian Composers' Union, 2 ul Ivan Vazov, Sofia. Union of Bulgarian Composers, 2 ul Ivan Vazov, Sofia. Cable: COMPOSITORI. Union of Musicians in Bulgaria, Alabin 52, Sofia.

DESIGN & ARTWORK

PLATING, PROCESSING & PRESSING PLANT

PRINTER & LITHOGRAPHER

TAPE CUSTOM DUPLICATOR

Balkanton Recs., 6 Haydoushka Polyana St., 1612 Sofia. Tel: 52-54-51, 51-86-27. Gen. Dir.: Alexander Yossifov; Gen. Mgr.: Konstantin Dragnev; Sales Mgr.: Marko Issakov; Sound Rec'g Mgr.: Mikhail Bojerianov.

CANADA

Population: 23,680,000. Rate of exchange: \$1 (US) = \$1.20 (Canadian). Holidays: January 1, Good Friday, Easter Monday, May 19 (Victoria Day & Queen's Birthday), July 1 (Dominion Day), September 1 (Labor Day), October 13 (Thanksgiving Day), November 11 (Remembrance Day), December 25 (Christmas Day). Additional holidays observed in P.Q. only: Epiphany, Ash Wednesday, Ascension Day, June 24 (St. John Baptiste), All Saints' Day, Conception Day.

RECORDS:

Records sold domestically: LP's 1980-52,395,682 units; 1979-53,860,890 units. Singles 1980-16,750,448 units; 1979-20,735,631 units. Discounting: Frequent.

Type of distribution: Approximately 90% of all distribution operates through manufacturer to sub-distributor (rack jobbers & one stops) to retailer arrangements. The remaining 10% is manufacturer to retailer.

Type of promotion: Radio still stands as the major promotional vehicle in English Canada. Television has some music shows. The major daily newspapers are devoting an increasing amount of space to music coverage. Quebec, which is predominately French speaking, receives complete support from all the media for local and international acts.

TAPE: Pre-recorded tape sold domestically: 8 tr. 1980-5,220,304 units; 1979-10,954,921 units. Cassette 1980-10,206,096 units; 1979-9,020,450 units.

• record & tape manufacturers

A D C 2000 Recs., 125 Dupont St., Toronto, Ont. MSR 1V4. Tel: (416) 961-2000. Pres.: Mike Komar.

A & M Recs. of Canada Ltd., 939 Warden Ave., Scarborough, Ont. M1L 4C5. Tel: (416) 752-7191. Telex: 06-963652. Pres.: Gerry Lacoursiere; Sr. VP & Gen. Mgr.: Joe Summers; VP Promo: Doug Chappell; VP Finance: Gary Hubbard; VP Sales: Bill Ott; Nat'l Promo. Mgr.: Jean Pierre Guilbert; Nat'l Pub. Mgr.: James Monaco; Troubadour Pub. Co-ord.: Lorna Richards; A&R Co-ord.: Michael Godin; Opns. Mgr.: Alex Fedorov; Art Dir.: David Andolf; Local Branch Mgr.: Ray Rosenberg.

Home office: USA. Branches: Calgary, Alta., 6812A Sixth St. SE. Postal Code: T2H 2K4. Tel: (403) 253-8411. Telex: 03-825736. Reg'l Mgr.: Al Harrison; Promo: Randy Wells; Sales: Don Jones, Dan Hobbs-Vancouver, B.C., 100-1334 W. Sixth Ave. Postal Code: V6H 1A7. Tel: (604) 734-7689. Telex: 04-51123. Reg'l Mgr.: Dave Pearce; Promo: David Brian; Sales: Rob Hartle; Mdsq.: Rob Thornton-Winnipeg, Man., 118 Campbell St. Postal Code: R3N 1B2. Tel: (204) 944-1872. Sales & Promo: Tom Jones-Halifax, N.S., PO Box 3504, Halifax, S. Postal Code: B3J 3J2. Tel: (902) 423-6533. Sales: Rudy Eysen-St. Laurent, P.Q., 970 Montee de Liesse, Suite 209. Postal Code: H4T 1W7. Tel: (514) 334-8550. Telex: 05-824709. Promo: Nick Carbone. Mktg.: Richard LaFrance; Sales: Roland & Clement Dufresne.

Labels: (Owned) A&M, (distributed) Artists House, Audiophile, Falcon, Flutbury, Haida, Harmonia, IRS, International Artists, Maze, Penny Farthing, Sloth, Solid Gold, Troubadour.

Int'l repps.: See listing in USA. A R C/Grayson Publ'ns & Rec'gs., PO Box 3044, Vancouver, B.C. V6B 3K5. Tel: (604) 929-7558. Dir.: J. Grayson.

A R C (USA), see CBS. A V I, see Quality.

Avalanche, see Unidisc. Abico, see PolyGram.

Able Recs. Co. Ltd., 450 Beaumont St. E., St. Bruno, P.Q. J3V 2R3. Tel: (514) 653-7838. Pres.: Christian Lefort; Gen. Mgr.: Louis Lefort.

Labels: (Owned) Able, Domino, Eden, Emotion, VIP. Int'l repps.: France (Albatros, BBZ, Delphine, International Shows, Rideau Rouge), USA (Can't Stop, East 83rd Prods).

Acclaim Recs., 3500 Glen Erin Dr., Unit 10, Mississauga, Ont. L5L 1W6. Tel: (416) 828-2582. Pres.: V. J. T. Mataseje; Gen. Mgr.: Stan Campbell.

Ace of Diamonds, see PolyGram. Adelphi, see Phonodisc.

Ades, see Archambault. Mike Adhins Recs., see Mainroads.

Allegro, see Moss. Alouette, see Archambault. Angel, see Capitol.

Anthem Recs. of Canada, c/o Oak Manor, PO Box 1000, 12261 Yonge St., Oak Ridges, Ont. L0G 1P0. Tel: (416) 773-4371. Telex: 06-986530. Chm.: Ray Daniels; Mng. Dir.: Tom Berry; A&R Dir.: Michael Tilka; (Distributed by Capitol).

Apex, see MCA. Aquarius Recs. of Canada Ltd., 354 Yoville St., Montreal P.Q. H2V 2C3. Tel: (514) 284-1001. Telex: 055-60958. Pres.: Terry Flood; P. Dan Lazare; VP Pub. & Adv. Bob Lemm; VP Promo: Don Farleton; Sec'y-Tres.: Jack Lazare; A&R: Bob Rags, Keith Brown. (Distributed by Capitol)

Aquitaine, see CBS. Archambault, see MZ.

Archambault Int. (Ed.), 500 St. Catherine St. E., Montreal, P.Q. H2L 2C6. Tel: (514) 849-6201. Cable: ARCHMUSIC. Co-Proprietor: Rosaire Archambault Sr.; Gen. Mgr.: Rosaire Archambault Jr.; Adv. & Promo: Celine Gravel.

Labels: (Owned) Alouette, Select; (licensed foreign) Studio SM (France);

BULGARIA

Population: 8,865,000. Rate of exchange: \$1 (US) = 0.96 leva. Per capita income: \$3,000. Holidays: January 1, May 1,2 (Labor Days), May 24 (Day of Slavonic Culture), September 9 (Liberation Day), November 7 (October Revolution Day).

• record & tape

manufacturers / distributors / importers

Balkanton Recs., 6 Haydoushka Polyana St., 1612 Sofia. Tel: 52-54-51, 51-86

- (distributed—not licensed) Ades, Assimil Language Courses, Calliope, Chant du Monde, Deesse, Eurodisc, Music For Pleasure, Musidisc, Trianon, Unidisc (France).
- Archiv, see PolyGram.
- Arc Sound Co. Ltd., 142 Sparks Ave., Toronto, Ont. M2H 2V9. Tel: (416) 499-5000.
- Argo, see PolyGram.
- Ariola, see Quality.
- Ariola (Netherlands), see Attic.
- Aris, see Peters Int'l.
- Arista, see Capitol.
- Armageddon, see Attic.
- Artists House, see A&M.
- Assimil Language Courses, see Archambault.
- Asylum, see WEA.
- Atco, see WEA.
- Atlantic, see WEA.
- Atoll, see MZ.
- Attic Recs. Ltd. (IFPI), 98 Queen St. E., Suite 3, Toronto, Ont. M5C 1S6. Tel: (416) 862-0352. Telex: 06-219815. Pres.: Alexander Marr; VP & Sales Mgr.: Tom Williams. (Distributed by CBS).
- Labels: (Owned) Attic, Basement, (licensed foreign) Ariola (Netherlands), Armageddon (UK), F Beat (UK), Global (Germany), Mushroom (Australia), RKM (Netherlands), Rockburgh (UK), Rounder (USA), Safari (UK), Waterhouse (USA).
- Int'l reps.: Australia (RCA), Germany (Teldec), New Zealand (RCA), Scandinavia (Electra), South Africa (Gallo).
- Audat, see World.
- Audiofidelity, see Phonodisc.
- Autophile, see A&M.
- Axe Recs. Ltd., 70 Craighurst Ave., Toronto, Ont. M4R 1J8. Tel: (416) 481-2922. Pres.: Greg Hambleton.
- Label: (Owned) Tuesday.
- B-Sharp Recs., 500 Francois, Suite 111, Montreal, P.Q. H3E 1E4.
- Label: (Licensed) Ripsaw (USA).
- Backstreet, see MCA.
- Banff, see Holborne.
- Bang, see CBS.
- Barclay, see PolyGram.
- Basement, see Attic.
- Bearsville, see WEA.
- Beau Bec (Les Prod'ns) Inc., 1207 Rue St. Andre, Montreal, P.Q. H2L 3S8. Tel: (514) 288-1154.
- Beggar's Banquet, see WEA.
- Bel Air, see Boot.
- Believe in a Dream, see CBS.
- Berandol Recs., 11 St. Joseph St., Toronto, Ont. M4Y 1J8. Tel: (416) 924-8121. Gen. Mgr.: Barbara L. Kroetsch.
- Best Buy, see RCA.
- Big Time, see PolyGram.
- Big Tree, see WEA.
- Birchmount, see Quality.
- Birdwing, see Word.
- Black Sun, see Unidisc.
- Black Tie, see Phonodisc.
- Bluebird, see RCA.
- Bleu Blanc Rouge, see MZ.
- Blue Note, see Capitol.
- Blue Sky, see CBS.
- Boardwalk, see CBS.
- Bobinson, see Production Connection.
- Bomb Recs., 33 Harbor Square, Suite 2626, Toronto, Ont. M5A 3K9. Tel: (416) 362-1661. (Also see Unidisc).
- Labels: (Owned) Bomb; (licensed foreign) Bomb (USA).
- Bomp, see Bomb.
- Boot Recs. Ltd., 1343 Matheson Blvd. W., Mississauga, Ont. L4W 1R1. Tel: (416) 625-2676. Cable: BOOTGROUP. Telex: 06-960-250.
- Int'l branch: USA.
- Labels: (Owned) Boot, Boot Master Concert Series, Cynda, Generation, MDR; (distributed) Bel Air, Harbour, Image, Riot.
- Bouquet, see PCRL.
- Brass, see Unidisc.
- Breakwater, see Phonodisc.
- Bridge, see Chapel/Bridge.
- Buddah, see Quality.
- C A M Canada Ltd./Experience (Les Eds.), 450 E. Beaumont, St. Bruno, P.Q. J3V 2R3. Tel: (514) 653-7838. Telex: 055-60229. Pres.: Christian Lefort; Gen. Mgr.: Louis Lefort.
- C B S Recs. (Canada) Ltd., 1121 Leshe St., Don Mills, Ont. M3C 2J9. Tel: (416) 447-3311. Telex: 06-966792. TWX: (610) 492-1366. Pres.: Bernie DiMatteo; Exec. VP: Jack Robertson; Sr. VP's: Stan Kulin, Brian Josing; VP Finance: Fred Rich; VP Personnel: Glen Lane; Sr. Mktg. Dir.: Graham Powers; Artist & Media Relations: Bill Bannon; Sr. Nat'l Sales Dir.: Don Oates; Creative Servs. Dir.: Maurice Kessel; English A&R Dir.: Jeff Burns; CBS Disques A&R Dir.: Pierre Dubord. Local branch: 5621 Finch Ave. E., Scarborough M1B 2T9. Tel: (416) 298-7700. TWX: (610) 492-1381. Ontario Reg'l Dir.: Garry Newman.
- Branches: Calgary, Alta., 519 Manitou Rd. SE. Postal Code: T2G 4C2. Tel: (403) 287-0823. Western Reg'l Branch Mgr.: D. Bertsch; Western Reg'l Mktg. Mgr.: B. Bondeson; Promo.: K. Zayac—Vancouver, B.C., Century Plaza, Suite 503, 1015 Burrard St. Postal Code: V6Z 1Y5. Tel: (604) 689-8667. Sales: B. Manlove, P. Brown; Promo.: P. Taylor, L. Wilson—Dorval, P.Q., 9245 Cote de Liesse Rd. Postal Code: H9P 2N9. Tel: (514) 631-9073. Eastern Reg'l Mgr.: R. Quintin; Reg'l Mktg. Mgr.: V. D'Amico; Promo.: R. Rattey, R. Ganache.
- Labels: (Owned) Capitol; (licensed domestic) Daffodil, TGO; (licensed foreign) Angel (USA), Arista (USA), Blue Note (USA), Chrysalis (USA), EMI America (USA), Harvest (UK), Liberty (USA), Muse (France), Passport (USA), Pathe (France), Seraphim (USA), United Artists (USA); (distributed—not licensed) Anthem, Aquarus, Grand.
- Capricorn, see PolyGram.
- Carats, see PCRL.
- Caribou, see CBS.
- Carrousel, see RCA.
- Casablanca, see PolyGram.
- Cavalcade, see Phonodisc.
- Celebration, see Quality.
- Celsius, see Trans-Canada.
- Celtic, see Holborne.
- Centennial, see RCA.
- Centre St., see Bruce Thompson.
- Century, see Word.
- Change Recs. Inc., 506 Adelaide St. E., Toronto, Ont. M5A 1N6. Tel: (416) 364-8512. Pres.: Syd Kessler; A&R: Tony Kosinec.
- Labels: (Owned) CRM, Change.
- Int'l reps.: Germany (Siegel/Jupiter), Japan (Watanabe).
- Chant du Monde, see Archambault.
- Chapel/Bridge Recs. (div. of Pacific Press Publ'g Ass'n), PO Box 398, Oshawa, Ont. L1H 7N4. Tel: (416) 579-2311.
- Home office: USA.
- Labels: (Owned) Bridge, Chapel.
- Charisma, see PolyGram.
- Charity, see Intermodal.
- Chiaroscuro, see Phonodisc.
- Chi-Sound, see RCA.
- Chrysalis, see Capitol.
- Circa, see Bruce Thompson.
- Circle, see MZ.
- Clean Cuts, see Phonodisc.
- Cleveland Int'l, see CBS.
- Club Series, see RCA.
- Cotegems, see RCA.
- Columbia, see CBS.
- Columbia Legacy collection, see CBS.
- Columbia Masterworks, see CBS.
- Condor, see Holborne.
- Contact, see MZ.
- Cooking Fat, see Phonodisc.
- Coral, see MCA.
- Cosmic Recs. of Canada, 292 Lorraine Dr., Baire d'Urle, P.Q. H9X 2R1. Tel: (514) 457-5959. Pres. & A&R Dir.: Hugh D. Dixon; VP & Controller: Clementine Dixon; Promo. Co-ord.: C.M.A. van Ogtrop.
- Labels: (Owned) Cosmic, Elevator, Fresh, Happinessville, Pamplousse.
- Cosmos, see Peters Int'l.
- Cotillion, see WEA.
- Country Oak, see Praise.
- Cubbyhole, see Rising.
- Curb, see CBS.
- Cyclade, see MZ.
- Cynda, see Boot.
- O G, see PolyGram.
- D J, see Unidisc.
- D R G, see RCA.
- Daffodil, see Capitol.
- Daitymple, see Phonodisc.
- Damon Prod'n Ltd., 6844 76 Ave., Edmonton, Alta. T6B 0A8. Tel: (403) 465-1071. Telex: 037-3764. Pres. & Prod': Garry L. McDonnell; Sec'y-Treas.: Wallis Petrak. (Distributed by RCA).
- Labels: (Owned) Damon, Mustard, Suite.
- Dark Horse, see WEA.
- Dawn Club, see Sackville.
- Oayspring, see Word.
- Deesse, see Archambault.
- De-Lite, see PolyGram.
- Deram, see PolyGram.
- Dipper 7 Ent's., 1414 Hillside Ave., Suite 101, Victoria, B.C. V8T 2B8. Tel: (604) 595-6709. Owner: Lou Jean Mollin; Gen. Mgr.: Arthur Trolley; Sales Mgr.: Robert Paul Mollin.
- Label: (Owned) Expo.
- Oiscotel, see CBS.
- OiscReet, see WEA.
- Disneyland, see Walt Disney.
- Walt Disney Music Canada Ltd., 270 Rexdale Blvd., Rexdale, Ont. M9W 1R2. Tel: (416) 743-5552. Gen. Mgr.: Jim Rayburn.
- Int'l branch: USA, Disneyland/Vista Recs.
- Labels: (Owned) Disneyland, Vista.
- Omino, see Able.
- Double Helix, see Phonodisc.
- Dove, see Master's Collection.
- Dream, see RCA.
- Dreamland, see PolyGram.
- Dynacom Communications Int'l, PO Box 702, Snowdon Sta., Montreal, P.Q. H3X 3X8. Tel: (514) 342-5200. Pres.: Oavid Leonard.
- Labels: (Owned) Dynacom, Monticana.
- Dynamic, see Holborne.
- E C M, see WEA.
- E G, see PolyGram.
- E M I America, see Capitol.
- Ebony, see Master's Collection.
- Eden, see Able.
- Edmar, see Holborne.
- Elektra, see WEA.
- Elephant Recs., 77 Berkeley St., Toronto, Ont. M5A 2W5. Tel: (416) 364-3387. Gen. Mgr.: Molly Thom.
- Elevator, see Cosmic.
- El Mocambo, see Phonodisc.
- Embryo, see WEA.
- Emerald City, see WEA.
- Emergency, see Unidisc.
- Emotion, see Able.
- Epic, see CBS.
- Erato, see RCA.
- Eurodisc, see Archambault.
- Excelsior, see Pickwick.
- Experience (Les Eds.), see CAM Canada.
- Expo, see Dipper 7.
- Extreme Recs., 125 Dupont St., Toronto, Ont. M5R 1V4. Tel: (416) 961-7433.
- F Beat, see Attic.
- F P Series, see Holborne.
- Factory, see PolyGram.
- Falcon Recs. Inc., 2764 Lakeshore Blvd. W., Toronto, Ont. M8V 1A9. Tel: (416) 625-3865. Telex: 065-22673. Pres.: Gerry Mischuk; Gen. Mgr.: Don Lorusso. (Distributed by A&M).
- Int'l rep.: Germany (Bellaphon).
- Famous Charisma, see WEA.
- Fantasy, see Phonodisc.
- Festivo, see PolyGram.
- Fiesta Rec. Corp. of Canada, c/o Peter Vineberg, 1420 Sherbrooke St. W., Montreal, P.Q. H3G 1K5. (Also see Holborne).
- Home office: USA.
- Finnadar, see WEA.
- First Int'l Recs., 11602 75 Ave., Edmonton, Alta. T6G 0J2. Tel: (403) 436-3096. Pres.: Frank Phillet; Gen. Mgr.: Neil Maciver.
- Fisher Folk, see Praise.
- Fix It in the Mix, see Phonodisc.
- Flarenasch, see MZ.
- Fleur, see PCRL & London.
- Flutterby, see A&M.
- Flying Mountain, see Phonodisc.
- Focus, see Production Connection.
- Fog, see Phonodisc.
- Foreign Exchange, see PCRL.
- Freedom, see RCA.
- Fresh, see Cosmic.
- Full Moon, see CBS.
- G T O, see CBS.
- Galaxy Recs. & Tapes Ltd., 744 Polson Ave., Winnipeg, Man. R2X 1M2. Tel: (204) 582-3371.
- Gamma Recs. Ltd., 3575 Blvd. St. Laurent, S-804, Montreal, P.Q. H2X 2T7. Tel: (514) 842-1788. Pres.: Jack Lazare; Gen. Mgr.: Daniel Lazare; Sales Mgr.: Francine Audette.
- Generation, see Boot.
- Grate, see Trans-Canada.
- Global, see Attic.
- Golden Eagle Recs., 55 S. Cumberland St., Thunder Bay, Ont. P7B 2T6. Tel: (807) 344-1511. Pres. A&R, Pub. & Promo.: Don Grashey.
- Int'l rep.: USA (Nationwide Sound).
- Golden Greats, see RCA.
- Gold Mind, see RCA.
- Gold Seal, see RCA.
- Gold Standard, see RCA.
- Good News, see Word.
- Gordy, see Quality.
- Grand, see Capitol.
- Grapevine, see Master's Collection.
- Grunt, see RCA.
- Gryphon, see RCA.
- H & S, see Phonodisc.
- Haifa, see A&M.
- John Hall Recs., see Mainroads.
- Handshake, see Quality.
- Hansa, see Quality.
- Happinessville, see Cosmic.
- Harbour, see Boot.
- Fred Harris, see Phonodisc.
- Harvest, see Capitol.
- Headfirst, see MCA.
- Heritage, see Holborne.
- Hilltop, see Pickwick.
- Holborne Dist. Co. Ltd., PO Box 9, Mount Albert, Ont. L0G 1M0. Tel: (416) 294-9398. Telex: 06-963548. Pres.: Frank P. Swain; Gen. Mgr.: H. Littlejohn; Sales Mgr.: Ray Johnston; West Indian Repertoire Mgr.: Stanley Gittens.
- Labels: (Owned) FP Series, Island Series; (licensed domestic) Banff, Canadian Cavalcade, Celtic, Condor, Heritage, Maple, Rodeo, Waterloo; (licensed foreign) Dynamic (Jamaica), Edmar (Bermuda), Jupiter (Germany), Merrydick (Barbados), Plant (UK), 3A (Martinique), Wiril (Barbados). (Also see listing in Record & Tape Wholesalers section)
- Hologram, see RCA.
- Horizon, see A&M, Praise & Production Connection.
- Horse, see MZ.
- Hot Vinyl, see RCA.
- House of Lords, see RCA.
- I R S, see A&M.
- Ibach, see MZ.
- Ibis, see RCA.
- Ice, see PolyGram.
- Image, see Boot & Phonodisc.
- Image VII, see Word.
- Impulse Magazine, see Phonodisc.
- Infinity, see MCA.
- Intercan, see Pickwick.
- Intermodal Prod'ns Ltd., PO Box 2199, Vancouver, B.C. V6B 3V7. Tel: (604) 688-1820. Pres.: John Rodney; VP Ops.: Evelyn Rodney.
- Labels: (Owned) Laser, Lasso, Ranch House, (distributed) Charity, Pops Update.
- International Artists, see A&M.
- Invitation a la Musique, see PolyGram.
- Island, see WEA.
- Island Series, see Holborne.
- J C Prod'ns, see Unidisc.
- Janz, see Word.
- Jare Int'l, see RCA.
- Jet, see CBS.
- Jim, see Word.
- Johnston, see CBS.

- Jupiter, see Holborne.
 K, see V Recs.
 K-tel Int'l Ltd., 1670 Inkster Blvd., Winnipeg, Man. R2X 2W8. Tel: (204) 633-8860. Telex: 07-587597. Exec VP: Mickey Eifenbein.
 Branch: Montreal, P.Q., 6665 St. James St. W. Postal Code: H4B 1V3. Tel: (514) 487-2382. Telex: 05-268800. Eastern Canada A&R Dir.: Art Young.
 Home office: USA.
 Kama Sutra, see Quality.
 Kebec Disc, 2322 Sherbrooke E., Montreal, P.Q. H2K 1E5. Tel: (514) 527-2397.
 Key, see Master's Collection
 Kicking Mule, see Phonodisc
 Kingsway, see Master's Collection.
 Kirshner, see CBS.
 Kneptune Int'l Recs. Ltd., Box 5236, Vancouver B.C. V6B 4B3. Tel: (604) 531-9331, 522-2711. Pres.: Kenny Harris.
 Int'l rep.: USA (Kneptune Int'l).
 Knight II, see Phonodisc.
 Kronos, see Peters Int'l.
 Lars, see Peters Int'l.
 Laser, see Intermodal.
 Lasso, see Intermodal.
 Legendary Performers, see RCA.
 Liberty, see Capitol.
 Life's Galaxy Prods'n, see RCA.
 Light, see Word.
 Likeable, see Phonodisc.
 Lyrs, see RCA.
 Little David, see WEA.
 Little People, see Praise.
 Little Pilgrim, see Master's Collection.
 Lollipop, see PolyGram.
 London, see PolyGram.
 London Digital, see PolyGram
 Lorimar, see CBS.
 Lotus, see RCA.
 Lucy, see Stony Plain.
 M B S, see Pickwick.
 M C A Recs. (Canada) Ltd., 2450 Victoria Park Ave., Willowdale, Ont. M2J 4A2. Tel: (416) 491-3000. TWX: 610-492-5234. Telex: 06-966876. VP/Gen. Mgr.: George R. Burns; Nat'l Promo. Mgr.: Lesley Soldat; Ontario Branch Mgr.: Michael McKelvie.
 Branches: Calgary, Alta., 1121 Centre St. N., Unit 310. Postal Code: T2E 7K6. Tel: (403) 230-3991. Branch Mgr.: Geoff Gibbons—Montreal, P.Q., 1500 Cote de Liesse, Suite 140, Lachine H8T 3E3. Tel: (514) 636-6095.
 Branch Mgr.: Frank Iacovella.
 Labels: (Omned) Apex, Backstreet, Coral, Infinity, MCA, Songbird, Volcano; (distributed—not licensed) Headfirst, Regency, Rocket, Shelter, Source, Southcoast, Unicorn
 M G M, see PolyGram.
 M N G, see Moss.
 M O R, see Boot.
 M Z Prods'n, 7033 Trans Canada Hwy., Suite 22D, Montreal, P.Q. H4T 1S2. Tel: (514) 336-1371. Telex: 05-827-542. Pres. & Int'l A&R: Michel Zarka.
 Labels: (Omned) Contact; (licensed foreign) Arabella, Atoll, Blue Blanc Rouge, Cyclade, Flarenasch, Horse, Ibach, Pathe-Marconi (all France); Circle (Italy), Polydor (Spain), Shiva (Belgium).
 Mad Dog, see Phonodisc.
 Mainroads Prods'n Inc., 100 Huntley St., Toronto, Ont. M4Y 2L1. Tel: (416) 961-8001. Pres.: David Manse; Mgr./A&R/US Relations: Bruce W. Stacey; Mktg./Promo.: Paul Kelly; Canadian Sales: Ken Meyer.
 Int'l branch: USA
 Labels: (Omned) Mainroads; (distributed) M ke Adkins Recs., John Hall Recs., Master Sound.
 Manna, see Word.
 Manohar, see Phonodisc.
 Manticore, see WEA.
 Maple, see Holborne.
 Maple Haze Music Ltd., 9615 56 Ave., Edmonton, Alta. T6E 0B2. Tel: (403) 436-3981. Pres.: Jean Leskew.
 Maranatha!, see Word.
 Marguerite, see PCRL.
 The Master's Collection Ltd. (Pilgrim-Canada), PO Box 189, Sta. W. Toronto, Ont. M6M 4Z9. Pres.: Paul J. Young; Sec'y: Diane Young; Sales Mgr.: Roy Burrage; Promos: Ted Gerber.
 Labels: (Omned) Little Pilgrim, Master's Collection, Pilgrim, Sharon; (distributed) Dove, Ebony, Grapevine, Key, Kingsway.
 Master Sound, see Mainroads.
 Mastersound Audiophile, see CBS.
 Matra, see Unidisc.
 Matrix, see CBS.
 Waze, see A&M.
 Ben McPeck Ltd., 131 Hazleton Ave., Toronto, Ont. M5R 2E4. Tel: (416) 923-3316.
 Mercury, see PolyGram.
 Mercury Golden Series, see PolyGram.
 Merrydisc, see Holborne.
 Metal Beat, see PolyGram.
 Michele Audio Canada Ltd., 491 Brimly Rd., Scarborough, Ont. M1J 1A4. Tel: (416) 264-4181.
 Home office: USA
 Milestone, see Phonodisc.
 Millennium, see RCA.
 Mr. Pickwick, see Pickwick.
 Modern, see WEA.
 Modulation Recs. Ltd./Module 1 Recs. Ltd./Disques Sirano Canada, 5514 Isabella St., Montreal, P.Q. H3X 1R6. Tel: (514) 487-0859. Telex: 055-66493. Pres.: Jehan V. Valiquet.
 Module 1 Recs. Ltd., see Modulation.
 Monticane, see Dyncam.
 Moss Music Group (Canada) Inc., 510 Coronat on Dr., Unit 17, West Hill, Ont. M1E 4X6. Tel: (416) 284-0126. Pres.: John Leatham; Sales Mgr.: Julian Rice.
 Home office: USA
 Labels: (Omned) Allegro, Canadiana, Candide, MMG, Storyville, Turn On, Vox Boxes, Vox/Turnabout; (distributed—not licensed) Toshiba-EMI (Japan).
 Motown, see Quality.
 Muse, see Capitol.
 Mushroom (Australia), see Attic.
 Music For Pleasure, see Archambault.
 Music Gallery Editions, see Phonodisc.
 Musidisc, see Archambault.
 Mustard, see Damon & RCA.
 Myrrh, see Word.
 Nemperor, see CBS & WEA.
 New Born, see Praise.
 NewWorld, see Word.
 NewSong, see Word.
 New Ventures, see Phonodisc.
 Nonesuch, see WEA.
 North Branch, see Phonodisc.
 North Track, see Phonodisc.
 Nova, see Pickwick.
 Ode, see CBS.
 Odyssey, see CBS.
 L'Oiseau Lyre, see PolyGram.
 Onari, see Sackville.
 Orient, see RCA.
 Ovation, see RCA.
 P B I, see Unidisc.
 P C M Recs., c/o Tri-Tel Assoc. Ltd., 105 Sparks Ave., Willowdale, Ont. M2H 2S5. Tel: (416) 499-5044.
 P C R L (Productions Carole Risch Ltd.), 2364 Sherbrooke St. E., Montreal, P.Q. H2K 1E6. Tel: (514) 526-2831. Telex: 055-61375. Pres. & Dir. Gen.: Carole Risch.
 Labels: (Omned) Bouquet, Carats, Fleur, Foreign Exchange, Marguerite, Quatre Saisons, Sterling.
 P M, see Post Meridiam & Phonodisc.
 P R T, see Phonodisc.
 Pablo, see RCA.
 Pacific, see WEA.
 Pamploumousse, see Cosmic.
 Paradise, see WEA.
 Park Lane Music Co., see Vera Cruz & CBS.
 Parrot, see PolyGram.
 Passport, see Capitol.
 Pathe, see Capitol.
 Pathe-Marconi, see MZ.
 Pavilion, see CBS.
 Penny Farthing, see A&M.
 Periwinkle Recs., 1262 Don Mills Rd., Suite 3A, Don Mills, Ont. M3B 2W7. Tel: (416) 445-0878.
 Peters Int'l Recs. Canada Ltd., 951 Denison St., Unit 17, Markham, Ont. L3R 3W9. Tel: (416) 490-8001.
 Home office: USA
 Labels: (Omned) Arris, Cosmos, Kronos, Lars, Peters Int'l.
 Philadelphia Int'l, see CBS.
 Philips, see PolyGram.
 Phonodisc Ltd., 30 Malley Rd., Scarborough, Ont. M1L 2E3. Tel: (416) 751-9610. Telex: 06-963629. Pres.: Jim Trainor; VP/Nat'l Sales Mgr.: Paul Lutes; Rec. Div. Mktg. Mgr.: Scott Harradine; Eastern Sales Mgr.: J. Grobbo.
 Branches: Calgary, Alta., 83, 2209-6651 Ranchview Dr. NW. Postal Code: T3G 1B3. Tel: (403) 239-2661. Mgr.: Gary Gow—Doux Montagnes, P.Q., PO Box 414. Postal Code: J7R 4K1. Tel: (514) 473-2645. Sales Rep.: Keith Hannah.
 Labels: Adelphi, Audiofidelity, Black Tie, Breakwater, Cadence, Cavalcade, Charoscuro, Clean Cuts, Cooking Fat, Dairympole, Double Helix, El Mocambo, Fantasy, Fix It in the Mix, Flying Mountain, Fog, H&S, Fred Harris, Image, Impulse Magazine, Kicking Mule, Knight II, Likeable, Mad Dog, Manohar, Milestone, Music Gallery Editions, New Ventures, North Branch, North Track, PM, PRT, Phonodisc, Polaris, Posterity, Posterity/Woodshed, Prestige, Rakish Paddy, Rumour, Rutabaga, Second Ave., Shagrock, Snocan, Solar, Songs, Squash, Stag Creek, Summit, Syntonic Research, Temple, Sydney Thompson, Viper, Will-o'-wind, World.
 Pickwick Recs. (div. of American Can Canada Inc.), 180 Station St., Ajax, Ont. L1S 1E7. Tel: (416) 683-1466. Telex: 06-981378. Gen. Mgr.: Alan Reid; Nat'l A&R & Mds. Mgr.: Allan Matthews.
 Labels: (Omned) Excelsior, Hilltop, Intercan, Mr. Pickwick, Pickwick, Pro-Arte, Quintessence; (licensed) CRI, CTL, MBS, Nova.
 Pilgrim, see Master's Collection.
 Planet, see WEA.
 Plant, see Holborne.
 Plantation, see Quality.
 Playboy, see Quality.
 Polaris, see Phonodisc.
 Polydor, see PolyGram.
 Polydor (Spain), see MZ.
 PolyGram Inc., 6000 Cote de Liesse, St. Laurent, P.Q. H4T 1E3. Tel: (514) 739-2701. Cable: POLYDISC. Telex: 05-825690. TWX: (610) 421-3509. Pres.: Peter Erdmann; Exec. VP & Gen. Mgr.: Dieter Radecki; VP Prod. Mgmt.: Leo da Silva; VP Classics Int'l: Vassilios Pollakis; VP Opgs. & Systems: Don Wedge; Nat'l Promo./Pub. Dir.: Bob Ansell; Sr. Prod. Mgr.: Michael Thernault; Mktg. & Sales Dir.: Ken Graydon; Prod. Mgr.: Derek Steede; Eastern Reg'l Mgr.: Gaston Careau; Eastern Reg'l Promo. Mgr.: Pierre Parent.
 Branches: Calgary, Alta., 7220 Fisher St. SE, Suite 110. Postal Code: T2H 2H8. Tel: (403) 253-7665. Telex: 03-821859. Promo. Mgr.: Harry Hrabinsky—Vancouver, B.C., 805 W. Broadway, Mezzanine. Postal Code: V5Z 1K1. Tel: (604) 873-2466. Telex: 04-54410. Branch Mgr.: Peter Behnke; Promo.: Monica Netupsky—Winnipeg, Man., c/o Philips Electronics, 401 Weston St. E. Postal Code: R3E 3H4. Tel: (204) 786-5748. Telex: 07-57786. Sales Rep.: Nancy Pellick—Toronto, Ont., Etobicoke Tower, 7th fl., 555 Burnhamthorpe Rd. W., Etobicoke M9C 2Y3. Tel: (416) 622-6680. Telex: 06-967755. Nat'l Accounts Dir.: Alun Elias; Central Reg'l Sales Mgr.: Herb Bradley; Promo.: Bobby Gade, Karen Gordon.
 Labels: Abkco, Ace of Diamonds, Archiv, Argo, Barclay, Big Time, Capricorn, Casablanca, Charisma, DG, De-Lite, Deram, Dreamland, EG, Factory, Festivo, Ice, Invitation a la Musique, Lollipop, London, London Digital, MGM, Mercury, Mercury Golden Series, Metal Beat, L'Oiseau Lyre, Parrot, Philips, Polydor, Polystar, RSD, Resonance, Rialto, Riva, SPSS, Spring, Threshold, UK, Vertigo, Verve, Virgin, Virgin Dindisc, Zappa.
 Polystar, see PolyGram.
 Pops Update, see Intermodal.
 Portrait, see CBS.
 Posterity, see Phonodisc.
 Posterity/Woodshed, see Phonodisc.
 Post Meridiam Prods'n Ltd., PO Box 103, Sta. A Toronto, Ont. M5W 1A2. Tel: (416) 751-9610. Pres.: Gene Perla; Gen. Mgr.: Lois Oki. (Distributed by Phonodisc).
 Home office: USA. PM.
 Label: (Omned) PM.
 Int'l reps.: Austria (Music Dist. in Germany), Canada (Phonodisc), Denmark (SteepleChase), Germany (Music Dist.), Italy (IRD), Japan (Teichiku), Switzerland (Music Dist. in Germany), UK (Cadillac).
 Praise Inds. Corp., 6979 Curragh Ave., Burnaby, B.C. V5J 4V6. Tel: (604)

- 438-8266. Gen. Mgr.: Paul Yaroshuck.
 Int'l branches: Australia, USA
 Labels: (Omned) Country Oak, Horizon, Little People, New Born, Praise, Tunessmith; (licensed—foreign) Fisher Folk (UK), Star Song (USA).
 Precision, see CBS.
 Prelude, see Quality.
 Prestige, see Phonodisc.
 Pro-Arte, see Pickwick.
 Production Connection Inc., 408 St. Gabriel, Montreal, P.Q. H2Y 2Z9. Tel: (514) 866-2021.
 Labels: (Omned) Bobinson, Focus, Horizon, Vierge.
 Psi Recs., 1747 W. Third Ave., Vancouver, B.C. V6J 1K7. Tel: (604) 732-3761. Mgr.: Robin Spurgin.
 Labels: (Omned) Psi, Ramophone.
 Pure Gold, see RCA.
 Quadratic, see RCA.
 Quality Recs. Ltd., 380 Birchmount Rd., Scarborough, Ont. M1K 1M7. Tel: (416) 698-5511. Telex: 06-219624. Pres.: George R. Struth; Pres. Custom Mfg. & Finance: Terry M. Lynd; VP Finance: Sidney Lambersky; A&R Dir.: John Driscoll; Bus. Affairs Dir.: Nadine Langlois; Local branch: 480 Tapscott Rd. Postal Code: M1B 1W3. Tel: (416) 291-5590. Telex: 06-526154. Mktg. Dir.: Barry J. Stafford; Promo.: John Small.
 Branch: St. Laurent, P.Q., 3767 Thimens Blvd., Suite 206. Postal Code: H4R 1W4. Tel: (514) 336-5930. Telex: 05-824749. Sales Mgr.: Yves Dupuis; Promo.: Michael Jastremsky.
 Labels: (Omned) Birchmount, Celebration, Quality, Ringside; (licensed foreign) AVI, Ariola, Buddha, Gordy, Handshake, Hansa, Kama Sutra, Motown, Plantation, Prelude, RFC, Radio, Ramwood, SSS Int'l, Scorpion, Sesame Street, Sunbird, Tamla, Vanguard, Ze; (distributed—not licensed) Ready.
 Quantum Recs. Ltd., 170-A Baldwin St., Toronto, Ont. M5T 1L8. Tel: (416) 366-6745. Telex: 06-218139. Pres.: Don Peuramaki; A&R Dir.: Mike Alyanak; VP Finance: Berge Alyanak; Bus. Affairs Dir.: Guy Campagnaro; Nat'l Press & Pub. Dir.: Parvez Tayeb.
 Quatre Saisons, see PCRL.
 Quintessence, see Pickwick.
 R C A Inc., Rec. Div., 101 Duncan Mill Rd., Suite 300, Don Mills, Ont. M3B 1Z3. Tel: (416) 449-9500. Telex: 06-966577. TWX: (610) 492-4746. VP & Gen. Mgr.: J. Edward Preston; Pres. Sunbury-Dunbar: Jack Feeney; Creative Affairs & Int'l Dir.: Andy Nagy; Opgs. Servs. Dir.: K.R. Gillies; Finance Dir.: Don Kollar; Mktg. Servs. Mgr.: Wayne R. Jordan; Mktg. Dir.: John Ford; Int'l Relations Mgr.: Helen Smith; Special Projects: Edward T. Traynor.
 Branches: Calgary, Alta., 4432 10 St. NE. Postal Code: T2E 6K3. Tel: (403) 276-8231. Sales & Promo. Mgr.: Terry Carson—Vancouver, B.C., 2876 Rupert St. Postal Code: V5M 3T7. Tel: (604) 438-7172. Sales & Promo. Mgr.: Leigh Alden—Winnipeg, Man., 1320 Church Ave. Postal Code: R2X 1G4. Tel: (204) 633-2666. District Sales Mgr.: Robert Tait—Halifax, N.S., 3611 Commission St. Postal Code: B3V 2X1. Tel: (902) 455-0409. Sales & Promo. Mgr.: Hanson Josey—Scarborough, Ont., 2245 Markham Rd. Postal Code: M1B 2W3. Tel: (416) 298-6497. TWX: (610) 491-1404. Telex: 06-526136. Sales & Promo. Mgr.: Jim Fotheringham—Montreal, P.Q., PO Box 987, Tour De La Cite, 300 Le Parizeau Postal Code: H2W 2N1. Tel: (514) 849-3251. Sales & Promo. Mgr.: Richard Galbois.
 Labels: (Omned) Best Buy (USA), Bluebird (USA), Canada Int'l, Centennial, Club Series, Golden Greats, Gold Seal (USA), Gold Standard (USA), Legendary Performers (USA), Lotus, Pure Gold (USA), Quadratic (USA), RCA (USA), Red Seal (USA), Vault Treasure, Victor (USA), Victrola (USA), Vix; (licensed domestic) Carrousel, Damon, Freedom, Hot Vinyl, House of Lords, Mustard, Orient, Rayne, Ritdong, Stony Plain, Tapestry, Tembo, 36; (licensed foreign) Colgems (USA), DRG (USA), Dream (USA), Erato (France), Gold Mind (USA), Grunt (USA), Gryphon (USA), Hologram (USA), Ibis (USA), Jare Int'l (France), Life's Galaxy (USA), Millennium (USA), Ovation (USA), Pablo (USA), Salsoul (USA), Saravah (France), Solar (USA), 20th Century Fox (USA), 20th Century Fox/Chi-Sound (USA), Trema (France), White Diamond (USA), Windsong (USA), Wooden Nickel (USA).
 R F C, see Quality.
 R K M see Attic.
 R S O, see PolyGram.
 Radio, see Quality.
 Rakish Paddy, see Phonodisc.
 Ranch House, see Intermodal.
 Ramophone, see Psi.
 Ranwood, see Quality.
 Rayne, see RCA.
 Ready Recs., 505 Queen St. E., Toronto, Ont. M5A 1V1. Tel: (416) 363-9164. Telex: 06-986766. Mgr.: Andrew Crosbie; Label Mgr.: Angus Mackay; Promo. Mgr.: Jean Schreiner. (Distributed by Quality)
 Red Seal, see RCA.
 Reel Recs. & Tapes Ltd., 1035 Richmond St., London, Ont. N6A 3J6. Tel: (519) 672-1904.
 Regency, see MCA.
 Reprise, see WEA.
 Republic, see RCA.
 Resonance, see PolyGram.
 Rialto, see PolyGram.
 Ringside, see Quality.
 Rio, see Unidisc.
 Riot, see Boot.
 Ripsaw, see B-Sharp.
 Rising Recs. Ltd., 111 Peter St., Toronto, Ont. M5V 2H1. Tel: (416) 363-4343. Pres.: Robert H. Hahn.
 Labels: (Omned) Cubbyhole, Rising.
 Ritdong, see RCA.
 Riva, see PolyGram.
 Rockburgh, see Attic.
 Rocket, see MCA.
 Rodeo, see Holborne.
 Rolling Stones, see WEA.
 Rouge, see Unidisc.
 Rounder, see Attic.
 Royalty Recs. of Canada Ltd., 9229 58 Ave., Edmonton, Alta. T6E 0B7. Tel: (403) 436-0665. Pres.: Jack Dubasz; VP: R. Harlan Smith; Artist Development Dir.: Danny Makarus; Pub. Dir.: Brenda Rudiger.
 Rumour, see Phonodisc.
 Rutabaga, see Phonodisc.
 S G M Recs. Ltd., PO Box 34374, Sta. D, Vancouver, B.C. V6J 4P3. Tel: (604) 879-7255.
 S P P S, see PolyGram.
 S S S Int'l, see Quality.
 Sackville Recs. Co., PO Box 87, Sta. J, Toronto, Ont. M4J 4X8. Tel: (416) 368-3149. Chief Execs.: John Norris, William E. Smith.

Labels: (Owned) Sackville, **(Licensed)** Dawn Club, Onan.
Int'l reps.: Finland (Audiowis), France (DAM), Germany (International Music Serv.), Italy (Hi-Fi), Japan (Victor), Netherlands (Agram), Switzerland (Planisphere), UK (Jazz Horizons), USA (Rick Ballard, City Hall, Daybreak Express, House Dist., Rounder).

Sacred, see Word.
 Safari, see Attic.
 Saisons, see Trans-Canada.
 Salsoul, see RCA.
 Saravah, see RCA.
 Scorpion, see Quality.
 Scotti Bros., see WEA.
 Second Ave., see Phonodisc.
 Select, see Archambault.
 Seraphim, see Capitol.
 Sesame Street, see Quality.
 Sevoté, see World Recs.
 Shagrock, see Phonodisc.
 Sharon, see Master's Collection.
 She, see WEA.
 Shelter, see MCA.
 Shwa, see MZ.
 Sirano, see Modulation.
 Sire, see WEA.
 Sloth, see A&M.
 Smile Recs. (div. of Northern Light & Sound Entertainment Corp.), 1659 Bayview Ave., Toronto, Ont. M4G 3C1 Tel: (416) 485-1157 Pres. David Coultts, VP A&R & Promo. Brian Ayres (Also see Taxi).
 Snocan, see Phonodisc.
 Solar, see Phonodisc & RCA.
 Solid Gold Recs., 180 Bloor St. W., Toronto, Ont. M5S 2V6 Tel: (416) 960-8161 (Also see A&M).
 Songbird, see MCA.
 Songs, see Phonodisc.
 Source, see MCA.
 Southcoast, see MCA.
 Sparrow, see Word.
 Spectra Scene, see CBS.
 Spring, see PolyGram.
 Springwater Prod'n's Ltd., 56 Clinton St., Guelph, Ont. N1H 5G5 Tel: (519) 824-7885, Pres. Homer Hogan, VP Dorothy Hogan.
 Squash, see Phonodisc.
 Stag Creek, see Phonodisc.
 Star Song, see Praise.
 Sterling, see PCRL.
 Strif, see CBS.
 Stony Plain Rec'g Co. Ltd., PO Box 861, Edmonton, Alta. T5J 2L8 Tel: (403) 477-6844, Mng. Dir.: Holger Petersen, Gen. Mgr.: Alvin Jahns (Distributed by RCA).
Labels: (Owned) Stony Plain, **(Licensed)** Lucy
Int'l reps.: Central America (Oideca), Japan (Trio/Kenwood), USA (First American), UK (Decca).
 Storyville, see Moss.
 Studio SM, see Archambault.
 Suite, see Damon.
 Summit, see Word & Phonodisc.
 Sunbird, see Quality.
 Sunflower, see V Recs.
 Sun-Scape Recs., PO Box 793, Sta. F., Toronto, Ont. M4Y 2N7 Tel: (416) 889-2713, Gen. Mgr.: David Nash, Sales Mgr.: Valerie Webster
Int'l branch: USA.
 Swan Song, see WEA.
 Synchronic Research, see Phonodisc.
 T G, see Capitol.
 T K, see CBS.
 T Neck, see CBS.
 Tabu, see CBS.
 Tania, see Quality.
 Tapestry Recs. & Tapes Ltd., Box 755, Sta. B., Ottawa, Ont. Tel: (613) 233-8871. (Also see RCA).
 Taxi Recs. (div. of The Great Canadian Entertainment Co. Inc.), 1659 Bayview Ave., Toronto, Ont. M4G 3C1 Tel: (416) 485-1157 Pres. Dave Coultts, VP: Brian Ayres. (Also see Smile).
Branch: Calgary, Alta., 818 16 Ave. NW, Suite 115 Postal Code: T2M 0K1. Tel: (403) 289-8870. Mgr. Jim Jordison
Int'l branches: England, USA.
 Telson, see CBS.
 Tembo, see RCA.
 Temple, see Phonodisc.
 36, see RCA.
 Bruce Thompson Music Corp. Ltd., 1310 Centre St. S., Calgary, Alta. T2G 2E2. Tel: (403) 269-7270. Pres. & Gen. Mgr.: Bruce Thompson; Promos. Mgr.: C. Montoya
Labels: (Owned) Centre St., Circa
 Sydney Thompson, see Phonodisc.
 3 A, see Holborne.
 Threshold, see PolyGram.
 Tiffany, see CBS.
 Toshiba-EMI, see Moss.
 Trans-Canada Recs. (div. of Quebecor Group Inc.), 7033 Trans Canada Hwy., St. Laurent, P.Q. H4T 1S2 Tel: (514) 336-7151. Telex: 058-24638. Gen. Mgr.: Denis Bergeron, Nat'l Sales Dir.: Robert Perusse, A&R Dir.: Walter Gardetti.
Branch: Sainte Foy, P.Q., 445 Rue Mendel Postal Code G1X 3X4 Tel: (418) 871-1410. Telex: 051-3319.
Labels: (Owned) Celsius, Girafe, Saisons, Trans-Canada.
 Trema, see RCA.
 Trianon, see Archambault.
 Troubadour, see A&M.
 True North Recs., 98 Queen St. E., Suite 28, Toronto, Ont. M5C 1S6. Tel: (416) 364-6040. Telex: 065-24566. Co-Owners: Bernard Finkelstein, B.C. Fiedler, Ass't: Debra Sherman; Promo: Stuart Raven Hill. (Distributed by CBS).
Int'l reps.: Worldwide (Millennium/RCA in USA) excluding Italy (Dischi), Japan (RCA).
 Tuesday, see Axe.
 Tunemith, see Praise.
 Turnabout, see Moss.
 Turn On, see Moss.
 20th Century-Fox, see RCA.
 20th Century-Fox/Chi-Sound, see RCA.
 U K, see PolyGram & V Recs.
 Ultra Recs., PO Box 128, Sta. T., Toronto, Ont. M6B 3Z9. Tel: (416) 783-5382. VP: G.W. Golden, Gen. Mgr.: Elaine Golden.

Umbrella Recs. (div. of Nimbus 9 Prod'n's Ltd.), 39 Hazelton Ave., Toronto, Ont. M5R 2E3 Tel: (416) 961-9688. Telex: 06-23364.
Int'l reps.: Australia (MR Acoustics), Austria & East European Countries (Hi-Fi), EEC & Middle East countries (Quadrant in UK), Malaysia (United Bearings), Singapore (United Bearings), UK (Quadrant), USA (Audio-Technica).
 Uncle Jam, see CBS.
 Unicorn, see MCA.
 Unidisc Rec., 668 Deslauriers, St. Laurent, P.Q. H4N 1W5. Tel: (514) 334-2373. Telex: 05-827542. Pres.: George Cucuzella; Gen. Mgr.: Joe Tortorici. Sales Mgr.: Nat. Marenia.
Labels: (Owned) Black Sun, Uniwave, **(Licensed domestic)** Bomb, DJ, JC Prod'n's, Maitra, PBI, Quantum, Rio, Rouge, VS, **(Licensed foreign)** Aava-lanche (France), Brass (USA), Emergency (USA).
 Unidisc (France), see Archambault.
 Unison Recs. Inc., 1310 Rue Larivière, Montreal, P.Q. H2L 1M8. Tel: (514) 527-4588. Pres. Steven Grossman, VP Prod'n: Peter Alves, VP: Harvey Finkelstein; Gen. Mgr. Lois Alves. (Also see CBS).
Int'l branch: USA, MSU Inc.
Int'l reps.: France (Carrère), USA (RCA, Warner Bros.), UK (EMI).
 United Artists, see Capitol.
 Unwave, see Unidisc.
 Unlimited Gold, see CBS.
 V I P, see Able.
 V Recs. Ltd., 221 Flora Ave., Winnipeg, Man. R2W 2P8. Tel: (204) 586-9729. Pres. Alex Groshak; Gen. Mgr.: Roman Swidinsky, Sales Mgr.: Mike Groshak.
Labels: K. Sunflower, UK. V.
 V S, see Unidisc.
 Val, see Velerio.
 Vamp, see Velerio.
 Vanguard, see Quality.
 Vault Treasure, see RCA.
 Velerio Americana Recs., 79 Lunnes Rd., Toronto, Ont. M8W 4M7 Tel: (416) 259-9182. Mng. Dir.: Jose Osana.
Labels: (Owned) Val, Vamp, Velerio.
 Vera Cruz Recs./Park Lane Music Co. Ltd., 10534 109 St., No. 202, Edmonton, Alta. T5H 3B2. Tel: (403) 426-1366. (Also see CBS).
 Vertigo, see PolyGram.
 Verve, see PolyGram.
 Victor, see RCA.
 Victrola, see RCA.
 Vierge, see Production Connection.
 Vik, see RCA.
 Viper, see Phonodisc.
 Virgin, see PolyGram.
 Virgin Dindisc, see PolyGram.
 Vista, see Walt Disney.
 Volcalion, see MCA.
 Vox Boxes, see Moss.
 W & A Music of Canada Ltd., 1810 Birchmount Rd., Scarborough, Ont. M1P 2J1 Tel: (416) 291-2515. Cable: WEATOR. Telex: 065-25434. Pres. Ken Middleton, Exec. VP: Ross Reynolds; VP Finance & Admin. Claude Sas-soun; VP Sales: Rene LaFlamme, Sales/Nat'l Accounts Dir.: Andy Abbate, Bus. Affairs Dir.: Joe Edwards; Opns. Dir.: D. Ambeault; Nat'l Promo. Mgr. Larry Green; English A&R: Jim Campbell; Artist Relations: Roger Desjardins; Pub. Mgr. D. Tollington, Warner Bros. Prod. Mgr. B. Johnston; E/A & Atlantic Prod. Mgr.: K. Cooke; Local Branch Mgr.: Mike Gatt.
Branches: Calgary, Alta., 6325 12 St. SE, Unit 7. Postal Code: T2H 2K1. Tel: (403) 259-3000. Western Reg'l Mgr.: Alex Clark-Vancouver, B.C., 40 E. Fifth Ave. Postal Code V5T 1G8. Tel: (604) 879-8681. Mgr.: Adrian Bilodeau-Winnipeg, Man., 24 Stevenson Rd., St. James R3H 0H8. Tel: (204) 633-9284. Mgr.: Don Coward-Montreal, P.Q., 735 Renaud Ave., Dorval H9P 2N1. Tel: (514) 636-8503. Mgr.: John Dufour, French A&R Pierre Belanger.
Labels: (Owned) Asylum, Atco, Atlantic, Big Tree, Cotillion, Elektra, Nonesuch, Reprise, WEA, Warner Bros., **(Licensed)** Bearsivle, Beggar's Banquet, Dark Horse, DiscReet, ECM, Emerald City, Embryo, Famous Charisma, Finnadar, Island, Little David, Manticore, Modern, Nemperor, Pacific, Paradise, Planet, Rolling Stones, Scotti Bros., She, Sire, Swan Song, Warner Curb, Warner-Spector, Westbound, Whitfield, Wing & Song.
 Warner Bros., see WEA.
 Warner Curb, see WEA.
 Warner-Spector, see WEA.
 Waterhouse, see Attic.
 Waterloo, see Holborne.
 Westbound, see WEA.
 White Diamond, see RCA.
 Whitfield, see WEA.
 Will-o-Wind, see Phonodisc.
 Windsong, see RCA.
 Wing & Song, see WEA.
 Wirf, see Holborne.

Wonderworld, see Word.
 Wooden Nickel, see RCA.
 Word Recs. Ltd., 7720 Alderbridge Way, Richmond, B.C. V6X 2A2. Tel: (604) 270-7231. Pres. & Adv. Dir.: Gerry B. Scott; VP: J.E. Scott; Sales & Mktg.: Phil Crofton, Doug Stark, Don Harbridge, Carl Teeple, Dwayne Daku, Duane Suderman, Nick Panaseiko.
Int'l branch: USA.
Branches: Edmonton, Alta., 4332 114 A St. Postal Code: T6S 1N7. Tel: (403) 437-3242-London, Ont., 152 Wellesley Crescent. Postal Code: N5Y 1J7. Tel: (519) 455-2097.
Labels: (Owned) Canaan, Century, Dayspring, Image VII, Myrrh, Sacred, Word; **(distributed)** Birdwing, Good News, Janz, Jim, Light, Manna, Maranatha!, NewSong, Newworld, Sparrow.
 World Recs. (div. of Shotgun Gimme Holdings Ltd.), PO Box 2000, Baseline Rd. W. at Courtice, Bowmanville, Ont. L1C 3Z3. Tel: (416) 576-0250. Toronto Tel: (416) 686-2828. Pres.: William Hewson; Gen. Mgr.: Bob Stone. (Also see Phonodisc).
Labels: (Owned) Audat, CTL, Sevoté, World.
 Zappa, see PolyGram.
 Ze, see Quality.

• music publishers

A La Portée (CAPAC), see Intermede.
 A Q E M Ltee (Agence Quebecoise de l'Édition Musicale) (CAPAC), see SMCL.
 A T V Music Group, 14 Donald St., Toronto, Ont. M4Y 1K2. Tel: (416) 967-3375. Pres.: Samuel S. Trust, Gen. Mgr.: Bernard H. Solomon, Prof. Mgr.: Val Azouli.
Int'l firms represented: ATV (UK, USA), ATV Northern (Australia), Cherry Lane (USA), Numan (UK), World Artist (USA).
Int'l reps.: Australia (ATV Northern), France (Alto), Germany (Global), Italy (ATV), Japan (Shinko), Netherlands (Nada), Scandinavia (Warner Bros.), UK (ATV), USA (ATV).
 A T V Music Publ'g of Canada Ltd. (PRO), see ATV Music Group.
 Abigail Music Ltd., see Chappell-Chappell.
 Abovewater Music (PRO), see Attic.
 Ailes Du Nord (PRO), see Intermede.
 Algord Music Ltd. (CAPAC), 372A Yonge St., Toronto, Ont. M5B 1S6. Tel: (416) 597-0066.
 Alicia Musik (CAPAC), see Intermede.
 Almo/Irving Music Of Canada Ltd. (CAPAC, PRO), 939 Warden Ave., Scarborough, Ont. M1L 4C5. Tel: (416) 752-7191. Telex: 06-963652. VP: Gerry Lacoursiere.
Int'l rep.: Worldwide excluding US & Canada (Rondor).
 Ancre (CAPAC), see Intermede.
 Angebec Music Publ'g (PRO), see Halben.
 Antrim Music (PRO), PO Box 4486, Vancouver, B.C. V6B 3Z8. Tel: (604) 681-8311. Gen. Mgr.: Les Weinstein.
 Aout (PRO), see Intermede.
 April Music (Canada) Ltd. (CAPAC), 1121 Leslie St., Don Mills, Ont. M3C 2J9. Tel: (416) 447-3311. Cable: COLRECORD. Dir.: Wayne Patton, Opns. Mgr.: Jeanne Danielson.
Int'l firms represented: April (Australia, Belgium, France, Germany, Israel, Italy, Japan, Netherlands, Spain, Sweden, South Africa, UK, USA), Blackwood (Greece), Favorite (Yugoslavia), Melograf (Argentina), Ed. Latino Americana (South America), Mundo Musical (Brazil, Costa Rica, Mexico, Venezuela).
Int'l reps.: Belgium (April), USA (April Blackwood).
 Aquarius Recs. Ltd. (CAPAC), 354 Youville St., Montreal, P.Q. H2Y 2C3. Tel: (514) 284-1001. Telex: 055-60958.
 Archambault Inc. (Ed.) (CAPAC), 500 St. Catherine St. E., Montreal, P.Q. H2L 2C6. Tel: (514) 849-6201. Cable: ARCHMUSIC. Co-Owner & Gen. Mgr.: Rosaire Archambault.
 Attic Publ'g Group, 98 Queen St. E., Toronto, Ont. M5C 1S6. Tel: (416) 862-0352. Telex: 06-21985. Pres.: Alexander Mar; Prof. Mgr.: Mark Caparol.
Int'l firms represented: Arista/Carsers Music (USA), Chinnichap, Roger Cook Music (USA), Global (Germany), Lollipop Music (Germany), Mensei (Germany), Ivan Mogul (USA), Polar Music (Sweden), RKM (Belgium), Solid Music (Australia), State Music (UK).
Int'l reps.: Australia (Essex, Rondor), Belgium (RKM), France (Claude Pascal), Germany (Global), Mexico & South America (Ivan Mogul), Netherlands (April), UK (Health Levy).
 Aussi (CAPAC), see Intermede.
 Axe Music (CAPAC), 70 Craighurst Ave., Toronto, Ont. M4R 1J8. Tel: (416) 481-2922. Pres. & Prof. Mgr.: Greg Hambleton.
Int'l rep.: Australia (Image Music).
 Badaeux (Prod'ns) (PRO), see Editeurs Associates.
 Basse-Ville (CAPAC), see Intermede.
 Belsize Park Music (PRO), see Axe.
 Berandol Music Ltd. (PRO), 11 St. Joseph St., Toronto, Ont. M4Y 1J8. Tel: (416) 924-8121. Contact: Barbara Kroetsch.
Int'l firms represented: Hargali (USA), Universal (UK).
Int'l reps.: Australia (Boosey & Hawkes), Japan (Zen-On), UK (Universal).
 Big Bay Music (PRO), see Attic.

EVERYTHING YOU EVER WANTED IN A SUB-PUBLISHER!



The logo for Morning Music Limited features a stylized sun or horizon graphic above the words "MORNING MUSIC" in a large, bold, sans-serif font. The word "LIMITED" is written vertically in a smaller font to the right of "MUSIC".

1443 Matheson Blvd W Mississauga Ontario L4W 1R1 Canada
 Telephone (416) 625-2676
 Cable BOOTGROUP/Telex 06-960250

- Black Sun Music (CAPAC), 668 Ouelletiers St., St. Laurent, P.Q. H4N 1W5. Tel: (514) 334-2373. Telex: (05) 827542. Pres. & Prof. Mgr.: Geroge Cucuzella; Gen. Mgr.: Joe Tortorico.
- Bluesone Music (CAPAC), see Arca.
- La Bobine, 408 St. Gabriel, Montreal, P.Q. H2Y 2Z9. Tel: (514) 866-2021. Telex: (05) 829633. Pres.: Alain Deland; Gen. Mgr.: Yves Godin.
- Breton-Cyr (CAPAC), see Intermede.
- Burlington Music of Canada Ltd. (CAPAC), 6265 Cote de Liesse, St. Laurent, P.Q. H4T 1C3. Tel: (514) 341-5350. Cable: FULLRANGE. Telex: (05) 824570. Pres.: F. C. Jamieson; VP: A. Khoury VP Mktg.: K. Verdoni.
- Home office: England, Burlington-Palace Group.
- Int'l branches: Australasia (Palace in Australia), Austria (Burlington), Benelux (Palace in Netherlands), France (Palace), Germany (Burlington), Italy (Palace), Orient (Burlington-Palace in Hong Kong), Portugal (Burlington), Scandinavia (Palace in Sweden), Spain (Burlington), Switzerland (Palace), USA (Burlington/Felsted).
- C A M Canada Ltd. (PRO), 1180 W. St. Antoine, Suite 600, Montreal, P.Q. H3C 1B4. Tel: (514) 861-9917. Telex: (05) 24 111. VP & Gen. Mgr.: Alain LeRoux.
- Int'l firms represented: CAM (Italy, Japan, Scandinavia, Spain), PEMA (France).
- Int'l repa.: Italy, Japan, Scandinavia & Spain (CAM), France (PEMA).
- Cabot Trail Music (CAPAC), see Morning.
- Canadian Brass Publ'ns (CAPAC), see Morning.
- CanCon Music (PRO), see Rising.
- Cannes Music (PRO), see Attic.
- Carricum (CAPAC), see Intermede.
- Carte Blanche Publ'g/Taxi Publ'g (PRO/CAPAC) 1310 Rue Lariviere, Montreal, P.Q. H2L 1M8. Tel: (514) 527-4588. Pres.: Steven Grossman; VP: Peter Alves; Gen. Mgr.: Louis E. Alves.
- Int'l repa.: Worldwide excluding Canada (Clear Sailing Music & Flash Flood Music), Administered by Copyright Sec. Bureau in USA).
- Cat Prod'ns (CAPAC), see Halben.
- Chappell & Co. Ltd. (PRO, CAPAC), 14 Birch Av., Toronto, Ont. M4V 1C9. Tel: (416) 922-2159. Cable: SYMPHONY.
- Chat (CAPAC), see Intermede.
- Cherry Lane Music (ASCAP), see Manna.
- Jean Chevier (CAPAC), see Intermede.
- Chien Noir (CAPAC), see Intermede.
- Chinook Music Publ'g (PRO), Box 269, RR 1, Bentley, Alta. T0C 0J0. Tel: (403) 748-2673. Pres. & Gen. Mgr.: Dick Domron.
- Cinema Scores (CAPAC), see Rising.
- Cirrus Music (PRO) (div. of Nimbus 9 Prod'ns Ltd.), 39 Hazelton Ave., Toronto, Ont. M5R 2E3. Tel: (416) 961-9688.
- Int'l affiliates: Septima Music Inc. (BMI), Trillium Music Inc. (ASCAP) (both USA).
- Int'l repa.: Australia (Image), Austria (Rudolf Slezak in Germany), Belgium (Universal Songs), Central America (CBS in USA), Czechoslovakia (Rudolf Slezak in Germany), France (Allo), Germany (Rudolf Slezak), Greece (Greophon), Israel (Israzemer), Italy (RCA), Japan (Asia), Netherlands (Universal Songs), New Zealand (Image in Australia), Poland (Rudolf Slezak in Germany), Scandinavia (Sweden Music in Sweden), South Africa (Laetrec), South America (CBS in USA), Spain (Armonico), Switzerland (Rudolf Slezak in Germany), U.S.A. (Septima).
- Comet Music of Canada (CAPAC), see ATV Music Group.
- Conception (CAPAC), see Intermede.
- Core Music Publ'g (CAPAC), c/o Oak Manor, PO Box 1000, 12261 Yonge St., Oak Ridge, Ont. L0G 1P0. Tel: (416) 881-3212. Telex: 06-986550. Pres.: Vic Wilson.
- Corinth Music (PRO)/Tarana Music (CAPAC), PO Box 31, Commerce Court Postal Sta., Toronto, Ont. M5L 1B2. Tel: (416) 863-3456. Chief Exec.: Robert W. Harvey.
- Int'l firm represented: Lady Casey (USA).
- Int'l repa.: France, Italy, Japan, South Africa (Interworld), USA (Lady Casey).
- Couleur (CAPAC), see Intermede.
- Cream & Sugar (CAPAC), see Simone.
- Crush Music (PRO), see Editeurs Associes.
- Crossroads Publ'g, see Mainroads.
- Crown-Vetch Music Ltd. (CAPAC), see Morning.
- Cyprine (CAPAC), see Intermede.
- D & L Music Publ'ns (PRO), 55 S. Cumberland St., Thunder Bay, Ont. P7B 2T6. Tel: (807) 344-1511. Pres. & Prof. Mgr.: Don Grashey.
- Int'l repa.: Benelux, France, Italy, Portugal, South Africa, Spain, UK (Merwyn Music in UK); USA (Cedarwood, Screen Gems-EMI).
- Danboro Publ'g Co. (PRO) (div. of Optam Ltd.), PO Box 2199, Vancouver, B.C. V6B 3V7. Tel: (604) 688-1820. Pres.: John Rodney; VP: Evelyn Rodney.
- Davian Music (CAPAC), see Gallant Robertson.
- Dawn of Creation Music Publ'g Co. (PRO), PO Box 452, Cambridge, Ont. N1R 5V5. Tel: (416) 924-8121. Pres.: Robert Liddell.
- Oebcar Music (PRO), see Morning.
- Deer Park Music (CAPAC), 2 St. Clair Ave. W., Toronto, Ont. M4V 1L6. Tel: (416) 924-1411.
- Oicap Music Publ'g Co. (CAPAC), see Hugh Dixon.
- Dipmo Music Publ'g Co. (PRO), see Hugh Dixon.
- Walt Disney Music of Canada, 270 Redvale Blvd., Rexdale, Ont. M9W 1R2. Tel: (416) 743-5552.
- Hugh Dixon Music Inc. (PRO), 292 Lorraine Dr., Baie d'Urfe, P.Q. H9X 2R1. Tel: (514) 457-5959. Pres.: Hugh D. Dixon; Gen. Mgr.: Tineke Dixon.
- Hugh Dixon Music Publ'g Co. (PRO), see Hugh Dixon.
- Doice Vita (CAPAC), see Intermede.
- Do Sol Publ'g (PRO), PO Box 2262, Dorval, P.Q. H9S 5J4. Tel: (514) 631-9384. Pres. & Prof. Mgr.: Robert Salagan.
- Dotted Eighth Music Publ'g (PRO)/Euphone Music Publ'g (CAPAC), 58 Phoebe St., Toronto, Ont. M5T 1A9. Tel: (416) 361-1853. Chief Exec.: Barry Kaplan.
- Int'l repa.: Australia & New Zealand (Festival in Australia), Europe (Tembo in UK), South & East Africa (Gallo in South Africa), UK (Calandar Recs.).
- Downchild Music (CAPAC), see Attic.
- Earth Born Music Inc. (PRO), see Halben.
- Eastend Music (PRO), see Halben.
- Editeff (CAPAC), see Intermede.
- Editeurs Associes, 2364 Sherbrooke E., Montreal, P.Q. H2K 1E6. Tel: (514) 526-2831. Dirs.: Carole Leeds, Andree Badaeux-Gosselin.
- Etsinore Music (PRO), see Rising.
- Empire Music Co. (PRO), 8553 Main, Vancouver, B.C. V5X 3M3. Tel: (604) 324-7732.
- Enteka (CAPAC), see Intermede.
- Entracte Music Publ'g Co. (CAPAC), see Halben.
- Espir (CAPAC), see Intermede.
- Etnos (CAPAC), see Intermede.
- Eyeball Wine Music (CAPAC), see Kitchen Table.
- Falcon House, 2264 Lakeshore Blvd. W., Toronto, Ont. M8V 1A9. Tel: (416) 625-3865. Telex: (06) 522673. Pres.: Gerry Mischuk; Gen. Mgr.: Don Lorusso.
- Fivetake Group Prod'ns Ltd., PO Box 2000, Baseline Rd. W. at Courtice Rd., Bowmanville, Ont. L1C 3Z3. Tel: (416) 576-0250, Toronto Tel: (416) 686-2828. Pres.: William Hewson; Gen. Mgr.: Bob Stone.
- Fogo Music (CAPAC), see Morning.
- Foot Note Music (BMI), see Simone.
- Freewheel Music (CAPAC), see Partisan.
- G R S of Canada Ltee., 347 Youville St., Montreal, P.Q. H3Y 2C3. Tel: (514) 284-2001. Chief Exec.: Tom Phil Norgoff, Rona Roberts.
- Home office: USA.
- Gallant Robertson Inc. (CAPAC), 4469 Sherbrooke St. W., Montreal, P.Q. H3Z 1E7. Tel: (514) 935-3717. Chm.: Ian Robertson; Gen. Mgr.: P. Gallant; Prof. Mgr.: Karen Rietschin.
- Gigue Eternelle (CAPAC), see Intermede.
- Giguette (CAPAC), see Intermede.
- Gimbleco West Music (PRO), see Kitchen Table.
- Gipe (CAPAC), see Intermede.
- Gog & Magog (PRO), see Intermede.
- Golden Publ'g (CAPAC), PO Box 128, Sta. T., Toronto, Ont. M6B 3Z9. Tel: (416) 783-5382. Mgr.: Elaine Golden.
- Gone Fishin' Music Ltd. (PRO), 6945 Isleview Rd., West Vancouver, B.C. Tel: (604) 922-2683. Pres.: Terry Jacks.
- Int'l firm represented: Rockfish (USA).
- Int'l repa.: Worldwide except Canada (Edward B. Marks in USA).
- Grand Chelem (CAPAC), see Intermede.
- Grand Fanal (CAPAC), see Intermede.
- Grand Leo (CAPAC), see Intermede.
- Alex Groshak Music Publ'g (CAPAC), see Morning.
- Hagood Hardy Music (PRO), see Attic.
- Halben Music Publ'g Co. (CAPAC), 4824 Cote des Neiges Rd., Suite 38, Montreal, P.Q. H3V 1G4. Tel: (514) 739-4774. Pres.: Ben Kaye.
- Frederick Harris Music Co. Ltd. (CAPAC), 529 Speers Rd., Oakville, Ont. L6K 2G4. Tel: (416) 845-3487/3572. Pres.: W. Ray Stephens.
- Int'l firms represented: Berkshire Publ'ns (USA), Alfred Lengnick (UK).
- Int'l repa.: Australia, South Africa, UK (Alfred Lengnick).
- Helping Hand Music (div. of Royal Recs. Mgmt. Ltd.), 9229 58 Ave., Edmonton, Alta. T6E 0B7. Tel: (403) 436-0665. Pres.: Jack Dubasz; Gen. Mgr.: R. Harlan Smith.
- Hoadley House Music (PRO), Box 5236, Vancouver, B.C. V6B 4B3. Tel: (604) 531-9331, 522-2711. Gen. Mgr.: Kenny Harris.
- I R O (Jan Robertson Org.) (PRO), see Gallant Robertson.
- Hot (PRO), see Intermede.
- Impulsions (CAPAC), see Intermede.
- Integrated Music (PRO), see Frank Swain.
- Interchange Publ'g Ltd. (PRO), 39 Ontario St., Toronto, Ont. M5A 2V1. Tel: (416) 364-8512. Cable: (06) 219699. Pres.: Jeffrey L. Smith; VP Bus. Affairs: Allen Shechtman.
- Int'l firms represented: Tubular Music (France); Cherry Red Music Ltd., Martin-Coulter Music, Mews Music (Steepey Dumping Music UK).
- Int'l repa.: Australia & New Zealand (WEA), Austria (Meridian), Belgium (Angus-Eurovox), Germany (Meridian), Japan (Watanabe), Luxembourg (Angus-Eurovox), Netherlands (Oldway), Switzerland (Meridian), UK (Mews).
- Intermede Musique, 825 Sherbrooke E., Suite 700, Montreal, P.Q. H2L 1K6. Gen. Mgr.: Lydie Wanner.
- Italcanto Canada (CAPAC), see Intermede.
- Itali Roots Music (PRO), see Morning.
- Izetta Brass Publ'ns (PRO), see Morning.
- J M L (CAPAC), see Intermede.
- J P F (CAPAC), see Intermede.
- Jah Music (CAPAC), see Morning.
- Jaune (CAPAC), see Intermede.
- Jerome (CAPAC), see Intermede.
- Jomark Publ'ns Inc. (CAPAC), 62 Ringrove Rd., Willowdale, Ont. M2R 2Z9. Int'l branch: USA.
- Jour de L'an (CAPAC), see Intermede.
- Kalevala (CAPAC), see Editeurs Associes.
- Kapocire (CAPAC), see Intermede.
- Kennebec Music Rec'gs (PRO), PO Box 357, St. Bruno, P.Q. J3V 5G8. Tel: (514) 461-0283. Pres. Dir. Gen.: Rancourt Rehjan; Gen. Mgr.: Lucette Mercier.
- Int'l firms represented: Aquarium Music, Francis Day, EM Prod'n Scorpis, Veranda Publ'g, YouYou Music (all France); Black Scorpion (USA).
- Int'l repa.: Belgium (April, Arabella, EMI-Eco Music, Veranda), France (Allo, April, Arabella, EMI-Eco Music, Veranda, YouYou), Greece (EMI), Netherlands (Arabella), Portugal (Valentim de Carvalho), Switzerland (Arabella, EMI-Eco Music, YouYou).
- E. C. Kerby Ltd. (CAPAC), 198 Davenport Rd., Toronto, Ont. M5R 1J2. Tel: (416) 922-9934. Pres. & Gen. Mgr.: Elvira C. Kerby; Prof. Mgr.: Franco Colombo.
- Int'l firms represented: Amphion (France), Consort (USA).
- Int'l repa.: France (Amphion), Netherlands (Albersen), Rest of Europe (G. Ricordi).
- King House Music Publ'g (CAPAC), 1020 Chanteny Dr., Orleans, Ont. K1C 2K9. Tel: (613) 824-5088. Chief Exec.: Bob King; Gen. Mgr.: Marie King.
- Int'l firm represented: San-Lyn Music (USA).
- King of the Sea Music (CAPAC)—Pres.: Kenny Harris—see Hoadley House.
- Kitchen Table Music (PRO), PO Box 861, Edmonton, Alta. T5J 2L8. Tel: (403) 477-6844. Mng. Dir.: Holger Petersen.
- Int'l firms represented: Bainbridge, Baron County, Oil Doug, John Hartford, Rolin, Weems (all USA); Looking Glass (UK).
- Int'l repa.: Europe (Heathside), Japan (Watanabe), USA (Bainbridge, Southern Pines).
- Kokioi (PRO), see Editeurs Associes.
- Kustor Music (PRO), see Halben.
- Lapapala Music (PRO), see Halben.
- LaPelle Music Publ'g (PRO), 1310 Centre St. S., Calgary, Alta. T2G 2E2. Tel: (403) 269-7270. Pres. & Gen. Mgr.: E. Bruce Thompson.
- La Rochelle (CAPAC), see Intermede.
- Laurence (CAPAC), see Intermede.
- Laurentian Music Ltd. (PRO), see Rising.
- Leeds Music (Canada) (CAPAC) (div. of MCA Canada Ltd.), MCA Bldg., 2450 Victoria Park Ave., Willowdale, Ont. M2J 4A2. Tel: (416) 491-3000. Cable: LEEOSMUSIC. Pres. & Gen. Mgr.: Bailey Bird.
- Home office: USA.
- Michel Lefrancois (CAPAC), see Intermede.
- Leslie Music Supply, PO Box 471, Oakville, Ont. L6J 5A8. Tel: (416) 844-3109.
- Int'l firms represented: Brodt (USA), J.B. Cramer (UK), Leonard Gould & Boltlett (UK), Pitman Hart (UK).
- Int'l repa.: UK (Robertson).
- Lexicon Music (ASCAP), see Manna.
- Lirana (CAPAC), see Intermede.
- Serge Locat (CAPAC), see Intermede.
- Lonsong Music Inc., 1055 Wilson Ave., Suite 600, Toronto, Ont. M3K 1Y9. Tel: (416) 630-2973. Pres.: Frank Longo.
- Love-Lies-Bleeding Music (PRO), see Partisan.
- Luton Music (PRO), see Frank Swain.
- MacLen Music of Canada (PRO), see ATV Music Group.
- Magnetic Movements (CAPAC), see Partisan.
- Mainroads Publ'g (CAPAC), 100 Huntley St., Toronto, Ont. M4V 2L1. Tel: (416) 961-8001. Pres.: David Manse.
- Maison Bleue (CAPAC), see Intermede.
- Manhole Music (PRO), 11602 75 Ave., Edmonton, Alta. T6G 0J2. Tel: (403) 436-3096. Pres.: N. MacIver; Gen. Mgr.: F. Phillet.
- Int'l repa.: Japan (GP Music).
- Manitou Music (PRO), see Leeds.
- Manna Music (ASCAP), PO Box 6900, Vancouver, B.C. V6B 4B5. Contact: Gerry Scott.
- Home office: USA.
- Marais Boulevard (PRO), see Intermede.
- The Master's Collection Ltd. (PRO), PO Box 189, Sta. W. Toronto, Ont. M6M 4Z9. Tel: (416) 746-1991. Mng. Dir.: Paul J. Young.
- Int'l firm represented: Parchment (UK).
- Maxess Music (CAPAC), see Rising.
- McMusic Ltd. (CAPAC), 14 Garthdale Court, No. 1, Downsview, Ont. M3H 5P8. Tel: (416) 635-6321. Pres.: Ian McLeish.
- Mede Musique Int'l (PRO), see Intermede.
- Mekia Publ'g (BMI), see Simone.
- Midnight Blue Music (PRO), 42 Brahm Ave., Willowdale, Ont. M2H 1H4. Tel: (416) 492-9916. Pres. & Gen. Mgr.: Birgitta Graham; Prof. Mgr.: Prakash John.
- Minda Music (PRO), see Rising.
- Minnalouise Music (PRO), PO Box 1175, Victoria, B.C. V8W 2T6. Tel: (604) 479-1002. Pres. & Gen. Mgr.: Jurgen Gothe.
- Modeles Enr. (Les Eds.) (PRO), 65 54 Ave., Pointe-aux-Trembles, P.Q. H1A 2T1. Tel: (514) 642-0648. Gen. Mgr.: Pat Di Stasio.
- Montina Music (PRO), PO Box 702, Snowdon Sta., Montreal, P.Q. H3X 3X8. Tel: (514) 342-5200. Pres. & Prof. Mgr.: David P. Leonard.
- Morning Music Ltd. (CAPAC), 1343 Bathurst Blvd., Mississauga, Ont. L4W 1R1. Tel: (416) 625-2676. Cable: BOOTGROUP. Telex: 06-960250. Pres.: Jory Krytiuk; VP: Tom C. Connors; Gen. Mgr.: Mark Atman; Admin. Mgr.: Ann Fuller; Copyright Mgr.: Mary Krytiuk; Promo: Peter Krytiuk.
- Int'l branches: England, Ireland, USA.
- Int'l firms represented: Joe Allen (USA), Altona (USA), Aunt Polly's (USA), Background (UK), Barrelhouse, Bathurst (USA), Biba (USA), Blue Band (USA), Blue Candle (USA), Blue Creek (USA), Blue Echo (USA), Blue Melody (USA), Boxer (USA), Bullfrog Ballades (USA), Champagne (USA), Chandos (USA), City Boy (UK), Cornbread (USA), Dean's List (USA), Emerald (UK), Emma (Ireland), Evening (USA), Family of Man (USA), Filmways (USA), First Floor (USA), Folklore (USA), Fruit (USA), Noel Gay (UK), Good Music (USA), Lloyl Green (USA), Hall-Clement (USA), I.B. Harms (USA), Harvey Wallbanger (USA), Heater-Gugley (USA), Hillgreen (USA), House of Cash (USA), Image (Australia), Inter Art (UK), Jack (USA), Jack & Bill (USA), Jando (USA), July (Australia), Jump (Italy), Kevin Lee (USA), Koko (USA), LS (USA), Laetrec (South Africa), Land of Song (UK), Crisly Lane (USA), Mata Hari (Netherlands), Morning Dew (USA), Mountainwood (USA), Musicways (USA), Mywomah (USA), Owlofus (USA), Pathfinder (USA), Photoplay (UK), Pix-Rox (USA), Programme (UK), Pulleybone (USA), Rainbird (Australia), Reveille (South Africa), Rokklok (USA), Selected Sound (Germany), Sewer Fire Hits (UK), Shanachie (USA), Sidewalk (USA), Siegel (Germany), Silver Dollar (USA), Song of Cash (USA), Squirrel (Ireland), Stonehill (USA), Street (UK), TEK (USA), Tammy Lee (USA), Vogue (USA), Harry Von Tizer (USA), Don Wayne (USA), Josef Weinberger (UK), Weltmusik (Austria), Wheeling (USA), Yamaha (Japan), Zomba Corp. (Switzerland, UK).
- Int'l repa.: Australia (Image), Austria (Melodie der Welt), Benelux (Hans Kusters), Central America (Edmusicus), Colombia (Codiscos), Czechoslovakia (Supraphon), Finland (Fazer), Germany (Melodie der Welt), Greece (Greophon), Iceland (Iceland Music), Israel (April), Italy (Curci, RCA), Japan (Yamaha), Mexico (Edmusicus), New Zealand (Image), Scandinavia (Sweden Music), South Africa (Laetrec, Reveille, Contagious), Southeast Asia (EMI), Spain (Montserat), Switzerland (Melodie der Welt), Venezuela (Ummusicus), Yugoslavia (Jugoton). (SEE ADVERTISEMENTS)
- Moss Music Group (Canada) Inc., 510 Coronation Dr., West Hill, Ont. M1E 4K6. Tel: (416) 284-0126. Pres.: John Leatham.
- Mount Albert Music (CAPAC), see Frank Swain.
- Mousse (CAPAC), see Intermede.
- Musi-Phile (PRO), see Intermede.
- Musiquette (CAPAC), see Intermede.
- Musselshwartz Music (PRO), see ATV Music Group.
- Nahel Publ'g (PRO), 5514 Isabella St., Montreal, P.Q. H3X 1R6. Tel: (514) 487-0859. Telex: (05) 564493. Pres.: Jehan V. Vaiquet.
- Nam (CAPAC), see Intermede.
- Neiljoy Music Publ'g Inc. (PRO), see Halben.
- Northern Gold Music (PRO), see Morning.
- Northern Light Music Publ'ns (PRO) (div. of Dipper 7 Ents.), 1414 Hillside Ave., Suite 101, Victoria, B.C. V8T 2B8. Tel: (604) 595-6709. Owner: Lou Jean Molin; Gen. Mgr.: Arthur Trolley; Sales: Robert Paul & Richard Molin.
- Noteworthy Publ'g Co. (PRO), 6979 Curragh Ave., Burnaby, B.C. V5T 4V6. Tel: (604) 438-8266. Gen. Mgr.: Paul Yaroshuk.
- Nothingbut Music (PRO), see Halben.
- Notre Musique (CAPAC), see Editeurs Associes.
- O M (CAPAC), see Intermede.
- 1, 2, 3, 4 (CAPAC), see Intermede.
- P L (CAPAC), see Intermede.
- P S I Publ'g (PRO), 1747 W. Third Ave., Vancouver, B.C. V6J 1K7. Tel: (604) 732-3761. Mgr.: Robin Spurgin.
- Pachyderm Music (CAPAC), 77 Berkeley St., Toronto, Ont. M5A 2W5. Tel: (416) 364-3387. Gen. Mgr.: Molly Thon.
- Palas House Publ'g (PRO), Box 7, RR 1, Beaverbank Rd., Lower Sackville, N.S. B4C 2S6. Tel: (902) 865-8023. Pres.: Joe Palaschuk.
- The Pangaea Music House (PRO), PO Box 609, Sta. F., Toronto, Ont. M4V 2L8. Tel: (416) 922-1600. Pres. & Gen. Mgr.: Tony Tobias.
- Int'l firm represented: I Love Life (USA).
- Partisan Music Prod'ns Inc. (CAPAC, PRO), PO Box 615, Don Mills, Ont. M3C 2T6. Tel: (416) 881-6619. Pres.: Frank Davies; Prof. Mgr.: Lynda Squires.
- Int'l repa.: Worldwide (April/Blackwood) excluding USA (Screen Gems-EMI).
- Partnership Music (CAPAC), see Partisan.
- Pedno (CAPAC), see Intermede.
- Pee Gee Music (CAPAC), see Gallant Robertson.

Peer Southern Org. (Canada) Ltd. (PRO, CAPAC), 180 Bloor St. W., Toronto, Ont. M5S 2Y6. Tel: (416) 924-5781. Cable: SOUTHMUSIC. Mng. Dir.: Matthew Helt.
Home office: USA.

People City Music Publ'g, see Lonsong.

Pet-Mac Publ'g (PRO), 6844 76 Ave., Edmonton, Alta. T6B 0A8. Tel: (403) 465-1071. Pres.: Garry L. McDonald; Gen. Mgr.: Wallis A. Petruk, Prof. Mgr.: Leonard A. Petruk.

Pig-Weed Music (PRO), see Rising.

Pocus Plum Publ'g (CAPAC), see Intermede.

Pondwater Music (CAPAC), see Attic.

Sarah Porte (PRO), see Intermede.

Presqu'ie (CAPAC), see Intermede.

Producers' Rec'g Org. (PRO), see Rising.

Quality Music Publ'g (PRO) (div. of Quality Recs. Ltd.), 380 Birchmount Rd., Scarborough, Ont. M1K 1M7. Tel: (416) 698-5511. Pres.: George R. Struth. Bus. Affairs Dir.: Nadine Langlois.
Int'l firms represented: AVI, Alotagood, Good Flavour, Intro, Kool, Old Shanty, Rycha, Slow Dancin', Sons Celeste.

Rainy River Music Ltd. (PRO), see Halben.

Ramophone Music (CAPAC), see PSI.

Rang Double (PRO), see Intermede.

Ravel (CAPAC), see Intermede.

Rebera (PRO), see Black Sun.

Reels of Rhyme (PRO), see Partisan.

Ria Music (PRO), see Golden.

Rideau Music Ltd. (CAPAC), see Rising.

Rising Recs. Ltd., 111 Peter St., Suite 620, Toronto, Ont. M5V 2H1. Tel: (416) 363-4343. Pres.: Robert H. Hahn.
Int'l repa.: CanCon-Ireland & UK (Valentine), Elnoise-World excluding Canada (Belwin Mills), Laurentian-USA (Copyright Serv. Bureau).

Robgal Music (PRO), see Gallant Robertson.

Robian Music (CAPAC), see Gallant Robertson.

Robley Music (PRO), see Gallant Robertson.

S M C Inc. (Les Prod'n), 450 Beaumont E., St. Bruno, P.Q. J3V 2R3. Tel: (514) 653-7838. Pres.: Christian Lefort; VP & Gen. Mgr.: Louis Lefort.
Int'l firms represented: Bagatelle, Bretagne, Le Minoiaure, Rideau Rouge, Scorpio, Tremplin-Delphine (all France); Ourium (Italy).

Sans Non (PRO), see Intermede.

Shee Wee Music (PRO), see Antrim & Attic.

Siam Music (CAPAC), see Simone.

Sibelius (Ed.) (PRO), see Editeurs Associes.

Simone Publ'g (CAPAC)/Mekla Publ'g (BM), 6000 Cavendish, Suite 605, Cote St. Luc, P.Q. H4W 2Y2. Tel: (514) 487-1573, 336-1371. Telex: (05) 824504, 827542. Pres.: Simone Zgarka; Gen. Mgr.: Michel Zgarka. (Mekla administered by Intermede)
Int'l firms represented: Aggy (France), Bleu Blanc Rouge (France), Chap-pell Iberica, Ibach (France), Shiva (Belgium).

Skimmers Pond Music (PRO), see Morning.

Snowberry Music (CAPAC) (div. of Northern Light & Sound Entertainment Corp. Ltd.), 1659 Bayview Ave., Toronto, Ont. M4G 3C1. Tel: (416) 485-1157. Pres.: David Coultis; VP: Brian Ayres.
Int'l repa.: UK (ATV), USA (Candy Mountain/Sweet Cherry).

Sock-CymbalMusic (PRO), see Halben.

Speckled Bird Music (CAPAC), see Morning.

Springwater Prod'n Ltd. (CAPAC), 56 Clinton St., Guelph, Ont. N1H 5G5. Tel: (519) 824-7885. Pres.: Homer Hogan; VP Gen. & Prof. Mgr.: Dorothy Hogan.
Int'l branch: USA.

Square Root Music (PRO), PO Box 581, Adelaide St. Sta., Toronto, Ont. M5C 2T6. Tel: (416) 364-3815. Cable: OBSMUSIC. Pres.: Don Bell.

Bruce W. Stacey Publ'g (PRO), see Mainroads.

Stony Plain Music (CAPAC), see Kitchen Table.

Sunbury/Dunbar Music (Canada) Ltd. (CMRRA), 101 Duncan Mill Rd., Suite 305, Don Mills, Ont. M3B 1Z3. Tel: (416) 449-4346. Telex: (06) 966577. Pres.: John R. Feeney; Admin. Dir.: Patricia Watts.
Int'l firms represented: Amsterdam (Netherlands), Antisya (USA), Associated (Australia), Blue Lake (USA), Coal Miner's (USA), Creative (USA), First-o-King (USA), Frebar (USA), Global (Japan), Golden West Melodies (USA), Funk Coal (USA), Loville (USA), Lucky Three (USA), Mason Jar (USA), Ovation (USA), Plum Creek (USA), Porter (USA), RCA (Brazil, France, Italy, Spain), Relay (Argentina), Salsoul (USA), Scott-Wolfe Songs (UK), Shenandoah (USA), Singletree (USA), Song Yard (USA), Streeter-ville (USA), Sunbury (UK), Terrace (USA), Velvet Apple (USA), W&N (USA).
Int'l repa.: Belgium (Universal), Colombia (Sonolux), Finland (Coda), Israel (Musicor), Netherlands (Universal), Norway (A/S Disco), Philippines (Mareco), South Africa (Laetrec), Sweden (Liberty), Switzerland (Musik-vertrieb).

Surprise (CAPAC), see Intermede.

Frank Swain Music (PRO), PO Box 9, Mount Albert, Ont. L0G 1M0. Tel: (416) 284-3085. Pres.: Frank P. Swain.

T M C Publ'g (CAPAC), see The Master's Collection.

Taxi Driver Music (div. of the Great Canadian Entertainment Co. Inc.) (CA-PAC), 1659 Bayview Ave., Toronto, Ont. M4G 3C1. Tel: (416) 485-1157. Pres.: Dave Coultis; Gen. Mgr.: Terri Hammer; Prof. Mgr.: Brian Ayres.
 Gordon V. Thompson Ltd. (CAPAC), 29 Birch Ave., Toronto, Ont. M4V 1E2. Tel: (416) 923-7329. Cable: GORTHOM. Pres. & Gen. Mgr.: John C. Bird; Prof. Mgr.: Jack Denton Hingworth.
Int'l firms represented: Aden Music Co., Amidan Music Co., Anacrusis Music Publ'g Co., Arena Music, Avas Music Publ'g Co., Abel Baer Music Corp., Batielf, Barton, Mel Bay (USA), Benson Co., Big Seven, Big 3, Boca Music Inc., Fred Bock Music Co., Bourne Co., Brandom Music Co., Michael Brent Publ'g Inc., Bulls-Eye Music Inc., George M. Cohan, Creston Music Co., Deerhaven Music Corp., Dorabot Music Co., Dunaway Music Corp., Fred Fisher, Four Jays Music Co., Forster, Gaither Music, Gamble-Hinged Music, George Music Inc., Greenbar Music Corp., Hollywood Music Ents. Ltd., Hodge Publ'g Co., Hy Lo Music, Kohn Music Corp., Laertes Music Co., Lansdowne Music Publ'rs, L'aries Music Corp., Leo Talent Inc., Lichelle Music Co., Lido Music Inc., Lincoln Music Corp., Lorenz Publ'g Co., Marpel, Milene, Montgomery, Music-Music-Music, Oakland Music Inc., Paragon Assoc. Inc., Pattern Music Inc., George Pincus & Sons, Planetary Music Co., Plymouth, Rocket Music Co., Rodeheaver Co., Royal Music Publ'g, St. Nicholas, G. Schirmer, Andrew Scott Inc., Shapiro Bernstein, Songsmiths Inc., Larry Spier, Tamblene Music Publ'g Co., Top Notch Music Corp., Trina Jill Music Corp., True Blue Music Publ'g Co., Walton, H. B. Webman, Wendy Music Inc., Winston Music Publ'rs, Word Inc., World Music Inc.

3 PM Music (CAPAC), see Pet-Mac.

Time Being Music Co. (PRO), see Morning.

Topi Tambo Music (CAPAC), see Frank Swain.

Du Triangle (CAPAC), see Intermede.

Troika Music (PRO), 1262 Don Mills Rd., Suite 3A, Don Mills, Ont. M3B 2W7. Tel: (416) 445-0878.

Universal (CAPAC), see Intermede.

Unreel Publ'g Co., 1035 Richmond St., London, Ont. N6A 3J6. Tel: (519) 672-1904. Contacts: Helen & John Victor.

V Music Publ'g Co. (CAPAC), see Morning.

Valcor (Eds.) (CAPAC), see Nahej.

Val D'Espoir (CAPAC), see Intermede.

Vanessa Music (CAPAC), see Halben.

Vetero Americana Music Publ'g (VAMP) (CAPAC), 79 Lunness Rd., Toronto, Ont. M8W 4M7. Tel: (416) 259-9182. Mng. Dir.: Jose Osana.

Vent Qui Vire (CAPAC), see Intermede.

Veron Music (PRO), 3500 Glen Erin Dr., Unit 10, Mississauga, Ont. L5L 1W6. Tel: (416) 828-2582. Pres.: S. Campbell; Gen. Mgr.: V.I.T. Mataseje.

Vert Pays (CAPAC), see Intermede.

Ville Emard Blues Publ'g (CAPAC), see Halben.

Vingt-Deux (CAPAC), see Intermede.

W A M Music Corp. Ltd., 901 Kenilworth Rd., Montreal, P.Q. H3R 2R5. Tel: (514) 341-6721. Gen. Mgr.: Leon Aronson.

Waldheim Music (PRO), see Rising.

Warhorse Music Publ'g, 8190 D'Aunis, St. Leoaard, P.Q. H1R 2M8.
Int'l firm represented: Southern Crescent (USA).

Welbeck Music of Canada Corp. (CAPAC), see ATV Music Group.

Westend Music (PRO), see Halben.

White Whisker Music (PRO), see ATV Music Group.

Windy Bay Music (PRO), see Halben.

Winnemucca Music (PRO), see Intermede.

Word Music (ASCAP), see Manna.

Y D (CAPAC), see Intermede.

• sheet music jobbers / suppliers

Academy of Musical Arts, 212 Lochiel St., Sarnia, Ont. N7T 4C7. Tel: (519) 344-6881/7683. Prof. Mgr.: Patrick C. Malito.

Algorid Music Ltd., 372A Yonge St., Toronto, Ont. M5B 1S6. Tel: (416) 597-0066.

Chappell & Co. Ltd., 14 Birch Ave., Toronto, Ont. M4V 1C9. Tel: (416) 922-2159.

Empire Music Co. Ltd., 8553 Main St., Vancouver, B.C. V5X 3M3. Tel: (604) 324-7732.

Frederick Harris Music Co. Ltd., 529 Speers Rd., Oakville, Ont. L6K 2G4. Tel: (416) 845-3487/3572. Pres.: W. Ray Stephens.

E. C. Kerby Ltd., 198 Oavenport Rd., Toronto, Ont. M5R 1J2. Tel: (416) 922-9934.

Leslie Music Supply, PO Box 471, Oakville, Ont. L6J 5A8. Tel: (416) 844-3109.

Morning Music Ltd., 1343 Matheson Blvd., Mississauga, Ont. L4W 1R1. Tel: (416) 625-2676. Cable: BOOTGROUP. Telex: 06-960250. Pres.: JURY Kry-tuk; VP: Tom C. Connors; Gen. Mgr.: Mark Altman.

Gordon V. Thompson Ltd., 29 Birch Ave., Toronto, Ont. M4V 1E2. Tel: (416) 923-7329. Pres.: John C. Bird.

• record & tape wholesalers

The wholesale function(s) of all companies is set in bold face and parentheses after each listing. The following abbreviations identify these functions: (D) Distributor; (OS) One Stop; (RJ) Rack Jobber; (I) Importer; (E) Exporter. The function of a branch or home office is indicated only when it differs from that of the listing.

ALBERTA

• CALGARY (Area Code 403)

A & M Calgary, 6812-A Sixth St. SE. Postal Code: T2H 2K4. Tel: 253-8411. Telex: 03-825736. Reg'l Mgr.: Al Harrison; Promo: Randy Wells; Sales: Don Jones, Dan Hobbs. (Rec. & Tape D).
Home office: Scarborough (Toronto Metropolitan Area), Ont. (See for prod. distributed).

A R S Recs. Canada (div. of CBS Recs. Canada Ltd.), 7310 Fifth St. SE. Postal Code: T2H 2G3. Tel: 259-3632. VP & Gen. Mgr.: Jerry Wipf; Mktg. Mgr.: Peter Anderson; Sales Dir.: Lyle Drake; Ops. Dir.: Mehdi Somani. (Rec. & Tape RJ)
Home office: Agincourt (Toronto Metropolitan Area), Ont.

CBS Recs. Canada Ltd., 7004-M Fifth St. SE, Glenmore Centre. Postal Code: T5H 2G3. Tel: 253-8719. TWX: (610) 821-2235. Western Reg'l Dir.: Bill Bouvette. (Rec. & Tape D)
Home office: Don Mills (Toronto Metropolitan Area), Ont. (See for prod. distributed)

Capitol Recs. EMI of Canada Ltd., 519 Manitou Rd. SE. Postal Code: T2G 4C2. Tel: 287-0823. Western Reg'l Mgr.: D. Bertsch. (Rec. & Tape D—see office in Toronto, Ont., for prod. distributed)

O J's Music Servs. Ltd. (Rec. OS) see Dee Jay's Music Dists.

Dee Jay's Music Dists. Ltd., 4524 Manilla Rd. SE. Postal Code: T2G 4B7. Tel: 243-0252. (Rec. D), (Rec. OS as OJ's Music Servs. Ltd.)
Labels: Motown, Quality.

Handelman Co. of Canada Ltd., 1135 64 Ave. SE, No. 106. Postal Code: T2H 3K7. Tel: 259-2800. (Rec. & Tape RJ)
Home office: USA—Crawson (Detroit Metropolitan Area), Mich.

MCA Dist'n (Canada) (div. of MCA Canada Ltd.), 1121 Centre St. N., Unit 310. Postal Code: T2E 7K6. Tel: 230-3991. TWX: (610) 821-6408. Sales Mgr.: Geoff Gibbons. (Rec. & Tape D)
Home office: Willowdale (Toronto Metropolitan Area), Ont. (See for prod. distributed).

Phonodisc Ltd., 83 2209, 6651 Ranchview Dr. NW. Postal Code: T3G 1B3. Tel: 239-2661. Mgr.: Gary Gow. (Rec. & Tape D)
Home office: Scarborough (Toronto Metropolitan Area), Ont. (See for prod. distributed)

PolyGram Dist'n Inc., 7220 Fisher St. SE, Suite 110. Postal Code: T2H 2H8. Telex: 03-821859. Promo Mgr.: Harry Hrabinsky. (Rec. & Tape D).
Home office: St.-Laurent (Montreal Metropolitan Area), P.Q. (See for prod. distributed).

RCA Inc., Rec. Div., 4432 10 St. NE. Postal Code: T2E 6K3. Tel: 276-8231. District Sales Mgr.: Terry Carson. (Rec. & Tape D—see office in Toronto, Ont., for prod. distributed)

W E A Music of Canada Ltd., 6325 12 St. E., Unit 7. Postal Code: T2H 2K1. Tel: 259-3000. Western Region Mgr.: Alex Clark. (Rec. & Tape D)
Home office: Scarborough (Toronto Metropolitan Area), Ont. (See for prod. distributed)

• EDMONTON (Area Code 403)

Northland Music Dists. Co. Ltd., 6846 76 Ave. Postal Code: T6B 0A8. Tel: 469-5066. Telex: 469-5066. Pres., Gen. Mgr. & Buyer: Bill Maxim. (Rec. OS & RJ).
Branch: Vancouver, B.C.
 Word Recs. Ltd., 4332 114A St. Postal Code: T6J 1N7. Tel: 437-3242. (Rec. & Tape D)
Home office: Richmond (Vancouver Area), B.C. (See for prod. distributed)

BRITISH COLUMBIA

• VANCOUVER AREA (Area Code 604)

A & M Vancouver, 100-1334 W. Sixth Ave. Postal Code: V6H 1A7. Tel: 734-7689. Telex: 04-51123. Reg'l Mgr.: Dave Pearce. Promo.: David Brian; Mktg./Mds: Rob Thornton; Sales: Tom Jones. (Rec. & Tape D)
Home office: Scarborough (Toronto Metropolitan Area), Ont. (See for prod. distributed)

CBS Recs. Canada Ltd., 1847 W. Broadway, Suite 101. Postal Code: V6J 1Y6. Tel: 734-5151. TWX: (610) 953-4916. Reg'l Sales Mgr.: Oon Gunter. (Rec. & Tape D)
Home office: Don Mills (Toronto Metropolitan Area), Ont. (See for prod. distributed)

Capitol Recs. EMI of Canada Ltd., Century Plaza, Suite 503, 1015 Burrard St. Postal Code: V6Z 1Y5. Tel: 689-8667. Sales Rep.: B. Manlove. (Rec. & Tape D—see office in Toronto, Ont., for prod. distributed)

La-Go Ents. (Rembrandt Holdings Ltd.), 3446 Bridgeway St. Postal Code: V5K 1B6. Tel: 294-6226. Owner & Mgr.: Robert Gallo; Albums Buyer: D. Thauber. (Rec. D).
Labels: Audio Fidelity, Boot, Diamond, El Mocambo, Fantasy, Fiesta, Galaxy, Gusto, Milestone, Prestige, Pye, Riverside, Ruby, Stax, Strata East, Summit, TCD
Accessories: Le-Bo.

Northland Music Dists. Co. Ltd., 10477 48 Ave., North Delta. Tel: 590-2616. Mgr.: Doug Watt. (Rec. OS & RJ)
Home office: Edmonton, Alta.

One Stop Rec'g Supplies. (Rec. OS)—Tel: 732-7313—see Emerson Short.

Pandorf Rec. Sales Ltd., 8048 Winston St., Burnaby V5A 2H5. Tel: 299-4394. Mgr.: I.S. Farquharson. (Rec. & Tape RJ)
Home office: Reddale (Toronto Metropolitan Area), Ont.

PolyGram Dist'n Inc., 805 W. Broadway, Mezzanine. Postal Code: V5Z 1K1. Tel: 873-2466. Telex: 04-54410. Western Reg'l Mgr.: Peter Behnke; Promo: Monica Netupshy. (Rec. & Tape D).
Home office: St.-Laurent (Montreal Metropolitan Area), P.Q. (See for prod. distributed)

RCA Inc., Rec. Div., 2876 Rupert St. Postal Code: V5M 3T7. Tel: 438-7172. District Sales Mgr.: Leigh Alden. (Rec. & Tape D—see office in Toronto, Ont., for prod. distributed)

Shannock Mktg. Assocs., Box 82314, 3941 Grant St., Burnaby V5C 5P8. Tel: 294-8566. Pres.: W. McCartney. (Rec. & Tape D)
Labels: Alshra, BBC, Disneyland, Fresh Aire, Granville, Mobile Fidelity, Storyville, Total.
Accessories: Alltop, Oenon, Dynasound, Marell, Recoton, Satin, Savoy, Saxton, Sound Guard, Swire Int'l, TOK.

Emerson Short, 1599 W. Fourth Ave. Postal Code: V6J 1L6. Tel: 733-0415. Owner & Sales Mgr.: Emerson Short. (Rec. & Tape D, I & E), (Rec. OS & RJ as One Stop Rec'g Supplies)
Labels: Advent, Ajax, All Ears, Alligator, Apon, Aviva, Blind Pig, Briar, Briko, Bullfrog, CMH, CMS, Cabot, Crystal Clear, DRG, Desmar, Dobbe, Emus, Entr' Actie (Canada), Entr' Actie imports, Fanfare, Four Leaf Clover, First American, Flying Fish, Gryphon, HNH, Impromising Artists, India Navigation, JCOA/WATT, Jazz Archives, Jazz Guild, Joyce, Mother Necessity, Muse, Music Minus One, Musica!rt, Muskadine, Nessa, Onari, PBR, Peter Pan, Potato, Rebel, Retrospect, Rocking Horse, Rogor, Sackville, Spotlite, Stash, Suite, Tifton, Unicorn, Varese/Sarabande, Versatile, Zim.
Labels imported: Black Saint (Italy), Varese/Sarabande (Japan, USA).
Accessories: Plastic-lined envelopes.

W E A Music of Canada Ltd., 40 E. Fifth Ave. Postal Code: V5T 1G8. Tel: 879-8681. Mgr.: Adrian Bitodeau. (Rec. & Tape D).
Home office: Scarborough (Toronto Metropolitan Area), Ont. (See for prod. distributed)

Word Recs. Ltd., 7720 Alderbridge Way, Richmond V6X 2A2. Tel: 270-7231. Pres. & Adv. Off.: Gerry B. Scott; VP: J.E. Scott; Sales & Mktg.: Phil Crofton, Dwayne Daku, Doug Stark, Don Harbridge, Carl Teeple, Duane Suderman, Nick Panoseiko. (Rec. & Tape D).
Branches: Edmonton, Alta.; London, Ont.
Labels: Birdwing, Canna, Century, Dayspring, Good News, Image VII, Jim, Janz, Light, Manna, Maranatha, Myrrh, New Song, Neworld, Sacred, Sparrow, Word.

MANITOBA

• WINNIPEG (Area Code 204)

Laurel Recs. Ltd., 120 Isabel St. Postal Code: R3A 1G4. Tel: 783-0436, 774-1052. Telex: 07-587504. Pres.: W.V. Sokulsky; Promo Dir.: Glen Gore-Smith. (Rec., Tape & Videocassette D)
Labels: Motown, Quality.
Accessories: Memorex, Savoy.

MCT R Dists. Ltd., 1733 St. Matthews Ave. Postal Code: R3H 0V8. Tel: 783-7201. Owner: Thomas Rathwell; Mgr.: Pat Christie; Albums & Tape Buyer: S. Astleford. (Rec. & Tape RJ)
Accessories: Agfa, Discwasher, Memorex.

National Rec. Dist. Ltd., 8 Plymouth St. Postal Code: R3C 2K9. Tel: 633-1412. Pres.: R.L. Lauze; VP Mktg.: K.J. Grouette Sr.; Buyer: Wayne Harmon. (Rec. & Tape RJ).

PolyGram Dist'n Inc., c/o Philips Electronics, 401 Weston St. E. Postal Code: R2E 3H4. Tel: 786-5748. Telex: 07-57786. Sales Rep.: Nancy Pellick. (Rec. & Tape D)
Home office: St.-Laurent (Montreal Metropolitan Area), P.Q. (See for prod. distributed)

RCA Inc., Rec. Div., 1320 Church Ave. Postal Code: R2X 1G4. Tel: 633-2666. District Sales Mgr.: Robert Tait. (Rec. & Tape D—see office in Toronto, Ont., for prod. distributed)

W E A Music of Canada Ltd., 24 Stevenson Rd., St. James R3H 0H8. Tel: 633-9284. Mgr.: Don Coward. (Rec. & Tape D).
Home office: Scarborough (Toronto Metropolitan Area), Ont. (See for prod. distributed).

NUMBER 1 IN CANADA for OVERSTOCKS DELETIONS SURPLUS

Special Offers on
All Labels

RECORDS

TAPES

ACCESSORIES

We Import
and Export

LISS INTERNATIONAL

3495 Thimmes Blvd.
Montreal, Quebec H4R 1V5
Telex: 05824667
(answerback: DYNATFONIC)
Tel: (514) 335-0615

LET US SUPPLY YOUR EVERY NEED
WE ARE

M&M EXPORTS

4515 Poirer Ville St. Laurent
Quebec, Canada H4R-2A4

Canada's
Fastest Growing
One Stop

Exporting to all Countries
All Major Labels
Many Minor Labels
Telex: (055) 62040
(Downstairs Mtl) or phone
514-271-6229



M&M EXPORTS

NEW BRUNSWICK

• MONCTON AREA (Area Code 506)

CBS Recs. Canada Ltd., 602 Blythwood Ave., Riverview E1B 2H5. Tel: 386-1515. Reg'l Sales Mgr.: Jim Bradley. (Rec. & Tape D)
Home office: Don Mills (Toronto Metropolitan Area), Ont. (See for prod. distributed)

Handeman Co. of Canada Ltd., 450 Edinburgh Dr. Postal Code: E1C 3B2 Tel: 389-9141. (Rec. & Tape RJ)
Home office: USA—Clawson (Detroit Metropolitan Area), Mich.

NEWFOUNDLAND

• ST. JOHN'S (Area Code 709)

A R S Recs. Canada (div. of CBS Recs. Canada Ltd.), 58 Kenmount Rd. Postal Code: A1B 3M9. Tel: 726-6970. Mgr.: Brian Sutton. (Sales only)
Home office: Agincourt (Toronto Metropolitan Area), Ont. (Rec. & Tape RJ)

NOVA SCOTIA

• HALIFAX AREA (Area Code 902)

A & M Halifax, PO Box 3504, Halifax South. Postal Code: B3J 3J2. Tel: 423-6533. Sales: Rudy Eysen. (Rec. & Tape D)
Home office: Scarborough (Toronto Metropolitan Area), Ont. (See for prod. distributed)

A R S Recs. Canada (div. of CBS Recs. Canada Ltd.), 100 Wright Ave., Burnside Industrial Park, Dartmouth B3B 1L2. Tel: 463-9344. Mgr.: Paul Atzema. (Rec. & Tape OS & RJ)
Home office: Agincourt (Toronto Metropolitan Area), Ont. (Rec. & Tape RJ)

R C A Inc., Rec. Div., 3611 Commission St. Postal Code: B3V 2X1. Tel: 455-0409. District Sales Mgr.: Hanson Josey. (Rec. & Tape D—see office in Toronto, Ont., for prod. distributed)

ONTARIO

• BOWMANVILLE (Area Code 416)

World Recs. (div. of Shotgun Gimme Holdings Ltd.), Box 2000, Baseline Rd. W. at Courthouse. Postal Code: L1C 3Z3. Tel: 576-0250. Mng. Dir.: R. Stone. (Rec. & Tape D & I)

• LONON (Area Code 519)

World Recs. Ltd., 152 Wellesley Crescent. Postal Code: N5V 1J7. Tel: 455-2097. (Rec. & Tape D)
Home office: Richmond (Vancouver Area), B.C. (See for prod. distrib. uted)

• MOUNT ALBERT (Area Code 416)

Holborne Dist'g Co. Ltd., PO Box 9. Postal Code: L0G 1M0. Tel: 294-9398. Mgr. & Buyer: Frank P. Swain. (Rec. & Tape D & I).
Labels: Abraham, Bluegrass, Condor, Cougar, Dynamic, Edmar, Elite, Fiesta, Geophone, Ice, Island series, Maple, Merryman, Murray Banks, Pebblygroove, Penny, Pioneer, Plant, REC, 3A, Trinidad, Waterloo. Imports Caribbean prod.

• OTTAWA (Area Code 613)

Eastern Ontario Rec. Dist. Ltd., 383 Winona Ave. Postal Code: K1Z 5H8. Tel: 722-1000. Pres.: Jack Slumkoski; Mgrs.: Jan & James Slumkoski; Buyer: Jan Slumkoski; Video: Jeff Slumkoski. (Rec. & Tape RJ)
Accessories: Ampex, Le-Bo, Memorex.

TC/AC/DC Discs Inc., 1050 Baxter Rd. Postal Code: K2C 3P1. Tel: 820-4522. Owners: Harold Levin, David Mozer, Mgr. & Albums Buyer: Miles Flood. (Rec. OS, I & E) (SEE ADVERTISEMENT)

• TORONTO METROPOLITAN AREA (Area Code 416)

A & M Toronto, 939 Warden Ave., Scarborough M1L 4C5. Tel: 752-7191. Telex: 06-963652. Reg'l Mgr.: Ray Rosenberg; Promo.: Pat Ryan; Sales: Hank Koch, Joe Toews, Mdsq.: Michelle Henderson. (Rec. & Tape D)
Branches: Calgary, Alta.; Vancouver, B.C.; Halifax, N.S.; St. Laurent (Montreal Metropolitan Area), P.Q.

Labels: A&M, Arist House, Falcon, Fluttermby, Haida, Horizon, IRS, International Artists, Maze, Punny Farthing, Sloth, Solid Gold, Troubadour.
A R S Recs. Canada (div. of CBS Recs. Canada Ltd.), 160 Milner Ave., Agincourt M1S 3B2. Tel: 293-1941. VP & Gen. Mgr.: Dave Redgers; Mktg Mgr.: Gusele Cline; Nat'l Admin. Mgr.: June LeQuyer. (Rec. & Tape RJ)
Branches: Calgary, Alta.; St. John's Nfld. (Sales only); Dartmouth (Halifax Area), N.S. (Rec. & Tape OS & RJ); Dorval (Montreal Metropolitan Area), P.Q.

Air Wax Rec. Imports, 100 Richmond St. E. Zip: M5C 2P9. Tel: 863-6089. Pres.: Thomas J. Wood; VP & Gen. Mgr.: Israel L. Shafr.
Alidisc Oists. Ltd., 64 Bullock Dr., Markham L3P 3P2. Tel: 294-9298. Pres.: Tony R. Frank; Buyer: Lee Aldridge. (Rec. & Tape OS & RJ)
Beaches Recs & Tapes Ltd., 950 Denison St., Unit 20, Markham L3R 3K5. Tel: 495-1175/1585. Telex: 06-986787. Owners: Bernie Letofsky, Willie Sportello; Mgr.: Len Wong; Singles & Albums Buyer: Willie Sportello. Local branch: Cheapies Recs & Tapes Ltd., 599-A Yonge St., Toronto M4Y 1Z4. Tel: 929-9756. Mgr.: Ross Patrick. (Rec. OS, I & E) (SEE ADVERTISEMENT)

B. Broughton Co. Ltd., 123 Queen St. E. Postal Code: M5C 1S1. Tel: 863-1656. Owner: Brian Broughton; Singles & Albums Buyer: John Killoran. (Rec. & Tape D, I & E)

Labels: Epcos Universal, Fontaine House, K&R, Pqstoral Arts Assocs. N.B., St. Laurent (Montreal Metropolitan Area), P.Q.
C B S Recs. (Canada) Ltd., 1121 Leslie St., Don Mills M3C 2J9. Tel: 447-3311. Telex: 06-966792. TWX: (610) 492-1366. VP Mktg./Sales: Stan Kuln, Sr. Mktg. Dir.: Graham Powers, Sr. Sales Dir.: Don Dates. Local branches: 5621 Finch Ave. E., Scarborough M1B 2T9. Tel: 298-4888. TWX: (610) 492-1381. Ontario/Manitoba Reg'l Dir.: Garry Newman. (Rec. & Tape D)

Branches: Calgary, Alta.; Vancouver, B.C.; Riverview (Moncton Area), N.B.; St. Laurent (Montreal Metropolitan Area), P.Q.
Rec. labels: ARC, Aquitaine, Attic, Blue Sky, CBS, CBS Direct, Caribou, Cleveland Entertainment Int'l., Columbia, Columbia Legacy, Columbia Masterworks, Epic, GTO, Jet, Kirshner, MAM, Matrix, Nempcor, Ode, Odyssey, Philadelphia Int'l., Portrait, Spectra-Scene, Stiff, Sweet City, TK, T-Neck, TSDP, Tabu, Telson, True North, Unison, Vera Cruz, Wolfgang, Cantrade, 18 Spadina Ave. Postal Code: M5V 2H6. Tel: 364-7766.
Distributes cutouts.

Capitol Recs.-EMI of Canada Ltd., 3109 American Dr., Malton L4V 1B2. Tel: 677-5050. VP Mktg.: R.H. Rowe. (Rec. & Tape D).
Labels: Angel, Anthem, Aquarius, Arista, Arista Freedom, Capitol, Chrysalis, DaFodil, EMI, EMI-America, GRP, Grand, Harvest, Liberty, Melodiya, Muse, Novus, Passport, Pathe, Seraphim, TGO, Takoma.
Coda Pub'ns, 337 King St. W. Postal Code: M5V 1J5. Tel: 368-3149. (Rec. D).

Labels: Blue Angel, Bountiful, Broadway, Cat, Circle, Dawn Club, EBM, FMP, Jazz Society, Jazz Studies, Jim Taylor Presents, Jump, Ogun, Queen Disc, Tax

Continental Recs. Co. Ltd., PO Box 2103, Bramalea L6T 3S3. Tel: 792-2048. Pres. & Buyer: Neil Patte. (Rec. D, OS, I & E)

Distributes oldies. RCA collector's series.

Datadisec Rec. Sales, 2247 Midland Ave., Unit 7. Postal Code: M1P 4R1. Tel: 292-2538. Telex: 065-26121. Owner: John Vagenas; Mgr.: Tasso Vagenas; Albums Buyer: Steve Wahrer. (Rec. RJ, I & E)
Disc Count Recs Int'l., 2 Sultan St., Suite 103. Postal Code: M5S 1L7. Tel: 967-7698. Mgr.: Jim Cassina; Buyer: Jan Faust. (Rec. & Tape I & E)
Exile Int'l., 31 Leading Rd., Resdale M9V 4B7. Tel: 749-3920. Telex: 06-527377. Owners: Cyril Kaye, Chris Jester. (Rec. & Tape E)

Handeman Co. of Canada Ltd., 2358 Midland Ave., Scarborough M1S 4A9. Tel: 298-0411. (Rec. & Tape RJ)

Home office: USA—Clawson (Detroit Metropolitan Area), Mich.
Ital Rec. Dist'g Co., 1339 St. Clair Ave. W. Postal Code: M6E 1C3. Tel: 654-8272. Owner: Pasquale Colangelo; Mgr.: Ettore Colangelo. (Rec. & Tape D, I & E)

Labels: CP, Ital, Moon, Venus.
Labels imported: CBS, CGD, Durium, EMI, Fonti Cetra, Phonogram, RCA, Ricordi, Saar (all Italy)

M C A Dist'n (Canada) (div. of MCA Canada Ltd.), 2450 Victoria Park Ave., Willowdale M2J 4A2. Tel: 491-3000. TWX: (610) 492-5204. Telex: 06-966876. VP & Gen. Mgr.: George Burns; Local Branch Mgr.: Mike McKeivie. (Rec. & Tape D)

Branches: Calgary, Alta.; Lachine (Montreal Metropolitan Area), P.Q.
Labels: Apex, Backstreet, Coral, Headfirst, Infinity, MCA, Regency, Rocket, Shelter, Songbird, Source, Southcoast, Uncorn, Vocalion.
Metrodisc Dists., Mktg. Div., 480 Tapscott Rd., Unit 1, Scarborough M1B 1W3. Tel: 291-5590. Mktg. Dir.: Barry J. Stafford. (Rec. & Tape D)
Branch: Montreal, P.Q.

Labels: AVI, All Platinum, Ariola, Birchmount, Buddah, Cadet, Celebration, Checker, Chess, Evolution, Gordy, Handshake, Hansa, Kama Sutra, Motown, Muscor, Plantation, Playboy, Poppy, Prelude, Private Sound, Quality, Radio Recs., Ranwood, Rare Earth, Ready, Ringside, Sun, Sunbird, Tama, Trilogy, Vanguard, Ze.

Phonodisc Ltd., 30 Malley Rd., Scarborough M1L 2E3. Tel: 751-9610. Telex: 06-963629. Pres.: Jim Trainor; Nat'l Sales Mgr.: Rob Lutes; Rec. Div. Mktg. Mgr.: Scott Harradine; Eastern Sales Mgr.: J. Grobbo. (Rec. & Tape D)

Branches: Calgary, Alta.; St. Laurent (Montreal Metropolitan Area), P.Q.
Labels: Adelphi, Audio Fidelity, Black Tie, Breakwater, Cadence, Cavalcade, Charescor, Clean Cuts, Cooking Fat, Oalrymie, Double Helix, El Mocambo, Fantasy, Fix It in the Mix, Flying Mountain, Gato, H&S, Harris, Image, Impulse Magazine, Kicking Mule, Knight II, Likeable, Mad Dog, Manohar, Milestone, Music Gallery, New Ventures, North Branch, North Track, PM, PRT, Phonodisc, Polaris, Posterity, Prestige, Rakish Paddy, Rumour, Rutabaga, Second Avenue Songs, Shagrock, Snocan, So tar, Squash, Stag Creek, Summit, Sydney Thompson, Syntonic Research, Temple, Viper, Wall of Wind, Woodshed, World

Accessories: Allisop, Arista, Bib, Crestmark, Decca, Fidelitytone, Hartzell, Intermetagnetics, Le-Bo, Memorex, Phonodisc, Ray-O-Vac, Reotone, Video.

Pindoff Rec. Sales Ltd., 31 Leading Rd., Resdale M9V 4B7. Tel: 741-4182. Pres.: K. Pandoff; VP & Gen. Mgr.: E.J. Campbell. (Rec. & Tape RJ)

Branches: Burnaby (Vancouver Area), B.C.; St. Laurent (Montreal Metropolitan Area), P.Q.

PolyGram Dist'n Inc., Etobico Tower, 7th fl., 555 Burnhamthorpe Rd. W., Etobicoke M9C 2Y3. Tel: 622-6680. Telex: 06-967755. VP Central Div.: Alun Elias; Central Reg'l Sales Mgr.: Herb Bradley; Promo.: Bobby Gale, Karen Gordon. (Rec. & Tape D)

Home office: St. Laurent (Montreal Metropolitan Area), P.Q. (See for prod. distributed)

R C A Inc., Rec. Div., 101 Duncan Mill Rd., Don Mills M3B 1Z3. Tel: 449-9500. Mktg. Servs. Mgr.: Wayne R. Jordan. Sales office: 2245 Markham Rd., Scarborough M1B 2W3. Tel: 298-6497. District Sales Mgr.: Jim Fotheringham. (Rec. & Tape D)

Labels: Best Buy, Bluebird, Canada Int'l., Carrousel, Centennial, Chi-Sound, Club Series, Colgems, DRG, Damon, Dream, Erato, Freedom, Golden Greats, Gold Mind, Gold Seal, Gold Standard, Grunt, Gryphon, Hologram, Hot Vinyl, House of Lords, Ibis, Jare Int'l., Legendary Performers, Life's Galaxy, Lyrus, Lotus, Midson Int'l., Millennium, Mustard, Orient, Ovation, Pablo, Pure Gold, Quadraxis, RCA, Rayne, Red Seal, Regency, Ritdon, Salsoul, Saravah, Solar, Stony Plain, Tapestry, Tembo, 36, Treme, 20th Century, Vault Treasure, Victor, Victrola, Vik, White Diamond, Windson, Wooden Nickel

Record Peddler, 115 Queen St. E. Postal Code: M5C 1S1. Tel: 368-8755. Owner: Ben Hoffman. (Rec. I)

Labels imported: Brain (Germany), Crass (UK), Factory (UK), 4AD (UK), Mute (UK), Ralph (USA), Rough Trade (UK, USA), Sky (Germany), Slash (USA), Spoon (Germany), Virgin (UK), also imports from Australia, Japan.

Records on Wheels Ltd., 153 Telson Rd., Markham L3R 1E7. Tel: 495-3550. Owners: Vito & Don Ierullo; Buyers: Singles & Albums: Greg Malta; Tape, Bruno Ierullo. (Rec. & Tape OS, I & E) (SEE ADVERTISEMENT)

Roblan Dists. Ltd., 274 Church St. Postal Code: M5B 1Z5. Tel: 977-6490. Telex: 06-22500.

Sound 21 Canada Inc. (div. of Polygram Inc.), 1224 Oundas St. E., Unit 6, Mississauga L4Y 4A2. Tel: 279-7682. Exec. VP: Jim Lemyre; Buyers: Singles, Stephen Ward; Albums & Tape, David Brown. (Rec. & Tape RJ)

Stereodyne Ltd., 3121 Universal Dr., Mississauga L4X 2E2. Tel: 625-8311. Pres.: R.B. Kerr; Sales Mgr.: W.J. Laing. (Rec. & Tape D)

Labels: Dynapak, Impact, Kids Corner, Rainbow, Starpak, Stereodyne.
Sunrise Rec. Dists., 3781 Victoria Park Ave., Unit 14, Scarborough M1W 3K5. Tel: 498-6601. Pres.: Malcolm Perlman, Mgr.: Ken Stowar; Buyers: Singles, Debra Gibson; Albums: Ken Stowar. (Rec. OS, RJ, I & E; Tape I & E)

Trend Recs & Tapes Ltd., 47 Racine Rd., Unit 6, Resdale M9W 6B2. Tel: 749-6601. Owners: Jack Inhaber, Allan Freedman; Mgr.: George Grathorne. (Rec. I & E, Tape I)

Labels: About Time, Acania, Alligator, Antilles, Apon, Arabesque, Bee Hive, Blind Pig, Bomb, Brain, CBS (Germany), CBS Special Prods., CMH, Cantabile, Cetra, Chalfont, Citadel, Clean Cuts, Contemporary, Crystal, Curtain Calls, Delmark, Delos, Denon, Discovery, Egg, Encore, Ent' Acte, 51 West, Flying Fish, Freerose, Gatemouth, Greensleeves, Hannibal, Harmonia Mundi (France, Germany), Historical, Hollywood Soundstage, India Navigation, In Sync, Interplay, JCOA, Jabula, Jackal, Jam, Jamey Abersold, Jazz a la Carte, Jazz Archives, Jazz Vault, Klavier, Labyrinth, MMO, MP5, Mango, Matrix, Melbourne, Moers, Muse, Muscraft, Musique d'Abord, Nessa, Nighthawk, PBR, Palo Alto, Paragon, Peter Pan, Phonos, Progressive, RCA (France, Germany), Rebel, Red Lightning, Ro, Rollo, Rough Trade, Sachville, Savoy, See Breeze, Sky, Slash, Steeplechase, Street, Sugar Hill, Theresia, Survival, Tifton, Timeless, Trend, Umbrella, Uncorn, Unique Jazz, VGM, Varese/Sarabande, Vee Jay, WAIT, West, Zim

W E A Music of Canada Ltd., 1810 Birchmount Rd., Scarborough M1P 2J1
Tel: 291-2515. Cable WEAATOR. VP Sales: Rene Laflamme, Nat'l Promo
Mgr. Larry Green. (Rec. & Tape D)
Branches: Calgary, Alta., Vancouver, B.C., Winnipeg, Man., Dorval (Mon-
treal Metropolitan Area), P.Q.
Labels: Asylum, Alco, Allantic, Bearsville, Beggar's Banquet, Beserkley,
Big Tree, Cotillion, Dark Horse, DiscReet, ECM, Elektra, Embryo, Emerald
City, Finnadar, Geffen, Island, Little David, Mantecore, Mirage, Modern,
Nemperor, Nonesuch, Pacific, Paradise, Planet, Reprise, Rolling Stones,
Sire, Swan Song, Warner Bros., Warner/Curb, Warner/Spector, Whitfield.
Wilson Int'l. Ost. Ents. (WIDE), PO Box 738, Station A, Scarborough M1K
5C4; 544 Birchmount Rd., No. 902, Scarborough M1K 1P3 Owner Pat-
rick D. Wilson. Mgr. Norman Wilson. (Rec. & Tape I & E)
Labels imported: Acanta (Germany), Amigo (Sweden), Ars Nova (Italy),
Aria (Czechoslovakia), Attacca (Germany), Bellaphon (Germany), CRD
(UK), Cassiopee (Italy), Classical (UK), Coronet (UK), Discophil (Ger-
many), Ducale (Italy), ECM (Germany), Enigma Classics (UK), Exploring
World (UK), Heritage (UK/Hungary), JCC (Japan), Lyricon (Sweden),
Lyrita (UK), Muza (Poland), Nimbus (UK), Pepita (Hungary),
Promit (Poland), Quadriglia (Italy), Sonac (Germany), Unicorn (UK),
Veriton (Poland), Vista (UK), Wergo (Germany).

• **WATERLOO (Area Code 519)**

Cari H. Sattler & Assocs. Ltd., 321 Weber St. N. Postal Code: N2J 3H8 Tel:
885-0670. (Tape RJ).

PRINCE EDWARD ISLAND

• **CHARLOTTETOWN (Area Code 902)**

Watts Ents. Ltd., 97 St. Peters Rd. Postal Code: C1A 5N9. Tel: 894-7549.
(Rec. & Tape D, OS & RJ)

Labels: Audio, Columbia, Impact, London, MCA, Praise, Quality, RCA, Tee
Vee, World.
Phonographs: BSR, Sony, Yamaha.
Playback equip.: Sony, Lloyd's, Yamaha.
Accessories: BASF, TDK, Tracs, Watts.

QUEBEC

• **MONTREAL METROPOLITAN AREA
(Area Code 514)**

A & M Montreal, 970 Montee de Liesse, St. Laurent H4T 1W7. Tel: 334-
8550. Telex: 05-824709. Reg'l. Mgr. Roland Dufresne. Promo: Nick Car-
bone; Mdsge: Richard LaFrance; Sales: Clement Dufresne, Andre Pa-
quette. (Rec. & Tape D)

Home office: Scarborough (Toronto Metropolitan Area), Ont. (See for
prod. distributed)

A R S Disques Canada (div. of CBS Recs. Canada Ltd.), 9429 Cote de Liesse,
Dorval H9P 2N9. Tel: 636-9081. Mgr.: Richard Beteac. (Rec. & Tape RJ).

Home office: Agincourt (Toronto Metropolitan Area), Ont.
Almada, 1700 Beaulac St., St. Laurent H4R 1W8. Tel: 337-6500. Mgr.: Amos
Ater; Buyers: D. Albums & Tape, Ronald Brasseur, OS Singles, Albums &
Tape, Richard Vincent. (Rec. & Tape D, OS & I)

Labels: A&F, ALA, Affinity, Appaloosa, Ararat, Archive of Folk & Jazz, Ar-
cobaleno, Arholoe, Aries, Aural Explorer, Aurizon, Aurora, Ayre, Bain-
bridge, Betty White, Biograph, Black Saint, Blue Chip, Blue Goose, Blues

Classics, Bobby Gimby, Bright Orange, Bulldog, Caedmon, Charly,
Choice, City Sounds, Classical Excellence, Classic Jazz, Classics for Pleas-
ure, Concord Jazz, Conversa-Phone, Cook, Country Gold, DRG, Drieland
Jubilee, Dr. Charly, Dover, Dyna West, Elephant, Emery Cook, Esperance,
Everest, Experiences Anonymes, Folklyric, Folkways, Fretless, GNP, Gate-
way, Glendale, Golden Age, Green Linnet, Huggett Family, Inner City, Ital,
Jazz Legacy, Joess, Joker, Kicking Mule, Laif, Legacy, Listen for Pleasure,
Living Language, Lynchord, Major, Marc, Mariposa, Mark 56, McGill,
Monitor, Monmouth-Evergreen, Morning Star, Mother of Pearl, Mountain
Railroad, Mudpie, Murray Hill, Music for Pleasure, Music Gallery, Nick,
No Holds Barred, Old Timey, Olympic, Om Kalsoum, Owen Sound Sum-
merfolk, Paredon, Passport, Pausa, Personal Choice, Petit Prince, Philo,
Pigeon Inlet, Queen Disc, Radiola, Request, Ridge Runner, Rounder,
Sandy Hook, Seeco, Setel, Sepia, Shanachie, Solid Smoke, Sonet, Sono
Cairo, Sono Disc, Soul Note, Springwater, Squash, Sukay, Slyphone, Ta-
manor, Tradition, Trans-Atlantic, Tropical, UP, United, Venus, Who's Who
in Jazz, Xanadu, Yazoo.

Accessories: Rec. care prod. (Disc-Stat), jackets & sleeves.

C B S Recs. Canada Ltd./CBS Disques Ltée., 1550 Rue Beaulac, St. Laurent
H4R 1W8. Tel: 337-8780. TWX: (610) 421-3191. Quebec Reg'l. Dir. Bill
Rotari. (Rec. & Tape D)

Home office: Don Mills (Toronto Metropolitan Area), Ont. (See for prod.
distributed)

Capitol Recs.: EMI of Canada Ltd., 9245 Cote de Liesse Rd., Dorval H9P 2N9
Tel: 631-9073. Eastern Reg'l. Mgr.: B. Quintin. (Rec. & Tape D—see office
in Toronto, Ont., for prod. distributed)

Downstairs Recs. Ltd., 668 Deslauriers St., St. Laurent H4N 1W5. Tel: 334-
2373. Telex: 05-827542. Owners: G. Cucuzzezza, G. Tortorici; Mgr.: N.
Iannizzi; Buyers: Singles, J. Lamothe, Albums, N. Iannizzi. (Rec. OS, RJ, I
& E)

Labels: Aavalanche, Athome, Black Sun, Broadway, Champagne, Dice,
Glass, Igloo, JC, MAD, Matra, Montrecco, PBI, Plastic Poison, Rouge,
Scorpio, Undisc, Unwawe, VS.

Handelman Co. of Canada Ltd., 4215 Poirier Blvd., St. Laurent H4R 2A4.
Tel: 337-7040. (Rec. & Tape RJ).

Home office: USA—Cawson (Detroit Metropolitan Area), Mich.
Liss Int'l., 3495 Thimens Blvd., St. Laurent H4R 1V5. Tel: 335-0615. Contact:
Ivor Liss. (Rec. E—deletions, budget lines) (SEE AD)

M C A Dist'n (Canada) (div. of MCA Canada Ltd.), 10500 Cote de Liesse,
Suite 140, Lachine H8T 3E3. Tel: 636-6095. TWX: (610) 421-3225. Mgr.:
Frank Iacovella. (Rec. & Tape D)

Home office: Willowdale (Toronto Metropolitan Area), Ont. (See for prod.
distributed)

M & M Exports, 7146 St. Lawrence Blvd. H2S 3E2. Tel: 271-6229. (SEE AD-
VERTISEMENT)

Metrodisc Dist's., 3767 Thimens Blvd., Suite 206. Postal Code: H4R 1W4.
Tel: 336-5930. Mgr.: Yves Dupuis. (Rec. & Tape D)

Home office: Toronto, Ont. (See for prod. distributed)

Milbank Music Corp., 245 Montee de Liesse. Postal Code: H4T 1N8. Tel:
341-4511. Telex: 05-825621. Cable: MILBANKMUS. (OS, I & E)

Multidisc Inc., 9375 Meaux St., St. Leonard H1R 3H3. Tel: 327-5070. Telex:
05-828592. (Rec. & Tape OS & RJ)

Phonodisc Ltd., PO Box 114, Deux Montagnes J7R 4K1. Tel: 473-2645. Sales
Rep.: Keith Hannah. (Rec. & Tape D)
Home office: Scarborough (Toronto Metropolitan Area), Ont. (See for
prod. distributed)

Pindoff Rec. Sales Ltd., 245 Montee de Liesse, St. Laurent H4T 1P5. Tel:
341-1210. Mgr.: Jacques Marquis. (Rec. & Tape RJ)

Home office: Rexdale (Toronto Metropolitan Area), Ont.

PolyGram Dist'n Inc., 6000 Cote de Liesse, St. Laurent H4T 1E3. Tel: 739-
2701. Telex: 05-825690. TWX: (610) 421-3509. Cable: POLYDISC. East-
ern Reg'l. Mgr.: Gaston Carreau, Eastern Reg'l. Promo. Mgr.: Pierre Parent;

Mktg. & Sales Dir.: Ken Graydon. (Rec. & Tape D)

Branches: Calgary, Alta., Vancouver, B.C., Winnipeg, Man., Etobicoke
(Toronto Metropolitan Area), Ont.

Labels: Abiko, Ace of Diamonds, Archiv, Argo, Barclay, Big Time, Capri-
corn, Casablanca, Charisma, Oe-Lite, Oeram, Deutsche Grammophon,
Dreamland, EG, Factory, Festivo, Ice, Invitation a la Dance, Lollipop, Lon-
don, London Digital, MGM, Mercury, Mercury Golden series, Metal Beat,
L'Oiseau Lyre, Parrot, Philips, Polydor, Polystar, RSO, Resonance, Rialto,
Rva, SPPS, Spring, Threshold, UK, Vertigo, Verve, Virgin, Virgin Dmdisc,
Zappa.

R C A Inc., Rec. Div., PO Box 987, Tour de la Cite: 300 Leo Parizeau. Postal
Code: H2W 2N1. Tel: 849-3251. District Sales Mgr.: Richard Galibos.

(Rec. & Tape D—see office in Toronto, Ont., for prod. distributed)

R M P Rec. Sales Co. Ltd., 300 Bates Rd. Postal Code: H3S 1A3. Tel: 739-
5662. Owner & Buyer: Leslie Faludi. (Rec. & Tape OS & RJ)

Trans-Canada Recs. (div. of Quebecor Group Inc.), 7033 Trans Canada Hwy.,
St. Laurent H4T 1S2. Tel: 336-7151. Telex: 058-24638. Gen. Mgr.: Denis
Bergeron, Nat'l Sales Dir.: Robert Perusse. (Rec. & Tape D & OS).

Branch: Ste-Foy, P.Q.

Labels: Aime, Amical, Armour, Baron, Beaubec, Bing Bang, Boulhane,
Boussole, Catalogne, Celsius, Clau-Ver, Distribuson, Enclume, Flash,
Focus, Fontane, Girafe, Interim, JMI, Luc Cousineau, Melon-Miel, Nobel,
No. 1, Phonix, Pro Culture, Pro-Spect, Saisons, Sas Int'l, Showbizz, Spec-
Art, Teresa Moskal, Tobie, Traffic, Trans-Canada, Yvon Plamondon.

W E A Music of Canada Ltd., 735 Renaud Ave., Dorval H9P 2N1. Tel: 636-
8503. Mgr.: John Dufour. (Rec. & Tape D).

Home office: Scarborough (Toronto Metropolitan Area), Ont. (See for
prod. distributed).

• **SAINTE FOY (Area Code 418)**

Trans-Canada Recs., 445 Rue Mendel. Postal Code: G1X 3X4. Tel: 871-1410.
Telex: 051-3319. (Rec. & Tape D & OS)

Home office: St. Laurent (Montreal Metropolitan Area), P.Q. (See for
prod. distributed)

• **services**

ASSOCIATIONS & PROFESSIONAL ORGANIZATIONS

A C T R A, see Association of Canadian Television & Radio Artists.

A F M, see American Federation of Musicians.

Academy of Country Music Entertainment, PO Box 574, Thornhill, Ont. L3T
4A2.

American Federation of Musicians (AFM), 101 Thorncliffe Park Dr., Toronto,
Ont. M4H 1M1. Tel: (416) 425-1831.

Association of Canadian Orchs., 56 The Esplanade, Suite 311, Toronto, Ont.
M5E 1A7. Tel: (416) 366-8834. Exec. Dir.: Betty Webster.

Association of Canadian Television & Radio Artists (ACTRA), 105 Carlton St.,
Toronto, Ont. M5B 1M2. Tel: (416) 977-6335.

British Columbia Touring Council, 572 Beatty St., Vancouver, B.C. V6B 2L3.
Tel: (604) 669-2800.

RECORDS ON WHEELS. RECORDS ON WHEELS.

Solid Gold Savings • Everyday.

**THE NUMBER 1 SUPPLIER TO THE
U.S., EUROPE AND THE WORLD!**

Wheels Has The Deals

We Specialize In Exporting Hundreds Of LP's
Exclusively Available To Canada!

We also distribute the NARDAM Label.

DELETES • SURPLUS • ALL MAJOR LABELS • MANY MINOR LABELS

RECORDS ON WHEELS

Telex: 069-986-125 • Phone: 1-416-495-3550

Address: 153 Telson Rd., Markham, Ontario, Canada L3R 1E7



Give the gift of music.

Contact Don

C A M A C (Canadian Amateur Musicians—Musiciens Amateurs du Canada), PO Box 353, Westmount, P.Q. H3Z 2T5. Tel: (514) 935-2272.
Canada Council, PO Box 1047, 255 Albert St., Ottawa, Ont. K1P 5V8. Tel: (613) 237-3400. Info: CANCONARTS. Dir.: Charles Lussier; Communications Serv. Information Officer: M. Claire Pierrard.

Canadian Amateur Music Making, 1165 Greene Ave., Westmount, P.Q. H3Z 2A2. Tel: (514) 935-2272.

Canadian Bureau for the Advancement of Music (CBAM), Exhibition Place, Toronto, Ont. M6K 3C3. Tel: (416) 366-7551. Mng. Dir.: Lt. Col. C.O. Hunt.

Canadian League of Composers, 1263 Bay St., Toronto, Ont. M5R 2C1. Tel: (416) 964-1364. Pres.: Victor Davies; Exec. Ass't: Josette Fitch.
Canadian Music Centre/Centre de Musique Canadienne (CMC), 1263 Bay St., Toronto, Ont. M5R 2C1. Tel: (416) 961-6601. Cable: CENTRECAN.
Canadian Music Council, 36 Elgin, Ottawa, Ont. K1P 5K5. Tel: (613) 238-5893.

Canadian Music Educators Ass'n (CMEA), Nat'l Resource Centre, PO Box 1461, St. Catharines, Ont. L2R 7J8. Tel: (416) 684-4664. Pres.: Winnifred Voigts; Music Resource Co-ord.: Wallace Laughton.
Canadian Music Publ'rs Ass'n, 111 Avenue Rd., Toronto, Ont. M5R 3J8. Sec'y: Paul M. Berry.

Canadian Rec'g Industry Ass'n, 89 Bloor St. E., Toronto, Ont. M4W 1A9. Tel: (416) 967-7272. Telex: (06) 219502. Pres.: Brian Robertson.

Jeunesses Musicales du Canada, 5253 Ave. du Parc, Suite 600, Montreal, P.Q. H2V 4P2. Cable: JEUMUSICA. Tel: (514) 271-2566.

Music Industry Educators Ass'n, c/o Trebas Institute, 1435 Bleury St., Suite 301, Montreal, P.Q. H3A 2H7. Tel: (514) 842-3E15. VP: David P. Leonard.
N A B E T, see National Ass'n of Broadcast Employees & Technicians.
National Ass'n of Broadcast Employers & Technicians (NABET), 1010 St. Catherine St. W., Montreal, P.Q. H3B 3R3. Tel: (514) 878-3141.

National Youth Orchestra of Canada (NYO), 76 Claries St. W., Toronto, Ont. M5S 1K8. Tel: (416) 922-5031. Gen. Dir.: John Brown.
Radio Canada Int'l, PO Box 6000, Montreal, P.Q. H3C 3A8. Tel: (514) 285-2454. Cable: INTRAD. Dir.: B. Zimmerman.

CATALOG SERVICES

Magna-Tape Mfg. Inc., 34 Greensboro Dr., Rexdale, Ont. M9W 1E1. Tel: (416) 245-7890. Telex: (06) 989393. (Tape only)

Parr's Print & Litho Ltd., 111 Ferrier St., Markham, Ont. L3R 3K6. Tel: (416) 495-3300. Pres.: R.A. Gray; Gen. Mgr.: D. Fulton; VP Sales: R.J. Humphreys.

Praise Inds. Corp., 6979 Curragh Ave., Burnaby, B.C. V5J 4V6. Tel: (604) 438-8266. Gen. Mgr.: Paul Yaroshuk. (Record & Tape)

Visual Diffusion Inc., 1165 Greene, Suite 2, Westmount, P.Q. H3Z 2A2. Tel: (514) 933-3642. Telex: (06) 219569.

DESIGN & ARTWORK

Dynacomm Communications Int'l, PO Box 702, Snowdon Sta., Montreal, P.Q. H3X 3K8. Tel: (514) 342-5200. Pres.: Dave Leonard. (Record only)

Global Prods., 350 Sorauraen Ave., Toronto, Ont. M6R 2G8. Tel: (416) 531-5751. Cable: GLOBOLPROD. (Tape only)

Golden Rec. Mfg. Ltd., 500 Coronation Dr., West Hill, Ont. M1E 4V7. Tel: (416) 281-9522.

Bill Hicks Design & Photography, 61 Gerie St., 2nd fl., Winnipeg, Man. R3A 1B5. Tel: (204) 943-1868.

Holborne Dist. Co. Ltd., PO Box 9, Mount Albert, Ont. L0G 1M0. Tel: (416) 294-9398. Pres.: Frank P. Swain; Custom Sales Mgr.: M.C. Swain.

Intermodal Prod's Ltd., PO Box 2199, Vancouver, B.C. V6B 3V7. Tel: (604) 688-1820. Pres. & Sales Mgr.: John Rodney; Adv. Mgr.: Evelyn Rodney.

Sheldon Kagan Prod's, 2555 Cote Vertu, Rm. 100, St. Laurent, P.Q. H4R 1Z6. Tel: (514) 331-7282. Gen. Mgr.: Sheldon Kagan; Sales Mgr.: Donny Kagan. (Record only)

Kitsch, Baroque & Rococo Advertising Consultants, PO Box 3576, Sta. C, Hamilton, Ont. L8H 7M9. Tel: (416) 544-7569.

Lithobac Canada Ltd., 600 Port-Royal W., Montreal, P.Q. H3L 2C5. Tel: (514) 388-1133.

Metro Graphic Inc., 2800 Francis Hughes Ave., Aval, P.Q. H7L 3M4. Tel: (514) 663-0370. Cable: METROGRAPH. Telex: (05) 560705. Pres.: Paul Kuzner; Gen. Mgr.: Sam Ungar; Sales Mgr.: Marvin Chankowsky. (Record only)

Ohi Assocs., PO Box 103, Sta. A, Toronto, Ont. M5W 1A2. Tel: (416) 481-8995.

Pacific Int'l Magnetics Inc., 200-11031 Bridgeport Rd., Richmond, B.C. V6X 3A2. Tel: (604) 273-6015/1851. Telex: (04) 357568. Pres.: Paul B. Brown.

Branch: Winnipeg, Man., 152 Emerson. Postal Code: R2G 1E9. Tel: (204) 338-0709.

Int'l Branch: USA, San Francisco, Calif.

Parr's Print & Litho Ltd., 111 Ferrier St., Markham, Ont. L3R 3K6. Tel: (416) 495-3300. Pres.: R.A. Gray; Gen. Mgr.: D. Fulton; VP Sales: R.J. Humphreys.

Praise Inds. Corp., 6979 Curragh Ave., Burnaby, B.C. V5J 4V6. Tel: (604) 438-8266. Gen. Mgr.: Paul Yaroshuk.

Ross-Elis Ltd., 300 Ann St., Montreal, P.Q. H3C 2K2. Tel: (514) 861-2411. Telex: (05) 267411.

Branch: Markham, Ont., 227 Idema Rd. Postal Code: L3R 1B1. Tel: (416) 495-9811. Telex: (06) 986895.

Shorewood Packaging Corp. of Canada Ltd., 2220 Midland Ave., Scarborough, Ont. M1P 3E6. Tel: (416) 292-3990. Telex: (065) 25228.

Branch: Montreal, P.Q., 1625 Chabanel St. W., Suite 1070. Postal Code: H4N 2S7. Tel: (514) 388-5745.

Home office: USA, New York, N.Y.

Studio Lorraine, 310 Ann St., Montreal, P.Q. H3C 2K1. Tel: (514) 861-2759. Telex: (05) 267411.

Visual Diffusion Inc., 1165 Greene, Suite 2, Westmount, P.Q. H3Z 2A2. Tel: (514) 933-3642. Telex: (06) 219569.

World Recs. (div. of Shotgun Gimme Holdings Ltd.), PO Box 2000, Baseline Rd. W. at Courthouse, Bowmanville, Ont. L1C 3Z3. Tel: (416) 576-0250. Toronto: 686-2828. Pres.: Bill Hewson; Gen. Mgr.: Bob Stone; Art Dir.: Doug Powers.

LICENSING ORGANIZATIONS, MUSIC

Canadian Musical Reproduction Rights Agency Ltd. (CMRRA), 111 Avenue Rd., Suite 702, Toronto, Ont. M5R 3J8. Tel: (416) 922-4170. Cable: MUS-RITES. Pres.: Al Mair; Gen. Mgr.: C.C. Devereux. (Mechanical & Synchronization rights only)

Composers, Authors & Publ'rs Ass'n of Canada Ltd. (CAPAC), 1240 Bay St., Toronto, Ont. M5R 2C2. Tel: (416) 924-4427. Gen. Mgr.: John V. Mills. (Performing rights only)

Branch: Vancouver, B.C., 1 Alexander St. Postal Code: V6A 1B2. Tel: (604) 689-8871—Montreal, P.Q., 1245 W. Sherbrooke. Postal Code: H3G 1G2. Tel: (514) 288-4755.

P R O Canada (Performing Rights Org. of Canada Ltd.), 41 Valleybrook Dr., Don Mills, Ont. M3B 2S6. Tel: (416) 445-3700. Cable: CANMUS TORONTO. Telex: (06) 966634. Pres.: Gordon F. Henderson; Mng. Dir.: Jan

Matejcek; Pub. & PR Mgr.: Nancy Gyokeros.

Branches: Vancouver, B.C., 1462 W. Pender St. Postal Code: V6G 2S2. Tel: (604) 688-7851—Montreal, P.Q., 625 President Kennedy Ave., Suite 1601. Postal Code: H3A 1K2. Tel: (514) 849-3294.

LICENSES, RECORD & TAPE

Holborne Dist. Co. Ltd., PO Box 9, Mount Albert, Ont. L0G 1M0. Tel: (416) 294-9398. Pres.: Frank P. Swain; Custom Sales Mgr.: M.C. Swain.

I R O Ltd., 4469 Sherbrooke St. W., Montreal, P.Q. H3Z 1E7. Tel: (514) 935-3717. (Record, Tape & Video)

International Audio Visual Ltd., PO Box 1096, Postal Code: V3J 6Z4; 224 Cayer St., Coquitlam, B.C. V3K 5B1. Tel: (604) 522-7955. Cable: IAVSOUND. Telex: (04) 351350. Pres.: Dr. Peter P. Allinger; VP Sales: Philip Allinger.

Praise Inds. Corp., 6979 Curragh Ave., Burnaby, B.C. V5J 4V6. Tel: (604) 438-8266. Gen. Mgr.: Paul Yaroshuk.

Visual Diffusion Inc., 1165 Greene, Suite 2, Westmount, P.Q. H3Z 2A2. Tel: (514) 933-3642. Telex: (06) 219569.

PLATING, PROCESSING & PRESSING PLANTS

Arc Sound Co. Ltd., 142 Sparks Ave., Willowdale, Ont. Tel: (416) 499-5000.
Capitol Recs.-EMI of Canada Ltd., 3109 American Dr., Mississauga, Ont. L4V 1B2. Tel: (416) 677-5050. Cable: CAPITOLREC. Telex: (06) 968619. Pres.: J.D. Evans. (Pressing only)

Branches: Calgary, Alta., 519 Manitou Rd. SE. Postal Code: T2G 4C2. Tel: (403) 287-0823—Vancouver, B.C., Century Plaza, Suite 503, 1015 Burrard St. Postal Code: V6Z 1Y5. Tel: (604) 689-8667—Dorval, P.Q., 9245 Cote de Liesse Rd. Postal Code: H9P 2N9. Tel: (514) 631-9073.

Cinram Ltd., 2255 Markham Rd., Scarborough, Ont. M1B 2W3. Tel: (416) 298-8190. Telex: (065) 26142.

Golden Rec. Mfg. Ltd., 500 Coronation Dr., West Hill, Ont. M1E 4V7. Tel: (416) 281-9522.

Holborne Dist. Co. Ltd., PO Box 9, Mount Albert, Ont. L0G 1M0. Tel: (416) 294-9398. Pres.: Frank P. Swain; Custom Sales Mgr.: M.C. Swain. (Plating & processing only)

Intermodal Prod's Ltd., PO Box 2199, Vancouver, B.C. V6B 3V7. Tel: (604) 688-1820. Pres. & Sales Mgr.: John Rodney; Adv. Mgr.: Evelyn Rodney.

Modern Album of Canada Ltd., 2450 Finch Ave. W., Unit 7, Weston, Ont. M9W 2E9. Tel: (416) 745-5033. (Plating & processing only)

Praise Inds. Corp., 6979 Curragh Ave., Burnaby, B.C. V5J 4V6. Tel: (604) 438-8266. Gen. Mgr.: Paul Yaroshuk. (Pressing only)

Quality Recs. Ltd., 380 Birchmount Rd., Scarborough, Ont. M1K 1M7. Tel: (416) 698-5511. Telex: (06) 219624. Pres. Custom Mfg. & Finance: Terry M. Lynd. (Pressing only)

Stereodyne Ltd., 3121 Universal Dr., Mississauga, Ont. L4X 2E2. Tel: (416) 625-8311.

World Recs. (div. of Shotgun Gimme Holdings Ltd.), PO Box 2000, Baseline Rd. W. at Courthouse, Bowmanville, Ont. L1C 3Z3. Tel: (416) 576-0250. Toronto: 686-2828. Pres.: Bill Hewson; Gen. Mgr.: Bob Stone. (PWG)

PRINTERS & LITHOGRAPHERS

Capitol Recs.-EMI of Canada Ltd., 3109 American Dr., Mississauga, Ont. L4V 1B2. Tel: (416) 677-5050. Cable: CAPITOLREC. Telex: (06) 968619. Pres.: J.D. Evans.

Branches: Calgary, Alta., 519 Manitou Rd. SE. Postal Code: T2G 4C2. Tel: (403) 287-0823—Vancouver, B.C., Century Plaza, Suite 503, 1015 Burrard St. Postal Code: V6Z 1Y5. Tel: (604) 689-8667—Dorval, P.Q., 9245 Cote de Liesse Rd. Postal Code: H9P 2N9. Tel: (514) 631-9073.

Global Prods., 350 Sorauraen Ave., Toronto, Ont. M6R 2G8. Tel: (416) 531-5751. Cable: GLOBOLPROD. (Tape only)

Golden Rec. Mfg. Ltd., 500 Coronation Dr., West Hill, Ont. M1E 4V7. Tel: (416) 281-9522.

Holborne Dist. Co. Ltd., PO Box 9, Mount Albert, Ont. L0G 1M0. Tel: (416) 294-9398. Pres.: Frank P. Swain; Custom Sales Mgr.: M.C. Swain.

Lithobac Canada Ltd., 600 Port-Royal W., Montreal, P.Q. H3L 2C5. Tel: (514) 388-1133.

Modern Album of Canada Ltd., 2450 Finch Ave. W., Unit 7, Weston, Ont. M9W 2E9. Tel: (416) 745-5033.

Pacific Int'l Magnetics Inc., 200-11031 Bridgeport Rd., Richmond, B.C. V6X 3A2. Tel: (604) 273-6015/1851. Telex: (04) 357568. Pres.: Paul B. Brown.

Branch: Winnipeg, Man., 152 Emerson. Postal Code: R2G 1E9. Tel: (204) 338-0709.

Int'l Branch: USA, San Francisco, Calif.

Parr's Print & Litho Ltd., 111 Ferrier St., Markham, Ont. L3R 3K6. Tel: (416) 495-3300. Pres.: R.A. Gray; Gen. Mgr.: D. Fulton; VP Sales: R.J. Humphreys.

Praise Inds. Corp., 6979 Curragh Ave., Burnaby, B.C. V5J 4V6. Tel: (604) 438-8266. Gen. Mgr.: Paul Yaroshuk.

Ross-Elis Ltd., 300 Ann St., Montreal, P.Q. H3C 2K2. Tel: (514) 861-2411. Telex: (05) 267411.

Branch: Markham, Ont., 227 Idema Rd., Postal Code: L3R 1B1. Tel: (416) 495-9811. Telex: (06) 986895.

Shorewood Packaging Corp. of Canada Ltd., 2220 Midland Ave., Scarborough, Ont. M1P 3E6. Tel: (416) 292-3990. Telex: (065) 25228.

Branch: Montreal, P.Q., 1625 Chabanel St. W., Suite 1070. Postal Code: H4N 2S7. Tel: (514) 388-5745.

Home office: USA, New York, N.Y.

World Recs. (div. of Shotgun Gimme Holdings Ltd.), PO Box 2000, Baseline Rd. W. at Courthouse, Bowmanville, Ont. L1C 3Z3. Tel: 576-0250, Toronto: 686-2828. Pres.: Bill Hewson; Gen. Mgr.: Bob Stone; Art Dir.: Doug Powers.

RECORD PROMOTION (including Public Relations & Publicity)

A D C 2000 Recs., 125 Dupont St., Toronto, Ont. M5R 1V4. Tel: (416) 961-2000. Pres.: Mike Komar.

A R Mktg. & Promo. Inc., 5514 Isabella Ave., Montreal, P.Q. H3X 1R6. Tel: (514) 487-0859. Telex: (055) 66493.

Alexis-Sterling Agency, (div. of Apple Sound Corp.), 3500 Glen Erin Dr., Unit 10, Mississauga, Ont. L5L 1W6. Tel: (416) 828-2582.

B B Publicity, 46 Arran Crescent, Willowdale, Ont. M2M 2W9. Tel: (416) 222-7573. VP: Jacob Neuhausen.

Home office: USA, New York, N.Y.

Don Bell Servs., PO Box 581, Adelaide St. Sta., Toronto, Ont. M5C 2I6. Tel: (416) 364-3815. Cable: DBSMUSIC. Mgr.: Don Bell.

Dynacomm Communications Int'l, PO Box 702, Snowdon Sta., Montreal, P.Q. H3X 3K8. Tel: (514) 342-5200. Pres.: Dave Leonard.

Bill Hicks Design & Photography, 61 Gerie St., 2nd fl., Winnipeg, Man. R3A 1B5. Tel: (204) 943-1868.

Intermodal Prod's Ltd., PO Box 2199, Vancouver, B.C. V6B 3V7. Tel: (604) 688-1820. Pres. & Sales Mgr.: John Rodney; Adv. Mgr.: Evelyn Rodney.

Sheldon Kagan & Assocs. Ltd., 2555 Cote Vertu, Montreal, P.Q. H4R 1Z6. Tel: (514) 331-7282. Gen. Mgr.: Sheldon Kagan; Sales Mgr.: Donny Kagan.

Ohi Assocs., PO Box 103, Sta. A, Toronto, Ont. M5W 1A2. Tel: (416) 481-

8995
PolyGram Inc., 6000 Cote de Liesse, St. Laurent, P.Q. H4T 1E3. Tel: (514) 739-2701. Cable: POLYDISC. Telex: (05) 825690.

Branches: Calgary, Alta., 7220 Fisher St. SE, Suite 110. Postal Code: T2H 2H8. Tel: (403) 253-7665. Telex: (03) 821859—Vancouver, B.C., Mezzanine, 805 W. Broadway. Postal Code: V5Z 1K1. Tel: (604) 873-2466.

Telex: (045) 4410—Winnipeg, Man., c/o Phillips Electronics, 401 Weston St. E. Postal Code: R3E 3H4. Tel: (204) 786-5748. Telex: (07) 57786—Ettobicoke, Ont., Etobico Tower, Suite 707, 555 Burnhamthorpe Rd. W. Postal Code: M9C 2Y3. Tel: (416) 622-6680. Telex: (06) 967755.

Praise Inds. Corp., 6979 Curragh Ave., Burnaby, B.C. V5J 4V6. Tel: (604) 438-8266. Gen. Mgr.: Paul Yaroshuk.

Visual Diffusion Inc., 1165 Greene, Suite 2, Westmount, P.Q. H3Z 2A2. Tel: (514) 933-3642. Telex: (06) 219569.

TAPE CUSTOM DUPLICATORS

TAPE PACKAGING & LABELING

The Audio and Video lines indicate the configurations which the firms duplicate. Companies which offer packaging and labeling of tape product are indicated by "(PWG)" which appears after the main body of their respective listings.

Capitol Recs.-EMI of Canada Ltd., 3109 American Dr., Mississauga, Ont. L4V 1B2. Tel: (416) 677-5050. Cable: CAPITOLREC. Telex: (06) 968619. Pres.: J. D. Evans.

Branches: Calgary, Alta., 519 Manitou Rd. SE. Postal Code: T2G 4C2. Tel: (403) 287-0823—Vancouver, B.C., Century Plaza, Suite 503, 1015 Burrard St. Postal Code: V6Z 1Y5. Tel: (604) 689-8667—Dorval, P.Q., 9245 Cote de Liesse Rd. Postal Code: H9P 2N9. Tel: (514) 631-9073.

Audio: 8-tr., cassette.

Cinram Ltd., 2255 Markham Rd., Scarborough, Ont. M1B 2W3. Tel: (416) 298-8190. Telex: (065) 26142.

Audio: 8-tr., cassette.

Eastern Sound Co. Ltd., 48 Yorkville Ave., Toronto, Ont. M4W 1L4. Tel: (416) 920-2211. Mgr.: Peter Holcomb.

Audio: Cassette, open reel.

Video: 4" Umatic cassette, 4" Beta & VHS cassette.

Global Prods., 350 Sorauraen Ave., Toronto, Ont. M6R 2G8. Tel: (416) 531-5751. Cable: GLOBOLPROD. (PWG)

Audio: 8-tr., cassette.

Golden Rec. Mfg. Ltd., 500 Coronation Dr., West Hill, Ont. M1E 4V7. Tel: (416) 281-9527. (PWG)

Audio: 8-tr., cassette.

Hardman Inds. Ltd., 34 Greensboro Dr., Rexdale, Ont. M9W 1E1. Tel: (416) 245-7890. Chm: Eric H. Hardman; Pres.: Eric S. Hardman; Nat'l Sales Mgr.: Carl Cooley. (PWG)

Audio: 8-tr., cassette.

Intermodal Prod's Ltd., PO Box 2199, Vancouver, B.C. V6B 3V7. Tel: (604) 688-1820. Pres. & Sales Mgr.: John Rodney; Adv. Mgr.: Evelyn Rodney.

Audio: 8-tr., cassette, open reel.

L S J Cassette Corp., 50 Don Park Rd., Unit 14, Markham, Ont. L3R 1J3. Tel: (416) 495-9378. (PWG)

Audio: Cassette.

Magna-Tape Mfg. Inc., 34 Greensboro Dr., Rexdale, Ont. M9W 1E1. Tel: (416) 245-7890. Telex: (06) 989393. (PWG)

Audio: 8-tr., cassette.

Pacific Int'l Magnetics Inc., 200-11031 Bridgeport Rd., Richmond, B.C. V6X 3A2. Tel: (604) 273-6015/1851. Telex: (04) 357568. Pres.: Paul B. Brown. (PWG—audio & video)

Branch: Winnipeg, Man., 152 Emerson. Postal Code: R2G 1E9. Tel: (204) 338-0709.

Int'l Branch: USA, San Francisco, Calif.

Audio: Cassette, open reel.

Piasetzki Recordatape Ontario Ltd. (PRT Tapes), 1489 Merivale Rd., Ottawa, Ont. K2E 5P3. Tel: (613) 224-6692. (PWG)

PolyGram Inc., 6000 Cote de Liesse, St. Laurent, P.Q. H4T 1E3. Tel: (514) 739-2701. Cable: POLYDISC. Telex: (05) 825690.

Branches: Calgary, Alta., 7220 Fisher St. SE, Suite 110. Postal Code: T2H 2H8. Tel: (403) 253-7665. Telex: (03) 821859—Vancouver, B.C., Mezzanine, 805 W. Broadway. Postal Code: V5Z 1K1. Tel: (604) 873-2466.

Telex: (045) 4410—Winnipeg, Man., c/o Phillips Electronics, 401 Weston St. E. Postal Code: R3E 3H4. Tel: (204) 786-5748. Telex: (07) 57786—Ettobicoke, Ont., Etobico Tower, Suite 707, 555 Burnhamthorpe Rd. W. Postal Code: M9C 2Y3. Tel: (

Audio: 8-tr.
Global Prods., 350 Sorauen Ave., Toronto, Ont. M6R 2G8 Tel: (416) 531-5751. Cable: GLOBOPROD.
Audio: 8-tr., cassette.
Pacific Int'l Magnetics Inc., 200-11031 Bridgeport Rd., Richmond, B.C. V6X 3A2 Tel: (604) 273-6015/1851. Telex: (04) 357568. Pres: Paul B. Brown
Branch: Winnipeg, Man., 152 Emerson. Postal Code: R2G 1E9 Tel: (204) 338-0709.
Int'l branch: USA.
Audio: Cassette components & shells
Brand name: Analyst.
Stereodyne Ltd., 3121 Universal Dr., Mississauga, Ont. L4X 2E2 Tel: (416) 625-8311
Audio: 8-tr. & cassette housings

EMPTY CARTRIDGES, CASSETTES & REELS

Amplex Canada Inc., 132 East Dr., Bramalea, Ont. L6T 3T9. Tel: (416) 791-3100. VP & Gen. Mgr.: J.L. Major. VP & Nat'l Magnetic Tape Prods. Mgr.: J.R. Pariselli.
Branches: Calgary, Alta., 1116-55 Ave. NE. Postal Code: T2E 6Y4 Tel: (403) 275-3444—(Dorval), P.Q. 729 Ave. Meloche. Postal Code: H9P 2S4. Tel: (514) 636-4840.
Audio: 8-tr., cassette, open reel
Analyst, see Pacific Int'l
Capitol, see Wilf Farrow
Data Packaging, see LSJ Cassette
Wilf Farrow Assocs. Ltd., 5200 Dixie Rd., Unit 33, Mississauga, Ont. L4W 1E4. Tel: (416) 625-8151. Pres. & Gen. Mgr.: Wilf Farrow. Sales Mgr.: Julie Thomson (Canadian sales office for Capitol Magnetic Tape Div.)
Audio: 8-tr., cassette, open reel
Brand name: Capitol.

Global Prods., 350 Sorauen Ave., Toronto, Ont. M6R 2G8 Tel: (416) 531-5751.
Audio: 8-tr., cassette.
Hardman Inds. Ltd., 34 Greensboro Dr., Rexdale, Ont. M9W 1E1 Tel: (416) 245-7890. Telex: (06) 989393. Chm. Eric H. Hardman. Pres.: Eric S. Hardman. Nat'l Sales Mgr.: Carl Cooley.
Audio: 8-tr. shells & 5 screw cassette shells (sonic welded)
I P S, see LSJ Cassette
L S J Cassette Corp., 50 Don Park Rd., Unit 14, Markham, Ont. L3R 1J3 Tel: (416) 495-9378.
Audio: 8-tr., cassette.
Brand names: Data Packaging, IPS, Lenco
Lenco, see LSJ Cassette
Pacific Int'l Magnetics Inc., 200-11031 Bridgeport Rd., Richmond, B.C. V6X 3A2. Tel: (604) 273-6015/1851. Telex: (04) 357568. Pres: Paul B. Brown
Branch: Winnipeg, Man., 152 Emerson. Postal Code: R2G 1E9. Tel: (204) 338-0709.
Int'l branch: USA
Audio: Cassettes, reels.
Brand name: Analyst.
Pan Canada Magnetics Ltd., 1072 Rangeview Rd., Port Credit, Ont. L5E 1H3 Tel: (416) 278-9851. Telex: (06) 960159.
Audio: All configurations.

Solo Prods., see Stereodyne
Stereodyne Ltd., 3121 Universal Dr., Mississauga, Ont. L4X 2E2. Tel: (416) 625-8311.
Audio: 8-tr. & cassette.
Brand Name: Solo Prods.

ENVELOPES & MAILERS

Golden Rec. Mfg. Ltd., 500 Coronation Dr., West Hill, Ont. M1E 4V7. Tel: (416) 281-9522. (M)
Pacific Int'l Magnetics Inc., 200-11031 Bridgeport Rd., Richmond, B.C. V6X 3A2. Tel: (604) 273-6015/1851. Telex: (04) 357568. Pres: Paul B. Brown.
Branch: Winnipeg, Man., 152 Emerson. Postal Code: R2G 1E9. Tel: (204) 338-0709.
Int'l branch: USA
Brand names: Analyst, Pro Design.
Ross-Ellis Ltd., 300 Ann St., Montreal, P.Q. H3C 2K2. Tel: (514) 861-2411. Telex: (05) 267411.
Branch: Markham, Ont., 227 Idema Rd. Postal Code: L3R 1B1. Tel: (416) 495-9811. Telex: (06) 986895.
Tri-Tel Assocs. Ltd., 105 Sparks Ave., Willowdale, Ont. M2H 2S5. Tel: (416) 499-5044. Telex: (06) 23443. Pres.: R.B. Finkle; Mktg. Mgr.: R.W. Finkle; Sales Mgr.: H.H. Gruenstein. (Envelopes & Mailers for Beta & VHS video-cassette)
World Recs. (div. of Shotgun Gimme Holdings Ltd.), PO Box 2000, Baseline Rd. W. at Courtice, Bowmanville, Ont. L1C 3Z3. Tel: (416) 576-0250. Toronto: 686-2828. Pres.: Bill Hewson; Gen. Mgr.: Bob Stone. (45, LP & Tape) (M)

JACKETS & SLEEVES

Custom Converters Printers Ltd., 563 The Queensway E., Mississauga, Ont. L5A 3K6. Tel: (416) 279-5256. Telex: (06) 961191. (Plastic inner sleeves for LP's)
Golden Rec. Mfg. Ltd., 500 Coronation Dr., West Hill, Ont. M1E 4V7. Tel: (416) 281-9522. (M)
Holborne Dist. Co. Ltd., PO Box 9, Mount Albert, Ont. L0G 1M0. Tel: (416) 294-9398. Pres.: Frank P. Swain; Custom Sales Mgr.: M.C. Swain. (LP only)
L S J Cassette Corp., 50 Don Park Rd., Unit 14, Markham, Ont. L3R 1J3. Tel: (416) 495-9378. (Sleeves only)
Lithobec Canada Ltd., 600 Port-Royal W., Montreal, P.Q. H3L 2C5. Tel: (514) 388-1133. (Jackets only) (M)
Metro Graphic Corp., 2800 Francis Hughes Ave., Laval, P.Q. H7L 3M4. Tel: (514) 663-0370. Cable: METROGRAPH. Telex: (05) 560705. Pres.: Paul Kizner; Gen. Mgr.: Sam Ungar; Sales Mgr.: Marvin Chankowsky. (Sleeves only) (M)
Modern Album of Canada Ltd., 2450 Finch Ave. W., Unit 7, Weston, Ont. M9M 2E9. Tel: (416) 745-5033. (Jackets & sleeves, record set boxes) (M)
Parr's Print & Litho Ltd., 111 Ferrier St., Markham, Ont. L3R 3K6. Tel: (416) 495-3300. Pres.: R.A. Gray; Gen. Mgr.: D. Fulton; VP Sales: R.J. Humphreys.
Ross-Ellis Ltd., 300 Ann St., Montreal, P.Q. H3C 2K2. Tel: (514) 861-2411. Telex: (05) 267411. (Videodisk)
Branch: Markham, Ont., 227 Idema Rd. Postal Code: L3R 1B1. Tel: (416) 495-9811. Telex: (06) 986895. (SEE ADVERTISEMENT)
Shorewood Packaging Corp. of Canada Ltd., 2220 Midland Ave.,

Scarborough, Ont. M1P 3E6. Tel: (416) 292-3990. Telex: (065) 25228. (M)
Branch: Montreal, P.Q., 1625 Chabanel St. W., Suite 1070. Postal Code: HAN 2S7. Tel: (514) 388-5745.
Home office: USA, New York, N.Y.
World Recs. (div. of Shotgun Gimme Holdings Ltd.), PO Box 2000, Baseline Rd. W. at Courtice, Bowmanville, Ont. L1C 3Z3. Tel: (416) 576-0250. Toronto: 686-2828. Pres.: Bill Hewson; Gen. Mgr.: Bob Stone. (LP only)

LABELS, DISK

Arc Sound Co. Ltd., 142 Sparks Ave., Willowdale, Ont. Tel: (416) 499-5000. (M)
Golden Rec. Mfg. Ltd., 500 Coronation Dr., West Hill, Ont. M1E 4V7. Tel: (416) 281-9522. (M)
Holborne Dist. Co. Ltd., PO Box 9, Mount Albert, Ont. L0G 1M0. Tel: (416) 294-9398. Pres.: Frank P. Swain; Custom Sales Mgr.: M.C. Swain. (45 & LP)
Metro Graphic Corp., 2800 Francis Hughes Ave., Laval, P.Q. H7L 3M4. Tel: (514) 663-0370. Cable: METROGRAPH. Telex: (05) 560705. Pres.: Paul Kizner; Gen. Mgr.: Sam Ungar; Sales Mgr.: Marvin Chankowsky. (M)
Parr's Print & Litho Ltd., 111 Ferrier St., Markham, Ont. L3R 3K6. Tel: (416) 495-3300. Pres.: R.A. Gray; Gen. Mgr.: D. Fulton; VP Sales: R.J. Humphreys.
Quality Recs. Ltd., 380 Birchmount Rd., Scarborough, Ont. M1K 1M7. Tel: (416) 698-5511. Telex: (06) 219624. Pres.: George R. Struth; Pres. Custom Mfg. & Finance: Terry M. Lynd; VP Finance: Sidney Lambersky. Local mktg. branch: 480 Tapscott Rd. Postal Code: M1B 1W3. Tel: 291-5590. Telex: (065) 26154. Mktg. Dir.: Barry J. Stafford.
World Recs. (div. of Shotgun Gimme Holdings Ltd.), PO Box 2000, Baseline Rd. W. at Courtice, Bowmanville, Ont. L1C 3Z3. Tel: (416) 576-0250. Toronto: 686-2828. Pres.: Bill Hewson; Gen. Mgr.: Bob Stone. (45 & LP) (M)

POLYETHYLENE BAG & SHRINKWRAP

L S J Cassette Corp., 50 Don Park Rd., Unit 14, Markham, Ont. L3R 1J3. Tel: (416) 495-9378.
Pacific Int'l Magnetics Inc., 200-11031 Bridgeport Rd., Richmond, B.C. V6X 3A2. Tel: (604) 273-6015/1851. Telex: (04) 357568. Pres.: Paul B. Brown. (Polybags only)
Branch: Winnipeg, Man., 152 Emerson. Postal Code: R2G 1E9. Tel: (204) 338-0709.
Int'l branch: USA
Phonodisc Ltd., 30 Malley Rd., Scarborough, Ont. M1L 2E3. Tel: (416) 751-9610. Telex: (06) 963629. Pres.: J.A. Trainor; Nat'l Sales Mgr.: R. Lutes; Eastern Sales Mgr.: J. Grobbo; Ont. Sales: S. Harradine, R. Caskenette; P.Q. Sales: K. Hannah; Western Sales Mgr.: G. Gow; Man. & Sask. Sales: G. Lipchen.
Branch: Vancouver, B.C., La-Go Music Ltd., 3446 Bridgeway St. Postal Code: V5K 1B6. Tel: (604) 294-6226.
World Recs. (div. of Shotgun Gimme Holdings Ltd.), PO Box 2000, Baseline Rd. at Courtice, Bowmanville, Ont. L1C 3Z3. Tel: (416) 576-0250. Toronto: 686-2828. Pres.: Bill Hewson; Gen. Mgr.: Bob Stone. (Polybags only)

PROFESSIONAL TAPE SUPPLIES

Edital, see McKeen Electronics
Holborne Dist. Co. Ltd., PO Box 9, Mount Albert, Ont. L0G 1M0. Tel: (416) 294-9398. Pres.: Frank P. Swain; Custom Sales Mgr.: M.C. Swain



tc/ac/dc
distributors inc.

**We Are Your
CANADIAN
CONTACT**

EXPORT • IMPORT

**New Releases
Overstock
Deletions**

**TC/AC/DC Distributors Canada
1050 Baxter Road
Ottawa, Ontario
Canada K2C 3P1
Phone: (613) 820-4522
or (613) 820-4580
Telex: 053 3778
Contact: Miles Flood**

NUMBER 1 IN CANADA for OVERSTOCKS DELETIONS SURPLUS

Special Offers on All Labels

RECORDS

TAPES

ACCESSORIES

We Import
and Export

LISS INTERNATIONAL

3495 Thimens B vd.
Montreal, Quebec H4R 1V5
Telex: 05824667
(answerback: DYNATRONIC)
Tel: (514) 335-0615

The best catalog
in Canada
is NOW bigger and better

BEACHES

RECORDS and TAPES LTD.

950 Denison Rd. Unit 20
Markham, Ontario,
Canada L3R 3K5
Telex: 06986787

SEND FOR IT

Write or phone today
for free catalogue

(416) 495-1175

(dealers only please)

BARGAINS AT ROCK BOTTOM PRICES

Audio: Cassette labels
McKeen Electronics Ltd., PO Box 4054, 780 Bank St., Ottawa, Ont. K1S 5B1.
Tel: (613) 236-7242. Telex: (05) 33381
Audio: Bulk erasers, splicing & editing equip
Brand names: Editall, WRE
Pacific Int'l Magnetics Inc., 200-11031 Bridgeport Rd., Richmond, B.C. V6X
3A2. Tel: (604) 273-6015/1851 Telex (04) 357568. Pres. Paul B
Brown.
Branch: Winnipeg, Man., 152 Emerson. Postal Code R2G 1E9. Tel (204)
338-0709
Int'l branch: USA
Audio: Splicing & leader tapes, cassette labels
Video: Videocassette labels
Brand names: Analyst, 3M
Ross-Ellis Ltd., 300 Ann St., Montreal, P.Q. H3C 2K2 Tel. (514) 861-2411.
Telex (06) 267411
Branch: Markham, Ont., 227 Idema Rd. Postal Code L3R 1B1 Tel. (416)
495-9811. Telex: (06) 986895.
Product: Cassette & videocassette labels.
Swire Intermagnetics Canada, 77 Steelcase Rd. W. Unit C. Markham, Ont
L3R 2M4. Tel (416) 495-0631. VP Canada. Brian Lundstram
Home office: USA
Product: "Phillips-style" cassette boxes.
W R E. see McKeen Electronics.
World Recs. (div. of Shotgun Gimme Holdings Ltd.), PO Box 2000, Baseline
Rd at Courtice, Bowmanville, Ont. L1C 3Z3 Tel (416) 576-0250 To-
ronto: 686-2828. Pres: Bill Hewson; Gen. Mgr. Bob Stone.
Audio: Cassette labels.

TAPE, BLANK LOADED

The numbers in parentheses following the 8-track & cassette configurations
show recording time in minutes; those following open reel configurations
show length of tape in feet.

Ampex Canada Inc., 132 East Or., Bramalea, Ont. L6T 3T9. Tel (416) 791
3100. VP & Gen Mgr. J.L. Major. VP & Nat'l Magnetic Tape Prods. Mgr.
J.R. Parselli.
Branches: Calgary, Alta., 1116-55 Ave. NE. Postal Code T2E 6Y4 Tel
(403) 275-3444-Dorval, P.Q., 729 Ave. Meloche. Postal Code H9P 2S4
Tel (514) 636-4840.
Audio: 8-tr. (45,90) cassette (45,60,90,120), open reel (1500', 2150',
2440', 3000', 3600'), broadcast.
Video: 1" open reel, 1/4" cassette (10,20,30,40,50,60), 1/4" EIAJ open reel
(1250', 2400')
Analyst: see Pacific Int'l
Audio Magnetics Corp. of Canada Ltd., 1180 MartinGrove Rd., Rexdale, Ont
M9W 5M9. Tel (416) 298 9111.
Audio: 8-tr. (40,80), cassette (45, 60, 90, 120), open reel
Brand names: Cycles, Tracs, Tracs Plus, XHE
B A S F (Canada) Inc., PO Box 430, Sta. St. Laurent, Montreal, P.Q. H4L 4V8.
5850 Cote de Liesse Rd., Town of Mt. Royal, P.Q. H4T 1B2. Tel (514)
341-5411. Telex (05) 827777
Audio: 8-tr., cassette, open reel
Capitol Recs. EMI of Canada Ltd., 3109 American Or., Mississauga, Ont. L4V
1B2 Tel (416) 677-5050 Cable CAPITOLREC Telex (06) 968619.
Pres. J.O. Evans
Branches: Calgary, Alta., 519 Manitou Rd. SE. Postal Code T2G 4C2 Tel
(403) 287-0823-Vancouver, B.C., Century Plaza, Suite 503, 1015 Bur-
rard St. Postal Code V6Z 1Y5 Tel (604) 689-8667-Dorval, P.Q., 9245
Cote de Liesse Rd. Postal Code: H9P 2W9 Tel (514) 631-9073
Audio: 8-tr., cassette
Cinram Ltd., 2255 Markham Rd., Scarborough, Ont. M1B 2W3. Tel (416)
298-8190. Telex (065) 26142
Audio: 8-tr., cassette
Cycles, see Audio Magnetics Corp
Edmund Scientific Prods. Co., 3500 Bathurst St., Toronto, Ont. M6A 2C6
Tel (416) 787-4584
Audio: Endless-loop cassette.
Wilf Farrow Assocs. Ltd., 5200 Oxie Rd., Unit 33, Mississauga, Ont. L4W
1E4. Tel (416) 625-8151. Pres. & Gen Mgr. Wilf Farrow, Sales Mgr.
Julie Thomson. (Canadian sales office for Capitol Magnetic Tape Div.)
Audio: Cassette.
Brand name: Capitol
Finetape Canada Ltd., 800 Islington Ave., Toronto, Ont. M8Z 4N7 Tel (416)
252-7209.
Audio: Cassette, open reel (600', 900', 1200', 1800').
Video: 1/4" Beta & VHS cassette.
Global Prods., 350 Soraura Ave., Toronto, Ont. M6R 2G8 Tel (416) 531
5751 Cable GLOBOLPROO.
Audio: 8-tr (40,45,80,90 & custom lengths), cassette (40,45,60,90 &
custom lengths), open reel
Hardman Inds. Ltd., 34 Greensboro Or., Rexdale, Ont. M9W 1E1 Tel (416)
245-7890. Telex: (06) 989393 Chm. Eric H. Hardman, Pres. Eric S
Hardman; Nat'l Sales Mgr. Carl Cooley.
Audio: 8-tr. (45,90), cassette (60,90).
Instart, see Pacific Int'l
International Audio Visual Ltd., PO Box 1096, Postal Code Y31 6Z4, 224
Cayer St., Coquitlam, B.C. V3K 5B1. Tel (604) 522-7955 Cable
IAVSOUNO Telex. (04) 351350. Pres. Or. Peter P. Allinger, VP Sales.
Philip Allinger
Audio: Cassette
Video: 1/4" Beta & VHS cassette
L S J Cassette Corp., 50 Don Park Rd., Unit 14, Markham, Ont. L3R 1J3 Tel
(416) 495-9378.
Audio: 8-tr. cassette
Brand name: Media
Le-Bo, see Phonodisc
Lecturecassette, see Pacific Int'l
Lettercassette, see Pacific Int'l
Magna Tape Mfg. Inc., 34 Greensboro Or., Rexdale, Ont. M9W 1E1 Tel
(416) 245-7890 Telex (06) 989393.
Audio: 8-tr., cassette, open reel
Maxell, see Tri-Tel Assocs
Media, see LSJ Cassette
Memorex, see Phonodisc
Pacific Int'l Magnetics Inc., 200 11031 Bridgeport Rd., Richmond, B.C. V6X
3A2 Tel (604) 273-6015/1851 Telex (04) 357568. Pres. Paul B
Brown.
Branch: Winnipeg, Man., 152 Emerson. Postal Code R2G 1E9. Tel (204)
338-0709
Int'l branch: USA
Audio: Cassette, open reel
Brand names: Analyst, Lecturecassette, Lettercassette, Instart.
Pan Can, see Pan Canada Magnetics
Pan Canada Magnetics Ltd., 1072 Rangeview Rd., Port Credit, Ont. L5E 1H3.

Tel (416) 278-9851 Telex: (06) 960159.
Audio: 8-tr., cassette, open reel.
Brand name: Pan Can, Pan Canada
Phonodisc Ltd., 30 Malley Rd., Scarborough, Ont. M1L 2E3 Tel: (416) 751-
9610. Telex: (06) 963629. Pres. J.A. Trainor; Nat'l Sales Mgr.: R. Lutes;
Eastern Sales Mgr.: J. Grobbo; Ont. Sales: S. Harradine, R. Caskenette;
P.Q. Sales: K. Hannah, Western Sales Mgr.: G. Gow, Man. & Sask. Sales:
G. Lipchen.
Branch: Vancouver, B.C., La-Go Music Ltd., 3446 Bridgeway St. Postal
Code: V5K 1B6. Tel: (604) 294-6226.
Audio: 8-tr. cassette, open reel
Brand names: Le-Bo, Memorex
Praise Inds. Corp., 6979 Curragh Ave., Burnaby, B.C. V5J 4V6. Tel: (604)
438-8266. Gen Mgr.: Paul Yaroshuk
Audio: 8-tr. cassette
Brand name: Presonic
Presonic, see Praise.
Sony Of Canada Ltd., 1370 Sony Pl., Winnipeg, Man. R3C 3C3. Tel (204)
284-7160.
Home office: Japan
Stereodyne Ltd., 3121 Universal Or., Mississauga, Ont. L4X 2E2 Tel (416)
625-8311
Audio: 8-tr. (40,45,80,90), cassette (60,90)
Brand name: Oynapak
Teac, see White Electronic.
Tracs, see Audio Magnetics
Tracs Plus, see Audio Magnetics.
Tri-Tel Assocs. Ltd., 105 Sparks Ave., Willowdale, Ont. M2H 2S5. Tel: (416)
499-5044. Telex: (06) 23443. Pres. R.B. Finkle; Mktg. Mgr. R.W. Finkle;
Sales Mgr. H.H. Gruenstein.
Audio: 8-tr., cassette, open reel
Video: 1/4" Beta & VHS cassette
Brand name: Maxell
White Electronic Development Corp. (1966) Ltd., 6300 Northam Or., Mal-
ton, Ont. L4V 1H7 Tel (416) 676-9090. Telex (06) 983584 (Importer)
Branch: Montreal, P.Q., 4750 Blvd. des Grandes Prairies. Postal Code
H1R 1A1 Tel (514) 326-4075
Audio: Cassette, open reel
Brand name: Teac
X H E, see Audio Magnetics

TAPE, BULK RAW

Agfa, see Photo Importing
Ampex Canada Inc., 132 East Or., Bramalea, Ont. L6T 3T9. Tel (416) 791
3100. VP & Gen Mgr. J.L. Major. VP & Nat'l Magnetic Tape Prods. Mgr.
J.R. Parselli.
Branches: Calgary, Alta., 1116-55 Ave. NE. Postal Code T2E 6Y4 Tel
(403) 275-3444-Dorval, P.Q., 729 Ave. Meloche. Postal Code: H9P 2S4
Tel (514) 636-4840.
Audio: 8-tr., cassette, open reel.
Analyst: see Pacific Int'l
B A S F (Canada) Ltd., PO Box 430, Sta. St. Laurent, Montreal, P.Q. H4L
4V8. 5850 Cote de Liesse Rd., Town of Mt. Royal, P.Q. H4T 1B2. Tel
(514) 341-5411. Telex (05) 827777
Audio: Cassette
Video: 1/4" cassette
Capitol, see Wilf Farrow
Wilf Farrow Assocs. Ltd., 5200 Oxie Rd., Unit 33, Mississauga, Ont. L4W
1E4 Tel (416) 625-8151. Pres. & Gen Mgr. Wilf Farrow, Sales Mgr.
Julie Thomson (Canadian sales office for Capitol Magnetic Tape Div.)
Audio: 8-tr., cassette
Brand name: Capitol
Finetape Canada Ltd., 800 Islington Ave., Toronto, Ont. M8Z 4N7 Tel (416)
252-7209.
Audio: Pancakes (7200', 8400', 10,100', 14,400', 16,800')
Global Prods., 350 Soraura Ave., Toronto, Ont. M6R 2G8 Tel (416) 531-
5751 Cable GLOBOLPROO.
Audio: 8-tr., cassette, open reel.
Instart, see Pacific Int'l
L S J Cassette Corp., 50 Don Park Rd., Unit 14, Markham, Ont. L3R 1J3. Tel.
(416) 495-9378.
Audio: 8-tr., cassette.
Brand name: Media
Lecturecassette, see Pacific Int'l
Lettercassette, see Pacific Int'l
Magna-Tape Mfg. Inc., 34 Greensboro Or., Rexdale, Ont. M8W 1E1 Tel
(416) 245-7890. Telex: (06) 989393.
Audio: Cassette
Media, see LSJ
Pacific Int'l Magnetics Inc., 200-11031 Bridgeport Rd., Richmond, B.C. V6X
3A2. Tel (604) 273-6015/1851. Telex (04) 357568. Pres.: Paul B
Brown.
Branch: Winnipeg, Man., 152 Emerson. Postal Code R2G 1E9. Tel (204)
338-0709
Audio: Cassette, open reel.
Brand names: Analyst, Lecturecassette, Lettercassette
Pan Canada Magnetics Ltd., 1072 Rangeview Rd., Port Credit, Ont. L5E 1H3.
Tel (416) 278-9851. Telex: (06) 960159.
Audio: 8-tr., cassette, open reel.
Photo Importing Agencies Ltd., 29 Gurney Crescent, Toronto, Ont. M6B 1S9.
Tel (416) 667-0700. Telex 22631.
Audio: 8-tr., cassette, open reel.
Brand name: Agfa
Praise Inds. Corp., 6979 Curragh Ave., Burnaby, B.C. V5J 4V6. Tel (604)
438-8266. Gen Mgr.: Paul Yaroshuk.
Audio: 8-tr., cassette.
Brand name: Presonic.

TAPE DUPLICATING & PROCESSING EQUIPMENT

Ampex Canada Inc., 132 East Or., Bramalea, Ont. L6T 3T9. Tel (416) 791
3100. VP & Gen. Mgr.: J.L. Major, VP & Nat'l Magnetic Tape Prods. Mgr.:
J.R. Parselli.
Branches: Calgary, Alta., 1116-55 Ave. NE. Postal Code: T2E 6Y4 Tel
(403) 275-3444-Dorval, P.Q., 729 Ave. Meloche. Postal Code: H9P 2S4.
Tel (514) 636-4840.
Product: Bin-loop duplicators, master reproducers
Brand names: Ampex, Stencil
B A S F (Canada) Inc., PO Box 430, Sta. St. Laurent, Montreal, P.Q. H4L 4V8.
5850 Cote de Liesse Rd., Town of Mt. Royal, P.Q. H4T 1B2. Tel. (514)
341-5411. Telex. (05) 827777
Product: Pancakes
Finetape Canada Ltd., 800 Islington Ave., Toronto, Ont. M8Z 4N7 Tel: (416)
252-7209.
Product: Audio tape coating, slitting machines.
Global Prods., 350 Soraura Ave., Toronto, Ont. M6R 2G8. Tel (416) 531-

5751 Cable: GLOBOLPROD.
Product: "In cassette" duplicator.
 Pacific Int'l Magnetics Inc., 200-11031 Bridgeport Rd., Richmond, B.C. V6X 3A2 Tel: (604) 273-6015/1851. Telex: (04) 357568 Pres. Paul B. Brown.
Branch: Winnipeg, Man., 152 Emerson. Postal Code R2G 1E9 Tel: (204) 338-0709.
Int'l branch: USA.
Product: Cassette duplicators.
Brand names: Pentagon, Sony.
 Pentagon, see Pacific Int'l.
 Sony, see Pacific Int'l.
 Stencil, see Ampex Canada.

TAPE PACKAGING & LABELING EQUIPMENT

Graham Fraser Pkg. Machinery Ltd., 50 Don Park Rd., Unit 5, Markham, Ont L3K 1J3 Tel: (416) 495-6944. Contact: Helmut Woerthe
Product: Tape packaging machines, conveyors, cartoners, fully automatic systems, specially designs.
 L S J Cassette Corp., 50 Don Park Rd., Unit 14, Markham, Ont L3R 1J3 Tel: (416) 495-9378.
Product: Cassette assembly, packaging & winding, Norelco standard, mini & micro cassette loads.
 Metro Graphic Inc., 2800 Francis Hughes Ave., Laval, P.Q. H7L 3M4 Tel: (514) 663-0370. Cable: METROGRAPH. Telex: (05) 560705. Pres.: Paul Kuzner, Gen. Mgr.: Sam Ungar, Sales Mgr.: Marvin Chankowsky.
Product: Label curing oven.

• accessories

Ampex Canada Inc., 132 East Dr., Bramalea, Ont. L6T 3T9 Tel: (416) 791-3100. VP & Gen. Mgr.: J.L. Major, VP & Nat'l Magnetic Tape Prods. Mgr. J.R. Pariselli.
Branches: Calgary, Alta., 1116-55 Ave. NE. Postal Code T2E 6Y4 Tel: (403) 275-3444—Dorval, P.Q., 729 Ave. Meloche. Postal Code: H9P 2S4 Tel: (514) 636-4840.
Product: Tape—head cleaners & demagnetizers, leader & splicing tape.
 Aspen, see Smyth Sound.
 BAS F (Canada) Inc., PO Box 430, Sta. St. Laurent, Montreal, P.Q. H4L 4V8, 5850 Cote de Liesse Rd., Town of Mt. Royal, P.Q. H4T 1B2 Tel: (514) 341-5411. Telex: (05) 827777.
Product: Tape—carrying & storage cases, head cleaners & demagnetizers, leader & splicing tape.
 O C L Micro-Electronics, 1500 W. Georgia St., Suite 1490, Vancouver, B.C. V6G 2T6 Tel: (604) 687-7747. Nat'l Sales & Promo. Mgr. Oaniel Riby.
Product: Tape—cassette storage units.
 Oulton, see Wilf Farrow.
 Empire Scientific Corp. Ltd., 65 Martin Ross Ave., Downsview, Ont. M3J 2L6 Tel: (416) 661-3910.
Home office: USA.
Product: Record—replacement styli.
 Wilf Farrow Assocs. Ltd., 5200 Dixie Rd., Unit 33, Mississauga, Ont. L4W 1E4 Tel: (416) 625-8151. Pres. & Gen. Mgr.: Wilf Farrow, Sales Mgr. Julie Thomson.
Product: Record—carrying & storage cases, record care prods., 45 rpm adaptors, replacement styli, Tape—carrying & storage cases, head cleaners & demagnetizers, leader & splicing tape (Oulton).
 Finetape Canada Ltd., 800 Islington Ave., Toronto, Ont. M8Z 4N7 Tel: (416) 252-7209.
Product: Tape—head cleaners, leader tape.
 Globol Prods., 350 Sorauen Ave., Toronto, Ont. M6R 2G8 Tel: (416) 531-5751. Cable: GLOBOLPROD.
Product: Record—carrying & storage cases, record care prods., 45 rpm adaptors, replacement styli, Tape—carrying & storage cases, head cleaners & demagnetizers, leader & splicing tape.
 Hardman Inds. Ltd., 34 Greensboro Dr., Rexdale, Ont. M9W 1E1 Tel: (416) 245-7890. Telex: (06) 989393. Chm. Eric H. Hardman, Pres. Eric S. Hardman, Nat'l Sales Mgr. Carl Cooley.
Product: Tape—head cleaners (Hi-Performance).
 Hi-Performance, see Hardman.
 International Audio Visual Ltd., PO Box 1096, Postal Code V3J 6Z4; 224 Cayer St., Coquitlam, B.C. V3K 5B1 Tel: (604) 252-7955. Cable: IAVSOUND. Telex: (04) 351350. Pres. Or. Peter P. Alinger, VP Sales Philip Alinger.
Product: Tape—carrying & storage cases, head cleaners, bulk erasers, demagnetizers, splicing & editing equip. (all audio).
 L S J Cassette Corp., 50 Oon Park Rd., Unit 14, Markham, Ont L3R 1J3 Tel: (416) 495-9378.
Product: Tape—head cleaners, demagnetizers.
 Magna-Tape Mfg. Inc., 34 Greensboro Dr., Rexdale, Ont. M9W 1E1 Tel: (416) 245-7890. Telex: (06) 989393.
Product: Tape—carrying & storage cases, head cleaners, demagnetizers, leader & splicing tape.
 Moss Music Group (Canada) Ltd., 510 Coronation Dr., Unit 17, West Hill, Ont. M1E 4X6 Tel: (416) 284-0126. Pres. & Gen. Mgr. John Leatham, Sales Mgr. Julian Rice.
Product: Record & Tape—carrying & storage cases.
 Pacific Int'l Magnetics Inc., 200-11031 Bridgeport Rd., Richmond, B.C. V6X 3A2 Tel: (604) 273-6015/1851. Telex: (04) 357568. Pres. Paul B. Brown.
Product: Tape—carrying & storage cases, head cleaners, bulk erasers, demagnetizers, splicing tape & equip. (all audio & video), leader tape (audio only).
 Pan Canada Magnetics Ltd., 1072 Rangeview Rd., Port Credit, Ont. L5E 1H3 Tel: (416) 278-9851. Telex: (06) 960159.
Product: Tape—carrying & storage cases, head cleaners & demagnetizers, leader tape.
 Permostat, see Tri-Tel.
 Phonodisc Ltd., 30 Malley Rd., Scarborough, Ont. M1L 2E3 Tel: (416) 751-9610. Telex: (06) 963629. Pres. J.A. Trainor; Nat'l Sales Mgr. R. Lutes, Eastern Sales Mgr. J. Grobbo; Ont. Sales S. Harradine, R. Caskenette, P.O. Sales K. Hannah; Western Sales Mgr.: G. Gow, Man. & Sask. Sales: G. Lipchen.
Branch: Vancouver, B.C., La-Go Music Ltd., 3446 Bridgeway St. Postal Code: V5K 1B6. Tel: (604) 294-6226.
Product: Record—carrying & storage cases, record care prods., 45 RPM adaptors, replacement styli, Tape—carrying & storage cases, head cleaners, demagnetizers, leader & splicing tape.
 Record Care, see Smyth.
 Smyth Sound Equip. Ltd., 595 Parc Industriel, Longueuil, P.Q. J4H 3V7 Tel: (514) 679-5490.
Product: Record—record care prods. (Watts, Record Care); replacement styli (Aspen); Tape—head cleaners, demagnetizers (Aspen).
 Sony Of Canada Ltd., 1370 Sony Pl., Winnipeg, Man. R3C 3C3. Tel: (204)

284-7160.
Home office: Japan.
Product: Tape—head demagnetizers, splicing & editing equip.
 Stanton, see Tri-Tel.
 Stereodyne Ltd., 3121 Universal Or., Mississauga, Ont. L4X 2E2 Tel: (416) 625-8311.
Product: Tape—head cleaners.
 Tri-Tel Assocs. Ltd., 105 Sparks Ave., Willowdale, Ont. M2H 2S5. Tel: (416) 499-5044. Telex: (06) 23443. Pres.: R.B. Finkle; Mktg. Mgr.: R.W. Finkle, Sales Mgr.: H.H. Gruenstein.
Product: Record—record care prods. (Permostat); turntable mats; replacement styli (Stanton); Tape—carrying & storage cases (audio & video), head cleaners (audio & video), demagnetizers (audio only).
 Watts, see Smyth.
 White Electronic Development Corp. (1966) Ltd., 6300 Northam Dr., Malton, Ont. L4V 1H7 Tel: (416) 676-9090.
Branch: Montreal, P.Q., 4750 Blvd. des Grandes Prairies. Postal Code: H1R 1A1 Tel: (514) 326-4075.
Product: Record—record care prods., Tape—head cleaners, & demagnetizers.

• store fixtures

BAS F (Canada) Inc., PO Box 430, Sta. St. Laurent, Montreal, P.Q. H4L 4V8; 5850 Cote de Liesse Rd., Town of Mt. Royal, P.Q. H4T 1B2 Tel: (514) 341-5411. Telex: (05) 827777.
Product: Tape display racks.
 Wilf Farrow Assocs. Ltd., 5200 Dixie Rd., Unit 33, Mississauga, Ont. L4W 1E4 Tel: (416) 625-8151. Pres. & Gen. Mgr.: Wilf Farrow, Sales Mgr. Julie Thomson.
Product: Record & tape display racks (Devon Design).
 Global Prods., 350 Sorauen Ave., Toronto, Ont. M6R 2G8 Tel: (416) 531-5751. Cable: GLOBOLPROD.
Product: Record & tape browser boxes, record & tape display racks, record & tape divider cards.
 Magna-Tape Mfg. Inc., 34 Greensboro Dr., Rexdale, Ont. M9W 1E1 Tel: (416) 245-7890. Telex: (06) 989393.
Product: Tape Browser boxes, tape display racks.
 Pacific Int'l Magnetics Inc., 200-11031 Bridgeport Rd., Richmond, B.C. V6X 3A2 Tel: (604) 273-6015/1851. Telex: (04) 357568. Pres. Paul B. Brown.
Branch: Winnipeg, Man., 152 Emerson. Postal Code: R2G 1E9 Tel: (204) 338-0709.
Int'l branch: USA.
Product: Tape display racks (audio).
 Phonodisc Ltd., 30 Malley Rd., Scarborough, Ont. M1L 2E3 Tel: (416) 751-9610. Telex: (06) 963629. Pres. J.A. Trainor; Nat'l Sales Mgr.: R. Lutes, Eastern Sales Mgr. J. Grobbo; Ont. Sales S. Harradine, R. Caskenette, P.O. Sales K. Hannah; Western Sales Mgr.: G. Gow, Man. & Sask. Sales: G. Lipchen.
Branch: Vancouver, B.C., La-Go Music Ltd., 3446 Bridgeway St. Postal Code: V5K 1B6. Tel: (604) 294-6226.
Product: Record divider cards.
 Praise Inds. Corp., 6979 Curragh Ave., Burnaby, B.C. V5J 4V6 Tel: (604) 438-8266. Pres. Paul Yaroshuk.
Product: Record browser boxes, record display racks, record divider cards.
 Tri-Tel Assocs. Ltd., 105 Sparks Ave., Willowdale, Ont. M2H 2S5. Tel: (416) 499-5044. Telex: (06) 23443. Pres.: R.B. Finkle; Mktg. Mgr. R.W. Finkle, Sales Mgr.: H.H. Gruenstein.
Product: Tape display racks (audio & video).

• jukebox manufacturer

Rowe (Canada), 9342 Cote de Liesse, Dorval, P.Q. H9P 2N9 Tel: (514) 636-4680.
Home office: USA.

• promotional merchandising aids

The following is a list of companies involved in the manufacturing, importing, distribution & retailing of items promoting the music industry and/or its artists. The key to symbols used is: (M) manufacturer; (I) importer; (D) distributor and (R) retailer.

Naughty Bits Music Promos. & Mds., PO Box 157, Sta. B, Toronto, Ont. M5T 2T3. Tel: (416) 862-0554.
Product: Buttons, badges.
 World Novellets, 89 King St. E., Hamilton, Ont. L8N 1A9 Tel: (416) 529-3395.
Product: Mirror pins.
 World Recs. (div. of Shotgun Gimme Holdings Ltd.), PO Box 2000, Baseline Rd. W. at Courtyce, Bowmanville, Ont. L1C 3Z3. Tel: (416) 576-0250. Toronto: 686-2828. Pres.: Bill Hewson, Gen. Mgr. Bob Stone, Art Dir.: Doug Powers.
Product: Posters (M).

CHILE

Population: 11,100,000
 Rate of exchange: \$1(US) = 39 pesos.
 Per capita income: \$1325
 Holidays: January 1, May 1 (Labor Day), Good Friday, May 21 (Navy Day), August 15 (Assumption), September 18 (Independence Day), September 19 (Army Day), October 12 (Columbus Day), November 1 (All Saints' Day), December 8, December 25.

• record & tape manufacturers / distributors / importers

Alba see Industria de Radio & Television
 Archiv, see Philips
 Arena, see Philips
 O G G, see Philips
 E M I Odeon Chilena SA (IFPI), Libertad 1227, Santiago 10 Tel: 737-069. Cable: TURNTABLE Mng Dir. Oavid Stockley, Sales & Int'l A&R Mgr. Guillermo Vera Larraín.
 Labels: (Owned) EMI-Odeon, (licensed) A&M (USA), Apple (UK), Arista-

Bell (USA), CBS (USA), Codiscos (Colombia), Favedica (Venezuela), IEMPSA (Peru), Island (UK), London (UK), Maria Peregó, Musart (Mexico), Private Stock (USA), Purple (UK), United Artists.
 Fermata Ltda (Eds. Musicales), Agustinas 853, Of. 619, Santiago. Tel: 32-720. Gen. Mgr.: Eliana Cisternas C.
Home office: Brazil, Discos RGE/Fermata.
 Labels: (Owned) Fermata, Pick, Premier, RGE, Som/Major, Young Fontana, see Philips.
 Heliodor, see Philips.
 I R T, see Industria de Radio & Television.
 Industria de Radio & Television SA (IFPI), Bustamante 596, Santiago. Tel: 22-7560. Cable: RADIOINTER. Tel: 278. Gen. Mgr. Mario Reyes.
 Labels: (Owned) Alba, (licensed) Ariola (Spain), Motown (USA), Parnaso (Argentina), RCA (USA)
 Int'l reps.: Argentina (Parnaso), Ecuador (IFESA), El Salvador (Oicesa), Mexico (Musart), Peru (FTA), Venezuela (Cordica).

M G M, see Philips
 Mercury, see Philips
 Odeon, see EMI
 Philips Chilena SA (IFPI), Casilla 2687, Av. Santa Maria 0760, Santiago. Tel: 378-371. Cable: PHILCHISA. Telex: 40239. Mng. Dir. Jorge Undurraga; Label Mgr.: Manuel Vera.
 Labels: (Owned) Archiv, OGG, Fontana, Heliodor, MGM, Mercury, Philips, Polydor, Smash Vertigo, Verve, (licensed) H. Astric (Monaco), Charisma (UK), Fresh Air (UK), Tony Hall Prods'ns (UK), Infopsea (Peru), Inter-rang, Jet (UK), MCA (USA), Mooncrest (UK), Mountain (UK), Onix (Ecuador), Peerless (Mexico), RSO (UK), Red Bullet (Netherlands), Rocket (USA), Roxbury (USA), Sono-Radio (Peru), Track (UK), Virrey (Peru), WWA (UK), Wam (Canada)

Pick, see Fermata
 Polydor, see Philips
 Premier, see Fermata
 Quatro Ltda (Productora & Distribuidora de Discos) (IFPI), Rancagua 0554, Santiago. Tel: 252-960, 231-811. Cable: OISCOSQUATRO. Pres.: Rolando Molina Reyes, Gen. Mgr. C. Hernan Greene V., Creative Dir.: Jaime Roman C.
 Labels: (Owned) Quatro, (licensed domestic) Arena, (licensed foreign) Ariola Int'l group (Benelux, Brazil, Germany, Mexico, Spain), Arista (UK, USA), Ariston (Italy), Baby (Italy), Bronze (UK), Delphine (France), Gamma (Mexico), Gas (Mexico), Hispavox (Spain), Island (UK), Microfon (Argentina), Motown (USA), Orleon (Mexico), Ri-Fi (Italy), Som (Brazil), Zafiro (Spain).
 R G E, see Fermata
 Smash, see Philips
 Som/Major, see Fermata.
 Sonidos, Avda Apoquindo 5232, Local 4, Santiago. Contact: Nancy Casassa Lara.
 Label: (Represented) Moss Music Group (USA)
 U T Z Corp. Ltda., Fernando Manterola 0453, Casilla 403 V, Santiago. Tel: 377-692. Cable: UTZCORP. Telex: SGO 260. Mng. Dir. & Gen. Mgr.: Ramon Utz Monsalve; Sales Mgr.: Rinaldo Rojas Ortiz.
 Labels: (Licensed foreign) Chantecter (Brazil), Continental (Brazil), GNP Crescendo (USA), JVC (Japan), Phonodisc (Brazil), Prelude (USA).

Vertigo, see Philips.
 Verve, see Philips.
 Young, see Fermata

• music publishers

Equus (Ediciones Musicales), Rancagua 554, Santiago. Tel: 252-960, 231-811. Dir. Gen. Jaime Roman C. Gen. Mgr.: Carlos Quezada H.
 Int'l firms represented: Alvorada (Brazil), Arlequim (Brazil), Ounbar (Canada), Edidon (Argentina), Gamma (Mexico), Grever Int'l (Mexico), Quiroga (Spain), RCA (Brazil, Italy, Mexico, Spain), Sunbury (Canada)
 Fermata Ltda (Eds. Musicales), Agustinas 853, Of. 619, Santiago. Tel: 32-720. Gen. Mgr. Eliana Cisternas C.
Home office: Brazil
 Int'l firms represented: Arapua (Brazil), Bourne group (USA), Combine (USA), Fermata (Brazil), Frank (USA), Dick James group (UK), Minerva, Arthur Napoleao (Brazil), Pedro, Portico, Seresta, Solmi, Sonata (Brazil).
 Peer Southern Org., see Southern.
 Sochem (Sociedad Chilena de Eds. Musicales) Ltda., Libertad 1227, Santiago 10 Tel: 737-069. Cable: TURNTABLE. Mng. Dir. Oavid H. Stockley.
 Int'l firms represented: Accord (Germany), Anagon (Netherlands), Ardmore & Beechwood (Belgium), Beechwood (Mexico, USA), Colombiana de Musica (Colombia), Consorcio de Eds. Musicales Peruanas (Peru), EGO (Spain), EMI (UK), MAI (Argentina), Palmar Marconi (France), Toshiba (Japan), La Voce del Padrone (Italy), Universal (Venezuela).
 Southern Music Int'l, Cruz 1469, Santiago.
Home office: USA, Peer Southern Org

• services

ASSOCIATIONS & PROFESSIONAL ORGANIZATIONS
 Instituto de Extension Musical, Compania 1264, Santiago. Tel: 89-438.
 S A T C H (Sociedad de Autores Teatrales de Chile), San Oiego 246, Santiago. Tel: 67-101, 66-2760

LICENSING ORGANIZATION, MUSIC

O A I C (Departamento del Derecho de Autor de la Universidad de Chile), San Antonio 427, 2nd fl., Santiago. Tel: 392-335. (Performing rights only)

PLATING, PROCESSING & PRESSING PLANTS

E M I Odeon Chilena SA, Libertad 1227, Santiago. Tel: 737-069. Cable: TURNTABLE. Mng. Dir. Oavid H. Stockley. (Pressing only)

PRINTERS & LITHOGRAPHERS

Philips Chilena SA, Casilla 2687, Av. Santa Maria 0760, Santiago. Tel: 378-371. Cable: PHILCHISA. Telex: 40239

TAPE CUSTOM DUPLICATORS

Philips Chilena SA, Casilla 2687, Av. Santa Maria 0760, Santiago. Tel: 378-371. Cable: PHILCHISA. Telex: 40239

Audio: Cassette

Quatro Ltda (Productora & Distribuidora de Discos), Rancagua 0554, Santiago. Tel: 252-960, 231-811. Cable: OISCOSQUATRO. Pres.: Rolando Molina Reyes, Gen. Mgr. C. Hernan Greene V., Creative Dir. Jaime Roman C.

Audio: Cassette

U T Z Corp. Ltda. Fernando Manterola 0453, Casilla 403 V, Santiago. Tel: 377-692. Cable: UTZCORP. Telex: SGO 260. Owner & Gen. Mgr.: Ramon Utz Monsalve, Sales Mgr.: Remaldo Rojas Ortiz.

Audio: cassette

• supplies

TAPE, BLANK LOADED & BULK RAW

Agfa-Gevaert Chilena de Productos Fonográficos L da., Casilla 139-D, Carlos Fernández 260, Santiago. Tel: 50-051, 56-7548 Telex: 289.
Audio: Blank—compact-cassette, open reel; raw—cassette, broadcast, studio.
Video: Cassette, open reel.
Brand names: Agfa Carat, Agfa Stereochrom, Agfa Videochrom.
 U T Z Corp. Ltda., Fernando Manterola 0453, Casilla 403-V, Santiago. Tel: 377-692. Cable: UTZCORP. Telex: SGD 260. Mng. Dir. & Gen. Mgr. Ramon Utz Monsalve; Sales Mgr.: Reinaldo Rojas Drtiz.
Audio: cassette.
Brand name: UTZ.

CHINA, PEOPLE'S REPUBLIC OF

Population: 950,000,000.
 Rate of exchange: \$1 (US) = 1.8 yuans
 Per capita income: \$375.
Holidays: January 1 (New Year's Day), February 16-19 (Spring Festival), May 1 (Labor Day), October 1, 2 (National Days).

• record & tape manufacturers / distributors / importers

China Rec. Factory (div. of Central Broadcasting Administration), 811 Heng Shan Rd., Shanghai 200030. Hsu-huai. Tel: (021) 374470 Telex: 2627 Dir.: Hsu Cheng-min.
 Pacific Audio & Video Co. Ltd. (affiliate of Guangdong Provincial Broadcasting Bureau), Broadcasting Bldg., Renmin Bei Rd., Canton. Tel: 35270, 30030 Telex: 1051 Gen. Mgr.: M.C. Lin; Sales Mgr.: K. Mak.

• services

ASSOCIATIONS & PROFESSIONAL ORGANIZATIONS

Central Conservatory of Music, Peking. Tel: 667120.
 Chinese Association of Musicians, Peking. Chm.: Lu Chi.

PRESSING PLANT

China Rec. Factory (div. of Central Broadcasting Administration), 811 Heng Shan Rd., Shanghai 200030. Hsu-huai. Tel: (021) 374470 Telex: 2627 Dir.: Hsu Cheng-min.

COLOMBIA

Population: 28,000,000.
 Rate of exchange: \$1 (US) = 54 pesos.
 Per capita income: \$515.
Holidays: January 1, January 6 (Epiphany), March 19 (St. Joseph's Day), March 30 (Palm Sunday), Easter Week, May 1 (Labor Day), May 15 (Ascension Day), Corpus Christi, June 13 (Thanksgiving), July 20 (Independence Day), August 7 (Battle of Boyaca), August 15 (Assumption), October 12 (Columbus Day), November 1 (All Saints' Day), November 11 (Independence of Cartagena), December 11 (Immaculate Conception), December 25.

RECORDS:

Note: Reliable information regarding the sales of records and tapes is hard to obtain. Record companies are unwilling to share their sales data not only with the press but also with their own association.

Record sales certification awards: There are no awards for selling a standardized number of records. However, each company presents year-end gold and silver awards for its own best sellers without ever revealing the sales figures.

Average retail price per record: LP's—\$5.31; super singles—\$2.55; singles—\$1.49.

Type of distribution: Manufacturer-to-retailer is the predominant marketing system in Colombia. Most of the record sales are through chains of retailers located in the major cities. In most smaller cities and towns, these chain retailers act as wholesalers to small stores.

Type of promotion: Radio is still the most important promotional medium for records. Television has been gaining slowly with numerous musicals that include promotion of foreign artists. The press is being used more heavily.

TAPE:

Market: 8-track has been almost completely phased out of the market. There has been a considerable growth in the sales of pre-recorded cassettes over the past five years, having been much aided by the sale of radio-cassette player combinations. The increasing sales of cassette units have benefited the sales of blank tapes, too, as recording off-the-air as well as from records becomes even more popular.

Average retail price per tape: Cassette—\$5.31.

RADIO STATIONS:

No. of commercial 300 (280 AM, 20 FM); no. of government 1.
Comment: The trend in radio programming has been towards more musical stations and fewer soap operas. Also, there is a revival of "live" radio, thus resulting in the phasing out of many pre-recorded programs.

TELEVISION STATIONS:

No. of channels 3; NISTC color (40%).
Comment: Programming is totally controlled by the governmental agency Invasión. Since August 1979, there has been a greater percentage of time allotted to cultural programs while "violent" programs have been almost completely eliminated. Musicals, while not a large percentage of total television time, still are among the most popular shows.

Manuel Bello

• record & tape manufacturers / distributors / importers

A D C, see FM

Page 206

Antillano, see Tropical.
 Archiv, see Philips.
 Armonia, see FM.
 Atraz, see Chaves.
 C B S SA (Discos) (IFPI), 5-81 Calle 80, Bogota, D.E. Tel: (2) 11-86-67. Cable: CDLRECORD. Telex: 43461. Gen. Dir.: Carlos A. Gutierrez T., Mktg. Dir.: Fidel Jaramillo Villa.
Labels: (Domestic) CBS, Epic (licensed foreign) A&M (USA), Angel (UK), Apple (UK), Capitol (USA), Walt Disney (USA), EMI (UK), Fania/Vaya (USA), Harmony (USA), Ddeon (Argentina), Pathe Marconi (France), United Artists (UK).

Int'l rep.: Worldwide (CBS).
 Caliente, see Sonolux.
 Calle, see Daro.
 Candil, see Chaves.
 Caribe, see Fuentes.
 Carnaval, see Victoria.
 Carrizal, see Sonolux.
 Chaves (Discos), 18-43 Carrera 23, Pasto. Tel: 20-51, 3138. Cable: DIS CHAVES. Gen. Mgr.: Ramiro Chaves L.; Sales Mgr.: Iliá de Chaves.
Labels: (Domestic) Atraz, Candil, Chaves, Emerald.
Int'l rep.: Costa Rica (Nueva Dia), Ecuador (Centenario), Netherlands (Dureco), Venezuela (BASF).

Codiscos (Compania Colombiana de Discos) SA, Apdo. Aereo 1428, 65-304 Calle 2 Sur, Medellin. Tel: 55-08-35, 55-08-95. Cable: CODISCOS. Telex: 6570. Pres.: Alfredo Diez M.; VP: Alvaro Arango G.; A&R Mgr.: Rafael Mejia P.; A&R Dir.: Marco F. Eusset.
Labels: (Domestic) Costeno, Famoso, Super 45, Super Play, Super Sencillo, Zeida; (licensed) ATC (Argentina), Alshire (USA), Atlas (Italy), Autobahn (Germany), Baby (Italy), Barclay (France), Caracol (Chile), Common Cause (USA), Continental (Brazil), Danny Daniel (Spain), Fantasy (USA), Fritluna (Sweden), Gamma (Mexico), Helix (Mexico), Hispavox (Spain), Hungaroton (Hungary), IB (France), Ricardo Kleiman (Argentina), LEM (France), MMS (Austria), Melody (Mexico), Microfon (Argentina), Musart (Mexico), Peruvox (Peru), Prolisa (Mexico), Promusa (Peru), Ri-Fi (Italy), Riviera (France), SDS (Sweden), Trova (Venezuela).
Int'l rep.: Ecuador (Famoso), Guatemala (Dideca), Mexico (Musart), Panama (Sonomundi), USA (TH), Venezuela (Discoeca).

Corporacion Musical Ltda., Carrera 47, No. 52-62, Apdo. Aereo 7011, Medellin. Cable: CONMUSICAL. Tel: 34-14-51. Gen. Mgr.: Hernan Restrepo Duque.
Label: (Represented) House of Falcon (USA).

Costeno, see Codiscos.
 D G G, see Philips.
 Daro Ltda. (Importaciones), 6-47 Calle 18, 11th fl., Bogota. Tel: 241-12-18, 243-36-66, 283-07-53. Cable: IMPODARD. Pres.: Simon Daro. Gen. Mgr.: Eduardo Calle.
Int'l branches: Canada, Toronto, Ont.; USA, Miami, Fla., New York, N.Y.

Labels: (Domestic) Calle, Daro, SAR, SIS, Simday; (licensed foreign) Argo, Decca (UK), London (USA), L'Diseau Lyre, Phase 4 (UK), Torres, Vega.
Int'l rep.: Argentina (EMI-Deon), Brazil (EMI-Deon), Chile (Sonotec), Costa Rica (Indica), Ecuador (Famoso), Mexico (EMLASA), Spain (SGAE), Venezuela (La Discoteca).

Delujo, see Fuentes.
 Diana, see Victoria.
 Discomoda de Colombia Ltda. (IFPI), Apdo. Aereo 29585, 46-65 Avda. Caracas, Bogota, D.E. Tel: 285-0311, 287-3136. Cable: DISCOMODA. Pres. Cesar Roldan. Gen. Mgr.: Enrique Estrada Duque. Sales Mgr.: Alfonso Gaitan C.
Home office: Venezuela.
Labels: (Domestic) Discomoda; (licensed) Alegre (USA), Belter (Spain), Discolando (USA), FTA (Peru), Favedica (Venezuela), Inca (USA), Lyra (Costa Rica), Musitron (USA), Tico (USA), West Side Latino (USA).
Int'l rep.: Central America (Lyra), Ecuador (Fediscos), Peru (FTA), USA (Discolando).

Elite, see Sociedad Int'l de Sonido.
 Emerald, see Chaves.
 Epic, see CBS.
 Extra, see Tropical.
 F M Discos & Cintas Ltda., Apdo. 13408, 20-43 Calle 13, Bogota, D.E. Tel: 277-9686, 247-5137. Cable: FM. Pres.: Francisco Montoya; Gen. Dir.: Humberto Moreno; Promo. Dir.: Camilo Mendoza, Sales Dir. Rafael Velazquez; Domestic A&R: Ricardo Acosta.
Labels: (Domestic) Armonia, F.M. Pare, Valtenato; (licensed) All Stars (Venezuela), Audio Fidelity (USA), Cayltrons (USA), Dial (Spain), Foca (Venezuela), IFESA (Ecuador), Musidisc (Brazil), Teca (USA); (distributed—not licensed) ADC, Sonico.
Int'l rep.: Central America (Fonica), Ecuador (IFESA), Mexico (Pren), Peru (Galdisa), USA (Cayltrons, Sonlat), Venezuela (Foca).

Fabuloso, see INS.
 Famoso, see Codiscos.
 Felito, see Sonolux.
 Fonoarte Ltda., Apdo. Aereo 83-03, 41-20 Calle 10, Medellin. Tel: 46-69-07, 46-61-09. Gen. Mgr.: Francisco J. Correa C. (Distributor/importer)
Labels: (Distributed—not licensed) Amadeo (Austria), Asylum (USA), Centrocor (Austria), Columbia (USA), Elektra (USA), Ensayo (Spain), Harmonia Mundi (France), Hungaroton (Hungary), Inner City (USA), Lyrichord (USA), MMD (USA), Mace (USA), Melodiya (USSR), Pepita (Hungary), Pueblo (Mexico), Qualiton (Hungary), Springboard (USA), Supraphon (Czechoslovakia), Turnabout (USA), Vanguard (USA), Vox (USA), Warner Bros. (USA).

Fontana, see Philips.
 Fuentes (Fabrica De Discos) Ltda. (IFPI), Apdo. Aereo 1960, 13-223 Carrera 51, Medellin. Tel: 35-13-00, 35-71-52. Cable: DISFUENTES Co. Pres. Pedro & Jose Maria Fuentes Estrada; Gen. Mgr.: Dr. Conrado Dominguez; Sales Mgr.: Jorge Gonzalez Botero; Int'l Mgr.: Javier Garcia M.
Labels: (Domestic) Caribe, Delujo, Fuentes; (licensed) Accion (Mexico), Arston (Italy), Auvu (Spain), Baby (Italy), Belter (Spain), Carosello (Italy), Gisne Raff (Mexico), Copacabana (Brazil), Corilo (Mexico), Coro (Mexico), Disqueras (Venezuela), Dynamic Sound (Jamaica), Eleven (Italy), Fonica (Guatemala), Ibach (France), Jupiter (Germany), Onix (Ecuador), Panart (USA), Paraso (USA), Peerless (Mexico), Prelude (USA), Quatro (Chile), Seeco (USA), Som (Brazil), Tonodisc (Argentina), Vanguard (USA), Velvet (USA, Venezuela), El Virrey (Peru); (distributed—not licensed) Eva

Int'l rep.: Brazil (Som), Chile (Quatro), Ecuador (Fediscos), France (Atoll), Guatemala (Fonica), Mexico (Peerless), Peru (El Virrey), Spain (Edgisa), USA (Sunshine), Venezuela (Disqueras).
 Grabarco Ltd., 21-35 Avda. de las Americas, Cali. Tel: 64-12-73
Label: (Represented) Kubaney (USA).

H B, see Incolve.
 I N S (Industria Nacional del Sonido) Ltda. (IFPI), Apdo. Aereo 3815, 5394 Carrera 73, Medellin. Tel: 34-55-44, 34-56-44. Mgr. Guillermo Zea Fernandez.

Labels: Fabuloso, INS, Metropoli, Silver; (represented) Condor, Corona, Falcon, Fonodisco, Infopesa, Music Hall, Rico, Solo.
 Ideal, see Tropical.
 Impacto, see Sonolux.
 Incolve Ltda. (Industria Musical Colombo Venezolana), 21 73 Carrera 7a, 5th fl., Bogota. Tel: 241-91-99, 283-83-45. Cable: INCOLVYE. Gen. Mgr.: Fanny Frasser.
Home office: Venezuela. El Palacio de la Musica
Labels: (Domestic) HB, Solex; (licensed) Alhambra (USA), Cream (USA), Delphine (Europe), Grabaciones Mundiales (Venezuela), Motown (USA), Palacio (Venezuela), Telefonken (Europe).

Industria Musical Colombo Venezolana, see Incolve.
 Industria Nacional del Sonido, see INS.
 Infopesa, see INS.
 Lyra, see Sonolux.
 Machuca, see Tropical.
 Mercury, see Philips.
 Metropoli, see INS.
 Drbe (Discos) SA, 13-79 Carrera 68-D, Bogota. Tel: 262-4400
Label: (Licensed foreign) MCA (USA)
 Papagayo, see Sociedad Int'l de Sonido
 Pare, see FM.
 Philips de Colombia SA (Industrias) (IFPI), Music Dept., 51-39 Calle 13, Bogota, D.E. Tel: 60-06-00. Cable: PHILCDLDM. Telex: 44776. Pres.: Henri C.M. Van de Wal; Gen. Mgr.: Alfonso Escobar Nieto; Sales Mgr.: Luis A. Garcia S.; Int'l Pop Label Mgr.: Leo Gabrinas.
Labels: (Domestic) Archiv, DGG, Fontana, Mercury, Philips, Polydor, Vertigo, Verve; (licensed) Alhambra (Spain), Dreamland (USA), EG, Guajiro (USA), Lollipop (Germany), Pablo (USA), RSD (USA).
Int'l rep.: Worldwide (Philips, Polydor).

Polydor, see Philips.
 R C U, see Victoria.
 Real, see Sonolux.
 S A R, see Daro.
 Silver, see INS.
 Simday, see Daro.
 Sociedad Int'l de Sonido, Apdo. Aereo 14380, 14-40 Calle 19, Bogota. Tel: 284-5818, 243-1515. Pres.: Eduardo Calle; Mng. Dir.: Guillermo Diez R. Int'l Dir. Clara Hochner.
Int'l branch: ELITE
Labels: (Domestic) Elite, Papagayo, SIS; (represented) Audiofidelity/Amberjack (USA), Baby (Italy), Caney (USA), Cinevox (Italy), Emergency (USA), Fania/Vaya (USA), Lo Mejor (USA), Musidisc (France), Sacodis (Ivory Coast), Sar (USA), Tipi/Sonografica (USA, Venezuela)
Int'l rep.: Ecuador (Famoso), Mexico (Ariola), Peru (IEMPSA), Venezuela (El Palacio de la Musica).

Solex, see Incolve.
 Sonico, see FM.
 Sonolux Industria Electro-Sonora SA (IFPI), 43 A-5 Calle 29, Medellin. Tel: 32-09-99, 32-28-45. Cable: SDNDLUX. Telex: 06512. Pres.: Sergio Berdugo Quintan; Artist Dir. Leon Cardona Garcia; Sales Mgr.: Juan Fernando Restrepo C.; Ass't to Pres.: Edgardo Quinceo Gil.
Labels: (Domestic) Caliente, Impacto, Lyra, Real, Sonolux; (licensed domestic) Carrizal, Felito; (licensed foreign) Andino (Peru), Ariola (worldwide), Buddah (USA), Can't Stop (USA), Dicesa (El Salvador), FENX (Ecuador), Marfer (Spain), Padisco (Panama), Promus (Venezuela), Roca (worldwide), Sonomex (Mexico), Sonoven (Venezuela), Surco (Argentina), Vanilla (Italy), Vogue (France), WEA (worldwide).
Int'l rep.: El Salvador (Dicesa), Ecuador (Fediscos), Mexico (Bertelsmann), Panama (Padisco), Peru (FTA), USA (Alhambra), Venezuela (Sonoven).

Super 45, see Codiscos.
 Super Play, see Codiscos.
 Super Sencillo, see Codiscos.
 Swing, see Tropical.
 Tropical (Discos) Ltda. (IFPI), 68-73 Calle 68-B, Barranquilla. Tel: 316-509, 315-645. Cable: RADIAG. Pres.: Emilio Fortou P.; Gen. & Sales Mgr.: Tony Fortou E.; A&R Mgr.: Jorge Fortou E.; Promo. Mgr. Adelaida Reyes de Fortou.
Labels: (Domestic) Antillano, Extra, Ideal, Swing, Tropical; (licensed domestic) Machuca; (licensed foreign) Ariola Eurodisc (Germany), Baby (Italy), Brass (USA), CID (Brazil), Countdown (Germany), Debs (Guade loupe), Fleche (France), Gema (Puerto Rico-USA), Graf (USA), Hansa Int'l (Germany), Inagua (USA), Metronome (Germany), Miami (USA), Mouse Music (Belgium), Phonogram (Netherlands), Rana (Puerto Rico), Request (USA), SMI (USA), Satrul (UK), Son*Art (Mexico), Sonet (Sweden), Sonodisc (France), Sweet City (USA), Unidisc (Canada)
Int'l rep.: Mexico (Aries), Venezuela (Fonodisco).

Universe, see Victoria.
 Valtenato, see FM.
 Vertigo, see Philips.
 Verve, see Philips.
 Victoria (Industrias Fonograficas) Ltda. (IFPI), Apdo. Aereo 3308, 25-144 Carrera 52, Medellin. Tel: 35-15-06. Cable: DISVICTRDIA. Pres. Dioneel Cardona Uruan. Gen. Mgr.: Oscar Martinez Maya; Sales Mgr.: Hernan Cardona Tobon.
Labels: (Domestic) Carnaval, Diana, RCU, Universe, Victoria; (licensed) Borinquen (Puerto Rico), Venus (Venezuela), ARV Int'l, Falcon, RIC, Ramy (all USA).
Int'l rep.: Mexico (Capitol), Spain (Marfer)

Zeida, see Codiscos.

• music publishers

C B S (Discos) SA, Div. Editorial, 5-81 Calle 80, Bogota. Tel: (2) 11-89-67. Cable: CDLRECORD. Telex: 43461. Gen. Dir.: Carlos Gutierrez T., Mgr.: Miguel Angel Valenzuela.
Int'l firms represented: April (worldwide), Blackwood (USA), EGD (Spain), Escorpion (Mexico), Itapu (Brazil), Kurshner (USA), MAI (Argentina).
Int'l rep.: Worldwide (April) excluding Argentina (Melograf), Mexico (Mundo Musical), USA (April-Blackwood).

Ecomus (Ed. Colombiana & Int'l de Musica Ltda.), 11 A-40 Carrera 43-A, Medellin. Tel: 46-51-38. Cable: ECDMUS. Mgr.: Sylvia N. Arango Duque.
Int'l firms represented: Beechwood (Mexico), Brambila (Mexico), Prodema (Peru), Quiroga (Spain), SADRAM (Ecuador), Union (Spain).
Int'l rep.: Argentina (Kom), Chile (Sochem), Ecuador (SADRAM), Mexico (Brambila), Peru (Continental), Spain (Quiroga), USA (Morro), Venezuela (Sedemusica).

Edmundo Ltda., Apdo. Aereo 55036, 53-94 Carrera 73, Medellin. Tel: 34-56-44, 34-75-71. Cable: EDIMUNDO. Mgr. Guillermo Zea Fernandez.
 Edimúsica (Ed. Int'l de Musica Ltda.), Apdo. Aereo 1960, 13-223 Carrera 51, Medellin. Tel: 35-13-00, 35-71-52. Cable: EDIMUSICA. Chief Exec.: Gonzalo Pelayez. Gen. Mgr.: Hugo Giraldo M.; Prof. Mgr.: Ignacio Lopez.
Int'l firms represented: Conedisa (Peru), Predisa (Mexico), Sayce (Ecu-

dor), Som (Brazil), Velvet (Venezuela).
Int'l reps.: Brazil (Augusta), Mexico (Predisa), Peru (Conedisa), Venezuela (Velvet).
Editor & Promotora Musical Colombia Ltda. (Ediprom), Apdo. 3308, 25 144 Carrera 52, Medellin. Tel: 35-52-54. Pres: Dioniel Cardona Uran; Gen Mgr: Bernardo Mejia Aguirre.
Int'l rep.: Worldwide (Leo).

F M (Ed Fonogramas Musicales Ltda.) Apdo 13408, 20-43 Calle 13, Bogota, D.E. Tel: 277-9686, 247-5137. Cable: FM Gen. Dir. Humberto Moreno.
Fonolon (Ed.), 51-39 Calle 13, Bogota. Tel. 60-06-00. Gen Mgr. Alfonso Escolar Nieto; Prof. Mgr. Aida de Angarita
Int'l firm represented: Intersong (Mexico)
Int'l rep.: Mexico (Intersong).

Peer de Colombia Ltda., 8-92 Calle 18, Bogota. Tel 241 9864. Cable PEERCO. Gen. Mgr.: Guillermo Fonseca
Home office: USA, Peer-Southern Div
Prodems (Promotora Colombiana de Musica) Ltda. Apdo Aereo 1428, 11 A 40 Carrera 43-A, Medellin. Tel: 46-51-38. Cable: PRODEMUS Mgr.: Sylvia Nora Arango Duque.

Int'l firms represented: Arabella (Spain), Continental (Peru), Discorama (Spain), Edimus (Venezuela), Edimus (Mexico), Fermata (Brazil), Maya (Guatemala), Rimo (Mexico), Sochem (Chile), Sumacosa (Venezuela)
Int'l reps.: Argentina (Korn), Chile (Sochem), Ecuador (SADRAM), Guatemala (Maya), Mexico (Edimus), Peru (Continental), Spain (Quoroga), USA (Morro), Venezuela (Sedemusica).

Sonolux Int'l SA (Promotora), 43 A-5 Calle 29, Medellin Tel: 32-09-99. Pres.: Carlos Julio Ardila Gaviira; Gen Mgr.: Sergio Berdugo Cuartas; Ass't to Pres.: Edgardo Quiceno Gil.
Int'l firms represented: Edicesa (El Salvador), Edm (Mexico), Jaguare (Brazil), RCA (Brazil, Italy), Relay (Argentina), Victor (Brazil).
Int'l reps.: Argentina (Relay), Brazil (Victor), Ecuador (Sadram), Italy (RCA), Mexico (Edim), Peru (Prodems), Spain (RCA), Venezuela (Drifra Unimusic), USA (Morro).

• **sheet music jobber / suppler**

Fonoarte Ltda., Apdo Aereo 83-03, 41-20 Calle 10, Medellin Tel: 46-69-07. Gen. Mgr.: Francisco J. Correa C.

• **services**

CATALOG SERVICES

Philips de Colombia (SA Industrias), Music Div., 51-39 Calle 13, Bogota, D.F. Tel: 60-06-00. Cable: PHILCOLDN. Telex: 44776. Pres.: Henri C.M. Van de Wal; Gen. Mgr.: Alfonso Escolar Nieto; Sales Mgr.: Luis A. Garcia S.; Int'l Rep. Label Mgr.: Leo Gabruians.

DESIGN & ARTWORK

Codiscos (Compania Colombiana de Discos SA), Apdo. Aereo 1428, 65-304 Calle 2 Sur, Medellin. Tel: 55-08-35, 55-08-95. Cable: CODISCOS. Telex: 6570. Pres.: Alfredo Diez M.; VP: Alvaro Arango G.
F M Discos & Cintas Ltda., Apdo. 13408, 20-43 Calle 13, Bogota, D.E. Tel: 277-9686. Cable: FM Gen. Dir.: Humberto Moreno
Fuentes (Fabrica de Discos) Ltda., Apdo Aereo 1960, 13-223 Carrera 51, Medellin. Tel: 35-13-00, 35-71-52. Cable: DISFUENTES. Co-Pres.: Pedro & Jose Maria Fuentes Estrada; Gen. Mgr.: Dr. Conrado Dominguez H.; Sales Mgr.: Jorge Gonzalez Botero; Int'l Mgr.: Javier Garcia Munoz
Litho Plastics Ltda., 68-73 Calle 68-B, Barranquilla. Tel: 316-509. Cable: RADIAG. Pres.: Emilio Fortou P.; Gen. Mgr.: Cecilia de Fortou; Sales Mgr.: Tony Fortou E.

Tropical (Discos) Ltda., 68-73 Calle 68-B, Barranquilla. Tel: 316-509, 325-858, 315-645, 325-362. Cable: RADIAG. Pres.: Emilio Fortou P.; VP: Cecilia de Fortou; Gen. & Sales Mgr.: Tony Fortou E.

LICENSING ORGANIZATION, MUSIC

SAYCD (Sociedad de Autores & Compositores de Colombia), 40-72 Carrera 19, Bogota. Tel: 2-87-08-01. Cable: SAYCO (Performing rights only.)

PLATING, PROCESSING & PRESSING PLANTS

C B S SA (Discos), 5-81 Calle 80, Bogota, D.E. Tel: (2) 11-86-67. Cable: CDLRECD. Telex: 43461. Gen. Dir. Carlos A. Gutierrez T.
Codiscos (Compania Colombiana de Discos SA), Apdo. Aereo 1428, 65-304 Calle 2 Sur, Medellin. Tel: 55-08-35, 55-08-95. Cable: CODISCOS. Telex: 6570. Pres.: Alfredo Diez M.; VP: Alvaro Arango G.
F M Discos & Cintas Ltda., Apdo. 13408, 20-43 Calle 13, Bogota, D.E. Tel: 277-9686. Cable: FM Gen. Dir.: Humberto Moreno
Fuentes (Fabrica de Discos) Ltda., Apdo Aereo 1960, 13-223 Carrera 51, Medellin. Tel: 35-13-00, 35-71-52. Cable: DISFUENTES. Co-Pres.: Pedro & Jose Maria Fuentes Estrada; Gen. Mgr.: Dr. Conrado Dominguez H.; Sales Mgr.: Jorge Gonzalez Botero; Int'l Mgr.: Javier Garcia Munoz
Philips de Colombia SA (Industrias), Music Div., 51-39 Calle 13, Bogota, D.E. Tel: 60-06-00. Cable: PHILCOLDN. Telex: 44776. Pres.: Henri C.M. Van de Wal; Gen. Mgr.: Alfonso Escolar Nieto; Sales Mgr.: Luis A. Garcia S.; Int'l Rep. Label Mgr.: Leo Gabruians

Sonolux Industria Electro Sonora SA, 43 A-5 Calle 29, Medellin Tel: 32-09-99. Pres.: Sergio Berdugo Cuartas; Gen. Mgr.: Leon Cardona Garcia; Sales Mgr.: Juan Fernando Restrepo C; Ass't to Pres.: Edgardo Quiceno Gil
Tropical (Discos) Ltda., 68-73 Calle 68-B, Barranquilla. Tel: 316-509, 325-858, 315-645, 325-362. Cable: RADIAG. Pres.: Emilio Fortou P.; VP: Cecilia de Fortou; Gen. & Sales Mgr.: Tony Fortou E.

PRINTERS & LITHOGRAPHERS

Codiscos (Compania Colombiana de Discos SA), Apdo. Aereo 1428, 65-304 Calle 2 Sur, Medellin. Tel: 55-08-35, 55-08-95. Cable: CODISCOS. Telex: 6570. Pres.: Alfredo Diez M.; VP: Alvaro Arango G.
F M Disco & Cintas Ltda., Apdo. 13408, 20-43 Calle 13, Bogota, D.E. Tel: 277-9686. Cable: FM Gen. Dir.: Humberto Moreno.
Fuentes (Fabrica de Discos) Ltda., Apdo. Aereo 1960, 13-223 Carrera 51, Medellin. Tel: 35-13-00, 35-71-52. Cable: DISFUENTES. Co-Pres.: Pedro & Jose Maria Fuentes Estrada; Gen. Mgr.: Dr. Conrado Dominguez H.; Sales Mgr.: Jorge Gonzalez Botero; Int'l Mgr.: Javier Garcia Munoz
Litho Plastics Ltda., 68-73 Calle 68-B, Barranquilla. Tel: 316-509. Cable: RADIAG. Pres.: Emilio Fortou P.; Gen. Mgr.: Cecilia de Fortou; Sales Mgr.: Tony Fortou E.

Sonolux Industria Electro-Sonora SA, 43 A-5 Calle 29, Medellin Tel: 32-09-99. Pres.: Sergio Berdugo Cuartas; Gen. Mgr.: Leon Cardona Garcia; Sales Mgr.: Juan Fernando Restrepo C; Ass't to Pres.: Edgardo Quiceno Gil.
Tropical (Discos) Ltda., 68-73 Calle 68-B, Barranquilla. Tel: 316-509, 325-858, 315-645, 325-362. Cable: RADIAG. Pres.: Emilio Fortou P.; VP: Cecilia de Fortou; Gen. & Sales Mgr.: Tony Fortou E.

RECORD PROMOTION

Fuentes (Fabrica de Discos) Ltda., Apdo. Aereo 1960, 13-223 Carrera 51, Medellin. Tel: 35-13-00, 35-71-52. Cable: DISFUENTES. Co-Pres.: Pedro & Jose Maria Fuentes Estrada; Gen. Mgr.: Dr. Conrado Dominguez H.

Sales Mgr. Jorge Gonzalez Botero; Int'l Mgr. Javier Garcia Munoz.
Promosonic Ltda., 68-73 Calle 68-B, Barranquilla. Tel: 316-509, 325-362. Cable: RADIAG. Gen. & Sales Mgr.: Tony Fortou E.
Tropical (Discos) Ltda., 68-73 Calle 68-B, Barranquilla. Tel: 316-509, 325-858, 315-645, 325-362. Cable: RADIAG. Pres.: Emilio Fortou P.; VP: Cecilia de Fortou; Gen. & Sales Mgr.: Tony Fortou E.

TAPE CUSTOM DUPLICATORS

Codiscos (Compania Colombiana de Discos SA), Apdo. Aereo 1428, 65-304 Calle 2 Sur, Medellin. Tel: 55-08-35, 55-08-95. Cable: CODISCOS. Telex: 6570. Pres.: Alfredo Diez M.; VP: Alvaro Arango G.
Audio: Cassette
F M Disco & Cintas Ltda., Apdo. 13408, 20-43 Calle 13, Bogota, D.E. Tel: 277-9686, 247-5137. Cable: FM Gen. Dir. Humberto Moreno
Audio: Cassette; open reel
Fonoarte Ltda., Apdo. Aereo 83-03, 41-20 Calle 10, Medellin. Tel: 46-69-07. Gen. Mgr.: Francisco J. Correa C.
Audio: Cassette
Video: 1/4" cassette (Beta).

Fuentes (Fabrica De Discos) Ltda., Apdo. Aereo 1960, 13-223 Carrera 51, Medellin. Tel: 35-13-00, 35-71-52. Cable: DISFUENTES. Co-Pres.: Pedro & Jose Maria Fuentes Estrada; Gen. Mgr.: Dr. Conrado Dominguez H.; Sales Mgr.: Jorge Gonzalez Botero; Int'l Mgr.: Javier Garcia Munoz.
Audio: 8-tr., cassette
Ingeson Ltda., Apdo. 4007, Bogota. Tel: 243-3613. Pres.: Manuel Dreznar (PIG)
Audio: 8-tr., cassette

Philips de Colombia SA (Industrias), Music Div., 51-39 Calle 13, Bogota, D.E. Tel: 60-06-00. Cable: PHILCOLDN. Telex: 44776. Pres.: Henri C.M. Van de Wal; Gen. Mgr.: Alfonso Escolar Nieto; Sales Mgr.: Luis A. Garcia S.; Int'l Rep. Label Mgr.: Leo Gabruians.
Audio: Cassette
Tropical (Discos) Ltda., 68-73 Calle 68-B, Barranquilla. Tel: 316-509, 325-858, 315-645, 325-362. Cable: RADIAG. Pres.: Emilio Fortou P.; VP: Cecilia de Fortou; Gen. & Sales Mgr.: Tony Fortou E.
Audio: Cassette; open reel

• **supplies**

CARTRIDGE & CASSETTE PARTS

Fuentes (Fabrica De Discos) Ltda., Apdo. Aereo 1960, 13-223 Carrera 51, Medellin. Tel: 35-13-00, 35-71-52. Cable: DISFUENTES. Co-Pres.: Pedro & Jose Maria Fuentes Estrada; Gen. Mgr.: Dr. Conrado Dominguez H.; Sales Mgr.: Jorge Gonzalez Botero; Int'l Mgr.: Javier Garcia Munoz.
Chief product: Hubs, rollers, shields, base & cover.
EMPTY CARTRIDGES, CASSETTES & REELS
Fuentes (Fabrica De Discos) Ltda., Apdo. Aereo 1960, 13-223 Carrera 51, Medellin. Tel: 35-13-00, 35-71-52. Cable: DISFUENTES. Co-Pres.: Pedro & Jose Maria Fuentes Estrada; Gen. Mgr.: Dr. Conrado Dominguez H.; Sales Mgr.: Jorge Gonzalez Botero; Int'l Mgr.: Javier Garcia Munoz
Ingeson Ltda., Apdo. 4007, Bogota. Tel: 243-3613. Pres.: Manuel Dreznar
Philips de Colombia SA (Industrias), Music Div., 51-39 Calle 13, Bogota, D.E. Tel: 60-06-00. Cable: PHILCOLDN. Telex: 44776. Pres.: Henri C.M. Van de Wal; Gen. Mgr.: Alfonso Escolar Nieto; Sales Mgr.: Luis A. Garcia S.; Int'l Rep. Label Mgr.: Leo Gabruians.
Audio: Cassette
Singer Prods. Cia. Ltda., 19-64 Carrera 10, D1. 703-5, Bogota. Tel: 81-24-74, 34-74-37. Cable: COREGIN
Brand name: Fidelipac.

ENVELOPES & MAILERS

Codiscos (Compania Colombiana de Discos SA), Apdo. Aereo 1428, 65-304 Calle 2 Sur, Medellin. Tel: 55-08-35, 55-08-95. Cable: CODISCOS. Telex: 6570. Pres.: Alfredo Diez M.; VP: Alvaro Arango G.
Tropical (Discos) Ltda., 68-73 Calle 68-B, Barranquilla. Tel: 316-509, 325-858, 315-645, 325-362. Cable: RADIAG. Pres.: Emilio Fortou P.; VP: Cecilia de Fortou; Gen. & Sales Mgr.: Tony Fortou E.

JACKETS & SLEEVES LABELS, DISK

Codiscos (Compania Colombiana de Discos SA), Apdo. Aereo 1428, 65-304 Calle 2 Sur, Medellin. Tel: 55-08-35, 55-08-95. Cable: CODISCOS. Telex: 6570. Pres.: Alfredo Diez M.; VP: Alvaro Arango G.
Fuentes (Fabrica De Discos) Ltda., Apdo. Aereo 1960, 13-223 Carrera 51, Medellin. Tel: 35-13-00, 35-71-52. Cable: DISFUENTES. Co-Pres.: Pedro & Jose Maria Fuentes Estrada; Gen. Mgr.: Dr. Conrado Dominguez H.; Sales Mgr.: Jorge Gonzalez Botero; Int'l Mgr.: Javier Garcia Munoz
Litho Plastics Ltda., 68-73 Calle 68-B, Barranquilla. Tel: 316-509. Cable: RADIAG. Pres.: Emilio Fortou P.; Gen. Mgr.: Cecilia de Fortou; Sales Mgr.: Tony Fortou E. (45, LP)
Tropical (Discos) Ltda., 68-73 Calle 68-B, Barranquilla. Tel: 316-509, 325-858, 315-645, 325-362. Cable: RADIAG. Pres.: Emilio Fortou P.; VP: Cecilia de Fortou; Gen. & Sales Mgr.: Tony Fortou E. (45, LP)

POLYETHYLENE BAGS & SHRINKWRAP

Codiscos (Compania Colombiana de Discos SA), Apdo. Aereo 1428, 65-304 Calle 2 Sur, Medellin. Tel: 55-08-35, 55-08-95. Cable: CODISCOS. Telex: 6570. Pres.: Alfredo Diez M.; VP: Alvaro Arango G. (Poly Bags only)

PROFESSIONAL TAPE SUPPLIES

Litho Plastics Ltda., 68-73 Calle 68-B, Barranquilla. Tel: 316-509. Cable: RADIAG. Pres.: Emilio Fortou P.; Gen. Mgr.: Cecilia de Fortou; Sales Mgr.: Tony Fortou E.
Audio: Cassette labels
Tropical (Discos) Ltda., 68-73 Calle 68-B, Barranquilla. Tel: 316-509, 325-858, 315-645, 325-362. Cable: RADIAG. Pres.: Emilio Fortou P.; VP: Cecilia de Fortou; Gen. & Sales Mgr.: Tony Fortou E.
Audio: Cassette labels.

TAPE, BLANK LOADED

Fonoarte Ltda., Apdo. Aereo 83-03, 41-20 Calle 10, Medellin. Tel: 46-69-07. Gen. Mgr.: Francisco J. Correa C. (Blank only)
Audio: Cassette; open reel
Brand names: Maxwell, Scotch, Sony, TDK
Fuentes (Fabrica De Discos) Ltda., Apdo. Aereo 1960, 13-223 Carrera 51, Medellin. Tel: 35-13-00, 35-71-52. Cable: DISFUENTES. Co-Pres.: Pedro & Jose Maria Fuentes Estrada; Gen. Mgr.: Dr. Conrado Dominguez H.; Sales Mgr.: Jorge Gonzalez Botero; Int'l Mgr.: Javier Garcia Munoz. (Blank only)
Audio: Cassette
Ingeson Ltda., Apdo. 4007, Bogota. Tel: 243-3613. Pres.: Manuel Dreznar.
Audio: Cassette
Brand names: Myltex, Panatonic, Sonex
Philips de Colombia SA (Industrias), Music Div., 51-39 Calle 13, Bogota, D.E. Tel: 60-06-00. Cable: PHILCOLDN. Telex: 44776. Pres.: Henri C.M. Van de Wal; Gen. Mgr.: Alfonso Escolar Nieto; Sales Mgr.: Luis A. Garcia

S. Int'l Rep. Label Mgr.: Leo Gabruians.
Audio: Cassette

TAPE DUPLICATING & PROCESSING EQUIPMENT

Ingeson Ltda., Apdo. 4007, Bogota. Tel: 243-3613. Pres.: Manuel Dreznar.
Chief product: Winders.
Brand name: Sonex.

• **accessories manufacturers**

Fonoarte Ltda., Apdo. Aereo 83-03, 41-20 Calle 10, Medellin. Tel: 46-69-07. Gen. Mgr.: Francisco J. Correa C.
Product: Record-record care prods., replacement styl: Tape-head cleaners, demagnetizers.

Philips de Colombia SA (Industrias), Music Div., 51-39 Calle 13, Bogota, D.E. Tel: 60-06-00. Cable: PHILCOLDN. Telex: 44776. Pres.: Henri C.M. Van de Wal; Gen. Mgr.: Alfonso Escolar Nieto; Sales Mgr.: Luis A. Garcia S.; Int'l Rep. Label Mgr.: Leo Gabruians.
Product: Carrying & storage cases; Record-record care prods., Tape-head cleaners, demagnetizers.

• **store fixtures manufacturer**

Fuentes (Fabrica De Discos) Ltda., Apdo. Aereo 1960, 13-223 Carrera 51, Medellin. Tel: 35-13-00, 35-71-52. Cable: DISFUENTES. Co-Pres.: Pedro & Jose Maria Fuentes Estrada; Gen. Mgr.: Dr. Conrado Dominguez H.; Sales Mgr.: Jorge Gonzalez Botero; Int'l Mgr.: Javier Garcia Munoz.
Product: Record & tape display racks.

• **jukebox title strip manufacturers**

Fuentes (Fabrica De Discos) Ltda., Apdo. Aereo 1960, 13-223 Carrera 51, Medellin. Tel: 35-13-00, 35-71-52. Cable: DISFUENTES. Co-Pres.: Pedro & Jose Maria Fuentes Estrada; Gen. Mgr.: Dr. Conrado Dominguez H.; Sales Mgr.: Jorge Gonzalez Botero; Int'l Mgr.: Javier Garcia Munoz
Litho Plastics Ltda., 68-73 Calle 68-B, Barranquilla. Tel: 316-509. Cable: RADIAG. Pres.: Emilio Fortou P.; Gen. Mgr.: Cecilia de Fortou; Sales Mgr.: Tony Fortou E.

COSTA RICA

Population: 2,190,000
Rate of exchange: \$1 (US) = 8.47 colon.
Per capita income: \$1,400
Holidays: January 1, March 19 (St. Joseph's Day), Easter Festival, April 11 (National Heroes Day), May 1 (Labor Day), July 25 (Annexation of Guanacosta), August 2 (Dad Lady of Angels), September 15 (Independence Day), October 12 (Columbus Day), December 25 & all important Christian religious holidays.

• **record & tape manufacturers / distributors / importers**

Gramusic SA, Apdo. 6360, 60 metros al norte de la Embajada Americana, Altos de la Casa Dinamarca, San Jose. Tel: 21-92-19. Cable: RUSAF.
Home office: Guatemala, Dideca (see for labels).
Indica (Industria de Discos Centroamericana) SA (IFPI), Apdo. 4093, San Jose. Tel: 35-93-22. Telex: 2308. Mng. Dir.: Eduardo Soto; A&R Dir.: Luis N. Salas
Int'l branches: El Salvador, Distribuidora Salvadorena de Discos SA; Guatemala, Distribuidora Guatemalteca de Discos SA; Honduras, Nicaragua, Distribuidora Panamena de Discos SA.
Labels: (Owned) Indica; (licensed) Almacenes de La Musica (Ecuador), Audio Fidelity (USA), Belter (Spain), CBS (worldwide), Daro (Colombia), Emporo (Ecuador), Fania (USA), Fonograma (Venezuela), Heriba (Bolivia), London (UK), Montilla (USA), Music Hall (Argentina), Palaco (Venezuela), Peerless (Mexico), Sora (Brazil), Sono Radio (Peru), TK (USA), Top Hits (Venezuela).
Int'l rep.: Worldwide (CBS).
Lyra (Discos) SA, 277 Desamparados, San Jose. Tel: 27-80-57.
Reuben & Co. Ltd., 132 First St., San Jose. Contact: Theodore Reuben Aguilera.
Label: (Represented) Moss Music Group (USA).
Johnny Salas, Apdo. 744, Paseo Estudiantes, San Jose. Tel: 23-8268
Label: (Represented) Leo (El Salvador)

• **music publisher**

Mundo Musical SA, Apdo. 4093, San Jose. Tel: 25-95-55.
Int'l firms represented: April (USA), Blue Seas (USA), Four Star (USA), Jac (USA), Lowery (USA), Melograf (Argentina), Mundo Musical (Brazil, Mexico).
Int'l reps.: Argentina (Melograf), Brazil (Mundo Musical), Mexico (Mundo Musical), USA (April).

• **services**

ASSOCIATION & PROFESSIONAL ORGANIZATION

Asociacion de Musicos & Compositores Costarricenses, Apdo. 4365, San Jose.

DESIGN & ARTWORK

PLATING, PROCESSING & PRESSING PLANT

PRINTER & LITHOGRAPHER

RECORD PROMOTION

Indica (Industria de Discos Centroamericana) SA, Apdo. 4093, San Jose. Tel: 35-93-22. Mng. Dir.: Eduardo Soto.

TAPE CUSTOM DUPLICATOR

Indica (Industria de Discos Centroamericana) SA, Apdo. 4093, San Jose. Tel: 35-93-22. Mng. Dir.: Eduardo Soto.
Audio: 8-tr., cassette.

• **accessories manufacturer**

Indica (Industria de Discos Centroamericana) SA, Apdo. 4093, San Jose. Tel: 35-93-22. Mng. Dir.: Eduardo Soto.
Product: Record-45 rpm adaptors.

CYPRUS

Population: 660,000
 Rate of exchange: \$1 (US) = 0.37 Cypriot pound.
 Per capita income: \$1580.
 Holidays: January 1, January 6 (Epiphany), January 30 (Birthday of the Prophet), March 25 (Greek Independence Day), Good Friday, Easter Monday, May 1 (Worker's Day), August 12 (Ramazan Bayram), October 28 (Greek National Day), October 29 (Turkish National Day), December 25, 26.

RECORDS & TAPE:

Records & pre-recorded tape imported (CIF value): 1979—71,000 units, \$206,000.
 Average retail price per pre-recorded cassette: Imported—\$11.90-\$15.40; locally duplicated—\$7.00-\$11.20; pirated—\$1.40-\$4.20.
 Average retail price per record: Imported—\$11.90-\$15.40. (Note: Locally manufactured records not available.)
 Pirated product: 95% of total sales.

RADIO & TELEVISION STATIONS:

No. of radio stations: 3 (AM/FM).
 No. of television stations: 1.

IMPORT/EXPORT REGULATIONS:

Records & cassettes (audio, video, blank, pre-recorded)—EEC 44% + 2.5% tax; other countries 52% + 3.5% tax. Tape recorders & turntables—EEC 34.5% + 2.5% tax; other countries 53% + 3.5% tax. Video recorders—EEC 52% + 2.5% tax, other countries 80% + 3.5% tax. (Note: All duties on CIF value)

• record & tape manufacturers / distributors / importers

CBS UK Ltd., 30-34 Sophoulis St., Nicosia. Tel: 41251. Cable: COLRECORD. Branch Mgr.: Gregory Konyanlian.
 Labels: (Owned) CBS, Epic; (represented) A&M (USA), CBS/Columbia (worldwide), Epic (worldwide), GRT (USA), MCA (USA), Minos (Greece), Panvox (Greece), Phonogram (Greece, Netherlands), Pickwick/Hallmark (UK), RCA (UK), Ricordi (Italy), United Artists (USA), Vanguard (USA), WEA (UK).
 Int'l rep.: Worldwide (CBS).
 Electroacoustic Supply Co. Ltd. (IFPI), PO Box 625, 152 Anexartissas St., Limassol. Tel: 64313, 64319. Telex: 2670. Mng. Dir.: E.A. Hadjoannou; Sec'y: T.P. Antoniadou.
 Branches: Larnaca, 27 Erievadis St. Tel: 54317—Nicosia, 7-9 Onassagorou St. Tel: 73429.
 Labels: (Owned) Stratexa-Sound Carrier; (licensed) Columbia (Greece), Decca (UK), EMI (Greece), PRT (UK); (distributed) DG (Germany), Lyra (Greece), Minerva (Greece), Polydor (Germany), Zodiac (Greece).
 Epic, see CBS.
 Stratexa-Sound Carrier, see Electroacoustic.

• services

PRINTER & LITHOGRAPHER

Sound Carriers Mfg. Ltd. (GATF), PO Box 625, Limassol. Tel: (051) 64313, 64319. Telex: 2670. Mng. Dir.: E.A. Hadjoannou; Sec'y: T.P. Antoniadou.

RECORD PROMOTION

CBS Recs. Ltd., 30-34 Sophoulis St., Nicosia. Tel: 41251. Cable: COLRECORD. Branch Mgr.: Gregory Konyanlian.

TAPE CUSTOM DUPLICATORS

CBS Recs. Ltd., 30-34 Sophoulis St., Nicosia. Tel: 41251. Cable: COLRECORD. Branch Mgr.: Gregory Konyanlian.

Audio: Cassette.
 Sound Carriers Mfg. Ltd. (GATF), PO Box 625, Limassol. Tel: (051) 64313, 64319. Telex: 2670. Mng. Dir.: E.A. Hadjoannou; Sec'y: T.P. Antoniadou. Audio: Cassette.

• supplies

TAPE, BLANK LOADED

CBS Recs. Ltd., 30-34 Sophoulis St., Nicosia. Tel: 41251. Cable: COLRECORD. Branch Mgr.: Gregory Konyanlian.

Audio: Cassette.
 Sound Carriers Mfg. Ltd. (GATF), PO Box 625, Limassol. Tel: (051) 64313, 64319. Telex: 2670. Mng. Dir.: E.A. Hadjoannou; Sec'y: T.P. Antoniadou. Audio: Cassette.

• accessories manufacturers

CBS Recs. Ltd., 30-34 Sophoulis St., Nicosia. Tel: 41251. Cable: COLRECORD. Branch Mgr.: Gregory Konyanlian.

Product: Record-record care products; Tape—head cleaners, demagnetizers, leader & splicing tape.

Sound Carriers Mfg. Ltd. (GATF), PO Box 625, Limassol. Tel: (051) 64313, 64319. Telex: 2670. Mng. Dir.: E.A. Hadjoannou; Sec'y: T.P. Antoniadou. Product: Record-carrying cases; Tape—cassette carrying cases, head cleaners.

• store fixtures manufacturer

CBS Recs. Ltd., 30-34 Sophoulis St., Nicosia. Tel: 41251. Cable: COLRECORD. Branch Mgr.: Gregory Konyanlian.

Product: Tape browser boxes, display racks.

CZECHOSLOVAKIA

Population: 15,098,000
 Rate of exchange: \$1 (US) = 5.80 koruna.
 Holidays: January 1, Easter Monday, May 1 (Labour Day), May 9 (Liberation Day), December 25, 26.

RECORDS:

Record sales certification awards: Gold LP—250,000 units sold in export

Records sold domestically including imports (retail value): LP's 1980—8,370,483 units, \$74,999,527; 1979—7,408,844 units, \$67,053,375. Singles & EP's 1980—3,700,000 units, \$7,659,000; 1979—3,710,000 units, \$8,141,801.

Records imported from countries other than USA: 1980—405,741 units; 1979—599,844 units.

Records exported to countries other than USA: 1980—1,412,758 units; 1979—1,722,000 units.

Average retail price per record: LP's—\$8.96; singles—\$2.07

Record club sales: 18% of LP's.

Discounting: Rarely.

Type of distribution: Opus and Supraphon own a chain of specialized retail shops. Pantan has a few retail shops of its own. These account for 70% of all sales. The remainder is done through the manufacturer-to-wholesaler-to-retailer system, with the chains of big department stores being especially important.

Type of promotion: Government-controlled radio plays an important part in the promotion of pop records. Supraphon publishes a monthly journal promoting the production of all three major record companies. Advertising in cinemas helps records that do not get radio airplay.

Jukeboxes: 2,200.

TAPE:

Market: Only cassettes are now selling. 8-tr., open reel and video are nil. The development of the cassette market has been slowed by the lack of hardware equipment and by insufficient production capacity.

Pre-recorded tape sold domestically including imports (retail value): Cassette 1980—610,280 units, \$6,564,351; 1979—442,922 units, \$5,234,000.

Average retail price per tape: Cassette—\$11.20

CONSUMER ELECTRONICS:

Percentage of homes with: Radios (100%); television sets—color (6%), b&w (92%); phonographs (35%); audio tape recorders (41%).

RADIO STATIONS:

No. of government stations: 1 AM, 3 FM.

Comment: One radio station programs pop music and short newscasts around the clock; another is devoted to classical music and high culture. Almost 50% of the broadcast music is from records, with the remainder from tapes produced on radio. Live transmissions are rare.

TELEVISION STATIONS:

No. of channels: 2 government, 65% color (SECAM).

Comment: Easy listening and middle of the road music predominate, with some emphasis also on brass band music. Jazz and rock are featured in rare special youth programs. Most programs are of local production; imports from Socialist countries are fairly frequent, imports from the West are rare.

IMPORT/EXPORT REGULATIONS:

Both license contracts and export/import deals are made with Socialist countries, importing of records from the West on a commercial basis is practically non-existent. Western product is limited in quantity on the basis of license contracts concluded by Supraphon and Opus. All export and import of finished product must go through state controlled export/import companies.

MARKET ANALYSIS:

After a period in which local production could hardly cover the demands of the buyers, it seems that the market is becoming slowly saturated. A certain part of local production is still custom pressed abroad.

Karel Gott holds an undisputed priority regarding sales, which show a predominance of MOR music. Interest in rock and disco records, however, is growing. There also is a good market for a local kind of country music. Sales of Western material issued on a license basis are hampered by foreign currency payments. Classical music forms the backbone of exports to the West, with license deals increasingly predominating over the export of finished product. Also, in the home market, classical sales are steady.

Supraphon's studios, now equipped for digital, are often used for custom recordings or co-productions with local symphonic orchestras, operatic ensembles, and for background and film music. Also, video recordings of classical repertoire with local orchestras and soloists are produced in co-production or on a custom basis.

Dr. Lubomir Doruzka

• record & tape manufacturers / distributors / importers

Artia (Foreign Trade Corp. for the export & import of cultural commodities), Ve Smeckach 30, 111 27 Prague 1. Tel: 24-60-41. Cable: ARTIAGRAMO. Telex: 121065. Pres. Ing. Miroslav Maruska; Gramo Div. Dir.: Dr. Roman Shokan; Gramo Div. Deputy Dir.: Ing. Vladimír Skola. (Artia is the sole exporter of Pantan and Supraphon records, pre-recorded cassettes and sheet music; it also is the sole exporter of pressing compound, custom pressing and record player sets, and the sole importer of record player sets, records and pre-recorded cassettes.)

Labels: (Distributed—not licensed) Pantan, Supraphon
 Opus Recs. & Publ'g House (IFPI), Dunajska 18, 899 23 Bratislava. Tel: 532-41, 507-83, 531-57. Telex: 92219. Pres. Dr. Ivan Stanislav; VP Bus. Affairs: Dr. Alexius Aust; VP A&R: Marian Jurik; Int'l Relations Dir.: Dr. Zlatica Mociukova. (Exported by Slovart)

Labels: (Owned) Opus; (licensed) Polygram group (worldwide), RCA (worldwide); (distributed—not licensed) Balkanton (Bulgaria), Deutsche (East Germany), EMI (India), Electrecord (Romania), Hungaroton (Hungary), Jugoton (Yugoslavia), Melodija (USSR), Pantan (Czechoslovakia), Polska Nagrania (Poland), Polydor (India), Supraphon (Czechoslovakia). Int'l reps.: Worldwide (RCA) excluding Belgium (SPI), British Commonwealth (OI), Canada (OI), Comecon Countries, France (SPI), Italy (RCA Italiana), Japan (Victor), South America (DI), Spain (Zafiro), USA (OI). Pantan (Publ'r of the Czech Music Fund) (IFPI), Rincni 12, 118 39 Prague 1. Tel: 538-151. Gen. Mgr.: Milos Konvalinka; Sales Mgr.: Drahomir Sulak. (Distributed by Artia)

Slovart Co. Ltd. (Foreign Trade Corp. for the import & export of cultural commodities), Gottwaldovo nam. 6, 805 32 Bratislava. Tel: 488-41, 427-81. Telex: 93394. Gen. Mgr.: Vladimír Múca; Rec. Dept. Mgr.: Peter Hrozencik; Mktg. Dir.: Mgr. Juraj Jurasek

Supraphon (IFPI), Palackeho 1, 112 99 Prague 1. Tel: 262-562, 261-608. Gen. Dir.: Jan Kvidera; Music Dir.: Dr. Olga Sotolova; Comm'l. Dir.: Karel Arbes; Int'l Dept. Mgr.: Dr. Pavel Smola.

Labels: (Owned) Supraphon; (distributed) Opus, Pantan, (represented) Amiga (East Germany), Ariola (West Germany), CBS (France, USA), EMI (UK), Eterna (East Germany), Jugoton (Yugoslavia), Melodija (USSR), Motown (USA), Muza (Poland), Polydor (West Germany), Qualiton (Hun-

gary), WEA group (USA).

Int'l reps.: Austria (Ariola), Belgium (Baltic), Brazil (Som), Denmark (Hede Nielsen), Finland (Oscophon), France (Ariola), East Germany (Deutsche), West Germany (Ariola), Greece (Phonisc), Italy (Ricordi), Japan (Nippon Columbia), Netherlands (Baltic), Norway (Scandinavian Dist'n), Spain (Ariola-Eurodisc), Switzerland (Ariola-Eurodisc), UK (Bond Street), USA (Pickwick, Qualiton)

• music publishers

Dilia (Theatrical & Literary Agency), Vysehradská 28, 128 24 Prague 2. Tel: (194222) 296-651. Mng. Dir.: Robert Jurak. (Sole representative for music-dramatic works in Czech Socialist Republic)

Opus Music Publ'g House, Dunajska 18, 899 23 Bratislava. Tel: 532-41, 507-83, 531-57. Telex: 92219. Pres. Dr. Ivan Stanislav; VP Bus. Affairs: Dr. Alexius Aust; VP A&R: Marian Jurik; Int'l Relations Dir.: Dr. Zlatica Mociukova

Int'l firms represented: Page Full of Hits (UK), Rondor (Worldwide)
 Int'l reps.: Worldwide (Classical in UK) excluding Comecon countries; Austria, Germany & Switzerland (Classical—Baerenreiter)

Pantan (Publ'r of the Czech Music Fund), Rincni 12, 118 39 Prague 1. Tel: 538-151

Int'l reps.: Austria, Benelux, Germany, Switzerland (all Baerenreiter in Germany); Western Hemisphere (G. Schirmer in USA)

Supraphon, Palackeho 1, 112 99 Prague 1. Tel: 262-562, 261-608. Dr. Viktor Kasak; Music Dir.: Dr. Olga Sotolova; Comm'l. Dir.: Karel Arbes; Int'l Dept. Mgr.: Dr. Pavel Smola

Int'l firms represented: ATV (UK), Barclay (France), Chappell (West Germany), Francis Day & Hunter (West Germany), Ock James (UK), Intersong (West Germany), Ivan Mogull (USA), RAK (UK), Hermann Schneider (Austria)

Int'l reps.: Austria (Baerenreiter in West Germany), Belgium (Baltic), Denmark (Hansen), France (Boosey & Hawkes), West Germany (Baerenreiter), Japan (Yamaha), Netherlands (Baerenreiter in West Germany), Norway (Harald Lyche), South America (Ricordi Americana), Sweden (Nordiska), Switzerland (Baerenreiter in West Germany), UK (Alfred Kalmus), USA (Boosey & Hawkes)

• services

ASSOCIATIONS & PROFESSIONAL ORGANIZATIONS

Association of Slovak Composers & Concert Artists, Sldkovicova 11, Bratislava. Tel: 33-794. Pres.: Eugen Suchon

Bratislavská Lyra (Int'l Pop Song Festival Bureau), Leningradská 5, Bratislava. Tel: 381-41, 349-48. Sec'y: Peter Horak

Czech Music Fund, Besedni 3, 118 00 Prague 1. Tel: 530-546. Dir.: Vladimír Sevcik

Dilia (Theatrical & Literary Agency), Vysehradská 28, 128 24 Prague 2. Tel: (194222) 296-651. Telex: 121367. Mng. Dir.: Robert Jurak

Guild of Czech Composers & Concert Artists, Valdejskeho nam. 1, Prague 1. Tel: 531-814. Pres.: Jan Seidel; Gen. Mgr.: Dr. Vaclav Kucera

Made in Publicity, Pletlova 5-7, Prague 1. Tel: 24-69-14. (Exclusive agency for promotion of & services to foreign companies in Czechoslovakia)

Music Information Centre of the Czech Music Fund, Besedni 3, 118 00 Prague 1. Tel: 530-546

Pragokonzert (Czechoslovak Art & Entertainment Agency), Maltzské nam. 1, 118 13 Prague 1. Tel: 537-248, 539-676. Telex: 121810. Dir.: Frantisek Hrabal. (Exclusive agency for all Czech & international artists & performers)

Rapid (Czechoslovak advertising agency), 28 Rijnka 13, Prague. Tel: 26-79-41, 21-39. (Exclusive agency for advertising by companies from abroad)

Slovak Music Fund, Fucikova 29, 801 00 Bratislava. Dir.: Alojz Stuska

Slovkoncert (Czechoslovak Artistic Agency), Leningradská 5, 890 36 Bratislava. Tel: 335-293, 337-232. Telex: 93485. Co-Dir.: Hammel Pavol; (Exclusive agency for all Slovak artists & performers)

LICENSING ORGANIZATIONS, MUSIC

OSA (Ochranný svaz autorský pro práva k dílu hudebnímu—Authors' Ass'n for Protection of Rights on Musical Works), Trda cs. armady 20, 160 56 Prague 6. Tel: 325-341. Cable: OSAUTOR. Mng. Dir.: Oldrich Flosman

(Mechanical & performing rights). (Affiliated with BIEM, OISAC)

S O Z A (Slovenský Ochranný Zvaz Autorský), Zvostenska 1, 883 27 Bratislava. Tel: 541-41, 557-96. Dir.: Andrej Gadius; Gen. Mgr.: Kristina Nemcova. (Mechanical & performing rights)

DENMARK

Population: 5,200,000
 Rate of exchange: \$1 (US) = 5.70 kroner.
 Per capita income: \$7,500.
 Holidays: January 1, Maunday Thursday, Good Friday, Easter Monday, Store Bededag (Danish Public Holiday—fourth Friday after Easter), Ascension Day, Whit Monday, June 5 (Constitution Day), December 25, 26.

RECORDS:

Note: All record and tape statistics cover IFPI members only.
 Record sales certification awards: Silver single—15,000 units, gold single—30,000 units, platinum single—100,000 units. Silver LP—25,000 units, gold LP—50,000 units, platinum LP—100,000 units.

Records sold domestically including imports (retail value): LP's 1980—4,367,000 units, \$42,518,000; 1979—4,609,000 units, \$42,900,000. Singles 1980—1,992,000 units, \$5,265,800; 1979—2,099,000 units, \$6,000,000.

Average retail price per record: LP's—\$11.00; singles—\$3.00.

Record club sales: 15% of total.

Discounting: Frequent.

Type of distribution: Manufacturer-to-retailer system predominates. There are two rack jobbers, the larger being owned by the five largest record companies. 80% of sales are through 550 retail shops; 12% through the rack jobbers; 5% through direct import.

Type of promotion: Radio and television are the most important, followed by the two biggest national newspapers, which have regular information about the music business. Vi Uge (35,000 circulation) and Ung Nu (30,000) also cover music. The specialist magazine MM covers jazz (fusion-rock) and has a circulation of about 12,000.

Jukeboxes: 9,000

TAPE:

Market: 8-tr. is out of the market now and cassettes have 100% of the pre-recorded tape market. 20% of households have open reel recorders and 69% have cassette recorders. About 70% of all cars have radios and 20%

cassette players, with the latter growing fast. The sales of cassette recorders are about 250,000 per year. Traditional record shops have competition from gas stations and supermarkets for the sale of tapes.

Pre-recorded tape sold domestically including imports (retail value): Cassette 1980-2,548,000 units, \$18,327,000; 1979-3,226,000 units, \$22,400,000.

Average retail price per tape: Cassette \$9.50

CONSUMER ELECTRONICS:

Number of homes with: AM radios-210,000 (10%), AM/FM radios-2,300,000 (90%); color television sets-1,500,000 (70%), b&w sets (30%); phonographs-1,250,000 (55%); audio tape recorders-1,400,000 (65%); video tape recorders-60,000 (3%).

RADIO STATIONS:

No. of government 1 (1 AM & 3 FM channels)

Comment: Program 1: News, classical music & culture; Program 2: Culture and regional news; Program 3: News & stereo rock, MDR & classical (6am-2am).

TELEVISION STATIONS:

No. of channels: 1 government, 90% color (PAL)

Comment: Denmark Radio is the only national channel, but 50% are able to see the two Swedish channels, 30% the three German stations, and 5% the one East German channel. Denmark Radio programming is mostly cultural, with a small amount of entertainment programs. There are plans for satellites to receive programs from Luxembourg, France, Italy and the United Kingdom.

IMPORT/EXPORT REGULATIONS

There are no regulations.

MARKET ANALYSIS:

Record and tape sales have slowed down, and expansion by major companies has stopped. Several people have left the record industry, other key persons formerly with major companies have started their own production companies and record labels and have taken quite a bit of the market share from the majors.

MDR and rock music predominate. There seems to be a trend toward Danish music with a folk flavor.

The import problem has been taken care of by rising prices, especially those concerned with the American dollar and the English pound. Only a fading share of the market is now garnered by imports.

Over the past few years, the production of Danish records has declined, and there are only a few Danish bands selling huge quantities of albums. The singles market is now more attractive because the economic crisis is forcing record buyers to be more selective, seeking the hit but not "filler" albums containing only one hit.

Knud Orsted.

• record & tape manufacturers / distributors / importers

A M Import, Brunstgade 21, DK-8000 Aarhus C. Tel: (06) 12 32 04. Mng. Dir. Aksel Nielsen. (Importer/Exporter)

Abra Cadabra, see Metronome.

Adelkrone Music, PO Box 5, DK-2750 Ballerup. Tel: (02) 97-08-90. Telex: 35342. Gen. Mgr.: Erik Lykke Jensen; Promo.: Karen Johansen. (Distributor/Importer)

Labels: (Imported) Cut-ouls.

Alpha Music ApS, Koeberggade 26, Copenhagen K. Tel: (01) 11-10-15. Telex: 15252. Chief Exec. Henning Schaefer.

Labels: (Owned) CSA; (distributed-not licensed) America (France), Bae-rentner (Germany), CRD (UK), Folkways (USA), Hallmark (UK), Jazz Anthology (France), Jazz Panorama (Sweden), Muse (USA), Musidisk (France), Pickwick (UK), Rounder (USA), Spolite (UK), Tax (Sweden), Topic (UK), Vogue (France), Wergo (Germany).

Amar Recs. ApS, Helsingborge 13, DK-2100 Copenhagen O. Tel: (01) 29-29-02. Chief Exec.: Peter Ingemann, Gen. Mgr.: Jette Michaelsen.

Label: (Owned) Amar.

Angel, see EMI.

Archiv, see Polydor.

Artist, see Ed. Wilhelm Hansen.

B B, see Dktav.

Ballistic, see EMI.

Banana, see Tuba.

Better Day, see Phonogram.

Blitz, see Tuba.

Blue Fox, see Montax.

Blue Note, see EMI.

Bovema Negram, see EMI.

Bumbo, see Per Meistrup.

C B S Recs. ApS (IFPI), Bogholder Alle 40, DK-2720 Vanlose. Tel: (01) 71-31-33. Telex: 27520. Mng. Dir.: Steen Sorgenfrei; Mktg. Mgr.: Bent Mørtzen; Sales Mgr.: Janne Laksoe.

Labels: (Owned) CBS, Embassy, Epic, Portrait; (licensed) A&M, Blue Sky, Caribou, De-Lite, Kirshner, Monument, Philadelphia Int'l, Salsoul, TK, Tappan Zee (all USA); GTD, Illegal, Jet (all UK); Ariola, Arista (both Germany); (distributed-not licensed) Exlibris, Fagot.

C S A, see Alpha & Sonet/Dansk.

California, see Moerks.

Capitol, see EMI.

Cirkeline, see Sonet/Dansk.

Classics for Pleasure, see EMI.

Columbia, see EMI.

Crystal, see EMI.

D G, see Polydor.

Dansk Music Import, 29 Nyrnberggade, DK-2300 Copenhagen S. Tel: (01) 57-73-74. Telex: 31464. Pres.: Frank Dbeil; Sales Mgr.: Kurt Wohler; Chief Accountant: Lizzie Poulsen.

Labels: (Distributed-not licensed) BBC (UK), Bis (Sweden), Caprice (Sweden), Cetra (Italy), Chandos (UK), IVC (Japan), Melodya (USSR), Schwann (Germany).

Dansk, see Sonet/Dansk.

Dansk Musik Antologi, see EMI.

Davs Prod'n ApS, Westend 3, DK-1661 Copenhagen V. Tel: (01) 31-13-25. Cable: DAVSMUSIK. Telex: 15013. Dwner: Kurt Andreasen, Sales Mgr.: Nellie Christensen.

Diplom, see Dktav.

Double Up, see EMI.

E M I (Electric & Musical Inds. Dansk-Engelsk) A/S (IFPI), Hoeffdingsvej 18, DK-2500 Valby-Copenhagen. Tel: (01) 30-67-11. Cable: GRAMMOPHDN. Telex: 16631. Mng. Dir.: Kurt Hvid Mikkielsen; A&R Mgr.: Cai Letner; Sales Mgr.: Die Jersee; Labels Mgrs.: Kenneth Valet, Ann-Christin Hallander.

Labels: (Owned) Angel, Ballistic, Blue Note, Bovema Negram, Capitol, Classics For Pleasure, Columbia, Crystal, Double Up, EMI, EMI America, EMI Int'l, EMI Toshiba, Electrola, Emidisc, HMV, Harvest, Hoerzu, Liberty, Music for Pleasure, Ddeon, Dne Up, Parlophone, Pathe, Regal Zonophone, Seraphim, Starline, Sunset, United Artists; (licensed) AVI (USA), Apple (UK), Artists House (USA), Boardwalk (USA), Bulldog (USA), Carere (France), Chisound (USA), Dansk Musik Antologi (Denmark), EMG (UK), Ember (UK), Fantasy (USA), Harmonia Mundi (Germany), Hitsville (USA), MPL (USA), Magnet (UK), Milestone (USA), Dasis (Germany), Pickwick (USA), Polar (Sweden), Prestige (USA), Purple (UK), RAK (UK), Rolling Stones (USA), Symphonica (UK), Unicorn (UK); (distributed-not licensed) Barclay (France), Sveriges Radio (Sweden).

Ecco, see Sonet/Dansk.

Eldorado, see Sonet/Dansk.

Electra (Grammofon A/S) (IFPI), Jydeholmen 15, DK-2720 Vanlose. Tel: (01) 79-17-00. Telex: 22621. Bd. Chm. Hans-Dve Eriksson, Gen. Mgr.: Die Jochimsen, Label Mgr. & Deputy Chief: Bengt Swan
Labels: (Licensed) Attic (Canada), Aura (UK), Avatar (UK), Buddha (USA), Camden (USA), Ensign (UK), Erato (France), Grunt (USA), Harmonia Mundi (France), Interord (Germany), Kama Sutra (USA), Logo (UK), MPS (Germany), Millennium (USA), Motown (USA), Dvation (USA), Pickwick (UK), Playboy (USA), RCA (worldwide), Rialto (UK), Solar (USA), Supraphon (Czechoslovakia), Swedish Society Discofil (Sweden), Telestar (Sweden), Transatlantic (UK), Victor (USA), Victrola (USA), Windsong (USA), 20th Century Fox (USA). (SEE ADVERTISEMENT)

Electrola, see EMI.

Embassy, see CBS.

Emidisc, see EMI.

Epic, see CBS.

Exlibris, see CBS.

Face the Music, Marstallsgade 14-4TV, DK-2100 Copenhagen O.

Label: (Represented) Redwood (USA).

Fagot, see CBS.

Favorit, see Polydor.

Fiasco, see Sonet/Dansk.

Fona Radio A/S, Marielundvej 28, DK-2730 Herlev. Mktg. Dir.: Soren Bostur-Sorensen.

Label: (Represented) Moss Music Group (USA).

Fontana, see Phonogram.

Frode Herloef & Co., Borgergade 14, DK-1300 Copenhagen K. Tel: (01) 98-50. Cable: SELECTAHERLDEEV. Pres.: Henning B. Petersen, Sales Mgr.: John Hansen. (Wholesaler/Importer)

Global Trading Recs. ApS, Stejthoej 17, DK-4400 Kalundborg. Tel: (03) 51-42-00. Telex: 44366. Dir.: L. M. Bagai. (Wholesaler)

Gold Label, see Per Meistrup.

Grammo Serv. A/S, Sandtoften 25, DK-2820 Copenhagen. Tel: (02) 88-04-33. Gen. Mgr.: Dlaf Egeland. (Importer/Exporter, Rack Jobber as Music Rack A/S)

H M V, see EMI.

Hamlet Prod'n ApS (IFPI), Karlslunde Landevej 24, DK-2690 Karlslunde. Tel: (03) 15-22-24. Cable: TAJMERSHDM. Telex: 43140. Chief Exec.: Eugen Tajmer; Prod.: Allan Mortensen. (Distributed by Sonet/Dansk)

Wilhelm Hansen (Ed.), Gothersgade 9-11, DK-1123 Copenhagen K. Tel: (01) 11-78-88. Cable: MUSIKHANSEN. Telex: 19912. Co-Pres.: Hanne & Lone Wilhelm Hansen; A&R: Svend Schat Holm; Sales Mgr.: Allan Jeppesen. (Distributed by Metronome)

Labels: (Owned) Artist, Ed. Wilhelm Hansen.

Int'l reps.: Norway (Artist, Norsk Musikforlag), Sweden (Artist, Nordiska).

Harlekin, see Metronome.

Harvest, see EMI.

Heliodor, see Polydor.

Hoerzu, see EMI.

K A B, see Pick Up.

K B Music ApS, PO Box 66, DK-2730 Herlev. Tel: (02) 84-47-69. Telex: 35407. Gen. Mgr.: Klaus Soerensen; Promo.: Jannie Jensen. (Distributor/Importer/Exporter)

K M F, see Kleinerts & Phonogram.

K-tel Int'l (Denmark) ApS, Tempovej 22, DK-2750 Ballerup. Tel: (02) 65-12-42. Telex: 35342. Pres.: Philip Kives; Gen. Mgr.: Erik Adelkrone; Controller: Ulla Holck.

Home office: USA.

Labels: (Owned) K-tel; (licensed) A&R (Netherlands), Arrival (Sweden), Can't Stop Prod'n (USA), Chart (Sweden), Chimo (UK), Commonwealth (Netherlands), ERA (USA), Impaci (Sweden), Imperial (Canada), Kendari (Netherlands), Lotus (Sweden, UK), Malaco (USA), PVK Creole (UK), Papagayo (Netherlands), Prelude (USA), Prism (USA), Rollin Rock (USA), Telstar (Netherlands).

Int'l reps.: Worldwide (K-tel)

Karusell, see Polydor.

Kleinerts Musik Forlag AS, Christian IX's Gade 7, DK-1111 Copenhagen K. Tel: (01) 12-34-32. Cable: MUSICKMF. Telex: 16600 Fotex DK, Attn: MUSICKMF. Pres.: John Rasmussen. (Distributed by PolyGram)

Labels: (Owned) KMF. Play.

Kleinnetten, see Sonet/Dansk.

Kong Paere, see Medley.

Liberty, see EMI.

Life, see Sonet/Dansk.

M V, see Montax.

Mascot, see Sonet/Dansk.

Medium, see Moerks.

Medley Recs. ApS (IFPI), Skellosevej 10, DK-2500 Valby. Tel: (01) 17-14-11. Telex: 19175. Chief Execs.: Poul Bruun, Michael Ritto; Press Officer: Kit Nielsen. (Distributed by PolyGram)

Labels: Kong Paere, Medley, Xenia.

Int'l reps.: Norway (Arne Bendiksen), Sweden (Planet).

Per Meistrup Prod'n Co., Artillerivej 40, DK-2300 Copenhagen S. Tel: (01) 57-09-10. Cable: MUSICABLE. Telex: 27204. Mng. Dir.: Hans J. Manscher, John Jones, Sales Mgr.: H.J. Hansen.

Labels: (Owned) Bumbo, Gold Label, PMP, Ra, (licensed) Ampro Prod'n (USA), Everest (USA), Motor (UK), White Dove (UK); (distributed-not licensed) Hungaroton, Papi, Quailton (all Hungary).

Int'l reps.: Finland (Allstars), Sweden (Montax), UK (White Dove).

Melody, see Polydor.

Mercury, see Phonogram.

Metronome Recs. A/S, Vibevej 31, DK-2400 Copenhagen NV. Tel: (01) 19-01-12. Cable: METROMUSIC. Telex: 27204. Mng. Dir.: Dlav Bennike, A&R: Jan Abramowitz.

Labels: (Owned) Metronome; (licensed) Asylum, Atco, Atlantic, Big Tree, Cotillion, Dark Horse, DiscReet, Elektra, Embryo, Mirage, Nonesuch, Orbit, Pacific, Paradise, Planet, RFC, Reprise, Scotti Bros., Sire, Swan Song, Warner Bros., Whitefield (all USA); Beggars Banquet, Laser, Lightning, Radar (all UK); ECM (Germany); (distributed-not licensed) Abra Cadabra, Wilhelm Hansen, Harlekin, Recca, Stuk.

Moerks Musikforlag, Christian IX's Gade 7, DK-1111 Copenhagen K. Tel:

(01) 12-34-32. Cable: MUSICKMF. Telex: 16600 Fotex DK, Attn: MUSICKMF. Pres.: John Rasmussen.

Labels: (Owned) California, Medium, Triola, (licensed) Durium (Italy), Explosion (UK), Flora (Norway), Im'Press (USA), Megafon (Sweden), Ranwood (USA).

Montax af 1980 A/S, Bransagervej 4, DK-9491 Pandrup. Tel: (08) 24-76-77. Telex: 69868. VP: Finn Jaffe.

Labels: (Owned) Blue Fox, MV, Queen, Stopp.

Musicat, see Sonet/Dansk.

Music for Pleasure, see EMI.

Music Rack A/S, Sandtoften 25, DK-2820 Copenhagen. Tel: (02) 88-04-33. Gen. Mgr.: Dlaf Egeland; Sales Mgr.: Palle Christensen. (Rack Jobber, Importer as Grammo Serv. A/S)

Music Serv. ApS, Westend 3, DK-1661 Copenhagen V. Tel: (01) 31-13-25. Cable: DAVSMUSIK. Telex: 15013. Dwner: Kurt Andreasen, Sales Mgr.: Nellie Christensen.

Labels: (Distributed) Davs, Frituna (Sweden), Pickwick Int'l (UK).

Ddeon, see EMI.

Dktav Musik (IFPI), Lundely 12, DK-2900 Hellerup. Tel: (01) 61-10-44. Gen. Mgr.: Fru Ella Binderup; Music Advisor: George Swensson.

Labels: (Owned) BB, Diplom, Dkta, Zac.

Dne Up, see EMI.

Dphelia, see Sonet/Dansk.

P M P, see Per Meistrup.

Parlophone, see EMI.

Pathe, see EMI.

Philips, see Phonogram.

Phonogram A/S (IFPI), Emdrupvej 115A, DK-2400 Copenhagen NV. Tel: (01) 69-25-22. Telex: 19202. Mng. Dir.: Stefan Fryland. (Also see PolyGram)

Labels: (Owned) Fontana, Mercury, Philips, Vertigo; (licensed) Ace of Clubs (UK), Ace of Diamonds (UK), Ace of Hearts (UK), Albion (UK), All Platinum (USA), Argo (UK), Beltona (UK), Biograph (USA), Chapter Dne (UK), Charisma (UK), Chess (USA), DJM (UK), Decca (UK), Deram (UK), Eclipse (UK), Emerald (UK), Ensign (UK), Global, Haven (UK), Haworth (USA), London (UK), Mountain (UK), L'Diseau Lyre (France), Dn Record (UK), Rex (UK), Rocket (UK), Smash-Riviera, Tembo (UK), Threshold (UK), Utopia (UK), Zappa; (distributed-not licensed) Better Day, KMF, Medley.

Pick Up Recs. ApS (IFPI), Gl. Kongevej 47-B, DK-1610 Copenhagen V. Tel: (01) 24-04-34. A&R & Gen. Mgr.: Peter Littauer.

Labels: (Owned) KAM, Pick Up.

Play, see Kleinerts.

Polydor A/S (IFPI), Emdrupvej 115A, DK-2400 Copenhagen NV. Tel: (01) 69-25-22. Telex: 19202. Gen. Mgr.: Stefan Fryland; Sales Mgr.: Joergen Kristiansen. (Also see PolyGram)

Labels: (Owned) Archiv, DG, Favorit, Heliodor, Karussell, Melody, Polydor, Resonance, Tip, Verve; (licensed) Backstreet (USA), Brain (Germany), Dreamland (USA), EG (UK), Fiction (UK), Hispavox (Spain), MCA (USA), MCA Coral (USA), Dyster (UK), Pablo (USA), Phil Spector Int'l (UK), RSD (UK), Spring (USA).

PolyGram Recs. A/S (IFPI), Emdrupvej 115A, DK-2400 Copenhagen NV. Tel: (01) 69-25-22. Telex: 19202. Mng. Dir.: Stefan Fryland.

Aliases: Phonogram A/S, Polydor A/S.

Popic Prod'n, PO Box 1278, DK-2300 Copenhagen S. Tel: (01) 95-05-71. Dir.: D. Trosgov, Sales Mgr.: Ditto Waldorf; A&R: Peer Ivan.

Portrait, see CBS.

Queen, see Montax.

R E C A Music Prod'n, Nykøbingvej 18, DK-4571 Grevninge. Tel: (03) 45-93-89. Dir.: Finn Remer; Gen. Mgr.: Die Steen Pedersen; Sales Mgr.: Carl C. Dalgaard. (Distributed by Metronome)

Labels: (Owned) RECA; (distributed-not licensed) Bestseller (Belgium), Jerome (Sweden), SMA (Sweden), Sounds Superb (Belgium).

Int'l reps.: Austria (Scan), Belgium (Bestseller, Scan), Germany (Scan), Netherlands (Scan), Norway (Metronome), Sweden (Metronome, SMA), Switzerland (Scan).

Ra, see Per Meistrup.

Recca, see Metronome.

Regal-Zonophone, see EMI.

Remi Music, Hedeparken 179, DK-2750 Ballerup. Tel: (02) 65-06-92. Pres.: Rene Gosvig.

Label: (Owned) Remi.

Resonance, see Polydor.

Royton Music (Scandinavia) ApS, Vordingborgevej 2, CK Th., DK-4700 Naestved. Tel: (03) 73-45-11/46-54. Chm. Benny Schou Spens.

Labels: (Licensed) Bluebird (Finland), Graduate (UK), Ice (UK), Nems (UK); (distributed-not licensed) Bastun (Sweden), Cherry Red (UK), Gull (UK), Heartbeat (UK), Pipi (UK), Planet (Sweden), Scranta (Sweden).

Int'l reps.: Finland (Bluebird), Norway (Arne Bendiksen), Sweden (Planet).

S A D, Svandamsgade 14, DK-5800 Nyborg. Tel: (09) 14-01-77. Dwner &

LOOKING FOR
A PARTNER
IN
SCANDINAVIA
SEE PAGE 307
SCANGROUP RECORDS

Dir. Palle Schmidt; Sales Mgr.: Carsten Schmidt (Distributor/Importer)
Label: (Distributed) SST (Germany).

Seraphim, see EMI

Sonet/Dansk Grammofon A/S (IFPI), St. Kongensgade 40, DK-1264 Copenhagen K. Tel: (01) 12-01-12. Cable: DANRECORD. Telex: 15252. Pres.: Karl Emil Knudsen; Sales & Mktg. Mgr.: Hardy Larsen; Danish A&R: Per Stan; Int'l Mgr.: Kent Hansen.

Labels: (Owned) Ecco, Frasco, Kleinert, Lfr., Mascot, Muscat, Sonet, Storyville, Tomo. (Licensed foreign) Ace (UK), Air (UK), Alligator (USA), Bearsville (USA), Beserkley (USA), Blueprint (UK), Bomp (USA), Bronze (UK), Calibre (UK), Caroline (UK), Chiswick (UK), Chrystal (UK), Criminal (UK), Cube (UK), Dindisc (UK), Electric (UK), Elite (Switzerland), Front Line (UK), Gazell (Sweden), Grand Prix (Sweden), H&L (USA), Island (UK), Kicking Mule (UK), Knapp Up (Sweden), MAM (UK), PRT (UK), Piccadilly (UK), Plantation (USA), Roulette (USA), SSS Int'l (USA), Safari (UK), Savoy (USA), Sonet (UK), Spec: Ity (UK), Spotlight (Sweden), Strand (Germany), Sue (UK), Sun (USA), Takoma (USA), Titanic (UK), 2 Tone (UK), Vanguard (USA), Virgin (UK), Ze (USA), (distributed-not licensed) CSA, Caribeline, Davs, Eloorado, Frituna (Sweden), Hamlet, Dphela, Starbox, Tubo.

Starbox A/S (IFPI), Store Kongensgade 40, DK-1264 Copenhagen K. Tel: (01) 12-01-12. Cable: STARBOX. Telex: 15252. Gen. Mgr.: Johnny Reimar. (Distributed by Sonet/Dansk)

Labels: (Owned) Starbox. (Licensed) Buena Vista (USA), Disneyland (USA)

Starline, see EMI

Star Sound A/S, Rørders I, DK-2760 Malov
SteepleChase Prod'n A/S (IFPI), Rosenvaengets Alle 5, DK-2100 Copenhagen O. Tel: (01) 26-01-44. Cable: STEEPRECFDS. Telex: 19144. Pres. & Mgt. Dir.: Nils Winther; Ass't Mgr.: Mihoko Warano.

Int'l branch: USA

Labels: (Owned) SteepleChase. (distributed-not licensed) Black Saint (Italy), ENJA (Germany), Nessa (USA), PM (USA), Queen Disc (Italy), Soulnote (Italy)

Int'l reps.: Austria (Bellaphon), Belgium (Agram), Canada (Trend), Finland (Discophon), France (Musica), Germany (Bellaphon), Italy (IRD), Japan (Shinsei, Sound Trading, Super Stop), Netherlands (Agram), Norway (Aurona), Portugal (Dargil), Spain (Edisa), Sweden (Adlib), Switzerland (Bellaphon), UK (Import Music Serv.), USA (Rick Ballard, House, Rounder)

Stopp, see Montax

Storyville, see Sonet/Dansk

Stuk, see Metronome

Sun Music A/S (IFPI), Vallekildevej 10, DK-4534 Høve. Tel: (03) 45 61 50. Pres.: Knud Thormod; Sales Mgr.: Bjarne Jensen, A&R Mgr.: Svend Christensen.

Labels: (Owned) Sun, Tip Top. (Licensed) Jingles (UK), Scranta (Sweden), Talent (Norway)

Sunset, see EMI

Television, Laerdalsgade 5, DK-2300 Copenhagen 5. Tel: (01) 52-11-85

Label: (Represented) Maranatha! (USA).

Tip, see Polydor

Tip Top Music, Vallekildevej 10A, DK-4534 Høve. Tel: (03) 45-69-90. Dir.: Bjarne Jensen. (Licensed to Sun)

Tono, see Sonet/Dansk

Triola, see Moerks

Tuba Recs. K/S, Amagervej 15, DK-1160 Copenhagen K. Tel: (01) 12-33-10. Cable: TUBAMUSIC. Telex: 15929. Pres.: Jerry Ritz; Promo. & Mktg. Mgr.: Lene Seikjaer. (Distributed by Sonet/Dansk)

Labels: (Owned) Banana, Blitz, Tubo, (Licensed foreign) Bluebird, M. Rees, Mariann, Mariann Int'l, Qcumber, TTR

Int'l reps.: Finland (Bluebird), Norway (Intervideo), Sweden (Mariann)

United Artists, see EMI

Vertigo, see Phonogram

Verve, see Polydor

Xenia, see Medley

Zac, see Dktav

• music publishers

Banana Music, see Tubo

Casadia, Skelmosevej 10, DK-2500 Valby. Tel: (01) 17-14-11. Chief Execs: Poul Bruun, Michael Ritto

Davs Musik, Normasvej 12, DK-2500 Valby. Tel: (01) 31-13-25. Cable: DAVSMUSIK. Telex: 15013. Owner: Kurt Andreasen.

EMI Music Publ'g (Denmark) A/S, Ny Desterogade 10, DK-1101 Copenhagen K. Tel: (01) 11-56-26. Telex: 27237. Gen. Mgr.: J. Joergensen
Home office: Sweden.

Int'l firms represented: Accord (Germany), Ambleside (UK), Anagon (Netherlands), Ardmore & Beechwood (Belgium, Mexico, South Africa, UK), Arion (Greece), Beechwood (Canada, USA, Belcas (New Zealand), Big Pig (UK), Black Swan (UK), Bowling Green (UK), Britten (UK), Castle (Australia), Central Songs (USA), Chankin (UK), Coppa (UK), Coronado (UK), Donna (UK), EGD (Spain), EMI (Greece, Switzerland, UK), Elstree (UK), Episode (UK), Ferris (UK), First Floor (UK), Francis Day & Hunter (France, Germany, Scandinavia, UK), Genius (USA), Good Time (USA), Heart's Delight (USA), ITAIPU (Brazil), Initial (UK), KPM group (UK), Kipper Songs (UK), Macmolecules (UK), Mammattan (UK), Marouani (France), Peter Maurice (UK), Minto (USA), Mutual (UK), Nightingale (UK), Odeon (Argentina), Open Door (USA), Pathe (Far East), Pathe-Maroni (France), Pedro (UK), Pepe (UK), Keith Prowse (UK), Reynolds (UK), Saffron (UK), Saturday (UK), Cyril Share (UK), Shanfid (UK), Shankin (UK), Sunlight (UK), Supersongs (UK), Telescope (UK), Tip Top Songs (UK), Tomorrow's Tunes (USA), Toshiba-EMI (Japan), Univista (UK), Varda (UK), Voce del Padrone (Italy), W&R (UK), World Wide (UK).
Int'l reps.: Argentina (Odeon), Australia (Castle), Belgium (Ardmore & Beechwood), Brazil (ITAIPU), Canada (Beechwood), Far East (Pathe), France (Francis Day & Hunter, Pathe-Maroni), Germany (Accord, Francis Day & Hunter), Greece (EMI), Italy (Voce del Padrone), Japan (Toshiba-EMI), Mexico (Beechwood), Netherlands (Anagon), New Zealand (Belcas), Spain (EGD), South Africa (Ardmore & Beechwood), UK (EMI), USA (Beechwood).

Wilhelm Hansen (Ed.), Gothersgade 9-11, DK-1123 Copenhagen K. Tel: (01) 11-78-88. Cable: MUSIKHANSEN. Telex: 19912. Co-Pres.: Hanne & Lone Wilhelm Hansen.

Branches: DK-8000 Aarhus, Graven 4-6—DK-5000 Odense, Klaregade 15.
Int'l branches: England, Germany, Norway, Sweden, USA.
Int'l firms represented: Anglo-Continental (UK), Ars Polona (Poland), Associated (USA), Boosey & Hawkes (France, UK), Campbell Connelly & Co. (UK), Cesky Hudební Fond (Czechoslovakia), J.&W. Chester (UK), Durand & Cie. (France), Faber (UK), Glocken (UK), Israel Music Institute (Israel), Kultura (Hungary), Moeck (Germany), Nordic Scngs (Norway, Sweden), Nordiska (Sweden), Norsk (Norway), Octava (UK), Oxford Univ. Press (UK), PWM (Poland), G. Schirmer (USA), Schott (Germany), Sonzogno

(Italy), Union (Spain), Universal (Austria), Tommy Valando (USA), Walton (USA), Josef Weinberger (UK)

Int'l reps.: Andorra (Boosey & Hawkes in France), Argentina (Gerard), Australia (Boosey & Hawkes), Austria (Universal), Belgium (Boosey & Hawkes in France), Canada (Leeds), France (Boosey & Hawkes, Italy (G. Ricordi), Luxembourg (Boosey & Hawkes in France), Mexico (Magna), Monaco (Boosey & Hawkes in France), Morocco (Boosey & Hawkes in France), Norway (Nordic Songs, Norsk), Portugal (Vidal Limona & Boceta in Spain), South Africa (Criterion), Spain (Vidal Limona & Boceta), Sweden (Nordic Songs, Nordiska), Tunisia (Boosey & Hawkes in France), UK (J.&W. Chester), USA (Alexander Broude, Magna, Walton), Uruguay (Gerard in Argentina).

Intersong A/S, Emdrupvej 115A, DK-2400 Copenhagen NV. Tel: (01) 69-25-22. Chief Exec.: D. Bergmann.

Kleinerts Musik Forlag A/S, Christian IX's Gade 7, DK-1111 Copenhagen K. Tel: (01) 12-34-32. Cable: MUSICKMF. Telex: 16600. Folex DK. Attn: MUSICKMF. Pres.: John Rasmussen

Int'l firms represented: Acuff-Rose (USA), Birdes (USA), Butter (USA), Churn (USA), East/Memphis (USA), Jec (USA), Mariposa (USA), Milene (USA), Fred Rose (USA), Sawgrass (USA), Sikorski (Germany).

M A Music (Europe), Artillerivej 40-10, DK-2300 Copenhagen S. Tel: (01) 57-09-10. Cable: MUSICALBE. Publ'g Dir.: Malle Andersen, Gen. Mgr.: Roy Marriot; Prof. Mgr.: John "Shelly" Jones

Int'l firms represented: Dee Cees (Scandinavia), Hammer (Germany), Kaliff (Scandinavia), Monkton (UK), PMP (Scandinavia), RTM (UK), Streetcorner (UK).

Int'l reps.: Scandinavia (PMP), UK (Streetcorner)

Per Meistrup Prod'n Co., Artillerivej 40, DK-2300 Copenhagen S. Tel: (01) 57-09-10. Cable: MUSICALBE. Pres.: Per Meistrup

Int'l firms represented: MA, Saffron, White Dove (all UK)

Int'l reps.: UK (MA, White Dove)

Moerks Musikforlag A/S, Christian IX's Gade 7, DK-1111 Copenhagen K. Tel: (01) 12-34-32. Cable: MUSICKMF. Telex: 16600. Folex DK. Attn: MUSICKMF. Pres.: John Rasmussen

Int'l firms represented: Reuter & Reuter (Sweden)

Multitone A/S, Vibevej 31, DK-2400 Copenhagen NV. Gen. Mgr.: Leif Pedersen.

Int'l firm represented: Multitone (Sweden)

Int'l rep.: Sweden (Multitone)

Netto Music, Bredgade 50, DK-9491 Pandrup. Tel: (08) 24-61-33. Telex: 69843. Gen. Mgr.: Mogens Villadsen, Export Mgr.: Allan M. Kristensen, Promo. Mgr.: Calle Nielsen.

Dktav Music, Lundvej 12, DK-2900 Hellerup Copenhagen. Tel: (01) 61-10-44. Gen. Mgr.: Fru Ella Bindrup, Music Advisor: George Swenson

Pick Up Music Publ'g, Gl. Kongevej 47 B, DK-1610 Copenhagen V. Tel: (01) 24-04-34. Mgr.: Peter Littauer.

Remi Music, Hedeparken 179, DK-2750 Ballerup. Tel: (02) 65-06-92. Pres.: Rene Gosvig.

Roymon Music, Vordingborgvej 2, CK Th., DK-4700 Naestved. Tel: (03) 73-45-11/46-54. Chief Exec.: Benny Schou Spens.

Int'l firms represented: Autobahn (Germany), Countdown (Germany), M&M (UK), Planet (Sweden), Snowball (Norway), Tal & Ton (Sweden).

Samfundet til Udgivelse af Dansk Musik (Society for Publishing Danish Music), Valkendorfsgade 3, DK-1151 Copenhagen K. Tel: (01) 13-54-05.

Chm.: Svend Erik Tarp, Gen. Mgr.: Kaethe Kirk.

Int'l reps.: Chester (UK), Eriks (Sweden), Eschig (France), Harassowitz (Germany), C. F. Peters (USA).

Sonet/Dansk Musik, St. Kongensgade 40, DK-1264 Copenhagen K. Tel: (01) 12-01-12. Cable: DANRECORD. Telex: 15252. Pres.: Karl Emil Knudsen, Prof. Mgr.: Inge Winckler.

Int'l firms represented: Emile (USA), Strawberry (UK), Summerland (UK)

Starbox A/S, Store Kongensgade 40, DK-1264 Copenhagen K. Tel: (01) 12-01-12. Telex: 15252. Gen. Mgr.: Johnny Reimar

SteepleChase Music, Slotsallén 16, DK-2930 Klampenborg. Tel: (01) 26-01-44. Telex: 19144. Chief Exec.: Nils Winther.

Int'l branch: USA

Int'l reps.: France (All Jazz), Japan (Victor)

Sun Music A/S, Vallekildevej 10, DK-4534 Høve. Tel: (03) 45-61-50. Pres.: Knud Thormod

Television, see Per Meistrup

Tuba (Publ'g) K/S, Amagervej 15, DK-1160 Copenhagen K. Tel: (01) 12-33-10. Cable: TUBAMUSIC. Telex: 15929. Pres.: Jerry Ritz; Promo. Mgr.: Lene Seikjaer; Prof. Mgr.: Michael Nielsen

Int'l firms represented: Mariann (Sweden), Super Top (Germany)

Westend Music, see Davs.

• services

ASSOCIATIONS & PROFESSIONAL ORGANIZATIONS

Danish Composers' Society, Valkendorfsgade 3, DK-1151 Copenhagen K. Tel: (01) 13-54-05. Chm.: Per Norgard, Sec'y: Kaethe Kirk

Danish Music Dealers' Ass'n, Frederiksberg Alle 29, Copenhagen V. Danish Music Publ'g Ass'n, Box 20, DK-6040 Egtved. Tel: (45) 55-14-11

Den Danske Gruppe af IFPI, Dslo Plads 14, DK-2100 Copenhagen Tel: (01) 42-21-66. Sec'y: John Schlueter.

Jazzcentret, Svennerupskov, DK-4683 Roseneide. Contact: Arvid Meyer

Musikforlæggerforeningen af 1972 (The Association of Danish Music Publ'rs of 1972), Box 20, DK-6040 Egtved. Tel: (45) 55-14-11

National Committee of the International Music Council, Raadhustr. 1, Copenhagen

S C A W C (Scandinavian Country & Western Corp.), PO Box 1278, DK-2300 Copenhagen S. Tel: (01) 95-05-71

Society for Publishing Danish Music (Samfundet til Udgivelse af Dansk Musik), Valkendorfsgade 3, DK-1151 Copenhagen K. Tel: (01) 13-54-05.

Chm.: Svend Erik Tarp; Gen. Mgr.: Kaethe Kirk.

Union of Danish Musicians, Vendersgade 25, DK-1363 Copenhagen K.

DESIGN & ARTWORK

EMI H Studio, Hovedskov 8, Grædstrup. Tel: (06) 76-00-49. Gen. Mgr.: Erik Hansen. (Rec. only)

Jesper Kilde Design, Havevej 2, DK-3060 Espergerode.

Johnsen + Johnsen A/S, Aldersgade 8, DK-2100 Copenhagen. Tel: (01) 29-86-86. Telex: 27286. Mgr.: Borge Thorsted; Sales Mgr.: Benny Stenberg.

Per Meistrup Prod'n, Artillerivej 40, DK-2300 Copenhagen S. Tel: (01) 57-09-10. Cable: MUSICALBE. Pres.: Per Meistrup; Prod'n: Helle Hansen.

Notex Offset A/S, Rosenkaeret 43, DK-2860 Soborg. Tel: (01) 67-33-00. Owner: Niels Lindahl. (Record/Tape/Video)

LICENSING ORGANIZATIONS, MUSIC

Gramex, Gothersgade 103-4, DK-1123 Copenhagen K. Tel: (01) 11-95-00. Gen. Mgr.: Ditto Lassen. (Performing rights only—records)

K D A, Rosenvaengets Hovedvej 14, DK-2100 Copenhagen D. Tel: (45) 138-9702. Cable: INTERKDDA. Gen. Mgr.: H. Lund Christiansen. (Per-

forming rights only)

Nordisk Copyright Bureau, Frederiksgade 17, DK-1265 Copenhagen K. Tel: (01) 12-87-00. Cable: CDPYRIGHT. Telex: 19371. (Mechanical rights only)

PLATING, PROCESSING & PRESSING PLANTS

Per Meistrup Prod'n, Artillerivej 40, DK-2300 Copenhagen S. Tel: (01) 57-09-10. Cable: MUSICALBE. Pres.: Per Meistrup; Prod'n: Helle Hansen.

PRINTERS & LITHOGRAPHERS

Borch Tryk A/S, Kogevej 14, Ringsted. Tel: (03) 61-07-77. Pres.: P. Borch. Johnsen + Johnsen A/S, Aldersgade 8, DK-2100 Copenhagen. Tel: (01) 29-86-86. Telex: 27286. Mgr.: Borge Thorsted; Sales Mgr.: Benny Stenberg.

Per Meistrup Prod'n, Artillerivej 40, DK-2300 Copenhagen S. Tel: (01) 57-09-10. Cable: MUSICALBE. Pres.: Per Meistrup; Prod'n: Helle Hansen.

Notex Offset A/S, Rosenkaeret 43, DK-2860 Soborg. Tel: (01) 67-33-00. Dwner: Niels Lindahl. (Record/Tape/Video)

RECORD PROMOTION

EMI H Studio, Hovedskov 8, Grædstrup. Tel: (06) 76-00-49. Gen. Mgr.: Erik Hansen.

Per Meistrup Prod'n, Artillerivej 40, DK-2300 Copenhagen S. Tel: (01) 57-09-10. Cable: MUSICALBE. Pres.: Per Meistrup; Prod'n: Helle Hansen.

Notex Offset A/S, Rosenkaeret 43, DK-2860 Soborg. Tel: (01) 67-33-00. Dwner: Niels Lindahl.

Popic Prod'n, PD Box 1278, DK-2300 Copenhagen S. Tel: (01) 95-05-71. Contact: Ditto Waldoff.

RECA Music Prod'n, Nykøbingvej 18, DK-4571 Grevinge. Tel: (03) 45-93-89. Dir.: Finn Reiner; Gen. Mgr.: Ole Steen Pedersen; Sales Mgr.: Carl C. Dalgaard.

Society for Publishing Danish Music (Samfundet til Udgivelse af Dansk Musik), Valkendorfsgade 3, DK-1151 Copenhagen K. Tel: (01) 13-54-05.

Chm.: Svend Erik Tarp; Gen. Mgr.: Kaethe Kirk.

Sun Mgmt., PO Box 3, DK-8362 Aarhus Hoerhing. Tel: (06) 13-17-66/78-09. Mgr.: Karl-Henrich Bartel.

Knud Thorbjørnsen A/S, 35 Grønnegade, DK-1107 Copenhagen K. Tel: (01) 12-26-10. Dwner: Knud Thorbjørnsen

Home office: Sweden, EMA-Telstar.

Tuba (Promo) K/S, Amagervej 15, DK-1160 Copenhagen K. Tel: (01) 12-33-10. Cable: TUBAMUSIC. Telex: 15929. Pres.: Jerry Ritz; Promo. & Mktg. Mgr.: Lene Seikjaer.

TAPE CUSTOM DUPLICATORS

EMI H Studio, Hovedskov 8, Grædstrup. Tel: (06) 76-00-49. Gen. Mgr.: Erik Hansen.

Video: 4" VHS cassette.

F H C-Electronics, Lindgreenvej 7, DK-1301 Copenhagen K. Tel: (01) 14-69-93. Cable: SELECTAHERLDEV. Pres.: Henning B. Petersen.

Audio: Cassette.

Holm Cassette A/S, Svanevej 12, DK-2400 Copenhagen NV. Tel: (01) 81-13-33. Gen. Mgr.: Joergen Holm; Sales Mgr.: Hans E. Jensen.

Per Meistrup Prod'n, Artillerivej 40, DK-2300 Copenhagen S. Tel: (01) 57-09-10. Cable: MUSICALBE. Pres.: Per Meistrup; Prod'n: Helle Hansen.

Audio: Cassette, open reel.

Tocano Cassette A/S, Vallekildevej 103, DK-4534 Høve. Tel: (03) 45-67-89. Gen. Mgr.: Alex Frederiksen; Studio Mgr.: Jan Didrup; Cassette Mgr.: Preben Graves.

• supplies

EMPTY CARTRIDGES, CASSETTES & REELS

Steen Hauerbach AS, Lyngbyvej 217, DK-2900 Hellerup-Copenhagen. Tel: (01) 61-10-11. Cable: MAGNETSTEN. Telex: 16779. Pres.: Steen Hauerbach; Sales Mgr.: Jorgen Thybro. (Importer)

Audio: Cassette.

ENVELOPES & MAILERS

Borch Tryk A/S, Kogevej 14, Ringsted. Tel: (03) 61-07-77. Pres.: P. Borch. EMI H Studio, Hovedskov 8, Grædstrup. Tel: (06) 76-00-49. Gen. Mgr.: Erik Hansen.

Johnsen + Johnsen A/S, 8 Aldersgade 8, DK-2100 Copenhagen. Tel: (01) 29-86-86. Telex: 27286. Gen. Mgr.: Borge Thorsted; Sales Mgr.: Benny Stenberg.

JACKETS & SLEEVES

Borch Tryk A/S, Kogevej 14, Ringsted. Tel: (03) 61-07-77. Pres.: P. Borch. (Jackets only)

Knud Hansen, Hejrevej, Copenhagen (Jackets only)

Per Meistrup Prod'n, Artillerivej 40, DK-2300 Copenhagen S. Tel: (01) 57-09-10. Cable: MUSICALBE. Pres.: Per Meistrup. (LP sleeves only)

LABELS, DISK POLYETHYLENE BAGS

Borch Tryk A/S, Kogevej 14, Ringsted. Tel: (03) 61-07-77. Pres.: P. Borch. Per Meistrup Prod'n, Artillerivej 40, DK-2300 Copenhagen S. Tel: (01) 57-09-10. Cable: MUSICALBE. Pres.: Per Meistrup. (45 & LP labels)

PROFESSIONAL TAPE SUPPLIES

Steen Hauerbach AS, Lyngbyvej 217, DK-2900 Hellerup-Copenhagen. Tel: (01) 61-10-11. Cable: MAGNETSTEN. Telex: 16779. Pres.: Steen Hauerbach; Sales Mgr.: Jorgen Thybro. (Importer)

Audio: 2", 1", 1/2" & 1/4" master tape.

Video: 2", 1", 1/2" cassette, 1/2" & 1/4" tape.

Brand name: Ampex.

RECORD MANUFACTURING EQUIPMENT

Ortolfon Mfg. A/S, Mosedalsvej 11B, DK-2500 Copenhagen-Valby. Tel: (01) 46-24-22. Cable: DRITDFDN. Telex: 27587. Mng. Dir.: Erik Rohmann; Technical Mgr.: Ib Petersen; Export Mgr.: Niels Jensen; Financial Mgr.: Niels Bornhoj.

Chief product: Cutting heads & disk cutting systems.

TAPE, BLANK LOADED & BULK RAW

Agfa-Gevaert A/S, Farverland, DK-2600 Glostrup. Tel: 96-67-66. Telex: 19214. Gen. Mgr.: J. Dau; Sales Mgr.: E. Hendrup.

Audio: Cassette, open reel.

Video: 1/2" cassette, open reel.

Brand names: Agfa Carat, Agfa Stereochrom, Agfa Videochrom.

Ampex, see Steen Hauerbach.

Audio Master, see EMI.

EMI (Dansk-Engelsk) A/S, Hoeffdingsvej 18, DK-2500 Valby-Copenhagen. Tel: (01) 30-67-11. Cable: GRAMMOPHDN. Telex: 16631. Mng. Dir.: Kurt Hviid Mikkelson; Sales Mgr.: Ole Jersee. (Blank only)</

(01) 61-10-11 Cable: MAGNETSTEN. Telex: 16779. Pres. Steen Hauerbach; Sales Mgr. Jorgen Thybro (Importer)
Audio: 8-tr. cassette, open reel
Video: 2" & open reel, 1" cartridge, 1/2" cassette, 1/4" EIAJ open reel, 1/2" Beta & VHS cassette.
 Brand names: Ampex, Fuji
 Per Meistrup Prod'n's, Artillerivej 40, DK 2300 Copenhagen S. Tel. (01) 57 09 10. Cable: MUSICABLE. Pres.: Per Meistrup
Audio: Cassette, open reel.
 Brand name: Mastertape

TAPE DUPLICATING & PROCESSING EQUIPMENT

Steen Hauerbach AS, Lyngbyvej 217, DK 2900 Hellerup-Copenhagen Tel: (01) 61 10 11 Cable: MAGNETSTEN. Telex: 16779 Pres. Steen Hauerbach; Sales Mgr. Jorgen Thybro (Importer)
Audio: Cassette loaders.
 Brand name: TTL

• accessories manufacturers

Audioscan, Dester Farimagsgade 28, DK-2100 Copenhagen D Tel. (01) 76 80 00
Product: Record—replacement styli
Brand name: Pickering
 Hagen-Diesen, Teglgårdsvej 105, DK 3050 Humlebaek Tel. (03) 19 14 47.
 Chief Exec. K. Hagen Diesen
Product: Record—record care prods., cartridges (Grace, Supex), Tape—head cleaners, demagnetizers

Steen Hauerbach AS, Lyngbyvej 217, DK 2900 Hellerup-Copenhagen Tel. (01) 61-10-11. Cable: MAGNETSTEN. Telex: 16779. Pres. Steen Hauerbach; Sales Mgr.: Jorgen Thybro.
Product: Tape—carrying & storage cases, leader & splicing tape.
 Drifon Mfg. A/S, Mosedalvej 11B, DK-2500 Copenhagen-Valby Tel. (01) 46-24-22 Cable: DRIFON. Telex: 27587 Mng Dir. Erik Romann; Technical Mgr.: Ib Petersen; Export Mgr.: Niels Jespersen, Financial Mgr.: Niels Borhoej
Product: Records—replacement styli.

• store fixtures

Johnsen & Johnsen A/S, Aldersrogade 8, DK 2100 Copenhagen Tel. (01) 29 86 86. Telex: 27286. Gen. Mgr. Borge Thorsted; Sales Mgr.: Benny Stenberg
Product: Record & tape display racks
 Kit Int'l (Denmark) ApS, Tempovej 22, DK 2750 Ballerup. Tel. (02) 65-12 42. Telex: 35342. Pres. Philip Kives; Gen. Mgr.: Erik Adelhron.
 Home office: USA
Product: Record browser boxes

• jukebox manufacturers

Bally-automater A/S, Roedager Alle 133, DK-2610 Roedovre Tel. (01) 70-10-87 Cable: BALCDP Mng Dir. Kaj Harders; Sales Mgr.: Jesper Maaloe
Brand names: Bally (USA), Midway (USA), NSM (Germany)
 Brodr. Joergensen, Rygaards Alle 104, DK-2900 Hellerup Tel. (01) 29-75-11
 Skandinavisk Grammofon Automat. Faborgvej 50, Himmelev, Roskilde. Tel. (03) 35-55-50.

DOMINICAN REPUBLIC

Population: 5,300,000
 Rate of exchange: \$1 (US) = 1 peso
 Per capita income: \$875

Holidays: January 1, January 6 (Feast of 3 Kings), January 21 (Attagracia Day), January 26 (Day of Duarte), February 27 (Independence Day), Good Friday, May 1 (Labor Day), Corpus Christi, August 16 (Restoration of Independence), September 24 (Mercedes Day), December 25

• record & tape manufacturers / distributors / importers

Bartolo I, see Productores Musicales.
 Caribe, see Distribuidores Musicales del Caribe
 Continental de Discos SA, Zona Ind'l Herrera, Calle I, Esq. L, Santo Domingo. Tel. 566-0511 Cable: CONTIDIS SANTO DOMINGO. Pres.: Miguel Angel Antor Yamin, Gen. Mgr. Jose Antor Yamin, Sales Mgr. Angel Antonio Alba B., Promo. & Sales Rep. Benjamin Bujosa M.
Labels: (Owned) Fonograma, Hermanos Antor, (licensed) CBS group (USA)
 Int'l reps.: USA (CBS), Venezuela (Fonorama, Hermanos Antor)
 Discomundo SA, Calle El Conde 404, Santo Domingo Tel. 685-2576/4682. Pres. Lic. Francisco A. Nina; VP: Rosa Nunez.
Labels: (Owned) Discomundo, (licensed) Ariola-Eurodisc (Mexico, Spain), Gas (Mexico), Teca (Mexico, USA), Tierrazo (Puerto Rico)
 Int'l rep.: USA (Teca)

Distribuidora Dominicana de Discos CporA, Conde 464, Santo Domingo Tel. 682-4058/2538. Pres. Gilberto Gonzalez; Gen. Mgr. Rodolfo Gonzalez D.

Labels: (Owned) Musicalia, (licensed) Alhambra (USA), Ansonia (USA), Bonniquen (USA), CTI (USA), Kubaney (USA), Marler (Spain), Movieplay (Spain), Musart (Mexico), Parachute (USA), Prelude (USA), Salsoul (USA), Secco/Tropical (USA), TR (USA), Velvet (USA, Venezuela)

Distribuidores Musicales del Caribe CporA, Calle Mercedes 363, Z 1, Santo Domingo Tel. 689-2978, 682-9213. Pres. Ignacio Mena; Gen. Mgr.: Pedro Vizzano; Sales Mgr. Salvador Rodriguez; Warehouse Mgr.: Boh Var Nunez.

Labels: (Owned) Caribe; (licensed foreign) Artomax (Puerto Rico), Bronco (Puerto Rico), Chrysalis, Disneyland-Vista (USA), RCA Victor (worldwide), 20th Century-Fox.

Fonograma, see Continental.
 La Guarachita (Empresas), PO Box 375, Calle El Conde 108, Santo Domingo. Tel. 689-2545 Pres. Rhadames Aracena; VP: Zunilda Read de Aracena.
Labels: (Owned) Guarachita, Ketty, Lucienne, Madalit, Zuni; (licensed) Audio Fidelity (USA), Billo (Venezuela), Decca (UK), Dorado (USA),

Fuentes (Colombia), London (USA), Manel (USA), Mary Lou (USA), Musicro (USA), Peerless (Mexico), Sonolux (Colombia), Sonos (Venezuela), Starbright (USA), Suaritos (USA), Top Hits (Venezuela).

Hermanos Antor, see Continental.
 Ketty, see La Guarachita.
 Lucienne, see La Guarachita.
 Madalit, see La Guarachita.
 Musicalia, see Distribuidora Dominicana de Discos.
 Productora & Distribuidora Nacional de Discos CporA, El Conde 464, Santo Domingo. Tel. (809) 688-9350. Cable: DISNADISCOS. Telex: 3264505. Pres. Gilberto Gonzalez Arenas; Gen. Mgr.: Rodolfo Gonzales Daussa
Labels: (Licensed foreign) ADH (Puerto Rico), Atlas (USA), Mercury (Germany), Microfon (USA), Philips (Germany), Polydor (Germany), RSD (USA).

Productores Musicales CporA (Promuca), PO Box 174-9, Ave. Nunez de Caceres S/N, Santo Domingo. Tel. 532-7906. Cable: IEMCA. Telex: 4267 (RCA), 3460429 (ITT). Pres.: Matilde Hasbun Vda. Selman; Gen. & Sales Mgr.: Ramon A. Blandino; Int'l Mgr.: Tirso Selman H.
Labels: (Owned) Bartolo I, Musicoro; (licensed foreign) Discolor (USA), Kubaney (USA)
 Int'l rep.: USA (Kubaney)
 Julio Tonos CporA, Apdo. 364, El Conde 251, Santo Domingo. Tel. (809) 682-5232. Pres.: Julio Tonos.
Labels: (Represented) MCA, United Artists.
 Salon de Estudios Mozart CporA, Calle El Conde 82, Santo Domingo Tel. 682-2640. Mng. Dir.: A. Blandino Soto.
 Zuni, see La Guarachita.

• services

DESIGN & ARTWORK

La Guarachita (Fabrica de Discos), Autopista Duarte Km. 6½, Santo Domingo. Tel. 565-5717.

PLATING, PROCESSING & PRESSING PLANTS PRINTERS & LITHOGRAPHERS

La Guarachita (Fabrica de Discos), Autopista Duarte Km. 6½, Santo Domingo. Tel. 565-5717.
 Industrias Antor CporA, Zona Ind'l Herrera, Calle I, Esq. L, Santo Domingo. Tel. 566-8666. Cable: ANTOR SANTO DOMINGO. Pres.: Miguel Angel Antor Yamin; Gen. Mgr.: Juan Dahajre; Prod'n & Sales Mgr.: Angel Antonio Alba. (Plating & pressing only)
 Productores Musicales CporA (Promuca), PO Box 174-9, Ave. Nunez de Caceres S/N, Santo Domingo. Tel. 532-7906. Cable: IEMCA. Pres.: Matilde Hasbun Vda. Selman; Gen. & Sales Mgr.: Ramon A. Blandino; Int'l Mgr.: Tirso Selman. (Plating, processing, pressing & cutting)

TAPE CUSTOM DUPLICATORS

Productores Musicales CporA (Promuca), PO Box 174-9, Ave. Nunez de Caceres S/N, Santo Domingo. Tel. 532-7906. Cable: IEMCA. Pres.: Matilde Hasbun Vda. Selman; Gen. & Sales Mgr.: Ramon A. Blandino; Int'l Mgr.: Tirso Selman.
Audio: 8-tr., cassette, open reel.

• supplies

CARTRIDGE & CASSETTE PARTS EMPTY CARTRIDGES, CASSETTES & REELS

Productores Musicales CporA (Promuca), PO Box 174-9, Ave. Nunez de Caceres S/N, Santo Domingo. Tel. 532-7906. Cable: IEMCA. Pres.: Matilde Hasbun Vda. Selman; Gen. & Sales Mgr.: Ramon A. Blandino; Int'l Mgr.: Tirso Selman.
Audio: Cassette.
Brand name: Dynamic Sound.

JACKETS & SLEEVES

LABELS, DISK

La Guarachita (Fabrica de Discos), Autopista Duarte Km. 6½, Santo Domingo. Tel. 565-5717.
 Productores Musicales CporA (Promuca), PO Box 174-9, Ave. Nunez de Caceres S/N, Santo Domingo. Tel. 532-7906. Cable: IEMCA. Pres.: Matilde Hasbun Vda. Selman; Gen. & Sales Mgr.: Ramon A. Blandino; Int'l Mgr.: Tirso Selman. (Jackets & sleeves only)

POLYETHYLENE BAGS & SHRINKWRAP

Productores Musicales CporA (Promuca), PO Box 174-9, Ave. Nunez de Caceres S/N, Santo Domingo. Tel. 532-7906. Cable: IEMCA. Pres.: Matilde Hasbun Vda. Selman; Gen. & Sales Mgr.: Ramon A. Blandino; Int'l Mgr.: Tirso Selman. (Poly Bags only)

TAPE, BLANK LOADED

Productores Musicales CporA (Promuca), PO Box 174-9, Ave. Nunez de Caceres S/N, Santo Domingo. Tel. 532-7906. Cable: IEMCA. Pres.: Matilde Hasbun Vda. Selman; Gen. & Sales Mgr.: Ramon A. Blandino; Int'l Mgr.: Tirso Selman.
Audio: 8-tr., cassette, open reel.
Brand name: Dynamic Sound.

• accessories

Productores Musicales CporA (Promuca), PO Box 174-9, Ave. Nunez de Caceres S/N, Santo Domingo. Tel. 532-7906. Cable: IEMCA. Pres.: Matilde Hasbun Vda. Selman; Gen. & Sales Mgr.: Ramon A. Blandino; Int'l Mgr.: Tirso Selman.
Product: Record—carrying & storage cases, replacement styli.

ECUADOR

Population: 7,900,000
 Rate of exchange: \$1 (US) = 30 35 sucres
 Per capita income: \$1,100

Holidays: January 1, Carnival, Holy Thursday, Good Friday, May 1 (Labor Day), May 24 (Battle of Pichincha), July 24 (Birthday of Simon Bolivar), August 10 (Independence Day), October 9 (Guayaquil Independence), October 12 (Columbus Day), November 3 (Cuenca Independence), December 6 (Founding of Quito), December 25 & religious holidays

• record & tape manufacturers / distributors / importers

Aguilar (Discos) SA, Apdo. 933, Velez 409 of 203, Guayaquil Tel. 352-248.

516 208 CABLE DISCFENIX. Pres.: Dr. Luis Aguilar Maldonado. Gen. Mgr.: Carlos E. Aguilar Maldonado. Sales Mgr.: Fernando Aguilar Maldonado; Ass't Mgr.: Roberto Aguilar Maldonado
Labels: (Owned) Aguilar, Fam. Fenix, Folklore, (licensed) IEMPSA (Peru), Remy (USA), Virrey (Peru).
 Int'l reps.: Colombia (Sonolux, Preludio), Mexico (DCM), Peru (IEMPSA, Virrey)

Centenario Recs Cia. Ltda., Av. Quito 4014 & El Dro, Guayaquil, Guayas Tel. 346-069 Cable: CENTNERRECDOS Gen. Mgr.: Medardo A. Silva; Sales Mgr.: Beatrice Lopez De Silva
Labels: (Owned) Centenario, Cosmos. Ecuatoriano, Mio; (licensed foreign) Orfeon (Mexico)
 Int'l reps.: Colombia (Chavez, Tropical), Peru (Cobos), USA (Dial), Venezuela (Promus)

Coloso, see Famoso
 Compania Procesadora de Discos SA (Coprodisa), Noguchi 1902, Guayaquil, Tel. 344 281 Mgr. Heriberto Ortega G. (Distributed by Emporio Musical)
Labels: (Owned) Coprodisa, (licensed foreign) Belter (Spain), Movieplay (Spain), Dlimpo (Spain).
 Coprodisa, see Compania Procesadora de Discos
 Cosmos, see Centenario
 Ecuatoriano, see Centenario
 Emporio Musical SA (IFPI), Lorenzo de Garacota 2813, Guayaquil Tel. 401-935, 402-228. Mgr.: Carlos Pino Plaza
Labels: (Owned) Dron, (Represented) CBS, IEMPSA, London, Som Estelar, see IFESA

Fadisa (Fabrica de Discos SA) (IFPI), Casillas 1339 & 2001, Kilometro 13 Via Los Chillos, Quito Tel. 311 157 Pres. & Sales Mgr.: Roberto Recalde C.; Gen. Mgr. Trajano Recalde; Prod'n Mgr.: Guillermo Recalde C.
Labels: (Owned) Fadisa, Rondador (licensed) Ariola (Spain, UK, USA), Peerless (Mexico), RCA (USA), Tropical (Colombia), El Virrey (Peru), Zafiro (Spain).
 Int'l reps.: Argentina (Chango, Microfon), El Salvador (Dicesa), France (Inter Musique), Peru (IEMPSA), Spain (Manolo Galvan, Dlimac).
 Fam, see Aguilar

Famoso (Industrias CA) (IFPI), Casilla 3514, Quito Tel. 453-393, 243-005 Cable: FAMOSS TEL 2580 Gen. Mgr. Gonzalo Jimenez Posada; Sales Mgr.: Fausto Carrera
Labels: (Owned) Coloso, Famoso, (licensed) Bambuco (Colombia), Barclay (France), Codiscos (Colombia), Columbia (Spain), Daro (Colombia), Delphine (France), Discoteca (Venezuela), FM (Colombia), Fonodisco (Venezuela), INS (Colombia), Infopasa (Peru), Lauro (Bolivia), Melod & (Mexico), Musart (Mexico), El Palacio de la Musica (Venezuela), Sca Americana (Argentina), Suramericana del Disco (Venezuela)
 Int'l reps.: Argentina (ATC), Bolivia (Lauro), Colombia (Codiscos), Mexico (Musart), Peru (IEMPSA), USA (Top Hits), Venezuela (Suramericana del Disco)

Fediscos (Fabrica Ecuatoriana de Discos SA), (IFPI), Apdo. 856, Kilometro 7½ via a La Costa, Guayaquil Tel. 350-100/309/861. Cable: FEDISCOS Telex: 3606. Pres.: Francisco Feraud-Aroca; Gen. Mgr.: Bronislaw Wierdak; Sales Mgr.: Jacinto Aspiazu
Labels: (Owned) Festival, Dnix, Teen, (licensed) Casablanca (USA), Discomoda (Venezuela), Fermata (Brazil), Fuentes (Colombia), MCA (USA), Philips (Netherlands), Polydor Int'l (Germany), Sonolux (Colombia), Velvet (Puerto Rico, Venezuela), WEA Int'l.
 Int'l reps.: Central America (Indica), Brazil (Fermata), Chile (Philips), Colombia (Fuentes), Peru (IEMPSA), USA (Ditoa), Venezuela (Unidas)

Fenix (Discos) SA, see Aguilar
 Festival, see Fediscos
 Folklore, see Aguilar

I F E S A (Industria Fonografica Ecuatoriana SA) (IFPI), Apdo. 3885, Caluchichima 704, Guayaquil Tel. 400-700, 401-931, 403-516 Cable: IFESA. Telex: 04 3512. Pres.: Luis Pino Yerow; Gen. Mgr.: Leticia Pino de Ortega; Mgr.: Augusto Villegas M. (Distributed by Emporio)
Labels: (Owned) Estelar, Lluvia de Estrellas, Sona, (licensed foreign) Int'l Stars (Venezuela), Aquario (Canada), Baby (Italy), Butterfly (USA), Capitol (USA), DJM (UK), Discos Accion (Mexico), Discos Latin (USA), EMI (UK), Euro (Italy), Fantasy (USA), Fonobosa (Colombia), Gamma (Canada, Mexico), Hispavox (Spain), Mericana (USA), Microton (Argentina), Ddeon (Worldwide), PDU (Switzerland), Petco (USA), Prelude (USA), Prism (USA), Private Stock (UK), Salsoul (USA), Sono Radio (Peru), United Artists (USA), Vanguard (USA), Victor (Japan)
 Int'l reps.: Colombia (FM), Mexico (Gamma), Panama (Prom-Disko), Peru (Sono Radio), Venezuela (Suramericana del Disco)

Lluvia de Estrellas, see IFESA
 Mio, see Centenario
 Mundo Musical Cia. Ltda., PO Box 6499, Quito. Tel. 242 912 Pres. Ricardo Wright; Gen. Mgr. Thomas Wright; Sales Mgr.: Roger Wright, Ass't: Ave-lina Jara (Distributor/Importer)
Labels: (Licensed foreign) Continental (Brazil), PMA (Argentina), Trova (Argentina)

Dnix, see Fediscos
 Orion, see Emporio
 Eco Roberto Recalde C. PD Box 1339 Quito.
Label: (Represented) Laurie (USA)
 Rondador, see Fadisa
 Sona, see IFESA
 Studio 2, Apdo. 2813, Guayaquil Tel. 510-652
Label: (Represented) Kubaney (USA)
 Teen, see Fediscos

• services

ASSOCIATIONS & PROFESSIONAL ORGANIZATIONS

Casa de la Cultura Ecuatoriana, Apdo. 67, Quito.
 Branches: Cuenca—Guayaquil, Casilla 3542

DESIGN & ARTWORK

Fediscos SA (Fabrica Ecuatoriana de Discos), Kilometro 7½ via La Costa, Guayaquil Tel. 350 100/309/861. Cable: FEDISCOS Telex: 3606. Gen. Mgr. Bronislaw Wierdak; Sales Mgr. Jacinto Aspiazu.

I F E S A (Industria Fonografica Ecuatoriana SA), Apdo. 3885, Caluchichima 704, Guayaquil Tel. 400-700, 403-516, 401-931. Pres.: Luis Pino Yerow; VP: Carlos Pino P., Gen. Mgr.: Leticia Pino de Ortega; Mgr.: Augusto Villegas.
Audio: 8-tr., cassette.

LICENSING ORGANIZATION, MUSIC

S A D R A M (Sociedad Anonima de Representacion & Administracion Musical Cia. Ltda.), Apdo. 3456, Lorenzo de Garacota 2811. Tel. 523-676

PLATING, PROCESSING & PRESSING PLANTS PRINTERS & LITHOGRAPHERS

Aguilar (Discos) SA, Km. 16 via a Daule, Guayaquil Tel. 352-248, 516-208 Cable: DISCFENIX. Pres. Dr. Luis Aguilar Maldonado; Gen. Mgr.: Carlos

E Aguilar Maldonado, Sales Mgr Fernando Aguilar Maldonado Ass't Mgr Roberto Aguilar Maldonado (Plating, processing & pressing only)
 Fediscos SA (Fabrica Ecuatoriana de Discos). Kilometro 7 1/2 via La Costa Guayaquil. Tel 350 100/309/861 Cable FEDISCOS Telex 3606 Gen Mgr Bronslaw Wierdak, Sales Mgr Jacinto Aspiazu
 I F E S A (Industria Fonografica Ecuatoriana SA) Apdo 3885 Calicuchima 704, Guayaquil Tel 400 700 403-516, 401 9-1 Pres Luis Pino Yerovi, VP Carlos Pino P. Gen Mgr Leticia Pino de Ortega Mgr Augusto Villegas (Printer & lithographer only)

TAPE CUSTOM DUPLICATORS

Fediscos SA (Fabrica Ecuatoriana de Discos) Kilometro 7 1/2 via La Costa Guayaquil Tel 350 100/309/861 Cable FEDISCOS Telex 3606 Gen Mgr Bronslaw Wierdak, Sales Mgr Jacinto Aspiazu
 Audio: Cassette

I F E S A (Industria Fonografica Ecuatoriana SA) Apdo 3885, Calicuchima 704 Guayaquil Tel 400 700, 403 516, 401 9-50 Pres Luis Pino Yerovi, VP Carlos Pino P. Gen Mgr Leticia Pino de Ortega, Mgr Augusto Villegas
 Audio: 8 tr. cassette

• supplies

**JACKETS & SLEEVES
 LABELS, DISK
 RAW MATERIALS**

Fediscos SA (Fabrica Ecuatoriana de Discos) Kilometro 7 1/2 via La Costa Guayaquil Tel 350 100/309/861 Cable FEDISCOS Telex 3606 Gen Mgr Bronslaw Wierdak, Sales Mgr Jacinto Aspiazu (Jackets sleeves labels molding compound)

• accessories manufacturer

Fediscos SA (Fabrica Ecuatoriana de Discos) Kilometro 7 1/2 via La Costa Guayaquil Tel 350 100/309/861 Cable FEDISCOS Telex 3606 Gen Mgr Bronslaw Wierdak, Sales Mgr Jacinto Aspiazu
 Product: Record—record care prods. 45 rpm adaptors, replacement stylus

**• jukebox title strip
 manufacturer**

Fediscos SA (Fabrica Ecuatoriana de Discos) Kilometro 7 1/2 via La Costa Guayaquil Tel 350 100/309/861 Cable FEDISCOS Telex 3606 Gen Mgr Bronslaw Wierdak, Sales Mgr Jacinto Aspiazu

EGYPT

Population: 40,525,000
 Rate of exchange: \$1 (US) = 0.69 Egyptian pound
 Per capita income: \$400
 Holidays: May 1 (Labor Day), June 18 (Evacuation Day), July 23 (Anniversary of the Revolution), October 6 (Military Day), October 24 (Suez Nat'l Day), traditional Christian & Mohammedan holidays.

**SEXUAL ABUSE
 OF CHILDREN.
 NOT TALKING ABOUT IT
 WON'T MAKE IT
 GO AWAY.**

It's real. Tens of thousands of children are sexually molested each year. Generally by a close friend, neighbor, parent or other member of the family. And we can't ignore the problem away. The abuse of children, whether it be sexual, physical, emotional or a form of neglect, damages young personalities and oftentimes results in death. An estimated one million children suffered from child abuse in America last year. A true tragedy because child abuse can be prevented. But not talking about it won't help.

**Abused children are
 helpless.
 Unless you help.**



**Write: National Committee for
 Prevention of Child Abuse,
 Box 2866, Chicago, Ill 60690**

A Public Service of This Magazine's
 & The Advertising Council

**• record & tape
 manufacturers /
 distributors / importers**

Sonar Ltd., 11 Kamal El Dine Salah, Garden City, Cairo. Tel 21374. Telex 92252 Mng Dirs. Dr. Hani Sabet, Kamal Dlama
 Sono Cairo Audio Video Co. (IFPI), Maspero TV Bldg., Kornish El Nil St., Cairo. Tel 754 809, 749-311. Bd. Chm.: Taha Nasr; Gen Mgr. Mohamad Gomaa, Comm'l Mgr. Michel Gerges.
 Int'l repts.: Austria, Canada, Switzerland, Tunisia, USA. Common Market (all Colifex), Greece (EMI Greece), Kuwait (Buzed Phone), Libya (El Toriy), Morocco (Alrassa)
 Michael Yacoumopoulos, 28 Saad Zaghloul, Alexandria. Tel: 805-934. Cable YALDS. Owner Michael Yacoumopoulos; Sales Mgr.: George Yacoumopoulos. (Distributor/Importer).
 Branches: Alexandria, 9 Stamboul St.—Cairo, 24 Soliman Pacha.
 Labels: (Represented) EMI group (UK)

• services

**DESIGN & ARTWORK
 PLATING, PROCESSING & PRESSING PLANT
 PRINTER & LITHOGRAPHER**

Sono Cairo Audio Video Co., Maspero TV Bldg., Kornish El Nil St., Cairo. Tel 754 809, 749-311. Bd. Chm.: Taha Nasr; Gen. Mgr.: Mohamad Gomaa; Comm'l Mgr. Michel Gerges

RECORD PROMOTION

Sonar Ltd., 11 Kamal El Dine Salah, Garden City, Cairo. Tel 21374. Telex 92252 Mng. Dirs. Dr. Hani Sabet, Kamal Dlama
 Sono Cairo Audio Video Co., Maspero TV Bldg., Kornish El Nil St., Cairo. Tel 754 809, 749-311. Bd. Chm. Taha Nasr; Gen. Mgr.: Mohamad Gomaa, Comm'l Mgr. Michel Gerges.

• supplies

TAPE, BLANK LOADED & BULK RAW

International Cassette & Tape Mfg. Co., 88 Kasr El Amr St., Cairo. Tel 21848. Telex 92503, 92529 Contacts: Jack L. Landis; John W. Bateman
 Audio: Cassette.
 Brand name: ICT High Output.

EL SALVADOR

Population: 4 540,000
 Rate of exchange: \$1 (US) = 2.50 colon
 Per capita income: \$700
 Holidays: January 1 Good Friday Easter Sunday May 1 (Labor Day), San Salvador's Feast, September 15 (Independence Day), October 12 (Columbus Day), All Souls Day, Anniversary of First Cry for Independence December 25

**• record & tape
 manufacturers /
 distributors / importers**

Bonidiscos Apdo 1393 Blvd del Ejercito Kilometro 5, San Salvador Tel 27 48 02 Telex 30235 Owner: Manuel Lombardo Aguilar
 Labels: (Owned) Bonidiscos, (licensed foreign) Baby (Italy) Butterfly (USA) Discomoda (Venezuela) Musdisc (Brazil) Pretude (USA) Vogue (France)
 Dicesa (Discos Centroamericanos SA) (IFPI), Apdo 847 Blvd del Ejercito Nacional Kilometro 5 Soyapango, San Salvador. Tel 27 08 55 Cable DICESA Pres. Jose Antonio Hutt; Gen. Mgr. Eduardo Hutt Sales Mgr. Alejandro Hutt
 Int'l branches: Costa Rica Guatemala Nicaragua Panama Discos de Panama
 Labels: (Licensed) Amanecer Del 76 (Spain), Atlantic (USA) Delphine (France), Disnevland (USA), Elektra/Asylum/Nonesuch (USA), Gas (Mexico), IEMPSA (Peru) Pye (UK), RCA (USA) Sonolux (Colombia) Trova (Spain), Warner Bros (USA), Zafiro (Spain)
 Int'l repts.: Colombia (Sonolux), Mexico (Gas), USA (Taurus Sound) Venezuela (Sono Vent)

Dideca see Musi Centro
 Distribuidora Salvadorense de Discos SA, Apdo (06) 960, Condominio Plaza Sunza, Locales 5y4 Carretera a Santa Tecla, San Salvador Tel 23 97 92 Telex 20090 Gen Mgr Jose M Chavarria
 Home office: Costa Rica Indica (see for labels)
 Indica see Distribuidora Salvadorense de Discos SA
 Kismet, see Leo
 Leo SA de CV, Colonia Santa Christina, Pasaje Santa Luisa 1043, San Salvador Tel (503) 22 6292, 22 8417 Telex 30077 Pres Ricardo Boet, Gen Mgr Arturo Rodriguez, Sales Mgr. Leonel Alvarez
 Labels: (Owned) Leo, (licensed) Alhambra (USA) Ansonia (USA) Casa blanca (USA), De Lite (USA), Ibis (USA), Infinity (USA) Kismet (El Salvador) London (UK) MCA (UK) Orleon (Mexico)
 Int'l repts.: Costa Rica (Johnny Nash) Guatemala (Miguel Angel Armas) Honduras (Disco & Cintas) Nicaragua (Fernando Flores)
 Mercado de Discos Apdo (06) 1393, Blvd del Ejercito Kilometro 5, San Salvador Tel 27 15 93, 27 05 20 Exec Mgr. Ana Magdalena de Aguilar (Importer/Distributor)
 Musi Centro Apdo (06) 111, 47 Avda Sur 118, San Salvador Tel 23 78 98 Cable MUSICENTRO Telex 30108 Gen Mgr. Rene Fuentes (Distributor)
 Home office: Guatemala Dideca (see for labels)

• music publisher

Edicesa (Ed. Centroamericana SA), Apdo 847, Blvd Ejercito Nacional Kilometro 5, Soyapango Tel 27-08 55 Pres. Jose Antonio Hutt Exec. Dir. Alejandro Hutt
 Int'l firms represented: Brambila (Mexico), Jaguare (Brazil) Mexicana de Musica (Mexico) Sono Inter (Colombia)
 Int'l repts.: Colombia (Sono Inter), Mexico (Mexicana de Musica)

• services

PRESSING PLANTS

El Bonto (Graficos) Apdo 1393, Blvd del Ejercito Kilometro 5 San Salva

dor Tel 27 48 02/49 25 Telex 30235 Chief Exec. Fabio Aguilar Murcia Gen Mgr Manuel L Aguilar
 Estudio de Grabaciones e Impresiones SA de CV (EGEISA) Apdo 847, Blvd Ejercito Nacional Kilometro 4 1/2, San Salvador Tel 27 08 55 Pres. Jose Antonio Hutt

PRINTERS & LITHOGRAPHERS

El Bonto (Graficos) Apdo 1393 Blvd del Ejercito Kilometro 5, San Salvador dor Tel 27 48 02/49 25 Telex 30235 Chief Exec. Fabio Aguilar Murcia Gen Mgr. Manuel L Aguilar (Lithographer)

TAPE CUSTOM DUPLICATOR

Boncassette Apdo 1393, Blvd del Ejercito Kilometro 5, San Salvador Tel 27 48 02/49 25 Telex 30235 Chief Exec. Fabio Aguilar Murcia, Gen Mgr. Manuel L Aguilar
 Audio: Cassette

FINLAND

Population: 4,787,751
 Population by age groups: 0-14—989,786; 15-24—779,793; 25-49—1,696,766; 50+—1,291,743
 Rate of exchange: \$1 (US) = 4.00 markka
 Per capita income: \$9,800
 Holidays: New Year's Day, Epiphany, Good Friday, Easter Monday, May 1 (Labor Day), Ascension Day, Whitmonday, Midsummer Day, All Saints' Day, December 6 (Independence Day), December 25, 26

RECORDS:

Record sales certification awards: Gold single—10,000 units, Gold LP—25,000 units, diamond LP—50,000 units; platinum LP—100,000 units.
 Note: Cassette sales are included with LP sales if contents are 1:1 Awards are controlled and distributed by AKT. Gold singles and platinum albums are extremely rare, but several albums, particularly domestic ones, have sold in excess of 50,000 copies
 Records sold domestically (IFPI member sales only; retail, including tax): 1980—2,334,443 units, \$23,696,000, 1979—2,152,526 units, \$19,800,700. EP's 1980—34,492 units, \$129,345, 1979—38,509 units, \$144,400. Singles 1980—436,793 units, \$1,200,000, 1979—407,365 units, \$1,120,000
 Records imported from USA (factory value, CIF): 1980—1,705,000 units, \$1,820,000, 1979—680,947 units, \$1,217,000
 Records exported to USA (factory value, FOB): 1980—5,870 units, \$22,700, 1979—7,387 units, \$40,750
 Records imported from countries other than USA (factory value, CIF): 1980—2,089,771 units, \$5,215,000, 1979—2,142,000 units, \$5,145,000
 Records exported to countries other than USA (factory value, FOB): 1980—238,207 units, \$662,500, 1979—149,525 units, \$411,500
 Average retail price per record: Full-priced LP's—\$11.75; EP's—\$4.10; singles—\$3.10
 TV merchandising: 16% of total.
 Record club sales: 10% of total.
 Discounting: Frequent.

Type of distribution: Manufacturer-to-wholesaler-to-retailer system is dominant again. Leading wholesalers and distributors to the trade are Finns candia (46%) and PEC-Musikkutukku (30%), the latter formed by CBS, EMI and PSD in 1979. Aanjaja Kuvatalennetunttajat accounts for some 60 per cent of the total record and pre-recorded tape sales in Finland. Rack jobbers are responsible for 40 per cent of retail sales outside AKT. Some 30 per cent of AKT sales are through conventional retail outlets. Direct imports (particularly from the US), dumping, pirate sales and home taping are major problems.

Type of promotion: Government-controlled radio and TV networks are most important. Jukeboxes and discotheques (nearly 250) are other useful outlets. Radio Luemborg, with its satisfactory medium wave reception at night, is quite popular among teenagers. Summer rock and pop festivals (over 20) feature many international acts and boost unknown local talent. Well established pop and rock magazines such as Soundi, DK, Suosikki, and Disco give good coverage on both international and local artists. Television advertising is rather popular, though expensive. There is no radio advertising.

Jukeboxes: 3,500.

TAPE:

Market: The sales ratio between records and pre-recorded tapes is 58 to 42 in favor of records, though it used to be a close 51 to 49 only a few years ago. 8-track and open reel are now virtually non-existent. There are currently some 1 1/4 million cassette recorder/players in consumer use. Some 6 to 7 million blank loaded cassettes were sold in 1980, a sign of heavy home taping. Video is still on a small scale, though there are about 15,000 video recorders in consumer use. Local production of video programs has started with Oy-Mainos TV Reklam AB and Video & AV Oy leading the way. Record companies are playing a "wait and see" game
 Pre-recorded tape sold domestically (IFPI); retail, including tax): Cassette 1980—2,051,388 units, \$18,330,000, 1979—1,784,010, \$15,174,000
 Pre-recorded tape imported from USA (factory value, CIF): 1980—201,356 units, \$210,000, 1979—54,435 units, \$151,000
 Pre-recorded tape exported to USA (factory value, FOB): 1980—2,091 units, \$7,500, 1979—865 units, \$5,780
 Pre-recorded tape imported from countries other than USA (factory value, CIF): 1980—1,066,629 units, \$2,040,000, 1979—1,487,600 units, \$2,285,000
 Pre-recorded tape exported to countries other than USA (factory value, FOB): 1980—130,364 units, \$418,000, 1979—84,590 units, \$237,300
 Average retail price per tape: Full-priced cassette—\$11.75

CONSUMER ELECTRONICS:

Number of homes with: Radios—2,600,000 (sets); television sets—1,538,259 (sets), 786,023 color, 752,236 b&w, phonographs—500,000; audio tape recorders—1,500,000; video tape recorders—15,000.

RADIO STATIONS:

No. of government 3.
 Comment: Program 1 is mainly spoken word, plays & topical shows. Program 2 is mostly popular, classical and jazz music with news and sports. Program 3 is Swedish language programming, available in coastal areas and some inland towns. The share of music in the two Finnish language networks is about 60%. Live pop and rock concerts are rare, but there is a tendency for more youth-oriented programming during after school hours.

TELEVISION STATIONS:

No. of channels: 2 government, 95% color (PAL)

Comment: Yleisradio, the parliamentary controlled broadcaster, is working on two channels nationwide. A private commercial company, Oy Maanos TV-Reklam, buys time from Yleisradio and sells it to advertisers. Programming is diversified and usually of high quality, though good musical shows are rare. International shows seen here include the Muppet Show, Soap, The Jeffersons, Ross Poldark, and Happy Days. Good musical shows are rare. A private CATV broadcasting company with about 65,000 subscribers is operating in the Helsinki area.

IMPORT/EXPORT REGULATIONS:

There are no custom duties on imports from EFTA, United Kingdom, Denmark and the USSR. All imports, without regard to country of origin, bear a 2% surcharge. No licenses are needed, except for trading with Socialist Block countries. Exports are duty free.

MARKET ANALYSIS

1980 saw AKT (The Finnish group of IFPI companies) sales value rise by 20%, thanks to heavy gains made by domestic cassettes. PSD Musiikki Oy, one of the country's oldest record companies, was bought by Scandia Musiikki Oy while Love Kustannus sold its record division to Jo hanna Kustannus. A distribution battle emerged between the Finnish Scandia and a relative newcomer, PEC-Musiikkikokkku, a company formed in 1979 by EMI, CBS and PSD. PEC has garnered about 35% of the distribution market share while Scandia has dropped to an all time low of about 43%.

1980 was the year of Finnish rock, the new wave, with names like Pelle Miljoona, Eppu Normaali, Hassinen Kone, Popeda and Maukka Perusjalko. The year also saw the return to rockability and heavy metal music and witnessed the continuing decline of MDR music and disco. The popular "Finnhits" series of television compilation albums was reported to have sold its one millionth copy. The death of artist and composer George Malminen shook the industry and fans alike.

Kari Helopatio

• record & tape manufacturers / distributors / importers

Harry Aaltonen Recs. & Minimus (IFPI), Haapaväylä, SF-03100 Nummela Tel: (13) 22661 Chief Exec: Harry Aaltonen

Labels: Duo, Minimus
Aantemusiikki Oy, Kahakya 8C, SF-02940 Espoo 94 Tel: 597 993
Angel, see EMI
Anuco, see Peka
Ape, see FinnDisc
Arrival, see K-tel

Audiomark Oy, Hissaajankatu 5, 08100 Helsinki 81 Tel: (90) 782 011
Audiovideopiste, Hameentie 35, SF-00500 Helsinki 50 Tel: (90) 753 3319 (Importer)

Audionis Oy, Raaeteintie 7, SF 04900 Kerava Tel: (90) 246 550 Cable
AUDIODIS, Chief Exec.: Lauri Nykopp, Sales Mgr.: Vesa Lehko

Labels: (Distributed—not licensed) Base-ESP (Italy), Bead (UK), Black Saint (Italy), FMP (Germany), Hat Hut (Switzerland, USA), Horo (Italy), Ictus (Italy), Incus (UK), India Navigation (USA), Jazz Live (Italy), Leo (UK), Lotus (Italy), Metalanguage (USA), Moers Music (Germany), Nine Winds (USA), PD Torch (Germany), Queen Disc (Italy), Red (Italy), Sackville (Canada), Soul Note (Italy).

Blue Note, see EMI.
Bluebird Music Dy (IFPI), Bulevardi 5 A 5, 00120 Helsinki 12 Tel: (90) 604 851. Telex: 124934 Mng. Dir.: Osmo A. Ruuskanen
Labels: (Owned) Bluebird, Birdie, (licensed foreign) Banana (Denmark), NAR (Netherlands), Goodwill (Sweden), Marann, Marlon (Germany), Marlim (Germany), Qcumber (Netherlands), Royton, TTR (Netherlands)

Blue Note, see EMI.
CBS Recs. Dy (IFPI), Valimotie 1, SF 00380 Helsinki 38 Tel: (90) 556 506 Telex: 122890. Gen. Mgr.: Antti Holma, Sales Mgr.: Timo Laukkanen.
Labels: (Owned) CBS, Cupol, Embassy, Epic, (licensed) Blue Sky (USA), Caribou (USA), Monument (USA), Philadelphia Int'l (USA), Young Blood (UK), (distributed—not licensed) ABM (USA), TK (USA).

C-Myynti Oy, Box 1503, Hameenpuisto 33 A 1, SF 33211 Tampere 21 Tel: (931) 33 506 Pres. & Gen. Mgr.: Lasse Marttinen.
Labels: (Represented) Belter, Clave, Gavola, Hispavox, Impacto, Dlympo (all Spain).

California, see Johanna
Capitol, see EMI
Chart, see K-tel
Columbia, see EMI
Concert Hall Society, Hameentie 157, Helsinki 56 Tel: (90) 790 022 Mng. Dir.: Harry Soderholm
Label: (Owned) Concert Hall

Cupol, see CBS.
Delta, see FinnDisc
Ogigelus Music Dy, Laiturinväntie 2, SF 00120 Helsinki 12 Tel: (90) 666 375. Gen. Mgr.: Ilkka Lehtinen (Importer)
Label: (Distributed—not licensed) O-Records.

Digit, see Finnlevy.
Disco-Lux Dy, Ulvilantie 5, SF-00350 Helsinki 35 Tel: 551 414
Discophon Dy (AB) (IFPI), Lansiportti 4A, SF 02210 Espoo 21 Tel: (90) 880 022. Cable: DISCO DY. Telex: 122705. Mng. Dir.: Johan Vikstedt, A&R Mgr.: Nari Majja, Sales Mgr.: Risto Kajanen
Labels: (Owned) Kerberos, (licensed foreign) Buddha (USA), Concorde (USA), Erato (France), GEM (UK), Interdisc (Germany), Logo (UK), Millemium (USA), Musca (Sweden), Dvathon (USA), Polar (Sweden), RCA (worldwide), Rialto (UK), Salsoul (USA), Solar (USA), SteepleChase (Denmark), Supraphon (Czechoslovakia), Swedish Society (Sweden), Telefunken (Germany), Telesat (Sweden), 20th Century-Fox (USA), Viking (Sweden) (SEE ADVERTISEMENT)

Duo, see Harry Aaltonen.
EMI Finland AB (Dy) (IFPI), Arinate 6 E, SF 00370 Helsinki 37 Tel: (90) 558 421. Cable: GRAMMOPHON. Telex: 122482 Mng. Dir.: Rolf Kronqvist, A&R Mgr.: Heikki Puhakka, Sales Mgr.: Eric Forsman
Labels: (Owned) Angel, Blue Note, Capitol, Columbia, EMI, EMI America, Electrola, HMV, Harvest, Liberty, Odeon, Parlophone, Pathe, Regal, Starline, Sunset, (licensed domestic) Love, (licensed foreign) Barclay (France), Carrere (France), Fantasy (USA), Flamingo (Sweden), Fritola (Sweden), MPL (UK), Magnet (UK), Milestone (USA), Prestige (USA), RAK (UK), Riviera (France), Rolling Stones (UK).

Eagle, see Tophits-Finnhits.
Edge, see Ethics.
Electrola, see EMI.
Embassy, see CBS.
Epic, see CBS

Erikoiskustannus Oy, Kverretie 10, SF-01650 Vantaa 65 Tel: (90) 844 752 Gen. Mgr.: Veli-Matti Kuparinen, Sales Mgr.: Antti Marvia
Labels: (Distributed—not licensed) East Anglian (UK), Jumbo (UK)

Int'l reps.: Belgium (Josef Segers), Germany (Peter Messingfeld), UK (East Anglian), USA (Giffler)

Ethics Musiikki Dy, Verkatelhaankatu 10, Turku 11. Tel: (921) 28021 Bd. Chm.: Martti Kulmala, Gen. Mgr.: Jouko Heyno (Distributed by Disco Phon)

Label: (Owned) Edge
Evergreen Dy (AB), PO Box 107, SF-00201 Helsinki 20 Tel: (90) 67 25 48 Telex: 123111 Mng. Dir.: Georg Uggla, Sales Mgr.: Sven Forsberg (Wholesaler/Importer/Mail Order)

Fazerin Musiikkikerho AB (Dy) (Fazer Music Club Ltd.) (IFPI), Hoylaamote 18, SF 00380 Helsinki 38 Tel: (90) 556 451 Telex: 121738. Mng. Dir.: Pauli Leimo, Mktg. Mgr.: Bo Bergman
Label: (Owned) Suomalainen Musiikkijärjestö (Finnish Music Library)

Fennica, see Society of Finnish Composers
Fifty Fifty see Studio 55/Fifty Fifty
Finlandia, see Finnlevy

FinnDisc AB (Dy) (IFPI), Takomonte 3C, SF 00380 Helsinki 38 Tel: (90) 558 797 Telex: 122782 Bd. Chm.: John Eric Westoe, Mng. Dir.: Jaakko Salo, Ariola Label Mgr.: Matti Kanerva (Distributed by Finlandia)
Labels: (Owned) Ape, Delta, Rondo, Salir, (licensed foreign) Ariola (Germany), MPA (Switzerland)

FinnGospel AB (Dy), Punavuorenkatu 3, SF-00120 Helsinki 12 Tel: (90) 658 868 Gen. Mgr.: Jan Erik Lindqvist, Sales Mgr.: Bjarne Bergsten
Labels: (Owned) FinnGospel, (licensed domestic) Touch Music, (distributed—not licensed) Benson group (USA), Cantio (Sweden), Clav (Sweden), Gospel House Music (Norway), Grapevine (UK), Marann (Sweden), Nye Toner (Denmark), Pilgrim (UK), Pilot (Sweden), Proprius (Sweden), Signatur (Sweden), Sirius (Sweden), Soist (Sweden), Talking Machine (Sweden)

Int'l reps.: Denmark (Nye Toner), Norway (Gospel House), Sweden (Gospel & Musikhuset, Proprius), UK (Pilgrim)

Finnish Music Library, see Fazerin
Finnlevy AB (Dy) (IFPI), Takomonte 3, SF 00380 Helsinki 38 Tel: (90) 558 797 Telex: 122782 Bd. Chm.: John Eric Westoe, Mng. Dir.: Leif Lindblad, Int'l A&R Mgr.: Gugi Kojluschkin, Local A&R Mgr.: Timo Lindstrom, Phonogram Label Mgr.: Jaakko Karilainen, Polydor Label Mgr.: Pekka Saelae, Finlandia Label & Classical Prod. Mgr.: Jaakko Borg (Distributed by Finlandia)

Labels: (Owned) Digit, Finlandia, Finnlevy, Kraek, Rytmii, Savel, Shokki, Triola, (licensed) Amadeo (Austria), Bis (Sweden), Casablanca (USA), Charisma (UK), DG (Germany), DJM (UK), Decca (UK), ECM (Germany), Fontana (Netherlands), London (UK), MCA (USA), MGM (USA), Melody (USSR), Mercury (USA), Metronome (Germany), Mountain (UK), Pablo (USA), Philips (Netherlands) Phil Spector Int'l (UK), Polydor Int'l (USA), RSD (UK), UK (UK), Utopia (UK), Vertigo (UK), Walt Disney (USA)

FinnScandia Musiikkiosakeyhtio, Takomonte 3, SF 00380 Helsinki 38 Tel: (90) 558 797 Mng. Dir.: John Eric Westoe, Mktg. Dir.: Leif Lindblad, Sales Mgr.: Timo Jokela, PR & Sales Prom.: Lasse Norres, Material Admin.: Hannu Linna (Administrator/Distributor) Note: FinnScandia is an administrative company for Finnlevy, FinnDisc, Scandia Musiikki, Levy Piste (Rack), and Fazerin Musiikkikerho (Music Club)

Labels: (Distributed) Finnlevy, FinnDisc, Scandia
Frog Music/Salo & Co., Iivinsiemenaaukio 2 A 9, 02260 Espoo 26 Tel: (90) 885 494 Chief Exec.: Harri Salo, Gen. Mgr.: Dili Pasonen. (Wholesaler/Importer)

Fuga Dy, Unioninkatu 28, SF-00100 Helsinki 10 Tel: (90) 631 181 Telex: 124692 Bd. Chm.: Erkki Nuoto, Mng. Dir.: Markku Nuoto
Labels: (Owned) Fuga, (distributed—not licensed) Abbey (UK), Bar enreiter (Germany), CRD (UK), Calliope (France), Claves (Switzerland), Da Camera (Germany), Gallo (Switzerland), Harmonia Mundi (France), Hispavox (Spain), Keyboard (UK), Konserthiakeskus (Finland), Organum (Finland), SFPP (France), Sastruphon (Germany), Studio SM (France), Unicorn (UK), Varese Sarabande (USA), Wergo (Germany)

Gold Disc, see Levytuottajat.
Gospel Sound, see Ristin Voitto
H M V, see EMI
Harvest, see EMI
Hi Hat, see Scandia
Hisle Levyt, PO Box 169, 13101 Hinna 10

Histona, see Sauna
Hitti, see Tophits-Finnhits
Ilona, see Tophits-Finnhits
Impact, see K-tel
Imperial, see K-tel

Indigenous Recs., c/o Nils Erik Valkeapaa, SF 99470 Karesuvanto
J P Musiikki Dy, Palovartiintie 13, SF 00750 Helsinki 75 Tel: 365 791 Mng. Dir.: Erkki Puumalainen, Prod'n Mgr.: Jarmo Jylha
Johanna Kustannus, Bernhardskatu 7 A 6, 00130 Helsinki 13 Tel: (90) 177 233 Pres.: Atte Blom

Labels: (Owned) California, Johanna (dist. by FinnScandia), Karhu, (licensed) Armageddon, Happy Birthday, Postcard, Rough Trade
Int'l rep.: Sweden (Tandan)

K-tel Int'l (Finland) Dy, Hameentie 4 A 2, 00530 Helsinki 53 Tel: 739 455 Telex: 123438 Gen. Mgr.: Marita Kaasalainen, Sales Mgr.: Jorma Leppa Aro

Home office: USA
Labels: (Owned) Arrival, Chart, Impact, Imperial, K-tel, Lotus, (licensed) Can't Stop (USA), Creole (UK), Ibis (USA), Malaco (USA), PVK (UK), Preiude (USA), Rollin' Rock (USA)

Karas Sana Dy, Frederikinkatu 61, SF 00100 Helsinki 10 Tel: (90) 694 2388 Cable: LDGDS Pres.: Mauri Tuikainen, Gen. Mgr.: Bruno Salo, Sales Mgr.: Dili Johansson
Label: (Owned) Sana Ja Savel

Karhu, see Johanna
Karva Levyt, Box 124, SF-48101 Kotka 10
Kerberos, see Discophon.
Kirjastopalevelu Dy, (Library Servs. Ltd.), Sarkimientie 5, SF 00210 Helsinki 21 Tel: (90) 692 6266. Mng. Dir.: Timo E. Karvinen (Distributor)

Kiss, see Polarvox
Kovu, see Sauna
Kompass Recs. Dy (IFPI), Hakolahtenkuja 4B, 00200 Helsinki 20 Tel: (90) 676 445 Pres.: Christian Schmidt
Labels: (Owned) Kompass, (distributed—not licensed) Rounder (USA)

Int'l reps.: Sweden (Amigo)
Konserthiakeskus, see Fuga.
Kraek, see Finnlevy
Kustannuskeskus Paiva Oy, PO Box 10, SF 13101 Hameenlinna 10 Tel: (917) 65 211. Dir.: Risto Kolkavuori

Ladyland Oy, Vuoluukiventie 11 L, 00710 Helsinki 71 Tel: 645 997 Mng. Dir.: Henrik Salohusala, (Importer)
Laiho Dy (Musiikki), Lustoite 3, SF-03100 Nummela Contact: Veikko Laiho
Label: (Represented) Moss Music Group (USA)

LeBaron Music Oy, Bulevardi 5 A 5, 00120 Helsinki 12 Tel: (90) 604 727 Telex: 124934 Mng. Dir.: Osmo A. Ruuskanen (Distributor)

Labels: (Distributed—not licensed) CNR (Netherlands), Goodwill (Sweden), TTR (Netherlands)

Leo Recs. Oy, PL 193, 00101 Helsinki 10: Huvilakatu 24 A 21, 00150 Helsinki 15 Tel: (90) 608 507 Telex: 121394 Owner: Edward Vesala.
Levy Piste AB (Dy), Takomonte 3, SF 00380 Helsinki 38 Tel: (90) 558 797 Telex: 122782 Mng. Dir.: Leif Lindblad (Wholesaler/Rack Jobber)

Levytuottajat Oy, Bulevardi 5 A 5, 00120 Helsinki 12 Tel: (90) 646 401. Telex: 124934 Mng. Dir.: Vekki Salmi, Sales Mgr.: Seppo Matintalo; Int'l Prod.: Jussi Ihonen (Distributed by Discophon outside Helsinki)

Labels: (Owned) Gold Disc, Mars, Rock'n
Liberty, see EMI
Lobo Ky, Bernhardskatu 7A, 00130 Helsinki 13 Tel: (90) 177 233 Exec. Harri Saksala

Lotus, see K-tel
Love Kustannus, Eerikinkatu 14 A 9, 00100 Helsinki 10 Exec.: Meiju Salonen
Label: (Owned) Ponsi

Love, see EMI
Lovebird, see Polarvox
M M K S, see Musiikkikonsultit
M N C, see Musiikkikonsultit
M & T Prods Dy, Kasenkatu 2B, 20700 Turku 70. Tel: (921) 330 323 Mng. Dir.: Jatti Ruohonen

Mars, see Levytuottajat
Mellow, see Musiikkikonsultit
Melsp, see Musiikkikonsultit
Midnight, see Musiikkikonsultit
Minimus, see Harry Aaltonen

Musiikkikonsultit Ky (Music Consultants Co.), Haameenkatu 1, SF-11100 Riihimäki 10 Tel: (914) 30 944, 36 260 Chief Exec.: Juhani Lahti
Labels: (Owned) Evergreen, MMKS, MNC, Mellow, Melsp, Midnight, Musko, SPLP

Musko, see Musiikkikonsultit
Naekoevammaisten Keskuksittito Ry, Maekelaankatu 50, SF 00510 Helsinki 51 Tel: (90) 77041 Mng. Dir.: Pentti Lappalainen (Cassette manufacturer for the blind)

Nukku Matti, see Polarvox
O M, see Diarin
Odeon, see EMI
Olarin Musiikki Oy, Meteornrata 3 B 42, SF 02210 Espoo 21 Tel: (90) 882 334. Mng. Dir.: Timo Narvanen (Distributed by Discophon)

Labels: (Owned) DM, Diarin
Organum, see Fuga
Otava, Uudenmaankatu 8 12, SF 00120 Helsinki 12 Tel: (90) 170 471
P E C Musiikkikokkku Dy, Arinate 6C, SF-00370 Helsinki 37 Tel: (90) 556 383 Mng. Dir.: Risto Kokkonmäki (Distributor)

Labels: (Distributed) CBS, EMI
P L Recs. Dy, Ruoholahdenkatu 16B, SF 11080 Helsinki 18. Contact: Pentti Lasanen
Parlophone, see EMI
Pathe, see EMI

Pekani Musiikki Dy, Aurakuja 5, SF 01630 Vantaa 63 Tel: 844 767. Mng. Dir.: Pekka Harkonen
Label: Anuco
Philips AB (Dy), Karvokatu 8, SF 00100 Helsinki 10 Tel: (90) 17 721. Gen. Mgr.: J.W. Brans

Poko Int'l, see Unitors
Poko Records, PO Box 104, 33201 Tampere 20 Tel: (931) 20 500 Telex: 22460 Mng. Dir.: Kari Helenius. (Also see Unitor)

Polarvox Dy (AFFP), Arinate 2, Helsinki 12 Tel: (90) 554 453 Cable: JUVDX Mng. Dir.: Leena Juurtonen, Gen. Mgr.: Jari Vaaenaenen
Labels: (Owned) Kiss, Lovebird, Nukku Matti, Polarvox, (licensed foreign) Aura (UK), Charly (UK), De Lite (USA), DeLuxe (Australia), Graduate (UK), Posh Boy (USA), Rockhouse (Netherlands), SDS (Sweden), Sal soul (USA), Sugar Hill (USA), Stiff (UK), Virgin (UK), (distributed—not licensed) Cherry Red (UK), DRG (USA), Planet (Sweden), Rascal (UK)

Int'l reps.: Denmark (Sonet), Sweden (Arne Bendixsen, SDS, Sonet)
Poimymusiikki Dy, Juhana Herttuante 7 C, SF 00600 Helsinki 60 Tel: (90) 795 942 (Distributor)

Ponsi, see Love Kustannus
Prisma, see Ristin Voitto
Quality Recs. Dy, PO Box 216, SF-00531 Helsinki 53. Tel: (90) 603372 Pres.: Matti Laipio, Sales Mgr.: Jarmo Santavuori

Labels: (Owned) Quality, (distributed—not licensed) Advent, Delmark, Yazoo (all USA), Flyright (UK)
Ra Recs. Dy, PO Box 102, SF 00181 Helsinki 18 Tel: (90) 648 948 Mng. Dir.: Jari Olli

Int'l rep.: Denmark (Per Meistrup)
Rebel Recs., Tuusulan 26, SF-04200 Kerava Tel: (90) 291 9766 Contact: Kari Hemonen

Regal, see EMI
Renne Recs., Kivivuorentie 4, SF-01620 Vantaa 62 Tel: (90) 890 131

LOOKING FOR
A PARTNER
IN
SCANDINAVIA
SEE PAGE 307
SCANGROUP RECORDS

Ristin Voitto Ry, Sinkkellonpolku, SF-01300 Vantaa. Tel: (90) 826-377. Pres. Eino O. Vanhala, Music Dept. Mgr.: Seppo J. Jaervinen.
Labels: (Owned) Gospel Sound, Prisma.

Rock'n, see Levytuottajat.

Rondo, see Finndisc.

Rytmi, see Finnlevy.

S P L P, see Musiikkikonsultit.

Safir, see Finndisc.

Sana Ja Savel, see Karas-Sana Oy.

Sauna-Musiikki Oy (Sauna Music Co. Ltd.), P.O. Box 36, 00661 Helsinki 66. Tel: (90) 745-050. Cable: SAUNAMUSIC. Admn. Dir.: Anja Lehtinen, Gen. & Sales Mgr.: Rauno Lehtinen. (Distributed by Finncandia)
Labels: (Owned) Historia, Koivu, Sauna, Sex-E. Yes-Jees.

Savel, see Finnlevy.

Scandia-Musiikki Oy (Scandia Music Co. Ltd.) (FPI), Takomonte 3, SF-00380 Helsinki 38. Tel: (90) 558-797. Cable: SCANOIAMUSIC. Telex: 121738. Bd. Chm.: John Eric Westöe, Mng. Dir.: Gugi Kokkijuschkin, WEA Label Mgr.: Ritva Karhula, Bronze, Chrysalis, Island, Pye & Sonet Label Mgr.: Matti Kanerva; Local A&R Mgr.: Tommi Luuhala. (Distributed by Finncandia)

Labels: (Owned) Hi-Hat, Scandia; (Licensod) A-yulum (USA), Atco (USA), Atlantic (USA), Bronze (UK), Chiswick (UK), Chrysalis (UK), Elektra (USA), Island (UK), Metronome (Sweden), Pye (UK), Reprise (USA), So net (Swedn, UK), Warner Bros. (USA).

Int'l firms represented: Scandinavia (Metronome & Sonet in Sweden).

Sex 6, see Sauna.

Sexyvox Oy, Raitalahdentie 11 B, SF-00570 Helsinki 57. Tel: (90) 688-112.

Shokki, see Finnlevy.

Society of Finnish Composers, Runeberginkatu 15 A 11, SF-00100 Helsinki 10. Tel: (90) 445-589.

Label: (Owned) Fennica.

Sokos Sound, see Suomen Osuuskappojen Keskuskuunta.

Starline, see EMI.
Studio 55/Fifty-Fifty Recs. (FFPI), Aurakatu 38, SF-20100 Turku 10. Tel: (921) 510-700.

Suni Oy, Koulukatu 1, SF-53100 Lappeenranta 10. Tel: (953) 12-800. Cable: SUNI. Sales Mgr.: Viljo Suni. (Importer)
Sunset, see EMI.

Suomalainen Musiikkikirjasto, see Fazerin

Suomalaisen Musiikin Julkistamisseura ry, PL 143, SF-00101 Helsinki 10. Chief Exec.: Ilkka Kuusisto.

Label: Tactus.

Suomen Osuuskappojen Keskuskuunta (SOK), Vilhonkatu 7, SF-00100 Helsinki 10. Tel: (90) 650-611. Cable: KESKUSKUNTA. (Distributor/Importer)

Labels: (Owned) Sokos Sound; (Licensod) Alshire (USA), Oscar (USA), Pickwick (UK, USA), (distributed-but-not-licensed) Europa (Germany)

Suuri Suomalainen Kirjakerho Oy, Koydenpujolaatu 2, SF-00180 Helsinki 18. Tel: (90) 601-522. Mng. Dir.: Pentti Aravi
Suuri Suomalainen Musiikkikerho Oy, Armatie 2 A, SF-00370 Helsinki 37. Tel: (90) 554-532. Cable: JUVVOX. Telex: 123166. Mng. Dir.: Leena Juuranto (Record club)

Taboroerlaget, Albertsgatan 31, 00180 Helsinki 18. Tel: (90) 643-401. Chief Exec.: Michael Soederlund.
Labels: (Represented) Hemmets Harold (Sweden), Maranatha! (USA), Prim (Sweden), Word.

Tactus, see Suomalaisen Musiikin Julkistamisseura
Tophits-Finnhits (FFPI), Lemmikkitie 19, SF-01350 Vantaa 35. Tel: (90) 831-449. Gen. Mgr.: Jorma Helander, Sales Mgr.: Timo Rantala.
Labels: (Owned) Eagle, Hilli, Iloina, Tophits-Finnhits.
Int'l rep.: Sweden (Nord Disc).

Triola, see Finnlevy.

Uutor Oy, Hallituskatu 11 A, SF-33201 Tampere 20. Tel: (931) 20-500. Telex: 22-460. Mng. Dir.: Kari E. Helenius; Sales Mgr.: Jukka Hynninen. Prod'n Mgr.: Pentti Palkoaho.

Labels: (Owned) Poko, Poko Int'l.

Vainon Sotin, Box 187, Vainonkatu 32, SF-40101 Jyväskylä 10. Tel: (941) 11 015. Owner: Heikki Ollinainen. (Distributor/Importer/Mail Order).

Valintatalo Oy, PO Box 176, Bulevardi 6, 00120 Helsinki 12. Tel: 602-011. Telex: 121637. Contact: Esko Koliseva. (Importer/Wholesaler)
Valitut Palat-Reader's Digest AB (Oy), Halsantie 4, SF-00420 Helsinki 42. Tel: (90) 563-2011. Telex: 122489. Mng. Dir.: Martti Immonen; Prod. Mgr.: Martti Virtanen. (Mail Order)

Yes-Jees, see Sauna.

• music publishers

A L R Musiikki Oy, c/o Hi-Hat Recs., Takomonte 1B, SF-00380 Helsinki 38. Tel: (90) 556-501. Contact: Tommi Luuhala.

Bluebird Music Oy, see LeBaron.

Coda (Ed.) (TEOSTO), Lansipolku 4A, SF-02210 Espoo 21. Tel: (90) 880-022. Cable: OISCOCY. Telex: 122705. Mng. Dir.: Johan Wikstedt; Gen. Mgr.: Maija Narhi.

Int'l firms represented: AdO (Italy), Ounbar (USA), RCA (Italy), Sunbury (UK, USA)

Ennio Music Ltd. (WOy), Aurakatu 38, SF-20100 Turku 10. Tel: (921) 510-700.
Int'l firm represented: Sonet (Sweden)

Fazer Musiikki Oy (TEOSTO), Takomonte 3 C, SF-00380 Helsinki 38. Tel: (90) 558-991. Telex: 122782. Publ'g Mgr.: Raimo Henriksson.

Finnmusic (Ed.), Ky. Rauno Lehtinen, Osuuskuuntane 50A, 00660 Helsinki 66. Tel: (90) 748-559. Cable: FINNMUSIC. Sec'y: Anja Lehtinen; Gen. Mgr.: Rauno Lehtinen.

Helander Prod'n Oy, Lemmikkitie 19, SF-01350 Vantaa 35. Tel: (90) 873-2029. Gen. Mgr.: Jorma Helander.
Imduco Kuustansuuhke, Armatie 6 E, SF-00370 Helsinki 37. Tel: (90) 558-421. Telex: 122482.

J V I Kustannus T-Mt, Kaernerinkatu 1 E 52, 00740 Helsinki 75. Tel: (90) 364-148. Gen. Mgr.: Jarmo Jylha.

Jasemusikkii Ky, PO Box 136, 13101 Haemeenlinna 10. Tel: (917) 23-146. Chief Exec.: Jarmo Sermiala.

Jee Jee Music Oy, Pakkamestarinranta 1, SF-00520 Helsinki 52. Tel: (90) 143-133. Telex: 123396. Gen. Mgr.: Timo Vaananen.
Int'l reps.: Sweden (Sonet), UK (Cherry Red), USA (Bomp)

Johanna Kustannus, Bernhardtinkatu 7 A 6, 00130 Helsinki 13. Tel: (90) 177-233. Pres.: Atte Blom; Gen. Mgr.: Eina Saksala.
Int'l rep.: Sweden (Tandem)

Jukka Kuopamaki & Co., see Fazer.
Karas-Sana Oy, Frederinkatu 61, 00100 Helsinki 10. Tel: (90) 694-2388.
Kirkon Nuorisoyon Keskus, Lisankatu 27 B, SF-01170 Helsinki 17.
Kompass Recs. Oy, Hakolahdenkatu 4B, 00200 Helsinki 20. Tel: (90) 676-445. Gen. Mgr.: Chris Schwindt.

LeBaron Music Oy, Bulevardi 5 A 5, 00120 Helsinki 12. Tel: (90) 604-851/727. Telex: 124934. Mng. Dir.: Osmo A. Ruskonen.

Levysevel Oy, Takomonte 3C, SF-00380 Helsinki 38. Tel: (90) 558-991.

Telex: 122782. Publ'g Mgr.: Raimo Henriksson.

Levytuottajat Oy, Mustannus, Bulevardi 5 A 5, 00120 Helsinki 12. Tel: (90) 646-401. Telex: 124934. Mng. Dir.: Vesa Salmi; Contact: Jussi Ilkonen

Erik Lindstrom Kustannus, Paivankilontie 7 A 1, SF-02210 Espoo 21. Musiikkikonsultit Ky, Haemeenkatu 1, SF-11100 Riihimaki 10. Tel: (914) 30-944, 36260. Chief Exec.: Juhani Lahti.

1 Rock Oy, PO Box 77, SF-00520 Helsinki 52. Tel: (90) 143-133. Telex: 123396. Chief Exec.: Timo Vaananen; Gen. Mgr.: Tikka Kallio.
Int'l rep.: Sweden (Sonet)

Olavin Musiikki Oy, Meteorinrata 3 B 42, SF-02210 Espoo 21. Tel: (90) 882-334. Mng. Dir.: Timo Narvanen

Polarmusic Oy, Arinatie 2, Helsinki, Tel: (90) 554-453. Cable: JUVVOX. Chief Exec.: Leena Juuranto.
Int'l firms represented: Charly (UK), Universal (Netherlands)

Ra Recs. Oy, PO Box 102, SF-00181 Helsinki 18. Tel: (90) 648-948. Mng. Dir.: Jari Olli
Int'l firm represented: PMP (Denmark).

Int'l rep.: Denmark (Per Mestrup).

Ristin Voitto, Sinkkellonpolku, SF-01300 Vantaa. Tel: (90) 826-377. Pres. Eino O. Vanhala, Music Dept. Mgr.: Seppo J. Jaervinen.

Scandia-Kustannus Oy (Scandia Publ'g Co. Ltd.), Takomonte 3C, SF-00380 Helsinki 38. Tel: (90) 556-818. Telex: 122782. Gen. Mgr.: Paavo Eimo.
Int'l firm represented: Warner Bros.

Sulasol Ry, Kluuvikatu 8, 00100 Helsinki 10.
Suomen Kanttori-Urkurilitto, Keskuskatu 44, SF-38700 Kankaanpaa

• services

ASSOCIATIONS & PROFESSIONAL ORGANIZATIONS

Aani-ja Kuvallennetuottajat ry (Finnish National Group of IFPI), Takomonte 3, SF-00380 Helsinki 38. Tel: (90) 551-021. Telex: 12 2782. Dir.: Arto Alaspaa.

Association of Finnish Musical Artists, Runeberginkatu 15 A 11, SF-00100 Helsinki 10. Tel: (90) 445-589.

Association of Finnish Music Institutes, Urho Kekkosenkatu 8 C 29, SF-00100 Helsinki 10. Tel: (3580) 694-3394. Chm.: Aarre Hemming; Gen. Mgr.: Maerta Kuokkanen.

Automatiivivokraajat ry (Renters of coin-operated machines ass'n), Ori-vedenkatu 12A, SF-33720 Tampere 72. Tel: (931) 170-500.

Elektroninen Tullikukauppaat (Importers & whsers. of electronic & hi fi installations & household appliances prods. org.), Mannerheimintie 76, SF-00250 Helsinki 25. Tel: (90) 441-651. Contact: Heikki Peutere.

Finnish Blues Society, Telakkakatu 2, SF-00150 Helsinki 15. Tel: 639-143.
Finnish Music Information Centre, Runeberginkatu 15 A 1, SF-00100 Helsinki 10. Tel: (90) 409-134. Pres.: Pekka Kallio; Exec. Sec'y: Kauko Karjalainen.

Finnish Rock Festivals Ass'n, Sepelalahdentie 14 B 10, SF-02230 Espoo 23. Tel: (90) 803-5110. Pres.: Kari A. Elo.

General Industry Group, Mariankatu 26 B 23, SF-00170 Helsinki 17. Tel: (90) 170-322.

Guild of Light Music Composers & Authors of Finland, Runeberginkatu 15 A 11, SF-00100 Helsinki 10. Tel: (90) 407-991. Chm.: Arthur Fuhrmann.

Helsinki Festival, Umoninkatu 28, SF-00100 Helsinki 10. Tel: (90) 659-688. Cable: FINNFEST. Entertainment Dept. Mgr.: Tapani Naerhi.

I F P I, see Aaeja.
Lavamuusikot ry (Ship Musicians), Mariankatu 15a A 12, SF-00170 Helsinki 17. Tel: (90) 662-218.

Musiikkialan Ammatyhdystysten Federaatio ry (MAF) (Federation of Trade Unions in the Field of Music), Mariankatu 15a A 12, SF-00170 Helsinki 17. Tel: (90) 662-218.

Note: MAF is the controlling organization for Lavamuusikot, Popmuusikot, Ravintolamuusikot.

National Committee of the International Music Council, Runeberginkatu 15 A 11, SF-00100, Helsinki 10. Sec'y: Tammi Kyro

National Section of the International Society for Contemporary Music, Errottajankatu 1-3 A 10, SF-00130 Helsinki 13.

Popmuusikot ry (Pop Musicians), Uudenmaankatu 36 O 21, 00120 Helsinki 12. Tel: (90) 640-760. Gen. Mgr.: Jussi Raittinen

Radionliikkeen Liitto ry (Radio retailers ass'n), Vuorimehenkatu 12, SF-00140 Helsinki 14. Tel: (90) 174-233. Chm.: Erkki Raitala.

Ravintolamuusikot ry (Restaurant Musicians), Uudenmaankatu 36 O 21, SF-00940 Helsinki 94. Tel: (90) 641-455.

Society of Finnish Composers, Runeberginkatu 15 A 11, SF-00100 Helsinki 10. Tel: (90) 445-589.

Suomen Jazzliitto (Finnish Jazz Federation), PL 54, SF-00101 Helsinki 10.
Suomen Musiikkien Liitto (Finnish Musicians Union), Uudenmaankatu 36 O 21, SF-00120 Helsinki 12. Tel: (90) 640-760.

Suomen Postimyynti ja Suoramainontaliitto ry. (Organization for mail order firms), Topeluksenkatu 41a, SF-00250 Helsinki 25. Tel: 418-795.

Suomen Soitteluosuusyhdistys ry (Finnish Ass'n of Musical Instrument Mfrs.), Manankatu 26 B 23, SF-00170 Helsinki 17. Tel: (90) 170-322.

Suomen Tsiikkujat ry (Professional disk jockey ass'n), Yrjon Katu 3, SF-15100 Lahti 10. Tel: (90) 662-218. Exec. Tapani Ripatti.

Suomen Tyovaen Musiikkiilto, Hallituskatu 19, SF-33200 Tampere 20. Tel: (931) 114-416.

CATALOG SERVICES

Original Recs. Oy, Aleksis Kivenkatu 10, SF-33210 Tampere 21. Tel: (931) 38124. Mgr.: Juhani Vesikko; Sales Mgr.: Pentti Martinen. (Rec.)

DESIGN & ARTWORK

Moonshine Oy, Pakkamestarinranta 1, SF-00520 Helsinki 52. Tel: (90) 143-133. Telex: 123396. Gen. Mgr.: Timo Vaananen; Prod'n Mgr.: Richard C. Stanley.

Rock-Along (Finland) Ltd., Sepelalahdentie 14 B 10, SF-02230 Espoo 23. Tel: (90) 803-5110. Pres.: Kari A. Elo.

Rocking Turtle Studio, Haemeenkatu 3 O 45, SF-00530 Helsinki 53. Tel: (90) 761-099.

Saftra, Lavanvarustajankatu 3, SF-00140 Helsinki 14. Tel: (90) 666-718.

LICENSING ORGANIZATIONS, MUSIC

Gramex, Runeberginkatu 15 A 6, 00100 Helsinki 10. Tel: (90) 493-371. Contact: Mrs. Kaisa Luuhala. (Radio/TV performance fees)

Sulasol (Suomen Laulajan ja Soittajan Liitto ry), Fredrikinkatu 61, SF-00100 Helsinki 10. Tel: (90) 694-3218. Chm.: Ahti Sonnenen; Gen. Mgr.: Jukka Kankanen.

T E O S T O ry (Saeveltaejaen Tekijaenoikeustormisto--Finnish Composers Int'l Copyright Bureau), Lauttasaaarentie 1, 00200 Helsinki 20. Tel: (90) 692-2511. Gen. Mgr.: Pekka Kallio. (Mechanical & performing rights)

PLATING, PROCESSING & PRESSING PLANTS

Cutting Room Oy, Huovitie 7, SF-00400 Helsinki 40. Tel: (90) 582-366. Mgr.: Rauno Luukkunen.

Leyos Oy/Finnvox Studios, Armatie 8, SF-00370 Helsinki 37. Tel: (90) 554-521. Telex: 123166. Gen. Mgr.: Kurt Juuranto; Mgr.: Erkki Ertesuo.

Manos-TV-Reklam AB (Oy) (MTV), Pasilankatu 44, SF-00240 Helsinki 24. Tel: (90) 413-300. Cable: COMTELE. Telex: 121544. Gen. Mgr.: Pentti Hanski; Ouply Gen. Mgr.: Jaakko Paavola; Sales Mgr.: Matti Kemilainen; Prod'n Mgr.: Kalevi Mattila.

Stereoasetit (Oy)-Stereooley AB, PO Box 40, SF-11101 Riihimaki 10; Teh- taankatu 13, SF-11100 Riihimaki 10. Tel: (914) 30-731. Export & Import Jukka Vainio. (Pressing only)

PRINTERS & LITHOGRAPHERS

Kirjapaino E. Kuronenky, Hoelvaenaoementie 18, SF-00380 Helsinki 38. Tel: (90) 558-955. Gen. Mgr.: Erkki Kuronen; Contact: Risto Mehtonen.

Ristin Voitto, Sinkkellonpolku, SF-01300 Vantaa. Tel: (90) 826-377. Pres.: Eino O. Vanhala, Gen. Mgr.: Seppo J. Jaervinen.

RECORD PROMOTION

Moonshine Oy, Pakkamestarinranta 1, SF-00520 Helsinki 52. Tel: (90) 143-133. Telex: 123396. Gen. Mgr.: Timo Vaananen; Prod'n Mgr.: Richard C. Stanley.

Rock-Along (Finland) Ltd., Sepelalahdentie 14 B 10, SF-02230 Espoo 23. Tel: (90) 803-5110. Pres.: Kari A. Elo.

Suomen Tsiikkuajat ry (Professional disk jockey ass'n), Yrjon Katu 3, 15100 Lahti 10. Tel: (918) 46-573. Exec.: Tapani Ripatti.

TAPE CUSTOM DUPLICATORS

Kasettimonikko Oy, Pohjolankatu 35 A 1, SF-00610 Helsinki 61. Tel: (90) 799-402.

Kasettimonistus Oy, Waino Aaltosentie 11 A, SF-00570 Helsinki. Tel: (90) 688-122.

Audio: Cassette.
Leyos Oy/Finnvox Studio, Armatie 8, SF-00370 Helsinki 37. Tel: (90) 554-521. Telex: 123166. Gen. Mgr.: Kurt Juuranto; Mgr.: Erkki Ertesuo.

Audio: Cassette.
Manos-TV-Reklam AB (Oy) (MTV), Pasilankatu 44, SF-00240 Helsinki 24. Tel: (90) 413-300. Cable: COMTELE. Telex: 121544. Gen. Mgr.: Pentti Hanski; Ouply Gen. Mgr.: Jaakko Paavola; Sales Mgr.: Matti Kemilainen; Prod'n Mgr.: Kalevi Mattila.

Audio: Cassette.
Video: 1/2" cassette, 1/4" cassette.
Stereoasetit (Oy)-Stereooley AB, PO Box 40, SF-11101 Riihimaki 10; Teh- taankatu 13, SF-11100 Riihimaki 10. Tel: (914) 30-731. Export & Import Jukka Vainio.

Audio: Cassette.

• supplies

EMPTY CASSETTES

Pyrkija Oy, Tastone, SF-20380 Turku 38. Tel: (921) 779-555. Contact: Arto Paim.

T P Tuotanto Oy, Valimontie 1B, SF-00380 Helsinki 38. Tel: (90) 551-039. Gen. Mgr.: Erkki O. Hautanen.

JACKETS & SLEEVES

Ofiset Oy, Tehtaankatu 27-29, SF-00150 Helsinki 15. Tel: 659-608. Mng. Dir.: K. Jarvinen.

Panomestari Oy, Kasarminkatu 15, SF-00130 Helsinki 13. Tel: (90) 13-061.

T P Tuotanto Oy, Valimontie 1B, SF-00380 Helsinki 38. Tel: (90) 551-039. Gen. Mgr.: Erkki O. Hautanen. (Jackets only)

Tanner-Pano Oy, Sammonkatu 52, SF-33540 Tampere 54.

LABELS, DISK

Original Recs./Musiikkijussti Oy, Aleksis Kivenkatu 10, SF-33210 Tampere 21. Tel: (931) 38-124. Mgr.: Jukka Keltto.

POLYETHYLENE BAGS

Amerplast Suomen & Co., SF-33730 Tampere 73.

PROFESSIONAL TAPE SUPPLIES

Moonshine Oy, Pakkamestarinranta 1, SF-00520 Helsinki 52. Tel: (90) 143-133. Telex: 123396. Gen. Mgr.: Timo Vaananen; Prod'n Mgr.: Richard C. Stanley.

Brand name: Metrosound.

3 M Oy (Suomen), Sinimaentie 20, SF-02630 Espoo 63. Tel: (90) 520-011. Mng. Dir.: Oag Helgestad; Sales Mgr.: C.E. Lindholm.

TAPE, BLANK LOADED

Agfa-Gevaert AB (Oy), Suomalaisentie 7, SF-02270 Espoo 27. Tel: 803-8133. Telex: 121187. Mng. Dir.: W. Staudinger; Sales Mgr.: B. Haestoe.

Audio: Compact-cassette, open reel.
Video: 2" open reel, 1/2" cassette, 1/4" cassette.

Brand name: Agfa.
Elektroposti Oy, Laentinen Papinkatu 6, SF-00530 Helsinki 53. Tel: (90) 753-6311, 675-199. Telex: 125144. Mng. Dir.: Kalevi Oittinen.

Audio: Cassette.
Europa, see Telagent.

Finnlevy Oy (AB), Takomonte 3, SF-00380 Helsinki 38. Tel: (90) 558-797.

Audio: Cassette.
Hectron Oy AB, Purotie 1-3, SF-00380 Helsinki 38. Tel: (90) 558-906. (Blank only)

Audio: Cassette, open reel.
Video: 1" open reel, 1/2" cassette, 1/4" Beta cassette.

Brand name: Sony.
Intertrade Oy, Toolonkatu 58, SF-00250 Helsinki 25. Tel: (90) 494-576

Brand name: Agfa.

TAPE PACKAGING & LABELING EQUIPMENT

Pyrkya Oy, Tastonie, SF-20380 Turku 38. Tel: (921) 779-555 Contact: Arto Palm.
T. P. Tuotanto Oy, Valimontie 18, SF-00380 Helsinki 38. Tel: (90) 551-039. Gen. Mgr.: Erkki D. Hautanen.

• accessories manufacturers

Finley Dy (AB), Takomitie 3, SF-00380 Helsinki 38. Tel: (90) 558-797.
Product: Record—record care prods.; Tape—head cleaners.
Finmende Dy, Karvaamokuja 3, SF-00380 Helsinki 38. Tel: 558-858.
Product: Record—replacement styl.
Brand name: Shure.
Moonshine Dy, Pakkamestarinranta 1, SF-00520 Helsinki 52. Tel: (90) 143 133. Telex: 123396. Gen. Mgr.: Timo Vaananen, Prod'n Mgr.: Richard C. Stanley.
Product: Carrying & storage cases; Record—record care prods.; Tape—head cleaners, demagnetizers, leader & splicing tape.
Musikkii Mosse AB (Dy), Ernkinkatu 9B, SF-20110 Turku 11. Tel: (921) 11 362. Gen. Mgr.: Mosse Seera. (Importer)
Product: Carrying & storage cases.
T. P. Tuotanto Oy, Valimontie 18, SF-00380 Helsinki 38. Tel: (90) 551-039. Gen. Mgr.: Erkki D. Hautanen.
Product: Carrying & storage cases.
R. Vikstrom Ltd. (Dy), Ulvilantie 29/4, SF-00350 Helsinki 35. Tel: (90) 551-647. (Importer)
Product: Record—replacement styl.
Brand name: Stanton.

• store fixtures manufacturers

Finley Dy (AB), Takomitie 3, SF-00380 Helsinki 38. Tel: (90) 558-797.
Product: Display racks.
Moonshine Dy, Pakkamestarinranta 1, SF-00520 Helsinki 52. Tel: (90) 143 133. Telex: 123396. Gen. Mgr.: Timo Vaananen, Prod'n Mgr.: Richard C. Stanley.
Product: Browser boxes, display racks.
T. P. Tuotanto Oy, Valimontie 18, SF-00380 Helsinki 38. Tel: (90) 551-039. Gen. Mgr.: Erkki D. Hautanen.
Product: Display racks.

FRANCE

Population: 53,800,000.

Population by age groups: 0-14—23%, 15-20—8%, 21-65—55%, 66+—14%.

Number of family units: 19,000,000.

Rate of exchange: \$1 (US) = 5.50 francs.

Per capita income: \$8,000.

Holidays: January 1, May 1 (Labor Day), Ascension Day, Assumption Day, July 14 (Bastille Day), November 1 (All Saints Day), November 11 (Armistice Day), December 25.

RECORDS:

Record sales certification awards: Gold single—500,000 units, platinum single—1,000,000 units, Gold LP—100,000 units, platinum LP—400,000 units.

Records sold domestically including imports: LP's 1980—65,000,000 units; 1979—64,935,967 units; EP's 1980—2,350,000 units; 1979—3,423,787 units; Singles 1980—55,000,000 units; 1979—55,330,068 units.

Records imported from USA (factory value, CIF): 1980—\$4,751,000. 1979—\$4,357,000.

Records exported to USA (factory value, FOB): 1980—\$4,751,000. 1979—\$4,357,000.

Records imported from countries other than USA (factory value, CIF): 1980—\$20,894,000; 1979—\$18,132,000.

Records exported to countries other than USA (factory value, FOB): 1980—\$36,863,000; 1979—\$39,198,000.

Record club sales: 11% of total.

Type of distribution: Mostly manufacturer to retailer, some wholesaler to retailer.

Promotion: There is an emphasis on discotheques as a means of promoting records.

Note: Manufacturers are forbidden by law to set or recommend retail prices.

TAPE:

Market: Although sales of pre-recorded tape are increasing, blank tape is still the best seller. The cassette is the preferred configuration 300,000 French homes now have equipment for videotape viewing, but since pre-recorded tapes have just recently been widely marketed, no trend in sales can be determined.

Pre-recorded tape sold domestically including imports: 8-tr 1980—5,000 units; 1979—21,798 units. Cassette 1980—21,000,000 units; 1979—18,483,883 units. Open reel 1979—8,120 units.

Pre-recorded tape imported from USA (factory value, CIF): 1980—\$1,781,000; 1979—\$937,000.

Pre-recorded tape exported to USA (factory value, FOB): 1980—\$375,000; 1979—\$152,000.

Pre-recorded tape imported from countries other than USA (factory value, CIF): 1980—\$11,336,000; 1979—\$8,162,000.

Pre-recorded tape exported to countries other than USA (factory value, FOB): 1980—\$6,937,000; 1979—\$6,971,000.

RECORDS & TAPE

Total records & pre-recorded tape sold at the retail level: 1980—144,000,000 units, \$750,000,000.

CONSUMER ELECTRONICS:

Percentage of homes with radios: (99% AM/FM 44%); television sets (90%, color 45%); photographs (83%); audio tape recorders (60%).

RADIO STATIONS:

No. of commercial 5; no. of government 6.

TELEVISION STATIONS:

No. of government 3; no. of commercial 2; 100% color (SECAM), Henry Kahn

• record & tape manufacturers / distributors / importers

A B A Disques, 302 Av. Jean-Jaures, 95100 Argenteuil. Tel. 980.08.17/46.34. Pres. Helene Marschal, Dir. Gen. Louis Marschal; Sales Mgr. Jean Rouly
Plant: 95810 Vallangouard, 14 bis Rue de l'Abbeville. Tel. 466.53.26.
A B Prod'ns SA, 55 Rue Pierre Charron, 75008 Paris. Tel: (01) 233 70 42. Telex: 660894. Pres. Dir. Gen. Claude Berda, Gen. Mgr. Jean Luc Azoulay; Sales Mgr.: Jean Bigot. (Distributed by CBS Disques)
Label: (Owned) AB
A F A Discara (Disques), 23 Rue Pierre Semard, 75009 Paris. Tel: (01) 526 52 47. Dir. Freddy Carrara; PR: Florence Carrara. Local branch: 75019 Paris, 50 Blvd. Serurier. Tel: (01) 205 68,19
Labels: (Owned) AFA Discara
A & M Recs. Europe (IFPI), 35 Av. Franklin D. Roosevelt, 75008 Paris. Tel: (01) 266 91 41. Mng. Dir. Marcus Bicknell; Mktg. Mgr. Russ Curry, Financial Dir. David Clapham, Promo. Cathy Dudemans. (Distributed by CBS)
Labels: (Owned) A&M. Horizon
Int'l reps: Austria (CBS), Belgium (CBS), Denmark (CBS), Finland (CBS), France (CBS), Germany (CBS), Greece (CBS), Israel (CBS), Italy (CBS), Netherlands (CBS), Norway (CBS), Portugal (Carvalho), Spain (CBS), Sweden (CBS), Switzerland (CBS), Yugoslavia (RTB)
A M P. see SFPP
A R S Studiofrance, 25 Rue Beranger, 92100 Boulogne. Tel: (21) 922 91 43. Dir. Roger Lacombe, Frederic Sichler.
A Z, see Disc AZ
Ariana, 175 Rue de Courcelles, 75017 Paris. Tel: (01) 766 03 54. Telex: 642728. Mng. Dir. Michele de Geyer, PR: Jean Claude Pellerin
Abbey Road Recs. c/o EMI/NWB, 94 96 Rue Lauriston, 75116 Paris. Tel: (01) 505 91 02. Telex: 612738. Exec. R.H. Cavassuto, Gen. Mgr. A. Hackler. (Distributed by EMI Pathe Marconi)
Labels: (Owned) Abbey Road, LTD. NWB
Int'l reps: Brazil (Som Brasil), France (EMI), Germany (EMI)
Accord, see Musidisc
Adele, see Phonogram
Ades SA, 54 Rue St Lazare, 75009 Paris. Tel: (01) 874.85.30. Telex: 280422
Labels: (Owned) Ades (distributed by Polydor), Enfants Sages, Petit Menestrel, Safta-Anthologie Sonore. (distributed) Disneyland, Vista
Int'l reps: Belgium (Polydor), Canada (Archambaud), Germany (Metro nome), Switzerland (Jean-Claude Vial)
Adria, see Daems
Affinity, see Charly
Agoria, see Chant du Monde
Ajaccio, see Daems
Albatros Prod'ns, 43 Rue Fessart, 92100 Boulogne/Billancourt. Tel: 603 41 93. Dir. Alain Barriere, Promo: Catherine Angelloz
Alleuia (Prod'n), 10 Rue St Florentin, 75001 Paris. Tel: (01) 260.85.05. Dir. Gen. Gerard Meys
Label: Temej
All Life, see Musica
Allo Music SA, 17 Rue Ballu, 75009 Paris. Tel: (01) 280 61 07. Telex: 280245. Pres. Max Amphoux, Int'l Mgr.: Maurice Bouchoux.
L'Arme de ... see Hugues Desalle.
America, see Musidisc
Anarchie Des Accords, 285 Rue St Jacques, 75005 Paris
Label: (Represented) County (USA)
Anasis, see Caravage
Anvers Musique Sarl, 35 Blvd. Rochechouart, 75009 Paris. Tel: (01) 280 18 56.
Aquitana, 52 Cours Alsace Lorraine, 33000 Bordeaux. Tel: 48.83 11, 91 19 08. Admin & Comm'l. Dir. Jean Lataste.
Arabella Sarl, 1 Rue Francois Ier, 75008 Paris. Tel: (01) 256 42 22. Telex: 650458. Gen. Mgr. Michel Poulain, Sales Mgr. Jacques Duchaussoy
Labels: (Owned) Arabella, Ariola, Ariola, Eurodisc
Arcade Recs., 9 Rue de Ponthieu, 75008 Paris. Tel: (01) 225 76 06. Mng. Dir. Georges Coqueru
Arcadius, see Caravage
Arc en Ciel, see Studio SM.
Arli, see Musica.
Arloik/Societe Bretonne d'Enregistrement, 14 Passage du Blavet, 56100 Lorent. Tel: (97) 21 23 91. Dir. Georges Gragic, Sales & Promo. Mgr. G. Bono
Labels: Arloik, Art & Musique, Heol, Iris, Keltia III
Argille, see RCA
Ariama, see Daems
Arias, 75 Rue Porte Dijeaux, Bordeaux. Tel: (56) 48 74 16. Chef. Exec. Guy Arias, Sales Mgr. Bernard Caubert. (Importer)
Ariola, see Arabella
Ariou (Disques), 36 Av. Hoche, 75008 Paris. Tel: (01) 563 76 70. Mng. Dir. & A&R Ariane Segal, Technical Dir. Claude Morel, Co-ord. & Int'l Frederic Segal, Art. Suzanne Nonette, Mlg. Beatrix Ariana, Promo. Margareth Losowski. (Distributed by CBS)
Labels: (Owned) Ariou, Quintessence
Int'l reps: Australia (Discuro), Belgium (Inelco), Brazil (CBS), Canada (J.M. Marchand), Germany (Teldec), Italy (Ducate), Japan (Nippon Columbia), Mexico (Gamma), Norway (Durho), Netherlands (CRCI), Spain (Hispanovox), Sweden (Electra), Switzerland (Disques Office), UK (Comfer), USA (MHS, Music Masters, Peters Int'l).
Arista, see Arabella
Art & Musique, see Arloik
Astree, see Chant du Monde & Domaine Musical.
Asylum, see WEA Filipacchi.
Atco, see WEA Filipacchi.
Atlantic, see WEA Filipacchi.
Atmosfera, see Musidisc.
Atmosphere, see International Rec.
Atoll Music (IFPI), 35 Rue Marbut, 75008 Paris. Tel: (01) 225.65.90. 256 36 71. Telex: 642082. Pres. Charles Ibguy; Comm'l: Martine Moscovitz. (Distributed by Atoll, Polydor, RCA)
Labels: (Owned) Atoll, Jonathan, Duragan, Ring.
Int'l reps: Belgium (Polydor), Germany (RMP), Greece (Phonogram), Italy (Ri-Fi), Japan (Victor), Netherlands (Telstar), Philippines (Victor), Scandinavia (SDS), South America (RCA), Spain (RCA), Switzerland (Disques Office), USA (Prelude).
Auvidis, 47/49 Rue Polonceau, 75018 Paris. Tel: (01) 264.75.31. Gen. Mgr.: Louis Bricard; Sales Mgr.: Jean-Paul Lemaire; Prod'n Mgr.: Jean-Pierre Metz.
Int'l reps: Belgium (Audiovisual), Germany (Calig), Spain (Caret), Switzerland (Saint Augustin).

Azaw (Disques), 55 Rue Marcadet, 75018 Paris. Tel: (01) 257.75.60. Dir. Gen. M. Daoud, Artistic Dir.: M. Idr.

B A M, see Disc AZ.

B B Z (Prod'ns) (IFPI), 21 Rue Jean-Mermoz, 75008 Paris. Tel: (01) 225.61.00. Telex: 250303. Pres. Rolande Bismuth, Int'l Mgr. Denis Wolff.

Labels: (Owned) BBZ Minotaure
Int'l reps: Canada (Able), Italy (Crisler), Japan (Nippon Phonogram), Netherlands (RCA), Portugal (Rossli).

Baboo, see Vogue.

Baccara, see WEA Filipacchi.

Barenreiter (Eds.), 1 Allee Jean de Ckegheem, 37170 Chambray les Tours. Tel: (47) 28.10.02. Dir. Mr. Bernstein.

Labels: (Owned) Astree, Valois.

Bagatelle SA, 10 Rue Washington, 75008 Paris. Tel: (01) 562.17.99. Telex: 640328. Pres. Denis Bourgeois. Gen. & Int'l Mgr.: Brigitte Bertholier Spahn.

Labels: (Owned) Bagatelle, Sava, Studio 10.

Balafon's Prod'ns, 54 Rue du Faubourg St-Honore, 75008 Paris. Tel: (01) 266.57.43, 266.55.29. Telex: Colsey 650613. Dir. Mrs. Fenard. Gen. Mgr. Kasseyo Seyo, Artistic Dir. Uta Bella.

Ballon Noir, 9 Passage Dagorno, 75020 Paris. Tel: (01) 370.88.32. Dir. Herve Bergerat. (Distributed by CBS)

Barclay (Compagnie Phonographique Francaise), 143 Av. Charles de Gaulle, 92521 Neuilly-sur-Seine. Tel: (01) 758.12.77. Cable: BARCLAYDISC. Pres. Eddie Barclay; Mng. Dir. Roger Maruani; Sales Mgr. Michel Bailan, Int'l Label Mgr. Jean Fernandez, Int'l Sales Mgr. Cyril Brilliant, Finance Mgr. Nicolas Tritz; Barclay A&R: Claude Righi; Riviera A&R: Leo Missur.

Labels: (Owned) Barclay, Blue Star, EGG, Riviera (licensed domestic) Call Me, EM, Malypense, (licensed foreign) Blitzkrieg, Decca, Green sleeves, Passport, Rolling Rock, Rough Trade.

Int'l reps: Argentina (RCA), Australia (Festival), Austria (Amadeo), Bolivia (Lauro), Brazil (RCA), Canada (PolyGram), Colombia (Codiscos), Denmark (EMI), Finland (EMI), Germany (Metronome), Greece (Minos Matsas), Israel (Litratone), Italy (Ricordi), Japan (King), Malta (Exotique), Mexico (Musart), Netherlands (CNR), Norway (EMI), Peru (FTA), Spain (Moveplay), Sweden (EMI), USA (Jem, Peters), Venezuela (Sura-

mericana), Yugoslavia (Jugoton).
Rene Baret SA, 26 Rue Marbut, 75008 Paris. Tel: (01) 256.28.80, 359.60.07, 723.98.11

Bearsville, see Carriere

Belcor, see Radio Programmes

Bella, see Daems

Belles Plages, see Daems

M. Benn, see Musca.

Paul Beuscher Recs., 27 Blvd. Beaumarchais, 75004 Paris. Tel: (01) 271 22 11. Cable: ALLMUSIC. Telex: 670877. Pres. Dir. Gen. Philippe Seiller.

Monsieur Jean Bienvenu, 81 Rue de Stalingrad, 38100 Grenoble. Tel: (76) 09 15 52. Gen. Mgr. Jean Bienvenu.

Label: (Owned) Dbo.

Biram France, 9 Rue de Versailles, 92430 Marnes-La-Coquette. Tel: (01) 741 61 98. Telex: 203249. Mgr.: Huguette Kluger.

Black & Blue, see WEA Filipacchi.

Bluebird, see RCA.

Blue Star, see Barclay.

Boite Magique, see P3

Bonnet, see Daems

Bouton d'Or, see Daems

Burlish, see WEA Filipacchi.

C A D I, 143 Rue du Chateau, 75014 Paris. Tel: (01) 563.17.27, 322 47 82. Telex: 202270. Pres. Dir. Gen. Raphael Duskin. (Distributor/Importer/Exporter)

C B D, see Carriere

C B S Disques (IFPI), 1 Rue de Chateau, 92522 Neuilly Cedex. Tel: (01) 758 14 22. Cable: CDIRECORD. Pres. Dir. Gen. Alain Levy, Sales Mgr.: Jean Claude Gastineau.

Labels: (Owned) Versailles, (licensed foreign) A&M (USA), Baby (Italy), CBS (USA), Epic (USA), GTO (UK), Illegal, Jet (USA), Lifesong (USA), Monument (USA), Portrait (USA), Safari (UK), TK (USA); (distributed—not licensed) AB, Arion, Ballon Noir, Deesse, Francis Dreyfus, Imedyazen, Kondo-Ra, Motors, Charlton Talar.

Int'l rep.: Worldwide (CBS)

C B S Int'l SA (European Regional Headquarters) (IFPI), 1 Rue du Chateau, 92522 Neuilly Tel: (01) 747 12 21. Telex: 613750. Cable: EURDCRI. SR VP European Dpns. Peter de Rougemont, Exec VP John A Dolan; VP Dpns. Patrick W Hurley, VP Creative Dpns. Dennis Killeen, VP Bus. De-

velopment Jacques Ferrari, Reg'l VP CBS Songs: Jeremy Pearce.

C L A R B Soul Bag, 25 Rue Trezel, 92300 Lavallois Perret. (Distributor).

C M C Recs. (Creative Musicale & Cinematographique), 60 Blvd. de Strasbourg, 75010 Paris. Tel: (01) 205.85.07. Telex: 642437. Gen. Mgr.



**Societe D'Editlons
Musicales Internationales
Paris, France**

- Pierre Arezki; Sales Mgr.: Patrick Balit.
- C N A I Fidsound (Compagnie Nationale d'Applications Ind'elles) (IFPI), 19 Rue Coysevox, 75018 Paris. Tel: (01) 228.05.91, 229.24.61. Pres. & Dir. Gen.: Jean-Claude Thuel-Chassaingne.
Label: (Owned) Fidsound.
- C N R, see Carrere.
- C R C, see Polydor.
- C Y, see WEA Filipacchi.
- Calazel, 12 Rue Saunerie, 34000 Montpellier. Tel: (67) 92.62.52. (Distributor/Wholesaler)
- Calliope, see WEA Filipacchi.
- Call Me, see Barclay.
- Camden, see RCA.
- Canetti, see Radio Programmes & Disc AZ.
- Capriccio, see Music Control.
- Caravage, 130 Rue Marius Aujan, 92300 Levallois-Perret. Tel: (01) 759.94.51. Pres. & Gen. Mgr.: Jean-Paul Smets. (Distributed by Carrere).
Labels: (Owned) Anaxis, Arcadius, Caravage, Caravage Chloé; (Licensed foreign) Raphaela (Germany), Sunshine (Germany).
- Caravan, see Carrere.
- Carlyne, see Musica.
- Caroline, see Carrere.
- Caroline (Studio), see Quenotte.
- Carrere (Disques), 27 Rue de Surenne, 75008 Paris. Tel: (01) 261.51.37. Telex: 641591. Pres. & Dir. Gen.: Claude Carrere; Gen. Mgr.: Pierre Haquet; Sales Mgr.: Lionel Delaube; Int'l: Nanou Lamblin; Export: Roger Durao.
Labels: (Distributed) Bearsville, CNR, Car-van, Caroline, Clemence, Cornelia, Farian, 5, Fleche, Force, General, Hansa, Heloise, Kuklos, Le-guz, Mary, Di-rando, Perfect, Rockhouse, Suelle, 39, Tonus, Underdog, Zigara.
Int'l reps: Argentina (Microfon), Belgium (Carrere), Canada (Carrere), Ecuador (Hesa), Germany (Carrere), Hong Kong (Pacific), Israel (CBS), Italy (Fonit Cetra), Mexico (Peerless), Netherlands (Carrere), Peru (Sica Peruana), Portugal (Polygram), Scandinavia (EMI) South Africa (EMI), Spain (CBS), Switzerland (Carrere), UK (Carrere), Venezuela (Ruices).
Cathedrals, see Studio SM.
- Cavalier, see RCA.
- Celluloid Musique & Communication, 9-bis Rue de la Villette, 75019 Paris. Tel: (01) 205.93.59. Telex: 212698. Gen. Mgr.: Gilbert Castro; Sales Mgr.: Jean Karakos.
Labels: (Owned) Celluloid; (Licensed domestic) Dorian, K; (Licensed foreign) Ralph (USA), Ze (USA).
Int'l reps: Benelus (Ariola), Germany (Ariola), Italy (CIGIDI), Spain (Ariola).
- Centre d'Etudes & de Realisations Audio-Visuelles, see CERA.
- Cercle 135, see Eurogram.
- Cereste, see Sopredim.
- Cezame, 2 Rue Flechier, 75009 Paris. Tel: (01) 878.45.23. Mng. Dirs.: Jean-Michel Gallois Montbrun, Frederic Leibovitz; Sales Mgr.: Valerie Cachoux.
Labels: (Owned) Cezame, Cobra.
- Chant du Monde (IFPI), 64 Rue Ampere, 75017 Paris. Tel: (01) 763.67.73. Pres. & Dir. Gen.: Jean Roire; Gen. Mgr.: Jean Mialthe.
Branch: 94600 Choisy le Roi, 164 Rue Constant Coquelin. Tel: 680.13.78.
Labels: (Licensed domestic) Chevanche, Galata, (Licensed foreign) Folkways (USA), Melodiya (USSR); (distributed-not licensed) Agoria, Astre, Unteledis, Valois (all France).
- Charly Recs & Tapes (France) SARL, 27 Rue de Rouen, 92400 Courbevoie. Tel: (01) 788.37.75. Mng. Dir.: Enzo Hamiltin.
Labels: (Owned) Affinity, Charly, Smark (distributed by Arabella); (Licensed foreign) Age, Atomic Art, Baron, Blue Bird, Chief, Cobra, Giorgio Gomelsky, Jewel, Mar-V-Lus, Midas, One-Derul, Paula, Plantation, Red Bird, Ronn, SSS Int'l, Sansu, Sun, Toddlin' Town, Vee Jay, Jerry Williams Jr. (all USA).
Int'l branches: Ireland, UK.
Int'l reps: Australia (U.A. Braunthal, Hollywood House, Musicland), Austria (Xithulus), Canada (Almada), Finland (Poravox), Germany (Teldec), Ireland (Spartan), Israel (Eastronics), Italy (Ariston), Japan (RCA), New Zealand (EMI), Poland (Tonpress), Spain (Audi), Sweden (Planet), Switzerland (Vogue), USA (City Hall, First American, Greenworld, Important, JEM, Rounder, Shanachie), Venezuela (RPM), Yugoslavia (Jugoton).
- Charmilles (Disques & Cassettes), 62 Mail des Charmilles, 10000 Troyes. Tel: (25) 81.05.62. Gen. Mgr.: Gilbert Delforge.
- Chevanche, see Chant du Monde.
- Chloé, see Caravage.
- Chrisal, 3 Villa du Poitou, 91800 Epinay sur Senart. Tel: 047.07.62. Dir.: Alain Ravel.
- Chromophonie, see Gratte-Ciel.
- Cinderella, see Daems.
- Classics for Pleasure, see Music for Pleasure.
- Clemence, see Carrere.
- Clouseau Musique SA, 65 Rue de Belleville, 75019 Paris. Tel: (01) 239.40.44. Telex: 212534. Dir.: Philippe Constantin.
Labels: (Licensed foreign) Albion (UK), Andrew Heath (UK), Black Hill (UK), Clash (UK), Din Song (UK), Fela Ransome Kuti (Niger), Garland Jeffreys (USA), Moon Martin (USA), Virgin (UK).
- Cobalt, see Musica.
- Cobra, see Cezame.
- Coda, see Disco Shop.
- Colombe (Disques), 4 Rue de la Colombe, 75004 Paris. Tel: (01) 633.37.08. Columbia (UK), see Pathe Marconi EMI.
- Comedia, 24 Rue Condorcet, 94430 Chennevières sur Marne. (Distributor)
- Consul-CM Recs. (Disques), 43 Rue de la Fraternite, 93100 Montreuil-sous-Bois. Tel: 364.68.44.
- Context, see Experience.
- Contour, see Impact.
- Contrast, see Michel Meyer.
- Contrepoint, see Vogue.
- Copains de la Boheme, see Daems.
- Corelia (Disques), Le Four Blanc, 91780 Cha o Saint Mars. Tel: (06) 495.41.93. Comm'l Dir.: Eliane Tribault; Tech. Dir.: Jean-Paul Eggermont.
- Cornelia, see Studio Damiens & Carrere.
- Cote d'Azur, see Diffusion Artistique.
- Cotillon, see WEA Filipacchi.
- Cransac, see Edwards.
- Cynus, see Musidisc.
- Cyl, see Musica.
- Cyracuse, see Daems.
- D A M, 95 Rue de France, 77300 Fontainebleau. (Importer)
- D C F, 6 Rue Monsieur le Prince, 75006 Paris. Tel: (01) 326.88.53. (Distributor/Wholesaler)
- D E M SA, 2 Av. Brown Sequart, 06000 Nice. Tel: (93) 81.11.31. Telex: 461043. Pres.: Victor Cohen; Dir. Gen.: Gilbert Cohen. (Wholesaler)
- D I A L (Diffusion Int'l d'Arts & Loisirs SA), 1 Blvd. Francois Arago, 91328 Wissous Cedex. Tel: (06) 011.99.60. Telex: 600313. Chief Exec.: S. Grynberg.
- D J M, see Dick James.
- Daems (Disques), 69 Rue des Archives, 75003 Paris. Tel: 272.74.83 (apres midi). Dir. Gen.: Victor Genaudeau.
Labels: (Owned) Adria, Ajaccio, Ariama, Bella, Belles Plages, Bonnet, Bouton d'Or, Cinderella, Copains de la Boheme, Cyracuse, Daems, Eriane, Faure, Flammes de Velours, Fonta, Les Grands d'Espagne, Iberia, Jacinthe, Jeunesse de France, Ladybird, Lecomte, Legal, Lopicings, Magister, Mioara Venter, Music for Ever, Noces & Banquets, Pastori, Promotion, Reflets d'Alsace, Reflets du Poitou, Rois du Musette, Ro sario, Santeliseo, Special Accordeon, Super Stars, Teurlay, Victor Michel, Wilyban.
- Daisy Music, 172 Av. Jean Jaures, 51100 Reims. Tel: (26) 09.70.53. Admin. Dir.: Jacky M. Portier; Artistic Dir.: Claude Moreau.
- Dave Music, 50 Rue Stendhal, 75020 Paris. Tel: (01) 636.66.36. Telex: 210611. Dir.: David Muffarz; Gen. Mgr.: Edith Muffarz.
Label: (Owned) Stip.
- Deesse, see Deesse-Septentrion & CBS Disques.
- Deesse-Septentrion (IFPI), 11 Rue Lepic, 75018 Paris. Tel: (01) 606.94.30, 255.92.19. Telex: 270105. Gen. Mgr.: Pierre Celie; Artistic Dir.: Michel Celie; Secy-Gen.: R.N. Tallarita. (Distributed by CBS)
Label: (Owned) Deesse.
Int'l reps: Belgium (Anvers-Radio), Canada (Archambault, Carole Risch), Netherlands (Sound), Spain (Auv), Switzerland (Disques-Office).
- Delove, 78 Av. des Champs Elysees, 75008 Paris. Tel: (01) 359.17.86. Telex: 280467. Chm.: Hubert Wayaffe; Mng. Dir.: Catherine Morisse.
- Delphine Prod'n SA, 5 Rue du Docteur Lancereux, 75008 Paris. Tel: (01) 562.01.02. Telex: 642908. Pres.: Paul de Sennerville; Gen. Mgr.: Olivier Toussaint; Int'l Mgr.: Marion de Froment; A&R Mgr.: Jean Baudlot. (Distributed by Disc AZ/Discodis)
Labels: (Owned) Delphine.
Int'l reps: Argentina (Tonodisc), Australia (WEA), Austria (Musica), Belgium (Polygram), Bolivia (Laurto), Brazil (CBS), Colombia (Incolve), Ecuador (Famoso), Finland (Sonet), Germany (Teldec), Greece (CBS), Israel (CBS), Italy (Discopi, RCA), Japan (Victor), Mexico (Gamma), Netherlands (CNR), Norway (Aene Bendixsen), Portugal (Mavna), South Africa (Gallo), Spain (Hispanavox), Sweden (Sonet), Switzerland (Musikvertrieb), UK (Sonet), Venezuela (Palacio de la Musica).
- De Plein Vent SARL, 5 Rue Jean Jaures, 07600 Vals les Bains. Tel: (75) 37.52.76. Telex: 345790. Dir.: Jean Gibaud.
Labels: (Owned) De Plein Vent, Prete-Moi Ta Plume, Trois Temps; (distributed-not licensed) Discadance.
- Hughes Desalle (Realisations Sonores) (IFPI), 5 Rue d'Artois, 75008 Paris. Tel: (01) 359.41.38, 278.77.88. Chief Exec.: P. Douzi.
Labels: (Owned) L'Ame de..., Disques Culturels Francais, Francais de Notre Temps, Hommes d'aujourd'hui, Poesie pour Tous.
- Detry Recs., 11 bis Rue Cdt. Pilot, 92200 Neuilly. Tel: (01) 624.84.85. Telex: 610753. Pres.: Jean-Louis Detry.
Labels: (Owned) Genal, Orange.
- Diffusion Artistique & Musicale, 95 Rue de France, 77300 Fontainebleau. Tel: (6) 422.07.20. Telex: 692723. Pres.: Didier Briard; Sales Mgr.: Andre Turban. (Distributor/Importer).
- Labels: (Licensed domestic) Cote d'Azur, Free Lance; (Licensed foreign) Bee Hive (USA), Blue Goose (USA), Concord (USA), Contemporary (USA), DRG (USA), EMI-Deleon (Brazil), Good Time Jazz (USA), India Navigation (USA), Indian House (USA), Interplay (USA), Jazz Dance (USA), Jazzology (USA), King Rare Bid (Germany, USA), Lyrichord (USA), Moers (Germany), Progressive (USA), Sackville (Canada), Shanachie (USA), Spotlight (UK), Sweet Earth (USA), Tool Room (USA), Yazoo (USA).
- Disc A7 France, 21 Silic 510, 20 Rue du Morvan, 94623 Rungis. Tel: 687.26.60. Telex: 642844. Dirs.: Benoit Buis, Francais Caussou, Victor Cohen, Guy Maheraut, Andre Tessanne, Jean Fumeron.
- Discadance, see De Plein Vent.
- DiscAZ-Discodis (IFPI), 32 Rue Francois ler, 75008 Paris. Tel: (01) 723.54.96. Telex: 290496. Gen. Mgr.: Pascal Farcouli; Mgt. Mgr.: Jean-Claude Corbineau; Prod. Mgr.: Henri Hoffmann; Int'l: Olivier Cossard, Claude Monet; Promo. Mgr.: Jacqueline Polloni Dagot; Adv. Mgr.: Divier Plat; Sales Mgr.: Jean-Claude Gagneux; Administrative Financial Mgr.: Alain Rabaud.
Labels: (Owned) AZ, BAM; (distributed) Canetti, Celluloid, Delove, Delphine, Hansa France, Hungaroton, Ibach, Ice, K-Tel, Lederman, Meys, Perides, Picabou, Scorpio, Souplet, Verchuren.
Int'l reps: Belgium (RCA), Canada (Beau Bec), Germany (Teldec), Portugal (Imavox), Switzerland (Disques-Office).
- Disc Africana, see Safari-Ambiance.
- Discara, see AFA.
- Discobird, 21 Rue Germain Pilon, 75018 Paris. (Distributor)
- Discodis, see DiscAZ.
- Disco-France SA, 124 bis Av. de Villiers, 75017 Paris. Tel: (01) 380.65.70. Telex: 290833. Dir. Gen.: Philippe Berge.
- Discoparade, 150 Blvd. Ney, 75018 Paris. Tel: (01) 252.37.14. (Jukebox trade distributor)
- Discophite Club de France, 6 Rue Monsieur le Prince, 75006 Paris. Tel: (01) 326.88.53. Telex: 202842. Dir. Gen.: Gregoire Katz (Distributor)
- Disco Shop, 22 Rue de la Republique, 94160 Saint Mandé. Tel: (01) 328.48.45, 365.14.37. Telex: 250303. Gen. Mgr.: Arlette Albohair.
Labels: (Distributed-not licensed domestic) Coda, Grand Druge, Licorine, Sappho, Valprias, Verseau; (distributed-not licensed foreign) Bis (Sweden), Chalfont (USA), Citadel (USA), Festivo (Netherlands), Folio Society (UK), Jecklin (Switzerland), Klavier (USA), Nimbus (UK), Saga (UK), Sarabande (USA), Spectrum (USA), Starlog (USA), Varese (USA).
- Discotheque de Paris, 55 bis Rue de Ponthieu, 75008 Paris. Tel: (01) 562.41.10, 562.77.48. Dir.: Jacques Mabilite.
- Discovalie, see P3.
- Disneyland, see Walt Disney & Ades.
- Walt Disney Prod'n France, 44 Av. des Champs-Elysees, 75008 Paris. Tel: (01) 359.17.80/02.20. Cable: MICKMUSE. Telex: 64062. Gen. Mgr.: Armand Bigte; Ass't: Madeleine Gate. (Distributed by Ades)
Home office: USA.
Labels: (Owned) Disneyland, Vista.
Disques Culturels Francais, see Hughes Desalle.
- Disques du Cavalier, 84220 Gordes. Tel: (90) 72.06.31.
- Divox, 93 Rue Robespierre, 62680 Mercourt. Tel: (21) 08.08.00. Gen. Mgr.: E. Stawski. (Distributor)
- Domaine Musical de Chambray, Allee Jean de Dckeghem, 37170 Chambray les Tours. Tel: (47) 28.10.02.
Labels: (Owned) Astree, Valois.
- Dorian, see Celluloid.
- Dragon Phenix, see Safari-Ambiance.
- Dreyfus, see CBS & Motors.
- Ducretet Thomson, see Pathe Marconi EMI.
- E G G, see Barclay.
- E M I, see Pathe Marconi EMI.
- E M Recs. (Europ Melodie), 11 Rue Bernoulli, 75008 Paris. Tel: (01) 522.81.36. Telex: 213980. Gen. Mgr.: Aubert Armand; Sales Mgr.: Hugo Paulin.
- Ecoute S'il Pleut, see RCA.
- Edwards Recs., 58 Rue du Docteur Calmette, 59320 Sequedun. Tel: (20) 07.57.01, 07.16.82. Telex: 120720. Gen. Mgr.: Theodore Georges Edwards.
Labels: (Owned) Edwards; (Licensed domestic) Cransac, JSB; (Licensed foreign) Intercord (Germany), Parsial (Belgium); (distributed-not licensed) BBC (UK), Biograph (USA), Cellier (Switzerland), Didié Blues (Netherlands), Diversea (Switzerland), Saphir (Germany), Topic (UK).
Elektra, see WEA Filipacchi.
- Emiltheco Music, 143 Blvd. Lebeuvre, 75015 Paris. Tel: (01) 250.64.46. Gen. Mgr.: Albert Cohen.
- Enfants Sages, see Ades.
- Epidaure, see Musidisc.
- Erato (Disques), 60 Rue de la Chaussée d'Antin, 75009 Paris. Tel: (01) 280.69.19. Cable: CDSTERAT. Pres. Dir. Gen.: Daniel Toscani du Plantier; Adjuvant Dir. Gen.: Michel Garcin; Press Servs.: Bernard Julien. (Distributed by RCA)
- Ereanu, see Daems.
- Erol, see SFPF.
- Escargot, see Sibecar.
- Esperance, see Sonodisc.
- Eurodisc, see Arabella & WEA Filipacchi.
- Eurogram (Societe Europeenne de Prod'n), 25 Rue du Lyand, Plaine St-Denis, 93200 Paris. Tel: (01) 243.43.40. Exec.: Jean Giaccardo; Sales Mgr.: Jean-Marie Voidie.
Labels: (Owned) Eurogram; (Licensed domestic) Cercle 135, French Line, Locomotive, Night & Day, Perspective; (Licensed foreign) Glette (Morane USA); (distributed-not licensed) Boorg (Luxembourg), Fordane (France), Gateway (USA), Metropole (France), Warner Music (France).
Int'l reps: Belgium (Sonica), Switzerland (Disque Office).
- Experience/Context, 8 Rue Emile Auloy, 75017 Paris. Tel: (01) 572.58.25, 572.42.45. Dir. Gen.: Philippe Doleau; Sales Mgr.: Jacques Galissant.
Labels: (Owned) Context, Experience, Impulse.
- F L V M, 23 Grande Rue, 95550 Bessancourt. Tel: (03) 960.70.97. Dir.: Jean-Marc Bailleur.
- F Y, see RCA.
- Fass Bee Int'l, see Studio Damiens.
- Faure, see Daems.
- Fauves, see Polydor.
- H. G. Carlo Ferrari Disques, 159 Av. de Wagram, 75017 Paris. Tel: (01) 622.08.37, 622.26.06. Dir. Gen.: Carlo Ferrari; Artistic Dir.: Marcel Vianot; PR: Rene Martigny.
- Festival, see Musidisc.
- Fidsound, see CNAI Fidsound.
- Fiesta 30 Rue Dr. Frinlay, 75015 Paris. Tel: (01) 578.15.18/24.75. Dir.: Patrick Chevalier.
- 5, see Carrere.
- Flammes de Velours, see Daems.
- Flarensch Prod'n Musicales, 57 Rue du Faubourg Montmartre, 75009 Paris. Tel: (01) 285.02.82, 878.68.75. Dir.: Alain Puglia. (Distributed by WEA Filipacchi)
- Flat Shot, see WEA Filipacchi.
- Flop Recs. Int'l Co., 21 Rue Jean Mermoz, 75018 Paris. Tel: (01) 225.61.00. Telex: 250303. Dir.: Denis Wolff.
Labels: (Distributed-not licensed) Musidisc, New Rose, Polydor.
- Fonta, see Daems.
- Fontana, see Phonogram.
- Fontgombault, see Studio SM.
- Force, see Carrere.
- Forlane, see Eurogram.
- Formule 1 (Prod'n Disques) (IFPI), 16 Rue Felicien David, 75016 Paris. Tel: (01) 524.69.10. Dir.: Guy Bayle. (Distributed by RCA).
- Francais de Notre Temps, see Hughes Desalle.
- France Radio Club, Le Hamel-Vitellier, 76450 Cany. Chm.: Daniel Lebeuvre.
- Free Bird, 19-23 Av. Jean Aicard, 75011 Paris. Tel: (01) 357.23.70. Telex: 240321. Dirs.: Bruno Baures, Dominique Buscali. (Distributor)
- Free Lance, see Diffusion Artistique.
- French Line, see Eurogram.
- Furax, see Music Machine.
- G A Rec., 31460 Loubens. Tel: (61) 83.12.55. Dir.: Gen.: Alain Grima.
- G I D (Guilde Int'l du Disque), Tour Franklin, 92081 Paris la Defense, Cedex 11. Tel: 776.42.21. Telex: 610053. Mgr.: Claude Chuteau.
- Galata, see Chant du Monde.
- Gamma Int'l's (Eds.), 10 Rue Pasteur, 92300 Levallois. Tel: 270.81.40. Telex: 42.220064. Pres.: Blanche Bidard; Press: Isabelle Compel.
- Garance, see RCA.
- Garima Prod'n SA, 93 Av. Niel, 75017 Paris. Tel: (01) 622.39.80. Pres. Dir. Gen.: Renato Cerr; Gen. Mgr.: Giancarlo Cerr.
- Gaumont, see WEA Filipacchi.
- Genal, see Detry.
- Generale Importation de Disques, 29 Rue de Consulat, 87400 Limoges. Tel: (55) 34.65.49. Telex: 580043. Gen. Mgr.: Fernand Daffos; Sales Mgr.: Evelyne Daffos. (Distributor/Importer)
- Imports from Italy, UK, USA.
- General, see Carrere.
- General Music France, see WEA Filipacchi.
- Globe, Tougout, 29234 Plouigneau. Tel: (98) 79.84.38. Admin. & Comm'l Dir.: M. le Houeron; Artistic Dir.: Jean Rene Nogues.
- Gold Seal, see RCA.
- Goss, see Musica.
- Grand Druge, see Disco Shop & Teleson.
- Grands d'Espagne, see Daems.
- Gratte-Ciel SARL, 23 Grande Rue, 95550 Bessancourt. Tel: (03) 960.70.97. Dir.: Jean-Marc Bailleur.
Labels: (Owned) Chromophonie, Gratte-Ciel.
- Guilde Int'l du Disque, see GID.
- Gypsy Prod'n, 28 Rue de la Reine Blanche, 75013 Paris. Tel: (01) 535.03.96. Gen. Mgr.: Louis Battut; Mgr.: Danyel Gerrard.
- Hachette (Prod'n Sonore), 79 Blvd. Saint Germain, 75006 Paris. Tel: (01) 329.12.24. Telex: 204434. Cable: HACHECI. Dir. & Sales Mgr.: Lyliane Aubrun; Gen. Mgr.: Marc Moinjeon.
- Hansa France, 39 Rue Jean Goujon, 75008 Paris. Tel: (01) 225.46.52. Telex: 642760. Dir. Gen.: Frank Lipski.
- Harmonia Mundi SA (IFPI), St. Michel de Provence, 04300 Forcalquier. Tel: (92) 76.61.02. Telex: 430519. Pres.: Bernard Coutaz; Dir. Gen.: Rene Gouffon; Prod': Robina Young.
- Heloise, 5 Rue Benouville, 75116 Paris. Tel: (01) 727.07.51. Telex: 613108. Pres.: Anges Saint-Pieux. (Distributed by Carrere)

- Heol, see Arfolk.
- Hexagone, 81 Rue Lemercier, 75017 Paris. Tel: (01) 229.09.79. Pres.: Rene Boyer; Int'l Mgr.: Gabriel Ibos.
- Labels: (Owned) Hexagone, Twin-Trees; (licensed foreign) Tempus (UK). Int'l reps: Belgium (WEA), Canada (Gamma/CBS), Denmark (Metronome), Italy (Ariston), Netherlands (WEA), Spain (Movieplay/CFE), Switzerland (Disques Office), UK (Projection).
- Hommes d'Aujourd'hui, see Hugues Desalle.
- Horse, see A&M.
- Horne Recs., 134 Rue D'Avron, 75020 Paris. Tel: (01) 373.66.75. Mng. Dir.: Tony Amaraggi; Sales Mgr.: Maria Amaraggi, UK Mgr.: Charles Blackwell.
- I M L, see Montparnasse 2000.
- I R I, see International Rec.
- I Rouge, see RCA.
- Ibach (Disques), 125 Av. de Versailles, 75016 Paris. Tel: 520.04.75. Telex: 201760. Pres.: H. Ibach; Assoc.: Charles Rineri. (Distributed by Disc'AZ)
- Iberia, see Daems.
- Ice, see Disc'AZ.
- Il, see RCA.
- Imadyazen, see CBS.
- Impact, 24 Blvd. de l'Hopital, 75005 Paris. Tel: (01) 535.35.50. Telex: 201760. Dir. Gen.: Christian Noaille.
- Labels: (Owned) Contour, Impact.
- Impulse, see Experience.
- International Dist'n Co. (IDC), 116 Champs Elysees, 75006 Paris. Tel: (01) 563.17.27. Telex: 641605. Mng. Dir.: Georges-Henri Lammert.
- International Prod'n Cinearts, 7, 25 Rue Cavendish, 75019 Paris. Tel: (01) 200.29.35. Gen. & Sales Mgr.: Laurent Bussaut. (Distributor/Importer)
- International Rec. Imports, 27 Rue de Rouen, 92400 Courbevoie. Tel: (01) 788.37.75. Owner: Enzo Hamilton; Gen. Mgr.: Jennifer Williams; Sales Mgr.: Jacques Hubert.
- Labels: (Owned) Atmosphere, IRI.
- International Shows SA (I.S. Drlando), 10 Rue Damremont, 75018 Paris. Tel: (01) 606.88.35. Dir.: I.S. Drlando; Admin.: Rosy Nosek.
- Label (Owned) Drlando. (Distributed by Carrere)
- Int'l reps: Canada (Able), Germany (Montana), Greece (Phonogram), Israel (CBS), Japan (King), UK (EMI).
- Iris, see P3 & Arfolk.
- Isadora, see RCA.
- J A D E Disques, 11 Rue des Gravieres, 92200 Neuilly/Seine. Tel: (01) 745.31.11, 391.98.49. Dir.: Alain Jaillard.
- Label: (Represented) Muza (Poland).
- J B P (Disques), 39 Rue Pasteur, 69001 Lyons. Tel: (07) 872.76.94.
- J C R (Disques), "La Roche d'Agne." Ileuil, 86240 Liguze. Tel: (49) 43.18.25. Mng. Dir.: Jean-Claude Riffaud; Dir.: Marianne Riffaud.
- J M S (Disques), 3 Rue Cesar Franck, 75015 Paris. Tel: (01) 566.42.00. Chief Exec.: Jean-Marie Sahnani. (Distributed by Polydor)
- J P C B Prod'ns Paris, 10 Blvd. des Batignolles, 75017 Paris. Tel: (01) 387.31.89. Telex: 280216F. Dir. & Sales Mgr.: Gerard Martin; Gen. Mgr.: Jean-Paul Bretagne.
- J S B, see Edwards.
- Jacinthe, see Daems.
- Jackman, see Playasound.
- Dick James Recs. (France) SARL, 10 Rue des Petites Ecuries, 75010 Paris. Tel: (01) 523.41.20. Contact: Rene Talar. (Distributed by Vogue)
- Label: (Owned) DJM.
- Jazz Anthology, see Musidisc.
- Jazz Legacy, see Vogue.
- Jazz Selection, see Vogue.
- Jazz Today, see Vogue.
- Jeunesse de France, see Daems.
- Jonathan, see Atoll & Polydor.
- Junquer d'OC SARL (IFPI), 9 Rue des Ecoles, 64110 Jurancon. Tel: (59) 32.32.52. Dir. Gen.: Jean Moureau.
- K, see Celluloid.
- K I C D Music, 64 Rue Sadi Carnot, 93170 Bagnollet. Tel: 360.95.52/54.74. Gen. Dir.: Benoit Kaufman; Admin. Dir.: Michel Cron.
- K-Tel Int'l (France) & Cie., 2 Palce du Palais Royal, 75001 Paris. Tel: (01) 297.06.70. Telex: 220176.
- Kaleidoscope, see Vogue.
- Kellenn, Kerwin, 29215 Guipavas. Tel: (98) 84.61.18
- Kelta, see Arfolk.
- Kondo-Ra, see CBS.
- Kouma, see Sonodisc.
- Kukios, see Carrere.
- L M C, 56 Blvd. Exelmans, 75016 Paris. Tel: 651.41.15. Dir.: Claudio del Monaco.
- L M C E (Lide Music Champs-Elysees), 78 Av. des Champs-Elysees, 75008 Paris. Tel: (01) 359.53.50.
- L T D, see Abbey Road.
- Ladybird, see Daems.
- Laguna, 71 Rue de Chignancourt, 75018 Paris. Tel: (01) 252.21.90, 257.29.50, 26.47.65. Admin. & Comm'l Dirs.: Messrs. Labarre & Vrutte.
- Lecomte, see Daems.
- Lederman, see Disc'AZ.
- Ledoux Recs., PO Box 25, 62 Rue Maurice-Rigolet, 91550 Paray Vieille Poste. Tel: 048.88.24. Dir.: Sylla M. Abou.
- Legal, see Daems.
- Michel Legrand (Prod'ns), 12 Rue de Penthièvre, 75008 Paris. Tel: (01) 266.40.42. Pres.: Marcelle Legrand; Gen. Mgr.: Marcel Rothel.
- Leguz, see Carrere.
- Francis Lemarque (Les Prod'ns), 18 Av. du Mesnil, 94210 La Varenne-St. Hilaire. Tel: 883.34.21.
- Let It Shine Recs., c/o Homerc, 9 Rue Jean Mermoz, 75008 Paris. Tel: (01) 720.09.09. Pres.: Philippe Renaux. (Distributed by Polydor)
- Libellule, see Music for Pleasure.
- Libet (Disques), 22 Rue Carnot, 76700 Harfleur. Gen. Mgr.: Guy Libet.
- Licorniere, see Disco Shop.
- Locomotive (Disques), 16 Av. Paul-Doumer, 75016 Paris. Tel: (01) 520.37.53. Telex: 614650. Dir. Gen.: Michel Lagens.
- Loopings, see Daems.
- Lumen, see Studio SM.
- Lyrion Music, 17 Av. Quibou, 94160 Saint Mandé. Tel: 365.57.46. Mktg. Dir.: Jean-Michel Tailade; Mgmt. Dir.: Patrick Liebermann.
- Labels: (Owned) Lyrion; (distributed-not licensed) Ars Polona (Poland), Shandar (France), Veia (France), Voix du Globe (France).
- M P D (Mirillon Prod'ns Disques), 35 Av. du Bac, 94210 La Varenne-St. Hilaire. Tel: 883.53.29. Gen. Mgr.: Louise Pon.
- Labels: (Owned) MPD, Mirillon.
- M P 2000, see Montparnasse 2000.
- M T E Co., 150 Blvd. Ney, 75018 Paris. Tel: (01) 252.37.14. Gen. Mgr.: Eric Ghenssia. (Distributed by CBS)
- Madeline, see RCA.
- Magiciens du Rythme, see Daems.
- Maia (Disques), 27 Rue de Bouloi, 75001 Paris. Tel: (01) 233.03.55. Dirs.: F. Chambon, G. Burgun.
- Majestic, see Radio-Programmes.
- Malfroy, 7 Rue Saint-Vincent, 40103 Dax Cedex. Tel: (58) 74.65.69. Owner: Dominique Malfroy; Technical & Artistic Dir.: Jean Malfroy.
- Malligat, see WEA Filipacchi.
- Malyense, see Barclay.
- Martinez, see RCA.
- Mary, see Carrere.
- Melinda K., 4 Rue Petrelle, 75009 Paris. Tel: 526.84.79. Telex: 642652. Pres.: Jean Louis Tersiguel; Dirs.: Agnes Lable. (Wholesaler/Exporter)
- Melodisc SARL, 36 Rue Mailly, 66000 Perpignan. Tel: (68) 34.65.40. Dir.: Georges Bannier.
- Mercury, see Phonogram.
- Metropole Recs., 1 Rue Danton, 75006 Paris. Tel: (01) 325.02.59. Telex: 260911. Pres.: Bernard Kreif; Prod'n Dir.: Daniel Goldschmit; Press: Marianne Comtell. (Distributed by Eurogram)
- Michel Meyer & Cie., 8 Rue de l'Est, 92100 Boulogne. Tel: (01) 605.43.21. Telex: 201336. Dir.: Michel Meyer; Gen. Mgr.: Philippe Terrier.
- Label: (Owned) Contrast.
- Meys, see Disc'AZ.
- Midi, see WEA Filipacchi.
- Milan, see Societe Phonogramme.
- Minoature, see BBZ.
- Miara Venter, see Daems.
- Mirliton, see MPD.
- Mode, see Vogue.
- Monastères, see Studio SM.
- Mondial Tele Show, see Phonogram.
- Mondiomusic, see Vogue.
- Montparnasse 2000, 22 Rue Drouot, 75009 Paris. Tel: (01) 246.48.47. Gen. Mgr.: Guy Szkolczak.
- Labels: (Owned) IML, MP 2000, ST GDP; (distributed) Zero Int'l.
- Int'l reps: Argentina (Annibal Libenson), Australia (Castle), Belgium (Prestation), Canada (Creasound), Germany (Inmus), Italy (Flipper), Scandinavia (Nordiska), UK (Modern).
- More, see Quenotte.
- Motors/Dreyfus (Disques), 26 Av. Kleber, 75116 Paris. Tel: (01) 500.77.07. Telex: 611130. Pres.: Francis Dreyfus; Ass't: Daniele Feuillat; Promo. Mgr.: Bernard Dulau. (Distributed by CBS)
- Labels: (Owned) Dreyfus, Motors.
- Int'l reps: Belgium, Luxembourg, Netherlands (all Ariola), Germany, Greece, Israel, Scandinavia, Spain (all CBS), Switzerland (Vogue/CPSA).
- Musica Dist'n SA., 39 Rue Huguerie, 33000 Bordeaux. Tel: (56) 48.97.79, 48.47.30. Owner: Alain Boucanus.
- Labels: (Owned) All Life, Musica; (distributed-not licensed domestic) Art, M. Benin, Carlyne, Cobalt, Cyl, Goss, Dpen, Scopozzule; (distributed-not licensed foreign) Appalosa (Italy), Black Saint (Italy), ENJA (Germany), Hat Hut (USA), Hora (Italy), ICP (Netherlands), Red (Italy), Soulnote (Italy), SteepleChase (Denmark), Timeless (Netherlands).
- Int'l reps: Germany (Helmut Marcuse), Italy (IREC), Switzerland (Plainsphare), USA-Calif. only (Rick Ballard).
- Musica Control (IFPI), 35 Rue la Boetie, 75008 Paris. Tel: (01) 561.17.44, 563.61.77. Dir.: Claude Fliniata; Gen. Mgr.: Pascale Randon.
- Labels: (Owned) Capriccio, Tou Lou Lou; (licensed domestic) 3A; (distributed-not licensed) Afrivision, NYTE, Tackle.
- Musica for Ever, see Daems.
- Musica for Pleasure (IFPI), 57 Blvd. de la Republique, 78400 Chatou. Tel: (03) 071.30.79. Telex: 698730. Pres. Dir. Gen.: A. Gerondeau; Sales Mgr.: G. Durampart; Finance & Admin.: J. Brown.
- Labels: (Owned) Classics for Pleasure, Libellule, Musica for Pleasure, Musica Melody.
- Musica Machine, 7 Rue de l'Ecole Polytechnique, 75005 Paris. Tel: (16) 634.09.22. Telex: 620893. Gen. Mgr.: Caroline Scrot.
- Labels: (Distributed-not licensed) Furax (France). Impact (France). Pickwick (UK).
- Musica Melody, see Musica for Pleasure.
- Musica-Zag, Vaunaveys, 26400 Crest. Tel: (75) 75.43.64. Dir.: Philippe Feladat; Gen. Mgr.: Sebastien Feladat.
- Int'l reps: Belgium (WEA), France (WEA), Canada (Fontane).
- Musidisc-Europe (Societe) (IFPI), 13-15 Rue Pages, 92152 Suresnes. Tel: 772.70.36. Telex: 630946. Pres.: Francois Grandchamp des Raux; Dir. Gen.: Jean Grandchamp des Raux; Dirs.: Serge Martiano, Jaime Dbszewicki; Prod. Dir.: Jean-Jacques Timmel; Press: Christine Lion.
- Labels: (Owned) Accord, America, Cynus, Festival, Jazz Anthology, Musidisc; (licensed) Arhoolie (USA), Fantasy (USA), Gull (UK), Milestone (USA), Prestige (USA), Splash (UK), Springboard (USA), Storyville (Denmark), Vanguard (USA); (distributed-not licensed) Atmosfera (France), CRD (UK), Epidaurie (France), Riverside (Japan).
- Musique Pour l'Image, 4 Rue de Beynes, Cressay, 78640 Neauphle le Chateau. Tel: (01) 489.03.07. Dir.: Robert Vigny.
- Musica France SARL, 65 Rue de Belleville, 75019 Paris. Tel: (01) 872.99.36. Pres.: David Zarl; Mng. Dir.: Gabriel Courlet.
- N W 8, see Abbey Road.
- Night & Day, see Eurogram.
- Noce & Banquets, see Daems.
- Nonesuch, see WEA Filipacchi.
- Dbio, see Monsieur Jean Bienvenu.
- Oceane, see Sonodisc.
- Odeon, see Pathe Marconi EMI.
- J-2-3, see Vendemiaire.
- Dpen, see Musica.
- Dr, see Salvador.
- Orange, see Detry.
- Drlando, see International Shows & Carrere.
- Claude Drlys, 6 Rue Capitaine Escudie, 31000 Toulouse. Tel: (61) 62.48.55.
- Drphee, see Compagnie Generale du Disque.
- Drphee-Disques, 24 Rue Assailit, 06000 Nice. Tel: (93) 85.48.95. Comm'l Dir. & Gen. Mgr.: Gerard Combe. (Importer-classical product)
- Labels: (Imported) ABC Dunhill (USA), Acania, Angel, Assimil, BASF, Bongiovanni, Bruno Walter Suci, CBS, Candela, Celra, Columbia, DG, Decca, EMI, Everest, Harmonia Mundi, Hungaroton, London, Mace, Melodiya, Monitor, Nonesuch, Dsusy, Philips, Quincentess (USA), RCA, Request, Saga, Seraphim, Supraphon, Turnabout, Vanguard, Victrola, Vox-Box, Westminster (USA).
- Duragan, see Atoll.
- Dwl Recs., 42 Rue Monge, 75005 Paris. Tel: (01) 331.63.59. Gen. Mgr.: Jean Jacques Pussiau. (Distributed by Free Bird)
- P A L M, see Vendemiaire.
- P F D (Production Francaise de Disques), 67 Rue des Freres Lumiere, 93330 Neuilly sur Marne. Tel: 300.53.00, 300.58.00. Telex: 212092. Chm.: E. Arav; Gen. Mgr.: N. Alshech; Sales Mgr.: J. Arav; Mfg. Mgr.: I. Alshech; PR: H. Arav.
- P 3 (Prod'ns) SARL, Lattelou, 29290 Milizac. Tel: (98) 03.27.52. Dir. Gen.: Renaud Richard.
- Labels: Boite Magique, Discovale, Iris.
- Pacific, see Vogue.
- Pastori, see Daems.
- Pathe Marconi EMI (IFPI), 36 Rue Pierret, 92200 Neuilly sur Seine. Tel: (01) 758.12.48. Cable: GRANDPHDNE. Telex: 613550. Pres. & Gen. Mgr.: Alain Gerondeau; Sales Mgr.: Yves Crevoisier; Mktg. Mgr.: Jacques Chazeau. A&R Mgr.: Alain De Ricou; Int'l Dept. Mgr.: Gilles Petard; French A&R Mgr.: Claude De Jacques.
- Labels: (Owned) Columbia, Duretelt Thomson, EMI, Ddeon, Pathe Marconi, Punch, Tranan, Voix de Son Maitre-VSM; (licensed) Angel (USA), Apple (UK), Arista (UK), Bovema (Netherlands), Butterfly (USA), Capitol (USA), Da Capo (Italy), Dicap (Chile), Electrola (Germany), Harvest (USA), Motown (USA), PDU (Italy), RAK (UK), Real (USA), Red Bus (UK), Rolling Stones (UK), Savoy (USA), Sire (USA), Tamla (USA), Trova (Argentina), Telefunken (Germany), Toshiba (Japan), Trojan (UK).
- Int'l reps: Bolivia (Discolandia), Colombia (CBS), Czechoslovakia (Arista), Dominican Republic (Julio Tonos), Ecuador (IFESA), Israel (CBS), Japan (Toshiba), Nicaragua (Sonido), Philippines (Uryna Prods.), Portugal (Valentim de Carvalho), Thailand (Kamol Sukosol), Uruguay (Palacio de la Musica), USA (EMI America), Venezuela (Los Ruices), Yugoslavia (Jugoton), rest of world (EMI).
- Pema Music, 5 Rue Denis-Poisson, 75017 Paris. Tel: (01) 574.43.72, 359.95.70. Telex: 260648. Gen. Mgr.: Georges Bacri; Sales Mgr.: Corinne Roche.
- Perfect, see Carrere.
- Pergola, see WEA Filipacchi.
- Perdes, see Disc'AZ.
- Perspective, see Eurogram.
- Petit Escargot, see Sibecar.
- Petit Menestrel, see Aides.
- Philips, see Phonogram.
- Phonogram SA (IFPI), 24 Blvd. de l'Hopital, 75005 Paris. Tel: (01) 336.32.30. Telex: 270673. Pres.: Jacques Caillat; Gen. Mgr.: Marc Grandemange; Sales Mgr.: Dominique Dauphin-Meunier; Int'l A&R Mgr.: Jean-Paul Commin.
- Labels: (Owned) Fontana, Impact, Mercury, Philips, Vertigo; (licensed domestic) Mondial Tele Show; (licensed foreign) Casablanca (USA), Charisma (UK), Island (UK); (distributed-not licensed) Adele (France), Biram (France), ECM (Germany), Rocket (UK).
- Int'l reps: Worldwide (Polygram).
- Picabou, see Disc'AZ.
- Plateforme 2000, 20-22 Rue Ballu, 75009 Paris. Tel: (01) 285.83.00. Telex: 642581. Pres.: Hubert Bailly.
- Playasound (Disques), 66 Rue de l'Est, 92100 Boulogne/Seine. Tel: 603.76.81. Gen. Mgr.: Alain Normand. (Distributed by Music-Control)
- Labels: (Owned) Playasound; (licensed domestic) Jackman.
- Int'l reps: Australia (Carima), Austria (Preisler), Belgium (Parsifal), Germany (Marcuse), Italy (IRD), Japan (Superst), Netherlands (Sound), Switzerland (Vogue), UK (Conifer), USA (Earth).
- Plein Soleil SARL, 6 Rue Galilee, 75116 Paris. Tel: (01) 723.90.10. Co-Pres.: Harry Auserhan, Bernard Ricci.
- Pluriel (Eds.), BP 21, 61350 Passais la Conception. Tel: (33) 38.77.23. Chief Exec.: Jean Foucher.
- Int'l rep: Europe (RCA/Sunbar).
- Poesie pour Tous, see Hugues Desalle.
- Polydor SA (IFPI), 2 Rue Cavallotti, 75882 Paris Cedex 18. Tel: (01) 522.05.39. Cable: PDLYDDRDISC. Telex: 650522. Pres. & Mng. Dir.: Alain Trossat; Sec'y Gen.: Patrice Fichet; Financial Mgr.: Gerard Lendrieux; Mktg. Mgr.: Gilles Paire; Sales Mgr.: Marcel Mangin; Creative Serv. Mgr.: Rene Gutton.
- Home office: Germany.
- Labels: (Owned) Polydor, Polydor Special, Triumph, Trump; (licensed foreign) Archiv (Germany), Deutsche Grammophon (Germany), Dreamland (USA), EG (UK), Energy (UK), Hispavox (Spain), Logo (UK), Lollipop (Germany), Magnet (UK), Metronome (Germany), RSD (USA), Transatlantic (UK), Verve (USA); (distributed-not licensed) Aides, Atoll, CRC, Fauves, JMS, Jonathan, Let It Shine, Ring, Saban, Sirocco, Tristan.
- PolyGram Inds. & Messageries (IFPI), Av. Maurice Ravel, 92160 Antony. Tel: 666.21.02. Telex: 270395. Directeur Pres.: Edmond Lang; Int'l Dir.: Fernand Pasquier; Sec'y Gen.: Bruno d'Orgeval; Technical Dir.: Christian March; Factory Dir.: P. Crapard; Comm'l Dir.: Jean-Michel Allays.
- PolyGram SA, 53 Av. Franklin D. Roosevelt, 75008 Paris. Tel: (01) 225.70.40. Chief Exec.: Louis R. Hazan; Sr. Legal Advisor: Michel Libermann; Finance & Admin. Mgr.: Jean-Claude Larue.
- Pop English Creations, 118 Rue Jean-Pierre Timbaud, 75011 Paris. Tel: (01) 805.63.12. Pres. & Gen. Mgr.: Michele Marie Dupire.
- Porte Oceane, 21 Rue de Berne, 75008 Paris. Tel: 387.46.51. Gen. Mgr.: Marguerite Santreuil.
- Pragmaphone, see PALM.
- Prete-Moi Tu Plume, see De Plein Vent.
- Prodes, 42 Av. Marechal Foch, 06000 Nice. Tel: (93) 80.06.02. Pres. & Dir. Gen.: F. Bauche; Gen. Mgr.: G. Lavaud; Sales Mgr.: Claude Mullender.
- Promotion, see Daems.
- Prosadis, 14 Av. Hoche, 75008 Paris. Tel: (01) 561.16.55. Mgr.: Claude Daffe.
- Publicis-Musique, see Radio-Programmes.
- Puccinella, see Sopredim.
- Puerta del Sol, 32 Blvd. de Clichy, 75018 Paris. Tel: (01) 264.27.81. Gen. Mgr.: Don Diego.
- Labels: (Represented) Clave (Spain), Dsvaldo Farres (USA), Puerta del Sol (Spain), Quiroga (Spain).
- Int'l rep: Spain (Quiroga).
- Punch, see Pathe Marconi EMI.
- Pure Gold, see RCA.
- Quenotte (Ed.), 86 Rue Haxo, 75020 Paris. Tel: (01) 363.95.19. Gen. Mgr.: Jacky Reggan.
- Labels: Caroline, More, Quenotte.
- Quincentess, see Arion.
- R C A SA (IFPI), Immeuble Matignon-Mermoz, 9 Av. Matignon, 75008 Paris. Tel: (01) 256.70.70. Telex: 650703. Pres. & Gen. Mgr.: Francois Dca.
- Home office: USA.
- Labels: (Owned) Bluebird, Camden, Gold Seal, Pure Gold, RCA, RCA Int'l, Red Seal, Star Series, Sunbar, Victor, Victrola; (licensed domestic) Cavalier, FY, Garance, Madeline, Temporet; (licensed foreign) Grunt (USA), KD (Canada), Pablo (USA), Valdene; (distributed-not licensed) Argille, Atoll, BBZ, Ecoute S'il Pleut, Erato, Garima, If I Rouge, Isadora, Martinez, Saravak, Sibecar, Trema.
- Int'l rep: Worldwide (RCA).
- R G R Prod'ns, 41 Rue du Chateau des Rentiers, 75013 Paris. Tel: (01) 583.67.77. Telex: 230301. Chief Exec.: Gerard Demaziere; Gen. Mgr.: Robert Vieux.
- Radar, see WEA Filipacchi.
- Radio-Programmes/Jacques Canetti, 24 Rue Hungenes & Coli, 75016 Paris.

Tel: (01) 605.28.70. Pres. Jacques Canetti; Dir. Gen.: Lucienne Canetti; PR Francoise Canetti. (Distributed by Disc'A.)
Labels: (Owned) Belior, Canetti, Majestic, Puflicis-Musique.
 Rames, 11 Rue Jean de Beauvais, 75005 Paris. Tel: (01) 329.75.06. Dirs.: Eric Vivie, J.L. Rizet. (Distributed by Polydor)
 Record Shop, 18 Rue Plisson, 94160 St-Mande. Tel: (01) 365.52.23. Telex: 240377. Pres. Dir. Gen.: Serge Kniazeff. (Distributor/Importer/Exporter)
 Red, see Sopredim.
 Red Seal, see RCA
 Reflets d'Alsace, see Daems.
 Reflets du Poulou, see Daems.
 Rempa/Caro Music, 94 Rue la Fontaine, 75016 Paris. Tel: (01) 525.51.31. 527.03.07. Dir.: Jacky Giordano.
 Reprise, see WEA Filipacchi.
 Ricordi, 12 Rue Rougemont, 75009 Paris. Tel: (01) 246.24.97. Pres.: Guido Rignano.
 Rigolo, see Salvador.
 Ring, see Atoll & Polydor.
 Riviera, see Barclay.
 Rochouise, see Carriere.
 Ros du Musette, see Daems.
 Rosano, see Daems.
 S E L/Levain (Disques), 1 Rue de l'Abbe Gregoire, 75006 Paris. Tel: (01) 222.15.84. Gen. Mgr.: Daniel Truchot.
Int'l reps: Belgium (Edibon), Canada (Levain)
 S E M A Sarl., PO Box 232, 03208 Vichy Cedex. Tel: (70) 32.08.41.
 S E R P (Societe d'Etudes & Relations Publiques); Disques (IFPI), 6 Rue de Beaune, 75007 Paris. Tel: (01) 261.09.73. Dirs.: J.M. Le Pen.
Int'l reps: Belgium (Phono-Office), Switzerland (Ste. Lugeon).
 S F P P (Societe Francaise de Prod'n Phonographiques) (IFPI), 10 Rue Pasteur, 92300 LeVallois. Tel: (01) 737.09.15. Telex: 220064. Mng. Dir.: Michel Bachelet.
Labels: (Owned) AMP, SFP, Sloughy, Spalax; (licensed foreign) Gamma (Canada); (distributed domestic-not licensed) Eroll; (distributed foreign-not licensed) Tangent (UK).
Int'l reps: Belgium (Schott), Canada (Musima-1), Germany (Bellaphon), Netherlands (Hosat), Sweden (SAM), Switzerland (Evasion).
 S M, see Studio SM.
 S P I, see Societe Phonogramme.
 S T GDP, see Montparnasse 2000.
 S V D A (Sirenes), Le Triangle Place Rene Descartes, Montpellier. Tel: (67) 4923.53. Telex: 490833, 480345. Gen. Mgr.: Robert Frances.
Int'l rep: USA (Mark Lee).
 Saban, see Polydor.
 Safari-Ambiance, 118-130 Av. Jean-Jaures, 75019 Paris. Tel: (01) 200.56.42, 201.59.81. Gen. Mgr.: Charles Mamataki; A&R Dir.: Colette Lacoste.
Labels: (Owned) Disc Africana, Dragon Phem, Volta Symphonie; (licensed foreign) Rite Sound (Jamaica, UK).
 Safta-Antologie Sonore, see Aedes.
 Salvador (Prod'n Artistiques & Musicales), 6 Pl. Vendome, 75001 Paris. Tel: (01) 260.87.80, 260.87.05. Pres. & Dir.: Henri Salvador.
Labels: (Owned) Dr. Rigolo, Salvador.
 Santeliseo, see Daems.
 Sappho, see Disco Shop.
 Saravak, see RCA.
 Sava, see Bagatelle.
 Schott Freres Sarl (IFPI), 35 Rue Jean Moulin 94300 Vincennes. Tel: 374.30.95. Dir.: Jean-Jacques Junne. (Distributor/Importer)
Labels: (Distributed-not licensed) Baerenreter (Germany), Cantate (Germany), Carus (Germany), Da Camera (Germany), FSM (Germany), Italia (Italy), Monitor (USA), Schwann (Germany), Tocatta (Germany), Unicorn (UK), Unisono (Germany), Vox (USA), *Mergo (Germany), Zephyr (Belgium).
 Scopmusic, 28 Rue Pere Louis de Jabrun, 33000 Bordeaux. Tel: (56) 81.18.84. Gen. Mgr.: Gerard Dulucq.
Labels: IDI, Scopmusic.
 Scoppuzze, 3 Rue Fenelon, 24200 Sarlat. Tel: (53) 59.35.15. Chief Exec.: Bernard Batzenschlager. (Distributed by Musica)
 Scorpio Music (Black Scorpio), 5 Rue Clement Marot, 75008 Paris. Tel: (01) 720.43.95. Telex: 642981. Pres.: Daniel Belolo; Sales Mgr.: Ginette Miramon.
 Secretariat Artistique Prod'n, 30 Rue Pierre Semard, 75009 Paris. Tel: (01) 526.49.20.
 Sephora Music, 45 Rue de Thillois, 51100 Reims. Tel: (26) 49.91.91. (Distributor)
 Storzando/Sirocco (Eds. Musicales) (IFPI), 42 Rue Laugier, 75017 Paris. Tel: (01) 267.04.69, 766.23.64. Telex: 260717. Dir.: Roger Tokarz. (Distributed by Polydor)
Label: (Owned) Sirocco.
Int'l reps: Australia (EMI, RCA), Austria (Ariola, Hansa, Teldec), Belgium (Barclay, Polydor), Brazil (Tapacar), Canada (RCA), France (Polydor), Germany (Ariola, Hansa, Teldec), Italy (Atlas, Phonogram), Japan (Phonogram), Mexico (CBS), Netherlands (Bovema, EMI), New Zealand (RCA), Scandinavia (Hansa), Spain (Zafiro), Switzerland (Polydor), UK (GTD, Hansa), USA (TK).
 Shandar-Andson 40 Rue Mazarine, 75006 Paris. Tel: (01) 326.84.35. Dir.: Chantal Darcy. (Distributed by Lyron)
Label: (Owned) Shandar.
 Sibcar, Prod'n Musicales, 99 Rue de Vaugirard, 75006 Paris. Tel: (01) 544.55.31. Dir.: Gilles Blevieus; Ass't Dir.: Sylvie Cuau. (Distributed by RCA).
Labels: (Owned) Escargot, Petit Escargot; (licensed foreign) Le Nordet, Presqu'ile (both Canada).
Int'l reps: Belgium (RCA), Spain (CEF), Switzerland (Evasion).
 Sigem (Sistema Globo de Edicoes Musicais), 31 Blvd. Suchet, 75016 Paris. Tel: (01) 527.03.12. Contact: Elyane Georgette Peyrot.
Home office: Brazil.
 Sirano Sarl., 60 Av. Raymond Poincare, 75016 Paris. Tel: (01) 553.97.50. Telex: 630082. Pres.: Jean-Claude Simard; Ctr.: Yves Roze; Promo.: Dorothee Becourd.
 Sirenes, see SVDA Sirenes.
 Sirocco, see Storzando/Sirocco & Polydor.
 Sloughy, see SFPF.
 Smack, see Charly.
 Societe Francaise de Prod'n Phonographiques, 10 Rue Pasteur, 92300 LeVallois. Tel: (01) 737.09.15. Dir. Gen.: Michel Bachelet; Admin.: Claude Ferrabouc; Artistic Dir.: Jacky Chalard; Label Mgr.: Gabriel Ibo.
 Societe Phonogramme Int'l, 22 bis Rue Pajol 75018 Paris. Tel: (01) 208.76.63. Telex: 240203. Mng. Dir.: Emmanuel Chabredon; Sales Mgr.: Jean Francois Boucher; Financial Dir.: Daniel Gibeau; Int'l Mgr.: Odrich Horak.
Labels: (Owned) Milan, SPI, Squire; (licensed foreign) Qurium (Italy), Dpus (Czechoslovakia), Salsoul (USA), Vox Musicalis (USA).

Int'l reps: Belgium (WEA), Germany (Warren), Netherlands (WEA), Switzerland (Metronome).
 Soleil Masque, see PALM.
 Solesmes, see Studio SM
 Sonafisc, see Sonadisc.
 Sonart (Disques), PD Box 1, 38700 La Tronche. Tel: (76) 88.01.58. Dir.: Yves Chauvet.
 Sonodisc (Societe Nouvelle de Distribution de Disques), 85 Rue Fondary, 75015 Paris. Tel: (01) 577.30.34. Cable: SDNDDISC. Telex: 204018. Pres. & Gen. Mgr.: Marcel Perse; Sales Mgr.: Michel David.
Labels: (Owned) Esperance, Kouma, Sonafisc; (licensed domestic) Oceane; (licensed foreign) Alegre (Latin America), Ararat (Armenia), Cofique (Latin America), Fania (Latin America), Gema (Latin America), Lys (Armenia), SLD (Lebanon), Seeco (Latin America), Songhoi (Africa), Sono Caro (Egypt), Tico (Latin America), Tropical (Latin America), Vaya (Latin America), Voice of Stars (Lebanon), WS Latino (Latin America); (distributed-not licensed) Debs (West Indies), Dzileka (Africa), Vacances (West Indies), Voix du Liban (Lebanon).
Int'l reps: Australia (Z Dist'), Canada (Almada), Egypt (Sono Cairo), Germany (Bellaphon), Italy (CBS-Sugar), Japan (Japan Musical Express), Lebanon (Voice of Stars), Morocco (Univers Dist'n), Netherlands (Sound Prods.), South Africa (CCP), Sweden (Amigo), Switzerland (Disques-Df-ice), UK (Confer), USA (International Book).
 Sopredim, 14-bis Cite Bauer, 75014 Paris. Tel: (01) 542.91.04. Chief Exec.: Suzy Ham.
Labels: Ceresite, Puccinella, Red.
 Souplet, see Disc'AZ.
 Spalax, see SFPF.
 Special Accordeon, see Daems.
 Squire, see Societe Phonogramme.
 Star Series, see RCA.
 Star's Music Recs., 84 Rue des Martyrs, 75018 Paris. Tel: (01) 285.59.31. Dir. Gen.: Jean-Claude Talar.
 Stern, see WEA Filipacchi.
 Ship, see Dave Music.
 Studio ABM/Disques JBP, 29 Rue Royale, 69001 Lyon. Tel: (78) 28.33.19.
 Studio Christal, 81 Rue de Collonges au Mont D'Or, Illhausern. Tel: (89) 71.80.40. Telex: 880815. Gen. Mgr.: Christian Bedez.
 Studio Damiens, 7 Rue Damiens, 92100 Boulogne. Tel: 608.51.51. Dir.: Guy Boyer; Gen. Mgr.: Elaine Boyer; Studio Mgr.: Andy Scott.
Labels: (Owned) Cornelia, Fash Bee Int'l
 Studio SM (IFPI), 3 Rue Nicholas Chuquet, 75017 Paris. Tel: (01) 267.01.37/02.63. Pres.: Maurice Robreau; Gen. Mgr.: Marc Bonnin; Sales Mgr.: Monique Ewertz.
Labels: (Owned) Arc en Ciel, Cathedrales, Fontgombault, Lumen, Monasteries, SM, Solesmes, Suyapa.
Int'l reps: Belgium (Edibon), Canada (Archambault), Germany (Dvres-za), Switzerland (Disques Df-ice).
 Studio 10, see Bagatelle.
 Sunbar, see RCA.
 Super Stars, see Daems.
 Suyapa, see Studio SM.
 Suzette, see Carriere.
 Swing, see Vogue.
 Symphony Land, 4 Rue Pierre DuPont, 75010 Paris. Tel: (01) 239.31.11. Gen. Mgr.: Jean-Claude Smits; Artistic Dirs.: Maurice Cervero, Janio Nilovic.
 Charles Talar, see CBS Disques.
 Teleson, 56 Rue General Girard, 76000 Rouen. Tel: (35) 71.28.74. Dir.: Jacques Maigret.
Int'l branch: USA.
Label: (Owned) Grand Drgue.
 Temey, see Alluvia.
 Temporel, 2 Rue du Marquis-de-Mores, 92380 Garches. Tel: 741.46.00. Pres.: Guy Beart. (Distributed by RCA)
Int'l reps: Belgium (RCA).
 Tempus, see WEA Filipacchi.
 Teurlay, see Daems
 39, see Carriere.
 3A, see Music Control.
 Tomahawk, see WEA Filipacchi.
 Tonus, see Carriere.
 You Lou Lou, see Music Control.
 Trema Disques (IFPI), 62 Rue Pierre Charron, 75008 Paris. Tel: (01) 256.08.82. Cable: TREMATCH. Telex: 630170. Co-Pres.: Jacques Revaux, Regis Talar; Mktg. Mgr.: Alain Revaud; Int'l Mgr.: Claude Ebrard. (Distributed by RCA)
Int'l reps: Belgium (Phonogram), Canada (Able), Portugal (Imavox), Switzerland (Disques-Df-ice).
 Treteaux Int'l, 20 Allee St. Exupery, 92390 Villeneuve-la-Garenne. Tel: 794.53.52, 798.12.84. Mng. Dir.: Jean Bergougnon; Dir. Gen.: Roger Ducoussel.
 Trianon, see Pathe Marconi EMI.
 Tristan, see Polydor
 Triumph, see Polydor.
 Trois Temps, see De Plein Vent
 Trump, see Polydor.
 Twin-Trees, see Hexagone
 U S Sounds Int'l of Paris, 1 Rue Jean-Perrin, 93155 Le Blanc Mesnil. Tel: 931.31.02. Telex: 212073. Mgr.: Henri Halpern. (Distributor/Importer)
 Underdog Recs., 97 Rue de Richeieu, 75002 Paris. Tel: (01) 296.87.78. Mng. Dir.: Dominic Lambin. (Distributed by Carriere)
 Undisc, 31 Rue de Fleurus, 75006 Paris. Tel: (01) 544.38.34. Gen. Mgr.: Serge Letort.
 Unileidis, see Chant du Monde.
 Uniteids, see Chant du Monde & Domaine Musical.
 Valprivas, see Disco Shop.
 Velia (Disques), 11 Blvd. Arago, 22000 Saint-Brieuc. Tel: 61.43.29. Dir. Gen.: Yves Philippe; Comm'l Dir.: Andre Glazot.
 Vendemiaire/PALM/1-2-3, 95 Rue de la Jonquierie, 75017 Paris. Tel: (01) 226.75.28. Gen. Mgr.: Jean-Pierre Graziani. (Distributed by SFPF)
Labels: (Owned) 1-2-3, PALM, Vendemiaire.
 Pierre Vernay (Eds.), Chemin de la Bosque, Celony, 13090 Aix-en-Provence. Tel: (42) 23.12.29. Exec.: Pierre Verney. (Distributed by Carriere)
Int'l rep: Brilly (USA).
 VerboDisc Prod'n, 6 Rue de la Tremaille, 75008 Paris. Tel: (01) 720.33.44, 720.33.52, 723.96.24. Dir.: Michel Bourla.
 Verchuren, see Disc'AZ.
 Vernou (Disques), Domaine de Vernou, PO Box 22, 37130 Langeais. Tel: (47) 96.80.59. Dir. Gen.: Andree Colson; Dirs.: Marie-Joseph Amiot, Jacqueline Legris.
 Versailles, see CBS Disques.
 Verseau, see Disco Shop.
 Vertigo, see Phonogram.

Victor, see RCA.
 Victor Michel, see Daems.
 Victrola, see RCA
 Video Concept, 34 Rue Aubert, 06000 Nice. Tel: 88.78.29. Comm'l Dir.: Mr. Maillet. (Distributor)
 Virgin France, 65 Rue de Belleville, 75019 Paris. Tel: (01) 239.40.44. Mng. Dir.: Patrick Zelnick.
Labels: (licensed foreign) Albion, Cherry Red, Dindisc, Factory, Virgin (all UK).
 Vista, see Wall Disney & Aedes.
 Vogue Prod'n Internationales Phonographiques (Vogue PIP) (IFPI), 82 Rue Maurice Grandcoing, 93430 Villette. Tel: 821.25.00. Cable: VDG-DISC. Telex: 620380. Pres.: Leon Cabat; Gen. Mgr.: Cesar Rossini; Int'l A&R Mgr.: Jean Noel Bourdier; Export Mgr.: Andre Vidal.
Int'l branches: Belgium (Vogue SA), Netherlands (VDF), Switzerland (CPSA).
Labels: (Owned) Contrepoint, Jazz Legacy, Jazz Selection, Jazz Today, Kaleidoscope, Mode, Mondo Music, Pacific Swing, Vogue; (licensed domestic) Baboo; (licensed foreign) AVI (USA), All Platinum (USA), Becket (USA), Boardwalk (USA), Buddha (USA), Cadet (USA), Chess (USA), Cream/Hi (USA), DJM (UK), D&M Sound (USA), Dami (USA), DeLite (USA), Freedom (UK), GNP Crescendo (USA), Graduate (UK), Inner City (USA), Kingdom (UK), Midson (USA), Motown (USA), Musart (Mexico), Mute (UK), PRT (UK), Pyramid (USA), Rialto (UK), Roulette (USA), Som-Copacabana (Brazil), Sonet (UK), Stiff (UK), Sugar Hill (USA), Trindade (Portugal), WMDT (USA).
Int'l reps: Brazil (Som), Colombia (Sonolux), Germany (Teldec), Mexico (Musart), Portugal (Trindade), South Africa (Teal), UK (PRT), Venezuela (Discorona), Yugoslavia (Jugoton).
 Vox de Son Maitre-VSM, see Pathe Marconi EMI.
 Vox du Globe, see Lyron.
 Volta Symphonie, see Safari-Ambiance.
 W E A Filipacchi Music (IFPI), 70 Av. des Champs-Elysees, 75008 Paris. Tel: (01) 359.12.90. Telex: 660816. Pres.: Daniel Filipacchi; Exec. VP: Bernard de Bosson; Gen. Mgr.: Geoffrey du Laz; Adjt. Mgr.: Christian Stiquet. Domestic Repertoire Mgr.: Jean-Pierre Bouty; Int'l Repertoire Mgr.: Marc Exiga.
Distribution & accounting branch: 18-30 Rue St. Antoine, 93 Montreuil.
Home office: USA, WEA Int'l.
Labels: (Owned) Asylum, Alco, Atlantic, Cotillion, Elektra, Mudi, None-such, Radar, Reprise, WEA, Warner Bros. You You (licensed foreign) Beggars Banquet (UK), Big Tree (USA), Bronze (UK), Dark Horse (USA), Disc'Reet (USA), Embryo (USA), Evasion (Switzerland), Innovative Communication (Germany), Little David (USA), Manticore (UK), Pacha (Canada), Paradise (USA), Planet (USA), Red Star (UK), Riva (UK), Swan Song (USA), Westbound (USA), Whitfield (USA), (distributed-not licensed) Baccara, Black & Blue, Burlesk, CY, Calliope, Eurodisc, Flarenasch, Flat Shot, Gaumont, General Music France, Malignator, Pergola, Stern, Tempus, Tomahawk, WIP.
 Warner Bros., see WEA Filipacchi.
 Warner Music, see Eurogram.
 West-Music, 64 Rue Sadi-Carnot, 93170 Bagnolet. Tel: 360.54.74, 360.95.52. Radio Tel: 391.31.40. Dir. Gen.: Benoit Kaufman; Admin. Dir.: Michael Cron.
 Willyban, see Daems.
 You You, see WEA Filipacchi.
 Zagora, see Carriere.
 Zero Int'l, see Montparnasse 2000.

• music publishers

A B A (Eds.), 302 Av. Jean-Jaures, 95100 Argenteuil. Tel: 980.08.17/46.34. Pres.: Helene Marischal; Dir. Gen.: Louis Marischal; Publ'g Dir.: Michel Vassili.
 A C D Music, see Mondo.
 A R B (Eds.), 21 Av. de l'Opera, 75001 Paris. Tel: (01) 261.61.02. Pres. Dir. Gen.: Anne Revel-Bertrand.
 A R T Music-France, 62 Rue Pierre Charron, 75008 Paris. Tel: (01) 256.08.82. Cable: TREMATCH. Telex: 630170. Pres.: Regis Talar; Int'l Mgr.: Claude Ebrard.
Int'l firms represented: Filmways (USA), Lambert & Potter (USA), Natural Songs (USA), Touch of Gold (USA), Tuneworks (USA).
Int'l reps: Canada (Benzel), Germany (Montana).
 Aariana, 175 Rue de Courcelles, 75017 Paris. Tel: (01) 766.03.54. Telex: 642728. Mng. Dir.: Michele de Geyer; PR: Jean Claude Pellerin.
 Abilene Music, see Robert Salvat.
 Acadia, 77 Rue de la Verrierie, 75004 Paris. Tel: (01) 826.41.69.
 Adele, 40 Av. Hoche, 75008 Paris. Tel: 408.10.30. Pres.: Simone Perret; Artistic Dir.: Pierre Perret.
 Aedes (Eds.), 54 Rue St. Lazare, 75009 Paris. Tel: (01) 874.85.30. Telex: 280422.
 Adorna Music, 12 Rue Desire Ruggieri, 75018 Paris. Tel: (01) 747.86.72. Writer: Jacques Duchene.
 Aggy Music (SACEM), 134 Rue d'Avron, 75020 Paris. Tel: (01) 373.66.75. Dir.: Tony Amarago.
 Louis Alberti (Musical EP), 252 Rue du Faubourg St. Honore, 75008 Paris. Tel: (01) 563.43.70. Gen. Mgr.: Louis Alberti.
 Albert/Warner Bros. Music-France, see PCCF.
 Alluvia, 10 Rue St. Florentin, 75001 Paris. Tel: (01) 260.85.05. Mgr.: Gerard Meyrs.
 Allo Music, 17 Rue Ballu, 75009 Paris. Tel: (01) 280.61.07. Telex: 280245. Pres.: Max Amphoux; Int'l Mgr.: Maurice Bouchoux.
 Des Alouettes (Eds.), 36 Rue des Alouettes, 75019 Paris. Tel: (01) 200.33.04. poste 32.70. Dir.: Henri Spade.
 Alpha (Eds. Musicales), 24 Rue Jacques Dulud, 92200 Neuilly. Tel: 624.96.24. Mng. Dir.: Jacques Wolfsohn.
 Amour (Eds.), 30 Rue Pierre Semard, 75009 Paris. Tel: (01) 526.49.20. Exec.: Nelly Amich; Gen. Mgr.: Miguel Cordoba.
 Amphion Sarl, 12 Rue Rougemont, 75009 Paris. Tel: (01) 246.24.97. Gen. Mgr.: Isabelle Berthou.
Int'l firms represented: Kerby (Canada), Ricordi (Italy), B. Schott's Soehne (Germany), Universal (Austria, UK).
Int'l reps: Austria (Universal), Canada (Kerby), Denmark (Wilhelm Hansen), Italy (Ricordi), UK (UMF).
 Amplitude, 35 Rue des Allies, 93800 Epinay sur Seine. Tel: (01) 826.41.69.
 Andorra, 52 Rue de Faubourg St. Martin, 75010 Paris. Tel: (01) 607.45.91.
 Anvers Musique Sarl., 35 Blvd. Rochechouart, 75009 Paris. Tel: (01) 280.18.56.
 April Music, 168 Av. Charles de Gaulle, 92200 Neuilly Sur Seine. Tel: 747.96.20. Gen. Mgr.: Pierre Habrand.
Int'l firms represented: Alotagood/Kool, Antisia, BRM, Boom, Bovina, Clay, Country Road, Dickiebird, Dimeola, Gold Bullion, Franne Golde, Graponca, Albert Hammond, Hatband, Hudmar, Inner Sanctum, Jool-songs, King's, Kipner, Lady Casey, Lucky, Mac Faye, Mitchell, Mor-Seil,

- Mouse, Music-Music, Napols, Neichell, Porcara, Roundabout, Sherlyn, Stovepipe, Tobias, Tuna Fish, Velocity, Worthless, Yo Mama's, Zap, Aquitana, 52 Cours d'Alsace-Lorraine, 33000 Bordeaux. Tel: (56) 81.83.11. Arabella Sari. (Eds. Musicales), 1 Rue Francis Ler, 75008 Paris. Tel: (01) 256.42.22. Telex: 650458. Gen. Mgr.: Michel Poulain.
- Int'l firms represented:** Arabella (Germany, Mexico, Netherlands, Spain, USA).
- Int'l reps:** Germany, Netherlands, Spain (all Arabella)
- Arpeges, 24 Rue Elter, 75018 Paris. Tel: (01) 229.21.31.
- Aiatane (Eds.), 10 Rue Damremont, 75018 Paris. Tel: (01) 606.88.35 Dir. I.S. Orlando.
- Atoil Music (SACEM), 35 Rue Marbeuf, 75008 Paris. Tel: (01) 225.65.90. 256.36.71. Telex: 642082. Pres.: Charles Ibgun.
- Int'l firms represented:** Beadle (UK), Gerig (Germany) Jessica (USA), MDW (Germany), Phase II (USA), Rekon (Germany), Ring (Germany), SMCL (Canada), Video (Italy).
- D'Auvergne 89 Rue de Nohament, 63100 Clermont-Ferrand. Tel: (1673) 36.29.06.
- B C D Family Music, 54 Rue d'Hauteville, 75010 Paris. Tel: (01) 246.81.33. Mng. Dir.: Claude Danu.
- Baboo Eds., see Mondo.
- Bacchanales (Eds.), 2 Rue de Puits d'Affetet, 77230 Moussy-le-Vieux. Tel: 430.93.53. Dir.: Alain Pommer.
- Branch: 75018 Paris, 88 Rue Lamarck. Tel: (01) 257.47.61
- Pierre Baetz & Co., 52 Rue du Faubourg St. Martin, 75010 Paris. Tel: (01) 607.45.91. Mgr.: Pierre Baetz.
- Bagatelle SA (SACEM), 10 Rue Washington, 75008 Paris. Tel: (01) 562.17.99. Telex: 640328. Pres.: Denis Bourgeois; Gen. & Int'l Mgr.: Brigitte Bertholter-Spahn.
- Int'l firms represented:** Alkatraz Corner, Athens, Bear Brown, Big Sky, Big Ten, Bitsum, Black Leather, Bourne, Buckley, Bucrenis, Busybody, Cape Ann, C'est Music, Cheap Thrills, Chicken Fried, Circustent, Coco, Curtom, Django, Dr. Livingstone I Presume, Dwarf, Elbomo, Four Aces, Gaucho, Groper, Hargrove, Ray Willie Hubbard, Joyful Wisdom, Joyride, Lark, Life Dance, Light, Lively Arts, Luppard, McDonald, McJohn, Mewg, Micache, Missing Link, Ivan Mogul, Multigun, Music Mgmt., NFL Films, Narrow Gate, Neath, Nevoc, Ninandy, Nunn, Ozone, Passing Cousins, Peach, Petra, Pink, Possie, Quackenbush, Ram's Horn, Red Shoes, Rolls Royce, Roswell, Sandbox, Scar, Serendipity, Sixteenth Avenue, Sky Forest, Southern Pines, Special Rider, Street People, Strong Arm, Summir, Three Dog Night, Tomeja, Trine, Tripoli, Weng, Wind, Wind Breeze, Winds & Dragons, Yaron, Yatta Songs, Ying Yang (all USA); Bourne, Bron, Cristabel, Osibounds, Tony Roberts (all UK); MPI, PMI (both Ireland)
- Int'l rep:** Canada (BAG).
- Banco (Eds.), see Robert Salvat.
- Eddie Barclay (Nouvelles Eds.), 44 Rue de Miromesnil, 75008 Paris. Tel: (01) 265.87.80. Pres.: Eddie Barclay; Mgrs.: Patrick Viaret, Georges Le Dert.
- Int'l firms represented:** Concourse (USA), EMP (USA), Fas (UK), Franco London (UK), Ricordi (Italy).
- Rene Baret SA, 26 Rue Marbeuf, 75008 Paris. Tel: (01) 256.28.80. 356.60.07, 723.98.11.
- Bastien Music, see Marouani.
- Belwin Mills France, see Francis O'Neill.
- Jean Bergougoux (Eds. Musicales), 3 Square Paul Claudel, 92390 Ville-neuve-la-Garenne. Tel: 798.12.84.
- Paul Beuscher (Eds.), 27 Blvd. Beaumarchais, 75004 Paris. Tel: (01) 271.22.11. Cable: ALLMUSIC. Telex: 670877. Pres. Dir. Gen.: Philippe Seiller.
- Int'l firms represented:** Edward B. Marks (USA), New Music Corp. (Belgium).
- Int'l rep:** Belgium (Vedette).
- Monsieur Jean Bienvu, 81 Rue de Stalingrad, 38100 Grenoble. Tel: (76) 09.15.52. Gen. Mgr.: Jean Bienvu.
- Big Box, see Marouani.
- Bigoudi Music, 12 Rue de Penthièvre, 75008 Paris. Tel: (01) 266.40.42.
- Gerard Billaudet Ed. SA, 14 Rue de l'Éclairer, 75010 Paris. Tel: (01) 770.14.46. Pres.-Dir. Gen.: Francois Derveaux.
- Int'l reps:** Austria (Muenchner Musik), Belgium (Clasyjaz), Canada (Filon), Germany (Muenchner Musik), Italy (Carthus), Japan (Buffet-Crampon), Mexico (Theodore Presser), UK (Alfred A. Katnis), USA (Theodore Presser).
- Black Tower Music, 12 Rue St. Anne, 75001 Paris. Tel: 706.53.13.
- Bleu Blanc Rouge (Les Eds.), 9 Rue de Versailles, 92430 Marnes-La-Coquette. Tel: (01) 741.6198. Cable: KLUGER. Telex 203249 Pres & Gen Mgr.: Huguette Kluger; Ass'l: Dominique Vacroux
- Int'l rep:** Belgium (Jean Kluger).
- Blunder Music, see Minotaure.
- Mario Bois BMB (Eds.), 17 Rue Richer, 75009 Paris. Tel: (01) 770.09.94. Gen. Mgr.: Mario Bois.
- Int'l firms represented:** Belwin Mills (USA), Curci (Italy), Doblinger (Austria), Novello (UK), Richard Schauer (UK), Sikorski (Germany), Weinberger (UK).
- Int'l reps:** Germany (Sikorski), USA (Belwin Mills).
- Boiero, 38 Rue des Albizzas, 06220 Vallauris. Tel: 64.08.55.
- Boona Music, 40 Cours Albert I, 75008 Paris. Tel: (01) 359.16.03
- Boosey & Hawkes, 7 Rue Boutard, 92200 Neuilly-Seine. Tel: (01) 747.89.92.
- Bousquet, 61 Faubourg St. Denis, 75010 Paris. Tel: (01) 770.15.35.
- Bretagne (Eds. Musicales), 43 Rue Fessart, 92100 Boulogne. Tel: 603.41.93. Contact: Martine Grossmyer.
- Bretlon (Eds.), 3 Rue Rossini, Paris. Tel: (01) 824.86.19. Pres. Dir. Gen.: Mme. Raoul Bretlon.
- Bridget Music, see Bagatelle.
- C B E Le Vepar, 95 Rue Champignonnet, 75018 Paris. Tel: (01) 251.49.95
- C M C, 60 Blvd. de Strasbourg, 75010 Paris. Tel: (01) 205.85.07. Gen. Mgr. Pierre Aezki.
- C N A I Fdsound, 19 Rue Coxevoix, 75018 Paris. Tel: (01) 228.05.91. 229.24.61. Pres. & Dir. Gen.: Jean-Claude Thuel-Chassaigne.
- C R C (Eds.), 93 Av. Niel, 75017 Paris. Tel: (01) 622.39.80. Pres. Dir. Gen. Giancarlo Cerr; Gen. Mgr.: Renaldo Cerr.
- Campbell Connelly France, see Francis D'Neill.
- Caramad, see Mondo.
- Caramel, see Mondo.
- Caravage (SACEM), 130 Rue Marius Aulan, 92300 Levallois-Perret. Tel: (01) 759.94.51. Pres. & Gen. Mgr.: Jean-Paul Smet.
- Int'l firms represented:** Mozart, Raphaela, Sunshine (all Germany).
- Caravelle (Nouvelles Eds. Musicales), 35 Blvd. Malherbes, 75008 Paris. Tel: (01) 265.08.93.
- Carla Music, 12 Av. de la Grande Armeé, 75017 Paris. Tel: (01) 764.13.47. Pres.: Carla Guiot; Dir. Gen.: Jean-Claude Oubois.
- Carrara, 86 Rue du Faubourg St. Martin, 75010 Paris. Tel: (01) 206.43.37
- Claude Carrere (Eds.), see Robert Salvat.
- Carrousel, see Mondo.
- Casanova Music, see Dick James
- Cat Music, see Minotaure
- Cayla, 33 Rue du Faubourg St. Martin, 75010 Paris. Tel: (01) 208.91.66
- Cedarwood, see SEMI.
- Cellulod Musique & Communication, 9-bis Rue de la Vilette, 75019 Paris. Tel: (01) 205.93.59. Telex 212698. Dir.: Gilbert Castro; Gen. Mgr.: Jean Karakos.
- Cezame Eds., 2 Rue Flechier, 75009 Paris. Tel: (01) 878.45.23. Mng. Dir.: Jean-Michel Gallios-Montbrun, Frederic Leiboviz.
- Chant du Monde, 64 Rue d'Amperre, 75017 Paris. Tel: (01) 763.67.73. Pres. & Dir. Gen. Jean Roire; Gen. Mgr.: Jean Miahlle.
- Chappell SA, 12 Rue de Penhièvre, 75008 Paris. Tel: (01) 266.40.42. Cable SYMPHDNY. Pres. & Dir. Gen. Gerard Davoust
- Int'l rep:** Worldwide (Chappell)
- Chiffre Neuf (Les Eds. du), 5 Rue d'Alsace, 75010 Paris. Tel: (01) 264.23.24. Gen. Mgr.: Helene Bignon.
- Choudens (Eds.), 38 Rue Jean Mermoz, 75008 Paris. Tel: (01) 266.62.97. 266.68.75.
- Chrissal, 3 Villa du Poutou, 91800 Epinay sur Senart. Tel: 047.07.62. Dir. Alain Ravat.
- Cirta (Eds.), see Marouani.
- Clouseau Musique, 65 Rue de Belleville, 75019 Paris. Tel: (01) 239.40.44. Dir.: Philippe Constantin.
- Collette Music, 6 Rue Galilee, 75008 Paris. Tel: (01) 723.90.10.
- Comptoir Music Francis (Comufra), 252 Rue du Faubourg St. Honore, 75008 Paris. Tel: (01) 622.50.16. Chief Exec.: Jacqueline Chenu. Gen. Mgr.: Christiane Legrand
- Costallat (Eds.), 60 Rue de la Chaussee d'Antin, 75009 Paris. Tel: (01) 280.69.19. Cable: COSTERAT. Pres.: Daniel Toscan du Plantier.
- Curci France, see Marouani
- Cyclade, Centre Commercial les 4 Temps, Cedex 25, 92092 Paris la Defense. Tel: 773.60.78. Telex: 611363. Chief Exec.: Lina Gallo.
- Cyril Prod's, 17 Rue Balu, 75009 Paris. Tel: (01) 280.61.07. Telex: 280245. Mgr.: Dominique David.
- d'Anella (Eds.), 118 Rue Legendre, 75017 Paris. Tel: (01) 878.76.96. Pres.: Marcel d'Anella; PR & Pub.: Marc Degat.
- Dany Music, 28 Rue de la Reine Blanche, 75013 Paris. Tel: (01) 535.03.96. Gen. Mgr.: Louis Battut; Mgr.: Danyel Gerard.
- Gilbert Delforge (Eds. Musicales), 62 Mail des Charmilles, 10000 Troyes. Tel: (25) 81.05.62. Gen. Mgr.: Gilbert Delforge.
- Delove, 78 Av. des Champs Elysees, 75008 Paris. Tel: (01) 359.17.86. Telex 280467. Chm.: Hubert Wyauff; Mng. Dir.: Catherine Morisse.
- Delphine Eds., 5 Rue du Docteur Lancereux, 75008 Paris. Tel: (01) 562.01.02. Telex: 642908. Pres.: Paul de Senneville; Gen. Mgr.: Olivier Toussaint.
- Int'l reps:** Argentina (Cian Dilo), Austria (Budde), Germany (Budde), Japan (Tajoy), Mexico (Gamma), Netherlands (Nada), Spain (Hispanovox), Sweden (Sone).
- Delrive (Ed.), Palais Bellecour, 14 Rue Trachel, 06000 Nice. Pres., Gen. & Sales Mgr.: Gerard Delrive.
- Int'l reps:** UK (Elkin), USA (Galaxy)
- Detry Music, 11 bis Rue Cdt. Pilot, 92200 Neuilly. Tel: (01) 624.84.85. Telex: 610753. Pres.: Jean-Louis Detry.
- Digoué Diodel, 39 Rue du Faubourg Saint-Martin, 75010 Paris. Tel: (01) 208.28.61.
- Discotheque de Paris, 55 bis Rue de Ponthieu, 75008 Paris. Tel: 562.81.10, 562.77.48.
- Walt Disney Prod's France, 44 Av. des Champs-Elysees, 75008 Paris. Tel: (01) 359.17.80/02.20. Cable: MICKMOUSE. Telex: 64062. Pres. & Dir. Gen.: Armand Bigle.
- Home office:** USA.
- Domaine Music de Chambray, Allee Jean de Ockeghem, 37170 Chambray les Tours. Tel: (47) 28.10.02.
- Francis Dreyfus Music/Eds. Labrador, 26 Av. Kleber, 75116 Paris. Tel: (01) 500.77.07. Telex: 611130. Pres.: Francis Dreyfus; Ass't: Daniele Feuillat; Promo Mgr.: Bernard Dulau.
- Int'l firms represented:** Aurs & Graces (UK), Al Jarreau (USA), And Son (UK), At Home/Relaxed (USA), Chicago (USA), Easy Money (USA), John Farrar (USA), Four Knights (USA), Robin Gibb (UK), Lazy Lizard (USA), Lorimar (USA), Lupus (UK), Lynnal/Jarak (USA), Don Williams (USA).
- Pierre Ouhautois, 10 Rue d'Arras, Athus les Arras, 62223 St. Laurent Blangy. Tel: (21) 55.38.81.
- Durand SA, 21 Rue Vernet, 75008 Paris. Pres.: Guy Kaufmann
- E R I A Societe d'Eds. Musicales, 68 Av. d'Iena, 75116 Paris. Tel: (01) 720.28.94. Pres. Dir. Gen.: Lydine de Warengien.
- E M A S (Eds. Musicales Ariane Segal), 36 Av. Hoche, 75008 Paris. Tel: (01) 563.76.70. Mng. Dir.: Ariane Segal
- Egg Music France, see Marouani.
- Emilhenco Music Sarl, 143 Blvd. Lefebvre, 75015 Paris. Tel: (01) 250.64.46. Contact: Albert Cohen.
- Int'l firms represented:** Beat (Italy), Boosey & Hawkes (UK), Cavendish (UK), New Music (Belgium)
- Int'l reps:** Belgium (New Music), Germany (Mento), Italy (Beat).
- Enoch, 193 Blvd. Perere, 75017 Paris. Tel: 574.01.72
- Erable (Eds.), Rue de l'Eglise, 95640 Breancon. Tel: (01) 466.60.12.
- Erkan, 3 Blvd. de la Liberation, 93 St. Denis. Tel: 243.50.58.
- Max Eschig (Eds.), 48 Rue de Rome, 75008 Paris. Tel: (01) 522.66.64. Dir. Gen.: Marianne Marietti; Dir.: Jean Marietti; Adjunct Dir.-Gen.: Philippe Marietti.
- Espace, 2 Rue du Marquis de Moies, 92380 Garches. Tel: 741.46.00
- Esperance (Eds.), 85 Rue Fondary, 75015 Paris. Tel: (01) 577.30.34. Cable: SONODISC. Telex: 204018. Gen. Mgr.: Marcel Perse.
- Int'l firms represented:** Fania (USA), Makeba (USA), Vaya (USA).
- Essex SA (Eds.), TRO-The Richmond Org., 28 Blvd. Poissonniere, 75009 Paris. Tel: (01) 824.45.54, 225.69.60. Pres. & Dir. Gen.: Marie-Anne de Gerus.
- Home office:** England & USA
- Int'l firms represented:** Essex (Belgium, UK), TRO-The Richmond Org. (USA).
- Int'l rep:** Worldwide including UK (Essex); Canada & USA (TRO-The Richmond Org.)
- Est-Ouest Music, 65 Rue de Belleville, 75019 Paris. Tel: 872.99.36. Pres. Gabriel Courlet, Promo. Mgr.: Mrs. Terry Glover
- Europ Melodie, 11 Rue Bernoulli, 75008 Paris. Tel: (01) 522.81.36. Telex: 213980. Gen. Mgr.: Aubert Armand; Prof. Mgr.: Thierry Moreau.
- Experience, 8 Rue Emile-Allez, 75017 Paris. Tel: (01) 572.58.25, 572.42.45. Dir.: Philippe Doiteau; Gen. Mgr.: Jacques Galissant.
- Fantasia (Eds.), 13 Rue Pages, 92152 Suresnes. Tel: 772.70.36. Telex 630946. Pres.: Jean Grandchamp desaux
- Int'l firm represented:** Tradition (USA)
- Fass Bee (Ed.), see Mondo.
- Fautes Baeghera (SACEM, SDRM), 1 Rue Alfred de Vigny, 75008 Paris. Tel: (01) 227.39.09. Pres.: Nicolas Sikorski; Gen. Mgr.: Alain-Pierre Locque.
- Fefe Music (Eds.), 21 Rue Lauriston, 75116 Paris. Tel: (01) 553.79.68
- Telex 610100.
- Fil Rouge, see Mondo.
- Flamophone, 12 1/2 Blvd. de l'Hopital, 75005 Paris. Tel: (01) 707.11.83.
- Flarenasch (Eds.), 57 Rue du Faubourg Montmartré, 75009 Paris. Tel: (01) 285.02.82, 878.68.75. Dir.: Alain Puglia.
- Fleurus, 31 Rue de Fleurus, 75006 Paris. Tel: (01) 544.38.34.
- Formule 1 (Eds.), see Robert Salvat.
- Forth, 4 Cite Chaptal, 75009 Paris. Tel: (01) 874.58.34.
- France-Etoile, 20 Rue de la Tremoille, 75008 Paris. Tel: (01) 720.76.78/78.85. Cable: BAGAD. Telex: 11180750.
- France-Melodie (Eds.), 94-96 Rue Lauriston, 75116 Paris. Tel: (01) 505.91.02. Telex: 612738. Gen. Mgr. Andre Hackiere.
- Int'l firms represented:** Al Gallico, Galleon & Algee, Turtle (all USA).
- France-Rec., 33 Rue Marc Seguin, 75018 Paris. Tel: (01) 206.71.08.
- Francis-Day SA Publ'n, 94-96 Rue Lauriston, 75116 Paris. Tel: 505.91.02. Cable: FRANDAY. Telex: 612738. Gen. Mgr.: Andre Hackiere.
- Int'l firms represented:** Agent Orange, Buzz Cason, Coal Miners, Cook-house, Coolwell, Desmoble, Equinox, Bobby Goldsboro, Granite, House of Gold, Kamakazi, Kidada, Marksmen, Mighty Three, Minax, Red Velvet, Seven Figure, Special, State of the Arts, Sun Disc, Conyong Twilly, Velbut Apple, Window, Yellow Brick Road, Zargon (all USA); Big Pig, Cam-Al, EMI, Alan Hawkshaw, Kipahulu, Pennne, Perfect, Performance, Tree (all UK).
- Froggy Music, 27-6 Rue de Noailles, 78000 Versailles. Tel: (03) 021.75.26.
- Gamma Int'l Eds.), 10 Rue Pasteur, 92300 Levallois. Tel: 270.81.40. Telex: 4220064. Pres.: Blanche Bidard; Press: Isabelle Campet.
- Garlick, see Marouani.
- J Garzon (Eds.), 13 Rue de l'Éclairer, 75010 Paris. Tel: 770.39.15. Pres. Dir. Gen.: Louis Garzon.
- Louis Gaste (Eds.), 5 Rue du Bois de Boulogne, 75116 Paris. Tel: (01) 500.53.53.
- Gaumont Eds. Musicales, 30 Av. Charles de Gaulle, 92200 Neuilly sur Seine. Tel: 747.01.50. Telex: 610162. Chief Exec.: Nicolas Seydoux.
- Gavroche Music, 3 Rue de Poissy, 93240 Stains. Tel: 822.27.64.
- Gilvo, 20 Rue de la Tremoille, 75008 Paris. Tel: (01) 720.76.78. Dir.: Leo Carrier; Gen. Mgr.: Gilbert di Nino.
- Gratte-Ciel, 23 Grande Rue, 95550 Bessancourt. Tel: (03) 960.70.97. Dir.: Jean-Marc Bailleur.
- Harm Music, see Intersong.
- Hansa France, 39 Rue Jean Guouy, 75008 Paris. Tel: (01) 225.46.52. Telex: 642760. Dir. Gen.: Frank Lipsch.
- Helian, 252 Rue du Faubourg St. Honore, 75008 Paris. Tel: (01) 622.50.16.
- Heloise, 5 Rue Benouville, 75116. Tel: (01) 727.07.51. Telex: 613108. Pres.: Agnes Saint-Preux.
- Hexagone (Eds.) (SACEM), 81 Rue Lemercier, 75017 Paris. Tel: (01) 229.09.79. Pres.: Rene Boyer; Int'l Mgr.: Gabriel Ibos.
- Int'l firms represented:** Belsize, Chibell, Grade One, Impact, Mother Goose, Nib, Our Music, Red Bus, Summit (all UK), Discotel.
- Hohner, 19 Rue Van Loo, 75016 Paris. Tel: (01) 224.63.50. Dir. Gen.: Jacques Coulon.
- Hortensia, 46 Rue de Douai, 75009 Paris. Tel: (01) 874.52.64.
- I B Music, 19 Rue de Margnan, 75008 Paris. Tel: (01) 225.52.97, 723.89.39. Telex: 642756. Pres.: Jean-Marc Berger.
- Ibach & Rimeri (Nouvelles Eds.), see RCA
- l'III (Eds. Musicales de SACEM), 81 Rue de Colonges au Mont d'Or, 68150 Illhausern. Tel: (89) 71.80.40. Telex: 880815. Gen. Mgr.: Christian Bedez.
- Import Diffusion Music, 42-44 Rue du Fer a Moulin, 75005 Paris. Tel: (01) 535.44.25. Mng. Dir.: Alain L. Pierson; Gen. Mgr.: P. Agone.
- Int'l firms represented:** Big 3 (USA), Bradley (USA), Charles Colin (USA), Columbia (USA), EMI (UK), Hal Leonard (USA), Music Sales (UK), Novello (UK), Studio PR (USA), Warner Bros. (USA).
- Int'l rep:** Belgium (Marcum), Switzerland (Songbook).
- Industrial Music, see Marouani.
- Intersong Paris, 6 Av. Franklin D. Roosevelt, 75008 Paris. Tel: (01) 225.66.70, 225.37.85. Cable: PARGRAM. Telex: 270673. Pres. Dir. Gen.: Jean-Jacques Tilche; Int'l Mgr.: Thomas J. Arena.
- Int'l firms represented:** Fred Ahlert (USA), Audigram (USA), Big Secret (UK), Blue Monster (USA), Blue Oyster Cult (USA), Blue Seas Music (USA), Boomtown Rats (UK), Burlington/Palace (UK), Carlin (UK), Casa David (USA), Caseyem (USA), Cherry (UK), Crusty (UK), Dynamone (USA), 5th Floor (USA), Fleetwood Mac (USA), Fort Knox (USA), Hill & Range (USA), Hit & Run (UK), Hudson Bay (USA), Jac (USA), Klarkee (USA), Litha (USA), Luckyy (USA), Magnet (UK), Mews (UK), Michael (USA), Midland (USA), Midsong (USA), Neon (UK), New York Times (USA), Palace (UK), Plantagen Visions (UK), Elvis Presley (USA), Quickmix (USA), Rare Blue (USA), Rick's (USA), Rocket (UK), Rock Hopper (USA), Seabreeze (UK), Sweet (UK), Thames Talent (UK), Tro (USA), 20th Century Fox (USA), Warnes (USA), Bruce Welch (UK), Yellow Dog (USA), Zomba (UK).
- Int'l reps:** Bron (UK), Erik (USA), Sonny Lester (UK), Muggins (USA), Sky Writing (UK).
- Interworld France, see Marouani.
- Intune Music, see Dick James.
- Dick James Music (France) Sarl., 10 Rue des Petites Ecuries, 75010 Paris. Tel: (01) 523.41.20. Mgr.: Rene Talar.
- Jip Music, 6 Av. Franklin Roosevelt, 75008 Paris. Tel: (01) 225.37.85/66.70. Chief Exec.: Jean-Pierre Savelli.
- Jobert SA (Societe des Eds.), 76 Rue Quincampoix, 75003 Paris. Tel: (01) 272.83.43. Gen. Mgr.: Mrs. Jobert-Georges.
- Int'l firms represented:** Elhan Vogel, Merion, Theodore Presser (all USA).
- Int'l reps:** Canada (Theodore Presser in USA), Mexico (Theodore Presser in USA), UK (UM/P), USA (Theodore Presser).
- Joubert, 25 Rue d'Hauteville, 75010 Paris. Tel: (01) 770.15.73.
- Justine Melody, 26 Rue de Bassano, 75116 Paris. Tel: (01) 723.40.60.
- K J C O Music (Ed.), 64 Rue Sadi Carnot, 93170 Bagnolet. Tel: 360.95.52. Dir.: B. Kaufman, B. Cron.
- Kassner/Monica, see SEMI.
- L M C E (Lido Music Champs Elysees), 78 Av. des Champs Elysees, 75008 Paris. Tel: (01) 359.53.30.
- L S B (Lewis Show Business), 122 Rue du Faubourg St. Martin, 75010 Paris. Tel: (01) 203.70.30. Telex: 280245. Gen. Mgr.: Willy Lewis; Int'l Relations: Gisela Clark.
- Michel Laguens Org., 47 Av. Paul Doumer, 75016 Paris. Tel: (01) 520.37.53. Telex: 611650. Pres.: Michel Laguens.
- Lamol, see Masouza.
- A Lasry, 62 Blvd. de Clichy, 75018 Paris. Tel: (01) 606.53.00.
- Latin Paradise Music, 7 Blvd. Malherbes, 75008 Paris. Tel: 266.65.50. Telex: 201150. Chm.: Jean Kriegl; Mng. Dir.: Yves Accary.
- Ledoux Recs., PO Box 25, 62 Rue Maurice-Rogier, 91550 Paray Vieille Poste. Tel: 048.88.24. Dir.: Sylla M. Abou.
- Alphonse Leduc (Eds. Musicales) (SACEM), 175 Rue St. Honore, 75040 Paris. Tel: (01) 296.89.11. Gen. Mgrs.: Claude & Gilbert Leduc.
- Int'l rep:** Argentina (Tow), Brazil (Bruno Quaimo), USA (United Music).

- Michel Legrand (Prod'ns), 12 Rue de Penthièvre, 75008 Paris. Tel: (01) 266.40.42. Pres.: Marcelle Legrand; Gen. Mgr.: Marcel Rothel. (Administered by Chappell).
- Frederic Lebovitz (Eds.) (SACEM), 2 Rue Flecher, 75009 Paris. Tel: (01) 878.45.23.
- Francis Lemarque, 18 Av. du Mesnil, 94210 La Varenne St. Hilaire. Tel: 883.34.21.
- Henry Lemoine (Eds.), 17 Rue Pigalle, 75009 Paris. Tel: (01) 874.09.25. Dir.: Max Lemoine.
- Int'l reps:** Belgium (Schott), Japan (Buffet-Crumpon), UK (United Music Publ'rs), USA (Theodore Presser).
- Levain (Eds. Musicales du), 1 Rue de l'Abbe Gregoire, 75006 Paris. Tel: (01) 222.15.84. Gen. Mgr.: Daniel Truchot.
- Lilas Music (SACEM), 8 Rue des Rasselins, 75020 Paris. Tel: (01) 373.22.91. 371.53.39. Telex: 220064. Pres. Dir.: Gen. Mgr.: Sylvain Krief.
- Lorgere Music, 10 Rue Washington, 75008 Paris. Tel: 883.96.67.
- M A M, 1 Rue Lamennais, 75008 Paris. Tel: (01) 563.38.51. 563.66.83. Dir. Charlie Ganem.
- Int'l firms represented:** Spanka (USA).
- M C A Music (France), 1 Rue Lamennais, 75008 Paris. Tel: (01) 563.66.83. 563.38.51. Dir.: Charlie Ganem.
- Int'l firms represented:** ABC, Alessi (USA), CIC (UK), Evita (UK), Far Out (USA), Gymhouse, Halesouth, Leeds (UK), MAM (UK), MCA (USA), Spoon, Threshold (UK), Valley (UK), Vector (USA).
- M K (Eds. Musicales) (SACEM), 44 Rue Etienne Marcel, 75002 Paris. Tel: (01) 233.07.30. Pres. & Gen. Mgr.: Monique Knuchel.
- M M Recs., 17 Impasse Raftet, 75018 Paris. Tel: (01) 527.52.57.
- M P D, 35 Rue du Bac, 94210 La Varenne. Tel: 883.53.29.
- Majestic Sarl (SACEM/SDRM), 24 Rue Nungesser & Coli, 75016 Paris. Tel: (01) 605.28.70.
- Malfroy, 7 Rue Saint-Vincent, 40103 Dax Cedex. Tel: (58) 74.65.69. Owner: Dominique Malfroy; Technical & Artistic Dir.: Jean Malfroy.
- A. Malypene, 6 Rue de la Grange aux Belles, 75010 Paris. Tel: (01) 285.04.25. Admin. Dir.: Jean Rossigneux.
- Mandarine, 25 Rue Duhesme, 75018 Paris. Tel: (01) 251.49.95.
- Charles Maniatakis (SACEM), 118-130 Av. Jean Jaures, 75019 Paris. Tel: (01) 200.56.42.
- March Music, 95 Rue de la Boetie, 75008 Paris. Tel: (01) 720.58.11. Mng. Dir.: Marie-France Seyrat.
- Marilu, see Mondo.
- E. B. Marks Music Corp., 25 Blvd. Beaumarchais, 75004 Paris. Tel: (01) 271.22.11.
- Marouani (Les Eds.), 37 Rue Marbeuf, 75008 Paris. Tel: (01) 723.54.51. Telex: 640578. Pres.: Gina Marouani; Gen. Mgr.: Gilbert Marouani.
- Int'l firms represented:** Blendingswell (USA), Broken Arrow (USA), Broken Bird (USA), Canopy (USA), Chapin (USA), Channing Cross (USA), Chrysalis (UK USA), Curci (Italy), Deshuffin (USA), Dima Di Laurentis (USA), East Memphis (USA), Eclair (USA), Eighties (USA), Gear (USA), Gnosso (USA), Guentli (USA), Interworld (USA), Lonsi Jack (USA), Kiss (USA), Lady Jane (USA), Little Dickens (USA), Loui Mitchell (USA), Portofino (USA), Rosy (USA), Rosy Silvers (USA), Saggie fire (USA), Sandy Songs (USA), Paul Simon (USA), Siqomb (USA), Small Hill (USA), Song Mountain (USA), Bruce Springsteen (USA), Stron (USA), Sumac (USA), Wayward (USA), Frank Zappa (USA), Warren 'evon (USA).
- Int'l reps:** Europe (EMI) excluding Netherlands (LEM-Basart), Germany, Mary Melody, 6 Rue d'Heliois, 75017 Paris. Tel: (01) 754.37.37. Dir.: Marie-Claude Lagarde, B.R. Itic.
- Masouza Music, 48 Av. Charles de Gaulle, 92200 Neuilly sur Seine. Tel: (01) 745.63.50. Gen. Mgr.: O. Zameczkowski.
- Maq (Prod'ns Eds. Musicales), 9 Passage Dagorno, 75020 Paris. Tel: (01) 370.88.32. Mgr.: Herve Bergerat.
- Maspacher SA (Eds.), Rue Jean Mermoz, 21 St. Guenault, 91031 Evry Cedex. Tel: (6) 078.43.11.
- Match France, see ART.
- Melorhin (Les Eds. Musicales), PO Box 22, 13 Rue Maurice Ravel, 68001 Colmar-Cedex. Tel: (89) 41.47.74, 41.80.01. P. es. & Gen. Mgr.: Fernand Erlsland.
- Metropolis (Eds.), 11 Rue de Provence, 75009 Paris. Tel: (01) 246.60.33. Contact: Pierre Ribert.
- Michel Meyer & Cie. (SACEM, SDRM), 8 Rue de l'Est, 92100 Boulogne. Tel: (01) 605.43.21. Telex: 201336. Dir.: Michel Meyer; Gen. Mgr.: Philippe Terner.
- Int'l firms represented:** Ai's Write, Antoine, Beulah, Big Mike, Ciano, Corda, Color World, Country Star, Finch, Forest Bay, Gewick, Grosvenor House, James Hendrix Ents., Hob & Nob, H-Ark, Kelly, Felix Kubik, Lucifer, Main Stage, Merrit & Norman, Nitfol, Odle, Peryal, Pineapple, Process, Purple Haze, Rhythm Valley, Right On, Satyricon, Showtime, Solar Sound, Soprano, Sorority Fraternity, Space Ark Ents., Startones, Stonebess, Sweet Stuff (all USA).
- Micra, 13 Rue Washington, 75008 Paris. Tel: (0) 225.43.03.
- Milan Music, 22-bis Rue Papoi, 75018 Paris. Tel: (01) 208.76.63. Telex: 240203. Dir.: Rene Meyer; Gen. Mgr.: Oldrich Horak.
- La Mithonnerie, Villefranche St. Phal, 89120 Charny. Tel: (86) 63.61.27. 11 Rue Feuilles, 14 Square de Port Royal, 75013 Paris. Tel: 555.94.64. Dir.: Bernard Bettane.
- Minerva, 142 Rue Montmartre, 75002 Paris. Tel: (01) 236.93.03.
- Minotaure (Eds.) (SACEM, SDRM), 21 Rue Jean Mermoz, 75008 Paris. Tel: (01) 225.61.00. Telex: 250303. Gen. Mgr.: Mr. Roland Bismuth; Int'l Denis Wolff.
- Int'l firms represented:** Bergans Banquet (UK).
- Int'l reps:** Canada (LMS), Germany (Montara), Italy (Crisler), Japan (Kay Music/Music), Netherlands (Ariola).
- Eddy Mitchell Music, 8 Blvd. de Strasbourg, 75010 Paris. Tel: (01) 209.26.27. Mgr.: Jean-Pierre Sammut; PR Mgr.: Michel Bellamar.
- Mondo Music, 20-bis Rue Louis Philippe, Neuilly. Tel: 745.00.10. Sec'y Gen.: Jacques Barouh.
- Int'l firms represented:** Alvorada (Brazil), East Barton (USA), Beverly (Brazil), Big Seven/Planetary (USA), Cream (USA), Equinox (USA), Mefidonal (Brazil), Montage (USA), RAK (UK), Skyview/Neil (USA), WMOOT (USA).
- Moma Music, c/o P. Wittig, 28 Av. Hoche, 75008 Paris. Tel: (01) 227.61.58. Montana, 71 Av. Kleber, 75016 Paris. Tel: (01) 727.04.05.
- Montparnasse 2000, 22 Rue Drouot, 75009 Paris. Tel: (01) 246.48.47. Gen. Mgr.: Guy Szakolczai.
- Int'l firms represented:** Canciones del Mundo (Spain), Canopo group (Italy), Gemelli (Italy), Guitarra (Spain), Imnus (Germany), Lutto (Italy), Omega (Italy), Polyband (Germany), Prestacion (Belgium), Semi Films (Italy).
- Int'l reps:** Argentina (Annibal Libenson), Belgium (Prestation), Canada (Crea Sound), Germany (Imnus), Japan (Yanami), Lebanon (SMT Film), Scandinavia (Nordiska in Sweden), UK (Printed Artists), Uruguay (Annibal Libenson).
- Musc Control (SACEM), 35 Rue La Boetie, 75008 Paris. Tel: (01) 561.17.44. Dir.: Claude Flinaux; Gen. Mgr.: Randon Pascalet; Prof. Mgr.: Gilles Sala.
- Music 18, 6 Rue Galilee, 75116 Paris. Tel: (01) 723.90.10. Dir.: Jacques Plant.
- Music For You, 71 Blvd. Gouvion St. Cyr, 75017 Paris. Tel: 572.27.70. Dir. Gen.: Bernard Bramnik.
- Musique & Communication, 9 bis Rue de la Villette, 75019 Paris. Tel: (01) 205.93.59. Telex: 212698. Dir.: Gilbert Castro; Gen. Mgr.: Jean Karakos.
- Musique Pour l'Image, 4 Rue de Beynes, Cressay, 78640 Neauphte le Chateau. Tel: (01) 489.03.07. Dir.: Robert Viger.
- N W 8 Music, 94 Rue Lauriston, 75116 Paris. Tel: (01) 505.91.02. Gen. Mgr.: Richard Lord.
- Int'l reps:** Worldwide (EMI group/Francis-Day).
- New York Paris Music, 35 Rue de la Rochefoucault, 92100 Roulogne. Tel: (01) 603.06.31. Pres.: Yves J. Hayat; Gen. Mgr.: Rose Marie Hayat.
- Int'l reps:** UK (Carlin, Island).
- Nouvelles Eds. Contemporaines (NEC), 23 Rue Pierre Semard, 75009 Paris. Tel: (01) 526.52.47. Chief Exec.: Freddy Carrara.
- Francis O'Neill Org. (FONO), 71 Rue de Provence, 75009 Paris. Tel: (01) 874.11.12. Cable: FONOMUSIC. Pres.: Francis O'Neill; Prof. Mgrs.: Jean-Pierre Besson, Paul Ives.
- Int'l firms represented:** Belwin-Mills France (UK, USA), Berimbau (Brazil), Campbell Connelly (UK), Compass (USA), Logo (UK), Memory Lane (USA), Salsoul (USA).
- Claude Orlyx, 6 Rue Capitaine Escudie, 31000 Toulouse. Tel: (61) 62.48.55.
- Ouvriers (Les Eds.), 12 Av. Soeur Rosalie, 75621 Paris Cedex 13. Tel: (01) 337.93.85. Gen. Mgr.: Max Pinchard.
- P A E Sarl, 143 Av. Charles de Gaulle, 92200 Neuilly sur Seine. Tel: (01) 265.87.80. Dir.: Pascal Auriat.
- P E C F (Productions & Eds. Cinematographiques Francaises, div. of Albert Warner Bros.) (SACEM), 18 Rue Troyon, Paris. Tel: (01) 267.15.35. Telex: 280542. Mng. Dir.: Jean Davoust.
- Int'l firms represented:** Advanced, Anterior (Esther Philips), Athwain, Atlas, Attraction, Baby Monica, Backlin, Bar None (Chris Hillman), Benchmark, Bi-Mar, Stephen Bishop, Bountiful, Brown's Mill, Bug, Burbank, Burda, Caledonia Soul, Camad, Camulus, Camwood, Castleford, Castle Hill, Catchup (Curtis Bros.), Chicken Fats, Chinmoy, Chi Sound, Cinco, Coffeepot, Bruce Cohn, Companion, Cottillon, Curton, Daedalus, Dakar, Daley City, Danor, Datnew, Davalbo, Debro, Desert Moon, Desert Rain, Diamondback, Don Pow, Elektra, Ezra, Far Fetched, Farina, Feckless, Ferguson, Festival, First Artists, Flat Town, Fleetwood, Food, Foscoe, Fox-Gimbel, Freyda, Fry King, Fry Queen, Gamble Hinged, Golden Spread, Gold Hill, Gold Line-Silverline, Good Friends, Grand National, Gringo, Van Halen, Hanbo, Harms, High Wave, High Tree, Hustlers, Icarus, Ice 9, Inherit, Inherit Todd Mark, Inner Earth, Jalyne, Jaz Bird, Jefferson, Jumptunes, Kapralki, Kicking Bear, Don Kershner, Kishner Songs, Kityhawk, Kuumba, Loma Alto, Ludmila, Mae-Ken, Mansa, Mansfield, Marsant, Mel Bren/Ditching, Van McCoy, Mr. Sunshine (Molly Hatchet), Montunes, New World, Nina, Nine Star, Nipper, Numero Uno, Open Hole, Oracle, Orlandao, Overdrive, Painless, Paisley, Paradox, Paternoster, Pepamar, Philo, Philipsongs, Pond, Poonies, Prairie League, Promo, Radio, Raydiola (Radio), Remick, Richbore, Road Canon, Rock Steady, Rodart, Romulus, Rose Hips, Round Wound Sound, Saloon Songs, Schubert, Seagrape (Karia Bonoff), Sedaka, Sesame Street, Shoes, Siesta, Skol, Sky Harbor, Skyliff, Skylark, Slim Chance, Stephen Stills, Stinson Day, Stone Canyon, Stone Flower, Superhype, Sure Enough (Dictators), Swallow Turn, Sweetpea, Tamariene, Tarka, Tash Howard, Tea Time, Tessa, Topographic, Triple O, Twiwer (Cretones), Upward Spiral, Van Cleaf, Van Jan, Viva, WB, W7, Walden, Warner Bros., Warner Records, Warner Tamerlane, Wax Tablet, Weillbrecht Harms, Wet Dreams, Whispersing, Wodresceng, Windocor, Winners Circle, Witmark, Waiper, Wow & Flutter, Yessongs, Zapata (all USA), J. Albert (Australia), Alpa (UK), Klatotons (Canada), MUZ (Germany), Sparta Florida (UK), Stutter (UK), Warner Bros. (Australia, UK), Winterfold (UK), Zingaro (D. Troiano) (Canada).
- Int'l reps:** Australia, Italy, UK, USA (all Warner Bros.); Germany (MUZ).
- P E M Charles Talar, 61 Rue de Ponthieu, 75008 Paris. Tel: (01) 359.15.78.
- Paco Rabanne, see New York Paris Music.
- Palace (Eds), see Intersong.
- Panache Sarl (Eds.), 4 Rue de la Caille, 92310 Sevres. Tel: (01) 507.14.14. Telex: 270188. Dir.: Paul Banes; Prof. Mgr.: Daniel Belan.
- Int'l firms represented:** Aches (USA), Arabella (UK), Bob Weston, Boofant, British Lion, (UK), Canaan (USA), Deep Purple (UK), Eiger (UK), GH (UK), Getaway (UK), Glenn Hughes (UK), Glove (UK), Gull (UK), Hancock (USA), Heathwave, Gibb (UK), Ian Gillan (UK), Inkwell (UK), Island (UK USA), Keep on Trucking, LED (UK), Mayflower (USA), Nazsongs (UK), Owl (UK), Pablo, Pal (UK), Quatermass (UK), Riva (UK), Robot/B&C Rock (UK), Rustler (UK), SP (UK), Static (UK), Werser.
- Int'l rep:** Worldwide (Panache).
- Panda (Eds. Musicales/Diffusion), 4 Rue de Sgt. Hoff, 75017 Paris. Tel: (01) 243.43.40. Exec.: Jean-Luc Giaccardo.
- Claude Pascal (Eds. Musicales), 5 Rue Denis Poisson, 75017 Paris. Tel: (01) 574.43.72. Telex: 641477. Gen. Mgr.: Claude Pascal.
- Int'l firms represented:** Big Brother (UK), Camex (USA), Canopy (USA), Chandos (USA), Chinnichap (UK), Country & Eastern (USA), Eaton (UK), First Artists (USA), Five Ways (UK), Folklore (USA), Gabriel Earl (USA), Golden Syrup (USA), Gypsy Boy (USA), Heath Levy (UK), Hilgreen (USA), Hush (UK), I've Got the Music (USA), Ladysmith (UK), Magic Frog (UK), Noel Gay (UK), No Exit/Rear Exit (USA), Paper (UK), Pondwater (Canada), Retrac (USA), Rockin' (UK), Sailor (USA), Satril (UK), Sonet (Sweden), Song Tailors (USA), Springtime (USA), Stage & Screen (UK), State (UK), Superpop (UK), Swell Sounds (USA), Tabasco (USA), Taradam (UK), Three T (USA), Valentine (UK), Venice (USA), Welk (USA), White Oak (USA).
- Pathe Marconi (Eds. & Prod'ns Musicales), 94/96 Rue Lauriston, 75116 Paris. Tel: (01) 505.91.02. Cable: EDIMARCO. Telex: 612738. Pres.: Francois Minchin; Gen. Mgr.: Jean Yves LeRo; Promo: Jane Garton; Copyright Mgr.: Françoise Puybasset; Bus. Affairs: Pierre Henry.
- Int'l firms represented:** Alan Cartee/Shoals Music Mill, Audrigon/Black Sheep, Barn, Braintree/Porchtree, Breeze Music/Switzerland, Capitol, Cayman/CSS, Cogent, Cole A Rama, Colgems/EMI, Crystal Jubilee, Dany, Garrett, Gigolo, Haampala, Iska/Hiyoko/Weteriti, Jacon/ Darnoc, Jobete/ Stone Diamond, KPM, Medicine Hat, Modern American/Charleville, Mulatto, New Era, Ninja/Drum, On Time, Open Door/Good Time, Palm Beach, Peacock/Stone Gold, Pure Songs, Ronger, Saint, Saturday/Shelby Singleton, Screen Gems, Stone & Green, Strander, Themes, Time Step/ Cledia, Tumbleweed, Trane, X-Ray.
- Int'l reps:** Worldwide (EMI).
- Patricia, see SEMI.
- Peer Int'l, see SEMI.
- Peer Southern, see SEMI.
- Pema Music, 5 Rue Denis-Poisson, 75017 Paris. Tel: (01) 574.43.72. 359.95.70. Telex: 260648. Gen. Mgr.: Georges Bacri.
- Int'l firms represented:** CAM (Italy, Spain).
- Int'l reps:** Argentina, Australia, Canada, Germany, Italy, Scandinavia, Spain, UK, USA (all CAM); Switzerland (Campana).
- Nicolas Perides (Eds.) (SACEM), 44 Rue Etienne Marcel, 75002 Paris. Tel: (01) 233.07.30. Gen. Mgr.: Nicolas Perides.
- Petit Cheval (Eds. du), 84220 Gordes. Tel: (90) 72.06.31.
- Philoppo, 24 Blvd. Poissonniere, 75009 Paris. Tel: (01) 824.89.24.
- Pianola Music, c/o Homeric, 9 Rue Jean Mermoz, 75008 Paris. Tel: (01) 720.09.09. Publ'r: Philippe Renaux.
- Plateforme 2000, 20 Rue Ballu, 75009 Paris. Tel: (01) 285.83.00. Telex: 642581. Pres.: Hubert Ballu.
- Plem Sodei Sarl (Eds. Musicales), 6 Rue Galilee, 75116 Paris. Tel: (01) 723.90.10. Co-Pres.: Harry Auerhan, Bernard Ricci.
- Pluriel (Eds.), BP 21, 61350 Passais la Conception. Tel: (33) 38.77.23. Gen. Mgr.: Jean Foucher.
- Int'l reps:** Canada (Intermede), Europe (Chappell), Japan (Ongakusha).
- Presence, 33 Rue du Faubourg St. Martin, 75010 Paris. Tel: (01) 607.89.05.
- Presses d'Île de France, 12 Rue de la Chaise, 75007 Paris. Tel: (01) 222.37.30.
- Presta Music, 7 Rue Damiens, 92100 Boulogne. Tel: (01) 608.51.51. Gen. Mgr.: Guy Boyer.
- Prosadis SA, 14 Av. Hoche, 75008 Paris. Tel: (01) 561.16.55. Mgr.: Claude Delfe.
- Puerta del Sol, 32 Blvd. Clichy, 75018 Paris. Tel: (01) 264.27.81. Gen. Mgr.: Don Diego.
- Int'l firms represented:** Clave (Spain), Puerta del Sol (Spain), Quiroga (Spain).
- Int'l reps:** Spain (Puerta del Sol, Quiroga).
- R C A/Publ'g Dept., 9 Av. Matignon, 75008 Paris. Tel: (01) 256.70.70. 359.92.60. Telex: 650703. Publ'g Mgr.: Michel Larmand.
- Int'l firms represented:** Antisla (USA), Cyclus (Germany), Dunbar-Sunbury (USA), 57th Street Entertainment (USA), Flowering Stone (USA), Holy Moly (USA), Koppelman-Bandier (USA), Laetrec (South Africa), Oakfield-Metal Machine (USA), RCA (Brazil, Italy, Mexico, Spain), Relay (Argentina), Saber Tooth (USA), Scott Tone (USA).
- Int'l reps:** Argentina (Relay), Canada (Dunbar-Sunbury), Germany (Cyclus), UK (Dunbar-Sunbury), worldwide (RCA).
- R G R, 41 Rue du Chateau des Rentiers, 75013 Paris. Tel: (01) 583.67.77. Telex: 230301. Chief Exec.: Gerard Demayzere; Gen. Mgr.: Robert Vioux.
- R M F (Radio-Musique), 22 Rue Bayard, 75002 Paris. Tel: (01) 720.44.44, 720.43.63. Gen. Mgr.: Gust Graas; Artistic Dir.: Roger Krecher.
- Rahowski (Eds.), 11 Rue des Gravières, 92200 Neuilly/Seine. Tel: (01) 745.31.11. 391.98.49.
- Rames II (SACEM), 11 Rue Jean de Bauvais, 75005 Paris. Tel: (01) 329.75.06. Dir.: Eric Vnie, J.L. Rizet.
- Remiga/Caro Music, 94 rue la Fontaine, 75016 Paris. Tel: (01) 525.51.31. 527.03.07. Dir.: Jacky Giordano.
- Retor 2000, 56 Rue de la Roquette, 75011 Paris. Tel: (01) 700.47.69.
- Revue de MusicoLogie, see Transatlantiques.
- Rhinoceros, 2 Rue Flecher, 75009 Paris. Tel: (01) 878.45.23. Dir. Gen.: Frederic Lebovitz.
- Ricordi (Eds.), 12 Rue Rougemont, 75009 Paris. Tel: (01) 246.24.97. Pres.: Guido Rignano.
- Rideau Rouge, 24 Rue de Longchamp, 75116 Paris. Tel: (01) 533.19.35. Cable: RIDORRUG. Telex: 613725. Pres.: Gilbert Becaud; Mng. Dir.: Marcel Leclerc.
- Int'l firms represented:** Black Bull (USA), Combine (USA), Gong (UK), Harrison's (UK), Resaka (USA), Stonebridge (USA).
- Int'l rep:** Canada (SMCL), Germany (Melodie der Welt).
- Robinson Music, 17 Rue Ballu, 75009 Paris. Tel: (01) 280.61.07. Telex: 280245. Owner & Mgr.: Jack Robinson.
- Royalty, 25 Rue d'Hautville, 75015 Paris. Tel: (01) 770.67.26.
- S E E P, 1 Rue Danton, 75006 Paris. Tel: (01) 325.02.59. Pres.: B. Krief.
- S E M I/Meridian, 5 Rue Lincoln, 75008 Paris. Tel: (01) 359.06.22. Telex: 642068. Mgr.: Mrs. Françoise Fay; Gen. Mgr.: Yves Heuze; Prof. Mgr.: Sylvain Collaro.
- S M (Eds.), 3 Nicolas Chouquet, 75017 Paris. Tel: (01) 267.01.37. Chief Exec.: Maurice Robreau; Ass't: Marc Bonnin.
- Saban Music, see Intersong.
- Saint-Jerome (Eds.), 1 Rue Saint-Jerome, 75018 Paris. Tel: (01) 254.44.47.
- Salabert (Eds.), 22 Rue Chauchat, 75009 Paris. Tel: (01) 824.55.60. Cable: SALABERTAS.
- Int'l firms represented:** Schirmer (Belgium, France, Israel, Portugal, Spain, Switzerland, Yugoslavia), Unom Musical Espagnole (Belgium, France, Luxembourg, Netherlands).
- Int'l reps:** Austria (Ahn & Simrock), Canada (Schirmer), Germany (Ahn & Simrock), Italy (Carisch), Spain (Unom Musical Espagnole) USA (Schirmer).
- Salad Music, 44 Rue Miromesnil, 75008 Paris. Tel: (01) 265.87.80. Pres.: Bernard Sant-Paul.
- Jean-Marie Salthan, 3 Rue Cesar-Franck, 75015 Paris. Tel: (01) 566.42.00. Gen. Mgr.: Jean-Marie Salthan.
- Henri Salvador (Eds. Musicales), 6 Pl. Vendome, 75001 Paris. Tel: (01) 260.87.80/05. Pres. & Dir. Gen.: Jacqueline Salvador; Gen. Mgr.: Henri Salvador.
- Robert Salvat (Eds.), 89 Rue La Boetie, 75008 Paris. Tel: (01) 359.76.54. Chief Exec.: Angele Salvat.
- Saravah, see RCA.
- Schott Freres, 35 Rue Jean Moulin, 94300 Vincennes. Tel: 374.30.95. Dir.: Jean-Jacques Junne.
- Home office: Belgium.
- Int'l firms represented:** Peters (UK, USA).
- Int'l reps:** Belgium, Germany (Schott); UK, USA (Peters).
- Scorpio Music (Black Scorpio), 5 Rue Clement Marot, 75008 Paris. Tel: (01) 720.43.95. Telex: 642981. Gen. Mgr.: Daniel Beloso.
- Int'l firms represented:** Peterman (UK), Street (UK).
- Int'l reps:** Argentina (Relay), Australia (Ivan Mogul), Austria (Intro Messel), Brazil (RCA), Germany (Intro Messel), Italy (Durium, RRR, Radio Recs.), Mexico (Ivan Mogul), Scandinavia (Sweden Music), South Africa (Zomba), Spain (RCA), UK (Zomba).
- Ariane Segal (Eds. Musicales), see EMAS.
- Sempall, 18 Rue Daunou, 75002 Paris. Tel: (01) 296.30.67.
- Septentrion (Eds. Musicales), 11 Rue Lepic, 75018 Paris. Tel: (01) 606.94.30, 255.92.19. Telex: 270105. Gen. Mgr.: Pierre Cétie.
- Int'l firm represented:** Coda (Belgium).
- Int'l rep:** Switzerland (Twenty).
- 707, see Eddie Barclay.
- Storzando/Sirocco (Eds. Musicales) (SACEM/SDRM), 42 Rue Laugier, 75017 Paris. Tel: (01) 766.23.64. Telex: 260717. Dir. Gen.: Roger Tokarz.
- Int'l firms represented:** Selected Sound (Germany), J. Weinberger (UK).
- Subcar (SACEM), 99 Rue de Vaugirard, 75006 Paris. Tel: (01) 544.55.31. Dir.: Gilles Bleves.
- Int'l firms represented:** Carricatum, Le Vent Qui Vire (both Canada).
- Int'l rep:** Canada (Le Vent Qui Vire).
- Sidome (Eds.), 18 Rue Papillon, 75009 Paris. Tel: (01) 523.29.60. Gen. Mgr.: Christian Dulcy.

Sigem (Sistema Globo de Edicoes Musicais), 31 Blvd. Suchet, 75016 Paris. Tel: (01) 527.03.12. Contact: Elyane Peyrot.
 Home office: Brazil.
 Sikorski France (Eds.), see Intersong.
 Slip Shot, see Masouza.
 Societe Francaise de Musicologie, see Transatlantiques.
 Societe Francaise de Prod'ns Phonographiques, 20 Rue Pasteur, 92300 Levallois. Tel: (01) 737.09.15. Dir. Gen.: Michel Bachelet; Admin'r: Claude Ferrabou; Artistic Dir.: Jacky Charlard; Label Mgr.: Gabriel Ibois.
 Soda Music (SACEM), 29 Rue de Margnan, 75008 Paris. Tel: (01) 320.36.48, 225.68.19. Cable: SODAMUS. Telex: 250973. Pres.: Roger Choukroun.
 Sonmage, 4 Rue de Beynes-Cressay, Neauphle le Vieux, 78640 Neauphle le Chateau. Tel: 489.03.07. Dir.: Robert Viger.
 Space, 2 bis Rue du Marquis-de-Mores, 92380 Garches. Tel: (01) 741.46.00. Chief Exec.: Guy Beart.
 Splendoid Music, 48 Rue Mataubiau, 31000 Toulouse. Tel: (61) 62.32.05. Chief Exec.: Christian Colombo.
 Studio Caroline, 86 Rue Haxo, 75020 Paris. Tel: (01) 363.95.19. Gen. Mgr.: Jacky Reggan.
 Studio Damiens, 7 Rue Damiens, 92100 Boulogne. Tel: 608.51.51.
 Studio d'Auteuil, 56 Rue d'Auteuil, 75016 Paris. Tel: (01) 224.76.74. Dir. Gen.: Marie Demaret.
 Sugarmusic France (Eds.), 90 Av. des Champs-Elysees, 75008 Paris. Tel: (01) 562.35.59, 562.35.49. Gen. Mgr.: Marcel Marouan.
 Home office: Italy.
 Int'l firms represented: Luna Park (Italy).
 Int'l rep.: Worldwide (Sugarmusic).
 Symphony Land, 4 Rue Pierre DuPont, 75010 Paris. Tel: (01) 239.31.11. Artistic Dir.: Maurice Ceverre, Janko Nilovic; Gen. Mgr.: Jean-Claude Smits.
 Syntex (Eds. Musicales) (SACEM), 124 Rue La Boetie, 75008 Paris. Tel: (01) 225.80.30. Co-Pres.: Raymond Drouet, Nadege Laboure; Gen. Mgr.: Charles Igbu.
 Sysmo, 136 Rue Championnet, 75018 Paris. Tel: (01) 255.64.62.
 Tabata Music, Route Nationale 307, 78810 Feucherolles. Tel: (03) 056.47.51. Telex: 697574. Pres.: Michel Foucher.
 Tanday Music (SACEM), 19 Rue Vignon, 75008 Paris. Tel: (01) 742.68.62. Gen. Mgr.: Eddie Vartan.
 Int'l firms represented: Demain (USA), Frank & Nancy (USA), MAJ (USA).
 Int'l rep.: Belgium (New Music), Germany (Montana), Italy (Curci), Japan (Watanabe).
 Tarantula Music, 42.44 Rue du Fer a Moulin, 75004 Paris. Tel: (01) 535.44.25. Chief Exec.: A.L. Person; Gen. Mgr.: P. Aeon. (Also see Import Diffusion)
 Int'l firms represented: Buzy, Marcom (both Belgium); Songbook (Switzerland).
 Tattoo Music, see Minotaure.
 Tonus Musica Andorra (SACEM), 128 Av. Meristell, Andorre la Vieille, Andorra. Tel: 22.071. Dir.: Patrick Van Der Gucht.
 Topomic Music (SACEM), 105 Rue de Normandie, 92400 Courbevoie. Tel: 788.09.46. Pres.: Pierre Jaubert.
 Traffic Music, see Mondo.
 Truff Bleu Monte Carlo, 10 Rue Magellan, 75008 Paris. Tel: (01) 720.96.60. Cable: TECHSDNDR. Tel: 610035. Dir. Gen.: Jean Gauthier; Gen. Mgr.: Raymond Gamedinger; Int'l: Frances Gramende.
 Transatlantiques (Eds. Musicales), 50 Rue Joseph de Maistre, 75018 Paris. Tel: (01) 228.21.40. Dir.: Patrick Marland.
 Int'l firms represented: Henn (Switzerland), Modern (Germany), United (UK).
 Int'l rep.: Germany (Dito Junne, Modern, Munchner), Japan (Buffet Crampson), Netherlands (Abersen), Spain (Real), UK (United), USA (Presser).
 Transit (Eds.), see RCA.
 Tremplin, 32 Rue Francois Premier, 75008 Paris. Tel: (01) 256.76.76. Telex: 290496. Dir.: Pascal Farcouit; Mgr.: Henri Hoffman; Ass't: Monique Moulin.
 Int'l rep.: Argentina (Clan Di), Germany (Rolf Budde), Japan (Tsayo), Spain (Hispavox), Sweden (Sweden).
 Tretreux Int'l, 20 Allee Saint-Eupery, 92390 Villeneuve la Garenne. Tel: (01) 794.53.52, 798.12.84.
 Tristar Music, 59 Blvd. de la Saussaye, 92200 Neuilly sur Seine. Tel: (01) 637.48.41. Gen. Mgr.: Valentin Coupeau.
 Tubular Music, 130 Av. Jean Jaures, 75019 Paris. Tel: (01) 201.60.85, 201.60.32. Dir.: Jean-Pierre Massiera.
 12,000 (Eds. Musicales), 71 Rue de Clignancourt, 75018 Paris. Tel: (01) 252.21.90, 076.75.64.
 23 (Eds.), 15 Av. Hoche, 75008 Paris. Tel: (01) 227.00.89/02.22. Tel: 210311. Mng. Dir.: Francis Lai; Gen. Mgr.: Colette Moughit.
 United Artists Music France SA, 25-27 Rue d'Astorg, 75008 Paris. Tel: (01) 742.33.95. Telex: 650292. Dir.: Franck Banyar; Admin. Dir.: Lucien Naour.
 Universelles, 52 Rue du Faubourg St. Martin, 75010 Paris. Tel: (01) 607.45.91.
 Vendome (Eds.), see SEMI.
 Pierre Verany (Eds.), Chemin de la Bosque, Celony, 13090 Aix en Provence. Tel: (42) 23.12.29. Exec.: Pierre Verany.
 Verboodis (Ed.), 6 Rue de la Tremoille, 75008 Paris. Tel: (01) 720.33.44, 720.33.52, 723.96.24. Dir.: Michel Bourla.
 Village (Ed.) (SACEM), 3 Rue Collet, 34000 Montpellier. Tel: (67) 60.78.88.
 Vogue Int'l (SACEM), 20 bis Rue Louis-Philippe, 92200 Neuilly sur Seine. Tel: 745.00.10. Pres.: Leon Cabat.
 Warner Music, 94 Rue la Fontaine, 75016 Paris. Tel: (01) 525.51.31, 527.03.07. Admin. & Comm'l Dir.: Eddie Warner.
 Johnny Williamson, 32 Rue des Pommiers, 93500 Pantin. Tel: 843.31.25.
 X Music, 44 Rue La Boetie, 75008 Paris. Tel: (01) 563.52.89/48.66. Dir.: Jean-Max Riviere; Gen. Mgr.: Thomas Noton.
 Young Memories, 37C3 Av. Franklin Roosevelt, 75008 Paris. Tel: (01) 359.63.01. Exec.: Anne Grandjann; Gen. & Int'l Mgr.: Martine Brunet.
 You You Music (SACEM), 8 Rue Marbeuf, 75008 Paris. Tel: (01) 720.63.30. Cable: WANGMUSIC. Telex: 660816. Chm.: Jean-Louis Sarin; Gen. Mgr.: Christian de Ronseray.
 Zagma, see Marouani.
 Aug. Zurlufh (Eds.), 73 Blvd. Raspail, 75006 Paris. Tel: (01) 548.68.60. Gen. Mgr.: Fernand Masson.
 Int'l firms represented: Aulos (Japan), Berandol (Canada), Hug Foetsch (Switzerland).

Artistes Musiciens Associes, 72 Champs-Elysees, 75008 Paris. Tel: (01) 359.66.28.
 Association de Recherches & d'Applications des Techniques Psychomusicales, 14 Rue des Freres-Morane, 75015 Paris. Tel: (01) 533.27.07.
 Association des Disco-Mobiles de France, 198-bis Blvd. de Stalingrad, 94500 Champigny sur Marne. Tel: (01) 706.24.25. Pres.: Jean-Michel Steward.
 Association Musicale Int'l'e d'Echanges, 39 Blvd. des Capucines, 75002 Paris. Tel: (01) 261.17.13. Gen. Mgr.: Catherine Colonna.
 B I E M (Bureau Int'l des Societes Gerant Les Droits d'Enregistrement & de Reproduction Mecanique), 11 Rue Keppel, 75116 Paris. Tel: (01) 70.55.91, 720.61.15. Cable: BIEMUSIC. Sec'y Gen.: Jean Elissabai.
 C E D A C (Centrale d'Editions Artistiques & Culturelles), 4 Rue Cassette, 75006 Paris. Tel: (01) 222.13.07. Gen. Mgr.: Ed Wagner.
 C I S A C (Confederation Int'l'e des Societes d'Auteurs & Compositeurs), 11 Rue Keppel, 75116 Paris. Tel: 720.59.37/22.52. Cable: INTERAUTEURS. Sec'y-Gen.: J.A. Ziegler.
 C D G D E P (Compagnie du Distribution & d'Edition Phonographiques & Litteraires), 33 Rue des Ardennes, 75940 Paris Cedex 19.
 Centre Nat'l d'Animation Musicale, 55 Rue de Varenne, 75006 Paris. Tel: (01) 222.93.60. Dir.: Michel Brigueot.
 Chambre Syndicale de la Facture Instrumentale (Musical Instrument Mfrs. Ass'n), 57 Av. de Villiers, 75017 Paris. Tel: (01) 267.05.50. Pres.: Bernard Mallot.
 Chambre Syndicale de l'Edition Musicale, 57 Av. de Villiers, 75017 Paris. Tel: (01) 267.05.50. Pres.: G. Roguere.
 Chambre Syndicale des Administrateurs de Concerts, 252 Rue du Faubourg St. Honore, 75008 Paris. Tel: (01) 563.20.08.
 Comite Nat'l de la Musique, 252 Faubourg St. Honore, 75008 Paris. Tel: (01) 563.48.58. Pres.: Claude A. Leduc; Gen. Mgr.: Jacques Masson-Forestier.
 E K L A Societe d'Eds. Musicales, 68 Av. d'Iena, 75116 Paris. Tel: (01) 720.28.94. Pres. Dir. Gen.: Lydwine de Warengien.
 F N I E (Federation Nat'l'e des Industries Electroniques), see GIEL.
 F N M (Federation Nat'l'e de la Musique), 57 Av. de Villiers, 75017 Paris. Tel: (01) 267.05.50.
 G A V E (Groupe Audio Visuel de l'Edition), 117 Blvd. St. Germain, 75006 Paris. Tel: (01) 329.21.01.
 G I C A (Groupement Intersyndical de la Communication Audiovisuelle), 117 Blvd. St. Germain, 75006 Paris. Tel: (01) 329.21.01.
 G I E P A (Groupement d'Interet Economique de l'Edition Phonographique & Audiovisuelle), 7 Rue du Heider, 75002 Paris. Tel: (01) 267.05.50.
 G I E L (Groupement des Industries Electroniques) (formerly FNIE), 11 Rue Hamelin, 75783 Paris Cedex 16. Tel: (01) 505.14.27. Telex: 611045.
 G P A V (Groupement de Professionnels de l'Audio-Visuel), 117 Blvd. St. Germain, 75006 Paris. Tel: (01) 329.21.01.
 I F C O M (Institut Francais de Formation aux Commerces & Metiers de la Musique), 93 Rue St. Lazare, 75009 Paris. Tel: (01) 280.05.42. Dir.: Christian Kiefer.
 I R T E France (Societe Informatique au Service du Show Business), 3 Rue de Provence, 75009 Paris. Tel: (01) 770.26.39.
 Institut National de l'Audiovisuel, Groupe de Recherches Musicales (INA-GRM), 116 Av. du President Kennedy, 75016 Paris. Tel: (01) 224.29.88.
 International Confederation of Popular Societies of Music, 121 Rue La Fayette, 75008 Paris.
 International Music Council, c/o UNESCO, 1 Rue Miollis, 75015 Paris. Tel: (01) 577.16.10 x 4835. Pres.: John P.L. Roberts; Exec. Sec'y: John Bor-noff.
 International Society for Contemporary Music, Conservatoire de Musique, 7 Pl. de la Republique, Strasbourg.
 Jeunesses Musicales de France, 14 Rue Francois-Miron, 75004 Paris. Tel: (01) 278.19.54, 887.64.81. Dir. Gen.: Jean-Pierre de Lavigne.
 Midem Org., 179 Av. Victor Hugo, 75116 Paris. Tel: (01) 505.14.03. Telex: 630547. Commissioner Gen.: Bernard Chevy; Int'l Dir.: Xavier Roy; Programme Mgr.: Gerald de Foucher; Int'l Sales Mgr.: Alain Benaim.
 National Section of the International Society for Contemporary Music, Bureau de Concerts Marcel de Valmetre, 7-11 Av. Delcasse, 75008 Paris. Tel: (01) 359.28.38.
 D R E P (Office de Relations Exterieures & de Promotion), 10 Rue Marechal-Foch, 06400 Cannes. Tel: 39.04.96, 99.16.40.
 Reunion des Theatres Lyriques Municipaux de France, 7 Rue du Heider, 75009 Paris. Tel: (01) 824.73.16. Pres.: Roger Marfaing.
 S C A R I (Syndicat des Constructeurs d'Appareils Radiorecepteurs & Tele-viseurs), 11 Rue Hamelin, 75783 Paris Cedex 16. Tel: (01) 505.14.27. Telex: SYVLECC 611045.
 S I E R E (Syndicat des Industries Electroniques de Reproduction & d'Enregistrement), 11 Rue Hamelin, 75783 Paris Cedex 16. Tel: (01) 505.14.27. Telex: 611045.
 S N E P A (Syndicat Nat'l de l'Edition Phonographique & Audio-Visuelle), 57 Av. de Villiers, 75017 Paris. Tel: (01) 267.05.50. Delegate Gen.: Pierre Chesnas.
 S N V C (Syndicat Nat'l de la Video-Communication), Tele 2000-Press, 43 Rue du Faubourg St. Honore, Paris. Tel: (01) 265.30.06.
 S D D I P (Societe de Distribution de Programmes), 22 Rue de l'Equerre, Z.A. de Bethunes, 95310 Saint-Denis l'Aumonte. Tel: 037.92.27. Dir. Gen.: Michel Berson.
 S P P I (Syndicat des Producteurs Phonographiques Independants), 252 Rue du Faubourg St. Honore, 75008 Paris. Tel: (01) 227.60.24.
 Snaccom (Syndicat Nat'l des Chets d'Orchestre & des Cadres de la Musi-que), Maison du Musicien, 2 bis Rue Victor Masse, 75009 Paris.
 Syndicate des Proprietaires Exploitants de Chapiteaux, Rte. de la Motte au Bois, Manor du Laurier, 5966P Merville. Tel: (28) 42.81.41.
 Syndicat des Artistes Musiciens Professionnels de Paris, 14-16 Rue des Lias, 75019 Paris. Tel: (01) 240.55.88.
 Syndicat des Chansonniers, Theatre des 2 Anes, 100 Blvd. de Clichy, 75009 Paris.
 Syndicat des Constructeurs d'Appareils Radiorecepteurs & Televiseurs, see SCART.
 Syndicat Francais des Artistes Interpretes (SFA), 21 bis Rue Victor Masse, 75009 Paris. Tel: (01) 285.88.11.
 Syndicat Nat'l de l'Edition Phonographique & Audiovisuelle, 57 Av. de Villiers, 75017 Paris. Tel: (01) 267.05.50.
 Syndicat Nat'l des Agents Artistiques de France, 33 Champs Elysees, Dfice 604, 75008 Paris. Tel: (01) 225.67.24.
 Syndicat Nat'l des Artistes Musiciens de France, 14-16 Rue des Lias, 75019 Paris. Tel: (01) 240.55.88.
 Syndicat Nat'l des Auteurs & des Compositeurs, 80 Rue Taibout, 75442 Paris Cedex 09. Tel: (01) 874.96.30, 526.31.83. Pres.: Jean Delannoy.
 Syndicat Nat'l des Entrepreneurs de Spectacles de Varietes, 7 Rue du Heider, 75009 Paris. Tel: (01) 824.73.16.
 Syndicat Nat'l des Producteurs de Spectacles de Varietes, 7 Rue du Heider, 75009 Paris. Tel: (01) 706.76.87. Pres.: Jack-Henri Sumere.
 Syndicat Nat'l Libres des Artistes de Varietes, 2 Rue de la Michodiere, 75009 Paris. Tel: (01) 742.35.86.

Syndicat Professionnel de la Critique Dramatique & Musicale, 52 Rue Richer, 75009 Paris. Tel: (01) 824.65.71.
 Union des Artistes, 7 Rue Henri-Rochefort, 75017 Paris. Tel: (01) 924.35.02.
CATALOG SERVICES
 E K L A Societe d'Eds. Musicales, 68 Av. d'Iena, 75116 Paris. Tel: (01) 720.28.94. Pres. Dir. Gen.: Lydwine de Warengien. (Record & Tape)
 Michel Meyer & Cie, 8 Rue de l'Est, 92100 Boulogne. Tel: (01) 605.43.21. Telex: 201336. Chief Exec.: Michel Meyer; Gen. Mgr.: Philippe Terrier. (Record & Tape)
 Pubison Audio Professional, 7-9 Rue Crespin du Gast, 75011 Paris. Tel: (01) 357.64.07. Dir.: Peter Dean; Gen. Mgr.: Dany Dean.
 Symphony Land, 4 Rue Pierre DuPont, 75010 Paris. Tel: (01) 239.31.11. Gen. Mgr.: Jean-Claude Smits. (Record)
DESIGN & ARTWORK
 Adolarc, 41 Rue Laugier, 75017 Paris. Tel: (01) 227.47.54., 267.22.11.
 Amphion, 12 Rue Rougemont, 75009 Paris. Tel: (01) 246.24.97.
 Audio Graphic Inds., 124-bis Av. de Villiers, 75017 Paris. Tel: (01) 380.65.70. Telex: 290833.
 Carabine Music, 124 Rue La Boetie, 75008 Paris. Tel: (01) 225.80.30. Co-Pres.: Raymond Drouet, Nadege Laboure; Gen. Mgr.: Charles Igbu.
 Dillard & Cie., 47-49 Rue Ploncoue, 75018 Paris. Tel: (01) 255.43.21. Telex: 650123. Dir.: Jean-Pierre Dillard; Sales Mgr.: Jean-Marc Delaie.
 Festa, 30 Rue du Dr. Finlay, 75015 Paris. Tel: (01) 578.15.18/24.75. Con-tacts: Marie & Patrick Chevalier.
 Fleche (Disques), 122 Blvd. Exelmans, 75016 Paris. Tel: (01) 525.20.73. Gen. Mgr.: Claude Francois; Admin. Dir.: Nicole Gruyer.
 Alain Grima, 31460 Louvens. Tel: (1661) 83.12.55.
 International Shows, 10 Rue Damremont, 75018 Paris. Tel: (01) 606.88.35.
 Iris Television, 9 bis Rue du Commandant Pilot, 92200 Neuilly Sur Seine. Tel: (01) 624.13.10. Telex: 613980.
 Michel Laguere Org., 47 Av. Paul Doumer, 75016 Paris. Tel: (01) 520.37.53. Telex: 611650. Pres.: Michel Laguere; Gen. Mgr.: Monique Dupuy.
 Jean-Pierre Leloir, 26 Rue Notre Dame des Victoires, 75002 Paris. Tel: (01) 296.27.97. Gen. Mgr.: Jean-Pierre Leloir.
 Malfroy, 7 Rue Saint-Vincent, 40103 Dax Cedex. Tel: (58) 74.65.69. Dwner: Dominique Malfroy; Technical Dir.: Jean Malfroy.
 Michel Meyer & Cie, 8 Rue de l'Est, 92100 Boulogne. Tel: (01) 605.43.21. Telex: 201336. Chief Exec.: Michel Meyer; Gen. Mgr.: Philippe Terrier. (Rec. only)
 Music Imprimerie, 252 Rue du Faubourg Saint-Honore, 75008 Paris. Tel: (01) 563.43.70.
 Plant: 91220 Bondoufle, Za la Marinierie, Rue G. Eiffel. Tel: 077.78.39.
 Symphony Land, 4 Rue Pierre DuPont, 75010 Paris. Tel: (01) 239.31.11. Gen. Mgr.: Jean-Claude Smits.
LICENSING ORGANIZATIONS, MUSIC
 A C E (Societe des Auteurs, Compositeurs & Editeurs), 62 Rue Blanche, 75009 Paris. Tel: (01) 874.94.81. Pres.: Gerard Davoust. (Mechanical rights only)
 E K L A Societe d'Eds. Musicales, 68 Av. d'Iena, 75116 Paris. Tel: (01) 720.28.94. Pres. Dir. Gen.: Lydwine de Warengien. (Performing & mechanical rights)
 S A C E M (Societe des Auteurs, Compositeurs & Editeurs de Musique), 225 Av. Charles de Gaulle, 92521 Neuilly-sur-Seine Cedex. Tel: (01) 747.56.50. Cable: MUSICA (Mechanical & performing rights).
 S D R M (Societe pour l'Administration du Droit de Reproduction Mecanique des Auteurs, Compositeurs & Editeurs), 225 Av. Charles de Gaulle, 92521 Neuilly-sur-Seine Cedex. Tel: (01) 747.56.50. Cable: MUSICA.
 S P E D I A M (Societe de Perception & de Distribution des Droits des Artistes Musiciens Interpretes & Executants), 14 Rue Notre Dame de Lorette, 75009 Paris. Tel: (01) 285.13.75. Pres.: Maurice Hussot. (Mechanical & performing rights).
LICENSORS, RECORD & TAPE
 E K L A Societe d'Eds. Musicales, 68 Av. d'Iena, 75116 Paris. Tel: (01) 720.28.94. Pres. Dir. Gen.: Lydwine de Warengien.
 Michel Meyer & Cie, 8 Rue de l'Est, 92100 Boulogne. Tel: (01) 605.43.21. Telex: 201336. Dir.: Michel Meyer; Gen. Mgr.: Philippe Terrier.
PLATING, PROCESSING & PRESSING PLANTS
 A B P, 5 Route de Lyon, 25720 Beure. Tel: (81) 83.35.85, 81.11.80. (Pressing only)
 Aeracem (Societe Nouvelle), PO Box 1, 61190 Tourouvre. Tel: (33) 25.06.13. Telex: 171015.
 Audio Graphic Inds., 124-bis Av. de Villiers, 75017 Paris. Tel: (01) 380.65.70. Telex: 290833.
 C N A I Fidsound (Compagnie Nationale d'Applications Ind'elles), 19 Rue Coysevox, 75018 Paris. Tel: (01) 228.05.91, 229.24.61. Pres. & Dir. Gen.: Jean-Claude Thuel-Chassaingne.
 Clementine Music, 14 bis Av. de l'Abbeville, 94810 Vallangouard. Tel: 466.53.26. Gen. Mgr.: Michel Vassiliu. (Pressing only)
 F L V M, 73 Grande Rue, 95550 Bessancourt. Tel: (03) 960.70.97. Dir.: Jean-Marc Bailleur.
 Fleche (Disques), 122 Blvd. Exelmans, 75016 Paris. Tel: (01) 525.20.73. Gen. Mgr.: Claude Francois; Admin. Dir.: Nicole Gruyer. (Pressing only).
 French Metropolitan Communications, c/o Leyco France, 170 Rue St. Charles, 75015 Paris. Tel: (01) 558.52.31. Telex: 203524. (Pressing only)
 Libet (Disques), 30 Rue Carnot, 76700 Harfleur. Gen. Mgr.: Guy Libet.
 M P D Disques, Rue J. Doitteau, 53700 Villames la Jubel. Tel: 16.43.03.27/35. Pres. Dir. Gen.: Pierre de Poix; Sales Mgr.: Monique de Poix.
 Mood Duplication, RN 307, 78810 Feucherolles. Tel: (03) 056.31.08. Telex: 698940. Pres.: M. Miller; Sales Mgrs.: P. Campiot, H. Louchet.
 Multi-Techniques, 55 bis Rue de Ponthieu, 75008 Paris. Tel: (01) 359.25.14. Telex: 650411. (Pressing only).
 Offset Press, 9 Rue Edouard Renell, 93000 Le Blanc-Mesnil. Tel: (01) 931.16.82. Telex: 641431. Chief Exec.: Yves Volant; Gen. Mgr.: Guy Volant. (Pressing only)
 P F D (Production Francaise de Disques), 67 Rue des Freres Lumiere, 93330 Neuilly sur Marne. Tel: 300.53.00, 300.58.00. Telex: 212092. Chm.: E. Arav; Gen. Mgr.: N. Alshech; Sales Mgr.: J. Arav; Mfg. Mgr.: I. Alshech; PR: H. Arav. (Pressing only)
 Pathe Marconi EMI, 36 Rue Pierret, 92200 Neuilly Sur Seine. Tel: (01) 758.12.48. Telex: 613550. Pres.: Alain Gerondeau.
 Factory: 78400 Chabou, 2 Rue Emile-Pathe. Tel: 071.92.00. Telex: 696768.
 Lucien Perlot, 13 Rue des Francs-Tireurs, 93120 La Courneuve. Tel: 833.86.71.
 PolyGram Inds. & Messageries, Av. Maurice Rayet, 92160 Antony. Tel: 666.21.02. Pres.: Edmond Lang; Int'l Dir.: Fernand Pasquier; Sec'y Gen.: Bruno d'Argeval; Technical Dir.: Christian March; Factory Dir.: P. Crapard; Comm'l Dir.: Jean-Michel Allays.
 Prosonor, 5 Av. des Tilleuls, 93700 Drancy. Tel: 830-58.19. (Pressing only)
 Satav-Satrape, 44 Rue Pierre Joseph Proudhon, 78800 Houilles. Tel: (03) 968.60.95. Telex: 698618.

• services

ASSOCIATIONS & PROFESSIONAL ORGANIZATIONS

A N S E (Association Nat'l'e des Studios d'Enregistrements Sonores), 161 Blvd. Lefevre, 75015 Paris. Tel: (01) 828.83.15.

Saters, Allee du Guerau, 28130 Maintenon. (Pressing only).
Vogue MPP (Manufacture de Prod'ns Phonographiques), 82 Rue Maurice Grandcoing, 93430 Villetaiseuse. Tel: 826.55.00. Cable: VOGDISC Paris. Telex: 620380. (Pressing only)
Voixgrave, 6 Rue de Lisbonne, 75008 Paris. Tel: (01) 522.66.84.

PRINTERS & LITHOGRAPHERS

A G P Mazarine, 22 Av. du President Wilson, 94230 Cachan.
A Tempo, 14 Rue Mollien, 92100 Boulogne. Tel: 604.35.74.
Adolard, 41 Rue Laugier, 75017 Paris. Tel: (01) 227.47.54., 267.22.11.
Aeracem (Societe Nouvelle), PO Box 1, 61190 Tourouvre. Tel: (33) 25.06.13. Telex: 171015.
Amphion, 12 Rue Rougemont, 75009 Paris. Tel: (31) 246.24.97.
Audio Graphic Inds., 124-bis Av. de Villiers, 75017 Paris. Tel: (01) 380.65.70. Telex: 290833.
C N A I Fidsound (Compagnie Nationale d'Applications Ind'elles), 19 Rue Coysoux, 75018 Paris. Tel: (01) 228.05.91, 229.24.61. Pres. & Dir. Gen.: Jean-Claude Thuel-Chassaingne.
Chaumes, 10 Rue du Dr. Lebel, 94300 Vincennes
Clementine Music, 14 bis Av. de l'Abbeville, 94810 Vallangoujard. Tel: 466.53.26. Gen. Mgr.: Michel Vassiliu.
Dillard & Cie., 47-49 Rue Polonceau, 75018 Paris. Tel: (01) 255.43.21. Telex: 650123. Dir.: Jean-Pierre Dillard; Sales Mgr.: Jean-Marc Delaye.
Dorel (Les Procédés), 45 Rue de Tocqueville, 75017 Paris. Tel: (01) 227.70.50.
Est Typo-Offset, 10 Rue du Dr. Lebel, 94300 Vincennes. Tel: 808.37.87.
Fiesta, 30 Rue du Dr. Finlay, 75015 Paris. Tel: (01) 578.15.18/24.75. Contacts: Marie & Patrick Chevalier.
Fleche (Disques), 122 Blvd. Exelmans, 75016 Paris. Tel: (01) 525.20.73. Gen. Mgr.: Claude Francois; Admin. Dir.: Nicole Gruyer.
Glory Impression Cartonage, 7 Rue Louis Armand, 92602 Asnieres. Tel: 790.62.31. Telex: 630110. Pres. Dir. Gen.: Marcel Glory; Technical Mgr.: Jacques Lesueur; Sales Mgr.: Frederic Bussiere.
Graphicolor, 24 Rue Thomas-Lemaître, 92000 Nanterre. Tel: 204.74.50.
Grenouilleau-Landais & Les Fils, 18 Rue Dom.-Deviennes, 33000 Bordeaux. Tel: (56) 91.49.56.
Main Grima, 31460 Loubens. Tel: (1661) 83.12.55.
I M C I, 122 bis Rue Aristide-Briand, 92300 Levallois-Perret. Tel: 737.69.08.
Imprimerie de Saint-Michel, 21 Des Granges, 87:40 Ambazac. Tel: (55) 56.63.25.
Imprimerie du Nord, 79 Rue du General Leclerc, 78400 Chatou. Tel: 071.38.80. Telex: 696040. Dir.: Jean Roubinet; Gen. Mgr.: Norman J. Garrod.
Imprimerie Saint-Roch, 144 Rue du Chemin-Vert, 75011 Paris. Tel: (01) 805.21.98.
International Shows, 10 Rue Damremont, 75018 Paris. Tel: (01) 606.88.35.
Iris Television, 9 bis Rue du Commandant Pilot, 92200 Neuilly Sur Seine. Tel: (1) 624.13.10. Telex: 613980.
Jat (Imprimerie), 20 Rue Molitor, 75016 Paris. Tel: (01) 651.62.90.
Levan (E.D.S.), 1 Rue de l'Abbe-Gregoire, 75006 Paris. Tel: (02) 222.15.84.
M K 44 Rue Etienne Marcel, 75002 Paris. Tel: 233.47.30. Pres. & Gen. Mgr.: Monique Knuchel.
M P D Disques, Rue J. Doitteau, 53700 Villaines la Juhel. Tel: 16.43.03.27/35. Pres. Dir. Gen.: Pierre de Poix; Sales Mgr.: Monique de Poix.
Malfroy, 7 Rue Saint-Vincent, 40103 Dax Cedex. Tel: (58) 74.65.69. Dwner: Dominique Malfroy; Technical Dir.: Jean Malfroy.
Montreuil Offset, 50 Rue Voltaire, 93100 Montreuil Tel: 374.46.39. Pres. & Dir. Gen.: Roger Mandin; Gen. Mgr.: Maurice Delaunay.
Mood Duplication, RN 307, 78810 Feucherolles. Tel: (03) 056.31.08. Telex: 698940. Pres.: M. Miller; Sales Mgrs.: P. Campiot, H. Louchet.
Music Imprimerie, 252 Rue du Faubourg Saint-Honore, 75008 Paris. Tel: (01) 563.43.70.
Plant: 91220 Bondoufle, Zai la Mariniere, Rue G. Eiffel. Tel: 077.78.39.
Offset Press, 9 Rue Edouard Renault, 93000 Le Blanc-Mesnil. Tel: (01) 931.16.82. Telex: 641431. Chief Exec.: Yves Volant; Gen. Mgr.: Guy Volant.
Photochromie, (La) 79 Av. Raspail, 94250 Gentilly. Tel: 588.70.71.
Publi GD, 62 Mail des Charmilles, 10000 Troyes. Tel: (25) 81.05.62. Gen. Mgr.: S. Delforge.
Resonances, 162 Rue du Faubourg-Saint-Denis, 75010 Paris. Tel: (01) 607.48.11.
Rop, 19 bis Allee des Sansonnets, 93320 Pavillon-sous-Bois. Tel: 738.53.79.
Roland, 82 Rue de Faubourg St. Martin, 75010 Paris. Tel: (01) 208.76.83.
Soder, 35 Rue Rene-Leynaud, 69000 Lyon. Tel: (78) 27.30.04.
Studio 92, 3 & 5 Rue Soderfno, 92100 Boulogne. Tel: 608.03.11.
Studio 621, 31460 Loubens Laurageais. Tel: (166) 83.12.55.
Symphony Land, 4 Rue Pierre Dupont, 75010 Paris. Tel: (01) 239.31.11. Gen. Mgr.: Jean-Claude Smits.
Verdier (Les Ateliers), 142 Rue de Cignancourt, 75018 Paris. Tel: (01) 606.53.97, 606.54.48.
Vogue MPP (Manufacture de Prod'ns Phonographiques), 82 Rue Maurice Grandcoing, 93430 Villetaiseuse. Tel: (01) 826.55.00. Cable: VOGDISC Paris. Telex: 620380.
Voixgrave, 18 Rue Pigalle, 75009 Paris. Tel: (01) 526.25.93., 874.25.73.

RECORD PROMOTION

(Including Public Relations & Publicity)
Amphion, 12 Rue Rougemont, 75009 Paris. Tel: (04) 246.24.97.
Briand, 7-9 Rue Stenlen, 75018 Paris. Tel: (01) 255.52.50. Telex 642083. Exec.: Guillaume Biro; Gen. Mgr.: Renan Biro; Sales Mgr.: David Reichntzer.
Context Recs., 8 Rue Emile-Alix, 75017 Paris. Tel: (01) 924.27.88. Dir.: Philippe Douteau; Gen. Mgr.: Jacques Galissant.
Robert Donat, 5 Rue Cardinet, 75017 Paris. Tel: (01) 766.50.50 Chief Exec.: Robert Donat.
E K L A Societe d'Eds. Musicales, 68 Av. d'Iena, 75116 Paris. Tel: (01) 720.28.94. Pres. Dir. Gen.: Lyndene de Warengien.
Ferber Studios, 56 Rue du Capitaine Ferber, 75020 Paris. Tel: (01) 636.31.01. Telex: 670379.
Fiesta, 30 Rue du Dr. Finlay, 75015 Paris. Tel: (01) 578.15.18/24.75. Contacts: Marie & Patrick Chevalier.
International Shows, 10 Rue Damremont, 75018 Paris. Tel: (01) 606.88.35.
M A B Publicite SA, 81 Blvd. Beaumarchais, 75003 Paris. Tel: 277.50.25.
M M Int'l, 122 Av. du Wagram, 75007 Paris. Tel: (01) 157.12.84. Dir.: Mash Worthington III.
Michel Meyer & Cie, 8 Rue de l'Est, 92100 Boulogne. Tel: (01) 605.43.21. Telex: 201336. Dir.: Michel Meyer; Gen. Mgr.: Philippe Terrier.
Sofac (Normandie), PO Box 12, Rue de Verdun, 75030 Elbeuf. Tel: (35) 77.41.41.
Johnny Stark, 122 Av. de Wagram, 75017 Paris. Tel: (01) 622.17.46. Cable: TELESHDW.
Symphony Land, 4 Rue Pierre Dupont, 75010 Parr. Tel: (01) 239.31.11. Gen. Mgr.: Jean-Claude Smits.

TÂPE CUSTOM DUPLICATORS

The Audio & Video lines indicate which configurations the firms duplicate. Companies which offer packaging & labeling services for tape product are indicated by: "PKG" which appears after the main body of their listings.
Audio Graphic Inds., 124-bis Av. de Villiers, 75017 Paris. Tel: (01) 380.65.70. Telex: 290833.
Audio Magnetics France, 129 Av. Charles de Gaulle, 92200 Neuilly. Tel: (01) 745.62.62. Telex: 611698. Gen. Mgr.: J. Arrighi de Casanova.
Audio & Video.
B A S F (Compagnie Francaise), 140 Rue Jules Guesde, 92303 Levallois. Tel: 739.33.22. Telex: 620445. Comm'l Dir.: Robert Kaplan.
Audio: Cassette & open reel.
C N A I Fidsound (Compagnie Nationale d'Applications Ind'elles), 19 Rue Coysoux, 75018 Paris. Tel: (01) 228.05.91, 229.24.61. Pres. & Dir. Gen.: Jean-Claude Thuel-Chassaingne.
Audio: 8-tr., 8-tr. quadraphonic, cassette, open reel & open reel quadraphonic.
Context, 30 Rue de Citeaux, 75012 Paris. Tel: (01) 345.73.30, 344.62.25. Dir. Gen.: Philippe Douteau.
Audio: 8-tr., 8-tr. quadraphonic, cassette & open reel.
De Plen Vent, 5 Rue Jean Jaures, 07600 Vals les Bains. Tel: (75) 37.52.76. Telex: 345790. Dir.: Jean Gibaud; Eng.: J.-Claude Millet. (PKG)
Audio: Cassette.
E D S, 16 Rue Gay Lussac, 94430 Chennevevers sur Marne. Tel: 594.21.42. Dir.: J.M. Simon; Technical Mgr.: M. Girardot.
Audio: Cassette.
Fiesta, 30 Rue du Dr. Finlay, 75015 Paris. Tel: (01) 578.15.18/24.75. Contacts: Marie & Patrick Chevalier.
Audio: Cassette.
Video: 1/2" U-matic, 1/4" VHS cassette.
Hi-Fi Diffusion, 19 Rue Yvande de l'Escarene, 06000 Nice. Tel: (93) 80.50.50.
Audio: Cassette.
Video: 1/2" U-matic, 1/4" Beta & VHS.
Iris Television, 9 bis Rue du Commandant Pilot, 92200 Neuilly Sur Seine. Tel: (1) 624.13.10. Telex: 613980. (PKG)
Video: 1" helical, 1/2" U-matic, 1/4" Beta, VHS & SVR.
Michel Laguens Dir., 47 Av. Paul Doumer, 75016 Paris. Tel: (01) 520.37.53. Telex: 611650. Pres.: Michel Laguens; Gen. Mgr.: Monique Dupuy; Sales Mgr.: Francoise Maderon.
M P D Disques, Rue J. Doitteau, 53700 Villaines la Juhel. Tel: 16.43.03.27/35. Pres. Dir. Gen.: Pierre de Poix; Sales Mgr.: Monique de Poix.
Audio: 8-tr., 8-tr. quadraphonic, cassette.
Malfroy, 7 Rue Saint-Vincent, 40103 Dax Cedex. Tel: (58) 74.65.69. Dwner: Dominique Malfroy; Technical Dir.: Jean Malfroy. (PKG)
Audio: Cassette.
Video: 1/2" Beta, 1/4" VHS.
Michel Meyer & Cie, 8 Rue de l'Est, 92100 Boulogne. Tel: (01) 605.43.27. Telex: 201336. Chief Exec.: Michel Meyer; Gen. Mgr.: Philippe Terrier.
Audio: 8-tr., cassette, open reel.
Video: 1" helical open reel.
Mood Duplication, RN 307, 78810 Feucherolles. Tel: (03) 056.31.08. Telex: 698940. Pres.: M. Miller; Sales Mgrs.: P. Campiot, H. Louchet.
Audio: Cassette, open reel.
Morning Star, 53 Rue du Faubourg St. Antoine, 75011 Paris. Tel: (01) 346.67.89.
Multi-Techniques, 55 bis Rue de Ponthieu, 75008 Paris. Tel: (01) 259.25.14. Telex: 650411.
Audio: Cassette, open reel.
Pathe Marconi EMI, 36 Rue Pierret, 92200 Neuilly Sur Seine. Tel: 758.12.48. Telex: 613550. Pres.: Alain Gerondeau.
Factory: 78400 Chatou, 2 Rue Emile Pathe. Tel: 071.92.00. Telex: 696768.
PolyGram Inds. & Messageries, Av. Maurice Ravel, 92160 Antony. Tel: 666.21.02. Pres.: Edmond Lang; Ind'l Dir.: Fernand Pasquier; Sec'y Gen.: Bruno D'Orgeval; Technical Dir.: Christian March; Factory Dir.: P. Crapard; Comm'l Dir.: Jean-Michel Allays.
Audio: Cassette.
Polysonor, 92 Rue de la Pompe, 75116 Paris. Tel: (01) 553.47.15. Gen. Mgr.: Mr. Moureaux-Nery.
Audio: Cassette, open reel.
Satav-Satrape, 44 Rue Pierre-Joseph Proudhon, 78800 Houilles. Tel: (03) 968.60.95. Telex: 698618.
Audio: Cassette, open reel.
Sema, BP 232, 03208 Vichy Cedex. Tel: (70) 32.08.41.
Societe Francaise de Prod'n, 36 Rue des Alouettes, 75019 Paris. Tel: (01) 203.99.04. Telex: 240888.
Audio: Cassette (all formats).
Stereophonic, 9 Rue Pestalozzi, 75005 Paris. Tel: (01) 331.08.35. 010.45.79. Chief Exec.: Roger Delonges.
Audio: Cassette, open reel.
Studio Hrigoyen-Marietane, Villefranche, 64100 Bayonne. Tel: (59) 25.52.50.
Sysmo Recs., 136 Rue Championnet, 75018 Paris. Tel: (01) 255.64.62.
Triumphator, 72 Av. du Gal-Leclerc, 75014 Paris.
V D M (Video Duplication Maintenance), 33 Rue des Poissonniers, 92200 Neuilly sur Seine. Tel: 745-6667. Telex: 612367. Dir. Gen.: J.B. Fetoux. (Video only)
Vogue MPP (Manufacture de Prod'ns Phonographiques), 82 Rue Maurice Grandcoing, 93430 Villetaiseuse. Tel: 826.55.00. Cable: VOGDISC Paris. Telex: 620380.
Audio: 8-tr., cassette.
Voixgrave, 18 Rue Pigalle, 75009 Paris. Tel: (01) 526.25.93., 874.25.73. (PKG)
Audio: 8-tr., cassette, open reel.

• supplies**CARTRIDGE & CASSETTE PARTS**

B A S F (Compagnie Francaise), 140 Rue Jules Guesde, 92303 Levallois. Tel: 739.33.22. Telex: 620445. Comm'l Dir.: Robert Kaplan.
C N A I Fidsound (Compagnie Nationale d'Applications Ind'elles), 19 Rue Coysoux, 75018 Paris. Tel: (01) 228.05.91, 229.24.61. Pres. & Dir. Gen.: Jean-Claude Thuel-Chassaingne.
Greencorp Magnetics, 16 Rue Ficatier, 92400 Courbevoie. Tel: (01) 333.27.40. Telex: 613188. European Sales Mgr.: F.G. Kinney.
Malfroy, 7 Rue Saint-Vincent, 40103 Dax Cedex. Tel: (58) 74.65.69. Dwner: Dominique Malfroy; Technical Dir.: Jean Malfroy.
Audio: Cassette parts.
Brand name: 3M.
Publication Audio Professional, 7-9 Rue Crespin du Gast, 75011 Paris. Tel: (01) 357.64.07. Dir.: Peter Dean; Gen. Mgr.: Dany Dean.
Rhône Poulenc Systemes, 47 Rue de l'Echat, 94000 Creteil. Tel: 207.48.90.

Telex: 230742. Chm. & Mgr.: Michel Fromont; Dept. Mgr.: Christian Yves Nomiccio; Int'l Mgr.: Louis Delaistier.

EMPTY CARTRIDGES, CASSETTES & REELS

Agfa-Gevaert, 274 Av. Napoleon Bonaparte, 92500 Rueil-Malmaison. Tel: 732.02.60. Cable: AGFAGEVA. Telex: 203374.
Audio: Reels.
Audio Graphic Inds., 124-bis Av. de Villiers, 75017 Paris. Tel: (01) 380.65.70. Telex: 290833.
B A S F (Compagnie Francaise), 140 Rue Jules Guesde, 92303 Levallois. Tel: 739.33.22. Telex: 620445. Comm'l Dir.: Robert Kaplan.
C N A I Fidsound (Compagnie Nationale d'Applications Ind'elles), 19 Rue Coysoux, 75018 Paris. Tel: (01) 228.05.91, 229.24.61. Pres. & Dir. Gen.: Jean-Claude Thuel-Chassaingne.
Diffusion Artistique & Musicale, 95 Rue de France, 77300 Fontainebleau. Tel: (06) 422.07.20. Telex: 692723. Pres.: Didier Briaud; Sales Mgr.: Andre Turban.
Audio & Video: All configurations.
Brand name: Century-Sound.
Greencorp Magnetics, 16 Rue Ficatier, 92400 Courbevoie. Tel: (01) 333.27.40. Telex: 613188. European Sales Mgr.: F.G. Kinney.
Audio: 8-tr., cassette, open reel.
M P D Disques, Rue J. Doitteau, 53700 Villaines la Juhel. Tel: 16.43.03.27/35. Pres. Dir. Gen.: Pierre de Poix; Sales Mgr.: Monique de Poix.
Ma-Co Sarl, 10 Rue Malakoff, 92600 Asnieres. Tel: 793.37.83. Gen. Mgr.: Ms Benadon.
Audio: Cartridges.
Malfroy, 7 Rue Saint-Vincent, 40103 Dax Cedex. Tel: (58) 74.65.69. Dwner: Dominique Malfroy; Technical Dir.: Jean Malfroy.
Audio: All configurations.
Rhône Poulenc Systemes, 47 Rue de l'Echat, 94000 Creteil. Tel: 207.48.90. Telex: 230742. Chm. & Mgr.: Michel Fromont; Dept. Mgr.: Christian Yves Nomiccio; Int'l Mgr.: Louis Delaistier. (Audio only)
Brand name: Pylal

ENVELOPES & MAILERS
Audio Graphic Inds., 124-bis Av. de Villiers, 75017 Paris. Tel: (01) 380.65.70. Telex: 290833.
C N A I Fidsound (Compagnie Nationale d'Applications Ind'elles), 19 Rue Coysoux, 75018 Paris. Tel: (01) 228.05.91, 229.24.61. Pres. & Dir. Gen.: Jean-Claude Thuel-Chassaingne.

JACKETS & SLEEVES
A Tempo, 14 Rue Mollien, 92100 Boulogne. Tel: 605.35.74.
Audio Graphic Inds., 124-bis Av. de Villiers, 75017 Paris. Tel: (01) 380.65.70. Telex: 290833. (Jackets only)
C N A I Fidsound (Compagnie Nationale d'Applications Ind'elles), 19 Rue Coysoux, 75018 Paris. Tel: (01) 228.05.91, 229.24.61. Pres. & Dir. Gen.: Jean-Claude Thuel-Chassaingne.
Chaumes, 10 Rue du Docteur-Lebel, 94300 Vincennes. Tel: 808.37.87.
Dillard & Cie., 47-49 Rue Polonceau, 75018 Paris. Tel: (01) 255.43.21. Telex: 650123. Dir.: Jean-Pierre Dillard; Sales Mgr.: Jean-Marc Delaye.
Dorel (Les Procédés), 45 Rue de Tocqueville, 75017 Paris. Tel: (01) 227.70.50.
F L V M, 73 Grande Rue, 95550 Bessancourt. Tel: (03) 960.70.97. Dir.: Jean-Marc Baileux. (LP Sleeves only)
Garceau SA, BPI, 1 Rue de la Paix, 75300 Ezy Sur Eure. Tel: (37) 64.74.12. Telex: 780739. (LP boxes).
Glory Impression Cartonage, 7 Rue Louis Armand, 92602 Asnieres. Tel: 790.62.31. Telex: 630110. Pres. Dir. Gen.: Marcel Glory; Technical Mgr.: Jacques Lesueur; Sales Mgr.: Frederic Bussiere.
Grenouilleau-Landais & Les Fils, 18 Rue Dom.-Deviennes, 33000 Bordeaux. Tel: (56) 91.49.56.
I M C I, 122 bis Rue Aristide-Briand, 92300 Levallois-Perret. Tel: 737.69.08.
Imprimerie du Nord, 79 Rue du General Leclerc, 78400 Chatou. Tel: 071.38.80. Telex: 696040. Dir.: Jean Roubinet; Gen. Mgr.: Norman J. Garrod. (Sleeves only).
Imprimerie St-Roch, 144 Rue du Chemin-Vert, 75011 Paris. Tel: (01) 805.21.98.
Libet (Disques), 30 Rue Carnot, 76700 Harfleur. Gen. Mgr.: Guy Libet.
M K 44 Rue Etienne Marcel, 75002 Paris. Tel: 233.37.30. Pres. & Gen. Mgr.: Monique Knuchel. (Jackets only).
M P D Disques, Rue J. Doitteau, 53700 Villaines la Juhel. Tel: 16.43.03. Pres. Dir. Gen.: Pierre de Poix; Sales Mgr.: Monique de Poix. (Jackets only)
Malfroy, 7 Rue Saint-Vincent, 40103 Dax Cedex. Tel: (58) 74.65.69. Dwner: Dominique Malfroy; Technical Dir.: Jean Malfroy. (LP Jackets & Sleeves)
Mood Duplication, RN 307, 78810 Feucherolles. Tel: (03) 056.31.08. Telex: 698940. Pres.: M. Miller; Sales Mgrs.: P. Campiot, H. Louchet.
Offset Press, 9 Rue Edouard Renault, 93000 Le Blanc-Mesnil. Tel: (01) 931.16.82. Telex: 641431. Chief Exec.: Yves Volant; Gen. Mgr.: Guy Volant.
Pathe Marconi EMI, 36 Rue Pierret, 92200 Neuilly Sur Seine. Tel: (01) 758.12.48. Telex: 613550. Pres.: Alain Gerondeau.
Factory: 78400 Chatou, 2 Rue Emile Pathe. Tel: 071.92.00. Telex: 696768. (Jackets only)
PolyGram Inds. & Messageries, Av. Maurice Ravel, 92160 Antony. Tel: 666.21.02. Pres.: Edmond Lang; Ind'l Dir.: Fernand Pasquier; Sec'y Gen.: Bruno D'Orgeval; Technical Dir.: Christian March; Factory Dir.: P. Crapard; Comm'l Dir.: Jean-Michel Allays.
Roland, 82 Rue du Faubourg St. Martin, 75010 Paris. Tel: (01) 208.76.83.
Satav-Satrape, 44 Rue Pierre-Joseph Proudhon, 78800 Houilles. Tel: (03) 968.60.95. Telex: 698618.
Studio 621, 31460 Loubens Laurageais. Tel: (1661) 83.12.55. (Sleeves only)
Verdier (Les Ateliers), 142 Rue de Cignancourt, 75018 Paris. Tel: (01) 606.53.97, 606.54.48.
Vogue MPP (Manufacture de Prod'ns Phonographiques) 82 Maurice Grandcoing, 93430 Villetaiseuse. Tel: (01) 826.55.00. Cable: VOGDISC Paris. Telex: 620380. (Jackets only).

LABELS, DISK

Audio Graphic Inds., 124-bis Av. de Villiers, 75017 Paris. Tel: (01) 380.65.70. Telex: 290833.
C N A I Fidsound (Compagnie Nationale d'Applications Ind'elles), 19 Rue Coysoux, 75018 Paris. Tel: (01) 228.05.91, 229.24.61. Pres. & Dir. Gen.: Jean-Claude Thuel-Chassaingne.
Charmilles (Disques & Cassettes), 62 Mail des Charmilles, 10000 Troyes. Tel: (25) 81.05.62. Gen. Mgr.: Gilbert Delforge.
Dorel (Les Procédés), 45 Rue de Tocqueville, 75017 Paris. Tel: (01) 227.70.50.
Glory Impression Cartonage, 7 Rue Louis Armand, 92602 Asnieres. Tel: 790.62.31. Telex: 630110. Pres. Dir. Gen.: Marcel Glory; Technical Mgr.: Jacques Lesueur; Sales Mgr.: Frederic Bussiere.
Grenouilleau-Landais & Les Fils, 18 Rue Dom.-Deviennes, 33000 Bordeaux. Tel: (56) 91.49.56.

I M C I, 122 bis Rue Aristide-Briand, 92300 Levallois-Perret. Tel: 737 69.08. Imprimerie Saint-Roch, 144 Rue du Chemin-Vert, 75011 Paris. Tel: (01) 805.21.98.
 M P D Disques, Rue J. Doitteau, 53700 Villaines la Juhel. Tel: 16 43.03.27/35. Pres. Dir. Gen.: Pierre de Poix; Sales Mgr.: Monique de Poix.
 Mood Duplication, RN 307, 78810 Feucherolles. Tel: (03) 056.31.08. Telex: 698940. Pres.: M. Miller, Sales Mgrs.: P. Campiot, H. Louchet.
 Offset Press, 9 Rue Edouard Renault, 93000 Le Blanc-Mesnil. Tel: (01) 931.16.82. Telex: 641431. Chief Exec.: Yves Volant; Gen. Mgr.: Guy Volant.
 PolyGram Inds. & Messageries, Av. Maurice Ravel, 92160 Antony. Tel: 666.21.02. Pres.: Edmond Lang. Ind'l Dir.: Fernand Pasquier; Sec'y Gen.: Bruno d'Argeval, Technical Dir.: Christian March; Factory Dir.: P. Crapard, Comm'l Dir.: Jean-Michel Allays.
 Rolland, 82 Rue du Faubourg St. Martin, 75010 Paris. Tel: (01) 208.76.83.
 Satav-Satrape, 44 Rue Pierre Joseph Proudhon, 78800 Houilles. Tel: (03) 968.60.95. Telex: 698618.
 Verdier (Les Aeliers), 142 Rue de Clignancourt, 75018 Paris. Tel: (01) 606.53.97. 606.54.48.

POLYETHYLENE BAG & SHRINKWRAP SUPPLIERS
 Satav-Satrape, 44 Rue Pierre Joseph Proudhon, 78800 Houilles. Tel: (03) 968.60.95. Telex: 698618. (Shrinkwrap only)
 Topodis, Le Petit Parc, Zone Industrielle, 78920 Ecquevilley Tel: 475.50.21. Telex: 698074. Gen. Mgr.: Andre Gervy. (Polybags only)

PROFESSIONAL TAPE SUPPLIES
 Agta Gevaert, 274 Av. Napoleon Bonaparte, 92500 Rueil-Malmaison. Tel: 732.02.60. Cable: AGFAGEVA. Telex: 203374
Audio: Calibration tapes, splicing & leader tapes, storage & shipping cases, NAB & CCIR hubs
 Malfroy, 7 Rue Saint-Vincent, 40103 Dax Cedex. Tel: (58) 74.65.69. Owner: Dominique Malfroy, Technical Dir.: Jean Malfroy
Audio: Cassette shipping cases.

RECORD MANUFACTURING EQUIPMENT
 Audio Graphic Inds., 124-bis Av. de Villiers, 75017 Paris. Tel: (01) 380.65.70. Telex: 290883.
Chief product: Automated injection-compression presses, automatic inking & bagging machines for 7" or 12" records.
 Rhone Poulenc Systems, 47 Rue de l'Echat, 94000 Creteil. Tel: 207.48.90. Telex: 230742. Chm. & Mgr.: Michel Fromont, Dept. Mgr.: Christian Yves Nomicmsio, Int'l Mgr.: Louis Delaister.
Product: Lacquers.
Brand name: Pyral.

TAPE, RAW & BLANK LOADED
 Agta-Gevaert, 274 Av. Napoleon Bonaparte, 92500 Rueil-Malmaison. Tel: 732.02.60. Cable: AGFAGEVA. Telex: 203374.
Audio: Raw—2", 1", 1/2", & 3/4" open reel; blank—cassette.
Video: Blank—2", 1", 1/2" U-matic, 3/4" Beta, VHS, SV & Video 2000 cassette.
 Ampex SA, 17-23 Rue du Dome, 92100 Boulogne. Tel: 609.91.55. Telex: 250025.
Audio: 2", 1", cassette, open reel.
Video: 2", 1", 1/2", 3/4" Beta & VHS.
 Audio Magnetics France, 129 Av. Charles de Gaulle, 92200 Neuilly. Tel: (01) 745.62.62. Telex: 611698. Gen. Mgr.: J. Arrighi de Casanova.
 Audio Plus, 20 Av. D'Ivry, 75013 Paris. Tel: (01) 585.15.99. Telex: 201197. (Raw only)
Audio: Cassette.
Brand name: Domain Magnetics.

B A S F (Compagnie Francaise), 140 Rue Jules Guesde, 92300 Levallois. Tel: (01) 739.33.22. Audio/Video Mgr.: Robert Kaplan; Sales Mgr.: Pierre Guenoun.
Audio: Cassette, open reel.
Video: 1" open reel, 3/4" cassette, 3/4" EIAJ open reel, 3/4" EIAJ cartridge.
 C N A I Fidsoun (Compagnie Nationale d'Applications Ind'elles), 19 Rue Coysouy, 75018 Paris. Tel: (01) 228.05.91, 229.24.61. Pres. & Dir. Gen.: Jean-Claude Thuel-Chassaingne.
Audio: 8-tr., cassette, open reel.
 Century-Sound, see Diffusion Artistique
 Diffusion Artistique & Musicale, 95 Rue de France, 77300 Fontainebleau. Tel: (06) 422.07.20. Telex: 692723. Pres.: Didier Braud; Sales Mgr.: Andre Turban.
Audio: Raw & blank—cassette.
Video: Raw—3/4" Beta, 3/4" VHS.
Brand name: Century-Sound
 Domain Magnetics, see Audio Plus.
 G-tape, see Greencorp.
 Greencorp Magnetics, 16 Rue Ficatier, 92400 Courbevoie. Tel: (01) 333.27.40. Telex: 613188. European Sales Mgr.: F.G. Kinney.
Audio: 8-tr., cassette, open reel
Video: 3/4" EIAJ open reel, 3/4" cassette.
Brand names: G-tape, Greencorp, Opus.
 International Prod'n Cinearts 7, 25 Rue Cavendish, 75019 Paris. Tel: (01) 200.29.35. Gen. & Sales Mgr.: Laurent Bussaut. (Importer)

Audio & Video: Raw & blank
 J V C Video France, 138 Av. du President Pompidou, Rueil Malmaison. Tel: (01) 708.92.12. Telex: 203627. (Blank only)
Audio: Cassette (120).
Video: 3/4" U-matic cassette, 3/4" VHS cassette.
 M F P E M I see Music for Pleasure.
 M P D Disques, Rue J. Doitteau, 53700 Villaines la Juhel. Tel: 16 43.03.27/35. Pres. Dir. Gen.: Pierre de Poix; Sales Mgr.: Monique de Poix. (Blank only).
Audio: 8 tr. cassette.
 Magnex, see Sonofrads.

Malfroy, 7 Rue Saint-Vincent, 40103 Dax Cedex. Tel: (58) 74.65.69. Owner: Dominique Malfroy, Technical Dir.: Jean Malfroy
Audio: Blank—cassette, open reel
 Mood Duplication, RN 307, 78810 Feucherolles. Tel: (03) 056.31.08. Telex: 698940. Pres.: M. Miller, Sales Mgrs.: P. Campiot, H. Louchet. (Blank only)
Audio: Cassette, open reel.
 Music for Pleasure, 57 Blvd de la Republique, 78400 Chatou. Tel: (03) 071.30.79. Telex: 698730. Gen. Mgr.: Alain Gerondeau, Sales Mgr.: G. Durampart; Finance & Admin.: M.J. Brown.
Audio: Cassette.
Brand name: MFP-EMI.
 Opus, see Greencorp.
 Pathe Marconi EMI, 36 Rue Pierret, 92200 Neuilly Sur Seine. Tel: (01) 758.12.48. Telex: 613550. Pres.: Alain Gerondeau.
 Factory: 78400 Chatou, 2 Rue Emile Pathe. Tel: 071.92.00. Telex: 696768.

Audio: Cassette, open reel
 Publion Audio Professional, 7-9 Rue Crespin du Gast, 75011 Paris. Tel: (01) 357.64.07. Dir.: Peter Dean; Gen. Mgr.: Dany Dean.
Audio: 8-tr., open reel.
Video: Blank—1" open reel, 3/4" EIAJ open reel
Brand names: Pyral, 3M.
 Pyral, see Rhone Poulenc & Publion.
 Rhone Poulenc Systems, 47 Rue de l'Echat, 94000 Creteil. Tel: 207.48.90. Telex: 230742. Chm. & Mgr.: Michel Fromont, Dept. Mgr.: Christian Yves Nomicmsio, Int'l Mgr.: Louis Delaister.
Audio: Cassette & open reel.
Brand name: Pyral.
 Sonofrads, 61 Rue de Ponthieu, 75008 Paris. Tel: (01) 359.15.18. Mng. Dir.: Jean Claude Ravier
Audio: Blank—cassette
Brand name: Magnex.
 3M, see Publion

TAPE DUPLICATING & PROCESSING EQUIPMENT
 Audio Plus, 20 Av. D'Ivry, 75013 Paris. Tel: (01) 585.15.99. Telex: 201197.
Product: Duplicators
Brand names: MTI, Telex.

B A S F (Compagnie Francaise), 140 Rue Jules Guesde, 92300 Levallois. Tel: 739.33.22. Telex: 620445. Comm'l Dir.: Robert Kaplan
 C N A I Fidsoun (Compagnie Nationale d'Applications Ind'elles), 19 Rue Coysouy, 75018 Paris. Tel: (01) 228.05.91, 229.24.61. Pres. & Dir. Gen.: Jean-Claude Thuel-Chassaingne.
 International Prod'n Cinearts 7, 25 Rue Cavendish, 75019 Paris. Tel: (01) 200.29.35. Gen. & Sales Mgr.: Laurent Bussaut. (Importer)

TAPE PACKAGING & LABELING EQUIPMENT
 International Prod'n Cinearts 7, 25 Rue Cavendish, 75019 Paris. Tel: (01) 200.29.35. Gen. & Sales Mgr.: Laurent Bussaut. (Importer)

• **accessories**
 Ampex SA, 1723 Rue du Dome, 92100 Boulogne. Tel: 609.91.55. Telex: 250025.
Product: Tape—carrying & storage cases, head cleaners, bulk erasers, de-magnetizers, leader tape, splicing tape & equip. (all audio & video).
 Audio Plus, 20 Av. D'Ivry, 75013 Paris. Tel: (01) 585.15.99. Telex: 201197.
Product: Tape—splicing blocks & tape (audio) (Brady, X-edited), head cleaning tape (Tapemasters).
 B A S F (Compagnie Francaise), 140 Rue Jules Guesde, 92300 Levallois. Tel: 739.33.22. Telex: 620445. Comm'l Dir.: Robert Kaplan
Product: Tape—leader & splicing tape.
 Delta Magnetics, 41 Quai des Martyrs de la Resistance, 78700 Conflans. Tel: 972.69.81.
Product: Record—replacement styli (Stanton).
 Greencorp Magnetics, 16 Rue Ficatier, 92400 Courbevoie. Tel: (01) 333.27.40. Telex: 613188. European Sales Mgr.: F.G. Kinney.
Product: Record—carrying & storage cases, record care prods., 45 rpm adaptors, Tape—head cleaners, demagnetizers, leader & splicing tape.
 Impregia SarL, 167 Rd. de St. Leu, Epinay Sur Seine. Tel: (01) 822.64.32. Contact: Jacques Fallard.
Product: Record—record care prods. (anti-static record cleaning material)

International Prod'n Cinearts 7, 25 Rue Cavendish, 75019 Paris. Tel: (01) 200.29.35. Gen. & Sales Mgr.: Laurent Bussaut. (Importer)
Product: Record—carrying & storage cases, 45 rpm adaptors, needles, Tape—carrying & storage cases, leader & splicing tape.
 Denis Lavanne (Ets.), 62 Rue des Deportes, 45200 Montargis. Tel: (38) 85.24.17.
Product: Record—record care prods.
 Ma-Co SarL, 10 Rue Malakoff, 92600 Asnieres. Tel: 793.37.83. Gen. Mgr.: Ms. Benadon.
Product: Record—record care prods., 45 rpm adaptors, replacement styli, Tape—head cleaners & demagnetizers.
 Mageco Electronc, 117 Rue d'Aguesseau, 92100 Boulogne. Tel: (01) 604.81.90. Telex: 204261.
Product: Record—cartridges, record care prods., replacement styli (Pickering).
 Publion Audio Professional, 7-9 Rue Crespin du Gast, 75011 Paris. Tel: (01) 357.64.07. Dir.: Peter Dean; Gen. Mgr.: Dany Dean.
Product: Record—carrying & storage cases, Tape—carrying & storage cases, head cleaners, demagnetizers, leader & splicing tape.
 Sofradim-Reon, 82 Rue Baudin, 92300 Levallois Perret. Tel: (01) 270.12.24/91.81. Chief Exec.: Michel Marcot, Gen. Mgr.: Francois Marcot
Product: Record—carrying & storage cases, record care prods., replacement styli, Tape—carrying & storage cases, head cleaners, demagnetizers, leader & splicing tape.
 Symphony Land, 4 Rue Pierre DuPont, 75010 Paris. Tel: (01) 239.31.11. Gen. Mgr.: Jean-Claude Smits.
Product: Record—carrying & storage cases.
 Topodis, Le Petit Parc, Zone Industrielle, 78920 Ecquevilley Tel: 475.50.21. Telex: 698074. Gen. Mgr.: Andre Gervy
Product: Record—carrying & storage cases, record care prods., 45 rpm adaptors; Tape—carrying & storage cases (video), head cleaners, demagnetizers

Vogue MPP (Manufacture de Prod'ns Photographiques) 82 Rue Maurice Grandcoing, 93430 Villetaneuse. Tel: (01) 826.55.00. Cable: VOUGDISC. Telex: 620380.
Product: Record—45 rpm adaptors.

• **promotional merchandising aids**

The following is a list of companies involved in the manufacturing, importing, distribution & retailing of items promoting the music industry and/or its artists. The key to symbols used is: (M) manufacturer; (I) importer; (D) distributor and (R) retailer.

Malfroy, 7 Rue Saint-Vincent, 40103 Dax Cedex. Tel: (58) 74.65.69. Owner: Dominique Malfroy, Technical Dir.: Jean Malfroy.
Product: Posters, T-Shirts (M).
 Publi G.D. Impressions T-Shirts, 62 Mail des Charmilles, 10000 Troyes. Tel: (25) 81 05.62.
Product: T-Shirts (M)

• **store fixtures**
 Etalagru SA, Rue Salvator Allende, Zone Industrielle, 91120 Palaiseau. Tel: (03) 011.53.20. Dir.: T.G. Jamson; Sales Mgr.: A.W. Jamson.
Product: "Anti-theft" cassette racks (Focus)
 Glory Impression Cartonnage, 7 Rue Louis Armand, 92602 Asnieres. Tel:

790.62.31. Telex: 630110. Pres. Dir. Gen.: Marcel Glory, Technical Mgr.: Jacques Lesueur, Sales Mgr.: Frederic Bussiere.
Product: Record browser boxes & divider cards.
 Greencorp Magnetics, 16 Rue Ficatier, 92400 Courbevoie. Tel: (01) 333.27.40. Telex: 613188. European Sales Mgr.: F.G. Kinney
Product: Divider cards.
 Topodis, Le Petit Parc, Zone Industrielle, 78920 Ecquevilley. Tel: 475.50.21. Telex: 698074. Gen. Mgr.: Andre Gervy.
Product: Record & tape browser boxes, display racks, divider cards.
 Video Diffusion Int'l, 9 Rue des Bons Enfants, 75001 Paris. Tel: (01) 261.43.85. Telex: 200695.
Product: Videotape security systems.

GERMAN DEMOCRATIC REPUBLIC (EAST)

Population: 16,750,000
 Rate of exchange: \$1 (US) = 19 ost marks
 Per capita income: \$5,300
 Holidays: January 1, Good Friday, May 1 (Labor Day), Whitsunday, October 7 (Republic Day), December 25, 26

• **record & tape manufacturers / distributors / importers**

Amiga, see Deutsche Schallplatten
 Aurora, see Deutsche Schallplatten
 Buchexport (Volkseigener Aussenhandelsbetrieb der Deutschen Demokratischen Republik), Leninstr. 16, DDR 7070 Leipzig. Tel: (051678) 76-61.
 Deutsche Schallplatten (VEB), Reichstagstr. 4/5, 108 Berlin. Tel: (3011) 220-9201.
Labels: (Owned) Amiga, Aurora, Eterna, Litera, Nova.
 Eterna, see Deutsche Schallplatten
 Litera, see Deutsche Schallplatten.
 Nova, see Deutsche Schallplatten.

• **music publishers**

Breitkopf & Haertel Musikverlag (VEB), Karlstr. 10, DDR-7010 Leipzig. Tel: (05611) 73-51. Gen. Mgr. Dr. Gunter Hempel; Sales Dir.: Werner Hennig
Int'l reps: Canada (Alexander Broude), West Germany (Breitkopf & Haertel—Wiesbaden), Mexico (Alexander Broude), Netherlands (De Eerste Muziekverlag), UK (Fontone), USA (Alexander Broude)
 Deutscher Verlag fuer Musik (VEB), see Breitkopf & Haertel
 Harth Musik Verlag/Pro Musica Verlag, Karl Liebknechtstr. 12, DDR 701 Leipzig. Tel: (05611) 3-26 12
Int'l reps: Australia, Canada, UK (Breitkopf & Haertel in UK); West Germany (Apollo)
 Friedrich Hofmeister Musikverlag (VEB), see Breitkopf & Haertel
 Lied der Zeit (VEB), Postfach 10, Rosa-Luxemburgstr. 41, DDR-1020 Berlin. Tel: (0311) 28 2-50-81.
 Litloff (Collection), see Peters
 Peters (Ed.) (VEB), Postfach 746, Talstr. 10, DDR-701 Leipzig. Tel: (05611) 7721. Cable: PETERSEDITIDN. Telex: 512381.
 Pro Musica Verlag, see Harth

• **services**

ASSOCIATIONS & PROFESSIONAL ORGANIZATIONS
 Association of Composers & Musicologists of the German Democratic Republic, Leipzigerstr. 26, DDR-108 Berlin. Tel: 220-2051.
 National Committee of the International Music Council, Leipzigerstr. 26, DDR-108 Berlin. Tel: 229-2772.
 Neue Bachgesellschaft, Int'l. Vereinigung, Karlstr. 10, DDR-701 Leipzig.
 Staatliches Komitee fuer Rundfunk, Nalepastr. 18-50, DDR 116 Berlin. Tel: 63-60.

LICENSING ORGANIZATION, MUSIC
 A W A (Anstalt zur Waehrung der Auffuehrungsrechte auf dem Gebiete der Musik), Storkowerstr. 134, DDR-1055 Berlin. Tel: 434-2757. Gen. Dir.: Klaus Eisenbarth. (Mechanical & performing rights)

GERMAN FEDERAL REPUBLIC (WEST)

Population: 61,439,000
 Rate of exchange: \$1 (US) = 2.43 marks.
 Holidays: January 1, Good Friday, Easter, May 1 (Labor Day), Ascension Day, Whit Monday, June 17, November (Repentance Day), December 25, 26.

RECORDS:
Record sales certification awards: Silver single—250,000 units; gold single—500,000 units; platinum single—1,000,000 units. Silver LP—100,000 units; gold LP—250,000 units; platinum LP—500,000 units.
Records sold domestically: LP's 1980—96,900,000 units; 1979—98,200,000 units. Singles 1980—45,000,000 units; 1979—47,800,000 units.
Records exported: 1980—32,300,000 units.
Average retail price per record: LP's—\$6.50; singles—\$2.50.
TV merchandising: 25% of total.
Record club sales: 10% of total.
Discounting: Frequent.
Type of distribution: Manufacturer-to-retailer accounts for 75% of total sales. Manufacturer-to-wholesaler-to-retailer & rack jobbing (there are three rack jobbers) divide another 10%, and direct importing by retailers constitutes the remaining 15%. Total wholesale transactions have increased. Export sales to the United Kingdom and United States are still increasing.
Type of promotion: All radio and TV stations are important sources, especially Radio Luxemburg in Luxemburg and the Belgium Radio with German programs. Also helpful are the numerous discoteques, part-time discos and key publications. The twelve radio stations and the British and American Forces Networks have 30 hit parades weekly. Three TV

channels carry weekly international pop shows. Second German Television (ZDF) has a monthly "hit parade" featuring only German speaking artists. All German stations are controlled by representatives of private organizations, the government and the public.

Jukeboxes: 85,000.

TAPE:

Market: There are no 8-track sales. Musicassettes sales increased by 2% in 1980 compared with 1979. There is a pre-recorded video boom, especially for VHS, which now has a market share of 70%. Demand for Video 2000 is increasing. About 375,000 video recorders were sold in Germany in 1980, with an estimated 600,000 sales expected for 1981.

Pre-recorded tape sold domestically: Cassette 1980—38,800,000 units; 1979—37,400,000 units.

Average retail price per tape: Cassette—\$9.00.

CONSUMER ELECTRONICS:

Percentage of homes with: Radios (95%); television sets (77%); phonographs (71%); audio tape recorders (60%); video tape recorders (4%).

RADIO STATIONS:

No. of government 12.
Comment: The pop programs of the German radio stations have international music. About 70% of the radio programs are music from the UK and USA.

TELEVISION STATIONS:

No. of government channels 3 (PAL color).
Comment: The most popular music shows are "Musikladen," "Showexpress," "Disco" and "Country Music."

IMPORT/EXPORT REGULATIONS

There are no problems in importing from countries of the European market. There are restrictions against the importation of US imports.

MARKET ANALYSIS:

The record market in 1980 stagnated, forcing some of the small dealers to close their shops and the industry to reduce releases by 30%.

Musical trends are to singer-songwriter in the German language and to heavy metal German groups. The concert scene for US and UK artists was booming. Peter Maffay had the number one album, "Revanche" (Metronome), which sold 1.2 million units from September to December. The most successful song of the year was "Santa Maria," sung and composed by Oliver Onions from Italy and released by Polydor. The most successful record companies were Deutsche Grammophon, Ariola, and EMI; for publishers, the top ones were Melodie der Welt, Intro and Peer.

Wolfgang Spahr

• record & tape manufacturers / distributors / importers

A A R, see Heinz Ulm.
A G M Schallplattenproduktion & Vertrieb, Kisslingweg 44, D-7130 Muhlacker. Tel: (07041) 47-66. Telex: (07) 263721. Ctr.: Arno Graul.
A M S Musica Sacra, see Schwann.
A T R MasterCut, see Audio Trade.
Abaca, see Imnus.
Abakus, see Studio Union.
Aban, see Mixtur.
Abanori, see Mixtur.
Acanta, see Fonoteam, Bellaphon & MusiContact.
Ada, see Esplanade.
Ahorn, see Teldec.
Agil Musik & Theater GmbH, Wendelsteinstr. 11, D-8316 Feldkirchen/Riem. Tel: (089) 903-2086.
Labels: Agil, Gold, VM.
Airlift Tontraeger Vertriebs GmbH (IFPI), Clausewitzstr. 4/III, D-1000 Berlin 12. Dir.: Maria Kopp, Wolfgang Maeder; Prod'n: Andy Novello, Lennie Portner, Alf Carder. (Distributor)
Branch: D-8400 Regensburg, Portnergasse 6. Tel: (0941) 56-13-51.
Labels: (Owned) Airlift, Firebird.
Int'l rep.: Switzerland (Trendworld).
Akropolis Musik & Film GmbH, Mauritssteinweg 5, D-5000 Cologne 1. Tel: (0221) 23-19-00. Mng. & Prod. Dir.: Peter Power; Sales Mgr.: Uly Jonas. (Distributed by EMI Electrola)
Aladin (Peter Drloff) GmbH & Co. KG, Rauhe Hecke 2, D-5000 Cologne 91. Tel: (0221) 86-23-02, 86-20-32. Telex: (08) 873648. Mng. Dir.: Peter Drloff; Financial Mgr.: Azora Bierke; A&R: Jurgen Hohmann.
Labels: (Owned) Aladin, Black Prince.
Albert Prod'n, Harvestehuder Weg 21, D-2000 Hamburg 13. Tel: (040) 44-30-61. European Div. Mgr.: Alex Young.
Alcophon AV GmbH & Co. KG (IFPI), Duenebergerstr. 111-113, D-2054 Geesthacht. Tel: (4152) 4031. Telex: 218707. Mng. Dir.: Hilmar Kumbartzky; Gen. Mgr.: Manfred von Mangoldt.
Labels: (Owned) Alcophon, Alcophon Super, Blacky.
Des Alpes Schallplatten Produktion GmbH (IFPI), Theodor Koerner Str. 7, D-7800 Wuertzburg. Tel: (0931) 73884, 71286. Telex: (06) 8810. Mng. Dir.: Ursula Danner. (Distributor/Importer)
Labels: (Owned) DA, Echo, Lilliput, Main; (distributed) Amati, Bella Musica, Supertone, Welt Melodie.
Aira-Schallplatten, A Ratajczak GmbH, Schmiedstr. 88-90, D-5120 Herzogenrath. Tel: (02406) 2095. Telex: (08) 329550 Chief Exec.: Richard Vanwersch; Gen. Mgrs.: Werner Zanders, Albert Ratajczak; Sales Mgr.: Albert Ratajczak. (Distributor/Importer—cutouts)
Altixon, see Palm.
Die Alte Drgel, see Da Camera.
Alternum, see Thorofon.
Amati, see Supertone, Bella Musica & Des Alpes.
Amayana, see Heinz Ulm.
Der Andere Song, see Hansa Musik.
Christian Anders Musikverlag & Produktion, Hoerwarthstr. 26, D-8000 Munich 40. Tel: (089) 18-42-23. Pres.: Christian Anders; Gen. Mgr.: Ann Busse. (Distributed by EMI Electrola)
Labels: (Owned) Chranders.
Angel, see EMI Electrola.
Angel Musikverlag & Produktion A. Engel KG (IFPI) Potsdamerstr. 92, D-1000 Berlin 30. Tel: (030) 782-3030. Chief Exec.: Anneliese Engel; Vice Mgr.: Guenter Engel.
Label: (Owned) Days.
Int'l reps.: Canada (Wilson), Finland (Fazer), Ireland (Crossbar, Wilson), Italy (Beat), UK (Crossbar, Wilson), USA (Integrity, Wilson).
Angelo Musikverlag, An der Alster 37, D-2000 Hamburg 1. Tel: (040) 280-2292. Chief Exec.: Just Pflach.
Label: (Owned) Angelo.
Antagon Musikgesellschaft Jens Michow (IFPI), Leahartzstr. 15, D-2000

Hamburg 20. Tel: (040) 48-44-43. Telex: 2173473. Mng. Dir.: Jens Michow.
Labels: (Owned) Antagon; (licensed) Hexagone.
Arcade (Deutschland) GmbH (IFPI), Leimenode 29, D-6000 Frankfurt/Main 1. Tel: (0611) 1543-0. Telex: (04) 189319. Mng. Dir.: Michael Levene; Gen. Mgr.: Karl-Heinz Jureit; Comm'l Mgr.: Karl-Heinz Engelandt; Sales Mgr.: Rosemarie Gaebke.
Home office: England.
Label: (Owned) Arcade.
Int'l reps.: Austria (Musica), Switzerland (Phonag).
Archiv Produktion, see DGG & Polydor.
Arcum Tontraegerproduktions GmbH, Waagepl. 4, D-3400 Goettingen. Tel: (0551) 5-79-22. Telex: 96646. Owners: Gerd Hahn, Siegfried Schaefer.
Label: Dmibus.
Arendo, see Jaguar.
Ariola, see Ariola-Eurodisc.
Ariola-Eurodisc GmbH (IFPI), Steinhäuserstr. 3, D-8000 Munich 80. Tel: (089) 4-13-61. Cable: EURODISC. Telex: (05) 23487. Pres.: Monti Luefner; Mng. Dir.: Friedrich Schmidt; Finance & Admin.: Dr. Joachim Kiener; Mktg. & Promo.: Albert Czapski; Sales Mgr.: Hans Knappe; Int'l Dept.: Dorus Sturm; Export Dept.: Geiso Mampell.
Ariola Int'l Group—Pres.: Monti Luefner; Sr. VP: Friedrich Schmidt; VP Bus. Affairs: Dr. Nicholas Becker; VP USA & Canada: Elliot Goldman; VP A&R Mktg.: Wim Schipper; VP Latin America Activities: Ramon Segura Martinez.
Int'l branches: Austria, Belgium, Brazil, France, Mexico, Netherlands, Spain, Switzerland, UK, USA.
Labels: (Owned) Ariola, Arista, Baccarola, Eurodisc, Novus, Savoy; (licensed domestic) Coconut, Hansa, Hansa der Andere Songs, Dasis, Rocktopus; (licensed foreign) Albion (UK), Bearsville (USA), Blueprint (UK), Bronze (UK), CGD (Italy), CMH (USA), Caroline (UK), Chrysalis (UK), Clan Celentano (Italy), Dawn (UK), Dindisc (UK), Golden Hour (UK), Handshake (USA), Island (UK), I Spy (UK), MCA—Backstreet, Coral, Infinity & ABC (USA), Manticore (UK), Melodia (USSR), Muzity (Italy), PRT (UK), President (UK), Riello (UK), Roulette (USA), Shelter (USA), Sire (UK, USA), Supraphon (Czechoslovakia), Tomato (USA), Virgin (UK).
Int'l reps.: Argentina (Microfon), Australia (Ariola—RCA, Arista—Festival), Bolivia (Lauro), Canada (Ariola—Quality, Arista—Capitol-EMI), Caribbean (West Indies), Central America (Dideca), Colombia (Sonolux), Denmark (CBS), Ecuador (Fadisa), Finland (Finndisc), East Germany (VEB), Greece (Phonogram), Hong Kong (Ariola—Pacific, Arista—EMI), India (EMI), Israel (Hed Arzi), Italy (CGD), Japan (Ariola—King, Arista—Nippon Phonogram), Korea (Ariola—Pacific/Seorabul, Arista—EMI), Malaysia (Ariola—Pacific/Araco, Arista—EMI), New Zealand (Ariola—RCA, Arista—EMI), Nigeria (Decca), Norway (CBS), Paragway (Microfon), Peru (FTA), Philippines (Ariola—Pacific/Docto Arts, Arista—Victor), Poland (EMI India), Portugal (Phonogram), Romania (EMI India), Singapore (Ariola—Pacific/Chiung Huat, Arista—EMI), South Africa (RPM), Sweden (CBS), Taiwan (Ariola—Pacific/Pac Int'l), Austria (EMI), Thailand (Ariola—Pacific/United, Arista—EMI), Turkey (Turkuola), USSR (Melodia), Uruguay (Microfon), Venezuela (Ariola—Cordica, Arista—Velvet), Yugoslavia (RTB).
Ariola, see Ariola-Eurodisc.
Armia Musikproduktion Erich Storz (IFPI), Hauptstr. 114, D-3360 Dsteerde am Harz. Tel: (05522) 45-11. Telex: (09) 65154. Gen. Dir.: Erich Storz; Gen. Mgr.: Marianne Dipitz; Sales Mgr.: Marianne Storz. (Also a Wholesaler as Storz GmbH)
Branches: D-2000 Hamburg, Heidenkampsweg 54. Tel: (040) 280-2939. Telex: (02) 162989—D-4800 Bielefeld, Am Kampchen 4. Tel: (0521) 25017. Telex: (09) 38058—D-8702 Estorf bei Wurtburg, Am Kohlerweg 6. Tel: (09305) 712. Telex: 068476.
Labels: (Owned) Armia, Storz.
arNda Schallplattenproduktion & Vertrieb, Frankfurter Landstr. 7, D-6380 Bad Homburg. Tel: (06172) 4-68-36. Dir.: Gunther Mueller.
Label: (Owned) arNda.
Arteg Prod'n, Schinkelweg 7, D-2000 Hamburg 60. Tel: (040) 279-9941. Dir.: Arno H. v. Vught Jr.
Artist Serv., Eppendorfer Baum 13, D-2000 Hamburg 20. Tel: (040) 47-80-22, 48-70-88. Telex: (02) 163078. Mng. Dir.: Eike Heitkamp; Gen. Mgr.: Thomas Fenn.
Labels: (Licensed foreign) Capitol Prod'n/Media (USA), Tortuga (Haiti).
Int'l rep.: Denmark (DH).
Aspekte, see Teldec.
Asylum, see WEA.
Atco, see WEA.
Atlantic, see WEA.
Audio Components Vertriebs GmbH, Postfach 762104, Ackermannstr. 36, D-2000 Hamburg 76. Tel: (040) 22-57-19. Telex: 211865. (Importer)
Label: Richardson (USA).
Audio Int'l, Gonenhemstr. 2b, D-6000 Frankfurt 56. Tel: 50-47-33. Telex: (04) 13039. Pres.: Hermann Hoffmann; Sales Mgr.: Randy Stahl.
Labels: (Owned) Celis; (distributed—not licensed) Century, Klavier, M&K Real Time, Sheffield Lab, Telarc (all USA); Audio Lab (Japan).
Audiophon Classic, see Multirand.
Audio Team, Kamp 24, D-2091 Marxen. Tel: (04185) 47-00. Telex: 2189382.
Label: (Distributed) Jeton.
Audio Trade GmbH, Kolonnenstr. 203, D-4100 Duisburg 1. Tel: (0203) 37-35-12. Telex: 855259. Mng. Dir.: Peter Muehlimeyer; Sales Mgr.: Dirk Feldmann.
Labels: (Owned) ATR MasterCut, Gale Maximum Fidelity; (licensed) Direct Disk (USA), Proprus (Sweden), Three Blind Mice (Japan), Umbrella (Canada).
Audite, see Fono.
Aulos, see Fono.
Auraton, see Heinz Ulm.
Autobahn Recs., Ortmsstr. 36, D-8000 Munich 81. Tel: (089) 98-56-25. Telex: 5216305. Owners: Michael Holm, Rainer Pietsch.
Autogram & Folk Recs., Burgstr. 9, D-4405 Nottuln (Kreis Muenster). Tel: (02502) 61-51. Gen. Mgr.: Willy Schwenken.
Labels: (Owned) Autogram, Doctro, Folk-Record, Monogram.
Aves Recs. & Tapes GmbH (IFPI), Harvestehuderweg 21, D-2000 Hamburg 13. Tel: (040) 41-70-07. Telex: 212659. Mng. Dir.: Horst F. Schmolz. (Distributed by Intercord)
Labels: (Owned) Aves, Avia; (represented) Cube (UK), Electric (UK).
Avia, see Aves.
Babsy, see TeleDisc.
Babylon, see Music Distributor
Bacillus, see Bellaphon.
Baccarola, see Ariola-Eurodisc.
Baerenreiter-Musicaphon, see Baerenreiter-Verlag & Disco-Center.
Baerenreiter-Verlag, Karl Voetterle GmbH & Co. KG, Heinrich-Schuetz-Allee 35, D-3500 Kassel/Wilhelmshohe. Tel: (0561) 30011. Telex: (09) 92376. Mng. Dir.: Wolfgang Matthei. (Distributed by Disco-Center)
Int'l branches: England, France, Switzerland.

Labels: (Owned) Baerenreiter-Musicaphon, Bosse-Musik-Medium-Erziehung.
Baltic-Recs., PO Box 4544, Holstenplatz 1-2, D-2300 Kiel 1. Tel: (0431) 9-11-04. Owner: Heinz Ziemann.
Batchwork, see Leszer.
Bear Family Recs. (IFPI), Eduard Grundow Str. 12, D-2800 Bremen 1. Tel: (0421) 78874. Dir. & Gen. Mgr.: Richard Weisz; Sales Mgr.: Hermann Knuelle.
Int'l branch: England.
Labels: (Owned) Bear Family; (represented) Hickory (USA).
Int'l reps.: Australia (Memory Lane), Japan (King), Switzerland (Gold), UK (Tonal), USA (City Hall, Down Home, Rounder).
Wolfgang Becken Communications, PO Box 100544, D-2000 Hamburg 1. Tel: (040) 46-49-90. Gen. Mgr.: Wolfgang Becken.
Label: (Owned) Kreuzberg.
Bella Musica Tontraeger GmbH (IFPI), Ismaningerstr. 102, D-8000 Munich 80. Tel: (089) 98-66-49. Telex: 5215935. Chief Exec.: Juergen Rinschler.
Labels: (Owned) Bella Musica; (licensed domestic) Amati, Startel, Supertone, Welt Melodie; (licensed foreign) Multisound.
Int'l rep.: Austria (Discoltrade).
Bellaphon Int'l, see Bellaphon.
Bellaphon Recs. GmbH & Co. KG Tontraegergesellschaft (IFPI), Mainzer Landstr. 87-89, D-6000 Frankfurt/Main 1. Tel: (0611) 23-08-01. Telex: (04) 16046. Pres.: Branko Zivanovic; Int'l Prod. Mgr.: Georg Zeiss; Classic Program Dir.: Richard Schneider; Nat'l Prod. Mgr.: Juergen Hofius; Bellaphon Int'l Sound Serv. Mgr.: Winfried Mergler.
Int'l branches: Austria, Switzerland.
Labels: (Owned) Bacillus, Bellaphon, Bellaphon Int'l, Bellaphon Klassik, Heimatland, Phifikus, Pick Up, Rare Bid, Schluselloch; (licensed domestic) Acanta, Cain, ENJA, First Class, Peggy; (licensed foreign) Aristocrate (France), Audio Fidelity (USA), Avator (UK), Fabulous (UK), Fresh (UK), Gordy (USA), Greenleaves (UK), Hiltville (USA), Jackson Sound (USA), Jamaica Sound (USA), King, Motown (USA), Mowest (USA), Mure (USA), Plantation (USA), Pompeii (USA), Power Rak (USA), Prudigal (USA), Rare Earth (USA), Roadshow (USA), Roxbury (USA), SSS Int'l (USA), Scott Bros. (USA), Soul (USA), Stax (USA), Starday King (USA), Sun (USA), Tamlia Motown (USA); (distributed—not licensed domestic) Birth, Biton, L + R, Nagara, Peg, Sesam, Wolfe; (distributed—not licensed foreign) Appalosa (Italy), Arnohio (USA), Black Saint (Italy), Bvhaast (Netherlands), Concord Jazz (USA), Delos (USA), Everest (USA), India Navigation (USA), JVC Direct Disk (Japan), Lyricchord (USA), Spotlight (UK), SteepleChase (Denmark), Timeless (Netherlands).
Int'l reps.: Austria (Bellaphon), Greece (Music Box), Portugal (Imavov), Spain (RCA), Switzerland (Bellaphon).
Berolina, see Fonoteam.
Berliten, see Mixtur-Schallplatten.
Das Beste GmbH (Verlag), Augustenstr. 1, D-7000 Stuttgart 1. Tel: (0711) 66-02-1. Telex: (07) 23539. Mng. Dir.: Werner Weidemann; Mktg. Dir.: Helge Weisner; Prod'n Mgr.: Klaus D. Mandl.
Big Sound, see Comma.
Bild am Sonntag Recs. (IFPI), Kaiser Wilhelm Str. 6, D-2000 Hamburg 36. Tel: 347-4254. Telex: (02) 11898. Gen. Mgr.: Joachim Luedicke.
Bingola, see Rudolf Bohnen.
Birth, see Bellaphon.
Biton, see Bellaphon.
Black Prince, see Aladin.
Blacky, see Alcophon.
Blossom, see Intersound.
Blubber Lips, see Rockport.
Blue Rose, see Pila.
Blues Beacon, see ENJA.
Boccaccio, see Jaguar.
Dieter Boek, Koelner Landstr. 719, D-4000 Duesseldorf 13. Tel: (0211) 76-38-07. Gen. Mgr.: Dieter Boek. (Distributor/Importer/Exporter).
Label: (Owned) NTR.
Rudolf Bohnen (Musikverlag & Prod'n), Klenzstr. 65/1, D-8000 Munich 5. Tel: (089) 201-2292.
Labels: (Owned) Bingola, Peggy.
Bosse-Musik-Medium-Erziehung, see Baerenreiter-Verlag.
Brain, see Metronome.
G. Braun (Verlag), PO Box 1709, Karl-Friedrich-Str. 14-18, D-7500 Karlsruhe 1. Tel: (0721) 165-1. Telex: (07) 826904. Gen. Mgr.: Karl Breh; Sales Mgr.: Erhard Albrecht.
Label: dhi-Tetschallplatten.
Int'l reps.: Austria (Erb), Switzerland (Music Consort).
Heinz Brinker Musikverlagsgesellschaft, Bruchstr. 49, D-4330 Muelheim-Ruehr. Tel: (0208) 47-81-33. Prod'r: Heinz Brinker; Sales Mgr.: Michael Brinker.
Label: Laguna.
Brockhoff (Ed.), see Fono.
Brunswick, see DGG.
Buena Vista, see Walt Disney.
Bunny, see WEA.
Burda-Schallplatten-Vertrieb, Burda-Hochhaus, D-7600 Dffenburg. Tel: (0781) 841.
Busch-Phonothek, see Polyband.
C B S Schallplatten GmbH (IFPI), Bleichstr. 64-66a, D-6000 Frankfurt/Main 1. Tel: (0611) 1-30-51. Cable: CDLRECDR. Telex: 416735. Mng. Dir.: Jorgen Larsen; Deputy Mng. Dir.: Karl G. Arbenz.
Home office: USA, CBS Recs. Int'l.
Labels: (Owned) CBS, Embassy, Epic, GTD, Maestro, Masterworks, Portrait; (licensed domestic) m music; (licensed foreign) A&M, Blue Sky, Caribou, Inivictus, Jet, Kirshner, Monument, Philadelphia Int'l, TK, Unlimited Gold (all USA); A&R (Netherlands).
C M P Recs., Postfach 445, D-5160 Duren. Tel: (0221) 599-2031. (Distributed by Teldec Import Serv.)
C M S, see Hardt.
C R D, see MusiContact.
C R P, see MOT.
Cady, see DPP.
Cain, see Bellaphon.
Caligua, see Calif Verlag.
Caligula, see Calif Verlag.
Calig Verlag GmbH, Renatastr. 71, D-8000 Munich 19. Tel: (089) 16-34-76. Pres.: Wolfgang Walter; Prod. Mgr.: Doris Hagen; Mktg. Dir.: Manfred Steenberg. (Distributed by Disco-Center)
Labels: (Owned) Calig, Caligua.
Int'l reps.: Austria (Car), Belgium (Nelco), Japan (Universal Corp.), Netherlands (HDSAT), Sweden (Soundmaster), Switzerland (Baerenreiter, Metronome).
Calliope, see MusiContact.
Camera, Postfach 1460, Hoffman von Fallerslebenstr. 8, D-3340 Wolfenbuettel. Tel: (05331) 4976. Owner: K.M. Moester.
Cantabria, see Manzana-Cantabria.
Cantate, Heinrich-Schultz-Allee 35, D-3500 Kassel-Wilhelmshohe. Tel:



GLOBAL MUSIC GROUP

PETER KIRSTEN
NEDERLINGERSTR. 21
D 8000 MÜNCHEN 19
PHONE: 089-151063
TELEX: 05-215 019

- (0561) 3-00-13. Telex: (09) 92376. Mng. Dir.: Wolfgang Matthei. (Dis-tributed by Disco-Center).
Labels: (Owmed) Cantate. SDG.
 Canto Musikproduktion GmbH & Co. KG (IFPI). Harnstorfer Weg 11, D-2106 Bendenstorf. Tel: (04183) 62-46. Pres. & Gen. Mgr.: Fred Christman. (Dis-tributed by Teldec)
Label: (Owmed) Pastels.
 Capella, see Thorolon.
 Capitol, see EMI Electrola.
 Carsound, see Deutsche Austrophon.
 Carus, see Fono.
 Cassette Maya, see Zarikoton.
 Casseton GmbH Musik-Cassetten-Werk, Sudetenstr. 73, D-8192 Gretsried 2. Tel: (08171) 3031. Telex: (05) 26331. (Tape only)
Label: see Hiltpolstein.
 Celia, see Audio Int'l.
 Center-Ton Center Music (Klaus Joachim Witowski). Luetzowufer 24, D-1000 Berlin 30. Tel: (030) 262-1336.
 Champ Recs., Gartenstr. 15a, D-8011 Baldham/Munich. Tel: (08106) 45-55. Contact: Robert Jung.
 Chranders, see Christian Anders.
 Christophorus-Verlag Herder GmbH, Hermann Heider Str. 4, D-7800 Freiburg im Breisgau. Tel: (0761) 27-171. Telex: (07) 721440. Mng. Dir.: Benno Baldes; Promo.: Horst Neumann. (Distributed by Deutsche Austrophon).
 Cine Art Int'l, see Jaguar.
 City, see Rocamar.
 Classics Collection, see Delta.
 Clear Sound, see Hansetsische.
 Conant Recs. GmbH (IFPI), Nachtigallenweg 34 D-5202 Hennesl 1. Tel: (02242) 3082. Telex: 889775. Owners: Karin Hartmann, Tony Hendrik. (Distributed by Ariola-Eurodisc)
Label: (Owmed) Coconut.
 Coda, see Radio-Music-Reeds.
 Colonia Musik Produktion GmbH (IFPI), Mauritiussteinweg 5, D-5000 Cologne 1. Tel: (0221) 23-19-00. Mng. Dir. & Prad'r: Peter Power; Sales Mgr.: Manfred Schmidt; Promo. Mgrs.: Uly Jones, Ingrid Broecker.
Label: (Owmed) Colonia.
 Colosseum, see Fono.
 Coloursound Library, see Show Business.
 Columbia, see EMI Electrola.
 Comes, see Suede.
 Comma Recs. & Tapes, Postfach 2145, D-6078 N u Isenburger. Tel: (6102) 56-40. Telex: 4185600. Dir.: Klaus Desterreich; Gen. Mgr.: Roland Bauer; Sales Mgr.: Theo Weinbauer.
Labels: (Owmed) Big Sound, Comma, Comma Int'l; (licenssed) Fonobosa (Columbia), IFESA (Ecuador).
Int'l rapa.: Central America (Sisa), Colombia (Fonobosa), Ecuador (IFESA).
 Concord, see Polyband.
 Le Connaisseur Schallplatten, PO Box 4807, Waldstr. 62, D-7500 Karlsruhe 1. Tel: (0721) 2-56-12. Gen. Mgr.: Klaus Döboda (Distributor/Importer).
Labels: (Distributed-not licenssed) Classical Excellence (USA), Grand Drigue (France), Meridian (UK), Drion (USA), Savastro (France), Sterling (Sweden).
 Connyland, see Phon & Ton.
 Conquest, see Lesser.
 Cotillon, see WEA.
 Countdown Music Musikvertrieb GmbH (IFPI), Harksheideweg 74, D-2085 Quickborn. Tel: (04106) 24-14, 50-15. Cable: COUNTMUS HAMBURG. Telex: 214534. Gen. Mgr.: Rainer Elzrodt; Int'l Mgr.: Thomas Fenn.
Label: (Owmed) Countdown.
 Coup, see Jaguar.
 Credo, see Junge Gemeinde.
 Crystal, see EMI Electrola.
 D A, see Des Alpes.
 D C M Schallplatten & Musicassetteproduktion (HFP), Fasanenstr. 3, D-1000 Berlin 12. Tel: (08651) 47-60. Mgr.: Alfr-d Dostal.
 D G, see DGG & Polydor.
 D G G (Deutsche Grammophon GmbH) (sub. of Polydor Int'l GmbH) (IFPI), PO Box 301240, Hohe Bleichen 14-16, D-2000 Hamburg 36. Tel: (0411) 35-96-1. Telex: (02) 163293. Pres.: Rudolf Gassner; Exec. VP's: Oskar Drechsler, Reinhard Stehn.
Labels: (Owmed) Archiv Produktion, Brunswick, Deutsche Grammophon (DG), Deutsche Grammophon Literatur, Heliodor, Karussell, MGM, Poly, Polydor, Verve; (licenssed domestic) ECM; (licenssed foreign) Capricorn (USA), Carrere (France), Dreamland (USA), Phil Spector Int'l (USA), RSO (UK), Track (UK).
 dhf-Textschallplatten, see G. Braun.
 Da Camera Schallplatten-Ed. GmbH (IFPI), Lame rstr. 10/12, Mannheim. Tel: (0621) 10-20-17. Pres.: Dr. Klaus Preis; Gen. Mgr.: Paul Krise; Sales Mgr.: Nikolaus Sastruphu. (Distributed by Disco-Center).
Labels: (Owmed) Die Alte Drgel, Da Camera, Impromptu, Sastruphu.
 Dacapo, see EMI Electrola.
 Danny's Pan, see Music Distributor.
 Days, see Angel.
 Decca, see Teldec.
 Delta Acoustic, see Music Distributor.
 Delta Music GmbH (IFPI), Zur Muehle, 2, D-5020 Frechen 4. Tel: (02234) 61015. Cable: DEMUS. Telex: (08) 89299. Pres.: Dr. K.J. Moll; Gen. Mgr.: P.H. Sautot; Sales Mgr.: Dr. W. Ammel.
Labels: (Owmed) Classic Collection, Delta, Pancora, Satyr.
 Derby, see Tonomatic.
 Deutsche Austrophon GmbH (IFPI), Auf dem Esch 3, D-2840 Diepholz. Tel: (05441) 13-44. Telex: (09) 41221. Gen. Mgr.: Rolf Neumann; Sales Mgrs.: Peter Stinboer, Rainer Koppermann.
Labels: (Owmed) Carsound, Mandolino, Orchestrola, Racket; (licenssed) Arithon (Switzerland), ESP-Collection (Switzerland), Elite Special (Switzerland); (Distributed-not licenssed) Christophorus, Flame, Folk Freak, JC, Jazz Point, Nash, Palm, Pelca, Selected Sound, Sky.
 Deutsche Buch-Gemeinschaft (C.A. Koch's Verlag Nachf.) Abt. Schallplatten-Gemeinschaft (IFPI), Berliner Allee 6, D-6100 Darmstadt. Tel: (06151) 866-1. Telex: (04) 19261. Mng. Dir.: Ernst Leonhard; Gen. & Sales Mgr.: Hans Moeller.
Label: (Owmed) Impression, Meteor.
 Deutsche Grammophon, see DGG & Polydor.
 Deutsche Grammophon Int'l Music Serv. (dept. of DGG), Wendenstr. 29, D-2000 Hamburg 1. Tel: (040) 24-16-01. Telex: 2163116. Mgr.: Michael Schalk; Sales Mgr.: Ernst Rueder. (Importer)
 Deutsche Grammophon Literatur, see DGG.
 Deutsche Oversea Recs. GmbH (IFPI), Sigismundstr. 15, D-7750 Konstanz. Tel: (07531) 245-17. Pres.: Michel Liber; Gen. Mgr.: Alice Liber; Sales Mgr.: Armin Troesch.
Int'l branch: Switzerland.
Labels: (Owmed) Diverse; (licenssed) Athenee (Greece), Auvidis (France), Diskosan (Turkey), Durium (Italy), Equipe (Italy), Fonit-Cetra (Italy), Jugoton (Yugoslavia), Maietti (Italy), Nimbus (UK), Popular (Greece), Pull (Italy), SM (France), Said (Italy), Select (Greece), Sonor (Italy), Togo (Italy), Unidisc (France), Vanilla (Italy), Variety (Italy), Zephyr (UK), (Distributed-not licenssed) Drange (Italy), Pearl (UK), Rubini (UK), Spark (Italy), Start (Italy), Taize (France).
Int'l rapa.: France (Edwards), Greece (Plomaritis), Italy (Durium).
 Deutscher Schallplatten-Club im Deutschen Bucherbund GmbH & Co., Libanonstr. 3-5, D-7000 Stuttgart 1. Tel: (0711) 2-17-91. Telex: (07) 23829. Mng. Dir.: Gerhard Fink.
 Deutsches Rotes Kreuz, see Phonogram.
 Deutsche Tanzmusik Produktion, Dhmstr. 9, D-8000 Munich 40. Tel: (089) 39-68-74. Mng. Dir.: Hans Lang.
Label: (Owmed) Edition Royal-Hans Lang, Royal Splendid.
 Direkt to Disk, see Sonic Arts.
 Disc Int'l GmbH, Koenigsbergerstr. 6-8, D-6000 Frankfurt 90. Tel: (0611) 70-34-43. Mng. Dir.: Gangolf Zimmermann.
Labels: (Owmed) Get Up! Lost & Found; (licenssed) Gael-Linn (Ireland), Shirak (Italy); (Distributed-not licenssed) Bluesboy, Classic Jazz Masters, Crown Prince, Everybody's, Jazz Society, Mr. R&B, Route 66, Saxophonograph, Stockholm, Swing Classics, Tax (all Sweden); Frog, Halcyon, Recommended, VJM (all UK); White Label (Netherlands).
Int'l rapa.: Luxembourg (Disques Int'l).
 Disco-Center (Vereinigtes Schallplatten-Vertriebs GmbH), Postbus 101029, Baerenreiterweg 6-8, Kassel-Wilhelmshohe. Tel: (0561) 3-20-21. Telex: (09) 92376. Mng. Dir.: Wolfgang Matthei; PR: Eberhard Schoepner.
Labels: (Owmed) Disco-Center; (distributed) Albatros, BIS, Baerenreiter-Musicaphon, Baltic-Reeds., Calig, Camerata, Cantate, Caprice, Christophorus, Claudius-Verlag, Claves, Da Camera, Fidulafon, Finlandia, Hungaroton, Impromptu, Muza, Pantone, Pelca, Quadrifon, Qualiton, RMB-Music, SDG, Sastruphu, Serenus, Sun five, Tudor, Zodiac.
 Disco-Train, see Karma.
 Disneyland, see Walt Disney.
 Walt Disney Prod'n GmbH, Savignystr. 76, D-6000 Frankfurt/Main. Tel: (0611) 74-77-74. Dir.: Horst Koblicsch; Mktg.: Rudolf Ludwig. (Distributed by Metronome)
Labels: (Owmed) Buena Vista, Disneyland.
Int'l rapa.: USA (Walt Disney).
 Divina, see Erich Jung.
 Doctor, see Autogram.
 Domino, see Music Distributor.
 Domiphon Music, Ballenweg 12, D-4790 Paderborn. Tel: (5251) 7-28-74. Telex: 936841. Gen. & Sales Mgr.: Bert Lique.
 Double Up, see EMI Electrola.
 Drive-In, see Suede.
 Dux (Ed.) Arthur Juerg (Musikverlag), Beethovenstr. 7, D-8032 Lochham. Tel: (089) 87-66-60.
Label: (Owmed) Dux.
 E B G, see Europaeische.
 E C M Recs./Verlag GmbH (IFPI), Gleichmannstr. 10, D-8000 Munich 60. Tel: (089) 85-10-48. Cable: ECMUSIC. Telex: (05) 21717. Co-Pres.: Manfred Eicher, Karl Egger; Sales Mgr.: Thomas Stoenand. (Distributed by DGG).
Labels: (Owmed) ECM, JAPO; (licenssed) WATT (USA).
Int'l rapa.: Andorra (Establishments Comando), Australia (Janda), Austria (Bellaphon), Belgium (Dureco), Brazil (WEA), Canada (Warner Bros.), Denmark (SteepleChase), Finland (Finley), France (Phonogram), Greece (EMI), Ireland (Tamsin), Italy (Giucar), Japan (Trio), Luxembourg (Dureco), Netherlands (Dureco), New Zealand (Phonogram), Norway (Polydor), Portugal (Dargil), South Africa (Polydor), Spain (Edigsa), Sweden (Amigo), Switzerland (Phonag), UK (PolyGram), USA (Warner Bros.).
 E H A, see Voggeneiter.
 E J M, see Erich Jung Musik.
 E M I America, see EMI Electrola.
 E M I Electrola GmbH (IFPI), Maarweg 149, D-5000 Cologne 41. Tel: (0221) 4-90-21. Cable: ELECTROLATM. Telex: (08) 881290. Mng. Dir.: Wilfried Jung, Friedrich E. Wottawa; Nat'l A&R Dir.: Manfred Zumbel; Int'l A&R Dir.: Jochen Kraus; Sales Dir.: Dr. Bernhard Krajewski.
Labels: (Owmed) Angel, Capitol, Columbia, Crystal, Dacapo, Double Up, EMI, EMI America, Electrola, Emidisc, HMV, Harvest, Liberty, Ddeon, Paraphon, Pathe Marconi, Prisma, Remig Zonophon, Sidewalk, Starline, Stateside, United Artists, Voce del Padrone, Voix de Son Maitre, La Voiz de Su Amo, Waverly, Welt Rekord; (distributed) Hoeruz, Kiangking, Musikant, Russi Raedocks, Trelit; (licenssed) (licenssed domestic) Musicians Rec. Co., Papagayo, Sabotini; (licenssed foreign) Apple (UK), Cairophone (Egypt), Encore (UK), Favorit (Austria), Kabarett aus Wien (Austria), Lebendige Vergangenheit (Austria), Monitor (USA), Dz (Australia), Preiser (Austria), RAK (UK), Rolling Stones (UK), Seraphim (USA), Soutelphon (Egypt), Sunburst (UK), Talsiman (UK), Toshiba (Japan), Trianon (France), Voix du Liban (Lebanon).
Label: World (UK).
Int'l rapa.: Worldwide (EMI).
 E N J A Recs. (European New Jazz Musik GmbH), 209 Nymphenburgerstr., D-8000 Munich 19. Tel: (089) 16-17-77, 16-51-72. Chief Exec.: Matthias Winkelmann; Gen. Mgr.: Horst Weber.
Labels: (Owmed) Blues Beacon (dist. by Plaene), ENJA (licenssed by Bellaphon).
Int'l rapa.: Denmark (SteepleChase), France (Musica 2000), Italy (IRD), Japan (Polydor), Netherlands (Agram), Portugal (Dargil), Spain (Bol), Sweden (Amigo), UK (Cadillac), USA (Inner City).
 E R P, see Kuckuck & Teldec Import Serv.
 Echo, see Des Alpes.
 Edition Royal-Hans Lang, see Deutsche Tanzmusik.
 Ego, see Plaene.
 Eigenstein Musikproduktion GmbH, Hansaring 80, D-5000 Cologne 1. Tel: (0221) 12-10-51. Chief Exec.: Wolfgang Hamm; Gen. Mgr.: Peter Schran; Sales Mgr.: Wolfgang Buelmann; Promo.: Elke Hiel.
Labels: (Owmed) Eigenstein, Riskant; (licenssed domestic) Tontraeger 58 Hagen; (licenssed foreign) Crammed (Belgium), Extraplattae (Austria), Hat Art (Switzerland), L'Drchestra (Italy), People Unite (UK); (Distributed-not licenssed) Rondo, Tritt, Warning/Alta Tak, Zick-Zack (all Germany); Bvhaast (Netherlands), Recommended (UK).
Int'l rapa.: Austria (Extraplattae), Netherlands (Bvhaast), Switzerland (Voxpop).
 Electrola, see EMI Electrola.
 Elektra, see WEA.
 Elias, see IDS.
 Elster, see Trion.
 Ewephon Recs., Nord-Ost Ring 11, D-7024 Filderstadt/Bernhausen 1. Tel: (0711) 70-27-49. Dir.: Luciano Wurzbürger; Gen. Mgr.: Jack Cunningham.
 Embassy, see CBS.
 Emidisc, see EMI Electrola.
 Emischerland Musikverlag & Musikproduktion, Postfach 652, Skagerrakstr. 35-35A, D4650 Geisenkirchen. Tel: (0209) 2-46-06. Chief Exec.: Gerd G. Fortak.
 Epic, see CBS.
 Erikoenig, see Hiltpolstein & Intercord.
 Eros, see Polyband.
 Erotica, see Polyband.
 Erus Technik GmbH (IFPI), Frankfurterstr. 7-11, D-6236 Eschborn. Tel: (06196) 493-1. Telex: (04) 15605. Gen. Mgr.: Norbert Hopf; Sales Mgr.: Georg Hofmann.
Labels: (Owmed) Erus; (licenssed foreign) Mobile Fidelity (USA).
 Esplanade GmbH (Ed.), Alsterdorferstr. 365, D-2000 Hamburg 60. Tel: (040) 51-82-11. Mgr.: Mrs. R. Liebe.
Labels: (Owmed) Ada, Esplanade, Moewe.
 Eulenspiegel Musikproduktion-Verlag-Vertrieb (IFPI), Marktstr. 1, D-2000 Hamburg 6. Tel: (040) 43-71-44. Telex: 2164524. Chief Exec.: Horst Tubbesing.
Labels: (Owmed) Eulenspiegel; (distributed-not licenssed) Autogram (Germany), Everest (Austria), Mulligan (Ireland), Plant Life (UK), D. Preisser (Austria), Rubber (UK), Shanachie (USA), Tara (Ireland), Thorofon (Germany).
Int'l rapa.: Austria (PolyGram).
 Eurocassette GmbH & Co. (IFPI), Mehringdamm 32/34, D-1000 Berlin 61. Tel: (030) 251-0331. Telex: (01) 83369. (Tape only)
Label: Multicassette.
 Eurodisc, see Ariola-Eurodisc.
 Europa, see Miller.
 Europaeische Bildungsgemeinschaft Verlags GmbH (div. of Bertelsmann), Lindenspuerstr. 32, D-7000 Stuttgart 1. Tel: (0711) 6-68-31.
Labels: (Owmed) EBG, Opera.
 Europuhon Musikproduktion, Rotkreuzplatz 2a, D-8000 Munich 19. Tel: (089) 16-90-49.
 Eurosound, see Falcon.
 Extra, see RCA.
 F M P, see Plaene.
 F S M, see Fono.
 Fairy Recs./Matuschka & Streibel, Kaisersstr. 209, D-75 Karlsruhe 1. Tel: (0721) 290155. Telex: 7826539 Hifa. Chief Exec.: Peter Streibel. (Distributor/Importer)
 Falcon Schallplatten, Rosner & Co., Postfach 1423, Ostrstr. 64, D-2000 Nordstedt 1. Tel: (040) 522-30-48. Telex: (02) 174646.
Labels: (Owmed) Eurosound, Falcon, Fideron, Golden Sound, Hit.
Int'l rapa.: Austria (Foto-Quelle), Denmark (Die Høglund), Netherlands (Foto-Quelle), Switzerland (Intertransit).
 Far Musikverlag, 18 Wittelsbacherstr., D-1000 Berlin 13. Tel: (030) 80-10-81. Cable: INTROMUSIK. Telex: 183008. Chief Execs.: Frank Farian, Peter & Thomas Meisel; Publ'g Dir.: Karl-Heinz Klempon.
 Fass, see Phonogram.
 Fidula-Verlag Johannes Holzmeister KG, Ahornweg 19/21, D-5407 Boppard-Buchanan. Tel: (06742) 24-88.
Labels: (Owmed) Fidula Cassette, Fidulafon (dist. by Disco-Center).
Int'l rapa.: Austria (Fidulafon), Switzerland (Hortulus).
 Firebird, see Airtiff.
 First Class, see Bellaphon & Fonotam.
 Flop Music Produktions GmbH, Hansa Str. 47, D-2000 Hamburg 13. Tel: (040) 45-67-07. Mgrs.: Peter Uecker, Reinhard Zaum.
Labels: (Owmed) Flop.
 Florett, see Falcon.
 Flower-Recs. Schallplatten, Rheinweg 29, D-5300 Bonn. Tel: (02221) 23-49-55. Owner & Gen. Mgr.: Horst Goetze. (Distributed by Deutsche Austrophon)
Labels: (Owmed) Flower-Recs.; (distributed) Juventus.
 Folk Freak, see Deutsche Austrophon.
 Folk-Record, see Autogram.
 Folk-Song, see Thorolon.
 Folkvariety Recs., Postfach 110142, D-2800 Bremen. Tel: (0421) 7-49-10. Owner: Juergen Fuess.
 Folkwerkstatt, see Plaene.
 Fono (Schallplattengesellschaft mbH) (IFPI), PO Box 2780, Friedrich-Eberstr. 110, D-4400 Muenster. Tel: (0251) 7-71-91. Telex: 892773. Pres. & Gen. Mgr.: Heinrich Brockhoff; Sales Mgr.: Christof Volk.
Labels: (Owmed) FSM; (distributed) Audite, Aulos, Brockhoff (Ed.), Carus, Colosseum, Tocatta; (represented) Armida (Switzerland), Sound Prods. (Netherlands), Candide (USA), Disques du Cavalier (France), Fono (Switzerland), Jucklin (Switzerland), Mirror Music (Austria), Drpheus (Switzerland), Turnabout (USA), Vox USA.
Int'l rapa.: Austria (Amadeo), Belgium (Schott Freres), France (Schott Freres), Netherlands (Sound Prods.), Switzerland (Jucklin), USA (Fonodisc).
 Foonetam Produktions & Vertriebsgesellschaft mbH, Iseplatz 8, D-2000 Hamburg 20. Tel: (040) 47-40-64. Gen. Mgr.: Klaus Laubrunn. (Distributed by Bellaphon).
Labels: Acanta, Berlinia, First Class, Heimat Melodie, Peg, Peggy, Piccolo.
Int'l rapa.: Worldwide (Musiccontact) excluding Austria, Switzerland (both Bellaphon).
 Fontana, see Phonogram.
 Foyer, see Musiccontact.
 Franke & Co. KG (Vereinigtes Verlags-Gesellschaft), Karlsbader Ring 54, 8060 Dachau. Tel: (08131) 1-39-22. Mng. Dir.: Paul Franke, Christian Unacka.
Labels: (Owmed) Gioriphon, Hypnopodia, Lingua Quick, Primaphon. Funktionelle Musik GmbH, Leharsr. 28, D-8000 Munich 60. Tel: (089) 83-60-38. Gen. Mgr.: Leo E. Horrigan; Sales Mgr.: Michael Hartmann.
 Funky Recs. (IFPI), Postfach 0267, D-1000 Berlin 41. Tel: (030) 796-1769. Cable: FUNKURWERLAG. Gen. Mgrs.: Jo Sehentai, Bert Hilby; Sales Mgr.: Jens Brettlay.
 G E M, see Hardt.
 G M V (Gigi Musikvertrieb) Schnabel GmbH, Kohlentwiete 6, D-2000 Hamburg 50. Tel: (040) 851-1131. Telex: 213308. Dir.: Dieter Schnabel. (Distributor/Importer-independent labels, deletions, overstocks)
 G T O, see CBS.
 Gala, see Multibrand.
 Gale Maximum Fidelity, see Audio Trade.
 Galenberg Studios, Forchenweg 21, D-7117 Bretzfeld-Schwabbach. Tel: (07946) 434. Gen. Mgr.: Ewald Schumacher.
 Gammarock Musik GmbH, Deilingenstr. 66, D-8000 Munich 22. Tel: (089) 22-13-63. Telex: (05) 29378. Co-Owners: Gerhard Augustin, Patrick Gammon.
Label: (Owmed) Gammarock.
 Get Up!, see Disc Int'l.
 Gigi Musikvertrieb, see GMV.
 Gillette, see Sonic Arts.
 Global Recs. (IFPI), Norderingerstr. 21, D-8000 Munich 19. Tel: (089) 15-

10-63. Cable: GLOBALMUSIC. Telex: (05) 215019. Pres.: Peter Kirsten; Label Mgr.: Rudi Martini. (Distributed by Metronome)
Label: (Owned) Global.
Int'l reps: Canada (Attic), UK (CBS). (SEE ADVERTISEMENT)

Globetrotter, see Polyband.
 Gloriphon, see Franke.
 Gold, see Agil.
 Golden Soul, see Sonic Arts.
 Golden Sound, see Falcon.
 Golden State, see Sonic Arts.
 Grekhphon, see Polyband.
 Gruner + Jahr AG & Co., Bereich Tontraeger, PO Box 302040, Fontenay 11, D-2000 Hamburg. Tel: (040) 41-18-31-75. Telex: 2173087. Chief Exec.: Wjo Euler; Admin. Mgr.: Manfred Heydeweller; Sales Mgr.: Manfred Sippli; Mktg. Mgr.: Winrich Derlien.
Labels: (Owned) Marifon, Marifon.
 Gruppe & Lied, see Thorofon.
 H M G Henning Handelsgesellschaft mbH, PO Box 1150, O-7263 Bad Liebenzell 1. Tel: (07243) 1-40-14. Telex: (07) 82864.
Branch: Ettlingen bei Karlsruhe, Englerstr. 24.
 H & L (Hoeren & Leren), see Schwann.
 H M V, see EMI Electrola.
 H T V, see Hansatische.
 Hammer, see Spring.
 Hannoton, see Studio-Ton.
 Hansa Int'l, see Hansa Musik.
 Hansa Musik Prod'n GmbH (IFPI), Wittelsbacherstr. 18, D-1000 Berlin 31. Tel: (030) 88-10-81. Cable: INTROMUSIK. Telex: 183008. Dirs.: Irmlrud, Peter & Thomas Meisel; Gen. Mgr.: Hans-Eberhard Blume; Sales Mgr.: Sylvia Schuettrumpf. (Licensed to Ariola-Eurodisc)
Labels: (Owned) Der Andere Song, Hansa, Hansa Int'l, Rocktopus.
 Hansatische Tontraeger Vertriebs GmbH (HTV), Grosser Kamp, D-2000 Hamburg-Barshuettel. Tel: (040) 670-1089. Telex: 2164047. Gen. Mgr.: Reiner Mogreite.
Labels: Audio Sound, HTV, Melo Cord, TT; (represented) Pickwick (UK).
 Happy Recs. Schallplatten GmbH (IFPI), Oederweg 26, D-6000 Frankfurt/Main. Tel: (0611) 59-03-19. Gen. Mgr.: Johann Michel; Gen. Mgr.: Adolf Wilms.
Label: (Owned) Happy.
 Hardt Casselten GmbH, Muehlenweg 3a, D-6370 Oberursel. Tel: (06172) 3-59-53. Gen. Mgr.: Wolfgang Engelhardt.
Labels: (Owned) GEM, Hardt; (licensed) CMS.
 Harmonia Mundi Schallplatten GmbH & Co. Musikproduktion, Karlstr. 60, D-7800 Freiburg. Tel: (0761) 25471, 25313. Telex: (07) 72552. Dir.: Rudolf Ruby. (Distributed by EMI)
Label: (Owned) Harmonia Mundi.
Int'l reps: Australia (Carina), Brazil (SOM), France (Harmonia Mundi), Italy (Fonit-Cetra), Japan (Teichiku), Spain (Odeon).
 Harvest, see EMI Electrola.
 Heimatland, see Bellaphon.
 Heimat Melodie, see Fonoteam & RCA.
 Heliodor, see DGG & Polydor.
 Helm, see Heinz Ulm.
 Henning, see Polyband.
 Herkules-Recs., Suedring 11, D-3502 Vellmar 1/Kassel. Tel: (0561) 82-27-73. Owner: Regina Theis.
 Hexagone, see Antagon.
 Hilltopstein (Tonstudio), NR 212, D-8551 Hilltopstein. Tel: (09192) 73-26. Telex: 624282. Owners: Jonas Porst, Manfred Neuner.
Labels: (Owned) Castle, Erkoenig (dist. by Intercord), Shark (dist. by Intercord), Up.
 Hit, see Falcon.
 Hitburger Musik GmbH, Geiselgasteg 80, D-80000 Munich 90. Tel: (089) 64-03-57, 64-02-67. Mng. Dir.: Andrea Andergest.
 Hit Pick Music, Baierlach 21A, D-8191 Herrnhäuser/Obb. Tel: (08179) 81-01. Prod'n Mgr.: Michael Frielinghaus; PR & Promo.: Sabine Jochums.
 Hoeren & Leren, see Schwann.
 Hoerzu, Kaiser-Wilhelmstr. 6, D-2000 Hamburg 36. Tel: (040) 347-2396/2831. (Distributed by EMI Electrola)
 Juliana Hopp GmbH, Backnangerstr. 74, D-7152 Grossaspach. Tel: (07191) 2-02-05. Telex: 7262116. Gen. Mgr.: Peter Hopp. (Record & Tape Wholesale/Importer/Exporter)
 Hypnopædia, see Franke.
 I C, see Innovative Communication.
 I D S (International Disc Serv.) (IFPI), PD Box 140105, Auf der Schanz 44, D-8500 Nuernberg 14; Tel: (09171) 6688. Telex: (06) 23987. Dirs.: Hans-Joachim Rabe; Gen. Mgr.: Walter Ruff; Sales Mgr.: Signd Lohr.
Int'l branches: France (Trimicon), USA (Tymicon).
Labels: (Owned) Elias, IDS, Programm.
 I D T-Music GmbH, Faunastr. 49, D-4000 Dusseldorf. Tel: (0211) 68-45-55. Chief Execs.: Dirk & Ingrid Tillen.
 I R S/Hjalmar Harms, PO Box 104501, D-2800 Bremen. Tel: (0421) 32-67-26. Mng. Dir.: Hjalmar Harms. (Distributor/Importer/Exporter)
 Impression, see Deutsche Buch-Gemeinschaft.
 Imprimptu, see Da Camera & Disco-Center.
 Innus (Internationaler Musik-Serv.), Elisabethstr. 38, D-8000 Munich 40. Tel: (089) 271-3781. Chief Exec. & Gen. Mgr.: Hans Wewerka.
Label: (Owned) Abacca.
 Innovative Communication (IC) (IFPI), Kirchstr. 6, D-3101 Winsen. Tel: (05143) 8003. Telex: 925019. Owner: Klaus Schulze; Gen. & Sales Mgr.: Klaus D. Mueller. (Distributed by Deutsche Austrophon)
Label: (Owned) IC.
Int'l reps: Austria (Amadeo), Japan (Disk Union), Netherlands (Simpel Fons), Norway (Union), Switzerland (Bellaphon), UK (Making Waves), USA (Greenworld, JEM).
 Intercord Tongesellschaft mbH (IFPI), Aizheimerstr. 26, D-7000 Stuttgart 75. Tel: (0711) 47-51-41. Telex: (07) 22814. Gen. Mgr.: Herbert R. Kolisch; Mktg. & Sales Mgr.: Volker A.W. Bell; Mktg. Ass'ts: Erika Deker, Klaus Munzer; Int'l A&R: Juergen Kramar, Nat'l A&R: Karl-Heinz Rothenburg; Classic Prod. Mgr.: Peter Springer; Press: Hans Derer; Promo.: Eva-Maria Brede, Marion Koenig.
Labels: (Owned) Intercord, Saphir, Spiegelei; (Distributed—not licensed) Aves, BBC, Black Lion, Blue Rose, Cellier, Chart Star, Cherry Red, Cube, Electric, Erkoenig, Freedom, Graduate (UK), Gull, Hi-Cream, Ice (UK), Kingdom, Ovation, Shark, Sonet (Sweden, UK), Toledo, Xenophon.
Int'l reps: Australia (Quality), Austria (Amadeo), Belgium (PMP-Eurovox), Canada (Bootgroup/Attic), Denmark (RCA-Hede Nielsen), Finland (Discophon), France (L'Oiseau Musique), Greece (Veran), Hong Kong (Studer-Revox, Hong Kong Recs.), Israel (Radiounion), Italy (Braconier), Japan (Teichiku), Luxembourg (SEI), Netherlands (EMI-Bovema), Norway (Disco A/S), Portugal (Moveplay), South Africa (U. Naumann), Spain (Movieplay), Sweden (Electra), Switzerland (Phonag), USA (Artistic Music, Jem Recs., Peters Int'l).
 International Music Serv., Hohe Bleichen 14-16, D-2000 Hamburg 36. Con-

tact: Juergen Wolfer.
Label: (Represented) Gatemouth Rec'g (USA).
 International Musikproduktion, Hochhaus, D-6096 Raunheim. Tel: (06142) 2-23-92, (06107) 4301. Cable: INTERMUSIC. Mng. Dir.: Wolfgang Heinrich; Adv.: Press & PR: Hedi Zoller.
 Intersound Musikverlag-Musikproduktion-Musikvertrieb GmbH & Co. KG (IFPI), Schleibinger Str. 10, D-8000 Munich 80. Tel: (089) 48-81-51. Dirs.: Gerhard & Rotheide Nharloz.
Labels: (Owned) Blossom, Intersound, Pro Viva, Studio One; (licensed) Crea Sound (Canada).
 Isartorn BeKa Schallplatten, Königswieserstr. 16, D-8035 Gauting bei Munich. Tel: (089) 850-1098/4111/4008. Mng. Dir.: Alfons Bauer. (Distributed by Deutsche Grammophon)
 Iton Musikproduktion-Verlag, Ludwigstr. 11, D-8033 Krailling. Tel: (089) 857-4499. Mng. Dir.: Ingo Klingebell.
 J C, see Deutsche Austrophon.
 J A P O, see ECM.
 Jaguar Musikproduktion (IFPI), Schierbrockerstr. 29, D-2875 Ganderkesee 3. Tel: (04221) 53497, 87622. Cable: JAGUARMUSIC. Dirs.: H. Schweitzer; Gen. Mgr.: Rolf Tobias; Sales Mgr.: H.J. Schweitzer Jr.; PR Mgr.: Frank Bartelt.
Int'l branches: Denmark, France.
Labels: (Owned) Cine Art Int'l, Coup, Jaguar; (distributed) Arendo, Boccaccio, PA.
Int'l reps: Benelux (Cero), Switzerland (Intercol).
 Jax Pax, see Juxy People.
 Jazz Aktuell (Vertrieb), Burgunderstr. 10, D-5000 Cologne 1.
Label: (Represented) Musicus Sound (USA).
 Jazz at the Cotton Club, see WAM.
 Jazz Point, see Deutsche Austrophon.
 Jeans, see Jupiter.
 Jeton Recs. GmbH (IFPI), Banaterstr. 8, D-7024 Filderstadt 4. Tel: (711) 28-23-03. Gen. Mgr.: Klaus Heiligenstuehler; Ass't to Gen. Mgr.: Annemarie Heiligenstuehler; A&R Mgr.: Wolfgang M. Schmidt. (Distributed by Audio Team)
Label: (Owned) Jeton.
Int'l rep: USA (Burns Audiotechnic).
 Jubilate, see Schwann.
 Juxy People, Anklaamer Ring 18, D-2000 Hamburg 73. Tel: (040) 647-62-80. Telex: 213540. Owner: Jimmy Prall.
Int'l branch: USA, JP Music.
Label: (Owned) Jax Pax.
 Juke Box, Steinstr. 53, D-8000 Munich 80. Tel: (089) 48-79-30, 48-77-95. Dir.: Harry Fox.
Labels: (Owned) Juke Box, Sex.
 Junge Gemeinde (Verlag), PO Box 979, Fangelsbachstr. 11, D-7000 Stuttgart 1. Tel: (0711) 64-30-15. Gen. Mgr.: Siegfried Krumrey.
Labels: (Owned) Credo, Trimedia.
Int'l reps: Austria (Buchhandlung der Methodisten Kirche), Switzerland (Christliches Verlagshaus).
 Erich Jung Musik (IFPI), Ledderhoseweg 19, D-6550 Bad Kreuznach. Tel: (0671) 6-90-07. Pres.: Erich Jung; Gen. Mgr.: W. Kullmann; Sales Mgr.: G. Kossmann.
Labels: Divina, EJM, Mirata.
 Jupi, see Jupiter.
 Jupinchen, see Jupiter.
 Jupiter Recs. GmbH & Co. KG, Hoechststr. 2, D-8000 Munich 80. Tel: (089) 98-49-26. Telex: (05) 22946. Owner & Pres.: Ralph Siegel; Gen. Mgr.: Werner Schueler; Sales Mgr.: Red Herschmann. (Distributed by Teldec)
Labels: (Owned) Jeans, Jupi, Jupinchen, Jupiter; (represented) Heiman (UK), Prelude (USA), Satril (UK).
Int'l reps: Austria, Benelux, Scandinavia, Switzerland (all Teldec); Argentina (Microfon), Bolivia (Laur), Brazil (Fermata), Colombia (Fuentes), Greece (Music Box), Hong Kong (Shun Cheung), Italy (Durum), Japan (Victor), Korea (Victor), Mexico (Musart), Spain (Columbia), Venezuela (Velvet).
 Juvenus, see Flower.
 K-tel Int'l GmbH, Schiltzerstr. 6-8, D-6000 Frankfurt/Main. Tel: (0611) 41-01-91. Telex: (04) 17292. Gen. Mgr.: Jens R. Boldt; Sales Mgr.: Frank Pletzsch.
Home office: USA.
 Kacha, see Lesser.
 Kaleidoskop, see Star.
 Karion, see MusicContact.
 Karna Musikproduktion GmbH, Hofbrunnstr. 11b, D-8000 Munich 71. Tel: (089) 79-90-41. Telex: (05) 28403. Pres.: Heimar Kunte; Promo. Head: Karin Wirthmann.
Labels: (Owned) Disco-Train, Karma.
Int'l reps: Austria, Benelux, Germany, Switzerland, Scandinavia (Polydor).
 Karussell, see DGG & Polydor.
 Fred Kersten Schallplatten-Produktion, Rambachstr. 3, D-6750 Kaiserslautern 31. Tel: (0631) 5-56-24. Owner: Fred Kersten.
Labels: (Owned) Kersten.
 Killdus, Sperberweg 7, D-5204 Lohmar Geber. Tel: (02246) 2578.
Label: (Represented) Ralph (USA).
 Kingsound, see Kingtone.
 Kingtone GmbH, Esmarchstr. 27, D-8000 Munich 50. Mng. Dir.: Erwin Koenig.
Labels: (Owned) Kingsound, Kingtone, Starsound.
 Kiosk, see Suede.
 Kitty, see Schulte & Gerth.
 Klassik, see Bellaphon.
 Klingklang, see EMI Electrola.
 J. Jacobsen Waren Kontor GmbH, see Membran.
 Kopf, see Roof-Music.
 D. Kretz (Automaten-Serv.), Sofienstr. 179, D-7500 Karlsruhe 1. Tel: (0721) 55-56-60, 59-07-20. Pres.: Dietrich Kretz; Sales Mgr.: Gertrud Drost. (Distributor/Importer).
 Kreuzberg, see Wolfgang Becken.
 Kuckuck Schallplatten, Habsburgerplatz 2/2, D-8000 Munich 40. Tel: (089) 33-20-78. Cable: RAHNPRODUCTIONS. Telex: (05) 215497. Owner: Eckart Rahn. (Distributed by Teldec Import Serv.)
Labels: ERP, Kuckuck.
 L & P (Leuenhagen & Paris), Lister Melle 39, D-3000 Hannover. Tel: (0511) 31-30-55.
 L + R Recs. GmbH, Kohlseweg 4, D-6072 Dreieich. Tel: (06103) 62081. Telex: 4185229. Chief Exec.: Horst Lippmann; Gen. Mgr.: Heinz Hartmann. (Distributed by Bellaphon)
Label: (Owned) L + R.
Int'l reps: France (SFPF), Italy (IRD), Norway (PolyGram), Spain (Edigsa).
 L S, see Suede.
 Laguna, see Heinz Brinker.

Lantern Produktion Wort & Music & Bild, PO Box 660226, D-2000 Hamburg 5. Tel: (040) 6-07-064. Owner: Hannes Flesner.
 Larry's Rec. Syndicate, Industriest. 10/1, D-7151 Auenwald 1. Tel: (07191) 54710. Telex: (07) 245948. (Importer/Exporter) (SEE ADVERTISEMENT)
 Lava, see Plaene.
 Lesser Int'l, Postfach 1525, Grafingerstr. 226, D-8360 Deggendorf. Tel: (0991) 30866. Telex: 69780.
Int'l branch: USA.
Labels: (Owned) Batchwork, Conquest, Kacha, Limo; (represented) Earth Int'l (USA).
Int'l rep: South America (Musidisc).
 Leuenhagen & Paris, see L & P & Schwann.
 Liberty, see EMI Electrola.
 Lilliput, see Des Alpes.
 Limo, see Lesser.
 Line Recs., Papenjuderstr. 16, D-2000 Hamburg 76. (Distributed by Teldec)
Label: (Represented) Waterhouse (USA).
 Lingua Quick, see Franke.
 Lollipop Musik, Juergen S. Korduleutsch KG, Landwehrstr. 85, D-2000 Munich 2. Tel: (089) 51-93-03. Telex: 529172. Pres.: Juergen S. Korduleutsch; Gen. Mgr.: Wolfgang Dorsch. (Licensed to Teldec)
Labels: (Owned) Lollipop, Vinyl; (licensed) Ace, Claridge, Legrand, Vee Jay (all USA).
Int'l reps: Africa (Polydor), Australia (RCA), Canada (Polydor), Central & South America (Polydor), France (Carrere, Polydor), Hong Kong (Pacific), Italy (WEA), Spain (Columbia), USA (Casablanca).
 Lord, see Schulte & Gerth.
 Lost & Found, see Disc Int'l.
 Lotus, see Rockport.
 m recs., Appenweierstr. D-7602 Oberkirch. Tel: (07802) 2805, 3819. Telex: 752613. Owners & Mgrs.: Werner Kimmig, Wilfried Richartz. (Distributed by CBS)
 M G M, see DGG.
 M M, see Teldec Import Serv.
 M O T Musikproduktion, Postfach 100202, Am Gutleuthofweg 26a, D-6900 Heidelberg 1. Tel: (06221) 80-38-00, 80-10-10. Mng. Dir.: Rudiger Eck. **Labels:** (Owned) CRP, MOT.
 M P N, see Hans-Juergen Schipper.
 M P S Recs. GmbH (IFPI), PO Box 1750, Richtofenstr. 3, D-7730 Villingen. Tel: (07721) 5-20-07. Telex: 792548. Pres. & Gen. Mgr.: Hans Georg Brunner-Schwer; Creative Servs. Head: Hans Pfitzer; Financial Dir. & Sec'y: Hans Wolschlaeger. (Distributed by Metronome).
Label: (Owned) MPS.
Int'l reps: Australia (Carina), Austria (Amadeo), Brazil (Som), Japan (Teichiku), New Zealand (Viking), Spain (Compania Fonografica Espanola), Switzerland (Metronome), USA (Pausa).
 M W M Recs. Munich, Ungerstr. 43, D-8000 Munich 40. Tel: (089) 36-150-53. Dir.: Michael Wilke. (Distributed by Teldec Import Serv.)
Label: (Owned) MWM.
Int'l reps: Sweden (EMI), UK (Roy Belcher-Big Bands).
 Made in Germany, see Remanded.
 Maerchenland, see OPP & Polyband.
 Maestro, see CBS.
 Magna Tontraeger Produktions GmbH (IFPI), Juliusstr. 10-11, D-1000 Berlin 44. Tel: (030) 68-440-28. Telex: (01) 83845. Dirs.: Juergen Freidank, Karl Moessnang. (Tape only)
Labels: (Owned) Magna, Music Mobile, Sandmaennchen; (licensed) International Artist (UK).
 Main, see Des Alpes.
 Maisonette, see UBM.
 Mandolino, see Deutsche Austrophon.
 Manuela Sound Musik, Alleestr. 47, D-4100 Duisburg. Tel: (0203) 56-06-86. Telex: 98257. Mng. Dir.: Heinrich Schaechter.
 Manzana-Cantabria Music (IFPI), Gudrunstr. 65, D-2000 Hamburg 56. Tel: (040) 81-83-88. Telex: (02) 173114. Pres.: Christian Lohse; Gen. Mgr.: Regina Heinrich.
Labels: (Owned) Canababria (dist. by Bellaphon), Manzana (dist. by Ocean).
 Helmut Marcuse (Schallplatten-Import), Thomasstr. 8, D-6000 Frankfurt/Main 1. Tel: (0611) 43-97-94, 44-10-22. Telex: (04) 189306. Chief Exec.: Helmut Marcuse. (Importer)
Labels: (Licensed) Affinity (UK), All Life (France), Bingow (France), Black & Blue (France), Canyon (USA), CBS Int'l, Charly (UK), DRG (USA), Folkways (USA), Freebird (France), Hed-Arzi (Israel), Les Tretoux (France), Lyricbord (USA), Musica (France), Pan Vox (Greece), Pickwick (USA), Playasound (France), Queen (Italy), RCA Int'l, Rediffusion (UK), Sonodisc (France), Varese (USA), Bruno Walter Soc. (USA).
 Marifon, see Gruner + Jahr.
 Marino Recs., Limbeckstr. 128, D-4630 Bochum 7. Tel: (0234) 23-17-60. Owner: Heinz Meiser.
Label: (Owned) Marino.
 Maritim, see Gruner + Jahr.

PEER SOUTHERN ORGANIZATION



LINKS THE WORLD

Peer Musikverlag GmbH
Hamburg, Germany

Masterworks, see CBS.
 Mediaphon (IFPI), Hiernann-Loewweg 57, D-5650 Solingen 11. Tel: (02122) 7-97-31. Chief Exec.: Dr. Udo Unger.
 Label: (Owned) Mediaphon.
 Int'l rep.: Switzerland (Phonog).
 Melo Cord, see Hanseatische.
 Melosmusik, see Teldec Import Serv.
 Membran GmbH (Musik-Vertrieb)/J. Jacobsen Waren Kontor GmbH, Weststr. 120, D-2000 Hamburg 76. Tel: (040) 220-12-56. Telex: 2161368. Pres.: Juergen Jacobsen, Gen. Mgr. Claus-Holger Lehlefeld; Sales Mgr.: Rainer Scheer.
 Mercury, see Phonogram.
 Meteor, see Deutsche Buch-Gemeinschaft.
 Metronome Musik GmbH (IFPI), Ueberseering 21, D-2000 Hamburg 60. Tel: (040) 63-80-31. Telex: (02) 174735. Mng. Dir.: Heino Wirth; A&R Mktg. Mgr.: Ruediger Litz; Sales Mgr.: Heiner Wieland; Int'l A&R Mgr.: Dellew Kroemer.
 Labels: (Owned) Brain, Global, Metronome, Nature, Reflektor, Zebra. (licensed foreign) Amadeo (Austria), Aura (UK) Barclay (France), CNR (Netherlands), CTI (USA), Can't Stop (USA), C.rosello (Italy), Chiswick (UK), DJM (UK), De-Lite (USA), Disney (France USA), Ensign (UK), Fiction (UK), Kudu (USA), Logo (UK), Passport (USA), Ricordi (Italy), Riviera (France), Safari, Transatlantic (UK), Vanguard (USA); (licensed domestic) MPS.
 Int'l reps.: Australia (Carina), Austria (Amadeo), Belgium (Barclay), Brazil (Som), Canada (PI Imports), Central America (Ricardo Boet), Denmark (Metronome), Finland (Finley), France (Phonogram), Israel (Litrato), Japan (Techiku), Malaysia (Phonogram), Netherlands (Anola), Norway (Polydor), Portugal (Phonogram), Singapore (Phonogram), South Africa (Gallo), Spain (Hispanavox), Sweden (Metronome), Switzerland (Metronome), UK (EMI, Logo), USA (German News, IEM, Peters Int'l).
 Michael & Co. Tontraeger Vertrieb GmbH, Spaldingstr. 1, D-2000 Hamburg 1. Tel: (02102) 45031. Telex: 8585241. Mng. Dir.: Peter Bertram. (Distributor)
 Branches: D-2000 Hamburg 1, Wendenstr. 25. Tel: (040) 280-3435. Telex: (02) 162916 - D-8000 Munich 45, Ingostraedterstr. 63. Tel: (089) 31-61-70. Telex: (05) 215910.
 Micula Recs., Goethestr. 11, D-8023 Pultach. Tel: (089) 793-0260. Gen. & Sales Mgr.: Hans Schmidbauer.
 Label: (Owned) Micula.
 Midi, see WEA.
 Miller Int'l Schallplatten GmbH (IFPI), Justus von Liebig-Ring 2-4, D-2085 Quickborn. Tel: (04106) 50-01. Telex: (02) 12336. Gen. Mgr.: Harald A. Kirsten.
 Labels: (Owned) Europa, Plus, Signal.
 Int'l reps.: Brazil (Fermata), Denmark (Irish Lydband), Israel (Unatex), Netherlands (MCR), New Zealand (Europa), Philippines (OctoArts), Portugal (Vadeca), Switzerland (Exclusa), USA (Sive Qua Non), Venezuela (Fermata).
 Mirata, see Erich Jung.
 Mitra, see Mixtur.
 Mixtur Schallplatten GmbH, Rosenheimerstr. 35, D-1000 Berlin 30. Tel: (030) 211-2050. Gen. Mgr.: Manfred Ganady.
 Labels: (Owned) Mixtur. (distributed domestic - not licensed) Aban, Abaron, Berilton, Mitra. (distributed foreign - not licensed) Abbey (UK), Adriano (Switzerland), Alpha (Belgium), Ars Nova (Italy), BMG (Netherlands), Bongiovanni (Italy), CRD (UK), Canlo di Vangelo (Netherlands), Duchesse (Belgium), Eco (Italy), Eufoda (Belgium), Eurosound (Netherlands), Festivo (Netherlands), Gallo (Switzerland), Jubal (Netherlands), Laran (Netherlands), Lesborne (Austria), M&M (Belgium), Martinphon (Netherlands), Mirasound (Netherlands), Miro (Italy), Musica Magna (Belgium), NKF (Norway), Omega Int'l (Netherlands), Pavlojen (Netherlands), Philips (Norway), Prelude (Netherlands), Religioso (Netherlands), Sonclair (Netherlands), VDE-Gallo (Switzerland), Welkom (Netherlands).
 Int'l reps.: Italy (Bongiovanni), Netherlands (Vista).
 Moers Music (IFPI), PO Box 1612, D-4130 Moers 1. Tel: (02841) 7741. Pres.: Burkhard Hennen; Gen. & Sales Mgr.: Axel Markens. (Distributed by Plaene)
 Label: (Owned) Moers.
 Moewe, see Esplanade.
 Monogram, see Autogram.
 Mountain Music, see Roland.
 Multibrand OHG Volker Ahrens & Co. (IFPI), August Mogler Str. 23, D-7100 Heilbronn/Neckar. Tel: (07131) 4-10-68. Telex: 728366. Mng. Dir.: Volker Ahrens.
 Labels: (Owned) Audiophon Classic, Gala, Silversound, Viola Classic.
 Multicassetta, see Eurocassetta.
 Musica Bavaria, see Schwann.
 musica viva Schallplatten, Sproetzerweg 25, D-21110 Buchholz. Tel: (04181) 3-34-53. Gen. Mgr.: Dielmur Will.
 Labels: (Owned) musica viva; (distributed - not licensed) Orpheus (Switzerland), Pape Verlag Berlin
 Int'l reps.: Austria (musica viva), Belgium (Schott Freres), France (Schott Freres), Italy (Musik-Import), Netherlands (Vista), Switzerland (Disc-Import).
 Music Distributor GmbH, Wendenstr. 25, D-2000 Hamburg 1. Tel: (040) 24-25-96. Gen. Mgr.: Dieter Moench; Sales Mgr.: Acim Grotelcaes; Prod. & Mktg. Mgr.: Matthias Doering. (Distributor)
 Labels: (Distributed domestic - not licensed) Babylon, Danny's Pan, Delta Acoustic, Domino, Pasterel, Timewind, Venu; (distributed foreign - not licensed) Cezame (France), Chymie (Ireland), Cobra (France), Happy Bird (Liechtenstein).
 Music Factory GmbH, PO Box 3640, Wehrgarten, D-6500 Mainz. Tel: (06131) 10-741. Pres.: Dr. Peter Hanser-Strecker; Gen. Mgr.: Juergen M. Luczak.
 Label: (Owned) Songbird.
 Musician's Rec. Co., see EMI Electrola.
 Music Mobile, see Magna.
 MusicContact GmbH, Dischingenstr. 5, D-6900 Heidelberg. Tel: (06221) 7-30-44. Telex: 461832. Gen. Mgr.: Hanno Pfisterer. (Distributor/Wholesaler/Exporter/Importer)
 Labels: (Licensed) Acanta, Kanon; (distributed - not licensed) CRD, Calpoe, Foyer, Umbrella; (exported) Aristocrate, Audite, Bellaphon Klassik, Brain, Colosseum, Da Camera, Deutsche Harmonis Mundi, Innovative Communication, L + R, Laudate, MPS, Pape Verlag Berlin, RCA Germany, Sky, Telefunken, Thorlon, Wergo. (SEE ADVERTISEMENT)
 Musicrod Musikprod'n & Verlag GmbH & Co., Moorweg 12, Gandersee 1. Tel: (04222) 18-16. Telex: 025655. Gen. Mgr.: Jacky Barkow.
 Labels: Emston, Musicrod.
 Musikart, see EMI Electrola.
 Musikskiste, see Plaene.
 N P R, see Dieter Boek.

Nagara, see Bellaphon.
 Nash, see Deutsche Austrophon.
 Nature, see Metronome.
 Niederdeutsche Stimmen, see Schuster.
 Noa-Musikproduktion, PD Box 2550, Schulstr. 5, D-4830 Gutersloh 1. Tel: (05241) 2-06-06, 2-06-26. Mng. Dir.: Nobby Morkes; Prod'n Mgr.: Chris Fischer.
 Nonesuch, see WEA.
 Nostalgia, see Sonic Arts.
 Nova, see Teldec.
 Novus, see Ariola-Eurodisc.
 D P P Schallplatten GmbH, Bonnerstr. 311/313, D-5000 Cologne-Bayenthal. Tel: (0221) 38-54-28. Telex: 08-882628. Mng. Dir.: Elen Jurgens.
 Labels: (Owned) Cady, Dpp; (distributed - not licensed) AVD, Concord, Maerchenland, Polyband, Topsound, Topsound-Classik.
 Dasis Recs., Arabellastr. 5/139, D-8000 Munich 81. Tel: (89) 92-32-30-00. Telex: (05) 22393. Gen. Mgr.: George Naschke. (Licensed to Ariola-Eurodisc)
 Label: (Owned) Dasis.
 Ddeen, see EMI Electrola.
 Dfers, see Rockport.
 Dhwrn Recs., Schlossgasse 12, D-8750 Aschaffenburg.
 Dmibus, see Arcum.
 Dpera, see Europaeische.
 Drchestrola, see Deutsche Austrophon.
 Dvseera, see Deutsche Dvseera.
 P A Schallplatten, PO Box 657, Hafendamm 46, D-2390 Flensburg. Tel: (0461) 2-71-90. Pres.: Jens Dieter Badura.
 Labels: (Owned) PA, PA Int'l, Pyramd, Werba-Ton
 Pallas GmbH (Schallplattenfabrik), Auf dem Esch 8, D-2840 Diepholz. Tel: (05441) 22-93, 28-12. Telex: (09) 41221. Gen. Mgr.: Rolf Neumann, Hans Drestrecher Sr.
 Palm Recs. (IFPI), Postfach 1120, D-6689 Merchweiler. Tel: (06825) 5021-5029. Telex: (04) 44826. Mng. Dir.: Hans Schmid; Gen. Mgr.: Eddy Bachinger.
 Labels: (Owned) Altaxon, Palm (dist. by Deutsche Austrophon).
 Pandora, see Delta.
 Papagayo, see EMI Electrola.
 Pape Verlag Berlin, Prinz Handjerystr. 26a, D-1000 Berlin 37. Tel: (030) 812-1754. Gen. Mgr.: Dr. Uwe Pape. (Distributed by musica viva)
 Label: (Owned) Pape Verlag Berlin.
 Int'l reps.: Austria (musica viva), Netherlands (Vista), Switzerland (Disc-Import), USA (German News).
 Parlophone, see EMI Electrola.
 Pastels, see Canto & Music Distributor.
 Pathe Marconi, see EMI Electrola.
 Pat Palmas, see Schwann.
 Peg, see Bellaphon & Fonoteam.
 Peggy, see Bellaphon, Rudolf Bohnen & Fonoteam.
 Peica, see Deutsche Austrophon & Disco-Center.
 Pergola, see Phonogram.
 Piffikus, see Bellaphon.
 Philips, see Phonogram.
 Phonogram GmbH (IFPI), Roedingsmarkt 14, D-2000 Hamburg 11. Tel: (040) 36-09-1. Cable: PHONDGRAM. Telex: (02) 15024. Mng. Dir.: Roland Kommerell; Deputy Mng. Dir.: Dr. Gerhard Weber; Sales Mgr.: Horst Dengler; Po Int'l Div. Mgr.: Louis Spillmann; Classical Div. Mgr.: Dr. Wilfried Daencke; Mds. & Exploitation Div. Mgr.: Helmut Schalek; Finance & Admin. Div. Mgr.: Christoph Schmidt.
 Branches: D-5000 Cologne 1, Hansaring 69-73. Tel: (0221) 13-50-13 - D-6000 Frankfurt 16, Muenchenerstr. 7. Tel: (0611) 23-00-21 - D-2000 Hamburg 1, Wendenstr. 29. Tel: (040) 280-13-61 - D-8000 Munich 46, Ingostraedterstr. 55. Tel: (089) 35-23-95.
 Import Serv.: D-3012 Langenhagen 1, In den Kolnweisen 44-48. Tel: (0511) 73-06-82.
 Labels: (Owned) Fass, Fontana, Mercury, Pergola, Philips, Polystar, Power Exchange, Star-Club, Vertigo; (licensed domestic) Deutsches Rotes Kreuz; (licensed foreign) Charisma (UK), Chrysalis (UK), DeLite (USA), Ensign (UK), Limgelicht, Lone Star (USA), Manhattan, Mountain Recs. (UK), Orpheus, Rocket (UK), Smash, Stable, Theatre Projects (Netherlands), 20th Century Fox (USA), Uno/World Festival (USA).
 Int'l reps.: Argentina (Phonogram), Australia (Phonogram), Austria (Phonogram), Belgium (Phonogram), Bolivia (Discolandia), Brazil (Companhia Brasileira de Discos - Phonogram), Canada (Polydor), Chile (Philips), Colombia (Philips), Denmark (Phonogram), Ecuador (Fedisos), Ethiopia (Philips), Finland (Finley), France (Phonogram), Ghana (Phonogram), Greece (Phonogram), Guatemala (Dideca), Hong Kong (Polydor), Iceland (Thorliefsson), India (Polydor), Ireland (Polydor), Israel (Litrato), Italy (Phonogram), Japan (Nippon Phonogram), Kenya (Phonogram), Lebanon (Philips), Mexico (Polydor), Morocco (Siemens), Netherlands (Phonogram), Nigeria (Phonogram), Norway (Phonogram), Paraguay (Philips), Peru (El Virrey), Portugal (Phonogram), Singapore (Phonogram), South Africa (Trotone), Spain (Fonogram), Sweden (Phonogram), Switzerland (Phonogram), Taiwan (Philips), Turkey (Gruenberg Ticaret), UK (Phonogram), USA (Phonogram), Uruguay (EDISA), Venezuela (Polydor), West Indies (West Indies Rec.), Zaire (Phonogram).
 Phon & Ton Schallplatten KG (IFPI), Scherbaumstr. 27, D-8000-Munich 83. Tel: (089) 670-6330. Gen. Mgr.: Konrad Wolf; Sales Mgr.: Irmgard Nuding; Promo. Mgr.: Bernd Schroeder.
 Labels: (Owned) Connyland, Phon & Ton.
 Piccolo, see Fonoteam.
 Pick Up, see Bellaphon.
 Pila Music GmbH, Postfach 1130, Bahnhofstr., D-7035 Waldenbuch. Tel: (0715) 4011. Telex: 723286. Gen. Mgr.: Volker Rittinghaus.
 Labels: (Licensed) Greentree, NewPax, Maranatha, Paragon (all USA); (distributed - not licensed) Banner & Bonnets, Canaan, Dayspring, Impact, Light, Myrrh, Solid Rock, Sparrow, Wing, Word (all USA); Blue Rose (Germany), Chapel Lane (UK), Kingsway (UK).
 Pilot, see Spring.
 Pinball Recs. GmbH, Nithackstr. 5, D-1000 Berlin 10. Tel: (030) 342-2219. Mng. Dir.: Joachim Heider. (Licensed to Teldec).
 Plaene GmbH (IFPI), Braunschweigerstr. 20, D-4600 Dortmund 1. Tel: (0231) 81-89-25. Telex: (08) 22292. Gen. Mgr.: Wolfgang Frickehaus; Sales Mgr.: Joachim Wunderlich; PR: Sonja Kappel.
 Labels: (Owned) Plaene; (licensed foreign) Dicap (Chile); (distributed - not licensed domestic) Ego, FMP, Folkwerkstadt, Lava, Moers, Musikskiste, Po Torch, Saitre-Verlag; (distributed - not licensed foreign) Amiga, Aurora, Egrem, Eterna, Litra (all East Germany); Le Chant du Monde, Follows (USA), Moveplay (Spain), Supraphon (Czechoslovakia).
 Int'l reps.: Austria (Buch), Belgium (Parisfal), Denmark (Alpha), East Germany (VEB), Netherlands (Sound Prods.), Switzerland (Melodie).

Int'l reps.: Austria (Buch), Denmark (Butik, Haderslev), East Germany (VEB), Netherlands (Sound Prods.), Switzerland (Melodie).
 Playboard, see Polyband.
 Plus, see Miller.
 Pollux, see Star.
 Poly, see DGG.
 Polyband Gesellschaft fuer Tontraeger GmbH & Co. KG (IFPI), Lindwurmstr. 95, 8000 Munich 2. Tel: (089) 53-08-81. Telex: (05) 22636. (Cassette mfr.) (Also see DPP).
 Labels: Busch-Phonothek, Concord, Eros, Erotica, Globeton, Grelphon, Henning, Maerchenland, Playboard, Polyband, Topsound, Yuhon.
 Polydor Int'l GmbH (a PolyGram Co.) (IFPI), PO Box 132266, Harvestehuder Weg 1-4, D-2000 Hamburg 13. Tel: (040) 44-18-11. Telex: 02-12434. Pres.: Tim Harrold; VP Popular: Udo von Stein; Classical A&R Dir. (Deutsche Grammophon): Prof. Dr. Hans Hirsch; Classical A&R Dir. (Archiv Prod.): Prof. Dr. Andreas Holscheider; Classical Prod. Mgmt.: Pali Meller Marcovicz.
 Labels: (Owned) Archiv Produktion, DG (Deutsche Grammophon), Meliodor, Karussell, Polydor, Verve; (licensed domestic) ECM, Hansa; (licensed foreign) Dreamland (USA), EG (UK), Hispanavox (Spain), Polar (Sweden), Phil Spector Int'l (USA), RSD (UK).
 PolyGram GmbH (IFPI), PO Box 132266, Harvestehuder Weg 1-4, D-2000 Hamburg 13. Tel: (040) 44-18-11. Cable: POLYGRAM. Telex: (02) 12434. Pres.: Dr. Wolfgang Hux; Exec. VPs: Kurt Kinkle, Dr. Hermann Franz, Karl-Heinz Busacker; VPs: George H. Baenge, Dr. Eckart Haas, Harvey L. Schein, Dr. Werner Vogelsang, Heinz T. Vogt, Willem L. Zalsman; PR Dir.: Herbert Winter.
 Note: PolyGram is a multi-media enterprise that creates, records, manufactures, markets and distributes music on records & tapes. Its activities include music publishing, motion picture and television films, video entertainment and instructional programs, and direct marketing and trading.
 PolyGram Direct Mktg. & Trading (div. of PolyGram GmbH), Harvestehuder Weg 1-4, PO Box 132266, D-2000 Hamburg. Pres.: G.M. Baenge. Tel: (040) 44-18-16-44. Telex: (02) 212434. (Distributor/Mail-Order)
 PolyGram Rec. Dpns. Int'l (IFPI), PO Box 132266, Harvestehuder Weg 1-4, D-2000 Hamburg 13. Tel: (040) 44-18-11. Cable: POLYGRAM. Telex: 02-12434. Pres.: Dr. Werner Vogelsang; Deputy Pres.: Richard Busch; Exec. VP: Henk Th. Hoksbergen; Sr. VP: Walter Stein-Schomburg; VP's: Anton van den Brink, Joop H. Buinink, Peter K. Burkowitz, Kuno von Einen, Horst G. Ewert, Jan C. van Houten.
 Note: PolyGram Rec. Dpns. (PRD) directs the PolyGram Group's recorded music activities. Within PRD Int'l, pop & classical product is created, developed and promoted by Phonogram Int'l, Polydor Int'l, and the Decca Rec. Co. Ltd.
 PolyGram Rec. Serv. GmbH, Postfach 1409, D-3000 Hanover 1; Klusriede 26, D-3012 Langenhagen. Tel: (049511) 7-30-61. Telex: 924077. Dir.: K. Tuch.
 Polystar, see Phonogram.
 Pool, see Teldec.
 Portobello, see Trion.
 Portrait, see CBS.
 Po Torch, see Plaene.
 Power Exchange, see Phonogram.
 Powerplay Music Recs. GmbH (IFPI), Dietrichsweier 3, D-7093 Jagsztel. Tel: (07967) 568, 349. Telex: 74553. Mng. Dir.: Stefan Schick; A&R Mgr.: Ingo Rietsch; Sales Mgr.: Harold Messner.
 Labels: (Owned) Powerplay, Surfrock.
 Primaphon, see Franke.
 Prisma, see EMI Electrola.
 Profi, (Walter Fitz & Fred Bertelmann KG), Eichenstr. 17, D-8033 Krailing. Tel: (089) 857-1454.
 Labels: (Owned) Profi, Zwoelfer.
 Profile, see Teldec.
 Prominent, see Teldec.
 Promogram, see IDS.
 Promotom & Bildproduktionsges mbH & Co., Adalbertstr. 47, D-8000 Munich 40. Tel: (089) 280-91-53. Telex: (05) 22493. Mng. Dir.: Hans E. Haberfeld.
 Pro Musica Musik & Kunstversand GmbH, Am Sandbach 32, D-4030 Ratingen. Tel: (02102) 47-00-79. Telex: (08) 585328. Chief Exec.: G. Wengler. (Direct Marketer)
 Pro Viva, see Intersound.
 Pyramid, see PA.
 R C A Schallplatten GmbH (IFPI), PO Box 7613, Dsterstr. 116, D-2000 Hamburg 19. Tel: (040) 49-02-1. Telex: (02) 14193. Mng. Dir.: Hans-Georg Baum; Finance & Admin. Mgr.: Helmut Hecht; A&R Mgr.: Manfred Helms; Int'l Mktg. Mgr.: Eckhart Hurdell; PR Mgr.: Gerg Puchstein; Sales Mgr.: Ernst-W. Teske; Adv. Mgr.: Garry Sambrowski; Promo. Mgr.: George Gibb; Int'l Pop Prod. Mgr.: Jimi Boyks.
 Home office: USA.
 Labels: (Owned) Extra, Special; (licensed domestic) Golden 12, Heimat Melodie, Seem, Ulstein Music; (licensed foreign) Camden, Celentano, Cheapshare, Culture Classique, Culture Lyrique, Gold Seal, Grunt, International, Italiana, Millennium, Neon, New York Int'l, Red Seal, Salsoul, Scratch, Solar, Special, Toscanini Edition, 20th Century, Victor, Victrola, Windsong, Wooden Nickel, Zilch (all USA); Erato (France), Numero Uno (Italy).
 R C O Show-Music Prod'n GmbH, Hubertusstr. 76, D-8035 Gauting. Tel: (089) 850-2790. Owner: Werner Berthold van der Bough.
 Racket Recs., see Deutsche Austrophon.
 Radio-Music-Recs., Bregenzstr. 13a, D-1000 Berlin 15. Tel: (030) 881-4280. Mng. Dir.: Paul Woltschach.
 Labels: (Owned) Coda, Radio Music (RMC).
 Rainbow Recs. GmbH, Peterweisser 4-8, D-6000 Frankfurt/Main. Tel: (0611) 43-01-75. Telex: 413037. Gen. Mgr.: Datty Ruth; Ass't to Gen. Mgr.: Helge Post; Sales Mgr.: Klaus Mewes. (Distributor/Importer of UK labels).
 Ranger Recs., Mauritiussteing 5, D-5000 Cologne 1. Tel: (0221) 24-25-49. Chief Exec.: Margaretha Braeutigam; Gen. Mgr.: Willy Braeutigam; Sales Mgr.: Cornelia Weingarten.
 Raphaelae Recs., PO Box 107, Liebigstr. 14, D-8230 Bad Reichenhall. Tel: (08651) 32-19. Pres.: Dr. Gustav Zagler; Gen. Mgr.: Guenther Zagler; Sales Mgr.: Peter Siwek.
 Labels: (Owned) Raphaelae, Zagler.
 Rare Bid, see Bellaphon.
 Raw Recs., Edward Gronowstr. 12, D-2800 Bremen 1. Tel: (0421) 78874. Label: (Represented) Belmont (USA).
 Recommended Recs. Germany, PO Box 183441, D-2800 Bremen 1. Tel: (0421) 34-74-20. Dir.: Heino P. Mainz; Finance, Mktg. & Policy Mgr.: Andy Ortman.
 Home office: England.
 Labels: (Owned) Made in Germany; (distributed - not licensed) Arcades

MusiCassetten-Verpackungs- Maschine Typ KZM

Packaging Machine Typ KZM

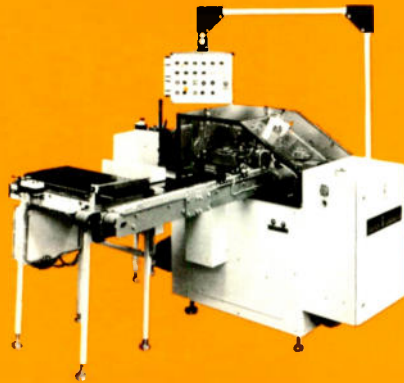

Für das vollautomatische Konfektionieren von
Compact-Cassette, Beilage und Etui.
Sondereinrichtung zum Falzen der Beilagen.
Leistung: konst. 55 sowie bis 65 bzw. 85/Min.,
höhere Leistung auf Anfrage.

For the fully automatic loading of
compact cassettes and descriptive literature
into plastic boxes.

Special equipment for folding inserts.
Capacity: const 55 as well as up to 65 or 85/min.,
please contact us for higher requirements.

Etikettierer Typ ETK 1 und ETK 1 S für MusiCassetten

Labeller Type ETK 1 and ETK 1 S
for compact cassettes

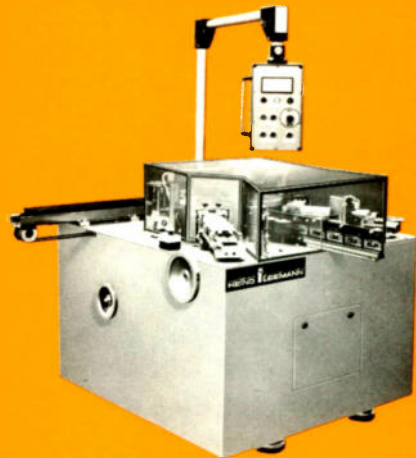

Leistung: bis 80 oder 120 Takte/Min.

Capacity: up to 80 or up to 120 cycl./min.

HEINO ILSEMANN GmbH

Zum Panrepel 24 · D-2800 Bremen 44

Tel.: (0421) 483083 · Telex: 244055 himab d

Bitte beachten Sie auch die Rückseite.

Bitte fordern Sie bei uns Prospekte an.

Please pay attention to the inner side of brochure.

**Kartonierer Typ MCB 1 K und
MCB 1 K S zum Einschachteln von
Boxen für Compact-Cassetten**

**Cartoning Machine Typ MCB 1 K and
MCB 1 K S for cartoning of boxes
for compact cassettes**



Leistung:

**MCB 1 K bis 80 Takte/Min.
MCB 1 K S bis 120 Takte/Min.**

Capacity:

**MCB 1 K up to 80 cycl./min.
MCB 1 K S up to 120 cycl./min.**

**Folien- oder Cellophaneinschlag-
Maschine Typ CM 1 und CM 1 S
für Compact-Cassetten in Etuis
(engster Einschlag ohne Schrumpfen)**

**Foil-Wrapping or Cellophane-
Wrapping Machine Type CM 1 and CM 1 S
for compact cassettes in snap-packs
(tightest wrapping without shrinking)**

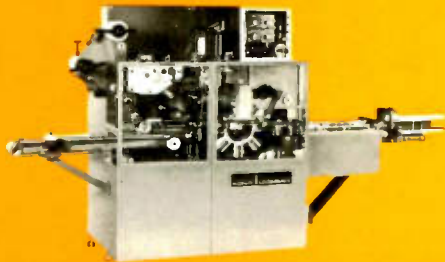

Leistung:

bis 90 Takte/Min. und bis 120 Takte/Min.

Capacity:

up to 90 cycl./min. and up to 120 cycl./min.

HEINO ILSEMANN GmbH

**Zum Panrepel 24 · D-2800 Bremen 44
Tel.: (04 21) 483083 · Telex: 244055 himab d**

Bitte beachten Sie auch die Rückseite.

Bitte fordern Sie bei uns Prospekte an.

Please pay attention to the inner side of brochure.

(UK), Alem (France), Corn Pride (USA), Gratie-Ciel (France), HP (USA), Kamikaze (Belgium), Love (Sweden), Manifest (Sweden), Mistur (Sweden), Musiknaekt Waxholm (Sweden), L'Orchestra (Italy), Piano (UK), Ralph (USA), Recommended (UK), Shandar (France), Silence (Sweden), Svenska Love (Sweden), Zeleste Edigsa (Spain).

Reflektor, see Metronome.

Regal Zonophone, see EMI Electrola.

Regina, see Ditto Wrede.

Repertoire, see Sonic Arts.

Reptoire Recs. & Tapes GmbH, Harvestehuder Weg 21, D-2000 Hamburg 13. Tel: (040) 44-60-21. Cable: SLEZAKMUSIC. Telex: 213425. Owners: Killy Kumberger, Rudi Slezak.

Reprise, see WEA.

Richter GmbH (IFPI), Am Sandbach 32, D-4030 Ratingen. Tel: (0203) 70-00-34/42-36. Telex: (08) 585241.

Rimpo Tontraeger GmbH & Co. KG, Prinz-Regentstr. 50-60, D-4630 Bochum 1. Tel: (0234) 7-20-53. Telex: 0825756. Gen. Mgr.: Herbert Ludwig; Sales Mgrs.: Bernd S. Kowalzik, Juergen Roemhild. (Wholesaler/Importer/Exporter/Distributor) (SEE ADVERTISEMENT)

Ring Recs., PO Box 1612, D-413 Moers 1. Label: (Represented) Muevistic Sound (USA).

Riskant, see Eigelstein.

Rocamar Music, Gardeschuetzenweg 61/63, D-1000 Berlin 45. Tel: (030) 834-5161. Chief Exec.: Ackhard Meier-Hardy. Labels: (Owned) Rocamar; (Distributed by Rocamar/Pa); (Licensed domestic) City.

Rockport Recs. GmbH, Kurfuerstenstr. 23, D-6050 Offenbach/Main. Tel: (0611) 86-89-36. Telex: 414896. Gen. Mgr.: Bernd Gruber; Sales Mgr.: Michael Humburg; A&R: Ruediger Eggert. Labels: (Owned) Blubber Lips, Lotus, Differs, Rockport; (distributed) Ananas, Anvil, Fussion, MS, Ornament, Peak, Pick (Switzerland), Sri Lanka, Trion. Int'l rep.: Switzerland (Pick).

Rocktopus, see Hansa.

Roland Recs. (IFPI), Furtwaenglerstr. 27, D-6900 Heidelberg. Tel: (06221) 47-27-11. Pres.: Roland Steinel; Gen. Mgr.: Joe Mountain; Sales Mgr.: Roman Saylor. Labels: (Owned) Mountain Music, Roland.

Rondo, see Eigelstein.

Roof-Music Schallplatten & Verlags GmbH (IFPI), Prinz-Regentstr. 50-60, D-4630 Bochum. Tel: (0234) 77-36-50. Telex: (08) 25756. Dir.: Horst Krause; Gen. Mgr.: Juergen Triesel; Sales Mgr.: Bernd Kowalzik. Labels: (Owned) Kopf, Roof; (Licensed) Potato (USA).

Rotaria, see Simon.

Royal Splendid, see Deutsche Tanzmusik.

Ruessl Raecords, see EMI Electrola & Star.

S A C P C M Digital, see Sonic Arts.

S D G, see Cantate & Disco-Center.

S + G, see Schulte + Gerth.

Sandmaennchen, see Magna.

Saphir, see Intercord.

Sastruphon, see Da Camera & Disco-Center.

Satehit, see EMI Electrola.

Satire-Verlag, see Plaene.

Satyr, see Delta.

Savoy, see Ariola-Eurodisc.

Schott Wergo, see Wergo.

Hans-Juergen Schipper Musik-Produktion, PO Box 1161, Fritz Reuter Str. 52, D-2940 Wilhelmshaven. Tel: (04421) 6-08-82. Mng. Dir.: Hans-Juergen Schipper. Labels: (Owned) MPN; (distributed) Unicorn.

Schiessloch, see Bellaphon.

Schulte + Gerth (Verlag), Emmeliusstr. 31, D-6334 Asslar. Tel: (06441) 84-61. Telex: 483794. Mng. Dir.: Klaus Gerth; Mgr.: Rainer Schaefer; Sales Mgr.: Christian Hellwig; Prod'n: Mike Weller, Margret Birkenfeld. Labels: (Owned) Kitty, Lord, S + G.

Peter Schuster, Wesersstr. 23, D-1000 Berlin. Label: (Represented) Ripsaw (USA).

Schuster (Verlag), Wilhelm-Sallmannstr. 11, Mozartstr. 54, D-2950 Leer/Ostfriesland. Tel: (0491) 27-73. Owner: Theo Schuster. (German dialects recs. only). Labels: (Owned) Schuster, Niederdeutsche Stimmen.

Schwann Paedagogischer Verlag GmbH (IFPI), Am Wehnhahn 100, D-4000 Duesseldorf. Tel: (0211) 36-03-01. Dir.: Dr. Paul Boehringer; Gen. Mgr.: Wilhelm Biswanger; Sales Mgr.: Elyert Koch. Labels: (Owned) AMS Musica Sacra, H&L (Hören & Lernen), Pat Pamos, Schwann Studio, VMS Musica Mundi; (distributed-not licensed domestic) Jubilate, Leuenhagen & Paris, Musica Bavaria; (distributed-not licensed foreign) Atlantis (Switzerland), Musique en Wallonie (Belgium), Zuercher Kammerorchester (Switzerland). Int'l reps.: Australia (Discuro), Austria (Bellaphon), Belgium (Schott), Denmark (Music Import), France (Schott), Italy (Bongiovanni), Luxembourg (Schott), Netherlands (Aibersen), South Africa (Kramer Ltd.), Sweden (Soundmaster), Switzerland (Bellaphon), USA (German News).

Scout, see Texel.

Seon, see RCA.

Selected Sound Musikverlag GmbH & Co. KG (IFPI), Poeseldorfer Weg 20, D-2000 Hamburg 13. Tel: (040) 410-5005. Telex: (02) 14909. Owner & Pres.: Peter M. Majewski. (Distributed by Deutsche Austrophon) Labels: (Owned) Selected Sound; (represented) Patchwork (France), Telemusic (France). Int'l reps.: France (Sforzando), Italy (Video), Netherlands (Dennis Music), Scandinavia (Nordiska), UK (Harmonic), USA (Peer-Southern).

Sesam, see Bellaphon.

777 Musik-Produktion-Verlag, Kirchstr. 8, D-4100 Duisburg 14. Tel: (02135) 61-16-7. Pres.: Lambertus B. de Jonge Sr.; PR: Werner Schwarz.

Sex, see Juke Box.

Shark, see Hitpollstein & Intercord.

Show Business (Ed.) (IFPI), Gunter Grefenuss & Co. oHG, Schumannstr. 8, D-8000 Munich 80. Tel: (089) 47-10-94. Chief Exec.: Dr. Gunter Grefenuss. Labels: (Owned) ColourSound Library, Show Business; (licensed foreign) Bagatelle (France); Aris, Beal, Cardium, Cenacolo, Duse, Music Parade, Nelson, Neride, New Bingo, Penia Phon, Picci, Pony, Rhombus, Seveman, Show Business. Int'l reps.: Australia (Penjane), France (L'illustration Musicale), Italy (Beal), Netherlands (Holland), USA (Sonatina).

Sidewalk, see EMI Electrola.

Siebenpunkt Verlags GmbH, Habsburger Platz 1, Rueckgebäude, D-8000 Munich 40. Tel: (089) 33-18-08. Gen. Mgr.: H. Schmidt

Sieg Ton, see WPL.

Signal, see Miller.

Silent Sun, see Trion.

Silversound, see Multibrand.

Simon Recs. (IFPI), Zigeunerweg 45, D-8104 Grainau. Tel: (08821) 88-71. Chief Exec.: Hans Arno Simon. Labels: (Owned) Rotaria, Simon.

Spoon, see Teldec Import Serv.

Sky Recs. GmbH (IFPI), Nordhauser Weg 16, D-2000 Hamburg 61. Tel: (040) 551-2641. Owners: Guenter Koerber, Hans-Joachim Viehr, Frank Michael Wiegand. (Distributed by Deutsche Austrophon). Int'l reps.: Australia (Europe Activity Ent's.), Austria (IMS, PolyGram), France (Stand By), Hong Kong (Hong Kong Recs.), Italy (IRD, Discoteca Pick-Up, Strawberry), Japan (Teichiku), Netherlands (Bertus Dist's.), Norway (Musikimport), Portugal (Valentim de Carvalho), Sweden (Sweetcont), Switzerland (Bellaphon), UK (Making Waves, Projection), USA (Greenword, JEM).

Snoopy, see UBM.

Songbird, see Music Factory.

Sonic Arts Corp., Lerchenstr. 30, D-6751 Rodenbach. Tel: (06374) 6921. Exec. VP: Herbert P. Haas. Labels: (Owned) Direkt to Disk, Gilette, Golden Soul, Golden State, Nox-talia, Repertoire, SAC-PCM Digital, Sonic Arts, Super Dimension Six. Int'l reps.: Switzerland (Star), USA (Golden State, Sonic Arts).

Soul City Rec. Shop, Badepsteinerstr. 44, D-2000 Hamburg 4. Tel: (040) 439-79-19. Tel: 2164169. Dir. & Sec'y: Karl B. Mills; Gen. Mgr.: Marion Moeller; Sales Mgr.: Giny Joseph. (Distributor/Importer) Labels: (Distributed-not licensed) Cha Cha, D-Roy, Grove, Hawkeye (all UK).

Special, see RCA.

Spiegelrei, see Intercord.

Spotlight, see Supertone.

Spring Music-Verlag & Produktion GmbH (IFPI), Leyboldstr. 1, D-5000 Cologne 51. Tel: (0221) 38-44-48. Gen. Mgr.: Guenter Faust. Labels: (Owned) Hammer, Pilot.

Square, see Star.

Squeaky Shoes Recs., Zollernstr. 18, D-775 Konstanz. Tel: (07531) 25889. Mng. Dir.: Heidegard Schneider. Int'l branch: England.

Star-Club, see Phonogram.

Starlet, see Supertone & Bella Musica.

Starline, see EMI Electrola.

Star Musikproduktion GmbH (IFPI), Wrangelstr. 5, D-2000 Hamburg 20. Tel: (040) 460-1056. Telex: 213485. Chief Exec.: Ralf Arne; Sales Mgr.: Jenny Arnie. Labels: (Owned) Kaleidoskop (dist. by EMI Electrola), Pollux, Ruessl Raecords (dist. by EMI Electrola), Square (dist. by Ruessl, Rimpo).

Starsound, see Kingtone.

Stateside, see EMI Electrola.

Steyer Disco, Nordendstr. 8, D-8019 Moosach. Tel: (08091) 9588. Owner, Pres. & Dir.: Peter Steyer; Gen. Mgr.: Rudolf Sax; Sales Mgr.: Anna Niesner. Labels: (Owned) Steyer Disco; (licensed domestic) Varia.

Stockfisch Produktion, Verlag & Vertrieb, Sanddorweg 13b, D-3300 Braunschweig. Tel: (0531) 5-10-38. Owners: Hans Dobrats, Gunter Pauller.

Storz, see Arminia.

Strand, see Teldec.

Studio One, see Intersound.

Studio-Ton MusiCassetten & Schallplatten R Produktion, Jordanstr. 18A, D-3000 Hannover. Tel: (0511) 81-33-34. Labels: (Owned) Hannoton, Studioton.

Studio Union im Lahn-Verlag, PO Box 140, Wiesbadenstr. 1, D-6250 Limburg/Lahn 1. Tel: (06431) 40-12-11. Mng. Dir.: Engelbert Tauscher; Press & PR: Raimund B. Zoellner. Labels: (Owned) Studio-Union; (licensed) Abakus.

Suewe (Vertriebs & Dienstleistungs GmbH & Co.) KG, Pressezentrum 06, D-6800 Mannheim 2. Tel: (0621) 19-21. Chief Exec.: Ernst Feuser. Labels: (Owned) Comes, Drive-In, Kiosk, LS (Leser-Service); (licensed) Unisono.

Summer, see WAM.

Sunrise Recs. GmbH, Sierichstr. 54, D-2000 Hamburg 60. Tel: (040) 279-4055. Telex: 2174680.

Super Dimension Six, see Sonic Arts.

Supertone Schallplatten Vertrieb (IFPI), Alfonsstr. 9/11, D-8000 Munich 19. Tel: (089) 18-37-88. Gen. Mgr.: Dr. Heinz Stein. (Licensed to Bella Musica) Labels: (Owned) Amati, Spotlight, Starlet, Supertone, Welt Melodie. Int'l reps.: Austria (Allround, Disco-Trade), Denmark (Dansk).

Surfrock, see Playplay.

T I S, see Teldec Import Serv.

T I, see Hanselische.

T W R, see Trans World.

Taxim Recs., Postfach 101143, D-2800 Bremen 1. Tel: (0421) 3164. Label: (Represented) Philo (USA).

Teldec Import Serv. (IFPI), Borsteler Chaussee 85-99a, D-2000 Hamburg 61. Tel: (040) 511-0055. Telex: 174537. Gen. Mgr.: Rolf Baehnk; Sales Mgrs.: Bernd Janke, Juergen Tiessen, Reimer Behr. (Distributor/Importer) Labels: (Owned) TIS, Telefonken; (licensed domestic) Line; (licensed foreign) Argo (UK), Arion (France, Italy), B&C (UK), Chess (USA), Creole (UC), Decca (UK), Delphine (France), Doryville (UK), Emerald (UK), Hindsight (USA), Saga (UK), Stiff (UK), Steram (Denmark, Sweden), Threshold (UK), Trojan (UK), Vogue (France); (distributed-not licensed domestic) CMP, ERP, Kuckuck, MM, MWM, Melosmusik, Pastels, Spoon, Verabra; (distributed-not licensed foreign) Affinity (UK), Catalyst (USA), Charly (UK), Contemporary (USA), Denon (Japan), FY (France), Flying Dutchman (USA), Flying Fish (USA), Gold (Switzerland), Good Time Jazz (USA), Lee Lambert (UK), London (UK, USA), Musidisc (France), RCA (Italy, UK, USA), Red Lightnin' (UK), Rounder (USA), Telarc (USA), Unicorn (UK).

Teldec Telefonken Decca Schallplatten GmbH (IFPI), Heussweg 25, D-2000 Hamburg 19. Tel: (040) 4-01-91. Cable: TELDEC. Telex: 02134545. Mng. Dir.: Kurt Richter, Gerhard Schulze; Domestic Sales Mgr.: Karl-Heinz Steike; Export Sales Mgr.: Elmar Hussing; A&R Int'l Gen. Mgr.: Nobby Varenholz; Nat'l A&R Mgr.: Horst Bork; Classical Mgr.: Heinrich Wertz; Pop Mktg. Mgr.: Manfred Peter. Labels: (Owned) Aspekte, Nova, Profile, Prominent, Strand, Teldec. Telefonken; (distributed) AZ (France), Arnon, All Platinum (USA), Arion (France), Arston (Italy), Atik (Canada), Barnaby (USA), Beat (Italy), Big Mouth (Switzerland), Buddha (USA), CBD (USA), Cadet (USA), Camden (UK), Checker (USA), Chess (USA), Columbia (Spain), Creole (UK), Decca (UK), Delphine (France), Everest (USA), First American (USA), Fonit-Cetra (Italy), Gryphon (USA), H&L (USA), Inelco (Belgium, Netherlands), Line, Lollipop, London (USA), MAM (UK), Magic Moon (UK), Magnet (UK), Pinnacle (UK), Pool (Germany), RPM (South Africa).

Sonet (Sweden), Stang (USA), Static (UK), Stiff (UK), Storyville (Sweden), Sugar Hill (USA), Teistar (Belgium, Netherlands), Trojan (UK), Vinyl, Vibration (USA), Vogue (France), Yop (Italy), Zomba (UK).

Teldec-Ed. Produktion, Tedgestr. 5A, D-3000 Hannover 1. Tel: (0511) 81-60-41. Mng. Dir.: Wolfgang Borges; Prod. Mgr.: Wolf Brandmeyer. Label: (Owned) UV Film-Recs; (distributed) Babsy.

Telefunken, see Telec.

Telemusic, see van der Bourg.

Tempo (Schallplatten-Vertrieb) Meissner & Co., PO Box 226, Rotwandstr. 16, D-8023 Pullach-Grossheide. Tel: (089) 79-42-86/66. Telex: (05) 212035. Mng. Dir.: Kurt Messelroder. Labels: (Owned) Scout, Texel, Whistler Music.

Texel (Ed.), PO Box 1165, Burgstr. 4, D-7830 Emmendingen. Tel: (07641) 21-78. Contacts: Renhard Egin, Eva Morgenstern. Labels: (Owned) Scout, Texel, Whistler Music.

Thorofon Schallplatten KG, Am Sande 7, D-3002 Wedemark 1. Tel: (05130) 41-76. Dirs.: Helga & Helmut Koeng. Labels: (Owned) Alternum, Capella, Folk-Song, Gruppe & Lied, Thorofon, Thorofon-Discus.

Thorofon-Discus, see Thorofon.

Timewind, see Music Distributor.

Tip Top Musikverlag & Prod'n, Fasanenstr. 71, D-1000 Berlin 15. Tel: (030) 883-3443. Owner: Egon Pfrenser. Label: (Owned) Ursus.

Toccata Schallplatten GmbH, Am Schlosspark 7, D-7812 Bad Krozingen. Tel: (07633) 37-00. Mng. Dir.: Rolf Jungmanns; PR: Dili-Matti Huovio. (Distributed by Fonof).

Int'l reps.: Belgium (Schott Freres), Finland (Fuga), France (Schott Freres), Switzerland (Musica), UK (Cambridge Music Shop).

Toledo Recs., Wittelsbacher Str. 18, D-1000 Berlin 31. Tel: (030) 88-10-81. Telex: 184174. Pres.: Guenter Henne, Karl Schmitz.

Tonomatic Tontraeger GmbH, Schwabstr. 2, D-80111 Hoehnenkirchen bei Munch. Tel: (08102) 81-36. Dir.: Johann Winkler; Gen. & Sales Mgr.: Margarethe Winkler; Promo: Marie-Luise Daum. Labels: (Owned) Derby, Tonomatic, Tonosound, Top Hat.

Tonosound, see Tonomatic.

Tontraeger 58 Hagen, see Eigelstein.

Top Hat, see Tonomatic.

Toppsound, see DPP & Polyband.

Top Star Musikproduktion & Recs., Adalbert Stifterstr. 1, D-6909 Walldorf. Tel: (06227) 1206. Dir. & Gen. Mgr.: Willi Reinehr; Sales Mgr.: Oliver Stone; Ass't Mgr.: Mike Silverstone. Label: (Owned) Top Star.

Trans World Recs., Bornackerstr. 39a, D-1000 Berlin 20. Tel: (030) 361-9019. Mng. Dir.: Horst Fuchs. (Distributed by Ariola-Eurodisc) Label: (Owned) TWR.

Trend Recs. (IFPI), Zietenstr. 59, D-6800 Mannheim 51. Tel: (0621) 79-27-69. Chief Exec.: Klaus R. Nagel; Gen. Mgrs.: Klaus R. & Heide Nagel.

Trimedia, see Junge Gemeinde.

Tritt, see Eigelstein.

Trion Sound Prod'n GmbH, Ginnheimer Landstr. 200, D-6000 Frankfurt/Main 50. Tel: (0611) 51-81-88. Mng. Dirs.: Wolf-Dieter Metzler, Hans-Walter Brossow. Labels: (Owned) Elster, Portobello, Silent Sun, Trion.

Troubadisc Frauenmusik Zeitung, Acrsstr. 62, D-8000 Munich. Label: (Represented) Redwood (USA).

Tuerkueola (IFPI), Hansangr 149, D-50000 Cologne 1. Tel: (0221) 73-50-35. Telex: 8885159. Pres. & Gen. Mgr.: Yilmaz Asocak; Sales Mgr.: Samim Uluc. Label: (Owned) Tuerkueola.

U B M Prod'n, Glockengasse 1, D-5000 Cologne 1. Tel: (0221) 21-08-18. Telex: (08) 881935. Pres.: Uwe Buschotter; Dir.: Harry Rosenstein. Labels: Mazonette, Snoopy, UBM.

U F A Int'l GmbH, Sonnenstr. 19, D-8000 Munich 2. Tel: (089) 55-79-57. Cable: UFADINT. Telex: (05) 23265. Gen. Mgr.: Dr. Josef Bamberger.

U T V-Film-Recs., see Teledisc.

Ulstein Musik, Kaiser Wilhelmstr. 6, D-2000 Hamburg 36. Tel: (040) 347-4254. (Distributed by RCA)

Henz Ulm-Musik GmbH, Voelckstr. 34, D-8900 Augsburg. Tel: (0821) 51-55-55. Dir.: Henz Ulm. Labels: (Owned) AAR, Amayana, Auraton, Helm; (licensed domestic) ENJA (tape only). Int'l reps.: Austria (Bellaphon), Greece (Music Box), Switzerland (Bellaphon).

Umbrella, see MusiContact.

Unicorn, see Hans-Juergen Schipper.

Unisono, see Suewe.

United Artists, see EMI Electrola.

Up, see Hitpollstein.

Urus, see Tip-Top.

V M, see Agil.

V M S Musica Mundi, see Schwann.

van der Bourg Verlage, Hubertusstr. 76, D-8035 Gauting. Tel: (089) 850-2790. Owner: Werner Berthold van der Bourg. Label: Telemusica.

Varia Recs. (IFPI), Plankenhofstr. 7, D-8000 Munich 81. Tel: (089) 93-18-88. Dir. & Gen. Mgr.: Werner H. Theisen; Sales Mgr.: Christa Meininger. Verabra, see Teldec Import Serv.

Venus Recs. GmbH (IFPI), Hauptstr. 33, D-5024 Pulheim 3. Tel: (02238) 3333, 2004. Telex: 8883241. Pres.: Dieter Dierks; Gen. Mgr.: Fred Hoock. (Distributed by Membran)

Venus-Sales Mgr.: Christine Schoenherr—see Music Distributor.

Vertigo, see Phonogram.

Verve, see DGG & Polydor.

Video & Musikvertrieb Rudolf Steiner GmbH, Ellwangerstr. 40, D-7085 Bodingten. Tel: (07632) 49-40. Telex: 0713776.

Videothek Programm GmbH, Possumoerweg 1, D-2000 Hamburg 60. Tel: (040) 27-17, 22-34. Telex: 0213214.

Vneta Musikverlag, Zietenstr. 59, D-6800 Mannheim 51. Tel: (0621) 79-27-69. Chief Exec.: Klaus R. Nagel; Sales Mgr.: Ebs Koeng; PR: Heide Nagel. Labels: (Licensed) Hudson (UK), Music Scene (Italy), Rouge (UK).

Vinyl, see Lollipop & Teldec.

Voila Classic, see Multibrand.

Voce del Padrone, see EMI Electrola.

Voggenreiter Verlag (IFPI), Viktorastr. 25, D-5300 Bonn-Bad Godesberg. Tel: (02281) 35-50-51. Telex: (08) 885662. Labels: (Owned) EHA, Xenophon (licensed to Intercord).

Vox de Son Matre, see EMI Electrola.

La Voiz de Su Amo, see EMI Electrola.

W A M Schallplatten Produktion GmbH (IFPI), Meteorstr. 11, D-2200 Elmshorn. Tel: (0421) 6-15-32. Exec. & Sales Mgr.: Klaus Meyer; A&R & Prod'n Mgr.: Dr. Peter Wehrspann. Labels: (Owned) WAM (Distributed by Phonogram Import Serv.), Jazz at the Cotton Club (Distributed by d&P musicservice); (licensed) Summer

(Distributed by d&p musicservice)
 Int'l reps: Australia (Quality), Denmark (Dann-H Music Imports), Italy (Discorama), Netherlands (Golden Age, Cor de Pater, Spronk), Spain (Belter), UK (Great Jazz), USA (Bill Barry, Sorland, Triangle Jazz).
 W E A Musik GmbH (IFPI), Arndtstr. 16, D-2000 Hamburg 76. Tel: (040) 22-80-50. Telex: (02) 14881. Mng. Dir. Siegfried E. Loch; Sales Mgr.: Henning Rintelen.
 Branches: D-5110 Nordorf, Record Serv. Dist'n Center, Max Plankstr. 1-9. Tel: (02404) 2-00-01. Gen. Mgr.: K.H. Rentrop-D-1000 Berlin, Detmolderstr. 15. Tel: (030) 853-4011. Telex: (01) 84616. Rep: Gerd Rehn-D-5000 Cologne, Kamekesstr. 37. Tel: (02-1) 51-75-62. Telex: (08) 83383. Rep: Barbara Wolf-D-6000 Frankfurt, Nordenstr. 30. Tel: (0611) 59-26-02. Telex: (04) 14073. Rep: Erich Schoepe-D-8000 Munich, Mauerkircherstr. 5. Tel: (089) 98-49-31. Telex: (05) 215177. Rep: Joerg Schmidt.
 Labels: (Owned) Asylum, Atco, Atlantic, Cotillion, Elektra, Mids, Nonesuch, Reprise, WEA Int'l, Warner Bros. (licensed domestic) Bunny, G.M.G. (licensed foreign) Big Tree (USA), Custom (USA), Dark Horse (USA), DiscReet (USA), F-Beat (UK), Finnadar (USA), Little David (USA), Pacific (USA), Planet (USA), RFC (USA), Rva (UK), Swan Song (USA), Target (UK), Whitfield (USA).
 W M S Music Serv. GmbH, Wolkebercher 14, D-4410 Warendorf. Tel: (02581) 70-21. Gen. Mgr.: Hans-Hermann Penn. (Rack jobber)
 W P L-Vertriebs U. Musikproduktion GmbH & Co. KG (IFPI), PO Box 6160, Hubertusstr. 11, D-5340 Bad Honnef 6 (Himberg). Tel: (02224) 80726. Mng. Dir.: Wolfgang Paul Lentz; Sales Mgr.: Werner Stinkens; PR: Beata Lenz
 Labels: (Owned) WPL, WPL Int'l. (licensed) Sieg Ton.
 Int'l rep: Benelus (WPL).
 Warner Bros., see WEA
 Warning/Ata Tak, see Eigenstein
 W. D. Warren Co. KG, im Steingrund 5, D-6072 Dreieich-Buchsschlag. Tel: (06103) 6 10v51. Cable: WAMESCO. Telex: (04) 185331. Dwner: William-Dirk Warren; Exec. VP: Eugene Elskens; VP Sales: Helmut Rossmair; VP & Controller: Karl Schoon. (Distributor / Importer).
 Waverley, see EMI Electrola
 Josef Weinberger GmbH, Dederweg 26, D-6000 Frankfurt/Main. Tel: (0611) 59-03-19. Pres.: Johann Michel.
 Welaton (Westphal & Lange KG), Hainhaus 2, D-3012 Langenhagen 5. Tel: (0511) 73-80-31. Telex: (09) 24057.
 Welt Melodie, see Supertone, Bella Musica & Des Alpes.
 Welt Rekord, see EMI Electrola.
 Werba-Ton, see PA
 Wergo Jazz, see Wergo Schallplatten.
 Wergo Spectrum, see Wergo Schallplatten.
 Wergo Schallplatten GmbH, PO Box 3640, D-6500 Mainz. Tel: (06131) 10741. Gen. Mgrs.: L. von Canstein, Juergen Luczak; Sales Mgr.: Dr. Peter Hanser-Strecker.
 Labels: (Owned) Wergo, Wergo Jazz, Wergo Spectrum, Schott Wergo; (represented) Image (Switzerland), MMO (USA).
 Int'l reps: Belgium & France (Schott Freres), Japan (Trio), Spain (Hispano), Switzerland (Record Serv.), USA (EAM).
 Wersi Music Prod'n GmbH (IFPI), Aachenerstr. 117, D-5000 Cologne 40. Tel: (02234) 7-10-16. Telex: (08) 89206. Mng. Dir.: Rudi Petry; Sales Mgr.: H.K. Hoppe.
 Whistler Music, see Telex.
 Wind Recs., Postfach 640157, D-5000 Cologne 40. Tel: (0221) 599-2031. Owner: Vera Brandes; Press: Holger Krueßmann.
 Wolfe, see Bellaphon.
 Ditto Weede Regina-Verlag, Postfach 6148, Schumannstr. 35, D-6200 Wiesbaden. Tel: (06121) 52-31-18. Chief Exec.: Harry Weede.
 Label: (Owned) Regina.
 X-Recs., Nordenstr. 30, D-6000 Frankfurt 1. Tel: (0611) 55-26-32. Telex: 414073. Gen. Mgrs.: Peter Hauke, Ingo Schant. (Distributed by Teldec)
 Label: (Owned) X-Recs.
 Int'l reps: Greece (Music-Box), Japan (RCA Victor), USA (X-Recs.).
 Xenophon, see Intercord & Voggenreiter.
 Yuhphon, see Polyband.
 Ziegler, see Raphaela.
 Zanklton, Kapuzinerstr. 48, D-8000 Munich 5. Tel: (089) 77-04-84. Chief Exec.: Michael Zanklton.
 Labels: (Owned) Zanklton; (licensed domestic) Cassette Maya.
 Zebra, see Melronne.
 Zick-Zack, see Eigenstein.
 Zwoerler, see Prof.

• music publishers

A M E Musikverlag Edward Kassner GmbH, Brahmsstr. 3, D-3000 Hannover 1. Tel: (0511) 66-70-61.
 A-R Musikverlag, Dreimehlenstr. 7-9, D-8000 Munich 5. Tel: (089) 76-16-31. Telex: 0529880. Owner: Armin Rahn.
 Aarton-Verlag, Forchenweg 21, D-7117 Bretzfeld-Schwabbach. Tel: (07946) 434. Telex: 728880. Gen. Mgr.: Ewald Schrafel.
 Abacus Music, Meteorstr. 11, D-2200 Elmhorn. Tel: (04121) 6-15-32. Gen. Mgr.: Klaus Meyer. (Also see Roba)
 Accord GmbH (Ed.), Maarweg 130, D-5000 Cologne 41. Tel: (0221) 54-30-36. Cable: ACCORDMUSIC. Telex: (08) 8883543. Gen. Mgr.: Holger Muel-ler.
 Int'l firms represented: Ardmore & Beechwood (Belgium, UK), Beechwood (USA), Beechwood de Mexico (Mexico), Castle (Australia), Central Songs (USA), Champs-Elysees (France), EGO (Spain), EMI-Brigadiers (South Africa), Eco (France), Gallico (USA), Glenwood (USA), Itaipu (Brazil), KPM (UK), MAI (Argentina), Marsaint (USA), Peter Maurice (UK), Pathe Marconi (France), Saturday (USA), Toshiba (Japan), Voce del Padrone (Italy).
 Int'l rep: Worldwide (EMI group).
 Acuf-Rose Musikverlag KG, Heinrich Barth Str. 30, D-2000 Hamburg 13. Tel: (040) 44-15-31. Telex: (02) 13211. Owners: Wesley Rose, Mildred Acuf; Rep.: Kirsten Gabriel. (Administered by Chappell)
 Agil Musik & Theater GmbH, Wendelsteinstr. 11, D-8016 Feldkirchen/Riem. Tel: (089) 903-2086.
 Int'l branch: USA.
 Albert/Francis, Day & Hunter, see Francis, Day & Hunter.
 Alcolphon AV GmbH & Co. KG (GEMA), Dueneoergerstr. 111-113, D-2054 Geesthacht. Tel: (4152) 4031. Telex: 218777. Mng. Dir.: Hilmar Kumbartzky; Gen. Mgr.: Manfred von Mangoldt.
 Alife (Ed./Joachim Heider Musikverlag), Nitzackstr. 5, D-1000 Berlin 10. Tel: (030) 342-2219. Owner: Joachim Heider; Gen. Mgr.: Christina Lehmann.
 Alice (Ed.), Mauritssteinweg 5, Cologne. Tel: (0221) 23-19-00. Chief Exec.: Peter Power; Gen. Mgr.: Howard Carjendate; Prof. Mgr.: Uly Jo-nan.

Int'l firms represented: Nada (Netherlands), Drma (Switzerland), Sinus (Belgium).
 Int'l reps: Belgium (Sinus), Switzerland (Drma)
 Christian Anders Musikverlag & Prod'n, Hoerwarthstr. 26, D-8000 Munich 40. Tel: (089) 36-53-66. Pres. Christian Anders; Gen. Mgr. Ann Busse.
 Angelo Musikverlag & Produktion A Engel KG, Potsdamstr. 92, D-1000 Berlin 30. Tel: (30) 782-3030. Chief Exec. & Gen. Mgr.: Anneliese Engel.
 Angelo Musikverlag, An der Aister 37, D-2000 Hamburg 1. Tel: (040) 280-2292. Telex: 0217878. Chief Exec. & Gen. Mgr.: Just Plach
 April Musikverlag GmbH, An der Aister 83, D-2000 Hamburg 1. Tel: (040) 24-07-45. Telex: 02-161240. Mng. Dir.: Jeremy Pearce; Deputy Mng. Dir.: Karl G. Arbenz; Publ'g Mgr.: Volker Spielberg.
 Home office: USA.
 Int'l firms represented: Ams & Graces (UK), American Int'l Pictures (USA), Batt (UK), Blendingwell (USA), Bovina (USA), Clay (USA), Country Road (USA), DiMeola (USA), Dufo (UK), EMP (USA), GTD (UK), Grajona (USA), Albert Hammond (USA), Hatband (USA), Herophant/Winter Blues/Derringer/Silver Steed (USA), Hudmar (USA), Jet (USA), Joel-sons/Impulsive (USA), Kipner (USA), Kirshner (USA), Little John/To-gether (USA), Dave Mason (USA), Mister Mellow (UK), Mr. Sun Shine (USA), Mor-Sell (USA), Numan (UK), Dionsong (UK), Spencer D. Proffer (USA), Rockin' (UK), Roundabout (USA), Satellite (UK), Sherylly (USA), Stave & Nickelodson (UK), Tradition (USA), Virgin/Dionsongs (UK), Weather Report (USA).
 Int'l rep: Worldwide (April/Blues).
 Arabella Musikverlag GmbH, Steinhäuserstr. 3, D-8000 Munich 80. Tel: (089) 4-13-61. Telex: 523487. Gen. Mgr.: Manno Ullrich.
 Paul C.R. Arends Verlag (GEMA), Hoehenweg 36, D-8219 Rimsting/Chiemsee. Tel: Prien 16-34. Pres. Gerda Arends; Gen. Mgr.: Michael Arends.
 Int'l firms represented: Hazyville (Switzerland), Noslen (USA), Basil Ramsey (UK).
 Int'l reps: Austria (Arends), Scandinavia (Lapland), Switzerland (Hazyville).
 Argus Musikverlag, Schwabellstr. 2, D-8011 Hoehenkirchen bei Munich. Tel: (08102) 81-36. Exec.: Johann Winkler.
 Aries Music GmbH, Koelnischtr. 4, D-3500 Kassel. Tel: (0561) 10-22-04. Telex: 992299. Chief Exec.: Siegfried Schaefer; Gen. Mgr.: Hubert Hanisch; Prof. Mgr.: Dietrich Prik.
 Int'l firm represented: ZAIRS (Poland).
 Ralf Arnie Musik Ed., see Star.
 Artist Serv. GmbH (GEMA), Eppendorfer Baum 13, D-2000 Hamburg 20. Tel: (040) 47-80-22. 48-70-88. Telex: (02) 163078. Mng. Dir.: Eike Heitkamp; Gen. Mgr.: Thomas Fenn.
 Int'l firms represented: Dollhouse, EuroScreen, Kronborg, Soundways, Unisound (all USA).
 Int'l reps: Scandinavia (Oh).
 Aspara Musik, see Blacksmith.
 Astora Verlag GmbH, Brandenburgerstr. 22, D-1000 Berlin 31. Tel: (030) 881-8898. Contact: Keine Aenderung.
 Atlas Musikverlag, Dr. Wernerstr. 4, D-8031 Grobenzell. Tel: (08142) 94-91. Owner & Mng. Dir.: Krenheld Steindler.
 Audio Musikverlag GmbH Co. KG, Ostpreussendamm 137/138, D-1000 Berlin 45. Tel: (030) 772-4054. Pres.: Joerg Schmeier.
 Aularc GmbH, Heussweg 25, D-2000 Hamburg 19. Tel: (040) 491-4145. Telex: 0213545. Gen. Mgr.: Nobby Varenholz.
 Autobahn Recs., Ortstr. 36, D-8000 Munich 81. Tel: (089) 98-56-25. Telex: 5216305. Owners: Michael Holm, Rainer Prietsch.
 Avanti (Ed.), see Werner H. Thesen.
 Axxis Musik GmbH, Arabellstr. 5/139, D-8000 Munich 81. Tel: (089) 92-32-27-00. Telex: 0522393. Mng. Dir.: Helga Dickmann.
 Barock-Musik-Verlag (BMV), see This.
 Wolfgang Becken Musikverlag (GEMA), Postfach 100544, D-2000 Hamburg 1; Appener Weg 3a, D-2000 Hamburg 20. Tel: (040) 46-49-90. Gen. Mgr.: Wolfgang Becken.
 Int'l firm represented: Weemeent (UK).
 Int'l rep: UK (Weemeent).
 Bella Musica Ed. Panoram GmbH, Ismaningerstr. 102, D-8000 Munich 80. Tel: (089) 98-66-49. Telex: 5215935. Chief Exec.: Juergen Rinschler.
 Int'l firm represented: Adora (Italy).
 Belver Music, Riedel & Co. KG, Manzer Landstr. 87-89, D-6000 Frankfurt/Main. Tel: (0611) 23-32-22. Telex: (04) 16046. Pres.: Branko Zwanovic.
 Int'l branch: Austria.
 Int'l firms represented: Bitsum, Kidada, Ranjick, Rat Trap, Shade Tree, Sigg, Shelby Singleton, State of the Arts, Vibratmar, Yellow Brick Road (all USA), Charly (UK), Mercedes (Canada), No Turns (Canada), One Way (Canada).
 Int'l rep: Scandinavia (Frost).
 Belmont Musikverlag GmbH, see Hammer.
 Benjamin Musikverlag, Werderstr. 44, D-2000 Hamburg 13. Tel: (040) 45-12-25-66-53.
 Anton J. Benjamin GmbH, Werderstr. 44, D-2000 Hamburg 13. Tel: (040) 45-12-25-66-53.
 Int'l firms represented: Henri Elick (USA), Casa Musicale Giuliana (Italy), Alfred Lengnick (UK), Muzicka Nakalada (Yugoslavia), G. Schirmer (USA).
 Int'l reps: USA (AMP).
 Albert Bennefeld, Schopenhauerstr. 23, D-1000 Berlin 38. Tel: (030) 801-5008.
 Friedel Bauschke Musikverlag, see Angelo.
 Blacksmith Music, Hauptstr. 81-85, D-6236 Eschborn. Tel: (06196) 46004. Telex: (04) 15615. Mng. Dir.: Hans Schmid; Gen. Mgr.: Volker Spielberg; Prof. Mgr.: Eddy Bachinger.
 Int'l firms represented: Greensleeves (UK), Happy Face (UK).
 Hermann Bohne Musikverlag, Bodanstr. 34, D-7750 Konstanz. Tel: (07531) 2-75-94. Mng. Dir.: Eise Hack.
 Rudolf Bohnen (Musikverlag & Prod'n), Klenzestr. 65, D-8000 Munich 5. Tel: (089) 201-2292.
 Bosworth & Co., Richtstr. 10, D-5000 Cologne 1. Tel: (0221) 21-14-79, 23-08-82. Pres.: Margaret Sinclair; Gen. Mgr.: Reimar Segebrecht.
 Bote & Bock, Hardenbergstr. 9a, D-1000 Berlin 12. Tel: (030) 312-3081.
 Harry Bredies Musikverlag, Postfach 9, D-7701 Buesingen. Tel: (07734) 6165. Mng. Dir.: Harry Bredies.
 Breeze Music (GEMA), Hauptstr. 33, D-5024 Pulheim 3. Tel: (02238) 33-33, 20-04. Telex: (08) 883241. Pres.: Dieter Dierks; Gen. Mgr.: Fred Hoock.
 Int'l branch: Switzerland.
 Int'l firms represented: Breeze (Switzerland), Payola (Belgium), Summer Breeze (USA).
 Int'l reps: France (Champs Elysees), Greece (Rose), Italy (Sugarmusic), Japan (Watanabe), Switzerland (Breeze), UK (Zomba), USA (Summer Breeze).
 Breitkopf & Haertel, PO Box 1707, Walkmuhstr. 52, D-6200 Wiesbaden. Tel: (06121) 40-20-31. Cable: BREITKOPF.
 Int'l firms represented: Costallat (France), Donemus (Netherlands),

Dover (USA), Fazer (Finland)
 Int'l reps: Australia (Allans), Brazil (Irmaos Vitale), France (Costallat), Greece (Phippie Nakas), UK (A.A. Kalmus) USA (AMP)
 Brinker Musikverlag, Bruchstr. 49, D-4330 Muelheim Ruerh. Tel: (0208) 47-81-33. Publ'r: Heinz Brundk; Prof. Mgr. Michael Brinker
 Brockhoff Ed. (GEMA), Friedrich Eberlstr. 110 D-4400 Muenster. Tel: (0251) 77488. Telex: 892773.
 Rolf Budde Musikverlag, Hohenzollerndamm 54A, D-1000 Berlin 33. Tel: (030) 823-4015. Telex: (01) 84770. Owners & Mng. Drs.: Annemarie, Andreas & Rolf Budde.
 Int'l firms represented: Alkatraz Corner (USA), Arabella (UK), Arnakata (UK), Associati (Ed.) (Italy), Belwin-Mills (USA), Bewlay Bros. (USA), Big Game (UK), British Lion (UK), Chandos (USA), Combine (USA), Consolidated (USA), Daybreak (USA), Delphine (France), Dorsey Brothers (USA), Fourth Floor (USA), Hilgrem Music (USA), Al Jarreau (USA), Joy-lul Wsdom (USA), Magcland (USA), Edward B. Marks (USA), Joe McDonald (USA), Memory Lane (UK), Ivan Mogull (USA), New Era (Netherlands), New Town Sound (UK), Purple (UK), Resaca (USA), G. Ricordi & Co. (Italy), Larry Spier (USA), Springtime (USA), Stillmann Song Co. (USA), Stranger (USA).
 Int'l reps: Austria (Gloria), Switzerland (Flora).
 Burlington Musikverlag GmbH (GEMA), Hoehenweg 36, D-8219 Rimsting/Chiemsee. Tel: Prien 16-34. Chm.: Dr. H.H. von Rauscher auf Weeg; Gen. Mgr.: Gerda Arends; Ass't Mgr.: Michael Arends.
 Int'l firms represented: Acclaim (USA), Burlington (UK), Con Bro (USA), Four Star (USA), Mikum (USA), Palace (UK), Singletree (USA), Stevenson, Tuchahoe (USA), Wiljex (USA).
 Int'l rep: Austria (Arends)
 Butterfly Musikverlag GmbH (GEMA), Ditto Heimannstr. 8, D-8022 Gruen-wald. Tel: (089) 641-1214. Telex: (05) 22279. Pres. Michael Kunze.
 Int'l firm represented: Sumac/Louise Jack Music (USA)
 Int'l rep: Rosalba (USA).
 C S B Kaminsky (Copyright Serv. Bureau) GmbH, Wilhelmstr. 10, D-2407 Bad Schwartau. Tel: (0451) 2-15-30. Contact: Pia Kaminsky
 Home office: USA.
 Calig Verlag GmbH, Renatastr. 71, D-8000 Munich 19. Tel: (089) 16-34-76. Mng. Dir.: Wolfgang Walter; Prod. Mgr.: Dors Hagen; Mng. Dir.: Manfred Stemberg.
 Cantabra Musikverlage, Gudrunstr. 65, D-2000 Hamburg 56. Tel: (040) 81-83-88. Telex: (02) 173114. Pres.: Christian Lohse.
 Int'l firms represented: Hispavox (Spain), Metropolitannes (France), Notas Magicas (Spain).
 Canzonetta (Ed.), PO Box 0108, Petzowstr. 13, D-1000 Berlin 39. Tel: (030) 805-2740. Pres. & Sales Mgr.: Frances Bochmann
 Capriccio Musikverlag GmbH, see Intersong Musikverlag
 Carrera Musikverlag, see Global.
 Chappell & Co. GmbH, Heinrich Barth Str. 30, D-2000 Hamburg 13. Tel: (040) 44-15-31. Telex: (02) 13211. Mng. Drs.: Heinz T. Vogt, George Hildebrand; Creative Affairs Gen. Mgr.: Willi Schloesser; Promo Mgr.: Brigitte Christel; Nat'l Exploitation, Kuno Dreyse, Special Projects: Juergen Tegge.
 Int'l firms represented: Albion (UK), American Jade (USA), Astromark (USA), Average (USA), Bleu Disque (USA), Chappo (UK), Early Morning/Moose (Canada), Frank (USA), Handle (UK), T.B. Harms (USA), Hustler (USA), Lowery (USA), Morris-Chappell (UK), Pippin The Friendly Ranger (UK), Pink Floyd (UK), RSD (UK), Saggiore (USA), Talking Heads (USA), Tres Jole (UK), Williamson (USA).
 Chiemgaw Musikproduktion Musikverlag GmbH, Schwarzbergstr. 6, D-8214 Bernau. Tel: (08051) 7366. Chief Exec.: Bernhard Oberlechner; Gen. Mgr.: Karl-Heinz Ruff.
 Fred Christmann (Musikverlag), Harmstorfer Weg 11, D-2106 Bendestorf. Tel: (04183) 62-46. Chief Exec. & Gen. Mgr.: Fred Christmann.
 Int'l firms represented: John S. Hardy Music (USA), Windham Hill Music (USA).
 Int'l rep: UK (Wilson Eds.)
 Cnedisc (Ed.), see Schlicht.
 Clarino (Ed.), see Wolfgang G. Winkel.
 R. D. Clevere Musikverlag (GEMA), Postfach 2145, D-6078 Neu Isenburg. Tel: (6102) 5-26-96. Telex: 4185600. Dir.: Norman Mack; Gen. Mgr.: Christian Marker; Prof. Mgr.: Tony Hernandez
 Clovox (Ed.), see Noble.
 Coconut Musik GmbH, Wittelsbacherstr. 18, D-1000 Berlin 31. Tel: (030) 88-10-81. Telex: 184174. Drs.: Karin Hartmann, Tony Hendrik.
 Compact Musikverlag GmbH, Mauritssteinweg 5, D-5000 Cologne 1. Tel: (0221) 24-25-49. Chief Exec.: Birgit Kalbelager; Gen. Mgr.: Willy Braeutgam.
 Compass Musik GmbH, see Melodie der Welt.
 Countdown Music, Dorfstr. 39, D-2081 Hasloh (Hamburg). Tel: (04106) 6-73-37. Telex: 214534. Owner & Gen. Mgr.: Rainer Elzrodt.
 Cron, see Funkturn.
 Cycilus Musikverlag GmbH (GEMA), Dsterstr. 116, D-2000 Hamburg 19. Tel: (04) 491-9071. Telex: (02) 11389. Gen. Mgr.: Hans-Georg Baum
 Int'l firms represented: Laurie (USA), Metal Machine (USA), RCA group.
 Saber Tooth (USA), Scott-Tone (USA).
 Int'l reps: Worldwide (RCA) excluding Austria (Josef Weinberger), USA.
 Dany Music, Drusuggasse 7-11, D-5000 Cologne 1. Tel: 23-48-33. Gen. Mgr.: Guenther Iigner, Hubert Terheggen
 Defroster (Ed.), see Global.
 Delay (Ed.), see Global.
 Delme, see Roba.
 Des Alpes (Ed.), Simon-Breu-str. 32, D-8700 Wuerzburg. Tel: (0931) 71286. Telex: (06) 8810. Mng. Dir.: Hans Richard Danner
 Dominique Musikverlag, Battenweg 12, D-4790 Paderborn. Tel: (5251) 7-28-74. Telex: 936841. Gen. Mgr.: Urich Lique.
 Dux (Ed.) Arthur Tuerk (Musikverlag), Beethovenerstr. 7, D-8032 Lochham. Tel: (089) 87-66-60. Gen. Mgr.: Liselotte Tuerk.
 Int'l firm represented: Italking (Italy).
 E N J A (European New Jazz) Musik GmbH, Nymphenburgerstr. 209, D-8000 Munich 19. Tel: (089) 16-17-77. Chief Exec.: Horst Weber; Gen. Mgr.: Matthias Winkelmann.
 Int'l firms represented: Amenable (USA), Cloudpash (USA), Ekapa (USA), Booker Ervin (USA), Tommy Flanagan (USA), Fly (Italy), Fourth Way (USA), Franton (Italy), Futures Passed (USA), Galeon (USA), Hocham (USA), Elvin Jones (USA), Kenjo Jones (USA), Lemac (USA), Lob II (USA), Lumont (Denmark), Matron (USA), Pat Lab (Canada), Phoebe (USA), Priceddon (USA), Ryka (USA), Sanasu (USA), Staja (USA), Stanshil (USA), Tushue (USA), Wallace (USA).
 Int'l reps: Italy (Franton), Japan (Sunkyo), USA (Black Sun, Mayflower).
 E R P Musikverlag Eckart Rahn (GEMA), Habsburgerplatz 2/2, D-8000 Munich 40. Tel: (089) 33-20-78. Cable: RAHNPRRODUCTIDNS. (05) 215497. Pres.: Eckart Rahn.
 Int'l branch: Switzerland.
 Ebony Musikverlag (GEMA), Ottostr. 9, D-8000 Munich 2. Tel: (089) 55-74-

69 Owner & Gen. Mgr Ingeborg Ogermann
Int'l firms represented: Corcovado, Glamorous, Helios, Monsapac (all USA)
Int'l rep.: Canada, USA (both Helios)
Effel Music (Ed.), Max Planckstr. 3, D 8013 Haar/Munich Tel (089) 430 2061 Chief Exec Maria M. Frauenberger, Gen Mgr Egon L. Frauenberger.
Eksus Musikverlag & Produktion GmbH, Bahnhofstr 119, D 6632 Saarwellingen Tel (06838) 7278. Telex 443149 Gen Mgr Juergen Wotter
Eldorado Musikverlag GmbH, see Intersong Musikverlag
Elite (Musikverlag Ed.), Lepzigerstr. 26, D-6200 Wiesbaden Tel (06121) 55-36-53 Cable ELITEEDITION Gen Mgr Dieter Poeping
Elscha Musikverlag, see Tonos
G. Engelhardt Musikverlag, Postfach 1728, D-637 Uebersee Tel (06172) 3 59-53 Gen. Mgr. Wolfgang Engelhardt
Esperanza/Casarca Musikverlag (Werner Treppe & Co.), Heimhuderstr 73, D-2000 Hamburg 13, Tel (040) 44-52-77. Telex 2173537 Gen Mgr Werner Treppe.
Int'l firm represented: Newkeys (USA)
Int'l rep: USA (Newkeys)
Esplanade GmbH (Ed.), Alsterdorferstr 365, D 2000 Hamburg 60 Tel (040) 51-82-11 Mgr. Mrs R. Liebe.
Eurocord (Ed.), see Noble
Europan/Peter Schaeffers (Musik-Ed.), Petersplatz 11, D 8000 Munich 2 Tel (089) 260-4091
Branch: D-1000 Berlin 19, Reichsstr. 4 Tel (030) 302 2084
Euro Show Musik, see Blacksmith
Far Musikverlag, 18 Wittelsbacherstr., D 1000 Berlin 13 Tel 88 10 81
Telex 183008 Owner Frank Farian; Publ'g Mgr Karl Heinz Klempnow
Fem (Hamburg) GmbH, see Intersong Musikverlag
Feuerstein & Thon (Ed.), see Midway
Finger Music Cos., Prinzregentenstr. 95, D-8000 Munich 80 Tel (089) 47 99-11 Cable FIMUS. Telex: (05) 24862 Owner & Pres Peter Peters.
Florida Musikverlag, see August Seith
Flying Dutchman (Ed.), see Angelo
Francis, Day & Hunter GmbH Musikverlag, Harvestehuderweg 21, D-2000 Hamburg 13, Tel: (040) 44-30-61 Cable ARPEGGIO Telex (02) 12530
Gen Mgr Peter Ende.
Home office: England.
Int'l firms represented: J. Albert (Australia), Audigram (USA), BBC (UK), Baby Bun (UK), Bema/Ameb (USA), Beserley (UK), Kate Bush (UK), Cansel (UK), Buzz Cason (USA), Cookhouse (USA), Coolwell/Granite (USA), EMI (UK), Forever Endeavor (USA), Forty Love (USA), Garden Court (USA), Jobete/Black Bull (USA), Kipahulu (USA), Kiss (USA), Maria (UK), Middle Road (UK), Peter Noone (USA), Queen (UK), Tom Robinson Band (UK), St. Annes (UK), Screen Gems (UK, USA)
Friedrich Wilhelm Froehlich, Ansbacherstr. 52, D-1000 Berlin 30, Tel (030) 24-13-77
Funklurm Verlag Musik-Schallplatten, Postfach D267, D 1000 Berlin 41 Tel (30) 796 1769 Cable: FUNKLURM VERLAG.
Int'l firms represented: Euram (Belgium), Fonor (Belgium, France, Netherlands), Jensch (Austria), Panton (Czechoslovakia), Polydisc (Austria), Wuerzburger (Italy)
Siegfried Gabler (Cortina-Musikverlag), PO Box 1926, D-7500 Karlsruhe 1, Tel. (0721) 69-54-89

Gabriel (Ed.) KG, Hahnenkampstr. 88, D-4970 Bad Deynhausen 2 Tel (05731) 5-12-00. Owner Paul H. Suelwald
Gammarock Musik GmbH, Dettingenstr. 66, D-8000 Munich 22 Tel (089) 22 13 63 Telex (05) 29378. Co-Owners Gerhard Augustin, Patrick Gammon
Int'l reps: France (Fono), USA (Jobete, United Artists)
Garda Musikverlag, see Angelo
Hans Gerth (Musikverlage), Drususgasse 7 11, D 5000 Cologne 1 Tel (0221) 23 48 33 Cable GERIGERVLAGE. Telex: (08) 881233 Co-Pres Erwin Boche, Guenter Ilgner, Geng Group Gen Mgr Juergen Thuernau, Essex Group Gen Mgr Brigitte Wallraff.
Int'l firms represented: AA Music (Belgium), Curci (Italy), RTV (Italy), Mondia Music (Switzerland), Sidem (Eds.) (Switzerland), Coda Music Ltd., Cromwell Music Ltd., Duchess Music Ltd., Eaton Music Ltd., Eel Pie Publ'g Ltd., Essex Music Int'l Ltd., Fabulous Music Ltd., Harmarlane Music Ltd., Leeds Music Ltd., MAM Music Publ'g Ltd., Meladream, Status Quo, Sundergrade Music Ltd., Sweet 'n' Sour, Tyler Music Ltd. (all UK), ABKCO, Cintercor Music Co., Cromwell Music Inc., Duchess Music Corp., Essex Music Inc., Evil Eye Music Inc., Folkways Music Publ'g Inc., Golden Syrup Music, Hollis Music Inc., Leeds Music Corp., Ludlow Music Inc., MCA Music Inc., TRD (all USA)
German News Musikverlag Guenter Koerber DHG, Nordhaeuser Weg 16, D 2000 Hamburg 61, Tel: (040) 551-2641
Int'l reps: Austria (Allround), Japan (GP Music)
Gero (Ed.), see Angelo
Klaus Gerth (Musikverlag) (GEMA), Emmelussstr 31, D-6334 Asslar, Tel (06441) 84-61 Telex 483794 Mng Dir. & Gen. Mgr Klaus Gerth
Govv Musikverlag, Destbergweg 6, D-3000 Hannover 71, Gen Mgr Thomas Voigt
Global Musikverlage, Global Musik GmbH, Nederingerstr. 21, D-8000 Munich 19 Tel (089) 15-10-63. Cable GLOBALMUSIC Telex (05) 215019. Owner & Mng Dir. Peter Kirsten.
Int'l firms represented: ATV Canada, Alaska, Amundo, B-D'Cult Songs, Earl Barton/Rose Bridge/ Strawberry Hill, Big Heart/Wooden Bear, Big Smoke, Big Teeth, Blue Chip, Boo-Fant Tunes, Brantree/Porchester, Broken Bird/Thin Ice, Broken Fiddle, Butterfly/BMG, Caesar's/ Tunesmith, Cashew, Cavalcade, Cellar, Chesterfield, Chicago, Chrysalis, Cleveland Entertainment, Cogent, Crabshaw, Cram Renruff/Brew, Creole, Crystal Jukebox, D'Accord, Dawnbreaker, Deep End, Doors/Alchemical, Easy, Entertainment Co./EMP/Music, Maximus, Fanfare-Bron, John Farrar, Fifth Star/Balloon, Fotomaker/Adrian Leghton, Fox Fanfare, Ganga, Gannet, Garrett, Grossos, Golden Mountain, Goody Two Tunes, Guerrilla/Staysail, Hancock, HarriSongs, Havemore-Wantmore, Homefire/Deep Canyon, Ice Age, International Aten, Intune, Jacon/Darnoc, Ja-Ma, Dick James, Jaspennila, Justin Case, Kamakazi, Lady Jane, Legion, Lido, Liedela/Dansnce, Little Dickens/Fool's Gold/Poco, Lornhole, MC/Meryn, Rod McKuen, Medicine Hat, Mel Bren/Ditch Road, Miles Ahead, Minas, Joni Mitchell/Crazy Crow/Squomb, Moonlight & Magnolias, Music Shoals, Narrow Gate/Four Aces, Perfect, Picasso/Catpach, Piraxus, Pondwater, Polo Grounds, Pop N'Roll, RMD, Rain Forest, Remohj, Brian Rohan, Rondor, Rosy, Rubicon, David Rubinson & Friends, Rumphyyboobah, Sailor/Dho River Valley, Boz Scaggs, John Sebastian, Paul Simon, Six Pictures, Somet, Special Rider/Big Sky, Dwarf/Ram's Horn, Billy Steinberg, Stevca/Richoroony/Wobble, Time Step/Celedia, Triumphsongs, Topanga, 20th Century, Victoria Falls/Lake Victoria, Weather Report/Mulatto/Miyako/Iska/Nefertiti/Barometer, Welbeck

Canada, Wet Dreams, Whitsett-Churchill, Wilsongs/Know/Make Me Smile/Play My Zevon, Zingaro
Int'l reps: Austria, Finland, Scandinavia, Switzerland, UK (all Global); USA (Global, Gee Em Gee) (SEE ADVERTISEMENT)
George Gluck Musik GmbH, Wittelsbacherstr. 18, D-1000 Berlin 31, Tel: (030) 88-10-81, Mng. Dir. George Gluck
Int'l firms represented: George Gluck (UK), Gray Matter (USA), Rosetta Stone (UK), Shaky (UK).
Int'l reps: Benelux (Fleet), France (Hansa), UK (George Gluck).
R. G. Gnauck (Musikverlag), see Paul Wottschach & Melodie der Welt
Gogo Ed. Musikverlag, Burgunderstr. 13, D-8000 Munich 40, Tel: (089) 300 7081 Telex 05215900. Owner: Helga Adler
Goldader (Ed.) (GEMA), see Wmtrup.
Goldfisch (Ed.) (GEMA), see Effel.
Go Pro, Gollin Musikverlag/Musikproduktion (GEMA), Beethovenstr. 15, D-7830 Emmendingen, Tel (07641) 4-32 15 Chief Exec.: Bernd Gollin.
Int'l rep.: USA (Marc Michael).
Gorilla Music Verlag GmbH, Hallerstr. 72, D-2000 Hamburg 13, Tel: (040) 410-2161 Telex 2173368. Mng Dirs. Frank Dostal, Achim Reichel.
Wlfi Griesinger Musikverlag, Posenhofenerstr. 27, D-8130 Starnberg, Tel. (08151) 1-36-17, Chief Exec.: Wlfi Griesinger.
Bernd Gruber Musikverlag, Kurfuerstenstr. 23, D-6050 Offenbach/Main, Tel (0611) 86-89-36 Telex 414895. Owner: Bernd Gruber, Press & Promo. Ruediger Eggert
Hammer Musik, Mannspergerstr. 113, D-7000 Stuttgart 75, Tel: (0711) 44-49 02, Chief Exec. Ingo Kleinhammer
Int'l firms represented: Blue Lake, Chromewood, Creative, Demain, Mick Lloyd, Loville, MAJ, Nuel, Plum Creek, Skyview, Streeterville, Terrace (all USA), Carousel (France), Cellier (Switzerland), Dead Good Tunes (UK), Munnycraft (UK), Vogue Int'l (France).
Int'l rep.: UK (Munnycraft).
Hanseatic Musikverlag GmbH, see Intersong Musikverlag
Happy Music Verlag GmbH & Co. KG, see Intersong Musikverlag
Hardjob (Ed.), see Paragon
Harmonie Verlagsgesellschaft mbH, see Intersong Musikverlag
Hausmusik-Verlag & Druckerei, Kaekenflur 24, D-2000 Hamburg 62, Tel: (040) 527-6916. Owner Irmgard Roenicke
Heinrichsofen's Verlag, PD Box 620, Liebigstr. 16, D-2940 Wilhelmshaven Tel (04421) 20-20-04. Pres. Otto Heinrich Noetzel, Gen. Mgr. Dr. Viktor Kreiner, Sales Mgr. Florian Noetzel
Int'l firms represented: Galaxy (USA), Galliard (UK), Highgate (USA), Israeli Music Publ'ns (Israel), Pegasus (Ed.) (Switzerland), Stainer & Bell (UK).
Int'l reps: Austria (Friedrich Hofmeister-Figaro), Israel (Israeli Music Publ'ns), Italy (Hortus Musicus), Netherlands (Heinrichsofen), Switzerland (Heinrichsofen), UK (Peters), USA (C.F. Peters).
Helm Music (GEMA), see Heinz Uim.
G Henle Verlag, PO Box 710466, Forstenneder Allee 122, D-8000 Munich 71, Tel (089) 75-40-96. Telex: (05) 216392.
Burkhard Hennen Publ'g, PD Box 1612, D-4130 Moers 1, Tel: (02841) 7741. Pres. Burkhard Hennen; Gen. Mgr. Axel Markens
Hirtburger Musik GmbH, Geiselgasteigstr. 80, D-8000 Munich 90, Tel: (089) 64-03-57 Pres. Andrea Andergast
Idee Verlag, Bornickerstr. 39a, D-1000 Berlin 20, Tel: (030) 368-5583. Mng Dirs. Hurst Fuchs, George Hildebrandt
Inter Musik/J. Michel KG, see Melodie der Welt



YOUR CONTACT IN GERMANY

RIMPO

WHOLESALE - IMPORT - EXPORT

ALL GERMAN LABELS DISTRIBUTED WORLDWIDE EXPORT & IMPORT
 DISTRIBUTION FOR INDEPENDENT PRODUCTS REQUESTED
 CATALOGS ON REQUEST



RIMPO Tonträger GmbH & Co. KG

Prinz-Regent-Str. 50-60
 4630 Bochum / West Germany

Tel. (02 34) 7 20 53-57
 Telex O825756 rimpo d

Intersong Int'l Musikverlag GmbH, Harvestehuder Weg 1-4, D-2000 Hamburg 13. Tel: (040) 41-4061. Telex: (021) 2434. Pres.: Heinz T. Voigt; Exec. VP: Ton Smits; VP: Nick Firth.

Note: This is the head office for the Intersong Org.

Int'l affiliates: Argentina (Korn), Australia (Intersong), Austria (Aberbach, Intersong), Belgium (Intersong-Primavera), Brazil (Intersong), Canada (Intersong), Denmark (Intersong), France (Intersong), Greece (Intersong), Italy (Intersong), Japan (Intersong), Mexico (Intersong), Netherlands (Intersong-Basart), Singapore (Intersong), South Africa (Intersong), Spain (Aberbach, Canciones del Mundo, Fontana), Sweden (Intersong), Switzerland (Intersong, Arena), UK (Intersong), USA (Intersong).

Int'l firms represented: (See Artemis, Netherlands).

Intersong (Musikverlag) GmbH, Hallerstr. 40, D-2000 Hamburg 13. Tel: (040) 41-29-31. Cable: INSONG. Telex: (02) 13211 PolyGram Publ'g Div. Pres.: Heinz T. Voigt; Gen. Mgr.: Horst Fuchs.

Int'l firms represented: Airport (UK), Ajay (UK), Albion (UK), Aliza-Thorah (USA), Ananas (Netherlands), Arjan Blackwood/Neghborhood (USA), Arawak (USA), Audigram (USA), Babies (UK), Bananas (Netherlands), Bellikat (USA), Berna (USA), Johnny Benstock (USA), Big Apple (USA), Bohannon (USA), Boomtown Rats (Switzerland), Brodehouse (UK), Bulk (UK), CTA (UK), Cape Ann (USA), Carlin (UK), Casablanca/Casaria (USA), Caseyem (USA), Charlotte (UK), Cheryl Yamila (USA), Clarke (USA), Damont (USA), Davaay (UK), Doctor Snuggles (UK), Doobie Bros. (USA), Double Exposure (USA), Dough Boy (USA), Druse/Ninja (USA), Francis Dreyfus (France), Betty Earland (USA), Erikhouse (UK), Estuary (USA), Fabel (Netherlands), Fair Field/Brightwater (USA), Father Prodn's (USA), Fleetwood Mac (USA), Fuse (UK), Gogly (Israel), Green Dream (UK), Harbar (UK), Hardcore/Mighty (USA), Hensley (UK), Hill & Range (USA), Hudson Bay (USA), Jimpire (USA), Jiru (USA), Josley (UK), Kaskal (USA), Keep on Trucking (UK), Kenya (UK), Klub (UK), Lazy Lizard/Kangaroo (UK), Sonny Lester (USA), Linda (USA), Liha (USA), Little Fugitive (USA), Little Lasso/Moonhill/Kurley M. (USA), Lous (USA), Lucky (USA), MTM (USA), Magnet (UK), Mayday (USA), Midland (USA), Mighty (USA), Mobetta (USA), Gayle Moran (USA), Muggins (USA), Neighborhood (USA), Ninja/Druse (USA), Normal (USA), Dam (UK), Dmug/Shirts (UK), Drange (UK), Angel Parker (UK), Phonopub (USA), Pickwick Int'l (USA), Pocket (Canada), Elvis Presley (USA), Quackmix (USA), Rainy City (UK), Ramsel (USA), Rare Blue/Monster Island (USA), Roaring Fork (USA), Rodra (USA), Samba (USA), Satsong (USA), Seabreeze (UK), Seacost (USA), Sky Harbor/Seagrap (USA), Sky Writing (UK), Sleazy Dumping (UK), Smoke (UK), Soldi Gold (Canada), Song (UK), Spelling Goldberg (USA), Subway Rhythm (USA), Sweet (UK), TH (UK), Teenage Heaven (USA), Ten East/Five West (USA), Thames Talent (USA), Times Square/Herald Square (USA), Tonechild (UK), Trio (USA), Wednesday Morning (USA), Wescraft/Bullhorn (USA), White Heaven (USA), Washbone Ash (UK), Worlds End (UK), Yellow Dog (USA), Zum (UK).

Int'l repa.: See Int'l affiliates of Intersong Int'l.

Intersound Musikverlag-Musikproduktion-Musikvertrieb GmbH & Co./Ed. Tonarichy KG, Schlegelingerstr. 10, D-8000 Munich 80. Tel: (089) 48-81-51. Dirs.: Rotheide & Gerhard Naholz.

Int'l repa.: Austria (G. Naholz), Belgium (Prestation), Canada (Sonatina), France (L'illustration Musicale), UK (KPM), USA (Sonatina).

Interworld Musikverlag GmbH, c/o UFA-Musikverlage, Sonnenstr. 19, D-8000 Munich 2.

Intona Music (GEMA), see Ebony.

Intro Gebr. Meisel, see listing under "M"

Dick James Musikverlag, see Global.

Peter Janssens Musik Verlag, Warendorferstr. 1, D-4404 Telgte. Tel: (02504) 24-74. Mng. Dir.: Wilgard Janssens.

Int'l repa.: UK (Evelyn & Hilary Talbot-Ponsonby).

Michael Jary Produktion, see Melodie der Welt.

Jeton Music, Banaterstr. 8, D-7024 Filderstadt 4. Tel: (711) 28-23-03.

Joni-Pressendienst, Marienbaderstr. 5, D-1000 Berlin 33. Tel: (030) 825-5044. Telex: (01) 84398. Chief Exec.: Joachim Wilhelm, Horst Lindow.

Juicy People/I. Pratt (GEMA), Anklamer Ring 18, D-2000 Hamburg 73. Tel: (040) 647-6280. Owner: Jimmy Pratt.

Int'l firms represented: Bill Holman, Little Sandy, Little Tristan, Song of Tiffany (all USA); non-exclusive-Caramba (Italy), Soss (Netherlands), Televs (Italy).

Juke Box, Steinstr. 53, D-8000 Munich 80. Tel: (089) 48-79-30. Dir.: Harry Fox.

Erich Jung-Verlag, Lederhosenweg 19, D-6550 Bad Kreuznach. Tel: (0671) 6-90-07. Pres.: Erich Jung.

Kanon Musikverlag GmbH, Dischingenstr. 5, D-6900 Heidelberg. Tel: (6221) 7-36-12. Telex: 461823. Gen. Mgr.: Hagen Frank; Int'l Mgr.: H.S. Pfisterer.

Fred Kersten (Musikverlag), see Funkturn.

Klawee Musikverlag, PO Box 40, Suedring 4, D-8069 Schweitenkirchen. Tel: (08444) 570. Owner: Klaus Weiss. Gen. Mgr.: Heide Weiss.

Klenkes (E.G.) (GEMA), see Wintrup.

Otto H. Knoechel (Musikverlag), Gartenstr. 28, D-8711 Obernreit. Tel: (09331) 23-38; (09332) 619. Owner & Dir.: Edu Hornischer.

Ulrich Koebel, Blechblaeserensemble, Ubostr. 21, D-8000 Munich 60.

Int'l firm represented: Brass Press (USA).

Komma Ed., Am Herberg 22, D-8210 Prien. Tel: (08051) 1529. Chief Exec.: Charly Niessen.

Konzept-Musik-Verlag, Henrich-Vogel-Str. 9, D-8000 Munich 71. Tel: 79-91-28, 791-6480. Pres.: Joachim Ludwig; VP & Sales Mgr.: Kristin Ludwig.

Kraut Music, see Roba.

Otto Kuhl Musikverlag, Am Hof 34-36, D-5000 Cologne. Tel: (0221) 21-22-76. Owner: J.M. Joseph; Mng. Dir.: R. Sommer.

Kuner Musik, see Blacksmith.

Landauer Tonstudio Musikverlag, see Roba.

Laudate Musikverlag, Gstaatterberg 8, D-8162 Schliersee. Tel: (08026) 65-75. Chief Exec.: Stefane Fliuhme.

Lesser Int'l, Postfach 1525, Gallingerstr. 226, D-8360 Deggendorf 1. Tel: (0991) 30866. Telex: 69780.

Lollipop (Ed./Ralph Siegel (GEMA), Hoechststr. 2, D-8000 Munich 2. Tel: (089) 98-49-26. Pres.: Juergen S. Kordulitsch; Gen. Mgr.: Walter Lichte. Prof. Mgr.: Jochen Neubauer.

Int'l firms represented: Ace, Schwartz (both USA).

Int'l repa.: Australia (ATV), Italy (Ricordi), USA (ATV).

Urs Lorenz (Musik-Ed.), see Tip-Top.

M C S (Music Contact System), Marawaldstr. 11, D-5000 Cologne 41. Tel: (0221) 43-82-83. Cable: MUSICCONTACT. Chief Execs.: Dirk Koch-Gadow, Juergen Fusschoeller.

Magazine-Music Musikverlag GmbH & Co. KG (GEMA), PO Box 302040, Fontenay 11, D-2000 Hamburg 36. Tel: (040) 41-18-21-05. Telex: (02) 11850. Dirs.: Hubert Terheggen, John Jahr Jr.; Gen. Mgr.: Peter Schmidt.

Int'l firms represented: Notas Magicas (Spain), Pilot (UK).

Int'l repa.: Belgium (RTM), France (Radio Music), Japan (Lux), Netherlands (Radio Music), Spain (Radio Pop), UK (Louvigny Marquee),

USA (Radmus).

Manto (Ed.), see Global.

Manta-Music, Widenmayerstr. 38, D-8000 Munich 22. Tel: (089) 22-41-45. Chief Exec.: Dieter Wendenfeld; Gen. Mgr.: Gerdi Bartelt.

Marabu Musik/I. Michel KG, see Melodie der Welt.

Marno Musikverlag-Produktion, Lumbeckstr. 128, D-4630 Bochum 7. Tel: (0234) 23-17-60. Owner: Heinz Messer.

Maum (Ed.), Muehlenfeldstr. 23, D-2800 Bremen 33. Tel: (0421) 25-92-91. Mng. Dir.: Wolfgang Roloff.

Intro Gebr. Meisel oHG (Ed.) (GEMA), Wittelsbacherstr. 18, D-1000 Berlin 31. Tel: (030) 88-10-81. Cable: INTRDMUSIK. Telex: 184174. Dirs.: Irmlrud, Peter & Thomas Meisel.

Int'l firms represented: ATV-Northern (UK), Ahab (USA), Bleu Disque (USA), Bron-Disba (UK), Camerica (USA), Ron Carter (USA), Castle Hill (USA), DebDave/Briarpatch (USA), Heath-Levy (UK), Heathwave (UK), I've Got The Music (USA), Roland Kluger (Benelux), Knight After Knight (USA), My Mama's Music (USA), Peris (USA), Perren-Vibes (USA), Ben Peters (USA), Planetary (USA), Scorpio (France), Song Tailors (USA), Sparta (UK), Steinberg (USA), Venice (USA), Welk (Germany).

Melodie der Welt/I. Michel KG Musikverlag, Grosse Friedbergerstr. 23-27, D-6000 Frankfurt/Main. Tel: (0611) 28-78-47. Cable: MELDIE. Telex: (04) 189248. Pres. Johann Michel; VP's: Wolfgang Mewes, Paul Lenz; Ass'l Mgr.: Guenther Koch.

Int'l firms represented: Melodie der Welt group-ATV (USA), AVI (USA), Achee (UK, USA), After Dark (USA), Fred Ahlert (USA), Alien (USA), Aliencore (USA), Alshure (USA), Aran Prod'n (Switzerland), At Home (USA), Big Secret (UK), Blue Harbor (USA), Blue Seas (USA), Blue Mountain (UK), Boca (USA), Bossa Fatata (USA), Bourne group (USA), Bowling Green (USA), Cannon group (USA), Center City (USA), Charleville (USA), Cheap Thrills (USA), Chinnichap (UK), Coast Highway (USA), Martin Cohen (USA), Co. Jac (USA), Colour Me Gue (UK), Conduche (USA), Covered Wagon (Canada), Cream group (USA), Crusty (UK), Curtis (UK), Dacapo (Austria), Diamond (UK), DiamondBack (USA), Dog Soldier (USA), Dump (USA), EMA (Switzerland), Editio (Switzerland), Eighties (USA), Famous (USA), Far Out (USA), Firesky (USA), Fish-Scent (USA), Fleetwood (UK), Foghorn (USA), Four Knights (USA), Frabjous (USA), Freedom (UK), Gale (UK), God Tunes (USA), Gold Forever (USA), Gold Sovereign (USA), Gopam (USA), Great Honesty (USA), Guli Songs (UK), Halcyon (UK), Hello There (USA), Hit & Run (UK), Holland Dozer Holland (USA), Hollywood Allstar (USA), Hubtones (USA), Icebag (USA), Island group (UK), Jac (USA), Jana (USA), Jec (USA), Kaiser (USA), Knollwood (USA), LBG Artistes (Netherlands), La Cenega (USA), Lady Casey (USA), Larball (USA), Lestercourt (UK), Levathan (UK), Levine & Brown (USA), Liberation (USA), Libra (UK), Light (USA), Little Dragon (USA), Lunatunes (USA), Mainman Saag (Switzerland), Mandina (USA), Manticores (UK), Mar/Vista (USA), Machee (USA), Mighty Three (USA), Milwaukee (USA), Mister Bones (USA), Modern American (USA), Mole (USA), Montunes (USA), Morning (Canada), Munchkin (USA), Musikvertrieb (Switzerland), New Times (USA), Nightwind (USA), Nineteen Eighty-Five (USA), No Sheet (USA), Dnaje (USA), No Time (USA), Open End/Oyster (USA), Pal Dog (USA), Peach Cobbler (USA), Pearized (USA), Petra (USA), Pedro (USA), Playboy (USA), Plangent Visions (UK), Plurkatz Krundle (USA), Pods (USA), Pure Songs (USA), RAK (UK), Raton Songs (USA), Relaxed (USA), Le Rideau Rouge (France), Rock Music Ltd. (UK), Rocksmith (USA), Rocky Mountain Nat'l Park (USA), Ronin (USA), Roycol (UK), SSP (UK), Leonard Sachs (USA), Cyril Shane (USA), Small Hill (USA), Sterling (USA), Street (UK), Sure Enough Tunes (Canada), Third Story (USA), Thursday (USA), Tree (USA), Tumbleweed (Australia), Van Halen (USA), Warfare (UK), Weed High Nightmare (USA), Josef Weinberger (Austria), Wicked Fly (UK), Wiener Musikproduktion (Austria), Wien Melodie (Austria), Wildflowers (USA), R.P. Winkelman Tunes (USA), Frank Zappa (USA), Compass Music Group-Compass (Netherlands), UK (USA); Frankfurt Tree group-Ally, Chu-Fin, Cross Keys, Double R, Green Grass, Kentree, Lonzo & Oscar, Makamilton, Makamint, Eddie Miller, Music in Color, Ruler, Southdown, Starway, Stallion, Tata Grande, Tree, Twitty Bird, Uncanny, Yesso, Warhawk; Inter Musik group-Anglo-Pic (USA), Backfin (USA), Chero (USA), Festival Attractions (USA), Frank (USA), Lee (USA), MPL (UK), Pic (USA), Rytoc (USA), Warock (USA); Johann Michel group-Aran Prod'n (Switzerland), Bl&H (USA), Beaver (USA), Beechmont (USA), Carlyle (USA), Montauk (USA), Music Crusaders (USA), Myriad (USA), Princess (USA), H.B. Webman (USA), We Three (USA).

Int'l repa.: Austria (Josef Weinberger, Wiener Musikproduktion, Wien Melodie), Switzerland (Editio, Musikvertrieb).

Joe Menke (Ed.), Hamburgerstr. 2, D-2105 Seevetal 3. Tel: (04105) 8-32-07; 8-26-08. Owner: Joe Menke.

Mento Music Group KG (GEMA), Schinkelstr. 7, D-2000 Hamburg 60. Tel: (040) 279-9941. Dir.: Arno H. v. Vught Jr.; Gen. Mgr.: Gertraud Witte.

Int'l firms represented: Auteursunie (Netherlands), Emilhenco (France), Lappala (Canada), Pengram (Denmark), Valentine (UK), Winterlea (Canada).

Int'l repa.: Austria (E. Hochmuth), Canada (Summerlea), France (Emilhenco), Japan (GP), Netherlands (Auteursunie), Scandinavia (Pengram), UK (Valentine), USA (PBR).

Metsa Musikverlag-Gen. Mgr.: Willy Braeutigam-see Compact.

Motonon (Ed.) (GEMA), see Schacht.

Johann Michel (Musikverlag), see Melodie der Welt.

Midway Musikverlag, Friedensstr. 14, D-4750 Unna-Massen. Tel: (2303) 5-22-33. Chief Exec.: Dirk Osterhaus.

Mifra (GEMA), see Schacht.

Mille Musik, Am Glockenberg, D-2114 Hollenstedt. Tel: (04165) 8-00-07. Mng. Dir.: Frank Mille; Gen. Mgr.: Barbara Mille.

Mimi's Music, Bekassinena 47A, D-2000 Hamburg 73. Tel: (040) 647-1097. Chief Execs.: Juergen Michalisen, Michael Nicht.

Montana (Ed.) (GEMA), Koeningstr. 121, D-8000 Munich 40. Tel: (089) 34-30-36. Cable: MONTANAMUSIC. Tel: 215200. Owner: Hans R. Beierlein; Gen. Mgr.: Rudolf Figge.

Int'l firms represented: Editions 23 (France), Roulette (France), Tanday Music (France).

Int'l repa.: France (Rosemarie Schnittler).

Moorea Music, Tesdorpfstr. 11, D-2000 Hamburg 13. Tel: (040) 410-2503. Telex: 2164506. Owner & Dir.: Ulrike Schoen; Gen. Mgr.: Eberhard Plag.

Int'l firms represented: Bubbles (UK), Wvaley (UK).

Moravia Music GmbH, Lichtenbergstr. 14, D-6000 Frankfurt/Main. Tel: (0611) 52-07-07. Gen. Mgr.: Robert Puschmann.

Mountain Music R. Stenel, Fortwaengerstr. 27, D-6900 Heidelberg. Tel: (06221) 47-27-11. Pres.: Roland Stenel; Gen. Mgr.: Joe Moutain; Prof. Mgr.: Roman Saylor.

Guenther Mueller (Musikverlag) (GEMA), Frankfurter Landstr. 7, D-6380 Bad Homburg. Tel: (06172) 4-68-36. Owner: Guenther Mueller.

Multimedia Music Verlags GmbH, see Peer.

Music Avenue, see Hammer.

Music Contact System, see MCS

Music in the Air Verlags GmbH, Herzog-Albrechtsstr. 6, D-8035 Gauting bei Munich. Tel: (089) 850-4344. Chief Execs.: Guenther E. Thoenen, Peter Rubin.

Music Sales GmbH, Kolnerstr. 199, D-5000 Cologne 90. Tel: (2203) 5-50-22. Telex: 8873463. Mng. Dirs.: Harald Peters, Lutz Wentscher.

Home office: USA

Int'l firm represented: EMI (UK).

Musictown (Ed.), Portnergasse 6, D-8400 Regensburg. Tel: (0941) 54-776. Owner & Dir.: Wolfgang Maeder; Gen. Mgr.: Maria Maeder.

Musikandel Verlag Ltd., Friedrich-Wilhelm-Str. 31, D-5300 Bonn 1. Tel: (0228) 23-85-65. Telex: 886727. Chief Exec.: Dr. H. H. Wittgen.

Musza Deutschland GmbH Musikverlag, Neuhäuserstr. 3, D-8000 Munich 2. Tel: (089) 26-30-30. Telex: (05) 22907. Chief Exec.: David Zard.

Int'l firm represented: Musica (Italy).

Noble Verlag GmbH, Haendelstr. 28, D-7000 Stuttgart 1. Tel: (0711) 69-82-78. Pres.: Dr. Udo Unger.

Int'l firms represented: Deman, MAJ, Springtime (all USA).

Int'l repa.: Austria (Josef Weinberger), Switzerland (Leuberg).

Octopus Musikverlag GmbH (GEMA), Theodor Heuss Ring 4, D-5000 Cologne 1. Tel: (0221) 13-70-05. Mgr.: Juergen Fritz.

Johannes Derfel Musikverlag & Buchvertrieb, Annfimerstr. 42, D-8000 Munich 40. Tel: (089) 34-39-83.

Claus Djerger Prod'n (GEMA), see Ebony.

Dymp-Edition GmbH, Platenstr. 6, D-8000 Munich 2. Tel: (089) 77-50-51. Pres.: Michael Theuer.

Drbs Musikverlag, Frankfurterstr. 420, D-5000 Cologne 91. Tel: (0221) 87-75-59. Telex: (08) 8773491. Owner: Heinz Boeninghausen.

Drlando-Musikverlag, Kapfenstr. 11, D-8000 Munich 21. Tel: (089) 56-74-26. Gen. Mgr.: H. Gartenmayer.

Dtvarn Music (GEMA), Scherbrokerstr. 2, D-2875 Ganderkesee 3. Tel: (04221) 87622. 53497. Cable: DTVARN. Dir.: H. Schweitzer Sr.; Gen. Mgr.: Carlo Tossa.

Int'l firms represented: Eimbom (Brazil).

Int'l repa.: Brazil (Eimbom).

Diverse Music, Sigismundstr. 15, D-7750 Konstanz. Tel: (07531) 245-17.

Int'l branch: Switzerland.

Int'l firm represented: Cecil (Switzerland).

P.A.Recs. Music Ed., Hafendamm 46, D-2390 Flensburg. Tel: (0461) 2-71-90. Chief Exec.: Jens Dieter Badura; Gen. Mgr.: Frank Melan.

Int'l repa.: Austria (Tyrolis), Belgium (F.M. Huppermans), Scandinavia (Fred Jensen), UK (Frank Bartelt), USA (K. Hausch).

P D E M Musikverlag, Fuggerstr. 19, D-1000 Berlin 30. Tel: (05143) 8003.

Telex: 925019. Owner: K.D. Mueller.

Int'l firm represented: Garrisons (USA).

Palma Musikverlag, see August Seith.

Pan (Ed.)/Hanseatic Musikverlage, Hallerstr. 40, D-2000 Hamburg 13. Tel: (040) 41-29-31. Chief Exec.: Horst Fuchs.

Panorama Song Musikverlag GmbH, see Intersong Musikverlag.

Paragon Musikverlag GmbH, Bundesallee 48, D-1000 Berlin 41. Tel: (030) 852-2007. Telex: 181619. Gen. Mgrs.: Erhard Wenzel, Bernd Rammen.

Peco (Ed.), see United Artists.

Peer Musikverlag GmbH (GEMA), Muehlenkamp 43, D-2000 Hamburg 60. Tel: (040) 271-3371. Cable: SDUTHMUSIC. Telex: (02) 13387. Mng. Dir.: Michael Karstedt.

Home office: USA, Peer-Southern.

Int'l firms represented: Alihond (UK), Astronaut (USA), Bacardi (USA), Cedarwood (USA), Jloral (USA), Roger Miller (UK), MUSA (Mexico), Parchment (USA), Peer-Southern Org. (Worldwide), Royal Oak (UK), Shade Tree (USA), Small Smile (UK), Sunbird Music (USA), Troika (USA), Vinco (UK).

Int'l repa.: Worldwide (Peer-Southern).

Peer-Southern Prodn's GmbH (GEMA), see Peer.

Penthouse (Ed.), Josef Raps-Str. 3, D-8000 Munich 40. Tel: (089) 32-58-39. Chief Exec. & Gen. Mgr.: Karl Heinz Ruff.

C. F. Peters Musikverlag, Kennedyallee 101, D-6000 Frankfurt/Main 70. Tel: (0611) 63-30-66. Cable: PETERSEDT. Tel: 411686. Gen. Mgr. Dr. Johannes Putschell.

Int'l branches: England, Switzerland, USA.

Int'l firms represented: Hinrichsen (UK), C.F. Peters (USA).

Int'l repa.: UK (Hinrichsen), USA (C.F. Peters).

Pango Music, Tesdorpfstr. 11, D-2000 Hamburg 13. Tel: (040) 45-61-60, 44-82-84. Telex: 211018. Gen. Mgr.: Rainer Felsen.

Plaene Musik, Adenauerallee 8, D-2000 Hamburg 1. Tel: (030) 24-12-31. Telex: 2164483. Chief Exec.: Wolfgang Frickenhausen.

Plagat (Ed.), see Paragon.

Ressow Musikverlag, Nuernbergerstr. 17, D-1000 Berlin 30. Tel: (030) 24-58-47. Mng. Dir.: Erich Plessow.

Point Music oHG, see Noble.

PolyGram Publ'g, Postfach 132266, Harvestehuder Weg 1-4, D-2000 Hamburg 13. Tel: (04940) 410-4061. Telex: 212434. Pres.: H.T. Voigt.

Polyphonic Musikverlag, see Funkturn.

Pool Music (GEMA), see Ebony.

Powerplay Music (GEMA), Dietrichsweiler 3, D-7093 Jagstzell. Tel: (07967) 568, 349. Telex: 745553. Mng. Dir.: Stefan Schick.

Josef Pressler (Musikverlag), PD Box 521, Braehausstr. 8, D-8000 Munich 1. Tel: (089) 22-40-51. Chief Execs.: Sabine Pressler, Inge Emslander-Pressler; Gen. Mgr.: Reinhard Taflerner.

Int'l firms represented: Berben (Italy), Charwood (UK), Delfner (USA), Forlives (Italy), Frederick Harris (Canada), Waterloo (Canada).

Int'l repa.: Italy (Zambon), UK (Charwood), USA (Delfner).

Presto-Jac, Joergensen Buchnen & Musikverlag & Co., see Hans Gerig.

Procom Music GmbH, see Moorea.

Progressive GmbH (Musikverlag), see Intersong Musikverlag.

Prom Verlagsgesellschaft mbH, Norderingstr. 21, D-8000 Munich 19. Tel: (089) 15-10-63. Cable: GLDBLDMUSIC. Telex: (05) 215019. Chief Exec.: Bernd Majewski; Gen. Mgr.: Alfred Meier. (Also see Global).

S. Plach GmbH & Co. KG, see Angelo.

Robert Puschmann Music, Karl Bennerstr. 51, D-6300 Giessen. Tel: (0641) 5-18-97. Owner: Robert Puschmann; Gen. Mgr.: Marianne Puschmann; Sales Mgr.: Anna Heiga Stadelmann-Rink; Rep.: Werner H. Mueck.

Quadrphonie (Ed.), see Werner H. Theisen.

Quint Musikverlag Stem & Co. Ed. Amati, Alfonsstr. 9/11, D-8000 Munich 19. Tel: (089) 18-37-88. Pres. & Gen. Mgr.: Dr. Heinz Stein.

Int'l repa.: Switzerland (Adora).

R G S Musik Rudolf G. Slezak-Owner: Rudolf G. Slezak. Gen. Mgr.: Christa Walczak; Prof. Mgr.: Peter Schmidt-see Rudolf Slezak.

Fred Rabold Musikverlag, Hellensstr. 42, D-7501 Busenbach. Tel: (07243) 6-11-89. Dir.: Fred Rabold.

Racing Music, see Roba.

Rallye Music, see Roba.

Raphael (Ed.), Liebigstr. 11/2, D-8230 Bad Reichenhall. Tel: (08651) 32-19. Pres. & Gen. Mgr.: Dr. Gustav Zagler.

Rhein-Ruhr-Film Musikverlag (GEMA), Koeningallee 124, D-4630 Bochum 1. Tel: (0234) 3-78-14. Telex: (08) 25729. Owner: Erwin Erlenkaemper.

Taunus Ton Technik

the supplier of a complete line
of equipment for the economic
production of high quality records

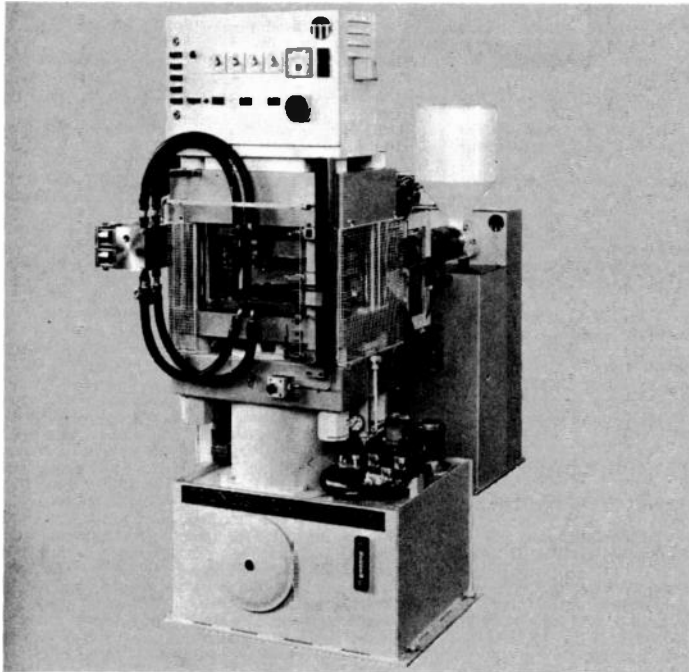

Fully Automatic Record Press (available in left or right hand version)

- Automatic and Manual Presses
- Extruders
- High Speed Moulds
- Trimmers
- Cooling Water Pumps
- Steam Boilers
- Hydraulic Supply Systems
- Packing Machines

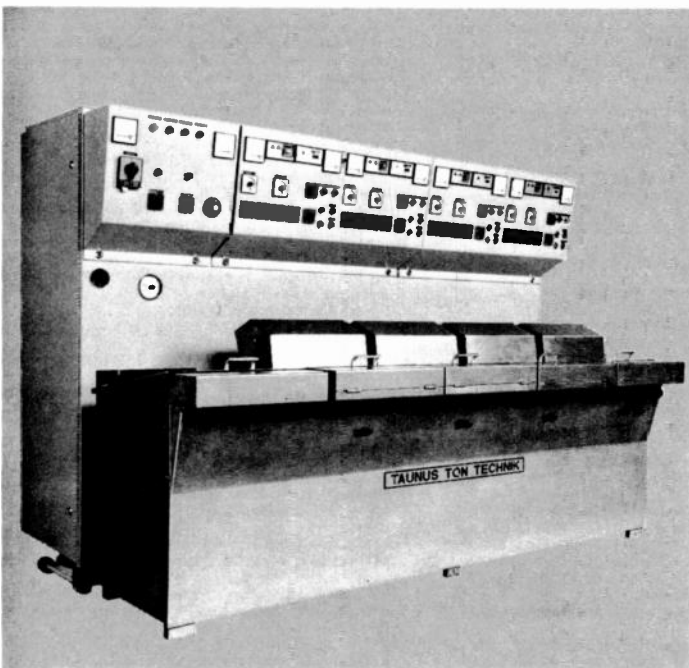

Record and Video Disk Plating Unit

- Galvanoplast Fine and Heavy
Nickel Plating Equipment up
to 400 Amps
- Automatic Silverplating Units
- Matrix Centering Units
- Automatic Matrix Grinders
- Chemicals

For complete information write or call:

TAUNUS TON TECHNIK

Alfred Petith KG · Max-Planck-Straße · 32 · D-6382 Friedrichsdorf 1
Germany · Telephone: (06172) 7 12 55 or 7 25 88 · Telex: 4 18 131 taton



Gen. Mgr.: Helmut Rohlfing.
 Ingrid Richter Musikvertrieb & Verlag, Pohlstr. 58, D-1000 Berlin 30. Tel: (030) 261-2682.
 Ring Music GmbH, Oederweg 26, D-6000 Frankfurt, Main. Tel: (0611) 59-03-19. Cable: WEINJOS. Gen. Mgrs.: Johann Michel, Adolf Wilms
 Int'l firm represented: Themes (UK).
 Riva (Ed.), see August Seith.
 Roba Music Verlag GmbH, Feldbrunnenstr. 50, D-2300 Hamburg 13. Tel: (040) 44-50-86. Telex: 2173377. Pres.: Rolf Barthe.
 Int'l firms represented: Angela (South Africa), An gro (USA), Bear Songs (UK), Black Neon (UK), Black Sheep (UK), Bu (USA), Cam-Ai (UK), Dizzy Heights (UK), Ellisclan (UK), Hard Work (USA), Kongrde (UK), Mercy (Canada), Modern (UK), Morning (Canada), Geoff Morrow (UK), Page Full of Hits (UK), Panache (UK, France), Radar/Vanilla (UK), Red Bus (UK), Satri (UK), Shanna (UK), Shiva (Bulgaria), Slow Dancing (USA), Valdene (UK), Verdigris/Tulsongs (USA), Vycloble (UK), Zomba (UK).
 Int'l reps.: Austria (Euro-Music), Netherlands (Roba).
 Rocamar Music (GEMA), Gardschutzenweg 61-63, D-1000 Berlin 45. Tel: (030) 834-5161. Chief Exec.: Eckhard Meier-Hardy.
 Int'l reps.: Austria (Polydisc), Scandinavia (Wulfitone), Switzerland (Activ), Venezuela (Grabaciones Arto).
 Rock Melody (Ed.), see Melodie der Welt.
 Rockoko Music GmbH, Wittelsbacherstr. 18, D-1000 Berlin Tel: (030) 88-10-81. Telex: 183008. Gen. Mgrs.: Peter Hauke, Peter Mesel.
 Int'l reps.: USA (Rockefeller, Rockoko).
 Roco Music R. Steinel, see Mountain.
 Ro Co-Ton (Ed.), Sigmund-Freud-Str. 36, D-5300 Bonn/Venusberg 1. Tel: (0228) 28-17-06. Owner & Dir.: Heinz Rosenen
 Rondo-Verlag GmbH, see Intersong Musikverlag.
 Ronny (Hamburg) Musikverlag GmbH, see Intersong Musikverlag.
 Roof Music Publ'g (GEMA), Prinz-Regentstr. 50-60, D-4630 Bochum. Tel: (0234) 77-36-50. Telex: (089) 25756. Chief Exec. Juergen Treibel; Gen. Mgr.: Horst Krause.
 Royal Musikverlag (Ed.): Hans Lang, Ohmstr. 9/0, D-8000 Munich 40. Tel: (089) 39-68-74. Chief Exec.: Hans Lang.
 Willy Rupprecht (Musikhaus), Dberer Baust. 39, D-8500 Nuernberg. Tel: (0911) 46-42-22.
 S M V Schacht Musikverlage, Adolfsstr. 45, D-2000 Hamburg 76. Tel: (040) 22-51-43. Owner & Gen. Mgr.: Alfred Schacht.
 S T S Music Int'l GmbH, Leonrodstr. 42, D-8000 Munich 19. Tel: (089) 18-60-68. Cable: TOGERMUSIK. Owners & Gen. Mgrs.: Jerry Toger, Mal Sondock, Ralph L. Seltzer.
 Int'l firm represented: Silver Nightingale (USA).
 S W P (Suedwest Promo./) Musikverlag Guenther B. Merkel, Hoehenweg 22, D-6901 Wehlmelsfeld. Tel: (06220) 1306. Dir.: Guenther B. Merkel; Press: Bernd W. Guelkerberger; Promo.: Wolfgang Rott; Exploitation Dept.: Sharon Levinson.
 Schacht Musikverlage (GEMA), Adolfsstr. 45, D-2000 Hamburg 76. Tel: (040) 22-51-43. Telex: 213723. Owner: Al Schacht.
 Int'l firms represented: Core (Canada), Cyclone (UK), Favor (USA), Mark-Cam (Canada), OH Hollywood (USA).
 Pepp Scherffer (Ed.), see Werner H. Thesen.
 Schlicht Musikverlage, Isabellastr. 72, D-8000 Munich 40. Tel: (089) 271-0561. Telex: 5215566. Chief Exec.: Harald Hoeller, Gen. Mgrs.: Elena Parker, Peik J. Schlicht.
 Schmolzi & Slezak Musik (GEMA)-Owners: Rudolf G. Slezak, Horst F. Schmolzi; Gen. Mgr.: Christa Walczak; Prof. Mgr. Peter Schmidt; Sec'y: Ursula Schulz-see Rudolf Slezak.
 B. Schott's Soehne, Weihenranger 11, D-6500 Mainz. Tel: (06131) 1-07-41. Cable: SCOTSON. Co-Pres.: Dr. Peter Hanser-Strecker, G. Schneider-Schott, Ludolf Freiherr von Canstein.
 Int'l firms represented: Max Eschig (France), Furstner (UK), Schott Frescs (Belgium), Sunvi Zerboni (Italy), Universal (Austria).
 Int'l reps.: Austria (Universal), France (Max Eschig), Japan (Schott), South America (Ricordi in Argentina & Brazil), UK (Schott), USA (EAM).
 August Seith Musikverlage, Haydnstr. 2, 3rd fl., D-8000 Munich 2. Tel: (089) 53-41-22. Gen. Mgr.: Fred Sammueller.
 Int'l rep.: Switzerland (Hablaton).
 Selected Sound Musikverlag GmbH & Co. KG (GEMA), Poesseldorfer Weg 20, D-2000 Hamburg 13. Tel: (040) 410-5005. Telex: (02) 14909. Owner & Gen. Mgr.: Peter M. Majewski.
 Int'l firms represented: MCT (France), Maya (Switzerland), Storzando (France), Technisonor (France).
 Int'l reps.: France (Storzando), Italy (Video), Netherlands (Dennis Music), Scandinavia (Nordiska), UK (Harmonic), U/A (Southern).
 Sereno Music (GEMA), see Breeze.
 Seychelles Music Publ'g & Prod'n (GEMA), PO Box 3152, D-5206 Neunkirchen 1/Cologne. Tel: (02247) 2019. Telex: 0888-639. Mng. Dir. & Gen. Mgr.: Walter Kahl; Prof. Mgr.: Tony Bunte.
 Shadows Music GmbH, see Intersong Musikverlag.
 Show Business (Ed.), Gunter Greffenus & Co. oHG, Schumannstr. 8, D-8000 Munich 80. Tel: (089) 47-10-94. Chief Exec. & Gen. Mgr.: Dr. Gunter Greffenus.
 Int'l firms represented: Beat (Italy), H-Iland (Netherlands), L'illustration (France), Penjane (Australia), Sonstina (USA).
 Siebenpunkt Verlags GmbH, Habsburger Platz 1, Rueckgebaeude, D-8000 Munich 40. Tel: (089) 33-18-08. Gen. Mgr.: H. Schmidt.
 Int'l firm represented: Presenca (Brazil).
 Int'l rep.: Austria (Euro-Music).
 Siegel Musikverlage, Hoehstr. 2, D-8000 Munich 80. Tel: (089) 98-49-26. Telex: 522946. Owner & Pres.: Ralph Siegel; Mng. Dir.: Joachim Neubauer; Gen. Mgr.: Werner Schueler; Int'l Mgr.: Helgard V. Schenkendorf.
 Int'l reps.: Australia (Step Seven), Austria (Siegel/Hochmuth, Step Two), Belgium (Step Eight), Brazil (Step Five), France (**Step Four), Netherlands (Step One), Scandinavia (Step Six), Switzerland (Yellow Bird), UK (Producers Workshop, Sound of Jupiter), USA (Golden Bridge, Old Friends, Siegel, Sounds of Jupiter).
 Sieg-Ton Georg Russman (Ed.), Drei Kaisereiche 19, D-5202 Hennes/Sieg 1. Tel: (02247) 33-55.
 Hans Sikorski (Int'l Musikverlage) (GEMA), Johnsaallee 23, D-2000 Hamburg 13. Tel: (040) 44-62-45. Telex: (02) 11027. Gen. Mgrs.: Dr. Hans Walfred & Hanna Sikorski.
 Int'l firms represented: Campbell Connelly (UK), Soviet State Publ'g (USSR).
 Int'l reps.: Austria (Novaton-Ed. Helbling), Denmark (Sikorski-Scandinavia), France (Sikorski-France), Italy (Maggiore), Netherlands (Sikorski-Basari), Spain (Sikorski Espanola), Switzerland (Nova), USA (Sikorski USA).
 Simon Music (Ed.), Zigeunerweg 45, D-8104 Grainau. Tel: (08821) 88-71. Gen. Mgr.: Ingeborg Simon.
 Rudolf Slezak Musikverlag GmbH (GEMA), Harvestehuder Weg 21, D-2000 Hamburg 13. Tel: (040) 44-60-21. Cable: SLEZAKMUSIC. Telex: 213425.

Owner: Rudolf G. Slezak; Gen. Mgr.: Christa Walczak; Copyright Mgr.: Peter Schmidt; Prof. & Promo. Mgrs.: John Newton, Christa Walczak; Sec'y Ursula Schulz.
 Int'l firms represented: RGS Musik Rudolf G. Slezak-Barn (UK), Bruno (UK), Industrial (France), Jackaroo (USA), Jacob & Jacob, Killy Ton, Konkurrenz, Looking Glass (UK), Macaulay (UK), No Exit (USA), Dnrmusic, Papa Tango, Rear Exit (USA), Silkie (USA), T Mac (UK), Westsongs; Schmolzi & Slezak-ABC/Dunhill (USA), ABM (USA), A Z (UK), Accabonac (USA), American Cowboy (USA), Beggar's Banquet (UK), Cappy (USA), Carpotone, Char Liz (USA), Cherry Lane (USA), Cherry River (USA), Cherry Wood (USA), Andrew Heath (UK), Hemlane (USA), High Road (USA), Jolly Rogers (USA), Lucky Bear (USA), M-3 (USA), Mar Ken (USA), Moonwater (UK), Musicubaldis, (UK), Milton Duan (USA), Tom Parker (UK), Phonoac Int'l (UK), Pondwater (Canada), Shepstone & Dibbens (UK), Superwop (UK), Three Brothers (USA), Trane (USA), Warnes (USA), White Elephant, Windsea (USA), Windstar (USA), Windy Jenny (USA), Rudolf Slezak Musikverlag GmbH-Blackhill (UK), Cirrus (Canada), Dark Cloud (USA), Face Down/Solid Smash (USA), Frettsongs & Clean Sheets (USA), Ben Ghazi (USA), Grever Int'l (Mexico), Heathside (UK), Robert Kingston (UK), Logo (UK), Neon (UK), Penjane (Australia), Tony Roberts (UK), Rough Trade (UK), Slane (UK), Strange (UK), Tembo (UK), Bruce Welch (UK).
 Int'l reps.: Australia (Penjane), Austria (Danubius), Benelux (AVIA), Mexico (Grever Int'l), USA (RGS, ATV).
 Sontono Musikverlag-Musikproduktion, Schleibinger Str. 10, D-8000 Munich 80. Tel: (089) 48-82-82. Dir.: Gerhard Narholz.
 Int'l firms represented: Emil Ascher (USA), Berry Music (UK), Crea Sound (Canada), KPM (UK), Musique Pour L'Image (France), Sonimage (France).
 Int'l reps.: Australia (Penjane), Austria (G. Narholz), Canada (Sonatina), France (L'illustration Musicale, Sonimage), South Africa (Plymouth), UK (KPM), USA (Sonatina).
 Spring Music-Verlag & Produktion GmbH, Leyboldstr. 1, D-5000 Cologne 51. Tel: (0221) 38-44-48. Gen. Mgr.: Guenter Faust.
 Star Musik Produktion GmbH, Wrangelstr. 5, D-2000 Hamburg 20. Tel: (040) 460-1056. Telex: 213485. Owner & Chief Exec. Ralf Arnie; Ass't Mgr.: Jenny Arnie.
 Toni Steingass (Musikverlag), Gustav Nachtigalstr. 26, D-5000 Cologne 60. Tel: (0221) 76-74-13. Dirs.: Tom & Hel Steingass.
 Storz KG (Musikverlag), Hauptstr. 114, D-3360 Osterode. Tel: (05522) 45-11. Telex: (09) 65154. Gen. Dir.: Erich Storz.
 Branches: D-4800 Bielefeld Am Koepfchen 4, Tel: (0521) 25017. Telex: (09) 38058-D8702 Estenfeld bei Wurtburg, Am Kohlering 6, Tel: (09305) 712. Telex: 068476. D-2000 Hamburg, Heidenkampsweg 54, Tel: (040) 280-2939. Telex: (02) 162989.
 Studio-Ton (Ed.), see Tip-Top.
 Sugar Music Verlags GmbH, Gruental 34, D-8000 Munich 81. Tel: (089) 98-66-91. Gen. Mgr.: Elio Gariboldi.
 Summerlea Music (GEMA), Schinkelstr. 7, D-2000 Hamburg 60. Tel: (040) 279-9941. Dir.: Arno H. v. Vught Jr.
 Int'l firms represented: Lappala, Winterlea (both Canada).
 Sunshine Ed., Kraiberg 42, D-8074 Gaimersheim. Tel: (08458) 488. Contact: Margot Liebold.
 Super Top Musikverlag GmbH, see Melodie der Welt.
 Supra Musikverlag (Ed.), Michel KG, see Melodie der Welt.
 Swington (Ed.)/(GEMA), Richtlofenstr. 3, D-7730 VS-Villingen. Tel: (07721) 52-007. Pres.: Hans Georg Brunner-Schwer; Contact: Willi Fruth.
 T M Musikverlag GmbH, see Intersong Musikverlag.
 Teledisc Ed./Prod., Tiedgestr. 54, D-3000 Hannover 1. Tel: (0511) 81-60-41. Chief Exec.: Wolfgang Borges.
 Telstar Music Verlag GmbH, Trogerstr. 48, D-8000 Munich 80. Tel: (089) 47-10-67. Telex: 523019. Pres.: Michelangelo La Bionda; A&R Mgr.: Carmelo La Bionda; Publ'g Mgr.: Harald Klofat.
 Testa-Music, Guentzestr. 54, D-1000 Berlin 31. Tel: (030) 87-07-40. Chief Exec.: Walter Ruff.
 Int'l rep.: Triad Music (USA).
 Tezel (Ed.), PO Box 1165, Burgstr. 4, O-7830 Emmendingen. Tel: (07641) 21-78. Contacts: Reinhard Egin, Eva Morgenstern.
 Thers (Musikverlag), Suedring 11, D-3502 Vellmar 1/Kassel. Tel: (0561) 82-27-73.
 Werner H. Thesen Musikverlage, Plankenhoferstr. 7, D-8000 Munich 70. Tel: (089) 93-18-88. Owner & Gen. Mgr.: Werner H. Thesen; Prof. Mgr.: Tanja Geuder.
 Int'l reps.: Denmark (Gustav Winckler), Japan (Sam Fox), Switzerland (Wilfr Bestgen), USA (Sam Fox).
 Thorofon H. Koenig KG, Am Sande 7, D-3002 Wedemark 1. Tel: (05130) 41-76. Dir.: Helga Koenig.
 Tip-Top Musikverlag, Fasanenstr. 71, D-1000 Berlin 15. Tel: (030) 883-3443. Owner: Egon Pirenger.
 Toledo Recs. & Publ'g, Wittelsbacher Str. 18, D-1000 Berlin 31. Tel: (030) 88-10-81. Telex: 184174. Pres.: Guenther Henne, Carl Schmitz.
 Tonos (Ed.), Astrastr. 9, D-6100 Darmstadt. Tel: (06151) 6-23-47. Owner: Franz Koenig.
 Int'l reps.: Brazil (Bruno Quano), USA (Seesaw).
 Toso Musikverlag (GEMA), Leonrodstr. 42, D-8000 Munich. Tel: (089) 18-60-68. Cable: TOGERMUSIC. Telex: (05) 215781. Owners & Gen. Mgrs.: Mal Sondock, Jerry Toger.
 Trend Music-Verlag (GEMA), Zietenstr. 59, D-6800 Mannheim 51. Tel: (0621) 79-27-69. Chief Execs.: Klaus R. & Heide Nagert; Gen. Mgr.: Klaus R. Nagel.
 Int'l firms represented: DeVega (Italy), Rouge & Hudson (UK).
 Trion Sound Prod'n GmbH-Musikverlag (GEMA), Ginnheimer Landstr. 200, D-6000 Frankfurt/Main 50. Tel: (0611) 51-81-88. Chief Execs.: Wolf-Dieter Melzer, Hans-Walter Bruessow; Gen. Mgr.: Wolf-Dieter Melzer.
 Tropical Music GmbH, Astrastr. 9, D-6100 Darmstadt. Tel: (0615) 6-23-47. Owners: Franz Koenig, Claus Schreiner.
 Int'l firms represented: Balao, Catavento, Luciana, Novo Rumo (all Brazil).
 Int'l reps.: Brazil (Balao, Catavento, Luciana, Novo Rumo).
 Tuerkofon Universal Musikverlags GmbH, Hansaring 149, D-5000 Cologne 1. Tel: (0221) 73-50-35. Telex: 8885159. Pres.: Yilmaz Asocel; Gen. Mgr.: Franz Lenning.
 Turnberg Verlag (GEMA), see Klaus Gerth.
 U B M (GEMA), Glockengasse 1, D-5000 Cologne 1. Tel: (0221) 21-08-18. Telex: (08) 881935. Pres.: Uwe Buschhotter; Dir.: Harry Rosenstein.
 U F A-Musikverlag, Sonnenstr. 19, D-8000 Munich 2. Tel: (089) 55-79-57. Cable: UFATON. Telex: (05) 23265. Gen. Mgr.: Dr. Josef Bamberger.
 Int'l firms represented: Amphonic (UK), Arista/Careers (USA), Camerica (USA), Corinth (Canada), Cumberland/Strong Box (USA), Walt Disney/Wonderland (USA), Desert Songs (UK), Early Morning (Canada), Evberlye (UK), GH (UK), Tony Hiller (UK), Interworld (USA), Jobete (USA), Kohaw (UK), Miran (USA), Musaza/Angelo Branduardi (Italy), Open Choice (UK), Peacock/Stonegold (USA), Riff Bros. (USA), Riva (UK), Southstrand (UK), Weiser (USA).
 Int'l rep.: Austria (MMS).
 Heinz Um-Musik GmbH (GEMA), Voelckstr. 34, D-8900 Augsburg. Tel: (0821) 51-55-55. Dir.: Heinz Um.
 United Artists Music GmbH, PD Box 201, Herzog Rudolfstr. 3, D-8000 Munich 22. Tel: (089) 22-51-75. Telex: 529378. Mng. Dir.: Gaby Richtig; Prof. Mgr.: Ingrid Schlusser.
 Int'l firms represented: Buddha/Kama Sutra, First State Holding, Sam Fox, Glasco, M&W, Pen-In-Hand, Powder, Robbins/Fest/Miller/Hastings, Silver Hill/Silver Ridge, Tempo, UA Music Int'l (all USA); United Artists (France, UK).
 Int'l rep.: Worldwide (United Artists).
 Valentine Musikverlag (GEMA), Schinkelstr. 7, D-2000 Hamburg 60. Tel: (040) 279-9941. Dirs. Mrs. P. Seward, Mr. Nice, Mr. Grnham; Gen. Mgr.: Arno H. v. Vught Jr.
 Int'l firms represented: Buckhorn, Derry, Hallnote, Jerry Chesnut, Jimmy's, PBR, St. Francis, Woodmont (all USA), Middle Eight (UK), North Country (Canada), Peter Piper (Canada).
 Int'l reps.: Worldwide (Valentine).
 Vineta Musikverlag (GEMA), Zietenstr. 59, D-6800 Mannheim 51. Tel: (0621) 79-27-69. Dir.: Klaus R. Nagel.
 Int'l firms represented: Devega (Italy), Genua (Italy), Hudson (UK), Jump (Italy), Rouge (UK).
 Vivo-Ton Musikverlag, see Thers.
 W P L Verlags-Vertriebs & Musikproduktion, Hubertusstr. 11, D-5340 Bad Honnef 6. Tel: (02224) 80726. Chief Exec. & Gen. Mgr.: Wolfgang P. Lentz.
 Int'l firms represented: Dancing Musikverlag (Belgium), RMI (Luxembourg).
 Int'l reps.: Belgium (Dancing), Luxembourg (RMI), Spain (RMI).
 Warner Bros. Music (Germany) GmbH, Mauerkircher Str. 5, D-8000 Munich 80. Tel: (089) 98-49-91. Telex: (05) 215177. Mng. Dir.: Siegfried E. Loch; Gen. Mgr.: Ed Hene.
 Int'l firms represented: Advanced, Alfred, Carmine Appice, Athawarn, Atlas, Auntie Gravity, Autumn, Badco, Barkay, Beverly Hills, Big Bang, Bilmar/Norway, Bleu Disque, Bridgeport, Bright, Caledonia Soul, Candlewick, Can Sound, Caren, Camad, Cass-Country, Castleford, C'est Chic, Chirmy, Chi-Sound, Gardens, David Allen Coe, Coffee-Pot, Cool Springs, Coral Reeler, Cottillon, Dakar, Day City, Devalbo, Dugga, Diamond Mine, Diamond Zero, Don Pow, Don Valley, Dorallo, Douglas, Dunbar, East Memphis, Easy Action, Easy Money, El Sueno, Evansongs, Face The Music, Fallwater, Far Fetched/Pond Tunes, Feckless, Ferguson, First Artist, Garco, Geflen, Glitterbest, Golden Spread, Good Friends, Good High, Grasshopper, Hallmark, Hanbo, Harms, Havona, N. Highwave, Holmes Line of Music, House of Houston, Ice Nine, Inherit, Inner Earth, Jakmas, Jaynne, Jazz Bird, Jeddah, Jude-Anne, Jump Tune, Katja, Howard Kenny, Kentucky Wonder, Kicking Bear, Kittyhawk, Klancey, Kloatons, Kr. Kuumba, Likely Story, Lifestuding, Little Macho, Longdom, MGM, Mack David, Magidson, Maitre d'Music, Makamilion, Makamint, Mansfield, Marsant, Mayfield, May 12th, Van McCoy, Lonette McKee, Mijac, Miran, Mississippi Mud, Mufti, Naked Snake, New World, Nick-D-Van, Nine, Nine Star, Northern Hemisphere, Nutty Sounds, Oakland, Old Canyon, Oide Grog, Open Window, Otherwise-Likewise, Overdrive, Prairie American, Parados, Peabo, Pendulum, Peparner, Philipsongs, Paine League, Public Domain, Pud, Quackenbush, Radio, Lou Rawls, Red Gator, Remick, Richbar, Road Canon, Rodart, Round World, Saloon Songs, Sergeant, Shan, Showbird, Slim Chance, Somerset, Songbird of Paradise, Southern Hemisphere, Southfield, Space Songs, Spheric, Steady State, Story & Sandy Songs, Superhype, Swallow Turn, Sweet Harmony, Swell Sounds, Takoma/Takehome, Tchaikovsky, Terra Firma, Tessa, Toddman, Tomopah & Tidewater, Topographic, Tortoise/Terapin, Tugknott, Upward Spiral, Variety, Vre Cruz, WB, Walden, Warner Tamarlane, Wax Table, Widescreen, Wine n' Dime, Wolf & Flutter, You, Zipcode, Zoo.
 Int'l reps.: Australia, Brazil, Canada, Greece, Italy, Netherlands, Scandinavia, South Africa, UK & USA (all Warner Bros.), France (PECF).
 Josef Weinberger GmbH, Oederweg 26, D-6000 Frankfurt/Main 1. Tel: (0611) 59-03-19. Cable: WEINJOS. Gen. Mgrs.: Johann Michel, Adolf Wilms.
 Int'l rep.: UK (Josef Weinberger).
 Lutz Wellnitz Musikverlag Alfred Schenz, Neuhauserstr. 3, D-8000 Munich 2. Tel: (089) 26-30-30. Telex: (05) 22907. Chief Exec.: Alfred Schenz.
 Berthold Wengert (Musikverlag), Hauptstr. 100, D-7507 Pfalzthal-Soellingen. Contact: Berthold Wengert.
 Wers Music Prod'n GmbH, Aachenerstr. 112, D-5000 Cologne 40. Tel: (02234) 7-10-16. Telex: (08) 89206. Mng. Dir.: Rudi Petry.
 Hans Wewerka (Musikverlag), Eisabethstr. 38, D-8000 Munich 40. Tel: (089) 271-3781. Chief Exec. & Gen. Mgr.: Hans Wewerka.
 Int'l firms represented: A Tempo Verlag (Austria), Card (France), Jugoton (Yugoslavia), Modern (France, Switzerland, UK), Montparnasse 2000 (France), Transatlantiques (Eds.) (France).
 Windkraft Music, Hamburgstr. 2, D-2105 Seevetal 3. Tel: (04105) 83-207. Dir.: Joe Menke; Gen. Mgr.: Giko Kroecker.
 Wolfgang G. Winkel Musikverlag, Lindwurmsstr. 95, D-8000 Munich 2. Tel: (089) 53-08-81. Telex: 522636.
 Enno Winkler Musikedition (GEMA), Tambercherstr. 4, D-1000 Berlin 46. Tel: (030) 775-5004. Gen. Mgr.: Dr. Enno A. Winkler.
 Branch: D-2057 Heimbek/Hamburg, Hebbelstr. 14. Tel: (040) 727-9287.
 Int'l branch: England.
 Int'l firm represented: Quincy (USA).
 Winterlea Music, see Menlo.
 Wintrup Music (GEMA), Heerstr. 62, D-4934 Horn-Bad Meinberg 1. Tel: (05234) 2976. Telex: 935779. Dir.: Walter Holzbaug; Prof. Mgr.: Georg Jankovics.
 Int'l firm represented: Soss (Netherlands).
 Int'l reps.: France (Virgin), Italy (Sugarmusic), Japan (Watanabe), Netherlands (Soss), UK (Virgn).
 Paul Wotschach Radio-Musikverlag, Breitenzgerstr. 13a, D-1000 Berlin 15. Tel: (030) 881-4280. Contact: Paul Wotschach. (Also see Melodie der Welt).
 Konrad Wolf Musikproduktion, Scherbaumstr. 27, D-8000 Munich 83. Tel: (089) 670-7078. Owner & Gen. Mgr.: Konrad Wolf.
 Otto Wrede Regina-Verlag, Postfach 6148, Schumannstr. 35, D-6200 Wiesbaden. Tel: (06121) 52-31-18. Chief Exec.: Harry Wrede.
 Int'l firm represented: Scherzando (Belgium).
 Int'l rep.: Austria (Fr. Holmeister-Figaro).
 The Wurzbürger Musik Publ'g Co. (GEMA), Nord-Ost-Ring 11, D-7024 Filzderstadt/Bernhausen 1. Tel: (0711) 70-27-49. Dir.: Luciano Wurzbürger; Gen. Mgr.: Jack Cunningham; Press & Pub.: Heinz Drossner.
 Int'l rep.: Italy (Alberto Avabile).
 Young Musikverlag GmbH, Wittelsbacherstr. 18, D-1000 Berlin 31. Tel: (030) 88-10-81. Telex: 184174. Dir.: Karl-Henrich Klempon.
 Youngster Musikverlag GmbH (GEMA), Wielandstr. 20, D-1000 Berlin 12. Tel: (030) 882-7383. Telex: 182989. Chief Execs.: Karl-Henrich Klempon, Jack White; Gen. Mgr.: Karl-Henrich Klempon.
 Int'l firms represented: Sunrise (USA), Sunset (USA).

Int'l rep.: Austria (MMS).
 Heinz Um-Musik GmbH (GEMA), Voelckstr. 34, D-8900 Augsburg. Tel: (0821) 51-55-55. Dir.: Heinz Um.
 United Artists Music GmbH, PD Box 201, Herzog Rudolfstr. 3, D-8000 Munich 22. Tel: (089) 22-51-75. Telex: 529378. Mng. Dir.: Gaby Richtig; Prof. Mgr.: Ingrid Schlusser.
 Int'l firms represented: Buddha/Kama Sutra, First State Holding, Sam Fox, Glasco, M&W, Pen-In-Hand, Powder, Robbins/Fest/Miller/Hastings, Silver Hill/Silver Ridge, Tempo, UA Music Int'l (all USA); United Artists (France, UK).
 Int'l rep.: Worldwide (United Artists).
 Valentine Musikverlag (GEMA), Schinkelstr. 7, D-2000 Hamburg 60. Tel: (040) 279-9941. Dirs. Mrs. P. Seward, Mr. Nice, Mr. Grnham; Gen. Mgr.: Arno H. v. Vught Jr.
 Int'l firms represented: Buckhorn, Derry, Hallnote, Jerry Chesnut, Jimmy's, PBR, St. Francis, Woodmont (all USA), Middle Eight (UK), North Country (Canada), Peter Piper (Canada).
 Int'l reps.: Worldwide (Valentine).
 Vineta Musikverlag (GEMA), Zietenstr. 59, D-6800 Mannheim 51. Tel: (0621) 79-27-69. Dir.: Klaus R. Nagel.
 Int'l firms represented: Devega (Italy), Genua (Italy), Hudson (UK), Jump (Italy), Rouge (UK).
 Vivo-Ton Musikverlag, see Thers.
 W P L Verlags-Vertriebs & Musikproduktion, Hubertusstr. 11, D-5340 Bad Honnef 6. Tel: (02224) 80726. Chief Exec. & Gen. Mgr.: Wolfgang P. Lentz.
 Int'l firms represented: Dancing Musikverlag (Belgium), RMI (Luxembourg).
 Int'l reps.: Belgium (Dancing), Luxembourg (RMI), Spain (RMI).
 Warner Bros. Music (Germany) GmbH, Mauerkircher Str. 5, D-8000 Munich 80. Tel: (089) 98-49-91. Telex: (05) 215177. Mng. Dir.: Siegfried E. Loch; Gen. Mgr.: Ed Hene.
 Int'l firms represented: Advanced, Alfred, Carmine Appice, Athawarn, Atlas, Auntie Gravity, Autumn, Badco, Barkay, Beverly Hills, Big Bang, Bilmar/Norway, Bleu Disque, Bridgeport, Bright, Caledonia Soul, Candlewick, Can Sound, Caren, Camad, Cass-Country, Castleford, C'est Chic, Chirmy, Chi-Sound, Gardens, David Allen Coe, Coffee-Pot, Cool Springs, Coral Reeler, Cottillon, Dakar, Day City, Devalbo, Dugga, Diamond Mine, Diamond Zero, Don Pow, Don Valley, Dorallo, Douglas, Dunbar, East Memphis, Easy Action, Easy Money, El Sueno, Evansongs, Face The Music, Fallwater, Far Fetched/Pond Tunes, Feckless, Ferguson, First Artist, Garco, Geflen, Glitterbest, Golden Spread, Good Friends, Good High, Grasshopper, Hallmark, Hanbo, Harms, Havona, N. Highwave, Holmes Line of Music, House of Houston, Ice Nine, Inherit, Inner Earth, Jakmas, Jaynne, Jazz Bird, Jeddah, Jude-Anne, Jump Tune, Katja, Howard Kenny, Kentucky Wonder, Kicking Bear, Kittyhawk, Klancey, Kloatons, Kr. Kuumba, Likely Story, Lifestuding, Little Macho, Longdom, MGM, Mack David, Magidson, Maitre d'Music, Makamilion, Makamint, Mansfield, Marsant, Mayfield, May 12th, Van McCoy, Lonette McKee, Mijac, Miran, Mississippi Mud, Mufti, Naked Snake, New World, Nick-D-Van, Nine, Nine Star, Northern Hemisphere, Nutty Sounds, Oakland, Old Canyon, Oide Grog, Open Window, Otherwise-Likewise, Overdrive, Prairie American, Parados, Peabo, Pendulum, Peparner, Philipsongs, Paine League, Public Domain, Pud, Quackenbush, Radio, Lou Rawls, Red Gator, Remick, Richbar, Road Canon, Rodart, Round World, Saloon Songs, Sergeant, Shan, Showbird, Slim Chance, Somerset, Songbird of Paradise, Southern Hemisphere, Southfield, Space Songs, Spheric, Steady State, Story & Sandy Songs, Superhype, Swallow Turn, Sweet Harmony, Swell Sounds, Takoma/Takehome, Tchaikovsky, Terra Firma, Tessa, Toddman, Tomopah & Tidewater, Topographic, Tortoise/Terapin, Tugknott, Upward Spiral, Variety, Vre Cruz, WB, Walden, Warner Tamarlane, Wax Table, Widescreen, Wine n' Dime, Wolf & Flutter, You, Zipcode, Zoo.
 Int'l reps.: Australia, Brazil, Canada, Greece, Italy, Netherlands, Scandinavia, South Africa, UK & USA (all Warner Bros.), France (PECF).
 Josef Weinberger GmbH, Oederweg 26, D-6000 Frankfurt/Main 1. Tel: (0611) 59-03-19. Cable: WEINJOS. Gen. Mgrs.: Johann Michel, Adolf Wilms.
 Int'l rep.: UK (Josef Weinberger).
 Lutz Wellnitz Musikverlag Alfred Schenz, Neuhauserstr. 3, D-8000 Munich 2. Tel: (089) 26-30-30. Telex: (05) 22907. Chief Exec.: Alfred Schenz.
 Berthold Wengert (Musikverlag), Hauptstr. 100, D-7507 Pfalzthal-Soellingen. Contact: Berthold Wengert.
 Wers Music Prod'n GmbH, Aachenerstr. 112, D-5000 Cologne 40. Tel: (02234) 7-10-16. Telex: (08) 89206. Mng. Dir.: Rudi Petry.
 Hans Wewerka (Musikverlag), Eisabethstr. 38, D-8000 Munich 40. Tel: (089) 271-3781. Chief Exec. & Gen. Mgr.: Hans Wewerka.
 Int'l firms represented: A Tempo Verlag (Austria), Card (France), Jugoton (Yugoslavia), Modern (France, Switzerland, UK), Montparnasse 2000 (France), Transatlantiques (Eds.) (France).
 Windkraft Music, Hamburgstr. 2, D-2105 Seevetal 3. Tel: (04105) 83-207. Dir.: Joe Menke; Gen. Mgr.: Giko Kroecker.
 Wolfgang G. Winkel Musikverlag, Lindwurmsstr. 95, D-8000 Munich 2. Tel: (089) 53-08-81. Telex: 522636.
 Enno Winkler Musikedition (GEMA), Tambercherstr. 4, D-1000 Berlin 46. Tel: (030) 775-5004. Gen. Mgr.: Dr. Enno A. Winkler.
 Branch: D-2057 Heimbek/Hamburg, Hebbelstr. 14. Tel: (040) 727-9287.
 Int'l branch: England.
 Int'l firm represented: Quincy (USA).
 Winterlea Music, see Menlo.
 Wintrup Music (GEMA), Heerstr. 62, D-4934 Horn-Bad Meinberg 1. Tel: (05234) 2976. Telex: 935779. Dir.: Walter Holzbaug; Prof. Mgr.: Georg Jankovics.
 Int'l firm represented: Soss (Netherlands).
 Int'l reps.: France (Virgin), Italy (Sugarmusic), Japan (Watanabe), Netherlands (Soss), UK (Virgn).
 Paul Wotschach Radio-Musikverlag, Breitenzgerstr. 13a, D-1000 Berlin 15. Tel: (030) 881-4280. Contact: Paul Wotschach. (Also see Melodie der Welt).
 Konrad Wolf Musikproduktion, Scherbaumstr. 27, D-8000 Munich 83. Tel: (089) 670-7078. Owner & Gen. Mgr.: Konrad Wolf.
 Otto Wrede Regina-Verlag, Postfach 6148, Schumannstr. 35, D-6200 Wiesbaden. Tel: (06121) 52-31-18. Chief Exec.: Harry Wrede.
 Int'l firm represented: Scherzando (Belgium).
 Int'l rep.: Austria (Fr. Holmeister-Figaro).
 The Wurzbürger Musik Publ'g Co. (GEMA), Nord-Ost-Ring 11, D-7024 Filzderstadt/Bernhausen 1. Tel: (0711) 70-27-49. Dir.: Luciano Wurzbürger; Gen. Mgr.: Jack Cunningham; Press & Pub.: Heinz Drossner.
 Int'l rep.: Italy (Alberto Avabile).
 Young Musikverlag GmbH, Wittelsbacherstr. 18, D-1000 Berlin 31. Tel: (030) 88-10-81. Telex: 184174. Dir.: Karl-Henrich Klempon.
 Youngster Musikverlag GmbH (GEMA), Wielandstr. 20, D-1000 Berlin 12. Tel: (030) 882-7383. Telex: 182989. Chief Execs.: Karl-Henrich Klempon, Jack White; Gen. Mgr.: Karl-Henrich Klempon.
 Int'l firms represented: Sunrise (USA), Sunset (USA).

Zamfr (Ed.) (GEMA), see Schacht.
 Zimmermann (Musikverlag), Gaugrafenstr. 19-23, D 6000 Frankfurt/Main 90. Tel: (0611) 78-45-47. Telex: 414664. Gen. Mgr. Maja-Maria Reis. Int'l regis.: UK (Novello), USA (G. Schirmer).
 23 (Eds.), see Montana.
 Zorro GmbH, Peter Drioff Musikverlage, Raue Hecke 2, D 5000 Cologne 91. Tel: (021) 86 38-77. Telex: 8873698. Owner Peter Drioff. Gen. Mgr. Olav Bjørke.

• **services**

ASSOCIATIONS & PROFESSIONAL ORGANIZATIONS

Arbeitsgemeinschaft Musikerziehung & Musikpflege des Deutschen Musikrates, Am Michaelshof 4a, D 5300 Bonn 2. Tel: (0228) 36-40-85
 Automatenunternehmer eV, Austerberg 18b, D 2000 Hamburg 63
 Automaten-Verband Baden Württemberg eV, Knoedlstr. 6, D-7000 Stuttgart 1. Tel: (0711) 48-31-41. Contact Dieter Schiltenshelm
 Automaten-Verband Niedersachsen eV, Yorkstr. 11, D 3000 Hannover Tel: (0511) 31-30-66
 Automaten-Verband Rheinland-Pfalz, 153 Kaiserstr., Karlsruhe
 Bayerischer Automaten-Verband eV, Neuhäuserstr. 34/III, D-8000 Munich 2. Contact: Otto Saumweber, Helmut Helfenben.
 Bundesverband der Phonographischen Wirtschaft eV, Katharinenstr. 11, D 2000 Hamburg 11. Tel: (040) 36-75-13. Telex: (02) 13546. Gen. Mgr. Dr. Norbert Thurow.
 D A G V (Deutscher Automaten Grosshandels-Verband) eV, Grosse Baeckerstr. 3, D-2000 Hamburg 1. Tel: (040) 36-57-45
 D A V (Deutscher Automaten-Verband) eV, Kaiser-Wilhelm-Ring 6-8, Cologne. Tel: (0221) 23-63-44.
 D M U (Deutsche Musik-Union) eV, Mauerkirchstr. 3, D-8000 Munich 80. Tel: (089) 98-12-53. Pres.: Lutz Helger, VP: Paul Halezki (Union for Composers of Pop, Film & TV Music)
 Deutsche Disc-Jockey Org. (DDD), Theaterstr. 66, D 5100 Aachen Tel: (0241) 4-83-51. Telex: (08) 32652. Mng. Dr. Klaus Quirin
 Deutsche Discoteken-Unternehmen (DDU), c/o Verlag Quirin GmbH, Theaterstr. 66, D-5100 Aachen Tel: (0241) 4-83-51. Telex: (08) 32652. Mng. Dr. Klaus Quirin
 Deutsche Jazz-Federatlon eV, Hirschlandsr. 132, D 7300 Esslingen Tel: (0711) 31-50-80. Pres.: Wolfram Roehrig
 Deutsche Landesgruppe der IFPI eV, see IFPI
 Deutsche Mozart-Gesellschaft eV, Karlstr. 6, D-8900 Augsburg Tel: 51-85-88.
 Deutsche Orchestervereinigung eV, Charlotte-Niese Str. 8, D 2000 Hamburg 52. Tel: (040) 82-55-51. Chief Exec. Guenther Engelmann, Gen. Mgr.: Peter Gurth
 Deutsche Phono-Akademie eV, Katharinenstr. 11, D-2000 Hamburg 11. Tel: (040) 36-75-12. Telex: (02) 13456. Dirs.: Dr. Helmut Storchmann, Klaus Peter Samson.
 Deutscher Autorenverband eV, Sophienstr. 2, D-3000 Hannover 1. Tel: (0511) 32-20-68. Dirs.: Dr. Walter Lowen, Helga Lipps
 Deutscher Komponisten-Verband, Bergengruenstr. 28, D-1000 Berlin 38. Tel: (030) 801-8065. Gen. Mgr. Marianne Augustin (Composers Ass'n)
 Deutscher Musikrat (Sektion Bundesrepublik Deutschland im Internationalen Musikrat) eV, Am Michaelshof 4a, D-5300 Bonn 2. Tel: (0228) 36-40-85. Pres.: Dr. Richard Jakoby, Gen. Sec'y: Dr. Andreas Eckhardt
 Deutscher Musikverband (DMV), Besenbinderhof 56, D-2000 Hamburg 1. Tel: (040) 24-67-68. Gen. Mgr.: Willi Suhr
 Deutscher Musikverleger-Verband eV, Friedrich-Wilhelm-Str. 31, D-5300 Bonn. Tel: (0228) 23-85-65. Telex: 886727. Gen. Mgr. Dr. H. Wittgen, Contact: Dr. A. Schneider (Music Publ'rs Ass'n)
 Deutscher Radio & Fernsehverband, Sachsenring 80, D-5000 Cologne 1. Tel: (0221) 32-20-91. Telex: (08) 881443. Dirs.: Gunter Preuten, Holger Wenzel.
 Deutscher Sängerbund eV, Bernhardtstr. 166, D-5000 Cologne-Bayenthal. Tel: (0221) 38-60-01. (Choral Federation)
 Deutsche Stiftung Musikleben, Brahmsallee 70, D 2000 Hamburg 13. Tel: (040) 44-71-58.
 Foerderverband Unabhangiger Musiker eV (FUM), Lindwenerweg 144, D 5000 Cologne 60. Tel: (0221) 599-2031.
 Genossenschaft Deutscher Buehnen-Angehoerigen, Feldbrunnenstr. 74, D 2000 Hamburg 13. Tel: (040) 44-51-85, 44-38-70. Telex: (02) 162684. Pres.: Hans Herdlein (Theater Union)
 Gesamtverband Deutscher Musikfachgeschaefte eV, Friedrich-Wilhelm-Str. 31, D-5300 Bonn. Tel: (0228) 23-85-65. Telex: 886727. Gen. Mgr.: Dr. H. Wittgen, Contact: Dr. A. Schneider (German Music Trade Ass'n)
 Gesellschaft fuer Musikforschung eV, Heinrich-Schutz-Allee 35, D-3500 Kassel-Wahlelmshohe. Tel: (0561) 300-12.
 Gesellschaft fuer Neue Musik eV, Kulturamt der Stadt Witten, Bergerstr. 25, D-5810 Witten. Tel: (02302) 57085. Telex: 8229101.
 Gesellschaft Zur Verwertung von Leistungs-Schutzrechten mbH (GVL), Esplanade 36a, D-2000 Hamburg 36. Tel: (040) 34 19-61. Dirs.: Dr. Rolf Duenwald, Dr. Norbert Thurow
 I F I P I (International Federation of Producers of Phonograms & Videograms), Deutsche Landesgruppe, Katharinenstr. 11, D-2000 Hamburg 11. Tel: (040) 36-74-05. Telex: 0213456. Dirs.: Richard Busch, Dr. Norbert Thurow.
 I F U (International Film Union), Schloss Calmuth, Remagen. Tel: 82 51.
 Ial Berufsverband Show & Unterhaltung, Besenbinderhof 60, D-2000 Hamburg 1. Tel: (040) 24-53-43. Dir.: Boris Bossi.
 Institut fuer Neue Musik & Musikerziehung eV, Grafenstr. 26, D-6100 Darmstadt. Tel: 2-30-62.
 Internationales Musikinstitut Darmstadt (IMD), Nieder Ramstaedterstr. 190, D-6100 Darmstadt. Tel: (06151) 13-24-16. Dir.: Friedrich Hommel.
 Musikalische Jugend Deutschlands eV—Jeunes Musicales, Marktplatz 12, D-6992 Weikersheim. Tel: (07934) 280. Telex: (5) 212511. Gen. Mgr.: Joerg Stiedl.
 Spidem (Spitzenverband Deutsche Musik), Adenauerallee 134, D 5300 Bonn 1. Tel: (0228) 21-93-70. Telex: (08) 861114. Pres.: Erich Schulte; Gen. Sec'y: Juergen Maahn.
 Spitzenverband Deutsche Musik, see Spidem
 Staatliches Institut fuer Musikforschung Preussischer Kulturbesitz, Stauffenbergstr. 14, D-1000 Berlin 30. Tel: (030) 261-1561. Dir. Prof. Dr. Hans-Peter Reinecke; Rep. Dr. Dagmar Droysen-Reber
 Union Deutscher Kuenstleragenten eV, Postfach 190247, Christophstr. 31, D-5000 Cologne 1. Tel: (0221) 13-14-32. Dirs.: Hermann Ahrens, Curt Richter.
 United European Publ'rs, Wittelsbacherstr. 18, D-1000 Berlin 31. Coord.: Hedi Ramadan.
 V D M K V (Verband Deutscher Musikerzieher & Konzertierender Kuenstler), Besenbinderstr. 17, D-1000 Berlin 12. Tel: (030) 342-2014. (Musicians & Music Teachers Ass'n)
 Verband der Deutschen Konzertdirektionen eV, Wlderstr. 12, D-8000 Munich. Tel: (089) 98-69-33. Telex: 0529912. Gen. Mgr.: Rudolf Kempf.

Verband der Norddeutschen Automaten-Gewerbes eV, Ahrensburgerstr. 58, D 2000 Hamburg-Wandsbek 70. Tel: (040) 656-0456
 Verband des Automaten-Gewerbes Schleswig-Holstein, Holsteinstr. 88/90, D-2300 Kiel 1. Tel: (0431) 9 12-56. Chief Exec. Siegfried Hohmann, Gen. Mgr. Dr. Peter Theede
 Verband Deutscher Buehnen-Verleger eV, Bundesallee 23, D 1000 Berlin 31. Tel: (030) 861-8088. Dirs.: Stefani Hunzinger, Ruth Gerlach
 Verband Deutscher Musikschulen eV, Villichgasse 17, D 5300 Bonn 2. Tel: (0228) 35-42-14. Dirs.: Diethard Wucher, Rainer Mehlig
 Verband Hessischer Automaten-Austeller, Gluckstr. 7, Frankfurt/Main
 Vereinigung Deutscher Musik-Bearbeiter eV, Sakrower Kirchweg 62, D 1000 Berlin 22. Tel: (030) 365 1153. Dir.: Ulrich Roeber
 Verein Zur Foerderung der Deutschen Tanz & Unterhaltungsmusik eV, Friedrich-Wilhelmstr. 31, D 5300 Bonn 1. Tel: (0228) 23 85 65. Dirs.: Franz Grothe, Dr. Hans-Henning Watgen
 Z D A (Zentralverband der Organisationen des Automaten-Artstell Gewerbes), Emserstr. 45, D-1000 Berlin 15. Tel: (030) 881 1975 (Operators Ass'n)
 Zentralverband der Elektrotechnischen Industrie eV, Fachverband 14 Unterhaltungselektronik, Stresemannallee 19, D 6000 Frankfurt/Main 70. Tel: (0611) 6-30-21. Telex: (04) 11035. Telecopier: (0611) 630-2317

CATALOG SERVICES

Achilles (Gebr.), Robenstr. 31, D-5100 Aachen Tel: (0241) 1 50-71. Telex: 0832714. Gen. Mgr.: Dr. H. Achilles, Sales Mgr.: Hans Bayartz (Rec., tape)
 Amerindian, An Der Alte Muehle 9, D 5067 Wesseling-Berzdorf. Tel: W02232) 51780. Chief Exec.: Ingrid Renate Roehre.

DESIGN & ARTWORK

Druck-Verlag Werbung, Freiburgerstr. 21, D-6900 Heidelberg 1. Tel: (06221) 3-37-79. Telex: 461538.
 Lesser Int'l, Postfach 1525, Grafingerstr. 226, D-8360 Deggendorf 1. Tel: (0991) 30866. Telex: 69780
 Medien Serv., Kirchstr. 6, D-3101 Winsen. Tel: W05143) 8003. Telex: 925019.
 Offshore Spezialversand, Klingelholz 35, D-5600 Wuppertal 2. Tel: (0202) 50-29-63.
 Ohr Musik Produktion GmbH, PO Box 850227, D-5000 Cologne 80. Tel: (0221) 68-25-74. Telex: 8873445. Pres.: Rolf Kasser
 Rhein-Ruhr-Film Tonstudio, Koensgallee 124, D 4630 Bochum 1. Tel: (0234) 3-78-14. Telex: (08) 25729. Chief Exec.: Helmut Rohlfing, Sales Mgr.: Erwin Erlenkaemper (Record only)
 Rocamar Music, Gardschuetzenweg 61-63, D 1000 Berlin 45. Tel: (030) 834 5161. Chief Exec.: Eckhard Meier-Hardy
 Hans Sikorski (Int'l Musicverlage), Johnsallee 23, D 2000 Hamburg 13. Tel: (040) 44-62-45. Telex: (02) 11027. Co-Pres.: Dr. Hans & Hanna Sikorski.
 Sonopress Gesellschaft fuer Tontraegerherstellung mbH, Carl Ber telsmannstr. 161, D-4830 Guelersloh 1. Tel: (05241) 801. Cable: SOND PRESS. Telex: 933822. Gen. Mgr.: Dr. Uwe Swentek, Sales Mgr.: Heinz Kirchberg.
 Tonomast Tontraeger GmbH, Schwabelstr. 2, D 8011 Hoehenkirchen bei Munich. Tel: (08102) 81-36. Chief Exec.: Johann Winkler, Sales Mgr. Margarethe Winkler.
 Heinz Ulm-Music GmbH, Voelkstr. 34, D-8900 Augsburg. Tel: (0821) 51 55

55. Cable: HELMMUSIC. Dir.: Heinz Ulm
 Videoring GmbH, PO Box 1167, Am Schierenberg 2, D 2106 Bendorfstr. Tel: (04183) 6035. Cable: VIDEORING. Telex: 2189719. Dirs.: Paul Moeckel, Mario Villavicencio

LICENSING ORGANIZATIONS, MUSIC

G E M A (Gesellschaft fuer Musikalische Auffuehrungs- und Mechanische Vervielfaeltigungsrechte), Herzog-Wilhelmstr. 28, D-8000 Munich 2. Tel: (089) 5-59-91. Pres. & Gen. Mgr.: Prof. Dr. Erich Schulte, Int'l Dir. Wolfgang Schreding (Mechanical & performing rights)
 G V L (Gesellschaft zur Verwertung von Leistungsschutzrechten mbH), Esplanade 36a, D 2000 Hamburg 36. Tel: (040) 34 19-61. Gen. Mgrs.: Dr. Rolf Duenwald, Dr. Norbert Thurow.

LICENSORS, RECORD & TAPE

Alcophon AV GmbH & Co., Duenebergerstr. 111 113, D 2054 Geesthacht. Tel: (4152) 4031. Telex: 218707. Mng. Dir. Hilmar Kumbartzky; Gen. Mgr.: Manfred von Mangoldt.
 Juicy People, Anklamring 18, D 2 Hamburg 73. Tel: (040) 647 6280. Owner: Jimmy Pratt.
 Lesser Int'l Music Org., Postfach 1525, Grafingerstr. 226, D 8360 Deggendorf 1. Tel: (0991) 30866. Telex: 69780.
 Loevmer GmbH, Obermebach 10, D-5065 Overath. Tel: (02206) 5559.
 Miller Int'l Schallplatten GmbH, Justus von Liebig-Ring 2, 4, D 2085 Quickborn. Tel: (04106) 50-01. Cable: MILIN. Telex: (02) 12386. Gen. Mgr.: Harald A. Kirsten.
 MusiContact GmbH, Dischingerstr. 5, D-6900 Heidelberg. Tel: (06221) 7-36-12. Telex: 461832. Gen. Mgr.: Hanno Pfisterer (SEE ADVERTISEMENT)
 Heinz Ulm-Music GmbH, Voelkstr. 34, D-8900 Augsburg. Tel: (0821) 51 55 55. Cable: HELMMUSIC. Dir.: Heinz Ulm
 Videoring GmbH, PO Box 1167, Am Schierenberg 2, D 2106 Bendorfstr. Tel: (04183) 6035. Cable: VIDEORING. Telex: 2189719. Dirs.: Paul Moeckel, Mario Villavicencio

PLATING, PROCESSING & PRESSING PLANTS

Artist Serv. GmbH, Eppendorfer Baum 13, D-2000 Hamburg 20. Tel: (040) 47-80-22, 48-70-88. Telex: (02) 163078. Mng. Dir.: Eike Heitkamp, Gen. Mgr.: Thomas Fenn. (Pressing only)
 Attacca Musikverlag, Dr. Hammacherstr. 3, D-4100 Duisburg Ruhrort. Tel: (02131) 8-13-78.
 Bellaphon Recs. GmbH & Co. KG, Mainzer Landstr. 87 89, D-6000 Frankfurt. Tel: (0611) 23-08-01. Telex: (04) 16046. Pres.: Branko Zivanovic
 Delta Music GmbH, Zur Muehle 2, D-5020 Frechen 4. Tel: (02234) 61015. Cable: DEMUS. Telex: (08) 89299. Pres.: Dr. K.J. Moll, Gen. Mgr.: P.H. Sautot, Sales Mgr.: Dr. W. Ammel. (Pressing only)
 E M I Electroira GmbH, Maarweg 149, D-5000 Cologne 41. Tel: (0221) 4-90-21. Cable: ELECTROLATDN. Telex: (08) 8881290. Mng. Dir.: Friedrich E. Wottawa, Sales Dir.: Dr. B. Krajewski, Technical Dept. & Dist'n Serv.: Dir. Klaus Brachthaeuser.
 Hamburg Schallplattenpresswerk, Werner-von-Siemensstr., D 2358. Kallenkirchen Industriegebiet Sud. Tel: (04191) 27-71. (Pressing only)
 I S (International Disc Serv.), PO Box 140105, D 8500 Nuernberg 14. Gen. Mgr.: Hans Joachim Rabe, Sales Mgr.: W. Ruff. (Pressing only)
 M P S Recs. GmbH, Richtigofenstr. 3, D-7730 Villingen. Tel: (07721) 5-20-07. Pres. & Gen. Mgr.: Hans Georg Brunner-Schwer, Creative Servs. Dir.: Hans Pfitzer. (Plating & processing only)
 M S Schallplatten GmbH & Co. KG, Mehlbachstr. 10, D 3140 Lueeneburg

BUSINESS WITH GERMANY

Export/ Distribution

Acanta,
Aristocrate, Audite,
Bellaphon Klassik,
Brain, da camera,
Deutsche Harmonia Mundi,

foyer
HNA GRM
THOROFON
erd
harmonia mundi FRANCE
UMBRELLA AUDIOPHILE RECORDINGS
VALOIS
HPC

FSM, Laudate,
Metronome, MPS, RBM,
RCA, Schwann, Sky,
Umbrella,
Wergo.

We specialise on quality.

MusiContact GMBH

DISCHINGERSTR 5
D-6900 HEIDLEBERG, WEST GERMANY. TEL: 06221 — 73044
TXL: 461832. GENERAL MANAGER HANNO PFISTERER

Te (04131) 3 31 40 (Pressing only)
 Miller Int'l Schallplatten GmbH, Justus-von-Liebig-Ring 2-4, D 2085 Quickborn Tel (04106) 50-01. Cable MILIN. Telex (02) 12386. Gen. Mgr. Harald A. Kirsten
 Pallas (Schallplattenfabrik) GmbH, Auf dem Esch 8, D-2840 Diepholz Tel (05441) 22-93, 28-12 Cable: PALLAS. Telex: 941221 Chief Execs. Rolf Neumann, Hans Destreicher Sr. (Pressing only)
 PolyGram Rec. Serv. GmbH, PO Box 1409, D-3000 Hannover 1 Tel (0511) 73061, 69681. Cable: POLYGRAM. Telex (09) 24077 Mng Dir. Karl Tuch
 Sonopress Gesellschaft fuer Tontraegerherstellung mbH, Carl Bertelsmann Str. 161, D-4830 Gutersloh 1. Tel (05241) 801. Telex: 933822 Gen. Mgr. Dr. Uwe Swentek, Sales Mgr. Heinz Kirchberg
 Teldec Telefonen-Decca Schallplatten GmbH, Heussweg 25, D-2000 Hamburg 19 Tel (040) 40-19-1 Cable TELDEC. Telex (02) 13545. Mng Dirs. Gerhard Schulze, Kurt Richter, (Audio & Video Disk Pressing) Factory: D-2353 Nortorf/Holstein, Postfach 160, Niedernstr. 37. Tel (04392) 381. Telex 0299610. Plant Dpns Dr John L. Schubach. Technical Opns Dir. Herbert Knothe
 Tempo (Schallplatten Vertrieb) Messner & Co., Rotwandstr. 16, D-8023 Pullach-Grosshesselohe. Tel (089) 79 42 86 Telex: (05) 212035 Mng Dir Kurt Messner

PRINTERS & LITHOGRAPHERS

Amerindian, An Der Alte Muehle 9, D-5067 Wesseling; Berzdorf Tel (02232) 51780 Chief Exec. Ingrid Renate Roehre
 Attacca Musikverlag, Dr Hammacherstr. 3, D-4100 Duisburg-Ruhrort. Tel (02131) 8-13 78.
 Druck-Verlag-Werbung, Freiburgerstr. 21, D-6903 Heidelberg 1 Tel (06221) 3-37 79. Telex: 461538
 I D S (International Disc Serv.), PO Box 140105, D-8500 Nuernberg 14 Gen Mgr. Hans-Joachim Rabe, Sales Mgr. W. Ruff
 Lesser Int'l, Postfach 1525, Graflingerstr. 226, D-8360 Deggendorf 1 Tel (0991) 30866. Telex: 69780
 Hans Sikorski (Int'l Musicverlage), Johnsaltee 23, D-2000 Hamburg 13 Tel (040) 44-62-45 Telex (02) 11027 Co-Pres. Dr. Hans & Hanna Sikorski
 Sonopress Gesellschaft fuer Tontraegerherstellung mbH, Carl Bertelsmannstr. 161, D-4830 Gutersloh 1. Tel (05241) 801. Cable SONOPRESS. Telex: 933822 Gen. Mgr. Dr. Uwe Swentek, Sales Mgr. Heinz Kirchberg
 Tempo (Schallplatten Vertrieb) Messner & Co., Rotwandstr. 16, D-8023 Pullach-Grosshesselohe. Tel (089) 79 42 86. Telex: (05) 212035. Mng Dir Kurt Messner
 Tonomatic Tontraeger GmbH, Schwabelstr. 2, D-8011 Hoehenkirchen bei Munch. Tel (08102) 81-36 Chief Exec. Johann Winkler, Sales Mgr. Margarethe Winkler
 The Wurzbürger Music Publ'g Co., Nord Ost Ring 11, D-7024 Filderstadt/Bernhausen 1 Tel (0711) 70-27-49 Dir. Luciano Wurzbürger, Gen. Mgr. Jack Cunningham

RECORD PROMOTION (including Public Relations & Publicity)

Amerindian, An Der Alte Muehle 9, D-5067 Wesseling; Berzdorf Tel (02232) 51780. Chief Exec. Ingrid Renate Roehre
 Antagon Musikgesellschaft mbH, Lenhartstr. 15, D-2000 Hamburg 20. Tel (040) 48 44 43 Telex: (02) 173473. Mng Dir. Jens Michow

B F C Int'l Promo. Co., PO Box 350245, D-5000 Cologne 30. Tel: (0221) 50-36-47 Gen. Mgr.: Gunther R. Kamphausen; Mngl. Dir.: Rudolf E. Kamphausen
 Bellaphon Recs. GmbH & Co. KG, Mainz Landstr. 87-89, D-6000 Frankfurt. Tel (0611) 23-08-01. Telex: (04) 16046. Pres. Branko Zivanovic
 Klaus Boehnke GmbH, Lessingstr. 3, D-2359 Henstedt-Ulzburg 3. Tel: (04193) 76-47. Dir. Klaus Boehnke
 D & P Music Serv., Meteorstr. 11, D-2200 Elmshorn Tel (04121) 61532 Owner: Klaus Meyer
 Hofman Concert & Musikpublizistik GmbH, Savignystr. 51, D-6000 Frankfurt/Main. Tel (0611) 74-60-68. Cable MUSICON. Telex: (04) 11499
 Hohlne (Rec'g) Studios GmbH, Nordendstr. 30, D-6000 Frankfurt/Main. Tel (0611) 55-65-66, 55-65-99
 I D S (International Disc Serv.), PO Box 140105, D-8500 Nuernberg 14 Gen. Mgr. Hans-Joachim Rabe, Sales Mgr. W. Ruff
 Juicy People, Anklamer Ring 18, D-2 Hamburg 73 Tel: (040) 647-6280. Owner Jimmy Pratt
 Juke Box, Sternstr. 53, D-8000 Munch 80 Tel: (089) 48 79 30, 48-77-95. Dir. Harry Fox
 Jumbo Prods., Lemped 79, D-2000 Hamburg. Mgr. Wilfried Mannes. Lesser Int'l, Postfach 1525, Graflingerstr. 226, D-8360 Deggendorf. Tel (0991) 30866. Telex: 69780
 Mento Music Group KG, Schinkelstr. 7, D-2000 Hamburg 60. Tel: (040) 279-9941. Dir. Arno H. v. Vught Jr. Gen. Mgr. Gertraud Witte
 Miller Int'l Schallplatten GmbH, Justus-von-Liebig-Ring 2-4, D-2085 Quickborn Tel (04106) 50-01 Cable MILIN. Telex (02) 12386. Gen. Mgr.: Harald A. Kirsten
 Offshore Spezialversand, Klingelhoh 35, D-5600 Wuppertal 2 Tel (0202) 50-29 63
 Dhr Musik Produktion GmbH, PO Box 850227, D-5000 Cologne 80. Tel: (0221) 68-25-74. Telex: 8873445 Pres. Rolf Kaiser
 Peter Pen Publ'kation, Lumburgerstr. 18, D-6240 Koeningstein/Taunus. Tel (06174) 2-24 24
 Schacht Musikverlage, Adolffstr. 45, D-2000 Hamburg 76 Tel (40) 22-51 43. Telex: 213723. Owner: Al Schacht
 Showbiz Walther Kahl, PO Box 1152, D-5206 Neunkirchen 1/Cologne. Tel (02247) 2017. Telex: 0889639. Mng. Dir. Walther Kahl
 Hans Sikorski (Int'l Musicverlage), Johnsaltee 23, D-2000 Hamburg 13. Tel (040) 44-62-45. Telex: (02) 11027 Co-Pres.: Dr. Hans & Hanna Sikorski
 T V D-Thomas Voigt Org. GmbH, Boedekerstr. 53, D-3000 Hanover 1. Tel: (0511) 33-20-33. Mng. Dir. Thomas Voigt
 Toger Musik GmbH, Leonrodstr. 42, D-8000 Munich 19. Tel (089) 18-60-68 Owner & Gen. Mgr. Jerry Toger
 Tonomatic Tontraeger GmbH, Schwabelstr. 2, D-8011 Hoehenkirchen bei Munch. Tel (08102) 81-36 Chief Exec. Johann Winkler; Sales Mgr.: Margarethe Winkler
 Triad Musicverlag, Guentzelstr. 54, D-1000 Berlin 31 Tel: (030) 87-07-40 Chief Exec. Walter Ruff
 Heinz Ullm-Musik GmbH, Voelkstr. 34, D-8900 Augsburg Tel (0821) 51-55-55. Cable: HELMMUSIC. Dir. Heinz Ullm
 The Wurzbürger Music Publ'g Co., Nord-Ost Ring 11, D-7024 Filderstadt/Bernhausen 1. Tel (0711) 70-27-49. Dir. Luciano Wurzbürger, Gen. Mgr. Jack Cunningham

TAPE CUSTOM DUPLICATORS TAPE PACKAGING & LABELING

The Audio and Video lines indicate the configurations which the firms duplicate. Companies which offer packaging and labeling of tape product are indicated by "(PKG)" which appears after the main body of their respective listings.

Alcophon AV GmbH & Co., Duenebergerstr. 111 113, D-2054 Geesthacht Tel (4152) 4031 Telex 218707. Mng. Dir. Hilmar Kumbartzky. Gen. Mgr. Manfred von Mangoldt (PKG)
 Audio: Cassette
 Amerindian, An Der Alte Muehle 9, D-5067 Wesseling; Berzdorf Tel (02232) 51780 Chief Exec. Ingrid Renate Roehre
 Audio: Cassette, open reel
 Artist Serv. GmbH, Eppendorfer Baum 13, D-2000 Hamburg 20 Tel: (040) 47-80-22, 48-70-88. Telex (02) 163078. Mng. Dir. Eike Heitkamp. Gen. Mgr. Thomas Fenn
 Audio: Cassette
 Attacca Musikverlag, Dr Hammacherstr. 3, D-4100 Duisburg-Ruhrort. Tel (02131) 8-13 78
 Auvis-Asona KG, Stollbergstr. 7, D-8000 Munich 22 Tel (089) 22-50-57 Cable ASDNA. Telex: (05) 22084. Dir.: Alf Kuerzeder
 Audio: Cassette, open reel
 Bauer GmbH & Co. KG (Tonstudio), Markgroeningenstr. 46, D-7140 Ludwigsburg-Eglosheim 10 Tel (07141) 3-10-97 Telex (07) 264806
 Audio: Cassette, open reel
 Bellaphon Recs. GmbH & Co. KG, Mainz Landstr. 87-89, D-6000 Frankfurt. Tel (0611) 23-08-01 Telex (04) 16046 Pres. Branko Zivanovic (PKG)
 Audio: Cassette
 Casselton GmbH, Sudetenstr. 73, D-8192 Geretsried 3. Tel (08171) 30 31. 3031-33 Telex (05) 26331 Gen. Mgr. Stan Zaoral, Sales Mgr. Horst Piskowski
 Audio: Cassette
 Video: 1/2" Beta & VHS cassette
 Delta Music GmbH, Zur Muehle 2, D-5020 Frechen 4 Tel (02234) 61015. Cable DEMUS. Telex: (08) 89299 Pres. Dr. K.J. Moll, Gen. Mgr. P.H. Sautol, Sales Mgr. Dr. W. Ammel.
 Audio: Cassette
 Eurocassette, Mehringdamm 32/34, D-1000 Berlin 61 Tel (030) 251-0331. Telex (01) 83369. Chief Exec.: Guenter A. Kiefer, Chief Eng. Klaus Mack
 Audio: 8-tr. cassette
 Video: 2" & 1" open reel, 1/4" cassette, 1/2" Beta, VHS & V-2000 cassette, 1/4" EIAJ cartridge, LVC, SVR
 I D S (International Disc Serv.), PO Box 140105, D-8500 Nuernberg 14 Gen. Mgr. Hans-Joachim Rabe, Sales Mgr. W. Ruff. (PKG only)
 I T P Tonband-Produktions KG, Rwo Verwaltungs GmbH & Co., Ballinstr. 16-18, D-1000 Berlin 47 Tel (030) 684-80-69 Cable 185320. Gen. Mgr.: Karl Blatz, Label Mgr. Jutta Buschenhagen.
 Audio: Cassette
 Loehmer GmbH, Dbermebach 10, D-5065 Dverath Tel (02206) 5559
 Audio: Cassette
 M C S Music & Cassette Supply GmbH, Lenzburgerstr. 2, D-7890 Waldshut. Tel: (07751) 32-58. Gen. Mgr.: Mario Taravella
 Audio: 8-tr., 8-tr. quadraphonic, cassette.
 M D R (Magnetic Disc Rec'g) GmbH Germany, PO Box 140105, D-8500 Nuernberg. Tel: (0911) 63-64-08, (09122) 8-64-40. Telex: (06) 23987. Dir.: Erich Rabe, Sales Mgr.: M. Rabe (PKG-video only)

Magna Tontraeger Produktions GmbH, Juliusstr. 10-11, D-1000 Berlin 44. Tel: (030) 684-80-58. Telex: 183845. Pres.: Juergen Freidank. (PKG)
 Audio: Cassette
 Video: 1/2" Beta & VHS cassette
 Miller Int'l Schallplatten GmbH, Justus-von-Liebig-Ring 2-4, D-2085 Quickborn. Tel: (04106) 50-01. Cable: MILIN. Telex: (02) 12386. Gen. Mgr. Harald A. Kirsten. (PKG)
 Audio: Cassette
 Orchestrola GmbH, PO Box 186, Auf Dem Esch 8, D-2840 Diepholz. Tel: (05441) 2293, 1812. Cable: PALLAS. Telex: (09) 41221. Gen. & Sales Mgr.: Rolf Neumann, Ass't: Ingeborg Grossmann.
 Audio: Cassette
 Polyband Gesellschaft fuer Tontraeger mbH & Co. KG, Sonnenstr. 20, D-8000 Munch 2. Tel: (089) 59 28-21. Telex: 522636. Chief Exec. Wolfgang C. Winkel
 Audio: Cassette, open reel
 Video: 1/4" cassette, 1/2" Beta & VHS cassette
 PolyGram Rec. Serv. GmbH, PO Box 1409, Podbelskiestr. 164, D-3000 Hanover 1. Tel (0511) 69-68-1. Telex: 922807
 Rhenus Music Fuer Fernseh, Film & Muscproduktion mbH & Co. KG, Otto Haehnstr., D-5000 Cologne 50. Tel: (0221) 38-01-47. Telex: 08881404. Gen. Mgr. Karl-Heinz Muenchow
 Dietrich Scharschmidt Studioausruestung, Gernotstr. 11, D-8000 Munch 40 Tel (089) 30-65-46. Cable: PROSTUDIO. Pres.: Dietrich Scharschmidt.
 Audio: Cassette, open reel
 Arthur Shishmanian Export-Import, Boeckmanstr. 15, D-2000 Hamburg 1. Tel (040) 24 67 74.
 Sonopress Gesellschaft fuer Tontraegerherstellung mbH, Carl Bertelsmannstr. 161, D-4830 Gutersloh 1. Tel (05241) 801. Cable: SDNDPRESS. Telex: 933822. Gen. Mgr.: Dr. Uwe Swentek, Sales Mgr. Heinz Kirchberg.
 Audio: Cassette
 Video: 1/4" Beta, VHS & Video 2000 Cassette
 Teldec Telefonen-Decca Schallplatten GmbH, Heussweg 25, D-2000 Hamburg 19 Tel (040) 40-19-1. Mng. Dirs. Gerhard Schulze, Kurt Richter.
 Factory: D-2353 Nortorf/Holstein, Postfach 160, Niedernstr. 37. Tel: (04392) 381. Telex 0299610. Plant Dpns Dir.: John L. Schubach; Technical Dpns. Dir. Herbert Knothe.
 Audio: Cassette
 Tonomatic Tontraeger GmbH, Schwabelstr. 2, D-8011 Hoehenkirchen bei Munch. Tel (08102) 81-36. Chief Exec. Johann Winkler; Sales Mgr.: Margarethe Winkler.
 Audio: Cassette
 Heinz Ullm-Musik GmbH, Voelkstr. 34, D-8900 Augsburg. Tel: (0821) 51-55-55. Cable: HELMMUSIC. Dir. Heinz Ullm
 Audio: Cassette
 Video: 1/4" Beta & VHS cassette
 V & C Video & Computer GmbH, Voelkstr. 34, D-8900 Augsburg. Tel: (0821) 51-68-68.
 Video: 1/2" VHS cassette
 Videoring GmbH, PO Box 1167, Am Schierenberg 2, D-2106 Bendenstorf. Tel: (04183) 6035. Cable: VIDEORING. Telex: 2189719. Dirs. Paul Moeckel, Mario Villavencio (PKG)
 Video: 2" & 1" open reel, 1/4" U-matic cassette, 1/2" Beta, VHS & V-2000 cassette.
 W. D. Warren Co. KG, Im Steingrund 5, D-6072 Dreieich-Buchschlag. Tel: (06103) 6-10-51. Cable: WAMESCO. Telex: (04) 185391. Owner: William Dirk Warren, Exec. VP: Eugene Eiskens, VP Sales: Helmut Rossmayer, VP & Controller: Karl Schoon.
 Video: 1/4" cassette, 1/2" EIAJ open reel.

• supplies

CARTRIDGE & CASSETTE PARTS

I C M GmbH, Lenzburgerstr. 2, D-7890 Waldshut. Tel: (7751) 3075. Telex: 792249. Pres.: Werner Weber, Mng. Dirs. Heinz Amann, Rolf Sager.
 Magna Produktions GmbH, Juliusstr. 10-11, D-1000 Berlin 44. Tel: (030) 684-80-58. Telex: 183845. Pres.: Juergen Freidank.
 Audio: Compact cassette parts
 Dietrich Scharschmidt Studioausruestung, Gernotstr. 11, D-8000 Munch 40. Tel: (089) 30-65-46. Cable: PROSTUDIO. Pres.: Dietrich Scharschmidt
 Audio: All cassette parts.
 Schweizer Design Eurosafe GmbH, Koenigsweg 3, D-4973 Vlotho. Tel: (05733) 50-41. Telex: 971217. Mng. Dirs. G. Deja, Dr. M. Gaer.
 Arthur Shishmanian Export-Import, Boeckmanstr. 15, D-2000 Hamburg 1. Tel (040) 24 67 74.
 3 M Deutschland GmbH, Carl Schurzstr. 1, D-404 Neuss 1. Tel (02101) 141.
 Gen. Mgr. Bo Eikman, Sales Mgr.: Juergen Wagner
 V & C Video & Computer GmbH, Voelkstr. 34, Augsburg, D-8900 Augsburg. Tel (0821) 51-68-68.
 Audio: Cassette labels.

EMPTY CARTRIDGES, CASSETTES & REELS

Agia-Gevaert AG, D-5090 Leverkusen 1. Tel: (0214) 301 Telex: 8510420. Chief Exec. Dr. W. Abeck, Gen. Mgr. W. Blauhut, Sales Mgr. K.W. Rinnebach.
 Audio & Video: Cassette
 Amerindian, An Der Alte Muehle 9, D-5067 Wesseling; Berzdorf Tel (02232) 51780. Chief Exec. Ingrid Renate Roehre
 Audio Club, see Magna
 Avelca, see Dietrich Scharschmidt
 Eurotape, PO Box 233, D-2408 Timmendorfer Strand. Tel: (04503) 38-49.
 Audio: 8-tr. cassette.
 I C M GmbH, Lenzburgerstr. 2, D-7890 Waldshut. Tel: (7751) 3075. Telex: 792249. Pres.: Werner Weber, Mng. Dirs. Heinz Amann, Rolf Sager.
 Magna Produktions GmbH, Juliusstr. 10-11, D-1000 Berlin 44. Tel: (030) 684-80-58. Telex: 183845. Pres.: Juergen Freidank.
 Audio: Open reel
 Video: Videocassette.
 Brand names: Audio Club, Magna
 Dietrich Scharschmidt Studioausruestung, Gernotstr. 11, D-8000 Munch 40. Tel: (089) 30-65-46. Cable: PROSTUDIO. Pres.: Dietrich Scharschmidt.
 Audio: Cassette
 Brand name: Avelca
 Scotch, see 3M
 3 M Deutschland GmbH, Carl Schurzstr. 1, D-404 Neuss 1. Tel (02101) 141.
 Gen. Mgr. Bo Eikman, Sales Mgr.: Juergen Wagner.
 Audio: 8-tr. cassette, open reel
 Video: Cartridge, cassette, open reel
 Brand name: Scotch.

LARRY'S RECORD SYNDICATE
 Phonograph Record & Video Wholesalers

ATTENTION IMPORTERS:

If you are looking for a reliable supplier from Germany, here it is! L. R. S. supplies:

- All kinds of records and musicassettes (rock/pop, jazz, classical) on ALL German major labels
- The same on most of German minor independent labels; some of them are available solely from our company
- 12 in. singles—both disco and rock stuff
- 7 in. 45 RPM singles—all in picture sleeves
- East European domestic, jazz and rock recordings—we have probably the largest catalogue of these records worldwide
- Rare collectors items, exclusive pres-sings etc (no bootlegs)
- Video tapes in PAL/VHS and PAL/Beta
- Audiophile Records, Japanese imports (complete range!)

Details and catalogues upon application
EFFICIENT, PERSONALIZED SERVICE

ATTENTION EXPORTERS:

We are always interested in the import of all kinds of records and tapes incl. video not available on German market.

Your catalogues and lists are always highly appreciated.

Please note that we are not interested in the "parallel import" business.

Industriestrasse 10/1 • 7151 Auenwald 1
 W-Germany • Telephone: (07191) 54710
 Telex: 07245948 Ira d • Cable: LARRYS AUENWALD

ENVELOPES & MAILERS

Achilles (Gebr.), Robensstr. 31, D-5100 Aachen. Tel: (0241) 1250 71. Telex 0832714. Gen. Mgr. Dr. H. Achilles, Sales Mgr. Hans Bayartz
Tempo (Schallplatten-Vertrieb) Meissner & Co., Rotwandstr. 16, D-8023 Pullach-Grosshesselohe. Tel: (089) 79 42 86. Telex: (05) 212035. Mng. Dir. Kurt Meissner.
Traid Musicverlag, Guentzelstr. 54, D-1000 Berlin 31. Tel: (030) 87-07-40. Chief Exec. Walter Ruff.
The Wurzbürger Music Publ'g Co., Nord-Dst-Ring 11, D-7024 Filderstadt 1, Bernhausen 1. Tel: (0711) 70-27-49. Dir. Luciano Wurzbürger, Gen. Mgr. Jack Cunninghamham.

JACKETS & SLEEVES

Achilles (Gebr.), Robensstr. 31, D-5100 Aachen. Tel: (0241) 1 50 71 Telex 0832714. Gen. Mgr. Dr. H. Achilles, Sales Mgr. Hans Bayartz.
Attacca Musikverlag, Dr. Hammacherstr. 3, D-4100 Duisburg-Ruhrort Tel (02131) 8-13-78.
Sonopress Gesellschaft fuer Tontraegerherstellung mbH, Carl Bertelsmann str. Bertelsmannstr. 161, D-4830 Guetersloh 1 Tel (05241) 801. Cable SONOPRESS. Telex: 933822. Gen. Mgr. Dr. Uwe Swientek, Sales Mgr. Heinz Kirchberg (Jackets only)
Tempo (Schallplatten-Vertrieb) Meissner & Co., Rotwandstr. 16, D-8023 Pullach-Grosshesselohe. Tel: (089) 79 42 86. Telex: (05) 212035. Mng. Dir. Kurt Meissner.
The Wurzbürger Music Publ'g Co., Nord-Dst-Ring 11, D-7024 Filderstadt/Bernhausen 1. Tel: (0711) 70-27-49. Dir. Luciano Wurzbürger, Gen. Mgr. Jack Cunninghamham (Jackets only)

LABELS, DISK

Achilles (Gebr.), Robensstr. 31, D-5100 Aachen. Tel: (0241) 1 50 71 Telex 0832714. Gen. Mgr. Dr. H. Achilles, Sales Mgr. Hans Bayartz.
Attacca Musikverlag, Dr. Hammacherstr. 3, D-4100 Duisburg-Ruhrort. Tel (02131) 8-13 78
Arthur Shishmanian Export-Import, Boeckmanstr 15, D-2000 Hamburg 1 Tel: (040) 24-67 74.
Tempo (Schallplatten-Vertrieb) Meissner & Co., Rotwandstr. 16, D-8023 Pullach-Grosshesselohe. Tel: (089) 79 42 86. Telex: (05) 212035. Mng. Dir. Kurt Meissner.
Henz Ulm-Musik GmbH, Voelkstr. 34, D-8900 Augsburg. Tel: (0821) 51-55-55. Cable: HELMMUSIC. Dir. Heinz Ulm
The Wurzbürger Music Publ'g Co., Nord-Dst-Ring 11, D-7024 Filderstadt/Bernhausen 1. Tel: (0711) 70-27-49. Dir. Luciano Wurzbürger, Gen. Mgr. Jack Cunninghamham

POLYETHYLENE BAG & SHRINKWRAP

Achilles (Gebr.), Robensstr. 31, D-5100 Aachen. Tel: (0241) 1 50 71 Telex 0832714. Gen. Mgr. Dr. H. Achilles, Sales Mgr. Hans Bayartz. (Polybags only)
Amerindian, An Der Alte Muehle 9, D-5067 Wesseling-Berzdorf Tel (02232) 51580. Chief Exec. Ingrid Renate Roehre (Polybags only)
Attacca Musikverlag, Dr. Hammacherstr. 3, D-4100 Duisburg-Ruhrort Tel (02131) 8-13-78. (Polybags only)
Tempo (Schallplatten-Vertrieb) Meissner & Co., Rotwandstr. 16, D-8023 Pullach-Grosshesselohe. Tel: (089) 79 42 86. Telex: (05) 212035. Mng. Dir. Kurt Meissner. (Polybags only)
Videoring GmbH, PO Box 1167, Am Schierenberg 2, D-2106 Bendestorf Tel (04183) 6035. Cable: VIDEORING. Telex 2189719. Dirs. Paul Moeckel, Mario Villavencio.

PROFESSIONAL TAPE SUPPLIES

T D K Electronics Europa GmbH, Georg-Glockstr. 14, D-4000 Dusseldorf Tel (0211) 43 48-91. Telex: 8584136. Mng. Dir. Takeshi Shibazaki, Sales Mgr. Wolfgang Lusch, Adv. Mgr. Toshinori Kiyose
Audio: Plastic cassette cases & labels.
Henz Ulm-Musik GmbH, Voelkstr. 34, D-8900 Augsburg Tel (0821) 51-55-55. Cable: HELMMUSIC. Dir. Heinz Ulm
Audio & video: Cassette labels.
V & C Video & Computer GmbH, Voelkstr. 34, D-8900 Augsburg Tel (0821) 51-68-68.
Video: Videocassette labels.

RAW MATERIALS

Zipperling Kessler & Co. (GmbH & Co.), PO Box 1464, Kornkamp 50, D-2070 Ahrensburg Tel (04102) 40201. Telex (02) 189842. Chief Exec. Juan Plass Giral.
Product: Record molding compounds

RECORD MANUFACTURING EQUIPMENT

A E G Telefunken, Lindenerstr. 15, D-3340 Wollenbuettel Tel (05331) 83 289. Telex 95651.
Chief product: Studio compander
Achilles (Gebr.), Robensstr. 31, D-5100 Aachen. Tel: (0241) 1 50 71 Telex 0832714. Gen. Mgr. Dr. H. Achilles, Sales Mgr. Hans Bayartz
Product: Label cutting machines.
Brand name: Peacomp
Taurus Ton Technik, Alfred Petrich KG, PO Box 1520, Max Planckstr., D 6832 Friedrichsdorf 1 Tel: (06172) 71255, 72588. Telex 418131
Chief product: Automatic & manual presses, record & videodisk plating units.
Teldec Telefunken-Decca Schallplatten GmbH, Heussweg 25, D-2000 Hamburg 19. Tel: (040) 40-19 1 Cable: TELDEC. Telex (02) 13545. Mng. Dirs. Gerhard Schulze, Kurt Richter.
Factory: D-2353 Nortorf/Holstein, Postfach 160, Niedernstr. 3 7 Tel: (04392) 381. Telex: 0299610. Plant Opts. Dir. John L. Schubach, Tech. nical Opts. Dir. Herbert Knothe
Chief product: Innersleaving, sleeveing & outersleaving machines

TAPE, BLANK LOADED & BULK RAW

Agfa Gevaert AG, D-5090 Leverkusen 1. Tel: (0214) 301. Telex 85 10420. Chief Exec. Dr. W. Abeck, Gen. Mgr. W. Blauhut, Sales Mgr. K.W. Rinnebach.
Audio: Blank-2", 1" & 1/2" open reel, cassette; raw-cassette, 1/4" open reel.
Video: Blank-2" & 1" open reel, 1/4" & 1/2" Beta & VHS cassette; raw-1/4" & 1/2" Beta & VHS cassette.
Alcophon AV GmbH & Co., Duenebergerstr. 111-113, D-2054 Geesthacht Tel: (4152) 4031. Telex: 218707. Mng. Dir.: Hilmar Kumbartzky, Gen. Mgr. Manfred von Mangoldt. (Blank only)
Audio: cassette.
Amerindian, An Der Alte Muehle 9, D-5067 Wesseling-Berzdorf Tel: (02232) 51780. Chief Exec. Ingrid Renate Roehre (Blank only).
Audio: Cassette, open reel.
Ampex Europa GmbH, Walter Kolbstr. 9-11, D-6000 Frankfurt 70. Tel: (0611) 60581. Telex 0413774. Gen. Mgr. E. Sadelier, Tape Sales Mgr. B. Schwartz.
Audio: 2", 1" & 1/2" open reel, cassette.
Video: Blank-2" open reel, 1" open reel, 1/4" cassette, 1/2" Beta & VHS

cassette

Audio Magnetics GmbH, Borsigstr. 5, D-6054 Rodgau-Niederroden Tel (06106) 7971. Telex 417884
Audio: 8-tr., cassette, open reel.
Avelca, see Dietrich Schar Schmidt

B A S F AG, Gottlieb-Daimlerstr. 10, D-6800 Mannheim 1 Tel: (0621) 40081. Telex: 462621. Chief Exec. H. Thurn, Gen. Mgr. H.J. Versemann, Sales Mgr. H.J. Seitz. (Blank only)
Audio: 2", 1" & 1/2" open reel, cassette.
Video: 1" open reel, 1/4" cassette, 1/2" Beta & VHS cassette
Cassetteon GmbH, Sudetenstr. 73, D-8192 Geretsried 2. Tel: (08171) 3031-33. Telex: (05) 26331. Gen. Mgr. Stan Zaoralek, Sales Mgr. Horst Piskowski.

E C, see Eurocassette
Eurocassette, Mehringdamm 32/34, D-1000 Berlin 61. Tel: (030) 251-0331. Telex (01) 83369. Chief Exec. Guenter A. Krieler, Chief Eng. Klaus Mack. (Blank only)
Audio: Cassette
Brand name: EC
Galaxy, see Toka
Tempo (Schallplatten-Vertrieb) Meissner & Co., Rotwandstr. 16, D-8023 Pullach-Grosshesselohe. Tel: (089) 79 42 86. Telex: (05) 212035. Mng. Dir. Kurt Meissner.

I C M GmbH, Lenzburgerstr. 2, D-7890 Waldshut. Tel: (7751) 3075. Telex 792249. Pres. Werner Weber; Mng. Dirs. Heinz Amman, Rolf Sager
I D S (International Disc Serv.), PO Box 140105, D-8500 Nuernberg 14. Gen. Mgr. Hans-Joachim Rabe; Sales Mgr. W. Ruff
Audio: Cassette, open reel

Inter-Cassette Ltd., Poststr. 14, D-2000 Hamburg 36. Tel: (040) 35-30 79. (Blank only) (Importer)
Home office: USA
Int'l branch: Hong Kong
Audio: Cassette

M C S Music & Cassette Supply GmbH, Lenzburgerstr. 2, D-7890 Waldshut Tel: (7751) 32-58. Gen. Mgr. Mario Taravella
Audio: 8-tr., cassette.

Magna Tontraeger Produktions GmbH, Juliusstr. 10-11, D-1000 Berlin 44. Tel: (030) 684-80-58. Telex 183845. Pres. Juergen Freidank, Sales Dr. Jakob Statz, Export Dir. J.H. Bruett (Raw only)
Audio: Cassette, open reel.
Video: 1/2" Beta & VHS cassette

Maxell Europe GmbH, Emanuel-Leutzstr. 1, D-4000 Dusseldorf 1 Tel: (0211) 59-40-83. Telex (08) 587288. Dir. T. Inoue.
Home office: Japan
Audio: Blank-8-tr., cassette, open reel, raw-8-tr., cassette
Video: Blank-1/2" cassette

Memorex, see W.D. Warren
Orchestra GmbH, PO Box 186, Auf Dem Esch 8, D-2840 Diepholz. Tel: (05441) 2293, 1812. Cable: PALAS. Telex: (09) 41221. Gen. & Sales Mgr.: Rolf Neumann, Ass't. Ingeborg Grossman
Audio: Cassette.

Dietrich Schar Schmidt Studioausruestung, Gernotstr. 11, D-8000 Munich 40. Tel: (089) 30-65-46. Cable: PROSTUDIO. Pres. Dietrich Schar Schmidt
Audio: Cassette, open reel.
Video: 1" open reel, 1/2" EIAJ open reel

Brand name: Avelca
Scotch, see 3M
Arthur Shishmanian Export-Import, Boeckmanstr. 15, D-2000 Hamburg 1 Tel: (040) 24-67-74. (Blank only)
Sony, see W.D. Warren

T D K Electronics Europa GmbH, Georg-Glockstr. 14, D-4000 Dusseldorf Tel (0211) 43 48-91. Telex: 8584136. Mng. Dir. Takeshi Shibazaki, Sales Mgr.: Wolfgang Lusch, Adv. Mgr. Toshinori Kiyose
Audio: Cassette, open reel
Video: 1/2" VHS cassette

3 M Deutschland GmbH, Carl Schurzstr. 1, D-404 Neuss 1. Tel: (02101) 141. Gen. Mgr. Bo Ekman, Sales Mgr. Juergen Wagner
Audio: 8-tr., cassette, open reel
Video: 1" open reel, 1/2" cartridge, 1/4" cassette, 1/2" EIAJ open reel, 1/4" EIAJ cartridge

Brand name: Scotch
Toka Vertriebsgesellschaft mbH, Im Gaessle 13, D-7250 Leonberg 7 Tel: (0611) 73 20 71. Pres. Hugo von Blumenthal
Audio: Cassette
Brand names: Galaxy, Toka

Triad Musikverlag, Guentzelstr. 54, D-1000 Berlin 31. Tel: (030) 87-07-40. Chief Exec. Walter Ruff
Audio: Raw-cassette, open reel
Video: Blank-1/2" cassette

W. D. Warren Co. KG, Im Steingrund 5, D-6072 Dreieich-Buchschlag Tel: (06103) 6-10-51. Cable: WAMESCO. Telex: (04) 185391. Owner: William Dirk Warren, Exec. VP. Eugene Elskens, VP. Sales: Helmut Rossmar, VP & Controller: Karl Schoon.
Video: 1/2" cassette, 1/2" EIAJ open reel
Brand names: Memorex, Sony

TAPE DUPLICATING & PROCESSING EQUIPMENT
Asona, see Avuis-Asona
Avuis-Asona KG, Stollbergstr. 7, D-8000 Munich 22. Tel: (089) 22-50 57. Cable: ASDNA. Telex: (05) 22084. Dir.: Alf Kuerzeder
Audio: Turnkey cassette duplicating plants, cassette duplicating equip
Brand name: Asona

Bellaphon Recs. GmbH & Co. KG, Mainzer Landstr. 87 89, D-6000 Frankfurt Tel: (06103) 23 08 01. Telex: (04) 16046. Pres. Branko Zivanovic
Machi, see Dietrich Schar Schmidt

Dietrich Schar Schmidt Studioausruestung, Gernotstr. 11, D-8000 Munich 40. Tel: (089) 30-65-46. Cable: PROSTUDIO. Pres.: Dietrich Schar Schmidt.
Audio: Cassette screwing machines.
Brand name: Machi

3 M Deutschland GmbH, Carl Schurzstr. 1, D-404 Neuss 1. Tel: (02101) 141. Gen. Mgr. Bo Ekman, Sales Mgr. Juergen Wagner
Audio: Cassette duplicators.
Brand name: Wollensak

Eberhard Vollmer, Schillerstr. 7, D-7310 Plochingen/N. Tel: (07153) 2 10 04. Cable: VOLLMERWERK. Gen. Mgr. & Eng. Eberhard Vollmer, Sales Mgr.: Ms. I. Marcon.
Wollensak, see 3M

TAPE PACKAGING & LABELING EQUIPMENT
Achilles (Gebr.), Robensstr. 31, D-5100 Aachen. Tel: (0241) 1 50 71 Telex 0832714. Gen. Mgr. Dr. H. Achilles, Sales Mgr. Hans Bayartz
Avuis-Asona KG, Stollbergstr. 7, D-8000 Munich 22. Tel: (089) 22 50 57. Cable: ASDNA. Telex: (05) 22084. Dir. Alf Kuerzeder

Product: Labeling equip

Heino Iseemann GmbH, Zum Panpelz 24, D-2800 Bremen 44. Tel: (0421) 48-30-83. Telex 244055. Chief Exec. Heino Iseemann (SEE ADVERTISEMENT)

Magna Produktions GmbH, Juliusstr. 10/11, D-1000 Berlin 44. Tel: (030) 684-80-58. Telex 183845. Pres. Juergen Freidank.

• accessories

Alcophon AV GmbH & Co., Duenebergerstr. 111-113, D-2054 Geesthacht. Tel: (4152) 4031. Telex: 218707. Mng. Dir.: Hilmar Kumbartzky, Gen. Mgr. Manfred von Mangoldt.
Product: Tape-carrying & storage cases (audio)

Agfa Gevaert AG, D-5090 Leverkusen 1. Tel: (0214) 301. Telex: 8510420. Chief Exec. Dr. W. Abeck, Gen. Mgr. W. Blauhut, Sales Mgr. K.W. Rinnebach.
Product: Tape-leader tape (audio), splicing tape & equip (audio)

Amerindian, An Der Alte Muehle 9, D-5067 Wesseling-Berzdorf Tel: (02232) 51780. Chief Exec. Ingrid Renate Roehre.
Product: Record-record care prods., replacement styli, Tape-leader tape, splicing tape & equip

Ampex Europa GmbH, Walter Kolbstr. 9-11, D-6000 Frankfurt 70. Tel: (0611) 60581. Telex 0413774. Gen. Mgr. E. Sadelier, Tape Sales Mgr. B. Schwartz.
Product: Tape-carrying & storage cases, head cleaners, bulk erasers, demagnetizers, leader tape, splicing tape & equip (all audio & video).

Audio Trade GmbH, Kolonnenstr. 203, D-4100 Duisburg 1. Tel: (0203) 37-35 12. Telex 855259. Mng. Dir. Peter Muehlhimer, Sales Mgr. Dirk Feldman.
Product: Record-record care prods., replacement styli, Tape-leader tape, splicing tape & equip

Avuis-Asona KG, Stollbergstr. 7, D-8000 Munich 22. Tel: (089) 22-50-57. Cable: ASDNA. Telex: (05) 22084. Dir. Alf Kuerzeder
Product: Tape-bulk erasers (audio), splicing tape & equip (audio).

I C M GmbH, Lenzburgerstr. 2, D-7890 Waldshut. Tel: (7751) 3075. Telex 792249. Pres. Werner Weber; Mng. Dirs. Heinz Amann, Rolf Sager
Product: Tape-carrying & storage cases, head cleaners, bulk erasers, demagnetizers, leader tape, splicing tape & equip (all audio & video).

I D S (International Disc Serv.), PO Box 140105, D-8500 Nuernberg 14. Gen. Mgr. Hans-Joachim Rabe, Sales Mgr. W. Ruff
Product: Tape-splicing tape & equip

Inter-Cassette Ltd., Poststr. 14, D-2000 Hamburg 36. Tel: (040) 35-30 79. Home office: USA
Int'l branch: Hong Kong
Product: Record-record care prods., sweep arms, Tape-head cleaners

D. Kretz (Automaten-Serv.), Yorkstr. 41, D-7500 Karlsruhe 1. Tel: (0721) 55 03 95. Pres. Diethelm Kretz; Sales Mgr. Gertrud Drost.
Product: Record-carrying & storage cases, record care prods., replacement styli, Tape-head cleaners, demagnetizers.

Magna Tontraeger Produktions GmbH, Juliusstr. 10-11, D-1000 Berlin 44. Tel: (030) 684-80 58. Telex: 183845. Pres. Juergen Freidank.
Product: Tape-carrying & storage cases (audio & video), head cleaners (audio), demagnetizers (audio), leader tape (audio & video), splicing tape & equip (audio & video).

Maxell Europe GmbH, Emanuel-Leutzstr. 1, D-4000 Dusseldorf 1. Tel: (0211) 59 40-83. Telex (08) 587288. Dir.: T. Inoue
Home office: Japan
Product: Tape-head cleaners

C. Melchers & Co., Postfach 102560, Schlachte 41, D-2800 Bremen. Tel: (0421) 316-9323
Product: Record-replacement styli (Pickering)

Orchestra GmbH, PO Box 186, Auf Dem Esch 8, D-2840 Diepholz. Tel: (05441) 2293, 1812. Cable: PALAS. Telex: (09) 41221. Gen. & Sales Mgr.: Rolf Neumann, Ass't. Ingeborg Grossman
Product: Record-carrying & storage cases, record care prods., 45 rpm adaptors, Tape-head cleaners & demagnetizers.

Pickering, see C. Melchers
Dietrich Schar Schmidt Studioausruestung, Gernotstr. 11, D-8000 Munich 40. Tel: (089) 30 65-46. Cable: PROSTUDIO. Pres. Dietrich Schar Schmidt
Product: Tape-head cleaners, demagnetizers, leader tape

Schweizer Design Eurosale GmbH, Koenigsweg 3, D-4973 Vlotho. Tel: (05733) 50-41. Telex: 971217. Mng. Dirs. G. Deja, Dr. M. Gaier.
Product: Record-carrying & storage cases, record care prods., Tape-carrying & storage cases, demagnetizers

Stanton, see Teledyne
T D K Electronics Europa GmbH, Georg-Glockstr. 14, D-4000 Dusseldorf Tel (0211) 43 48-91. Telex: 8584136. Mng. Dir. Takeshi Shibazaki, Sales Mgr. Wolfgang Lusch, Adv. Mgr. Toshinori Kiyose
Product: Tape-head cleaners (audio & video), demagnetizers (audio)

Teac Tonband-Anlagen Vertriebs GmbH, Egerstr. 2, D-6200 Wiesbaden Erbenheim Tel: (06121) 742-25. Telex: (04) 186159. Mgr. Masao Morita
Product: Tape-head cleaners, demagnetizers

Teledyne Acoustic Research, Burgstr. 6-8, D-6200 Wiesbaden Tel: (06121) 3 91 71
Product: Record-replacement styli (Stanton)

3 M Deutschland GmbH, Carl Schurzstr. 1, D-404 Neuss 1. Tel: (02101) 141. Gen. Mgr. Bo Ekman, Sales Mgr. Juergen Wagner
Product: Tape-leader tape, splicing tape & equip

Videoring GmbH, PO Box 1167, Am Schierenberg 2, D-2106 Bendestorf. Tel: (04183) 6035. Cable: VIDEORING. Telex 2189719. Dirs. Paul Moeckel, Mario Villavencio
Product: Tape-carrying & storage cases (video)

W. D. Warren Co. KG, Im Steingrund 5, D-6072 Dreieich-Buchschlag Tel: (06103) 6-10-51. Cable: WAMESCO. Telex: (04) 185391. Owner: William Dirk Warren, Exec. VP. Eugene Elskens, VP. Sales: Helmut Rossmar, VP & Controller: Karl Schoon.
Product: Record-replacement styli. Tape-carrying & storage cases

• store fixtures manufacturers

Achilles (Gebr.), Robensstr. 31, D-5100 Aachen. Tel: (0241) 1 50 71 Telex 0832714. Gen. Mgr. Dr. H. Achilles, Sales Mgr. Hans Bayartz
Product: Record & tape display racks

Alcophon AV GmbH & Co., Duenebergerstr. 111-113, D-2054 Geesthacht Tel: (4152) 4031. Telex 218707. Mng. Dir.: Hilmar Kumbartzky, Gen. Mgr. Manfred von Mangoldt.
Product: Tape display racks & dividers cards (audio)

Amerindian, An Der Alte Muehle 9, D-5067 Wesseling-Berzdorf Tel: (02232) 51780. Chief Exec. Ingrid Renate Roehre.
Product: Display racks, divider cards

Audio Trade GmbH, Kolonnenstr. 203, D-4100 Duisburg 1. Tel: (0203) 37 35 12. Telex 855259. Mng. Dir. Peter Muehlhimer, Sales Mgr. Dirk Feldman

Product: Record display racks
 D. Kretz (Automaten Serv.), Yorkstr. 41, D-7500 Karlsruhe 1, Tel. (0721) 55-03-95. Pres. Diethelm Kretz; Sales Mgr.: Gertrud Drost.
 Product: Display racks
 Schweizer Design Eurosale GmbH, Koenigsweg 3, D-4973 Vlotho. Tel. (05733) 50-41. Telex 971217 Mng. Dirs.: G. Deja, Dr. M. Gaier.
 Product: Record & Tape browser boxes, record display racks
 3 M Deutschland GmbH, Carl Schurzstr. 1, D-404 Neuss 1, Tel. (02101) 141. Gen. Mgr.: Bo Ekman; Sales Mgr.: Juergen Wagner.
 Product: Display racks
 W. D. Warren Co. KG, Im Steingrund 5, D-6072 Dreieich-Buchschiag. Tel. (06103) 6-10-51. Cable: WAMESCO. Telex: (04 185391) Owner: William Dirk Warren, Exec. VP: Eugene Eiskens; VP Sales: Helmut Rossmairer, VP & Controller: Karl Schoon
 Product: Display racks.

GREECE

Population: 9,600,000.
 Population by age groups: 0-14 2,600,000; 15-24 2,700,000; 25-49 2,700,000; 50+ 1,600,000.
 Rate of exchange: \$1 (US) = 57 drachmas.
 Per capita income: \$4,380.
 Holidays: January 1, 6, March 25 (National Day), Good Friday, Easter Monday, May 1, August 15 (Assumption), October 28 (National Day), December 25, 26.

RECORDS:

Record sales certification awards: Gold single—50,000 units, platinum single—100,000 units. Gold LP—50,000 units, platinum LP—100,000 units.
 Records sold domestically including imports (retail value): LP's 1980—6,300,000 units, \$27,631,000; 1979—5,700,000 units, \$24,868,000. Singles 1980—200,000 units, \$235,000; 1979—340,000 units, \$411,000.
 Records exported to USA (factory value, FOB): 1980—120,000 units, \$330,000; 1979—100,000 units, \$275,000.
 Records imported from countries other than USA (factory value, CIF): 300,000 units, \$1,050,000; 1979—250,000 units, \$875,000.
 Records exported to countries other than USA (factory value, FOB): 1980—400,000 units, \$1,100,000; 1979—400,000 units, \$1,100,000.
 Average retail price per record: LP's—\$4.40; singles—\$1.18.

TV merchandising:

None.
 Record club sales: None.
 Discounting: Frequent.
 Type of distribution: Manufacturer-to-retailer predominates, though manufacturer-wholesaler-retailer accounts for an appreciable part of sales volume.
 Type of promotion: Radio and television are the most important promotion vehicles, largely through music programs paid for by the record companies.

TAPE:

Market: Cassettes dominate the market but are themselves dominated by a piracy that eats an estimated 85% of the total sales.
 Pre-recorded tape sold domestically including imports (retail value): 8-tr. 1980—50,000 units, \$193,000; 1979—60,000 units, \$210,000. Cassette 1980—2,400,000 units, \$9,316,000; 1979—2,800,000 units, \$12,243,000.

Pre-recorded tape exported to USA (factory value, FOB): 1980—50,000 units, \$130,000; 1979—50,000 units, \$130,000.

Pre-recorded tape exported to countries other than USA (factory value, FOB): 1980—1,500,000 units, \$3,000,000; 1979—2,000,000 units, \$4,800,000.

Average retail price per tape: 8-tr.—\$4.00; cassette—\$3.88.

RADIO STATIONS:

No. of government: 2.
 Comment: Music is overwhelmingly recorded. Innovations in programming have thus far been discouraged. Most programs are compiled and paid for by record companies.

TELEVISION STATIONS:

No. of channels: 2 government, 90% color (SECAM).
 Comment: Videotape predominates over live transmission, with the latter being confined to news bulletin and outdoor events. Recording companies provide programmers with video clips of their artists.

IMPORT/EXPORT REGULATIONS:

Import duties and other levies total about 43% of the CIF value of the shipment. There are no export regulations.

MARKET ANALYSIS:

In the past year, television advertising was used successfully for the first time in the selling of album compilations of international repertoire. Overall, international and local recordings are still divided about evenly. Although 1980 was a sluggish year for the Greek recording industry, there are indications that business was up as of spring 1981.

• record & tape manufacturers / distributors / importers

Angel, see Columbia-EMI.
 Apollon, see Spiros Piperakis.
 Apple, see Columbia-EMI.
 Archiv, see PolyGram.
 Astron, see Spiros Piperakis.
 Boem, see Spiros Piperakis.
 British Prod'n Import, 13 Third September St., Athens. Tel: 821-3918. Gen. Mgr.: D. Patrinos.
 Label: New Sty (UK).
 CBS (Disk) AEBE (IFPI), PO Box 37, Halandri, 311 Messoghion Ave., Athens. Tel: (01) 672-2150. Cable: CDLRECORD. Telex: 216220. Mng. Dir.: & Gen. Mgr.: Sol Rabinowitz; Sales Mgr.: Costas Nikitas.
 Labels: (Owned) CBS, Embassy, Epic, Portrait; (licensed) A&M (USA), ARC (USA), Aarona (France), All Platinum (USA), Ariola (Netherlands), Audio (Germany), Audioidelity (USA), Boardwalk (USA), CGD (Italy), Chess (USA), Cleveland Int'l (USA), Delphine (France), Dreyfus (France), Emergency (USA), Friedrich Prod'n (Switzerland), Gold Unlimited (USA), Handshake (USA), Philadelphia Int'l (USA), Pool (Germany), Prelude (USA), Ricordi (Italy), Salsoul (USA), Shelter (JSA), Sonet (Sweden),

Sugar Hill (USA), TK (USA), Vanguard (USA).
 Int'l rep.: Worldwide (CBS).
 Calypso, see Music Box.
 Capitol, see Columbia-EMI.
 Columbia-EMI Greece SA (IFPI), PO Box 287, Central Sta., 127 Heraclio St., Rizopolis, Athens. Tel: (021) 252-7502/7102/3602/3702. Cable: EMIRECORD. Telex: 214192. Mng. Dir.: Alan C. Boxer, Finance & Admin. Dir.: D. Gaetanakis; Sales Mgr.: E. Terzis; Mgr. & Studios Dir.: C. Kyriakos. (Also see EMIat).
 Labels: (Owned) Angel, Apple, Capitol, Columbia, EMI, EMI Araby, HMV, Harvest, MFP, Odeon, Parlophone, Pathe, Regal, Toshiba-EMI; (licensed) Almadin Al Funny (Libya), Ashark (Saudi Arabia), Baidaphon (Lebanon), Balkanton (Bulgaria), Bovema Negram (Netherlands), Bronze (UK), Buzaiphone (Kuwait), Byblos (Syria), Cairophon (Lebanon), Club du Disque Arabe (France), DJM (UK), Duniaphon (Lebanon), ECM (Germany), El Fen (Tunisia), Harem (Netherlands), Ima (Libya), Island (UK), Kouloubiophone (Morocco), Liberty (USA), MCA (USA), MPL (USA), Meloulouphone (Tunisia), Morphon (Egypt), Motown (USA), Munsphone (Sudan), Nefertiti (Egypt), Divia Newton-John (USA), Pink Floyd (UK), Promotone (Netherlands), Queen (UK), RAK (UK), Rajaphone (Saudi Arabia), Rolling Stones (UK), Sono Cairo (Egypt), Southeb (Egypt), Sout El Hayal (Egypt), Sout El Kheir (Algeria), Southeban (Egypt), Sout El Kabee (Libya), Sout Omnia (Saudi Arabia), Sudanphone (Sudan), Union (Syria), United Artists (USA), Voice of Beirut (Lebanon), Voice of Lebanon (Lebanon), Voi de l'Islam (Egypt), Voi de l'Orient (Lebanon), Zida (Lebanon).

Int'l rep.: Cyprus (Electroacoustic), Netherlands (Sound Prods.), USA (Rashid Sales), worldwide (EMI).
 Control, see Spiros Piperakis.
 Coronet, see Spiros Piperakis.
 Crete, see Panivar.
 D G G, see PolyGram.
 Dionysos, see General.
 Do-Re, see Spiros Piperakis.
 E M I, see Columbia-EMI & EMIal.
 Echo Ltd., 2 Korae St., Athens 132. Tel: (01) 323-4774. Gen. Mgr.: Zgon Thelemis. (Distributor/Importer/Exporter).
 Embassy, see CBS.
 EMI SA (IFPI), 127 Heraclio St., Rizopolis, Athens 904. Tel: (021) 252-3602/3702/7502/7102. Cable: EMIRECORD. Telex: 214071. Chm.: Alan C. Boxer, Gen. Mgr.: George Petsilas; Adv. & PR: B. Apostolides; Sales Mgr.: S. Xanthopoulos; Finance & Admin.: S. Spouris; Int'l Repertoire: G. Kivellios; Classical Repertoire & Imports: Georgia Zissi. (Distributor/Importer).
 Branch: Salamina, 18 Chrys. Smyrnis. Tel: (031) 263-110, 224-669. Mgr.: Basil Metaxopoulos.
 Labels: (Licensed domestic) Columbia, EMI, Regal; (licensed foreign) Angel (UK), Apple (UK), Balkanton (Bulgaria), Blue Note (USA), Bovema Negram (Netherlands), Bronze (UK), Capitol (USA), DJM (UK), ECM (Germany), EMI America (USA), EMI Electrola (Germany), HMV (UK), Harvest (UK), Island (UK), Liberty (USA), MCA (USA), MFP (UK), MPL (UK), Motown (USA), Odeon (Spain), Divia Newton-John (USA), Parlophone (UK), Pathe (France), Pink Floyd (UK), Promotone (Netherlands), Queen (UK), RAK (UK), Toshiba-EMI (Japan), United Artists (USA).

Epic, see CBS.
 Fidelity, see PolyGram.
 Fontana, see PolyGram.
 G P C, see General.
 Galaxy, see General.
 General Gramophone K. Elefth. Makou, 79-81 Sokratous Str., Athens. Tel: 522-6843/8030. Chief Exec.: Konstantina Makou; Gen. Mgr.: Eleftherios Makos.
 Int'l rep.: Australia (Carras Emporium, P. Salapatas), Canada (Venus), Cyprus (Andreas Aristodimou), Germany (G. Krakas, E. Papachristou), Sweden (Zorbas K. Theocharidis), UK (N.T. Patalis), USA (Takis Paralikas).
 General Publ'g Co. SA (IFPI), 11 Kriezotou St., Athens 134. Tel: (01) 361-5529/6798. Cable: LYRAHELLAS. Telex: 219920. Pres. & Mng. Dir.: Alexander Patsifas; Sales Mgr.: Kyriakos Maraveias; Int'l Mgr.: Takis Sifros.
 Branch: Thessaloniki, 64 Tsimiski St., Athens. Tel: (031) 277-306. Mgr.: Arsenus Stergiou.

Labels: (Owned) Dionysos, Lyra, Minerva, Notos, Zodiac; (distributed—not licensed) GPC, Galaxy, Polytron.
 Int'l rep.: Australia (Politis), Canada (Peters Int'l), Cyprus (Electro-acoustic Supply), USA (Peters Int'l).
 Greek Communications Co., 17 Stourarna St., Athens. Tel: 627-796. Int'l Mgr.: Alex G. Carras.
 Greka, see Spiros Piperakis.
 H M V, see Columbia-EMI.
 Harvest, see Columbia-EMI.
 Heliodor, see PolyGram.
 Independent Prod'n, 13 Third September St., Athens. Tel: (031) 522-7472.
 Cable: MELODY ATHENS. Pres.: Anthony Ploma; Sales Mgr.: Georges Pliomaritis, PR: A. Pliomaritis Jr.
 Labels: (Owned) Independent, Lucky, Patrinos; (distributed—not licensed) Oversea (Switzerland).
 Int'l rep.: USA (Dino Joannidis).
 Inter Mercat, PO Box 1032, Thessaloniki. Tel: (31) 276785. Mng. Dir.: Vasilios Touronis. (Importer/Exporter).
 T. Koussis, 19 Halkiondili Str., Athens 102. Tel: (021) 523-9477/2957. Chief Exec.: T. Koussis. (Importer/Exporter).
 Lakis Kleopas Prod'n, 10 Salaminos St., Thessaloniki. Tel: (31) 516-493. Telex: 418339. Pres. & Gen. Mgr.: Lakis Kleopas; Sales Mgr.: George Kleopas; Artistic Mgr.: Lefty Kongalides.
 Kyklades, 33 Veranzorou St., Athens.
 Kykos Recs., 3 Karageorgi Servias, Athens 126. Tel: (01) 323-2312. Gen. Mgr.: D. Thelemis. (Distributor/Importer/Exporter).
 Lucky, see Independent.
 Lyra, see General.
 M F P, see Columbia-EMI.
 M G M, see PolyGram.
 Macedonia, see Panivar.
 Margo, see Minos Matsas.
 Minos Matsas & Son Co. Ltd. (IFPI), 245-247 Messoghion Ave., Athens. Tel: (021) 671-1811. Cable: MINOSMAR. Telex: 218647. Bd. Chm.: Maks Matsas; Gen. Mgr.: Roula Matsas; Sales Mgr.: V. Michailidis; Int'l Dept. Mgr.: Mikis Corinthos.
 Labels: (Owned) Margo, Minos, Standard; (licensed) Barclay (France), Bearsville (USA), Can't Stop Prod'n (USA), Cream (USA), Durco (Netherlands), Ensign (UK), Logo (UK), RCA (USA), Scratch (UK), 20th Century (USA).
 Int'l rep.: Australia (George Young), Canada (Peters Int'l), USA (Peters Int'l).
 Mediterranean Recs., 29 Biskini St., Athens. Tel: (00301) 770-9994. Gen.

Mgr.: Evangelos Pitsilidis.
 Melody, see Spiros Piperakis.
 Mercury, see PolyGram.
 Minerva, see General.
 Minos, see Minos Matsas.
 Monitor, see Spiros Piperakis.
 Music-Box Martin Th. Gesar SA (IFPI), 52 Eleftheriou Venizelou Ave., Kalithea, Athens. Tel: (021) 958-0243/1135. Cable: THDMS. Telex: 221082. Pres.: Martin Th. Gesar; Gen. Mgr.: Marika Gesar; Ass't Mgr.: Toula Akasoglou; Sales Mgr.: Grigoris Alvanidis.
 Branch: Thessaloniki, 1 Kanolou Di. Tel: 261-288. Gen. Mgr.: George Kleopas.
 Labels: (Owned) Calypso, Music Box, Pan-Vox; (licensed) Ariston (Italy), Avator (UK), Baram (Belgium, France), Cherry Red (UK), Crescendo (USA), Decca (UK), Durium (Italy), Fantasy (USA), Graduate (UK), Hansa (Germany), Hispavox (Spain), Ice (UK), Jupiter (Germany), Kultura (Hungary), Magnet (UK), PRT (UK), Polar (Sweden), RRM (Belgium), Ronde let (UK), Safari (UK), Stax (USA), Vogue (France).
 Int'l rep.: Australia (Carras Emporium), UK (Andreas Patalis), USA (Peters Int'l).
 Motos, see General.
 Odeon, see Columbia-EMI.
 Olympia, see Panivar.
 Olympic, see PolyGram.
 Panivar Recs. SA, 18 Pireos St., Athens 101. Tel: (021) 523-5867. Cable: PANIVAR. Pres.: Pavlos Vardoulakis; Gen. Mgr.: Nouli Vardoulakis; Sales Mgr.: Dimitri Vardoulakis. Local branches: 21 Zinonos St. Tel: 523-6384; 63 Athinas St. Tel: 324-2764.
 Branches: Eratikon, Crete, 24 1978 St. Tel: 88758—Khamia, Crete, 1 Koraka St. Tel: 53765—Piraeus, 38 Akti Poseidonos. Tel: 417-8059.
 Labels: (Owned) Crete, Macedonia, Dymyia, Panivar, Special, Victory; (licensed foreign) Criminal (UK), Ri-Fi (Italy).
 Int'l rep.: Australia (Theodoros Petropoulos, Salapatas), Belgium (Bull-ant), Canada (Peters Int'l), Cyprus (Garabet Indjirjian), Germany (George Krakas, George Lazos/Do-Re-Mi, Stylianos Serafim), UK (KK, Nik. Andreas Patalis), USA (Peters Int'l).
 Pan-Vox, see Music Box.
 Parlophone, see Columbia-EMI.
 Pathe, see Columbia-EMI.
 Patrinos, see Independent.
 Philips, see PolyGram.
 Spiros Piperakis, 59 Miaouli St., Moscato-Athens 59. Tel: (021) 481-5508.
 Labels: (Owned) Greka; (distributed) Apollon, Astron, Boem, Control, Coronet, Do-Re, Melody, Monitor, Panivar, Revans, Veneta.
 Plomaritis Prod'n, 13 Third September St. (office), 13 Eptanissou (factory), Athens. Tel: 522-7472, 821-3918. Cable: MELODY. Gen. Mgr.: Anthony Plomaritis; Sales Mgr.: Georges A. Plomaritis.
 Labels: Athenee, Lucky (Italy), Melody, Popular, Top Pop's (Germany, UK, USA).
 Polydor, see PolyGram.
 PolyGram Recs. SA (IFPI), 296 Messoghion Ave., Cholargos, Athens. Tel: (021) 652-4213. Cable: POLYGRAM ATHENS. Telex: 216124. Mng. Dir. & Gen. Mgr.: Nicolas Antipapas; Sales Mgr.: Pantele Emmanuilidis; Foreign Repertoire Prod. Mgr.: John Petridis; PR Mgr.: Jacques Menahem.
 Branch: Salamina, 15 Proxenou Koromila. Tel: (031) 267-121, 274-543.
 Mgr.: John Sokratidis.
 Labels: (Owned) Archiv, DGG, Fidelity, Fontana, Heliodor, MGM, Mercury, Dymyic, Philips, Polydor, Vertigo, Verve; (licensed foreign) Ariola (Germany), Arista (USA), Baby (Italy), Butterfly (USA), Buddha (USA), Charicorn (USA), Carrere (France), Casablanca (USA), Charisma (UK), Chery (UK), Checker (USA), Chess (USA), Chrysalis (UK), Chiswick (UK), EG (UK), Ensign (UK), Mooncrest (UK), Mountain (UK), Orlando (France), Oyster (USA), Pablo (USA), Passport (USA), RSO (UK), Rocket (UK), Stiff (UK), Track (UK), Virgin (UK).
 Int'l rep.: Cyprus (CBS), USA (Peters Int'l), worldwide (PolyGram).
 Polyphon, 2 Third September St., Athens. Tel: (021) 538-790.
 Polytron, see General.
 Portrait, see CBS.
 Progress Ltd., Platia Theatrou 24, Athens 113. Tel: (01) 991-1175. (Importer)

Regal, see Columbia-EMI & EMIal.
 Revans, see Spiros Piperakis.
 Seagull, 17 Stourarna St., Athens.
 Select Prod'n, 13 Eptanissou, Athens. Tel: (021) 821-3918. Cable: SELECT. Mgr. & Prod'r: Lukis Ploma; Gen. Mgr.: Anthony Plomaritis; Sales Mgr.: Georges Plomaritis.
 Label: (Owned) Select.
 Int'l rep.: Australia (L. Paschalidis), Libya (Aris Ploma), UK (Kibo Trading), USA (D. Joannidis).
 Special, see Panivar.
 Standard, see Minos Matsas.
 Studio 1 Hi Fi, 51 Proxenou Koromila St., Thessaloniki. Tel: (031) 221-212, 262-989. Gen. Mgr.: Leandre Kupur.
 Labels: (Distributed—not licensed) Crystal Clear (USA), Denon PCM (Japan).
 Toshiba-EMI, see Columbia-EMI.
 Veneta, see Spiros Piperakis.
 Veran Rec. Co., 24 Tsimiski St., Thessaloniki. Tel: 272560. Pres.: Michael Theodoros; Gen. Mgr.: Antonio Vergias; Sales Mgr.: Thomas Philippides.
 Labels: (Owned) Veran; (licensed foreign) Ariola-Eurodisc (Germany), Cyclade (France), Gillette-Madison (USA), Lollipop (Germany), (Brazil), Splash (UK), Telefunken (Germany), Trema (France).
 Vertigo, see PolyGram.
 Verve, see PolyGram.
 Victory, see Panivar.
 W E A Recs. Ltd. (IFPI), 319 Messoghion, Athens. Tel: (021) 671-7355. Cable: WEAREC. Mng. Dir.: Evodoros Demetriou; Sales Mgr.: Ion Stamboulieh; A&R Mgr.: Vassos Tsimidopoulos.
 Zodiac, see General.

• music publishers

Blackwood Music Publ'g Co. Ltd., PO Box 37, Halandri, 311 Messoghion Ave., Athens. Tel: (01) 672-5284. Cable: CDLRECORD. Telex: 216220. VP: Sol Rabinowitz; Admin.: Maria Margariti.
 Int'l firms represented: Motogood/Kool, April, Arabella, BRM, Badboy/KYD, Barney, Earl Barton, Robin Batteau, Bema, Big Seven, Blend-igwell, Big Seas, Boem, Bovina, Byrdland, Casa David, C'est Minus/Quackenbush, Chandos, Claudine, Clay, Country Road, Corbellia, Der-ringer, Dickiebird, DiMeola, Dolo, Drummer, Flying Crown, Folklore, Fourteenth Hour, Gabriel Earl, Gamma, Gold Bullion/Hifalutin, Franne Golde, Graponca/Davale, Grand Pasha/Sasha, Great Stoned Hiway, Al-berl Hammond, Hatband, Heath Levy, Hierophant, Hilgreen, Hudmar, In-ner Sanctum, Jac, Jet, Joelsongs/Impulsive, King's X, Stephen A. Kipner.

Kirshner/CBS, Koppelman/Cortlandt, Lady Casey, Lambert & Potter, Little John/Iwagether, Macfay, Mainsail, Mecca Prod./Kahil/Gibran, Robert Mellin, Midob, Mine, Mr. Sun Shine, Mitchell, Mor-Sell, Mouse House, Music Pool/Notes Now, Napolis, Nelchell, New Hidden Valley, Otot, Petra, Buster Poindexter, Porcari, RSPV, Rehtakol Veets, Rondor/Iring/Milma, Roundabout, Salsout, Saybrook, Sheefire, Sheryl, Sheronda, Skyhill, Silver Steed, Star Spangled, Steinberg, Stovepipe, Strong Arm, Sugar, Sweet Jenny, Tobias/Lebowsky, Tuna Fish, 20th Century Fox, Velocity, Welk group, Westbrook, Winter Blues, Winter Wind, Worthless/Pointless/Propane, Yo' Mama's, Zap/Lee.

C S B/Greece, c/o Arc Music Ltd., 10 Kadmuou Milioussin St., Nea Smyrni, Athens.

Int'l firm represented: Copyright Serv. Bureau (USA).

Cora (Ed.), 59 Miaouli St., Moscatto-Athens 59. Tel: (021) 481 5508.

E M I Music Publ'g (Greece) Ltd., PO Box 287, Central Sta., 127 Heraclion St., Rizopolis, Athens. Tel: (021) 252-7502/7102/3602/3702. Cable: EMIRECORD. Telex: 214192. Mng. Dir.: Alan C. Boxer.

Int'l firms represented: Accord (Germany), Alkatraz (USA), Ardmore & Beechwood (Belgium), Belriver (Italy), Big Pig (UK), Kale Bush (UK), Valentim de Carvalho (Portugal), Colgems (USA), Deep Purple, EGO (Spain), EMI (Belgium, Netherlands, Sweden, Switzerland, UK), EMI Film & Theatre (UK), Eca (France), Gang of Four (UK), Dick James (UK), Kipahulu (USA), LEM (France), Mabrak (UK), Pathe-Marconi (France), Queen (UK), Red Bus (UK), Rideau Rouge (France), Tom Robinson (UK), Rolling Stones (UK), Screen Gems-EMI (USA), Storzando (France), Tree (USA), Vapors (UK).

General Publ'g Co. Ltd., 11 Kriezouli St., Athens 134. Tel: (01) 361-5529/6798. Cable: LYRAHELALAS.

Grecophon, 52 Eleftheriou Venizelou Av., Kalithea, Athens. Tel: 958-0243/1135. Cable: GRECOPHON. Dir.: Marika Gesar.

Int'l firms represented: Boot (Canada), Moring (Canada), RKM (Belgium), Riva (UK), Siegel (Germany), Valenine (UK).

Int'l rep.: Canada (Morning).

Icaros Publ'g Co., see General International Publ'ns, see Select.

Intersong Hellas Ltd., 296 Messoghion Ave., Cholargos, Athens 142. Tel: (021) 652-4213. Cable: POLYGRAM Telex: 216124. Mng. Dir.: Nicolas Antipapas. Gen. Mgr.: Costas Zougris.

Int'l firms represented: Abigail (USA), Affinita (USA), Ajaye (USA), Alamenta (USA), Aliza-Thorah (USA), Audiogram (USA), Roy Ayers (UK), Bar-mour (USA), Johnny Belland (USA), Bellkat (USA), Johnny Brienstock (USA), B.O. Cult Songs (USA), Hamilton Bohannon (USA), Boomtown Rats (Switzerland), Bridge House (USA), Brightwater (USA), Broken Arrow (USA), Brown Sound (USA), Bulk (UK), CAM (USA), CIA (UK), Cafe Americana, Cape Ann (USA), Cape May (USA), Carlin (worldwide), Causho (UK), Chappell (worldwide), Charlotte (UK), Cherry (UK), Allan Clarke's (UK), Clarke (USA), Bob Cor (UK), Crited (USA), Mike Curb, Davray (UK), Eumr Deodato (USA), Diagonal (UK), Walt Disney (USA), Doraflo/Bleu Disque (USA), Double Exposure (USA), Francis Dreyfus (France), Dynatone (USA), Betty Earlard (USA), East (USA), Elbomo (USA), Elvis (USA), Every Little Tune (USA), Fairfield (USA), Fantasia (France), Wes Farrell (USA), Fast Western (USA), Father (USA), Fescue (UK), Five West (USA), Fleetwood Mac (USA), Four Knights (USA), Fuse (UK), Giving Room (USA), Good Morning (UK), Guerrilla (USA), Hallelujah (Israel), Herald Square (USA), Hinky Dink (UK), Hit & Run (UK), I Ain't In It (UK), Island (UK), Jadar (USA), Jimpre (UK), Jiru (USA), Tom Johnston (USA), Josley (UK), Kenya (USA), Kingsley Sound (USA), Kings Point (USA), Klub (UK), Kongride (UK), Kurley (USA), Laurel Canyon (USA), Letha (USA), Little Dickens (USA), Little Lasso (USA), MTM (USA), Edward B. Marks (USA), McFleet (USA), Mews (UK), Midland (USA), Mid-song (USA), Mimcy (USA), Joni Mitchell (USA), Arnie Mogull (USA), Montones (UK), David Mook (USA), Moonhill (USA), Mourbar (USA), Mountain (UK), Omaha (UK), Open End (USA), Oyster (USA), Peterman (UK), Pickwick Int'l (USA), Piedmont (USA), Pinson (USA), Pocket Full of Tunes (USA), Propane (UK), Prophet (USA), Quickmix (USA), RSO (UK), Rare Bird (UK), John Richbourg (USA), Rick's (USA), Roaring Fork (USA), Rockhopper (USA), Rockmere (UK), Rodna & Berna, Steve Rowland (UK), Ryan (UK), Sam Songs (UK), Siquomb (USA), Sky Forest (USA), Sky Harbor (USA), Sky Writing (UK), Sleepy Dumping (UK), Song (UK), Stonebridge (USA), Strobe Light (USA), Sweet (UK), TH (USA), Tallyrand (USA), Talmont (USA), Tan Soul (USA), Ten East (USA), Thin Ice (USA), Third Story (USA), Three Cheers (USA), Times Square (USA), Tuff (UK), R.P. Winkelman Tunes (USA), Yellow Dog (USA), Frank Zappa (USA), Zum (UK).

Int'l rep.: Worldwide (Intersong).

Minos Matsas & Son Co. Ltd., 245 247 Messoghion Ave., Athens 142. Tel: (021) 671-1811. Cable: MINOSMAR. Bd. Chm.: Makis Matsas.

Mediterranean Publ'g, 29 Biskini St., Athens 622. Tel: (00301) 770-9994. Gen. Mgr.: Evangelos Pitsilidis.

Melody Publ'g, see Select.

Ivan Mogull Music Assocs., c/o AEPI, 14 Delighanni St., Athens 148.

Plomartitis Publ'rs, 13 Eptanissou, Athens. Tel: (021) 821-3918. Gen. Mgr.: Anthony Plomartitis.

Int'l firms represented: D. Caras (Australia), Grafarola (Italy), Dino Joannidis (USA).

Int'l rep.: USA (P. Petropoulos).

Select Publ'rs, 13 Eptanissou Kypseli, Athens. Tel: (031) 821-3920. Gen. Mgr.: G.P. Lucky.

Int'l branches: Canada, England, France, Italy, Switzerland, USA.

Int'l firms represented: Ariston (Italy), Constantinidis (Egypt), Cora (Italy), Curci (Italy), El Fan (Egypt), Haddad (Lebanon), King (Japan), Leonard (Italy), Melodia (Italy), Mohamed Nasr (Libya), Perou (France), G. Records (Italy), R.F.I. (Italy).

Int'l rep.: Australia (Caras), Canada (Christofer Papas, Parthenon Cassettes), France (Perou), Italy (Cora), South Africa (Gallo), USA (Dinos Constantinou, Dino Joannidis, Petropoulos).

• services

ASSOCIATIONS & PROFESSIONAL ORGANIZATIONS

Association of Greek Composers, 38 Mitropoleos St., Athens.

E.R.T. (Eliniki Radiophonia Tileorassi), PO Box 19, Aghia Paraskevi, Athens. Tel: 65-95-970. Cable: RADIOSTATHENS. Telex: 216066. Dir. Gen. C. Hondros. Radio Dir.: E. Lekkas.

Federation of Musical Ass'n's of Greece, 3 Averoff St., Athens.

Jazz & Pop Club, Thessaloniki.

National Committee of the International Music Council, 38 Mitropoleos St., Athens. Tel: 223-302.

Union of Greek Musicians, 38 Mitropoleos St., Athens.

Union of TV Viewers & Radio Listeners, 57 Panepistimou St., Athens.

LICENSING ORGANIZATION, MUSIC

A.E.P.I. (Societe Hellenique pour la Protection de la Propriete Intellectuelle SA), 14 Delighanni St., Athens 148. Tel: (021) 821-3917, 822-8006. Mng. Dir.: Constantin Macris.

Binboard 1981-1982 International Buyer's Guide

DESIGN & ARTWORK LICENSOR, RECORD & TAPE

PLATING, PROCESSING & PRESSING PLANT

Columbia-EMI Greece SA, PO Box 287, Central Sta., 127 Heraclion St., Rizopolis, Athens. Tel: (021) 252-7502/7102/3602/3702. Cable: EMIRECORD. Telex: 214192. Mng. Dir.: Alan C. Boxer. Finance & Admin. Dir.: D. Gaetanakis. Sales Mgr.: E. Terzis, Mig. & Studios Dir.: C. Kyriakos.

RECORD PROMOTION

Columbia-EMI Greece SA, PO Box 287, Central Sta., 127 Heraclion St., Rizopolis, Athens. Tel: (021) 252-7502/7102/3602/3702. Cable: EMIRECORD. Telex: 214192. Mng. Dir.: Alan C. Boxer. Finance & Admin. Dir.: D. Gaetanakis. Sales Mgr.: E. Terzis, Mig. & Studios Dir.: C. Kyriakos.

Lakis Kleopas Prod'ns, 10 Salamini St., Thessaloniki. Tel: (31) 516-493. Telex: 418339. Pres. & Gen. Mgr.: Lakis Kleopas. Sales Mgr.: George Kleopas. Artistic Mgr.: Lefty Kongalides.

TAPE CUSTOM DUPLICATOR

Columbia-EMI Greece SA, PO Box 287, Central Sta., 127 Heraclion St., Rizopolis, Athens. Tel: (021) 252-7502/7102/3602/3702. Cable: EMIRECORD. Telex: 214192. Mng. Dir.: Alan C. Boxer. Finance & Admin. Dir.: D. Gaetanakis. Sales Mgr.: E. Terzis, Mig. & Studios Dir.: C. Kyriakos. Audio: 8-tr. cassette.

• supplies

CARTRIDGE & CASSETTE PARTS

Costas Vlassopoulos & Co., 2 Alex. Papanastasiou St., New Filadelfia, Athens. Tel: (01) 252-0696. Cable: INTERSONIC. Telex: 214312. Mng. Dir.: Costas Vlassopoulos. Import & Export Mgr.: A. Primiakis. Chief product: All 8-tr. & cassette parts.

EMPTY CARTRIDGES, CASSETTES & REELS

Costas Vlassopoulos & Co., 2 Alex. Papanastasiou St., New Filadelfia, Athens. Tel: (01) 252-0696. Cable: INTERSONIC. Telex: 214312. Mng. Dir.: Costas Vlassopoulos. Import & Export Mgr.: A. Primiakis. Audio: 8-tr. & cassette. Brand name: Intersonic.

JACKETS & SLEEVES

Columbia-EMI Greece SA, PO Box 287, Central Sta., 127 Heraclion St., Rizopolis, Athens. Tel: (021) 252-7502/7102/3602/3702. Cable: EMIRECORD. Telex: 214192. Mng. Dir.: Alan C. Boxer. Finance & Admin. Dir.: D. Gaetanakis. Sales Mgr.: E. Terzis, Mig. & Studios Dir.: C. Kyriakos. (LP)

PROFESSIONAL TAPE SUPPLIES

Columbia-EMI Greece SA, PO Box 287, Central Sta., 127 Heraclion St., Rizopolis, Athens. Tel: (021) 252-7502/7102/3602/3702. Cable: EMIRECORD. Telex: 214192. Mng. Dir.: Alan C. Boxer. Finance & Admin. Dir.: D. Gaetanakis. Sales Mgr.: E. Terzis, Mig. & Studios Dir.: C. Kyriakos. Audio: Cassette labels.

TAPE, BLANK LOADED & BULK RAW

Agfa Gevaert AE, PO Box 17, Stilianou Gonata 16, Athens-Peristeri. Tel: 574-2311. Gen. Mgr.: A. Nofthardt. Sales Mgr.: A. Bouboulas. Audio: Blank—cassette, open reel, raw—cassette.

Brand names: Agfa Carat, Agfa Ferrocolor, Agfa Stereochrome, Agfa Super Ferro Dynamic, Agfa Videochrom.

Columbia-EMI Greece SA, PO Box 287, Central Sta., 127 Heraclion St., Rizopolis, Athens. Tel: (021) 252-7502/7102/3602/3702. Cable: EMIRECORD. Telex: 214192. Mng. Dir.: Alan C. Boxer. Finance & Admin. Dir.: D. Gaetanakis. Sales Mgr.: E. Terzis, Mig. & Studios Dir.: C. Kyriakos.

Dr. O.A. Delis AG, Paleologou Benizelou 5, Athens 117. Tel: 325-0301. Telex: 215336. Cable: DELICHIMIKI. Chief Exec.: Antonios Fotopoulos. Sales Mgr.: T. Kokkinopoulos. Audio & Video: Cassette.

Brand name: BASF.

Echo Ltd., 2 Korae St., Athens 132. Tel: (01) 323-4774. Gen. Mgr.: Zenon Themelis. (Distributor/Importer/Exporter)

Audio: Blank—cassette.

Magnetic Hellas Ltd., 6-8 Frangon St., Thessaloniki.

Audio: 8-tr. cassette, open reel.

Brand name: Audio Magnetics.

Costas Vlassopoulos & Co., 2 Alex. Papanastasiou St., New Filadelfia, Athens. Tel: (01) 252-0696. Cable: INTERSONIC. Telex: 214312. Mng. Dir.: Costas Vlassopoulos. Import & Export Mgr.: A. Primiakis.

Audio: Blank—8-tr. & cassette.

Brand name: Intersonic.

• accessories

manufacturers

Kinotexnikh OE, 47 Stourara, Athens. Tel: 360-6998.

Product: Record—replacement styli.

Brand name: Stanton.

Sprots Pnerakis, 59 Miaouli St., Moscatto-Athens 59. Tel: (021) 481-5508.

Product: Record—45 rpm adaptors.

Plomartitis Prod'ns, 13 Third September St., Athens. Tel: (031) 522-7472, 821-3918. Cable: MELODY. Pres. Anthony Plomartitis. Sales Mgr.: Georges Plomartitis.

Product: Carrying & storage cases.

• accessories

manufacturers

Kinotexnikh OE, 47 Stourara, Athens. Tel: 360-6998.

Product: Record—replacement styli.

Brand name: Stanton.

Sprots Pnerakis, 59 Miaouli St., Moscatto-Athens 59. Tel: (021) 481-5508.

Product: Record—45 rpm adaptors.

Plomartitis Prod'ns, 13 Third September St., Athens. Tel: (031) 522-7472, 821-3918. Cable: MELODY. Pres. Anthony Plomartitis. Sales Mgr.: Georges Plomartitis.

Product: Carrying & storage cases.

• accessories

manufacturers

Kinotexnikh OE, 47 Stourara, Athens. Tel: 360-6998.

Product: Record—replacement styli.

Brand name: Stanton.

Sprots Pnerakis, 59 Miaouli St., Moscatto-Athens 59. Tel: (021) 481-5508.

Product: Record—45 rpm adaptors.

Plomartitis Prod'ns, 13 Third September St., Athens. Tel: (031) 522-7472, 821-3918. Cable: MELODY. Pres. Anthony Plomartitis. Sales Mgr.: Georges Plomartitis.

Product: Carrying & storage cases.

• accessories

manufacturers

Kinotexnikh OE, 47 Stourara, Athens. Tel: 360-6998.

Salvador 1980—546,394 units, 1979—290,868 units. Nicaragua 1980—2,031 units, 1979—none. USA 1979—25,602 units.

Exports to: Costa Rica 1980—680,733 units, 1979—632,701 units. El Salvador 1980—464,637 units, 1979—235,034 units. Honduras 1980—551,625 units, 1979—552,335 units. Nicaragua 1980—485,863 units, 1979—243,080 units.

Type of distribution: Due to cultural and geographical factors, there is no common distribution pattern. Each record company has its own system.

Type of promotion: Radio stations are an important means of promoting product. Record companies take into account station ratings and whether or not a station makes or simply plays the hits.

TAPE:

Because of the uneven geography of Guatemala, surrounded by mountains and volcanos, and the inhabitation by a 40% Indian population that lives in huts without electricity, transistor radios and tape recorders are in great demand. Thus, cassette sales are approaching the sales level of records and in some places they have surpassed it. 8-tr. is non-existent. Open reel is primarily bought by an elite group that likes classical music. Video recorder sales are developing slowly, having a high supply but a low demand.

RADIO STATIONS:

No. of commercial: 104 (92 AM, 12 FM).

No. of government: 6.

Comment: Programming consisting of romantic ballads sung in Spanish is the most popular. There are at least five stations programming youth-oriented material in English. Ranchera music (Mexican folklore), liked much in the provinces, is losing its popularity. Other programming includes that aimed at housewives and instrumental, the latter primarily featured on FM. Due to the geography, radio stations must use repeaters to reach the different zones, and in the majority of the cases, each zone has its own station, which is not influenced by the capital stations.

TELEVISION STATIONS:

Comment: Programming includes series, novels, films, news, movies, specials, and international shows and programs via satellite. The government channel features educational and cultural programs. All stations are associated with OTI.

IMPORT/EXPORT REGULATIONS:

There are no regulations.

MARKET ANALYSIS:

In 1980, the Guatemalan record market felt the effects of the negative economic situation that existed in Central America. The result was reduced demand.

Record company managers implemented efficient measures like trimming catalogs and increasing promotion for the remaining product. The aims of the companies toward the radio stations and buyers improved through more creativity and push. Soundtracks helped sales, too.

The major record companies increased sales by 10% to 15% over 1979.

Among the best promotions were Dideca's "Larga Vida del Rock" (Rock's Long Life) in which the company backed acts like Black Sabbath, Deep Purple, Paul McCartney, Queen, Genesis and Eric Clapton. Also, CBS-Indica, started a strong Salsa push, which coincided with its representing the Fania label.

The primary romantic ballad artists were Julio Iglesias, Roberto Carlos, Camilo Sesto, Jose Luis Rodriguez, Albert Hammond, Leo Oan, Jose Luis Perales, Napoleon, Jose Jose, Juan Gabriel, Emmanuel, Roco Durcal, Daniel Chinchilla, Viki Carr, and Manolo Torres. Foreign artists attaining good sales included Queen, Kenny Rogers, Andy Gibb, Steve Wonder, Paul McCartney, Diana Ross, the Commodores, the Rolling Stones, Bob Marley, Barry Manilow, Barbra Streisand, Willie Cliton, Michael Jackson, Phil Floyd, Santana, Christopher Cross, John Lennon, Donna Summer, Kiss and Lipps Inc.

Marimba recordings attained their traditionally significant sales during the last months of the year. Companies promoting this type of music had excellent sales.

Pepe Estrada

• record & tape manufacturers / distributors / Importers

Casa Avelar, 18 Calle 3-59 & 6-61, Zone 1, Guatemala City. Tel: 80-243, 28-545, 81-465. Gen. Mgr.: Salvador Avelar Guerra; Sales Mgr.: Ana Maria Avelar C.

Labels: (Owned) Leo, Tikal, Xelaju.

Int'l reps.: Mexico (Rea), Puerto Rico (Taurus), USA (Taurus).

Oideca (Discos de Centroamerica) (IFPI), Apartado Postal 1792, 12 Calle 3-27, Zone 1, Guatemala City. Tel: 533-695, 519-602, 29-634, 537-137. Cable: DIDECA. Telex: 5413. Pres.: Byron Galvez-Thompson; Gen. Mgr.: Juan Jose Pezzarossi. Int'l Mgr.: Blanca Avila. Local branch: Impulso SA, Apdo. Postal 1792, 12 Calle 3-27, Zone 1, Guatemala City. Tel: 519-602, 533-695. Telex: 5413. Pres.: Mario Galvez-Thompson; Sales Mgr.: Byron Hernandez.

Int'l branches: Costa Rica, Gramusic, El Salvador, Musi Centro, Honduras, Audio Ritmo, Nicaragua Dideca; Panama, Sonomundi.

Labels: (Owned) Dideca, (licensed foreign) Ariola Int'l (Spain), Arista (USA), Billo's (Venezuela), CR (USA), Capitol (USA), Caracol (Colombia), Codiscos (Colombia), Corpordisco (Venezuela), Disqueras Unidas (Venezuela), EMI (UK), EMI America (USA), Falcon (USA), Fantasy (USA), Gamma (Mexico), Guitarra (Mexico), Hispavox (Spain), Melody (Mexico), Motown (USA), Movieplay (Spain), Odeon (UK), Phonogram (Netherlands), Polydor (Germany), Sonovon (Venezuela), Suradisco (Venezuela), United Artists (USA), Velvet (Venezuela), West Side Latino (USA).

Dila (Discos Latinoamericanos SA), Av. de las Americas 14-15, Zone 14, Guatemala City. Tel: 681-530. Pres.: Augusto Diaz-Duran; Gen. Mgr.: Marco Antonio Garcia. Sales Mgr.: Sylvia de Molina.

Labels: (Owned) Dila, (licensed) Alhambra (Spain), Musart (Mexico).

Int'l reps.: Argentina (Cordobesa), Colombia (Codiscos), Ecuador (Fam oco), Mexico (Musart), Peru (EMPSA), USA (Record Disks of America).

Discos de Centroamerica, see Dideca.

Discos Latinoamericanos SA, see Dila.

Distribuidora Guatemalteca de Discos SA, 4 Ave. 13-25, Zone 9, Guatemala City. Tel: 31-65-64. Telex: 5171. Gen. Mgr.: Arnoldo Calvo Aparicio.

Home office: Costa Rica. Indica (see for labels).

Int'l rep.: Worldwide (CBS).

Electrodisco, 9A Avenida 7-05, Zone 1, Guatemala City. Tel: 535-405. Cable: ELDIS. Gen. Mgr.: Miguel Angel Armas. (Distributor/Importer/Exporter)

Indica, see Distribuidora Guatemalteca.

Leo, see Casa Avelar.

Mars Recs & Tapes, 1A Avenida D-15, Zone 2, Guatemala City. Tel: 28-254, 535-405. Cable: MARS. Gen. Mgr.: Miguel Angel Armas.

Labels: (Owned) Mars, (licensed) Nicolas Oliva (Argentina), Para (Argen-

GUATEMALA

Population: 7,477,427

Population by age groups: 0-14—678,160; 15-24—470,272; 25-49—184,502; 50+—1,077,779

Rate of exchange: \$1 (US) = 10 quetzal

Per capita income: \$985

Holidays: January 1, Holy Week (Thurs-Sun.), May 1 (Labor Day), June 30 (Army Day), September 15 (Independence Day), October 20 (Revolution of 1944), November 1, December 25

RECORDS & TAPE:

Record sales certification awards: Since there is no organization in charge of tabulating record sales, no certified awards can be given. Some independent associations present annual awards to the most popular artists, but these associations are not always recognized and accepted in general.

Record companies are very reserved about giving sales information.

Imports from: Costa Rica 1980—1,035,834 units, 1979—637,900 units. El

lina); (distributed) Alhambra (USA), Casablanca (USA), Decca (UK), De-Lite (USA), Leo (El Salvador), London (UK), MCA (USA).
Musical, Ing. M. R. Wunderlich, 13 Calle 9-62, Zone 1, Guatemala City. Tel: 29-645. Cable: MUSICAL. Telex: 5485. Pres.: Mario R. Wunderlich, Gen. Mgr.: Jean G. Wunderlich, Sales Mgr.: Guillermo Tulio Gonzalez. (Importer)
Tikal, see Casa Avelar.
Xelaju, see Casa Avelar.

• **music publishers**

Dimasi, 12 Calle 3-27, Zone 1, Guatemala City. Tel: 519602. Cable: DIDECA. Telex: 5413. Gen. Mgr.: Otto Schwarz, Gen. Mgr.: Blanca Avila.
Maya Musical SA, Av. de las Americas 14-15, Zone 14, Guatemala City. Tel: 681-530. Pres.: Augusto Diaz-Duran; Gen. Mgr.: Luis Estrada Roy.
Int'l firms represented: ABC Dunhill (USA), Acapulco (Mexico), American Broadcasting (USA), Brambila (Mexico), Discorama (Spain), Edimusa (Mexico), Estrella (Mexico), Fermata (Brazil), Hnos. Marquez (Mexico), Morning (Canada), Prodemus (Colombia), Sadram (Ecuador).
Int'l reps.: Colombia (Prodemus), Ecuador (Sadram), Mexico (Edimusa)

• **services**

ASSOCIATIONS & PROFESSIONAL ORGANIZATIONS

A G A Y C (Asociacion Guatemalteca de Autores & Compositores), 14 Calle 11-42, Zone 1, Guatemala City. Tel: 84-921/251

**DESIGN & ARTWORK
 PRINTER & LITHOGRAPHER
 PLATING, PROCESSING & PRESSING PLANT**

Discos de Centroamerica SA, Apdo. 1792, 12 Calle 3-27, Zone 1, Guatemala City. Tel: 519602, 533695, 516907. Cable: DIDECA. Telex: 5413. Pres.: Byron Galvez Thompson, Sales Mgr.: Ernesto Porras.

TAPE CUSTOM DUPLICATOR

Discos de Centroamerica SA, Apdo. 1792, 12 Calle 3-27, Zone 1, Guatemala City. Tel: 519602, 533695, 516907. Cable: DIDECA. Telex: 5413. Pres.: Byron Galvez Thompson, Sales Mgr.: Ernesto Porras.
Audio: Cassette.

• **accessories**

Electrodisco, 9A Avenida 7-05, Zone 1, Guatemala City. Tel: 535-405. Cable: ELDIS. Gen. Mgr.: Miguel Angel Armas. (Distributor/Importer/Exporter)
Brand name: Ampex.
Mars Recs. & Tapes, 1A Avenida D-15, Zone 2, Guatemala City. Tel: 28-254, 535-405. Cable: MARS. Gen. Mgr.: Miguel Angel Armas. (Importer)
Brand name: Duotone.

HONG KONG

Population: 4,730,000
Rate of exchange: \$1 (US) = 5.5 Hong Kong dollars.
Per capita income: \$2100
Holidays: January 1, Chinese New Year, April 21 (Queen's Birthday), June 17 (Tuen Ng Festival), August 25 (Liberation Day), Mid-Autumn Festival, December 25, 26 & Christian holidays.

• **record & tape manufacturers / distributors / importers**

Amo Rec. Corp. (IFPI), PO Box 95170, Tsim Sha Tsui Sta., 68 Waterloo Rd., Flat A-1, Kowloon. Tel: (3) 7139847. Gen. Mgr.: Paul Leung.
Labels: (Owned) Amo, Kinder, Musa
Angel, see EMI
Archiv, see PolyGram
Asylum, see WEA
Atco, see WEA
Atlantic, see WEA
C B S/Sony Hong Kong Ltd. (IFPI), 122-124 Connaught Rd., C. 22/F, Hong Kong. Tel: (5) 457227. Cable: CBSDDNYHKL. Telex: 74936 Mng. Dir.: Peter C.H. Chiu, A&R Mgr.: Tony Lee, Sales Mgr.: Angela Hon.
Labels: (Owned) CBS/Sony, (licensed foreign) APA, ARC, Bang, Bethel hem, Boardwalk, Blue Horizon, Blue Sky, Caribou, Cat, Columbia, Colum bia Masterworks, Dash, Drive, Epic, Full Moon, 5TD, Glades, Inivictus, Jet, Kalimba, KC & the Sunshine, Kirshner, Marlin, Mums, Nempcor, Neighbourhood, Ode, Odyssey, Dikeh, Philadelphia Int'l., Portrait, Sunshine Sound, TK, T.Neck, Tappan Zee, Unlimited Gold, Windfall (all USA); CBS (UK, USA), CBS/Harmony (UK, USA), Epic/Scny (Japan), Shintee (Tai wan)
Capitol, see EMI.
Casablanca, see PolyGram
Columbia, see EMI.
Cosdel (Hong Kong) Ltd. (IFPI), Central Sta., 1319-1310 Champion Bldg., 301-9 Nathan Rd., Kowloon. Tel: (3) 302347. Cable: HKCDLTK. Mng. Dir.: Kenneth L. Cole, T.K. Whang, Dir. & Sales Mgr.: Robert Wong.
Reg'l branch: Singapore.
Labels: (Licensed foreign) Bethlehem, Colgems, Flying Dutchman, Grunt Millennium, New York Int'l., Roadshow/Nature's Music, RCA, Solar, Tat-toe, 20th Century-Fox, 20th Century/Chi Music, Windsong (all USA), (distributed - not licensed) Pickwick (UK)
Crown Rec. Co. (IFPI), 34A Kennedy Rd., 7th fl., Hong Kong. Tel: (5) 237845, 249534. Mng. Dir.: Tung Lau.
Labels: (Owned) Crown, Eagle, (licensed) Michelle (USA)
D G G, see PolyGram
Decca, see PolyGram
Diamond, see PolyGram
Double Up, see EMI
EMI (Hong Kong) Ltd. (IFPI), 11 Fa Po St., You Ya Tsuen, Kowloon. Tel: (3) 810321. Cable: EMIITRDN. Telex: 33512. Mng. Dir.: Neil Sarsheld, Creative Dir.: K.K. Wong.
Labels: (Owned) Angel, Capitol, Columbia (UK), Double Up, EMI, Encore, HMV, Harvest, Liberty, MFP (Music for Pleasures), Odeon, One Up, Parlo phone, Pathe, Phoenix, Regal, Regal Zonophone, Sounds Superb, Star line, Talisman, Waverley, (represented) Ariola (USA), Bronze (UK), DJM (UK), Disneyland (USA), Motown (USA), RAK (UK)
Eagle, see Crown
Elektra, see WEA
Encore, see EMI

Excel Hi Fi Co., Central Bldg., Rm. 708, Pedder St., Hong Kong.
Label: (Represented) Delos (USA)
Fontana, see PolyGram
Geffen, see WEA
Green House Christian Book Co., PD Box 4221, Kowloon Central PO, Hong Kong.
Label: (Represented) Maranatha! (USA)
H K, see Pacific
H M V, see EMI
Harvest, see EMI.
Hong Kong King Yoko Ltd. (IFPI), Far East Mansion, Rm. K 17/F, 5-6 Middle Rd., Kowloon. Tel: (3) 66-89-34, 66-80-42. Cable: KINGYOKD. Gen. Mgr.: Miss C.H. Koh, Sales Mgr.: Kenny K.W. Mok.
Labels: (Owned) Kinster, (licensed foreign) Better Days, Denon, Electric Brd., Flying Disk, Flying Dog, Invitation, JVC, King, Kitty, Polydor, Seven Sea, Toho, Tokuma, Toshiba-EMI, Watanabe, Yupiteru, Zen (all Japan); Artists House, Butterfly, CTI, Century, Kudu, Parachute (all USA); (distributed - not licensed) Alfa (Japan), Radio City (Japan).
Hong Kong Recs. Co. Ltd., Kai It Bldg., 9th fl., 58 Pak Tai St., Kowloon. Tel: (3) 02-52 51. Mng. Dir.: Klaus Heymann (Distributor for Pacific Music)
Jones Co., 722 Tung Ying Bldg., 7th fl., 100 Nathan Rd., Kowloon. (Distribu tor)
Kan's Int'l. Co. Ltd., 90A Broadway, 20th fl., MFSC, Kowloon. Tel: (3) 727478.
Label: (Distributed) IAG (USA)
Kinder, see Amo
Kinster, see Hong Kong King Yoko
Lee's Sound Eng'g Ltd., 301-4 Luk Ho Tong Bldg., 31 Queens' Rd., Central. Tel: (5) 265523. Telex: 780-76208. Mng. Dir.: SF Lee.
Label: (Represented) Direct Disk (USA).
Liberty, see EMI
M F P (Music For Pleasure), see EMI
M G M, see PolyGram
Mercury, see PolyGram
Moutrie & Co. (Hong Kong) Ltd. (IFPI), Prince's Bldg., UG20 & UG23, 5D Ice House St., Tel: (5) 239-305. Mng. Dir.: Napoleon Ng, Gen. Mgr.: Eilen Ng, Sales Mgr.: Constance Ng.
Musa, see Amo.
Nonesuch, see WEA
Odeon, see EMI
One Up, see EMI.
Pacific Music Co. Ltd. (formerly Studer Revox (HK) Ltd.) (IFPI), Kai It Bldg., 9th fl., 58 Pak Tai St., Kowloon. Tel: (3) 02-52 51. Cable: PRDMUSIC. Mng. Dir.: Klaus Heymann; Gen. Mgr.: John D. Bishop, Sales Mgr.: Thomas Yeung. (Distributed by Hong Kong Recs.)
Labels: (Owned) HK, (licensed foreign) Ariola/Eurodisc (Germany, UK, USA), Baby (Italy), Carrere (France), Chrysalis (UK, Europa (Germany), Fantasy group (USA), Harmonia Mundi (France, Germany), Hungaroton (Hungary), Intercord (Germany), Opus (Czechoslovakia), Supraphon (Czechoslovakia), Telefunken (Germany), Turnabout (USA), Virgin (UK), Vox (USA), (distributed - not licensed) Erato (France), Inner City (USA), Melodiya (USSR), Redifusion (USA), Unicorn (UK)
Int'l reps.: EEC except UK (Ariola/Eurodisc), Japan (Victor)
Parlophone, see EMI
Pathe, see EMI
Philips, see PolyGram
Phoenix, see EMI
Polydor, see PolyGram
PolyGram Recs. Ltd. (IFPI), Garley Bldg., Rm. 1503, 233-239 Nathan Rd., Kowloon. Tel: (852) 3-674138. Cable: POLYDDR. Telex: 75884. Mng. Dir.: Norman Cheng, A&R Dir.: Ricky Fung, Int'l. Repertoire Div. Mgr.: Douglas Chan, Classical Mktg. Mgr.: Peter D'Almeida & Castro.
Labels: (Owned) Archiv, Casablanca, DGG, Decca, Diamond, Fontana, MGM, Mercury, Philips, Polydor, RSD, Vertigo, Verve, (represented) A&M (USA), ECM (Germany), Hansa (Germany), Pablo (USA), Polar (Sweden)
Progressive Workshop/Philip Ching, 14-C, Block 8, Nam Fung Chuen, Quarry Bay. Tel: (3) 91-03-89.
Label: (Represented) Theresa (USA)
R S D, see PolyGram
Regal, see EMI
Regal Zonophone, see EMI
Reprise, see WEA
Shun Cheong Rec. Co. Ltd. (IFPI), 1208/9 Bank Centre, 636 Nathan Rd., Kowloon. Tel: (3) 853007, 322397. Cable: SHUNMARIO. Telex: 83314. Mng. Dir. & Gen. Mgr.: Raymond K.P. Ng, Sales Mgr.: Mok Yip-Ping. (Distributor)
Labels: (Licensed) AVI (USA), Bainbridge (USA), Barclay/Egg (France), Buddha (USA), Can't Stop (USA), Claude Hoppe (UK), Cream/HI (USA), Everest (USA), Jupiter (Germany), Ktel (UK), Prelude (USA), Rampage (UK), Ramwood (USA), Sirh (UK), TGD (Canada), Transatlantic (UK), Van guard (USA), Vogue (France), (distributed - not licensed) Alshire (USA), Arco/H&L (USA), De-Lite (USA), Delphine (France), MCA (UK, USA)
Sounds Superb, see EMI
Starline, see EMI
Studer-Revox, see Pacific
Talisman, see EMI
Vertigo, see PolyGram
Verve, see PolyGram
W E A Recs. Ltd. (IFPI), 2/F Landwide Bldg., 118-120 Austin Rd., Kowloon. Tel: (3) 697421. Telex: 83979. Dir.: Paul Ewing, Sales Mgr.: Henry Chow.
Home office: USA
Labels: (Owned) Asylum, Atco, Atlantic, Elektra, Geffen, Nonesuch, Reprise, WEA, Warner Bros. (all USA), (licensed) Big Tree, Curlew, Dark Horse, DiscReet, Embryo, Little David, Mantecore, Paradise, Planet, Scotti Bros., Sure, Swan Song, Warner/Curb, Westbound, Whitfield (all USA), Island (UK)
Warner Bros., see WEA
Watermelon Prods., 70 Conduit Rd., Flat 1C, Hong Kong. Tel: (5) 451719. (Distributor/Importer)
Waverley, see EMI
Yes Recs. Ltd., Sincere Insurance Bldg., 4th fl., West Wing, Rm. 3, Hennessy Rd., Hong Kong. Tel: (5) 271168. Telex: 83429. Gen. Mgr.: Oscar Yeung Chiu Sheung. (Distributor/Importer)

• music publishers

April Music Publ'g (Hong Kong), 122-124 Connaught Rd., C. 22/F, Hong Kong. Tel: (5) 457447. Cable: CBSDDNYHKL. Telex: 74936 Mng. Dir.: Peter C.H. Chiu.
Int'l firms represented: Alotagood/Kool, Antisya, April, Arabella, Badboy/Kyd, Barnaby, Robin Balleau, Blendingmeat, Blue Dyer Cult, Boom, Bo vina, Bread & Butter, Byrdland Camp, Claudine, Clay, Country Road, Coverdale, Coyote, Derringer, Dickiebird, Dolot, Drum & Fiddle, Drum mer, Ether, Flying Crown, Fourteenth Hour, Gamma, Gold Bullion/Hifalu

tin, Gospel Birds, Great Honesty, Great Stoned Hiway, Albert Hammond, Kershner/Hudmar, Sheethire/Porcara, Joelsongs/Impulsive, Kamikazi, Kirshner/CBS, Light, Litha, Little Johno/Together, MacFaye, Madson, Mansail, Mecca/Kahlil/Gelbran, Micame, Mine, Mitchell, Music House, Music Pool/Notes Now, Nibrich, Nicoya, North Chester, Northridge, Nouvelles Eds. Meridia, Oceans Blue/Silver Blue, Pacific, Petra, Buster Poudexter, PPI/Palopic, RSPV, Saybrook, Sheryln, Sheronda, Silver Steed, Spelligold/SWAT, Star Spangled/American Wordway, Stovepipe, Strong Arm, Summit, Sweet Jenny, Tuna Fish, Larry Weiss, Westbrook, Winter Blues, Winter Wind, Yo'Mama's Zap
E M I Music Publ'g (SE Asia) Ltd., 11 Fa Po St., You Yat Tsuen, Kowloon. Tel: (3) 810321. Cable: EMIIMUSE. Telex: 33512. Cable: EMIIMUS. Gen. Mgr.: Irene Ho.
Reg'l branches: Malaysia, Singapore.
Int'l firms represented: ABC/Dunhill (USA), ATV (UK, USA), Admont (USA), J. Albert & Son (Australia), Alchemical (USA), Alfa (Japan), American Broadcasting (USA), Ardmore & Beechwood (UK), Beechwood (USA), Big Pig (UK), Big Sky (USA), BrainTree (USA), Brent (USA), Bruton (USA), Bug (USA), Caleb (USA), Campbell Connelly (UK), Candlewyck (USA), Carlin (UK), Castle (Australia), Chrysalis (UK), Colgems-EMI (USA), Copyright Service Bureau (USA), Cream (USA), Donna (UK), Dwarf (UK), EMI Music (UK), Early Morning (Canada), Eaton (UK), Edwardson (UK), Essex (Australia), B. Feldman (UK), Leo Feist (UK, USA), Francis Day & Hunter (UK), Robin Gibb (UK), Glenwood (USA), Golden Egg (UK), Gallo (UK), Gypsy Boy (USA), Hollenbeck (USA), India (USA), Infinity (USA), Intune (UK), Dick James (UK), Jasperilla (USA), Jonathan (Australia), Kennedy Street (UK), Lady Jane (USA), Light (UK), Lupus (UK), MPL Communications (UK), Maribus (UK), Martin-Coutler (UK), Peter Maurice (UK), Memory Lane (UK), Mews (UK), Morning (Canada), Nippon Television (Japan), Northern Songs (UK), Olde Grog (USA), Porchester (USA), Keith Prowse (UK), Ram's Horn (USA), Razzle (Australia), Red Bus (UK), Robbins (UK, USA), Rolling Stones (UK), Rondor (UK, USA), Scorpio (France), Screen (Austria), Screen Gems-EMI (USA), Shaftesbury (UK), Shillelagh (USA), Shinko (Japan), Shoetunes & Shoesongs (USA), Smadager (USA), Snow (USA), Special Rider (USA), Sweet Summer Night (USA), Televs (France), Toshiba-EMI (Japan), Tree (USA), Tumble weed (Australia), TV Asahi (Japan), Unart (USA), United Artists (UK, USA), Warner Bros. (UK), Walt Disney (USA), Watanabe (Japan), Wonder land (USA), Lawrence Wright (UK), Yamaha (Japan), Zanzea (USA)
Intersong (Hong Kong) Ltd., Garley Bldg., Rm. 1001, Nathan Rd., Kowloon. Tel: (3) 674138. Cable: PDLYDDR. HONG KONG. Telex: 75884. Dir.: Norman Cheng; Sec'y: Canton Lee, Publ'g Officer: Jenny Fung
Int'l firms represented: Artemis group, Chappell group
W E A Music Publ'g Ltd., 2/F Landwide Bldg., 118-120 Austin Rd., Kowloon. Tel: (3) 697421. Telex: 83979. Dir.: Paul Ewing, Gen. Mgr.: Josephine Lau.
Int'l firms represented: Devalbo, Douglas, Ice Nine, Sergeant, Warner Bros. (all USA)

• **services**

**DESIGN & ARTWORK
 RECORD PROMOTION**
Creative Workshop Ltd., 1105-1406 Korea Center. Tel: 447483, 436399, 436390. Mng. Dir.: Michael Pope

PLATING, PROCESSING & PRESSING PLANT
C B S/Sony Hong Kong Ltd., 122-124 Connaught Rd., C. 22/F, Hong Kong. Tel: (5) 457227. Cable: CBSDDNYHKL. Telex: 74936 Mng. Dir.: Peter C.H. Chiu

TAPE CUSTOM DUPLICATORS
C B S/Sony Hong Kong Ltd., 122-124 Connaught Rd., C. 22/F, Hong Kong. Tel: (5) 457227. Cable: CBSDDNYHKL. Telex: 74936 Mng. Dir.: Peter C.H. Chiu
Audio: Cassette
Crown Rec. Co., 34A Kennedy Rd., 7th fl., Hong Kong. Tel: (5) 237845. Mng. Dir.: Tung Lau.
Audio: Cassette

• **supplies**

CARRIDGE & CASSETTE PARTS
Greencorp Magnetics Ltd., 801 China Bldg., Pedder St., Hong Kong. Tel: (5) 254527. Telex: 83583
Yorknetics Ltd., GPD Box 9789, 313 Central Bldg., Pedder St., Hong Kong. Tel: (5) 25-45-27. Telex: 83583
Audio: Cassette

EMPTY CARTRIDGES, CASSETTES & REELS
Summit Magnetics Ltd., E. Tat Factory Bldg., 21st fl., Heung Yip Rd., Wong Chuk Hang, Aberdeen. Telex: 76264
Audio: Cassette
Yorknetics Ltd., GPD Box 9789, 313 Central Bldg., Pedder St., Hong Kong. Tel: (5) 25-45-27. Telex: 83583
Audio: Cassette

TAPE, BLANK LOADED & BULK RAW
Audio Consultants Co. Ltd., Kai It Bldg., 9th fl., 58 Pak Tai St., Kowloon. Tel: (3) 02-52 51. Cable: PRDMUSIC. Mng. Dir.: Klaus Heymann, Gen. Mgr.: John D. Bishop, Sales Mgr.: John Ho.
Audio: Open reel
Brand name: Racial Zonal
Crown Rec. Co. (IFPI), 34A Kennedy Rd., 7th fl., Hong Kong. Tel: (5) 237845.
Audio: Cassette
Greencorp Magnetics Ltd., 801 China Bldg., Pedder St., Hong Kong. Tel: (5) 254527. Telex: 83583.
Audio: 8-tr. cassette & open reel
Video: 1/2" EIAJ open reel
Inter Cassette (Hong Kong) Ltd., Man Fong Ind'l Bldg., 13 F, Flat A, 7 Cheung Lee St., Chauwan Tel: (5) 572282. Cable: INCASSETTE. Telex: 85938. Pres.: Wes Le Marr, Gen. Mgr.: Terrance Ma.
Home office: USA
Audio: Cassette
Brand names: Soundline, "private" labels
International Video Corp., Ocean Centre, Suite 1311, Tsim Sha Tsui, Kowloon. Tel: (3) 690416, 685406. Telex: 84154
Video: 2" & 1" professional
Jebson & Co. Ltd., Agfa-Gevaert Dept., PO Box 97, Pedder Bldg., 6th fl., Hong Kong. Tel: (5) 253061. Telex: 73221, 73769
Audio: Blank - compact-cassette, open reel, raw - cassette, broadcast, studio
Video: Cassette, open reel
Brand names: Agfa Caral, Agfa Stereochrom, Agfa Videochrom
Phoenix Audio Ltd., Tung Sun Commercial Centre, 200 Lockhart Rd., Hong Kong. Tel: (5) 74-72-99. Cable: PHNIXAUDIO. Telex: 65855. Mng. Dir.:

Paul Lloyd, Carol Lant; Gen. Mgr.: K.K. Ng
Audio: Cassette.
Brand name: Agfa Gevaert
 Swire Magnetics Ltd., PO Box 1, General PO, Hong Kong, Contacts Dr David Smith, Tim Allan-Smith
 Yorkinetics Ltd., GPO Box 9789, 313 Central Bldg., Pedder St., Hong Kong Tel: (5) 25 45 27 Telex: 83583 (Blank only)
Audio: Cassette
Brand name: Arja

**PROFESSIONAL TAPE SUPPLIES
 TAPE DUPLICATING & PROCESSING EQUIPMENT**

Phoenix Audio Ltd., Tung Sun Commercial Centre, 200 Lockhart Rd., Hong Kong, Tel: (5) 74-72-99. Cable: PHNIXAUDIO Telex: 65855 Mng Dirs
 Paul Lloyd, Carol Lant; Gen. Mgr.: K.K. Ng
Audio: Infonics duplicators, King loaders, Garner degaussers, MCI speed winders.

• **accessories
 manufacturers**

Audio Consultants Co. Ltd., Kai Iti Bldg., 9th fl., 58 Pak Tai St., Kowloon Tel: (3) 02-52-51. Cable: PROMUSIC Mng. Dir.: Klaus Heymann. Gen. Mgr.: John D. Bishop, Sales Mgr.: John Ho
Product: Record-record care prods., Tape-head cleaners, demagnetizers, leader & splicing tape
 Greencorp Magnetics Ltd., 801 China Bldg., Pedder St., Hong Kong Tel: (5) 254527 Telex: 83583
Product: Carrying & storage cases, Record-record care prods., 45 rpm adaptors, Tape-head cleaners, demagnetizers, leader & splicing tape
 Inter-Cassette (Hong Kong) Ltd., Man Fong Ind'l Bldg., 13-F, Flat A, 7 Cheung Lee St., Chaiwan, Tel: (5) 572282. Cable: INCASSETTE Telex: 85938 Pres. Wes Le Marr; Gen. Mgr.: Terrance Ma
Home office: USA

Product: Record-carrying & storage cases, record care prods., 45 rpm adaptors, Tape-carrying & storage cases, head cleaners, bulk erasers, demagnetizers, leader & splicing tape
 Summit Magnetics Ltd., E. Tat Factory Bldg., 21st fl., Hueng Yip Rd., Wong Chuck Hang, Aberdeen, Telex: 76264
Product: Tape-head cleaners
 Yorkinetics Ltd., GPO Box 9789, 313 Central Bldg., Pedder St., Hong Kong Tel: (5) 25 45 27 Telex: 83583
Product: Record-record care prods., Tape-carrying & storage cases, head cleaners, demagnetizers, leader tape

• **store fixtures
 manufacturers**

Greencorp Magnetics Ltd., 801 China Bldg., Pedder St., Hong Kong Tel: (5) 254527 Telex: 83583
Product: Divider cards
 Inter-Cassette (Hong Kong) Ltd., Man Fong Ind'l Bldg., 13-F, Flat A, 7 Cheung Lee St., Chaiwan, Tel: (5) 572282. Cable: INCASSETTE Telex: 85938 Pres. Wes Le Marr, Gen. Mgr.: Terrance Ma
Product: Record & tape display racks.

• **Jukebox Importer**

Coskel (Hong Kong) Ltd., PO Box 2650, Central Sta. 1309 1310 Champion Bldg. 301-9 Nathan Rd., Kowloon, Tel: (3) 302347 Cable: HKCOLTEK Mng. Dirs: Kenneth L. Cole, T.K. Whang, Dir. & Sales Mgr.: Robert Wong
Brand name: Wurlitzer (Germany)

HUNGARY

Population: 10,713,000
Rate of exchange: \$1 (US) = 31.25 forints
Per capita income: \$2,016
Holidays: January 1, Easter Monday, April 4 (Liberation Day), November 7 (Russian October Revolution Day), December 25.

RECORDS:

Record sales certification awards: Gold LP—50,000 units (classical), 100,000 (pop).
Records sold domestically including imports (retail value): LP's 1980—5,868,000 units, \$23,652,173; 1979—5,146,000 units, \$19,400,000. EP's & Singles 1980—1,243,000 units, \$1,565,217. EP's 1979—2,000 units, \$4,000. Singles 1979—1,428,000 units, \$1,980,000.
Records exported to USA (factory value—FOB): 1980—83,523 units, \$130,916; 1979—69,641 units, \$86,874.
Records imported from countries other than USA (factory value—CIF): 1980—1,792,271 units, \$3,761,940; 1979—1,115,000 units, \$2,787,500.
Records exported to countries other than USA (factory value—FOB): 1980—1,344,407 units, \$2,710,039; 1979—1,536,000 units, \$2,560,200.
Average retail price per record: LP's—\$3.47; EP's—\$1.73; Singles—\$1.30.
Discounting: Rare.

Type of distribution: Records are distributed through the Hungarian Rec. Mfg. Co. to record shops, bookstores with record departments, department stores, etc. Discounting is left up to the discretion of directors of department stores, with chiefs of shops being authorized to make discount sales on any slow moving product.

Type of promotion: Radio and television disk jockeys play a great role in securing publicity in general. There are youth weeklies and magazines that publish individual charts based not on record sales but on letters sent by readers, thus making them unreliable and in certain cases manipulated. Radio has a pop chart with the weekly "Ifjusag/Youth," which has nothing to do with sales but depends on letters received from listeners, which do not always correlate with general opinion.

Jukeboxes: 500.

TAPE:

Market: Currently, there is no pre-recorded video market. Home taping of videos is also unknown as there is no equipment yet manufactured in Hungary and the importation of American and Japanese equipment is very expensive. A few private enterprises have equipment for their own purposes.

Pre-recorded tape sold domestically including imports (retail value): Cassette 1980—553,000 units, \$3,043,078; 1979—382,000 units, \$2,045,434.

Pre-recorded tape exported to USA (factory value—FOB): 1980—3,424 units, \$6883; 1979—2,241 units, \$4,641.

Pre-recorded tape imported from countries other than USA (factory value—CIF): 1980—24,025 units, \$50,469.

Pre-recorded tape exported to countries other than USA (factory value—FOB): 1980—17,576 units, \$36,909; 1979—11,300 units, \$23,730.
Average retail price per tape: Cassette—\$5.86.

CONSUMER ELECTRONICS:

Number of homes with: Radios—2,608,000; television sets—2,766,000.

RADIO STATIONS

No. of AM 3; no. of FM 31 (all government).
Comment: In general, all music is recorded. Important concerts and opera premieres are broadcast live. Hungarian Radio recently has promoted much jazz live in addition to recorded product of Hungarian and foreign groups. It also sponsors jazz events in provincial towns and arranges for some jazz festivals. Foreign jazz record manufacturers seeking the promotion of their recordings should contact the Jazz Editor of Hungarian Radio's Music Dept.

TELEVISION STATIONS:

No. of government channels 6; 70% color (SECAM).
Comment: Hungarian television programming features much news, politics, foreign serials, Muppet shows with Hungarian texts, Hungarian co-productions with Eastern and Western countries, and films. The number of repeat shows is sometimes annoying. There are also relays of theatrical productions, pop shows, music and concerts.

IMPORT/EXPORT REGULATIONS:

Postal parcels up to 300 forints inland value are free of custom duty. One record is allowed duty free, otherwise, the duty is rather high. Tourists traveling to Hungary can import 5 LP's free of charge. In general, customs for recorders, cassette recorder units, etc., sent by mail are 60% of the inland value. If imported by travelers the percentage is 40%. If foreign travelers re-export the items they import they do not pay any duties.

MARKET ANALYSIS

During the past year, the evening newspaper, Esti Hirlap, started criticizing the Hungarian Rec. Co. regarding pop groups, speaking of protectionism for some groups and the non-recording of other rather successful groups, especially those of provincial origin. Two television programs featured representatives of the newspaper and record company, with the latter defending its position on recording established groups with sales between 100,000 to 250,000 LP's.

The record company also makes a strong promotion effort through Pesti Muzs, the Budapest Program, covering weekly events and presenting articles about popular and less popular artists. Artists and groups not appearing in this weekly claim manipulation but there has been no proof.

Paul Gyongy

• **record & tape
 manufacturers /
 distributors / importers**

Hungarian Rec. Co. (IFPI), Vorosmaryi ter 1, 1051 Budapest V, Tel: 176-222. Cable: QUALITON Telex: 22-6504. Gen. Dir.: Jenő Bors, Sales Mgr.: Mrs. J. Lendvai. (Distributed by Kultura)
Labels: (Owned) Hungaroton, Pepita, Qualiton; (Licensed) Barclay (France), CBS (Italy, UK), Decca (UK), EMI (UK), Hansa (Germany), PolyGram (Germany), Phonogram (Netherlands), United Artists (UK)
Int'l repps.: France (AZ, Pathe Marconi), Hong Kong (Hong Kong), Japan (King), Luxembourg (Intermusique), Mexico (Gamma), Spain (Hispanovox), UK (Barry, EMI)

Hungaroton, see Hungarian Rec. & Kultura.
 Kultura—Hungarian Foreign Trading Co., PO Box 149, H-1389 Budapest 62. Tel: 388-511. Telex: 22-4441. Music Dept. Mng. Dir.: Jozsef Bakó; Rec. Dept. Dir.: Marta Wiszkidenszky, Export/Import Mgrs.: Katalin Maros, George Gregusc.
Labels: (Distributed) Hungaroton, Pepita, Qualiton; (Licensed) Decca (UK), EMI (UK), Philips (Netherlands), Polydor (Germany)
Int'l repps.: Argentina (Pepita), Austria (Read & Co.), Austria (Libro-Disco), Belgium (Baltic), Canada (Alexander Trading), Denmark (Per Meistrup), Egypt (General Egyptian Book Org.), Finland (Finnlevy), France (Disc'AZ), Germany (Disco-Center), Greece (Music Box), Hong Kong (Sluder-Revox), India (Gramophone), Italy (Carisch), Japan (King), Lebanon (Sis. Libanase), Mexico (Gamma), Netherlands (Sound Prods.), Spain (Hispanovox), Sweden (EMI), Switzerland (Sade), Turkey (Faruk Erengul), UK (Parlole), USA (Qualiton), Yugoslavia (Forum, Jugoton).
 Pepita, see Hungarian Rec. & Kultura.
 Qualiton, see Hungarian Rec. & Kultura.

• **music publishers**

Edito Musica Budapest, Vorosmaryi ter 1, H-1051 Budapest. Tel: 184-228. Cable: EDITIONMUSICA. Mng. Dir.: Laszlo Sarlos
Int'l firms represented: Boosey & Hawkes (UK), Ricordi (Italy)
Int'l repps.: Canada, France, Germany, Sweden, UK, USA (all Boosey & Hawkes), Austria (Universal), Finland (Fazer), Italy (Ricordi), Netherlands (Broekmans & van Poppel), Spain (Real Musical), Switzerland (Kunzelmann)

Kultura—Hungarian Foreign Trading Co., PO Box 149, H-1389 Budapest 62. Tel: 388-511. Telex: 22-4441. Music Dept. Mng. Dir.: Jozsef Bakó; Music Dept. Dir.: Erzsébet Kovacs
Int'l repps.: Australia (Boosey & Hawkes), Austria (Hofmeister), Belgium (Adagio), Canada (Boosey & Hawkes), Denmark (Wilhelm Hansen), Finland (Musik Fazer, Hellas Piano), France (Boosey & Hawkes), West Germany (Boosey & Hawkes), Greece (Nakas), Israel (From Music Supply, Steiner Music Supply), Italy (Ricordi), Japan (Yamaha), Netherlands (Broekmans & van Poppel), Norway (Norsk), Spain (Real Musical), Sweden (Boosey & Hawkes), Switzerland (Kunzelmann), UK (Boosey & Hawkes), USA (Boosey & Hawkes), Yugoslavia (Muzicka Nakhida, Mladost)

• **services**

ASSOCIATIONS & PROFESSIONAL ORGANIZATIONS

Budapesti Zenei Versenyek es Festivalok Irodaja (Budapest Office of Music Competitions & Festivals, Office of Bartok Semmar), PO Box 80, Vorosmaryi ter 1, H-1366 Budapest V. Tel: 179-910. Cable: FESTIVALBURD. Dir.: Peter Gorog; Gen. Sec'y: Edith Galambos.
 Institute for Musicology of the Hungarian Academy of Sciences (including Bartok Archives & Museum of History of Music), PO Box 28, H-1250 Budapest I. Tel: 161-522/208. Dir.: Prof. Zoltan Falvy.
 Interconcert (International Concert Mgmt.), Vorosmaryi ter 1, H-1368 Budapest V. Tel: 176-222. Cable: INTERCONCERT. Press Officer: Karoly Sailer.
 Magyar Nepkozartsasag Muveszeti Alapja (Art Foundation of the Hungarian

Peoples Republic), Bathori utca 10, Budapest V. Chief Musical Section Vice Dir.: Paul Gyongy.
 Magyar Zenemuveszek Szovetsege (Association of Hungarian Musicians), Vorosmaryi ter 1, H-1364 Budapest V. Tel: 184-243. Cable: MUSIC UNION. Sec'y Gen.: Istvan Lang.
 Mahir (Compagnie Hongroise de Publicite), Kozraktar U-6-H, H-1093 Budapest. Tel: 18-04-30. Organizer: Laszlo Bartos.
 O R I (Orszagos Rendezo Iroda—Hungarian Nat'l Mgmt. of Light Music), Vorosmaryi ter 1, H-1815 Budapest. Tel: 176-353. Telex: 224121. Gen. Mgr.: Gyorgy Bali.
 Union of Hungarian Musicians, Gorkij fasor 38, Budapest VI. Tel: 211-120. Cable: MUDOSZ.

**CATALOG SERVICES
 DESIGN & ARTWORK**

Kultura—Hungarian Foreign Trading Co., PO Box 149, H-1389 Budapest 62. Tel: 388-511. Telex: 22-4441. Music Dept. Mng. Dir.: Jozsef Bakó; Rec. Dept. Dir.: Marta Wiszkidenszky

LICENSING ORGANIZATIONS, MUSIC

Artisjus (Bureau Hongrois pour la Protection des Droits d'Auteur), Vorosmaryi ter 1, H-1051 Budapest. Tel: (0361) 176-222, 184-629. Gen. Mgr.: Mihaly Ficsor, Dir. & Music Dept. Head: Dr. Imre Mora. (Mechanical & performing rights).

**LICENSOR, RECORD & TAPE
 PRINTER & LITHOGRAPHER**

Kultura—Hungarian Foreign Trading Co., PO Box 149, H-1389 Budapest 62. Tel: 388-511. Telex: 22-4441. Music Dept. Mng. Dir.: Jozsef Bakó; Rec. Dept. Dir.: Marta Wiszkidenszky.

• **supplies
 ENVELOPES & MAILERS
 JACKETS & SLEEVES**

Kultura—Hungarian Foreign Trading Co., PO Box 149, H-1389 Budapest 62. Tel: 388-511. Telex: 22-4441. Music Dept. Mng. Dir.: Jozsef Bakó; Rec. Dept. Dir.: Marta Wiszkidenszky.

ICELAND

Population: 227,500
Rate of exchange: \$1 (US) = 256 krona
Per capita income: \$6,000
Holidays: January 1, Holy Thursday, Good Friday, Easter Monday, May 1 (La bor Day), May 15 (Ascension Day), May 26 (Whit Monday), June 17 (National Day), December 25, 26 (Boxing Day)

• **record & tape
 manufacturers /
 distributors / importers**

Boka og Bladautgafan, Hatuni 2, 105 Reykjavik. Tel: (91) 2 07 35. Mgr.: Gudni Einarsson.
Labels: (Owned) Blada og Bokautgafan, (distributed—not licensed) Maranatha! (USA), Prim (Sweden), Word (USA)
 Falkinn Ltd. (IFPI), Sudurlandsbraut 8, 105 Reykjavik. Tel: (91) 8 46 70. Cable: FALKINN Telex: 2078. Mng. Dir.: Olafur Haraldsson
Labels: (Owned) Falkinn; (Licensed foreign) Ariola (Germany), Arista (USA), Barclay (France), Capitol (USA), DJM (UK), Delphine (France), EMI (UK), Island (UK), Liberty United Artists (USA), PolyGram (Germany, Netherlands), RSO (USA), Vogue (France); (distributed—not licensed) Decca (UK), RCA (UK, USA), Teldec (Germany).
 Geimsteinn HF, Skolavog 12, 230 Keflavik. Tel: (92) 2717. Pres.: G. Runar Juljussen, Ass't Mgr.: Porir Baldursson.
 R. Gudmundsson, PO Box 1143, Skiolavorustig 42, 101 Reykjavik. Hlyodfaerahus Reykjavikur HF, Laufveggi 96, Reykjavik. Tel: (91) 1 36 56. (Importer)

Hljompleutulgafan HF Icelandic Rec's & Music Inc., Laugavegur 33, 101 Reykjavik. Tel: (91) 29544. Chm. & Dir.: Jon Olafsson, Prod'r: Magnus Kjartansson.
 Iceland Music Information Center, Freyjugata 1, Reykjavik. Tel: 42037. Gen. Mgr.: Thorleif Sigurbjornsson
Labels: Bis (Sweden), CP: (USA), Cap (Sweden), ITM.
Int'l repp.: UK (Gramophone Exchange)
 I T M, see Iceland Music Information Center.
 Radio Budin HF, Klappargist 26, Reykjavik. (Distributor/Importer)
 Stal Ltd. (IFPI), Sudurlandsbraut 8, 105 Reykjavik. Tel: (91) 8 46 70 Telex: 2078. Mng. Dir.: Olafur Haraldsson.

• **music publishers**

Geimsteinn HF (STEF), Skolavog 12, 230 Keflavik. Tel: (92) 27 17. Pres.: G. Runar Juljussen.
 Icelandic Music Inc., Laugavegur 33, 101 Reykjavik. Tel: (91) 29544. Telex: 2187. Chm. & Dir.: Jon Olafsson.
 Iceland Music Information Center, Freyjugata 1, Reykjavik. Tel: 42037. Gen. Mgr.: Thorleif Sigurbjornsson.
Int'l repps.: Germany (Bote & Bock), UK (A. Lengnick), USA (Henri Elkan).
 Islandia Ed., PO Box 978, Reykjavik. Tel: 21185.
 Musica Islandica, see Iceland Music Information Center.

• **services**

ASSOCIATIONS & PROFESSIONAL ORGANIZATIONS

Iceland Div. of Int'l Federation of the Phonographic Inds. (IFPI), Sudurlandsbraut 8, Reykjavik. Tel: (91) 8 46 70.
 Icelandic Composers Society (Tonshaldafelag Islands), Laufavegur 40, Reykjavik. Tel: (91) 1 61 73.
 Iceland Music Information Center, PO Box 978, Freyjugata 1, Reykjavik. Tel: 42037.
 Society of Icelandic Musical Artists (Félag íslenskra tónlistarmanna), Skolegerdi 47, Kopavogur. Tel: 41740.

CATALOG SERVICES

Falkinn Ltd., Sudurlandsbraut 8, 105 Reykjavik. Tel: (91) 8 46 70. Cable: FALKINN Telex: 2078. Mng. Dir.: Olafur Haraldsson.

LICENSING ORGANIZATION, MUSIC

S T E F (Samband Tonshalda og Eigenda Flutningsrettar), Laufavegur 40, Reykjavik.

TAPE, BLANK LOADED

Falkinn Ltd., Sudurlandsbraut 8, 105 Reykjavik Tel. (91) 8 4670 Cable FALKINN Telex: 2078. Mng. Dir. Dlafur Haraldsson

- **accessories manufacturers**

Falkinn Ltd., Sudurlandsbraut 8, 105 Reykjavik Tel. (91) 8 4670 Cable FALKINN Telex: 2078. Mng. Dir. Dlafur Haraldsson.
Product: Record—record care products, 45 rpm adaptors, replacement styli. Tape—carrying & storage cases, head cleaners, demagnetizers, leader & splicing tape.

E. Fasting & Co H.S., Bergstadastreti 10, Reykjavik Tel. 21565
Product: Needles
Brand name: Pickering

- **store fixtures**

Falkinn Ltd., Sudurlandsbraut 8, 105 Reykjavik Tel. (91) 8 46 70 Telex 2078. Mng. Dir. Dlafur Haraldsson
Product: Record & tape browser boxes, record display racks, record divider cards.

INDIA

Population: 680,000,000

Rate of exchange: \$1 (US) = 8.47 rupees.

Per capita income: \$150

Holidays: January 1, January 26 (Republic Day), August 15 (Independence Day), October 2 (Mahatma Gandhi's Birthday), December 25.

- **record & tape manufacturers / distributors / importers**

Angel, see The Gramophone Co.

Capitol, see The Gramophone Co.

Columbia, see The Gramophone Co.

Electroband (India) Pvt. Ltd., 162/69, Lake Gardens, Calcutta 700045 Tel. (42) 42-3175. Mng. Dir.: Sankar Biswas; Dir.: Krishna Biswas (Cas settles)

Fontana, see Music India.

The Gramophone Co. of India Ltd., PD Box 699, Calcutta 700001; 33 Jessore Rd., Dum Dum, Calcutta 700028. Tel. 57 2431/4163 Cable EMITRDN. Telex (021) 7007. Mng. Dir. Anil Sud. Sales Mgr. M.A. Rafique, Nat'l A&R & Gen. Mgr. Y.K. Dubey, Mktg. & Promc. Mgr. P.K. Banerjee, Exp. port. Mgr. G. Vijayakumar, Rec'g. Copyright & Royalties Mgr. T.P. Roy Choudhury. Local branch: 2 Ripon St.

Branches: Bombay, Calcutta, Delhi, Gauhati, Kanpur, Madras
Labels: (Owned) Angel, Capitol, Columbia, HMV, Deon, Regal, (licensed) A&M (USA), Bronze (UK), Decca (UK), Island (UK), Motown (USA), Pye (UK), RCA (USA), United Artists (USA), WEA (USA).

H.M.V., see The Gramophone Co.

Karussel, see Music India.

M.G.M., see Music India.

Mercury, see Music India.

Music India Ltd. (IFPI), 16/2 Sterling Centre, Dr. Annie Besant Rd., Worli, Bombay 400 018. Tel. 899027 Cable MUSICINDIA Telex 0115913. Exec. Chm. Shashi Patel; Mktg. & Sales Mgr. V.J. Lazarus.
Labels: (Owned) Fontana, Karussel, M.G.M., Mercury, Music India, Philips, Polydor, Soundtrack, Vertigo, Verve, (licensed) Capricorn, Casablanca, Dreamland, RSD (all USA)

Deeon, see The Gramophone Co.

Philips, see Music India.

Polydor, see Music India.

Regal, see The Gramophone Co.

Soundtrack, see Music India.

Vertigo, see Polydor.

Verve, see Music India.

- **services**

ASSOCIATIONS & PROFESSIONAL ORGANIZATIONS

The Madras Musical Ass'n, PD Box 1412, 53 Sr. Iyengaray Rd., T. Nagar, Madras 600017.

DESIGN & ARTWORK**PLATING, PROCESSING & PRESSING PLANT**

The Gramophone Co. of India Ltd., PD Box 699, Calcutta 700001, 33 Jessore Rd., Dum Dum, Calcutta 700028. Tel. 57-2431. Cable: EMITRDN. Telex (021) 7007. Mng. Dir. Anil Sud. Sales Mgr. M.A. Rafique.

TAPE CUSTOM DUPLICATOR

The Gramophone Co. of India Ltd., PO Box 699, Calcutta 700001; 33 Jessore Rd., Dum Dum, Calcutta 700028. Tel. 57-2431. Cable: EMITRDN. Telex (021) 7007. Mng. Dir. Anil Sud. Sales Mgr. M.A. Rafique
Audio: 8-tr., cassette

- **supplies**

CARTRIDGE & CASSETTE PARTS

Vimal Ent's Ltd., 64 Industrial Estate, Umbergaon, Gujarat 396171 Tel. 342, 234, 338, 264. Cable: VIMALTAPE. Dir. P.H. Ganatra, Gen. Mgr. J.M. Raja, Sales Mgr. V.P. Ganatra, Exec. Eng. M. Sajjad
Audio: Cassette
Brand name: Yogesh

EMPTY CARTRIDGES, CASSETTES & REELS

Vimal Ent's Ltd., 64 Industrial Estate, Umbergaon, Gujarat 396171 Tel. 342, 234, 338, 264. Cable: VIMALTAPE. Dir. P.H. Ganatra, Gen. Mgr. J.M. Raja, Sales Mgr. V.P. Ganatra, Exec. Eng. M. Sajjad
Audio: Cassettes, reels
Brand names: Vimaltape, Yogesh

TAPE, BLANK LOADED & BULK RAW

B.A.S.F. India Ltd., PO Box 19108, Maybaker House, Sudam Kulu Ahire Marg, Bombay 400025. Tel. 463-7033 Cable: BASFIHIA Telex (011) 2538, 6223. Sales Mgr.: H.E. Kizelbosh
Audio & Video: Cassette, open reel

Electroband (India) Pvt. Ltd., 162/69 Lake Gardens, Calcutta 700045. Mng. Dir. Sankar Biswas, Dir. Krishna Biswas (Blank only)
Susmit Sangita Intermagnetics Private Ltd., 148 Hazaribagh Rd., Ranchi 834001. Contact: R.G. Poddar

Vimal Ent's Ltd., 64 Industrial Estate, Umbergaon, Gujarat 396171 Tel. 342, 234, 338, 264. Cable: VIMALTAPE. Dir. P.H. Ganatra, Gen. Mgr. J.M. Raja, Sales Mgr. V.P. Ganatra, Exec. Eng. M. Sajjad
Audio: Cassette, open reel
Brand names: Yogesh Vimaltape

- **accessories manufacturer**

The Gramophone Co. of India Ltd., PD Box 699, Calcutta 700001, 33 Jessore Rd., Dum Dum, Calcutta 700028. Tel. 57 2431/4163. Cable: EMITRDN. Telex (021) 7007. Mng. Dir. Anil Sud. Sales Mgr. M.A. Rafique.
Product: Record—replacement styli.

IRELAND

Population: 3,192,000

Rate of exchange: \$1.54 (US) = 1 pound.

Holidays: January 1, March 17 (St. Patrick's Day), Good Friday, Easter Monday, First Mondays in June & August, Last Monday in October, December 25, 26.

RECORDS:

Record sales certification awards: Note: There are no official industry figures set for the award of silver, gold or platinum disks. From time to time, awards are made by record companies. A gold disk has been given for 100,000 singles and a silver one for 25,000 singles.
Average retail price per record: LP's \$8.40; EP's—\$4.20; singles \$2.42.
Record club sales: Minimal.

Type of distribution: Manufacturer-to-wholesaler-to-retailer predominates. There are two rack jobbers.

Type of promotion: Radio, television, newspapers and magazines are the key media for promotion. There has been increased exposure for modern music with the emergence of new television (RTE 2) and radio (Radio 2) channels.

TAPE:

Market: Cassettes account for a 30% share of the record and pre-recorded tape markets.

Average retail price per tape: 8-tr. & cassette—\$8.93.

RADIO & TELEVISION STATIONS:

Radio has substantial coverage of classical and popular music, mainly recorded. The two government-operated radio and television stations cover a wide range of music. In addition, there are many pirate radio stations on the air. Some of Radio 2's disk jockeys and producers formerly worked for the pirates.

IMPORT/EXPORT REGULATIONS:

There is a 40% duty on records, plus a 10% VAT. As of May 1, 1980, there was a 25% VAT levied on cassettes.

Ken Stewart

- **record & tape manufacturers / distributors / importers**

A.R.A. see EMI.

Avoca Musical Inds. Inc., Upper Market St., Ennis, County Clare. Tel. Ennis 21644. Dir. Sylvester Keane.

Int'l branch: USA.

Labels: (Owned) Avoca, Blarney Castle, IMI

Bandbox Ltd., 3 Lower Mount St. Dublin. Tel. (01) 688-393

Blackbird Recs., 14 Hawkins St., Dublin 2. Tel. (01) 714-855. Telex: 31561

Mng. Dir.: Maurice Cassidy.

Label: (Owned) Dgham.

Blarney Castle, see Avoca.

C.B.S. Recs. (IFPI), 111 Cork St., Dublin 8. Tel. 780-133. Telex: 5724. Chief Exec. David E. Duke; Mktg. Mgr. William Kavanagh; Sales Mgr. Maurice Byrne.

Labels: (Owned) CBS, Epic, Portrait, (distributed) A&M, DJM, GTD, Island, Jel, MCA, Monument, Ronco, Stiff

C.M.R. Ltd. (IFPI), Main St., Castlepollard, Co. Westmeath. Tel. Dublin 774229, Castlepollard 61176. Gen. Mgr. & Dir. Donie Cassidy. (Distributed by Chart)

Label: (Owned) CMR.

Capitol, see EMI.

Carlton Prod's Ltd., John F. Kennedy Dr., Dublin 12. Tel. (01) 505 773. Telex: 30544. Chief Exec.: Robert McGratten; Gen. Mgr. Patrick Trundle, Sales Mgr. Vincent Smialek.

Chart Recs. Ltd., IMS House, 5 Lombard St. E., Dublin 1. Tel. (01) 713-426. Chief Exec. & Sales Mgr.: Peter D'Berne; Gen. Mgr. Noel Cusack; Secy. Mary D'Berne.

Labels: (Distributed—not licensed) ARA, Avoca, CMR, Cabaret, Circa, Dolphin, Emerald Gem, Glenside, Hawk, Heritage, Homespun, Kells, Mint, Oats, Outlet, Play, RTE, Release, Shanachie, Solo, Tara, Top Spin

Checker Recs. Ltd., IMS House, 5 Lombard St., Dublin 2.

Chyme Music Ltd. (IFPI), John F. Kennedy Dr., Dublin 12. Tel. 505-773. Telex: 30544. Chief Exec.: Robert McGratten; Gen. Mgr.: Patrick Trundle, Sales Mgr. Vincent Smialek. (Distributed by Pickwick & PolyGram)

Labels: (Owned) Chyme, (licensed foreign) Graduate (UK)
Int'l reps.: Germany (Membran), Netherlands (Sound Prods.), UK (Spartan)

Claddagh Recs. Ltd. (IFPI), Dame House, Dame St., Dublin 2. Tel. (01) 778 034/943. Chm. Gareth Browne, Gen. Mgr. Annie Henry, Sales Mgr. Kathy Marsh

Labels: (Owned) Claddagh, Phaeton, (licensed) AMR (UK), (distributed—not licensed) Celtic Music (UK), Free Reed (UK), Front Hall (USA), Gael Linn, Plant Life (UK), Sam (UK), Tara

Int'l reps.: (Licensees) Europe (Polydor), UK (CBS), USA (CBS, Shanachie); (distributors) Australia (James Taylor), Canada (Celtic), France (Keltia), Germany (Canzone), Netherlands (Sound Prods.), UK (Jazz Servs.), USA (Shanachie)

Classics for Pleasure, see EMI.

Columbia, see EMI.

Comhaltas, see Hawk.

Crashed Recs., 106/7 Middle Abbey St., Dublin 1. Tel. (01) 747-235. Mgr. Sheila Butterly.

Demesne Rec. Co. Ltd. (IFPI), 22 Ellis Quay, Dublin 7. Tel. (01) 720-411. Chm.: John M. Walsh; Mng. Dir. & Gen. Mgr. Patrick D'Neil; Dir. & Sales Mgr. Anthony McEvoy. (Distributor/Importer)

Labels: (Licensed) Prickwick (UK), (distributed—not licensed) CBS, Clad-

dagh, Denver, Dolphin, EMI, Heritage, Philips (UK), RCA (UK), Release, WEA (UK)

Dirty Nellys, see Dolphin

Dolphin Traders Ltd. (IFPI), 97-A Talbot St., Dublin 1. Tel: 777-788. Chm. & Dir.: Joseph P. O'Reilly; Dir. & Gen. Mgr. Brian J. Barker.

Labels: (Owned) Dirty Nellys, Dolphin, Spire, Truskel; (distributed—not licensed) Avoca

Int'l reps.: Canada (Boot), France (Nevez Diffusion), UK (Outlet in Northern Ireland, I&B), USA (Release).

Double Up, see EMI.

E.M.I. (Ireland) Ltd. (IFPI), Dublin Ind'l Estate, 130 Slaney Rd., Finglas, Dublin 11. Tel. (01) 309-077. Cable: EMITRDN. Telex: 24535. Dir. & Gen. Mgr.: Terry D'Rourke, Mktg. & Sales Dir.: Freddie Middleton.

Labels: (Owned) Capitol, Classics for Pleasure, Columbia, Double Up, EMI, EMI America, EMI Int'l, HMV, Harvest, Liberty-United, Music for Pleasure, One Up, Parlophone, Sovereign, Starline, Stateside, Sunset, Talsman, Waverly, World, Zonophone; (licensed) Motown, Mowest, Prudigal, Purple, RAK, Rare Earth; (distributed—not licensed) ARA, Claddagh, Dolphin, Outlet/Homespun

Emerald, see Solomon & Peres.

Epic, see CBS.

Gael-Linn, 26 Merrion Sq., Dublin 2. Tel. (01) 767-283.

H.M.V., see EMI.

Harvest, see EMI.

Hawk Recs. (IFPI), IMS House, 5/6 Lombard St., Dublin 2. Tel. (01) 774 229/220, 779-762. Mng. Dir.: Brian Molloy; Gen. Mgr.: Marcus Connaughton.

Labels: Comhaltas, Hawk, Immediate, Lunar, Misty, Nems, Opal, Puck, Ram, Stop, Target

Int'l rep.: Canada (Boot)

Tommy Hayden Ents., 12 Pembroke Rd., Ballsbridge, Dublin. Tel. (01) 789-599

Heritage, see Demesne.

Hit, see Release.

Homespun Rec'g Co., 13 Conyngham Rd., Dublin. Tel. (01) 714-688/879.

Horslips Recs. Ltd. (IFPI), 66 Dartmouth Square, Dublin 6. Tel. (01) 689-366, 689-613. Chief Exec.: Jim Slye; Gen. Mgr.: Angela Caffrey; Sales Mgr.: Sandra Clarke. (Distributed by Chart, Pickwick, Solomon & Peres)

Int'l rep.: Worldwide (Phonogram) excluding Ireland.

I.M.I., see Avoca.

Immediate, see Hawk.

Independent Music Sales, 5/6 Lombard St., Dublin 2. Tel. (01) 779-046, 720-498, 723-364. Gen. Mgr.: Gerry D'Byrne; Sales Mgr.: Peter D'Berne. (Distributor)

Labels: (Distributed) Claddagh, Hawk, Hit, Musikkelt, Nems, Dats, Outlet, Play, Prize, R&D, Ram, Release, Shaft, Solo, Tap, Top Spin

K-tel Int'l (Ireland) Ltd., 31 Ballsbridge Terr., Dublin 4. Tel. (01) 601-944. Telex: 24263. Mng. Dir.: Brendan Harvey.

Home office: USA.

Kick, see Meglo.

Liberty-United, see EMI.

Livra Recs. Ltd., 11 Chapel St., Dublin 1. Tel. 748-169/792. Dir.: Gerald Davis.

Lunar, see Hawk.

M.P.I. Recs., 39 Serpentine Ave., Dublin 4. Telex: 683638. Mng. Dir.: Philip Green.

Meglo Recs. Ltd. (IFPI), 24 Upper Fitzwilliam St., Dublin 2. Tel. (01) 681-298/065. Cable: MEGLD. Telex: 33268. Mng. Dir.: Patrick Dunne, Sales Mgr.: Michael Dunne. (Distributed by EMI, Chart, WEA)

Labels: (Owned) Kick, Meglo; (licensed) WBE (Australia)
Int'l reps.: Northern Ireland (Symphonia), UK (Spartan)

Menlo-Int'l Recs., Ballincurra, Limerick. Tel. Limerick 47375.

Mint, see Solomon & Peres.

Misty, see Hawk & Solomon & Peres.

Mulligan Music Ltd., 101 Templeogue Rd., Dublin 6. Tel. (01) 905-133.

Music for Pleasure, see EMI.

Musikkelt, see Independent Music.

Nems, see Hawk.

Oats, see Independent Music.

Official Recs., Lettercollum House, Trimoleague, Bandon County Cork.

Home Office: USA.

Ogham, see Blackbird.

Olympic Recs., 28 Gardiner Pl., Dublin. Tel. (01) 745-545

One Up, see EMI.

Opal, see Hawk.

Outlet/Homespun, see EMI.

Parlophone, see EMI.

Phaeton, see Claddagh.

Phonogram, see PolyGram.

Pickwick Recs. Ltd., 70 Dublin Ind'l Estate, Finglas, Dublin 11. Tel. (01) 308-511. Telex: 32992. Gen. Mgr.: Shay Hennessy.

Plamas Recs., 106/107 Middle Abbey St., Dublin 1. Tel. (01) 747-235. Gen. Mgr.: Sheila Butterly.

Polydor, see PolyGram.

PolyGram Recs. Ltd. (IFPI), John F. Kennedy Rd., Dublin 12. Tel. (01) 508-256. Telex: 30434. Mng. Dir.: John J. Woods; Sales Mgr.: Jim Morrissey; Admin'r.: Terry Clarkin.

Labels: (Owned) Phonogram group, Polydor group; (licensed foreign) Chrysalis group, Pye group (both UK).

Portrait, see CBS.

Puck, see Hawk.

Quartz Recs., 20 Shielmartin Dr., Sutton, Dublin 13. Tel. (01) 325-437. Mng. Dir.: Jerry Hughes, Gen. Mgr.: Peter J. John.

R.C.I., see The Record Company of Ireland

R & D, see Independent Music.

Ram, see Hawk.

The Record Company of Ireland, 66 Dartmouth Square, Dublin 6. Tel. (01) 689-366/613. Chief Exec.: Jim Slye, Gen. Mgr.: Angela Caffrey, Sales Mgr.: Sandra Clarke. (Distributed by Chart, Pickwick, Solomon & Peres)

Release Recs. Ltd. (IFPI), 5/6 Lombard St., Dublin 2. Tel. (01) 779-046, 784-529/182. Mng. Dir.: Michael Clerkin; Gen. Mgr.: Michael D'Riordan

Int'l branch: USA

Labels: (Owned) Hit, Release, Solo, (represented) Ritx (UK)
Int'l reps.: Netherlands (Sound Prods.), UK (I & B. Spartan), USA (Release)

Rip-Off, see Solomon & Peres.

Shaft, see Independent Music.

Siemens (Ireland) Ltd., 49 Middle Abbey St., Dublin 1. Tel. (01) 49975. Sales Mgr.: J. D'Donnell.

Solo, see Release.

Solomon & Peres Ltd., Dublin Ind'l Estate, 106-B, Finglas, Dublin 11. Tel. (01) 309-922. Telex: 30937. Mng. Dir.: Mervyn A. Solomon, Gen. Mgr.: Shay Hennessy.

Home office: Northern Ireland in UK.

Labels: (Owned) Emerald, Mint, Rip Diff; **(distributed—not licensed)** Ar cade, Charley, Chiswick, Decca, Ember, Enterprise, Galaxy, Logo, RCA, Stiff, WEA (all UK), Claddagh, Hawk, Misty, Release

Sovereign, see EMI
Spider Recs Ltd., 12 Pembroke Rd., Dublin 4 Tel: (01) 789 599/606. 600 527 Dirs. Tony Byrne, Louis Walsh, Tommy Hayden (Distributed by CBS)

Spin Recs Ltd., Bree, Castleblayney, Monaghan Tel: (042) 31822 Mng Dir. Kevin Ward

Label: (Owned) Top Spin
Int'l repts.: Netherlands (Sound Prods.), Scandinavia (Calle Nielson Randers), UK (England-I&B, Northern Ireland-Dutlet, Scotland-Clyde Factors, Ross)

Spire, see Dolphin
Starline, see EMI
Stateside, see EMI

Stop, see Hawk
Sunset, see EMI
Sympho Co Ltd., 56 Harcourt St., Dublin 2 Tel: (01) 758 523 Cable EIRE

Home office: Northern Ireland in UK

Labels: (Owned) Spin, (represented) DJM

Talisman, see EMI
Tap, see Independent Music
Tara Ents Ltd., 5 Tara St., Dublin 2 Tel: (01) 776 921, 771 650 Telex 32618 Mng. Dir. John Cook

Labels: (Owned) Tara, (distributed—not licensed) Shanachie (USA)
Int'l repts.: Australia (Counterpoint), France (Kelta), Germany (Eu lenspiegel), Italy (IRD), Netherlands (Sound Prods.), UK (Relay), USA (Rounder, Shanachie)

Target, see Hawk
Topspin, see Spin & Independent Music
Triskel, see Dolphin

W E A Recs. (Ireland) Ltd. (IFPI), Dublin Ind'l Estate, 130 Slaney Rd., Finglas, Dublin 11, Tel: (01) 309 069. Telex: 24535. Gen. Mgr. Clive Hudson;
Promo & A&R: Chris Roche, Sales Mgr. Brian Wynne
Waltons Music Ltd., 2-5 N. Frederick St., Dublin Tel: (01) 747 805

Waverley, see EMI
World, see EMI
Zonophone, see EMI

• music publishers

Bandbox Ltd., 3 Lower Mount St., Dublin Tel: (01) 688 393
Bardis Music Ltd., 2 Carleton Terr., Novara Rd., Bray, Co. Wicklow Tel: (01) 862 074, 867 802. Mng. Dir. Peter Bardon

Briar Music, see Swing
Castle Music, Main St., Castlepollard, Co. Westmeath Tel: Dublin 774229
Castlepollard 61176 Chief Exec. Donie Cassidy

Celtic Songs, 97A Talbot St., Dublin 1 Tel: 777 788 Mng. Dir. Brian J. Barker; Gen. Mgr. Maureen McNamee

Int'l repts.: Canada (Morning)
Dark Fox Music, 106/107 Middle Abbey St., Dublin 1 Tel: (01) 747 235 Mng. Dir. Johnny Lappin

Emerald Music, Dublin Ind'l Estate, 106 B, Finglas, Dublin 11 Tel: (0001) 309 922/209. Gen. & Sales Mgr. Louis Solomon

Home office: Northern Ireland in UK
Int'l firms represented: Aesop's Fable (USA), Jumping Jade (USA), SPR (USA)

Int'l repts.: Australia (Leeds), France (Nouvelles, DK), South Africa (Inter song), Ddsysey (USA)

Emtune, Dublin Ind'l Estate, 130 Slaney Rd., Finglas, Dublin 11, Tel: 309 077 Cable EMITRDN Telex 24535 Dir. & Gen. Mgr. Terry D'Rourke

Emma Music Ltd., 5/6 Lombard St., Dublin 2 Tel: (01) 784 420 Mng. Dir. Michael Clerkin; Gen. Mgr. Michael D'Riordan

Int'l firms represented: Forest (Netherlands), King of Music (USA), Morning (Canada), Quartermass (UK), Radar (UK), Valentine group (UK), Vanilla (UK)

Green Grass Music (MCPS, PRS), Carrick Rd., Drumshanbo, County Leitrim Tel: Drumshanbo 13, Dublin 305118

Int'l firms represented: Bocu (UK), Contention (USA), Hello Darlin' (USA), Kelly & Lloyd (USA), Mick Lloyd (USA), Ricci Mareno (USA), Morn ing (Canada)

Int'l repts.: USA (Mick Lloyd)
Keady Music, 14 Hawkins St., Dublin 2 Tel: (01) 714 855 Telex 31561 McCullough Pigott Ltd., 11/13 Suffolk St., Dublin 2 Tel: (01) 773 138/161

Meglo Music Ltd. (MCPS), 24 Upper Fitzwilliam St., Dublin 2 Tel: (01) 681 298/065, 941 536 Cable MEGLED Telex 33268 Mng. Dir. Patrick Dunne

Int'l firms represented: Festival, Tumbleweed (both Australia)
Mid Music, 5 Tara St., Dublin 2 Tel: (01) 776 921, 771 650. Telex 32618 Mng. Dir. John Cook

Music Publ'rs of Ireland, 35 Westland Row, Dublin Tel: (01) 762 024
Dism. Music, 14 Hawkins St., Dublin 2 Tel: (01) 714 409 Mng. Dir. Shay Healy

Raglan Music, J.F. Kennedy Rd. Dublin 12 Tel: (01) 508 256 Telex 30434 Chief Exec. John J. Woods

Int'l firm represented: Chappell Int'l (UK)
Int'l repts.: Worldwide (Chappell Int'l)

Regina Music, 9/10 Hanover St. E. Dublin 2 Tel: (01) 784 755 Gen. Mgr. Michael H. Geoghegan, Promo Mgr. Phyl Mitton

Saint Music, 20 Shielmartin Dr., Sutton, Dublin 13 Tel: (01) 325 437 Mng. Dir. Pete St. John, Gen. Mgr. Jerry Hughes

Sally Ann Songs, 20 Shielmartin Dr., Sutton, Dublin 13 Tel: (01) 325 437 Mng. Dir. Jerry Hughes; Gen. Mgr. John Cook

Int'l repts.: Worldwide (Campbell Connelly)
Soodlum Music Co., 153 Downpatrick Rd., Crumlin, Dublin 12

Spider Music Ltd., 12 Pembroke Rd., Dublin 4, Tel: (01) 789 237/371
Squirrel Music, IMS House, 3 Lombard St., Dublin 2 Tel: (01) 774 229, 779 762 Mng. Dir. Brian Molloy, Gen. Mgr. Marcus Connaughton

Swing Music, 56 Moore St., Dublin 1 Tel: (01) 729-998 Gen. Mgr. Marcus Connaughton

Three Two Music Ltd., 26 Bigger Rd., Dublin 12 Tel: (01) 501 139 Gen. Mgr. John McBrean

Verno Ltd. (MCPS, PRS), 7 Cowper Dr., Dublin 6 Tel: (01) 973 722 Mng. Dir. Bill Whelan

Waltons Music Ltd., 2-5 N. Frederick St., Dublin Tel: (01) 747 805

Woodtown Music Publ'ns Ltd., Woodtown Manor, Rathfarham, Dublin 16. Tel: (01) 778-034. Chm. Garech Browne; Sec'y Jane Bolton

• services

ASSOCIATIONS & PROFESSIONAL ORGANIZATIONS

The Arts Council, 70 Merrion Square, Dublin 2 Tel: (01) 764 685 Dir. C. D'Brien

International Songwriters Ass'n Ltd., Raheen, Limerick City Tel: (061) 28837 Chm. James D. Liddane

Irish Ballrooms & Bands Ass'n, 62 Catherine St., Limerick Tel: 49678 Mgr. Edna D'Riordan

Irish Federation of Musicians & Assoc'd Professions, 63 Lower Gardiner St., Dublin 1 Tel: (001) 744 645

Irish Music Inds., 15 Herbert St., Dublin 2 Tel: 766-940 Gen. Mgr. Michael D'Riordan

Irish Nat'l Group of IFPI, c/o Gael Linn Recs., 26 Merrion Sq., Dublin 2 Tel: (01) 767-283

R I M P A (Republic of Ireland Music Publ'rs Ass'n), 15 Herbert St., Dublin 2 Tel: (01) 766-940 Chm. Michael D'Riordan; Sec'y: Vincent Smialek, Pr. Johnny Lappin

Republic of Ireland Music Publ'rs Ass'n, see RIMPA

CATALOG SERVICES

Abbey Music Ltd., 70 Middle Abbey St., Dublin 1 Tel: (01) 787 177/251/292/393 Chief Exec. Raymond J. Kelly, Gen. Retail & Sales Mgr. Roy Watson Cooper

Solomon & Peres Ltd., Dublin Ind'l Estate, 106 B, Finglas, Dublin 11, Tel: (01) 309 922 Telex: 30937 Mng. Dir. Mervyn A. Solomon, Gen. Mgr.: Shay Hennessy

LICENSING ORGANIZATIONS, MUSIC
M C P S (Mechanical Copyright Protection Society) Ltd., 15 Herbert St., Dublin 2 Tel: 766-940/996 Gen. Mgr. David Buskell

P R S (Performing Right Society) Ltd., 15 Herbert St., Dublin 2 Tel: 767 388, 761-181 Mgr. Pat Condon

PLATING, PROCESSING & PRESSING PLANTS
Carlton Prod'ns Ltd., John F. Kennedy Dr., Naas Rd., Dublin 12 Tel: (01) 505-773 Cable DISCTAPE Telex 30544 Mng. Dir. Robert McGrattan; Gen. Mgr. Patrick Trundle, Sales Mgr.: Vincent Smialek

Audio: Cassette
RECORD PROMOTION
Marcus Connaughton, 56 Moore St., Dublin 1 Tel: (01) 729 998

E M I (Ireland) Ltd., Dublin Ind'l Estate, 130 Slaney Rd., Finglas, Dublin 11, Tel: 309 077 Cable EMITRDN Telex 24535 Dir. & Gen. Mgr.: Terry D'Rourke, Mktg. & Sales Dir. Freddie Middleton

Music Mktg., 71 Middle Abbey St., Dublin 1 Tel: (01) 742 627, 851 128 Enda D'Riordan Promo., Entertainment & Pub., 62 Catherine St., Limerick. Tel: (061) 49678, 42265

Solomon & Peres Ltd., Dublin Ind'l Estate, 106 B, Finglas, Dublin 11, Tel: (01) 309 922 Telex: 30937 Mng. Dir. Mervyn A. Solomon, Gen. Mgr.: Shay Hennessy

TAPE CUSTOM DUPLICATORS
Apex Electrical Co. Ltd., 56 Moore St., Dublin 1 Tel: 729 998 Chief Exec. Joseph P. D'Reilly, Gen. Mgr. Maureen McNamee, Sales Mgr. Peter Doyle

Audio: Cassette
Carlton Prod'ns Ltd., John F. Kennedy Dr., Naas Rd., Dublin 12 Tel: (01) 505-773 Cable DISCTAPE Telex 30544 Mng. Dir. Robert McGrattan; Gen. Mgr. Patrick Trundle, Sales Mgr.: Vincent Smialek

Audio: Cassette
Contek Teoranta, Carraroe, County Galway Tel: Galway 72144. Mng. Dir.: Dr. P. Garvey

Audio: cassette, open reel

• supplies
CARTRIDGE & CASSETTE PARTS
EMPTY CARTRIDGES, CASSETTES & REELS
PROFESSIONAL TAPE SUPPLIES
TAPE, BLANK LOADED & BULK RAW

Agia Gevaert Ltd., PD Box 368A, John F. Kennedy Dr., Naas Rd., Dublin 12. Tel: (01) 506-733 Telex 5429 Mng. Dir. Mr. Vervoort, Sales Mgr. Mr. Eggers

Audio: Blank—compact cassette, open reel, raw—cassette, broadcast, studio

Video: Cassette, open reel
Brand names: Agia Carat, Agia Stereochrom, Agia Videochrom

Denis Coakley Ltd., Clonee, County Meath. Tel: (01) 214-011. Cable DECD Telex: 5277 Gen. Mgr.: Mervyn Groves (Raw & blank loaded tape only)

Audio: Blank—cassette, open reel, raw—cassette
Video: Blank—"I" open reel, "4" U-Matic, "4" Beta & VHS cassette, LVC
Brand name: BASF

Contek Teoranta, Carraroe, County Galway Tel: Galway 72144. Mng. Dir.: Dr. P. Garvey (Blank loaded tape only)
Branch: England

Audio: Cassette
Brand names: Audio Gold Int'l, Contek UHE

• accessories
manufacturers / Importers

Abbey Music Ltd., 70 Middle Abbey St., Dublin 1 Tel: (01) 787 177/251/292/393 Chief Exec. Raymond J. Kelly, Gen. Retail & Sales Mgr. Roy Watson Cooper

Product: Record—carrying & storage cases, record care prods., replacement styli; Tape—head cleaners, demagnetizers, leader & splicing tape

Contek Teoranta, Carraroe, County Galway Tel: Galway 72144. Mng. Dir.: Dr. P. Garvey
Branch: England

Product: Tape—head cleaners, demagnetizers, leader & splicing tape.
Demesne Recs Ltd., 22 Ellis Quay, Dublin 7 Tel: (01) 720-411 (Distributor/Importer)

Product: Tape—carrying & storage cases
Independent Music Sales, 5/6 Lombard St., Dublin 2 Tel: (01) 779-046. Gen. Mgr. Gerry D'Byrne; Sales Mgr. Peter D'Byrne

Product: Record—record care prods.; Tape—carrying & storage cases, head cleaners, demagnetizers

Solomon & Peres Ltd., Dublin Ind'l Estate, 106 B, Finglas, Dublin 11, Tel: (01) 309 922 Telex: 30937 Mng. Dir. Mervyn A. Solomon; Gen. Mgr.: Shay Hennessy

Product: Record—carrying & storage cases, record care prods., 45 rpm adapters, replacement styli; Tape—carrying & storage cases, head cleaners, demagnetizers, leader & splicing tape

• store fixtures
manufacturers / Importers

Abbey Music Ltd., 70 Middle Abbey St., Dublin 1 Tel: (01) 787 177/251/292/393 Chief Exec. Raymond J. Kelly, Gen. Retail & Sales Mgr.: Roy

Watson Cooper

Product: Tape display racks

August Engraving Co. Ltd., 9 Burgh Quay, Dublin 2 Tel: (01) 719-275/688

Mng. Dir. Tony Byrne

Product: Record & tape divider cards

ISRAEL

Population: 3,820,000

Rate of exchange: \$1 (US) = 11.4 shekels

Per capita income: \$3,675

Holidays: (Note: Holidays begin at sundown of the preceding evening.)
Passover week, April 21 (Independence Day), May 21 (Shavuot), July 22 (Tisha B'Av), September 11 & 12 (Jewish New Year/Rosh Hashanah), September 20 (Day of Atonement/Yom Kippur), September 25 (Sukkot), October 3 (Simhat Torah)

• record & tape manufacturers / distributors / Importers

Amir & Efrat, see Isradisc

Arton, see Hed Arz

C B S Recs. Ltd. (IFPI), PO Box 681, Tel Aviv 61006; 50 Thon St., Industrial Zone, Holon 58811 Tel: (972 3) 80 01 91. Cable: CDLRECDRD Telex: 33422 Mng. Dir.: Daniel Yadin; Bus. Affairs Mgr.: Ronald Cole, Mktg. Dir.: Ronnie Braun; Int'l A&R: Tony Godot; Int'l Serv. Co-ord.: Jennifer Aruch; Sales Mgr.: Dave Meyerson

Reg'l branch: Cyprus, CBS (UK) Ltd.
Labels: (Owned) CBS, Embassy, Epic, Portrait; (Licensed) ABC (USA), A&M (worldwide), ARC (USA), Angel (UK), Bang (USA), Blue Sky (USA), CGD (Italy), Capitol (USA), Caribou (USA), Carrere (France), Cleveland Int'l (USA), GTD (UK), Handshake (USA), Jet (USA), Kirschner (USA), Liberty (UK, USA), MCA (USA), Monument (USA), PIR (USA), Polar (Sweden), Salsoul (USA), Sire (USA), Saltil (UK, TK (USA), Tabu (USA), Tappan Zee (USA), T-Neck (USA)

Int'l repts.: Worldwide (CBS)

Carmel, see Hataklit
Chimo, see K-tel
D R G, see Gal-Ron

Disneyland, see Hataklit
Dzigan, see Gal-Ron

Eastrones Ltd. (IFPI), PO Box 39300, 11 Rozans St., Tel Baruch, Tel Aviv 61392 Tel: (03) 47-51-51 Cable: EASTRONIX Telex: 33638 Mng. Dir.: Dov Peleg; Sales Mgr.: Joseph Shoam

Labels: (Owned) Maestro, (represented) Acanta (Germany), Affinity (UK), Avatar (UK), CTI (USA), Charly (UK), Cream (USA), Erato (France, UK), Grunt (USA), Harmonia Mundi (Germany), Hi (USA), Inner City (USA), Logo (UK), MMD (USA), Motown (USA), RCA (worldwide), 20th Century-Fox (USA), Vanguard (USA)

Embassy, see CBS
Epic, see CBS
F H M M, see Gal-Ron

Folk 2000, see Hataklit
Gal & Moyal, see Unatech

Gal-Ron Ltd. (IFPI), 10 Sheinkin St., Tel Aviv Tel: (03) 28 07 39, 28 89-01. Cable: ZELREX Telex: 341118 Gen. Mgr.: A. Zborowski; Sales Mgr.: I. Levi

Labels: (Owned) DRG, Dzigan, Gal-Ron, Gloria, Ron-Phon; (distributed) FHMM, Studio; (licensed) Evasion (Switzerland), Festival (France), GSF (USA), MK (USSR), Motors (France), DSI (France), Ri-Fi (Italy), Sonoplay (Spain), Victor (Japan)

Gal-Ton, see Gal-Ron
Gloria, see Gal-Ron

Good Music, see Hataklit
Hataklit Ltd. (IFPI), PO Box 4292, 11 Herzl St., Haifa Tel: (04) 64-55-21, 66-99-50. Cable: RECDMUSIC Telex: 46400 Mng. Dir.: Dov Zeira; Gen. Mgr.: Sara Zeira, Int'l A&R Mgr.: Gedi Livneh; Sales Mgr.: Henri Teicher

Branch: Tel Aviv, 19 Pinskyer St. Tel: (03) 29-30-08, 28-31-17. A&R Mgr.: Zvi Kagan

Labels: (Owned) Carmel, Disneyland, Folk 2000, Good Music, Idan, Ilanot, Krypton, Moody Sound, Teen, Top Hits, Top Sound; (Licensed) Alshire (USA), Archive of Folk & Jazz Music (USA), Archive of Piano Music (USA), BBZ (France), Biram (France), Clave (Spain), Concert Disk (USA), Contempo (UK), Counterpoint (USA), Esoteric (USA), Gavotta (Spain), Hi-Fi (USA), Hispavox (Spain), La Comedia Francaise (USA), Legacy (USA), Mashine (France), Milestone (USA), Mode (France), Olympic (USA), Palette (Belgium), Period (USA), RKM (Belgium), Roulette (USA), Topkapi (France), Tradition (USA), Up (Belgium), Vogue (France)

Int'l repts.: Benelus (RKM), France (Vogue), Netherlands (CNR), USA (House of Menorah)

Hazamir Music Ltd. (IFPI), 68 Jaffa St., Jerusalem Tel: (02) 23-31-46. Telex: 44801 Mng. Dir. & Gen. Mgr. Eli Mamane; Promo. Dir.: Ramy Levy. (Distributed by Hataklit)

Label: (Distributed—not licensed) Metronome (Germany)

Hed Arzi, The General Music Co. Ltd. (IFPI), 4 Hilon St., Ramat Gan 52522 Tel: (03) 72-20-03 Cable: HEDARZI Telex: 341667 Mng. Dir.: Zeev Lewin; Deputy Mng. Dir.: Ernest Stroh; Int'l Mgr.: Avi Brand

Labels: (Owned) Arton, Hed Arzi; (Licensed) Ariola (Germany), Arista (USA), Atlantic (USA), Double Dee (UK), Elektra/Asylum (USA), Fonit-Cetra (Italy), Gefen (USA), Red Bus (UK), Virgin (UK), WEA (USA), Warner Bros. (USA)

Idan, see Hataklit
Ilanot, see Hataklit

Isradisc Ltd., PO Box 230, 8 Smolenskin St., Tel Aviv Tel: (03) 23-48-38, 24-91-93. Cable: PALORIENT Pres.: Absalom Rubin, Gen. Mgr.: Nessim Yoseph; Sales Mgr.: Amos Barzel, Prod'n Mgr.: Zeev Ullman

Labels: (Owned) Amir & Efrat, Isradisc, Israel
Int'l repts.: House of Menorah (USA)

Israel, see Isradisc
K-tel Int'l (Israel) Ltd., Harugey Maichut 7, Tel Aviv 69714 Tel: (03) 48-31-65. Cable: ISRALCTRA Telex: 922-46621 A&R & Promo. Mgr.: Uri Coheu

Labels: (Owned) Chimo, K-tel, Orange, (Licensed foreign) Can't Stop (USA), Chrysalis (UK), DJM (UK), Hansa (Germany), Island (UK), Stiff (UK), 2 Tone (UK)

Int'l repts.: Worldwide (K-tel)
Koliphone Recs., 29 Raquel St., Jaffa Tel Aviv Tel: (03) 82-60-47, 83-23-70

Kolton, see Unatec.
 Krypton, see Hatakhit.
 Litratone Ltd. (IFPI), 7 Harugey Malchut St., Tel Aviv 69714. Tel: (03) 48-31-64. Cable: ISRALECTRA. Telex: 922-46622. Mng. Dir.: David Fuchs. Labels: (Owned) Phonod, Rec-O-Hit, Shai; (Licensed) Amadeo (Austria), Archiv (Germany), Barclay (France), Capricorn (USA), Casablanca (USA), Charisma (UK), Cube (UK), DG (Germany), Fontana (France, UK), Haven (USA), Heliodor (Germany), MGM (USA), Mercury (France, USA), Metro-nome (Germany), Philips (France, Netherlands, USA), Polydor (Germany), RSD (UK, USA), Rocket (UK), Track (UK), Vertigo, Veve (USA)
 Int'l rep.: Worldwide (PolyGram).

Maestro, see Eastronics.
 Moody Sound, see Hatakhit.
 Orange, see K-tel.
 Phonod, see Litratone.
 Portrait, see CBS.
 Rec-O-Hit, see Litratone.
 Ron-Phon, see Gal-Ron.
 Shai, see Litratone.
 Studio One, 33 Allenby Rd., Tel Aviv. Tel: (03) 5 66-56. (Distributed by Gal Ron)
 Label: (Owned) Studio
 Teen, see Hatakhit.
 Top Hits, see Hatakhit.
 Top Sound, see Hatakhit.
 Unatec Import Export Ltd. (IFPI), PO Box 2467, 29 Lilienblum St., Tel Aviv Tel: (03) 65-57-76, 65-98-41. Cable: UNAIMEX. Telex: 35770. Gen. Mgr. Jerry Janowski, Sales Mgr. Ronnie Janowski
 Labels: (Owned) Gal & Meytal, Kolton; (Licensed foreign) Audiofidelity (USA), Baerenreiter (Germany), Carosello (Italy), Europa (Germany), Gold (Switzerland), Lollipop (Germany), MPS (Germany), Maritim (Germany), Panarecord (Italy), Saar (Italy), Tel'unken (Germany), Turca phon (Switzerland).

• music publishers

April Music Ltd. (ACUM), PO Box 681, Tel Aviv 61006; 50 Thon St., Industrial Zone, Holon 58811. Tel: (972-3) 80-01-91. Cable: CDRECORD. Telex: 33422. Gen. Mgr. Ronald Cole
 Int'l firms represented: ABC/Dunhill (USA), JTV (UK), April/Blackwood (worldwide), Boom (USA), Chandos (USA), Gabriel Earl (USA), Hammond (USA), Hudmar (USA), Joetsongs/Impulsive (USA), Kirshner (USA), Northern Songs (UK), Rock (USA), Rondo Irving/Almo (UK, USA), Sheryl (USA), Tuna Fish (USA), Union (Sweden), Lawrence Wright (UK)
 Int'l rep.: Worldwide (April/Blackwood).

I C L P (Israel Composers League Publ'ns Ltd.), 73 Nordau Blvd., Tel Aviv Tel: (03) 44-03-95

Ilanot Music Publ'g, PO Box 4292, 11 Herzl St., Haifa. Tel: (04) 66-99-50, 64-55-21. Cable: RECDMUSIC HAIFA. Telex: 46400. Mng. Dir.: Dov Zeira.
 Int'l firms represented: Abigail (USA), Alshire group (USA), Bleu Blanc Rouge (France), Cayman (USA), Cheshire (USA), Cissy (USA), Dava (USA), Walt Disney (USA), Heath Levy (UK), Ladysmith (UK), Minotaure (France), RKM (Belgium), Rocket (UK), Wonerland (USA).

Israeli Music Publ'ns Ltd. (ACUM), PO Box 6011, Tel Aviv 61060, 105 Rehov Ben Yehuda, Tel Aviv. Tel: (03) 23-20-78. Cable: ISMUSICA
 Int'l firms represented: Bote & Bock (Germany), Breitkopf (Germany), Carisch (Italy), Curci (Italy), Durand (France), Eschig (France), Faber (UK), Hans Gerig (Germany), Heinrichshofen-Impero-Pegasus (Germany, Switzerland), Leduc (France), Dxford Univ. Press (UK), Schott (Germany, UK), Hans Sikorski (Germany), Zimmermann (Germany).
 Int'l reps.: Germany, Scandinavia (both Impero-Verlag), Benelus, France, Portugal, Spain & UK (all Peters-London); Italy (Carisch), USA (Theodore Presser).

Israel Music Institute (IMI), PO Box 11253, 6 Chen Blvd., Tel Aviv 64071. Tel: (03) 28-43-97. Mng. Dir.: William Y. Elias.
 Int'l firms represented: Baerenreiter (West Germany), Ricordi Americana (Argentina), G. Ricordi (Italy).

Int'l reps.: Argentina (Ricordi Americana), Austria (Universal), Canada (Boosey & Hawkes), Denmark (Wilhelm Hansen), France (Boosey & Hawkes), Germany (Baerenreiter), Italy (G. Ricordi), Netherlands (Alber sen), Norway (Harald Lyché), Sweden (Nordiska), Switzerland (Jecklin), UK (Universal), USA (Boosey & Hawkes).

Isratav, PO Box 230, 8 Smolenskin St., Tel Aviv. Tel: (03) 23-48-38, 24-91-93. Pres. Absalom Rubin, Gen. Mgr. Edna Rubin

Israzem Music Publ'g Ltd., see Ilanot.
 Litratone Publ'g Ltd., 7 Harugey Malchut St., Tel Aviv 69714. Tel: (03) 48-31-64. Cable: ISRALECTRA. Telex: 922-46621. Mng. Dir.: David Fuchs, Mgr. Ilana Cohen Zedeck.

Int'l firms represented: Artemis, Chappell, Intersong
 Music Library, Culture & Education Ents. Ltd., General Federation of Labor, 53 Weitzman St., Tel Aviv. Tel: (03) 21-91-83. Gen. Mgr. Sami Zur
 Muscor Ltd., 11 Rozanis St., Tel Baruch, Tel Aviv E1392. Tel: (03) 47-51-51. Cable: EASTRONIX. Telex: 33638. Dir.: Dov Peleg.
 Int'l firms represented: Birdce, Butler, Carex, Churn, Cream, East/Memphis, Fi, Jec (all USA).

Noga, PO Box 4025, Jerusalem

Osnat Publ'g Ltd., 4 Hilazon St., Ramat Gan 52-52. Tel: (03) 72203. Cable: HEDARZI. Telex: 341677. Mng. Dir.: Zeev Lewin, Prof. Mgr.: Ernst Stroh

Pa'amoni, see Subar.
 Sharon, see Subar.

Subar Music Publ'g Co. Ltd. (ACUM), 21 Any Ma'armin St., Ramat Hasharon 47212. Tel: (03) 47-13-23. Gen. Mgr. Dr. Optira Bar Eilan
 Int'l firms represented: Charing Cross (USA), Playboy (USA), Screen Gems EMI (USA), Sparta Florida (UK), Sugarmusic (Italy), Suvini Zerboni (Italy), United Artists group (USA), World (Belgium).

• services

ASSOCIATIONS & PROFESSIONAL ORGANIZATIONS

International Society for Contemporary Music, League of Composers in Israel, PO Box 11180, Tel Aviv. Tel: (03) 44-03-35

Israeli Centre of the International Music Council, PO Box 176, Jerusalem

Israeli Music Information Centre (SMIC), PO Box 1253, 6 Chen Blvd., Tel Aviv 64071. Tel: (03) 28-43-97. Mng. Dir.: William Y. Elias

Israeli Music Institute (IMI), PO Box 11253, 6 Chen Blvd., Tel Aviv 64071. Tel: (03) 28-43-97. Mng. Dir.: William Y. Elias

LICENSING ORGANIZATION, MUSIC

A C U M (Authors, Composers & Music Publ'ns Ass'n), PO Box 14220, 118/120 Rothschild Blvd., Tel Aviv 61140. Tel: (03) 24-01-15. Cable: ACU MEMIS. Telex: 35770. Dir. Gen. Ran Kedat; Gen. Sec'y: J. Ben-David

PLATING, PROCESSING & PRESSING PANTS

C B S Recs. Ltd., PO Box 681, Tel Aviv 61006; 50 Thon St., Industrial Zone, Holon 58811. Tel: (972-3) 80-01-91. Cable: CDRECORD. Telex: 33422

Mng. Dir.: Daniel Yadin; Mfg. & Whse. Dir.: Gabriel Renitzky.
 Hed Azzi, The General Music Co. Ltd., 4 Hilazon St., Ramat Gan 52522. Tel: 72-20-03. Cable: HEDARZI. Telex: 341667. Mng. Dir.: Zeev Lewin.

PRINTER & LITHOGRAPHER

C B S Recs. Ltd., PO Box 681, Tel Aviv 61006; 50 Thon St., Industrial Zone, Holon 58811. Tel: (972-3) 80-01-91. Cable: CDRECORD. Telex: 33422. Mng. Dir.: Daniel Yadin, Mfg. & Whse. Dir.: Gabriel Renitzky.

TAPE CUSTOM DUPLICATORS

TAPE PACKAGING & LABELING

The Audio and Video lines indicate the configurations which the firms duplicate. Companies which offer packaging and labeling of tape product are indicated by "(PRG)" which appears after the main body of their respective listings.

C B S Recs. Ltd., PO Box 681, Tel Aviv 61006; 50 Thon St., Industrial Zone, Holon 58811. Tel: (972-3) 80-01-91. Cable: CDRECORD. Telex: 33422. Mng. Dir.: Daniel Yadin, Mfg. & Whse. Dir.: Gabriel Renitzky.
 Audio: Cassette.

Domain Magnetics Ltd., PO Box 27085, Tozeret St., Jerusalem. Tel: (02) 85-22-80. Telex: 26431. Dir.: Warren Green, Mktg./Sales Dirs.: F.G. Kinney, David Sable. (PRG-audio only)
 Audio: Cassette

Hed Azzi, The General Music Co. Ltd., 4 Hilazon St., Ramat Gan 52522. Tel: 72-20-03. Cable: HEDARZI. Telex: 341667. Mng. Dir.: Zeev Lewin
 Audio: 8-tr., cassette

M D T Cassettes Dupl'g & Rec'g Studio Ltd., Industrial Center, Maskith St., Herzelia B. Tel: (052) 58619. Telex: 341667. Mng. Dir.: Moshe Sadan

• supplies

CARTRIDGE & CASSETTE PARTS

Domain Magnetics Ltd., PO Box 27085, Tozeret St., Jerusalem. Tel: (02) 85-22-80. Telex: 26431. Dir.: Warren Green, Mktg./Sales Dirs.: F.G. Kinney, David Sable
 Audio: Cassette, open reel

EMPTY CARTRIDGES, CASSETTES & REELS

Domain Magnetics Ltd., PO Box 27085, Tozeret St., Jerusalem. Tel: (02) 85-22-80. Telex: 26431. Dir.: Warren Green, Mktg./Sales Dirs.: F.G. Kinney, David Sable
 Audio: Cassette, open reel

Palatchi & Co., PO Box 36572, Tel Aviv, 111 Allenby St., Tamar Passage. Tel: (03) 61-56-14. Telex: 341118/For x 5998. Mng. Dir.: Isaac E. Palatchi, Gen. Mgr.: Yakov Bensinyor; Sales Mgr.: Rosette Palatchi (Importer/Exporter)
 Audio: Cassette.

ENVELOPES & MAILERS
 Unatec Import Export Ltd., 29 Lilienblum St., Tel Aviv. Tel: (03) 65-57-76, 65-98-41. Cable: UNAIMEX. Gen. Mgr.: Jerry Janowski; Sales Mgr.: Ronnie Janowski. (Importer/Exporter)

JACKETS & SLEEVES
 LABELS, DISK
 C B S Recs. Ltd., PO Box 681, Tel Aviv 61006; 50 Thon St., Industrial Zone, Holon 58811. Tel: (972-3) 80-01-91. Cable: CDRECORD. Telex: 33422. Mng. Dir.: Daniel Yadin, Mfg. & Whse. Dir.: Gabriel Renitzky.

Unatec Import Export Ltd., 29 Lilienblum St., Tel Aviv. Tel: (03) 65-57-76, 65-98-41. Cable: UNAIMEX. Gen. Mgr.: Jerry Janowski; Sales Mgr.: Ronnie Janowski. (Importer/Exporter)

PROFESSIONAL TAPE SUPPLIES
 Domain Magnetics Ltd., PO Box 27085, Tozeret St., Jerusalem. Tel: (02) 85-22-80. Telex: 26431. Dir.: Warren Green, Mktg./Sales Dirs.: F.G. Kinney, David Sable.
 Audio: Cassette Boxes.

TAPE, BLANK LOADED & BULK RAW
 Agla-Gevaert, see S. Getter

Domain Magnetics Ltd., PO Box 27085, Tozeret St., Jerusalem. Tel: (02) 85-22-80. Telex: 26431. Dir.: Warren Green, Mktg./Sales Dirs.: F.G. Kinney, David Sable.
 Audio: Cassette, open reel.
 Brand names: Domain, Opus.

S. Getter (Photo) Ltd., 98 Jabotinsky Rd., Petah Tikva, Kiryat Arje. Tel: 92-69-12. Cable: GETTERCD TELAVIV. Mng. Dir.: Paul Heger.
 Audio: Blank—Compact cassette, open reel, raw—cassette, broadcast, studio.
 Video: Cassette, open reel.

Brand names: Agla Carat, Agla Stereochrom, Agla Videochrom
 Dpus, see Domain.

Palatchi & Co., PO Box 36572, Tel Aviv, 111 Allenby St., Tamar Passage. Tel: (03) 61-56-14. Telex: 341118/For x 5998. Mng. Dir.: Isaac E. Palatchi, Gen. Mgr.: Yakov Bensinyor; Sales Mgr.: Rosette Palatchi (Importer/Exporter)
 Audio: Blank—cassette, open reel; Raw—cassette
 Video: Blank—"b" Beta & VHS cassette.
 Brand names: Ana, G-Tape, Dpus, cassette.

TAPE DUPLICATING & PROCESSING EQUIPMENT
 Comhol Ltd., PO Box 39840, 24 Feinberg St., Tel Aviv. Tel: (03) 22-49-22, 41-03-40. Telex: 341118 X 5518. Mng. Dir.: Eddie Wiegandfeld (Importer)
 Audio: High speed duplicators, 8 tr. & cassette loaders & tape exercisers
 Brand names: Audiomatic, Electro Sound, Pentagon.

• accessories
 manufacturers
 Domain Magnetics Ltd., PO Box 27085, Tozeret St., Jerusalem. Tel: (02) 85-22-80. Telex: 26431. Dir.: Warren Green; Mktg./Sales Dirs.: F.G. Kinney, David Sable

Product: Tape—head cleaners, demagnetizers, leader & splicing tape
 Palatchi & Co., PO Box 36572, Tel Aviv, 111 Allenby St., Tamar Passage. Tel: (03) 61-56-14. Telex: 341118/For x 5998. Mng. Dir.: Isaac E. Palatchi, Gen. Mgr.: Yakov Bensinyor; Sales Mgr.: Rosette Palatchi (Importer/Exporter)
 Product: Tape—carrying & storage cases, head cleaners, demagnetizers
 Unatec Import Export Ltd., 29 Lilienblum St., Tel Aviv. Tel: (03) 65-57-76, 65-98-41. Cable: UNAIMEX. Gen. Mgr.: Jerry Janowski; Sales Mgr.: Ronnie Janowski (Importer/Exporter)
 Product: Record—carrying & storage cases, record care prods., 45 rpm adaptors, Tape—carrying & storage cases, head cleaners, demagnetizers.

• store fixtures
 Unatec Import Export Ltd., 29 Lilienblum St., Tel Aviv. Tel: (03) 65-57-76,

65-98-41. Cable: UNAIMEX. Gen. Mgr.: Jerry Janowski; Sales Mgr.: Ronnie Janowski. (Importer/Exporter)
 Product: Record display racks.

ITALY

Population: 57,570,000
 Number of family units: 18,150,000
 Rate of exchange: \$1 (US) = 1,180 lire
 Holidays: January 1, January 6 (Epiphany), Easter Monday, April 25 (Liberation Day), May 1 (Labor Day), August 15 (Assumption), November 1 (All Saints' Day), December 8 (Immaculate Conception), December 25, December 26 (St. Stephen's Day).

RECORDS:

Record sales certification awards: Gold single—1,000,000 units. Gold LP—250,000 units; platinum LP—500,000 units. Note: There is no official regulation for these awards. The figures given are applied by some major record companies. Other companies award their acts gold records when they reach global sales of 1 million units with two or more records, even mixing configurations. Gold and platinum awards (silver ones are not used) are still considered as promotional means, each company feeling free to set its own rules.

Records: sold domestically including imports (retail value): LP's 1979—20,000,000 units, \$135,400,000. Singles 1979—26,500,000 units \$46,640,000

Average retail price per record (including 14% AVT): LP's—\$6.77. Singles—\$1.76

TV merchandising: 3% of total sales.
 Record club sales: 1% of total.

Discounting: Frequent.
 Type of distribution: The manufacturer-to-retailer system predominates

There is no rack jobbing. Wholesalers account for about 25% of the market. About one-half of the nearly 1,500 specialist shops are seen as being fully reliable by the industry.

Type of promotion: Since the summer of 1979 there has been an impressive growth of the touring scene, involving national and international acts. Local radio stations compete with national television (RAI) as to promotional value.

Jukeboxes: 20,000.

TAPE:
 Market: 8 track has virtually disappeared. Video tape sales are growing. Cassettes dominate the market, with hardware sales constantly growing. The Italian market is adversely affected by piracy. In 1979, at least 6.5 million cassette units were sold as pirated or counterfeited product. The share going to illegal manufacturers is estimated to be between 40% and 50%. Several police raids have contributed to slowing down the unlawful product, but a stricter law is still being awaited. The quality of the illegal product has improved.

Pre-recorded tape sold domestically including imports: Cassette 1979—9,000,000 units, \$60,930,000

Average retail price per tape: Cassette—\$6.77.

CONSUMER ELECTRONICS
 Number of units in households: Radios—16,900,000. AM—4,200,000. AM/FM—12,700,000. Television sets—20,600,000. color—4,500,000. b/w—16,100,000; phonographs—6,330,000. audio tape recorders—10,400,000. video tape recorders—45,000.

RADIO STATIONS:
 No. of commercial 2,000; no. of government 3

Comment: A few leading local stations in major towns function as powerful promotional channels. National radio (RAI) is contributing to the wider interest in classical music.

TELEVISION STATIONS:
 No. of commercial 300, no. of government 3; 90% color (PAL)

Comment: National television (RAI) affects the singles market through popular music shows, songs used as signature themes of various programs often hit the charts. Local stations are adding pop music to their programming.

IMPORT/EXPORT REGULATIONS:
 No customs are charged to members of the European Economic Community, but a 14% VAT must be paid on imports from all countries. Daniele Caroli

• record & tape
 manufacturers /
 distributors / importers

A R C, see RCA
 A T V, see Ricordi

Ace of Clubs, see Decca
 Ace of Diamonds, see Decca
 Agenda, see Base

Albatros, see Sciascia
 Alpha, see CGD

America Recs., Galleria del Corso 2, 20122 Milan. Tel: (02) 704-006. Chief Exec.: Nunzia Angeramo; Gen. Mgr.: Giovanni Samele

Amiamoci, see Ricordi
 Angel, see EMI
 Angelicum, see Sciascia

Artomano, see Ri-Fi
 Appaloosa, see IRE
 Apple, see EMI

Archiv, see PolyGram
 Arcophon, see Sciascia

Area, see Studio G
 Argo, see Decca

Arnelte, see Carosello
 Arston Srl (IFPI), Via Massimo Gorki 21, Strada Zivido, 20098 San Giuliano (Milan) Tel: (02) 984 6974. Telex: 321466. Pres.: Alfredo Rossi; Gen. Mgr.: Antonio Celano; Sales Mgr.: Riccardo Benini; Int'l Mgr.: Graham Johnson (Distributed by Ricordi)

Branch: 00195 Rome, Via Cantore 17, Tel: (06) 386 259. Telex: 614509

Labels: (Owned) Arston, Auditorio Classico, Cultura Popolare, Jazz Story, Dxford, (Licensed foreign) Affinity (UK), Charly (UK), Cherry Red (UK), Graduate (UK), Hexagone (France), Ice (UK), Safari (UK), Shelter (USA)

Int'l reps.: Argentina (RCA), Australia (Colossal), Brazil (RCA), Canada (Global), Chile (Quatro), Colombia (Fuentes), Greece (Music Box), Portu-



*...not exactly the biggest,
but the best!*

CONTACT US! Baby Records - via Timavo, 34 - Milan - Italy - phone 6071266 - telex 313502

gal (Vadeca), Switzerland (Musikvertrieb). (SEE ADVERTISEMENT)

Arkadia, see Fonit-Cetra.

Ars Nova, see Sciascia.

Ascolto, see CGD.

Asylum, see WEA.

Alco, see WEA.

Atlantic, see WEA.

Atlas Reccs. (IFPI), Corso Buenos Aires 10, 20124 Milan. Tel: (02) 271.5972, 273.163. Telex: 333414. Pres. & Gen. Mgr.: Alessandro Coppola; Int'l Mgr.: Ron Hanson; Press & Promo: Mgr.: Daniela Festari; PR: Claudio Meroni. (Distributed by PolyGram)

Labels: (Owned) Atlas, Clover.

Int'l repa.: Argentina (Musidisc, Sicomercanz), Colombia (Codiscos) Spain (Columbia). (SEE ADVERTISEMENT)

Autogramm SpA, Via Vallosa 38, 25050 Passirano (Brescia). Tel: (030) 657.360. Telex: 300850. Owner & Mng. Dir.: Edoardo Cattaneo; Gen. Mgr.: Francesco Nervi; Sales Mgrs.: Italo Capoferri, Romano De Scalzi.

Label: (Owned) Audioson.

Audioson, see Autogramm.

Auditorio Classico, see Ariston.

B S D Reccs., Via Roberto de Santis 7, Scala B, 84100 Salerno. Tel: (089) 323.704. Gen. Mgr.: Cristina Barbieri.

Home office: USA.

Baby Reccs. Srl (IFPI), Via Timavo 34, 20124 Milan. Tel: (02) 606.1474/1266. Cable: BABYRECORDS. Telex: 313502. Pres.: Freddy Naggar. (Distributed by CGD-Messaggerie Musicali)

Labels: (Owned) Baby, For Sale.

Int'l repa.: Austria (EMI Electrola), Belgium (Hiversum), Brazil (Som), Colombia (Codiscos), Ecuador (IFESA), Germany (EMI Electrola), Netherlands (Hiversum), Portugal (Radio Triunfo), Spain (CBS), Switzerland (Musikvertrieb). (SEE ADVERTISEMENT)

Ballo, see Belmusic.

Base Rec., Via Castiglione 109, (warehouse) Via Callamarini 26, 40136 Bologna. Tel: (051) 534.697. Telex: 511483. Dir.: Giuseppe Nannucci; Gen. Mgr.: Alberto Caroli; Sales Mgr.: Antonio Foresi.

Labels: (Owned) Agenda, Base; (licensed foreign) Armageddon (UK), ESP (USA), Factory (UK), Gull (UK), Red Lightnin' (UK), Rough Trade (UK), Uniteledis (France).

Int'l repa.: (For ESP) Germany (Posy), Netherlands (Nuis), UK (Cadillac).

Beat Reccs. Co. Srl (IFPI), Via Filippo Nicolai 16, 00136 Rome. Tel: (06) 348.497, 347.139. Cable: BEATRECORD. Telex: 612513. Gen. Mgr.: Franco de Gemini; Int'l Mgr.: Luciana Morello (Distributed by Fonit-Cetra).

Labels: (Owned) Beat, Pentaphon, Perladisc, Pomy; (distributed-not licensed) Amphonic (UK), ECAP (France), Eurobeat (UK), Euroson (UK), Illustration Musicale (France), Show Business (Germany).

Int'l rep.: UK (Eurobeat).

Belcanto, see Sciascia.

Bella, see Phonotype.

La Bella Bella, 50040 Snano (Florence).

Label: (Represented) Mutevonic Sound (USA).

Belmusic Srl, Via Tolmezzo 18, 20132 Milan. Tel: (02) 282.8905. Gen. Mgr.: Severino Pecchenini; Sales Mgr.: Domizia Gandolfi.

Labels: (Owned) Ballo, Belmusic, Gemini, Piggy, Snap

Bellmusic, see Ri-Fi.

Best Sound, see RCA.

Birba, see Ricordi.

Black Saint, see IRECC.

Black Shell, see Village Voice.

Bologna, see CGD.

Francesco Bongiovanni Reccs., Via Rizzoli 28-E, 40125 Bologna. Tel: (051) 225722. Gen. Mgr.: Giancarlo Bongiovanni.

Labels: (Owned) Bongiovanni, Il mito dell'opera; (licensed) Carillon (Spain), Mizar; (distributed-not licensed) Adriano (Switzerland), Mixtur (Germany).

Int'l rep.: Germany (Mixtur).

Bread, see CGD.

Broadway, see Ducale.

Bubble, see CGD.

C A M (Creazioni Artistiche Musicali) SpA, Via Virgilio 8, 00193 Rome. Tel: (06) 382.021. Cable: CAMUSIC. Telex: 611374. Pres.: Giuseppe Camp; Prod'n Dir.: Giuseppe Giacchi; Sales Mgr.: Bruno Bianchi.

C B D Reccs., Via Bocca di Leone 6, 00187 Rome. Tel: (06) 679.9664. Public Telex: 610110.

Home office: USA.

C B S Dischi SpA (IFPI), Via Amedei 9, 20123 Milan. Tel: (02) 809.521. Telex: 33286. Mng. Dir.: Piero La Falce; Controller: David J. Kinsley; Mktg. Mgr.: Fernando Grignani; Sales Mgr.: Franco Paradiso; Local A&R Mgr.: Fabrizio Intra; Dps. Dir.: Franco Negri. Distribution center: Via Lombardia 32, Sesto Uteriano. Tel: 988.0685.

Labels: (Owned) CBS, Epic, Masterworks, Portrait; (licensed) A&M (USA), ARC (USA), Bang (USA), Blue Sky (USA), Caribou (USA), Full Moon (USA), GTD (UK), Kirshner (USA), Monument (USA), Nempor

(USA), Philadelphia Int'l (USA), TK (USA), Tappan Zee (USA), Unlimited Gold (USA).

C G D-Messaggerie Musicali SpA (IFPI), Via Quintiliano 40, 20138 Milan. Tel: (02) 50.84. Cable: CIGDISC. Telex: 321063. Mng. Dirs.: Piero Sugar, Franco Crepas; Gen. Mgr.: Sandro Delor; Financial Mgr.: Cesare Vajani; Mktg. Mgr.: Roberto Guerrazzi; Sales Mgr.: Romano Razzini; Promo. Mgr.: Johnny Porta; A&R Dir.: Alfredo Cerruti; Artistic Prod'n Mgr.: Gianni Dal Dello; Prod'n Mgr.: Cesare Brunelli; Pressing Plant Mgr.: Luciano Zernigani; Bus. Affairs Mgr.: Silvana Perivelli; Personnel Mgr.: Alberto Ferrari; Int'l Prod. Mgr.: Maurizio Cannici; Int'l Licensing & Promo. Mgr.: Adelfo Forni; Rome Office: Magda Reggiani.

Branches: Bologna, Catania, Florence, Naples, Padua, Rome.

Labels: (Owned) Ascolto, CGD, CGD Calycanthus, CGD Classics, CGD Come il Vento, CGD Paradiso, CGD Turbo, CGD Vanilla, Clan, Derby, Energy, Record Bazaar, Rockland, VIP; (licensed) AVI/Derby (USA), Arabella (France), Ariola (Germany), Arista (Germany), Beserkley (USA), Buena Vista (USA), Butterfly/Derby (USA), CTI (USA), Celluloid (France), Charlie Brown (USA), Cherry/Derby (USA), Cream (USA), DJM (UK), Disneyland (USA), Eurodisc (Germany), Impasion/Derby (USA), Kudu (USA), LA 5 (USA), Prelude (USA), Savoy (USA), West End/Derby (USA); (distributed) Alpha, Baby, Bologna, Bread, Bubble, CDD, La Ciminiera, Coronado Prod'n, Cristoforo Colombo, Disc Piu, Ducale, Full Time Prod'n, Isola, LBI, LEITAM, Lasapa, Lettera A, Number 3, L'Orchestra, POM, Polaris, PolySound, Ponzio, Sorpasso.

Int'l repa.: CGD-worldwide (CBS Int'l), excluding Austria, Germany, Netherlands & Switzerland (all Ariola); Japan (King); Canada, UK, USA; Clan-worldwide (Ariola). (SEE ADVERTISEMENT)

C L S Reccs. SaS, Viale Sabotino 2, Milan. Tel: (02) 871.370. Pres.: Detto Mariano; Gen. Mgr.: Lina De Sautto; Sales Mgr.: Silvio De Sutti. (Distributed by Ricordi)

Labels: (Owned) CLS, Camaleo, Love; (distributed-not licensed) America, Kris, MB.

C & M Discografica di Cavalieri & C. Ed. Musicali Srl, Via Isonzo 206, Bari. Tel: (080) 224.610. Gen. Dir.: Lino Cavalieri; PR: Giuseppe Accettura. (Distributed by Panarecord)

Labels: (Distributed-not licensed) C&M, Flop, Fonocomer, Sinusoid.

Int'l repa.: North & South America (Panarecord).

C D D, see CGD.

C R A M P S, see PolyGram.

Cabaret, see Ricordi.

Cadis, see Phonotype.

California, see Ricordi.

Calycanthus, see CGD.

Camaleo, see CLS.

Canadian American, see Produttori Associati.

Canaria, see Fonit-Cetra.

Canopo (Gruppo Ed.), Via A Riboty 22, 00195 Rome. Tel: (06) 315.615.

Labels: (Owned) Canopo, Deneb, Flirt, Flower, Folkmusic, Octopus; (represented) MP 2000 (France).

Capitol, see EMI.

Cardinale, see Ricordi.

Carosello CEMED Srl (IFPI), Galleria del Corso 4, 20122 Milan. Tel: (02) 793.008. Cable: CURCIMUSIC. Telex: 332683. Pres.: Giuseppe Gramitto Ricci; Gen. Mgr.: Lucio Salvini. (Distributed by Ricordi).

Labels: (Owned) Ariete, Carosello, Costanza, Curci, Frog, Mustang; (licensed) All Platinum, Buddha, Cadet, Checker, Chess, De-Lite, Jubilee, Pacific Arts, Pyramid, Rollin' Rock, Roulette, Stang, Sugar Hill, Sutra, Turbo, Vibration (all USA); Big Bear (UK), Rockhouse (Netherlands).

Int'l repa.: Austria, Germany, Switzerland (all Melroneo); Belgium (Ariola).

Caru Dischi, Piazza Garibaldi 6B, 21013 Gallarate.

Label: (Represented) Sierra/Briar (USA).

Casablanca, see PolyGram.

Centrole, see 103.

Cetra, see Fonit-Cetra.

Charter Line, see WEA.

Chic, see WEA.

Cao Reccs. Srl (IFPI), Corso Buenos Aires 45, Milan. Tel: (02) 287.0081. Cable: CIADRECORDS. Mng. Dir.: Giorgio Perlici; Int'l & Pub. Mgr.: Flora Brocchetti. (Distributed by Ricordi)

Branch: 00195 Rome, Viale Mazzini 4. Tel: (06) 382.668, 383.532.

Int'l repa.: Argentina (Colour Television Discographic), Austria (Amadeo), Switzerland (Amadeo).

Cicala, see Durium.

Cicagna, see Fonit-Cetra.

Cielo-Video (Ed. Musicali), Galleria del Corso 2, 20122 Milan. Tel: (02) 705.231. Pres.: Virgilio Panzuti; Gen. Mgr.: Dante Panzuti; Sales Mgrs.: Dante & Virgilio Panzuti.

Labels: (Owned) Play, VIP, Video; (distributed-not licensed) Epervier (France), Selected Sound (Germany), Tele-Music (France).

Int'l repa.: France (A. Luterau & Storzando), Germany (Selected Sound).

Cime-Mezar, see Fonit-Cetra.

La Ciminiera, see CGD.

Cinevox Reccs. SpA (IFPI), Via Romeo Romei 15, Rome. Tel: (06) 311.280, 311.870. Telex: 616241. Pres.: Carlo Bixio; Sales Mgr.: Benini Renzo. (Distributed by Ricordi)

Labels: (Owned) Cinevox, Rang, Zip

Clan, see CGD.

Classic For Pleasure, see EMI.

Classics, see CGD.

Clover, see Atlas.

College, see Ri-Fi.

Columbia, see EMI.

Come il Vento Srl (Ed. Musicali & Discografiche), Via Montenapoleone 29, 20121 Milan. Tel: (02) 700.725/574, 791.665. Gen. Mgr.: Michele del Vecchio. (Also see CGD).

Concertazione, see Panarecord.

Coronado Prod'n, see CGD.

Corsair, see Sciascia.

Costanza, see Carosello.

Cristoforo Colombo, see CGD.

Cultura Popolare, see Ariston.

Curci, see Carosello.

D D F, see Due Pi di Gianfranco Coda.

D G, see PolyGram.

D R F, see Due Pi di Gianfranco Coda.

Dany, see Pinciana.

Das Alte Werk, see Decca.

Decca-Cime, see Decca.

Decca Dischi Italia SpA (IFPI), Via Brisa 3, 20123 Milan. Tel: (02) 809.136. Cable: DECCITAL. Mng. Dir.: Romano Bacchini; A&R Mgr.: Paolo Tosi; Sales Mgr.: Luigi Negro.

Home office: UK.

Labels: (Owned) Ace of Clubs, Ace of Diamonds, Argo, Das Alte Werk, Decca, Decca-Cime, Deram, Eclipse, Grifphon, London, L'Diseau Lyre, Storyville, Strand, Telefunken, Threshold.

Della Quercia (Dischi), Via Caminadella 9, 20100 Milan. Tel: (02) 89.37.02. Gen. Mgr.: Giorgio Gaslini.

Delta Srl, Corso Buenos Aires 10, Milan. Tel: (02) 271.5972, 273.163. Telex: 333414. Gen. Mgr.: Alessandro Coppola; Sales Mgr.: Claudio Meroni.

Label: (Owned) Delta.

Deneb, see Canopo.

Deram, see Decca.

Derby, see CGD.

Devil, see Saar.

Diapasons, see Ecofina.

The Dig It Int'l Reccs. Srl (IFPI), Corso Vittorio Emanuele 22, Milan. Tel: (02) 780.778. Gen. Mgr.: Pippo La Rosa. (Distributed by EMI)

Labels: (Represented) Key (USA), Trema (France), Yona (France).

Int'l repa.: France (Eurodisc, Trema), Germany (Teldec), UK (Creole), USA (Cigolo).

Dimar Dischi, Corso D'Augusto 49, 47037 Rimini. Tel: (0541) 5.42.98. Telex: 550398. Owner: Bruno Focchi.

Dir, see Panarecord.

Disco Piu Srl, Via Ascansio Sforza 41, Milan. Tel: (02) 839.1810/4385. Telex: 315413. Mng. Dir.: Maria Cantadore; Gen. Mgr.: Gian Piero Simonacchi. (Distributed by CGD-Messaggerie Musicali).

Divergo, see PolyGram.

Ducale Ind. Musicali SpA, Via Per Cadrezzate 5, 21020 Brebbia (Varese). Tel: (0332) 770.784/189. Telex: 380231. Pres. & Gen. Mgr.: Davide Malaton. (Distributed by CGD).

Labels: (Owned) Broadway, Ducale, EDM, Italdisc; (licensed) Arion (France), Bainbridge (USA). (SEE ADVERTISEMENT)

Ducretet Thomson, see EMI.

Due Pi di Gianfranco Coda, Delle Vigne 1, Reano (Turin). Tel: (011) 932.711.

Labels: (Owned) DDF, DKF, Folklore, Nastroteca.

Int'l repa.: USA (Fiesta).

Duke, see IRECC.

Durium SpA (IFPI), Via Manzoni 40/42, 20121 Milan. Tel: (02) 701.008, 701.705. Cable: DURIMUM. Telex: 333564. Pres. & Gen. Mgr.: Krirkor Mintangian; A&R Mgr.: Aurelio Ajroldi; Sales Mgr.: Amleto Silvestri; Int'l Dept. Mgr.: Elisabet Mintangian.

Labels: (Owned) Cicala, Durium, Sprint, Start; (licensed) Can't Stop Prod'ns (USA), Frank Farian Prod'n (Germany), Hansa (Germany), Jupiter (Germany), Magnet (UK), RRM (Belgium); (distributed-not licensed) Memory Music, Mister, Targa.

Int'l repa.: Argentina (Sicamericana), Bolivia (Lauro), Brazil (Fermata), Canada (Globo), Ecuador (Ecuatoriana de Sonido), France (SPI), Germany (Deutsche Oversea, Hansa), Greece (Music Box), Jamaica (Federal), Japan (Cosdel), Kuwait (Kananawati), Lebanon (Societe Libanaise du Disque), Mexico (Musart), Netherlands (Phonogram), South Africa (Teal), Switzerland (Phonag), Syria (Kananawati), Turkey (Turkuola Yilmaz Ascol), Uruguay (Sondor).

Dynamic, see Panarecord.

E D M, see Ducale.

E M G Discografica, Via S. Sebastiano 16, 80134 Naples. Tel: (081) 452.597. Pres.: Pasquale Liguri.

E M I Italiana SpA, Via Bergamo 315, 21042 Caronno Pertusella (Varese) Tel: (02) 965.0701. Cable: EMITAL SARDNND. Telex: 312679. Mng. Dir. Alexis Rotelli; A&R Mgr.: Gianpiero Scussel; Comm'l Mgr.: Roberto Magrini; Mktg. Mgr.: Franco Cabrin; Financial Controller: Alberto Vignati.

Labels: (Owned) Angel, Apple, Capitol, Classic For Pleasure, Columbia, Ducretet Thomson, EMI, EMI America, EMI Discoteca Classica, EMI Int'l, EMI Studio, Electrola, Emidisc, Harvest, His Master's Voice, MPL, Music for Pleasure, Deon, Parlophone, Pathe, Purple, Regal, Regal Zonophone, Seraphim, Sidewalk, Stateside, Die Stimme Seines Herrn, T Rex, La Voce del Padrone; (distributed) CBD, Dig-It, PDU; (licensed) Liberty/UA (UK, USA), Melodia (USSR), Motown (USA), Prodigal (USA), RAK (UK), Rolling Stones (UK), Sunbelt (UK).

E S P, see IRECC.

Eclipse, see Decca.

Ecofina Srl (IFPI), Via Leopardi 8, 20123 Milan. Tel: (02) 86.90.121, 806.125. Chief Exec.: Mourad Sabet; Factory Technical Mgr.: Roberto Roccabella.

Factory: Milan, Via Monviso 21. Tel: (02) 314.766.

Labels: (Owned) Diapasons, Ecofina. (SEE ADVERTISEMENT)

Edibi, see Sviluppo Discografico del Mezzogiorno.

Edig/Galletti, see RCA.

Electrola, see EMI.

Elektra, see WEA.

Eleven Music Co. Srl (IFPI), Via Rossini 8, 20090 Cesano Boscone. Tel: (02) 349.8107. Cable: PAGANMUSIC. Pres. & Gen. Mgr.: Aldo Pagani.

Labels: (Owned) Eleven, Elevegreen, Ivore, Dn the Rocks.

Elevegreen, see Eleven.

Emanuela Disc, see RCA.

Emidisc, see EMI.

Energy, see CGD.

Epic, see CBS.

Euro Int'l, see Ricordi.

Expanded Music, Via Sant'Isaia 49, 40123 Bologna. Tel: (051) 269.461. Chief Exec.: Carla Nannucci; Gen. Mgr.: Giovanni Natale; Sales Mgr.: Ico Venturoli.

Labels: (Owned) Italian (licensed to Ricordi), Tnx; (licensed) Felish, In dustrial, Postcard (all UK); (distributed-not licensed) Bomp (USA).

F M A Srl (Ed. Musicali & Discografiche), Galleria del Corso 2, 20122 Milan. Tel: (02) 796.823, 796.266. Mng. Dir.: Federico Monti Arduini.

F I Team, see Panarecord.

Fans, see Phonotype.

Fiammetta's, see Stereomaster.

Fiumara Ed. Musicali & Discografiche Srl, Via Adda 28, 20041 Agrate Brianza (Milan). Tel: (02) 650.983. Gen. Mgr.: Franco Reitano; Sales Mgr.: Gege Reitano. (Distributed by Durium)

Label: (Owned) Mister. (SEE ADVERTISEMENT)

Flirt, see Canopo.

Flower, see Canopo.

Fly, see Village Voice.

Folklore, see Due Pi di Gianfranco Coda.

Folkmusic, see Canopo.

Fonit-Cetra SpA (IFPI), Via G. Meda 45, 20141 Milan. Tel: (02) 843.2551. Cable: FDNITCETRA. Telex: 314653. Pres.: Leone Piccioni; Mng. Dir.: Carlo Fontana; Gen. Mgr.: Silvano Giuntini; Int'l Mgr.: Luigi Arduino. Branch: 00153 Rome, Via Pietro Roselli 4. Tel: (06) 50.615.9.

Labels: (Owned) Cetra, Fonit, International, Traccia; (distributed) Ar-



Edizioni Southern Music SRL
Milan, Italy

PANARECORD Sp.A.

ESTABLISHED IN 1978

IS THE "ONLY DISTRIBUTION COMPANY"
IN ITALY

WE ARE INTERESTED IN TURNING YOUR PRODUCTS
INTO HITS IN ITALY, ON LICENSE OR IMPORT
OR DISTRIBUTION BASES.

PANARECORD S.P.A. - V. CIMAROSA N° 4 - MILANO TEL. 430046 - 485609 TELEX 340014 PANAR-I
PUBLISHING DIVISION: PANAMUSIC IMPORT - EXPORT DEPARTMENT: DISCOKEY V. MALAGA N° 4 - MILANO - TEL. 4224506

U.S.A. RAPPRESENTATIVE: MARISA DE LUCA PHONE (212) 5827854 - NEW YORK



IT PAYS
TO BE
WITH
ATLAS



YOUR
NEXT HIT
COULD BE
OURS
IN ITALY



Corso Buenos Aires, 10
20124 Milano - Italy
Tel. (02) 2715972 /
273163
Telex: 333414

Adia, Beat, Canara, Cicogna, Cime Mizar, Patto, Pull, (licensed foreign)
Acania (Germany), Carrere (France), Fantasy (USA), GNP Crescendo
(USA), Galaxy (USA), Harmonia Mundi (Germany), Milestone (USA),
Pablo (USA), Prestige (USA), Stax (USA)
Int'l reps: Argentina (American Rec'g), Australia (Carinia), Brazil (Grav-
aces Cont. Discos), France (Carrere), Germany (Oversea), Japan (King),
Mexico (Gamma), Portugal (Empresa), Spain (Hispanovox), USA (CBS-
classical, Peters Int'l) (SEE ADVERTISEMENT)
Fontana, see PolyGram
Forever, see Panarecord
For Sale, see Baby
Frog, see Carosello
Full Time Prod'n, see CGD
G & G, see Ricordi
Gemini, see Belmusic
General Music, Viale Liegi 41, 06198 Rome. Tel. (06) 850.358, 865.307
Gen Mgr. Enrico de Mels
Label: (Owned) General Music
Int'l rep.: France (WEA Filipacchi)
Gitas, see R-Fi
Golden Rec., Via San Paolo 15, 20121 Milan Tel. (02) 874.460. Owner &
Prod'r Percle Boschetti
Green Light, see Saar
Griphon, see Decca
Grog, see Studio G
Harmony, see Saar
Harvest, see EMI
Hello, see RCA
His Master's Voice, see EMI
Hit Hit Hurra, see Ricordi
Horo, see Village Voice
I A F, see R-Fi
I R D (International Rec. Dist'n) Srl, Via San G B de la Salle 4, 20132 Milan
Tel. (02) 259 1700/2064. Telex 315493 Pres. Giovanni Bonandrin,
Sales Mgr. Franco Ratti.
Labels: (Distributed—not licensed) AECO (USA), About Time (USA),
Adelphi (USA), Advent (USA), Affinity (UK), Airway (USA), Ak-Ba (USA),
Alligator (USA), Amadeo (Austria), Amazing (USA), Amigo (Sweden), An-
drew's (USA), Anima (USA), Appaloosa, Arhoolie (USA), Bee Hive (USA),
Big Daddy (USA), Biograph (USA), Birth (Germany), Biscuit City (USA),
Black & Blue (France), Black Saint, Blind Pig (USA), Blue Beat (Ger-
many), Blue Goose (USA), Blue Marge (France), Blues Classic (USA),
Bvhast (Netherlands), Calig (Germany), Candide (USA), Charlie (UK),
Chiaroscuro (USA), Choice (USA), Circle (Germany), Classic Jazz Masters
(Sweden), Contemporary (USA), Corvo (USA), County (USA), Creative
World (USA), ORG (USA), Dawn Club (Germany), Delmark (USA), Discov-
ery (USA), Dragon (Sweden), ENJA (Germany), FMP (Germany), Fate
(USA), First American (USA), Fluid (France), Flying Fish (USA), Flying
High (USA), Flyright (UK), Fo k Lyric (USA), Fountain Retrieval (UK),
Four Leaf Clover (USA), Fox American Retrospective (USA), Gatemouth
(USA), Good Time Jazz (USA), Gramavision (USA), Gryphon (USA), Hat
Hut (Switzerland), Hep (UK), Herwin (USA), Honeydew (USA), IAI (USA),
ICP (Netherlands), IPS (USA), Ictus, Incus (UK), India Navigation (USA),
Inner City (USA), Interplay (USA), Jazz (USA), Jazz Bird (USA), Jazz Craft
(Denmark), Jazz Society (Sweden), Kaleidoscope (USA), Karma (USA),
Labor (USA), Lovely (USA), ,yricbord (USA), MMO (USA), Mamlish
(USA), Metalanguage (USA), Monitor (USA), Mosaic (UK), Mountain Rail
road (USA), Mulligan (Ireland), Muse (USA), Musica (France), Musicraft
(USA), Mustevic (USA), Nessa (USA), Nighthawk (USA), Nimbus (USA),
Nine Winds (USA), Opun (UK), Onani (Canada), Owl (France), PM (USA),
Philly Jazz (USA), Philo (USA), Phoenix (USA), M D Polimeni (USA),
Propius (Sweden), Pumpkin (USA), Quark (USA), Queen Disc, RCA
(Black & White, Blue Bird, Master—France), Rainlight (USA), Rarities
(UK), Rebel (USA), Red, Red Bud (USA), Red Lightnin' (UK), Rhino
(USA), Ridge Runner (USA), Ring (Germany), Rounder (USA), Sackville
(Canada), Seabreeze (USA), Shanachie (USA), Sierra Briar (USA), Sky
(Germany), Soul Note, Spivey (USA), Spottite (UK), Stash (USA),
SteepleChase (Denmark), Strata East (USA), Sugar Hill (USA), Sun
(France), Takoma (USA), Tapioca (France), Tax (Sweden), Theresa
(USA), Three Blind Mice (Japan), Timeless (Netherlands), Tomato (USA),
Trend (USA), Turnabout (USA), Unitedis (France), VGM (USA), VJM
(UK), Vinyl (Germany), Vox (USA) Wagon Tracks (USA), Waterhouse
(USA), Waterland (Netherlands), Wave (UK), Wheeler (USA), Windham
Hill (USA), World Jazz (UK), Xanadu (USA), Yazoo (USA) (SEE ADVER-
TISEMENT)
I R E C (International Rec. Export Co.) Srl, Via San G.B. de la Salle 4, 20132
Milan Tel. (02) 259 2326 Telex 315493 Pres Giovanni Bonandrin
Label: (Owned) Appaloosa, Black Saint, Soul Note, (distributed—not li-

icensed) Dischi Della Quercia, Duke, ESP, Ictus, Modern Jazz, Queen Disc,
Red.
Int'l reps.: Australia (Larrikin), Austria (Bellaphon), Canada (Almada),
Denmark (SteepleChase), Finland (Audiovis), France (Musica), Germany
(Bellaphon), Japan (Super Slop), Netherlands (Nuis-Bedrijven), Sweden
(Amigo), Switzerland (Plainsphere), UK (Projection), USA (Rounder)
(SEE ADVERTISEMENT)
I T, see RCA
Ictus Recs. SnC, PO Box 6, Succ. 11, Bologna. Tel. (051) 583.550. Gen
Mgr. Carla Lugli; Prod'r & Music Dir. Andrea Centazzo (Distributed by
IRO)
Int'l reps.: Germany (Moers), Japan (Disk Union), UK (Cadillac), USA
(Rick Ballard)
International, see Font-Cetra
Intingo, see Ricordi
Ippopotamo, see PolyGram
Isoia, see CGD
Italdisc, see Ducaie
Italian, see Expanded & Ricordi
It-Why Recs. & Tapes, Via Montenapoleone 29, Milan Tel. (02) 700.574
Mng. Dir. Paolo Cattaneo; Gen Mgr. Michele Galasso
Ivoire, see Eleven
Jazz Story, see Arston
Joker, see Saar
Jump Recs., Galleria del Corso 2, 20122 Milan Tel. (02) 705.231. Gen. &
Sales Mgrs.: Virgilio & Oante Panzuti
Labels: (Owned) Jump, Music Scene, (represented) Intersound (Ger-
many), Selection/Multisound (Belgium)
Int'l reps.: Australia (Penjane), Austria (Vineta/Liveton/Bavariaton/Tip
Top), Belgium (Multisound), Canada (Morning), France (Presence/
Warner/ Atoll), Germany (Vineta/Liveton/Bavariaton/Tip Top), Japan
(Illust), Netherlands (Multisound), New Zealand (Penjane), Scandinavia
(Camp), South Africa (Gallo), Switzerland (Vineta/Liveton/Bavariaton/
Tip Top), USA (TRF)
Junghans, see Phonotype
K-tel Int'l Italy Srl, Piazza Mirabello 1, 20121 Milan Tel. (02) 657.2791.
Telex 314239 Pres. Raymond Kives; Gen. & Sales Mgr. Liriana Azzolini
(Distributed by RCA)
Home office: USA
Kappa-O, see Phonotype
Koka, see WEA
L B I, see CGD
L E I T A M, see CGO
L M Recs., Viale Baracca 58, 48100 Ravenna
Laboratorio, see Produttori Associati
La Luna, see Produttori Associati
Lasapa, see CGD
Las Vegas, see Sidet
Leondisco, see Phonotype
Leonsoko, see Stereomaster.
Lettera A, see CGD
Lollipop, see WEA
London, see Decca
Love, see CLS
M G M, see PolyGram
M P L, see EMI
Magma, see Studio G
Masterworks, see CBS
Memory Music, see Durum
Mercury, see PolyGram
Metro, see PolyGram
Millenote, see Sidet
Miro, see PolyGram
Mister, see Fiumara & Durum
Mr. Disc Org., see Panarecord
Il mito dell'opera, see Francesco Bongiovanni
Muzar, see Francesco Bongiovanni
Modern Jazz, see IREC
Monitor, see RCA
Movimento Musica Srl, Via S. Maurizio 13, 20123 Milan Tel. (02) 872.341.
864.423 Telex 313017 Mng. Dir. Salvatore Caruselli
Label: (Owned) Movimento Musica
Music for Pleasure, see EMI
Music Power, see Saar
Music Scene, see Jump
Mustang, see Carosello
Nastroeca, see Due Pi di Gianfranco Coda
New Jazz Collection, see Sciascia

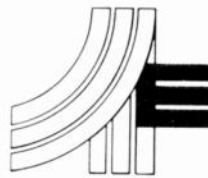

ECOFINA

**YOUR CASSETTE CUSTOM
DUPLICATOR IN EUROPE
Quality-Quantity-Price**

Next Step, see Red.
 Nonesuch, see WEA
 Number 3, see CGD.
 Numero Uno Srl, Galleria del Corso 2, 20122 Milan. Tel: (02) 799.331/127.
 Cable: NUMERUNO. Telex: 310689. Pres.: Giuseppe Ornato, Gen. Mgr.:
 Antonio Coni. (Distributed by RCA)
 Int'l rep.: Worldwide (RCA).
 Octopus, see Canopo.
 Odeon, see EMI.
 Off, see Produttori Associati.
 L'Oiseau Lyre, see Decca.
 On the Rocks, see Eleven.
 103 Ed. Musicali & Discografiche Srl, Via Binda 33, 20143 Milan. Tel (02)
 404.7574, (051) 911.163. Gen. Mgr.: Luigi Barion.
 L'Orchestra-Societa Cooperativa a Responsabilita Limitata, Via Moscova 13,
 Milan. Tel: (02) 653.160, 657.5635. Pres.: Franco Fabbri; Sales Mgr.:
 Lidia Brasca; PR: Umberto Silvestri. (Distributed by CGD)
 Int'l reps.: Belgium (Recommended), East Germany (Amiga), France
 (Recommended), Germany (Eigelstein), Switzerland (Voxpop), UK (Rec-
 ommended).
 Orizzonte, see Ricordi.
 Out, see Ri-Fi.
 Oxford, see Ariston.
 P D U, see EMI.
 P O M, see CGD.
 Panarecord Spa (IFPI), Via Cimara 4, 20144 Milan. Tel: (02) 430.046,
 485.609. Telex: 340014. Pres.: Dr. Sergio de Gennaro; Gen. Mgr.: Mario
 Paretto; Sales Mgr.: Franco Caleca.
 Branches: Bologna, Discospress, Via Barberia 13 Tel: (051) 276.697.
 Contact: Mr. Chiodini-Florence, Record One Stop, Corso Vittorio
 Emanuele Orlando 3, Scandicci. Tel: (055) 257.8663. Contact: Mr. Ago-
 pian-Rome, Record Center 80, Via Brennero 7. Tel. (06) 894.959. Con-
 tact: Mr. Pallagrosi.
 Int'l branch: USA, M&E.
 Labels: (Owned) F1 Team, Panarecord; (licensed domestic) Concerta-
 zione, Oire, Dynamic, Forever, Mr. Disc Org., Synusoid, Splash, Wep; (li-
 censed foreign) Albion (UK), Astan Music (Switzerland), Aura (UK) Inter-
 cord (Germany), Salsoul (USA). (SEE ADVERTISEMENT)
 Paradiso, see CGD.
 Parlophone, see EMI.
 Passport, see Saar.
 Pathe, see EMI.
 Patto, see Fonit-Cetra.
 Peer-Southern Prod'ns Srl, Piazza del Liberty 2, 20121 Milan Tel (02)
 796.473. Mng. Dir.: Alberto Carrsch.
 Penny, see Ri-Fi.
 Penny Oro, see Ri-Fi.
 Pentaphon, see Beat.
 Perladisc, see Beat.
 Petrus, see Stop.
 Philips, see PolyGram
 Phonorama, see Stereomaster.
 Phonotype Rec. Srl (IFPI), Via Enrico de Marinis 4, 80134 Naples. Tel:
 (081) 205.873, 206.642. (Distributed by RCA).
 Labels: (Owned) Cadis, Fans, Kappa-O, Leondisco, Phonotype, Universal;
 (distributed) Bella, Junghans.
 Int'l reps.: Australia (Minstrel), Canada (International Rec'g), Japan
 (King), USA (L. Rossi), Venezuela (Radio Capri).
 Piggy, see Belmusic.
 Pinciana Music Srl (IFPI), Via Giovanni Branca 35, 00153 Rome. Tel: (06)
 575.8776. Gen. Mgr.: Fulvio Corradini.
 Labels: (Owned) Dany, Pinciana, Speedy.
 Play, see Cielo-Video.
 Polaris, see CGD.
 Polydor, see PolyGram.
 PolyGram Dischi SpA (IFPI), Viale Regina Giovanna 29, 20129 Milan. Tel:
 (02) 204.841. Cable: COMINFON. Telex: 334140. Mng. Dir.: Marco Big-
 notti; Sales Dir.: Mario Gabelli; A&R Development Dir.: Bruno Tibaldi;
 Pub. Mgr.: Bruno Fedetto; Admin.: Luigi Sanvito.
 Labels: (Owned) Archiv, Casablanca, OG, Fontana, MGM, Mercury, Metro,
 Mirto, Philips, Polydor, Vertigo, Verve; (licensed foreign) Charisma (UK),
 Cube (UK), Dreamland (USA), EG (UK), Electric (UK), Rocket (UK), RSO
 (USA); (distributed-not licensed) Atlas, CRAMPS, Divergo, Ippopotamo.
 Int'l reps.: Worldwide (Phonogram, Polydor, Polygram).
 Polysound, see CGD.
 Pony, see Beat.
 Ponso, see CGD.
 Portrait, see CBS.
 Primary, see Ri-Fi.
 Produttori Associati Srl (IFPI), Via General Fara 39, 20124 Milan. Tel (02)
 666.176. Pres.: Antonio Casetta.
 Labels: (Owned) Canadian American, Laboratorio, La Luna, Off, Produt-
 tori Associati.
 Publidisco, see Ri-Fi.
 Puhl, see Fonit-Cetra.
 Purple, see EMI.
 Quadrifoglio, see Sciascia.
 Queen Disc, see IREC.
 R C A SpA, Via San Alessandro 7, Rome. Tel: (06) 43.661. Telex: 614028.
 Pres.: Giuseppe Ornato; Gen. Mgr.: Ennio Meis; Mktg. Mgr.: Luciano Ber-
 nacchi.
 Home office: USA.
 Distribution branches: Bologna, Via le Orsani 2. Tel: 393.800, 396.954.
 Mgr.: P. Margelli-Catania, Piazza Nettuno 10-15. Tel: 491.486/464.
 Mgr.: S. Sparaventi-Florence, Via Ghibellina 3/R. Tel: 679.868,
 675.063. Mgr.: A. Barsotti-Genova, Piazza Rossetti 8/R. Tel: 591.610,
 581.123. Mgr.: M. Biotti-Milano, Piazza Umanitaria 2. Tel: 545.2467.
 546.1632. Mgr.: G. Rossi-Naples, Via Augusto Righi 50 (6 Traversa).
 Tel: 760.9468/9077. Mgr.: F. Zezza-Padua, Via B. Pellegrino 115. Tel:
 35.639, 651.652. Mgr.: R. Buzzanca-Pescara, Via L'Aquila 25. Tel:
 32.977, 22.097. Mgr.: F. Pietrostefani-Rome, Via Tiburtina Km. 12. Tel:
 412.5177/5349. Mgr.: A. Celli-Torino, Via Gorizia 144. Tel: 328.570/458.
 Mgr.: A. Occhetti.
 Labels: (Owned) RCA Cinemathe, RCA Int'l, RCA Italiana, RCA Lineatre,
 RCA Original Cast, Red Seal, Victor, Victrola; (licensed domestic) ARC,
 Best Sound, Edig/Galletti, Emanuela Disc, Hello, IT, K-tel, Monitor, Nu-
 mero Uno, Phonotype, Radio, Spaghetti, Storm, Zerolandia; (licensed for-
 eign) BBC Ent's. (UK), Buddah (USA), Chiswick (UK), Erato (France),
 Grunt (USA), Hansa (Germany), Midsong (USA), Millennium (USA), Pre-
 lude (USA), Real (UK), Salsoul (USA), Sire (USA), Solar (USA), Stiff (UK).
 Int'l rep.: Worldwide (RCA).

Radat, see WEA
 Radio Recs., see Sidet & RCA
 Rang, see Cinevox.

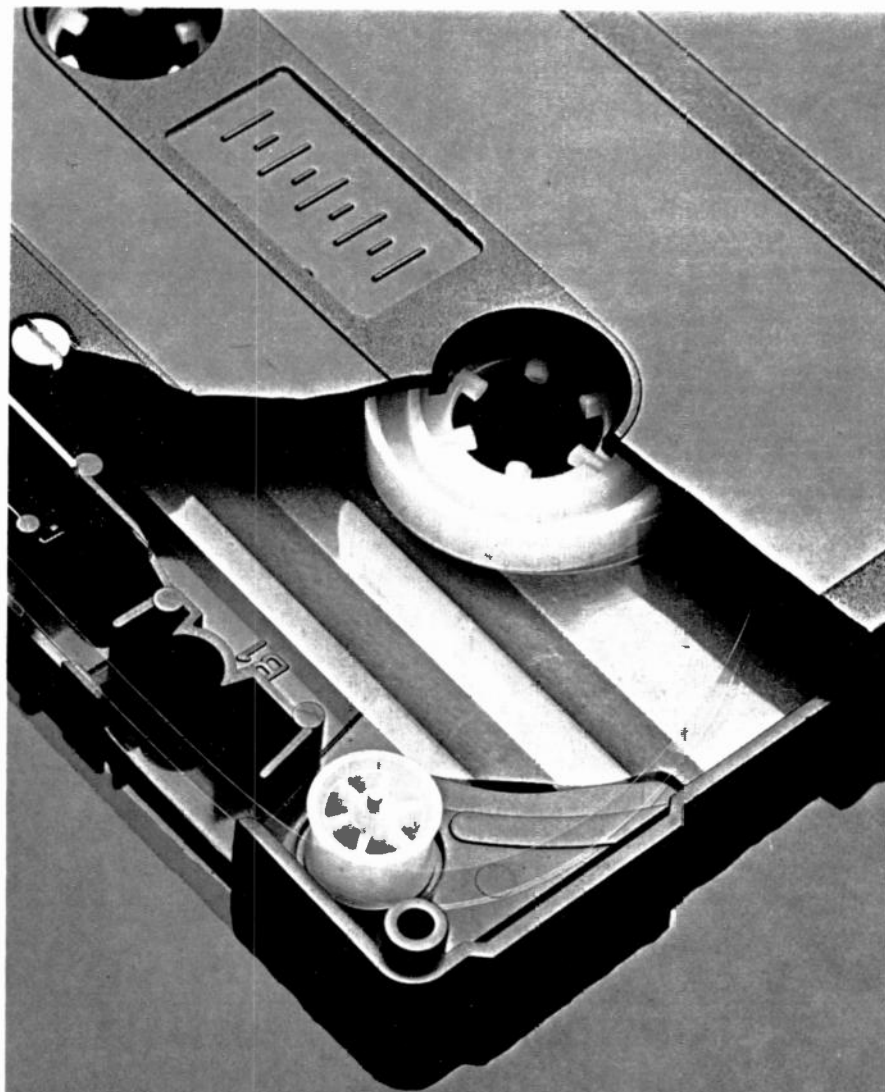

sssssilent
 mech-a-nism
 ('mek-ə-,niz-əm)

NUOVA SIAT



Nuova Siat. s.r.l.
 Via Dell'Orto, 21
 21047 Saronno (VA) - Italia
 Tel. 02-9607450 - 9607485
 Telex 335884 N SIAT

Raretone Music Library. Via Bonnet 6/A. 20154 Milan. Tel: (02) 657.5714
Label: (Represented) Zim (USA)
 Recommended Recs.: Via Milazzo 32, 40121 Bologna. Contact: Giovanni Di Simone.
Home office: England
 Record Bazaar. see CGD
 Recordclam. see Sidel
 Red Rec. Via Caminadella 9, 20100 Milan. Tel: (42) 805.5454. Gen. Mgr. Sergio Veschi. (Distributed by IRD/IREC)
Labels: (Owned) Next Step, Red
Int'l rep.: Worldwide (IREC in Italy)
 Red Seal. see RCA
 Regal. see EMI
 Regal Zonophone. see EMI
 Replica. see Sciascia
 Reprise. see WEA
 Ricordi Int'l. see Ricordi SpA
 Ricordi SpA (Dischi). Via Berchet 2, 20122 Milan. Tel: (02) 88.81. Cable: IDRODIR. Telex: 310777. Pres.: Gianni Babin; Mng. Dir.: Guido Rignano. Sales Mgr.: Rolando Bachermi.
Labels: (Owned) Orizzonte, Ricordi Int'l. (**licensed domestic**) AIV, Amamocci, Birba, Cabaret, California, Carosello, Ciao, Cinevox, Euro Int'l, G&G, Hit Hit Hurra, Italian, SIF, Sciascia, TTC, Ticket. (**licensed foreign**) ABC (USA), Amadeo (Austria), Avatar (UK), Barclay (France), Bearsville (USA), Big Bear (UK), Bronze (UK), Chiswick (UK), Criminal (UK), De Lite (USA), Dindisc (UK), EGG (France), Frog (UK), Impulse (USA), Infinity (USA), Island Ze (UK), Kicking Mule (USA), Logo (UK), MCA (USA), Mantecore (UK), Melodia (USSR), PRT (UK), PWM (Poland), Pyramid (USA), Regency (USA), Rialto (UK), Roulette (USA), Sierra (USA), Sonet (Sweden), Sugar Hill (USA), Supraphon (Czechoslovakia), Vanguard (USA), Virgin (UK), WMDT (USA), Ze (UK). (**distributed—not licensed**) Arston, CLS, Cardinal, Intingo.
Int'l reps.: Argentina (Microfon), Austria (Amadeo), Brazil (Top Tape), Canada (Global), Germany (Metronome), Greece (CBS), Japan (King), Spain (Aniela), Switzerland (Metronome), Uruguay (Microfon), Venezuela (Grabaciones Mundiales), Yugoslavia (RTL)
 Ri-Fi Rec. Co. SpA (IFPI). Corso Buenos Aires 77, 20124 Milan. Tel: (02) 27.36.41. Cable: RIFIRECORD. Telex: 316624. Chm.: Vittoria Mereu. Int'l Mgr.: Gianfranco Finamore. Sales Mgr.: Mario Giampietro.
Branch: Rome, Via A. Cantore 19. Tel: (06) 31.92.10.
Labels: (Owned) Antoniano, Colledge, Dut, Penny, Penny Oro, Primary, Publiscio, Ri-Fi, Studio, Variety. (**licensed**) Atoll (France), Attack (UK), Continental (Brazil), Everest (USA), Flarenasci (France), Horse (UK), Karma (Germany), Miami (UK), Mooncrest (UK), RMP (Germany), Saga (UK), Trojan (UK), Victor (Japan), Victoria (Germany), Vogue (France). (**distributed—not licensed**) Bellmusic, Gilas, IAI
Int'l reps.: Argentina (Microfon), Australia (Colossal, Minstrel), Austria (Bellaphon), Belgium (Musicanova, Phonogram), Brazil (Continental, Alldisc), Canada (Global), Chile (Quatro), Colombia (Codiscos), Ecuador (Codiscos), France (Arena, Atoll), Germany (Bellaphon), Greece (Panivar), Israel (Gal Ron), Japan (King), Lebanon (SLO), Luxembourg (Disco-sol), Malta (Brizz, Exotique), Netherlands (Sound Prods., Benelux Music), Peru (FTA), Portugal (Valentim de Carvalho), South Africa (Mycos), Spain (Columbia, RCA), Switzerland (Disques Office), USA (Fiesta, Little), Venezuela (Disco de Moda).
 Rockland. see CGD

S D M. see Sviluppo Discografico del Mezzogiorno
 SIF (Societa Italiana Fonografica) Srl. Via Ascanio Sforza 41, 20136 Milan. Tel: (02) 839.1810/4385. Telex: 315413. Mng. Dir.: Gian Piero Simon-tacchi. (Distributed by Ricordi)
 Saar Srl (IFPI). Viale di Porta Vercellina 14, 20123 Milan. Tel: (02) 46.96.251. Cable: SAAR. Telex: 79449. Pres. & Gen. Mgr.: Walter Guertler. Sales Mgr.: Sergio Balloni. A&R Mgr.: Ezio Leoni
Labels: (Owned) Devil, Green Light, Harmony, Joker, Music Power, Passport, Signal, Up
 Sabrina. see Stereomaster
 Sciascia SaS (Ed.) (IFPI). Via Brodolini, 20089 Rozzano (Milan). Tel: (02) 82.54.123. Pres. & Gen. Mgr.: Armando Sciascia. Sales Mgr.: Sergio Sciascia.
Labels: (Owned) Albatros, Angelicum, Arcophon, Ars Nova, Belcanto, Corsair, New Jazz Collection, Quadrifoglio, Replica, 6-Phase Superstereo, Spider, Vedette, Way Out, Zodiaco. (**licensed**) Baerenreiter Musicaphon (Germany), CRD (UK), Chant du Monde (France), Folkways (USA), Harmonia Mundi (France), Paredon (USA), Rounder (USA), UNESCO collection (Germany)
Int'l reps.: Argentina (Kena), France (Dom Disques), Germany (Disco Center), Greece (Philodisc), Switzerland (Phonag)
 Senza Fine Edizioni Srl. Piazzetta Pattari 2, 20122 Milan. Tel: (02) 805.8909/8968
 Seraphim. see EMI
 Sidel Ed. Srl. Piazzetta Pattari 2, 20122 Milan. Tel: (02) 804.818. 861.165. Cable: MILLENOTE. Pres.: Emanuele Daniele; Gen. Mgr.: Franca Daniele; PR: Luciana Medini
Labels: (Owned) Las Vegas, Millenote, Radio Recs., Recordclam, Telespazio
Int'l rep.: Worldwide (RCA)
 Sidewalk. see EMI
 Signal. see Saar
 Franco Simone. see WEA
 Sirio. see Sviluppo Discografico del Mezzogiorno
 6-Phase Superstereo. see Sciascia
 Snap. see Bellmusic
 Societa Italiana Fonografica. see SIF
 Sonorex SpA. Via Bonfadina 14, 25046 Cazzago San Martino (Brescia). Tel: (030) 725.382. Telex: 30826. Pres.: Giuseppe Zani; Gen. Mgr.: Bruno Raineri; Sales Mgr.: Italo Capoferrri
Labels: Audiogramm, Sonorex.
 Sorpasso. see CGD
 Soulfinder Int'l Rec. Imports di Carola Mirabelli. Via G.B. Vico 12, 20123 Milan. Tel: (02) 431.319. Telex: 311250. Gen. & Sales Mgr.: Carola Mirabelli (Importer)
 Soul Note. see IREC
 Spaghetti Recs. & Tapes, Galleria del Corso 2, Milan. Tel: (02) 794.129/729. Pres.: Sandro Colombini. (Distributed by RCA)
Labels: (Owned) Spaghetti, Spaghettri Blues
 Speedy. see Pinciana
 Spider. see Sciascia
 Splash SaS. Via Enea Zanfagna 7, Naples. Tel: (081) 635.183. 627.222. Chief Exec.: Peppino di Capri; Gen. Mgr.: Giuseppe Faiella. (Distributed by Panarecord)
 Sprint. see Durium
 Starmaker. see Stereomaster

Start. see Durium
 Stateside. see EMI
 Stereomaster & Phonographic Center Co. Srl. Galleria del Corso 2, 20122 Milan. Tel: (02) 790.096. Owner: Giuseppina Bagatta. A&R & Prod'n: Giuseppe De Vecchi; Press & Pub.: Yvonne Saltarelli
Labels: (Owned) Fiammetta's, Leonsoico, Phonorama, Sabrina, Star-maker, Stereomaster
 Die Stimme Seines Herrn. see EMI
 Stop Recs. Via Pineta Sacchetti 484, 00168 Rome. Tel: (06) 628.0210. Gen. Mgr.: Pietro Perdoni
Labels: (Owned) Petrus, Stop
Int'l reps.: Hungary (Pepita), Romania (Electrecord)
 Storm. see Sviluppo Discografico del Mezzogiorno & RCA
 Storyville. see Decca
 Strand. see Decca
 Studio. see Ri-Fi
 Studio G. Srl. Via del Forte di San Martino 11, 16145 Genoa. Tel: (010) 301.920. 369.723. Pres.: G.B. De Scalzi
Labels: (Owned) Area, Grog, Magna
Int'l reps.: France (Arabella), Germany (Ariola Eurodisc), USA (Peters Int'l)
 Suono Recs. Srl. Via Manin 111, 30174 Venice-Mestre. Tel: (041) 972.229. Dir.: Tony Tasinato
 Sviluppo Discografico del Mezzogiorno SpA. Via dei Fiorentini 21, 80133 Naples.
Labels: (Owned) Edibi, SOM, Sirio, Storm
 Synusoid. see Panarecord
 T Rex. see EMI
 T I C. see Ricordi
 Targa Italiana Srl. Viale Pasubio 6/8, 20154 Milan. Tel: (02) 650.356/410. Pres.: Mario Rapallo. (Distributed by Durium)
Label: (Owned) Iarga
 Telefunken. see Decca
 Telespazio. see Sidel
 Threshold. see Decca
 Ticket. see Ricordi
 Inne. see Expanded
 Traccia. see Fonti-Cetra
 Transex Srl. Via Dogana 1, 20123 Milan. Tel: (02) 805.7645. 862.730. Cable: TRANSEXPORI. Telex: 320405. Gen. Mgr.: Edip Saban. (Distributor/Importer/Exporter)
Label: (Imported) Melodiya (USSR)
 Turbo. see CGD
 Universal. see Phonotype
 Up. see Saar
 V I P. see CGD & Cielo-Video
 Variety. see Ri-Fi
 Vedette. see Sciascia
 Vertigo. see PolyGram
 Verve. see PolyGram
 Victor. see RCA
 Victrola. see RCA
 Video. see Cielo-Video
 Village Voice Srl. Via Asiago 2, 00195 Rome. Tel: (06) 361.2458. Pres.: Aldo Sinesio; Gen. Mgr.: Gianni Gualberto; Sales Mgr.: Donald Daams. Technical branch: Via delle Codette 31-B, 00060 Riano (Rome). Tel: (06)

FOR YOUNG INDEPENDENT RECORD COMPANIES AND PRODUCERS YOUR ITALIAN OUTLET IS

Ariston music

A COMPLETE INDUSTRIAL CYCLE

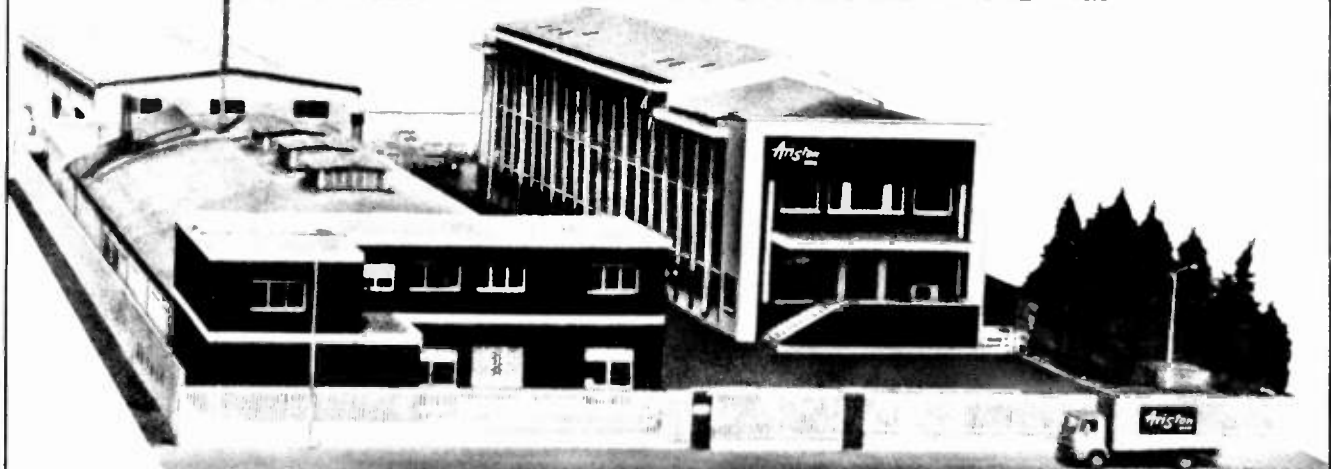

Head Office:
 Via M. Gorki, 21 20098 SAN GIULIANO MILANESE (Milan - Italy)
 Tel. (02) 9846974/5/6/7/8/9 - Telex: 321466 ARIMUS I
 Cables: ARISTONMUSIC

Branch Office:
 Via Cantore, 17 - 00195 ROME (Italy)
 Tel. (06) 386259 - Telex: 614509 ARIMUS I

903.4356.
 Labels: (Owens) Black Shell, Fly, Horo.
 Int'l rep.: Japan (CAM).
 Vitamin Recs., Via Turati 29, 20121 Milan. Tel: (02) 654.140, 632.656
 Telex: 313871. Admin'r: Roberto de Gaetano, Gen. & A&R Mgr: Gianni
 Guarnieri; Int'l Mgr.: Alma Pozzati.
 Label: (Owens) Vitamin.
 La Voce del Padrone, see EMI.
 W E A Italiana SpA (IFPI), Via Milano 16, 20090 Redecesio di Segrate (Mi-
 lan). Tel: (02) 2.16.81. Telex: 320688. Mng. Dir.: Giuseppe Velona, Sales
 Mgr.: Giancarlo Spadacenta
 Branch: 00195 Rome, Via Cantore 17. Tel (06) 359.95.26, 388.317
 Home office: USA, WEA Int'l.
 Labels: (Owens) Asylum, Alco, Atlantic, Charter Line, Elektra, Nonesuch,
 Radar, Reprise, WEA, Warner Bros.; (licensed) Beggar's Banquet (UK),
 Big Tree (USA), Cotillion (USA), Dark Horse (USA), Geffen (USA), Swan
 Song (USA); (distributed—not licensed) Chic, Koko, Lollipop, Franco Si-
 mone.
 Warner Bros., see WEA
 Way Dut, see Sciascia
 Wep, see Panarecord.
 Zerolandia, see RCA.
 Zeus Rec. Srl (IFPI), Piazzetta Matilde Serao 15, 80132 Naples. Tel (081)
 406.791, 415.997. Contact: Ciro Barrucci, Gen. Mgr.: Antonio Barrucci.
 Zip, see Cinevox.
 Zodiaco, see Sciascia.

• music publishers

A B R, see Sugarmusic.
 Giuseppe Accettura, Viale de Laurentis 6, Bari. Tel: (080) 420.113, 363.964
 Chief Exec.: Giuseppe Accettura.
 Accordo Ed. Musicali (SIAE), see Curci.
 Acqua Azzurra Srl (SIAE), see Numero Uno.
 Acuff-Rose, see Sugarmusic.
 Agenda Ed. Musicali, Via Castiglione 109, 40136 Bologna. Tel (051)
 534.697, 237.528. Telex: 511483. Mng. Dir.: Alberto Caroli; Gen. Mgr.:
 Antonio Foresti.
 Int'l firms represented: United Int'l Copyright Reps (USA), Syndicore
 (USA).
 Albert/Franton, see Franton.
 Allegro Srl, see Bixio Music Group.
 D'Anzi Ed. (SIAE), see Curci.
 April Music Srl, Via Amadei 9, 20123 Milan. Tel: (02) 809.521. Telex:
 33286. Dir.: Antonio Marrapodi.
 Home office: USA, April/Blackwood.
 Int'l rep.: USA (April/Blackwood).
 Argo Ed. Musicali Srl (SIAE), Via Vittorio Veneto 7, 00187 Rome. Tel (06)
 463.294. Gen. Sec'y: Alessandra Perlusz.
 Ariete Ed. Musicali (SIAE), see Curci.
 Arston Srl (SIAE), Via Massimo Gorli 21, Strada Zivido, 20098 San Giuliano
 (Milan). Tel: (02) 98.46.974. Telex: 321466. Pres. Alfredo Rossi; Gen
 Mgr.: Antonio Celano; Prof. Mgr.: Luigi Fedele, Copyright Dept. Fermo
 Tonali.
 Branch: 00195 Rome, Via Cantore 17, Tel (06) 386.259. Telex: 614509
 Int'l firms represented: British Lion, Mister Mellow, Paper, RAK, Rocket,
 Sweet 'N' Sour, Valentine (all UK); Arston (France), Brammus (Brazil,
 USA), MEC (Germany). (SEE ADVERTISEMENT)
 Mario Aromando Ed. Musicali Srl (SIAE), Via Quintiliano 40, 20138 Milan.
 Tel: (02) 5084. Cable: ESSEXITALIANA. Telex: 321063. Pres. Piero
 Sugar; Gen. Mgr.: Sandro Pieralli.
 Int'l firms represented: Abigari, Amnestoy, Commander, Drolet, Eastlake,
 Encino, Fall River, Harral, Howard Beach, Hulaws, MJQ, Marpet, Sanga,
 Schroeder, Storming, TRO/The Richmond Org., Tickson, Valley Meadow
 (all USA).
 Int'l rep.: USA (TRO Group).
 Aromando, see Sugarmusic.
 Aseo (Ed. Musicali), see Curci.
 Atlas Music, Corso Buenos Aires 10, 20124 Milan. Tel: (02) 271.5972. Telex:
 333414. Pres. & Gen. Mgr.: Alessandro Coppola. (SEE ADVERTISEMENT)
 Audisam Ed. Musicali, Galleria del Corso 2, 20122 Milan. Tel: (02) 704.006.
 Chief Exec.: Nunzia Angeramo; Gen. Mgr.: Giovanni Samele. Prof. Mgr.:
 Romano Romanini.
 Beat Recs. Co. Ed. Musicali Srl (SIAE), Via Filippo Nicolai 16, 00136 Rome.
 Tel: (06) 348.497, 347.139. Cable: BEATRECDRO. Telex: 612513. Gen.
 Mgr.: Franco de Gemini.
 Int'l firms represented: Amphonic (UK), Emilhenco (France), Eurobeat
 (UK), Illustration Musicale (France), Jerry Williams (USA), Show Busi-
 ness (Germany).
 Int'l rep.: UK (Eurobeat).
 Bixio CA, see Bixio Music Group.
 Bixio CEMSA SpA, see Bixio Music Group.
 Bixio Music Group (SIAE), Via Romeo Romei 15, Rome. Tel: (06) 311.280,
 311.870. Telex: 616241. Pres. Carlo Bixio. Gen. Mgr.: Andrea Bixio.
 Int'l rep.: Belgium, France. (both Bixio).
 Bixio Sam, see Bixio Music Group.
 Blue Team Music, Srl, Via Milano 16, 20090 Redecesio di Segrate (Milan).
 Tel: (02) 2.16.81. Telex: 320688. Mng. Dir.: Giuseppe Velona, Prof. Mgr.:
 Marco Gaido.
 Bongiovanni (Ed. Musicali), Via Rizzoli 28, 40125 Bologna. Tel: (051)
 225.722. Gen. Mgr.: Giancarlo Bongiovanni.
 Int'l rep.: USA (Belwin-Mills).
 Buffalo Bill, see Sugarmusic.
 CA M (Creazioni Artistiche Musicali) SpA (SIAE), Via Virgilio 8, 00193 Rome.
 Tel: (06) 382.021. Cable: CAMUSIC. Telex: 611374. Pres. Giuseppe
 Campi.
 Int'l branches: Australia, England, Germany, Japan, Scandinavia, Spain,
 Sweden, USA.
 Int'l rep.: Brazil (Arlequin), Canada (Experience), France (Pema Music,
 SIMEPP), Switzerland (Campana).
 Canopo (Gruppo Ed.) (SIAE), Via A. Riboty 22, 00195 Rome. Tel: (06)
 315.615.
 Int'l firm represented: Montparnasse 2000 (France).
 Int'l rep.: Belgium (Multi Sound), France (Montparnasse 2000).
 La Canzone Ed. Musicali, Galleria del Corso 4, 20122 Milan. Tel: (02)
 793.601. Gen. & Prof. Mgr.: Gabriele G. Abbate.
 Canzoni Moderne Ca-Mo, see Sugarmusic.
 Carsch SpA (SIAE), Via General Fara 39, 20124 Milan. Tel: (02) 670.2741/
 2835. Pres. Sandro Galil.
 Int'l firms represented: Baerenreiter (Germany), Boosey & Hawkes (UK),
 Breitkopf & Haertel (Germany), Broude Brothers (USA), Editio Musica
 (Hungary), Faber (UK), Henie (Germany), Novello & Co (UK), Salabert
 (France).
 Int'l rep.: France (Eschig), Germany (Baerenreiter).
 Carosello Ed. Musicali & Discografiche (SIAE), see Curci.

The "must" in records...

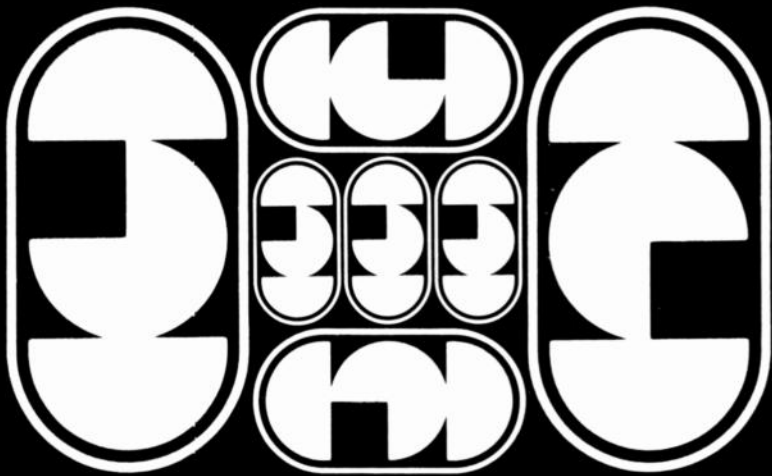

...recording and...

IDEA

RECORDING



...publishing in Italy



gruppo editoriale sugar

**via Quintiliano, 40 - 20138 MILAN
phone 5084 - ITALY**

TELEVIS

**is your
right
partner,
we are
wild on
promotion
and
money
makers!**

Please contact



**TELEVIS
edizioni musicali s.r.l.**

20124 Milano - Via Timavo, 34
Telefono 68 80 889

Telex 313502

Casa Della Musica, see Bixio Music Group
Casa Editrice Musicale Raffaele Izzo (SIAE), see Curci
Casa Musicale Edizioni Carrara S.r.l., Via A. de Catepjo 4, 24100 Bergamo
Tel (035) 243 618
Centotre, see 103
Century Music Italiana (SIAE), see Curci
Cervino Ed. Musicali (SIAE), see Curci
Chappell (Ed.) SpA (SIAE), Corso Buenos Aires 79, Milan Tel (02)
670 9116 Cable SINFONIA Telex 316682 Mng Dir. Adriano Solaro,
Gen Mgr. Pieter Keun, Prof. Mgr. Luigi Bartolotta
Int'l firms represented: Chappell Int'l (worldwide), Famous/Paramount
(USA), Hanna/Barbera (USA), Lowery (USA), Performance (USA), Pink
Floyd (UK), RSD (UK, USA), Stonebridge (USA)
Int'l rep.: Worldwide (Chappell Int'l)
La Cicala, see Sugarmusic
Cielo Video (Ed. Musicali) (SIAE), Galleria del Corso 2, 20122 Milan Tel
(02) 705 231 Pres. Virgilio Panzuti, Gen. Mgr. Dante Panzuti
Int'l firms represented: A. Lutereau (France), Selected Sound (Ger-
many), Storzando (France)
Clan, see Sugarmusic
Cobra, see Sugarmusic
Come Il Vento S.r.l. (Ed. Musicali & Discografiche) (SIAE), Via Montena-
leone 29, 20121 Milan Tel (02) 700 725/574 791 665 Mng Dir &
Gen. Mgr. Michele del Vecchio
Curci S.r.l. (Eds.) (SIAE), Galleria del Corso 4, 20122 Milan Tel (02)
794 746 Cable CURCIMUSIC Telex 332683 Pres. & Gen. Mgr.: Giu-
seppe Gramitto Ricci
Int'l reps.: Austria (Titania Hans Gerig), Benelux (Curci), Brazil (Curci),
Canada (Italcanto), France (Curci), Germany (Titania Hans Gerig), Portu-
gal (Curci), Spain (Curci), Switzerland (Ciao)
Decca Ed. Musicali S.r.l. (SIAE), Via Brisa 3, 20123 Milan Tel (02) 809 136
Cable DECCITAL Telex 34209 Gen. Mgr. Romano Bacchini
Derss Ed. Musicali S.n.C., Via Leoncavallo 14, 20131 Milan Tel (02) 780 778
Gen. Mgr. Evelina Bettolo
The Dig It Eds S.r.l., Corso Vittorio Emanuele 22, Milan Tel (02) 780 778
Chief Exec. Pippo La Rosa
Int'l firms represented: Art (France), Yona (France)
Int'l reps.: Austria (Teldec), France (Arabella, Art, Yona), Germany (Tel-
dec)
Di Lazzaro, see Sugarmusic
Disco Piu S.r.l. Ed. Musicali, Via Ascano Storza 41, Milan Tel (02)
839 1810/4385 Telex 315413 Mng Dir. Maria Cantadore, Gen. Mgr.
Gian Piero Simontacchi
Ducale Ed. Musicali S.r.l. (SIAE), Via Per Cadrezzate 5, 21020 Brebbia (Va-
rese) Tel (0322) 770 784/189 Telex 380231. (SEE ADVERTISEMENT)
Durium Ed. Musicali (SIAE), Via Manzoni 40/42, 20121 Milan Tel (02)
701 872 Cable DURIMUM Telex 333564 Pres. Krikor Mintangian, Gen.
Mgr. Franco Cassano, Int'l Mgr. Elisabeth Mintangian
Int'l firms represented: Black Scorpio (USA), Far (Germany), RKM (Bel-
gium)
Ediesse, see Sugarmusic
Elettra Ed. Musicali, Via al Forte di San Martino 11, 16145 Genoa Tel (010)
301 920, 369 723 Pres. G. B. De Scalzi
Eleven Music Co. S.r.l. (SIAE), Via Rossini 8, 20090 Cesano Boscone Tel (02)
349 8107 Cable PAGANMUSIC Chief Exec.: Aldo Pagani, Gen. Mgr.

Graziella Bolzoni
Eliseo (Ed. Musicali), see Sciascia
Essex Italiana (Ed. Musicali) S.r.l. (SIAE), Via Quintiliano 40, 20138 Milan
Tel (02) 5084 Cable ESSEKITALIANA Telex 321063 Co. Pres.: Howe
Richmond, David Platz; Gen. Mgr.: Sandro Pieralli (Also see Sugar
music)
Int'l firms represented: Abako (USA), Caulflower (UK), EG (UK), Eel Pie
(UK), Esoteric (UK), Essex group (UK), Fabulous (UK), Hy Lo (USA), Kags
(UK), Las Palmas (USA), Latimer (UK), Marsmith (USA), Memory Lane
(UK), Misty River (UK), New Ikon (UK), Pierrepont (USA), Shalfmere
(UK), Starling (UK, USA), Tapestry (UK), Whistle Rhymes (UK), World
Film Servs. (UK)
Int'l reps.: France (NFC Ed. Musicales), UK (Essex Music Group), USA
(TRG Group)
Essex Music Inc., see Mario Aromando
F.M.A. S.r.l. (Ed. Musicali & Discografiche), Galleria del Corso 2, 20122 Milan
Tel (02) 796 823, 796 266 Mng. Dir. Federico Monti Arduini
Fado (SIAE), see Curci
Farella Splash, Viale Elena 17/B, 80122 Naples, Tel. (081) 635.183 Gen.
Mgr. Giuseppe Farella
La Falena, see Sugarmusic
Fast (SIAE), see Curci
Ferretti-Happel (Ed.) (GEMA), Via Goldoni 6/A, 46100 Mantova Tel (0376)
367.677 Gen. Mgr. Silvano Ferretti
Festival Ed. Musicali (SIAE), see Curci
Fiumara Ed. Musicali & Discografiche S.r.l., Via Adda 28, 20041 Agrate
Brianza (Milan) Tel (02) 650.983 Gen. & Prof. Mgr.: Franco Reitano
(SEE ADVERTISEMENT)
Flipper Ed. Musicali, see Canopo
Fly Rec. Ed. Musicali S.r.l., Via Asiago 2, 00195 Rome Tel. (06) 361 24 58
Chm. Aldo Sinesio, Gen. Mgr. Gianni Gualberto, Prof. Mgr. Cristina
Ripamonti
Int'l rep.: Japan (CAM)
Fonti-Cetra SpA, see Goldfinger
Fono Cine (Ed. Musicali), Via San Paolo 15, 20121 Milan Tel (02) 874 460
Owner & Gen. Mgr. Pericle Boschetti
Franton Music S.r.l. (SIAE), Via Manin 111, 30174 Venice-Mestre Tel (041)
940 322 Telex 410874 Co. Pres. Tony Tassinato, Francesco Sanavio, Fi-
nancial Mgr. Riccardo Bernardello
Int'l firms represented: AA (Belgium), Accabonac (USA), J. Albert (Aus-
tralia), Albet (USA), Alrac (USA), American Cowboy (USA), Andante
(USA), And (USA), Antisa (USA), Arden (USA), Annakata (UK), Atomic
(USA), Aud Sun (USA), Barometer (USA), Gary Bartz (USA), Bee Keeper
(USA), Beeswax (USA), Beggars Banquet (UK), Brg (USA), Birdwing
(USA), Black Sun (USA), Borzo (USA), Cable Car (USA), Callee (USA),
Can (Germany), Candle (USA), Cappy (USA), Castle (USA), Castle Hill
(USA), Celestial Harmonies (USA), Charly (UK), Cherry Lane (USA),
Cherry River (USA), Clouseau (France), Coast Highway (USA), Coryell
(USA), d'Abo (USA), Daksel (USA), Dex (USA), Dinsong (UK), Dizio
(USA), ENIA (Germany), Early Morning (Canada), Earmark (USA), Fiction
(USA), Firesign (UK), Flanagan (USA), Floyd's (USA), Food (USA), Fourth
Floor (USA), Futures Passed (USA), GH (UK), Gaeda (USA), Gillan (USA),
Haapala (USA), Haversstraw (USA), Andrew Heath (UK), Heathwave (UK),
His Eye (USA), Hitman (USA), Honey Dew (USA), Horseshoe Canyon
(USA), Hot Kitchen (USA), Humanoid (USA), Bobbi Humphrey (USA), A-
berta Hunter (USA), Hynde House Di Hits (UK), Iska (USA), Elvin Jones

IF YOU
ARE LOOKING
FOR A
DISTRIBUTOR
WE ARE
YOUR ITALIAN
CONNECTION



**INTERNATIONAL
RECORD
DISTRIBUTION s.r.l.**
Via San G.B. de La Salle, 4
20132 MILANO
tel. (02) 25.91.700/25.92.064
TELEX 315493

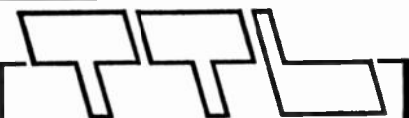

TAPE TECHNOLOGY LABORATORY
di Rizza Attilio

NEW! MOD. 515
FULLY AUTOMATIC
MAGNETIC TAPE WINDER
SELF FEEDER CASSETTE
WITH SIDE SELECTOR



Via Pirandello 4/A - Milano - Tel. (02) 4695213 - ITALY

PRODUCTION.

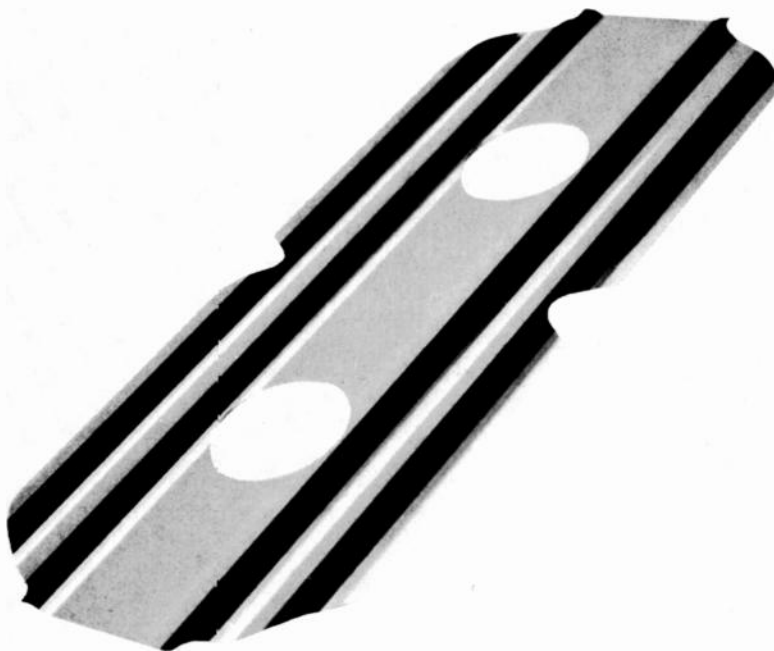

when you
are looking at
the particulars
of technology.



A.T.B. spa
20030 Senago
Milano Italy
30, Palmiro Togliatti
telefono 02 9989976/7/8
TLX 334457 ATIBIX I.

(USA), Quincy Jones (USA), Kidada (USA), La-de-Die (USA), Lauralee (USA), Liberation (USA), Roger Linn (USA), Local Yokel (USA), Lupe (USA), M 3 (USA), Magicland (USA), Mar Ken (USA), Jon Mark (USA), Mayflower (USA), Miyako (USA), Modern (UK), Moose (Canada), Bryan Morrison (UK), Mouzon (USA), Mowgli (USA), Mulatto (USA), Narwhal (USA), Nefertiti (USA), New Times (USA), Nineden (UK), Nomis (Hong Kong), No 11 (USA), Dakshira (USA), Milton Okun (USA), Ondine (USA), Open End (USA), James Osterberg (USA), Other Side (USA), Oyster (USA), Pablo (USA), Pacific View (USA), Pastorius (USA), Pauper (USA), Phrase Text (USA), Real To Real (USA), Red Stripe (USA), Riva (UK), Riv bea (USA), Rohm (USA), Seldak (USA), Silhouette (USA), Skyhill (USA), Smith Tunes (USA), Solar Plexus (USA), Song & Dance (USA), Sparrow (USA), State Of the Arts (USA), Sweet Jelly Roll (USA), Synthesis (USA), Tark (USA), Tarka (USA), Teddy Jack (USA), Third World (USA), Thorius (USA), Timtobe (UK), Tomi (USA), True Crescendo (USA), Tubbs Hill (USA), Tumbleweed (Australia), Uneathly (USA), Unit Core (USA), Vida (USA), Virgin (UK), Wallace (USA), Watt (USA), Jerry Weintraub (USA), Wesser (USA), Don Williams (USA), Tony Wilson (USA), Windsea (USA), Windstar (USA), Wishbone (USA), Wondebuns (USA), World Artists (USA), Yellow Brick (USA), Zid (USA), Znarg (USA)

Int'l rep.: USA (Ralph L. Seltzer)

Gale Italiana, see Bixio Music Group

Gargano/Rockmasters Inc., Via Venini 38/1, Milan Tel (02) 285 3710
Prof. Mgr. M. Gargano

Home office: USA, Rockmasters

Gustavo Gori SaS (SIAE), Via G. Mazzini 26, 21052 Busto Arsizio Tel (0331) 639 531 Gen. Mgr. Dr. Giuseppe Gallazzi

General Music, Viale Liegi 41, 00198 Rome Tel (06) 850 358, 865 307
Gen. Mgr. Enrico de Meis

Int'l firm represented: General Music (France)

Globo Ed. Musicali (SIAE), Via S. Sebastiano 16, 80134 Naples Tel (081) 452 597 Gen. Mgr. Pasquale Liguori

Goldfinger Ed. Musicali Srl, Via G. Meda 45, 20141 Milan Tel (02) 84.32 551 Cable FONITCETRA Telex 314653 Chief Exec. Wilma Battigelli, Gen. Mgr. Giancarlo Charamello

Granadine Music Srl, see Bixio Music Group

Grandi Firme della Canzone, see Bixio Music Group

I M I (International Music of Italy), see Sciascia

Insieme, see Sugarmusic

Interdemos, see Sugarmusic

Intersong Italiana Ed. Musicali Srl, Corso Buenos Aires 79, Milan Tel (02) 670.9116 Cable SINFONIA Telex 316682 Mng. Dir. Adriano Solaro

Gen. Mgr. Pieter Keun, Prof. Mgr. Maria Antonietta Giorgini

Home offices: Germany, Intersong Int'l; Netherlands, Artemis

Int'l firms represented: Andustin (USA), Arnel, Berna, Big Shorty (USA), Hamilton Bohannon (USA), Brown Sound (USA), CTA (UK), Carlin (UK), Charlotte (UK), Cherry (UK), Cried (USA), Eumir Deodato, Diagonal (USA), Dough Boy (USA), Dynafone (USA), Fort Knox, Fuse (UK), Colo (USA), Hanseatic-Leo Leandros (Germany), Harbar (UK), Hazy, Hudson Bay, Jadar (USA), Jay & Cee, Jimpire, Kenya, Little Fugitive (USA), Luckyo, Magnet (UK), Martin Coulter (UK), Mews (UK), Midland (USA), Midsong (USA), Mighty (UK), Mobetta (USA), Montunes (USA), Nineteen Eighty-Five (USA), Normal, Open End, Oyster, Pants Down (USA), Pocket Full of Tunes (USA), Progressive (Germany), Quartet, Robert Riley (USA), Rodra, Samba (USA), Son Lo, Sweet (UK), TH (UK), Tansoul (USA), Timtobe (UK), Trio, US Songs, R.P. Winkelman Tunes (USA), Xanadu, Yellow Dog

Int'l rep.: Worldwide (Intersong Int'l)

Italcanto (SIAE), see Curci

Italian Yank Ed. Musicali (SIAE), see Curci

It-Why Discografiche (Ed. Musicali) (SIAE), Via Montenapoleone 29, Milan Tel (02) 700 574 Mng. Dir. Paolo Caltaneo, Gen. Mgr. Michele Galasso

Int'l rep.: Worldwide (Usignolo)

Ivana, see Sugarmusic

Dick James Music Italiana, see Sugarmusic

Jump Ed. Musicali (SIAE), Galleria del Corso 2, 20122 Milan Tel (02) 705 231 Gen. Mgrs. Virgilio & Dante Panzuli

Int'l firms represented: Intersound (Germany), Selection/Multisound (Belgium)

Int'l reps.: Australia (Penjane), Austria (Vineta/Liveton/Bavariaton/Tip Top), Belgium (Multisound), Canada (Morning), France (Presence/Warner/Atoll), Germany (Vineta/Liveton/Bavariaton/Tip Top), Japan (Illust), Netherlands (Multisound), New Zealand (Penjane) Scandinavia (Camp), South Africa (Gallo), Switzerland (Vineta/Liveton/Bavariaton/Tip Top), USA (TRF)

M A M Music Publ'g Italia, see Sugarmusic

M C A Music Italy Srl, Via Quintiliano 40, 20138 Milan Tel (02) 5084
Cable SUGARMUSIC Telex 321063 Gen. Mgr. Ettore Carrera, Prof. Mgr. Mariangela Roveda, (Also see Sugarmusic)

Int'l firms represented: CIC (UK), Evita (UK), Four Knights (USA), Infinity (USA), Leeds (UK), MAM (UK), MCA group (USA), Spanka (USA), Three Knights (USA), Valley (UK)

Margherita, see Sugarmusic

Market Ed. Musicali, see Canopo

Mascheroni, see Sugarmusic

Mascotte, see Sugarmusic

Peter Maurice, see Sugarmusic

Melodi, see Sugarmusic

Misura Ed. Musicali Srl, Galleria del Corso 4, 20122 Milan Prof. Mgr. Michele Francesco

Montagne Verdi, see Sugarmusic

Movimento Musica Ed., Via S. Maurizio 13, 20123 Milan Tel (02) 872 341, 864 423 Telex 313017 Mng. Dir. Salvatore Caruselli

Musica & Dischi Ed. Musicali, Via Giannone 2, 20154 Milan Tel (02) 389 059/936 Mgr. Mario de Luigi

Musica Et Machina, Via Sant'Isaia 49, 40123 Bologna Tel (051) 269 461
Pres. Giovanni Natale, Gen. Mgr. Nino Jorfinio

Music Union (SIAE), see Curci

Neapolis (Ed.), Le Regina Margherita 140, Rome

Nido, see Bixio Music Group

Nula Ed. (SIAE), Galleria del Corso 4, 20122 Milan Tel (02) 794 266 Gen. Mgr. Alessandro Friggieri

Number Two (Ed. Musicali) (SIAE), see Curci

Numero Uno Srl (SIAE), Galleria del Corso 2, 20122 Milan Tel (02) 799 331/127 Cable NUMERUND Telex 310689 Pres. Giuseppe Ornatò, Gen. Mgr. Antonio Comi

Int'l reps.: Austria, Germany, Switzerland (Cyclus in Germany), Portugal, Spain (RCA in Spain)

103 Ed. Musicali & Discografiche Srl, Via Binda 33, 20143 Milan Tel (02) 404 7574, (051) 911 163 Gen. Mgr. Luigi Baron

Panamusic Srl, Via Cimara 4, 20144 Milan Tel (02) 430 046, 485 609
Telex 340014 Pres. Dr. Sergio de Gennaro

Peer-Southern Org., see Southern



polimek S.R.L.

C-O cassettes

- Screw
- Sonic welded
- Multiple leader color
- Tabs in or out
- Colors

Cassette - Boxes

POLIMEK s.r.l.

20017 Rho (Milano) Italia
Via Pace, 64
Tel. (02) 9301742 - 9309484
Telex: 330501 AVANMII

EXCLUSIVE
MANUFACTURER
CO's and BOXES To:
AUDIO MEDIA
SALISBURY—ENGLAND

FOR ALL YOUR NEEDS
OF
**MUSIC
INDUSTRY
PRODUCTS**
CONTACT US



LENED AUTOMATIC PRESSES
FOR 7" & 12" RECORDS

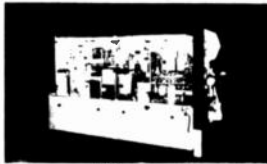

GIMA MU-7
AUTOMATIC ASSEMBLING
OF C-O CASSETTES

DUCALE



**FROM
ITALY
THE
DAVIDE
MATALON
GROUP
FOR
THE
WORLD
OF
MUSIC**

100% ALL-STAR High Quality Musical
Equipment Catalogue in
31200 DREZZANO (Milano) Italy
Telephone: 02/3121174/175/176/178/179/180
Telex: 3300211 Ducale I

RECORDS - TAPE - CASSETTES
C-O - BOXES - MOULDS
COMPLETE PLANTS FOR
RECORDS AND CASSETTES

OUR LABELS



RECORDS
BAINBRIDGE



Pinciana Music SnC, (SIAE), Via Giovanni Branca 35, 00153 Rome. Tel: (06) 575.8776. Gen. Mgr.: Fulvio Corradini.
Platz Music, see Sugarmusic.
R C A Publ'g Group, Via San Alessandro 7, 00131 Rome. Tel: (06) 436.61.
Cable: RCA Telex. 610428. Pres.: Giuseppe Ornato; Dir.: Mario Cantini; Foreign Catalogs Admin'r: Vincent Messina. Int'l Copyright Mgr.: Sante Cecconi.
Home office: USA
Int'l firms represented: Aberbach (USA), Almo/Irving (USA), Amsterdam Marathon (Netherlands), Associated (Australia), Belwin-Mills (UK, USA), Blackhill (UK), Bleu Disque (USA), Brintree (USA), Cayman (USA), Copyright Serv. Bureau (USA), Cyclus (Germany), Dizzy Heights (UK), EDIM (Mexico), Family of Man (USA), 57th Street Entertainment Group (USA), Formula (USA), Sam Fox (USA), Gladys (USA), Hill & Range (USA), House of Cash (USA), Hudson Bay (USA), Laurie (USA), Leosong (UK), Edward B. Marks (USA), Metal Machine (USA), Ivan Mogull (USA), Morning Music Group (Canada, UK, USA), Muscle Shoals Sound (USA), Oakfield Ave. (USA), Plangent Visions (UK), Porchester (USA), Elvis Presley (USA), RCA (Brazil, France, Spain), Red Network/Blue Network (USA), Relay (Argentina), Rock (UK), Rondor (Australia, Canada, UK, USA), Saber Tooth (USA), Salsoul/Lucky Three (USA), Scott-Tone (USA), Songs of Cash (USA), Street (UK), Sunbury (UK), Sunbury Dunbar (Canada), Tru-mur/Phylmar (USA), Zomba Corp. (Switzerland), Zomba Mgmt. (UK)
Int'l reps.: Argentina (Relay), Australia (Associated), Brazil (RCA), Canada (Sunbury/Dunbar), France (RCA), Germany (Cyclus), Japan (Global), Mexico (EDIM), Netherlands (Amsterdam Marathon), Spain (RCA), UK (Sunbury), USA (Blue Network/Red Network)
R T Y Ed Musicali (SIAE), see Curci.
Resolute, see Sugarmusic.
Revelation, see Sugarmusic.
G Records & C. SpA (SIAE), Via Berchet 2, 20121 Milan. Tel: (02) 88.81.
Cable: RADIOREK Telex: 310177. Mng. Dir.: Guido Rignano, Int'l Publ'g Mgr. Vittorio Somalvico
Int'l firms represented: ATV (UK, USA), Achee (USA), Albion (UK), Alien (USA), Alshire Int'l (USA), Arc (USA), Bar None (USA), Eddie Barclay (France), Barton (USA), Belway (USA), Big Elk group (USA), Bilmar (USA), Black Scorpio (USA), Blue Street (USA), Le Bon Aire (USA), Boston group (USA), Mel Bren (USA), Bridgeport (USA), Broken Arrow (USA), Broken Bird (USA), Bug (USA), Burlington (UK), Canopy (USA), C'est Music (USA), Chic (USA), Chriswood (USA), Chrysalis (UK), Combine (USA), Roger Cook (USA), Cookhouse (USA), Cotillion (USA), Crabshaw (USA), Crazy Crow (USA), Dark Horse (USA), Mack David (USA), Debmar/Rambled (USA), Ditch Road (USA), Easy (USA), Eaton (UK), Eighties (USA), Eldorado & Hillwood (USA), Emanuel (USA), FFD/Aspen (USA), John Far-rar (USA), Feckless (USA), Fifth Floor (USA), First Artist (USA), Fleetwood (UK), Fleur (USA), Frabjous Approx (USA), Freshwater (UK), Ganga (USA), Gates (USA), Geffen (USA), Gnossos (USA), God Tunes (USA), Goodman group (USA), Guerrilla (USA), Van Halen (USA), Hancock (USA), Harrison's (USA), Heart Delight (USA), Hit & Run (UK), Ice Age (USA), Ice Nine (USA), Island (UK, USA), Dick James (UK), Kamakazi (USA), Kipner (USA), Know (USA), Lambert & Potter (USA), Leatherhead (USA), John Lennon (UK), Lenono (USA), Libra (UK), Lido (USA), Light (USA), Little Dragon (USA), Logo (UK), Lunatunes (USA), MGM-Variety (USA), Mainman (Switzerland), Manticore (UK), Material World (USA), Medicine Hat (USA), Micache (USA), Mighty Three (USA), Miram Mijac (USA), Joni Mitchell (USA), Mole (USA), Giorgio Moroder (USA), Mother-tongue (USA), Munchkin (USA), Naked Snake (USA), Ninth (USA), North-ern Songs (UK), Norway (USA), Nuestra Canterbury (USA), Oakland (USA), Open Choice (UK), Painless (USA), Petra (USA), Picalic Publ'g (USA), Play My Music (USA), Plurikanz (USA), Poco Publ'g (USA), Pop 'N' Roll (USA), Portofino (USA), Pure Prairie League (USA), Pure Songs (USA), Quackenbush (USA), REO Speedwagon (USA), Rabbit Songs (USA), Ramsel (USA), Raydiola (USA), Razzle (UK), Red Gator (USA), Re-saca (USA), Rosy Publ'g (USA), Rotgut (USA), Rough Trade (UK), Round Wound Sound (USA), Roxlam (USA), Saggi-fire (USA), Sailor (USA), Satur-day (USA), Savona (USA), Saxsong (UK), Boz Scaggs (USA), Scent (USA), Scorpio (France), Shillelagh (USA), Shoesong (USA), Shot (USA), Silver Fiddle (USA), Paul Simon (USA), Siquomb (USA), Siren Songs (USA), Small Hill (USA), Southfield (USA), Sparta Florida (UK), Special Music Group (USA), Bruce Springsteen (USA), Strange Euphoria (USA), Strong Arm (USA), Swell Sound (USA), Tannen (USA), Tauripin Tunes (USA), Tessa Publ'g (USA), Thin Ice/Broken Bird/Puzi Puzi (USA), Third Story (USA), Tonopah & Tidewater (USA), Trane (USA), UFO (USA), VAAP (USSR), Venice (USA), Warner Bros. (UK, USA), Wayward (USA), Weed High Nightmare (USA), West Berkeley Soundcigum (USA), White Oaks Songs (USA), Windecor (USA), Wow & Flutter (USA), Lawrence Wright (UK), You You (France), Yinop (USA), Frank Zappa (USA), Zevon (USA)
Int'l reps.: Argentina (Ricordi Americana), Belgium (Nada), Brazil (Ricordi Brasileira), France (Barclay), Germany (Drei Ringe), Greece (Black-wood), Japan (Watanabe), Mexico (EMLASA), Netherlands (Nada), Portu-gal (Clipper's), Spain (Clipper's), Switzerland (Seventh Music).
Ri-Fi Music Publ'g Group (SIAE), Via Eustachii 31, 20129 Milan. Tel: (02) 20.22.08. Chm. Roberto Rossi, Mgr.: Marincho Rigaldi.
Int'l branches: Spain, USA.
S I F (Societa Italiana Fonografica) Srl, Via Ascanio Storza 41, 20136 Milan. Tel: (02) 839.1810/4385. Telex: 315413. Mng. Dir.: Gian Piero Simon-tacchi.
Saar Ed. Musicali (SIAE), Viale di Porta Vercellina 14, 20123 Milan. Tel: (02) 46.96.251. Cable: SAAR. Pres. & Gen. Mgr.: Walter Guertler.
A. Schroeder Music (Italy) Srl (Ed.), Via Quintiliano 40, 20138 Milan. Tel: (02) 50.84.
Home office: USA
Int'l firms represented: Aloud, Anim, Arbutus, Arch, Avaris, Bagimin, Bella Godiva, Boscoe, Burlac, Catch Fire, Cat Mother, Dandy Dittys, Dreams & Visions, Emm-Jay, Fitness King, Fool Killers, Fourvurus Survival, Kim Fowley, Golden Unlimited, Great Montana, Hedley Songs, Home-coming, Humdrum, January, Jenji, Joans Bones, Joint, LaLanne, Larbell, Lassie, Last Laugh, Lazy Canary, Magnanimous, Manistee, Mempro, Mike Wide River, Mother Hen, My Baby's, Next Stop, One Stop, Pierhead, Pit-field, Rebecca Raccoon, Ref-Nel, Roynorth, Sa-Vette, Sea-Lark, Sepe, Skin, Stewart-Nms, Summertime, Super Songs, Tjucva, Va-De-tta, Van-couver, Very Own, Wrathor, Yamela, Zekiefield Follies.
Sciascia Ed. Musicali (SIAE), Via Brodolini, 20089 Rozzano (Milan). Tel: (02) 82.58.041. Pres. Armando Sciascia
Senza Fine Srl (Ed.) Piazzetta Paffari 2, 20122 Milan. Tel: (02) 805.8909/8968
Int'l branch: England
Int'l firms represented: Barn, Barn-Slade, Bay City, Carlin (UK), Catrine (UK), Robin Gibb (UK), Lupus (UK), Pink Floyd (UK), Space Songs, State, Robert Stigwood Org. (UK), Walrus (UK), Wizard.
Settenote Srl, Via Turati 29, 20121 Milan. Tel: (02) 654.140, 632.656.
Telex: 313871. Admin'r: Roberto de Gaetano; Gen. & A&R Mgr.: Gianni Guarnieri, Prof. & Int'l Mgr.: Alma Pozzati.
Sidel (Ed.) (SIAE), Piazzetta Paffari 2, 20122 Milan. Tel: (02) 804.818.

861 165 Cable MILLENDTE Dwner Emanuele Daniele, Gen Mgr Franca Daniele
Int'l rep.: Germany (Amalpa)
 Sofia, see Sugarmusic
 Southern Music (SIAE), Piazza del Liberty 2, 20121 Milan Tel (02) 796 473 Gen Mgr Alberto Carisch
Home office: USA, Peer Southern Drg
Int'l firm represented: Southern (worldwide)
Int'l rep.: Worldwide (Southern)
 Spaghetti Music, Galleria del Corso 2, Milan Tel (02) 794 129/729 Pres Sandro Colombini
 Star (SIAE), see Curci
 Successo, see Sugarmusic
 Sugarmusic Group (SIAE), Via Quintiliano 40, 20138 Milan Tel (02) 50 84 Telex 321063 Pres Piero Sugar, Mng Dir Ettore Carrera, Admin Mgr Alberto Ferrari, Int'l Prof Mgr Mariangela Roveda, Prod Mgr Franco Dal Dello
Int'l branches: Argentina, Australia, Benelux Brazil Canada France Germany, Greece, Japan, Mexico, Scandinavia, Spain, Switzerland, UK USA
Int'l firms represented: AVI group (USA), Acuff Rose group (UK, USA), Arborne (USA), Algee (USA), Audre Mae (USA), Biba (USA), Blecman & Hedges (USA), Bleung (USA), Boca (USA), Brandom (USA), Raoul Brelton (France), Brut (USA), Buttermilk Sky (USA), Caleb (USA), Carlin (UK), Alan Cartee (USA), Champagne (USA), Char Liz (USA), Martin Cohen group (USA), Column 1 & II (USA), Dana Don (USA), Desert Moon (USA), Desert Rain (USA), Walt Disney Music (USA), Don Michael (USA), Easy Listening (USA), Fab (USA), Fremantle (USA), Galleon (USA), Al Gallico (USA), Gear (USA), Robin Gibb (UK), Giochen (UK), Golden Withers (USA), Good Flavour (USA), Gopam group (USA) Green Dream (UK), Gypsy Boy (USA), Hall Clement (USA), Halwill (USA), Harlem (UK), Harmonic Music Library (UK), Highway Dne (USA), Tony Hiller (UK), Holly wood Allstar (USA), Jack & Bill (USA), Jarak (USA), Lupus (UK), Lynnal (USA), March Hare (USA), Mariposa (USA), Quinn Martin (USA), Mericana (USA), Milene (USA), La Nuit Blanche (USA), Dctave (USA), Phylmar (USA), Publi (USA), Publicare (USA), Pump It Up (USA), QM (USA), Radar (USA), Teddy Randazzo (USA), Raton Songs (USA), Razzle Dazzle (USA), Red Bus (UK), Fred Rose (USA), Shoals (USA), Silver Dagger (USA), Sigem (Brazil), Singing Hills (USA), Slow Dancing (USA), Sonet group (Sweden), Song Yard (USA), Stainless (USA), Three Brothers (USA), Triple D (USA), Trumar (USA), Vanilla (UK), Velvet Apple (USA), Vogue (USA), Harry Von Tilzer (USA), Weinberger (UK), Welk group (USA), Wirrick (USA), Wonderland (USA)
 Suono Ed Musicali (SIAE), Via Manni 111, 30174 Venice/Mestre Tel (041) 972 229 Gen Mgr Tony Tasinato
Int'l firms represented: Alucard (UK), Excellency (UK), GW Jr (USA) Isalee (USA) Seafood (USA), Strange (UK), Yessongs (UK)
 Savini Zerboni, see Sugarmusic
 Targa Italiana Ed Musicali, Viale Pasubio 6/8, 20154 Milan Tel (02) 650 410/356 Chief Exec Mario Rapallo
 Televis Eds Musicali Srl, Piazza Masson 3, 20123 Milan Tel (02) 68 80 889 Telex 313502 Gen Mgr Freddy Naggjar
Int'l firms represented: Alvarada, Beverly, Meridional, 7 Notas (all Brazil)
Int'l reps.: Argentina (Sugar), Belgium (Hiversum), Brazil (Beverly),

Mexico (Edimusa), Netherlands (Hiversum), Spain (Sugarmusic) (SEE ADVERTISEMENT)
 Tender, see Sugarmusic
 Tiber, see Sugarmusic
 Tickle Ed Musicali Srl, Piazzetta Pattari 2, Milan Tel (02) 861 165 804 818 Cable MILLENDTE, Dwner Franca Daniele (Affiliated with Sidel)
 United Artists (Italy) Srl (Ed Musicali), Via Beccaria 5, 20122 Milan Tel 794 746 Cable CURCIMUSIC Telex 332683 Gen Mgr Giuseppe Gramitto Ricci, Prof Mgr Abbate G Gabriele
 Universale Srl (SIAE), see Numero Uno
 23 Italee Srl (Ed) (SIAE), Via Albani 7, 20149 Milan Tel (02) 49 86 449 Mng Dir Liliana Azzolini
Int'l rep.: UK (Mansen)
 La Voce del Padrone (SIAE), Galleria del Corso 2, 20122 Milan Tel (02) 704 401/603 Cable ARPEGGIO Telex 315123 Mng Dir Alexis Rotelli, Gen Mgr Roberto Citterio
Int'l rep.: Worldwide (EMI group)
 World Music, see Sugarmusic

• **services**

ASSOCIATIONS & PROFESSIONAL ORGANIZATIONS

A F I (Associazione dei Fonografici Italiani), Via Vittor Pisani 22, 20124 Milan Tel (02) 652 636, 659.8773 Sec'y Gen Dr Ernesto Magnani, (As sociation of Italian rec cos)
 A I D E M (Associazione Italiana Degli Ed di Musica), Piazza del Liberty 2, 20121 Milan Tel (02) 796 473 (Italian Music Publ's Ass'n)
 U N E M I (Unione Editori di Musica Italiani), Via Berchet 2, Milan Tel (02) 88 81. Cable IDROCIR Telex 31177 Pres Eugenio Clausetti (Union of Italian Music Publ's)

CATALOG SERVICES

Phonotype Rec Srl, Via Enrico de Marinis 4, 80134 Naples Tel (081) 206 642, 205.873 (Rec & tape)
 Saar Srl, Viale di Porta Vercellina 14, 20123 Milan Tel (02) 469 6251 Pres Walter Gurtler, Sales Mgr Sergio Balloni

DESIGN & ARTWORK

Mario Convertino, Via Giovannino dei Grassi 3, 20123 Milan Tel (02) 808 716
 Gianni Greguoli, Via Vincenzo Monti 77, Milan, Tel (02) 498 9467 Ass't Luca Greguoli
 Luciano Tallarini, Via Giannone 2, 20154 Milan Tel (02) 316 427 Chief Exec. Luciano Tallarini

LICENSING ORGANIZATION, MUSIC

S I A E (Societa Italiana degli Autori ed Editori), Viale della Letteratura 30, 00100 Rome Tel (06) 59 90 Cable AUTDRI Pres Luigi Conte, Gen Mgr Lucio Capogrossi (General Performing & Mechanical Rights Society)

PLATING, PROCESSING & PRESSING PLANTS

Ducale Ind Musicali SpA, Via Per Cadrezzate 5, 21020 Brebbia (Varese) Tel (0332) 770.784/189 Cable DUCALEMUSIC BREBBIA (VARESE), Telex 380231 Pres. & Gen Mgr Davide Matalon (SEE ADVERTISE MENT)
 Durium SpA, Via Manzoni 40/42, 20121 Milan, Tel (02) 701.703, 701 705,

701 008 Telex 333564 Pres. & Mng Dir. Krikor Mintangan, Sales Mgr Amieto Silvestri, Int'l Dept. Mgr Elisabel Mintangan (Pressing only)
 E M I Italiana SpA, Via Bergamo 315, 21042 Caronno Pertusella (Varese), Tel (02) 965 0701, Cable EMITAL SARDNND Telex 312679, Mng Dir Alexis Rotelli, Comm'l Mgr. Roberto Magrini, Mktg Mgr Franco Cabrini, Factory Mgr Claudio Cattaneo
 International Compact Cassette Snc, Via Larga, 25024 Pozzano di Leno, Brescia Tel: (030) 906 484/7196 Telex 301247 Dwner Pier Antonio Cavagnoli (SEE ADVERTISEMENT)
 M I P (Music Ind Prod'ns) Srl, Via San Luca 10, Milan Tel (02) 837 0908 Mng Dir Mariene Matalon, Gen Mgr. David Matalon, Int'l Mgrs. Dan iela & Manuela Matalon
 Phonoster SpA, Via G. Rossini 2, 20067 Tribiano (Milan), Tel (02) 906 0711 Cable PHNDNSTERMILAN Telex 310239, Ind'l Mgr. Giuliano Bearzi
 Phonotype Rec Srl, Via Enrico de Marinis 4, 80134 Naples Tel (081) 206.642, 205.873 (Pressing only)
 Pressmusic Srl, Via Liberta 3, 27018 Viduggio (Pavia), Tel (0382) 69553 Admin'r Antonio Faraone, Gen Mgr Enzo Novarini (Pressing only)
 R C A SpA, Via San Alessandro 7, Rome Tel (06) 43.661 Telex 610428 Pres Giuseppe Drnato; Gen Mgr Ennio Melis, Mktg Mgr Luciano Bernacchi
Home office: USA
 Saar Srl, Via Gramsci 4, 20016 Pero (Milan) Tel 353 0573/0564, Pres Walter Gurtler
 Start Inc, Corso Garibaldi 120, 20030 Seveso (Milan) Tel (0362) 508 701, Cable STARTI Telex 312080 Pres Mario Colombo, Gen Mgr. Dario De Benedetti, Sales Mgr Luigi Cane, (Pressing only)
 Studio G Srl, Via al Forte di San Martino 11, 16145 Genna, Tel (010) 301 920, 369 723 Pres. & Gen. Mgr G B De Scalzi
 Zeus Rec Srl, Piazzetta Matilde Serao 15, 80132 Naples Tel (081) 406 791, 415 997

PRINTERS & LITHOGRAPHERS
 G T E (General Tape Equip.) Srl, Via Ragusa 8, Milan Tel (02) 689.8065, Telex: 333046 Gen. Mgr Dittaviano Clerici Bagozzi (tape only)

RECORD PROMOTION (including Public Relations & Publicity)
 Paolo Cattaneo Ents., Via Montenapoleone 29, Milan Tel (02) 700 574 C & M Di Cavalieri & C Srl, Rec'g Studios, Via Isonzo 206, Bari, Tel (080) 224.610 Gen Dir.: Lino Cavalieri.
 E M I Italiana SpA, Via Bergamo 315, 21042 Caronno Pertusella (Varese) Tel (02) 965.0701 Cable EMITAL SARDNND Telex 312679 Mng Dir. Alexis Rotelli, Comm'l Mgr Roberto Magrini, Mktg Mgr Franco Cabrini, Factory Mgr Claudio Cattaneo
 Harpo's Bazaar, Via Sant'Isara 49, 40123 Bologna Tel: (051) 269 461 Movimento Musica Srl, Via S. Maurizio 13, 20123 Milan Tel (02) 872 341, 864 423, Telex 313017 Mng. Dir. Salvatore Caruselli
 Panarecord SpA, Via Cimarosa 4, 20144 Milan Tel (02) 430.046, 485 609, Telex 340014 Pres. Dr Sergio de Gennaro, Gen Mgr Mario Paoletti, Sales Mgr. Franco Caleca (SEE ADVERTISEMENT)

TAPE CUSTOM DUPLICATORS TAPE PACKAGING & LABELING

The Audio & Video lines indicate the configurations which the firms du-

WE INTRODUCE OUR CREDITS IN THE WORLD OF CLASSIC & POP MUSIC

CLASSIC

- Claudio Abbado
- Arturo Benedetti Michelangeli
- Maria Callas
- Wilhelm Furtwängler
- Dimitri Mitropoulos
- David Oistrakh
- Luciano Pavarotti
- Maurizio Pollini
- Katia Ricciarelli
- Arthur Rubinstein
- Rudolf Serkin
- Renata Tebaldi
- Arturo Toscanini
- Lucia Valentini

POP

- Umberto Balsamo
- Drupi
- Eugenio Finardi
- Filipponi
- Sandro Giacobbe
- Idea 2
- Musicanova
- New Trolls
- Mauro Pagani
- Michele Pecora
- Sergio Silvestri
- Roberto Soffici
- Valentina

FONT CETRA

MUSIC IN ITALY.

“Production line for music cassette boxes WORKING CYCLE IS ENTIRELY AUTOMATIC, from molding to assembling, to packing.

Molding machines can be excluded from the line”

S.T.M. S.n.C.
ITALY
20060 Vignate
(Milano)
Via Lombardia
Tel. no. 02/95.80.22

Tapematic of luciano perego

TMD 900 HS High speed loader
TMD 1000 Labelling
TMD 670 Boxing
VIDEO 3 Video tape loader



Via Unione 13/Mezzago/Mi/Italy
Tel. 039/692359
Telex 340233 Tapemi

pligate. Companies which offer packaging & labeling of tape product are indicated by “(PRG)” which appears after the main body of their respective listings.

Amplex Italiana SpA, Via Riccardo Gigante 4, 00143 Rome Tel (06) 546 991 Cable AMPEX Telex 610492 Mng Dir Riccardo Crippa, Sales Mgr Dino Grossi
Home office: USA
Audio: 8 tr. cassette

Audiogram SpA, Via Vallosa 38, 25050 Passirano (Brescia) Tel (030) 657 360 Telex 300850 Owner & Mng Dir Edoardo Cattaneo, Gen Mgr Francesco Nervi, Sales Mgrs Italo Capoferri, Romano De Scalzi
Audio: 8 tr. cassette, open reel

Avelca SpA, Via Emanuela 16, 21047 Saronno (Varese) Tel (02) 960 5413/3248 Telex 335884 Admin'r & Gen Mgr Sergio Moretti
(PRG)
Audio: Cassette

Avelca Video Rec SpA, Via Lumiere 4, 20093 Cologno Monzese (Milan) Tel (02) 253 2524 Telex 26502 Mng Dir & Gen Mgr Luciano Porilli, Mktg Mgr Ambrigo Campanari, Tech Dir Lamberto Milan (PRG)
Audio: Cassette

Video: 1" open reel, 1" cartridge, 1/4" Umatic, 1/4" EIAI cartridge
Ducale Ind Musicali SpA, Via Per Cadrezzate 5, 21020 Brebbia (Varese) Tel (0332) 770 784/189 Telex 380231 Cable DUCALEMUSIC Pres & Gen Mgr Davide Matalon (PRG)
Audio: 8 tr. cassette, open reel (SEE ADVERTISEMENT)

Duplimate Srl, Via Pietro Della Valle 20, 20132 Milan Tel (02) 256 4770 Gen Mgr Guido Mezzadra, Sales Mgr Enrico Mezzadra
Audio: Cassette, open reel

Dupli Video Sound Snc, Via Pomezia 10/A, Milan Tel (02) 285 3517 Mng Dir Franco Venturato, Prod'n Mgr Ezio Mazzuccato (PRG)
Audio: 8 tr. cassette, open reel

Duplo Magnetic, Via Leida 8, 37135 Verona Tel (045) 504 491
Audio: 8 tr. 8 tr. quadraphonic, open reel, open reel quadraphonic
Durema (Duplicazioni Regrazioni Magnetiche) SpA, Via Impera 28, 21042 Milan Tel (02) 843 7344/0740 Mng. Dir. Gen & Sales Mgr Dr Claudio Occhiena, Technical Mgr Paolo Maggolini
Audio: 8 tr. cassette, open reel

Video: 1" open reel, 1/4" cassette, 1/4" VHS
Durum SpA, Via Manzoni 40/42, 20121 Milan Tel (02) 701.703, 701.705, 701.008 Telex 333564 Pres & Mng. Dir Krikor Mintangian, Sales Mgr Amleto Silvestri, Int'l Dept. Mgr Elisabet Mintangian (PRG)
Audio: Cassette

E M I Italiana SpA, Via Bergamo 315, 21042 Caronno Pertusella (Varese) Tel (02) 965 0701 Cable EMITAL SARONNO Telex 312679 Mng. Dir Alexis Rotelli, Comm'l Mgr Roberto Magrini, Mktg Mgr Franco Cabrini, Factory Mgr Claudio Cattaneo
Audio: 8 tr. cassette, open reel

Ecofina Srl, Via Leopardi 8, 20123 Milan Tel (02) 869 0121 Chief Exec Mourad Sabet Factory: Via Monviso 21 Tel (02) 314 766 Factory Technical Mgr Roberto Roccella (PRG)
Audio: Cassette (SEE ADVERTISEMENT)

Europa Studio Tape, Via Ponte Nuovo 2, Milan Tel (02) 256 7655
Audio: Cassette

Genca (General Cassette) SaS, Via Don Minzoni 16, 20061 Carugate (Milan) Tel (02) 904-8815 Telex 31371, 37607
Audio: 8 tr. cassette

Gramegna, Via Sago 72, 20100 Milan Tel (02) 255 1241 Telex 321497 API 2308 Pres. Franco Gramegna (PRG only)

Italyplast Snc, Via Pezzotta 6, Albino (Bergamo) Tel (035) 752.141 Co Pres. Franco Galimberti, Attilio Balduzzi, Giuseppe Mismetti, Mktg Mgr Franco Galimberti, Gen Affairs Mgr Attilio Balduzzi, Technical Mgr Giuseppe Mismetti (PRG)
Audio: Cassette

M D A Srl, Via San Giuseppe 137, 21047 Saronno Tel (02) 962-0914 Telex 380426 Chief Exec Roberto Macchi, Gen Mgr Pinuccia Grassi, Sales Mgr Eugenia Maffizzoni
Audio: 8 tr. cassette

M I P (Music Ind Prod'ns) Srl, Via San Luca 10, Milan Tel (02) 837 0908 Mng Dir Marlene Matalon, Gen Mgr David Matalon, Int'l Mgrs Daniela & Manuela Matalon (PRG)
Audio: 8 tr. cassette.

Mitras di Cappellini Alfredo & Giorgio, Via Cavezzoli 8/A, 20100 Milan Tel (02) 289.9206 Gen Mgr Alfredo Cappellini (PRG only)
Ogem, Via Mecenate 30/26, 20100 Milan Tel (02) 506 1281 Gen Mgr G Guarnerio (PRG only)

Phonoster SpA, Via G. Rossini 2, 20067 Tribiano (Milan) Tel (02) 906 0711 Cable: PHONOSTER MILAN Telex 310239 Ind'l Mgr Giuliano Bearzi
Phonotype Rec. Srl, Via Enrico de Marinis 4, 80134 Naples Tel (081) 206 642, 205 873
Audio: 8 tr. cassette

Ponzone & Vico, Via Marconi 87, 17017 Millesimo (Savona) Tel (019) 56256 Chief Exec. Vico Umberto (PRG only)

R C A SpA, Via San Alessandro 7, Rome Tel (06) 43 661 Telex 610428 Pres Giuseppe Ornato, Gen Mgr Ennio Melis, Comm'l Mgr Luciano Bernacchi
Home office: USA
Audio: 8 tr. cassette

Ricordi SpA (Dischi), Via Baretta 11, 20100 Milan Tel (02) 539 2392 Telex 310177 Admin Mgr Giuseppe Maurili
Audio: Cassette

Saar Srl, Via Gramsci 4, 20016 Pero (Milan) Tel 353 0573/0564 Pres Walter Gurtler
Audio: Cassette

Sitma SpA, Via Vignolesi 85, 41057 Spilamberto (Modena) Tel (059) 78 42 57 Telex 510250 Pres Aris Ballestrazzi (PRG only)

Start Inc., Corso Garibaldi 120, 20030 Seveso (Milan) Tel (0362) 508 701 Cable: START Telex 312080 Pres Mario Colombo, Gen Mgr Dario De Benedetti, Sales Mgr Luigi Cane (PRG only-audio)

3 M Italia SpA, San Felice Segrate (Milan) Tel (02) 75 451 Telex 31275, 31159 Mng. Dir T Skoog, Sales & Mktg Mgr G Mariano
Audio: 8 tr. cassette, open reel
Video: 1" open reel, 1/4" cassette, 1/4" EIAI open reel, 1/4" EIAI cartridge.

• supplies

CARTRIDGE & CASSETTE PARTS

A T B SpA, Via Palmiro Togliatti 30, 20030 Senago (Milan) Tel (02) 998 9976 Cable ATIBISENAGO Telex 334457 Mng Dir Abramo Bordignon
Audio: Single & band-assembled components for cassettes, digital cassettes & 8 tr. spring pads 5 antifriction liners, full, flat & flat-foam shields in any magnetic alloy, customer designed supplies. (SEE ADVERTISEMENT)

Amplex Italiana SpA, Via Riccardo Gigante 4, Rome Tel (06) 546 991 Cable: AMPEX ROME Telex 610492 Mng. Dir Riccardo Crippa, Sales

Mgr Dino Grossi

Home office: USA

Audio & Video: Plastic cassette parts.

Audiogram SpA, Via Vallosa 38, 25050 Passirano (Brescia) Tel: (030) 657 360 Telex 300850 Owner & Mng Dir: Edoardo Cattaneo, Gen. Mgr. Francesco Nervi, Sales Mgrs. Italo Capoferri, Romano De Scalzi, Avelca SpA, Via Emanuela 16, 21047 Saronno (Varese) Tel (02) 960 5413/3248, Telex: 335884, Mng. Dir. & Gen. Mgr.: Sergio Moretti, Bresolin Corrado, Via XXV Aprile 205, 20092 Cinsello Balsamo (Milan). Tel (02) 618-8064 Pres. Corrado Bresolin.
Audio: All parts

Duplimate Srl, Via Pietro Della Valle 20, 20132 Milan. Tel: (02) 256.4770. Gen Mgr. Guido Mezzadra, Sales Mgr.: Enrico Mezzadra.
F I L P (Fabbrica Isolanti Laminati Plastici) SpA, Piazza Giolitti 8, 20133 Milan. Tel (02) 235.350, 230.982

Audio: Cassette components, leader & leader personalized, antifriction & antistatic liners, spring pads, flat & flat-foam shields.
Fraem (Societa Individuale di Gaetani Cesare), Via Niccodemi 5, 20154 Milan. Tel (02) 367.693. Gen Mgr.: Cesare Gaetani.
Genca (General Cassette) SaS, Don Minzoni 16, 20061 Carugate (Milan). Tel (02) 904-8815 Telex 31371, 37607.
Audio: Hubs & rollers

G. S. Ghelli, Via Alberti 8, 20149 Milan. Tel: (02) 38.14.18. Gen. Mgr.: Paolo Ghelli

International Compact Cassette Snc, Via Larga, 25024 Porzano di Leno, Brescia. Tel: (030) 906.484/7196 Telex: 301247 Owner: Pier Antonio Cavagnoli. (SEE ADVERTISEMENT)

Italyplast Snc, Via Pezzotta 6, Albino (Bergamo). Tel (035) 752.141. Co-Pres. Franco Galimberti, Attilio Balduzzi, Giuseppe Mismetti, Mktg. Mgr. Franco Galimberti, Gen. Affairs Mgr.: Attilio Balduzzi, Technical Mgr.: Giuseppe Mismetti.

Piella Lampugnani, Via Mincio 2, 20139 Milan. Tel: (02) 539.1103. Gen. Mgr. Raffaele Lampugnani (Audio only)

M D A Srl, Via San Giuseppe 137, 21047 Saronno. Tel: (02) 962-0914. Telex 380426. Chief Exec.: Roberto Macchi, Gen. Mgr.: Pinuccia Grassi, Sales Mgr. Eugenia Maffizzoni.

Music Box, Via Adua, 25005 Passirano (Brescia). Tel: (030) 65.73.68. Gen. Mgr. Franco Rossetti.

Nuova SIAT (Societa Italiana Articolari Tecnici) Srl, Via dell'Orto 21, 21047 Saronno (Varese) Tel (02) 960 7485/7450 Cable: NSIAT. Telex: 335884. Mng. Dir. Edoardo Benetton. (SEE ADVERTISEMENT)

Start Inc., Corso Garibaldi 120, 20030 Seveso (Milan). Tel: (0362) 508.701. Cable: START Telex 312080 Pres. Mario Colombo, Gen. Mgr.: Dario De Benedetti, Sales Mgr. Luigi Cane.
Audio: 8 tr. cassette.
Brand names: Comp-Ray, Tecno-Ray.

EMPTY CARTRIDGES, CASSETTES & REELS

A T B SpA, Via Palmiro Togliatti 30, 20030 Senago (Milan) Tel: (02) 998-9976. Cable: ATIBISENAGO. Telex: 334457. Mng. Dir. Abramo Bordignon. (SEE ADVERTISEMENT)

Amplex Italiana SpA, Via Riccardo Gigante 4, 00143 Rome. Tel. (06) 546.991. Cable: AMPEX. Telex: 610492 Mng. Dir.: Riccardo Crippa, Sales Mgr. Dino Grossi
Home office: USA

Audio: 8 tr. cartridge, cassette, reels

Video: 2", 1" reels, 1/4" cassette, 1/4" Beta & VHS cassette.

Brand names: Amplex, Shamrock

Audiogram SpA, Via Vallosa 38, 25050 Passirano (Brescia) Tel: (030) 657 360 Telex 300850 Owner & Mng. Dir.: Edoardo Cattaneo, Gen. Mgr.: Francesco Nervi, Sales Mgrs. Italo Capoferri, Romano De Scalzi
Audio: 8 tr. cassette

Avelca SpA, Via Emanuela 16, 21047 Saronno (Varese). Tel: (02) 960 5413/ 3248. Telex: 335884. Mng. Dir. & Gen. Mgr.: Sergio Moretti.
Audio: 8 tr. cassette.

Bresolin Corrado, Via XXV Aprile 205, 20092 Cinsello Balsamo (Milan). Tel: (02) 618-8064. Pres. Corrado Bresolin.
Audio: 8 tr. cassette.

Comp-Ray, see Start

Ducale Ind. Musicali SpA, Via Per Cadrezzate 5, 21020 Brebbia (Varese). Tel: (0332) 770.784/189. Cable: DUCALEMUSIC BREBBIA (VARESE). Telex: 380231. Pres. & Gen. Mgr. Davide Matalon. (SEE ADVERTISEMENT)

Europa Compact Cassette Snc, Via Martiri Della Libertà 53, 25035 Ospitaletto (Brescia) Tel: (030) 640.134. Telex 300260. Mng. Dir.: Ronaldo Bianchi.
Audio: Cassette

F I L P (Fabbrica Isolanti Laminati Plastici) SpA, Piazza Giolitti 8, 20133 Milan. Tel: (02) 235.350, 230.982

Fraem (Societa Individuale di Gaetani Cesare), Via Niccodemi 5, 20154 Milan. Tel: (02) 367.693. Gen. Mgr.: Cesare Gaetani.

G T E (General Tape Equip.) Srl, Via Ragusa 8, 20125 Milan. Tel: (02) 689-8065. Telex: 333046. Gen. Mgr.: Ottaviano Clerici Bagozzi.
Audio: 8 tr. cassette.

Genca (General Cassette) SaS, Via Don Minzoni 16, 20061 Carugate (Milan). Tel: (02) 904-8815 Telex 31371, 37607.
Audio: Cassette
Brand name: King Sound

G. S. Ghelli, Via Alberti 8, 20149 Milan. Tel: (02) 38.14.48. Gen. Mgr.: Paolo Ghelli

Audio: Cassette
International Compact Cassette Snc, Via Larga, 25024 Porzano di Leno, Brescia. Tel: (030) 906.484/7196 Telex: 301247. Owner: Pier Antonio Cavagnoli. (SEE ADVERTISEMENT)

Italyplast Snc, Via Pezzotta 6, Albino (Bergamo). Tel: (035) 752.141. Co-Pres. Franco Galimberti, Attilio Balduzzi, Giuseppe Mismetti, Mktg. Mgr. Franco Galimberti, Gen. Affairs Mgr.: Attilio Balduzzi, Technical Mgr.: Giuseppe Mismetti.

King Sound, see Genca.

Piella Lampugnani, Via Mincio 2, 20139 Milan. Tel: (02) 539.1103. Gen. Mgr. Raffaele Lampugnani.
Audio: Cassette.

Leat Jet, see Start

M D A Srl, Via San Giuseppe 137, 21047 Saronno. Tel: (02) 962-0914. Telex 380426. Chief Exec. Roberto Macchi, Gen. Mgr. Pinuccia Grassi, Sales Mgr. Eugenia Maffizzoni.
Audio: 8 tr. cassette.

M I P (Music Ind. Prod'ns) Srl, Via San Luca 10, Milan. Tel: (02) 837.0908. Mng. Dir. Marlene Matalon. Gen. Mgr.: David Matalon, Int'l Mgr.: Daniela & Manuela Matalon
Audio: Cassettes.

Music Box, Via Adua, 25005 Passirano (Brescia). Tel: (030) 65.73.68. Gen. Mgr. Franco Rossetti.
Nuova SIAT (Societa Italiana Articolari Tecnici) Srl, Via dell'Orto 21, 21047

Saronno (Varese). Tel: (02) 960.7485/7450. Cable: NSIAT Telex. 335884. Mng. Dir.: Edoardo Benetton.
 Audio: 8-tr. cartridge, cassette & reels; boxes.
Brand name: SIAT. (SEE ADVERTISEMENT)
 Pigmeme S.r.l. Via Colomi 28. 21100 Varese. Tel: (0332) 311.233.
 Polimek S.r.l. Via Pace 64. 20017 Rho (Milan). Tel: (02) 930.1742/9484.
 Telex: 330501. Chief Exec.: Rosario Mandina. Gen. Mgr.: Girolamo Magotti.
 Audio: Cassette. (SEE ADVERTISEMENT)
S I A T. see Nuova
 Scotch, see JM
 Shamrock, see Ampex
 Start Inc., Corso Garibaldi 120. 20030 Seveso (Milan). Tel: (0362) 508.701.
 Cable: START. Telex: 312080. Pres.: Mario Colombo. Gen. Mgr.: Dario De Benedetti. Sales Mgr.: Luigi Cane.
 Audio: 8-tr., cassette.
Brand names: Lear Jet, Comp-Ray, Techno-Ray
 Techno-Ray, see Start
3 M Italia SpA. San Felice Segrate (Milan). Tel: (02) 75.451. Mng. Dir.: T.S. Shoop. Sales & Mktg. Mgr.: G. Marzano.
 Audio: Reels.
Brand name: Scotch
 Ve-Ma, Viale Dell'Industria 57. 20037 Paderno Dugnano (Milan). Tel: (02) 918.2713. Sales Mgr.: Gino Tonelli.
 Vemas S.r.l. Via Lavoro Industria, Rudiano (Brescia). Tel: (030) 716.211.
 Telex: 30060

JACKETS & SLEEVES

Barbierstampa, Via San Rocco 6, Milan. Tel: (02) 541.964. (Sleeves only)
 Puzzi Amicare, Via de Vizzi 86, Cinisello Balsamo (Milan). Tel: 928.88/21 (Sleeves only).

LABELS, OISK

E M I Italiana SpA, Via Bergamo 315, 21042 Caronno Pertusella (Varese). Tel: (02) 965.0701. Cable: EMITAL SARONNO. Telex: 312679. Mng. Dir.: Alexis Rotelli. Comm'l Mgr.: Roberto Magrini. Mktg. Mgr.: Franco Cabrini. Factory Mgr.: Claudio Cattaneo.

POLYETHYLENE BAGS & SHRINKWRAP

Gramegna, Via Siao 72. 20100 Milan. Tel: (02) 255.1241. Telex: 321497 API 2308. Pres.: Franco Gramegna. (Polybags only)
 Mitras di Cappellini Alfredo & Giorgio, Via Cavezoli 8/A. 20100 Milan. Tel: (02) 289.9206. Gen. Mgr.: Alfredo Cappellini. (Polybags only)
 Ogem, Via Mecenate 30/26. 20100 Milan. Tel: (02) 506.1281. Gen. Mgr.: G. Guarniero. (Polybags only)
 Sitma SpA, Via Vignolesi 85, 41057 Spilamberto (Modena). Tel: (059) 78.42.57. Telex: 510250. Pres.: Ans Ballestrazzi. (Polybags only)

PROFESSIONAL TAPE SUPPLIES

Agfa-Gevaert SpA, Viale de Gasperi, 20151 Milan. Tel: (02) 307.401. Telex: 37182. Chief Exec.: Benito Chucchini. Sales Mgr.: Giorgio Dordoni. Mktg.: Giorgio Regarda.
 Product: Magnetic film.
 Musical Instruments, Via Como 19, 22065 Mariano Comense (Como). Tel: (031) 749.212.
 Audio: Cassette boxes
 Polimek S.r.l., Via Pace 64, 20017 Rho (Milan). Tel: (02) 930.1742/9484.

Telex: 330501. Chief Exec.: Rosario Mandina. Gen. Mgr.: Girolamo Magotti
 Audio: Cassette boxes. (SEE ADVERTISEMENT)
 Trulzi, Via Vialba 56, 20026 Novate Milanese (Milan). Tel: (02) 354.1661/1785.
 Audio: Plastic shelves for cassettes.

RECORD MANUFACTURING EQUIPMENT

B M B SpA, Via E. Roselli 12, 25100 Brescia. Tel: (030) 348.191. Telex: 300895. Gen. Mgr.: Domenico Bugatti.
 B M Costruzioni Elettroniche, Via Donizzetti 50, 20052 Monza (Milan). Tel: (039) 21207, 21205. Gen. Mgr.: Ferruccio Bazzi.
 Ducale Ind. Musicali SpA, Via Per Cadrezzate 5, 21020 Brebbia (Varese). Tel: (0332) 770.784/189. Cable: DUCALEMUSIC BREBBIA (VARESE). Telex: 380231. Pres. & Gen. Mgr.: Davide Matalon. (Importer) (SEE ADVERTISEMENT)
 I D R A SpA, Via Triumfina 13, 25100 Brescia. Tel: (030) 30.36.61., 39.33.71. Telex: 300034. Pres.: Adamo Pasotti. Sales Mgr.: Giuseppe Pasotti.
 Product: Record presses
 Fontana Luigi & Cia. SaS, Via Brioschi 62, 20141 Milan. Tel: (02) 849.3231.
 Product: Record presses.
 Metallmeccanica Plast SpA, Via Ferioni 83, 22070 Bulgarograsso (Como). Tel: (031) 931.464. Cable: METALMEC Telex: 380169. Gen. Mgr.: Franco Gian. Sales Mgr.: Dr. Nicola Liso.
 Product: Record injection molding machines.
 Negri-Bossi SpA, PO Box 3784, 20100 Milan, Viale Europa 64, 20093 Cologno Monzese (Milan). Tel: (02) 254-7922/9751. Cable: NEGRIBOS. Telex: 312008.
 Product: Injection molding machines.
 Sandretto (Filli), Via de Amici 44, 10097 Regina Margherita (Turin). Tel: 790.270.
 Terenzo, Via Soffredini 34, 20126 Milan. Tel: (02) 257.2239/2242.

TAPE, BLANK LOADS & BULK RAW

Agfa-Gevaert SpA, Viale de Gasperi, 20151 Milan. Tel: (02) 307.401. Telex: 37182. Chief Exec.: Benito Chucchini. Sales Mgr.: Giorgio Dordoni. Mktg.: Giorgio Regarda.
 Audio: Blank-cassette, open reel, raw-cassette.
 Video: 1" open reel.
 Ampex Italiana SpA, Via Riccardo Gigante 4, 00143 Rome. Tel: (06) 546.991. Cable: AMPLEX. Telex: 610492. Mng. Dir.: Riccardo Crippa. Sales Mgr.: Dino Grossi.
 Home office: USA
 Audio: Cassette, open reel
 Video: Blank-2" quad, 1" open reel, 1/2" cassette, 1/4" EIAJ open reel, 1/4" Beta cassette.
 Audiogram SpA, Via Vallosa 38, 25050 Passirano (Brescia). Tel: (030) 657.360. Telex: 300850. Owner & Mng. Dir.: Edoardo Cattaneo. Gen. Mgr.: Francesco Nervi. Sales Mgrs.: Italo Capoferrri, Romano De Scalzi.
 Audio: 8-tr., cassette, open reel
 Video: 1/2" VHS cassette.
 Avecla SpA, Via Emanuela 16, 21047 Saronno (Varese). Tel: (02) 960.5413/3248. Telex: 335884. Mng. Dir. & Gen. Mgr.: Sergio Moretti.
 Audio: 8-tr., cassette.

Bresolin Corrado, Via XXV Aprile 205, 20092 Cinisello Balsamo (Milan). Tel: (02) 618-8064. Pres.: Corrado Bresolin. (Blank only)
 Audio: 8-tr., cassette.

Diamante, see Start
 Diplomatic S.r.l., Via Pietro Della Valle 20, 20132 Milan. Tel: (02) 256.4770. Gen. Mgr.: Guido Mezzadra. Sales Mgr.: Enrico Mezzadra
 Audio: Cassette, open reel.

Fraem (Societa Individuale di Gaetani Cesare), Via Niccodemi 5, 20156 Milan. Tel: (02) 367.693. Gen. Mgr.: Cesare Gaetani. (Blank only)
 Audio: 8-tr., cassette, open reel.

G T E (General Tape Equip.) S.r.l., Via Ragusa 8, 20125 Milan. Tel: 689-8065. Telex: 333046. Gen. Mgr.: Ottaviano Clerici Bagozzi. (Blank only)
 Audio: 8-tr., cassette.

Genca (General Cassette) SaS, Via Don Minzoni 16, 20061 Carugate (Milan). Tel: (02) 904-8815. Telex: 31371, 37607 (Blank only)
 Audio: 8-tr., cassette.

Italyplast Snc, Via Pezzotta 6, Albino (Bergamo). Tel: (035) 752.141. Co-Pres.: Franco Galimberti, Attilio Balduzzi, Giuseppe Mismetti, Mktg. Mgr.: Franco Galimberti, Gen. Affairs Mgr.: Attilio Balduzzi, Technical Mgr.: Giuseppe Mismetti.
 Audio: Cassette.

M D A Cassettes S.r.l., Via San Giuseppe 137, 21047 Saronno. Tel: (02) 962.0914. Chief Exec.: Roberto Macchi, Gen. Mgr.: Pinuccia Grassi. Sales Mgr.: Eugenia Maffuzoni.
 Audio: 8-tr., cassette.

Magnex SpA, Via G.B. Grassi 97, 20157 Milan. Tel: (02) 355.5146, 357.0946. Cable: SELECHIMIT. Telex: 331269. Pres.: Dr. Luigi Lang. Gen. Mgr.: Dr. Roberto Sanzone. Plant Mgr.: Giorgio Seitun
 Audio: Cassette. (SEE ADVERTISEMENT)

Musical Instruments, Via Como 19, 22065 Manano Comense (Como). Tel: (031) 749.212.
 Audio: Cassette

Music Box, Via Adua, 25005 Passirano (Brescia). Tel: (030) 65.73.68. Gen. Mgr.: Franco Rossetti. (Blank only)
 Audio: Cassette

Nuova SIAT (Societa Italiana Articoli Tecnici) S.r.l., Via dell'Orto 21, 21047 Saronno (Varese). Tel: (02) 960.7485/7450. Cable: NSIAT. Telex: 335884. Mng. Dir.: Edoardo Benetton. (Blank only)
 Audio: 8-tr., cassette. (SEE ADVERTISEMENT)

Polimek S.r.l., Via Pace 64, 20017 Rho (Milan). Tel: (02) 930.1742/9484. Telex: 330501. Chief Exec.: Rosario Mandina. Gen. Mgr.: Girolamo Magotti. (Raw only)
 Audio: Cassette. (SEE ADVERTISEMENT)

Racall, see Roje
 Roje Telecomunicazioni SpA, Via Sant'Anatole 15, 20147 Milan. Tel: (02) 415.4141. Gen. Mgr.: Ezio Tunesi.
 Audio: Cassette, open reel.

Brand name: Racall
 S E C I, see Magnex
 Scotch, see JM

Sonorex Tape SpA, Via Bonfadina 14, 25046 Cazzago San Martino (Brescia). Tel: (030) 725.382. Telex: 300826. Adm. Dir.: Antonio Magri. Sales Execs.: I. Capoferrri, R. Descalzi. (Raw only)
 Audio: 8-tr., cassette, open reel.

Start Inc., Corso Garibaldi 120, 20030 Seveso (Milan). Tel: (0362) 508.701. Cable: START. Telex: 312080. Pres.: Mario Colombo. Gen. Mgr.: Dario De Benedetti. Sales Mgr.: Luigi Cane. (Blank only)
 Audio: Cassette.

Brand name: Diamante
 3 M Italia SpA, San Felice Segrate (Milan). Tel: (02) 75.451. Telex: 31275.

Exporters of most Italian labels

IREC S.R.L.

VIA SAN G.B. DE LA SALLE, 4
 20132 MILANO
 tel. (02) 25.92.326
 TELEX 315493 IRD

Worldwide Distributors of

**Red Record
 Queen-Disc
 Producers of
 Soul Note
 Black Saint
 Appaloosa**

WE ARE YOUR COMPANY

MISTER

Produzioni FIUMARA srl
Edizioni Musicali e discografiche

Produzioni FREMUS srl
Edizioni Musicali e discografiche

Artisti:
 Diana Morini
 Francois Petit
 Frank Michael
 Questions
 Vanadium
 Luca Chinnici
 Franco Alberto
 Leo Ceroni
 Judy Karol
 Demetrio Aroi
 Leo Sardo
 Francisco Calabras
 Pippo Patti
 Mino Reitano
 3+4 di Romagna
 Trio Sardinia folk

MINO REITANO

OMAGGIO A NAPOLI

IO TI AMERO

Adresse:
AGRATE BRIANZA (MILANO) ITALY
 Via Adda - Tel. 039/650983
 650984 - 650989 - 650962

INTERNATIONAL COMPACT CASSETTE S.N.C.

DI CAVAGNOLI PIER ANTONIO
 VIA LARGA
 25024 PORZANO DI LENO
 (BRESCIA), ITALY
 TELEPHONE: 030/906484 - 9067196
 TELEX: 301247 CRALEN I CAVAGNOLI

Sole Agent for UK and Ireland:
R.P.L. EVANS
 Tel.: FARINGDON (0367) 20262,
 Telex 858623

Sole Agent for Scandinavian Countries:
STIG LASSEN
 Tel.: COPENHAGEN (01) 620488

- C-O COMPACT CASSETTE
- LIBRARY BOXES
- 8-TRACK CARTRIDGES
- BLANK CASSETTES

31159 Mng. Dir. T. S. Skoog, Sales & Mktg. Mgr. G. Mariano
 Audio: 8 tr., cassette, open reel
 Video: 1" open reel, 1" cartridge, 1/4" cassette, 1/4" cassette, 1/4" EIAJ open reel, 1/4" EIAJ cartridge
 Brand name: Scotch.

TAPE DUPLICATING & PROCESSING EQUIPMENT

A E G Telefunken SpA, Via Clerici 2/4, 20099 Sesto S. Giovanni (Milan)
 Tel: (02) 242 7812/8147/9190, 247 1176 Telex 312455 Dept Mgr A Bosco, Sales Mgr. G. Angeletti
 Audio: Duplicators, winders, C D & blank cassette assemblers
 Brand name: Telefunken

Ampex Italiana SpA, Via Riccardo Gigante 4, 00143 Rome Tel: (06) 546 991 Cable AMPEX Telex 610492 Mng. Dir. Riccardo Crippa, Sales Mgr. Dino Grossi
 Home office: USA
 Audio: Duplicators

Ducale Ind. Musicali SpA, Via Per Cadrezzate 5, 21020 Brebbia (Varese)
 Tel: (0332) 770 784/189 Cable DUCALEMUSIC BREBBIA (VARESE)
 Telex: 380231. Pres. & Gen. Mgr. Davide Matalon (Audio only) (SEE ADVERTISEMENT)

Fraem (Societa' individuale di Gaetani Cesare), Via Niccodemi 5, 20156 Milan
 Tel: (02) 367 693 Gen. Mgr. Cesare Gaetani
 Audio: Assembling & winding equip.

G T E (General Tape Equip.) Srl, Via Ragusa 8, 20115 Milan Tel: 689 8065
 Telex 333046 Gen. Mgr. Dttaviano Clerici Bogazzio
 Audio: Automatic, semi-automatic & manual tape winders, high speed duplicators, automatic cassette assemblers & automatic cassette screw-driver, Ampex compatible slaves

M D A Srl, Via San Giuseppe 137, 21047 Saronno, Tel: (02) 962.0914 Chief Exec. Roberto Macchi, Gen. Mgr. Pinuccia Grassi, Sales Mgr. Eugenia Maffizzoni (Audio only)
 Audio: Processing equip.

Magnex SpA, Via G B Grassi 97, 20157 Milan Tel: (02) 355 5146, 357 0946 Cable SELECHIMIT Telex 331269 Pres.: Dr. Luigi Lang, Gen. Mgr. Dr. Roberto Sanzone, Plant Mgr. Giorgio Seitun
 Audio: Coating & slitting equip. (SEE ADVERTISEMENT)

Roje Telecomunicazioni SpA, Via Sant'Anatolone 15, 20147 Milan, Tel: (02) 415 4141 Cable TELEROJE Telex 332202

S E C I, see Magnex
 Sumat Srl, Via San Giuseppe 137, Saronno (Varese), Tel: (02) 962 0915 Gen. Mgr., Roberto Macchi, (Manufacturer/Importer)
 Audio: Automatic cassette winders, tools

T T L (Tape Technology Lab.) di Rizza Attilio, Via Pirandello 4/A, 20144 Milan, Tel: (02) 469 5213, 498 4371 Pres. A. Attilio Rizza
 Audio: Cassette winders. (SEE ADVERTISEMENT)

Tapematic, Via Unione 13, 20050 Mezzago (Milan) Tel: (039) 692 359
 Telex: 340233. Dir.: Luciano Perego, Technical Mgr. Giovanni Brignani
 Audio: Tailoring machines w/loaders. (SEE ADVERTISEMENT)

Telefunken, see AEG-Telefunken

TAPE PACKAGING & LABELING EQUIPMENT

G I M A (Gruppo Industriale Macchine Automatiche) Srl, Via Caduti di Amola 18, 40132 Bologna, Tel: (051) 40 23 53 Telex: 211663
 Product: Fully automatic C-D assembling systems (SEE ADVERTISEMENT)

G T E (General Tape Equip.) Srl, Via Ragusa 8, 20125 Milan Tel: 689 8065, 376 4171 Telex: 333046

Product: Automatic cassette labeling & boxing machines
 I D R A SpA, Via Triumfina 13, 25100 Brescia Tel: (030) 30 36 61, 39 33 71 Telex: 300034. Pres. Adamo Pasotti, Sales Mgr. Giuseppe Pa soffi

Audio: Cassette "shelving" machinery
 M D A Srl, Via San Giuseppe 137, 21047 Saronno Tel: (02) 962 0914
 Telex: 380426 Chief Exec. Roberto Macchi, Gen. Mgr. Pinuccia Grassi, Sales Mgr. Eugenia Maffizzoni

S T M (System Transfer Matic), Via Lombardia, 20060 Vignate (Milan), Tel: (02) 958 0227
 Product: Cassette assembly & packaging equip. (SEE ADVERTISEMENT)

Start Inc., Corso Garibaldi 120, 20030 Seveso (Milan) Tel: (0362) 508 701
 Cable START Telex 312080. Pres. Mario Colombo, Gen. Mgr. Dario De Benedetti, Sales Mgr. Luigi Cane

Sumat Srl, Via San Giuseppe 137, 21047 Saronno, Tel: (02) 962 0915
 Mgr. Roberto Macchi (Manufacturer/Importer)
 Product: Cassette & cartridge plastic shelves pressing machines, boxes pressing machines, cassettes info-boxes automatic injectors

Tapematic, Via Unione 13, 20050 Mezzago (Milan) Tel: (039) 692 359
 Telex: 340233 Dir. Luciano Perego Technical Mgr. Giovanni Brignani (Audio only)
 Product: Boxing & labeling machines. (SEE ADVERTISEMENT)

Techno Ray, see Start

• accessories

Agfa Gevaert SpA, Viale de Gasperi, 20151 Milan, Tel: (02) 307 401. Telex: 37182 Chief Exec. Benito Chucchini, Sales Mgr.: Giorgio Dordoni, Mktg. Giorgio Regorda

Product: Tape-head cleaners, demagnetizers, leader & splicing tape.
 Ampex Italiana SpA, Via Riccardo Gigante 4, 00143 Rome, Tel: (06) 546 991 Cable AMPEX Telex 610492. Mng. Dir. Riccardo Crippa, Sales Mgr. Dino Grossi
 Home office: USA

Product: Tape-head cleaners, demagnetizers, leader & splicing tape
 Audiogram SpA, Via Vallosa 38, 25050 Passirano (Brescia) Tel: (030) 657 360 Telex: 300850. Owner & Mng. Dir. Edoardo Cattaneo; Gen. Mgr. Francesco Nerv. Sales Mgrs. Italo Capoferri, Romano De Scalzi

Product: Tape-head cleaners, leader tape
 Avelca SpA, Via Emanuela 16, 21047 Saronno (Varese), Tel: (02) 960 5413/ 3248. Telex: 335884 Admin'r & Gen. Mgr., Sergio Moretti
 Product: Record-record care prods.

Bresolin Corrado, Via XXV Aprile 205, 20092 Cinisello Balsamo (Milan) Tel: (02) 618 8064 Pres. Corrado Bresolin
 Product: Tape-carrying & storage cases, head cleaners, demagnetizers

Ducale Ind. Musicali SpA, Via Per Cadrezzate 5, 21020 Brebbia (Varese). Tel: (0332) 770 784/189 Telex 382031. Pres. & Gen. Mgr. Davide Matalon

Product: Tape-leader & splicing tape. (SEE ADVERTISEMENT)
 Duplomatic Srl, Via Pietro Della Valle 20, 20132 Milan Tel: (02) 256 4770
 Gen. Mgr. Guido Mezzadra; Sales Mgr. Enrico Mezzadra

Product: Tape-leader & splicing tape
 Ecofina Srl, Via Leopardi 8, 20123 Milan, Tel: (02) 806 125, 869 0121
 Chief Exec. Mourad Sabety; Factory Technical Mgr. Roberto Roccabella

Product: Tape-carrying & storage cases, head cleaners, demagnetizers (all audio) (SEE ADVERTISEMENT)
 International Compact Cassette Snc, Via Larga, 25024 Porzano di Leno, Brescia Tel: (030) 906 484/7196 Telex: 301247 Owner Pier Antonio Cavagnoli
 Product: Tape-head cleaners, demagnetizers, leader tape. (SEE ADVERTISEMENT)

Italyplast Snc, Via Pezzotta 6, Albino (Bergamo), Tel: (035) 752 141. Co. Pres. Franco Galimberti, Attilio Balduzzi, Giuseppe Mismetti, Mktg. Mgr. Franco Galimberti, Gen. Affairs Mgr. Attilio Balduzzi, Technical Mgr. Giuseppe Mismetti

Product: Tape-head cleaners, demagnetizers
 M D A Srl, Via San Giuseppe 137, 21047 Saronno Tel: (02) 962 0914
 Telex: 380426 Chief Exec. Roberto Macchi, Gen. Mgr. Pinuccia Grassi, Sales Mgr. Eugenia Maffizzoni

Product: Tape-head cleaners, demagnetizers, cassette testers, cassette tools & moulds, tape certifiers
 M I P (Music Ind. Prods) Srl, Via San Luca 10, Milan Tel: (02) 837 0908
 Mng. Dir. Marlene Matalon, Gen. Mgr. David Matalon, Int'l Mgrs. Daniela & Manuela Matalon

Product: Record-carrying & storage cases, Tape-leader tape.
 Magnex SpA, Via G B Grassi 97, 20157 Milan, Tel: (02) 355 5146, 357 0946 Cable SELECHIMIT Telex 331269 Pres. Dr. Luigi Lang; Gen. Mgr. Dr. Roberto Sanzone, Plant Mgr. Giorgio Seitun

Product: Tape-head cleaners, demagnetizers, leader tape (SEE ADVERTISEMENT)
 New Hobby In Style, Via Gabriele d'Annunzio 15, 20052 Monza Tel: (039) 74 51 02. Cable NEWHOBBY Chief Exec. Rosella Sangalli; Gen. & Sales Mgr. Stefano Nocera, Foreign Dept. Giancarlo Zanini

Product: Record-carrying & storage cases, record care prods., 45 RPM adaptors, replacement styli, Tape-carrying & storage cases, head cleaners, demagnetizers, splicing tape
 Roje Telecomunicazioni SpA, Via Sant'Anatolone 15, 20147 Milan, Tel: (02) 415 4141 Gen. Mgr. Ezioe Tunesi
 Product: Tape-leader tape

Siemens SpA (Societa' Italiana Telecomunicazione), Via A. Canova 19/A, Milan Tel: (02) 43 88 (Importer)
 Product: Record-replacement styli (Stanton)

Sonorex Tape SpA, Via Bonfadina 14, Cazzago San Martino (Brescia) Tel: (030) 725 382 Telex: 300826. Admin. Dir. Antonio Magri; Sales Execs. I. Capoferri, R. Descalzi
 Product: Tape-head cleaners, demagnetizers, leader tape

Stanton, see Siemens
 Start Inc., Corso Garibaldi 120, 20030 Seveso (Milan) Tel: (0362) 508 701
 Cable START Telex 312080 Pres. Mario Colombo, Gen. Mgr. Dario De Benedetti, Sales Mgr. Luigi Cane

Product: Tape-head cleaners, demagnetizers
 Sumat Srl, Via San Giuseppe 137, 21047 Saronno Tel: (02) 962 0915
 Telex 380426 Gen. Mgr. Roberto Macchi

Product: Tape-head cleaners, demagnetizers
 3 M Italia SpA, San Felice Segrate (Milan) Tel: (02) 75 451, Telex 31275, 31195 Mng. Dir. T. Skoog, Sales & Mktg. Mgr. G. Mariano
 Product: Tape-carrying & storage cases, head cleaners, demagnetizers, leader & splicing tape

Universal Plastics, Via G. Di Vittorio 2, Inzago (Milan) Tel: (02) 95 40 79 / 47 55 Telex 321615
 Product: Record-storage modules (45 & LP)
 Videosuono di Maurizio Caliani, Via Sangallo 30, 20125 Milan, Tel: (02) 717 051/351
 Product: Record-carrying & storage cases, record care prods., 45 RPM

adapters: Tape-carrying & storage cases (audio & video), head cleaners (audio), bulk erasers (audio), demagnetizers (audio), tape care prods. (audio)

• promotional merchandising aids

Soullinder Int'l Rec. Imports di Carola Mirabelli, Via G.B. Vico 12, 21230 Milan, Tel: (02) 431 319. Telex: 311250. Gen. & Sales Mgr., Carola Mirabelli
 Product: Posters, patches, jackets, mirror albums (all I, R)

• store fixtures

Focchi Display, Via Circonvallazione Dvest 9, 47037 Rimini (Forlì), Tel: (0541) 74 00 55 Telex 550686
 Product: Record display racks, (Ellepi System)

New Hobby In Style, Via Gabriele d'Annunzio 15, 20052 Monza, Tel: (039) 74 51 02. Cable NEWHOBBY Chief Exec. Rosella Sangalli, Gen. & Sales Mgr. Stefano Nocera, Foreign Dept. Giancarlo Zanini
 Product: Browser boxes, display racks

Saar Srl, Viale di Porta Vercellina 14, 20123 Milan, Tel: 469 6251 Pres. Walter Gurtler, Sales Mgr. Sergio Balloni
 Product: Browser boxes, display racks

IVORY COAST, REPUBLIC OF

Population: 6,700,000
 Rate of exchange: \$1 (US) = 225 CFA francs
 Per capita income: \$850
 Holidays: January 1, Easter Monday, May 1, Ascension Day, August 15 (Assumption), November 1, December 7, 25 & traditional Muslim holidays (2 days variable)

• record & tape manufacturers / distributors / importers

Kibaru, see Societe Ivoirienne du Disque
 S I D, see Societe Ivoirienne du Disque
 Societe Ivoirienne du Disque (IFPI), 10 BP 503, Abidjan 10, Tel: 36 10 25
 Cable SID Telex: 3193 Pres. & Gen. Mgr., Catherine Oro. (Manufacturer/Distributor/Importer)

Labels: (Owned) Kibaru, SID, Sound Explosion, (Licensed) Amour (Canada), Gallo (South Africa), Mal's (USA), Namaco (Nigeria), Virgin (UK); AIT, Africa, Ba Ba, Bana Beru, Do-7, King Kong, Lokwe, Moto Moto, Muziki du Zaire, Nyang Omaki, Owang Jaber, PDK, Sungura (all Kenya); (distributed-not licensed) Rogers All Stars (Nigeria)

Sound Explosion, see Societe Ivoirienne du Disque
 W E A West Africa, BP 4335 Poste D'Abidjan, Plateau D'Abidjan Tel: 361 577/268. Mng. Dir. Guy Gluck
 Home office: USA

• services DESIGN & ARTWORK

Societe Ivoirienne du Disque, 10 BP 503, Abidjan 10, Tel: 36 10 25. Cable SID Telex 3193. Pres. & Gen. Mgr., Catherine Oro.

PRESSING PLANT

Societe Ivoirienne du Disque, 10 BP 503, Abidjan 10, Tel: 36 10 25. Cable SID Telex: 3193. Pres. & Gen. Mgr. Catherine Oro.

• supplies JACKETS & SLEEVES LABELS, DISK POLYETHYLENE BAGS

Societe Ivoirienne du Disque, 10 BP 503, Abidjan 10, Tel: 36 10 25. Cable SID, Telex 3193. Pres. & Gen. Mgr. Catherine Oro.

• accessories

Societe Ivoirienne du Disque, 10 BP 503, Abidjan 10, Tel: 36 10 25. Cable SID Telex: 3193. Pres. & Gen. Mgr. Catherine Oro.
 Product: Record-carrying cases.

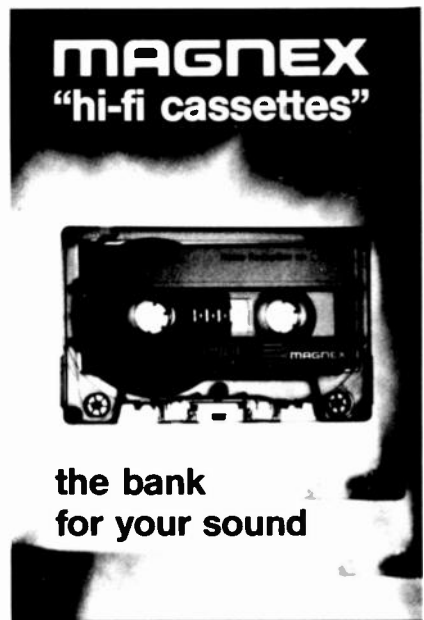

MAGNEX
 "hi-fi cassettes"



the bank for your sound

Distribution worldwide network is going to be established. Present distributors are covering the following countries:

For free areas please contact us by telephone or telex.

Via G.B. Grassi, 97
 20157 MILAN - ITALY
 Telephone (5 L.) 02/35.55.146
 Telex 331269



Just reminding you that USO has been taking your concern to our servicemen and women worldwide for 40 years.

Dionne Warwick

40th Anniversary

1981

JAMAICA

Population: 2,100,000.
Rate of exchange: \$1 (US) = 1.55 Jamaican dollars
Per capita income: \$1,496
Holidays: January 1. Ash Wednesday. Good Friday. Easter Monday. May 23 (Labor Day). August 4 (Independence Day). October 20 (National Heroes Day). December 25. 26 (Boxing Day)

• record & tape manufacturers / distributors / importers

Blank, see Record Specialists.
C G Recs. Ltd., 5 Hope St., Halfway Tree, Kingston 10. Tel: (809) 929-1128. Telex: 2252 Champion. Contact Alvin Ranglin.
Label: (Licensed foreign) MCA—records (USA).
Cariffa, see Record Specialists.
Champion, see Record Specialists.
Crystal, see Federal.
Dynamic, see Dynamic Sounds.
Dynamic Sounds Rec'g Co. Ltd. (IFPI), 15 Bell Rd., Kingston 11. Tel: 933-9138/9168. Cable: DYNASOUND. Telex: 2296. Pres: Byron A. Lee; VP & Comptroller: Cecil Warren; Gen. Mgr. Michel Khouri; Sales Mgr.: L. Gray. Labels: (Owned) Dynamic, Jaguar, Lion, Melrose, Panther, Tiger, Tysott, Wede Bete, (licensed) Archiv (Germany), Ariola America (USA), Atlantic (USA), Bang (USA), CTI (USA), Casablanca (USA), Creole (UK), H&L (USA), Polar (Sweden), Polydor (Germany), Rainwood (USA), Salsoul (USA), Springboard (USA), State (UK), TK (USA).
Int'l reps.: Africa (WEA), South Africa (EMI), UK (Creole, State).
Federal Rec. Mfg. Co. Ltd. (IFPI), 220 Marcus Garvey Dr., Kingston 11. Tel: 923-9978/7375. Telex: 2294. Cable: FEDERREC.
Labels: (Owned) Federal, LTD, Wildflower, (licensed) Buddah (USA), CBS (UK, USA), Columbia (UK, USA), Epic (USA), Hi (UK, USA), Marlin (USA), Philadelphia Int'l (USA), Portrait (USA), RCA (USA), T-Neck (USA), TSOP (USA), (distributed—not licensed) Crystal, Playback.
Gorgon, see Sonic Sounds.
Jaguar, see Dynamic Sounds.
L T D, see Federal.
Lion, see Dynamic Sounds.
Melrose, see Dynamic Sounds.
Multitapes Ltd., 15 Bell Rd., Kingston 11. Tel: (92) 39130. Telex: 2296. Pres: Byron Lee; VP: Cecil Warren; Gen. Mgr.: Michael F. Khouri; Sales Mgr.: Junior Gray.
Audio: Cassette labels.
Playback, see Federal.
Record Specialists Ltd. (IFPI), 1-3 Torrington Rd., Kingston. Tel: (809) 922-4865/6287. Cable: SOUNDTRACK. Telex: 2252. Exec. Dir.: George Benson, Dir. & Sec'y: Maryon Benson, Sales Mgr. Delroy Morrison.
Labels: (Owned) Blank, Cariffa, Champion, Saturn, Star, Venus, (licensed foreign) Disneyland Vista (USA), MCA—tapes (USA), Majestic (USA), Mo town (USA), Salsoul (USA), Universal (USA), Word (UK).
Salurn, see Record Specialists.
Snapper, see Sonic Sounds.
Sonic Sounds Rec. Mfg. Co. Ltd., 14 Retirement Rd., Kingston 5. Tel: 926-2036/1204. Cable: VIBES. Mng. Dir.: Neville O. Lee.
Labels: (Owned) Gorgon, Snapper, Somic, Thunderbolt, Tuna, Volcano, (licensed foreign) Arista (USA), Capitol (USA), EMI (UK), United Artists (USA), WIRL (Barbados).
Star, see Record Specialists.
Thunderbolt, see Sonic Sounds.
Tiger, see Dynamic Sounds.
Tuna, see Sonic Sounds.
Tysott, see Dynamic Sounds.
Venus, see Record Specialists.
Volcano, see Sonic Sounds.
Wede Bete, see Dynamic Sounds.
Wildflower, see Federal.

• music publishers

Par-Lay-Yoo Music Ltd., see Woodwater.
Record Specialists Ltd., 1 Torrington Rd., Kingston, WI. Tel: 922-4865/6287. Cable: SOUNDTRACK. Telex: 2252. Exec. Dir.: George Benson; Dir. & Sec'y: Maryon Benson; Sales Mgr.: Delroy Morrison.
Int'l firm represented: Big Seven (USA).
Sheila Music Corp. Ltd. (BMI), 15 Bell Rd., Kingston 11. Tel: 933-9138/9130. Cable: DYNASOUND. Mng. Dir.: Sheila Lee.
Int'l firms represented: Cottillion, Devalbo, Douglas, Ice Nine/Fry King, Marsaint, Quackenbush, Sergeant Music/Saloon Songs, Story Songs, Viva, Warner Bros. group (all USA), State (UK).
Int'l reps.: South Africa (Plymouth), rest of world (State).
Woodwater Music Ltd., 220 Marcus Garvey Dr., Kingston 11. Tel: 923-8817. Cable: FEORREC. Telex: 2294.
Int'l firms represented: ATV (UK), Buckhorn (USA), Burlington (UK), Keymen (USA), Morning (Canada), Palace (UK).
Int'l reps.: Benelux (Universal Songs), Canada (Morning), Europe (April, Blackwood), South Africa (Impact), USA (Wetwater).

• services

DESIGN & ARTWORK PLATING, PROCESSING & PRESSING PLANTS PRINTERS & LITHOGRAPHERS RECORD PROMOTION

Federal Rec. Mfg. Co. Ltd., 220 Marcus Garvey Dr., Kingston 11. Tel: 923-7375. Cable: FEDERREC. Telex: 2294.
Multitapes Ltd., 15 Bell Rd., Kingston 11. Tel: (92) 39130. Telex: 2296. Pres: Byron Lee; VP: Cecil Warren; Gen. Mgr.: Michael F. Khouri; Sales Mgr.: Junior Gray.
TAPE CUSTOM DUPLICATORS
X 9 Electronics & Rec'g Tapes Ltd., PO Box 306, 14 Northside Plaza, Kingston 6. Tel: 927-0939, 937-0212. Gen. Mgr.: Suelan Chung.
Home office: USA. Aries Int'l.
Audio: 8 tr., cassette, open reel.

• supplies

CARTRIDGE & CASSETTE PARTS EMPTY CARTRIDGES, CASSETTES & REELS

Dynamic Sounds Rec'g Co. Ltd., 15 Bell Rd., Kingston 11. Tel: 933-9168

Pres: Byron Lee, Sales Mgr.: Junior Gray.
Brand name: Dynasette.

JACKETS & SLEEVES LABELS, DISK

Dynamic Sounds Rec'g Co. Ltd., 15 Bell Rd., Kingston 11. Tel: 933-9168. Pres: Byron Lee, Sales Mgr.: Junior Gray.
Federal Rec. Mfg. Co. Ltd., 220 Marcus Garvey Dr., Kingston 11. Tel: 923-8817. Cable: FEDERREC. Telex: 2294.
Multitapes Ltd., 15 Bell Rd., Kingston 11. Tel: (92) 39130. Telex: 2296. Pres: Byron Lee; VP: Cecil Warren; Gen. Mgr.: Michael F. Khouri; Sales Mgr.: Junior Gray (Sleeves only).

PROFESSIONAL TAPE SUPPLIES

Multitapes Ltd., 15 Bell Rd., Kingston 11. Tel: (92) 39130. Telex: 2296. Pres: Byron Lee; VP: Cecil Warren; Gen. Mgr.: Michael F. Khouri; Sales Mgr.: Junior Gray.
Audio: Cassette labels.

TAPE, BLANK LOADED

Multitapes Ltd., 15 Bell Rd., Kingston 11. Tel: (92) 39130. Telex: 2296. Pres: Byron Lee; VP: Cecil Warren; Gen. Mgr.: Michael F. Khouri; Sales Mgr.: Junior Gray.
Audio: 2", 1", 8-tr., open reel.
X 9 Electronics & Rec'g Tape Co. Ltd., PO Box 306, 14 Northside Plaza, Kingston 6. Tel: 927-0939. Gen. Mgr.: Suelan Chung.
Home office: USA. Aries Int'l.
Audio: 8 tr., cassette.

JAPAN

Population: 115,822,000
Rate of exchange: \$1 (US) = 223 yen (floating).
Per capita income: \$6,249.
Holidays: January 1. January 15 (Adult's Day), February 11 (Founding Day), Vernal Equinox Day, April 29 (Emperor's Birthday), May 3 (Constitution Day), May 5 (Children's Day), September 15 (Respect for Aged Day), Autumnal Equinox Day, October 10 (Athletics Day), November 3 (Culture Day), November 23 (Labor Thanksgiving Day). (If a holiday falls on a Sunday, it is celebrated on Monday).

RECORDS & TAPES:

Record production: Singles & LP's 1980—194,900,000 units, \$888,430,000; 1979—198,800,000 units, \$850,119,000.
Tape production: 1980—79,970,000 units, \$547,100,000; 1979—61,300,000 units, \$447,000,000.
Records imported: 1980—\$23,650,000; 1979—\$24,330,000.
Records exported: 1980—\$6,700,000; 1979—\$5,100,000.
Record club sales: 10% of total.
Discounting: Rare.
Type of distribution: Manufacturer-to-retailer. "Contracted stores," record retailers who are directly connected with record manufacturers, constitute the core of the distribution system. This distribution system is supplemented by wholesalers who have their own distribution route made up of "non-contractors." Major mass merchandise discount chains and students' cooperative stores also handle records. Some retailers specialize in handling imported records.
Type of promotion: Radio and discotheques for international music and TV for domestic music are the most important means of promotion. There are several fan magazines which cover both the domestic and international music scenes extensively.

RADIO STATIONS:

No. of commercial: 48 AM, 4 FM; no. of government: 2 AM, 1 FM.

TELEVISION STATIONS:

No. of government channels: 2. commercial channels: 88 (all color).

• record & tape manufacturers / distributors / importers

A N Z Inc., 27-13 Higashiyama-cho, Itabashi-ku, Tokyo 174. Tel: (03) 972-1369. Cable: ANZKEEPS. Pres: Terukazu Arita. (Importer)
Labels: (Owned) Alligator Jazz Club; (represented) Jazzology-GHB (USA).
A R G Corp., 306 Towa Roppongi Coop., 4-2-20 Roppongi, Minato-ku, Tokyo 106. Tel: (03) 583-7781/7746. Cable: & Sales Mgr.: Hideaki Utsumi; Rep.: Masashi Kitamura, Bus. Dept.: Hiroshi Masuda. (Distributor/Importer)
Label: (Licensed foreign) All Ears (USA).
Aardvark, see Canyon.
Abeno-Meikyoku-Do, 4-13-19 Abenosuji, Abeno-ku, Osaka 545. Tel: (06) 622-0373. (Distributor).
Agharta, see Canyon.
Alfa Recs Inc., 3-5-39 Shibaura, Minato-ku, Tokyo 108. Tel: (03) 455-1791. Cable: ALASSOCIA. Telex: 2424537. Pres: Kunihiko Murai; VP & A&R: Sho Kawazoe; Gen. Mgr.: Chuichi Kaneko; Sales Mgr.: Junichi Yanai; A&M Label Mgr.: Ken Kambai. (Distributed by Victor)
Labels: (Owned) Alfa; (licensed foreign) A&M (USA), Horizon (USA).
Int'l reps.: Europe, UK, USA (all A&M).
Alligator Jazz Club, see ANZ.
Apollon Music Ind'l Corp. (IFPI), 1-5 Wakaba, Shinjuku-ku, Tokyo 160. Tel: (03) 353-0191. Pres: Misa Watanabe; Gen. Mgr.: Hideki Hayashi; Sales Mgr.: Ruyuro Uchida. (Tape only).
Archiv, see Polydor.
Artisco, see Canyon.
Asahi Music Servs. Inc., c/o Asahi Broadcasting Corp., 2-2-48 Ohyo-do-Minami, Ohyo-do-ku, Osaka 531. Tel: (06) 458-5321. Pres: Kinkichi Kanbara; Gen. Mgr.: Kazuyuki Yagi; Sales Mgr.: Shuzo Asai.
Label: (Owned) Asahi Muspak.
Branch: Tokyo, 2-6-3 Shiba Park, Minato-ku, Zone: 105. Tel: (03) 436-5771. Cable: ASAHIHOSO TOKYO.
Asahi Muspak, see Asahi Music Servs.
Asylum, see Warner-Pioneer.
Athens Rec. Ind. Co. Ltd., 3-4-9 Ginza, Chuo-ku, Tokyo 104. Tel: (03) 542-6651. Cable: ATHENCORO. Pres: Hiroshi Hirano.
Atlantic, see Warner-Pioneer.
Atlas, see Yupiteru Ind.
B O M Serv. Ltd., 6-5-18 Kawamo, Takarazuka, Hyogo 665. Tel: (0797) 87-0561. Pres: Toshio Watanabe; VP: Saburo Watanabe.
Labels: (Owned) Red Clay; (licensed) American Heritage, Bay, County, Flying Fish, Grassound, Old Homestead, Outlet, Puritan, Rebel, Revonah,

Ridge Runner, Rounder, Shiloh, Sonyatone, Sugar Hill (all USA). (distributed—not licensed) Biograph, CMH, Takoma, Veltco (all USA).

Black, see Teschiku.

Black Hawk & Co., 2-18-3 Dogenzaka, Shibuya-ku, Tokyo. Contact: Yoshinori Mizukami. (Distributor)

Label: (Represented) Biscuit City (USA)

Bluegrass Ents. Tokyo, Kasai Bldg., 6-15-1 Honkomagome, Bunkyo-ku, Tokyo 113. Tel: (03) 946-4663. (Distributor).

Blues Interactions Inc., 5-18-11-201 Daizawa, Setagaya-ku, Tokyo 155. Tel: (03) 412-1293. Cable: PEAVINE. Pres: Yasufumi Higurashi; Gen. Mgr.: Akira Kochi.

Labels: (Owned) P Vine Special; (licensed foreign) Giant (USA), Jewel (USA), Joliet (USA), Joromi (Nigeria), Dne-Deiful (USA), Paula (USA), Ronn (USA), Rotel (USA), 3A (France); (distributed—not licensed) Superstar (Haiti).

Bourbon, see Tokuma.

C B S/Sony Inc. (IFPI), PO Box 17, Tokyo Int'l Airport, Tokyo 149. 1-4 Ichigaya-Tamachi, Shinjuku-ku, Tokyo 162. Tel: (03) 266-5803. Cable: CBSOSONYRECORD. Telex: 24766. Pres: Toshio Ozawa; Gen. Mgr.: Yoshiyuki Isomura; Sales Mgr.: Yoshikatsu Inoue.

Labels: (Owned) CBS/Sony, Little Gang, Openskye, People, Sound Development, Tee, UMI; (licensed foreign) ARC, Bang, Bearville, Believe In A Dream, Blue Sky, Caribou, Columbia, Curb, Jet, Johnston, Kirshner, Lormar, Monument, Nemperor, Odyssey, Pavilion, Philadelphia Int'l, Precision, Startite, TK, T-Neck, Tabu, Tappan Zee, Uncle Jam, Unlimited Gold (all USA); Ricordi (Italy).

Int'l reps.: Worldwide (CBS), Hong Kong (CBS/Sony), Korea (Jigu), Malaysia (EMI), Philippines (Blackgold), Singapore (EMI), Taiwan (Hai Shan).

Camellia, see Polydor.

Canyon Int'l, see Canyon Recs.

Canyon Recs. Inc. (IFPI), 4-3-31 Kudan Kita, Chiyoda-ku, Tokyo 102. Tel: (03) 265-4161. Telex: 2324208. Pres: Shigeaki Hazama; Mng. Dir.: Akira Ijichi; Sales Mgr.: Kunihiro Shimpo.

Int'l branch: USA.

Labels: (Owned) Aardvark, Agharta, Artisco, Canyon, Canyon Int'l, Cine-Disc, F, NAV, SOH, See Saw; (licensed foreign) Scotti Bros. (USA).

Casablanca, see PolyStar.

Cine-Oisc, see Canyon.

Climax, see Tokuma.

Columbia, see Nippon Columbia.

Cosdel (Japan) Ltd., Hibiya Park Bldg., Rm. 923, 1-8-1 Yuraku-cho, Chiyoda-ku, Tokyo 100. Tel: (03) 271-5861. Cable: COSDEL. Pres: Kenneth L. Cole. (Distributor)

Label: (Licensed) Durium (Italy).

Crown Rec. Co. Ltd., 2-10-8 Akasaka, Minato-ku, Tokyo 107. Tel: (03) 582-4741. Pres: Masanori Itoh; Gen. Mgr.: Noboru Saito; Sales Mgr.: Kazu-shige Tsuyuki.

D G, see Polydor.

Dan, see Tokuma.

Denon, see Nippon Columbia.

Disc Center Co. Ltd., CPO Box 874, Osaka 530 91. Tel: (06) 323-6350. Cable: DISCAREA. Telex: 64488. Pres: Yasutoshi Gotoh; Gen. Mgr.: Kaoru Umeda. (Distributor/Importer/Exporter)

Discomate Recs. Co. Ltd. (IFPI), Akasaka Mahabie Bldg., 3-4-3 Akasaka, Minato-ku, Tokyo 107. Tel: (03) 585-9111. Telex: 2425228. Pres: Takayasu Yoshioha; Exec. VP: Toshiro Hoshino; Sales Mgr.: Ikuo Kogasaki. (Distributed by Victor)

Label: (Owned) Discomate; (licensed) Polar (Sweden). (SEE ADVERTISEMENT)

Disk Union Co. Ltd., 2-13-1 Iidabashi, Chiyoda-ku, Tokyo 102. Tel: (03) 264-7930. Cable: DISKUNION. Telex: 25425. Pres: Teruichi Hirohata; Mng. Dir.: Kazuo Futuda. (Distributor/Importer/Exporter).

Doughnut, see Toshiba EMI.

East Wind, see Nippon Phonogram.

Elektra, see Warner-Pioneer.

Epic/Sony Inc., 8F Shin-Aoyama Bldg. Nishi, 1-1-1 Minami-Aoyama, Minato-ku, Tokyo 107. Tel: (03) 475-2640. Cable: EPIC SONY. Telex: 2424132. Exec. Mng. Dir.: Shugo Matsuo; Gen. Mgr.: Hiroaki Ishikawa; Sales Mgr.: Junichi Watanabe; A&R Promo. Dir.: Terry Tsutsumi.

Labels: (Owned) Epic/Sony; (licensed foreign) CBS, Epic (USA), GTO (UK), Portrait (USA).

Express, see Toshiba EMI.

F, see Canyon.

Flying Oisc, see Victor.

Flying Dog, see Victor.

For Life Recs. Inc., 10F Odakyu Minamiyama Bldg. 7-8-1, Minato-ku, Tokyo. Tel: (03) 406-6955.

Frasco, see Nippon Phonogram.

Free Flight, see Warner-Pioneer.

Fullhouse, see Trio.

G & G Sounds Corp., 3-15-15 Izumi, Higashi-ku, Nagoya, Aichi 461. Tel: (052) 971-5030. Pres: Yoshio Tanahashi. (Distributor/Importer)



**Southern Music Publishing Co.
(Japan) Ltd.
Tokyo, Japan**

TELEX 02429228 DISCO J
 TEL (03)585-9111
 Minato-ku Tokyo Japan 107
 ADDRESS Makabe Bldg 2F 3-4-3 Akasaka
 An all-round independent record company
 (not only disco music)

discomate records



NOTE

ESTABLISHMENT July 18 1975
 AUTHORIZED CAPITAL 350 Million Yen
 EMPLOYEE 40
 MAIN STOCKHOLDERS
 TBSI Tokyo Broadcasting System Inc.)
 JVC/Victor Company of Japan Ltd.)

**"The independent records company
 is very important to us."
 This is an authentic vivid sounds.**

BLUES / R & B / SOUL / ROCK / REGGAE
 Manufacture & Distribute under license

Import is our specialty



VIVID SOUND CORPORATION
 23-8, 2-CHOME, SHIMOMEGURO,
 MEGURO-KU, TOKYO 153, JAPAN
 PHONE: 03-490-1070

Globe, see Victor.
 Gyugya Kawahara-cho Ten, Sangyoun, Kawahara-cho, Cyukyo-ku, Kyoto
 Label: (Represented) Sierra/Briar (USA)
 Hara Int'l Inc., 1-2-5 Shirokanedai, Minato-ku, Tokyo 108. Tel (03) 445-4545
 Cable HARAINI TOKYO. Chm. & Gen. Mgr. R.N. Uehara, Office Mgr. N. Yunoki.
 Harmony House Recs., 3-1 Kanda Surugadai, Chiyoda-ku 101, Tokyo
 Label: (Represented) Sierra/Briar (USA).
 Harvest, see Tokuma.
 Herald Music Inc., 2-20-15 Shimbashi, Minato-ku, Tokyo. Tel (03) 573-1287.
 Cable HERALOPTICTURE (Distributor/Importer)
 Invitation, see Victor.
 J V C, see Victor.
 Japan Cardinals Corp., Kono Bldg 2F, 41-23 Udagawacho, Shibuya-ku Tokyo 150. Tel (03) 463-9661
 Cable JICAROT. Telex 2422497 Chm. Akio Takaoka, Pres. Eiji Miki. (Importer/Exporter)
 Labels: (Distributed—not licensed) all labels (USA), Astree (France), Cal Ilope (France), OGG (Germany), EMI (UK), Erato (France), Electroa (Germany), Eurodisk (Germany), Musidisc (France), Pathe (France), Teledec (Germany), Unicorn (UK).
 Japan Publ'ns Trading Co. Ltd., 1-2-1 Sarugaku-cho, Chiyoda-ku, Tokyo 101 Tel. (03) 292-3751
 Cable SHUTSUO. Telex: 27161. Pres. Toshio Mura yama, Gen. Mgr. T. Kishi, Mgr. M. Kokubo. (Distributor/Exporter).
 Japan Rec Trading Co. Ltd., Daichi Honan Bldg., 2-8-17 Minami Ikebukuro, Toshima-ku, Tokyo 171. Tel (03) 984-1587. Telex: 2722447 Pres. Si-ru Guchi. Oir. Shunji Obata. (Importer).
 Japan Soul Agency, 1-5-11 Sakurayosu, Setagaya-ku, Tokyo 156 Tel (03) 302-0208.
 Cable JSATRCO. Telex 2424586. Chief Exec. Kazuo Akimoto, Gen. Mgr. Nobuhiro Sindo, Sales Mgr. Eiko Yamaguchi (Distributor/Importer)
 Jujiya Gakki, 3-21 Nishiki-cho, Kanda, Chiyoda-ku, Tokyo 100 Tel (03) 293-4671
 K tel Int'l (Japan) Ltd., 1-2-8 Nihombashi, Chuo-ku, Tokyo 103 Tel (03) 274-4391
 Telex 2222337 Pres. Tetsutaro Iida, Exec. VP Raymond Kives; Gen. Mgr. Shogo Ishii
 Home office: USA.
 Kenwood, see Trio
 Kikka Trading Co. Inc., 1-7-9 Asagaya Minami, Sugnamu-ku, Tokyo 166 Tel (03) 583-5476, 311 1682
 Cable KIKKAING Telex: 02422797. Mng. Oir. Arata Yamamoto. (Exporter).
 Labels: (Exported) Major jazz & rock labels & soundtracks
 King Rec. Co. Ltd (IFPI), 2-12-13 Otowa, Bunkyo-ku, Tokyo 112. Tel. (03) 945-2131. Telex: 24963. Pres. Shin Tomoda, Gen. Mgr. Goh Makino. Sales Mgr. Yoshiaki Kajiyama, Int'l Pops Repertoire Mgr. Kazuo Takeda.
 Labels: (Owned) King, Paddle Wheel, Seven Seas, Windmill. (Licensed) Argo, Ariston, Artists House, Barclay, Butterfly, CGO, CTI, Contemporary, Disneyland, Fonti Cetra, Hungaroton, London, R. Fi, Telefunken, United Artists, Vanguard.
 Int'l reps.: Australia (Festival), Brazil (Alltplay), France (Compagnie Phonographique Francaise, Societe Francaise du Son), Hong Kong (Hong Kong King Yoko), UK (London), USA (Vanguard)
 Kitty Ents. Inc., Kobayashi Bldg., 7th fl., 1-14-11 Shibuya, Shibuya-ku, Tokyo 150 Tel. (03) 499-4711 Telex: 2425338. Pres. Harum Ogawa, Promo. Mgr. Yutaka Tanaka, Int'l Mgr. Kazuo Munakata. (Also see Polydor)
 Kyushu-Ongaku-Sangyo, Ishii Bldg., 3-16-13 Hakataekimae, Hakata-ku, Fukuoka-shi 812. Tel. (092) 29-0117. (Distributor).
 Llac Shoji, 1-0, Oshoy-machi, Minami-ku, Osaka 542. Tel. (06) 244-0901 (Distributor).
 Little Gang, see CBS/Sony
 Lost City Co. Ltd., 3-5-10 San Nomiya-cho, Kobe 650. Tel: (078) 331-3770.
 Chief Exec. Motohiro Nozaki, Gen. Mgr. Mamoru Okutani, Sales Mgr. Kazuki Yamana. (Distributor/Importer).
 Lucky Shokai, 2-4-1 Iwamoto-cho, Chiyoda-ku, Tokyo 101 Tel. (03) 861-7134. (Distributor)
 Ma Ma, see Tokuma.
 Max, see Super Stop.
 Mercury, see Nippon Phonogram & Nihon Mercury
 Minorophone, see Tokuma.
 Muse Trading Co. Ltd., New Atago Bldg., Atago 2-4-9, Tokyo 105 Tel. (03) 438-2525.
 Cable MUSETTA. Pres. Naokazu Kumagai, Gen. Mgr. Kazuo Kumagai. (Distributor/Importer).
 Music Minus One Japan, 3-25 Azabu Ikura, Minato-ku, Tokyo 106. (Distributor)
 Home office: USA
 Music Shop Kunihara, 8 Niyo, Asahikawa, Hokkaido Tel (0166) 23-5266. (Distributor).
 N A V, see Canyon.
 Nadja, see Trio.
 Nihon Mercury Rec Ltd., 2-7-3 Yamato-cho, Nakano-ku, Tokyo 165. Tel (03) 337-8970.
 Label: (Owned) Mercury
 Nippon Columbia Co. Ltd (IFPI), 4-14-14 Akasaka, Minato-ku, Tokyo 107 Tel (03) 584-8111.
 Cable NIPPONCOLUMBIA Telex 22591. Pres. Takashi Shobochi, Rec. Div. Dir. & Gen. Mgr.: Mitsugu Kumamoto, A&R Div. Dir. Gen. Mgr. Toshio Nemoto; Int'l Repertoire Gen. Mgr. Shuzo Kobayashi; Licensing Mgr. Hajime Saito, Export Mgr. Saburo Wake.
 Labels: (Owned) Columbia, Denon. (Licensed) Accent (Belgium), Bae reneiter Musicaphon (Germany), Cantate (Germany), Chandos (UK), Claudius (Germany), Da Camera (Germany), Desimar (USA), Disney (USA), Everest (USA), Ex Libris (Switzerland), Folkways (USA), MK (USSR), Mondiodis (France), Mouloudji (France), Musicaliter (Germany), Muza (Poland), Nobody's Business (UK), PPK (Netherlands), Pelca (Switzerland), Phonag (Switzerland), PolyGram (Italy), Preiser (Austria), Protone (USA), Public Image (UK), Roccoco (Canada), Roulette (USA), Seeco (USA), Supraphon (Czechoslovakia), Transatlantic (USA), Turcaphon (Switzerland), Bruno Walter Society (USA)
 Int'l reps.: Brazil (Alltplay), France (Erato, Sofrason), Mexico (Cisne), Spain (Discophon, Hispavox), USA (CBS, Everest, Vox)
 Int'l reps. for Denon PCM: Australia (Janda), Canada (Trend), Denmark (So & Hoyem), France (Harmonique Diffusion), Germany (Teldec), Hong Kong (Tadin Radio Serv.), Italy (Franco Crippa), Netherlands (Penhold), New Zealand (EMI), Singapore (Chang Husat), Spain (Gaplasa), Switzerland (Audio Compo), UK (Eumig), USA (Discwasher)
 Nippon Gakki Co. Ltd., 7-9-18 Ginza, Chuo-ku, Tokyo 104. Tel (03) 572-3111.
 Cable YAMAHAPIANO. Telex: 252-2824. (Distributor/Importer)
 Nippon Gakki Shibuya-Ten, 2-10-7 Dogenzaka, Shibuya-ku, Tokyo.
 Label: (Represented) Sierra/Briar (USA).
 Nippon Phonogram Co. Ltd (IFPI), Wako Bldg., 4-8-5 Roppongi, Minato-ku, Tokyo 106. Tel (03) 479-3711
 Cable NIPPINDISC Telex 2423224. Pres. Nobuya Itoh; Gen. Mgr. Reijiro Itoh, Sales Mgr. Ryuzo Tajima, Int'l Mgr. Tadao Sekiguchi.
 Labels: (Owned) East Wind, Frasco, Mercury, Philips, Vertigo, (Licensed) Arista (USA), Charisma (UK), Shelter (USA), Timeless (Netherlands).

(distributed—not licensed) Casablanca. (SEE ADVERTISEMENT)
 Nonesuch, see Warner-Pioneer
 Openske, see CBS/Sony
 Overseas, see Teichiku
 P Vine Special, see Blues Interactions.
 Paddle Wheel, see King.
 People, see CBS/Sony
 Phenix Trading, Central PO Box 631, Osaka 530-91. Tel (06) 363-7106, 365-5521. Telex 64219. Pres. Kikuo Tarumoto, Gen. Mgr.: Morio Nakatsu; Sales Mgr. Toshio Hashioka, Ass't Mgr. Yutaka Matsumura. (Distributor/Importer).
 Philips, see Nippon Phonogram
 Pioneer, see Warner-Pioneer
 Pirates, see World Rec.
 Polydor KK (IFPI), 1-8-4 Ohashi, Meguro-ku, Tokyo 153 Tel: (03) 462-5131
 Telex 2422033. Pres. Seichiro Koh, Mng. Oirs.: Atsutaka Torio, Hideo Murakami, Sales Mgr. Sozo Fujita, A&R Mgr. Yasuhiro Igarashi, Special Project Mgr. Yasuo Fujisawa
 Labels: (Owned) Archiv, Camella, OG, Kitty, Polydor, Sanrio, Time Verve. (Licensed) Claves (Switzerland), Oreamland (USA), Handshake (USA), MGM (USA), Pablo (USA), RSO (USA), Seon (Germany).
 Polystar Co. Ltd. Ellie Bldg., 6th fl., 5-1-2 Minami-Aoyama, Minato-ku, Tokyo 107 Tel (03) 406-8161 Telex 27746. Pres. J.O. Biersbach; Gen. Mgr. Akio Onodera; Sales Mgr.: Yasuo Morimoto. (Distributor).
 Labels: (Owned) Casablanca, (Licensed) Brain (Germany), Metronome (Germany).
 Pooh Yokocho Co. Ltd., Printemps Bldg., 2F, 447-14 Kajicho, Kawara machi Imadegawasaagaru, Kamigyoku, Kyoto 602. Tel: (075) 256-2856
 Pres. Hideaki Matsuka, Gen. Mgr. Kenji Matsuka; Sales Mgr.: Hirokata Sakai. (Distributor/Importer—cutouts/Exporter)
 Labels: (Licensed domestic) CBS/Sony, Epic/Sony, King, Nippon Columbia, Nippon Phonogram, P.Vine, Polydor, RVC, Red Clay, Toshiba-EMI, Trio, Victor, Vivid Sound, Warner-Pioneer, (distributed—not licensed) Boot (Canada), County, Crystal Clear, Direct Osc, Flying Fish, Flying High, Grass Mountain, Kaleidoscope, Kicking Mule, Music Minus One, Old Homestead, Rebel, Ridge Runner, Rounder, Sugar Hill, Takoma (all USA).
 R V C Corp., 1-7-8 Shibuya, Shibuya-ku, Tokyo 150. Tel (03) 499-3311
 Cable RYCARORECOR. Telex 2425162. Pres. Ichiro Okuno.
 Labels: (Licensed) Erato (France), RCA (USA) (SEE ADVERTISEMENT)
 Radio City Rec. Ltd., 1-5 Wakaba, Shinjuku-ku, Tokyo 160. Tel (03) 357-2511. (Distributed by Victor)
 Rainbow Recs., Xerox Corner, Taiseido 8F, 1-22-4 Jinnan, Shibuya-ku, Tokyo 150 Tel (03) 464-6038. Chief Exec. Satoshi Sasaki, Gen. Mgr. Midori Ochiai, Sales Mgr. Naoya Yamauchi (One Stop/Distributor/Importer)
 The Reader's Digest of Japan Ltd., Palace Side Bldg., 1-1-1 Hitotsubashi, Chiyoda-ku, Tokyo 100 Tel (03) 284-4141. (Distributor).
 Recommended Recs. Japan, 401 Rikuzo Bldg., 2-46-9 Matsubara, Setagaya-ku, Tokyo 156 Contact Hideaki Utsumi
 Home office: England.
 Record Shop OM, Shida Bldg. 1F, 7-16-15 Nishi Shinjuku, Shinjuku-ku, Tokyo 160. (Distributor)
 Label: (Represented) Mustevic Sound (USA).
 Red Clay, see BOM.
 Reprise, see Warner-Pioneer
 Ryogaya Co., Ltd., PO Box 10, 2-2-7 Honcho, Nagaoka, Nagaoka 940. Tel: (0258) 35-4500. Cable: RYONGO Telex 03232108 Pres. Tamaki Shmizu, Gen. Mgr. Yoshio Shimizu. (Distributor/Importer/Exporter)
 S M S, see Sound Mktg.
 S O H, see Canyon.
 Sanrio, see Polydor
 See Saw, see Canyon
 Seven Seas, see King.
 Seikodo Co. Ltd., Mitsui Ikebukuro Bldg., 2-27-9 Minami Ikebukuro, Toshima-ku, Tokyo 171 Tel (03) 988-8221 Pres. Masanobu Ihara. (Distributor).
 Shinjuku Rec. Co. Inc., 7-9-6 Nishi Shinjuku, Shinjuku-ku, Tokyo. Tel (03) 363-3669 Gen. Mgr. M. Fujiwara. (Importer)
 Label: (Represented) Sierra/Briar (USA).
 Shinseido Co. Ltd., 1-23-17 Kamigy, Sugnamu, Tokyo Tel: (03) 393-5151.
 Cable SHINSEIO Telex: 23585. Pres. Masamori Miyazaki, Mng. Oir. Jiro Ohtake. (Distributor/Importer/Exporter/Retailer).
 Shinsei Serv. Co. Ltd., 3-51 Andojibahori, Minami-ku, Osaka 542. Tel: (06) 245-6061
 Cable SALWELL Telex: 63753. Dir. Ryushin Sakata; Gen. Mgr. Susumu Irie; Sales Mgr. Shinichi Nakajima. (Importer)
 Branch: Tokyo, 1-1 Honcho, Nihonbashi, Chuo-ku 103. Mgr. Ryo Miura.
 Sound Development, see CBS/Sony.
 Sounds Mktg. System Inc., Kaisei Bldg., 5th fl., 1-8-10 Azabudai, Minato-ku, Tokyo 150. Tel (03) 586-9031
 Cable SMSRECORDS Telex: 29321. Pres. Shin Watanabe, Sr. Mng. Dir. Tetsu Aoyagi, Int'l Dept. Dir.: Kathleen H. Connelly.
 Label: (Licensed foreign) Ice (UK)
 Sound Trading Co. Ltd., Fukide Bldg., 4-1-13 Toranomon, Minato-ku, Tokyo 105 Tel (03) 438-0290 Telex 28254. Pres. Masao Yorozu, Planning Mgr. Hisaichi Urushiyama, Import/Export Mgr. Kunihiko Yashiro, Sales Mgr. Hitoshi Iijima. (Importer/Exporter)
 Sumiya Ltd., 2-10-16 Shibuya, Shibuya-ku, Tokyo 150 Tel: (03) 406-4966. Telex 2422097. Pres. Shigeru Kawabe. (Distributor/Importer/Exporter)
 Sunkyo Music Co. Ltd., Yamagata Bldg., 1-14-7 Nishi-Shimbashi, Minato-ku, Tokyo 105 Tel (03) 501-2667 Pres. Ichiro Takeuchi. (Importer of recorded masters)
 Super Stop Inc., 8-114 Nishijuku, Minoo, Osaka 562 Tel (0727) 28-2351
 Cable SUPERSTOP Telex 5324169 Pres. Hirakazu Sasabe, Gen. Mgr. Tomizo Miyagawa; Sales Mgr. Kuniharu Watase. Local branch: 2-26-11 Bishoen, Abeno-ku, Osaka 545. Tel (06) 713-2715. (Distributor/Importer/Exporter)
 Labels: (Owned) Max, (distributed—not licensed) Appaloosa (Italy), Black Saint (Italy), Dragon (Sweden), Queen Disc (Italy), Soul Note (Italy)
 T K R, see Takara
 Takara Mfg Co. Ltd., 2-29-12 Tamagawa, Ohta-ku, Tokyo 144. Tel: (03) 759-3151.
 Label: (Owned) Takara "TKR"
 Tam, see Toho
 Tambourine Recs., 671-3 Shobaru, Minami-ku, Fukuoka 815
 Label: (Represented) Buttermilk (USA).
 Tee, see CBS/Sony
 Teichiku Recs Co. Ltd (IFPI), 1-2 Nishi-Shimbashi, Minato-ku, Tokyo 105 Tel (03) 502-7213 Telex 2224237. Pres. Shigeji Nanko, Gen. Int'l & Copyright Div. Mgr. Ichiro Kinoue, Sales Mgr. Minoru Dzaki.
 Labels: (Owned) Black, Overseas, Teichiku, Union, (Licensed) Audio Fidelity (USA), Beserky (USA), Catalyst (USA), Chiaroscuro (USA), Contempo (UK), Hansa (Germany), Harmonia Mundi (Germany), IPG (France), MPS (Germany), Metronome (Germany), Weys (France), Pro

VICTOR/JVC COMMUNICATES



WITH MUSIC/VIDEO

JVC

VICTOR MUSICAL INDUSTRIES, INC.
26-18, 4-CHOME JINGUMAE, SHIBUYA-KU
TOKYO 150, JAPAN TEL 405-5151
Cable: VICRECORD Tokyo Telex VICREC J242-4293

L.A. BRANCH OFFICE
9000 Sunset Blvd. Suite 702
Los Angeles, Calif 90069
Tel. 213-274-6210

VICTOR MUSIC PUBLISHING, CO. INC.
26-18, 4-CHOME JINGUMAE, SHIBUYA-KU
TOKYO 150, JAPAN Tel. 404-3201

VICTOR ARTISTS CORP. OF JAPAN
26-18, 4-CHOME JINGUMAE, SHIBUYA-KU
TOKYO 150, JAPAN TEL 402-8181

gressive (USA), Pye (UK), Sonet (Sweden), Storzville (Denmark), Temey (France), Vee Jay (USA), Xanadu (USA)

Time, see Polydor

Toho Recs. Co. Ltd., 1-2-1 Yuraku cho, Chiyoda-ku, Tokyo 100 Tel (03) 503-9531. (Distributed by Victor)

Int'l branches: Brazil, Italy, Hong Kong, USA

Labels: (Owned) Tam, Toho, (licensed) BYG (France), Black Jazz (USA), Ovalton (USA), Vogue (France)

Tokuma Musical Inds. Co. Ltd. (IFPI), 1-18-21 Shimbashi, Minato-ku, Tokyo Tel (03) 591-9161. Cable TOKUMAONKO Telex 28438 Chief Exec Yasuyoshi Tokuma, Gen Mgr Masatoshi Kimura, Sales Mgr. Shigemitsu Suzuki

Labels: (Owned) Bourbon, Climax, Dan, Harves., Ma Ma, Minorophone, (represented) Deutsche Schallplatten (East Germany)

Int'l rep.: Worldwide (Island)

Tokyo Denka Co Ltd, 577 Hamasaku, Asakashi Saitama-ken 351 Tel (0484) 71-2456 Cable TEDECO Mng Dir Akihiko Ogawa

Toshiba-EMI Ltd., 2-2-17 Akasaka, Minato-ku, Tokyo 107 Tel (03) 585-1111. Cable TOSHIBAEMILT Telex 2422112 Pres Noboru Takamiya, Dirs K. Ueno, Y. Machida, T. Takatori, T. Yoshimoto, I. Kato

Labels: (Owned) Doughnut, Express, Toshiba, (licensed) Angel (UK), Capitol (USA), Chrysalis (UK), Concord (USA), EMI (UK), Island (UK), MPL (UK), Odeon (worldwide), Private Stock (USA), RAK (UK), Rolling Stones (UK), Stateside (UK)

Int'l reps.: France (Pathe Marconi-EMI), Germany (EMI Electrola), Netherlands (EMI Holland), UK (EMI), USA (Capitol) (SEE ADVERTISEMENT)

Towa Kikaku & Co Inc., c/o Bluegrass Ents. Tokyo, Kasai Bldg., 6-15-1 Honkomagome, Bunkyo-ku, Tokyo 113 Tel (03) 946-4663. (Distributor) Trash, see Trio.

Trio Recs./Trio Kenwood Corp (IFPI), 5-2-1 Roppongi, Minato-ku, Tokyo 106. Tel (03) 404-4391. Cable TRIODISC. Telex 2426776 Exec Dir Makoto Oka, Gen. Mgr Tazuo Fujii, ECM Label Mgr Kenny Inaoka, Sales Mgr. Akiharu Tashiro, Copyright & Licensing Yochi Maeda

Labels: (Owned) Fullhouse, Nadja, Trash, Trio, Whynot, (licensed) Alshire (USA), Arhoolie (USA), Bel Car (USA), Black Lion (USA), Choice (USA), Delmark (USA), ECM (Germany), First American (USA), Flying Fish (USA), Freedom (UK), KG (USA), LAX (USA), Anita O' Day (USA), Rounder (USA), Stony Plain (Canada), Trojan (UK) (SEE ADVERTISEMENT)

U D C, see URC

U M I, see CBS/Sony

U R C Recs Inc., 311 Yamayasu Bldg., 1 Togano-cho, Kita-ku, Osaka 530 Tel (06) 314-1631.

Labels: (Owned) URC, UDC

Umon, see Teichiku

Universal Corp. of Japan Ltd., 1-17-9 Uchikanda, Chiyoda-ku, Tokyo 101 Tel. (03) 291-0326 Cable UNICORECORD Mng. Dir. Kiyoshi Narita, Gen Mgr Junji Narita. (Importer)

Vap Inc., Mason Hiraikawa 2F, 2-5-2 Hiraikawa ch. Chiyoda-ku, Tokyo Tel (03) 234-5710 Telex 129410

Vertigo, see Nippon Phonogram

Verve, see Polydor.

Victor Musical Inds. Inc (IFPI), Harajuku Piazza Bldg., 4-26-18 Jingumae, Shibuya-ku, Tokyo 150. Tel (03) 405-5151 Cable VICRECORD Telex 242-4293. Pres., Saburo Watanabe, Sr. Mng. Dir. Shoo Kaneko, Int'l Div Mgr. Yoshihisa Honda

Int'l branch: USA, JVC Cutting Center Inc

Labels: (Owned) Flying Disk, Flying Dog, Globe, Invitation, JVC, Victor, Zen, (licensed foreign) Cream, Emanem, Fantasy, Firesign, Galaxy, Gusto, Hi, MCA, Midsong, Milestone, Motown, Prelude, Prestige, Prodigal, Pyramid, Riverside, Stax, Tomato (all USA), Albion, Aura, Avatar, Bronze, Enigma, Gull, Hansa, Incus, Nimbus, Penny Farthing, Pinnacle, Realto, Rockburgh, Stiff, Symphonica, Virgin (all UK); Aravell, Boona, Calliope, Delphine, Friederich's Prod'ns, Harmonia Mundi (all France); Jupiter (Germany), Aretio (Cuba), Baby (Italy), Change (Canada), China (China), Durium (Italy), Electrecord (Romania), Hspavox (Spain), Jugoslav (Yugoslavia), Melodya (USSR), Opus (Czechoslovakia), Panton (Czechoslovakia), Sackville (Canada), Trova (Argentina), True North (Canada), Turcaphon (Switzerland), (distributed-not licensed) A&M (USA), Alfa, Discamate, Radio City (all Japan)

Int'l reps.: Brazil (Victorono), Chile (Uiz), Cuba (Aretio), Ecuador (IFESA), Hong Kong (King Yoko), Korea (Daedo), New Zealand (Music World), Philippines (A&W, OctoArts, Victor), Portugal (Trindade), Singapore (Chang Huat), Switzerland (Turcaphon), Taiwan (First), USSR (Melodya) (SEE ADVERTISEMENT)

Wind Sound Corp., 2-23-8 Shimomeguro, Meguro-ku, Tokyo 153 Tel (03) 490-1070 Cable VIVID SOUND. Pres. Fumio Nagano, VP Masayasu Odakawa, Gen Mgr Kazuo Nagano

Labels: (Licensed foreign) Ace, Alarm/Murco, Crayon, Goldwax/Music Garden, Imagination, JR Prod'ns, Le Cam/Charley, Malaco/Chimneyville (all USA) (SEE ADVERTISEMENT)

W E A, see Warner-Pioneer

Warner Bros., see Warner-Pioneer

Warner-Pioneer Corp. (IFPI), Aoyama Twin Tower Bldg., 14th fl., 1-1-1 Minami-Aoyama, Aoyama, Minato-ku, Tokyo 107 Tel (03) 475-2051 Cable WARBPIONEER Telex 26876 Pres. Kichhei Sawa, Mng Dirs Keith Bruce, Yukio Sakamoto, Int'l Mgr., Hiroki Imao

Home office: USA, WEA Int'l

Labels: (Owned) Asylum, Atlantic, Elektra, Nonesuch, Pioneer, Reprise, WEA Warner Bros., (licensed domestic) Free Flight, (licensed foreign) Chiswick (UK), Dark Horse (USA), Geffen (USA), Swan Song (UK), Vox (USA)

Whynot, see Trio

Windmill, see King

Winners Recs Shop, Sanethouse 505, Saneicho 25, Shinjuku-ku, Tokyo Tel (03) 341-1835. Telex: 2324125. Pres. T. Kohno. (Importer)

World Family Rec Co Ltd., Minami Aoyama Daichi Bldg., 5-1-10 Minami-Aoyama, Minato-ku, Tokyo 107 Tel. (03) 407-5121. Pres.: Shigeru Saito. (Distributor)

World Rec. Co. Ltd., Aisan Bldg., 4F, 1-9-3 Hiraikawa cho, Chiyoda-ku, Tokyo 102 Tel (03) 230-0526

Label: (Owned) Pirates

Yamano Music Co Ltd., 4-5-6 Ganza, Chuo-ku, Tokyo 154 Tel (03) 562-5051 Pres. Mike M Yamano, Gen Mgr Susumu Watanabe, Sales Mgr Kiyoshi Okano. (Importer)

Yupiter Ind Co Ltd (IFPI), 5-4-35-408 Minami Aoyama, Minato-ku, Tokyo 107 Tel (03) 406-1711 Telex 2424071. Pres. Gohei Suzuki, Gen Mgr Masahiko Tanaka; Sales Mgr. Tokuhiko Gomi

Labels: (Owned) Altras, Yupiteru; (licensed) Swedish (Sweden)

Zen, see Victor

• music publishers

A B C Sounds Inc., Nikko Bldg., No. 614, 1-4-26 K Takanawa, Minato-ku,

Tokyo 108 Tel (03) 445-0558.

A M P (Aoyama Music Promc.) Co. Ltd. (Jasrac), Horaya Bldg., 5-2-1 Roppongi, Minato-ku, Tokyo 106. Tel (03) 404-9111. Cable: AOYAMAMU-SICPRO. Telex 2423715 Pres. Yoshio Aoyama

Int'l firms represented: Rolf Budd (Germany), Meridian (Germany), Michael (USA), Ron Myers (USA), Poplico (France), SIF (Italy)

A N Z Inc (Alligator Jazz Club), 27-13 Higashiyama-cho, Itabashi-ku, Tokyo 174 Tel (03) 972-1369 Cable ANZKEEPS. Pres. Terukazu Arita

Akizuki Music (Jasrac), 1333 Nishi Ozumi, Nerima-ku, Tokyo 117 Tel (03) 921-0223. Dir. Tomomi Akizuki, Gen. Mgr.: Shizuko Ohtomo

Alfa Music Ltd., Studio City Bldg., 3-5-39 Shiba, Minato-ku, Tokyo 108. Tel: (03) 452-7976. Telex 2424537 ALFAJN Pres. Kay Murai

Int'l firms represented: Eddie Barclay (France), Canopy (USA), Kamakazi (USA), Kongridge (UK), Maouani (France), Masong (USA), Redeye (USA), White Oak (USA)

All Staff Music Co Ltd (Jasrac), Fontaine Bldg., 5-13-13 Roppongi, Minato-ku, Tokyo 106 Tel. (03) 583-9841 Pres. Takao Imaizumi; Gen. Mgr. Atsuko Iwasaki

Aoyama Music Promo., see AMP

Apri Music Inc. (Japan), PO Box 17, Tokyo Int'l Airport, Tokyo 149 Tel (03) 266-5803 Cable CBSOHWRECORD Telex 24766 Pres. Toshio Ozawa; Assoc. Gen. Mgr. Namihito Sasaki

Int'l firms represented: Apri/Blackwood (worldwide), BRM, Bovina, Country Road, Derringer, Dickiebird, Don Kirshner, EmDee/Musical Frontiers, Grajona, Albert Hammond, Hierophant, Homegrown, Hudram, Impulsive, Jet, Joelsongs, Little John, Petra, Sheryl/Kimlyn, Stung Arm, Tuna Fish, Winter Blues (all USA)

Arrow Music Corp., New Aoyama Bldg. East, 1-1-1 Minami-Aoyama, Minato-ku, Tokyo Tel (03) 475-2151 Cable: WARBPIONEER. Telex: 26876. Pres.: Kichhei Sawa, Gen. Mgr.: Keith Bruce, Yukio Sakamoto; Prof. Mgr.: Yoshio Niwano

Int'l firms represented: Brooker, Al Gallico, Hattress/Spinners, Sazar, Tenelen, Turtle, Wilson (all USA); Iohann (Canada)

Barbara Music Publ'rs, Sakuragaoka Urban Life Bldg., A-309, 21-12 Sakuragaoka, Shibuya-ku, Tokyo 150. Tel. (03) 496-2635

Big Hill Music Publ'rs, No. 11-1, Chateau Ahasaka, 6-5-22 Ahasaka, Minato-ku, Tokyo 107 Tel. (03) 582-7870

Bon Music Publ'rs, 2-5-5 Hiraikawa-cho, Chiyoda-ku, Tokyo 102. Tel: (06) 263-5847

Int'l reps.: Brazil (RCA), South Africa (EMI Brigadiers), USA (Southern)

Burning Publ'rs Co Ltd., 102 Akasakada Mansion, 7-6-11 Akasaka, Minato-ku, Tokyo 107. Tel: (03) +86-1968/2076. Chief Exec. Ikuo Suho; Gen. Mgr. Norio Higuchi, Sales Mgr. Takamasa Takeyama

C A M Japan Ltd., 2-6-4 Girza, Chuo-ku, Tokyo 104 Tel (03) 562-0111 Cable: TOWATOWA. Telex 124141 Pres. Nagamasa Kawakita, Gen. Mgr.: Shigeaki Oeda, Sales Mgr.: Yoshihiko Suzuki

Home office: Italy

C B C Music KK, CBC Kaikan nai, 4-15 Shinei-cho, Naka-ku, Nagoya-shi, Aichi-ken 460 Tel (052) 241-8080

C S B Ltd/Hara Int'l, 1-2-5 Shirokanedai, Minato-ku, Tokyo 108

Int'l firm represented: Copyright Serv Bureau (USA)

Carrot Music Inc., Shirashi Bldg., 1-2 Yotsuya, Shinjuku-ku, Tokyo Tel (03) 357-4334 Cable TANACARRO Pres.: Masami Tanaka, Prof. Mgr. Yukiko Uehara

Cherry Lane Music Ltd., Harajuku Piazza Bldg., 4-26-18 Jingumae, Shibuya-ku, Tokyo

From the world to Japan. From Japan to the world.



HIDEKI SAIJO



Records and Tapes



ISAO TOMITA

Creative Force with Virtuosity

• RVC Corporation, affiliated with RCA and Japon Victor • GLOBAL MUSIC PUBLISHING CORPORATION

ADDRESS:1-7-8, Shibuya, Shibuya-ku, Tokyo 150, Japan Telephone:(03)499-3311 Cable:RVCRA RECORD, Telex:242-5162

NICHION, INC.

BIGGEST AND MOST ACTIVE PUBLISHER IN JAPAN!



WE KNOW:

How to promote your song
and when to release it,
Where to go and who to see,
What to do and why,
And we know
we are your best partner!

We are proud to represent valuable catalogues of:

(NICHION INC.)
CAMPBELL CONNELLY
DICK JAMES MUSIC
FAMOUS MUSIC
LEEDS MUSIC
M. A. M. MUSIC
MCA MUSIC
ROBERT KINGSTON MUSIC
WARNER BROS. MUSIC

(HIGH NOTE PUBLISHING CO. LTD.)
BIG SEVEN MUSIC
BOURNE COMPANY
METUS COPYRIGHT MANAGEMENT
PEER SOUTHERN ORGANIZATION
THE WELK MUSIC GROUP

NICHION, INC.

Address: Wako Magadori Bldg. 4-1 Aoyama
3-chome, Minato-ku, Tokyo 106
Cable: PUBLISHMUSIC TOKYO
Telex: MLNICH 129610
Telephone: (03) 584-4711 (03) 584-2771

NICHION STUDIO

Address: 12 Min Bldg. 4-10 Shinjuku Park
3-chome, Minato-ku, Tokyo 105 Japan
Telephone: (011) 437-5644

WE TAKE OUR PRIDE IN OUR PROMOTION FORCE.



nippon phonogram co., ltd.

Wako Bldg., 8-5, Roppongi 4-chome, Minato-ku, Tokyo 106
Telephone : (03) 479-3711
Cable Address : NIPHILDISC TOKYO
Telex : (242) 3224



MUSIC TOKYO COMPANY
(formerly called Tokyo Music Pub Co. Ltd.)

Wako Bldg., Roppongi 4-chome, Minato-ku, Tokyo 106
Telephone : (03) 401-9327
Cable Address : MUSICATO TOKYO
Telex : (242) 3224

Home office: (USA)
 Chuo Music Publ'g Co. Ltd., Shochiku Kaikan Bldg., 1-12-16 Tsukiji, Chuo-ku, Tokyo 104. Tel: (03) 542-8857
 Church Music Publ'g Society Japan, 1-41-12 Minami-Dgikubo, Suginami-ku, Tokyo 107. Tel: (03) 334-3247
Int'l firms represented: Concordia (USA), Novello (UK), Ricordi (Italy), Schirmer (USA), United (UK)
 Columbia Music Publ'g Co. Ltd., 4-14-14 Akasaka, Minato-ku, Tokyo 107. Tel: (03) 584-8111. Pres. Minoru Harada; Copyright Mgr. Minoru Sakurada.
Int'l firms represented: Adagio (Spain), Constant Delourney (Belgium), GP (USA), Garima (France), Charles E. King (USA), Narcisse (France), Ninth Etheral (USA), Zzelesta (Spain)
Int'l rep.: USA (GP Music)
 Crown Music Publ'g Inc., 2-10-8 Akasaka, Minato-ku, Tokyo 107. Tel: (03) 582-4741. Pres. Taketsuna Kamei; Gen. Mgr. Sukeyuki Takeuchi.
 Walt Disney Ent's. of Japan Ltd., Horaiya Bldg., 5-2-1 Roppongi, Minato-ku, Tokyo 106. Tel: (03) 404-1815, 412-8218. Cable: MICKYMOUSE. Contact: Matsuo Yokoyama.
Int'l firms represented: Walt Disney Music (USA), Wonderland (USA)
 Doornob Publ'g Agency Ltd., Shibuya Sanshin Bldg., Suite 501, 29-33 Sakuragaoka-cho, Shibuya-ku, Tokyo 150. Tel: (03) 476-5837. Cable: DDDRRKY. Telex: 27637. Pres. Yuki Watanabe.
Int'l firms represented: Beggars Banquet/Andrew Heath (UK), Street (UK), Tropical (Germany)
 Ever Green Music Publ'rs Ltd. (Jasrac), see Nichon.
 Fuji Telecasting Music Co. Ltd., c/o Fuji Telecasting Co. Ltd., 7 Kawada-cho Ichigaya, Shinjuku-ku, Tokyo 162. Tel: (03) 319-6177, 357-7021
 G.P. Music Corp. (Jasrac), Belza Ebisu Bldg., 2nd fl., 3-16-1 Higashi, Shibuya-ku, Tokyo 151. Tel: (03) 499-0270. Cable: SATMUS. Telex: 27436. Pres. Daniel Nemshitsk. VP & Gen. Mgr. Knut Kraft; Sales & Promo Dir. Kei Fujiwara
Int'l branch: USA
Int'l firms represented: Capability (USA), Cuda (Belgium), Crescent (Canada), Eiger (UK), Led Songs (UK), Little Tistan (USA), Lodge (UK), Manhole (Canada), Naz (UK), On Stage (UK), Panache (UK), Robot (UK), Stalom (Canada), Song of Tiffany (USA), Sos: (Netherlands), Volatile (USA)
 Geier Music Publ'rs Co. Ltd., Nakamura Bldg., 3-13-13 Akasaka, Minato-ku, Tokyo 107. Tel: (03) 584-0943
 Geion Music Publ'g Co. Ltd., Nakazawa Bldg., 58 Yoyogi, Shibuya-ku, Tokyo 151. Tel: (03) 379-2266
 Global Music Publ'g Corp. (Jasrac), Asahi Seimei Bldg., 1-7-8 Shibuya, Shibuya-ku, Tokyo 150. Tel: (03) 499-3311. Cable: RVCRCARECDRD. Telex: 2425162. Chief Exec. Ichiro Dhuno, Gen. Mgr. Katsuma Kato
Int'l firms represented: Alvorada (Brazil), Amsterdam Marathon (Netherlands), Associated (Australia), Bayanhan (Philippines), Beverly (Brazil), Bral (USA), Cyclus (Germany), Dunbar (Canada), EDIM (Mexico), 57th Street (USA), Give Me A Break (USA), Jaguar (Brazil), Just Dver The Street (USA), KBL (USA), Kidada (USA), Koppelman-Bandier (USA), Leme (Brazil), Meridional (Brazil), Metal Machine (USA), Dakfield Avenue (USA), RCA (France, Italy), 7 Notas (Brazil), Songs of Bandier-Koppelman (USA), Songs of Manhattan Island (USA), Sunbury (Canada, UK), Victor (Brazil)
Int'l reps: Australia (Associated), Brazil (Victor), Canada (Sunbury), France (RCA), Germany (Cyclus), Netherlands (Amsterdam Marathon).

Hands Music Publ'g Co. Ltd., see Thunder
 Hara Int'l Inc. (Jasrac), 1-2-5 Shirakinedai, Minato-ku, Tokyo 108. Tel: (03) 445-4545. Cable: HARAIN TDKYD. Pres. M. Uehara, Chm. & Gen. Mgr. R.N. Uehara
Int'l firms represented: APB, Acton Green, Peter Bardens, Fleetwood, Leosong, Rachel (all UK), Amadeo Bro, Roy Ayers, Benny Bird, Big Ears, Butterfly group, Cayman, Cole-Arama, Content, Beverly Culver, Fame, Bobby Goldsboro, Rick Hall, Kelson Herston, Hice Haus, Horse Hairs, House of Gold, Impact, Janon, Maj, Muscle Shoals Sound, New Beginnings, Onaje, Premier, Selma, S'houette, SinDrome, Staples, Xargon, Yes (all USA); Swinglora (Germany)
Int'l reps: Australia (Leosong), Brazil (CSB), France (CSB), Germany (Copyright Serv. Bureau), Spain (CSB), UK (Leosong), USA (Copyright Serv. Bureau)
 The Heibon Publ'g Co. Ltd., 3-13-7 Ginza, Chuo-ku, Tokyo 104. Tel: (03) 541-3211
 Herald Music Inc., Shimbashi-Ekimaie Bldg., No. 1, 2-20-15 Shimbashi, Minato-ku, Tokyo 105. Tel: (03) 573-1281. Cable: HERALDPICTURE. Telex: 23386
Int'l branches: France, Italy, USA
 High Note Publ'g Co. Ltd. (Jasrac), Akasaka Makabe Bldg., 3-4-3 Akasaka, Minato-ku, Tokyo 107. Tel: (03) 584-2771. Cable: HIGHNOTE. Telex: 26610. Pres. Tsugi Sakagami
Int'l firms represented: Big Seven (USA), Bourne (UK, USA), Mietus Copyright (USA), Welk (USA)
Int'l rep.: USA, see Thunder
 Intersong KK (Jasrac), Horaiya Bldg., 5th fl., 5-2-1 Roppongi, Minato-ku, Tokyo 106. Tel: (03) 405-5531. Pres. D. Bliersbach, Sr. Mng. Dir.: H. Takahashi; Mng. Dir.: T. Sato
Home office: Germany
Int'l firms represented: Blue Dyster Cult (Canada), Carlin group (UK), Casablanca (USA), Fleetwood Mac (USA), Hill & Range (USA), Hudson Bay & Fort Knox group (USA), Intersong group (worldwide), Luckyu (USA), Martin-Coulier (UK), Mews (UK), RSD group (UK)
 Interworld Music (Far East) Ltd., c/o Taiyo Music Inc., Miyahiro Bldg., Kita Aoyama 3-5-15, Minato-ku, Tokyo 107. Tel: (03) 470-2751. Cable: TAIYDMUSIC. Telex: 26512. Rep. Dir.: Tatsuji Nagashima
Int'l firms represented: Six Continents group - BRC, Dunbar, Good Friday, January, Joans Bones, Julio Brian, Sea-Lark, World Song group - Arch, Avco Embassy Films, High Sierra, Hog, Sunbury, full catalogs - Aloud, Anim, Ariola America, Artists, Backroom, Badfinger, Bagamin, Beanstalk, Blues Groove, Cat Mother, Chuca, Cos-K, David Courtney, Daywin, Connie Ducharme, East Hill, Eclipse, Egg, Emm Jay, Englewood, Faceache, Finale, Fitness King, Five Arts, Flight, Flying High, Fortune, Golden Clover, Haymarket, Hollyweed, Holmby, Instructional Children's Music, Interworld, Joint, Jonco, Kiss Me Baby, Kreimers, La Lanne, Lite & Brite, Long Rifle, Marlor, Mass, Maudrom, Northridge, Pitfield, Promenade, Rami, Roliram, Sarine, Sarinent Songs, Scherzo, Larry Shayne, Southdale, Trans-Atlantic, Tridem, Tuningfork, Twinchris, US Arabella, Up Beat, Vancouver, Wizzybus, Yolk, limited catalogs - Adscio, Alfa, Angelshell, Anim, Banshee, Barjon, Bella Godiva, Benny Berman, Bernross, Big & Little, Big Sioux, Blue Balloon, Blue Guitar, Bog, Boscoe, Bo-West, Brooklyn, Cabrin, California, Catch Fire, Central Tunes, Chcken, Cornth/Squashish, Czarina, Dreams & Visions, Drucker, El Dorado, Emana, Equinox, Feature, Fourvuv Survival, Kim Fowley, Golden Hill, Green Mountain, Greenwillow, Hamshire House, Hedley Songs, Homecoming,

Hoochie Coochie, Hot Cha, Hot Cider, Humdrum, Immediate, Immy, In-tune, Janion, Jenji, Jonathan, Kikaku, King of the Jungle, Kitty Anne, Kiz zie, Klen Green, Larbell, Last Laugh, Lazy Canary, Lenta, Lump Celery, Living Legend, Lynwood/Muffit, Mainstee, Marbra, McKenzie, Melcher, Memphis Five, Mempro, Mile Wide River, Mills & Mills, Morning Glory, Mother Hen, Mutel Library Serv., My Baby's Music, New Chamber, Nodlew, Nycom, Dultregeous/Speckled Bird, Pamco, Pine Knob, Pleyla, Plucky Tunes, Pojo, Portnow Miller, Henry Price, Prolis, RCB, RK, Rascel, Rats & Snakes, Rebecca Raccoon, Rojnorth, Rutri, Sassy Brat, Sa-Vette, Sepe, Shonte, Sight & Sound, Silent Partner, Skin, Sodos, Solitaire, Stewart-Nims, Summertree, Sunbow, THT, Tender Night, Tijuca, Tutti Camarata, Uncle Josh's Song Emporium, Vadeita, David Werner, Westgate, Woldox, Wolper, Woogie, Yameta, Zekefield Folles, Zethus, Zugrace
 J.C.M. see Japan Central Music
 Japan Soviet Music Japan Ltd. (Jasrac), c/o Nichon Inc., Akasaka Makabe Bldg. 5F, 3-4-3 Akasaka, Minato-ku, Tokyo 107. Tel: (03) 584-2771. Cable: REVUEJAPAN. Telex: 26610. Dirs.: Stephen M. & Frances Lillian James; Pres. Richard L. James
Home office: England
 Japan Central Music (JCM), 1-5 Wakaba, Shinjuku-ku, Tokyo 160. Tel: (03) 359-7825. Telex: 232294
Int'l branches: England, USA
Int'l firms represented: Bayanhan (Philippines), Scott-Wolfe (UK), Sunbury (UK)
Int'l reps: UK (Watal Asanuma), USA (Creative Ent Int'l). (SEE ADVERTISEMENT)
 Japan Soviet Music Inc., Stork Bldg., 3-4 Hongoku-cho, Chuo-ku, Tokyo 103. Tel: (03) 243-1601. Pres. Yoichi Noguchi
Int'l firm represented: VAAP-USSR copyright agency (USSR)
 Jenika Music Co. Ltd., 301 Sun Minami Aoyama, 3-14-14 Minami Aoyama, Tokyo 107. Tel: (03) 479-4588. Telex: 127359. Pres.: Ion Nomura; Prof. Mgr. Kaoru Misawa, Int'l Mgr.: Maria Shimizu
 Kaeru Prod'n Co. (Jasrac), see Nichon
 Kitty Music Corp., Kobayashi Bldg., 7F, 1-14-11 Shibuya, Shibuya-ku, Tokyo 150. Tel: (03) 499-4711. Telex: 2425338. Pres. Hidenori Taga; Gen. Mgr. Yoshihiro Kanda
 Kogakusha Music Publ'g Co. Ltd., 1-1-11 Misakicho, Chiyoda-ku, Tokyo 101. Tel: (03) 291-4313. Cable: GAKUSHA-MUSIC. Pres.: Kanji Hara; Gen. Mgr. Ryukichi Hara
 Kyuken Music Publ'g Co. Ltd., Hiya Park Bldg., Rm. 923, 1-8-1 Yurakucho, Chiyoda-ku, Tokyo 100. Tel: (03) 271-5861. Rep. Dir. Kenneth L. Cole
 Lee (Tokyo) KK, c/o Taiyo Music Inc., Miyahiro Bldg., 3-5-15 Kita-Aoyama, Minato-ku, Tokyo 107. Tel: (03) 470-2751. Cable: TAIYDMUSIC. Telex: 26512. Rep. Dir.: Hideo Nagashima (Administered by Taiyo Music)
Int'l firms represented: Ardmore (USA), Cherio (USA), Frank (USA), Llee (USA), McCartney (UK), Melody Lane (USA), Morley (USA), Pic (USA), Rytvoc (USA), Warock (USA)
 Lux Music Tokyo KK (Jasrac), 2-12 Dgawa-Machi, Kanda, Chiyoda-ku, Tokyo 101. Tel: (03) 292-2865. Telex: 25224. Co-Pres.: Shoichi Kusano, Hubert Terheggen
Int'l firms represented: Apollo (Belgium), Celta (USA), Foycd Europe (Belgium), Louvigny Marquee (UK), Magazine (Germany), Radio Music (France, Luxembourg, Netherlands), Radio Pop (Spain), Radio Tele (Belgium, Germany, Netherlands), Radmus (USA)
 M.C.A. Music KK (Jasrac), c/o Nichon Inc., Inc., Akasaka Makabe Bldg., 3-4



SPACE PIRATE CAPTAIN HARLOCK



LULU, THE FLOWER ANGEL



CYBORG 009



CANDY CANDY



VOLTS V



JEEG THE STEEL ROBOT



TIGER MASK II



HELLO, SANDYBELL

We have music copyrights and original soundtracks on TV animation films and TV movies.

TV ASAHI MUSIC CO., LTD.

ADDRESS 6-4-10 ROPPONGI, MINATO-KU, TOKYO, JAPAN 106
 PHONE: TOKYO 405-3194
 TELEX: JAPAN 22520 (TVASAHI)

GOOD MUSIC IS OUR BUSINESS



Pacific Music Publishing Co., Ltd.

Roppongi 659 Building 6-5-9 Roppongi, Minato-ku Tokyo 106, Japan
PHONE 03-479-4101 TELEX J29240 PMP TOKYO

***THE MOST
ACTIVE AND RELIABLE
ORGANIZATION***



President
TAKEO HORI

HORI GROUP

TOP MUSIC PUBLISHING CO., LTD.

One of the top five music publishers in Japan. Established in 1965.

HORI PRODUCTION, INC.

Talent management agency which constantly place 5-6 artists on local hit chart. Established in 1960.

HORI KIKAKU PRODUCTION, LTD.

One of the most well known film production companies in Japan. Established in 1969.

HORI GROUP HEADQUARTER LTD.

*Address: Hori Group Meguro Bldg., 2-5, 1-chome, Shimomeguro,
Meguro-ku, Tokyo Telephone: (03) 490-4601
Cable Address: HORIPROMUSIC TOKYO
Telex: 2468436 HORIGR J*

Yano Music Publ'g Co. Ltd. (Jasrac), 201 Dommu Parfum, 3-15-7 Roppongi, Minato-ku, Tokyo. Tel: (03) 586-8321. Pres. Hiroshi Ohkura.

CATALOG SERVICES

Clarion Co. Ltd., 1-22-10 Dogenzaka, Shibuya-ku, Tokyo 150. Tel: (03) 463 6161.

Int'l branches: Germany, Hong Kong, USA.

Sumotomo 3M Co. Ltd., 3M Bldg., 2-33-1 Tamagawa-dai, Setagaya-ku, Tokyo 158. Tel: (03) 709-8480 (Tape only)

DESIGN & ARTWORK

Japan Musicolor Co. Ltd., Higashi-Ueno 6-19-17, Chitoh-ku, Tokyo 110. Tel: (03) 845-3231. Telex: 23419. Pres.: Yoshio Tamura; Gen. Mgr.: Shigehiro Ashida. (Record only)

Nippon Columbia Co. Ltd., 4-14-14 Akasaka, Minato-ku, Tokyo 107. Tel: (03) 584-8111. Cable: NIPPONCOLUMBIA. Telex: 22591. Pres.: Takami Shobochi; Dir.: Mitsugu Kumamoto.

P C C (KK), Shibuya Central Bldg., 5F, 3-14 Udagawa-cho, Shibuya-ku, Tokyo. Tel: (03) 464-6045.

Spirit Ent. Inc., Kojimachi Royal Bldg., 4-7 Kojimachi, Chiyoda-ku, Tokyo 102. Tel: (03) 230-1611. Cable: SPIRITENTER. Telex: 23419. Chief Exec. Akio Tamura.

Teichiku Recs. Co. Ltd., 1-2 Nishi-Shimbashi, Minato-ku, Tokyo 105. Tel: (03) 502-7213. Cable: TEICHIKU. Telex: (02) 224237. Pres.: Shigeji Nanko; Gen. Mgr.: Ichiro Kinoue; Sales Mgr.: Minoru Ozaki.

Toyo Kasei Co. Ltd., 2-5-5 Hirakawa-cho, Chiyoda-ku, Tokyo 102. Tel: (03) 264-3041. (Record only)

LICENSING ORGANIZATION, MUSIC

J A S R A C (Japanese Society for Rights of Authors, Composers & Publ'rs), JASRAC House, 1-7-13 Nishishimbashi, Minato-ku, Tokyo 105. Tel: (03) 502-6551. Cable: JASRAC. Bd. Chm.: Koichiro Kunishio; Pres.: Ryoichi Hattori; Mng. Dir.: Junichi Kobayashi; Int'l Oept. Mgr.: Hiroaki Miyazawa

PLATING, PROCESSING & PRESSING PLANTS

Athene Rec. Ind'l Co. Ltd., 3-4-9 Ginza, Chuo-ku, Tokyo 104. Tel: (03) 542 6651. Cable: ATHENCORO. Pres.: Hiroshi Mirano

C B S/Sony Recs. Inc., 1561-2 Akawa, Ohigawa-cho, Shida-gun, Shizuoka-ken 421-02. Tel: (05462) 2-1321. Cable: CBSSONY. Pres.: Toshio Ozawa; Gen. Mgr.: Tokio Sasaki.

Japan Musicolor Co. Ltd., Higashi-Ueno 6-19-17, Chitoh-ku, Tokyo 110. Tel: (03) 845-3231. Telex: 23419. Pres.: Yoshio Tamura; Gen. Mgr.: Shigehiro Ashida. (Pressing of standard & picture disks only)

King Rec. Co. Ltd., 2-12-13 Otowa, Bunkyo-ku, Tokyo 112. Tel: (03) 945-2131. Telex: 24963. Vice Chm.: Kazumitsu Machiji; Pres.: Shim Tomoda; Gen. Mgr.: Goh Makino; Sales Mgr.: Yoshiaki Kajiyama

Nippon Columbia Co. Ltd., 4-14-14 Akasaka, Minato-ku, Tokyo 107. Tel: (03) 584-8111. Cable: NIPPONCOLUMBIA. Telex: 22591. Pres.: Takami Shobochi; Dir.: Mitsugu Kumamoto.

PolyGram Rec. Serv. KK, 1000 Kamisukiahara, Showa-cho, Yamanashi pref 409-38. Tel: (0552) 75-4411. Chm.: J. Oefer Blierbach; Vice Chm.: Sei-cho Koh; Pres.: Takao Yanagimoto.

Spirit Ent. Inc., Kojimachi Royal Bldg., 4-7 Kojimachi, Chiyoda-ku, Tokyo 102. Tel: (03) 230-1611. Cable: SPIRITENTER. Telex: 23419. Chief Exec.: Akio Tamura. (Pressing only)

Teichiku Recs. Ltd., 1-2 Nishi-Shimbashi, Minato-ku, Tokyo 105. Tel: (03) 502-7213. Cable: TEICHIKU. Telex: (02) 224237. Pres.: Shigeji Nanko.

Gen. Mgr.: Ichiro Kinoue; Sales Mgr.: Minoru Ozaki. (Pressing only)

Toyo Kasei Co. Ltd., 2-5-5 Hirakawa-cho, Chiyoda-ku, Tokyo 102. Tel: (03) 264-3041.

Victor Co. of Japan Ltd., 4-1 Nihonbashi-Honcho, Chuo-ku, Tokyo 103. Tel: (03) 241-7811. Cable: VICTOREXPORT. Telex: 26222. Int'l subsidiaries: Canada, England, France, Germany, Singapore, USA (all JVC)

PRINTERS & LITHOGRAPHERS

Japan Musicolor Co. Ltd., Higashi-Ueno 6-19-17, Chitoh-ku, Tokyo 110. Tel: (03) 845-3231. Telex: 23419. Pres.: Yoshio Tamura; Gen. Mgr.: Shigehiro Ashida. (Record only)

Nippon Columbia Co. Ltd., 4-14-14 Akasaka, Minato-ku, Tokyo 107. Tel: (03) 584-8111. Cable: NIPPONCOLUMBIA. Telex: 22591. Pres.: Takami Shobochi; Dir.: Mitsugu Kumamoto.

Spirit Ent. Inc., Kojimachi Royal Bldg., 4-7 Kojimachi, Chiyoda-ku, Tokyo 102. Tel: (03) 230-1611. Telex: 23419. Chief Exec.: Akio Tamura. (Tape only)

Teichiku Recs. Co. Ltd., 1-2 Nishi-Shimbashi, Minato-ku, Tokyo 105. Tel: (03) 502-7213. Cable: TEICHIKU. Telex: (02) 224237. Pres.: Shigeji Nanko; Gen. Mgr.: Ichiro Kinoue; Sales Mgr.: Minoru Ozaki.

Toyo Kasei Co. Ltd., 2-5-5 Hirakawa-cho, Chiyoda-ku, Tokyo 102. Tel: (03) 264-3041. (Record only)

RECORD PROMOTION

(including Public Relations & Publicity)

Aoyama Music Promo. Co. Ltd., Horaiya Bldg., 7F, 5-2-1 Roppongi, Minato-ku, Tokyo 106. Tel: (03) 454-6665, 404-9111. Telex: 2423715. Cable: AOYAMAMUSICPRO. Pres.: Yoshio Aoyama; Gen. Mgr.: Masanobu Ono.

Asahi Music Servs. Inc., c/o Asahi Broadcasting Corp., 2-2-48 Ohyo-do-Minami, Ohyo-do-ku, Osaka 531. Tel: (06) 458-5321. Cable: ASAHIHOSO OS-ATA. Telex: 63680. Branch: Tokyo, 2-6-3 Shiba Park, Minato-ku, Zone 105. Tel: (03) 436-5771. Cable: ASAHIHOSO TOKYO.

Ishii Music Promo., Fugetsudo Bldg., 6-6-1 Ginza, Chuo-ku, Tokyo 104. Tel: (03) 572-0351.

Japan Soul Agency, 1-5-11 Sakurajoyasu, Setagaya-ku, Tokyo 156. Tel: (03) 302-0208. Cable: JSATRCO. Telex: 2424586.

Kitty Ents. Inc., Kobayashi Bldg., 7th fl., 1-14-11 Shibuya, Shibuya-ku, Tokyo 150. Tel: (03) 499-4711. Telex: 2425338.

Kyodo Tokyo Inc., Kyodo Bldg., 3-6-18 Kita-Aoyama, Minato-ku, Tokyo 112. Tel: (03) 407-8131. Cable: KYODOTOYO

Nippon Columbia Co. Ltd., 4-14-14 Akasaka, Minato-ku, Tokyo 107. Tel: (03) 584-8111. Cable: NIPPONCOLUMBIA. Telex: 22591. Pres.: Takami Shobochi; Dir.: Mitsugu Kumamoto.

Spirit Ent. Inc., Kojimachi Royal Bldg., 4-7 Kojimachi, Chiyoda-ku, Tokyo 102. Tel: (03) 230-1611. Cable: SPIRITENTER. Telex: 23419. Chief Exec.: Akio Tamura.

Teichiku Recs. Co. Ltd., 1-2 Nishi-Shimbashi, Minato-ku, Tokyo 105. Tel: (03) 502-7213. Cable: TEICHIKU. Telex: (02) 224237. Pres.: Shigeji Nanko; Gen. Mgr.: Ichiro Kinoue; Sales Mgr.: Minoru Ozaki.

Udo Artists Inc., Miya-cho Bldg., Suite 2, 3-8-37 Minami-Aoyama, Minato-ku, Tokyo 107. Tel: (03) 402-7281. Cable: UDOARTISTSPRO. Telex: 26552.

Universal Orient Promos. Inc., Oshoro Bldg., 3-15-3 Akasaka, Minato-ku, Tokyo. Tel: (03) 585-3045. Cable: KAJIPROMOTE. Telex: 28621. Pres.:

Toyo Yokoyama.

Victor Artists Corp. of Japan, 4-26-18 Jingumae, Shibuya-ku, Tokyo 150. Tel: (03) 402-8181.

Int'l branches: Canada, England, USA (all JVC). (SEE ADVERTISEMENT)

Young Japan Inc., Miyahiro Bldg., 7th fl., Kita-Aoyama 3-5-15, Minato-ku, Tokyo 107. Tel: (03) 470-3641. Telex: 26512. Pres.: Ken Hosokawa. Exec. VP: Akio Onodera.

TAPE CUSTOM DUPLICATORS

TAPE PACKAGING & LABELING

The Audio & Video lines indicate the configurations which the firms duplicate. Companies which offer packaging and labeling of tape product are indicated by "(PRG)" which appears after the main body of their respective listings.

Apollo Music Ind'l Corp., 1-5 Wakaba-cho, Shinjuku-ku, Tokyo 160. Tel: (03) 353-0191. Audio: 8-tr., cassette, open reel.

C B S/Sony Recs. Inc., 1561-2 Aikawa, Ohigawa-cho, Shida-gun, Shizuoka-ken 421-02. Tel: (05462) 2-1321. Cable: CBSSONY. Pres.: Toshio Ozawa; Gen. Mgr.: Tokio Sasaki. Audio: 8-tr., cassette.

Nippon Columbia Co. Ltd., 4-14-14 Akasaka, Minato-ku, Tokyo 107. Tel: (03) 584-8111. Cable: NIPPONCOLUMBIA. Telex: 22591. Pres.: Takami Shobochi; Dir.: Mitsugu Kumamoto. (PRG-audio)

PolyGram Rec. Serv. KK, 1000 Kamisukiahara, Showa-cho, Yamanashi pref. 409-38. Tel: (0552) 75-4411. Chm.: J. Oefer Bliersbach; Vice Chm.: Sei-cho Koh; Pres.: Takao Yanagimoto. Audio: Cassette

Spirit Ent. Inc., Kojimachi Royal Bldg., 4-7 Kojimachi, Chiyoda-ku, Tokyo 102. Tel: (03) 230-1611. Cable: SPIRITENTER. Telex: 23419. Chief Exec.: Akio Tamura. (PRG-video only) Audio: Open reel.

Video: 2" quad, 1" open reel, ¾" U-matic cassette, ¼" Beta & VHS cassette

T B S Serv. Co. Ltd., 5-3-50 Akasaka, Minato-ku, Tokyo 107. Tel: (03) 582 7351. Audio: 8-tr., cassette, open reel.

Video: 1" open reel, ¾" U-matic cassette, ¼" Beta & VHS cassette.

T O K Electronics Co. Ltd., 1-13-1 Nihonbashi, Chuo-ku, Tokyo 103. Tel: (03) 278-5111. Cable: TOKCORE. Pres.: Fukuro Sano; Gen. Mgr.: Shohachi Okuyama.

Audio: 8-tr., cassette, open reel. Video: ¾" U-matic cassette, ¼" VHS & Beta cassette.

Teichiku Recs. Co. Ltd., 1-2 Nishi-Shimbashi, Minato-ku, Tokyo 105. Tel: (03) 502-7213. Cable: TEICHIKU. Telex: (02) 224237. Pres.: Shigeji Nanko; Gen. Mgr.: Ichiro Kinoue; Sales Mgr.: Minoru Ozaki. (PRG) Audio: Cassette, open reel.

Victor Co. of Japan Ltd., 4-1 Nihonbashi-Honcho, Chuo-ku, Tokyo 103. Tel: (03) 241-7811. Cable: VICTOREXPORT. Telex: 26222. Int'l subsidiaries: Canada, England, France, Germany, Singapore, USA (all JVC) Audio: Cassette (standard & metal), open reel. Video: ¾" U-matic cassette, ¼" VHS cassette.

• supplies

CARTRIDGE & CASSETTE PARTS

Magnadyne Corp., Royal Higashi Azabu Bldg., 2-23 Higashi Azabu, Minato-ku, Tokyo 106. Tel: (03) 583-8335. Home office: USA.

EMPTY CARTRIDGES, CASSETTES & REELS

Magnadyne Corp., Royal Higashi Azabu Bldg., 2-23 Higashi Azabu, Minato-ku, Tokyo 106. Tel: (03) 583-8335. Home office: USA. Audio: 8-tr.

Sony Corp., PO Box 10, Airport PO, Tokyo 149. 6-7-35 Kita-Shinagawa, Shinagawa-ku, Tokyo 141. Tel: (03) 448-2111. Cable: SONYCORP. Telex: 22262, 24666

Int'l branches: Brazil, Canada, England, Germany, Greece, Hong Kong, Panama, Singapore, South Africa, Switzerland, USA. Audio & Video: Reels.

ENVELOPES & MAILERS

JACKETS & SLEEVES

LABELS, DISK

POLYETHYLENE BAG & SHRINKWRAP

Magnadyne Corp., Royal Higashi Azabu Bldg., 2-23 Higashi Azabu, Minato-ku, Tokyo 106. Tel: (03) 583-8335. (Sleeves & shrinkwrap only) Home office: USA.

Nippon Columbia Co. Ltd., 4-14-14 Akasaka, Minato-ku, Tokyo 107. Tel: (03) 584-8111. Cable: NIPPONCOLUMBIA. Telex: 22591. Pres.: Takami Shobochi; Dir.: Mitsugu Kumamoto. (Envelopes & Mailers, Jackets & Sleeves, Labels, Polybags)

Teichiku Recs. Co. Ltd., 1-2 Nishi-Shimbashi, Minato-ku, Tokyo 105. Tel: (03) 502-7213. Cable: TEICHIKU. Telex: (02) 224237. Pres.: Shigeji Nanko; Gen. Mgr.: Ichiro Kinoue; Sales Mgr.: Minoru Ozaki. (Sleeves, Labels)

PROFESSIONAL TAPE SUPPLIES

B A S F Japan Ltd., Tozan Bldg., 4-9 Nihonbashi-Honcho, Chuo-ku, Tokyo 103. Tel: (03) 270-1461. Telex: 2222130. Pres.: Or. Cantzler; Gen. Mgr.: H. Kreuels; Sales Mgr.: K. Suzuki. Audio: O.I.N. calibration tapes.

Namiki Precision Jewel Co. Ltd., 3-22-8 Adachi-ku, Shinden, Tokyo 123. Tel: (03) 919-0101. Cable: NAMIKI. Telex: 2722288. Pres.: Kazu Namiki; VP: Nobushiro Namiki; Gen. Mgr.: Shoji Namiki; Sales Mgr.: Mastaka Shimizu. Int'l branch: USA.

Product: Magnetic tape heads. Victor Co. of Japan Ltd., 4-1 Nihonbashi-Honcho, Chuo-ku, Tokyo 103. Tel: (03) 241-7811. Cable: VICTOREXPORT. Telex: 26222. Int'l subsidiaries: Canada, England, France, Germany, Singapore, USA (all JVC).

Audio: Test tape, heads, splicing & editing equip. Brand name: JVC.

RECORD MANUFACTURING EQUIPMENT

Magnadyne Corp., Royal Higashi Azabu Bldg., 2-23 Higashi Azabu, Minato-ku, Tokyo 106. Tel: (03) 583-8335. Home office: USA.

Chief product: Shrink packaging. Namiki Precision Jewel Co. Ltd., 3-22-8 Adachi-ku, Shinden, Tokyo 123. Tel: (03) 919-0101. Cable: NAMIKI. Telex: 2722288. Pres.: Kazu Namiki; VP: Nobushiro Namiki; Gen. Mgr.: Shoji Namiki; Sales Mgr.: Mastaka Shi-

SOUND INN

NTV

NIPPON TELEVISION MUSIC CORPORATION

YANBANCHO ANNEX 6-5 YANBANCHO
CHIYODA-KU, TOKYO JAPAN
Tel: 262-2221
Cable: NTVMUSIC Telex: J29410

Address	NTV Yanbancho Annex 5-6, Yanbancho, Chiyoda-ku, Tokyo, Japan
Telephone	Tokyo (03) 262-2221
Telex	J29410 NTVMUSIC
Cable	NTVM

mizu.
Int'l branch: USA.
Product: Cutting styl.
Nippon Columbia Co. Ltd., 4-14-14 Akasaka, Minato-ku, Tokyo 107. Tel: (03) 584-8111. Cable: NIPPONCOLUMBIA. Telex: 22591. Pres.: Takami Shobochi, Dir.; Mitsugu Kumamoto.
Chief product: PCM equip.
Brand name: Denon
Teichiku Recs. Co. Ltd., 1-2 Nishi-Shimbashi, Minato-ku, Tokyo 105. Tel: (03) 502-7213. Cable: TEICHIKU. Telex: (02) 224237. Pres.: Shigeji Nanko; Gen. Mgr.: Ichiro Kinoue; Sales Mgr.: Minoru Ozaki.

TAPE, BLANK LOADED & BULK RAW
Ampex Japan Ltd., New Belle Mode Bldg., 3-3 Kojimachi, Chiyoda-ku, Tokyo 102. Tel: (03) 264-7331. Cable: VIDEETAPE.
Audio: 2", 1", cassette, open reel.
Video: 2", 1", 1/2", 1/4" Beta & VHS.
B A S F Japan Ltd., Tozan Bldg., 4-9 Nihonbashi-Honcho, Chuo-ku, Tokyo 103. Tel: (03) 270-1461. Telex: 2222130. Pres.: Dr. Cantzler; Gen. Mgr.: H. Kreuels; Sales Mgr.: K. Suzuki.
Audio: Cassette, open reel.
Video: Blank-1" open reel, 1/2" U-matic cassette, 1/4" cassette reel, raw-1/4" U-matic cassette
Fujifilm Photo Film Co. Ltd., 2-26-30, Nishi-Azabu, Minato-ku, Tokyo 106. Tel: (03) 406-2409. Cable: FUJIFILM. Telex: 24306. Pres.: Minoru Ohnishi; Sales Mgr.: Juntaro Suzuki, Hiroshi Ashizawa. (Blank only)
Int'l branches: Australia, Brazil, Canada, England, Germany, Hong Kong, Korea, Philippines, Singapore, Taiwan, Thailand, USA.
Audio: Cassette.
Video: 2" quad, 1" open reel, 1/2" U-matic cassette, 1/4" Beta & VHS cassette.
Hitachi Maxell Ltd., Ginza Toho Seimei Bldg., 3-3-1 Ginza Chuo-ku, Tokyo 104. Tel: (03) 567-6221. Cable: MAXELLELEC. Telex: 26391. Int'l Dept. Dir.: Ken Kakura; Sales Mgr.: Tom Inoue; Ass't Sales Mgr.: Bob Fujiwara. (Blank only)
Int'l branches: Germany, Hong Kong, Kuwait, Singapore, USA
Audio: 8-tr, cassette, open reel.
Video: 1/2" U-matic cassette, 1/4" Beta & VHS cassette
Brand name: Maxell.
J V C, see Victor.
Magnadyne Corp., Royal Higashi Azabu Bldg., 2-23 Higashi Azabu, Minato-ku, Tokyo 106. Tel: (03) 583-8335. (Blank only)
Home office: USA.
Audio: 8-tr.
Matsushita Electric Ind'l Co. Ltd., 1006 Daza Kadoma, Kadoma-city, Osaka 571. Tel: (06) 908-1121. Cable: MATSUDEN MORIGUCHI. Telex: 63426. Pres.: Toshihiko Yamashita. (Blank only)
Int'l branches: Germany, USA
Audio: Cassette, open reel.
Video: 1/2" U-matic cassette, 1/4" EIAJ open reel, 1/4" EIAJ cartridge, 1/4" VHS cassette, 1/4" VHS.
Brand names: National/Panasonic. Technics.
Maxell, see Hitachi.
National/Panasonic, see Matsushita.
Nippon Columbia Co. Ltd., 4-14-14 Akasaka, Minato-ku, Tokyo 107. Tel: (03) 584-8111. Cable: NIPPONCOLUMBIA. Telex: 22591. Pres.: Takami

Shobochi, Dir.; Mitsugu Kumamoto.
Audio: Cassette, open reel.
Video: Blank-Open reel, 1/2" U-matic cassette, 1/4" cassette, Raw-1/4" U-matic cassette.
Scotch, see Sumotomo.
Sony Corp., PO Box 10, Airport PO, Tokyo 149, 6-7-35 Kita-Shinagawa, Shinagawa-ku, Tokyo 141. Tel: (03) 448-2111. Cable: SONYCORP. Telex: 22262, 24666. (Blank only)
Int'l branches: Brazil, Canada, England, Germany, Greece, Hong Kong, Panama, Singapore, South Africa, Switzerland, USA.
Audio: 8-tr, cassette, open reel.
Video: 1" open reel, 1/2" cassette, 1/4" EIAJ open reel, 1/4" Beta cassette.
Sumotomo 3M Co. Ltd., 3M Bldg., 2-33-1 Tamagawa-dai, Setagaya-ku, Tokyo 158. Tel: (03) 709-8480.
Audio: Blank-2", 1" & 1/2" open reel, raw-8-tr.
Video: Blank-2" & 1" open reel, 1/2" cassette, 1/4" Beta & VHS cassette.
Brand name: Scotch
T D K Electronics Co. Ltd., 1-13-1 Nihonbashi, Chuo-ku, Tokyo 103. Tel: (03) 278-5111. Cable: TOKCORE. Pres.: Fukujiro Sono; Gen. Mgr.: Shohachi Okuyama.
Int'l branches: Germany, UK, USA
Audio: 8-tr, cassette, open reel.
Video: 1/2" U-matic cassette, 1/4" VHS & Beta cassette.
Technics, see Matsushita.
Victor Co. Of Japan Ltd., 4-1 Nihonbashi-Honcho, Chuo-ku, Tokyo 103. Tel: (03) 241-7811. Cable: VICTOREXPORT. Telex: 26222 (Blank only)
Int'l subsidiaries: Canada, England, France, Germany, Singapore, USA (all JVC).
Audio: Cassette.
Video: 1/2" U-matic cassette, 1/4" VHS cassette.
Brand name: JVC.

TAPE DUPLICATING & PROCESSING EQUIPMENT

Magnadyne Corp., Royal Higashi Azabu Bldg., 2-23 Higashi Azabu, Minato-ku, Tokyo 106. Tel: (03) 583-8335.
Home office: USA
Audio: 8-tr. duplicating equip
Matsushita Electric Ind'l Co. Ltd., 1006 Daza Kadoma, Kadoma-city, Osaka 571. Tel: (06) 908-1121. Cable: MATSUDEN MORIGUCHI. Telex: 63426. Pres.: Toshihiko Yamashita.
Int'l branches: Germany, USA
Video: Duplicators.
Brand name: National/Panasonic.
Otari Electric Co. Ltd., 4-29-18 Minami Ogikubo, Suginami-ku, Tokyo 167. Tel: (03) 333-9631. Cable: OTARIDENKI. Telex: 26604. Pres.: Masayuki Hosoda; Sales & Adv. Mgr.: Takao Aoki.
Audio: High speed tape duplicators (8x, 16x, 32x, 64x), tape winders.
Video: Tape winders.
Sony Corp., PO Box 10, Airport PO, Tokyo 149; 6-7-35 Kita-Shinagawa, Shinagawa-ku, Tokyo 141. Tel: (03) 448-2111. Cable: SONYCORP. Telex: 22262, 24666.
Int'l branches: Brazil, Canada, England, Germany, Greece, Hong Kong, Panama, Singapore, South Africa, Switzerland, USA.
Audio & Video: Duplicators.

• accessories

Akai Electric Co. Ltd., 2-12-14 Higashi-Kojiya, Ohta-1-ku, Tokyo 144. Tel: (03) 742-5111.
Product: Tape-head cleaners, demagnetizers.
Ampex Japan Ltd., New Belle Mode Bldg., 3-3 Kojimachi, Chiyoda-ku, Tokyo 102. Tel: (03) 264-7331. Cable: VIDEETAPE.
Product: Tape-carrying & storage cases, head cleaners, bulk erasers, demagnetizers, leader tape, splicing tape & equip. (all audio & video).
Clarion Co. Ltd., 1-22-10 Dogenzaka, Shibuya-ku, Tokyo 150. Tel: (03) 463-6161.
Int'l branches: Germany, Hong Kong, USA.
Product: Carrying & storage cases.
Hitachi Maxell Ltd., Ginza Toho Seimei Bldg., 3-3-1 Ginza Chuo-ku, Tokyo 104. Tel: (03) 567-6221. Cable: MAXELLELEC. Int'l Dept. Dir.: Ken Kakura; Sales Mgr.: Tom Inoue; Ass't Sales Mgr.: Bob Fujiwara.
Int'l branches: Germany, Hong Kong, Kuwait, Singapore, USA.
Product: Tape-cassette head cleaners (audio & video).
Magnadyne Corp., Royal Higashi Azabu Bldg., 2-23 Higashi Azabu, Minato-ku, Tokyo 106. Tel: (03) 583-8335.
Home office: USA.
Product: Record-record care prods.; Tape-storage cases, splicing tape.
Nagaoka Seiki, 3-16-3 Kita-Otsuka, Toshima-ku, Tokyo 170.
Product: Record-replacement styl.
Namiki Precision Jewel Co. Ltd., 3-22-8 Adachi-ku, Shinjuku, Tokyo 123. Tel: (03) 919-0101. Cable: NAMIKI. Telex: 272288. Pres.: Kazu Namiki; VP: Nobushiro Namiki, Gen. Mgr.: Shoji Namiki; Sales Mgr.: Mastaka Shimizu
Int'l branch: USA.
Product: Record-replacement styl.
Nippon Chikushin, 3-9-35 Tozuka-cho, Shinjuku-ku, Tokyo 160.
Product: Record-replacement styl.
Nippon Columbia Co. Ltd., 4-14-14 Akasaka, Minato-ku, Tokyo 107. Tel: (03) 584-8111. Cable: NIPPONCOLUMBIA. Telex: 22591. Pres.: Takami Shobochi, Dir.; Mitsugu Kumamoto.
Product: Tape-demagnetizers.
Ogura Jewel Ind. Co. Ltd., 5-7-12 Omori Kita, Ota-ku, Tokyo 143. Tel: (03) 763-3111. Telex: 02466048.
Product: Record-replacement styl.
Sharp Corp., 22-22 Nagaike-cho, Abeno-ku, Osaka 545. Tel: (06) 621-1221. Cable: LABOMET
Sony Corp., PO Box 10, Airport PO, Tokyo 149; 6-7-35 Kita-Shinagawa, Shinagawa-ku, Tokyo 141. Tel: (03) 448-2111. Cable: SONYCORP. Telex: 22262, 24666.
Int'l branches: Brazil, Canada, England, Germany, Greece, Hong Kong, Panama, Singapore, South Africa, Switzerland, USA.
Product: Record-replacement styl; Tape-head cleaners, demagnetizers, splicing tape.
Sumotomo 3M Co. Ltd., 3M Bldg., 2-33-1 Tamagawa-dai, Setagaya-ku, Tokyo 158. Tel: (03) 709-8480
Product: Tape-leader & splicing tape.
T D K Electronics Co. Ltd., 1-13-1 Nihonbashi, Chuo-ku, Tokyo 103. Tel: (03) 278-5111. Cable: TOKCORE. Pres.: Fukujiro Sono; Gen. Mgr.: Shohachi Okuyama.
Int'l branches: Germany, UK, USA.
Product: Tape-head cleaners, demagnetizers, leader & splicing tape.

New Picture Disks with Superior Sound

- * New production method ensures sound quality equivalent to that of regular black records.
- * Patents applied for for new method in Japan and major countries, including U.S., Britain, West Germany, Italy and Holland.
- * Ideal for promotion and premiums, as well as general sales.
- * Export orders being accepted.

Example: 30cm LP Picture Disk; 100,000 disks (¥290(yen basis) FOB Nara factory; delivery 60 days after receipt of master tape and separate color transparencies.



Picture disk of Rod Stewart's song, "Oh God, I Wish I Was Home Tonight," for Nikkia Black-50.

JAPAN MUSICOLOR CO.
Tokyo Office: 2-11-19 Ginza, Chuo-ku, Tokyo 104
Tel: 03-545-1921
Nara Factory: 862 Rokujochi, Nara City 630
Tel: 0742-45-4571

Tamradio, see Tamura
 Tamura Saisakusho Co. Ltd., Han-Ei Daiichi Bldg., 1-10-3 Shinjuku, Shinjuku-ku, Tokyo 166. Tel (03) 356-7211.
 Product: Tape—bulk erasers (audio)
 Teac Corp., 3-7-3 Naka-cho, Musashino-shi, Tokyo 180. Tel (0422) 53-1111. Cable: TEAC MITAKA. Telex: 2822551. Pres. Noboru Yanase. Audio Div. Gen. Mgr.: Yukio Koide, Int'l Dept. Gen. Mgr.: Masao Morita
 Int'l branches: Australia, USA.
 Product: Tape—carrying & storage cases, head cleaners, bulk erasers, de magnetizers (all audio).
 Victor Co. of Japan Ltd., 4-1 Nihonbashi-Honcho, Chuo-ku, Tokyo 103. Tel (03) 241-7811. Cable: VICTOREXPORT. Telex: 26222.
 Int'l subsidiaries: Canada, England, France, Germany, Singapore, USA.
 Product: Record—replacement stylus

• promotional merchandising aids

The following is a list of companies involved in the manufacturing, importing, distribution & retailing of items promoting the music industry and/or its artists. The key to symbols used is: (M) manufacturer; (I) importer; (D) distributor and (R) retailer.

Japan Soul Agency, 1-5-11 Sakurajyosui, Setagaya-ku, Tokyo 156. Tel (03) 302-0208. Cable: JSATRCO. Telex: 2424586.
 Product: Posters (I, D), patches (I, D).

• store fixtures

Clarion Co. Ltd., 1-22-10 Dogenzaka, Shibuya-ku Tokyo 150. Tel (03) 463-6161
 Int'l branches: Germany, Hong Kong, USA
 Product: Browser boxes, display racks
 Young Japan Ent. Inc., 5-F Emerald Bldg., 4th fl., 12-7 Udagawa-cho, Shibuya-ku, Tokyo 150. Tel (03) 476-3256. Pres. Ken Hosokawa, Exec VP Akio Onodera, Exec. Prod'r: Chikanori Kikuchi

KENYA

Population: 15,800,000
 Rate of exchange: \$1 (US) = 8.3 shillings
 Per capita income: \$1,500
 Holidays: January 1, Good Friday, Easter Monday, May 1 (Labor Day), June 1 (Madaraka Day), 10th Ulfittur, October 20 (Kenya's Day), December 12 (Independence Day), 25 (Christmas), 26 (Boxing Day)

RECORDS:

Note: There are no accurate figures for the importation and exportation of recorded product. Amounts listed in these areas are estimates only.
 Record sales certification awards: Silver single—30,000 units, gold single—60,000 units; platinum single—100,000 units. Silver LP—5,000 units, gold LP—10,000 units, platinum LP—25,000 units.

Records sold domestically including imports: LP's 1980—150,000 units, 1979—180,000 units. Singles 1980—2,500,000 units, 1979—2,500,000 units.

Records imported from countries other than USA: 1980—50,000 units, 1979—60,000 units.

Records exported to countries other than USA: 1980—200,000 units, 1979—300,000 units.

Average retail price per record: LP's—\$9.60, singles—\$1.70
 Discounting: Frequent

Type of distribution: One manufacturer supplies the major licensees/distributors who sell direct to retail outlets. The small market prevents wide coverage. Sales channels are from the center of Nairobi to Mombasa, Kisumu and Nakuru primarily, with redistribution to the villages.

Type of promotion: Radio is the main promotion vehicle as much emphasis is placed on airplay exposure. There is also some advertising in magazines and newspapers. Because of the prohibitive cost, television advertising is used very little. A new television program, proposed and now accepted, will be the first of its kind in East Africa and will give exposure to local and international acts.

Jukeboxes: 120

TAPE:

Market: There are no 8-track sales whatsoever. Piracy is still a great problem and especially with cassette duplication. The sales ratio of blank tape to pre-recorded tape is about 100 to 1. If PI action is working at curbing the problem, the cassette market is now in the embryonic stage. Importation of cassettes and tape is banned to protect the local industry.

There is no legitimate video market but there are many pirate libraries and sales points in all kinds of shops, from butcheries to pharmacies.
 Pre-recorded tape sold domestically including imports: Cassette 1980—80,000 units, 1979—65,000 units
 Pre-recorded tape imported from countries other than USA: 1980—40,000 units, 1979—30,000 units
 Average retail price per tape: Cassette—\$11.50

RADIO STATIONS:

No. of government: 3
 Comment: The three radio stations are under the Voice of Kenya and broadcast in three languages. News and information are featured, with about 40% of air time going to music.

TELEVISION STATIONS:

No. of government channels: 1
 Comment: Television programming features educational programs and imported dramas, "sitcoms" are shown from 8 p.m. on. About 2% of the programming time is devoted to music.

IMPORT/EXPORT REGULATIONS:

According to a government policy statement of September 1980, no importation of records and tapes is allowed. Materials are subject to import license application being processed. Regarding exports, the markets around Kenya are still cut off by political differences and internal strife but West Africa and Central Africa continue to deal with Kenya on a limited scale.

MARKET ANALYSIS:

Import restrictions have meant grave difficulties for manufacturers because of the lack of raw materials but on the other hand there has been an increase in the demand for locally processed records. The rise in the sales of these records has been offset by the economic restrictions in the economy which have meant that turnover has remained static, with unit sales having dropped due price increases of approximately 20% over the past year. Pirated cassettes are still a considerable threat and video piracy also is becoming a big business.

Zairean music has shown a marked resurgence in popularity along with international repertoire, both accounting for about 65% to 70% of the market. For international product, R&B and disco are still predominant with country following closely behind.

With the establishment of the fully recognized IFPI Kenyan body there should finally be some unification to combat the piracy that has long plagued the market but it appears as though it will be several years before Kenya's economy is healthy enough to allow growth in the recording industry. R. Andrews

• record & tape manufacturers / distributors / importers

A I T Recs (Kenya) Ltd. (IFPI), PO Box 41152, Nairobi. Tel 24725, 26732, 334-127. Cable: DREWSCO. Telex: 22684. Mng. Dir.: M.R. Andrews. Sales Dir.: R.J. Andrews.
 Labels: (Owned) AIT, Africa, Ba Ba, Bana Beru, Do 7, King Kong, Lolwe, Makassy, Masantula, Mazembe, Moto Moto, Musiki du Zaire, Nyang Omaki, Owang Jaber, POK, Sungura, (licensed domestic) Kung Fu, (licensed foreign) Capitol (USA), EMI (UK), Fantasy (USA), MCA (USA), RCA (USA), RPM (South Africa), Stax (USA), Teal (South Africa), United Artists (USA)

A S I, see PolyGram
 Africa, see AIT
 African Beat, see PolyGram
 Apollo, see PolyGram
 Ba Ba, see AIT
 Bana Beru, see AIT
 C B S Recs. Kenya Ltd., PO Box 66299, Nairobi
 Do-7, see AITs
 King Kong, see AIT
 Kung Fu, see AIT
 Lolwe, see AIT
 Makassy, see AIT
 Masantula, see AIT
 Mazembe, see AIT
 Mercury, see PolyGram
 Moto Moto, see AIT
 Musiki du Zaire, see AIT
 Nyang Omaki, see AIT
 Owang Jaber, see AIT
 P. A., see PolyGram
 P. O. K., see AIT
 Phonogram, see PolyGram
 PolyGram Recs Ltd (IFPI), PO Box 43695, Nairobi. Tel 557558. Cable: PHONREC. Telex 22847. Mng. Dir.: Dr. J.H. Kinzi, Comm'l Mgr.: J. Cost

abr, Financial Admn'r: F. Schnebel.
 Labels: (Owned) ASL, African Beat, Apollo, Mercury, PA, Phonogram group, Polydor group, Vibao, (licensed) African, De-Lite, Hansa, Isa, Motown, Pye (UK), RSO.
 Int'l rep.: Worldwide (PolyGram).
 Polygram, see PolyGram
 Sungura, see AIT
 Vibao, see PolyGram

• music publisher

E I T Publ'g, PO Box 41152, Nairobi. Tel 24725, 26732. Cable: DREWSCO. Telex 22864. Mng. Dir.: M.R. Andrews

• services

PLATING, PROCESSING & PRESSING PLANTS
 East African Recs. Ltd., PO Box 43695, Nairobi. Mng. Dir.: J.H. Kinzi, Factory Mgr.: G. Vieweger.

TAPE CUSTOM DUPLICATOR

East African Recs. Ltd., PO Box 43695, Nairobi. Mng. Dir.: J.H. Kinzi, Factory Mgr.: G. Vieweger.
 Audio: Cassette

• accessories importer

A I T Recs (Kenya) Ltd., PO Box 41152, Nairobi. Tel 24725, 26732, 334-127. Cable: DREWSCO. Telex 22684. Mng. Dir.: M.R. Andrews. Sales Dir.: R.J. Andrews (Importer).
 Product: Record—record care prods., 45 rpm adaptors, Tape—head cleaners & demagnetizers, leader & splicing tape

KOREA, SOUTH

Population: 38,700,000
 Rate of exchange: \$1 (US) = 500 won
 Per capita income: \$1,000
 Holidays: January 1-3 (New Year's Days), March 1 (Independence Movement Day), March 10 (Labor Day), April 5 (Arbor Day), May 5 (Children's Day), May 21 (Lord Buddha's Birthday), June 6 (Memorial Day), July 7 (Constitution Day), August 15 (Liberation Day), September 23 (Moon Festival Day), October 1 (Armed Forces Day), October 3 (National Foundation Day), October 9 (Korean Alphabet Day), December 25.

• record & tape manufacturers / distributors / importers

Arts Int'l, Hae Young Bldg., 148 Anuk Dong, Chongro-ku, Seoul.
 Label: (Licensed foreign) Cream (USA).
 Hit Rec Co., Sebu PO Box 11, 109-12 Ung Am Dong, Seo Dae Moon Koo, Seoul. Tel 388-1279. Pres: Tae Bong Lee. Gen. Mgr.: Eung Kyun Kim; Sales Mgr.: Hwan Pyong Lee.
 Labels: (Owned) Hit, (licensed) Seven Seas (Italy), Teletunken (Germany), Vanguard (USA).
 Jigu Recs Corp. (IFPI), 233 Daeja-Ri, Byokje-Eup, Koyang Kun, Kyongki-Do 120-66. Pres: Jeongsoo Lim, Jaewoo Lim, Sales Mgr.: Kwanchol Lee.
 Label: (Licensed) RCA (USA).
 Int'l reps.: Japan (CBS/Sony), USA (RCA).
 Oasis Rec Co. (IFPI), 196-18 Anyang 7 Dong, Anyang 171. Tel: (1343) 2-1761. Cable: OASIS. Pres.: Jim Seok Sohn, Gen. Mgr.: P.M. Kim, Sales Mgr.: K.I. Suk.
 Labels: (Owned) Oasis, (licensed) EMI (UK), WEA (USA).
 Sung Eun Ltd (IFPI), CPD Box 1234, Seoul. Tel (02) 445-0141. Cable: SEMGRAM. Telex 23395. Pres.: Lee Sung Hee; Gen. Mgr.: Chae Young Wha; Sales Mgr.: Lee Han Woo.
 Labels: (Owned) Sung Eun, (licensed foreign) A&M (USA), Archv (Germany), Casablanca (USA), Decca/London (UK, USA), Dreamland (USA), Hansa (Germany), MGM (USA), Pergola (Netherlands), Philips/Fontana (Netherlands), Polydor/DG (Germany), RSO (USA)

• music publisher

Sam Ho Music Publ'g. Co., Won Ho Ro 2 Gta 92-2, Seoul. Tel 713-2388.
 Prof. Mgr.: Kim Jung Tae.

LEBANON

Population: 3,000,000
 Rate of exchange: \$1 (US) = 4.32 pounds
 Per capita income: \$950
 Holidays: January 1, February 9 (St. Maron), Good Friday, May 1 (Labor Day), August 15 (Assumption), November 22 (Independence Day), December 25, Moslem & Christian religious holidays

• record & tape manufacturers / distributors / importers

Archv, see Societe Mitri Murr & Fils
 Archv, see Philips Liban
 A Chahine & Fils, Hazmieh Chirah Blvd., Beirut. Tel 452 750/563. Cable: CHAHINEMUSIQUE. Pres.: Joseph A. Chahine, Gen. Mgr.: Bernard A. Chahine, Sales Mgrs.: Abdallah J. Chahine, Boutros Maroun, Joe Letayf.
 Labels: (Owned) Voix de L'Orient, (distributed—not licensed) A&M (UK), Barclay (France), Bronze (UK), Capitol (UK), Carrere (France), OJM (UK), EMI (UK), EMI Int'l (UK), Fantasy (USA), Harvest (UK), His Master's Voice (UK), Island (UK), Motown (UK), Music For Pleasure (UK), Parlophone (UK), Pathe (France), Purple (UK), RAK (UK), Rocket (UK), Sonopresse (France), Tamia (UK), Trema (France), Treteaux (France).
 Int'l reps.: France (Pathe Marconi EMI), Greece (EMI)
 D. G., see Philips Liban
 Empire, see Societe Libanaise du Disque
 Fontana, see Philips Liban
 Hamada, see Societe Libanaise du Disque

LOOKING FOR NEW!!



J.C.M. has the EXPERIENCE, the STAFF and NATION-WIDERADIO NETWORK to help you find NEW OUTLET for Your music in JAPAN.

• A SUBSIDIARY of BUNKAHOSO BROADCASTING INC. (JOOR)
 [BUNKAHOSO BROADCASTING INC. is Key Station of National Radio Network]
 ADDRESS: 5-1 CHOME - SHINJUKU-KU TOKYO JAPAN
 PHONE: (03) 359 7825 TELEX: 2322841 (JOJCM J)

• U.S.A. OFFICE
 AIPD ACIS/HIMMSI
 ADDRESS: 7046 HOLLYWOOD BLVD. SUITE 510
 HOLLYWOOD CALIF. 90028
 PHONE: (213) 463 9929

• ENGLAND OFFICE
 CECO ASANUMA (M) J
 ADDRESS: FLAT, NEW HOUSE 65C
 HARLBOROUGH PLACE, LONDON N 16 B
 PHONE: (01) 329 4641

Heliodor, see Philips Liban
 Romeo Lahoud Prods, see Societe Libanaise du Disque
 M G M, see Philips Liban
 Melodisc, see Societe Libanaise du Disque
 Mercury, see Philips Liban
 Metrophon, see Societe Mitr Murr & Fils
 Philips Liban SA, Phonogram Dept., PO Box 670, Ave Sami Solh, Beirut. Tel 382 300 Cable PHILIBAN. Gen Mgr.: W Raben. Sales Mgr.: Roger Ghosn.
Labels: (Owned) Archw. DG, Fontana, Heliodor, MGM, Mercury, Philips, Polydor, Polyphon Triumph, Vertigo, Verve. (Licensed) A&M, Atlantic, ARI, Platinum, B&C, Big Tree, Biram, Bus Stop, CTI, Capricorn, Carver, Charisma, Clearlight, ECM, Ensign, Fresh Air, GM, GTO, Hispavox, Hot Foot, Jet, Just Sunshine, Kalan, Kalondour, Keltia, Kudu, Marzelle, Mooncrest, Moun tain, Oyster, Pablo, Passport, Pergola, Phil Spector, Power Exchange, RSO Ring-O, Shelter, Sire, Sonopresse, Spring, State, Track, Transatlantic, Trojan, 20th Century, WWA, Zagora
Int'l reps.: Worldwide (Phonogram, Polydor)
 Polydor, see Philips Liban
 Polyphon, see Philips Liban
 S L D, see Societe Libanaise du Disque
 Societe Libanaise du Disque Sa (L-PI), PO Box 4758, Cinema Empire Bldg, Gouraud St., Beirut. Tel. 362533, 365205, 932787. Cable CINEMPIRE. Telex: 21633. Pres. & Gen. Mgr. Mario G. Haddad; Prod'n Mgr. Joseph Tabet.
Labels: (Owned) Empire, Melo-disc, SLO, (Licensed) Albatros (France), Ariola (Germany), Asylum (UK), Atco (USA), Atlantic (USA), CGD (Italy), Dark Horse (France), Durium (Italy), Elektra (USA), Hansa (Germany), Reprise (USA), Ri-Fi (Italy), Warner Bros (USA). (distributed—not licensed) Disc'AZ (France), Ades (France), Barclay (France), Big Tree (France), Erato (France), Eurodisc (France), Flamophone (France), Flarensch (France), Hamada, Hungaroton (Hungary), Romeo Lahoud, Malignator (France), Manticore (France), Musidisc (France), Rolling Stones (USA), Swan Song (USA), Unart, Westbound (USA), Whitfield (France)
Int'l reps.: France (Sonodisc), USA (Monitor, Peters Int'l)
 Societe Mitr Murr & Fils, PO Box 11 1211, Beirut. Tel. 24 46 20, 22 38 08.
Labels: (Owned) Arc, Metrophon, (represented) Chapter One (UK), Decca (UK), Oeram (UK), London (UK), MAM (UK), Pink Elephant (Belgium), Rex (UK), Saout El-Hob (Egypt), Threshold (UK), UK (UK), Vega (France), Weekend (Belgium)
Int'l reps.: Belgium (Fonior), Egypt (Saout El-Hob), France (Societe Francaise du Son), UK (Decca),
 Triumph, see Philips Liban
 Unart, see Societe Libanaise du Disque
 Vertigo, see Philips Liban
 Verve, see Philips Liban
 Voix de L'Orient, see A. Chahine & Fils

Classical, country and jazz figure strongly, too. Live shows are featured daily on FM.

TELEVISION STATIONS

No. of government channels 2; 2% color (PAL)
Comment: About 30% of the programs are locally produced, including news, documentaries, sports, plays and musicals. Imported music shows are limited to the MOR format.

IMPORT/EXPORT REGULATIONS

All imports are subject to a tax duty of 45% + 5% + 5%. Despite this high rate, imports of tapes, hi-fi equipment and records have registered a steady upward trend. Tax duty for exports, conversely, is very much less and is encouraged.

Christie Leo

• record & tape manufacturers / distributors / importers

Anca Musical Sdn Bhd, 58 Jalan Midah 1, Taman Midah, Cheras, Kuala Lumpur. Tel: 612-031. Mng. Dir.: Wong Kim Leng.
 Angel, see EMI.
 Baal Recs., 5115 Wisma Central, Jalan Ampang, Kuala Lumpur. Tel: 209 836.
Labels: (Owned) Baal, Best of Everything, (Licensed) ABC, H&L (both USA).
 Best of Everything, see Baal.
 Capitol, see EMI.
 Columbia, see EMI.
 D G G, see PolyGram.
 Double Up, see EMI.
 E M I (Malaysia) Sdn. Bhd. (IFPI), 1 Lorong Haji Taib Satu, Kuala Lumpur 02-07. Tel: (03) 924133, 924261, 924392. Cable: EMITRON. Telex: 30682. Dir. & Gen. Mgr.: M. Comerford; Mktg & Sales Mgr.: Ronald Chong; Int'l A&R Mgr.: Connie Cheong; Domestic A&R Mgr.: S.P. Beh.
Home office: England.
Labels: (Owned) Angel, Capitol, Columbia, Double Up, EMI, HMY, Harvest, MFP, One Up, Parlophone, Pathe, Regal, Sonopresse, Sound Super, Starline, (Licensed) Arista (USA), Bronze (UK), CBS (USA), Oisneyland (USA), Oyna (Philippines), Epic (USA), Island (UK), MAM (UK), Magnet (UK), Motown (USA), Passport (USA), Private Stock (USA), Purple (UK), RAK (UK), Rolling Stones (UK), Rare Earth (UK), Rocket (UK), Sherbet (Australia).
Int'l rep.: Worldwide (EMI).

Elastic, see Musico.
 Fontana, see PolyGram.
 Golden Voice Musical Inds. Sendirian Berhad, Tasek Ind'l Estate, Lot 11, Tasek Square, Ipoh, Perak. Tel: (05) 4-555.
 H M V, see EMI.
 Harvest, see EMI.
 Hup Hup Sdn. Bhd. (IFPI), 66-68 Jalan Raja Chulan, Kuala Lumpur. Tel: (03) 207-904/524. Cable: DISCKING. Mng. Dir.: C.H. Ng, Gen. Mgr.: A.W. Ng.
Label: (Owned) Life.
 King Musical Inds. Sdn Bhd., Lot 5, Jalan 13/2, Petaling Jaya, Selangor. Tel: (03) 561103, 561203. Cable: DISCKING. Telex: 33581. Mng. Dir.: Ng Lian Chin; Gen. Mgr.: Ng Cheong Kien.
 Life, see Hup Hup.
 M F P, see EMI.
 Malaysia Recs. Sdn. Bhd., Lot 8244, Lorong 51A/222B, Kawasan Miel, Petaling Jaya, Selangor. Tel: (03) 773-685, 773-604. Cable: MAYREC. Chm.: M.C. Brown, Factory Mgr.: Heng Yok Hong.
 Mercury, see PolyGram.
 Musico (Malaysia) Sdn Bhd., China Insurance Bldg., Rm. 301, 174 Jalan Tuanku Abdul Rahman, Kuala Lumpur. Tel: 924-959. Mgr.: Khorjin Seong.
Labels: (Owned) Elastic, (represented) Barclay, Blue Note (USA), Casablanca, Fantasy (USA), JVC, King, Prestige (USA), United Artists (Germany, UK, USA).
 One Up, see EMI.
 Parlophone, see EMI.
 Pathe, see EMI.
 Philips, see PolyGram.
 Polydor, see PolyGram.
 PolyGram Recs. Sdn. Bhd., Jalan Bukit Bintang, 1st & 2nd fl., No. 20, Kuala Lumpur. Tel: 422-747, 429-395.
Regional headquarters: Singapore.
Labels: (Owned) OGG, Fontana, Mercury, Philips, Polydor, RSO, Vertigo, (represented) A&M (USA), Archw (Germany), BBC (UK), Capricorn (USA), Casablanca (USA), Charisma (UK), Chelsea (UK), Oecca group, Oureco (Netherlands), Ensign (UK), GTO (UK), London, MGM, Monument, Pablo (Germany), Ring-O (UK), Rocket (USA).
 R S O, see PolyGram.
 Regal, see EMI.
 Sonopresse, see EMI.
 Sound Superb, see EMI.
 Starline, see EMI.
 Vertigo, see PolyGram.
 W E A Recs. Sdn. Bhd. (IFPI), Lot 8-24 Sun Complex, Jalan Bukit Bintang, Kuala Lumpur 06-24. Tel: 422-551. Telex: 30754. Dir. & Gen. Mgr.: Frankie Cheah, Sales Mgr.: Eddie Goh.
Home office: USA.

• music publishers

Anca Musical Sdn. Bhd., 58 Jalan Midah 1, Taman Midah, Cheras, Kuala Lumpur. Tel: 612-031. Mng. Dir.: Wong Kim Leng.
 Pustaka Muzik EMI (Malaysia) Sdn. Bhd., 1 Lorong Haji Taib Satu, Kuala Lumpur 02-07. Tel: (03) 924133, 924261, 924392. Cable: EMITRON. Telex: 30682. Mng. Dir.: Michael Comerford, Gen. Mgr.: S.P. Beh.
Int'l firm represented: EMI (Hong Kong).
Int'l rep.: UK (EMI)

• services

DESIGN & ARTWORK

Golden Voice Musical Inds. Sendirian Berhad, Tasek Ind'l Estate, Lot 11, Tasek Square, Ipoh, Perak. Tel: (05) 4-555.
 King Musical Inds. Sdn. Bhd., Lot 5, Jalan 13/2, Petaling Jaya, Selangor. Tel: (03) 561103, 561203. Cable: DISCKING. Telex: 33581. Mng. Dir.: Ng Lian Chin; Gen. Mgr.: Ng Cheong Kien.
 U N I Ent. Sdn. Bhd., 290 Jalan Raja Laut, Kuala Lumpur. Tel: (03) 922-971/115/291/088. Cable: UNIGHOH. Telex: 31341. Mng. Dir.: S.S. Goh; Gen. Mgr.: Peter S.C. Goh, Sales Mgr.: Colin Edmonds; Office Mgr.: Liao How Soon, Factory Mgr.: Robert Goh.

PLATING, PROCESSING & PRESSING PLANTS

Golden Voice Musical Inds. Sendirian Berhad, Tasek Ind'l Estate, Lot 11, Tasek Square, Ipoh, Perak. Tel: (05) 4-555.
 King Musical Inds. Sdn. Bhd., Lot 5, Jalan 13/2, Petaling Jaya, Selangor. Tel: (03) 561103, 561203. Cable: DISCKING. Telex: 33581. Mng. Dir.: Ng Lian Chin; Gen. Mgr.: Ng Cheong Kien.
 Malaysia Recs. Sdn. Bhd., Lot 8244, Lorong 51A/222B, Kawasan Miel, Petaling Jaya, Selangor. Tel: (03) 773-685, 773-604. Cable: MAYREC. Chm.: M.C. Brown, Factory Mgr.: Heng Yok Hong. (Pressing only)
 U N I Ent. Sdn. Bhd., 290 Jalan Raja Laut, Kuala Lumpur. Tel: (03) 922-971/115/291/088. Cable: UNIGHOH. Telex: 31341. Mng. Dir.: S.S. Goh; Gen. Mgr.: Peter S.C. Goh, Sales Mgr.: Colin Edmonds; Office Mgr.: Liao How Soon, Factory Mgr.: Robert Goh.

PRINTERS & LITHOGRAPHERS

Golden Voice Musical Inds. Sendirian Berhad, Tasek Ind'l Estate, Lot 11, Tasek Square, Ipoh, Perak. Tel: (05) 4-555.
 King Musical Inds. Sdn. Bhd., Lot 5, Jalan 13/2, Petaling Jaya, Selangor. Tel: (03) 561103, 561203. Cable: DISCKING. Telex: 33581. Mng. Dir.: Ng Lian Chin; Gen. Mgr.: Ng Cheong Kien. (Rec. only)
 Panda Inds. Sendirian Berhad, Kamunting Ind'l Estate, Taiping, Perak. Tel: 822-246.
Int'l branch: USA, Spectrotape.
 U N I Ent. Sdn. Bhd., 290 Jalan Raja Laut, Kuala Lumpur. Tel: (03) 922-971/115/291/088. Cable: UNIGHOH. Telex: 31341. Mng. Dir.: S.S. Goh; Gen. Mgr.: Peter S.C. Goh, Sales Mgr.: Colin Edmonds; Office Mgr.: Liao How Soon, Factory Mgr.: Robert Goh.

TAPE CUSTOM DUPLICATORS

Anca Musical Sdn. Bhd., 58 Jalan Midah 1, Taman Midah, Cheras, Kuala Lumpur. Tel: 612-031. Mng. Dir.: Wong Kim Leng.
 Emitape (Malaysia) Sdn. Bhd., 1 Lorong Haji Taib Satu, Kuala Lumpur 02-07. Tel: (03) 924133, 924261, 924392. Cable: EMITRON. Telex: 30682. Mng. Dir.: M. Comerford, Gen. Mgr.: Jenny Thong.
Audio: 8-tr., cassette.

Golden Voice Musical Inds. Sendirian Berhad, Tasek Ind'l Estate, Lot 11, Tasek Square, Ipoh, Perak. Tel: (05) 4-555.
Audio: 8-tr., cassette & open reel.

King Musical Inds. Sdn. Bhd., Lot 5, Jalan 13/2, Petaling Jaya, Selangor. Tel: (03) 561103, 561203. Cable: DISCKING. Telex: 33581. Mng. Dir.: Ng Lian Chin; Gen. Mgr.: Ng Cheong Kien.
 U N I Ent. Sdn. Bhd., 290 Jalan Raja Laut, Kuala Lumpur. Tel: (03) 922-971/115/291/088. Cable: UNIGHOH. Telex: 31341. Mng. Dir.: S.S. Goh; Gen. Mgr.: Peter S.C. Goh, Sales Mgr.: Colin Edmonds; Office Mgr.: Liao How Soon, Factory Mgr.: Robert Goh.

• supplies

CARTRIDGE & CASSETTE PARTS

U N I Ent. Sdn. Bhd., 290 Jalan Raja Laut, Kuala Lumpur. Tel: (03) 922-971/115/291/088. Cable: UNIGHOH. Telex: 31341. Mng. Dir.: S.S. Goh; Gen. Mgr.: Peter S.C. Goh; Sales Mgr.: Colin Edmonds; Office Mgr.: Liao How Soon; Factory Mgr.: Robert Goh.
Audio: All plastic parts.

EMPTY CARTRIDGES, CASSETTES & REELS

Anca Musical Sdn. Bhd., 58 Jalan Midah 1, Taman Midah, Cheras, Kuala Lumpur. Tel: 612-031. Mng. Dir.: Wong Kim Leng.
 Panda Inds. Sendirian Berhad, Kamunting Ind'l Estate, Taiping, West Malaysia. Tel: (05) 822-246, 823-499. Cable: PANDATAPE.
Int'l branch: USA, Spectrotape.
Audio: Cassette.
 U N I Ent. Sdn. Bhd., 290 Jalan Raja Laut, Kuala Lumpur. Tel: (03) 922-971/115/291/088. Cable: UNIGHOH. Telex: 31341. Mng. Dir.: S.S. Goh; Gen. Mgr.: Peter S.C. Goh; Sales Mgr.: Colin Edmonds; Office Mgr.: Liao How Soon; Factory Mgr.: Robert Goh.
Brand name: UNI-EI Mar.

JACKETS & SLEEVES

LABELS, DISK

Golden Voice Musical Inds. Sendirian Berhad, Tasek Ind'l Estate, Lot 11, Tasek Square, Ipoh, Perak. Tel: (05) 4-555.
 King Musical Inds. Sdn. Bhd., Lot 5, Jalan 13/2, Petaling Jaya, Selangor. Tel: (03) 561103, 561203. Cable: DISCKING. Telex: 33581. Mng. Dir.: Ng Lian Chin; Gen. Mgr.: Ng Cheong Kien.
 U N I Ent. Sdn. Bhd., 290 Jalan Raja Laut, Kuala Lumpur. Tel: (03) 922-971/115/291/088. Cable: UNIGHOH. Telex: 31341. Mng. Dir.: S.S. Goh; Gen. Mgr.: Peter S.C. Goh; Sales Mgr.: Colin Edmonds; Office Mgr.: Liao How Soon; Factory Mgr.: Robert Goh. (Labels only)

POLYETHYLENE BAGS

Golden Voice Musical Inds. Sendirian Berhad, Tasek Ind'l Estate, Lot 11, Tasek Square, Ipoh, Perak. Tel: (05) 4-555.

RECORD MANUFACTURING EQUIPMENT

U N I Ent. Sdn. Bhd., 290 Jalan Raja Laut, Kuala Lumpur. Tel: (03) 922-971/115/291/088. Cable: UNIGHOH. Telex: 31341. Mng. Dir.: S.S. Goh; Gen. Mgr.: Peter S.C. Goh; Sales Mgr.: Colin Edmonds; Office Mgr.: Liao How Soon; Factory Mgr.: Robert Goh.
Chief product: Presses.
Brand name: Finebilt.

TAPE, BLANK LOADED & BULK RAW

Agia Carat, see East Asiatic.
 Agia Stereochrom, see East Asiatic.
 Agia Videochrom, see East Asiatic.
 Ampex, see Eastland.
 Anca Musical Sdn. Bhd., 58 Jalan Midah 1, Taman Midah, Cheras, Kuala Lumpur. Tel: 612-031. Mng. Dir.: Wong Kim Leng.
 Audiopak, see Emitape.
 Capitolpak, see Emitape.
 East Asiatic Co. Ltd., PO Box 354, 84 Jalan Ampang, Kuala Lumpur. Tel: 25121. Telex: 246.
Audio: Blank—compact-cassette, open reel; raw—cassette, broadcast, studio.
Video: Cassette, open reel.
Brand names: Agia Carat, Agia Stereochrom, Agia Videochrom.
 Eastland Trading Co., 301 Jalan Pekeliling, Kuala Lumpur 17-01. Tel: 25-302. Cable: EASTLAND. Sales Mgr.: Wong Boon Sam. (Importer/Exporter)
Reg'l headquarters: Singapore.
Audio: Cassette, open reel.
Brand name: Ampex.
 Emitape (Malaysia) Sdn. Bhd., 1 Lorong Haji Taib Satu, Kuala Lumpur 02-07. Tel: (03) 924133, 924261, 924392. Cable: EMITRON. Telex: 30682. Mng. Dir.: M. Comerford, Gen. Mgr.: Jenny Thong. (Blank only)

MALAYSIA

Population: 12,264,345.
 Population by age groups: 0-14 (16%); 15-24 (22%); 25-49 (43%); 50+ (19%).
 Number of family units: 2,457,000.
 Weekly income per household: Under \$40 (8%), \$40-\$60 (21%); \$60-\$80 (11%); over \$80 (86.1%).
 Rate of exchange: \$1 (US) = 2.15 ringgits.
 Per capita income: \$786.
 Holidays: January 1, Chinese New Year (2 days), Prophet Muhammad's Birthday, Labor Day, Vesak Day (Buddhist festival), King's Birthday, National Day, Hari Raya Puasa (Walay Fasting festival) (2 days), Deepavali (Hindu festival), Awal Muharram (Malay religious holiday), Hari Raya Haji (Malay New Year), Christmas.

RECORDS

Record sales certification awards: Silver LP—15,000 units, Gold LP—25,000 units; platinum LP—50,000 units.
 Records sold domestically including imports: LP's 1979—2,100,000 units.
 Records imported from USA: 1979—130,000 units.
 Records imported from countries other than USA: 1979—6,235 units.
 Records exported to countries other than USA: 1979—1,430 units.
 Average retail price per record: Int'l LP's pressed locally—\$6.98.
 TV merchandising: 28% of total sales.
 Discounting: Frequent.

Type of distribution: The manufacturer-to-retailer distribution trend continues to be predominant although the manufacturer-to-wholesaler-to-retailer system has gained prominence and now controls 30% of total sales. Most of the privately owned retail outlets account for 85% of business while manufacturer-owned outlets control 9%, with the remainder going directly from the manufacturer to the consumer.

Type of promotion: Radio and television, which allocate 42% to MOR material, are the most important means. Newspaper and magazine reviews also rate highly although press advertisements, which have proved successful before, are rarely featured. Videotape screenings have declined in promotions, perhaps due to high import taxes. Live performances and concerts remain a major form of promotion.

Labels: 50.

TAPE

Pre-recorded tape sold domestically including imports: 8 tr. 1979—750,000 units. Cassette 1979—3,200,000 units.
Market: The most important note concerns the retail price reductions of both 8-tr. and cassette. Cassette equipment, which is largely available at all leading hi-fi stores, has seen its sales increase dramatically in the past year, mostly as a result of upgrading existing equipment. Also interesting to note is that the quality of cassettes is now below average, perhaps accounting for the reduction in prices.
 Average retail price per tape: 3 tr.—\$6.50, cassette—\$5.60

CONSUMER ELECTRONICS

Percentage of homes with: Radios (94%), AM only (73%), AM/FM (21%), television sets (86%), color (31%), b&w (55%), phonographs (66%), audio tape recorders (84%), video tape recorders (3%)

RADIO STATIONS

No. of government 1 (AM/FM).
Comment: Music accounts for about 70% of the airtime, news, sports commentaries, features and documentaries make up the remainder. FM, which is restricted to Kuala Lumpur & selected areas, is 100% music. Popular and MOR music predominates, of which 40% is local repertoire.

Audio: 8-tr., cassette.

Brand names: Audiopak, Capitolpak, Emtape.

Panda Inds. Sendirian Berhad, Kamunting Ind'l Estate, Taping, West Malaysia. Tel: (05) 822-246, 823-499. Cable: PANDATAPE. (Blank only) Int'l branch: USA. Spectrotape.

Audio: 8-tr. & cassette.

U N I Ent. Sdn. Bhd., 290 Jalan Raja Laut, Kuala Lumpur. Tel: (03) 922-971/115/291/088. Cable: UNIGDH. Telex: 31341. Mng. Dir.: S.S. Goh. Gen. Mgr.: Peter S.C. Goh. Sales Mgr.: Colin Edmonds. Dfice Mgr.: Liao How Soon, Factory Mgr.: Robert Goh.

Audio: 8-tr., cassette.

TAPE DUPLICATING & PROCESSING EQUIPMENT

Eastland Trading Co., 301 Jalan Pekeliling, Kuala Lumpur 17 01. Tel: 25-302. Cable: EASTLAND. Sales Mgr.: Wong Boon Sam. (Importer/Exporter)

Reg'l headquarters: Singapore.

Audio: Duplicators.

Brand names: Ampex, Pentagon.

U N I Ent. Sdn. Bhd., 290 Jalan Raja Laut, Kuala Lumpur. Tel: (03) 922-971/115/291/088. Cable: UNIGDH. Telex: 31341. Mng. Dir.: S.S. Goh. Gen. Mgr.: Peter S.C. Goh. Sales Mgr.: Colin Edmonds. Dfice Mgr.: Liao How Soon, Factory Mgr.: Robert Goh.

Audio: Duplicators, winders.

Brand name: Ed-Pic, King.

TAPE PACKAGING & LABELING EQUIPMENT

U N I Ent. Sdn. Bhd., 290 Jalan Raja Laut, Kuala Lumpur. Tel: (03) 922-971/115/291/088. Cable: UNIGDH. Telex: 31341. Mng. Dir.: S.S. Goh. Gen. Mgr.: Peter S.C. Goh. Sales Mgr.: Colin Edmonds. Dfice Mgr.: Liao How Soon, Factory Mgr.: Robert Goh.

• accessories manufacturers

Golden Voice Musical Inds. Sendirian Berhad, Tasek Ind'l Estate, Lot 11, Tasek Square, Ipoh, Perak. Tel: (05) 4-555.

Product: Carrying & storage cases.

Panda Inds. Sendirian Berhad, Kamunting Ind'l Estate, Taping, West Malaysia. Tel: (05) 822-246, 823-499. Cable: PANDATAPE.

Product: Tape-head cleaners.

U N I Ent. Sdn. Bhd., 290 Jalan Raja Laut, Kuala Lumpur. Tel: (03) 922-971/115/291/088. Cable: UNIGDH. Telex: 31341. Mng. Dir.: S.S. Goh. Gen. Mgr.: Peter S.C. Goh. Sales Mgr.: Colin Edmonds. Dfice Mgr.: Liao How Soon, Factory Mgr.: Robert Goh.

Product: Record-record care prods., Tape-carrying & storage cases, head cleaners, demagnetizers, leader & splicing tape.

• store fixtures manufacturers

Panda Inds. Sendirian Berhad, Kamunting Ind'l Estate, Taping, West Malaysia. Tel: (05) 822-246, 823-499. Cable: PANDATAPE.

Product: Tape display racks.

U N I Ent. Sdn. Bhd., 290 Jalan Raja Laut, Kuala Lumpur. Tel: (03) 922-971/115/291/088. Cable: UNIGDH. Telex: 31341. Mng. Dir.: S.S. Goh. Gen. Mgr.: Peter S.C. Goh. Sales Mgr.: Colin Edmonds. Dfice Mgr.: Liao How Soon, Factory Mgr.: Robert Goh.

Product: Tape display racks.

MEXICO

Population: 70,000,000

Rate of exchange: \$1 (US) = 22.65 pesos

Holidays: January 1, February 5 (Promulgation of the Constitution), March 21 (Birth of Benito Juarez), May 1 (Labor Day), May 5 (Cinco de Mayo), September 15 & 16 (Independence Day), October 12 (Columbus Day), November 20 (Anniversary of the Revolution), December 25.

RECORDS & TAPE:

Records & Pre-recorded tape sold domestically (retail value): 1979-\$275,000,000

RECORDS:

Records sold domestically including imports: LP's '979-30,000,000 units EP's 1979-9,016,800 units. Singles 1979-33,439,200 units

Average retail price per record: LP's-\$3.80-\$6.50. EP's-\$1.40-\$1.98. singles-\$1.55.

Type of distribution: Manufacturer-to-retailer system predominates

Type of promotion: Radio & tv concerts are the most important.

Jobs: 27,000.

TAPE:

Pre-recorded tape sold domestically including imports: 8-tr 1979-1,080,000 units. Cassette 1979-5,700,000 units

Average retail price per tape: 8-tr-\$4.70; cassette-\$5.00-\$12.70.

TELEVISION STATIONS:

No. of channels 25, 100% in color

Marv Fisher

• record & tape manufacturers / distributors / importers

A C (Discos) (Central de Grabaciones), Mayorazgo E3, Col. General Anaya, Mexico, 13. D.F. Tel: (905) 534-3370. Dir. Gen. Carlos Gomez Barrera. Gen. Mgr.: Jose Antonio Zavala, Sales Mgr.: Rolando Islas, Admin. Dir.: Horacio Calderon.

Labels: (Owned) Clasica, Especial, Kabah, Palenque, Tulum.

A M S Recs. SA (Fabrica de Discos), Jerico 64, Mexico. D.F. Tel: (905) 760-3441.

Acapulco, see Musart.

Accion, see Coro.

Allergia SA (Discos), Xochicalco 242-2, Mexico 12. D.F. Tel: (905) 543-2470. Int'l rep.: USA (Fama).

America (Producciones de Discos) SA, Av. Chapultepec 57, 2nd fl., Mexico 7. D.F. Tel: (905) 578-8018. Pres. Alejandro Quintero Ramirez, Gen. Mgr. Javier T. Salas Pares.

Labels: America, Telediscos

Int'l reps.: El Salvador (Dicesa), USA (America Profono), Venezuela (Sonografica).

Angel, see EMI-Capitol.

Archiv, see PolyGram

Arcoiris Musical, see Centro Musical de Tijuana

Ariel, see Mexicanos

Ariola America, see Bertelsmann

Ariola World, see Bertelsmann

Arista, see Bertelsmann

Avon, see Coro

Beitar, see PolyGram

Bertelsmann de Mexico SA (IFPI), Ave. de las Fuentes 41-A, 4th fl., Tecama-chalco, Mexico 10, D.F. Tel: (905) 589-8400. Cable: ARIME. Telex: 1777674. Mng. Dir. Fernando Hernandez R., Gen. Mgr. Hector Mendoza Labels: (Owned) Ariola America, Ariola World, Arista, (licensed foreign)

Bronze (UK), Hansa (Germany), Island (UK), MCA (USA), Microfon (Argentina), Sire (USA), Sonolux (Colombia), Tomato (USA), Virgin (UK).

Int'l reps.: Bolivia (Lauro), Chile (Quatro), Colombia (Sonolux), Dominican Republic (Discomundo), Ecuador (Fadisa), Guatemala (Dideca), Panama (Sonomundi), Peru (FTA), Venezuela (Cordica), USA (Caytronics).

Brisa, see Helix

C B S/Columbia Int'l SA, Av. 16 de Septiembre 784, Naucalpan. Tel: (905) 576-0333. Cable: COLRECORD. Pres. Jose Manuel Villarreal P., VP & Gen. Mgr. Armando de Llano Arana; Comm'l Dir. Raul Bejarano Teja.

Mktg. Dir. Antonio Flores Herrera; A&R Dir. Javier Martinez Martinez.

Labels: (Owned) CBS, Epic, Harmony, Dkeh, Sultana, (licensed foreign) A&M, Bang, Buena Vista, Calla, Caribou, GDE, GTD, Jet, Kirsner, Nemperor, Philadelphia Int'l, Postart, TK, T-Neck, Tabu, Tappan Zee. Unlimited Gold, (all USA)

Int'l reps.: Worldwide (CBS Int'l) except USA (Caytronics)

Camden, see RCA

Capitol, see EMI-Capitol

Cara, see Grever

Casablanca, see PolyGram

Cash, see Grever

Centro Musical de Tijuana SA, PD Box 292, San Ysidro, Calif. 92073. USA. 917 Constitution Ave., Tijuana, B.C. Tel: (903) 385-1322. Pres. Luis B. Alonso, VP Tessa Alonso, Sales Mgr. Manuel Magdaleno C.

Labels: (Owned) Arcoiris Musical, Rainbow Music; (distributed) Alhambra, Arcano, Arriba, Ariola, CBS, Capitol, Caytronics, Coco, Columbia, Fama, Fania Int'l, Fiesta, Fuentes, Gala, Gamma, Hispavox, Latin Int'l, Melody, Miami, Montilla, Musart, Nova Vox, Peerless, Polydor, Pronto, Raff, RCA, Safari, Sonido Int'l, Super Sonido

Int'l rep.: USA (Fresta)

Ciro, see Coro

Cisne Raff SA (Discos) (IFPI), Calle Carraces 64, Mexico 19, D.F. Tel: (905) 563-2800. Pres. Raul Fichas, Gen. Mgr. Ramon Martinez Duran, Comm'l Mgr. Ignacio Aguilar de la Torre. Promo & Pub. Francisco Jimenez.

Int'l branch: USA. Raff Recs

Labels: (Owned) Cisne, Diablo, Gaviota, Hot Rock, Raff, (licensed foreign) Dark (Venezuela), Disc Jockey (Argentina), Hurricane (USA), Mex Melody (USA), Moveplay (Spain), Nippon Columbia (Japan), Norteno (USA), Playboy (USA), Ric (USA), SISA (Nicaragua)

Int'l rep.: Nicaragua (SISA) (SEE ADVERTISEMENT)

Cladripo SA (Discos), Miraflores 823, Mexico 13. D.F. Clasica, see AC.

Clave, see Gamma

Colibri, see Sonomedios

Corito, see Coro

Coro SA (IFPI), Bahía de Perula 80, Mexico 10, D.F. Tel: (905) 531-2900. Pres. & Gen. Mgr. Federico E. Rojas, Gen. Mgr. Gloria Escobar.

Labels: (Owned) Accion, Avon, Corito, Coro, Coro, Lyra, Musik, Redova Int'l reps.: Argentina (American Rec'g), Colombia (Fuentes), Guatemala (Fonica), USA (Safari), Venezuela (Discorona).

Cronos SA (Discos), Av. Obregon 1824, Guadaluajara, Jal. Tel: (9136) 18-63-84.

D C M, see Discos & Cintas Melody

D E L A (Director de la Coordinación & Explotación de artista & repertorio para Latinoamérica), M.A. de Quevedo 531, Mexico 21, D.F. Tel: (905) 554-2712/1422. Cable: GRAMMAPHDN. Telex: (017) 74520, 71227. Dir. Alejandro Parodi, Latin America Dir.-Delegate. Andre Toffel. (Liaison office for Polydor & Phonogram group of companies in Latin America)

D G, see PolyGram

Diablo, see Cisne

Diana, see Gamma

Dimsa, see Mexicanos

Discobolo, see Discos & Cintas Melody

Disco Hit, see Hit

Discos & Cintas Melody SA (IFPI), Lago Chalco 122, Mexico 17, D.F. Tel: (905) 250-1499. Cable: MELMEX. Pres. Jose Ignacio Morales Perea, Exec. VP Sergio Blanchet, Gen. Mgr. Victor Marquez Mar., Int'l Herbe Pompeyo

Labels: (Owned) DCM, Discobolo, Melody, (licensed) Big Mouth (Switzerland), Fenix (Ecuador), Moveplay (Spain), Nova Vox (USA), Vanguard (USA)

Int'l reps.: Central America (Dideca), Colombia (Codiscos), Spain (Moveplay), USA (Profono), Venezuela (La Discoteca) (SEE AD)

E M I-Capitol de Mexico SA de CV (IFPI), Rio Balsas 49, Mexico 5, D.F. Tel: (905) 525-1700. Cable: CAPRECORDS. Telex: 01777406. Mng. Dir.: David Stockley, Gen. Mgr. Roberto Figueroa, Sales Mgr. Salvador Esparza.

Labels: (Owned) Angel, Capitol, EMI, EMI America, Liberty, Odeon, Seraphim

Int'l reps.: Worldwide (EMI group) excluding Bolivia (Dueni), Central America (Dideca), Colombia (CBS), Ecuador (IFESA), Peru (IEMPSA), USA (Alhambra), Venezuela (Los Ruices)

Eco, see Peerless

El Dorado, see Producciones Musicales

Epic, see CBS/Columbia

Especial, see AC

F A (Discos), Revillagigedo 96-405, Mexico 1. D.F. Tel: (905) 510-2595. Fenix, see Peerless.

Fiel, see Industria Disquera Mexicana

Fiesta (Discos), Av. Antonio de Mendoza 1099, Mexicali, B.C. Tel: (903) 8-13-88

Int'l rep.: USA (Fogata)

Flama, see Gas

Fonomez SA, Apdo M-9496, Mexico 13, D.F. Tel: (905) 539-0961, 532-2083. Cable: FDNMEX. Dir. Miguel Moreno Franco, Gen. Mgr. Carlos Emoreno Aguilar, Sales Mgr. Esteban Alarcón

Labels: (Owned) Fonomez, Galaxia, Ja-Ja, Karma, Sideral, Stereo Star, (licensed) Orbita (Colombia)

Int'l reps.: Costa Rica, El Salvador, Guatemala, Honduras, Nicaragua, Panama (all Lyra), Venezuela (Suramericana)

Fontana, see PolyGram

Galaxia, see Fonomez

Gamma SA (IFPI), Apdo 7762, Zone 1, Emerson 304, 1st fl., Mexico 5, D.F. Tel: (905) 545-6735. Cable: GAMMADISC. Telex: 1772424. Pres. Jose M.

Vidal Zapater; Mng. Dir. Luis M. Moyano, Sales Mgr. Fidel Barquet.

Labels: (Owned) Clave, Diana, Gamma, Golondrina, (represented) ATC (Argentina), Amadeo (Austria), Arnon (France), BWD (UK), Bearsville (USA), Butterfly (USA), BTI (USA), Century (USA), Chiswick (UK), Copacabana (Brazil), Delphine (France), Dideca (Guatemala), Discomoda (Venezuela), Erato (France), Everest (USA), Fama (USA), Fantasy (USA), Fonit-Cetra (Italy), Hallmark (UK), Harmonia Mundi (France), Hispavox (Spain), Hungaroton (Hungary), IFESA (Ecuador), JDC (USA), Mastro-piero (Argentina), Original Sound (USA), Orlandi Bru (USA), PRT (UK), Pausa (USA), Promus (Venezuela), RKM (Belgium), Rascal (UK), Scotti Bros. (USA), Supraphon (Czechoslovakia), Symphony Tone (Austria), Trova (Argentina), Eds. 23 (France), West End (USA), West Side (USA)

Int'l reps.: Argentina (Microfon), Australia (Festival), Bolivia (Lauro), Brazil (Gravacos Elétricas), Central America (Dideca), Chile (Quatro), Colombia (Codiscos), Ecuador (IFESA), Peru (El Virrey), Spain (Hispa vox), USA (West Side), Uruguay (Palacio de la Musica). (SEE AD)

Gas-Norteno, see Gas

Gas SA (Discos), Av. de los 100 Metros 1201, Mexico, D.F. Tel: (905) 754-3403. Pres. Guillermo Acosta, VP Jesus Acosta, Promo & Pub. Laura Acosta

Int'l branch: USA

Labels: (Owned) Flama, Gas, Gas-Norteno, Inter-Gas, (licensed domestic) Audiolon, (licensed foreign) Beverly (Spain), Dicesa (El Salvador), Famoso (Ecuador), Gema (USA), Infopesa (Peru), Mundo (Dominican Republic), Dibe (Colombia), TK (Argentina), Velvet (Venezuela)

Int'l reps.: BRAZIL (Chantecler, Fermata), Peru (Infopesa), Venezuela (Velvet) (SEE ADVERTISEMENT)

Gaviota, see Cisne

Gemins, see Guitarra.

Golden, see Juventa

Golondrina, see Gamma

Gomez Dist., Apdo. 1395, Mexico 1, D.F. Contract Jorge Gomez

Label: (Represented) Stinson (USA)

Grabaciones Mexicanas SA, Veterinarios 16, Mexico 8, D.F. Tel: (905) 582-9362.

Label: (Owned) Grabamex.

Grabamex, see Grabaciones Mexicanas

Grever Prod'n SA, Yaupeque 107, Mexico 11, D.F. Tel: (905) 286-0599. Cable: GREVERINT. Pres. Charles Grever, Gen. Mgr. Angel Hernandez

Home office: USA, A-Side Dist'g

Labels: (Owned) Cara, Cash, Lado-A.

Guitarra SA (Discos), Nilo 50, Mexico 16, D.F. Tel: (905) 527-9163. Dir. & Gen. Mgr. Luis Alberto San Martín, Sales Mgr. Carlos Leví.

Labels: (Owned) Guitarra, Mediterraneo, Nevada, (licensed domestic) Gemins, (licensed foreign) Ansonia (USA), Barnaby (USA), Dial (Spain), Everest (USA), Musidisc (Brazil), Parnaso (Argentina), Project 3 (USA), Sonet (Sweden)

Int'l reps.: Argentina (Parnaso), Guatemala (Dideca), Spain (Dial), USA (Godel), Venezuela (Duplica)

Harmony, see CBS/Columbia

Heliodor, see PolyGram

Helix (Discos), Divlar 29, Mexico 19, D.F. Tel: (905) 563-0100. Dir. Gen. Carlos Camacho, Artist Director Mgr. Armando Martinez; Promo Mgr. Hector Menia; Sales Mgr. Alberto Yanez; Admin. Mgr. Amado Fournier.

Labels: Brisa, Helix, Impacto, Sasiam (SEE ADVERTISEMENT)

Hit (Discos) SA, Luz Savinon 1707, Colonia Navarre, Mexico 13, D.F. Tel: (905) 590-2889. Pres. Marco Antonio Lugo, Gen. Mgr. Sergio Rodriguez; Sales Mgr. Antonio Barcenas

Labels: (Owned) Disco Hit, Hit, Super Hit, (licensed foreign) Teca (USA)

Int'l reps.: Colombia (Industria Nacional del Sonido), Venezuela (Corpodisco), USA (TH)

Hot Rock, see Cisne

Impacto, see Helix

Industria Disquera Mexicana SA, C Central Sur 385, Mexico 15, D.F. Tel: (905) 355-0570

Labels: Fiel, Tono

Inter-Gas, see Gas

Ja Ja, see Fonomez

Juventa (Ed. Musical), Tonalá 194-G, Mexico 7, D.F. Tel: (905) 574-1278. Pres. & Gen. Mgr.: Rosamaria Gonzalez Romero, VP Jorge Batalla Salgado, A&R Rafael de Paz Gonzalez.

Labels: (Owned) Golden, Juventa, (represented) Armez (USA)

Kabah, see AC

Karma, see Fonomez

Karusell, see PolyGram

Lado-A, see Grever

Laurel (Ed.), see Peerless

Libelula, see Sonomedios

Liberty, see EMI-Capitol

Lubata (Producciones) SA, Cuesta 12, Pedregal-Diente, Mexico 20, D.F. Label: (Represented) Delos (USA).

Lyra, see Coro

M G M, see PolyGram

Magneto, see Sonomedios

Malibu (Discos), Palma Nte. 315-115, Mexico 1, D.F. Tel: (905) 512-4202.

Labels: (Owned) Malibu, Serape.

Maya, see Mexicanos

Mediterraneo, see Guitarra

Melody, see Discos & Cintas Melody

Mercury, see PolyGram

Mexicanos (Discos) SA/Drleon Videovox SA (IFPI), Alce Blanco 26, San Bartolo, Naucalpan. Tel: (905) 576-8300/1500. Pres. Rogelio Aczarraga.

Int'l branch: USA, Drleon

Labels: (Owned) Ariel, Dimsa, Maya, Drleon, Premier, Studio, (represented) Carrere (France), Dalida (France), Fonografica Espanola (Spain), International Shows (France), Music Hall (Argentina), Pye (UK), Sabu (Argentina), Sonolux (Colombia)

Int'l reps.: Argentina (Music Hall), Central America (Indica), Colombia (Sonolux), Japan (Techiku), Peru (El Virrey), Spain (Moveplay), Venezuela (Dark).

Musart SA (Discos) (IFPI), Av. Cutlahuac 2335, Mexico 16, D.F. Tel: (905) 527-0100, 399-6600. Pres. Eduardo L. Baptista, Gen. Mgr.: Eduardo A. Baptista, Sales Mgr. Francisco Llopis; Int'l Mgr. Andres Baptista

Labels: (Owned) Acapulco, Musart, Norteno, Dasis, Trebol, (licensed) Alshre Int'l (USA), Audio-Musik (Germany), Baby (Italy), Barclay (France), Belfer (Spain), Biram (Belgium), Boona (France), Bowema Negram (Netherlands), Brasilia (USA), CNR (Netherlands), CR (USA), Buddha (USA), Can't Stop (USA), Canta Brna (Germany), Codiscos (Colombia), Columbia (Spain), Countdown (Germany), Creole (UK), Crescendo (USA), DLI (USA), Dila (Guatemala), Durum (Italy), Egrem (Cuba), Elver (Belgium), Gapoca (USA), Golden Sands (USA), Goodmusic (Italy), Jupier (Germany), La Discoteca (Venezuela), Logo (UK), Luna (USA), Marouani

IN MEXICO

Discos musart



**FOR LICENSING AGREEMENTS IN MASTERS
OF YOUR PRODUCT OR OUR CATALOGUE
CONTACT: Mr. ANDRES BAPTISTA, VICE-PRESIDENT**

DISCOS MUSART, S. A. de C. V.
APDO. POSTAL 17503 MEXICO 17, D. F. MEXICO
TELS: (905) 3-99-66-00 - 5-27-01-00
TELEX: 17-71493, MEXICO CITY

**The reliability of close to half a century in the business
and the competitiveness of the 80's**

come together in

Discos Peerless

Contact us and find out for yourself

Fábrica de Discos Peerless, S. A.

LAGUNA DE MAYRAN 232 MEXICO 17, D. F. TELS. 531-33-20 con 10 Líneas
Cable: Peerless Telex: 1777606



DISCOS CISNE RAFF

SOUND OF THE 80's

with a catalog including:
**NAPOLEON, GUALBERTO CASTRO,
 EDUARDO NUÑEZ,
 ALONDRA, PAULINA
 GUIU, THREE SOULS IN MY
 MIND, OLINSSER, LOS
 PALADINES, MASSIAS, Y LOS
 SUPREMOS & MENUDO**

Our doors are open for the entire
 world and available for negotiations
 with other countries . . .

DISCOS CISNE RAFF
 CARRACCI 64 MEX.19, D.F.
 TEL: 563 2800



(France). Splash (UK), Sugar Hill (USA), Symphony Tone (Switzerland). This Record Co (UK), Vogue (France), Zahro (Spain), Zagora (France).
(distributed—not licensed) DLV
 Int'l reps.: Argentina (Sicamer cana), Belgium (Vogue), Bolivia (Disco landia Dueri), Chile (EMI), Colombia (Códicos, Discomoda), Dominican Republic (Distribuidora Dominicana), Ecuador (IFESA), France (Vogue), Guatemala (Dila), Luxembourg (Vogue), Netherlands (Vogue), Peru (IMPESA), Spain (Zahro), USA (Musical Recs Dist of America), Venezuela (La Discoteca) (SEE ADVERTISEMENT)
 Musik, see Coro
 Nevada, see Guitarra
 Norteno, see Musart
 Dasis, see Musart
 Odeon, see EMI-Capitol
 Dkeh, see CBS/Columbia
 Omega, see Son*Art
 Orfeon, see Mexicanos
 Palenque, see AC
 Peerless SA (Fabrica de Discos) (IFPI), Laguna de Mayran 232, Mexico 17, D.F. Tel (905) 531 3320, 545 7215 Cable PEERLESS, Telex (017) 77606. Exec Pres Heinz Kinckwort, Gen. Dir Peter Ulrich, Gen Mgr Juergen Ulrich, Comm'l Mgr Reinhard Kruuska, Int'l Mgr Frank J P. Se-gura
Labels: (Owned) Eco, Fenix, Laurel (Ed.), Peerless, (licensed) Alhambra (USA), Armada & Fernandez (USA), Baby (Italy), CCI Prods (USA), Car rere (France), Cyclade (France), Decca (UK), Delmar (USA), Del Valle (USA), Exaaact (France), Fadisa (Ecuador), Feraud Guzman (Ecuador), Fonor (Belgium), Freedom Sound (USA), Fuentes (Colombia), Goody (Italy), Ibach (France), Indica (Costa Rica), Industrial Sono-Radio (Peru), London (Canada, USA), Magnet (UK), Microton (Argentina), Moss Music Group (USA), Onix (Ecuador), Palacio (Venezuela), Prism (USA), R&N (USA), Richmond (UK), SMI (USA), Seeco (USA), Som (Brazil), Sonet (Sweden), Teldec (Germany), Toledo (Germany), Traverse (Germany), Velvet (Venezuela), El Virrey (Peru), WMDT (USA), Zagora (France)
 Int'l reps.: Argentina (Microton), Bolivia (Lauro), Chile (Philips), Co lombia (Fuentes), Costa Rica (Indica), Ecuador (Fadisa), Peru (El Virrey), USA (Sunshine) Venezuela (Palacio de la Musica). (SEE ADVERTISE- MENT)
 Philips, see PolyGram
 Polydor, see PolyGram
 PolyGram SA de CV, Apdo 21-069, Av Miguel Angel de Quevedo 531, Mex- ico 21, D.F. Tel (905) 554 1422 Cable GRAMMOPHON Telex (017) 74520 Mng Dir Alejandro Parodi, Comm'l Mgr Luis Noriega, Promo & Pub Herbe Pompeyo
Home office: Germany
 Labels: (Owned) Archiv, Belart, Casablanca, DG, Fontana, Melodior, Ka russell, MGM, Mercury, Philips, Polydor, Spectrum, Vertigo, Verve, (rep- resented) Egre (Cuba)
 Int'l reps.: Chile (Philips), Colombia (Philips), Ecuador (Fediscos), Guatemala (Dideca), USA (Velvet). Worldwide (PolyGram group) (SEE ADVERTISEMENT)
 Premier, see Mexicanos
 Producciones Musicales SA, Xochicatco Nte 38 1, Mexico 12, D.F. Tel (905) 530-6595
 Label: El Dorado
 Promart SA, Angel Urraza 428 3, Mexico 12, D.F. Tel (905) 559 7524
 Promofon (Promotora Fonografica), Calle Sahuayo 82, Mexico 2, D.F. Tel (905) 529-3582. Owner Gabriel Gonzalez de la O, Gen Mgr O Guiller mina Lozano
 R C A SA de CV, Av de Cuauhahuac 2519, Col Xochimanca, Mexico 16, D F Tel (905) 527 6020 Pres & Dir: Gen Louis Couttoulenc, VP & Gen Mgr Guillermo Infante; Sales Mgr Jose Martin del Campo, Artistic & Creative Mgr Renato Lopez M., Promo & Pub Mgr. Kuku Estevez
Labels: (Owned) Camden, RCA, (represented) Hansa (Germany), Mel low (Germany), Millennium (USA), Polar (Sweden), Roadshow (USA), Salsoul (USA), Talpro (USA), Windsong (USA)
 Int'l reps.: Bolivia (Prodisco), Chile (IRI), Colombia (Sonolux), Costa Rica (Dicesa), Dominican Republic (Caribe), Ecuador (Fadisa), El Salva dor (Dicesa), Guatemala (Dicesa), Honduras (Dicesa), Panama (Dicesa), Peru (Fabricantes Tecnicos Asociados), Trinidad (International Rec'g), Uruguay (American Prods), Venezuela (Cordica) (SEE ADVERTISEMENT)
 Raff, see Cisne
 Rainbow Music, see Centro Musical de Tijuana
 Redova, see Coro
 Regis, see Son*Art
 Rex (Discos), Norte 75, No 2537, Mexico 16, D.F. Tel (905) 399 2779 Pres & Gen Mgr Jorge Acosta
 Sasiari SA (Discos), Segovia 40, Col Alamos, Mexico 13, D.F. Tel (905) 530 5612, 538 4596
 Serape, see Malibu
 Seraphim, see EMI-Capitol
 Sideral, see Fonomex
 Son*Art SA (Discos), Lago Hielmar 26, Mexico 17, D.F. Tel (905) 531 8100 Pres Teodoro Mantecon Olavarrieta; Comm'l Mgr Ber ardo Gonzalez Bernaldez
Labels: (Owned) Son*Art, Omega, Regis; (represented) Dinsa (Peru), Discophon (Spain), Flash (Spain), Fonica (Guatemala), Global (Argen- tina), Imperial (Venezuela), King (Japan), Kubaney (USA), Maiveta (Ar gentina), Tal (Colombia), Vega (France)
 Int'l reps.: Argentina (Global), Guatemala (Fono Industrial), Peru (DINSA), Spain (Flash)
 Sonomedios SA, Av Vallarta 2590, Guadalajara, Jal Tel (9136) 16 56 10 Gen. Dir Alejandro Diaz Romo, Gen Mgr Robert A Dubin West
Labels: (Owned) Colibri, Libelula, Magneto
 Spectrum, see PolyGram
 Stereo Star, see Fonomex
 Studio, see Mexicanos
 Sultana, see CBS/Columbia
 Super Hit, see Hit
 Telediscos, see America
 Tequila (Discos), Ignacio Esteva, Mexico 18, D.F. Tel (905) 515 3590/ 6484 Owner & Mgr Dario Zorzano
 Tono, see Industria Disquera Mexicana
 Trebol, see Musart
 Tulum, see AC
 Vertigo, see PolyGram
 Verve, see PolyGram
 W E A (Producciones) SA de CV, Acapulco 3/, Mexico 7, D.F. Tel (905) 553 6688 Telex 1777204 Answerback WARN ME Mng Dir Rene Leon
 Zodiac SA (Discos), JJ Herrera 98, Mexico 14, D.F. Tel (905) 577-8179 Zorba Discos, Hamburgo 113, Mexico 6, D.F. Tel (905) 533 5412 (SEE AD- VERTISEMENT)
• music publishers
 A V H Musical, see Alfa

Acuariana, see Intersong
 Adriana (Ed.), see Intersong
 Alfa Mus c, Playa Tecoluitla 452, Col Marte, Mexico 13, D.F. Tel (905) 579 7830/1211 Gen Mgr Tere Beltran, Prof Mgr Magdalena Diva
 Alma Musical, see Intersong
 America Musical SA, Av Chapultepec 57, 2nd fl, Mexico 7, D.F. Tel (905) 578 8049, Pres Alejandro Quintero Ramirez, Gen Mgr Javier T Salas Pares
 Amor (Eds), see Intersong
 Arabella Mexico SA, Fuente de Troncos 24, Tecamachalco, Mexico 10, D.F. Tel (905) 589-6867 Cable ARIME Telex 1777674 Gen Mgr Fer nando Hernandez, Admin Co-ord. Ismael Zavaleta
 Int'l firms represented: Arabella (worldwide), Bel Canto (Germany), Bron (UK), Copyright Serv Bureau (USA), Grand Artist (USA), Hit (Spain), Tom Parker (UK)
 Arsa (Ed.), see Intersong
 Azul & Oro, see Alfa
 Barra Musical, see Intersong
 Beechwood de Mexico SA de CV (SACM), Rio Danubio 46, Mexico 5, D.F. Tel (905) 511-3742 Cable BEECHMEX Telex 01777406 EMI Music Publ'g Latin America Gen Mgr & Supervisor Arg Jose G Cruz Ayala
Int'l firms represented: ATV (UK, USA), Arista (USA), Baboo (France), Big Pig (UK), Black Bull (USA), Bug (USA), Capitol (USA), Chicago (USA), Continental (Peru), Bob Dylan (USA), EMI group (worldwide), Eaton (UK), Eighties (France), Far Out (USA), John Farrar (USA), Flavius (USA), France Étoile (France), Al Gallico (USA), Gates (USA), Goodman group (USA), Heath Levy (UK), Intro/Hansa/Mesel (Germany), Jobete (USA), Kamakazi (USA), Kipahulu (USA), Kiss (USA), Lennon (UK), Lollipop/ Lambda (Germany), Lupus (USA), MPL (UK), Macaulay (UK), Perren Vibes/Bull Pen (USA), Purple (UK, USA), Queen (UK), RAK/Chinnichap (UK), RFT (USA), Red Bus/Our Music (UK), Rolling Stones (UK), Rondor group (UK, USA), Screen Gems/ Colgems (USA), Joan Manuel Serrat (Spain), Superhype (USA), Tree Int'l (USA), Union Songs/Potar (Swe den), Warner Bros (USA)
 Int'l reps.: Colombia (Ecomus), Peru (Continental), worldwide (EMI group). (SEE ADVERTISEMENT)
 Blanco Musical, see Intersong
 Botero Musimax (EMMAC, SACM), see Mexicana de Musica
 Boni Collazo Eds Musicales, Apdo. 9982, Administracion de Correos 1, Mex- ico 1, D.F.
 Brambila Musical Mexico SA, Av Cuauhahuac 2305, Mexico 17, D.F. Tel (905) 527 8383 Cable MUSBRAM Gen Mgr Rogelio Brambila Pelayo, 2nd VP J Eleanor Alexander, Ass't Mgr Josefina Rodriguez, Act'g Dept Edmundo Sanchez
Int'l firms represented: ANSA (Argentina), Bourne (USA), Campbell Con nelly (UK), Casa Latina (USA), Conedisa (Peru), Criterion (USA), Ecomus (Colombia), Robert Kingston (UK), MRT (USA), Mendaur (Spain), Nor- teno (USA)
 Int'l reps.: Argentina (MAI), Chile (Sochem), Colombia (Ecomus), Ecua dor (SADRAM), Peru (Conedisa), Spain (Mendaur), UK (Robert King ston), USA (Songs of Mexico), Venezuela (Alfonso Sanchez Lopez)
 Buendia Musical, see Intersong
 Cadena Musical, see Intersong
 Campe (EMMAC, SACM), see Mexicana de Musica
 Capricornio (Ed.), see Intersong
 Cetuma (EMMAC, SACM), see Mexicana de Musica

DEAR PUBLISHER:

WE ARE EAGER
 TO PUBLISH
 YOUR MUSIC
 IN MEXICO !

WE ARE EFFICIENT

CONTACT US
 RIGHT AWAY



EDITORA MUSICAL MUSART, S. A. DE C. V.
 AV. CUAUHUAHUAC 2327 MEXICO 16, D. F. MEXICO. CABLE MUSART
 TEL. 3-99-38-33. TELEX: 17-71493 APOD. POSTAL 17503 MEXICO, D.F.

Compositor de Cuba (Ed.), Regina 43, Rm 201 Mexico 1 D F Tel (905) 585 3163
 Coro SA (Ed.), Bahía de Perula 80, Mexico 10 D F Tel (905) 531 2900
 Our Federico E Rojas
 J Cory de Mexico, see Intersong
 Oe La Colina Musical, see Intersong
 Demetrio (Ed Mus) SA, see Intersong
 Oo Mi Sol (Ed.), see Intersong
 E M H A, see Intersong
 E M L A S A (Ed Musical Latino Americana SA), Guillermo Prieto 76, Mexico 4, O F Tel (905) 592 4966 Gen Mgr Mario de Jesus
Int'l firms represented: Acuff/Rcse (USA), Alvorada (Brazil) Apolo (Argentina), Arlequin (Brazil), Big Seven (USA), Big Three (USA) Brandom (USA), Champion (USA), Charing Cross (USA), Cherry Lane (USA), Claridge (USA), Combine (USA), Cream (USA) Curci (Italy) Duchess (USA), Leo Feist (USA), Glaser (USA), Hastings (USA), Hispavox (Spain), Interworld (USA), Irmaos Vitale (Brazil), Leeds (USA) MCA (USA), Metric (USA), Miller (USA), Morro (USA), Northern (USA), Orbe (Venezuela) Orbita (Argentina), Planetary Nom (USA), Ricordi (Italy) Robbins (USA) Shamley (USA), Shelter (USA) S-yhill (USA) Spanka (USA), Sugarmusic (Italy), Travis (USA), United Artists (USA), Valgroup (USA), Vogue (USA), Weik (USA) (SEE ADVERTISEMENT)
 E M M I (Ed Mexicana de Musica Int'l) SA Mariano Escobedo 166 1st & 2nd Hs, Mexico 17, D F Tel (905) 545 6940 Gen Mgr Ramon F Paz Prof Mgr Aurelio Estrada
Int'l firms represented: Alpha, Ardmore, Artists Audicon Broadcast, Camarillo, Cedarwood, Continental Curror Emily, Fox Gimbel General, Malaco Miyako, Peer Southern, Porgie, Romance & Ding Dong, Sheryln/Kumbel, Terrace, Vanlee, Virginia
 E M R I S A (Eds Musicales & Representaciones Int'l SA) Xochicalco 242 Mexico 12, D F Tel (905) 543 2470
Int'l rep: USA (LAFCAP)
 Edimusa (Editora Musical Musart SA), Av Cuitláhuac 2327 Mexico 16 D F Tel (905) 399 3833 Cable MUSART Dir Gen Eduardo A Baptista Lucio, Gen Mgr Alberto Vega Aranda
Int'l firms represented: Chrysalis (UK), Compass (UK) Discorama (Spain), Fermata (Brazil), Dick James group (UK), Ivan Mogull (USA) Morning (Canada), Notas Magicas (Spain) Prelude Trumar Phylmar (USA), Prodemus (Colombia), Stirling McQueen (UK)
Int'l reps: Argentina (Relay), Belgium (New Music), Brazil (RCA) Canada (Vander), Colombia (Prodemus), Spain (Discorama/Piramide) USA (Vander) Venezuela (Universal) (SEE ADVERTISEMENT)
 Ed Mexicana de Musica Int'l see EMMI
 Ed Musical Latino Americana SA, see EMLASA
 Emroth (EMMAC SACM), see Mexicana de Musica
 Estrada (Ed Mus), see Intersong
 Face (Promotora) (BMI), Revilgageddo 96 405, Mexico 1 O F Tel (905) 510 2595
 Feluchini Music, see Intersong
 Fresa Mexicana (Ed) see Intersong
 Fusa Eds, see Intersong
 Galaxia, see Intersong
 Gamma SA (Eds Musicales), Apdo 7762, Zone 1 Emerson 304 Mexico 5 D F Tel (905) 545 6735 Cab e GAMMADISC Tele 1772424 Exec Mgr Luis M Moyano Ass't Exec Mgr Hugo Navarro
Int'l firms represented: Ariston (Italy), CAM (Italy), C1 (USA) Callon

Love (USA), Delphine (France), Equinox (USA), Far Out (USA), Garrett (USA), Gesterite (USA), Hispavox (Spain) Intervox (Belgium), Jackson (USA) RKM (Belgium), Televs Gabric (Italy) Valentine (Belgium)
Int'l reps: Portugal & Spain (both Hispavox) (SEE ADVERTISEMENT)
 Gas Musical SA, see Intersong
 Geminis Musical SA, Schiller 228 1 Col Polanco, Mexico 5, O F Tel (905) 250 7228, 545 4784 Gen Dir Enrique Marquez
Int'l firm represented: Parnaso (Argentina)
 Golondrina (Ed.), see Intersong
 Grever Int'l SA, Yatepec 107 Col Condesa Mexico 11, O F Tel (905) 286 0599 Telex 1772093 Pres Charles Grever Gen Mgr Angel Hernan dez
Int'l firms represented: Handy Bros, T B Harms, MAM, Edward B Marks G Schirmer (all USA)
Int'l reps: Colombia (Exitos), Ecuador (SADRAM), Germany (Rudolf Stezak), Peru (SAORAM), Spain (Discorama), USA (Golden Sands Ents)
 Guadalajara Musical SA, Av Vallarta 2590, Guadalajara, Jal Tel (9136) 16 56 10 Pres Alejandro Diaz Romo, Gen Mgr Alfredo Romo Barron Guitarra (Eds Musicales), Nilo 50, Mexico 16, O F Tel (905) 527 9163 Dir Luis Alberto San Martin, Gen Mgr Enrique Marquez
 Huaxyacac (Eds), see Intersong
 I C (Ed.), see Intersong
 Iara (Ed) see Intersong
 Impulsora Musical Bajacaliforniana, Av Antonio De Mendoza 1099 Mexicali, B C Tel (903) 8 13 88
 Inca Musical, see Intersong
 Inter Mol (SACM), Luz Savinon 1707, Colonia Narvarte Mexico 13, O F Tel (905) 590 2889 Owner & Mgr Marco Antonio Lugo
 Intersong SA, Ejercito Nacional 209, 3rd fl, Col Veronica Anzures, Mexico 5, O F Tel (905) 531 7030 Gen Mgr Alfonso Garcia Santillana
Int'l firms represented: Artemis (Netherlands) Aurelius (USA), Burlington/Palace (UK), Chappell Int'l (UK), Egrem (Cuba), Intersong Int'l (Germany) Leftover (USA) Scully (USA), Solaris (USA), Up With People (USA), Williamson (USA)
Int'l rep: Worldwide (Intersong Int'l)
 Juventa (Ed Musical), Tonalá 194 G, Mexico 7, D F Tel (905) 574 1278 Pres & Gen Mgr Rosamaria Gonzalez Romero
Int'l firms represented: Canciones del Mundo (Spain), Korn (Argentina) Melodias (Ecuador), Nueva Ola (Panama), Rhyma (Colombia), Smart (Argentina), Susy (Italy) Tone (Japan), Unmusic (Japan)
Int'l reps: Argentina (Korn), Colombia (Rhyma), Japan (Tone) Spain (SGAE)
 Lagab (Eds Musicales) SA, see Intersong
 Latino Americana SA (Ed Musical) see EMLASA
 Luz y Sombra (EMMAC, SACM), see Mexicana de Musica
 M Musical (EMMAC, SACM), see Mexicana de Musica
 Mantram (Ed), see Intersong
 Manzamusic, see Intersong
 Mato (Ed Mus) see Intersong
 Mexicana de Musica SA de CV (Ed) (EMMAC, SACM), Poniente 44 No 3612, Col Xochimanca, Mexico 16, D F Tel (905) 399 9088 Cable MEXRCA Telex 00173867 Pres Louis Coustolenc Gen Mgr Juan del Rey y Lenero, Int'l Mgr Jorge Perez Flores
Int'l firms represented: Aliza Thorax, Antisya, Baby O, CAM, Cherry Lane Cherry Wood Clandalee Desert Moon Dizzy Heights, EMP, Green Mountain, Quincy Jones, Kidada, Ladysmith, Ledaclan, Metal Machine, Miami Trans, Michael's Music, Nick O Val, Oakheld, Saber Tooth, Salsoul, Scott Tone, Sondo Latino, State, Thomas Fundora, Triple O, White/Dwarf, Yellow Brick Road (all USA), Editio (Hungary), Plein Soleil (France), Polar (Sweden), Rocket (UK), Satril (UK), Street (UK), Union (Sweden)
Int'l reps: Argentina (Relay), Australia (Associated Music), Bolivia (Boliviana), Brazil (RCA), Canada (Sunbury/Dunbar), Ecuador (ORAMA), El Salvador (Edicesa), France (RCA), Germany (Cyclus) Italy (RCA), Japan (Global), Peru (Perumusic) Spain (RCA), UK (Sunbury), Venezuela (Unmusic)
 Musica de Mexico (BMI, SACM), Esteve 26A Mexico 18, O F Tel (905) 515 3590/6484 Pres & Gen Mgr Dario A Zorzano
Int'l reps: Germany (Melodie der Welt), Japan (Unmusic), Spain (SGAE)
 Musical del Bravo (Ed), Olumba 342 Col Mitras Centro Monterrey, N L Tel 48 00 38
 Musicales & Representaciones Int'l SA (Eds) see EMRISA
 Musicastil SA, Salvatierra 58, San Angel Inn, Mexico 20, D F Tel (905) 683 0288/0501 Gen Dir Lic Jorge Garcia Castil, Comm'l Dir Ron Kristy Prod'n Dir Jorge Dominguez
 Musinova SA (Ed), Calle Carracci 64 Mexico 19, D F Tel (905) 563 2800
Int'l firms represented: Bleu Blanc Rouge (France), Oundee (USA), Mangione (Brazil), Petko (USA), Striking (USA)
 Musitodo (Ed), see Intersong
 N P A (Nueva Promotora Artística) see Intersong
 Nayali Musical, see Intersong
 Orleon SA (Ed), Av Universidad 1273, Mexico 12, D F Tel (905) 534 6054/52
 P H A M (Promotora Hispano Americana de Musica) SA, Mariano Escobedo 166 2nd fl, Mexico 17, D F Tel (905) 545 6855, 531 3190 Cable PHAM Gen Mgr Ramon F Paz, Prof Mgr Aurelio Estrada
 P I M (Productores Independientes de Mexico) SA, Insurgentes Sur 1722 1002 Mexico 21, O F Tel (905) 534 4386 Chief Exec & Gen Mgr Alfredo Marcelo Gil
 Paulino Musical, see Intersong
 Piscis Musical, see Intersong
 Predisa, see Promociones & Ediciones
 Productores Independientes de Mexico, see PIM
 Promociones & Ediciones Int'l SA (Predisa), Mariano Escobedo 201 Mexico 17, D F Tel (905) 545 7215 Telex 01777606 Pres Heinz Klinck wort, Gen Mgr Peter Ulrich, Prof Mgr Jose Luis Vela
Int'l firms represented: Carrere (France), Earth (USA), Edimusic (Colombia), Montage (USA), R&N (USA), Rhyma (Colombia)
Int'l reps: Brazil (Euterpe), Colombia (Edimusic), Spain (Canciones del Mundo)
 Promotora Mexicana de Musica SA E Zapata 52, Mexico 13, D F Tel (905) 539 1514 Dir Carlos E Moreno, Gen Mgr Miguel Moreno Aguilar
 Promusica, see Intersong
 Rampel see Intersong
 Reyna Hnos., see Intersong
 Reyna Musical, see Intersong
 G Ricordi & Co Inc, Paseo de la Reforma 481 A Mexico 5, O F Tel (905) 553 7506/ 7451
 Rimo SA (Eds Musicales) Emerson 150, 4th fl, Mexico 5 O F Tel (905) 250 1196 Gen Mgr Humberto Rios
Int'l reps: Central America (Dimasa), Spain (Tracic), USA (Mexican Music Center)
 Roaga SA (Promociones & Eds), Revilgageddo 96 202, Mexico 1, O F Tel (905) 518 4311

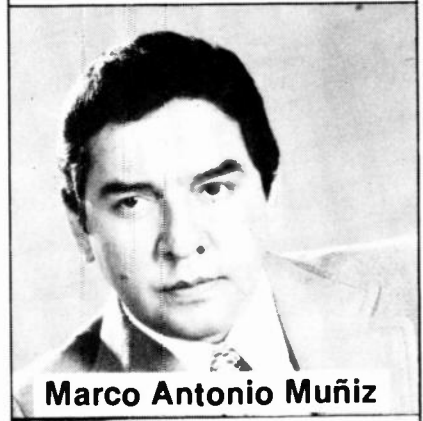

Marco Antonio Muñoz



Yolanda del Río

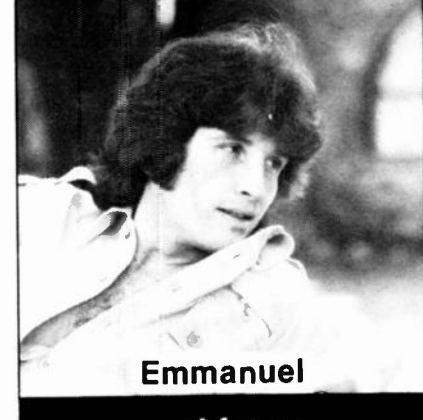

Emmanuel

en el futuro
RCA
 seguirá siendo la N° 1

RCA S.A. de C.V.
 Av. Cuitláhuac No. 2519
 México 16, D.F.

EMLASA

Editorial Musical Latino Americana, S. A.

Representing:

- Acuff-Rose Pub., Inc.
- Big Seven Music Corp.
- Charing Cross Music, Inc.
- Cherry Lane Music Co.
- Combine Music, Inc.
- Cream Music Publ.
- Duchess Music Co-p.
- Ediciones Curci
- G. Ricordi S.P.A.
- Hastings Music Corp.
- Interworld Music Group
- Irmaos Vitale, S.A.
- Leeds Music Corp.
- Leo Feist, Inc.
- MCA Music
- Miller Music Corp.
- Northern Music Corp.
- Planetary Music Co.
- Robbins Music Co.
- Shelter Publishing Group
- Spanka Music Corp.
- Sugar Music
- United Artists Music Co.
- Valentine Music Group
- The Weik Music Group
- ... and many more

MARIO DE JESUS, Gen. Mgr.
Guillermo Prieto 76
México 4, D.F.
Tel. 592-49-66

**DISCOS GAMMA
&
EDICIONES
MUSICALES
GAMMA**

"most experienced
company in promotion
and distribution of
international catalogs
in Mexico"

P.O. Box 7762
México 1, D.F.
PHONE: 545-67-35
CABLE: GAMMADISC
TELEX:
1772424 GAMMAME

DISCOSA MEXICANA S.A. DE C.V.

helix

Olivar 29 - Col. Alfonso XIII
Delegación Alvaro Obregón
01460 México, D.F.-México

Our Publisher:

**EDITEMAS****EDITORA TEMAS MUSICALES S.A.**

same address

BECAUSE IT'S **helix**

... IT'S HITTING

a member of Discosa Internacional

Ro Musical, see Intersong
Rumont Musical, see Intersong
Safari Musical, see Intersong
Sagitario Musical, see Intersong
Selene (Ed.), see Intersong
Sol Musical, see Intersong
Son*Art SA, Lago Hielmar 26, Mexico 17, D.F. Tel (905) 531-8101. Pres. Teodoro Mantecon Dlavarrleta. Comm'l Mgr. Bernardo Gonzalez Bernaldez
Temas Musicales SA, Segovia 40 Col Alamos, Mexico 13, D.F. Tel (905) 530-5612, 538-4596
Tierra Musical, see Intersong
Tijuana Rose, see Intersong
Tux Musical, see Intersong
Yolloxochitl (Ed. Mus.), see Intersong
Zarviv Music, see Intersong

• services**ASSOCIATIONS & PROFESSIONAL ORGANIZATIONS**

Amprofon (Asociación Mexicana de Productores de Fonogramas AC), Guana juato 65, Mexico 7, D.F. Tel (950) 574-7411.
Camara Nacional de la Industria de Radio & Television, Av. Horacio, No 1013, Col Polanco, Mexico 5, D.F. Tel (5) 250 2577, 545 6767. Cable. CAMINRA Pres Luis Ignacio Santibanez F. Gen. Mgr. Emilio Velasco Diaz, Information & Investigation Center Mgr. Maria Delia Garcia y Baragan

DESIGN & ARTWORK

C B S/Columbia Int'l SA, Av 16 de Septiembre 784, Naucalpan Tel (905) 576 0333 Pres. Jose Manuel Villareal P. VP & Gen. Dir. Armando de Llano Arana
Centro Musical de Tijuana SA, PD Box 292, San Ysidro, Calif. 90273, USA, 917 Constitucion Ave., Tijuana, B.C. Tel (706) 685-1322 Pres. Luis B. Alonso, VP. Tessa Alonso, Sales Mgr. Manuel Magdaleno C.
Coro SA, Bahía de Perula 80, Mexico 10, D.F. Tel (905) 531-2900 Pres & Gen. Mgr. Federico E. Rojas; Sales Mgr. Gloria Escobar
Fabricaciones Fonográficas SA, Nubia No 40, Isidro Fabela S/N Parque Ind Santiago Tanquistingo, Mexico 16, D.F. Gen. Mgr. Javier Franco
Laminados & Acabados Especiales SA, Divlar 27, Colonia Alfonso XIII, Mexico 19, D.F. Tel (905) 563-9625
Mexicanos SA (Discos)/Drfeon Videovox SA, Aice Blanco 26, San Bartolo, Naucalpan Tel (905) 576-1500
Musart SA (Discos), Av. Cuhtlahuac 2335, Mexico 16, D.F. Tel (905) 399-2332 Cable MUSART Pres. Eduardo L. Baptista, VP. Andres Baptista, Gen. Mgr. Eduardo A. Baptista, Sales Mgr. Francisco Llopis
Promofon SA (Promotora Fonográfica), Apdo. 110-034, Calle Sahuayo 82, Mexico 2, D.F. Tel (905) 529 3582 Dwner Gabriel Gonzalez de la D. Gen. Mgr. D. Guillermina Lozano
R C A SA de CV, Av. Cuhtlahuac 2519, Col. Xochimanca, Mexico 16, D.F. Tel (905) 527-6020
Sonomedios SA, Av. Vallarta 2590, Guadalajara, Jal. Tel. (9136) 16-56-10 (Record only)

LICENSING ORGANIZATIONS, MUSIC

E M M A C (Editores Mexicanos de Musica, Asociación Civil), Av. Juarez 18, Desp. 206, Mexico 1, D.F. Tel (905) 521 5855
Fonocentro/LAFCAP, Av. Cuhtlahuac 2305, Mexico 17, D.F. Tel (905) 527 8383 Mng. Dir. Rogelio Brambila, Ass't Licensing Mgr. Jose Antonio Llobet (Mechanical rights)
Home office: USA
S A C M (Sociedad de Autores & Compositores de Musica S de A), San Felipe 143, Colonia General Anaya, Mexico 13, D.F. Tel (905) 524 2104/ 2118 Cable. CDMPAS Pres. Consuelo Velazquez; Gen. Dir. Carlos Gomez Barera, Int'l Dept. Head Jose Luis Caballero (Performing rights)

LICENSORS, RECORD & TAPE

Centro Musical de Tijuana SA, PD Box 292, San Ysidro, Calif. 90273, USA, 917 Constitucion Ave., Tijuana, B.C. Tel (706) 685-1322 Pres. Luis B. Alonso, VP. Tessa Alonso, Sales Mgr. Manuel Magdaleno C.
Peerless SA (Fabrica de Discos), Laguna de Mayran 232, Mexico 17, D.F. Tel (905) 531-3320, 545-7215 Telex (017) 77606 Exec. Pres. Heinz Klinckwort, Gen. Dir. Peter Ulrich, Gen. Mgr. Juergen Ulrich, Comm'l Mgr. Reinhard Kruska, Int'l Mgr. Frank J.P. Segura

PLATING, PROCESSING & PRESSING PLANTS

C B S/Columbia Int'l SA, Av 16 de Septiembre 784, Naucalpan, Tel (905) 576 0333 Pres. Jose Manuel Villareal P., VP & Gen. Dir. Armando de Llano Arana
Centro Musical de Tijuana SA, PD Box 292, San Ysidro, Calif. 90273, USA, 917 Constitucion Ave., Tijuana, B.C. Tel (706) 685 1322. Pres.: Luis B. Alonso, VP. Tessa Alonso, Sales Mgr. Manuel Magdaleno C. (Pressing only)
Coro SA, Bahía de Perula 80, Mexico 10, D.F. Tel (905) 531 2900 Pres & Gen. Mgr. Federico E. Rojas; Sales Mgr. Gloria Escobar
E M I Capitol de Mexico SA de CV, Rio Balsas 49, Mexico 5, D.F. Tel (905) 525 1700 Cable CAPRECORDS Telex (017) 77406. Mng. Dir. David Stockley, Gen. Mgr. Roberto F. Figueroa
Fabricaciones Fonográficas SA, Nubia No 40, Isidro Fabela S/N Parque Ind Santiago Tanquistingo, Mexico 16, D.F. Gen. Mgr. Javier Franco (Pressing only)
Guitarra SA (Discos), Nilo 50, Mexico 16, D.F. Tel (905) 527-9163, Dir. Luis Alberto San Martin, Sales Mgr. Carlos Levi (Pressing only)
Helix (Discos & Cintas), Divlar 29, Mexico 19, D.F. Tel (905) 563 0110 Gen. Dir. Carmelo Flores; Promo & Pub. Andrea Cordova (Pressing only)
Laminados & Acabados Especiales SA, Divlar 27, Colonia Alfonso XIII, Mexico 19, D.F. Tel (905) 563 9625 Pres. Rafael Fichaci Gonzalez; Admin Mgr. Raul J Castro; Prod'n Mgr. Marco Antonio Renteria, Mgr. Raul J Castro, Sales Mgr. Alma Fichaci de Rivas
Matrices SA (Discos), Lago Chalco 122, Mexico 17, D.F. Tel (905) 250 1499 Cable MELMEX, Pres. Jose Ignacio Morales Perea, Gen. Mgr. Enrique de Noriega S
Mexicanos (Discos) SA/Drfeon Videovox SA, Aice Blanco 26, San Bartolo, Naucalpan Tel (905) 576 1500
Musart SA (Discos), Av. Cuhtlahuac 2335, Mexico 16, D.F. Tel (905) 399-2332 Pres. Eduardo L. Baptista, VP. Andres Baptista, Gen. Mgr. Eduardo A. Baptista, Sales Mgr. Francisco Llopis (Plating & processing only)
Peerless SA (Fabrica de Discos), Laguna de Mayran 232, Mexico 17, D.F. Tel (905) 531-3320, 545-7215 Telex (017) 77606 Exec. Pres. Heinz Klinckwort, Gen. Dir. Peter Ulrich, Gen. Mgr. Juergen Ulrich, Comm'l Mgr. Reinhard Kruska, Int'l Mgr. Frank J.P. Segura. (SEE ADVERTISEMENT)
Promofon SA (Promotora Fonográfica), Apdo. 110-034, Calle Sahuayo 82, Mexico 2, D.F. Tel (905) 529 3582 Dwner Gabriel Gonzalez de la D.

Gen. Mgr. D. Guillermina Lozano. (Pressing only)
R C A SA de CV, Av. Cuhtlahuac 2519, Col. Xochimanca, Mexico 16, D.F. Tel (905) 527-6020. Pres & Dir. Gen. Luis Coutourenc; Sales Mgr.: Jose Martin del Campo, Promo. & Pub. Mgr. Kuku Estevez.

PRINTERS & LITHOGRAPHERS

C B S/Columbia Int'l SA, Av 16 de Septiembre 784, Naucalpan, Tel (905) 576-0333 Pres.: Jose Manuel Villareal P. VP & Gen. Dir., Armando de Llano Arana
Coro SA, Bahía de Perula 80, Mexico 10, D.F. Tel (905) 531-2900 Pres. & Gen. Mgr. Federico E. Rojas, Sales Mgr. Gloria Escobar
Fabricaciones Fonográficas SA, Nubia No 40, Isidro Fabela S/N Parque Ind Santiago Tanquistingo, Mexico 16, D.F. Gen. Mgr. Javier Franco
Guitarra SA (Discos), Nilo 50, Mexico 16, D.F. Tel (905) 527-9163, Dir. Luis Alberto San Martin, Sales Mgr. Carlos Levi
I M E SA, Sanctorum 86, Mexico 17, D.F. Tel (905) 563-9625
Laminados & Acabados Especiales SA, Divlar 27, Colonia Alfonso XIII, Mexico 19, D.F. Tel (905) 563-9625
Mexicanos SA (Discos)/Drfeon Videovox SA, Aice Blanco 26, San Bartolo, Naucalpan, Tel (905) 576-1500
Musart SA (Discos), Av. Cuhtlahuac 2335, Mexico 16, D.F. Tel (905) 399-2332 Cable MUSART Pres. Eduardo L. Baptista, VP. Andres Baptista, Gen. Mgr. Eduardo A. Baptista; Sales Mgr.: Francisco Llopis (Record only)
Peerless SA (Fabrica de Discos), Laguna de Mayran 232, Mexico 17, D.F. Tel (905) 531 3320, 545-7215 Telex (017) 77606 Exec. Pres. Heinz Klinckwort; Gen. Dir. Peter Ulrich, Gen. Mgr. Juergen Ulrich; Commercial Mgr. Reinhard Kruska; Int'l Dir. Frank J.P. Segura (SEE ADVERTISEMENT)
R C A SA de CV, Av. Cuhtlahuac 2519, Col. Xochimanca, Mexico 16, D.F. Tel (905) 527 6020 (Record only)
Stereo Jet de Mexico SA, Calle Dos 13-B, Naucalpan Tel (905) 576-6866 (Tape only)

RECORD PROMOTION

Fabricaciones Fonográficas SA, Nubia No 40, Isidro Fabela S/N Parque Ind Santiago Tanquistingo, Mexico 16, D.F. Gen. Mgr. Javier Franco
Musart SA (Discos), Av. Cuhtlahuac 2335, Mexico 16, D.F. Tel (905) 399-2332 Cable MUSART Pres. Eduardo L. Baptista; VP. Andres Baptista, Gen. Mgr. Eduardo A. Baptista; Sales Mgr. Francisco Llopis
Sonomedios SA, Av. Vallarta 2590, Guadalajara, Jal. Tel (9136) 16-56-10 Pres. Alejandro Diaz, Gen. Mgr. Alfredo Romo, Sales Mgr. Enrique Corvea

**TAPE CUSTOM DUPLICATORS
TAPE PACKAGING & LABELING**

The Audio and Video lines indicate the configurations which the firms duplicate. Companies which offer packaging and labeling of tape product are indicated by "(PKG)" which appears after the main body of their respective listings.

A V Sistemas SA, Saitillo No. 90, Mexico 11, D.F. Tel (905) 515 0918, 562 7972. Pres.: Eduardo Serrato B.; Gen. Mgr. Adolfo de la Huerta S., Sales Mgr. Sergio Martinez M., Technical Dir. David Baksht L. (PKG)
Audio: Cassette
C B S/Columbia Int'l SA, Av 16 de Septiembre 784, Naucalpan Tel (905) 576-0333. Pres. Jose Manuel Villareal P. VP & Gen. Dir. Armando de Llano Arana (PKG)
Audio: 8 tr., cassette
Coro SA, Bahía de Perula 80, Mexico 10, D.F. Tel (905) 531 2900 Pres. & Gen. Mgr. Federico E. Rojas, Sales Mgr. Gloria Escobar
Audio: 8 tr., cassette
Dupliasset SA, Jose Vasconcelos 218, Mexico 11, D.F. Tel 553 12-06, 286 14-97. Gen. Mgr. Roberto J. Benitez, Maintenance Eng. Gustavo Casello B
Audio: 8 tr., cassette, open reel
E M I-Capitol de Mexico SA de CV, Rio Balsas 49, Mexico 5, D.F. Tel (905) 525 1700 Cable CAPRECORDS Telex (017) 77406 Mng. Dir. David Stockley, Gen. Mgr. Roberto F. Figueroa
Audio: 8 tr., cassette
Laminados & Acabados Especiales SA, Divlar 27, Colonia Alfonso XIII, Mexico 19, D.F. Tel (905) 563-9625
Audio: Cassette
Matrices SA (Discos), Lago Chalco 122, Mexico 17, D.F. Tel (05) 250 1499 Cable MELMEX, Campero
Audio: 8 tr., cassette
Mexicanos SA (Discos)/Drfeon Videovox SA, Aice Blanco 26, San Bartolo, Naucalpan Tel (905) 576 1500
Audio: 8 tr., cassette, open reel
Multitrack SA, Nubia No 40, Isidro Fabela S/N Parque Ind Santiago Tanquistingo, Mexico 16, D.F. Gen. Mgr. Diga San Martin
Audio: Cassette
Musart SA (Discos), Av. Cuhtlahuac 2335, Mexico 16, D.F. Tel (905) 399-2332 Cable MUSART Pres. Eduardo L. Baptista, VP. Andres Baptista, Gen. Mgr. Eduardo A. Baptista, Sales Mgr. Francisco Llopis (PKG)
Audio: Cassette, open reel
Peerless SA (Fabrica de Discos), Laguna de Mayran 232, Mexico 17, D.F. Tel (905) 531-3320, 545-7215 Telex (017) 77606 Exec. Pres. Heinz Klinckwort, Gen. Dir. Peter Ulrich, Gen. Mgr. Juergen Ulrich, Comm'l Mgr. Reinhard Kruska, Int'l Mgr. Frank J.P. Segura
Audio: Cassette. (SEE ADVERTISEMENT)
Promofon SA (Promotora Fonográfica), Apdo. 110-034, Calle Sahuayo 82, Mexico 2, D.F. Tel (905) 529 3582 Dwner Gabriel Gonzalez de la D.
Gen. Mgr. D. Guillermina Lozano
Audio: Cassette
Sonomedios SA, Av. Vallarta 2590, Guadalajara, Jal. Tel (9136) 16-56-10
Audio: Cassette, open reel
Sovi SA, Arquemedes 98, Mexico 5, D.F. Tel (905) 250 6000/6200
Audio: 8 tr., cassette, open reel
Stereo Jet de Mexico SA, Calle Dos 13 B, Naucalpan Tel (905) 576 6866
Audio: 8 tr., cassette, open reel

• supplies**CARTRIDGE & CASSETTE PARTS**

Musart SA (Discos), Av. Cuhtlahuac 2335, Mexico 16, D.F. Tel (905) 399-2332 Cable MUSART Pres. Eduardo L. Baptista, VP. Andres Baptista, Gen. Mgr. Eduardo A. Baptista, Sales Mgr. Francisco Llopis

ENVELOPES & MAILERS

Musart SA (Discos), Av. Cuhtlahuac 2335, Mexico 16, D.F. Tel (905) 399-2332 Cable MUSART Pres. Eduardo L. Baptista, VP. Andres Baptista, Gen. Mgr. Eduardo A. Baptista, Sales Mgr. Francisco Llopis

JACKETS & SLEEVES LABELS, DISK

C B S/Columbia Int'l SA, Av. 16 de Septiembre 784, Naucalpan Tel (905) 576 0333. Pres., Jose Manuel Millareal P., VP & Gen Dir Armando de Llano Arana
 Mexicanos SA (Discos)/Orfeon Videovox SA, Alce Blanco 26, San Bartolo, Naucalpan Tel (905) 576-1500
 Musart SA (Discos), Av. Cuiclahuac 2335, Mexico 16, D.F. Tel (905) 399 2332 Cable MUSART Pres. Eduardo L. Baptista, VP Andres Baptista, Gen Mgr. Eduardo A. Baptista, Sales Mgr. Francisco Llopias
 R C A SA de CV, Av. Cuiclahuac 23 9, Col. Xochimilca, Mexico 16, D.F. Tel (905) 527-6020 Pres & Dir. Gen. Louis Couttolenc, Sales Mgr. Jose Martin del Campo, Promo & Fub. Mgr. Kuku Estevez

POLYETHYLENE BAG & SHRINKWRAP

Musart SA (Discos), Av. Cuiclahuac 2335, Mexico 16, D.F. Tel (905) 399 2332, Cable MUSART Pres. Eduardo L. Baptista, VP Andres Baptista, Gen Mgr. Eduardo A. Baptista, Sales Mgr. Francisco Llopias

RECORD MANUFACTURING EQUIPMENT

Mexicanos SA (Discos) SA/Orfeon Videovox SA, Alce Blanco 26, San Bartolo, Naucalpan Tel (905) 576-1500

TAPE, BLANK LOADED & BULK RAW

Agfa-Gevaert de Mexico SA, Apdo. 7256, Mexico 1, D.F., Ing. Zapadores 1, Naucalpan Tel 761-800 Telex (017) 74479

Audio: Blank—compact-cassette, open reel, raw—cassette, broadcast, studio

Video: Cassette

Amplex de Mexico SA de CV, Div. Del Norte 1832, Col. Portales, Mexico 13 D.F. Tel (905) 539-6870, 532 5126 Telex (01) 773951 Dir. Miguel A. Hernandez, Admin. Mgr. Isaias Trujillo, Audio Prods. Sales Mgr. R. Garcia, Video Prods. Sales Mgr. Oscar Luna, Tape Prods. Sales Mgr. M. Santillana
 Audio: 8-tr., cassette, open reel
 Video: 2" quad, 1" open reel, 1/2" U-matic cassette, 1/2" Cassette
 Montage Mexico SA, PO Box 244, Ciudad Ind. El Framboyan, Lotes 1, 2 & 3, Veracruz Tel 3 42 00

Audio: 8-tr., cassette, open reel

Musart SA (Discos), Av. Cuiclahuac 2335, Mexico 16, D.F. Tel (905) 399 2332 Cable MUSART Pres. Eduardo L. Baptista, VP Andres Baptista, Gen Mgr. Eduardo A. Baptista, Sales Mgr. Francisco Llopias

Audio: Cassette

Brand name: Prosonic

Prosonic, see Musart

Sovi SA, Arquimedes 98, Mexico 5, D.F. Tel (905) 250 6000/6200

Audio: 8-tr., cassette, open reel

TAPE DUPLICATING & PROCESSING EQUIPMENT

Amplex de Mexico SA de CV, Div. Del Norte 1832, Col. Portales, Mexico 13, D.F. Tel (905) 539-6870, 532 5126 Telex (01) 773951 Dir. Miguel A. Hernandez, Admin. Mgr. Isaias Trujillo, Audio Prods. Sales Mgr. R. Garcia, Video Prods. Sales Mgr. Oscar Luna, Tape Prods. Sales Mgr. M. Santillana
 Audio: Recorders

Video: Recorders, cameras & switchers.

Musart SA (Discos), Av. Cuiclahuac 2335, Mexico 16, D.F. Tel (905) 399 2332 Cable MUSART Pres. Eduardo L. Baptista, VP Andres Baptista, Gen. Mgr. Eduardo A. Baptista, Sales Mgr. Francisco Llopias

TAPE PACKAGING & LABELING EQUIPMENT

Musart SA (Discos), Av. Cuiclahuac 2335, Mexico 16, D.F. Tel (905) 399 2332 Cable MUSART Pres. Eduardo L. Baptista, VP Andres Baptista, Gen Mgr. Eduardo A. Baptista, Sales Mgr. Francisco Llopias

• accessories

Amplex de Mexico SA de CV, Div. Del Norte 1832, Col. Portales, Mexico 13, D.F. Tel (905) 539-6870, 532 5126 Telex (01) 773951 Dir. Miguel A. Hernandez, Admin. Mgr., Isaias Trujillo, Audio Prods. Sales Mgr. R. Garcia, Video Prods. Sales Mgr. Oscar Luna, Tape Prods. Sales Mgr. M. Santillana

Product: Tape—head cleaners & demagnetizers, leader & splicing tape
 Aurex SA de CV, Calzada Tulyehualco 3370, Mexico 23, D.F. Tel (905) 845 2268, 670 0277, Chm. Federico Valdes, Gen Mgr. Ernesto Valdes, Sales Mgr. Ramiro Gamboa

Product: Tape—head cleaners, demagnetizers, leader tape
 Centro Musical de Tijuana SA, PO Box 292, San Ysidro, Calif. 92073, USA, 917 Constitution Ave., Tijuana, B.C. Tel (706) 685 1322 Pres. Luis B. Alonso, VP. Tessa Alonso, Sa. es Mgr. Manuel Magdalena C.

Product: Record—carrying & storage cases, record car pads, 45 rpm adaptors, replacement styli, Tape—carrying & storage cases
 Sovi SA, Arquimedes 98, Mexico 5, D.F. Tel (905) 250-6000/6200

Product: Tape—leader tape.

• jukebox manufacturers

Ami de Mexico SA, Calz. Tlatelco 231, Mexico 16, D.F. Tel (905) 556 8611 Cable MEXAMI Telex 01777392 Pres. Benjamin Rosental, Gen Mgr. Jorge A. Kuri
 Fonografos Automaticos Evans SA, Via Dr. Gustavo Baz 49, Puente de Vigas, Mexico Tel 572 4744

Industrias Nacionales de Sonido SA, Apdo. 22036, Calz. Mexico Xochimilco 4861, Mexico 10, D.F. Tel (905) 573 2413 Cable ASTRONISSA Telex (017) 74282 Local branch: La Feria SA, Rep. de Chile 7, Mexico 1, D.F. Tel (905) 585 1311. (Importer only)

Brand name: Astrovox.

Manufacturera de Sinfonotas SA, Av. Jardin 330, Col. del Gas, Mexico 15, D.F. Tel (905) 355-3199
 Sonata SA (Corp.), PO Box 22036, Mexico 22, Tel (905) 573 2413 Pres. David L. Romero Sr., Gen Mgr. Raul C. Romero, Sales Mgr. J. LaraValle

NETHERLANDS

Population: 14,100,000
 Population by age groups: 0-14—3,184,000, 15-24—2,439,000, 25-49—4,823,000; 50+—3,645,000.
 Rate of exchange: \$1 (US) = 2.10 guilders
 Per capita income: \$4,825
 Holidays: New Year's Day, Easter Monday, April 30 (Queen's Birthday), Ascension Day, Whitsunday, Whitmonday, December 25 & 26

RECORDS:

Record sales certification awards: Gold single—100,000 units, platinum

Billboard 1981-1982 International Buyer's Guide

single—150,000 units Gold LP—25,000 units, platinum LP—50,000 units

Records sold domestically including imports (retail value): LP's 1980—27,000,000 units, 1979—32,000,000 units Singles 1980—14,000,000 units, 1979—17,000,000 units, \$35,000,000

Average retail price per record: LP's—\$7.10, singles—\$2.40.

TV merchandising: 10% to 15% of total.

Record club sales: 6% of total.

Discounting: Frequent.

Type of distribution: Manufacturer-to-retailer is the traditional main-line of distribution. Because of parallel imports, which created rather important wholesale companies, manufacturer to wholesaler-to-retailer is rising strongly. Rack jobbing is decreasing and is only marginal economically.

Type of promotion: Pop music is primarily promoted on television programs like "Top Pop" (AVRO), "Countdown" (VOO) and "Starclub" (TRDS). This repertoire is also promoted on Hilversum 3, one of the four national radio channels. Recently recorded Dutch language product is getting heavy promotion from pirate radio stations. Classical music is pushed mainly on Hilversum 4. Oor (Ear) is the leading music magazine. Other prominent magazines include Muziek Express, Muziek Parade, Hitkrant and Popfoto. Classical is principally featured in the magazines Disk, Luster and Muziek Deze Maand. The daily newspapers are paying attention to all local and international musical trends

Jukeboxes: 6,000

TAPE:

Market: Evaluations concerning Dutch tape sales are not very encouraging. Not more than 10% of the money available for sound carriers is spent on pre-recorded muscassettes. An enormous increase in the sale of blank tape and ever increasing home taping activities are cited as reasons

Pre-recorded tape sold domestically including imports (retail value): Cassette 1980—4,500,000 units; 1979—4,000,000 units

Average retail price per tape: Cassette—\$7.10

RADIO STATIONS:

No. of government 4 (1 AM, 3 FM)

Comment: Hilversum 1 and Hilversum 2 have the most varied recorded and live music and programming. Hilversum 3 is pop oriented and Hilversum 4 classical. Dutch language productions are now receiving better airplay primarily because of pirate radio stations. Commercials for records via radio are slowly losing their impact

TELEVISION STATIONS

No. of channels 2 government, 95% color

Comment: Programming is split among nine companies. In most cases the background of these companies is political or religious. Veronica (VOO) is the Netherlands youngest broadcasting company, now about four years old. The size of a company depends upon the number of subscribers, with TROS the biggest.

Almost all Dutch television companies keep abreast of the types of music being played in the Netherlands and other countries. Pop music is presented on a regular basis by Veronica ("Countdown"), TROS ("Starclub") and AVRO ("Top Pop"). The last mentioned program will be trimmed to 25 minutes in the fall of 1981 because AVRO management has the impression that pop music is losing its impact in the Netherlands. On the other hand, MDR and Dutch language music are getting more play on the various programs

Pirate stations, which are transmitting their programs via cable systems, are becoming a big threat to the entire Dutch broadcasting system. In Amsterdam alone, there are more than 10 of these stations. According to a recent statement by Mrs. Neelie Smit-Kroes, the Dutch Under-Minister of Communications, it is hard to stop these stations, mainly because the law is still not far-reaching enough

IMPORT/EXPORT REGULATIONS:

The European Community desires a flow of goods between the member states, which means that import and export regulations are kept to a minimum

MARKET ANALYSIS:

The Dutch record industry is in a far from blossoming state due to the bad economic situation. It is highly unlikely that matters will become better in the near future. Thus, all companies are trying to cut costs. One attempt at this is the joint mailing of release lists by RCA, Inteco, VIP, Teistar and Duraco. This experiment is being carried out by the Dutch Top 40 Foundation, the organization behind the Netherlands' most prominent chart system.

Record companies are also keen on diversification now in order to get maximum turnover. Video, electronic games and posters are among the fields being entered.

Last year there were some reorganizations. RCA Holland merged with RCA Belgium into RCA Benelux. And there were stronger ties between the Dutch and Belgian Ariola companies, now under one managing director. Also, a few production units were formed, including TTR for WEA Benelux and A+R (now ANR) for CBS

Record sales declined in 1980 because of piracy, home taping, and because records are rather quickly losing their impact as a leisure time product. Pop music is getting less attention and MOR music is getting more. This means that some companies are focusing their advertising campaigns on the 25-40 age group

Although the situation is far from optimistic, companies are doing their utmost to create interest in product. Two of these are a 10 day long record event, which will be held in the fall of 1981, and an International Disco Fair held at the same time

Willem Hoos.

• record & tape manufacturers / distributors / importers

A A P Recs. BV, PO Box 37, Antloepspoor 238, Maarssehn Tel (03465) 6 22 76. Pres. Joop Gerrits, Sales Mgr. Jochem van Renesse
 Labels: (Owned) AAP, Armada, Oe Zilvervloot, (licensed foreign) Lach arette (France)
 Int'l rep.: France (Lacharette).

A R S I S, Steegstr. 16, 6041 EA Roermond Tel (04750) 3-36-98. Dir. L.P.M. Lindeman. (Record Distributor)
 Agram BV, Arnhemseweg 10, 6731 BS Otterlo. Tel (08382) 631. Dir. Henk Coops.

Agram-Blues, see Nuis Bedrijven
 Aladin Music BV, Gasthuisstr. 3, 5171 GC Kaatsheuvel
 Albersen & Co. BV (Muziekhandel), Gr. Hertoginnelaan 182, 2517 EV The Hague Tel (070) 45-60 00. Chief Execs. J.B.M. & H.E.A.M. Albersen. (Distributor/importer)

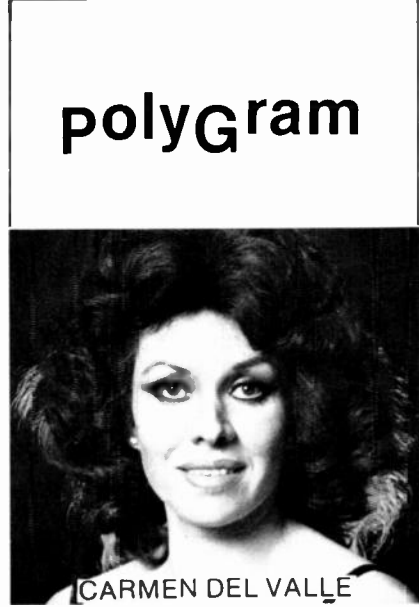

CARMEN DEL VALLE



VICTOR ITURBE "PIRULI"



FERNANDO RIBA



OSCAR CHAVEZ

POLYGRAM DISCOS, S.A. DE C.V.
 Av. Miguel Angel de Quevedo N.º. 531
 México 21, D.F.

**WE ARE NOW ON
AN
INTERNATIONAL
FLIGHT
AND WE'D LIKE MORE
IMPORTANT LABELS
ON OUR BAGGAGE**

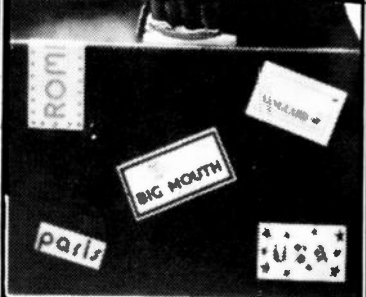

**HERBE POMPELLO / MANAGER
INTERNATIONAL REPERTOIRE
DISCOS Y CINTAS MELODY, S.A.
L. CHALCO 122 México 17, D. F.
TELEFONO 250 14 99
MELODY CABLE MELMEX**

Labels: (Licensed foreign) Italia (Italy), Schwann (Germany), Wergo (Germany)
All Rock, see Collector
Amor Sound Prod'n, Hendrikkade Pr 121, Amsterdam Tel (020) 26-65 21
Arcade Nederland BV, Industrieweg 11, Postbus 172, 4130 ED Vianen Tel (03473) 21-84 Telex 40420, Mng Dir Herman Heinsbroek, Creative Servs. Mgr. Rob Lemmen, Prod. Mgr Peter Bushoff, Sales Mgr Rien van Hooydonk
Home office: England
Labels: Arcade, Crown, Pearl, Trent, Villa
Archiv, see Polydor
Andre Arend Agency, Vnesel C de 49A, Rotterdam Tel (010) 25-44-61
Ariola Benelux BV (IFPI), Kenaustr 1.3, 2011 MV Haarlem Tel (023) 31 92-90, Telex 41385, Mng Dir Wim Schipper, Deputy Mng Dir Anton Witkamp, Sales Mgr Jaap Groeters
Home office: Germany
Labels: (Owned) Ariola, Arista, Eurodisc, (licensed domestic) Fleet, (licensed foreign) Albion (UK), Bronze (UK), Chrysalis (UK, USA), Hansa (Germany, UK), Island (UK), Jupiter (Germany), MCA (UK, USA) Shelter (USA), Tomato (USA), Virgin (UK)
Arista, see Ariola
Armada, see AAP
Arrival, see K tel
Artist & Rec Co., Kenaustr 3, Haarlem Tel (023) 32 27 25
Asylum, see WEA
Atco, see WEA
Atlantic, see WEA
Audio Import BV, Herengracht 28, 1015 BL Amsterdam, Tel (020) 25-65 12 Telex 41605, Chief Exec Frits de Vnes (Record Importer)
Label: (Represented) dbx (USA)
Audio Recs BV, Rozenpad 2, 6862 BR Dosterbeek Tel (085) 33 44 20
Automatic, see WEA
B E L Sound, Buursterstraat 356, Erschede Tel (053) 76 30 22
B M G Grammofoonplaten, Molenvlietsedijk 23 25, 4691 HS Tholen, Tel (01660) 3226
B M R, see Best Music
Herman Batelaan Prod'n, Moerbeigaarde 112, Zoetermeer Tel (079) 31 36 37 Gen Mgr Herman Batelaan, Sales Mgr Verona Vanessa
Labels: (Owned) Chapter 2, Esart
De Bazun, Rossinrode 19, 2717 GN Zoetermeer Tel (079) 21 53-00 Pres Nanja Leroy, Gen. Mgr Ger Leroy (Licensed to Vista)
Labels: (Owned) de Bazun, Paviljoen
BeGe, see Wim Berkers
Benelux Music Inds., see Telstar
Benson Music Co., Paradysweg 28, 7607 TT Almelo Tel (05490) 1 19 30 Chief Exec John Phillip Benson, Gen Mgr Daphne Benson
Labels: (Licensed) Crystal, Shawnee, WIM (all USA)
Wim Berkers Prod'n, PO Box 32, Harmoniestr 1, Deurne Tel (04930) 2543 Gen Mgr Wim Berkers
Label: BeGe
Bertus Distributie BV, Industrieweg 45-B, 2651 BC Berkel en Rodenrijs Tel (01891) 57 22 Telex 26385 BETS, Dir. Jan van der Linden, Gen Mgr Almer Apon, Sales Mgr Michel de Rutter, Buyer Bram Apon (Distributor)
Best Music, Crispynstr 9, 5171 CH Kaatsheuvel Tel (04167) 7 32 70 Mng Dir Peter van Best

Label: (Owned) BMR
Blazer Recs BV, Antwerpseweg 9 007, 2803 PB Gouda Tel (01820) 1-47 66 Telex 20736, Mng. Dir Peter Lassman. (Distributor/Importer/Exporter)
Carol Bloom, Overtoom 11, 1054 HA Amsterdam
Label: (Represented) Redwood (USA)
Blossom Recs, Valkenboslaan 180 The Hague Tel (070) 45-13 79
Blue Note, see EMI Recs
Born Free Prod'n, Albertus Perkstr 35, Hilversum Tel (035) 4 77 49
Johan van den Boschaerd, Winkelsteede 246, The Hague Tel (070) 67 03 07
Boschec Grammofoonplaten (IFPI), PD Box 53, Aerdenhout, Tel (035) 1 27 61 Owner Willem Boschec, Gen Mgr H R Boschec v.d. Laan.
Labels: (Owned) Kritos, Nevofoon, Dnys, Target, Traffic, (distributed) CPR, (represented) Alvorada (Portugal), Boosey & Hawkes (UK), Carioca (Portugal), Clave (Portugal), Copacabana (Portugal), Estudio (Portugal), Intersound (Germany), Orfeu (Portugal), Rapsodia (Portugal), Roda (Portugal), Selected Sound (Germany), Sonoton (Germany), Telemusic (France), Undisc (France)
Ted Bouwens Prod'n, Herik 1, Huizen Tel (03451) 43-48
Bulldog Producties, Velduidstr 2, Leerdam Tel (03451) 43-48
Byhaast Grammofoonplaten, Prinseneiland 99, 1013 LN Amsterdam Tel (020) 23 97 99
C & A Prod'n, Hubertusdijk 15, Roosendaal Tel (01650) 4-16-11
C B S Grammofoonplaten BV (IFPI), Postbus 6175, Stationsplein 82-84, Haarlem Tel (023) 31 94-10 Telex 41051 Dir.: Koos de Vreeze, Sales Mgr Wil Nagel, Press & Promo Dick Pieren
Home office: USA, CBS Int'l
C B S Int'l Mfg & Serv Center, Postbus 6336, Nijverheidweg 32 36, 2031 CP Haarlem Tel (023) 319410
C N R (BV Grammofoonplaten Maatschappij) (IFPI), Gouwzeestr 1 3, 1380 AE Weesp Tel (02940) 1 52-44 Cable CENER Telex 12523 Mng Dir Kees Baas, Sales & Mktg Mgr Henk Opstelten, Admin Mgr Kees Hilhorst, Repertory Dept Mgr Dennis Kloeth, Promo Mgr Ruud van Dulkenraad
Labels: (Owned) CNR, Injection, (licensed) AVI (USA), Affinity (UK), Barclay (France), Beggar's Banquet (UK), Brain (Germany), Carriere (France), Don't Fall Off the Mountain (UK), Ensing (UK), 4AD (UK), Inter cord (Germany), Melodia (USSR), Metronome (Germany), RKM (Belgium), Situation Two (UK), Zomba (UK)
C P R, see Boschec
C R I, see Vista
Cantilena BV, Kerkhoflaan bij 52, 1160 AB Zwanenburg Tel (02907) 25 93, 44 58 Dir George L de Vnes, Ass't Ariana de Vnes van Wicken
Labels: (Owned) Cantilena, (distributed-not licensed) Delos (USA), Grand Digue (France), Mitra (Germany), Solstice (France), Stentorian (USA)
Canto di Vangelo, see Vista
Capitol, see EMI Recs
Capri, see Dureco
Capriola, see Dureco
Carrere Holland BV, Gouwzeestr 1 3, Weesp, Tel (02940) 1 52-44 Telex 12523 PR Michel Damen (Licensed to CNR)
Casablanca, see Phonogram BV & Phonogram Int'l BV
Chanowski Prod MM BV, Prinsengracht 856, Amsterdam Tel (020) 24-55 80 Telex 13415
Chapter 2, see Herman Batelaan
Cinefoon Producties, Postbus 95, Epe Tel (05782) 23 04
Cinerec Supraphon Holland NV, Frans Halslaan 2, Hilversum Tel (02150) 1 53 53, 4 94 38 Telex 43232
Label: (Licensed) Supraphon (Czechoslovakia)
Circle, see Grammoservice
Collector Recs, PO Box 2296, 3000 CG Rotterdam Tel (010) 22 48-89
Labels: (Owned) All Rock, Collector, Down South, Pro Forma, Unknown, White Label
Int'l repps: Belgium (Monopole), France (Lezard Rock), Germany (RAW), UK (Flyright), USA (Down Home, J Taylor)
Combidisc BV, Pisanostr 57, 5623 CB Eindhoven Tel (040) 43 93 92 Telex 59078, Contact Martin Brouwers. (Distributor/Importer)
Commonwealth, see K tel
Condor, see Mike Vincent
Continental Sound, PO Box 81065, Rotterdam Tel (010) 21 10 98, 21-48 28, Pres. Leen La Riviere, Gen Mgr Nico Zwarts: Sales Mgr. Jan Deurlo
Labels: (Owned) Free; (licensed) CS (USA), Catacombs (Canada) Janz Team (Germany), (distributed-not licensed) Abacus (Germany)
Corduoy Prod'n, Catherine van Renneslaan 10, Hilversum Tel (035) 4-75 41
Coreco, see Munich
Cotillon, see WEA
Cross Road Studios, Heschweg 85a, Dss Tel (04120) 2 56 00
Crossroad, see Munich
Crown, see Arcade
D G, see Polydor
D G R, see Weton Wesgram
D S C, see Dutch Swing College
De Bazun, see under B
De Zilvervloot, see AAP
Dial, see Diwa
Disco de Man DDM Prods BV, Munstr 20, 1162 EJ Maastricht, Tel (043) 1 21 17 Gen Mgr Cees de Man (Distributed by Dureco BV)
Labels: (Owned) DDM, Plato, (licensed) Acanta Pop (Germany), Jumbo/Eap (UK)
Disque Roermond BV, Hendriklaan 18, Roermond Dir E Kamzoll (Distributor)
Diwa Recs., PO Box 612, 7550 AP Hengelo DV Tel (074) 4 27-62, Dir Dick Waanders
Labels: (Owned) Dial, Diwa
Doira, see Polydor
Dominion, see K tel
Down South, see Collector
Duo, see Martin A van Olderen & Munich
Dureco (Dutch Rec Co.) BV, Pampuslaan 45, 1380 AA Weesp Tel (02940) 1-53 21 Cable RECMUS Telex 14409 Mng Dir A E Palmans, Mktg Mgr M A C de Raaf, A&R Mgr A van Nunatten, int'l Mgr C W. Jansen, Contract Mgr Eye Kliffen
Branch: Hilversum, Burg v Hellenburg Hubarlaan 7 Tel (035) 23 49 11, 1 13 77
Labels: (Owned) Capri, Capriola, Dureco, Dureco Benelux, Elf Provincien, Fajalobie, Golden Diddies, Omega, Te Deum, (licensed domestic) Goena Goena, Ivory Tower, Mirasound, Plato, Timeless, (licensed foreign) Audio Fidelity (USA), Creole (UK), ECM (Germany), Ice (UK), Japo (Germany), Penny Farthing (UK), Pilot (UK), Rialto (UK), Young Blood (UK), Zahro (Spain)



**NOW AVAILABLE
FOR DISTRIBUTION
OF ENGLISH
LANGUAGE PRODUCT
IN MEXICO**

★ ★ ★ ★ ★
**AV. LAZARO CARDENAS
1201**
★ ★ ★ ★ ★
(antes Av. 100 Mts.)
**Unidad Industrial Vallejo
07800 Mexico, D.F.
Tel. 754-3055**

**No.1
MUSIC PUBLISHER IN MEXICO**
BEECHWOOD
BEECHWOOD DE MEXICO, S.A. de C.V.
RIO DANUBIO 1046 06500 MEXICO D.F.



Teléfono 511 3742, Telex 1777406 EMICME

DISCOS
ZORBA
RECORDS & TAPES
**REPRESENTING BRANDS
AND PRODUCING**

**TRY US.
WE CAN MAKE IT
give us a call**

**TELS. 905(533-5412) (533-5413)
HAMBURGO 113 MEXICO, 6 D.F.
G. MANAGER: Carlos Misraichi**

- Dureco Benelus, see Dureco.
- Evan Durlacher Audio-Visual Prod'n's, Nagtglaslaan 18, Naarden. Tel: (02159) 4-27-60; Amsterdam Tel: (020) 24-37-81.
Labels: (Owned) Durlaphone, Dbeisik, Pop Sound, Veronica.
- Durlaphone, see Evan Durlacher.
- Durob Audio, Asslerlaan 4, 525 XJ Vijlmen.
Label: (Represented) Sheffield Lab (USA).
- Dutch Swing College Rec. Prods BV (IFPI), Sir Winston Churchilllaan 519, Ryswyk 2H. Tel: (070) 94-66-57. Cable: ARLI. Chief Exec. & Gen. Mgr.: Arie Ligthart.
Label: (Owned) DSC.
- Int'l repps.: Belgium (Sound Prods.), Canada (Holland Magazines), Germany (Aniola-Eurodisc), Middle & Far East (Phonogram Int'l), USA (Everest).
- E & E Recs., PO Box 1525, 1000 BM Amsterdam. Tel: (020) 16-32-42. Gen. Mgr. Peter Rensen; Sales Mgr. John Bake. (Distributed by International Rec. Dist'n)
Labels: (Owned) E&E, Moonbase, West World.
- E M I-America, see EMI Recs.
- E M I-EAR (European A&R & Mktg.), PO Box 739, Bronsteeweg 49, Heemstede. Tel: (023) 31-93-80. Telex 41902. Dir.: R. R. Kruuze. Gen. Mgr.: Dick van Vliet.
- E M I Holland BV, Bronsteeweg 49, Heemstede. Tel: (023) 31-93-80. Telex: 41257. Mng. Dir.: L.A.P.A. Verhelst; Finance Dir.: J.C. La Grou; Sales Mgr.: J. Gaasterland; Mktg. Mgr.: R. Denekamp, Int'l Div. Mgr.: W. Hoppenbrouwers.
Note: EMI Holland BV is a holding company for the following firms: EMI Publ'g, EMI Recs. Holland BV, EMI Hi Fi BV, EMI Holland Produktie BV, Gramophonehouse BV.
- E M I Recs. Holland BV (IFPI), Bronsteeweg 49, Heemstede. Tel: (023) 31-93-80. Telex: 41257. Mng. Dir.: Bert Verhelst; Sales Mgr.: Jan Gaasterland.
Labels: (Owned) Blue Note, Capitol, EMI, EMI-America, Harvest, Liberty, Odeon, Parlophone, Sunset; (Licensed) DJM, Fantasy, Magnet, Milestone, RAK, Rolling Stones.
- Editio Laran, de Constant Rebecquestr. 104, The Hague. Tel: (070) 45-89-17. Chief Exec.: Max Hallensleben; Sales Mgr.: C. H. Hallensleben.
Labels: (Owned) Editio Laran; (Licensed to Vista); (Licensed domestic) Hallensleben.
Int'l repps.: Germany (Mistur).
- Elektra, see WEA
- EH Provincien, see Dureco.
- Energy Recs., Postbus 6541, 4802 I-M Breda. Tel: (076) 65-36-29. (Also see Xantippe)
- Esart, see Herman Batalelan.
- Eurodisc, see Aniola.
- Eurosound Studios BV, Dijkstraat 5, Herveld. Tel: (08880) 10-48. Dir. & Sales Mgr.: J. de Groot; Gen. Mgr.: E. Scheerder; Eng.: A. Vonk. (Also see Sound Prods. & Vista)
Labels: (Owned) Eurosound, KRD Klassiek.
- F S V Dist's., Regentessealaan 64, The Hague. (Distributor/Importer)
Labels: (Represented) All Ears (USA).
- Fajalobie, see Dureco.
- Festivo, see Vista.
- Fidelity, see Sound-Prod's.
- Flandria, see Limbo Phone.
- Flying Dutchman, PO Box 170, Iepenlaan 60, 2012 AD Bloemendaal. Tel: (023) 26-05-55. Telex: 41242. Pts.: Theo Roos.
Fontana, see Phonogram BV & Phonogram Int'l BV.
- Fountain Sound & Vision BV, Utrechtsestraat 105, Amsterdam. Tel: (020) 25-96-01. Telex: 33796. Mng. Dir.: Tom Jones. (Distributor)
- Free, see Continental Sound & GMI.
- G M I Recs. BV (Gospel Music Int'l), PO Box 210, 6880-DE Velp. Tel: (085) 64-68-15. Telex: 75079. Chief Exec.: L. Pool; Sales & Gen. Mgr.: J. Groeneveld.
Labels: (Owned) Free, GMI; (Licensed) Birdwing, Canaan, Day Spring, Grapevine, Greentree, Heartwarming, Impact, Jim, Lamb & Lion, Light, Maranathal, Messianic, Myrrh, Pilgrim, Solid Rock, Sparrow, Star Song, Tempo, Word (all USA); Dove (UK), Kingsway (UK), Scripture in Song (Australia).
- G T L Prod'n's, Neptunusstr. 29-31, IJmuiden. Tel: (02550) 2-08-20.
- Gloysound, Thorbeckstr. 7, Veenoord. Tel: (05915) 1273. (Licensed to Vista).
- Gnome, see Telstar.
- Goena Goena, see Dureco.
- Golden Age Recs., Stevinstr. 14, Alphen a/d Rijn. Tel: (01720) 7-44-91.
Label: (Represented) Mutual Music (USA).
- Golden Lion Recs. BV, PO Box 181, Peerikampiaan 5, Hilversum. Tel: (02150) 1-59-53. Chief Exec.: D. De Vilder.
- Golden Oldies, see Dureco.
- Gorilla Recs. BV, Lange Poten 15a, The Hague. Tel: (070) 64-21-73. Telex: 32240.
- Gospel Music Int'l, see GMI.
- Grammoservice BV, Spaarndamsweg 410-414, 2022 EA Haarlem. Tel: (023) 25-85-21. Telex: 41062. Dir.: A.A.M. Luyck; Sales Mgrs.: S.C. Ossewaarde, P.J. Schreijer.
Label: (Owned) Circle.
- Hallensleben, see Editio Laran.
- Harlekijn Holland BV, Kerkdijk 11 3615 BA Westbroek. Tel: (03469) 14-44. Telex: 40220. (Licensed to Poydorp)
- Harmoniagram, see Harmonia-Uitgave.
- Harmonia-Uitgave, Roeljesweg 23, Hilversum. Tel: (035) 1-43-18. Gen. Mgr.: Hans Zijderlaan; Mgr.: Frits Ham; Sales Mgr.: J.G. Zijderlaan.
Labels: (Owned) Harmoniagram.
- Harvest, see EMI Recs.
- Hekre, see Henk Kreeftmeyer.
- Helodur, see Polydor.
- Hep, see K-tel.
- Hilversum Music BV, Emmastr. 13a, 1211 NE Hilversum. Tel: (035) 23-46-46. Telex: 73254. Pres.: Charly Prick.
Int'l repps.: Austria, Germany, Switzerland (all Electrola).
- Alberto de Hond Music Import-Export BV, Roetersstr. 18a, 1018 WD Amsterdam. Tel: (020) 24-12-25, 22-96-23. Telex: 17171. Pres.: Alberto de Hond; VP: Mrs. V.J. de Hond.
- Platenprod Mij de Goede Hoop Bakkerstr. 1, 6999 BC Hummelo. Tel: (08348) 10-60.
- Hosat (Holland South America Trading), Noorderde 105a, 2514 GE The Hague. Tel: (070) 46-51-22. Cir.: H.J. da Silva; Sales Mgr.: M. de Jong. (Distributor)
- Hunky Prod'n's, Machineweg 8, 1394 AV Nederhorst Den Berg. Tel: (02945) 17-91.
- I-Scream, see Inelco.
- Idee Sound, Koningsweg 15, Alkmaar. Tel: (072) 1-08-19. Gen. Mgr.: J.V. Doorn. (Distributor/Importer)
- Inelco Recs. & Tapes BV (IFPI), Turfsteckerstr. 63, 1431 GD Aalsmeer. Tel: (02977) 2-88-55. Telex: 14683. Mng. Dir.: Jan Mascini; Int'l A&R Mgr.: Ric. Urmel; Sales Mgr.: Jaap Beutler.
Labels: (Owned) Lark; (Licensed domestic) I-Scream, Keystone, Papagayo, Rockaway, Rockhouse; (Licensed foreign) Aura, (UK), Avatar (UK), Baby (Italy), Cool King (UK), Criminal (UK), Earlobe (UK), Energy (UK), H&L (USA), MAM (UK), Dvation (USA), Polish (USA), Shaftesbury (UK), Sonet (Sweden, UK), Stiff (UK), Trema (France); (distributed-not licensed) Varagram.
- Int'l repps.: Austria (Teldec), Germany (Teldec), Italy (Baby), Scandinavia (Sonet), Switzerland (Teldec).
- Injection, see CNR.
- International Rec. Dist'n Amsterdam (IRDA), PO Box 1525, 1000 BM Amsterdam. Tel: (020) 16-32-42. Gen. Mgr.: Peter Rensen.
Labels: (Owned) E&E, Moonbase, Zen.
- International Sound Retail, Regentessealaan 64, 2562 CV, The Hague. Tel: (070) 45-33-00. Owner: Andre J. Fontijn; Gen. Mgr.: Jorita Uuyk.
Iris, see Telstar.
- Ivory Tower Recs., Tussveld 55, Bornebroek. Tel: (05408) 718. Dir.: Fred Rootvelde; Gen. Mgr.: Angie Rootvelde. (Licensed to Dureco)
Labels: (Owned) Ivory Tower, NL, SR.
- J. J., see Oldway-Windmill.
- Jojo Recs., Herengracht 113, Amsterdam. Tel: (020) 23-27-27. (Also see Oldway-Windmill)
- Jox, see Henk Kreeftmeyer.
- Jubal, see Vista.
- Jungle Jam, see WEA
- K M K, see Vista.
- K R O Klassiek, see Eurosound.
- K-tel (Holland) BV, Oude Schipholweg 885, 2143 CD Boesinghede. Tel: (02505) 683, 474. Telex: 41199. Gen. Mgr.: Peter Kloeth; Sales Mgr.: Hans Gouweelos; Financial Controller: Ed Gerritsen; Special Projects Benelus & A&R Mgr.: Paul Coudwener.
Home office: USA.
Labels: (Owned) Arrival, Commonwealth, Dominion, Hep, K-tel.
- Karusell, see Polydor.
- Kelrec BV, Reguliersbreestr. 3, Amsterdam. Tel: (020) 23-37-50. Pres.: Hans Kellerman.
- Kendan, see Telstar.
- Keystone, see Inelco.
- Killroy, see Telstar.
- Klomp, see Xantippe.
- J. A. W. Koers, PO Box 1373, 9701 BJ Groningen. Tel: (050) 41-19-67. (Importer)
- Henk Kreeftmeyer Org., Abraham Bloemestr. 6, 3514 VP Utrecht. Tel: (030) 71-08-73. Telex: 73250. Dir.: Henk Kreeftmeyer; Int'l Sales Mgr.: John Wespord.
Labels: (Owned) Hekre, Jox, Pussycat; (Licensed) Buckboard, Musicor, Springboard, Uprfront.
- Kritos, see Boscheck.
- Han Kuper Ent's., De Boelelaan 435, 1082 RJ Amsterdam. Tel: (020) 42-93-96. Gen. Mgr.: Wm Johan Kuper.
- Ladybird Prod'n's BV, Huizerweg 13, Blaricum. Tel: (02153) 8-67-30.
Lark, see Inelco.
- Laudate, see Telstar.
- Laurens, see Vista.
- Liberty, see EMI Recs.
- Limbo, see Limbo Phone.
- Limbo Phone, Meersenerweg 313, 6224 AJ Maastricht. Tel: (043) 62-20-18. Dir.: Johnny Blenco; Gen. Mgr.: J. Vnezelaar; Sales Mgr.: A. Vnezelaar-Essers.
Labels: (Owned) Flandria, Limbo.
- Limeight, see Phonogram Int'l.
- Lorele, see Telstar.
- M G M, see Polydor.
- Mamicha Music BV, Pettelaarseweg 25, 5126 BG 's-Hertogenbosch. Tel: (073) 14-73-34, 13-83-52, 13-21-71. Telex: 41605. Pres.: Wilhelm Vermeulen Windsant.
Labels: Betopop (Canada), Mamicha, Starfighter, VVR.
Int'l repps.: Belgium (Inelco).
- Mammoth Rec. Prod'n's, Postbus 450, Westersingel 83, Bergen Op Zoom. Tel: (01640) 3-33-59.
- Martiniphon, see Vista.
- Mavis, see Verschoor.
- Mawogram, see Vista.
- Mercury, see Phonogram BV & Phonogram Int'l BV.
- Metro, see Polydor.
- Midi, see WEA
- Miller Int'l Grammofoonplaten BV, Oud Blaricummerweg 25a, Laren NH. Tel: (02153) 8-30-36.
- Mirasound, Langstr. 51, 8130 BB Wijhe. Tel: (05702) 18-26. Dir.: G. Voskuylen.
Labels: (Owned) Mirasound (licensed to Dureco); (distributed-not licensed) CMS (USA).
- Moon Base, see West World.
- Moonbase, see E&E & International Rec. Dist'n.
- Munch Recs. BV (IFPI), Albert Schweitzerlaan 9, 6721 AW Bennekom. Tel: (08389) 67-77. Cable: MIUREC. Pres.: J. C. Zomer. Gen. Mgr.: Ben Matijssen; Sales Mgr.: Huub Trautwein.
Labels: (Owned) Munch, Stof; (Licensed domestic) Oldie Blues, St. Anna; (distributed-not licensed) Advent (USA), Ar Folk (France), Autogram (Germany), Blue Labor (USA), Celtic Music (UK), Cezame (France), Contemp (Germany), Coreco (Netherlands), Crossroad (Netherlands), Dingles (UK), Duo (Netherlands), Earwig (USA), Evasion (France), Flying Fish (USA), Free Bird (France), GMP (Germany), Highway (UK), Inche-cronn (USA), Iona (UK), JSP (UK), Joke (Germany), Kettle (UK), L&R (Germany), Mosaic (UK), Mulligan (Ireland), Ornament (Germany), Pan (Netherlands), Pan Audio (UK), Parsifal (Belgium), Rare Bid (Germany), Rounder (USA), Shanachie (USA), Springthyme (UK), Tara (Ireland), Temple (UK), Topic (UK), WAM (Germany), Waterfront (UK), Waterland (Netherlands).
- Int'l repps.: Belgium (Parsifal), Germany (Bellaphon, Plaene), Switzerland (Pck), UK (Highway), USA (Shanachie).
- Music House, Postbus 60, Maarn. Tel: (03432) 27-90.
- Musidor BV, Herengracht 566, 1017 GH Amsterdam. Tel: (020) 25-71-60. Telex: 16593. Mng. Dirs.: A.J. van der Marel, A.J.D. Wilkinson.
Label: (Owned) Rolling Stones.
- N L, see Ivory Tower.
- Nederlandse Boekenclub, Prinsenvinkelpark 2, The Hague. Tel: (070) 51-43-51. Gen. Dir.: P. Schreuder; Gen. Mgr.: J. Kasander. (Distributor/Importer)
- Nevofoon, see Boscheck.
- Nonesuch, see WEA
- Nuss Bedrijven BV, Marijkelaan 21, 2421 CR Nieuwkoop. Tel: (01725) 36-72. Cable: DISTRINIUS. Dir.: Bert Nuis; Gen. Mgr.: Dick Roseboom; Sales Mgr.: Tom van Boven.
Labels: (Owned) Agram-Blues; (distributed-not licensed) Amigo (Sweden), Appalocosa (Italy), Base-ESP (Italy), Biograph (USA), Black Saint (Italy), CLS (Italy), Discocorp (USA), Folkways (USA), Font-Cetra (Italy), Herwin (USA), Klavier (USA), L&R (Germany), Lynchord (USA), Melodya (USSR), 1750 Arch (USA), Oversea (Switzerland), Pearl (UK), Queen (Italy), Radiola (USA), Rare Bid (Germany), Red Record (Italy), Route 66 (Sweden), Sandy Hook (USA), Soul Note (Italy), Summit (USA).
Int'l repps.: Germany (Bellaphon), Italy (IRD), Sweden (Amigo), UK (Cadillac, Swift), USA (City Hall, Rounder, Shanachie).
- Dbeisik, see Evan Durlacher.
- Octopus, Postbus 67, Marterkamp 40, Driebergen. Tel: (03438) 44-08.
- Odeon, see EMI Recs.
- Ojee, see Telstar.
- Martin A. van Olderen Oldie Blues, Blues Rec. Center, Postbus 12538, Maas-dreihof 175, 1106 NG Amsterdam. Tel: (020) 96-11-11. Owner & Dir.: Martin A. van Olderen. (Distributed by Munich)
Labels: (Owned) Duo, Oldie Blues; (distributed-not licensed) Blue Silver (France), Earwig (USA), Flyright (UK), Ornament (Germany), Red Lightnin' (UK).
Int'l repps.: Germany (Ornament), UK (Flyright/Swift), USA (Shanley).
- Oldie Blues, see Munich & Martin A. van Olderen.
- Oldway-Windmill Org., Oldway Studio, Streuveilaan 12, 4707 CH Roosendaal. Tel: (01650) 4-39-26. Telex: 74083. Gen. Mgr.: Jan Verborgt; A&R: Hans Jongmans; Press & Promo.: Jacq van Loon.
Labels: (Owned) JI, Jojo.
- Omega, see Dureco.
- 1000 Idiolen, see RCA.
- Only Yesterday, Jan Henkstr. 72, The Hague. Tel: (070) 65-41-86. (Importer)
- Onys, see Boscheck.
- Orion, see Polydor.
- P C M P Inc., PO Box 469, 3130 AL Vlaardingen. Tel: (010) 35-71-20.
- Panoramic, see Verschoor.
- Papagayo Recs., Emmastr. 13a, 1211 NE Hilversum. Tel: (035) 23-46-46. Telex: 73254. Mng. Dir.: Charly Prick. (Distributed by Inelco.)
Labels: (Owned) Papagayo; (Licensed foreign) Baby (Italy).
Int'l repps.: Austria (EMI Electrola), Germany (EMI Electrola), Scandinavia (K-tel), Switzerland (EMI Electrola).
- Parlophone, see EMI Recs.
- Pastor Recs., Bartelhorstr. 42, Haarlem. Tel: (023) 31-08-65. Cable: PAS-REC. Telex: 41642. Dir.: K. Th. Pastor; Gen. Mgr.: C. Sieckerman; Sales Mgr.: M. Koelman. (Distributor/Importer)
Labels: (Represented) Atlas, Bahiaphone, Boussophone, Carrophone, Casaphone, Dounia, Uniaphone, El Feth, Fran, Koutoubiaphone, Lyr, Nabiaphone, Oasis, Olympic, Sono Cairo, Soutelphan, Viking, Voix du Globe, Voix du Lebanon, Voix du Stars; (distributed-not licensed) Lyrchord, Monitor, Rounder (all USA).
- Paviljoen, see de Bazuin & Vista.
- Pearl, see Arcade.
- Peer Southern Prod'n's (PSP), Larenweg 159, Hilversum. Tel: (035) 83-12-14.
- Philips, see Phonogram BV & Phonogram Int'l BV.
- Phonogram BV (a PolyGram Co.) (IFPI), Catharina van Renneslaan 10, 1217 CX Hilversum. Tel: (035) 4-75-41. Telex: 43302. Mng. Dir.: Willem Barents; Admin'r: Adri Twtig; Nat'l A&R Dir.: Otto Vnezenberg; Pop Prod. Mgr.: Jaap Houthing; Mktg. Mgr.: Rob Edwards.
Labels: (Owned) Casablanca, Fontana, Mercury, Philips, Vertigo; (Licensed foreign) Argo (UK), Charisma (UK), Decca (UK), Decca Bellona (UK), Deram (UK), Durium (Italy), Ensign (UK), Haven (USA), Landsdown (UK), London (UK), Manhattan (USA), Mountain (UK), L'Oiseau Lyre (UK), Power Exchange (UK), Threshold (UK), 20th Century (USA), Utopia (UK), Utopia Music (UK).
- Phonogram Int'l BV (a PolyGram Co.) (IFPI), PO Box 23, 3740 AA Baarn; Gerrit van der Veenlaan 4, 3743 DN Baarn. Tel: (02154) 1-99-11. Cable: PHDNINT. Telex: 43400. Pres.: Henk Th. Holsbergen; Exec. VP: Aart Dabhuisen; VP: Ernst Th. van der Vossen.
Labels: (Owned) Casablanca, Fontana, Limeight, Mercury, Philips, Vertigo; (Licensed foreign) Charisma (UK), Manhattan (USA), Mountain (UK), Rocket (UK).
- Pico Recs., Ganzenhoef 28, Amsterdam. Tel: (020) 99-47-36. Dir.: Hans Douw; Gen. Mgr.: Kees Kuiper; Sales Mgr.: Atma Ramchalaan. (Distributor/Importer)
- Plato, see Disco de Man & Dureco.
- Plures, Postbus 80480, 1005 BL Amsterdam; Burgemeester Cramergracht 110, 1064 AJ Amsterdam. Tel: (020) 13-07-08. Gen. Mgr.: W. van Middelendorp.
Label: (Owned) Phares.
Int'l repps.: UK (Zircon), USA (Jem).
- Polydor BV (IFPI), Albertus Perkrstr. 35, 1217 NL Hilversum; PO Box 2057, 1200 CB Hilversum. Tel: (035) 23-49-41. Telex: 73352. Mng. Dir.: Nico van Biemen; Mktg. Mgr.: Anton Witkamp; Sales Mgr.: Andre van der Leest; Nat'l A&R Mgr.: Harry Knipschild; Promo. Mgr.: Kees van Weijen;

Holland Music B.V.
Hilversum, Holland

Adv Mgr George Cramer, Press Mgr Michael Peterson, Prod Mgrs Tom Steenberg, Jan Loman, Henk Keuter, Richard de Jong.
Labels: (Owned) Archiv, DG, Heliodor, Karussell, MGM, Metro, Drion, Polydor, Triumph, Verve, (licensed domestic) Dona, Harlekin, (licensed foreign) Capricorn (USA), Cube (UK), EG (UK), Electric (UK), Energy (UK), Fiction (UK), Oyster (USA), Phil Spector (USA), Polar (Sweden), RSO (UK, USA), Spring (USA), Track (UK)

PolyGram BV (IFPI), PO Box 23, 3740 AA Baarn, Gerrit van der Veenlaan 4, 3743 DN Baarn Tel. (02154) 1 99 11 Telex 43400 Pres Wolfgang Hx. Exec VP's Kurt Kinkele, Karl-Heinz Busacker, Dr Hermann Franz, VP's George H. Baenge, Dr Eckart Haas, Harvey L. Schein, Dr Werner Vogel-sang, Heinz T Voigt, Willem L Zalsman, PR Dir Herbert Winter
Note: PolyGram is a multi-media enterprise that creates, records, manu-factures, markets, and distributes music on records and tapes. Its activi-ties include music publishing, motion picture and television films, video entertainment, instructional programs, direct marketing and trading

PolyGram Nederland BV (IFPI), PO Box 23, 3740 AA Baarn, Gerrit van der Veenlaan 4, 3743 DN Baarn Tel. (02154) 1 99 11 Telex 43400 Pres Henk Th Holsbergen, Exec VP Robert A E Stuyt, VP Roal H Kraefft, PR Dir Jan Lubinstein
Note: PolyGram Nederland BV co ordinates all activities of the PolyGram Group in the Netherlands

PolyGram Rec Dps The Netherlands, PO Box 23, 3740 AA Baarn, Gerrit van der Veenlaan 4, 3743 DN Baarn Tel. (02154) 1 99 11 Telex 43400 Pres. & Chief Exec Officer Ton van den Brink
Note: PolyGram Rec. Dps. The Netherlands co-ordinates all music activi-ties of PolyGram in the Netherlands

PolyGram Rec. Serv. PO Box 380, 1115 ZH Duivendrecht, van der Madeweg 12 14a, 1099 BT Amsterdam Tel (3120) 93 48 34 Telex 12048 Dir A.P.J. Roomans
 Pop Sound, see Evan Durlacher
 Power Music, Postbus 2030, 's-Hertogenbosch Tel (073) 14-73 34 Telex 50819
 Prelude, see Vista
 Prima Budget Serv. BV, Industrieweg 45 B, 2651 BC Berkel en Rodenrijs Tel. (01891) 5722, Telex 26385, Dir Jan van der Linden, Gen Mgr Angelique Jongeneel, Sales Mgr Jacques Aekema
 Pro Forma, see Collector
 Purple Eye Prod'n BV, Flevolaan 41, Naarden, Tel. (02159) 4 62 66 Telex 43191 Dir J Brands
 Pussycat Recs., A Bloemzaertstr 6, 3514 UP Utrecht Tel (030) 71-96-87 Telex 40996. (Also see Henk Kreeftmeyer)

R C A BV (IFPI), Prins Hendriklaan 26, 1075 BD Amsterdam, Tel. (020) 64 00-81 Telex 18063 Mng Dir Cees Wessels, Comm'l Mgr Frank Lee man, Controller Ben Haasdyk, Promo Mgr Jaap Poort
Labels: (Licensed domestic) 1000 Idioten, (licensed foreign) AZ (France), Ace (UK), BBZ Prod'n (France), Big Beat (UK), Blue Bird (USA), Chiswick (UK), DRG (USA), EMC (UK), Erato (France), Flying Dutchman (USA), Gem Tomy (UK), Gold Mind (USA), Grunt (USA), Gry phon (USA), Mericana (USA), Midsong (USA), Millennium (USA), New York Int'l (USA), Numero Uno (Italy), 1000 Idioten (Netherlands), Dpus Klassek (Germany), RCA (USA), RCA Camden (USA), RCA Gold Seal (USA), RCA Pure Gold (USA), RCA Red Seal (USA), Safari (UK), Salsoul (USA), RCA (Germany), Solar (USA), 20th Century-Fox (USA), White Dia mond (USA), Windsong (USA), Wooden Nickel (USA)

Rackstar, see Telstar
 Radio Music Nederland, PO Box 338, Bussum Tel 4 62 66 Dirs Guus Jan sen, Hubert Terheggen
 Rams Horn Recs. BV, PO Box 26, 2110 AA Aardenhout Tel (023) 24 91 31 Telex 41193 Dirs Guido & Simone Weyprecht, Sales Wim van Duyn
Labels: (Owned) Rams Horn, (licensed) Brunswick, Cats Jazz, Prelude
 Record Serv. Benelux BV, Franse Akker 9, 4824 AL Breda Tel (076) 41 48 00 Telex 54926 Dir J Puijpe, Gen Mgr P V Kuyjeren, Sales Mgr H Ranselaar (Record Distributor)

Rec Track Nederland BV, PO Box 113, 3600 AC Maarsse Tel (030) 43 11 44 Telex 40354 Dir. Gen & Sales Mgr M C Groeneveld (Manufac turer/Distributor/Importer/Exporter)
 Red Bull Prod'n, PO Box 231, 1200 AE Mijlervest Tel (035) 85 78 41 Telex 43956 Dir Willem J van Kooten
 Religioso, see Vista
 Reprise, see WEA

Ring Recs. Orchiidestr 19a, Hilversum, Tel. (02150) 4 38 41 Mng Dir Niek Lucas, Gen Mgr Theo de Vos, Prod'n Mgr Nick P Lucas, Creative Dir Joop Doderer, Co ord Mgr Mrs Rietje Redijk
 Road Runner Prod'n BV, Willemparkweg 123, 107, GW Amsterdam Tel (020) 73-60-84, Dir.: Cees Wessels
 Rockaway, see Inelco
 Rockhouse Recs. de Platenboer BV, Stortenbekerstr 5, 2421 ES Nieuwkoop Tel (07125) 14-32 Telex 39524 Dir. Bert Rockhuizen, Gen Mgr Francces Rockhuizen (Distributed by Inelco)
Labels: (Owned) Rockhouse, (licensed foreign) Bomp (USA), Harlem (USA), Poko (Finland), Red Lightnin' (UK), Solid Smoke (USA)
 Int'l repps.: Austria (Bellaphon, Master, Teldec), Belgium (Inelco), Canada (Boot), Denmark (Sonet), Finland (Polarvox), France (Carrere, Rempa), Germany (Bellaphon, Master, Teldec), Ireland (Charly), Italy (Carosello,

Cemed), New Zealand (EMI), Norway (Sonet), Spain (Auv), Sweden (So net), Switzerland (Bellaphon, Master, Teldec), UK (Charly)
 Rolling Stones, see Musidor
 Rubber Recs., NZ Voorburgwal 140, Amsterdam Tel (020) 42-59-52
 Rutogrom, Van Ostadestr 284, The Hague Tel (070) 33 76-90, 29-34-87
 S R, see Ivory Tower
 St. Anna, see Munich
 Score Recs. BV, Rudonck 16, 4824 AjeBreda Tel (076) 41 77 44 Gen Mgr Andre Grootaert

Labels: (Owned) Score, (distributed-not licensed) Alpha (Belgium), Ameca (France), Bel Air (France), Big Beat (France), Festival (France), Jazz Anthology (France), Monopole (Belgium), Musidisc (France), Second Life Recs. A J Ernststr 9, 1083 GP Amsterdam Tel (020) 42-92-88 Cable SYLVAINSHDOW Dir. Sylvain J de Haas, Gen Mgr Erna de Haas

Skyrocket, see Mike Vincent
 Sonclair, see Vista
 Sonopresse BV, PO Box 751, Stuwadorstr 106, Rotterdam Tel (010) 84-47 10, 84 86 47 Telex 28478 Mng Dir Leo Ritmeester
 Sound Prods Holland BV (IFPI), Doodrechtsewijk 16a, Loosdrecht Tel (02158) 51 01 Telex 43260 Dir Gert Vandermeent, Gen Mgr Marijke Bosch, Sales Mgr Paul Karling

Labels: (Owned) Fideho, (licensed domestic) Friends, Universe, (licensed foreign) BBC (UK), Budapest (Hungary), Cherry Red (UK), Emal (Greece), Graduate (UK), (distributed-not licensed) CRD (UK), Chyme (Ireland), Contemporary (USA), Delta (Germany), Fono (Germany), Har monia Mundi (France), Hungaroton (Hungary), Muza (Poland), Plaene (Germany), Saga (UK), Turnabout (UK), Uncorn (UK)
 Int'l repps.: Germany (Delta), Switzerland (Tudor)

Sound Track, see Xantippe
 Space Prod'n, Finmark 4, 3831 JG Leusden C Tel (033) 94-18-88 Dir John Russell
 Starfighter, see Mamcha
 Stichting Voor Mekaar, Postbus 4688, Amsterdam Tel (020) 23-71-40
 Stool, see Munich
 Sunset, see EMI Recs

Sure Shot Music BV, Dude Udenseweg 29, Uden Tel (04132) 6-88-23 Telex 50819, Gen & Sales Mgr R Peters, A&R Mgr & Prod'r T Peters (Distributor/Exporter)
 Swingmaster Recs., Krutlaan 21A, 9711 TW Groningen
 T & Prod'n, Amersfoortseweg 18, Hus Ter Heide Tel (03404) 3 17 28
 T R R, see WEA

Target, see Bosheek
 Te Deum, see Dureco
 Teleonic BV, Koningsnellen 25, 3762 DA Soest
 Telstar Recs. BV, PO Box 70, 6000 AB Weert, Ulenweg 38, 6006 SK Weert, Tel (04950) 3-56 40 Telex 37576 Dir & Nat'l Repertoire Mgr Johnny Hoes, Gen Mgr Jacques Hoes, Sales Mgr Adri Jan Hoes, Prod. Mgr S Djamschidi, Press, Promo & Adv Mgr Bert Salden, Export Mgr Joseph Verbiest, Radio & TV Promo. Bert Smit, Rude de Raaff, Annie de Reuver, Int'l Repertoire Mgrs Adri-Jan Hoes, Bert Salden, A&R Johnny Hoes Jr
Labels: (Owned) Gnome, Iris, Kendari, Killroy, Laudate, Lorelei, Dje, Rackstar, Telstar

Int'l rep.: Belgium, Luxembourg (both Phonogram)
 Timeless, see Wim Wigt & Dureco
 Top Format Prod'n, Parklaan 95, Haarlem Tel (023) 32-06-40, Telex 241538
 Traffic, see Bosheek
 Trent, see Arcade
 Triumph, see Polydor
 Tutor Country, see Mike Vincent

Unsong Prod'n, Dranje Nassaulaan 25, Amsterdam Tel (020) 79-70 47
 Universe Prod'n, Spanjaardlaan 33, Leeuwarden Tel (05100) 2 01 94, 2 45 22 Pres Wobbe van Seijen
 Univox, Postbus 143, Paterswoldseweg 21A, Groningen Tel (050) 12-23-60
 Unknown, see Collector
 Urk, see Vista

V I P Recs BV (IFPI), PO Box 234, 1430 AE Aalsmeer Tel (02977) 4 10 21 Telex 11837 Mng Dir Roger Meytemans, Gen Mgr Edo Peek (Dis tributed by Inelco Recs & Tapes)
Labels: (Licensed foreign) All Platinum (USA), Blueprint (UK), Board walk (USA), Buddah (USA), Cadet (USA), Calbre (UK), Checker (USA), Chess (USA), Copacabana (USA), Cream-Hi (USA), De Lite (USA), GNP Crescendo (USA), Ibis (France), Kingdom (UK), Klub (UK), Melba (France), Motown (USA), PRT (UK), Precision (UK), Pyramid (France), Rare Earth (USA), Roulette (USA), Sugar Hill (USA), Tamlia (USA), Van guard (USA), Vogue (France), WMDT (USA)

V V R, see Mamcha
 Van den Bosch & Van Nieuwkoop BV/Boni Recs BV Lyvbaanstr 4, Katwijk Tel (10718) 2-39 04, Telex 39010 Co Pres G van den Bosch, J van Nieuwkoop, Sales Mgr J Frei (Distributor/Importer)
 Vara (Omroepvereniging), Postbus 1991, Middenweg 1, 1200 BZ Hilversum Tel (035) 71 19 11 Telex: 43212 Dir H Swets, Gen Mgr Th van der Kolk (Distributed by Inelco)

Label: (Owned) Varagram
 Varagram, see Vara
 Veronica, see Evan Durlacher
 Verschoor, Dr A. Kuyperstr. 46, 2841 CK Moordrecht Tel (01827) 23 57 Chief Exec V Verschoor (Distributed by Vista)
Labels: (Owned) Mavis, Panaramic
 Vertigo, see Phonogram BV & Phonogram Int'l BV
 Verve, see Polydor
 Villa, see Arcade

Mike Vincent Prod'n BV, Pettelaarseweg 25, 5216 BG 's-Hertogenbosch Tel (073) 14 73 34, 13 83 52, Telex: 41605 Pres Wilhelm Vermeulen Wdsant (Distributed by Mamcha Music)
Labels: (Owned) Condor, Skyrocket, Tutor Country, Vliegende Hollander
 Visco Prod'n BV, Graafsebaan 40, 5242 JM Rosmalen Tel (04192) 91 51, Telex 50671

Vista Recs., Flegelstr 11, 5306 AV Brakel Tel (04187) 18-85 Dir. John A Vis, Gen Mgr Carla Vis, Sales Mgr Fokke Antonides, Repertory Dept. Ellen T Gilde
Labels: (Owned) Canto di Vangelo, Laurens, Vista, Welkom, (licensed do-mestic) Bazun, CRI, Editio Laran, Eurosound, Festivo, Glorioso, Jubal KMK, Martiniphon, Mawogram, Paviljoen, Prelude, Religioso, Sonclair, Urk, (distributed-not licensed) Abanori (Germany), Abbey (UK), Advent (USA), Alpha (Belgium), Berlinon (Germany), Cathedral (UK), Cinesound (UK), Credo (Sweden), Da Camera (Germany), Eco (Italy), Edic (France), Finlandia (Finland), CRC (USA), Gallo (Switzerland), Hed Azri (Israel), Hibiscus (New Zealand), Improptu (Germany), Lesborne (Austria), Lyr urchod (USA), Mixtur (Germany), Monumenta Belgicae Musicae (Bel gium), Motette (Germany), Organum (Finland), Pape Drgeldokumente (Germany), Peica (Germany), Psalite (Germany), Sastruphon (Ger

many), Sterling (Sweden), Stil (France), Telarc (USA), VDE (Switzerland), Vista (UK), Walcher (Germany)
 Int'l rep.: Belgium (Leman & Gorie), Germany (Mixtur)
 Vliegende Hollander, see Mike Vincent
 W E A Int'l, see WEA

W E A Recs. BV, (IFPI), Burg Lambooylaan 21, 1217 LB Hilversum Tel (035) 1 54 53 Cable WEARC Mng Dir Ben Bouders, Gen Mgr Hans Tonno, Sales Mgr Ger v d Meys, Financial Controller Kees de Widdt
Home office: USA, WEA Int'l
Labels: (Owned) Asylum, Atco, Alliantic, Automatic, Cotillon, Elektra, Midi, Nonesuch, Reprise, TTR, WEA, WEA Int'l, Warner Bros., (Licensed) Big Tree (USA), Black & Blue/Isabel/Ahead (France), Dark Horse (USA), DiscReet (USA), Enigma (USA), F Beat (UK), Flarenasch (France), Heza gone (France), Jungle Jam, Korova (UK), Laser (UK), Little David (USA), Maligator (France), Milan (France), Mirage (USA), Drk (USA), Paradise (USA), Passport (USA), Planet (USA), Pogo (UK), RFC (USA), Radar (UK), Real (USA), Reprise (USA), Rwa (USA), She (UK), SFC (USA), Swan Song (USA), Whitfield (USA)

W S P, see Weton Wesgram
 W S P Select, see Weton Wesgram
 Warner Bros., see WEA
 Welkom, see Vista
 Westland Studio's, Industriestri 21, 2671 CT Naaldwyk Tel (01740) 2-40-87 Chief Exec W A Westbroek, P van der Hout
 West World Recs., PO Box 633, Amsterdam, Tel (020) 16 32 42, Gen Mgr Peter Rensen

Labels: (Owned) Moon Base, West World
 Weton-Wesgram BV, Veerlaan 84 92, 3072 ZZ Rotterdam Tel (010) 86-11 66 Telex 28798 Chief Exec M A Eggelsheim, Gen Mgr Chr van Duin
Labels: (Owned) DGR, WSP, WSP Select, (distributed) Joker, Surprise, Walt Disney
 Int'l repps.: Belgium (Keusing), Finland (Polarvox), France (Dave), Swe den (Music for All), Switzerland (Jelmoli), UK (Music Peddlers)

White Label, see Collector
 Wim Wigt Prod'n/Timeless Recs., PO Box 201, Roghorst 303, 6700 AE Wa geningen Tel (08370) 1-34 40, 1 34 45, Telex: 45991 Dir Wim Wigt
Labels: (Owned) Timeless, (distributed-not licensed) Black Saint (Italy), Circle (Germany), Huro (Italy), ICP, SteepleChase (Denmark)
 Int'l repps.: Austria (Bellaphon), France (Musica), Germany (Bellaphon), Italy (IRD), Japan (Nippon Phonogram), Switzerland (Bellaphon), UK (Jazz Horizons), USA (Wim Wigt)

Xantippe Prod'n BV, Hazeпад 8 b, 4825 AV Breda Tel (076) 71 01-05 Dirs J C M Cornel, A J M Vermeulen, Gen & Sales Mgr Jacques Cornet (Distributed by Record Serv. Benelux)
Labels: (Owned) Egm, Klomp, Sound Track, Xantippe
 Int'l repps.: Belgium, Luxembourg (both Record Serv. Benelux)
 Xilovox, Stodponk 51A, 5715 PD Lierop, Tel (04920) 4 40 14
 Zen, see International Rec. Dist'n

• music publishers

A R S I S, Steegstr 16, 6041 EA Roermond Tel (04750) 3 36 98
 Int'l firm represented: Arc en Gel (Belgium)
 Accordia Musica, Jelle Eelmsmastr 11hs, Amsterdam Tel (020) 11 22 53
 Acorn Music, Tabaksweg 6, Elst Tel (08346) 17 34
 Action Music, see EMI Music Publg
 Albersen & Co BV (Muziekhandel), Groot Hertoginnelaan 182, 2517 EV The Hague Tel (070) 45 60 00 Chief Execs J B M & H E A M Albersen, Alco Music Int'l BV, Machineweg 8, 1394 AV Nederhorst den Berg Tel (02945) 17 91, Mng Dir Wim Hauei

All Ears Music, Groeneweg 25, Amsterdam, Tel (020) 22 86 90
 All Rock Music Publi's, PO Box 2296, 3000 GG Rotterdam Tel (010) 22 48 89 Gen Mgr Cees Klop
 Int'l firms represented: Acropolis, Banks, Bo An, Charlie Roach, Island, Larrax, Linco, McClendon, Bob Smith (all USA)
 Int'l repps.: Belgium (Monopole), UK (Travis)

Allegro (Ed.), see Van Teeseling
 W Alphenaar CV, Kruisweg 47 49, Haarlem Tel (023) 32 02 44
 G Alsbach & Co, Flevolaan 41, Naarden Tel (02159) 4 62 66
 Ananas, Flevolaan 41, Naarden Tel (02159) 4 62 66 Chief Exec. John Brands
 April Music Holland BV, Dude Enghweg 24, 1217 JD Hilversum Tel (035) 4 91 42, Telex 73384 Gen Mgr Koos de Vreeze, Exec Mgr Joost van Os

Ariola Music Benelux BV, Lindenheuvel 3, 1217 JV Hilversum, Tel: (035) 23 22-41 Telex: 43639 Mng Dir Wim Schipper, Gen Mgr Tom Collins
 Int'l firms represented: Arista/Careers, Fast Western, Mayflower, Min otaur, Bryan Morrison, Pt. Tom Robinson
 ARI Music Publg Co. (SIEMRA), 519 Sir Winston Churchilllaan, Ryswyk ZH Tel (070) 94 66-57 Chief Exec & Gen Mgr Arie Ligthart
 Ars Nova (Muziekuitgeverij), Oostsingel 92, Goes Tel (01100) 1-58-16
 Int'l rep.: USA (Presser Co.) (Also see Joh de Heer)

Artemis BV (Muziekuitgeverij), Gerrit van der Veenlaan 4, Baarn Tel (02154) 1 95 99, 1 66 83 Cable MUZARTEM Telex 43400 Pres Heinz T Voigt, Gen Mgr: Anton Smitz
 Int'l firms represented: ATV, Andros, Argus, Arnakata, Audigram, Bana nans, Baron, Barton, Johnny Brienstock, Big Apple, Big Pig, Blue Gum, Blue Oyster Cuit, Bob Cor, Hamilton Bohannon, Boomtown Rats, Bregman Vocco & Conn, Bridge House, Broken Fiddle, Bron, Bug, Bulb, Bushka, CAM, CIA, Cate Americana, Carlin, Charlotte, Clarke, Con tagious, Dabe, Darnont, Dawray, Dayn, Doctor Snuggles, Double Bios, Double Exposure, Dough Boy, Francis Dreyfus, Dynatone, EDM, Erik House, Wes Farrell, Father, Fedora, Fifth Floor, Fischerz Baban, Fleetwood Mac, Fort Knox, Fuse, GH, Gentoo, Giving Room, Gnosnos, Gogly, Guerrilla, Hallelujah, Harlene, Health/Ley, Hensley, Hit & Run, House of Gemini, Hudson Bay, Island, Jet, Jimpre, Jedo, Jru, Josley, Kaskat, Kenya, Klub, Kongrde, Lambert & Potter, Leadsheet Land, Leross, Sonny Lester, Litha, Lois, Luckyy, MIM, Magazine, Magnet, Marson, Martin-Coulter, John Martyn, Mayday, Mews, Midsong, Neighborhood, Normal, Not For All Seasons, Dmfug, Orange, Peacock, Pickwick Int'l, Pocket, Quick Mix, RSD, Rare Blue/Monster Island, Reno/Metz, Ricks, Rolling Fork, Rockhopper, Rodra Berna, Ryan, Sailor, Seabreeze, Scott/Waffle, Sheepstone & Dibbens, Siqomb, Simon Sousson, Sky Harbor, Sky Writing, Sleepy Dumping, Songwriters Workshop, Special, Aaton Spelling Split Enz, Bruce Springsteen, Sumac, Sweet, Ten East, Times Talent, Third Story, Third World, Peter Thomas, Times Square, Timbobe, Tonedchild, Trane, Tru, 20th Century, Vanilla, White Haven, Wire, Windecor, Worlds End, Yellow Dog, Zum

Ass Artists Munich Music BV, Postbus 37, Maarsse Tel (03465) 6 22 76
 Associated Artists Int'l BV, PO Box 37, Antloepspoor 238, Maarsse Tel (03465) 6 22 76 Gen Mgr Joop Gerrits, Prof Mgr Jochem van Re nesse
 Atlantica Ed., Zeddameweg 38, 's Heerenberg Tel (08346) 14 36
 Aussie Music, Henri Dunantstr 53, Brunssum Tel (045) 25 32 08

Billboard 1981-1982 International Buyer's Guide

for the Benelux:



UNIVERSAL SONGS

25 Oranje Nassaulaan
 1075 AJ Amsterdam
 Phone: 020-797047

Auteursunie BV, Vondelstr. 90, 1054 GN Amsterdam. Tel: (020) 18-63-24.
Gen. Mgr. Wim van Vught
Int'l firms represented: Mento (Germany), Valentine (UK), Valgroup (UK)
Int'l rep.: Germany (Mento).
Avion Music, see EMI Music Publ'g.
(B) Company of the Two P(i)eters, see Company of the Two P(i)eters.
B. E. L. Sound, Buursterstr. 356, Enschede. Tel: (053) 76 30-22.
B M G Music, Molenvlietsedijk 23-25 4691 HS Tholen. Tel: (01660) 3226.
Baltic (Nederland), Postbus 37, Maarssen. Tel: (03465) 6-22-76
Anne Bank (Ed.) BV, PO Box 60061, 1005 GB Amsterdam; Anna Vondelstr. 13, 1054 GX Amsterdam. Tel: (020) 18-24-93. Dir. H. Oostendorp
Int'l firm represented: Doblinger (Austria)
Baranda Music, Sporkhout 48, Huizen. Tel: (02152) 5-04-99
Basset Music, see Mamicha.
Beau Harbour Music, see Company of the Two P(i)eters.
Behind The Dikes Music, see Warner Bros.
Bel Harbour Music, see Company of the Two P(i)eters.
Benelus Music Publ'g, PO Box 70, 6000 AB Weert; Uilenweg 38, 6006 SK Weert. Tel: (04950) 3-56-40. Telex: 37576. Gen. Mgr.: Jacques Hoes.
J. Ph. Benson, PO Box 59, 7260 AB Borne. Tel: (05490) 1-19-30. Dir. John Phillip Benson.
Best Music, Craspystr. 9, 5171 CH Kaatsheuvel. Tel: (04167) 7 32-70. Mng. Dr. Peter van Best.
Black Night, see Nada.
Blenco Music, Meersenerweg 313, Maasricht. Tel: (043) 62-20-18. Dir. J. Vneelaar; Prof. Mgr. Johnny Blenco.
Blow Music CV, Poelhekkelaan 10, 5544 TN Eindhoven. Tel: (040) 11 47-94.
Mng. Dr. Ms. W. van Schalkwijk
Boekencentrum BV, see Joh de Heer.
Bowevill, see Hilversum.
Broekmans & Van Poppel, Van Baer estr. 92-94, Amsterdam. Tel: (020) 72-80-84, 79-65-75, 79-61-26. Pres. G. Ganziotti; Sales Mgr.: P. J. A. Ganziotti.
Int'l firms represented: Chester (UK), Forsyth Bros. (UK), Kultura (Hungary), Russian State Music (USSR), Warren & Philips (UK).
Int'l rep.: USA (Peters).
Bureau voor Uitgave van Nederlandse Orgelmuziek, Dahliastr. 30, Koog a. d. Zaan. Tel: (075) 16-22-94.
C. C. see Mamicha.
C N C Products BV, Seelingsingel 17, 4811 CN Breda. Tel: (076) 14 16 72.
Contact: Angelique van Buuren.
Carlton Music, Jules Haeckstr. 4011, 7553 XJ Hengelo. Tel: (074) 43 27-06.
Centrale Muziekhandel, Cuyppstr. A23, Amersfoort. Tel: (033) 1-60-70.
Chackay Music, see Blenco.
Chappell & Co Holland BV, PO Box: 338, Bussum; Flevolaan 41, 1411 KC Naarden. Tel: (02159) 4 62-66. Mgr.: Jan De Winter.
Cheese Music, Eemmeer 15, Spakenburg. Tel: (03499) 23 70. Telex: 41605 Tekom/NL Spring.
Cloggy Music, see EMI Music Publ'g.
Coehoorn Music, see EMI Music Publ'g.
Colt Music, see Blenco.
Company of the Two P(i)eters BV, PO Box 1299, Lindendreef 3, 1200 BG Hilversum. Tel: (035) 23-22-41. Telex: 43639 Dirs. Peter Schoonhoven, Pieter van Bodegraven.
Int'l firms represented: Agent Orange, Alkatraz Corner, Big Heart, Big Sky, Candlewick, Cleveland Int'l, Daksel, Dav-Mel, Dizzy Heights, Druse, Dwarf, Emmet Meltdown, Forever Endeavor, Four Aces, Frozen Butterfly, Golden Cornflake, Hancock, Harlem/Halwell, Ice Age, Garland Jeffreys, Jimm-Ed, John & JH, Jondora, Jorful Wisdom, Kentucky Wonder, Kidada, Charles Kippis, Kiss, Le Bone Air, Light, McDonald, Mel-Dav, Moonlight & Magnolias, Narrow Gate, Old Grog, Open End, Oyster, Pinball, Polo Grounds, Pop 'n Roll, Pure Prairie League, Ram's Horn, Rockstam, Sel-dah, Shoesongs, Shoeunes, Singing Ink, Special Rider, State of the Arts, Sun Disc, Tumbleweed, Tutone-Keller, Twist Party Int'l, Vicous Circle, William H. Withers/Bleumig/Golden Withers, X-Factor, Yellow Brick Road (all USA), Blue Moon (Switzerland), Robin Gibb (UK), Planteng Visions (UK), Robin Song (France).
Int'l reps.: Belgium (B) Company of the Two P(i)eters, UK, USA (Company of the two P(i)eters).
Continental Sound, PO Box 81065, Rotterdam. Tel: (010) 21 10 98, 21-48 28. Or. Leen La Riviere.
Coolwine Music, Albertus Perkstr. 35, Hilversum. Tel: (035) 4-77-49.
Corona Int'l, Margrietlaan 28, 1735 HE 't Veld. Tel: (02262) 21-34. Dir. Jan C. Buijs.
Creighton Musicology, Musica Antiqua, Lassuslaan 45, Bilthoven. Tel: (030) 78 37 14.
Crusade Music, Stationsweg 43, Hoogezand. Tel: (05980) 9-26 35.
Cuchoo Music, Provincialeweg 47, 1561 KM Krommenie. Tel: (075) 21 50 21. Dir. Joop Koekkoek.
Joh de Heer & Zn. BV (Handelmij); Rozenlaan 113, Rotterdam. Tel: (010) 22 09 88. Dir. J. A. de Heer.
Int'l firms represented: Bayle & Ferguson (UK), Chris Boss (USA), Bratfish (Germany), Schubert & Co (Germany), Seifert (Germany).
Dennis Music BV, PO Box 585, Bloemstr. 32, 1200 AN Hilversum. Tel: (035) 1-27-61. Telex: 41998. Owner: Willem Bosheck, Gen. Mgr. Ronny Bosheck van der Laan.
Int'l firms represented: Boosey & Hawkes (UK), Ed. Caramba (Italy), La Fleur & Sons (UK), Selected Sound (Germany), Slorzando (France), Si-rocchio (France), Sonoton (Germany), Stock Music (Belgium), Technisonor (France).
Int'l rep.: Belgium (Stock Music).
De Toorts (Muziekuitgeverij), PO Box 576, Nijverheidsweg 1, Haarlem. Tel: (023) 31-93-60.
Dirty River Prod'n's, Utrechtseweg 10a, Hilversum. Tel: (035) 4 03-34. Mng. Dr. Ferry Wenneke.
Dokhum Eds., PO Box 189, Gravenstein 33, 2804 GS Gouda. Tel: (01820) 1 83-14. Gen. Mgr.: W. L. Dokkum.
Drenthe Music, see Dustbug.
Driving Wheels Music, see EMI Music Publ'g.
Dustbug Music, Flevolaan 41, Naarden. Tel: (02159) 4 62-66. Chief Exec. Andre de Raaf.
Dutch Energy Music, Hazepad 8-b, 4825 AV Breda. Tel: (076) 71 01 05. Dir. J. C. M. Cornel. Prof. Mgr. Jacques Cornel.
Int'l reps.: Belgium, Luxemburg (both Benelus).
Dutch Rec. Centre Ltd., Oudegracht 305, Utrecht. Tel: (030) 31-20-51.
Dutchy Publ'g BV, Pampuslaan 45, 1380 AA Weesp. Tel: (02940) 1-00-00, 1 53 21. Cable: RECMUS. Telex: 14409. Mng. Dir. Janne Bosmans, Prof. Mgr.: Rob Ebbens.
Int'l firms represented: AMT (France), Bens (Belgium), Bospel (Belgium), Diamond (UK), Fonior (Belgium), Grande Avenue (France), Kass ner (UK), Klaus Lorenzen (Germany), Meteoron (Germany), Page Full of Hits (UK), Polar (Sweden), Sutton-Miller (USA), Union Songs (Sweden), Whitsett Churchill (UK, USA).

E & E Music, PO Box 1525, 1000 BM Amsterdam. Tel: (020) 16-32-42. Gen. Mgr. Peter Rensen; Prof. Mgr.: John Bake.
E M I E A R Music BV, Postbus 739, Bronsteeweg 49, Heemstede. Tel: (023) 31-93-80. Telex: 41902. Mng. Dir. R.R. Kruijze; Gen. Mgr. D. v. Vliet.
E M I Music Publ'g Holland BV, Coehoornstr. 71, 1222 RS Hilversum. Tel: (035) 83-18-04. Telex: 73117. Mng. Dir. Frans de Wit, Prof. Mgr.: Roek Willemze, Gen. Admin. Mgr.: Chris van Houten.
Int'l firms represented: AVI (USA), Admiral One (UK), Alaska (UK), Alein (USA), Algee (USA), Alucard (UK), Ambleside (UK), Ameh (USA), Ardmore & Beechwood (UK), Aristocrat (UK), BBC (UK), Backroad (USA), Dense Barry (USA), Beechwood (USA), Bema (USA), Bernhardt (USA), Berry (UK), Big Ben (UK), Black Bull (USA), Black Swan (UK), Blue Street (USA), Bolingbroke (UK), Bosso Fataka (USA), Buddy (USA), Bug (USA), Calgula (USA), Chibell (UK), Colgems (USA), Cross Keys (USA), Dawson's Cove (USA), Deep Canyon (USA), Diamond Back (USA), Dix (UK), Dixie Bow (USA), Donna (UK), Dynamic Cat (UK), Easy Listening (USA), ERM (UK), European (UK), Evansongs/Somerset (USA), Excel lency (UK), Fate (USA), B. Feldman & Co. (UK), First Floor (UK), Fish Scent (USA), Forty Love (USA), Sam Fox (UK), Francis Day (UK), Frank & Nancy (USA), G&A (UK), Galleon (USA), Al Gallico (USA), Garnett (UK), Garrett (USA), Giant (UK), Goblet (USA), Good Tunes (USA), Good Time (USA), Grade One (USA), Heart's Delight (USA), Hermetic (UK), Hol-lingfield (UK), Homefire (USA), Icebag (USA), Jackson (USA), Jobete (USA), KPM (UK), Keep On Trucking (UK), Kennedy (UK), Kipahulu (USA), Large (USA), Little Dragon (USA), Little Switzerland (USA), Lord Jake (USA), Lunatunes (USA), Mad Lad (USA), Maicaboom (USA), Man-chester (UK), Mandina (USA), Mandy (USA), Manticore (UK), Marlboro (UK), Peter Maurice (UK), McDonald (USA), Medicine Hat (USA), Mole (USA), Moss Rose (UK), Mother Pearl (USA), Munchkin (USA), Mutual (UK), New Acme (UK), New Town Sound (UK), Neutral Grey (USA), Peter Noone (UK), Open Door (USA), Our Music (UK), Peacock (USA), Pin Russ (USA), Plurkantz-Krundle (USA), Pods (USA), Polo Grounds (USA), Prodi-gal Son (USA), Pride Fire (USA), Keith Prowse (UK), Queen (UK), Rams Head (USA), Ranjack (USA), Rattrap (USA), Red Bus (UK), Roar (UK), Rocksmith (USA), Rock Steady (USA), Ron Joy (USA), Rosy (USA), Rob-bins (UK, USA), Sams (Australia), Box Scaggs (USA), Schlaga (USA), Screen Gems (UK, USA), Sealfood (USA), Serlu (USA), Siggy (USA), Shk (UK), Stage & Screen (USA), Stone Diamond (USA), Stone Gold (USA), T Mac (UK), Tree (USA), Tribune (UK), Twitty Bird (USA), United Artists (USA), Valbrimar (USA), Van Halen (USA), Varda (UK), Walt Disney/Won-derland (USA), Larry Weiss (USA), Wmnot (USA), World Copyrights (UK), Frank Zappa (USA).
Int'l rep.: Worldwide (EMI).
Eerste Muziekcentrale BV, Flevolaan 41, Naarden. Tel: (02159) 4-62-66.
Electric Co., see Company of the Two P(i)eters.
Empire Music, see Company of the Two P(i)eters.
Ericsongs Delft BV, Menno ter Braaklaan 73, Delft. Tel: (015) 56 56-54.
Gen. Mgr.: Eric De Bruyn.
Essex Muziek Holland BV (BUMA), Oranje Nassaulaan 25, Amsterdam. Tel: (020) 79 70-47, 79 63-48. Gen. Mgr. Wim Landman, Prof. Mgr. Bram Kezer.
Home office: England.
Int'l firm represented: Essex group (UK), TRO (USA).
Esso & Co. NV, Flevolaan 41, Naarden. Tel: (02159) 4-62-66.
Fabel Music, Prinsengracht 854, Amsterdam. Tel: (020) 24-55-80.
Festa (Uitgeverij), Toernstr. 34, Winschoten. Tel: (05970) 31 84.
Finn Music, see Company of the Two P(i)eters.
Flame Music Publ'rs, Schippersstr. 5, Amsterdam. Tel: (020) 23 46-92.
Int'l rep.: UK (Charly).
Fleet Publ'g SA, Lindendreef 3, 1217 JV Hilversum. Tel: (035) 23-18-47.
Telex: 73335. Mng. Dirs.: Roland Kluger, Rob Aardse; Gen. Mgr. Gerda Felleman.
Int'l firms represented: Early Morning, Gas Song, Gray Matter, Intro/Hansa, Shediac.
Forest Music, Nieuw Loosdrechtseweg 195, Loosdrecht. Tel: (2158) 51 01.
Telex: 43260. Dir. Marijke Bosch.
Int'l firm represented: Release (Ireland).
Fruitcake Music, see EMI Music Publ'g.
G M I Music, Kerkstr. 20, Velp. Tel: (085) 64-68 15. Chief Exec.: L. Pool.
Sales Mgr.: J. & P.S. Groeneveld.
Geronimo Music, see Company of the Two P(i)eters.
Good News, Postbus 197, Rotterdam. Tel: (010) 56-11 63.
Goot & Sticht BV, Postbus 17, Vaartweg 51, 1211 JE Hilversum. Tel: (035) 4 81-46.
Gospel Prod'n's, Postbus 55, Rentmeesterslaan 91, Amstelveen. Tel: (020) 43-16-03, 31 69 12.
Saul B. Groen BV, Ferd. Bolstr. 6, Amsterdam. Tel: (020) 76 22-40. Dir. S.B. Groen; Mgr.: M. de Heer.
Hammamel Music, see Mamicha.
Happy Holland Music, see Intermusic.
Harbour Recs., see Company of the Two P(i)eters.
Harmonia Uitgave, Roelthiesweg 23, Hilversum. Tel: (035) 1-43-18. Chief Exec.: Hans Zijderlaan; Gen. Mgr.: J.G. Zijderlaan; Mgr.: Frits Ham.
Int'l firms represented: Boosey & Hawkes (UK), Bosworth & Co. (Ger-many), J. & W. Chester (UK), Aug. Cranz (Germany), F. E. C. Leuckart (Ger-many), PAN (Switzerland), Emil Rabe (Germany), Suenova (Germany), Universal (Austria).
Int'l reps.: Switzerland (Emil Ruh), UK (Alfred A. Kalmus).
Chr. Bond van Harmonie en Fanfarekorpsen, Jonkerslaan 73, Grijskerk. Tel: (05947) 22 33.
Heartbreak Songs, see EMI Music Publ'g.
Harry Heltzel, Oosterweg 9, Maastricht. Tel: (043) 1 69-90.
Heuwelkemeijer (Ed.) BV, Dorpsstr. 16, 1746 AC Dirksborn. Tel: (02245) 976.
Hilversum Happy Music, see Associated Artists.
Hilversum Music BV, Emmastr. 13a, 1211 NE Hilversum. Tel: (035) 23 46-46. Telex: 73254. Pres.: Charly Prack.
Int'l firms represented: Antisa (USA), Center City (USA), Chrysalis (UK, USA), Frabjous (USA), Hans Gerig (Germany), Gene Kennedy (USA), OAS (USA), Michael O'Connor/O'Connor Songs (USA), Ovaton (USA), Retrac (USA), Rubicon (USA), Tamsin (USA), Tomake (USA), Window (USA).
Hirschland Music, see Company of the Two P(i)eters.
Hoax Music, Tolbertvaart 10, Tolbert. Tel: (05945) 95 08.
J. Hofman, Tuinbouwstr. 59a, Groningen.
Hohner Nederland BV, PO Box 158, Albertus Perkstr. 16, Hilversum. Tel: (035) 4 24-83.
Holland Music BV (Peer Southern Org.), Larenseweg 159, 1221 CL Hilver-sum. Tel: (035) 83-12-14. Cable: SOUTHMUSIC. Telex: 73097. Mng. Dir. Peter van Epen; Prof. Mgr.: Frank Wisse.
Int'l firms represented: Amphonic (UK), Bruton (UK), Capitol (USA), Ce-darwood (USA), Core (Canada), Crea Sound (Canada), Harmonic (UK), KPM (UK), Mark Cain (Canada), Monophone (France), Themes (UK).
Home Music Ents. BV, PO Box 1267, 1200 BG Hilversum, Coehoornstr. 5, 1222 RR Hilversum. Tel: (035) 83 36 35. Mng. Dir. Charles Ritton.

NADA MUSIC B.V. NEW DAYGLOW MUSIC B.V. RED BULLET PRODUCTIONS B.V.

FOR HITS IN/FROM HOLLAND

**NADA MUSIC B.V.
NEW DAYGLOW MUSIC, B.V.
RED BULLET
PRODUCTIONS, B.V.**
Alexandria 2,
P.O. Box 231,
1213XS
HILVERSUM,
HOLLAND
Phone: 035-857841
Telex: 43956

Int'l firms represented: Beggar's Banquet (UK), Black Sheep (UK), Charly (UK), Hit & Run (UK), Tom Parker (UK), Roycol Agency (UK), Rozniq (USA), Rye-Boy (USA), Schwartz (USA), Shelley (UK), Slezak Group (Germany), Sonet (Sweden, UK)

Housewre Music, see Company of the Two P(i)eters

I-Scream, see Hilversum

Intermelodie, see Associated Artists

Intermusic BV, PO Box 312, Elkbosserweg 114, Hilversum. Tel: (035) 4-41-40. Pres.: Ceas van Zijteld

Int'l firms represented: Audio Musikverlag (Germany), Mr. Sam (UK), Morgan (UK)

Intersong-Basart Publi' Group BV, PO Box 338, Bussum. Tel: (02159) 4-62-66. Dir.: John Brands. Gen. Mgr.: A. de Raaf

Int'l firms represented: ABC/Dunhill, Aberbach, Bourne, Burlington, Campbell-Connelly, Carlin, Combine, Heath Bevy, Hill & Range, Dick James, Intersong Int'l, MCA, Edward B. Marks, Marouan, Palace, Shelby Singleton

Int'l rep.: Belgium (Basart)

Interworld Music BV (BUMA), Oranje Nassaulaan 25, Amsterdam. Tel: (020) 79-70-47, 79-63-48. Gen. Mgr.: Wim Landman; Prof. Mgr.: Bram Keizer
Home office: USA

Int'l firms represented: Cherry Lane (USA), Interworld (UK), Six Continents (USA), World Song (USA)

Jive la Five Music, see Company of the Two P(i)eters

Jongeneel (Uitgeverij), Gouwe 33, Gouda. Tel: (0820) 1-27-26. K. tel, see Hilversum

Kelrec BV, Reguliersbreestraat 3, Amsterdam. Tel: (020) 23-37-50

Keytone Music, see Company of the Two P(i)eters

Klabanz Prods., see Dutch Energy

Klang Music, see Company of the Two P(i)eters

Kluger Holland, Beethovenstr. 150hs, 1077 JJ Amsterdam. Tel: (020) 79-21-05. Telex: 18417. Mng. Dir.: Roland Kluger; Gen. Mgr.: Gerda Felleman

Int'l firms represented: Acuff-Rose (USA), Raoul Breton (France), Chess (USA), Deb Dave (USA), Heavy (USA), Perren Vibes (USA), Pi Gem (USA), RKM (Belgium), Paul Simon (USA), Sugar (Italy), Washbone (USA), World (Belgium)

Int'l rep.: Belgium (Kluger Int'l)

Konela Muziekuitgave BV, Postbus 279, Stadhoudersring 17, Zoetermeer. Tel: (079) 16-55-61. Dir.: J.G. v. Eck

Krips Muziek, Thorbeckelaan 71, The Hague. Tel: (070) 68-96-55. Pres.: P.H. de Slegte

L O C Songs, see Company of the Two P(i)eters

Ladyvon Music, Postbus 100, Westerweg 33, Bergen NH. Tel: (02208) 54-79

W. F. Lichtenauer, Kruspelen 44, 3012 CC Rotterdam. Tel: (010) 11-82-35. Lundenberg, see Joh. de Heer

J. J. Lispet (BUMA), see Universal Songs

Luma Music, see Company of the Two P(i)eters

Lupa Music Holland, Utrechtseweg 10A, 1213 TS Hilversum. Tel: (035) 23-40-01, 23-46-12. Telex: 73253. Gen. Mgr.: Loes van de Pavert

Mamcha Music BV, Peltelareweg 25, 5216 BC 's-Hertogenbosch. Tel: (073) 13-83-52, 14-73-34, 13-21-71. Tel: 41505. Pres.: Wilhelm Vermeulen Windsant

Int'l firm represented: Lucky Sunny Day (Canada)

Marathon Music Publi' BV, Prins Hendriklaan 26, 1375 BD Amsterdam. Tel: (020) 64-00-81. Telex: 18063. Mng. Dir.: Ceas Wessels; Gen. Mgr.: Tony Berk

Int'l firm represented: Scotti Bros. (USA)

Int'l rep.: USA (Scotti Bros./Saber Tooth)

Charles Martin Music, A.J. Ernststr. 9, 1083 GP Amsterdam. Tel: (020) 42-92-88. Cable: SYLVAINSHOW. Dir.: Sylvain J. de Haas; Gen. Mgr.: Erna de Haas

Master Songs, see EMI Music Publi'g

Maywood Music, see EMI Music Publi'g

Jerry McEasels Music, see Mamcha

Stef Meeder BV, 's-Gravenlandseweg 620, 3119 NA Schiedam. Tel: (010) 70-39-19

Melodia Muziekuitgaven, Amstel 52, Amsterdam C. Tel: (020) 23-08-00; (035) 4-81-04. Pres.: Cor Smit

Milner Music, Spanjaardslaan 33, Leeuwarden. Tel: (05100) 2-01-94, 2-45-22. Pres.: Wobbe van Seijen

Molenaar's Muziekcentrale NV, Industrieweg 23, 1521 ND Wormerveer. Tel: (075) 28-68-59. Pres.: Jan Molenaar; Dir.: Bob Molenaar

Int'l firm represented: Martin (France)

Int'l reps.: France (Martin), Luxembourg (Pierre Wagner), Norway (Tonika), Switzerland (Ruh)

Multi Male Music, see Company of the Two P(i)eters

Munch Music, Larenseweg 159, 1221 CL Hilversum. Tel: (035) 83-12-14. Cable: SOUTHMUSIC. Telex: 73097. Pres.: J.C. Zomer; Gen. Mgr.: Peter van Epen; Prof. Mgr.: Frank Wisse

Int'l reps.: Worldwide (Holland Music, Peer Southern)

Muziekuitgeverij Donar, see Warner Bros

Nada Music BV, Alexanderlaan 2, 1213 XS Hilversum. Tel: (035) 85-78-41. Telex: 43956. Mng. Dir.: Willem van Kooten; Prof. Mgr.: Carl Bolger

Int'l firms represented: ATV (UK, USA), Ackee (USA), Barn (UK), Blackhill (UK), Black Neon (UK), Blendingwell (USA), Casino (Canada), Curtis (UK), Dark Cloud (USA), Eliscian (UK), Fourth Floor (USA), Ganga (UK), Gear (USA), Andrew Heath (UK), Heath Wave (UK), Hightree (USA), Hustler's (USA), Island (UK, USA), Teddy Jack (USA), Hans Kusters (Belgium), Lambert & Potter (USA), Larball (USA), Lynn & Yarrak (UK), Macaulay (UK), Marksmen (UK), Nanelen (UK), No Exit (USA), Painless (USA), Panache (UK), Paper (UK), Rayola (USA), Ricordi (Italy), Tony Roberts (UK), Rock (UK), Rocket (UK), Rockin' (USA), Graham Sacler (UK), Sailor (USA), Skyhill (USA), Bruce Springshen (USA), State (UK), Street (UK), Sweet Summer Night (USA), Tessa (USA), Three Hats (USA), Wiksons (USA), Wow & Flutter (USA), Zebra (USA), Zomba (UK)

Int'l reps.: Belgium (Hans Kusters), USA (Dayglow, Nada). (SEE ADVERTISEMENT)

Nalupa Music, see Company of the Two P(i)eters

Nederlands Blokfluitcentrum, Oude Gracht 305, Utrecht. Tel: (030) 31-20-51

New Bingo Songs, see Warner Bros

New Sound-Amsterdam BV, Rooseveltlaan 75, 1074 AE Amsterdam. Tel: (020) 46-00-58. Dir.: A. Ettema

Number One Music Holland BV, see Dustbug

O! Music, see Intermusic

Old Mill Music, Oldway Studio, Streuvelaan 12, 47C7 CH Roosendaal. Tel: (01650) 4-39-26. Telex: 74083. Dir.: Jan Verbogt, Geoff Hardisty

Peer-Southern Org., see Holland Music

Pernot Music, see Hilversum

John M. Pijlman, Croomcamp 2, Amsterdam. Tel: (020) 19-62-91

Pin Point Music, see Warner Bros

J. Poeltuy, Deurloost, 18, 1078 JA Amsterdam. Tel: (020) 72-28-27

Prime Cut Music, see Company of the Two P(i)eters

Promobil BV, Herengracht 566, 1017 CH Amsterdam. Tel: (020) 25-71-60. Telex: 16593. Mng. Dir. & Gen. Mgr.: A.J.D. Wilkinson

Pussycat Music, see EMI Music Publi'g

R & R Music, see Intermusic

Radio City Prod'ns, see Intermusic

Reba Producties, PO Box 259, Sassenstr. 52, Zwolle. Tel: (05200) 1-50-04. (Also see Joh. de Heer)

Rung Eds., Orchestr. 19a, Hilversum. Tel: (02150) 4-38-41. Mng. Dir.: Niek Lucas; Gen. Mgr.: Theo de Vos; Prod'n Mgr.: Nick P. Lucas; Creative Dir.: Joop Dodder; Co-ord. Mgr.: Mrs. Rietje Riedijk

Rockhouse Music, Stortenbekerstr. 5, 2421 ES Nieuwkoop. Tel: (01725) 14-32. Telex: 39524. Dir.: Bert Rockhuizen; Gen. Mgr.: Frances Rockhuizen

Rockrose Music Publi'g, PD Box 170, Iepenlaan 60, 2012 AD Bloemendaal. Tel: (023) 26-05-55. Telex: 41242. Pres.: Theo Roos; Prof. Mgr.: Mirjam Emanuels

Rose Garden Music, see EMI Music Publi'g

Rubber Ball Music, see Company of the Two P(i)eters

Russell's Music Inc., Finnmark 4, 3831 JG Leusden C. Tel: (033) 94-18-88. Dir.: John Russell

A. V. D. Schaaf & Zn. BV, Postbus 1076, Kulstr. Ter. H200, Enschede. Tel: (053) 31-75-45

Schroen Muziekcentrale, Dorpstr. 45, 6093 EA Heythuysen. Tel: (04749) 19-89

Schweitzer Music, Alanstr. 55, 1551 RA Westzaan. Tel: (075) 16-06-24. Gen. Mgr.: Richard Schweitzer

Sea-Weed Music, see EMI Music Publi'g

Sibo Music, see EMI Music Publi'g

Sight & Sound Int'l Inc., PO Box 125, Waalwijk. Tel: (04160) 3-84-88. Dir.: Jan DeGraaf

Sikorski Basart, see Intersong-Basart

Sinsons, see Company of the Two P(i)eters

Smeets Kooruitgaven (BUMA), see Universal Songs

Leo Smeets, Postbus 2612, The Hague. Tel: (070) 24-85-56

J. H. Smit, Keizersgracht 695, Amsterdam. Tel: (020) 23-65-08

Cor B. Smit's Muziehandel, Amstel 52, 1017 AB Amsterdam. Tel: (020) 23-88-00. (035) 4-81-04. Chief Exec.: Cor Smit

Solo Music, Postbus 32, Harmoniestr. 1, Deurne. Tel: (04930) 25-43. Dir. & Gen. Mgr.: Wim Berkers

Soss Music, Trekweg 8, 2516 ES The Hague. Tel: (070) 88-23-38. Pres.: Dick Zwilker; Gen. Mgr.: Aad Link

Int'l reps.: France (Salhani), Japan (GP), Mexico (Beechwood), Spain (Canciones del Mundo), USA (Blev Disque)

Spargo Music, see Hilversum

Step One Music BV, Koningsnneweg 49, Hilversum. Tel: (035) 23-21-41. Telex: 73061. Mng. Dir.: Ben E. Bunders; Gen. Mgr.: Arjen Witte

Int'l firms represented: Boardwalk, Filmways, Goldboro, House of Gold, Mighty Three, Musicways, Mycenea (all USA), Ralph Siegel (Germany)

Nighting Klavarskribo, PO Box 39, 2980 AA Ridderkerk; Benedenrijweg 355, 2983 GE Ridderkerk. Tel: (01800) 1-27-24. Gen. Mgr.: C. Kooyman

Int'l rep.: UK (Klavarskribo Institute)

Talent Music, see Company of the Two P(i)eters

Tierolf Muziekcentrale BV, PO Box 18, Markt 90-92, 4700 AA Roosendaal. Tel: (01650) 4-12-55. Pres.: A.W.H. Vergaueven

Int'l firms represented: Georg Bauer (Germany) Champel (France), Charles Colin (USA), Criterion (USA), Ernst Mosch/Ewton (Germany), Musca (Belgium), Emil Ruh (Switzerland), Rundel (Germany), Scherzando (Belgium)

Int'l reps.: Belgium (Gasp), France (Champel), Switzerland (Emil Ruh), USA (Henn Elkan)

Timeless Music BV, Poelhekelaan 10, 5644 TN Eindhoven. Tel: (040) 11-47-94. Dirs.: Jan van Schalkwijk, David Read

Int'l firm represented: Robert Melin group

Tippy Music, see Mamcha

Toon Hermans Music, see Hilversum

Universal Songs BV (BUMA), Oranje Nassaulaan 25, Amsterdam 9. Tel: (020) 79-70-47, 79-63-48. Cable: UNISDNG. Telex: 14475. Mng. Dir.: Wim Landman; Gen. Mgr.: Bram Keizer; Prof. Mgr.: Fred Buhrs

Int'l firms represented: J. Albert & Son (Australia), Apocolypse (UK), Beaumont (UK), Belwin Mills (UK, USA), John T. Benson (USA), Blue Echo (USA), Blue Melody (USA), Fred Bock (USA), Braintree (USA), British Lion (UK), Chinnichap/RAK (UK), Clandie/Ledacian (USA), Clean Sheets (USA), Cookhouse Music (USA), Deep Purple (UK), Dunamis (USA), Dunbar (USA), 57th Street Entertainment (USA), Frettsongs (USA), Gaither (USA), Gentry (USA), Greensteves (UK), Hamblen (USA), Heathside (UK), Hope (USA), Jack (USA), Jando (USA), Janz (Germany), Kidada (USA), Lady Jane (USA), Later Rain (USA), Lexicon (USA), Log Music (UK), Manna (USA), Maranatha Music (USA), Memory Lane (UK, USA), Ivan Mogull (USA), Morning (Canada), New Benson (USA), New Pax (USA), Nimbus 9 (Canada), Northern Songs (UK), Paragon (USA), Purple (UK), RAK (UK), Redheaver (USA), Rondor (UK, USA), ScotWolfe (UK), Spaniel (UK), Strange (UK), Sunbury (UK, USA), Tembo (UK), 20th Century (USA), Lawrence Welk (USA), Word (UK, USA), Lawrence Wright (UK). (SEE ADVERTISEMENT)

Utopia, see Hilversum

V O G G, see Joh. de Heer

Kracht van Dmhoog, see Joh. de Heer

Van Teeseling (Muziekuitgaverij), Buurmanweg 29B, 6525 RV Nijmegen. Tel: (080) 56-27-58. Dir.: Rob van Teeseling

Int'l firms represented: Alpuerto (Spain), Doberman (Canada), Institute of Guitar & String Instruments (Germany), Reuter & Reuter (Sweden), Studio PR (USA)

Van 't Hoens, Oostzeedijk 364, Rotterdam. Tel: (010) 13-82-66

Vincent Music, see Mamcha

W W Music, PO Box 201, 6700 AE Wageningen. Tel: (08370) 1-34-40. Telex: 45991. Pres.: Wim Wigt

J. A. H. Wagenaar, Dudedracht 109, 3511 AG Utrecht. Tel: (030) 31-04-09, 31-07-77

Warner Bros. Music Holland BV, Koningsnneweg 49, 1217 KV Hilversum. Tel: (035) 23-21-41. Telex: 73061. Mng. Dir.: Ben Bunders; Gen. Mgr.: Arjen Witte

Int'l firms represented: Cotillon (USA), Riva/GH (UK), Third World (USA), Warner Bros. (USA)

Int'l reps.: Worldwide (Warner Bros.) excluding Japan (Nichon), Portugal (Clipper), Spain (Clipper)

Weird Music, Amstelkade 15, Amsterdam. Tel: (020) 76-20-96

J. A. Wiest, Hofstedeerstr. 73b, Rotterdam. Tel: (010) 25-48-84

J. C. Willemsen, Postbus 79, Hof 37, Amersfoort. Tel: (033) 1-62-25

Herman Zengerink (Muziekuitgaverij), Utrilsstr. 24, 3533 SN Utrecht. Tel: (030) 93-06-85. Mng. Dir.: Herman Zengerink

Int'l firms represented: Carrara (Italy), Edelweiss (Belgium), Paulus (Switzerland)

Xantippe Prods., see Dutch Energy

• services

ASSOCIATIONS & PROFESSIONAL ORGANIZATIONS

Amsterdam Arts Council, Town Hall, Rm. 133, D.Z. Voorburgwal 199, Amsterdam

Audiovisuelle Beroepsver (NBF), Keizersgracht 238, Amsterdam. Tel: (020) 24-66-33

Conamus (Foundation), PO Box 929, 1200 AX Hilversum. Tel: (035) 1-90-18. Mng. Dir.: John De Mol

Documentatiecentrum voor Nederlandse Groepen & Artiesten, PO Box 3524, Amsterdam. Tel: (020) 16-32-42

Donemus (Documentation of Netherlands Music), Paulus Potterstr. 14, Amsterdam. Tel: (020) 76-44-36. Dir.: R. Starreveld; Promo. Dir.: P. Hertzberger

Dutch Nat'l Group of EPFI, see NVPI

Gaudeamus Foundation (Promotion of Contemporary Music), PO Box 30, 3720 AA Bilthoven. Tel: (0103130) 78-70-33

Genootschap van Nederlandse Componisten (Society of Dutch Composers), Marius Bauerstr. 30, 1062 AR Amsterdam. Tel: (020) 15-68-22. Pres.: Reinbert de Leeuw

Jeugd & Muziek (Youth & Music), Roemer Visserstr. 42, 1054 EZ Amsterdam. Tel: (020) 16-37-01, 76-75-11. Gen. Mgr.: Jur Naessens; Rec'g Eng.: Bart Hermelin

N K T V (Koninklijke Nederlandse Toonkunstenaars Vereniging: Royal Netherlands Musicians' Society), Mierevelstr. Van 13, Amsterdam. Tel: (020) 76-13-67

Kunstenbond FNV, Passeerdersgracht 32, Amsterdam. Tel: (020) 22-00-25. Chm.: Hans Boswinkel; Gen. Mgr.: Willem Wanrooij

Music Papers Ass'n & Music Dealers Org., PO Box 338, Bussum. Tel: (02159) 4-62-66

Muziek Informatie Beurs, PO Box 1525, 1000 BM Amsterdam. Tel: (020) 16-32-42. Gen. Mgr.: Peter Rensen; PR Mgr.: Bart van der Linden

N T B (Nederlandse Toonkunstenaars Bond), Keizersgracht 628, 1017 ER Amsterdam. Tel: (020) 23-03-47

N V G D (Nederlandse Vereniging van Grammofoon Detailhandelaren), PO Box 5259, Roelof Hartplein 23, Amsterdam. Tel: 79-04-42, 79-15-11. Chm.: A.J. Felis; Office Dir.: R.L. Woltz

N V P I (Nederlandse Vereniging van Producenten & Importeurs van Beeld- & Geluidsdragers (Dutch Nat'l Group of IFPI), PO Box 7000, Amsteldijk 166, 1079 LH Amsterdam. Tel: (020) 44-41-29. Telex: 11107. Mng. Dir.: Leo Boudewijns

National Disc Jockey Org., PO Box 633, Amsterdam. Tel: (020) 16-32-42

Nederlandse Dmroep Stichting (Radio & TV), PO Box 10, Hilversum. Tel: (035) 77-91-11

Nederlandse Vereniging van Grammofoonplatenhandelaren, (Record Retailers' Ass'n), PO Box 5259, Roelof Hartplein 23, Amsterdam. Tel: (020) 79-15-11, 79-04-42. Chm.: A.J. Felis; Mng. Dir.: R.L. Woltz

Nederlandse Vereniging voor Grammofoonplaten Importeurs & Fabrikanten, see NVPI

Stichting CAP (Commercial Activities), PO Box 5259, Roelof Hartplein 23, Amsterdam. Tel: (020) 79-15-11, 79-04-42. Chm.: A.J. Felis; Dir.: R.L. Woltz

Stichting Contactorgaan Electronische Muziek (Contact Centre Foundation for Electronic Music), PO Box 30, 3720 AA Bilthoven. Tel: (0103130) 78-70-33

Stichting Nationale Platenbond (NVGD), Distributor of the Dutch Record Token System, PO Box 5259, Roelof Hartplein 23, Amsterdam. Tel: (020) 79-15-11, 79-04-42. Chm.: R.L. Woltz

U N I M (Vereniging van Uitgevers van Nederlandse & Internationale Muziek), Amstel 52, Amsterdam. Tel: (020) 23-88-00. (035) 4-01-04. Sec'y: C. Smit

V E M I (Vereniging van Muziekinstrumentenhandelaren: Retailers of Musical Instruments Org.), Nieuwe Binnenweg 132, Rotterdam. Tel: (010) 36-17-29, 36-19-29

Vereniging van Muziekhandelaren & Uitgevers in Nederland (Dutch Music Retailers & Music Publi's Ass'n), Amstel 52, Amsterdam. Tel: (020) 23-88-00. (035) 4-01-04. Sec'y: Cor Smit

Vereniging voor Nederlandse Muziekgeschiedenis (Society for Dutch Music History), Drift 21, 3512 BR Utrecht. Tel: (030) 31-68-41. Pres.: Maarten Vente; Gen. Mgr.: Elbert van Zoeren; Sec'y: Rudolf Rasch

W T L (Ver. v. Woord en Toonichters Der Lichte Muziek) (Dutch Guild of Songwriters), Obrechtstr. 51, Amsterdam. Tel: (020) 79-21-52

CATALOG SERVICES

Benelux Music Inds., PO Box 70, 6000 AB Weert, Uilenweg 38, 6006 SK Weert. Tel: (04950) 3-56-40. Telex: 37576. Dir.: Johnny Hoes; Gen. Mgr.: Jacques Hoes; Sales Mgr.: Adriaan Hoes; Prod. Mgr.: Sjayer Djamshchidi. (Rec. & Tape)

Martin A. van Ouderen Oldie Blues, Blues Rec. Centre, Postbus 12538, Maasdriehoek 175, 1106 NG Amsterdam. Tel: (020) 96-11-11. Dwnsr & Dir.: Martin A. van Ouderen

Pico Recs., Ganzenhoef 28, Amsterdam. Tel: (020) 99-47-36. Dir.: Hans Douw; Gen. Mgr.: Kees Kuiper; Sales Mgr.: Alma Ramchalaan

DESIGN & ARTWORK

Action Mgmt. Hilversum BV, PO Box 312, Elkbosserweg 114, Hilversum. Tel: (035) 4-41-40

Almere Printing BV, Draaibrugweg 19, 1300 AA Almere. Tel: (03240) 2-05-54. Telex: 70442. Mng. Dir.: Koert Bolhuis; Sales Mgr.: Wim Trouw

Benelux Music Inds., PO Box 70, 6000 AB Weert, Uilenweg 38, 6006 SK Weert. Tel: (04950) 3-56-40. Telex: 37576. Dir.: Johnny Hoes; Gen. Mgr.: Jacques Hoes; Sales Mgr.: Adriaan Hoes; Prod. Mgr.: Sjayer Djamshchidi

C B S Grammofoonplaten BV, Nijverheidsweg 32-36, 2031 CP Haarlem. Tel: (023) 31-94-10. Cable: COLRECORD. Telex: 41538. Gen. Mgr.: Peter P. Bouwens; Sales Mgr.: W.F. Ariens

Continental Sound, PO Box 81065, Rotterdam. Tel: (010) 21-10-98, 21-48-28. Pres.: Leon La Riviere; Gen. Mgr.: Nico Zwarts

Drukkerij van de Steeg BV, Postbus 110, 7500 AC Enschede. Tel: (053) 61-33-44. Sales Mgr.: H.H. Smit

E & E Prof'ns, PO Box 1525, 1000 BM Amsterdam. Tel: (020) 16-32-42. Gen. Mgr.: Peter Rensen

E M I Servs. Benelux BV, PO Box 333, 5400 AH Uden; Industrielaan 24, 5406 XC Uden. Tel: (04112) 68155. Cable: EMI NP. Telex: 50477. Dir. & Gen. Mgr.: Dr. U.R. Muellicer

Flame Concern, Sippersstr. 5, Amsterdam. Tel: (020) 23-46-92

Ivory Tower Recs., Tusselveld 55, Bomerbroek. Tel: (05408) 78-12. Dir.: Fred Rootveld; Gen. Mgr.: Angie Rootveld

Munch Recs. BV, Albert Schweitzerlaan 9, 6721 AW Bennekom. Tel: (08389) 67-77. Pres.: J. C. Zomer; Gen. Mgr.: Ben Mattijssen; Sales Mgr.: Huub Trautwein

Nederlandse Normaal Drukkerij BV (Bramson Groep), PO Box 191, 3800 AD Amersfoort; Nijverheidsweg Noord 126-128, Amersfoort. Tel: (033) 3-16-64. Telex: 79448

P C M P Inc. Holland, PO Box 479, 3130 AL, Vlaardingen. Tel: (010) 35-71-

20.
Polydor BV, Albertus Perkstraat 35, 1217 NL Hilversum Tel: (035) 234941
Telex: 73352 Mng. Dir. Nico van Bremen
Ring Recs., Orchideestr. 19a, Hilversum Tel: (02150) 4:38:41 Mng. Dir.
Niek Lucas, Gen. Mgr. Theo de Vos, Prod'n Mgr. Nick P. Lucas, Creative
Dir. Joop Doderer, Co-ord. Mgr. Mrs. Rietje Riedijk
Universe Prod'n, Spanjaardslaan 33, Leeuwarden Tel: (05100) 2-01:94. 2
45:22 Pres. Wobbe van Seijen Sales Mgr. Wim de Vries
Wax Europe, Kattengat 2, 1012 SZ Amsterdam Tel: (020) 25-48-14 Pres.
Morton D. Wax, European Mgr. Jules Farber.

LICENSING ORGANIZATIONS, MUSIC

B U M A (Vereniging), Marius Bauerstr. 30, 1062 AR Amsterdam Tel: (020)
15-68-22. Cable: JUSAUCTORIUM. Oirs. J.H. Verhagen. G.P. Willemsen
(Performing rights only)
S T E M R A, Marius Bauerstr. 30, 1062 AR Amsterdam Tel: (020) 15-68-22
(Mechanical rights only)

LICENSORS, RECORD & TAPE

Action Mgmt. Hilversum BV, PO Box 312, Elkbosserweg 114, Hilversum Tel
(035) 4-41-40.

Benelux Music Inds., PO Box 70, 6000 AB Weert, Uilenweg 38, 6006 SK
Weert. Tel: (04950) 3:56:40 Telex 37576 Dir. Johnny Hoes, Gen. Mgr.
Jacque Hoes, Sales Mgr. Adri-Jan Hoes, Prod. Mgr. Sjayer Ojamschidi.
C B S Grammofoonplaten BV, Oept. of Mfg. Opts., Nijverheidsweg 32:36,
2031 CP Haarlem Tel: (023) 31:94:10 Cable: COLRECORD. Telex
41538. Gen. Mgr. Peter P. Bouwens, Sales Mgr. W.F. Arens.
Cruquius BV, Biekersvaartweg 45, Heemstede Tel: (023) 28:25:12/23-53
Telex 41392. Gen. Mgr. Rien Dusterhof.

Mamcha Music BV Int'l, Pettelaarseweg 25, 5216 BG 's-Hertogenbosch. Tel:
(073) 14-73:34. Cable: MMCHA. Telex: 41605
Munich Recs. BV, Albert Schweitzerlaan 9, 6721 AW Bennekom. Tel:
(08389) 67:77 Pres. J.C. Zomer. Gen. Mgr. Ben Matijssen, Sales Mgr.
Huub Trautwein.

PLATING, PROCESSING & PRESSING PLANTS

Benelux Music Inds., PO Box 70, 6000 AB Weert, Uilenweg 38, 6006 SK
Weert. Tel: (04950) 3:56:40 Telex 37576 Dir. Johnny Hoes, Gen. Mgr.
Jacque Hoes, Sales Mgr. Adri-Jan Hoes, Prod. Mgr. S. Ojamschidi.

C B S Grammofoonplaten BV, Oept. of Mfg. Opts., Nijverheidsweg 32:36,
2031 CP Haarlem Tel: (023) 31:94:10 Cable: COLRECORD. Telex
41538. Gen. Mgr. Peter P. Bouwens, Sales Mgr. W.F. Arens.

Dureco BV, Pampustaan 45, 1380 AA Weesp. Tel: (2940) 1-53:21. Cable
RECMUS. Telex 16619 Mng. Dir. A.E. Palmans, Factory Mgr. H. Rid
derhoff. (Pressing only)

E M I Servs. Benelux BV, PO Box 333, 5400 AH Uden, Industrielaan 24, 5406
XC Uden. Tel: (04132) 6:81:55. Cable: EMIHP. Telex 50477 Dir. & Gen.
Mgr. Or. U.R. Mueller.

PolyGram Rec. Serv. BV, PO Box 23 3740 AA Baarn, Torenlaan 17, 3742 CR
Baarn. Tel: (02154) 1:99:11 Cable: PHONINT. Telex 43400 Mng. Dir.
Ton Roomans.

Ross Handelondernemng BV, PO Box 36, 5140 AA Waalwijk, Grotestr. 69,
5141 JN Waalwijk Tel: (04160) 3:25:81 Cable: ROXS. Telex 35040 Dir.
Chris van Oelt.

Sonclar Nederland, PO Box 1110, Hilversum. Tel: (035) 6:21:46.
Sonopresse BV, PO Box 751, Sluwaaloorst 106, Rotterdam Tel: (010) 84
47:10, 84:86:47 Telex 28478. Mng. Dir. Leo Ritmeester. (Pressing
only)

PRINTERS & LITHOGRAPHERS

Almere Printing BV, Oraaibrugweg 19, 1300 AA Almere Tel: (03240) 2:05
54 Telex 70442 Mng. Dir. Koert Bolhuis, Sales Mgr. Wim Trouw
Amsterdam Drukkerij, N. Berchemstraat 1, Amsterdam. Tel: (020) 79:10:45,
13:52:02.

Benelux Music Inds., PO Box 70, 6000 AB Weert, Uilenweg 38, 6006 SK
Weert. Tel: (04950) 3:56:40 Telex 37576 Dir. Johnny Hoes, Gen. Mgr.
Jacque Hoes, Sales Mgr. Adri-Jan Hoes, Prod. Mgr. Sjayer Ojamschidi.
Bijeldrukkerij Nederland, Binnenkant 40, Amsterdam Tel: (020) 22:16:31.
C B S Grammofoonplaten BV, Nijverheidsweg 32:36, 2031 CP Haarlem Tel:
(023) 31:94:10 Cable: COLRECORD. Telex 41538 Gen. Mgr. Peter P.
Bouwens, Sales Mgr. W.F. Arens.

Continental Sound, PO Box 81065, Rotterdam. Tel: (010) 21 10:98 21 48
28. Pres. Leen La Riviere, Gen. Mgr. Nico Zwarts.
Joh. de Heer & Zn. BV (Handelmijs), Rozenlaan 113, Rotterdam. Tel: (010)
22:09:88. Mng. Dir. J.A. de Heer

Orukkerij van de Steeg BV, Postbus 110, 7500 AC Enschede. Tel: (053) 61
33 44 Sales Mgr. H. H. Smit.

E M I Servs. Benelux BV, PO Box 333 5400 AH Uden, Industrielaan 24, 5406
XC Uden Tel: (04132) 6:81:55 Cable: EMIHP. Telex 50477 Dir. & Gen.
Mgr. Or. U.R. Mueller.

Flame Concern, Schippersstr. 5, Amsterdam Tel: (020) 23:46:92
Habo/Ocasto Grafische Industrie, Coloradodreef 18, 3565 BT Utrecht Tel:
(030) 61-68-21. Telex 47315 Mng. Dir. J.A. Meijer, Mgr. L. Mulder,
Sales Mgr. R. Meijer

Moonlight, Hurwenesstr. 5, Rossum Tel: (04182) 790.
N N D, PO Box 191, Amersfoort. Tel: (033) 3:16:64
Nederlandse Normaal Orukkerij BV (Bramson Groep), PO Box 191, 3800 AO
Amersfoort; Nijverheidsweg Noord 126-128, Amersfoort Tel: (033) 3:16
64. Telex: 79448.

P C M P Inc. Holland, PO Box 479, 3130 AL, Vlaardingen Tel: (010) 35:71-
20

Polydor BV, Albertus Perkstraat 35, 1217 NL Hilversum Tel: (035) 234941
Telex: 73352 Mng. Dir. Nico van Bremen

Arno van Orsouw BV, Oostenburgervoorstr. 71-73, Amsterdam Tel: (020)
22:28:98; 25:21:13. Telex 1344? Chief Exec. Arjo van Orsouw

RECORD PROMOTION

(Including Public Relations & Publicity)

Action Mgmt. Hilversum BV, PO Box 312, Elkbosserweg 114, Hilversum Tel
(035) 4-41-40.

Albensen & Co. BV (Muziekhandel), Groot Hertoginnelaan 182, 2517 EV, The
Hague Tel: (070) 45:60:00. Exers. J.B.M. & H.E.A.M. Albensen

Almere Printing BV, Oraaibrugweg 19, 1300 AA Almere. Tel: (03240) 2:05
54 Telex: 70442 Mng. Dir. Koert Bolhuis, Sales Mgr. Wim Trouw
Herman Batelean Promos, Moerbeegaarde 112, Zoetermeer Tel: (079) 31
36:37 Gen. Mgr. Herman Batelean, Sales Mgr. Verona Vanessa

Benelux Music Inds., PO Box 70, 6000 AB Weert, Uilenweg 38, 6006 SK
Weert. Tel: (04950) 3:56:40 Telex: 37576 Dir. Johnny Hoes, Gen. Mgr.
Jacque Hoes, Sales Mgr. Adri-Jan Hoes, Prod. Mgr. Sjayer Ojamschidi.
Louis Bolsius Theater & Organisatiebureau BV, Nieuwlandstr. 28, 5038 SN Til
burg Tel: (013) 32:30:77 Cable: BOLSIUS. Gen. Mgr. Louis Bolsius.

Conamus (Foundation), PO Box 929, 1200 AX Hilversum Tel: (035) 1:90:18
Mng. Dir. John Oe Mol

Continental Sound, PO Box 81065, Rotterdam Tel: (010) 21 10:98, 21 48
28. Pres. Leen La Riviere, Gen. Mgr. Nico Zwarts.
Cosmos Prod'n, PO Box 250, Kerkrade NL. Tel: (045) 45-45-01. Gen. Mgr.

J.H. Smith, Sales Mgr. W. Toussaint.

Osco Serv., PO Box 3524, Amsterdam. Tel: (020) 16:32:42
E & E Prod'n, PO Box 15625, 1000 BM Amsterdam Tel: (020) 16:32:42
Gen. Mgr. Peter Rensen.

E P M S (European Promo. & Mgmt. Serv.), PO Box 170, IJpenlaan 60, 2012
AO Bloemendaal Tel: (023) 26:05:55. Telex: 41242 Pres. & Co-ord.
Theo Roos.

Fleet Benelux BV, PO Box 6111, 2001 HC Haarlem; Kenaustraat 3, 2011 MV
Haarlem Tel: (023) 31:94:69. Telex: 71188. Owners: Robert A. Aardse,
Peter Messel

Flying Outchman, PO Box 170, IJpenlaan 60, 2012 AO Bloemendaal Tel:
(023) 26:05:55. Telex: 41242 Pres. Theo Roos.

Foto Groep BV/Fonorama BV, PO Box 1806, Naarderstr. 35, 1200 BV Hilver
sum Tel: (035) 1:98:41. Telex: 73306. Sales Mgr. Ben Vos

Joop Koekoek, Provincialeweg 47, Krommenie Tel: (075) 21:50:21 Gen. &
Sales Mgr. Joop Koekoek

Lion Artists Mgmt. BV, Moltzerof 20, 3052 VA Rotterdam. Tel: (010) 22:52-
22. Or. H. van der Mer

Mamcha Music BV Int'l, Pettelaarseweg 25, 5216 BG 's-Hertogenbosch Tel:
(073) 14:73:34. Cable: MMCHA. Telex: 41605

Mojo Concerts BV, PO Box 3035, 2061 OA OeIt. Tel: (015) 12:19:80 Oirs
Leon Ramakers, Berry Visser

Munich Recs. BV, Albert Schweitzerlaan 9, 6721 AW Bennekom. Tel:
(08389) 67:77 Pres. J.C. Zomer. Gen. Mgr. Ben Matijssen, Sales Mgr.
Huub Trautwein.

Muziek & Showbureau Jan Vis BV, Graafsebaan 40, 5242 JM Rosmalen Tel:
(04192) 91:51 Telex 50671 Mng. Dir. Jan Vis

National Osc. Jockey Org., PO Box 633, Amsterdam Tel: (020) 16:32:42
National Promoting System, PO Box 1035, Leiden Tel: (071) 6-03:07. Gen.
Mgr. Fred van Ouden

Number One Music Holland BV, Gallenkampsweg 31, Soest Tel: (02155)
1:03:10 Mng. Dir. Eric Boom

P C M P Inc. Holland, PO Box 479, 3130 AL, Vlaardingen Tel: (010) 35:71-
20

Pico, Ganzenhoef 28, Amsterdam Dir. Hans Douw, Gen. Mgr. K. Kuiper,
Sales Mgr. A. Ramschalaan

Ring Recs., Orchideestr. 19a, Hilversum Tel: (02150) 4:38:41 Mng. Dir.
Niek Lucas, Gen. Mgr. Theo de Vos, Prod'n Mgr. Nick P. Lucas, Creative
Dir. Joop Doderer, Co-ord. Mgr. Mrs. Rietje Riedijk

Sylvain's Show Prod'n, A.J. Ernststr. 9, 1083 GP Amsterdam Tel: (020) 42
92:88. Or. Sylvain J. de Haas, Gen. Mgr. Erna de Haas

Universe Prod'n, Spanjaardslaan 33, Leeuwarden Tel: (05100) 2:01:94. 2
45:22 Pres. Wobbe van Seijen, Sales Mgr. Wim de Vries

Aad van Holstein, Handellaan 176, 2671 VJ Naaldwijk Tel: (01740) 2:57:61.
Ben Vreeburg, St. Camer 46, Oe. Bilt. Tel: (030) 76:27:55
Wax Europe, Kattengat 2, 1012 SZ Amsterdam Tel: (020) 25-48-14 Pres.
Morton D. Wax, European Mgr. Jules Farber

Wim Wigt Prod'n, PO Box 201, Roghorst, 303, 6700 AE Wageningen Tel:
(08370) 1:34:40. Chief Exec. Wim Wigt

TAPE CUSTOM DUPLICATORS

TAPE PACKAGING & LABELING

The Audio and Video lines indicate the configurations which the firms dupli-
cate. Companies which offer packaging and labeling of tape product are
indicated by "(PKG)" which appears after the main body of their respective
listings.

Audio Studio & Magnetronics BV, de Welstr. 10-12, Arnhem Tel: (085) 22
91:23 Telex 75037 Pres. Gert van der Garde, Gen. Mgr. Alfred van der
Garde, Chief Eng. Charles van Cattenburch

Benelux Music Inds., PO Box 70, 6000 AB Weert, Uilenweg 38, 6006 SK
Weert. Tel: (04950) 3:56:40 Telex 37576 Dir. Johnny Hoes, Gen. Mgr.
Jacque Hoes, Sales Mgr. Adri-Jan Hoes, Prod. Mgr. Sjayer Ojamschidi.
(PKG-video only)

C B S Grammofoonplaten BV, Nijverheidsweg 32:36, 2031 CP Haarlem Tel:
(023) 31:94:10 Cable: COLRECORD. Telex: 41538. Gen. Mgr. Peter P.
Bouwens, Sales Mgr. W.F. Arens.

E M I Servs. Benelux BV, PO Box 333, 5400 AH Uden, Industrielaan 24, 5406
XC Uden. Tel: (04132) 6:81:55 Cable: EMIHP. Telex 50477 Dir. & Gen.
Mgr. Or. U.R. Mueller

M C R Prod'n BV, Hooglandseweg 62, 3813 AS Amersfoort. Tel: (033)
723401 Telex 79388. Mng. Dir. Foppe Damste, Chief Eng., Ben Uy-
tens

Polydor BV, Albertus Perkstraat 35, 1217 NL Hilversum Tel: (035) 234941.
Telex: 73352. Mng. Dir. Nico van Bremen.

Sonortape Nederland BV, PO Box 113, Zonnebaan 42, 3600 AC Maarssen.
Tel: (030) 43:11:44 Telex: 40354. Chief Exec. M.C. Groeneweld

Van der Garde's Audio Studios BV, Oe. Welstr. 10-12, 6814 AP Arnhem Tel:
(0031) 85 22:91:23. Or. Gert van der Garde

Audio: Cassette

ENVELOPES & MAILERS

Joh. de Heer & Zn. BV (Handelmijs), Rozenlaan 113, Rotterdam Tel: (010)
22:09:88. Or. J.A. de Heer

E & E Prod'n, PO Box 15625, 1000 BM Amsterdam Tel: (020) 16:32:42
Gen. Mgr. Peter Rensen

Nederlandse Normaal Orukkerij BV (Bramson Groep), PO Box 191, 3800 AO
Amersfoort; Nijverheidsweg Noord 126-128, Amersfoort Tel: (033) 3:16
64. Telex: 79448

P C M P Inc. Holland, PO Box 479, 3130 AL, Vlaardingen Tel: (010)
35:71:20

JACKETS & SLEEVES

LABELS, DISK

Almere Printing BV, Oraaibrugweg 19, 1300 AA Almere Tel: (03240) 2:05
54. Telex: 70442 Mng. Dir. Koert Bolhuis, Sales Mgr. Wim Trouw (Jack
ets & Sleeves only—LP & Videodisk)

Benelux Music Inds., PO Box 70, 6000 AB Weert, Uilenweg 38, 6006 SK
Weert. Tel: (04950) 3:56:40 Telex: 37576. Dir. Johnny Hoes, Gen. Mgr.

Jacque Hoes, Sales Mgr. Adri-Jan Hoes, Prod. Mgr. Sjayer Ojamschidi.
(Labels only—45 & LP)

C B S Grammofoonplaten BV, Nijverheidsweg 32:36, 2031 CP Haarlem.
Tel: (023) 31:94:10 Cable: COLRECORD. Telex: 41538. Gen. Mgr. Peter
P. Bouwens, Sales Mgr. W.F. Arens.

Orukkerij van de Steeg, Postbus 110, 7500 AC Enschede. Tel: (053) 61:33
44. (Sleeves only)

E M I Servs. Benelux BV, PO Box 333, 5400 AH Uden, Industrielaan 24, 5406
XC Uden. Tel: (04132) 6:81:55 Cable: EMIHP. Telex: 50477 Dir. & Gen.
Mgr. Or. U.R. Mueller. (Jackets & Sleeves—LP only; Labels—45 rpm
only)

Magnetronics BV, Oe. Welstr. 12, Arnhem 6814 AP. Tel: (085) 22:91:23. Or.
Alfred van der Garde. (Labels only)

Nederlandse Normaal Orukkerij BV (Bramson Groep), PO Box 191, 3800 AO
Amersfoort; Nijverheidsweg Noord 126-128, Amersfoort Tel: (033) 3:16
64. Telex: 79448

Oliman Handelsaanschappij BV, PO Box 84, A. Einsteinweg 3, Alphen a/d
Rijn. Tel: (01720) 3:16:31 Telex: 39796. (Labels only—45 & LP)

P C M P Inc. Holland, PO Box 469, 3130 AL, Vlaardingen Tel: (010) 35:71-
20. (Sleeves only)

Arno van Orsouw BV, Oostenburgervoorstr. 71-73, 1018 MP Amsterdam Tel:
(020) 22:28:98; 25:21:13. Telex 13442. Mng. Dir. Arno van Orsouw.
Zeeldrukkerij van Beers, Postbus 1123, West Havendijk 14, 4703 NZ Roosendaal.
(Sleeves only)

PROFESSIONAL TAPE SUPPLIES

Benelux Music Inds., PO Box 70, 6000 AB Weert, Uilenweg 38, 6006 SK
Weert. Tel: (04950) 3:56:40 Telex 37576 Dir. Johnny Hoes, Gen. Mgr.
Jacque Hoes, Sales Mgr. Adri-Jan Hoes, Prod. Mgr. Sjayer Ojamschidi.
Product: Cassette labels.

Nederlandse Normaal Orukkerij (Bramson Groep), PO Box 191, 3800 AO
Amersfoort, Nijverheidsweg Noord 126-128, Amersfoort. Tel: (033) 3:16
64. Telex 79448

Audio: Inlays

Video: Boxes

Arno van Orsouw BV, Oostenburgervoorstr. 71, 1018 MP Amsterdam Tel:
(020) 22:28:98; 25:21:13. Telex 13442. Dir. Arno van Orsouw
Product: Cartridge labels

RAW MATERIALS

RECORD MANUFACTURING EQUIPMENT

Ros Handelondernemng BV, PO Box 36, 5140 AA Waalwijk, Grotestr. 69,
5141 JN Waalwijk Tel: (04160) 3:25:81. Cable: ROXS. Telex 35040
Cnm. Chris van Delft

Product: Aprevil PVC record compound, press molds
Brand names: Amvico, Oelvorst

TAPE DUPLICATING & PROCESSING EQUIPMENT

Audio Studio & Magnetronics BV, de Welstr. 10-12, Arnhem. Tel: (085) 22
91:23. Telex 75037. Pres. Gert van der Garde, Gen. Mgr. Alfred van der
Garde, Chief Eng. Charles van Cattenburch

Audio: Duplicators, loaders

Brand name: Telefunken

TAPE, BLANK LOADED & BULK RAW

Agfa-Gevaert NV, Polakweg 10-11, Rijswijk Tel: (070) 90:66:80. Mng. Dir.
J. Davignon, Sales Mgr. D. van den Broek

Audio: Cassette, open reel

Video: 1" open reel, 1 1/2" cartridges, 1/2" cassette

Ampex BV, PO Box 9026, 3506 GA Utrecht, Zamenhofdreef 65A, 3562 JY
Utrecht Tel: (030) 61:29:21 Cable: AMPLEX. Telex 47856. Mgr. G.C.A.
de Jong

Audio: 2", 1", cassette, open reel

Video: 2", 1", 1/2", 1/4" Beta & VHS

Audioscript BV, Postbus 82, Loosdrechtseweg 107, Loosdrecht. Tel: (02158)
5104. Oirs. P. Oe Ruig, J.L. Cluysenaer (Blank only)

Audio: Cassette

Brand name: Luxman

Audio Studio & Magnetronics BV, de Welstr. 10-12, Arnhem. Tel: (085) 22
91:23. Telex 75037. Pres. Gert van der Garde, Gen. Mgr. Alfred van der
Garde, Chief Eng. Charles van Cattenburch

Audio: Cassette, open reel

Video: 1/2" EIAJ cartridge

B A S F Nederland BV, PO Box 1019, Kadestr. 1. Tel: (085) 71:71:71 Telex
45111. Sales Mgr. Willem van Workum

Audio & video: Cassette & open reel

P C M P Inc. Holland, PO Box 479, 3130 AL, Vlaardingen Tel: (010) 35:71-
20. (Raw only)

Audio: Cassette, open reel

P O Magnetics, Magneetband Fabriek Oosterhout BV, PO Box 82, Molensstr.
37, 4900 AB Oosterhout NB. Tel: (016) 205:59:10

• accessories

Ampex BV, PO Box 9026, 3506 GA Utrecht, Zamenhofdreef 65A, 3562 JY
Utrecht Tel: (030) 61:29:21 Cable: AMPLEX. Telex 47856. Mgr. G.C.A.
de Jong

Product: Tape—carrying & storage cases, head cleaners, bulk erasers, de-
magnetizers, leader tape, splicing tape & equip. (all audio & video)

Audioscript BV, Postbus 82, Nieuw Loosdrechtseweg 107, Loosdrecht Tel:
(02158) 5104. Oirs. P. de Ruig, J.L. Cluysenaer

Product: Record—replacement styli
Orukkerij van de Steeg BV, Postbus 110, 7500 AC Enschede Tel: (053) 61
33 44 Sales Mgr. H.H. Smit

Product: Tape—carrying & storage cases

Inelco Nederland BV, Turfsterkerstr. 63, 1431 GO Aalsmeer Tel: (02977)
28855. Cable: INTELECT. Telex: 14683

Product: Record—replacement styli (Pickering)

its artists. The key to symbols used is: (M) manufacturer; (I) importer; (D) distributor and (R) retailer.

Almere Printing BV, Draaibrugweg 19, 1300 AA Almere. Tel: (03240) 2-05 54 Telex 70442 Mng Dir. Koert Bolhuis, Sites Mgr Wim Trouw. Product: Posters (M)

Flame Concern, Schipperstr 5, Amsterdam Tel: (020) 23-46-92 Product: Posters (M), T-shirts (M)

• store fixtures

Almere Printing BV, Draaibrugweg 19, 1300 AA Almere. Tel: (03240) 2-05 54 Telex 70442 Mng Dir. Koert Bolhuis, Sites Mgr Wim Trouw. Product: Record & tape browser boxes, display racks, divider cards

NEW ZEALAND

Population: 3,148,000

Rate of exchange: \$1 (US) = 1.16 NZ dollar.

Per capita income: \$4,750

Holidays: January 1, April 25 (Anzac Day), Good Friday, Easter Monday, June 5 (Queen's Birthday), October 25, December 25, 26.

RECORDS & TAPE

Records & cassettes sold domestically: 1979—\$6,000,000.

• record & tape manufacturers / distributors / importers

Archiv, see PolyGram

Asylum, see WEA

Atco, see WEA

Atlantic, see WEA

Bunk, see CBS

CBS Recs (New Zealand) Ltd (IFPI), PO Box 37-277, Parnell, Auckland. Tel: (09) 79-75-08. Cable: CBSREC. Telex: 21490 Mng Dir. John McCready, Finance Mgr: Michael Glading, Sales Mgr: Murray Thom. Labels: (Owned) CBS, Epic, Portrait, (Licensed domestic) Bunk, Ripper, Stebbing, Stunn, (Licensed foreign) Boardwalk (USA), Ensign (UK), Illegal (USA), Jet (UK), Nempor (USA), TK (U.S.A.)

Capitol, see EMI

Columbia, see EMI

D G, see PolyGram

Ode, see Sacred

EMI (New Zealand) Ltd (IFPI), PO Box 30849, 408 Hutt Rd., Lower Hutt, Wellington. Tel: 666-979. Cable: EMITRON. Telex: 3413. Mng Dir. D. Snell

Branches: Auckland, PO Box 1931 Tel: 775-185. Telex: 21708

Labels: (Owned) Capitol, Columbia, EMI, HMV Harvest, (Licensed) Arista (USA), BBC (UK), Decca (UK), Oisneyland (USA), Motown (USA), RAK (UK), United Artists.

Elektra, see WEA

Epic, see CBS

Festival Recs. (NZ) Ltd (IFPI), 69 Carlton Gore Rd., Newmarket, Auckland 2. Tel: 33-885. Gen. Mgr. Ray Porter, Gen. Mgr. Ass't Jerry Wise, Nat'l Promos. Mgr. Victor Stent. Home office: Australia.

Labels: (Owned) Festival, Interfusion; (Licensed domestic) Key, (Licensed foreign) A&M (USA), ATA (Australia), Ad-Rhythm (UK), Barclay (France), Bearsville (USA), Benny Bird (USA), Beserkeley (USA), Blackbird (USA), Blue Labor (USA), Bronze (UK), Butterfly (USA), Chrysalis (UK), Concord (USA), DJM (UK), Fantasy (USA), Festival (Worldwide), GNP Crescendo/Accent (USA), Hispavox (Spain), Immediate (UK), Island (UK, USA), Magnet (UK), Mainstream (USA), Milestone (USA), Monument (USA), Mushroom (Australia), Pinnacle Storyteller (UK), Prestige (USA), Project 3 (USA), Ranwood (USA), Safari (USA), Shelby Singleton group (USA), Shelter (USA), Stanyan (USA), Stax (USA), Sydney Thompson (UK), Tacoma (USA), Vogue (France).

Five Star, see Ode

Fontana, see PolyGram

H M V, see EMI

Harvest, see EMI

Hibiscus, see Kiwi/Pacific

Hoghton Hughes Ltd., see Music World

Inn, see Innovation

Innovation Ent's Ltd., PO Box 45-108, 27 Bayside Ave., Te Atatu, Auckland 8. Tel: 44-444. Mng. Dir. Errol J. Peters, Gen. Mgr. Ginny Peters, Sales Mgr. Austin Roberts.

Labels: (Owned) Inn, Innovation, (Licensed) Canary, E-Volve, Raven (all USA)

Int'l rep.: USA (E-Volve)

Interfusion, see Festival

K-tel Int'l (New Zealand) Ltd., PO Box 2614, 140 Victoria St., Auckland 1. Tel: 797-166.

Home office: USA

Key, see Zodiac & Festival

Kiddisc, see Music World

Kiwi, see Kiwi/Pacific

Kiwi/Pacific Recs Ltd., PO Box 826, 182 Wakefield St., Wellington. Tel: 849-981. Cable: KIWITONE. Mng. Dir. Tony Vercoe

Labels: (Owned) Hibiscus, Kiwi, Tartar, (represented) Folkways (USA), Kiddy Kassettes (UK), Melodya (USSR), Phio (USA)

Int'l Reps.: Australia (J.A. Braunthal, Edwost. Achper), Canada (Koala Books), Pacific (Microphone, Pacific, Occidental)

M G M, see PolyGram

Mandrill, see PolyGram

Marmalade Recs. (N.Z.) Ltd., 13 Sturdee St., Wellington. Tel: (04) 859-050. Telex: 3850. Mng. Dir. Rocky Douche

Mercury, see PolyGram

G. W. Moore Ltd., PO Box 29012, Greenwood's Corner, Auckland. Label: (Licensed) Singcord (USA)

Music For Millions, see Music World

Music World Ltd. (Hoghton Hughes Ltd.) (IFPI), PO Box 7134, 75 Hawdon St., Christchurch. Tel: 63-187. Cable: MASTEROSC. Telex: 4611. Mng. Dir.: Hoghton Hughes, Sales Mgr.: R. Curry

Labels: (Owned) Kiddisc, Music For Millions, Music World, Tee Vee, (Licensed) Arrowtubs (UK), Astor (Australia), Barnaby (USA), Beatt (UK), Boot (Canada), Carlton (Ireland), Crest (Australia), Cyclone (USA), Danton (UK), Dyna House (Australia), EMS (Australia), Ember (UK), Emerald

(UK), Enterprise (UK), Everest (USA), Fable (Australia), GRT Janus (USA), Galaxy (UK), Gusto (USA), Hawk (Ireland), Image (Australia), Ivan Berg (UK), J&B (Australia), Jupiter (Germany), Karma (Germany), Locomotive (France), Magnetic Video Corp. (USA), Mulligan (Ireland), Multi-Sound (UK), Paradiso (USA), Peter Pan (USA), Pickwick Int'l (UK), Rediffusion (UK), Release (Ireland), Scepter (USA), Sonet (Sweden), Specialty (USA), Sportdisc (UK), Springboard (USA), Summit (Australia), Sutton-Miller (USA), Sydney Thompson (UK), Victor (Japan), W&G (Australia), Wand (USA)

Int'l rep.: Australia (EMS, Image, J&B, W&G), Canada (V Recs), France (Locomotive), Ireland (Hawk), Philippines (Octo Arts), UK (Emerald, Multiple Sounds), South Africa (David Gresham), USA (Everest, Gillette-Madison, Magnetic Video, Request)

Henry B. Norcross, PO Box 21-101, Auckland 8. Tel: (83) 67-019. Cable: HENRYBEE. Mng. Dir. Henry B. Norcross, Gen. Mgr. John F. Parker, Sales Mgr. Ian R. Jackson, Educational Mgr. Graham J. Wadams. Ode Rec. Co. Ltd. (IFPI), 199 Karangahape Rd., Auckland. Tel: 370-007. Mng. Dir.: Terence P. O'Neill-Joyce, Gen. Mgr. Robyn Kennerley

Reg'l branch: Fiji

Int'l branches: Australia, Cook Islands, PO Box 247, Raro Tonga. Labels: (Owned) Five Star, Ode, Sonet, Thyme, (Licensed) Ariola-Eurodisc (Germany), Avan-Guard (Australia), EMI-Electrola (Germany), Fable (Australia), Fidelity Sound (USA), Stony Plain (Canada), Supraphon (Czechoslovakia), Vanguard (USA)

Int'l Reps.: Australia (Avan-Guard), South Africa (Sweet William), Tonga (Lemoto), USA (Fidelity Sound)

Osborn Inds., PO Box 212, Hastings.

Label: (Represented) Maranatha! (USA)

Peak, see Urliwin

Philips, see PolyGram

Polydor, see PolyGram

PolyGram Rec. Serv. Ltd. (IFPI), PO Box 3517, Wexford Rd., Miramar, Wellington. Tel: 888-080. Cable: ARGENTA. Telex: 3798. Mng. Dir. J. Graham Broughton; Gen. Mgr. R.G. Donohue, Sales Mgr. Stuart H. Rubin

Branches: Auckland, PO Box 37452, Parnell, PolyGram House, 77 Grafton Rd. Tel: 775-663, 794-561. Telex: 2951 (Nat'l Sales & Mktg. Offices)

Labels: (Owned) Archiv, OG, Fontana, MGM, Mercury, Philips, Polydor, Solid Gold, Vertigo, Verve; (Licensed domestic) Mandrill, (Licensed foreign) All Platinum (USA), Attic (Canada), B&C (UK), Bronze (UK), CTI (USA), Cadet (USA), Capricorn (USA), Casablanca (USA), Charisma (UK), Chess (USA), Cream (USA), ECM (Germany), EG (UK), Ensign (UK), Infinity (USA), MCA (USA), Mooncrest (UK), Neighborhood (USA), Pablo (UK), Pye (UK), RSO (USA), Rocket (UK), Roulette (USA), Saga (UK), Phil Spector (USA), Spring (USA), StiH (UK), Track (UK)

The Ponsonby Gramophone Rec. Co. Ltd., 112 Albert St., Auckland. Tel: 362-295. Cable: DIRECORD

Labels: (Owned) Ponsonby Gramophone, (Licensed) CTI, Kudu, Lifesong (all USA)

Portrait, see CBS

RCA Ltd. New Zealand (IFPI), 23 Norman Spencer Dr., Wiri. Tel: Auckland 278-9189. Telex: 2208. Mng. Dir.: Brian E.W. Smith, Gen. Mgr. Barry Forrester, Promos./Label Mgr.: David Moule

Labels: (Licensed foreign) A&M (USA), Ariola (Germany), Buddha (USA), Can't Stop (USA), Criminal (UK), Eureka (Australia), Hansa (Germany), Lifesong (USA), Midsong (USA), Millennium (USA), Polar (Sweden), Roulette (USA), Tembo (UK), 20th Century-Fox (USA), Windsong (USA)

R T C (New Zealand) Ltd. (IFPI), PO Box 3825, 487 Parnell Rd., Parnell, Auckland. Tel: 799-963. Telex: 21831. Mng. Dir.: Brian Pitts; Nat'l Promos. Mgr.: Kama Fitzgerald; Finance Dir.: Patrick O'Sullivan

Labels: (Full-Price) (Owned) RTC, Stewed Goose, (Licensed foreign) Albion (UK), Armageddon (UK), Aura (UK), Avatar (UK), Beggars Banquet (UK), Cherry Red (UK), Chopper (UK), Cleopatra (Australia), Dindisc (UK), Factory (UK), Frontline (UK), Graduate (UK), Ice (UK), KR (UK), Liberation (Australia), Missing Link (Australia), Nems (UK), PVK (UK), Passport (USA), Polish (USA), Rockburgh (UK), Rondel (UK), Safari (UK), San Juan (USA), Supermusic (UK), Surrey Sound (UK), Videomaster (UK), Virgin (UK), Warwick (UK), (distributed—not licensed) Crystal Clear, Oelos, Nautilus, Telarc (all USA), (Mid-Price Racking) (Owned) RTC, (Licensed foreign) CBS, Dansan, Endeavour, Epic, Fontana, Golden Hour, Harmony, MGM, MSO, Mercury, Philips, Polydor, Polystar, Pye, Solid Gold, (distributed—not licensed) MCA

Int'l rep.: Australia (Liberation, Musicland)

Reader's Digest Ass'n (NZ) Ltd., PO Box 37073, Parnell, Auckland 1. Tel: 770-339. Cable: READIGEST. Gen. Mgr.: Robert Morley

Home office: USA

Ripper, see CBS

Sacred Recs. (NZ) Ltd. (IFPI), Oxford St., Levin. Tel: (069) 84-005. Cable: SACOROS. Mng. Dir.: Peter R. Harris

Labels: (Owned) Destiny, Sacred, (Licensed) Canaan (USA), Dayspring (USA), Good News (USA), Image 7 (Canada), Lamb & Lion (USA), Light (USA), Myrrh (USA), New Pax (USA), New Song (USA), Paragon (USA), Sacred (USA), Seed (USA), Solid Rock (USA), Word (Canada, UK, USA)

Solid Gold, see PolyGram

Sonet, see Ode

Stebbing, see CBS

Stewed Goose, see RTC

Stunn, see CBS

Tartar, see Kiwi/Pacific

Tee Vee, see Music World

Thyme, see Ode

Urliwin Int'l Mktg. Ltd. (IFPI), 72 Riccarton Rd., Christchurch 4. Tel: 487-009. Cable: URLIMARK

Labels: (Owned) Peak, (represented) Artistes Francaises (France), Delmark (UK), Everest (USA), Societe Francaise de Prods'ns Phonographiques (France), Starlight (UK)

Vertigo, see PolyGram

Verve, see PolyGram

Viking Sevenses Ltd. (IFPI), PO Box 1431, 5-9 Tory St., Wellington. Tel: 859-759. Cable: VIKSEVEN. Mng. Dir.: Murdoch Riley, Gen. Mgr. Keith Southern

Int'l branch: England

Labels: (Licensed) Alshire (USA), Argo (UK), Carnia (Australia), MPS (Germany), Monitor (USA), Turnabout (USA), (distributed—not licensed) Telefunken (Germany)

Int'l rep.: USA (Carnia, Fiesta, Monitor)

Warner Bros. see WEA

Zodiac Recs. Ltd. (IFPI), 108-110 Jervois Rd., Auckland 2. Tel: 761-218

762-426. Mng. Dir. E.C. Stebbing, Sales Mgr. E. MacCallum. Labels: (Owned) Key, Zodiac, (Licensed) Carnia (Australia), Telefunken (Germany)

• music publishers

Anton's Songs, 75 Hawdon St., Christchurch. Tel: 63-187. Cable: MASTER OISC. Mng. Dir.: Hoghton Hughes

Int'l firms represented: Morning Music Group (Canada)

Int'l rep.: Canada (Morning Music), Ireland (Squirrel Music)

Chappell & Co. Ltd., PO Box 2766, Nimmo's Bldg., 2nd fl., 89 Willis St., Wellington. Tel: 736-165. Gen. Mgr. David M. Bolden

Int'l firms represented: (See Chappell in Australia)

Innovation Music Ltd. (APRA), 27 Bayside Ave., Te Atatu, Auckland 8. Tel: 44-444. Mng. Dir. Errol J. Peters, Gen. Mgr.: Ginny Peters

Int'l firms represented: Billy O (Australia), Swan Sea (USA)

Int'l rep.: Australia (Essex)

Josephine & Ephraim Music, 87 Wilson St., Hawera Taranaki. Tel: 7537. Gen. Mgr.: Barletta Prime, Gen. Mgr.: Oalvanus Prime, Prof. Mgr.: Eddie Prime

Int'l rep.: Australia, Indonesia, Singapore, Thailand, UK, USA (Josephine & Ephraim)

Kiwi Music, PO Box 826, 182 Wakefield St., Wellington. Tel: 849-981. Cable: KIWITONE. Mng. Dir.: Tony Vercoe

Dennis Mason Music, see Josephine & Ephraim

Ode Music, 199 Karangahape Rd., Auckland. Tel: 370-007. Mng. Dir.: Terence P. O'Neill-Joyce

Int'l firms represented: Flying Dutchman, Sweet William (both South Africa), Shwee Gee (Canada)

Orlando Music (N.Z.) Ltd., 13 Sturdee St., Wellington. Tel: (04) 859-051. Telex: 3850. Dir.: Rocky Douche; Gen. Mgr.: Jeanie Douche

Int'l rep.: Australia (Rondor)

Peer Southern Org., see Southern

Ponsonby Gramophone, 112 Albert St., Auckland. Tel: 362-295

R T C Music (Publishers) Ltd. (APRA), PO Box 3825, Auckland. Tel: 799-964. Telex: 21831. Mng. Dir.: Brian Pitts, Gen. Mgr.: Patrick O'Sullivan

Int'l firms represented: Dinsong, Panache, Virgin (all UK)

Sandy Music Co. Ltd. (APRA), 5-7 Tory St., Wellington. Tel: 859-759. Cable: VIKSEVEN. Mgr.: Murdoch Riley

Home office: Australia, Sevenses Publi'g Pty. Ltd.

Sevenses Publi'g Pty. Ltd., see Sandy

Southern Music Publi'g Co. (Australasia) Pty. Ltd., PO Box 656, 12 Security Bldg., 198 Queen St., Auckland. Tel: 23-851. Cable: SOUTHMUSIC

Home office: USA, Peer-Southern Org.

Int'l firm represented: Sam Fox (USA)

Word Music (ASCAP), Oxford St., Levin. Tel: (069) 84-005. Cable: SACORDS. Mng. Dir.: P.R. Harris

Int'l firms represented: Canaanland, Lexicon, Rodeheaver, Word (all USA)

Int'l rep.: USA (Word)

• services

ASSOCIATIONS & PROFESSIONAL ORGANIZATIONS

New Zealand Radio & Television Mfrs. Federation, PO Box 9130, Wellington. Tel: (4) 843-688. Telex: 31129. Sr. Exec. Officer: Noel Derry

Recording Ind. Ass'n of New Zealand Inc., PO Box 9241, Wellington. Tel: 843-523. Cable: PHONOGRAPH. Mgr.: F.W. Smith

CATALOG SERVICES

Record Publ's Ltd., PO Box 9241, Wellington. Tel: 843-523. Cable: PHONOGRAPH. (Rec. only)

Whitcoulls Ltd., 76 Kent Terr., Wellington. Tel: 721-921. Cable: PRINT-PAC. Telex: 3579. Prod. Div. Reg'l Mgr.: O.A. Pemberton, Sales Mgr.: B.H. Smith

DESIGN & ARTWORK

Whitcoulls Ltd., 76 Kent Terr., Wellington. Tel: 721-921. Cable: PRINT-PAC. Telex: 3579. Prod. Div. Reg'l Mgr.: D.A. Pemberton, Sales Mgr.: B.H. Smith

LICENSING ORGANIZATIONS, MUSIC

A P R A (Australasian Performing Right Ass'n Ltd.), BNSW Bldg., 318-324 Lambton Quay, Wellington. Tel: 724-430 (Performing rights only)

Home office: Australia

Phonographic Performances (New Zealand) Ltd. PO Box 9241, Wellington. Tel: 843-523. Cable: PHONOGRAPH. (Performing rights only)

LICENSOR, RECORD & TAPE

Word (NZ) Ltd., Oxford St., Levin. Tel: (069) 84-005. Cable: SACORDS. Mng. Dir.: P.R. Harris

PLATING, PROCESSING & PRESSING PLANTS

E M I Mig. Ltd., 408 Hutt Rd., Lower Hutt, Wellington. Tel: 666-979. Cable: EMITRON. Mng. Dir.: D. Snell

PolyGram Rec. Serv. Ltd., PO Box 3517, Wellington. Tel: 888-080. Telex: 3798. Chief Exec. J. Graham Broughton; Gen. Mgr.: R. Oonohue

PRINTERS & LITHOGRAPHERS

Cello-Kraft Ltd., 61 Ira St., Wellington. Tel: 886-831. Mng. Dir. R.C. Murray; Mgr. E.L. Verrall

PolyGram Rec. Serv. Ltd., PO Box 3517, Wellington. Tel: 888-080. Telex: 3798. Chief Exec. J. Graham Broughton; Gen. Mgr.: R. Donohue

Rotlaw's Ltd., 90-100 Hanson St., Wellington. Tel: 894-095

Whitcoulls Ltd., 76 Kent Terr., Wellington. Tel: 721-921. Cable: PRINT-PAC. Telex: 3579. Prod. Div. Reg'l Mgr.: O.A. Pemberton, Sales Mgr.: B.H. Smith

RECORD PROMOTION

Record Publ's Ltd., PO Box 9241, Wellington. Tel: 843-523. Cable: PHONOGRAPH

Word (NZ) Ltd., Oxford St., Levin. Tel: (069) 84-005. Cable: SACORDS. Mng. Dir.: P.R. Harris

TAPE CUSTOM DUPLICATORS

E M I Mig. Ltd., 408 Hutt Rd., Lower Hutt, Wellington. Tel: 666-979. Cable: EMITRON. Mng. Dir.: D. Snell

Audio: Cassette

PolyGram Rec. Serv. Ltd., PO Box 3517, Wellington. Tel: 888-080. Telex: 3798. Chief Exec. J. Graham Broughton; Gen. Mgr.: R. Oonohue

Audio: Cassette

Tape Transcriptions Ltd., PO Box 8665, Symonds St., Auckland. Tel: 798-734. Mng. Dir.: Phil T. Stebbing

Audio: Cassette

• supplies

EMPTY CARTRIDGES, CASSETTES & REELS

Billboard 1981-1982 International Buyer's Guide

E M I Mfg. Ltd., 408 Hutt Rd., Lower Hutt, Wellington. Tel: 666 979. Cable: EMITRON. Mng. Dir.: D. Snell.
 PolyGram Rec. Serv. Ltd., PO Box 3517, Wellington. Tel: 888-080. Telex: 3798. Chief Exec.: J. Graham Broughton, Gen. Mgr.: R. Donohue.
Audio: Cassette.
Brand name: Philips.
 Videx Systems Ltd., PO Box 3273, Auckland. Tel: (09) 478-3636. Telex: 21057. Dir.: G.L. Jones.
Audio & Video: Reels.

ENVELOPES & MAILERS

Whitcoulls Ltd., 76 Kent Terr., Wellington C3. Tel: 721-921. Cable: PRINT-PAC. Telex: 3579. Prod. Div. Reg'l Mgr.: D.A. Pemberton; Sales Mgr.: B.H. Smith.

JACKETS & SLEEVES

Cello-Kraft Ltd., 61 Ira St., Wellington 3. Tel: 886-831. Mng. Dir.: R.C. Murray. Mgr.: E.L. Verrall.
 Rotowau Ltd., 90 Lono Hanson St., Wellington. Tel: 894-095.
 Whitcoulls Ltd., 76 Kent Terr., Wellington C3. Tel: 721-921. Cable: PRINT-PAC. Telex: 3579. Prod. Div. Reg'l Mgr.: D.A. Pemberton; Sales Mgr.: B.H. Smith.
 Word (NZ) Ltd., Dxford St., Levin. Tel: 84-005. Cable: SACDRDS. Mng. Dir.: P.R. Harris.

LABELS, DISK

E M I Mfg. Ltd., 408 Hutt Rd., Lower Hutt, Wellington. Tel: 666-979. Cable: EMITRON. Mng. Dir.: D. Snell.
 PolyGram Rec. Serv. Ltd., PO Box 3517, Wellington. Tel: 888-080. Telex: 3798. Chief Exec.: J. Graham Broughton, Gen. Mgr.: R. Donohue.
 Whitcoulls Ltd., 76 Kent Terr., Wellington C3. Tel: 721-921. Cable: PRINT-PAC. Telex: 3579. Prod. Div. Reg'l Mgr.: D.A. Pemberton; Sales Mgr.: B.H. Smith.

POLYETHYLENE BAGS & SHRINKWRAP

Whitcoulls Ltd., 76 Kent Terr., Wellington C3. Tel: 721-921. Cable: PRINT-PAC. Telex: 3579. Prod. Div. Reg'l Mgr.: D.A. Pemberton; Sales Mgr.: B.H. Smith. (Poly Bags only)

TAPE, BLANK LOADED & BULK RAW

Agfa Gevaert (New Zealand) Ltd., GPO Box 215, Shroff's Bldg., 99-101 Hobson St., Auckland 1. Tel: 34-742/717. Telex: 2934.
Audio: 8-tr., cassette, open reel
Video: Blank— $\frac{1}{4}$ " Beta & VHS cassette, V2000, SVC/LVC; raw—2" quad, 1" open reel, $\frac{3}{4}$ " U-Matic cassette, $\frac{1}{4}$ "
Brand name: Agfa.

Ampex, see Videx.

Capitol, see EMI.

E M I Mfg. Ltd., 408 Hutt Rd., Lower Hutt, Wellington. Tel: 666-979. Cable: EMITRON. Mng. Dir.: D. Snell. (Blank only)
Audio: Cassette
Brand names: EMI, Capitol.

Magnetic Prods. Ltd., 108-110 Jervois Rd., Auckland 2. Tel: 760-607. Mng. Dir.: Greg Watson. (Blank only)
Audio: Cassette, open reel.
Brand name: Pyral.

Music World Ltd. (Hoghton Hughes Ltd.), PO Box 7134, 75 Hawdon St., Christchurch. Tel: 63-187. Cable: MASTERDISC. Mng. Dir.: Hoghton Hughes; Sales Mgr.: R. Curry. (Blank only)
Audio: Cassette.

Philips, see PolyGram.

PolyGram Rec. Serv. Ltd., PO Box 3517, Wellington. Tel: 888-080. Telex: 3798. Chief Exec.: J. Graham Broughton; Gen. Mgr.: R. Donohue.
Audio: Cassette.
Brand name: Philips.

Pyral, see Magnetic Prods.

Videx Systems Ltd., PO Box 3273, Auckland. Tel: (09) 478-3636. Telex: 21057. Dir.: G.L. Jones. (Blank only)
Audio: Cassette, open reel.
Video: 2" quad, 1" helical, $\frac{3}{4}$ " U-matic Cassette, $\frac{1}{4}$ " Beta & VHS cassette.
Brand name: Ampex.

TAPE DUPLICATING & PROCESSING EQUIPMENT

Magnetic Prods. Ltd., 108-110 Jervois Rd., Auckland 2. Tel: 760-607. Mng. Dir.: Greg Watson.
Product: Cassette duplicators & loaders
Brand name: Recortec.

• accessories manufacturers

Agfa Gevaert (New Zealand) Ltd., GPO Box 215, Shroff's Bldg., 99-101 Hobson St., Auckland 1. Tel: 34-742/717. Telex: 2934.
Product: Tape-carrying & storage cases (audio), head cleaners (audio, video).
 Music World Ltd. (Hoghton Hughes Ltd.), PO Box 7134, 75 Hawdon St., Christchurch. Tel: 63-187. Cable: MASTERDISC. Mng. Dir.: Hoghton Hughes; Sales Mgr.: R. Curry.
Product: Record-record care prods., storage racks; Tape-head cleaners, demagnetizers, cassette storage racks.
 Whitcoulls Ltd., 76 Kent Terr., Wellington C3. Tel: 721-921. Cable: PRINT-PAC. Telex: 3579. Prod. Div. Reg'l Mgr.: D.A. Pemberton; Sales Mgr.: B.H. Smith.
Product: Carrying & storage cases.

NICARAGUA

Population: 2,500,000
Rate of exchange: \$1 (US) = 7 cordoba
Per capita income: \$800
Holidays: January 1, Easter Week, May 1 (Labor Day), July 19 (Liberation Day), September 14 (Battle of San Jacinto), September 15 (Independence Day), October 12 (Columbus Day), December 25

• record & tape manufacturers / distributors / importers

Dicesa (Discos Centroamericanos SA), Edif. de la Galeria de Arte Contemporaneo, Reparto Nva. Reforma, 180 Varas al S del Rest. Rincon Espanol, Managua. Tel: 26123

Billboard 1981-1982 International Buyer's Guide

Home office: El Salvador (see for labels)
 Dideca (Discos de Centroamerica SA), Apartado Postal 2144, Managua. Tel: 23915. Cable: ARDELI
Home office: Guatemala (see for labels)
 Fernando Flores, Del ATC 75 Varas al Norte-Fte. Dr. Filiberto H. Adams, Leon. Tel: 4100
Label: (Represented) Leo (El Salvador)
 Indica (Nicaragua) SA, Apdo. 2622, Colonia Centroamerica K.655, Managua. Tel: 71523. Sales Mgr.: Vela Rocha Silva
Home office: Costa Rica (see for labels)

NIGERIA

Population: 75,000,000
Rate of exchange: \$1 (US) = 0.64 naira
Per capita income: \$500
Holidays: January 1, October 1 (Independence Day), December 25, traditional Moslem & Christian holidays.

• record & tape manufacturers / distributors / importers

Afrosidia, see Decca
 Bridge, see Record Market
 Capitol, see EMI.
 Casablanca, see PolyGram
 Cinterdisc, see Record Market.
 Coret Recs., PMB 21512, Ikeja, Lagos. Tel: 830065. Mng. Dir.: George Ddarley
Int'l branch: Ghana, Box 7657, Accra.
 D G G, see PolyGram.
 Decca (West Africa) Ltd. (IFPI), PO Box 412, 4 Faramobi Ajike St., Ikorodu Rd., Lagos. Tel: 962246. Cable: DECCAWA. Mng. Dir.: Robert Deges; Exec. Dir.: Alhaji S.A. Akinbolu; Mktg. Mgr.: T.I. Diloronyomi; Sales Mgr.: V.D. Nwoogwugu.
Labels: (Owned) Afrosidia, Decca, (licensed) Ariola/Arista, Deram (UK), London (UK), Trojan (UK), UK (UK)
Int'l repps.: France (Sofrason), UK (Decca)
 E M I (Nigeria) Ltd. (IFPI), Dregun Rd., Ikeja, Lagos. Tel: (08) 45-164. Cable: EMITRON. Mng. Dir.: G.A. Beyering; Acting Mng. Dir.: D.A. Akinyemi; Sales Mgr.: Laurence Agbenro
Branches: Oritsha, 30 Old Market Rd. Contact: G.K. Dior—Benin, Block 12B Sapele Rd. Contact: C.U. Nwaiga—Kaduna, 5 Alli Akilu Rd. Contact: Mallam M. Shehu.
Labels: (Owned) Capitol, EMI, HMV, MFP, Parlophone, Radic, United Artists, (licensed foreign) Atlantic (USA), Ballistic (UK), Creole (UK), Dynamic (Jamaica), Elektra (USA), Ice (UK), RAK (UK), Rolling Stones (UK), Warner Bros (USA)
Int'l repps.: UK (EMI).

Examtag Int'l Agency, Box 2131, 7 Dkosi Rd., Dntsha, Alhambra State.
Label: (Represented) Maranatha! (USA).

Fontana, see PolyGram.
 H M V, see EMI.
 M F P, see EMI.
 Mercury, see PolyGram.
 P. N. Dnyekwelu Trading Co., PO Box 1864, 3 Sokoto Rd., 1 Dkwei St., Dntsha.
Label: (Licensed) Vanguard (USA).

Parlophone, see EMI
 Philips, see PolyGram
 Polydor, see PolyGram
 PolyGram Recs. Ltd. (IFPI), PO Box 2997, Imam Dauda St., Bolex House, Lagos. Tel: (01) 830-563. Cable: PHILREC. Telex: 96121297. Mng. Dir.: Arie van Leeuwen, Financial Mgr.: N.M.C. Dhechukwu, A&R Mgr.: Mrs. Keji Dkunowo.
Labels: (Owned) Casablanca, DGG, Fontana, Mercury, Philips, Polydor, RSD, (licensed) Hansa (Germany), Polar (Sweden), Atlantic, Elektra, Motown, Tania, Warner Bros. (all USA)
Int'l rep.: Worldwide (PolyGram)

R S D, see PolyGram.
 Radic, see EMI

Record Market (Nigeria) Ltd., PO Box 6371, 89 Bamgbose St., Lagos. Tel: 57-945. Cable: RODPUB. (Manufacturer/Distributor/One Stop/Rack Jobber/Importer)
Int'l branch: Ivory Coast, Cinterdisc.
Labels: (Owned) Bridge, Cinterdisc, (licensed) EMI, Nigeria
 Senn Sound (West Africa) Ltd., PO Box 1262, 37 Adeniran Dgusanya St., Surulere, Lagos. Tel: 848-337. Cable: SENNSOUND. Pres.: Kaye Abraham Sr.; Gen. Mgr.: Mrs. Y.A. Abraham; Sales Mgr.: C.N. Dhajuba. (Distributor/Importer)
 Tabansi Recs., 5/9 Dregun Rd., PMB 21458 Ikeja, Lagos.
Label: (Licensed) Cream-H (USA)
 United Artists, see EMI

• services

DESIGN & ARTWORK

E M I (Nigeria) Ltd., Dregun Rd., Ikeja, Lagos. Tel: (08) 45-164. Cable: EMITRON. Mng. Dir.: G.A. Beyering; Acting Mng. Dir.: D.A. Akinyemi; Sales Mgr.: Laurence Agbenro.

PLATING, PROCESSING & PRESSING PLANTS

Decca (West Africa) Ltd., PO Box 412, 4 Faramobi Ajike St., Ikorodu Rd., Lagos. Cable: DECCAWA. Mng. Dir.: Robert Deges; Exec. Dir.: Alhaji S.A. Akinbolu; Mktg. Mgr.: T.I. Diloronyomi; Sales Mgr.: V.D. Nwoogwugu
 E M I (Nigeria) Ltd., Dregun Rd., Ikeja, Lagos. Tel: (08) 45-164. Cable: EMITRON. Mng. Dir.: G.A. Beyering; Acting Mng. Dir.: D.A. Akinyemi; Sales Mgr.: Laurence Agbenro
 PolyGram Recs. Ltd., PO Box 2997, Bolex House, Imam Dauda St., Lagos. Tel: 830-563. Cable: PHILREC. Telex: 96121297. Mng. Dir.: Arie van Leeuwen, Financial Mgr.: N.M.C. Dhechukwu, Factory Mgr.: A.C.Aso.

PRINTER & LITHOGRAPHER

E M I (Nigeria) Ltd., Dregun Rd., Ikeja, Lagos. Tel: (08) 45-164. Cable: EMITRON. Mng. Dir.: G.A. Beyering; Acting Mng. Dir.: D.A. Akinyemi; Sales Mgr.: Laurence Agbenro.

TAPE CUSTOM DUPLICATORS

E M I (Nigeria) Ltd., Dregun Rd., Ikeja, Lagos. Tel: (08) 45-164. Cable: EMITRON. Mng. Dir.: G.A. Beyering; Acting Mng. Dir.: D.A. Akinyemi;

Sales Mgr.: Laurence Agbenro
Audio: 8-tr., cassette.

• supplies JACKETS & SLEEVES LABELS, DISK

E M I (Nigeria) Ltd., Dregun Rd., Ikeja, Lagos. Tel: (08) 45-164. Cable: EMITRON. Mng. Dir.: G.A. Beyering; Acting Mng. Dir.: D.A. Akinyemi; Sales Mgr.: Laurence Agbenro.

TAPE, BLANK LOADED & BULK RAW

Deekay & Sons, PO Box 2065, 18 Ereko St., Lagos.
Audio: 8-tr., cassette, open reel
Brand name: Audio Magnetics.
 E M I (Nigeria) Ltd., Dregun Rd., Ikeja, Lagos. Tel: (08) 45-164. Cable: EMITRON. Mng. Dir.: G.A. Beyering; Acting Mng. Dir.: D.A. Akinyemi; Sales Mgr.: Laurence Agbenro.
Audio: Cassette, open reel
Brand name: EMI-Emistar
 Senn Sound (West Africa) Ltd., PO Box 1262, 37 Adeniran Dgusanya St., Surulere, Lagos. Tel: 848-337. Cable: SENNSOUND. Pres.: Kaye Abraham Sr.; Gen. Mgr.: Mrs. Y.A. Abraham; Sales Mgr.: C.N. Dhajuba
Audio: Blank—8 tr., cassette, raw—8 tr., cassette, open reel.
Video: Blank— $\frac{1}{4}$ " cassette.

• accessories manufacturer

Senn Sound (West Africa) Ltd., PO Box 1262, 37 Adeniran Dgusanya St., Surulere, Lagos. Tel: 848-337. Cable: SENNSOUND. Pres.: Kaye Abraham Sr.; Gen. Mgr.: Mrs. Y.A. Abraham; Sales Mgr.: C.N. Dhajuba.
Product: Record-replacement stylus, Tape-head cleaners, demagnetizers

• store fixtures manufacturer

Senn Sound (West Africa) Ltd., PO Box 1262, 37 Adeniran Dgusanya St., Surulere, Lagos. Tel: 848-337. Cable: SENNSOUND. Pres.: Kaye Abraham Sr.; Gen. Mgr.: Mrs. Y.A. Abraham; Sales Mgr.: C.N. Dhajuba
Product: Browser boxes, display racks, record divider cards

NORWAY

Population: 4,079,498
Number of family units: 1,400,000
Rate of exchange: \$1 (US) = 5.19 krone.
Per capita income: \$5,812
Holidays: January 1, Easter (Good Thursday through Easter Monday), May 1 (Labor Day), May 17 (Constitution Day), Ascension Day, Whitsunday, Whitmonday, December 25, 26.

NOTE:

All figures reported are for IFPI members. Non-IFPI turnover and direct imports are estimated to be an additional 10% to 15%

RECORDS:

Record sales certification awards: Silver single—25,000 units; gold single—50,000 units; platinum single—100,000 units. Silver LP—25,000 units; gold LP—50,000 units; platinum LP—100,000 units.
Records sold domestically including imports: LP's 1980—3,730,000 units; 1979—4,200,000 units. Singles 1980—588,000 units; 1979—509,000 units.

Average retail price per record: LP's—\$8.06; Singles—\$2.07.

TV merchandising: None

Record club sales: 6-7% of total.

Discounting: Rare

Type of distribution: Manufacturer-to-retailer system predominates. There are two major rack jobbers, one of which is owned by the Norwegian record industry. Specialty shops account for 70-75% of consumer sales.
Type of promotion: Television is the most important medium, followed by radio (one channel each). Most of Norway's 160 daily newspapers have album reviews, and some have a weekly music page. There are three music newspapers with limited circulation. Some important weekly magazines have music columns.
Jukeboxes: 1500.

TAPE:

Pre-recorded tape sold domestically including imports: Cassette 1980—3,230,000 units; 1979—3,230,000 units.
Average retail price per tape: Cassette—\$8.96

CONSUMER ELECTRONICS:

Number of homes with: Radios—1,400,000 (99.9%); television sets—1,163,431 (83%), color—704,063 (50%), b&w—459,368 (33%); phonographs 875,000 (56.2%); audio tape recorders—1,800,000

RADIO STATIONS

No. of government: 1.
Comment: Programming is a mixture of cultural, political, educational, entertainment, and news features. About 60% of the music programming is pre-recorded & 40% is broadcast live. The ratio of classical music to popular is approximately 44/56.

TELEVISION STATIONS:

No. of channels: 1. government, 90% color (PAL).
Comment: Norwegian television programming is similar to that for radio except for less music.

• record & tape manufacturers / distributors / importers

Akkompagnementsplaten, see Norsk Grammofonkompani.
 Angsgar Forlag A/S, Møllergatan 26, Oslo 1. Tel: (02) 20-85-18.
 Arctic Recs., Brattørgaten 5, N-7000 Trondheim. Tel: (075) 21-1-90. Telex: 55574. Mng. Dir.: Kolbjørn Aistad; Gen. Mgr.: Gunnar Hordvik; Label Mgr.: Svein Strugstad. (Distributed by Polydor)
 Arken, see Gospelhouse.
 Barneplaten, see Norsk Grammofonkompani.
 Arne Bendiksen A/S (IFPI), Østerdalsgaten 1, Oslo 6. Tel: (02) 67-67-90. Cable: BENDIKMUSIC. Telex: (856) 19689. Pres.: Arne Bendiksen; Gen.

Mgr.: Pal Skai; Sales Mgr.: John Norman; Int'l Mgr.: Terje Engen.
Labels: (Owned) Flora, Flower, Forum, Sonet Norsk, Triola; (licensed domestic) Tambourine, (licensed foreign) Berskeri (UK), Bronze (UK), Chiswick (UK), Chrysalis (UK), Cube/Electric (UK+), Island (UK), Megafon (Sweden), Pye (UK), Sonet (Denmark, Sweden, UK), Sun (USA), Vanguard (USA), Virgin (UK), Vox (USA); (distributed) Sensible Sound.
Blue Note, see EMI.
CBS Recs. A/S (IFPI), Oslove Akerveien 19, Okern, Oslo 5. Tel: (02) 15-29 00. Telex: (856) 19356. Mng. Dir.: Per A. Jensen; Sales Mgr.: Bjorn Kristiansen; Local A&R Mgr.: Kristian Lindeman.
Labels: (Owned) CBS, Cupol, Embassy, Epic, GTC, Maestro, Masterworks, Portrait; (licensed) A&M (USA), ARC (USA), Ariola (Germany), Arista (USA), Jet (USA), Kirshner (USA), Monument (USA), Philadelphia Int'l (USA), TK (USA), T-Neck (USA), (distributed-not licensed) Decibel (Norway), Frya Skilling (Sweden), Glendisc (Sweden), Round-Up (Sweden).
Int'l rep.: Worldwide (CBS).
Cantor Corp. A/S, Postboks 16, N-1315 Nesoya. P.res.: Per C. Oahlistrom. Gen. Mgr. Finn Stokkland. (Record & tape exporter-cutouts)
Capitol, see EMI.
Classics for Pleasure, see EMI.
Columbia, see EMI.
Continental Consult AS (IFPI), Postboks 3707, Gamlebyen, Oslo 1. Tel: (02) 68-65-62. Telex: 19341. Pres.: Barry Matheson; G-n. Mgr. Borre Brenne.
Labels: (Owned) Continental, Country Collection, Hammer, Hjemmet, Home's, Horizon, Maxi; (licensed) De-Lite (USA).
Country Collection, see Continental.
Cupol, see CBS.
D B Recs., Oscarsgt. 15, Oslo 3. Tel: (02) 60-76-13. Gen. Mgrs.: Helge & Paul Karlson. (Distributed by CBS)
Decca, see PolyGram.
Double Up, see EMI.
E M I Norsk A/S (IFPI), Postboks 42, Korsvoll, Frysjaeveien 33, Oslo. Tel: (02) 23-14-88. Cable: EMIGRAM. Telex: (856) 16294. Mng. Dir.: Hans Ro Mktg. & A&R Mgr.: Fredrik Mueller; Sales Mgr.: Frode Skulstad.
Labels: (Owned) Blue Note, Capitol, Classics for Pleasure, Columbia, Double Up, EMI, EMI-EAR, EMI America, EMI Int'l Electrola, Emidisc, Encore, HMV, Harvest, Hoerzu, Liberty, Music for Pleasure, Odeon, One Up, Parlophone, Pathe, Regal Zonophone, Seraphim, Sidewalk, Starline, Studio Two, Sunset, Talisman, United Artists, Volksplatte, Waverly, World Rec. Club; (licensed) Apple (UK), Barclay (France), Blue Star (France), Carriere (France), Egg (France), Fantasy (USA), Flam (Sweden), Galaxy (USA), Hungaroton (Hungary), Kultura, Magnet (UK), Milestone (USA), Platina (Sweden), Prestige (USA), Purple (UK), RAK (UK), Rolling Stones (UK), Star (USA); (distributed-not licensed) Skandinavisk Artist Prod'n. Electrola, see EMI.
Jorg-Fr. Ellertsen A/S (IFPI), Jernbanetorget 4, Oslo 1. Tel: (02) 425883. Cable: TROLLMUSIC. Telex: 19871. Dir. Jorg-Fr. Ellertsen. (Distributed by Polygram)
Label: (Owned) Troll.
Embassy, see CBS.
Emidisc, see EMI.
Encore, see EMI.
Epic, see CBS.
Eventyrlipaten, see Norsk Grammofonkompani.
Filadelfiaforlaget A/S, Box 6757, St. Olavsplass, Oslo 1. Tel: (02) 11-13-10. Mng. Dir.: Knud Rambol.
Label: (Owned) Klango.
Flora, see Arne Bendiksen.
Flower, see Arne Bendiksen.
Fontana, see PolyGram.
Forum, see Arne Bendiksen.
G T O, see CBS.
Gospelhouse Music AS (IFPI), Box 33, 1342 Jar. Tel: (02) 53-23-78. Mgr.: Helge Fjalslett; Prod.: Kjell Fjalslett.
Labels: (Owned) Gospelhouse; (licensed domestic) Aken; (distributed-not licensed) CBS, Cupol (Sweden), EMI, Green Tree (USA), Heart Warming (USA), Impact (USA), Lamb & Lion (USA), Mariann (Sweden), New Pax (USA), Pilgrim (USA), Pilot (Sweden), RCA, Refuge (USA), Sharon, Snowflake.
Int'l reps.: Denmark (Nye Toner), Finland (Finningspel), Sweden (Gospel & Musikhuset).
H M Y, see EMI.
Hammer, see Continental.
Harmoni, see Norsk Grammofonkompani.
Harvest, see EMI.
Helgelands LP-Import, Postboks 120, 5501 Haugesund Tel: (047) 29943. Gen. Mgr. Sten Olav Helgeland.
Labels: (Distributed-not licensed) Folkways (USA), Heilo, Highway (UK), Mulligan (Ireland), Phlo (USA), Trailer/Leader (UK).
Hjemmet, see Continental.
Hoerzu, see EMI.
Hollet's Hammerhead, Enebakkveien 164, Oslo 6. Tel: (02) 19-36-16. Mgr.: Rune Hollet. (Wholesaler/Importer/Exporter)
Home's, see Continental.
Horizon, see Continental.
Intervideo A/S, PO Box 32, Ljan, Oslo 11. Tel: (02) -9-72-00. Telex 17755. Video Mgr.: Hans Petter Gjersoe; Music Mgr.: Gaer Hamnes.
Labels: (Owned) Intervideo; (licensed) A&R (Netherlands), Arrival (Canada, UK), CNR (Netherlands), Can't Stop (USA), Mervyn Conn (UK), Greole (UK), Impact (Canada), Imperial (Canada), K-tel Int'l (Canada, UK), Lotus (UK), PVK (UK), Papagayo (Netherlands), Prelude (USA), TTR (Netherlands), WMOT (USA), Young Blood (UK); (distributed-not licensed) Goodwill (Sweden), Koster (Sweden), Magna (Germany), Mariann (Sweden), My Label (Sweden), Octave, Ronco (UK), Rose, Tor (Sweden), Warwick (UK).
Jargalaedu, see Mai.
K-tel, see Intervideo.
Karusell, see PolyGram.
Klango, see Filadelfiaforlaget.
Kolbet, see Mai.
Kulturadet, see PolyGram.
Liberty, see EMI.
Maestro, see CBS.
Mai (Plateselskapet) A/S, Boks 6575, Rodelokka, (Islo 5. Tel: (02) 35-36-36. Mng. Dir.: Saemund Fiskvik; Sales Mgr.: Keth Ege; Import Mgr.: Tor Bernhardsen.
Labels: (Owned) Mai, Kolbet; (distributed-not licensed) Amar (Denmark), Greensteves (UK), Horn (Denmark), Jargalaedu, Mistur (Sweden), Muskatet Waxholm (Sweden), October (Sweden), Ralph (USA), Rough Trade (UK), Silence (Sweden), TJ (USA).
Masterworks, see CBS.
Mayco A/S, PO Box 22, Kjelsasv 32, Oslo 4. Tel: (02) 22-54-00. Telex: 72353. Pres.: Arne Iversen; Gen. Mgr.: May-Britt Iversen

Labels: (Distributed-not licensed) Century, Delos, Fresh Aire, M&K, Mobile Fidelity, Nautlius, Sheffield Lab, Telarc (all USA); JVC, RVC (both Japan).
Maxi, see Continental.
Mellow Madness Rose Music, Parkv 5, Oslo 3. Tel: (02) 60-06-23. Mgr.: Bjorn Tveten.
Mercury, see PolyGram.
Musica, see Talent.
Music for Pleasure, see EMI.
Narvesen A/S, B. Narvesensvei 2, Oslo 6. Tel: (02) 19-40-20. Telex: 16835. Mng. Dir.: Finn Skedsmo; Prod. Mgr. Asboernd Soegstad. (Distributor/Importer)
New Noise Prod'n, Postboks 299, 1751 Halden. Tel: (031) 84791. Creative Dir.: Henning Kyttne.
Nor-Disc, see PolyGram.
Norid, see Dag Waerner.
Norsk Grammofonkompani A/S (IFPI), Fagerhoeyveien 2, N-1324 Lysaker. Tel: (02) 53-34-72. Gen. Mgr.: O. Knudsen.
Labels: (Owned) Akkompagnementsplaten, Barneplaten, Eventyrplaten, Harmoni, (distributed-not licensed) Music Minus One (USA).
NoteBene, Wolffsgate 5, Oslo 3. Tel: (02) 46-81-44. Mgr.: Ole Sorli.
Octave, see Intervideo.
Odeon, see EMI.
Oh Yeah!, see Dag Waerner.
On, see PolyGram.
One Up, see EMI.
Oscar Recs., Postboks 113, Boler, Oslo 6.
Label: (Represented) Ripsaw (USA).
Parlophone, see EMI.
Pathe, see EMI.
Philips, see PolyGram.
Play Music A/S, Kjelsasveien 174, Oslo 8. Tel: (02) 23-57-80. Mng. Dir.: Advokat Ragnar Heidel; Sales Mgr.: Kjell Haugen. (Distributor/Importer)
Labels: (Distributed) all Norwegian labels.
Polydor, see Serv. Marcus Thranesgate 2, Torshov/Oslo 4. Tel: (472) 37-99-44. Telex: 18252. Dir.: Peter Kaatee.
PolyGram Recs. A/S (IFPI), Marcus Thranesgate 2, Oslo 4. Tel: (02) 37-29-05. Telex: 18521. Mng. Dir.: Sigurd Johannessen; Gen. Mgr.: Michael Aas; Financial Dir.: Bob Doornbos; Sales Mgr.: Mats Nilsson.
Labels: (Owned) Decca, Fontana, Karusell, Kulturadet, Mercury, Nor-Disc, On, Philips, Polydor, Vertigo, Zarepta; (Phonogram group-represented) Albion, Amadeo, Better Day, Bis, Casablanca, Charisma, Deram, Electra (Sweden), Frluna, Hagbart, Harmonia Mundi, Heilo, Impact, Dick James, MAM, Matrix, Mountain, Polar, Rocket, Rondo, Sire, Smash, Sonora, Staff, Superstar, Teldec, Tembo, Threshold, Trojan, Troll, Unicorn, Varese; (Polydor group-represented) Ad Lib, Archiv, Arctic, Asylum, Atco, Atlantic, Backstreet, Beggars Banquet, Big Tree, Bluebell, CTI, Camp, Capricorn, Cat, Cotillon, Deutsche Grammophon, DiscReet, ECM, EG, Elektra (USA), Ex Libris, Fiction, Goldhawk, Heliodor, Hispavox, MCA, Metronome, Midi, NKF, Nonesuch, Norsk Metronome, Pablo, Paradise, RSO, Reprise, Riva, Rockburgh, Swan Song, Verve, WEA Int'l, Warner Bros.
Portrait, see CBS.
Olaf T. Ranum A/S, Whsle. Dept., Olav Tryggvasonsgaten 18, N-7000 Trondheim. Tel: (075) 28-355, 27-729. Cable: MUSIKRANUM. Gen. Mgr.: Olaf T. Ranum; Sales Mgr.: Sverre Granholt.
Recommended Recs., Siemdsalsveien 77, Oslo 3. Contact: Tormod Opedal.
Home office: England.
Regal Zonophone, see EMI.
Rikajo Agentur & Handel, Postboks 147, Paradis, Bergen. Tel: 27-12-72. Mgr.: John Kolbeinsen. (Importer/Exporter)
Rocade, Roald Alle Larsen & Co., PO Box 1004, Skostredet 5, 5001 Bergen. Tel: (05) 21-35-69, 16-54-93. Mgr.: Roald Alle Larsen.
Labels: (Owned) Rocade; (licensed foreign) American Heritage (USA), Belmont (USA); (distributed-not licensed) Gusto (USA), Sugar Hill-country (USA), Westwood (UK).
Int'l rep.: UK (Westwood).
Rose, see Intervideo.
St. Olav Bokhandel A/S, Akersveien 5, Oslo 1. Mgr. Sidsel Aasrud. (Importer)
Sensible Sound, see Arne Bendiksen.
Seraphim, see EMI.
Sidewalk, see EMI.
Siemens Norge A/S, Rosenborggaten 19, Oslo 1.
Sinar Musik A/S, PO Box 92, Ljan, Oslo 11. Tel: (02) 28-05-80. Chief Exec.: Amund Hoff Berge; Gen. Mgr.: L.Y. Dalot. (Distributor/Importer)
Labels: (Distributed) Caprice (Sweden), Plant Life (UK), Rounder (USA), Topic (UK).
Skandinavisk Artist Prod'n, Torggt. 7, Oslo 1. Tel: (02) 41-88-85. Dir.: Leif Hemmingsen; Sales & Promo.: Per Ostmark. (Distributed by EMI)
Labels: (Owned) Snowflake; (licensed foreign) SOS (Sweden), Sugarhill (USA), T-Bone (Sweden).
Int'l reps.: Benelus (Phonogram), France (Polydor), Germany (Phonogram), Italy (Durium), Portugal (EMI), Sweden (EMI), UK (CBS).
Snowflake, see Skandinavisk.
Sonet Norsk, see Arne Bendiksen.
Starline, see EMI.
Strawberry, see Dag Waerner.
Studio Two, see EMI.
Sunset, see EMI.
Talent Music Org. A/S (IFPI), PO Box 2814, Toyen, Kjolberggaten 29, Oslo 6. Tel: (02) 67-95-40. Cable: MUSICA Telex: 17079. Mng. Dir.: Odd Ronning-Arnesen, A&R Mgr.: Arve Sigvaldsen; Sales & Dist'n Mgr.: Harald M. Kristiansen; Mktg. & Promo. Mgr.: Helge Westbye.
Labels: (Owned) Musica, Talent; (licensed) Aura (UK), Avatar (UK), Bellaphon (Germany), Ensign (UK), Erato (France), Intercord (Germany), Logo (UK), Motown (USA), Ovalton (USA), Pickwick (UK), RCA (USA), Rialto (UK), Swedish Society (Sweden), Telefunken (Germany), Viking (Sweden); (distributed-not licensed) Tonep.
Int'l rep.: Sweden (Scranta). (SEE ADVERTISEMENT)
Talman, see EMI.
Tambourine, see Arne Bendiksen.
Toba Import, Postboks 252, N-5401 Stord. Tel: (054) 1-58-41. Mgr.: Jon Endal. (Importer/Exporter)
Tonep, see Talent & Toneproduksjon.
Toneproduksjon A/S, PO Box 150, Salmakerstien 5D, 1501 Moss. Tel: (032) 58373. Gen. Mgr.: Kjell Hjemmen; Sales Mgr.: Morten Kristiansen. (Distributed by Talent).
Label: (Owned) Tonep.
Trola, see Arne Bendiksen.
Troll, see Jorg-Fr. Ellertsen.
United Artists, see EMI.
Union, see Dag Waerner.

Vakenatt, see Dag Waerner.
Veps, see Dag Waerner.
Vertigo, see PolyGram.
Vilde Vinge, see Dag Waerner.
Volksplatte, see EMI.
Waverly, see EMI.
Dag Waerner Prod'n, Siemdsalsv. 77, Oslo 3. Tel: (472) 14-76-89. Telex: 1850. Chief Exec.: Dag Waerner; Sales Mgr.: T. Opedal.
Labels: (Owned) Strawberry, Union; (licensed) Factory (UK); (distributed-not licensed) A-Disc (Sweden), Blue Silver (France), first American (USA), Flying Fish (USA), IC (Germany), JEM (USA), Norid, Oh Yeah !, Pulse (USA), Rag Baby (UK), Rhino (USA), Rough Trade (UK), Sierra (USA), Sky (Germany), Solid Smoke (USA), Spoon (Germany), Vakenatt, Veps, Vilde Vinge, Vinyard (UK), Zado.
World Rec. Club, see EMI.
Zado, see Dag Waerner.
Zarepta, see PolyGram.

• music publishers

Arctic Songs, Brattgatten 5, N-7000 Trondheim. Tel: (075) 21-1-90. Mng. Dir.: Kolbjørn Alstad; Gen. Mgr.: Gunnar Hordvik. (Administered by Frost Music).
Arne Bendiksen A/S, Osterdalsgaten 1, Oslo 6. Tel: (02) 67-67-90. Cable: BENDIKMUSIC. Telex: 19689. Dir.: Arne Bendiksen; Gen. Mgr.: Philip A. Kruse. (Also see Frost)
Int'l firms represented: Black Sheep (UK), Cherry (UK), EMI (Denmark), Noel Gay (UK), Jobete (USA), Imudco (Denmark, Sweden), Magellan (USA), Multitone (Sweden), Reuter & Reuter (Sweden), Sonet (Sweden), Southern (Sweden), Stonebridge (USA).
Benny Borg Music, see Frost.
Buccaneer Music, see Frost.
Butterfly Music, see Skjønhaalsforlagene.
Chappell Norway, Marcus Thranesgate 2, Oslo 4. Tel: (02) 37-29-05. Telex: 18521. Mng. Dir.: Sigurd Johannessen; Ass't: Aase Mathisen.
Int'l reps.: Worldwide (Chappell, Intersong).
Continental Consult AS, Postboks 3707, Gamlebyen, Oslo 1. Tel: (02) 68-65-62. Telex: 19341. Pres.: Barry Matheson; Gen. Mgr.: Borre Brenne.
Int'l reps.: Australia (Image), France (Panache), Germany (X-Recs.), Netherlands (Hoes), UK (Panache).
Disco, see Talent.
Jorg-Fr. Ellertsen A/S, Jernbanetorget 4, Oslo 1. Tel: (02) 42-58-83. Cable: TROLLMUSIC. Telex: 19871. Pres.: Jorg-Fr. Ellertsen.
Hans Erichsen Musikforlag, see Skjønhaalsforlagene.
Euronett Publ'g, see Arne Bendiksen & Frost.
Filadelfiaforlaget A/S, Box 6757, St. Olavsplass, Oslo 1. Tel: (02) 11-13-10.
Frost Music A/S, PO Box 38, Reistad, Oslo 5. Tel: (02) 41-96-90, 41-97-93. Mng. Dir.: Philip A. Kruse; Gen. Mgr.: Holger Gulbrandsen.
Int'l firms represented: Big 3 (USA), Cherry (UK), Columbia Pictures (USA), EMI (Sweden), Forsyth (UK), Neil A. Kjos (USA), Luverne (USA), Mungles (UK), Multitone (Sweden), Next Plateau (USA), Peer-Southern, RMO (UK), Reuter & Reuter (Sweden), Sonotone (Germany), Southern (Sweden), Studio PR (USA), Sweden (Sweden), Warner Bros. (Sweden).
Gospelhouse Music, see Frost.
Harmoni House, see Arne Bendiksen & Frost.
Arnt Haugen, see Frost.
Harmoniforlaget, see Frost.
Carl M. Iversen, see Arne Bendiksen & Frost.
Kare Kornelussen, see Frost.
Lyche (Ed.), Kongensgate 2, Oslo 1. Tel: (02) 33-24-15.
Manu A/S, see Frost.
Mellow Madness Rose Music, Parkv 5, Oslo 3. Tel: (02) 60-06-23. Mgr.: Bjorn Tveten.
Musikk-Huset A/S (TONO, NCB), Karl Johansgaten 45, Oslo 1. Tel: (02) 33-48-97. Mng. Dir.: Arne Damsgaard.
Int'l firms represented: Anderson (Sweden), Carl Gehrmann (Sweden), Abr. Lundquist (Sweden), Moeck (Germany), Scherzando (Belgium).
Int'l rep.: Sweden (Carl Gehrmann).
Norsk Melodiforlag, see Skjønhaalsforlagene.
Norsk Musikforlag A/S, Postboks 1499, Vika, Karl Johansgaten 39, Oslo 1. Tel: (02) 33-59-95. Mng. Dir.: Fr. J. Backer-Groendahl Jr.; Dir.: Leif Dramstad; Pop Div. Gen. Mgr.: Gert Opitz.
Int'l firms represented: Air (Sweden), April (Worldwide), Belwin-Mills (UK, USA), Barton (UK, USA), Boosey & Hawkes (UK), Chandos (UK), Chappell Nordiska (Sweden), J.&W. Chester (UK), Editio Musica (Hungary), Essex (Sweden), Hansen (USA), Wilhelm Hansen (Denmark), Intersong-Forlagene (Sweden), Magnamus-Baton (USA), Nordic Songs (Denmark, Sweden), Nordiska (Sweden), Shawnee Press (USA), Hans Sikorski (Germany), Staff (USA), Walton (USA), Wynne (USA).
Int'l reps.: Denmark (Wilhelm Hansen), Germany (Wilhelm Hansen), Sweden (Nordiska), UK (J.&W. Chester), USA (Walton-Choral).
Norway Music, see Skjønhaalsforlagene.
O A S Music, see Frost.
Skandia Musikkproduksjon, see Arne Bendiksen & Frost.
Oscar Skau, see Arne Bendiksen & Frost.
Skjønhaalsforlagene, PO Box 141, Parkveien 1, N-2501 Tynset. Tel: (063-61100) 8566. Gen. Mgr.: Erik Skjønhaals.
Snowball Songs (Scandinavia) A/S, PO Box 551, Sentrum, Oslo 1. Tel: (02) 25-01-10. Telex: 19974. Dir.: Charles R. Forbes. (Also see Frost)
Int'l firms represented: KeySound (Denmark), Levytuottajat (Finland), MAM (UK), Magazine (Germany), Royton (Denmark).
Int'l reps.: Austria (Teldec/Autocrat), Benelus (Roba), Denmark (Royton/Keysound), Finland (Fazer/Lyvytuottajat), Germany (Teldec/Autocrat), Ireland (Meglo), Spain (Hispavox), Sweden (K-tel), Switzerland (Teldec/Autocrat), UK (Performance).
Snowflake Music, Torggt. 7, Oslo 1. Tel: (02) 41-96-90. Dir.: Leif Hemmingsen; Gen. Mgr.: Philip A. Kruse. (Also see Frost)
Talent Music, PO Box 2814, Toyen, Kjolberggaten 29, Oslo 6. Tel: (02) 67-95-40. Cable: MUSICA Telex: 17079. Mgr.: Lars Boerke.
Int'l firm represented: Melodie Der Welt (Germany).
Int'l reps.: Germany (Schacht).

• services

ASSOCIATIONS & PROFESSIONAL ORGANIZATIONS
Grammofonplategrossistenes Forening (Record Wholesalers' Ass'n), PO Box 4352, Torshov, Oslo 4. Tel: (02) 37-29-05. Chm.: Michael Aas.
Norges Musikkhandlerforbund (Record Dealers' Org.), Prinsens 2, Oslo 1. Tel: (02) 33-01-60.
Den Norske Gruppen (IFPI Norge), Postboks 42, Korsvoll, Frysjaeveien 33, Oslo 8. Tel: (02) 23-14-88. Telex: 16294.
Norsk Musikerforbund (Norwegian Musicians' Union), Stortingsgaten 28, Oslo 1. Tel: (02) 42-55-21. Pres.: Sigurd Lonseth.
Ny Musikk (Norwegian Section of the International Society for Contempo-

rary Music), Tordenskioldsgate 68, Oslo 1. Tel: (02) 41-96-75. Chief Exec. Nils Bjerkestrand.

DESIGN & ARTWORK

Cantor Corp. A/S, Postboks 16, N-1315 Nesoya. Pres. Per C. Dahlstrom, Gen. Mgr. Finn Stokkland.
Nidaros Studio AS, Nordslettveien 2, 7000 Trondheim. Tel: (075) 67966. Telex 19341.

LICENSING ORGANIZATIONS, MUSIC

Norwegian Composers' Society, Klingenbergsgaten 5, Oslo 1. Tel: (010472) 42-56-78.

T D N D (Norsk Komponistforenings Internasjonale Musikkbyrå), Klingenbergsgaten 5, Oslo 1. Tel: (02) 42-18-08.

PLATING, PROCESSING & PRESSING PLANTS

UH Cornelussen & Co., Fagerthoy Str. 2, Oslo 2. Tel: (067) 35176, 53-34-72. (Pressing only)

Norsk Grammofonkompani A/S, Fagerthoyveien 2, N-1324 Lysaker. Tel: (02) 53-34-72. Gen. Mgr. D. Knudsen. (Pressing only)

PolyGram Rec. Serv. (div. of PolyGram Recs. A/S), Sagveien 11, Oslo 4. Tel: (02) 37-99-44. Gen. Mgr. Peter Kaatee.

PRINTERS & LITHOGRAPHERS

Nidaros Studio AS, Nordslettveien 2, 7000 Trondheim. Tel: (075) 67966. Telex 19341.

PolyGram Rec. Serv. (div. of PolyGram Recs. A/S), Sagveien 11, Oslo 4. Tel: (02) 37-99-44. Gen. Mgr. Peter Kaatee.

RECORD PROMOTION

Arne Bendiksen A/S, Osterdalsgaten 1, Oslo 6. Tel: (02) 67-67-90. Cable BENDIKMUSIC. Telex 19689. Dir.: Arne Bendiksen, Gen. Mgr. Pal Skar. Continental Consult AS, Postboks 3767, Gamlebyen, Oslo 1. Tel: (02) 68-65-62. Telex 19341. Pres.: Barry Matheson, Gen. Mgr. Borre Brenne.

TAPE CUSTOM DUPLICATORS

Roger Arnhoff Studio A/S, St. Dlavsgaten 26, Oslo 3. Tel: (02) 11-06-35. Telex 16686. Pres. & Gen. Mgr. Roger Arnhoff. (PKG-audio).

Audio: Cassette.
Video: 1" helical, 3/4" U-matic cassette, 1/2" Beta & VHS cassette.

Arne Bendiksen A/S, Osterdalsgaten 1, Oslo 6. Tel: (02) 67-67-90. Cable BENDIKMUSIC. Telex 19689. Dir.: Arne Bendiksen, Gen. Mgr. Pal Skar.

Audio: Cassette.
Video: 3/4" cassette, 1/2" EIAJ cartridge.

Cantor Corp. A/S, Postboks 16, N-1315 Nesoya. Pres. Per C. Dahlstrom, Gen. Mgr. Finn Stokkland.

Audio: Cassette.
Nidaros Studio AS, Nordslettveien 2, 7000 Trondheim. Tel: (075) 67966. Telex 19341.

Audio: Cassette.
PolyGram Rec. Serv. (div. of PolyGram Recs. A/S), Sagveien 11, Oslo 4. Tel: (02) 37-99-44. Gen. Mgr. Peter Kaatee.

Norsk Grammofonkompani A/S, Fagerthoyveien 2, N-1324 Lysaker. Tel: (02) 53-34-72. Gen. Mgr. D. Knudsen.

• supplies

CARTRIDGE & CASSETTE PARTS

EMPTY CARTRIDGES, CASSETTES & REELS

Cantor Corp. A/S, Postboks 16, N-1315 Nesoya. Pres. Per C. Dahlstrom, Gen. Mgr. Finn Stokkland.

Audio: Cassette.
Brand name: Cantortape.

JACKETS & SLEEVES

PolyGram Rec. Serv. (div. of PolyGram Recs. A/S), Sagveien 11, Oslo 4. Tel: (02) 37-99-44. Gen. Mgr. Peter Kaatee.

RAW MATERIALS

S E S A/S, Osterdalsgt 11, Oslo 6. Tel: (02) 60-68-40.
Product: Plastic materials.

TAPE, BLANK LOADED & B/LK RAW

Agfa-Gevaert A/S, Postboks 2008, Thv. Meyersgate 11, 9, Oslo 5. Tel: (02) 37-68-90. Telex: 18325. Mng. Dir.: A. Naper, Dept. Mgr.: G. Larsen.

Audio: Blank-compact cassette, open reel, raw-cassette, broadcast, studio.

Video: Cassette, open reel.
Brand names: Agfa Carat, Agfa Stereochrom, Agfa Videochrom.

B A S F Norge A/S, PO Box 46, Drammensvein 114, Oslo 2. Tel: 44-18-08. Cable: CDLDUR. Telex: 11284.

Audio: Blank-cassette, open reel, raw-cassette.
Video: 1" reel, 3/4" cassette, 1/2" cassette.

Arne Bendiksen A/S, Osterdalsgaten 1, Oslo 6. Tel: (02) 67-67-90. Cable BENDIKMUSIC. Telex 19689. Dir.: Arne Bendiksen, Gen. Mgr. Pal Skar.

(Blank only)
Audio & video: Cassette.
Brand name: Ampex.

Cantor Corp. A/S, Postboks 16, N-1315 Nesoya. Pres. Per C. Dahlstrom, Gen. Mgr. Finn Stokkland.

Audio: Cassette, open reel.
Brand name: Cantortape.

• accessories manufacturers

B A S F Norge A/S, PO Box 46, Drammensvein 114, Skoyen, Oslo 2. Tel: (02) 44-18-08. Cable: CDLDUR. Telex: 11284.

Product: Tape-carrying & storage cases, head cleaners, demagnetizers, leader & splicing tape.

Arne Bendiksen A/S, Osterdalsgaten 1, Oslo 6. Tel: (02) 67-67-90. Cable BENDIKMUSIC. Telex 19689. Dir.: Arne Bendiksen, Gen. Mgr. Pal Skar.

Product: Record-record care prods., Tape-head cleaners, demagnetizers.
Brand name: A. M. Kemi.

Fering Elektrikk A/S, Nils Hansens vei 3-7, Oslo 6. Tel: (02) 19-62-00. Telex: 16435. Mng. Dir.: Sigurd Fering, Sales Mgr.: Kjell Smedsaas.

Product: Record-replacement sylv.
Brand names: Stanton

Shandinavisk Elektrikk A/S, Ostre Akervei 99, Oslo 5. Tel: 15-00-90.

Product: Record-replacement sylv.
Brand name: Pickering.

• store fixtures manufacturers

Arne Bendiksen A/S, Osterdalsgaten 1, Oslo 6. Tel: (02) 67-67-90. Cable: Billboard 1981-1982 International Buyer's Guide

BENDIKMUSIC. Telex 19689. Dir.: Arne Bendiksen, Gen. Mgr. Pal Skar.
Product: Tape display racks.

PAKISTAN

Population: 79,000,000

Rate of exchange: \$1 (US) = 9.9 rupees.

Per capita income: \$210

Holidays: March 23 (Pakistan Day), May 1 (May Day), August 14 (Independence Day), September 11, December 25 & religious holidays

• record & tape manufacturers / distributors / importers

E M I (Pakistan) Ltd, C/28 Estate Ave. SITE, Karachi 28. Tel: 29-01-21. Cable: EMITRON. Mng. Dir.: S. Mansoor Bokhari, Sales Gen. Mgr.: Ahmedullah Siddiqi, Finance Mgr. & Sec'y: Sabir Ahmed Khan. Branch: Lahore, Shadin Bldg. 9-A, The Mall. Tel: 52353.

Home office: England
Labels: (Owned) Capitol, Columbia, HMV, Parlophone, Stateside. (Licensed) Apple, Decca, Liberty, London, RCA (all UK)

• supplies

TAPE, BLANK LOADED & BULK RAW

B A S F Pakistan Ltd, Karachi 46-A, Block 6, PECHS. Tel: 430418. Cable: BADIILN. Telex 2704. Sales Mgr.: F. Zueger.

Audio: Cassette, open reel

PANAMA

Population: 1,900,000

Rate of exchange: \$1 (US) = 1 balboa.

Per capita income: \$1350

Holidays: January 1, January 9 (Day of Mourning), Carnival, Holy Thursday Good Friday, May 1 (Labor Day), October 11 (Anniversary of the 1968 Revolution), November 3 (Founding of the Republic), November 4 (Day of the National Flag), November 28 (Independence from Spain), December 8 (Mother's Day), December 25

• record & tape manufacturers / distributors / importers

Continental de Discos SA, Aptdo. 456, Panama 9-A. Tel: 27 0127. Cable: DISCOS. Pres. & Gen. Mgr.: Alcides Almanza Jr., Sales Mgr.: Arturo Grimaldo

Labels: (Owned) Continental, Emily, Happy, (licensed foreign) Armada & Fernandez (USA), Artomas (Puerto Rico), Bronco (Puerto Rico), Kubaney (USA), Mary Lou (USA), Modiner (USA), New Generation (Puerto Rico), Diva Cantu (USA), PDC (Puerto Rico), Performance (Puerto Rico), Rana (Puerto Rico), Romey's (Trinidad), Teca (USA), WIRL (Barbados)
Int'l reg.: Guatemala (Fonica), Venezuela (Velvet)

Dicesa, see Discos de Panama
Dideca, see Sonomundi

Discos de Panama SA (IFPI), Centro Ind'l Drillac, Calle 1a, Panama. Tel: 61-0201/0000/0267. Cable: PADISCD. Gen. Mgr.: Carolina Arosemena Q., Sales Vicente Mague, Promo: Eduardo Bragan.

Home office: El Salvador, Dicesa (see for labels)

Distribudora Panamena de Discos SA, Aptdo. 9614, Edif. Amelia Local 1 Bajos, Calle F, El Cangrejo, Panama 4. Tel: 64-58-03. Cable: DISPADISA.

Telex 2050. Gen. Mgr.: Gabriel Munoz Zapata.
Home office: Costa Rica, Indica (see for labels)

Emily, see Continental de Discos
Happy, see Continental de Discos

Indica, see Distribudora Panamena
Istmenos (Discos) SA, Aptdo. 3340, Calle 45, No. 46, Panama 4. Tel: 23-8665.

Labels: (Owned) Latino, Taboga, (represented) Kubaney (USA), Sono Radio (Peru)

Int'l reg.: Peru (Sono-Radio), Latino, see Istmenos

Libreria Rubyl SA, Aptdo. 18-B, Av. 3 de Noviembre, David. Tel: 75-4339. Pres.: Ruben D. Cabrera; Gen. Mgr.: Viola G. Cabrera. (Distributor/Importer)

Label: (Distributed—not licensed) Nevada (Spain).

Padisco, Centro Ind'l Drillac, Calle 1A, Panama. Tel: 61-0201. Gen. Mgr.: Carolina Arosemena

Label: (Licensed foreign) RCA (USA)

Sonomundi SA, Aptdo. 6-4297, Estafeta El Dorado, Edif. Condor, 1st fl., Calle 45, Panama. Tel: 69-4669, 69-4884. Telex: 0377-2048.

Home office: Guatemala, Dideca (see for labels).

Taboga, see Istmenos

• music publisher

Ed. Musical de Panama SA (BIEM), Aptdo. 3340, Calle 45, No. 46, Panama. Tel: 23-8665.

Int'l firm represented: Edimusa (Peru).

Int'l reg.: Peru (Edimusa)

• services

DESIGN & ARTWORK

Discos de Panama SA, Centro Ind'l Drillac, Calle 1a, Panama. Tel: 61-0201/0000/0267. Cable: PADISCD (Rec. only)

PLATING, PROCESSING & PRESSING PLANTS

Discos de Panama SA, Centro Ind'l Drillac, Calle 1a, Panama. Tel: 61-0201/0000/0267. Cable: PADISCD (Pressing only)

Istmenos (Discos) SA, Aptdo. 3340, Calle 45, No. 46, Panama 4. Tel: 23-8665

PRINTER & LITHOGRAPHER

RECORD PROMOTION
Discos de Panama SA, Centro Ind'l Drillac, Calle 1a, Panama. Tel: 61-0201/

0000/0267. Cable: PADISCD (Rec. only)

TAPE CUSTOM DUPLICATOR

Istmenos (Discos) SA, Aptdo. 3340, Calle 45, No. 46, Panama. Tel: 23-8665

• accessories importer

Libreria Rubyl SA, Aptdo. 18-B, Av. 3 de Noviembre, David. Tel: 75-4339. Pres.: Ruben D. Cabrera; Gen. Mgr.: Viola G. Cabrera.

Product: Carrying & storage cases, Record-record care prods., 45 rpm adaptors, replacement sylv.

• store fixtures importer

Libreria Rubyl SA, Aptdo. 18-B, Av. 3 de Noviembre, David. Tel: 75-4339. Pres.: Ruben D. Cabrera; Gen. Mgr.: Viola G. Cabrera.

Product: Tape display racks

PERU

Population: 17,293,083

Rate of exchange: \$1 (US) = 416 sols.

Holidays: January 1, April 3, 4, May 1 (Labor Day), June 24, July 28, 29 (Independence Anniversary), August 30 (St. Rose of Lima Day), October 9 (Day of National Dignity), November 1 (All Saints Day), December 8, 25.

RECORDS:

Records sold domestically including imports (retail value): LP's 1979-1,960,000 units, \$8,251,600. Singles 1979-7,150,000 units, \$5,268,421.

Record club sales: None.

Discounting: Frequent.

Type of distribution: The manufacturer-to-retailer system predominates. About 15% of sales are made by ambulatory merchants in the streets.

Type of promotion: Radio and television are the most important means. There is some promotion in newspapers and magazines by means of articles and advertising.

TAPE:

Market: The cassette share of the music market is about 12%. There are no open reel or 8-track sales.

Pre-recorded tape sold domestically including imports (retail value): Cassette 1979-352,000 units, \$1,632,075.

RADIO STATIONS:

No. of AM 312, FM 9 (80% commercial, 20% government).

Comment: The top stations play pop music from U.S. (80%) and Spain (20%).

TELEVISION STATIONS:

No. of networks 3 (40% PAL color).

Comment: The programming mix is comprised of U.S. series, music programs via satellite from Spain, pre-recorded videotapes of drama from Argentina and Mexico (top of the surveys), local shows, sports, and news.

IMPORT/EXPORT REGULATIONS:

For importation it is necessary to have a license if the merchandise value is over \$2,000. The tax rate (CIF value) is 56% for records, 56% for pre-recorded tapes, and 36% for stamps. An imported record costs more than three times a local record.

MARKET ANALYSIS:

There are about 11.5 million people living in the Peruvian cities, with about 3.4 million of them between 12 and 34 years old. Of the latter figure, only 35% have the age and money to be a record buyer.

Last year, a typical hit single sold about 40,000 copies and a hit LP sold about 6,000 copies. There are five basic musical styles: Disco/pop/rock (35%), Salsa, foreign in Spanish, local "Chicha," and Peruvian folklore.

• record & tape manufacturers / distributors / importers

Bambu, see IEMPSA

Bang!, see RPM

Corona, see Industrial Sono-Radio.

Disa, see Galvano.

F T A (Fabricantes Tecnicos Asociados) SA (IFPI), Panamericana Norte, Km. 13.5, Lima. Tel: 23-12-30, 31-42-85. Cable: FTALIMA. Telex: 20126. Mng. Dir.: Carlos Torres D., Rec. Div. Mgr.: Divaldo Vazquez.

LOOKING FOR A PARTNER IN SCANDINAVIA SEE PAGE 307

SCANGROUP RECORDS



Labels: (Owned) FTA, (licensed) Arvola (Germany), Arista (UK, USA), Barclay (France), Buddha (USA), Chrysalis (UK), Dcsea (El Salvador), Discosoda (Colombia), Ensign (UK), Hansa (Germany), Island (UK), Libra/Alhambra (USA), Musidisc (Brazil), PRT (UK), RCA (USA), Rialto (UK), 20th Century (USA).

Int'l reps.: Colombia (Discomoda), Ecuador (Studio)

Fabricantes Tecnicos Asociados. see FTA
Faro, see Galvano.

Galdisa, see Galvano.

Galvano Disco SA (Galdisa), Guillermo Dansey 19 0 "A", Lima Tel: 51-86-40 Cable GALOISA Telex 20472 Pres. Alber o Maravi, Gen Mgr Rolando Ore Garvan

Labels: (Owned) Disa, Faro, Infopesa, Midas, Pandora, Soulatino, (licensed) Ariston (Italy), Baby (Italy), FM (Colombia), Caribe (Venezuela), Kubaney (USA), Microfon (Argentina), Velvet (Venezuela)

Int'l reps.: Argentina (Microfon), Colombia (USA), Ecuador (Famoso), Mexico (Alimar), Uruguay (Renvar), Venezuela (Velvet)

I E M P S A (Industrias Electricas & Musicales Peruanas SA) (IFPI), Av. Guillermo Dansey 1247, Lima, Tel 32 40 05, 31 81 12 Cable IEMPSA Telex 25570 Mng. Dir. Augusto Sarria Salas, Admin. & Finance Mgr Rodolfo Canseco Torres; Mktg. Div Mgr. Ezequiel Solo H., Prod. Div Mgr. Augusto Sarria Aguirre; Mktg. Div. Mgr. ose Mogollon I

Labels: (Owned) Bambu, IEMPSA. Lider. (licensed) Borinquen (Puerto Rico), Butterfly (USA), Capitol (USA), Codiscos (Colombia), Combo (USA), EMI (UK), Fonodisco (Venezuela), Liberty/United Artists (USA), Lyra (Bolivia), Melody (Mexico), Musart (Mexico), Orfeon (Mexico), Seeco (USA), TR (USA), TTH (USA), Top Hits (USA, Venezuela)

Int'l reps.: Worldwide (EMI) excluding Bolivia (Oscolorando), Colombia (Codiscos), Ecuador (Alm. Musica Aguilari, Condor, Emporio Musical, Fadsa, J.D. Feraud Guzman, Primicias Musicales); Mexico (Capitol), USA (TH), Venezuela (Top Hits)

Industrial Sono-Radio SA (IFPI), Av. Republica de Panama 1427, Balconillo, Lima 13 Tel 72-33 54 Cable SONORADIO Telex 20385 Bd Pres Luis Grana Podesta, Exec. Dir. Luis A Aubry, Exec. VP & Gen. Mgr. Jaime Delgado Aparicio; Sales Mgr. Enrique Queroiro

Labels: (Owned) Corona, Sono-Radio, (licensed) Alhambra (Spain), CBS Int'l (worldwide), Fania (USA), IFESA (Ecuador)

Int'l reps.: Argentina (CBS), Bolivia (Oscolorando Oueri), Chile (Philips), Colombia (CBS), Costa Rica (CBS/Indica), Ecuador (IFESA), Mexico (CBS), USA (Alhambra), Venezuela (CBS)

Industrias Electricas & Musicales Peruanas SA, see IEMPSA
Infopesa, see Galvano
Lider, see IEMPSA

M A G, see Sica Peruana
Midas, see Galvano
Pandora, see Galvano

Petco SA Moquegua 157, Of. 213, Lima 1 Tel 28 87 30 Contact Philip Petrone

Int'l branch: USA, Petco Int'l
Int'l reps.: Colombia (Fonobos), Ecuador (IFESA), Mexico (Musart), Puerto Rico (Rio Piedras), Venezuela (Sonover)

R P M Estudios SrO, Div. Fonografica, Manco Capac 495, Miraflores-Lima, Tel: 45 7912, 45 6868, Gen. Mgr. Luis Nevares R.

Label: (Owned) Bang!
Rempez Orbe SA, Av. Nicolas de Pierola 243, 2nd fl., Lima. Contact Manuel Garcia-Larco

Label: (Represented) Moss Music Group (USA)
Sica Peruana SA, Oiscos MAG (IFPI), Jr. Oroya :24, Lima, Tel. 236371 Cable SICAPERU Pres. & Gen. Mgr. Manuel Guerrero, Sales Mgr. Carlos M. Guerrero

Labels: (Owned) MAG, (licensed foreign) Biaret (France), Carrere (France), Prelude (USA), Salsoul (USA)

Sono-Radio, see Industrial Sono-Radio
Soulatino, see Galvano

El Virrey Industrias Musicales SA (IFPI), Av. Republica de Panama 3551, San Isidro, Lima 27 Tel 40-46-00 Cable VIRREY Telex: (354) 20276 Gen. Mgr. Enrique Brenner T., A&R & Int'l Mgr. Wieland Kalka; Comm'l Mgr. Jorge Galarcep E

Labels: (Owned) Virrey, Zeta, (licensed) Ansoma (USA), Asylum (USA), Atlantic (USA), Casablanca (USA), OGG (Germany), Oceca (UK), Oisneyland (USA), Elektra (USA), Fadsa (Ecuador), Fantasy (USA), Fuentes (Colombia), Gamma (Mexico), Gelfen (USA), Gema (Puerto Rico), Hispano (Spain), MCA (USA), MGM (Worldwide), Mercury (USA), Motown (USA), Palacio (Venezuela), Peerless (Mexico), Philips (worldwide), Polydor (worldwide), RSO (USA), Reprise (USA), Vertigo (worldwide), Verve (worldwide), WEA (Worldwide), Warner Bros (USA)

Int'l reps.: Bolivia (Imperio, Lauro), Colombia (Fuentes), Guatemala (Diceda), Mexico (Peerless), Puerto Rico (Velvet), USA (Velvet), worldwide (PolyGram)

Zeta, see El Virrey

• **music publishers**
Consortio de Eds. Musicales Peruanas SA, Av. Larco 743, Of. 402, Lima 18. Tel 47 48 31 Cable CONEDISA Pres. August Sarria Salas, Mgr. Gladys Watanabe (Also see Continental & RPM)

Int'l firms represented: Brambla (Mexico), Intersong (Brasil), Korn (Argentina), Sadram (Ecuador), Sochem (Chile), Unimusica (Venezuela)

Int'l reps.: Argentina (Korn), Brazil (Intersong), Chile (Sochem), Ecuador (Sadram), Mexico (Brambla), Venezuela (Unimusica)

Continental (Ed.), Av. Larco 743, Of. 402, Miraflores, Lima Tel 47-48-31, 45-14-82 Mgr., Gladys Watanabe (Also see Consortio)

Int'l firms represented: Beechwood (Mexico), Comus (Colombia), Musica Argentina Int'l (Argentina), Prodemus (Colombia), Sochem (Chile)

Int'l reps.: Chile (Sochem), Colombia (Comus, Prodemus), Mexico (Beechwood)

Edimusa (Ed. Musicales SA), Los Topacios 141, Lima, Tel 72-33-54, Luz (Ed.) SA, see Consortio
Maravi Music, see Ollantay
Musicales (Ed.) SA, see Consortio

Ollantay Music SA (Ed.), Guillermo Dansey 1912, Lima Tel 51 86-40 Cable EDOMSA Telex: 20472 Gen. Mgr. Alberto Maravi
Int'l firms represented: Edition (Argentina), Televis (Italy)

Int'l rep.: Argentina (Edition)
Petco SA, Moquegua 157, Of. 213, Lima 1 Tel 28 87 30 Contact: Philip Petrone
Int'l branch: USA, Petco Int'l
Int'l rep.: Worldwide (Mundo Musical)

R P M Estudios SrL, Div. Editorial, Manco Capac 495, Miraflores-Lima, Tel 45-7912, 45-6868, Gen. Mgr.: Luis Nevares R.

• **services**
DESIGN & ARTWORK
Galvano Disco SA (Galdisa), Guillermo Dansey 1910 "A", Lima Tel 51-86-

40 Cable GALOISA Telex 20472 Pres. Alberto Maravi, Gen Mgr Rolando Ore Garvan

I E M P S A (Industrias Electricas & Musicales Peruanas SA), Av. Guillermo Dansey 1247, Lima, Tel: 32 40 05, 31 81 12 Cable IEMPSA Telex 25570 Mng. Dir. Augusto Sarria Salas, Admin. & Finance Mgr Rodolfo Canseco Torres

Industrial Sono-Radio SA, Av. Republica de Panama 1427, Lima 13 Tel 72-33 54 Cable SONORADIO Telex 20385 Bd Pres. Luis Grana Podesta; Exec. Dir. Luis A Aubry, Exec. VP & Gen. Mgr. Jaime Delgado Aparicio; Sales Mgr. Enrique Queroiro, Int'l Dept. Maria Elena Tassara.

LICENSING ORGANIZATION, MUSIC
A P D A Y C (Asociacion Peruana de Autores & Compositores), Jiron Ica 559, Lima Tel. 32 92 65 Cable APOAYC Gen. Mgr. Orlando Galvez Montalvo

Fonoperu, Av. Emancipacion 271, Of. 138, Mezz., Lima Tel: 28-16-17 Mng. Dir. Ruben A Salaverri (Mechanical rights only)

LICENSOR, RECORD & TAPE
Industrial Sono-Radio SA, Av. Republica de Panama 1427, Lima 13 Tel 72-33 54 Cable SONORADIO Telex 20385 Bd. Pres. Luis Grana Podesta; Exec. Dir. Luis A Aubry, Exec. VP & Gen. Mgr. Jaime Delgado Aparicio; Sales Mgr. Enrique Queroiro, Int'l Dept. Maria Elena Tassara

PLATING, PROCESSING & PRESSING PLANTS
Galvano Disco SA (Galdisa), Guillermo Dansey 1910 "A", Lima, Tel: 51-86-40 Cable GALOISA Telex 20472 Pres. Alberto Maravi, Gen Mgr Rolando Ore Garvan

I E M P S A (Industrias Electricas & Musicales Peruanas SA), Av. Guillermo Dansey 1247, Lima, Tel 32 40 05, 31 81 12 Cable IEMPSA Telex 25570 Mng. Dir. Augusto Sarria Salas; Admin. & Finance Mgr.: Rodolfo Canseco Torres

Industrial Sono-Radio SA, Av. Republica de Panama 1427, Lima 13 Tel 72-33 54 Cable SONORADIO Telex 20385 Bd. Pres. Luis Grana Podesta, Exec. Dir. Luis A Aubry, Exec. VP & Gen. Mgr. Jaime Delgado Aparicio; Sales Mgr. Enrique Queroiro, Int'l Dept. Maria Elena Tassara

Sica Peruana SA, Jr. Oroya 224, Lima, Tel 236371, 237559 Cable SICA-PERU Pres. & Gen. Mgr. Manuel Guerrero, Sales Mgr. Carlos M. Guerrero

El Virrey Industrias Musicales SA, Av. Republica de Panama 3551, San Isidro, Lima 27 Tel 40-46-00 Cable VIRREY Telex (354) 20276 Gen. Mgr.: Enrique Brenner T., Comm'l Mgr. Jorge Galarcep E

PRINTERS & LITHOGRAPHERS
I E M P S A (Industrias Electricas & Musicales Peruanas SA), Av. Guillermo Dansey 1247, Lima Tel 32 40 05, 31 81 12 Cable IEMPSA Telex 25570 Mng. Dir. Augusto Sarria Salas; Admin. & Finance Mgr.: Rodolfo Canseco Torres

Imprenta Editora Osco SA, Pasaje Velarde 106, Lima, Tel 24 84 28, 23-16-72 Gen. Mgr. Marcial Garcia Villavicencio

Industrial Sono-Radio SA, Av. Republica de Panama 1427, Lima 13, Tel 72-33 54 Cable SONORADIO Telex 20385 Bd. Pres. Luis Grana Podesta; Exec. Dir. Luis A Aubry, Exec. VP & Gen. Mgr. Jaime Delgado Aparicio; Sales Mgr. Enrique Queroiro, Int'l Dept. Maria Elena Tassara

Sica Peruana SA, Jr. Oroya 224, Lima, Tel 236371, 237559 Cable SICA-PERU Pres. & Gen. Mgr. Manuel Guerrero, Sales Mgr. Carlos M. Guerrero

El Virrey Industrias Musicales SA, Av. Republica de Panama 3551, San Isidro, Lima 27 Tel 40-46-00 Cable VIRREY Telex (354) 20276 Gen. Mgr. Enrique Brenner T., Comm'l Mgr. Jorge Galarcep E

RECORD PROMOTION
I E M P S A (Industrias Electricas & Musicales Peruanas SA), Av. Guillermo Dansey 1247, Lima Tel 32 40 05, 31 81 12 Cable IEMPSA Telex 25570 Mng. Dir. Augusto Sarria Salas; Admin. & Finance Mgr.: Rodolfo Canseco Torres

Industrial Sono-Radio SA, Av. Republica de Panama 1427, Lima 13, Tel 72-33 54 Cable SONORADIO Telex 20385 Bd. Pres. Luis Grana Podesta; Exec. Dir. Luis A Aubry, Exec. VP & Gen. Mgr. Jaime Delgado Aparicio; Sales Mgr. Enrique Queroiro, Int'l Dept. Maria Elena Tassara

Sica Peruana SA, Jr. Oroya 224, Lima, Tel 236371, 237559 Cable SICA-PERU Pres. & Gen. Mgr. Manuel Guerrero, Sales Mgr. Carlos M. Guerrero

El Virrey Industrias Musicales SA, Av. Republica de Panama 3551, San Isidro, Lima 27 Tel 40-46-00 Cable VIRREY Telex (354) 20276 Gen. Mgr. Enrique Brenner T., Comm'l Mgr. Jorge Galarcep E

RECORD PROMOTION
I E M P S A (Industrias Electricas & Musicales Peruanas SA), Av. Guillermo Dansey 1247, Lima Tel 32 40 05, 31 81 12 Cable IEMPSA Telex 25570 Mng. Dir. Augusto Sarria Salas; Admin. & Finance Mgr.: Rodolfo Canseco Torres

Industrial Sono-Radio SA, Av. Republica de Panama 1427, Lima 13, Tel 72-33 54 Cable SONORADIO Telex 20385 Bd. Pres. Luis Grana Podesta; Exec. Dir. Luis A Aubry, Exec. VP & Gen. Mgr. Jaime Delgado Aparicio; Sales Mgr. Enrique Queroiro, Int'l Dept. Maria Elena Tassara

Sica Peruana SA, Jr. Oroya 224, Lima, Tel 236371, 237559 Cable SICA-PERU Pres. & Gen. Mgr. Manuel Guerrero, Sales Mgr. Carlos M. Guerrero

El Virrey Industrias Musicales SA, Av. Republica de Panama 3551, San Isidro, Lima 27 Tel 40-46-00 Cable VIRREY Telex (354) 20276 Gen. Mgr. Enrique Brenner T., Comm'l Mgr. Jorge Galarcep E

TAPE CUSTOM DUPLICATORS
TAPE PACKAGING & LABELING
The Audio and Video lines indicate the configurations which the firms duplicate. Companies which offer packaging and labeling of tape product are indicated by "(PKG)" which appears after the main body of their respective listings.

Estemac Laboratorio Electronico SA, Casilla 224, Lima 18, Tel 45-55-30, 45-65-97 Cable ESTEMAC Telex 25385 Pres. Heinz O. Schleusner; Gen. Mgr. Oswaldo Garcia

Audio: Cassette, open reel
Galvano Disco SA (Galdisa), Guillermo Dansey 1910 "A", Lima, Tel 51-86-40 Cable GALDISA Telex 20472 Pres. Alberto Maravi, Gen. Mgr. Rolando Ore Garvan

Audio: 8-tr
I E M P S A (Industrias Electricas & Musicales Peruanas SA), Av. Guillermo Dansey 1247, Lima Tel 32 40 05, 31 81 12 Cable IEMPSA Telex 25570 Mng. Dir. Augusto Sarria Salas; Admin. & Finance Mgr.: Rodolfo Canseco Torres. (PKG-audio only)

Audio: Cassette
Industrial Sono-Radio SA, Av. Republica de Panama 1427, Lima 13, Tel 72-33 54 Cable SONORADIO Telex 20385 Bd. Pres. Luis Grana Podesta; Exec. Dir. Luis A Aubry, Exec. VP & Gen. Mgr. Jaime Delgado Aparicio; Sales Mgr. Enrique Queroiro, Int'l Dept. Maria Elena Tassara (PKG)

Audio: Cassette
Sica Peruana SA, Jr. Oroya 224, Lima, Tel: 236371, 237559 Cable: SICA-PERU Pres. & Gen. Mgr. Manuel Guerrero, Sales Mgr. Carlos M. Guerrero

Audio: Cassette
El Virrey Industrias Musicales SA, Av. Republica de Panama 3551, San Isidro, Lima 27 Tel 40-46-00 Cable VIRREY Telex (354) 20276 Gen. Mgr. Enrique Brenner T., Comm'l Mgr. Jorge Galarcep E

Audio: Cassette

• **supplies**
EMPTY CARTRIDGES, CASSETTES & REELS
Estemac Laboratorio Electronico SA, Casilla 224, Lima 18 Tel: 45-55-30, 45-65-97 Cable: ESTEMAC Telex 25385 Pres. Heinz D. Schleusner; Gen. Mgr. Oswaldo Garcia

Brand names: Agfa, Estabel-Agfa

JACKETS & SLEEVES
LABELS, DISK
I E M P S A (Industrias Electricas & Musicales Peruanas SA), Av. Guillermo Dansey 1247, Lima, Tel 32 40 05, 31 81 12 Cable IEMPSA Telex 25570 Mng. Dir. Augusto Sarria Salas; Admin. & Finance Mgr.: Rodolfo

Canseco Torres
Sica Peruana SA, Jr. Oroya 224, Lima, Tel 236371, 237559 Cable SICA-PERU Pres. & Gen. Mgr. Manuel Guerrero, Sales Mgr. Carlos M. Guerrero (45, LP)

El Virrey Industrias Musicales SA, Av. Republica de Panama 3551, San Isidro, Lima 27 Tel 40-46-00 Cable VIRREY Telex (354) 20276 Gen. Mgr. Enrique Brenner T., Comm'l Mgr. Jorge Galarcep E (45, LP)

POLYETHYLENE BAGS & SHRINKWRAP
Sica Peruana SA, Jr. Oroya 224, Lima, Tel 236371, 237559 Cable SICA-PERU Pres. & Gen. Mgr. Manuel Guerrero, Sales Mgr. Carlos M. Guerrero (Poly Bags only)

PROFESSIONAL TAPE SUPPLIES
El Virrey Industrias Musicales SA, Av. Republic de Panama 3551, San Isidro, Lima 27 Tel 40-46-00 Cable VIRREY Telex (354) 20276 Gen. Mgr.: Enrique Brenner T., Comm'l Mgr. Jorge Galarcep E

Audio: Cassette labels

RECORD MANUFACTURING EQUIPMENT
Estemac Laboratorio Electronico SA, Casilla 224, Lima 18, Tel: 45-55-30, 45-65-97 Cable ESTEMAC Telex 25385 Pres. Heinz O. Schleusner; Gen. Mgr. Oswaldo Garcia

Brand name: Alpha EuropaFilm

TAPE, BLANK LOADED & BULK RAW
Estemac Laboratorio Electronico SA, Casilla 224, Lima 18, Tel: 45-55-30, 45-65-97 Cable ESTEMAC Telex 25385 Mng. Dir.: Heinz O. Schleusner; Gen. Mgr. Oswaldo Garcia

Audio: Cassette, open reel
Brand name: Estabel-Agfa

TAPE DUPLICATING & PROCESSING EQUIPMENT
Estemac Laboratorio Electronico SA, Casilla 224, Lima 18, Tel 45-55-30, 45-65-97 Cable ESTEMAC Telex 25385 Pres. Heinz O. Schleusner; Gen. Mgr. Oswaldo Garcia

Audio: Duplicating equip., loaders
Brand names: Cassette, Lyrec, RTW, TTL

• **accessories manufacturer**
Estemac Laboratorio Electronico SA, Casilla 224, Lima 18, Tel 45-55-30, 45-65-97 Cable ESTEMAC Telex 25385 Pres. Heinz O. Schleusner; Gen. Mgr. Oswaldo Garcia

Product: Record-carrying & storage cases, Tape-carrying & storage cases, head cleaners, bulk erasers, demagnetizers, leader tape, splicing tape & equip

PHILIPPINES

Population: 47,000,000.
Rate of exchange: \$1 (US) = 7.80 pesos.
Per Capita Income: \$591.
Holidays: January 1 (New Year's), Holy Thursday, Good Friday, April 9 (Bataan Day), May 1 (Labor Day), June 12 (Independence Day), July 4 (Philippine-American Friendship Day), October 1 (National Heroes Day), December 25 (Christmas), December 31 (Rizal Day)

• record & tape manufacturers / distributors / importers

A R C Rec. Sales (formerly Fortune Rec. Sales), JLB Bldg., 5th fl., Ronquillo, Quapo, Manila, Tel 40-91-47, Cnm & Pres. Buddy O. De Vera; Gen. Mgr. Reynaldo O. De Vera, Sales Mgr. Quintin Mendoza. (Also see Alpha Recs.)

Labels: (Distributed-not licensed domestic) ARC, Alpha, Bicolandia, Cap. Cycle, Fama, Fame, Jonal, Kinaham, Mayon, Musika, Northern, VIP; (distributed-not licensed foreign) Arrow, Countdown, Gamma, Good Vibrations, International Artists, Solid Gold, Spure, Top Twenty, Warwick, Windmill.

A & W Horizon, see A&W Recs.
A & W Recs. Int'l (IFPI), Vergel de Oros Bldg., 2nd fl., 530 Evangelista St., Quapo, Manila, Tel 40-54-51, Cable: AWREC Telex: 27968 Pres. Allan J. Villar; VP Int'l Willie J. Villar, Mng. Dir. Mike Jamir; Prod'n Mgr. Isy Villar, Finance Mgr. Efrén Gacugia; Promos. Reggie Mendoza; Promos. & Prod'n: Jose Edwin Villalva

Labels: (Owned) A&W, A&W Horizon, Cerveza, Osisco, Sagittarius; (licensed domestic) Mango, Villar, (licensed foreign) AVI (USA), Cadet (USA), Cream/Hi (USA), Everest (USA), Emergency (USA), George Greeley Prod'n (USA), JVC/Victor (Japan), King (Japan), Michele Audio (USA), Prism (USA), Rampage (UK), Ranwood (USA), Sweet City (USA), Sydney Thompson (UK), Turicaphon (Switzerland), Vanguard (USA).

Action, see Marco
Ad & Ad, see Platinum
Admiral, see Empire

Allied Artists, see Entertainment Mgmt.
Alpha Recs. Corp., JLB Bldg., 3rd fl., Ronquillo, Quapo, Manila, Tel: 47-12-47, 40-91-47, Pres. & Gen. Mgr. Buddy O. De Vera; EVP & Int'l Dir.: Reynaldo O. De Vera; VP Special Projects: Rey Cruz Jr.; Treas.: Erlinda F. De Vera; A&R: Engie Ocampo, Rey Palac, Velhene Saturno; Promo. Dir. Bedette Villanueva; Creative Dir. Rudy Retanan; Sales Mgr. Quintin Mendoza; Office Mgr. Cecille de Guzman; MM Sales Mgr.: Mike Hiscia; Luzon Sales Mgrs.: Rene Torres, Lito Florencio, Accounting Head: Luis Cueto; Visayan Sales Mgr.: Ben Balboa; Mindanao Sales Mgr.: Bastie Balboa. (Distributed by ARC & Lady Lynn)

Labels: (Owned) ARC, Alpha, Bicolandia, Cap. Cycle, Fame, Jonal, Kayumanggi, Kinaham, Mayon, Metro, Musika, Northern, VIP; (licensed) Arrow, International Artists, Solid Gold, Top Twenty (all UK); Countdown (Germany), Excelsior (USA), Importe/12 (USA), Killyroy (Netherlands), Plum (Germany), Prism (USA), Telstar (Netherlands).

American Artists, see Empire
Anahaw, see Platinum
April, see OctoArts

Arlo, see Entertainment Mgmt.
Asco, see Video Vision
Asylum, see WEA
Arco, see WEA
Atlantic, see WEA
Banaga, see Offspring
Bicolandia, see Alpha
Blackgold Recs. Corp., PO Box AC270, 782 Aurora Blvd., Cubao, Quezon

City. Tel: 70-40-81. Cable: VIMUSCO. Telex: 74242056. Pres. & Chief Exec. Officer: Vicente del Rosario Jr.; Adv. & Promos. Mgr.: Brenda Bayhon; Int'l A&R: Victor Jose; Domestic A&R: Felicio Bautista; Int'l Co-ord: Dolly W. Karandang. (Also see Vicor).

Label: (Owned) Blackgold; (represented) CBS/Sony.

Bobby, see VMI.

Booma, see Offspring.

Canary, see OctoArts.

Canon, see Empire.

Cap, see Alpha.

Cerveza, see A&W.

Chipack, see Offspring.

Chi Reet, see Offspring.

Circle, see Empire.

Contex, see Entertainment Mgmt.

Continental Artists, see Video Vision.

Cotillion, see WEA.

Crystal, see JEM.

Cycle, see Alpha.

Dimension, see Video Vision.

Disc Corp. of the Philippines, Maya Bldg., Suite 1, 678 E. De Los Santos Ave., Cubao, Quezon D-3001. Tel: 98-69-40, 96-81-91, 96-81-91. Cable DISCOPHIL Manila. Exec. VP & Gen. Mgr.: Danilo P. Divares; Admin. Officer & Comptroller: Malov V. Chpeco.

Labels: (Licensed foreign) Ariola (Germany), Buddah (USA), Casablanca (USA), Fantasy (USA), Hansa-Das s (Germany), Interglobal Music (Canada), Janus-GRU (USA), Jupiter (Canada), Milestone (USA), Prestige (USA), Salsoul (USA), Springboard (USA).

Disco, see A&W.

Dyna-Parlophone, see Dyna Prods.

Dyna Prods. Inc. (IFPI), 135 Second Ave., Grace Park, Caloocan City, Manila. Tel: 23-23-62/67-35, 40-51-11/15. Cable: DYPRD. Telex: 40361. Pres. Albert Tan; Exec. VP: James G. Dy; Gen. Mgr.: Tan Huy Bin, Sales Mgr.: Vicente Iy.

Labels: (Owned) Dyna, Dyna-Parlophone, Humig, Jive, Sinamar; (licensed) A&M (USA), Angel (USA), Ariola (Hong Kong), Audio Fidelity (USA), Capitol (USA), Casablanca (USA), DG (Germany), DJM (UK), DM (USA), Decca (UK), EMI (UK), FarTasy (Hong Kong), Festival (Australia), Fontana (Netherlands), Hansa (Germany), Lollipop (Hong Kong), London (UK), MAM (UK), Mercury (Netherlands), Midson (USA), Music for Pleasure (UK), Philips (Netherlands), Pickwick (UK), Polydor (Germany) Project 3 (USA), RSD (USA), Rocket (UK), Sugar Hill (USA), Telefunken (Germany), United Artists (USA), Vertigo (Netherlands).

Egypt & Cairo, see Offspring.

Elektra, see WEA.

Empire Entertainment Corp., PO Box 967, Dynasty Cinema Bldg., 827-831 Rizal Ave., Santa Cruz, Manila. Tel: 27-34-71. Cable: EMPINT.

Labels: (Owned) Admiral, American Artists, Cannon, Circle, Fanfare, Masterpiece, Movietone, Quadrant, Soundtracks; (licensed) Arcade (USA), Avenue (USA), Design (USA), Encounter, Europa (Germany), Europa Ex-sult (Germany), Forest, GSF, Golden Ear, Happy Time (USA), Hilltop (USA), Hit (Ireland), Instant Learning Series (USA), Irs, Kilroy (USA), Mr. Pickwick (USA), Mode (France), Mondiomusic (France), PIP (USA), Pacific, Peter Rabbit (USA), Pickwick Int'l (USA), Play (USA), Playhour (USA), R&R (USA), Release (Ireland), Sesame Street (USA), Showcase (USA), Somerset (Germany), Sonne (Germany), Stereo Plus 3, Swing, Tel-star (Belgium).

Encore, see Platinum.

Entertainment Mgmt. & Mktg. Inc., Dynasty Super Cinema Bldg., Rizal Ave., Manila. Tel: 27-34-72.

Labels: (Owned) Allied Artists, Arlo, Contex, Hit Sound, Quad, Ten; (represented) AU (USA), Avenue (UK), Boss (USA), Cherry (USA), Jade (USA), Love (USA), Mongo (USA), MuscDisc (USA), National (USA), Diga (Sweden), Pop (USA), Royal (USA), Vnus (USA), Young America (USA), Zet (UK).

Everstar, see Video Vision.

Express, see VMI.

Fame, see Alpha.

Fanfare, see Empire.

Fastbreak, see Offspring.

Filipinas Rec. Corp., 131 Del Monte Ave., Quezon City 3010. el. 3545-20. Cable: FILRECO.

The Flag, see Platinum.

Funstuff Inc., Jade Bldg., Suite 406 71 Aurora Blvd., Santa Mesa, Manila. Tel: 61-95-03. Chief Exec.: Juliet Ang.

Labels: (Licensed foreign) Sesame Street (USA).

Grand, see Video Vision.

Grandeur, see Platinum.

Groundsound, see Platinum.

Guestar, see Video Vision.

Hidcor, see Home Inds.

Humig, see Dyna Prods.

Hit 100, see VMI.

Hit Sound, see Entertainment Mgmt.

Home Inds. Development Corp. (IFPI), PO Box 34, Quezon City. Tel: 50-86-61. Cable: HDIMID. Telex: 7420409. Pres.: Alfredo M. Lustre; Gen. Mgr.: Antonio U. Lustre.

Labels: (Owned) Hidcor; (licensed foreign) Ariola (USA), Hi/Cream (USA), Infinity (USA), MCA (USA), Magnel (UK), Parachute (USA), Prelude (USA).

Honey, see Mareco.

Klubga, see Offspring.

J E M Rec'g Co. Inc., 160 20 Ave., Cubao, Quezon City. Tel: 78-15-27, 77-24-11, 78-48-67. Pres. & Gen. Mgr.: Wilfrido B. Cruz; VP Dpns. Wigberto Gonzalez; VP Int'l Opns. & Mktg.: Margot M. Gallardo; Controller: Nelo Alerta; Adv. & Promos. Mgr.: Edith M. Gallardo; PR Mgr.: Rose Y. Duma; Visayas & Mindanao Sales & Promos. Mgr.: Versim Enad.

Labels: (Owned) Crystal, JEM; (licensed foreign) Ampro, CTI, West End (all USA); (distributed-not licensed) New Yorker (USA). Int'l rep.: USA (J&M).

Jive, see Dyna Prods.

Jonal, see Alpha.

Jubell, see Platinum.

Kaymanggi, see Alpha.

Kinsham, see Alpha.

Lady Lynn Rec. Center, 533 Evangelista, Quiapo, Manila. Tel: 48-82-21, 40-65-96. Gen. Mgr.: Erinda F. De Vera; Sales Mgr.: Reilita P. Torres. (Distributor)

Labels: (Distributed) Alpha group.

Luzvimin, see Platinum.

Mabuhay, see Mareco.

Mango, see A&W & Mareco.

Mareco Inc., 131 Del Monte Ave., Quezon City 3010. Tel: 35-45-26. Cable: VILMARECO. Telex: 7337577.

Labels: (Owned) Action, Honey, Mabuhay, Mango, Superstar, Villar; (represented) GNP Crescendo, Monitor, Ranwood (all USA); Hispavox (Spain).

Masterpiece, see Empire.

Mayon, see Alpha.

Metro, see Alpha.

MGMitten, see Video Vision.

Mico Inds., Inc., PO Box 2364, Mico Tower Bldg., Sales & Ronquillo Sts., Santa Cruz, Manila. Tel: 49-57-80. Cable: MICOINDUST.

Label: (Owned) Mico.

Movietone, see Empire.

Musika, see Alpha.

Nanniplat, see Offspring.

Nonesuch, see WEA.

Northern, see Alpha.

Number 1, see Video Vision.

OctoArts Int'l Inc., 945 E. de los Santos Ave., Quezon City. Tel: 968-143, 996-584. Cable: DCTOARTS. Telex: 40404, 14862 (Capwire). Pres. & Gen. Mgr.: Orlando R. Ilacad; VP Sales: Ramonico R. Ilacad; VP Dpns.: Chito R. Ilacad; VP Domestic A&R: Sunny R. Ilacad; Int'l Labels Mgr.: Ricky R. Ilacad; Int'l Affairs Mgr.: Baby A. Gil; Purchasing Mgr.: Guy Ilacad; Finance Officer: Francis Justo; Creative Dir.: Willy Monzon; PR Mgr.: Aster A. Amoyo.

Labels: (Owned) April, Canary, OctoArts; (licensed foreign) Ariola (Germany), UK, USA, Baby (Italy), Carrere (France), Chrysalis (UK), H&L (USA), Hansa (UK), Miller (Germany), Motown (USA), Music World (New Zealand), Prelude (USA), Satril (UK), Victor (Japan), Virgin (UK).

Offspring Recs. Int'l, PO Box AC 468, Cubao, Quezon City. Tel: (632) 78-06-06. Cable: SPRINGPROD. Bd. Chm. & Pres.: Danee Samonte; VP Dpns: Oscar Aquino III; VP A&R: Jacinto Negrim Garon; Gen. Mgr.: Robert Baruan; Sales Mgr.: Cash Toura.

Labels: (Owned) Chpacq, Egypt & Cairo, Fastbreak, Ikiuga, Nanniplat, Offspring, Siloto Delight, Zacrot; (licensed domestic) Banaga, Booma, Chi Reet, Soundtrack, Sunkit; (licensed foreign) Delvecchio (Italy), Kusnima (India), La Vacara (USA), Ponching (China), PO Pong (Japan), Sital (Thailand); (distributed-not licensed) Aimagom. Int'l rep.: Hong Kong (Piao See), Japan (Po Pong), Thailand (Apurahan), Uganda (Nazareno, Negrim & Garon), UK (Bootalow), USA (Dabiana, LaVacara).

P M P, see Platinum.

Pearl, see Video Vision.

Plaka Ilocano, see VMI.

Plaka Pilipino, see Vicor.

Platinum Recs., JLB Bldg., 2nd fl., Ronquillo St., Quiapo, Manila. Tel: 40-46-15, 48-97-14. Pres.: Eli L. Balboa; Gen. Mgr.: Sebastian Balboa; Sales Mgr.: Al Balboa.

Labels: (Owned) Encore, The Flag, Grandeur, Groundsound, Jubell, Luzvimin, PMP, Sheiks; (distributed-not licensed) Ad & Ad, Anahaw, Solid Gold, TRC.

PopHits, see Video Vision.

PopMachines, see Video Vision.

PopTunes, see Video Vision.

Praise Inc., 175 Santa Domingo, San Francisco Del Monte, Quezon City.

Label: (Represented) Maranatha! (USA).

President, see Video Vision.

Quad, see Entertainment Mgmt.

Quadrant, see Empire.

Red White & Blue, see Video Vision.

Reprise, see WEA.

Sagittarius, see A&W.

Saturday, see Video Vision.

Sheiks, see Platinum.

Siloto Delight, see Offspring.

Sinamar, see Dyna Prods.

Solid Gold, see Platinum.

Soundtrack, see Offspring.

Soundtracks, see Empire.

Stars & Stripes, see Video Vision.

Suarez Recs., 60 Prosperidad St., Malabon. Tel: 22-41-94. Chief Exec.: Simplicio U. Suarez.

Sunokit, see Offspring.

Sunshine, see Vicor.

Superstar, see Mareco.

T R C, see Platinum.

Target, see Video Vision.

Ten, see Entertainment Mgmt.

Ugat, see Vicor.

V A, see VMI.

V I P, see Alpha.

V M I Gold, see VMI Music.

V M I Music Corp., PO Box 4042, Manila; 77 0. Tuazon St., Corner Sen. M. Cuenco St., Quezon City, Manila. Tel: 610-663, 623-588, 625-805. Bd. Chm. Lim Han Eng. Pres. & Gen. Mgr.: Victor Que; VP Accounting: Annette Que; VP Labels: Liberato Quelicu; VP Finance: Conchita Chua; VP Legal: George Bangayan; Sales Mgr.: Ramon T. Lao; A&R: Kendrick Timothy; Adv. & Promos: Constanza Mazon; Special Projects: Yulo Go; Davao Sales: Rose Hao; Cebu Sales: John Dy; Luzon Sales: Jun Cu.

Labels: (Owned) Bobby, Express, Hit 100, Plaka Ilocano, VA, VMI, VMI Gold, (licensed) Disco (Italy), MC Group (Germany), Vanguard (USA).

Vicor Music Corp., PO Box AC270, Vicor Bldg., 782 Aurora Blvd., Cubao, Quezon City. Tel: 70-40-81. Cable: VIMUSCO. Telex: 74242056. Pres. & Chief Exec. Officer: Vicente del Rosario Jr.; Exec. VP: Antonio M. Dcampo; SVP Finance & Admin.: Quirino Munoz; VP Finance & Admin.: Teresita R. Cruz; VP Mktg.: Ricardo R. del Rosario; AVP Creative Research: George Cancoso; AVP Personnel & Admin.: Ricardo Abcede; AVP Sales: Alberto Monzon; AVP PR: Norma Japitana; Int'l Co-ord.: Dolly W. Karandang; PR Mgr.: Zaida Gomez; Comptroller: Claire Diapo; Int'l A&R: Fred Samantela; Adv. & Promos. Mgr.: Joel Japita; Accounting Mgr.: Angel Magno; Purchasing Mgr.: Peter Soong; Plant Mgr.: Patricio Cabrera; Creative Dir.: Edwin Que; Domestic A&R: Spanky Rigor.

Labels: (Owned) Plaka Pilipino, Sunshine, Ugat, Victor; (represented) Arista (USA), Oe-lite, Disneyland (USA), RCA (USA), Victor (Japan), Vista (USA).

Video Vision Inc., Dynasty Super Cinema Bldg., Rizal Ave., Manila. Tel: (2) 27-34-73. Cable: DIMENSION.

Labels: (Owned) Asco, Dimension, MGMitten, Pearl, Saturday, Vvivi; (distributed) Continental Artists, Everstar, Grand, Guestar, Number 1, Pop Hits, PopMachines, PopTunes, President, Red White & Blue, Stars & Stripes, Target, Winston.

Villar, see Mareco & A&W.

Vvivi, see Video Vision.

W E A Recs., Manufacturers Bldg., Mezzanine fl., Plaza Santa Cruz, Manila 2805. Tel: 47-73-81. Cable: WEAREC. Telex: 40609. Pres.: James G. Dy; Gen. Mgr.: Ramon Chuaying.

Labels: (Owned) Asylum, Atco, Atlantic, Cotillion, Elektra, Nonesuch, Reprise, Warner Bros.; (licensed) Big Tree, Brother, Court, Island, Little David, Mirage, Paradise, Swan Song, Warner Curb, Whitfield (all USA). Warner Bros., see WEA.

Wear's Rec., 51 Auraula St., Mandaluyong, Rizal. Tel: 70-03-14. (Distributed by Vicor)

Winston, see Video Vision.

Wonderland Recs., 1835 F.B. Harrison, Pasay City. Tel: 59-05-31. Dwner & Gen. Mgr.: Alice Cabahug; Exec. Ass't: Yvette Ledesma; Sales Mgr.: Mike I. Cabahug.

Zacrot, see Offspring.

• music publishers

B A M I (Bayanihan Music Philippines Inc.), Vicor Bldg., 782 Aurora Blvd., Cubao, Quezon City. Tel: 70-40-81. Cable: VIMUSCO. Telex: 74242056. Pres. & Chief Exec. Officer: Vicente del Rosario Jr.; Exec. VP: Amado A. Amador; Ass't VP: Linda Marqueses; Int'l Co-ord.: Dolly W. Karandang.

F A M I (Fil-Am Music Inc.), Calvo Bldg., Rm. 220, Escolta, Manila. Tel: 40-35-05. Cable: FAMI.

J E M Rec'g Co. Inc., 160 20 Ave., Cubao, Quezon City. Tel: 78-15-27, 77-24-11, 78-48-67. Pres. & Gen. Mgr.: Wilfrido B. Cruz.

Lustre Music Publ'g Corp., PO Box 4140, Manila. Cable: HOMID. Telex: 7420409.

Mareco Inc. (FAMI), 131 Del Monte Ave., Quezon City. Tel: 35-45-26. Cable: VILMARECO.

Int'l rep.: USA (L.I. Wrtkoff).

Metro Music Masters Inc., JLB Bldg., 5th fl., Ronquillo, Quiapo, Manila. Tel: 40-63-21. Pres.: Buddy O. De Vera.

Sound Music House, Dynasty Super Cinema Bldg., Rizal Ave., Manila. Tel: 27-34-73.

S. S. Suarez Music Co. (Filscap, Musika), 60 Prosperidad St., Malabon, Metro Manila. Tel: 22-41-94. Gen. Mgr.: Simplicio U. Suarez.

Int'l reps.: Japan (Toho); USA (Gerard de la Chappelle).

Wonderland Recs. (Fiscap), 1835 F.B. Harrison, Pasay City. Tel: 59-03-31. Pres. & Gen. Mgr.: Alice Cabahug; Exec. Ass't: Yvette Ledesma; Sales Mgr.: Mike I. Cabahug.

Int'l rep.: Australia (Jonathan).

• services

ASSOCIATIONS & PROFESSIONAL ORGANIZATIONS

Artists Guild of the Philippines, c/o College of the Holy Spirit, 16 E. Mendiola St., Manila.

Cultural Foundation of the Philippines, San Luis Terraces, Rm. 502, E.M. Kalaw St., Ermita, Manila. Tel: 40-46-12.

League of Filipino Composers, 1665 Taft Ave., Manila.

Manila Symphony Society, PO Box 664, Elks Club Bldg., Roxas Blvd., Manila. Tel: 70-73-13. Cable: SYMPHONY.

Music Promotion Foundation of the Philippines, Ysmael Bldg., 1845 Taft Ave., Manila. Cable: MUSIPROM.

National Band Ass'n of the Philippines, 70 Boston St., Cubao, Quezon City. Tel: 70-34-94.

National Music Council of the Philippines, c/o UNESCO Nat'l Commission, Ministry of Foreign Affairs, Padre Faura St., Manila 2801. Tel: 57-29-91. Cable: UNACOM.

R I A P (Record Ind. Ass'n of the Philippines), c/o Manuel P. Villar, r. Calvo Bldg., Escolta, Manila. Tel: 47-11-83, 40-10-81.

CATALOG SERVICES

Blackgold Recs. Corp., PO Box AC270, 782 Aurora Blvd., Cubao, Quezon City. Tel: 70-40-81. Cable: VIMUSCO. Telex: 74242056. Pres. & Chief Exec. Officer: Vicente del Rosario Jr.; Plant Mgr.: Patricio Cabrera.

Soundtrack Studios Inc., Philand Bldg., 3rd fl., Santillan St., Makati. Tel: (632) 828-8475, 874-734. Cable: SOUNDTRACKCAST. Chm. & Pres.: Greg Garcia; Exec. VP & Treas.: DANE Santonaga; Gen. Mgr.: Jacinto Negrim Garon; Sales Mgr.: Ernie Ereve; Floor Dpns. Mgr.: Dagul Tabayande. (Tape only)

Vicor Music Corp., PO Box AC270, Vicor Bldg., 782 Aurora Blvd., Cubao, Quezon City. Tel: 70-40-81. Cable: VIMUSCO. Telex: 74242056. Pres. & Chief Exec. Officer: Vicente del Rosario Jr.; Plant Mgr.: Patricio Cabrera.

Design & Artwork

Blackgold Recs. Corp., PO Box AC270, 782 Aurora Blvd., Cubao, Quezon City. Tel: 70-40-81. Cable: VIMUSCO. Telex: 74242056. Pres. & Chief Exec. Officer: Vicente del Rosario Jr.

Funstuff Inc., Jade Bldg., Suite 406, 71 Aurora Blvd., Santa Mesa, Manila. Tel: 61-95-03. Chief Exec.: Juliet Ang.

J E M Rec'g Co. Inc., 160 20 Ave., Cubao, Quezon City. Tel: 78-15-27, 77-24-11, 78-48-67. Pres. & Gen. Mgr.: Wilfrido B. Cruz.

Mareco Inc., 131 Del Monte Ave., Quezon City 3010. Tel: 35-45-26. Cable: VILMARECO.

Oskar Salazar Int'l Agency, PO Box 3739, Manila 2800. Tel: 60-48-44. Cable: RAZALAS. Exec. Dir.: Oskar Salazar.

V M I Music Corp., 77 D. Tuazon St., Corner Sen. M. Cuenco St., Quezon City, Manila. Tel: 610-663, 623-588, 625-805. Pres.: Victor Que; Sales Mgr.: Ramon T. Lao.

Vicor Music Corp., PO Box AC270, Vicor Bldg., 782 Aurora Blvd., Cubao, Quezon City. Tel: 70-40-81. Cable: VIMUSCO. Telex: 74242056. Pres. & Chief Exec. Officer: Vicente del Rosario Jr.

Licensing Organizations, Music

B A M I (Bayanihan Music Philippines Inc.), 782 Aurora Blvd., Cubao, Quezon City. Pres. & Chief Exec. Officer: Vicente del Rosario Jr.; Exec. VP: Amado A. Amador; Ass't VP: Linda Marqueses.

F A M I (Fil-Am Music Inc.), Calvo Bldg., Rm. 220, Escolta, Manila. Tel: 40-35-05. Cable: FAMI. (Represents SESAC mechanical rights)

Filscap (Filipino Society of Composers, Authors & Publishers), Republic Supermarket Bldg., Rm. 243, Rizal Ave., Santa Cruz, Manila. Tel: 49-27-88. Pres.: Felipe P. de Leon; Exec. Dir. & Corp. Secy.: Simplicio U. Suarez. (Performing rights only)

Musika Inc., Republic Supermarket Bldg., Rm. 243, Rizal Ave., Santa Cruz, Manila. Tel: 49-27-88. Pres.: Esteban B. Bautista; Gen. Mgr. & Corp. Secy.: Simplicio U. Suarez. (Mechanical rights only)

Oskar Salazar Int'l Agency, PO Box 3739, Manila 2800. Tel: 60-48-44. Cable: RAZALAS. Exec. Dir.: Oskar Salazar. (Mechanical rights rep.)

Plating, Processing & Pressing Plants

Atlas Rec'g Co., 35 F. Josef St., Concepcion, Marikina, Metro Manila. Tel: 697-2056. Gen. Mgr.: Roger D. De Vera; Plant Mgr.: Noli O. Dtreza. (Pressing only)

Blackgold Recs. Corp., PO Box AC270, 782 Aurora Blvd., Cubao, Quezon City. Tel: 70-40-81. Cable: VIMUSCO. Telex: 74242056. Pres. & Chief Exec. Officer: Vicente del Rosario Jr.; Plant Mgr.: Patricio Cabrera.

Dyna Prods. Inc., 135 Second Ave., Grace Park, Caloocan City, Manila. Tel:

23-23-62/67-35, 40-51-11/16. Cable: DYPRO Telex: 40361. Pres. Albert Tan, Exec. VP: James G. Dy, Gen. Mgr.: Tan Huy Bin, Sales Mgr. Vicente Ly.
 Filipinas Rec. Corp., 131 Del Monte Ave., Quezon City 3010. Tel: 35-45-20. Cable: FILRECO
 Home Inds. Development Corp., PO Box 4140, Manila. Cable: HOMID. Telex: 7420409
 J E M Rec'g Co. Inc., 160 20 Ave., Cubao, Quezon City. Tel: 78-15-27, 77-24-11, 78-48-67. Pres. & Gen. Mgr.: Wilfrido B. Cruz. Pressing Plant Mgr. Wigberto Gonzalez.
 Mareco Inc., 131 Del Monte Ave., Quezon City 3010. Tel: 35-45-26. Cable: VILMARECO.
 V M I Music Corp., 77 D. Tuazon St., Corner Sen. M. Cuenco St., Quezon City, Manila. Tel: 610-663, 623-588, 625-805. Pres. Victor Que. Sales Mgr. Ramon T. Lao (Pressing only)
 Vicor Music Corp., PO Box AC270, Vicor Bldg., 782 Aurora Blvd., Cubao, Quezon City. Tel: 70-40-81. Cable: VIMUSCO. Telex: 74242056. Pres. & Chief Exec. Officer: Vicente del Rosario Jr., Plant Mgr.: Patricio Cabrera.
 W E A Recs., Manufacturers Bldg., Mezzanine fl., Plaza Santa Cruz, Manila 2805. Tel: 47-73-81. Cable: WEAREC. Telex: 40609. Pres. James G. Dy, Gen. Mgr.: Ramon Chuaying (Pressing only)

PRINTERS & LITHOGRAPHERS

Blackgold Recs. Corp., PO Box AC270, 782 Aurora Blvd., Cubao, Quezon City. Tel: 70-40-81. Cable: VIMUSCO. Telex: 74242056. Pres. & Chief Exec. Officer: Vicente del Rosario Jr.
 Filipinas Rec. Corp., 131 Del Monte Ave., Quezon City 3010. Tel: 35-45-20. Cable: FILRECO.
 Funstuff Inc., Jade Bldg., Suite 406, 71 Aurora Blvd., Santa Mesa, Manila. Tel: 61-95-03. Chief Exec. Juliet Ang.
 Home Inds. Development Corp., PO Box 4140, Manila. Cable: HOMID. Telex: 7420409.
 Mareco Inc., 131 Del Monte Ave., Quezon City 3010. Tel: 35-45-26. Cable: VILMARECO.
 V M I Music Corp., 77 D. Tuazon St., Corner Sen. M. Cuenco St., Quezon City, Manila. Tel: 62-58-05, 62-35-88, 61-06-63. Pres. Victor Que. Sales Mgr. Ramon Lao
 Vicor Music Corp., PO Box AC270, Vicor Bldg., 782 Aurora Blvd., Cubao, Quezon City. Tel: 70-40-81. Cable: VIMUSCO. Telex: 74242056. Pres. & Chief Exec. Officer: Vicente del Rosario Jr.

RECORD PROMOTION

Dimads, c/o Sound Int'l, PO Box 967, Manila.
 Entertainment Mgmt & Mktg. Inc., c/o Red, White & Blue Cinemas, 878?? Aurora Blvd., Cubao, Quezon City. Tel: 78-52-31
 Fit Am Music Inc., Calvo Bldg., Rm. 220, Escolta, Manila. Tel: 40-35-05. Cable: FAMI.
 J E M Rec'g Co. Inc., 160 20 Ave., Cubao, Quezon City. Tel: 78-15-27, 77-24-11, 78-48-67. Pres. & Gen. Mgr. Wilfrido B. Cruz.
 Oskar Salazar Int'l Agency, PO Box 3739, Manila 2800. Tel: 60-48-44. Cable: RAZALAS. Exec. Dir. Oskar Salazar.
 Soundtrack Studios Inc., Philand Bldg., 3rd fl., Santolan St., Makati. Tel: (632) 828-8475, 874-734. Cable: SOUNDTRACKEAST. Chm. & Pres. Greg Garcia, Exec. VP & Treas. Danee Samonte; Gen. Mgr. Jacinto Negrini Garon, Sales Mgr.: Ernie Erve; Floor Opm. Mgr. Dagul Tabayande.
 V M I Music Corp., 77 D. Tuazon St., Corner Sen. M. Cuenco St., Quezon City, Manila. Tel: 62-58-05, 62-35-88, 61-06-63. Pres. Victor Que. Sales Mgr.: Ramon Lao
 Vicor Entertainment Corp., PO Box AC270, Vicor Bldg., 782 Aurora Blvd., Cubao, Quezon City. Tel: 70-40-81. Cable: VIMUSCO. Telex: 74242056. Pres. & Chief Exec. Officer: Vicente del Rosario Jr., Int'l Co-ord. Dolly W. Karandang; Exec. VP: Mina del Rosario

TAPE CUSTOM DUPLICATORS

TAPE PACKAGING & LABELING
 The Audio and Video lines indicate the configurations which the firms duplicate. Companies which offer packaging and labeling of tape product are indicated by "(PKG)" which appears after the main body of their respective listings.

Blackgold Recs. Corp., PO Box AC270, 782 Aurora Blvd., Cubao, Quezon City. Tel: 70-40-81. Cable: VIMUSCO. Telex: 74242056. Pres. & Chief Exec. Officer: Vicente del Rosario Jr., Plant Mgr.: Patricio Cabrera. (PKG)
 Dyna Prods. Inc., 135 Second Ave., Grace Park, Carooan City, Manila. Tel: 23-23-62/67-35, 40-51-11/16. Cable: DYPRO Telex: 40361. Pres. Albert Tan, Exec. VP: James G. Dy, Gen. Mgr.: Tan Huy Bin, Sales Mgr. Vicente Ly.
 Empire Electronics Corp., 20-A Magdalena Hemady St., corner Aurora Blvd., Quezon City. Tel: 70-16-66, 70-05-88. Cable: SOUND Manila. Telex: 7422020. Pres. Benjamin P. Sarmiento; VP Finance & Admin. Joven T. Castaneda; VP Mktg. Leonida S. Rabe; Mgmt. Support Group Dir. Jacobo M. Serina.
 Audio: Cassette, open reel.
 Filipinas Rec. Corp., 131 Del Monte Ave., Quezon City 3010. Tel: 35-45-20. Cable: FILRECO
 Home Inds. Development Corp., PO Box 4140, Manila. Cable: HOMID. Telex: 7420409.
 Audio: Cassette.
 J E M Rec'g Co. Inc., 160 20 Ave., Cubao, Quezon City. Tel: 78-15-27, 77-24-11, 78-48-67. Pres. & Gen. Mgr.: Wilfrido B. Cruz.
 Mareco Inc., 131 Del Monte Ave., Quezon City 3010. Tel: 35-45-26. Cable: VILMARECO.
 OctoArts Int'l Inc., 945 E. de los Santos Ave., Quezon City. Tel: 968-143. Cable: OCTOARTS. Telex: 40404. Pres. & Gen. Mgr. Orlando R. Ilacad.
 Audio: Cassette.
 V M I Music Corp., 77 D. Tuazon St., Corner Sen. M. Cuenco St., Quezon City, Manila. Tel: 62-58-05, 62-35-88, 61-06-63. Pres. Victor Que. Sales Mgr. Ramon Lao (PKG)
 Audio: Cassette, open reel.
 Vicor Music Corp., PO Box AC270, Vicor Bldg., 782 Aurora Blvd., Cubao, Quezon City. Tel: 70-40-81. Cable: VIMUSCO. Telex: 74242056. Pres. & Chief Exec. Officer: Vicente del Rosario Jr., Plant Mgr.: Patricio Cabrera. (PKG)

EMPTY CARTRIDGES, CASSETTES & REELS

Blackgold Recs. Corp., PO Box AC270, 782 Aurora Blvd., Cubao, Quezon City. Tel: 70-40-81. Cable: VIMUSCO. Telex: 74242056. Pres. & Chief Exec. Officer: Vicente del Rosario Jr., Plant Mgr.: Patricio Cabrera
 Empire Electronics Corp., 20-A Magdalena Hemady St., corner Aurora Blvd., Quezon City. Tel: 70-16-66, 70-05-88. Cable: SOUND Manila. Telex: 7422020. Pres. Benjamin P. Sarmiento; VP Finance & Admin. Joven T. Castaneda; VP Mktg. Leonida S. Rabe; Mgmt. Support Group Dir. Jacobo M. Serina. (Distributor/Importer)
 Audio: Reel, broadcast cartridge.
 Video: Open reel.
 Brand name: Fidelipac.
 3 M Philippines Inc., 3M House, Yabut Bldg., E. de los Santos Ave., Makati,

Ruzal Tel: 86-70-61. Cable: TRIMINCO. Mng. Dir.: R. G. Harber, Group Sales Mgr. Renato P. Batucan Jr.
 Audio & Video: Cassette, open reel
 Brand name: Scotch
 Vicor Music Corp., PO Box AC270, Vicor Bldg., 782 Aurora Blvd., Cubao, Quezon City. Tel: 70-40-81. Cable: VIMUSCO. Telex: 74242056. Pres. & Chief Exec. Officer: Vicente del Rosario Jr., Plant Mgr.: Patricio Cabrera

ENVELOPES & MAILERS

Blackgold Recs. Corp., PO Box AC270, 782 Aurora Blvd., Cubao, Quezon City. Tel: 70-40-81. Cable: VIMUSCO. Telex: 74242056. Pres. & Chief Exec. Officer: Vicente del Rosario Jr., Plant Mgr.: Patricio Cabrera.
 Mareco Inc., 131 Del Monte Ave., Quezon City 3010. Tel: 35-45-26. Cable: VILMARECO
 V M I Music Corp., 77 D. Tuazon St., Corner Sen. M. Cuenco St., Quezon City, Manila. Tel: 610-663, 623-588, 625-805. Pres. Victor Que. Sales Mgr. Ramon T. Lao
 Vicor Music Corp., PO Box AC270, Vicor Bldg., 782 Aurora Blvd., Cubao, Quezon City. Tel: 70-40-81. Cable: VIMUSCO. Telex: 74242056. Pres. & Chief Exec. Officer: Vicente del Rosario Jr., Plant Mgr.: Patricio Cabrera.

JACKETS & SLEEVES

LABELS, DISK
 Blackgold Recs. Corp., PO Box AC270, 782 Aurora Blvd., Cubao, Quezon City. Tel: 70-40-81. Cable: VIMUSCO. Telex: 74242056. Pres. & Chief Exec. Officer: Vicente del Rosario Jr., Plant Mgr.: Patricio Cabrera
 Home Inds. Development Corp., PO Box 4140, Manila. Cable: HOMID. Telex: 7420409.
 J E M Rec'g Co. Inc., 160 20 Ave., Cubao, Quezon City. Tel: 78-15-27, 77-24-11, 78-48-67. Pres. & Gen. Mgr.: Wilfrido B. Cruz.
 Mareco Inc., 131 Del Monte Ave., Quezon City 3010. Tel: 35-45-26. Cable: VILMARECO
 V M I Music Corp., 77 D. Tuazon St., Corner Sen. M. Cuenco St., Quezon City, Manila. Tel: 62-58-05, 62-35-88, 61-06-63. Pres. Victor Que. Sales Mgr. Ramon Lao.
 Vicor Music Corp., PO Box AC270, Vicor Bldg., 782 Aurora Blvd., Cubao, Quezon City. Tel: 70-40-81. Cable: VIMUSCO. Telex: 74242056. Pres. & Chief Exec. Officer: Vicente del Rosario Jr., Plant Mgr.: Patricio Cabrera.

POLYETHYLENE BAGS

Mareco Inc., 131 Del Monte Ave., Quezon City 3010. Tel: 35-45-26. Cable: VILMARECO
 V M I Music Corp., 77 D. Tuazon St., Corner Sen. M. Cuenco St., Quezon City, Manila. Tel: 610-663, 623-588, 625-805. Pres. Victor Que. Sales Mgr. Ramon T. Lao.

RECORD MANUFACTURING EQUIPMENT

Empire Electronics Corp., 20-A Magdalena Hemady St., corner Aurora Blvd., Quezon City. Tel: 70-16-66, 70-05-88. Cable: SOUND Manila. Telex: 7422020. Pres. Benjamin P. Sarmiento; VP Finance & Admin. Joven T. Castaneda; VP Mktg. Leonida S. Rabe; Mgmt. Support Group Dir. Jacobo M. Serina. (Distributor/Importer)
 Chief product: Disk-cutting equipment.
 Brand name: Neumann.

TAPE, BLANK LOADED & BULK RAW

Empire Electronics Corp., 20-A Magdalena Hemady St., corner Aurora Blvd., Quezon City. Tel: 70-16-66, 70-05-88. Cable: SOUND Manila. Telex: 7422020. Pres. Benjamin P. Sarmiento; VP Finance & Admin. Joven T. Castaneda; VP Mktg. Leonida S. Rabe; Mgmt. Support Group Dir. Jacobo M. Serina. (Distributor/Importer)
 Audio: Blank-cassette, open reel; Raw-open reel. Video: Blank-1" open reel, 1/2" EIAJ open reel
 Brand name: 3M.
 Soundtrack Studios Inc., Philand Bldg., 3rd fl., Santolan St., Makati. Tel: (632) 828-8475, 874-734. Cable: SOUNDTRACKEAST. Chm. & Pres.: Greg Garcia; Exec. VP & Treas. Danee Samonte. Gen. Mgr. Jacinto Negrini Garon; Sales Mgr.: Ernie Erve; Floor Opm. Mgr. Dagul Tabayande.
 Video: 1/2" & 1/4" cassette.
 Brand names: Fuji, JVC, Panasonic, RCA, Sony, TDK, Toshiba
 3 M Philippines Inc., 3M House, Yabut Bldg., E. de los Santos Ave., Makati, Ruzal Tel: 86-70-61. Cable: TRIMINCO. Mng. Dir.: R. G. Harber; Group Sales Mgr. Renato P. Batucan Jr.
 Audio: Cassette.
 Video: Blank-1" open reel, 1/2" cassette, 1/4" EIAJ open reel, 1/2" EIAJ cartridge
 Brand name: Scotch
 V M I Music Corp., 77 D. Tuazon St., Corner Sen. M. Cuenco St., Quezon City, Manila. Tel: 610-663, 623-588, 625-805. Pres. Victor Que. Sales Mgr.: Ramon T. Lao. (Blank only)
 Audio: Cassette.

TAPE DUPLICATING EQUIPMENT

Empire Electronics Corp., 20-A Magdalena Hemady St., corner Aurora Blvd., Quezon City. Tel: 70-16-66, 70-05-88. Cable: SOUND Manila. Telex: 7422020. Pres. Benjamin P. Sarmiento; VP Finance & Admin. Joven T. Castaneda; VP Mktg. Leonida S. Rabe; Mgmt. Support Group Dir. Jacobo M. Serina. (Distributor/Importer)
 Audio: High-speed duplicators.
 Brand name: Pentagon.

TAPE PACKAGING & LABELING EQUIPMENT

V M I Music Corp., 77 D. Tuazon St., Corner Sen. M. Cuenco St., Quezon City, Manila. Tel: 610-663, 623-588, 625-805. Pres. Victor Que. Sales Mgr. Ramon T. Lao.

accessories manufacturers

Blackgold Recs. Corp., PO Box AC270, 782 Aurora Blvd., Cubao, Quezon City. Tel: 70-40-81. Cable: VIMUSCO. Telex: 74242056. Pres. & Chief Exec. Officer: Vicente del Rosario Jr., Plant Mgr.: Patricio Cabrera.
 Product: Record-record care prods., 45 RPM adaptors.
 Empire Electronics Corp., 20-A Magdalena Hemady St., corner Aurora Blvd., Quezon City. Tel: 70-16-66, 70-05-88. Cable: SOUND Manila. Telex: 7422020. Pres. Benjamin P. Sarmiento; VP Finance & Admin. Joven T. Castaneda; VP Mktg. Leonida S. Rabe; Mgmt. Support Group Dir. Jacobo M. Serina. (Distributor/Importer)
 Product: Record-replacement styli; tape-head cleaners, demagnetizers.
 3 M Philippines Inc., 3M House, Yabut Bldg., E. de los Santos Ave., Makati, Ruzal Tel: 86-70-61. Cable: TRIMINCO. Mng. Dir.: R. G. Harber; Group Sales Mgr. Renato P. Batucan Jr.
 Product: Tape-head cleaners, leader tape
 V M I Music Corp., 77 D. Tuazon St., Corner Sen. M. Cuenco St., Quezon City, Manila. Tel: 610-663, 623-588, 625-805. Pres. Victor Que. Sales Mgr. Ramon T. Lao
 Product: Record-record care prods., replacement styli, leader & splicing

tape.
 Vicor Music Corp., PO Box AC270, Vicor Bldg., 782 Aurora Blvd., Cubao, Quezon City. Tel: 70-40-81. Cable: VIMUSCO. Telex: 74242056. Pres. & Chief Exec. Officer: Vicente del Rosario Jr., Plant Mgr.: Patricio Cabrera
 Product: Record-record care prods., 45 RPM adaptors.

store fixtures manufacturers

Blackgold Recs. Corp., PO Box AC270, 782 Aurora Blvd., Cubao, Quezon City. Tel: 70-40-81. Cable: VIMUSCO. Telex: 74242056. Pres. & Chief Exec. Officer: Vicente del Rosario Jr., Plant Mgr.: Patricio Cabrera.
 Product: Display racks.
 Empire Electronics Corp., 20-A Magdalena Hemady St., corner Aurora Blvd., Quezon City. Tel: 70-16-66, 70-05-88. Cable: SOUND Manila. Telex: 7422020. Pres. Benjamin P. Sarmiento; VP Finance & Admin. Joven T. Castaneda; VP Mktg. Leonida S. Rabe; Mgmt. Support Group Dir. Jacobo M. Serina. (Distributor/Importer)
 Product: Tape display racks
 V M I Music Corp., 77 D. Tuazon St., Corner Sen. M. Cuenco St., Quezon City, Manila. Tel: 610-663, 623-588, 625-805. Pres. Victor Que. Sales Mgr.: Ramon T. Lao
 Product: Record & tape display racks, divider cards
 Vicor Music Corp., PO Box AC270, Vicor Bldg., 782 Aurora Blvd., Cubao, Quezon City. Tel: 70-40-81. Cable: VIMUSCO. Telex: 74242056. Pres. & Chief Exec. Officer: Vicente del Rosario Jr., Plant Mgr.: Patricio Cabrera.
 Product: Display racks.

POLAND

Population: 36,000,000.
 Population by age groups: 0-14-8,549,000; 15-24-6,408,000; 25-49-12,160,000; 50+-8,883,000.
 Rate of exchange: \$1 (US) = 34 zlotys.
 Per capita income: \$2,000.
 Holidays: January 1 (New Year's), Easter Monday, May 1 (Labor Day), June (Corpus Christi), July 22 (Polish National Day), November 1 (All Saints Day), December 25, 26.

RECORDS:

Record sales certification awards: Gold EP-100,000 units. Gold LP-135,000 units.
 Records sold domestically including imports: LP's 1980-5,500,000 units; 1979-3,494,600 units. EP's 1980-224,763 units, 1979-250,000 units
 Records imported from countries other than USA: 1979-949,943 units, \$1,900,000.
 Records exported to countries other than USA: 1980-1,100,000 units, \$3,300,000; 1979-1,000,000 units, \$3,000,000.
 Average retail price per record: LP's-\$8.00; singles-\$1.50.
 Discounting: Never.
 Type of distribution: Manufacturer-to-wholesaler-to-retailer system.
 Type of promotion: The main source of record promotion is radio. Other sources include music magazines and pop columns in weekly and daily publications.

TAPE:

Market: The main cassette manufacturer, Wifon (owned by Polish Radio and TV), has stopped production because of the lack of imported material. State-owned Polskie Nagrania and Tompress have the same problems. There is no market for 8-tr. cartridges.
 Pre-recorded tape sold domestically including imports: Cassette 1980-1,131,463 units; 1979-1,004,400 units.
 Average retail price per tape: Cassette-\$4.00-6.00.

CONSUMER ELECTRONICS

Percentage of homes with: Television sets-color (8%), b/w (96%); phonographs (29%).

RADIO STATIONS:

All government; no. of AM 30, no. of FM 37.
 Comments: Music, all of which is pre-recorded, accounts for 60% of all programming. One-half of this percentage is made up of pop and jazz.

TELEVISION STATIONS:

No. of channels: 2 government, 90% color (SECAM).
 Comments: Programming comprises newsreels, political programs, sports, variety shows, and movies.

IMPORT/EXPORT REGULATIONS:

All companies are state-owned. Contacts with record companies can be made through Ars Polona.

MARKET ANALYSIS:

Polish audiences are interested in music that is in vogue, especially that from Great Britain and the USA. There are many popularity polls organized by magazines, radio and television, but the winning songs cannot be purchased on records. A list of the most popular foreign tunes popularized by Polish Radio but unavailable as records on the Polish market include "Dear Yoko," John Lennon; "I Ain't Gonna Stand For It," Stevie Wonder; "Rapture," Blondie; "What Do You Do For Money Honey?," AC/DC; "A Woman In Love," Barbra Streisand; "Xanadu," Olivia Newton-John & Electric Light Orchestra; "Another One Bites The Dust," Queen; and "Super Trouper," Abba. New wave groups are very popular.

Roman Wischilo

record & tape manufacturers / distributors / importers

Ars Polona, Foreign Trade Int., Krakowskie Przedmiescie 7, 00-068 Warsaw. Tel: 26-12 01. Cable: ARSPOLOHA. Telex: 813498. Music Div. Dir.: Wladyslaw Duda, Rec. Dept. Mgr.: Maria Wilk.
 Labels: Muza, Pronit, Tompress, Veriton.
 Int'l reps.: Australia (Contal), Belgium (Eurovox), Canada (Polish Alliance Press), Finland (Kansankulturi), France (Cepelia, Erato, Lion), Italy (Ricordi), Japan (Nippon Columbia), Netherlands (Phonogram, Sound Prods.), Spain (Zafiro), UK (Pointra), USA (Polish Rec. Center).
 P P Polska Nagrania, Dluga 5, Warsaw 00-263. Tel: 31-03-49. Cable: POLNAG. Gen. Mgr.: Wlodzimierz Pospiech. (Distributed by Ars Polona)
 Labels: (Owned) Muza.
 P W M Edition (Polskie Wydawnictwo Muzyczne), Foreign Trade Office, Krakowskie Przedmiescie 7, 00-068 Warsaw. Tel: 26-12 01. Cable: PEWUEM

BEHAZET. Telex: 813498. Dir.: Władysław Duda, Rec. Dept. Mgr. Zbigniew Zych. (Contact for record import & export).
Int'l regns.: Australia (Carina, Contal), Belgium (Eurovox), Canada (AA, Polish Alliance Press) Germany (Disco Center), Italy (Font Cetra, Recordi), Japan (Nippon Columbia), Netherlands (Phonogram, Sound Prods.), Spain (Zafiro), UK (Earlscourt), USA (Polish Rec. Center, Artopol)
 Donizy Piatkowski, ul. W. Komarowa 8, 62 051 Poznan-Wiry.
Label: (represented) Touche (USA).
 Tompress-KAW (Krajowa Agencja Wydawnicza), Wilcza 46, 00-679 Warszawa. Tel: 20-26-63. Telex: 813487. Mng. Dr. Alexandra Kepa, Sales Mgr.: Tadeusz Zepietzki, Int'l Relations: Marek Prowniczek
 Wifon Recs. & Tapes (IFPI), Woronicza 17, 00-950 Warszawa. Tel: 47-86-80. Telex: 817023. Mng. Dr.: Dariusz Retelski, Sales Mgr.: Eugeniusz Matejko, Technical Mgr.: Tadeusz Czechak.

• music publishers

Authors' Agency Ltd., ul. Hipotečna 2, 00-950 Warszawa. Tel: 27-58-76. Telex: 812470. Gen. Mgr.: Władysław Jakubowski, Prof. Mgr.: Bianka Skorzewska.
 Ars Polona, Foreign Trade Ent., Krakowskie Przedmieście 7, 00-068 Warszawa. Tel: 26-12-01. Cable: ARSPOLONA. Telex: 813498. Music Div. Dir. Władysław Duda, Sheet Music Mgr. Anna Skorzewska.
Int'l regns.: Denmark (Hansen), Finland (Fazer), France (Salabert), Italy (Ricordi), Netherlands (Albersen), Norway (Norsk), Sweden (Nordiska), Switzerland (Jecklin). Hire & sale—France (Boosey & Hawkes), Germany (Moeck), Japan (Nippon Gakki), Switzerland (Pan), UK (Kalmus), USA (Marks).
 P W M Polskie Wydawnictwo Muzyczne, Foreign Trade Office, Krakowskie Przedmieście 7, 00-068 Warszawa. Tel: 26-12-01. Cable: PEWUEMBEHA-ZET. Telex: 813498. Sheet Music Mgr.: Teresa Mochtaik. (Contact for music import & export).
Int'l regns.: Orchestral materials hire—Denmark (Hansen), Finland (Fazer), France (Salabert), Germany (Moeck), Italy (Ricordi), Netherlands (Albersen), Norway (Norsk), Sweden (Nordiska), Switzerland (Jecklin); hire and sale—Germany (Moeck), Japan (Nippon Gakki), UK (Kalmus), sales—France (Boosey & Hawkes), USA (Marks, Chopin works), Switzerland (Pelikan).
 Synkopka PWM, Senatorska 13/15, 00-075 Warszawa. Tel: 26-70-97. Cable: PEWUEMWAR. Dir. Jerzy Jasienki, Gen. Mgr.: Mieczysław Tomaszewski.

• services

ASSOCIATIONS & PROFESSIONAL ORGANIZATIONS

Association of Polish Musicians, Krucza 24/26, 00-526 Warszawa. Tel: 21-86-47, 29-34-94. Pres.: Stefan Sulkowski, Gen. Mgr.: Jadwiga Brzostowska, Gen. Sec'y: Edward Dulski.
 Jeunesses Musicales of Poland, Chief Council, Castle of Ostrogski, Okólnik 1, Warszawa. Tel: 27-95-93.
 National Section of the International Society for Contemporary Music, Polish Section, Centrum Sztuki, Studio, PKiN, 00 901 Warszawa. Tel: 20-02-11. Cable: POLSIMC.
 Polish Music Council, National Committee of the International Music Council, Rynek Starego Miasta 27, 00-272 Warszawa. Tel: 31-06-07.
 Polskie Stowarzyszenie Jazzowe (Polish Jazz Society), PO Box 282, Rutkowskiego 20/5, 00-020 Warszawa. Tel: 27-65-81. Cable: POLJAZZ. Telex: 812275. Pres.: Tomasz Tuzickiewicz.
 Towarzystwo im. Fryderyka Chopina - Frederic Chopin Society, ul. Okólnik 1, Zamek Ostrogski, 00-368 Warszawa. Gen. Mgr.: Wiktor Weinbaum.
 Union of Polish Composers (Związek Kompozytorów Polskich), Rynek Starego Miasta 27, 00-272 Warszawa. Tel: 31-16-34, 31-17-41.
 Warszawskie Towarzystwo Muzyczne im. Stanisława Moniuszki (Warsaw Music Society), Morskie Oko 2, Warszawa.
 Henryk Wieniawski Music Society, Śwetosławska 7, 61-840 Poznań. Tel: 526-42. Gen. Mgr.: Edmund Grabkowski.
 Z A K R (Związek Polskich Autorów i Kompozytorów Utworów Rozrywkowych—Ass'n of Polish Authors & Composers of Pop Music), ul. Hipotečna 2, 00-950 Warszawa. Tel: 27-60-61 x 44. Gen. Sec'y: Jacek Korczakowski, VP's: Piotr Figiel, Mateusz Świeciecki.

LICENSING ORGANIZATIONS, MUSIC

Authors' Agency Ltd., ul. Hipotečna 2, 00-950 Warszawa. Tel: 27-58-76. Telex: 812470. Gen. Mgr.: Władysław Jakubowski, Prof. Mgr.: Bianka Skorzewska. (Performing rights only).
 Z A I K S (Society of Authors), ul. Hipotečna 2, 00-950 Warszawa. Tel: 27-60-61. (Mechanical & performing rights).

RECORD PROMOTION

Authors' Agency Ltd., ul. Hipotečna 2, 00-950 Warszawa. Tel: 27-58-76. Telex: 812470. Gen. Mgr.: Władysław Jakubowski, Prof. Mgr.: Bianka Skorzewska.

TAPE CUSTOM DUPLICATORS

Wifon Recs. & Tapes, Woronicza 17, 00-950 Warszawa. Tel: 47-86-80. Telex: 814441. Mng. Dr.: Dariusz Retelski, Sales Mgr.: Eugeniusz Matejko, Technical Mgr.: Tadeusz Czechak.
 Audio: Cassette.

• supplies

TAPE, BLANK LOADED & BULK RAW

P H Z Transactor SA, PO Box 276, ul. Stawki 2, 00-950 Warszawa. Tel: 39-53-76, 39-61-54, 39-69-12, 39-70-17. Telex: 813288, 812359.
 Brand name: BASF

PORTUGAL

Population: 9,700,000

Rate of exchange: \$1 (US) = 63 escudos.

Per capita income: \$1,840.

Holidays: January 1, April 25 (Freedom Day), May 1 (Workers' Day), June 10 (Community Day), October 5 (Republic Day), December 1 (Independence Day), December 25, various religious days and Carnival.

RECORDS:

Record sales certification awards: Silver single—30,000 units; gold single—50,000 units. Silver LP—15,000 units; gold LP—30,000 units.

Records sold domestically including imports (retail value): LP's 1980—4,000,000 units, \$24,760,000. Singles 1980—3,500,000 units, \$6,650,000.

Records exported to USA (factory value, FOB): 1979—97,826 units, \$113,571.

Records exported to countries other than USA (factory value, FOB): 1979—1,253,172 units, \$2,392,952.

Average retail price per record: LP's—\$6.19; singles—\$1.90.

Record club sales: 9.5% of total.

Discounting: Rare in main shops, frequent in popular shops.

Type of distribution: Manufacturer-to-retailer predominates but the main record companies have their own retail outlets in urban areas.

Type of promotion: Radio is the top promotion vehicle but the impact of television on sales has increased as more time is being spent on pop, folk and rock music, especially Portuguese rock artists. Five music magazines and almost all newspapers ad in the coverage.

TAPE:

Market: Due to the fight against piracy, cassette sales increased about 20%. The ratio of disk to cassette is changing significantly, with it being 90% records and only 10% cassette in 1979 versus 75%/25% in 1980. Video is used as a promotional tool for exhibitions and window displays but the prices of hardware and software are still too expensive for most consumers 8-tr is rare.

Pre-recorded tape sold domestically including imports (retail value): Cassette 1980—1,000,000 units, \$6,190,000.

Pre-recorded tape exported to USA (factory value, FOB): 1979—591 units, \$1,413.

Pre-recorded tape exported to countries other than USA (factory value, FOB): 1979—97,012 units, \$203,158.

Average retail price per tape: Cassette—\$6.19.

RADIO STATIONS:

No. of commercial (3 (1 AM, 2 FM); no. of government (6 (4 AM, 2 FM)).
 Comment: One channel plays classical music; the others play a variety of programs, including live pop shows.

TELEVISION STATIONS:

No. of government channels: 2, 70% color (PAL).
 Comment: Television programming consists of news, political and social debates, arts, national and international pop series, sports, rock and MOR music shows, and concerts of classical music.

IMPORT/EXPORT REGULATIONS:

On imports there is a 30% Brussels regulation duty, plus 60%, an advance deposit, without interest, is required, and no financing is available.

MARKET ANALYSIS:

The year of 1980 was a very good one for rock music concerts by UK acts such as the Police, Lene Lovich, Peter Gabriel, Fischer-Z, Mike Oldfield, Camel, and the Blues Band. The live shows increased record sales and paved the way for Portuguese rock groups headed by Rui Veloso and Banda Sonora. UHF (both with number one disks), Rogueno, Street Kids, Jalumega, GNR, Salada de Frutas and Taxi. The movement was fully supported by local record companies and was headed by Valentim de Carvalho, EMI's licensee in Portugal.

Record buyers in general showed preferences for British acts. Pink Floyd was the top group, followed by the Police, but MOR fans liked local PolyGram's female quartet, As Doce, who took several gold records and toured the country with much success. Sergio Godinho topped the social song scene and attracted many people to his concerts.

The local record market is very colorful in flags and music, with national acts trying to compete with foreign product in a variety of music styles from white reggae, hard rock, straight rock to MOR. Despite an economic crisis and inflation, record and cassette sales increased in 1980, with the former up 15% and the latter 20%.

The highlights of the local music scene were the concerts by Joan Baez in Cascais (acclaimed as the "top musical event of the year"), and Brazilian singers Chico Buarque, Simone and Edo Lobo, who topped the bill of the open-air festival organized by the weekly publication Avante. The audience in Lisbon was estimated at 200,000. Fernando Tométe

• record & tape manufacturers / distributors / importers

Alfama, see Teleclra.
 Algarve, see Radio Trunfo
 Alvorada, see Radio Trunfo
 Alvorada Int'l, see Radio Trunfo
 Aquila, see Radio Trunfo
 Archv, see PolyGram
 Banda, see Moveplay
 Belter (Discos) Lda., Rua Constitucão 74, Porto. Tel: 498041.
 Branch: Lisbon, Av. Defensores Chaves 3, 3rd fl. E. Tel: 59062.
 Home office: Spain.
 Labels: (Owned) Belter, Olympo, Saef.
 Bonzaio, see Joquei
 Boom, see Nova.
 Valentim de Carvalho Ci. Sarl., Rua Nova do Almada 95-99, 1200 Lisbon. Tel: 367051. Telex: 18420. Co-Pres.: Dr. Maria da Graça B. de Carvalho, Rui Valentim de Carvalho, Francisco Vasconcelos, Financial Dir.: Dr. Antonio dos Santos, Rec. Dept. Mgr.: Paulo Gil, Local A&R: Mario Martins, Promo.: David Ferreira.

Labels: (Owned) VC, (licensed) A&M (USA), Ace of Clubs (UK), Ace of Diamonds (UK), Apple (UK), Ardeck (UK), Argo (UK), Blue Note (USA), CFP (UK), CRAMP'S (Italy), Capitol (USA), Columbia (UK), Decca (UK), Deram (UK), EMI (UK), EMI-AMA (USA), HMV (UK), Harvest (UK), Horizon (USA), Liberty (USA), London (USA), MAM (UK), Odeon (Brazil, Spain), L'Oiseau Lyre (France), MFP (UK), Parlophone (UK), Pathe (France), Private Stock (USA), Purple (UK), RAK (UK), Regal (UK), Ri-Fi (Italy), Rolling Stones (UK), Sky (Germany), Stateside (UK), Sunset (USA), Telefunken (Germany), Threshold (UK), United Artists (USA).

Castro, Paz & Ca. Lda., Rua Julio Dinis 945, Porto. Tel: 65932.
 Labels: (Owned) Clave, (represented) Ades (France), Poplandia (Spain), Valois (France).
 Int'l regns.: Canada (Penco), France (CBS), Netherlands (Bosheck), USA (Penco).
 Clave, see Castro, Paz
 D G, see PolyGram.
 Danova, see Nova.

Dargil (Sociedade Comercial Dargil Lda.), Av. 5 de Outubro 35, 1000 Lisbon. Tel: 574914. Cable: DARGIL. Telex: 18416. Chief Exec.: Jose Correa Mendes, Gen. Mgr.: Detlev Mastbaum, Sales Mgr.: Paulo Reis.
 Labels: (Licensed foreign) ENJA (Germany), Everest (USA), Gillette (USA), Joker (Italy), MPS (Germany), Rounder (USA), SteepleChase (Denmark), Up (Italy); (distributed—not licensed) ECM (Germany).

Diapasao, see Sasseti.
 Disco Falado, see Sasseti.
 Edisco (Expressa Editora & Distribuidora de Disco Lda.), Rua Dr. Alves da

Veiga 175, 4000 Oporto. Tel: 560455, 564201. Gen. Mgrs.: Laurindo Oliveira, Armando Cerqueira, Maria Fernanda Correia, Joaquim Goncalves; Domestic & Int'l A&R: Armando Cerqueira.
 Labels: (Owned) Edisco, Rapsodia, (licensed) Le Chant du Monde (France), Font Cetra (Italy).
 Edisom (Edicao & Producao de Som Lda.), Rua Antonio Enes 16-2A, 1000 Lisbon. Tel: 548890, 530129. Telex: 18888. Gen. Mgr.: Carlos Jorge, Promo. Mgr.: Antonio Manuel Rolo Duarte, Domestic A&R: Ze Da Ponte, Lus Pedro Fonseca.

Labels: (Owned) Som, World; (licensed) CNR (Netherlands), Kingdom (UK), Metronome (Germany), Mute (UK), Quember (Netherlands).
 Estudio, see Mundusom.
 Fenix, see Arnaldo Trindade.
 Flash, see Teleclra.
 Fontana, see PolyGram.
 Gavota, see Rossil.

Gira Industrias de Som Lda. (IFPI), Av. Melo Falcão 36 S/L/25q, Póntinha, 1675 Lisbon. Tel: 995457. Telex: 15697. Dir.: Fernando Maia, Gen. Mgr.: Martins Dos Santos, Sales Mgr.: Jose Monteiro; Int'l Dept.: Helena Gil.
 Labels: (Licensed foreign) Red Bus (UK), Satril (UK).

Gladio, see Teleclra.
 Guida da Musica, see Sasseti.
 Harmonia, see Radio Trunfo.
 Heliodor, see PolyGram.

Imavox Som & Imagem Sarl (IFPI), Av. Conselheiro Fernando de Sousa 19, 4th fl., 1000 Lisbon. Tel: 656025. Telex: 13050. Pres. Mng. Council: Jose Luis A. Alves da Cunha; Gen. Mgr.: Joel Nelson M. Vaz; Sales Mgr.: Luis F.A. Santos.
 Labels: (Owned) Imavox; (licensed) Disc' AZ (France), BBC (UK), Bellaphon (Germany), Cani Stop (USA), Carabine (France), De-Lite (USA), Delphine (France), Trema (France), Young Memories (France).

Joquei (Disco) Lda., Parque Residencial Miraflores, Lote 101-6B, Alges, Lisbon. Tel: 217719.
 Labels: (Owned) Bonzaio, (represented) Activ Tapes (Switzerland), Sunshine Tapes (USA).

L I S, see Rossil.
 M G M, see PolyGram.
 Melodia, see Radio Trunfo.
 Mercury, see PolyGram.

Moveplay Portuguesa Discografica Sarl (IFPI), Rua Gregorio Lopes, Lote 1524, Loja A, Encosta do Restelo, 1400 Lisbon. Tel: 615496. Pres. & Gen. Mgr.: Joao Maia, Sales Mgr.: Carlos Boloninha; Account Mgr.: Fernando Santos.

Labels: (Owned) Banda, Moveplay, PSST, (licensed) Barclay (France), Ca. Fonografica Espanola (Spain), Chiswick (UK), DJM (UK), Discap (Chile), Egg (France), Pretude (USA), Riviera (France), Zafiro (Spain).
 Mundusom Sociedade Ind'l do Som Sarl—Discos Estudio, Rua Rodrigo da Fonseca 204 r/c, Lisbon 1. Tel: 688173.
 Labels: (Owned) Estudio, Trevo, (represented) Monitor (USA).

Int'l regns.: France (Nogueira), South Africa (Arratia), USA (Alvorada).
 Nova/ Companhia de Musica (Ed. Musicas) Lda. (IFPI), Rua Angelina Vidal 23/2/E, 1100 Lisbon. Tel: 842076, 843631. Telex: 18578. Owner & Pres.: Jose Manuel Monteiro Fortunato; Gen. Mgr.: Joao Palhais Milheiras, Sales Mgr.: Fernando Morais, Nat'l A&R: Ramon Galarza; Classical A&R: J. Simoes da Hora; Int'l Strk & Sre Label Mgr.: Antonio Sergio Ferrao; Promo. Mgr.: Luis Lourenco.

Labels: (Owned) Boom, Danova; (licensed foreign) Aura (UK), Butterfly (USA), Calendar (UK), Erato (France), Quality (Canada), RKM (Belgium), RPM (South Africa), Sire (USA), Springboard (USA), Stiff (UK); (distributed—not licensed) Cherry Red (UK), Real (UK), Satril (UK), Sojazz (Netherlands), Timeless (Netherlands), Warm (UK).

Olympo, see Belter.
 Onda, see Vadeca.
 Orfeu, see Arnaldo Trindade.
 Oris, Editora de Discos & Fitras Gravadas Lda., Rua do Cabo 30, 1200 Lisbon. Tel: 602411. Mgr.: Jose Carlos Moura Sobral.

P S S T, see Moveplay.
 Philips, see PolyGram.
 Pintainho, see Rossil.
 Polydor, see PolyGram.

PolyGram Discos Sarl (IFPI), Rua Prof. Renaldo dos Santos 12, 1500 Lisbon. Tel: 787101. Cable: POLYGRAM. Telex: 14074. Mng. Dir.: Rodrigo Mann, A&R Mgr.: Toze Brito; Mktg. Mgr.: Daniel Gouveia.
 Labels: (Owned) Archv, DG, Fontana, Heliodor, MGM, Mercury, Philips, Polydor, Vertigo, (licensed) Ariola, Chrysalis (UK), Island (UK), MCA (UK).

Int'l regns.: Worldwide (Phonogram & Polydor).
 R P E, see Radio Producoes.
 R T, see Radio Trunfo.

Radio Producoes Europa Lda. (IFPI), Rua Dom Fias Roupinho 50-A, 1900 Lisbon. Tel: 826503. Chief Exec.: Dias Coelho, Gen. Mgr.: Fernando Maia, Sales Mgr.: Martins dos Santos, Promo. Mgr.: Francisco Brandao Ferreira.
 Labels: (Owned) RPE, (licensed foreign) Logo/Transatlantic (UK); (distributed—not licensed) JDC (USA), Lala (France), Les 3 Oranges Blues (France).

Radio Trunfo Lda. (IFPI), Travessa Central do Seixo, 4465 S. Mamede de Infesta. Tel: 950152, 956094. Cable: RATRIL. Telex: 23127. Co-Gen Mgrs.: Arnaldo Trindade, Jose Serafim, Deputy Gen. Mgrs.: Arnaldo Trindade Jr., Daniel Sousa, Financial Controller: Jose Simoes, Tech. Projects: Lourenco da Silva.

Branch: Lisbon, Rua do Carmo 23. Tel: 327683, 34708. Mgr.: Daniel Sousa, Sales & Mktg.: Carlos Lacerda, A&R: Bernardo Brito & Cunha; Promo.: Fernando Matias.

Int'l branches: Angola, PO Box 3875, Rua Luis de Camoes 93, 2nd fl., Luanda—Mozambique, PO Box 4364, Paiva de Andrada 365, Lourenco Marques.
 Labels: (Owned) Algarve, Alvorada, Alvorada Int'l, Aquila, Harmonia, Melodia, RT, Sereia, Sintra; (represented) Asylum (USA), Atco (USA), Atlantic (USA), Baby (Italy), Beverly Hills (USA), Big Tree (USA), Cartaz (Brazil), Charger (Brazil), Clave (Spain), Copacabana (Brazil), Colillon (USA), Eurovox (Belgium), Fantasy (USA), Gamma (Mexico), Harmony (USA), Hispavox (Spain), Little David (USA), Melodiya (USSR), Midi (USA), Milestone (USA), Nemperor (USA), Nonesech (USA), Odyssey (USA), Pacific (USA), Portrait (USA), Prestige (USA), Reprise (USA), Som (Brazil), Swan Song (USA), Vanguard (USA), Warner Bros. (USA).

Int'l regns.: Mexico (Gamma), Spain (Hispavox).
 Rapsodia, see Edisco.
 Roda, see Vadeca.
 Roda Int'l, see Vadeca.

Rossil (Edicoes) Lda. (IFPI), Av. Joao Crisostomo 39, 1st fl., 1000 Lisbon. Tel: 40043, 40053. Telex: 15836. Mng. Drs.: Jose Antonio Crespo, Carlos Faria, Int'l Mgr.: Jean Jacques Salembier, Promo. Mgr.: Policarpo de Freitas, Sales Mgr.: Paiva Gomes.

Labels: (Domod) Gaiwota, LIS, Pintainho, Rossic; (licensed foreign) Activ (Switzerland), Avatar (UK), Bearsville (USA), Dreole (UK), Graf (USA), Legion (UK), Pinnacle (UK), Sirocco (France), Sonet (UK), Splash (UK), West End (USA).
Saeft, see Belter.
Sasseti—Sociedade Portuguesa de Musica & Som SarL, Av. Conselheiro Fernando de Sousa 25 A/B, Lisbon. Tel: 656094. T. fax: 13384. Gen. Mgr.: A. Marques de Almeida; Music Div. Mgr.: Fernando Carvalheira; A&R: Jorge Zagalo.
Labels: (Domod) Diapasoa, Disco Falado, Guida da Musica, Sasseti, Zip-Zip; (licensed foreign) Amadeo (Austria), Le Ciant du Monde (France), ESP (USA), Everest (USA), Harmonia Mundi (France), Melodia (USSR), Muza (Poland), Supraphon (Czechoslovakia), Wergo (Germany).
Int'l rep.: Spain (Edgusa).

Sereia, see Radio Trunfo.
Sintra, see Radio Trunfo.
Som, see Edison.
Telectra—Empresa Technica de Equipamentos Electricos SarL (IFPI), Apdo. 2531, Rua Rodrigo da Fonseca 103, 1000 Lisbon. Tel: 686072. Telex: 12598. Pres.: Fernando Serrano. Gen. Mgr.: Jose Varatojo da Silva; A&R: L. Cunha.
Labels: (Domod) Alfama, Flash, Gladio, Telectra; (licensed) RCA group (USA).
Int'l rep.: South Africa (Teal), USA (Penco).

Trevo, see Mundusom.
Arnaldo Trindade & Ca. Lda. (IFPI), Rua de Santa Catarina 117, Porto. Tel: (02) 381341. Cable: RADILECTRA. Telex: 22266. Pres.: Arnaldo Trindade; Gen. Mgr.: Fernando Pereira. Co-ord.: Arnaldo Trindade Jr.
Promo. branch: Lisbon, Rua Alexandre Herculano 7A. Tel: (01) 539368, 576895. Telex: 13644. Mgr.: Rui Mota Alves.
Labels: (Domod) Fenix, Orfeu, (licensed) Cream (USA), Durum (Italy), PRT (UK), Vogue (France); (distributed—not licensed) Clian (Italy), Victor (Japan).
Int'l rep.: Benelux (Vogue), France (Vogue), Germany (Plaene), Spain (CFE, Hispavox), Switzerland (Vogue), USA (Penco), Venezuela (Grabaciones Mundiales).

V C, see Valentin de Carvalho.
V D C, see Vadeca.
V D C Int'l, see Vadeca.
V M, see Vadeca.

Vadeca-J.C. Donas Lda. (IFPI), Rua 31 de Janeiro 210, 4000 Porto. Tel: 20471. Telex: 23437. Pres. & Gen. Mgr.: Francisco Vasconcelos; Financial Dir.: Alcino Barrento; Local A&R: Carlos Cunha, Promo. Fernando Rocha.
Branch: 1500 Lisbon, Rua Prof. Renaldo dos Santos, Lote 2. Tel: 789333, 786718, 788476. Telex: 14027. Int'l A&R: Idio Viana; Promo.: Luzete Grilo, Frederico Santos.
Labels: (Domod) Ornda, Roda Roda Int'l, VDC, VDC Int'l, VM; (licensed foreign) CID (Brazil), Carosello (Italy), Durco (Netherlands), Miller (Germany); (represented) Alhambra (Spain), RigE (Brazil), Virgin (UK).

Vertigo, see PolyGram.
World, see Edison.
Zip-Zip, see Sasseti.

• **music publishers**

Belter (Ed.), Rua Constituciao 74, Porto. Tel: 498041. Dir.: A. Figueiredo.
Branch: Lisbon, Av. Defensores Chaves 3, 3rd fl. E. Tel: 59062.
Home office: Spain.

Valentin de Carvalho Ci. SarL, Rua Nova do Almada 95-99, 1200 Lisbon. Tel: 367051. Telex: 18420. Co-Pres.: Dr. Maria da Graca B. de Carvalho, Rui Valentin de Carvalho, Francisco Vasconcelos; Financial Dir.: Dr. Antonio dos Santos; Publ'g Mgr.: Henrique Amoroso.
Int'l firms represented: Chibell (UK), EMI (wor. dwide), Grade One (UK), Morning (Canada), Mother Goose (UK), Dur (UX), Red Bus (UK), Rondor (USA), Sigem (Brazil), Virgin (UK).

Costa Pinto (Ed. Musicais) Lda. (SPA), Rua Ega o Queoz 20, 3rd fl., Lisbon. Tel: 562850. Pres.: Jorge Costa Pinto; Gen. Mgr.: Maria de Fatima. Edison (Edicao & Producao de Som Lda.), Rua Antonio Enes 16-2A, 1000 Lisbon. Tel: 548890, 530219. Telex: 18888. Gen. Mgr.: Carlos Jorge.
Muscat (Ed. Musicais Arnaldo Trindade & Ca. Lda.) (SPA), Rua de Campolide 103-C, 1000 Lisbon. Tel: (01) 688922, 681866, 658726. Cable: RADILECTRA. Pres.: Arnaldo M. Trindade; Gen. Mgr.: Fernando Albuquerque.

Int'l firms represented: Bihah (Netherlands), Essex (France), Nada (Netherlands), New Daylow (Netherlands), Pi-net (Netherlands), Radio Music Int'l (Luxembourg), Tee Set (Netherlands), Union Songs (Sweden), Universal Songs (Netherlands), Veronica (Netherlands).
Int'l rep.: Brazil (Fermata), Finland (Love), Is-ael (April), Japan (MCA), UK (ATV).

Sasseti—Sociedade Portuguesa de Musica & Som SarL, Av. Conselheiro Fernando de Sousa 25 A/B, Lisbon. Tel: 656094. T. fax: 13384. Gen. Mgr.: A. Marques de Almeida.

Telectra (Eds. Musicais), Rua Rodrigo da Fonseca 103, 1000 Lisbon. Tel: 686072. Telex: 12598. Pres.: Fernando Serrano. Gen. Mgr.: Jose Varatojo da Silva.
Int'l firms represented: Baltic (Belgium), RCA (Brazil, Italy, Spain), Victor (Brazil).

Trunfo (Ed. Musicais), Travessa Central do Seixo 4465 S. Mamede de Infesta. Tel: 950152, 956094. Cable: RATRIL. Tel. x: 23127. Co-Gen. Mgrs.: Arnaldo Trindade, Jose Seralim; Ass't to Gen. Mgr.: Joao Nobre.

• **services**

ASSOCIATIONS & PROFESSIONAL ORGANIZATIONS

Circulo de Cultura Musical, Rossio 45, Lisbon 4.
Grupo Portugues de Produtores de Fonogramas & Videogramas (GPPFV), c/o PolyGram Discos SarL, Rua Prof. Renaldo dos Santos 12, Lojas C/O, 1500 Lisbon. Tel: 789381. Telex: 12214, 16454.
International Music Council, Nat'l Committee, Instituto de Alta Cultura, Prace do Principe Real 14, Lisbon.

DESIGN & ARTWORK

Valentin de Carvalho Ci. SarL, Rua Nova do Almada 95-99, 1200 Lisbon. Tel: 367051. Telex: 18420. Co-Pres.: Dr. Maria da Graca B. de Carvalho, Rui Valentin de Carvalho, Francisco Vasconcelos; Financial Dir.: Dr. Antonio dos Santos.
Castro, Paz & Ca. Lda., Rua Julio Dinis 945, Porto. Tel: 65932.
Radio Trunfo Lda., Lugar do Seixo, 4465 S. Mamede de Infesta. Tel: 950152, 956094. O&A Mgr.: Antonio Matos.

LICENSING ORGANIZATIONS, MUSIC

S P A (Sociedade Portuguesa de Autores), Av. Duque de Loule 31, 1098 Lisbon. Codex. Tel: 578320, 578370. Cable: AUTORES. Pres.: Dr. Luiz Francisco Rebelo, (Mechanical & performing rights).

PLATING, PROCESSING & PRESSING PLANTS

Valentin de Carvalho Ci. SarL, Rua Nova do Almada 95-99, 1200 Lisbon. Tel: 367051. Telex: 18420. Co-Pres.: Dr. Maria da Graca B. de Carvalho, Rui Valentin de Carvalho, Francisco Vasconcelos; Financial Dir.: Dr. Antonio dos Santos.

Fono-Companhia Ind'l de Discos Lda., Rua Angelina Vidal 23, 1100 Lisbon. Tel: 842076, 843631. Chief Exec.: Jose Manuel Monteiro Fortunato; Gen. Mgr.: Joao Palhais Milheires.
Radio Triunfo Lda., (Pressing) Lugar do Seixo, 4465 S. Mamede de Infesta. Tel: 950152, 956094; (Plating & Processing) Rua Campo do Lendo 208, 4200 Porto. Tel: 485876. Factory Mgr.: Francisco Taveira; Technical Servs. Mgr.: Domingos Lupi Nogueira; Plating & Processing Mgr.: Eugenio de Vasconcelos.

PRINTER & LITHOGRAPHER

Valentin de Carvalho Ci. SarL, Rua Nova do Almada 95-99, 1200 Lisbon. Tel: 367051. Telex: 18420. Co-Pres.: Dr. Maria da Graca B. de Carvalho, Rui Valentin de Carvalho, Francisco Vasconcelos; Financial Dir.: Dr. Antonio dos Santos.

RECORD PROMOTION

Arnaldo Trindade & Ca. Lda., Rua de Santa Catarina 117, 4000 Porto. Tel: (02) 381341. Cable: RADILECTRA. Telex: 22266. Pres.: Arnaldo Trindade; Gen. Mgr.: Fernando Pereira; Co-ord.: Arnaldo Trindade Jr.

TAPE CUSTOM DUPLICATORS

Valentin de Carvalho Ci. SarL, Rua Nova do Almada 95-99, 1200 Lisbon. Tel: 367051. Telex: 18420. Co-Pres.: Dr. Maria da Graca B. de Carvalho, Rui Valentin de Carvalho, Francisco Vasconcelos; Financial Dir.: Dr. Antonio dos Santos.

Radio Producoes Europa Lda., Rua Dom Fuas Roupinho 50-A, 1900 Lisbon. Tel: 826503. Chief Exec.: Dias Coelho; Gen. Mgr.: Jose Manuel Nunesfortes; Gen. Exec.: Fernando Maia Rodrigues Goncalves.

Audio: Cassette, open reel.
Radio Trunfo Lda., Rua Anselmo Brancamp 297, 4000 Porto. Tel: 567964.
Dept. Chief: Arindo Moreira.
Audio: 8-tr. & cassette.

• **supplies**

TAPE, BLANK LOADED & BULK RAW

Agfa-Gevaert Lda., Av. 25 de Abril 9, 2795 Linda a Velha. Tel: 2190031. Cable: AGFACEVA. Telex: 12630. Mng. Dir.: J. Kindt; Gen. Mgr.: B. Worthmann.

Audio: Blank—compact-cassette, open reel; raw—cassette, broadcast, studio.

Video: Cassette, open reel.
Brand names: Agfa Carat, Agfa Stereochrom, Agfa Videochrom.

Amperele Electronica Ind'l Lda., Apdo. 4008, Av. Fontes Pereira de Melo 47, 4th fl., 1000 Lisbon. Tel: 532227, 532698. Cable: AMPEREL. Telex: 18588. Gen. Mgr.: A.C. Romao; Sales Mgr.: A. Dias. (Blank only)

Audio: 8-tr., cassette, open reel.
Video: 2" & 1" open reel, 1/4" & 1/2" cassette.
Brand name: Ampex.

Audio Magnetica Lda., Apdo. 72, Sitio do Pedrogao, Caldes da Rainha. Tel: (012) 23041. Telex: 16289 (Audio & Video)

B A S F Portuguesa Lda., Apdo. 1438, Rua de Santa Barbara 46, 5th fl., Lisbon 1. Tel: 562511. Cable: BASF. Telex: 12219. Sales Mgr.: Peter Broese. (Blank only)

Audio Cassette, open reel.
Video: 1" cartridge, 1/2" EIAJ cartridge.
Radio Trunfo Lda., Rua Anselmo Brancamp 297, 4000 Porto. Tel: 567964.
Dept. Chief: Arindo Moreira. (Blank only).
Audio: 8-tr., cassette.

TAPE DUPLICATING & PROCESSING EQUIPMENT

Amperele Electronica Ind'l Lda., Apdo. 4008, Av. Fontes Pereira de Melo 47, 4th fl., 1000 Lisbon. Tel: 532227, 532698. Cable: AMPEREL. Telex: 18588. Gen. Mgr.: A.C. Romao; Sales Mgr.: A. Dias.

Audio: Masters, slaves, recorders.
Video: 1" recorders.
Brand name: Ampex.

• **accessories manufacturers**

Amperele Electronica Ind'l Lda., Apdo. 4008, Av. Fontes Pereira de Melo 47, 4th fl., 1000 Lisbon. Tel: 532227, 532698. Cable: AMPEREL. Telex: 18588. Gen. Mgr.: A.C. Romao; Sales Mgr.: A. Dias.

Product: Tape—carrying & storage cases, head cleaners, demagnetizers, leader & splicing tape.

Joyer (Disco) Lda., Parque Residencial Miraflores, Lote 101-6B, Alges. Lisbon. Tel: 217719.
Product: Record—record care prods., replacement styli; Tape—head cleaners, demagnetizers.

PUERTO RICO

Note: For Puerto Rican listings, please refer to the United States section.

ROMANIA

Population: 22,048,305.
Rate of exchange: \$1 (US) = 4.97 lei.
Per capita income: \$1,100.
Holidays: January 1 & 2, May 1 & 2 (Labor Day & Youth Day), August 23 (Liberation Day).

RECORDS:

Record sales certification awards: None.
Type of distribution: There are over 3000 stores in which records are sold, including the cooperative system, bookstores, and specialized stores. Electrecord produces about 6.5 million records yearly. Every three months Electrecord representatives have contract talks and meetings with business representatives; the latter ones having previously decided how many copies are to be published of each record. These meetings are without mediators.
Type of promotion: Radio and television are the most important means.

Television is dominated by MDR music. Every three to four months, Electrecord edits a magazine, "Discul" (The Record), which presents the latest records: "Saptamna," "Flacara," "Tribuna," "Cronica," "Scintea Tineretului," and "Orizont" have permanent musical columns dedicated to records and charts.

Average retail price per record: Domestic LPs—\$4.00-\$5.60. EPs & singles—\$1.40-\$2.40. Import LPs \$8.80 (from Socialist countries), \$15 (from Indian companies); EPs & singles—\$3.00-\$3.40.

Jukeboxes: 40.

TAPE:

Comment: 8-track is not yet used officially. Cassette & open reel tapes are very popular, especially for the former since the introduction of Romanian cassette players. Blank open reel tape is imported from West Germany (Agfa) and East Germany (Drow); blank cassette tape is imported from West Germany, East Germany, Hungary, Switzerland, Israel, and Greece.

CONSUMER ELECTRONICS:

Number of homes with: Radios—3,195,000, television sets—3,588,000 (all b/w), phonographs—925,000, color television sets & videotape recorders—"small numbers.

RADIO STATIONS:

No. stations: 83.
Comment: 40% of programming is MDR and rock, 35% classical, and 25% folklore.

TELEVISION STATIONS:

No. of stations: 294 (39 provincial).
Comment: Romania does not yet produce programs in color but the establishment of a color recording station should change this.

IMPORT/EXPORT REGULATIONS:

Record importing and exporting is done by ILEXIM, which imports from Socialist and Indian companies only. Regarding Western music, Electrecord releases records under license. A group of Romanian artists, including Georgehe Zamir (Philips) and Catalin Tircolea (Arista), have contracts with Western companies.

• **record & tape manufacturers / distributors / importers**

Electrecord, Str. Emil Bodnarus 94, 78702 Bucharest 1. Tel: 78.60.78. Telex: 10086. Gen. Mgr.: Grigore Petreanu; Music Dept. Chief: Daniela Caraman Folea; Artistic Mgr.: Vasile Srtiu.

Labels: (Domod) Electrecord; (licensed) B&J (UK), CBS (France), CBS-Sugar (Italy), Delta (Germany), International Shows (France), Juan Valiori (Spain), Metronome (Germany), Montana (Germany), PIPS (Switzerland), Philips (UK), Stop (Italy), Studio 33 (Netherlands), Symphony Tone Prod'n (Switzerland), Transworld (Switzerland), Trilogy (USA).
Int'l rep.: Canada (Archambault), Germany (Bellaphon, Delta), Japan (Victor), Netherlands (Basart), Switzerland (Symphony Tone), USA (Monitor).

I L E X I M, Str. 13 Decembrie nr. 3, 70116 Bucharest 1. Tel: 13.98.75, 15.76.72. Musical Sec'y: Adrian Stefanescu. (Importer/Exporter)

• **music publisher**

Editura Muzicala (The Musical Publ'g House), Str. Poiana Narciselor 6, 70718 Bucharest 1. Tel: 16.40.99.

• **services**

ASSOCIATIONS & PROFESSIONAL ORGANIZATIONS

A R I A (Romanian Agency for Artists' Mgmt.), Str. 16 Ienachita Vacarescu, 70528 Bucharest. Tel: (90) 13.70.08. Telex: 10139. Mgr.: Carol Cozma. Ass't Mgr.: Georgehe Ravas; Musicologist: Vasile Donose; Foreign Relations Dept. Dir.: Alexandru Dima.

A T M (Association of Artists from Theatrical & Musical Institutions), Blvd. Schitu Magureanu 1, 70626 Bucharest 6. Tel: 13.41.72/44.99. VP: Dina Cocea; Sec'y: Ana Toboaru.

Composers' Union (Ununea Compozitorilor), Str. 2 Constantin Esarcu, Bucharest. Tel: (90) 16.37.47. Pres.: Petre Brancusi; VP's: Zeno Vancea, Romeo Ghircosau; Sec'y's: Dr. Vasile Tomescu, Theodor Grigoriu, Laurentiu Profeta, Wilhelm Berger.

Socialist Culture & Education Council (Consiliul Culturii si Educatiei Socialiste), Casa Scintei, Piata Scintei 1, 71341 Bucharest 1. Tel: 17.60.10/20. Music Mgr.: Nicolae Cainiun.

LICENSOR, RECORD & TAPE PLATING, PRESSING & PROCESSING PLANT

Electrecord, Str. Emil Bodnarus 94, 78702 Bucharest. Tel: 78.60.78. Telex: 10086. Gen. Mgr.: Grigore Petreanu.

PRINTERS & LITHOGRAPHERS

Editura Muzicala (The Musical Publ'g House), Str. Poiana Narciselor 6, 70718 Bucharest 1. Tel: 16.40.99.
Electrecord, Str. Emil Bodnarus 94, 78702 Bucharest. Tel: 78.60.78. Telex: 10086. Gen. Mgr.: Grigore Petreanu.

TAPE CUSTOM DUPLICATOR

TAPE PACKAGING & LABELING

Electrecord, Str. Emil Bodnarus 94, 78702 Bucharest. Tel: 78.60.78. Telex: 10086. Gen. Mgr.: Grigore Petreanu.
Audio: Cassette.

JACKETS & SLEEVES

LABELS, DISK POLYETHYLENE BAGS

PROFESSIONAL TAPE SUPPLIES
Electrecord, Str. Emil Bodnarus 94, 78702 Bucharest. Tel: 78.60.78. Telex: 10086. Gen. Mgr.: Grigore Petreanu. (LP jackets & sleeves; 45, LP & cassette labels; Poly Bags)

• **supplies**

TAPE, BLANK LOADED & BULK RAW

Electrecord, Str. Emil Bodnarus 94, 78702 Bucharest. Tel: 78.60.78. Telex: 10086. Gen. Mgr.: Grigore Petreanu. (Blank only)

Audio: Cassette.
Reprezentanta tehnica-comerciala, Str. Giuseppe Garibaldi 14, Bucharest 1. Tel: 79.62.10/35. Telex: 11695.
Brand name: BASF.

SINGAPORE

Population: 2,370,000
Rate of exchange: 1 (US) = 2.10 Singapore dollars
Per capita income: \$3,260
Holidays: New Year's Day, Chinese New Year, Good Friday, May 1 (Labor Day), August 9 (National Day), November 11 (Deepavali), December 25.

RECORDS:

Record sales certification awards: None
Records sold domestically including imports (retail value): LPs 1980-\$8,100,000; 1979-\$7,000,000

Average retail price per record: LP \$- \$5.20

Type of distribution: Distribution channels include manufacturer-to-whole-saler to retailer and manufacturer-to-retailer. Also, there has been a growth of rack jobbing with a local flavor, that is, wholesalers distribute to outlying districts of Singapore.

Type of promotion: The main types of promotion are airplay, record company sponsored programs, advertising in relevant magazines, news papers, and tie-ins with movies and discos.

Jukeboxes: None (banned).

RADIO STATIONS:

No. of commercial: 2, no. of government: 2

Comment: Recorded music, mostly MOR and AOR, is featured on radio programs, with other types of music frequently heard on programs sponsored by individual record companies.

TELEVISION STATIONS:

No. of channels: 2 government, 90% color (PAL)

Comment: More musical/variety shows are being aired, with most of them being imported from the United States.

IMPORT/EXPORT REGULATIONS:

Records and tapes must be seen and approved by the Controller of Undersirable Publications of the Ministry of Culture. Therefore, objectionable songs are not allowed, primarily those with drug connotations and related subjects.

MARKET ANALYSIS:

Piracy is still very rampant, with some estimates near 70% of the total market. The Copyright Law is not being enforced but a recent ruling by the Chief Justice has endorsed the act as being workable. Industry executives expect authorities to clamp down on piracy as promised recently by a cabinet minister. Industry members also expect a revision in the Copyright Act with stiffer penalties for pirates. All indications point to stronger enforcement in the next year.

Local and ethnic recordings are still the main lifeblood of record companies accounting for roughly 60% of the legitimate market. Such recordings include Chinese and Malay material, and their sales level is expected to continue, perhaps even expanding.

International repertoire is comprised mainly of MOR and AOR based on United States top 40 programming. New wave is not making any headway in Singapore.

Peter Ong

• record & tape manufacturers / distributors / importers

Alby Commercial Ents. Pte. Ltd., 41C Thong Tek Bldg., 15 Scotts Rd., Singapore 0922. (Importer)

Label: (Represented) Maranatha' (USA)

Angel, see EMI

Baal Recs. Pte. Ltd. (IFPI), 803 Marina House, Shenton Way, Singapore 0207 Tel: 221-5484 Cable BAALPROD Dir. Balram Shotam

Regional branches: China, Hong Kong, Malaysia

Int'l branch: England

Labels: (Owned) Baal, Best of Everything, (Licensed) Salsoul (USA)

Best of Everything, see Baal

Borneo Co. Pte. Ltd., PO Box 898, Inchope House, 450/452 Alexandra Rd., Singapore 0511. Tel: 62 5111 Cable BORNEO (Importer)

Capitol, see EMI

Chang Huat Co. Pte. Ltd., 195/199 Outram Park, Singapore 0316 Tel: 220 3444, 222-2973 Cable CHIPMUP-KS Telex 26785. Chm. Prielak Chang, Gen. Mgr. T. T. Quek, Sales Mgr. Koh Kok Thye

Labels: (Owned) Echo, Elastic, (represented) Avatar (UK, USA), De Lite (USA), Delphine (France), Denor PCM (Japan), JVC (Japan), Kinster (Hong Kong), MCA (UK, USA), Toshiba (Japan)

Cogent, see Unisong

Columbia, see EMI

Cosdel (Singapore) Pte. Ltd. (IFPI), Units 1C 5C, Block 11, 3rd fl., Kallang Bahru, Kallang Basin Ind' Estate, Singapore 1233 Tel: 258 9944 Cable COSDEL Chm. Kenneth L. Cole, Mng. Dir. S. P. Sim, Sales Mgr. Willie Lim (Distributor/Importer)

Reg'l headquarters: Hong Kong

Labels: (Licensed) Cream-Hi (USA), Ourium (Italy), Festival (Australia), Lion's Gate, RCA group (USA), (distributed-not licensed) First American, Pickwick Int'l

D. G., see PolyGram

Double Up, see EMI

E. M. I. (Singapore) Pte. Ltd. (IFPI), PO Box 182, MacDonald House, 3rd fl., Orchard Rd., Singapore 0923. Tel: 337-7686 Cable EMITRON Telex 25652. Mng. Dir. John Forrest, Sales Mgr. Sahul Hamid

Home office: England

Labels: (Owned) Angel, Capitol, Columbia, Double Up, EMI, Encore, HMV, Harvest, MFP (Music for Pleasure), One Up, Parlophone, Pathe, Regal, Regal Zonophone, Sounds Superb, Talisman, Waverley, (represented) Arista (USA), Bronze (UK), CBS, Sony (Japan), Disneyland (USA), Motown (USA), RAK (UK), United Artists (USA)

Int'l rep.: Worldwide (EMI)

Eagle, see Teo Kwan

Eastland Trading (S) Pte. Ltd., GPO Box 1128, 283A Selegie Shopping & Office Complex, Selegie Rd., Singapore 0718. Tel: 337 1021. Cable EASTLAND Telex 33485. Chm. & Mng. Dir. Tee Sin Quek, Sales Dir. See G. Quek. (Importer)

Label: (Represented) Crystal Clear (USA)

Echo, see Chang Huat

Elastic, see Chang Huat

Encore, see EMI

Fontana, see PolyGram

H. M. V., see EMI

Harvest, see EMI

Hup Hup Sdn Bhd., 5 Lorong Tukang Lima, Singapore 2261 Tel: 65 1187/1333 Cable HUPHONIC Mng. Dir. Ng Lian Chin, Oirs. Ms. Ng Ay Yin, Ms. Ng Ay Na (Distributor)

Home office: Malaysia

Label: (Distributed) Life

Hwee Seng (Pte) Ltd., 219 Kallang Bahru, Singapore 1233 Tel: 258-8322 Cable AUDIO Telex 23611. Sales Mgr. Robert Tham

Label: (Represented) Direct Disk (USA)

E. S. Isaac & Co. Pte. Ltd., 35A Hongkong St., Singapore 1 Tel: 438 460/466 Cable ISAACNCO. (Distributor)

Labels: (Distributed-not licensed) Accent (USA), Angel (India), Columbia (India), Crescendo (USA), Everest (USA), HMV (India), Hi Fi (USA), Odeon (India), Parlophone (India), Telefunken (Germany), Vogue (France)

Int'l reps.: France (Vogue), Germany (Teldec), India (Gramophone)

Island Music Oists., Golden Mile Shopping Centre, 7th fl., Suite 5817, Beach Rd. Singapore 7 Tel: 221 9210/9325 Telex 25466 (Distributor)

Kwang Sia Pte. Ltd., PO Box 1018, Colombo Court, Singapore 9117, Colombo Court, Rm. 308, 3rd fl., N. Bridge Rd., Singapore 0617 Tel: 336 5166 Cable KWANGSIACO Telex 26689. Dir. Ricky Ang; Mng. Dir. Keng Seah Ang. Labels: Singapore 0617, G3 Capitol Shopping Centre, N. Bridge Rd. Tel: 338 5659-Singapore 0617, B7/8 Colombo Court, N. Bridge Rd. Tel: 338 4013, 336 3171 (Importer)

Life Rec. Inds. (Pte) Ltd., 5 Lorong Tukang Lima, Jurong Town, Singapore 2261 Tel: 265-1333/1187 Cable LIFERECORD Telex 33581. Wholesale Dept.: 232 Serangoon Rd. Tel: 293 0129/3404

M. F. P., see EMI

Mercury, see PolyGram

Music for Pleasure, see EMI

One Up, see EMI

Parlophone, see EMI

Pathe, see EMI

Philips, see PolyGram

Polydor, see PolyGram

PolyGram Recs. Pte. Ltd. (IFPI), 6 Joo Koon Circle, Tuas, Jurong, Singapore 2262 Tel: 268-1255 Cable PHONRECORD Telex 24829. Mng. Dir. Norman Cheng; Controller: Johnny Sng Chin Watt

Reg'l branch: Malaysia

Labels: (Owned) DG, Fontana, Mercury, Philips, Polydor, RSO (represented) A&M, CTI (USA), Capricorn (USA), Charisma (UK), De-Lite (USA), H&L (USA), Jupiter (Germany), MCA (USA), MGM, Metronome, Monument, Pabo (Germany), Rocket, 20th Century (USA), Vertigo, Verve

Int'l reps.: Worldwide (Phonogram, Polydor)

R. S. O., see PolyGram

Regal, see EMI

Regal Zonophone, see EMI

Scripture Union Christian Book Centre, 36H Prinsep St., Singapore 7. Gen. Mgr. Winston Yap

Labels: (Distributed-not licensed) Pilgrim (UK), Word (USA)

Singapore Audio, 225 Plaza Singapura, 2nd fl., Orchard Rd., Singapore 9. Label: (Represented) Sheffield Lab (USA)

Sounds Superb, see EMI

Talisman, see EMI

Teo Kwan Electric Recs. Co., 17 Oboby Ghuat, Singapore 9 Tel: 360 402, 328-265. Cable KWANGELECT

Label: (Owned) Eagle

Tony, see Tony Wong

Two Plus Ents. Pte. Ltd., 131 Orchard View, 1st fl., Singapore 9. Telex 786-23511. Contact: Frankie C. C. Tan

Label: (Represented) Direct Disk (USA)

Unisong Pte. Ltd., Shaw Towers, No. 125, Beach Rd., Singapore 7. Tel: 293 4379. Gen. Mgr. Kueh Sor Teo, Sales Mgr. Tay Chor Huan

Labels: (Owned) Cogent, Unisong

W. E. A. Recs. Pte. Ltd. (IFPI), 20/F Shaw Towers, Suite 2009, Beach Rd. Singapore 0718 Tel: 294-2601. Cable WEARECORD Telex 25958. Financial Controller: Yip Yuen Han, Gen. Mgr. Jimmy Wee, Sales Mgr.: Ronnie Lok

Home office: USA

Labels: (Licensed) Asylum, Atco, Atlantic, Big Tree, Carrere, Cotillon, Dark Horse, Elektra/Asylum, Geffen, Planet, RFC, Reprise, Scotti Bros., Sire, Swan Song, Virgin, Warner Bros., Whitehead (all USA), Island (UK), Pacific (Hong Kong)

Waverley, see EMI

Tony Wong Co. (Pte.) Ltd. (IFPI), 16F, Block 9, Kallang Pl., Singapore 1233 Tel: (65) 235-3847 Cable AUDIOTAPE Telex 23252. Mng. Dir. Tony C.K. Wong; Gen. Mgr. Chow Yue Teng, Sales Mgr.: Eddy Chew

Label: (Owned) Tony

Int'l reps.: Hong Kong (Wing Hing), Indonesia (P.T. Padang), Thailand (Lepso)

• music publishers

Baal Music, 803 Marina House, Shenton Way, Singapore 0207 Tel: 221 5484. Cable BAALPROD Dir. Balram Shotam

Int'l reps.: France (EPOC), Germany (Accord), Japan (Shinko), Latin America (Fermata)

E. M. I. Music Publ'g (Singapore) Pte. Ltd., MacDonald House, 3rd fl., Orchard Rd., Singapore 0923. Tel: 327-686. Cable EMITRON Telex 25652. Mng. Dir. John Forrest, Prof. Mgr. Adeline Fong

Interpong Far East Pte. Ltd., 6 Joo Koon Circle, Tuas, Jurong, Singapore 2262 Tel: 268-1255 Cable PHONRECORD Telex 24829. Mng. Dir. Norman Cheng; Admin'r: Johnny Sng Chin Watt

Int'l firms represented: Acuff Rose, Ascherberg Hopwood & Crew, Balloon Head, Bena, Irving Berlin, Canopy, Chappell, Ensign, Famous, Fox Fanfare, Albert Hammond, Hot Cha, Lowery, Mayday, E. H. Morris, Osmond, Pilot, RSO, Ranger, Fred Rose, Saggiere, Robert Stigwood Group, Subiddu, Unichappell, White Cloud (all UK)

Int'l reps.: Worldwide (Interpong), Netherlands (Artemis)

Josephine & Ephraim Music, PO Box 176, Kiltiney Rd., Singapore 9123 Tel: 94 865. Or. Aileen Keating

Home office: New Zealand

Int'l reps.: Southeast Asia (Josephine & Ephraim)

W. E. A. Music Pte. Ltd. 20/F Shaw Towers, Suite 2009, Beach Rd., Singapore 0718 Tel: 294-2601. Cable WEARECORD Telex 25958. Financial Controller: Yip Yuen Han, Gen. Mgr. Jimmy Wee

Tony Wong Co. (Pte.) Ltd., 16F, Block 9, Kallang Pl., Singapore 1233 Tel: (65) 235-3847 Cable AUDIOTAPE Telex 23252. Mng. Dir. Tony C.K. Wong

• services

DESIGN & ARTWORK

Craft Print Pte. Ltd., PSA Multi Storey Complex, Unit 513, Block 3, 5th fl.,

PSA Pasir Panjang Rd., Singapore 0511 Tel: 275 1816. Cable CRAFT PRINT Telex 26862. Dir.: Dora Ong; Gen. Mgr. Charlie Chan

Life Recs. Inds. Pte. Ltd., 5 Lorong Tukang Lima, Singapore 2261 Tel: 265 1333/1187, 261 0752 Cable LIFERECORD Telex 33581. Mng. Dir. Ng Lian Chin

Media Ace Pte. Ltd., 506 Colombo Court, 5th fl., Singapore 0617 Tel: 338 2512/1181 Cable STARSHOW Mng. Dir. Wilson David

Unigoh (Singapore) Pte. Ltd., 67 Jalan Jambu Ayer, Hock Seng Garden, Bukit Timah, Singapore 21 Tel: 667 027. Mng. Dir. S.S. Goh, Gen. Mgr. Samuel Chong

Home office: Malaysia, UNI

PLATING, PROCESSING & PRESSING PLANTS

E. M. I. (Singapore) Pte. Ltd., 6 Wan Lee Rd., Jurong Town, Singapore 22. Tel: 650 544/183, 652 092. Mng. Dir. John Forrest; Technical Mgr.: Lee Tuck Ming, Factory Admin. Mgr.: Wee Tiong Wah

Hardie Trading (S) Pte. Ltd., Tanglin PO Box 212, Zone: 9124, 603 Shaw House, 6th fl., Orchard Rd., Singapore 0923. Tel: 235 2394/2210 Telex 21203 Mgr. M. G. Buscombe

Life Rec. Inds. Pte. Ltd., 5 Lorong Tukang Lima, Jurong Town, Singapore 2261 Tel: 265 1333/1187, 261 0752 Cable LIFERECORD Telex 33581. Mng. Dir. Ng Lian Chin

PolyGram Recs. Pte. Ltd., 6 Joo Koon Circle, Tuas, Jurong, Singapore 2262 Tel: 268-1255 Cable PHONRECORD Telex 24829. Mng. Dir. Norman Cheng; Controller: Johnny Sng Chin Watt; Factory Mgr.: Ng An Yang

Unigoh (Singapore) Pte. Ltd., 67 Jalan Jambu Ayer, Hock Seng Garden, Bukit Timah, Singapore 21 Tel: 667 027. Mng. Dir. S.S. Goh, Gen. Mgr. Samuel Chong (Pressing only)

Home office: Malaysia, UNI

Unique Art Record Ind'l Ents. Pte. Ltd., 1-E, Lot 16, Section 2, Lorong Tukang Lima, Jurong Town, Singapore 2261 Tel: 268 5166/4230 Cable CASETCO. Telex 35131. Dir. S.T. Tsai

Audio: Cassette

PRINTERS & LITHOGRAPHERS

Craft Print Pte. Ltd., PSA Multi Storey Complex, Unit 513, Block 3, 5th fl., Pasir Panjang Rd., Singapore 0511 Tel: 275-1816. Cable CRAFTPRINT Telex 26862. Dir.: Dora Ong, Gen. Mgr.: Charlie Chan

Life Recs. Inds. Pte. Ltd., 5 Lorong Tukang Lima, Singapore 2261 Tel: 265 1333/1187, 261 0752 Cable LIFERECORD Telex 33581. Mng. Dir. Ng Lian Chin

Media Ace Pte. Ltd., 506 Colombo Court, 5th fl., Singapore 0617 Tel: 338 2512/1181 Cable STARSHOW Mng. Dir. Wilson David

RECORD PROMOTION

Baal Recs. Pte. Ltd., 803 Marina House, Shenton Way, Singapore 0207 Tel: 221-5484. Cable BALLPROD. Dir. Balram Shotam

Gabco Pte. Ltd., 22 Jalan Hiram Manis, Singapore 1027 Tel: 633 005. Cable GABBY Telex 25070. Chm. Philip C.M. Seow; Gen. Mgr. Jacques Fong, Sales Mgr.: Cindy Chang

Rediffusion (Singapore) Pte. Ltd., 182 Clemente Ave., Singapore 0923. Cable REDIFFUSE. Mng. Dir.: Jack Snowden; Gen. Mgr.: Noel Symons, Programme Controller: Ong Su Tow

TAPE CUSTOM DUPLICATORS

E. M. I. (Singapore) Pte. Ltd., 6 Wan Lee Rd., Jurong Town, Singapore 22. Tel: 650-544/183, 652-092. Mng. Dir. John Forrest; Technical Mgr.: Lee Tuck Ming, Factory Admin. Mgr.: Wee Tiong Wah

Eastland Trading (S) Pte. Ltd., GPO Box 1128, 283A Selegie Shopping & Office Complex, Selegie Rd., Singapore 0718 Tel: 337 1021. Cable EASTLAND Telex 33485. Chm. & Mng. Dir. Tee Sin Quek, Sales Dir. See G. Quek

Audio: 8-tr. cassette, open reel

Video: 2" quad, 1" helical, 1/2" Beta & VHS cassette

Life Recs. Inds. Pte. Ltd., 5 Lorong Tukang Lima, Singapore 2261 Tel: 265 1333/1187, 261 0752 Cable LIFERECORD Telex 33581. Mng. Dir. Ng Lian Chin

Audio: Cassette

Otari Nampo Electronic & Sound Inds. (Pte.) Ltd., Redhill Ind'l Estate, 3809D, Block 1, Jalan Bukit Merah, Singapore 0315 Tel: 272 3774. Mng. Dir. Chang Hin Chong; Tech. Adviser: Yoshio Nabetani

Audio: cassette

PolyGram Recs. Pte. Ltd., 6 Joo Koon Circle, Tuas, Jurong, Singapore 22. Tel: 268 1255. Cable PHONRECORD Telex 24829. Mng. Dir. Norman Cheng, Gen. Mgr.: Johnny Sng Chin Watt

Rediffusion (Singapore) Pte. Ltd., 182 Clemente Ave., Singapore 0923. Cable REDIFFUSE. Telex: 24114. Mng. Dir.: Jack Snowden, Gen. Mgr.: Noel Symons; Programme Controller: Ong Su Tow

Audio: Cassette, open reel

Unimagnetic Pte. Ltd., 1-D, Lot 16, Section 2, Lorong Tukang Lima, Jurong Town, Singapore 2261. Tel: 268 4230/5166 Cable CASETCO. Telex 35131. Dir. S.T. Tsai; Sales Mgr.: Thomas D. Pereira

Audio: Cassette

Tony Wong Co. (Pte.) Ltd., 16 F, Block 9, Kallang Pl., Singapore 1233 Tel: (65) 235-3847 Cable AUDIOTAPE Telex 23252. Mng. Dir. Tony C.K. Wong

Audio: 8-tr. cassette

• supplies

CARTRIDGE & CASSETTE PARTS

Unigoh (Singapore) Pte. Ltd., 67 Jalan Jambu Ayer, Hock Seng Garden, Bukit Timah, Singapore 21 Tel: 667 027. Mng. Dir. S.S. Goh, Gen. Mgr.: Samuel Chong

Home office: Malaysia, UNI

Audio: All plastic parts

Unimagnetic Pte. Ltd., 1-D, Lot 16, Section 2, Lorong Tukang Lima, Jurong Town, Singapore 2261. Tel: 268 4230/5166 Cable CASETCO Telex 35131. Dir. S.T. Tsai, Sales Mgr.: Thomas O. Pereira

Audio: Cassette parts

Tony Wong Co. (Pte.) Ltd., 16F, Block 9, Kallang Pl. Singapore 1233 Tel: (65) 235-3847 Cable AUDIOTAPE Telex 23252. Mng. Dir. Tony C.K. Wong

Audio: All 8-tr. & cassette parts

EMPTY CARTRIDGES, CASSETTES & REELS

Kwang Sia Pte. Ltd., PO Box 1018, Colombo Court, Singapore 9117, Colombo Court, Rm. 308, 3rd fl., N. Bridge Rd., Singapore 0617. Tel: 336-5166. Cable KWANGSIACO Telex 26689. Dir.: Ricky Ang; Mng. Dir. Keng Seah Ang (Importer)

Otari Nampo Electronic & Sound Inds. (Pte.) Ltd., Redhill Ind'l Estate, 3809D, Block 1, Jalan Bukit Merah, Singapore 0315 Tel: 272-3774. Mng. Dir. Chang Hin Chong; Tech. Adviser: Yoshio Nabetani

Audio: 8-tr. & cassette

Unigoh (Singapore) Pte. Ltd., 67 Jalan Jambu Ayer, Hock Seng Garden, Bukit Timah, Singapore 21 Tel: 667 027. Mng. Dir. S.S. Goh, Gen. Mgr. Samuel Chong

Samuel Chong
Home office: Malaysia, UNI
Brand name: UNI El Mar
 Tony Wong Co (Pte.) Ltd., 16F, Block 9, Kallang Pl, Singapore 1233 Tel (65) 235 347 Cable AUDIOTAPE Telex 23242 Mng Dir Tony C K Wong
Audio: 8 tr, cassette
Brand name: Tony

JACKETS & SLEEVES LABELS, DISK

Craft Print Pte Ltd, PSA Multi Storey Complex, Lnt 513, Block 3 5th fl, Pasir Panjang Rd, Singapore 0511 Tel 275 1116 Cable CRAFTPRINT Telex 26862 Dir Dora Ong, Gen Mgr, Charlie Chan
 Unigoh (Singapore) Pte. Ltd., 67 Jalan Jambu Ayer, Hock Seng Garden, Bu kit Timah, Singapore 21 Tel 667 027 Mng Dir S S Goh, Gen Mgr Samuel Chong
Home office: Malaysia, UNI

RECORD MANUFACTURING EQUIPMENT

Hardie Trading (Servs) Pty Ltd, Tanglin PO Box 212 Zone 9124 603 Shaw House 6th fl, Orchard Rd, Singapore 0923 Tel 235 2394/2210 Telex 21203 Mgr M G Buscombe (Importer)
Product: Transco master recording blanks
 Unigoh (Singapore) Pte. Ltd., 67 Jalan Jambu Ayer, Hock Seng Garden, Bu kit Timah, Singapore 21 Tel 667 027 Mng Dir S S Goh, Gen Mgr Samuel Chong
Home office: Malaysia, UNI
Brand name: Finebit

TAPE, BLANK LOADED & BULK RAW

Agfa Carat, see East Asiatic
 Agfa Stereochrom, see East Asiatic
 Agfa Videochrom, see East Asiatic
 Ampex, see Eastland
 B A S F, see Jebson & Jessen
 East Asiatic Co Pte Ltd, Agfa Gevaert Dept, Frinlayson House 1st fl, Raf Iles Quay, Singapore 1 Tel 981201 Telex 2 234 Agfa Gevaert Dept Dr Andrew Heng Seng Par
Audio: Blank—compact cassette open reel raw—cassette broadcast studio
Video: Cassette, open reel
Brand names: Agfa Carat, Agfa Stereochrom, Agfa Videochrom
 Eastland Trading (S) Pte Ltd, GPO Box 1128, 283A Selegie Shopping & Office Complex, Selegie Rd, Singapore 0718 Tel 337 1021 Cable EASTLAND Telex 33485 Chm & Mng Dir Lee Sin Quek, Sales Dir See Gi Quek
Audio: Raw—cassette, open reel
Brand name: Ampex

Emitate, see EMI
 Intermagnetics Singapore Pte. Ltd., Woodlands Factory Bldg, Block 15 No 10, Rd 9, Marsiling Ind Estate, Singapore 24 Contact Mr Lian Jebson & Jessen (Singapore) Ltd., PO Box 2444, Supreme House, 10th fl, Penang Rd, Singapore 9 Tel 32 8361 Cable IEJBESSEN Telex 21487 Dr A Pons
Audio & Video: Cassette, open reel
Brand name: BASF
 Kwang Sia Pte Ltd., PO Box 1018, Colombo Court, Singapore 9117, Colombo Court, Rm. 308 3rd fl, N Bridge Rd, Singapore 0617 Tel 336 5166 Cable KWANGSIACO Telex 26689 Dr Ricky Ang Mng Dir Keng Seah Ang (Importer) (Blank only)
Audio: Cassette
Video:

Otari Nampo Electronic & Sound Inds (Pte.) Ltd, Redhill Ind Estate 38090, Block 1, Jalan Bukit Merah, Singapore C315 Tel 272 3774 Mng Dir Chang Han Chong, Tech Adviser Yoshio Habelani

Audio: 8 tr & cassette
 Sankei, see Unimagnetic
 Tony, see Tony Wong
 Unigoh (Singapore) Pte. Ltd., 67 Jalan Jambu Ayer, Hock Seng Garden, Bu kit Timah, Singapore 21 Tel 667 027 Mng Dir S S Goh, Gen Mgr Samuel Chong
Home office: Malaysia, UNI
Audio: 8 tr, cassette

Unimagnetic Pte Ltd., 1 D Lot 16, Section 2, Lorong Tukang Lima, Jurong Town, Singapore 2261 Tel: 268 4230/5166 Cable CASSETCO Telex 35131 Dir S T Tsai, Sales Mgr Thomas D Perreira (Blank Only)
Audio: Cassette
Brand name: Sankei

Tony Wong Co (Pte.) Ltd., 16F, Block 9, Kallang Pl, Singapore 1233 Tel (65) 235 3847 Cable AUDIOTAPE Telex 23252 Mng Dir Tony C K Wong
Audio: 8 tr cassette
Brand name: Tony

TAPE DUPLICATING & PROCESSING EQUIPMENT

Eastland Trading (S) Pte. Ltd., GPO Box 1128, 283A Selegie Shopping & Office Complex, Selegie Rd, Singapore 0718 Tel 337 1021 Cable EASTLAND Telex 33485 Chm & Mng Dir Lee Sin Quek, Sales Dir See Gi Quek
Audio: Duplicators
Brand names: Ampex, Pentagon
 Jebson & Jessen (Singapore) Ltd., PO Box 2444, Supreme House, 10th fl, Penang Rd, Singapore 9 Tel 32 8361 Cable IEJBESSEN Telex 21487 Dr A Pons
Audio: Pancakes
Brand name: BASF
 Unigoh (Singapore) Pte. Ltd., 67 Jalan Jambu Ayer, Hock Seng Garden, Bu kit Timah, Singapore 21 Tel 667 027 Mng Dir S S Goh, Gen Mgr Samuel Chong
Home office: Malaysia, UNI
Audio: Duplicators, winders
Brand names: Ed Pic, King

• accessories

Eastland Trading (S) Pte. Ltd., GPO Box 1128, 283A Selegie Shopping & Office Complex, Selegie Rd, Singapore 0718 Tel 337 1021 Cable EASTLAND Telex 33485 Chm & Mng Dir Lee Sin Quek, Sales Dir See Gi Quek
Product: Record—record care prods (Robins' Watts) replacement styli
 Tape—head cleaners, bulk erasers, demagnetizers, leader & splicing tape (all audio & video)

Kwang Sia Pte Ltd., PO Box 1018, Colombo Court, Singapore 9117, Colombo Court, Rm. 308, 3rd fl, N Bridge Rd, Singapore 0617 Tel 336 5166 Cable KWANGSIACO Telex 26689 Dr Ricky Ang, Mng Dir

Keng Seah Ang (Importer)
Product: Record—carrying & storage cases, record care prods, replace ment styli
 Unigoh (Singapore) Pte. Ltd., 67 Jalan Jambu Ayer, Hock Seng Garden, Bu kit Timah, Singapore 21 Tel 667 027 Mng Dir S S Goh, Gen Mgr Samuel Chong
Home office: Malaysia, UNI
Product: Record—record care prods, Tape—carrying & storage cases head cleaners, demagnetizers, leader & splicing tape

• store fixtures

Unigoh (Singapore) Pte. Ltd., 67 Jalan Jambu Ayer, Hock Seng Garden, Bu kit Timah, Singapore 21 Tel 667 027 Mng Dir S S Goh, Gen Mgr Samuel Chong
Home office: Malaysia, UNI
Product: Tape display racks

SOUTH AFRICA, REPUBLIC OF

Population: 24,091,000
Rate of exchange: \$1 (US) = 0.81 rand
Per capita income: \$935
Holidays: January 1, April 6 (Founders Day), May 31 (Republic Day), October 10 (Kruger Day), December 16 (Day of the Vow) and all traditional Christian holidays

RECORDS:

Record sales certification awards: Gold single—25,000 units, platinum single—100,000 units, Gold LP—20,000 units, platinum LP—50,000 units
Records sold domestically including imports (retail value): LP's 1980—\$44,538,792, 1979—\$31,934,752, Singles 1980—\$13,635,954, 1979—\$12,221,191
Records imported from USA: 1980—416,015 units, 1979—292,879 units
Records imported from countries other than USA: 1980—269,989 units, 1979—226,793 units

Average retail price per record: LP's—\$8.19, singles—\$2.00
Record club sales: None
Discounting: Frequent
Type of distribution: Manufacturer to retailer, Rack jobbing through national chain stores accounts for a large percentage of sales.

Type of promotion: Radio is the main promotional medium. Singles charts are compiled weekly by the Springbok Radio, Radio 5, Disco Top 10 and the 20 Best Sellers. Television features two weekly programs, Pop Shop and Easy Beat, both with film clips of international and local artists. International artists on tour are interviewed on radio and television. Some newspapers regularly publish supplements on all facets of the entertainment industry. Springbok Radio and the record industry sponsor an annual contest to find the top South African artist and songwriter. There is a stage show at which the Gold Star trophies are presented to the winners, and this is broadcast live on the national network.

Jukeboxes: 500

TAPE:

Market: Cassettes have completely superseded 8-track. Cassette player/recorders and radio cassette player/recorders for portable and auto use, along with the more technically elaborate music centers, are widely available in the marketplace.

Pre-recorded tape sold domestically including imports (retail value): 8 tr 1979—\$321,737, Cassette 1980—\$29,235,618, 1979—\$14,805,301
Pre-recorded tape imported from USA: 1980—49,285 units, 1979—22,820 units

Pre-recorded tape imported from countries other than USA: 117,581 units, 1979—85,946 units

Average retail price per tape: Cassette—\$8.19

CONSUMER ELECTRONICS:

Number of homes with: AM/FM radios—2,500,000 (55%), television sets 1,500,000 (33%), phonographs—2,000,000 (44%), audio tape recorders—1,000,000 (22%)

RADIO STATIONS:

No. of independent channels 2, SABC channels 16 (5 AM, 13 FM)
Comment: Pop, MOR, classical and indigenous African records are used for a very substantial part of SABC's radio programs, particularly on the regional music stations—Radio Highveld, Port Natal, Good Hope and Radio Five—and on the programs for African people in seven tribal languages. The independent Capital Radio, based in Transkei, and Channel 702 in Bophutatswana are also record music stations.

TELEVISION STATIONS:

No. of channels 1 commercial (SABC), 100% color (PAL)
Comment: The current 42 hours per-week one channel service commenced on January 5, 1976, and introduced spot advertising on January 1, 1978. A second channel, TV2, will open in 1982 to initially serve the Nguni and Sotho language groups, a third channel, TV3, is planned for 1983 or 1984 for other African language groups such as Zulu, Xhosa, and Tswana. The current TV1 channel features news, detective and adventure, fiction, travel, wildlife and science documentaries, drama, opera, ballet, the arts, orchestral concerts, the church, and children's shows.

IMPORT/EXPORT REGULATIONS:

Import permits are required for records. Custom duty is 10% of FOB and 20% excise duty. Import permits are not required for pre-recorded tapes. Custom duty is 20% on FOB and 20% excise duty. Exporters arrange for irrevocable documentary credit to be opened in their favor by the importers' bankers for the amounts to be paid by draft payable at sight or at a future date. Usual shipping documents are required. Export credit insurance and forward exchange cover are available.

MARKET ANALYSIS:

The record industry shared in the high level of economic activity and consumer spending in South Africa in 1980. Overall retail sales increased in value by almost 49% over 1979. By configuration, LPs were up 39%, singles 11% and cassettes 98%. The longtime popularity of country music is even more on an upward curve, a trend substantiated by television and radio programs and by country music festivals. There is a revival in oldtime American jazz, and jazz clubs have a steady following. Rock and roll maintains its popularity. Sales of

records by black artists of indigenous music continue their upward swing. In fact, South African recordings in general now have a major influence in sales patterns due in part to sophisticated and technically advanced studio productions.

The number one spot in the weekly Springbok Radio 1980 singles chart was hit by top selling artists, including Suzi Quatro with "She's In Love With You", Michael Jackson, "Don't Stop Till You Get Enough", Pink Floyd, "Another Brick In The Wall", Styx, "Babe", Captain & Tennille, "Do That To Me One More Time", KC & The Sunshine Band, "Please Don't Go", Nolan Sisters, "I'm In The Mood For Dancing", Goombay Dance Band, "Sun Of Jamaica", Janis Ian, "Fly Too High", Pretenders, "Brass In Pocket", Village People, "Take That Look Off Your Face", Joy, "Paradise Road", Village Music, "Can't Stop The Music", Abba, "The Winner Takes It All", Diana Ross, "Upside Down", Ballyhoo, "Man On The Moon", and Barbra Streisand, "Woman In Love."

The South African Copyright Act of 1978 provides substantial fines and/or imprisonment for making or importing or distributing and selling unauthorized copies of records and prerecorded tapes. Home taping continues to be a problem and as in all other countries the industry has made representations for a royalty levy on sales of blank tapes and hardware.

William Ford Fraser

• record & tape manufacturers / distributors / importers

Akulaiwa, see EMI-Brigadiers
 All Great, see EMI-Brigadiers
 Amahubu, see WEA
 Angel, see EMI-Brigadiers
 Asylum, see WEA
 Atco, see WEA
 Atlantic, see WEA
 B & S Int'l, see B & S Music
 B & S Music Pty Ltd, 16 Edward St., Regents Park, Johannesburg Tel. 26-5010 Ours E Schroder, Martin Ettin, B. Vaughn, Gen. Mgr. Estelle Vaughn, Sales Mgr. Roger Rubin
Labels: (Owned) B&S Int'l, Dog, Platinum, Promise, Rejoice, Thokozo, Int'l reg., USA (Copyright Serv. Bureau)

Bam, see CCP
 Beat City, see WEA
 Black Cat, see CCP
 Black Music, see CCP
 Black Music, see EMI-Brigadiers
 Boots, see CCP
 Brigadiers, see EMI-Brigadiers
 Buffalo, see David Gresham & Teal
 Bullet, see CCP
 Butterfly, see Gramophone
 C B S, see Gramophone
 C C P Rec. Co (Pty) Ltd., 32 Steele St., Steeledale, Johannesburg 2197 Tel (11) 613 2011 Cable SOUNDBOX Telex 8-7406 Mng. Dir. Howard Ipp

Labels: (Owned) Black Cat, Black Music, Bullet, CCP, Hi Trax, Horse, Hot Stuff, Intuthuko, Lake Victoria, Mabob City, Reggae, Spes Bona, Yash ingoma, Zimbabwe, (Licensed) Creole (UK), De Lite (USA), Salsoul (USA), Stiff (UK), Virgin (UK), (distributed—not licensed) Bam, Boots, Onosaur, Freeway, Hot Music, Jaguar, Kqasa, Minc, Sound Rays, Transistor

C T V, see EMI-Brigadiers
 Cafe Society, see RPM
 Capitol, see EMI-Brigadiers
 Chocolate City, see WEA
 Church, see Teal
 City Special, see Teal
 Columbia, see EMI-Brigadiers
 Contempo, see EMI-Brigadiers
 Cool Blue, see EMI-Brigadiers
 Colillion, see WEA
 D G P Int'l, see David Gresham
 Dephon, see Trulone
 Onosaur, see CCP
 Oog, see B&S

Double Up, see EMI-Brigadiers
 Dynamite, see EMI Music for Pleasure
 E M I, see EMI-Brigadiers
 E M I America, see EMI-Brigadiers
 E M I Brigadiers (Pty) Ltd (IFPI), 32 Steele St., Steeledale, Johannesburg 2197 Tel (11) 613 2011 Cable SOUNDBOX Telex 8-7406 Mng. Dir. C R Kelly, Mktg & Repertoire Or Allan McInnes
Labels: (Owned) Akulaiwa, Angel, Blue Note, Brigadiers, Capitol, Columbia, Contempo, Cool Blue, Double Up, EMI, EMI America, EMI Int'l, Goli, Gull, HMV, Harvest, Jamloti, Kaya Lami, Listen to the Wild, Moleto, N'Kanyazi, Odeon, One up, Oz, Parlophone, Purple, Regal Zonophone, Ring Safari, Shona Langa, Side Walk, Starline, Stateside, Swinger, Umsakazo, United/Liberty, Zodiac, (Licensed foreign) BBC (UK), Carrere (France), Chiswick (UK), Purple (UK), RAK (UK), Wizard (Australia), (distributed—not licensed) All Great, CTV, FFP, Fast, Fist, Gudla Gudla, MFA, MJR, More Music Hits, Nash, Oula, Red Label, SOV, Spinnu, Summit, Sunshine, Tiger, 2 Good

E M I Int'l, see EMI-Brigadiers
 E M I Music for Pleasure (Pty) Ltd (IFPI), 32 Steele St., Steeledale, Johannesburg Tel (11) 613 2011 Cable SOUNDBOX Telex 87409 Mng. Dir. Neville Blignaut, Sales Mgr. Barry Bothma, Mktg. Mgr. John du Plooy
Labels: (Owned) Dynamite, Flame, Mellow Mood, Skyline, (Licensed foreign) Classics for Pleasure, Music for Pleasure, Music Way, Sounds Superb (all UK)

Elektra, see WEA
 Embassy, see Gramophone
 Embudane, see Gramophone
 Epic, see Gramophone
 Epidemic, see RPM
 Explosion, see RPM
 Ezomdabu, see Gallo
 F F P, see EMI-Brigadiers
 F G B, see Gallo
 Fast, see EMI-Brigadiers
 Fast Move, see RPM
 Fen City, see Trulone
 Fist, see EMI-Brigadiers
 Flame, see EMI Music for Pleasure
 Freeway, see CCP & Music Incorporated

G R C, see Gramophone.
 Gallo (Africa) Ltd., PO Box 6216, 130 Kerk St., Johannesburg 2000. Tel: (11) 28-2400. Cable: GALLOTONE. Te ex: 80153. Dir.: Peter Gallo; Creative Dir.: Peter Lotis; Gen. Mgr.: Fred Bugnatto; A&R & Promo. Dir.: Ivor Haarburger.
Labels: (Owned) Ezomdabu, FGB, Gallo, Gumba Gumba, Inkonkoni, MIW, Mashalasha, Mavuthela, Motella, PG Super, Smanje Manje, Soul Jazz, Soul Jazz Pop, Ziyaluma, Zobo; **(licensed domestic)** The Sun, **(licensed foreign)** Bronze (UK), Butterfly (USA), CTI (USA), Chrysalis (UK), Decca (UK), Delphine (France), Disneyland (USA), Hansa (Germany), Hispavox (Spain), Island (UK), MCA (USA) Shelter (USA).
 Go Go, see Teal.
 Goli, see EMI-Brigadiers.
 Good as Gold, see Reveille.
 Grace, see WEA
 Gramophone Rec. Co. (Pty.) Ltd. (GRC) (IFPI), PO Box 2445, 132 Kerk St., Johannesburg. Tel: (11) 37-2827. Cable: AFRICORD. Telex: 8-0153. Mng. Dir.: Percy Golemba; Gen. Mgr. & Sales Mgr.: John De Beer; A&R Mgr.: Fred Pearson.
Labels: (Owned) Butterfly, CBS, Embassy, Emdubane, Epic, GRC, HVN, Harmony, Imbongi, Intuhuko, Jive Marabi, Masterpiece, Portrait, Soul Train, **(licensed)** Caribou, GTO, Jet, Kershner, Monument, Ode, Philadelphia Int'l, Prelude, TK, T-Neck, Tappan Zee (all USA).
 David Gresham Prod'ns (Pty.) Ltd., PO Box 626, Zone: 2000; 30 Eloff St., Johannesburg 2001. Tel: (011) 21-5029/5041. Cable: DAVEGRESH. Telex: 8-3645. Chm. & Mng. Dir.: D. Gresham; Sales Mgr.: Allan Gold swain; A&R Mgr.: Dennis East; Prod'r: Julian Laxton. (Distributed by Teal)
Labels: (Owned) Buffalo, DGP Int'l, Mpumemelo, NTU, Nitty Gritty; **(licensed foreign)** Red Bus, Splash (UK)
 Int'l rep.: USA (David Gresham).
 Groove, see JoBurg.
 Gudla-Gudla, see EMI-Brigadiers.
 Gull, see EMI-Brigadiers.
 Gumba Gumba, see Gallo.
 H M V, see EMI-Brigadiers.
 H V N, see Gramophone.
 Harmony, see Gramophone.
 Harvest, see EMI-Brigadiers.
 Highway Soul, see WEA.
 Hi Trax, see CCP.
 Hit Special, see Teal.
 Horse, see CCP.
 Hot Beat, see RPM.
 Hot Music, see CCP & Music Incorporated.
 Hot Stuff, see CCP.
 Imbongi, see Gramophone.
 Ingagasi, see Teal.
 Ingwenya, see WEA.
 Inkonkoni, see Gallo.
 Intuhuko, see CCP & Gramophone.
 Invisible Church Investments, 65 Prince Alfred St., Durban 4001. Tel: (031) 37-5414.
Label: (Represented) Maranatha! (USA).
 Ipi Tombi, see Teal.
 Jaguar, see CCP.
 Jamloti, see EMI-Brigadiers.
 Jive Marabi, see Gramophone.
 JoBurg Import, see JoBurg Recs.
 JoBurg Recs & Music Publ'g (Pty.) Ltd., PO Box 93005, Yeoville, 2198 Johannesburg. Tel: (011) 41-3727. Mng. Dir.: Stan Cohen. (Distributed by WEA)
Labels: (Owned) Groove, JoBurg, JoBurg Import, King, RSA, Sound of Soul, Soweto.
 Jordan, see Revelation.
 Kalahari, see Teal.
 Kaya-Lami, see EMI-Brigadiers.
 King, see JoBurg.
 Knockout, see RPM.
 Kqasa, see CCP.
 Lake Victoria, see CCP.
 Listen to the Wild, see EMI-Brigadiers.
 M F A, see EMI-Brigadiers.
 M I W, see Gallo.
 M J R, see EMI-Brigadiers.
 Maboc City, see CCP.
 Magic of Music, see Teal.
 Maghuta, see Teal.
 Mariner Music (Pty.) Ltd., Box 28550, Sunnyside, Pretoria 0132. Tel: (012) 44-4290. Cable: MUSIPUB. Telex: 8-0153. Pres.: Robert Schroeder. Gen. Mgr.: Roy Bulkin; Sales Mgr.: Moeller Louw. (Distributed by Gallo)
Label: (Owned) Rob Roy.
 Mashalasha, see Gallo.
 Masterpiece, see Gramophone.
 Mavuthela, see Gallo.
 Mellow Mood, see EMI Music for Pleasure.
 Minc, see CCP & Music Incorporated.
 Molelo, see EMI-Brigadiers.
 Moonlight, see Teal.
 Moonshine, see Trutone.
 More Music Hits, see EMI-Brigadiers.
 Motella, see Gallo.
 Mpumemelo, see David Gresham & Teal.
 Music for Pleasure, see EMI Music for Pleasure.
 Music Incorporated (Pty.) Ltd., PO Box 39950, Bramley, Johannesburg 2018. Tel: (011) 37-9446. Telex: 8-6246. Mng. Dir.: Hilton Rosenthal. (Distributed by CCP)
Labels: (Owned) Freeway, Hot Music, Minc, Sound Rays; **(licensed foreign)** WMOOT (USA).
 Music Machine, see Teal.
 N T U, see David Gresham.
 Nash, see EMI-Brigadiers.
 Nitty Gritty, see David Gresham & Teal.
 N'Kanyazi, see EMI-Brigadiers.
 Nonesuch, see WEA.
 Odeon, see EMI-Brigadiers.
 One-up, see EMI-Brigadiers.
 One Way, see Reveille.
 Oula, see EMI-Brigadiers.
 Oz, see EMI-Brigadiers.
 P G Super, see Gallo.
 Parlophone, see EMI-Brigadiers.
 Peace, see Revelation.
 Phonogram, see Trutone.

Plastik, see Teal.
 Platinum, see B&S.
 Plum, see Teal.
 Polydor, see Trutone.
 Portrait, see Gramophone.
 Pride, see WEA.
 Promise, see B&S.
 Purple, see EMI-Brigadiers.
 R P M Rec. Co. (Pty.) Ltd. (IFPI), RPM House, PO Box 2807, Zone: 2000, 62 Goud St., Johannesburg 2001. Tel: (11) 29-2583. Cable: PHONOSOUND. Telex: 8-0859. Exec. Chm.: Matt Mann; Mng. Dir.: Ivor Schlosberg; Sales Mgr.: Peter Cooke; Musical Dir.: Dan Hill.
Labels: (Owned) Cafe Society, Epidemic, Explosion, Fast Move, Hot Beat, Knockout, RPM, Shumba, Spotlight; **(licensed)** A&M (UK, USA), Ariola (worldwide), Arista (UK, USA), Bearsville (USA), DJM (UK, USA), Island (UK, USA), Magnet (UK), Motown (UK, USA), Savoy (USA).
 Int'l rep.s: Austria, Germany, Switzerland (all Teldec); Benelux (Ariola)
 R S A, see JoBurg.
 Rave, see Trutone.
 The Record Centre, E14 Old Mutual Centre, Exchange Place, Cape Town 8001. Tel: 43-5258. Mng. Dir.: Andrew McKenzie. (Distributor/Importer/Exporter)
 Red Label, see EMI-Brigadiers.
 Regal Zonophone, see EMI-Brigadiers.
 Reggae, see CCP.
 Rejoice, see B&S.
 Reprise, see WEA.
 Rev, see Reveille.
 Reveille Recs. (Pty.) Ltd., PO Box 261141, Johannesburg 2023. Tel: (011) 23-5276/1866. Mng. Dir.: Audrey Smith.
Labels: (Owned) Good as Gold, One Way, Rev, Reveille.
 Revelation Recs (Pty.) Ltd., PO Box 32414, Braamfontein, Johannesburg. Tel: (011) 724-0511. Pres.: Peter E. Morkel; Mng. Dir.: P. Gavin Morkel; A&R Mgr.: David R. Ornellas; Sales Mgr.: J. Woodrow.
Labels: (Owned) Jordan, Peace, Revelation, Sonskyn; **(licensed foreign)** David Ingles (USA); **(distributed-not licensed)** Roger McDuff (USA).
 Ring, see EMI-Brigadiers.
 Rob Roy, see Mariner.
 S D V, see EMI-Brigadiers.
 Safari, see EMI-Brigadiers.
 Shona Langa, see EMI-Brigadiers.
 Shumba, see RPM.
 Side Walk, see EMI-Brigadiers.
 Skyline, see EMI Music for Pleasure.
 Smanje Manje, see Gallo.
 Sonskyn, see Revelation.
 Soul Jazz, see Gallo.
 Soul Jazz Pop, see Gallo.
 Soul Soul, see Teal.
 Soul Train, see Gramophone.
 Sound Rays, see CCP & Music Incorporated.
 Sound of Soul, see JoBurg.
 Soweto, see JoBurg & WEA.
 Spes Bona, see CCP.
 Spinna, see EMI-Brigadiers.
 Spotlight, see RPM.
 Springboard, see Trutone.
 Starline, see EMI-Brigadiers.
 Stateside, see EMI-Brigadiers.
 Summit, see EMI-Brigadiers.
 The Sun, see Gallo.
 Sunshine Recs. (Pty.) Ltd., 480 Cork Ave., Ferndale, Randburg, 2194 Transvaal. Tel: (011) 793-2913. Cable: BREAKAWAY. Telex: 4-24841. Mng. Dir.: Grahame Beggs; Gen. Mgr.: Christine Beggs. (Distributed by EMI-Brigadiers)
Label: (Represented) Abba.
 Swinger, see EMI-Brigadiers.
 Symphonia Studios Pty Ltd., PO Box 656, Bedford View 2008. Tel: 53-4225. Telex: 8-3260. Mng. Dir.: H. M. Zacek.
Label: (Licensed foreign) Sheffield (USA).
 Teal Rec. Co. Ltd. (IFPI), PO Box 4105, Johannesburg 2000. Tel: (011) 28-2400. Cable: TEALREC. Telex: 8-0312. Chm.: A. G. J. McGrath; Mng. Dir.: P. Gallo; Sales Mgr.: I. Nathan; Promo. Mgr.: A. Marshall; Prod'n Mgr.: H.R. Friedman.
Labels: (Owned) Church, City Special, Go Go, Hit Special, Ingagasi, Kalahari; **Magik of Music, Maphuta, Moonlight, Music Machine, Plastik, Plum, Soul Soul; (licensed domestic)** Ipi Tombi, **(licensed)** Attic (USA), Awendo Rakedo (Kenya), Barclay (UK), Boardwalk (USA), Durium (Italy), Fantasy (USA), Golden Hour (UK), Koth Kirombi (Kenya), Kung Fu (Kenya), Milestone (USA), PRT (UK), Prestige (USA), RCA (USA), Rialto (UK), Stax (USA), Sugar Hill (USA), Vogue (France); **(distributed-not licensed)** Buffalo, Mpumemelo, Nitty Gritty.
 Int'l rep.: USA (Arrow, Edelstein, Gross & Margolis).
 Third Ear, see WEA.
 Thokoza, see B&S.
 Tiger, see EMI-Brigadiers.
 Transistor, see CCP.
 Trutone Music (IFPI), PO Box 9299, Zone: 2000, 132 Kerk St., 5th fl., Johannesburg 2001. Tel: (11) 29-7149. Telex: 8-0312. Mng. Dir.: Bruce Mackenzie; Nat'l Sales Mgr.: Geoff Furniss; Polydor Div. Mgr.: Bill Prout-Jones; Phonogram Div. Mgr.: Val Bryant; Classical Mgr.: Wilhe Bredenhahn; Local Exec. Prod'r: Emil Zoghby.
Labels: (Owned) Rave, Trutone; **(licensed)** Archiv (Germany), Caedmon (USA), Casablanca (USA), Charisma (UK), OG (Germany), ORG (USA), ECM (Germany), EG (UK), Fontana (Netherlands), Heliodor (Germany), Inner City (USA), Karussell (Germany), MGM (USA), MMO (USA), MPS (Germany), Mercury (USA), Pablo (USA), Philips (Netherlands), Polydor (Germany), Prelude (USA), Privilege (Germany), RSD (UK), Rocket (UK), Spoken Arts (USA), Spring (USA), Turnabout (UK), Vertigo (UK), Verve (USA, Japan), Vox (USA); **(distributed-not licensed)** Deophon, Fen City, Moonshine, Springboard.
 Int'l rep.s: Worldwide (Phonogram & Polydor).
 The Turntable (Pty.) Ltd. (IFPI), PO Box 4645, Upper OK Mall, Carlton Centre, Johannesburg 2001. Tel: (11) 21-1471. Telex: 4-24688. Mng. Dir.: Kenneth Marks; Gen. Mgr.: Sol Marks; Sales Mgr.: Ingrid Saeke. (Distributor/Importer)
 Z Good, see EMI-Brigadiers.
 Umsakazo, see EMI-Brigadiers.
 United/Liberty, see EMI-Brigadiers.
 W E A Int'l, see WEA Recs.
 W E A Recs. (Pty.) Ltd. (IFPI), PO Box 17356, Hillbrow 2038; 20 Ridge Rd., Parktown, Johannesburg 2193. Tel: (011) 643-3141. Cable: WEAR. ECORSA Telex: 4-24139. Mng. Dir.: Derek Hannan; Financial Dir.: Michael Oldfield.

Home office: USA, WEA Int'l.
Labels: (Owned) Amahubu, Asylum, Atco, Atlantic, Beat City, Chocolate City, Cotillon, Elektra, Highway Soul, Ingwenya, Nonesuch, Pride, Reprise, WEA Int'l, Warner Bros. **(licensed foreign)** Beggars Banquet (UK), Dark Horse (USA), Lightning (UK), Logo (UK), Luapula (Zambia), Oyeoyo Ring (Kenya), Planet (USA), Radar (UK), Riva (UK), Shungu (Zimbabwe), Sire (USA), Swan Song (USA), **(distributed-not licensed)** Grace, JoBurg, Soweto, Stanyan (USA), Third Ear.
 Warner Bros., see WEA
 Word of Life Whistle, PO Box 698, Florida 1710. Tel: (011) 672-1192. Chief Exec.: R. B. Beeson; Gen. Mgr.: Miss C. Christopherson.
Label: (Represented) Singcord (USA).
 Yashingoma, see CCP.
 Zimbabwe, see CCP.
 Ziyaluma, see Gallo.
 Zobo, see Gallo.
 Zodiac, see EMI-Brigadiers.

• **music publishers**

A G Music, see Clan.
 Acuff-Rose SA (Pty.) Ltd., Silvern Centre, 3rd fl., Nugget & Market Sts., Johannesburg 2001. Tel: (11) 23-5276, 23-1866. Chief Exec.: Audrey Smith.
 Int'l firms represented: Milene, Fred Rose (both USA); Acuff-Rose group (worldwide).
 Angela Music Publ'g Co. (Pty.) Ltd., 4 Goudvis Rd., Melrose N., Johannesburg 2196. Tel: (11) 788-6094. Telex: 4-25063. Mng. Dir.: Terry Dempsey; Gen. Mgr. Carrie Dempsey.
 Int'l firm represented: Sesame Songs (UK).
 Int'l rep.s: Benelux (Nada), Germany (Roba), Japan (Watanabe), Scandinavia (Sweden).
 Breakaway Music Co. (Pty.) Ltd., 480 Cork Ave., Ferndale, Randburg, 2194 Transvaal. Tel: (011) 793-2913. Cable: BREAKAWAY. Telex: 4-24841. Mng. Dir.: Grahame M. Beggs; Gen. Mgr.: Jenni Harris.
 Int'l firm represented: Polar (Sweden).
 Buffalo, see Gallo.
 Carstens de Waal Music (Pty.) Ltd., see Gallo.
 Cherry Lane Music Co. (Pty.) Ltd., PO Box 379, 239 Afeskor Bldg., 32 Third Ave., Wynberg Sandton, Bergvlei 2012. Gen. Mgr.: Anton Alberts.
Home office: USA.
 City Limits Music, see Minc.
 Clan Music Publ'g Co. (Pty.) Ltd., PO Box 2807, Zone: 2000; 62 Goud St., Johannesburg 2001. Tel: (11) 29-2583. Cable: PHONOSOUND. Telex: 8-0859. Chm. & Mng. Dir.: Matt Mann; Gen. Mgr.: Robbie Kallenbach.
 Int'l firms represented: Leo Feist (USA), Hastings (USA), Interworld (USA), Dick James (UK), Magnet (UK), Miller (USA), Robbins (USA), Shelby Singleton (USA), Sparta Florida (UK), United Artists (USA).
 Int'l rep.: UK (RPM/Blue Chip).
 Contagious Music (Pty.) Ltd., see Clan.
 Copyright Serv. Bureau SA (Pty.) Ltd., 16 Edward St., Regents Park, Johannesburg 2197. Tel: (11) 26-9112. Mng. Dir.: Martin Ettin, Ernest Schroeder; Gen. Mgr.: Estelle Vaughn, Prof. Mgr.: Buddy Vaughn.
 Int'l firm represented: Copyright Serv. Bureau (USA).
 Int'l rep.: USA (Copyright Serv. Bureau).
 Deophon (Pty.) Ltd., see Reveille.
 E M I-Brigadiers Music (Pty.) Ltd. (SAMRO), 32 Steele St., Steeledale, Johannesburg 2197. Tel: (11) 613-2011. Cable: ABEEMUSIC. Telex: 87409. Mng. Dir.s: A. Venter, Clive Kelly; Gen. Mgr.: Andre Viljoen; Prof. Mgr.: Joe Nofal.
 Int'l firms represented: Bay City (UK), Big Secret (UK), Bob The Dog (UK), Capitol Prod'n (USA), Chibell (UK), Crusty (UK), Dynamic Cat (UK), Gold Hill (USA), Grade One (UK), Hollingfield (UK), Jarak (USA), Lynnal (UK), Martin-Coulter (UK), Mews (UK), Mother Goose (UK), Nisbet & Beck (UK), Our (UK), Porter (USA), Red Bus (UK), Song Yard (USA), Stephen Stills (USA), Velvet Apple (USA), W & N (USA).
 Int'l rep.: Worldwide (EMI).
 E M I Music Publ'g (South Africa) (Pty.) Ltd. (SAMRO), 32 Steele St., Steeledale, Johannesburg 2197. Tel: (11) 613-2011. Cable: ABEEMUSIC. Telex: 87409. Mng. Dir.: Clive Kelly; Gen. Mgr.: Andre Viljoen, Prof. Mgr.: Joe Nofal.
 Int'l firms represented: Ambleside (UK), Ardmore & Beechwood (UK), Berry (UK), Black Swan (UK), Colgems-EMI (USA), Combine (UK), Cross Keys (USA), Dix (UK), Donna (UK), EMI Film & Theatre (UK), EMI Music (UK), B. Feldman (UK), First Floor (UK), Sam Fox (UK), Francis Oay & Hunter (UK), Garnett (UK), Hermusic, RPM (UK), Kennedy Street (UK), Manchester (UK), Marlboro (UK), Peter Maurice (UK), Moss Rose (UK), Mutual (UK), Keith Prowse (UK), Roar (UK), Screen Gems (UK, USA), Tree (USA), Tribune (UK), Varda (UK), World Copyrights (UK).
 Int'l rep.: Worldwide (EMI).
 Essex Music Group (Pty.) Ltd., PO Box 6857, Johannesburg. Tel: (11) 643-5415. Cable: SEXMUS. Mng. Dir.: Kevin J. O'Hara.
 Flying Outchman (Pty.) Ltd., see Clan.
 G R P C, see Gallo.



**Southern Music Publishing Co.
 (South Africa) Pty. Ltd.
 Johannesburg,
 Republic of South Africa**

Gallo Music (Music Publ'g Co. of Africa Pty. Ltd.) (SAMRO), PO Box 6216, 130 Kerk St., Johannesburg 2000. Tel: (11) 24-2400. Cable: MUSIPUB. Telex: 8-0153. Mng. Dir.: Peter Gallo; Gen. Mgr.: John Edmond.
Int'l firms represented: Acker (USA), Anissa, April, Arista/Career (USA), Arwyn, Bleung, Braintree (USA), Brew (USA), Brownnut, Claritz (USA), Cherry Lane, Chinnichap (UK), Chrysalis group (UK), Cladale, Compass (USA), Cookhouse group, Cram Renfart, Walt Disney (USA), Eaton (UK), John Farrar, Fools Gold, Geffen, Golden Withers, Heart group, Jaspersilla (USA), Jim Ed (USA), Jump, KPM, Lad: Jane (USA), Heath Levy (UK), Ledacian, Lennon, Lions Head, Little Dickens (USA), Louvigny-Marque (UK), McCartney (UK), Marksmen (UK), Masculine, Megabyte, Moonlight & Magnolias, Murray Deutch group (USA), Pennine Songs, Planetary Nom, Poco, Porchester, RAK (UK), Rondor (USA), Cyril Shane (UK), Larry Shane, Shelter, Shilelagh (USA), Skyhill (USA), Sleepy Dimpling (UK), Steinberg, Sunbury (UK), Turbleweed (Australia), 20th Century (USA), Welk group (USA).

Gold, see Gallo.
 Goldrush Music, see Angela.
 Head's Music (Pty.) Ltd., see Reveille.
 Impala Music Co., see Gallo.
 Intersong (Pty.) Ltd., PO Box 10678, 130 Kerk St., Johannesburg 2000. Tel: (11) 37-6480. Cable: BELINDSONG. Telex: 8-4153. Dir.: B. Mackenzie; Gen. Mgr.: Art Heathie; Prof. Mgr.: N. Edward.
Int'l firms represented: Abigail (Australia), CAM (USA), Chappell (worldwide), Hill & Range (USA), Intersong group: (worldwide), Kamikaze (USA), Penjane (Australia), RSO (UK, USA), Saggiere (USA).
Int'l reps: Worldwide (Chappell, Intersong).

Joburg Recs. & Music Publ'g (Pty.) Ltd. (SAMRO), PO Box 93005, Yeoville, 2198 Johannesburg. Tel: (011) 41-3727. Mng. Dir.: Stan Cohen.
 Jonathan Music (South Africa) (Pty.) Ltd., PO Box 6857, Johannesburg. Tel: (11) 643-5415. Cable: SEXMUS. Chm.: Barry Kimberley; Mng. Dir.: Kevin O'Hara; Dir.: Vicky Bentick-Kimberley.
Int'l firms represented: Agent Orange, DeShuffin, Filmways, Modest, Musicways, Paul Simon, Bruce Springsteen, Sun Disc, TZ, Tannen, Turkey, Wayward (all USA).
 Jordan Music (Southern Africa) (SAMRO), PO Box 32414, Braamfontein, Johannesburg. Tel: (011) 724-0511. Pres.: Pete E. Morkel; Mng. Dir.: P. Gavin Morkel. Gen. Mgr.: Dave Ornellas, Prof. Mgr.: J. Woodrow.
 Juluka Music, see Minc.

Laetec Music Ltd., PO Box 6216, Zone: 2000; njallo Centre, 2nd fl., 130 Kerk St., Johannesburg 2001. Tel: (11) 28-2400. Dir.: Peter Gallo; Gen. Mgr.: John Edmond.
Int'l firms represented: Blue Ribbon/Tristar group (UK), Blue Seas (USA), Casa David (USA), C'est (USA), Gopam (USA), House of God (USA), Hungry Mountain (USA), Jac (USA), Kiss (USA), Lambert & Potter (USA), Morning (Canada, USA), Natural Songs (USA), Pattern (UK), Quackenbush (USA).
Int'l reps: Worldwide (Arrow, Edelstein, Gross & Margolis) except Australia (Associated), Canada (Morning).

Leeds Music (Africa) (Pty.) Ltd., PO Box 6216, Gallo Centre, Kerk & Goud Sts., Johannesburg 2000. Tel: (11) 28-2400. Cable: LEEDSMUSIK. Telex: 8-0153. Gen. Mgr.: Peter Lotts.
Int'l firms represented: ABC-Dunhill (USA), ATV (UK), American Broadcasting (USA), Four Knights (UK), Graduate (UK), Tony Hillier (UK), Leeds (UK), MAM (UK), MCA (USA), Northern Songs (UK), Lawrence Wright (UK).

Lunhill, see Gallo.
 Little Monster Music (Pty.) Ltd. (SAMRO), PO Box 626, Johannesburg 2001. Tel: (011) 21-5029, 21-5041. Cable: DAVEGRSH. Telex: 8-3645. Mng. Dir.: Dennis East, David Gresham, Gen. Mgr.: Dennis East, Prof. Mgr.: Pat Challis.
Int'l firms represented: Betsize (UK), Black Sheep (UK), Goldfresh (USA), Red Bus (UK), State (UK).
Int'l rep.: USA (Goldfresh).

Mamba Music (SAMRO), see Little Monster.
 Mavuthela, see Gallo.
 Melin Music (Pty.) Ltd., PO Box 11254, Zone: 2000; 32 Steele St., Steeledale, Johannesburg 2001. Tel: (011) 613-2911. Cable: ABEEMUSIC. Telex: 87409. Dir.: B. Papert; Gen. Mgr.: Andre Viljoen; Prof. Mgr.: Joe Nofal.
Int'l firms represented: Robert Mellin, Sherwin (both UK).

Meloding, see Gallo.
 Melody Music (Pty.) Ltd., see Gallo.
 Merritone, see Gallo.
 Minc Music, PO Box 39950, Bramley, Johannesburg 2018. Tel: (011) 37-9446. Telex: 8-6246. Mng. Dir.: Hilton Rosenthal.
 Ivan Moguil Music (South Africa) (Pty.) Ltd., PO Box 6857, Johannesburg. Tel: (11) 643-5415. Cable: SEXMUS. Mng. Dir.: Kevin J. O'Hara.

Musciprec Publ'rs (Pty.) Ltd. (NORM, SAMRO), P3 Box 11254, Zone: 2000; 32 Steele St., Steeledale, Johannesburg 2197. Tel: (11) 613-2011. Cable: SOUNDBOX. Telex: 8-7409. Mng. Dir.: Clive Calder; Gen. Mgr.: Andre Viljoen; Prof. Mgr.: Joe Nofal.
Int'l firms represented: J. Albert (Australia), Blackhill (UK), Black Scorpio (France), Boomtown Rats (Switzerland), Cam-AI (USA), City Boy (UK), GH (UK), Grade & Lynton (USA), Lerca (France), Lucky Three (USA), Macaulay (UK), Mushroom (Australia), Joel Gay (UK), Riva (UK), Salsoul (USA), Scorpio (France), Street (UK).
Int'l reps: Switzerland, UK (both Zomba).

Peer Southern Org., see Southern Music.
 David Platz Music (South Africa) (Pty.) Ltd., PO Box 6857, Johannesburg. Tel: (11) 643-5415. Cable: SEXMUS. Dir.: David & Paul Platz, Kevin O'Hara.
 Plymouth Music (Pty.) Ltd. (SAMRO), PO Box 11254, Zone: 2000; 32 Steele St., Steeledale, Johannesburg 2001. Tel: (011) 613-2011. Cable: ABEEMUSIC. Telex: 87409. Dir.: B. Papert; Gen. Mgr.: Andre Viljoen; Prof. Mgr.: Joe Nofal.

Int'l firms represented: Allegro Holdings (UK), Campbell Connelly (UK), Chackfield (UK), Eros (UK), Intersound (Germany), Lemmel (UK), Andre Luterau (France), Manette (UK), Mason (UK), Medway (UK), Rimusic (UK), Senlak (UK), Sheila (USA), Sonoton (Germany), Tonarch (Germany).

Reveille Music (Pty.) Ltd., PO Box 261141, Johannesburg 2023. Tel: (011) 23-5276/1866. Mng. Dir.: Audrey Smith, Gen. Mgr.: Leslie Madinga; Prof. Mgr.: Laura Bernstein.
Int'l firms represented: ATV (USA), Big Sky (USA), Birdees, Blue Band (Canada), Blue Echo (Canada), Blue Melody (Canada), Blue Street, Blythwood, Brothers Three, Brougham-Hall (USA), Buckhorn (USA), Bullpen (USA), Butter Churn, Combina group (USA), Comet (USA), Cream, Dark Cloud, Deerwood, Dwarf, Early Morning, East Memphis, Easy Money (USA), Equinox (USA), First Generation, Greenwich, Iza, Lady Casey (USA), Mandina (USA), Meredith (USA), Mijac, Moccasin, Muscle, Music City, Perren-Vibes (USA), Pop 'N' Roll, Ram's Horn (USA), Ranjack, Rat Trap, Resaca (USA), Return (USA), Rocksmith (USA), Box Scaggs, Siggy, Silver Soul, Southern Nights, Special Rider (USA), Sweco (USA), Sweet

Summer Night, Tennessee Swamp Fox, Tuff, Venice, Vibritmar, War Drum (USA), Welbeck, Wimot, Youngun.

Roon Antelope Music, see Gallo.
 Robroy Music, PO Box 28530, Sunnyside, Pretoria 0132. Tel: (012) 44-1558. Cable: MUSIPUB. Telex: 8-0153. Pres.: Roy Bulkin; Gen. Mgr.: Robert Schroeder; Prof. Mgr.: Moeller Louw.

Int'l rep.: UK (Zomba).
 Silversongs (Pty.) Ltd., see Clan.
 Snider Kruike, see Southern Music.
 Southern Music Publ'g Co. (SA) (Pty.) Ltd., 62 St. Patrick's Rd., Houghton, Johannesburg 2198. Tel: 648-5404. Cable: SOUTHMUSIC. Dir.: Glyn Taylor.

Home office: USA, Peer-Southern Org.
Firms represented: Edward Kassner (UK), Snider Kruike.
 Southern Sky Music (Pty.) Ltd., see Clan.
 Tiba Music, see Minc.
 Tradeilus & Co., PO Box 3159, Durban 4000. Tel: (031) 69137. Cable: AC-CORDIO. Telex: 6-0389. Pres.: H. Tradeilus; Int'l Div. Dir.: E. Rasch; Prof. Mgr.: Ronald Chetty.

Int'l firms represented: Alfred (USA), Chappell (UK, USA), Hal Leonard (USA), Melbay (USA), Music Sales (UK).

Valentine Music (SA), see Reveille.
 Warner Bros. Music (South Africa) (Pty.) Ltd., PO Box 6857, Johannesburg. Tel: (11) 643-5415. Cable: SEXMUS. Dir.: Kevin J. O'Hara, Derek Hannan, Ed Silvers, Leonard Golove.

Int'l firms represented: Blendingwell, Briarpatch, Bug, Candlewyck, Marty Cooper, Crabshaw, Dawnbreaker, Dabbada, Delcini, Diana, Durango, Ecnirp, Emanuel, Evansongs, Floodlede, Fourth Floor, Frozen Butterly, Gnossos, Jasmine, Kidada, Le Bone Aire, Malaco, Mel Bren, Milk Money, Naked Snake, Olde Grog, Purple Bull, Roaring Fork, Shoe songs, Shoetunes, Somerset, State of the Arts, Twist Party, Victorious Circle, Warner Bros., Warnes, Yellow Brick Road, Zevon (all USA); Neon, Plant-gent Visions, Virgin (all UK).

Int'l reps: Australia, Brazil, Germany, Italy, Netherlands, Sweden, UK, USA (all Warner Bros.); France (PECF).

Yackamo Music (SAMRO), PO Box 626, Johannesburg 2000. Tel: (011) 21-5029/5041. Cable: DAVEGRESH. Telex: 8-3645. Chm. & Mng. Dir.: David Gresham; Dir.: Allan Goldswain, T.J. Masingi.
Int'l rep.: USA (Goldfresh).

• sheet jobber / supplier

Tradeilus & Co., PO Box 3159, Durban 4000. Tel: (031) 69137. Cable: AC-CORDIO. Telex: 60389. Pres.: H. Tradeilus; Int'l Div. Dir.: E. Rasch.

• services

ASSOCIATIONS & PROFESSIONAL ORGANIZATIONS

Association of the Southern African Phonographic Ind. (ASAPI), PO Box 5411, Johannesburg. Tel: (11) 613-2011. Sec'y-Treas.: W.F. Fraser.
 Southern African Record & Tape Oists. Ass'n, PO Box 8213, Johannesburg 2000. Tel: (11) 613-2011. Telex: 87409. Chm. C.R. Kelly, Sec'y-Treas. W.F. Fraser.

LICENSING ORGANIZATIONS, MUSIC

D A L R O (Dramatic, Artistic & Literary Rights Org. Pty. Ltd.), PO Box 9292, Johannesburg 2000; SAMRO House, DeBeer & Juta Sts., Braamfontein 2001. Tel: 725-2580. Cable: LITTERA. Mng. Dir.: Gideon Roos. (Performing, recording & reprographic rights for literary, dramatic & artistic works).

N O R M (National Org. for Reproduction Rights in Music in Southern Africa Ltd.), PO Box 4378, Zone: 2000; 1017 Bosman Bldg., 99 Eloff St., Johannesburg 2001. Tel: (011) 29-0627. Chm.: George Hardie; Sec'y: Kathleen Webb. (Mechanical rights only).

S A M R O (Southern African Music Rights Org. Ltd.), PO Box 9292, Johannesburg 2000; SAMRO House, De Beer & Juta Sts., Braamfontein 2001. Tel: 725-2580. Cable: ACISUM. Mng. Dir.: Gideon Roos. (Performing rights only).

S A R R A L (South African Rec'g Rights Ass'n Ltd.), PO Box 4378, Zone: 2000; 1017 Bosman Bldg., 99 Eloff St., Johannesburg. Tel: (11) 29-0627. Cable: MCRIGHTS. Mng. Dir.: G.R. Hardie. (Mechanical rights only).

PLATING, PROCESSING & PRESSING PLANTS

E M I Inds. (South Africa) Pty. Ltd., 32 Steele St., Steeledale, Johannesburg 2197. Tel: (11) 613-2011. Cable: SOUNDBOX. Telex: 87406. Factory Div. Dir. & Gen. Mgr.: E. Cumings.

Gallo (Africa) Ltd., PO Box 6216, Gallo Centre, Kerk & Goud Sts., Johannesburg 2000. Tel: (11) 28-2400. Cable: GALLOTONE. Dir.: Peter Gallo. (Pressing only).

PRINTERS & LITHOGRAPHERS

E M I Inds. (South Africa) Pty. Ltd., 32 Steele St., Steeledale, Johannesburg 2197. Tel: (11) 613-2011. Cable: SOUNDBOX. Telex: 87406. Factory Div. Dir. & Gen. Mgr.: E. Cumings.

Interpak (Pty.) Ltd., PO Box 8009, 34 Barbara Rd., Elandsfontein, Transvaal 1406. Tel: (011) 58-8900. Cable: INPAKOR. Rec. Pac. Mgr.: J.N. Berz.

RECORD PROMOTION

The Turntable (Pty.) Ltd., PO Box 4645, Upper OK Mall, Carlton Centre, Johannesburg 2001. Tel: (11) 21-1471. Telex: 4-24688. Mng. Dir.: Kenneth Marks; Gen. Mgr.: Sol Marks; Sales Mgr.: Ingrid Saeke.

TAPE CUSTOM DUPLICATORS

E M I Inds. (South Africa) Pty. Ltd., 32 Steele St., Steeledale, Johannesburg 2197. Tel: (11) 613-2011. Cable: SOUNDBOX. Telex: 87406. Factory Div. Dir. & Gen. Mgr.: E. Cumings.

Gallo (Africa) Ltd., PO Box 6216, Gallo Centre, Kerk & Goud Sts., Johannesburg 2000. Tel: (11) 28-2400. Cable: GALLOTONE. Dir.: Peter Gallo.

Audio: 8-tr., cassette.
 Magnetic Duplicating Servs., PO Box 302, Somerset West 7130. Tel: (024) 36338. Chief Exec.: Geoff Carman.

Audio: Cassette.
 Trutone Music, PO Box 9299, Johannesburg 2000. Tel: (11) 29-7149. Telex: 8-0312. Mng. Dir.: Bruce Mackenzie.

• supplies

CARTRIDGE & CASSETTE PARTS

Magnetic Duplicating Servs., PO Box 302, Somerset West 7130. Tel: (024) 36338. Chief Exec.: Geoff Carman.

Audio: Cassette pulleys, hubs, cushion foils.
 Trutone Music, PO Box 9299, Johannesburg 2000. Tel: (11) 29-7149. Telex: 8-0312. Mng. Dir.: Bruce Mackenzie.

Audio: Cassette boxes, lids & halves.
EMPTY CARTRIDGES, CASSETTES & REELS
 Magnetic Duplicating Servs., PO Box 302, Somerset West 7130. Tel: (024)

36338. Chief Exec.: Geoff Carman.

Audio: Cassette.

Trutone Music, PO Box 9299, Johannesburg 2000. Tel: (11) 29-7149. Telex: 8-0312. Mng. Dir.: Bruce Mackenzie.

Audio: Cassette.

JACKETS & SLEEVES

LABELS, DISK

Interpak (Pty.) Ltd., PO Box 8009, 34 Barbara Rd., Elandsfontein, Transvaal 1406. Tel: (011) 58-8900. Cable: INPAKOR. Rec. Pac. Mgr.: J.N. Berz. (45. LP)

The Turntable (Pty.) Ltd., PO Box 4645, Upper OK Mall, Carlton Centre, Johannesburg 2001. Tel: (11) 21-1471. Telex: 4-24688. Mng. Dir.: Kenneth Marks; Gen. Mgr.: Sol Marks; Sales Mgr.: Ingrid Saeke. (Distributor/Importer—Labels)

POLYETHYLENE BAGS & SHRINKWRAP

RAW MATERIALS

RECORD MANUFACTURING EQUIPMENT

The Turntable (Pty.) Ltd., PO Box 4645, Upper OK Mall, Carlton Centre, Johannesburg 2001. Tel: (11) 21-1471. Telex: 4-24688. Mng. Dir.: Kenneth Marks; Gen. Mgr.: Sol Marks; Sales Mgr.: Ingrid Saeke. (Distributor/Importer)

PROFESSIONAL TAPE SUPPLIES

Interpak (Pty.) Ltd., PO Box 8009, 34 Barbara Rd., Elandsfontein, Transvaal 1406. Tel: (011) 58-8900. Cable: INPAKOR. Rec. Pac. Mgr.: J.N. Berz. (Distributor/Importer)
Audio: Cassette labels.

TAPE, BLANK LOADED & BULK RAW

Agfa-Photo (Pty.) Ltd., PO Box 1366, Johannesburg 2000; Wrench Rd., Isando. Tel: 36-2811. Cable: MATAAOR. Telex: 8-7936, 8-8558, 8-6406. (Blank only)

Audio: 2", 1", cassette, open reel.
Video: ½" Beta & VHS cassette.

B A S F South Africa (Pty.) Ltd., 68 Fifth St., Johannesburg 2001. Tel: (011) 673-5311. Cable: BASASF. Telex: 80304. Sales Mgr.: Mr. Mueller.

Audio: 2", 1", cassette, open reel.
Video: 1" open reel, ¾" cassette, ½" Beta & VHS cassette

Intermagics Transkei Pty. Ltd., PO Box 959, Vuwinda Heights, Umtata 5100, Transkei. Contact: Frank G. Goodchild.
 Magnetic Duplicating Servs., PO Box 302, Somerset West 7130. Tel: (024) 36338. Chief Exec.: Geoff Carman.

Audio: Cassette.
Brand name: Fun Time Int'l.

• accessories

Agfa-Photo (Pty.) Ltd., PO Box 1366, Johannesburg 2000; Wrench Rd., Isando. Tel: 36-2811. Cable: MATAAOR. Telex: 8-7936, 8-8558, 8-6406.

Product: Tape-head cleaners, leader & splicing tape.
 Symphonia Studios Pty. Ltd., PO Box 656, Bedford View 2008. Tel: 53-4225. Telex: 8-3250. Mng. Dir.: H.M. Zacek.

Product: Record—record care products, turntable mats.
 The Turntable (Pty.) Ltd., PO Box 4645, Upper OK Mall, Carlton Centre, Johannesburg 2001. Tel: (11) 21-1471. Telex: 4-24688. Mng. Dir.: Kenneth Marks; Gen. Mgr.: Sol Marks; Sales Mgr.: Ingrid Saeke. (Distributor/Importer)

Product: Record—carrying & storage cases, record care products, turntable mats, 45 RPM adaptors, replacement stylus, tape—carrying & storage cases, head cleaners, bulk erasers, demagnetizers, leader & splicing tape.

• store fixtures

The Turntable (Pty.) Ltd., PO Box 4645, Upper OK Mall, Carlton Centre, Johannesburg 2001. Tel: (11) 21-1471. Telex: 4-24688. Mng. Dir.: Kenneth Marks; Gen. Mgr.: Sol Marks; Sales Mgr.: Ingrid Saeke.

Product: Record & tape browser boxes, display racks, divider cards, security systems.

SPAIN

Population: 37,800,000

Rate of exchange: \$1 (US) = 95 pesetas

Per capita income: \$3,800.

Holidays: January 1 (Circumcision of the Lord), January 6 (Epiphany), May 1 (Labor Day), June 24 (St. John's Day), July 25 (St. James Day), August 15 (Assumption), October 12 (Columbus Day), November 1 (All Saints' Day), December 8 (Immaculate Conception), December 25 (Christmas), other Christian holidays.

RECORDS:

Record sales certification awards: Gold single—75,000 units. Gold LP—50,000 units, platinum LP—150,000 units

Records sold domestically including imports (retail value): LP's 1979—15,000,000 units, \$110,000,000. Singles 1979—7,000,000 units, \$12,500,000.

Average retail price per record: LP's—\$3.57 \$9.28. singles—\$1.43 \$2.50. **Record club sales:** 9% of total

Discounting: Rare

Type of distribution: Manufacturer to-wholesaler to retailer (20%) manufacturer to-retailer (73%), rack jobbing (5%), mail (2%)

Type of promotion: Promotion is made through the press (3%), radio (59%), television (30%), discotheques (7%), other (1%)

Jukeboxes: 17,000

TAPE:

Pre-recorded tape sold domestically including imports (retail value): 8-tr 1979—200,000 units, \$1,142,857. Cassette 1979—23,000,000 units, \$164,285,714

Average retail price per tape: 8-tr \$5.70. cassette—\$7.14

CONSUMER ELECTRONICS

Number of homes with: Phonographs—3,200,000 (32%), audio tape recorders—5,700,000 (58%), video tape recorders—40,000 (.4%)

RADIO STATIONS:

No. of commercial 338, no. of government 63, no. of AM 181, no. of FM 220
Comment: Programming is broken down into music (40%), news (20%), amusing (20%), cultural (12%), publicity (8%)
Music programming is further broken down into: pop (75%), folk and flamenco (18%), classical (6%) and jazz (1%), with 97% recorded and 3% live

TELEVISION STATIONS:

No of channels 2

Comment: Programming is broken down into films and telefilms (40%), news (20%), amusing (10%), cultural (10%), sports (10%), children's (6%), music (4%).

IMPORT/EXPORT REGULATIONS:

Record and tape exportation is free. Record importation is free but import rights represent a 55% increase over the retail price in the country of origin. Fernando Salaverri

• record & tape manufacturers / distributors / Importers

A S C E, see Movieplay.

Afrodita, Pantor Murillo 31, Alicante.

Alba, see Edigsa.

Alid, Tres Senoras 1-5, Barcelona 21.

Alhambra, see Columbia.

Als 4 Vents, see Apolo & Edigsa

Amalgama, see EMI-Odeon.

Apolo Recs., Mascaro 23, Barcelona 32. Tel: (91) 236-6169. Chief Exec.

Angel Fabregues Moria.

Labels: Als 4 Vents, Orips, Tandem, Tauro.

Archiv, see Polydor.

Aries-Canary Recs., San Vicente Ferrer 73, Santa Cruz de Tenerife, Canary Islands. Tel: (922) 27-65-63. Gen. Mgr.: Jose Luis Gutierrez Solano; Int'l Mgr.: Jose Manuel Garcia Santos.

Ariola, see Ariola-Eurodisc.

Ariola Eurodisc SA (IFPI), Calle Aragcn 204, 4th fl., Barcelona 11. Tel: (93) 254-9805. Cable: HISPARIOLA. Telex: 52771. VP Ariola Int'l Group: Ramon Segura Martinez, Gen. Mgr.: Alberto Serra Pujol, Int'l Div.: Jose E. Luzzardo; Mktg. Div.: Carlos Sanmartin Gonzalez; Admin. Div.: Emilio Pere; Sales Mgr.: Camilo Muedra Fontanet

Branch: Madrid 10, General Martinez Compos 9, 1st fl. Tel: (91) 447-4026. Telex: 23537.

Labels: (Owned) Ariola, Eurodisc, Vergara; (licensed foreign) Arista (USA), Bronze (UK), Island (UK), MCA (USA), Manticore (UK), Mericana (USA), Microfon (Argentina), Ricordi (Italy), Shelter (USA), Tomato (USA), Virgin (UK).

Int'l repps.: Argentina (Microfon), Bolivia (Lauro), Central America (Odeca), Chile (Quatro), Colombia (Sonolux), Ecuador (Faisa), Mexico (Bertelsmann), Peru (FTA), Portugal (PolyGram), USA (Mericana), Venezuela (Cordica).

Ari, see EMI-Odeon.

Arte & Ciencia, Ygeneta 2, San Sebastian

Audiens, see CIMASA.

Audio mundo, see Portadores.

Audio & Video SA (IFPI), Vallehermoso 32, Madrid 15 Tel: (91) 448 0955

Gen. Mgr.: Fidel Perez Hernandez.

Labels: (Owned): Audio, Azar, Boa, Fase, Iris, Jack, Magnetic, Off. Spot.

Auditorium, see Phonic.

Auvil Ed. de Audio/Visuales SA (IFPI), Octor Carulla 31-33, Barcelona 17. Tel: (93) 212-7967. Telex: 51539. Gen. Mgr.: Alfonso R. Serra; Sales Mgr.: Antonio R. Ibanez; Int'l Dept.: Roberto Canto.

Labels: (Owned) Auvil, Loco, Neuronium; (licensed) Affinity (UK), Charly (UK), Dresse (France), Posh Boy (USA), R&B (UK), Rockhouse (Netherlands), (distributed-not licensed) ORG, Hansa (Germany), La La (France), Mouse (Belgium), Roudier (USA).

Int'l repps.: Argentina (American Rec'g), Colombia (Fuentes), Greece (General), Venezuela (Cordiscos).

Azar, see Audio & Video.

B & F Ent's, Jose Martinez Velasco E. Madrid 30. Tel: (91) 273-2467. Mng. Dir.: Mir. Platon, Export Div. Mgr.: Miguel Fernandez. (Importer/ Exporter)

Pablo Lopez Balada, Portugalete 5, Barcelona Tel: (93) 243-2579 Chief Exec.: Pablo Lopez Balada; Sales Mgr.: Mir. Rouras

Label: Palobal.

Barnafon, see Zafiro.

Bass-Orms, Pantor Mir 9, Bajos, Barcelona 31 Tel: (93) 357-4250/0646.

Pres. & Prod'r. Ramon Farran.

Labels: (Owned) Orms

Belpas SA, Apdo. 13, San Carlos, Ibiza. Tel: 33-03-45. Dir: Erik Schoenland.

Belter SA (Oscos) (IFPI), Calle Goms 1, Barcelona 23. Tel: (93) 211 5500

Cable: BELTEROISC. Telex: 51259 Mng. Dir: Francisco Roses; Sub Dir: Gen.: Gabriel Orfila; Int'l Div.: Antonio Figueiredo; Export Or: Ignacio Janer.

Branch: Madrid, Salut 17. Tel: (91) 231-61-69. Cable: BELOISC. Telex: 42065.

Int'l branch: Portugal.

Labels: (Owned) Belter, Impacto, Ocre, Olivo, Olympo, Sauce Int'l; (licensed) Midson (USA), Motown (USA), Salsoul (USA); (distributed-not licensed) Oacapo, Ensayo, Zamba.

Int'l repps.: Argentina (Microfon Tonodisc), Australia (Carinia), Bolivia (Lauro), Central America (Promidisco), Chile (EMI Odeon), Colombia (Oscomod), Dominican Republic (Alhambra), Ecuador (Coprodisa), Mexico (Musart), Peru (Quatro) Puerto Rico (Alhambra), Switzerland (Finsterwald & Cantacuzene), USA (Alhambra), Venezuela (Suramericana) (SEE ADVERTISEMENT)

Bibao Trading SA Import-Export, Marques del Puerto 9, Bibao 8. Tel: (94) 415-5255 Cable: VELLIOOMUSA Telex: 31351. Gen. Mgr.: Ramon A. Rodamians; Sales Mgr.: Jose A del Campo. (Distributor/Importer/ Exporter)

Label: (Distributed-not licensed) Music Minus One (USA)

Boa, see Audio & Video.

Bocaccio, see Compania Fonografica Espanola & Zafiro.

C A M Espana SA, Arturo Sona 157, Madrid 33. Tel: (91) 413-2837/29450

Cable: EOMUSICAM. Telex: 23955.

Branch: Barcelona 23, Padua 38, 1st & 2nd fls Tel: 211 2936. Telex 54483. Admin. Mgr.: Giuseppe Lull; Prod'r Mgr.: Fabrizio Oamiani.

C B SA (Oscos), Av. del Generalísimo 25, 9th fl., Madrid 16. Tel: (91) 455-3845/4026. Cable: COLRECORD Telex 22890 Gen. Mgr.: Tomas Munoz; Sales Mgr.: Roberto Navarro

Branch: Barcelona, Tuset 19-21, 2nd fl Tel: (93) 200-21-44.

Labels: (Owned) CBS; (licensed) CGO (Italy), Lifesong (USA), Tappan Zee (USA).

Int'l repps.: Worldwide (CBS Int'l).

C I M A S A (Compania Industrial de Materiales Acusticos SA), Vallehermoso 14, Madrid 15 Tel: (91) 448 22.00/ 04/08

Label: (Owned) Audiens

Cabra, see Edigsa.

Cala O'R, see Mailer

Camden, see RCA

Cancela Tape, see Zafiro.

Capitol, see EMI-Odeon.

Cardisc SA, Pte Garrofers 19-21, Bajos 4a, Barcelona 26. Tel: (93) 347-3766/3933. Gen. Mgr.: Carlos Gimenez Pertinez; Sales Mgr.: Luis Garcia Porras

Carrillon, see Edigsa.

Carnaby, see Columbia.

Casablanca, see Fonogram.

Caudal, see Zafiro.

Chapa, see Zafiro.

Chinchele, see Movieplay.

Circulo de Lectores (Club de Oiscos) SA, Valencia 344, Barcelona 9. Tel: (93) 258.76.00. Cable: CILEC. Dir.: Juan Maymo.

Labels: (Owned) Oriador, Pergola.

Clave, see Hispavox.

Clavel, see Portadores

Cofasa (Columbia Fonogram Asociadas SA) (IFPI), Av. de America & Hernandez de Tejada, Madrid 27. Tel: (91) 267-4200. Gen. Mgr.: Kees Ton.

Columbia SA (Oscos) (IFPI), Apdo. 2299, Av. de los Madrones 27, Parque Conde de Orgaz, Madrid 33. Tel: (91) 200-8040. Cable: OISCOLUMBIA. Telex: 44316. Pres.: Aurora Inurrieta; Mng. Dir.: Enrique Inurrieta; Gen. Mgr.: Enrique M. Garcia; Int'l Mgr.: Gerhard Haltermann; Mktg. Mgr.: Antonio Martinez; Financial Mgr.: Antonio Fernandez-Peinado; Export/Import Mgr.: Ramon Fernandez; Musical Dir.: Jose Luis Navarro; Promo. Dir.: Gabriel Gonzalez; Int'l Promo.: Vicente de Juan; Int'l Repertoire: Jose Manuel Gonzalez-Cuevas.

Branches: Barcelona 37, Geron 176. Tel: (93) 257-9007. Mgr.: Rafael Olive, Sales Mgr.: Manuel Cespedes; Promo.: Romy Felis; Classical Repertoire Mgr.: Juan Arnau.

Int'l branches: Las Palmas de Gran Canaria; USA, Alhambra.

Labels: (Owned) Alhambra, Carnaby, Columbia, Iberia; (distributed) Copacabana (Brazil), Jupiter (Germany), Magnet (UK), Melodiya (USSR), Pablo (USA), Polar (Sweden), Ricordi (Italy), Som (Brazil), Strih (UK), Telefunken (Germany), UIMP (France).

Int'l repps.: Argentina (Oscosa), Bolivia (Lauro), Brazil (Som Industria & Comercio), Chile (EMI), Colombia (Philips), Ecuador (Famoso), Mexico (Teldec), Greece (Music-Box, Minos Matsas), Japan (King), Mexico (Oscosa), Peru (Industrial Sonoradio), Portugal (Vadeca), Switzerland (Musikvertrieb), Turkey (Melodi), USA (Alhambra), USSR (Melodiya), Uruguay (Sondor), Venezuela (Grabaciones Mundiales).

Compania Fonografica Espanola (IFPI), Augusto Figueroa 39, Madrid 4. Tel: (91) 222-7474. Cable: MILOISC. Gen. Mgr.: Carlos Perez Alvaro; A&R Mgr.: Jose Manuel Yanes; Guimbarda Mgr.: Manuel Dominguez. (Distributed by Zafiro)

Labels: (Owned) Bocaccio, Explosion, Guimbarda, Jazz-Stop, Poplandia; (licensed foreign) Arfolk (France), Cezame (France), L'Escargot (France), Everest (USA), Flying Fish (USA), Hexagone (France), High Peak (UK), Keltia III (France), Logo (UK), MPS (Germany), Philo (USA), Plant Life (UK), Radial Choice (UK), Request (USA), Revolucion (France), Rounder (USA), Rubber (UK), Sonet (UK), Spolithe (UK), Temple (UK), Topic (UK), Transatlantic (UK), Ventador (France).

R Cuxart (Eds.), Montecasino 2, Barcelona 6. Tel: (93) 201-5899. Chief Exec.: Ramon Cuxart.

Labels: (Owned) Eda, Stereo 4a Dimension; (licensed) 12

Int'l repps.: Germany (Stereo Tape), UK (Coombe).

O G G, see Polydor.

O I S C A N, Canalejas 61-1 Izqd., Las Palmas, Canary Islands Tel: (928) 36-7558. Chief Exec.: Jose Luis Gomez de Luis

Oacapo, see Belter.

Oceca, see Fonogram.

Oada, see Oial.

Oial Oscos SA, Po. De La Castellana 247, Madrid 16. Tel: (91) 733-5243.

Cable: OIALOISCOS. Gen. Mgr.: Laurentino Ramos. Sales Mgr.: Carlos Fernandez; Int'l Mgr.: Inma Ruiz.

Labels: (Owned) Oada, Oiamante, Oiapason, Limoeiro, Nevada, (licensed) A-S (USA), Ansonia (USA), Audiomasters (USA), BBC (UK), Circle Line (Argentina), Everest (USA), Folkways (USA), Garzon (France), Gruner & Jahr (Germany), Guitarra (Mexico), Intercord (Germany), Koala (USA), E. Musicall Video (Italy), Opus (Czechoslovakia), Orion (USA), San Juan group (USA), Tapeacar (Brazil), Top Tape (Brazil), Vee Jay Int'l (USA)

Int'l repps.: Argentina (Circle Line), Brazil (Tapeacar, Top Tape), Bolivia (Oscolandia), Chile (Sonidos), Colombia (FM), Ecuador (Ecusson), Luxembourg (Geopress Int'l), Mexico (Guitarra), Panama (Libreria Rubyl), Turkey (Melody), Venezuela (Sonografica Venezolana), USA (Raiph L. Seltzer).

Oiamante, see Oial.

Oiapason, see Oial.

Diplo, see Phonic.

Oscobal SA, C. Felipe de Paz, 4, Barcelona 28 Tel: (93) 339-2776. Gen. Mgr.: Jose Manuel Gonzales (Tape Manufacturer/Distributor)

Labels: Oscobal, Sira, Sueve.

Oscophon SA (IFPI), Calle Valencia 288, Barcelona 7 Tel: (93) 215-1324.

Owner: Antoni Serra Gomez.

Labels: (licensed) ALA (USA), Bulldog (UK), Crescendo (USA), Everest (UK), PVK (UK), Palacio de la Musica (Venezuela), Phonoco (UK), Vaya-Fania (USA), Sonet (Denmark).

Orps, see Apolo.

Orms, see Bass-Orms.

E M E C, see Movieplay.

E M I-Odeon SA (IFPI), Via Augusta 2 bis, 4th fl., Barcelona 6. Tel: (93) 217-0500. Cable: GRAMOFONO. Telex: 52497. Pres.: Luis Sagi-Vela, Gen. Mgr.: Pierre Maget; Deputy Mgr.: Alberto Cardona; EMI-Odeon Div. Opns. Mgr.: Rafael Gil; Sales Mgr.: Julio Esclusa.

Branch: Madrid 13, Plaza de Ramales 2 Tel: (91) 242-5207.

Labels: (Owned) Amalgama, Ark, Capitol, EMI, Harvest, Liberty-United Artists, Odeon, Pathe, Reflejo, Regal, La Voz de Su Amo, (licensed) Deutsche Harmonia Mundi (Germany), Oiscos Top-Hits (Venezuela), La Osetoleca (Venezuela), MPL Communications (UK), Pink Floyd (UK), Promotone (Netherlands), Purple (UK), RAK (UK), Valentim de Carvalho (Portugal).

Eda, see R. Cuxart.

Edigsa (Ed. General SA) (IFPI), Gran Via de les Corts Catalanes 654, Barcelona 10. Tel: (93) 302-2516. Gen. Mgr.: Manuel Sancho.

Labels: (Owned) Alba, Als 4 Vents, Cabra, Edigsa, Oliba, Pardal, Pebrots, Xestral, Zeleste, (licensed) Acanta (Germany), Balkanton (Bulgaria), Bearsville (USA), Big Beat (France), Le Chant du Monde (France), Cherry Red (UK), ORG (USA), ECM (Germany), Factory (UK), First American (USA), Folkways (USA), Fuentes (Colombia), Greensteves (UK), Harmonia Mundi (France), Japo (Germany), L&R (Germany), Pantan (Czechoslovakia), SM (France), Sono Caro (Egypt), SteepleChase (Denmark), Watt (Germany); (distributed-not licensed) Carrillon

Int'l repps.: France (Le Chant du Monde, Harmonia Mundi).

Ensayo, see Belter

Epic (div. of Oiscos CBS SA) (IFPI), Po de la Castellana 93, Madrid 16. Tel: (91) 455-3845/4026. Cable: COLRECORD. Telex: 22890. Mng. Dir.: Stig-von Bahr; Gen. Mgr.: Ramon Crespo; Sales Mgr.: Roberto Navarro.

Labels: (Owned) Epic; (licensed) A&M (USA), Ariston (Italy), Boardwalk (USA), CGO (Italy), Caribou (USA), Carrere (France), Cleveland Int'l (USA), Oreflux (France), Full Moon (USA), GTO (UK), Jet (UK), Kirshner (USA), Nemperor (USA), Orfeon (Mexico), Philadelphia Int'l (USA), Star-lite (USA), Sweet City (USA), TK (USA), T-Neck (USA), Trema (France)

Espectra, see Sintonia.

Eulonac, La Fuente 16, Abrera (Barcelona)

Eurodisc, see Ariola-Eurodisc.

Explosion, see Compania Fonografica Espanola & Zafiro

Fase, see Audio & Video.

Ferysa, Virgen de Aranzazu 21, Madrid 34. Contact: Fernando Rodriguez Polo.

Label: (Represented) Moss Music Group (USA).

Ficlo Mktg., Plaza Cardona 11, Barcelona 6. Tel: (93) 251-95-77 (Distributor)

Fisam SA, Guillermo Tell 21, Barcelona 12. Tel: (93) 228-0905. Gen. Mgr.: Ezequiel Beaumont; Sales Mgr.: Inmaculada Mateo. (Distributor/ Importer)

Fonal, see Mailer.

Fono-2 Recs., Apdo. 22022, Nueva Zelanda 50, Madrid 35. Tel: (91) 216-4652. Chief Exec.: Jose Luis Alvarez Sanchez.

Labels: (Owned) JLA, (licensed) Stereo Tape (Germany)

Int'l repp.: Germany (Stereo Tape).

Fonogram SA (IFPI), Av. de America & Hernandez de Tejada s/n, Madrid 27. Tel: (91) 267-4200. Telex: 22849. Dir. Mgr.: Jose Pascual; Gen. Mgr.: Mariano de Zungu, Pop Mktg.: Patrick Noel Burke; Sales Mgr.: Frascincio Hernandez.

Branch: Barcelona 37, Calle Bruch 136. Tel: (93) 207-4512. Mgr.: Luis Lope.

Labels: (Owned) Casablanca, Oceca, Fontana, Mercury, Philips, Vertigo, (licensed) CNR (Netherlands), Charisma (UK), Oe-Lite (USA)

Fontana, see Fonogram.

Gades, see Izquierdo.

Gala, see RCA.

Gaviota, see Hispavox.

Gold Seal, see RCA.

Gong, see Movieplay.

Graficas Foco SA (IFPI), Av. de America & Hernandez de Tejada, Madrid 27. Tel: (91) 267-4200. Gen. Mgr.: Kees Ton

Guimbarda, see Compania Fonografica Espanola

Harvest, see EMI-Odeon.

Hispavox SA (IFPI), Torrelaguna 64, Madrid 27. Tel: (91) 415-2304. Cable: VOXSA. Telex: 22931, 46859. Pres.: Jose Manuel Vidal Zapater, Mng. Dir.: Jose Luis Gil Rodriguez; Deputy Mng. Dir.: Saul Tagarro, Int'l Dir.: Luis Calvo, Int'l A&R: Carlos J. Casado

Branch: Barcelona 13, Calle Marina 291 Tel: (93) 235 2390 Telex 52599.

Labels: (Owned) Clave, Gaviota, Hispavox, (licensed) Alvorada (Portugal), Amadeo (Austria) Arion (France), Asylum (USA), Atlantic (USA), Baby (Italy), CITI (USA), Chant du Monde (France), Copacabana (Brazil), Oamont (UK), Oak Horse (USA), Delphine (France), Oisemyland (USA), Elektra (USA), Erato (France), Fantasy (USA), Gamma (Mexico), Hungaroton (Hungary), Milestone, Nonesuch (USA), Prestige, Reprise (USA), Sire (USA), Stax (USA), Swan Song (UK), Vanguard (USA) Vox (USA), Warner Bros. (USA) Wergo (Germany).

Int'l repps.: Australia (Festival), Austria (Polydor), Belgium (Polydor), Bolivia (Lauro), Canada (Polydor Warner Bros.), Central America (Odeca), Chile (Quatro), Colombia (Codicisco), Dominican Republic (Mozart), Ecuador (IFESA), France (Arion, Erato, Polydor) Germany (Polydor), Greece (Music Box), Israel (Hataik), Japan (Nippon Columbia, Victor), Mexico (Gamma), New Zealand (Festival), Peru (El Virrey), Portugal (Radio Trunfo), South Africa (Gallo), USA (Alhambra, Musical Heritage, Sire, Warner Bros., West Side Latino, Vox) USSR (Melodiya), Uruguay (Palacio de la Musica), Venezuela (Distribuidora Sonografica Venezolana), Love, Yugoslavia (RTB)

Iberia, see Columbia

Iberca del Sonido, Principe 12, Madrid

Impacto, see Belter

Imperial Int'l SA, Velazquez 101, Madrid 6 Tel: (91) 411-2613 Telex 43448. Gen. Mgr.: Alain Milhaud, Sales Mgr.: Angel Lopez Sanchez

Labels: (Owned) K-Tel, 333

Indalo, see RCA

Iris, see Audio & Video

Izquierdo Producciones Oscograficas, Avda Carrero Blanco 10, Chiclana de la Frontera, Cadiz. Tel: (956) 40 09 95 Chief Exec.: Rafael Izquierdo

Labels: Gades, PIO

J L A, see Fono-2

Jack, see Audio & Video.

Jazz Stop, see Compania Fonografica Espanola.

K tel, see Imperial

Kardantax, see Movieplay.

LINKS THE WORLD

Southern Music Espanola, S.A.

Barcelona, Spain

Liberty-United Artists, see EMI-Deon.

Lico, see Auri.

Limoire, see Dial.

Lineatres, see RCA.

Lord Pop, Ferrer del Rio 33, Madrid 28.

M G A (Eds. & Producciones Fonograficas), Constitucion 127, Barcelona 14.

Tel: (93) 332-5166. Gen. Mgr.: Manuel Gimenez Alvarez.

M G M, see Polydor.

Magnetic, see Audio & Video.

Maller SA, Vicente Juan Rosello 22, Palma de Mallorca. Tel: (971) 284-166.

Dir. Gen.: Miguel Aller Martin.

Labels: (Owned) Cala D'Or, Fonal, Maller.

Marler SA (IFPI), Paseo de la Virgen del Puerto 7, Madrid 5. Tel: (91) 765-7800. Chief Exec.: Antonio Martinez; Gen. Mgr.: Emilio Fernandez; Sales Mgr.: Vicente Jimenez.

Labels: (Owned) Marler, Succes, Trama, Turquesa, Valor; (licensed) Everest (USA), Record Serv. (Italy), Roulette (USA), Sweet City (USA), Turicaphon (Switzerland), Vox (USA).

Int'l reps.: Colombia (Sonolux), Costa Rica (Dnda Nueva), Dominican Republic (Distribuidora Dominicana), France (Musidisc), Guatemala (Discos & Cassettes), Mexico (Alamo), Nicaragua (Discos & Cassettes), Panama (Dnda Nueva), USA (Godel), Venezuela (Discorama).

Mercurio Discos, Jaime Hermida 9 Bis, Madrid 17. Tel: (91) 204-6993. Dir.: Gen.: Cruz Gonzalez Sanz.

Mercury, see Fonogram.

Metodos Vvientes SA, Muntaner 479, Barcelona 21.

Mirio, see RCA.

Montilla, see Zafiro.

Movieplay SA (IFPI), Fernando El Santo 17, 2nd fl., Madrid 4. Tel: (91) 419-7013, 419-7266. Telex: 43861. Gen. Mgr.: Juan Santabaya; Ass't Gen.: Julio Fernandez-Cuelto; Sales Mgr.: Jorge Camps; A&R Mgr.: Gustavo Ramado; Promo. & Pub. Mgr.: Juan-Jose Gutierrez; Int'l Mgr.: Juan C. Cifuentes.

Branch: Barcelona 6, Tuset 34. Tel: (93) 218-8030. Mgr.: Manuel Ibanez.

Labels: (Owned) Chinchic, Gong, Kardantsa, Movieplay, Serano, Xeira, Yupi; (licensed) Alshire (USA), Areito (Cuba), Avator (UK), Barclay (France), Chiswick (UK), Condo/Disap (France), Egg (France), Everest (USA), Graduate (UK), Ice (UK), Intercord (Germany), Nueva Trova (Cuba), Orleon (Mexico), Red Bus (UK), Red Shadow (UK), Rondlet (UK), Safari (UK), Stage Coach (UK); (distributed-not licensed) ASCE, EMEC.

Int'l reps.: Argentina (Discosa), Australia (Festival), Austria (Intercord), Chile (Nerce), Colombia (Orbe, Philips), Costa Rica (Dideca), Dominican Republic (Alhambra), Ecuador (Coprodisa), El Salvador (Dideca), France (Chant du Monde), Germany (Intercord), Guatemala (Dideca), Honduras (Dideca), Italy (Durium), Japan (Toshiba), Mexico (Discosa), Nicaragua (Dideca), Panama (Sonomundi), Peru (El Virrey), USA (Alhambra, RCA), Venezuela (Grabaciones Murgales).

Neuroniun, see Auri.

Nevada, see Dial.

Nore, see Belter.

Odeon, see EMI-Deon.

OH, see Audio & Video.

Ofta, see Edigsa.

Olym, see Belter.

Oriado, see Circulo de Lectores.

P D S, see Portadores de Sonido.

P I D, see Izquierdo.

Palobal, see Pablo Lopez Balada.

Pan & Musica, Apartado de Correos 2441, Barcelona.

Pardal, see Edigsa.

Pathe, see EMI-Deon.

Pax (IFPI), Enrique Jardi Poncela 4, Madrid 16. Tel: (91) 250-5310. Cable: DISCDPAX. Telex: 45051. Dir.: Jose M. Burgos Gonzalez; Dir.: Catalina Jaume.

Pazo SA, Enamorados 34, Barcelona 13.

Pebrots, see Edigsa.

Percasa, Via Carpetana 71, Madrid 19.

Pergola, see Circulo de Lectores.

Philips, see Fonogram.

Phonic SA, Calle Madrazo 14, 3rd fl., Barcelona 6. Tel: (93) 228-0905. Pres.: Jorge Doncos; Sales Mgr.: Gen. Mgr.: Luis Quiñtana; Jaime Ferrer.

Labels: (Owned) Auditorium, Diplo, Phonic; (licensed) Ampro (USA), Arrowtats (UK), Beatt Int'l (UK), Crypto (France), M. Laguens (France), Stereo Tape (Germany), Yee-Jay (USA), Who's Who In Jazz (USA), Ramon Recard, Cuesta de Santo Domingo, Madrid 1. Tel: (91) 241-0509/0580. Dir.: Maximo Baratas.

Polydor SA (IFPI), Agastia s/n, corner of Av. de America, Madrid 27. Tel: (91) 267-4200. Telex: 22849. Chief Exec.: Carlos Borrallo; Gen. Mgr.: Mariano de Zuniga; Sales Mgr.: Julio Herrero.

Branch: Barcelona 9, Bruch 136. Tel: (93) 207-0739. Contact: Antonio Rovira.

Labels: (Owned) Archiv, DGG, MGM, Polydor (licensed) Dreamland (USA), EG (UK), RSO (UK).

Poplandia, see Compania Fonografica Espanola & Zafiro.

Portadores de Sonido SA, Hortaleza 118, Madrid 4. Tel: (91) 410-3130. Gen. Mgr.: J.M. Estebaranz Mansilla.

Labels: (Owned) Audiomundo, Clavel, PDS; (licensed) Beatt (UK), Magnet (Switzerland).

Puput, see Zafiro.

Puzzle, see Zafiro.

R C A SA, Dr. Fleming 43, Madrid 16. Tel: (91) 457-4600. Gen. Mgr.: Alberto Gaites; A&R & Int'l Liaison: Ernesto Duarte.

Branch: Barcelona.

Labels: (Owned) Camden, Gala, Gold Seal, Indalo, Lineatres, Mirio, RCA, Red Seal, Victor, Victrola, Vix, White Diamond; (licensed) AWB, Aura, Bacillus, Bellaphon, Buddha, Butterfly, CAM, Chantarelle, Chrysalis, Gen. Grunt, IB, Inphasion, Millennium, Numero Uno, Reader's Digest, Salsoul, Som Livre, 20th Century-Fox, Two Tone.

Int'l reps.: Worldwide (RCA).

Real Musical SA, Carlos III, No. 1, Madrid 13. Tel: (91) 241-3007/3105. Tel: 45643. Dir. Gen.: Ramon Jimenez Barrado. Gen. Mgr.: Jose Antonio Jimenez; Sales Mgr.: Andres Ruiz Tarazona; Sales Ass't: Mercedes Tarazona Matilla. (Distributor/Importer)

Labels: Acanta, Ariola, Belter/Ensayo, CBS, Candide (Canada), Decca/Columbia, Deutsche Grammophon, Dial, Discophon, EMI, Edigsa, Etnos, Hispavox, Movieplay, Philips, RCA, Rubini (Italy) Supraphon (Czechoslovakia), Vox (UK), Zafiro.

Red Seal, see RCA.

Reflejo, see EMI-Deon.

Regal, see EMI-Deon.

Sauce Int'l, see Belter.

Serano, see Movieplay.

Serdisco, see Zafiro.

Seven 7, Fuente del Coll 15, Barcelona 23. Tel: (93) 219-4566. Mgr.: Manuel Gomez.

Singleton Prod'n, Via Augusta 59, Desp. 804, Barcelona 6. Tel: (93) 228-3800. Telex: 97700. Gen. Mgr.: William H. Singleton; Admin. & Finance: Madlen E. Singleton; Sales Mgr. & Serv.: Ronald F. Burke.

Label: (Owned) Vampire.

Sintonia SA (IFPI), Vallehermoso 32, Madrid 15. Tel: (91) 445-8678. Gen. Mgr.: Bartolome Espadale.

Labels: (Owned) Espectra, Sintonia.

Sira, see Discobal.

Spot, see Audio & Video.

Stereo 4a Dimension, see R. Cuxart.

Succes, see Marler.

Sueve, see Discobal.

Tandem, see Apolo.

Tauro, see Apolo.

333, see Imperial.

Trama, see Marler.

Triton (Eds.) (IFPI), Lepanto 392, Barcelona 25. Tel: (93) 235-6325. Chief Exec.: Miquel Carbonell; Gen. Mgr.: Narcis Vidal; Sales Mgr.: Albert Ver-net.

Turquesa, see Marler.

12, R. Cuxart.

Valor, see Marler.

Vampire, see Singleton.

Vergara, see Ariola-Eurodisc.

Victor, see Fonogram.

Virgo, see RCA.

Victoria (AS Musical Discos), Larrard 34, Barcelona 24. Tel: 214-7302. Dir. Gen.: Juan Aules Sabartes.

Victrola, see RCA.

Vieta Audio Electronica SA, Calle Bolivia 239, Barcelona 20.

Label: (Represented) Delos (USA).

Vix, see RCA.

La Voz de Su Amo, see EMI-Deon.

Wah-Wah Producciones Discograficas, Saliente, A. Madrid 30. Tel: (91) 274-3208. Telex: 43241. Pres.: Ricardo Manzanares. (Importer/Exporter)

White Diamond, see RCA.

Xeira, see Movieplay.

Xistral, see Edigsa.

Xoxoa, Gral. Davila, 12 Bilbao. Tel: 443.08.58. Dir. Gen.: Jesus Jaima Yarritu Buruchaga; PR: Itziar Aranchamendi Ercilla.

Yupi, see Movieplay.

Zafiro Group (IFPI), Adpo. 14177, Av. de Cantabria 2-4 & 6, Madrid 22. Tel: (91) 742-1261. Cable: ZAFIRD. Telex: 22690. Mng. Dir.: Esteban Garcia Morenos; Gen. Mgr.: Antonio Ortega; Sales Mgr.: Jose Luis Ortiz; Int'l Mgr.: Angel Prieto.

Labels: (Owned) Barnafon, Canceled Tape, Caudal, Chapa, Montilla, Pupun, Puzzle, Serdisco, Zafiro; (licensed) Cetra (Italy), Fonit (Italy), Dick James (UK), Mezhkigna (USSR), PRT (UK), PWM (Poland), Saga/Trojan (UK), Slovart (Czechoslovakia); (distributed-not licensed) Bocaccio, Explosion, Musart (Mexico), Poplandia, Transatlantic (UK).

Int'l reps.: Argentina (Phonogram), Chile (Quatro), Colombia (Orbe), Ecuador (Fadisa), El Salvador (Dicesa), Mexico (Musart), USA (Alhambra), Uruguay (Variety), Venezuela (Polydor).

Zambra, see Belter.

Zartos SA, San Elias 11, Barcelona 6. Tel: (93) 200-9318. Chief Exec.: Mercedes Mozar; Gen. Mgr.: Pilar Matos. (Distributor)

Int'l reps.: Argentina (Redondel), Mexico (Tiempo).

Zeleste, see Edigsa.

Zzestia SA, Pedro Muguruza 8, 5th fl., Madrid 16. Tel: (91) 250-37.11. Gen. Mgr.: Rafael Martos.

• music publishers

Acropoli (SGAE), Av. Jose Antonio 68, Madrid 13. Tel: (91) 248-3180.

Adagio Eds. Musicales (SGAE), see Quiroga.

Albert/EGD, see EGO.

Alier (Ed.), Carmen 27, Madrid 13. Tel: (91) 221-97.71.

April Music (SGAE), Av. Generalissimo 25, 9th fl., Madrid 16. Tel: (91) 455-3845. Cable: COLRECDR MADRID. Telex: (831) 22890. Gen. Mgr.: Antonio Perez Solis.

Int'l firms represented: April (worldwide).

Int'l reps.: Worldwide (April).

Arabella Eds. Musicales SA, Calle Aragon 204, 4th fl., Barcelona 11. Tel: (93) 254-9805. Cable: HISPARDILA. Telex: 52771. Gen. Mgrs.: Alberto Serra, Ramon J. Segura.

Home office: Germany.

Int'l firms represented: Arabella (Germany, Mexico).

Int'l reps.: Argentina (Edifon), Central America (Dimasa), Colombia (Sono Inter), Mexico (Arabella), USA (Trina Jill), Venezuela (Unimusica).

Aries-Canary Recs., San Vicente Ferrer 73, Santa Cruz de Tenerife, Canary Islands. Tel: (922) 27-65-63. Gen. Mgr.: Jose Luis Gutierrez Solano; Int'l Mgr.: Jose Manuel Garcia Santos.

Arpa Eds. Musicales (SGAE), see Quiroga.

Audiens (Ed.), Vallehermoso 14, Madrid 15. Tel: (91) 448-2200/04-08.

Barna, Via Layetana 158, Bajos, Barcelona 9. Tel: (93) 228-69-67.

Belter SL (Eds. Musicales) (SGAE), Salut 17, Madrid. Tel: (91) 231-61-69.

Cable: BELDISC. Telex: 42065. Dir.: Manuel Cubedo.

Int'l firms represented: RKM (Belgium).

Int'l reps.: Belgium (Roland Kluger), Germany (Ralf Arnie, Intro, Minerva), USA (CAM-USA).

Bocaccio Eds. Musicales (SGAE), Recoletos 11-2C, Madrid 1. Tel: (91) 276-9230. Cable: EDIMDMT. Gen. Mgr.: Margarita Tamames.

Int'l firms represented: Andante, Avid, Big, Black Sun, Castle Hill, Celestial Harmonies, Coryell, D'Abbo, Dex, Dizlo, Free Jazz, Futures Passed, Gaeda, Gillian, Greenwich, Jackzone, Jon Mark, Joyride, Laureate, Mandina, Mayflower, Milet, Mouton, Elena Mouton, Ondine, Phase Two, Real to Real, Rocksmith, Rohm, Silkie, Solar Plexus, Smith Tunes, Tarik, Timbobe, Unit Core, Venice, Vido, Watt Works, Wonderbuns, Zid (all USA); Robinsons (France).

Boom Eds. Musicales, see Quiroga.

C A M Espana SA, Arturo Soria 157, Madrid 33. Tel: (91) 413-2837/2945. Cable: EDIMUSICAM. Telex: 23955.

Branch: Barcelona 23, Padua 30, 1st & 2nd fls. Tel: 211-2936. Telex: 54483. Admin. Mgr.: Giuseppe Lulli; Prod'n Mgr.: Fabrizio Damiani.

Int'l firms represented: Andrew Heath (UK), Compass (USA), DJM (UK), Grever (Mexico), Marquez (Mexico), Radio Tele Lux (France), Reina (Colombia), Acapulco (Mexico), Valentine (UK).

Int'l rep.: Mexico (Discorama).

Cadencia (Eds.) (SGAE), Virgen de Aranzazu 23, Local F, Madrid 34. Tel: (91) 729-1544. Pres.: Carmen Macicor Jadraque; Gen. Mgr.: Federico Moreno-Torres Jr.

Int'l firm represented: Five Continents (USA).

Int'l reps.: Belgium (New Music), France (Caravelle), Mexico (Brambila), USA (Casa Latina).

Canciones del Mundo SA, Magallanes 25, Madrid 3. Tel: (91) 448-2350.

Gen. Mgr.: Luis Regatero.

Branch: Barcelona 37, Bruch 136-138. Tel: (93) 207-4202.

Int'l firms represented: Canciones del Mundo SA—Big Seven, Blue Seas, Leo Fest, Fox Fanfare, Hastings, Medoc/Goodman group (USA), Plan etary, Planetary-Nom, Shelby Singleton, Twentieth Century (all USA), Robert Mellin Iberica SA—Robert Mellin (UK, USA), Eds. Musicales Symphony SA.

Carcelle SA (SGAE), Ronda San Pablo 11, Barcelona 15. Tel: (93) 242-5410

Chappell Iberica SA, Magallanes 25, Madrid 3. Tel: (91) 448-2350. Gen. Mgr.: Luis Regatero.

Home office: USA.

Int'l firms represented: Acuff-Rose (USA), Irving Berlin (USA), Chappell (France, UK), Chappell-Morris (UK, USA), Famous (USA), Welk group (USA).

Clipper's (Grupo Ed.) (SGAE), Rambla de Catalunya 10, 3rd fl., Barcelona 7. Tel: (93) 317-4686/90. Telex: 51539. Chief Exec.: Julio Guu Clara; Dir.: Julio Guu Arbeloa, Francisco Vinuesa Gimenez.

Int'l firms represented: ATV (UK, USA), Annakata (UK), Blue Street (USA), Bug (USA), Campbell Connelly (UK), Cherry Lane (USA), Combine (USA), Cotillon (USA), DeShuffin (USA), Eaton (UK), Eighties (USA), John Farrar (USA), Feckless (USA), Robin Gibb (UK), Gold Hill (USA), Tony Hiller (USA), Ice Age (USA), Interworld (USA), Island (UK, USA), Jump Tunes (USA), Lupus (UK), Moonlight & Magnolias (USA), Northern Songs (UK), Plangent Visions (UK), Resaca (USA), Recordi (Italy), Rock (UK), Boz Scaggs (USA), Paul Simon (USA), Small Hill (USA), Bruce Springsteen (USA), Warner Bros. group (UK, USA), Wow & Flutter (USA), Lawrence Wright (UK).

Code Eds. Musicales, see Quiroga.

Daimon Eds., Manuel Tamayo, Provensa 284, Barcelona 8. Tel: (93) 215-0358. Cable: EDIDAIDM. Telex: 97648

Dial Discos Ed. Musicales SA, Po. De La Castellana 247, Madrid 16. Tel: (91) 733-5243. Cable: DIALDISCD MADRID. Gen. Mgr.: Laurentino Ramos.

Int'l Mgr.: Inna Ruiz.

Discorama Eds. Musicales, Av. de Jose Antonio 62, Madrid 13. Tel: (91) 248-0404. Mng. Dir.: Eduardo Bartrina de Caso; Gen. Mgr.: Gerd Muller.

Int'l firms represented: Acapulco (Mexico), Andrew Heath (UK), Compass (USA), DJM (UK), Grever (Mexico), Marquez (Mexico), Radio Tele Lux (France), Reina (Colombia), Valentine (UK).

Int'l rep.: Mexico (Discorama).

E D A Montecasino 2, Barcelona 6. Tel: (93) 201-5899. Chief Exec.: Ramon Cuxart.

E G D Musical SA, Edif. Windsor, 6th fl., No. 4a, Diagonal 474, Barcelona 6. Tel: (93) 232-6242. Cable: EGDIMUSICAL. Telex: 52497. Gen. Mgr.: Pierre Maget; Mgr.: Avelino Esparza.

Int'l firms represented: BBC (UK), Black Bull (USA), Chinnchapp (UK), Colgems (USA), Cross Keys (USA), Deep Purple (UK), EMI group (worldwide), Equator (UK), Francis-Day (France), Jobete (USA), Kipahulu (USA), LEM (France), MPT (UK, USA), Mabrak/Peter Tosh (USA), Queen (UK), RAK (UK), Rocket (UK), Rolling Stones (UK), Saturday (USA), Screen Gems/EMI (UK, USA), Stone Diamond (USA), Sumac (USA), Tree.

E M E C (Eds. Musicales Espanola Contemporanea) (SGAE), see Quiroga.

Essex Espanola SA (Eds.) (SGAE), Diputacion 337, Barcelona 9. Tel: (93) 225-8489. Telex: 54040. Gen. Mgr.: Jose Carreras Moysi.

Branch: Madrid 16, Encina 36. Tel: (91) 221-3650.

Int'l firms represented: Essex group (UK), TRD group (USA)

Farran Musica, Pintor Mir 9, Bajos, Barcelona 31. Tel: (93) 357-4250/0646

Pres.: Ramon Farran; Gen. Mgr.: Antonio Serra.

Fiesta en Triana (Ed.), Virgen de Lujan 47, 2nd fl., Barcelona. Tel: (93) 2792-84.

Fontana SA (Eds. Musicales), Magallanes 25, Madrid 3. Tel: (91) 448-2350

Cable: EDIFON. Gen. Mgr.: Luis Regatero.

Int'l firms represented: Abigail (UK), P.E. Baker (UK), Bizarre (USA), Hudson Bay (USA), RSO (UK), Reno-Mex (USA), St. George (UK).

Hispanda (Eds.), Av. Jose Antonio 31, Madrid 13. Tel: (91) 231-2633, 222-6092. Dir.: Julian Suarez Ruiz; Gen. Mgr.: Julian-Mario Suarez Gomez.

Int'l firms represented: SESAC (USA).

Int'l rep.: USA (SESAC).

Hispavox SA (Eds. Musicales), Torreleguana 64, Madrid 27. Tel: (91) 413-38-07. Cable: EDIVIX. Telex: 22931, 46859. Mng. Dir.: Jose Luis Gil.

Int'l firms represented: Char-Liz (USA), Cicco (USA), Delphine (France), Delta Research (USA), Emlasa (Mexico), Gamma (Mexico), Gold Sovereign (USA), Hastings (USA), Jondora (USA), Quincy Jones (USA), Kiss (USA), Knollwood (USA), Mabelsons (Denmark), Mr. Bones (USA), Morro (USA), Orpheum (USA), Parker (USA), Peacock (USA), Porter (USA), Prestige (USA), RKM (Belgium), Ranjock (USA), Rat Trap (USA), Robbins (USA), Siggy (USA), Song Yard (USA), Sterling (USA), Stone Gold (USA), Sweet Summer Night (USA), Three Brothers (USA), Thursday (USA), Tri-Sound (USA), United Artists (USA), Vabritmar (USA), Velvet Apple (USA), W&M (USA), Walt Disney (USA), Wonderland (USA).

Int'l reps.: Mexico (Gamma), Portugal (Radio Trunfo), USA (Barnegat).

M G A (Eds. & Producciones Fonograficas), Constitucion 127, Barcelona 14. Tel: (93) 332-5166. Gen. Mgr.: Manuel Gimenez Alvarez.

Manoir (Ed.), Berlin 95-97, Entlo. A, Barcelona. Tel: (93) 250-3907. Dir. Alberto Ros Blasco; Gen. Mgr.: Manolo Catalan Gil.

Marler SA (Eds. Musicales), Paseo de la Virgen del Puerto 7, Madrid 5. Tel: (91) 265-78-00. Chief Exec.: Antonio Martinez; Gen. Mgr.: Emilio Fernandez.

Int'l firms represented: Arneh, Bema (both USA).

Int'l reps.: Belgium (Valentin), Colombia (Edipron),

2592. Cable: LEONARD. Gen. Mgr.: Gabriel Lara Cano.
Int'l firms represented: Big 3 (USA), Chappell (UK), Cherry Lane (USA), Columbia Pictures (USA), EMI (UK), Fermata (Brazil), Hal Leonard (USA), Music Sales (UK), Warner Bros. (USA).
Notas Magicas SA (Grupo Ed.) (SGAE), Calle Requeros 8, Madrid 4. Tel: (91) 419-1406/8591. Cable: EDIMAGICAS. Pres.: Enrique Inurrieta. Gen. Mgr.: Enrique Garea. Prof. Mgr.: Fernando Mitjavila.
Int'l reps.: Canada (Ivan Mogull); Germany (Magazine, Hans Sikorski); Mexico (Ivan Mogull Latina), UK (Burlington), USA (Ivan Mogull).
Nuesch Publ'g Co. (SUISA), Via Augusta 59, Desp. 805, Barcelona 6. Tel: (93) 228-3800. Telex: 54015. Chief Exec. & Gen. Mgr.: Madlen E. Singleton.
Palma Music, see EGO
Paulinas (Eds.), Protasio Gomez 15, Madrid 27. Tel: (91) 742-0511/5113.
Pax (Ed. Musicales), Enrique Jardié Poncela 4, Madrid 16. Tel: (91) 250-5310. Cable: DISCOPAX. Telex: 45051. Dir.: Jose M. Burgos Gonzalez. Peer-Southern Org., see Southern Music.
Penta-Music SA (SGAE), Fernando E. Santo 17, 2nd fl., Madrid 4. Tel: (91) 419-7013. Gen. Mgr.: Juan Santabaya, Mgr.: Valentín Rodríguez.
Quiroga (Eds.) (SGAE), Alcala 70, Madrid 9. Tel: (91) 276-3950/66. Cable: QUIROGAMUSIC. Telex: 42710. Fcnote: 42 00057. Pres.: Manuel Lopez-Quiroga. Gen. Mgr.: Carlos P. Carcio, Prof. Mgr.: Manuel Lopez-Quiroga Jr.
Branch: Barcelona 2, Canuda 45. Tel: (93) 318-6049. Gen. Mgr.: Jose Cruells Solbes.

Int'l firms represented: ABC/DLHill (USA), Alshire (USA), American Broadcasting (USA), Amphion (France), M.P. Bieleff (Germany), Belwin-Mills (UK, USA), Breitkopf & Haertel (Germany), Carrsch (Italy), Copyright Serv. Bureau (USA), Chant du Monde (France), Desert/Breakaway (UK), Ecomus (Colombia), Gardea Rake (USA), General (USA), Hans Gering (Germany), Gopam (USA), Greensleeves (UK), Homefire/Deep Canyon (USA), Intune (UK), Lady Jane (USA), Leosong (UK), Lido (USA), Edward B. Maris (USA), Musibacana (Cuba), Eds. Musicales (Cuba), Dirbe (Venezuela), C.F. Peters (Germany), Prodomus (Colombia), Pump It Up (USA), Tony Roberts (UK), Rockin' (UK), B. Schott's Sohne (Germany), A. Schroeder (USA), Skyhill (USA), Stagecoach (USA), Summi Zerboni (Italy), Thomas Fund (USA), Tonos (Germany), Universal (Austria, UK).
Int'l reps.: Colombia (Ecomus), Mexico (Pacifico), Peru (Perumusic).
R C A Espanola SA (Eds. Musicales), Dr. Fleming 43, Madrid 16. Tel: (91) 457-4600. Telex: 22460. Pres.: Alberto Galtes; Dir.: Antonio Martinez.
Int'l firms represented: Associated (Australia), Big Sky (USA), Can't Stop (USA), Chrysalis (UK), Cold Weather (USA), Dizzy Heights (UK), Dwarf (USA), Eureka (Italy), Four Aces USA, GH (UK), Green Mountain (USA), Island, Lucky Three (USA), Lynnal/Jarak (USA), Memory Lane (USA), Metal Machine (USA), Oakfield Avenue (USA), Milton Okun/Cherry River (USA), RCA (worldwide), Ram's Horn (USA), Riva (UK), Rondor (USA), Saber Tooth (USA), Salsoul (USA), Scorpio/Black Scorpio (France), Scott-Tone (USA), Scott-Wolfe (UK), Sono Int (Colombia), Sparta Florida group (UK), Special Rider (USA), Larry Spier (USA), Street (UK), Topspin/Lojo (Netherlands), Zebre Discorde/Bayanhian (USA), Zomba (Switzerland, UK).
Int'l rep.: Worldwide (RCA).

Real Musical SA, Carlos III, No. 1, Madrid 13. Tel: (91) 241-3007/3105. Telex: 45643. Dir. Gen.: Ramon Jimenez Barrado; Gen. Mgr.: Jose Antonio Jimenez.
Int'l firms represented: Belwin Mills (USA), Billaudot (France), Breitkopf & Haertel (East Germany), Curci (Italy), Deutscher (East Germany), Faber & Faber (UK), Heugel (France), Hofmeister (East Germany), Edwin F. Kalmus (USA), Musica Budapest (Hungary), PWM (Poland), Peters (East Germany), Schott's Sohne Mainz (West Germany), Transatlantiques (France), Universal (Austria), Wiener Urtext (Austria), Zambon (Italy).
Ritmo & Melodia (SGAE), see Quiroga
Segra Eds., Valencia 288, Barcelona. Tel: (93) 215-1324. Owner: Antoni Serra Gomez; Gen. Mgr.: A. Graus Queralt.
Sintonia SA Eds. Musicales, Vallehermoso 32, Madrid 15. Tel: (91) 445-8678. Gen. Mgr.: Bartolome Espadale.

Int'l firms represented: Berry (UK), Bruton (UK), De Wolfe (UK), Hudson (UK), KPM (UK), Mozart (Germany, UK), Raphael (Germany), Rouge (UK), Sonoton (Germany), Sylvester (UK), Themes Int'l (UK).
Southern Music Espanola SA (SGAE), Diputacion 337, Barcelona 9. Tel: (93) 225-6197. Telex: 54040. Chief Exec.: Jose Carreras Moys.
Branches: Madrid 4, Hortaleta 18. Tel: (91) 231-0661—Valencia 5, Arzobispo Melio 3. Tel: (960) 33 19 25.
Home office: USA, Southern Music Publ'g Co. Inc.
Int'l firms represented: Leeds (UK, USA), MAM group (UK), MCA (USA), Southern-Peer group (worldwide).
Talisman-Ronald SA, see EGO
Union Musical Espanola SA (SGAE), Carrera de San Jeronimo 26, Madrid 14. Tel: (91) 429-4877.
World Music Espanola (SGAE), Diputacion 337, Barcelona 9. Tel: (93) 225-6197. Gen. Mgr.: Jose Carreras Moys.
Branch: Madrid 4, Hortaleta 18. Tel: (91) 231-0661.
Zzelesta (Eds. Musicales) (SGAE), see Quiroga

• services
ASSOCIATIONS & PROFESSIONAL ORGANIZATIONS
A E D E M (Asociacion Espanola de Editores de Musica), Carrera de San Jeronimo 29, Madrid 14. Tel: (91) 455-5995. Telex: 22890. Pres.: Antonio Perez Solis.
A N A I P (Asociacion Espanola de Industriales de Plasticos), Raimundo Fernandez Villaverde 45, Madrid 3. Tel: (91) 234-7697. Pres.: Ramon M. Azcue. Gen. Mgr.: Jose M. Cavanillas.
A N E R S (Asociacion Nacional de Empresas de Registro de Sonido), Cinco 25, Madrid 2. Exec. Sec'y.: Jose Luis Uguet de Resayre.
A P Y M E F (Asociacion de la Pequena & Mediana Empresa Fonografica), Mascaro 23, Barcelona 32. Tel: (93) 236-1856. Pres.: Ramon Cuxart Guardia; Gen. Mgr.: Angel Fabregues Morla.
Asociacion de la Pequena & Mediana Empresa Fonografica, see APYMEF
Asociacion Espanola de Editores de Musica, San Jeronimo 29, Madrid 14.
Asociacion Fonografica Espanola, Avda. del Brasil 17, 8th fl., Madrid 20. Tel: (91) 455-6395.
Direccion General de Musica & Teatro Ministerio de Cultura, Po. de la Castellana 109, Madrid.
International Music Council, Nat'l Committee, Martin de los Heros 56, Madrid 8. Tel: 241-5841.
International Society for Contemporary Music, Nat'l Section, Martin de los Heros 56, Madrid 8. Tel: 241-5641.
Juventudes Musicales de Barcelona (Jeunesses Musicales), Pau Claris 139, 4th fl., Barcelona 9. Tel: (93) 215-3657.
Organizaciones Artisticas Centano, Rosellon 366, Barcelona 25. Tel: (93) 258-0868. Chief Exec.: Antonio Centano. Gen. Mgr.: Luis Centano.
Sindicato Nacional del Papel & Artes Graficas, Fernandez de la Hoz 12, Madrid 4. Tel: 419-1750.

CATALOG SERVICES
Forma Grafica SA, Tomas Breton 51, Naves 4 & 6, Madrid 7. Tel: (91) 227-9115, 239-8832. Dir.: Javier Campollo; Pres.: Vicente Baez.
Iberofon SA, Av. Fuentemars 35, Poligono Ind'l Costada, Madrid. Tel: (91) 671-2200. Telex: 42797.

DESIGN & ARTWORK
Jose Luis Alvarez, Apdo. 22022, Valdesangil 71-2-A, Madrid 35. Tel: (91) 216-4652. Mgr.: Jose Luis Alvarez; Sales Mgr.: Angelines Bustos.
Caro SL (Industrias Graficas), Isabelita Usera 80, Madrid 26. Tel: (91) 475-6924.
D I S C A N, Canalejas 61-1 Izqd., Las Palmas, Canary Islands. Tel: (928) 36-7558. Chief Exec.: Jose Luis Gomez de Luis.
Ediciones Deportivas ALG, San Raimundo, Madrid.
Edigsa (Ed. General SA), Gran Via de les Corts Catalanes 654, Barcelona 10. Tel: (93) 302-2516. Chief Exec.: Manuel Sancho.
Iberofon SA, Av. Fuentemars 35, Poligono Ind'l Costada, Madrid. Tel: (91) 671-2200. Telex: 42797.
Portadores de Sonido SA, Hortaleta 118, Madrid 4. Tel: (91) 410-3130. Gen. Mgr.: J.M. Estebarez Mansilla.
S A I C Graficas Armar, Juan de Austria 70, Barcelona. Tel: (93) 309-79-87.

LICENSING ORGANIZATION, MUSIC
S G A E (Sociedad General de Autores de Espana), Fernando VI 4, Madrid 4. Tel: (91) 419-21.00. Cable: SOGETORES. Telex: 46469.

PLATING, PROCESSING & PRESSING PLANTS
Barnafon SA, Av. de la Fama 16, Cornellá de Llobregat, Barcelona. Tel: (93) 377-15-63. Telex: 54144. (Pressing only).
Colasa (Columbia Fonogram Asociadas SA), Av. de America & Hernandez de Tejada, Madrid 27. Tel: (91) 267-4200. Gen. Mgr.: Kees Ton.
E M I-Odeon SA, Poligono Manso Mateu, Prat de Llobregat, Barcelona. Tel: (93) 379-0508. Telex: 52497. Factory Mgr.: S. Matamoros. (Pressing only).
Hispavox SA, Torrelaguna 64, Madrid 27. Tel: (91) 415-23.04. Telex: 22931. Cable: VOX. Mng. Dir.: Jose Luis Gil; Special Projects: Gonzalo Llodra. **Iberofon SA, Av. Fuentemars 35, Poligono Ind'l Costada, Madrid. Tel: (91) 671-2200. Telex: 42797.**
Sonopresse, Torrelaguna 64, Madrid 27. Tel: (91) 415-23.04. Cable: VDX. Telex: 22931. Gen. Mgr.: Luis Vidal Zapater. (Plating & pressing only).
Vergara, General Mola 9, Barcelona 9. Tel: (93) 257-94.05. (Pressing only).

PRINTERS & LITHOGRAPHERS
Caro SL (Industrias Graficas), Isabelita Usera 80, Madrid 26. Tel: (91) 475-6924.
Graficas Foco SA, Av. de America & Hernandez de Tejada, Madrid 27. Tel: (91) 415-23.04. Gen. Mgr.: Kees Ton; Admin'r: Pedro Checa.
Iberofon SA, Av. Fuentemars 35, Poligono Ind'l Costada, Madrid. Tel: (91) 671-2200. Telex: 42797.
Portadores de Sonido SA, Hortaleta 118, Madrid 4. Tel: (91) 410-3130. Gen. Mgr.: J.M. Estebarez Mansilla.
S A I C Graficas Armar, Juan de Austria 70, Barcelona. Tel: (93) 309-79-87.

RECORD PROMOTION
Jose Luis Alvarez, Apartado 22022, Valdesangil 71-2-A, Madrid 35. Tel: (91) 216-4652. Mgr.: Jose Luis Alvarez; Sales Mgr.: Angelines Bustos.
D I S C A N, Canalejas 61-1 Izqd., Las Palmas, Canary Islands. Tel: (928) 36-7558. Chief Exec.: Jose Luis Gomez de Luis.
Donnelley Espanola SA, Av. del Generalísimo 43, Madrid 20. Tel: (91) 270-24-90.
Branch: Barcelona 14, Juan Guell 135-137. Tel: (93) 250-91.00.
Ediciones Deportivas ALG, San Raimundo, Madrid.
Edigsa (Ed. General SA), Gran Via de les Corts Catalanes 654, Barcelona 10. Tel: (93) 302-2516. Chief Exec.: Manuel Sancho.
Iberofon SA, Av. Fuentemars 35, Poligono Ind'l Costada, Madrid. Tel: (91) 671-2200. Telex: 42797.
Melodix, Pedro Muguruza 8, 5th fl., Madrid 16. Tel: (91) 250-37.11.
Real Musical SA, Carlos III, No. 1, Madrid 13. Tel: (91) 241-3007/3105. Telex: 45643. Dir. Gen.: Ramon Jimenez Barrado; Gen. Mgr.: Jose Antonio Jimenez; Sales Mgr.: Andres Ruiz Tarazona.

TAPE CUSTOM DUPLICATORS
C E C S A (Compania de Electronica & Comunicaciones SA), Trovador 5, Barcelona 26. Tel: (93) 255-1307. Telex: 54536. Gen. Mgr.: Juan Dettell.
Audio: 8-tr., 8-tr. quadraphonic, cassette, open reel.
C I M A S A (Compania Industrial de Materiales Acusticos SA), Vallehermoso 14, Madrid 15. Tel: (91) 448-22.00/04/08.
Colasa (Columbia Fonogram Asociadas SA), Av. de America & Hernandez Tejada, Madrid 27. Tel: (91) 267-4200. Gen. Mgr.: Kees Ton.
Audio: Cassette.
D I S C A N, Canalejas 61-1 Izqd., Las Palmas, Canary Islands. Tel: (928) 36-7558. Chief Exec.: Jose Luis Gomez de Luis. (PKG)
Audio: Cassette.
E M I-Odeon SA, Poligono Manso Mateu, Prat de Llobregat, Barcelona. Tel: (93) 379-0508. Telex: 52497. Factory Mgr.: S. Matamoros.
Audio: Cassette.
Hispavox SA, Torrelaguna 64, Madrid 27. Tel: (91) 415-23.04. Telex: 22931. Cable: VOX. Mng. Dir.: Jose Luis Gil; Special Projects: Gonzalo Llodra. (PKG)
Audio: Cassette.
Iberofon SA, Av. Fuentemars 35, Poligono Ind'l Costada, Madrid. Tel: (91) 671-2200. Telex: 42797. (PKG)
Audio: 8-tr., 8-tr. quadraphonic, cassette.
Person Iberica SA, Torre de Vidale 42-44, Barcelona 12. Tel: (93) 219-0612. Mng. Dir.: Olegario Godo; Gen. Mgr.: Jaime Gratacos.
Phonic SA, Calle Madrazo 14, Barcelona 6. Tel: (93) 228-0905. Pres.: Jorge Doncos; Gen. Mgr.: Luis Quintana; Sales Mgr.: Jaime Ferrer.
Audio: Cassette.
Portadores de Sonido SA, Hortaleta 118, Madrid 4. Tel: (91) 410-3130. Gen. Mgr.: J.M. Estebarez Mansilla.
Audio: 8-tr., 8-tr. quadraphonic, cassette, open reel.
Sintonia SA, Vallehermoso 32, Madrid 15. Tel: (91) 445-8678. Gen. Mgr.: Bartolome Espadale.
Audio: 8-tr., cassette, open reel.
Sonitex SA, Gomis 42, Barcelona 23. Tel: (93) 212-6295. Chief Exec.: Gorette Palau.
Audio: Cassette, open reel.

• supplies
CARTRIDGE & CASSETTE PARTS
Iberofon SA, Av. Fuentemars 35, Poligono Ind'l Costada, Madrid. Tel: (91) 671-2200. Telex: 42797.
Person Iberica SA, Torre de Vidale 42-44, Barcelona 12. Tel: (93) 219-0612. Mng. Dir.: Olegario Godo; Gen. Mgr.: Jaime Gratacos.
Jose-Maria Sala Elementos Audiovisuales, Ronda San Antonio 21, Barcelona.

Tel: (93) 243-6207. Mgr.: Jose-Maria Sala.
EMPTY CARTRIDGES, CASSETTES & REELS
Audio Magnetics, see Portadores
C E C S A (Compania de Electronica & Comunicaciones SA), Trovador 5, Barcelona 13. Tel: (93) 255-1307. Telex: 54536. Gen. Mgr.: Juan Dettell.
Audio: 8-tr., cassette, open reel.
Iberofon SA, Av. Fuentemars 35, Poligono Ind'l Costada, Madrid. Tel: (91) 671-2200. Telex: 42797.
Person Iberica SA, Torre de Vidale 42-44, Barcelona 12. Tel: (93) 219-0612. Mng. Dir.: Olegario Godo; Gen. Mgr.: Jaime Gratacos.
Audio: Cassette.
Portadores de Sonido SA, Hortaleta 118, Madrid 4. Tel: (91) 410-3130. Gen. Mgr.: J.M. Estebarez Mansilla.
Audio: 8-tr., 8-tr. quadraphonic & cassette.
Brand name: Audio Magnetics.

ENVELOPES & MAILERS
Iberofon SA, Av. Fuentemars 35, Poligono Ind'l Costada, Madrid. Tel: (91) 671-2200. Telex: 42797.

JACKETS & SLEEVES
Artigraha, Tucan 12, Madrid 19. Tel: (91) 228-92.09. (Jackets only)
Forma Grafica SA, Tomas Breton 51, Naves 4 & 6, Madrid 7. Tel: (91) 227-9115, 239-8832. Dir.: Javier Campollo; Pres.: Vicente Baez.
Graficas Foco SA, Av. de America & Hernandez de Tejada, Madrid 27. Tel: (91) 267-4200. Gen. Mgr.: Kees Ton.
Hispavox SA, Torrelaguna 64, Madrid 27. Tel: (91) 415-23.04. Telex: 22931. Cable: VOX. Mng. Dir.: Jose Luis Gil; Special Projects: Gonzalo Llodra. **Hostench SA (Talleres Graficos),** Corcega 231-233, Barcelona 36. Tel: (93) 220-5537. Cable: FERHOSVILA. (Jackets only).
Iberofon SA, Av. Fuentemars 35, Poligono Ind'l Costada, Madrid. Tel: (91) 671-2200. Telex: 42797.
Martin (Graficas), Anafil 5, Madrid 19. (Jackets only)
Ofset ALG, San Raimundo 31, Madrid 20. (Jackets only)
Selector SA, Julian Tamarit 53, Madrid. Tel: (91) 204-21.64. (Jackets only)

LABELS, DISK POLYETHYLENE BAGS
Forma Grafica SA, Tomas Breton 51, Naves 4 & 6, Madrid 7. Tel: (91) 227-9115, 239-8832. Dir.: Javier Campollo; Pres.: Vicente Baez.
Graficas Foco SA, Av. de America & Hernandez de Tejada, Madrid 27. Tel: (91) 267-4200. Gen. Mgr.: Kees Ton. (Labels only).
Hispavox SA, Torrelaguna 64, Madrid 27. Tel: (91) 415-23.04. Telex: 22931. Cable: VOX. Mng. Dir.: Jose Luis Gil; Special Projects: Gonzalo Llodra. **Iberofon SA, Av. Fuentemars 35, Poligono Ind'l Costada, Madrid. Tel: (91) 671-2200. Telex: 42797. (Labels only)**

TAPE, BLANK LOADED & BULK RAW
Agfa-Gevaert SA, Paseo de Gracia 111, Barcelona 8. Tel: (93) 227-3002. Telex: 52644. Mng. Dir.: E. Carton.
Audio: Blank—compact-cassette, open reel; raw—cassette, broadcast, studio.
Video: Cassette, open reel.
Brand names: Agfa Carat, Agfa Stereochrom, Agfa Videochrom.
Audio Magnetics, see Redim.
B A S F Espanola, Paseo de Gracia 99, Barcelona 8. Tel: (93) 215-1354. Audio-Video Prods. Mgr.: Jorge Guardia; Sales Mgr.: Carlos Wuest. (Blank only)
C E C S A (Compania de Electronica & Comunicaciones SA), Trovador 5, Barcelona 13. Tel: (93) 255-1307. Telex: 54536. Gen. Mgr.: Juan Dettell. (Blank only)
Audio: 8-tr., cassette, open reel.
Iberofon SA, Av. Fuentemars 35, Poligono Ind'l Costada, Madrid. Tel: (91) 671-2200. Telex: 42797.
Audio: 8-tr., cassette.
Portadores de Sonido SA, Hortaleta 118, Madrid 4. Tel: (91) 410-3130. Gen. Mgr.: J.M. Estebarez Mansilla. (Blank only)
Audio: 8-tr., cassette.
Redim, Comandante Zorita 6, Madrid.
Audio: 8-tr., cassette, open reel.
Brand name: Audio Magnetics.
Scotch, see 3M.
3 M Espana SA, Josefa Varcarel 31, Madrid 27. Tel: (91) 742-00.12. Telex: 27499. Mng. Dir.: G.J. Partington; Gen. Mgr.: Esteban Lopez; Sales Mgr.: Antonio Vergara; Mktg. Mgr.: Manuel Martin de Barbadillo.
Audio: Blank—8-tr., cassette, open reel, raw—cassette.
Video: Blank—2", 1" open reel, ¾" cassette, ¼" Beta & VHS cassette.
Brand name: "Scotch".

• accessories manufacturers
Audio SA, La Granada 34, Barcelona 6. Tel: (93) 217-1554. Telex: 54293. Gen. Mgr.: Carlos Pueyo; Sales Mgr.: Antonio Colome.
Product: Record—replacement styl.
Brand name: Pickering.
Fisam SA, Guillermo Tell 21, Barcelona 12. Tel: (93) 228-0905. Gen. Mgr.: Ezequiel Beaumont; Sales Mgr.: Inmaculada Mateo.
Product: Record—carrying & storage cases, record care prods.; Tape—carrying & storage cases, head cleaners, demagnetizers.
Iberofon SA, Av. Fuentemars 35, Poligono Ind'l Costada, Madrid. Tel: (91) 671-2200. Telex: 42797.
Product: Carrying & storage cases; Record—45 rpm adaptors; Tape—leader tape.
Mabel, Calle Ripollés 84, Barcelona 13. Tel: (93) 235-4000.
Product: Record—replacement styl.
Brand name: Stanton.
Portadores de Sonido SA, Hortaleta 118, Madrid 4. Tel: (91) 410-3130. Gen. Mgr.: J.M. Estebarez Mansilla.
Product: Tape—head cleaners.
3 M Espana SA, Josefa Varcarel 31, Madrid 27. Tel: (91) 742-00.12. Telex: 27499. Mng. Dir.: G.J. Partington; Gen. Mgr.: Esteban Lopez; Sales Mgr.: Antonio Vergara; Mktg. Mgr.: Manuel Martin de Barbadillo.
Product: Tape—head cleaners, demagnetizers, leader & splicing tape.

• store fixtures
Fisam SA, Guillermo Tell 21, Barcelona 12. Tel: (93) 228-0905. Gen. Mgr.: Ezequiel Beaumont; Sales Mgr.: Inmaculada Mateo.
Product: Record & tape browser boxes, display racks, divider cards.

SUDAN

Population: 17,760,000

Rate of exchange: \$1 (US) = 0.35 Sudan pound

Per capita income: \$300

Holidays: January 1 (Independence Day), March 3 (Unity Day), May 25 (Revolution Day), October 12 (Republican Day), December 25, and various Mohammedan religious holidays

• record & tape manufacturer / importer / distributor

Munophone Rec'g Co., PD Box 2380, Khartoum Tel 73355, 81388, 73990.

Labels: (Owned) Munophone; (represented) Chahatphone (Chad), Sono Cairo (Egypt), Sout el Phan (Egypt, Greece)

Int'l reps.: Chad (Chahatphone), Egypt (Sono Cairo), Ethiopia (Impex Radio, Yared Music Shop), Libya (El Fezani)

• services

CATALOG SERVICES DESIGN & ARTWORK PRINTER & LITHOGRAPHER RECORD PROMOTION

Munophone Rec'g Co., PD Box 2380, Khartoum Tel 73355, 73990, 81388 (all rec. only)

• accessories & store fixtures

Munophone Rec'g Co., PD Box 2380, Khartoum Tel 73355, 81388, 73990

Product: Record-carrying & storage cases, record care prods., 45 rpm adaptors, replacement styli, needles, browser boxes, display racks, di-vider cards

SURINAM

Population: 400,000

Per capita income: \$1600

Holidays: January, 1, Good Friday, May 1 (Labor D.), July 1 (Day of Freedom), November 25 (Independence Day), December 25, 26

• record & tape manufacturer / distributors / importers

Didi Recs., PD Box 183, 2420 Paramaribo, Maleb-trumstr. 4, 2438 Paramaribo Tel 76398

Int'l branches: Netherlands, A.M. Girwar

Labels: (Owned) Didi, Did Gold

• services

DESIGN & ARTWORK RECORD PROMOTION

Didi Recs., PD Box 183, 2420 Paramaribo, Malebatrumstr. 4, 2438 Paramaribo Tel 76398

SWEDEN

Population: 8,000,000

Rate of exchange: \$1 (US) = 4.80 krona

Holidays: January 1, Epiphany, Good Friday, Easter Monday, May 1, Ascension Day, Whit Monday, Mid Summer Day, December 25, 26

RECORDS

Record sales certification awards: Gold single—25,000 units, platinum single—50,000 units, Gold LP—50,000 units, platinum LP—100,000 units

Records sold domestically: LP's 1980—15,700,000 units, \$135,000,000, 1979—16,000,000 units, \$140,000,000, Singles 1980—2,100,000 units, \$6,100,000, 1979—1,900,000 units, \$4,975,000

Average retail price per record: LP's—\$8.95, singles—\$2.90

Record club sales: 10% 15% of total.

Discounting: Frequent

Type of distribution: Manufacturer to retailer system predominates. There are two major rack jobbers, which comprise about 15% of the market. Direct importing is frequent and is estimated to account for at least 25% of the market and about 30%-35% of full price album sales

Type of promotion: Government-controlled and non-commercial radio and TV are the prime media for the promotion of records. The major daily evening newspapers are important for advertisements and reviews. The newly started bimonthly magazine, Schlager, has proved to be important. Discos are also significant, as are in-store video presentations and the UK radio station Radio Luxembourg.

Jukeboxes: 1,000

TAPE:

Market: Sales of pre-recorded cassettes were up 4% in units and 14% in turnover, the latter due to price increases, and are now about 3.5 million units. However, sales of blank cassettes are still about ten times that of pre-recorded. About 4% of the Swedish households have video equipment, with VHS having about 75% of this market, followed by Beta and VCR. The pre-recorded video tape market is flourishing and is now dominated by rentals.

Pre-recorded tape sold domestically: Cassette 1980—3,473,000 units, \$31,100,000, 1979—3,000,000 units, \$30,950,000

Average retail price per tape: Cassette—\$8.95

CONSUMER ELECTRONICS:

Percentage of homes with: Radios (97%), television sets (95%), color (66%), bbw (50%); phonographs (60%), audio tape recorders (60%), video tape recorders (4%)

RADIO STATIONS

No. of commercial 3 (FM), no. of government 1 (AM)

Comment: One channel (P3) plays primarily recorded music 24 hours daily, although the percentage has lowered in the last year. 24 local radio stations are now in operation

TELEVISION STATIONS:

No. of channels: 2 government, 95% color (PAL)

Comment: The two non-commercial channels each transmit about 40 hours per week. Programs featuring rock and pop are quite rare and have ratings of only 10% to 20% of the viewers

MARKET ANALYSIS

Sales have more or less stagnated, but turnover is up a few percentage points due to price increases during 1980. The problems remain the same: Home taping and direct imports. Home taping is still the major problem, with blank tape sales being ten times higher than that of pre-recorded. A levy on blank tape is expected to come before the end of 1981. Direct imports are now estimated to be at least 25% of the market, and certain current albums have about 35% or more sales from direct imports. Canada is the biggest source for these albums.

But although IFPI reported sales are down, the consumption of music is higher than ever before. Many new bands are playing everywhere, and many new independent labels are now in business. Swedish talent is having a higher share of the Top 20 album sales than ever before, and although top sales for an album today are not the 250,000 units they were three years ago, international acts like Bruce Springsteen and local acts like Abba and Gyllene Tider still sell in that quantity. **Leif Schulman**

• record & tape manufacturer / distributors / importers

Abata Handels AB, Vanadisplan 5, S-113 31 Stockholm Tel (08) 33 75 48 (Distributor)

Ad Lib Dist'n AB, PO Box 52, Skattegaardsvaegen 49, S-162 11 Vaellingby Tel (08) 739 26-50/22 08 Exec: Ivan Sundberg (Distributor/Importer)

Labels: (Distributed—not licensed) Audio Fidelity, Audiophile, CBS Collectors, CBS Encore, CBS S1 West, Chiaroscuro, Choice, Classic Jazz, Concord Jazz, GHB, Image, Improv, Inner City, Jazzology, Monmouth Ev ergreen, Progressive (all USA), Ahead, Black & Blue, MCM, Riverboat (all France), Jazzcraft, Matrix, SteepleChase (all Denmark), Bluebell, Coop, Fermal, Kenneth, Lyricon (all Sweden); Timeless (Netherlands)

Advent, see Amigo

Amigo Musik AB (IFPI), PO Box 6058, Norrbackagatan 47, S-10231 Stockholm Tel (08) 34 89 25 Cable: GEDDAHL Telex 17840 Pres: Per Andersson, A&R Mgr: Jan Boguist, Sales Mgr: Laila Munther, Label Mgr: Soeren Lundberg

Labels: (Owned) Advent, Amigo, (distributed—not licensed) Advent (USA), Album (France), American (France), Anatolia (Sweden), Bae renreiter (Germany), Bee Hive (USA), Black Saint (Italy), Blue Goose (USA), Blue Sound (France), Bulfrog (USA), Candy Apple (USA), Cas sandra (USA), Cellier (Switzerland), Chant du Monde (France), Contem porary (USA), Deesse (France), Delmark (USA), ECM (Germany), ENJA (Germany), FMP (Germany), Festival (France), Folksang (Sweden), Folk ways (USA), Four Leaf Clover (Sweden), Free Reed (UK), Frog (Sweden), Gael Linn (Ireland), Hello (Norway), Improvising Artists (USA), JAPD (Germany), JCDA (USA), Jefferson (Sweden), Joliet (USA), Le Roi du Blues (USA), Moveplay (Spain), Musidisc (France), Muskadine (USA), Nighthawk (USA), Dcora (France), Paredon (USA), Pearl (USA), Plaene (Germany), Playa Sound (France), Red Lightnin' (UK), SAJ (Germany), Salfra (Sweden), Solid Smoke (USA), Sonodisc (France), Spottite (UK), Swamp (Sweden), Trojan (UK), Vedette (Italy), Vogue (France), Watt (Germany), Yazoo (USA)

Anatolia, see Amigo

Anette, see Lido Prod'n

Angel, see EMI

Archiv, see PolyGram

Arrival, see TMC

Arrow Recs., PO Box 295, S 580 01 Linköping Tel (013) 121 997. Gen Mgr: B. Roger Fransson (Importer)

Artist, see Nordiska

Asylum, see WEA Metronome

Atco, see WEA Metronome

Atlantic, see WEA Metronome

Audactiv, see EMI

Barnparaden, see Nordiska

Bastun Studio AB, Bastugatan 39, S 117 25 Stockholm Tel (08) 84-18 75 Pres: Peter Olsson, A&R Dir: Anders Larsson

Labels: (Owned) SWS, YTF

Be-Bop, see Tandan

Arne Bill Prod'n AB, Groendalsvaegen 18, S 147 00 Tumba Tel 379-00, 317 91

Labels: (Owned) Bill, Butler

Blitz, see Swecont

Bluebell, see Ad Lib

Blue Horizon, Styrbordsvagen 44, Oxelesund Tel (0155) 3 30 47

Blue Note, see EMI

Bohus AB (Grammofon) (IFPI), PO Box 24, S 442 01 Kungälv Tel (0303) 109 90, 168 71 Mng Dir: Bjarne Lundqvist, Gen Mgr: Gert Leng strand (Distributed by Marriann)

Boogie, see Scrinta & Mii

Bourre, see Skandinavisk Musikstans

Bra Musik/Skandinavisk Press AB, PO Box 803, S 201 80 Malmö Tel (040) 10 18 30 Telex 32575 Mng Dir: Rolf Nilstam, A&R Prod Mgr: Hans Ingvar Hansson, Mktg Mgr: Richard Larsson

Label: (Owned) United Music Int'l

Int'l reps.: Denmark (Skandinavisk Press), Finland (Mestarikestannus), Norway (Skandinavisk Press)

Buda, see EMI

Bums, see EMI

Butler, see Arne Bill

C.M. (Concert Music), see EMI

C.B.S. Recs. AB, (IFPI), PO Box 20037, Mariehallsvaegen 40, S-161 20 Bromma Tel (08) 98 02 50 Cable: COLRECORD, Telex: 17736 Mng. Dir: Sten af Klinteberg, Financia Mgr: Ingmar Ostberg, Mktg. Mgr: Lennart Backman

Labels: (Owned) CBS, Cupol, Embassy, Epic, Harmony, Portrait, (distributed) Glendisc, Round Up, (licensed) A&M (USA), Ariola (Germany), Arista (UK, USA), GTG (UK), Jet (USA), Monument (USA), Philadelphia Int'l (USA), TK (USA), T-Neck (USA)

Int'l rep.: Worldwide (CBS)

California Sweden Grammofon Co., PO Box 117, S 721 05 Vasteras, Tel: (021) 13 12 11, 35 66-10 Mng. Dir.: Sture Redin.

Labels: (Owned) California, Centy, Memphis, Montana, Omega, RR, Record, Sunrise, Swede, Sweden, WMP

Capitol, see EMI

Casablanca, see PolyGram

Centy, see California

Cewe, see Epok

Chart, see TMC

Cirkus, see Sonet

Cisco, see Kountry Korral

Click Recs./BBS Musik AB (IFPI), PO Box 12, S 780 45 Bjoerbo Tel: (0241) 2 34 95 Mng Dir: Lollo Berglund, Sales Mgr: Rolf Hallgren, Int'l Sales Mgr: Les Carillon (Distributed by Ad Lib, BBS, EMI)

Labels: (Owned) Click, Coop, CruX, (licensed foreign) Paddelwheef (Japan)

Int'l rep.: Japan (Nippon Flamingo)

Walter Cogn, Bromsvagen 25, S 125 30 Alvsjo Tel (08) 47 35-46 (Distributor)

Columbia, see EMI

Coop, see Ad Lib & Click

Coop Clinic, see Music Ultra

Cotillon, see WEA Metronome

Cross Road, see Marriann

CruX, see Click

Crystal, see EMI

Cupol, see CBS

D.G., see PolyGram

D.I. Special, see W Sign

D.N., see Play

Dacapo, see EMI

Dance record, see Marilla

Double Up, see EMI

Dragon Recs./Westin & Wallgren, Lovbergsvagen 9, S-132 00 Saltjö-Boo Tel (08) 747-9332 Gen Mgr: Lars Vestin, Sales Mgr: Jan Wallgren.

Dux, see PolyGram

E.M.I. Svenska AB, Box 1289, Tritonvaegen 17, S 171 25 Solna, Tel: (08) 730-0060 Cable: EMIGRAM, Telex: 10046 Mng Dir: Rolf Nygren; Mktg. Mgr: Peder Hedstrand, Sales Mgr: Hans Bretholtz; Promo Mgr: Bengt Berg, Int'l A&R Mgr: Lars Bremer

Labels: (Owned) Angel, Blue Note, Capitol, Columbia, Crystal, Dacapo, Double Up, EMI, EMI America, EMI Int'l, Electrola, Emdisc, Encore, HMV, Harvest, Liberty, Music for Pleasure, Odeon, One Up, Parlophone, Pathe, Radic, Regal, Regal Zonophone, Rondo, Seraphim, Souvenir, Starline, Stateside, Sunset, Talisman, Tower, United Artists, Waverly, Zonophone, (licensed) Ballistic (UK), Barclay (France), Bulldog (UK), Carrere (France), Classic, Delta, Deutsche Harmonia Mundi (Germany), Egg (France), Ember (UK), Fantasy (USA), Magnet (UK), Matumbo (UK), Milestone (USA), Pickwick (USA), Prestige (USA), Purple (UK), RAK (UK), Ricordi (Italy), Riviera (France), Rolling Stones (UK), Rondo, SWS, Springboard (USA), Stax (USA), Tammi (UK), World Rec Club (UK); (distributed—not licensed) Audactiv, Boogie, Buda, Bums, Click, CM (Concert Music), Fair Play, Flam, Fortuna, Gadd, Galaxy, Glenn Music, Granite, Hamu, Jollywood Music, Kason, Kaw, Maestro, Montescuma, Moon, Nugget, Pang, Platina, RC (Rock & Country), Royal, SIR, SR, Sagia, Scrinta, Sun Music, Talent, Ters, Triol, Troll Music

Elder, see Marilla

Efel, see Europa Produktion

Electra (Grammofon AB) (IFPI), PO Box 14, Dstergatan 4, S-163 93 Spanga Stockholm Tel: (08) 751 0406, Telex: 14075 Pres: Sixten Eriksson, Gen Mgr: Hans-Dve Eriksson; A&R Int'l: Klas Burling; A&R Domestic: Carl-Eric Hjelm, Sales Mgr: Hans Lindqvist; Press Officer: Lennart Andersson

Labels: (Owned) Musica, Swedish Society Discofil, Telestar, Viking; (licensed foreign) Das Alte Werk (Germany), Arion (Italy), Altic (Canada), Aura (UK), Avatar (UK), BBC (UK), Box (UK), Cheapshare (UK), DeLuxe (Australia), Ensign (UK), Erato (France), Grunt (USA), Harmonia Mundi (France), Intercord (Germany), Jupiter (Germany), Logo (UK), Lollipop (Germany), Melodyia (USSR), Millennium (USA), Motown (USA), Nova (Germany), Ovalton (USA), Pickwick (UK), Prom (Germany), RCA (USA), Rag Baby (USA), Rialto (UK), Spiegelei (Germany), Strand (Germany), Supraphon (Czechoslovakia), Teldex (Germany), Telemunken (Germany), Transatlantic (UK), Turnabout (USA), 20th Century-Fox (USA), Why-Fi (UK), Vox (USA), Zilch (UK) (SEE ADVERTISEMENT)

Electrola, see EMI

Elektra, see WEA Metronome

Embassy, see CBS

Emdisc, see EMI

Encore, see EMI

Entertainer, see Sound of Scandinavia

Epic, see CBS

Epok Skivforlag, Vintergatan 10B, Ornskoldsvik Tel (0660) 300-52

Labels: (Owned) Cewe, Epok

Christer T. Eriksson & Son AB, PO Box 317, S-181 03 Lidinge Tel: (08) 766 0290 Telex: 10155 Mng Dir: Christer T. Eriksson; Sales Mgr.: Claes Eriksson (Distributor/Importer/Exporter)

Sven Eriksson (Ingenjorsfirma), PO Box 834, S 121 08 Johanneshov Tel: (08) 19-90-50 Telex: 13210 Dwner Sven Eriksson

Label: (Represented) Sheffield Lab (USA)

Ess Rosing AB, Luntmakargatan 59, S 113 58 Stockholm Tel: (08) 34-64-01 Telex: 12080, Dir.: Brian Shack, (Distributor)

Europa-Produktion AB, Rasundsvagen 45, S 171 52 Solna, Tel: (08) 83-31-05

Labels: (Owned) Efel, Olga

F.beat, see PolyGram

Fair Play, see EMI

Fermal, see Ad Lib

Fiktra AB, PO Box 49021, Kungsholmsstrand 169, S-100 28 Stockholm 49 Tel: (08) 54-81-07 (Distributor)

Flam, see EMI

Folksang, see Amigo

Flop, see Sonet

Fontana, see PolyGram

Forsyte New Music, Box 4021, S 171 55 Solna Tel: (08) 83-45-09

Label: (Represented) Theresa (USA)

Fortuna, see EMI

Four Leaf Clover, Jaernvaegsgatan 70, S-172 35 Sundbyberg Tel: (08) 98-28-08, 55. Exec.: Lars Samuelson (Distributed by Amigo)

Fralsningsarmens Handelsavdelning, PO Box 5090, Dstermalmsgatan 71, S 102 42 Stockholm 5, Tel: (08) 63-17-00 (Distributor)

Frituna Produktion AB, Vaertavaegen 15, S 115 28 Stockholm Tel: (08) 63-13-45, Telex: 12328 Pres: Goeran Walther; VP A&R: Claes af Gejerstam (Distributed by Sonet)

Int'l branches: Denmark, France

Int'l reps.: Finland (EMI), Norway (Phonogram)

Frog, see Amigo

G D C (Grammofonbolagens Distributionscentral) AB, Dalvagen 4, Solna. Tel: (08) 730-0720. Pres.: Gorar Stenberg; Sales Mgrs.: Rolf Hellensjö, Stig Stahl, Peter Werner. (Distributor)
Gadd, see EMI.
Galaxy, see Scranita & EMI.
Gamla Stenkator, see Record Trad ng.
Gayotte, see Skandinavisk Musiktjänst.
Gazel, see Sonet.
Gilda Recs, Arkitektvaegen 24, Fack, S-161 09 Bromma. Tel: (08) 80-30-95. Chief Exec.: Ragnar Blomstrom.
Glendisc, Vallvagen 2, S-182 75 Stocksund. Tel: (08) 85-68-00. (Distributed by CBS)
Glenn Music, see EMI.
Goodwill, see Mariann.
Grammoplast AB, Box 8019, S-163 08 Spanga. Tel: (08) 761-7060. Dir.: Svante Raaet; Gen. Mgr.: Hans Johnsson.
Grand Prix, see Sonet.
Granite, see EMI.
Gummesons Book/Music Publ'r, PO Box 6302, Tegnergatan 8, S-113 81 Stockholm. Tel: (08) 15-18-30. Telex: 14275. Gen. Mgr.: Ulf Hemdahl; Sales Mgr.: Ingemar Eriksson; A&R Mgr.: Leif Lundberg.
Labels: (Owned) Signatur, Sirius, Solist; (distributed—not licensed) Fingospel (Finland), K-tel (Ireland, UK), Lu-Mi (Norway).
H M V, see EMI.
Hamu, see EMI.
Haparanda Budget Line Recs, Selmredalsvagen 22, S-166 55 Hagersten. Tel: (08) 46 15 11.
Happy Birthday Recs—Exec. Prod'r: Bo Waldersten; Int'l A&R: Sanji P. Tandann—see Sound of Scandinavia
Harmony, see CBS.
Harvest, see EMI.
Heavy Sound, Regeringsgatan 89, S-111 39 Stockholm. Tel: (08) 11-81-14. Cable: HEAVY. Telex: 14339. Mng. Dir.: Torbjørn Hullegard.
Label: (Owned) Heavy Sound.
Hemmetts Haerold, see Prim.
Hemmetts Journal AB, Fack, S-212 05 Malmö. Tel: (040) 934560. Telex: 32449. Mng. Dir.: Jan Morch.
Impact, see TMC.
Imperial, see TMC.
Inter-Disc, see Record Trading.
Iver Rec'g Co. AB, Grev Turegatan 38, S-114 38 Stockholm. Tel: (08) 67-99-10. Cable: SOUTHMUSIC.
Label: (Represented) Spark (UK).
Int'l rep.: Worldwide (Peer-Southern).
Jefferson, see Scandinavian Blues Ass'n & Amigo.
Jockey, see Record Trading.
Jollywood Music, see EMI.
K B Rec AB/Shushu Rec. Ltd., PO Box 4153, S-203 12 Malmö. Tel: (040) 232-996. Dir.: Ken Brown; Gen. & Sales Mgr.: Ulla Nielsson.
Labels: (Owned) KB, ShuShu.
K-tel, see TMC.
Kason, see EMI.
Kawi, see EMI.
Kenneth, see Ad Lib.
Knappupp, see Sonet.
Kontra Punkt, see Record Trading.
Koster, see Mariann.
Kountry Korral Prod'ns, PO Box 8914, S-720 08 Vasteras 8. Tel: (021) 18-86-20/90. Pres.: Lillies Ohlsson.
Labels: (Owned) Cosco, Kountry Korral.
L P Fyndel AB, PO Box 70, S-815 01 Tierp. Tel: (0293) 131-65. Telex: 47126. Gen. Mgr.: Karl-David Kistrom; Sales Mgrs.: Kjell Gronberg, Nils-Erik Kistrom. (Distributor/Importer)
Liberty, see EMI.
Lido Prod'n, Fack 131, S-531 01 Lidköping. Tel: (0510) 231-25.
Label: (Owned) Anette.
Lilla Huset Musik AB, Stationsgatan 4, S-827 00 Ljusdal. Tel: (0651) 157-00. Chief Exec.: Boerje Bergstrom.
Label: (Owned) Wigwam.
Lotus, see TMC.
Lyricon, see Ad Lib.
M N W, see Musiknaetet Waxholm.
Maestro, see EMI.
Marcus Music AB (IFPI), Raesundavaegen 45, S-171 52 Solna. Tel: (08) 730-0400. Deputy Dir.: Margaretha Andersson; Gen. Mgr.: Lars Rosin; Sales Mgr.: Ann-Birgitt Carlsson; Chief Exec.: Christer Berg. (Distributed by Tor)
Mariann Int'l Recs, Hornsgatan 78, S-117 21 Stockholm. Tel: (08) 84-58-88. Telex: 17936. VP: Benny Fedlund.
Labels: (Owned) Mariann; (distributed—not licensed) Bohus, Cross Road, Goodwill, Koster, Rainbow, Signatur, Sirius, Solist, Starec (all Sweden); Aquarius, Warwick (UK).
Int'l reps.: Denmark, Finland, Norway (all EMI).
Mariella Grammofon AB (IFPI), Parmmaetargatan 9, S-112 24 Stockholm. Tel: (08) 54-18-30. Telex: 10625. Pres.: Hans Edler
Labels: (Owned) Dance-record Edler, Mariella.
Memphis, see California.
Mercury, see PolyGram.
Metronome, see WEA Metronome.
Montana, see California.
Montax AB, Klockaregatan 27, Falkenberg S-311 00. Tel: (0346) 81060.
Montesuma, see EMI.
Moondisc, see Sound of Scandinavia.
Moonshine, see Safir.
Mudist, see Music Ultra.
Musica, see Electra.
Music Consult AB, Östgötagatan 17, S-116 25 Stockholm. Tel: (08) 44-03-80. Telex: 12597 Import Mgr. Johan Gereholts (Distributor/Importer) (SEE ADVERTISEMENT)
Musica for Pleasure, see EMI
Musica Ultra Dist'n Inc. (Mudist), PO Box 6084, S-200 11 Malmö. Tel: (040) 23-90-60, 23-90-70. Cable: PROSTGATAN. Pres.: Christer Gardsby; A&R Mgr.: Ronny Kintleberg.
Labels: (Owned) Mudist, YTF; (distributed—not licensed) Coop Clinic, EMI.
Musiknaetet Waxholm AB (MNW), Radhusgatan 12, Box 71, S-185 00 Vaxholm. Tel: (0764) 323-45. Gen. Mgr.: Jan-Olof Schill; Sales Mgr.: Lizzie Jørgensen; Studio Mgr.: Curt-Ake Stefan; Prod'n: Tomas Gabrielson, Jonas Sjöestrom. (Distributed by SAM).
Label: (Owned) MNW.
Int'l reps.: Denmark (SAM), Norway (MAI).
Noon, see EMI.
Nonesch, see WEA Metronome.
Nordiska Musikforlaget AB (IFPI), PO Box 745, S-101 30 Stockholm 1. Tel: (08) 13 24-80. Cable: MUSICALIA. Telex: 11859. Pres.: Bengt Edwards-son; Sales Mgr.: Tony Lonn.

Labels: (Owned) Artist, Barnparaden; (licensed) Acanta (Germany), All Stars (France), BASF/Acanta (Germany), Claves (Switzerland), Montparnasse 2000 (France), Music Minus One (USA), Selected Sound (Germany) reps.: Denmark (Wilhelm Hansen), Finland (Scandia-Musikk), Norway (Norsk).
Nugget, see EMI.
Odeon, see EMI.
Oiga, see Europa-Produktion.
Omega, see California.
One Up, see EMI.
Onskesagan, see Record Trading.
Lilith Örongröjd, c/o Birgitta Olsson, Bondegatan 63 II, S-116 34 Stockholm.
Label: (Represented) Redwood (USA).
Pang, see EMI.
Parlophone, see EMI.
Pathe, see EMI.
Philips, see PolyGram.
Photograph, see W-Sign.
Pilot Music AB, Fack, S-171 19 Solna. Tel: (08) 730-0810. Pres.: Kjell Samuelson; Gen. Mgr.: Rolf Samuelson; Sales Mgr.: Bertil Lindholm.
Planet Recs & Music, Framnaesbacken 12, S-171 42 Solna. Tel: (08) 83-73-00. Cable: PLANREC. Telex: 14392. Pres. & Mng. Dir.: Mats Olsson, Local A&R Mgr.: Anders Larsson; Press & Promo.: Madeleine Midenstrand. (Distributed by Sound of Scandinavia)
Labels: (Owned) Bastun, Planet; (licensed foreign) Atomic Art (USA), Celluloid (France), Cherry Red (UK), Cream (USA), Dingles (UK), Graduate (UK), Gull (UK), Heartbeat (UK), Hi (USA), Ice (UK), Medley (Denmark), Miracle (UK), Nems (UK), Pipe (UK), Xanadu (USA), (distributed—not licensed) Affinity (UK), Charly (UK), Different (UK), Intercord (Germany), Smack (UK).
Int'l reps.: Denmark (Rayton), Finland (Polarvox), Norway (Arne Bendixsen).
Platina Recs AB, St. Arodsgratan 29, H. Backa, S-422 43 Gothenburg. Tel: (031) 52-66-50. Pres.: Evert Jakobsson. (Distributed by EMI)
Playback Inspelnings AB, Gustav Adolfs Tor 10, S-211 39 Malmö. Gen. Mgr.: Lennart Christiansson.
Label: (Owned) Playback
Play Music AB, PO Box 112, Vinterg. 5, S-172 23 Sundbyberg. Tel: (08) 98-54-30. Cable: PLAYMU. Telex: 11967. Int'l Contact: Ake Wikke. (Distributor/Importer/Rackjobber)
Int'l branch: Norway.
Labels: (Owned) Play; (distributed) CBS, EMI, Electra, GDC, Mariann, Metronome, Phonogram, Polar, Polydor, Sonet.
Polar Music Int'l AB, PO Box 26072, Baldersgatan 1, S-100 41 Stockholm. Tel: (08) 14-30-20. Cable: SWEDENMUSIC. Telex: 11959. Pres. & Gen. Mgr.: Stig Anderson; VP: Goerel Hanser; Promo. Mgr.: Marie Anderson; Label Mgr.: Hans Bergkvist.
Labels: (Owned) Polar; (distributed) Boardwalk (USA).
PolyGram Direct Mktg. Scandinavian Org., PO Box 50202, Foretagsvagen 14, Arlov, S-20212 Malmö. Tel: (40) 43-64-50. Telex: 32771.
PolyGram Recs AB, PO Box 3093, Dalvagen 4, S-171 03 Solna. Tel: (08) 730-0940. Cable: POLYGS. Telex: 10466. Mng. Dir.: Per-Arne Lindholm; Fin. & Adm. Dir. & Deputy Mng. Dir.: Benno Norholm, Local A&R MOR. Nicola: Wohrmann-Hill; Local A&R Rock/Pop: Stefan Schroder; Int'l A&R Mgrs.: Ace Blomberg, Robert Hulman, Eva Soederqvist; Sales Mgr.: Gun nar Johnson.
Labels: (Owned) Archiv, Casablanca, DG, Dur, Fontana, Mercury, Philips, Smash, Sonora, Vertigo, Verve; (licensed foreign) Albon (UK), Back Door (UK), Backstreet (USA), Bram (Germany), Charisma (UK), DJM (UK), Do It (UK), Dreamland (USA), EG (UK), Fbeat (UK), Fiction (UK), Harmonia Mundi (France), Illusive (UK), Intersound, MCA (USA), Mountain (UK), PRE (UK), RSO (UK), Robot (Netherlands), Rocket (UK), Sire (USA), Spring (USA), Stiff (UK), Zomba; (distributed—not licensed) F-beat, Proprius, Svenska Ljud
Portrait, see CBS
Prestige AB (Scandinavian Music Club), Foretagsvagen 14, S-202 12 Malmö. Tel: (40) 43-64-50. Telex: 32771. Chief Exec.: S. Rosdahl.
Prim Recs (IFPI), Dagenhuset, S-105 36 Stockholm. Tel: (08) 13-03-40. Pres.: Perre Larsson; Gen. Mgr.: Larsen Janson; Sales Mgr.: David Edstrom; Prod'n: Lennart Sjöeholm, Svante Bengtsson
Labels: (Owned) Hemmetts Haerold, Prim; (licensed foreign) Birdwing, Dayspring, Good News, Lamb & Lion, Light, Maranatha!, Myrrh, Solid Rock, Sparrow, Spirit (all USA); Word (UK, USA)
Int'l reps.: Finland (Laborforlaget), Norway (Prim/Fidelifalforlaget).
Proprius, see PolyGram.
R C (Rock & Country), see EMI.
R R, see California.
Radic, see EMI.
Rainbow, see Mariann.
Record, see California.
Record Trading AB, Box 211, S-183 23 Taebj. Tel: (08) 758-3700. Cable: GALVANOMATRIS. Telex: 11350. Pres.: Kurt Westman
Labels: (Owned) Gamla Stenkator, Inter-Disc, Jockey, Kontra Punkt, Onskesagan, Super-Sound; (distributed—not licensed) Aishire (USA), Audio master (USA), Opus (Czechoslovakia), Power (UK), Supraphon (Czechoslovakia).
Regal, see EMI.
Regal Zonophone, see EMI.
Reprise, see WEA Metronome.
Rock & Country Recs, PO Box 83, Stationsgatan 13, S-310 58 Vessigebro. Tel: (0346) 206-59. Gen. Mgr.: Christer Malmeister; Sales Mgr.: Bertil Janson. (Distributor/Importer)
Labels: (Owned) Rock & Country; (licensed foreign) Cha Cha, Oore, Gold band, Judd, Razorback, Sarg, Showay, Yucca
Rollis Grammofonskiv AB, PO Box 291, S-201 22 Malmö. Tel: (040) 23-41-01. Mng. Dir.: Hans Ingvar Hansson; Pres.: Lennart Carlsson; Sales Mgrs.: U. Andersson, J. Eriksson. (Wholesaler/Importer/Exporter)
Rondo, see EMI.
Ronny's Music, PO Box 4297, S-203 14 Malmö. Tel: (040) 12-89 12. Pres. Ronny Hall (Importer of oldies singles)
Round Up, see CBS.
Royal, see EMI
S A M Dist'n Musik AB, Box 15, S-185 00 Vaxholm. Tel: (0764) 32600. 31590. Telex: 15268. Chief Exec.: Peter Karlsson; Sales Mgr.: Goran Thuresson; Export/Import Mgrs.: Hans Andersson, Ann-Marie Beckman, David Parmacek. (Distributor/Importer/Exporter)
Labels: (Distributed) A-disk, Ack Waermeland, Agdur, Alternativ, Arion, Ball, Bauta, Bellatrix, Bertil Staf, Blues Boy, Borta Pa Vinden, Bruksta tern, Brust, Checkpoint Charlie, Chiekkommitten Clanka Lanka, Cockroach, Dragvisa, Dohjort, Emma, Europa, FNK Vaexpo, Forsa Ljud, Fra Teatern, Gisa, Girsbaeck Prod'n, Heart Work, Hemliga Bolaget, Huv,

Husa-Spelet, Jaekt, Jaemtaengen, Jatari, Jukebox, Kaellan, Kloack, Krokben, Lag, Lilla Raeven, Lydbarrakaden, Lydskyddfoereningen Myrben, Lydsparet, Manifest, Maskros, Massproduktion, Minne Foer Luet, Mr. R&B, Mislur, Mora Traesk, Musiklaget, Musiknaetet Waxholm, Narren, Norbergsspelet, Och Ordning, Open, Pandora, Patric, Petca, Piglet, RKOB, Rikets Alfaer, Rip, Rockvindr, Route 66, Rykka, Silence, Sista Bussen, Slick, Sla Tillbaka, Sloboban, Somos, Stockholm, Stranded, Subversiv, SvartVirt. Svenska Jazzrisfoerbundet, Svenska Love, Svenska Popfabriken, Tall, Tonkraft, Trend, Tropic Dream, Tredje Taget, Urspar, Vinden Vaender, Vulcan (all Sweden); AMP (France), Bay (USA), Factory (UK), Genlyd (Denmark), Greenleaves (UK), Irmgard (Denmark), Karma (Denmark), KSL (Denmark), LKJ (UK), MAI (Norway), Makossa (USA), Ogtave (Norway), Ogun (UK), Pumpkin (USA), Ralph (USA), Rambler (USA), Red Lightnin (UK), Ritmo (Denmark), Rough Trade (UK), SFP (France), Solar Plexus (Denmark), String (UK), Systematic (USA), TJ (USA), Tangent (UK), Tiden (Denmark), Topic (UK), Ulo (Denmark).
Int'l reps.: Denmark (Dansk SAM), Germany (Egelstein, Teldec), Norway (MAI), USA (Greenworld).
S I R, see EMI
S O S, see Sound of Scandinavia.
S R, see EMI & Swedish Radio.
S W S, see Bastun & EMI.
Safir Music of Scandinavia AB (IFPI), Hollandargatan 32, S-113 50 Stockholm. Tel: (08) 30-59-83. Gen. Mgr.: Stefan Nordin; Sales Mgr.: Lennart Fries.
Labels: (Owned) Moonshine, Safir; (licensed) Laser (Australia).
Int'l reps.: Canada, UK, USA (all Moonshine).
Safir, see Amigo.
Sagra, see EMI.
Sarec Recs, Box 4010, S-141 04 Huddinge. (Distributor)
Scandinavian Blues Ass'n, Tallkrogsvaegen 8, S-122 33 Enskede. Tel: (08) 59-54 43. Pres.: Joergen Sandin (Distributed by Amigo)
Label: (Owned) Jefferson.
Int'l rep.: Worldwide (Amigo in Sweden.)
Scranita Grammofon, PO Box 2037, Haesaengsvaegen 3, S-691 02 Karlskoga. Tel: (0586) 534-49. Mng. Dir.: Ebbe Nilsson; Gen. Mgr.: Per Nilsson; Sales Mgr.: Sten Nilsson, Studio Mgr.: Ache Svensson. (Distributed by EMI)
Labels: (Owned) Boogie, Galaxy, Scranita.
Int'l reps.: Denmark (Sun), Norway (Talent Music Org.).
Seelig & Co. (AB), PO Box 17120, Solna Contact: Ragnar Berglund.
Label: (Represented) Moss Music Group (USA).
Seraphim, see EMI.
ShuShu, see KB.
Signatur, see Gummesons & Mariann.
Sirius, see Gummesons & Mariann.
Skandinavisk Musiktjänst, Sandbacksgatan 4, S-116 21 Stockholm. Tel: (08) 43-88-85.
Labels: (Owned) Bourre, Gavotte.
Skandinavisk Press, see Bra.
Smash, see PolyGram.
Smile Recs, Storgatan 39, S-211 42 Malmö. Tel: (040) 97-60-62. Telex: 33290. Mng. Dir.: Lars Hansson; Gen. Mgr.: Susanne Lind.
Int'l branch: England.
Labels: (Owned) Smile; (distributed—not licensed) BBC (UK), Peerless (UK), Schwann (Germany)
Smokestack Rec. Sales, PO Box 29005, S-100 52 Stockholm. Tel: (08) 62-77-22. Chief Exec.: Hans Schweitz, Hans Andreasson. (Distributor/Impor ter)
Labels: (Distributed—not licensed) Ace of Spades (USA), Crown (USA), Delta Swing (USA), Earwig (USA), Flash Back (USA), Flyright (UK), Juke Joint (USA), Maggie (UK), Razor (USA), Tria (USA), White Label (Netherlands).
Snur, see WEA Metronome.
Solist, see Gummesons & Mariann.
Sonet Grammofon AB (IFPI), Box 1205, Atlasvaegen 1, S-181 23 Lidingöe. Tel: (08) 767-0150. Cable: SONETMUSIC. Telex: 10037. Pres.: Gunnar Bergstrom; Gen. Mgr.: Dag Haeggqvist; Dir.: Sven Lindholm; PR Mgr.: Lars-Olof Helen.
Int'l branch: England.
Labels: (Owned) Circus, Flop, Gazell, Grand Prix, Knappupp, Sonet, Spotlight, Storyville; (distributed) Frituna, Vanity Fair; (licensed) Air (UK), Alligator (USA), Arhoolie (USA), Bearsville (USA), Blueprint (UK), Blues Classics (USA), Bomp (USA), Bronze (UK), Calibre (UK), Caroline (UK), Chiswick (UK), Chrysalis (UK, USA), Collectors Classics (Denmark), Cube (UK), Electric (UK), Elite (Switzerland), Excello (USA), Exibris (Denmark), GNP (Norway), Flower (Norway), Flying Fish (USA), Golden Hour (UK), Flora Crescendo (USA), Golden Guinea (UK), Golden Mout (UK), H&L (USA), Island (UK), JCOA (USA), Jazz Piano (Denmark), Jazz Unlimited (Denmark), Kicking Mule (USA), MAM (UK), Mute (UK), Nashboro (USA), Old Timey (USA), Piccadilly (UK), Plantation (USA), Preci-sion (UK), Pye (UK), Rockhouse (Netherlands), Roulette (USA), Rounder (USA), SSS Int'l (USA), Safari (UK), Savoy (USA), Specialty (USA), Speedball (UK), Strand (Germany), Sun (USA), Takoma (USA), Trola (Norway).

PEER-SOUTHERN ORGANIZATION
 LINKS THE WORLD
 Southern Music A.B.
 Stockholm, Sweden



Leaders in Records and Publishing in Scandinavia

Denmark
SONET/DANSK GRAMMOFON A/S
 Finland
SONET/SCANDIA
 Norway
SONET NORWAY AS
 Sweden
SONET GRAMMOFON AB

and in England
SONET RECORDS & PUBLISHING LTD
 121 Ledbury Road, London W11

WANTED

Cassettes by well-known artists at GOOD PRICES and of TOP QUALITY

REWARD

A good customer.

Contact: Johan Gereholt (Import Manager)



music consult ab
 ÖSTERGÅTGATAN 17 · 116 25 STOCKHOLM
 TEL 08-44 03 00 TELEF 12587 MUSIKSÖKN S

Vanguard (USA), Virgin (UK), Ze (USA)
 Int'l reps.: Denmark (Sonet/Dansk), Finland (Sonet/Scandia), Norway (Arne Bendiksen) (SEE ADVERTISEMENT)
 Sonora, see PolyGram
 Sound of Scandinavia & Rec'g AB, PO Box 1108, Storaengsvaegen 22, S 141 23 Huddinge Tel (08) 774 0780 Cable SDSRECE Telex 12601 Pres & Mng Dir. Led Bigert, Mktg Mgr Jan Boerklund
 Labels: (Owned) Entertainer, Moondisc SDS, T Bone, (licensed domestic) Happy Birthday, (licensed foreign) All Platinum Cadet, Checker, Chess, De Lite, IBC, Salsoul, Stang, Sugar Hill, Turbo Vibration (all USA) Armageddon, Blue Chip, Hedonics, Hot Box (all UK) (distributed-not licensed domestic) Adventure, Bastun, Be Bop, Castor, Foxy, GOK, Hen dix, Mamma, Moon Shine, Planet TMA, Tandan Tylon Wave Zea phone, (distributed-not licensed foreign) Affinity, Celluloid, Charly Cherry Red, Chopper, Different, Dingles, Graduate Gull, Heart Beat, Hi Ice, Miracle, News, Rondelet, Royton, Splash, Wanted, Warwick (all UK) Cream (USA), Intercord (Germany), Medley (Denmark), Eds 23 (France) Xandy (USA)
 Int'l reps.: Denmark (CBS), Finland (Polarvox), Norway (Continental Consult, EMI) (SEE ADVERTISEMENT)
 Souvenir, see EMI
 Soven, see W-Sign
 Spotlight, see Sonet
 Starac, see Mariann
 Starline, see EMI
 Stateside, see EMI
 Storyville Recs. AB (IFPI), Atlasvaegen 1, S 181 23 Lidingsö Tel (08) 767 0150 Cable SDNETMUSIC Stockholm Telex 10037 Mgn Dir Dag Haeggqvist, Dir Karl Emil Knudsen (Also see Sonet)
 Int'l reps.: Canada (Moss), Denmark (Sonet), Finland (Scandia), Germany (Teldec), Japan (Teichiku), Netherlands (Sound Prods.), Norway (Arne Bendiksen), USA (Moss)
 Sun Music, see EMI
 Sunrise, see California
 Super Sound, see Record Trading
 Svenska Ljud, see PolyGram
 Sweet Recs AB, PO Box 347, Gamla Brogatan 34, S 101 24 Stockholm Tel (08) 21 33 25, 21 67 94 Telex 12481 Dwner Wolfgang Jediczka (Distributor/Importer/Exporter)
 Labels: (Owned) Blitz, (distributed-not licensed) Bellaphon, Brain Sky (all Germany), Orange (USA), Skydog (France)
 Swede, see California
 Sweden, see California
 Swedish Radio Co Phonogram (IFPI), Døensternsgatan 20, S 105 18 Stockholm Tel (08) 784 0000 Cable BROADCAST Telex 10000 Gen Mgr Britt Marie Bystedt, SR Gen & Sales Mgr Hans Westman
 Label: (Owned) SR
 Int'l rep.: UK (Conifer)
 Swedish Rec. Pool AB, Box 403, Malmkskallnsgatan 21, S 101 25 Stockholm Tel (08) 21 25 03 Pres Hans Kjell, Gen Mgr John Wallin Sales Mgr Michel Petre (Distributor/Importer/Exporter)
 Swedish Society Discotif, see Electra
 T Bone, see Sound of Scandinavia
 T M C (The Music Co AB), PO Box 503, S 183 25 Taey Tel (08) 756 72 55 Telex 14021 Pres G Soederian
 Labels: (Owned) Arrival, Chart, Impact, Imperial, K tel, Lotus, (licensed) CNR (Netherlands), Can't Stop (USA), Creole (UK), Malaco (USA), PVK (UK), Papagayo (Netherlands), Palo (UK), Rallin' Rock (USA), WMDT (USA), Young Blood (UK)
 Tab Recs., PO Box 210, S 732 00 Arboga Tel (0589) 103 50 Gen Mgr Harry Holm
 Talent, see EMI
 Talsman, see EMI
 Tandan Recs AB, Marknadsvaegen 297, S 183 34 Taey Tel (08) 768 3900 Telex 12601 Dir Sanji P Tandan, Controller Frederick Von Rosen, US Prod Label Mgr John Wallin, European Prod Label Mgr Michel Petre, Exec Prod'r Hans Kjell (Distributed by Sound of Scandinavia)
 Labels: (Owned) Be Bop, Tandan
 Tape Center AB, PO Box 7202, S 103 84 Stockholm Tel (08) 10 83 38 Gen Mgr Carsten Meyer
 Telestar, see Electra
 Ters, see EMI
 Tonola Grammoton AB, Box 1106, S-400 30 Goteborg Telex 854 27441 Contact Harry Svensson
 Label: (Represented) Direct Disk (USA)
 Tower, see EMI
 Troll, see EMI
 Troll Music, see EMI
 United Artists, see EMI
 United Music Int'l, see Bra
 Vanity Fair, see Sonet
 Vertigo, see PolyGram
 Verve, see PolyGram
 Viking, see Electra
 W E A Metronome Recs AB (IFPI), Storaengsvaegen 22, S 115 34 Stockholm Tel (08) 61 06 16 Cable METROREC Telex 19022 Mng Dir Boerje Ekberg, Anders Burman
 Labels: (Owned) Asylum, Atco Atlantic, Cotillion, Elektra, Metronome, Noneseuch, Reprise, Snurr, Warner Bros., (licensed foreign) Big Tree, Dark Horse, Embryo, Finnadar, Little David, Paradise, Planet, RFC Swan Song, WMDT, Whitfield, Wing & A Prayer (all USA)
 W M P, see California
 W Sign Mktg AB, Lohavagen 57, S 183 42 Taey Tel (0762) 129 62 Telex 13161 Chief Exec C Wendel
 Labels: (Owned) DJ Special, Phonograph, (licensed) Space, (distributed) cut outs & overstocks
 Int'l rep: USA (JRB)
 Warner Bros., see WEA Metronome
 Waverley, see EMI
 Wigwam, see Lilla Huset
 Y F, see Bastun & Music Ultra
 Zonophone, see EMI

• music publishers

Air Music Scandinavia AB, PO Box 10220, Valhallavagen 134, S 100 55 Stockholm Tel (08) 63 07 20 Telex 12335 Pres Sture Borgedahl, Gen Mgr Lars Wiggman
 Int'l firms represented: ATV (USA), Air (UK), Air & Graces (UK), J Albert & Son (Australia), Ian Anderson (UK), Austindin (USA), Antipodes (Australia), Antrisa (USA), Barn (UK), Earl Barton (USA) Beautiful Sunday (UK), Beggar's Banquet (UK), Big Bang (USA), Big Secret (UK), Big Sky (USA), Black Coffee (USA), Black Sheep (USA), Blanned (UK), Blend

ingwell (USA), Blue Seas/Jac (USA), Brew (USA), Brown Sound (USA), Bruce Wolley (UK), Bug (USA), Caesar (UK), Callee (USA), Camal (UK), Alan Cartee (USA), Ronald Carter (USA), Cest (USA), Cheap Thrills (USA) Cherry Lane (USA), Chicago (USA), Chicken Key (USA), Chrys A Lee (UK), Chrysalis (USA), Claire (UK), Clandalce (USA) Cod (UK), Com bine (USA), Comet (UK), Cookhouse (USA), Core (Canada) Cram Renraff (USA) Crazy Cajun (USA), Alvin Crow (USA), Cuckoo (UK), Curtis/Parkins (UK), Dawnbreaker (USA), Dayn (UK), Desert/Breakaway (UK), Dirty Trinks (UK), Divines (USA), Durango/Decim (USA), Dwarf (USA), ERP (UK), Earmark (USA), Eaton (UK) Fast Western (UK) Fennario (USA), Fiction (USA), Fiddler (UK), 57th Street Entertainment (USA), Friesign (UK), Four Aces (USA) Frank & Nancy (USA), Freshwater (UK) Gannet (UK) Gem (UK), Golden Syrup (USA), Grade & Lynton (UK), Great Honesty (USA), Gull Songs (UK), Heathwave (UK), Hightree (USA) Tony Miller (UK), Hobbitron (USA), Hush (UK), Indian Brandee (UK), J&H (USA), Jobete (USA), Johi (USA), Juniper (UK), Kamakazi (USA), Kidada (USA), Knollwood (USA), Koppelman Bandier (USA), Ladysmith (UK) Lambert & Potter (USA), Lido (USA), Light (USA), Little Dickens (USA), Logo (UK), Lornhale (USA), Lucky Three (USA), Lunch (USA) Macaulay (UK), Maciver Hine (UK), Madlad/Ron Joy (USA), Maison Rouge (USA), Mandina (USA), Mautoglade (UK), Mel Dav/Dav Mel (USA) Metal Machine (USA), Miceache (USA), Montunes (USA), Music Mgmt (USA) Music Mll (USA), Naked Snake (USA), Narrow Gate (USA), Natural Songs (USA), New Acme (UK), New Hidden Valley (USA), Northern Songs (UK), Oakfield Ave (USA), Ohio River Valley Songs (USA), PRP (UK), Page Full of Hits (UK), Pants Down (USA) Performance (UK) Jerry Peters/Golden Cornflake (USA), Petra (USA), Plumb On (USA), Poca (USA), Prophecy Publ'g (USA), Publishing Home (USA), Quarry (UK), Quartet (UK), Ram's Horn (USA), Ready (UK), Resaca (USA), Rocket (UK), Rockstam (USA), Ronjoy (USA), Roolfarn (UK), Rosebridge (USA), Ryerson (USA), SWS (USA) Sailor (USA), Saints (Australia), Salsoul (USA), Shanna (UK) Shawbury (UK), Shoals Music Mill (USA) Shoes (USA), Shoe Shine (UK) Shoelures/Shoesongs (UK), Silkue (USA), Silver Cloud (UK), Silver Nightingale (USA), Six Pictures (USA) Small Faces (UK), Sorn (USA) Space Opera (USA), Sparrowpit (UK), Special Rider (USA), State (UK), Steeley Span (UK), Sterling (UK), Stevia (UK), Stirling McQueen (UK), Stone Diamond (USA), Strange (UK), Stratsong (UK), Strawberry (UK), Strong Arm (USA) Sunlight (USA), Sunshine (UK), Sweet Summer (USA), Swell Sounds (USA), Synergistic (USA) Thursday (USA), Tintagel (USA), Titanic (UK), Tone (UK), Tomeshire (UK), Touch of Gold (USA), Tres Johe (USA), Triangle (USA), Tumbleweed (Australia), Tuneworks (USA), Valen tine (UK), Wax (USA), Window/Tomake (USA), Windstar (USA), R P Win kelman Tunas (USA), Wobble (UK) Bruce Wolley (UK), Writer's Night (USA), Yaronne (USA)

Albert/Air see Air

Amigo Musik AB, PO Box 6058, Norra Stationsgatan 91 93, S 102 31 Stockholm 6 Tel (08) 34 01 95 Telex 17840 Pres Jan Boquist
 And Publ'g Co (d/w of TMC AB) PO Box 503, S 183 25 Taey Tel (08) 756 72 55 Telex 14021 Pres G Soederian
 April Music Scandinavia AB, PO Box 20037, Mariehallsvagen 40, S 161 20 Bromma Tel (08) 98 02 50 Cable COLRECORD Telex (854) 17736 Gen Mgr Rolf Persson Prof Mgr Stefan Egmar
 Int'l firms represented: Graduate, Jet, Rough Trade, Velvet Apple, Virgin
 Int'l rep.: Worldwide (April)

Belinda (Scandinavia) AB, Box 5222, Skeppargatan 48, S 102 45 Stockholm 5 Tel (08) 63 54 90

Blitz Publ'g, PO Box 347, Gamla Brogatan 34, S 101 24 Stockholm Tel (08) 21 67 94, 21 33 25 Telex 12481 Dwner & Mgr Wolfgang Jediczka Brass Center, Box 4303, Stjobergsiden 16, S 400 40 Goteborg Tel (031) 24 65 20

Int'l firm represented: Brass Press (USA)
 Hans Busch Musikforlag AB, Stubbskogen 3, S 181 47 Lidingsö Tel (08) 765 1230

Camp Music Corp AB, Jaernvaegsgatan 70, S-172 35 Sundbyerg Tel (08) 98 28 08/55 Exec Lars Samuelson
 Int'l firms represented: Arlequin, Cara Nova, Musisom, Tonga (all Brazil)

Careless Music, Box 7003, S 163 07 Spanga Tel (08) 36 50 20 Chief Exec Les Carlton

E M I Music Publ'g (Sweden) AB, Ynglingagatan 17, S 191 53 Stockholm Tel (08) 23 66 80 Cable TURNTABLE Telex 12587 Mng Dir Bengt Sundstroem Prof Mgr Tommy Hallden

Int'l branch: Denmark
 Int'l firms represented: Accord (Germany), Ambleside (UK), Ardmore & Beechwood (Belgium, Mexico, South Africa, UK), Ashtar (USA), Avant Garde (USA), BBC Ents (UK), Beechwood (Canada, USA), Belcas (New Zealand), Belwin Mills (UK), Bema (USA), Big Ben (UK), Big Pig (UK), Black Swan (UK) Blendingwell (USA), Bowling Green (UK), Britten (UK) Buddah (USA), Kate Bush (UK), CHC (UK), Cable Car (USA), Johnny Carter (UK), Castle (Australia) Central Songs (USA), Champs Elysees (France), Chankin (UK), Chippewa (UK), Chu Fin (USA), Clowns (UK) Colgems (USA), Columbia (Austria) Consortway (UK) Coppa (UK), Coronado (UK), Cross Keys (USA), Francis Day & Hunter (France, Germany, Scandinavia, UK), Dean Street (UK) Dominion (USA), Donna (UK) Dreamers (UK), EGO (Spain), EMI (Greece, Netherlands, Southeast Asia, Switzerland) EMI Brigadiers (South Africa), EMI Television Programs (USA), Elovac (USA), Elstree (UK) Episode (UK) Equator (UK), Leo Fest (USA), B Feldman (UK), Ferris (UK) First Floor (UK), Forty Love (UK), Four Two Four (USA) Sam Fox (UK), G&A (UK), Gaetana (USA), Gallagher & Lyle (UK), Genus (USA) Giant (USA), Glasco (USA), Glenwood (USA), Golden Torch (USA), Gold Horizon (USA), Good Time (USA), Grand Canyon (USA), Hastings (USA) Heart's Delight (USA) Neal Hefzi (USA) Homecoming (USA), How About (UK), Initial (UK) Itapui (Brazil), Jet (USA), KPM group (UK), Kama Rippa (USA), Kama Sutra (UK, USA), Kennedy Street (UK), Kentree (USA), Kipahulu (UK), Kipper Songs (UK), Kling Klang (UK), Koppelman Rubin (USA), Legacy (USA), Legion (UK) Lonzo & Oscar (USA) MAI (Argentina), MPL Communications (UK) Mabrak (UK), Macmelodies (UK), Manhattan (UK) Marchar (USA) Marouam (France), Martin Cooper (USA), Metromedia (UK), Miles (UK), Miller (USA), Mima (USA), Mortimer (UK), Musicciastar (UK) Mutual (UK) My Ace (UK), Mysongs (UK), Neverbreak (UK), New York Times (USA), Nightingale (UK), Odeon (Argentina), Open Door (USA), Parasondo (USA) Palthe (Far East) Palthe Marconi (France), Pepe (UK), Penn (USA) Petal (UK), Powder (USA) Prima Donna (USA), Keith Prowse (UK), Queen (UK), Gerry Rafferty (UK) Rastar (USA) Reynolds (UK), Robbins (UK, USA), Tom Robinson (UK), Rolling Stones (UK) Roll ing Tide (USA) Ruler (USA), Saffron (UK) Sahara (UK), Sanah (UK) Sand B (USA), Sansu (USA), Saturday (USA) Sawgrass (USA), Scratch wood (UK), Screen Gems (UK, USA), Shanfield (UK), Sheldon (UK, USA) Sochem (Chile), Solar Plexus (USA) Southtown (USA) Spectrum VII (USA), Starway (USA), Strada (USA), Street Tunes (UK) Charles Strouse (USA), Sugaratown (UK), Summerhill (USA) Summerfree (USA), Sunbeam (USA) Sunlight (UK), Supersongs (UK), Super Supa (USA), Survivor (USA) TR (UK), Tata Grande (USA), Telescope (UK), Tempo (USA) Tip

ALPHA Automatic Record Pressing System
for Audio and Video.
Sold and serviced worldwide.

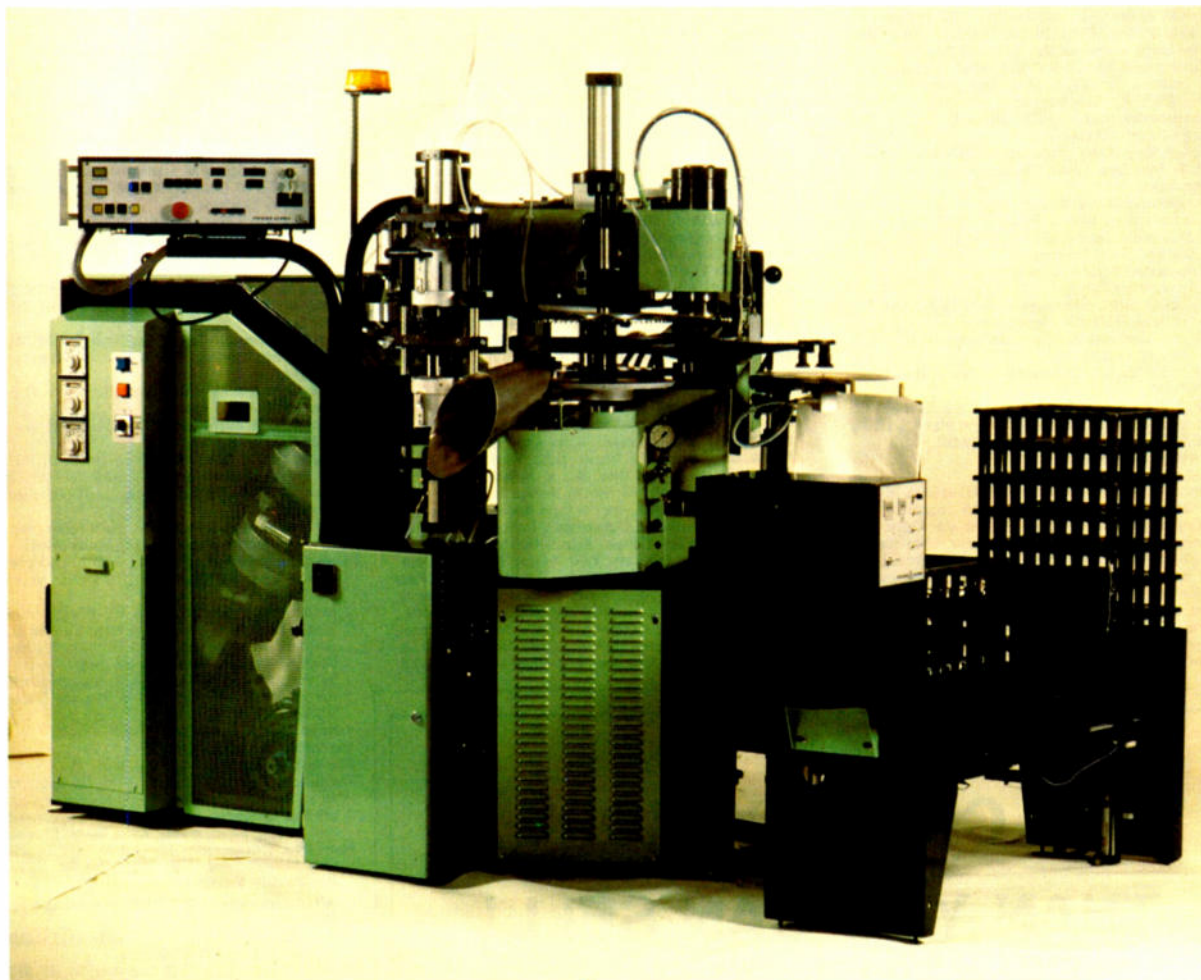

Gramophone record press Alpha Delta 12 for LP's with our new sleeving unit.

You can depend on **ALPHA's** complete
line of products for the record pressing industry.
More than 700 presses in production today.

*Write, phone or telex
for information:*

TOOLEX  **ALPHA AB**

Box 176 / Esplanaden 10 S-172 25 SUNDBYBERG / Sweden
Telex 13378 Telephone 46 · 8 28 90 30

Top (UK), Tomorrows Tunes (USA), Too Rock (USA), Toshiba-EMI (Japan), Tree (USA), Trident (UK), Trides (USA), Twitty Bird (USA), Conway Twitty (USA), Unart (USA), Uncanny (USA), United Artists (France, Germany, UK, USA), Univista (UK), Valentim de Carvalho (Portugal), Varda (UK), Vassar's (USA), Voce del Padrone (Ita y), W&R (UK), Warhawk (USA), Larry Weiss (UK), Willow Way (USA), Bobby Womack (UK), World Wide (UK)

Int'l reps: Argentina (MAI), Australia (Castle), Austria (Columbia), Belgium (Ardmore & Beechwood), Brazil (ITAIPI), Canada (Beechwood), Chile (Sochem), Far East (Pathe), France (Francis Day & Hunter, Pathe Marconi), Germany (Accord, Francis Day & Hueter), Greece (EMI), Hong Kong (EMI), Italy (Voce del Padrone), Japan (Toshiba-EMI), Mexico (Beechwood), Netherlands (EMI), New Zealand (Belcas), South Africa (Ardmore & Beechwood), Spain (EGO), Switzerland (EMI), UK (EMI), USA (Beechwood)

Hans Edler Music AB, Krysshammansvaegen 10, Stockholm Tel (08) 83-49-40 Telex 10625 Pres. Hans Edler

Ehringforlagen AB, PO Box 5268, Linnegatan 9/E1, S-102 45 Stockholm Tel (08) 63-07 60 Cable EHRLINGMUSIK Pres. Thore Ehrling, Gen. Mgr. Staffan Ehrling, Professional Mgr. Bo Giran Edling

Essex AB (Musikforlaget) (STIM), PO Box 10220, Valhallavagen 134, S-100 83-49 40 Stockholm Tel (08) 63 07 20 Cable: AIRMUSIC Telex 12335 Pres & Gen Mgr. Sture Borgedahl

Int'l firms represented: Essex group (UK), TRD (USA)

Int'l reps.: UK (Essex), USA (TRO)

Fidafalifa Forlaget AB (STIM/NCB), Dagenhusst. S-105 36 Stockholm Tel (08) 13-03 40 Pres. Sverre Larsson, Gen. Mgr. Lars Eric Jansson

Int'l branch: Norway

Int'l firms represented: Manna, Maranatha, Word (all USA)

Flamingo Music Publ'g AB, c/o Air Music, PO Box 10220, Valhallavagen 134, 37, S 100 55 Stockholm Tel (08) 63-07 20 T-lex 12335 Pres. Sture Borgedahl, Gen. Mgr. Roland Fernberg

Int'l firm represented: Nippon Flamingo (Japan)

Int'l rep.: Japan (Nippon Flamingo)

Frituna Produktion AB (STIM), Vaertavagen 15, S-115 28 Stockholm Tel (08) 63-13 45 Telex 12328 Pres. Goeran Wellner

Gavotte Music, c/o Skandinavisk Musikförlag, Sandbacksgatan 4, S-116 21 Stockholm, Tel (08) 43 88 85

Carl Gehrman, PO Box 505, S 101 26 Stockholm Tel (08) 10 30-04 Cable MUSIKGEHRMAN

GlenSongs AB, Vallvagen 2, S 182 75 Stockholm Tel (08) 85 68 00

Gummessons Book/Music Publ'g, PO Box 6302, Tegnergatan 8, S 113 81 Stockholm Tel (08) 15 18 30 Gen. Mgr. Ulf Heimdahl

Int'l firm represented: Janz (Germany)

Hendrix Music, see Safir

Intersong-Forlagen AB, PO Box 3094, Dalvagen 4, S-171 03 Solna Tel. (08) 83 08 90, Cable SONORA, Telex 12383 Pres. Olle Bergman

Int'l firms represented: American Songs—Allied Arc, Blue Ribbon, Conrad, Downey, East West, English, Ghana, Gladstone, Green Bros & Knight, Harman, Hot Point, Jewel, Lyco, Robert Lyons, Merrimac Our Children's Music, Ralston, Red Seal, Regent, Rico, Sunflower, Tristan, Belinda—Aberbach group, Ashtree Holdings, Blue Gum, Buddha, Carlin group, Elvis, Hudson Bay, Jeff Lynne, Kama Rippa, Kama Sutra, Omlug/Shirts, Peterman, Pickwick, Quartet, Sweet, Trio, US Songs, White Haven, Xanadu Xongs, Yellow Dog, Chappel—A&R, Airsteam, Albion, Anglo-Pic, Antique, Anton, Anvil, Arden, Ascherberg Hopwood & Crew, Average, Avia-

tor, Avocet, Aznavour, BDM, BNP, Begonia Melodies, Benton, Irving Berlin, Big B, Big H, Big L, Boston, Boston Butler, Bregman Vocco & Conn, Brut, Bundin, Burke & Van Heusen, Canadiana, Canal, Charisma, Chewable, Chilly Winds, Clara, Clondyke, Corlab, Cosmic Echoes, Country, D&J Arson, Degar, Diplomat, Dobbins, Donna, Druze, EFOS, Early Morning Prod'n, Ensign, Era, Erie, Famous, Finner, Forrest Hills, Gear, Gershwin, Goble, Guard, Stephen Hackett, Half of Fame, Halmet, Handle, Hanna Barbera, Charles Hansen, Hartene, T. B. Harms, Harwin, Hip Trip, Holly Vine, Honky Tonk, Hulla-Balloo, Hummit, Ironside, Ivanhoe, JP, Jay's, Julie, Kaiser, Kajanus Ltd., Kander & Ebb, Ken-Glen, Keyboard Pendulum, Kiss Songs, Leeds, Michel LeGrand, Little Fugitive, MRC, Magic Mouth, Megusta, Meridian, Merlin, Moon, Edwin H. Morris, Mother Pearl, Motion Picture, Music Machine, Muso Mail, New Christy, Omar, Para-Thumb, Patricia, Pentangle, Piliow, Pilot, Pineapple, Pink Floyd, Poppin the Friendly Ringer, Please, Promoco, Pure Noise, Pure Songs, Pussy, Quail, Red Anchor, Red Bullet, Revelation, Rhineland, Road, Don Robertson, Rondell, Donald Rose, Saggiavel, Douglas Salm, Salmaker, Sarah, Scotia Songs, Sarah, Shediak, Smbro, Sock Cymbal, South Mountain, Spaniel, Sparrow, Spectrum VII, Stonebridge, Subbudo, Super, Tashman, Tebo, Thank You, Think Big, Thunderbird, Tom Tom, Top Hat, Tr-Chappell, Twentieth Century, Unichappell, Universal Songs, Van Hoy, Harry Von Tilzer, Wardo, Warman, Wilhamson Willis, Monty Wilson, Wren, Intersong—Armag, Ajay, Albert, Aiza Thorah, Airc, Ananas, Annuccius, Arawak, Alberts BV/Santa Esmeralda, Audigram, Babes, Back Track, Bagatelle, Bananas, Baron, Bear Brown, John Betand, Belkhat, Big Apple, Big Note, Big Seven, Boomtown Rats, Bovina, Brain Orain, Bridge House, Brighthouse, Broken Arrow, Bron, Buckwheat, Bulb, Bushka, CAM, Cafe Americana, Callee, Cape Ann, Casablanca, Caseyem, Caspat, Cedarwood, Celestial, Cerrone, Chanson, Charlotte, Clarkee, Stanley Clarke, Claudia, Clave, Clay, Clonine, Common Good, Contagious, Coral Rock, Crazy Cow, Cried, Crusty, Mike Curb, Dabe, Oamont, Diagonal, Dyon, Dingles, Walt Disney Prod., Donna, Doobie Bros., Double Aitch, Double Exposure, Dough Boy, Down Town, Draitell, Francis Dreyfus, Dwarf, EOM, Betty Earland, Eldorado, Elliscan, Enz, Eric, Erik, Eternity, Every Little Tune, Fabel, Fairfield, Father, Fifth Floor, Flam, Flat Lizard, Fleadieedle, Fleetwood Mac, Fuse, Peter Gabriel, Ganja, Gentoo, Getaway, Gibb Bros., Gnossos, Gogly, Gone Fishing, Richard Gottelher & Jru, Green Dream, Guys 'N' Dolls, Hallelujah, Hamilton Bohannon, Hanscutt, Happy, Harbor, Hardcore, Harlene, Hazy, Heavy Metal, Hensley, Herald Square, High Class, Hilliard, Hit & Run, Hustlers, Intersong Int'l, Intersong Ltd., Intersong USA, Jam, Jimpire, Jiru/Slumbe Bunny, Kangaroo, Kaskat, Kenya, Kings Point, Klubb, Kongrude, Lagos, Laser, Lazy Lizard, Lead Sheet Land, Leo Leandros, Leros, Sonny Lester, Litha, Little Fugitive, Lois, Lucky, MTM, Magnet, Marco Marks, Martin-Coulter, Matragun, Maybe, Mayday, Mews, Michael, Midland, Midsong, Milk Money, Maimarsh, Joni Mitchell, Mobbetta, Montag, Gayle Moran group, Muggins, Nelson, New Sound, New York Times, Nineteen Eighty Five, Our Hems, Noodle Tunes, Normal, OAM, Olofsons, Omnipotent, Orange, Our Own Thing, Pal Dog, Norrie Paramor, Angel Parker, Phonopub, Piedmont, Pit, Pocket Full of Tunes, Polite, Polypub, Progressive, Quark, Quick Mix, RSO, Rainy City, Rapp Mets, Rare Blue/Monster Island, Peter Rice, Rickis, Rococtet, Roaring Fork, Rockfish, Rockhopper, Rodra-Berna, St. George, Samba, Sarnos, Seabreeze, Seacoast, Seagrape, September, Shepstone & Oibbens, Silver Chalice, Silver Fiddle, Siquomb, Sky Forest, Sky Harbor, Skyhill/Audigram, Sky Writing, Sleepy Dumpling, Rudolf Slezak, Snug, Some Really Good, Song, Soquel, Special, Steve & Nickel-

odeon, Studio PR, Subway Rhythm, Sunbeam, TH, Takya, Tauripin Tunes, Televis, Tembo, Ten East/Five West, Thalian, Thames Talent, Time, Torbal, Times Square, Toneshire, Tony Banks, Top of the Town, Trane, Trane, Triple Three, Twist Party, UFO, Valando, Vanila, Wallsongs, Wed, Wednesday Morning, Welsh Witch, Wemar, Windocor, Worlds End, Zevon, Zum: Dick James—Nto, Ammo-James, Airgee, Bailey, Casanova, Cookaway, Edward Cox, Crest, Crystal, Spencer Davis, Debonaire, Dee Mac, Dee Tee, Filmusic, Friarmer, Golden Egg, Gallo, Gwyneth, Intune, Jamsham, Josid, Lords, Love Songs, Maribus, Medallion, Nuova, Pall Mail, Really Useful Co., Les Reed, Santa Ponsa, Shair, Tic Toc, Together, Tudor, Utopia, Vr-Jon, Wonder, Zoom, Mellin Musical Rights—Algonquin, Anglia Television, Ansur, Big Leaf, Big Tree, Blackberry, Franklin Boyd, Crown, Elmin, Flying D, Franco-London, Great North American, Great Sterling, In-Sync, Lloyd Logan, Mellin Corp., Robert Mellin, Music Makers, Ed Neapolis, Pub. Pamco, Penthouse, Popo, Pumpkin, Rosnque, Sherwin, Trans Gul

John's Music (STIM, NCB), see Sonet

Key Music Prod'n, PO Box 2037, S-691 02 Karlskoga Tel: (0586) 392-80

Mng. Dir. Per Nilsson

Int'l firm represented: Sun (Denmark)

Kountry Korral Prods, PO Box 8014, S-720 08 Vasteras 8 Tel (021) 18-86-20/90 Pres. Lillies Ohlsson

Liberty AB (Ed.), PO Box 14, S-163 93 Stockholm, Tel (08) 751-04-60, Telex: 14075 Ten, Mgr. Hans-Ove Eriksson, Prof. Mgr. Ingela Forsman, Lilla Huset Musikproduktion, Stationsgatan 4, S-827 00 Ljusdal, Tel (0651) 157-00 Chief Exec. Boerje Bergstrom

Abr. Lundquist Musikforlag AB, Katarina Bangata 17, S-116 25 Stockholm Tel (08) 43-67-67 Cable: LUNDRROUND Pres.: Helge Roundquist; Sales Mgr. Anders Roundquist

Int'l rep.: Norway (Musikk-Huset)

Marcus Music-Imudico, Raesundavaegen 45, S-171 52 Solna Tel (08) 730-0400 Pres.: Marcus Oesterdahl; Gen. Mgr. Bengt Sundstrom

Midnight Sun (STIM, NCB), see Sonet

Multitone AB, Storaengsgatan 27, S-115 34 Stockholm Tel (08) 61-13-16 Cable: METROREC, Telex 19022 Pres.: Boerje Ekberg; Gen. Mgr. Sven-Olov Bagge

Int'l firms represented: Char-Liz, Fox-Gumble, Gold Hill, March Hare, No Exit, Rear Exit, Story Songs, Three Brothers, Artie Wayne (all USA), Fleetwood (UK)

Musikaetel Washolm AB (MNV), Radhusgatan 12, Box 71 S 185 00 Vaxholm, Tel (0764) 323-45

Mustang Music AB, Bergsgatan 19, S-117 34 Stockholm Tel (08) 68-35-20, Pres.: Ove Hansson

Branch: S-411 29 Goteberg, Landalabergen 20 Tel (031) 16-26 90

Nordic Songs AB, PO Box 745, S-101 30 Stockholm 1 Tel (08) 13-24-80 Cable: MUSICALIA, Telex 11859 Pres. Bengt Edwardsson, Prof. Mgr. Tony Lonn

Int'l firms represented: Barton (UK), Sparta Florida group (UK)

Int'l reps.: Denmark (Wilhelm Hansen), Norway (Norsk)

Nordiska Musikforlaget AB, PO Box 745, S-101 30 Stockholm 1, Tel (08) 13-24-80 Cable: MUSICALIA, Telex 11859 Pres.: Bengt Edwardsson, Prof. Mgr. Tony Lonn

Int'l firms represented: J.&W. Chester (UK), Wilhelm Hansen (Denmark), Impala (France), Nicky James (UK), Montparnasse 2000 (France), Norsk (Norway), Selected Sound (Germany), Hans Sikorski (Germany), Union (Spain), Walton (USA), Wilhelmiana (Germany)

Int'l reps.: Denmark (Wilhelm Hansen), Germany (Wilhelm Hansen), Norway (Norsk), UK (J.&W. Chester), USA (Alexander Broude, Magna, G. Schirmer, Walton)

Notverket (STIM, NCB), see Sonet

Peer-Southern Org., see Southern Music

Pike Music, see Safir

Pilot Music AB, Fack, S-171 19 Solna, Tel (08) 730-0810 Pres. Kjell Samuelson, Gen. Mgr. Olle Samuelson

Int'l firms represented: John T. Benson, Oaystar, Dimension, Goldline, Heart Warming, Impact, Journey, Mama, Rambo, Silverline (all USA)

Planet Music, Frammaesbacken 12, S-171 42 Solna, Tel (08) 83-73-00 Cable: PLANREC Telex 14392 Pres & Mng Dir. Mats Olsson, Prof. Mgr. Madelene Midenstrand

Int'l firms represented: CAM (Italy), Memory Lane, Larry Spier, Spier (all USA)

Platina Musikforlag, St. Arodsagan 29, H. Backa, S 422 43 Gothenburg Tel (031) 52-66-50 Pres.: Evert Jakobsson

Play Music, PO Box 112, S 172 23 Sundbyberg, Tel (08) 98-54-30 Telex 11967 Int'l Contact: Ake Wilke

Safir Music Publ'g, Hollandargatan 32, S 113 59 Stockholm Tel (08) 30-59-83 Gen. Mgr. Stefan Nordin

Int'l firms represented: A&L (USA), Big Heart (USA), Bixio (Italy), Oynablast (USA), House of Bryant (USA), Intermusic (Netherlands), Laser (Australia), MMS (Switzerland), Sudden Rush (USA), Very Nice (USA), Wooden Heart (USA)

Int'l reps.: Australia (Laser), Austria (Nada), Benelus (Nada), Brazil (RCE-Fermata), Germany (Nada), Italy (Durum), Switzerland (Nada), UK (Bonsor), USA (Very Nice)

Sonet Music AB (STIM/NCB), Box 1205, Atlasvaegen 1, S-181 23 Lidingsoe Tel (08) 767 0150 Telex 10037 Gen. Mgr. Dag Haeggqvist, Prof. Mgr. Ola Hakansson

Int'l branch: England

Int'l firms represented: Akee (USA), Akila (USA), Alcatraz Corner (USA), Ameba (USA), Amigos de Musica (USA), And Son (UK), Armadillo (USA), Arends (Germany), Arista (USA), Arnas (USA), Jack Bartley, Big Game (UK), Blue Cheer (USA), Blue Mountain (UK), Canaan, Canterbury (USA), Careers (USA), Carrera (Germany), Charing Cross (USA), Chibell (UK), Chuckie Tunes (USA), Coal Miners (USA), Collins (UK), Copper Basin (USA), County Seat (USA), Oella (USA), DeShufflin (USA), Diamond Touch (USA), Oogfish (USA), Oovan (USA), Emile (USA), Eyeball (USA), Fantasy Songs (UK), Fedora, Food (USA), Fuzzy (USA), Gambol (USA), Ricky Gardner (UK), Robin Gibb (UK), Global (Germany), Go (UK), Half (UK), Hara Kiri (UK), John Hartford (USA), Hitman, Hit Songs (UK), Hodolog (USA), Horseshoe Canyon, Hounddog (USA), House of Dreams (UK), Hurriganes (Finland), Inkwell (UK), Island (UK, USA), Jayman (UK), Jonan (USA), Joyful Wisdom (USA), Keepers Cottage (UK), Keep on Trucking (UK), Keymack, Kicking Mule (USA), King Coal (USA), King Street (USA), La Oe Ole, Larball (USA), Liegrade (UK), Roger Linn, Lingo, Lupus (UK), Mama Gail (UK), Marklon (UK), McDonald (USA), Modest (USA), Moonlight & Magnolias (USA), Morrison (UK), Morning Glory (USA), Mother Goose (UK), Neal (USA), Number 11 (USA), Oakshre (USA), Pacific View, Pat (UK), Penelope (UK), Pigfoot (USA), Plangent Visions (UK), Porpouse (UK), Prince Street (USA), Radar (UK), Rafterly Songs (UK), Red Stripe, Robertson Brown (UK), Rock (UK), Rockin' (UK), Brian Rohen & Assocs (USA), Rydm, Doug Sahm (USA), Saltwa (USA), Savgos (USA), Scott Wolfe (UK), Seaford (USA), Seven Brothers (USA), Shade of Joy (USA), Paul Simon (USA), Skyhill (USA), Skiview (USA), Socks (UK), Sonet (UK), Bruce Springsteen, Stainless (USA), Steamboat

WE CAN BUY MORE THAN YOU CAN SELL!

As Scandinavia's leading importer/wholesaler we need the best price for EMI, CBS and Polydor records.
If you have an offer please contact:

Johan Gereholt
(Import Manager)

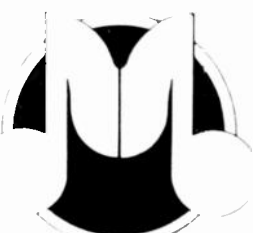

music consult ab

Ostgotagatan 17 S-116 25 Stockholm
Tel. 08-44 03 80 · Telex 12597 Musicon S

Gothic (USA), Sugar Daddy (USA), Sunbury (UK), Superficial (USA), Sweet Nana (USA), TZ (USA), Tannen (USA), Tarka (USA), Teddy Jack (USA), Tempest (UK), Thorlux, Toad Hall (UK), Tradition (USA), Turkey (USA), UFD (USA), Vanas (USA), Vanilla (UK), Venice (USA), Vishnu's Revenge, Warlock (UK), Wayward (USA), White Line (USA), Don Williams, Winsack (UK), Wrsbone (USA), Wizard (USA) (SEE ADVERTISEMENT)

Sound Of Scandinavia & Rec's AB, PO Box 1108, Storaengsvaegen 22, S-141 23 Huddinge. Tel: (08) 774-0780 Cable SDRSREC Telex 12601 Pres. & Mgr. Dir.: Leaf Bigert.

Southern Music AB (STIM, MCB), Grev Turegatan 38, S-114 38 Stockholm. Tel: (08) 67-99-10. Cable: SCUTHMUSIC. Telex: 12250. Mgr.: Ivan Nordstrom.

Home office: USA, Peer-Southern Org.

Sweden Music AB, Baldersgatan 1, PO Box 26072, S-100 41 Stockholm. Tel: (08) 14-30-20 Telex: 11959. Pres. & Gen. Mgr.: Stig Anderson; VP: Anders Moren

Int'l firms represented: ATV (UK), Agent Drange (USA), Ahab (USA), Alchemical (USA), All Seasons (USA), Andalusian (USA), Ariola America (USA), Amakarta (UK), Audigram (USA), Biblo (USA), Big Hill (USA), Bill Black (USA), Blackbyrd (USA), Blue Harbor (USA), Boca/Raton (USA), Brintree (UK), Briarpatch (USA), Mark Cain (USA), Can't Stop (USA), Cartew (UK), Center City (USA), Champagne (USA), Chandos (USA), Chinnchup (UK), Cirrus (Canada), DeByrd (USA), Desert Moon (USA), Doors (USA), Equinox (USA), Everblue (UK), Foghorn (USA), Gabriel Earl (USA), Garrett (USA), Gas Songs (UK), Geoff & Eddie (USA), Golden Withers (USA), Bobby Goldsboro (USA), Gypsy-Boy (USA), Hall-Clement (USA), Alan Hawkshaw (UK), Heath Levy (UK, USA), Hillgreen (USA), Dan Hoffman (USA), House of Gold (USA), Hungry Mountain (USA), Intro (Germany), Jack & Bill (USA), Jarak (USA), Jaspersilla (USA), Kiddio (USA), Kinky (USA), Knight After Knight (USA), Stephen A. Kipner (USA), Lady Jane (USA), Lazy Lizard (UK), Louvigny (UK), Love-Zager, Lowery (USA), Lynal (USA), Lyn-Lou (USA), Maplehill (USA), Mimas (USA), Music Equily (USA), My Mama's (USA), Ivan Mogull (USA), Moss Rose (USA), Neon (UK), Newkeys (USA), New Seasons (USA), Orange Tree (USA), Partner (USA), Pennine (UK), Perk's (USA), Perren Vubes (USA), Ben Peters (USA), P-Gem (USA), Probcross (USA), Porchester (USA), RAK (UK), Razole (UK), Remohi (USA), Roadshow (USA), Rondor group (USA), S. Shiles (UK), Scorpio (France), Scott-Tone (USA), John Sebastian (USA), Shnellagh (USA), Shelby Singleton (USA), Sigem (Brazil), Slow Dancing (USA), Steinberg (USA), Sumac (USA), Sylvia's Mother's (USA), Threshold (UK), Tomake (USA), TriSong (USA), US Arabella (USA), Valley (UK), Vogue (USA), Harry Von Tilzer (USA), Bruce Welch (UK), Wherefore (USA), Window (USA), Whitesett Churchhill (UK), Wind & Sand (USA), Wishbone (USA), Lawrence Wright (UK), Xavier (USA), Frank Zappa (USA), Zargon (USA), **Reuter & Reuter Forlags AB - Black Bull (USA), Cay (USA), Consolidated (USA), Dorsey Bros. (USA), Jack Elliott (USA), Embassy (USA), Evergreen (USA), Hamilton S. Gordon (USA), G. Henle (Germany), Lowell (USA), Mecca (USA), Monogram (USA), Prophet (USA), Raw (USA), J. J. Robbins & Sons (USA), G. Schirmer (USA), Sentinel (USA), 62 Revue (USA), Stonebridge (USA), Tallyrand (USA), H B Webman group (USA), Yankee (USA)**

Int'l rep.: UK (Bocu)

Tab Music/Textab Musikfoerlag, PO Box 210, S-732 00 Arboga. Tel: (0589) 103-50 Contact Harry Holm.

Target Music AB, Arkitektvaegen 24, Fack, S-161 09 Bromma. Tel: (08) 80-30-95 Mng Dir. Tue Sibby, Gen. Mgr. Ragnar Blomstrom.

Int'l firms represented: Crabshaw, Siren Songs (both USA), Paitle (France)

Warner Bros Music (Scandinavia) AB, PO Box 4082, Hoeghdsvaegen 28, S-182 04 Enebyberg. Tel: (08) 768-7150/4844. Telex 12812. Pres.: Lenard Desmond, Prof. Mgr.: Hans Desmond

Int'l firms represented: Advanced, Alessi, Agpa, Carmine Appice, Athwain, Atlas, Attraction, Auntie Gravity, Ayton, Baby Monica, Badco, Barkay, Bar None, Benchmark, Beverly Hills, Big Bang, Big Kitty, Bil-Mar, Bleu Disque, Blue Jeans, Blue Street, B D' Cult Songs, Bridgeport, Brown's Mill, Burbank, Burda, Caledonia Soul, Camad, Canasta, Cane Garden, Cass County, Castle Hill, Charys, Chic, China, Chi-Sound, Chin-mo, Cinco, David Allan Coe, Companion, Cool Springs, Martin Cooper, Coral Reeler, Cotillion, Cricket, Crow Jane Alley, Curfom, Dakar, Daly City, Darkroom, Devalbo, Dgigs, Diamond Mine, Diamond-Zero, Ditch Road, Don Pow, Dorafllo, Double R, Douglas, Easy Money, Eichies, Elektra, Ezra, Feckless, Ferguson, Fingers, First Artists, Flames of Albion, Four Jays, Fozbass, Freejunket, Freyda, Fry King, Gamble Hinged, Ganesh, Gates, Gava Dima, Gear, Cemigo, Golden Spread, Good High, Grand National Songs, Grasshopper, Gringo, Hallmark, Halfway, Hanbo, Harms, Havona, High Wave, Hippedaye, Holmes Line, Hombro, House of Huston, Ice Age, Ice Nine, Inherit, Inherent-Todd/Mark, Inner Earth, Jakma, Jalynne Jazz Bird, Jeddrah, Jcily Cheeks, Jump Tunes, Katja, Howard Kenny, Kicking Bear, Kitty Hawk, Klancey, Know, Kru, Kuumba, Likely Story, Little Macho, Loma Alto, Longdog, MGM, Mack David, Magicland, Magidson, Mahamillion, Makamint, Mansheld, Marsaint, Mayfield, May 12th, Van McCoy, Lonette McKee, Mel Bren, Mercury Bird, Midnight Hour, Mississippi Mud, Moon & Stars, Nebraska, New World, Randy Newman, Nick D Val, Nine, Niehay, Nina, Nine Star, Nipper, Norway, Dakland, Di the Roses, Did Canyon, Open Window, Paine American, Parados, Peabo, Pending, Pepamar, Play My Music, Precedent, Primal Energy, Pronto Public Domain Foundation, Pud, Radio, Ranjack, Rat Trap, Red Cloud, Red Gator, Remck, Road Canon, Rodart, Rosy, Saloon Songs, Sanctum, Satsongs, Box Scaggs, Sergeant, Showlor, Shubert, Siesta, Siggys, Small Hill, Snow, Song & Dance, Songbirds of Paradise, Southfield, Space Songs, Speed, Stone Canyon, Stone Flower, Strange Euphoria, Superhype, Sure Enough Tunes, Swallow Turn, Sweet Pea, Taco Tunes, Teatime, Ten Speed, Terra Firma, Tessa, Tidewater & Tonopah, Tobey, Topographic, Trampler Devon, Upward Spiral, Vabritmar, Variety, Vera Cruz, Visa, Viva, Walden, Warner Bros, Warner Sevenarts, Warner Tamerlane, Wei Chi, Widescreen, Wine N Dine, M Witmark & Sons, Wow & Flutter, Xamol, Zapata, Zeon (all USA), AHA, Alted, Autumn, Bright, Brunel, Colims, Crezent, Daga, GH, Ganga, Glitterbest, Harrisons, Kinney, Litedust-ring, London Town, Manspring, Marsam, Material World, Moggie, PPR, Pendulum, Rare, Riva, Tony Roberts, Rough Trade, Sky, Skylark, Slim Chance, Slutter, Tay Devlin, Tchaikovsky, Peter Walsh, Warner Bros, Wessea, Winterfold, Zoo (all JK), PEF, Warner Bros, You You (all France), ATV, Don Valley, Klaatsbons, Welbeck (all Canada), Lambda/Lolipop, MUZ, Neue Welt, Warner Bros (all Germany), Alco, Anns, Boozy, Donar, Didway, Payola, Pink Point, Salsbury Plain, Spheric, Warner Bros (all Netherlands), Laetrec, Third Ear, Warner Bros (all South Africa), Warner Bros (Australia, Brazil, Italy)

Int'l reps.: Australia, Brazil, France, Germany, Italy, Netherlands, South Africa, UK, USA (all Warner Bros)

• services
ASSOCIATIONS & PROFESSIONAL ORGANIZATIONS
F S T (Foereningen Svenska Tonsaettare) (Society of Swedish Composers),

PO Box 5091, S-102 42 Stockholm 5. Tel: (08) 24-29-50.
National Committee of the International Music Council, c/o Royal Academy of Music, Blasieholmstorg 8, S-111 48 Stockholm.
National Section of the International Society for Contemporary Music, Prastgatan 28, Stockholm.
S K A P (Society of Swedish Popular Composers & Authors), PO Box 5091, S-102 42 Stockholm 5. Tel: (08) 24-29-50. Pres.: Bo-Göeran Edling.
Scandinavian Blues Ass'n, Tallkrogsvaegen 8, S-122 33 Enskede. Tel: (08) 59-54-43. Pres.: Joergen Sandin.
Society of Swedish Composers, see FST.
Society of Swedish Popular Composers & Authors, see SKAP.
Svenska Gruppen IFPI, PO Box 1008, S-171 23 Solna; Ankdamsmgatan 5H, S-171 43 Solna. Tel: (08) 730-57-80. Telex: 19139.
Swedish Music Information Centre, PO Box 5091, S-102 42 Stockholm 5; Birger Jarlsgatan 6B, Stockholm.
Swedish Music Publ'rs Ass'n (Svenska Musikfoerlaeggareforeningen upa), c/o MIC, Box 5091, S-102 42 Stockholm. Tel: (08) 24-29-50, 25-07-99. Pres.: Kettil Sharby; Gen. Mgr.: Christian Sylvan.

DESIGN & ARTWORK
Bohus Studio, PO Box 24, S-442 01 Kungälv. Tel: (0303) 109-90, 168-71. Gen. Mgr.: Gert Lengstrand.
Filadelfia Forlaget AB, Dagenhuset, S-105 36 Stockholm. Tel: (08) 13-03-40.
Interpromco PR, c/o Skandinavisk Musikintjanst, Sandbacksgatan 4, S-116 21 Stockholm. Tel: (08) 43-88-85.
Studioland AB, PO Box 2161, Edeby Quarn, S-103 14 Stockholm 2. Tel: (08) 40-46-56. Mng. Dir.: Thure D. Aberg.

LICENSING ORGANIZATION, MUSIC
S T I M (Svenska Tonsaettare Int'l)la Musikbyrå - Swedish Performing Rights Society, PO Box 1539, S-111 85 Stockholm. Tel: (08) 24-29-50. Pres.: Ove Rainer; Gen. Mgr.: Hans Nordmark. (Performing rights only).

PLATING, PROCESSING & PRESSING PLANTS
Europa Film, Rec. Plating Div., PO Box 20065, S-161 20 Bromma 20. Tel: (08) 98-77-00. Cable: EURDPASTUD. Telex: 17656. Pres.: Torbjorn Sjoberg. Gen. Mgr.: Bengt Runsten; Sales Mgr.: Eric Augustsson. (Plating & processing only)
Grammoplast AB, Box 8019, S-163 08 Sponga. Tel: (08) 761-7060. Dir.: Svante Raaet; Gen. Mgr.: Hans Johansson. (Pressing only)
Heger Plastics AB, Stallarholmen. Tel: (0152) 405-85.
Home office: Norway.

Skandinaviska Grammophon AB, PO Box 148, Industrigatan 12, S-662 00 Aemael. Tel: (0532) 12-290. Telex: 5390. Mng. Dir.: Sven Samuelsson.
Svensk Grammofonindustri (AB), Box 22, S-197 00 Bro. Tel: (0758) 4-61-85. Gen. Mgr.: Jan-Erik Uddegard.
Toolex Alpha AB, Box 176, S-172 25 Sundbyberg. Tel: (08) 28-90-30. Telex: 13378. Mng. Dir. & Gen. Mgr.: Desten Nilsson, Sales Mgr.: Gunnar Aze.

PRINTERS & LITHOGRAPHERS
Filadelfia Forlaget AB, Dagenhuset, S-105 36 Stockholm. Tel: (08) 13-03-40.
Skoevde Offsettryck AB, PO Box 246, S-541 00 Skoevde. Tel: (0500) 34015. Gen. Mgr.: Bo Meijer.

RECORD PROMOTION
E M A Telstar AB, PO Box 18, S-181 21 Lidingö. Tel: (08) 767 0110. Telex: 12234. Contact: Thomas Johansson.
Int'l branch: Denmark, Knud Thorbjornsen.

Foljparkernas Artistformling, Swedenborgsgatan 1, S-116 48 Stockholm. Tel: (08) 44-01-20.
Interpromco PR, c/o Skandinavisk Musikintjanst, Sandbacksgatan 4, S-116 21 Stockholm. Tel: (08) 43-88-85.
K B Rec. AB/ShuShu Rec. Ltd., Box 4153, S-203 12 Malmö. Tel: (040) 232-996. Dir.: Ken Brown; Gen. Mgr.: Ulla Nielsson.
Marcus Music AB, Raesundavaegen 45, S-171 52 Solna. Tel: (08) 730-0400. Pres.: Marcus Desterdahl; Gen. Mgr.: Christer Berg; Sales Mgr.: Ann-Birgit Carlsson; Chief Eng.: Joergen Thuresson.
Studioland AB, PO Box 2161, Edeby Quarn, S-103 14 Stockholm 2. Tel: (08) 40-46-56. Mng. Dir.: Thure D. Aberg.
Telstar Konsertbureau AB, Fosstrabacken 24, S-127 37 Skarholmen. Tel: (08) 46-25-75.
Svante Widen Agencies, Snoedroppsgrand 15, S-162 41 Vaellingby/Stockholm. Tel: (08) 38-18-37. Mgr.: Svante Widen.

**TAPE CUSTOM DUPLICATORS
TAPE PACKAGING & LABELING**
The Audio and Video lines indicate the configurations which the firms duplicate. Companies which offer packaging and labeling of tape product are indicated by "(PRG)" which appears after the main body of their respective listings.

Marcus Music AB, Raesundavaegen 45, S-171 52 Solna. Tel: (08) 730-0400. Pres.: Marcus Desterdahl; Gen. Mgr.: Christer Berg; Sales Mgr.: Ann-Birgit Carlsson; Chief Eng.: Joergen Thuresson.
Audio: Cassette.
Playback Inspelings AB, Gustav Adolfs Torg 10, S-211 39 Malmö. Gen. Mgr.: Lennart Christianson.
Audio: Cassette, open reel.
Skandinaviska Grammophon AB, PO Box 148, Industrigatan 12, S-662 00 Aemael. Tel: (0532) 12-290. Telex: 5390. Mng. Dir.: Sven Samuelsson.
Audio: Cassette.
Svensk Grammofonindustri (AB), Box 22, S-197 00 Bro. Tel: (0758) 4-61-85. Gen. Mgr.: Jan-Erik Uddegard.
Audio: Cassette.
Talkback Studios AB, Luetzengatan 12, S-115 23 Stockholm. Tel: (08) 62 01-79, 62-01-09. Pres.: C.G. Langenskiöld; Gen. & Sales Mgr.: Ulf Zvedberg; Technical Mgr.: Gunnar Silins.
Audio: Cassette, open reel.
Toolex Alpha AB, Box 176, S-172 25 Sundbyberg. Tel: (08) 28-90 30. Telex: 13378. Mng. Dir. & Gen. Mgr.: Desten Nilsson, Sales Mgr.: Gunnar Aze.
Audio: Cassette.

• supplies
EMPTY CARTRIDGES, CASSETTES & REELS
Ampex AB, Rissneleden 8, S-172 07 Sundbyberg. Tel: (08) 28-29-10. Cable: VIDEOTAPE. Telex: 10867. Gen. Mgr.: W. Bjoerkiund.
Audio: Cassette boxes.
Videogram, PO Box 295, S-58001 Linköping. Tel: (013) 12 19-97. Telex: 50029. Gen. Mgr.: Roger B. Fransson, Sec'y: H. Birgitta Karlsson (Video only)

PROFESSIONAL TAPE SUPPLIES
Ampex AB, Rissneleden 8, S-172 07 Sundbyberg. Tel: (08) 28-29-10. Cable: VIDEOTAPE. Telex: 10867. Gen. Mgr.: W. Bjoerkiund.



SCANGROUP RECORDS

Your key to the Scandinavian market.

We are four independent record companies with over 25 years of experience in the Scandinavian market. As a group, we can open this market for Your products! We know the dealers, the buyers and the market, so

Make Scangroup Your marketing and licensing partner in Scandinavia!

You can get more information about Scangroup from:

<p>Grammofon AS ELECTRA 15 JYDEHOLMEN DK 2720 VANLOSE, COPENHAGEN DENMARK Tel: 0179 17 00 Telex: 22621</p>	<p>Grammofon AB ELECTRA P.O.Box 14, S-163 93 Stockholm Sweden Tel.: 08/751 04 00 Telex: 14075</p>	<p>DISCOPHON OY Lansiportti 4 A SF - 02210 Espoo 21 Finland Tel.: 90/880 0220 Telex: 12-2705</p>	<p>TALENT MUSIC ORGANISATION AS P.O.Box 2814, Tøyen Oslo 6 Norway Tel.: 02/67 95 40 Telex: 17079</p>
---	--	---	---

RAW MATERIALS

Svensk Grammfonindustri (AB), Box 22, S-197 0C Bro Tel (0758) 4-61 85.
Gen Mgr Jan-Erik Uddegard
Chief product: Vinyl

RECORD MANUFACTURING EQUIPMENT

Alpha, see Toolex.
Europa Film AB, PO Box 20065, S-161 20 Bromma Tel (08) 98 77 00
Cable: EUROFASTUO. Telex: 17656 Pres. Torbjorn Sjoeborg, Gen Mgr. Bengt Runsten, Sales Mgr.: Eric Augustsson
Chief product: Plating equip
Toolex Alpha AB, Box 176, S-172 25 Sundbyberg, Tel (08) 28 90-30, Telex 13378. Mng. Dir. Gen. Mgr. Oesten Nilsson; Sales Mgr. Gunnar Ase
Chief product: Automatic record presses
Brand names: Alpha Delta 7, Alpha Delta 12 (SEE ADVERTISEMENT)

TAPE, BLANK LOADED & BULK RAW

Agfa-Gevaert AB, Torshamnsgatan 18, Stockholm Tel (08) 751-03-00
Cable: AGFAGEVAERT Mng. Dir. Raymond Van Roosbroeck, Sales Mgr. Lennart Karsbrink
Audio: Cassette, open reel.
Video: Blank-2" & 1" open reel.
Brand name: Agfa
Amplex AB, Rissneleden 8, S-172 07 Sundbyberg Tel (08) 28-29-10 Cable VIDEOTAPE. Telex: 10867 Gen. Mgr. W. Bjoerklund.
Audio: 8-tr. cassette, open reel.
Video: 1" open reel, 1/2" cassette, 1/4" EIAJ open reel, Beta, VHS
B A S F Svenska AB, PO Box 53008, Kungsportsavenyen 31-35, S-400 14 Goeteborg 53, Tel (031) 81-32-60, Cable: BASIMPORT Telex: 2327, Sales Mgr. Bo Hartzell.
Audio & Video: Cassette, open reel

Ekman & Co Import AB, Box 300, Stora Nygatan 29, S-401 24 Gothenburg Tel (031) 17-45-80, Cable: EKMANS. Telex: 2353, 20763
Audio: Cassette.
Brand name: Oenon.

Talkback Studios AB, Leutzengatan 12, S-115 23 Stockholm Tel (08) 62 01 79, 62 01-09. Pres. C. Langenskoild, Gen. & Sales Mgr.: Ulf Zwedberg (Blank only)
Audio: Cassette.
Brand name: LSI-Compupac.

Track Tape AB, Box 9031, Bronsaldersgatan 7, S-260 39 Malmoe Tel (40) 22-45-60 Telex: 33553 Gen. Mgr. Ingegerd Engfelt.
Audio: Cassette.

Videogram, PO Box 295, S-58001 Linkoeping, Tel (013) 12 19 97 Telex 50029, Gen. Mgr. Roger B. Fransson, Sec'y H. Birgitta Karlsson
Video: 1/2" cassette.

TAPE DUPLICATING & PROCESSING EQUIPMENT

Amplex AB, Rissneleden 8, S-172 07 Sundbyberg, Tel (08) 28-29-10 Cable VIDEOTAPE. Telex: 10867 Gen. Mgr. W. Bjoerklund.
Audio: Duplicators.

• accessories manufacturers

Amigo Musik AB, PO Box 6058, Norra Stationsgatan 91-93, S-102 31 Stock

holm 6 Tel (08) 34-01-95 Telex 15840 Pres Per-Anders Boquist, Sales Mgr.: Laila Munther.
Product: Record-45 rpm adaptors
Amplex AB, Rissneleden 8, S-172 07 Sundbyberg Tel (08) 28-29-10 Telex 10867 Gen Mgr. W. Bjoerklund
Product: Tape-head cleaners, demagnetizers
Georg Dahlberg AB, PO Box 6058, Norra Stationsgatan 91-93, S-102 31 Stockholm 6 Tel (08) 34 01 95 Cable GEODAH. Telex: 17840, Pres Per Anders Boquist.
Product: Record-replacement styl, Tape-carrying & storage cases, head cleaners, demagnetizers
Ella Radio & Television AB, Industrivagen 23, S 171 17 Solna Tel (08) 730 0700, Telex 10479, Mng. Dir. Gunnar Roth, Sales Mgr. Arne Ununger.
Product: Record-record care prods., replacement styl, Tape-head cleaners, demagnetizers, leader & splicing tape
Sven Eriksson Audio, PO Box 834, S-121 08 Johanneshov, Tel (08) 19-90-50, Telex 13210, Owner, Sven Eriksson, Sales Mgr. Gunnar Silins. (Im porter)
Product: Record-record care prods., replacement styl, Tape-head cleaners, demagnetizers.
N A S A B, Chalmersgatan 27a, S-411 35 Goeteborg Tel (031) 18 86-20
Product: Record-replacement styl.
Brand name: Pickering.
P. F. Samson Aktiebolag, Sveavaegen 1, S-335 00 Gnosjö Tel (0370) 9-18-71, 9-22-10, Cable: SAMSONGNOSJOE Telex 70392 Gen Mgr. Percy F Samson, Sec'y Renate Samson.
Product: Record-stands

• store fixtures manufacturers

Amigo Musik AB, PO Box 6058, Norra Stationsgatan 91-93, S-102 31 Stockholm 6, Tel (08) 34 01-95 Telex 17840, Pres Per-Anders Boquist, Sales Mgr. Laila Munther.
Product: Record divider cards.
Fors & Forss AB, PO Box 100, S-170 11 Orottningsholm Tel (08) 759-0090 Mng. Dir. Haekan Forss, Sales Mgr. Ingrid Windeklide.
Product: X-track record, MC, video & tape display racks.

SWITZERLAND

Population: 6,300,000
Population by age groups: 0-19 (28%), 20-39 (31%), 40-59 (24%), 60+ (18%)
Rate of exchange: \$1 (US) = 2.10 francs.
Per capita income: \$15,200
Holidays: January 1 & 2, Good Friday, Easter Monday, May 1 (certain cantons), Ascension Day, August 1 (Swiss National Day), December 25 & 26, plus a number of local holidays

RECORDS:
Record sales certification awards: Gold single-50,000 units, platinum

single-100,000 units, Gold LP-25,000 units, platinum LP-50,000 units.
Records sold domestically including imports (retail value): LP's 1980-\$77,000,000, 1979-8,000,000 units, \$70,000,000 Singles 1980-\$12,000,000, 1979-3,000,000 units, \$11,000,000
Average retail price per record: LPs-\$8.40, singles \$2.40
Record club sales: Less than 5% of total
Discounting: Rare

Type of distribution: Most of the international representatives operate as importer/wholesalers. Smaller independent record companies use wholesalers. Six rack jobbers account for about 40% of total recording sales, large shopping chains split the remaining 60%. With the weaker Swiss franc, direct imports are losing ground. However, for the rarely and specialty market-mainly jazz, blues and folk-they play a vital role that is independent of currency fluctuations. Club sales are becoming less important.

Type of promotion: Newspapers and record companies are not always on friendly terms as the former tend to emphasize their independence and progressiveness with hypercritical reviews. The information monopoly has become more delicate with Black, the largest circulation daily news paper, having acquired Good News, a major concert agency German, French and UK music press product is sold at almost all newsstands. Major magazines include Pop/Rocky and Music Scene. Television, radio and concert promotion is limited. With the successful launch of the first commercial radio station, Radio 24, record companies have a new promotional outlet that they frequently use.

Jukeboxes: 19,000

TAPE:

Market: 8-track is non-existent. The pre-recorded audio cassette market accounts for about 50% of the total cassette market. Widespread home duplication has increased sales of blank cassettes. About 75% of all new cars are sold with stereo radio/tape equipment. The video market is expanding rapidly, with VHS having a share of 70%, Beta 20% and Video 2000 10%. Pre-recorded tapes, which sell for \$100 to \$150, are primarily offered on a rental basis. Up to now, current boxoffice movies were not available.

Pre-recorded tape sold domestically including imports (retail value): Cassette 1980-\$30,000,000; 1979-4,400,000 units, \$27,000,000
Average retail price per tape: Cassette-\$8.90

CONSUMER ELECTRONICS:

Percentage of homes with: Radios (95%); television sets (85%), color (63%), b/w (37%); phonographs (78%); audio tape recorders (85%); video tape recorders (5%)

RADIO STATIONS:

No. of commercial 1; no. of government 6 (3 AM, 3 FM)
Comment: The first commercial and privately owned radio station, Radio 24, which broadcasts from Italy into metropolitan Zurich, has won legal battles before Italian courts against the Swiss government monopoly. Radio 24, which operates without interruption or interference, has provoked the government owned stations to introduce an MOR music night program without commercials. Concurrence is also met by the powerful broadcasting stations such as Sudwestfunk (Germany), Radio Luxembourg and the Austrian stations which are very popular among the younger generation.

ARE YOUR PRODUCTS REPRESENTED IN THE IMPORTANT SCANDINAVIAN MARKET? WE ARE THE COMPANY FOR YOU!

★ THE BOPPERZ ★

the RADIOS



Sound of Scandinavia

FREE STYLE

CHRIS LINN

BITCH BOYS

RODNEY OHMAN



Sound of Scandinavia

Lena Ericsson

Sound of Scandinavia group of companies is one of the few independent Scandinavian facilities that cover the whole chain from production to marketing and distribution, as well as publishing.



Sound of Scandinavia Box 1108

S-141 23 Huddinge Sweden

Phone 46-08-774 07 80 Telex 12601 SOSREC S

TELEVISION STATIONS:

No. of channels: 3 government, 100% color (PAL).
Comment: German and Austrian programs increase their popularity at the expense of Swiss programs. A close television network provides Swiss homes with 12 channels including local German programs and three French programs. The Swiss programmers still have not succeeded in presenting an attractive music program. Video music tapes are shown frequently. The Swiss launch of a new television satellite in conjunction with Austria is under discussion. It would offer international programs and would be able to reach the remote regions of the Swiss Alps. Its introduction is not expected before 1985. Swiss publishers are also contemplating the introduction of a private cable network that would specialize in regional programs.

MARKET ANALYSIS:

Switzerland has recovered from the negative effects of a strong Swiss franc which supported parallel imports. Turnover has been satisfactory, but profit expectations are not always met as Switzerland is considered to be a high cost country. The growth of the recorded music market at a total annual turnover of about \$115 million seems to have reached its limits. Record company executives have responded by reducing labor and inventory.

Subsidiaries of international record companies such as PolyGram, CBS, and EMI, lead the market. Musikvertrieb Ltd is the major independent company. The tendency to produce more local artists with international standing has proved successful for country singer Suzanne Klee (EMI) and hard rock band Krokus (Ariola). This development has resulted in increased local production by new names like Vic Vergat (FM), Betty Legler (Big Mouth), Irmsch (EMI), Bitch (Bellaphon), Tickets (Ariola) and Trampolin (CBS).

There is a noticeable interest for dialect rock music, which is offered at its best by Polo Hofer. Anglo-American product still dominates the charts, but Italian hits by Adriano Celentano and Umberto Tozzi have fared well. The Swiss have no emphatic preferences in music tastes, but experimental music such as new wave is not readily accepted. Conservatism prevails as the release policy of the record companies.

The Swiss market is divided into three major ethnic markets/language regions—German, French, Italian—a factor that complicates matters for the record companies. Radio 24 has enabled them to promote their product more directly. Government-owned stations are now renewing their program policies.

Major international artists regularly visit Switzerland. Concerts are organized by the two major concert agencies, Good News and Free & Virgin. The Hallenstadion of Zurich, with a capacity of 12,000, is the largest Swiss venue. Towns like Basel, Bern, Lucerne, Geneva and Lausanne have concert halls with seating up to 3,000. The major festivals like Montreux (jazz and classical), Lucerne (classical), Nyon (folk), Zurich (jazz) and Lugano (jazz) are very popular and attract visitors from all over Europe. An increased popularity of open air festivals with local artists has occurred recently. Unfortunately, Switzerland has a lack of smaller venues, but youth centers, found in almost all Swiss cities, offer cheaper and smaller concert facilities.

Recording studios such as Mountsin (Montreux), Aquarius (Geneva), and Powerplay (Zurich) meet international standards. The major record companies are preparing themselves for the promising video market. In the meantime, they await to see whether the rental or sales system will succeed. *Pierre F. Haesler*

• record & tape manufacturers / distributors / importers

A P V Prod'n Ltd, Postfach A 135, Graben 1, CH 6301 Zug Tel (042) 21 30 42 Pres. August P. Viliger, AR & Promo Margrit Viliger
 Labels: Image, Montana, Trio

A R A see Metronome
 Acty Recs AG, Postfach 18, CH-9753 Mollis Tel (058) 34 27 34 Telex 875145 Co-Pres. Jakob Baumgartner, Claudio Deldegan, Christoph Berger
 Labels: (Owned) Acty, Acty Special, Creaty

African Violet, see America Sound
 Air, see Musicland
 Aktuell, see Musicland & Pick
 Alpha, see Electromusic
 Alpina, see Electromusic
 America Sound, Scheuchzerstr 33, CH 8022 Zurich Tel (01) 362 01 82 Telex 57666 Dwner & Pres. Kathi Schnyder, Gen Mgr. Peter Schnyder, Sales Mgrs. Kathi & Peter Schnyder (Distributor/Importer)
 Labels: (Owned) African Violet, America Sound, (licensed domestic) Willisau Live, (distributed-not licensed) Biber (Germany), Flame (Germany), Mood (Germany), PM (USAV Philips (Brazil)), Sandra (Germany)

Angel, see EMI
 Archiv, see PolyGram
 Ariola Eurodisc AG (IFPI), Letzigraben 89, CH 8047 Zurich Tel (01) 54 53 90 Telex 53436 Mng Dir. Ludwig Schmucki, Deputy Mng Dir & A&R Mgr. Bruno Huber, Mktg & Promo Mgr. Marco Zanotta (Distributed by Musikvertrieb)
 Labels: (Owned) Ariola, Baccarola, Eurodisc, (licensed foreign) Albon (UK), Arabella (France), Arists (USA), Athena (Germany), Bearsville (USA), Bronze (UK), Bubble (Netherlands), GGD group (Italy), CMH (USA), Chrysalis (UK), Clan Celentano (Italy), Coconut, Coral (USA), Din Disc (UK), Freedom (USA), GRP (USA), Go-Feet (USA), Handshake (USA), Hamball (UK), Hansa (Germany), I Spy (USA), Infinity (USA), Island (UK), Joy (UK), MCA (UK, USA), Mani:core (UK), Musiza (Italy), Novus (USA), (Dass) (Germany), Decan/Ariola, FBR Int'l (USA), Palmbeach (UK), Presi dent (UK), Real (UK), Red Star (USA), Rialto (UK), Rockburgh (UK), Rocktopus (Germany), Savoy (USA), Shelter (USA), Sire (USA), Souplet (France), Supraphon (Czechoslovakia), Tomato (USA), Two Tone (UK), Vergara (Spain), Virgin (UK), Ze (UK), Zoom (USA)

Artiphon, see Turcaphon & Musikvertrieb
 Artone, see CBS
 Arts Managers, 80-82 Rt. de Chene, CH 1208 Geneva Contact R. Torre
 Label: (Represented) Moss Music Group (USA)
 Artus, see Electromusic
 Asmahen, see Turcaphon
 Asylum, see WEA
 Atco, see WEA
 Atlantic, see WEA

B I Branticket, see Bellaphon
 Babyphon, see Bellaphon
 Baccarola, see Ariola Eurodisc
 Bacillus, see Bellaphon
 Baerenreiter Verlag Basel AG, Neuwellerstr 15, CH 4015 Basel Tel (061) 39 58 99 Telex 64472 Mng Dir. Franz Kobel

Labels: (Owned) Baerenreiter Muscaphon, (distributed) Calig. Cantate, Carus, Da Camera, JSV, RMB, Sastruphon
 Bardaphon, see Turcaphon
 Barclay PolyGram Recs SA (IFPI), Rue du Roveray 14, CH 1207 Geneva Tel (022) 36 56 80 Cable: BARCLAYDISC Telex 23368. Deputy Mng Dir Claude Aubert
 Home office: France
 Labels: (Owned) Barclay, Blue Star, EGG, Riviera, Riviera LM, (distributed domestic-not licensed) Beau Lac de Bale, DSB, Stamy, (distributed foreign-not licensed) Ahead, Albatros, Aquarius, Arc en Ciel, Michel Berger, Black & Blue, Ceira, Duetto, EM, Encyclopedie de l'Orgue, Erato, FY, Fiori Musical, Fonit, Forlane, General Music, Greensleeves, Isabel, Italia, Malypense, Musique, Pablo, Palcoscenico, Pellicano, Pe rrides, Tresors, Vanstory

Basilisk, see Electromusic
 Beau Lac de Bale, see Barclay PolyGram
 Bellaphon AG (IFPI), Farbhofstr 21, CH 8048 Zurich Tel (01) 62 74 02
 Chief Exec. B. Zvanovic, Gen Mgr. Mario Magistris
 Home office: German Federal Republic
 Labels: (Owned) Bacillus, Bellaphon, Pfiffikus, (licensed) Boardwalk, Concord Jazz, Gordy, Rare Earth, Scotti Bros., Sta., Tamia Motown (all USA), Acania (Germany), (distributed-not licensed) African Volets (Germany), Alfa (Japan), Amayana (Germany), America Sound (Germany), Austicate (France), Artists House (USA), Audioidentity (USA), Avalar (UK), BT Branticket (Switzerland), Babyphon (Germany, Switzerland), Biber (Germany), Black Saint (Italy), Blue Angel (Germany), Blues Beat (Germany), Burning Sound (UK), Bvhaast (Netherlands), Cain (Germany), Circle (Germany), Coco (France), Delos (USA), Disco Party Pac, ENJA (Germany), Everest (USA), FMP (Germany), Flame (Germany), Flying Dog (Japan), IREC (Italy), Invitation (Japan), JSP (UK), JVC (Japan), L&R (Germany), Leuenhagen & Paris (Germany), Lyrichord (USA), MMD (USA), Muse (USA), Musique en Wallonie (Germany), Nagara (Germany), Natural Resources (USA), Nessa (USA), Pastels (Germany), Patmos (Germany), Pepta (Hungary), Pick Up (Germany), Prodigal (USA), Rare Bird (Germany), Record 2 (Germany), Richey (USA), SSS Int'l (USA), Sackville (Canada), Schwann (Germany), Sine Qua Non (USA), Sky (Germany), Soul (USA), Soul Note (Italy), Spolite (UK), Star Sound (Switzerland), Steeplechase (Denmark), Sun (USA), Swiss Sound (Switzerland), Time less (Netherlands), VM (Austria), VPA/Red (Italy), Venus (Germany), Vic tor (USA), Woolite (Germany), Zen (Japan)

Brimbo, see Metronome
 Blue Note, see EMI
 Blue Star, see Barclay PolyGram
 Brunswick, see PolyGram
 C B S Schallplatten AG (IFPI), Dberneuhofstr 6, CH 6340 Baar Tel (042) 33 33 63 Telex 868874 Mng Dir Norman D. Block Sales Mgr. Achille Koeliker, Mktg Mgr. Edith Jakob
 Home office: USA, CBS Recs Int'l

Labels: (Owned) Artone, CBS, Embassy, Epic, GTD, Harmony, Master works, Odyssey, Diek, Portrait, Versailles, (licensed) A&M (USA), Abbott (USA), Aladin (Germany), Arhoolie (USA), Bang (USA), Bethlehem (USA), Blue Classics (USA), Blue Sky (USA), Caribou (USA), Catoca (Germany), Changes (USA), Channel (USA), Cleveland Int'l (USA), Dart (UK), Date (USA), Fillmore (USA), Funckler (Netherlands), Go (USA), Hickory (USA), Him (USA), Horizon (USA), Illegal (UK), Invictus (USA), Jet (UK), Kalei doscope (UK), Kirschner (USA), Libra (Italy), Londa (Germany), Love (Germany), MRC (Germany), Metromedia (USA), Meys (France), Monu ment (USA), Dde (USA), Didtime (USA), Did Time (USA), Pavillon (USA), Philadelphia Int'l (USA), Platinum (France), Raglan (USA), Star lite (USA), TK (USA), Tabu (USA), Tappan Zee (USA), UPC (USA), Yee Jay (France), Yum Yum (USA)

C C T (Compact Cassettes Trading AG), Birmensdorferstr 55, CH-8036 Zurich Tel (01) 241 47 11 Telex 58975 Pres. Hugo von Blumenthal
 Label: (Owned) Galaxy
 C P S A (Coe de Prod'n Sonores & Audiovisuelles), Place du Grand Mont, CH 1052 Le Mont/Lausanne Chief Exec. Aurel Trost, Gen Mgr. Pierre Henri Dumont (Distributor/Importer)
 Labels: (distributed-not licensed) Black Lion (UK), Celluloid (France), Dreyfus (Germany), Motors (France), Movieplay (Spain), Pye (UK), RKM (Belgium), Roulette (USA), Vogue (France)

Caele, see IRC
 Capitol, see EMI
 Carex, see Eures
 Casound, see Turcaphon
 Casablanca, see PolyGram
 Casinno, see EMI
 Cellier, see Disques Office & Phonag
 Chalet Recs/Friederich's Prod'n, 13 Rue Margnac, CH 1206 Geneva Tel 47 68 10 Telex 289789 Pres. Gen & Sales Mgr. Jean-Claude Frieder iche Int'l Recs: Benelux (Trem in France), Canada (Chalet), Central & South America (RCA), France (Trem in France), Greece (CBS), Hong Kong (Victor in Japan), Indonesia (Victor in Japan), Italy (Carosello), Japan (Victor), Mexico (RCA), Scandinavia (RCA), Singapore (Victor in Japan), South Africa (Gramophone), South America (RCA), Spain (CBS/Epic), Switzerland (Trem in France), Taiwan (Victor in Japan), USA (Chalet), Yugoslavia (Jugoton)

Charis, see Musicland
 Classic Pick, see Pick
 Claves Schallplatten & Musikverlag, Truelweg 14, CH 3600 Thun Tel (033) 23 16 49 Cable CLAVES Gen Mgr. Marguerite Deutschler Mueber
 Label: (Owned) Claves
 Int'l reps: Austria (Musikhaus Dr. Faessler, Desterreichischer Schallplat tenklub der Jugend), Belgium (La Boite a Musique), Canada (Mer dienne), Finland (Fuga), France (Les Magasin FNAC), Germany (Disco center), Hong Kong (Paclic), Israel (Israeli Music Publ'n), Italy (La Bot tega Discant.ca), Japan (Polydor), Netherlands (Mosat), Sweden (Nor dska), UK (Gantuti), USA (Brilly Imports)

Cobra, see EMI
 Collector's, see IRC
 Coloraphon Schallplatten, Hopfengarten, CH 9451 Eichberg Tel (071) 75 27 55 Mng Dir. Carl Nauher (Distributed by Finsterwald & Cantacuzene)
 Columbia, see EMI
 Core SA, Rue Gambetta 22, CH-1815 Clarens Montreux Tel 61 38 88 Gen Mgr. Georges Chorasas, Sales Mgr. Alberto Chellini
 Label: (Represented) Latin Percussion Ventures (USA)

Cotillon, see WEA
 Creativ, see Acty Recs
 Crystal, see EMI
 Custom, see Metronome
 D G, see PolyGram

Dacapo, see EMI
 Discoson, see Metronome
 Disc Import, Seebahnstr 111, CH 8003 Zurich Tel (01) 461 34 28. Chief Exec. K. J. Oberleitner (Distributor/Importer)
 Labels: (Distributed-not licensed) Ars Nova (Italy), BIR (USA), Bongio vanni (Italy), Ceira Lo (Italy), Chalfont (USA), Citadel (USA), DRG (USA), Discocorp (USA), Discopacifica (Canada), Discophonia (Germany), Discore ale (France), Entr'Acte (USA), Klavier (USA), Melodram (Italy), Metro pole (France), Musica Viva (Germany), Dpera Rara (UK), Dpus (Czechoslovakia), Drphus, PBR (USA), Pape (Germany), Relief (Liechtenstein), Replica (Italy), Starlog (USA), Varese Sarabande (USA)

Disques Office (IFPI), Rte. de la Glane 35, CH 1700 Fribourg Tel (037) 24 62 61 Telex 36424 Gen Mgr. Jean-Claude Vial, Sales Mgr. Bernard Chassot
 Labels: (Owned) Cellier, Disques-Office, Frontier, Lazer, Via Music; (rep resented) AZ Bam, Accord, Adele, Ades (France), America (France), Ar folk, Arhoolie (USA), Arion, Atoli, Ballon Noir, Biograph (USA), CT— Charles Talar (France), Canetti (France), Cavalier, Cezame (France), Club du Disque Arabe, Cobra, Debs, Deesse (France), Disneyland (France), Ed ict, Elver, Encyclopedie Sonore, Festival, Free Bird, GT—Gerard Tourmer (France), Hexagone (France), Ibach, Jazz Anthologie, Kebeç, Disc, Musi dc (Belgium), Ocora, Dwl, Petit Menestrel (France), Ri-Fi (Italy), Rigolo (France), Saravah, Serp, Sono Caro, Sonodisc, Storyville, Trem a, Vista (USA), Carrere Group—Apollo, Caroline, Eagle, Fleche, Formula No 1, Heloise

Int'l reps: Belgium (Musidisc), Canada (Gamma, Presqu'ile), France (Musidisc), Germany (Bellaphon), Italy (Ducate), Japan (RCA)
 Double Up, see EMI
 Duraphon Recs, Drosselstr 20, CH 4106 Therwil Tel (061) 73 76 36 Gen. Mgr. Hugo Durand
 Labels: Duraphon, Podium, Slava, Sympatic
 E G G, see Barclay PolyGram
 E M I America, see EMI Recs
 E M I Recs (Switzerland) AG (IFPI), Buckhauserstr. 24, CH-8048 Zurich Tel: (01) 54 00 10 Cable: EMI RECDROS Telex: 822150. Mng Dir.: Guy De luz, NCD Div Gen Mgr. Kurt Cattaneo, A&R Mgr. Lauro M. Burkhalter, Sales Mgr.: Max Trostel, Mktg Mgr.: Beat Hausherr

Labels: (Owned) Angel, Blue Note, Capitol, Casino, Cobra, Columbia, Crystal, Dacapo, Double Up, EMI, EMI America, Electrola group, Emdisc, HMV, Harvest, Hoer Zu, Imperial, Kaleidoskop, Liberty, MFP, Matumbi, Mute, Odeon, One Up, Parlophone, Pathe, Punch, Regal, Regal Zono phone, Seraphim, Sidewalk, Starline, Sunset, Tranon, United Artists, Waverly, Zonophone; (licensed domestic) Eisener; (licensed foreign) Apple (UK), Ardeck (UK), Chlanders (Germany), Colorot (Germany), Good Time Jazz (USA), Harmonia Mundi (Germany), King King (Germany), MPL (UK), Musicians (Germany), Musikant (Germany), Papagayo (Neth erlands), Purple (UK), RAK (UK), Rolling Stones (UK), Ruessel (Ger many), Salari (UK), Sunburst (UK), Weltrekord (Germany)

E M R, see Electromusic
 E S P Collection, see Turcaphon & Musikvertrieb
 Editio Serv SA, 9 Ter Ch. de Roches, CH-1200 Geneva, Tel: (022) 35 52 82 Telex 23640 Gen Mgr. David Josefowitz
 Labels: Concert Hall, Guide Int'l du Disque, Jazztone, Varieton
 88 Upright, see IRC
 Einhorn, see Metronome
 Electrola group, see EMI
 Electromusic AG (IFPI), Baslerstr 9, CH-4102 Binningen 1 Tel: (061) 47 75 50 Cable: EMAG Telex: 63754, Prod'n & Sales Mgr.: Dito Aebi; PR: Kurt Mettler

Labels: (Owned) Alpina, EMR, Tell; (distributed) AGM (Germany), Alpha, Artus, Basilisk, Chant du Monde (France), Laelkekeemg, Swiss Hit, Vero Disc
 Elektra, see WEA
 Elite, see Turcaphon
 Elite Special, see Turcaphon & Musikvertrieb
 Eisener, see EMI
 Embassy, see CBS
 Emdisc, see EMI
 Epic, see CBS

Ere du Verseau, PD Box 90, CH-1211 Geneva 1 Cable: REGDRINT, Chief Exec. M. Regor; Press: Regine Hillars.
 Eures Recs, Hochstr 152, CH-8330 Pfaffikon-Zurich Tel (01) 950 22 31. Gen & Sales Mgr.: Hans Rudolf Buechli (Distributed by Finsterwald & Cantacuzene)
 Labels: (Owned) Eures, Carex (8 tr.), Lunarex (4 tr.)
 Eurodisc, see Ariola Eurodisc
 Evason SA, Place du Grand Mont, CH-1052 Le Mont/Lausanne Tel (021) 33 33 55. Pres. Francois Vautier, Gen. Mgr.: Gaston Schaefer

Labels: (Owned) Evason, (distributed-not licensed) Auvidis (France), Big Beat (France), Cal'Conc. (France), Escargot (France), Gamma (Can ada), JDP, Marie Josee, Mary Melody (France), Moshe Nam (France), Munch (Netherlands), Plant Life (UK), Playasound (France), Production 3A (France), Request (USA), Rounder (USA), SFPF (France), Umdisc (France), VDE
 Ex Libris AG Grammoclub, Hermetschloosstr 77, CH-8048 Zurich, Tel: (01) 62 51 00 Telex 52501 Mng Dir. Dr. Franz Lamprecht; Mktg Dir.: Dr. Erland Herkenrath
 Exclusiv Schallplatten, Gettenwilerstr 16, CH-9000 St. Gallen Tel (071) 23 23 33 Mng Dir. Rello Sonderegger
 F & C, see Finsterwald & Cantacuzene
 Fass, see PolyGram
 Favorit, see John Lay
 Finsterwald & Cantacuzene (IFPI), 70 Ave des Alpes, Montreux, Tel (021) 62 45 55 Cable: DISQUES, Telex: 24686, Admin'r. Jean-Jacques Finster wald, Gen. Mgr.: Ivan Cantacuzene

Labels: (Owned) F&C, (distributed) Coloraphon, Eures, Star; (rep resented) Amali (Germany), Arrow (UK), Beller (Spain), Cash (Germany), Cetra Dpera (USA), Charade (France), Cigala (Italy), Circus (Italy), Clave (Spain), Collector (UK), Colledge (Italy), Comedie Francaise (USA), Con cert Disc (USA), Counterpoint-Esoteric (USA), Coup (Germany), DDM (France), Design (USA), Discophon (Spain), Durum (Italy), Echo (Ger many), Eden Roc (France), Equipe (Italy), Everest (USA), Freedom (Italy), Gaviota (Spain), Hebra (Belgium), Hispavox (Spain), Impacto (Spain), Joki (Italy), Jolly (Italy), Legacy (USA), Little (Italy), Man (Germany), Megaphone (France), Musart (Mexico), Music (Italy), Dym pc (USA), Dympo (Spain), Dmnia (Italy), Period (USA), Pickwick (USA), Primaphon (Germany), RIS (France, Italy), Royal (Italy), Scala (USA), Signal (Italy), Song (Germany), Spotlight (Germany), Sprint (Italy), Start (France), Stella (Italy), Tradition (USA), Welt Melodie (Germany), Zahro (Spain)

Fono GmbH, Seidenhofstr 14, CH-6002 Lucerne Tel: (041) 22 22 88. Con tacts: Henriette & Dr. Paul Cron
 Fontana, see PolyGram
 Foraton, see Musicland

Friedrich's Prod'ns. see Chalet.
 Frontier, see Disques-Office.
 G T D, see CBS.
 Galaxy, see CCI.
 Gallo, see VDE-Gallo.
 Gold Recs., Alte Landstr. 23, CH-8942 Oberlen. Tel: (01) 720.82.00.
 Telex: 590133. Owner: Bernard Henron.
 Label: (Owned) Gold, Prive Disc.
 Int'l repts.: Australia (Carina), Austria (Amadeo), Germany (Disco-Center Kassel, Teldec), Italy (Durium).
 Golden-Jet, see Metronome.
 Gong, see Metronome.
 H M V, see EMI.
 Hallelujah, see Phonag.
 Harmony, see CBS.
 Harvest, see EMI.
 Hzylnd, see Mabel.
 Helidor, see PolyGram.
 Helvetia, see Phonag.
 Hoer Zu, see EMI.
 Hot Pick, see Pick.
 Hug & Co. Musikverlag Zurich (IFPI), Limmatquai 26-28, CH-8022 Zurich. Tel: (01) 251.68.50. Cable: MUSIKHUG. Owner & Gen. Mgr.: Erika Hug. (Distributed by Music Consort)
 Label: (Owned) Pelca.
 Int'l repts.: Germany (Disco Center).
 Hurrican, see Metronome.
 I R C (International Rec. Center), PO Box 249, CH-8049 Zurich. Tel: (01) 56.25.15. Dir.: Theo Zwicky.
 Labels: (Owned) Caete, Collector's Jazz Circle 88 Upright, Star Performance, (licensed) Jazz Club (France), Swiss Jazz; (distributed-not licensed) Arcadia (USA), Black Jack (Germany), Dawn Club (Germany), Delmark (USA), Fat Cat's Jazz (USA), IAJRC (USA), Jazum (USA), Rarities (UK), Roots (Austria), Sackville (Canada), Vintage Jazz Mart-VJM (UK).
 Int'l repts.: UK (Jazz Music), USA (City Hall).
 Image, see APV & Record Serv.
 Impact, see PolyGram.
 Imperial, see EMI.
 Indian, see Metronome.
 International Pick, see Pick.
 International Rec. Center, see IRC.
 Intertape Ltd., Spinnerstr. 17, CH-8753 Mollis. Tel: (058) 34.31.34. Telex: 75162. Gen. Mgr.: Peter Baumgartner. (Distributor)
 Intimus, see Turicaphon & Musikvertrieb.
 Iramac, Burgerstr. 17, CH-6000 Lucerne.
 Home office: France.
 J D P, see Evasion.
 Jecklin & Co. (IFPI), Raemistr. 30 & 42, CH-8024 Zurich. Tel: (01) 47.35.20. Cable: JECKLINC. Telex: 58507. Chief Execs.: Hans & Peter Jecklin. (Distributor as Musica AG)
 Labels: (Owned) Jecklin-Disco, Jecklin-Exempla; (distributed-not licensed) CRD (UK), Candide (USA), Crystal Clear (USA), Fono (Germany), Jeton, Presser (Austria), ricordi (Italy), Sheffield (USA), Turnabout (USA), Vox (France).
 Int'l repts.: France (Disco-Shop Paris), Germany (Fono Muenster), Italy (Ricordi), UK (Comler), USA (Fonodisc Int'l).
 Jazz Circle, see IRC.
 Jubila, see Metronome.
 K B L Prod'ns, 22 Av. de Miremont, CH-1206 Geneva. Tel: (022) 46.26.95.
 Prod'ns: Daniel Farni, Christian Oestreicher.
 K-tel Int'l (Switzerland) AG, Laurenzgasse 6, CH-8035 Zurich. Tel: (01) 363.50.50. Telex: 59464. Mng. Dirs.: Josef Fae-sler, Rene Bauer; Press & Promo.: Edith Sasser.
 Kaleidoskop, see EMI.
 Karussell, see PolyGram.
 Kick, see DBH.
 Kings Rock Corp., Kalbtrestr. 71, CH-8003 Zurich. Tel: (01) 66.22.26.
 Label: (Represented) Maranatha! (USA).
 Lake County Recs., Fritz Courvoisier 15, CH-2300 La Chaux-de-Fonds. Tel: (039) 22.63.03. Owner: Michel Cattin; Gen. & Sales Mgr.: Eliane Cattin.
 Labels: (Owned) Lake County; (distributed-not licensed) major labels.
 Int'l repts.: Australia (Bunnyip), Belgium (Blackjack), France (Rock 'n' Roll Promos.), Germany (Bear Family, Dieter Bock), Netherlands (DIWA), Sweden (Kountry Korral, Rock & Country), UK (Swift), USA (Vile Platte, Wis).
 Laellekeeng, see Electromusic.
 John Lay, Bundesstr. 9-13, CH-6003 Lucerne. Tel: (041) 23.44.55. Telex: 78610. Chief Exec.: John Lay; Mng. Dir.: Manfred S. Lay. Gen. Mgr.: Kurt S. Lay.
 Sales office: CH-6002 Zurich; Seestr. 45. Tel: (01) 36.67.10.
 Labels: Favorit, Layola.
 Layola, see John Lay.
 Lazer, see Disques-Office.
 Liberty, see EMI.
 Lunarex, see Eures.
 M C H, see Metronome.
 M F P, see EMI.
 M P A, see Metronome.
 M P V, see Musciand.
 M R A, see Metronome.
 Mabel Recs., Im Koller 17, CH-8706 Feldmeilen. Tel: (01) 923.49.17. Telex: 75437. Pres.: R. Hazy Osterwald; Gen. & Sales Mgr.: Renato Cerutti. (Licensed to Phonag).
 Labels: (Owned) Mabel, Hazyland; (licensed foreign) Arabela (France), Chart (USA), Mounted (USA); (distributed-not licensed) Arca, Hazohr (both Canada).
 Int'l repts.: Australia (Quarint), Austria (Amadeo, Earl), Belgium (Avers Radio, Supreme), Brazil (Central Tape), Canada (Arca, Select), France (Polydor), Germany (DCM, Metronome), Italy (Saar), South Africa (Teal), USA (Soul Vista).
 Mandolino, see Turicaphon.
 Marex SA, Via Generoso 6, CH-6900 Lugano. Tel: (091) 54.87.53. Telex: 73208. (Distributor/Importer/Exporter).
 Marie Josee, see Evasion.
 Masterworks, see CBS.
 Matumbi, see EMI.
 Max, see Metronome.
 Maxi, see Metronome.
 Memory Music, Postfach 18, CH-8753 Mollis. Tel: (058) 34.27.34. Telex: 875145. Co-Pres.: Jakob Baumgartner, Christoph Berger. (Distributed by Actv)
 Mercury, see PolyGram.
 Meteor, see Metronome.
 Metronome Recs. AG (IFPI), Toedistr. 68, CH-8110 Horgen 1. Tel: (01) 725.36.83. Telex: 52941. Pres.: Juerg Zehnder; Sales Mgr.: Max Gfeller; Custom Labels Div. Mgr.: Reinhard Frey.
 Labels: (Owned) ARA, Custom, Discophon, Golden-Jet, Gong, Jubila, MCH, MRA, Max, Maxi, Meteor, Metronome, Mustang, Pony, Top-Osc. Top Disc Gold; (licensed) Acorn (UK), Alligator (UK, USA), Amadeo (Austria), Atom (Austria), Big Bear (UK), Big T (UK), Bram (Germany), Butterfly (Germany, USA), CH-Recs. (Switzerland), CNR (Germany, Netherlands), CNI (USA), Can't Stop (Germany, USA), Carosello (Italy), Chswick (UK), Cao (Italy), Cinevox (Italy), DJM (Germany, UK), Einhorn (Switzerland), Ensign (Germany, UK), Factory (Germany, UK), Fado (Italy), Fantasy (Germany, USA), Fiction (Germany), Flying Fish (Sweden, UK), Folk (UK), Frog (Italy), Global (Germany), Hallmark (UK), Jewell (Germany), Kicking Mule (Sweden, UK), Kudu (USA), Lax (Germany, UK), Leader & Trailer (UK), Logo (UK), Lupus (Italy), MPS (Germany), Metronome (Germany), Milan (France), Milestone (Germany, USA), Nature (Germany), Nems (Germany, USA), Drizzonte (Italy), PMC (Germany), Pacific Arts (Germany, USA), Passport (Germany, USA), Produttori Associati (Italy), Psycho (UK), Pyramid (Italy), Reflektor (Germany), Ricordi (Italy), Riverside (Germany, USA), Rubber (UK), SPI (France), Salsoul (France, USA), Sonet (Sweden, UK), Specialty (Sweden, UK), Sussex (USA), Tangent (UK), 2001/2002 (Germany), Xtra (UK), Zebra (Germany); (distributed-not licensed) Bere, Bimbo, Calg (Germany), Carabine (France), Champ (Austria), Contour (UK), DSC (Netherlands), Fagaro, GRT (Canada), Gold, Hurrican, Indian, Lotus (Italy), MC-Recs., MPA, Opus (Czechoslovakia), Oxford Univ. Press (UK), PSM, Panton (Czechoslovakia), Pickwick (UK, USA), Supraphon (Czechoslovakia), Symphonica (UK), Tyrolis (Austria).
 Mimos GmbH, Durrmattweg 9, CH-4144 Ariesheim. Tel: (061) 72.16.72. Montana, see APV & Record Serv.
 Musexport Ltd., Clos Belmont 12, CH-1211 Geneva 6. Contact: Norbert Ayer. (Importer/Exporter).
 Musica AG, Raemistr. 42, CH-8024 Zurich. Tel: (01) 47.35.20. Telex: 58507. Mng. Dir.: Hans Jecklin; Press & Promo.: Benno Frei, Felix Biegen.
 Music Consort AG (IFPI), Badenerstr. 531, CH-8048 Zurich. Tel: (01) 491.72.51. Telex: 59108. Chief Exec.: Wlodek Glowacz.
 Labels: (Distributed-not licensed domestic) Pan, Pelca, Tudor; (distributed-not licensed foreign) Accent (Belgium), Astree (France), Caprice (Sweden), Christophorus (Germany), Harmonia Mundi (France), Lyrichord (USA), Monitor (USA), Motette (Germany), Music Minus One (USA), Tangent (UK), Valois (France).
 Musciand AG, Althardstr. 224, CH-8105 Regensdorf/Zurich. Tel: (01) 840.60.40. Telex: 56359. Pres. & Gen. Mgr.: Gian Carlo Astore; Domestic Sales Mgr.: Hans Vetterli; Sales Dir.: Fredy P. Frei; R&D Dir.: Richard Steiner.
 Int'l branch: Austria.
 Labels: (Owned) Ar, Aktuell, Charis, Foraton, MPV, Musciand, S-3000, Yega 2000.
 Int'l repts.: Austria (Musciand), Germany (All-Music), Norway (Sanitas Als), Sweden (Agenturfirma Tobasson).
 Music Radio Promos, PO Box 1134, CH-8047 Zurich. Dir.: Alex Pfund.
 Int'l firm representation: Music Radio Promos (UK).
 Musikvertrieb AG (IFPI), Badenerstr. 555, CH-8040 Zurich. Tel: (01) 54.97.54. Cable: MUSIKVERTRIEB. Telex: 52740. Pres.: Dr. Jack Dimenstein; Rec. Dept. Mgr.: Lucien Monnerat; Sales Mgr.: Juerg Hoffman. (Distributor/Importer).
 Labels: (licensed domestic) Artiphon, ESP-Collection, Elite Special, Intimus, Swiss Jazz; (licensed foreign) Arston (Italy), Asylum (USA), Atco (USA), Atlantic (USA), Autobahn (Germany), BTM (USA), Baby (Italy), Beggars Banquet (UK), Beserkeley (USA), Big Mouth, Buddha (USA), CAM (Italy), Crossover (USA), Dark Horse (USA), Decca (UK), Delphine (France), DiscReet (USA), Elektra (USA), Grunt (USA), Hed Arzi (Israel), Janus (USA), Jupiter (Germany), Lollipop, London (UK), Magnet (UK), Millennium (USA), Nonesuch (USA), Nova (UK), Numero Uno (Italy), Pinnball, Planet (Germany), RCA (USA), Radar, Reprise (USA), Stiff (UK), Storyville (Germany), Swan Song (USA), Strand (USA), Telefunken (Germany), Threshold (UK), Trojan (UK), 20th Century-Fox (USA), WEA Int'l (USA), Warner Bros. (USA), X-Recs. (Germany); (distributed-not licensed) Ariola (Germany), Arista (USA), Athena (Germany), Baccarola (Germany), Blue Mountain, Bronze (UK), CGD (Italy), Chrysalis (UK), Clan Celentano (Italy), Eurodisc (Germany), Hansa (Germany), Island, MCA (USA), Mantecore (UK), Melodia, President (UK), Red Star, Shelter, Speedball, Supraphon (Czechoslovakia), Vergara (Spain), Virgin (UK).
 Mustang, see Metronome.
 Nonesuch, see WEA.
 Note, see EMI.
 D B H Musikverlag (Dito B. Hartmann) (IFPI), PD Box 585, CH-6901 Lugano 1. Tel: (091) 68.55.86. Pres.: Dito B. Hartmann.
 Labels: (Owned) Kick, OBH.
 D S B, see Barclay-PolyGram.
 Odeon, see EMI.
 Odyssey, see CBS.
 Dkeh, see CBS.
 One Up, see EMI.
 Orchestrola, see Turicaphon.
 Orpheus Schallplatten, Postfach, CH-4108 Witterswil. Tel: (061) 73.13.30. Gen. Mgr.: Hanspeter Aeschlimann. (Distributed by Disc-Import)
 Label: (Owned) Orpheus.
 Int'l repts.: Austria (musica viva), France (Schott Freres), Germany (musica viva), UK (Gamut).
 Oversea Recs. AG, Zuercherstr. 35, CH-8154 Oberglatt/Zurich. Tel: (01) 850.32.39. Cable: OVERSEAREC. Telex: 56479. Pres.: Michel Liber; Sales Mgr.: Alice Liber.
 Int'l branch: Germany, Deutsche Oversea.
 Labels: (Owned) Oversea; (represented) Athenee (Greece), el Bimbo (Italy), Diskosan (Turkey), Edwards (France), Garnet (Germany), Luxembourg Sound (Luxembourg), Maetli (Italy), Melody (Greece), Mia (Italy), Nimbus (UK), Oiseau Musician (France), Pearl (UK), Rubim (UK), Sadi (Italy), Sonor (Italy), Studio SM (France), Togo (Italy), Zephyr (Italy).
 Int'l repts.: France (Edwards), Germany (Deutsche Oversea), Italy (Durium).
 P D U Ed. Discografiche & Musicali SA (IFPI), Via Generoso 6, CH-6900 Lugano. Tel: (091) 54.86.81, 54.87.51. Telex: 73208. Admin'r: Alberto Colmeberg.
 Int'l branch: Italy.
 P S M, see Metronome.
 Pan, see Music Consort.
 Panorama Int'l, Panini AG, Rumlängstr. 43/53, CH-8052 Zurich. Telex: 845-58835. Contacts: P. Nel, P. Hollenstein.
 Label: (Represented) Direct Disk (USA).
 Parlophone, see EMI.
 Paroles, see VDE-Gallo.
 Pathe, see EMI.
 Pelca, see Hug & Music Consort.

Piffikus, see Bellaphon.
 Philips, see PolyGram.
 Phonag Schallplatten AG (IFPI), Wartstr. 6, CH-8400 Winterthur. Tel: (052) 23.62.31. Cable: PHONAG. Telex: 76281. Owner: Helmut Bischof; Gen. Mgr.: Heinz Rehmann; A&R Mgr.: Richard Brocon.
 Labels: (Owned) Hallelujah, Helvetia, Phonag; (licensed domestic) Cellier, Mabel; (licensed foreign) Arcadia (Germany), Aves (Germany), ECM (Germany), Durium (Italy), GIG (Austria), Intercord (Germany), Jazz Point (Germany), Maritim/Mariton (Germany), Vanguard (USA), Vedette (Italy).
 Pick Recs. (IFPI), Brunniweinstr. 26, CH-8049 Zurich. Tel: (01) 56.44.40. Cable: MUSIICCENTER. Telex: 56636. Pres. & Gen. Mgr.: Jane Peterer; Sales Mgr.: Steve Peterer.
 Labels: (Owned) Aktuell, Classic Pick, Hot Pick, International Pick, Pick, Pickli, Swiss Made; (licensed foreign) Abersold Jamey (USA), Albatros (Germany), Eterna (East Germany), FMP (Germany), Folkways (USA), Folkwerkstatt (Germany), Inner City (USA), Isis (Germany), Jaguar (Germany), MIMO (USA), Moers (Germany), Mueller Prod'ns (Germany), Nova (East Germany), Ornamet, Peak (Germany), Paene (Germany), Quadrologia (Italy), Rockport (Germany), SAJ (Germany), SPR, Studio PR (USA), Topic, Trill, Village Songs.
 Pickli, see Pick.
 Podium, see Duraphon.
 Poly, see PolyGram.
 Polydor, see PolyGram.
 Polyfar, see PolyGram.
 PolyGram Recs. AG (IFPI), Bahnhofstr. 6, CH-8952 Schlieren. Tel: (01) 730.52.00. Telex: 55530. Gen. Mgr.: Wolfgang Zimmermann; Sales Mgr.: H.U. Ruetschi; Mktg. Mgr.: Peter Frei; Pop Label Mgrs.: Manfred Wapli, Alex Pfund, Robert Sulzer; Classical Mgrs.: Werner Seyboth, Werner Guttering; Adv. Mgr.: K.H. Fahrni; A&R Mgrs.: Victor Pelli, Rene Wicky.
 Labels: (Owned) Archiv, Barclay, Brunswick, Casablanca, DG, Fass, Fontana, Heliodor, Impact, Karussell, Mercury, Philips, Poly, Polydor, Polyfar, Polystar, Rothkreuz, Star-Club, Swiss Gold, Vertigo; (licensed) Back Door (UK), Barn (UK), Biograph (USA), Blue Jeans (Germany), Capricorn (USA), Charisma (UK), Chess (USA), EastWind, Cramps (Italy), Disques H (France), Dreamland (USA), EG (UK), EastWind (Japan), Ember (UK), Kalondour (France), Marzelle (France), Midsong Int'l (USA), Pablo (USA), Pairo (Sweden), RSD (USA), Rocket (UK), Schenoutz (Switzerland), Sirocco (France), Phil Spectra Int'l (UK, USA), Les 3 Oranges Bleues (France), Track (UK), Verve (USA), Zagora (France).
 Polystar, see PolyGram.
 Pony, see Metronome.
 Poplight Recs. Ltd., PO Box 4070, Muehleidorstr. 5, CH-3001 Berne. Tel: (031) 55.66.88, 55.55.42. Telex: 33967. Gen. Mgr.: Max Westsch; Sales Mgr.: Thomas Geiser. (Distributor/Importer/One-Stop)
 Portrait, see CBS.
 Prive Disc, see Gold.
 PUNCH, see EMI.
 R B Mktg., Waldstr. 8, CH-9008 St. Gallen. Tel: (071) 24.31.15. (Importer).
 Recommended Recs., Seestr. 324, CH-8038 Zurich. Tel: (01) 45.24.41. Contact: Daniel Waldemar.
 Home office: England.
 Record Serv. Ltd., Muttenerstr. 129, CH-4133 Pratteln. Tel: (061) 81.30.81. Telex: 63896. Owners: Jacky Studach, Jean Pierre Solberger.
 Labels: Image, Montana, Turo; (distributed-not licensed) Audiophile, GHB, Gusto, Jazology, Chris LeDoux, Progressive (all USA); Europa, Sandra, Wergo (all Germany); Big R (UK).
 Regal, see EMI.
 Regal Zonophone, see EMI.
 Reprise, see WEA.
 Riviera, see Barclay-PolyGram.
 Riviera LM, see Barclay-PolyGram.
 Rothkreuz, see PolyGram.
 S-3000, see Musciand.
 Alfred Sacher, Oettingenstr. 39, CH-4000 Basel. Tel: (061) 32.46.20. (Importer).
 Friedrich Schait, Via Industria 1, CH-6900 Lugano. Tel: (091) 3.88.66, 3.47.55. Dir.: Friedrich Schait. (Wholesaler/Importer-tape).
 Schnoutz, see PolyGram.
 Seraphim, see EMI.
 Sidwalk, see EMI.
 Sky, see BB.
 Stava, see Duraphon.
 Sonographic Rec'g Co. AG, Kampstr. 16, CH-8952 Schlieren. Tel: (01) 730.22.29. Pres.: R. Egh; Gen. Mgr.: W.A. Wettler; Sales Mgr.: A. Brand.
 Label: (Owned) Sonographic.
 Stamy, see Barclay-PolyGram.
 Star Recs., PD Box 25, CH-7270 Davos 2. Tel: (083) 3.54.38. Gen. Mgr.: B. Bestgen.
 Labels: (Owned) Star, Swiss Sound.
 Star-Club, see PolyGram.
 Starline, see EMI.
 Star Performance, see IRC.
 Star Sound, see Bellaphon.
 Sunset, see EMI.
 Swiss Gold, see PolyGram.
 Swiss Hit, see Electromusic.
 Swiss Jazz, see Turicaphon, IRC & Musikvertrieb.
 Swiss Made, see Pick.
 Swiss Sound, see Star & Bellaphon.
 Sympatic, see Duraphon.
 Tacoun SA, Rue St. Pierre 26, CH-1700 Fribourg. Tel: (021) 62.45.55.
 Teli, see Electromusic.
 Top Disc, see Metronome.
 Top Disc Gold, see Metronome.
 Trianon, see EMI.
 Trio, see APV & Record Serv.
 Tudor Rec'g AG, Badenerstr. 531, CH-8048 Zurich. Tel: (01) 491.72.50. Telex: 59108. Chief Exec.: Wlodek Glowacz. (Distributed by Music Consort)
 Label: (Owned) Tudor.
 Int'l repts.: Austria (Amadeo), France (Harmonia Mundi), Germany (Osco-Center), UK (Parnote).
 Turicaphon AG Schweizer Schallplattenfabrik, CH-8611 Redikon/Zurich. Tel: (01) 941.13.11. Telex: 52645. Cable: TURICAPHON RIEDIKON. Pres. & Gen. Mgr.: Hans Oestreicher Sr.; Sales Mgr.: Hans Oestreicher Jr. (Distributed by Musikvertrieb).
 Labels: (Owned) Artiphon, Carsound, ESP-Collection, Elite, Elite Special, Intimus, Mandolino, Orchestrola, Swiss Jazz; (distributed) Asmahon, Bardaphon (both Lebanon).
 Int'l repts.: Australia (Carina), Austria (Amadeo), Belgium (Ineco), Brazil (Gravacos Electricas), Denmark (Sonet-Starbo), Finland (Poujousmaiden), France (Sopholest), Germany (Deutsche Austrophon), Italy (Musik-

Billboard 1981-1982 International Buyer's Guide

import/Pilego), Japan (Victor), Netherlands (Sound Prods.), Norway (Arne Bendiksen), Spain (Marler), Sweden (Sonet), USA (Fiesta, Peters), Yugoslavia (Jugoton)

United Artists, see EMI

V D E Gallo, Rue de l'Alé 46, CH-1000 Lausanne 9, Tel: (021) 22.80.24 Gen Mgr: Olivier Bultex; Ass't Mgr: Helene Rossi. (Distributed by Vogue & Evasion)

Labels: (Owned) Gallo, Paroles, VDE
Int'l reps: Australia (World Rec. Int'l), Austria (Mitur), Belgium (Edi bon), Canada (Meridienne), Finland (Fuga), France (SFPP), Germany (Mitur), Japan (Universal Corp.), Luxembourg (Edibon), Netherlands (Vista), New Zealand (World Rec. Int'l), Sweden (Sterling), USA (Records Int'l Theodore Front)

Vega 2000, see Musicland

Vero Disc, see Electromusic

Versailles, see CBS

Vertigo, see PolyGram

Via Music, see Disques-Office

Vogue, Place du Grand Mont, CH-1052 Le Mont/Lausanne Tel: 33.33.55 Commercial Dir.: Pierre Henry Dumont; Admin. Dir.: Aurel Trost

W E A Int'l (European artists relations office & audio/video planning div.), Chillon 16, CH-1820 Montreux Tel: (021) 61.64.31, 61.29.51 Cable MONTREUXSDUNOS; Telex: 453178 European Artist Relations Dir. Claude Nuss; European Tour Co-ord. Jaquelyne Ledent Vilam (Distributed by Musikvertrieb)

Home office: USA
Labels: (Owned) Asylum, Alca, Atlantic, Cotillion, Elektra, Nonesuch, Reprise, Warner Bros.; (Licensed) Big Tree (USA), Little David (USA), Swan Song (UK), Warner Curb (USA), Westbound (USA), Whitefield (USA); (distributed-not licensed) Bearsville, Dark Horse, Planet (all USA)

Warner Bros., see WEA

Waverly, see EMI

Willisau Live, see America Sound

Young Electronics, 24.26 Ave de la Gare Des Eaux-Vives, CH 1211 Geneve 6
Label: (Represented) Sheffield Lab (USA)

Zonophone, see EMI

Zyloglog Verlag, Eigenweg 20, CH-3073 Guemligen Tel: (031) 52.20.30

• **music publishers**

Abram Music, Postfach A.135, Graben 1, CH 6301 Zug, Tel: (042) 21.30.42 Gen. Mgr: August P. Villiger

Amadeus Verlag, Mottelstr. 62, CH-8405 Winterthur, Tel: (052) 28.20.38 Mng. Dir.: Bernhard Paeuler

Ascona Music, see Wintasco

Breeze Music Switzerland, Via Serodine 17, CH-6612 Ascona, Tel: (93) 35.32.51 Owner & Dir.: Corné Dierks-Fortman

Burkhard & Co. Verlag, CH-8487 Zell, Tel: (052) 35.15.14

Cantate Domino, Case Postale 233, CH-1870 Monthey, Tel: (025) 71.35.85 Mng. Dir.: Lucien Genoux

Capricorn Artist Promo Ltd., PO Box 8121, Jungstr. 15a, CH 8050 Zurich, Tel: (01) 302.21.33 Telex: 55217 Pres.: Helena Angstmann; Gen. Mgr: Freddy J. Angstmann

Int'l rep.: Germany (Hans Wewerka)

Coda AC (Ed.), Brunnwiesenstr. 26, CH-8049 Zurich, Tel: (01) 56.44.40 (Affiliated with Jane Peterer)

Int'l firms represented: Meisel Prod'n, Montana (both Germany)

Int'l reps.: Austria (Melodie), Germany (M. Hohner), Netherlands (De Eerste Muziek Centrale)

Cron (Ed.), Seidenholstr. 14, CH 6002 Lucerne, Tel: (041)e23.43.25 Gen. Mgr.: Dr. Paul Cron

Int'l firms represented: A. Boehm (Germany), Styria (Austria)

E M I Music Pub'g (Switzerland) SA, Badenerstr. 567, CH-8048 Zurich, Tel: (01) 54.00.10 Telex: 55695 Mng. Dir.: Guy Deluz

Int'l firms represented: EMI group, Francis Day, Marouani (all France)

Edio SA, Badenerstr. 555, CH-8048 Zurich, Tel: (01) 491.64.77 Pres.: Dr. Veit Wyler; Gen. Mgr.: Sarah Dimenstein

Int'l firms represented: Acuff Rose Music (USA), Melodie der Welt (Germany)

Edition Musikproduktionen (ML, SUIA) c/o Metronome Recs. AG, Troedstr. 68, CH-8810 Horgen 1, Tel: (31) 725.36.83 Telex: 52941 Pres.: Juerg Zehnder; Publ. Mgr.: Reinhard Frey

Int'l firms represented: Abramo Allione (Italy), Associati (Italy), Rolf Budde Musikverlag KG (Germany), Eurovox (Belgium), Farran Musica (Spain), Interox (Belgium), Noble (Germany), Peterman & Co. Ltd (UK), Real (Italy), Royal (Germany), Swington (Ed.) (Germany), Valente (Belgium)

Int'l rep.: Germany (Royal)

Eiblat Musikverlag, see DBH

Elwe Musikverlag, Zelgrankstr. 1, CH-8964 Rudolfstetten, Tel: (057) 5.78.79

Ere du Versau, PO Box 90, CH 1211 Geneva 1, Chief Exec.: Mr. Regor Eulenberg (Ed.) GmbH, Albert Puntzenmatten, CH-8134 Adliswil

Evasion SA, Place du Grand Mont, CH-1052 Le Mont/Lausanne, Tel: (021) 33.33.55 Pres.: Francois Vautier; Gen. Mgr.: Gaston Schaefer

Fantlan Music H. & B. Liechti & Co. (SUISA/ML), Rue de Hesse 8-10, CH-1211 Geneva 11, Tel: (022) 21.77.66 Telex: 28657 Mng. Dir.: Heinz Liechti; Gen. Mgr.: Bertrand Liechti

Int'l firms represented: CAM (Italy), Essex (UK), Fermata Group (Brazil), Gerg (Germany), Goodman Group (USA), Roland Kluger (Belgium), Mills (USA), Radio Music Int'l (Luxembourg), Sugar (Italy)

Finsterwald & Cantacuzene Eds. Musicales, Av. des Alpes 70 CH-1820 Montreux, Tel: (021) 62.45.55 Pres.: Jean-Jacques Finsterwald; Gen. Mgr.: Ivan Cantacuzene

Int'l firms represented: Belmont (Germany), Durum (Italy), Fiumara (Italy), Maas (Italy), Saar (Italy)

Friedrich's Prod'n, 13 Rue Marignac, CH-1206 Geneva, Tel: 47.68.10 Telex: 289789 Pres.: Jean-Claude Friederich

Gorbex Musikverlag, Postfach 118, CH-5432 Neuenhof, Tel: (056) 83.32.43 Hazzyville (Ed.), Im Koller 17, CH-8706 Feldmeilen, Tel: (01) 923.49.18 Cable: OSTERWALDMUSIC, Telex: 75437 Pres. R. Hazy Osterwid; Gen. Mgr.: Renato Cerutti

Int'l firms represented: Allround (Austria), Arabella (France), Paul C.R. Arends (Germany), Hazyland (Germany), Eugene McDaniels (USA), Moon Shadow Music (Germany), Prach (USA), Shirley (Germany), Trumpf (Germany), Yonah (USA)

Int'l reps.: Austria (Allround), Belgium (Frankie, Virgo), Canada (Arca), Germany (Paul C.R. Arends), South Africa (Laetec)

Helbing (Ed.) AG, Pfaffenstr. 6, CH-8604 Volketswil, Tel: (01) 945.43.93 Cable: HELBLINGMUSIC, Telex: 56062 Pres.: Peter Brunner

Helena Music, see Wintasco

Hug & Co. Musikverlag, Limmatquai 26-28, CH-8022 Zurich, Tel: (01) 251.68.50 Cable: MUSIKHLG, Owner & Gen. Mgr.: Erika Hug

Int'l reps.: Germany (Barenreiter), UK (Barenreiter, C.F. Peters), USA

(C.F. Peters)

I M P A C T (International Music Publ'rs & Composers Trust) SA, Box 10, Via del Tiglio 11, CH-6900 Cassarate/Lugano, Tel: (091) 51.80.71

Int'l firms represented: Jana, Mongo

Jacky Music, see Wintasco

K B L, 22, Av. de Miremont, CH-1206 Geneva, Tel: (022) 46.26.95 Chief Exec.: Christian Drestreicher

Kneusslin (Ed.), Amelstr. 43, Basel, Tel: (061) 35.90.58 Chief Exec.: Fred rich Kneusslin

Int'l reps.: Canada (C.F. Peters in USA), France (Max Eschig), Germany (Haensler), UK (Peters), USA (C.F. Peters)

Lausanne Musique (SUISA), Rue de l'Alé 46, CH 1000 Lausanne 9, Tel: (021) 22.80.24 Gen. Mgr.: Olivier Bultex

Lemania Music, see Ere du Versau

Macumba (Eds.) Musicales SA, Place du Grand Mont, 1052 Le Mont/Lausanne, Tel: (21) 33.33.55 Gen. Mgrs.: Pierre-Henri Dumont, Aurel Trost, Mueiller & Schade AG, Postfach 67, CH-3000 Berne 7, Tel: (031) 22.16.91

Musik Club Verlag (SUISA), Alte Landstr. 23, CH-8942 Dberrieden, Tel: (01) 720.82.03 Telex: 59013 Owner: Bernard Henrion

Musicaud AG, Althardstr. 224, CH-8105 Regensdorf/Zurich, Tel: (01) 840.60.40 Telex: 56359 Chief Exec.: Gian Carlo Astore

Musik Today SA, Baarerstr. 57, CH-6301 Zug, Tel: (042) 21.07.45

Musikvertrieb AG, Badenerstr. 555, CH-8048 Zurich, Tel: (01) 54.97.54 Telex: 52740 Pres. Dr. Jack Dimenstein; Mgr.: Sarah Dimenstein

Int'l firms represented: Global (Germany), Melodie der Welt (Germany), Ivan Mogull (USA), Valentine Music Group Ltd (UK)

Nikto (Eds.), Av. de la Grenade 6, CH-1207 Geneva, Tel: (022) 35.17.62 Cable: NIKTDPRESS

Nuesch Publg Co., Postfach 176, CH-9230 Flawil

Int'l branch: Spain

D B H Musikverlag (Dito B. Hartmann), PD Box 585, CH 6901 Lugano 1, Tel: (091) 68.55.86 Pres.: Dito B. Hartmann

Int'l rep.: Japan (Hara)

Drma Verlag, Postfach 18, CH-8753 Mollis, Tel: (058) 34.27.34 Telex: 875145 Gen. Mgrs.: Jakob Baumgartner, Christoph Berger

Dversee Music, Zuercherstr. 35, CH-8154 Dberglatt, Tel: (01) 850.32.39 Telex: 56479 Pres.: Michel Liber

P D U Eds. Discografiche & Musicali SA, Via Generoso 6, CH-6900 Lugano, Tel: (091) 54.86.81, 54.87.51 Telex: 73208 Admin'r: Alberto Collemberg

Int'l branch: Italy

Peer Southern Drg., see Southern Music

Pegasus (Ed.), Casella Postale 1, CH-6605 Locarno-Monti

Jane Peterer Publ'g, Brunnwiesenstr. 26, CH-8049 Zurich, Tel: (01) 56.44.40 Cable: MUSICCENTER Pres.: Jane Peterer

Int'l firms represented: Melodie (ed.) - United Artists Group (Germany, USA)

Int'l reps.: Austria (Melodie), France (Hohner), Germany (M. Hohner), Latin America (Columbia Pictures), Netherlands (De eerste Muziekcentrale), USA (Studio PR)

E Ruh Verlag, Zurichstr. 33, CH-8134 Adliswil, Tel: (01) 710.63.13

Say Yes Music AG, Seestr. 12, CH-6072 Sachseln, Tel: (4141) 66.30.06 Telex: (45) 54138 Gen. Mgr.: Dr. Hermann Stern

Southern Music AG, Pfaffenstr. 6, CH-8604 Volketswil, Tel: (01) 945.43.93 Cable: SDUTHMUSIC, Telex: 56062 Mgr.: Rita Brunner

Home office: USA, Peer Southern Drg

Int'l firms represented: Alba, Arela, Casapark, Marbot, Morel, Multi Media, Peer Southern Prod'n, Robin, Team (all Germany), Alrhond (USA), Cedarwood (USA), Malaco (USA), Roger Muller (USA), Musa (Mexico), Peer-Southern Drg (worldwide), Royal Dak (USA), Small Smile (UK), Sunbird (Canada), Vinco (UK)

Tudor Ed. (Switzerland), Badenerstr. 531, CH-8048 Zurich, Tel: (01) 491.72.50 Telex: 59108 Chief Exec.: Wlodek Glowacz

Turcaphon (Ed.) AG, Winterthurstr. 40, CH-8610 Uster/Zurich, Tel: (01) 941.14.34 Cable: TURCAPHOND RIEDIKON, Telex: 52645 Pres. & Gen. Mgr.: Han Drestreicher Sr.

Violanda Musik Verlag, Gramat 4, CH-8862 Schuebelsch, Tel: (055) 64.41.43 Pres. & Gen. Mgr.: Eugene Tiel

Walter Wild Eds., Postfach, CH-8712 Staefa

Wintasco Publ'g SA, PO Box 412, CH-8040 Zurich, Tel: (01) 242.83.10 Telex: 812217 Pres.: Ernst Burkhalter; Mng. Dir.: Helen Eberhard; Gen. Mgr.: Renato Burkhalter

Zomba Corp., Alpensir 14, CH-6300 Zug, Tel: (042) 21.14.66 Cable: IURZD Telex: 78867 Dir.: R. Karel Zoller

Int'l reps.: Australia (Warner Bros.), Austria (Roby), Belgium (Nada), Canada (Morning), France (Intersong), Germany (Roba), Ireland (Zomba), Netherlands (Nada), New Zealand (Warner Bros.), South Africa (Muspiece), UK, USA (Zomba)

Zurich AG (Musikverlag & Buehnenvertrieb), Utoquai 41, CH-8008 Zurich, Tel: (01) 252.77.88 Cable: ZURICHMUSIK Dir.: Dr. Rolf Corradi

• **services**

ASSOCIATIONS & PROFESSIONAL ORGANIZATIONS

Communaute de Travail Pour la Diffusion de la Musique Suisse, Av. du Grammont 11 bis, CH-1000 Lausanne 13, Tel: (021) 26.63.71

European Ass'n of Music Festivals, Villa Moynier, Rue de Lausanne 122, Geneva

European Broadcasting Union, PD Box 193, Ancienne Rt. 17A, CH 1211 Geneva 20, Tel: (022) 98.77.66 Cable: UNIRADIL, Telex: 289193 Sec'y Gen. Regis de Kalbermaten; Legal Affairs: Marcel Ce. TV Program Dept. Miro Vileck, Radio Program Dept. Anthony M. Dean, Technical Centre: Rudolf Gressman

F I M (Federation Int'l des Musiciens), Hofackerstr. 7, CH 8032 Zurich, Tel: (01) 55.66.11

I F P I Schweiz (Schweizer Landesgruppe der IFPI), Toblerstr. 76A, CH-8044 Zurich, Tel: (01) 252.58.66/41.23 Telex: 57517

S M V (Swiss Musicians Union), Elisabethenstr. 2, CH-4051 Basel, Tel: (061) 23.87.86 Chief Exec.: Hans Heusi; Gen. Mgr.: Dr. Peter Kuster

Swiss Musicians' Ass'n, Av. du Grammont 11 bis, CH-1000 Lausanne 13, Tel: (021) 26.63.71

DESIGN & ARTWORK

Acheret Design Studios, Schaffhauserstr. 15, Zurich, Tel: (01) 60.38.72

E. Schweizer Design AG, Spaltenrotweg 4, CH-4051 Basel, Tel: (061) 22.17.65 Gen. Mgr.: Peter Krummenacher

Int'l branches: Germany, USA

Sonographic Rec'g Co. AG, Kampstr. 16, CH-8952 Schlieren, Tel: (01) 730.22.29 Pres. R. Egli; Gen. Mgr.: W.A. Wettler; Sales Mgr.: A. Brand

LICENSING ORGANIZATIONS, MUSIC

S U I S A (Schweizerische Gesellschaft fuer die Rechte der Urheber musikalischer Werke), Bellaristr. 82, CH-8038 Zurich, Tel: (01) 45.77.00

Cable: SUIA Telex: 59876 (Performing & Mechanical Rights)

Symphony Tone Prod'n, Rte. de Lussy 30, CH-1162 St. Prex/Vaud, Tel: (021) 76.10.26 Pres.: Imre Rozsa; Gen. Mgr.: Lea Manhart (Performing

rights only)

LICENSORS, RECORD & TAPE

Cross Ltd., PO Box 44, Aegerstr. 2, CH-6340 Baar, Tel: (042) 31.64.88 Telex: 865152 Mng. Dir.: Rolf Albiner

PLATING, PROCESSING & PRESSING PLANTS

M C S (Music & Cassette Supply Ltd.), Schufelstr., CH-8863 Buttikon SZ, (055) 67.14.14 Telex: 75144 Pres.: Werner Weber; Gen. Mgr.: Mario Taravela; Sales Mgr.: Ulrich Plocher

Sonographic Rec'g Co. AG, Kampstr. 16, CH-8952 Schlieren, Tel: (01) 730.22.29 Pres. R. Egli; Gen. Mgr.: W.A. Wettler; Sales Mgr.: A. Brand

Turcaphon AG Schweizer Schallplattenfabrik, CH-8611 Riedikon/Zurich, Tel: (01) 941.13.11

PRINTER & LITHOGRAPHER

Guide Suisse Du Spectacle, PO Box 90, CH 1211 Geneva 1

RECORD PROMOTION

(including Public Relations & Publicity)

Evasion SA, Place du Grand Mont, CH-1052 Le Mont/Lausanne, Tel: (021) 33.33.55 Pres.: Francois Vautier; Gen. Mgr.: Gaston Schaefer

TAPE CUSTOM DUPLICATORS

TAPE PACKAGING & LABELING

The Audio and Video lines indicate the configurations which the firms duplicate. Companies which offer packaging and labeling of tape product are indicated by "(PKG)" which appears after the main body of their respective listings.

Atlantida SA, Chemin Moise-Duboulet 49, CH-1211 Geneva 28, Tel: (022) 98.33.22 Cable: ASAINTER

Cross Ltd., PO Box 44, Aegerstr. 2, CH-6340 Baar, Tel: (042) 31.64.88 Telex: 865152 Mng. Dir.: Rolf Albiner (PKG only-audio)

Intertape Ltd. (International Tape Drg.), Spinnerstr. 21, CH-8753 Mollis, Tel: (058) 34.31.34 Telex: 75162 Gen. Mgr.: Peter Baumgartner; Sales Mgr.: Louis Bischof

Audio: Cassette, open reel

Video: 1" helical open reel, 1/2" U-matic cassette, 1/2" Beta & VHS cassette

M C S (Music & Cassette Supply Ltd.), Schufelstr., CH-8863 Buttikon SZ, Tel: (055) 67.14.14 Telex: 75144 Pres.: Werner Weber; Gen. Mgr.: Mario Taravela; Sales Mgr.: Ulrich Plocher

Int'l branch: Germany

Audio: 8 tr., cassette, open reel

Musicaud AG, Althardstr. 224, CH-8105 Regensdorf/Zurich, Tel: (01) 840.60.40 Telex: 56359 Pres. & Gen. Mgr.: Gian Carlo Astore

Audio: 8 tr., cassette, open reel

Ruba, Beerli & Co./Arthoch CH E. Beerli, PD Box 300, Claragraben 78, CH 4000 Basel, Tel: (061) 33.23.94

Union Studios E. Heers, Schulstr. 56, CH-8105 Regensdorf

Werbomatic, Gramat 4, CH-8862 Schuebelsch, Tel: (055) 64.41.43 Gen. Mgr.: Eugene Tiel

Video: 1/2" Beta & VHS cassette

• **supplies**

CARTRIDGE & CASSETTE PARTS

Alchemo AG, Althardstr. 224, CH-8105 Regensdorf, Tel: (01) 840.66.06 Telex: 56359 Pres. & Gen. Mgr.: Gian Carlo Astore; Sales Mgr.: Alfred K. Egli; Adm'n. Supervisor: Walter R. Lang

Audio: Cassette bodies, hubs, rolls, foils, pads, shields, all cartridge plastic parts, library cases

C C T (Compact Cassettes Trading AG), Birmsendorferstr. 55, CH-8036 Zurich, Tel: (01) 241.47.11 Telex: 58975 Pres.: Hugo von Blumenthal

I C M Ltd., Muehlebachstr. 27, CH-8800 Thalwil, Tel: (01) 720.29.42 Telex: 53759 Pres.: Werner Weber; Gen. Mgr.: Andy Baur; Sales Mgr.: Rolf Sager (SEE ADVERTISEMENT)

Lake County Recs., Fritz Courvoisier 15, CH 2300 La Chaux-de-Fonds, Tel: (039) 22.63.03 Chief Exec.: Michel Cattin; Gen. & Sales Mgr.: Eliane Cattin

Lenco Moulding SA, rue de l'Industrie, CH 1781 Courtaman, Tel: (037) 34.19.15 Gen. Mgr.: Gerard Koerberle; Sales Mgr.: Zita Koerberle (SEE ADVERTISEMENT)

Toka AG, see CCT

EMPTY CARTRIDGES, CASSETTES, & REELS

Alchemo AG, Althardstr. 224, CH-8105 Regensdorf, Tel: (01) 840.66.06 Telex: 56359 Pres. & Gen. Mgr.: Gian Carlo Astore; Sales Mgr.: Alfred K. Egli; Adm'n. Supervisor: Walter R. Lang

Audio: Cassettes, cartridges, digital cassettes.

C C T (Compact Cassettes Trading AG), Birmsendorferstr. 55, CH-8036 Zurich, Tel: (01) 241.47.11 Telex: 58975 Pres.: Hugo von Blumenthal (Video only)

I C M Ltd., Muehlebachstr. 27, CH-8800 Thalwil, Tel: (01) 720.29.42 Telex: 53759 Pres.: Werner Weber; Gen. Mgr.: Andy Baur; Sales Mgr.: Rolf Sager (SEE ADVERTISEMENT)

Lake County Recs., Fritz Courvoisier 15, CH 2300 La Chaux-de-Fonds, Tel: (039) 22.63.03 Chief Exec.: Michel Cattin; Gen. & Sales Mgr.: Eliane Cattin

Lenco Moulding SA, rue de l'Industrie, CH 1781 Courtaman, Tel: (037) 34.19.15 Gen. Mgr.: Gerard Koerberle; Sales Mgr.: Zita Koerberle

Audio: C D cassettes (SEE ADVERTISEMENT)

Musicaud AG, Althardstr. 224, CH-8105 Regensdorf/Zurich, Tel: (01) 840.60.40 Telex: 56359 Pres. & Gen. Mgr.: Gian Carlo Astore

ENVELOPES & MAILERS

Turcaphon AG Schweizer Schallplattenfabrik, CH-8611 Riedikon/Zurich, Tel: (01) 941.13.11

JACKETS & SLEEVES

LABELS, DISK

Sonographic Rec'g Co. AG, Kampstr. 16, CH-8952 Schlieren, Tel: (01) 730.22.29 Pres. R. Egli; Gen. Mgr.: W.A. Wettler; Sales Mgr.: A. Brand (Jackets & labels only)

Turcaphon AG Schweizer Schallplattenfabrik, CH-8611 Riedikon/Zurich, Tel: (01) 941.43.11 (Jackets & sleeves only)

POLYETHYLENE BAGS & SHRINKWRAP

Sonographic Rec'g Co. AG, Kampstr. 16, CH-8952 Schlieren, Tel: (01) 730.22.29 Pres. R. Egli; Gen. Mgr.: W.A. Wettler; Sales Mgr.: A. Brand

PROFESSIONAL TAPE SUPPLIES

Cross Ltd., PO Box 44, Aegerstr. 2, CH-6340 Baar, Tel: (042) 31.64.88 Telex: 865152 Mng. Dir.: Rolf Albiner

Product: Cassette labels

TAPE, BLANK LOAEO & BULK RAW

Agfa Gevaert AG/SA, Stettbachstr 7, CH 8600 Duebendorf Tel Zurich 821 02 40 Telex 56961 Zurich Mng Dir R Klett Sales Mgr H Mueller
Audio: Blank Compact cassette open reel, raw—cassette broadcast studio
Video: Cassette
 Alchemco AG, Althardstr 224, CH 8105 Regensdorf Tel (01) 840 66 06 Telex 56359 Pres & Gen Mgr Gian Carlo Astore, Sales Mgr Alfred K Eggli, Admin Supervisor Walter R Lang
Audio: Raw—8 tr, cassette, open reel, blank—8 tr, cassette
 Ampex World Opns SA, Rt des Arsenaux 9, CH 701 Fribourg Tel (037) 81 31 11 Cable VIDEOTAPE Telex 36196 Tape Sales Mgr J O Renevey
Audio: 2" 1" cassette, open reel
Video: 2" 1" 1/2" Beta & VHS
 Audio Electronic AG, Raffelstr 25, CH 8045 Zurich Tel (01) 66 26 90 Telex 56556 Chm Manfred Frank, Sales Mgr Ed Isenring (Importer) (Blank only)
Audio: Cassette, open reel
Brand name: Fujip

Audio Magnetics SA Geneva, 2 Rte des Acacias, CH 1217 Geneva 24, Tel (022) 43 51 15 Telex 27152 Gen Mgr Jean Pierre Murbach, Sales Mgr Werner Meier, Mktg Mgr Jean Jacques Eschenmoser
 Int'l subsidiaries: England France Germany, Portugal (All Audio Magnetics)
Audio: 8 tr, cassette & open reel
 B A S F (Switzerland) AG, Appolal, CH 8820 Waedenswil Tel (01) 783 91 11 Telex (08) 75275
Home office: Germany
Audio: Blank—2", 1", cassette, open reel
Video: Raw—1", Blank—1", 1/2" U matic cassette, 1/2" Beta & VHS
 B B H Videocopy Ltd, Spammerstr 21, CH 8753 Mollis Tel (058) 34 31 36 Telex (08) 75162 Gen Mgr Peter Baumgartner, Sales Mgr Louis Bischof (Blank only)
Video: 1/2" U matic cassette 1/2" Beta & VHS cassette
 Cross Ltd, PO Box 44, Aegerstr 2, CH 6340 Baar Tel (042) 31 64 88 Telex 865152 Mng Dir Rolf Albinger (Blank only)
Audio: Cassette
 Fuji, see Audio Electronic
 I.C.M Ltd, Muehlebachstr 27, CH 8800 Thalwil Tel (01) 720 29 42 Telex 53759 Pres Werner Weber, Gen Mgr Andy Baur, Sales Mgr Rolf Sager (Raw only) (SEE ADVERTISEMENT)

Lenco Moulding SA, rue de l'Industrie CH 1781 Courtaman Tel (037) 34 19 15 Gen Mgr Gerard Koerberle, Sales Mgr Rita Koerberle (Blank only)
Audio: Cassette (SEE ADVERTISEMENT)
 M C S (Music & Cassettes Supply Ltd), Schufelstr CH 8863 Buttikon SZ Tel (055) 67 14 14 Telex 875144 Pres Werner Weber, Gen Mgr Mario Taravella (Blank only)
 MagnaTec Inc, Schwarztort 36, CH 3007 Bern, Tel (031) 25 44 74 Telex 32923 Gen Mgr Dr P J Wyman (Consulting & Engineering)
 Musciland AG, Althardstr 224, CH 8105 Regensdorf/Zurich Tel (01) 840 60 40 Telex 56359 Pres & Gen Mgr Gian Carlo Astore
Audio: 8 tr cassette, open reel
 Pyral (Products) SA, 3 Rue Beau Site CH 1211 Geneva Tel 44 65 50 Telex 23756 (Blank only)
Home office: France
 Revox ELA AG, Althardstr 146, CH 8105 Regensdorf Tel (01) 840 26 71 Pres Willi Studer, Gen Mgr Michel Ray (Blank only)
Audio: Open reel
 Sony Overseas SA, Baarerstr 59, CH 6301 Zug Tel (042) 23 31 21 (Blank only)
Audio: Cassette, open reel
Video: 1" open reel, 1/2" cassette, 1/2" EIAJ cartridge

TAPE DUPLICATING EQUIPMENT

Alchemco AG, Althardstr 224, CH 8105 Regensdorf Tel (01) 840 66 06 Telex 56359 Pres & Gen Mgr Gian Carlo Astore, Sales Mgr Alfred K Eggli, Admin Supervisor Walter R Lang
Audio: Quality control equipment for CC production cassette winders, audio acoustical equipment
 Audio Magnetics SA Geneva, PO Box 54, 2 Rte des Acacias, CH 1227 Geneva Tel (022) 43 51 15 Telex 27152 Gen Mgr Jean Pierre Murbach, Sales Mgr Werner Meier, Mktg Mgr Jean Jacques Eschenmoser
 Int'l subsidiaries: England, France, Germany, Portugal (All Audio Magnetics)
Audio: 8 tr, cassette & open reel copiers & duplicators
Brand name: Pentagon
 Cetelec Int'l Ltd, Steinbachstr 3, CH 6317 Oberwil Zug Tel (042) 21 53 32 Telex 78806
Audio: High speed duplicators
Brand name: Gauss
 Gaus, see Cetelec Int'l
 Intertechnica (div of Nichibe Technical Consultants Ltd) Case Postale 475, 4 Rue Ami Lullin, CH 1211 Geneva 3
Audio: Design & implementation of facilities
 Sony Overseas SA, Baarerstr 59, CH 6300 Zug Tel (042) 23 31 21

TAPE PACKAGING & LABELING EQUIPMENT

Cross Ltd, PO Box 44, Aegerstr 2, CH 6340 Baar Tel (042) 31 64 88 Telex 865152 Mng Dir Rolf Albinger
Product: Cassette boxing & labeling machines

• accessories

Alchemco AG, Althardstr 224, CH 8105 Regensdorf Tel (01) 840 66 06 Telex 56359 Pres & Gen Mgr Gian Carlo Astore, Sales Mgr Alfred K Eggli, Admin Supervisor Walter R Lang
Product: Tape—carrying & storage cases, head cleaners, demagnetizers leader & splicing tape
 Ampex World Opns SA, Rt des Arsenaux 9, CH 701 Fribourg Tel (037) 81 31 11 Cable VIDEOTAPE Telex 36196 Tape Sales Mgr J D Renevey
Product: Tape—carrying & storage cases, head cleaners, bulk erasers, demagnetizers, leader tape, splicing tape & equip. (All audio & video)
 Dynavox Electronics, route de Villars 105, CH 1700 Fribourg Tel (037) 24 55 30
Product: Record—replacement stylus
Brand name: Pickering
 Electromusic AG, Baslerstr 9, CH 4102 Binningen 1 Tel (061) 47 75 50 Cable EMAG Telex 63754 Prod'n & Sales Mgr Otto Aebi, PR Kurt Mettler
Product: Record—carrying & storage cases record care prods turntable

45 rpm adaptors, Tape—carrying & storage cases (audio, video), head cleaners (audio), splicing tape & equip (audio)
 I.C.M Ltd, Muehlebachstr 27, CH 8800 Thalwil Tel (01) 720 29 42 Telex 53759 Pres Werner Weber, Gen Mgr Andy Baur, Sales Dir Rolf Sager
Product: Tape—carrying & storage cases (SEE ADVERTISEMENT)
 Lake County Recs, Fritz Courvoisier 15, CH 2300 La Chaux de Fonds Tel (039) 22 63 03 Owner Michel Cattin, Gen & Sales Mgr Eliane Cattin
Product: Record—45 RPM adaptors, replacement stylus
 M C S (Music & Cassette Supply Ltd), Schufelstr, CH 8863 Buttikon SZ Tel (055) 67 14 14 Telex 75144 Pres Werner Weber, Gen Mgr Mario Taravella, Sales Mgr Ulrich Plocher
Int'l branch: Germany
Product: Tape—head cleaners
 Musciland AG, Althardstr 224, CH 8105 Regensdorf/Zurich Tel (01) 840 60 40 Telex 56359 Pres & Gen Mgr Gian Carlo Astore
Product: Tape—carrying & storage cases, head cleaners & demagnetizers
 Revox ELA AG, Althardstr 146, CH 8105 Regensdorf Tel (01) 840 26 71 Pres Willi Studer, Gen Mgr Michel Ray
Product: Tape—carrying & storage cases head cleaners
 E Schweizer Design AG, Spalenorweg 54, CH 4051 Basel Tel (061) 22 17 65 Telex 63403 Gen Mgr Peter Krummenacher
Int'l branches: Germany, USA
Product: Record—carrying & storage cases record care prods, Tape—head cleaners
 Thorens Franz AG, Hardstr 41, CH 5430 Wettingen Tel (056) 26 28 61 Cable THORENS Telex 53682 Mng Dir Remy A Thorens Sales Dir Armin Graf
Product: Record—carrying & storage cases record care prods (Metro care), turntable mats, 45 RPM adaptors, replacement stylus, Tape—carrying & storage cases, head cleaners, splicing tape & equip. (all audio)

• store fixtures
 Alchemco AG, Althardstr 224, CH 8105 Regensdorf Zurich Tel (01) 840 66 06 Telex 56359 Pres & Gen Mgr Gian Carlo Astore Sales Mgr Alfred K Eggli, Admin Supervisor Walter R Lang
Product: Tape display racks
 Musciland AG, Althardstr 224, CH 8105 Regensdorf Zurich Tel (01) 840 60 40 Telex 56359 Pres & Gen Mgr Gian Carlo Astore
Product: Tape display racks
 E Schweizer Design AG, Spalenorweg 54, CH 4051 Basel Tel (061) 22 17 65 Telex 63403 Gen Mgr Peter Krummenacher
Int'l branches: Germany USA
Product: Browser boxes, display racks

TAIWAN (REPUBLIC OF CHINA)

Population: 17,380,000
Rate of exchange: \$1 (US) = 38.02 yuans
Per capita income: \$1 415
Holidays: January 1, 2 (Founding of Republic of China), Spring Festival, March 29 (Youth Day), April 4 (China Ming Festival) June 17 (Dragon Boat Festival), Mid Autumn Festival, September 29 (Birthday of Confucius), October 10 (National Day), October 25 (Restoration Day) October 31 (Birthday of Chiang Kai Shek) November 12 (Birthday of Dr Sun Yat Sen), December 25 (Constitution Day)

• record & tape manufacturers / distributors / importers

Archiv, see Philips
 Baal Recs (Taiwan) Ltd, PO Box 65 Chams Bldg 66 Sec 2 Taipei Tel 361 2151
Labels: (Owmed) Baal, Best of Everything
 Best of Everything, see Baal
 Casablanca, see Philips
 D G see Philips
 Decca, see Philips
 Discophone, see Pacific Int'l
 First Recs Ltd, 116 Cheng ye N Rd, San Chung City, Taipei 241 Tel 97; 2462
Label: (Licensed) Arrowlabs (UK)
 Fontana, see Philips
 Four Seas Rec Publ'g Co Ltd (IFPI) 167 Si Ning Rd, Taipei Tel 961 0187, 381 6142 Cable FOURSEAS Telex 21475 Gen Mgr C Y Liao Sales Mgr C Y Tan
Labels: (Owmed) Four Seas, (Licensed) Phonogram (Netherlands) WEA (USA)
 Hsin Chao Childhood Education Publ'n Co., 115 Chung Hua Market 2nd fl, Section 8, Taipei Tel (02) 331 7748, 361 1493
 Interdisc, see Pacific Int'l
 karussell, see Philips
 Leico Rec Factory Co Ltd, PO Box 3360, 1 Ln 19, Chung Teh Rd, Taipei Tel (02) 541 3792, 571 4927 Plant: 9 Ln 57, Hua Chang Rd, Hsin Chung Chen
 Lintair Eng & Trading Ltd (IFPI), 7 Jen Ai Rd, 7th fl, Sec 2, Taipei Tel (02) 321 4454 Cable LINFAR Telex 22563 Mng Dir Lintair L F Chang
Labels: (Licensed) Decca (UK) Polar (Sweden), (distributed—not licensed) Cam (Italy), Coombe (UK), Yupiteru (Japan)
 London, see Philips
 Lucky Rec Co Ltd, No 2 8, Ln 116, Section 2, Chung Shang N Rd, Taipei 104 Tel (02) 511 8115, 521-8182 Cable BAOJIANG Pres & Gen Mgr Chiu San Iseng
 M G M, see Philips
 Mercury, see Philips
 Modern Musical Instruments Corp., PO Box 3811, Taipei Tel 391 7815/7817 Cable MOORNUSIC (Distributor/Importer)
Label: (Represented) MMO (USA)
 Orient Trading & Ind. Ltd, PO Box 324C, 50 Nanking E Rd, 5th fl, Section 1, Taipei Tel (02) 551 0484, 511 2415, 517 2379 Cable OTCLTO (importer of tapes)
 Pacific Int'l Music & Publ'g Co Ltd, PO Box 46 338, Taipei Tel (02) 511 4580 Telex 11524 Chief Exec Harry Heide, Gen Mgr Jean Tsuang

Labels: (Owmed) Discophone, Interdisc, Pacific, Star Disc (licensed) EMI (Hong Kong, Singapore)
 Philips Taiwan Ltd /PolyGram Liaison Office, PO Box 22978, 57 I Chung Shan N Rd, Section 2 7th fl, Taipei Tel (02) 563 1717 Cable PHILI CHINE Telex 21570
Labels: (Owmed) Archiv, Casablanca, DG, Decca, Fontana, Karussell, London, MGM, Mercury Philips Polydor, replacement, Vertigo (licensed) A&M (USA), RSO (USA)
 Polydor, see Philips
 Polystar, see Philips
 R O C Corp., President Bldg, Rm 602, 592 Linsheng N Rd, Taipei Tel (02) 581 2603
 Ring Ring Recs Ind Co Ltd, 33 Ln 190 Cheng I N Rd, Sanchung City Taipei Hsien Tel (02) 971 2432
 Song Jwu Rec Co, 19 7 Chung Hua II Rd Kaohsiung Tel 273312
 Star Disc, see Pacific Int'l
 Taiwan Electric Development Corp., Tedco House, 25 Chung Shan N Rd, Section 2, Taipei 104 Tel (02) 541 3525, 551 2525 Cable TEOCO Pres & Gen Mgr Chengchih Chen, Sales Mgr Yewow Chen
Labels: (Distributed—not licensed) Angel (USA), Capitol (USA), DG (Germany), Decca (Germany), Polydor (Germany), RCA (Germany), Seraphim (USA) Telefunken (Germany)
 Taiwan Kolin Co Ltd (IFPI), 35 Po Ai Rd, 3rd fl, Taipei Tel (02) 314 9973 Cable TKOLIN Telex 11102 Chm K C Lee, Gen Mgr J P Liu, Sales Mgr C J Liu
Labels: (Owmed) Kolin (licensed foreign) A&M (USA), DG (Germany), Hansa (Germany), Philips (Netherlands) Polydor (Germany), RSO (USA)
Int'l reps: Hong Kong, Singapore & Southeast area (PolyGram)
 Taiwan Pony Music Ent Co Ltd, Pony Bldg, 5th fl, 92 I Kum Minn St, Taipei 100 Tel (02) 381 7188
Label: (Represented) EMI
Int'l rep: Worldwide (EMI)
 Vertigo, see Philips

• music publishers

Eagle Ents Co Ltd, PO Box 22655, 1C Kuang Lung Bldg, 3 I Chen Chiang St, Taipei 100 Tel (02) 391 4823 4926 0215 Cable EAGLECOLTO Telex 11387
 Four Seas Publ'g Co Ltd, 167 Si Ning Rd, Taipei Tel (02) 961 0187, 381 6142 Cable FOURSEAS Telex 21475 Gen Mgr C Y Liao Sales Mgr C Y Tan
 Pacific Int'l Music & Publ'g Co Ltd, PO Box 46 338, Taipei Tel (02) 511 4580 Telex 11524 Chief Exec Harry Heide Gen Mgr Jean Tsuang

• services

ASSOCIATIONS & PROFESSIONAL ORGANIZATIONS
 Taiwan Importers & Exporters Ass'n, Taipei Tel (02) 311 4049 1687
 Taiwan Regional Ass'n of Record Mfrs., 55 Chung Hua Market 3rd fl, Jen Section, Taipei Tel (02) 311 0276

DESIGN & ARTWORK

Taiwan Pony Music Ent Co Ltd, Pony Bldg, 5th fl, 92 I Kum Minn St, Taipei Tel (02) 381 7188

PLATING, PROCESSING & PRESSING PLANTS

Eagle Ents Co Ltd, PO Box 22655, 1C Kuang Lung Bldg, 3 I Chen Chiang St, Taipei 100 Tel (02) 391 4823 4926 0215 Cable EAGLECOLTO Telex 11387 (Pressing only)
 Four Seas Rec Publ'g Co Ltd, 167 Si Ning Rd, Taipei Tel 961 0187, 381 6142 Cable FOURSEAS Telex 21475 Gen Mgr C Y Liao, Sales Mgr C Y Tan
 Gold Well Chemical Inds Co Ltd, 8 Chung Xi Rd, Shihlin, Taipei Tel (02) 831 4556, 832 2357 Cable GOLDWELL Telex 22251
 Lintair Eng & Trading Ltd, 7 Jen Ai Rd, 7th fl, Sec 2, Taipei Tel (02) 321 4454 Cable LINFAR Telex 22563 Mng Dir Lintair L F Chang
 Lucky Rec Co Ltd, No 2 8, Ln 116, Section 2, Chung Shang N Rd, Taipei 104 Tel (02) 511 8115, 521 8182 Cable BAOJIANG Pres & Gen Mgr Chiu San Iseng
 Taiwan Pony Music Ent Co Ltd, Pony Bldg, 5th fl, 92 I Kum Minn St, Taipei Tel (02) 381 7188 (Pressing only)

PRINTERS & LITHOGRAPHERS

Kuo Fong Colored Printing Co., 231 Fu Chiang Rd, Tainan Tel 26900 31688
 Lintair Eng & Trading Ltd, 7 Jen Ai Rd, 7th fl, Sec 2, Taipei Tel (02) 321 4454 Cable LINFAR Telex 22563 Mng Dir Lintair L F Chang (Record only)
 Taiwan Pony Music Ent Co Ltd, Pony Bldg, 5th fl, 92 I Kum Minn St, Taipei Tel (02) 381 7188

RECORD PROMOTION

Four Seas Rec Publ'g Co Ltd, 167 Si Ning Rd, Taipei Tel 961 0187, 381 6142 Cable FOURSEAS Telex 21475 Gen Mgr C Y Liao, Sales Mgr C Y Tan
 Taiwan Pony Music Ent Co Ltd, Pony Bldg, 5th fl, 92 I Kum Minn St, Taipei Tel (02) 381 7188

TAPE CUSTOM DUPLICATORS

Four Seas Rec Publ'g Co Ltd, 167 Si Ning Rd, Taipei Tel 961 0187, 381 6142 Cable FOURSEAS Telex 21475 Gen Mgr C Y Liao, Sales Mgr C Y Tan
Audio: Cassette
 Lintair Eng & Trading Ltd, 7 Jen Ai Rd, 7th fl, Sec 2, Taipei Tel (02) 321 4454 Cable LINFAR Telex 22563 Mng Dir Lintair L F Chang
Audio: 8 tr, cassette
 Oriental Trading Corp., PO Box 55 186, 145 9 Chang Chun Rd, Taipei Tel (02) 581 6286 Cable ORTACO
Audio: 8 tr, 8 tr quadraphonic cassette open reel
 Taiwan Pony Music Ent Co Ltd, Pony Bldg, 5th fl, 92 I Kum Minn St, Taipei Tel (02) 381 7188
Audio: 8 tr & cassette
Video: 1/2" cassette

• supplies

CARTRIDGE & CASSETTE PARTS

Four Seas Rec Publ'g Co Ltd, 167 Si Ning Rd, Taipei Tel 961 0187 381 6142 Cable FOURSEAS Telex 21475 Gen Mgr C Y Liao, Sales Mgr C Y Tan
 Liang Ming Trading Co Ltd, 92 Hsin Sheng S Rd, Section 3 Taipei Tel (02) 721-8436, 711 3061 Cable MSETCO (Importer)
 Oriental Trading Corp., PO Box 55 186, 145 9 Chang Chun Rd, Taipei Tel (02) 581 6286 Cable ORTACO

EMPTY CARTRIDGES, CASSETTES & REELS

Fuyuan Trading Co, PO Box 939, 22 I Ln 42, 2nd fl, Chung Shan N Rd

Section 2, Taipei Tel (02) 511-3016 (Importer)
 Liu Bros. (Taiwan) Ltd., PO Box 58534, 1 Ta Hu St., Nei Hu District, Taipei
 Tel (02) 711 0658 (Importer)
 Taiwan Pony Music Ent Co Ltd., Pony Bldg, 5th Fl., 92 1 Kum Minn St.,
 Taipei Tel (02) 381 7188
 Audio: Cassette.

**JACKETS & SLEEVES
 LABELS, DISK**

Eagle Ents. Co Ltd., PO Box 22655, 1C Kuang Lung Bldg, 3 1 Chen Chiang
 St., Taipei 100 Tel (02) 391 4823/4926/0215 Cable EAGLECOLTD
 Telex 11387 (Sleeves & labels only)
 Lucky Rec Co Ltd., No. 2-8, Ln. 116, Section 2, Chung Shang N Rd., Taipei
 104, Tel: (02) 511 8115, 521-8182 Cable BAOJIANG Pres & Gen Mgr
 Chiu San Tseng
 Tong Dah Plastics Co Ltd., 28 Shih Chia Ln., Shih Chia Li, East District,
 Taichung Tel 224844, 236384 Cable TONDA Telex 56156 Local
 branch: 54 Shih Fu Rd Tel 226688 (Jackets & sleeves only)
 Int'l branch: USA

POLYETHYLENE BAGS

Eagle Ents. Co Ltd., PO Box 22655, 1C Kuang Lung Bldg, 3 1 Chen Chiang
 St., Taipei 100 Tel (02) 391 4823/4926/0215 Cable EAGLECOLTD
 Telex 11387
 Jeou Long Plastic Works Ltd., 37 Tatu St., Tatu Hshang, Taichung Sheng
 Tel (046) 99-22-90, 99-26-47, Pres. R.H Hwang, Gen Mgr C.M Lai
 Plant: 950 San Tien Rd., Section 3, Tatu Hshang
 Branch: Taipei, Morson Trading Co Ltd., 74 Section 2, Chang An E Rd
 Tel (02) 521-0364/5838, 561-3789
 Tong Dah Plastics Co Ltd., 28 Shih Chia Ln., Shih Chia Li, East District,
 Taichung Tel 224844, 236384 Cable TONDA Telex 56156 Local
 branch: 54 Shih Fu Rd Tel 226688
 Int'l branch: USA
 Tylene Inds (Taiwan) Ltd., PO Box 3608, 18 Ln 135, Chung Shan N Rd.,
 Section 1, Taipei Tel (02) 522-3237 Bd Chm H.N Zee, Sec'y Janny
 Shaw
 Plant: Tao Yuan, 3 Hsing Lu Rd., Kuei Shan Ind'l Zone

RAW MATERIALS

Gold Well Chemical Inds. Co Ltd., 135 Chung Xi Rd., Shihlin, Taipei Tel
 (02) 831 4556, 832 2357 Cable GOLDWELL Telex 22251
 Product: PVC copolymer, dry blended powder.

TAPE, BLANK LOADED & BULK RAW

A D I, see Oriental Trading
 Betamax, see Shinlee
 Intermagnetics Taiwan Corp., 2 Lin Sun South Rd., 7th Fl., Rm. 3, Taipei
 Contact J J Chen
 Linfair Eng'g & Trading Ltd., 7 Jen Ai Rd., 7th Fl., Sec. 2, Taiwan, Tel (02)
 321 4454, Cable LINFPAIR Telex 22563 Mng Dir Linfair L F Chang
 (Blank only)
 Audio: Open reel
 Brand name: Rascal Zonal

Liu Bros. (Taiwan) Ltd., PO Box 58534, 1 Ta Hu St., Nei Hu District, Taipei
 Tel (02) 711 0658 (Importer-audio, blank only)
 Mercuries & Assocs. Ltd., PO Box 3155, 138-140 Chung King N. Rd., Section
 4, Shih Lin District, Taipei, Tel (02) 812-6100 Cable MERCURY (im-
 porter-audio, blank only)
 Oriental Trading Corp., PO Box 55 186, 145 9 Chang Chun Rd., Taipei Tel
 581 6286 Cable ORTACO
 Audio: 8 tr., cassette & open reel
 Brand name: ADI

Overseas Friend Co Ltd., PO Box 878, 144 Mankou St., Rm. 808, Section 1,
 Taipei, Tel 331441, Cable IRVINGTONG (Importer-audio, blank only)
 Brand name: Philips
 Philips, see Overseas Friend
 Rascal-Zonal, see Linfair
 Shinlee Co Ltd., 372 Lin Sen N. Rd., 2nd Fl., Taipei Tel (02) 521 0282
 Telex 11154 (Importer)
 Audio: Blank-8 tr., cassette, open reel
 Video: Blank-1" open reel, 1/2" U matic, 1/4" EIAJ open reel, 1/4" cassette,
 raw-1/4" U matic, 1/4" EIAJ open reel
 Brand name: Betamax

Taiwan Southeastern Asia Ent Corp. Ltd., PO Box 670, 111 Chungking S
 Rd., 2nd fl., Section 1, Taipei Tel (02) 311 6596, 361 4802 Cable
 SEACO Telex 11175 (Importer-audio, blank only)

TAPE DUPLICATING & PROCESSING EQUIPMENT

Four Seas Rec. Publ'g Co Ltd., 167 Si Nng Rd., Taipei Tel 961 0187, 381
 6142 Cable FOURSEAS Telex 21475 Gen Mgr C.Y. Luo, Sales Mgr
 C.Y. Tan
 Kuo Yi Trading Co Ltd., 12 2 Chang An Rd. E, Section 1, Taipei Gen Mgr
 S.L. Lin (Importer)
 Linfair Eng'g & Trading Ltd., 7 Jen Ai Rd., 7th Fl., Sec. 2, Taiwan, Tel (02)
 321 4454, Cable LINFPAIR Telex 22563 Mng Dir Linfair L F Chang
 Audio: Duplicators
 Brand name: Electro-Sound

• accessories manufacturers

Linfair Eng'g & Trading Ltd., 7 Jen Ai Rd., 7th Fl., Sec. 2, Taipei Tel (02)
 321 4454, Cable LINFPAIR Telex 22563 Mng Dir Linfair L F Chang
 Product: Record-record care prods., replacement styli, Tape-head
 cleaners, demagnetizers
 Oriental Trading Corp., PO Box 55 186, 145 9 Chang Chun Rd Taipei Tel
 (02) 581 6286 Cable ORTACO
 Product: Tape-head cleaners, demagnetizers, leader & splicing tape
 Taiwan Pony Music Ent Co Ltd., Pony Bldg, 5th Fl., 92 1 Kum Minn St.,
 Taipei Tel (02) 381 7188 (Importer)
 Product: Tape-leader & splicing tape

• store fixtures manufacturer

Oriental Trading Corp., PO Box 55 186, 145-9 Chang Chun Rd., Taipei Tel
 (02) 581 6286 Cable ORTACO
 Product: Display racks

THAILAND

Population: 46,600,000
 Rate of exchange: \$1 (US) = 20 baht

Billboard 1981-1982 International Buyer's Guide

Per capita income: \$500

Holidays: January 1, February 13 (Makha Buja), April 6, May 1 (Labor Day),
 May 5 (Coronation Day), July 1, August 12 (Queen's Birthday), December
 5 (King's Birthday), December 10 (Constitution Day), & all Buddhist
 holidays

**• record & tape
 manufacturers /
 distributors / importers**

Black & White Co. Ltd., PO Box 335, Thai Lai Thong Bldg, 52/4 6 Sura-
 wongse Rd., Bangkok Tel 31 939, 33 720, 31 241 Local branch: 900
 Mahachai Rd.
 Central Trading Co Ltd., PO Box 471, Bangkok 5 Contact Suthkiati
 Chualthwat
 Label: (Represented) Laurie (USA)

Ching Thai Regd Ord Partnership, Burapa Palace, 669 671 Chakrapet Rd.,
 Bangkok 2 Tel 221 4471/4241 Cable CHINTAI/COM Pres Matiri
 Boondiskulchok, Gen Mgr Kavee Boondiskulchok, Sales Mgr Kamol
 Boondiskulchok (Distributor/Importer from UK & USA)
 Labels: (Distributed foreign-not licensed) Amsterdam, Atlantic, Capitol,
 Columbia, Command, Dolton, Dunhill, Elektra, Epic, Liberty, London,
 MCA, MGM, Mercury, Motown, Nonesuch, Pride, RCA, United Artists,
 Warner Bros (all USA)

K.S., see Thai Phonograph
 Sri Krung Phonograph Rec Co Ltd 129 Sukumvit 21, Bangkok Tel (3)
 920-208, 918 380 Cable VASUVAT Owner Manit Vasuvat, Gen Mgr
 Chaichan Vasuvat, Sales Mgr Pomphan Vasuvat
 Labels: (Owned) MV Master Voice SRS Sri Krung, SPC Sri Krung, Solina
 Sona Tape
 Int'l rep.: Germany (Asona), USA (RCA Int'l)

M.V. Master Voice, see Sri Krung
 S.K.S., see Sri Krung
 S.P.C., see Sri Krung
 Solina, see Sri Krung
 Sona Tape, see Sri Krung
 Thai Phonograph Rec Co Ltd, 857 Mahachai Rd., Bangkok Tel 286 1648
 Mng Dir Sukit Pachimsawat, Gen Mgr Tian Chunsirpong
 Label: (Owned) KS
 United Recs Tape Co., 160/4 New Rd., Samoyd, Bangkok Exec Dir
 Sugree Chorakan

• music publisher

Kamol Sukosol Co Ltd., 857 Mahachai Rd., Bangkok Tel 222 5131 Mng
 Dir Sukit Pachimsawat, Gen Mgr Tian Chunsirpong

• services

**DESIGN & ARTWORK
 PLATING, PROCESSING & PRESSING PLANTS**

Sri Krung Phonograph Rec Co Ltd 129 Sukumvit 21, Bangkok Tel 920
 208 Cable VASUVAT Owner Manit Vasuvat, Gen Mgr Chaichan Vasu-
 vat, Sales Mgr Pomphan Vasuvat
 Thai Phonograph Rec Co Ltd, 857 Mahachai Rd., Bangkok Tel 286-1648
 Mng Dir Sukit Pachimsawat, Gen Mgr Tian Chunsirpong

**PRINTER & LITHOGRAPHER
 RECORD PROMOTION**

Sri Krung Phonograph Rec Co Ltd, 129 Sukumvit 21, Bangkok Tel (3)
 920-208 Cable VASUVAT Owner Manit Vasuvat, Gen Mgr Chaichan
 Vasuvat, Sales Mgr Pomphan Vasuvat

TAPE CUSTOM DUPLICATORS

Sri Krung Phonograph Rec Co Ltd., 129 Sukumvit 21, Bangkok Tel 920
 208 Cable VASUVAT Owner Manit Vasuvat, Gen Mgr Chaichan Vasu-
 vat, Sales Mgr Pomphan Vasuvat
 Audio: Cassette
 Thai Phonograph Rec Co Ltd., 857 Mahachai Rd., Bangkok Tel 286 1648
 Mng Dir Sukit Pachimsawat, Gen Mgr Tian Chunsirpong
 Audio: Cassette, open reel

• supplies

**CARTRIDGE & CASSETTE PARTS
 EMPTY CARTRIDGES, CASSETTES & REELS**

TAPE, BLANK LOADED & BULK RAW
 Intermagnetics (Thailand) Corp Ltd., 164/11 N Sathorn Rd., Bangkok Tel
 233 2860, 234 4590 Cable TIENHONG Telex 87293 Contact S C
 Yuan (Blank only)
 Audio: 8 tr., cassette

Sri Krung Phonograph Record Co Ltd., 129 Sukumvit 21, Bangkok Tel 920
 208, 918 380 Cable VASUVAT Owner Manit Vasuvat, Gen Mgr Cha-
 ichan Vasuvat, Sales Mgr Pomphan Vasuvat
 Product: Cassette parts & blank loaded tape, empty cassettes & reels,
 sleeves & processing equip
 Brand names: MV, Solina, Vasuvat

**• accessories
 manufacturer**

Sri Krung Phonograph Rec Co Ltd, 129 Sukumvit 21, Bangkok Tel 920
 208 Cable VASUVAT Owner Manit Vasuvat, Gen Mgr Chaichan Vasu-
 vat, Sales Mgr Pomphan Vasuvat
 Product: Tape-carrying & storage cases, head cleaners, demagnetizers,
 leader & splicing tape

TRINIDAD & TOBAGO

Population: 1,140,000
 Rate of exchange: \$1 (US) = 2 38 Trinidad & Tobago dollars
 Per capita income: \$3 200
 Holidays: January 1 Good Friday Easter Monday Whit Monday, Corpus
 Christi, June 19 (Labor Day), August 4 (Discovery Day), August 31
 (Independence Day), September 24 (Republic Day) October 25 26

RADIO STATIONS

No of commercial I government 1
 Comment: The commercial station transmits in both AM & FM The govern-
 ment owned transmits in AM, FM and FM stereo

TELEVISION

Comment: There is one government owned station transmitting two chan-
 nels in black & white

**• record & tape
 manufacturers /
 distributors / importers**

Boack see Solardisc
 C.I.O. see Record Specialists
 C.S.S. see Caribbean
 Caribbean Rec'g Co. Ltd. Mangot & Gordon Sts Mount Hope Port of
 Spain Trinidad Tel (638) 3354

Labels: (Owned) CSS Village, (distributed) Helen Disc Hewanorra
 Mamwa Miralfores Sempet Suriname Telco (represented) Camille
 Casa Grande (both USA)
 Int'l rep.: Barbados (WIRL)

Catelli see Record Specialists
 D.D.S. see Record Specialists
 Helen Disc see Caribbean
 Hewanorra see Caribbean
 K.M. Recs. Ltd., see Record Specialists
 Leo see Solardisc
 Kamit see Record Specialists
 Kalaloo, see Record Specialists
 Kalinda see Record Specialists
 Mamwa see Caribbean
 Miralfores see Caribbean

Record Specialists (Trinidad) Ltd /KH Recs Ltd (IFFI), 4 Milling Ave. Sea
 Lots, Port of Spain, Trinidad Tel (62) 31092 36435 37789 Cable
 HEATSINK Mng Dir Kerry Richards
 Labels: (Owned) Kamit, Kalaloo Kalinda (licensed domestic) CLO Cat
 eli, DDS Ritchies SH Trinidad (licensed foreign) Arrow (Montserrat)

Int'l reps.: Africa Europe UK (all Tackle) USA (Charlie)
 Hilton D. Rhyner 54 Prince St. Port of Spain Trinidad Tel (62) 35673
 Gen Mgr Hilton D. Rhyner, Sales Mgr Cleve Calderon (Importer)
 Ritchies, see Record Specialists
 S.M. see Record Specialists

Semp see Solardisc
 Sharc Sound Servs Ltd PO Box 1010 Trinidad Tel (62) 26580 Chm
 Hugh A Robertson (Licensed to Solardisc)
 Label: (Owned) Sharc
 Sharc see Solardisc
 Sempet see Caribbean
 Solardisc Dist'g Co Ltd 11 Saddle Rd Maraval Trinidad Tel (62) 26580
 Cable SOLARDISC Gen Mgr Rawle Jeffrey Sales Mgr Deirdre Prescod
 (Distributor)

Labels: (Licensed domestic) Sharc, (distributed-not licensed) Boack
 Leo, Semp Startrex, Think
 Startrex, see Solardisc
 Suriname see Caribbean
 Telco see Caribbean
 Think see Solardisc
 Trinidad Recs., see Record Specialists
 Village see Caribbean

Labels: (Licensed domestic) Sharc, (distributed-not licensed) Boack
 Leo, Semp Startrex, Think
 Startrex, see Solardisc
 Suriname see Caribbean
 Telco see Caribbean
 Think see Solardisc
 Trinidad Recs., see Record Specialists
 Village see Caribbean

• music publishers

Cucumber Music (PRS) 90 Frederick St Port of Spain Chief Exec Ben
 Romany
 K.H. Music 4 Milling Ave. Sea Lots Port of Spain Tel (62) 36435 31092
 37789 Cable HEATSINK Mng Dir Kerry Richards
 Int'l reps: France (Bagatelle) UK (PRS)
 Witelco Music Co., High St Siparia Trinidad Tel (649) 2415

• services

**DESIGN & ARTWORK
 PLATING, PROCESSING & PRESSING PLANT**

Record Specialists (Trinidad) Ltd 4 Milling Ave. Sea Lots Port of Spain
 Trinidad Tel (62) 31092 36435 37789 Cable HEATSINK Mng Dir
 Kerry Richards

RECORD PROMOTION

Infinity Electronics Inc 22 Esperanza Village California Trinidad Cable
 INFINITY Mng Dir Ryan F Ali Sales Mgr Hadeed Ali

TAPE CUSTOM DUPLICATORS

TAPE PACKAGING & LABELING
 The Audio and Video lines indicate the configurations which the firms dupli-
 cate. Companies which offer packaging and labeling of tape product are
 indicated by "(PKG)" which appears after the main body of their respective
 listings.

Infinity Electronics Inc 22 Esperanza Village California Trinidad Cable
 INFINITY Mng Dir Ryan F Ali Sales Mgr Hadeed Ali (PKG)
 Audio: 8 tr cassette open reel
 Video: 1/2" cassette

Record Specialists (Trinidad) Ltd 4 Milling Ave. Sea Lots Port of Spain
 Trinidad Tel (62) 31092 36435 37789 Cable HEATSINK Mng Dir
 Kerry Richards (PKG audio only)
 Audio: Cassette

• supplies

EMPTY CARTRIDGES, CASSETTES & REELS

Infinity Electronics Inc 22 Esperanza Village California Trinidad Cable
 INFINITY Mng Dir Ryan F Ali Sales Mgr Hadeed Ali
 Audio: 8 tr cassette open reel

LABELS, DISK

Record Specialists (Trinidad) Ltd 4 Milling Ave. Sea Lots Port of Spain
 Trinidad Tel (62) 31092 36435 37789 Cable HEATSINK Mng Dir
 Kerry Richards

PROFESSIONAL TAPE SUPPLIES

Infinity Electronics Inc 22 Esperanza Village California Trinidad Cable
 INFINITY Mng Dir Ryan F Ali Sales Mgr Hadeed Ali
 Audio: Master splicing tape (3" 2" 1") master open reel
 Brand name: Agfa

TAPE, BLANK LOADED & BULK RAW

Infinity Electronics Inc 22 Esperanza Village California Trinidad Cable
 INFINITY Mng Dir Ryan F Ali, Sales Mgr Hadeed Ali
 Audio: Blank-8 tr cassette raw-cassette
 Video: Blank-1/2" cassette

**TAPE DUPLICATING & PROCESSING EQUIPMENT
TAPE PACKAGING & LABELING EQUIPMENT**

Infinity Electronics Inc. 22 Esperanza Village, California Trinidad Cable
INFINITY Mng. Or Ryan F Ali, Sales Mgr Hadeed Ah

• **accessories importer**

Hilton O Rhyner, 54 Prince St., Port-of-Spain, Trinidad Tel (62) 35673
Gen Mgr Hilton D Rhyner, Sales Mgr Cleve Calderon
Product: Record—record care prods., 45 rpm adaptors, replacement styl
Tape—head cleaners, demagnetizers

TURKEY

Population: 44,600,000
Rate of exchange: \$1 (US) = 107 lira
Per capita income: \$1060

Holidays: January 1, April 23 (National Sovereignty Day), May 1 (Spring Day), May 19 (Youth & Sports Day), May 26, 27 (Freedom & Constitution Day), August 15 (Victory Day), October 29, 30 (Republic Day), & important religious holidays

• **record & tape manufacturers / distributors / importers**

A S. see Muzikservis
Acar, see Oncu
Ada, see Muzikservis
Aras, see Kent
Bip, see Yonca

Elektronal Elektronik Aletler Sanayi Ve Ticaret AS, Ankara Devlet Yolu 25, Sogankil Kartal, Istanbul, Tel 53 51 40 Cable ELEKTROSAN Telex 23169 Pres. Hayati Kamhi, Gen Mgr Alen Giz, Sales Mgr Hulya Kara

Labels: (Owned) Pop, Teletrans.

Enter, see Oncu
Forte, see Yonca
Gozde, see Oncu
Grand, see Oncu
Gunes, see Oncu
H O P, see Yanki
Hap, see Yonca
Imce, see Melodi
I No Plakcılık, see Yanki
Istanbul, see Muzikservis.
Jet, see Muzikservis.

Kent Muzik Ticaret ve Pazariama Ltd., PO Box 24 IMC Blok 6 No 6328 Unkapani, Istanbul Tel (11) 26 34 65 Chief Exec Umir Guner, Gen Mgr Ali Riza Guner, Sales Mgr Omer Borazancı

Labels: (Owned) Aras, Kent, Super Audio Technic, Zenith, (distributed) BMI (Netherlands), Capitol (USA), Carosello (Italy) Columbia (UK) Du reco (Netherlands), EMI (Netherlands), His Master's Voice (UK) Liberty (USA), Parlophone (UK), Plaksan, Regal (UK), Sonet (Sweden) Sunset (USA), United Artists (USA), Yemgun Int'l raps.: Germany (Yilmal Exp)

Koda, see Yonca
Lolipop, see Oncu

Melodi Rec'g & Sound Ind (IFPI), 348 Istiklal Caddesi, Istanbul Tel (92) 44 26 36 Cable MELODI Gen Mgr Kayihan Caglayan, Sales Mgr Turgut Caglayan, A&R Mgr. Yahe Dilacar

Labels: (Owned) Melodi, (licensed foreign) ABC (USA), Alhambra (Spain), Atlantic (USA), BBC (UK), Bronze (UK) Casablanca (USA), Ois cos Columbia (Spain), DJM (UK), Decca (UK), El-skra/Asylum (USA), Infinity (USA), Intercord (Germany), London (UK, USA), MCA (USA), Mil lenium (USA), Motown/Gordy/Tamla (USA), JCA (USA), Swan Song (UK) WEA Int'l (USA), Warner Bros (USA), (distributed—not licensed) Baby (Italy), Bovema Negram W/Netherlands), Cial (Spain) Fomior (Bel gium), Imce, Killroy (Netherlands), Nevada (Spain), I Numara, Sun (France), Victor Music (Japan)

Meteor, see Oncu
Metro, see Oncu

Metronom, see Muzikservis
Meylon, see Oncu

Muzikservis, Nazmi Senel Prod'n, IMC Blok 6, No 6319, Unkapani, Istanbul Tel (11) 20 85 65, 27-87-82 Pres Nazmi Senel, Gen Mgr Tunay Akdeniz, Sales Mgr Abdullah Turan

Labels: (Owned) AS, Ada, Istanbul, Metronom, Perdon, (distributed—not licensed) Jet, Satellite Star, West, Zenith

Oncu, IMC 5452, Unkapani, Istanbul Tel (11) 28 25 08 Telex 22308 Gen Mgr Oktay Gork, Sales Mgr Siki Azaz

Labels: (Owned) Gunes, Oncu, (licensed foreign) Copacabana (Brazil), Som (Brazil), (distributed—not licensed) Acar, Erter, Gozde, Grand, Loli pop, Meteor, Metro, Meylon Yasam

I Numara, see Melodi
Pardon, see Muzikservis.

Plaksan Plak Sanayi AS (IFPI), Bagcilar Yolu, Marmara Cad., No 12 Gungoren, Istanbul, Tel 71 67 34 Cable SANPLAK Chm Leon Gruenberg, Gen Mgr Engin Tunasar

Labels: (Licensed foreign) CBS (USA), EMI (UK), Philips (Netherlands) Polar (Sweden), Polydor (Germany)

Pop, see Elektronal
Satellite, see Muzikservis

Star, see Muzikservis
Super Audio Technic, see Kent

Teletrans, see Elektronal
West, see Muzikservis.

Yanki Yapim Ltd (IFPI), IMC Blok 6, No 6437 Unkapani, Istanbul Tel 22 07 15 Pres Atilla Cilanbol, Gen Mgr Kadri A Demirturk, Sales Mgr Ali Insan Oral, Contract Mgr Yasef Alguidas

Labels: (Licensed) Durum (Italy), Hansa Int'l (Germany), (distributed—not licensed) Ariola Eurodisc (Germany), Bar-lay (France), Cyclon (France), HOP, I No Plakcılık, Int'l Show (France), Ye (UK), Saar (Italy) Int'l raps.: France (Dalida, Cyclon, Orlando, Show Int'l), Germany (Ariola Eurodisc, Hansa), Italy (Baby, Durum, Saar), UK (Pye)

Yasam, see Oncu
Yemgun, see Kent

Yonca Plak Ve Ses End, PO Box 14, Unkapani IMC 6433 Unkapan, Istanbul Tel (11) 28 01 65 Gen Mgr Ergin Bener, Sales Mgr Hayrettin Calik

lic
Labels: (Owned) Yonca (licensed domestic) Bip, Forte, Koda, (licensed foreign) Fairytale (Denmark), (distributed—not licensed) Hap Int'l rep.: Denmark (Fairytale)

Zenith, see Kent & Muzikservis

• **music publishers**

Kent Music Edisyon, PO Box 66, Unkapani, Istanbul Tel (11) 20-85 65 Chief Exec Nazmi Senel, Gen Mgr Mrs Beyhan Pastumaz

Kent Music Ltd PO Box 24, IMC Blok 6, No 6328, Unkapani, Istanbul, Tel (11) 26 34 65 Chief Exec Umir Guner, Gen Mgr Ali Riza Guner Odeon Ticaret AO, PO Box 533, Rızapasa Yokusu, Mılas Han, Istanbul, Tel (92) 26-32-60 Chm Leon Gruenberg, Gen Mgr Benno Merowich Yonca Music-Ergin Bener, IMC 6433 Unkapani, Istanbul, Tel (11) 28-01-65

• **services**

ASSOCIATION & PROFESSIONAL ORGANIZATION

Association of Phonograph Music Prod'rs (Fono Muzik Prod'uterleri Or negi), Halkali Caddesi 85, Yesilkoy-Istanbul.

DESIGN & ARTWORK

Tekmanyetik San Ve Tic AS, 1375 Sok N 25/104, Izmir Tel (051) 13 33 72, 14 55 26 Telex 52572 Pres Aslan Onel, Gen Mgr Ataman Bukey, Sales Mgr Teoman Gurgan

Tekoplast, see Tekmanyetik

LICENSOR, RECORD & TAPE

Muzikservis, IMC Blok 6, No 6319, Unkapani, Istanbul Tel (11) 20 85 65 Pres Nazmi Senel, Gen Mgr Tunay Akdeniz, Sales Mgr Abdullah Turan

PLATING, PROCESSING & PRESSING PLANTS

Melodi Rec'g & Sound Ind., 348 Istiklal Caddesi, Istanbul Tel (92) 44 26 36 Cable MELODI Gen Mgr Kayihan Caglayan, Sales Mgr Turgut Caglayan

Muzikservis, IMC Blok 6, No 6319, Unkapani, Istanbul Tel (11) 20-85 65 Pres. Nazmi Senel, Gen Mgr Tunay Akdeniz, Sales Mgr Abdullah Turan (Pressing only)

Plaksan Plak Sanayi AS, Bagcilar Yolu, Marmara Cad No 12 Gungoren, Istanbul Tel 71 67 34 Cable SANPLAK Chm Leon Gruenberg, Gen Mgr Engin Tunasar

PRINTERS & LITHOGRAPHERS

Tekmanyetik San Ve Tic AS, 1375 Sok N 25/104, Izmir Tel (051) 13 33 72, 14 55 26 Telex 52572 Pres Aslan Onel, Gen Mgr Ataman Bukey, Sales Mgr Teoman Gurgan

Tekoplast, see Tekmanyetik.

RECORD PROMOTION

Kent Muzik Ticaret ve Pazariama Ltd., PO Box 24, IMC Blok 6, No 6328, Unkapani, Istanbul Tel (11) 26 34 65 Chief Exec Umir Guner, Gen Mgr Ali Riza Guner, Sales Mgr Omer Borazancı

Muzikservis, IMC Blok 6, No 6319, Unkapani, Istanbul Tel (11) 20 85 65 Pres. Nazmi Senel, Gen Mgr Tunay Akdeniz, Sales Mgr Abdullah Turan

**TAPE CUSTOM DUPLICATORS
TAPE PACKAGING & LABELING**

The Audio and Video lines indicate the configurations which the firms duplicate. Companies which offer packaging and labeling of tape product are indicated by "(PKG)" which appears after the main body of their respective listings.

Kent Muzik Ticaret ve Pazariama Ltd., PO Box 24, IMC Blok 6, No 6328, Unkapani, Istanbul Tel (11) 26 34 65 Chief Exec Umir Guner, Gen Mgr Ali Riza Guner, Sales Mgr Omer Borazancı (PKG)

Melodi Rec'g & Sound Ind 348 Istiklal Caddesi, Istanbul Tel (92) 44 26 36 Cable MELODI Gen Mgr Kayihan Caglayan, Sales Mgr Turgut Caglayan

Audio: 8 tr., cassette, open reel

Muzikservis, IMC Blok 6, No 6319, Unkapani, Istanbul Tel (11) 20 85 65 Pres. Nazmi Senel, Gen Mgr Tunay Akdeniz, Sales Mgr Abdullah Turan (PKG)

Audio: Cassette

Plaksan Plak Sanayi AS, Bagcilar Yolu, Marmara Cad No 12, Gungoren, Istanbul Tel 71 67 34 Cable SANPLAK Chm Leon Gruenberg, Gen Mgr Engin Tunasar

Audio: Cassette

Tekmanyetik San Ve Tic AS, 1375 Sok N 25/104 Izmir Tel (051) 13 33 72, 14 55 26 Telex 52572 Pres Aslan Onel, Gen Mgr Ataman Bukey, Sales Mgr Teoman Gurgan (PKG)

Audio: 8 tr cassette, open reel

Video: 4" Beta & VHS cassette

Tekoplast, see Tekmanyetik

Yonca Plak Ve Ses End, PO Box 14 Unkapani IMC 6433 Unkapan, Istanbul Tel (11) 28 01 65 Gen Mgr Ergin Bener Sales Mgr Hayrettin Calik lic (PKG)

• **supplies**

**CARTRIDGE & CASSETTE PARTS
EMPTY CARTRIDGES, CASSETTES & REELS**

Elektronal Elektronik Aletler Sanayi Ve Ticaret AS, Ankara Devlet Yolu 25, Sogankil Kartal Istanbul Tel 53 51 40 Cable ELEKTROSAN Telex 23169 Pres Hayati Kamhi, Gen Mgr Alen Giz, Sales Mgr Hulya Kara

Audio: Cassette hubs, rollers, shelves, shields, screws, spring pads, empty cassettes.

Plaksan Plak Sanayi AS, Bagcilar Yolu, Marmara Cad., No 12, Gungoren, Istanbul Tel 71 67 34 Cable SANPLAK Chm Leon Gruenberg, Gen Mgr Engin Tunasar

Audio: Cassette

Tekmanyetik San Ve Tic AS, 1375 Sok N 25/104 Izmir Tel (051) 13 33 72, 14 55 26 Telex 52572 Pres Aslan Onel, Gen Mgr Ataman Bukey, Sales Mgr Teoman Gurgan

Audio: 8 tr. cassette, open reel

Video: 4" Beta & VHS cassette
Brand names: Audio—Penta, Polar, Raks, Sabra, video—Master
Tekoplast, see Tekmanyetik

TAPE, BLANK LOADED & BULK RAW

Elektronal Elektronik Aletler Sanayi Ve Ticaret AS, Ankara Devlet Yolu 25, Sogankil Kartal Istanbul Tel 53 51 40 Cable ELEKTROSAN Telex

23169 Pres Hayati Kamhi, Gen Mgr Alen Giz, Sales Mgr Hulya Kara
Audio: Cassette

Tekmanyetik San Ve Tic AS, 1375 Sok N 25/104, Izmir Tel (051) 13 33 72, 14-55-26 Telex 52572 Pres Aslan Onel, Gen Mgr Ataman Bukey, Sales Mgr Teoman Gurgan

Audio: 8 tr. cassette, open reel

Video: 4" Beta & VHS cassette
Brand names: Audio—Penta, Polar, Raks, Sabra, video—Master
Tekoplast, see Tekmanyetik.

• **accessories manufacturers**

Melodi Rec'g & Sound Ind., 348 Istiklal Caddesi, Istanbul Tel (92) 44-26-36 Cable MELODI Gen Mgr.: Kayihan Caglayan, Sales Mgr Turgut Caglayan

Product: Carrying & storage cases
Tekmanyetik San Ve Tic AS, 1375 Sok N 25/104, Izmir Tel (051) 13-33-72, 14-55-26 Telex 52572 Pres Aslan Onel, Gen Mgr Ataman Bukey, Sales Mgr Teoman Gurgan

Product: Tape—carrying & storage cases, head cleaners, demagnetizers, leader & splicing tape

Tekoplast, see Tekmanyetik

Yonca Plak Ve Ses End, PO Box 14, Unkapani, IMC 6433 Unkapan, Istanbul Tel (01) 28-01-65 Gen Mgr Ergin Bener, Sales Mgr Hayrettin Calik lic

Product: Carrying & storage cases, record care prods

USSR

Population: 262,442,000
Rate of exchange: \$1 (US) = 6475 rubles
Per capita income: \$2,010

Holidays: January 1, March 8 (Int'l Women's Day), May 1, 2 (May Day) May 9 (VE Day), October 7 (Soviet Constitution), November 7, 8 (October Revolution)

RECORDS:

Record sales certification awards: None

Record production: 1979—"slightly over" 200,000,000 units

Average retail price per record: Pop & jazz stereo LP's—\$3 25 & \$4 50 classical stereo LP's—\$2 19, mono & stereo singles (with 3 or 4 songs)—\$1 28, flexible mono singles—\$ 90

Record club sales: None

Discounting: Rare, although clearance sales at extremely low prices have been recently effected by some outlets

Type of distribution: Manufacturer to wholesaler-to retailer is the major form of distribution. Wholesaler-to customer distribution exists only in the form of mail order service. Nationwide retailing through newstands has been in effect since 1969. There is no rack jobbing or one stopping in the usual form

Need for specialized record shops (retail outlets) operated by Melodia is apparent. Until now, all retail outlets have been operated by Ministry of Trade organizations. Certain quantities of records are retailed by Soyuz pechat (press distribution agency) through its newstands

Type of promotion: The government controls all airways, and there are no charts of best selling records. However, Melodia promotes new recordings through handbills and through a program broadcast weekly by Mayak Radio on long and medium wavelengths. It also will publish a special record/tape monthly magazine, with a catalog bulletin format, aimed at the general record collector and buyer. New releases are also advertised in "Soviet Culture," in the bi-weekly "Musical Life," and in some local newspapers and periodicals. Radio and television programs featuring recorded music are also a valuable means of promotion, as are sales exhibitions held periodically by East European companies in the major cities

"Muzykalny Kiosk" ("Musical Newsstand"), a weekly 30 minute program on the Central TV, which promotes mainly new classical releases and some pop, jazz, easy listening and folk. There are also various radio & TV programs in Estonia, Latvia and Tbilisi, dealing with promotion and record reviewing. Klub, national bi-weekly magazines, runs "New Disks" column, in which most of the new Melodia releases (classical, pop, jazz, folk, literature) are reviewed by music critics and journalists, with some cover-sleeves reproduced. The leading national youth paper, Kom somolskaya Pravda, as well as a number of local youth papers, launched new columns devoted entirely to the local and international pop, rock and disco music scene. Readers' polls are published once a month and they spotlight the most popular and best selling recording artists and bands

Jukeboxes: 15,000 20,000

TAPE:

Market: Since the pre-recorded cassette was introduced in 1971, it has become the dominant configuration, with almost no industrial production of pre-recorded open reel and no production of 8 track cartridge. The national companies continue to present more sophisticated tape hardware. Two recently introduced high quality open reel tape recorders are the Mayak-001 Stereo retailing for 1,000 rubles (\$1544) and the Elektronika-003 Stereo for 1,500 rubles (\$2316). Mass production of these two is expected soon. Pre-recorded cassettes, selling for twice the price of albums, are becoming more popular but still do not rival albums in sales. Melodiya does not release cassette versions of its album releases. Pre-recorded software consists of odd collections of various easy listening or Russian pop or folk music and usually sells out quickly. Cassettes continue to have high production costs, with a pre-recorded cassette being about \$1 more expensive than a blank one
Average retail price per tape: Cassette—\$6 81

RADIO STATIONS:

No of government 222
Comment: All radio stations are government owned. Most cities have access to cable broadcasting. There are over 30 FM stations. Radio Leningrad transmits for about 40 hours each week in FM stereo, programming classical (20 hours), pop and easy listening (12 13 hours) and literature. The news and music format of Mayak Radio is widely listened to. There is a trend toward the launching of more FM stations with a large percentage of stereo broadcasting as the national companies introduce more stereo tuners and radios

TELEVISION STATIONS:

Comment: All television stations are government owned. Moscow has four channels, one of which is Central (nationwide). Most cities have their own stations, and the Central program is received everywhere, thus there

is two channel television in most of the USSR. The Central channel is fully color, other channels are partially color. SECAM type of color system is used. Both classical and easy listening music are utilized by television stations nationally. In 1978, up to 83% of the overall population in the USSR could see national television programs.

IMPORT/EXPORT REGULATIONS:

All import/export of records is controlled through Mezhdunarodnaya Kniga in Moscow. The quota for records received privately from abroad, excepting East European nations, is one unit. A customs duty of 5 rubles is charged for each additional unit enclosed. The same regulation applies to promotion copies mailed to private persons. Vadim D. Yurchenkov

• record & tape manufacturers / distributors / importers

Melodia, 24 Tverskoi Blvd, Moscow K-9, Tel 229-9248, Cable MDSCVA
Dir Gen P.I. Shabanov
Mezhdunarodnaya Kniga (V/O), 32/34 Smolenskaya-Sennaya Pl., Moscow 121200, Tel 244 1022 Cable MEZHKNIGA Tel 411160 Gen Dir Youry B. Leonov, Gen Mgr Igor N. Preferansky; US Sales Mgr Valery M. Sokolov; Sr Export Oleg S. Popov
Labels (Owned) Melodia. (licensed foreign) Ariola (West Germany), CBS (USA), CNR (Netherlands), Chant du Monde (France), Columbia (Spain), EMI (UK), MCA (USA), Polydor (Germany), Ricordi (Italy), Zafiro (Spain); (distributed—not licensed) Amiga (East Germany), Balkanton (Bulgaria), Eterna (East Germany), Gramophone (India), Hungaroton (Hungary), Muza (Poland), Opus (Czechoslovakia), Qualiton (Hungary), RTB (Yugo slavia), Supraphon (Czechoslovakia)
Int'l reps: France (Chant du Monde), Germany (Ariola, Polydor), Italy (Ricordi), Japan (Victor), Netherlands (CNR), UK (EMI), USA (Moss Music Group, Pickwick Int'l)

• music publishers

Muzychna Ukraina, Ul Pushhinskaya 32 Kiev Tel 25 2104
Soviet Composer Publ's, 14-12 Sadovaya-Triumfalnaya St., 103006 Moscow Tel 209-2384
Branch: Leningrad, 45 Gertsen St.
State Publ's Music, Neglinnaya 14, Moscow K 45
V A A P (The Copyright Agency of the USSR), Bolshaya Bronnaya 6A, 103104 Moscow K104 Tel 203-5355, Cable AVTOR Telex 411327 411452
Chm Boris D Pankin, Music & Drama Dept Dir Valeri Ivanov
Int'l reps: Austria (Universal), Finland (Fazer), France (Chart du Monde), Germany (Hans Sikorski), Italy (G Ricordi), Japan (Japan Soviet), UK (Boosey & Hawkes), USA (G Schirmer)

• services

ASSOCIATIONS & PROFESSIONAL ORGANIZATIONS

Muzfond Ul Golvvalda 10 Moscow A 47
National Committee of the International Music Council, c/o Union of Composers of the USSR Ul Nyezhdanovi 8, Moscow K 9
Sovskusstvo (div of V/D Mezhdunarodnaya Kniga), Smolenskaya Sennaya pl 32 34, 121200 Moscow Tel 244 1022 Cable MEZHKNIGA Telex 411160 Dir Igor N Preferansky
State Committee of Broadcasting & Television, Ul Pyatnitskaya 25 Moscow Tel 233 6356 Cable MDSKVARADID
Union of Composers of the USSR Ul Nyezhdanovi 8 Moscow K 9 Tel 229 5444 4893
Branch: Leningrad Ul Gertzena 45 Tel 12 16 23

LICENSING ORGANIZATION, MUSIC

Sovskusstvo (div of V/D Mezhdunarodnaya Kniga), Smolenskaya Sennaya pl 32 34, 121200 Moscow Tel 244 1022 Cable MEZHKNIGA Telex 411160 Dir Igor N Preferansky
V A A P (The Copyright Agency of the USSR), Bolshaya Bronnaya 6A, 103104 Moscow K104 Tel 203 5355 Cable AVTOR Telex 411327, 411452
Chm Boris D Pankin, Music & Drama Dept Dir Valeri Ivanov

PRESSING PLANTS

Melodia, ul Kalitziema 40, Riga
V S G (Vsesoyuznaya Studiya Gramzapis), Ul Stankevitcha 8, Moscow K 9
Branches: Leningrad, Ul Tselovchynaya 6—Moscow region, Aprelevsky, St Aprelevska—Yashkent, Ul Druzha Narodov 4

TAPE CUSTOM DUPLICATOR

Kazan, Photozlatinovy Plant, Kazan, Tassr
Audio: Cassette

• supplies

TAPE, BLANK LOADEO & BULK RAW

Melodia, Ivazse 12 Taitin 16 (Blank only)
Audio: Cassette
Pereslavl Zalesski Chemical Plant Pereslavl Zalesski, Yaroslavl Obl
Audio: Open reel
Shostka Chemical Plant Shostka, Sumsykaya Obl
Audio: Open reel
Vertretung der BASF Ul Lunatscharskogo 7, 121002 Moscow Tel 241-75 09 Cable BASF Telex 413167
Brand name: BASF

UNITED KINGDOM

Population: 55,900,000
Population by age groups: 0-14—11,500,000, 15-24—8,900,000, 25-49—15,600,000, 50+—19,900,000
Rate of exchange: 1 pound = 2.00
Per capita income: \$5,500
Holidays: January 1, Good Friday, Easter Monday, First Monday in May, Last Monday in May, Last Monday in August, December 25, December 26 (Boxing Day)

RECORDS:

Record sales certification awards: Silver single—250,000 units, gold single—500,000 units, platinum single—1,000,000 units. Silver LP—60,000 full price units, 120,000 budget units, gold LP—100,000 full price units, 200,000 budget units, platinum LP—300,000 full price units, 600,000 budget units.
Records sold domestically including imports (retail value): LP's 1980—67,400,000 units, \$445,000,000, 1979—74,500,000 units, \$483,000,000. Singles 1980—77,800,000 units, \$141,000,000, 1979—89,100,000 units, \$150,000,000

Records imported from USA (factory value, CIF): 1980—6,000,000 units, \$18,000,000, 1979—4,000,000 units, \$15,000,000
Records exported to USA (factory value, FOB): 1980—2,500,000 units, \$9,000,000, 1979—4,000,000 units, \$11,000,000
Records imported from countries other than USA (factory value, CIF): 1980—16,000,000 units, \$50,000,000; 1979—11,000,000 units, \$25,000,000
Records exported to countries other than USA (factory value, FOB): 1980—10,000,000 units, \$25,000,000; 1979—16,000,000 units, \$50,000,000
Typical retail price per record: LPs—\$7.99, singles—\$2.00
TV merchandising: 18% of total.
Record club sales: 6% of total.
Discounting: Frequent.
Type of distribution: Mail-order sales are increasing—up to 18% from 13% in 1979; manufacturer-to-wholesaler-to-retailer system is down to about 50% from 60% in 1979; racks account for 20%; one-stops have 10%.
Type of promotion: TV advertising is now very important, with billings in 1980 around \$50,000,000. Radio is also important.
Jukeboxes: 60,000

TAPE:

Market: Audio—Cassettes entirely, but blanks are destroying industry. Video—VHS has 70% of market, Beta 30%.
Pre-recorded tape sold domestically including imports (retail value): Cassette 1980—25,200,000 units, \$105,000,000; 1979—23,500,000 units.
Pre-recorded tape imported from USA (factory value, CIF): 1980—100,000 units, \$500,000, 1979—100,000 units, \$500,000
Pre-recorded tape exported to USA (factory value, FOB): 1980—250,000 units, \$1,000,000, 1979—750,000 units, \$2,250,000
Pre-recorded tape imported from countries other than USA (factory value, CIF): 1980—1,500,000 units, \$5,000,000, 1979—500,000 units, \$2,500,000
Pre-recorded tape exported to countries other than USA (factory value, FOB): 1980—1,500,000 units, \$7,500,000, 1979—2,500,000 units, \$7,500,000
Typical retail price per tape: cassette—\$8.50.

CONSUMER ELECTRONICS:

Number of homes with: Radios—19,200,000 (96%), AM only—13,200,000 (66%), AM/FM—6,000,000 (30%); television sets—18,000,000 (90%), color 15,000,000 (75%), b&w—3,000,000 (15%), phonographs—16,000,000 (80%), audio tape recorders—13,800,000 (69%), video tape recorders—600,000 (3%)

RADIO STATIONS:

No of commercial 25 local, No of BBC 4 national & 22 local
Comment: Predominantly pre recorded music programs

TELEVISION STATIONS:

No of channels 2 BBC, 1 commercial, 75% color
Comment: Very good mixture, but musical content is not strong

IMPORT/EXPORT REGULATIONS:

There are no tariff or quota restrictions. Current rates of customs duty and VAT are payable. The unauthorized importation of copyrighted recordings from outside the EEC is illegal

MARKET ANALYSIS:

On the whole, 1980 was a very bad year for UK based record companies. Total revenue of \$504 million was more than \$120 million less than was needed to stay level in real terms with 1979. But it may be that there has been a slight plateauing in the market's response to recessionary effects. Whilst the total remained strong, parallel imports were still an attractive proposition for independent wholesalers & retailers. It is thought that the volume of parallel imports of LP's alone totalled some 18 million units during the year.
Compared with 1979, when 74.5 million LP units were delivered to the trade, there has been a drop of over seven million units to 67.4 million. This follows a drop in 11 million units in the previous year and it must be rather more than coincidental that the loss in volume over the past two years has been matched by replacements at a cheaper price overseas. The low price of imports has clearly had an effect on UK prices and the average price of an LP increased by less than 2% during the year, compared with inflation rates which averaged 18%.
The price of pre-recorded tapes actually showed a fall during the year and this doubtless contributed to a volume increase of 7.3% over the year, rising to over 13% at the sale end. Clearly, record companies are doing well in the promotion and year of recorded music in this medium, since it was far and away the most successful sector. It has never been the pre-recorded tape market which has suffered most from the effects of home taping, this illegal practice takes its toll primarily on discs, and it goes without saying that the effect of this scourge was again felt in 1980 and probably prevented sales of at least \$300 million at wholesale (well over \$400 million at retail).
Overall singles declined during the year by some 11 million units (down 13%) to 77.8 million, when prices increased only by 8% to an average representing just under \$2 at retail

• record & tape manufacturers / distributors / importers

A B K, see Discourses
A B M, see Discourses
A C Recs Ltd, 120 Marylebone Ln., London W1 Tel (01) 486 0596, 935 6732 Chm: Jim Beach; Mng Dir Gavin W Dare, A&R Dirs: Dave Howman, Chris Harding; Mktg Dir Michael J Ashwell, Exec Ass't Sue Marsh. (Distributed by RCA)
Label: (Licensed domestic) Celebrity
A & M Recs. Ltd., A&M House, 136 140 New Kings Rd, London SW6 4LZ Tel: (01) 736 3311 Telex: 916342 Sr VP Derek Green, Sr Dir Tony Burdfield, Mktg Dir John Cokell, Sales Dir Bill Groves, Pub Dir Mike Hales, Promo: Alan McGee (Distributed by CBS)
Home office: USA
A M Z Rec'g Ltd., Amazon Studios, Music House, 15D Stoppage Ln., Simonswood, Liverpool L33 4YA Tel (051) 546 6444 (Distributed by PRT)
Label: Amazon
A Side, see Sonet
A S V, see Academy Sound
A S V Living Era, see Academy Sound
A S V Transacord, see Academy Sound
Aardvark Ltd., 107 Whitham Rd, Sheffield S10 2SL Tel (0742) 669218 Mng Dir M D Featherby Deconinck, Gen Mgr A Bailey (Distributed by Kingsley Sound & Vision, Rough Trade)
Labels: (Owned) Aardvark Limited Edition, (licensed) Hologram, Prod uct

Abbey Recs. (IFPI), 47/51 Chalton St., London NW1 1HY. Tel: (01) 388 0621. Chief Exec.: S.J. Fraser; Sales Mgr: John Walton. (Distributed by Gamut, Lugton, Parnote, Symphola, H.R. Taylor)
Absord Recs., 20 Cotton Ln., Withington, Manchester M20 9UX. Tel: (061) 445-2661.
Academy Sound & Vision Ltd., 115 Fulham Rd., London SW3 6RL. Tel: (01) 589-5293. Mng. Dir.: H.J. Usill; Gen. Mgr.: J. Boyce; Sales Mgr.: A. Welch. (Distributed by PRT)
Labels: (Owned) ASV, ASV Living Era; (licensed domestic) ASV Transacord.
Acanthus, see Nimbus.
Accessory, see Fast Product
Ace, see Cheswick & Dakwood.
Ace of Clubs, see Decca.
Ace of Diamonds, see Decca.
Action, see B&C.
Acuff-Rose Music Ltd., 129 Park St., London W1. Tel: (01) 629-0392. Gen. Mgr.: Tony Peters.
Home office: USA
Labels: (Owned) Hickory, TRX.
Aerc Prodn's Ltd., PO Box 22, Woking, Surrey GU20 7QU. Tel: (04862) 54082. Chief Exec.: Steve C. Smith
Affinity, see Charly.
Aggro Recs., 3A Ashfield Parade, Southgate, London N14 5EH. Tel: (01) 886-6236. Mng. Dir.: Riss Chantelle
Agra Music Recs., 4 Welton Rd., Wedgock Estate, Warwick CV34 5YA. Tel: (0926) 45123, 498-924. Owner: Sheila L. Bird; Gen. Mgr.: David Rawlings; Sales Mgr.: Dave Sheriff; Promo.: Dave Ling.
Antree Recs. Ltd., 6 Antree Rd., Pervate, Middx. UB6 7LJ. Tel: (01) 998-0911. Cable: SCARLETT GREENFORD. Telex: 8952387 AINDISC. Mng. Dir.: Michael J. Collins; Gen. Mgr.: John E. Jennings; Sales Mgr.: Wendy Kayrl. (Importer)
Aur Recs. Ltd., 12 Stratford Pl., London. Tel: (01) 408-2355. Cable: CHRYSALIS. Chm.: George Martin; Mng. Dir.: John Burgess. (Distributed by Chrysalis).
Albion Recs. Ltd., 147 Dxford St., London W1. Tel: (01) 734-9072. Telex: 8954780. Mng. Dirs.: Derek Savage, Dai Davies; Sec'y: William Feeny; Label/Mktg. Mgr.: Alan Bellman; A&R Mgr.: Mark Anders; Promos. Mgr.: Jane Wallace; Int'l Mgr.: Katy Feeny; Press & Pub.: Julian Henry; Prod'n Co-ord.: Anne Winwood.
Int'l reps: Australia (Liberation), Benelus (Ariola), France (Virgin), Germany (Ariola), Italy (Panarecord), Japan (Victor), New Zealand (Liberation), Scandinavia (Phonogram), South Africa (Transistor), South America (RCA).
Alien Heat, see Skeleton.
Alien Recs. Ltd., 109 New Bond St., London W1. Tel: (01) 408-2350. Dir.: Nigel Lucas; Gen. Mgr.: Charlene Bowen; Sales Mgr.: Ziro Baby.
Alley Cat, see Humber.
Alois Recs., 3 Bucks Cross Cottages, Bucks Cross Rd., Chelsfield, Kent BR6 7RW. Tel: (0689) 28544. Chief Exec.: Carl Anthony Snape.
Alted Prodn's, 37B New Cavendish St., London W1M 8JL. Tel: (01) 486-5353. Chief Execs.: Ted Lemon, Alex Hughes.
Label: Top
Int'l reps: Austria (TTR), France (Vogue), Germany (TTR), Netherlands (Vogue), Sweden (TTR), Switzerland (Vogue).
Amalisa, Paunceford Court, Munsley, Ledbury, Hereford. Tel: (053) 183407. Chief Exec.: Charles Lucy (Distributed by Pinnacle)
Int'l branch: USA
Amazon, see AMZ
Amberlee Recs. Ltd., Amberlee House, 387 Harrow Rd., London W9. Tel: (01) 866 7748. Mng. Dir.: John Peters. (Distributed by Amberlee, Lugton, H.R. Taylor)
Labels: (Owned) Amberlee, Eyemark; (represented) Doric (USA)
Int'l rep.: USA (Doric)
Amber Music, Wellow Mead, Wellow Dr., Sherfield English, nr. Romsey, Hants. Tel: (0202) 34041. Mng. Dir.: James Montgomery. (Distributed by Amber, Pinnacle)
Amber Recs., Wylstone Leds, Monmouth NP5 3SR. Tel: (0600) 890 682. Dirs.: N. Lubin, M. & G. Reynolds. (Distributed by Nimbus).
Ambulance, see Stuart Johnson.
Ames Electronics, 183 Queen's Crescent, London NW5 4DS. Tel: (01) 267 6752. Mng. Dir.: Mr. Asgar, Serv. Mgr.: W. Coxen. (Importer/Exporter)
Ami Recs., 22 Denmark St. 3rd fl., London WC2H 8NA. Tel: (01) 836-1921/5229. (Distributed by PRT).
Amon Ra, see Sydsc.
Anchor Recs. 72 The Street, Kennington, Ashford, Kent TN24 9HS
Labels: (Represented) Epoch/NAL (USA)
Anglia Rec. Dist's., 6 Fitzroy Ln., Cambridge, Cambs. Tel: (0223) 352 639. (Distributor/Importer/Exporter)
Anglo Recs., 30 Limekiln Ln., Bridlington, North Humberside YO16 5TH. Tel: (0262) 76388. Dir. & Prod'r.: Robert Fisher.
Antic, see WEA
Anti-Pop, 20 Bigg Market, 2nd fl., Newcastle upon Tyne NE2 2AN. Tel: (0632) 25786. Proprietors: A. Inman, P. Branton. (Distributed by Pinnacle, Red Rhino, Rough Trade)



Southern Music Publishing Co. Ltd. London, England

Apollon Sound, 32 Ellerdale Rd., London NW3. Tel. (01) 435-5255. Pres. & Gen. Mgr.: H. Hirschmann. (Distributed by Rare Rec'd Eds., One Stop & Non Stop.)
Int'l reps.: Europe (Kunzelmann) excluding Germany (Musica).
 Applause, see Riva.
 Aqua Pink Ents., 62 Gloucester Pl., London W1. Tel: (01) 486-1486. Mng. Dir.: Oscar Paris. (Importer)
 Aquamus, see President.
 Arcade Recs. (Int'l) UK. 115-123 Bayham St., London NW1 0AL Tel (01) 485-5622. Telex: 25584. Int'l Dir. A&R Sylvia Curd.
Int'l branches: Germany, Netherlands
 Archiv, see Polydor.
 Ardeck, see EMI Recs.
 Argo, see Decca.
 Ariola/Arista (IFPI), 3 Cavendish Square, London W1M 9HA. Tel: (01) 580 5566. Telex: 298933. Mng. Dir.: Andrew Pryor. Bus. Affairs Dir.: David Simone; Comm'l Dir.: David Adams; Sr. Mgr.: Brian Yates; Mktg. Mgr. Tim Read; A&R Head: Simon Potts; Promo: Alison Short, Winston Lee; Int'l Development Head: John Britley.
Labels: (Owned) Ariola, Arista, Bell, GRP, Goal, Jo-Fee, I-Spy, Mother in Law, Novus, Savoy; (distributed—not licensed) Double D, Handshake, Hansa, Tee.
Int'l reps.: Australia (Festival, RCA), Canada (Capitol), Italy (CGD), Japan (King Nippon), Scandinavia (RCA), South Africa (RPM), rest of world (Ariola).
 Arista, see Ariola/Arista.
 Armageddon Recs. Ltd., 56 Standard Rd., London NW10. Tel (01) 731-4572. Telex: 22164. Mng. Dir.: Richard Bishop; Gen. Mgr.: David Loader, Prod'n Mgr.: Peter Dyer (Distributed by Stage One)
Int'l branch: USA.
Labels: (Owned) Armageddon, Hedonics, Wally-au; (licensed domestic) Hotbox, Musclebound; (licensed foreign) Plan B (USA).
Int'l reps.: Austria (SPI), Canada (Attic/Polydor), Denmark (SDS), Finland (Joanna), France (Disc'AZ, SPI), Germany (Roal/Rimpo), Italy (Base), Netherlands (Bertus), New Zealand (RC), Norway (SDS), Sweden (SDS), Switzerland (SPI).
 Arrival, see K-tel.
 Arrival Recs., 39 Leyton Rd., Harpenden, Herts. Tel: (05827) 5098 Mng. Dir.: David Blaylock; Dir.: Judy Dixon (Distributed by Pinnacle)
Int'l reps.: Austria, Germany, Scandinavia & Switzerland (all Deutsche Grammophon).
 Artistic, see Submarine.
 Artium, see BBC.
 Ash, see Zella.
 Asylum, see WEA.
 Alco, see WEA.
 Athena, see Don't Panic.
 Atlantic, see WEA.
 Attack, see B&C & Trojan.
 Attrix Recs., 3 Sydney St., Brighton, Surrey BN1 4EN Tel: (0273) 2781, 608941. Chief Execs.: Rick & Julie Blair; Prod'r: Terry Newbery. (Distributed by Pinnacle & Rough Trade)
 Audio Visual Library Servs. Ltd., 10 12 Powdrake Rd., Grangemouth, Strathgushe FK3 9UT. Tel: (0324) 471521. Mng. Dir.: Charles B. Wood; Sales Mgr.: Rosemary Grant. (Distributed by Audio Visual Library, Lugton)
Labels: (Owned) Candlelight, Colophone; (distributed—not licensed) JNP (USA).
Int'l reps.: Australia & New Zealand (Deun & Mason).
 Audio Wholesale, 115B Trafalgar Rd., Greenwich, London SE10 Tel: (01) 853-0797. (Distributor)
 Aura Recs. Ltd., 1 Kendall Pl., London W1H 3AG. Tel: (01) 486-5288. Telex: 24224 Ref. 3145. Mng. Dir.: Aaron Sixx. (Distributed by Spartan)
Int'l reps.: Austria (Amadeo), Belgium (Inelco), Denmark (Electra) Finland (Polarvox), France (Musidisc), Germany (Metronome), Greece (Minos Matsas), Ireland (Pickwick), Italy (Paaarocord), Netherlands (Inelco), New Zealand (RTC), Norway (Talent Prods.), Portugal (Gira), Sweden (Electra), Switzerland (Office), Yugoslavia (RTVL).
 Automatic Rec. Co. Ltd., 5 Avery Row, London W1X 9TA. Tel: (01) 493-9744. Telex: 299978. Mng. Dir.: Nick Mobbs
 Avada, see Rola.
 Avatar Rec. & Screenworks Ltd., 62 Pall Mall, London SW1Y 5HZ. Tel: (01) 930-5361. Chm. & Dir.: Jon Brewer; Gen. Mgr. & Sales Mgr.: Mike Ever ett. (Distributed by Spartan).
Int'l reps.: Argentina (Movieplay), Australia (7 Recs.), Benelux (Inelco), France (Disc'AZ), Germany (Bellaphon), Greece (Musica Box), Israel (Electronics), Italy (Ricordi), Mexico (Movieplay), Scandinavia (Grammofon), Spain (Movieplay).
 B & C Recs. & Tapes, The Langham, Portland Pl., London W1A 1AA. Tel: (01) 580-4468. Cable: BROADCASTS. Telex: 265781. Chief Exec: Alan Bilard; A&R Mgr.: Mike Harding; Sales & Mktg. Mgr.: James Fleming; Bus. Affairs Mgr.: Mehmet Arman. (Distributed by Pys)
Labels: (Owned) Artium, BBC, Beeb
Int'l reps.: Argentina (Tonodisc), Australia (Phogram), Canada (Total Recs.), Denmark (Danish), Germany (Intercord, Italy (RCA), Netherlands (Sound Prods.), New Zealand (EMI), Norway (Electra), South Africa (EMI-Bigadiers), Spain (Dial), Sweden (Electra) USA (Gemcom)
 B & C Recs. Ltd., 326 Kensal Rd., London W10 5BL Tel: (01) 969-6651 Telex: 261500. Mng. Dir.: Marcel Ridd. Int'l Mgr.: Lynne Kentish. (Distributed by Pinnacle).
 Affiliated firm: Saga Recs. Ltd.
Labels: (Owned) Action, Attack, B&C, B&C, Home, Lowbte, Mooncrest, Trojan.
Int'l reps.: Belgium (EMI), Canada (Almada), Denmark (CSA), Finland (PSO), France (Pathe Marconi), Germany (Teldec), Italy (Ri-Fi), Japan (Trio), Netherlands (EMI-Holland), Spain (Zafiro).
 B G S Prods. Ltd., Kirkland Park Studios, Leteham Rd., Strathaven, Scotland ML10 6EE. Tel: (0357) 21130. Mng. Dir.: W.B. Garden. Pub./Promos. Exec.: Dougie Stevenson. (Distributed by Clyde Factors, Con corde, Fergus Davidson, Ross)
Labels: (Owned) BGS Chord, Country House.
 B G S Prod'n Group, Superfly House, Camden High St., London NW1. Tel: (01) 388-5959/5950. Mng. Dir.: B.G. Sullivan; Dir. J. Scrase.
Labels: (Owned) BGS, Libra Int'l.
 B P M, PO Box 40, Hownslow, Middx. TW4 5DH Tel (01) 570-9495 Chief Exec.: K. Todd.
 B T W Rec'd Music Library, 125 Myddleton Rd., Wood Green, London N11 4NG. Tel: (01) 888 6655. Dirs.: John Ross Borthwick, R.J.T. Borthwick.
 Baaf Recs. Ltd. (IFPI), 62 Gloucester Pl., London W1. Tel: (01) 486-1486 Cable: BAALON LDN W2. Telex 25836. Mng. Dir.: Colin J. Brain, A&R Jay Shotam. (Distributed by Pys). (Also see Collins Int'l)
Labels: (Owned) Baaf, Best of Everything, Root.
 Back Collectors, see Oryx.
 Badge Recs., 14 New Burlington St., London W1X 2LR. Tel: (01) 734-3251 Cable: CARLSONG. Telex: 267488. Mng. Dir. Freddy Bienstock; A&R: Robert Bienstock.
 Bamboo, see Storm.
 Baners & Bonnets, see Word.
 Barak, see President.
 Paul Barrett Rock 'n' Roll Ents., 14 Albert Crescent, Penarth, South Glam organ, South Wales. Tel: (0222) 704279. Chief Exec. & A&R Dir.: Pam Barrett. Gen. Mgr.: Adrian Owlett; Sales Mgr.: Nigel Molden. (Distributed by Paul Barrett, Pinnacle)
Labels: (Owned) Crazy Rhythm, Magnum Force
Int'l reps.: Finland (Polarvox), France (Big Beat).
 Harry Barter Prod'n Ltd., 73 Newman St., London W1. Tel: (01) 631 3247 Chief Exec.: Harry Barter. (Distributed by Spartan)
Label: (Owned) Rewind.
 Bartlett Bliss Prod'ns, 39 Warwick Gardens, London W14 8PH. Tel: (01) 603 2451 Mng. Dir.: Peter Bartlett; Gen. Mgr. Barbara Bliss (Distributed by Lugton)
Label: Tellastory.
Int'l reps.: Australia (KGC, Scund Information), Canada (PolyGram), South Africa (EMI).
 Battle of the Bands Ltd., 266 London House, Fulham Rd., London SW10. Tel: (01) 352-9530. Dirs.: Anthony Forrest, Dan Cherubini.
 Beeb, see BBC.
 John Beecher Recs. & Books, 41 Elm Rd., New Malden, Surrey KT3 3HD. Tel: (01) 942-7235 Contacts: John Beecher, Yvonne Trengrove. (Importer/Exporter)
 Beeswing, see Broadside.
 Beggars Banquet Recs. Ltd., 8 Hogarth Rd., Earl's Court, London SW5. Tel: (01) 370-6175. Telex: 915733. Mng. Dir. Martin Mills; Gen. Mgr.: Peter Kent; Sales Mgr.: Ivo-Watts Russell (Distributed by WEA)
Labels: (Owned) Beggars Banquet, Don't Fall Off The Mountain, 4 AD, Situation 2
Int'l reps.: Benelux (CNR), rest of world (WEA)
 Bell, see Ariola/Arista
 Belmont Recs., Scotia House, 169 Knightsbridge, London SW7. Tel: (01) 589 1400. Telex: 22642. Mng. Dir. M. Hanau; Mktg. Mgr.: K. Ashton
 Belzsee, see Splash.
 Beltona, see Decca.
 Ivan Berg Assoc. (Audio Publ'g) Ltd., 35A Broadhurst Gardens, London NW6 3QT Tel: (01) 624-7785. Mng. Dir.: Ivan Berg. (Distributed by Spartan)
Labels: (Owned) Chron, Ivan Berg
Int'l reps.: Australia (Music World), New Zealand (Music World), South Africa (Disc Jockey Music).
 Best of Everything, see Baaf
 Better Boogie Discs, 1 Long Acre, Covent Garden, London WC2 Tel: (01) 836-0555. Dir. Carole Striker. (Distributed by Fresh, Rough Trade)
Label: (Owned) Strike.
 Bibi Magnetics Ltd. 101/105 Plough Rd., London SW11 2BI. Tel: (01) 223-5955. Dir. K.H. Bourke-Borrows; Gen. Mgr.: M. Shepherd; Sales Mgr.: G. Pearman; Export Mgr.: D. Power.
Labels: (Owned) Bibi, High Life, Look Listen & Learn, Drchid; (distributed—not licensed) Music For You (France).
 Big Bear Recs., 190 Monument Rd., Birmingham B16 8UU. Tel: (021) 454-7020. Cable: BEARSONGS. Mng. Dir.: Jim Simpson; Gen. Mgr. Kate Munn. (Distributed by Pinnacle)
Labels: (Owned) Big Bear, Grandstand, Truckers Delight.
Int'l reps.: France (ADA), Italy (Carosello), South Africa (WEA), Spain (Santos), Sweden (PolyGram).
 Big Beat, see Chiswick.
 Big Ben, see Tangent.
 Big Cock, see Hit.
 Big Muff Recs., 9 Forres House, Cameron Close, Brentwood, Essex. Tel: (0277) 225551. Chm. Graham Smith; Gen. Mgr. Harry Spooner. Sales Mgr. Lucy Smith; Promo. Mgr.: Ian Davey. (Distributed by Pinnacle)
 Big 'R' Recs. (Europe) Ltd., 29 High St., Biggar, Lanarkshire, Scotland ML12 6ED. Tel: (0899) 205666. Telex: 78357. Mng. Dir.: Drew Taylor. Gen. Mgr.: Trudy MacKenzie; Sales Mgr.: Christine Dewar.
Labels: (Owned) Big 'R'; (represented) Column One, Door Knob (both USA)
 Billy Goat, see Chick A Boom
 Birds Nest, see Happy Face
 Black Label Recs., 62 The Chase, London SW4. Tel: (01) 404 5011 Mng. Dir. John Owen Williams; Gen. Mgr. Paul Smith (Distributed by Stage One)
 Black Mountain Recs., PO Box 207, Mumbles, Swansea, Wales. Tel: (0792) 43984. Mng. Dir.: M.D. Evans.
 Black Music National Dist'n., 44 Cloudestale Rd., Tooting, London SW17 Tel: (01) 223-6543. Chm.: Oscar Clarod. (Distributor)
 Black Panther Recs., 112 Sunny Gardens Rd., London NW4. Tel: (01) 203-1324. Chief Exec.: John Stedman. Sales Mgr.: K. Pryor.
 Terry Blood (Recs.) Ltd., Rosevale Rd., Units 18/20, Chesterton, Newcastle-Under-Lyme, Staffs. Tel: (0782) 620-321. Telex: 367106. Chief Exec.: Terry Blood, Gen. Mgr. Graham Vernon. (Distributor/Importer)
 Blue Chip Recs. (IFPI), 132 Western Rd., Mitcham, London, Tel: (01) 648-7000. Labels Mgr.: Matt Hayward. (Distributed by PRT)
Labels: (Owned) Blue Chip, Gallo, RPM.
Int'l reps.: Austria (Teldec), Benelux (Ariola), Germany (Teldec), Scandinavia (Sound of Scandinavia), South Africa (RPM), Switzerland (Teldec)
 Blue Inc Recs. Ltd., 155 Church St., London W2 1NA. Tel: (01) 723-9090/6561. Mng. Dirs.: Billy Russell, Billy Carruthers.
Labels: (Owned) Blue Inc, Index.
 Blueport Recs., 752 Kelvin Grove, Sandyford, Newcastle. Tel: (0632) 812-377. 612-849. Prime Co-ord. Mike Maurice; Promos. Mgr.: Tony Glover. (Distributed by Spartan)
 Bond Street Music Ltd., 100 New Bond St., London W1Y 9LG. Tel: (01) 629-5454. Mng. Dir.: Stanley Simmonds; Gen. Mgr. Norman Austin. (Im porter) (Distributed by Lugton, H.R. Taylor)
Labels: (Licensed foreign) Pantan, Supraphon (both Czechoslovakia)
 Boring Recs., 23 Dalkeith Ave. Bishopbriggs, Glasgow, Scotland. Tel: (041) 772 2290. Mng. Dir. Graham Scott; Dirs.: Stan Workman, Dougie Burns.
 Boulevard, see Saga.
 Bridge House Recs. Ltd., 23 Barking Rd., Cannoning Town, London E16. Tel: (01) 476-2889. Pres. Chris Thompson; Gen. Mgr. Terence Murphy; Sales Mgr.: Colin Barton, Admn. Mgr.: John McGeady.
Int'l rep.: France (Underdog).
 Bright Recs., 34/36 Maddox St., London W1. Tel: (01) 408 0288 Mng. Dir.: Martin Wyatt
 Britannia Music Co. Ltd. (IFPI), 60-70 Roden St., Wford, Essex IG1 2AQ. Tel: (01) 553-3333. Cable: ACBLDN. Telex 896073 Mng. Dir.: Michael J Pateman.
 Note: Direct marketer/distributor for PolyGram group and third party labels.
 Britannia Recs., 32 Thames Court, Victoria Ave., Hurst Park, East Molesey KT8 9TP. Tel: (01) 979-0914. Chief Execs.: Michael O. St. Clair, M. Miller. (Distributed by Spartan)
 Broadcast Recs. Ltd., 51 Rossiter Rd., London SW12 Tel: (01) 675-1832.

Cable: REDFOX. Mng. Dir. Tim Hodgkinson; Gen. Mgr.: Henry Cow. (Dis tributed by Recommended)
Int'l reps.: France (Celluloid), Italy (L'Orchestra), USA (Random Radar, Red).
 Broadside Recs., Studley House, Limes Rd., Tettenhall, Wolverhampton WY6 8RB. Founder: Jon Raven (Distributed by Jazz Servs., Pinnacle, H.R. Taylor)
Labels: (Owned) Beeswing, Jester's Court.
 Bronze Recs. Ltd., 100 Chalk Farm Rd., London NW1 8EH. Tel: (01) 267-4499. Cable: HITMUSIC. Telex: 261653. Mng. Dir.: Gerry Bron; Gen. Mgr.: Robert Lemon; Int'l Co-ord.: Gordon Simpson. (Licensed to Polydor)
Int'l reps.: Argentina (Microton), Australia (Festival), Austria (Ariola), Belgium (Ariola), Bolivia (Lauro), Brazil (Ariola), Chile (Quatro), Colombia (Sonolux), Ecuador (Fadisa), France (WEA Filipacchi), Germany (Ariola), Greece (EMI), Guatemala (Dideca), Hong Kong (EMI), India (EMI), Ireland (PolyGram), Italy (Ricordi), Japan (Victor), Malaysia (EMI), Mexico (Ariola), Netherlands (Ariola), New Zealand (Festival), Peru (FTA), Philippines (EMI), Portugal (Phonogram), Scandinavia (Sonet), Singapore (EMI), South Africa (Gallo), Spain (Ariola), Switzerland (Ariola), Thailand (EMI), USA (PolyGram), Venezuela (Cedice), Yugoslavia (Jugoton).
 Bruce's Rec. Shop, 45 Shandwick Pl., Edinburgh, Scotland EH2 4RG. Tel: (031) 229-3689. Telex: 777493. Mng. Dirs.: Brian Findlay, Roy Lake. (Im porter) (Exporter as Brian Findlay Exports)
 Harvey Boat, 84 Church St., London NW8. Tel: (01) 724-3711. Dir.: Alan Taub. (Distributor/Importer)
Label: Merryman-REC (Barbados)
 Buena Vista, see Walt Disney.
 Buffalo, see Dawn.
 Bulldog Recs. (IFPI), PD Box 130, Hove, East Sussex BN3 6QU. Tel: (0273) 550088. Cable: KRUGERENTS. Telex: 877050 Chief Exec.: Jeffrey S. Kruger; Mng. Dir.: Leslie Lewis; Creative Affairs: Howard Kruger; Shipping Mgr.: Ray Finella; Royalties & Licensing: Margaret Bace. (Distributed by Caroline Exports, Clyde Factors, Lugton, Pacific, President, Solomon & Peres, H.R. Taylor)
Int'l branch: USA.
Labels: (Owned) Bulldog, Ember, Energy, Great Voices of the Century, Int'l reps.: Argentina (Sicamericana), Belgium (Vogue), Brazil (Com panha Ind'l), Som, Canada (Almada), Costa Rica (Lyr), Czechoslovakia (Opus), Denmark (EMI), Finland (EMI), Germany (Teldec), Israel (CBS), Italy (Durium), Kenya (AIT), Netherlands (Inelco), New Zealand (Music World), Nigeria (Phonogram), Norway (EMI), Philippines (Disc Corp.), South Africa (David Gresham), Spain (Discophon), Sweden (EMI), Uruguay (Palacio de la Musica), Venezuela (Palacio de la Musica).
 Bullet, see Neon.
 Bullseye Recs., AIR House, Spennymoor, Co. Durham. Tel: (0388) 814-632 Chief Execs.: Colin Pearson, John Wray. Gen. Mgr.: Loyd Smith; Sales Mgr.: A.P. Blackett
 Bumper, see Mainline.
 Bungey Banker-Jukes Int'l Ltd., 10-12 Carlisle St., London W1V 5RF. Tel: (01) 734-4000. Telex: 27778. Mng. Dir.: Stephen Banker-Jukes; Gen. Mgr. Bob Fisher; Exec. Ass't.: Dee Hodden. (Distributed by Pinnacle, RCA, TBC)
Labels: (Owned) Peach River, Underworld; (licensed foreign) Rag Baby, Waterhouse (both USA).
Int'l rep.: Worldwide (RCA)
 Burning Rome Recs., 32 Alexander St., London W2 Tel: (01) 229-8236
Labels: (Owned) Burning Rome, SS, Test Pressing.
Int'l rep.: USA (Stiff).
 Butt Recs. Ltd., 27 Aylmer Rd., Shepherds Bush, London W12 9LG. Tel: (01) 749-3730. Mng. Dir.: Brian Leale. (Distributed by Spartan)
Labels: (Owned) Butt; (licensed foreign) Poshboy (USA).
 By-Pass Recs. Ltd., 27-29 Portland St., Kilmarnock, Scotland. Tel: (0563) 36280. Telex: 777425. Mng. Dir.: Ken Richardson; Gen. Mgr.: Inez Richardson; Sales Mgr.: Huntly Stuart. (Distributor/Importer)
 C B S Recs. (IFPI), 17/19 Soho Square, London W1V 6HE. Tel: (01) 734-8181. Cable: COLRECORD. Telex: 24203 Chm.: Maurice L. Dberstein; Mng. Dir.: David Betheridge, Sr. Dir.: Tony Woolcott; UK A&R Dir.: Muff Winwood, Int'l A&R Dir.: Peter Robinson, Comm'l Dir.: Jack Florey; Finance Dir.: John Field; Sales Dir.: John Mar, Bus. Affairs Dir.: Tim Bowen; Admn. Dir.: John Brooks; Sec'y: Vesi Arvi.
Home office: USA.
Labels: (Owned) CBS, Epic, Embassy, Odyssey, Portrait; (licensed) Blue Sky, Caribou, Full Moon, Kaleidoscope, Kirshner, Monument, Mums, Nemperor, Ode, Philadelphia Int'l, Prelude, TK, Tabu, Unlimited Gold; (distributed—not licensed) A&M, Creole, DJM, GTO, Galaxy, Jet, MCA, Oasis, Stiff, Virgin, Warwick.
Int'l rep.: Worldwide (CBS).
 C M C Recs. Ltd., 14 New Burlington St., London W1X 2LR. Tel: (01) 734-3251. Cable: CARLSONG. Telex: 267488. Dirs.: Frederick & Miriam Biens-tock, R. Derek Knobb, Mike Collier.
 C R C, see Orix.
 C R D Recs. (IFPI), PO Box 26, Stanmore, Middx. Tel: (01) 958-7695. Chief Exec.: Graham Pauncefort, Artistic Dir.: Simon Lawman. (Distributed by Unicorn)
Int'l reps.: Australia (Janda), Belgium (PMP), Canada (Vanguard), Finland (Fuga), Germany (MusContact), Netherlands (Sound Prods.), Norway (Per Neby), Sweden (Sound Doctor), Switzerland (Musica), USA (Vanguard).
 Cactus, see Creole.
 Cadillac Music & Recs., 180 Shaftesbury Ave., London WC2H 8SL. Tel: (01) 836-3646. Mng. Partner: John Jack.
Labels: (Owned) Cadillac; (distributed—not licensed) Affinity, Bead, Blackthorne, Bvhaast, Charlie, Dawn Club, ENJA, Evavidis, FMP, Flyright, Hefty Jazz, Highway, Incus, JMS, Lee Lambert, Leader, Moers, Mosaic, Nola, Dgun, Plant, Incus, Rarities, Red Lightn, Spottite, Steam.
Int'l reps.: France (Palm), Germany (Moers), Netherlands (Bvhaast), Sweden (Amgo), Switzerland (Planisphere), USA (Daybreak, Rick Ba-lard).
 Cambridge Classical Recs., 5 King's Parade, Cambridge, CB2 1SJ. Tel: (0223) 350-565. Mng. Dir.: Edward Turner, Dr. Christopher Hills.
 Camden, see RCA & Pickwick Int'l.
 Camp, see JSD.
 Canaan, see Word.
 Candhaven, see Metropolitan.
 Candlelight, see Audio Visual Library.
 Canolfin, see Oryx.
 Canterbury Pop Recs., 13 Long Port, Canterbury, Tel: (0227) Canterbury 56172. Chief Exec.: David R. McRollerson; Gen. Mgr.: H.C.D. Sparks. (Dis tributed by Bonaparte, Pinnacle, Rough Trade, Virgin)
 Capitol, see EMI.
 Capricorn, see Polydor.
 Capstan Music, 40 Camden High St., London NW1 Tel: (01) 485-3232.

Billboard 1981-1982 International Buyer's Guide

Chief Execs.: Peter L. Wells, Richard Freemantle; Gen. Mgr.: Chris Williams; Sales Mgr.: Simon Musgrave; Press & Promo. Mgr.: Tom Hoogerwerf; Accounts: Marion Stanley.

Dave Carey, 1b Mitcham Ln., Streatham, London SW16 (Distributor/Imp Port).

Carmel Music Ltd., 4 Cliff Ave., Westcliff-on-Sea, Essex SS0 7AJ. Tel: (0702) 338-593. Mng. Dir.: Peter Eden; Sec'y: Glynis Eden (Distributed by Lugton, H.R. Taylor).

Carnaby Recs. (div. of Mervyn Conn Dr.), MC House, 14 Drange St., London WC2E. Tel: (01) 930-7502. Telex: 23343. Mng. Dir.: Mervyn Conn.

Labels: (Owned) Carnaby, Nashville Int'l

Caroline Exports Ltd., 56 Standard Rd., London NW10 6ES. Tel: (01) 961 2919. Cable: BUMBLEBEE. Telex: 22164. Mng. Dir.: Adrian T. Rose, Sales Mgr.: Tony Harris. (Distributor/Exporter).

Carrere Recs. UK Ltd. (IFPI), 20-22 Queen St., Mayfair, London W1X 7PJ. Tel: (01) 493-7406. Telex: 8953657. Mng. Dir.: Freddy Cannon; Promo. Mgr.: Geoff Scourfield; A&R Mgr.: Peter Hinton. (Distributed by WEA)

Int'l reps.: Australia (EMI), Austria (Polydor), Germany (Polydor), Greece (Phonogram), Italy (Font-Cetra), Netherlands (CNR), Scandinavia (EMI), South Africa (EMI), Spain (CBS).

Carrot, see Nola.

Casablanca, see Phonogram.

Casino Classics Recs., 3 Pennington St., Hindley, Wigan, Lancs. WN2 3AH. Tel: (0942) 57430. Mng. Dir.: Russ Winstanley. (Also see Robert Kingston)

Cassette Developments (AudioSonic) Ltd., Micra House, 138 Lower Mortlake Rd., Richmond, Surrey TW9 2JZ. Tel: (01) 940-8186. Cable: MICRDNETIC. Telex: 8813481. Mng. Dir.: D Dixon

Labels: (Owned) Coronet, Coronet Philharmonic

Castle Recs., The Castle, 93 Castle Hill Rd., Hindley, Wigan, Lancs. WN2 4BH. Tel: (0942) 58777. Chief Exec.: D. Hughes, Gen. Mgr.: S.P. Millard. (Also see LE)

Labels: Castle, Nelson

Cavalis Ltd., 82 Rivington St., London EC2. Tel: (01) 739-8116. Telex: 27950. Chief Exec.: D.A. Robinson. (Distributed by Jet Star, Pinnacle)

Labels: Cavalis, Matastick

Int'l reps.: Italy (WEP), South Africa (Moonshine), USA (Halfmoon).

Celebrity, see AC & RCA.

Celestial Sound Prod'ns, 28 South Villas, London NW1. Tel: (01) 485 0269. (Distributed by Bonaparte, Pinnacle, Rough Trade, Virgin)

Labels: Celestial Sound, Sound Ceremony

Celis Recs., 220 West End Ln., London NW6. Tel: (01) 286 2543. Chief Exec.: Geoff Mann. (Distributed by Rough Trade)

Central Recs. Suppliers, 86/87 Wilton Rd., London SW1V 1DN. Tel: (01) 834-9506, 828-4825. Dir.: S. Howard

Chameleon Recs., 19 S. Molton St., London W1. Tel: (01) 629-9719. Telex: 261805. Mng. Dir.: Mike Loveday.

Champ Recs., 57 Victoria Rd., Chingford, London E4 6BZ. Tel: (01) 529 1943. Mng. Dir. & A&R Dir.: Richard de Silva. (Distributed by Mike Day & Truckers Paradise)

Labels: (Owned) Champ, Platform

Chapel Lane, 67 Windmill Dr., Croxley Green, Richmansworth, Herts. Con. Iact: Norman Miller.

Labels: (Represented) Hartson (USA).

Charisma Recs. Ltd. (IFPI), 90 Wadour St., London W1. Tel: (01) 434 1351. Chm.: Tony Stratton-Smith; Mng. Dir.: Brian C.A. Gibbon. (Distributed by Phonogram)

Int'l reps.: Worldwide (Phonogram Int'l/PolyGram).

Cherry Recs. Ltd. (IFPI), 156-166 Ilderton Rd., London SE15. Tel: (01) 732 5642/5647. Telex: 934386. Chm.: Jean Luc Young, Mng. Dir.: Joop Visser, Prod. Mgr.: Cliff White; Finance Admin. Dr.: Pat Evans. (Distributed by Spartan)

Labels: (Owned) Affinity, Charly, Georgio Gomelsky, Smack; (licensed foreign) Atomic Art, Baron, Bethlehem, Chief/Age, Cobra/USA, Jewel, Dne-Derful/Mar-V-Lus, Paula, Plantation, Red Bird/Blue Bird, Ronn, SSS Int'l, Sansu, Sun, Vee Jay, Jerry Williams Jr. (all USA), Charly Int'l (Den mark), Rockhouse (Netherlands), Toddlin' Town/Midas.

Int'l reps.: Australia (UJA Braunthal, Hollywood House, Musicland), Austria (Ithulux), Canada (Almada), Finland (Polarvox), France (Charly), Germany (Teldec), Ireland (Spartan), Israel (Eastronics), Italy (Ariston), Japan (RCA), New Zealand (EMI), Poland (Tonpress), Spain (Auv), Sweden (Planet), Switzerland (Vogue), USA (City Hall, First American, Green world, Important, Jem, Rounder, Shanachie), Venezuela (RPM), Yugo slavia (Jugoton)

Cheapskate Recs., 35 Portland Pl., London W1. Tel: (01) 637 2111. Telex: 25929. Mng. Dir.: Chas Chandler. (Distributed by RCA)

Cherry Red Recs. Ltd. (IFPI), 53 Kensington Garden Square, London W2. Tel: (01) 229-8854. Telex: 943763. Mng. Dir.: Ian McNay; A&R: Mike Alway (Distributed by Pinnacle)

Labels: (Owned) Berry Red, Passion; (licensed) City, Heartbeat, Pipe.

Int'l reps.: Belgium (Sound Prod.), France (Virgin), Germany (Intercord), Greece (Music Box), Italy (Ariston), Netherlands (Sound Prod.), Scandinavia (Planet), Spain (Edgusa)

Chevron, see Multiple Sound

Chick-A-Boom Ltd., 27 Egmont Rd., Sutton, Surrey SM2 5JR. Tel: (01) 642-2896. Gen. Mgr.: Chris Barnsby. (Distributed by Tonal)

Labels: (Owned) Billy Goat, Chick-A-Boom, Jon; (distributed-not licensed domestic) Crazy Rhythm, Red A. (distributed-not licensed foreign) Bear Family (Germany), Wix (USA)

Chips, 19 Upper Brook St., London W1. Tel: (01) 409-3277. Telex: 267310. Label Mgr.: Mike Evans. (Distributed by PRT)

Chiron, see Ivan Berg

Chiswick Recs., 3/5 Kentish Town Rd., London NW1. Tel: (01) 267-5192. Telex: 893805. Mng. Dirs.: Ted Carroll, Trevor Churchill; Creative Dir.: Roger Armstrong; Ace/Big Beat Label Mgr.: Donna Cotten. (Distributed by EMI, Pinnacle)

Labels: (Owned) Ace, Big Beat, Chiswick, Thrust; (distributed-not licensed) Redwood (Canada).

Int'l reps.: Australia (EMI), Austria (Metronome), Benelux (RCA), France (Pathe Marconi-EMI), Germany (Metronome), Greece (PolyGram), Ireland (PolyGram), Italy (Ricordi), Japan (Warner-Pioneer), Mexico (Gamma), New Zealand (EMI), Scandinavia (Sonet), South Africa (EMI Brigadiers), Spain (Movieplay), Switzerland (Metronome), Venezuela (Lu Rucces).

Chopper Recs., 9 11 Richmond Bldgs., Dean St., London W1V 5AH. Tel: (01) 439-3058. Dir.: Geoff Morrow; Gen. Mgr.: Philip Foster. (Distributed by RCA)

Chrysalis Recs. Ltd. (IFPI), 12 Stratford Place, London W1. Tel: (01) 408 2355. Telex: 21753. Joint Chm.: Chris Wright, Terry Ellis, Mng. Dir.: Doug D'Arcy, Dir.: Terys Connolly; A&R Dir.: Roy Eldridge, Financial Dir.: Nigel Butterfield; Int'l Dir.: Des Brown. (Distributed by Tandem, Phonodisc)

Int'l branch: USA.

Labels: (Owned) Air, Chrysalis, Reformation, Two Tone

Int'l reps.: Australia (Festival), Austria (Ariola), Benelux (Ariola), France (RCA), Germany (Ariola), Greece (Phonogram), Ireland (PolyGram), Italy (RCA), Japan (Toshiba/EMI), New Zealand (Festival), Portugal (Phonogram), Scandinavia (Sonet), South America (RCA), Spain (RCA), Switzerland (Ariola), USA (Chrysalis).

Circle in the Square Recs., 49 Derby St., Kelvingrove, Glasgow, Scotland. Tel: (041) 334 5099. Chief Exec.: Brian Young, Sales Mgr.: Alison Bye. (Distributed by Rough Trade)

City, see Cherry Red.

City Sounds Recs. & Tapes Ltd., 8 Procter St., London WC1. Tel: (01) 242 1863, 405-5454. Dr.: J.R. Wright; Buyer: M. Clarke.

Classics For Pleasure, see Music For Pleasure

Clay Recs. Ltd., 26 Hope St., Hanley, Stoke-on-Trent, Staffs. Tel: (0782) 273324. Dirs.: Mike Stone, John Spencer.

Clearview, see Elie Jay.

Cloud 9 Prod'ns Ltd., Music House, 1 SD, Stoppage Ln., Simonswood, Liverpool L33 4YA. Tel: (051) 548-9690. Mng. Dir.: Mike Glasspole; Prod'n Dir.: Dave Roylance, Mktg. Dir.: Dave Preston.

Clubland, see Stuart Johnson.

Clyde Factors (Electrical) Ltd., 79 Washington St., Glasgow G3 8BD. Tel: (041) 221-9844. Chm. & Mng. Dir.: Edward Woolson; Dir.: Michael Woolson.

Note: Distributes all major labels and is sole distributor for Pickwick Recs. & Tapes in Scotland.

Coast Recs., The Music Works Studios, 23 Benwell Rd., London, N7. Tel: (01) 609-1377. Mng. Dir.: Kevin Wyatt-Lowell; A&R Mgr.: George Lillington. (Distributed by Coast, Projection)

Labels: (Owned) Coast; (distributed-not licensed) Dild School, Pilluck Cobra, see EMI.

Cocoteau Recs., PO Box 134A, Thames Ditton, Surrey KT2 0TY. Tel: (01) 398 6413. Chief Exec.: Mark Ryde. (Distributed by Rough Trade/Fresh)

Collectors Choice, see Response.

Collins Int'l (Jaroch Ltd.), 25 Park Way, Burnt Oak, Edgware, Middx. Tel: (01) 951-3177. Cable: CDLINE. Telex: 894152 CDLINE. Mng. Dir.: Jeffrey Collins; Gen. Mgr.: Louis Jacobs; Sec'y: Annette Collins.

Labels: (Owned) Echo; (licensed) Barul.

Jeffrey Collins (Whistle), 25 Park Way, Burnt Oak, Edgware, Middx. HA8 5EX. Tel: (01) 951-3177. Cable: JCW. Telex: 894152 CDLINE. Mng. Dir.: Jeffrey Collins; Gen. Mgr.: Louis Jacobs; Co-Dr.: Stanley Osterly. (Distributor/Importer)

Colophone, see Audio Visual Library.

Colortone Rec. Co. Ltd., The Studio, 69 Dukes Ave., New Malden, Surrey. Tel: (01) 942-1347. Mng. Dir.: Sigg Jackson; Gen. Mgr.: David Brown, Sales Mgr.: Michael Fletcher.

Labels: (Owned) Colortone, Spectrum.

Columbia, see EMI.

Conifer Recs. (John G. Deacon Ltd.) (IFPI), Horton Rd., West Drayton, Middx. UB7 8NP. Tel: (08954) 48531, 40450, 49140, 49149. Telex: 27492. Mng. Dir.: John G. Deacon, Finance Dir.: R.C. Roper; Gen. Mgr.: M. J. Yarrow; Sales/Promo. Mgr.: Alison Wenham.

Labels: (Owned) Conifer; (distributed) Lyrita, World; (imported-exclusive) Ariola (Germany-classical only), Arion (France), Bluebell (Sweden), CDA (France), Caprice (Sweden), Cellier (Switzerland), DRG (USA), EMI imported, Erato (France), Jeklin (Switzerland), Milan (France), Playasound (France), Sonodisc (France), Sterling (Sweden), Swedish Radio (Sweden); (imported-not exclusive) all Arab music produced by EMI Greece & Sonodisc (France), Barclay Classics (France), CBS (France), Carrere (France), RCA (France).

Conquest, see World Recs.

Contour, see Pickwick.

Cool Rockers, see Greensteves.

Cornerstone, see Symphonia.

Coronet, see Cassette Developments.

Coronet Philharmonic, see Cassette Developments.

Cosmopolitan, see Dryx.

Cotillon, see WEA

Country & Eastern, see Phoenix.

Country House, see BGS.

Country & Western Imports, see Jazz Imports

Crash, see Satril.

Crazy Rhythm, see Paul Barrett.

Crazy Viking, see Young Blood.

Cream, see Global Rec. Sales.

Creole Recs. Ltd., 91-93 High St., Harlesden, London NW10. Tel: (01) 965 9223. Cable: CREMUS. Telex: 28905. Mng. Dir.: Bruce D. White. (Distributed by CBS)

Labels: (Owned) Cactus, Creole, Polo, Savannah, Stag; (licensed foreign) Dynamic (Jamaica).

Int'l reps.: Australia (Seven), Benelux (Dureco), Brazil (K-tel), France (Musidisc), Germany (Teldec), Greece (Music Box), Israel (Hatakli), Portugal (Rossi), Scandinavia (K-tel), South Africa (CCP).

Crownium Recs., 51 Court Lodge Rd., Horley, Surrey. Tel: (073-784) 3932. (01) 588-8846. Owner: Jim Graham; Gen. & Sales Mgr.: Pete Kunzler. (Distributed by Jetstar & Rough Trade)

Cruise Recs., 275 Kensal Rd., London W10 5BD. Tel: (01) 969-3719. Dirs.: Paul Wateridge, David Hendley.

Crystal, see President.

Cube Recs. Ltd., Essex House, 19/20 Poland St., London W1V 3DD. Tel: (01) 734 8121. Cable: SEXMUS. Mng. Dir.: David Plat.

Labels: (Owned) Cube, Electric, Fly.

Int'l reps.: Argentina (Polydor), Australasia (EMI), Austria (Aves), Belgium (Polydor), France (Polydor), Israel (Polydor), Italy (Polydor), Netherlands (Polydor), Spain (Polydor), Switzerland (Aves).

Custom, see Zero

D C L, see Discourses.

D C M, see Discourses.

D C D, see Discourses.

D D P, see Hammer.

D G, see Polydor

D I Ltd. (IFPI), 13 Bank Square, Wilmslow, Cheshire SK9 1AN. Tel: (0625) 527844. Cable: IINDISC. Telex: 635091. Mng. Dir.: Irving Wilson; Gen. Mgr.: Lesley Thompson; Sales Mgr.: F. Naffel.

Labels: (Owned) Euroson; (licensed foreign) Bagatelle (France), MCR (Netherlands), Dpus (Czechoslovakia).

Int'l reps.: Australia (EMI), Czechoslovakia (Dpus), Germany (Phon und Ton), Japan (Teichiku), USA (Everest).

D J M Recs. Ltd. (IFPI), James House, 5 Theobalds Rd., London WC1X 8SE. Tel: (01) 242-6886. Cable: DEJMAUS. Telex: 27135. Mng. Dir.: Stephen M. James; Gen. Mgr.: Paul M. Davis. (Distributed by CBS).

Labels: (Owned) DJM; (licensed foreign) Hilltak (USA).

Int'l reps.: Argentina (American Recs.), Austria (Amadeo), Australia (Festival), Belgium (Vogue), Bolivia (Laur), Canada (London), Colombia

(CBS), Denmark (PolyGram), Finland (Finnlevy), France (Vogue), East Germany (Deutsche), West Germany (Metronome), Ghana (Core), Greece (EMI), Hong Kong (EMI), Iceland (Falkinn), India (Gramophone), Ireland (CBS), Israel (K-tel), Italy (CGO), Malaysia (EMI), Malta (Record Centre), Mexico (Musart), Netherlands (EMI), Norway (PolyGram), Panama (Sonomundi), Peru (Sica Peruna), Philippines (Dyna), Singapore (EMI), South Africa (RPM), Spain (Zafiro), Sweden (PolyGram), Switzerland (Metronome), Thailand (EMI), USA (DIM), Uruguay (American Recs.), Venezuela (Productora Musical), Yugoslavia (Jugoton)

D T P Inc./Vanessa Music & Recs., 86 St. Bernard's Rd., East Ham, London E6 1PE. Tel: (01) 472-9682. Mng. Dir.: Don Todd; Sr. Eng.: Peter Cope land.

Labels: (Owned) Vanessa.

Int'l rep.: USA (Evelyn).

Daddy Kool, 94 Dean St., London W1. Tel: (01) 437-3535.

Labels: (Represented) Disc Disk/Joint Int'l (USA).

Damont Recs. (Sales) Ltd. (IFPI), Blyth Rd., Hayes, Middx. UB3 1BY. Tel: (01) 573-5122. Telex: 934076. Mng. Dir.: Monty Press; Deputy Mng. Dir.: Frank Pearce.

Labels: (Owned) Happy House, Stereo Gold Award.

Dansan Recs. Theatreland Ltd., 14 Soho St., London W1V 6HB. Tel: (01) 437-2245. Mng. Dir.: David Marcus; Gen. Mgr.: Tommy Sanderson, Sales Mgr.: David Mills. (Distributed by Gold, Lugton, Pinnacle, H.R. Taylor, Wynd Up)

Labels: (Owned) Dansan, Leisure, Oliver "D"

Dart, see President.

Fergus Davidson Assocs. Ltd., 1 Benham Ln., Croydon, Surrey CR0 2RU. Tel: (01) 689-6824. Cable: TRIMULGERY. Telex: 28905. Chm. & Mng. Dir.: Fergus Davidson. (Distributor/Importer)

Labels: Anvil, Arnold-Taylor, Audicord, Audio Chess, BGS, Bartlett Bliss, Ivan Berg, EB, EBEC, Educational Tapes, Embryo, Holborne (Canada), Laser Cassettes, Music Masters, Norwich, DDe (New Zealand), REL, Scottish, Scots, Seminar Cassettes, Shona, Times Cassettes, Wairudaw, Witlowdale, Zeus.

Dawn Promotions & Agency Ltd., 186 Casterton Rd., Stamford, Lincs. Tel: (0780) 51736. Chm. & Mng. Dir.: Ken Cox; Gen. Mgr.: W.A. Cox, Sales Mgr.: John Wright.

Labels: (Owned) Buffalo, Soul Stop, Weasel.

Dayspring, see Word.

Dead Dog Recs., 292/3 High St., Lincoln, Lincs LN2 1AL. Tel: (0522) 38322. Mng. Dir. & Sales Mgr.: Andy Stephenson; Gen. Mgr.: Martin Paton, Mktg., Promos. & Press Officer: Helen Garside.

Labels: (Owned) Dead Dog; (distributed-not licensed) Almost, Loose End, Dakwood, Stark.

Decca Recs. (UK), 50 New Bond St., London W1V 9HA. Tel: (01) 499-4600. Cable: PHNDRECE. Telex: 261583. Acting Chief Exec.: Ramon Lopez; Gen. Mgr.: John Preston.

Labels: (Owned) Decca, Deram, London; (licensed foreign) Barclay (France), Telefunken/Teldec (Germany).

Int'l reps.: See Decca Int'l.

The Decca Rec. Co. Ltd. (Decca Int'l) (IFPI), 1 Rockley Rd., London W14 0DL. Tel: (01) 743-9111. Cable: DECCORD. Telex: 23533. Dirs.: David G. Fine, Willem Back, Peter Kaatze, Reinhard Klässen, Ray Winshull; Int'l Dpns. & Pop Mktg. Mgr.: Marcel Stellman; Direct Export/Special Projects Mgr.: Charles Shiddell; Mktg. Mgr.: Pop Int'l: Roger Bull; Classical Mktg. & Artists Relations Mgr.: David Rickerby; Int'l Promos. Mgr. (Classical) John Kehoe; Gen. Mgr. Rec'g. Tom Stephenson, PolyGram Leisure Ltd. - Chm.: David G. Fine; Sec'y: Alan Roberts. (Distributed by PolyGram Rec. Dpns. Ltd.)

Labels: (Owned) Ace of Clubs, Ace of Diamonds, Argo, Bellona, Decca, Deram, Eclipse, London, L'Diseau Lyre, Quillon (Wales), Rex, Threshold, Vocation; (licensed foreign) Telefunken (Germany).

Int'l reps.: Argentina (PolyGram), Australia (PolyGram), Austria (Musica Schallplatten), Barbados (West Indies Recs.), Belgium (Phonogram), Bolivia (Discodisc), Brazil (PolyGram), Canada (PolyGram), Chile (Philips), China (Linfair), Colombia (Daro), Costa Rica (Leo in El Salvador), Denmark (PolyGram), Dominican Republic (La Guarachita), Ecua dor (Emporio Musical), El Salvador (Leo), Finland (Finnlevy), France (Barclay, Germany (Teldec), Greece (PolyGram), Guatemala (Leo in El Salvador), Honduras (Leo in El Salvador), Hong Kong (PolyGram), Hungary (Kultura), Ireland (PolyGram), Israel (Symphonia), Italy (Decca), Jamaica (West Indies Recs. in Barbados), Japan (Kmg), Kenya (PolyGram), Korea (Sung Eum), Malaysia (PolyGram), Mexico (PolyGram), Netherlands (Phonogram), New Zealand (PolyGram), Nicaragua (Leo in El Salvador), Norway (PolyGram), Panama (Leo in El Salvador), Peru (El Virrey), Philippines (Dyna), Portugal (Carvalho), Singapore (PolyGram), South Africa (Trutone), Spain (Fonogram), Sweden (PolyGram), Switzerland (Musivertreib), Turkey (Melodi), USA (PolyGram), Uruguay (Clave), Venezuela (PolyGram), Yugoslavia (Jugoton)

December Songs, 42 Park View Rd., Neasden, London NW10 1AL. Tel: (01) 450-5987. Gen. Mgr.: Todd Lutterott. (Distributed by Pinnacle)

Labels: (Owned) December Songs, Vasko, Waiting-In-Vain.

Delos Music, 182 Lansbury Dr., Hayes, Middx. Tel: 573-6299. Dir.: Pat Lynn, Gen. Mgr.: Richard Benjamin.

Deluge, see Parrot.

Dema Directions Ltd., 18 West Mill, Clifton, Bristol B8 4BQ. Tel: (0272) 35994, 35867. Chief Exec.: Dennis Ackerman; Gen. Mgr.: Shirley Acker man; Sales Mgr.: Dennis Mann.

Labels: (Owned) Firebrand, Great Western.

Chris Denning Ltd., 418 Poole Rd., Parkstone, Poole, Dorset BH12 1DF. Tel: (0202) 736185. Mng. Dir.: Chris Denning. Sec'y: M. Denning

Label: Live Wire.

Denver Recs., 87 Carlton Ave., North Wembley, Middx. HAD 3RB. Tel: (01) 908 0187. Owner: John McCauley. (Distributed by WEA)

Int'l rep.: Worldwide (WEA)

Depford Fun City, see Fauly

Deram, see Decca.

Derry, see Dulet.

Deutsche Grammophon, see Polydor

Deutsche Harmonia Mundi, see Harmonia Mundi

Dindisc Ltd., 61-63 Portobello Rd., London W11 3DD. Tel: (01) 221 7535. Telex: 22542. Mng. Dir.: Carol Wilson, Mktg. Mgr.: Nicky Davies, Art Dir.: Peter Saville; Promo. Mgr.: Donna Thompson.

Label: (Licensed) Sntazo

Int'l reps.: Australia (CBS), Austria (Ariola), Belgium (Ariola), Canada (PolyGram), Denmark (Sonet), Finland (Polarvox), Germany (Ariola), Greece (PolyGram), Hong Kong (Pacific), Ireland (Virgin), Israel (Gen eral), Italy (Ricordi), Mexico (Bertelsmann), Netherlands (Ariola), New Zealand (Record & Tape Co.), Norway (Arne Bendiksen), Portugal (VDC), South Africa (Gallo), Spain (Ariola), Sweden (Sonet), Switzerland (Ariola), Yugoslavia (Jugoton)

Dingle's Recs. Ltd., 322 Whitechurch Ln., Canons Park, Edgware, Middx. Tel: (01) 952-3551. Chief Exec.: R.L. Holt, Gen. Mgr.: R.N. Slater. (Distrib uted by Spart)

Discourses Ltd., 36 Crescent Rd., Tunbridge Wells, Kent TN1 2LZ. Tel: (0892) 26397. Mng. Dir.: Robert F. Hardcastle; Gen. Mgr.: A.H. James. (Distributed by Lugton.)
Labels: (Owned) ABK, ABM, DCL, DCM, DCD
 Discovery Recs., 91 Kingston St., Michael, Chippingham, Wills. Tel: (024975) 537. Telex: 444275. Mng. Dir. & Gen. Mgr.: M.S. Cox; Sales Mgr.: N.H. Annot. (Importer)
Labels: (Distributed—not licensed) Accord, Black & White, CBS, Chess, Deesse, Jazz Legacy, Musicdisc, Dcora, RCA, Vogue (all France).
 Discs Int'l., 29 Riding House St., London W1. Tel: (01) 637-9099. Chief Exec.: Peter J. Scally
Labels: (Owned) Discs Int'l. Limited Edition.
 Disneyland, see Walt Disney.
 Walt Disney Prod'n's Ltd., 68 Pall Mall, London SW1Y 5EX. Tel: (01) 839-8010. Telex: 21532. Chief Exec.: Keith Bates. (Distributed by EMI, Reader's Digest, Ronco)
Labels: (Owned) Buena Vista, Disneyland.
 Do It Recs. Ltd., 81 Harley House, Marylebone Rd., London NW1. Tel: (01) 486-3602/8855. Telex: 21879. 25247. Mng. Dir.: Max Tregoning; Dir.: Ian Tregoning.
Labels: (Owned) Do It; (licensed foreign) Ralph (USA).
 Dollops, see Stage Coach.
 Domino, see Tabitha.
 Don't Fall Off the Mountain, see Beggars Banquet.
 Don't Panic Prod'n's Ltd., 15 Trinity Rd., London SW17 7SD. Dirs.: Ian & Nick Titchener.
Labels: (Owned) Athena, Don't Panic, Rush Release, Titch-Tunes.
 Dorian, see Emblem.
 Double D Recs. Ltd., 25 Bruton St., 3rd fl., London W1X 7DB. Tel: (01) 493-9701. Mng. Dir.: Dave Dee; Gen. Mgr.: Harry D-herby; Int'l Mgr.: Heather Paton.
Labels: Double D (dist. by Ariola), Fatal Charm (dist. by Stage Dne), His Master's Vice (dist. by Stage Dne).
 Int'l repts.: Austria, Belgium, Brazil, France, Germany, Mexico, Netherlands, Spain, Switzerland, USA (all Ariola).
 Double Gold, see President.
 Double Up, see EMI.
 Dove, see Kingsway.
 Downing Recs., 45/47 London Rd., Liverpool 3. Tel: (051) 207-7218. Chief Exec.: R. K. Downing; Gen. Mgr.: L. Roberts; Sales Mgr.: L. Simms.
Labels: (Owned) Downing; (licensed domestic) Liverpool Sounds, Spider, Stag.
 DuoKtail, see Phoenix.
 Duck, see Meridian.
 Dynamite Recs. Ltd., Parkgate House, 33 Parkgate Rd., London SW11 4NP. Tel: (01) 223-7547. Telex: 917463. Chm.: Harry Lee; Mng. Dir.: Seymour Fisher.
 E F D S S, see The Folk Shop.
 E G Recs. Ltd., 63A Kings Rd., London SW3 4NT. Tel: (01) 730-2162. Telex: 919205. Dirs.: Samuel G. Alder, Mark A. Fenwick. (Also see Polydor)
 Int'l branch: USA.
 E M I Music Ltd., 30 Gloucester Pl., London W1A 1ES. Tel: (01) 486-6022. Cable: EMIGREAT. Telex: 8953682. Chm. & Chief Exec.: Bhaskar Menon; Pres. & Chief Operating Officer: Ken East; Finance Dir.: Tony Todman; Bus. Affairs & Copyright Dir.: Guy C. Marriott; Technical Resources Dir.: Wally Rand; Mfg. & Dist'n Resources Dir.: Tad Anderson. Int'l Licensee Controller: Ken Butcher; Int'l Repertoire Controller: Ron Harris; Person nel Dir.: Allen Harford.
 E M I Recs. (UK) (IFPI), EMI House, 20 Manchester Square, London W1A 1ES. Tel: (01) 486-4488. Cable: EMIRECDRD. Telex: 22643. Mng. Dir.: Cliff Busby; Finance Admin. Dir.: Colin Hodgson; Mktg. Dir.: Peter Buckle; A&R Dir.: Terry Slater; Int'l Div. Gen. Mgr.: Richard Lytelton; Bus. Affairs Mgr.: Roger Drage; Pub. Exec.: Brian Southall; Bus. Planning Mgr.: Simon Iskander; Sales Gen. Mgr.: Mike Edwards; Audio Visual Projects Mgr.: Geoff Kempin; MDR Gen. Mgr.: Vic Lanza; Classical Gen. Mgr.: John Patrick; Capitol Gen. Mgr.: Martyn Cox; EMI-Harvest Gen. Mgr.: John Cavanagh; Nat'l Promos. Mgr.: Geoff Allerton; Repertoire Mktg. Mgr.: David Hughes.
Labels: (Owned) Ardeck, Capitol, Cobra, Columbia, Double Up, EMI, EMI America, EMI Digital, EMI Int'l, Encore, Executive, HMV, Harvest, Liberty, Note, Nut, Odeon, One Up, Parlophone, Regal Zonophone, Sidewalk, Starline, Talsman, Waverley; (licensed) Chiswick, Island, Rolling Stones, Tamm.
 E S S P: Electronic Synthesizer Sound Projects, The Sound House, PD Box 37b, East Molesey, Surrey KT8 9JB. Chief Exec.: Dave Townsend.
Labels: (Owned) ESSP, Synthesis, Synthesizer I experience.
 Eagle, see Legion.
 Earlobe Recs., 29-31 Dxford St., 5th fl., London W1. Tel: (01) 734-3793. Contact: Larry Uttal.
 Ebony, see Pilgrim.
 Echo, see Collins Int'l.
 Eclipse, see Decca.
 Effects, see Ronco.
 Electric, see Cube.
 Elektra, see WEA.
 Elite Recs. Ltd., 3 Library Parade, Craven Park Rd., London NW10 8SG. Tel: (01) 965-6041, 961-5091. Mng. Dir.: Andrzej Szcuka; Sales Mgr.: Jeremy Pike.
Labels: Elite, No.
 Ellie Jay (Prod'n's) Ltd., 97 Judd St., London WC1. Tel: (01) 388-5771. Telex: 896116. Mng. Dir.: Jack Applebaum; Gen. Mgr.: Paul Heeren; Sales Mgr.: Andy Soppel.
Labels: (Owned) Ellie Jay (distributed by Pinnacle), Jab (distributed by Spartan); (licensed domestic) Vu; (distributed—not licensed) Clearview.
 Embassy, see CBS.
 Ember, see Bulldog.
 Emblem Recs. Ltd., 2 Bridge St., Strathaven, Strathclyde, Scotland ML10 6AN. Tel: (0357) 20386. Mng. Dir.: John McLarty; Sales Dir.: J. Houston Fyfe.
Labels: (Owned) Dorian, Emblem, London.
 Emerald Recs. Ltd. (IFPI), 120 Coach Rd., Templepatrick, Ballyclare, County Antrim, Northern Ireland BT39 0HB. Tel: (08494) 32711. Telex: 747293. Mng. Dir.: Mervyn A. Solomon; Gen. Mgr.: Les Paterson; Rec'g Mgr.: George Doherty; Promos.: Betty Monteith. (Distributed by Chart, Pickwick, Solomon & Peres, Spartan)
Labels: (Owned) Emerald, Great Bands, Mint, Mint Julep, Rip Off.
 Int'l repts.: Australia (Image), Benelux (Dureco in Netherlands), Canada (Morning, Quality, RCA), France (Jacky), Italy (Ar ston), Japan (Polydor), New Zealand (Music World, Viking), USA (Country-Int'l), Fiesta, Gillette-Madison, Tradition).
 Encore, see EMI.
 Energy, see Bulldog.
 Ensign Recs. Ltd., 44 Seymour Pl., London W1. Tel: (01) 723-8464. Telex: 299612. Mng. Dir.: Nigel Grainger; Gen. Mgr.: Dorsen Loader; A&R Mgr.: Chris Hill; Int'l Mgr.: Gregg Lynn. (Distributed by RCA)

Int'l repts.: Europe (RCA) excluding Austria, Germany & Switzerland (all Metronome); Benelux (CNR); Central & South America, Israel, USSR (all RCA); Australia (Astor), New Zealand (CBS), South Africa (RPM).
 Enterprise Recs. Ltd., Unit 1B, 2 Faraday Way, Westminster Ind'l Estate, Woolwich SE 18. Tel: (01) 855-3421. Cable: KASSMUSIC. Mng. Dir.: Edward Kassner.
Labels: (See President).
 Epic, see CBS.
 Esquire Recs. Talent Ltd. (IFPI), 9 Harebell Hill, Cobham, Surrey. Tel: Cobham (09326) 2316. Chief Exec.: Peter Newbrook. (Distributed by Cadillac, Jazz Music, Jazz Servs. Unlimited, Swift, H.R. Taylor, Chris Wellard)
Labels: (Owned) Esquire, Starline.
 Eurobeat Ltd. (IFPI), 13 Bank Square, Wilmslow, Cheshire SK9 1A9. Tel: (0625) 527844. Cable: IMDISC. Telex: 635091. Mng. Dir.: Irving Wilson; Gen. Mgr.: Lesley Thompson; Sales Mgr.: Fiona Sutcliffe. (Importer)
Labels: (Representations) Beat, Duse, Penta-Phon, Pony, West (all Italy).
 Int'l repts.: Australia (EMI), Italy (Beat).
 Euroson, see DI.
 Evangelical Recs., 152 Rowhedge Rd., Rowhedge, Colchester, Essex CO5 7JP. Tel: (0206) 865769. Dir.: M. Lear.
 Evolution Recs., 48 Gloucester Square, London W2. Tel: (01) 402-9373. Dirs.: Johnny Jones, John Michel, Philip Lewis. (Distributed by RCA)
 Excaltiber, see Red Bus & PRT.
 Excelsius, see Dryx.
 Executive, see EMI.
 Expan Mktg. Ltd., E. Marden, Chichester, Sussex PO18 9JE. Tel: (024359) 200. Telex: 86485. Dir.: Bill Waite. (Exporter)
 Exploited, see Supermusic.
 Exploring the World of Music, see Dryx.
 Express Recs., 8 Park St., Lincoln, Lincs. LN1 1UF. Tel: (0522) 33285. Mng. Dir.: Andy Stephenson. (Distributed by Pinnacle)
 Eyemark, see Amberlee.
 F-Beat, see WEA.
 F X Recs., 3 Muswell Ave., London N10. Tel: (01) 444-6870. Dirs.: Ken Gibson, Pat Crumly. (Distributed by Spartan)
 Fabled Medusa Music Co., Circle House South, 65-67 Wembley Hill Rd., Wembley, Middx. HA9 8DP. Tel: (01) 903-6455. Telex: 923421. Mng. Dir.: Colin Meddock.
 Fable Recs. Ltd., 50 Regents Park Rd., London NW1 7SX. Tel: (01) 586-5591. Telex: 299220. Gen. Mgrs.: Roger Whittaker, Irene Collins.
 Fanfare Recs., 1 Broomfield Close, Rydes Hill, Guildford, Surrey GU3 3AW. Tel: (0483) 61684. Mng. Dir.: L.G. Farley.
 Fast Production/Pop Aural, 3/4 E. Norton Pl., Abbeyhill, Edinburgh, Scotland EH7 5DR. Tel: (031) 661-5811. Mng. Dir.: Bob Last; Gen. Mgr.: Hilary M. Morrison; Sales Mgr.: Simon Best. (Distributed by Bonaparte, Fast Prod., Jem/PVC, Pinnacle, Rough Trade, Spartan, Stage Dne, Virgin)
Labels: (Owned) Accessory, Fast Production, Pop Aural.
 Int'l repts.: USA (Rough Trade).
 Faulty Prod'n., 41B Bienheim Crescent, London W11 2EF. Tel: (01) 727-0734. Pres.: Miles Copeland III; Gen. Mgr.: Nick Jones; Sales Mgr.: Steve Tannett. (Distributed by Faulty & A&M)
Labels: (Owned) USA (Rough Trade).
 Faulty Prod'n., 41B Bienheim Crescent, London W11 2EF. Tel: (01) 727-0734. Pres.: Miles Copeland III; Gen. Mgr.: Nick Jones; Sales Mgr.: Steve Tannett. (Distributed by Faulty & A&M)
Labels: (Owned) USA (Rough Trade).
 (Owned) Deptford Fun City, Illegal, Step-Forward; (licensed) IRS.
 Int'l repts.: Worldwide (CBS) excluding Canada, UK, USA.
 Feelgood Recs. Ltd., 14 New Burlington St., London W1X 2LR. Tel: (01) 734-3251. Cable: CARLSNDG. Telex: 267488. Dirs.: Freddy Bienstock, Mike Collier, R. Derek Knibb, Dave Watson.
 Felish Recs. Ltd., 40 Denbigh St., Flat 3, London SW1. Tel: (01) 828-1978. Mng. Dir.: Rod Pearce; Gen. Mgr.: Steve Marshall.
Labels: (Owned) USA.
 Int'l repts.: Australia (Gap), Italy (Italian Recs.).
 Brian Findlay Exports, 45 Shandwick Pl., Edinburgh, Scotland. Tel: (031) 229-3689. Telex: 777493. Gen. & Sales Mgr.: Brian Findlay; Exports Mgr.: Jean Hardie; Ass't: Fiona Powell. (Importer as Bruce's Rec. Shop)
 Firebrand Recs., 18 West Mall, Clifton, Bristol BS8 4BQ. Tel: (0272) 35994. Mng. Dir.: D. Acherman. (Also see Dema)
 First Head, see Submarine.
 Fisher & Lane, 30 Limekiln Ln., Bridlington, North Humberside YO16 5TH. Tel: (0262) 76388.
 Flame, see Nimbus.
 Flamingo Recs., 14 New Burlington St., London W1. Tel: (01) 734-3251. Telex: 267488. Mng. Dir.: Mike Collier.
 Flapper, see Pavilion.
 Flash Prod'n's, 6 Holland Park, Basement Apt., London W11. Tel: (01) 229-0663. Mng. Dir.: Paul K. Walden.
 Fly, see Cube.
 Flying Disc, see JVC.
 Flying Dubs Prod'n's, 204 Mitchem Ln., Streatham, London SW16 6NT. Tel: (01) 677-9883. Mng. Dir.: S. Jeffery; Gen. Mgr.: Angela Graham.
 Flyover Recs., 15 Queen Caroline St., London W6. Tel: (01) 748-1595. Telex: 8951917. Dir.: Louis Raynor; Gen. Mgr.: W. Raynor; Sales Mgr.: P. Callahan.
 Flyright Recs., 20 Endwell Rd., Bexhill-on-Sea, East Sussex TN39 3EP. Tel: (0424) 214-390. Gen. Mgr.: W.J. Bruce Bastard. (Distributed by Swift).
Labels: (Owned) Flyright; (licensed) Magpie.
 Folk, see Duetlet.
 The Folk Shop, Cecil Sharp House, 2 Regents Park Rd., London NW1 7AY. Tel: (01) 485-2206. Dir.: S.A. Matthews; Sales Mgr.: Diane Moody.
 Branches: Exeter, Devon EX4 4JA, 10 Richmond Rd. Tel: (0392) 77285. Mgr.: T. Brown—Leeds LS7 4PU, 5 Norfolk Mount, Chapel Allerton. Tel: (0352) 694-764—Kettering, Northants, 26 Montagu St. Tel: (0536) 83931. Mgr.: Barry Lewis—Newmarket, Suffolk, High View, Ashfield Green, Wickhampton. Tel: (044082) 666. Mgr.: Peter Dashedwood.
Label: (Owned) EFDSS.
 Folktraks Cassettes, 2 Fircliff Park, Portishead, Bristol BS20 9HQ. Tel: (0272) 842209. Dir.: Peter Kennedy.
 Fontana, see Phonogram.
 Forsyth Bros. Ltd., 126 Deansgate, Manchester M3 2GR. Tel: (061) 834-3281. Mng. Dir.: D.R. Loat; Sales Mgr.: H. J. Fullaway.
 Fountain, see Retrieval.
 4 AD, see Beggars Banquet.
 Foyle, see Duetlet Rec'g.
 Free Reed, see High Peak.
 Fresh Air Recs. Ltd. (div. of Tony Hall Group of Companies), 9 Carnaby St., London W1V 1PG. Tel: (01) 437-1958. Cable: TASTES. Mng. Dir.: Tony Hall; Promo: Jeffrey Toms-Smith.
 Fresh Recs., 359 Edgware Rd., London W2. Tel: (01) 402-5485, 258-0572, 724-2377/2350. Telex: 896559. Gen. Mgr.: Alex How; Label Mgr.: Alan Hauser; Sales Mgr.: Charlie Casey; Import/Export Mgr.: Steve Brown.
Labels: (Owned) Fresh; (licensed domestic) Nighthawk; (distributed—not licensed) Bridgeway Clay, Electro-Space, Red.
 Int'l repts.: Austria (Bellaphon), Finland (Polarvox), Germany (Bellaphon), Switzerland (Bellaphon).
 Frog Recs., 24 Haig Rd., Stanmore, Middx. Tel: (01) 954-0959. Mng. Dir.: Bob Clifford.

Labels: (Owned) Frog; (distributed—not licensed) Honeymoon (France).
 From the Jazz Vault, see SPAS.
 Front Line, see Virgin.
 Futurist, see Ultimate.
 G I Recs. Ltd., 37/39 Cockburn St., Edinburgh, Scotland. Telex: 727329.
 Mng. Dir.: Gordon Inglis. (Distributor/Importer)
 G M, see Riva & WEA
 G R P, see Ariola/Arista.
 G T D Recs. (IFPI), 37 Soho Square, London W1. Tel: (01) 439-8971. Telex 24327. Mng. Dir.: Dick Leahy; Press Officer & Mktg. Dir.: Michael Peyton (Distributed by CBS)
Labels: (Owned) Esquire, Starline.
 Int'l repts.: Worldwide (CBS).
 Galaxy Tape & Disc. Co. Ltd. (IFPI), 223 Regent St., London W1R 8TD. Tel: (01) 734-9768. Telex: 24170. Gen. & Sales Mgr.: Philip R. Solomon. (Distributed by CBS)
 Gallery, see Lightning & WEA.
 Gallo, see Blue Chip.
 Gama Recs. Ltd., 498-500 Harrow Rd., London W9. Tel: (01) 960-0955. Telex: 925671. Mng. Dir.: Max Hole.
Labels: (Owned) Australia (CBS), Canada (Passport), New Zealand (CBS), USA (Passport), rest of world (Decca).
 Gamut Publ'n's Ltd. (Gamut Dist'n), All Saints' Passage, Cambridge CB2 3LT. Tel: (223) 358669. Chm.: H.A.I. Woolfenden; Gen. Mgr.: L.W. Smallwood; Sales Mgr.: Michael Deacon.
Labels: (Owned) Gamut; (distributed—not licensed domestic) Abbey, Aerco, Alpha, Bedivere, Guild, Oxford University Press, Vista, Woodward; (distributed—not licensed foreign) Cantilena (Netherlands), Claves (Switzerland), FSM Toccata (Germany), Festivo (Netherlands), Grand Digue (France), Mitra (Germany), Orpheus (Switzerland), Simax (Norway).
 Gazell, see Sonet.
 Ron Geesin, Headrest, Street End Ln., Broadoak, Heathfield, Sussex TN21 8TU. Tel: (04352) 39-94. Dir.: Ron Geesin.
Labels: (Owned) Ron Geesin; (distributed—not licensed) KPM.
 Int'l repts.: Norway (Bat), USA (JEM).
 Gemini, see President.
 Gem Recs., 115-123 Bayham St., London NW1 0AL. Tel: (01) 485-5622. Telex: 25584. Mng. Dir.: David Simone.
 Gimel Recs. (sub. of The Talis Scholars Ltd.), 166 Grove End Gardens, London NW8. Tel: (01) 289-1028. Mng. Dir.: Peter Phillips; Comm'l Dir.: Steve C. Smith.
 Global Recs., 38 Biddulph Mansions, Biddulph Rd., London W9 1HX. Tel: (01) 289-6337. Telex: 21879. Pres.: Peter Kirsten; Gen. Mgr.: Peter Knight Jr.
Labels: (Owned) Canada (Attic), Germany (Metronome), Netherlands (WEA).
 Global Rec. Sales, Canada House, 3 Chestow St., Manchester M1 5EN. Tel: (061) 236-5368. Proprietor: Edwin J. Balber; Gen. Mgr.: Bryan Balber; Sales Mgr.: D. Annis. (Distributor/Importer)
Labels: (Owned) Cream, Swan.
 Gloster Disco & Music Centre, 9 Market Parade, Gloucester GL1 1RL. Tel: (0452) 33084, 419567. Telex: 437223. Contact: John Stewart. (Wholesaler/Importer/Exporter) (SEE ADVERTISEMENT)
 Goal, see Ariola/Arista.
 Go-Fee, see Ariola/Arista.
 Golden Era, see Wilcox.
 Gold Recs., 20 Hyde Park Pl., Bayswater Rd., London W2 2LP. Tel: (01) 723-7985.
 Gold Recs. Ltd., 83 Leonard St., London ECA 4RB. Tel: (01) 729-5411.
 S. Gold & Sons Ltd., 779 High Rd., Leytonstone, London E11 4QS. Tel: (01) 556-2429/8380, 558-2121. Telex: 894793. Chief Exec.: Barrie Gold; Sales Mgr.: Tony Gold. (Distributor)
Labels: (Distributed—not licensed) A&M, Anchor, Beggars Banquet, CBS, Charisma, Charly, Chrysalis, Creole, DJM, Decca, EMI, GTO, Island, Jet, K-tel, Logo, Magnet, Music For Pleasure, Piccadilly, Phonogram, Polydor, Pyle, RCA, Ronco, Stiff, United Artists, Virgin, WEA, Warwick.
 Good Seal, see RCA.
 Goldsmith, see Hot Lead.
 Goldspinners Ltd., PO Box 226, Glamour House, 47 Bengal St., Manchester M60 4AL. Tel: (061) 228-1488. Contact: Eddie Leahy. (Distributor/Wholesaler)
 Georgio Comelsky, see Charly.
 Good City, see Ultimate.
 Good Vibrations Recs., 102 Great Victoria St., Belfast, Northern Ireland BT2 7BE. Tel: 29152. Chief Exec.: Terri Hooley. (Distributed by Good Vibrations & Rough Trade)
Labels: (Owned) Good Vibrations, Good Vibrations Int'l.
 Graduate Recs., 1 Union St., Dudley, West Midlands DY2 8PG. Tel: Dudley (0384) 59048, 211-159. Mng. Dir.: David Virr; Co-Dir.: Susan Virr; Sec'y: Sandra Marshall. (Distributed by Graduate & Spartan)
 Grampan Recs. Ltd., Airport Ind'l Estate, Wick, Calthness. Tel: (0955) 2787. Telex: 75107. Mng. Dir.: James W. Johnston; Gen. Mgr.: John Hunter.
Labels: (Owned) Grampan, Morven.
 Grand Prix, see Sonet.
 Grandstand Recs., see Big Bear.
 Grapevine, see Pilgrim.
 Gray & Butt, 45 King St., Stanford-Le-Hope, Essex SS17 0HI. Tel: (03756) 3041. Sales Dir.: Peter Butt; Gen. Mgr.: Russell Butt. (Distributor/Exporter/Wholesaler)
 Great Bands, see Emerald & Solomon & Peres.
 Great Jazz Whistle, 26 Wenderford Rd., Bromley, Kent. Tel: (01) 460-1139. Owner: G.C. Collier.
Label: (Owned) Reality.
 Great Voices of the Century, see Bulldog.
 Great Western, see Dema.
 Greensleeves Recs. & Tapes, 44 Uxbridge Rd., Shepherds Bush, London W12. Tel: (01) 749-3277. Mng. Dir.: C.J. Sedgwick; Sales Mgr.: Chris Cracknell. (Distributed by Jetstar & Spartan).
Labels: (Owned) Cool Rockers, Greensleeves.
 Int'l repts.: Austria (Bellaphon), Belgium (EMI), France (Barclay), Germany (Bellaphon), Netherlands (Ineco), Switzerland (Barclay).
 Grosvenor Recs., Grosvenor Rec'g Studios, 16 Grosvenor Rd., Handsworth Wood, Birmingham B20 3NP. Tel: (021) 356-9636. Mng. Dir. & Gen. Mgr.: John Richard Taylor. (Also see Hollick & Taylor)
 Grove Music, 425-C Harrow Rd., London W10. Tel: (01) 969-2824. Mng. Dir.: R. Plummer; Gen. Mgr.: M. Campbell.
 Guild Recs., 4 Chestnut Rd., Kingston-on-Thames, Surrey KT2 5AP. Tel: (01) 546-2916. Partners: Nicolas Ware, Barry Rose. (Distributed by Cassion)
 Gull Recs. (IFPI), 33 Portland Rd., Holland Park, London W11 4LH. Tel: (01) 229-9631. Cable: GULLRECDR. Telex: 24224 Ref. 2275. Mng. Dir.: David Howells. (Distributed by PRT)
Labels: (Owned) Gull, Miracle.
 Int'l repts.: France (SPT), Germany (Intercord), Italy (Base), Netherlands (Friends), Sweden (Planet), Switzerland (Phonag).

Gundog Recs., PO Box 6, Ringwood, Hamps. Dir. Philip Gesshand-Tait. (Distributed by Spartan)

Gun Recs., 101-103 Baker St., London W1M 2BE. Tel. (01) 935-3906. 486-8738. Mng. Dir. Barry Kirsch

H & L Recs. Ltd., 122 Shenley Rd., Borehamwood, Herts. Tel. (01) 207-2373. Dir. & Sales Mgr. J. Weston, Dir. L. Woolley, Gen. Mgr. H. Caplan. (Distributor/Importer)

H M V, see EMI

Halcyn, see VJMS

Haltmark, see Pickwick

Hammer Recs. Ltd., PO Box 4BT, 35-37 Wardour St., London W1A 4BT. Tel. (01) 734-7195. Mng. Dir. Des Dolan, Dir. Phyllis Rooney. (Distributed by Hammer & PRT)

Labels: (Owned) DDP, Hammer. (distributed—not licensed) Inferred, Poplar, Scratch

Int'l repts.: Belgium (Elver, Surprise), France (Ibach, Scarpio), Germany (Aniola), Scandinavia (Hammer of Scandinavia)

Hansa Prod'n Ltd., 12 Bruton St. London W1X 7AH. Tel. (01) 493-9766. Telex. 298777. Mng. Dir. Peter Meisel, Dir. Trudy Meisel. (Also see Aniola/Arista)

Label: (Licensed) Aniola-Hansa

Happy Face Recs., The Old Smithy, Post Office Ln., Kempsey, Worcs. Tel. (0905) 820-659. Telex. 339821. Dir. Muff Murrin. (Distributed by Happy Face, PRT, Pinnacle)

Labels: (Owned) Birds Nest, Happy Face, Taaga

Int'l rep.: Germany (Wolff)

Happy House, see Damont

Harbor Recs. Ltd., 73 Newman St., London W1. Tel. (01) 637-4623. Chief Exec. John Schroeder

Harmonia Mundi, 47/51 Chalton St., London NW1 1HY. Tel. (01) 380 0752

Labels: (Owned) Harmonia Mundi France. (distributed—not licensed) Acania (Germany), Astree (France), Callope (France), La Camera Magna (Germany), Foyer (Italy), Harmonia Mundi Deutsche (Germany), MPS (Germany), Tudor (Switzerland), Valdis (France).

Harris & Goldring Ltd., Soundra House, Rear of 239 Edgware Rd., London NW9 6LU. Tel. (01) 200-7383. Telex. 923574. Daners: Neville Harris, Maurice Goldring. (Wholesaler/Rack Jobber)

Harvest, see EMI

Heartbeat, see Cherry Red

Heath Levy Music Co. Ltd., 184 186 Regent St., London W1R 5DF. Tel. (01) 439-7731. Telex. 27557. Mng. Dirs. Geoffrey Heath, Eddie Levy

Heavy Metal Recs., 165 Wolverhampton Rd., Sedgley, Dudley DY3 1QR. Tel. (09073) 2211, 3356. Partners: Paul Birch, Juanita Anderson

Labels: (Owned) Heavy Metal, Revolver

Int'l rep.: Germany (Phonogram)

Hedonics, see Armageddon

Heebeegeebees, see Original

Helios Recs., 28 Dalrymple Crescent, Edinburgh, Scotland: EH9 2NX. Tel. (031) 667-3633. Chief Exec. James Douglas

Helios, see Hyperion

Hep Recs., 34 London St., Edinburgh, Scotland. Tel. (031) 556-7083

Owner: Alastair Robertson. (Distributed by Cadillac, JSL, Jazz Music, Lugton, Swift, TDL, H.R. Taylor, Chris Wellard)

Int'l repts.: Canada (Trend), Japan (Nawa Trading), Switzerland (Plains phase), USA (City Hall, Zim)

Hermes, see Nimbus

Hex Recs. Ltd., Aldwych House, 53/55 Bethel St., Norwich NR2 1NR. Tel. (0603) 23138. Mng. Dir. Clive Hall, Sales Mgr. Alice Aadvark. (Distributed by Rough Trade)

Labels: (Owned) Hex, Paper Pig

Hickory, see Acuff-Rose

High Life, see Bibi Magnetics

High Peak Prods Ltd., Belper, Derby DE5 1BD. Gen. Mgr. B. Vaughan. Tel. (077382) 7910 x 5. (Distributed by JSU, Projection)

Label: (Owned) Free Reed

Int'l repts.: Australia (World Rec. Club), Spain (Guimbarda), USA (Rounder)

Highway Recs. Ltd., 6A Foregate St., Astwood Bank, Redditch, Worcs. Tel. (052789) 3737. Chief Exec. John Zollman, Gen. Mgr. Sue Zollman. (Distributed by JSU, Jazz Music, Projection, Wynd Up)

Labels: (Owned) Highway, Park. (licensed) Leader, Trailer

Int'l repts.: Netherlands (Munch), New Zealand (Club Folk), Norway (Helgeland's Imports), USA (Alcazar)

Hill & Dale, see Leader Sound

Hip Recs., 91A George St., Atrincham, Cheshire WA14 1RF. Tel. (061) 941-3810. Execs. Geoff Hardisty, Mike Reuben, Brian Gilbert

His Master's Voice (HMV), see EMI

Hit Recs., 4 Mount Villas, West Norwood, London SE27. Tel. (01) 670 2642. Chief Exec. Mike Spenser, Gen. Mgr. Johnny Walker, Sales Mgr. Gary Stannard. (Distributed by Bonaparte, Rock-Off, Rough Trade, Vynle Solu Iyon)

Labels: (Owned) Big Cock, Hit

Hollick & Taylor Rec'g Co. Ltd., 16 Grosvenor Rd., Handsworth Wood, Birmingham B20 3NP. Tel. 356-9636. Gen. Mgr. John R. Taylor, Sales Mgr. Jean Taylor. (Distributed by Lugton, H.R. Taylor)

Labels: (Owned) Grosvenor, Hollick & Taylor

Hologram, see Aardvark

Homespun, see Outlet

Hook Line 'N' Sinker Recs., 6a Foulden Rd., Stoke Newington, London N16. Tel. (01) 249-7501. Mng. Dir. Graham Wood, Dirs. S.N. McCready, P.J. Sullivan, A.W. Ruffie. Sales Mgr. Henry Wood. (Distributed by Dead Good, Graduate, Plastic Fantastic, Rough Trade)

Horizon Rec'g Studios Ltd., Horizon House, Warwick Rd., Coventry. Tel. (0203) 21000. Chief Exec.: Barry H. Thomas

Labels: (Owned) Peeping Tom, Square

Horse, see B&C

Hostage Recs. (sub of Bienenstock Publ'g), 20 Belsize Park, London NW3. Tel. (01) 431-0864, 485 1257. Dir. Mel Taggart, Gen. Mgr. Ray Roberts

Hotbox, see Armageddon

Hotel Recs. Ltd., 45 Mount Ash Rd., Sydenham, London SE26 6LY. Tel. (01) 699-5835/7626. Mng. Dir. Frank Rodgers. (Distributed by Spartan)

Hot Lead Recs., 34 Lake Terr., Hunslet, Leeds, York LS10 2JG. Tel. (0532) 700 010. Mng. Dir. Ian R. Smith, Gen. Mgr. A. M. Cain, Sales Mgr. Maurice Lee

Labels: (Owned) Goldsmith, Hot Lead

Human Recs. Ltd., 284 Pentonville Rd., London N1 9NR. Tel. (01) 278-3481. Telex. 893807. Chief Exec. Steve Melnysh, Gen. Mgr. Chris Youle. (Distributed by Stage One) (Importer/Exporter as Napoleon Recs.)

Humber Recs., 49 Newmarket St., Grimsby, South Humberside. Tel. (0472) 40152. Owner: L.A. Johnson

Labels: (Owned) Alley Cat, Humber, Riot, Top Hat

Hyperion Recs. Ltd., PO Box 25, London SE9 1AX. Tel. (01) 859 6156. Telex. 896170. Mng. Dir. Ted Perry. (Distributed by Lugton/Uncorn)

Labels: (Owned) Helos, Hyperion

I & B Recs. Ltd., 240A Kilburn High Rd., London NW6. Tel. (01) 328-9021. Dir. Martin McDonald, Sales Dir. Bill Delaney. (Distributor)

I R C (The Initial Rec'g Co. Ltd.), 1 Melville Rd., Edgbaston, Birmingham 16. Tel. (021) 454-4666. Chief Exec. Karel Beer; Gen. Mgr. Eugen Beer. (Distributed by Spartan)

I R S, see Faulty

I-Spy, see Arista

Ice Recs. Ltd. (HFP), 81 Dsbaldeston Rd., London N16 6NP. Tel. (01) 806-3252. Chm. Eddy Grant, Gen. Mgr. Alpine Grant, Sales Mgr. Rudolph Grant, Financial Controller Stan Blackburne

Int'l branch: Barbados, West Indies, Searles Factory, Christ Church. Tel. 88382. Telex. 2210. Exec. Frank Willison

Igus, see Klux & Musac

Illegal, see Faulty

Illuminated, see Kingsley Sound & Vision

Immediate, see Nems

Impact, see Toxic

Imperial, see A Tel

Import Music Serv., 54 Maddox St., London W1R 9PA. Tel. (01) 499 3161/3187. Telex. 271333. Gen. Mgr. Barry Griffiths. (Distributor/Importer)

Labels: (Owned) Artists House (USA), Barclay (France), Charisma, Concord Jazz (USA), Contemporary (USA), Deutsche Grammophon, ECM (Germany), East Wind, Emarcy, Fontana, Good Time Jazz (USA), MGM, Mercury, Philips, Polydor, RSC, Sandra (Germany), Steeple-Chase (Denmark), Vertigo, Verve

The Impulse Org., 71 High St. E., WallSEND NE28 7RJ. Tyne & Wear. Tel. (0632) 624 999, 626794. Dir. David Wood, Gen. Mgr. Steve Thompson

Labels: (Owned) Neat, Wudwink. (distributed—not licensed) Beverley, Picador, Prince

Incus Recs./Compatible Rec'g & Publ'g Ltd., 112 Hounslow Rd., Twickenham, Middx. TW2 7HB. Tel. (01) 898 4095. Pres. Derek Bailey, Gen. Mgr. Evan Parker, Sales Mgr. M.T. Minay. (Distributed by Cadillac, Jazz Servs. Unim Ted)

Int'l repts.: Germany (FMP), USA (Metalanguage)

Independent Recs., 39 Harmer St., Gravesend, Kent. Tel. (0474) 65687. Chief Exec. John W. Dram, Studio Mgr. David Price

Independent Rec., Sales, 110 Eltham Hill, Eltham, London SE9 5EF. Tel. (01) 850-3161

Label: (Represented) Mutual Music (USA)

Index, see Blue Inc

Indigo, see Dval

Industrial Recs. Ltd., 10 Martello St., London E8. Tel. (01) 254-9178. Mng. Dir. Peter Christopherson, Gen. Mgr. Cozey P. Dridge

Inevitable Hit Machine, see Inevitable Recs.

Inevitable Recs., Bold St., Paradise Suite 126A, Liverpool. Tel. (051) 546-6444, 708-8594

Labels: Inevitable, Inevitable Hit Machine

Inferno Recs. Ltd., 3 Dale End, Birmingham B4 7LN. Tel. (021) 236 9201/5493, 233 1246. Telex. 337072. Dirs. Brian Harris, Keith Thornton, Gen. Mgr. Ray Shepherd, Sales Mgr. Peter Elliot. (Distributor/Importer)

Inset, see Outlet

Instant Recs., 71 St. George's Rd., Cheltenham, Glos. Tel. (0242) 23304. Mng. Dir. & Sales Mgr. Martin Mitchell, Gen. Mgr. Frank Mitchell, Arts

Marylebone delivers the goods.

Representing the best of the UK's independent labels for worldwide licensing and business management.

Representing companies in Europe and South America for the acquisition of international repertoire.

Providing business management and consultancy services to UK Artists and visiting American Artists undertaking UK and European tours.

Providing business management and consultancy services specialising in records and music publishing.

Contact: Tony Calder
Marylebone
Management Service
Limited P.O. Box 212
LONDON SW1
Telephone:
01-730 7291

Telex: 8955771 Music G
Cables:
MARYLEBONEMUSIC
LONDON SW1

Marylebone Music

ic. Dir.: Kury Mitchell.
 International, see RCA.
 Invtcl. see Sydney Thompson.
 Isis Musik, 174a Cavaye Pl., London SW10 9PR Tel: (01) 373-8344 Chm.
 G. Anya, Gen. Mgr.: S. Sommare. (Distributed by Rough Trade)
 Int'l reps.: Australia (Diggerdoo), France (FNA)
 Island Recs Ltd. (IFPI), 22 St. Peter's Square, London W6 9NW Tel: (01)
 741 1511. Cable ACKEE. Telex 934541. Mng. Dir.: Martin Davis, Dir.:
 Dave Domingo, Bus. Affairs Dir.: Tom Hayes; Financial Dir.: Tony Poye; Int'l
 Dir.: Phil Cooper. (Distributed by EMI)
 Int'l branch: USA
 Labels: (Owned) Island, (licensed) Bearsville (USA), Grove, Shelter
 (USA), Ze (France, USA)
 Int'l reps.: Argentina (Microton), Australia (Festival), Austria (Ariola),
 Belgium (Ariola), Brazil (Ariola), Canada (WEA), Chile (Quatro), Colombia
 (Sonolux), Denmark (Sonet), Ecuador (Fadisa), Finland (Scandia),
 France (Phonogram), Germany (Ariola), Greece (EMI), Guatemala (Di
 deca), Hong Kong (WEA), Iceland (Falkinn), India (EMI), Ireland (CBS),
 Israel (K-tel), Italy (Ricordi), Japan (Toshiba-EMI), Kenya (CBS),
 Malaysia (WEA), Mexico (Ariola), Netherlands (Ariola), New Zealand (Festi-
 val), Nigeria (CBS), Norway (Arne Bendiksen), Peru (FTA), Philippines
 (WEA), Portugal (PolyGram), Singapore (WEA), South Africa (RPM),
 Spain (Ariola), Sweden (Sonet), Switzerland (Ariola), Taiwan (WEA), Thai-
 land (WEA), Venezuela (Cordica) USA (Island), Yugoslavia (Jugoton),
 Zimbabwe (RPM).
 J M Recs., Badgers Wood, Cadbury Camp Ln., Clugton in Gordano, Bristol
 BS20 9SB. Tel: (0272) 854675 Mng. Dir.: John Miles (Distributed by
 PRT)
 J S D Recs., 62 Berners St., London W1P 4AE Tel: (01) 580-4720 Telex:
 261298 Mng. Dir.: Joseph Stanley; Gen. Mgr.: Nigel Murray. (Distributed by
 Spartaco)
 Labels: (Owned) Camp, JSD, Mettle, (licensed) September 2nd
 J S P Recs., 112 Sunny Gardens Rd., London NW4. Tel: (01) 203 1324. Mng.
 Dir.: John Stedman; Gen. Mgr.: Shanny Stedman; Sales Mgr.: George
 Wade.
 Labels: (Owned) JSP, (licensed foreign) A&J, Bandera, DTP, Goodie
 Train, Laredo, Margaret, Vanessa (all USA); (distributed-not licensed)
 Baron (USA), Blue Angel (Germany), CJ (USA), Dusty Road (USA), Faith
 (USA), Route 66 (Sweden).
 J S U, see Jazz Servs. Unlimited.
 JVC (UK) Ltd., Eldonwall Trading Estate, Staples Corner, 6/8 Priestley Way,
 London NW2 7AF. Tel: (01) 450-2621 Telex: 92332D. Chm. & Co-Mng.
 Dir.: K. Lowy; Sales Mgr.: G. Barc; Video Sales Mgr.: P. Newell, Hi-Fi Sales
 Mgr.: D. Potts.
 Depot: Leeds 12, 15/17 Copley Hill Way, Copley Hill Trading Estate. Tel:
 (0532) 457385. Telex 557906
 Labels: (Owned) Flying Disc, JVC.
 Jab, see Elite Jay
 Jammy Recs., Inchbank House, 957 Dumbarton Rd., Glasgow, Scotland G14
 9UF Tel: (041) 334-9722. Gen. & Sales Mgr.: Andrew Harvey. Label Mgr.:
 John MacCallan, Press & Promos Mgr.: Andy Collier
 Jarow Prod'n Ltd., 24 York St., London W1. Tel: (01) 487-4266. Dir.: Alan
 Price. Gen. Mgr.: John Price. (Distributed by Stage One)
 Label: (Owned) Key.
 Jay Boy, see President.
 Jazz City, see Wilco.
 Jazz Horizons Ltd., 4 Hoestock Rd., Sawbridgeworth, Herts. CM21 DDD. Tel:
 (0279) 725863, 724572. Chief Exec.: Colin A. Kellam. (Importer)
 Labels: (Imported-exclusive) Daybreak (Netherlands), De Lux (USA),
 Duke (Italy), Hi-Fi (Switzerland), JRC (USA), Jam Session (USA), Jath
 (USA), Jump (Italy), Lotus (Italy), Matrix (Denmark), Metronome (Den-
 mark), Muse (USA), Dnari (Canada), Phoenix (USA), Progressive (USA),
 Revelation (USA), Sackville (Canada), Shoestring (USA), Stash (USA),
 Timeless (Netherlands), Zm (USA); (distributed) Cicala (Italy), Conn
 Rarities (Italy), Jazz Connoisseur (Italy), Jazz Live (Italy), Joker (Italy),
 Natural Organic (USA), Queenisc (Italy), Unique Jazz (Italy).
 Jazz Imports, 152 Toms Ln., Kings Langley, Herts. WD4 8NZ. Tel: (0927)
 64399. Mng. Dir.: Ken Wyatt. (Distributor). (Also Country & Western Im-
 ports, London Theatrical Sales)
 Jazz Music, 7 Kildare Rd., Swinton, Manchester M27 3AB. Tel: (061) 794-
 3525. Chief Exec.: Les Greaves; Gen. Mgr.: Jutta Greaves; Sales Mgr.: J.L.
 Greaves; Warehouse Mgr.: Marc Greaves.
 Labels: (Distributed-not licensed) AB (Germany), Acorn (UK), Aircheck
 (USA), Alamo (UK), Artemis (Sweden), Artistic (UK), Barron (USA), Beeh-
 ve (USA), Big Bear (UK), Black Eagle (UK), Blue Bag (UK), Blue Parrot
 (UK), Blue Rhythm (Germany), Bodswell (USA), Borch Music Box
 (USA), CJMD (UK), Caele (Switzerland), Celtic (UK), Chaz Jazz (USA),
 Cicala (Italy), Claddagh (Ireland), Classic Jazz (USA), Classic Jazz Mas-
 ters (Sweden), Collectors Classics (Switzerland), Collectors Items (UK),
 Collectors Recs. (Switzerland), Comhallas (Ireland), Connoisseur Rarities
 (USA), Dawn Club (Germany), Daybreak (Denmark), De-Luxe (Italy),
 Dixie (USA), Dragon (Sweden), ESP/Base (Italy), 88-Upright (Switzer-
 land), Elite Special (Switzerland), Esquire (UK), Everybody's (Sweden),
 Faith (USA), Fantare (USA), Fat Cat (USA), Fellside (UK), First Heard
 (UK), Flight (UK), Folk Heritage (UK), Fountain (UK), Free Reed (UK),
 Fuse (UK), G&W (UK), Gaeil Inn (Ireland), Gaps (Switzerland), Giants of
 Jazz (UK), Glendale (USA), Golden Era (USA), Grapenhausner (UK),
 Gusto (USA), Halcyon (UK), Halshaw (UK), Hefty Jazz (UK), Henri (USA),
 Hep (UK), Herwin (USA), Highway (UK), Hill & Dale (UK), Incheoninn
 (Ireland), Interplay (USA), Iona (Ireland), JRC/Jath (USA), JSP (UK), JTC
 (UK), Jam (UK), Jam Session (USA), Jazzum (USA), Jazz Club (Switzer-
 land), Jazz Connoisseur (Italy), Jazz Document (Sweden), Jazz Groove
 (UK), Jazz Legacy (France), Jazz Live (Italy), Jazz Mark (USA), Jazz
 Society (Sweden), Jazz Vault (UK), Joke (Germany), Joker (Italy), Jump
 (Italy), Kings of Jazz (Italy), LMC (UK), LTDI (UK), Land of Jazz (USA),
 Leader (UK), Lee Lambert (UK), Look (UK), Lotus (Italy), Lyric (Aus-
 tralia), MWM (Germany, UK), Magic (UK), Magpie (UK), Matrix (Den-
 mark), Metronome (Denmark), Mr. R & B (Denmark), Mole Jazz (UK),
 Monmouth Evergreen (USA), Mood (Germany), Mosaic (UK), Mother
 Earth (UK), Mulligan (Ireland), Muse (USA), Muza (Poland), Natural Or-
 ganic (USA), Neovox (UK), Noia (UK), Nor Jazz (UK), Dgun (UK), Dnari
 (USA), Dnari (UK), Park (UK), Philly Jazz (USA), Phoenix (USA), Phon-
 thetic (Sweden), Progressive (USA), Proprius (Sweden), Pumpkin (USA),
 Queen Disc (Italy), Radio Archives (USA), Raphaela (UK), Rarities (UK),
 Red Lightnin' (UK), Replica (Italy), Revelation (USA), Ri-Disc (Switzer-
 land), Riliphon (Germany), Rip DFI (UK), Rondo (UK), Route 66 (Den-
 mark), Rubber (UK), SRT (UK), Sackville (USA), Saydisc (UK), Scarcrow
 (Germany), 77 Recs. (UK), Shamrock (USA), Shanachie (USA), Shoe-
 string (USA), Silver Hill (UK), Snatch (UK), Solid Sender (Germany), Spo-
 ke (USA), Spottite (UK), Springtime (UK), Star Performance (Switzer-
 land), Stash (USA), Steam (UK), Storyville (Denmark), String (UK),
 Sunbeam (USA), Survival (USA), Swinghouse (UK), Swing World (UK),
 Syndicate Chapter (UK), Tank (UK), Tara (Ireland), Tax (Sweden), Tema
 (UK), Temple (UK), Timeless (Netherlands), Topic (UK), Totem (USA),

Um/Base (Italy), Union Pacific (UK), Unique Jazz (USA), Up (USA), VGM
 (USA), VJM (UK), Vantage (USA), Vogue (France), Vortex (UK), Water-
 front (UK), Wave (UK), Westwood (UK), Whoopee (UK), Wildebeest (UK),
 Wizard (UK), Woodworm (UK), World Jazz (UK), Zm (USA), Zodiac (UK)
 Jazz Servs. Unlimited, 21 Bull Green, Halifax HX1 2RZ. Tel: (0422) 64773
 Owner: John M. Pilgrim; Gen. Mgr.: Phil Harvey; Sales Mgr.: P. Martin.
 (Distributor/importer)
 Labels: (Distributed-not licensed) AK, Acorn, Actual, Advent (USA), Af-
 family, Agram, Amigo, Artistic, Banshee, Big Bear, Big Ben, Black Eagle,
 BlackThorne, Blue Bag, Blue Beat, Blue Parrot, Broadside Sam, Bur-
 lington, Cadillac, Celtic, Charly, Chiltern Sound, Circle (Germany), Col-
 lectors Items, Contemporary, Cream, Dawn Club (Germany), Delmark
 (USA), Dixie, Dutch Swing College, EGD, ENJA (Germany), Esquire, FMP/
 SAJ, Fellside, First Heard, Flyright, Folklore, Fountain, Free Reed, Free-
 less, G & W, Giants of Jazz, Glencoe, Glendale, Greenwich Village, Hal-
 cyon/LC, Hefty Jazz, Hep, Highway, Hobo, Honeydew, Hora (Italy), Im-
 provising Artists (USA), Incus, India Navigation (USA), Interplay, Iona,
 JMS, JSP, Jam, Jazz Live (Italy), Jazzcraft (Denmark), Joker (Italy), Jump,
 Kettle, Lee Lambert, Leader/Trans, Little Luke, Look, Manic, Matrix,
 Megaphone, Melodic, Milestone, Moers, Mosaic, Mother Earth, Mulli-
 gan, Muza, Nat Organic, Neovox, Nessa, New Orleans (USA), Nola, Dg-
 ham, Dgun, Didie Blues, Original, PMR, Phoenix, Phontastic, Pizza, Plain,
 Plant Life, Prestige, Progressive, Pumpkin (USA), Queen Disc (Italy),
 RCA Rarities (Sweden), Red Ball, Red Lightnin', Red Rag, Red Recs., Re-
 velation, Ripoff, Rondo (Germany), Rossendale, Route 66, Rubber, Sack-
 ville (Canada), Sandra, Saydisc, Scarcrow, 77, Shanachie, Shoestring
 (USA), Solid Sender (West Germany), Spittalball (USA), Spottite,
 Springtime, Stash (USA), Steam, String, Sweet Folk, Swing House,
 Swing World, Syndicate Chapter, Tangent, Tara, Temple, Timeless (Neth-
 erlands), Topic, Tradition, Transark, Union Pacific (USA), VJM, Vantage,
 Vendermaire, Vinyl (Germany), Vortex, Waterfront, Waterland (Neth-
 erlands), Wave, Westwood, White Meadow, Whoopee, Who's Who, Wizard,
 World Jazz, Zm (USA), Zodiac.
 Jet Recs. Inc. (UK), 51/53 Islip St., Kentish Town, London NW5. Tel: (01)
 267-2967. Telex: 261478. Dirs.: Simon G. Goodman, John E. Camp.
 Jester's Court, see Broadside.
 Jet Recs. Ltd. (IFPI), 102/104 Gloucester Pl., London W1H 3PH Tel: (01)
 486-6040. Telex: 298995. Pres.: Don Arden, VP: David Arden. (Distrib-
 uted by CBS)
 Int'l branch: USA
 Int'l rep.: Worldwide (CBS)
 Jet Star Recs., 78 Craven Park Rd., London NW10. Tel: (01) 961 5818.
 Telex: 8952720. (Distributor/importer)
 Stuart Johnson Prod'n Ltd., 1 Gledwood Dr., Hayes, Middx. Tel: (01) 573-
 87. Chief Exec.: Stuart Johnson
 Labels: (Owned) Ambulance, Clubland
 Jon, see Chick A-Boom
 Joy, see President.
 K S V, see Kingsley
 K-tel Int'l (UK) Ltd., K-tel House, 620 Western Ave., London W3 0TU. Tel:
 (01) 992-8000 Telex 934195 Mng. Dir.: Colin Ashby, Mktg. Mgr.: David
 Smith, A&R Int'l.: Don Reedman, Financial Controller: Adrian Moulds; Int'l
 A&R Mgr.: Ian A. Wener; Int'l Mktg. Mgr.: Carey Budnick, Promo Mgr.:
 Ian Summer.
 Labels: Arrival, Imperial, K-tel, Kilo, Lotus
 Key, see Jarow & Kingsway.
 Kicking Mule, see Sonet.
 Kilo, see K-tel.
 Kingdom Recs., 9/11 Monmouth St., London WC2H 9DA. Tel: (01) 836-
 4761. Telex: 261507. Mng. Dir.: Terry King
 Kingsley Sound & Vision Ltd., 120 Kings Rd., Fleet, Hants. Tel: (02514)
 20053. Telex: 858893. Chief Exec.: Patrick Smith, Keith Bagley.
 Labels: (Owned) Illuminated, KSV, Kingsley Sounds, (distributed-not li-
 censed) Aardvark, Dmng Dul, Holligram, Hotshot, No Peer, nothing
 Shaking, Paramingo, Spasmodic, Strange Orchestra, Zoolomperone.
 Robert Kingston Prod'n Ltd. (IFPI), 34 Windmill St., London W1P 1HH. Tel:
 (01) 636-9242. Chm.: Robert Kingston, Gen. Mgr.: Barry Kingston. (Distrib-
 uted by PRT)
 Labels: (Owned) Casino Classics, RK; (licensed) DBM
 Kingsway Music Ltd., Lottbridge Drive, Eastbourne, East Sussex BN23 6NT.
 Tel: (0323) 27454. Mng. Dir.: Geoffrey Ronald Shearn, Sales Mgr.: Nigel
 Colman.
 Labels: (Owned) Dove, Key, Kingsway.
 Int'l rep.: USA (Star Song).
 Klub Recs. Ltd., Baltic Chambers, 1st fl., 50 Washington St., Glasgow, Scot-
 land. Tel: (041) 221-0777. Mng. Dir.: Gus McDonald, Dir.: Isabel Waugh.
 (Distributed by PRT) (Also see Music)
 Labels: Iguis, Lochshore, DK.
 Int'l rep.: Worldwide (PRT)
 Kona Publ'n Inc., 335 City Rd., London EC1.
 Label: (Represented) Dficial (USA)
 Korova Recs., 17 Berners St., London W1P 3DD. Tel: (01) 637 3771. Mng.
 Dir.: Rob Dickens; Gen. Mgr.: Peter Reichardt. (Also see WEA)
 L E Recs., Nelson House, Castle Hill Rd., Handley, Wigan, Lancs. WN2 4BH.
 Tel: (0942) 56122. Telex: 62594. Mng. Dir.: W. Leyland, Gen. Mgr.: D.
 Larbey; Sales Mgr.: D. Hughes.
 Labels: (Owned) Castle, LE, PH.
 L D E Recs., 28 Lexington St., London W1H 3HR. Tel: (01) 734-3443. Dir.:
 Hiroshi Kato; Prod'n: Hiroshi Kato, Tokiyoshi Harada.
 The Label Rec. Co., 106 Dawes Rd., Fulham, London SW6 7EG. Tel: (01)
 385-5660/6012. Mng. Dir.: Caruzo Fuller, Tech. Dir. & Prod'r: David
 Goodman; Nat'l Sales & Mktg. Dir.: Tony Mathias
 Lee Lambert Recs., 506-508 Kingsbury Rd., London NW9. Tel: (01) 204
 9422. Cable: LAMMETALS. Telex: 896772. Mng. Dir.: Howard Lambert.
 Prod'n Dir.: Bill Lee. (Distributed by Cadillac, Jazz Servs. Unlimited, TDI,
 Chis Wellard, Wynd Up).
 Lapwing Recs., 14 Thriston Rd., Edinburgh, Scotland EH9 1AN. Tel:
 (031) 447-7959. Dir.: A. Coghill.
 Laser Recs. Ltd., 2 Station Pl., Finsbury Park, London N4. Tel: (01) 263-
 8955. Dir.: Alan J. Davison; Gen. Mgr.: Sandra Brooks; Sales Mgr.: Alex
 Sardinha.
 Int'l rep.: Worldwide (WEA) excluding USA.
 Lasgo Exports, 105-109 Oxford St., London W1. Tel: (01) 439-8766, 734-
 5520. Telex: 8953053. Mng. Dir.: Peter Lassman; Export Dir.: Mark Balla-
 ban; Sales Mgr.: Richard Stern. (Exporter) (SEE ADVERTISEMENT)
 Leader Sound Ltd., 209 Rochdale Rd., Greenfield, Halifax, West Yorks. HX4
 8JE. Tel: (0422) 76161. Mng. Dir.: Bill Leader. (Distributed by Highway)
 Labels: (Owned) Hill & Dale, Leader, Trailer.
 Legion Music/Eagle Recs. (IFPI), 16 Bloomfield Terr., London SW1. Tel:
 (01) 730-9581. Mng. Dir.: Brian Hutch; Gen. Mgr.: Mickey Keen. (Distrib-
 uted by Pinnacle)
 Label: (Owned) Eagle.
 Leisure, see Dansan.
 Leo Sound, 193 Rose Ln., Mossley Hill, Liverpool L18 5EA. Tel: (051) 724-

5612/4553. Mng. Dir.: John Milton; Gen. Mgr.: Jackie Maxwell; Sales
 Mgr.: David Maxwell. (Distributed by Stage One)
 Labels: (Owned) Leo, Silver Hammer.
 Liberty, see EMI Recs.
 Libra Int'l, see BGS.
 Lightning Recs. Ltd., 841 Harrow Rd., Harlesden, London NW10 5NH. Tel:
 (01) 969-7155. Telex: 927813. Mng. Dir.: Raymond M. Laren; Mktg./A&R
 Dir.: Keith Yershon; Financial/Bus. Dir.: Norman Mandell.
 Labels: (Owned) Gallery, Lightning, Old God, Revival, Scope (distrib-
 uted-not licensed) Rock Star, Rollin' Rock (USA)
 Limeight Recs. Ltd., 33 Newman St., London W1P 3PA. Tel: (01) 637-5753.
 Mng. Dir.: John Weston.
 Limited Edition, see Aardvark & Discs Int'l
 Lion Recs., 9 Red Lion Yard, Colchester, Essex. Tel: (0206) 66899. Mgr.:
 Steve Marshall.
 Lismor Recs., 42 Kilmarnock Rd., Glasgow, Scotland G41 3NH. Tel: (041)
 632-9269. Owners: Ronnie Simpson, J. Andrew Harvey.
 Labels: (Owned) Lismor, Neptune, Pulsar, Ryme Time.
 Int'l reps.: Australia (Astor), USA (Fiesta).
 Listen For Pleasure, see Music For Pleasure.
 Little Pilgrim, see Pilgrim.
 Liverpool Sounds, see Downing.
 Live Wire, see Chris Denning.
 Lochshore, see Klub & Music.
 Logo Recs. (IFPI), 119 Wardour St., London W1V 3TD. Tel: (01) 734-6710
 Cable: TRADISC Telex 23880. Mng. Dir.: Geoff Hamington; Sales Mgr.:
 Peter Masson. (Licensed to RCA)
 Labels: (Owned) Logo, Transatlantic.
 Int'l reps.: Australia (7), Austria (Metronome), France (Polydor), Ger-
 many (Metronome), Italy (Ricordi), Japan (Nippon Columbia), Switzer-
 land (Metronome).
 London, see Decca.
 London Theatrical Sales, see Jazz Imports.
 Look Listen & Learn, see Bibi Magnetics
 Look Recs. Ltd. (IFPI), September Sound Studios, 38 Knowl Rd., Golcar,
 Huddersfield, West Yorks. HD7 4AN. Tel: (0484) 658895. Mng. Dir.: Ste-
 phen Goddard, Sec'y: Denis Gallivan, Eng.: Bob Whiteley; (Distributed by
 Jazz Music, Jazz Servs. Unlimited, H.R. Taylor)
 Labels: (Owned) Look, September Sound.
 Loose Change, see Rare Rhythm
 Lotuse, see K-tel.
 Loudon, see Emblem.
 Lowbile, see B&C.
 Lugton Co. Ltd., PD Box 182, Cross Ln., Hornsey, London N8 7SB. Tel: (01)
 348-9122. Cable: MAXITDNE. Telex: 25618. Mng. Dir.: Walter Ficker,
 Gen. Mgr.: Walter Collins; Sales Mgr.: Roger Cornwell. (Distributor).
 Labels: (Distributed-not licensed) AJP, Agrab, Affinity, All About Music,
 Amberlee, Ampro, Anvil, Aquarius, Arcade, Audio Impact, Avenue, BBC,
 Barak, Barboli Society, Bear Family, Big Ben, Big R. Blue Beat, Bravo,
 Bulldog, Caedmon, Camden Classics, Capitol, Chandros, Charly, Clove,
 Contour, Crystal, Crystal Clear, Dansan, Dart, Deyse, Discourses,
 Dynamic, Ebonite, Energy, Enterprise, Fab, Flightstream, Foldback, Ge-
 min, Gold, Grosvenor, Halcyon, Hallmark, Her, Heritage, Hotrock, Howl-
 and & West. Human, Hyperion, Ikon, Impact, Invtcl. Island, JVC, Jay Boy,
 Jazz Vault, K-tel, Kuddecraft, Kiddy Kassetto, Kidstuff, Limited Edition,
 Line, Lingsaphone, Lotus, Major Richards, Manhattan, Melodisc, Melo
 dia, Meridian, Metrosound, Mnt, Mr. Pickwick, Music from York, Music
 Lovers, Music Masters, Nautlius, Nems, News, New World, Doford Uni-
 versity Press, Parada, Pickwick, Pizza Express, Polyphonic, President,
 Quality Prod's, RCA Camden, RCA Camden Classics, RCA Gold Seal, RCA
 Int'l, Radio Edinburgh, Response, Rhoscopy, Rollercoaster, Ronco, SRT,
 Saydisc, Seville, Shell, Bdr, Shure Test Recs., Sky, Sonodisc, Sound Stor-
 es, Spinal, Sportsdisc, Steeplechase, Submarine, Supraphon, Terraviva,
 Swinghouse, Tangent, Technical, Telarc, Tella Story, Tema, Temp,
 Thames, Third World, Sydney Thompson, Tuatha, UJA, Unicorn, Value For
 Money, Viking, Virgin, Walt Disney, Warwick, World Jazz.
 Lyrita Rec'd Edition. (IFPI), 99 Green Ln., Burnham, Slough SL1 8EG. Tel:
 (06286) 4208. Owner: A.R. Itter. (Distributed by Conifer)
 Label: (Owned) Lyrita.
 Int'l reps.: Australia (World Rec. Club).
 M A M Recs. Ltd., 24/25 New Bond St., London W1. Tel: (01) 629-9255.
 Cable: MAMARITSE. Telex: 27867. Mng. Dir.: Geoffrey Everitt. (Also see
 PRT)
 M A P, see Magnum Artists.
 M C A Recs. Ltd. (IFPI), 1 Great Pulteney St., London W1R 3FW. Tel: (01)
 439-9951. Telex: 27782. Mng. Dir.: Stuart Watson; Gen. Mgr.: Martin Sal-
 terthwaite; Sales Mgr.: John Bickley. (Distributed by CBS)
 Labels: (Licensed) ABC (USA), MCA (UK, USA), MCA Coral (UK, USA),
 M C C B, see Recommended.
 M G M, see Polydor.
 M H G Cassettes/Warm Recs., Daily Rd., Maybole, Ayrshire, Scotland KA19
 7AX. Tel: (0655) 82200. Chm.: Mary Harrison-Goudie, Gen. Mgr. & Sales
 Mgr.: Ru de Castro. (Distributed by Pinnacle)
 Labels: (Owned) MHG Cassettes, MHG Recs., Warm; (domestic labels
 licensed for Portugal) Battle of the Bands, Cherry Red, Grove, Manic,
 Pop Aural, Rascal, Record Shack, Rewind, Rok, Rondelet, Rough Trade,
 Skatch.
 Int'l reps.: Portugal (Castro & Lorena, MHG/Warm).
 M W M, see Maxwell Warehouse.
 Madrigal Recs., Elberton Manor, Dveston near Bristol, Glos. Tel: (0454)
 421-371. Telex: 44529. Mng. Dir.: Nick Sandiford.
 Magic, see Submarine.
 Magnet Recs. Ltd. (IFPI), Magnet House, 22 York St., London W1H 1FD. Tel:
 (01) 486-8151. Cable: MAGLNDNDN. Telex: 25537. Chm. & Mng. Dir.:
 Michael Abraham Levy; Gen. Mgr. & Sales Mgr.: Graham Mabbutt.
 Int'l reps.: Argentina (RCA), Australia (Festival), Austria (Musica), Bene-
 lux (EMI), Brazil (RCA), Canada (CBS, Kat Family, MCA), France (Poly-
 dor), Germany (Teldec), Greece (Music Box), Ireland (PolyGram), Israel
 (Hed Arzi), Italy (Durium), Japan (CBS/Sony, Discomate, Japan Recs.),
 Mexico (Peerless), New Zealand (Festival), Scandinavia (EMI), South Af-
 rica (RPM), Spain (Columbia), Switzerland (Musikvertrieb), USA (CBS,
 Kat Family, MCA), Yugoslavia (Jugoslavica).
 Magnum Artists Prod'n, Vision House, 21 Market Hill, Southam, Royal
 Leamington Spa, Warwick, CV33 0AJ. Tel: (092681) 4642. Dirs.: Roger
 Upright, Mike Tobin. (Distributed by PRT)
 Label: (Owned) MAP.
 Magnum Force Recs. & Music Ltd., 1 Sandels Way, Beaconsfield, Bucks. HP9
 2AB. Tel: (04946) 4072. Dirs.: Paul Barrett, Nigel Madon, Adrian Dwelt.
 (Distributed by Pinnacle)
 Labels: (Owned) Magnum Force; (licensed) Prelude.
 Magpie, see Flyright.
 Maiden Music Ltd., 1 Maltravers St., London WC2. Tel: (01) 240-2002. Mng.
 Dir.: B.E. D'Keef; Gen. Mgr.: R. Morris; Sales Mgr.: R. Hill. (Distributed by
 Spartaco)

We Design & Build Exhibition Stands

The complete Exhibition Package

MIDEM, MIP.T.V., CANNES FILM FESTIVAL,
VIDCOM, AND ANY EXHIBITION IN EUROPE



Though primarily concerned with exhibitions, our professional design team work in a variety of areas such as: packaging-point of sale material-corporate identity - record sleeve design - publicity material - window dressing and product design.

Our objectives are to maintain a high standard of design and finish.

Some of our services include . . .

- Designing a stand specifically to meet your requirements.
- Supplying: furniture - floor covering - decor - graphics - finished artwork and promotional aids.
- Organising the hire of video or any other specialist equipment.
- Liassing with official contractors, exhibition organisers and local authorities.

The Amazing
EXHIBITIONISTS



Contact: Lawrence Miller
Telephone 01-851 9324.
24 hour answering service

The Amazing Exhibitionists 39a Mottingham Road, London, England SE9 4QZ Telex 21792 (ref. 3595)

Int'l rep.: Netherlands (Ring).
 Mainline Rec. Co. Ltd., 51 Leslie Park Rd., Croydon, Surrey. Tel: (01) 656-7919. Telex: 896691. Mng. Dir.: Peter Collins; Gen. Mgr.: Richard Jones; Sales Mgr.: Dave Histed; Warehouse Mgr.: Paul Hewlett.
 Label: (Owned) Bumper.
 Mainspring Recs., 2 Derby Crescent, Sunbury-On-Thames, Middx. Tel: (76) 82358. Dir.: Bob Britton.
 Making Waves Rec. Dist'n, 10 Southwick Mews, London W2. Tel: (01) 262-7377. Partner & Financial Exec.: Clive Davison; Partner & Gen. Mgr.: Dave Lawrence; Sales Mgr.: Barry Martin.
 Labels: (Owned) Making Waves; (distributed-not licensed domestic) Afinity, Burlington, Charly, Flyright, Free Reed, Initial, Jigsaw, Maggie, Mole, Mooncrest, Plant Life, Pulse, Rag Baby, Rec Lightning, Rocksteady, Rooster, Strung, Topic, Trojan; (distributed-not licensed foreign) Ace (USA), Adelphi (USA), Advent (USA), Amazing (USA), Arhoolie (USA), Blind Pig (USA), Blue Goose (USA), Blues Classics (USA), Bullfrog (USA), Celestial Harmonies (USA), Claddagh (Ireland), Clean Cuts (USA), Fate (USA), Flying Fish (USA), Flying High (USA), Folkways (USA), India Navigation (USA), Innovative Communication (Germany), Kaleidoscope (USA), Kuckuck (Germany), Mr. R&B (Sweden), Mulligan (Ireland), Munich (Netherlands), Musketime (USA), Nessa (USA), Nighthawk (USA), Diddle Blues (USA), Old Timey (USA), Dmac (USA), Paris Album (France), Philo (USA), Pure Freude (Germany), Rainlight (USA), Rebel (USA), Ridge Runner (USA), Rinconada (USA), Rounder (USA), Route 66 (Sweden), Shanachie (USA), Sky (Germany), Solid Smoke (USA), Spoon (Germany), Sugar Hill (USA), Tara (Ireland), United (USA), Windham Hill (USA), Yazoo (USA).
 Marble Arch, see Pickwick.
 Marshalls, see Pilgrim.
 The Martyrwell Music Co. Ltd., 40 Bramham Gardens, London SW5. Tel: (01) 370-5353. Chm.: N.J.W. Stewart. (Distributed by Virgin)
 Matastick, see Cavalis.
 Mawson Wareham (Music) Ltd., Heath House, 11 Blackett St., Newcastle-upon-Tyne. Tel: (0632) 26461. (Distributed by Spartan)
 Labels: (Owned) MWM, Rubber, Vallium.
 Int'l repa.: Australia (Counterpoint), Denmark (Triangle), Germany (Eulenspiegel), Italy (Ricordi), New Zealand (Club Folk), Spain (Compania Fonografica), Switzerland (Be-Bo), USA (Cown Home, Rounder).
 Max's Kansas City, see President.
 Melodic, see H.R. Taylor.
 Mercedes Music Corp. (UK) Ltd., 54 Hanover Steps, St. George's Fields, London W2 2YG. Tel: (01) 724-1681, 954-4120. Telex: 24224 ref. 2722. Mng. Dir.: Colin Medlock; Gen. Mgr.: Bernard Bain.
 Merco, see Multiple Sound.
 Mercury, see Phonogram.
 Meridian Recs., PO Box 317, Eltham, London SE9 4SF. Tel: (01) 857-3213. Chief Exec.: John Shuttleworth; Gen. Mgr.: Francis Loring. (Distributed by Lugton, H.R. Taylor)
 Labels: (Owned) Duo, Meridian.
 Int'l repa.: Australia (Counterpoint), Chile (Musitaden), France (Adda), Norway (Tangen Audio), Sweden (Musik Dist.).
 Metal Rec'g & Publ'g Ltd., 75 Woodpark Dr., Knareborough HG5 9DL. Tel: (0423) 863-776. Chief Exec.: Frank Stuart-Brown. (Distributed by Pinnacle)
 Metropolitan & Belmont Recs. Ltd., Scotia House, 169 Knightsbridge, London SW7. Tel: (01) 589-1400. Telex: 22264. Mng. Dir.: Mark R.F. Hanau; Sales Mgr.: A. Carson.
 Labels: Candhaven, Metropolitan, SF Original, Talkie Tapes.
 Mettle, see ISO.
 Midland Rec. Co., Chase Rd., Brownhills, West Midlands WS8 6JT. Tel: (05433) 3083, 78222. Telex: 919-249. Mng. Dir.: W.P. Riley. (Distributor-cutouts/Importer/Exporter).
 Branch: Brentford, Middx. TW9 9EW, Western House, Great West Rd. Tel: (01) 568-7482.
 Mike's Country Music Room, 18 Hilton Ave., Hilton, Aberdeen, Scotland AB2 3RE. Tel: (0224) 44776. Chief Exec.: Mike Craig; Gen. Mgr.: Angela Craig. (Distributor/Importer)
 Labels: (Distributed-not licensed) Amazing, Blind Pig, Country, Cowboy Carl, Delta, Flying Fish, Flying High, Greenhays, Heritage, Leather, Mountain, Old Homestead, Pedaca, Rebel, Regency, Fich R Tone, Ridge Runner, Rounder, Sierra/Briar, Sugar Hill (all USA).
 Mike Mingard Org., 9-11 Monmouth St., London WC2H 9DA. Tel: (01) 836-4761. Chm.: Mike Mingard.
 Mint, see Emerald & Solomon & Peres.
 Mint Julep, see Emerald & Solomon & Peres.
 Miracle, see Gull.
 Mr. Pickwick, see Pickwick.
 Mojo Dist'n, 55 Boscombe Rd., London W12. Tel: (01) 743-2138. Contacts: M. & Peter Claridge, Steve Hillier. (Distributor)
 Monson Recs. Ltd., The Cottage, Reading Rd., Lower Basildon, Reading, Berks RG8 9NL. Tel: (049162) 789. Contact: Del Taylor.
 Mooncrest, see B&C.
 Morven, see Gramplan.
 Moss Music, 6 Allhalland St., Bideford, Devon. Tel: Bideford 5994. Chief Exec.: Eric A. Moss. (Importer/One Stop)
 Mother in Law, see Ariola/Arista.
 Motor Recs. Ltd., 346 Farnham Rd., Slough, Berks. Tel: (0753) 29628. Telex: 847807. Mng. Dir.: Don Gallacher.
 Motown Recs. Ltd., 16 Curzon St., London W1. Tel: (01) 493-1603. Telex: 8811658. VP Int'l Opns.: Peter Prince; Gen. Mgr.: James Fisher.
 Home office: USA.
 Labels: (Owned) Motown, Mowset, Prodigal, Rare Earth.
 Mountain Recs. Ltd. (IFPI), 49 Mount St., London W1Y 5RE. Tel: (01) 491-2904. Telex: 269398. Chm. & Mng. Dir.: Derek N'col; Gen. Mgr.: P.A. Nicol.
 Int'l rep.: Worldwide (Phonogram Int'l) excluding Canada & USA (A&M, RCA).
 Mowset, see Motown.
 Multicord Recs., 3 Ravensworth View, Dunston, Tyne & Wear. Tel: (0632) 609-209. Dir.: Ken McKenzie; Chief Exec.: Malcolm Hall; Prod'n Mgr.: Do-reen Stephenson.
 Labels: (Owned) Multicord, Porage.
 Multiple Sound Dists. Ltd., 79 Blythe Rd., London W14 DHP. Tel: (01) 602-3483. Cable: MULTISOUND. Telex: 914382. Chm. Ian F. Miles; Dir.: Anne Miles; Sales Dir.: M. Hitches; Finance Dir.: P. Param.
 Labels: (Owned) Chevron, Merco, Parade, Spire, Tempo, Warwick, Windmill.
 Int'l repa.: Worldwide (CBS), excluding Canada (A&M), New Zealand (Music World).
 Musac (Scotland) Ltd., Baltic Chambers, 50 Wellington St., Glasgow, Scotland G2 6HJ. Tel: (041) 221-1948. Mng. Dir.: Angus Ian McDonald; Sales Mgr.: Douglas MacLeod. (Distributed by PRT) (also see Klub)
 Labels: Iqus, Lochshore, OK.
 Muscbebound, see Armageddon.

Music for Pleasure Ltd. (IFPI), 1-3 Unbridge Rd., Hayes, Middx. Tel: (01) 561-3125. Telex: 934614. Mng. Dir.: E.J. Harris; Financial Dir.: G. McDade; Mktg. Mgr.: S. Foster.
 Labels: (Owned) Classics for Pleasure, Listen For Pleasure, Music for Pleasure.
 Int'l repa.: Worldwide (EMI Int'l) excluding Australia (EMI-Listen for Pleasure only).
 Myrrh, see Word.
 N.Y.O. Recs., 11 Victor Rd., Harrow, Middx. HA2 6PT. Tel: (01) 863-2717. Mng. Dir.: W.M.A. Ashton.
 Nada-Pulse Recs., 11 Woodfield Gardens, Leigh-on-Sea, Essex. Tel: (0702) 72294. Mng. Dir.: Dave Lawrence. (Distributed by Making Waves).
 Labels: (Owned) Nada, Pulse.
 Int'l repa.: Australia (Musicland), Italy (IRD), Scandinavia (Uniton), USA (Greenworld, Jem).
 Napoleon Recs. see Human (SEE ADVERTISEMENT)
 Nashville Int'l, see Camby.
 Neat, see Impulse.
 Nelson Recs., Nelson House, Castle Hill Rd., Hindley, Wigan, Lancs. Tel: (0942) 58777. (Also see Castle)
 Nems Recs. Ltd., 31 Kings Rd., London SW3 4RD. Tel: (01) 730-9416. Telex: 913884. Chief Exec.: Patrick Meehan; Gen. Mgr.: Peter Parkinson; Sales Mgr.: Ian Atkins; Promos. Mgr.: Bruno Dean.
 Labels: (Owned) Immediate, Nems.
 Int'l repa.: Australia (Festival), Benelux (Dureco), Brazil (RGE/Fermata), France (Arabella), Italy (RCA), South Africa (Trutone), Spain (Mediteraneo).
 Neon Recs. Ltd. (Bulle Recs. Mail Order), Astonfields Ind. Estate, Unit 4, Romford Rd., Stafford. Tel: (0785) 41311. Telex: 367140. Mng. Dir.: David W. Salmon; Gen. Mgr.: Mark D. Stevenson. (Distributor/Importer)
 Neptune Recs. Ltd., 31 Old Burlington St., Mayfair, London W1. Tel: (01) 437-2066. Mng. Dir.: Linda Turner.
 Neptune, see Lismor.
 Nervous Recs., Block 36, Flat 4, Dabbs Hill Ln., Northolt, Middx. Tel: (01) 422-3462. Mng. Dir.: Roy Williams; Partner: Stuart Webster. (Distributed by Pinnacle, Swift, Tonal)
 Label: Nervous Int'l.
 New Hormones Prods. Ltd., 50 Newton St., Manchester M1 2EA. Tel: (061) 236-9849/9840. Contacts: Richard Boon, Stuart James, Peter Wright, Margaret Trotter. (Distributed by Rough Trade, Virgin)
 Labels: (Owned) New Hormones; (distributed-not licensed) Defensive.
 New Music Ents., 259 Marvels Ln., Grove Park, London SE12 9PT. Tel: (01) 857-6189. Mng. Dir.: Paul Davis; Gen. Mgr.: Ron Palmer; Sales Mgr.: Roger Hill; Dist'n Mgr.: Hazel Davis.
 Labels: (Owned) New Music; (distributed-not licensed) Herald (USA), (distributed-not licensed) Pilot (Sweden).
 Int'l repa.: Sweden (Pilot), USA (Herald).
 New World, see President.
 Nighthawk, see Fresh.
 Nimbus Recs. Ltd., Wyastone Leys, Nonmouth NP5 3SR. Tel: (0600) 890682. Telex: 498378. Dirs.: N. Libin, M. & G. Reynolds.
 Label: (Owned) Acanthus, Amber, Flame, Hermes, Nimbus, RNR, Sphinx.
 No, see Eite.
 NoLa Recs., 16 Clement Close, Purley, Surrey CR2 4BY. Tel: (01) 668-6772. Chief Exec.: Thomas N. Stagg. (Distributed by Cadillac, Jazz Music, Jazz Servs. Unlimited, NoLa, Swift, VJM, Chris Wellard)
 Labels: (Owned) Carrot, NoLa.
 Int'l repa.: USA (Gentilly).
 Noneseuch, see WEA
 Non Stop Recs. Ltd., 11 Cross Keys Close, London W1. Tel: (01) 486-5741. (Distributor)
 Nostalgia, see Wilcox.
 Note, see EMI.
 Novus, see Ariola/Arista.
 Nut, see EMI.
 D C R, see Orbach & Chambers
 O K, see Klub & Musac.
 O K Wave, see Old Knew Wave.
 Oakwood Recs./Ace Recs., 75 Strode Park Rd., Herne Bay, Kent. Tel: (02273) 4066. Mgr.: Graeme Quanton Jones, Sales Mgr.: Chris Bailey.
 Labels: Ace, Oakwood.
 Ocean Recs. Ltd., 91-93 High St., Harlesden, London NW10. Tel: (01) 965-9223. Cable: CREMUS Mng. Dir.: David Brooks; Gen. Mgr.: Susan Mann; Sales Mgr.: Alan Brooks. (Distributed by CBS/Creole)
 Labels: (Owned) Ocean, Pastiche.
 Int'l repa.: Germany (Teldec), Netherlands (Dureco), Scandinavia (K-Tel).
 Odeon, see EMI.
 Odyssey, see CBS.
 Off Street Recs., 1 Gledwood Dr., Hayes, Middx UB4 0AG. Tel: (01) 573-8744. Chief Execs.: Stuart Johnson, Kris Staines. (Distributed by Pinnacle)
 L'Oiseau Lyre, see Decca.
 Old Gold, see Lightning.
 Oldies Unlimited, Dukes Way, St. Georges, Telford, Shropshire TF2 9NQ. Tel: (0952) 612244, 617625, 618264. Telex: 35493. Chief Exec.: Anthony Lewis; Sales Mgr.: T. Heath. (Distributor/Importer-excess stock, cut-outs-singles)
 Old Knew Wave Recs., c/o The Victory Cafe, 54 Eversholt St., Somers Town, London NW1. Co-ord.: Keith Armstrong. (Distributed by S. Gold & Son, Old Knew Wave, Rough Trade)
 Labels: (Owned) OK Wave, Old Knew Wave.
 Oliver "D", see Dansan.
 101 Recs. Ltd., 101 St. Johns Hill, London SW11. Tel: (01) 228-0597. Mng. Dir.: Frank Sansom; Gen. Mgr.: Bob Salmons; Sales Mgr.: Bob Barnes. One Up, see EMI.
 Opus, see Saga.
 Orange Recs., 15 Old Church St., London SW3. Tel: (01) 351-3340. Chm. Clifford S. Cooper; Mng. Dir.: Dennis R. Sinnott.
 Orbach & Chambers Ltd., 74 Long Ln., London EC1. Tel: (01) 606 9373. Mng. Dir.: Michael Chambers.
 Label: (Owned) OCR.
 Orchid, see Bibi Magnetica.
 Ornel/Welsh Arts Council, 53 Charles St., Cardiff, Wales. Tel: (0222) 395 548. Dir.: A.M. Thomas; Gen. Mgr.: Meic Stephens; Sales Mgr.: Peter Finch.
 Original Recs. Ltd., 2 Bloomsbury Pl., London WC1. Tel: (01) 580-6996. Dirs.: Laurence Aston, Don Mousseau. Exec. Ass'ts: Helena Blakemore, Alison Spark.
 Labels: (Owned) Heebeegbeebes, Original.
 Int'l repa.: Australia & New Zealand (Powderworks)
 Oryx Recs. Ltd., 281 Snowdon Quay, Portlathmad, Gwynedd, Wales.
 Labels: Bach Collectors, Canofan, Cosmopolitan, Excelsius, Exploring the World of Music, Dryx, 3 Centuries of Music.
 Outlet Rec'g Co. Ltd. (IFPI), Duttlet House, 48 Smithfield Square, W. Bel

fast, Northern Ireland BT1 1JD. Tel: (0232) 22826. Mng. Dir.: William M.A. McBurney; Gen. Mgr.: James Gough; Sales Mgr.: Ray McGuigan; Accounts Dir.: Ann Collin.
 Labels: (Owned) CRC, Derry, Folk, Foyle, Homespun, Inset, Outlet, Praise, R&O, Soccer, Ulster, Zip; (distributed-not licensed) ARA, Aisling, Bar, Blackbird, Bonus, Claddagh, Denver, Dolphin, EMI, Free Reed, Gaeil Linn, Glenside, Harp, Hawk, Horslip, Isle, ID, Leaf, Lismor, Misty, Mulligan, Oats, Olympic, Play, Poor Genes, RMI, Release, Resistance, Ruby, Shamrock, Sharp, Silver Hill, Solo, Star, Tap, Topic, Top Spin, Tralee, Tribune, Triskel, Velvet.
 Oval Recs. Ltd., 11 Loston Rd., London SW4 DDG. Tel: (01) 622-0111. Dirs.: Charlie Gillett, Gordon Nelki.
 Labels: (Owned) Indigo, Oval; (licensed foreign) In-Swallow (USA).
 Int'l repa.: Australia (Gap).
 P H, see LE.
 P R T, 132 Western Rd., Mitcham, Surrey CR4 3UT. Tel: (01) 648-7000. Telex: 264003. Gen. Mgr.: Howard Barrow, A&R/Mktg. Dir.: Matt Hawkwood; UK Sales Mgr.: Tony Smith; Sec'y/Contract Mgr.: Madeline Hayward; Export Mgr.: Harry Castle.
 Labels: (Licensed domestic) Excalibur, MAM, Red Bus, Rialto, Splash, Sugarhill; (licensed foreign) Buddha, Casablanca, Cream/HV, Vanguard (all USA); Vogue (France); (distributed-not licensed) Academy, Ariola, BBC, Klub, Magnet, RK, Sonet.
 Int'l repa.: Australia (Astor), Belgium (Vogue), Canada (Phonodisc), France (Vogue), Germany (Ariola), Italy (Ricordi), Scandinavia (Sonet), South Africa (Teal), Spain (Zafiro).
 P V C, see Pacific.
 P V K Recs., Sands Estate, Stewart House, Hillbottom Rd., High Wycombe, Bucks. Tel: (0494) 36301. Telex: 837173. Chm.: Peter Cormack; Gen. Mgr.: Geoff Robinson; Sales Mgr.: Cliff Stewart. (Distributed by Spartan)
 Int'l repa.: France (Musidisc), Germany (Teldec), Israel (Hataklit), New Zealand (RTC), Scandinavia (K-Tel), Spain (Discom).
 Pacific Recs. Ltd., 51-53 Islip St., Kentish Town, London NW5. Tel: (01) 267-2917. Telex: 261478. Gen. Mgr.: Pete Macklin; Sales Mgr.: Geoff Wilmott. (Distributor/Importer)
 Labels: (Owned) PVC, Passport, Visa; (distributed-not licensed) EMI (Australia), Ralph (USA), Red Rhino (USA), Solid Smoke (USA).
 Int'l repa.: USA (Jem).
 Panda Recs., 2 Catherine St., Seaside, Llanelli, Dyfed SA15 2PA. Tel: (05542) 52490, 58913. Chief Exec.: Paul Adams; Gen. Mgr.: A. Phillips.
 Paper Pig, see Hery.
 Paper Recs. Ltd., 31 Old Burlington St., London W1X 1LB. Tel: (01) 437-6216. Telex: 25968. Chm.: Laurence Ronson; Gen. Mgr.: Kevin Eade; Sales Mgr.: Billy Lawrie.
 Parade, see Multiple Sound.
 Park, see Highway.
 Park Lane Recs., 9 Hiltgate St., London W8 7SP. Tel: (01) 727-2791. Telex: 25728. Gen. Mgr.: Philip Straight.
 Parlophone, see EMI.
 Parnote Dist'n, 47-51 Chalton St., London NW1 1HY. Tel: (01) 388-9906. Telex: 21792 ref. 854. Mng. Dir.: Alan Goulden; Gen. Mgr.: Harry Williams; Mktg. Mgr.: Bernard Pallut. (Distributor/Importer/Exporter)
 Labels: (Owned) Deluge; (distributed-not licensed domestic) Abbey, Cameo Classic, Nimbus, Pearl, Rubin, Sunday Opera, (distributed-not licensed foreign) Acantha (Germany), Adera (France), Bongiovanni (Italy), Calliope (France), Da Camera (Germany), Discocorp (USA), Foyer (Italy), HRE (USA), Harmonia Mundi (France, Germany), Hungaroton (Hungary), Ingram (France), Italo (Italy), MFS (Germany), Melodram (Italy), Opera Rara, Paragon (Italy), Preiser (Austria), RCA (Italy), Ricordi (Italy), Tudor (Switzerland), Turnabout-Vox (USA), Vanguard Classical (USA), Voce (USA), Valois (France).
 Passion, see Cherry Red.
 Passport Recs., 51/53 Islip St., Kentish Town, London NW5. Tel: (01) 257-2967. (Also see Pacific)
 Pastiche, see Ocean.
 Pavilion Recs. Ltd., 48 High St., Pembury, Tunbridge Wells, Kent. Tel: 2042. Pres. Gen. & Sales Mgr.: Charles Haynes.
 Labels: (Owned) Flapper, Pavilion, Pearl.
 Int'l repa.: Australia (Counterpoint), Canada (Almada), France (LMC), Germany (Deutsche Oversea), Ireland (Lam Green), Italy (Florence Int'l), New Zealand (Marbeck), Norway (Nebj), Switzerland (Oversea), USA (Qualiton).
 Peach River, see Bungey Bankier-Jukes Int'l.
 Pearl, see Pavilion.
 Pear Recs., 7 Woodside Grove, Harburn, Stockton-on-Tees, Cleveland. Mng. Dir.: Alan Cole; Gen. Mgr.: Andrew Ormston; Sales Mgr.: Chris Andrews.
 Peeping Tom, see Horizon.
 Peerless Rec. Co. Ltd. (IFPI), Gunshot Farm House, Gunshot Common, Wisborough Green, Sussex RH14 0AQ. Tel: (0403) 752-373. Mng. Dir.: Derek Lawson.
 Labels: (Owned) Oryx, Peerless, Proms. (licensed) CMS (USA), Desto (USA).
 Pendulum Music Ltd., 11 Cross Keys Close, London W1M 5FY. Tel: (01) 486-0596. Telex: 23733. Mng. Dir.: Johnny Stirling.
 Philips, see Phonogram.
 Phoenix Rec. & Filmworks, 14 Melville Terr., Edinburgh, Scotland. Tel: (031) 667-1310. Mng. Dir.: John Mayer; Sales Mgr.: Mike Connor. (Distributed by Spartan)
 Labels: (Owned) Country & Eastern, Ducktail, Phoenix, Playaway
 Int'l repa.: France (Disc'Az), Netherlands (Fleet Benelus).
 Phonogram Ltd. (IFPI), 49 New Bond St., London W1Y 9XA. Tel: (01) 491-4600. Telex: (851) 261583. Mng. Dir.: Brian Shepherd, A&R Dir.: Chris Briggs; Admin. Dir.: Neil McEwan; Mktg. Mgr.: Tony Powell, Legal Dir.: John Kennedy.
 Labels: (Owned) Casablanca, Fontana, Mercury, Philips. (licensed foreign) Can't Stop, De-Lite (both USA); (distributed-not licensed) Charisma.
 Int'l repa.: Worldwide (PolyGram).
 Pickwick Int'l Inc. (GB) Ltd. (IFPI), The Hyde Ind'l Estate, The Hyde, London NW9 6JU. Tel: (01) 200-7000. Cable: PICKREC. Telex: 922170. Chief Execs.: Monty Lewis, John Frun; Gen. Mgr.: Alan Friedlander; Pickwick Rec. Dist. Gen. Mgr.: Steven Lewis.
 Labels: (Owned) Hallmark, Mr. Pickwick, Pickwick, (licensed) Camden, Contour, Hallmark/Marble Arch.
 Int'l repa.: Argentina (EMI), Brazil (RCA), Mexico (Gamma)
 Pickwick Rec. Dists. Ltd., The Hyde Ind'l Estate, The Hyde, London NW9 6JU. Tel: (01) 200-7000. Cable: PICKREC. Telex: 922170. Chief Exec.: Stephen Lewis.
 Pilgrim Recs., 1 Bath St., London EC1 9LB. Tel: (01) 251-2925. Mng. Dir.: David A. Payne; Gen. Mgr.: John Paculabo.
 Labels: (Owned) Ebony, Grapevine, Little Pilgrim, Marshalls, Pilgrim, Sharon; (licensed foreign) HeatWarming, Impact, Lamb & Lion, New-Pax, Paragon, Refuge (all USA).
 Int'l repa.: Denmark (Nye Toner), Finland (Finagospel), Netherlands

(GMI), Norway (Gospel Music), Sweden (Gospel Music)
 Pinnacle Recs., Electron House, Cray Ave., Orpington, Kent BR5 3QJ Tel (0689) 25741 Telex 896141 Chm Terry Scully, Gen Mgr Tony Berry, Sales Mgr Robin Wells, Int'l Dir Laurie MacGregor
Labels: (Owned) Pinnacle, Street Beat, (distributed) Ace/Chswick, Ar rival, Cherry Red, Eagle, Earlobe, Factory Faulty Prods., Goodfoot Groove, Magnum Force, Trojan
 Int'l reps.: Benelux (Telstar), France (CBS, Disc'AZ), Germany (Teldec), Italy (CGD), Scandinavia (Mariann), USA (Epic)
 Pipe, see Cherry Red
 Plankton Recs., 28 Earham Grove, Forest Gate, London E7 9AW Tel (01) 534-8500 Sr Partner Simon Law
Labels: (Owned) Plankton, (licensed foreign) Gutta (Sweden)
 Int'l rep.: Sweden (Ernvik/Gutta)
 Plant Life Recs Ltd (IFPI), 60 St James St London SW1 1LE Tel (01) 499 4341 Telex 266537 (Distributed by JSU & Projection)
 Plant Music Ltd., 60 St James St., London SW1A 1LE Tel (01) 499 4341 Chief Exec A Yadgaroff, Gen Mgr S Margu, Label Mgr L Yadgaroff, A&R S Twigg
 Plastic Fantastic Recs., 22 Tavistock St., London WC2A 7PH Tel (01) 240 1032, Mng Dirs Tony Randolph, Paul Rodriguez, Ethnic Prod Dir Ty rone Patterson (Distributed by Pinnacle)
Labels: (Owned) Plastic Fantastic, Ultra
 Platform, see Champ
 Playaway, see Phoenix
 Pleasdeck Ltd., 45 Barrington Court, Colney Hatch Ln., Muswell Hill, London N10 Tel (01) 883 0775 Mng Dirs John Glover, Peter Booth (Distrib uted by Stage Dne)
Label: (Owned) Street Tunes
 Plura, see Zircon
 Polo, see Creole
 Polydor Ltd., 15 St George St., London W1A 2BR Tel (01) 499 8686 Telex (851) 27133 Mng Dir A J Morris, A&R Dir Jim Cook, Int'l Exploratio n John Peron, Mktg Mgr Nigel Reveler, Pop Prod George McManus, Press & PR Andy Hoy, Promo Arthur Sheriff, Legal & Bus Affairs Clive Fisher
Labels: (Owned) Archiv, Capricorn, Deutsche Grammophon, EG, MGM, Polydor, Privilege, RSO, Verve, (licensed domestic) Bronze, (licensed forei gn) CTI, Dreamland, Fiction, Kudu, Phil Spector Int'l, Spring
 PolyGram Leisure Ltd., 15 St George St., London W1A 2BR Tel (01) 499 3751 Cable SYMPHDNY Telex 268403 Chm & Chief Exec David G Fine, Legal & Bus Affairs MA Kuhn Finance & Admin W Poldervaart, Rec Opns R Lopez
 PolyGram Rec Opns Ltd (IFPI), 15 St George St London W1A 2BR Tel (01) 499 3751 Telex (851) 27133 Mng Dir Ramon Lopez, Comm'l Dir Clive Swanson, Finance & Admin Dir John Crane
 Polyphonic Reproductions Ltd., 77 779 Dudden Hill Ln., London NW10 1BD Tel (01) 459 6194 Mng Dir, Stan Kitchen (Distributed by Lugton Pin nacle, H R Taylor, Wynd Up)
 Polysonics Int'l Ltd., Polysonics House, 248 Walton Rd., East Molesey, Sur rey K18 9AZ Tel (01) 979 8283 Mng Dir Stanleigh A Bader (Also see Silversound City)
 Pop Aural, see Fast Product
 Porage, see Multicord
 Portrait, see CBS
 Posh Recs Ltd., 31 Kings Rd., London SW3 Tel (01) 730 9461 Telex 913804 Mng Dir John Sherry (Distributed by Pinnacle)
 Praise, see Outlet
 Prelude, see Magnum Force
 President Recs Ltd (IFPI), Broadmead House, 21 Panton St., London SW1 Tel (01) 839 4672 Cable KASSMUSIC Telex 24158 Mng Dir Edward Kassner, Gen & Sales Mgr David Kassner, Financial Mgr Brian M D Seed (Distributed by Clyde Factors, Enterprise, Lugton Solomon & Peres Symphola, H R Taylor, Wynd Up)
Labels: (Owned) Aquarius (France), Barak, Crystal, Oart, Double Gold, Enterprise Gemini, Jay Boy, Jay, Max's Kansas City, New World, Presi dent, Rhapsody, Sewille, Sky, Spiral, Sticky, Thunderbird, Torpedo, (li censed) Bulldog, Energy, (distributed—not licensed) Manhattan, Phoe nix
 Prima, see State
 Privilege, see Polydor
 Prodigal, see Motown
 Product, see Aardvark
 Projection Recs., 74 High St Old Town, Leigh on Sea Essex Tel (0702) 72281, 714 025, 714 017 Telex 995701 Chief Exec Dave Hatfield Gen Mgr Tony Krivit, Sales Mgr Phil Barker
Labels: (Owned) Waterfront, (Distributed—not licensed) Actual (UK), Adelphi (USA), Aeco (USA), American Heritage, Appaloosa, Arhoolie (USA) Artists House (USA), Atem (France), Atmosphere (France), Avada (UK), Bay (USA), Black Saint (Italy), Blind Pig (USA), Blue Goose (USA), Blues Classics (USA), Burlington (UK), CMH (USA), Claddagh (Ireland), Cobra (France), County (USA), Oroem (UK), Flying Fish (USA) Folk Legacy (USA) Folk Lync (USA), Folkways (USA), Free Reed (UK), Fret less (USA), Gael Linn (Ireland), Green Linnet (USA), Hexagone (France), Highway (UK), IAI (USA) Ictus (Italy), India Navigation (USA), JSP (UK), Kaleidoscope (USA), Leader (UK), Lovely Music (USA), Moers (Ger many), Mosaic (UK), Mulligan (Ireland), Nessa (USA), Ogun (UK), Oldie Blues (USA), Old Timey (USA), Photo (USA), Plant Life (UK), Rebel (USA), Red Lightning (UK), Ridge Runner (USA), Rounder (USA), Rubber (UK), Shanachie (USA), Shandar (France), Shiloh (USA), Sky (Germany), Solid Smoke (USA), Soul Note (Italy), Steam (UK), Sugar Hill (USA), Syndicate Chapter (UK), Tara (Ireland), Temple (UK), Topic (UK), Union Pacific (UK), Wave (UK), Wergo (Germany), Whid Isle (USA), Yazoo (USA)
 Int'l reps.: Belgium (Parsifal), Germany (Sprignus), Italy (IRD), Nether lands (Sayer Lud), Switzerland (Be Bop)
 Proms, see Peerless
 Pulsar, see Lismor
 Pulse, see Nada Pulse
 Qualiton (Wales), see Decca
 Quality Recs Ltd 43 Victoria Rd, Romford, Essex RM1 2DO Tel Romford 28413 Dir O J Davies, (Distributed by Lugton)
 R A K Recs Ltd, 42 48 Charlbert St., London NW8 Tel (01) 586 2012 Mng Dir Mickie Most, Dir David Most, Gen Mgr Ron Madison, Sales Mgr Dave Crowe
 Int'l reps.: Worldwide except Canada & USA (EMI)
 R & B, see Red Bus
 R C A (UK) Ltd Rec Div (IFPI), 1 Bedford Ave., London WC1B 3DT Tel (01) 499 4100 Telex 21349 Mng Dir Oon Ellis, Deputy Mng Dir / Comm'l John Howes, Deputy Mng Dir / Financial Ed Lavish, Sales Mgr Dave Harner
Distribution branch: West Midlands, Lyng Ln., West Bromwich Tel (021) 525 3000
Labels: (Owned) Camden (dist by Pickwick Int'l), RCA Gold Seal, RCA Int'l, RCA Red Seal, RCA Victor, (licensed domestic) Celebrity Cheap

skate, Ensign, Logo, Scratch, Why Fi, Zilch (licensed foreign) De Luxe (Australia), Fantasy (USA), Galaxy (USA), Milestone (USA), Montage (USA), Pablo (USA), Prestige (USA), Stax (USA), (distributed) Recorded Delivery
 Int'l rep.: Worldwide (RCA Int'l)
 R E L Recs Ltd (IFPI), 7A Atholl Pl, Edinburgh, Scotland EH3 8HP Tel (031) 229 9651 Mng Dir Neil Ross
 R K, see Robert Kingston
 R K L, see Wilcox
 R M, see Record Mart
 R N R, see Nimbus
 R & O, see Outlet
 R P M, see Blue Chip
 R S O Recs Ltd (IFPI), 67 Brook St, London W1Y 1YE Tel (01) 629 9121 Telex 264267 Mng Dir Rod Gunner, Gen Mgr Ashley Newton (Also see Polydor)
Labels: (Owned) RSO (licensed foreign) Dreamland
 Int'l rep.: Worldwide (PolyGram)
 Raccoon, see Westwood
 Radar, see WEA
 Radioactive Recs., 49 Greek St, London W1 Tel (01) 437 7418 Pres Len Beadle, Gen Mgr Steve Elson, Sales Mgr Diver Smallman (Distrib uted by PRT)
 Rage Recs., 5 Theobalds Rd, London WC1X 8SE Tel (01) 242 6886 Cable DEJAMUS Telex 27135 Gen Mgr Nick Stolberg (Distributed by CBS)
 Int'l reps.: Same as for DJM
 Rainbow Recs., 103 Hillside Ave, Chelmsford, Essex Tel (0245) 60853 Mng Dir Terry Gisborne
 Rampage Recs Ltd., 29 Ruston Mews, London W11 1RB Tel (01) 221 7179 Cable PENSDNG, Telex 8954665 Pensong Mng Dir Larry Page
 Random Recs., 96 Huntingdon Rd., London N2 Tel (01) 444 8979 Mng Dir Roger Walton
 Rare Earth, see Motown
 Rare Rec'd Eds., 54 Lymington Rd., London NW6 Tel (01) 435 1476, Chief Exec Michael G Thomas
 Rare Recs Ltd., 13 Bank Square, Wilmslow Cheshire SK9 1A9 Tel (0625) 522017 Mng Dir Irving Wilson, Gen Mgr E S Scrivings Sales Mgr Alan Wilson (Distributor/Importer)
 Rare Rhythm Recs., 1 Lucy St., Manchester M15 4BX Tel (061) 872 3816 3995-3082 Telex 665181 Mng Dir Kevin Kinsella, Gen Mgr Steve McGarry, Sales Mgr Norma Huntbath
Labels: (Owned) Loose Change, Rare Rhythm, Ventilation
 Rascal Recs Ltd., 13 Hill Rise, Richmond, Surrey Tel (01) 940 5283 Telex 8813271 Mng Dirs David Myers, Colin Gershman, Gen Mgr Paul Jenkins, Sales Mgr Harry Goldbaum, Comm'l Mgr Peter Wells
 Int'l reps.: Argentina (Sicamericana), Austria (Teldec) Benelux (Bar clay), Denmark (Sonet), Finland (Sonet), France (Barclay, Musidisc), Germany (Teldec), Norway (Sonet), South Africa (EMI), Spain (Zafiro), Sweden (Sonet), Switzerland (Teldec)
 Rather Recs., Meadowbank, Hall Ln., Harbury, near Leamington Spa, War wickshire Chief Exec A N Godfrey (Distributed by Rough Trade)
 Rat Race Recs Ltd., 10A Belmont St top II, Chalk Farm London NW1 Tel (01) 985 8944 Mng Dir George Colson (Distributed by Fresh Gradu ate, Inferno, Red Rhino, Rough Trade, Stage One, Wynd Up)
 Reader's Digest Ass'n Ltd., 25 Berkeley Square, London W1X 6AB Tel (01) 629 8144 Rec., Tape & Equip Mgr Ian Wright, Mktg Mgr Derek

Holder
Home office: USA
 Real, see WEA
 Reality, see Great Jazz
 Recommended Recs. 583 Wandsworth Rd., London SW8 Tel (01) 622 8834, 720 0171 Mng Dirs Chris Culler, Steven Rickard, Gen Mgr Chris Booth, Sales Mgr Paul Nichols
 Int'l branches: Belgium, Germany, Italy, Japan, Norway, Switzerland
Labels: (Owned) Recommended, (distributed—not licensed) Arc, Atem (France) Black Noise, Bozi Mlyn (Canada), Broadcast, Celluloid (France), Crammed Discs (Belgium), HP (USA), MCCB (Netherlands), Metalanguage (USA), L'Orchestra (Italy), Piano, Ralph (USA), Random Radar (USA), Re, Rift, SAM (Sweden), SCOPA (France), Saturn (USA), Say Day Bew (USA) Seeland (USA), Spacebox (Germany), Squeaky Shoes, Sunrise (Switzerland), Woolf
 Int'l rep.: Germany (Unterschlagen)
 Record Corner, 27 Bedford Hill, Balham SW12 9EX, London Tel (01) 673 1066/7130 Buyer Dave Hastings, salesman Terry Davis (Dne Stop, Importer)
 Recorded Delivery Recs Ltd., 9 11 Richmond Bldgs, Dean St, London W1V SAH Tel (01) 439-3058 Chief Exec Paul Murphy, Laurence Bristol, Gen Mgr Philip Foster (Distributed by RCA)
 Record Mart, 16 London Hill, Rayleigh, Essex SS6 7HP Tel (0268) 776 555 Dir Frank K Bailey, Gen Mgr DR Glenister
Labels: (Owned) RM, (licensed foreign) Olympic (USA), Ruby (USA) (dis tributed—not licensed) Erwin, Fortune, Glenn, Goldband, Hi Q, Mar Vel, Money, Pone, Specialty, Strate 8, Tab, Yucca (all USA)
 Record Mdsrs Ltd., Crown Works, Clayton Rd., Hayes, Middx UB3 1HS Tel (01) 848 7511 Telex 934027 Mng Dir S H Akhtar, Comm'l Dir D R Hammond, Finance Dir S S Nobbs (Record & Tape Rack Jobber)
 Recreational, see Revolver
 Red Bus Recs (Int'l) Ltd., 34 Salisbury St., London NW8 Tel (01) 402 9111 Telex 268048 Mng Dirs Eliot M Cohen, Elhs Elias, Promo Mgr Douglas Kean (Distributed by PRT)
Labels: (Owned) Excaliber, R&B, Red Bus
 Int'l reps.: Austria (RCA), Belgium (WEA), Canada (Umdisc), Germany (RCA), Ireland (PRT), Luxembourg (WEA), Netherlands (ITR), Portugal (GIRA) Spain (Movieplay)
 Reddington's Rare Recs., 14 20 Moor St., Queensway, Birmingham B4 7UH Tel (021) 643 2017 Mng Dir Daniel Reddington, Gen Mgr Robert Cleverly, Sales Mgr Timothy Ellis
 Int'l reps.: Worldwide (Logo, MCA)
 Red Hot Recs./Supersdisc Mail, 330 Norwood Rd., West Norwood, London SE27 9AF Tel (01) 761 2292 Mng Dir A L Ford (Distributor/Whole saier) (Also see Tomat)
 Redifusion Int'l Music Ltd (IFPI), 11 Great Mariborough St London W1 Tel (01) 734-0343 Telex 27950 Mng Dir Ron Smith
 Red Lightnin' Recs The White House, The Street, Northlopham, Diss Nor folk Tel (037) 988 693 Dir Peter Shertser; Gen Mgr Christine Palmer, Sales Mgr Bruce Simmons
 Int'l reps.: France (Ceresco), Germany (Teldec), Italy (IRD) Netherlands (Sayer Lud), Norway (Scandinavian Dist.), Sweden (Amgo), USA (City Hall, Shanachie)
 Red Rag Recs., 1 St Albans Rd., Kingston, Surrey Tel (01) 549 9181 Chief Exec Alan Robinson
 Redrock Recs., 11 Salehurst Close, Kenton, Harrow, Middx. Tel (01) 204

We wholesale, import, export and we're fast!

What is it we wholesale, import and export?
 Contact John Stewart and he will tell you about our range of quality discotèque equipment, records and 12" singles. Find out how reliable and quick we really are!

GLOSTER DISCO & MUSIC CENTRE

Gloster Disco & Music Centre

9 Market Parade, Gloucester, GL1 1RL.

Telephone: (0452) 33084/419567.

Telex: 437223.

- 1035 Chief Exec. & Gen. Mgr. Michael Redway
Red Seal. see RCA
Red Stripe. see Sonet.
Re Entry. see Rotate
Reflection Recs., 26 Eastbourne Ave., Acton, London W3. Tel: (01) 560 0079. Gen. Mgr. Derek J. Smith; Mktg. Mgr.: Rob Cox.
Labels: (Owned) Reflection. Reflection Workshop.
Int'l reps.: Australia (Move), USA (Morehouse-Barlow).
Reflection Workshop. see Reflection.
Reformation. see Chrystal.
Regal Zonophone. see EMI.
Regal Recs. Ltd., 9 Cherington Rd., London W7 3-L. Tel: (01) 579-6125/4249 Telex: 266383. Mng. Dir.: John Winnert; Import/Export Dir.: Trude Hunt. (Distributor/Importer/Exporter)
Labels: (Distributed—not licensed) K-tel, Ronco, Tara (Ireland).
Reprise. see WEA
Re Recs Ltd., 583 Wandsworth Rd., London SW8. Tel: (01) 627-0436. Cable: REDFOX. Mng. Dir. Chris Cutler (Distributed by Recommended)
Int'l reps.: Italy (L'Orchestra), USA (Ralph, Random Rada).
Response Recs., Ogbear Cottage, North Tameror, nr. Holsworthy, Devon Tel: (040927) 361. Chief Exec.: Mike Clare. (Distributed by Lugton, PRT, Response)
Labels: (Owned) Collectors Choice, Response
Retrieval Recs. 48 Eversley Ave., Barnehurst, Kent DA7 6RB. Tel. Erith (0327) 33875. Joint Partners: Norman Stevens, Ron Jewson, John R.T. Davies
Labels: (Owned) Fountain, Retrieval.
Int'l reps.: USA (City Hall, Zim).
Retrospect. see World.
Revival. see Lightning
Revolution. see Steel City.
Revolver Recs., 1 Berkeley Crescent, The Triangle, Clifton, Bristol. Tel: (0272) 299105. Owner: Chris Parker. Gen. Mgr.: Lloyd Harris. (Distributed by Revolver, Rough Trade)
Label: (Owned) Recreational.
Revolver. see Heavy Metal.
Rewind. see Harry Barter.
Rex. see Decca.
Rhapsody. see President.
Rialto Recs. Ltd., 4 Yeomans Row, London SW3. T-1 (01) 584-2441. Chief Execs.: Nick & Tim Heath. (Distributed by PRT)
Int'l branch: USA
Int'l reps.: Argentina (Sicamericana), Australia (Astor), Denmark (Hede Nielsen), Finland (Discophon), France (Vogue), Germany (Ariola), Greece (Music Box), Ireland (PolyGram), Italy (Dischi), Japan (Victor), Mexico (Gamma), Netherlands (Dureco), New Zealand (PolyGram), Norway (Disco A/S), Peru (FTA), South Africa (Tel), Spain (Zafro), Sweden (Electra), Venezuela (El Disco de Moda).
Riot. see Humber.
Rip Off. see Emerald & Solomon & Peres.
Riva Recs. Ltd., (IFPI), 2 New Kings Rd., London SW6 4SA. Tel: (01) 731-4131. Telex: 28781. Mng. Dir.: Bill Stonebridge. (Distributed by WEA)
Labels: Applause, GM, Riva
River Recs. Ltd., Alembic House, 11th fl., Albert Embankment, London SE1 7TY. Tel: (01) 582 7622. Chief Exec.: Bill Martin. (Distributed by Pinnacle).
Robin Recs. PO Box 3, Hesse, North Humberdale. Tel: (0482) 649193. Cable: MACHD MUSIC. Mng. Dir.: Robin Carew.
Robinson's Recs., 26 Blackfriars St., Manchester, Lancs. M3 5BP. Tel: (061) 832 2701. Dir.: Arthur Robinson. Gen. Mgr.: Kath Roberts; Sales Mgr.: Richard Cooper. (Distributor/Importer)
Labels: (Distributed—not licensed) Big R, Pinnacle (both UK); AEI, Cereberus, Citadel, Contemporary, Corinthian, Creative World, Mark 56, Monmouth, Muse, Radiola, Ranwood, Rebecca, Rouncer, Sandy Hook, Soundtrack, Spokane, Tolern, Varese (all USA).
Rockburgh Recs. Ltd., PO Box 283, London SW6 2IU. Tel: (01) 351-4333. Telex: 261507. Mng. Dir.: Sandy Robertson; Mktg. Mgr.: Paul Brown; Int'l Liaison: Beverley Thompson. (Distributed by Polydor & Spartan)
Rocket Rec. Co., 104 Lancaster Gate, London W2 3AT. Tel: (01) 258-3585. Telex: 265870. Chm.: John Reid; Dir.: Elton John; Gen. Mgr.: John Hall.
Int'l rep.: Worldwide (Phonogram Int'l) excluding Canada & USA.
Rockney. see Towerbell.
Rockstar Recs., 23 Crescent Rd., London E18. Tel: (01) 501-2173. Dir.: Janice Barrett. (Distributed by Spartan)
Rota Recs./Avada Recs., Nortolk House, Well Walk, Cheltenham, Glos. Tel: (0242) 38543. Chief Exec.: Steve Hutt. (Distributed by JSU, Projection, Spartan)
Labels: (Owned) Avada, Rola
Rollercoaster Recs., PO Box 18F, Chessington, Surrey KT9 1UZ. Tel: (01) 397-8957. Cable: CHIRPING Chessington. Chief Exec.: John Beecher; Gen. Mgr.: Yvonne Trengove
Labels: (Owned) Rollercoaster, Spade. (licensed foreign) Arzee (USA).
Rolling Stones. see EMI.
Ronco Teleproducts (UK) Ltd., 111 Mortlake Rd., New, Richmond, Surrey TW9 4AB. Tel: (01) 876-8682. Telex: 928215. Int'l Recs. Dir.: Barry Collier. Gen. Mgr.: Sean D'Brien; Sales Mgr.: Laura Freeman.
Labels: (Owned) Effects, Ronco.
Rondelet Music & Recs., 98 Marples Ave., Mansfield Woodhouse, Nottinghamshire NG19 9HB. Tel: (0623) 31390. Partners: M. Comerford, A. Campion. (Distributed by Spartan)
Labels: (Owned) Rondelet; (licensed foreign) Halfmoon (USA), Rollin' Rock (USA).
Int'l reps.: Argentina, Bolivia, Chile, Ecuador, French Guyana, Paraguay, Peru, Spain, Surinam, Uruguay (all Moveplay); Australia, Cook Island, New Caledonia, New Hebrides, New Zealand, Tahiti (all RTC); Austria, Germany, Switzerland (all Bellaphon); Cyprus, Greece (both Music Box); Finland, Scandinavia (both Planet), Portugal (Warm).
Rondercrest Ltd., 17 Queensway, Dunstable, Beds. Tel: (0582) 62325. Mng. Dir.: Keith Granger; Sales Mgr.: Pam Grangea (Distributed by Pinnacle).
Rooster Blues Recs., PO Box 148, London W9 1DY. Tel: (01) 286-2993. Partners: Mick & Cilla Higgins.
Roots. see Baa!
Rose Recs., Garden Office, 67 Belsize Park Gardens, London NW3 4JN. Tel: (01) 722-5686. Mng. Dir.: J.D. Butcher; Sales Mgr.: P. Cadenhead. (Distributor/Importer)
Rotate Recs., 17 Station Rd., London SE25 5AH. Tel: (01) 771-5777. Chief Exec.: Steve Hutchings; Gen. Mgr.: Dave Lucy; Sale: Mgr. Pat Renham.
Labels: (Owned) Re-Entry, Rotate.
Rough Trade Dist'n Ltd., 137 Bienenheim Crescent, London W11. Tel: (01) 221 1100. Telex: 299579. Artist Development; Susan Johnson, A&R; Geoff Travis, Press & Promo; Scott Perring; Sales Mgr.: Richard Scott.
Labels: (Owned) Rough Tapes, Rough Trade. (licensed) Postcard, Y. (distributed—not licensed) Black Rocks, Crass, Factory, Inevitable, Malicious
Damage, Mute, Object, Solomonic, Vindaloo.
Int'l reps.: Australia (Gap), Austr (Phonogram), Canada (Rough Trade), Finland (Johanna), France (Barclay), Germany (Phonogram), Italy (Base), Japan (Japan Recs.), New Zealand (Gap), Switzerland (Phonogram), USA (Rough Trade).
Rox Rec Co. Ltd., 255 Liscard Rd., Wallasey, Merseyside. Tel: (051) 639-9270. Mng. Dir. David Crosby. (Distributed by Spartan)
Rubber. see Mawson Warehouse.
Rumours Whistle, 3 Lockwood Walk, Romford, Essex. Tel: (70) 24038. Dir.: Clive Spelman. (Distributor/Importer).
Runaway Recs. Ltd., 38 North Row, London W1. Tel: (01) 491-3175. Telex: 23840. Dirs.: Tony Adams, Steve Colyer; Exec. VP: Adrian Rudge.
Labels: (Owned) Runaway; licensed foreign Warbride.
Rush Release. see Don't Panic.
Rutland Recs., 71 Rutland Rd., Chesterfield, Derby. S40 1ND. Tel: (0246) 79976. Cable: HEDLEY. Mng. Dir.: Tony Hedley; Gen. Mgr.: Greg Boynton. (Distributed by Pinnacle)
Ryemuse. see Spot.
Ryme Time. see Lismor.
S F Original. see Metropolitan.
S D S Songs Ltd., 19 Etheibert Rd., Cliftonville, Kent CT9 1SH. Tel: (0843) 294128. Mng. Dir.: Frank Foy.
S P & S Recs. Ltd., Wharf Rd., Stratford E15 2SU. Tel: (01) 555-4321. Telex: 8951427. Mng. Dir.: Peter Harris; Sales Mgr.: John Glocker; Export Mgr.: Peter Stack. (Distributor)
Labels: Manchester M4 GF, Glamor House, 47 Bengal St. Tel: (061) 228-6655. Telex: 666300. Gen. Mgr.: Mike Nolan.
Label: (Licensed domestic) From the Jazz Vault.
S R T Recs., 987 High Rd., London N12 8QA. Tel: (01) 446 3218. Mng. Dir.: George Bellamy; Sales Mgr.: D.J. Richardson. (Distributed by Pinnacle, Lugton, H.R. Taylor)
S S Label. see Burning Rome.
Sacred. see Word.
Safari Recs., 42 Manchester St., London W1M 5PE. Tel: (01) 486-6141. Telex: 25247. Dirs.: Anthony Edwards, John A. Crag. (Distributed by Spartan)
Saga Recs. Ltd., 326 Kensal Rd., London W10 5BL. Tel: (01) 969-6651. Telex: 261500. Mng. Dir.: Marcel Rodd; Int'l Mgr.: Lynne Kentish. (Distributed by Unicorn)
Affiliated firm: B & C Recs' Ltd.
Labels: (Owned) Boulevard, Dupus, Saga.
Int'l reps.: Australia (Braunthal), Belgium (EMI), Canada (Almada), Denmark (CSA), Finland (PSD), Germany (Teldec), Italy (Ri-Fi), Japan (Tno), Netherlands (Sound Prods), Spain (Zafro).
Sain (Recordiau) Cyl. Ffordd Llanyfryn, Penygroes, Caernarfon, Gwynedd, Wales. Tel: (028681) 732. Mng. Dir.: Huw Jones.
Labels: (Owned) Sain, Tryfan.
Satriel Recs. Ltd. (IFPI) (div. of Henry Hadaway Drg.), 444 Finchley Rd., London NW2 2ZY. Tel: (01) 435-8063. Cable: SATRIELREC. Telex: 261331. Mng. Dir.: Henry Hadaway; Gen. & Studio Mgr.: Paul Hodsman; A&R Dir.: Tony Todd. (Distributed by PRT)
Labels: (Owned) Crash, Satriel.
Int'l reps.: Benelux (Johnny Hoes), Germany (Jupiter), Greece (Music Box), Israel (CBS), Italy (Fonit Cetra), Philippines (Decca), Portugal (Gira), Spain (Zafro).
Savannah. see Creole.
Savoy. see Ariola/Arista.
Sawmills. see Sonet.
Saydisc Recs., The Barton, Ingtestone Common, Badminton, Glos. GL9 1BX. Tel: (045) 424-266. Chief Exec.: Gef Lucena; Sales Mgr.: Genny Luena. (Distributed by Jazz Servs. Unlimited, Lugton, Saydisc, H.R. Taylor Ltd.)
Labels: (Owned) Amon Ra, Saydisc, Village Thing.
Scope. see Lightning.
Scotia Dist'n, 46 High St., Edinburgh Scotland. Tel: (031) 557-0029. Telex: 727507. Partners: Phil West, Derrick Wrenn; Sales Mgr.: John Allan. (Distributor/Importer)
Scratch Recs. Ltd., Shepperton Studio Centre, Shepperton, Middx. Tel: (09328) 66531. Telex: 929416. Mng. Dir.: Brian Adams; Gen. Mgr.: David Parmor; Sales Mgr.: Barry Lyons; PR: Sue Matthews. (Distributed by RCA)
Sea Horse Recs., 2 Lamballe Pl., London NW3. Tel: (01) 435-7765. Dirs.: Teddy A. Ruster, Allan Austin. (Distributed by Pinnacle)
Secret Recs. Ltd., 52A Princess St., Luton, Beds. Tel: Luton 32219. Mng. Dir.: Martin Hookes; Sales Dir.: Roger Brunton. (Distributed by Spartan)
Sentinel Recs. (Cornwall) Ltd., Paul, Penzance, Cornwall. Tel: (0736) 73246. Telex: 45143 SEN. Chief Exec. & Gen. Mgr.: Job Morris; Sec'y: Irene Morris.
September 2nd. see JSD.
September Sound. see Look.
Seville. see President.
Sharon. see Pilgrim.
Shell. see Towerbell.
Showtime. see Wilcox.
Sidewalk. see EMI.
Silver Hammer. see Leo Sound.
Siversound City/Polysyns Int'l Ltd., Polysyns House, 248 Walton Rd., East Molesey, Surrey KT8 0HT. Tel: (01) 979-8283. Chm.: Eric J.P.C. Lombard Knight; Dirs.: Stanleigh A. Bader, Robin H. Sculthorp. (Wholesaler/Exporter)
Simons Recs. Ltd., 335 Barking Rd., East Ham, London E6. Tel: (01) 552-5211. Telex: 897654. Dirs.: Warren Goldberg, Paul Feldman, Maureen Preen; Sales Mgr.: Jon Sweeney. (Wholesaler/Importer)
Sir. see Westwood.
Sire. see WEA
Situation 2. see Beggars Banquet.
Skeleton Recs., 46 Argyle St., Birkenhead, Merseyside. Tel: (051) 647-4505/9650. Gen. Mgr.: Roland Hodson; Prod'n Mgr.: John Weaver. (Distributed by Pinnacle)
Labels: (Owned) Skeleton; (licensed domestic) Alien Heat.
Sky. see President.
Smack. see Charly.
Small Wonder Recs. Ltd., 162 Hoe St., London E17. Tel: (01) 520-5036. Chief Exec.: Peter & Mari Stennett. (Distributed by Rough Trade, Small Wonder).
Snatzo. see Dindisc.
Soccer. see Duttel Rec'g.
Solid Gold Recs. Ltd., 14 New Burlington St., London W1X 2LR. Tel: (01) 734-3251. Chief Exec.: Mike Collier.
Solomon & Peres Ltd., 120 Coach Rd., Templepatrick, Ballyclare, Co. Antrim, Northern Ireland BT39 0HB. Tel: (08494) 32711, 32693. Telex: 747293. Mng. Dir.: Mervyn A. Solomon; Gen. Mgr.: Les Paterson; Rec. Mgr.: Michael Ross. (Distributor)
Int'l branch: Ireland.
Labels: (Owned) Emerald, Great Bands, Mint, Mint Julep, Rip Off; (dis-

- tributed—not licensed) A&M, Anchor, Arcade, Ariola, Arista, Beserkey, Big R, CBS, Chrystalis, Creole, DJM, Decca, Double D, EMI, Island, K-tel, Multiple Sound, Phonogram, Polydor, Precision Tapes, Pyc, RCA, Ronco, Spartan, Virgin, WEA, Warwick.
Some Bizarre Label, 292/3 High St., Lincoln, Lincs. LN2 1AL. Tel: (0522) 38322. Gen. Mgr.: Martin Patton; Sales Mgr.: Stephen Taylor. (Distributed by Phonogram)
Sonet Recs. & Publ'g Ltd. (IFPI), 121 Ledbury Rd., London W11 2AQ. Tel: (01) 229-7267. Telex: 25793. Mng. Dir.: Rodney Buckle; Gen. Mgr.: Alan Whaley; Sales Mgr.: Brian Harris. (Distributed by Pyc/Sonet)
Home office: Sweden.
Labels: (Owned) A-Side, Gazell, Grand Prix, Kicking Mule, Red Stripe, Sonet, Titanic; (licensed domestic) Sawmills; (licensed foreign) Aliigator (USA), Specially (USA), Takoma (USA), Texas Re-Cord (USA); (distributed—not licensed) Mute.
Int'l reps.: Argentina (America), Australia (Larrikin), Austria (Amadeo), Belgium (Vogue), Brazil (Fermata), Denmark (Sonet), Finland (Scandia/Sonet), France (Vogue), Germany (Intercord) Greece (CBS), Ireland (Tara/Golden Disc), Italy (Ricordi), Netherlands (Inelco), Norway (Arne Bendiksen), Portugal (Rossi), Spain (CFE, Columbia), Sweden (Sonet), Switzerland (Metronome). (SEE ADVERTISEMENT)
Songwriters Workshop Ltd., 53 Brompton Rd., London SW3. Tel: (01) 589-7434. Chm.: Mel Morris; Gen. Mgr.: Tim Hollier. (Distributed by Spartan)
Soul Stop. see Dawn Promotions.
Sound Ceremony Recs., see Celestial Sound.
Sounds Ahead Mail Order, The Studio, 1 Benscham Ln., Croydon, Surrey CRD 2 RU. Tel: (01) 689-6618. Mng. Dir.: A.T. Gregory. (Distributor/Importer/Exporter)
Sounds Express & Midland Rec. Co., Western House, Great West Rd., Brentford, Middx. TW8 9EW. Tel: (01) 568-7482. Co-Dirs.: Colin S. Walkden, John E. Camp, Ray G. Nash. (Distributor/Importer)
Sovereign Recs., 18 Lancaster Mews, London W2 3QE. Tel: (01) 723-4499. Telex: 923400. Mng. Dir.: Ben Nisbet.
Spade. see Rollercoaster.
Spartan Recs. Ltd., 3 Sevenex Parade, London Rd., Wembley, Middx. Tel: (01) 903-4753. Telex: 923175. Mng. Dir.: T.A. McDonnell; Dir.: D.G. Thomas; Sales Mgr.: Les Tomlin. (Distributor)
Spectacle Recs., 11 Connaught Pl., London W2. Tel: (01) 258-0077. Mng. Dir.: Ms. Saffron Summerfield. (Distributed by Jazz Servs. Unlimited, Scotia)
Int'l reps.: Belgium (CCC), Netherlands (Windmill).
Spectrum. see Colorzone.
Sphinx. see Nimbus.
Spider. see Downing.
Spin. see Symphola.
Spinach Recs., 8 Nursery Rd., Prestwich, Manchester M25 7DN. Tel: (061) 773-8914. Dir.: Lionel Levine; Gen. Mgr.: A. MacDonald. (Distributed by Stage One)
Spiral. see President.
Spire. see Multiple Sound.
Splash Recs. Ltd., 38 North Row, London W1R 1DH. Tel: (01) 409-0287. Telex: 23840. Mng. Dir.: Charles Peate; Dirs.: Clive Scott, Iris Giebler, Des Dwyer.
Labels: (Owned) Belsize, Splash.
Int'l reps.: Australia (7 Recs.), Benelux (CNR), Brazil (K-tel), Hong Kong (WEA), Japan (Teichiku), Mexico (Musart), New Zealand (7 Recs.), Portugal (Rossil), Scandinavia (Tyfon), South Africa (David Gresham).
Spock Ents., 11 Bothwell St., 4th fl., Glasgow, Scotland. Tel: (041) 221-6000. Label Mgr.: Allan Mawn; Sales Mgr.: Kath Reilly. (Distributed by Stage One)
Spotlite Recs., 103 London Rd., Sawbridgeworth, Herts. CM21 9JJ. Tel: (0279) 725-863, 724-572. Owner: Tony Williams; Sales Mgr.: Cne Williams. (Distributed by Cadillac Music, Jazz Music, Jazz Servs. Unlimited, Spotlite)
Int'l reps.: Austria (Bellaphon), Benelux (Agram), Canada (Almada), Coda-Trend), Coda-Trend), Denmark (Alpha), France (AMG), Germany (Bellaphon), Italy (IRD), Japan (Stateside), Sweden (Damjo), Switzerland (Bellaphon), USA (Arista House, R. Ballard, Rounder).
Spot Recs. Ltd., 11A Sharples St., London NW1. Tel: (01) 586-7746. Mng. Dir.: John Hudson; Gen. Mgr.: Kale Hudson.
Labels: (Owned) Ryemuse, Spot.
Springthyme Recs., Balmacalm House, Balmacalm, Kingskettle, Fife, Scotland KY7 7TJ. Tel: (0337) 30773. Dir.: Peter Shephard. (Distributed by Springthyme, Celtic, Clyde Factors, Jazz Servs. Unlimited, Non Stop, Projection, Ross)
Labels: (Owned) Springthyme; (distributed) Celtic, Iona.
Springtime. see 21st Century Leisure.
Square. see Horizon.
Squeaky Shoes Recs., 387 Wandsworth Rd., London SW8. Tel: (01) 622-8834. Mng. Dir.: Alvaro Pena-Rojas. (Distributed by Rough Trade)
Int'l branch: Germany.
Stag. see Creole & Downing.
Stage Coach Recs., 15 Claremont Rd., Westcliff-on-Sea, Essex SS0 7DX. Tel: (0702) 43464. Telex: 24224. Mng. Dirs.: Barry Collings, Cyril Wayne. (Distributed by Pinnacle)
Labels: (Owned) Dollpos, Stage Coach.
Stage One Music, 14 Sebert Rd., London E7. Tel: (01) 534-5472. Dirs.: John & Ronald Bassett.
Stage One (Recs.) Ltd., Parshire House, 2 Kings Rd., Haslemere, Surrey GU27 2QA. Tel: (0428) 4001. Telex: 858226. Mng. Dir.: Nigel Hockley; Mktg. Dir.: Terry Shand; Export Inquiries: Naomi Krell; Labels Mgr.: Dave Fagene; Import Dir.: Nick Anstey. (Distributor/Importer/Exporter)
Labels: (Owned) Stage One; (distributed) Double D, Hannibal, Happy Birthday, Human, Immediate, Key, Nems, Secret, Statistik. (SEE ADVERTISEMENT)
Stairway Recs., Obscura House, 12A Dollard St., London SE11. Tel: (01) 582-1522. Telex: 27806. Mng. Dir.: Jon Samuel.
Stallion Recs. Ltd., 76 Roebuck House, Palace St., Victoria, London SW1. Tel: (01) 828-0227/8260. Telex: 893007. Mng. Dir.: Johnny Toogood; European Mgr.: Joe Napoli. (Distributed by PRT)
Int'l reps.: France (Polydor), Germany (Ariola), Italy (CBS), Netherlands (Ariola), Poland (Tonopress).
Stark Prods., 298 Messingham Rd., Scone, Perth, South Humberdale DN17 2QY. Tel: (07224) 66941. Dir.: C.D. Leaning.
Starline. see EMI.
Starlite. see Esquire.
State Recs. Ltd. (IFPI), 26/27 Castlereagh St., London W1M 5YR. Tel: (01) 402-2191. Telex: 25740. Chm. & Mng. Dir.: Wayne Bickerton; Dir.: Carole

Bickerton, A&R John Trott
Labels: (Owned) Prima State
 Henry Stave & Co. (div. of Redifusion Int'l Music Ltd.), 11 Great Marlborough St., London W1V 1DE Tel: (01) 734 0343 Telex: 27950 Mono Ref 1006 (Importer/Exporter)
 Steel City Ents Ltd., 19 S. Gallery, Exchange St., Sheffield, Tel: (0742) 293866 Mng Dir: Peter Martin, Sales Mgr: D. Hoykin
Labels: (Owned) Revolution, Steel City
 Step Forward, see Faulty
 Stereo Gold Award, see Damont
 Sticky, see Vineyard & President
 Stiff Recs., 9/11 Woodfield Rd., London W9 Tel: (01) 289 6221 Telex: 299894 Mng Dir: Dave Robinson, Gen. Mgrs: Alan Cowdery, Paul Conroy, Press Officer: Nigel Dick, Radio & TV Promo: Sonnie Rae (Distributed by CBS)
 Int'l reps.: Australia (Festival), Austria (Musica Schallplatten), Belgium (Inelco), Canada (Stiff/Epic, Stiff/Columbia, Stiff Canada/Attic), Denmark (Phonogram), Finland (Polarvox), France (Vogue), Germany (Teldec), Greece (PolyGram), Hong Kong (Shun Cheong), Iceland (Steinar), Ireland (CBS), Italy (RCA), Japan (Victor), Mexico (Musart), Netherlands (Inelco), New Zealand (PolyGram), Norway (PolyGram), South Africa (CCP), Spain (Columbia), Sweden (Phonogram), Switzerland (Musikvertrieb), USA (Stiff/Epic, Stiff/Columbia, Stiff America), Yugoslavia (RTV)
 Storm Recs., 133 Park Rd., Blackpool FY1 4ET Tel: (0253) 27357 Mng. Dir: Wayne Paulo, Gen. Mgr: Lenny Harris, Sales Mgr: Estelle Paulo
Labels: (Owned) Storm (distributed-not licensed) Addictive, Bamboo
 Strathclyde Sound & Video Ltd., PO Box 59, Glasgow G2 1LR Scotland Tel: (041) 221 2222 Mng. Dir: Raymond E. Dorr, Presentation/Prod'n Mgr: P.R. Black
Label: (Owned) Strathclyde Sounds
 Street Beat, see Pinnacle
 Street Tunes, see Plexdeck
 Strike Recs., see Better Boogie
 String, see Topic
 Submarine Recs., 63 Whitehall Park, London N19 3TW Tel: (01) 272 4321 Chief Exec.: Frank Greene, John Bennett (Distributed by Submarine), Jazz Music, Lugton, Swift, TDL, Chris Wellard
Labels: (Owned) Magic, (licensed domestic) Artistic, First Heard, Swing House, Swing World
 Subway Recs. (div. of Barry McCloud Ents Ltd.), Isabel House, Suite 29, 46 47 Victoria Rd., Surbiton, Surrey Tel: (01) 399 5324 Telex: 896616 Mng. Dir: Barry McCloud, Ass't to Mng. Dir: Kimberley Mounsey, Promo Dir: Marion Wright (Distributed by Spartan)
 Sugarhill, see PRT
 Sunburst Recs. Ltd., 25 Newman St., London W1 Tel: (01) 323 1272 Dirs: John Coletta, R. Moger
 Sun Island Music, 3 Pres de la Mer, Greve d'Azette, Jersey, Channel Islands (Distributor/Importer) (Also see Harris & Goldring)
Label: (Distributed) Pickwick
 Superdisc Mail, see Red Hot
 Supermusic Ltd., 9A Halcroft Ln., Copmanthorpe, York YO2 3SU Tel: (0904) 703401, 797090, Mng. Dir: Mal Spence, Gen. Mgr: Dave Leaper, Sales Mgr: Al Martin (Distributed by Nems/Secret)
Labels: (Owned) Exploited, Supermusic
 Int'l reps.: Australia (RTIC), New Zealand (RTIC)
 Superstition Recs. Ltd., 19 Crescent Rd., East Grinstead, Sussex Tel: (0342) 312261 Mng. Dir: John Collins, Sales Mgr: Carol Collins (Distributed by Spartan)
 The Surrey Sound Rec. Label Ltd., 70 Kingston Rd., Leatherhead, Surrey Tel: (3723) 79444 Telex: 24637 Mng. Dir: Mike Cobb, Gen. Mgr: Joy Watson
 Swamp Recs., 6 Cheveley Mews, London Rd., Sunningdale, Berks SL5 5UD Tel: (0990) 26425, 20342 Mng. Dirs: Bob & John Hardman (Distributed by PRT)
 Swan, see Global Rec. Sales
 Swan Song Recs., 484 Kings Rd., Chelsea, London SW10 0LF Tel: (01) 351 4151 Telex: 919735 (Licensed to WEA)
 Sweet Folk All Recs. Ltd., 74 Shrewsbury Ln., Shooters Hill, London SE18 Tel: (01) 854 4014 Dir. & Gen. Mgr: Joe Stead (Distributed by Jazz Servs., Chris Wellard, Wynd Up)
 Swift Rec. Dists., 3 Wilton Rd., Bexhill-on-Sea, East Sussex TN40 1HY Tel: (0424) 220028 Telex: 957082 Gen. Mgr: Robin L. Gosden, Sales Mgr: Dave Carter, Order/Dispatch Mgr: Peter Stacey (Distributor/Importer)
 Swift Rec. Exports, 3 Wilton Rd., Bexhill-on-Sea, East Sussex TN40 1HY Tel: (0424) 220028 Telex: 957082 Gen. Mgr: Simon Napier (Distributor/Exporter)
 Swing House, see Submarine
 Swing World, see Submarine
 Symphonia Recs. Ltd., Fountain House, Suite 207, Donegal Pl., Belfast, Northern Ireland Tel: (0232) 28642 Telex: 747534 Chief Exec: Bert McCormick, Mng. Dir: R Gordon Smyth, Gen. Mgr: Gerry Lang
Labels: (Owned) Cornerstone, Spn
 Synthesis, see ESSP
 Synthesizer Experience, see ESSP
 T R X, see Acuff Rose
 Taaga, see Happy Face
 Tabitha Music Ltd., 39 Cordery Rd., St. Thomas, Exeter, Devon EX2 9DJ Tel: (0392) 79914 Mng. Dir: Graham Sclater, Gen. Mgr: D. Sclater
Labels: (Owned) Domino, Tabitha
 Int'l reps.: Belgium (Barclay), Netherlands (CNR), Spain (Trova)
 Talisman, see EMI
 Talkie Tapes, see Metropolitan
 Talk Tapes, 13 Crofton Rd., London NW5 1EL Tel: (01) 485 9981 Contact: M. N. Kendall
Label: (Distributed) Zeus
 Tamarin, see WEA
 Tammi, see EMI
 Tandy's Recs. Ltd., Anderson Rd., Warley, West Midlands B66 4BB Tel: (021) 429 6441 Telex: 338459 Mng. Dir: F. J. Tandy, Purchasing Mgr: Dave Jones, Export Sales Mgr: Mike Webster (Distributor/Exporter)
 Tangent Recs. Ltd. (IFPI), 176A Holland Rd., London W14 8AH Tel: (01) 603 0893 Mng. Dir: Mike Steyn (Distributed by Lugton, Spartan, H.R. Taylor)
Labels: (Owned) Big Ben, Tangent
 Int'l reps.: Belgium (Parsifal), Canada (Almada), Denmark (Mac's), France (Harmonia Mundi), Germany (DGG), Netherlands (Hosat), Norway (Sinar), Sweden (SAM), Switzerland (Music Consort), USA (International Book & Rec.)
 Tank Recs., 4 Welton Rd., Wedgcock Estate, Warwick CV34 5YA Tel: (0926) 45123, 498924 Owner: S.L. Bird
 Taxi Recs., 2 Disraeli St., Leicester LE2 8LX Tel: 836977 Mgr: Chris Woodcock
 Home office: Canada

M. R. Taylor (Birmingham) Ltd., 139 Bromsgrove St., Birmingham B5 6RG Tel: (021) 622 2377 Mng. Dir: Derek Wareham; Sales Dir: Colin Grant, Financial Dir: Roy Jones (Distributed by H.R. Taylor, Lugton)
Labels: (Owned) Sound Stores, (licensed) Melodisc
 Teakfield Publ'g Co. Ltd., Gower House, Croft Rd., Aldershot, Hants. GU11 3HR Tel: (0252) 331551 Telex: 858623 TELBUR Mng. Dir: N. Farrow, Dirs: M. J. Hanrahan, G. Cyriax (Distributor/Importer)
Labels: (Represented) Caedmon Spoken Word (USA), Lyrichord (USA), Telefunken/Teldec (Germany), see Decca
 Tellastory, see Bartlett Bliss
 Tembo Recs. Ltd., 50 Regents Park Rd., London NW1 7SX Tel: (01) 586 5591 Telex: 299220 Gen. Mgrs: Roger Whitaker, Irene Collins
 Tempo, see Multiple Sound
 Test Pressing, see Burning Rome
 Thrd Kind Recs. Ltd., 11 Seaton Rd., Easton, Bristol BS5 6BM Tel: (0272) 511523, 550293 Chief Exec.: Ronald Green (Distributed by Pinnacle, Revolver, Rough Trade)
 Tinsite Recs. Ltd., 65 Berkeley St., Glasgow, Scotland G3 7DX Tel: (041) 248 2791 Gen. Mgr: John Cutler (Distributed by Clyde Factors, Ross)
 Sydney Thompson Recs., Eastcote Point, Pinner, Middx HA5 2AL Tel: (01) 866 8310 Dir: Sydney Thompson (Distributed by Gold & Sons, Lugton, H.R. Taylor, Sydney Thompson)
Label: (Owned) Invicta
 3 Centuries of Music, see Dryx
 Threshold, see Decca
 Thrust, see Chiswick
 Thunderbird, see President
 Titanic, see Sonet
 Titch Tunes, see Don't Panic
 Tonal Recs., 330 Norwood Rd., West Norwood, London SE27 9AF Tel: (01) 761 2292 Dirs: Alan Ford, Tony Martin
Label: (Owned) Red Hot
 Top, see Alted
 Top Hat, see Humber
 Topic Recs. Ltd., 50 Stroud Green Rd., London N4 Tel: (01) 263-6403 Mng. Dir: Tony Engle, PR: Tony Russell
Labels: (Owned) Impact, String, Topic, Topic/Free Reed
 Int'l reps.: Australia (Larrikin), Benelux (Parsifal), Canada (Almada), France (Edwards), Germany (Anvil, Spraggan), Ireland (Mulligan), Italy (IRD), Norway (Sinar), Sweden (Sam), Switzerland (Be-Bop), USA (Rounder, Shanachie)
 Toppro, see President
 Towerbell Recs. Ltd., 32/4 Gondar Gardens, London NW6 1HG Tel: (01) 794 6702 Telex: 8952387 Mng. Dir: Robert England, Gen. Mgr: Colin Smythe, Sales Mgr.: Susan England, A&R Mgr: Danny Fury (Distributed by PRT)
Labels: (Owned) Rockney, Shell, Towerbell
 Trailer, see Highway & Leader
 Transatlantic, see Logo
 Trial Recs., Moncliff off High St., Acton, nr. Sudbury, Suffolk Tel: (0787) 77317 Chief Exec.: Stephen Guy-Clarke (Distributed by Pinnacle)
 Trojan Recs. Ltd., 104 High St., Marlesden, London NW10 4SL Tel: (01) 961 4565 Cable: MUSICALITY Telex: 261500 Mng. Dir: Marcel Rodd; Gen. Mgr: Clive Stanhope, Int'l Mgr: Lynne Kentish, A&R Mgr: David Hendley (Distributed by Trojan & Pinnacle) (Also see B&C)
Labels: (Owned) Attack, Trojan

Int'l reps.: Germany (Teldec), Italy (Ri-Fi), Japan (Trova), Spain (Zafiro)
 Truckers Delight, see Big Bear
 Tryfan, see Sam
 Turnabout, see Vox
 21st Century Leisure Ltd., 41 Cotswold Gardens, London NW2 1QT Tel: (01) 458-8991 Mng. Dir: Martin Lewis
Labels: (Owned) Springtime, 21st Century
 Two Ten Recs., Paramount Int'l Estate, Unit 2, Sandown Rd., Watford, Herts. Tel: Watford 34146 Mng. Dir.: Geoffrey Brand (Distributed by H.R. Taylor)
 Two Tone, see Chrysalis
 U K Recs., 48 Grafton Way, London W1P 5LB Tel: (01) 387-5851 Pres: Jonathan King
Int'l branch: USA
Labels: (Owned) UK, UK American
 Ulster, see Duttel
 Ultimate Recs. Ltd., 26 Broad St. Ave., London EC2 Tel: (01) 638-3755 Mng. Dir: James Player, Gen. Mgr: Tony Cummings (Distributed by Pinnacle)
Labels: Futurist, Good City, Ultimate
 Ultra, see Plastic Fantastic
 Underworld, see Bungey Banker-Jukes Int'l
 Unicorn Recs. Ltd., The Manor House, Markfield, Leicester LE6 0UN Tel: (05305) 3138 Telex: 341728 Mng. Dir: John C. Goldsmith, Sales Mgr: William Simmons, Export Dir: Nigel J. Brandt
Labels: (Owned) Unicorn, Unicorn-Kanchana, (distributed-not licensed domestic) CRD, Hyperion, Saga, (distributed-not licensed foreign) Centaur (USA), Chalfont (USA), Citadel (USA), Crystal Clear (USA), Delos (USA), Finlandia (Finland), Sheffield Lab (USA), Telarc (USA), Varese Sarabande (USA)
 Int'l reps.: Australia (Janda), Belgium (PMP), Canada (Trend), Denmark (Phonogram Classical), Finland (Fuga), France (Schott Freres), Germany (Teldec), Hong Kong (Pacific), Italy (Florence Int'l), Japan (Japan Cardinals), Netherlands (Sound Prods.), Norway (PolyGram), South Africa (Recordia), Spain (Ferysa), Sweden (Sound Doctor), USA (Euroclass)
 United Dairies Recs., PO Box 18, Richmond, Surrey TW10 6ND Tel: (01) 940-4025 Mng. Dir.: John Fothergill
 Universal Rec. Co., 5 Doricote Rd., London SW18 Tel: (01) 870 1683 Pres.: Pierre Tubbs; Gen. Mgr.: Peter Kovacs, Sales Mgr.: Rick Steele (Distributed by Spartan)
Label: (Owned) Urco
 Uptown Recs., 5 Victoria Rd., Mablethorpe, Lincs Tel: (05213) 2625 Chief Exec.: Carl Tebbott (Distributed by Dne Stop Network & Pinnacle)
Label: (Owned) Wizzo
 Urco, see Universal
 V C L Video Servs. Ltd., 58 Parker St., London WC2 Tel: (01) 405-3732 Mng. Dir: Alan Judd (Video/Rec. Distributor)
 V J M S (Vintage Jazz Music Society) Recs., 12 Slough Ln., London NW9 8QL Tel: (01) 205-2587 Chief Exec.: Steve Lane, Sales Mgr.: Kaye Sear (Distributed by Jazz Music, Lugton, Swift, Chris Wellard)
Labels: (Owned) Halcyon, VJM, (distributed-not licensed domestic) Fountain, Hefty Jazz, Hep, Nola, Retrieval, Sunshine, (distributed-not licensed foreign) Arcadia (USA), Biograph (USA), Cal Jazz (Netherlands), Center (USA), Dawn (USA), Historical (USA), Melodone (USA)
 Int'l reps.: Canada (Coda), Italy (Hi Fi)

**OPTICAL INSTRUMENTS
 AND EQUIPMENT
 FOR RECORD TAPE AND
 VIDEO DISC PRODUCTION**

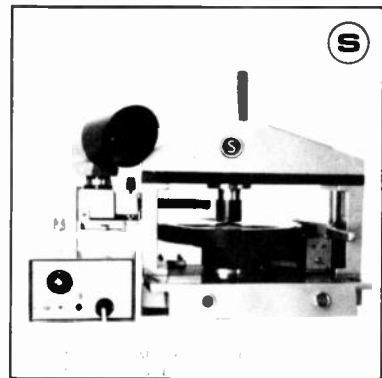
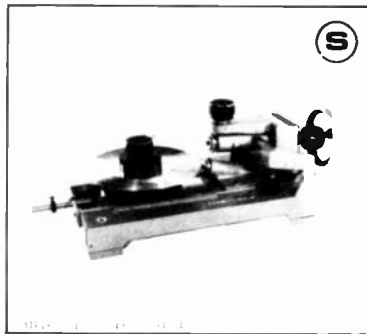

P & J SIBERT & CO
 181 FINBOROUGH ROAD
 LONDON SW1D 9AP
 ENGLAND
 TEL : 01 373 9508 / 01 330 0770
 TELEX : 894823

Vague Recs., 147 Lower Parliament St., Nottingham NG1 1EE. Tel: (0602) 598-212. Mng. Dir.: Steve Baker.
 Vallium, see Mawson Warehouse
 Vanessa, see DTP
 Vasko, see December Songs
 Ventilation, see Rare Rhythm
 Verve, see Polydor
 Victor, see RCA
 Video Music, see World of Video 2000.
 Video Recs. Ltd., 189 London Rd., North End, Portsmouth, Hants. PO2 9AE. Tel: (0705) 812449. Mng. Dir.: Jason Anthony; A&R: Jake Anthony.
 Int'l repps.: Belgium (Phonogram), France (Phonogram), Japan (Trio Kenwood), Switzerland (Phonogram).
 Videostars, see Wienybuds
 Village Thing, see Saydisc
 Vineyard Prod'ns, 5 Oak House, 13 Parson St., London NW4. Tel: (01) 203-1750. Telex: 22164. Mng. Dir.: David Loudon. (Distributed by Spartan).
 Labels: (Owned) Sticky; (Licensed foreign) Posoboy.
 Vintage Jazz Music Society, see VJMS
 Virgin Recs. (Retail) Ltd., 32/34 Avon Trading Estate, Avonmore Rd., London W14. Tel: (01) 603-4588. Chief Buyer: Jim Webster. (Distributor/Importer—cut-outs).
 Virgin Recs. Ltd. (IFI), 2 Vernon Yard, 119 Portcubello Rd., London W11. Tel: (01) 727-8070. Telex: 22542. Chm.: Richard Branson; Mng. Dir.: Simon Draper; Gen. Mgr.: Steve Lewis; Sales Mgr.: Ann Kelly; Pub. Dir.: Al Clark; Int'l Mgr.: Lisa Anderson; Mktg. Mgr.: Jeremy Lascelles; Promo. Dir.: Tessa Watts. (Distributed by CBS).
 Labels: (Owned) Din-Disc, Front Line, Virgin; (Licensed) Metalbeat.
 Int'l repps.: Australia (CBS), Austria (Ariola), Belgium (Ariola), Canada (Polygram), Finland (Polavox), Germany (Ariola), Italy (Ricordi), Japan (Victor), Netherlands (Ariola), New Zealand (RTC), Norway (Arne Bendiksen), Spain (Ariola), Sweden (Sonet), Switzerland (Ariola), USA (Epic/CBS).
 Visa, see Pacific.
 Vista Recs. Ltd. (IFI), PO Box 6, Gerrards Cross., Bucks. SL9 7AE. Tel: Gerrards Cross 86000. Mng. Dir.: Colin Symthe; Dir.: Robert Angles. (Distributed by Gamut).
 Int'l repp.: Worldwide (Gamut) excluding USA (German News Servs.).
 Vocal, see Decca.
 Vox Prod'ns (GB) Ltd. (IFI), 11 Elgwood House, Wellington Rd., London NW8 9TG. Tel: (01) 722-1208. Mng. Dir.: P. Fejer. (Distributed by Decca).
 Home office: USA.
 Labels: (Owned) Turnabout, Vox.
 Voyage Int'l Recs. Ltd., 264 Lavender Hill, Battersea, London SW11. Tel: (01) 223-6543. Mng. Dir.: Reg McLean; Gen. Mgr.: T. Sims; Sales Mgr.: Delores Reid. (Distributed by Pinnacle)
 Yu, see Ellie Jay.
 W E A Recs. Ltd., 20 Broadwick St., London W1V 23H. Tel: (01) 434-3232. Telex: 261425. Mng. Dir.: Charles Levson; Finance & Admin. Dir.: Ed Byrnes; A&R Dir.: Targuin Gotsch; Int'l Dir.: Phil Straight; Mktg. Dir.: Mike Heap; Promo. Dir.: Bill Fowler; Press Dir.: Maura Bellas; Gen. Mgr.: Geoff Grimes.
 Distribution branch: Wembley, Middx. HAO 1FL, Alperton Ln. Tel: (01) 998-8844. Telex: 936460.
 Manufacturing branch: West Drayton, Middx. UB8 8NP, Horton Rd. Tel: (81) 48531. Telex: 27492. Dpns. Dir.: Roy Mat hews.
 Home office: USA. WEA Int'l.
 Labels: (Owned) Antic, Asylum, Atco, Atlantic, Cotillion, Elektra, Nonesuch, Reprise, Sire, WEA, Warner Bros. (licensed domestic) Beggars Banquet, Carrere, F-Beat, GM, Gallery, Korova, Radar, Real, Riva, Tamarini, (licensed foreign) Automatic, Dark Horse, Geffen, Hansa, Paradise, Planet, Scotti, Solar, Swan Song, Whitefield.
 W R D Ltd. (Worldwide Rec. Dists. Ltd.), 35 Gt. Russell St., London WC1. Tel: (01) 636-3925. Telex: 8953415. Mng. Dir.: S. Johnson. (Distributor/Importer/Exporter)
 Waiting-in-Vain, see December Songs.
 Waldo's Recs., 4 Liverpool Rd., St. Albans, Herts. Tel: (0727) 32109. Pres.: Philip Lloyd-Smee; Gen. Mgr.: Nathan Calte; A&R Rep.: Millicent Black. (Distributed by Rough Trade)
 Warm Recs., see MHG.
 Warner Bros., see WEA.
 Warning, see Zircon.
 Warrens Recs. Ltd., 16-18 Hollen St., London W1. Tel: (01) 734-6822. Mng. Dir.: Warren Goldberg. (Distributor)
 Warwick, see CBS & Multiple Sound.
 Waterfront Music Ltd., The Did Custom House, 74 High St., Did Town, Leigh-on-Sea, Essex. Tel: (0702) 714-025. Joint Mng. Dirs.: Richie Bull, Dave Hatfield. (Also see Projection)
 Int'l repps.: Belgium (Parsifal), Germany (Spriguns), Italy (IRD), Netherlands (Sayer Lud), Switzerland (Be-Bop), USA (Silo).
 Waterhouse Recs., 10-12 Carlisle St., London W1V 5JF. (Distributed by BBI)
 Home office: USA.
 Waterloo Recs. Ltd., Waterloo House, 155 Upper St., London N1. Tel: (01) 354-2724. Mng. Dir.: John Cooper; Dir.: M. A. Ashwell.
 Wattau, see Armageddon.
 Waverly, see EMI.
 Weasel, see Dawn Promotions.
 Chris Wellard Independent Rec. Sales, 110 Eltham F-11, Eltham, London SE9 5EF. Tel: (01) 850-3161. Owner, Gen. Mgr. & Sales Mgr.: C.C. Wellard. (Distributor/Importer).
 Labels: (Distributed—not licensed) Alamo, Amigo, Appaloosa, Artemis, Artistic, BBS, Bee Hive, Beerdonk, Big Band Int'l, Black Cat, Black Eagle, Black Saint, Blue Bag, Blue Parrot, Bodeswell, Boogie Woogie, Burlington, Celebrity, Chandos, Swing Jazz Masters, Collectors Classics, Collectors Items, Dutch Swing Collection, Esquire, Everybody's Fantasy, Firebrand, First Heard, Flightright, Folklore, Fonda, Fore, Fountain, Four Leaf Clover, Free Reed, GM, G&W, Galaxy, Giants of Jazz, Glendale, Golden Era, Grappenhauer, Greenwich Village, 4&E, Halcyon, Harbour, Hetty Jazz, Hep, Incehronn, Ingo, International, JSP, JTC, Jam, Jam Session, Jazz Document, Jazz Galore, Jazz Piano, Jazz Unlimited, Jazz Vault, Jezabel, KC, Kenneth, Kon-Ti, Lee Lambert, Land D Jazz, Live, Lula Whites, MKS, Magic, Maggie, Master Jazz, Melocnic, Meteor, Milenburg, Milestone, Mole, Mother Earth, Neovox, Next, Nola, Nostalgia, Dward, Pablo, Phontastic, Pine, Pizza Express, Plant Life, Polish Jazz, Prestige, Proprius, Pumpkin, RCA, RCA Int'l, Rambler, Raphael, Raretone, Rarities, Regis, Route 66, Sackville, Saville, 77, Shamrock Shanachie, Small, Son, Soul Note, Standing Room Only, Slash, Shaz, Steam, Storyville, Sweet Folk & Country, Swing Classics, Swing House, Swing Master, Swing World, Tax, VJM, Vantage, Vortex, Waterfront, Wave, Western, White Label, Whoopee, Wildebeest, Wizard, World Jazz, Zodiac.
 Westwood Recs Ltd., Montgomery, Powys, Wales SW 16LU. Tel: (068681) 427. Mng. Dir.: Gordon R. Davies. (Distributed by I&B. Jazz Servs. Unlimited, Pinnacle, Ross, H.R. Taylor)
 Labels: (Owned) Raccoon, Sir, Westwood.

Int'l repps.: Norway & Sweden (Rocade).
 Whiteorse Music Ltd., 86 Turnham Green Terr., London W4. Tel: (01) 994-4895. Dir.: Norton York (Distributed by Spartan)
 Whoopee Rec. Prod'n Co. Ltd., PO Box 743, Putney, London SW15. Tel: (01) 789-4169. Cable: WHDDPEEMUSIC. Telex: 923591. Dir.: Bob Kerr; Gen. Mgr. & Sales Mgr.: John Jones.
 Why-Fi, see RCA
 Wienybuds Ltd., 18 Abercorn Rd., Stanmore, Middx. Tel: (01) 954-1463. Dirs.: Ian A. Wiener, Carey Budnick.
 Labels: Videostars, Wienybuds.
 Wilcox Org. Ltd. (IFI), 1099A Finchley Rd., Golders Green, London NW11. Tel: (01) 455-6620. Chief Exec.: Herb W. Wilcox; Gen. Mgr.: Karen Kendall; Sales Mgr.: J. Rhyer Scott.
 Labels: (Owned) Golden Era, Jazz City, Nostalgia, RKL, Showtime, Zodiac. Int'l repp.: USA (World Recs.).
 Windmill, see Multiple Sound.
 Windsonic Rec. Exports Ltd., St. Edmunds Church, Cornwall Rd., Croydon, Surrey. Tel: (01) 688-6836. Telex: 896218. Mng. Dir.: Steve Mason; Gen. Mgr.: Mike Chapman; Sales Mgr.: Sean Sullivan (Distributor) (SEE ADVERTISEMENT)
 Wizzo, see UpTown.
 Women's Rev. Per Minute, 62 Woodstock Rd., Birmingham B13 9BN. Contact: Caroline Mutton.
 Label: (Represented) Redwood (USA).
 Woolf Recs., 51 Rossiter Rd., London SW12. Tel: (01) 675-1832. Dir.: Bill Glons; Gen. Mgr.: Tim Hodgkinson; Sales Mgr.: Michael Hobbs.
 Richard Wootton, 21 Welbourne Court, Anerly Rd., London SE20.
 Label: (Represented) Amazing (USA).
 Word (UK) Ltd. (IFI), Northbridge Rd., Berkhamsted, Herts. HP4 1EH. Tel: (04427) 74711. Chm.: W.T. Hamilton; Mng. Dir.: Ian Hamilton; Gen. Mgr.: John Trimmer; Sr. Sales Exec.: D. Bruce; Sales/Mktg. Mgr.: Terence Carey.
 Labels: (Owned) Canaan, Dayspring, Myrrh, Sacred, Word; (Licensed domestic) Banners & Bonnets; (Licensed foreign) Birdwing (USA), Lamb & Lion (USA), Light (USA), Maranatha! (USA), Solid Rock (USA), Sparrow (USA).
 Int'l repp.: Australia (Sacred), Benelux (GMI), Canada (Word), Germany (Blue Rose & Dia), New Zealand (Sacred), Nigeria (DeCross), South Africa (Grace), Sweden (Prim), Switzerland (Kings Rock), West Indies (Record Pressers).
 World Jazz Recs. Ltd., 57 Bromhill Rd., Dringpton, Kent BR6 0EN. Tel: (0689) 26232. Chm.: John B. Hickox; Gen. Mgr.: Gerry Finningley.
 Home office: USA.
 Int'l repp.: Scandinavia (Amigo).
 World of Video 2000 Ltd., Cassette House, 329 Hunslet Rd., Leeds LS10 1NJ. Tel: (0532) 706066. Telex: 52993. Joint Mng. Dir.: Colin W. Marler. (Videocassette labels)
 Labels: (Licensed) Video Music, World of Video 2000.
 World Recs. Ltd., Parkbridge House, Little Green, Richmond, Surrey. Tel: (01) 940-8331. Mng. Dir.: Austin Bennett. (Distributed by EMI).
 Labels: (Owned) Conquest, Retrospect, World.
 Wudwnk, see The Impulse Drg.
 Wynd Up Recs. Ltd., Greengate Ln., Prestwich, Manchester. Tel: (061) 798-9252/0533. Telex: 667985. Mng. Dir.: Colin Reilly; Gen. Mgr.: B. Patchett; Sales Mgr.: L. D'Meara; Purchasing Dir.: N.K. Raggett; Warehouse Mgr.: B. Moore.
 Yorke Recs., 31 Thornhill Square, London N1 1BQ. Tel: (01) 607-0849. Owner: Rodney Stafford. (Importer of double bass discs)
 Young Blood Recs., 46 Ledbury Rd., London W11 2AJ. Tel: (01) 727-8723. Mng. Dir.: Jan Dlosson. (Distributed by PolyGram)
 Labels: Crazy Viking, Young Blood.
 Zela Recs. (Birmingham) Ltd., Walker Hall, Ampton Rd., Edgbaston, Birmingham B15 2UJ. Tel: (021) 455-0645. Mng. Dir.: Johnny Haynes; Gen. Mgr.: A. J. Haynes; Rec'g Studio Mgr.: Al Price.
 Labels: (Owned) Ash, Zella.
 Zero Rec'g & Publ'g, 36 Pemberton Rd., Telford, Salop TF5 0BL. Tel: (0952) 3490. Chief Exec.: Phil Summers.
 Labels: (Owned) Custom, Zero.
 Zeus Rec'g Co. Ltd., Wimpole House, 29 Wimpole St., London W1. Tel: (01) 631-5042. Dirs.: Zouma Benhalla, Basil Hope Gibsons. (Cassettes only)
 Int'l repps.: Australia (Educational Media Australia), USA (EAV, Univ. of Colorado)
 Zich, see RCA.
 Zip, see Duttel.
 Zircon Recs. Ltd., 452 Fulham Rd., London SW6 1BY. Tel: (01) 381-1391. Mng. Dir.: M.J. Bransby-Williams; Gen. Mgr.: Mike Williams; Sales Mgr.: Stuart Fox.
 Labels: (Owned) Zircon; (Licensed domestic) Plexex, Warning.
 Int'l repps.: Germany (Phonogram), Netherlands (Bertus), USA (Jem).
 Zodiac, see Wilcox
 Zoom Recs., Castleclyff, Suite 2, 25 Johnston Terr., Edinburgh, Scotland EH1 2NH. Tel: (031) 225-5755. Mng. Dir.: Bruce Findlay.

• music publishers

A I M Music Ltd., 43 Queen Anne, Dunfermline, Scotland. Mng. Dir.: A. I. Muir.
 A J Music Ltd., see Kassner.
 A M P Music Ltd., see Carlin.
 A P B Music Co. Ltd., 46a Montagu Square, London W1. Telex: 925859. Mng. Dir.: Chris Parry.
 A R & M Music, 20 Fitzroy Square, London W1. Tel: (01) 387-7781. Mng. Dir.: Brian Hutch; Gen. Mgr.: Wilfred Bruce. (Affiliated with EMI)
 Int'l repps.: Europe excluding UK & Ireland (Inter-song Int'l), Australia (Mushrooms), New Zealand (Stunning).
 A T Y Music Ltd., 24 Bruton St., Mayfair, London W1X 7DA. Tel: (01) 409-2211. Cable: SUGARSUGAR. Telex: 28526. Mng. Dir.: Peter Phillips.
 Int'l repps.: USA.
 Int'l firms represented: ATV, Ahab, Algee, Altam, Amundo, Angel Wing, Ascent/Aroma, Attache, Big Heart, Billabong, Blackbyrd, Brougham Hall, Bulpen, Donald Byrd, Castle Hill, Cliffhouse, Comet, Cumberland, De Byrd, Elgy, First Artists, Lowell Fuson, G. W.P. Golden Cornflake, Golden Field, Harmony & Grits, Lady Casey, Lambert & Potter, Larball, Lieden, Lucky Three, Madlad, Mandina, Metro, Ror Monitza, Moonlight & Magnolias, Natural Songs, Kenny Nolan, Northern Light & Sound, Oceans Blue, Peach Cobbler, Perks, Perren Vives, Primus Artists, Return, Paul Ritchey, Rocksmith, Ronjy, Salsoul, Sandstrom, Saine, Shoetunes/Shoestring, Sigler Street, Silver Blue, Smile, Solid Gold, Sounds of Memphis, Sounds of Nolan, Ray Stevens, Stone City, Strong Box, Sweco, Targo, Touch of Gold, Tri-Song, Turtle, Welbeck, Windchime, Wooden Bear, Zonal (all USA); ATV Northern (Australia), Allo (France), Attic (Canada), Bunyip (Australia), Cycus (Germany), Evans Gudinski (Australia), No Sheet (Netherlands), Pondwater (Canada), Saints (Australia), UEP.
 Int'l repps.: Africa (Leeds), Australia (ATV/Northern Songs), Austria (In-

tro), Belgium (Hans Kusters), Canada (ATV), Central & South America (excluding Mexico (Artemis), Far East (Pathe), France (Allo), Germany (Intro), Greece (Blackwood), Israel (April), Italy (ATV Italiana), Japan (Shinko), Luxembourg (Hans Kusters), Mexico (ATV), Netherlands (New Daylong), New Zealand (ATV/Northern Songs), Portugal (Clipper's), Scandinavia (Sweden), South Africa (Leeds), Spain (Clipper's), Switzerland (Music Today), USA (ATV).
 A-Z Music, c/o Vineyard Rec's Studios, Vineyard Sanctuary St., London SE1. Tel: (01) 403-0007. Mng. Dir.: Annette Marie Barrett.
 Abacus Music Ltd., see Carlin.
 Abigail Music Ltd., see RSD.
 Absurd Music, 20 Cotton Ln., Withington, Manchester M20 9UX. Tel: (061) 445-2661. Gen. Mgr.: Lawrence Beedle.
 Int'l repp.: Worldwide (ATV).
 Acton Green Music Ltd. (Leosong/PRS), 15 Great Western Rd., London W9. Tel: (01) 289-1021. Telex: 299611. Mng. Dirs.: Doug Smith, Wayne Bardell; Gen. Mgr.: Wayne Bardell; Prof. Mgr.: Gillian Massey.
 Acuff-Rose Music Ltd., 129 Park St., London W1. Tel: (01) 629-0392. Gen. Mgr.: Tony Peters. (Affiliated with Chappell)
 Home office: USA.
 Ad-Chorel Music Ltd. (PRS/MPA), Broughton House, 62 Broughton St., Edinburgh, Scotland. Tel: (031) 557-2528. Mng. Dir.: Neil Ross; Gen. Mgr.: Alison Service.
 Admiral One Music Ltd., see Margaret Brace.
 Agra Music, 4 Welton Rd., Wedgwood Estate, Warwick CV34 5YA. Tel: (0926) 45123. Mng. Dir.: Sheila L. Bird.
 Aggro Music, see Andy Patch & Margaret Brace.
 Air Music Ltd., 12 Stratford Pl., London, Tel: (01) 408-2355. Cable: CHRYSA-LIS. Chm.: George Martin. (Affiliated with Chrysalis)
 Int'l firm represented: Air (Sweden).
 Airs & Graces Music (PRS), 4 Dorset & Cambridge Mansions, Flat D, Did Marylebone Rd., London NW1. Tel: (01) 723-2454. Mng. Dir.: Martin Hall, Tony Leighton
 Air Traffic Control Musik, see Laserium Musik.
 Albert Gate Court Music Ltd.—Dirs.: Jonathan & Gunilla Rowlands—see Hush.
 Albion Music Ltd., 147 Dorset St., London W1. Tel: (01) 734-9072. Telex: 8954780. Dirs.: Dai Davies, Derek Savage; Gen. Mgr.: Mark Anders.
 Int'l repps.: Australia (Mushroom), Benelux (Chappell), France (Clouseau), Germany (Chappell), Italy (Ricordi), Portugal (Chappell), Scandinavia (Chappell), South America (Chappell), Spain (Chappell).
 Algeo Music Co., 17 Palace Gate, London W8 5LS. Tel: (01) 589-6472. Mng. Dir.: George Ehrlich.
 Int'l firms represented: Con Bro (USA), Magazine (Germany).
 Alice Music Ltd., 9 Cavendish Square, London W1M 0DU. Tel: (01) 995-1191.
 Alien Music Ltd. (PRS), 109 New Bond St., London W1. Tel: (01) 408-2350. Dir.: Charlene Bowen; Gen. Mgr.: Nigel Lucas; Prof. Mgr.: Zoro Baby.
 Int'l repp.: Germany (Schacht).
 Always Music, 5 Staple Inn, London WC1.
 Almanac Music, see Performance.
 Alted Music, 37-B New Cavendish St., London W1M 8JR. Tel: (01) 486-5353. Chief Exec.: Ted Lemon, Alex Hughes. (Affiliated with Warner Bros.)
 Int'l repp.: Worldwide (Warner Bros.)
 Ambassador Music Ltd., 22 Denmark St., London WC2. Tel: (01) 836-5996. Cable: AMBAMUSIC. Pres.: George Pincus.
 Home office: USA. Gil Music.
 Amber Music (PRS, MCPS), Wellow Mead, Wellow Drive, Sheffield English nr. Romsay, Hants. SO5 0DU. Tel: (0202) 34041. Mng. Dir.: James Montgomery.
 Amen Music Ltd., see Carlin.
 Amicus, see Street Corner.
 Amigo Music Ltd. (PRS), Kerchesters, Waterhouse Ln., Kingswood, Surrey. Tel: (073) 832837. Cable: AMPHDNIC. Mng. Dir.: Syd Dale; Gen. Mgr.: Fay Gibbs.
 Int'l repps.: Australia (Chappell), France (Warner), Germany (Bavariatan), Italy (West), Netherlands (Holland), New Zealand (Castle), USA (Emil Ascher).
 Anastasia Group of Cos., 62 Pall Mall, London SW1. Tel: (01) 930-5361. Mng. Dir.: Jon Brewer; Dir.: Robert Patterson.
 Andersong Music, 165 Wolverhampton Rd., Sedgley, Dudley, West Midlands. Tel: (09073) 2211, 3356. Partners: Juanita Anderson, Paul Birch.
 Andwellia Music Ltd., see Carlin.
 Andy Patch Music, 83 Leonard St., London EC2A 4RB. Tel: (01) 729-5411. (Administered by Margaret Brace).
 Angle Music, Toftrees, Church Rd., Woldingham, Surrey. Tel: Woldingham 2386. Mng. Dir.: David Mackay; Gen. Mgr.: Peter Parr-Head.
 Int'l repps.: USA (David Mackay, Sabre).
 Anita Music Ltd., see Carlin.
 Anna Music Ltd., see Miriamusic.
 Apex Music Ltd., 12 Elgin Mansions, Elgin Ave., London W9. Tel: (01) 794-7191.
 Apple Pie Music Ltd., Hurworth Cottage, Croft Rd., Hurworth, Darlington, Durham. Tel: (0325) 721-143, 720-792. Mng. Dir.: Elaine Saffer.
 April Music Ltd., 54 Greek St., London, Tel: (01) 439-1845. Cable: APRIMUSIC. Telex: 24203. Mng. Dir.: Len Beadle; Prof. Mgr.: Paul Bessell.
 Int'l firms represented: Bruiser, Carol Nan, Chesyl, Clay, Country/Black, Derringer Dickiebird, Dijon, Dimeola, Double Diamond, Dozier, Ether Gello Cheby, Fullness, Albert Hammond, Hartene, Hatband, Hickory Grove, Hierophant, Hudman, Ian Hunter, Impulsive, Jerry Lyn, Joelsons, Lazy Libra, Ramsey Lewis, Dave Mason, Mideb/Eric McArthur, Mr. Sunshine, Mott, Novalee, Oceans Blue, PH Factor, Power, Power Exchange, RSPY, Richie Rose, Ragmop, Sanyook, Scorpiom, Sherry, Silver Blue, Silver Steed, Sunsigner, Tradition, Tuna Fish, Xenon, Stan Vincent, Westbrook, Winter Blues, Winder Wind (all USA), Wetwater/Woodwater (Jamaica).
 Int'l repps.: Argentina (Melogra), Australia (April), Austria (Wien Melodie), Belgium (April), Brazil (Mundo Musical), Canada (April/Blackwood), Central America (Mundo Musical), Chile (Melogra), Costa Rica (Mundo Musical), France (April), Germany (April), Greece (Blackwood), Israel (April), Italy (April), Japan (April), Luxembourg (April), Mexico (Mundo Musical), Netherlands (April), New Zealand (April), Norway (Arne Bendiksen), South Africa (April), Spain (April), Sweden (April), USA (April/Blackwood), Uruguay (Melogra).
 Aquarius, 102-104 Gloucester Pl., London W1H 3PN. Tel: (01) 486-6040. Telex: 298995. Mng. Dir.: Don Arden.
 Arcades Music, 33 Pearnon St., London SW1. Tel: (01) 627-0436. Cable: REDFDX. Dir.: Chris Cutler.
 Arcadia Music Publ'g Co. Ltd. (MCPS), PO Box 1, Rickmansworth, Herts. WD3 3AZ. Tel: (01) 584-6671. Mng. Dir.: John Wallington.
 Art Art Music Ltd., see Carlin.
 Argot Music Co., see Valentine.
 Arista Music, see Intersword.

- Aristocrat Music Ltd., 9/11 Monmouth St., London WC2. Tel: (01) 836-4761. Telex: 261507 Mng. Dir.: Terry King.
- D. & J. Aron Ents., 22 Denmark St., London W1. Tel: (01) 836-5996. Chm.: Deke Aron. Mng. Dir.: Derek Everett. (Affiliated with Chappell)
- Int'l rep.: Worldwide (Chappell)**
- Aranakata Music Ltd. (PRS), 101 Oxford & Cambridge Mansions, Transept St., London NW1 53L. Tel: (01) 723-8424. Cable: ARNAKATA. Telex: 24956. Dirs.: Lloyd Beiny, Mike Dolan.
- Int'l firms represented:** Bleu Disques, Damit, Good Fortune (all USA).
- Int'l reps.: Benelux (Intersong), France (Eddie Barclay), Germany (Budde), Italy (Franton), Japan (Watanabe), Netherlands (Intersong), Scandinavia (Sweden).**
- Arny's Music, see Spaniel.
- Arretta Music Ltd., Electron House, Cray Ave., St. Mary Cray, Dripington, Kent BR5 3QJ. Tel: (0689) 25741. Telex: 896141. Dirs.: Terry Scully, Laurie MacGregor.
- Arthur's Mothers Music Ltd., see Valentine.
- Ascherberg Hopwood & Crew Ltd., see Chappell.
- Edwin Ashdown Ltd., 275-281 Cricklewood Broadway, London NW2 6QR. Tel: (01) 450-5237. Mng. Dir.: S.E. Ashdown; Dr.: J.R. Sharpe; Sec'y: M.E. Pope.
- Int'l firms represented:** Enoch (France).
- Int'l rep.: Canada (Boosey & Hawkes).**
- Ashtra Holdings (Eire) Ltd., 223 Regent St., London W1R 8TD. Tel: (01) 734-9768. Telex: 24170. Dir.: Philip R. Dir.: Philip R. Solomon. (Administered by Margaret Brace)
- Int'l firms represented:** Impact (South Africa)
- Int'l rep.: South Africa (Impact)**
- A Side Music, see Sonet.
- Asterisk Music, PO Box 18F, Chessington, Surrey KT9 1UJ. Tel: (01) 397-8957. Cable: CHIRPING. Chief Execs.: John Beecher, Tony Atkins, Gen. Mgr.: Yvonne Trengove.
- Astra Int'l Entertainments, Thornley St., Wolverhampton. Tel: (0902) 26628. 28084. Mng. Dir.: Tony Perry, Dirs.: Alan Clayton, George Maddocks.
- Aura Music Ltd., 1 Kendall Pl., London W1H 3AG. Tel: (01) 486-5288. Telex: 24224. Tel: 3145. Mng. Dir.: Aaron Sixx.
- The Automatic Music Co. Ltd., 5 Avery Row, London W1X 9HA. Tel: (01) 493-9744. Telex: 299978. Mng. Dir.: N.A. Mobbs.
- Aven Music Ltd., see Warner Bros.
- Avens Music Ltd., 81 Harley House, Marylebone Rd., London NW1. Tel: (01) 487-5587. Telex: 298415. Mng. Dir.: Sam Mortimer; Prof. Mgr.: Brian Freshwater.
- Int'l firm represented:** Schmolzi Slezak Music (Germany)
- Aviation Music, 102-104 Gloucester Pl., London W1H 3PH. Tel: (01) 486-0997. Telex: 298995. Mng. Dir.: Peter Felslead, Gen. Mgr.: Grant Black
- Axle Music Ltd., 27 Arkwright Rd., Hampstead, London NW3 6RI. Tel: (01) 435-9601. Chief Exec.: Ken Howard.
- Aza Music Co., 652 Finchley Rd., London NW11. Tel: (01) 458-7288. Dir.: Morris Aza.
- B A T Music Ltd., 47 Fulham Broadway, London SW6 1AE. Tel: (01) 381-2464. Mng. Dir.: Bernard Theobald.
- Int'l rep.: Europe (April)**
- B B J Connelly Music Ltd., 37 Soho Square, London W1V 5DG. Tel: (01) 439-9181. Telex: 27778. Chm.: Michael Bungey, Gen. Mgr.: Roy Berry
- B & C Music Ltd. (PRS), see Panache
- B K Music Ltd. (PRS), 7 Harley St., London W1. Tel: (01) 636-1285. Dirs.: John Bassett, Lorna Kirtland.
- B S Music Ltd., see Carlin.
- B T W (Music) Ltd., 125 Myddleton Rd., Wood Green, London N22. Tel: (01) 888-6655. Co-Dirs.: John Ross Borthwick, R.J.T. Borthwick.
- B W D Music Co. Ltd., see Margaret Brace.
- Baal Recs. Music, 62 Gloucester Pl., London W1. Tel: (01) 486-1486. Cable: BAALDN. Telex: 25836. Mng. Dir.: Colin J. Brain; Gen. Mgr.: Jay Shotam.
- Baby Music Ltd., 40 Denbigh St., London SW1. Tel: (01) 828-1978. Chief Exec.: R. Pearce.
- Bandlin Music Ltd., see Carlin.
- Banks Music Publ'ns, 139 Holgate Rd., York. Tel: (0904) 21818. Owner: Ramsay Silver.
- Barenreiter Ltd., 17-18 Bucklersbury, Hitchin, Herts. SG5 1BB.
- Int'l firms represented:** Alkor, Bosse, Nagel, Stauda (all Germany); Broude (USA), Pelikan (Switzerland).
- Barn Publ'g Ltd., 35 Portland Pl., London W1. Tel: (01) 637-2111. Cable: BARNEMUS. Telex: 25929. Chm.: Chas Chandler; Mng. Dir.: Sam Mortimer; Prof. Mgr.: John Bright.
- Barton Music Ltd., see Sparta Florida.
- Basement Music, 6 Pembroke Rd., London W11. Tel: (01) 221-1522. Chief Execs.: John Teffer, Eileen Treacy.
- Battle of the Bands (Music) Ltd., see RMD.
- Beadle Music Ltd., see MAM.
- Beal Stuttard & Co. Ltd., see Margaret Brace.
- Bearsongs (PRS), 190 Monument Rd., Birmingham B16 8UU. Tel: (021) 454-7020. Cable: BEARSDNGS. Mng. Dir.: Kate Munn.
- Int'l reps.: Australia (Jonathan), Benelux (Warner Bros.), Germany (Roba), New Zealand (Jonathan), South Africa (Warner Bros.).**
- Beaumont Music, 20-24 Beaumont Rd., Chiswick, London W4. Tel: (01) 995-5432. Chief Execs.: Piers Ford-Crush, Philip Love.
- Beautiful Music Ltd., see Kassner.
- Beautiful Sunday Music Ltd., Flemington House, Gollanfield, By Inverness, Scotland. Tel: (06676) 2304. Telex: 75209. Mng. Dir.: Rod McQueen.
- Bee Bee Music Ltd., PO Box 472, London SW7 2QB. Tel: (01) 373-3269. Cable: JDLUSTIG. Telex: 21879. Attn: Lustig. Mng. Dir.: Jo Lustig, Gen. Mgr.: Dee Lustig.
- Sara Bee Music Ltd., 17 Ronneby Close, Weybridge, Surrey KT13 9SB. Tel: (98) 42689. Dir.: Shirley Selwood, Gen. Mgr.: Clive Selwood.
- Beggars Banquet Music Ltd., 8 Hogarth Rd., Carr's Court, London SW5. Tel: (01) 370-6175. Telex: 915733. Mng. Dir.: Nick Austin; Prof. Mgr.: Martin Mills.
- Int'l reps.: Australia (Rondor), Benelux (Rudolf Slezak), France (Moutaure), Germany (Rudolf Slezak), Italy (Franton), Japan (Door Knob), New Zealand (Rondor).**
- Beffern, see Island.
- Belsize Music Ltd., 38 North Row, London W1. Tel: (01) 491-3175. Mng. Dir.: Charles Peate, Gen. Mgr.: Iris Giebler.
- Int'l reps.: Canada (Belsize), Scandinavia (Air), USA (Belsize).**
- Belwin-Mills Music Ltd., 250 Purley Way, Croydon, Surrey CR9 4QD. Tel: (01) 681-0855. Cable: BELMILMUS. Telex: 8953180. Mng. Dir.: Cyril Gee, Gen. Mgr.: Malcolm Binney.
- Home office: USA**
- Int'l firms represented:** Alfred, Mel Bay, Byron-Douglas, Cirone, Deshon, Dover, Charles Foley, Franco Colombo, J. Fischer & Bro., H.W. Gray, HSP, Edwin F. Kalmus, Robert King, Edward B. Marks, McAfee, Mills, Multimood, Music Boutique, Pro-Art, Schmitt, Hans Sikorski, Southern, Summit, Volkwein Bros., Dale Zdenek.
- Int'l reps.: Popular Music - Australasia, Austria, Belgium, France, Ger-**
- many, Luxembourg, Scandinavia, Switzerland, Western Hemisphere (all Belwin-Mills); Italy (RCA), Japan (Toa), Netherlands (Universal Songs), Portugal (Mills), South Korea (Toa), Spain (Mills), Taiwan (Toa). **Serious Music - Belgium, Europe No. 1 Radio Station, France, Luxembourg, Monaco (all Mario Bois); Japan, South Korea, Taiwan (all Toa); Western Hemisphere (Belwin-Mills). **Printed prod. - Denmark (Kleinerts), Finland (Fazer), France (Mario Bois), Hong Kong (Tom Lee), Luxembourg (Mario Bois), Monaco (Mario Bois), Norway (Norsk), Sweden (Thore Ehrling), Western Hemisphere (Belwin-Mills).****
- Benday Music Ltd., see Carlin.
- Bens Music Ltd., see Kassner.
- Bettytunes Music Ltd., see Valentine.
- Benstock Music Co., 2 Murray St., Camden Town, London NW1. Tel: (01) 431-0864, 485-1257. Dirs.: Mel Taggart, Ray Roberts.
- Big Ben Music Ltd., 18 Lancaster Mews, London W2 3QE. Tel: (01) 723-4499. Dir.: Ben Nisbet. (Administered by Margaret Brace).
- Big Ear Music, see Satril.
- Big Pig Music Ltd., see Rocket.
- Big Secret Music Ltd., 184-186 Regent St., London W1R 5DF. Tel: (01) 439-6679. Cable: LOVESDNGS. Telex: 27557. Joint Chm.: Guy Fletcher, Doug Flett.
- Int'l reps.: Australia (Matthews), Austria (Melodie der Welt), Belgium (Hans Kusters), Canada (Big Secret), France (Intersong), Germany (Melodie der Welt), Luxembourg (Intersong), New Zealand (Matthews), Portugal (April), Scandinavia (Air), South Africa (EMI Brigadiers), Spain (April), Switzerland (Melodie der Welt), USA (Big Secret).**
- Big Spiff Music, The White House, The Street, North Lopham, Diss, Norfolk. Tel: (037988) 693. Owner & Dir.: Peter Shertser; Gen. Mgr.: Brett Housego; Sales Mgr.: Bruce Simmons. (Affiliated with Paul Rodriguez)
- Billy Goat Music, see Chick-A-Boom.
- Birth Music Ltd., see DionSong.
- Biscuit Music Ltd., 17 Ronneby Close, Weybridge, Surrey KT13 9SB. Tel: (98) 42689. Mng. Dir.: Clive Selwood, Gen. Mgr.: S. Selwood. (Affiliated with Sara Bee)
- Bishop Music, 12 Hill Rd., St. Johns Wood, London NW8. Tel: (01) 286-4025. Mng. Dir.: Ann Bishop.
- Blackbird Music, Badgers Wood, Cadbury Camp Ln., Clapton-In-Gordano, Bristol BS20 9SB. Tel: (0272) 856770. Dirs.: J. Miles, P. Budd, T. Baylis, T. Banner.
- Black Eye, see Desert Songs.
- Black Gold Music, see Middle Road.
- Black Jack Music (PRS), see Panache.
- Black Neon Ltd., 40 Oxford & Cambridge Mansions, Flat D, Old Marylebone Rd., London NW1. Tel: (01) 723-2454. Telex: 847777. Mng. Dir.: Nigel Haines, Gen. Mgr.: Alan Bown.
- Int'l reps.: Benelux (Nada), France (Francis Dreyfus), Germany (Roba).**
- Black Sheep Music Ltd., Fulmer Gardens House, Fulmer, Bucks. Tel: (02816) 2143, 2109. Telex: 849208. Mng. Dirs.: Ben & Linda Findon; Gen. & Prof. Mgr.: Cliff Smith.
- Int'l firm represented:** Bubbly (USA).
- Int'l reps.: Australia (ATV Northern), Germany (Roba), Japan (Pacific), Scandinavia (Air), South Africa (Little Monster).**
- Black & White Music Corp. Ltd., 9 Devonport, 23 Southwick St., London W2. Tel: (01) 402-9650/5041. Cable: SOUNDNSRIGHT. Chief Execs.: A. Barnett, Tim Knight.
- Joe Bloggs Music Ltd., see Carlin.
- Blosmay Music Ltd., see Carlin.
- Bluebell Music (MGPS), see Isa.
- Bluebird Music Ltd., 155 Church St., London W2 1NA. Tel: (01) 723-6561/9090. Chief Execs.: Billy Russell, Billy Carruthers.
- Blue Cat Music, see Asterisk.
- Blue Gum Music Ltd. (PRS), see Bruce Welch.
- Blue Mountain Music, see Island.
- Blueport Publ'g Co., 52 Kelvin Grove, Sandyford, Newcastle. Tel: (0632) 612-849, 812-377. Prime Co-ord.: Mike Maurice; Promos. Mgr.: Tony Glover.
- Blueytones Publ'g, PO Box 472, London SW7 2QB. Tel: (01) 723-2454. Telex: 21879. (Also see ATV)
- Bocu Music Ltd., 48 Grafton Way, London W1P 5LB. Tel: (01) 388-7653. Cable: MARQUIMUS. Telex: 298976. Mng. Dir.: John Spalding, Gen. Mgr.: Carole Broughton; Prof. Mgr.: Howard Huntridge.
- Int'l firms represented:** Barthel, Bill Black, Equinox, Good Flavour, Jarak, Lynam, Lyn Lou, Nelltone, Partner, Slow Dancing, Songtailors, Wimot, Window (all USA), Polar, Sweden, Union Songs (all Scandinavia).
- Bongo Music, see Rascal.
- Bonney Music Ltd., see Kassner.
- Boogie Music, see Beautiful Sunday.
- Boosey & Hawkes Music Publ'rs Ltd., 295 Regent St., London W1R 8JH. Tel: (01) 580-2060. Cable: SONDRDUS. Mng. Dir.: R.A. Fell.
- Int'l branches:** Australia, Canada, France, Germany, South Africa, Sweden, USA.
- Int'l firms represented:** Barry (South America), Ed. Musica Budapest (Hungary) Carl Fischer (USA), Luvorne (USA), Suvini Zerboni (Italy), YAAP (USSR).
- Int'l reps.: Austria (Eirich), Denmark (Wilhelm Hansen), Finland (Musik Fazer), Italy (Carsch), Japan (Nippon Gakki), Netherlands (Albersen), Norway (Norsk), South America (Barry), Spain (Vidal Limona), Sweden (Carl Gehrman).**
- Bottom Dollar Music, see Million Dollar.
- Bourne Music Ltd., 34/36 Maddox St., London W1R 9PD. Tel: (01) 493-6412. Dir.: M.B. Bourne.
- Boy Eats Girl Music, see Illegal.
- Boy Songs, see Panache.
- Margaret Brace Copyright Bureau Ltd., 11 Great Marlborough St., 2nd fl. rear, London W1A 4QD. Tel: (01) 437-3711. Mng. Dir.: Margaret Brace; Gen. Mgr.: Sandra Cackett.
- Int'l firm represented:** Bizet (Belgium).
- Bradgate Bush Music Publ'g, 69 New Bond St., London W1. Tel: (01) 408-1606. Mng. Dir.: A. Gourvish.
- Brampton Music Ltd. (div. of Tony Hall Group of Music Cos.), 9 Carnaby St., London W1V 1PG. Tel: (01) 437-1958. Cable: TASTES. Mng. Dir.: Tony Hall.
- Int'l firms represented:** Frozen Butterfly, Mac Man, Viza (all USA).
- Brand New Music, 1 Derby St., London W1V 7HD. Tel: (01) 493-9637. Telex: 892756. Mng. Dir.: Mike Vernon. (Also see Handle)
- Bridge House Music Ltd., 23 Barking Rd., Canning Town, London E16. Tel: (01) 476-2889. Pres.: Chris Thompson; Gen. Mgr.: Terence Murphy. (Affiliated with Mews)
- Int'l rep.: Worldwide (Martin-Couller).**
- Bright Music Ltd., see Warner Bros.
- Bron Drg. Ltd., 100 Chalk Farm Rd., London NW1 8EH. Tel: (01) 267-4499. Cable: HITMUSIC. Telex: 261653. Dr.: Sydney Bron; Gen. Mgr.: Ron

ATTENTION RECORD IMPORTERS!

If you wonder why your competitors sell at cheaper prices and have new releases first, they are probably dealing with us.



RECORD

EXPORTS

"Acknowledged as the best"

We offer a comprehensive service on ALL U.K. product, combining a first class information service with the cheapest prices around.

(12" disco, singles, independent labels, rock, jazz, classical)
Simply The Finest Service Available in the U.K.

ST. EDMUNDS CHURCH · CORNWALL ROAD
CROYDON SURREY
TEL. 01-688 6836 TLX 896218 WINDS

McCright
Int'l firms represented: Selay Artists (Netherlands), Munchin (USA), Frank Zappa (USA).
Int'l reps: Argentina (Relay), Australia (Intersong), Austria (Aberbach), Belgium (Intersong), Brazil (Fermata), Canada (Belinda), France (Intersong), Germany (Chappell), Greece (Intersong), Israel (Litratone), Italy (Intersong), Japan (Intersong), Mexico (Intersong), Netherlands (Intersong), Singapore (Intersong), South Africa (Intersong), Spain (Canciones del Mundo), Sweden (Intersong), Switzerland (Aberbach), USA (Intersong), Venezuela (Polydor).
 Brookside Music, see Asterisk.
 C. Brill Ltd., 18 Tiverton Rd., London NW10 3HL Tel: (01) 969-3776. Chief Exec.: K. Schick.
Int'l branch: France.
 Brunswick Music Publ'g Co. Ltd., see Margaret Brace
 Buckingham Music, 14 New Burlington St., London W1 Tel: (01) 734 3251
 Cable: CARLSONG. Chief Exec.: Graham Smith. Gen. Mgr. Dave Watson.
Int'l rep: Worldwide (Carlin).
 Bulk Music Ltd., Baltic Chambers, 50 Wellington St., Glasgow, Scotland Tel: (041) 221 0777. Chief Exec. Isabel G. Waugh, Dir. & Gen. Mgr. Angus McDonald. (Affiliated with Mews)
 Bulldog Music Co., see Valentine.
 Bullseye Music, AIR House, Spennywood, Co Durham Tel: (0388) 814 632.
 Chief Execs.: Colin Pearson, John Wray. Gen. Mgr.: A.P. Blackett.
 Bumper Publ'g, 51 Leslie Park Rd., Croydon, Surrey. Tel: (01) 656-7919.
 Telex: 896691. Joint Mng. Dir.: Paul Mews, Gen. Mgr.: Richard Jones.
 Burlington Music Co. Ltd., 40 S. Audley St., London W1Y 5DH Tel: (01) 499-0067. Dir.: Bruno Kretschmer.
Int'l firms represented: Acclaim, Bocephus, Com Bro, Four Star, Frebar, Golden West Melodies, Open Road, Single Tree, Tuckahoe, Western
Int'l reps: Argentina, Australasia, Benelux, Brazil, France, Greece, Italy, Japan, Rhodesia, South Africa, Spain, Sweden, Switzerland (all Intersong); Austria (Arends), Canada (Burlington), Czechoslovakia (Supraphon), Far East (Burlington-Palace), Germany (Arends).
 Burnt Ash Music Co., see Valentine.
 Byzance Ltd. (PRS), 8 Ganway Rd., London W2. Tel: (01) 221-5597. Chm.: Eric Daugu. Gen. Mgrs.: Eric Daugu, Charles Harbier.
 C & D Music, see D.B.J. Arlon.
 C J Music, see Stage Coach
 C T A Music Ltd., see Carlin
 Cadillac Music, 180 Shaftesbury Ave., London WC2H 8SJ Tel: (01) 836 3646. Chief Exec.: John Jack.
 Calendar Music, 89 Chiswick High Rd., London W4. Tel: (01) 995-3682.
 Cable: SUNARTISTE. Mng. Dir.: Don Lawson; Gen. Mgr.: Curiah Lawson.
Int'l reps: Australia (Chappell), Austria (Aberbach), Canada (Morning), Germany (Aberbach), Switzerland (Aberbach).
 Camad Publ'rs Ltd., see Carlin.
 Campbell Connelly & Co. Ltd. (PRS), 37 Soho Sq London W1Y 5DG Tel: (01) 439-9181. Dirs.: Roy Berry, Reg Munnis.
 Howard Campbell Music, 1010 Harwood Rd., London SW6. Tel: (01) 731-6736. Chief Exec. Howard Campbell
 Candle Music Ltd., 101 103 Baker St., London W1M 2BE Tel: (01) 935-3906, 486-8738. Mng. Dir. Stavros Spyropoulos, Gen Mgrs Barry Kirsch, Charlie Spencer.
 Capstan Music, see Neutral Zones.
 Captain Beaky Music Ltd., 117C Fulham Rd., London SW3. Tel: (01) 589 6293. Mng. Dir. Jonathan Rowlands, Gen. Mgr.: Judy London.
 Captain Billy's Music Ltd., see Margaret Brace.
 Cardinal Music Ltd., see Carlin.
 Carlin Music Corp., 14 New Burlington St., London W1X 2LR. Tel: (01) 734 3251. Cable: CARLSDNGS. Telex: 267488. Pres. Freddy Benstock; Exec. VP: R. Derek Knibb; VP's: Paul Rich, Miriam Benstock, Dir.: Mike Collier, Carmel Music Ltd., 4 Cliff Ave., Westcliff-on-Sea, Essex SS0 7AJ. Tel: (0702) 338593. Mng. Dir.: Peter Eden.
 Carrere Music Ltd., 20-22 Queen St., Mayfair, London W1X 7PJ. Tel: (01) 493-7406. Telex: 8953657. Mng. Dir. Freddy Cannon
 Carson Music Ltd., see Margaret Brace
 Casino Music, see Satrii.
 Castle Hill Music (PRS), 34 Lake Terr., Hunslet, Leeds, Yorks. LS10 2JG. Tel: (0532) 700-010. Mng. Dir.: Ian R. Smith, Gen. Mgr.: A.M. Cain; Prof. Mgr.: M. Lee.
Int'l rep: Canada, USA (both Integrity)
 Casrator Music, Daily Rd., Maybole Ayrshire, Scotland KA19 7AX. Tel: (0655) 82200. Dwner: Ruu de Castro.
Firms represented in Portugal: Blitzmusik (Germany), Cardoso (Portugal), Cherry Red (UK), Duke (UK), Nervous (UK), Record Shack (UK).
Int'l firm represented: Cardoso (Portugal).
Int'l rep: Portugal (Cardoso).
 Catalyst (Music Publ'g) Ltd. (MCPs, PRS), 38 Biddulph Mansions, Biddulph Rd., London W9 1HX Tel: (01) 289 6337. Telex 21879 Mng. Dir.: Peter Knight Jr.
 Catapult Music Ltd., see Acton Green.
 Cathy Music, 15 Knowl Rd., Golcar, Huddersfield Tel: (0484) 657-054. Chief Exec. Mike Storey. (Affiliated with Valentine)
 Cats Eye Music, see Margaret Brace & State.
 Cats Whiskers Music Ltd., 45 Rudloe Rd., London SW12. Tel: (01) 673-2733. Mng. Dir.: Helen Aguil, Gen. Mgr.: John Dummer. (Affiliated with Rondor)
 Cavalcade Music Ltd., 138 New Bond St., London W1. Tel: (01) 493-9681. Cable: CAVCAD. Telex: 8954791. Dirs.: J.A. Fogarty, R.A. Liversage; Gen. Mgr.: R. A. Liversage.
 Cee Cee Music, see Asterisk.
 Celebration Servs. (Post Green) Ltd., 57 Dorchester Rd., Lytchett Minster, Poole, Dorset BH16 6JE. Tel: (0202) 623651. Cable: CELSERV Mng. Dir. Philip Bradshaw. Gen. Mgr.: Robert Ellis.
Int'l rep: USA (Redeemer Books).
 Celebrity Music Ltd., 120 Marylebone Ln., London W1 Tel: (01) 935-6732, 486-0596. Mng. Dir. Gavin W. Dare.
 Celis Music Co., 220 West End Ln., London NW6. Tel: (01) 286-2543. Chief Exec.: Geoff Mann.
 Frank Chacksfield Music Ltd., Allegro, Elm Walk, Farnborough Park, Dprington, Kent BR6 8LX. Tel: Farnborough 55509 Cable: GDLDISCS. Mng. Dir.: Frank Chacksfield
 Chameleon Publ'g, 19 S. Molton St., London W1 Tel: (01) 629 9719. Telex 261805 Mng. Dir.: Mike Loveday
 Champ Music, 57 Victoria Rd., Chingford, London E4 6BZ Tel: (01) 529-1943. Mng. Dir. & A&R Dir.: Richard de Sylva. (Affiliated with ATV)
 Chandos Music Ltd., 41 Charing Cross Rd., London WC2. Tel: (01) 437-1448/5512 Telex 27950/195. Mng. Dir.: Brian Couzens; Gen. Mgr.: Janet Dsborn.
Int'l reps: Japan (Shinko), Norway (Norsk).
 Chandos (Rec's) Ltd., see Chandos Music.
 Chantelle Music Ltd. (PRS, MCPs), 3a Ashfield Parade, Southgate, London N14. Tel: (01) 886-6236. Mng. Dir.: Riss Chantelle.
 Chappell/Aznavour Ltd., see Chappell.

Chappell Int'l Music Publ'rs Ltd., 129 Park St., London W1Y 3FA. Tel: (01) 493-1641. Telex: 268403. Exec. VP: N.L.D. Firth.
 Chappell Morris Ltd., see Chappell.
 Chappell Music Ltd., 129 Park St., London W1Y 3FA. Tel: (01) 629-7600. Cable: SYMPHDNY. Telex: 268403. Chm.: D.G. Fines; Dirs.: J.R. Simon, E.C. Holmes, J.J. King, S. Stevenson.
 Charisma Music Publ'g Co. Ltd., 90 Wardour St., London W1. Tel: (01) 434-1351. Chm.: Tony Stratton-Smith; Mng. Dir.: Brian C.A. Gibbon. (Affiliated with Chappell)
Int'l reps: Worldwide (Chappell) excluding USA (Hudson Bay).
 Charlotte Music Ltd., 9 Bryanston Mews West, London W1. Tel: (01) 723-8416. Chief Exec. Terry Sylvester, Dir. Robin Britten.
 Charly Publ'g Ltd. (PRS, MCPs), 46 47 Pall Mall, London SW1Y 5JG. Tel: (01) 839-3143 Telex 8813252. 299945
Int'l firms represented: Gorilla Queen, Mr. Dagg, Mack Smith, Sweet Family, Vapac, Jerry Williams Jr (all USA), Charly Int'l (Denmark), Rockhouse (Netherlands).
Int'l reps: Austria, Germany, Switzerland (all Beliver); Italy (Franton)
 Charmwood Music, 12 Barrington Rd., Leicester Tel: (0533) 707251.
Int'l firms represented: ABC (Austria), Josef Preissler (Germany).
 Chasday Music Ltd., see Towerbell.
 Chasday Music, 49 Greek St., London W1. Tel: (01) 437 7418 Chm.: David Mindel; Gen. Mgr. David Seys
 Cherry Red Music, 53 Kensington Garden Square, London W1 4BA. Tel: (01) 229-8854. Telex: 943763 Mng. Dir. Iain McNay; Gen. Mgr.: Theo Chalmers, Prof. Mgr. Mike Alway.
 J. & W. Chester, E.D. Wilhelm Hansen London Ltd.: 7.9 Eagle Court, London EC1M 5QD. Tel: (01) 253-6947. Cable: GUARNERIUS Telex: 919934. Mng. Dir. R.H.P. Boyle
Int'l firms represented: Wilhelm Hansen (Denmark, Germany), Nordiska/Wilhelm Hansen (Sweden), Norsk (Norway)
Int'l reps: Denmark, Germany, Norway, Sweden (all Wilhelm Hansen); USA (Alexander Broude—choral music only, Magnamusic Baton).
 Chibell Music Ltd., see Red Bus.
 Chick-A-Boom Ltd., 27 Egmont Rd., Sutton, Surrey SM2 5JR. Tel: (01) 642-2896. Gen. Mgr. Chris Barnsbury.
Int'l rep: Worldwide (Asterisk).
 Chinnichap Publ'g Ltd. (PRS), 5 Clarges St., London W1Y 7PH. Tel: (01) 493-1409, 629-9516. Mng. Dir.: L. Woolf.
 Chippglo Music Ltd., see Asterisk
 Choral Music (UEP), 29 Paddington St. London W1. Tel: (01) 486-2362. Dirs.: Robert F. Howes, Barbara Courtney King; Gen. Mgrs. John G. Malcolm, Steve Davies.
Int'l reps: Austria, Germany, Switzerland (all George Giuck); Benelux (WEA)
 Chrysalis Music Ltd., 12 Stratford Place, London W1N 9AF. Tel: (01) 408-2355. Telex 21753. Joint Chm. Chris Wright, Terry Ellis; Gen. Mgr.: Stuart Slater.
Domestic firms represented internationally: Air (London), Air Publ'g, Alucard, Ian Anderson, Blandfeld, Bubbles, Chrys A-Live, Elf, Fwester, GDAL, Grenyoco, Longmanor, Maison Rouge, Mesty Daves, PRP, Salamander & Son, Schenker Songs, Sirius, Steelee Span, Talbyrd, ThTh, Vinyale.
Domestic firms expired but retained: David Dundas, Mintknoll, Rockbottom
Int'l firms represented: Alkatraz Corner, Bear Brown, Bitsum, Brown Sound, Chinswood, Chrysalis, Cookhouse, Roger Cook, Joyful Wisdom, McDonald, Moth, Mother Tongue, Murfeezeongs, Pants Down, Pic A Lic, Rare Blue, Red Admiral, Seaford, Six Pictures, Winds & Dragons, Winkelman.
Int'l reps: Australia (Festival), France (Marouan), Germany (Global), Hong Kong (EMI), Japan (Pacific), Netherlands (Hiversum), South Africa (Galto), Sweden (Air), USA (Chrysalis).
 City Music Ltd., see Kassner.
 Clarence Music Ltd., see Universal Songs.
 Classic Editions, 13 Bank Square, Wimslow, Cheshire SK9 1AN. Tel: (0625) 527844. Cable: IMDISC. Telex: 635091. Mng. Dir. Irving Wilson; Gen. Mgr.: Lesley Thompson; Prof. Mgr. Fiona Sutcliffe.
Int'l firms represented: Curci (Italy), Dupis (Czechoslovakia), Supraphon (Czechoslovakia).
Int'l rep: USA (DI).
 V4C Recs. Ltd., 26 Hope St., Stoke on Trent Tel: (0782) 273324. Dir. Mike Stone; Gen. Mgr. John Spencer (Affiliated with Intersong)
 Clifton Music Ltd., see Sonet.
 Cloud 9 Music, Music House ISD Stogage Ln., Simonswood, Liverpool. Tel: (051) 548-9690. Mng. Dir.: Mike Giasspole. (Affiliated with Green Dream/Carlin)
 Barry Collings Music, 15 Claremont Rd., Westcliff-on-Sea, Essex SS0 7DX Tel: (0702) 43644. Mng. Dir.: Barry Collings
 Collins Music Co., Townsend House, Flat 2, 22/25 Dean St., London W1Y 5AL. Tel: (01) 437 0189. Chief Exec. Peter Collins
 Compass Music Ltd. (PRS), 21 Barrett St., 2nd fl., London W1 Tel: (01) 499 3349. Cable: CDMPMUSIC
 Compatible Rec'g & Publ'g Ltd., 112 Hounslow Rd., Twickenham, Middx. TW2 7HB Tel: (01) 898 4095. Mng. Dir. Derek Bailey, Gen. Mgr. Evan Parker.
 Concert Publ'g Co., 166 198 Liverpool Rd., London N1. Tel: (01) 607-9166.
 Partner: John Collins; Gen. Mgr. J. McFadyen
 Consortway Music Ltd., 42 Priory Ave., London W4 Tel: (01) 995 7470. Dir. K.E. Kaye; Gen. Mgr. Boz Bosley
Int'l rep: Worldwide (Dick James) excluding UK
 Contagious Music, 2/3 Golden Square, London W1 Tel: (01) 437 7545. Cable: BLUECHIP Telex 8952208 Mng. Dir. Ivar Schlosberg
Int'l firms represented: Clan, Contagious (both South Africa).
Int'l reps: Germany (Global), Japan (Watanabe), South Africa (Clan), USA (Chrysalis)
 Contempo Music Ltd., see Carlin
 Corner Stone Music Ltd., see Valentine
 Coronation Music Ltd., 1 Bath St., London EC1 9LB Tel: (01) 251 2925.
 Mng. Dir.: David A. Payne, Gen. Mgr.: John Paculabro
Int'l rep: USA (Coronation)
 Coronet Music Ltd., see Carlin
 Cortinas Music, see Illegal
 Corus Music, see Louvigny
 Coslow Kassner Ltd., see Kassner
 Craighall Music, 68 Craighall Rd., Edinburgh EH6 4RL. Scotland Tel: (031) 552-3685.
 Crazy Music, The Tanners Arms Office, New Bridge St., Newcastle upon-Tyne. Tel: (0632) 24052, 24062. Mng. Dir. Barry McKay, Gen. Mgr. Chris Cox.
 Crazy Rhythm, see Magnum.
 Crazy Viking Music Co. Ltd., see Dolsong
 Creative Music Corp. (PRS), K-tel House, 620 Western Ave., London W1 0TU. Tel: (01) 992-8000. Contact: Steve Drath

Creole Music Ltd., 91-93 High St., Harlesden, London NW10. Tel: (01) 965-9232. Cable: CREMUS. Telex: 28905. Mng. Dir.: Bruce D. White.
Int'l firm represented: Sheila (Jamaica).
 Crossbar Music Co., see Valentine.
 Crossdoor Music Co., see Valentine.
 Cupid Music Publ'g, see Margaret Brace.
 Curb Carlin Music Ltd., see Carlin.
 Curtis Music Ltd., see Carlin.
 Cyhoeddau Sain, Fford Llanyfryn, Penygroes, Caernarfon, Gwynedd, Wales, Tel: (026881) 732. Mng. Dir.: Huw Jones.
 D J Music, 76 Roebuck House, Victoria, London SW1. Tel: (01) 834-4502.
 Dirs.: Johnny Toogood, Danny Kamara; Gen. Mgr.: Joe Napoli.
 DaCosta Courtenay Music Ltd., 10A Cheval Pl., Knightsbridge, London SW7 1ES. Tel: (01) 584-5622. Dirs.: David & Dee Beale, David Chapman.
Int'l rep: Worldwide (ATV).
 Dami Music, Blythe Rd., Hayes, Middx Tel: (01) 573 5122
 Dance Music, PD Box 403, 81 Harley House, Marylebone Rd., London NW1. Tel: (01) 486-3602/8855. Telex 25247. 21879.
Int'l firm represented: Pale Pachyderm (USA).
 Dartsongs, 32-34 Gondar Garden, London NW6 Tel: (01) 794-6702.
 Contact: Bob England (Affiliated with Asterisk)
 Davray Music Ltd., 84/86 Tottenham Ln, Hornsey, London N8 7EE. Tel: (01) 340 7873. Chief Exec. & Gen. Mgr. Raymond Douglas Dawes. (Affiliated with Carlin & Konkwest)
Int'l reps: Europe (Carlin, Kassner), USA (Harry Fox).
 Dead Good Tunes, 29/23 High St., Lincoln, Lincs. LN2 1AL. Tel: (0522) 38322. Mng. Dir.: Andy Stephenson; Gen. Mgr.: Martin Patton.
Int'l rep: Worldwide (Street Corner).
 December Songs (PRS, MCPs), 42 Park View Rd., Neasden, London NW10 1AL. Tel: (01) 450-5987. Gen. Mgr.: Todd Luttorid. (Also see Cacophon).
 Deep End Music Ltd., 22 Duverton Court, Adelaide Rd., Surbiton, Surrey KT6 4TB. Tel: (01) 390-1879. Mng. Dir.: Colin Forsey; Gen. Mgr.: Sue Forsey.
 Del-Lepp Music (PRS), see Marksman.
 Delos Music, 182 Lansbury Dr., Hayes, Middx. Tel: 573-6299. Dr.: Pat Lynn; Gen. Mgr.: Richard Benjamin.
 Dema Music (PRS), 18 West Mall, Clifton, Bristol BS8 4BQ Tel: (0272) 35994. Chief Exec.: D.W. Ackerman.
 Denker Music Ltd., see Kassner.
 Denis Denning Ltd., 418 Poole Rd., Parkstone, Poole, Dorset. BH12 1DF. Tel: (0202) 761859. Mng. Dir. Chris Denning; Sec'y: M. Denning.
 Kenny Denton Music, see Sonet
 Deoc Music Ltd., see Carlin.
 Deotford Songs, see Illegal.
 Desert Songs, 216 Randolph Ave., The Basement, London W9. Tel: (01) 624 8252/5224. Telex: 28526. Dirs.: Julian Spear, Terry D'Neil, Peter Phillips, Julian Appleton. (Affiliated with ATV)
Int'l reps: Benelux (Nada), Canada (Chrysalis), France (Allo), Israel (April), Italy (ATV), Japan (Pacific), Scandinavia (Ar), Spain (Quiroga), USA (Chrysalis).
 Design Music Ltd., see Carlin
 Destiny Music Ltd., see Carlin.
 Johnny Devlin Music Ltd., see Carlin.
 De Wolfe Ltd. (MCPs), 80/88 Wardour St., London W1Y 3LF. Tel: (01) 439-8481. Dir.: James Sylvester de Wolfe.
 Ann Dex Music, see Spandee.
 Dice Music, see Tabitha.
 Digt Music Ltd., see Dolsong.
 A. DiMartino Music Ltd., see Valentine.
 Dim Dork Music Publ'g, 46 Argyle St., Birkenhead, Merseyside. Tel: (051) 647-4505. Exec. Mgr.: John Weaver; Gen. Mgr.: Roland Hodson.
 Dinsdale Ltd., 61-63 Portobello Rd., London W11 3DD. Tel: (01) 221-7535. Telex: 22542. Mng. Dir.: Carol Wilson; Mktg. Mgr. Nicky Davies; Art Dir.: Peter Saville; Promo. Mgr.: Donna Thompson.
 Label: (Lixamand domestic) Satrio.
Int'l reps: Australia (Festival), Austria (Ariola), Belgium (Ariola), Canada (PolyGram), Denmark (Sonet), Finland (Polarvox), Germany (Ariola), Greece (PolyGram), Hong Kong (Pacific), Ireland (Virgin), Israel (General), Italy (Ricordi), Mexico (Bertelsmann), Netherlands (Ariola), New Zealand (Record & Tape Co.), Norway (Aren Bendiksen), Portugal (VDC), South Africa (Galto), Spain (Ariola), Sweden (Sonet), Switzerland (Ariola), Yugoslavia (Jugoton)
 Dinsong Ltd., 61/63 Portobello Rd., London W11. Tel: (01) 221-7535. Mng. Dir.: Carol Wilson; Prof. Mgr.: Diane Wray. (Also see Virgin)
Int'l firms represented: Skyhill/Tarka, Don Williams
Int'l reps: Argentina (Melograf), Australia (April), Austria (April), Belgium (April), Brazil (Mundo), Canada (April/Blackwood), Central America (Mundo), Colombia (CBS), Finland (April), France (Clouseau), Germany (April), Iceland (April), Italy (Franton), Japan (Victor), Luxembourg (April), Mexico (Mundo), Netherlands (April), New Zealand (RTC), Porgual (Valentim de Carvalho), Scandinavia (April), South Africa (Warner Bros.), Spain (April), Switzerland (April), USA (Chappell), Venezuela (CBS).
 Walt Disney Prod'n's Ltd., 68 Pall Mall, London SW1Y 5EX. Tel: (01) 839-8010. Telex: 21532. Chief Exec. Keith S. Bales.
Home office: USA.
 Dizzy Heights Music Publ'g Ltd., 44 Seymour Pl., London W1. Tel: (01) 723-8464. Telex: 299612. Chief Execs.: N. Grange, C. Hill.
Int'l reps: Australia (Essex), Austria (Roba), Benelux (Company of Two Pijeters), Central & South America (RCA), Germany (Roba), Italy (RCA), Mexico (RCA), New Zealand (Essex), Portugal (RCA), Spain (RCA), Switzerland (Roba).
 Dolsongs Music, see Stage Coach.
 Double D Music, 25 Bruton St., 3rd fl., London W1. Tel: (01) 493-9701. Mng. Dir.: Dave Dee, Gen. Mgr. Harry Doherty; Prof. Mgr.: Heather Paton
 Drop Top Music, PO Box 148, London W9 1DY. Tel: (01) 286-2993. Partners: Mick & Cilla Huggins.
Int'l branch: USA.
 Duffo Music, see Sparta Florida
 Duffo Publ'g Ltd., see Performance.
 Dukelodge Ents. Ltd., 36 Holland Park, London W11 Tel: (01) 229-2876.
 Mng. Dir.: John Gilbert. (Affiliated with Carlin)
 Dynamic Cat Music Ltd. (PRS), 69 New Bond St., London W1Y 9DE. Tel: (01) 408-1788. Mng. Dir.: Peter Barnes. (Also see Rock)
 E G Music Ltd., 63A Kings Rd., London SW3 4NT. Tel: (01) 730 2162. Dirs.: Mark Fenwick, Sam Alder.
Int'l reps: Canada, USA (both EG in USA)
 EMI Music Publ'g Ltd., 138-140 Charing Cross Rd., London WC2H 0LD. Tel: (01) 836-6699. Cable: EMIUMUS Telex: 269189. Mng. Dir.: Ron White; Comm'l Affairs Dir.: Peter Smits; Financial Dir. & Overseas Supervision: David Gray; Dir.: Gen. Mgr. Roy Tompsett; Standard Catalogues MDR Dir. & Gen. Mgr.: Kay D'Dwyer; Popular Repertoire Dir. & Gen. Mgr.: Brian Hopkins; Publ'ns & Servs. Dir.: Pat Howgill; Int'l Mgr.: Fred J.

Marks.
Int'l firms represented: Ameb, Audigram, BRS Prod'ns, Bema, Black Sheep, Bandora, Jeff Barry, Blair/Bellhop, Bolingbroke, Bowling Green, Combine, Daniel N. Crewe, Forty Love, Frascotti, Al Gallico, Gopam, Heart's Delight, Kling Klang, Kipahulu, Charles Kupps, Kiss Songs, Lord Jake, Mabrax Inc., Mycenae, Neighborhood, Open Dr., RFT, Red Robin/Seven Figure, Eddie Reeves, Quotic, Resaca, Rip/Keka, Saturday, Specialgroup, Sundisc, Top Sail, Trachelle, Tree, Twity Bird, Larry Weiss (all USA); J. Albert & Son (Australia), Marouani (France), Tumbleweed/Antipodes (Australia), VAAP (USSR).

Early Bird Music Publ'g Co. Ltd., see Carlin.
 Earthshaker Music Ltd., see Performance.
 Eaton Music Ltd., 8 W. Eaton Pl., Belgavia, London SW1 Tel: (01) 235 9046. Mng. Dir.: Terry Dales.
Int'l firms represented: Black Molasses, Briarpatch, Calmet, Cadogan, Canopy, Company of the Two P's, Jeters, Debdave, Dump, Easy Money, Elliott-Ferguson, Fergell, Gerik, Golden Syrup, Jacko, Kingdom, Mandus, Pison Oak, Quarry, Sabre/Round, Shogun, Stage & Screen, Status Quo/Shawbury, Sundergrade, Taradam, Twenty Nine, Vistamar, White Oak, William Tell, Witzend, Woodrun.
Int'l reps: Australasia, Austria, Benelux, Canada, France, Germany, Italy, Japan, Portugal, Scandinavia, Spain, Switzerland, USA (all Eaton), Central & South America (Beechwood), South Africa (Gallo)
 John Edward Music Ltd., 38/40 Upper Clapton Rd., London E5 8BQ. Tel: (01) 806 1121. Dir.: John Edward.
 Kevin Eggers Music Ltd., see Carlin.
 Eger Music Ltd./NazSongs/LeD Songs, 49 Mount St., London W1Y 5RE. Tel: (01) 491-2904. Telex: 269398. Mng. Dir.: Derek Nicol. (Administered by Panache)
 Elite Recs. Ltd. (MCPS), 3 Library Parade, Craven Park Rd., London NW10. Tel: (01) 965-6041, 961-5091. Mng. Dir.: Andrzej Sojka
 Emerald Music Ltd. (PRS), 120 Coach Rd., Templepatrick, Ballyclare, County Antrim BT39 0HB, Northern Ireland. Tel: (08494) 32711. Mng. Dir.: Mervyn A. Solomon. Gen. Mgr.: L.R. Paterson. (Administered by Margaret Brace)
Int'l firms represented: Aesop's Fables (USA), Bospel (Netherlands), Helping Hand (Canada), Jumping Jack (USA), SPR (USA).
Int'l reps: Canada (Morning), France (DK Music), Netherlands (Bospel), South Africa (Intersong), USA (Odyssey).
 Emerson Ed. (allied with June Emerson-Wind Music) Windmill Farm, High St., Ampleforth, Yorks. Tel: (04393) 324. Chief Exec. Geoffrey Emerson.
Int'l firms represented: Brass Press, Robert King, Music for Brass, (all USA), Daei/Muramatsu (Japan).
Int'l rep: USA (Robert King).
 Engel Songs Ltd., see Carlin.
 English Folk Dance & Song Society, Cecil Sharp House, 2 Regents Park Rd., London NW1 7AY. Tel: (01) 485-2206. Dir.: S.A. Matthews.
 Enquiry Music Ltd., see Carlin.
 Esquire Music Co., 9 Harebell Hill, Cobham, Surrey. Tel: Cobham (09326) 2316. Chief Exec. Peter Newbrook.
Int'l firm represented: Su-Kay (USA)
 Eurobeat Ltd., 13 Bank Square, Wilmslow, Cheshire SK9 1AN. Tel: (0625) 527844. Cable: IMOISICE. Telex: 635091. Mng. Dir.: Irving Wilson, Gen. Mgr.: Lesley Thompson, Prof. Mgr.: Fiona Sutcliffe
Int'l firms represented: Beat, Prima, West (all Italy)
Int'l reps: Italy (Beat), USA (OI).
 Evolution, see Island.
 Express Music (London) Ltd., The Studio, 69 Dukes Ave., New Malden, Surrey. Tel: (01) 942-1347. Cable: EXMUSE. Mng. Dir. Siggy Jackson, Gen. Mgr. Adrian Jankowski.
Int'l branch: USA
 Express Songs, 8 Park St., Lincoln, Lincs. LN1 1UF. Tel: (0522) 33285. Mng. Dir.: Andy Stephenson. (Affiliated with Leeds)
Int'l rep: Worldwide (MCA/Leeds).
 F B Music Ltd., see Carlin.
 F X Music, 3 Muswell Ave., London N10. Tel: (01) 444-6780. Dirs.: Ken Gibson, Pat Crumly
 Faber Music Ltd., 3 Queen Square, London WC1N 3AU. Tel: (01) 278-6881. Cable: FABBAF. Telex: 299633. Chm. Dr. Donald Mitchell; Mng. Mgr. Martin Kingsbury
Int'l reps: Australia (Boosey & Hawkes), Canada (Boosey & Hawkes), Germany (Baerenreiter), USA (G. Schirmer).
 Fanfare Music Co. Ltd., 27 Forest Dr., Keston, Kent. Tel: Keston 54491. (01) 200-7000. Cable: ATMUS BROMLEY. Mng. Dir. Fred Jackson.
Int'l firms represented: Five Continents (USA), Le Bill (USA)
Int'l rep: Germany (Fanfare).
 Fantasy Songs Ltd., see Island.
 Far Out Music Ltd., see Carlin.
 Fast Western Ltd., 2 York House, Upper Montagu St., London W1. Tel: (01) 723-9559. Mng. Dir.: Richard Lee.
Int'l reps: Benelux (Ariola), France (Claude Pascal), Scandinavia (Ari), Spain (Discorama).
 Fearland Music Ltd., see Carlin.
 Fentone Music Ltd., 20 Earham St., London WC2H 9LN. Tel: (01) 836-3066. Cable: FENTONE. Mng. Dir. Larry Fenton.
Int'l firms represented: Breitkopf & Haertel, Deutscher Verlag Fuer Musik, Friedrich Hofmeister, Pro Musica (all East Germany), Friedrich Hofmeister, Neue Musik, Notaset, Schroth, Tischer & Jagenberg, Friedrich Vieweg (all West Germany), Columbia, Continuo, Neil A. Kjos, Luck's Music Library, Tetra (all USA), Berben (Italy), Fenette (UK), Nova (UK).
Int'l reps: Canada, Mexico, USA (all Alexander Broude), Germany (Anton J. Benjamin), Netherlands (English Music Guild), Scandinavia (Procura Invent), Switzerland (Pan).
 Fernlea Music Ltd., see Chandos.
 Festival Music Pty. Ltd., 28 Harley House, Marylebone Rd., London NW1 5HF. Tel: (01) 935-3837. Telex 269086.
 Home office: Australia.
 Felish Music, see Sonet.
 Fiesta Music Ltd., see Carlin.
 Filmscores Ltd., see Chandos.
 Finger, see Silver Hammer.
 Finger Music Ltd., see Carlin.
 First Music Ltd., see Kassner.
 Fisher & Lane Music, 30 Limekiln Ln., Brdington, North Humberside YO16 5TH. Tel: (0262) 76388. Dir. & Gen. Mgr.: Robert Fisher.
 Fish Co. Music Ltd., see Street Tunes.
 Fish Music Publ'g, see Margaret Brace.
 Flash Music Ltd., 6 Holland Park, Basement Apt., London W11. Tel: (01) 229-0663. Mng. Dir.: Paul K. Walden.
 Flip Flop Music, see Asterisk.
 Fluke Music Ltd., see Carlin.
 Flying Duck Music Ltd., 69 New Bond St., London SW1. Tel: (01) 408-1606. Chief Exec.: J. F. Townley.
 Flyright Music, 3 Wilton Rd., Beahill on Sea, East Sussex. Tel: (0424) 220-028. Chief Exec.: Simon A. Napier, W.J.B. Bastin.
Int'l firms represented: Flat Town, Jamil, Whitewing (all USA).
 Folktracks & Soundpost Publ'ns, 2 Fricliff Park, Portishead, Bristol BS20 9HQ. Tel: (0272) 842209. Dir.: Peter Kennedy.
Int'l rep: USA (Folkife).
 Forsyth Bros. Ltd., 126 Deansgate, Manchester M3 2GR. Tel: (061) 834 3281. Mng. Dir.: O.R. Loat.
 Freedom Songs Ltd., see Island.
 Free Reed Music, c/o High Peak Prods. Ltd., Belper, Derby DE5 1BD. Tel: (077382) 7910 x 5. Gen. Mgr.: B. Vaughan. (Administered by Leosong)
 Fresh Air Music Ltd. (div. of Tony Hall Group of Music Cos.), 9 Carnaby St., London W1V 1PG. Tel: (01) 437-1958. Cable: TASTES. Mng. Dir.: Tony Hall.
Int'l firm represented: Come Il Vento (Italy).
 Fresh Tunes, 359 Edgware Rd., London W2. Tel: (01) 724-2350. Telex: 896559. Gen. Mgr.: Alex Howe, Prof. Mgr.: Alan Hauser.
 Freshwater Music Ltd., see Island.
 Friends Music Ltd., see Carlin.
 Frog Music, 24 Hag Rd., Stanmore, Middx. Tel: (01) 954-0959. Mng. Dir.: Bob Clifford.
 Fugal Songs Ltd., see Carlin.
 Fuse Music Ltd. (PRS), 40 Dafoad & Cambridge Mansions, Did Marylebone Rd., London NW1. Tel: (01) 723-2454. Telex: 847777. Mng. Dir.: Nigel Haines; Gen. Mgr.: Alan Bown.
Int'l reps: France (Francis Dreyfus), rest of world excluding France, North America, UK (Intersong).
 Fyne Music, 2 Chester Ave., Southport, Lancs. PR9 7ET. Tel: (0704) 24666. Dirs.: Lou & Gwen Fyne.
 G G Music Ltd., see Rocket.
 G A Music Ltd. (PRS), see Riva.
 G K Music Ltd., see Margaret Brace.
 G L H Music Ltd., see Kassner.
 G T Publ'g Ltd., 115/123 Bayham St., London NW1. Tel: (01) 485-5622. Telex: 25584. Mng. Dir. & Gen. Mgr.: Edward Christie.
 Gaberlunzie Music, see Margaret Brace.
 Gale & Gayles Ltd., see Kassner.
 Gamut Publ'ns Ltd., All Saints' Passage, Cambridge CB2 3LT. Tel: (0223) 51786. Chm.: H.A.J. Woolfenden; Gen. Mgr.: Mrs. L.W. Smallwood.
Int'l firms represented: Maurice W. Riley (USA), Sweet Pies (USA).
Int'l rep: USA (Magnamusic).
 Garron Music, Kirklund Park Studios, Letham Rd., Strathaven, Scotland ML10 6EE. Tel: (0357) 21130. Dir.: W.B. Garden.
 Gas Songs, 184-186 Regent St., London W1. Tel: (01) 439-7731. Telex: 27557. Mng. Dir.: Ray Williams.
 Noel Gay Music Co. Ltd., 24 Denmark St., London WC2H 8NJ. Tel: (01) 836-3941. Cable: NOELGAY. Telex: 21760. Mng. Dir. Richard Armitage; Gen. Mgr.: Charles Armitage.
Int'l reps: Australasia (Rango), France (Claude Pascal), Netherlands (Gaba), South Africa (Muspiece), USA (Noel Gay).
 Geobell Music Co. Ltd., 987 High Rd., Finchley, London N12. Tel: (01) 446-3218. Mng. Dir.: George Bellamy.
 George & Dragon Prod'n Ltd., see Panache.
 Getaway Music Ltd., see Carlin.
 Ghost Music Ltd., see Performance.
 Glitterbest Music Ltd., see Warner Bros.
 Global Music (GEMA, MCPS, PRS), 38 Biddulph Mansions, Biddulph Rd., London W9 1HX. Tel: (01) 289-6337. Pres.: Peter Kirsten; Gen. Mgr.: Peter Knight Jr.
 Glocken Verlag Ltd., 10/16 Rathbone St., London W1P 2BJ. Tel: (01) 580-2827. Dirs.: Dr. O. Blau, R.M. Toeman, S. Buchman.
 Gloria Music, see Carlin.
 Glorious Box Ltd., see Desert Songs.
 George Gluck Music Ltd., 23 Bruton St., London W1. Tel: (01) 493-1067. Telex: 8934728. Mng. Dir.: George Gluck.
Int'l firms represented: George Gluck (Germany), Gray Matter (USA).
Int'l reps: Benelux (Fleet), France (Hansa), Germany (George Gluck).
 Golden City Music Ltd., see Carlin.
 Goldpol Music, Sands Estate, Stewart House, Hillbottom Rd., High Wycombe, Bucks. Tel: (0494) 36301. Telex: 837173. Chm.: Peter Cormack; Mng. Mgr.: Geoff Robinson.
 Goldsmith Music (PRS), see Castle Hill.
 Golora Music Co., see Valentine.
 Good Music Ltd., see Carlin.
 Jack Good Music Publ'g Co. Ltd., see Carlin.
 Good Move Music, 27 Spedan Close, Branch Hill, London NW3. Tel: (01) 435-5302. Mng. Dir.: Phil Simmonds.
 Gopher Songs Ltd., see Performance.
 Gospel Music, see Carlin.
 Grade One Music Ltd., see Red Bus.
 Grade One Recs. Ltd., see Red Bus.
 Graduate Music, 1 Union St., Dudley, West Midlands DY2 8PG. Tel: (0384) 59048, 211159. Mng. Dir.: David Vorr, Co-Dir.: Susan Vorr, Sec'y: Sandra Marshall.
 Grafton Music Ltd., 11-14 Craffon St., Flat 2, London W1. Tel: (01) 493-4465. Mng. Dir.: Kevin Eade.
Int'l firms represented: Erik House, House of Eric (both USA).
 Grand Prix Music, see Sonet.
 Grant Music Ltd., see Marco.
 Graphic Music Ltd., see Carlin.
 Graystock Ltd., 7 Fitzroy Square, London W1P 6AS. Tel: (01) 387-3434. Mng. Dir.: Robert Glatter.
 Green Dream Music, Music House, ISO Stoppage Ln., Simonswood, Liverpool L33 4YA. Tel: (051) 546-6444/0434. Gen. Mgr.: J.J. Lewis. (Affiliated with Carlin).
 Greensleeves Music, see Sparta Florida.
 Greensleeves Publ'g, 44 Uxbridge Rd., Shepherds Bush, London W12. Tel: (01) 749-3277. Mng. Dir.: Chris Sedgwick.
Int'l reps: Benelux (Universal), Germany (April), Spain (Boom).
 Grosvenor Music Co. Ltd., see Kassner.
 Grove Music Ltd., see Carlin.
 Gull Songs, 33 Portland Rd., Holland Park, London W11 4LH. Tel: (01) 229-9631. Cable: GULLRECORD. Telex: 24224. Ref. 2275. Mng. Dir.: David Howells.
Int'l reps: Austria (Melodie der Welt), France (Panache), Germany (Melodie Der Welt), Scandinavia (MA), USA (Creative).
 Gurt Music Ltd., see Carlin.
 Bill Haley Music, see Sonet.
 Handle Music, 1 Derby St., London W1. Tel: (01) 493-9637. Mng. Dir.: David Walker. Telex: 892756. (Also see Brand New Music).
 Hansa Prod'n Ltd., 12 Bruton St., London W1X 7AH. Tel: (01) 493-9766. Telex: 298777. Mng. Dir.: Peter Meisel.
 Hansen House (London) Ltd., 64 Dean St., London W1V 5HG. Tel: (01) 439-7797. Telex: 847777. Attn: Hansen House 125. Gen. Mgr.: F. Harper.
Int'l firms represented: Hansen House (USA), Shattering Int'l (USA).
 Happy Face Music Publ'g Co. (MPA), The Old Smithy, Post Office Ln., Kempsey, Worcs. WR5 3NS. Tel: (0905) 820-659. Cable: SMITHYSOUND.
 Chief Exec.: Muff Muffin; Gen. Mgr.: V.B. Murrin.
Int'l reps: France (April/Blacksmith), Germany (April/Blacksmith), Venezuela (Disco Modo).
 Hardor Music Co., see Valentine.
 Lee Hazlewood Music Ltd., see Carlin.
 Hazy Music Ltd., 9 Ravenscroft Ave., London NW11 0SA. Tel: (01) 455-4556. Mng. Dir.: Barbara M. Hayes.
Int'l reps:—Pentangle only: Africa, Asia, Australasia, Europe, Middle East, South America (all Chappell), Canada, USA (both Warner Bros.).
 Heartbeat Music, see Cherry Red.
 Heath Levy Music Co. Ltd., 184/186 Regent St., London W1R 5DF. Tel: (01) 439-7731. Telex: 27557. Mng. Dirs.: Geoffrey Heath, Edward Levy.
 Health Music Ltd., 4 Yeomans Row, London SW3. Tel: (01) 584-2441. Joint Mng. Dirs.: Tim & Nick Heath. (Affiliated with Warner Bros.)
Int'l rep: Worldwide (Warner Bros.)
 Allan Heather Music, see Valentine.
 Heaven Music & War-Cops Music, 114 South Hill Park, London NW3. Tel: (01) 435-0710. Chief Exec.: Vic Coppersmith-Heaven.
 Heavy Metal Music, see Andersong.
 Hedley Music, 71 Rutland Rd., Chesterfield, Derbys. S40 1ND. Tel: (0246) 79976. Mng. Dir.: Tony Hedley; Gen. Mgr.: Malcolm Perkins.
Int'l branch: USA
 Heiman Music Ltd., 6-10 Lexington St., London W1R 3HS. Tel: (01) 734-7443. Telex: 893773. Mng. Dir.: Nick Heiman; Gen. Mgr.: Simon Mortimer.
Int'l reps: Germany (Meridian), Israel (May), Netherlands (Belbo—films only, Step One—songs only), Switzerland (Yellow Bird).
 Hensley Music Publ'g Co. Ltd., 29 Clarendon Rd., London W11. Tel: (01) 727-5118. Mng. Dir.: Tony Eyers. (Affiliated with Intersong)
Int'l firms represented: Midnight Sun (Sweden).
Int'l rep: Worldwide (Intersong).
 Hercules Music Ltd., see Carlin.
 Highland Music Co. Ltd., see Beautiful Sunday.
 Highway Music, 6A Foregate St., Astwood Bank, Redditch, Worcs. Tel: (052789) 3737. Chief Exec.: John Zollman; Gen. Mgr.: Sue Zollman.
 Hilda Music, see Stage Coach.
 Tony Hiller Music Ltd., 24 Bruton St., London W1X 7DA. Tel: (01) 409-2211. Cable: TONYMUSIC. Chm.: Tony Hiller. (Affiliated with ATV)
Int'l reps: Australia (ATV), Canada (Attic), France (Vogue), Germany (Disconot).
 Hippo Songs, see Metal.
 Hit & Run Music Publ'g Ltd., 55-59 Shaftesbury Ave., London W1V 7AA. Tel: (01) 439-8451. Telex: 8952998. Chm.: John Anthony Smith; Gen. Mgr.: Gareth J. Perkins.
Int'l firms represented: Hidden Pun (Canada, USA), Run It (USA), Venerable (USA).
Int'l reps: Worldwide (Intersong) excluding Australia (Essex), Austria (Melodie der Welt), Benelux (Home), Canada (Hidden Pun), Germany (Melodie der Welt), Italy (Ricordi), Japan (Shinko), New Zealand (Essex), Switzerland (Melodie der Welt), USA (Hidden Pun).
 Hollywood Music, see John Edward.
 Horizon Music Publ'g, Horizon House, Warwick Rd., Coventry. Tel: (0203) 21000. Chief Exec.: Barry H. Thomas.

STAGE ONE (Records) Ltd.



WORLDWIDE IMPORT/EXPORT and DISTRIBUTION.

- EXCLUSIVE DISTRIBUTION OF MAJOR & INDEPENDENT LABELS IN U.K. & U.S.
- EUROPE'S LEADING WHOLESALE OF MID-PRICE & CUT-OUT PRODUCT.
- LARGEST SELECTION OF AMERICAN, JAPANESE, AUSTRALIAN AND EUROPEAN FULL PRICE IMPORTS IN THE U.K.

Exclusive U.S. representatives:
 Intercontinental Records & Cassettes
 200 Robbins Lane
 Jericho
 L.I. New York 11753
 Phone: (516) 938-9610
 Telex: 126316

MEET US AT M.I.D.E.M. '82
STAGE ONE (Records) Ltd.
 2 KINGS ROAD, HASLEMERE,
 SURREY, ENGLAND.
 Telephone: (0428) 4001
 Telex: 858226 Stage 1

Hotel Publ'g, 45 Mount Ash Rd., Sydenham, London SE26 6LY. Tel: (01) 669 5835/7626. Mng. Dir.: Frank Rodgers.

Howlin' Music Ltd., 70 Gloucester Pl., London W1. Tel: (01) 935-4965; Air Call (01) 828-5621. Code 1970. Chief Exec.: Howard Marks.

Humber Music Ltd., PO Box 3, Hestle, North Humberside. Tel: (0482) 649193. Cable: MACHO MUSIC. Telex: 667461. Catalog Mgr.: Robin Carew. (Affiliated with Carlin)

Humber Songs, 49 Newmarket St., Grimsby, South Humberside. Tel: (0472) 40152. Owner: L.A. Johnson

Hush Music Ltd., 117C Fulham Rd., London SW3. Tel: (01) 589-6293. Dirs.: Jonathan Rowlands, Judy London.

Int'l firm represented: Siegel (Germany).

Illegal Music Ltd., 41-B Coddington Mews, Blenheim Crescent, London W11 2EF. Tel: (01) 727-0734. Dirs.: Miles A. Copeland III, Carolann Jackson; Prof. Mgr.: Carolann Jackson.

Int'l firm represented: Illegal Songs (USA)

Int'l rep.: USA (Illegal Songs)

Illuminating Music, see Oracle.

Imagine Music Ltd., see Rocket.

Incidental Music, 50 Newton St., Manchester M1 2EA. Tel: (061) 236-9849/9840. Contacts: Richard Boon, Peter Wright, Margaret Trotter.

Industrial Recs. Ltd. (PRS), 10 Martello St., London E8. Tel: (01) 254-9178. Mng. Dir.: Peter Christopherson; Gen. Mgr.: Chris Carter.

Inevitable Music, 126A Bold St., Paradise Suite, Liverpool. Tel: (051) 546-6444, 708-8594. Chief Execs.: Jeremy Lewis, Pete Fullwell.

Injun, 7 Mill Cottages, Bucks Green, West Sussex. Tel: Rudgwick 2829. Chief Exec.: P. M. Chalmers; Gen. Mgr.: A. Berwick.

Int'l firms represented: Grandweath, Showay (both USA)

Inkwell Music Ltd. (PRS), 69 New Bond St., London W1Y 9DE. Tel: (01) 408-1788. Mng. Dir.: Peter Barnes.

Instant Music, see John Edward.

Interascal Music, see Rascal.

Inter-song Music Ltd., 40 S. Audley St., London W1. T. I: (01) 499-0067. Mng. Dir.: Bruno Kretschmar.

Int'l firms represented: Affinita, Ajay, Aliza-Tho ah, Audigram, Bellikat, Hamilton Bohannon, Bullhorn, Cale Americana, Cape Ann, Cape May, Clarkee, Claudia, Doobie Bros., Father, Fifth Floor, Five West, Jimpire, Jru, Kaskat, Kenya, Kings Point, Litha, Little Lasso, MTM, Mayday, Mumsey, Pocket, Quick Mix, Rick's, Roaring Rock, Seacoast, Sign of the Twins, Subway Rhythm, Ten East, Thalian, Three Cheers, Vanilla, Wescraft (all USA); Hanseatc/Happy (Germany); Gogcy, Hallelujah (both Israel).

Int'l reps.: Australia (Intersong), Austria (Aberbach), Belgium (Intersong Primavera), Brazil (Intersong), Canada (Belinda/Intersong), Denmark (Intersong), France (Intersong Continental, Intersong Pigalle, Intersong Paris), Germany (Aberbach, Artemis, Intersong Int'l), Greece (Intersong Hellas), Japan (Intersong), Mexico (Intersong), Netherlands (Artemis, Intersong Basart), Singapore (Intersong), South Africa (Intersong), Spain (Canciones del Mundo, Ed. Fontana), Sweden (Intersong), Switzerland (Aberbach, Arena), USA (Belinda/Intersong).

Intersong Int'l Musikverlag GmbH, 40 S. Audley St., London W1R 5DH. Tel: (01) 493-5042. Cable: SYMPHONY. Telex: 268401. Pres.: Heinz T. Voigt. Gen. Mgr.: Hein van der Ree.

Int'l firms represented: (See Artemis in the Netherlands).

Int'l reps.: (See Intersong Int'l in Germany).

Interworld Music Ltd., 15 Berkeley St., 6th fl., London W1X 5AE. Tel: (01) 491-3401. Cable: INTERMUSIC. Telex: 298847. Dir.: Harold E. Spencer.

Int'l firms represented: Blue Seas, Cherry Lam, Jac, Six Continents, World Song (all USA).

Iza Music (MCP/Brinco), 42 Kilmarnock Rd., Glasgow, Scotland G41 3NH. Tel: (041) 632-9269. Owners: Ronnie Simpson, Andrew Harvey.

Island Music Ltd., 22 St. Peters Square, London W6 9NW. Tel: (01) 741-1511. Cable: ACKEE. Mng. Dir.: Peter Cornish; Dir.: Keith Aspden.

Int'l firms represented: AWW Ent's., Ackee, Boo Int'l, Bungalow, Canaan, Chicago, Cri Cri, Island, Knight After Knight, Two Knight, Zen Sounds (all USA).

Int'l reps.: Argentina (Korn), Austria (Wien Melodie), Belgium (Hans Kuster), Brazil (Intersong), France (Panache), Germany (Melodie der Welt), Greece (Intersong), Italy (Ricordi), Mexico (Intersong), Netherlands (Nada), Portugal (RCA), Scandinavia (Sonet), South Africa (Gallo), Spain (RCA), Switzerland (Wien Melodie), USA (Island).

J B Music, see Margaret Brace.

J P Music Ltd., see Margaret Brace.

Jab Music, 97 Judd St., London WC1. Tel: (01) 388-5771. Telex: 896616. Mng. Oirs.: Jack Applebaum, Barry McCloud.

Jackson Rec'g Co. Ltd., The Studios, Rickmansworth, Herts. Tel: (09237) 72351. Cable: JACMUSIC. Telex: 262284.

Jade Music, Hurston House, Stoke Rd., Kingston-upon-Thames, Surrey. Tel: (01) 924-6240. Telex: 22914. Mng. Dir.: Gray Jones; Gen. Mgr.: Edward J. Fisk. (Affiliated with EMI)

Dick James Music Ltd., James House, 5 Theobalds Ed., London WC1X 8SE. Tel: (01) 242-6886. Cable: DEJAMUS. Telex: 273135. Chief Exec.: Dick James; Gen. Mgr.: David Jones.

Int'l firms represented: Dejamus, Dick James, Eimly, Edward B. Marks, Franklin, Gobiet/Mother Pearl, Koolba, New Continent, Proboscis, Sutton Miller (all USA); Tic-Toc (Switzerland).

Jammy Music Publ's Ltd., Inchbank House, 957 Dumbarton Rd., Glasgow, Scotland G14 9UF. Tel: (041) 334-9722. Mng. Dir.: John MacCallum; Gen. Mgr.: Andrew Harvey.

Janna Music Ltd., 10 Oakdene Ave., Mile Oak, Portlisle-by-Sea, Sussex. Tel: (0273) 419441. Mng. Dir.: John MacLeod.

Janvo Ltd.—Dirs.: Terry Scully, Laurie MacGregor, Jeremy Paul—see Arretta.

Japan Central Music Ltd., 65C Marlborough Pl., London NW8. Tel: (01) 328-4641. Contact: Coco Asanuma.

Home office: Japan.

Jarrow Music Ltd., 24 York St., London W1. Tel: (01) 487-4266. Dir.: Alan Price; Gen. Mgr.: John Price.

Jayman Music Ltd., see Performance.

Jet Music Inc., 102-104 Gloucester Pl., London W1. Tel: (01) 486-6040. Telex: 298995. Chm. & Mng. Dir.: Don Arden.

Jetstar Publ's Ltd., see Carlin.

Jewel Music Publ'g Co. Ltd., see Chappell.

Jug-Saw Music Ltd., 115 Old Lodge Ln., Purley, Surrey. Tel: (01) 668-3457. Dirs.: Dave & Sue Williams.

Joak Music Co., see Margaret Brace.

Joanelne Music Ltd., see Carlin.

Jobete Music (UK) Ltd., 16 Curzon St., London W. Tel: (01) 493-1603. Telex: 8811658. Mng. Dir.: Peter Prince; Gen. Mgr.: James Fisher; Prof. Mgr.: Ivan Chandler.

Joyley Music Ltd., see Carlin.

Kalmann Music Ltd., see Carlin.

Alfred A. Kalmus Ltd., 2/3 Fareham St. (Dean St.), London W1V 4DU. Tel: (01) 437-5203. Cable: ALKAMUS. Dirs.: J. Palmer, M. Herrmann, W.M. Colteran, A. Schlee (Austrian), S. G. Harpner (Austrian).

Kareem Music, see Performance.

Kassner Assoc'd Publ'rs, Broadmead House, 21 Panton St., London SW1. Tel: (01) 839-4672. Cable: KASSMUSIC. Telex: 24158. Mng. Dir.: Edward Kassner; Gen. Mgr.: David Kassner.

Int'l reps.: Australia (Leosong), Belgium (Bents), France (Monica), Germany (AME), Japan (Victor), Netherlands (Dutchy), South Africa (South-east), USA (Copyright Serv. Bureau).

Keep Calm Music, 15 Trinity Rd., London SW17 7SD. Tel: (01) 672-9121. Dirs.: Ian & Nick Titchener.

Keepers Cottage Music Ltd., see Island.

Keep On Trucking, see Island.

Kenbill Music (PRS, MCP/PS), Flat 2, Queens, 26 The Broadway, Hornsey, London N8 9DE. Tel: (01) 637-4623. Owner: William Crompton; Mng. Dir.: John Schroeder.

Kenmar Music Co., 11 Great Marlborough St., 2nd fl. rear, London W1A 4QD. Tel: (01) 437-3711. Owner: Margaret Brace; Gen. Mgr.: Sandra Cackett. (Also see Margaret Brace & Marrow)

Int'l rep.: Australia (Castle).

Kennedy St. Music Ltd., see EMI.

Kenrick Music Ltd., 50 Cadogan Square, Flat 3, London SW1X 0JW. Tel: (01) 589-7111/8861. Telex: 268048. Gen. Mgr.: Nicola Merton.

Kicking Mule/Sonet, see Sonet.

Kieron Music Ltd., see Carlin.

King Size Songs Ltd., see Carlin.

Robert Kingston Music Ltd., 34 Windmill St., London W1P 1HH. Tel: (01) 636-9242. Chm.: Robert Charles Kingston; Gen. Mgr.: Barry Kingston.

Int'l firms represented: Bolero Musicmax (Mexico), Brambila (Mexico), Musicways/Real Fine Songs (USA), Nichon (Japan), September (USA).

Int'l reps.: Germany (Schmolzi Slezak), Mexico (Bolero Musicmax), USA (Musicways).

Knox Music Ltd., see Carlin.

Konkwest Music Ltd., 84/86 Tottenham Ln., Hornsey, London N8 7EE. Tel: (01) 340-7873/4757. Dir.: Ray Davies; Gen. Mgr.: Dave Davies. (Affiliated with Carlin)

Int'l reps.: Europe (Kassner, Sparta Florida), USA (Harry Fox).

Krystannar Music Ltd., 33 Park Chase, Wembley, Middx. Tel: (01) 902-2024. Mng. Dir.: Eddie Stevens; Gen. Mgr.: Leslie Manninger.

L E Music, Nelson House, Castle Hill Rd., Hindley, Wigan, Lancs. WN2 4BH. Tel: (0942) 55871. Telex: 62594. Chief Exec.: W. Leyland; Gen. Mgr.: D. Larbey.

L O E Music, 28 Lexington St., London W1R 3HR. Tel: (01) 734-3443. Cable: LDEGROUP. Mng. Dir.: Hiroshi Kato; Gen. Mgr.: Jim Russell.

Int'l firm represented: Music Boutique (Japan).

Lakeview Music Ltd., see Leeds.

Lee Lambert Music Ltd. (PRS), 506-508 Kingsbury Rd., London NW9. Tel: (01) 204-9422. Cable: LANMETALS. Mng. Dirs.: Bill Lee, Howard Lambert.

Lancaster Corbett Music Ltd., see Street Tunes.

Lark Music Ltd., see Carlin.

Larkworth Ltd. (PRS), see Panache.

Laserium Music, 79 Fitzneal St., East Acton, London W12. Mng. Dirs.: Paul & Renata Gadd; Gen. Mgr.: Renata Gadd.

Laser Music Ltd., 2 Station Pl., Finsbury Park, London N4. Tel: (01) 263-8955. Dir.: Alan J. Dawson; Gen. Mgr.: Sandra Brooks.

Int'l rep.: Worldwide (Intersong).

Latchmere Music Co., see Valentine.

Leading Note Ltd., 209 Rochdale Rd., Greetland, Halifax, West Yorks. HX4 8JE. Tel: (0422) 76161. Mng. Dir.: Bill Leader. (Also see Logo)

Leeds Music Ltd., 138 Piccadilly, London W1V 9FH. Tel: (01) 629-7211. Cable: LEEDSMUSIC. Telex: 22409, 22219. Mng. Dir.: Cyril Simons; Dirs.: Robert Lamont, Ray Webb; Copyright Mgr.: Robert Lamont; Co. Sec'y: Ray Webb; Exploitation Mgr.: Alma Warren.

Int'l firms represented: Far Out, Four Knights (USA), Rawlous, Spooone, Three Knights (USA), Vector (USA).

Int'l reps.: Argentina (Korn), Australia (Leeds), Brazil (MCA), Canada (Leeds), France (MCA), Germany (MCA), Italy (Pickwick), Japan (MCA), Netherlands (MCA), South Africa (Leeds), Spain (Southern), Sweden (MCA), USA (MCA).

Leiber-Stoller Songs Ltd., see Carlin.

Alfred Lengnick & Co. Ltd., Purley Oaks Studio, 421a Brighton Rd., South Croydon, Surrey CR2 6YR. Tel: (01) 660-7646. Mng. Dir.: C.R.L. Avenell; Gen. Mgr.: Mrs. L. Jackson.

Int'l firms represented: CeBeDeM (Belgium), Frederick Harris (Canada), Icelandic Music (Iceland).

Int'l reps.: Canada (Frederick Harris), South Africa (SA Music Dists.), USA (Frederick Harris)

Cecil Lennox Ltd., see Kassner.

Leosong Copyright Serv. Bureau Ltd., 4-a Newman Passage, London W1. Tel: (01) 580-7118. Mng. Dir.: David A. Simmons; Gen. Mgr.: Ray S. Ellis.

Int'l reps.: Australia (Leosong Copyright Serv.), Brazil (CSB), Denmark (NCB), France (CSB), Germany (CSB), Israel (Acum), Italy (RCA), Japan (CSB Ltd./Hara Int'l), South Africa (Copyright Serv. Bureau), Spain (Quorago), USA (Copyright Serv. Bureau).

Libra Music Ltd., 22 St. Peters Square, London W6. Tel: (01) 351-4333. Chief Exec.: Sandy Robertson (Affiliated with Island).

Light Music Ltd., 33 Brynston Square, Suite 18, London W1H 7LR. Tel: (01) 402-4810. Telex: 8952387 Ref. Lyttleton. Mng. Dir.: Trevor Lyttleton; Gen. Mgr.: George Albon; Prof. Mgr.: Ann Rachlin.

Lightning Music Ltd., 841 Harrow Rd., Harlesden, London NW10 5NH. Tel: (01) 969-5255/7155. Telex: 927813. Chm.: Raymond Laren.

Lindsay Music, Brook House, 24 Royston St., Pottton, Sandy, Beds. Tel: (0767) 260033.

Int'l rep.: USA (Henri Elkan)

Linear Music, see Cherry Red.

Linvoy Music Ltd., see Carlin.

Lip Servs. Ent's. Ltd., 2 Unwin Mansions, Queens Club Gardens, London W14 9TH. Tel: (01) 385-3759. Mng. Dir.: Michael Walsh

Litendusting Music, see Warner Bros.

Logic Music Ltd. (PRS), see Panache.

Logo Songs, 119 Wardour St., London W1V 3TD. Tel: (01) 734-6710. Cable: TRADISC. Telex: 25532. Mng. Dir.: Geoff Hannington, Gen. Mgr.: Bill Cochran.

Int'l firms represented: Char-Liz (USA), Intermusic (Netherlands), Kitchen Patch (Canada), Linda (USA), Rodeo (USA), Rosebud (USA), VIP New Bag (USA).

Int'l reps.: Far East (Heathside—Burlington-Palace), South America (Fermata), Austria (Slezak), Belgium (Universal), Canada (Heathside—BIC), France (Heathside—Francis O'Neill), Germany (Slezak), Italy (Heathside—Armando; Logo—Ricordi), Japan (Heathside—TRO-Essex), Mexico (Heathside—Consortio), Netherlands (Universal), South Africa (Heathside—Musicpiece), Spain (Heathside—Southern), Sweden (Sonet), London Pro Musica, 155 Ferndale Rd., London SW4 7RR. Tel: (01) 733-9797.

Int'l reps.: Germany (F. Haenssler), Netherlands (English Music Guild),

USA (E.C. Schirmer).

Looking Glass Music, 498-500 Harrow Rd., London W9. Tel: (01) 960-5577. Telex: 925671. Mng. Dirs.: Max Hole, David Simmons. (Affiliated with Mole & Wrytree)

Lounging Music Co. Ltd., 38 Hertford St., London W1Y 8BA. Tel: (01) 493-5961. Cable: RADLUXADVE. Telex: 263912. Mng. Dir.: John G. Reed; Ass't to Mng. Dir.: Francesca Levermore.

Int'l reps.: Belgium (Radio Tele), Scandinavia (Sweden), South Africa (Gallo).

Lucky Penny Music Ltd., see Margaret Brace.

Ludix Music Ltd., see Carlin.

Lupus Music Co. Ltd. (PRS), 1 Hyde Park Pl., Flat 3, London W2 2LH. Tel: (01) 402-9238. Cable: BRYMO W2. Chief Exec.: Bryan Morrison.

Kenny Lynch Music Ltd., see Carlin.

Lyndon-Martin Publ'g Co., see Valentine.

Lynton Muir Music Ltd.—Dirs.: Terry Scully, Paul Lynton, Laurie MacGregor—see Arretta.

M A M Publ'g, 24/25 New Bond St., London W1Y 9HD. Tel: (01) 629-9255. Cable: MAMARTISTE. Telex: 27867. Gen. Mgr.: Len Beadle; Creative Dir.: Martin Pursey.

M G L Music Ltd. (MCP/PS, PRS), 133 Oxford St., London W1.

M G P (Musical Graphic Publ'g) (PRS), 10 Clifton Terr., Winchester SO22 5BJ. Tel: (0962) 64755. Dir. & Gen. Mgr.: Clifford J. Bevan.

M & M Music Ltd., 58 Paddington St., London W1M 3RR. Tel: (01) 486-4173. Cable: JACKTONE. Chief Exec.: Tony Hatch, Gen. Mgr.: Leslie Burgess.

Int'l reps.: Canada (Jacktone/MCA), USA (Jacktone/MCA).

M P L Communications Ltd., 1 Soho Square, London W1V 6BQ. Tel: (01) 439-6621. Telex: 21294.

Mac Music Ltd., see Carlin.

Macrae Music Ltd., see Carlin.

Magnet Music Ltd., Magnet House, 22 York St., London W1H 1FD. Tel: (01) 486-8151. Cable: MAGLONDON. Telex: 25537. Mng. Dir.: Michael A. Levy; Dir.: Brian Reza; Gen. Mgr.: Paul Barber.

Int'l reps.: Worldwide (Artemis) excluding Canada, Puerto Rico, USA (all Arista/Interworld), Botswana, Lesotho, Malawi, Rhodesia, South Africa, Southwest Africa, Swaziland (all Clan), Japan (Nichion, Watanabe); Channel Isles, Isle of Man, Ireland, Northern Ireland.

Magnum Articles Publ'g Ltd., Vivian House, 21 Market Hill, Southam, Royal Leamington Spa, Warwickshire CV33 0AJ. Tel: (092681) 4642. Oirs.: Roger Upright, Mike Tobin.

Magnum Force Music, 1 Sandels Way, Beaconsfield, Bucks. HP27 2AB. Tel: (09496) 4072. Dirs.: Paul Barrett, Nigel Molden, Adrian Owielt.

Magnum Music/Crazy Rhythm, 15 Albert Crescent, Penarth, South Glamorgan. Tel: (0222) 704279. Chief Exec.: Nigel Molden; Gen. Mgr.: Adrian Owielt; Prof. Mgr.: Paul Barrett.

Maiden Music Ltd., 1 Maltravers St., London WC2. Tel: (01) 240-0512. Cable: MAIDEN. Mng. Dir.: B.E. O'Keef; Gen. Mgr.: N. Grimshaw; Prof. Mgr.: R. Morris. (Affiliated with Valentine)

Int'l firms represented: Fantasia (Ireland), Ring Recs. (Netherlands), Major Seven, see Island.

Sue Manning Music Publ'g Ltd., 27 Redcliffe Rd., London SW10. Tel: (01) 352-5634. Mng. Dir.: Sue Manor.

Manor Music Co. Ltd., see Carlin.

Mansum Music, 13 Bank Square, Wimslow, Cheshire SK9 1AN. Tel: (0625) 527844. Cable: IMDISC. Mng. Dir.: Irving Whire, Gen. Mgr.: Lesley Thompson.

Int'l rep.: USA (DI).

Marathon Music Ltd., see Valentine.

Marco Music Ltd., 81 Osbaldeston Rd., London N16 6NP. Tel: (01) 806-3252. Chm.: Eddy Grant; Gen. Mgr.: Pauline Grant; Admin.: Alpine Grant; Prof. Mgr.: Rudolph Grant. (Also see Intersong)

Marlyn Music Co., see Carlin.

Marksman Music Publ's Ltd. (PRS), 58 Queen Anne St., London W1. Tel: (01) 486-7171. Telex: 267486. Mng. Dir.: Hedley Leyton; Gen. Mgr.: Tommy Sanderson.

Int'l reps.: Australia (Matthews), France (Francis Day), Japan (Watanabe), Netherlands (Nada/Dayglow), Scandinavia (Sweden), South Africa (Gallo), USA (Marksman).

Maria Music (PRS), see Marksman.

Marquis Music Co. Ltd. (PRS), 48 Grafton Way, London W1P 5LB. Tel: (01) 388-7653. Cable: MARQUIMUS. Telex: 298976. Dirs.: E.M. Roncoroni, Ken Jones; Gen. Mgr.: Carole Broughton.

Int'l reps.: USA (Manspring, Mainstay).

Marrow Music (MCP/PS, PRS), 39 Harmer St., Gravesend, Kent. Tel: (0474) 65687. Dir.: John W. Oram; Gen. Mgr.: Margaret Shears.

Marshall, Morgan & Scott Publ'ns Ltd., 1 Bath St., London EC1V 9LB. Tel: (01) 251-2925. Cable: GRAPHO. Telex: 262364. Mng. Dir.: David Payne.

Int'l firms represented: Benson, Singispiration (both USA).

Martin-Coulter Music Ltd., Alembic House, 11th fl., 93 Albert Embankment, London SE1 7TY. Tel: (01) 582-7622. Telex: 8814567. Dirs.: Bill Martin, Bernard Brown; Gen. Mgr.: Richard Gillison.

Int'l firm represented: East Memphis (USA).

Int'l reps.: Worldwide (Intersong) excluding Australia (Warner Bros.), Austria (Melodie der Welt), France (Dick James), Germany (Melodie der Welt), New Zealand (Warner Bros. in Australia), Switzerland (Melodie der Welt).

David Martin Music Ltd., High Holborn House, 52/54 High Holborn, London WC1. Tel: (01) 242-9642. Mng. Dir.: Lionel Martin; Gen. Mgr.: David Gee.

Nigel Martinez Music, see Interworld.

Marvel Music (MCP/PS), 11 Bethel St., 4th fl., Glasgow. Tel: (041) 221-6000. Gen. Mgr.: Kath Reilly; Int'l Mgr.: Allan Mawn.

Mashy Music, see D.J. Arlon.

Matchbox Music, see Saydisc.

Mautogale Music Ltd., 22 Denmark St., London WC2. Tel: (01) 836-5996. Chief Exec.: Stuart Reid, Frank Coachworth.

Mawson & Wareham Music Ltd., Health House 11, Blackett St., Newcastle upon Tyne NE1 5BS. Tel: (0632) 26461. Mng. Dir.: Brian Mawson; Gen. Mgr.: Geoff Heslop.

Int'l rep.: Australia (Matthews).

McCloud 7 Music, Isabel House, Suite 29, 46-47 Victoria Rd., Surbiton, Surrey. Tel: (01) 399-5324. Telex: 896616. Mng. Dir.: Barry McCloud.

McFarlane Music, see Performance.

Mediant Music Ltd., see Kassner.

Robert Mellin Ltd. (PRS), 24 Parkside, Knightsbridge, London SW1. Tel: (01) 245-9026. Cable: MELLINMUSIC. Chief Exec.: Robert Mellin; Gen. Mgr.: David Read.

Home office: USA.

Int'l firms represented: Ampco (USA), Big Leaf (USA), Neapolis (Italy), Pamco (USA).

Int'l reps.: Australasia (Robert Mellin in Australia), Austria (Robert Mellin), Belgium (Music Rights Society), Canada (Robert Mellin), France (Robert Mellin), Germany (Robert Mellin), Greece (Blackwood), Italy (Neapolis), Japan (Musical Rights Tokyo), Netherlands (Timeless), Portu-

gal (Robert Mellin in Spain), Scandinavia (Mellin in Sweden), South Africa (Robert Mellin), Spain (Robert Mellin), Switzerland (Robert Mellin), USA (Robert Mellin)

Memory Lane Music Ltd (PRS), Gray's Inn 6 Raymond Bldgs, London WC1R 5BZ Tel (01) 242 8404 Telex 21143 Mng Dir Larry Spier, Dirs Dorothy Spier, M Alexander (Administered by Carlin)

Int'l branch: USA

Int'l firms represented: Black Sun, Brunetti, Giacomo, Matra, Rebera, Va sula (all Canada), Baldursson, Blend, Caltigula, Discus, Douglas Arthur, JoRo, Jude Mude, Major Songs, Memory Lane, Mouton, Pencil Mark, Songs Music, Larry Spier, Thorawood (all USA)

Int'l reps: Argentina (Melograf), Australasia (Leeds), Austria (Rolf Budde), Belgium (Universal Songs), Bolivia (Melograf), Brazil (Fermata), Canada (Larry Spier), Central America (Ivan Mogul), Chile (Melograf), France (Francis O'Neill), Germany (Rolf Budde), Greece (Intersong), Hong Kong (EMI), Israel (April), Italy (Essex), Japan (Pacific), Malaysia (EMI), Mexico (Ivan Mogul), Netherlands (Universal Songs), Paraguay (Melograf), Portugal (RCA), Scandinavia (Aur), Singapore (EMI), South Africa (Chappell/Intersong), Spain (RCA), Switzerland (Rolf Budde), USA (Larry Spier), Uruguay (Melograf)

Mercedes Music Corp. (UK) Ltd., St George's Field, 54 Hanover Steps, London W2 2YG Tel (01) 954 4170, 724 1681 Telex 74224 RF Tel 2722 Chm Bernard Bain, Gen Mgr Colin Medlock

Int'l firm represented: Mercedes (USA)

Int'l rep: USA (Mercedes)

Mervyn Music (div of Mervyn Conn Org.), MC House, 14 Orange St., London WC2 Tel (01) 930 7502 Mng Dir Mervyn Conn

Metal Rec'g & Publ'g Ltd., 75 Woodpark Dr., Knarborough HG5 90L, Tel (0423) 863 776 Chm Frank Stuart Brown.

Int'l rep: Worldwide (Hippo Songs/Warner Bros)

Metropolitan Music, 8a Froggatt Gardens, Hampstead, London NW3 Tel (01) 435 8803 Mng Dir Mark R F Hanau, Gen Mgr Paul Rodriguez

Mettle Music (Publ'g), 62 Berners St, London W1P 4AE Tel (01) 580 4720 Cable METTLEMUSIC Telex 261298 Mng Dir Joseph R Stanley, Gen Mgr Nigel Murray

Mews, see Bulk

Middle Eight Music Ltd., see Valentine
Middle Road Publ'g Ltd., 73A Glasgow Rd., Blanefield, Glasgow, Scotland G63 9HY Tel (0360) 70177 Or I C McCredie

Midnight Music Ltd., see Valentine
Milion Dollar Music, 12 Praed Mews, London W2 1QY Tel (01) 402 1261 Mng Dir Byron Godfrey, Gen Mgr Tim Harris, Ass't to Mng Dir Mary Lyn Powrie

Mingles Music Ltd., see Cherry Music
Miracle Songs Ltd., see Carlin

Miramusic Ltd (formerly Zack Lawrence Music Ltd.), 1 Gianteam Rd, Stan more, Middx HA7 4NW Tel (01) 954 2025 Gen Mgr Zack Lawrence

Mister Mellow Music Ltd., see Carlin

Misty River Music Ltd., 11 Oxford Circus Ave., 231 Oxford St., London W1 Tel (01) 437 4492 Chief Exec Bruce May, Gen Mgr Joanna Cadman

Moffett Dickinson Publ'g Co., see Valentine
Moments Music Ltd./Spectrum Music, 4 Yarrowbce, Adelaide Rd, Surbiton, Surrey Tel (01) 399 7043 Telex 887277 Chief Exec Al Dickinson

Int'l reps: Australia (Jonathan), Benelux (Holland), France (Intersong), Germany (Gerg), Italy (Saar), Spain (Southern), Switzerland (Memory)

Monston Music Ltd., see Margaret Brace
Monston Music Ltd., The Cottage, Reading Rd, Lower Basildon, Reading, Berks RG8 9NL Tel (049162) 789 Mng Dir Oel Taylor

Morecut Music, 6/8 Emerson St., London SE1 Tel (01) 928 9858/9779 Mng Dir Brian Hutch (Affiliated with Chappell)

More Music, see Illegal
Mother Earth Music, see Spectacle
Motor Music Ltd., see Acton Green

Mountain Music Ltd., see Carlin
Movietunes Ltd., 292/3 High St., Lincoln, Lincs LN2 1AL Tel (0522) 38322 Mng Dir & Prof Mgr Martin Patton, Gen Mgr Stephen Taylor

Mozart Ed (Great Britain) Ltd (PRS), 199 Wardour St., London W1V 3FA Tel (01) 734 3711 Dir Dr G Zagler, Mng Dir H Frankel

Multi Music, see Warner Bros.
Multicord Music, 3 Ravensworth View, Dunston, Tyne & Wear Tel (0632) 609 209 Or Ken McKenzie, Prod'n Mgr Doreen Stephenson

Multiple Music, 79 Blythe Rd., London W14 0HP Tel (01) 602 3483 Cable MULTISDUND Telex 914382 Chm Ian F Miles, Gen Mgr Anne Miles

Munncroft Ltd., 33 Portland Rd., Holland Park, London W11 4HL Tel (01) 229 9633 Mng Dir Ken Street

Int'l reps: France (Panache), Germany (Hammer), Scandinavia (MA)
Musical Publ'rs Ltd., 136 Fellows Rd., London NW3 3JH Tel (01) 722 9027 Dir RA Agoult

Musdeals Music Ltd., see Bocu
Music Sales Ltd., 78 Newman St., London W1P 3LA Tel (01) 636 9033 Telex 21892 Mng Dir Robert Wise, Gen Mgr Frank Johnson

Int'l branches: Australia, USA
Int'l reps: Australia, Germany, USA (Music Sales Corp)

Muso Mail Ltd - Execs Del Taylor, Alexis Korner - see Monsoon
Mute Music, see Sonet

Myers Music Ltd., see Kassner
Nautisongs (PRS), see Panache
Naz Songs, see Panache

Neat Music, 71 High St E., Walsend NE28 7RJ, Tyne & Wear Tel (0632) 624999 Chief Exec David Wood, Gen Mgr Judith Wood

Nems Publ'g Ltd., 31 Kings Rd., London SW3 4RD Tel (01) 730 9461 Cable NEMSENT Telex 913884 Gen Mgr Tony Chapman

Neptune Music Publ'g Ltd., 31 Old Burlington St., London W1 Tel (01) 437 2066 Chief Exec John Aspy

Neutral Zones Music, 4 Chillingworth Rd, London N7 Tel (01) 609 1746 Mng Dir Paul Jenkins, Gen Mgr Peter Wells, Prof Mgr Terry Bolton

New Acme Music Co (UK) Ltd - Dirs Jonathan Rowlands, Judy London - see Hush
New Malden Music Co., see Valentine

New Music Ents., 259 Marvels Ln., Grove Park, London SE12 9P1 Tel (01) 857 6189 Mng Dir Paul Davis, Gen Mgr Ron Palmer
Int'l firms represented: Bridge (USA), Silhouette (USA)

New Town Sound Ltd., 326 Kensal Rd., London W10 5BL Tel (01) 969 6651 Cable MUSICALITY Telex 261500 Mng Dir Marcel Rood
Int'l reps: Belgium (Ardmore & Beechwood), France (Francis O'Neill), Germany (Rolf Budde), Japan (Tayo), Luxembourg (Ardmore & Beechwood)

Nicola Music, see Ocean
Nightingale Music Ltd., Chelsea Wharf, Unw 8, 15 Lots Rd, London SW10 Tel (01) 499 2949 Telex 25460 Chief Exec John C Gaydon

2619 Mng Dir Terry Noon, Gen Mgr Vicki Masters
Noon Scott Music Ltd - Mng Dirs Terry Noon, John Scott - see Noon
J Norris Music Publ'g Co. Ltd., see Kassner

Novelbond Ltd., see Valentine
Novello & Co. Ltd., Bournemouth, Sevenoaks, Kent TN15 8DT Tel (0732) 883261

Numan Music Ltd., see Performance
Nutmeg Ltd., see Valentine
Nuttly Sounds Ltd., see Warner Bros

O K Wave Music, c/o The Victory Cafe, 54 Evershott St Somers Town, London NW1 Gen Mgr Keith Armstrong
Oaktree Music Ltd., see Carlin

Obelisk Music (PRS), 32 Ellerdale Rd, London NW3 Tel (01) 435 5255
Pres & Gen Mgr Heinz Herschmann

Int'l firms represented: Adasta Musik, Kunzelmann, Melo Musik (all Switzerland), Kunzelmann (Germany)
Int'l rep: Germany, Switzerland (both Kunzelmann)

Ocean Music, 91 93 High St., Harlesden, London NW10 Tel (01) 965 9223
Cable CREMUS, Mng Dir David Brooks, Gen Mgr Susan Mann (Affiliated with Creole)

Int'l rep: Worldwide (Creole) excluding Canada, France, Japan, USA
October Music Ltd., see Carlin
Off Street Music, 1 Gledwood Dr., Hayes, Middx Tel (01) 573 8744 Mng Or Stuart Johnson, Gen Mgr Kris Staines

Off the Wall, see Island
Trisha O'Keefe Music Ltd., 19 Acie Ln., London SW2 5RS Tel (01) 274 0164 Dir Trisha O'Keefe

Old New Wave Music, see OK Wave
Olafsong Music, 6 Heath Close, London W5, Tel (01) 991-0993/2208
Cable BLUEYES Pres Jan Olafsson

Int'l firms represented: Black Coffee, Crazy Cajun, Lady Jane, Olofson, Prophecy (all USA)
Int'l reps: Benelux (Basart), France (Carrere), Scandinavia (Intersong)

Olrac Songs, see Asterisk
Ondra Music, 62 The Chase, London SW4 Tel (01) 404 5011 Mng Dir John Owen Williams

100 K Music Ltd., September Sound Studios, 38 Knowl Rd., Golcar, Hud dersfield, West Yorks, HD7 4AN Tel (0484) 658895 Dir & Sec'y Denis Gallivan

One Note Music, see Asterisk
Openchoice Ltd., see Fresh Air
Oracle Music Ltd., 120 Kings Rd., Fleet, Hants Tel (02514) 20053 Telex 858893 Mng Dir Patrick Smith, Gen Mgrs Chris Cook, Keith Bagley

Orange Publ'g, 15 Old Church St., London SW3 Tel (01) 351 3340. Chm Cliff Cooper, Mng Or Dennis R. Sinnott
Orbach & Chambers Ltd., 74 Long Ln., London EC1 Tel (01) 606 9373
Mng Or Michael Chambers

Original Music Ltd., 2 Bloomsbury Pl., London WC1 Tel (01) 580 6996
Joint Mng Dirs Laurence Aston, Oon Mousseau

O'Rourke Music, see Performance
Our Music Ltd., see Red Bus
Oval Music Ltd (PRS, MCPS), 11 Liston Rd, London SW4 00G Tel (01) 622 0111 Dirs Charlie Gillett, Gordon Nelki

Over the Top Prod'ns, see Margaret Brace
Oxford Music, 1 Abbey St., Eynsham, Oxon Tel (0865) 880 240, 880 222
Mng Dir Harry F Mudd

P C Music, see Margaret Brace
P H A B (Philip H.A. Bailey) Music, 3 Acacia Or., Woodham Weybridge, Surrey Tel (09323) 48174 Mng Dir Philip H.A. Bailey

Page Full of Hits Ltd., 29 Ruston Mews, London W11 1RB, Tel (01) 221 7179 Cable PENSONG Telex 8954665 Pensong, Mng Dir Larry Page
Panache Music Ltd (PRS), 362 York Rd., London SW18 1SP Tel (01) 870 8522 Telex 892878, Or Malcolm Forrester

Int'l firms represented: Andante, Marcus Barone, Big, Black Sun, Castle Hill, Celestial Harmonie, Coryell, Oex, John Doe, Oock of the Bay, Free Jazz, Futures Passed, Gaeda, Gillian, Grimes Creek, Hancock, Chris Hills, Jackaroo, Josco, Joyride, Lauralee, Little Bros., Lupe, Mackie, Jon Mark, Mayflower, Millet, Mouzon, Eivena Mouzon, Music Mgmt, Ondine, One to One, On Strike, Other, Pabito, Phrase Text, Powerplay, Real to Real, Retrac, Rohm, Royalty Control, SPQR, Sheepshead Bay, Silkie, Simbora, So lar Plexus, Tarik, Thames Talent, Tom, Trumar, Unit Core, Utom, Vida, Wah Watson, Weiser, Whiteflash, Wonderbuns, You Call This Music, Zid (all USA), Can (Germany), Cerrone/Don Ray (France), Scorpio/Black Scorpio (France)

Int'l reps: Australasia (Festival), Austria (Roba), Belgium (Hans Kusters), Brazil (Fermata), Far East (Intersong in Hong Kong), France (Panache), Germany (Roba), Greece (Intersong), Italy (RCA), Japan (GP), Luxembourg (Hans Kuster), Netherlands (Nada), Switzerland (Roba)

Pan Musik Ltd., see Kassner
Paper Music Ltd., 31 Old Burlington St., London W1X 1LB Tel (01) 434 1081 Telex 25968 Chm Laurence Ronson, Mng Or Billy Lawrence, Gen Mgr Kevin Eade

Int'l reps: Australia (Essex), Austria (Siegel), Belgium (Hans Kuster), Canada (Irving/Almo), France (Claude Pascal), Germany (Siegel), Italy (Ariston), Japan (Pacific), Netherlands (Nada), New Zealand (Essex), Scandinavia (Sweden), Switzerland (Siegel), USA (Irving/Almo), rest of world (April)

Paragon Publ'g, 19 Smithfield, Belfast, Northern Ireland, Tel (0232) 656 959 Chief Exec J O P McCourt

Parchment Music, see Coronation
Pastiche Music, see Deean
Pearl Music, see Margaret Brace

Pedro Music Ltd., see Carlin
Peer Southern Org., see Southern
Peers Music Ltd., 6 Oenmark Pl., London WC2 Tel (01) 836 6699 Dir Kay O'Wayer

Pelican Music, see Munncroft
Pendulum Music, 11 Cross Keys Close, London W1M 5FY Tel (01) 486 0596 Telex 23733 Mng Or Johnny Stirling, Mng Dir Stuart Newton (Affiliated with Warner Bros.)

Pennant Music, Warm House, 111 Mathias Rd, London N16 Tel (01) 254 9602 Owner L.A. Pennant, Gen Mgr R de Castro. (Also see Castrator)

Pennine Songs (PRS), see Marksmen
Performance Music Ltd., see Performance
Performance Music Ltd., Shepperton Studio Centre, Shepperton, Middx Tel (09328) 66531 Telex 929416 Mng Or David Paramor

Scott Perry Songs Ltd (MCPS, PRS), see MGL
Pelerman & Co. Ltd., see Carlin
Peters Ed. Ltd., 10 Baches St., London N1 6ON Tel (01) 253-1638 Cable MUSIPETERS Gen Mgr Jonson Dyer Local branch: 119 Wardour St, London W1V 4OW Tel (01) 437 1456

Int'l firms represented: Belafel (Germany), Carsch (Italy), de Santis (Italy), Forberg (Germany), Hennrichshofen (Germany), Hug & Co (Switzerland), Israeli Music Publ'ns (Israel), Kneusslin (Switzerland), Lienua

Schlesinger (Germany), Litloff (Germany), C F Peters (Germany), USA, Zanibon (Italy)

Phonebooth Music Ltd., see Street Tunes
Pickle Music Co., see Valentine
Pierhead Music Ltd., see Margaret Brace

Pilot Music Ltd (PRS, MCPS), Culross Manor, Faygate near Horsham, West Sussex Tel (029383) 331 Mng Or Miki Dalton, Gen Mgr Lea Dalton
Int'l reps: Worldwide (Chappell) excluding Germany (Magazine), USA (MCA)

Pinball Music, Bond Street House, 14 Chford St, London W1 Tel (01) 499 2933 Telex 24224 Mng Dir DJ Vaughan
Pineapple Music, 8 Nursery Rd., Prestwich, Manchester M25 7DN Tel (061) 773 8914 Dir Lionel Levine

Pink Floyd Music Publ'rs Ltd (PRS), 69 New Bond St., London W1Y 9DE Tel (01) 408 1788 Telex 263226 Mng Dir Peter Barnes

Pipe Music, see Cherry Red
Pixie Music Co Ltd., 186 Casterton Rd., Stamford, Lincs Tel (0780) 51736
Mng Or K M Cox, Gen Mgr WA Cox

Plangent Visions Music Ltd (PRS), 69 New Bond St., London W1Y 9DL Tel (01) 408 1788 Mng Or Peter Barnes
Plant Life Music Ltd., 60 St James's St., London SW1 1LE Tel (01) 499 4341 Telex 266537

Int'l reps: Worldwide (Leosong Copyright Serv. Bureau)
Point Music Ltd., The Point, 9 Eccleston St., London SW1 Tel (01) 730 4201/9777 Mng Dir Rupert Merton

Int'l rep: Germany (Francis Day & Hunter)
Polyphone Music Co Ltd (MCPS), see Arcadia
Porpoise Music, see Island

George Porter Music, see Margaret Brace
Posh Music Ltd., 31 Kings Rd., London SW3 Tel (01) 730 9461 Telex 913804 Mng Dir John B Sherry

Power Music Prod'ns, 11A Sharpleshall St., London NW1 Tel (01) 586 7746 Mng Dir & Prof Mgr Kate Hudson, Gen Mgr John Hudson
Prestige Music Ltd., 48 Grafton Way, London W1P 5LB Tel (01) 388 7653
Cable MARQUIMUSIC Telex 298976 Mng Dir John Spalding, Gen Mgr Carole Broughton, Prof Mgr Howard Huntridge

Int'l firms represented: Asha, Greco, John, Jondora, Mumbi, Myrtle Monroe, Orpheum, Parker, Prestige, Tru Sound (all USA)
Preston Stevens Music Co. Ltd., Lansdowne House, Lansdowne Rd, London W11 Tel (01) 727 0041 Gen Mgr M C Keene

Int'l rep: Austria, Germany, Switzerland (all Schmolzi & Slezak in Germany)

Alan Price Music Ltd., see Carlin
Pulse Music, 11 Woodfield Gardens, Leigh-on-Sea Tel (0702) 72294 Mng Or Dave Lawrence

Quartet Music Ltd., see Carlin
R A K Publ'g Ltd., 42 48 Charlbert St., London NW8 Tel (01) 586-2012
Dir David Most, Gen Mgr Ron Maddison

Int'l reps: Argentina (Melograf), Australia (Castle), Czechoslovakia (Supraphon), France (Baboo), Germany (Melodie der Welt), Hong Kong (Burlington Palace), Israel (April), Italy (Ed. Musicali Melodici), Japan (Toshba), South Africa (Music Publ'g Co.), Spain (EGO), Sweden (Swe den Music), USA (F-melch)

R J Music, "The Return," Clifford Rd., Barnet, Herts EN5 5NZ Tel (01) 440 9788 Mng Dir Roger James, Gen Mgr Christine Sparks

R M O Music Co (PRS), Lex House, 100 Chalk Farm Rd., London NW1 8EH

LASGO EXPORTS



WORLDWIDE EXPORTERS OF RECORDS AND CASSETTES

We offer the entire U.K. catalogue of L.P.'s, cassettes, 12 inch and 7 inch singles, cassette singles, picture discs and all independent label product

Our reputation worldwide is built on fast and efficient deliveries backed up by a friendly sales team and up to the minute new product information.

Your market is our business;
Contact the export professionals,

Mark Ballabon
or
Richard Stern

Telephone: 01-439 8766 or 01-734 5520.
Telex: 8953053 LASGO G
London, England.

Tel: (01) 267-4499. Cable: HITMUSIC. Telex: 261653. Mng. Dir.: Ron McCreight.
Int'l firm represented: Magnetic.
Int'l repa.: Worldwide (Intersong) excluding Australia (Rondor), Benelux (Intersong Basart), Germany (Global), Italy (Curci), Japan (Pacific), Scandinavia (Frost), USA (Reno-Metz).
 R D Music Ltd., see Margaret Brace.
 R S M Music Ltd., 81 Harley House, Marylebone Rn., London NW1. Tel: (01) 487-5587. Mng. Dir.: Sam Mortimer.
 R S D Publ'g Ltd., 67 Brook St., London W1Y 1YE. Tel: (01) 629-9121. Telex: 264267. Mng. Dir.: Rod Gunner; Gen. Mgr.: Alexander Sinclair.
Int'l firms represented: Brothers Gibb (Netherlands), Casserole (USA), Red Cow (USA), Stigwood (USA).
Int'l repa.: Worldwide (Chappell).
 R T Music, see Asterisk.
 R T L Music, 111 Mortlake Rd., New, Richmond, Surrey TW9 4AB. Tel: (01) 876-8682. Telex: 928215. Gen. Mgr.: Sean D'Brien.
 R W Music Ltd., see Carlin.
 Radioactive Music Ltd., see Cherry Music.
 Rascal Music, 1-3 Hill Rise, Richmond, Surrey. Tel: (01) 940-5283. Telex: 8813271. Mng. Dirs.: David Myers, Colin Gershman; Gen. Mgr.: Paul Jenkins.
Int'l firms represented: Autoplastique (France), CMG (South Africa), Mundo del Sol (Spain), Riesenpimmel (Germany), Roughwater (USA), Squareblock Sounds (Canada).
Int'l repa.: Austria, Germany, Switzerland (all Hans Gerig); Benelux (The Company), South Africa (Transistor).
 Rat Race Music, 10A Belmont St., top fl., Chalk Farm, London NW1. Tel: (01) 985-8944. Mng. Dir.: George Colson.
 Raymar Music Co., see Valentine.
 Recorded Delivery Music, 9-11 Richmond Bldgs., Dean St., London W1V 5AH. Tel: (01) 439-3058. Chief Exec.: Paul Murphy; Gen. Mgrs.: Philip Foster, Rosemary Schmecker.
 Red Bus Music (Int'l) Ltd., 34 Salisbury St., London NW8 8QE. Tel: (01) 402-9111. Telex: 268048. Chief Exec.: Eliot M. Cohen, Ellis Elias; Copy-right Mgr.: Sandra Maylam.
Int'l repa.: Australia (Castle), Austria (Roba), Germany (Roba), Greece (EMI), Italy (Buffalo Bill), Japan (Pacific), Mexico (Beethoven), Netherlands (EMI), New Zealand (Castle), Peru (Perumusic), South Africa (Little Monster), Spain (Bocaccio), Switzerland (Roba).
 Redrock Music Ltd., 11 Salehurst Close, Kenton, Harrow. Middx. Tel: (01) 204-1035. Chief Exec. & Gen. Mgr.: Michael Rodway.
 Red Sounds Publ'g, see Rascal.
 Red Stripe Music, see Sonet.
 Redwood Music Ltd., see Carlin.
 Reggae Giant Music (PRS), see Castle Hill.
 Response Music Ltd., Debeare Cottage, North Tamerton, near Holsworthy, Devon. Tel: (040927) 361. Chief Exec.: Mike Claire.
 Revenge Music, see Cherry Red.
 Richcourt Music Ltd. (PRS), 17 Boltons Court, 21E Old Brompton Rd., London SW5. Tel: (01) 370-2919. Telex: 912881. Mng. Dir.: Barry Alexander.
Int'l repa.: Australia (Castle), Brazil (Itaipu), Germany (Accord), Mexico (Beethoven).
 Richtrick Music Co., see Valentine.
 Ridewood Ltd., see Carlin.
 Riding Light Music Co., see Valentine.
 Riva Music Ltd. (PRS), 2 New Kings Rd., London SW6. Tel: (01) 731-4131. Cable: RIVALIDN. Telex: 28781. Mng. Dir.: Dennis Collopy.
Domestic firms represented internationally: Dump (Australia), Heathwave (Canada, USA), Quarry (Australia).
Int'l firms represented: Avir (USA), BRM (Australia), Cushing Murray (USA), HG (USA), Riva (USA).
Int'l repa.: Australasia (Rondor), Austria (Discont), Benelux (Warner Bros.), Canada (Riva, HG), Far East (Arrow), France (Panache), Germany (Discont), Greece (Grecophon), Italy (Franton), Japan (Arrow), Scandinavia (Warner Bros.), South Africa (Musicpiece), Spain (RCA), Switzerland (Discont), USA (Riva, HG).
 Robertson Brown Assocs. Ltd., PO Box 283, London SW6 2JU. Tel: (01) 351-4333. Telex: 261507. Chief Execs.: Paul Brown, Sandy Robertson. (Affiliated with Island)
 Robertson Publ'ns, The Windmill, Wexover, Aylesbury, Bucks. HP22 6JJ. Tel: (0296) 623107. Mng. Partner: Kenneth Robertson.
Int'l firms represented: Lawson-Gould (USA), Leslie (Canada), Paul Price (USA), Waterloo (Canada).
Int'l repa.: Canada (Boosey & Hawkes), South Africa (SA), USA (Theodore Presser).
 Tony Roberts Music, 62 Pall Mall, London SW1. Tel: (01) 930-1105. Telex: 893259. Mng. Dir.: Tony Roberts. (Also see Chameleon).
Int'l repa.: USA (Tony Roberts).
 Robot Music Ltd., see Panache.
 Rock Artists Music Publ'g Ltd., 2 Urwin Mansions, Queens Club Gardens, London W14 9TH. Tel: (01) 385-3759. Gen. Mgr.: Michael Walsh. (Also see Lip Sens).
Int'l repa.: Australia (Albert & Son), Austria (Intersong), Belgium (Hans Kusters), Canada (April Blackwood), Europe (April Blackwood), Germany (Intersong), Japan (April Blackwood), Luxembourg (Hans Kusters), Netherlands (New Dayglow), New Zealand (Albert & Son), Switzerland (Intersong), USA (April Blackwood), rest of world (April Blackwood).
 Rockbottom Music Ltd., see RMD.
 Rocket Publ'g, 104 Lancaster Gate, London W2 3NT. Tel: (01) 258-3585. Telex: 265870. Mng. Dir.: Jim Doyle.
Int'l firms represented: Alrac/Watt Works, British Rocket, Newton House, Rocket Songs (all USA).
 Rockin' Music, 3 Kentish Town Rd., London NW1. Tel: (01) 267-5192. Telex: 893805. Joint Mng. Dirs.: Trevor Churchill, Ed Carroll.
Int'l firms represented: Charlie Fitch (USA), Leon Rene (USA).
Int'l repa.: Australia (Warner Bros.), Austria (Chippell), Benelux (Nada), Canada (Complicit Tonz), France (Claude Pascal), Germany (Chappell), Italy (Ricordi), Japan (Intersong), New Zealand (Warner Bros.), Scandinavia (Sonet), South Africa (Musicpiece) Spain (Quiroga-Penta), Switzerland (Chappell), USA (Complicit Tonz).
 Rock Music Co. Ltd. (PRS), 69 New Bond St., London W1Y 9DE. Tel: (01) 408-1788. Telex: 263226. Mng. Dir.: Peter Barnes.
 Rollercoaster Music, see Asterisk.
 Rondel Music & Recs., 98 Marples Ave., Mansfield Woodhouse, Nottinghamshire NG19 9HB. Tel: (0623) 31390. Partners: M. Comerford, A. Campion. Gen. Mgr.: M. Comerford.
Int'l repa.: Worldwide (Rondelet).
 Rondereest, 17 Queensway, Dunstable, Beds. LU5 4ET. Tel: (0582) 62325.
 Rondor Music (London) Ltd., Rondor House, 10a Parsons Green, London SW6 4TW. Tel: (01) 731-4161. Cable: RDNDORLDN. Telex: 8951674. Mng. Dir.: Bob Grace.
Home office: USA.
Int'l firms represented: Almo, Arnas, David Baiteau, Bitchin Guy, Blue

Harbor (USA), Braintree, Charleville, Clams Casino (USA), Clean Sheets, Doors, Dovan (USA), Down in Dixie (USA), Excessive (USA), Face the Music (USA), John Farrar (USA), Foghorn (USA), Frettsongs, Hendricks, Hollenbeck, Iodine (USA), Iska, Irving, Jasperilla, Jowco, Miles Ahead, Miyako, Modern American, Mualatto, Nefeliriti, Porchester, Rosy, Saggi-fiere, Tangerine, Vanas (USA), Walkin' Fish, Weather Report, X-Ray.
Int'l repa.: Australia (Rondor), Belgium (Universal), Brazil (ITAIPIU), Canada (Irving/Alco), Chile (Sochem), Czechoslovakia (Dpus), France (Pathe Marconi), Germany (Global), Greece (Blackwood), Hong Kong (Pathe), Italy (RCA), Japan (Pacific), Mexico (Beethoven), Netherlands (Universal), Portugal (Valentim de Carvalho), South Africa (Music Publ'g Co.), Spain (RCA), Sweden (Sweden Music), USA (Irving/Almo).
 Rouge Music Ltd., 84 Wardour St., London W1V 3LF. Tel: (01) 734-1310. Rough Trade Music Ltd., 137 Blehmien Crescent, London W11. Tel: (01) 229-5736. Chief Exec.: Anne Clark.
Int'l branch: USA
Int'l repa.: Australasia (Gap), Austria (Rudolf Slezak), Canada (Rough Trade), France (Warner Bros.), Germany (Rudolf Slezak), Italy (Ricordi), Japan (Nichion), Switzerland (Rudolf Slezak), USA (Rough Trade).
 Round Music Co. Ltd., Tottrees, Church Rd., Woldingham, Surrey. Tel: 2386. Mng. Dir.: David Mackay; Gen. Mgr.: Michael Challis.
 Roundabout Music Ltd., 9 Hillgate St., London W8 7SP. Tel: (01) 727-2791. Telex: 25728. Chief Exec.: Pat Fairley.
 Adrian Rudge Music, 38 North Row, London W1. Tel: (01) 491-3175. Telex: 23840. Dir.: Adrian Rudge.
Int'l firms represented: Mike Corbin (USA), Warbride (USA).
 Rush Music Ltd., see Kassner.
 Rydim, see Island.
 S D S Songs Ltd., 19 Ethelbert Rd., Cliftonville, Kent CT9 1SH. Tel: (0843) 294128. Mng. Dir.: Frank Foy.
 Saffred Music Ltd., Hurworth Cottage, Hurworth, Darlington, Durham. Tel: (0325) 721-143, 720-792. Mng. Dir. & Gen. Mgr.: Elaine Saffer.
 St. Annes Music Ltd., Kennedy House, Stamford St., Altrincham, Cheshire. Tel: (061) 941-5151. Cable: KENTESH. Telex: 666255. Dirs.: Danny Betesh, Harvey Lisberg, Ric Dixon.
Int'l firms represented: Razzle Dazzle Music (USA), Teddy Randazzo (USA).
Int'l repa.: Albania, Austria, Bulgaria, Czechoslovakia, Germany, Greece, Hungary, Poland, Romania, Switzerland, Turkey, USSR (all Francis Day & Hunter in Germany); Australia, New Zealand, British Solomon Islands, Christmas Island, Ellice Island, Fiji Islands, Gilbert Island, Nauru, New Guinea, New Hebrides, Norfolk Island, Tonga Island, Western Samoa (all Essex in Australia); Belgium (Intersong Primavera), Canada (Man-Ken), France (Alto), Japan (Pacific), Luxembourg (Intersong Primavera in Belgium), Netherlands (Intersong Basart), Portugal (Canciones del Mundo), Scandinavia (Sweden), Spain (Canciones del Mundo), USA (Man-Ken).
 St. Gregory Publ'g Co., 64 Pineheath Rd., High Kelling, Holt, Norfolk NR25 6RH. Tel: Holt 2288.
 Sally Music Co. Ltd., see Valentine.
 Sam Songs Ltd., see Carlin.
 Sarah Music, 9A Halfcourt Ln., Copman Thorpe, York. Tel: (0904) 703-401, 797-090. Mng. Dir.: Mal Spence; Gen. Mgr.: Dave Leaper. (Affiliated with Chappell)
Int'l firm represented: Tin Pan Alley (Australia).
Int'l repa.: Worldwide (Chappell).
 Sarm Songs, Osborn House, 9-13 Osborn St., London E1 6TD. Tel: (01) 247-1311. Mng. Dir.: John Sinclair; Gen. Mgr.: Jill Sinclair.
Int'l repa.: Germany (Siegel).
 Satellite Music Ltd., see Performance.
 Satril Music Ltd., (div. of Henry Hadaway Drg.), Satril House, 444 Finchley Rd., London NW2 2HY. Tel: (01) 435-8063. Cable: SATRIALREC. Telex: 261331. Mng. Dir.: Henry Hadaway; Gen. Mgr.: Paul Hodsmann; Prof. Mgr.: Tony Todd.
Int'l repa.: Brazil (Top Tape), France (Claude Pascal), Israel (April), Italy (Curci), Netherlands (Step One), Norway (Talent), Sweden (SDS).
 Sava Music, see Satril.
 Saydisc Recs., The Barton, Ingletstone Common, Badminton, Glos. GL9 1BX. Tel: (045424) 266. Chief Execs.: Gelf & Genny Lucena.
 Schaeffers-Kassner Music Ltd., see Kassner.
 Richard Schauer (PRS), Lyra House, 67 Belsize Ln., London NW3 5AX. Tel: (01) 794-8038. Mng. Dir.: Irene Retford.
Int'l firms represented: Muscus, E.C. Schirmer (both USA); Scherzando (Belgium).
Int'l repa.: USA (Associated Music Publ'rs).
 G. Schirmer Ltd. (MCPs, PRS), 140 Strand, London WC2R 1H6. Tel: (01) 836-4011. Chief Exec. & Gen. Mgr.: Julian Mitchell-Dawson.
 Scotus Music Publ'ns Ltd. (PRS, MCPs, MRS, PPL), 28 Dalrymple Crescent, Edinburgh, Scotland EH9 2NX. Tel: (031) 667-3633. Cable: MUSICA VIVA. Mng. Dir.: James Douglas.
Int'l firms represented: Finnish Music Information Centre (Finland), PWM-Baciewicz & Block only (Poland).
 Seabreeze Music Ltd., 25 Newman St., London W1P 3HA. Tel: (01) 323-1272. Mng. Dir.: John Coletta; Prof. Mgr.: R. Moger. (Affiliated with Warner Bros).
 Sea Dream Music, 28 Earham Grove, Forest Gate, London E7 9AW. Tel: (01) 534-8500. Senior Partner & Gen. Mgr.: Simon Law.
Int'l firm represented: Ernvik (Sweden).
Int'l repa.: Sweden (Ernvik).
 Sea Horse Music Publ'g, 2 Lamballe Pl., London NW3. Tel: (01) 435-7765. Dirs.: Teddy A. Ruster, Allan Austin.
 Secret Music Ltd., 52 A Princess St., Luton, Beds. Tel: Luton 32219. Mng. Dir.: Martin Hookes; Sales Dir.: Roger Bruntton.
 Sidney A. Seidenberg Music Ltd., see Carlin.
 Semprini Music Ltd., see Carlin.
 Sentinel Music, Paul, Penzance, Cornwall. Tel: (0736) 73246. Telex: 45143 Ref. SEN. Ref. 111. Chief Exec. & Gen. Mgr.: Job Morris; Sec'y: Irene Morris.
 September Music Ltd. (MCPs), 209 Denby Dale Rd., Wakefield, Yorks. WF2 7AJ. Tel: (0924) 79589. Chm.: Frances Dowley; Gen. Mgr.: J. Lees.
 Sesame Songs Ltd., 70 Kingston Rd., Leatherhead, Surrey. Tel: (03723) Leatherhead 79444. Telex: 24637. Chief Execs.: Mike Cobb, Nigel Gray.
Int'l firm represented: Angela (South Africa).
Int'l repa.: South Africa (Angela).
 77 Music, 77 Charing Cross Rd., London WC2H 0AA. Tel: (01) 437-4197. Owner: D.A. Dobell.
 Seven Music, see Aura.
 Seven Seven Music Ltd., see Chandos.
 Shadams Music Ltd., see Carlin.
 Shadows Music Ltd., see Carlin.
 Cyril Shane Drg., 14 New Burlington St., London W1X 2LR. Tel: (01) 734-3251. Telex: 267488. Pres.: Cyril Shane.
Int'l firms represented: Aliben, Brother Hubbard, Broude/Bregman, Cashew, Fat Zach, Fix Int'l, Hexachord, House of Sham, Hubtones, Jadder, Ruzamu, Skinny Zach, Spiral, Stevarim, Thunderclap, Wedge (all USA).

Int'l repa.: Australasia (Allans), Austria (Melodie der Welt), Far East (Pathe), Germany (Melodie der Welt), Scandinavia (EMI), South Africa (Gallo), Switzerland (Melodie der Welt).
 Shanghai Music Ltd. (MCPs, PRS), see Pilot.
 Shanna Music, see Carlin.
 Shapiro, Bernstein & Co. Ltd., 184/186 Regent St., London W1R 5DF. Tel: (01) 439-7731. Cable: BERNSTEIN. Telex: 27557. Chief Exec.: Mike Fletcher.
Int'l firms represented: Camelback Mountain, Glad, Newcomer, Painted Desert, Ponderosa, Shapiro Bernstein, Skidmore, Yuma (all USA).
Int'l repa.: Australasia (Wallaby), Japan (Shinko).
 Sheaf Music Ltd., 184 Regent St., Suite 308/9, London W1. Tel: (01) 734-2088. Chief Exec.: David Apps.
Int'l repa.: Canada, USA (both Mayflower).
 Sheet Music Publ'g, 29 Riding House St., London W1. Tel: (01) 637-9099. Chief Exec.: P.J. Scally; Gen. Mgr.: B. Levene.
Int'l firm represented: IntoMusic (Ireland).
Int'l repa.: Australia (Jenny G.C. Young), France (Mirielle Perraudin), Ireland (William A. Crowley), Jersey (L.A. Scally), USA (Linda Mark).
 Shelley Music Ltd., see Margaret Brace.
 Sherwood Recs. Ltd., 95 Elm Park Gardens, Suite 31, Chelsea, London SW10 9QE. Tel: (01) 352-6486. Telex: 922488/155. Chm.: John Norwell; Mgr.: Stephen Jensen; Prof. Mgr.: Peter Simpson.
Int'l firms represented: Climax (USA), JSN (USA), Tassenberg (Germany).
Int'l repa.: USA (JSN).
 Shirley Music Ltd., see Margaret Brace.
 Showcase, see Valentine.
 Signalgrade, see Island.
 Silver Hammer Music, 193 Rose Ln., Mossley Hill, Liverpool L18 5EA. Tel: (051) 724-5612/4553. Mng. Dir.: John Mitton; Gen. Mgr.: Jackie Maxwell.
 Simbar Music, see Carlin.
 Singatune Publ'g, 63 Grosvenor St., London W1. Tel: (01) 493-7831. Cable WEDGE. Telex: 261466. Mng. Dir.: A.M. Gordon.
 Singstar Inc., 28 George IV Bridge, Edinburgh 1, Scotland. Tel: (031) 225-4816. Partner: T.C. Danson-Smith.
 Skerryrock Ltd., see Island.
 Slamina Music Ltd., see Carlin.
 Sledge Music Ltd., see Carlin.
 Sli Music, see Asterisk.
 Small Wonder Music Ltd., 162 Hoe St., London E17. Tel: (01) 520-5036. Chief Execs.: Pete & Mari Stennett.
 Smash Bros., see Island.
 Smash Music, see Light.
 R. Smith & Co. Ltd., Paramount Ind'l Estate, Unit 2, Sandown Rd., Watford, Herts. Tel: Watford 34146. Mng. Dir.: Geoffrey Brand.
Int'l firm represented: Bourne (USA).
 Smooth Music Ltd., see Carlin.
 Snapper Songs, see Asterisk.
 Snob Music Ltd.-Execs.: Del Taylor, Stephen Parsons-see Monsoon.
 Softrock Music Ltd., see Songwriters Workshop.
 Soho Recs., 39 Hereford Rd., London W2. Tel: (01) 229-8911. Mng. Dirs.: S. Brennan, P. Gaston.
 Some Bizzare, see Dead Good.
 Sound Recs. & Publ'g, 121 Ledbury Rd., London W11 2AQ. Tel: (01) 229-7267. Cable: SDNETMUSIC. Telex: 25793. Mng. Dir.: Rodney Buckle; Gen. & Prof. Mgr.: Alan Whaley.
Int'l firms represented: Andsome, Audophone, Avalon, Bad Boy, Barren Country, La Bonne Musique, Chu Fin, Crawdad, Dildoug, Emile, Eyeball, Fay Fay, Green Isle, Green Dew, Happy Valley, John Hartford, Heavy Traffic, Hologol, Joliet, Kicking Mule, Augie Meyers, Nest, Diwen, Piccolo, Rockin' Dopsis, Roim, Round Wound Sound, Douglas Sham, Shelby Singleton, Skywren, SonDick, Stainless Stone, Country, Terrapin, Texas Rec., George Thorogood, Toad Hall, Tortoise, Wall to Wall, Western Head (all USA); Hank C. Burnette, John's Music, Sonet (all Sweden); (part representation) Delphine (France), Flat Town (USA), Hazel (Jamaica), Jamil (USA), Tailormade (USA), Whitewing (USA).
Int'l repa.: Austria (Manito), France (Louis III), Germany (Manito), Italy (Tiber), Netherlands (Sonet), Scandinavia (Sonet), Spain (Notas Magicas), Switzerland (Manito), USA (Emile, Stainless).
 Song Music Publ'g Ltd., 101 St. Johns Hill, London SW11. Tel: (01) 228-0597. Mng. Dir.: Frank Sansom.
 Songs for Today Ltd. (Incorporating Florida Music Co.), PO Box 130, Hove, East Sussex BN3 6QU. Tel: (0273) 550088. Cable: KRUGERENTS. Telex: 877050. Chm.: Jeffrey Kruger; Pres.: Howard Kruger; Copyright & Licensing: Margaret Brace.
Int'l branch: USA.
Int'l firms represented: Fourth House, Fresh Memory, GlenTan, Hillbrow, Kenwood, Otis, Po Wee, Seventh Sun, Sublime.
 Songwriters Workshop Ltd., 53 Brompton Rd., London SW3. Tel: (01) 589-7434. Chm.: Mel Morris; Gen. & Prof. Mgr.: Tim Hollier.
Int'l repa.: Europe (Intersong).
 Soundcare Music, see Rascal.
 Sound Diagrams (MCPs, PRS), 3/4 E. Norton Pl., Abbeyhill, Edinburgh, Scotland EH7 5DR. Tel: (031) 661-5811. Mng. Dir.: Bob Last; Gen. Mgr.: Hilary M. Morrison; Sales Mgr.: Simon Best.
 Southern Music Publ'g Co. Ltd., 8 Denmark St., London WC2H 8LT. Tel: (01) 836-4524. Cable: SDUTH-MUSIC. Dirs.: T.F. Ward, Monique & Ralph (II) Peer, D.R. King; Prof. Mgr.: Marjorie Murray.
Home office: USA, Southern Music Publ'g Co. Inc.
 South of Jupiter Music Ltd., see Carlin.
 Southstrand Music Ltd., 6 Holland Park, Basement Apt., London W11. Tel: (01) 229-0663. Mng. Dir.: Paul K. Walden. (Also see Flash)
 Spade Songs, see Asterisk.
 Spaniel Music Ltd., Dockens Water, Blashford, Ringwood, Hamts. Tel: (04254) 2645. Dir.: P. Goodhand-Tait.
Int'l firms represented: Australia (Sundowner), Coburn (New Zealand).
Int'l repa.: Australia (Coburn/Sundowner), Austria (Siegel), Benelux (Universal Songs), France (Chappell), Germany (Siegel), Italy (Chappell), Japan (Chappell), New Zealand (Coburn/Sundowner), Scandinavia (Chappell), Switzerland (Siegel), USA (Chappell).
 Sparta Florida Music Group Ltd., Carlton Tower Pl., Suite 4, Sloane St., London SW1X 9PZ. Tel: (01) 235-0168. Cable: HALMUSIC. Telex: 8956057. Chm.: Hal Shaper; Gen. Mgr.: Mike Berry.
Int'l repa.: Canada (Gemrod), Europe (Sparta Florida in the Netherlands), Germany (Intro), Japan (Taiyo), Spain (RCA), USA (Gemrod).
 Spectacle Music, 11 Connaught Pl., London W2. Tel: (01) 258-0077. Mng. Dir.: Ms. Saffron Summerfield.
 Sphenusations, 12 Northfield Rd., Dnehouse, Stowmarket, Suffolk IP14 3HF. Tel: (04492) 3388. Chief Exec.: James Butt.
 Spider Music, see Margaret Brace.
 Springs Music Ltd., see Carlin.
 Springer Music, see Spaniel.

Springpark Music Ltd., 5 Marston Close, Swiss Cottage, London NW6 4EY. Tel: (01) 328-7676. Mng. Dir.: Ray Davies.
Int'l rep.: Benelux (Kluger Int'l), Canada (Franklyn Boyd), Germany (Melodie Der Welt), USA (Franklyn Boyd).
 Springtime Music, Balmalcolm House, Balmalcolm, Kingskettle, Fife KY7 7TJ. Tel: (0337) Ladybank 30773. Dir.: Peter Shephard.
 Stable Music, 4 Chalcut Rd., London NW1.
 Stage Coach Music, 15 Claremont Rd., Westcliff-on-Sea SSO 7DX. Tel: (0702) 43464. Telex: 24224 Ref. 181. Mng. Dirs.: Barry Collings, Cyril Wayne.
Int'l rep.: Mexico, Portugal, Spain (all Quiroga).
 Stage One Music (PRS), 14 Sebert Rd., London E7 0NQ. Tel: (01) 534-5472. Chief Exec.: John Bassett.
 Stagetruck (Music Publ'g) Ltd., 57 Duke St., Grosvenor Square, London W1. Tel: (01) 493-5015. Cable: STAGETRUCK. Chm & Mng. Dir.: Simon Caplan; Dirs.: Terry James, Neil Shestobal. (Also see Leosong)
Int'l rep.: Australia (Mathews Copyright Bureau), Brazil (Copyright Serv. Bureau); USA (Copyright Serv. Bureau).
 Stainer & Bell Ltd., 82 High Rd., East Finchley, London N2 9PW. Tel: (01) 444-9135. Mng. Dir.: Bernard A. Braley.
Int'l rep.: USA (Galaxy).
 Stallion Music, 76 Roebuck House, Palace St., London SW1. Tel: (01) 828-0227/8260. Mng. Dir.: J. Toogood. (Also see Metal)
 Standard Music, 21 Poland St., London W1. Tel: (01) 437-2402. Telex: 27201. Promos. Mgr.: Laura Beedle. (Also see Essex)
 Stanmore Music, see Margaret Brace.
 Stanza Music, 11 Victor Rd., Harrow, Middx. HA2 6PT. Tel: (01) 863-2717. Mng. Dir.: W.M. Ashton.
Int'l rep.: USA (Kendor—selected titles).
 State Music Ltd., 26/27 Castlereagh St., London W1H 5YR. Tel: (01) 402-2191. Telex: 25740. Mng. Dir.: Wayne Bickerton; Copyright & Royalty Mgr.: Bert Bullen.
Int'l rep.: Australia (Essex), Austria (Intro Messel), Benelux (Nada), France (Claude Pascal), Germany (Intro Messel), Switzerland (Intro Messel).
 Stave & Nickelodeon Music Ltd., 51 Kilmaine Rd., London SW6. Tel: (01) 385-2470. Mng. Dir.: Nicholas Martin; Prof. Mgr.: Steve Glen. (Affiliated with RAK)
Int'l rep.: Austria, Germany & Switzerland (Aprily); rest of world (Intersong).
 John Stedman Music Publ'g (MCPS, PRS), 112 Sunney Gardens Rd., London NW4. Tel: (01) 203-1324. Mng. Dir.: John Stedman.
Int'l firms represented: Goodie Train, Prolific, Rogerman, Sundown (all USA).
 Steel City Music, 19 S. Gallery, Exchange St., Sheffield. Tel: (0742) 23366. Mng. Dir.: Peter Martin.
 Steinar Music, see Songwriters Workshop.
 Step-Forward Music, see illegal.
 Miriam Rose Stern Agency Inc., 14 New Burlington St., London W1X 2LR. Tel: (01) 734-3251.
Home office: USA
 Note: Corporation representing heirs of songwriters, administering reversionary rights emanating from United Kingdom, Canada, Australasia, Ireland, Republic of South Africa.
 Stink Horn Music, see Asterisk.
 Stickysongs, Huntsman's Cottage, Kennel Ln., Windlesham, Surrey. Tel: (0276) 72132. Mng. Dir.: Peter Gosling.
 Storm Music, 133 Park Rd., Blackpool FY1 4ET. Tel: (0253) 27357. Owner: Wayne Paulo; Gen. Mgr.: Estelle Paulo.
 Stratsongs Ltd., see Carlin.
 Strawberry M Ltd., see Sonet.
 Street Corner Music, 33 Portland Rd., Holland Park, London W11 4LH. Tel: (01) 299-9631. Dir.: Ken Street.
Int'l firms represented: Blue Lake (USA), Creative (USA), Hammer (Germany), Lorville (USA), MA (Scandinavia), Mason Jar (USA), Musik Avenue (Germany), Streeterville (USA), Terrace (USA).
Int'l rep.: France (Panache), Germany (Hammer), Scandinavia (MA).
 Street Music Ltd. (PRS), 165/7 Willesden High Rd., London NW10 2SG. Tel: (01) 451-3044. Telex: 919884. Dirs.: Clive Calder, Dave Robinson; Gen. Mgr.: Jan Garner; Prof. Mgr.: Steven R. Howard.
Int'l rep.: Australia (Mushroom), Austria (Melodie Der Welt), Belgium (Nada), Canada (Morning), France (Scorpio), Germany (Melodie Der Welt), Italy (RCA), Japan (Pacific), Netherlands (Nada), New Zealand (Mushroom), South Africa (Musicprece), Spain (RCA), Switzerland (Melodie Der Welt), USA (Participation).
 Street Tunes Ltd., 45 Barrington Court, Colney Hatch Ln., Muswell Hill, London N10. Tel: (01) 883-0775. Mng. Dir. & Gen. Mgr.: John Glover; Prof. Mgr.: Steve Rowles.
Int'l rep.: Australia (Matthews).
 Strike Music, 1 Long Acre, Covent Garden, London WC2. Tel: (01) 836-0555. Mng. Dir.: Carole Striker. (Affiliated with Dorco)
Int'l firm represented: Tuff Turkey Toons (USA).
Int'l rep.: USA (Tuff Turkey Toons).
 Stripe Music, see Rascal.
 Studio G (PRS), Ridgway House, Great Brington, Northampton. Tel: (060125) 511. Mng. Dir.: John Gale.
Int'l firms represented: Roland Kluger (Belgium), Omnimusic (USA), Parry (Canada).
 Studio Music Co., 77/79 Dudden Hill Ln., London NW10 1BD. Tel: (01) 459-6194. Owner: Stan Kitchen.
 Success Music Ltd., see Kassner.
 Summit Music Ltd., 38 North Row, London W1. Tel: (01) 499-2014. Mng. Dir.: Charles Peate; Gen. Mgr.: Clive Scott.
Int'l rep.: Canada (Gong Dimension), Scandinavia (Air), USA (Gong Dimension).
 Sunburst Recs. Ltd., 25 Newman St., London W1. Tel: (01) 323-1272. Dirs.: John Coletta, Andrew Tribe.
 Sunbury Music Ltd. (PRS), 155-157 Oxford St., London W1. Tel: (01) 437-2468. Telex: 910829. Mng. Dir.: John Merritt; Admin. Mgr.: Grant Goodchild.
Int'l firms represented: Andustin (USA), Antrisa (USA), Chess (USA), Cyclus (Germany), EDIM (Mexico), GW Jr. (USA), Global (Japan), Bobby Goldsboro (USA), House of Gold (USA), Kidada/Rashida (USA), Koppelman-Bandier (USA), Metal Machine, Oakfield Avenue, Pi-Gem (USA), RCA (Brazil, France, Italy, Spain), Relay (Argentina), Roz-Tense (USA), Rust (USA), Schwartz (USA), Sunbury Ounbar (Canada).
Int'l rep.: Argentina (Relay), Belgium (Universal Songs), Brazil (RCA Victor), Canada (Sunbury Ounbar), France (RCA), Germany (Cyclus), Hong Kong (Burlington-Palace), Italy (RCA), Japan (Global), Mexico (EDIM), Netherlands (Universal Songs), Scandinavia (Sonet), Singapore (Burlington-Palace), South Africa (Galio), Spain (RCA).
 Sunlight Music Prod'ns Ltd., 51 Maida Vale, London W9 1SL. Tel: (01) 289-3366. Chief Exec.: Jimmy Duncan; Gen. Mgr.: Monique Dahmann.
 Sun-Pacific Music (London) Ltd., PO Box 78, London SE19. Tel: (01) 653-

8457. Cable: TREBLIG. Mng. Dir.: Gilbert Gibson; Gen. Mgr.: Alyson Bray; Prof. Mgr.: Graham Tucker.
Int'l firms represented: Black Stave (USA), Gold Stave (USA), Main Stave (USA), Sun-Pacific (South Africa).
Int'l rep.: South Africa (Sun-Pacific), USA (Main Stave).
 Sunset Music, The Music Works, 23 Benwell Rd., London N7. Tel: (01) 609-1377. Mng. Dir.: Kevin Wyatt-Lown.
 Sun Valley Songs, 23 Denmark Pl., London WC2H 8NL. Tel: (01) 836-7148.
Int'l firm represented: Derby (USA).
 Supersongs Ltd., see Carlin.
 Surefire Music Ltd., 10 Maddox St., London W1. Tel: (01) 499-5887. Mng. Dir.: Chris Arnold; Gen. Mgr.: Lamona Snow; Prof. & Int'l Mgr.: Miss Nicky Hodder.
 Sutton Sound Ltd. (MCPS), 80 Queensway, London W2 3RL. Tel: (01) 262-9066. Chm.: Ivan Sutton; Gen. Mgr.: Mark Sutton.
 Swamp Music, 6 Cheyeville Mews, London Rd., Sunningdale, Berks. SL5 0VD. Tel: (0990) 26425, 20342. Mng. Dirs.: Bob & John Hardman.
 Swan & Co. (Music Publ'rs) Ltd. (MCPS), see Arabia.
 Swansong Music Ltd., see Carlin.
 Sweet 'N' Sour Songs, (PRS), 42 Manchester St., London W1. Tel: (01) 486-6141. Dirs.: Anthony Edwards, John A. Craig.
Int'l rep.: Austria (Gerig), Belgium (Universal Songs), France (Panache), Germany (Gerig), Netherlands (Universal Songs), Scandinavia (Sonet), Switzerland (Gerig).
 Sweet Publ'g Ltd., see Carlin.
 Swishdale, see State.
 Symbolic Music Publ'g Ltd., see Margaret Brace.
 Symetric Music, 1 Melville Rd., Edgbaston, Birmingham 16. Tel: (021) 454-4666. Chief Exec.: Karel Beer; Gen. Mgr.: Eugen Beer.
 Sympathy Music Ltd., see Carlin.
 T M Music Ltd., see Carlin.
 T R O Essex Music Ltd., see Leeds.
 Tabitha Music Ltd., 39 Cordery Rd., St. Thomas, Exeter EX2 9DJ. Tel: (0392) 79914. Mng. Dir.: Graham Scratler; Gen. Mgr.: Denise Scatler.
Int'l firm represented: Sound of Scandinavia (Sweden).
Int'l rep.: Spain (Monserrat).
 Tangent Music Ltd., 176a Holland Rd., London W14 8AH. Tel: (01) 603-0893.
 Tank Music, see Morecut.
 Tanspan, see Asterisk.
 Tarot Music Ltd., see Carlin.
 Tartan Music Ltd. (PRS), see Riva.
 Tatham Music, see Margaret Brace.
 Teenage Heaven, see Carlin.
 Teley City Music Ltd., see Miriamusic.
 Tembo Music, 50 Regents Park Rd., London NW1 7SX. Tel: (01) 586-5591. Telex: 299220. Gen. Mgrs.: Roger Whittaker, Irene Collins.
 Alan Tew (Music) Ltd., Bushy, Tye Green, Cressing, Braintree, Essex CM7 8HU. Tel: (0376) 23860. Chief Exec.: Alan Tew.
 Thames Publ'g, 14 Barby Rd., London W10 6AR. Tel: (01) 969-3579. Publ'g Mgr.: John Bishop.
 Thank You Music, Lottbridge Grove, Eastbourne, East Sussex BN23 6NT. Tel: (0323) 27454. Mng. Dir.: Geoffrey Ronald Shearn.
Int'l firm represented: Star Song (USA).
 Therapy Music, see Carlin.
 Third Kind Recs. Ltd., 11 Seaton Rd., Easton, Bristol BS5 6BH. Tel: (0272) 511523, 550293. Chief Exec.: Ronald Green.
 Throat Music Ltd., see RSC.
 Tincabell Music Ltd., 37 Soho Square, London W1. Tel: (01) 439-8971. Telex: 24327. Mng. Dir.: Dick Leahy; Prof. Mgr.: Leslie Turnbull.
 Tinderbox Music (PRS), see Marksmen.
 Titannicus Ltd., see Carlin.
 David Toff Music Publ'g Co. Ltd., see Margaret Brace.
 Tollak Music Co. Ltd., see Carlin.
 Tollie Music Ltd., see Carlin.
 Too Much Music Ltd., see Performance.
 Topic Recs. (Music) Ltd., 50 Stroud Green Rd., London N4 3EF. Tel: (01) 263-6403. Chief Exec.: Tony Engle.
 Torill Music, see Satril.
 Towerbell Publ'g Co. Ltd., 32/4 Gondar Gardens, London NW6 1HG. Tel: (01) 794-6702. Telex: 8952387. Mng. Dir.: Robert England; Gen. Mgr.: Natasha England.
 Tower Bridge Music Ltd., 1 Gledwood Dr., Hayes, Middx. Tel: (01) 573-8744. Chief Exec.: Stuart Johnson.
 Train Publ'g Plan Ltd., see Carlin.
 Trekfarm Ltd. (PRS), 24 Hartley Hill, Purley, Surrey. Tel: (01) 668-1051. Dirs.: Harold J. Sporo, Alan A. Freeman.
 Eddie Tre-Vett Music Ltd., see Carlin.
 Trnal Publ'g, Mondrice off High St., Acton, Sudbury, Suffolk. Tel: (07873) 77317. Mng. Dir.: Stephen Guy-Clarke. (Affiliated with EMI)
 Trident Recs. Ltd./Nereus Music, see Margaret Brace.
 Trio Music Co. Ltd., see Carlin.
 21st Century Music, 41 Gotswood Gardens, London NW2 1QT. Tel: (01) 458-8991. Mng. Dir.: Martin Lewis.
 Twist & Shout Ltd., 41 Alderbrook Rd., Suite B, Clapham South, London SW12. Tel: (01) 673-3240. Dir.: Clive Solomon; Gen. Mgr.: Steven Weeks.
 Two Way Music Ltd., see Carlin.
 Ultimate Music Ltd., 26 Broad Street Ave., London EC2. Tel: (01) 638-3755. Mng. Dir.: James Player; Gen. Mgr.: Tony Cummings.
 United Artists Music Ltd., Mortimer House, 37/41 Mortimer St., London W1A 2JL. Tel: (01) 636-1655. Cable: UNARTISCO. Telex: 261818. Gen. Mgr.: Brian Yell.
Home office: USA
Int'l firms represented: Bar-Thel, Frandell, Liz-Bet, Primebeat, Rich-Car, Robbins, Tempo, UA Music Int'l, Unart (all USA).
Int'l rep.: Argentina (Musical-Korn Intersong), Australia (United Artists), Austria (United Artists), Belgium (United Artists), Brazil (Meridional), France (United Artists), Germany (United Artists), Hong Kong (EMI), Israel (Subar), Italy (United Artists), Japan (United Artists), Mexico (Ed. Musical Latino Americana), Netherlands (United Artists), South Africa (United Artists), Spain (Hispanovox), Sweden (United Artists), Switzerland (United Artists).
 United Music Publ'rs Ltd., 1 Montague St., Russell Square, London WC1B 5BS. Tel: (01) 636-5171. Cable: MUSIKNOTEN. Dirs.: Julia Avaly, E.A. Roseman. (Also see United 2)
Int'l firms represented: Amphion (France), Bornemann (France), Chant du Monde (France), Choudens (France), Combre (France), Costallat (France), A. Cranz (Belgium, Germany), Durand (France), EFM (France), Ekan-Yogel (USA), Enoch—orchestral catalog (France), Hamelle (France), Henn (Switzerland), Heugel (France), J. Jobert (France), Alphonse Leduc (France), H. Lemoine (France), L'oiseau-Lyre (France), Rideau-Rouge (France), Transatlantiques (France), Union Musical Española (Spain).

Int'l rep.: France (Transatlantiques), Scandinavia (Wilhelm Hansen), USA (Theodore Presser).
 United 2 Music Ltd., 1 Montague St., Russell Square, London WC1B 5BS. Tel: (01) 636-5171. Cable: MUSIKNOTEN. (Also see United Music).
 Unit Prods Ltd., see Kassner.
 Universal Songs Ltd., 5 Dorlcote Rd., London SW18. Tel: (01) 870-1683. Mng. Dir.: Pierre Tubbs; Prof. Mgr.: Gabi Prewi.
 University of Wales Press, 6 Gwyneth St., Cathays, Cardiff CF2 4YD, Wales. Tel: (0222) 31919. Dir.: John Rhys.
 Unwind Publ'g, 73 Newman St., London W1. Tel: (01) 631-3247. Chief Exec.: Harry Barter. (Administered by Margaret Brace).
 Valentine Music Group Ltd., 7 Garrick St., London WC2E 9AR. Tel: (01) 240-1628. Cable: VALGROUP. Mng. Dir.: John Nice; Gen. Mgr.: Pat Seward; Promo. Mgr.: Martin Grinham; Prof. Mgr.: Alan Buck.
Int'l firms represented: BBP, Bear Claw, Buchhorn, CME, Chesdel, Jerry Chesnut, Chesnut House, Chicago Times, Cordova, Daval, Derry, DeWhit, Donna Lee, Doormouse, Evaluator, Geronomo, Halfnote, Honeysuckle, House of Bryant, House of Longhorn, Imagination, Jimmy's Music, Laura-bob, Little David, Maripoh, Meredith, Mother Martha, Ojo, PBR, Paskey, Peglars, Pergee, Rahman, Red Dwarf, Royal Hill, St. Francis, Shifty/Fel-far, Sicum, Silverhill, Soft, Stallings, Ten-Hi, Valgroup, Valswift, Veight, War Drum, Woodmont (all USA), BJC, CanCon, Maxess (all Canada).
Int'l rep.: Argentina (Valgroup), Australia (Valentine), Belgium (Hans Kusters), Brazil (Valgroup), Canada (Valgroup), France (Valentine), Germany (Valentine), Greece (Valentine), Hong Kong (Valentine), Ireland (Valentine), Italy (Valentine), Japan (Valgroup), Mexico (Valgroup), Netherlands (Valentine), Scandinavia (Air), Singapore (Valentine), South Africa (Valentine), Spain (Valentine), Switzerland (Valentine), USA (Valgroup).
 Vanessa Music & Recs., 86 St. Bernard's Rd., East Ham, London E6 1PE. Tel: (01) 472-9682. Mng. Dir.: Don Todd; Gen. Mgr.: Helen Keen.
Int'l firm represented: Evelyn (USA).
Int'l rep.: USA (Evelyn).
 Verge Music, see Asterisk.
 Vicious Music, see RMO.
 Vicki Music Ltd., see Carlin.
 Video Recs. Ltd., 189 London Rd., North End, Portsmouth, Hants. PO2 9AE. Tel: (0705) 812449. Mng. Dir.: Jason Anthony. (Affiliated with Warner Bros.)
Int'l rep.: France (Intersong).
 Village Thing Music Ltd., see Saydisc.
 Virgin Music (Publish'rs) Ltd. (PRS), 95-99 Ladbroke Grove, London W11. Tel: (01) 229-1282. Telex: 8954617. Mng. Dir.: Richard Griffiths; Gen. Mgr.: Brian Dunham.
Int'l firms represented: Oveo, James Osterberg, Skyhill/Tarka, Ubu, Don Williams (all USA).
Int'l rep.: Argentina (Melograf), Australia (April), Austria (April), Belgium (April), Brazil (Mundo), Canada (April), Central America (Mundo), Colombia (CBS), France (Clouseau), Germany (April), Iceland (April), Italy (Franton), Japan (Victor), Mexico (Mundo), Netherlands (April), New Zealand (RITC), Scandinavia (April), South Africa (Warner Bros.), Spain (April), Switzerland (April), USA (Chappell), Venezuela (CBS Colombia).
 Voyage Songs Ltd., 264 Lavender Hill, Battersea, London SW11. Tel: (01) 223-6543. Mng. Dir.: Reg McLean.
 Wail Music, No. 1 The Elms, Vine Rd., Barnes, London SW13. Tel: (01) 878-



**ENGINEERS & CONSULTANTS
TO THE RECORD INDUSTRY**

**THE QUALITY SERVICE
COMPANY**

**For the best in Machines, Advice,
and Service.**

LENED AUTOMATIC PRESSES
Agents and Spares Stockists

AUDIOMATRIX A-V PLAYING UNITS
ELECTRO SOUND DUPLICATORS
and Musitech's own range of equipment for almost every process including the new Matrix Plating Equipment and all accessories.

HIGH QUALITY PLATING SERVICE
Quality is the keynote of our Matrix Processing Division.

CONSULTANCY
Expert advice on every aspect of Manufacturing and Management

DESIGN
Machinery, Layouts and Systems.

INSTALLATIONS
From a single machine or extension to complete factories.

TELEPHONE:
ROY MATTHEWS on High Wycombe (0494) 37526

OR WRITE:
MUSITECH LIMITED
11-13 Temple End,
High Wycombe, Bucks. HP13 5DM
England

VISITORS WELCOME

4229. Contact. Carolyn Smyth.
Brent Walker Music Ltd., see Margaret Brace.
Walnut Music & Mgmt., 89 Victoria Mansions, S. Lambeth Rd., London SW8.
Tel: (01) 735-4596. Mng. Dir.: Eamonn Sherbock; Gen. Mgr.: Philippa J. Brown.
F. & R. Walsh Ltd., see Margaret Brace.
Warland Music Ltd., see Carlin.
Warlock Music Ltd., see Island.
Warner Bros. Music Ltd., 17 Berners St., London W1P 3DD. Tel: (01) 637-3771. Cable: WANGLOSAX. Telex: 25522. Mng. Dir.: Robert Dickins; Gen. Mgr.: Peter Reichardt.
Home office: USA.
Int'l firms represented: Broken Arrow, Broken Bird, Bug, C'Est, Chic, Co-tillon, Crazy Crow, Double Exposure, Earmark, Evansongs Somerset, Feckless/ Jump Tunes, Fifth Star, Fourth Floor, Fry King, Giving Room, Grossos, Gold Hill, Guerilla, Ice Age, Ice Nin', Justincase, Luckyu, Joni Mitchell, Modern Love, Naked Snake, Normal, Painless, Pink Flower/ Fleedleedle, Quackenbush, Raydiola, Boz Scaggs, Silver Fiddle, Siqoumb, Superhype, Tessa, Van Halen, WB, Wow & Flutter (all USA).
Int'l reprs.: Australia (Warner Bros.), Brazil (Warner Bros.), France (PECF), Germany (Warner Bros.), Hong Kong (EMI), Italy (Warner Bros.), Japan (Nichion), Netherlands (Warner Bros.), South Africa (WEA), Spain (Hispavox), Sweden (Warner Bros.), USA (Warner Bros.).
Watanabe Europe, 18 Charing Cross Rd., Suite 29/31, London WC2H 0HR. Tel: (01) 240-1185. Telex: 8812808. Gen. Mgr.: Kaz Utsunomiya.
Home office: Japan.
Waterfront Publ'g, 157 Notley Rd., Brantree, Essex. Tel: (0376) 22219.
Partners: Richie Bull, Dave Hatfield.
Watermelon Songs, see Margaret Brace.
Watteau Music, 5 Dak House, 13 Parson St., London NW4. Tel: (01) 203-1750. Telex: 22164. Mng. Dir.: David Loader; Prof. Mgr.: Richard Bishop.
Int'l firms represented: Aberland (USA), Acys (USA).
Wayne Music, see Stage Coach.
Jeff Wayne Music Ltd., Oliver House, 8/9 Ivor P., London NW1. Tel: (01) 402-9244. Telex: 261234. Mng. Dir.: Jeff Wayne.
H & B Webman & Co. Ltd., 6 Raymond Bldgs., Grays Inn, London WC1R 5BZ. Tel: (01) 242-8404. Telex: 21143. Mng. Dir.: Hal Webman; Dir.: Sec'y: M. Alexander.
Int'l branch: USA
Int'l firms represented: BL&H, Beaver, Beechmont, Carlyle, Emperor, Maple Leaf, Margarita, Montauk, Music Creators, Myriad, Pinebrook, Princess, Rex, We Three.
Josef Weinberger Ltd. (PRS), 10/16 Rathbone St., London W1P 2BJ. Tel: (01) 580-2827. Cable: OPERETTA. Dir.: Richard M. Toeman; Promo Mgr.: George Baker.
Bruce Welch Music Ltd. (PRS), 64 Stirling Court, Marshall St., London W1. Tel: (01) 434-1839. Telex: 25247 Atin. Neun. Chm.: Bruce Welch; Int'l Mgr.: Sara Toniola.
Int'l reprs.: Australia (Essex), France (Intersong), Germany (Rudolf Slezak), Netherlands (Nada), Scandinavia (Swed-ni), South Africa (Warner Bros.).
Wellington Music, Waterloo House, 155 Upper St., London N1. Tel: (01) 354-2724. Mng. Dir.: John Cooper.
Wessex Music Ltd., see Margaret Brace.
Westminster Music Ltd., Essex House, 19/20 Poland St., London W1V 3DD. Tel: (01) 734-8121. Cable: SEXMUS. Telex: 22701. Mng. Dir.: David Platz.
Int'l reprs.: Australasia, France, Germany, Italy, Netherlands, Spain (all Essex); Japan (TRO Essex), USA (TRO).
Westwood Music (PRS, MCPS), Montgomery, Powys SY15 6LU, Wales. Tel: (068681) 427. Dir.: Gordon R. Davies.
Wey Valley Music Ltd. (MCPS), PO Box 22, Woking, Surrey GU22 7QU. Tel: (04862) 20277. Chief Exec.: Steve Smith.
White Elephant Music, see Asterisk.
Frank White Music, see Steel City.
Whitrose Music Ltd. (PRS), 86 Turnham Green Terr., London W4. Tel: (01) 994 4895. Dir.: Norton York.
Widowmaker Music Ltd., see Carlin.
Widwood Music Ltd., see Leeds.
Sue Wilkinson Music Ltd. (MCPS, PRS), 11A Radnor Pl., London W2. Tel: (01) 723-3860. Mng. Dir.: Sue Wilkinson; Gen. Mgr.: Mrs. E. Wilkinson.
Williamson Music Ltd., see Chappell.
Will Need Music, 13 Bank Square, Wilmslow, Cheshire SK9 1AN. Tel: (0625) 527844. Cable: IMDISC. Telex: 635091. Mng. Dir.: Irving Wilson; Gen. Mgr.: Lesley Thompson; Prof. Mgr.: Fiona Sutcliffe.
Int'l firms represented: Bagatelle (France), Iniermusic (Switzerland).
Int'l reprs.: USA (01)
Willow Music, 15 Burwood Ave., Eastcote, Pinner, Middx. Tel: (01) 866-4865. Mng. Dir.: Gordon Gray.
Willow Tree Music Ltd., see Heaman.
Wilson Eds., 13 Bank Square, Wilmslow, Cheshire SK9 1AN. Tel: (0625) 527844. Cable: IMDISC. Telex: 635091. Mng. Dir.: Irving Wilson; Gen. Mgr.: Lesley Thompson; Prof. Mgr.: Fiona Sutcliffe.
Int'l firms represented: Archambault (Canada), Argyle (USA), Beethoven (USA), Frost (Norway), Polish Authors Agency (Poland), Spina (USA).
Int'l reprs.: Sweden (Dictum), USA (01).
Graham Wood Music, 6a Foulden Rd., Stoke New ngrton, London N16. Tel: (01) 249-7501. Mng. Dir. & Gen. Mgr.: Graham Wood.
Int'l reprs.: Worldwide (Paul Rodriguez).
Word Music (UK) (MCPS, PRS), Park Ln., Hemel Hempstead, Herts. HP2 4TD. Tel: (0442) 50132. Mng. Dir.: William T. Hamilton.
Home office: USA.
Int'l firms represented: Birdwing, Canaanland, Candle, Norman J. Clayton, Crouch, Dayspring, First Monday, His Eye, Journey, Latter Rain, Lexicon, Libus, Luminar, Promiseland, Rodeheaver, Sacred Songs, Sparrow, Ward (all USA).
Int'l reprs.: Benelus (Universal Songs), Germany (Hansler), Scandinavia (Prim), South Africa (Grace, WEA).
World Music Workshop Ltd. (PRS), 33 Newman St., London W1P 3PA. Tel: (01) 637-5753. Dirs.: Peter G. Stemming, Roy Morris, Gen. Mgr.: Cathi Gibson.
Int'l reprs.: Worldwide (Chappell).
Xanadu Musik, 79 Fitzneal St., East Acton, London W12. Tel: (01) 743-3402. Mng. Dir.: Paul Gadd; Gen. Mgr.: Jeff Lynne.
Y-Not Music (PRS), see Riva.
Yobongs Ltd., Rise Hatch, Sandy Ln., Tealby, Lincs. Tel: (01) 981-4825. Mng. Dir.: C. Withers Green. (Affiliated with Street Tunes)
Yorkie Ed., 31 Thornhill Square, London N1 1BQ. Tel: (01) 607-0849. Owner: Rodney Slatford.
Int'l reprs.: Austria, Germany, Netherlands, Scandinavia, Switzerland (all Bote & Bock); USA (Galaxy).
Young Blood Music Ltd., 138 New Bond St., London W1Y 9FB. Tel: (01) 493-9681. Cable: YUNGBLOOD. Telex: 268048. Mng. Dir.: Gerry Black.
Your Music Ltd., 39 Leyton Rd., Harpenden, Herts. Tel: (05827) 5098. Mng.

Dir.: David Blaylock; Gen. Mgr.: John Beecher.
Yukon Music Ltd., see Kassner.
Zan Music, see Carlin.
Zela Music Co. (MCPS), Walker Hall, Ampton Rd., Edgbaston, Birmingham B15 2JJ. Tel: (021) 455-0645. Dir.: William Johnny Haynes; Gen. Mgr.: A.J. Haynes.
Zero Publ'g, 36 Pemberton Rd., Telford, Salop TF5 0BL. Tel: (0952) 3490. Chief Exec.: Phil Summers.
Zomba Music Publ's Ltd. (PRS), Zomba House, 165-167 Willesden High Rd., London NW10 2SG. Tel: (01) 451-3044. Telex: 919884. Dirs.: Clive Calder, Ralph Simon; Gen. Mgr.: Jan Garner; Prof. Mgr.: Steven Howard.
Int'l firms represented: Can't Stop (USA), Matragun (USA), Musicpiece (South Africa), Scorpio (France), Zomba (Switzerland, USA).
Int'l reprs.: Australia (Warner Bros.), Austria (Roba), Belgium (Hans Kusters), Canada (Morning), France (Intersong), Germany (Roba), Italy (RCA), Japan (Pacific), Netherlands (Nada), New Zealand (Warner Bros.), South Africa (Musicpiece), Spain (RCA), Switzerland (Roba), USA (Zomba).
Zoo Music, see Warner Bros.
Zum Music, 45 Shandwick Pl., Edinburgh, Scotland. Tel: (031) 229-3533. Mng. Dir.: Bruce R. Findlay.
Zum Publ'g, see Martin-Coultter.

• sheet music distributor / publisher

Music Sales Ltd., 78 Newman St., London W1P 3LA. Tel: (01) 636-9033. Telex: 21892. Mng. Dir.: Robert Wise; Gen. Mgr.: Frank Johnson.

• services

ASSOCIATIONS & PROFESSIONAL ORGANIZATIONS
A P R S (Association of Professional Rec'g Studios Ltd.), 23 Chestnut Ave., Chorleywood, Herts. WD3 4HA. Tel: (09237) 72907. Sec'y: Edward L. Masek.

Amusement Trade Ass'n (ATA), see British Amusement Catering Trades.
Arts Council of Great Britain, 105 Piccadilly, London W1V 0AU. Tel: (01) 629-9495.
Associated Trade Publ'ns Ltd., 259 Grays Inn Rd., London WC1. Tel: (01) 837-3311.

Association of British Orchestras, Francis House, Francis St., London SW1P 1DE. Tel: (01) 606-1507. Sec'y: John May.
Association of Cinematograph Television & Allied Technicians (ACTT), 2 Soho Square, London N1.

Association of Exhibition Organisers, 17 Castle St., High Wycombe, Bucks. HP13 6RU. Tel: (0494) 30430. Dir.: G.A.M. Ritson.
Association of Independent Radio Contractors Ltd., 8 Great James St., London WC1N 3DA. Tel: (01) 405 5036. Telex: 24543. Dir.: B. Coppen-Gardner; Mktg. Exec.: R. Tillett.

Association of Music Inds., 62 Park View, Hatch End, Pinner, Middx. HA5 4LN. Tel: (01) 428-4700.
Association of Sound & Communications Eng's. Ltd., 47 Windsor Rd., Slough, Berks. SL1 2EE. Tel: (0753) 39455. Chief Exec. & Sec'y: Douglas W. Joyce.

B I R S, see British Institute of Rec'd Sound.
B P I, see British Phonographic Ind.
British Academy of Songwriters, Composers & Authors (incorporating Songwriters' Guild of Great Britain), 148 Charing Cross Rd., London WC2H 0LB. Tel: (01) 240-2823. Cable: SINGBRIT. Pres.: David Heneker; Gen. Sec'y: Marilyn Worley.

British Artists' Equity Ass'n, 8 Harley St., London W1N 2AB. Tel: (01) 637-9311. 636 6367.
British Amusement Catering Trades Ass'n, 122 Clapham Common, North Side, London SW4 9SP. Tel: (01) 228-4107. (incorporating Amusement Caterers Ass'n, Amusement Trades Ass'n, Phonograph Operators Ass'n, & Ass'n of Prize Bingo Operators)

British Audio Promos. Ltd., 414A Edgware Rd., London W2 1ED. Tel: (01) 402-9145.
British Copyright Council, 29/33 Berners St., London W1P 4AA. Tel: (01) 580 5544.
British Country Music Ass'n, PO Box 2, Newton Abbot, Devon. Chm.: Jim Marshall; Vice Chm.: Mike Storey; Sec'y: Eddy Edwards.

British Federation of Music Festivals, 106 Gloucester Pl., London W1M 3DB. Tel: (01) 935-6371.
British Institute of Rec'd Sound (BIRS), 29 Exhibition Rd., London SW7. Tel: (01) 589-6603. Dir.: Dr. A. King.

British Music Information Centre, 10 Stratford Pl. London W1N 9AE. Tel: (01) 499-8567. Librarian: Roger W. Wright.
British Phonographic Ind. Ltd. (BPI), Roxburgh House, 273 Regent St., London W1. Tel: (01) 629-8642. Dir.: Gen. John Deacon.

British Radio & Electronic Equip. Mrs. Ass'n (BREMA), Twentieth Century House, 31 Soho Square, London W1V 5DG. Tel: (01) 734-7471. Telex: 27869. Dir.: O.P. Suttton; Sec'y: R.B.S. Purdy.
British Tape Ind. Ass'n, see European Tape Ind. Ass'n.

British Videogram Ass'n Ltd., Thorpe House, London WC2H 9ED. Tel: (01) 240-1474. Telex: 263201. Chm.: Donald MacLean; Gen. Mgr.: Norman Abbott.
Campaign for Independent Broadcasting, 13 Ashwood House, London NW4. Tel: (01) 203-0861. Gen. Sec'y: J.W. Wyndham-Kaye; Hon. Press & PR: Martin Rosen.

Composers' Guild of Great Britain, 10 Stratford Pl., London W1N 9AE. Tel: (01) 499-8567. Gen. Sec'y: E. Yeoman.
Copyright Receipt Office of the British Library, British Library, 2 Sheraton St., London W1V 4BH. Tel: (01) 636-1544 x 339.

Country Music Ass'n (Great Britain), PO Box 2LG, London W1M 1AS. Tel: (01) 935-0413. Chm.: Tony Byworth; Vice-Chm.: David Sandison; Pres.: Mervyn Conn; Treas.: Jeff Forrest; Sec'y: Mike Hutson.
The Disc Jockey Federation of Great Britain, 1 Low Farm Cottage, Drayton, Northw NRB 8RR. Tel: (0603) 860-241. Chm.: Theo Loyla.

Distributive Ind. Training Board (DITB), MacLaren House, Talbot Rd., Stretford, Manchester M32 0FP. Tel: (061) 872-2494. Information Dir.: Harold Webb.
E M C (European Music Consultants), High St., Hatfield Broad Oak, Essex. CM17 0HZ. Tel: (0279-70) 671. Telex: 817606. Dir.: Don Morris.

The English Folk Dance & Song Society, Cecil Sharp House, 2 Regents Park Rd., London NW1 7AY. Tel: (01) 485-2206.
Entertainment Agents' Ass'n, 18 Charing Cross Rd., London WC2H 0HR. Tel: (01) 240-1724.

European Tape Ind. Ass'n, 8 St. Bride St., London EC4A 4DA. Tel: (01) 353-3020. Telex: 24276.
Federation of British Artists, 17 Carlton House Terr., London SW1. Tel: (01) 935-9791.

Federation of British Audio, Federation Offices, Twentieth Century House, 31 Soho Square, London W1V 5DG. Tel: (01) 734-7471. Telex: 27869.

Chm.: T.K. Monks.
Federation of Music Industry Orgs., 98 Greenfield Ave., Carpenders Park, Watford, Herts. Tel: (01) 428-1590. Chm.: P. Howgill; Sec'y: R. Ivey.
I F P I (International Federation of Producers of Phonograms & Videograms), IFPI Secretariat, 123 Pall Mall, London SW1Y 5EA. Tel: (01) 930-1752. Cable: INTERFONIC. Telex: 919044. Dir. Gen.: John Hall QC.
Incorporated Society of Musicians, 10 Stratford Pl., London W1N 9AE. Tel: (01) 629-4413. Gen. Sec'y: Susan M. Aicock.
International Ass'n of Music Libraries, UK Branch, Birmingham School of Music, Library, Paradise Circus, Birmingham B3 3HG. Tel: (021) 359-6851 x 204. Gen. Sec'y: Miss S. M. Clegg.
International Federation of Popular Music Publ'rs., c/o MPA Ltd., 73-75 Mortimer St., London W1. Tel: (01) 580-3399. Acting Sec'y: Gen.: L.P. Smits.
International Federation of Producers of Phonograms & Videograms, see IFPI.

Interpar (International Performing Artists' Rec'gs Ltd.), BCM-Interpar, London WC1V 6XX. Dirs.: C.S. & J.A.L. Sterling.
Jazz Centre Society Ltd., 35 Great Russell St., London WC1. Tel: (01) 580-8532. Dir.: Charles Alexander.

London Orchestral Ass'n, 13/14 Archer St., Great Windmill St., London W1V 7HG. Tel: (01) 437-1588.
M P A (Music Publ'rs' Ass'n) Ltd., Kingsway House, 7th fl., 103 Kingsway, London WC2B 6DQ. Tel: (01) 831-7591. Pres.: R. N. White; VP: Tony Poo; Sec'y: Peter Dawsell; Ass't Sec'y: Janice Cable.

Master Music Printers & Engravers Ass'n, Plantation Rd., Amersham, Bucks. HP5 6HJ. Tel: (02403) 5525. Sec'y: Rodney E. Smith.
Music Copyright Serv. Bureau, 35 Reddings, Weylyn Garden City, Herts. AL8 7LA. Tel: (07073) 24359. Dir.: Dennis Berry.

Musicians' Union, 60-62 Clapham Rd., London SW9 0JJ. Tel: (01) 582-5566. Sec'y: John Morton.
Music Trades Ass'n, PO Box 249, London W4 5EX. Tel: (01) 994-7592. Sec'y: Gen.: Arthur F. Spencer-Bolland.

Music Trades Benevolent Society, c/o Ramsdens, 22 Beach Rd., Lowestoft, Suffolk NR 3 1EA. Tel: (0502) 62819.
Music Trades Training Centre Ltd., see Music Trades Ass'n.

National Federation of Music Societies, Francis House, Francis St., London SW1P 1DE. Tel: (01) 828-7320. Gen. Sec'y: John Crisp.
National Music Council of Great Britain, c/o British Music Information Centre, 10 Stratford Pl., London W1N 9AE. Tel: (01) 499-8567. Chm.: John Morton; Deputy Chm.: Robert Montgomery; Admin'r: Elizabeth Yeoman.

Personal Managers Ass'n Ltd., 91 Regent St., 4th fl., London W1R 8RU. Tel: (01) 734-7311.
Phonographic Performance Ltd., Ganton House, 14/22 Ganton St., London W1. Tel: (01) 437-0311. Gen. Mgr.: H.G.S. Gilbert; Sec'y: J.B. Love.

Piano Mfrs' Ass'n, 22 Beach Rd., Lowestoft, Suffolk. Sec'y: Gerald Brasted.
Radio, Electrical & Television Retailers Ass'n Ltd. (RETRA), RETRA House, 57-61 Newington Causeway, London SE1 6BE. Tel: (01) 403-1463. Dir.: R.T. Edom; Information Officer: C.M. Ward.

Radio Whisirs Federation, Broadway House, The Broadway, London SW19 1RL. Tel: (01) 540-9756. Sec'y: Mervyn Thomas.
Record & Video Retailers Ass'n, PO Box 249, London W4 5EX. Tel: (01) 994-7592.

Royal Musical Ass'n (Music Library), Great Russell St., London WC1B 3DG. Tel: (01) 636-1544. Pres.: A. Hyatt King; Sec'y: Malcolm Turner.
Royallycheck, 13 Clifton Way, Hutton Brentwood. Tel: (0277) 214-776. Dir.: Ron Rice.

Scottish Arts Council, 19 Charlotte Square, Edinburgh, Scotland ED2 4MF. Tel: (031) 226-6051.
Sing For Pleasure, 26 Bedford Square, London WC1B 3HU. Tel: (01) 636-4066.

Songwriters' Guild of Great Britain, see British Academy of Songwriters, Composers & Authors.
Standing Conference For Amateur Music, 26 Bedford Square, London WC1B 3HU. Tel: (01) 636-4066.

Tours Unlimited, 11 Marshallsea Rd., London SE1. Tel: (01) 407-6781.
Variety Club of Great Britain, Avon House, 3rd fl. E., 360 Oxford St., London W1N 0DY. Tel: (01) 491-4521. Promoter: Ron Cribben.

Video Copyright Protection Society Ltd., Visnews House, Cumberland Ave., London NW10 7EH. Tel: (01) 961-0764. Telex: 22678.
Welsh Arts Council, Hoist House, 9 Museum Pl., Cardiff, Wales CF1 3NX. Tel: (0222) 394-711.

CATALOG SERVICES

Francis Antony Ltd., Trenance Mill, Blowinghouse Hill, St. Austell, Cornwall PL25 5AH. Tel: (0726) 3476, 61264.
Bradleys Tapemaster Tape Directory, Kempsey, Worcs. WR5 3PN. Tel: (0905) 820-137, 352-131. Editor & Compiler: James Bradley; Research: Kathleen Bradley. (Tape only)

Format (Sussex) Ltd., Jubilee Rd., Burgess Hill, Sussex. Tel: (04446) 45245.
Tel: 87322. Mng. Dir.: Ted Light.
Lightning Recs. Ltd., 841 Harrow Rd., Harlesden, London NW10 5NH. Tel: (01) 969-7155/5255. Mng. Dir.: Raymond Laren; A&R & Mktg. Dir.: Keith Yershon; Dist'n & Jukebox Dir.: David Powell; Commercial Mgr.: Siad Reza. (Rec. only)

Musac (Scotland) Ltd., Baltic Chambers, 50 Wellington St., Glasgow, Scotland G2 6HJ. Tel: (041) 221-1948. Mng. Dir.: Angus McDonald; Sales Mgr.: Douglas MacLeod. (Rec. & tape)

Music Master, Music House, 1 de Cham Ave., Hastings, Sussex. Tel: (0424) 440104. Mng. Dir.: John Humphries; Gen. Mgr.: Eleri Hayes; Sales Mgr.: Lee Breaker; Subscriptions: Ann Spink.
James Upton Ltd. (div. of Tinsley-Rob Group), 98-138 Barford St., Birmingham B5 6AP. Tel: (021) 692-1171.

Wynd-Up Recs. Ltd., Greengate Ln., Prestwich, Manchester M25 7HW. Tel: (061) 798-0533/9252. Mng. Dir.: Colin Reilly; Gen. Mgr. & Dist'n Dir.: B. Patchett; Sales Dir.: L.J. O'Meara. Local branch: Accessories Div., 14 Birch Ln., Longlight, Manchester. Tel: (061) 224-2823.
Branch: Glasgow, Scotland, Tradeston Ind'l Estate, 7 Kilmirne Pl. Tel: (041) 429-5155.

DESIGN & ARTWORK

A M C (Associated Mktg. Co.), The High St., Hatfield Broad Oak, Essex. Tel: (0279-70) 671. Telex: 817606. Contacts: Don Morris, Janet Verdon.
A P Creative Servs. Ltd., 26/28 Brewer St., London W1R 3FW. Tel: (01) 734-9823. Mng. Dir.: Anthony Palk; Gen. Mgr.: Steve Walker; Sales Exec.: Gillian Bowman.

Album Graphics (UK) Ltd., 2 Goodwin's Court, 55 St. Martin's Ln., London WC2. Tel: (01) 240-1319. Telex: 21879, 25247. UK Rep.: Linda Halpin. (Record only)
Home office: USA, Chicago Ill.

Alfa Display & Design, 28 Beechwood, Fordingbridge, Hants. Tel: (0425) 53943. Chief Exec.: Colin Knappan.
Amazing Exhibitionists Ltd., 52/56 Church Path, London W4 5BN. Tel: (01) 995-3555. Telex: 21792. Ref. 3595. Dirs. Janet Lampert, Lawrence Miller, Alex Forbes (SEE ADVERTISEMENT)

- Amberlee Recs. Ltd., 387 Harrow Rd., London W9. Tel: (01) 866-7748. Mgr. Dr. John Peters; Sales Mgr.: Dorian Lamas.
- Anemone Sound Facilities Ltd., 10A Poford St., London W1. Tel: (01) 439-9611. Tel: 8812286. Mng. Dir.: Aaron Gersfield, Gen. Mgr. Derek Hanlon; Sales Mgr.: Simon Patrick. (Tape only)
- Arlingheight Ltd., see Target.
- Arrowtats Ltd., Humber Rd., London NW2 6EP. Tel: (01) 450-2411. Telex 923034. Mng. Dir.: Maurice Mindel, Sales Mgr. Alex Murray, Prod. Mgr.: Paul Rinne.
- Artsleaves, 17 Sussex Square, Flat 1, Brighton, Sussex BN2 5AA. Designer Nigel Goodall.
- Audioemic Ltd., 34-36 Crown St., Reading, Berks. RG1 2SN. Tel: (0734) 595647. Dir. Martin Maynard; Gen. Mgr. Mary Thomas; Sales Mgr.: Henry Smithson.
- B B B (Be-Bop Badges), 3 Monister Rd., Burnley, Lancs BB10 2PX. Tel: (0282) 53046. Contact Mike Leonard.
- B G S Prod'n's Ltd., Kirkland Park Studios, Lelham Rd., Strathaven, Scotland ML10 6EE. Tel: (0357) 21130. Dir. W.B. Garden; Sales Mgr. Dougie Stevenson; Maintenance Eng. Stuart Currie.
- Badge Sales, 48 Carnaby St., London W1 1PF. Tel: (01) 437-5121. Mng. Dir.: William Smith; Gen. Mgr.: Oscar Zanello; Sales Mgr.: David Kerry Ivan Berg Assoc. (Audio Publ'g) Ltd., 35A Broadhurst Gardens, London NW6 3QT. Tel: (01) 624-7785. Mng. Dir.: Ivan Berg.
- Bird Sound Studios, 4 Welton Rd., Wednock Estate, Warwick CV34 5YA. Tel: (0926) 45124. Owner: Sheila L. Bird; Gen. Mgr.: David Rawlings, Sales Mgr.: Dave Sheriff, Promo.: Dave Long.
- Blueput Music, 81 Osborne Rd., Jesmond, Newcastle-upon-Tyne NE2 2AN. Tel: (0632) 816-855. Chief Exec.: Maurice Rosoff; Gen. Mgr.: Ian Gurney, Sales Mgr.: Nigel Harrison; Promo. Mgr.: Antoine Legris.
- Camron Design Ltd., 32 Pancras Rd., London NW1 2QP. Tel: (01) 837-8328. Dir.: Malcolm Macdonald, Lynda Watkins, John Cameron.
- Cassette Developments (Audiosonic Ltd.), Micra House, 138 Lower Mortlake Rd., Richmond, Surrey TW9 2JZ. Tel: (01) 940-8186. Cable: MICRONETICS. Telex: 8813481. Gen. Mgr.: D. Dixon. (Tape only)
- Castle Studio, 93 Castle Hill Rd., Hindley, Wigan, Lancs. WN2 4BH. Tel: (0942) 58777. Chief Exec.: Simon Paul Millard.
- Chess Creative Servs. Ltd., 14A Shouldham St., London W1. Tel: (01) 723-8233. Partners: A. Smith, P.J. Lacy.
- Coach House Studio Div./Ice Recs. Ltd., 81-A Dsbaldeston Rd., Stamford Hill, London N16. Tel: (01) 806-3252. Mng. Dir.: Eddy Grant; Gen. Mgr.: Alpine Grant; Sales Mgr.: Rudolph Grant; Financial Controller: Stan Blackburn.
- Brian Cooke Photography, 19 Shorts Gardens, London WC2H 9AT. Tel: (01) 836-3004. Chief Exec.: Brian Cooke. (Photography)
- Cooke Key Assocs. (Mktg) Ltd., 19 Shorts Gardens, London WC2H 9AT. Tel: (01) 240-1846/1926. Mng. Dir.: Tony Hutchinson; Gen. Mgr.: Marcus Anley. (Rec. only)
- Coombe Music Ltd., Hurston House, Stoke Rd., Kingston-upon-Thames, Surrey. Tel: (01) 942-6240. Telex: 22914.
- Glen Coombes Design Studios, 25 Macklin St., London WC2B 5NH. Tel: (01) 242-1993.
- Cream Creative Mktg. Ltd., The Cloisters, 11 Salem Rd., London W2. Tel: (01) 221-5155.
- Crommum Recs., 15 Trafalgar Dr., Walton-on-Thames, Surrey KT12 1MY. Tel: (073-784) 3932. (09322) 42160. Chm.: Jim Grahame; Gen. & Sales Mgr.: Raphael Wise. (Recs. only)
- Crommum's, 51 Court Lodge Rd., Horley, Surrey. Tel: (073) 784-3932. (01) 588-8846. Chief Exec.: Jim Grahame; Sales Mgr.: Pete Kunzler; Chief Eng.: Tim Woods.
- D T P Inc., 3 Alfred St., Weston-Super-Mare, Avon BS23 1PZ. Tel: (0934) 21932. Mng. Dir. Don Todd.
- Beryl Davis Assocs., 24 Beresford Rd., Wallasey, Merseyside L45 0J. Tel: (051) 639-2265/3559. Chief Exec.: Beryl Davis; Sales Mgr.: Eunice Williamson.
- Delga Press Ltd., Dingwall House, 8 Marlborough Rd., Bromley, Kent. BR2 9NH. Tel: (01) 460-0112. Tel: 8951346. Mng. Dir. R.E. Edwards; Gen. Dir.: R.N. Roadnight; Dir.: R.G. Fromard; Sales Dir.: P.H. Grey.
- Duplitate, 1/7 Harewood Ave., London NW11 6LE. Tel: (01) 724-2497. Chief Exec. & Gen. Mgr.: B. Lambden, Sales Mgr.: R. Jackson-Moore. (Tape only)
- Edrad Creative Services, Radio House, Old Mill Rd., Kings Langley, Herts. Tel: (09277) 67479.
- Electronic Mfg. (Sales) Ltd., Devonshire House, High St., Birmingham B12 0LP. Tel: (021) 772-7145. Cable FIESTA. Telex: 336409. Dir.: R.W. Thomas, L.J. Laney.
- Elle Jay (Prod'n) Ltd., 97 Judd St., London WC1. Tel: (01) 388-5771. Mng. Dir.: Jack Applebaum; Prod'n Mgr. Andrew Sopot. Prod'n Co-Ord. Paul Heeren.
- Falcon Pub., 169A High St., Beckenham, Kent. Sales Mgr. G. Ford.
- Golden Era Recs Ltd., 1099-A Finchley Rd., London NW11. Tel: (01) 455-6620. Dir.: Bert Wilcox.
- Grampan Recs. Ltd., Airport Ind'l Estate, Wick, Caithness, Scotland. Tel: (0955) 2787. Telex: 75107. Dir.: J. Johnston; Mgr.: John Hunter. (Pressing only)
- Halstan & Co. Ltd., Plantation Rd., Amersham, Bucks. HP6 6HJ. Tel: (02403) 5525. Cable: HALSTANSIC. Mng. Dir. R.E. Smith; Sales Mgr.: W. Shrimpton; Ass't Sales Mgr.: L. Thorpe; Sec'y: R. Yerby.
- E. Hannibal & Co. Ltd., Pinfold Rd., Thurston, Leicester. Tel: (0533) 695413. Telex: 34627. Mng. Dir.: Chris Hatherington; Ass't Mng. Dir. Roger Stewart; Music Div. Sales Dir.: Derek Deighton.
- Happy Face Music, The Divi Studio, Post Office Ln., Kempsey, Worce. Tel: (0905) 820659. Cable: SMITHYSOUND. Chief Exec. Muff Martin, Gen. Mgr.: V.B. Murlin.
- Harrison & Sons (London) Ltd., Printing House Ln., Hayes, Middx. UB3 1HQ. Tel: (01) 573-3828. Telex: 23744. Mng. Dir. J.A. Woodcock, Comm'l Dir.: B.I. Hobbitt, Sales Dir.: D.S. Robinson; Prod. Mgr.: M.S. Fitzgerald; John Harwood-Bee Assocs., The Folly, Folly Island, Hertford, Herts. Tel: (0992) 551233. Telex: 817861. Mng. Dir.: John Harwood-Bee.
- Immediate Sound Servs. Ltd., 6 Drisman Rd., London N1 5QJ. Tel: (01) 739-9672. Telex: 914382. Mng. Mgr.: J.W. Hart.
- Independent Rec. Co., 39 Harmer St., Gravesend, Kent. Tel: (0474) 65687. Chief Exec.: J.W. Oram
- Industrial Recs. Ltd., 10 Martello St., London E8. Tel: (01) 254-9178. Mng. Dir.: Peter Christopherson; Gen. Mgr.: Cosy P.Orridge; Sales Mgr.: David Brooks; Gen. Exec.: Joyce Sinclair.
- J S D Group of Cos., 62 Berners St., London W1P 3AG. Tel: (01) 580-4720. Tel: 261298. Mng. Dir.: Joseph R. Stanley; Gen. Mgr.: N.P.J. Murrey.
- Jab Drg. Ltd., 100 Wardour St., London W1. Dir.: John Bright.
- T. Richard Johnson Ltd., MAM House, 24/25 New Bond St., London W1. Tel: (01) 493-7535. Chm.: Terry Johnson; Mng. Dir.: Alan Smith.
- Jubilee Graphics, 101 Wardour St., London W1. Tel: (01) 437-8572.
- Keenap Polythene Supplies Ltd., Coronation Place, Guildhall Ln., Leicester. Tel: (0533) 20084, 537806.
- Kingsley Sound & Vision Ltd., I.M. Studios Div., 120 Kings Rd., Fleet, Hants. Tel: (02514) 20053. Telex: 858893.
- Krystal Promos., 48 Abbeydale Rd. S., Millhouses, Sheffield. Tel: (0742) 365638.
- Steve Lane Musical & Publicity Servs., 12 Slough Ln., Kingsbury, London NW9 8QL. Tel: (01) 205-2587. Owner: Steve Lane; Gen. Mgr.: K.C. Sear.
- Leader Sound Ltd., 209 Rochdale Rd., Greenland, Halifax, West Yorks. HX4 8JE. Tel: (0422) 76161. Mng. Dir.: Bill Leader; Sec'y: Helen Leader; Lindsey's Colour Serv., 88 Teesdale St., London E2. Tel: (01) 729-5462. Mng. Dir.: Ray Mack; Sales Dir.: David Wall.
- London Features Int'l Ltd., Dorset Lodge, 8 Dorset Square, London NW1 6PU. Tel: (01) 723-4204. Cable: LDNPX. Telex: 25884. Mng. Dir.: John M. Halsall. (Photo library & studio facility repro servs.)
- London Rec'g Co., 1099A Finchley Rd., London NW11. Tel: (01) 455-6620. Chief Exec.: Herb Wilcox.
- M H G Cassettes/Warm Recs., Daily Rd., Maybole, Ayrshire, Scotland KA19 7AX. Tel: (0655) 82200. Chm.: Mary Harrison-Goudie. Gen. & Sales Mgr. Rui de Castro.
- M T I (Motivation Techniques Int'l) Ltd., 70/71 New Bond St., London W1Y 9DE. Tel: (01) 493-6757. Telex: 23529. Chief Exec.: Tom Parkinson. Creative Dir.: Jo Mirowski.
- Metropolitan Communications, 8a Frognal Gardens, London NW3 6UX. Tel: (01) 435-8803. Mng. Dir.: Mark R.F. Hanau; Sales Mgr.: R. Hanau; Admin.: A. Lohmeyer.
- Modern Pub., New Hiberna House, Winchester Walk, London SE1. Tel: (01) 403-6332. Chief Exec.: Alan Edwards; Gen. Mgr.: Eugene Manzi.
- Mushroom Studios, 18 W. Mall, Clifton, Bristol BS8 4BG. Tel: (0272) 35994, 35867. Chief Exec.: D. Ackerman; Gen. Mgr.: S.A. Ackerman. (Rec. only)
- Music Radio Promos., PO Box 400, Kings Langley, Herts. Tel: (09277) 64014. Mng. Dir. & Gen. Mgr.: Mike Baron; Sales Mgr.: Peter Duncan; Pub'l'g Dir.: Nik Dakley.
- Nelson Rec'g Studio, Nelson House, 93 Castle Hill Rd., Hindley, Wigan, Lancs. WN2 4BH. Tel: (0942) 58777. Contacts: S.M. Millard, W. Leyland.
- Noted Designs Ltd., Isabel House, Suite 29, 46-47 Victoria Rd., Surbiton, Surrey. Tel: (01) 399-5324. Telex: 896616. Mng. Dir.: Babette Landau, Barry McCloud.
- Dakwood Rec'g Studios, 75 Strode Park Rd., Herne Bay, Kent. Tel: (02273) 4066. Mgr.: Graeme Quntion-Jones.
- P D Graphics Ltd., 14 Forest Rd., Woodford Green, Essex CO4. Tel: (01) 504-1549. Mng. Dir.: Philip Duffy; Gen. Mgr.: John Soper.
- Panda Recs., 2 Catherine St., Seaside, Llanelli, Dyfed, South Wales. Tel: (05542) 58913, 52490. Dir.: Paul Adams; Sales Mgr.: Alan Phillips.
- Pan-Graphics (Edinburgh) Ltd., 21 A Grosvenor St., Edinburgh, Scotland EH12 5ED. Tel: (031) 225-9502. Creative & Art Dir.: Jonathan F. Field.
- Phonogram Ltd., 50 New Bond St., London W1Y 9HA. Tel: (01) 491-4600. Cable: PHDNREC. Telex: 261583. Mng. Dir.: K.N. Malpanth; Mktg. Mgr.: T. Powell; A&R Dir.: B. Shephard.
- Pinnacle Recs., 9 Dean St., London W1V 5RL. Tel: (01) 734-4543. Telex: 896141. Origination. Chm.: Terry Scully; Gen. Mgr.: Tony Berry; Sales Mgr.: George Hollway.
- Pisces Publicity & Design, 4 Did Mill Rd., Hunton Bridge, Herts. Tel: Kings Langley 64049.
- Porter & Pocock Assocs. Ltd., 72 Westfields Ave., London SW13 0AU. Tel: (01) 878-4366/2595. Mng. Dir.: R. Alexander Porter.
- Positive Designs, 17 Station Rd., London SE25 5AH. Tel: (01) 771-5777. Chief Exec.: Steve Hutchings; Gen. Mgr.: Dave Lucy; Sales Mgr.: Nick Miller.
- Real Custom Prod'n's, The Camp, Montgomery, Powys SY15 6LU. Tel: (066881) 427. Chief Exec.: Richard G. Davies; Sales Mgr.: George B. Pryce.
- Realmeath Ltd., 15/23 Porteus Rd., London W2. Tel: (01) 723-8495. Dir.: Bryan Whitman.
- Record Company Servs., 1/3 Sedley Pl., London W1R 1HH. Tel: (01) 409-2336. Telex: 4081735. Dir.: E.J. Foster, A.C. Walling-Darrell.
- Rock Art Studios, 10 Barley Mow Passage, Chiswick, London W4. Tel: (01) 994-6477. Telex: 8811418. Mng. Dir.: Peter Small; Mktg. Mgr.: Mal Burns.
- Rooster Recs., PO Box 148, London W9 1DY. Tel: (01) 286-2993.
- S R T Prod'n's Ltd., 987 High Rd., Finchley, London N12. Tel: (01) 446-3218. Mng. Dir.: George Bellamy; Sales Mgr.: Dave Richardson.
- Sams Recs. Servs. (SRS), 78 Durham Rd., London SW20. Tel: (01) 947-9000. Chief Exec.: Max Wright; Gen. Mgr.: Andy Titcombe; Sales Mgr.: Barry Wright; Office Mgr.: Pat Savage.
- Seabrook/Graves/Aslett Assocs. Ltd., 25 Dover St., London W1. Tel: (01) 492-0451.
- Sea Cruise Prod'n's (UK), 35 Great Russell St., London WC1. Tel: (01) 636-3925. Mng. Dir.: Terry Wagborne. (Record only)
- Home office: USA, Ken Keene Int'l.
- Senol Printing Ltd., 4 Hardwicks Way, London SW8 4AJ. Tel: (01) 874-5775. Mng. Dir.: M.M. Gunn; Dir.: P.J. Smith, J.H. Rolfe.
- Shadow Creative Design, 17 Beaminster House, Dorset Rd., London SW8 1EL. Tel: (01) 582-3510. Chief Exec.: Nigel Harris; Gen. Mgr.: Colin Brown.
- Sound, 1 Ogden'shaw Mews, Maidenhead, Berks. Tel: (0628) 33011. Mng. Dir.: I.S. Webb; Sales Mgr.: M. Lloyd; Adv. Mgr.: C. McVie.
- Sound Connection, 85 Ashley Rd., Montpellier, Bristol 6. Tel: (0272) 554-721. Chief Exec.: Chris David; Gen. Mgr.: Kenny Wheeler. (Rec. only)
- Simon Stable Promos., 46 Westland, Launton, Oxon. Tel: (08692) 2831. Chief Exec.: Simon Stable; Gen. Mgr.: Stephanie De La Bedoyere; Sales Mgr.: Daniel De La Bedoyere; Musical Dir.: Fang Stable.
- Steelguard Security Tape Display Systems, Pembroke Studios, 3A Bensham Ln., West Croydon, Surrey. Tel: (01) 689-1877/7878. Mng. Dir. Paul Holmes; Gen. Mgr.: Phillip Harrison; Sales Mgr.: Brian Forcutt.
- Storm Rec'g Studios, 133 Park Rd., Blackpool, Lancs. FY1 4ET. Tel: (0253) 27357, 23095. Mng. Dir.: Wayne Paul; Gen. Mgr.: Lenny Harris.
- Strathclyde Sound & Video Ltd., PO Box 59, Buchanan St., Glasgow, Scotland G2 1LR. Tel: (041) 221-2222. Telex: 779047.
- Supersat Ltd., 17/18 Great Pulteney St., London W1R 3DG. Tel: (01) 437-4173. Mng. Dir.: D. Reade.
- T R J, see T. Richard Johnson.
- Target Promos., The Studio, 1 Bensham Ln., Croydon, Surrey CR2 2RU. Tel: (01) 689-6618. Chief Exec.: A.T. Gregory, L.J. Adams; Sales Mgr. & Sec'y: Mrs. M. Souter; Export Mgr.: M. Wright.
- Visualeyes Ltd., 19 Shorts Gardens, London W2H 9AT. Tel: (01) 836-3004. Mng. Dir.: Brian Cooke; Gen. Mgr.: Allan Jones. (Photography)
- Waldo's Ent's., 4 Liverpool Rd., St. Albans, Herts. Tel: (0727) 23109. Pres.: Philip Lloyd-Smee; Gen. Mgr.: Nathan Cattle.
- Wardour Motion Picture Co. Ltd., 11 Wardour Mews, London W1. Tel: (01) 439-4313. Dir.: M.J. Sutton; Gen. & Sales Mgr.: Christie Gillingham.
- West Central Printing Co. Ltd., 33/34 Rathbone Pl., London W1P 1AD. Tel: (01) 636-8572. Mng. Dir.: H. Leonard Temple; Gen. Mgr.: Stan Heiser; Print Ed.: John Barry.
- Xanadu Constructional & Mechanical Eng's., 79 Fitzneal St., East Acton, London W12. Tel: (01) 743-3402. Mng. Dir.: Paul Gadd; Co-Dir. & Sales Mgr.: Don Arden; Gen. Mgr.: Jeff Lynne. (Rec. only)
- James Yorke Ltd., Oak House, High St., Northleach, Gloucestershire GL54 3ET. Tel: (04516) 666 Telex: 858623, 858393. Chief Exec.: J. Scarlett;
- Sales Dir.: Peter Fanshawe, Studio Mgr.: Peter Rinne.
- Ziver Soker Sales, 74 Newman St., London W1P 3LA. Tel: (01) 580-3237.

LICENSING ORGANIZATIONS, MUSIC

A S C A P (American Society of Composers, Authors & Publ'rs), 60 Dld Compton St., Suite 3, London W1. Tel: (01) 437-3994. Telex: 25833. UK Int'l Rep.: Lawrence Ross. (Performing rights only)

Home office: USA.

B M I (Broadcast Music Inc.), 302 Drake House, Dolphin Square, London SW1. Tel: (01) 834-9918. Contact: Robert Musel.

M C P S (Mechanical-Copyright Protection Society Ltd.), Elgar House, 41 Streamham High Rd., London SW16 1ER. Tel: (01) 769-4400. Cable: MECDLICD. Mng. Dir.: R.W. Montgomery; Sec'y: K.R.D. Lowe; Comm'l Dpns. Controller: G.J. Churchill. (Mechanical rights only)

P R S (The Performing Right Society Ltd.), 29/33 Berners St., London W1P 4AA. Tel: (01) 580-5544. Cable: PERFDRIGHT. Telex: 892678. Chief Exec.: M.J. Freegard (Performing rights only)

Phonographic Performance Ltd., Ganton House, 14/22 Ganton St., London W1. Tel: (01) 437-0311. Gen. Mgr.: H.G.S. Gilbert; Sec'y: I.B. Love. (Broadcasting & public performing rights)

LICENSORS, RECORD & TAPE

Coombe Music Ltd., Hurston House, Stoke Rd., Kingston-upon-Thames, Surrey. Tel: (01) 942-6240. Telex: 22914.

Free Range Rec'g Studios, 22 Tavistock St., London WC2A 7PH. Tel: (01) 836-7608. Chief Exec.: Marsha Abson; Gen. Mgr.: D.B. Grisdale; Sales Mgr.: Neville Wills.

Golden Era Rec's Ltd., 1099-A Finchley Rd., London NW11. Tel: (01) 455-6620. Dir.: Bert Wilcox.

London Rec'g Co., 1099A Finchley Rd., London NW11. Tel: (01) 455-6620. Chief Exec.: Herb Wilcox.

M H G Cassettes/Warm Recs., Daily Rd., Maybole, Ayrshire, Scotland KA19 7AX. Tel: (0655) 82200. Chm.: Mary Harrison-Goudie. Gen. & Sales Mgr.: Rui de Castro.

Marylebone Music, 68 Eccleston Square Mews, London SW1 1QN. Tel: (01) 834-7164. Telex: 8955771. Dir.: Tony Calder, Bob Newby, Nick Stanton. (Represents companies overseas; also represents labels for worldwide licensing). (SEE ADVERTISEMENT)

Supersmuc Ltd., 9A Hallcroft Ln., Copmanthorpe, York YO2 3SU. Tel: (0904) 703401, 707909. Mng. Dir.: Mal Adams; Gen. Mgr.: Dave Leaper; Sales Mgr.: Al Martin.

PLATING, PROCESSING & PRESSING PLANTS

Allied Recs. Ltd., 326 Kensal Rd., London W8 5BL. Tel: (01) 969-6651. Cable: MUSICALITY. Telex: 261500. Mng. Dir.: David Escott.

Audioemic, 34-36 Crown St., Reading, Berks. Tel: (0734) 595-647. Dir.: Martin Maynard. (Pressing only)

Audio Plastics, 7/9 Wedmore St., Upper Holloway, London N19 4RU. Tel: (01) 263-1378. Chief Exec.: Paul Lynton. (Pressing only)

C B S Mfg. (div. of CBS (UK) Ltd.), 17/19 Soho Square, London W1V 6HE. Tel: (01) 734-8181. Cable: CDLCRECM. Telex: 24203. Mng. Dir.: John A. Wheeler.

Coach House Studio Div./Ice Recs. Ltd., 81-A Dsbaldeston Rd., Stamford Hill, London N16. Tel: (01) 806-3252. Mng. Dir.: Eddy Grant; Gen. Mgr.: Alpine Grant; Sales Mgr.: Rudolph Grant; Financial Controller: Stan Blackburn.

Condor Litho, 35 Sylvan Grove, London SE15. Tel: (01) 639-9911. Chief Exec.: Michael J. Andrews; Gen. Mgr.: George Moss. (Plating & processing only)

Damont Recs. Ltd., Blyth Rd., Hayes, Middx. UB3 1BY. Tel: (01) 573-5122. Telex: 934076. Mng. Dir.: Monty Peters; Deputy Mng. Dir.: Frank Pearce.

Disctek Ltd., 25 Favell Dr., Parkside, Milton Keynes MK4 1AL. Tel: (0908) 502332. Chm.: James E. Skinner; Mng. Dir.: Mark R. Simmonds. (Manufacturing consultants)

Disctek (Plating) Ltd., 25 Favell Dr., Parkside, Milton Keynes MK4 1AL. Tel: (0908) 502332. Chm.: James E. Skinner; Mng. Dir.: Derek Brown; Factory Dpns.: Mark R. Simmonds. (Processing & plating)

E M I Recs. (UK) Ltd., 1/3 Unbride Rd., Hayes, Middx. UB4 5SY. Tel: (01) 561-8722. Mng. Dir.: R. Lopez; Ass't Dir.: R. Shenton; Special Projects Mgr.: D.L. Watson.

Elite Jay (Prod'n) Ltd., 97 Judd St., London WC1. Tel: (01) 388-5771. Mng. Dir.: Jack Applebaum; Prod'n Mgr.: Andrew Sopot; Prod'n Co-Ord.: Paul Heeren.

Grampan Recs. Ltd., Airport Ind'l Estate, Wick, Caithness, Scotland. Tel: (0955) 2787. Telex: 75107. Dir.: J. Johnston; Mgr.: John Hunter. (Pressing only)

Ice Recs. (Factory) Div., Rollins St., Ilderton Rd., London SE15. Tel: (01) 639-8901, 806-3252. Mng. Dir.: Eddy Grant; Gen. Mgr.: George Grant.

Immediate Sound Servs. Ltd., 6 Orsman Rd., London N1 5QJ. Tel: (01) 739-9672. Telex: 914382. Mng. Mgr.: J.W. Hart.

London Rec'g Co., 1099A Finchley Rd., London NW11. Tel: (01) 455-6620. Chief Exec.: Herb Wilcox.

Lynntone Recs., 7/9 Wedmore St., London N19 4RU. Tel: (01) 263-1378. Telex: 8954674. Mng. Dir.: Paul S. Lynton. (Electroplating/pressing-7" & 12" flex stumdisks)

M & C Pressings Ltd., The Manse, Milfield, Wooler, Northumberland. Tel: Milfield 295. Dir.: M. Counsell. (Pressing only)

M V S (Rec. Pressing) Ltd., 22-24 Cubitt St., London WC1X 0LR. Tel: (01) 278-3379. Telex: 8954102. Chm.: Jeffrey Trendell; Sales Dir.: Nicholas C. Flower; Tech Dir.: Ron W. Havelil.

Mayking Recs. Ltd., 57 Portobello Rd., London W11. Tel: (01) 727-2614. Chief Exec.: B. Bonnar; Gen. Mgr.: Al Bedford.

Metropolitan Communications, 8a Frognal Gardens, Hampstead, London NW3 6UX. Tel: (01) 435-8803. Telex: 299733. Pres.: Mark R.F. Hanau.

Motor Recs., 346 Farnham Rd., Slough, Berks. Tel: (0753) 29628. Telex: 847804. Mng. Dir.: Colin Gallacher. (Pressing only)

Musitech Ltd., 11-13 Temple Ind. High Wycombe, Bucks HP13 5DM. Tel: (0494) 37526. Contact: Roy Matthews. (SEE ADVERTISEMENT)

Nelson Recs., Nelson House, Castle Hill Rd., Hindley, Wigan, Lancs. Tel: (0942) 58777. (Pressing only)

Nimbus Recs. Ltd., Wyastone Leys, Monmouth NP5 3SR. Tel: (06060) 890-682. Telex: 498378.

Oakwood Rec'g Studios, 75 Strode Park Rd., Herne Bay, Kent. Tel: (02273) 4066. Mgr.: Graeme Quntion-Jones.

Drake Recs. Ltd., Sterling Ind'l Estate, Rainham Rd. S., Dagenham, Essex RM10 8HP. Tel: (01) 592-0242. Mng. Dir.: Peter Robey; Gen. Mgr.: Peter S. Hall.

P R Recs. Ltd., Hamilton Works, Station Rd., London SW19 2LP. Tel: (01) 543-4344. Mng. Dir. & Sales Mgr.: Phil Race; Gen. Mgr.: Ray Young; Prod'n Mgr.: Bill Dedman.

Plastic Sound Ltd., Vastre Ind'l Estate, Newtown, Powys, Mid-Wales. Tel: 26520. Dir.: A. Green, G.R. Davies, J.W. Edwards.

PolyGram Rec. Opns. Ltd., Record Works, Walkhamstown Ave., London E4 8S2. Tel: (01) 527-2300. Telex: 896383. Tech. Dir.: W.W. Bryant; Comm'l Dst'n: B.W. Dean; Factory Mgr.: V. Gowland; Finance & Admin.: A. Marks. (Pressing only)

Distribution: **Howford, Essex RM6 4QR**, Clyde Works, Grove Rd., Chadwell Heath. Tel: (01) 590-6088. Telex: 896556.

Precision Recs. & Tapes Ltd. (PRT), 132 Western Rd., Mitcham CR4 3UT. Tel: (01) 648-7000. Cable: PYREC. Telex: 28259. Mng. Dir.: Derek Honey; Dir. & Gen. Mgr.: Trevor Welch; Dir.: Alan Cornish; Bus. Affairs Dir.: David Giffen; Sales Mgr.: Alan Welch; Factory & Studio Mgr.: Howard Barrow. (Pressing only)

Production Express Int'l, 19 Kynaston Rd., Bromley, Kent. Tel: (01) 857-2713. Telex: 8813831. Mng. Dir.: Bobbie Dahd.

R W Graphics Ltd., 83 Copers Cope Rd., Unit 4A, Beckenham, Kent. Tel: (01) 658-3029. (Plating only)

Real Custom Prods. The Camp, Montgomery, Powys SY15 6LU. Tel: (068681) 427. Chief Exec.: Richard G. Davies; Sales Mgr.: George B. Pryce.

Record Company Servs., 1/3 Sedley Pl., London W1R 1HH. Tel: (01) 409-2336. Telex: 4081735. Dirs.: E.J. Foster, A.C. Watling-Darrell.

S R T Prods Ltd., 987 High Rd., Finchley, London N12. Tel: (01) 446-3218. Mng. Dir.: George Bellamy; Sales Mgr.: Dave Richardson.

Sound for Industry Ltd. (div. of MacNeil Press Ltd.), Newhams Row, 175 Bermondsey St., London SE1 3UW. Tel: (01) 4C3-0044. Telex: 883177. Mng. Dir.: John E. Moon; Gen. Mgr.: W. Bonner. (Flexidisc recs. pressing only)

Statelene Ltd., 9 Bodnant Ave., Leicester LE5 5RB. Tel: (0533) 736256. Mng. Dir.: Andrew W. Lipinski; Technical Dir.: J. Szabowski.

Factory: **Wellingtonborough, Northants. NN8 1EE**, Grant Rd. Tel: (0933) 7442. Telex: 311852.

Tinsley-Robor Mig. Ltd. (div. of Tinsley-Robor Group). Tinsley House, 67 Rosoman St., London EC1. Tel: (01) 278-2726. (Pressing only)

Vineyard Prods., 56 Standard Rd., London NW10. Tel: (01) 961-2919. Cable: BUMBLEBEE. Chief Exec.: Brian Leafe.

Xenadu Constructional & Mechanical Eng., 79 Fitzneal St., East Acton, London W12. Tel: (01) 743-3402. Mng. Dir.: Paul Gadd; Co-Dir. & Sales Mgr.: Don Arden; Gen. Mgr.: Jeff Lynne. (Pressing only)

Zella Recs. (Birmingham) Ltd., Walker Hall, Anpton Rd., Edgbaston, Birmingham B15 2UJ. Tel: (021) 455-0645. Mng. Dir.: William Johnny Haynes; Gen. Mgr.: A.J. Haynes.

PRINTERS & LITHOGRAPHERS

A M C (Associated Mktg. Co.), The High St., Hatfield Broad Oak, Essex. Tel: (0279-70) 671. Telex: 817606. Contacts: Don Morris, Janet Verdon.

Album Graphics (UK) Ltd., 2 Goodwin's Court, 55 St. Martin's Ln., London WC2. Tel: (01) 240-1319. Telex: 21879, 25247. UK Rep.: Linda Halpin. (Record only)

Home office: USA, Chicago, Ill.

Amberlee Recs. Ltd., 387 Harrow Rd., London W9. T: (01) 866-7748. Mng. Dir.: John Peters; Sales Mgr.: Orlean Lamas.

Francis Antony Ltd., Trenance Mill, Blowinghouse Hill, St. Austell, Cornwall PL25 5AH. Tel: (0726) 3476, 61264.

Arnold Reproduction Co., 77/79 Duddell Hill Ln., London NW10 1BD. Tel: (01) 459-6194. Owner: Stan Kitchen; Gen. Mgr.: Peter Hunt.

Arrowtals Ltd., Humber Rd., London NW2 6EP. Tel: (01) 450-2411. Telex: 923034. Mng. Dir.: Maurice Mindel; Sales Mgr.: Alex Murray; Prod. Mgr.: Paul Rinne.

Audicord Recs., 387 Harrow Rd., London W9. Tel: (01) 866-7748. Chief Exec.: K. Mellor.

Audiogetic Ltd., 34-36 Crown St., Reading, Berks. RG1 2SN. Tel: (0734) 595647. Dir.: Martin Maynard.

Badge Sales, 48 Carnaby St., London W1V 1PF. Tel: (01) 437-5121. Mng. Dir.: William Smith; Gen. Mgr.: Oscar Zanella; Sales Mgr.: David Kerry.

Ballantine Advertising Ltd., 11 Talbot Square, London W2. Tel: (01) 723-4439.

Ivan Berg Assocs. (Audio Publ'g) Ltd., 35A Broadhurst Gardens, London NW6 3QT. Tel: (01) 624-7785. Mng. Dir.: Ivan Berg.

Capricorn Graphics, PO Box 1, Dfferton Ind'l Estate, Hemphaw Ln., Stockport SK2 5TX. Tel: (061) 480-8241.

Caroline Exports Ltd., 56 Standard Rd., London NW10 6ES. Tel: (01) 961-2919. Cable: BUMBLEBEE. Telex: 21264. Mng. Dir.: A.T. Rose; Studio/Electronics Exec.: C. Sthianou.

Cassette Developments (Audio sonic) Ltd., Micra House, 138 Lower Mortlake Rd., Richmond, Surrey TW9 2JZ. Tel: (01) 940-8186. Cable: MICRONETICS. Telex: 8813481. Gen. Mgr.: D. Dixon. (Tape only)

Cassette & Rec. Servs. Ltd., Eastcotts Rd., Bedford. Tel: (0234) 56317. Mng. Dir.: P. J. Norbury; Works Dir.: P. Moore.

Clout & Baker Ltd., Chalkin Works, Parkwood Ind'l Estate, Bircholt Rd., Maidstone, Kent. Tel: (0622) 673261. Chm.: P.F. Chalkin; Sales Dir.: John Benoy; Works Dir.: Robin Burr.

Coach House Studio Div./Ice Recs. Ltd., 81-A Dsbaldeston Rd., Stamford Hill, London N16. Tel: (01) 806-3252. Mng. Dir.: Eddy Grant; Gen. Mgr.: Alpine Grant; Sales Mgr.: Rudolph Grant; Financial Controller: Stan Blackburn.

Condor Litho Ltd., 35 Sylvan Grove, London SE15. Tel: (01) 639-9911. Mng. Dir.: Michael J. Andrews; Gen. Mgr.: George Moss.

L. A. Cousins & Ltd., 26 Grandens Ave., Hackney, London E8. Tel: (01) 985-4211. Owner: L.A. Cousins; Gen. Mgr.: S. Franks.

Cream Creative Mktg. Ltd., The Cloisters, 11 Salem Rd., London W2. Tel: (01) 221-5155.

Deleja Press Ltd., Dingwall House, 8 Marlborough Rd., Bromley, Kent BR2 5NH. Tel: (01) 460-0112. Telex: 8951346. Mng. Dir.: R.E. Edwards; Gen. Dir.: R.N. Roadnight; Dir.: R.G. Froment; Sales Dir.: P.H. Grey.

Duplitape, 1/7 Harewood Ave., London NW1 6LE. Tel: (01) 724-2497. Chief Exec. & Gen. Mgr.: B. Lambden; Sales Mgr.: R. Jackson-Moore.

E C Graphics Ltd. (div. of Tinsley-Robor Group Ltd.), 67 Rosoman St., London EC1. Tel: (01) 278-8054. Telex: 267985. Mng. Dir.: R.D. Vickers; Sales Mgr.: T.D. Stevens.

Ellie Jay (Prods) Ltd., 97 Judd St., London WC1. Tel: (01) 388-5771. Mng. Dir.: Jack Applebaum; Prod'n Mgr.: Andrew Soper; Prod'n Co-ord.: Paul Heeren.

Falcon Pub., 169A High St., Beckenham, Kent. Sales Mgr.: G. Ford.

Format (Sussex) Ltd. (div. of Tinsley-Robor Group Ltd.), Jubilee Rd., Burgess Hill, Sussex. Tel: (04446) 45245. Telex: 87322. Mng. Dir.: Ted Light.

Garrod & Lothhouse Ltd., Chaldon Rd., Caterham-on-the-Hill, Surrey. Tel: (Caterham) 45266. Telex: 262554. Chm. & Mng. Dir.: Norman J. Garrod; Sales Mgr.: Christopher Garrod.

Golden Era Rec'gs Ltd., 1099-A Finchley Rd., London NW11. Tel: (01) 455-6620. Dir.: Bert Wilcox.

Grampian Recs Ltd., Airport Ind'l Estate, Wick, Caithness, Scotland. Tel: (0955) 2787. Telex: 75107. Dir.: J. Johnston; Mng. Dir.: John Hunter.

Halstan & Co. Ltd., Plantation Rd., Amersham, Bucks. HP6 6HJ. Tel: (02403) 5525. Cable: HALSTANSIC. Mng. Dir.: R.E. Smith; Sales Mgr.: W. Shrimpton; Ass't Sales Mgr.: L. Thorge. Sec'y: R. Yerby.

E. Hannibal & Co. Ltd., Pinfold Rd., Thurston, Leicester LE4 8AP. Tel: (0533) 695413. Telex: 34627. Mng. Dir.: Chris Heffington; Ass't Mng. Dir.: Roger Stewart; Music Div. Sales Dir.: Derek Deighton.

Harrison & Sons (London) Ltd., Printing House Ln., Hayes, Middx. UB3 1HQ.

Tel: (01) 573-3828. Telex: 23744. Mng. Dir.: J.A. Modlock; Comm'l Dir.: B.L. Hibbit; Sales Dir.: D.S. Robinson; Prod. Mgr.: M.S. Fitzgerald.

John Harwood-Bee Assocs., The Folly, Folly Island, Hertford, Herts. Tel: (0992) 551233. Telex: 817861. Mng. Dir.: John Harwood-Bee.

Howards (Slough) Printers Ltd., Mill St., Slough, Berks. SL2 5DT. Tel: (0753) 32271. Sales Dir.: Tony Thompson.

Independent Rec. Co., 39 Harmer St., Gravesend, Kent. Tel: (0474) 65687. Chief Exec.: J.W. Oram.

Job Org. Ltd., 100 Wadour St., London W1. Dir.: John Bright.

Jubilee Graphics, 101 Wadour St., London W1. Tel: (01) 437-8572.

K Tape Servs., Norfolk Street Studio, Norfolk St., Worthing, Sussex BN11 4BB. Tel: (0903) 205053.

Keapac Polythene Supplies Ltd., Coronation Place, Guildhall Ln., Leicester. Tel: (0533) 20084, 537806.

Steve Lane Musical & Publicity Servs., 12 Slough Ln., Kingsbury, London NW9 8QL. Tel: (01) 205-2587. Owner: Steve Lane. Gen. Mgr.: K.C. Sear.

Lindsey's Colour Serv., 88 Teesdale St., London E2. Tel: (01) 729-5462. Mng. Dir.: Ray Mack; Sales Dir.: David Wall.

London Rec'g Co., 1099A Finchley Rd., London NW11. Tel: (01) 455-6620. Chief Exec.: Herb Wilcox.

M H G Cassettes/Warm Recs., Daily Rd., Maybole, Ayrshire, Scotland KA19 7AX. Tel: (0655) 82200. Chm.: Mary Harrison-Goudie; Gen. & Sales Mgr.: Rui de Castro.

Nelson Rec'g Studio, Nelson House, 93 Castle Hill Rd., Hindley, Wigan, Lancs. WN2 4BH. Tel: (0942) 58777. Contacts: S.M. Millard, W. Leyland.

Nightingale Music Ltd., Berkeley Square House, 12 Berkeley Square, London W1. Tel: (01) 491-3070. Telex: 25460. Mng. Dir.: John Gyard.

Oakwood Rec'g Studios, 75 Strode Park Rd., Herne Bay, Kent. Tel: (02273) 4066. Mgr.: Graeme Quinton-Jones.

Porter & Pocock Assoc. Ltd., 72 Westfields Ave., London SW13 0AU. Tel: (01) 878-4366/2595. Mng. Dir.: R. Alexander Porter.

Positive Designs, 17 Station Rd., London SE25 5AH. Tel: (01) 771-5777. Chief Exec.: Steve Hutchings; Gen. Mgr.: Dave Lucy; Sales Mgr.: Nick Miller.

Production Express Int'l, 19 Kynaston Rd., Bromley, Kent. Tel: (01) 857-2713. Telex: 8813831. Mng. Dir.: Bobbie Dahd.

Real Custom Prods. The Camp, Montgomery, Powys SY15 6LU. Tel: (068681) 427. Chief Exec.: Richard G. Davies; Sales Mgr.: George B. Pryce.

Realhealth Ltd., 15/23 Porteus Rd., London W2. Tel: (01) 723-8495. Dir.: Bryan Whitman.

Rock Art Studios, 10 Barley Mow Passage, Chiswick, London W4. Tel: (01) 994-6477. Telex: 8811418. Mng. Dir.: Peter Small; Mktg. Mgr.: Mal Burns.

Rooster Recs., PO Box 148, London W9 1DY. Tel: (01) 286-2993.

S R T Prods Ltd., 987 High St., Finchley, London N12. Tel: (01) 446-3218. Mng. Dir.: George Bellamy; Sales Mgr.: Dave Richardson.

Sea Cruise Prods (UK), 35 Great Russell St., London WC1. Tel: (01) 636-3925. Gen. Mgr.: Terry Wahlgren. (Record only)

Home office: USA, Ken Keene Int'l.

Senol Printing Ltd., 4 Hardwicks Way, London SW18 4AJ. Tel: (01) 874-5775. Mng. Dir.: Mrs. M.M. Gunn; Dirs.: P.L. Smith, J.J. Rolle.

Shalford Press Ltd., 85b Bradford St., Bramtree, Essex CM7 6AU. Tel: (0376) 21125. Mng. Dir.: R. Capon.

Shorewood Packaging Co. Ltd., College Rd., Aston Clinton, Bucks. HP2 5EZ. Tel: (0296) 630421. Telex: 83495. Gen. Mgr.: Denis Rex; Sales Mgr.: Lionel Rose; Works Mgr.: Reg Ward.

Home office: USA, New York, N.Y.

Sound, I Odgershaw Mews, Maidenhead, Berks. Tel: (0628) 33011. Mng. Dir.: I.S. Webb; Sales Mgr.: M. Lloyd; Adv. Mgr.: C. McVie.

Robert Stace & Co. Ltd., Chalkin Works, Longfield Rd., Tunbridge Wells, Kent. Tel: (0892) 24225. Telex: 95577. Chm. & Mng. Dir.: P.W. Barker; Ass't Mng. Dir.: A.G. Long; Sales Dir.: D. Brewer.

Steelguard Security Tape Display Systems, Pembroke Studios, 3A Bensham Ln., West Croynon, Surrey. Tel: (01) 689-1877/7878. Mng. Dir.: Paul Holmes; Gen. Mgr.: Philip Harrison; Sales Mgr.: Brian Forscutt.

Templerung Ltd., 29 Wates Way, Mitcham, Surrey. Tel: (01) 640-3025. Sales Mgr.: Henry Dyson.

Vineyard Prods., 56 Standard Rd., London NW10. Tel: (01) 961-2919. Cable: BUMBLEBEE. Chief Exec.: Brian Leafe.

West Bros. Printers Ltd., 12 Milton Rd., Aylesbury, Bucks. Tel: (0296) 23211. Telex: 837216. Mng. Dir.: Peter G. West; Gen. Mgr.: H.E.V. Pinnell; Sales Mgr.: Derek Higgs.

West Central Printing Co. Ltd., 33/34 Rathbone Pl., London W1P 1AD. Tel: (01) 636-8572. Mng. Dir.: H. Leonard Temple; Gen. Mgr.: Stan Heiser; Print Ed.: John Barry.

P. G. Wood & Son (Printers) Ltd., 32 Church St., Dagenham, Essex RM10 9UU. Tel: (01) 595-5115. Telex: 897417. Mng. Dir.: Peter Wood; Gen. Mgr.: Chris Sanford; Sales Mgr.: Phil Douglas; Works Mgr.: Greg Bell.

James York Ltd., Oak House, High St., Northleach, Gloucestershire GL54 3ET. Tel: (04516) 666. Telex: 858623, 858393. Chief Exec.: J. Scarlett; Sales Dir.: Peter Fanshawe; Studio Mgr.: Peter Rinne.

Zver Soker Sales, 74 Newman St., London W1P 3LA. Tel: (01) 580-3237.

RECORD PROMOTION (including Public Relations & Publicity)

A M C (Associated Mktg. Co.), The High St., Hatfield Broad Oak, Essex. Tel: (0279-70) 671. Telex: 817606. Contacts: Don Morris, Janet Verdon.

Keith Altham, Lincoln House, 56 Old Compton St., London W1. Tel: (01) 439-6325.

Amazing Exhibitionists Ltd., 52/56 Church Path, London W4 5BN. Tel: (01) 995-3555. Dirs.: Lawrence Miller, Janet Lamport, Alex Forbes (SEE AD)

Anglia Rec. Dist., 6 Fitzroy Ln., Cambridge, Cambs. Tel: (0223) 352-639.

Astra Int'l Entertainments, Thornley St., Wolverhampton. Tel: (0902) 26628, 28084. Mng. Dir.: Tony Perry. Dirs.: George Maddocks, Alan Clayton, John Elcock.

Atlas Photography, 4 New Burlington St., London W1X 1FE. Tel: (01) 734-8746. Mng. Dir.: Ron Bull.

B B B (Be-Box Badges), 3 Honister Rd., Burnley, Lancs. BB10 2PX. Tel: (0282) 53046. Contact: Mike Leonard.

B G S Prods Ltd., Kirkland Park Studios, Letham Rd., Strathaven, Scotland ML10 6EE. Tel: (0357) 21130. Mng. Dir.: W.B. Garden, Pub. & Promos. Exec.: Dougie Stevenson.

B T W (Music) Ltd., 125 Middleton Rd., Wood Green, London N22 4NG. Tel: (01) 888-6555. Dirs.: John Ross Borthwick, R.J.T. Borthwick.

Bird Sound Studios, 4 Welton Rd., Wedgock Estate, Warwick CV34 5YA. Tel: (0926) 45124. Owner: Sheila L. Bird; Gen. Mgr.: David Rawlings; Sales Mgr.: Dave Sheriff; Promo: Dave Ling.

Blueput Music, 81 Osborne Rd., Jesmond, Newcastle-on-Tyne NE2 2AN. Tel: (0632) 816-855. Chief Exec.: Maurice Roof; Gen. Mgr.: Ian Gurney; Sales Mgr.: Nigel Harrison; Promos. Mgr.: Antoine Legris.

Tony Brainsby Pub. Ltd., 16-B Edith Grove, London SW10. Tel: (01) 834-8341.

Bullet Ltd., 36 Boston Pl., London NW1. Tel: (01) 724-0814, 723-1062.

Mng. Dirs.: B.L. Evans, E.S. Coxhead.

Howard Campbell Promos., 1010 Harwood Rd., London SW6. Tel: (01) 731-6736. Chief Exec.: Howard Campbell.

Camron Design Ltd., 32 Pancras Rd., London NW1 2QP. Tel: (01) 837-8328.

Dirs.: Malcolm Macdonald, Lynda Watkins, John Cameron.

Capricorn Graphics, PO Box 1, Offerton Ind'l Estate, Hemphaw Ln., Stockport SK2 5TX. Tel: (061) 480-8241.

Carousel Prods. Ltd., 21 St. Andrew St., Plymouth, South Devon PL1 2OH. Tel: (0752) 25781, 60293, 774-381 (evenings). Mng. Dir.: P. Simonds.

Lindsey Clennell Videofilm Ltd., 22 Earlham St., London WC2 9B. Tel: (01) 836-9211. Dir.: Lindsey Clennell.

Contact Promos., 20 Great Portland St., London W1. Tel: (01) 631-3247.

Dir.: Harry Barber.

Glenn Coombs Design Studios, 25 Macklin St., London WC2B 5NH. Tel: (01) 242-1993.

Cream Creative Mktg. Ltd., The Cloisters, 11 Salem Rd., London W2. Tel: (01) 221-5155.

Crownmontons, 51 Court Lodge Rd., Horley, Surrey. Tel: (073) 784-3932, (01) 588-8846. Chief Exec.: Jim Graham; Sales Mgr.: Pete Kunzler; Chief Eng.: Tim Woods.

D T P Inc., 3 Alfred St., Weston-Super-Mare, Avon BS23 1PZ. Tel: (0934) 21932. Mng. Dir.: Don Todd.

Beryl Davis Assocs., 24 Beresford Rd., Wallasey, Merseyside L45 0JJ. Tel: (051) 639-2265/3559. Chief Exec.: Beryl Davis; Sales Mgr.: Eunice Williamson.

Chris Denning Ltd., 418 Poole Rd., Parkstone, Poole, Dorset BH12 1DF. Tel: (0202) 761859. Mng. Dir.: Chris Denning.

Diamond Promo. & Pub., 3 Paddington St., London W1M 3LA. Tel: (01) 486-9695. Mng. Dir.: Wally Morgan.

Douglas Dee-Jay, 13 Burnbrae, Twechar, Kilsyth, Glasgow, Scotland. Tel: Kilsyth 821-120. Mng. Dir.: Norman Whitehall; Gen. Mgr.: Tom Bell; Sales Mgr.: John Cowie; Overseas Liaison: Hans Anderson.

Dynamic Mktg., 105 Dunstable St., Amphil, Beds. Tel: (0525) 402-703. Mng. Dir.: Dominic Bowen; Gen. Mgr.: Colin O'Leary; Art Dir.: Peter Brooks.

Ellie Jay (Prods) Ltd., 97 Judd St., London WC1. Tel: (01) 388-5771. Mng. Dir.: Jack Applebaum; Prod'n Co-ord.: Paul Heeren.

George Eirich, 17 Palace Gate, London W8 5LS. Tel: (01) 589-6472. Chief Exec. & Gen. Mgr.: George Eirich.

Ehrly Yours Ltd., 23/24 Easton St., London WC1. Tel: (01) 278-0103. Mng. Dir.: Sid Shaw; Gen. & Sales Mgr.: Paul Jardine; PR: David Griffiths.

Evolution Music Promos., 48 Gloucester Square, London W2. Tel: (01) 402-9373. Dirs.: Johnny Jones, John Michel, Philip Lewis.

Fan Club Centre, Basement Studio, 33 Norton Rd., Hove, Brighton BN3 3BF. Tel: (0273) 72097.

Focus Mktg. & Communications, 87 Lambton Rd., London SW20 0LW. Tel: (01) 947-4454. Mng. Dir.: Brian Oliver; Account Exec.: Lyn Oliver.

Free Range Rec'g Studios, 22 Tavistock St., London WC2A 7PH. Tel: (01) 836-7608. Chief Exec.: Marsha Abson; Gen. Mgr.: D.B. Grisdale; Sales Mgr.: Neville Wills.

Frog Prods., 24 Haig Rd., Stanmore, Middx. Tel: (01) 954-0959. Mng. Dir.: Bob Clifford.

Front Line Mktg., 5 Cnderhills Rd., Holmfirth, West Yorks. Tel: (048489) 6892. Mng. Dirs.: John Piper, Geoff Dolding.

Brian Gibson Publicity, Hurst Grange Cottage, Aboune Rd., Hurstpierpoint, Sussex. Tel: (0273) 833-914. Mng. Dir.: Brian Gibson.

Golden Era Rec'gs Ltd., 1099-A Finchley Rd., London NW11. Tel: (01) 455-6620. Dir.: Bert Wilcox.

Great Big Designs, 35A Caermarvon St., Glasgow, Scotland G3 6HP. Tel: (041) 332-2370. Chief Exec.: Cliff G. Hanley.

Tony Hall Promos. (div. of Tony Hall Group of Cos.), 9 Carnaby St., London W1V 1PG. Tel: (01) 437-1958. Cable: TASTES. Mng. Dir.: Tony Hall; Promo. Mgr.: Jeffrey Toms-Smith.

Jennie Halsall Public Relations Consultants, 12-13 Henrietta St., Suite 99, London WC2. Tel: (01) 240-5601. Telex: 25884. Mng. Dir.: Jennie Halsall.

Happy Face Music, The Old Smithy, Post Office Ln., Kempsey, Worcs. WR5 3NS. Tel: (0905) 820-659/566. Cable: SMITHYSOUND. Chief Exec.: Wuff Murlin; Gen. Mgr.: V. B. Murlin.

Harrison Promos., 66 Beaufort Rd., London. Tel: (01) 997-9650. Promos. Dir.: Mark Harrison.

John Harwood-Bee Assocs., The Folly, Folly Island, Hertford, Herts. Tel: (0992) 551233. Telex: 817861. Mng. Dir.: John Harwood-Bee.

Hazell-Smith, 36 37 Malden Ln., London WC2. Tel: (01) 240-3284. Mng. Dir.: Peter Hazell-Smith.

Heavy Pub., 498-500 Harrow Rd., London W9. Tel: (01) 960-0955. Telex: 62571. Chief Exec.: Joe O'Neil, Mick Wall; European & British Reg'l Press Officer: Nod Cobb.

The Howlin' Promo Co., 70 Gloucester Pl., London W1. Tel: (01) 935-4965; Air Call (01) 828-5621 code 1970. Chief Exec.: Howard Marks.

Humberside Studios, Grimsby Rd., Laceby, Grimsby, South Humberside. Tel: (0472) 40152, 71582. Chief Exec.: L.A. Johnson.

Hunt-Leigh (Showcard & Display) Co. Ltd., Unit C, 1A Menin Works, Bond Rd., Mitcham, Surrey CR4 3BG. Tel: (01) 640-7407.

Independent Pub., 113 Burntwood Ln., London SW17. Tel: (01) 947-3279. Dir.: Geoff Deane.

Independent Rec. Co., 39 Harmer St., Gravesend, Kent. Tel: (0474) 65687. Chief Exec.: J.W. Oram.

Industrial Recs. Ltd., 10 Martello St., London E8. Tel: (01) 254-9178. Dir.: Peter Christopherson; Gen. Mgr.: Cosy P-Dridge; Sales Mgr.: David Brooks; Gen. Exec.: Joyce Sinclair.

Infrared Recs., 1 Hyde Park Square, Rm. 12, London W2 2JZ. Tel: (01) 402-9855. Chief Exec.: Roger Howard.

J S D Ents., 62 Berners St., London W1P 3AE. Tel: (01) 580-4720. Telex: 261298. Chm.: Joseph R. Stanley; Gen. Mgr.: E.J. Widing.

Jazzstace, 142 London Rd., Rayleigh, Essex. Tel: (0268) 772-178.

T. Richard Johnson Ltd., MAM House, 24/25 New Bond St., London W1. Tel: (01) 493-7535. Chm. Terry Johnson; Mng. Dir.: Alan Smith.

L E Advertising, Nelson House, Castle Hill Rd., Hindley, Wigan WN2 4BH. Tel: (0942) 58555.

L D E Entertainment Ltd., LDE Group, 28 Lexington St., London W1R 3HR. Tel: (01) 734-3443. Cable: LDCEGROUP. Telex: 24224. Mng. Dir.: Hiroshi Kato; Gen. Mgr.: Jim Russell; Sales Mgr.: Tokiyoshi Harada. (Promotion for Japan)

Steve Lane Musical & Publicity Servs., 12 Slough Ln., Kingsbury, London NW9 8QL. Tel: (01) 205-2587. Owner: Steve Lane. Gen. Mgr.: K.C. Sear.

Laserium Public Relations, 79 Fitzneal St., East Acton, London W12. Liaison & Promo. Co. Ltd., 70 Gloucester Pl., London W1. Tel: (01) 935-5988. Dirs.: Gary Dawson, Clifford Gee.

Lightning Recs. Ltd., 841 Harrow Rd., Harlesden, London NW10 5NH. Tel: (01) 969-7155/5255. Cable: LARREC. Telex: 927813. Mng. Dir.: Raymond Lane; Ass't & Mktg. Dir.: Keith Yershon; Dist'n & Juicebox Dir.: David Powell; Commercial Dir.: Sjad Reza.

Listen Fine Ltd., 22 Gibson Square, London N1 OPD. Tel: (01) 840-3444 x 12. Mng. Dir.: G. Lawson.

London Rec'g Co., 1099A Finchley Rd., London NW11. Tel: (01) 455-6620
 Chief Exec.: Herb Wilcox.
 M H G Cassettes/Warm Recs., Daily Rd., Maybole, Ayrshire, Scotland KA19
 7AX. Tel: (0655) 82200. Chm.: Mary Harrison-Goudie. Gen. & Sales Mgr.:
 Rui de Castro.
 Magnum Assoc. Promos., Vivian House, 21 Market Hill, Southam, Warwicks.
 Tel: (092681) 4642. Mng. Dir.: Mike Tobin; Co-Dir.: Roger Upright.
 Mike Mansfield Ent's., see Monster Movies.
 Marlybone Music, 68 Eccleston Square Mews, London SW1 1QN. Tel: (01)
 834-7164. Telex: 8955771. Dirs.: Tony Calder, Bob Newby, Nick Stuart.
 (Represents companies overseas; represents labels for worldwide
 licensing) (SEE ADVERTISEMENT)
 Barry McCloud Promos. Ltd., Isabel House, Suite 29, 46-47 Victoria Rd.,
 Surbiton, Surrey. Tel: (01) 399-5324. Telex: 896616. Mng. Dir.: Barry
 McCloud; Promo. Direct. Gen. Mgr.: Kimberly Mounsey.
 McKinley Mktg. Consultants Ltd., Triumph House, Suite 210, 189 Regent
 St., London W1R 7WD. Tel: (01) 434-3776. Contact: Colin Hadley.
 Mercer Servs./Razamat, 40-42 Church St., Burnley, Lancs. BB11 2DL. Tel:
 (0282) 53046, 56156, 55731.
 Modern Pub., New Iberia House, Winchester Walk, London SE1. Tel: (01)
 403-6332. Chief Exec.: Alan Edwards; Gen. Mgr.: Eugene Manzi.
 Monster Movies Ltd., 9 Great Chappell St., London W1. Tel: (01) 434-2021.
 Prod'r & Dir.: Mike Mansfield.
 Mushroom Studios, 18 W. Mall, Clifton, Bristol BS8 4BG. Tel: (0272) 35994,
 35867. Chief Exec.: O. Ackerman; Gen. Mgr.: S.A. Ackerman.
 Nelson Rec'g Studio, Nelson House, 93 Castle Hill Rd., Hindley, Wigan,
 Lancs. WN2 4BH. Tel: (0942) 58777. Contacts: S.M. Millard, W. Leyland.
 Newsflash Publicity, Superfly House, 9 Camden High St., London NW1. Tel:
 (01) 388-5950.
 Norfolk Area Disk Jockeys Ass'n, 4 Aerodrome Rd., Thorpe, Norwich, Norfolk
 NR7 0BD. Tel: (0603) 35084. Sec'y: Pete May.
 Northern Disco Promo. Servs., 116 Churchgate, Southport, Merseyside. Tel:
 (0704) 212-505. Chief Exec.: Ron Ellis.
 Oakwood Rec'g Studios, 75 Strode Park Rd., Heme Bay, Kent. Tel: (02273)
 40-66. Mgr.: Graeme Quinton-Jones.
 Kay O'Dwyer Publicity Ltd., 6 Denmark Pl., London WC2. Tel: (01) 836-
 6699. Dir.: Kay O'Dwyer.
 Old Smyth Rec'g Studio, Old Smyth Post Office Ln., Kempsey, Worcs. Tel:
 (0905) 820659. Chief Exec.: Muff Murlin; Gen. Mgr.: Val Biddle.
 P M S Mail Order Handling, The High St., Hatfield Broad Oak, Essex. Tel:
 (0279) 70671. Telex: 817606 Mgr.: Lynda Murphy.
 Panda Recs., 2 Catherine St., Seaside, Llanelli, Dyfed, South Wales. Tel:
 (05542) 58913, 52490. Chief Exec.: Paul Adams; Gen. Mgr.: Alan
 Phillips.
 Pen To Paper, Stafford Barton, Bolton near Winkfield, Devon
 Pilsner Pub., 1 Melville Rd., Edgbaston, Birmingham B16 9LN. Tel: (021)
 454-4666. Chief Exec.: Eugen Beer; Gen. Mgr.: Gareth Davies.
 Pinnacle Recs., 371/375 Kenning Ln., Kennington, London SE11. Tel: (01)
 582-2238. Telex: 896141. Chm. & Mng. Dir.: Terry Scully; Gen. Mgr.:
 Tony Berry; Int'l: Newton Wilks.
 Porter & Pocock Assocs. Ltd., 72 Westfields Ave., London SW13 0AU. Tel:
 (01) 878-4366/2595. Mng. Dir.: R. Alexander Porter.
 Positive Designs, 17 Station Rd., London SE25 5AH. Tel: (01) 771-5777
 Chief Exec.: Steve Hutchins; Gen. Mgr.: Dave Lucy; Sales Mgr.: Nick
 Miller.
 R A L, 49 Burnt Ash Ln., Bromley, Kent. Tel: (01) 464-9600.
 R T P (Record Television Promos.), 22 Acland Rd., London SW6. Tel: (01)
 731-3215. Dir.: Richard Figgs.
 Rainbow Servs., 1B St. Andrew St., Plymouth, Devon. Tel: (0752) 660293
 (day), 774381 (night). Chief Exec.: Phil. E.R. Simonds.
 Realmhead Ltd., 15/23 Porteus Rd., London W2. Tel: (01) 723-8495. Dir.:
 Bryan Whitman.
 Record Sales, 72 Newman St., London W1. Tel: (01) 636-9251. Telex:
 8812733. Dir.: Richard Jakubowski.
 Ridge Farm Studios, Capel, Surrey. Tel: Dorking (0306) 711202.
 Rime Ent's. Ltd., 3 Paddington St., London W1M 3JA. Tel: (01) 486-9695.
 Mng. Dir.: Alan James; PA to Alan James: Suzanne Ibbotson. Northern
 Promo Mgr.: Erica Hughes; Midland Promo Mgr.: Martin Fredrick.
 Richard Robson Assocs. Ltd., Roxburgh House, 273-287 Regent St., London
 W1R 8BN. Tel: (01) 491-4998, 629-8641. Mng. Dir.: Richard Robson;
 Gen. Mgr.: Marjorie Robson.
 Rock Art Studios, 10 Barley Mow Passage, Chiswick, Middx. W4. Tel: (01)
 994-6477. Telex: 8811418. Mng. Dir.: Peter Small; Mktg. Mgr.: Mal
 Burns.
 Rogers & Cowan Inc., 27 Albemarle St., London W1X 3FA. Tel: (01) 499-
 0691. Telex: 25571. Pres. Int'l Div: Margaret Gardner, Int'l Div. Music
 Dept. Dir.: Ray Fox-Cumming.
 Rush Release Ltd., 15 Trinity Rd., London SW17 7SD. Tel: (01) 672-9121
 Dirs.: Ian & Nick Titchener; Promos Mgr.: Robert Blennman.
 Saffred Music Ltd., Hurworth Cottage, Croft Rd., Hurworth, Darlington,
 Durham. Tel: (0325) 721 143/720-792. Mng. Dir.: Elaine Saffer; Gen
 Mgr.: C. Morris.
 St. Pierre Pub., 24 Beauval Rd., Dulwich, London SE22 8UQ. Tel: (01) 693-
 6463, 235-8243. Exec.: Roger St. Pierre; Promo. Dir.: Bernie Cochrane
 Sams Rec. Servs. (SRS), 78 Durham Rd., London SW20. Tel: (01) 947-9000.
 Chief Exec.: Max Wright; Gen. Mgr.: Andy Titcombe; Sales Mgr.: Barry
 Wright; Office Mgr.: Pat Savage
 Scope Recs., see Lightning.
 Sea Cruise Prod'ns (UK), 35 Great Russell St., London WC1. Tel: (01) 636-
 3925. Gen. Mgr.: Terry Wagborne.
 Home office: USA.
 Solomon & Peres Ltd., 120 Coach Rd., Templepatrick, Ballyclare, County
 Antrim, Northern Ireland BT39 0HB. Tel: (08494) 32711. Telex: 747293
 Mng. Dir.: Mervyn A. Solomon; Gen. Mgr.: Les Paterson; Sales Mgr.: Noel
 A. Spiller; Record & Tape Div. Mgr.: Michael H. Ross; Country Music Sales
 Co. ord.: Betty Monteith
 Simon Stable Promos., 46 Westend, Launton, Oxon. Tel: (08692) 2831.
 Chief Exec.: Simon Stable; Gen. Mgr.: Stephanie De La Bedoyere; Sales
 Mgr.: Daniel De La Bedoyere; Musical Dir.: Fang Stable.
 Peter Summerfield Int'l Ltd., 19 Upper Brook St., London W1. Tel: (01) 409-
 3277. Telex: 267310. Mng. Dir.: Peter Summerfield
 Supermusic Ltd., 9A Hallcroft Ln., Copmanthorpe, York YO2 3SU. Tel:
 (0904) 703401, 797090. Mng. Dir.: Mal Spence; Gen. Mgr.: Dave Leaper;
 Sales Mgr.: Al Martin
 T R J, see T. Richard Johnson.
 Target Promos., The Studio, 1 Bensham Ln., Croydon, Surrey CR0 2RU. Tel:
 (01) 689-6141. Chief Exec.: A.T. Gregory, L.J. Adams.
 21st Century Leisure Ltd., 41 Cotswold Gardens, London NW2 1QT. Tel: (01)
 458-8991. Mng. Dir.: Martin Lewis.
 Vinyl Dreams, Corporation St., Birmingham City Centre. Dir.: John Regan
 Wardour Motion Picture Co. Ltd., 11 Wardour Mews, London W1. Tel: (01)
 439-4313. Dir.: M.J. Sutton, Gen. & Sales Mgr.: Christine Gillingham
 Wave Music Publicity, 284 Derinton Rd., London SW17. Tel: (01) 672-6918
 Mng. Dir.: Max Needham; Sec'y: Ursula Needham

Jeff Wayne Music (Advertising) Ltd., Oliver House, 8/9 Ivor Pl., London NW1
 6BY. Tel: (01) 402-9244. Telex: 261234. Mng. Dir.: Jeff Wayne; Gen.
 Mgrs. & Dirs.: Alison Wallace, Isabel Griffiths
 Wilde Rock Promos. Co. Ltd., 110 Clarendon Rd., London W11. Tel: (01)
 229-3831. Chief Exec.: L. Devenay.
 Int'l branch: Germany, Jumbo Prod'ns.
 Kanadu Constructional & Mechanical Eng's., 79 Fitzzel St., East Acton,
 London W12. Tel: (01) 743-3402. Mng. Dir.: Paul Gadd; Co-Dir. & Sales
 Mgr.: Don Arden; Gen. Mgr.: Jeff Lynne

TAPE CUSTOM DUPLICATORS TAPE PACKAGING & LABELING

The Audio and Video lines indicate the configurations which the firms
 duplicate. Companies which offer packaging and labeling of tape product
 are indicated by "(PKG)" which appears after the main body of their
 respective listings.

Aardvark Design & Publicity, 145 Croydon Rd., Beckenham, Kent BR3 3RB.
 Tel: (01) 658-4386. Mng. Dir.: Paul Smith. (PKG)
 Ablex Ltd. (sub. of Decca Ltd.), Harcourt, Halesfield 14, Telford, Salop TF7
 4QR. Tel: (0952) 584131. Telex: 35649. Mgr.: Peter Banks
 Audio: Cassette.
 Amberlee Recs. Ltd., 387 Harrow Rd., London W9. Tel: (01) 866-7748. Mng.
 Dir.: John Peters; Sales Mgr.: Orlean Lamas. (PKG)
 Audio: Cassette, open reel.
 Anemone Sound Facilities Ltd., 10A Poland St., London W1. Tel: (01) 439-
 9611. Telex: 8812286. Mng. Dir.: Aaron Gershfield; Gen. Mgr.: Derek
 Hanlon; Sales Mgr.: Simon Patrick. (PKG)
 Audio: 8 tr., cassette.
 Audicore Recs., 387 Harrow Rd., London W9. Tel: (01) 866-7748. Chief
 Exec.: K. Mellor. (PKG)
 Audio: Cassette, open reel.
 Audiogenic Ltd., 34-36 Crown St., Reading, Berks. RG1 2SN. Tel: (0734)
 595647. Dir.: Martin Maynard. (PKG-audio & video)
 Audio: Cassette; open reel.
 Audio + Video Ltd., Video House, 48 Charlotte St., London W1P 1LX. Tel:
 (01) 580-7161. Telex: 22345. Mng. Dir.: Irvin C. Pannaman; Sales Mgr.:
 Andrew Bourne; Adv. Mgr.: D. Ubsell. (PKG)
 Video: 2" quad, 1" helical, 1/2" cassette, 1/2" Beta & VHS cassette.
 Ivan Recs. Assocs. (Audio Publ'g) Ltd., 35A Broadhurst Gardens, London
 NW6 3QT. Tel: (01) 624-7785. Mng. Dir.: Ivan Berg. (PKG-audio only)
 Audio: Cassette.
 Bibi Magnetics Ltd., 101/105 Plough Rd., London SW11 2BJ. Tel: (01) 223-
 5955. Telex: 917732. Dir.: K. H. Bourke-Borrowes; Gen. Mgr.: M
 Shepherd.
 Audio: Cassette.
 Bird Sound Studios, 4 Welton Rd., Wedgcock Estate, Warwick CV34 5YA. Tel:
 (0926) 45214. Owner: Sheila L. Bird; Gen. Mgr.: David Rawlings; Sales
 Mgr.: Dave Sheriff; Promo.: Dave Ling.
 Audio: Cassette.
 Harvey Boat, 84 Church St., London NW8. Tel: (01) 724 3711. Chief Exec.:
 Alan Taub.
 Audio: Cassette.
 C B S Mfg. (div. of CBS (UK) Ltd.), 17/19 Soho Square, London W1V 6HE.
 Tel: (01) 734-8181. Cable: COLRECMAN. Telex: 24203. Mng. Dir.: John A.
 Wheeler. (PKG)
 Audio: Cassette.
 C P H Video, 22 Cadogan Court, Draycott Ave., London SW3 3BX. Tel: (01)
 589-8286. Cable: THESPIAN.
 Video: 1/2" Beta & VHS cassette.
 Ca Va Rec'g Studios, 201 St. Vincent St., Glasgow, Scotland. Tel: (041) 221-
 9407. Cable: CAVA. Chief Exec.: Brian Young; Sales Mgr.: Alison Bye;
 Ass't Studio Mgr.: Cy Jack.
 Audio: Cassette.
 Caroline Exports Ltd., 56 Standard Rd., London NW10 6ES. Tel: (01) 961-
 7919. Cable: BUMBLEBEE. Telex: 22164. Gen. Mgr.: Dave Loader.
 Projects Programs: C. Stylianou. (PKG only)
 Cassette Developments (Audiosonic) Ltd., Micra House, 138 Lower Mortlake
 Rd., Richmond, Surrey TW9 2JL. Tel: (01) 940-8186. Cable:
 MICRONETICS. Telex: 8813481. Gen. Mgr. O. Dixon. (PKG)
 Audio: Cassette.
 Cassette Rec'g Co. (UK) Ltd., Unit 2, Riverway, Harlow, Essex CM20 2ON.
 Tel: (0279) 39256. Mng. Dir.: H.L. Collins; Gen. Mgr.: Michael Newton;
 Mktg. Dir.: C.J. Sanford.
 Audio: Cassette
 Castle Studio, 93 Castle Hill Rd., Hindley, Wigan, Lancs. WN2 4BH. Tel:
 (0942) 58777. Chief Exec.: Simon Paul Millard.
 Audio: Cassette, open reel.
 Video: 1/2" cassette, VHS.
 Cintron Group, Grove House, 551 London Rd., Isleworth, Middx. TW7 4DS.
 Tel: (01) 568-0131. Telex: 935054
 Video: 1" helical open reel, 1/2" U-matic, 1/2" Beta & VHS cassette.
 Club Video Ltd., 120 Marlybone Ln., London W1M 5FZ. Tel: (01) 935-2464.
 Telex: 23733.
 Video: 1/2" U-matic, 1/2" VHS.
 Coach House Studio Div./Ice Recs. Ltd., 81 A Osbaldeston Rd., Stamford
 Hill, London N16. Tel: (01) 806-3252. Mng. Dir.: Eddy Grant; Gen. Mgr.:
 Ailigne Grant; Sales Mgr.: Rudolph Grant; Financial Controller: Stan
 Blackburn.
 Audio: Cassette.
 Contek Magnetics Ltd., 90 Walnut Tree Close, Guildford, Surrey GU1 4UJ.
 Tel: (0483) 503222. Telex: 859403. Mng. Dir.: Gerald P. Creagh; Comm'l
 Mgr.: Fred MacDonald
 Audio: Cassette
 Cream Creative Mktg. Ltd., The Cloisters, 11 Salem Rd., London W2. Tel:
 (01) 221-5155. (PKG only-audio & video)
 D T P Inc., 3 Alfred St., Weston-Super-Mare, Avon BS23 1PZ. Tel: (0934)
 21932. Mng. Dir.: Don Todd.
 Audio: Cassette, open reel.
 Video: 1" open reel.
 Damont Recs. Ltd., Blyth Rd., Hayes, Middx. UB3 1BY. Tel: (01) 573 5122.
 Telex: 934076. Mng. Dir.: Monty Presky; Deputy Mng. Dir.: Frank Pearce
 Audio: Cassette
 Decca Rec. Co. Ltd., see Ablex
 Discourses Ltd., 36 Crescent Rd., Tunbridge Wells, Kent TN1 2LZ. Tel:
 (0892) 26397. Mng. Dir.: Robert F. Hardcastle. Gen. Mgr.: Anthony
 James
 Audio: Cassette, open reel.
 Duplitape, 177 Harewood Ave., London NW1. Tel: (01) 724 2497. Telex
 21879. Chief Exec. & Gen. Mgr. B. Lambden; Sales Mgr.: R. Jackson-
 Moore
 Audio: Cassette
 E M I Recs. (UK) Ltd., 1/3 Uxbridge Rd., Hayes, Middx. UB4 0SY. Tel: (01)
 561-8722. Mng. Dir.: R. Lopez; Ass't Dir.: R. Shenton; Special Projects
 Mgr.: D.L. Watson.

Audio: Cassette
 Ellie Jay (Prod'ns) Ltd., 97 Judd St., London WC1. Tel: (01) 388-5771. Mng.
 Dir.: Jack Applebaum; Prod. Mgr.: Andrew Soper; Prod'n Co-Ord.: Paul
 Heeren.
 Audio: Cassette.
 Evangelical Recs., 152 Rowhedge Rd., Rowhedge, Colchester, Essex CO5
 7JP. Tel: (0206) 865769. Dir.: M. Lear.
 Audio: Cassette.
 Folktracass, 2 Fulcril Park, Porlishhead, Bristol BS20 9HQ. Tel:
 (0272) 842209. Dir.: Peter Kennedy.
 Audio: Cassette.
 Fraser-Peacock Assocs. Ltd., 94 High St., Wimbledon Village, London SW19
 5EG. Tel: (01) 947-7551. Dirs.: David R. Tuckman, G.F. Peacock. (PKG)
 Audio: Cassette.
 Free Range Rec'g Studios, 22 Tavistock St., London WC2A 7PH. Tel: (01)
 836-7608. Chief Exec.: Marsha Abson; Gen. Mgr.: D.B. Grisdale; Sales
 Mgr.: Neville Wilks.
 Audio: Cassette.
 Video: 1/2" U-matic cassette, 1/2" Beta & VHS cassette.
 Garrod & Lofthouse Ltd., Chaldon Rd., Caterham-on-the-Hill, Surrey. Tel:
 (Caterham) 45266. Chm. & Mng. Dir.: Norman J. Garrod; Sales Mgr.:
 Christopher Garrod. (PKG only)
 Golden Era Rec'g Ltd., 1099A Finchley Rd., London NW11. Tel: (01) 455-
 6620. Dir.: Bert Wilcox. (PKG)
 Audio: 8-tr., cassette, open reel.
 Grampan Recs. Ltd., Airport Ind'l Estate, Wick, Caithness, Scotland. Tel:
 (0955) 2787. Telex: 75107. Dir.: J. Johnston; Mgr.: John Hunter. (PKG)
 Audio: Cassette.
 H & R, 255 Liscard Rd., Wallasey, Merseyside. Tel: (051) 639-9270. Mng.
 Dir.: David Crosby; Gen. Mgr.: Roger Baskeyfield; Ass't Gen. Mgr.: Peter
 Coleman. (PKG-audio only)
 Audio: Cassette.
 Happy Face Music, The Old Smithy, Post Office Ln., Kempsey, Worcs. WR5
 3NS. Tel: (0905) 820-659, 820-566. Cable: SMITHYSOUND. Chief Exec.:
 Muff Murlin; Gen. Mgr.: V.B. Murlin.
 Video: 1/2" Beta & VHS cassette.
 Harbor Tape Servs. Ltd., 73 Newman St., London W1. Tel: (01) 636-6095.
 Chief Exec.: John Schroeder.
 Audio: Cassette, open reel.
 Video: 1/2" U-matic cassette, 1/2" Beta & VHS cassette.
 Humberstone Studios, Grimsby Rd., Lacey, Grimsby, South Humberside. Tel:
 (0472) 40152, 71582. Chief Exec.: L.A. Johnson.
 Audio: Cassette, open reel.
 I B C Sound Rec'g Studios Ltd., 35 Portland Pl., London W1N 3AG. Tel: (01)
 637-2111. Telex: 264413. Mng. Dir.: John D. Tucker; Technical Dir.:
 Dennis King; Studio Mgr.: Michael Claydon. (PKG)
 Audio: Cassette, open reel.
 Immediate Sound Servs. Ltd., 6 Orsman Rd., London N1 5QJ. Tel: (01) 459-
 9672. Telex: 914382. Mng. Dir.: J.W. Hart. (PKG)
 Audio: 8 tr., cassette.
 Independent Rec. Co., 39 Harmer St., Gravesend, Kent. Tel: (0474) 65687
 Chief Exec.: I.W. Oram.
 Audio: 8 tr., cassette, open reel.
 Industrial Recs. Ltd., 10 Martello St., London E8. Tel: (01) 254-9178. Mng.
 Dir.: Peter Christopherson; Gen. Mgr.: Cosy P. Dridge; Sales Mgr.: David
 Brooks; Gen. Exec.: Joyce Sinclair.
 Audio: Cassette.
 Intervention Video Ltd., McKay Trading Estate, Unit 1, Kensal Rd., London
 W10. Tel: (01) 969-8210. (PKG)
 Video: 1" helical, 1/2" U-matic.
 J S O Group of Cos., 62 Berners St., London W1P 3AG. Tel: (01) 580-4720
 Telex: 261298. Mng. Dir.: Joseph R. Stanley; Gen. Mgr.: N.P.J. Murrey.
 Video: 1" cartridge, 1/2" U-matic cassette, 1/2" EIAJ cartridge.
 K K Tape Servs., Norfolk Street Studio, Norfolk St., Worthing, Sussex. BN11
 4BB. Tel: (0903) 205053.
 Audio: Cassette.
 Kay Labs Ltd., 22 Soho Square, London W1V 5FJ. Tel: (01) 437-7811. Telex:
 28483. (Video only)
 S. Kempner Ltd., 498 Honeyopt Ln., Stanmore, Middx. HA7 1JZ. Tel: (01)
 952-5262. Telex: 21400. Sales Dir.: Paul R.S. Rogers; Sales Mgr.: Aidan
 Coles. (PKG only-audio & video)
 L T S, see London Transcription Servs.
 Leader Sound Ltd., 209 Rochdale Rd., Greetland, Halifax, West Yorks. HX4
 8JE. Tel: (0422) 76161. Mng. Dir.: Bill Leader; Sec'y: Helen Leader.
 Audio: Open reel.
 Leeholme Audio Servs. Ltd., 350-4 Leabridge Rd., Leyton, London E10 7LD.
 Tel: (01) 556-4748. Dir. & Sec'y: Yvonne Holmes; Sales Dir.: Mike Kitson;
 Prod'n Dir.: David West
 Audio: Cassette.
 Linguaphone Institute Ltd., Trading Estate, 252/253 Argyle Ave., Slough,
 Berks. SL1 4HA. Tel: Slough 23200. Telex: 849377. Dir. Mgr.: John King.
 Audio: Cassette.
 London Rec'g Co., 1099A Finchley Rd., London NW11. Tel: (01) 455-6620.
 Chief Exec.: Herb Wilcox
 Audio: 8-tr., cassette, open reel
 Video: 2" quad, 1" helical, 1/2" U-matic cassette, 1/2" Beta & VHS
 cassette.
 London Transcription Servs., 23 Denmark Pl., London WC2H 8NL. Tel: (01)
 836-7148.
 Audio: Cassette, open reel.
 M H G Cassettes/Warm Recs., Daily Rd., Maybole, Ayrshire, Scotland KA19
 7AX. Tel: (0655) 82200. Chm.: Mary Harrison-Goudie; Gen. & Sales Mgr.:
 Rui de Castro. (PKG)
 Audio: Cassette.
 Magnetic Video UK, 1 Perivale Park, Greenford, Middx. Tel: (01) 997-2552.
 Sales Mgr.: J.R. Daly
 Video: 1/2" Beta, VHS & V-2000 videocassette.
 Mayking Recs. Ltd., 57 Portobello Rd., London W11. Tel: (01) 727-2614.
 Chief Exec.: B. Bonnar; Gen. Mgr.: Al Redford.
 Audio: Cassette.
 Metropolitan Communications, 8a Frognaal Gardens, London NW3 6UX. Tel:
 (01) 435-8803. Mng. Dir.: Mark R.F. Hanau; Sales Mgr.: R. Hanau;
 Admin.: A. Lohmeyer
 Audio: Cassette.
 Video: 1/2" cassette.
 Mushroom Studios, 18 W. Mall, Clifton, Bristol BS8 4BG. Tel: (0272) 35994,
 35867. Chief Exec. D. Ackerman; Gen. Mgr.: S.A. Ackerman.
 Audio: 8-tr., cassette, open reel.
 Nelson Rec'g Studio, Nelson House, 93 Castle Hill Rd., Hindley, Wigan,
 Lancs. WN2 4BH. Tel: (0942) 58777. Contacts: S.M. Millard, W. Leyland.
 Audio: Cassette.
 Video: 1/2" cassette, 1/2" VHS cassette
 Old Smyth Rec'g Studio, Old Smyth Post Office Ln., Kempsey, Worcs. Tel:

(0905) 820659. Chief Exec.: Muff Murfin; Gen. Mgr.: Val Biddle; Engs.: Colin Owen, Paul Robbins, Robin Sidebotham
Audio: Cassette
Video: 1/2" Beta & VHS cassette.

P M S Mail Order Handling, The High St., Hatfield Broad Oak, Essex. Tel: (0279) 70671. Telex: 817866. Mgr.: Lynda Murphy. (P&G only)
Pebble Recs. Ltd., 46 Maddox St., London W1. Tel: (01) 629-3266, 491-4140. Telex: 25247. Mng. Dir.: James Pollard, Gen. Mgr.: Julia Sicombe.
Audio: 8-tr., cassette, open reel.

Phonogram Ltd., 50 New Bond St., London W1Y 3HA. Tel: (01) 491-4600. Cable: PHONREC. Telex: 261583. Mng. Dir.: K.M. Maiphant; Mktg. Mgr.: T. Powell; A&R Dir.: B. Shepherd; Tape Mgr.: Roy Wilkins.
Audio: Cassette.

Plant Life Recs. Ltd., Edison Chambers, 109A Barcroft, Hitchin, Herts. Tel: (0462) 58555. Chm. Nigel Pegrum; Gen. Mgr.: Geoffrey Ide; Sales Mgr.: John Garrad.
Audio: 8-tr.

PolyGram Rec. Opns Ltd., Walthamstow Ave., London E4 8SZ. Tel: (01) 527-2300. Telex: 896383. Tech. Dir.: W.W. Bryant; Factory Mgr.: V. Gowland; Tape Prods. Mfg. Mgr.: F.W. Street.
Audio: Cassette.

Production Express Int'l, 19 Kynaston Rd., Bromley, Kent. Tel: (01) 857-2713. Telex: 8813831. Mng. Dir.: Bobbie Dahdi.
Audio: Cassette.

Real Custom, The Camp, Montgomery, Powys SY15 6LU. Tel: (068681) 427 Mgr.: G.R. Davies.
Audio: Cassette.

S R T Prod's Ltd., 987 High Rd., Finchley, London N12. Tel: (01) 446-3218 Mng. Dir.: George Bellamy; Sales Mgr.: Dave Richardson.
Audio: Cassette.

Scorpio Sound Ltd., 19/20 Euston Centre, London NW1 3JH. Tel: (01) 388-0263. Telex: 8814427. Mgr.: Peter Hoskins. (Video only)

Sentinel Recs. (Cornwall) Ltd., Paul, Penzance Cornwall. Tel: (0736) 73246. Telex: 45608. Chief Exec. & Gen. Mgr.: Job Morris.
Audio: Cassette.

September Sound Studios, 38 Knowl Rd., Golar, Muddersfield, West Yorks. HD7 4AN. Tel: (0484) 658895. Mng. Dir.: Stephen Goddard; Eng.: Bob Whiteley.
Audio: Cassette.

Sound, 1 Dgdershaw Mews, Maidenhead, Berks. Tel: (0628) 33011. Mng. Dir.: I.S. Webb; Sales Mgr.: M. Lloyd; Adv. Mgr.: C. McVie.
Audio: Cassette.
Video: 1/2" U-matic cassette, 1/2" VHS cassette.

Soundpost Studios, Firchill House, Portsmouth, Bristol, Avon BS20 9HQ. Tel: (0272) 842209. Dir.: Peter Kennedy.
Audio: Cassette.

Spaceward Ltd., 34-35 Clarendon St., Cambridge CB1 1JP. Tel: (0223) 64263. Mng. Dir.: Gary Lucas.
Audio: Cassette, open reel.
Video: 1/2" cassette, 1/2" Beta & VHS cassette.

Spot Recs. Ltd., 64 S. Molton St., London W1. Tel: (01) 499-7173. Gen. & Studio Mgr.: Kate Hudson. Local Branch: 11A Sharpleshall St., London NW1. Tel: (01) 586-7746.
Audio: Cassette, open reel.
Video: 1" helical.

Simon Stable Promos., 46 Westend, Launton, Oxon. Tel: (08692) 2831. Chief Exec. Simon Stable; Gen. Mgr.: Stephanie De La Bedoyere; Sales Mgr.: Daniel De La Bedoyere; Musical Dir.: Faug Stable. (P&G)
Audio: Cassette

Storm Rec'g Studios, 133 Park Rd., Blackpool, Lancs. FY1 4ET. Tel: (0253) 27357, 23095. Mng. Dir.: Wayne Paulo; Gen. Mgr.: Lenny Harris.
Audio: Cassette.

Strathclyde Video, PO Box 59, Buchanan St., Glasgow, Scotland G2 1LR. Tel: (041) 221-2244. Telex: 779097. Ref. H007.
Audio: Cassette.
Video: 1/2" VHS cassette.

T D Rec'gs, 1 Cleveland Park Crescent, Waltham Forest, London E17. Tel: (01) 520-0414.

T R A D Electronics Sales Ltd., 149B St. Albans Rd., Watford, Herts. WD2 5BB. Tel: (92) 47988. Telex: 262741. Mng. Dir.: J.E. Southard.
Audio: Cassette.

Tape Copying Servs. Ltd., 199A Gloucester Pl., London NW6. Tel: (01) 723-6301. Dirs.: Robert Austin, Linda Curtis, John Grows.
Audio: Cassette.

The Tape Dupl'g Co. Ltd., 4-10 North Rd., Islington, London N7 9HN. Tel: (01) 609-0087. Telex: 264773. Mng. Dir.: Peter Robey. (P&G)
Audio: Cassette.

Television Int'l Opns. Ltd. (TVI), 9-11 Windmill St., London W1P 1HF. Tel: (01) 637-2477. Cable: INCOLOUR. Telex: 2682JB.
Video: 2" quad & helical, 1" helical, 1/2" U-matic cassette, 1/2" Beta & VHS cassette.

Theatre Projects Servs. Ltd. Rec'g Studio, 11/13 Neals Yard, Monmouth St., London WC2. Tel: (01) 836-1168. Cable: THEATRELIT. Telex: 27522. Mng. Dir.: John Ball; Studio Mgr.: Roger Norwood
Audio: Open reel.

Wardour Motion Picture Co. Ltd., 11 Wardour Mews, London W1. Tel: (01) 439-4313. Dirs.: M.J. Sutton, Gen. & Sales Mgr.: Marc Eskenazi. (P&G)
Video: 1/2" VHS cassette.

World of Video 2000 Ltd., Cassette House, 329 Hunslet Rd., Leeds LS10 1NJ. Tel: (0532) 706066. Telex: 55293. Mng. Dir.: Raymond Linton, Colin W. Marler. (P&G—video only)
Video: 1/2" Beta & VHS cassette, 1/2" cassette.

James York Ltd., Oak House, High St. Northleach, Gloucestershire GL54 3ET. Tel: (04516) 666. Telex: 858623, 858933. Chief Exec.: J. Scarlett; Sales Dir.: Peter Fanshawe; Studio Mgr.: Peter Rinne. (P&G)
Audio: Cassette.

TAPE DUPLICATOR/MARKETERS

Metropolitan Communications, 8A Frouga Gardens London NW3 6UX. Tel: (01) 435-8803. Mng. Dir.: Mark R.F. Hanau; Sales Mgr.: R. Hanau; Admin.: A. Lohmeyer.
Labels: Belmont, Talkie Tapes, Venus.
Pebble Recs. Ltd., 46 Maddox St., London W1. Tel: (01) 629-3266, 491-4140. Telex: 25247. Mng. Dir.: James Pollard, Gen. Mgr.: Julia Sicombe.
Label: Sound & Picture (Kuwait).

• **supplies**

CARTRIDGE & CASSETTE PARTS

C S B Ltd., 5/7 Carnaby St., London W1V 1PG. Tel: (01) 439-9281. Telex: 896691. Mng. Dir.: Malafida Hall; Dir. & Prod'n Mgr.: Mike Shaw; Sales Mgr.: Paul Cumming; Int'l: Caroline Lacy-Thompson.
Cosmocord Ltd., Eleanor Cross Rd., Waltham Cross, Herts. EN8 7NX. Tel: Lea Valley 716-666. Cable: ACOS WALTHAM CROSS. Telex: 24294. Mng. Dir.: V.J. Snyer; Sales & Mktg. Dir.: G.E. Brewin.

E M I Tape Ltd., Tape House, Dawley Rd., Hayes, Middx. UB3 1BT. Tel: (01) 573-3888. Cable: EMITAPE LONDON. Telex: 932161. Mng. Dir.: E.A. Naef; Comm'l Controller: P.K. Mitchell; Gen. Sales Mgr.: P. Sollitt; Mktg. Mgr.: M.W. Cross.
Audio: Cassette parts.

Landmark (Precision Mouldings) Ltd., 2 Albion Way, Langford Rd., Biggleswade, Beds. Tel: (0767) 314-231. Telex: 23384. Mng. Dir.: David Ritchie; Prod'n Dir.: George Jardine; Works Dir.: Don Pearson.
Branch: Puttlers Bar, Herts., Deneaway House, Darkes Ln.
Audio: Plastic molded parts.

Musonic, see Ziphurst.

Professional Tapes Ltd., Cassette House, 329 Hunslet Rd., Leeds LS10 1NJ. Tel: (0532) 706066. Telex: 55293. Mng. Dir.: Raymond Linton; Gen. Mgr.: Yusuf Nurgat; Sales Dir.: Colin W. Marler.
Audio: Screws for cassette assembly.

Pyral Magnetics Ltd., Courtlands Rd., Eastbourne, Sussex. Tel: (0323) 638-965. Mng. Dir.: H.J. Hutchings; Sales Mgr.: James Hutchings.
S & B Export Servs., see Ziphurst.

S & B Trading, see Ziphurst.

Thorn Consumer Electronics Ltd., 284 Southbury Rd., Enfield, Middx. EN1 1TJ. Tel: (01) 366-1155. Telex: 263201. Mng. Dir.: R.E. Norman; Sales Dir.: J. Ross; Adv. Mgr.: M.L. Doman.
Audio: Cassette mechanisms.

Ziphurst Ltd., Stylus House, 34/38 Verulam Rd., St. Albans, Herts. AL3 4DF. Tel: (0727) 50611. Telex: 28675. Mng. Dir.: P.H. Blank; Gen. Mgr.: Stephen H. Blank; Sales Dir.: B. Blank; Warehouse Mgr.: D.N. Lever.
Audio: Cassette parts.

EMPTY CARTRIDGES, CASSETTES & REELS

Ablex Ltd. (sub. of Decca Ltd.), Harcourt, Halesfield 14, Telford, Salop TF7 4QR. Tel: (0952) 584131. Telex: 35649. Mgr.: Peter Banks.
Audio: Cassette.

Akar (UK) Ltd., Haslemere Heathrow Estate, Unit 12, Silver Jubilee Way, Hounslow TW4 6NF. Tel: (01) 897-7171. (Video only)
Audiopak/EMI, see Lee.

Avcom Systems Ltd., Newton Works, Stanlake Mews, London W12 7HA. Tel: (01) 749-2201. Cable: CINEPRO. Telex: 892513. Mng. Dir.: Eric R. Bastin; Sales Dir.: Nick Gillerton; Adv. Mgr.: Bridget King.
Audio: Cassette.

C B S Mfg. (div. of CBS (UK) Ltd.), 17/19 Soho Square, London W1V 6HE. Tel: (01) 734-8181. Cable: COLRECOWAN. Telex: 24203. Mng. Dir.: John A. Wheeler.

C S B Ltd., 5/7 Carnaby St., London W1V 1PG. Tel: (01) 439-9281. Telex: 896691. Mng. Dir.: Malafida Hall; Dir. & Prod'n Mgr.: Mike Shaw; Sales Mgr.: Paul Cumming; Int'l: Caroline Lacy-Thompson.
Copel, see Cosmocord.

Cosmocord Ltd., Eleanor Cross Rd., Waltham Cross, Herts. EN8 7NX. Tel: Lea Valley 716-666. Cable: ACOS WALTHAM CROSS. Telex: 24294. Mng. Dir.: V.J. Snyer; Sales & Mktg. Dir.: G.E. Brewin.
Audio: 8-tr., cassette, open reel.
Brand name: Copel.

E M I Tape Ltd., Tape House, Dawley Rd., Hayes, Middx. UB3 1BT. Tel: (01) 573-3888. Cable: EMITAPE LONDON. Telex: 932161. Mng. Dir.: E.A. Naef; Comm'l Controller: P.K. Mitchell; Gen. Sales Mgr.: P. Sollitt; Mktg. Mgr.: M.W. Cross. (Audio & Video)

Fidelipac, see SIS.

Fraser-Peacock Assocs. Ltd., 94 High St., Wembleton Village, London SW19 5EG. Tel: (01) 947-7551. Dir.: David R. Tuckman.
Audio: Cassette.
Video: Cassette.

Landmark (Precision Mouldings) Ltd., 2 Albion Way, Langford Rd., Biggleswade, Beds. Tel: (0767) 314-231. Telex: 23384. Mng. Dir.: David Ritchie; Prod'n Dir.: George Jardine; Works Dir.: Don Pearson.
Branch: Puttlers Bar, Herts., Deneaway House, Darkes Ln.
Audio: 8-tr., cassette.

Lee Eng'g Ltd., Napier House, Bridge St., Walton-on-Thames, Surrey KT12 1AP. Tel: Walton-on-Thames 43124. Cable: LEETECH. Telex: 928475. Mng. Dir.: Thomas Lee; Gen. Mgr.: Chris Welsh; Sales Eng.: J. Trievnor.
Audio: NAB Cartridge.
Brand name: Audiopak/EMI.

Musonic, see Ziphurst.

National Panasonic (UK) Ltd., 300-318 Bath Rd., Slough, Berks. SL1 6JB. Tel: (0753) 34522. Cable: PANASONIC. Telex: 847652. Mng. Dir.: A. Imura; Sales Mgr.: T. Nishigaki; Adv. Mgr.: P. Hamblin.
Branches: Falkirk, Strirlingshire, Scotland, Etna Rd. Tel: (0324) 20821.
Reg'l Sales Mgr.: A. Douglas—Normanton, Wakefield, Yorks., Don Pedro Ave. Tel: (0924) 890980. Reg'l Sales Mgr.: K. Spencer.
Video: 1/2" U-matic, 1/2" VHS cassette, 1/2" EIAJ open reel, 1/2" EIAJ cartridge.
Brand name: Panasonic.

Panasonic, see National Panasonic.

Professional Tapes Ltd., Cassette House, 329 Hunslet Rd., Leeds LS10 1NJ. Tel: (0532) 706066. Telex: 55293. Mng. Dir.: Raymond Linton; Gen. Mgr.: Yusuf Nurgat; Sales Dir.: Colin W. Marler.
Audio: Cassette.

S & B Export Servs., see Ziphurst.

S & B Trading, see Ziphurst.

S I S Ltd., 57 St. Andrews Rd., Northampton NN1 2PB. Tel: (0604) 32965, 30559. Mng. Dir.: D.P.D. Mitchell; Sales Mgr.: I. Brown.
Audio: NAB "A" & "C".
Brand name: Fidelipac.

Scotch, see 3M.

Start, see Tape Dupl'g Co.

The Tape Dupl'g Co. Ltd., Freedex House, 4-10 North Rd., Islington, London N7 9HN. Tel: (01) 609-0087. Telex: 264773. Mng. Dir.: Peter Robey.
Audio: Cartridge, cassette.
Brand name: Start (Italy).

3 M United Kingdom Ltd., PO Box 1, 3M House, Bracknell, Berks. RG12 1JU. Tel: (0344) 26726. Telex: 849371. Mng. Dir.: Donn Osmon; Div. Dir.: P.G. Hutchings; Sales & Mktg. Mgr.: C. Hobbs; Mktg. Co-ord.: P.A. Stockwell-Jones.
Reg'l sales offices: Belfast BT1 5JE, Northern Ireland, 11 Donegall Square S, Edm. Tel: (0232) 42811, 42926—Birmingham B3 3EL, Edmund House, 12-22 Newhall St. Tel: (021) 236-5077—Glasgow G4 0AY, Scotland, 3M House, 9 Canal St. Tel: (041) 332-9622—London SE20 7TR, PO Box 38, Yeoman House, 63 Croydon Rd., Penge. Tel: (01) 659-2323—Manchester M15 4PA, 3M House, 28 Great Jackson St. Tel: (061) 236-8500.
Audio: 8-tr., cassette & open reel.
Video: Open reel, cassette.
Brand name: Scotch.
Ziphurst Ltd., Stylus House, 34/38 Verulam Rd., St. Albans, Herts. AL3 4DF. Tel: (0727) 50611. Telex: 28675. Mng. Dir.: P.H. Blank; Gen. Mgr.: Ste-

phen H. Blank; Sales Dir.: B. Blank; Warehouse Mgr.: D.M. Lever.
Audio: Cassette.
Brand name: Musonic.

ENVELOPES & MAILERS

Barrester Music Co. Ltd., 50 Bute St., Luton, Beds. Tel: (0582) 29335. Mng. Dir.: John Barratt.

C S B Ltd., 5/7 Carnaby St., London W1V 1PG. Tel: (01) 439-9281. Telex: 896691. Mng. Dir.: Malafida Hall; Dir. & Prod'n Mgr.: Mike Shaw; Sales Mgr.: Paul Cumming; Int'l: Caroline Lacy-Thompson.

Clout & Baker Ltd., Chalkin Works, Parkwood Ind'l Estate, Bircholt Rd., Maidstone, Kent. Tel: (0622) 673261. Chm.: D.P. Chalkin; Sales Dir.: John Henry; Works Dir.: Robin Burr.

Ellie Jay (Prod'n) Ltd., 97 Judd St., London WC1. Tel: (01) 388-5711. Mng. Dir.: Jack Applebaum; Prod'n Mgr.: Andrew Soper; Prod'n Co-ord.: Paul Heeren. (Rec. mailers)

Howards Printers (Slough) Ltd. (div. of Tinsley-Robor Group), Mill St., Slough, Berks. Tel: (0753) 32271. (Envelopes only)

Keenpac Polythene Supplies Ltd., Coronation Place, Guildhall Ln., Leicester. Tel: (0533) 20084, 537806.

London Rec'g Co., 1099A Finchley Rd., London NW11. Tel: (01) 455-6620. Chief Exec.: Herb Wilcox.

Sound for Industry Ltd. (div. of MacNeil Press Ltd.), Newhams Row, 175 Bermondsey St., London SE1 3UW. Tel: (01) 403-0044. Cable: SFI. Telex: 883177. Dir.: John E. Moon; Gen. Mgr.: W. Maciejewski.

Robert Stace & Co. Ltd., Chalkin Works, Longfield Rd., Tunbridge Wells, Kent. Tel: (0892) 24225. Cable: 95577. Chm. & Mng. Dir.: P.W. Barker; Ass't Mng. Dir.: A.G. Long; Sales Dir.: D. Brewer.

Wilton Pkg., 2 Ronalds Rd., London N5. Tel: (01) 607-0041. Chief Execs.: Cara Craig, Tony Minton. (Envelopes for 45, LP & videocassette)

JACKETS & SLEEVES

A M C (Associated Mktg. Co.), The High St., Hatfield Broad Oak, Essex. Tel: (0279-70) 671. Telex: 817606. Contacts: Don Morris, Janet Verdon.
Akenmay Print & Pkg. Servs. Ltd., Riverside House, Rye Rd., Hoddesdon, Herts. EN11 0ES. Tel: (61) 42821. Mng. Dir.: J. M. Maciejewski; Works Dir.: A.W. Sknpo.

Album Graphics (UK) Ltd., 2 Goodwin's Court, 55 St. Martin's Ln., London WC2. Tel: (01) 240-1319. Telex: 21879, 25247. UK Rep.: Linda Halpin.
Home office: USA, Chicago, Ill.

Artsteves, 17 Sussex Square, Flat 1, Brighton, Sussex BN2 5AA. Designer: Nigel Goodall. (Sleeves only)

John V. Armstrong Ltd., 142 Charing Cross Rd., London WC2. Tel: (01) 836-8121. (Sleeves only)

Artist Partners Ltd., 14 Ham Yard, Great Windmill St., London W1. Tel: (01) 734-7991. (Sleeves only)

Bird Sound Studios, Welton Rd., Wedgock Estate, Warwick CV34 5YA. Tel: (0926) 45124. Owner: Sheila L. Bird; Gen. Mgr.: David Raynages; Sales Mgr.: Dave Sheriff.

C S B Ltd., 5/7 Carnaby St., London W1V 1PG. Tel: (01) 439-9281. Telex: 896691. Mng. Dir.: Malafida Hall; Dir. & Prod'n Mgr.: Mike Shaw; Sales Mgr.: Paul Cumming; Int'l: Caroline Lacy-Thompson.

Castle Studio, 93 Castle Hill Rd., Hindley, Wigan, Lancs. WN2 4BH. Tel: (0942) 58777. Chief Exec.: Simon Paul Millard. (Sleeves only)

Clout & Baker Ltd., Chalkin Works, Parkwood Ind'l Estate, Bircholt Rd., Maidstone, Kent. Tel: (0622) 673261. Chm.: D.P. Chalkin; Sales Dir.: John Henry; Works Dir.: Robin Burr. (Sleeves only)

Cream Creative Mktg. Ltd., The Cloisters, 11 Salem Rd., London W2. Tel: (01) 221-5155. (LP & Videodisk)

Delga Press Ltd., Dingwall House, 8 Marlborough Rd., Bromley, Kent BR2 9NH. Tel: (01) 460-0112. Telex: 8951346. Mng. Dir.: R.E. Edwards; Gen. Dir.: R.N. Roadnight; Dir.: R.G. Froment; Sales Mgr.: P.H. Grey. (Sleeves only)

Ellie Jay (Prod'n) Ltd., 97 Judd St., London WC1. Tel: (01) 388-5711. Mng. Dir.: Jack Applebaum; Prod'n Mgr.: Andrew Soper; Prod'n Co-ord.: Paul Heeren (45 & LP)

Garrod & Lofthouse Ltd., Chaldon Rd., Caterham-on-the-Hill, Surrey. Tel: (Caterham) 45266. Telex: 262554. Chm. & Mng. Dir.: Norman J. Garrod; Sales Mgr.: Christopher Garrod.

Golden Era Rec'gs Ltd., 1099A Finchley Rd., London NW11. Tel: (01) 455-6620. Dir.: Bert Wilcox. (LP & Videodisk)

E. Hannibal & Co. Ltd., Pinfold Rd., Thurmarston, Leicester. Tel: (0533) 695413. Telex: 34627. Mng. Dir.: Chris Hetherington; Ass't Mng. Dir.: Roger Stewart; Music Dir.: Derek Deighton.

Keenpac Polythene Supplies Ltd., Coronation Place, Guildhall Ln., Leicester. Tel: (0533) 20084, 537806. (Sleeves only—PVC/Polythene type)

London Rec'g Co., 1099A Finchley Rd., London NW11. Tel: (01) 455-6620. Chief Exec.: Herb Wilcox. (LP)

M H G Cassettes/Warm Recs., Daily Rd., Maybole, Ayrshire, Scotland KA19 7AX. Tel: (0655) 82200. Chm.: Mary Harrison-Goudie; Gen. & Sales Mgr.: Rui de Castro. (LP)

Frank S. Manley (Printers) Ltd., 22 Monson Rd., London NW10. Tel: (01) 965-7326. (Sleeves only)

Musonic Ltd., see Ziphurst.

J. Osawa & Co. (UK) Ltd., 10 Forge Court, Reading Rd., Yateley, Camberley, Surrey. Tel: (0252) 875-919. Telex: 858917. Bus. Mgr.: L.G. Roberts (Sleeves only)

P T T Developments Ltd., Fulving Mill Ln., Welwyn, Herts. Tel: (043871) 4088. Chief Exec.: R.C. Byles. (Sleeves only)

Plastic Sales Leicester Ltd., 10/12 Darford Rd., Leicester LE2 2PQ. Tel: (0533) 833-691. Chief Exec.: T.H. Winfield.

Positive Designs, 17 Station Rd., London SE25 5AH. Tel: (01) 771-5777. Chief Exec.: Steve Hutchings; Gen. Mgr.: Dave Lucy; Sales Mgr.: Nick Miller. (LP)

The Presto Copying Serv., The Studio, Gatesden Flats, Cromer St., London WC1. Tel: (01) 837-8660. (Sleeves only)

Production Express Int'l, 19 Kynaston Rd., Bromley, Kent. Tel: (01) 854-2713. Telex: 8813831. Mng. Dir.: Bobbie Dahdi.

Purpac Plastics Ltd., 138 Miles Rd., Epsom, Surrey. Tel: Epsom 21674, 40322. Telex: 925207. Mng. Dir.: J.M. Fuller; Sales Mgr.: M. Pink. (Sleeves only)

Real Custom Prod'n, The Camp, Montgomery, Powys SY15 6LU. Tel: (068681) 427. Chief Exec.: Richard G. Davies; Sales Mgr.: George B. Pryce. (Sleeves only)

Record Company Servs., 1/3 Sedley Pl., London W1R 1HH. Tel: (01) 409-2336. Telecopier: 4081735. Dirs.: E.J. Foster, A.C. Watling-Darrell. (Sleeves only)

Robor Ltd. (div. of Tinsley-Robor Group), Churchill Ind'l Estate, Lancing, Sussex BN15 8TX. Tel: (09063) 5381. (Sleeves only)

S & B Export Servs., see Ziphurst.

S & B Trading, see Ziphurst.

S R T Rec. Prod'n Ltd., 987 High Rd., Finchley, London N12. Tel: (01) 446-3218. Mng. Dir.: George Bellamy; Gen. Mgr.: J. Townsend; Sales Mgr.: Dave Richardson. (Sleeves only)

Senol Printing Ltd., 4 Hardwicks Way, London SW18 4AJ. Tel: (01) 874 5775. Mng. Dir.: M.M. Gunn; Dirs.: P.L. Smith; J.H. Rolfe.
Shannon Dist'n Ltd., 30 Holloway Rd., London N7. Tel: (01) 607-8544/3838. (Sleeves only)

Shorewood Packaging Co. Ltd., College Rd., Aston Clinton, Bucks. HP2 5EZ. Tel: (0296) 630421. Telex: 83495. Gen. Mgr.: Denis Rex; Sales Mgr.: Lionel G. Rose; Works Mgr.: Reg Ward.
Home office: USA, New York, N.Y.

Robert Stace & Co. Ltd., Chalkin Works, Longfield Rd., Tunbridge Wells, Kent. Tel: (0892) 24225. Telex: 95577. Chm. & Mng. Dir.: P.W. Barker; Ass't Mng. Dir.: A.G. Long; Sales Dir.: D. Brewer.
Storm Rec'g Studios, 133 Park Rd., Blackpool, Lancs. FY1 4ET. Tel: (0253) 23095, 27357. Mng. Dir.: Wayne Paulo; Gen. Mgr.: Lenny Harris. (Sleeves only)

Studio G, 195 Wardour St., London W1. Tel: (01) 734-5784. (Sleeves only)
Tinsley-Robor Mfg. Ltd. (div. of Tinsley-Robor Group), Tinsley House, 67 Rosoman St., London EC1. Tel: (01) 278-2726. (Sleeves only)
James Upton Ltd. (div. of Tinsley-Robor Group), 98-138 Barford St., Birmingham B5 6AP. Tel: (021) 692-1171. (Sleeves only)
Vintage Jazz Music Society Recs., 12 Slough Ln., Kingsbury, London NW9 8QL. Tel: (01) 205-2587. Partners: Steve Lane, Trevor Benwell, John Wadley; Sec'y: Steve Lane. (LP only)
Wardour Motion Picture Co. Ltd., 11 Wardour Mews, London W1. Tel: (01) 439-4313. Dr.: M.J. Sutton; Gen. & Sales Mgr.: Christie Gillingham.
West Bros. Printers Ltd., 12 Milton Rd., Aylesbury, Bucks. Tel: (0296) 23211. Telex: 837216. Mng. Dir.: Peter G. West; Gen. Mgr.: H.E.V. Pinell; Sales Mgr.: Derek Higgs.
P. G. Wood & Son (Printers) Ltd., 32 Church St., Dagenham, Essex RM10 9UU. Tel: (01) 595-5115. Telex: 897417. Mng. Dir.: Peter Wood; Gen. Mgr.: Chris Sanford; Sales Mgr.: Phil Douglas; Works Mgr.: Greg Bell.
Xanadu Construction & Mechanical Eng's., 79 Fitzneal St., East Acton, London W12. Tel: (01) 743-3402. Mng. Dir.: Paul Gadd; Co-Dir. & Sales Mgr.: Don Arden; Gen. Mgr.: Jeff Lynne. (Sleeves only)
Ziphurst Ltd., Stylus House, 34/38 Verulam Rd., St. Albans, Herts. AL3 4DF. Tel: (0727) 50611. Telex: 28675. Mng. Dir.: P.H. Blank; Gen. Mgr. Stephen H. Blank; Sales Dir.: B. Blank; Warehouse Mgr.: D.N. Lever. (Sleeves only)

LABELS, DISK

A M C (Associated Mktg. Co.), The High St., Halford Broad Oak, Essex. Tel: (0279-70) 671. Telex: 817606. Contacts: Don Morris, Janet Verdon.
John V. Armstrong Ltd., 142 Charing Cross Rd., London WC2. Tel: (01) 836 8121.

Bird Sound Studios, Welton Rd., Wedgock Estate, Warwick CV34 5YA. Tel: (0926) 45124. Owner: Sheila L. Bird; Gen. Mgr.: David Rawlings; Sales Mgr.: Dave Sheriff.

C S B Ltd., 5/7 Carnaby St., London W1V 1PG. Tel: (01) 439-9281. Telex: 896691. Mng. Dir.: Malinda Hall; Dir. & Prod'n Mgr.: Mike Shaw; Sales Mgr.: Paul Cumming; Int'l: Caroline Lacy-Thompson.
Cassette & Rec. Servs., Eastcotts Rd., Bedford. Tel: (0234) 56317. Mng. Dir.: P.J. Norbury; Works Dir.: P. Moore.

L. A. Cousins & Co. Ltd., 26 Grosvenor Ave., Hackney, London E8. Tel: (01) 985-4211. Owner: L.A. Cousins; Gen. Mgr.: S. Franks.
Cream Creative Mktg. Ltd., The Cloisters, 11 Salem Rd., London W2. Tel: (01) 221-5155. (45 & LP)

Delga Press Ltd., Dingwall House, 8 Marlborough Rd., Bromley, Kent BR2 9NH. Tel: (01) 460-0112. Telex: 8951346. Mng. Dir.: R.E. Edwards; Gen. Dir.: R.N. Roadnight; Dir.: R.G. Froment; Sales Mgr.: P.H. Serry.
Ellie Jay (Prod'n) Ltd., 97 Judd St., London WC1. Tel: (01) 388-5771. Mng. Dir.: Jack Applebaum; Prod. Mgr.: Andrew Soper; Prod'n Co-Ord.: Paul Heeren (45 & LP)

Garrod & Lofthouse Ltd., Chaldon Rd., Caterham-on-the-Hill, Surrey. Tel: (Caterham) 45266. Telex: 262554. Chm. & Mng. Dir.: Norman J. Garrod; Sales Mgr.: Christopher Garrod.

Golden Era Rec'g Ltd., 1099-A Finchley Rd., London NW11. Tel: (01) 455-6620. Dir.: Bert Wilcox. (45 & LP)
E. Hannibal & Co. Ltd., Pinfold Rd., Thurston, Leicester LE4 8AP. Tel: (0533) 695413. Telex: 34627. Mng. Dir.: Chris Hetherington; Ass't Mng. Dir.: Roger Stewart; Music Dir.: Derek Dighton.

Harrison & Sons (London) Ltd., Printing House Ln., Hayes, Middx. UB3 1HQ. Tel: (01) 573-3828. Telex: 23744. Mng. Dir.: J.A. Modlock; Comm'l Dir.: B.L. Hibbitt; Sales Dir.: D.S. Robinson; Prod. Mgr.: M.S. Fitzgerald.
John Meyer Paper Ltd., 72 Fleet St., London EC4Y 1JL. Tel: (01) 353-0541. Cable: HEYPAPER. Chm.: John M. Meyer. (Paper manufacturer)

London Rec'g Co., 1099A Finchley Rd., London NW11. Tel: (01) 455-6620. Chief Exec.: Herb Wilcox. (45, LP)
M H G Cassettes/Warm Recs., Daily Rd., Maybole, Ayrshire, Scotland KA19 7AX. Tel: (0655) 82200. Chm.: Mary Harrison-Goudie; Gen. & Sales Mgr.: Rui de Castro. (45, LP)

Frank S. Manley (Printers) Ltd., 22 Monson Rd., London NW10. Tel: (01) 965-7326.

I. Markovits Ltd., 1/2/3 Cobbold Mews, London W12. Tel: (01) 743-1131. Cable: NAMEPLATE. Mng. Dir.: I. Markovits; Dir.: T.P. Johnstone.
Positive Designs, 17 Station Rd., London SE25 5AH. Tel: (01) 771-5777. Chief Exec.: Steve Hutchins; Gen. Mgr.: Dave Lucy; Sales Mgr.: Nick Miller. (45, LP)

The Presto Copying Serv., The Studio, Gatesden Flats, Cromer St., London WC1. Tel: (01) 837-8660.
Production Express Int'l, 19 Kynaston Rd., Bromley, Kent. Tel: (01) 857-2713. Telex: 8813831. Mng. Dir.: Bobbie Dahki.

Real Custom Prod'n, The Camp, Montgomery, Powys SY15 6LU. Tel: (068681) 427. Chief Exec.: Richard G. Davies; Sales Mgr.: George B. Price.

Record Company Servs., 1/3 Sedley Pl., London W1R 1HH. Tel: (01) 409 2336. Telex: 4081735. Dirs.: E.J. Foster, A.C. Watling-Darrell.
S R T Rec. Prod'n Ltd., 987 High Rd., Finchley, London N12. Tel: (01) 446-3218. Mng. Dir.: George Bellamy; Gen. Mgr.: J. Townsend; Sales Mgr.: Dave Richardson.

Shalford Press Ltd., 85b Bradford St., Baintree, Essex CM7 6AU. Tel: (0376) 21125. Mng. Dir.: R. Capon. (45 & LP)
Shannon Dist'n Ltd., 30 Holloway Rd., London N7. Tel: (01) 607-8544/3828.

Smith Press (Raynes Park) Ltd., 36 W. Barnes Ln., London SW20. Tel: (01) 946-8781.
Robert Stace & Co. Ltd., Chalkin Works, Longfield Rd., Tunbridge Wells, Kent. Tel: (0892) 24225. Telex: 95577. Chm. & Mng. Dir.: P.W. Barker; Ass't Mng. Dir.: A.G. Long; Sales Dir.: D. Brewer.

Storm Rec'g Studios, 133 Park Rd., Blackpool, Lancs. FY1 4ET. Tel: (0253) 23095, 27357. Mng. Dir.: Wayne Paulo; Gen. Mgr.: Lenny Harris.
Tinsley-Robor Labels Ltd. (div. of Tinsley-Robor Group), 31 Rea St. S., Birmingham B5 6LB. Tel: (021) 692-1171.

Tinsley-Robor Mfg. Ltd. (div. of Tinsley-Robor Group), Tinsley House, 67 Rosoman St., London EC1. Tel: (01) 278-2726.

Vintage Jazz Music Society Recs., 12 Slough Ln., Kingsbury, London NW9 8QL. Tel: (01) 205-2587. Partners: Steve Lane, Trevor Benwell, John Wadley; Sec'y: Steve Lane. (LP only)
West Bros. Printers Ltd., 12 Milton Rd., Aylesbury, Bucks. Tel: (0296) 23211. Telex: 837216. Mng. Dir.: Peter G. West; Mng. Dir.: H.E.V. Pinell; Sales Mgr.: Derek Higgs.

P. G. Wood & Son (Printers) Ltd., 32 Church St., Dagenham, Essex RM10 9UU. Tel: (01) 595-5115. Telex: 897417. Mng. Dir.: Peter Wood; Gen. Mgr.: Chris Sanford; Sales Mgr.: Phil Douglas; Works Mgr.: Greg Bell.
Xanadu Construction & Mechanical Eng's., 79 Fitzneal St., East Acton, London W12. Tel: (01) 743-3402. Mng. Dir.: Paul Gadd; Co-Dir. & Sales Mgr.: Don Arden; Gen. Mgr.: Jeff Lynne.

POLYETHYLENE BAG & SHRINKWRAP MANUFACTURERS

Audio + Video Ltd., 48 Charlotte St., London W1P 1LX. Tel: (01) 580-7161. Telex: 22345. (Shrinkwrap only)
C S B Ltd., 5/7 Carnaby St., London W1V 1PG. Tel: (01) 439-9281. Telex: 896691. Mng. Dir.: Malinda Hall; Dir. & Prod'n Mgr.: Mike Shaw; Sales Mgr.: Paul Cumming; Int'l: Caroline Lacy-Thompson. (Polybags only)

Keenpac Polythene Supplies Ltd., Coronation Pl., Guildhall Ln., Leicester. Tel: (0533) 20084, 537806. (Polybags only)
S. Kemper Ltd., 498 Honeyput Ln., Stanmore, Middx. HA7 1JZ. Tel: (01) 952-5262. Telex: 21400. Sales Dir.: Paul R.S. Rogers; Sales Mgr.: Aidan Coles.

Lindsey's Colour Serv., 88 Teesdale St., London E2. Tel: (01) 729-5462. Mng. Dir.: Ray Mack; Sales Dir.: David Wall. (Polybags only)
M & G Packaging (Essex) Ltd., 53 Pavilion Dr., Leigh-on-Sea, Essex. Tel: (0702) 712-381. Mng. Dir.: M.H. Goldring. (Polybags only)
Musonic Ltd., see Ziphurst.

Pinnacle Recs., 9 Dean St., London W1. Tel: (01) 734-4543. Telex: 896141. Orpington. Chm.: Terry Scully; Gen. Mgr.: Tony Berry; Sales Mgr.: George Holloway. (Polybags only)
Plastic Sales Leicester Ltd., 10/12 Dartford Rd., Leicester LE2 2PQ. Tel: (0533) 833-691. Chief Exec.: T.H. Winfield. (Polybags only)

Robor Ltd. (div. of Tinsley-Robor Group), Churchill Ind'l Estate, Lancing, Sussex BN15 8TX. Tel: (09063) 5381. (Polybags only)
S & B Export Servs., see Ziphurst.
S & B Trading, see Ziphurst.

Shannon Dist'n Ltd., 30 Holloway Rd., London N7. Tel: (01) 607-8544/3828. (Polybags only)
Simon Stable Promos, 46 West End, Launton, Oxfordshire. Tel: (08692) 2831. Mng. Dir.: Count S.C. de la Bedoyere; Gen. Mgr.: Judy Dyble; Sales Mgr.: Simon Stable. (Shrinkwrap only)

Robert Stace & Co. Ltd., Chalkin Works, Longfield Rd., Tunbridge Wells, Kent. Tel: (0892) 24225. Telex: 95577. Chm. & Mng. Dir.: P.W. Barker; Ass't Mng. Dir.: A.G. Long; Sales Dir.: D. Brewer. (Polybags only)
James Yorkie Ltd., Oak House, High St., Northleach, Gloucestershire GL54 3ET. Tel: (04516) 666. Telex: 858623, 858393. Chief Exec.: J. Scarlett; Sales Dir.: Peter Fanshawe; Studio Mgr.: Peter Rinne. (Shrinkwrap only)

Ziphurst Ltd., Stylus House, 34/38 Verulam Rd., St. Albans, Herts. AL3 4DF. Tel: (0727) 50611. Telex: 28675. Mng. Dir.: P.H. Blank; Gen. Mgr.: Stephen H. Blank; Sales Dir.: B. Blank; Warehouse Mgr.: D.N. Lever. (Polybags only)

PROFESSIONAL TAPE SUPPLIES
A T (Associated Tape Ltd.), 214 Bowes Rd., Southgate, London N11. Tel: (01) 368-2309. (Importer)
Audio: Automatic 8-tr. changer.
Brand name: Telex.

Amos of Exeter Ltd., Weircliffe Court, Exwick, Exeter, Devon. EX4 2AG. Tel: (0392) 72-132. Cable: AMOS EXETER. Telex: 42786. Mng. Dir.: R.E. Amos
Audio & Video: Bulk tape erasers.
Brand name: Weircliffe.

Balkantine Advertising, 11 Talbot Square, London W2. Tel: (01) 723-4439
Audio: Cassette labels.
Cream Creative Mktg. Ltd., The Cloisters, 11 Salem Rd., London W2. Tel: (01) 221-5155.
Audio: Cassette labels.
Video: Cassette labels.

Editall, see Scenic Sounds.
Ellie Jay (Prod'n) Ltd., 97 Judd St., London WC1. Tel: (01) 388-5771. Mng. Dir.: Jack Applebaum; Prod'n Mgr.: Andrew Soper; Prod'n Co-ord.: Paul Heeren.
Audio: Cassette labels.
Video: Cassette labels.

A. C. Farrell Ltd., Kenyon Ltd., Sheffield S1 4BD. Tel: (0742) 78901.
Audio: Bulk erasers.
Format (Sussex) Ltd. (div. of Tinsley-Robor Group), Jubilee Rd., Burgess Hill, Sussex. Tel: (0446) 45245.
Audio: Cassette inlay cards.

Golden Era Rec'g Ltd., 1099-A Finchley Rd., London NW11. Tel: (01) 455-6620. Dir.: Bert Wilcox.
Audio: Cassette labels.
K K Tape Servs., Norfolk Street Studio, Norfolk St., Worthing, Sussex. BN11 4BB. Tel: (0903) 205053.
Audio: Cassette labels.

Lindsey's Colour Serv., 88 Teesdale St., London E2. Tel: (01) 729-5462. Mng. Dir.: Ray Mack; Sales Dir.: David Wall.
Audio: Cassette labels.
Video: Cassette labels.

M H G Cassettes/Warm Recs., Daily Rd., Maybole, Ayrshire, Scotland KA19 7AX. Tel: (0655) 82200. Chm.: Mary Harrison-Goudie; Gen. & Sales Mgr.: Rui de Castro.
Audio: Cassette labels.
Positive Designs, 17 Station Rd., London SE25 5AH. Tel: (01) 771-5777. Chief Exec.: Steve Hutchins; Gen. Mgr.: Dave Lucy; Sales Mgr.: Nick Miller.
Audio: Cassette labels.

Robor Ltd. (div. of Tinsley-Robor Group), Churchill Ind'l Estate, Lancing, Sussex BN15 8TX. Tel: (09063) 5381.
Video: Packaging materials.
S S E, see Scenic Sounds.
Scenic Sounds Equip., 97-99 Dean St., London W1. Tel: (01) 734-2812. Telex: 27939.
Audio: Splicing & editing equip.
Brand names: Editall, SSE, Xedit.

Scotch, see 3M.
Shalford Press Ltd., 85b Bradford St., Baintree, Essex. Tel: (0376) 21125. Mng. Dir.: R. Capon.
Audio: Cassette labels.
Telex, see AT.

Tinsley-Robor Labels Ltd. (div. of Tinsley-Robor Group), 31 Rea St. S., Birmingham B5 6LB. Tel: (021) 692-1171.
Audio: Cassette labels.

Vintage Jazz Music Society Recs., 12 Slough Ln., Kingsbury, London NW9 8QL. Tel: (01) 205-2587. Partners: Steve Lane, Trevor Benwell, John Wadley; Sec'y: Steve Lane.

Audio: Cassette labels.
Weircliffe, see Amos of Exeter.
Xedit, see Scenic Sounds.
James Yorkie Ltd., Oak House, High St., Northleach, Gloucestershire GL54 3ET. Tel: (04516) 666. Telex: 858623, 858393. Chief Exec.: J. Scarlett; Sales Dir.: Peter Fanshawe; Studio Mgr.: Peter Rinne.
Audio: Cassette labels.

RECORD MANUFACTURING EQUIPMENT
Han-O-Disc, see Metropolitan.
Lened, see Professional Tape.
Metropolitan Communications, 8A Frogna Gardens, London NW3 6UX. Tel: (01) 435-8803. Mng. Dir.: Mark R.F. Hanau.
Chief product: Assembly machines, 10K & MKII welders.
Brand name: Han-O-Disc.

Professional Tape Mktg. Assoc. Ltd., Cassette House, 57 Manor Park Cres. Cent, Edgware, Middx. Tel: (01) 951-0488. Telex: 945309. Mng. Dir.: Ray Linton; Gen. Mgr.: Roger Morley.
Chief product: Automatic presses.
Brand name: Lened

P. & J. Sibert & Co., 161 Finborough Rd., West Brompton, London SW10 9AP. Tel: (01) 373-9509. (sales) 330-0770. Technical Sales: Alan & Paul Sibert.
Chief product: Optical automatic center press, eccentricity testing equipment (stamps & pressings), record stylus & groove inspection equipment, optical de-clicking unit, warp & centricity record tester w/digital display, stamper trimmer cuts 6" 14" diameter.
Brand name: Optical Auto Record Cent Press, Optical Record Centricity Test Table, Record Stylus Photo Microscope, Record Pressing Centricity Tester, Stamper Trimmer, De-Clicking Turntable & Stereo Microscope, Record Warp & Centricity Digital-Display Tester. (SEE ADVERTISEMENT)

TAPE, BLANK LOADED & BULK RAW
Ablex Ltd. (sub. of Decca Ltd.), Harcourt, Halesfield 14, Telford, Salop TF7 4QR. Tel: (0952) 584131. Telex: 35649. Mgr.: Peter Banks.
Audio: Cassette.
Brand name: Decca
Acoustic Dynamic, see TDK.

Adastra Electronics Ltd., Cricklewood Trading Estate, Unit N22, Clarendon Rd., London W12 1TU. Tel: (01) 452-6288. Cable: WESTQUIP. Mgr. Mr.: Michael Leaver; Gen. & Sales Mgr.: B. Marks.
Audio: Cassette, open reel.
Brand name: Synacassette, Synchronape

Agla-Gevaert Ltd., 27 Great West Rd., Brentford, Middx. TW8 9AX. Tel: (01) 560-2131. Cable: ARTOVEG. Telex: 28154. Mng. Dir.: R. P. Dickinson; Magnetic Prods. Div.: W. M. Way; Mktg. Mgr.: E.A. Bowden.
Home office: Germany.
Audio: Blank—Cassette, open reel; Raw—cassette.
Video: Blank—"1" open reel, "4" cassette

Anwa Sales & Serv. (UK) Ltd., 30/32 Concord Rd., Westwood Park Trading Estate, Westing Ave., London W3 0TH. Tel: (01) 993-1672. Telex: 936239. Mng. Dir.: S.R. Chorley; Sales Mgr.: D.J. Wright; Adv. & Press Officer: T.D. Spuro.
Ampex Great Britain Ltd., Acire Rd., Reading, Berks. RG2 0QR. Tel: (0734) 85200. Cable: AMPLEX READING. Telex: 847611. Gen. Mgr.: W. Scullion; Tape Sales Mgr.: J. Cripps; Adv. Mgr.: P. Vaughan.
Audio: 2", 1", cassette, open reel.
Video: 2" broadcast, 1" open reel, "4" U-matic cassette, "4" Beta & VHS cassette

Audio Logic Ltd., 34-36 Crown St., Reading, Berks. RG1 2SN. Tel: (0734) 595647. Dir.: Martin Maynard; Gen. Mgr.: Mary Thomas; Sales Mgr.: Henry Smithson. (Blank only)
Audio: Cassette.
Audio Gold Int'l., see Context.

Audio Magnetics Inc. (UK) Ltd., 121 Loverock Rd., Reading, Berks. RG3 1JZ. Tel: (0734) 598036. Telex: 849113. Mng. Dir.: Nigel W. Bryden; UK Sales Mgr.: Hugh Smith.
Audio: 8-tr. cassette, open reel.
Audiopak/EMI, see Lee Eng'g.

Audiosonic, see Cassette Developments.
Audua, see TDK.
Avcom Systems Ltd., Newton Works, Staniake Mews, London W12 7HA. Tel: (01) 749-2201. Cable: CINEPRO. Telex: 892513. Mng. Dir.: Eric R. Bastin; Sales Dir.: Nick Gilmore; Adv. Mgr.: Bridget King. (Blank only)
Audio: Cassette (cotton lengths).

B A S F UK Ltd., 4 Fitzroy Square, London W1P 5AD. Tel: (01) 388-4200. Telex: 28649. Dir. Mgr.: H.C. Pattinson; Prof. Prods. Mgr.: R.M. Hine. (Blank only)
Audio: 2", 1", cassette, open reel.
F W O. Bauch Ltd., 49 Theobald St., Boreham Wood, Herts. Tel: (01) 953-0091. Telex: 27502. Mng. Dir.: John Bauch; Sales Mgr.: Vaughan Waller; Press Officer: David Neal.
Audio: Open reel.
Brand name: Revox.

Bibi Magnetics Ltd., 101/105 Plough Rd., London SW11 2BI. Tel: (01) 223-5955. Telex: 917732. Dir.: K. H. Bourke-Borrowes; Gen. Mgr.: M. Shepherd.
Audio: Cassette.
Harvey Bust, 84 Church St., London NW8. Tel: (01) 724-3711. Chief Exec.: Alan Taub.
Audio: Cassette
Brand name: Miles Gregory

C P H Video, 22 Cadogan Court, Draycott Ave., London SW3 3BX. Tel: (01) 589-8286. Cable: THESPIAN.
Video: "4" Beta & VHS cassette
Cambrasound Ltd., Freeder House, 4/10 North Rd., Islington, London N7 9HN. Tel: (01) 607-8141. Cable: METROS G. Telex: 264773. Mng. Dirs.: David Mason, Peter Eden, Sales Mgr.: Peter Welsh. (Blank only)
Audio: Cassette.
Brand name: Cambra.

Capitol Magnetics (div. of EMI Tape Ltd.), Tape House, Dawley Rd., Hayes, Middx. UB3 1BT. Tel: (01) 573-7860. Cable: EMITAPE. London. Tel: 932161. Mng. Dir.: E.A. Naef; Gen. Mgr.: P. Solitt.
Audio: 8-tr., Cassette, open reel.
Brand name: Blank—The Master Tape, raw—Capitol

Captain Video, 665 Fulham Rd., London SW6. Tel: (01) 736-7411. Telex: 8953552. Dir.: Bruce Higgin; Gen. Mgr.: R. Barkley-Smith. (Blank only)
Video: "4" VHS cassette.
Cassette Chrome, see Simon Stable.

Cassette Developments (Audiosonic) Ltd., Micra House, 138 Lower Mortlake Rd., Richmond, Surrey TW9 2JZ. Tel: (01) 940-8186. Cable: MICRO-NETICS. Telex: 8813481. Gen. Mgr.: D. Dixon.

- Audio:** Cassette.
Brand name: Audiosonic.
 Cassette Rec'g Co. (UK) Ltd., Unit 2, Rverway, Harlow, Essex CM20 2DN. Tel: (0279) 39256. Mng. Dir.: H.L. Collins; Gen. Mgr.: Michael Newton; Mktg. Dir.: C.J. Sanford. (Blank only)
Audio: Cassette
 David Cavalier Ltd., 75 Holloway Rd., London N7 3JZ. Tel: (01) 359-5305
 Telex: 21120. Pres.: David Cavalier. (Blank only)
Audio: Cassette, open reel.
Brand name: Yashima.
 Certron, see Laitex.
 Cloud 9 Video, ISD, Stoggate Ln., Simonswood, Liverpool L33 4YA. Tel: (051) 548-9690. Mng. Dir.: Mike Glasspole; Prod'n Dir.: Dave Roylance. (Blank only)
Video: 4" VHS Cassette.
Brand name: Studio Plus.
 Contek Magnetics Ltd., 90 Walnut Tree Close, Guildford, Surrey GU1 4UJ. Tel: (0483) 503222. Telex: 859403. Mng. Dir.: Gerald P. Creagh; Comm'l Mgr.: Fred MacDonald.
Audio: Cassette.
Brand name: Audio Gold Int'l, Contek UHE.
 D & B Tape Servs., 23 Croydon Rd., Reigate, Surrey RH2 0LY. Tel: 49505. Owner: E.G. Dowley.
Audio: 8-tr., cassette, broadcast.
 Decca, see Ablex & Selecta.
 Duplitape, 1/7 Harewood Ave., London NW1. Tel: (01) 724-2497. Telex: 21879. Chief Exec. & Gen. Mgr.: B. Lambden; Sales Mgr.: R. Jackson Moore. (Blank only)
Audio: Cassette.
Brand name: ITD.
 Dynamic, see TDK.
 E M 1 Tape Ltd., Tape House, Dawley Rd., Hayes, Middx. UB3 1BT. Tel: (01) 573-3888. Cable: EMITAPE LONDON. Telex: 832161. Mng. Dir.: E.A. Naef; Comm'l Controller: P.K. Mitchell; Gen. Sales Mgr.: P. Solitt; Mktg. Mgr.: M.W. Cross.
Audio: 2", 1", 8-tr., cassette, open reel.
Video: Blank-4" Beta & VHS cassette.
 Eagle Int'l, Precision Centre, Heather Park Dr., Wembley, Middx. HA0 1SU. Tel: (01) 902-8832. Cable: EAGLINT. Telex: 922131. Mng. Dir.: W. Morrow; Mktg. Dir.: R. Woolf.
Audio: Cassette.
Brand name: New Int'l.
 Ferrotape, see North East Audio.
 Fidelipac, see SIS Rec'g.
 Fraser Peacock Assocs. Ltd., 94 High St., Wimbledon Village, London SW19 5EG. Tel: (01) 947-7551. Drs.: David R. Tuckman, G.F. Peacock. (Blank only)
Audio: Cassette.
 Fuji, see Pyret.
 Golding Audio Ltd., 26 Hythe Quay, Colchester, Essex. Tel: (0206) 77224. Mng. Dir.: A.B. Golding; Dir.: D.P. Golding; Gen. Mgr.: P. Walsh; Sales Mgr.: R.K. Golding. (Blank only)
Audio: 8-tr., cassette.
 Grampan Recs. Ltd., Airport Ind'l Estate, Wick, Cuthness, Scotland. Tel: (0955) 2787. Telex: 75707. Dir.: J. Johnston; Mgr.: John Hunter. (Blank only)
Audio: Cassette.
 I T D, see Duplitape.
 International Video Corp. (UK) Ltd., 10 Portman Rd., Reading, Berks. RG3 1JR. Tel: (0734) 585421. Cable: INTERVIDEO. Telex: 847579.
Video: 2" & 1" open reel.
 J S D Entis, 62 Berners St., London W1P 3AE. Tel: (01) 580-4720. Telex: 261298. Chm.: J. Stanley; Gen. Mgr.: E.J. Wilding.
Video: 4" U-matic cassette, 4" Beta & VHS cassette.
 J V C (UK) Ltd., Staples Corner, London NW2 7AF. Tel: (01) 450-2621. Telex: 923320. Mng. Dir.: Kurt Lowy; Sales Dir.: G. Barr; Adv. & Press Officer: Geoff Fleming.
Video: 4" VHS cassette.
 Laitex & Co. Ltd., Laitex House, 1 Canal St., Manchester M60 4AX. Tel: (061) 236 8186. Cable: ALMIGHTY. Telex: 669431. Drs.: R.J. Mulchand, K.C. Bhavnani. (Blank only)
Audio: Cassette.
Brand names: Certron, Monatone, Winthronics.
 Lee Eng'g Ltd., Napier House, Bridge St., Walton-on-Thames, Surrey KT12 1AP. Tel: Walton-on-Thames 43124. Cable: LEETECH. Telex: 928475. Mng. Dir.: Thomas Lee; Gen. Mgr.: Chris Welsh; Sales Eng.: J. Trevnor. (Raw only)
Audio: 2", 1", 8-tr., cassette, open reel.
Brand name: Audiotape/EMI.
 London Rec'g Co., 1099A Finchley Rd., London NW11 Tel: (01) 455-6620
 Chief Exec.: Herb Wilcox
Audio: Cassette, open reel.
 The Master Tape, see Capitol.
 Mayfair, see Professional Tapes
 Media Sound, see Metropolitan Communications.
 Memorex (UK) Ltd., Memorex House, 94-106 Church St., Staines, Middx. TW18 4XU. Tel: Staines 51488. Cable: MRXLON. Telex: (851) 935013. Mng. Dir.: M. Kitching; Gen. Mgr.: James W. Dulgar; Sales Mgr.: L. Galton. (Blank only)
Audio: Cassette
Video: 4" Beta & VHS cassette.
 Metropolitan Communications, 84 Frogna Gardens, London NW3 6UX. Tel: (01) 435-8803. Mng. Dir.: Mark R.F. Hanau; Sales Mgr.: R. Hanau; Adm'n.: A. Lohmeyer. (Blank only)
Audio: Cassette.
Brand name: Media Sound.
 Miles Gregory, see Harvey Buat
 Monatone, see Laitex.
 Musonic, see Ziphurst
 National Panasonic (UK) Ltd., 300-318 Bath Rd., Slough, Berks. SL1 6JB. Tel: (0753) 34522. Cable: PANASONIC. Telex: 847652. Mng. Dir.: A. Imura; Sales Mgr.: T. Nishigaki; Adv. Mgr.: P. Hamblin. (Blank only)
 Branches: Falkirk, Stirlingshire, Scotland, Etna Rd. Tel: (0324) 20821.
 Reg'l Sales Mgr.: A. Douglas-Normanton, Wakefield, Yorks., Don Pedro Ave. Tel: (0924) 890980. Reg'l Sales Mgr.: K. Spencer
Video: 4" U-matic cassette, 4" VHS cassette, 4" EIAJ open reel, 4" EIAJ cartridge
Brand name: Panasonic
 New Int'l, see Eagle.
 North East Audio Ltd., Simonside Works, South Shields, Tyne & Wear NE34 9NX. Tel: (0632) 566321. Mng. Dir.: A.J. Hellwell; Gen. Mgr.: Tom Batey; Sales Mgr.: Jim Farrer.
Brand name: Ferrotape.
 J Osawa & Co (UK) Ltd., 10 Forge Court, Reading Rd., Yateley, Camberley, Surrey. Tel: (0252) 875-919. Telex: 858917. Bus. Mgr.: L.G. Roberts. (Blank only)
Audio: Cassette
 P T I, see Professional Tapes.
 P T I Developments Ltd., 52 The Maltings, Stanstead Abbots, Herts. SG12 8HG. Tel: (0920) 870864.
 Panasonic, see National Panasonic.
 Paragon Int'l Prods., 16 Holmes St., Belfast, Northern Ireland. Tel: (0232) 48260. Dir.: John D.P. McCourt; Gen. Mgr.: Anne Heaps; Sales Mgr.: Edwina Heaps.
Audio: Cassette, open reel.
 Pebble Recs. Ltd., 46 Maddox St., London W1. Tel: (01) 629-3266, 491-4140. Telex: 25247. Mng. Dir.: James Pollard; Gen. Mgr.: Julia Stoccombe.
Audio: 8-tr., cassette.
 Philips Electrical Ltd., City House, London Rd., Croydon, Surrey. Tel: (01) 689-2166. Telex: 946169.
Audio: Cassette, open reel.
Video: 4" EIAJ open reel, 4" V 2000 cassette.
 Products 2000, The Maltings, 63 High St., Ware, Herts. SG12 9AD. Tel: (0920) 66242. Mng. Dir.: R.C. Byles; Gen. Mgr.: C.W. Byles. (Blank only)
Audio: Cassette.
Brand name: Sonorex/Audiogram.
 Professional Tapes Ltd., Cassette House, 329 Hunstret Rd., Leeds LS10 1NJ. Tel: (0532) 706066. Telex: 55293. Mng. Dir.: Raymond Linton; Gen. Mgr.: Yusuf Nurgat; Sales Dir.: Colin W. Marler.
Audio: Cassette.
Brand name: PTL, Professional, Mayfair.
 Pyral Magnetics Ltd., Courtlands Rd., Eastbourne, Sussex. Tel: (0323) 638965. Mng. Dir.: H.J. Hutchings; Sales Mgr.: James Hutchings
Audio: Cassette, open reel.
 Pysler Ltd., Croftway Way, Edenbridge, Kent TN8 6HA. Tel: (0732) 864111. Telex: 95527. Mng. Dir.: J.P. Tilt; Sales Dir.: J.R. Carpenter.
Audio: Cassette (90).
Brand name: Fujip.
 Racial-Zonal Ltd., Station Hill, Pound Hill, Crawley, Sussex RH10 4AZ. Tel: (0293) 34982. Cable: CASSETTES CRAWLEY. Telex: 87651. Mng. Dir.: D.S. Worman; Gen. Sales Mgr.: John Rooke; A/V Sales Mgr.: Eric Mould; Cassette Div. Sales Mgr.: Michel Jones.
Audio: Cassette, open reel.
 Record Company Servs., 1/3 Sedley Pl., London W1R 1HH. Tel: (01) 409 2336. Telex: 4081735. Drs.: E.J. Foster, A.C. Watling-Darrell.
Audio: Cassette.
 Revor, see F.W.D. Bauch.
 Ross Electronics, 32 Rathbone Pl., London W1P 1AD. Tel: (01) 580-7112. Cable: ROSSLECT. Telex: 22747. Pres.: Ross I.L. Marks; Gen. & Sales Mgr.: A.C. Murphy. (Blank only)
Audio: Cassette.
 S & B Export Servs., see Ziphurst.
 S & B Trading, see Ziphurst.
 S I S Ltd., 57 St. Andrews Rd., Northampton NN1 2PB. Tel: (0604) 32965, 30559. Mng. Dir.: D.P.D. Mitchell; Sales Mgr.: I. Brown.
Audio: NAB "A" & "C"
Brand name: Fidelipac
 Scotch, see 3M.
 Selecta (London) (div. of Decca Rec. Co. Ltd.), 125/127 Lee High Rd., Lewisham, London SE13 5NX. Tel: (01) 852 9171/9191. Telex: 896029. Gen. Mgr.: J.D. Roberts; Sales Mgr.: D. Barsby; Sales Co-ord.: E. Packham. (Blank only)
Audio: Cassette.
Brand name: Decca.
 Sonorex/Audiogram, see Products 2000.
 Sony (UK) Ltd., Pyrene House, Sunbury Cross, Sunbury-on-Thames, Middx. Tel: (76) 87644. Telex: 266371. London. Pres.: W.H. Fulton; Sales Mgr.: D.W. Reeves. (Blank only)
Video: 1" open reel ("C" format), 4" U-matic cassette, 4" EIAJ open reel, 4" Beta cassette.
 Soundrider, see James York.
 Simon Stable Promos, 46 Westend Launton, Dixon. Tel: (08692) 2831. Chief Exec.: Simon Stable; Gen. Mgr.: Stephanie De La Bedoyere; Sales Mgr.: Daniel De La Bedoyere; Musical Dir.: Fang Stable.
Audio: Cassette.
Brand name: Casserette Chrome
 Studio Plus, see Cloud Nine
 Super Avilyn, see TDK.
 Syncassette, see Adastra
 Synchrotape, see Adastra.
 T D K Tape Dist (UK) Ltd., 341 Brighton Rd., South Croydon, Surrey CR2 6EQ. Tel: 688-7372. Telex: 946727. Mng. Dir.: J.C. Buchan; Sales Mgr.: Derek Huthwaite.
Audio: Blank-8-tr., cassette, open reel, raw-cassette.
Brand names: Acoustic Dynamic, Audia, Dynamic, Super Avilyn.
 T R A D Electronics Sales Ltd., 149B St. Albans Rd., Watford, Herts. WD2 5BB. Tel: (92) 47988. Telex: 262741. Mng. Dir.: J.E. Southard.
Audio: Cassette, open reel.
 The Tape Dupl'g Co. Ltd., Freedex House, 4-10 North Rd., Islington, London N7 9HN. Tel: (01) 609-0087. Telex: 264773. Mng. Dir.: Peter Robey.
Audio: Blank-cassette, Raw-8-tr.
 3 M United Kingdom Ltd., PO Box 1, 3M House, Bracknell, Berks. RG12 1JU. Tel: (0344) 26726. Telex: 849371. Mng. Dir.: Donn Osmon; Div. Dir.: P.G. Hutchings; Sales & Mktg. Mgr.: C. Hobbs; Mktg. Co-ord.: P.A. Stockwell Jones.
 Reg'l sales offices: Belfast BT1 5JE, Northern Ireland, 11 Donegal Square S. Tel: (0232) 42811, 42926-Birmingham B3 3EL, Edmund House, 12-22 Newhall St. Tel: (021) 236-5077-Glasgow G4 0AY, Scotland, 3M House, 9 Canal St. Tel: (041) 332-9622-London SE20 7TR, PO Box 38, Yeoman House, 63 Croydon Rd., Penge. Tel: (01) 659-2323-Manchester M15 4PA, 3M House, 28 Great Jackson St. Tel: (061) 236-8500.
Audio: Cassette, blankcassettes.
Brand name: Scotch.
 Trio, see B.H. Morris.
TAPE PACKAGING & LABELING EQUIPMENT
 S. Kempner Ltd., 498 Honeyopt Ln., Stanmore, Middx. HA7 1JZ. Tel: (01) 952-5262. Telex: 21400. Sales Dir.: Paul R.S. Rogers; Sales Mgr.: Audan Coles.
Product: Shrinkwrapping machines.
 Lennard Developments Ltd., 206 Chase Side, Enfield, Middx. EN2 0QX. Tel: (01) 363-8238. Cable: LENNARD ENFIELD. Mng. Dir.: E.G. Lennard.
Product: Cassette labelling machines (Auvus-Asona).
 Professional Tapes Ltd., Cassette House, 329 Hunstret Rd., Leeds LS10 1NJ. Tel: (0532) 706066. Telex: 55293. Mng. Dir.: Raymond Linton; Gen. Mgr.: Yusuf Nurgat; Sales Dir.: Colin W. Marler
Product: Cassette labelling machines.
• accessories
 Ablex Ltd. (sub. of Decca Ltd.), Harcourt, Halesfield 14, Telford, Salop TF7 4QR. Tel: (0952) 584131. Telex: 35649. Mgr.: Peter Banks
Product: Tape-head cleaners (audio)
 Adastra Electronics Ltd., Cricklewood Trading Estate, Unit N22, Clarendon Rd., London NW2 1TU. Tel: (01) 452-6288. Cable: WESTQUIP LONDON NW2. Mng. Dir.: Michael Leaver, Gen. & Sales Mgr.: B. Marks.
Product: Tape-carrying & storage cases, head cleaners, demagnetizers
 Agfa Gevaert Ltd., 27 Great West Rd., Brentford, Middx. Tel: (01) 560-2131. Cable: ARTDVEG. Telex: 28154. Mng. Dir.: R.P. Dickinson. Magnetic Prods. Div. Mgr.: W.M. May, Mktg. Mgr.: E.A. Bowden
Home office: Germany
Product: Tape-splicing & editing equip.
 Ailsop 3, see Network Mktg.

Amplex Great Britain Ltd., Acree Rd., Reading, Berks. RG2 0QR. Tel: (0734) 85200. Cable: AMPEX READING. Telex: 847611. Gen. Mgr.: W. Scullion, Tape Sales Mgr.: J. Cripps. Adv. Mgr.: P. Vaughan.
Product: Tape-carrying & storage cases, head cleaners, bulk erasers, demagnetizers, leader tape, splicing tape & equip. (all audio & video)

Arrowtaps Ltd., Humber Rd., London NW2 6EP. Tel: (01) 450-2411. Telex: 923034. Mng. Dir.: Maurice Mindel; Sales Mgr.: Alex Murray; Prod. Mgr.: Paul Rinne.
Product: Record-record care prods.; Tape-carrying & storage cases, head cleaners, demagnetizers, leader & splicing tape.

Audio Magnetics Inc. (UK) Ltd., 121 Lovelock Rd., Reading, Berks. RG3 1JZ. Tel: (0734) 598036. Telex: 849113. Mng. Dir.: Nigel W. Bryden; UK Sales Mgr.: Hugh Smith.
Audio: Tape-cassette hubs.

Audio Technica Ltd., Hunstrel Trading Estate, Low Rd., Leeds LS10 1DL. Tel: (0532) 771-441. Telex: 557991.
Product: Record-record care prods.; cleaners, replacement styli.

Audio + Video Ltd., Video House, 48 Charlotte St., London W1P 1LX. Tel: (01) 580-7161. Telex: 22345. Mng. Dir.: Irvin C. Pannaman; Sales Mgr.: Andrew Bourne; Adv. Mgr.: Don Ubbeld.
Product: Tape-bulk erasers (video).

B A S F UK Ltd., 4 Fitzroy Square, London W1P 5AD. Tel: (01) 388-4200. Telex: 28649. Div. Mgr.: H.C. Pattinson; Prof. Prods. Mgr.: R.M. Hine.
Product: Record-record care prods.; Tape-head cleaners, leader tape, splicing tape & equip. (all audio).

Barrester Music Co. Ltd., 50 Bute St., Luton, Beds. LU1 2EP. Tel: (0582) 29355. Telex: 825115. Mng. Dir.: John Barratt.
Product: Record-record care prods., turntable mats; Tape-carrying & storage cases.

F. W. D. Bauch Ltd., 49 Theobald St., Boreham Wood, Herts. Tel: (01) 953-0091. Telex: 27502. Mng. Dir.: John Bauch; Sales Mgr.: Vaughan Waller, Press Officer: David Neal.
Product: Tape-head cleaners, demagnetizers, leader & splicing tape (Revox).

Bib Hi-Fi Accessories Ltd., Kelsey House, Wood Ln. End, Hemel Hempstead, Herts. HP2 4RQ. Tel: (0442) 61291. Telex: 826437. Chm. & Mng. Dir.: P.B. Arabi; UK Sales Dir.: J. Embley; Int'l Sales Dir.: R.G. Everett.
Product: Record-record care prods.; Tape-carrying & storage cases, head cleaners, bulk erasers, demagnetizers, splicing tape & equip., audio cassette winder, video maintenance kit.

Bibi Magnetics Ltd., 101/105 Plough Rd., London SW11 2BJ. Tel: (01) 223 5955. Telex: 917732. Dir.: K. H. Bourke-Borrows; Gen. Mgr.: M. Shep herd.
Product: Tape-head cleaners, demagnetizers.

Book Binders of London, 11 Ronalds Rd., Highbury, London N5 1XJ. Tel: (01) 607-3361.
Product: Video storage cases (book style).

Harvey Buat, 84 Church St., London NW8. Tel: (01) 724-3711. Chief Exec. Alan Taub.
Product: Tape-carrying & storage cases, head cleaners, demagnetizers.

C B S Mfg. (div. of CBS (UK) Ltd.), 17/19 Soho Square, London W1V 6HE. Tel: (01) 734-8181. Cable: CDLRECMAN. Telex: 24203. Mng. Dir. John A Wheeler.
Product: Tape-cassette library cases.

Cambrasound Ltd., Freddex House, 4/10 North Rd., Islington, London N7 9HN. Tel: (01) 607-8141. Cable: METRDS G. Telex: 264773. Mng. Dir. Gerald Ambrose; Sales & Mktg. Dir.: Peter Eden; Sales Mgr.: Peter Welsh.
Product: Record-carrying & storage cases, record care prods., turntable mats, 45 rpm adaptors, replacement styli; Tape-carrying & storage cases (video), head cleaners, bulk erasers, demagnetizers, leader tape, splicing tape.

Cassette Developments (Audioisonic) Ltd., Micra House, 138 Lower Mortlake Rd., Richmond, Surrey TW9 2JZ. Tel: (01) 940-8186. Cable: MICRD NETICS. Telex: 8813481. Gen. Mgr.: D. Dixon.
Product: Tape-head cleaners, demagnetizers.

Cintron Group, Grove House, 551 London Rd., Isleworth, Middx. TW7 4DS. Tel: (01) 568-0131. Telex: 935054.
Product: Tape-demagnetizers.

Clendish (Mail Drider) Ltd., 7 Trinity Court, Grays Inn Rd., London WC1. Tel: (01) 837-9088. Pres.: Erna Smith; Gen. Mgr.: Beatrice Parker.
Product: Record-record care prods.

Cloud 9 Video, ISD, Stoppage Ln., Simonswood, Liverpool L33 4YA. Tel: (051) 548-9690. Mng. Dir.: Mike Glasspole; Prod'n Dir.: Dave Royle.
Product: Tape-library cases (video).

Colclene, see Future Film.

Condor Electronics Ltd., Woodman Works, 204 Durnford Rd., London SW19 8DR. Tel: (01) 947-9511. Telex: 928502. Mng. Dir. C.A. Wolff.
Product: Record-record care prods., replacement styli; Tape-head cleaners, demagnetizers.

Contek Magnetics Ltd., 90 Walnut Tree Close, Guildford, Surrey GU1 4UJ. Tel: (0483) 503222. Telex: 859403. Mng. Dir.: Gerald P. Creagh; Comm'l Mgr.: Fred MacDonald.
Product: Tape-head cleaners (audio).

Cosmocord Ltd., Eleanor Cross Rd., Waltham Cross, Herts. EN8 7NX. Tel: Lea Valley 716-666. Cable: ACDS. Telex: 24294. Mng. Dir.: V.J. Siver, Sales & Mktg. Dir.: G.E. Brewin.
Product: Record-record care prods., 45 rpm adaptors, replacement styli, Tape-carrying & storage cases, head cleaners, demagnetizers.

Crown Arrow Co., 8 Gate Lodge Close, Round Spinney, Northampton NN3 4RJ. Tel: (0604) 48744. Telex: 311165. Owner: Robert J. Parfitt.
Product: Record-carrying & storage cases; Tape-carrying & storage cases (audio & video), head cleaners.

D & B Tape Servs., 23 Croydon Rd., Reigate, Surrey RH2 0LY. Tel: 49505. Owner: E.G. Dowley.
Product: Tape-head cleaners, demagnetizers.

Discleaner, see Vac-D-Rec.

E M I Tape Ltd., Tape House, Dawley Rd., Hayes, Middx. UB3 1BT. Tel: (01) 573-3888. Cable: EMITAPE LDNDON. Telex: 932161. Mng. Dir. E.A. Naef; Comm'l Controller: P.K. Mitchell; Gen. Sales Mgr.: P. Sollitt; Mktg Mgr.: M.W. Cross.
Product: Tape-head cleaners, leader tape (both audio).

Eagle Int'l, Precision Centre, Heather Park Dr., Wembley, Middx. HA0 1SU. Tel: (01) 902-8832. Cable: EAGLINT. Telex: 922131. Mng. Dir.: W. Mor row; Mktg. Dir.: R. Woolf.
Product: Record-replacement styli; Tape-bulk erasers, demagnetizers. Editall, see Scenic Sounds.

Edwards Construction Co., 4 Brunswick Dr., Harrogate, North Yorks HG1 2PZ. Tel: Harrogate 60921. Local plant: The Chapel, 282 Skipton Rd. Tel 500442.
Local plant: The Chapel, 282 Skipton Rd. Tel. 500442.
Product: Record-record & hi-fi cabinets (Superflex); Tape-video cabinets (Videoflex).

Eicon Magnetek, see Pro-Bel.

Emerald Recs. Ltd., 120 Coach Rd., Templepatrick, Ballyclare, Co. Antrim.

Northern Ireland BT39 0HB. Tel: (08494) 32711. Telex: 747293. Mng. Dir.: Mervyn Solomon; Gen. Mgr.: Les R. Paterson; Sales Mgr.: Noel A. Spiller.
Product: Record-replacement styli

Entre, see Lentek.

Ferroglyph, see North East Audio

N & S.B. Field & Co. Ltd./Record Housing, 17 A Newham Rd., Wood Green N22. Tel: (01) 888-7487. Chm.: N. Field; Gen. Mgr.: F. Davis; Sales Mgr. J. Edwards; Promo. Dir.: M.L. Field.
Product: Record-carrying & storage cases.

Fitall Prods. Ltd., Castguard Rd., Larne, Northern Ireland. Tel: (0574) 3015. Telex: 747386. Mng. Dir.: C. Rumble.
Product: Tape-storage cases

Future Film Developments (Allotrope Ltd.), 36/38 Lexington St., London W1R 3HR. Tel: (01) 437-1892. Cable: ALLDIRPE LDNDON W1. Telex: 21624. Drs. C.S. Young, Tim Blackham; Sales Mgr. John Dent.
Product: Tape-head cleaners (Colclene).

Golding Audio Ltd., 26 Hyde Quay, Colchester, Essex. Tel: (0206) 77224. Mng. Dir.: A.B. Golding; Dir.: D.P. Golding, Gen. Mgr.: P. Walsh, Sales Mgr.: R.K. Golding.
Product: Tape-carrying & storage cases, head cleaners, demagnetizers

C E Hammond & Co. Ltd., 105/109 Dyster Ln., Byfleet, Surrey KT14 7JH. Tel: (09323) 51051. Telex: 262525. Mng. Dir.: Peter M. Hammond; Sales Mgr.: Tony Smith; Co. Sec'y: Edgar A. Thomson.
Product: Record & Tape-storage cases.

Hi-Fi Pro, 22/24 Buckingham Palace Rd., London SW1. Tel: (01) 834-9382. Telex: 929679. Dir.: Ms. M. H. Ling; Gen. Mgr.: Jeff Hill.
Product: Record-45 rpm adaptors, replacement styli, Tape-head cleaners, demagnetizers, leader & splicing tape.

Hughgate Acoustics, 38 Jamestown Rd., London NW1 7EJ. Tel: (01) 267 4936.
Product: Record-replacement styli.

Immediate Sound Servs. Ltd., 6 Drsmar Rd., London N1 5QJ. Tel: (01) 739 9672. Telex: 914382. Mng. Dir.: J.W. Hart.
Product: Record-carrying & storage cases, record care prods.

Istead Audio Visual, 38 The Tything, Worcester. Tel: (0905) 29713. Telex 335294.
Product: Tape-videocassette storage cabinets

Kitel Int'l (UK) Ltd., 620 Western Ave., London W3. Tel: (01) 992 8000. Cable: KAYTELE. Telex: 934195. Mng. Dir.: Tony Johnson; Sales Mgr.: Colin Ashby.
Product: Record & Tape-carrying & storage cases.

Known (UK) Ltd., 37 Churchill Way, Fleckney, Leics. Tel: (0533) 40331. Telex: 342467.
Product: Record-carrying & storage cases, record care prods. Tape-carrying & storage cases (audio & video), head cleaners (audio & video), demagnetizers (audio)

L G R Prods., 105 Eastern Esplanade, Southend-on-Sea, Essex. Tel: (0702) 56595. Owner: L.G. Raven.
Product: Carrying & storage cases.

Landmark (Precision Mouldings) Ltd., 2 Albion Way, Langford Rd., Biggles wade, Beds. Tel: (0767) 314 231. Telex: 23384. Mng. Dir. David Ritchie, Works Dir. Don Pearson, Prod'n Dir. George Jardine.
Branch: Potters Bar, Herts., Deneway House, Darnes Ln.
Product: Tape-head cleaners, demagnetizers, cassette library cases.

Lee Eng'g Ltd., Napier House, Bridge St., Walton-on-Thames, Surrey KT12 1AP. Tel: 43124. Cable: LEETECH. Telex: 928475. Mng. Dir. Thomas Lee; Gen. Mgr.: Chris Welsh; Sales Eng.: J. Trevnor.
Product: Tape-carrying & storage cases, head cleaners, demagnetizers, splicing tape (Nortronics).

Leavers Rich Equip. Ltd., Ltd., 319 Trinity Rd., Wandsworth, London SW18 3SL. Tel: (01) 874-9054. Cable: LEEMAG. Telex: 923455.
Product: Tape-bulk erasers (audio & video), demagnetizers (audio & video)

Lennard Developments Ltd., 206 Chase Side, Enfield, Middx. EN2 0QX. Tel: (01) 363-8238. Cable: LENNARD ENFIELD. Mng. Dir.: E.G. Lennard.
Product: Record-record care prods., 45 RPM adaptors, replacement styli, Tape-carrying & storage cases, head cleaners, demagnetizers, splicing tape.

Lentek Audio Ltd., Ind'l Estate, Edson Rd., St Ives, Huntingdon, Cambs PE17 4LF. Tel: (0480) 62225. Telex: 32303. Dir.: L.W. Scofield.
Product: Record-replacement styli (Entre)

Lightning Recs. Ltd., 841 Harrow Rd., Harlesden, London NW10 5NH. Tel: (01) 969 7155/5255. Telex: 927813. Mng. Dir.: Raymond Laren; A/R & Mktg. Dir.: Keith Yershon, Dist'n & Jukebox Dir. David Powell, Commercial Dir. Sad Reza.
Product: Record-45 rpm adaptors.

Liverwise Bindery, 9/12 Zennor Rd., London SW12. Tel: (01) 673-1216.
Product: Tape-videocassette slip cases.

Lugton & Co. Ltd., PD Box 182, Cross Ln., Hornsey, London N8 7SB. Tel: (01) 348 9122. Telex: 25618. Mng. Dir. Walter Ficker; Gen. Mgr. W. Collins.
Product: Record-carrying & storage cases, record care prods., turntable mats, 45 rpm adaptors, replacement styli, Tape-carrying & storage cases (audio & video), head cleaners (audio & video), bulk erasers (audio), demagnetizers (audio), leader & splicing tape (audio)

Milly Prods. Ltd., New Mansion House, i73/191 Wellington Rd S., Stockport, Cheshire. Tel: (061) 480-8142. Cable: PDWMAR. Telex: 667700.
Product: Record-record care prods. (Pixall, Permostat)

Musac (Scotland) Ltd., Baltic Chambers, 50 Wellington St., Glasgow, Scotland G2 6HJ. Tel: (041) 221 1948. Mng. Dir. Angus McDonald; Sales Mgr. Douglas MacLeod.
Product: Record-carrying & storage cases, record care prods., turntable mats, 45 rpm adaptors, replacement styli, Tape-carrying & storage cases (audio & video), head cleaners (audio & video), demagnetizers (audio), leader tape (audio), splicing tape & equip. (audio).

Musicaise Ltd., Camberwell Ind'l Estate, Unit 6, Denmark Rd., London SE5. Tel: (01) 737-0480. Mng. Dir.: John Hardman, Prod'n Mgr. Marilyn Ward.
Product: Record-carrying & storage cases, record care prods., Tape-carrying & storage cases, head cleaners, demagnetizers

Musonic, see Ziphurst.

Network Mktg. Ltd., Middlesex House, 29 45 High St., Edgware, Middx. HA8 7HH. Tel: (01) 952 6225. Telex: 261341.
Product: Tape-"non abrasive" type head cleaning cassettes (audio & video) (Allsp 3)

North East Audio Ltd., Simonside Works, South Shields Tyne & Wear NE34 9NX. Tel: (0632) 566321. Mng. Dir. A.J. Hellwell; Gen. Mgr. Tom Baley, Sales Mgr. Jim Farrier.
Product: Tape-head demagnetizers, test tapes (Ferroglyph)

Nortronics, see Lee

J. Osawa & Co (UK) Ltd., 10 Forge Court, Reading Rd., Yateley, Camberley, Surrey. Tel: (0252) 875 919. Telex: 858917. Bus. Mgr.: L.G. Roberts.
Product: Record-record care prods., replacement styli, Tape-head cleaners, demagnetizers, splicing tape

Dsmabel Ltd., 46 Kenilworth Rd., Edgware, Middx. HA8 8YG. Tel: 958-9314. Mng. Dir.: D. Greenlich.
Product: Tape-bulk erasers, head demagnetizers.

P T T Developments Ltd., 52 The Mallings, Stanstead Abbots, Herts. SG12 8HG. Tel: (0920) 870864.
Product: Tape-carrying & storage cases (audio, video).

Parostatik, see Cecil Watts.

Permostat, see Milly

Philips Electrical Ltd., City House, London Rd., Croydon, Surrey. Tel: (01) 689-2166. Telex: 946169.
Product: Tape-cassette head cleaning tape, leader & splicing tape.

Pinnacle Recs., 371/375 Kenning Ln., London SE11. Tel: (01) 582-2238. Telex: 896141. Dpington. Chm. Terry Scully; Gen. Mgr.: Tony Berry; Int'l. Newton Wells.
Product: Record-carrying & storage cases, record care prods., replacement styli, Tape-head cleaners, demagnetizers.

Pixall, see Milly

Plastic Sales Leicester Ltd., 10/12 Dartford Rd., Leicester LE2 7PQ. Tel: (0533) 833691. Chief Exec.: T.H. Winfield; Gen. Mgr.: Mrs. B.E. Flude.
Product: Carrying & storage cases.

Pro-Bel Ltd., Terrace Rd., Binfield, Bracknell, Berks. Tel: (0344) 56969. Telex: 848314. Mng. Dir.: Derek Owen; Press Officer: K. Bryan.
Product: Tape-2" & 1" tape cleaner/profiler (Elcon Magnetek).

Professional Tapes Ltd., Cassette House, 329 Hunslet Rd., Leeds LS10 1JN. Tel: (0532) 706066. Telex: 55293. Mng. Dir. Raymond Linton; Gen. Mgr. Yusuf Nurgat; Sales Dir. Colin W. Marler.
Product: Tape-head cleaners, splicing tape.

Purpaa Plastics Ltd., 138 Miles Rd., Epsom, Surrey. Tel: Epsom 21644, 40322. Telex: 925207. Mng. Dir.: J.M. Fuller; Sales Mgr.: M. Pink.
Product: Record & Tape-carrying & storage cases.

Pyral Magnetics Ltd., Courtlands Rd., Eastbourne, Sussex. Tel: (0323) 638965. Mng. Dir. Harry Hutchings; Sales Mgr.: James Hutchings.
Product: Tape-leader tape.

Pysler Ltd., Fircroft Way, Edenbridge, Kent. Tel: (0732) 864111. Telex: 95527. Mng. Dir.: J.P. Tait; Sales Dir.: Malcolm Blockley.
Product: Record-record care prods. preservative (Sound Guard); Tape-head cleaners & demagnetizers.

Quality Audio Supplies, Wollaton Rd., Beeston, Notts. Tel: (0602) 25-22-22.
Product: Tape-head cleaners.

Quality Plastic Supplies, 13 Summerstown, Wandsworth, London SW17. Tel: (01) 946-8388.
Product: Tape-plastic video albums, protective cases for videocassette.

R I Audio, Kernick Rd., Penryn, Cornwall TR10 9DQ. Tel: (0326) 72753. Cable: RIMICRDN. Sales Dir.: A. Lee.
Product: Record-record care prods.

Racal-Zonal Ltd., Station Hill, Pound Hill, Crawley, Sussex RH10 4AZ. Tel: (0293) 34982. Cable: CASSETTES CRAWLEY. Telex: 87651. Mng. Dir.: D.S. Worman; Gen. Sales Mgr. John Rooke; A/V Sales Mgr. Eric Mould.
Product: Tape-head cleaners, leader tape.

Record Holding Soundmaster, 17A Newham Rd., Wood Green N22. Tel: (01) 889 0139. Co-Chm.: M.L. Field; Gen. Mgr.: J. Cohen; Sales Mgr.: J. Devan, Prod'n/Buyer: F. Davis.
Product: Record & Tape-carrying & storage cases, storage racks, cabinets, trolleys

Revox, see F.W.D. Bauch

Riverside Ltd., 107 High St., Evesham, Worcs. Tel: (0386) 47766. Contact: Harry Dixon.
Product: Record-carrying & storage cases.

Ross Electronics, 32 Rathbone Pl., London W1P 1AD. Tel: (01) 580-7112. Cable: RDSSELECT. Telex: 22747. Pres. Ross I.L. Marks; Gen. & Sales Mgr.: A.C. Murphy.
Product: Record-record care prods

S & B Export Servs., see Ziphurst.

S & B Trading, see Ziphurst

Scenic Sounds Equip. Ltd., 97-99 Dean St., London W1V 5RA. Tel: (01) 734-2812. Telex: 27939.
Product: Tape-splicing, editing equip. (Editall, Xedit).

Scullthorp Plastics Ltd., 248 Walton Rd., East Molesey, Surrey. Tel: (01) 941 2929. Mng. Dir.: R.H. Scullthorp, Gen. Mgr.: J. Pointon, Sales Mgr.: Miss M. Winter; Export Mgr.: Mrs. A. Wade.
Product: Carrying & storage cases.

Securette Ltd., Bluebridge Ind'l Estate, 5 First Ave., Halstead, Essex CD9 2EX. Tel: (0787) 475912. Mng. Dir.: Bruce J. Samson, Dir.: Mary B. Radcliffe.
Product: Tape-storage cases

P & J Sibert & Co., 161 Finborough Rd., West Brompton, London SW10 9AP. Tel: (01) 373 9509. Technical Sales: Alan & Paul Sibert.
Product: Record-stylus inspection equip., Tape-head inspection equip. (SEE ADVERTISEMENT)

Solomon & Peres Ltd., 120 Coach Rd., Templepatrick, Ballyclare, Co. Antrim, Northern Ireland BT39 0HB. Tel: (08494) 32711. Telex: 747293. Mng. Dir. Mervyn A. Solomon, Gen. Mgr.: Les Paterson; Rec.: Tape Mgr.: Michael H. Ross; Sales Mgr.: Noel A. Spiller.
Product: Record-record care prods., replacement styli; Tape-head cleaners, demagnetizers

Sound Guard, see Pysler

Stanton, see Wilflex

Superflex, see Edwards.

T D K Tape Dist. (UK) Ltd., 341 Brighton Rd., South Croydon, Surrey CR2 6EQ. Tel: (01) 688 7372. Telex: 946727. Mng. Dir. J.C. Buchan; Sales Mgr. Derek Huthwaite.
Product: Tape-head cleaners, demagnetizers.

3 M United Kingdom Ltd., PD Box 1, 3M House, Bracknell, Berks. RG12 1JU. Tel: (0344) 26726. Telex: 849371. Mng. Dir.: Donn Dmsom, Div. Dir.: P.G. Hutchings; Sales & Mktg. Mgr.: C. Hobbs; Mktg. Co-ord.: P.A. Stockwell-Jones.
Reg'l sales offices: Belfast BT1 5JE, Northern Ireland, 11 Donegall Square S. Tel: (0232) 42811, 42926-Birmingham B3 3EL, Edmond House, 12 22 Newhall St. Tel: (021) 236-5077-Glasgow G4 0AY, Scotland, 3M House, 9 Canal St. Tel: (041) 332-9622-London SE20 7TR, PD Box 38, Yeoman House, 63 Croydon Rd., Pengo. Tel: (01) 659-2323-Manchester M15 4PA, 3M House, 28 Great Jackson St. Tel: (061)236-8500.
Product: Record-turntable mats; Tape-head cleaners, leader & splicing tape.

V D R Int'l, Unit 16F, Randles Rd., Knowsley, Merseyside L34 9EZ. Tel: (051) 548 7400. Telex: 627791. Mng. Dir. Jim Thornton.
Product: Record-record care prods. (Discleaner, Vac-D-Rec)

Vac D Rec, see VDR.

Videoflex, see Edwards.

Cecil E. Watts Ltd., Darby House, Lower Hampton Rd., Sunbury-on-Thames, Middx. Tel: Sunbury 83252. Cable: DUSTBUG. Telex: 27750. Mng. Dir.: Mrs. A.H. Watts; Gen. Mgr.: D.W. Luxford; Sales Mgr.: Mrs. S.A.C. Luxford. Watts

Product: Record—record car prods. "Dust Eug." Disc. Preener, Manual Parastat, Hi Fi Parastat, Parostatik, X static, Fumid Mop, Trade Parastat, Stylus cleaner.

West 4 Tapes & Recs. 169 Chiswick High Rd., London W4 2DR Tel (01) 994 5879

Product: Record—polythene lined covers, cardboard (master bags) for LP's & singles

Wilmax Ltd., Compton House, New Malden, Surrey KT3 4DE Tel (01) 949 2545

Product: Record—replacement styli (Stanton)

World of Video 2000 Ltd., Cassette House, 329 Hunslet Rd., Leeds LS10 1NJ Tel (0532) 706066 Telex 55293 Mng Dirs Raymond Linton, Colin W Marler

Product: Tape—carrying & storage cases (video), bulk erasers (audio & video)

Wind-Up Recs Ltd., Greengate Ln., Prestwich, Manchester Tel (061) 798 9252/0533 Mng Dir Colin Reilly, Gen Mgr & Dist'n Dir B Patchett, Sales Dir L.J. D Meara Local branch: Acc-sores Div. 14 Birch Ln., Longsight, Manchester Tel (061) 224 2823.

Branch: Glasgow, Scotland, Tradeston Ind'l Estate, 7 Kilbirnie Pl. Tel (041) 429 5155

Product: Record—carrying & storage cases, record car prods., 45 rpm adaptors, replacement styli, Tape—head cleaners, demagnetizers, leader & splicing tape.

Xanadu Constructional & Mechanical Eng's. 79 Firzeal St., East Acton, London W12 Tel (01) 743 3402 Mng Dir Paul Cadd, Co-Dir & Sales Mgr Don Arden, Gen Mgr. Jeff Lynne

Product: Record—45 rpm adaptors, replacement styli

Xedit, see Scenic Sounds

X static, see Cecil Watts

M Young & Co., Industrial Estate, Southgate Ave., Mildenhall, Suffolk IP28 7AT Tel Mildenhall 712553 Partner: M. Young

Product: Record—polythene lined covers, mas er bags, cardboard record covers, Tape—cassette master bags

Martin Instruments Ltd., 15 Richmond Grove, Surbiton, Surrey KT6 6AH Tel (01) 399 0966 Cable ZEEPA SURBITON Telex 929679 Mng Dir W Ling, Sales Mgr R.S. English

Audio: Record—carrying & storage cases, record car prods., replacement styli, Tape—head spray demagnetizers, bulk erasers

Zerostat Components Ltd., Burrell Road Ind'l Estate, St. Ives, Huntingdon, Cambs. Tel (0480) 62225 Telex 32303. Dir R.F. Wooley

Product: Record—record car prods

Ziphurst Ltd., Stylus House, 34/38 Verulam Rd., St. Albans, Herts AL3 4DF Tel (0727) 50611 Telex 28675 Mng Dir P.H. Blank, Gen Mgr Stephen H. Blank, Sales Dir B. Blank, Warehouse Mgr D.N. Lever

Product: Record—carrying & storage cases, record car prods., 45 rpm adaptors, replacement styli, Tape—head cleaners, demagnetizers, leader & splicing tape (Musonic)

• promotional merchandising aids

The following is a list of companies involved in the manufacturing, importing, distribution & retailing of items promoting the music industry and/or its artists. The key to symbols used is: (M) manufacturer; (I) importer; (D) distributor and (R) retailer.

Anabas Prods. Ltd., Chesham Close Ind'l Estate, Cedar Rd., Romford, Essex RM7 7EX Tel Romford 21318

Product: Posters (M, D)

Apollo Tour Mktg., Basement Studio, 33 Norton Rd., Hove, Brighton BN3 3BF Tel (0273) 720297, (01) 589 5023 Chief Exec. Nando Valverde, Gen Mgr Eleanor Leonard, Sales Mgr Steve Jones, European Sales Mgr L. Tucker

Product: Posters, ties

Badge Sales, 48 Carnaby St., London W1V 1PF Tel (01) 437 5121 Mng Dir William Smith, Gen & Sales Mgr Paul Zanello, Sales Mgr David Kerry

Product: Posters, patches, badges (all M)

Ballantine Advertising, 11 Talbot Square, London W2 Tel (01) 723 4439

Product: Posters (M), T-shirts (M)

Chess Creative Servs. Ltd., 14A Shoultham St., London W1 Tel (01) 723 8233 Partners A. Smith, P.J. Lacy

Product: Posters, belt buckles, T-shirts, hats/caps, keychains, patches, jackets (all M)

Cream Creative Mktg. Ltd., The Cloisters, 11 Salem Rd., London W2 Tel (01) 221 5155

Product: Posters, belt buckles, T-shirts, hats/caps, keychains, patches, jackets (all M, D)

Dazzlebourne Ltd., 41 B Blenheim Crescent, London W11 2EF Tel (01) 727-0734 Mng Dir Harry T. Murlowski (M., D, R)

Product: Posters, belt buckles, T-shirts, hats/caps, keychains, patches, jackets

Eivisy Young Ltd., 23/24 Easton St., London WC1 Tel (01) 278-0103 Mng Dir Sid Shaw, Gen & Sales Mgr Paul Jardine, PR David Griffiths

Product: Posters, belt buckles, T-shirts, keychains, patches (all I, D, R)

Format (Sussex) Ltd., Jubilee Rd., Burgess Hill, Sussex Tel (04446) 45245 Telex 87322 Mng Dir Ted Light

Product: Posters (M)

Front Line Mktg., 5 Cunderhills Rd., Holfmirth, West Yorks Tel (048489) 6892 Mng Dirs John Piper, Geoff Dolding

Product: T-shirts, keychains, patches, badges (all M)

John Harwood Bee Assocs., The Folly, Folly Island, Hertford, Herts. Tel (0922) 551233 Telex 817961 Mng Dir John Harwood Bee

Product: Posters, T-shirts (both M)

Howards Printers (Slough) Ltd., Mill St., Slough Tel (0753) 32271

Product: Posters (M)

Jubilee Graphics, 101 Wardour St., London W1 Tel (01) 437 8572

Product: Posters, T-shirts, jackets (all M)

Lindsey's Colour Serv., 88 Teasdale St., London E2 Tel (01) 729-5462 Mng Dir Ray Mack, Sales Dir David Wall

Product: Posters, T-shirts, patches, jackets, badges (all M)

Mercer Servs./Razamatiz, 40 42 Church St., Burnley, Lancs BB11 2DL Tel (0282) 53046, 56156, 55731

Product: Patches (M), jackets (D)

Pm Badge Co., PO Box 22, Banbury Tel (0295) 57321 Telex 837424 Chief Exec. G. Pearson

Product: Badges (M)

Positive Designs, 17 Station Rd., London SE25 5AH Tel (01) 771 5777 Chief Exec. Steve Hutchins, Gen Mgr Dave Lucy, Sales Mgr Nick Miller

Product: Posters (M, R), belt buckles (D), T-shirts (D), hats/caps (D), keychains (D), patches (M, R), jackets (D, R), badges (M, D, R).

Scandecor Ltd., 3 Armadale Rd., Feltham, Middx T-I (01) 890 8174 Telex 934367 Mng Dir Lennart Groth, Sales & Mktg Mgr Peter Winship

Product: Posters (M, D), badges (D)

Templing Ltd., 29 Wates Way, Mitcham, Surrey Tel (01) 640 3025 Sales Mgr. Henry Dyson

Product: Posters (M)

James Upton Ltd., (div of Tinsley Robor Group), 98-138 Barford St., Birmingham B5 6AP Tel (021) 692 1171.

Product: Posters

Windsong Rec Exports Ltd., St Edmunds Church, Cornwall Rd., Croydon, Surrey Tel (01) 688-6836 Telex 896218 Dir Mgr Steve Mason, Gen Mgr Mike Chapman, Sales Mgr. Sean Sullivan

Product: Belt buckles, T-shirts, keychains, patches, jackets, badges, (all D)

• store fixture manufacturers

Alfa Dispay & Design, 28 Beechwood, Fordingbridge, Hants LP6 1DB Tel (0425) 53943

Product: Record & tape browser boxes, record & tape display racks

Amazing Exhibitionists Ltd., 52/56 Church Path, London W4 5BD Tel (01) 995 3555 Telex 936311 Dirs. Arastou Azar, Lawrence Miller, Sales Mgr. Janet Lamport

Product: Browser boxes, display racks, divider cards.

Arjay Shopfitters Ltd., 54 Lower Marsh Ln., Kingston upon-Thames, Surrey KT1 3BJ Tel (01) 390 2101, Chief Exec. P.E. Champion, Sales Mgr. R.J. Jarrett

Product: Browser boxes, display racks.

Ateha Tape Racks, 23 Station Rd. Ind'l Estate, Hailsham, East Sussex BN27 2ER Tel (0323) 843191, Mng Dir G. J. Willamowski

Product: Record & tape (audio & video) display racks

Ballantine Advertising, 11 Talbot Square, London W2 Tel (01) 723 4439

Product: Record divider cards

Bilabel, 3 Speedwell Close, Chandlerford Ind'l Estate, Eastleigh, Hants. Tel (04215) 63434 Gen Mgr & Mktg. Dir. Malcolm Paton, Sales Mgr. Martin Bennett

Product: Browser boxes, display racks, divider cards.

Broomhall Joinery Co. Ltd., 222 High St., Uxbridge, Middx. Tel 37311, Mng Dir S.J. Hurley, Gen Mgr R.F. Allen.

Product: Record browser boxes, record display racks.

Caroline Exports Ltd., 56 Standford Rd., London NW10 6ES, Tel (01) 961-2919, Cable BUMBLEBEE Telex 22164, Mng Dir A.T. Rose, Studio/Electronics Exec. C. Stylianou.

Product: Browser boxes, displays racks, divider cards.

Chess Creative Servs. Ltd., 14A Shoultham St., London W1, Tel (01) 723-8233 Partners A. Smith, P.J. Lacy

Product: Browser boxes, display racks, divider cards

Crown Merton (div of T.I. Corfield & Buckle Ltd.), Trafalgar Works, Station Rd., Merton Abbey, London SW19 2NJ Tel (01) 542-1144

Product: Hi fi tube & wire storage equip

Decor Shopfitting Servs. Ltd., Horton Bank Top Mills, Cooper Ln., Bradford, Tel 76109

Branch: Cupar, Fife, Scotland, G. Walker Audio, The Studio, South Bridge, Tel 2400

Film & Television Prod'n Servs., Pinewood Studios, Iwer Heath, Bucks.

Product: Tape display racks.

Fittall Prods. Ltd., Coastguard Rd., Larne, Northern Ireland Tel (0574) 3015 Telex 747386 Mng Dir C. Rumble

Product: Tape display racks

Format (Sussex) Ltd., Jubilee Rd., Burgess Hill, Sussex Tel (04446) 45245 Telex 87322 Mng Dir Ted Light

Product: Record & tape (audio & video) browser boxes

Gray & Butt Ltd., 45 King St., Stanford Le Hope, Essex, Tel (03756) 3041, Sales Dir Peter Butt, Gen Mgr Russell Butt

Product: Browser boxes, display racks

E Hannibal & Co. Ltd., Pinfold Rd., Thurmaston, Leicester Tel (0533) 695413 Telex 34627 Mng Dir Chris Hetherington, Ass't Mng Dir. Roger Stewart, Music Div Sales Dir Derek Deighton

Product: Browser boxes, divider cards

Howards Silk Screen (Slough) Ltd., (div of Tinsley Robor Group), Albion Close, Petersfield Ave., Slough, Berks Tel (0753) 31442

Product: Point of purchase materials

Hunt Leigh (Showard & Display Co.), 119 Alterberg Gardens, London SW11 1JQ

Jubilee Graphics, 101 Wardour St., London W1 Tel (01) 437 8572

Product: Record & tape (audio & video) browser boxes, record & tape (audio & video) divider cards.

S Kempner Ltd., 498 Honeyput Ln., Stanmore, Middx. HA7 1JZ Tel (01) 952 5262 Telex 21400 Sales Dir Paul R.S. Rogers, Sales Mgr Aidan Coles

Product: Record & tape (audio & video) security systems.

Lightning Recs. Ltd., 841 Harrow Rd., Harlesden, London NW10 5NH, Tel (01) 969 7155/5255 Telex 927813, Mng Dir Raymond Laren, AR & Mktg Dir Keith Yershon, Dist'n & Jukebox Dir David Powell, Commercial Dir. Siad Reza

Product: Record display racks, browser boxes, divider cards

Lugton & Co. Ltd., PO Box 182, Cross Ln., Hornsey, London N8 7SB Tel (01) 348-9122 Telex 25618 Mng Dir Walter Ficker, Gen Mgr W. Collins

Product: Record browser boxes

Metropolitan Communications, 8a Froggall Gardens, London NW3 6UX Tel: (01) 435 8803 Mng Dir Mark R.F. Hanau, Sales Mgr. R. Hanau; Admin. A. Lohmeyer

Product: Audio sampler

Musonic, see Ziphurst

Plastic Sales Leicester Ltd., 10/12 Dartford Rd., Leicester LE2 7PQ, Tel: (0533) 833691 Chief Exec. T. H. Winfield, Gen Mgr. Mrs. B. E. Flude

Product: Record & tape divider cards

Reamhealth Ltd., 15/23 Porteus Rd., London W2 Tel (01) 723-8495, Dir: Bryan Whitman

Product: Browser boxes, display racks, divider cards

Royco Designs Ltd., Coastguard Rd., Larne, Northern Ireland Tel (0574) 3015 Telex 747386

Int'l branch: Canada.

Product: Tape display racks for 8-tr. cassette & Beta & VHS videocassette (Space Saver)

Securette Ltd., Bluebridge Ind'l Estate, 5 First Ave., Halstead, Essex CD9 2EX Tel (0787) 475912 Mng Dir Bruce J. Samson; Dir Mary B. Radcliffe

Product: Record & tape display racks, record divider cards, tape security systems

Securison Ltd., Securivision House, Scholes Ln., Prestwich, Manchester Tel (061) 798 9525, (01) 202 0102

Product: Security Systems (closed circuit TV)

T D K Tape Dist. (UK) Ltd., 341 Brighton Rd., South Croydon, Surrey CR2 6EQ Tel (01) 688 7372 Telex. 946727 Mng Dir. J.C. Buchan, Sales Mgr. Derek Huthwaite

Product: Display racks

Trade Distributors Northern, 400 Great Horton Rd., Bradford, West Yorks. Tel (0274) 76809

Product: Browser Boxes.

World of Video 2000 Ltd., Cassette House, 329 Hunslet Rd., Leeds LS10 1NJ Tel (0532) 706066 Telex 55293 Mng Dirs Raymond Linton, Colin W. Marler

Product: Video browser boxes.

Wynd-Up Recs. Ltd., Greengate Ln., Prestwich, Manchester M25 7HW Tel (061) 798-9252/0533 Mng Dir. Colin Reilly, Gen Mgr & Dist'n Dir: B. Patchett, Sales Dir. L.J. D'Meara Local branch: Accessories Div. 14 Birch Ln., Longsight, Manchester Tel (061) 224 2823.

Branch: Glasgow, Scotland, Tradeston Ind'l Estate, 7 Kilbirnie Pl. Tel (041) 429 5155

Product: Browser boxes, display racks, divider cards.

Ziphurst Ltd., Stylus House, 34/38 Verulam Rd., St. Albans, Herts, AL3 4DF. Tel: (0727) 50611 Telex 28675, Mng. Dir. P.H. Blank, Gen. Dir. D.N. Lever, Sales Dir. B. Blank, Prod'n Dir. S.H. Blank

Product: Browser boxes, display racks, divider cards (Musonic)

• jukebox title strips

Lightning Recs Ltd., 841 Harrow Rd., Harlesden, London NW10 5NH, Tel (01) 969-7155/5255 Telex. 927813 Mng. Dir., Raymond Laren.

URUGUAY

Population: 3,000,000.

Rate of exchange: \$1 (US) = 9.2 new pesos.

Holidays: January 1, January 6 (Holy Kings' Day), February (Monday & Tuesday of Carnival), March-April (Holy or Tourism Week), April 19 (Landing of the 33), May 1 (Workers Day), May 18 (Battle of Las Piedras), June 19 (Birthday of Artigas), July 18 (First Constitution Day), August 25 (Independence Day), October 12 (Columbus Day), November 2 (All Souls Day), December 8 (Blessing of the Waters), December 25.

RECORDS:

Records sold domestically (retail value): LP's 1980—314,572 units, \$2,516,576, 1979—470,611 units, \$2,870,309. Classical LP's 1980—11,932 units, \$107,388; 1979—16,958 units, \$112,048. Singles & EP's 1980—35,429 units, \$106,287; 1979—58,267 units, \$111,055.

Records exported to USA (factory value, FOB): 1979—\$87,392.

Records exported to countries other than USA (factory value, FOB): 1979—\$85,600.

Average retail price per record: Pop LP's—\$8.00; Classical LP's—\$9.00; singles—\$3.00

Discounting: Frequent.

Type of distribution: Manufacturer-to-retailer, with a 30% markup. Large manufacturers own retail shops, which sell product from all companies. The month of June has many specially promoted discount sales of up to 50%. In 1981, pre-recorded cassettes were included in this sale for the first time. Most retailers keep a permanent discount desk.

Type of promotion: Manufacturers send free samples to disk jockeys and newspaper commentators, as well as to large Montevideo discotheques. Product advertising is not extremely important but does appear on radio, television and also in "Hit," a free monthly magazine with commentaries on new releases and information about artists. Major companies produce 5-minute promotional radio programs.

TAPE:

Market: The pre-recorded cassette market continued its growth during 1980, though at a slower pace than in the previous two years. Sales in Uruguay became almost equal to that of LP's and the trend seems to be continuing in 1981, which is resulting in releasing of only cassettes for many titles.

Pre-recorded tape sold domestically including imports: Cassette 1980—295,204 units, \$2,656,836; 1979—186,764 units, \$1,542,524.

Average retail price per tape: Cassette—\$9.00

CONSUMER ELECTRONICS:

Number of homes with: Radios—376,000 (99%), AM/FM—194,000 (51%); television sets—b&w 354,000 (93%), color 10,000 (3%).

RADIO STATIONS:

No. of commercial: 88 (85 AM, 3 FM); no. of government: 5 (4 AM, 1 FM).

Comment: International pop music predominates on commercial stations. In Montevideo, two AM and two FM stations program almost exclusively English sung songs; the others mainly present Spanish-sung product, but they also include Anglo-American hits. "Tropical," local and Latin American folk, tango, Brazilian and jazz are found on special disk jockey programs.

TELEVISION STATIONS:

No. of channels: 19, 18 commercial, 1 government

Comment: TV stations keep a daily eight-hour programming schedule. Almost all programs are foreign-produced films and serials, mainly from Argentina and the US. International pop music, through films, and local folk and "tropical," as well as sports (basketball, soccer), do not have a significant percentage of the programming time.

IMPORT/EXPORT REGULATIONS:

Taxes on imports have been gradually diminishing since 1974, according to the liberal government policy. This has resulted in an increase of imports of all kinds, including records and pre-recorded cassettes, and especially from the US and Europe. It has included the importation of LP and cassette covers from the US, Brazil, and Argentina by some local producers.

MARKET ANALYSIS:

Pop music from Spain gained importance in 1980 through the success of Ariola artists Angela Carrasco and Camilo Sesto. Carrasco's "Quereite a ti" and "Gracias por la Musica," the Spanish-sung album by Abba were the top LP's of the year, followed by ELD's "Discovery," "The Wall" by Pink Floyd, "La Conga de Katunga" and the soundtrack from "Can't Stop The Music." The top single was Neil Diamond's "September Morn." Top local productions included two albums with radio transcriptions of a soccer championship, local "tropical" music by the groups Sonido Cotopaxi, Sonora Cienfuegos and Combo Camaguey, and folk artists Dmar Romero, Canciones para no dormir la siesta and Labranos Carro. The dramatic decline in record market sales led, in the beginning of 1981, to the close of APSA's pressing plant. The industry is greatly concerned

by the drop, and this situation was scarcely lightened by the growth of pre-recorded cassette sales
Carlos Alberto Martins

• **record & tape manufacturers / distributors / importers**

APSA (American Prods. SA) (IFPI), Av Italia 4230 Montevideo Tel 59 42 17. Dir. David Wegbrat; Gen. Mgr. Norman Arlin, Sales Mgrs. Eduardo Castro, Mario Vera, A&R Mgr. Carlos Dumpierez
Labels: (Owned) Citrus; (licensed) Albion (UK), Backstreet (USA), Barclay (France), Can't Stop (USA), Chrysalis (UK), Ensign (UK), Grunt (USA), Hansa (Germany), Harem (USA), It (Italy), MCA (USA), Millenium (USA), Polar (Sweden), RCA (worldwide), Riviera (France), Salsoul (USA), Sigla (Brazil), 20th Century-Fox (USA), Vanilla (Italy), Windsong (USA)
Int'l rep.: Worldwide (RCA Int'l)

Ayu, see Tacuabe.
Citrus, see APSA
Clave (IEMSA) (IFPI), La Paz 2243, Montevideo Tel 4 5065, 41-4020
Cable CLALIM Mng Dir Leon Jurburg
Labels: (Owned) Clave, (licensed) Copacabana (Brazil), Decca (UK), Discomoda (Venezuela), London (USA), Seeco (USA), Threshold (UK), Trova (Argentina), WEA group
Daisy, see EDISA

EDISA (IFPI), Nueva York 1176, Montevideo Tel 91 20 61 Mng Dir Juan Carlos Garcia, A&R Mgrs. Laura Gioscia, Alberto Bosca
Labels: (Owned) Daisy, (licensed foreign) ABC (USA), Charisma (UK), DGG (Germany), Fontana (worldwide), H&L (USA), Island (UK), MGM (USA), Microfon (Argentina), PolyGram (worldwide), RSO (UK), Rocket (UK)

Ricardo & Rodolfo Gioscia, see Palacio de la Musica.
Macondo Ltda., Ituzango 1324, Escritorio 203, Montevideo, Tel 90 03-37 Pres. Luis Orlando Onel Hidalgo, Gen. Mgr. Luis Orlando Onel Riviezzo, Promo. Werther Brito, Eduardo Ribero
Label: (Owned) Macondo

Maloa Recs Ltd., Carlos Roa 1476, Montevideo, Tel 49 8944, Mng Dir Gabriela Egues de Silva, Adm Dir.: Mario Lopez Azagra, A&R Dir. Alberto Trunfo
Labels: (Owned) Maloa, (licensed) Arlon (Argentina), Cabal (Argentina), Chantecler (Brazil), Martin Meyer (Argentina), Tennessee (Argentina) Drleo, see Palacio

Palacio de la Musica Ricardo & Rodolfo Gioscia SA (IFPI), Av. 18 de Julio 1100, Montevideo Tel 90 01 13/48 25/84 31, 91 74 40/65 85, 98 61 21 Cable: GIOSPIAND Pres. Ricardo Gioscia Zamalvide, A&R Mgrs. Rossana Gioscia, Ricardo Do Carmo
Labels: (Owned) Drleo, (licensed) Angel (UK), Apple (UK), Arista (USA), Capitol (USA), Delphine (France), EMI group (UK), Hispavox (Spain), Magnet (UK), Pampa (Argentina), Private Stock (UK), Tonodisc (Argentina), United Artists (USA), (distributed—not licensed) Supraphon (Czechoslovakia)

Palma, see Tacuabe
Renew Variety Recs. SA, Av 18 de Julio 1224, 2nd Fl. Montevideo Tel 98 56 89, 91 21 82 Cable: MONTECARL TV Dirs. Hugo & Daniel Romay Salvo; Gen. Mgr. Cr. Pedro Mino, Sales Mgr. Ernesto Averbug, A&R Dir. Alfredo Lerios
Labels: (Owned) Renew Variety, (licensed) ATC (Argentina), Ariola (worldwide), Basart (Netherlands), Chantecler (Brazil), Continental (Brazil), Infopesa (Peru), K tel (USA), R: Fi (Italy), Zafiro Novola (Spain)

Renvar SA, Avda 18 de Julio 1224, 2nd Fl., Montevideo Tel 98 39 87, 98 56 89 Telex 834 Dir Gen Daniel Romay Salvo, Gen Mgr. Cr. Pedro Mino, Artistic Dir. Alfredo Lerios
Label: (Licensed) Continental (Brazil)

Sondor SA (IFPI), Nicaragua 1478, Montevideo Tel 29 75 30 Cable SON DDRADA Telex 6474 Pres. Enrique Abal Salvo, VP Pablo Echevarria, Gen. Mgr. Enrique Abal Olu, Sales Mgr. Omar Montano
Labels: (Owned) Sondor, (licensed) A&M, CBS Int'l (USA), Disc Jockey (Argentina), Durium (Italy), Epic (USA), Music Hall (Argentina), Sazam (Argentina), Surco (Argentina), Telefunken (Germany)
Int'l rep.: Worldwide (CBS)

Tacuabe (Eds.), Treinta & Tres 1483, Escritorio 19, Montevideo Tel 91 10 65, 98-41 40, A&R Dir. Coriun Aharonian, Sales Mgr. Ruben Diviera
Labels: (Owned) Ayu, Palma, Tacuabe, (licensed) Le Chant du Monde (France), La Cornamusa (Argentina), Edgisa (Spain), Moshe Naïm (France), Tacape (Brazil)
Int'l reps.: Argentina (La Cornamusa), Brazil (Tacape), France (Le Chant du Monde), Spain (Edgisa)

• **music publishers**

Circle Line Eds. Int'les, Cooper 2101, Montevideo Tel 39 6475 Gen Dir. J. Osztveck Fried, Gen. Mgr. Mario Grandal
Int'l firms represented: Paul Beuscher, Bretagne, Claude Carrere, Isa belle, Sforzando, Tremplin (all France), Elypeyrot (Europe)
Int'l rep.: Europe (Elypeyrot)

Tacuabe (Eds.) (AGADU), Treinta & Tres 1483, Escritorio 19, Montevideo Tel 91 10 65, 98-41 40, A&R Dir. Coriun Aharonian
Racara Ltda., Nicaragua 1478, Montevideo Tel 29 7530 Cable SONDD RADA Telex 6474 Pres. Enrique Abal Olu
Int'l firms represented: April (USA), CBS group (worldwide), Melograft (Argentina), Pamsco (Argentina)

• **services**

ASSOCIATIONS & PROFESSIONAL ORGANIZATIONS

Asociacion de Educadores Musicales. Pablo de Maria 1561, Montevideo Tel 41 45 65 Pres. Nilda Gonzalez Gentia
Asociacion Estudiantes de Musica (AEMUS), Colonia 1065, Montevideo Pres. Zulma Harambure, VP. Enrique Visca, Sec'y Susana Pruntes
Asociacion Uruguaya de Musicos. Maldonado 983, Montevideo Tel 98 73 70 Pres. Roberto Garcia Devita; Sec'y Jorge Delgado, Treas. Cervantes Acosta
Camara Uruguaya del Disco. Canelones 1974, Montevideo Tel 4 30 52 Pres. Norman Arlin, VP Ricardo Gioscia Zamalvide, Exec. Sec'y Dir. Plinio Borggio, Sec'y Juan Carlos Garcia, Treas. Enrique Abal
Centro Cultural de Musica. Av. 18 de Julio 1006, 6th fl., Montevideo
Juventudes Musicales del Uruguay. Rio Negro 1228, Montevideo Tel 90 55 75 Pres. Hugo Balzo, Sec'y Maria Tania Siver
Sociedad Uruguaya de Interpretes (SUDEI), Canelones 1090, Montevideo Pres. Orlando Romanelli, VP. Rogelio Coll, Sec'y Jose Maria Lorenzo, Treas. Guillermo Aguirre
Sociedad Uruguaya de Musica Contemporanea. Casilla de Correo 1328, Montevideo Pres. Hector A Tosar, Sec'y Coriun Aharonian

DESIGN & ARTWORK

Artegraf Ltda. Florida 1477, Montevideo Tel 98 60-38 (Record only) Estudio 3, Rio Branco 1320, Of. 302, Montevideo Tel 98 25-24, Gen. Mgr. Juan Jose Gatto
F I M A S A (Fabrica de Instrumentos Musicales & Afines SA), Nueva York 1176, Montevideo Tel 91 6074
Imprenta AS, PO Box 1600, Rincon 387, Montevideo Tel 91 45 76, 98 56 68 Telex Artega UX737 Pres & Gen. Mgr. Jorge de Artega, Sales Mgr. Eduardo Diaz
Imprenta Garcia SA, Rio Branco 1481 83, Montevideo Tel 90 51 75 Rec. Ind. Serv. Mgr. Israel Garcia Atruaola

LICENSING ORGANIZATION, MUSIC

AGADU (Asociacion Gen. de Autores del Uruguay) Canelones 1130, Montevideo Tel 90 31 88 Pres. Antonio Italiano, Gen. Mgr. Rodolfo M. Co-sentino, Sec'y Luis Eduardo Echeongelay, (Mechanical & performing rights)

PLATING, PROCESSING & PRESSING PLANTS

Clave (IEMSA), La Paz 2243, Montevideo Tel 4 5065, 41-4020 Cable CLALIM Mng Dir. Leon Jurburg
F I M A S A (Fabrica de Instrumentos Musicales & Afines SA), Nueva York 1176, Montevideo Tel 91 6074
Sondor SA, Nicaragua 1478, Montevideo Tel 29 75 30 Cable SONDD RADA Pres. Enrique Abal Salvo, VP Pablo Echevarria, Gen. Mgr. Enrique Abal Olu, Sales Mgr. Omar Montano

PRINTERS & LITHOGRAPHERS

Artegraf Ltda. Florida 1477, Montevideo Tel 98 60 38 (Record only) Pablo Cardellino—Publigráf, Magallanes 1240, Montevideo Tel 41 41 13 Pres. Pablo Cardellino
F I M A S A (Fabrica de Instrumentos Musicales & Afines SA), Nueva York 1176, Montevideo Tel 91 6074
Imprenta AS, PO Box 1600, Rincon 387, Montevideo Tel 91 45 76, 98 56 68 Telex Artega UX737. Pres & Gen. Mgr. Jorge de Artega, Sales Mgr. Eduardo Diaz
Imprenta Cervantes (Socolovsky SA), Calle Durazno 939, Montevideo Tel 98 24 35, 91 72 32 Pres & Gen. Mgr. Jaime Socolovsky
Imprenta Garcia SA, Rio Branco 1481 83, Montevideo Tel 90 51 75 Rec. Ind. Serv. Mgr. Israel Garcia Atruaola
Lagomarsino SA, Sarandi 429, Montevideo Tel 90 23 45 Pres. Daniel Lagomarsino, Gen. Mgr. Alberto Lagomarsino

RECORD PROMOTION

Imprenta AS, PO Box 1600, Rincon 387, Montevideo Tel 91 45 76, 98 56 68 Telex Artega UX737 Pres & Gen. Mgr. Jorge de Artega, Sales Mgr. Eduardo Diaz
Imprenta Garcia SA, Rio Branco 1481 83, Montevideo Tel 90 51 75 Rec. Ind. Serv. Mgr. Israel Garcia Atruaola

TAPE CUSTOM DUPLICATORS

Clave (IEMSA), La Paz 2243, Montevideo Tel 4 5065, 41-4020 Cable CLALIM Mng Dir. Leon Jurburg
Audio: Cassette
Sondor SA, Nicaragua 1478, Montevideo Tel 29 75 30 Cable SONDD RADA Pres. Enrique Abal Salvo, VP Pablo Echevarria, Gen. Mgr. Enrique Abal Olu, Sales Mgr. Omar Montano
Audio: Cassette

• **supplies**

TAPE, BLANK LOAEO

A P S A (American Prods. SA), Av. Italia 4230, Montevideo Tel 59 42 17 Dir. David Wegbrat, Gen. Mgr. Norman Arlin, Sales Mgrs. Eduardo Castro, David Vera
Audio: Cassette
Sondor SA, Nicaragua 1478, Montevideo Tel 29 75 30 Cable SONDD RADA Pres. Enrique Abal Salvo, VP Pablo Echevarria, Gen. Mgr. Enrique Abal Olu, Sales Mgr. Omar Montano (CBS Int'l only)
Audio: Cassette

ENVELOPES & MAILERS

Imprenta Garcia SA, Rio Branco 1481 83, Montevideo Tel 90 51 75 Rec. Ind. Serv. Mgr. Israel Garcia Atruaola

JACKETS & SLEEVES

Artegraf Ltda. Florida 1477, Montevideo Tel 98 60 38 (Jackets only)
F I M A S A (Fabrica de Instrumentos Musicales & Afines SA), Nueva York 1176, Montevideo Tel 91 6074 (LP)
Imprenta AS, PO Box 1600, Rincon 387, Montevideo Tel 91 45 76, 98 56 68 Telex Artega UX737 Pres & Gen. Mgr. Jorge de Artega, Sales Mgr. Eduardo Diaz (Jackets only)
Imprenta Cervantes (Socolovsky SA), Calle Durazno 939, Montevideo Tel 98 24 35, 91 72 32 Pres & Gen. Mgr. Jaime Socolovsky (Jackets only)
Imprenta Garcia SA, Rio Branco 1481 83, Montevideo Tel 90 51 75 Rec. Ind. Serv. Mgr. Israel Garcia Atruaola
Lagomarsino SA, Sarandi 429, Montevideo Tel 90 23 45 Pres. Daniel Lagomarsino, Gen. Mgr. Alberto Lagomarsino

LABELS, DISK

F I M A S A (Fabrica de Instrumentos Musicales & Afines SA), Nueva York 1176, Montevideo Tel 91 6074 (45, LP)
Imprenta Garcia SA, Rio Branco 1481 83, Montevideo Tel 90 51 75 Rec. Ind. Serv. Mgr. Israel Garcia Atruaola
Lagomarsino SA, Sarandi 429, Montevideo Tel 90 23 45 Pres. Daniel Lagomarsino, Gen. Mgr. Alberto Lagomarsino

PROFESSIONAL TAPE SUPPLIES

F I M A S A (Fabrica de Instrumentos Musicales & Afines SA), Nueva York 1176, Montevideo Tel 91 6074
Audio: Cassette labels

• **accessories manufacturers**

Clave (IEMSA), La Paz 2243, Montevideo Tel 4 5065, 41-4020 Cable CLALIM Mng Dir. Leon Jurburg
Product: Record—record care prods
Sondor SA, Nicaragua 1478, Montevideo Tel 29 75 30 Cable SONDD RADA Pres. Enrique Abal Salvo, VP Pablo Echevarria, Gen. Mgr. Enrique Abal Olu, Sales Mgr. Omar Montano
Product: Record—45 rpm adaptors

Rate of exchange: \$1 (US) = 4.29 bolivars

Per capita income: \$3000

Holidays: January 1, January 6 (Epiphany), Carnival, March 19 (St. Joseph's Day), Holy Thursday, Good Friday, Holy Saturday, April 19 (Declaration of Independence), May 1 (Labor Day), Ascension, Corpus Christi, June 24 (Battle of Carabobo), June 29 (Sts. Peter & Paul), July 5 (Independence Day), July 24 (Simon Bolivar's Birthday), August (Assumption), October 12 (Columbus Day), November 1 (All Saints' Day), Immaculate Conception, December 25

• **record & tape manufacturers / distributors / importers**

All Stars (Producciones) CA, Apdo. Postal 29175, Caracas 1021-A Tel (02) 38-84-97 Cable ALLSTARS Pres.: A. Casas Freire, Gen. Mgr. Benito Viente, Sales Mgr. Victor H. Labrador
Labels: (Owned) All Stars, Morichal, (licensed foreign) Hispavox (Spain), Fantasy, Galaxy, Milestone, Prestige, Slast (all USA)
Int'l reps.: Colombia (FM), Ecuador (IFESA), Mexico (Gamma), Spain (Hispavox)

**Allum's Maracabo Import CA, Centro Plaza, Nivel Ave. Francisco Miranda, Los Palos Grandes, Caracas 1062, Tel (02) 283 8031 Cable STERED Telex 31183 Exec. VP Irvin K. Allum Jr., Gen. Mgr. Dennis Fernandez, Sales Mgr. Mary Allum
Label: (Licensed foreign) Concord Jazz (USA)**

Andino, see San Sebastian de Dro
Andisco, see Divensa
Archiv, see PolyGram
Buitemo J. Annl. Apdo. 62185, Chacao, Caracas (Importer)
B A S F Venezolana SA (IFPI), Edificio BASF, Calle Milan, Urb. Ind'l Los Ruices Sur, Caracas 107 Tel (02) 22 72-221 Cable BASF Pres.: Roland Schemp; Gen. Mgr. Hans Albrecht, Sales Mgr. Jeanette Mendez, Prod. Mgr. Brigitte Schoner
Labels: (Owned) BASF, (licensed) Disneyland Vista (USA), Durium (Italy), Egrem (Cuba), Music Asse (USA), PPK (USA), Trova (Argentina)
Int'l reps.: Italy (Durium), USA (Disneylandia, PPK)

Bilo, see Unidas
Buho GM, see Grabaciones Mundiales
C B S / Columbia CA (IFPI) Apdo. 70169, Edif. Maploca II, 4th fl., Av. Principa los Cortijos de Lourdes, Los Ruices, Caracas 1071 Tel (02) 239-61 06 Cable CDLRECDRD Telex 25437 Gen. Dir. Gonzalo Pena de la Torre, A&R Gen. Mgr. Armando Calderon
Labels: (Owned) CBS/Columbia, Columbia, Epic, (licensed) A&M, American Int'l, Barnaby, Blue Sky, Boardwalk, Cleveland Int'l, Kirshner, Lorrmar, Monument, Ode, Philadelphia Int'l, Sam, TK, Tabu, Tappan Zee, Un limited Gold, Zappa (all USA), Apple (UK), Jet (UK)

C L R, see Los Ruices
Cokada, see PolyGram
Colibri, see Sonografica
Color, see Top Hits
Columbia, see CBS/Columbia
Cordica (Corp. Latinoamericana del Disco CA) (IFPI), Apdo. 70232, Edificio La Discoteca, 3rd fl., Calle Milan, Urbanizacion Los Ruices Sur, Caracas 107 Tel (02) 22-64 22 Cable CORDIS Comm'l Mgr. Sussy M de Von Schwedler, Sales Mgr. Antonio Farias
Labels: (Owned) Cordis, (represented) Ariola (Spain), RCA Victor (USA)
Cordis, see Cordica

Corposidco CA, Apdo. 19336, Edif. Iripina, Local 1, Mezzanina, Muerto a Go bernador, Caracas Tel 45 58 50, 45 08 78 Mng Dir. Manuel E. Pulido, Sales Mgr. Hugo Davila
Labels: (Owned) Salari, (licensed foreign) Auvi (Spain), Belter (Spain), MCP (USA), TR (USA), Teca (USA)
Int'l reps.: Argentina (Microfon), Chile (Philips), Colombia (Fuentes), Costa Rica (Gramisco), Ecuador (Fediscos), Guatemala (Discos de Centro America), Mexico (Peerless), Panama (Sonomundi), Peru (Infopesa), Puerto Rico (Velvet)

D G, see PolyGram
**El Disco de Moda CA, Pedras a Palmita, Caracas 1010 Tei (02) 42 19 87, 42 87 38, 42 07 67 Cable DISCDMODA Pres. Cesar Roldan, VP Victor Diver, Gen. Mgr. Alfonso Ramirez, Sales Mgr. Quiliano Molina
Label: (Owned) Discomoda (DCM)
Int'l reps.: (See Discomoda Int'l)**

Discomoda Int'l (IFPI), Apdo. 3402, 4a Calle Urbanizacion Ind'l Carapa, No 40, Caracas 1101 Tel (02) 49 74-94 Cable DISCDMODA Pres. Cesar Roldan, VP Victor Diver, Gen. Mgr. Peter Cernik S., Sales Mgr. Jesus E Espinoza, Label Mgr. Rafael Rivas, RRRP Mgr. Hector Vargas
Int'l branch: Colombia; Discomoda de Colombia Ltda
Labels: (Owned) Discomoda Jukebox, Mucer, OK, Orbe, (licensed foreign) Ampro (USA), BBC (UK), Baret (France), Caleidond (Mexico), Discolandia (USA), Gamma (Mexico), Guavacos Electricas (Brazil), Gull (UK), Happy Face (UK), Mustron (USA), Ovacion (USA), Pye (UK), RKM (Bene lux), Rampage (UK), Ri Fi (Italy), Satril (UK), Talent (Norway), Toledo (Germany)

Int'l reps.: Argentina (EMI Odeon), Bolivia (Lauro), Chile (EMI Odeon), Costa Rica (Bonidiscos), Ecuador (Fediscos), El Salvador (Bonidiscos), Guatemala (Bonidiscos), Honduras (Bonidiscos), Mexico (Gamma), Nicaragua (Bonidiscos), Peru (Industrial Sonarido), USA (Discolandia)
Discorona CA, Apdo. 5995, Caracas Tel 42 73 30
Label: (Represented) Kubaney (USA)

La Discoteca CA, Apdo. 70498, Edificio La Discoteca, Calle Milan 402, Urbanizacion Los Ruices Sur, Caracas 107 Tel (02) 22 64 22 Cable LADICO TECA Pres. Wilhelm Ricken, Comm'l Mgr. Enrique Barros
Labels: (Owned) Lad. Sonus, (represented) Ansonia (USA), Bambuco (Colombia), Codiscos (Colombia), Marveta (USA), Musart (Mexico), Pan art (USA)

Int'l reps.: Colombia (TH), Costa Rica (Indica), Dominican Republic (TH USA), Ecuador (Famoso), Mexico (Musart), Peru (IEMPSA), Spain (EMI Odeon), USA (TH)
Disk, see Sonografica
Oivensa Disquera Venezolana SA (IFPI), Edo. Tachira, Carrera 14 2 81, La Concordia, San Cristobal Tel (076) 27022, 27475 Pres. Achim Wicke, Gen. Mgr. Rafael Oihaves, Sales Mgr. Fernando Herran
Labels: (Owned) Andisco, Divensa, (licensed foreign) Yuriko (Mexico)
Int'l rep.: Mexico (Yuriko)

Epic, see CBS/Columbia
Eros, see Sonografica
Fontana, see PolyGram
Grabaciones Mundiales CA (IFPI), Edif. Galaxia, Planta Baja, Boletia Norte, Calle Santa Clara, Caracas Tel (02) 34 75 71 Cable PAMUSICA Telex 26232 Pres. Arlindo Andrade Silva, VP Ernesto Ave. Label Mgr. Jorge Andrade, Sales Mgr. Danny Hawkins
Labels: (Owned) Buho GM, (licensed foreign) Alhambra (Spain), Aris

VENEZUELA

Population: 14,000,000

(Italy), Atlantic/Alco (USA), Copacabana (Brazil), Cotillion (USA), Elektra/Asylum (USA), Libra (USA), Luznel : Puerto Rico, Movieplay (Spain), Nonesuch (USA), Nuestra (Puerto Rico), Orfeu (Portugal), Papa gayo (Puerto Rico), Reprise (USA), Records (Italy), Telefunken (Germany), Tierrazo (Puerto Rico), WEA (Worldwide), Warner Bros (USA)
Int'l reps.: Colombia (Incolve), USA (Alhambra)
 Gramsca, see El Palacio de la Musica
 H B, see El Palacio de la Musica
 Helidor, see PolyGram
 Interamericana de Grabaciones SA, Apdo 70862, Edif Lance, Piso 2, Sector Sur La Urbina, Los Ruices, Caracas 107 Tel (02) 38 74 91, Pres Prudencio Sanchez, VP Julio Cesar Cortez, Gen Mgr Orlando E Montiel
 Jukebox, see Discomoda
 Karussell, see PolyGram
 Lad, see La Discoteca
 Latino, see Suramericana
 Latinoamericana del Disco CA (Corp), see Cordica
 M G M, see PolyGram
 Mercury, see PolyGram
 Morichal, see All Stars
 Mucer, see Discomoda
 O K, see Discomoda
 Orbe, see Discomoda
 El Palacio de la Musica SA (IFPI), Apdo. 3637, Guayabal a Venado 4 1, Caracas 1010A Tel (02) 93-43 11 Cable PAMUSICA Telex 26232 Pres Ernesto Aue, VP Herbert Venjakob, Gen Mgr Miguel Angel Pina, Sales Mgr Carlos von Einem
Labels: (Owned) Gramsca, HB, Palacio, Soles, Tee Ven, (licensed) Alegre (USA), Buddah (USA), Coco (USA), Colique (USA), Delphine (France), Fama (USA), International (USA), Liberty (USA), Motown (USA), Peerless (Mexico), Seeco (USA), Tico (USA), Vanguard (USA), Telex (USA), West Side (USA)
Int'l reps.: Central America (Indica), Colombia (Incolve), Ecuador (Famoso), Mexico (Peerless), Peru (El Virrey), USA (West Side), rest of world (Polydor)
 Philips, see PolyGram
 Polydor, see PolyGram
 PolyGram Discos SA, Apdo 5458, Edificio PolyGram, 1st fl, Calle 6 & B, La Urbina, Caracas 1074 Tel (02) 35-08 25 Telex 24235 Gen Mgr Helga Moslener, Finance & Admin. Mgr Freerk Abma, A&R Paul Ehrlich, A&R Nat'l Folklore Jose Bello
Labels: (Owned) Archiv, Cokada, DG, Fontana, Helidor, Karussell, MGM, Mercury, Philips, Polydor, Tip, Vertigo, Verve, (licensed) Bronco (Puerto Rico), Casablanca (USA), Chocolate City (USA), Decca (UK), Fauves Puma (France), Lollipop (Germany), London (USA), RSO (UK), Rocket (UK), Spring (USA), Zahro (Spain)
 R P M Discos CA, Edif Roviers, 3rd fl, No. 5, Cipreses a Santa Teresa Tel 45-43-81 Pres Robert Buckley, Promo Mgr C-sar Esquivia, PR Carlos Alamo, Int'l Mgr Leon Ras
Labels: (Owned) RPM, (represented) National, Prelude, Red Greg (all USA)
 Los Ruices SA (Corp), Apdo 70251, Calle Milan 402, Urbanizacion Los Ruices Sur, Caracas 107 Tel (02) 22 64 22 Cable ODEONSA, Pres Wilhelm Ricken, Mktg Mgr Salvador Perez
Labels: (Owned) CLR, (licensed) Capitol (USA), Carrere (France), Chiswick (UK), De-Lite (USA), Discap (Luxembourg), EMI (worldwide), EMI America (USA), Harvest (UK), Purple (UK)
 Safari, see Corpodisco
 San Sebastian de Oro (Fundacion), Calle 5 & Av Oriental, Urbanizacion Merida Qta Zunimar, San Cristobal, Tel (076) 2 74 55, 3-60 05, (Distributor/importer)

Labels: (Distributed—not licensed) Andino, (represented) Ambuco (Colombia), Sonolux (Colombia).
 Solex, see El Palacio de la Musica
 Sonografica Venezolana CA (Dist), Apdo 19347, Caracas 1014A Tel (02) 41 39 91 Telex 21195, Dir Gen & Gen Mgr Gerardo Rodriguez, Sales Mgr Gumerindo Miranda
Labels: (Owned) Colibri, Disk, Eros, Sonografica.
 Sonoven CA, Apdo 4672, Bucare a Puente Junin, Edif El Sol, Local C, Caracas Tel 42 77 50, 42 00 04 Cable SONOLUX
Labels: (Represented) Arco Iris (El Salvador), Dicesa (El Salvador), Discuba (USA), FTA (Peru), M&M (USA), Rafalo (Colombia), Rumba (USA), Sol de America (Chile), Sonolux (Colombia), Sonomex (Mexico)
 Sonus, see La Discoteca
 Suramericana del Disco Srl (IFPI), Esq. Puente Restaurador, Mezzanina, Caracas Tel (02) 441 4444/4233 Cable SURADISCO Pres Antonio Jose Segura Gomez, VP Hernando Izquierdo Fonseca, Promo Dir Jorge Garcia
Labels: (Owned) Latino, Venus, Yare, (licensed) Alshire (USA), Barclay (France), Belter (Spain), Famoso (Ecuador), Fonobox (Colombia), Fonomex (Mexico), Santana (Colombia), Vergara (Colombia), Victoria (Colombia)
Int'l reps: Colombia (Victoria), Ecuador (Famoso), Guatemala (Dideca), Panama (Dideca), Peru (FTA)
 Tele Ven, see El Palacio de la Musica
 Tip, see PolyGram
 Top Hits CA (Discos), Apdo 70499, Edificio Continmaca, Calle Milan 402, Urbanizacion Los Ruices Sur, Caracas 107 Tel (02) 22 64 22 Cable LA DICOITECA Pres. Wilhelm Ricken, Comm'l Mgr Oscar Serfaty
Labels: (Owned) Color, Top Hits
Int'l reps.: Central America (Indica), Argentina (CBS), Chile (EMI Odeon), Colombia (TH), Dominican Republic (TH-USA) Ecuador (Famoso), Mexico (Musart), Peru (IEMPSA), Spain (EMI Odeon), USA (TH) Unidas (Disqueras) CA, Apdo 8087, Venado a Piedras, Residencias Las Piedras, Local 4, Caracas Tel (02) 45 06 17, 45-01 64 Cable OISU NICRA
Labels: (Licensed domestic) Billo, (represented) Fuentes, Intermusique, Jupiter, Microfon, Orleon, Springboard, Xino
 Velvet de Venezuela SA, Apdo 19134, Edificio Andrea Doria, Off 1, Rio a Puente Soublette, Caracas 101 Tel (02) 41 40 62, 42 20 19 Cable VELVESA Telex 26263 Pres Jose Page Barrios, Gen & Sales Mgr Antonio Valenilla, A&R Mgr Luis F Mendoza, Int'l Affairs Mgr Carlos Ray bans
Int'l branch: USA
Labels: (Licensed) Arista (USA), Chiao (Italy), Fuentes (Colombia), Gema (USA), Ibis (USA), Infopesa (Peru), MCA (USA), Prelude (USA), Splash (UK)
Int'l reps.: Argentina (Microfon), Central America (Dideca), Chile (Philips), Colombia (Fedicsos), Ecuador (Fedicsos), Peru (Infopesa), Puerto Rico (Velvet), Spain (RCA, Intermusique)
 Venus, see Suramericana
 Vertigo, see PolyGram
 Verve, see PolyGram
 Yare, see Suramericana

• music publishers

M L L CA (Producciones Musicales), Av La Colina, Quinta, Elyraida, Las Acacias, Caracas 104
 Mundo Musical Publ'g, Apdo 70169, Maploca II, 4th fl, Av Principal Los Cortijos de Lourdes, Los Ruices, Caracas 1071 Tel (02) 239 61 06

Cable COLRECORD Telex 25437 Gen Dir Gonzalo Pena de la Torre, Gen Mgr Mario Garcia
Int'l firms represented: April (worldwide), Blackwood (Canada, Germany, Greece, USA), CBS (Colombia), EMI Odeon (Chile), Melograf (Argentina), Mundo Musical (Latin America)
Int'l reps.: Worldwide (April) excluding Latin America (Mundo Musical) Orbe Ecs, Musicales, PO Box 3402, 4a Calle Urbanizacion Ind'l Carapa, No 40, Caracas 101 Tel (02) 49 74 91 Cable ORBEMUSA Pres Cesar Roldan, VP Victor Oliver, Gen Mgr Ligia de Garcia
Int'l firms represented: Amanecer 76 (Spain), Marler (Spain), Morro (USA), Muscol (Colombia), Pamscos (Argentina), Prodema (Peru), SA-DRAM (Ecuador)
Int'l reps.: Argentina (Pamscos), Canada (Morro), Central America (EM (ASA), Colombia (Discomoda), Ecuador (SADRAM), Mexico (EMLASA), Peru (Prodema), Spain (Amanecer 76), USA (Morro)
 San Sebastian de Oro (Fundacion), Calle 5 & Av Oriental, Urbanizacion Merida Qta Zunimar, San Cristobal Tel (076) 2 74 55
 Suramericana Musica (Ed.), Esq. Puente Restaurador, Mezzanina, Caracas Tel (02) 45 10 24, 45 20 53 Cable SURADISCO
 Universal Music Publ'g CA (Unimusca), Apdo 70419, Av. Milan 402, Urbanizacion Los Ruices Sur, Caracas 107 Tel (02) 22 64 22 Cable UNIMU SICA Pres Wilhelm Ricken
 Velvet (Ed Muscosa) CA, Apdo 19134, Caracas 1014-A Tel (02) 42-20 19, Cable VELVESA Telex 26263 Pres Jose Page Barrios, Gen Mgr. Armenia Angelino
Int'l firms represented: Coco (USA), Edimusca (Colombia), Orleon (Mexico)

• services

DESIGN & ARTWORK

Litho Album CA, Av Principal de la Yaguara-Calle 7, Centro Yaguara, Local 5, Caracas 101 Tel (02) 443-76-22
 Orbemusa, Apdo 3402, 4a Calle Urbanizacion Ind'l Carapa, No 40, Caracas 1020 Tel (02) 49 74 91 Cable FAVEOICA Pres Cesar Roldan; VP Victor Oliver, Gen Co ord Alfonso Ramirez, Opns. Mgr Clemente Sposito, Maintenance Mgr Alvaro Rodriguez
 San Sebastian de Oro (Fundacion), Calle 5 & Av Oriental, Urbanizacion Merida Qta Zunimar, San Cristobal Tel (076) 2 74 55, 3-60-05

LICENSING ORGANIZATION, MUSIC

S A C V E N (Sociedad de Autores & Compositores de Venezuela), Edif VAM, 9th fl, Torre Oeste, Av Andres Bello, Caracas 1050, Tel (02) 573-2389/1589/0167 Dir Gen Luis Alfonso Larraín (Mechanical, performing & theatrical rights)

PLATING, PROCESSING & PRESSING PLANTS

Audio Matrices de Venezuela CA, Rio a Puente Soublette, Edif Andrea Doria, Of 3, Caracas Tel (02) 41 01 23 Chief Exec. Jose Page Barrios, Gen Mgr Humberto Torrealba (Disk mastering only)
 Crodisca (Productora Crodilla de Discos CA), Apdo 70498, Edificio La Discoteca, Calle Milan 402, Urbanizacion Los Ruices Sur, Caracas 107 Tel (02) 22 64 22 Cable LADICOTECA Pres Wilhelm Ricken, Mgr. Dr Klaus Koller
 Dark (Fabrica de Discos), Apdo 8087, Avda Intercomunal de Antimano 60, Urb Carapa, Caracas 101 Tel (02) 49 49 09, 49 80-79
 Favedica (Fabrica Venezolana de Discos CA), Apdo 3402, 4a Calle Urbanizacion Ind'l Carapa, No 40, Caracas 1100 Tel (02) 49 74 91 Cable: FAVE OICA Pres Cesar Roldan, VP Victor Oliver, Gen Mgr Jesus Colmenares, Maintenance Mgr Alvaro Rodriguez
 Gramsca (Grabaciones de America SA), Piedras a Pte Restaurador 128, Caracas 101 Tel (02) 41 54 22 Cable PAMUSICA Telex 26232 Pres Gladys de Aponte, VP Herbert Venjakob
 Sonografica Venezolana CA (Ind'l), Apdo 19347, Caracas 1014A Tel (02) 41 39 91 Telex 21195 Or Gen & Gen Mgr Gerardo Rodriguez, Sales Mgr Gumerindo Miranda. (Pressing only)

PRINTERS & LITHOGRAPHERS

Crodisca (Productora Crodilla de Discos CA), Apdo 70498, Edificio La Discoteca, Calle Milan 402, Urbanizacion Los Ruices Sur, Caracas 107 Tel (02) 22 64 22 Cable LAOICOTECA Pres Wilhelm Ricken, Mgr. Dr. Klaus Koller
 Favedica (Fabrica Venezolana de Discos CA), Apdo 3402, 4a Calle Urbanizacion Ind'l Carapa, No 40, Caracas 101 Tel (02) 49 74 91 Cable FAVE OICA Pres Cesar Roldan, VP Victor Oliver, Gen Mgr. Jesus Colmenares, Maintenance Mgr Alvaro Rodriguez
 Grabaciones Mundiales CA, Edif Galaxia, Planta Baja, Bolenta Norte, Calle Santa Clara, Caracas Tel (02) 34 75 71 Cable PAMUSICA Telex 26232 Pres Arlindo Andrade Silva, VP Ernesto Aue
 Litho Album CA, Av Principal de la Yaguara Calle 7, Centro Yaguara, Local 5, Caracas 101 Tel (02) 443 76 22
 Orbemusa, Apdo 3402, 4a Calle Urbanizacion Ind'l Carapa No 40, Caracas 1020 Tel (02) 49 74 91 Cable FAVEOICA Pres Cesar Roldan, Gen Co ord Alfonso Ramirez, Opns. Mgr. Clemente Sposito, Maintenance Mgr Alvaro Rodriguez
 Sonografica Venezolana CA (Ind'l), Apdo 19347, Caracas 1014A, Tel (02) 41 39 91 Telex 21195 Or Gen & Gen Mgr Gerardo Rodriguez, Sales Mgr Gumerindo Miranda

RECORD PROMOTION

San Sebastian de Oro (Fundacion), Calle 5 & Av Oriental, Urbanizacion Merida Qta Zunimar, San Cristobal Tel (076) 2 74 55, 3 60 05

TAPE CUSTOM DUPLICATORS
 TAPE PACKAGING & LABELING

The Audio and Video lines indicate the configurations which the firms duplicate. Companies which offer packaging and labeling of tape product are indicated by "(PKG)" which appears after the main body of their respective listings.

Favedica (Fabrica Venezolana de Discos CA), Apdo 3402, 4a Calle Urbanizacion Ind'l Carapa, No 40, Caracas 101 Tel (02) 49 74 91
 Cable FAVEOICA Pres Cesar Roldan, VP Victor Oliver, Gen Mgr Jesus Colmenares, Maintenance Mgr Alvaro Rodriguez (PKG)
Audio: Cassette
 Lider Multicassette CA, Apdo 19134, Rio a Puente Soublette, Edif Andrea Doria, Mezzanina, Caracas 101 Tel (02) 42 76 32
Audio: 8 tr., cassette
 PolyGram Discos SA, Apdo 5458, Edificio PolyGram, 1st fl, Calle 6 & B, La Urbina, Caracas 1070 A Tel (02) 35 08 25 Cable POLYOR Telex 24235 Gen Mgr Helga Moslener, Tech Mgr Werner Hohmann
 Sonografica Venezolana CA (Ind'l), Apdo 19347, Caracas 1014A, Tel (02) 41 39 91 Telex 21195 Or Gen & Gen Mgr Gerardo Rodriguez, Sales Mgr Gumerindo Miranda (PKG—audio only)
 Sonus Electronics CA, Apdo 70380, Edificio La Discoteca, Urbanizacion Los Ruices Sur, Caracas 107 Tel (02) 22 64 22 Cable SONUS
Audio: 8 tr., cassette, open reel

How a sneeze on the other side of the world can affect your work force.



Flu is serious business. It spreads like wildfire. And has been known to cripple a nation's work force.
 The UN's World Health Organization keeps track of flu and identifies viruses so that people can be inoculated in time.
 The UN also has just about wiped out smallpox all over the

world. It keeps check on cholera, yellow fever, polio, and malaria.
 By helping people everywhere, the UN is helping people right here. And that's nothing to sneeze at.

The UN means business. American business should know.
 Get the whole story. Send for a free booklet, "The You in the UN." Write to UN Assoc., 300 E. 42nd St., N.Y. 10017.

 A Public Service of This Magazine & The Advertising Council

• **supplies**

CARTRIDGE & CASSETTE PARTS
EMPTY CARTRIDGES, CASSETTES & REELS

Allum's Maracabo Import CA, Centro Plaza, Nivel Ave. Francisco Miranda, Los Palos Grandes, Caracas 1062 Tel (02) 283-8031 Cable STEREO. Telex: 31183. Exec. VP: Irvin K. Allum Jr., Gen. Mgr. Dennis Fernandez. Sales Mgr. Mary Allum.

B A S F Venezolana SA, Edificio BASF, Calle Milan, Urb. Ind'l Los Ruices Sur, Caracas 107. Tel (02) 22-72-22. Cable BASF Pres. Roland Schempel, Gen. Mgr. Hans Albrecht; Sales Mgr. Jeanette Mendez, Prod. Mgr. Carlos Themann. Audio: Cassette.

JACKETS & SLEEVES
LABELS, OISK

Favedica (Fabrica Venezolana de Discos CA), Apdo. 3402, 4a Calle Urbanizacion Ind'l Carapa, No. 40, Caracas 101 Tel (02) 49-74-91. Cable FAVE-OICA. Pres. Cesar Roldan, VP: Victor Oliver, Gen. Mgr. Jesus Colme-nares, Maintenance Mgr. Alvaro Rodriguez.

TAPE, BLANK LOAEO & BULK RAW

B A S F Venezolana SA, Apdo. Edificio BASF, Calle Milan, Urb. Ind'l Los Ruices Sur, Caracas 107. Tel (02) 22-72-22. Cable BASF Pres. Roland Schempel, Gen. Mgr. Hans Albrecht; Sales Mgr. Jeanette Mendez, Prod. Mgr. Carlos Themann. (Blank only) Audio: Cassette.

Favedica (Fabrica Venezolana de Discos CA), Apdo. 3402, 4a Calle Urbanizacion Ind'l Carapa, No. 40, Caracas 101 Tel (02) 49-74-91. Cable FAVE-OICA. Pres. Cesar Roldan, VP: Victor Oliver, Gen. Mgr. Jesus Colme-nares, Maintenance Mgr. Alvaro Rodriguez. Audio: Cassette. Brand name: Oiscodoma (OCM).

• **accessories importer**

Allum's Maracabo Import CA, Centro Plaza, Nivel Ave. Francisco Miranda, Los Palos Grandes, Caracas 1062 Tel (02) 283-8031. Cable STEREO. Telex: 31183. Exec. VP: Irvin K. Allum Jr., Gen. Mgr. Dennis Fernandez. Sales Mgr. Mary Allum. Product: Record-carrying & storage cases, record care products, turntable mats, 45 rpm adaptors, replacement styli, tape-carrying & storage cases, head cleaners, bulk erasers, demagnetizers, leader & splicing tape.

VIRGIN ISLANDS (U.S.)

Population: 101,000.

• **record & tape manufacturers / distributors / importers**

Conrad (of St. Thomas) Ltd., PO Box 3187, Kronprindsens Gade Sta., St. Thomas 00801 Tel (809) 774-2433 (Distributor)

Branch: USA

Westindy Music Co. Inc., PO Box 2896, 86 Main St., St. Thomas 00801 Tel (809) 774-4488. Pres. Wilbur La Motta, Gen. Mgr. Leroy A. La Motta. Labels: (Owned) Cultural Dimensions, Westindy. Int'l reps.: Barbados (WIRL), Jamaica (Dynamic), Trinidad (Record Specialists), USA (Pickwick)

• **music publisher**

Westindy Music Co. Inc. (ASCAP), PO Box 2896, 86 Main St., St. Thomas 00801 Tel (809) 774-4488. Cable WESTINDY. Pres. Wilbur La Motta

YUGOSLAVIA

Population: 23,000,000.

Rate of exchange: \$1 (US) = 34 New Dinars

Per capita income: \$2,000.

Holidays: January 1 & 2 (New Year's), April 27, May 1 & 2 (Labor Day), July 4, 22, November 1 (Slovenia), November 29 & 30 (Day of the Republic).

RECORDS & TAPES:

Note: Sales figures are rough estimations since no company reports the exact sales

Record sales certification awards: Silver single—50,000 units, gold single—100,000 units; platinum single—200,000 units. Silver LP—12,500 units, gold LP—25,000 units; platinum LP—50,000 units.

Records & tapes sold domestically including imports (retail value): LP's & cassettes 1980—11,000,000 units; \$28,600,000. 1979—10,000,000 units; \$23,000,000. Singles 1980—4,500,000 units; \$3,150,000. 1979—5,000,000 units; \$3,000,000.

Records exported to USA (factory value, FOB): 1980—50,000 units; \$100,000.

Records exported to countries other than USA (factory value, FOB): 1980—650,000 units; \$1,300,000.

Average retail price per record: LP's—\$3.30; singles—\$1.00

Discounting: Rare

Type of distribution: Manufacturer to retailer exclusively.

Type of promotion: Mainly newspaper advertisements, radio, television, and posters.

TAPE:

Market: The cassette is the prevailing and fastest growing segment. There are no 8-tr. and open reel. Video is very minor.

CONSUMER ELECTRONICS:

Number of homes with: Radios—4,634,000 (85%), television sets—4,189,000 (72%), color sets—300,000 (6%)

RADIO STATIONS

No. of government 10 major and 250 minor radio stations

Comment: Programs are mainly recorded, with repertoire being officially declared to be 70% domestic and 30% international

TELEVISION STATIONS:

No. of government channels: 4, 30% in color (PAL)

Comment: Television shows feature informative programs, films, serials, live broadcasts of sports, and musical events

IMPORT/EXPORT REGULATIONS:

The importation of records and muscassettes is not permitted. Exports are primarily to territories where emigrants or workers abroad are resident, that is, West Germany, Austria, Switzerland, Sweden, France, Canada and Australia.

MARKET ANALYSIS:

The entire music industry reports an average increase in turnover of about 30% for the past year, which is mostly due to price increases and partly to unit growth. Most labels cut down on the relicensing of product due to the difficulties in paying royalties. There was a very strong influence of new wave music.

Jugoton and RTB Belgrade are still the leading companies, followed by RTV Ljubljana, Jugodisk and Suzy. Silver Wings, a new act, sold over 200,000 units on one release.

Mitja Volcic

• **record & tape manufacturers / distributors / importers**

Oiskoton Produkcija Gramofonskih Ploca & Kazeta, Hasana Brkica 58a, 71000 Sarajevo. Tel (071) 33-613, 33-583. Dir.: Milosevic Vajo, Sales Mgr.: Bilic Nenad; Musical Mgr.: Vujovic Slobodan. Label: (Owned) Oiskoton. Int'l reps.: USA (Motown).

Helidon Tovarna Gramofonskih Plosc, Vodnikova 42, 61000 Ljubljana. Tel: (061) 55-179. Gen. Mgr.: Ousan Orolc; Sales Mgr.: Jozc Kosar, Prod'r.: Vilko Ovsenic. (Distributed by Suzy).

Labels: (Owned) Helidon, (represented) Decca, Telefunken (West Germany).

Jugodisk (IFPI), Ljubicka 15, Belgrade. Tel: (11) 473-009. VP: Bozidar Gocik, Gen. Mgr.: Zavadim Jovanovic; Sales Mgr.: Orvnic Ratibor; Int'l Mgr.: Radomir Kricic.

Jugoslovenska Kniga, Obilicev Venac 24, Belgrade. Tel: 623-799. (Importer/Exporter)

Jugoton (IFPI), Niska bb, 41040 Zagreb. Tel (041) 251-155. Cable JUGOTON Telex: 21857. Gen. Mgr.: Stevan Piller. Int'l Mgr.: Branko Plavsic; Repertoire Dept. Head: Dubravko Majnarcic, Int'l Repertoire & Label Mgr.: Veljko Despot, A&R Vojno Kundic; Classical Div.: Vida Ramuscak; Folk Repertoire: Mirko Gavrilovic; Children's & Spoken Word Editor: Ljerkica Markovic.

Labels: (Owned) Jugoton, (licensed foreign) Barclay (France), Bronze (UK), Capitol (USA), Charly (UK), DJM (UK), Decca (UK), EMI (UK), Elite Special (Switzerland), Fantasy (USA), Hansa (Germany), Island (UK), Milestone (USA), Prestige (USA), RCA (USA), RAK (UK), United Artists (USA), Virgin (UK), Vogue (France)

Prosveta, PO Box 555, Terazje 16, 11001 Belgrade. Tel: 20-566. Telex: 11609. Dir.: Slavko Kalaba. (Importer/Exporter)

R T B, see Record Prod'n.

RTV Recs. & Tapes, Dalmatnova 17, 61000 Ljubljana. Tel: (061) 311-922. Telex: 31118. Mng. Dir.: Igor Robeznik, Label Mgr.: Anđej Sifer. Labels: (Owned) RTV Ljubljana, (licensed) Sabablanca (USA), Chrysalis (UK), Ricordi (Italy), Stiff (UK).

Record Prod'n of Radio-Television Belgrade (IFPI), Makedonska St. 21, 11000 Belgrade. Tel: 320-277. Cable RTB RECORDS Telex: 12030. Gen. Mgr.: Stanko Terzic.

Labels: (Owned) RTB, (licensed) A&M (Europe, USA), Ariola-Eurodisc (France, Germany, Spain, USA), Cherry Pie (Australia), First American (USA), Hispavox (Spain), Polar (Sweden), PolyGram (Germany, Netherlands), Teldec/Storyville (Germany), Timeless (Netherlands). Int'l reps.: Germany (RCA), Netherlands (Phonogram Int'l/PolyGram), USA (Everest, Olympic).

Sarajevodisk, Djure Dzakovic 17, Sarajevo. Tel: (071) 23027. Dir.: Muradif Brkic. (Distributor)

Studio B Produkcija Gramofonskih Ploca, (Radiodifuzna Org.), PO Box 10, Masarikova 5, 11000 Belgrade. Tel: (011) 684-798. Dir.: Dragan Markovic, Gen. Mgr.: Oragan Vidak, Sales Mgr.: Zorica Mladenovic, Musical Editor: Slobodan Konjovic.

Labels: (Owned) Studio B, (licensed) EMI (UK), Pye (UK). Sumadija—Produkcija Ploca, Batocian kod Kragujevca. Tel: (034) 81-187. Suzy Recs. (div. of Zalozba Obzorja Maribor), PO Box 729, Gruska 10, 41000 Zagreb. Tel: (041) 519-955. Cable: PGP SUZYZGB.

Labels: (Owned) Suzy, (distributed) Helidon, (licensed) CBS (USA), WEA Int'l (USA). Int'l reps.: USA (CBS, WEA Int'l).

• **music publishers**

Favorite Music, PO Box 729, Gruska 10, 41000 Zagreb. Tel: (041) 519-955. Cable: PGP SUZYZGB.

Interest: see Favorite.

Jugoton Eds. Musicales—JEM, Niska bb, 41040 Zagreb. Tel: (041) 251-155. Cable JUGOTON Telex: 21857. Gen. Mgr.: Stevan Piller, Publ'g Mgr.: Simsa Skarica.

Kinet Music (Eds. Musicales), Vinogradska 3, 41000 Zagreb. Tel: (041) 573-462. Pres. & Gen. Mgr.: Mario Kinet.

Int'l firms represented: Accord (West Germany), Bruzia (Australia), Curci (Italy), Devega (Italy), Mascotte (Italy), Musica & Dischi (Italy), Sonoton (West Germany), Union (Sweden), Weltmusik (Austria).

Int'l rep.: Italy (Musica & Dischi), West Germany (Accord).

RTV Recs & Tapes, Dalmatnova 10, 61000 Ljubljana. Tel: (061) 311-922. Telex: 31118. Mng. Dir.: Igor Robeznik.

Dragan Schmitzanic, PO Box 543, Marticeva 21 11, 41000 Zagreb.

Int'l firm represented: April Blackwood (USA). Zabavne Melodije, Bercslaviceva 9, 41000 Zagreb. Tel: (041) 442-084.

• **services**

ASSOCIATIONS & PROFESSIONAL ORGANIZATIONS

Association of Jazz & Light Music Musicians, Kneza Milosa St. 10, 11000 Belgrade. Tel: 333-627.

Composers Association of Croatia, Bercslaviceva 9, 41000 Zagreb. Tel: (041) 440-025.

F I O O F (Federation Int'le des Organisateur des Festivals), PO Box 370, 58000 Split. Tel: (058) 514-014. Cable: FIDOF Telex: 26350. Pres.: Augusto Alguero, Sec'y Gen.: Armando Moreno, Ambassador: Les Reed.

Jugoslovenska Radio-Televizija (Radio & TV), Borisa Kidrica 70/1, 11000 Belgrade. Tel: (011) 433-647, 433-718. Cable: JURATE. Telex: 11469.

National Committee of the Int'l Music Council, Misarska 12-14, Belgrade. Tel: (011) 334-771.

S O K O J (Savez Drganzacija Kompozitora Jugoslavije), Misarska 12-14,

11000 Belgrade. Tel: (011) 334-771. Cable: SOKOJ. Pres. of Presidency Vojin Komadina; Sec'y: Toma Prosev. Union of Yugoslav Performing Artists, Terazje 26, Belgrade. Tel: (011) 322-732.

LICENSING ORGANIZATIONS, MUSIC

S O K O J (Savez Organizacija Kompozitora Jugoslavije), Misarska 12-14, 11000 Belgrade. Tel: (011) 334-771. Pres. of Presidency Vojin Komadina, Sec'y: Toma Prosev. (Mechanical & performing rights). Zavod za zastitu autorskih malih prava (Performing & Mechanical Rights Society), Misarska 12, Belgrade.

PLATING, PROCESSING & PRESSING PLANTS

Helidon Tovarna Gramofonskih Plosc, Vodnikova 42, 61000 Ljubljana. Tel: (061) 55-179. Gen. Mgr.: Ousan Orolc; Sales Mgr.: Jozc Kosar, Prod'r.: Vilko Ovsenic. (Pressing plant only).

Jugoton Recs., Niska bb, 41040 Zagreb. Tel: (041) 251-155. Cable: JUGOTON Telex: 21857. Gen. Mgr.: Stevan Piller, Prod'n Mgr.: Stjepan Novak.

PRINTER & LITHOGRAPHER

Jugoton Recs., Niska bb, 41040 Zagreb. Tel: (041) 251-155. Cable: JUGOTON Telex: 21857. Gen. Mgr.: Stevan Piller, Prod'n Mgr.: Stjepan Novak.

RECORD PROMOTION

R T V Ljubljana Recs. & Tapes, Tavcarjeva 17, 61000 Ljubljana. Tel: (061) 313-039. Telex: 31118. Mng. Dir.: Jure Robeznik; Ass't Mng. Dir.: Int'l: Dusan Velkaverh.

TAPE CUSTOM DUPLICATORS
TAPE PACKAGING & LABELING

The Audio and Video lines indicate the configurations which the firms duplicate. Companies which offer packaging and labeling of tape product are indicated by "(PRG)" which appears after the main body of their respective listings.

Jugoton Recs., Niska bb, 41040 Zagreb. Tel: (041) 251-155. Cable: JUGOTON Telex: 21857. Gen. Mgr.: Stevan Piller, Prod'n Mgr.: Stjepan Novak.

Audio: Cassette.

R T V Ljubljana Recs. & Tapes, Tavcarjeva 17, 61000 Ljubljana. Tel: (061) 313-039. Telex: 31118. Mng. Dir.: Jure Robeznik; Ass't Mng. Dir.: Int'l: Dusan Velkaverh. (PRG)

Audio: Cassette.

• **supplies**

PROFESSIONAL TAPE SUPPLIES
TAPE, BLANK LOAEO & BULK RAW
TAPE DUPLICATING EQUIPMENT

Progres-Hemoteks Direkcija BASF, Knez Mihajlova 27/II, YU-11000 Belgrade. Tel: 624-222. Cable: JUGOPROGRES Telex: 11109.

• **accessories manufacturer**

Jugoton Recs., Niska bb, 41040 Zagreb. Tel: (041) 251-155. Cable: JUGOTON Telex: 21857. Gen. Mgr.: Stevan Piller, Prod'n Mgr.: Stjepan Novak. Product: Record—45 rpm adaptors.

\$1 Billion

That's the size of the worldwide Spanish-Language Music/Recording Market reached by Billboard en Español

Billboard en Español. Edited for the industry decision-makers. News. Articles. Latest reports from over 20 top correspondents. Plus regional and international charts on Spanish-Language product. Phone (212) 764-7375. Telex (int'l) 621089 • 1515 Broadway, NYC 10036.

Billboard EN ESPAÑOL

TO Billboard En Español, 1515 Broadway, NY, NY 10036

I want to subscribe for one year at \$65 per year

Send me advertising rates and data

Name _____

Phone _____

Company _____

Address _____

City _____

State _____ Zip _____



RECORD COLLECTORS! TRIVIA BUFFS!
 NOSTALGIA FANS! RADIO PROGRAMMERS...
 AND EVERYONE INTERESTED
 IN MUSIC PAST AND PRESENT!

BILLBOARD'S RESEARCH AIDS PACKAGES, compiled from Billboard's Charts, have been prepared for radio programmers, record buffs, oldies collectors—they are essential for anyone involved in pop, country, soul, adult contemporary, classical, jazz, gospel—all areas of music!

WHAT'S AVAILABLE?

NUMBER ONE RECORDS (any package listed with the number "1"):
 A listing of every record that reached the Number One position on Billboard's charts for the period covered, week-by-week. Lists issue date, title, artist, label—in order of issue date.

TOP TEN RECORDS (any package listed with the number "2"):
 A listing of every record that reached any of the Top Ten positions on Billboard's charts for the period covered. Records are listed in alphabetical order by title within each year. Where duplicate versions of the same tune (cover records) occur, they are listed alphabetically by artist's last name. In cases where a record reached Top Ten in one year and was also in the Top Ten the following or a later year, it is listed in both years. Records marked with a "#1" indicate that the record reached the Number One position in the year in which it is so marked. Lists title, artist, label.

TOP RECORDS OF THE YEAR (any package listed with the number "3"):
 A listing of the best records of each year, based on a recap of the weekly charts for each year covered. Lists title, artist, label.

POP SINGLES

- A-1 Number One Pop Singles, 1941 through Present \$50.00
- A-2 Top Ten Pop Singles, 1947 through Present 50.00
- A-3 Top Pop Singles of the Year, 1946 through Present 50.00

POP ALBUMS

- B-1 Number One Pop Albums, 1947 to Present 50.00
- B-2 Top Ten Pop Albums, August 1948 to Present 50.00
- B-3 Top Pop Albums of the Year, 1956 to Present 50.00

COUNTRY SINGLES

- C-1 Number One Country Singles, 1948 to Present 50.00
- C-2 Top Ten Country Singles, 1948 to Present 50.00
- C-3 Top Country Singles of the Year, 1946 to Present 50.00

COUNTRY ALBUMS

- D-1 Number One Country Albums, 1964 to Present 25.00
- D-2 Top Ten Country Albums, 1964 to Present 25.00
- D-3 Top Country Albums of the Year, 1965 to Present 25.00

SOUL (RHYTHM & BLUES) SINGLES

- E-1 Number One Soul Singles, 1948 to Present 50.00
- E-2 Top Ten Soul Singles, 1948 to Present 50.00
- E-3 Top Soul Singles of the Year, 1946 to Present 50.00

SOUL (RHYTHM & BLUES) ALBUMS

- F-1 Number One Soul Albums, 1965 to Present 25.00
- F-2 Top Ten Soul Albums, 1965 to Present 25.00
- F-3 Top Soul Albums of the Year, 1966 to Present 25.00

ADULT CONTEMPORARY SINGLES

- G-1 Number One Adult Contemporary Singles, 1961 to Present 30.00
- G-2 Top Ten Adult Contemporary Singles, 1961 to Present 30.00
- G-3 Adult Contemporary Singles of the Year, 1966 to Present 30.00

CLASSICAL ALBUMS

- H-1 Number One Classical Albums, 1969 to Present 20.00
- H-2 Top Ten Classical Albums, 1969 to Present 20.00
- H-3 Top Classical Albums of the Year, 1969 to Present 20.00

JAZZ ALBUMS

- I-1 Number One Jazz Albums, 1969 to Present 20.00
- I-2 Top Ten Jazz Albums, 1969 to Present 20.00
- I-3 Top Jazz Albums of the Year, 1969 to Present 20.00

SPIRITUAL GOSPEL ALBUMS (SOUL GOSPEL)

- K-1 Number One Gospel Albums, 1974 to Present 15.00
- K-2 Top Ten Gospel Albums, 1974 to Present 15.00
- K-3 Top Gospel Albums of the Year, 1974 to Present 15.00

GREATEST HITS

- J Top 1000 Greatest Hits of All Time, 1956-1977 75.00
 (1978 Present Top 100 Included)
- L Yearend Issue—"Talent In Action" 7.00
 (Limited Stock Available)
- M Bicentennial Issue—"Music/Records/200"—History Of The Music/Record Industry 25.00
 (Limited Stock Available)

NOTE: Individual years of the Number One, Top Ten, or Top-of-the-Year listings may be purchased separately at \$5.00 each. Photo copies of individual weekly charts are available as follows: 1 to 4 pages: \$3.50 per page, 5 or more pages: \$3.00 per page.

Billboard Chart Research
 9107 Wilshire Blvd
 Los Angeles, CA 90023

Please send me the following Research Aids Packages
 (please list by code number):

I am enclosing a check or money order in the amount of \$
 (sorry there is no billing available for this service).

Name

Company

Address

City

State

Zip

SUPPLIES

• Continued from page 164

- Delta Magnetics Corp., 1901 McDonald Ave., Brooklyn N.Y. 11223 Tel (212) 627 6556. Telex 642271
Audio: Norelco style cassette boxes, leader tape (on reels or in web form)
- Disc Graphics (div. of Pickwick Int'l Inc.), 10 Gilpin Ave., Hauppauge N.Y. 11787. Tel (516) 234 1400
Audio: 8 tr & cassette labels
- Dyna/Day Plastics Inc. (sub. of American Sound), 6270 Country Club Rd. Tucson, Ariz. 85706. Tel. (602) 746 1001 Pres. Frank S. Day, VP & Gen Mgr. Larry Rossier, Sales Leslie Day
Sales offices: North Hollywood, Calif., 8120 Webb Ave. Zip 91605 Tel (213) 768 6100 Sales Dir. Bill Dawson-Closter, N.J., 317 Harrington Ave. Zip 07624 Tel (201) 767 9033 VP Mktg. Paul Adams
Audio: "Norelco style" cassette boxes
- El Mar Plastics Inc., 821 E. Artesia Blvd., Carson, Calif. 90746 Tel (213) 327 3180 Cable: ELMAR TWX (910) 346-6940 Pres. Allen Schor
Audio: Ampex, Norelco & soft poly style cassette boxes, open reel boxes, 8 tr & cassette splicing tape (SEE ADVERTISEMENT)
- Fenton Label Co., Coral & Buckwalter Sts., Philadelphia, Pa. 19124 Tel (215) 288 2910
Audio: 8 tr & cassette labels
- Fidelipac Corp., 109 Gauthier Dr., Mount Laurel, N.J. 08057 Tel (609) 235 3511 TWX (710) 897 0254 Pres. Roger Thanhauser, Sales & Mktg Mgr. Arthur Constantine
Audio: 8 tr labels
- Filam Nat'l Plastics Inc., 13984 Orange Ave., Paramount, Calif. 90723 Tel (213) 630 2500
Audio: Norelco & soft poly style cassette boxes, 1/4" NAB hubs, cassette hub locks (SEE ADVERTISEMENT)
- Fuji Photo Film USA Inc., Magnetic Tape Div., 350 Fifth Ave., 70th fl., New York, N.Y. 10118 Tel (212) 736 3335 VP & Gen Mgr. John Dale, Nat'l Sales Mgr. John Birmingham, Adv. Mgr. Margaretha Bystrom
Product: Fire retardant plastic shippers for 1" & 2" tape
- G C Electronics, 400 S. Wyman St., Rockford, Ill. 61101 Tel (815) 968 9661 Cable: GCELECT VP & Gen Mgr. Wayne Tompe, Sales & Special Mkts. Dir. James E. Heighway, Adv. Joyce Donahue
Audio: Head demagnetizers, bulk erasers, splicing & editing equip., cartridge & cassette head cleaners
Video: head cleaners & demagnetizers, connectors
- Gabriel Mfg. Co. Inc., 125 S. Liberty Dr., Stony Point, N.Y. 10980 Tel (914) 942 0100 Pres. Ed Gabriel, VP. Richard Gabriel, Gen. Mgr. Vin Tullio, Adv. Mgr. Ellen Gabriel
Audio: All types of plastic cassette boxes
- Gem Bilt Container Corp., 48 20 50 Ave., Woodside, N.Y. 11377 Tel (212) 784 8800
Audio & Video: Corrugated cartons, folders & mailers.
- Georgia Pacific Corp., 290 Ferry St., Newark, N.J. 07105 Tel (201) 344 2300
Audio: Cellulose acetate film
Brand name: Xcel
- Golly Co., 2320 E. 26 St., Minneapolis, Minn. 55406 Tel (612) 721 7466 Gen. Mgr. Les Malmquist, Mktg. Scott Birchfield
Audio: Cassette labels
Video: Videocassette labels
- Gotham Audio Corp., 741 Washington St., New York, N.Y. 10014 Tel (212) 741 7411 Pres. Stephen F. Temmer, Sales Mgr. Russell D. Hamm
Audio: Splicing & editing equip. (Gotham), precision tape timer (Lyrec)
- H R C Printing, 5252 E. Trindle Rd., Mechanicsburg, Pa. 17055 Tel (717) 766 0943 Gen. Mgr. Donald E. Baldwin
Audio: Cassette labels
Video: Videocassette labels (SEE ADVERTISEMENT)
- A C. Hampson Printing Co., 168 City Hill St., Naugatuck, Conn. 06770 Tel (203) 729 2294 Pres. Augustus D. Hampson, Sales Mgr. John W. Berry
Audio: Pressure sensitive & heat seal cassette labels, cassette inserts
Video: Videocassette labels
- Hi Flex Corp., 404 Artillery Rd., Taylors, S.C. 29687 Tel (803) 268 2363
Audio: Cassette leader tape
- I C I United States Inc., Plastics Div., New Murphy Rd., Wilmington Del. 19897 Tel (302) 575 3000
Audio & video: Polyester film tape base
Brand name: Melinex
- I P S., 107 Bridge Rd., Hauppauge, N.Y. 11787 Tel (516) 234 3322
Audio: Norelco style cassette boxes
- Image Devices Inc., 1825 NE 149 St., Miami, Fla. 33181 Tel (305) 945 1111 Telex 519348 TWX (810) 845 4242 Sales Mgr. Bill Reiter
Audio: Pressure sensitive labels
- Industrial Audio Film Servs. Inc., 6228 Oakton St. Morton Grove, Ill. 60053 Tel (312) 965-8400
Audio: Cassette labels
- Infopak, see Audio Accessories
- Infonics Inc., PO Box 1111, 238 Hwy. 212, Michigan City, Ind. 46360 Tel (219) 879 3381 Telex 233111
Audio: Alignment tapes, kits, duplicator peripherals (SEE ADVERTISEMENT)
- International Rec'g Co., 49 Desmond Ave., Bronxville, N.Y. 10708 Tel (914) 337 5726. Pres. Claire Re
Audio: Recorder & duplicator magnetic heads, replacement parts for Ortofon equipment
Brand names: Heads-Bogen (Germany) Recorder parts-Ortofon (Denmark)
- Joyce Molding Corp., 501 Division St., Boonton, N.J. 07005 Tel (201) 334 2020
Audio: Norelco & soft poly style cassette boxes
Brand name: Max Sound (SEE ADVERTISEMENT)
- Ken-Del Prods Inc., 111 Valley Rd., Richardson Park Del. 19804 Tel (302) 655 7488
Audio: Cassette labels
- Keystone Printed Specialties Co. Inc., 321 Pear St., Scranton, Pa. 18505 Tel (717) 346-1761 Pres. M.C. Fischer, Sales & Adv. Mgr. Martin C. Fischer
Audio: 4-tr. 8 tr & cassette labels
Video: Videocassette labels (SEE ADVERTISEMENT)
- Lafayette Radio Electronics Corp., 111 Jericho Tpk., Syosset N.Y. 11791 Tel (516) 921 7700
Audio: Tape splicers
- Le-Bo Prods Co. Inc. (div. of Peerless VidTronics Corp.), 58 60 Grand Ave., Maspeth, N.Y. 11378 Tel (212) 894 5155 Cable: LEBOPRODUX Telex 424790 Pres. Peter Dayton
Audio: Cassette mailers, cassette labels (SEE ADVERTISEMENT)
- Lee Myles Assocs., 160 E. 56 St., New York, N.Y. 10022 Tel (212) 758 3232 Cable: LEE MYLES Pres. Robert M. Miller, VP. Howard Roseff
Audio: Cassette labels
Video: Videocassette labels (SEE ADVERTISEMENT)
- Lenco Co., PO Box 160, 10240 Deerpark Rd., Waverly, Neb. 68462 Tel (402) 786 7488 Pres. Don Leonhardt, Mktg. Dir. Brad Harse Sales Mgr. Daryl Chapelle
Audio: Ampex, Norelco & soft poly style cassette boxes, display boxes, cassette leader tape (SEE ADVERTISEMENT)
- Lion Rec'g Servs. Inc., 1905 Fairview Ave. NE, Washington, D.C. 20002 Tel (202) 832 7883 Pres. Harold H. Lion, Sales & Adv. Mgr. Jim Fox
Audio: Cassette labels
- Lupps Inc., 1630 Euclid St., Santa Monica, Calif. 90404 Tel (213) 450 1324
Audio: Magnetic heads
- Loranger Mfg. Corp., Entertainment Prods. Div., 10 48 Clark St., Warren, Pa. 15665 Tel (814) 723 8600 VP: Robert Loranger
Audio: Norelco style cassette boxes (SEE ADVERTISEMENT)
- Lyrec, see Gotham
- M R L, see Magnetic Reference Lab
- Mac Murray Press Inc., 230 W. 17 St., New York, N.Y. 10011 Tel (212) 924 1530 Pres. Bernard Lerman, Sales Mgr. Arnold Kohn
Audio: Cassette labels
Video: Videocassette labels (SEE ADVERTISEMENT)
- Magna, see, see Columbia Magnetics
- Magnetic Reference Lab. Inc., 229 Polaris Ave., Suite 4, Mountain View, Calif. 94043 Tel (415) 965 8187 Pres. John G. McKnight
Audio: Test tapes
Brand name: MRL
- Mastro Inds. Inc., 3040 Webster Ave., Bronx, N.Y. 10467 Tel (212) 547 5600 Pres. Mario Maccaferri
Audio: Ampex & Norelco style cassette boxes, reels for bulk cassette tape
- Melmax, see ICI
- Max Sound, see Joyce Molding
- Media Int'l Inc., 425 N. Michigan, Chicago, Ill. 60611 Tel (312) 467 5430 Pres. Duane Lundeen, VP. Margaret Lundeen, Gen. Mgr. Al Masters
Audio: Cassette labels
- Mike's Print Shop, 2507 Grm. Waco, Tex. 76707 Tel (817) 752 2321
Owner: Mike Stanley
Audio: Pressure sensitive cassette labels
- Mission Plastics South Inc., 341 Hill Ave., Nashville, Tenn. 37210 Tel (615) 244 5668
Factory: Jackson, Tenn., 74 Mission Dr. Zip 38301 Tel (901) 423 0810
Audio: Norelco-style cassette boxes
- Modern Album & Finishing Co. Inc., Cardinal Ind'l Park, Gilpin Ave., Hauppauge, N.Y. 11787 Tel (516) 234 1100 NYC (212) 291 7600 Pres. G.D. Thomas, Sales Mgr. R.A. Froehlig
Branches: Burbank, Calif., Modern Album of California Inc., 3116 Vanowen St. Zip 91505 Tel (213) 845 7655 Pres. William S. Pine, Sales Mgr. Raymond Gardocki-Terre Haute, Ind., Modern Album of Indiana, 1299 Voorhees St. Zip 47808 Tel (812) 235-6001-Nashville, Tenn., Modern Album of Tennessee Inc., 457 Chestnut, Zip 37203 Tel (615) 255 7461
Product: Audiocassette & videocassette labels, "set-up" boxes, cartridge & cassette boxes, slip cases
- Molded Ind'l Plastics, 151 Wakelee Ave., Ansonia Conn. 06401 Tel (203) 735 2331
Audio: 5", 7" & 10 1/2" hinged paper reel boxes, hubs for raw or blank tape
- Musicassette Dupli's of Hawaii, PO Box 12210, Honolulu, Hawaii 96822 Tel (808) 533 4165
Audio: Cassette labels
- N A C, see National Audio
- Namiki Precision Jewel Co. Ltd., 15 Essex Rd., Paramus, N.J. 07652 Tel (201) 368 8310 TWX (710) 990 1273
Home office: Japan
Audio: Magnetic tape heads
- National Audio Co. Inc., Box 3657 GS, Springfield, Mo. 65804 Tel (417) 883 5377
Audio: Cassette boxes, 8 tr & cassette library labels
Brand name: NAC
- North American Tape Oup'g Co., 15414 Cabrito Rd., Van Nuys, Calif. 91406 Tel (213) 781 7650 VP & Gen Mgr. Norm Teter, Mktg. Dir. Larry Stagnaro
Audio: Cassette labels
- Nortronics Co. Inc., 8101 10 Ave. N. Minneapolis, Minn. 55427 Tel (612) 545 0401 Nat'l Sales Mgr. Ken Lubitz
Audio: Magnetic replacement heads, professional recorder maintenance prods. including head cleaners, demagnetizers, bulk erasers, splicing blocks & tabs, alignment tapes & head lapping kits
Video: Videotape recorder maintenance supplies
Brand names: Audio-Nortronics, Performance Series, Video-Recorder Care
- Olympic, see Burlington Audio
- Ortofon, see International Rec'g
- P S C Prod'n's, 985 Waimanu St., Honolulu, Hawaii 96814 Tel (808) 537 5695 Pres. Michael Tanaka
Audio: Cassette labels
- Pacific Int'l Magnetics Inc., 185 Berry St., No. 3865, San Francisco, Calif. 94107 Tel (415) 495 8830
Home office: Canada
Audio: Cassette labels
Video: Videocassette labels
- Pak-Wik Corp., 128 Tivoli St., Albany, N.Y. 12207 Tel (518) 465 4556 Pres. Samuel A. Strasser, Sales Mgr. Myron S. Strasser Jr.
Audio: Folding cartons for 8 tr & cassette, 45 RPM record backers
Video: Folding cartons for videocassette (Beta & VHS)
- Pauli Prods., PO Box 29, Collingswood, N.J. 08108 Tel (609) 547 8925 Pres. Joseph A. Pauli, VP. Zara May Pauli
Audio: Cassette labels & insert cards (SEE ADVERTISEMENT)
- Pedersen Label Printing Co., 11152 Fleetwood St., Sun Valley, Calif. 91352 Tel (213) 768 3122 Pres. Herman A. Fredriksz, Prod. Mgr. S. Kado naga
Audio: 8 tr, cassette & box labels, cassette inserts
- Peerless Vid Tronics Corp., 60 West St., Bloomfield, N.J. 07003 Tel (201) 429 8600 Pres. Herb Ravis, Sales Mgr. Andy Danzico
Video: Videocassette packaging
- Permatap Prods Co. Inc., 105 Quail Valley Rd., Social Circle, Ga. 30279 Tel (404) 787 1910 Pres. W.B. Thompson
Audio: Splicing tape & pre-cut tabs
- Phylco Audio, 4709 Brooks St., Montclair, Calif. 91763 Tel (714) 621 9561
Owner: Robert Deates, Gen. Mgr. Rick Deates
Audio: Cassette labels
- Polyline Corp., 1233 Rand Rd., Des Plaines, Ill. 60016 Tel (312) 298 5300 Pres. John Kaiser
Audio: Soft hinged cassette boxes (SEE ADVERTISEMENT)
- Poly-Matrix Inc., 40 Downing Ind'l Park, Pittsfield, Mass. 01201 Tel (413) 499 3550 Pres. William A. Ruffo, Mktg. & Sales Dir. Timothy P. Wilsey, Molding Mgr.: Michael Thrower
Audio: Norelco type cassette boxes
- Poly Plastic Packaging Co. Inc., 44 80 11 St., Long Island City, N.Y. 11101 Tel (212) 392 8670
Audio & Video: Polypropylene & polyethylene packaging
- Pressure Sensitive Tape & Label Corp., 135 Schmitt Blvd., Farmingdale, N.Y. 11735. Tel (516) 293 7300
Video: Labels
- Prestige Label Corp., 255 Oser Ave., Hauppauge, N.Y. 11787 Tel (516) 273 0020
Audio: 8-tr & cassette pressure sensitive labels & stickers.

(Continued on page 348)

What's good for Upper Volta is good for the USA.

Somewhere in the hills of Upper Volta there are rich deposits of manganese. The problem is getting there. The solution is a railroad, built with a loan from the United Nations Development Program.

The UN has also helped unearth iron in Bolivia. Copper in Malaysia. Tin off the coast of Indonesia. America needs these raw materials. In return, the develop-

ing nations become markets for American goods and know-how.

The fact is 80% of American money given through the UN to developing nations is returned in the form of orders for American products and services.

The UN means business. American business should know. Get the whole story. Send for a free booklet, "The You in the UN." Write to UN Assoc., 300 E. 42nd St., N.Y. 10017.



A Public Service of This Magazine & The Advertising Council

SUCCESS

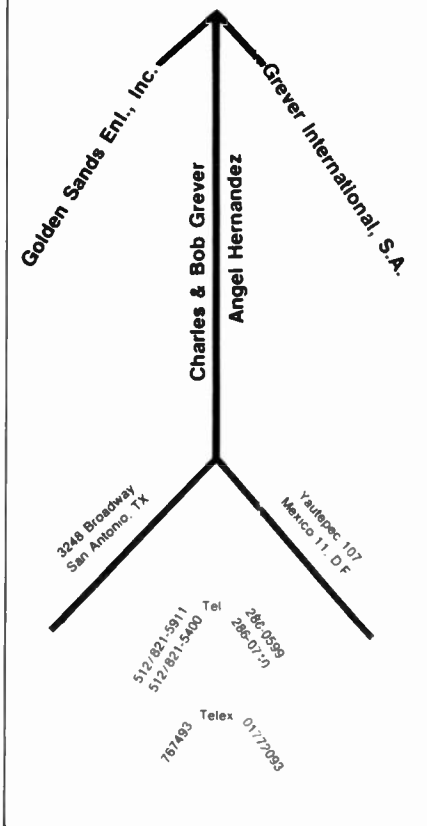

GEMINIS MUSICAL, S.A.

Administrator Of:

**LIANA MUSICAL, S.A.
ROMANTICO MUSICAL, S.A.
ANA MUSICAL, S.A. DE C.V.
PLANEACION MUSICAL, S.A.
EDICIONES GUITARRA, S.A.**

Please Contact:

**ENRIQUE MARQUEZ
GENERAL DIRECTOR**

Schiller 228-1 Tels:
Col. Polanco 250-72-28
Mexico 5, D.F. 545-47-84

SUPPLIES

• Continued from page 347

Performance, see Nortronics
Progressive Label & Litho Co., 286 Stanhope St., Brooklyn, N.Y. 11237 Tel: (212) 497-2320 Pres.: Jerome J. Rood, Gen. Mgr.: Bernie Stein
Audio: 8-tr. & cassette labels. (SEE ADVERTISEMENT)
Promedeus Arts Inc., 1776 Broadway, New York, N.Y. 10019 Tel: (212) 586-3770 Pres.: Lew Morris, Sales Mgr. Jerry Present, Adv. Mgr. Ron Parisi
Audio & Video: Promotional tape & labels
Pro 1 Audio Visual Inc., PO Box 33, Highland Park, Ill. 60035 Tel: (312) 433-4575 Pres.: R.L. Pink, VP J. Pink, Sales Mgr.: M.M. Pink Adv. Mgr. O.O. Pink
Audio: Cassette labels
Q/Splice, see Weblek
Q-A-I Inc., 640 Dell Rd., Carlstadt, N.J. 07072 Tel: (201) 460-0060, NYC (212) 964-1714 Pres.: Steve Dauman, Sales Mgr.: Bernie Ratowsky
Audio: 8-tr. & cassette labels, cueing & splicing tapes, end tabs
Video: Videocassette labels
Queens Lithographing Corp., 52-35 Barnett Ave., Long Island City, N.Y. 11104 Tel: (212) 457-7700, Chief Exec. Officer: Eric Kaltman, Pres.: Leonard Verebay, Sr. VP Sales: Richard Roth
Branch: Hollywood, Calif., 6290 Sunset Blvd., Suite 304, Zip 90028 Tel: (213) 464-7700
Plant: Indianapolis, Inc., Rutgers Packaging Corp., 620 S. Belmont Ave. Zip: 46221 Tel: 635-7777, VP & Gen. Mgr.: Manny Ungar
Audio: 8-tr. & cassette labels, boxes, inserts, slipcases & collars. (SEE ADVERTISEMENT)
R H M Inds. Ltd., 180 Orville Dr., Bohemia, N.Y. 11716 Tel: (516) 567-7222 NYC: (212) 895-9344
Audio: 8-tr. labels, cassette labels & inserts
Video: Videocassette labels
Recorder Care, see Nortronics
Reco-Sleeve Packaging, 620 S. Belmont, Indianapolis, Ind. 46221 Tel: (317) 635-7777, Pres.: Leonard Verebay, Sales & Adv. Mgr.: Leonard Omond
Audio: Cassette inserts
Reliance Plastics & Packaging Div., Reliance Folding Carton Corp., 225 Bellville Ave., Bloomfield, N.J. 07003 Tel: (201) 748-2222, Pres.: Marshall Weingarden, Sales Mgr.: Marion Burtleigh
Audio: Corrugated mailers for cassette
Video: Corrugated mailers for videocassettes
Robins Inds. Corp., 75 Austin Blvd., Commack, N.Y. 11725 Tel: (516) 543-5200, Pres.: Herman Post, VP Sales: Stu Cane
Audio: Cassette mailers & boxes, open reel boxes
Rutgers Packaging Corp. (div. of Queens Lithographing Corp.), 620 S. Belmont Ave., Indianapolis, Ind. 46221 Tel: (317) 635-7777, TWX (810) 341-3457, 341-3400 Pres.: Abe Garde, Sales & Adv. Mgr.: Morton Shecter
Audio: Cassette labels
Video: Cassette labels
S T L, see Standard Tape Lab & Taber Mfg
Saki Magnetics Inc., 5770 Uplander Way, Culver City, Calif. 90230 Tel: (213) 649-5983
Audio: Ferrite magnetic recording heads
Shape Inc., PO Box 366, Biddeford Ind'l Park, Biddeford, Me. 04005 Tel: (207) 282-6155
Audio: Norelco style cassette boxes (SEE ADVERTISEMENT)
Shorewood Packaging Corp., 10 E. 53 St., New York, N.Y. 10022 Tel: (212) 371-1500 Pres.: Paul Shore, Exec. VP: Floyd S. Glinert, VP Special Projects: Marc Shore, VP Nat'l Sales: Ken Rosenblum
Branch: Los Angeles, Calif., 1830 Glendale Blvd. Zip: 90026 Tel: (213) 660-3043 VP West Coast Sales: Jim Palmer-La Grange, Ga., SPC Co. 1707 Shorewood Dr. Zip: 30240 WATS Tel: (800) 241-0186 Plant Mgr.: Ken McCabe-Farmingdale, N.Y., 55 Engineers Ln. Zip: 11735 Tel: (516) 694-8230
Audio: 6" x 6" 8-tr. & cassette packaging, cassette labels
Video: Beta & VHS videocassette packaging
Sonar Radio Corp., 3000 Stirling Rd., Hollywood, Fla. 33021 Tel: (305) 981-8800 Chm. Bernard E. Klein
Product: Videocassette bulk eraser
Brand name: Videoraser
Soundmark Corp., 4950 Nome St., Unit C, Denver, Colo. 80239 Tel: (303) 371-3076
Audio: Cassette labels & custom packaging
Standard Tape Lab Inc., 26120 Eden Landing Rd., No. 5, Hayward, Calif. 94545 Tel: (415) 786-3546 Pres.: Frank G. Lennert
Audio: Test tapes
Brand name: STI

Stanford Int'l, PO Box 609, 569 Laurel St., San Carlos, Calif. 94070. Tel: (415) 592-5958, Pres.: Fred Dobbs; Opns. Mgr.: Jan Oillard.
Audio: Cassette labels.
Stephens Electronics Inc., 3513 Pacific Ave., Burbank, Calif. 91505. Tel: (213) 842-5116 Pres.: John F. Stephens; Sales Mgr.: Bobbi Murphy, Adv. Mgr.: Gina D'Esopo
Audio: Professional 2" editing blocks.
Studio Magnetics Co. Inc., 12 Long Island Ave., Holtsville, N.Y. 11742. Tel: (516) 289-3400 Pres.: George Clahane; VP: Craig M. Balaban
Audio: cassette editing kit, splicing, sensing & leader tape, "soft-plastic," Ampex & Norelco style cassette boxes, pressure-sensitive labels & mailing envelopes.
Super Prod'ns, PO Box 1569, 31 Industrial Park, Hendersonville, Tenn. 37075 Tel: (615) 822-5080 Pres.: Gordon Cash.
Audio: Cassette labels
Video: Videocassette labels
Switchcraft Inc., 5555 N. Elston Ave., Chicago, Ill. 60630 Tel: (312) 792-2700
Audio: Connectors, cable assemblies, adapters, patch cord systems, jacks & plugs
T D K Electronics Corp., 755 Eastgate Blvd., Garden City, N.Y. 11530. Tel: (516) 746-0880 Telex: 144535 VP & Gen. Mgr.: Ken Kohda; Sales Mgr.: John Schaffin; Video Prod. Mgr.: Ed Pessara
Branches: Irvine, Calif., 2102 E. Alton St. Zip: 92714. Tel: (714) 979-5811 WATS: (800) 854-0123 Div. Mgr.: Lee Adams-Marietta, Ga., 4062 Kingston Court, Zip: 30067. Tel: (404) 952-4600 Reg'l Mgr.: George Castee-Des Plaines, Ill., 1011 E. Touhy Ave., Suite 165, Zip: 60018. Tel: (312) 297-1341. WATS: (800) 323-5956. Reg'l Mgr.: Jack Pender.
Audio: Test tapes, head demagnetizers, labels & index cards. (SEE ADVERTISEMENT)
Tabereras, see Taber Mfg
Taber Mfg. & Eng'g Co., 2081 Edison Ave., San Leandro, Calif. 94577. Tel: (415) 635-3831
Audio: Heads, bulk erasers, test tapes.
Brand names: Taber, Taberacer, STL
Tapemaker Sales Co. Inc., 48 Urban Ave., Westbury, N.Y. 11590. Tel: (516) 333-2700. Pres.: Arthur Brandwin; Office Mgr.: Karen Sitkhoff
Audio: Splicing & sensing tape, pre-cut Q-tabs, cassette labels.
Video: Splicing tabs, leader tape & head cleaning tape for Beta & VHS cassette.
Thalco Audio Inc., 2 Dickens Ave., Dix Hills, N.Y. 11746. Tel: (516) 667-1616 Chief Exec.: Michael Thaler
Audio: Norelco & soft-poly style cassette boxes
Trackmaster Inc., 1310 S. Dixie Hwy. W., Pompano Beach, Fla. 33060. Tel: (305) 943-2334. Pres.: Roy Parsons, Sec'y-Treas.: Lupe Parsons
Audio: Cassette labels. (SEE ADVERTISEMENT)
Tri-Lon Color Lithographers Ltd., 54 W. 21 St., New York, N.Y. 10010. Tel: (212) 255-6140 Pres.: Morris Strickler; VP: David Strickler
Audio: 8-tr. & cassette inserts & labels.
Tropical Paper Box Co., 7000 NW 25 St., Miami, Fla. 33122. Tel: (305) 592-5520
Audio: 8-tr. & cassette boxes.
U M C Electronics Co., 460 Sackett Point Rd., North Haven, Conn. 06473. Tel: (203) 288-7731 Telex: 963510 Pres.: James C. Leu; Nat'l Sales Mgr.: Bernard H. Ribillard
Audio: Heads, motors
Brand name: Beau
Universal Marking Systems Inc., 2320 E. 26 St., Minneapolis, Minn. 55406. Tel: (612) 721-7466
Audio: Cassette labels, case liners
Video: Cassette labels
Vaughn Assocs., PO Box 5808, Sarasota, Fla. 33579. Tel: (813) 924-3734
Audio: Cassette labels
Veritas Electronics Corp., 22 Grand Ave., Farmingdale, N.Y. 11735. Tel: (516) 541-5373
Audio: Head demagnetizers, bulk erasers, cassette & open reel splicers
Viceoraser, see Sonar Radio
W R E, see Wide Range Electronics
Edward R. White Inc., 18 E. 41 St., New York, N.Y. 10017 Tel: (212) 687-2167 Pres. & Sales Mgr.: Lawrence Goldstein
Audio: Tape envelopes & mailers
Wide Range Electronics Corp., 2119 Schuetz Rd., St. Louis, Mo. 63141. Tel: (314) 567-5366
Audio: Bulk erasers, degaussers, magnetic erasing pencil
Brand name: WRE
Wills Printing Co., PO Box 211, Arlington, Tex. 76010 Tel: (817) 572-1414 Pres.: Calvin Willis
Audio: Cassette labels
Xcel, see Georgia-Pacific.

STORE FIXTURES

• Continued from page 175

PO Box 76, 15 Henderson Dr. Zip: 07006. Tel: (201) 575-2000-Cincinnati, Ohio, 4835 Para Dr. Zip: 45237 Tel: (513) 242-2313-Cleveland, Ohio, 12200 Brookpark Rd. Zip: 44130 Tel: (216) 267-1800-Philadelphia, Pa., 5698 Rising Sun Ave. Zip: 19120. Tel: (215) 728-5300-Dallas, Tex., 2121 Santa Anna Ave. Zip: 75228. Tel: (214) 324-8100-Seattle, Wash., Andover Ind'l Park, 100 Andover Park W. Zip: 98188. Tel: (206) 244-7200
Product: Tape display racks (Scotch). (M)
Voorhies Ent's Inc., 2869 Westford Blvd., Stow, Ohio 44224. Tel: (216) 688-5811 Pres. Sales & Adv. Mgr.: Robert Voorhies; Treas.: Jennie Voorhies
Product: Moving video signs (Starbrite Video Advertiser)
Vulcan Binder & Cover (div. of EBSCO Inds. Inc.), PO Box 29, Vincent, Ala. 35178. Tel: (205) 672-2241 VP: R. Denson Parker; Sales Mgr.: John R. Boleslawski, Adv. Mgr.: B.R. Cummings
Product: Tape display racks (M)
Dick Wagner, 5930 Penfield Ave., Woodland Hills, Calif. 91367. Tel: (213) 992-6266
Product: Record display racks (Directree)
Wills Music Co., 7380 Industrial Rd., Florence, Ky. 41042. Tel: (606) 283-2050 Pres.: Edward R. Cranley
Product: Sheet music display racks
Wremaid Prod. Corp. (div. of Cove Four Slide), 60 West Ave., Patchogue, N.Y. 11772. Tel: (516) 475-0193 Pres.: Barry Jaffe, Sales Mgr.: A. Boden, Adv. Mgr.: Leigh Boden
Product: Record & tape display racks. (M)

DISCOS
Fuentes

LA GRABACION COLOMBIANA
DE FAMA INTERNACIONAL

Cra. 51 No. 13-223 Po. Box. 1960 - Tels. 357152 - 351300
Medellin Colombia-Suramerica

ADVERTISERS INDEX

A-1 RECORD SALES	90	DISCO FUENTES	348
ABA RECORD DIST. INC.	80	DISCOS GAMMA	278
ASR RECORDING SERVICES CORP.	121	DISCOS GAS	280
ATB SPA	255	DISC TRADING CO.	96
AFRICAN RECORD CENTER DIST. LTD.	94	DISKMAKERS	117
AGFA-GEVAERT INC.	351	DONNAK INDUSTRIES	134
ALCO RESEARCH	109	DUCALE	256
ALPHA DISTRIBUTING CORP.	91	DUNN ASSOCIATES, CHET	136
AMAZING EXHIBITIONISTS	321	DUOTONE CO. INC.	172
AMERICAN MUSIC MARKETING	63	DUTCH EAST INDIA TRADING	84
AMERICAN RECORDING	178	DYNA SOUND	167
AMERICAN RECORD SALES	81	EMI CAPITOL	347
ARIOLA	350	ERH SALES	110
ARISTA ENTERPRISES	172	EASTERN PACIFIC SOUND INC.	62
ARISTON MUSIC	252	ECO FINA	250
ATLAS RECORDING & MUSIC	250	EDIM	349
AUDIO INDUSTRIES	132	EDIMUSA	276
AUDIOMATIC CORP.	113, 157, 159	EL MAR PLASTICS	137
AUTO TEK	162	ELTRON EXPORT	84
AUTO VEND INC.	143	EMLASA	277
BMI	39	ESKIN INC., DAVID	92
BABY RECORDS	247	EVA-TONE SOUND SHEETS INC.	35, 36
BALDWIN SOUND PRODUCTIONS INC.	116	FAMOUS MUSIC	51
BEACHES RECORDS & TAPES	204	FILAM PLASTICS	130, 134
BEECHWOOD	280	FISCHER MUSIC JOBBERS INC., CARL	45
BERKLEY AIR SERVICES CORP.	86	FLUMARA SRL	258
BESTWAY CORP.	117	FONIT CETRA	257
BILLBOARD EN ESPANOL	345	GALGANO DIST. (CHICAGO)	70
BONAPARTE RECORDS	65	GALIKO MUSIC & FILM PDTNS	93
BONDED SERVICES	104	GEMINIS MUSICAL	348
BROWN PAPER BAG CO. INC.	139	GIMA SRL	163
BURLINGTON AUDIO TAPES INC.	156	GLOBAL MUSIC GROUP	225
CBS RECORDS INTERNATIONAL	177	GLOSTER DISCO & MUSIC CENTER	323
CGD MESSAGGERIE MUSICAL SPA	253	GOPHER PRODUCTS	173
CANDY STRIPE ENTERTAINMENT	86	GREAT ATLANTIC & PACIFIC MUSIC CO.	77
CANDY STRIPE RECORDS	Back Cover	GREEN WORLD DIST.	60
CARDINAL EXPORT	83	GREVER INTERNATIONAL	348
CASSETTE PRODUCTIONS INC.	123	HRC PRINTING CO.	106
CERTRON	146	HARBOR RECORD EXPORT CORP.	88
CETEC GAUSS	165	HEINO ILSEMANN GUBN	229, 230
CETEC-VEGA	29	HELIX	278
CHAPMAN DISTRIBUTION	64	HONE'S ONE STOP REC. DIST.	92
CLOSE OUT RECORDS	82	HOPE INTERNATIONAL	84
COLLEGE OF RECORDING ARTS	34	HOUSE DISTRIBUTORS	77
COLUMBIA PICTURES PUBLISHING	49	ICM LTD.	132
COUNTRYWIDE RECORDS & TAPES	88	IRD INT'L REC. DIST.	254
CUSTOM CARTRIDGES	154	I REC SRL	259
CUT CORNERS	94	IS MUSIC	73
DANCE-IT DIST.	60	IMAGE RECORDS	183
DARO EXPORTS	96	IMPORTANT RECORD DISTRIBUTORS	88
DATA PACKAGING	151	IMPORT-O-DISC	90
DISCO CISNE RAFF	276	INFONICS	125
DISCOMATE RECORDS	262	INTERCONTINENTAL RECORD & CASSETTE	89

Lenco moulding

The swiss quality

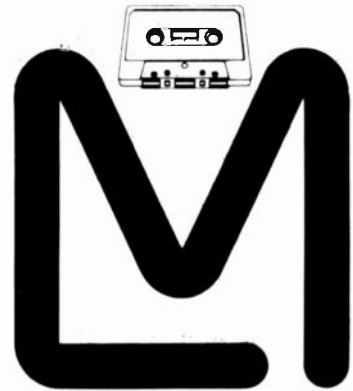

Lenco-Moulding SA

rue de l'Industrie
CH-1781 Courtaman
tél. 037 34 19 15



TRIO RECORDS
one of the most promising sons of ours
TRIO-KENWOOD CORPORATION

2-1, 5-chome, Roppongi, Minato-ku, Tokyo 106 JAPAN
tel: 03-404-4391 tix: 242-6776 TRIREC J cable: TRIODISC TOKYO

TRIO RECORDS, a division of TRIO-KENWOOD CORP.
6-17, 3-chome, Aobadai, Meguro-ku, Tokyo 153 JAPAN



**YOUNG
SUCCESSFUL
COMPANY
IN MEXICO
THANKS TO OUR
LABELS
DISTRIBUTED**



BIG STARS
ALCATRAZ
CARLOS LARA
CHICO CHE Y LA CRISIS
DENISE DE KALAFE
DORIAN
ESTELA NUÑEZ
JOSE JOSE
JOSE LUIS MORENO
JUAN GABRIEL
LOS SEPULTUREROS
MARIACHI AMERICA
NATALIA BAEZA
ROCIO DURCAL
SOCIOS DEL RITMO

AV. DE LAS FUENTES 41-A
40. PISO
TECAMACHALCO
ESTADO DE MEXICO
TELEPHONE 589-84-00
MEXICO

ADVERTISERS INDEX

INTERNATIONAL BOOK & RECORD DIST	95	SKYDISC INC.	87
INTERNATIONAL COMPACT CASSETTE	259	SLUIS M.	87
JCM	272	SOMMERS, HENRY T	55
J&R MUSIC WORLD	90	SONET	304
JSJ TAPE DIST	68	SOUND GUARD	171
JVC CUTTING CENTER	111	SOUND OF SCANDINAVIA	308
JAMIE / GUYEN RECORDS	30	SOUND UNLIMITED	71
JANDA RECORDS	182	SOUTHERN MACHINE & TOOL	144
JEM RECORDS INC	79, 80	SQUARE DEAL RECORDS	64
K-DISC	112	STAGE ONE (RECORDS) LTD.	329
KEYSTONE PRINTED SPECIALISTS	105	STAK-IT	174
KING INSTRUMENTS	147	STAN'S DIST	73
KING PIN PRESSING CO	112	STAR TITLE STRIP CO. INC.	61
KINNARA DISTRIBUTION	70	STRATFORD DIST	89
LARRY'S RECORD SYNDICATE	238	SUN PLASTICS	116
LASGO EXPORTS	331	SURPLUS RECORDS & TAPES	80
LEBO / PEERLESS	170	SYMPHONETTE MUSIC DIST	63
LEE-MYLES ASSOCIATES	31	TC/AC/DC DISTRIBUTORS	203
LEWCO COMPANY	135	TDK ELECTRONICS	153
LENCO-MOULDING SA	349	TTL	254
LENED INTERNATIONAL CORP	145	TV ASAHU	266
LEONARD PUBLISHING, HAL	47	TALBOTT, JOE	115
LIBERTY FIXTURES	175	TAPE COM	126
LISS INTERNATIONAL	81, 200, 204	TAPE KING	82
LITTLE WAREHOUSE	122	TAPEMATIC OF LUCIANO PEREGU	258
LORANGER MFG. CORP	149	TARA DISTRIBUTING	67
MPC RESEARCH AIDS	346	TAUNUS TAS TECNIK	235
MJS ENTERTAINMENT CORP	85	TELEVIS EDIZIONI	254
M&M EXPORT	200	TONG DISTRIBUTORS	67
MTI CORPORATION	160	TOOLEX ALPHA AB	305
MACMURRAY PRESS	108	TOP MUSIC PUBLISHING	267
MAGNEPAX INTERNATIONAL INC	158	TOSHIBA EM	268
MAGNETIC MARKETING	158	TRACY-VAL CORP	116
MAGNETIC MEDIA	155	TRANS-AM INDUSTRIES	131
MAGNEX	260	TRANSCO PRODUCTS CORP	143
MALVERNE DISTRIBUTORS	86	TRES LANTA RECORD PRESSING	110
MARYLEBONE MUSIC	319	TRIO RECORDS	269
MASTER RECORDING	164	UNIVERSAL RECORD DIST	97
MAX-SOUND DIV	162	UNIVERSAL RECORDS & TAPES	100
MELODY	280	UNIVERSAL SONG	189, 282
MET RICHMOND SALES	82	VICTOR MUSICAL INDUSTRIES	263
MOGULL MUSIC, IVAN	46	VINYL VENDERS	75
MORNING MUSIC	197	VIVID SOUNDS	262
MUSART	275	WAKEFIELD MFG.	114
MUSICANZA	96	WAMID INC.	92
MUSIC BROKERS	65	WATANABE MUSIC PUBL	269
MUSICONSULT AB	304, 306	WAX ASSOCS. MORTY	119
MUSICONTRACT	237	WEA RECORD MFG.	110
MUSIC MARKETING	27	WELK MUSIC	43
MUSICRAMA REC. & TAPE DIST	82	WES TAPE	148
MUSIC TIME INC	172	WIND SONG	327
MUSI TECH LTD	333	WIN RECORDS	93
NTV MUSIC PUBLISHING	270	ZORBA	280
NADA MUSIC	283		
NASHVILLE ALBUM PRODUCTIONS	116		
NASHVILLE RECORD PRODUCTION	112		
NATIONWIDE SOUND	32		
NEW LIGHT DIST	72		
NICHION	265		
NIPPON PHONOGRAM	265		
NUOVA SIAT SRL	139, 251		
ONEWAY RECORDS	95		
OVERLAND PRODUCTS	136		
PACIFIC MUSIC PUBLISHING	267		
PANA RECORD SPA	249		
PASSAVANT CORPORATION	154		
PAVLI PRODUCTS	142		
PEERLESS	275		
PEER SOUTHERN	181, 215, 227, 248, 261, 281, 297, 299, 303, 315		
PERFORMANCE REC. & TAPE DIST	79		
PETERS INTERNATIONAL	96		
PICKWICK DISTRIBUTION	69		
POLIMEK SRL	256		
POLYGRAM SA	279		
POLYLINE CORP	137		
PROGRESSIVE LABEL	141		
PROMO RECORD DIST CO.	79		
QCA	114		
QUAD EIGHT	25		
QUEENS LITHO	107		
RCA-MEXICO	277		
RCA RECORDS INTERNATIONAL	179		
RGH RECORD MFG CO	115		
RVC CORPORATION	264		
RAC-A-RECORD	72		
RAINBO RECORDS	115		
RANDOM DISTRIBUTION CORP	92		
RAVE	120		
RECORDS & TAPES INC.	78		
RECORDS ON WHEELS	201		
RECORTEC	156		
RECOTON CORP	2		
REVIEW ENTERPRISES (USA) INC.	138		
RIMPO GmbH	233		
ROSENTHAL, A.J.	98		
ROSS ELLIS LTD	140		
ROUNDER RECORDS	74		
RUBY SALES	68		
SESAC	53		
S.T.M.	258		
SAN JUAN MUSIC GROUP	109		
SAVOY MFG. CO	168		
SCANDIA PACKAGING	161		
SCAN GROUP	209, 213, 289, 307		
SCHACT, JANE	118		
SCHULTZ INC. ALBERT	84		
SCORPIO MUSIC DIST	99		
SCHWARTZ BROS	66		
SESAME STREET RECORDS	33		
SHAPE INC	133		
SHINKO MUSIC PUB	271		
SIBERT & CO., P & J	325		



**EDITORIAL MEXICANA
DE MUSICA S.A. de C.V.**

**SERIOUSNESS
AND PRESTIGE
AT THE SERVICE
OF ALL AUTHORS
AND COMPOSERS
OF MUSIC**

Poniente 44
Número 3612
Esq. Norte 75
Col. Xochimanca
Mex. 16, D.F.
Tel: 399-9088 at 44
with 7 lines



The Sound Performer!

Your performance demands the finest! Get it with Agfa Studio Mastering, Video, and Bulk Cassette Tape. It's the tape that has been performing to the highest standards of artists and engineers alike; and continues to out-perform other tape - with quality, reliability, and consistency.

The Sound Performer - producing quality images for sight and sound...

**Agfa
Magnetic
Tape**

AGFA-GEVAERT, INC.
275 North Street, Teterboro, N.J. 07608
(201) 288-4100

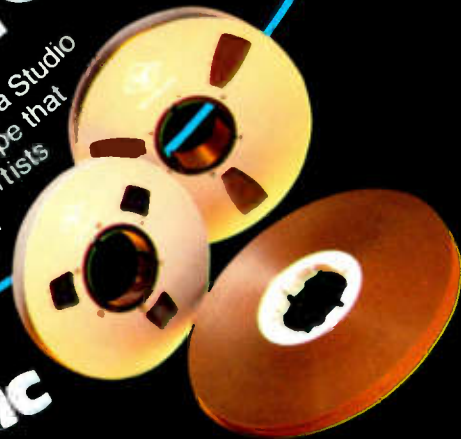

CANDY STRIPE ENTERTAINMENT Corp. PRESENTS:



THE ADVENTURES OF Captain CANDY STRIPE

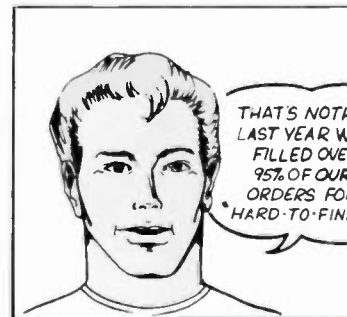

"Contact Us For World-Wide Wholesale Distribution Of:

- LP's, Tapes and 45's
- Current Releases, back catalog and oldies
- Blank Audio and Video Tapes
- Children's records
- Record collector's price guides
- Fast, Friendly Service
- Quick Overseas Delivery
- And much more!

We're Specialists in hard-to-find LP's, tapes and cut-outs!"

maxell IT'S WORTH IT.



BASF
For the best recordings you'll ever make.



"Candy"

CANDY STRIPE ENTERTAINMENT Corp.

371 South Main Street, Freeport, New York, USA 11520 (516) 379-5151 • (212) 895-3930
TOLL FREE: 800-645-3747 (Outside New York State) Continental USA only
TELEX: 126851 CANSTRIPE, FREE