

Billboard

1966-67 INTERNATIONAL

BUYER'S GUIDE

OF THE MUSIC-RECORD INDUSTRY



Market Data Report

U.S. and International
Record Manufacturers

Independent Record Producers

Music Publishers

Rack Jobbers

Distributors

One Stops

Importers & Exporters

Jacket and
Label Manufacturers

Tape and Record Licensors

Music Licensing Organizations

Pressing Plants

Promotion & Publicity

Recording Studios

Studio Equipment

TAPE SECTION

Including tape CARtridge
and reel-to-reel breakdowns

Phonograph Manufacturers

International Market Report

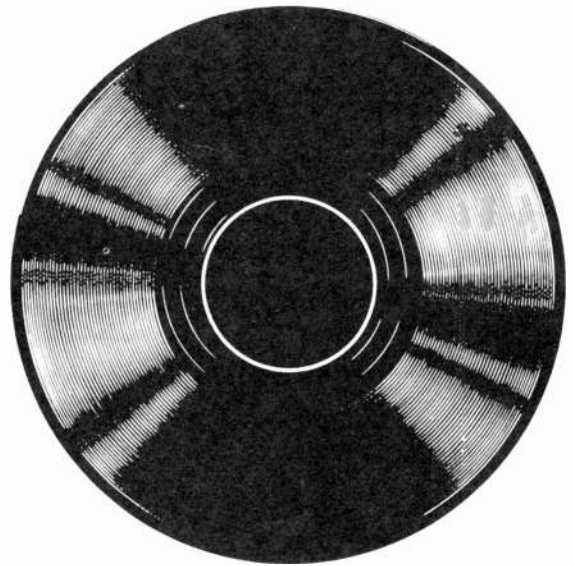

about records



ONE OF THE THINGS IN WHICH A SMALL COUNTRY
CAN BE GREAT



COME AND SEE THE
GRAMOPHONEHOUSE
AT HEEMSTEDE, HOLLAND
(since 20 years as
good a reputation
as **EMI** has all over
the world)



THESE ARE THE ARTISTS

HERB ALPERT & THE TIJUANA BRASS
BAJA MARIMBA BAND
WE FIVE
CHRIS MONTEZ
BRASIL '66
LUCILLE STARR
THE CANADIAN SWEETHEARTS
FRANK GORSHIN
BILL DANA
DON FRANCKS
CAPTAIN BEEFHEART & HIS MAGIC BAND
THE GRADS
THE ROGER NICHOLS TRIO
LA BERT ELLIS
GIL GARFIELD
CAPTAIN ZOOM DANTE
JOE PHILLIPS
BRYCE COEFIELD
THE WOODEN NICKLES
THE SECRETS
THE SIMS TWINS
JAMES CRAWFORD
BECKETT QUINTET

WHO MAKE



The Biggest Little Catalog

MGM

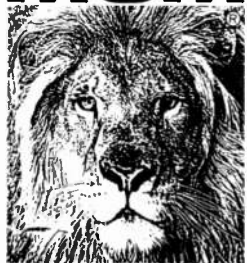

RECORDS

VERVE
FOLKWAYS



metro



RECORDS

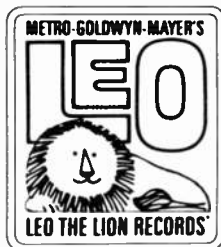

THE MGM FAMILY

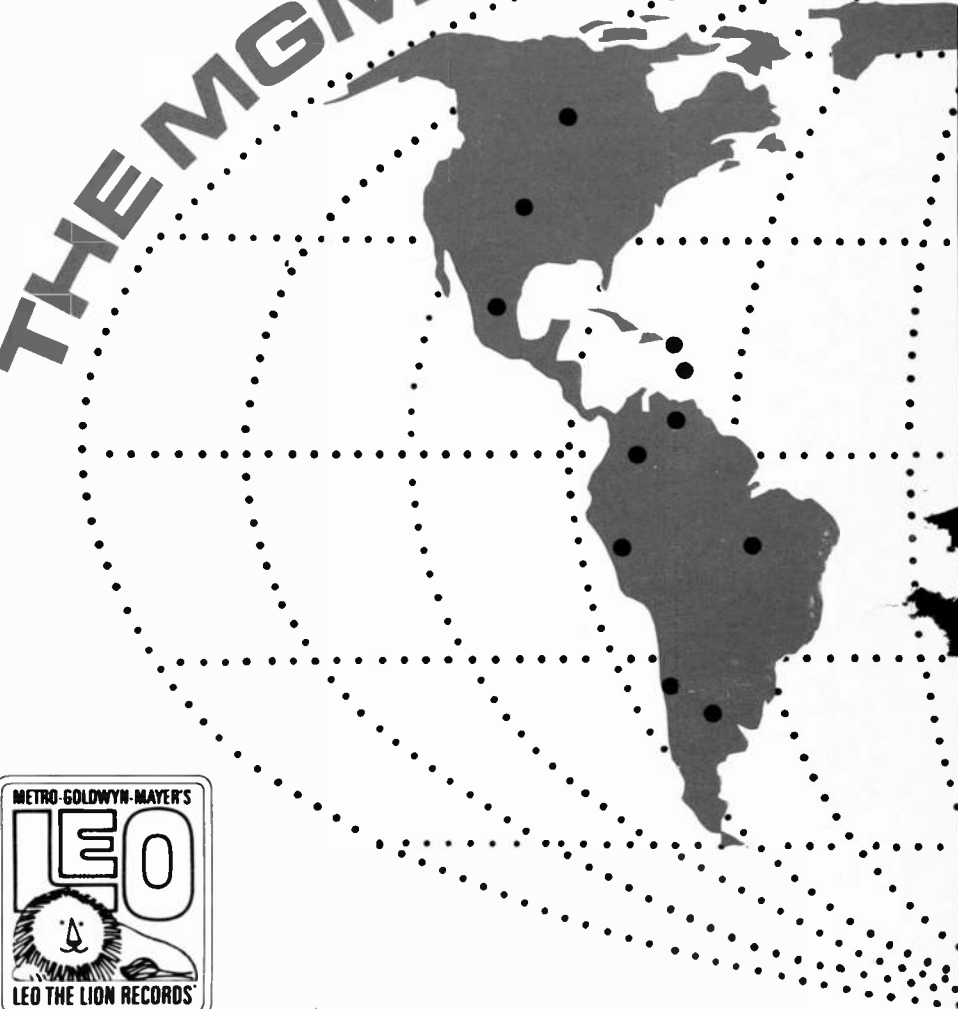

• **ARGENTINA**—Philips Argentina S. A., Cordoba 1351-9° Piso, Buenos Aires, MGM/VERVE • **AUSTRALIA**—E. M. I. (Australia) Ltd., 301 Castlereagh Street, Sydney, N. S. W., MGM; Radio Corporation Pty., Ltd., 161-173 Sturt Street, So. Melbourne, VERVE • **AUSTRIA**—Polyphon Schallplatten mbh, Mariahilferstrasse 127, Vienna, MGM/VERVE • **BELGIUM**—S. A. Siemens, N. V. 116, Chaussee de Charleroi, Brussels, MGM/VERVE • **BRAZIL**—Companhia Brasileira de Discos, Avenida Rio Branco 311-4° Andar, Rio de Janeiro, MGM; Som Industria e Comercio, S. A., Avenida Casper Libero, 58.12°, Sao Paulo, VERVE • **CANADA**—Quality Records, Ltd., 380 Bricmount Road, Scarborough, Ontario, MGM/VERVE • **CHILE**—Philips Chilena de Productos Electricos, Av. Santa Maria 0760, Santiago, MGM/VERVE • **COLOMBIA**—Philips Colombiana S. A., Calle 13 No. 51-03, Bogota, MGM/VERVE • **DENMARK**—Skandinavisk Grammophon Akt., Hoffdingsvej 18, Copenhagen-Valby, MGM; Nordisk Polyphon A/S, Emdrupvej 115, Copenhagen N. V., VERVE • **ENGLAND**—E. M. I. Records Ltd., 20 Manchester Square, London, W. 1., MGM/VERVE • **FINLAND**—Fintone Oy, P. O. Box 10033, Helsinki, VERVE • **FRANCE**—Polydor S. A. Paris, 2 Rue Cavalotti, Paris 18, MGM/VERVE • **GERMANY**—Deutsche Grammophon Ges. mbh, Harvestehuder Weg 1-4, Hamburg 13, MGM/VERVE • **GREECE**—Columbia Graphophone Co. of Greece Ltd., P. O. Box 287 Athens, MGM • **HOLLAND**—Polydor Nederland N. V., Piet Heinplein 5, The Hague, MGM/VERVE • **HONG KONG**—E. M. I. (Hong Kong) Ltd., 305 The Chartered Bank Bldg., Executive Office • **INDIA**—The Grammophon Limitet Sirketi, P. O. Box 48, Calcutta, MGM • **IRELAND**—The Grammophon Co. Ltd., 23 Lower Dominick Street, Dublin, MGM/VERVE • **ISRAEL**—Hed-Arzi, 4 Hilazon Street, Ramat-Gam, MGM/VERVE • **JAPAN**—Nippon Grammophon Co., Ltd., International Division,

CIRCLES THE GLOBE

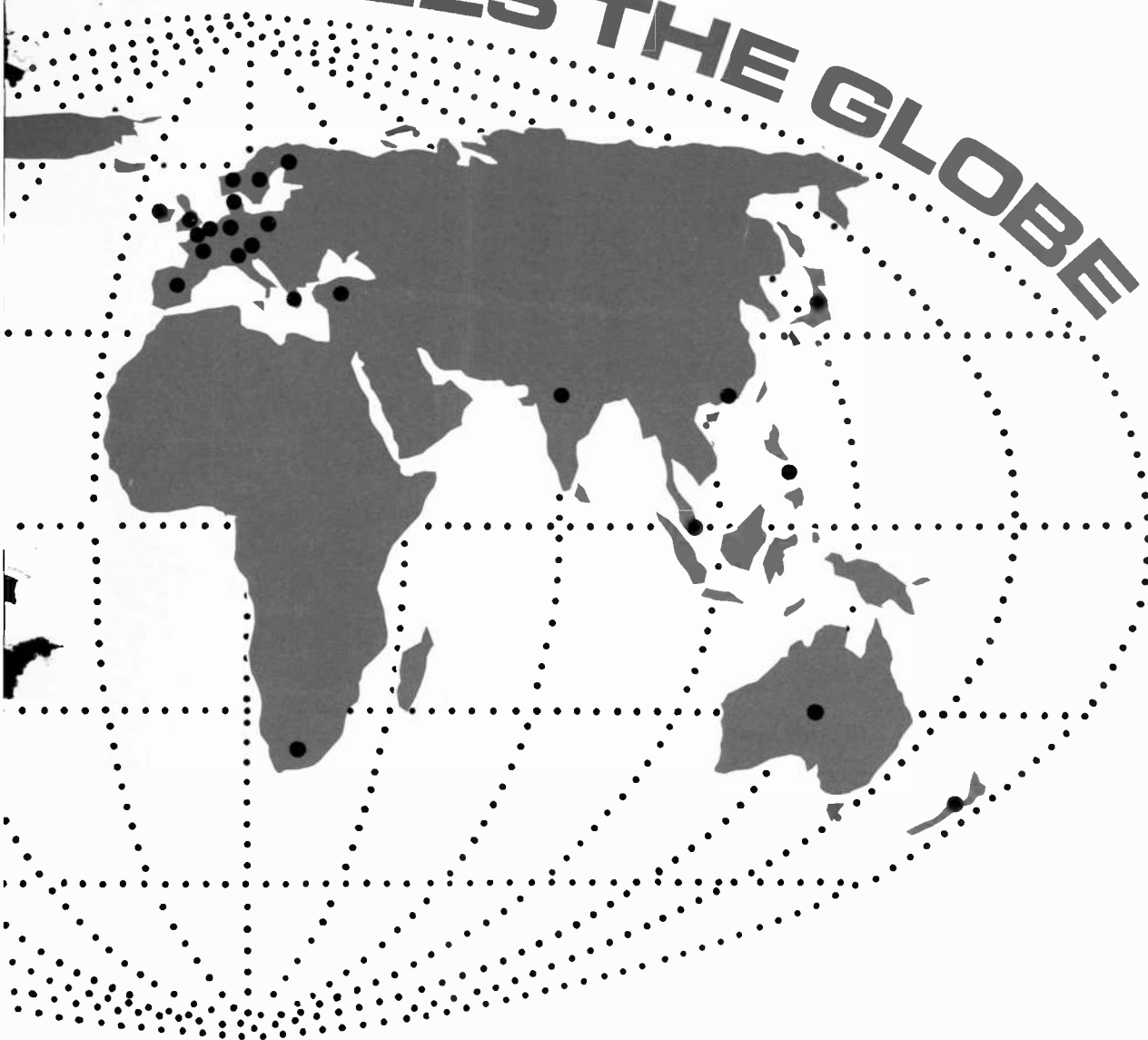

Kimura Building 7, 1-Chome, Shinbashi, Shiba, Minato-ku, Toyko, MGM/VERVE • **MEXICO**—Dusa Universales S. A., Tiber 58, Mexico D. F., MGM/VERVE • **NEW ZEALAND**—His Master's Voice (N. Z.) Ltd., 162-172 Wakefield Street, Wellington, MGM; Allied International Records, Ltd., P. O. Box 3043, Auckland C. 1, VERVE • **NORWAY**—Iversen and Frogh, Youngsgate 1, Oslo, MGM; A/S Nor-Disc, Rosenborggt. 19, Postboks 5219, Oslo 3, VERVE • **PERU**—El Virrey Ind. Musicales S. A., Av. Mexico No. 238, Lima, MGM/VERVE • **PHILIPPINES**—Mareco Inc., 131 Del Monte Ave., Quezon City, MGM/VERVE • **POLAND**—Ars Polona, Krakowskie Przedmiescie 7, Warsaw, MGM/VERVE • **PUERTO RICO**—Juan Martinez Vela Inc., 358 San Francisco, P. O. Box 2027, San Juan, MGM/VERVE • **SINGAPORE**—The Borneo Co., Ltd., Crosby House, P. O. Box 898, Singapore 1, MGM • **SOUTH AFRICA**—E. M. I. (So. Africa) Pty. Ltd., P. O. Box 11254, Johannesburg, MGM; Trutone (Pty.), Ltd., 32 Bosman Road, Ophirton, Johannesburg, VERVE • **SPAIN**—Fonogram S. A., Avda. De America y Hernandez De Tejada, APDO. De Correos 35019, Madrid 17, MGM; Compania del Gramofono-Odeon S. A. E., Apartado de Correos 588, Barcelona 11, VERVE • **SWEDEN**—Skandinaviska Grammophon Akt., Sandhamnsgatan 39, Box 27053, Stockholm 27, MGM; Karusell Grammofon AB, Fack, Solna 1, Stockholm, VERVE • **SWITZERLAND**—Siemens, Elektriztaetserzeugnisse AG, 35 Loewenstrasse, Zurich, MGM/VERVE • **TURKEY**—Grammophon Limitet Sirketi, P. O. Box No. 3, Yesilkoy, Istanbul, MGM • **VENEZUELA**—Siemens Venezolana S. A., Apartado 3615, Caracas, MGM/VERVE • **WEST INDIES**—West Indies Records Ltd., 13 Bell Road, Industrial Estate, Kingston 11, MGM/VERVE • **MGM/VERVE EUROPEAN REPRESENTATIVE**—Mr. John E. Nathan, MGM Records, 37 Rue Condorcet, Paris, France.

MGM, VERVE, VERVE/FOLKWAYS, METRO, LEO THE LION and VSP Records are divisions of Metro-Goldwyn-Mayer Inc.

The Billboard Publishing Company
2160 Patterson St., Cincinnati, O. 45214
Tel.: Area Code 513, 381-6450

Publisher

Hal B. Cook New York Office

Editorial Office

165 W. 46th St., New York, N. Y. 10036
Area Code 212, PL 7-2800
Cable: BILLBOARD NEWYORK

Editor-in-Chief Lee Zhito
Editors Paul Ackerman,
Aaron Sternfield

Department Editors, New York
Music Editor Paul Ackerman
Associate Editor Mike Gross
Chief Copy Editor Robert Sobel
Radio-TV Programming Claude R. Hall

Department Editors

Audio, Coin Machines Editor
. Ray Brack, Chicago

U. S. Editorial Offices

Cincinnati, Exec. News Editor Wm. J. Sachs
Chicago, Midwest Editor Ray Brack
Washington Bureau Chief Mildred Hall
Hollywood, W. Coast News Eliot Tiegel

Special Projects Division

General Manager Andrew J. Csida
Director, Reviews and Charts Don Owens
Manager, Record Market

Research Andy Tomko
Manager, Charts Laurie Schenker
Supervisor, Print Services Bill Courtney

Production Department, New York
Art Director Virgil Arnett

General Advertising Office, N. Y.
Director of Sales Denis Hylano
Promotion Director Geraldine Platt
Midwest Music Sales Richard Wilson
West Coast Gen. Mgr. Bill Wardlow
Nashville Gen. Mgr. Mark-Clark Bates

Coin Machine Adv., Chicago
Coin Machine Ad. Mgr. Richard Wilson

Classified Ads, Chicago

Classified Ad Mgr. John O'Neil

Circulation Sales, New York

Circulation Manager Milton Gorbulew

Subscription Fulfillment

Send Form 3579 to
2160 Patterson St., Cincinnati, O. 45214
Fulfillment Manager Joseph Pace

U. S. Branch Offices

Chicago, Ill. 60601, 188 W. Randolph
Area Code 312, CE 6-9818

Hollywood, Cal. 90069, 9000 Sunset Blvd
Area Code 213, 273-1555

Nashville, Tenn. 37219, 226 Capital Blvd
Area Code 615, 244-1836

Washington, D. C. 20005,
733 15th St., N.W.
Woodward Bldg., Rm. 533
Area Code 202, 393-2580

International Office

European Office Andre de Vekey, Dir
European Editor Don Wedge
15 Hanover Square, London W.1
HYde Park 3659
Cable: Billboard London

SALES INTERNATIONAL

Canada

Kit Morgan, 22 Tichester Rd., Apt. 107,
Toronto 10

Italy

Germano Ruscelitto, Via Padova 154
Milano, Italy
Sam'l Steinman, Piazza S. Anselmo 1,
Rome, Italy

Japan

Kanjil Suzuki/Japan Trade Service, Ltd.,
2-1-408, 3 Chome Otsuka, Bunkyo-ku,
Tokyo



CONTENTS

MARKET DATA REPORT	11
RECORD MANUFACTURERS	18
U. S. MUSIC PUBLISHERS	56
U. S. RECORD WHOLESALERS	
Distributors	77
Rack Jobbers	107
One-Stops	111
Importers & Exporters	121
SERVICES & SUPPLIES FOR THE U. S. MUSIC-RECORD INDUSTRY	123
Design & Artwork	123
Direct-Mail Service	123
Envelopes & Mailers	123
Jacket Manufacturers	124
Label Manufacturers	126
Licensors, Tape & Record	128
Machine Shop	128
Materials Milling Plants	130
Music Licensing Organizations	130
Plating Plants	132
Polyethylene Bags	134
Pressing Plants	134
Printers & Lithographers	139
Processing Plants	140
Promotion & Publicity	140
Recording Studios	143
Shipping Services	148
Sleeves	150
Studio Equipment	147
Trade Associations	149
TAPE SECTION	152
Tape CARtridge and reel-to-reel manufacturers and licensed duplicators/distributors	152
Playback Equipment	155
Tape Duplicators	160
Raw Tape	152
CARtridge Case Manufacturers	152
RECORD DEALER ACCESSORIES AND SUPPLIES	163
Browser Boxes	163
Carrying Cases	163
Catalog Services	163
Cleaners, Cloths & Brushes	163
Needles	164
Racks	166
Title Strips	166
PHONOGRAPH MANUFACTURERS	168
INTERNATIONAL MUSIC-RECORD SECTION	171

CBS Records has friends in high places.

You doubt it? Check the list below.
CBS Schallplatten is in Winterthur, Switzerland.
We have friends in low places, too. CBS
Grammofonplatten is in Haarlem, The Netherlands.

What we offer wherever we are is the full
facilities of the world's largest and most
comprehensive music services operation.
Able to nail down any job you can dream up.
From recording your artists to pressing your
records to promoting your hits to
publishing your tunes to handling your

whole catalog for international distribution.

And don't be misled by the length
of the list. Those affiliates are exporters, too.
That means we have about 100 national
outlets all told. (And all sold.)

It adds up to worldwide coverage.
It boils down to your only logical choice.

Do you get the feeling that we get around?
Right you are. CBS Records is everywhere.
There's no getting away from it.

Argentina: Discos CBS, S.A.—Buenos Aires
Australia: Australian Record Company, Ltd.—
East Sydney, New South Wales
Austria: CBS Schallplattengesellschaft mbH—Vienna
Belgium: Disques CBS Fonoplaten—Brussels
Bolivia: "Discolandia" Dueri & Cia. Ltda.—La Paz
Brazil: Discos CBS, S.A.—Rio de Janeiro
Canada: Columbia Records of Canada, Ltd.—Don Mills, Ontario
Chile: Goluboff Industrias Fonográficas S.A.—Santiago
Colombia: Discos CBS, S.A.—Bogotá
Costa Rica: Industria de Discos Centroamericana Ltda.—San José
Denmark: Nordisk Polyphon Aktieselskab—Copenhagen
Dominican Republic:
Agencia Musical La Guarachita—Santo Domingo
Ecuador: Emporio Musical S.A.—Guayaquil
Finland: Musik-Fazer—Helsinki
France: Société Art, Technique et Commerce—Paris
Germany: CBS Schallplatten GmbH—Frankfurt
Greece: Music-Box—Athens
Hong Kong/Macao: Colonial Trading Company—Hong Kong
Israel: CBS Records (Israel) Ltd.—Tel-Aviv
Italy: CBS Italiana—Milan
Jamaica: West Indies Records, Ltd.—Kingston
Japan: Nippon Columbia Company, Ltd.—Tokyo
Malaysia: Hup Hup Ltd.—Selangor, Malaya
Mexico: Discos CBS, S.A.—Naucalpan
Netherlands: CBS Grammofonplatten—Haarlem
New Zealand: Philips Records (N.Z.) Ltd.—Wellington
Norway: Norsk Phonogram A/S—Oslo
Peru: Industrial Sono-Radio, S.A.—Lima
Philippines: Mareco, Inc.—Quezon City
Portugal: Radio Triunfo, Lda.—Pôrto
Republic of South Africa:
Gramophone Record Company Ltd.—Johannesburg
Spain: Discophon—Barcelona
Sweden: A. B. Philips-Sonora—Stockholm
Switzerland: CBS Schallplatten—Winterthur
United Kingdom: CBS Records Ltd.—London
United States: Miami Records—Miami, Florida
Uruguay: Sondor S.A.—Montevideo
Venezuela: La Discoteca, C.A.—Caracas

CBS Records/Entertaining the Entire World 

CBS Records International: 51 West 52 Street, New York, N.Y. 10019, (212) 765-4321. Cable COLRECORD; Telex 421782

MORE HITS...



**WARNER BROS.
RECORDS**

ALEXANDER & THE HAMILTONS □ THE BANTAMS □ BEAU BRUMMELS □ THE BLOOD BROS. □
BONNIE □ FREDDIE CANNON □ DORIVAL CAYMMI □ PETULA CLARK □ BILL COSBY □ JAMES
DARREN □ DICK & DEE DEE □ JIMMY DURANTE □ EASTSIDE KIDS □ STEVE ELLIOT □ THE EVERLY
BROTHERS □ THE GIRLS FROM BAHIA □ JOHN GOLDEN □ TONY HATCH □ THE HONEYCOMBS
ANTONIO CARLOS JOBIM □ JOHNNY KEATING □ ANITA KERR □ THE KING FAMILY □ THE KING
SISTERS □ THE MARKETTS □ THE MEXICALI SINGERS □ THE NEW ORDER □ OUR GANG □ PAT
& ANDRE □ EMILIO PERICOLI □ BONNIE PRUDDEN □ JOHNNY SEA □ ALLAN SHERMAN □ CONNIE
STEVENS □ MEL TAYLOR □ THE TIKIS □ TEDDY AND THE TOMCATS □ JACKIE TRENT □ MARCOS
VALLE □ LEROY VAN DYKE □ ALEXANDER & THE HAMILTONS □ BANTAMS □ BEAU BRUMMELS
ALEXANDER & THE HAMILTONS □ THE BANTAMS □ BEAU BRUMMELS □ THE BLOOD BROS. □
BONNIE □ FREDDIE CANNON □ DORIVAL CAYMMI □ PETULA CLARK □ BILL COSBY □ JAMES
DARREN □ DICK & DEE DEE □ JIMMY DURANTE □ EASTSIDE KIDS □ STEVE ELLIOT □ THE EVERLY
BROTHERS □ THE GIRLS FROM BAHIA □ JOHN GOLDEN □ TONY HATCH □ THE HONEYCOMBS

MORE OFTEN!!



THE ALIIS □ CHARLES AZNAVOUR □ HAROLD BETTERS □ THE BLOSSOMS □ JAMES BOWEN □ JUDY BRANCH □ JACQUES BREL □ DONNA BUTTERWORTH □ JIMMIE & VELLA CAMERON □ BING CROSBY □ SAMMY DAVIS JR. □ DINO, DESI & BILLY □ DUANE EDDY □ HAL FRAZIER □ ERNIE FREEMAN □ THE GAS COMPANY □ JONNA GAULT □ JOAO GILBERTO □ BUDDY GRECO □ GEORGE GREELEY □ TAMMY GRIMES □ JUDY HENSKE □ DON HO □ MORGANA KING □ THE KINKS □ BAKER KNIGHT □ BUDDY KNOX □ TOM LEHRER □ TRINI LOPEZ □ THE MAGNIFICENT 7 □ DEAN MARTIN □ DEANA MARTIN □ GEORGE McCURN □ GUY MITCHELL □ THE MOJO MEN □ CHRISTINE NELSON □ JACK NITZSCHE □ MARTY PAICH □ THE PARIS SISTERS □ MIKE POST □ LLOYD PRICE □ THE ELECTRIC PRUNES □ DON RANDI □ NELSON RIDDLE □ THE RING-A-DINGS □ THE ROCKIN' BERRIES □ SANDIE SHAW □ FRANK SINATRA □ FRANK SINATRA JR. □ NANCY SINATRA □ KEELY SMITH □ DANNY WARNER □ THE ILL WINDS □ THE ALIIS □ THE ALIIS □ CHARLES AZNAVOUR □ HAROLD BETTERS □ THE BLOSSOMS □ JAMES

The Sounds That Sell Around The World

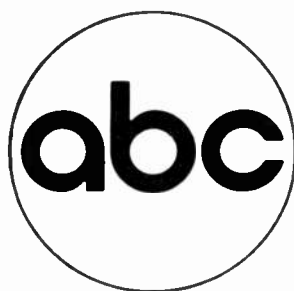

RECORDS

NEW YORK

BEVERLY HILLS

A SUBSIDIARY OF AMERICAN BROADCASTING COMPANIES, INC.

1330 AVENUE OF THE AMERICAS, NEW YORK, N.Y. 10019

ABC • COMMAND • IMPULSE • DUNHILL • WESTMINSTER • GRAND AWARD • MUSIC GUILD • WHITEHALL
Exclusive Distributor for: 20th CENTURY FOX • JERDEN • TANGERINE • BOOM • OLIVER • SIMON SAYS

Market Data Report

Record Boom Continues Unabated

RETAIL record sales in 1965, aided by the booming economy and the removal of the federal excise tax, hit an all-time high of \$789,000,000, an increase of nearly 14 per cent over the previous year.

Gains were scored in all outlet categories, with the greatest percentage increase (21.5) in rack jobbing operations. Rack jobbers are now responsible for 37.3 per cent of the dollar volume, topped only by stores with 42.9 per cent. Part of the increase in rack sales can be explained by the growth in the economy, but racks are also stocking in greater depth than ever before, and hence they're selling a wider variety of product.

While retail stores increased their total sales from \$321,000,000 to \$346,000,000, their share of market dropped from 46.3 per cent to 43.9 per cent. The momma and papa outlets continue to decline in numbers, and the new breed of record retailer is aggressive, knowledgeable and expansion minded. Many record shops are opening branches, increasing their purchasing power, using the latest inventory control methods, and, in effect, operating as chain stores.

The retrenchment and reorganization of 1964 seems to have paid off for record clubs and mail order operations in 1965. Sales jumped from \$92,000,000 to \$110-

000,000, with sales increases in existing companies, and with new clubs and mail order houses entering the field.

While the number of album releases declined slightly, album sales jumped from \$515,000,000 to \$598,000,000, an increase of 16.1 per cent.

Singles releases increased from 6,504 to 7,116, but the sales increase was only 8 per cent—from \$175,000,000 to \$189,000,000. In 1965, the albums had a 75.8 per cent share of market, with singles accounting for 24 per cent. The balance, .2 per cent of the market, is EP's.

The increase in album sales is accounted partially for by the growing number of multiple-record sets, particularly in operas.

Phonograph sales continue to rise—5,800,000 sets were sold in 1965, and the projected 1966 figure is 6,100,000 sets.

Stereo phonograph sales were 3,600,000 for the third straight year, and early reports indicate a slight increase for 1966.

The radio picture continues bright. An estimated 242,000,000 sets were in use last year, with some 4,039 AM radio stations and 1,408 FM outlets. Television sets in use rose from 69,000,000 to an estimated 72,000,000.

RECORDS RELEASED—1955 THRU 1965

SINGLES

Singles	Year	Annual % Change
4,542	1955	—
4,451	1956	-2%
4,649	1957	+4%
4,576	1958	-2%
5,812	1959	+27%
5,797	1960	-0.3%
6,036	1961	+4%
6,700	1962	+11%
6,543	1963	-2%
6,504	1964	-0.6%
7,116	1965	+9%

LP's

LP's	Year	Annual % Change
1,615	1955	—
2,500	1956	+55%
3,000	1957	+20%
3,471	1958	+16%
3,480	1959	+0.3%
3,112	1960	-11%
2,927	1961	-6%
3,655	1962	+25%
3,686	1963	+1%
3,553	1964	-4%
3,546	1965	-0.2%

Market Data Report

TOTAL DOLLAR SALES—by Type of Outlet

(reported in millions of dollars at retail selling price)

Type of Outlet	1961	1962	1963	1964	1965	Change	1965 Share of Market
STORES	305	319	307	321	346	up 7.8%	43.9%
RACKS	147	197	214	242	294	up 21.5%	37.3%
JUKE BOXES	35	35	42	38	39	up 2.6%	4.9%
CLUBS & MAIL ORDER	100	100	95	92	110	up 19.6%	13.9%
TOTAL INDUSTRY	587	651	658	693	789	up 13.9%	100.0%

TOTAL UNIT SALES—by Type of Outlet

(reported in millions of units)

Type of Outlet	1961	1962	1963	1964	1965	Change	1965 Share of Market
STORES	160	171	164	170	185	up 8.8%	40.4%
RACKS	100	136	143	159	191	up 20.1%	37.8%
JUKE BOXES	50	49	60	54	55	up 1.9%	12.8%
CLUBS & MAIL ORDER	45	45	41	38	46	up 21.1%	9.0%
TOTAL INDUSTRY	355	401	408	421	477	up 13.3%	100.0%

UNIT SALES OF LP's—by Type of Outlet

(reported in millions of units)

Type of Outlet	1961	1962	1963	1964	1965	Change	1965 Share of Market
STORES	68	70	66	68	76	up 11.8%	33.3%
RACKS	60	76	79	86	106	up 23.3%	46.5%
CLUBS & MAIL ORDER	45	45	41	38	46	up 21.1%	20.2%
TOTAL INDUSTRY	173	191	186	192	228	up 18.8%	100.0%

Note: Above table does not include EP unit sales, which amounted to 2.3 million in 1964 and 1.5 million in 1965.

DOLLAR SALES—by Type of Record

(reported in millions of dollars)

Type of Record	1961	1962	1963	1964	1965	Change	1965 Share of Market
LP'S	441	486	485	515	598	up 16.1%	75.8%
SINGLES	141	161	170	175	189	up 8.0%	24.0%
EP'S	5	4	3	3	2	down 33.3%	0.2%
TOTAL INDUSTRY	587	651	658	693	789	up 13.9%	100.0%

UNIT SALES OF SINGLES—by Type of Outlet

(reported in millions of units)

Type of Outlet	1961	1962	1963	1964	1965	Change	1965 Share of Market
STORES	92	101	98	101	108	up 6.9%	43.7%
RACKS	40	60	64	71	84	up 18.3%	43.0%
JUKE BOXES	50	49	60	54	55	up 1.9%	22.3%
TOTAL INDUSTRY	182	210	222	226	247	up 9.3%	100.0%

Note: Above table does not include EP unit sales, which amounted to 2.3 million in 1964 and 1.5 million in 1965.

UNIT SALES BY TYPE OF RECORD

Type of Record	Total Industry 1965 vs. 1964		Retail Stores 1965 vs. 1964		Rack Jobbers 1965 vs. 1964	
SINGLES	52.0%	54.1%	58.7%	59.8%	44.2%	45.2%
LP'S	48.0%	45.9%	41.3%	40.2%	55.8%	54.8%
	<u>100.0%</u>	<u>100.0%</u>	<u>100.0%</u>	<u>100.0%</u>	<u>100.0%</u>	<u>100.0%</u>

Market Data Report

HISTORICAL NOTES:

1877—Edison first reproduced sound using tin foil cylinders. Invention labeled "phonograph."

1886—"Graphophone" patented by Bell and Tainter. Recordings made on wax cylinders.

1887—American Graphophone Company formed in Bridgeport, Conn., to produce the Bell-Tainter invention. Record industry is launched.

1889—Columbia Phonograph Company organized to market American Graphophone products.

1891—Berliner first records on discs.

1897—American Graphophone opens London branch: Columbia Graphophone Company, Ltd.

1901—Victor Talking Machine Company formed. Disc recordings marketed.

1902—Columbia and Victor share disc recording patents.

1903—Royalty system first used to compensate recording artists.

1912—Industry abandons cylinder recordings.

1912—Beginning of the first "Golden Age" of records. Many new labels and artists.

1922—General industry decline brought about by increasing appeal of radio.

1925—Development of electrical recording process. Microphones replace the recording horn.

1930—Depression causes second general record industry decline.

1930's—Radio begins to turn to records and music and is more and more exposed via the airwaves in this decade. This exposure sells records in greater numbers.

1934—American Decca Record Company organized.

1940's—New labels join the industry's leaders: MGM, Capitol, Mercury, London and others.

1948—High-fidelity recording and new turntable speeds introduced: Columbia's LP and Victor's 45 rpm systems.

1952—Record Industry Assoc. of America organized.

1954—Rock & Roll becomes popular.

1955—Columbia Record Club established.

1958—Stereophonic LP recordings introduced in fall of this year.

1959—Rock & Roll declines somewhat—LP's on rise.

1960—Stereo has advantageous effect, increasing LP dollar and LP unit sales, offsetting decline in singles sale.

1961—Fewer million-selling singles. Twist craze. LP sales continue to rise. Racks show good sales gain—now approx. 25% total gross.

1962—Summer season one of best for singles in history of business. Racks register 24% gain over 1961 as they take on more leased departments; stores up close to 5%.

1963—In a normal growth period for records and in a time of national prosperity, record sales in 1963 did not keep pace. A Christmas sales that did not come up to expectations, combined with changes in the marketing and merchandising of records, held 1963 down to a 1% increase over 1962.

1964—Year noted for Beatles invasion followed by approximately three dozen other British artists. LP sales registered greatest gain. August 1964 one of the best months ever for singles sales. Good Christmas season plus good third quarter edged industry over previous year by approximately 5%.

1965—U.S. Excise Tax on records rescinded.

1966—Breakthrough of tape CARtridge, with the nation's three major automobile manufacturers promoting tape units in new cars.

U. S. RECORD SALES 1921 — 1965

(Source: Record Industry Association of America. Excise tax payments, estimates from other data.)

YEAR	SALES IN MILLIONS OF DOLLARS	YEARLY PERCENT CHANGE
1921	\$106	— %
1922	92	-13.2%
1923	79	-14.1%
1924	68	-13.9%
1925	59	-13.2%
1926	70	+18.6%
1927	70	
1928	73	+4.3%
1929	75	+2.7%
1930	46	-38.7%
1931	18	-60.9%
1932	11	-38.9%
1933	6	-45.5%
1934	7	+16.7%
1935	9	+28.6%
1936	11	+22.2%
1937	13	+18.2%
1938	26	+100%
1939	44	+69.2%
1940	48	+9.1%
1941	51	+6.3%
1942	55	+7.8%
1943	66	+20%
1944	66	
1945	109	+65.2%
1946	218	+100%
1947	224	+2.8%
1948	189	-15.6%
1949	173	-8.5%
1950	189	+9.2%
1951	196	+3.7%
1952	208	+6.1%
1953	210	+1%
1954	199	-5.2%
1955	250	+25.6%
1956	336	+34.4%
1957	405	+20.5%
1958	445	+9.9%
1959	518	+16.4%
1960	521	+6%
1961	587	+12.7%
1962	651	+10.9%
1963	658	+1.1%
1964	693	+5.3%
1965	789	+13.9%

1970 (estimated)
1.2 BILLION DOLLARS

(Dollars) U. S. RECORD SALES 1921 — 1965

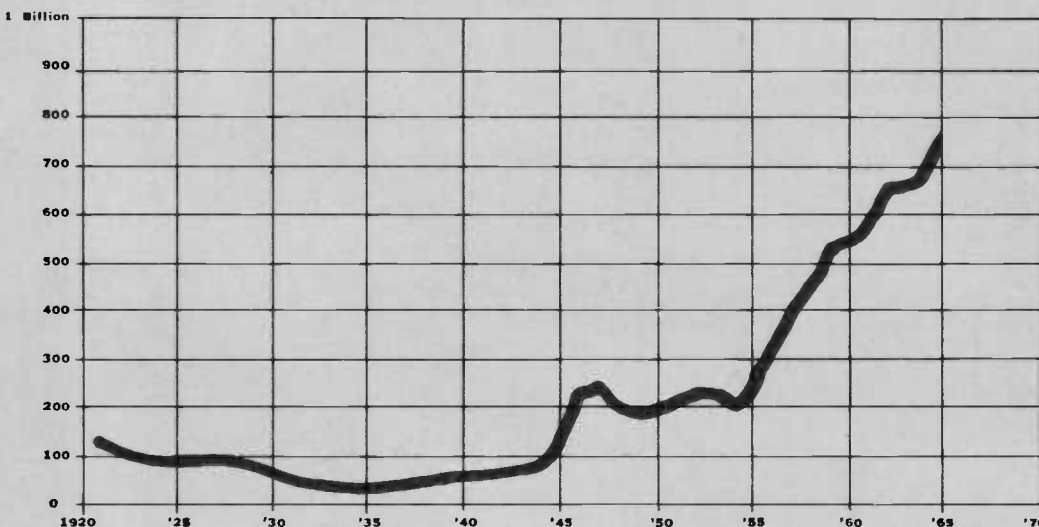

PHONOGRAPH SALES

	1950	1951	1952	1953	1954	1955	1956	1957	1958	1959	1960	1961	1962	1963	1964	1965	1966 (est.)	
TOTAL UNITS SOLD (millions)	→	—	—	1.3	1.6	2.7	3.0	4.1	4.9	4.1	4.6	4.6	4.0	4.8	5.0	5.2	5.8	6.1
					+69%	+11%	+37%	+20%					+20%	+4%	+4%	+12%	+5%	
STEREO UNITS SOLD (millions)	→	—	—	—	—	—	—	—	1.2	2.7	3.4	2.9	3.5	3.6	3.6	3.6	3.7	
STEREO % OF ALL SALES	→	—	—	—	—	—	—	—	30%	62%	74%	73%	72%	71%	70%	62%	61%	

RADIO SETS IN USE (including autos)

	1950	1951	1952	1953	1954	1955	1956	1957	1958	1959	1960	1961	1962	1963	1964	1965 (est.)	
(millions)	→	96	105	111	118	121	124	135	143	146	156	168	184	200	214	228	242

TELEVISION SETS IN USE

	1950	1951	1952	1953	1954	1955	1956	1957	1958	1959	1960	1961	1962	1963	1964	1965 (est.)	
(millions)	→	10	16	21	27	33	37	43	47	51	54	57	60	63	66	69	72

RADIO STATIONS IN THE U.S.

		1954	1955	1956	1957	1958	1959	1960	1961	1962	1963	1964	1965 (est.)
AM STATIONS	→	2,669	2,824	3,008	3,195	3,326	3,398	3,539	3,693	3,810	3,937	4,009	4,039
FM STATIONS	→	552	540	530	537	578	688	815	960	1,081	1,146	1,270	1,408
FM-STEREO STATIONS	→	—	—	—	—	—	—	—	57	181	203	308	350



HAS PRESSING



HAS RECORDING



HAS DISTRIBUTION

IF YOU WANT WORLD-WIDE

THE GREATEST RECORDING ORGANISATION IN THE WORLD

PLANTS IN OVER 40 COUNTRIES

STUDIOS IN 38 COUNTRIES

FACILITIES IN EVERY MAJOR TERRITORY

SALES LOOK TO



EMI LIMITED · HAYES · MIDDLESEX · ENGLAND

U.S. Record Manufacturers

A

- A A**, 250 W. 57 St., New York, N. Y. Tel.: (212) 765-3350. Pres.: A. Massler; VP: A. Shimkin; VP Sales & Mktg.: S. Raiken. Labels: AA, Golden.
- A A A (Tri-A)**, 6290 Sunset Blvd., Suite 616, Hollywood, Calif. 90028. Tel.: (213) HO 9-5591. Pres.: George Jay.
- A B C**, 1330 Ave. of the Americas, New York, N. Y. 10019. Tel.: (212) LT 1-7777. Cable: ABPAREC. Pres.: Larry Newton; Exec. VP & Int'l: Harry Levine; A&R Dir.: Bob Thiele; VP Sales & Promo.: Howard Stark; Sales Mgr.: Bud Katzel; Pub. & Adv. Dir.: Rick Ward; Promo. Dir.: Mike Becce.
- Branches:** Beverly Hills, Calif., 449 S. Beverly Dr. Tel.: (213) CR 8-1130. VPs: Jay Lasker & Lou Adler.—Chicago, Ill., 1303 S. Michigan Ave. Tel.: (312) 427-3035. Midwest A&R Dir.: Johnny Pate.—Nashville, Tenn., 905 16 Ave. S. Tel.: (615) 256-5694. South A&R Dir.: Fred Carter.
- Labels: (owned) ABC, Impulse, Command, Grand Award, Westminster, Music Guild, Dunhill, Whitehall, (distributed) Jerden, Tangerine, Boom, Oliver, Simon Says, 20th Century-Fox, Movie-tone.
- Int'l representatives:** Argentina (Famous), Australia (Festival), Belgium (Anvers Radio), Bolivia (Philips), Canada (Sparton), Costa Rica (Indica), Denmark (I. S. Dansk), England (EMI), France (Sofrason), Germany (Philips), Holland (Artone), Hong Kong (Festival), Israel (Hed Arzi), Italy (La Voce Del Padrone), Jamaica (Paradisc), Japan (King), Lebanon (Philips), Mexico (Gamma), Peru (El Virrey), Philippines (Mareco), South Africa (Teal), Spain (Hispanvox), Sweden (Karussell), Uruguay (Philips), Venezuela (El Palacio de la Musica), Yugoslavia (Radio Television Belgrad). (SEE ADVERTISEMENT)
- A B S** (see Dover, New Orleans).
- A & M**, 8255 Sunset Blvd., Suite 201, Hollywood, Calif. 90046. Tel.: (213) 656-5330. Pres.: Jerry Moss; VP: Herb Alpert; Prod'r: Tom LiPuma; Nat'l Sales Mgr.: Bob Fead; Nat'l Promo.: Don Graham; Int'l & Gen. Mgr.: Gil Friesen. **Branch:** Philadelphia, Pa.: Bill Mulhearn, 47 St. & City Line. Labels: Almo, Omen.
- Int'l representatives:** Central & South America (Transglobal, New York), Europe & Japan (London Records, New York).
- A P I**, 2991 Ingleddale Terr., Los Angeles, Calif. 90039. Tel.: (213) 662-3656. A&R Prod'n Dir.: Brian Ross.
- A R A**, 3830 N. Seventh St., Phoenix, Ariz. 85014. Tel.: (602) 277-4723. Pres.: Bill Thorne; VP & Gen. Mgr.: Floyd M. Ramsey; A&R: Floyd Ramsey, Waylon Jennings, Don Owens, Jim Music. Labels: ARA, Ramco, Republic.
- A S A** (see Met Richmond Latin Rec. Sales).
- Aardvark Ent's.**, 609 Fifth Ave., New York, N. Y. 10022. Tel.: (212) PL 9-5324. Pres.: Mrs. Ramona Crehan. Labels: Aardvark, Piccolo.
- Abbey**, 160 Passaic Ave., Kearny, N. J. Tel.: (201) 998-8181. N. Y. C. Tel.: (212) LW 4-0891. Gen. Mgr.: Henry S. Rosenberg. Label: Connoisseur.
- Abel (see Laurie).
- Abnak Music Ent's.**, 1630 Life Bldg., Oallas, Tex. 75202. Tel.: (214) RI 2-7040, 6428. Pres.: John H. Abdnor. Labels: Abnak, Britania, Jetstar, Startime.
- Abundant Sounds** (see Fred Miles Presents).
- Academic Rec'g Institute**, 4727 Oakshire, No. 1, Houston, Tex. 77027. Tel.: (713) MO 6-5266. Pres.: Mack G. Reed.
- Academy**, 157 W. 57 St., New York, N. Y. 10019. Tel.: (212) LT 1-7490. Owners: A. Levington & J. Gibbs (distributed by Amy-Mala-Bell).
- Accent**, 6533 Hollywood Blvd., Hollywood, Calif. 90028. Tel.: (213) 469-1621. Pres.: Scott Seely (distributed by GNP Crescendo).
- Achilleian** (see Zaraks).
- Action**, P. O. Box 5, Youngstown, Ohio. Tel.: (216) 746-8464. Pres.: Terry Grimm.
- Acurela** (see Epstein Ent's.).
- Adaire**, 1036 Red Bird Rd., Augusta, Ga. 30904. Tel.: (404) 736-3154. Owner: Blanche C. Carter. Labels: Adaire, Cantor, Margo.
- Adco**, 7527 Juler Ave., Cincinnati, Ohio 45243. Tel.: (513) 561-7818. Pres.: Jack Adkins.
- Admiral** (see Amy-Mala-Bell).
- Adrian Assocs.**, 6660 Biscayne Blvd., Miami, Fla. 33138. Tel.: (305) 757-1626. Pres.: Michael Adrian.
- Branch:** New York, N. Y., 130 W. 42 St., New York, N. Y. 10036. Tel.: (212) PE 6-0936. (SEE ADVERTISEMENT)
- Advance**, 6376 Yucca St., Hollywood, Calif. 90028. Tel.: (213) HO 3-2151 & 465-6258. Owner: Tim Gayle.
- Adventure** (see Amy-Mala-Bell).
- Aeolian-Skinner**, 549 E. Fourth St., Boston, Mass. 02127. Tel.: (617) AN 8-2232.
- Aesop's Label**, 9358 James Ave. S., Minneapolis, Minn. 55431. Tel.: (612) 888-4459. Owner: Harley Toberman.
- Aetna** (div. of Shreve-Nash Ent's.), P. O. Box 105, 1842 Line Ave., Shreveport, La. Tel.: (318) 422-7376. Gen. Mgr.: Dick Martin.
- Air**, P. O. Box 833, Riverside Sta., Miami, Fla. 33135. Pres.: Jack A. Curry.
- Alear**, 420 20 St., West Point, Va. Tel.: 240 (no direct dial). Pres.: Dean Greer.
- Alector**, 367 W. 34 St., New York, N. Y. 10001. Tel.: (212) LO 3-2831. Pres.: Ted Starke.
- Alegre** (see Roullette).
- Alert** (see Atco).
- Allagash**, P. O. Box 1181, Bangor, Me. 04401. Tel.: (207) 942-9637. Pres.: Daniel B. Fulkerson.
- Allan**, P. O. Box 940, Indianapolis, Ind. 46206. M'g'g Dir.: Jerry Duane Allan.
- Allandale**, 3635 Allandale, Memphis, Tenn. 38111. Tel.: (901) 324-4640. Pres. A&R & Adv.: Style Wooten; VP: Thomas Grissom; Sales, Mktg. & Promo.: Dennis Turnipseed; Pub.: Melba Knoblock.
- Allegro**, P. O. Box 11371, Los Angeles, Calif. 90011. Tel.: (213) FA 1-5654. Pres.: Dunlap J. Cawthron.
- Allegro** (see Pickwick Int'l).
- Alley**, 213 E. Monroe, Jonesboro, Ark. Tel.: (501) WE 5-2161. Pres.: Joe Lee.
- Allied**, 2437 E. 57 St., Los Angeles, Calif. 90058. Tel.: (213) 582-0841. Cable: Allrecord. Pres.: Daken K. Brodhead; VP: John F. Wegner.
- Alma**, Brooklyn, N. Y. (see Met Richmond Latin Rec. Sales).
- Alma**, 18108 Parthenia St., Northridge, Calif. 91326. Tel.: (213) DI 5-2400. Pres.: Hugh S. Edwards. Labels: Alma, Christian Faith.
- Almanac**, P. O. Box 7532, Houston, Tex. 77007. Talent Dir.: Mack McCormick; Sales Dir.: J. D. Horn.
- Al-Matt** (see Alta).
- Almo** (see A&M)
- Aloha** (see Trend).
- Alon**, 4318 MacArthur Blvd., New Orleans, La. 70114. Tel.: (504) 367-3104. Pres.: Joseph Banashak.
- Alpha** (see Don-El).
- Alshire Presents** (see Budget Sound).
- Alta**, 508 S. Main St., Altus, Okla. Tel.: (405) HU 2-6275. Cable: ALRECO. Pres.: Don R. Booker; VP A&R, Pub. & Adv.: Robert Jeter; Promo.: Bill Grubbs.
- Branch:** West Covina, Calif.: 1142 Azusa Ave. Tel.: (213) 966-5184. Cable: WEALRECO. Rep.: James Lopina. Labels: Alta, Al-Matt, Kingdom.
- Alte Werke** (see London).
- Alto** (see Atlas).
- Alvera**, P. O. Box 9304, Tulsa Okla. 74107. Tel.: (918) 242-3283. Pres. & Gen. Mgr.: Al Clauser; VP: Vera Clauser; A&R: Henry Clauser; Sales: Walter Clark; Pub., Promo. & Adv.: Vera Longan. Labels: Alvera, Target.
- Amadeo** (see Apon).
- Ambassador**, 2990 W. Pico, Los Angeles, Calif. 90006.
- Ambassador**, 145 Komorn St., Newark, N. J. 07105. Tel.: (201) MA 3-4214. Mgr.: Mark Friedman. **Branch:** Los Angeles, Calif., 742 E. 61 St. Tel.: (213) 231-2144. Contact: Fred Levi.
- Labels: Compose, Diplomat, Guest Star, Look & Listen, Peter Pan, Pirouette, Playmate, Rocking Horse, Scripture, Tifton.
- Ambat**, 1667 Central Pkwy., Cincinnati, Ohio 45214. Tel.: (513) 621-3252, 3253. Pres.: Vernon W. Hawks.
- Branch:** Dayton, Ohio, 1336 Xenia Ave. Zip: 45410.
- Amber**, 2856 Kennedy Blvd., Jersey City, N. J. Tel.: (201) 653-5681. VP: Jeff LeRose; A&R: V. Dean; Sales: Stan Krause.
- Amcan** (see Canadian American).
- American Grammophone**, 10513 Santa Monica Blvd., Los Angeles, Calif. 90025. Tel.: (213) 474-3565. Pres.: Randy Sparks.
- American Rec. Prod'n Assistants** (see Bil80).
- Amherst**, 153 Walton Dr., Buffalo, N. Y. 14226. Tel.: (716) TF 9-1482. Pres.: John H. Warfel.
- Amphora Music**, 1727 Division St., Davenport, Iowa. 52804. Pres.: Frank L. Engel. Labels: Amphora, Decora.
- Amy-Mala-Bell**, 1776 Broadway, New York, N. Y. 10019. Tel.: (212) PL 7-6081. Gen. Mgr.: Larry Uttal; Sales & Promo. Mgr.: Fred de Mann.
- Labels: Academy, Admiral, Adventure, Amy, Aurora, Bell, Big Hill, Big Top, Dynovoice, E, Eskee, Flashback, General Int'l, Goldwax, Mala, Maxx, Musicland USA, New Voice, Rotate, Sansu, Sphere Sound.
- Int'l representatives:** Canada (Quality), All other (EMI).
- Angel**, 1750 N. Vine St., Hollywood, Calif. 90028. Tel.: (213) 462-6252. Cable: Caprecords. Pres.: Alan W. Livingston; A&R: Robert Myers; Classical Mdsq. Mgr.: Brad Engel. **Branch:** New York, N. Y., 1290 Ave. of the Americas. Zip: 10019. Tel.: (212) PL 7-7470. Sales: Jack Cohen.
- Int'l representatives:** The classical material released in the U. S. on the Angel label is released abroad on the following EMI labels: Britain (British Columbia, HMV), France (La Voix de Son Maitre, Pathe-Marconi), Germany (Electrola), Italy (La Voce del Padrone) (see Capitol).
- Angelicum** (see Apon).
- Angeltone** (see Atlas).
- Ansonia**, 992 Columbus Ave., New York, N. Y. 10025. Tel.: (212) UN 5-2121. Pres.: Ralph Perez.
- Antares**, 663 Fifth Ave., New York, N.Y. 10022. Tel.: (212) EL 5-5633. Pres.: William A. Wiggins.
- Anthem** (see Texas Sound Studios).
- Antiqua Prod'ns**, 1650 Broadway, New York, N. Y. 10019. Tel.: (212) 757-2750. Pres.: Sales & Mktg.: Sam Goldner; Exec. VP & A&R: Johnny Brantley. Labels: Music World, Marx X.
- Anzac** (see Trend).
- Apache**, 3320 Barham Blvd., Hollywood, Calif. 90028. Tel.: (213) HO 4-3653. Mgr.: Chic Matthews.
- Apon**, P. O. Box 131, Grand Central Sta., 1541 First Ave., New York, N. Y. 10017. Tel.: (212) YU 8-0450. Pres.: Andrej Poncic. Labels: Amadeo, Angelicum, Discapon, Harmonia Mundi.
- Apostle** (see Happy Hearts).
- Applause** (see CBC Ent's.).
- Api-To**, P. O. Box 284, 45 Elm St., Wyandotte, Mich. 48192. Tel.: (313) 285-0375. Owners & Prod'rs: Lou & Cozetta Miller. **Branch:** Clinton, Tenn., c/o L. Miller, Rt. 2, Box 46.
- Ara** (see Atlantic).
- Aravel**, 46-23 Crane St., Long Island City, N. Y. 111001. Tel.: (212) EX 2-6442. Pres.: Herbert Borchardt.

continued on page 23



THE SIXTY-EIGHTH YEAR

1965
1966

For the First Time on Records

- DONIZETTI: *Il Campanello*, Mariotti, De Sanctis, Rafanelli, Rinaldo, La Fenice Venice/Gracis
- BOHUSLAV MARINU: *Fantasia concertante*. Margrit Weber/Kubelik
- LIEDER BY MAX REGER on the occasion of the 50th anniversary of his death (May 11th, 1966)
Dietrich Fischer-Dieskau, Baritone.
- PALESTRINA: *Missa Hodie Christus natus est*. Regensburg Cathedral Choir
- TELEMANN: *Ino-Cantata*. Janowitz, Chamber Orchestra Hamburg Telemann Society/Boettcher
- WORKS BY WERNER EGK on the occasion of the composer's 65th birthday (May 17th, 1966).

Available For the First Time in Stereo

- SCHOENBERG: *Gurre-Lieder*. Borkh, Töpfer, Schachtschneider, Fehenberger, Engen, Fiedler, Bavarian Radio Chorus and Orchestra/Kubelik
- PALESTRINA: *Improperia. Missa Assumpta est Maria*. Regensburg Cathedral Choir/Schrems

Important New Releases

- DONIZETTI: "*Don Pasquale*". Mariotti, Basiola, Benelli, Maccianti, Frati, Florence May Festival/Gracis
- MASCAGNI: "*Cavalleria Rusticana*".
- LEONCAVALLO: "*Pagliacci*". Cossotto, Martino, Carlyle, Bergonzi, Guelfi, Taddei, Panerai. Karajan's first opera

recordings for Deutsche Grammophon Gesellschaft. Production with La Scala of Milan.

MOZART: "*Abduction from the Seraglio*". Köth, Schädle, Wunderlich. Lenz. Böhme, Choir and Orchestra Bavarian State Opera Munich/Jochum. Incidentally, all five of Mozart's important operas are now available in new stereo versions on Deutsche Grammophon Gesellschaft.

FIRST RELEASE by the young German violinist Edith Peinemann.

DVORAK: *Concerto for Violin*. RAVEL: *Tzigane*. Czech Philharmonic/Maag

THE COMPLETION of our series of Bruckner's Symphonies in stereo made progress, and Nos. 1, 5, 8, and 9 are now available—all with Eugen Jochum and the Berlin Philharmonic

BARTOK: *Concerto*. Berlin Philharmonic/Karajan

GOUNOD: *St. Cecilia Mass*. Seefried, Stolze, Uhde, Czech Philharmonic/Markevitch

SCHUBERT: *Mass No. 5 in A flat major*. Stader, Hoeffgen, Haefliger, Uhde, Regensburg Cathedral Choir, Bavarian Radio Symphony/Ratzinger

BACH: *Christmas Oratorio*. Janowitz, Ludwig, Wunderlich, Crass, Munich Bach Choir and Orchestra/Richter

BACH: *Brandenburg Concertos, Suites Nos. 2 and 3*. Berlin Philharmonic/Karajan

BEETHOVEN'S complete works for violoncello and piano, Fournier/Kempff

FIRST LIEDER RECITAL by Fritz Wunderlich. Beethoven, Schubert, Schumann ("Dichterliebe")

FIRST RELEASE by the young 'cellist Anja Thauer. Reger: *Suite for Violoncello Solo in A Minor*. Françaix. *Fantasy for Violoncello and Piano*

SCHUBERT: *Winterreise*. Dietrich Fischer-Dieskau's first recording of the cycle for Deutsche Grammophon Gesellschaft



Awards

The first complete European recording of Alban Berg's "Wozzeck" with Dietrich Fischer-Dieskau and Evelyn Lear under Karl Böhm was awarded:
Grand Prix du Disque
AS "WORLD'S BEST RECORDING"
Grammy 1965
AS "BEST OPERATIC RECORDING"

Awards also went to
FRITZ WUNDERLICH for his interpretation of the role of Tamino in Mozart's "Magic Flute" and
DIETRICH FISCHER-DIESKAU for his interpretation of Schubert's "Winterreise" and Schumann's "Dichterliebe"
AS "BEST SINGER OF THE YEAR" (ORPHEE D'OR)

Furthermore the following records have won awards:

SCHOENBERG: *Gurre-Lieder*. Bavarian Radio Chorus and Orchestra/Kubelik (Grand Prix, Premio della Critica Discografica Italiana)

TELEMANN: *Musique de Table*. Schola Cantorum Basiliensis/Wenzinger (Grand Prix)
"Baroque Music for Trumpet Virtuoso". Adolf Scherbaum (Edison-Prize)

BEETHOVEN: *Piano Sonata (Hammerklavier) op. 106*. Kempff (Edison-Prize)

MAHLER: *Kindertotenlieder*. Fischer-Dieskau, Böhm (Edison-Prize)

SARTRE: *Huis Clos* (Edison-Prize).

SIBELIUS: *Violin Concerto*. Ferras, Berlin Philharmonic/Karajan (Grand Prix, Edison-Prize)

R. STRAUSS: *Krämerspiegel*. Fischer-Dieskau (Prize of the German Schallplattenkritik)

HENZE: *Elegy for Young Lovers*. (Prize of the German Schallplattenkritik)

Artists Around the World

Our artists were busy as ever touring the globe. Here's where you could find some of them during recent months:

JAPAN

Herbert von Karajan and the Berlin Philharmonic again paid a visit and played to capacity wherever they went.

Tamàs Vàsàry, our most promising young

pianist, made his first appearance and became a favorite with the public and the reviewers.

Pierre Fournier paid another visit, as well as the Deutsche Oper Berlin.

USA

Karl Böhm gave his annual series of performances at the Met, this time giving us *Fidelio* and *Salome*.

The Amadeus Quartet finished their most extensive tour since their debut. Jörg Demus, Pierre Fournier, Ernst Haefliger, Wilhelm Kempff, Rafael Kubelik, Edith Peinemann, Thomas Stewart, Tamàs Vàsàry and Nicanor Zabaleta all performed again for American audiences.

EUROPE

Many of our artists made their annual tours of the musical centres of Europe, among them Géza Anda with the Camerata Academica, Christian Ferras, Rita Streich, and Fritz Wunderlich. A great many of our artists participated at the Festival in Salzburg, Lucerne, Vienna, Bayreuth, Berlin, Munich, Edinburgh and Holland.

Distribution and Sales Activities

On September 1st, 1965, Deutsche Grammophon published the subscription for the "Masterworks in De Luxe Albums", containing three albums: 1.) F. Chopin: "Selected Works for Piano", 2.) F. Schubert: "Chamber Music", 3.) W. A. Mozart: "Magic Flute" under the baton of Dr. Karl Böhm. This campaign was started in many European countries: Belgium, Denmark, Germany, Finland, Norway, France, Greece, Great Britain, Holland, Italy, Austria, Sweden, Switzerland. In some countries, the "Christmas Oratorio" under Karl Richter was also part of the subscription. The idea of subscription, initiated by Deutsche Grammophon in 1962, has now become a well-established annual event, eagerly awaited by public, trade and press.

The addition of the MGM and Verve catalogue gave our subsidiary in Japan the much desired big American catalogue, necessary to make Nippon Grammophon, Toyko, truly one of the major record companies. Eighteen important dealers from Japan paid a visit to the plants of Deutsche Grammophon in Hanover and to their central office, Hamburg, in May 1966.

Moreover, about one hundred Scandinavian dealers went to see the central office in Ham-



burg and were informed in advance about the important campaigns in Autumn: the subscription and the new release of the classical Heliodor series.

The major effort that Deutsche Grammophon is putting behind its activities in the United Kingdom is already paying off. Not only did Bert Kaempfert's recording of "Bye, Bye Blues" reach a prominent place in the LP and Single charts, but the recording "Substitute" by "The Who" reached a top position on the Single charts.

Another innovation of Deutsche Grammophon has also become an institution by now with the trade in Europe. In 1966 the "V66" was bought by more than 2,500 dealers, each "V66" containing several hundred LP's. The important campaign of Archive Productions in August 1966 will bring 10 new releases, among them 3 LP's with works by Heinrich Schütz, sung by the Kreuzchor Dresden under Rudolf Mauersberger. New attractive design and presentation of the record-sleeves have been started.

The confidence of American record companies in the distribution and promotion abilities of Deutsche Grammophon Gesellschaft is further enhanced by the fact that Atlantic Records has given us the rights to their catalogue for the United Kingdom and the Netherlands.



The following are some of the young, vigorous and dynamic subsidiaries of Deutsche Grammophon Gesellschaft.

Polydor S.A., Paris; Polydor Records Ltd., London; Polydor N.V., The Hague; Polydor S.A., Brussels; Polydor, Hamburg; Polydor Records Ltd., Montreal. Also represented in all other dollar markets the world over.

The cradle of internationally acclaimed artists

Italy:	Orietta Berti
France:	Leny Escudero, Marcel Amont
United Kingdom:	The Who
Netherlands:	Golden Earrings
Japan:	Sachiko Nishida, Alfred Hause, Mari Sono
South Africa:	Kallmann Choir
Norway:	The Pussycats, Wencke Myhre
Belgium:	John Larry

Greece: Pnos Tsanetis
 Venezuela: Quinteto Contrapunto
 Germany: Freddy, Roy Black
 Sweden: The Spotnicks
 and Bert Kaempfert everywhere!!

Latest News from Polydor

BERT KAEMPFERT'S two singles—"Moon Over Naples" and "Bye-Bye Blues"—were bestsellers practically the whole world over. Bert has recently scored his first Hollywood movie, "A Man Could Get Killed"; and Frank Sinatra has recorded the theme, "Strangers in the Night."

The American hit, "The Ballad of the Green Berets" has been recorded by FREDDY in a German version. As "Hundert Mann und ein Befehl," the song is topping the German charts.

PETER ALEXANDER left Polydor after 14 years. But one of his latest Polydor recordings, "Müssen Frauen einsam sein?" is fast becoming a hit in every German-speaking country.

Polydor welcomes two important new stars: WENCKE MYHRE and ROY BLACK. They are among the five Polydor artists performing at the 1966 German Song Festival in Baden-Baden. Both have frequent hits on the German charts.

THE GÜNTER KALLMANN CHOIR and CRAZY OTTO have returned from an unbelievably successful ten-week tour of South Africa.

The German musical "Heimweh nach St. Pauli" with FREDDY in the leading role ran well over a hundred performances in Hamburg.

The famous KURT EDELHAGEN ORCHESTRA toured throughout North Africa. The Swedish group, "THE SPOTNICKS" returned from a brilliantly successful tour of Mexico and Japan.

FREDDY was awarded his ninth Golden Record.

BERT KAEMPFERT placed in the British Single and LP Hit Parade.

Sweden's LILL LINDFORS and Norway's ASE KIEVELAND won second and third prize in the Eurovision Song Contest.

Polydor Records, London signed a long-term contract with the famous British group, "THE WHO."

CLAUS OGERMAN recorded his first singles for Polydor in the United States.



LABELS WE OWN OR REPRESENT

Represented in:

ADEN · AFGHANISTAN
ANGOLA · ARGENTINA
AUSTRALIA
AUSTRIA · BAHAMAS
BAHREIN · BELGIUM
BOLIVIA · BRAZIL
BULGARIA
BURUNDI/RUANDA
CAMEROON · CANADA
CANARY ISLANDS
CEYLON · CHILE
COLOMBIA · CONGO
COSTA RICA
CURACAO
CYPRUS · DENMARK
CZECHOSLOVAKIA
DOM. REPUBLIC
ECUADOR · EGYPT
ETHIOPIA · FINLAND
FRANCE
FRENCH SOMALILAND
FORMER FRENCH
WEST AFRICA
GAMBIA/SURINAM
GHANA · GIBRALTAR
GREAT BRITAIN
GREECE
GUINEA · GUYANA
HAITI · HOLLAND
HONDURAS
HUNGARY · ICELAND
INDIA · INDONESIA
IRAN · IRAQ
ISRAEL · ITALY
IVORY COAST
JAMAICA
JAPAN · JORDAN
CAPE VERDE ISLANDS
KENYA · KUWAIT
LEBANON · LIBERIA
LIBYA · LUXEMBURG
MACAO · MADEIRA
MALAYSIA/SINGAPORE
MALTA · MEXICO
MONACO
MOZAMBIQUE
MOROCCO
NEW GUINEA
NEW ZEALAND
NICARAGUA · NIGERIA
NORWAY · OCEANIA
PARAGUAY · PERU
TRUCIAL COAST
POLAND · PORTUGAL
PORT. TIMOR
RHODESIA · RUMANIA
EL SALVADOR
SAUDI ARABIA
SENEGAL
SIERRA LEONE
SOMALILAND · SPAIN
SPAN. GUINEA
SUDAN · SURINAM
SOUTH AFRICA · SYRIA
SOUTH WEST AFRICA
SWEDEN
SWITZERLAND
TANZANIA
THAILAND
TOGO · TUNISIA
TURKEY
USSR · UGANDA
URUGUAY
VENEZUELA
VIETNAM
USA · YUGOSLAVIA

	ARCHIVE PRODUCTION		
	<i>Brunswick</i>	<i>Command</i>	<i>ATLANTIC</i>
MGM		UNITED ARTISTS	<i>Kama Sutra</i>

The labels with the world-wide reputation for technical perfection

... DGG's stereo is as good as expected ... "The American Record Guide", New York, January 1965
... The recording is of the highest quality ... "The Gramophone", London, March 1965
... This recording must certainly go to the head of the class ... "The American Record Guide", New York, April 1965
... this new recording strikes me as the all-round best ... "The American Record Guide", New York, August 1965
... The stereo recording gives splendid quality and definition ... "Records and Recording", London, June 1965
... these records seem to me outstanding ... "The Gramophone", London, May 1966
... great credit to the technicians who have reproduced so well ... "Saturday Review", New York, 30. April 1966
... much better recorded than ... "Library Journal", New York, 1. May 1966
... The sound is absolutely top-class ... "The Gramophone", London, May 1966
... the orchestral recording reaches demonstration standards ... "Hi-Fi News", London, May 1966

MANAGEMENT AND ADMINISTRATION

2 Hamburg 13 · Harvestehuder Weg 1—4

RECORDING STUDIOS

Berlin, Hamburg, Hannover, Köln, München
Paris, Wien

PRESSING PLANTS

Werk I: 3 Hannover, Podbielskistrasse 164
Werk II: 3012 Langenhagen (Hannover),
Klusriede 26

AFFILIATED AND OTHER COMPANIES:

POLYPHON
SCHALLPLATTEN GESELLSCHAFT MBH
Mariahilfer Strasse 127
Wien VI/Austria

SA POLYDOR NV
116, Chaussée de Charleroi, Brussels/Belgium

POLYDOR RECORDS CANADA LTD.
407 McGill Street
Montreal 1 / Quebec / Canada

POLYDOR RECORDS LTD.
17-21 Stratford Place
London W 1 / England

FINTONE OY
Munkkisaarekatu 2
Box 10033
Helsinki/Finland

POLYDOR S. A. PARIS
2, Rue Cavallotti
Paris (18^e)/France

POLYDOR NEDERLAND NV
Piet Heinplein 5, The Hague/Holland

SA POLYDOR LUXEMBURG
17, Rue Glesener, Luxemburg

DISCOS UNIVERSALES S.A. DUSA
Calle Rio Tiber 58
Mexico 5 / D.F. / Mexico

A/S NOR-DISC
Postboks 5219 Majorstua, Oslo 3/Norway

KARUSELL GRAMMOFON AB
Postfack
Solna 1 b/Stockholm/Sweden

NIPPON GRAMMOPHON CO. LTD.
Kimura Building
6—6, 1-chome, Shinbashi, Minato-ku
Tokyo/Japan

BUDGET LINE RECORD MANUFACTURERS

continued

U.S. Record Manufacturers

A A, 250 W. 57 St., New York, N. Y. 10019. Tel: (212) 765-3350. Pres.: A. Massler; VP: A. Shimkin, S. Raiken; Sales: I. Sevartz. Labels: AA, Golden.

A S A (see Met Richmond Latin Rec. Sales).

Allegro (see Pickwick/33).

Alma (see Met Richmond Latin Rec. Sales).

Alshire Presents (Budget Sound), 222 W. Orange Grove Ave., Burbank, Calif. 91502. Tel: (213) 849-4671. Sales Mgr.: Howard Alperin. Labels: Alshire Presents, Paloma, Somerset, Stereo Fidelity.

Ambassador, 145 Komorn St., Newark, N. J. 07105. Tel: (201) MA 3-4214. Mgr.: Mark Friedman. Labels: Ambassador, Compose, Diplomat, Guest Star, Look & Listen, Peter Pan, Pirouette, Playmates, Rocking Horse, Scripture, Tifton.

B B M (see Met Richmond Latin Rec. Sales).

B R C (see Met Richmond Latin Rec. Sales).

Baronet (see Premier Albums).

Baroneza (see Met Richmond Latin Rec. Sales).

Blue Ribbon (see Premier Albums).

Bocar (see Met Richmond Latin Rec. Sales).

Bronjo (Seeco), 39 W. 60 St., New York, N. Y. 10023. Tel: (212) JU 6-3620. Pres.: Sidney Siegel.

Camden (RCA Victor), 155 E. 24 St., New York, N. Y. 10010. Tel: (212) MU 9-7200. A&R: Ethel Gabriel.

Carvier (see Met Richmond Latin Rec. Sales).

Compose (see Ambassador).

Cornerstone (see Supreme).

Coronet (see Premier Albums).

Cricket (see Pickwick/33).

Crown, 5810 S. Normandie Ave., Los Angeles, Calif. Tel: (213) 753-2481. Pres.: Saul Bihari. Branch: New York, N. Y., Crown East, 6 W. Broadway. Tel: (212) DI 9-3900. Sales Mgr.: Robert K. Herrington. Labels: Crown, Custom, Discos Corona, Robin Hood.

Custom (see Crown).

Design (see Pickwick/33).

Diplomat (see Ambassador).

Directional Sound (see Premier Albums).

Discos Corona (see Crown).

Disneyland, 800 Sonora Ave., Glendale, Calif. Tel: (213) 845-3141. Pres.: James A. Johnson.

Dover, 180 Varick St., New York, N. Y. 10014. Tel: (212) AL 5-3755. Pres.: Hayward Cirker.

Eddissa (see Met Richmond Latin Rec. Sales).

Everyman (Vanguard), 154 W. 14 St., New York, N. Y. 10011. Tel: (212) EM 1-8811. Pres.: Maynard Solomon.

Family, 64 Mechanic St., New Rochelle, N. Y. Tel: (914) NE 3-6059. Pres.: H. L. Lengsfelder.

Golden (see AA).

Grand Prix (see Pickwick/33).

Guest Star (see Ambassador).

Hamilton (Dot), 1507 N. Vine St., Hollywood, Calif. 90028. Tel: (213) HO 2-6608. VP Sales: George Cooper.

Hanna-Barbera, 3400 W. Cahuenga Blvd., Hollywood, Calif. 90028. Tel: (213) 466-1371. Contact: Don Bohanan.

Happy Time (see Pickwick/33).

Harmony (Columbia), 51 W. 52 St., New York, N. Y. 10019. Tel: (212) 765-4321. Mgr.: Bruce Lundvall.

Heliodor (MGM), 1540 Broadway, New York, N. Y. 10036. Tel: (212) JU 2-2000. Contact: Dick DeCosta. Labels: Leo the Lion, Metro, VSP.

Hilltop (see Pickwick/33).

Jardin (see Met Richmond Latin Rec. Sales).

Jazzland (Orpheum Prod'ns), 235 W. 46 St., New York, N. Y. 10036. Tel: (212) 765-1330. Pres.: Jack F. Doran.

Jody (Vantage), 1849 W. 107 St., Chicago, Ill. 60643. Tel: (312) 335-1109. Cable: VANTAGE. Branch: Pottstown, Pa., PO Box 212. Zip: 19464. Tel: (215) 323-3336.

Leo the Lion (see Heliodor).

Little World (Cameo-Parkway), 1650 Broadway, New York, N. Y. 10019. Tel: (212) JU 6-3120. Exec. VP: Gene Malis.

Look & Listen (see Ambassador).

Mace (Scepter), 254 W. 54 St., New York, N. Y. 10019. Tel: (212) CI 5-2170. VP & Sales: Marvin Schlachter.

Majorette (see Little World).

Mercury Wing (Mercury), 35 E. Wacker Dr., Chicago, Ill. 60601. Tel: (312) DE 2-5788. N.Y.C. Tel: (212) PL 9-2727. Contact: Harry Kelly.

Met Richmond Latin Rec. Sales, 723 E. 81 St., Brooklyn, N. Y. Tel: (212) RN 3-1212. Pres.: David Last. Labels: ASA, Alma, BBM, BRC, Baroneza, Bocar, Carvier, Eddissa, Jardin, Mona, Norca, Reli, Somar.

Metro (see Heliodor).

Miro (Monitor), 156 Fifth Ave., New York, N. Y. 10010. Tel: (212) YU 9-2323. Sales: Rose N. Rubin.

Mona (see Met Richmond Latin Rec. Sales).

Music Guild (Westminster), 1330 Ave. of the Americas, New York, N. Y. 10019. Tel: (212) LT 1-7777. Gen. Mgr.: Marty Goldstein.

Musical Heritage Society, 1991 Broadway, New York, N. Y. 10023. Tel: (212) TR 3-6130. Pres.: M. Naida.

Nashville (Starday), PO Box 115-M, Madison, Tenn. Tel: (615) 228-2575. Sales: Tina Drake. Labels: Nashville, Starday Economy.

Nonesuch (Elektra), 51 W. 51 St., New York, N. Y. 10019. Tel: (212) JU 2-7711. Pres.: Jac Holzman.

Norca (see Met Richmond Latin Rec. Sales).

Paloma (see Alshire Presents).

Panda (see Parliament).

Parliament (Connoisseur), 160 Passaic Ave., Kearny, N. J. Tel: (201) WY B-8181. N.Y.C. Tel: (212) LW 4-0891. Sales: Jerome Geller. Labels: Panda, Parliament.

Peter Pan (see Ambassador).

Pickwick/33 (Pickwick Int'l), B-16 43 Ave., Long Island City, N. Y. 11101. Tel: (212) EM 1-8811. Pres.: Cy Leslie. Labels: Allegro, Cricket, Design, Grand Prix, Happy Time, Hilltop, Pickwick/33.

Pirouette (see Ambassador).

Playmates (see Ambassador).

Popside (see Jazzland).

Premier (see Premier Albums).

Premier Albums, 1650 Broadway, New York, N. Y. 10019. Tel: (212) JU 6-5253. Pres.: Philip Landwehr. Labels: Baronet, Blue Ribbon, Coronet, Directional Sound, Premier, Spin-O-Rama, Twinkle.

R C A Victor (RCA Victor), 155 E. 24 St., New York, N. Y. 10010. Tel: (212) MU 9-7200. A&R: Howard Scott.

Reli (see Met Richmond Latin Rec. Sales).

Richmond (London), 539 W. 25 St., New York, N. Y. Tel: (212) OR 5-6060. Mgr.: Jack Blumenthal.

Robin Hood (see Crown).

Rocking Horse (see Ambassador).

Scripture (see Ambassador).

Somar (see Met Richmond Latin Rec. Sales).

Somerset (see Alshire Presents).

Spin-O-Rama (see Premier Albums).

Starday Economy (see Nashville).

Stereo Fidelity (see Alshire Presents).

Sunset (Liberty), 6920 Sunset Blvd., Los Angeles, Calif. 90028. Tel: (213) 464-8101. Div. Mgr.: E. Barsky.

Supreme, 304 S. Brand, Glendale, Calif. Tel: (213) 245-3646. Mgr.: Paul Michelson. Labels: Cornerstone, Supreme.

Surrey (Mira), 9028 Sunset Blvd., Los Angeles, Calif. 90069. Tel: (213) 278-1125. Pres.: Randall Wood.

Sword (Word), PO Box 1790, Waco, Tex. 76703. Tel: (817) PR 2-7650. Sales: William Jelley.

Tifton (see Ambassador).

Time, 1290 Sixth Ave., New York, N. Y. 10019. Tel: (212) 247-0655. Pres.: Bob Shad.

Tropical (see Bronjo).

Turnabout (Vox), 211 E. 43 St., New York, N. Y. 10017. Tel: (212) TN 7-9360. Sales Mgr.: Thomas Di Vita.

Twinkle (see Premier Albums).

V S P (see Heliodor).

Vocalion (Decca), 445 Park Ave., New York, N. Y. 10022. Tel: (212) PL 2-1600. Sales Mgr.: C. Brennan.

Wyncote (Cameo-Parkway), 309 S. Broad St., Philadelphia, Pa. Tel: (215) KI 5-1140. N.Y.C. Tel: (212) WO 6-2220. Sales Mgr.: Clark Geartner.

Arbe, 3768 Webb Ln., Tucson, Ariz. 85716. Tel: (602) 793-8830. Pres.: Rex Bingham.

Arcade, 2733 Kensington Ave., Philadelphia, Pa. Tel: (215) NE 4-8487. Pres.: Jack Howard.

Archive (see Deutsche Grammophon).

Archive of Folk Music (see Everest).

Arctic (see Jamie/Guydon Dist. Corp.).

Ardent, 1457 National, Memphis, Tenn. 38122. Tel: (901) 324-5368. Mgr.: John Fry.

Argo (see London).

Arhoolie, P. O. Box 5073, Berkeley, Calif. 94705. Tel: (415) TH 1-8624. Pres.: Chris A. Strachwitz. Labels: Arhoolie, Blue Classics, Old Timey, Raglan. Int'l representative: Holland (Fontana).

Aria (see Bilbo).

Aria (see Bilbo).

Aristophane, 1564 Broadway, New York, N. Y. 10036. Tel: (212) LT 1-0244.

Arlen Rec. of Philadelphia, 1836 Bertram Rd., Hunt Valley, Pa. Tel: (215) WI 7-3879. Pres.: Harry Finfer.

Arrawak (see Cash Prod'ns).

Arriba (see Trend).

ART RECORDS

Specializing in hotel and night club "live" Albums and in Caribbean and Latin American Folk Music Albums.

-LABELS-

ART-CITADELLE-UNITY

Lucho Azcarraga — Blind Blake — Andre Toussaint — Calypso Mama — Calypso Eddie — Lad Richards — Percentie Brothers — The Four Bits — The Personalities — Al Fike — Bill Barner — The Interludes — Ronnie Propnet — Bob Bellows — Andy Bartha — Bonnie Anderson — Ken Watkins — Monte Bleu — The Sandpipers — Abbey Albert — The Puchinellos — Madeleine — Arnie and Chise.

For Catalogs—Fliers, Write:

ART RECORDS SALES COMPANY

P.O. Box 66, Miami, Fla. 33168
Telephone: 305/688-8022
Cable Address: Artrecords

Art, P. O. Box 66, 1063 N. W. 119 St., Miami, Fla. 33168. Tel: (305) 688-8022. Cable: ARTRECORDS. Pres. & A&R: Harold E. Doane; VP: Vivian Doane; Mktg. Mgr.: George Bates; Promo. Mgr.: David Dunn. Labels: Art, Citadelle, Unity. Int'l representatives: Colombia (Bambuco), Costa Rica (Indica), Italy (Italdisc).

Art Sound (see Stereodiddies).

Artcraft, 1640 Poe Ave., Orlando, Fla. Tel: (305) 424-7746. Mgr. Dir.: William G. Woods (distributed by Audio Fidelity).

Artia (see Connoisseur).

Artists Life, P. O. Box 634, 1211 E. Mayfair Ave., Orange, Calif. 92669. Tel: (714) 538-4484. Pres.: Howard L. Reynolds. Labels: Artists Life, Bowery, Nebraska, Pleasant Peasant, Polka-Favorites, PolkaLand, Rave.

Arvee (see Everest).

Arwin, 250 N. Canon Dr., Beverly Hills, Calif. Tel: (213) 271-7121. VP Don Genson.

Arzee, 1739 N. Third St., Philadelphia, Pa. 19122. Tel: (215) RE 9-6970. Pres.: Rosario Lefavi.

Asch (see Folkways).

Ascot (see United Artists).

Associated Artists, 6367 Selma Ave., Hollywood, Calif. 90028. Tel: (213) HO 5-6121. Pres.: Keith W. Clark; A&R: Jesse Hodges; Promo. & Pub.: Tom Culver.

Associated Prod'ns Int'l (see A.P.I.).

Astoria, P. O. Box 365, Wilton, Conn. 06867. N. Y. C. Tel: CY 5-2272. Mgr.: Rene Albi.

Astro (see Parnaso).

Atco, 1841 Broadway, New York, N. Y. 10023. Tel: (212) PL 7-6306. Cable: Atcomusic. Pres.: Ahmet Ertegun; VP: Jerry Wexler & Nesuhi Ertegun; A&R: A. & N. Ertegun & J. Wexler; Sales: Bob Kornheiser & Len Sachs; Int'l: Nesuhi Ertegun; Pub. & Adv.: Bob Rolontz. Labels: Alert, Brit, Brook-lyn, Carla, Cee-Jam, Dunwich, Fame, Heidi, Joker, Jotis, Karen, Lemco, Minaret, Moonglow, Redda, Tomorrow, Triumph, Vault, Volt, Way Out, York. Int'l representatives: (see Atlantic).

continued

Atila, P. O. Box 1522. Zip: 43603; 318 Summit St., Toledo, Ohio 43604. Tel.: (419) 243-3256. Pres.: Sid Goldstein; A&R Dir.: Johnny Paris.

Atlanta Sound Rec'g Studio, 524 Plasters Ave. N.E., Atlanta, Ga. 30324. Tel.: (404) 874-2781. Pres.: H. H. Brooks.
Labels: Sounds of Atlanta, World Wide.

Atlantic, 1841 Broadway, New York, N. Y. 10023. Tel.: (212) PL 7-6306. Cable: Atcomusic. Pres.: Ahmet Ertegun; VP: Jerry Wexler & Nesuhi Ertegun; A&R: A. & N. Ertegun & J. Wexler; Sales: Bob Kornheiser & Len Sachs; Int'l: Nesuhi Ertegun; Pub. & Adv.: Bob Rolontz.
Labels: Ara, Dade, Dial, Focus, Instant, Keetch, LaMonde, Lost-Nite, Lu Pine, Norman, Rosemart, Safice, Shirley, Sound of Soul, Stax.
Int'l representatives: Argentina (Surco), Australia (Festival), Belgium (Barclay), Canada (Quality), Denmark (Metronome), England (Polydor), Finland (Metronome), France (Barclay), Germany (Metronome), Greece (Dionysos), Holland (Bovema), Hong Kong (Cosdel), Israel (Hataklit), Italy (Saa), Japan (Cosdel), Mexico (RCA Mexicana), New Zealand (Festival), Norway (Metronome), Peru (Distribuidora Peruana), Philippines (Mareco), Singapore (Cosdel), South Africa (Gallo), Spain (Belter), Sweden (Metronome), Turkey (EMI) (SEE ADVERTISEMENT)

Atlas, CBS Bldg., Suite 203, 1697 Broadway, New York, N. Y. Tel.: (212) CI 5-2857. Pres.: Thomas Robinson; Music Dir.: Kelly Owens; Pub. Dir.: Grace Meehan; Promo.: Denny Hall Jr. & Henry Hines.
Labels: Alto, Angeltone, Atlas.

Atom (see Royce).

Atwell, P. O. Box 42, Lafayette, Tenn. 37083. Tel.: (615) 666-2400. Owner: Loryn Atwell.

Audicon (see Laurie).

Audio Book, 4220 W. Jefferson Blvd., Los Angeles, Calif. 90016. Tel.: (213) 731-8880. VP: L. H. Selent.

Audio Fidelity, 221 W. 57, New York, N. Y. 10019. Tel.: (212) 757-7111. Cable: Audio-Fidel; Pres.: Herman D. Gimbel; VP Sales: Harold Drayson;

Music Dir.: Edward Newmark; A&R: William Hamilton & Carl Shaw; Adv., Pub. & Promo. Dir.: Diane Terman; VP Int'l Sales: Carl Greenberg.

Labels: Audio Fidelity, Audio Masterworks, Audio Rarities, Karate, Kinor, Little Darlin'.
Int'l representatives: Aden (Bhicajee Cowasjee), Argentina (Microfon), Australia (Electronic Inds.), Belgium (Anvers Radio), Brazil (Som/Maior), Canada (Phonodisc), Central America (Indica), Colombia (Importaciones Daro), Denmark (Tono), Hong Kong (Jardine Matheson), Israel (Isralectra), Italy (CGD), Japan (Nippon Columbia), Mexico (Agujas y Discos), Netherlands (CNR), Philippines (Pacific Promotions), Singapore (William Jacks), South Africa (Gallo), Thailand (Ching Thai), United Kingdom (Transatlantic), Venezuela (Distribuidora Nacional de Discos).

Audio-Lab (see King).

Audio Masterworks (see Audio Fidelity).

Audio Rarities (see Audio Fidelity).

Audio Recorders of Arizona (see ARA).

Audio-Spectrum (see Budget Sound).

Audiotax, 821 19 Ave. S., Nashville, Tenn. 37203. Tel.: (615) 242-5585. Pres.: Bill Connor.
Labels: Format, Toad.

Audition Rec'g, P. O. Box 9429, Rochester, N. Y. 14604.

Aurora, 25 W. 56 St., New York, N. Y. 10019. Tel.: (212) JU 2-8810. Pres.: Aaron Schroeder. (distributed by Amy-Mala-Bell).

Aurora Int'l, 25 W. 56 St., New York, N. Y. 10019. Tel.: (212) JU 2-8810. Pres.: Aaron Schroeder.

George Avakian Prod'ns, 15 E. 48 St., Suite 202, New York, N. Y. 10017. Tel.: (212) PL 3-0100. Owner: George Avakian.

Avalon, P. O. Box 3240, Huntsville, Ala. 35810. Pres.: Sam Monday.

Avant Garde, 250 W. 57 St., New York, N. Y. Tel.: (212) 246-1344. Sales Mgr.: Walter Blumberg. Labels: Avant Garde, Lincoln Square.

Avoca, P. O. Box 393, Westbury, N. Y. 11590. Tel.: (516) 433-2910. Pres.: Francis X. Cashin.

Azteca (see Budget Sound).

B

B-Atlas, 2226 McDonald Ave., Brooklyn, N. Y. 11223. Tel.: (212) 372-9336. A&R Dir.: Vincent Vallis.
Labels: B-Atlas, Jody.

B B M (see Met Richmond Latin Rec. Sales).

B & F, 3046 E. 123 St., Cleveland, Ohio 44120. Tel.: (216) LO 1-5524. Pres.: Frank Szappanos.

B R C (see Met Richmond Latin Rec. Sales).

B T Puppy (see Jay-Gee).

B-W Music, P. O. Box 337, Wooster, Ohio 44691. Tel.: (216) 262-3571. Pres.: Quentin (Reed) Welty.

Ba-By Luv (see MRM).

Bach Guild (see Vanguard).

Backbeat (see Peacock).

Bakton, P. O. Box 249, Cooper Sta., New York, N. Y. 10003. Pres.: Randy Weston. Tel.: (212) 674-1524.

Balboa, 16027 Sunburst St., Sepulveda, Calif. 91343. Tel.: (213) 892-0044. Pres.: Larry Fofine.

Baldwin, GPO Box 1958, New York, N. Y. 10001. Contacts: Aubrey Mayhew & Donald Lytle.

Balkan Int'l, 6917-19 W. Cermak Rd., Berwyn, Ill. Tel.: (312) GU 4-6436. Owner: Slavco A. V. Hlad.

Ballad, 4741 LeDuc St., St. Louis, Mo. 63113. Tel.: (314) JE 1-3482. Pres.: O. D. Washington.
Int'l representatives: Canada (Robert J. Stone Assoc.), all other (EMI).

Band Box, 5135 W. 41 Ave., Denver, Colo. 80212. Tel.: (303) 455-4118. Pres.: Vicky Morosan.
Labels: Band Box, Keyboard, Rustique, Spicey, Valerie.

Bandera Ents., 3035 W. 38 St., Chicago, Ill. 60632. Tel.: (312) 847-0900. Pres.: Vi Muszynski.
Labels: Bandera, Fiasco, Jerico Road, Laredo.

Bandolero, 9525 Gschwind, El Paso, Tex. Tel.: (915) 755-0859. Owner: Jack Hardin.

Bang, 1650 Broadway, New York, N. Y. 10019. Tel.: (212) LT 1-3740. Pres.: Bert Berns.
Labels: Bang, Shout.

Banner, 15 W. 20 St., New York, N. Y. 10011. Tel.: (212) 989-2255. Pres.: Manny Wells.

Banner, 2010 52 St., Lubbock, Tex. Tel.: (806) SH 4-5496. Pres.: Bill C. Crawford.

continued on page 26

AROUND THE WORLD ON 3 LABELS

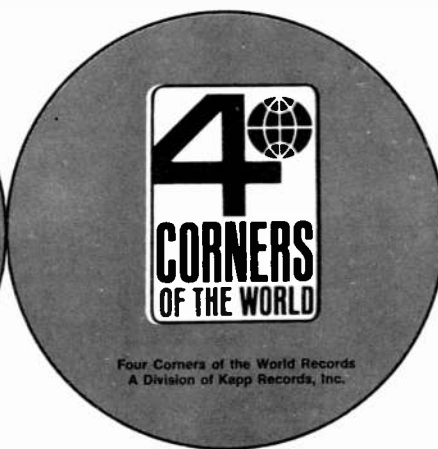

Kapp Records, Inc., 136 East 57th Street, New York, N.Y. 10022

BIGGER PROFITS and MORE SALES FROM REDISCO!











FREE GOODS
FOR SMART
BUYERS

FREE GOODS
FOR SMART
BUYERS

DIAMOND NEEDLES at BELOW WHOLESALE PRICES!

Here are the 16 diamond needles that will cover 95% of replacement calls. Buy any 12 get any one **FREE!**

\$5.95 EACH / **YOUR COST \$1.19** EACH
SUGGESTED LIST COST

 Replacement for Sonotone 2T Order #1385DS Monaural. 2	 Replacement for Shure N4 Order #1427DS Monaural. 3	 Replacement for Sonotone 3T Order #1460DS Monaural. 4	 Replacement for Sonotone 8T Order #1503DS Stereo. 5	 Replacement for G.E. VR11 Order #14700 Monaural. 1
 Replacement for Sonotone 8TA Order #1522XDS Stereo. 6	 Replacement for Sonotone 5T Order #1532XDS Stereo. 8	 Replacement for Astatic 17(M11) Order #1537XDS Stereo. 9	 Replacement for Electrovoice 132 Order #1548XDS Stereo. 10	 Replacement for Sonotone 16T Order #1540XDS Stereo. 11

\$4.95 EA SUGGESTED LIST / **YOUR COST \$1.09** EACH

 Replacement for Ronette BF40 Order #1504D Stereo. 12	 Replacement for Electrovoice 21D, 26D Order #1506D Stereo. 13	 Replacement for Astatic N8, Vaco ST20, 40, Ronette 10200 Order #1464D Monaural. 14	 Replacement for Astatic N8, Ronette 10200, Vaco ST20, 40 Order #1464XD Stereo. 15	 Replacement for B.S.R. TCB Order #1513XD Stereo. 16
---	--	---	--	--

REDISCO, THE NATION'S LARGEST SUPPLIER OF PHONOGRAPH NEEDLES.

FREE! REDISCO'S COMPLETE LISTING OF EVERY MANUFACTURED PHONOGRAPH NEEDLE - SEND FOR THIS LISTING AND SEE THE TREMENDOUS PROFITS YOU CAN EARN!

One Stop - One Day Service! Strictly Wholesale - Orders Filled and Shipped Same Day Received! No Extras! No Gimmicks! Quantity Discount Programs Always Available!

RONETTE ASTATIC REPLACEMENT NEEDLES

PACKAGED 12 ON DISPLAY CARD
1 or 2 CARDS \$4.99 per cd. 3 or MORE CARDS \$3.99 per cd.
EARN \$27.24 PROFIT PER CARD!

VM & BSR SPINDLES

Sensationally low priced offer!
Retail \$2.95 ea.
Your Cost 95¢ ea.
Order 1 or 100 at this low price!

FREE 45 R.P.M. ADAPTERS

5 to an envelope, 25¢ list
- 24 on each display card
Your Cost \$1.75 per card.
* 1 card FREE with purchase of 5 cards!

FREE RECORD CLEANING CLOTH

High quality cleaning cloth
\$1 list.
Your Cost \$1.75 Doz.
* Buy 12 - get 1 FREE!

SAPPHIRE NEEDLES (SYNTHETIC)

SPECIAL! BUY ALL 3 CARDS
GROSS \$102 - YOUR COST ONLY \$20
YOU CAN'T BEAT THIS OFFER!

RONNETTE #BF40 1504-12

No. 1504
TIP: SAPPHIRE
SPEED: LP/STEREO
USE FOR: Ronette-Stereo BF 40
INSTRUCTIONS: Clip on type needle. Pull off old needle. Clip on new one.

RETAIL PRICE \$30 PER CARD

\$5.99 per card

ELECTROVOICE #21D 26D 1506-12

No. 1506
TIP: SAPPHIRE
SPEED: LP/STEREO
USE FOR: Electro-Voice Stereo 21D, 26DST.
INSTRUCTIONS: Clip on type needle. Pull off old needle. Clip on new one.

RETAIL PRICE \$30 PER CARD

\$5.99 per card

SONOTONE #2T 1385-12

No. 1385
TIP: SAPPHIRE
SPEED: ALL
USE FOR: Sonotone-W9980 & 2TS.
INSTRUCTIONS: Life spring clip under cartridge to remove old holder. Replace in similar fashion.

RETAIL PRICE \$42 PER CARD

\$8.99 per card

REDISCO

The nation's number one

THE RECORDS DISTRIBUTING CO.

wholesale one-stop/one-day service

(SEND US YOUR ADDRESS SO YOU CAN BE ON OUR MAILING LIST)

USE THIS HANDY REDISCO ORDER FORM

DIAMOND NEEDLES	
QUANTITY	NEEDLE NUMBER
	NUMBER 1
	NUMBER 2
	NUMBER 3
	NUMBER 4
	NUMBER 5
	NUMBER 6
	NUMBER 7
	NUMBER 8
	NUMBER 9
	NUMBER 10
	NUMBER 11
	NUMBER 12
	NUMBER 13
	NUMBER 14
	NUMBER 15
	NUMBER 16

RONETTE ASTATIC REPLACEMENT NEEDLES

QUANTITY CARD(S)

SPINDLES

VM Reg. BSR Short BSR Reg.

QUANTITY QUANTITY QUANTITY

45 R.P.M. ADAPTERS

QUANTITY

RECORD CLEANING CLOTH

QUANTITY

SAPPHIRE NEEDLES

QUANTITY CARD NUMBER

NO. 1504-12

NO. 1506-12

NO. 1385-12

REDISCO - 1815 GUILFORD AVENUE
BALTIMORE, MARYLAND 21202

SHIP TO...

NAME

ADDRESS

CITY

STATE

ZIP CODE

U.P.S. BUS. PARCEL POST
 C.O.D. SPECIAL DELIVERY
 CHECK ENCLOSED

continued

- Banshee, 100 Park Pl., Newark, N. J. 07102. Tel.: (201) MA 2-8453. Pres.: Joseph Schulman.
- Barbizon, 1564 Broadway, New York, N. Y. 10036. Tel.: (212) 265-9575. Pres.: Don Anthony.
- Barclay (France), c/o Record & Tape Sales, 821 Broadway, New York, N. Y. 10003. Tel.: (212) OR 4-6400. Pres.: Robert Staub.
- Barenreiter, c/o Record & Tape Sales, 821 Broadway, New York, N. Y. 10003. Tel.: (212) OR 4-6400. Pres.: Robert Staub.
- Baronet (see Premier Albums).
- Baroneza (see Met Richmond Latin Rec. Sales).
- Baroque (see Everest).
- Bart, 500 N.E. 79 St., Miami, Fla. 33138. Tel.: (305) 754-1619.1610. Pres.: Nick Bartell; VP: Steadman Stahl; Promo: Morty Wax. Branch: Ft. Lauderdale, Fla., P. O. Box 831, Zip: 33302.
- Bartok, 200 W. 57 St., New York, N. Y. 10019. Tel.: (212) JU 6-2896. Pres.: Peter Bartok.
- Base, 1930 Woodside Rd., Augusta, Ga. 30906. Tel.: (404) 798-4341. Mgr.: Calvin S. Robinson.
- Battle (see Orpheum Prod'ns).
- Bay-Tone, 1509 Filmore St., San Francisco, Calif. 94115. Mgr.: Bradbury Taylor. Branch: Kalamazoo, Mich., 821 Porter St. Pres.: Victor Taylor.
- Beacon, 518 W. 50 St., New York, N. Y. 10019. Tel.: (212) 245-7658. Pres.: Joe Davis. Labels: Beacon, Burdett, Davis.
- Bear, Rt. 1, Box 104, Groveland, Fla. Tel.: (305) 429-2098. Owner: Lucile B. Peddy.
- Bear, 257 Plymouth N., Minneapolis, Minn. 55411. Tel.: (612) 332-7131. Mgr.: Allen Abrams.
- Beckingham (see Epstein Ent.).
- Bee, 664 Schuylkill Ave., Reading, Pa. 19601. Tel.: (215) 374-2750. Pres.: Grover Barbour. Labels: Bee, Sundance.
- Tommy Bee Prod'ns, P. O. Box 8207, Sta. C, Albuquerque, N. M. 87112. Tel.: (505) 265-4039. Mgr.: Thomas Benegas.
- Beechwood, 312 Harkleroad Ave., Kingsport, Tenn. Tel.: (615) 245-6026. Owner & Mgr.: Ernest B. Wallen.
- Beehive (see Santaville).
- Bell (see Amy-Mala-Bell).
- Bellaire, P. O. Box 125, 5008 Bissonnet, Bellaire, Tex. 77402. Tel.: (713) MO 7-5701. Owner: Donald Janicek. Labels: Bellaire, Betty, Bonanza, Chapel, Fun-E, Heidi.
- Bervel, 615 Dauphine St., New Orleans, La. 70016. Pres.: Carey James Tate.
- Bethlehem (see King).
- Betty, Bellaire, Tex. (see Bellaire).
- Betty, Chicago, Ill. (see Mor-Sun Prod'ns).
- Beulah (see McKinnon).
- Bible Voice, P. O. Box 3521, Valley Federal Tower Bldg., 6842 Van Nuys Blvd., Suite 406, Van Nuys, Calif. 91405. Tel.: (213) ST 7-5600. SEE ADVERTISEMENT
- Big Bunny, 300 W. 55 St., New York, N. Y. Tel.: (212) 246-4982. Pres.: Bunny Jones.
- Big Hill (see Amy-Mala-Bell).
- Big Scott, 1819 E. 31 Ave., Denver, Colo. 80205. Tel.: (303) 333-8086. Pres.: James C. Scott Sr., VP A&R: Jim Scott Jr.; VP Sales, Mktg. & Promo.: Charles W. Jones. Labels: Big Scott, Denver.
- Big Style (see Cotton Town Jubile).
- Big T Ent's., 4069 Shamrock Dr., Burlington, N. C. Contact: Glenn Thompson.
- Big Three (see Hawk).
- Big Top (see Amy-Mala-Bell).
- BiBo Ent's., White Plains, Ky. 42464. Pres.: Bill Springer. Labels: American Rec. Prod'n Assistants, Aria.
- Bing (see Park Ave.).
- Bi-Ru, 923 University Ave., Indianapolis, Ind. 46201. Tel.: (317) 359-0462. Pres.: Bill Rucker. Labels: Bi-Ru, Jet, Solid Gold.
- Biscayne, 642 E. 64 St., Chicago, Ill. 60637. Tel.: (312) 752-4382. Pres.: William C. Tyson.
- Bismark, P. O. Box 313, 230 W. Hickory St., Denton, Tex. 76202. Tel.: (817) 387-5335. Pres.: George Rickrich.
- Bitoa (see Stereodiddies).
- Black Gold, 605 Chelsea, Memphis, Tenn. 38107. Tel.: (901) 523-1190. Owners: Judd F. Wood & Tom Phillips.
- Black Gold, P. O. Box 488, Marshall, Tex.
- Blackhawk (see Jameco).
- Blaine (see Jay-Gee).
- Block, 422 E. 32 St., Paterson, N. J. Tel.: (201) 525-3027. Pres.: Robert Block; PR: Richard Kaltz. Branches: East Paterson, Lodi, Newton, N. J.
- Blue Angel, 4914 Wellsworth Ave., Louisville, Ky. 40216. Tel.: (502) 447-0670. Owner: Wesley Daugherty.
- Blue Cat (see Red Bird).
- Blue Hen (see Three Star).
- Blue Horizon, 716 N. Rentz Ave., Warrington, Fla. 32507. Tel.: (904) 456-2695. Pres.: Larry L. Stevens; VP, Sales & Mktg. Rep.: Calvin Brooks; Prod'rs: Ed White & Larry Stevens; Pub. Mgr.: Tom Arnold; Adv. Mgr.: Danny Trainer; Promo. Mgr.: Lynn Lee. Labels: Blue Horizon, Seagull.
- Blue Masque (see Crusader).
- Blue Note (see Liberty).
- Blue Ribbon, P. O. Drawer 30, Staunton, Ill. 62088. Tel.: (618) NE 5-2510. Pres.: Chaw Mank. Labels: Blue Ribbon, Blu-J.
- Blue Ribbon (see Premier Albums).
- Blues Classics (see Arhoolie).
- Bluestown (see Stop).
- Blu-J (see Blue Ribbon).
- Bocar (see Met Richmond Latin Rec. Sales).
- Boite a Musique, c/o Record & Tape Sales, 821 Broadway, New York, N. Y. 10003. Tel.: (212) OR 4-6400. Pres.: Robert Staub.
- Bo-Kay, 3712 N.E. 28, Ft. Worth, Tex. 76111. Tel.: (817) TE 8-2402. Owner & Pres.: Jesse Smith.
- Bo-Mar Ent's., Carlton House, Suite 439, 550 Grant St., Pittsburgh, Pa. 15219. Tel.: (412) 471-1733. Pres.: James V. Interval Jr.
- Bonanza (see Bellaire).
- Boney, 900 Prospect Ave., Norfolk, Neb. Tel.: (402) FR 1-3384. Pres.: Jim Hall.
- Bonnie Bee, 62 Hillside Ave., Somerville, N. J. 08876. Tel.: (609) RA 5-9460. Pres.: Bonnie B. King.
- Boom (see ABC).
- Boone, US 42, Union, Ky. 41091. Tel.: (606) 384-3384. Pres.: Bobby Bobo.
- Borda (see King).
- Bornand Music Box, 139 Fourth Ave., Pelham, N. Y. 10803. Tel.: (914) PE 8-1506. Pres.: R. C. Bornand.
- Boss, P. O. Box 14422, Tampa, Fla. 33609. Tel.: (813) 839-4880. Owner: John Brumage.
- Boss, 9912 Taylorsville Rd., Louisville, Ky. 40299. Tel.: (502) 267-5466. Contact: Tim Tyler.
- Boston, 48 W. 22 St., New York, N. Y. 10010.
- Bounty (see Elektra).
- Bowery, P. O. Box 713, Del Mar, Calif. Tel.: (714) 755-2156. Owner: Oliver H. Williamson (distributed by Artists Life).
- Boyle-Conway, 445 Rhode Island Ave., Bricktown, N. J. Tel.: (201) 899-8635. Co-owner: Thomas Boyles. Branch: Teaneck, N. J., 1157 Julia St. Tel.: (201) 833-2431. Co-owner: Ed Conway Jr. (distributed by Celtic Rec'g Prod'ns).
- Bragg, 720 17 Ave. S., Nashville, Tenn. Tel.: (615) 244-1795. Pres.: Neil Wilburn.
- Brian Ross Prod'ns (see API).
- Brit (see Atco).
- Britania (see Abnak Music Ent's).
- Brite-Star, P. O. Box 56, Downtown, Newbury, Ohio 44065. Tel.: (216) JO 4-2211. Mgr. & A&R Dir.: Tex Clark; Pub. Dir.: Judy Parker; Adv.: Jack Greene; Promo.: Joey Sasso. Branches: Lakeland, Fla., P. O. Box 281. Tel.: (813) 686-0150. Mgr.: Gerry Nicks.—Springfield, Mo., 1406 Nora. Mgr.: Worth Becker.—New York, N. Y., 525 Lexington Ave., Suite 427. Tel.: (212) PL 3-4951. Promo. Chief: Joey Sasso. Labels: Brite-Star, Bryte, Elgin, Roy.
- Britestar, P. O. Box 825, Bloomington, Ind. 47401. Pres.: Red Wiseman; Gen. Mgr. & A&R: Ray Guyce. Int'l representative: England (Greenbuck Dist.).
- Broadside (see Folkways).
- Broadway (see Sue).
- Bronco, Hollywood, Calif. (see Stereo-Fi Corp. of Calif.).
- Bronco, McAllen, Tex. (see Falcon).
- Bronjo (see Seeco).
- Bronze, 1510 N. W. 53 St., Miami, Fla. Tel.: (305) 691-1815. Pres.: Bobby Darnell.
- Brook-lyn (see Atco).
- Brosh, 3223 W. Birchwood Ave., Milwaukee, Wis. 53221. Tel.: (414) AT 1-7363. Mgr.: J. Brosh.
- Bruno Hi-Fi, P. O. Box 365, Wilton, Conn. 06897. Tel.: (203) 847-2311. N. Y. C. Tel.: (212) CY 5-2272. Pres.: Bruno G. Ronty.
- Brunswick (see Decca. For Int'l representatives see Coral).
- Bryte (see Brite-Star).
- Frank Buck (see listing under F).
- Buckley, 1707 Church, Nashville, Tenn. Tel.: (615) 254-8809. Owner: Louis Buckley.
- Buddy, 500 Locust St., Marshall, Tex. 75670. Tel.: (214) WE 5-2582. Pres.: A. T. Young; VP's: Buddy & Bobby Young.
- Budget Sound (formerly Miller Int'l), 222 W. Orange Grove Ave., Burbank, Calif. 91502. Tel.: (213) 849-4671. Cable: Budsound. Pres. & Int'l: Al Sherman; Gen. Mgr. & Adv.: Ricardo Ceja; A&R Prod'n: David L. Miller; Sales Mgr.: Howard Alperin; Pub. & Promo.: Sam Laine. Labels: Somerset, Stereo Fidelity, Audio Spectrum, Alshire Presents, Aria Senza Voci, Paloma, Azteca.
- Int'l representatives: Angola (Gallo), Argentina (EMI Odeon), Australia (Astor Electronics), Belgium (Vogue), Brazil (EMI Odeon), Burma (Pye), Canada (Arc Sound), Central Africa (Gallo), Costa Rica (Orfeon-Videovox), El Salvador (Orfeon-Videovox), England (Pye), Finland (Pye), Formosa (Nippon Columbia), France (Vogue), Greenland (Pye), Guatemala (Orfeon-Videovox), Holland (Pye), Honduras (Orfeon-Videovox), Iceland (Pye), India (Pye), Ireland (Pye), Israel (Pye), Japan (Nippon Columbia), Kenya (Gallo), Korea (Nippon Columbia), Mexico (Orfeon-Videovox), Mozambique (Gallo), Norway (Pye), Okinawa (Nippon Columbia), Pakistan (Pye), Philippines (Federal), South Africa (Gallo), Sweden (Europa Film), Switzerland (Vogue), Tanzania (Gallo), Uganda (Gallo).
- Buena Vista (see Disneyland).
- Buff, Delevan, N. Y. 14042. Tel.: (716) 492-2623. Pres.: Art Dedrick.
- Bullfrog (see Music Research).
- Burchten, 3635 Allandale, Memphis, Tenn. 38111. Tel.: (901) 324-4640. Pres.: Marvin Burcham; VP, A&R & Promo.: Style Wooten; Sales & Mktg.: Ruby Wooten; Pub.: Barbara Burcham; Adv.: Thomas Grissom.
- Burdett (see Beacon).

C

- C B C Ent's., P. O. Box 111, Ralston, Neb. 68051. Tel.: (402) 733-4007. Pres. & Pop A&R: Scott A. Cameron; VP, Pub., Adv. & Promo.: Michael L. Borchansky; VP, Sales & Mktg.: Charles N. Canuso. Labels: Applause, J&T, MMC, Sea-Mist.
- C B G, P. O. Box 666, Montebello, Calif. Tel.: (213) 728-7553. Pres.: Charles B. Gallegos.
- C F P (see Fuller).
- C J, 4803 Indiana Ave., Chicago, Ill. 60615. Tel.: (312) AT 5-1616. Pres.: Carl Jones. Labels: C J, Colt, Firma.
- C L W, 7855 W. Colfax, Lakewood, Colo. Tel.: (303) 238-3907. Pres.: Jim Ward. Labels: CLW, Kaye.
- C R (see Cherokeeland).
- C R P (see Celtic Rec'g Prod'ns).
- Cab, P. O. Box 620, 120 W. 125 St., New York, N. Y. 10027. Tel.: (212) AC 2-5900. Gen. Mgr.: Camille E. Hodge.
- Cadet, 5810 S. Normandie Ave., Los Angeles, Calif. Cadet (formerly Argo), 2120 S. Michigan Ave., Chicago, Ill. 60616. Tel.: (312) 225-2770. Cable: CHESREC. Pres.: Philip T. Chess; A&R: Esmond Edwards; Sales & Mktg. VP: Dick LaPalm; Pub.: Bill Hegner Assocs.; Adv.: Mar-Ken Ent's.; Promo.: Michael Telano; Int'l VP: Marshall Chess. Branch: Los Angeles, Calif., 1607 El Centro. Zip: 90028. Tel.: (213) 462-4950. Sales & Promo.: Paul Gayten (see Chess & Checker).
- Cadet, P. O. Box 36, Burnett, Wis. Tel.: (414) 689-2215. Pres.: Don Peachey.
- Caedmon, 505 Eighth Ave., New York, N. Y. 10001. Tel.: (212) LW 4-3122. Cable: Caedmon. Pres. & A&R: Marianne Mantell; Int'l & A&R: Barbara Holdridge; Sales: Bob O'Brien. Labels: Caedmon, Shakespeare Rec'g Society, Theatre Rec'g Society. Int'l representatives: Australia, England, Europe, New Zealand, South Africa (all Philips).
- Cafe (see Cash Prod'ns).
- Calico (see Laurie).
- California (see Contemporary).
- Calten Rec. Prod'ns, 3635 Allandale Rd., Memphis, Tenn. 38111. Tel.: (901) 324-4640. Pres. & Adv.: Cecil Caldwell; VP, Pop A&R & Pub.: Style Wooten; VP Classical A&R & Promo.: James E. Caldwell; Sales & Mktg.: Rosemary Caldwell. Cambridge, 473 Washington St., Wellesley, Mass. 02181. Tel.: (617) 235-3557. Pres.: Charles P. Fisher.
- Camden (see RCA Victor).
- Cameo-Parkway, 309 S. Broad St., Philadelphia, Pa. 19107. Tel.: (215) KI 5-1140. Cable: Campark. Pres.: J. R. Griffith; Exec. VP: Alfred Rosen-

continued on page 28

MAKING STRIDES THE WORLD OVER

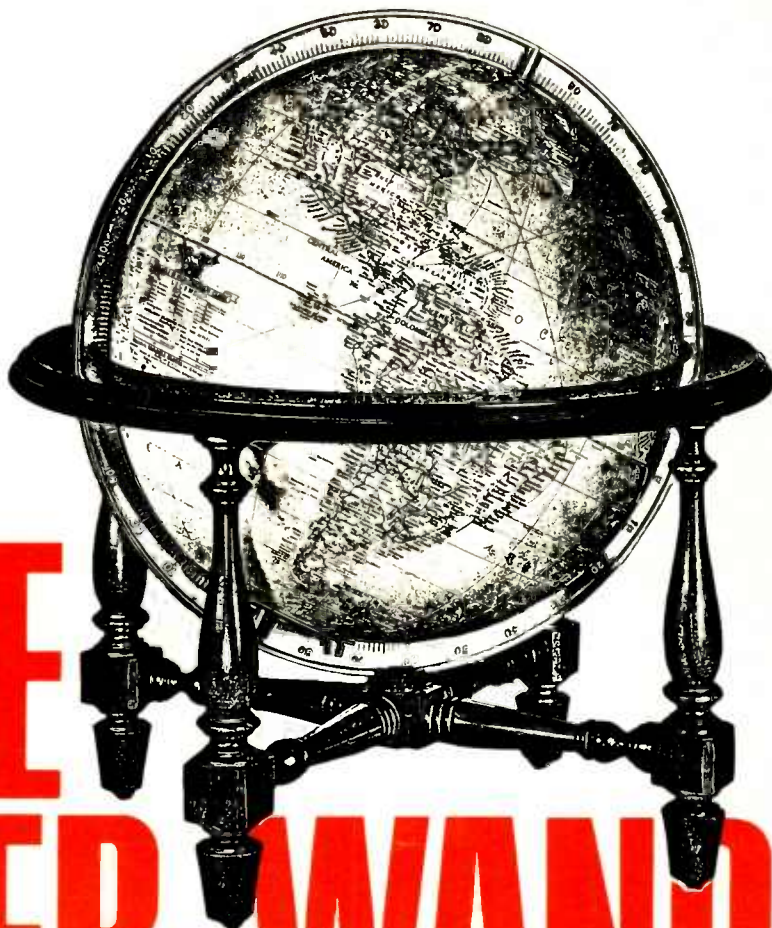

THE SCEPTER-WAND ORGANIZATION

**SCEPTER RECORDS
WAND RECORDS
FLORENCE GREENBERG
MARVIN SCHLACTER
SCEPTER-WAND INT'L
JOSEPH ZERGA
WAND MANAGEMENT
PAUL CANTOR
FLOMAR MUSIC
HOB RECORDS
MACE RECORDS**

SCEPTER-WAND RECORDS 254 W. 54th St., New York, N.Y. 10019 Tel. (212) 615-2170

Cable: SCEPTERMUS

continued

thal; A&R: Earl Shelton; Nat'l Promo. Mgr.: Cecil Holmes; Wyncote Recs. Sales Mgr.: Clark Gearner.

Branch: New York, N. Y., 1650 Broadway. Tel.: (212) JU 6-3120. Sales Mgr.: Neil Bogart.

Labels: (owned) Cameo, Fairmount, Parkway, Wyncote; (distributed) Lucky 11, Windy "C."

Camille (see Cab).

Campei (see Parnaso).

Canaan (see Word).

Canadian American, Box 1755, Grand Forks, N. D. 58201. Pres.: Leonard Zimmer.

Labels: Amcan, Canadian American.

Canary, P. O. Box 1336, 1108 Davis, Redwood City, Calif. 94403. Tel.: (415) 369-0728. Pres.: Earl Miles.

Branch: Vancouver, Wash., 208 S. E. 107 Ave.

Canary, 439 Brewer Dr., Nashville, Tenn. 37211. Tel.: (615) 832-5660. Exec. Prod'r: J. C. Rhoton Jr.

Labels: Canary, PRC.

Cantagallo Int'l, c/o Zissu, Marcus & Stein, 292 Madison Ave., New York, N. Y. Tel.: (212) MU 3-0966. Pres.: H. W. Schemke.

Cantor (see Adaire).

Capa, 803-R Government St., Mobile, Ala. 36602. Tel.: (205) HE 3-3941. Pres.: James A. Whiting.

Capco, 106 Southard Ave., Rockville Centre, New York. Tel.: (516) 536-6585. Gen. Mgr.: Joe Cal Cagno.

Capitol, 1750 N. Vine St., Hollywood, Calif. 90028. Tel.: (213) 462-6252. Cable: Caprecords. Bd. Chm. & Chief Exec. Officer: Glenn E. Wallichs; Pres.: Alan W. Livingston; Capitol Dist. Corp. Pres.: Stanley M. Gortikov; A&R VP: Voyle Gilmore; Nat'l Sales Mgr. & VP: William B. Tallant Jr.; Nat'l Mds'g Mgr. & VP: Brown Meggs; Pop Album Mds'g Mgr.: Jack Schnyder; Pop Singles Mds'g Mgr.: Ken Mansfield; Western Press Mgr.: Ron Pepper; Int'l: Richard Rising.

Branch: New York, N. Y., 1290 Ave. of the Americas, Rm. 3214. Zip: 10019. Tel.: (212) PL 7-7470. Eastern Ops. Dir.: Thomas Morgan; A&R: Roy Batachio; Press: Christie Barter.

Labels: Capitol, Angel, Tower, Capitol Imports.

Int'l representatives: Argentina (Musica Argen-

tina y Internacional), Australia (EMI), Austria (Columbia), Belgium (Gramophone), Brazil (EMI), Chile (EMI) Odeon), Colombia (Colombiana de Discos), Costa Rica (Indica), Denmark (Skandinavisks), England (EMI), Finland (R. E. Westerland), France (LIME Pathe Marconi), Germany (Electrola), Greece (Columbia), Holland (Bovema), India (Gramophone), Ireland (Gramophone), Italy (La Voce Del Padrone), Jamaica (Gloken), Japan (Toshiba), Mexico (Musart), New Zealand (HMV), Norway (EMI), Pakistan (Gramophone), Peru (EMI), Philippines (Mareco), Portugal (Valentim De Carvalho), South Africa (EMI), Spain (Odeon), Sweden (Skandinavisk Odeon), Switzerland (Musikvertrieb), Turkey (Gramofon Turk), Uruguay (Ricardo y Rodolfo Gioscia), Venezuela (Fabrica Venezolana de Discos).

Capitol Imports, Capitol Rec. Int'l Corp., 1290 Ave. of the Americas, New York, N. Y. 10019. Tel.: (212) PL 7-7470. Cable: Caprecords. VP & Gen. Mgr.: Richard J. Rising; A&R: Robert H. Reid.

Branch: Hollywood, Calif., 1750 N. Vine St. Zip: 90028.

Labels: Ducretet-Thomson (France), Odeon (Denmark, England, France, Germany, India, Italy, Spain), Parlophone (England, Italy), Pathe (France, Italy), Regal (Italy, Spain).

Caprice, 1619 Broadway, Suite 514, New York, N. Y. 10019. Tel.: (212) CI 5-1249. Contacts: Frank Stanton & Andy Badale.

Caprice, Dallas, Tex. (see Vandam).

Captain (see Golden State).

Carib (see Caribbean Folk Music).

Caribbean Folk Music, P. O. Box 748, Miami Springs, Fla. 33166. Tel.: (305) 885-3738. Pres.: Patricia V. Jacobs.

Home Office: Nassau, Bahamas, P. O. Box 174. Tel.: 28784. Cable: Tropical.

Labels: Carib, Famo, Island Artists, Westindy.

Carillon, 520 Fifth Ave., New York, N. Y. 10036. Tel.: (212) MU 2-5844. Pres.: Jack W. Meyerson.

Carl (see Jake's Music Shop).

Carla (see Atco).

Carlo (see Major Mgmt.).

Carlson-Int'l Prod'g Corp., 509 Fifth Ave., New York, N. Y. 10017. Tel.: (212) MU 7-2570. Gen. Mgr., Sales & Mktg.: Louis J. Ferriol; A&R & Promo.: Bruce Holms; Pub.: Michael Paolino; Adv.: Jerry Roth.

Labels: Cavalcade Corde, Noveline, Now!, 3-J. Int'l representatives: Italy (Carlson Int'l).

Carnival, 350 Chadwick Ave., Newark, N. J. 07112. Tel.: (201) 242-6719. Pres.: Joseph Evans.

Labels: Carnival, Chadwick. (SEE ADVERTISE-MENT)

Carol (see Sims).

Carriage, 2702 Fairfield Ave., Fort Wayne, Ind. Tel.: (219) 456-1903. Mgr.: R. A. Steinke.

Carsan, P. O. Box 19024, Houston, Tex. 77024. Tel.: (713) HO 5-6044. Pres.: Edward C. Benjamin.

Carvier (see Met Richmond Latin Rec. Sales).

Casa Grande, P. O. Box 113, 6 Carter Pl., Woburn, Mass. 01802. Tel.: (617) 933-1474. Prop. & Gen. Mgr.: Frank P. Pappalardo; PR: Jeanne McCarthy; Music Dept.: Steve Dinan; Pub. Adviser: Mary DeConto.

Labels: Casa Grande, Don-Mar, Shawmut.

Casark (see Georden Prod'ns).

Cash Prod'ns, 761 Elton Ave., Bronx, N. Y. 10451. Tel.: (212) LU 5-3660. Pres.: Garfield Ricketts; Pop A&R Dir.: Ray Jones; A&R (R&B): Joe Simmons; Sales & Promo. Mgr.: William Parker.

Labels: Arrawak, Cafe, Faith.

Casual (see Lotassco).

Casual, 126 W. 42 St., New York, N. Y. 10036. Tel.: (212) LO 5-9524. VP: Lamont Cranston.

Cathay, 5637 Monte Verde Dr., Santa Rosa, Calif. 95405. Tel.: (707) 544-2588. Gen. Mgrs.: Kathy & Frank Whitney.

Cavalcade (see Carlson Int'l Prod'g Corp.).

Cavalier (see World Entns.).

Cee-Jam (see Atco).

Celest, 855 Majestic Ave., Norfolk, Va. 23504. Tel.: (703) 627-4037. Owners: Ralph & Nettie Brickers.

Celtic Rec'g Prod'ns, 1157 Julia St., Teaneck, N. J. 07666. Tel.: (201) 833-2431. Pres.: Edward F. Conway; VP, Gen. Mgr. & Int'l: Edward F. Conway Jr.; A&R Dir.: Ed Daniels.

Labels: (owned) CRP, Ebbtide, Julia, Starfire, Swingline; (distributed) Boyles-Conway, Dynamic Sound, Hastings.

Int'l representatives: Canada (Quality), All other (Transglobal). Julia distributed throughout world by 20th Century-Fox.

continued on page 30

DOVER RECORDS, INC.

WHITE CLIFFS

NOLA

DEE-SU

EIGHT-BALL

FRISCO

PITTER-PAT

MANHATTAN

EL-TEE

TONIK

TAILGATE

VIRGIL

ABS

ALL DISTRIBUTED BY:
DOVER RECORDS, INC.
 BOB ROBIN, EXECUTIVE VICE PRESIDENT
 748 CAMP STREET • NEW ORLEANS, LA. 70130
 TEL.: (504) 523-7474

Mosrite Talent

•
Mosrite Quality

•
Mosrite Service

= A Company You
Can Depend On



MOSRITE RECORDS

1424 "P" Street, Bakersfield, Calif. 93301

Area Code 805-327-7281

"Country Music Capital of the World"

continued

Centaur Prod'ns, 1 Skyline Dr., Burbank, Calif. 91501. Tel.: (213) 842-5338. Owner: Douglas Lyon.

Centaur Recs., 82 Aldine St., Rochester, N. Y. 14619. Tel.: (716) FA 8-4649 & BE 5-4229. Pres.: Martha B. Pitoni; Gen. Mgr. & Pop A&R Prod'r: Ven Pitoni; Sales & Mktg., Pub. & Promo. Mgr.: Marv Steffey; Adv.: Dennis Majzak.
Labels: Centaur, Jingle, Sea-King.
Int'l representatives: New Zealand (Peak).

Center City (see McKinnon).

Century 21, Hollywood, Calif. (see Trend).

Century 21, P. O. Box 10795, Charlotte, N. C. 28201. Tel.: (704) 333-0431. Pres.: Curtis Harty.
Labels: Century 21, Contour.

Cetra, 97 Chambers St., New York, N. Y. 10007. Tel.: (212) BE 3-6280. Pres.: Martin Silvers.

Chadwick (see Carnival).

Challenge, 9220 Sunset Blvd., Suite 312, Los Angeles, Calif. 90069. Tel.: (213) 273-6860. Pres., A&R & Int'l: Joe E. Johnson; VP & Sales: Melvin J. Bly.
Labels: Challenge, LJ.
Int'l representatives: Australia (EMI), Belgium (Decca), Canada (Compo), Denmark (Nordisk Polyphon), France (Societe Francaise du Son), Germany (Teldec), Holland (Decca), Italy (Decca), Jamaica (Island), Japan (King), Malaysia (Decca Orient), Mexico (Tizoc), New Zealand (HMV), Philippines (Federal), South Africa (Gallo), Sweden (Telefunken), Switzerland (Musikvertrieb), Yugoslavia (Jugoton).

Chalon, 1223 N. Highland Ave., Hollywood, Calif. 90028. Tel.: (213) HO 2-4948. Pres.: William A. Walker.

Champ, 829 E. Vernon, Los Angeles, Calif. 90001. Tel.: (213) 295-6071. Contact: Ann Lacoste.

Chancellor, 116 Central Park S., New York, N. Y. 10019. Tel.: (212) CI 6-3811. Mgr.: Stanley Polley

Chanson, 410 N First, Pulaski, Tenn. 38478. Tel.: (615) 363-1780. Pres. & A&R: James Brown.
Labels: Chanson, JBP, Tee Vee.

Chante, 10 W. Camden Ave., Moorestown, N. J. 08057. Tel.: (609) BE 5-9699. Pres.: Louis Alfieri.

Chapel (see Bellaire).

Charger, 6411 Hollywood Blvd., Hollywood, Calif. 90028. Tel.: (213) HO 6-3455. Pres.: Harry Maselow.

Chart, 806 16 Ave. S., Nashville, Tenn. 37203. Tel.: (615) 254-7708. Pres. & A&R: Ott Stephens; VP Sales, Adv. & Pub.: B. L. Williamson; Promo.: Mirl Williamson.
Labels: Chart, Great.
Int'l representative: Canada (ARC Sound).

Chartbuster, 1203 28 St. N.W., Washington, D. C. Tel.: (202) 333-6646. Pres., A&R, Sales & Mktg.: Bobby Poe; VP, Adv. & Pub.: Mitch Corday; Promo.: Jack Dabney.
Labels: Chartbuster, Kansoma, Manchester, Top Forty.

Charter, 649 N. Bronson Ave., Los Angeles, Calif. 90004. Tel.: (213) 462-8600. Pres.: Robert D. Summers.

Chas, P. O. Box 7262, Ft. Worth, Tex. 76111. Tel.: (817) TE 8-9401. Gen. Mgr.: Charles Stewart.
Labels: Chas, Hue.

Chase (see Rainbow).

Chattahoochee, 9165 Sunset Blvd., Los Angeles, Calif. 90069. Tel.: (213) 275-5021. Pres.: Ruth Conte.

Cheatham, 2016 N. Prairie Ave., Dallas, Tex. 75204. Tel.: (214) TA 6-5286. Pres.: J. R. Cheatham.

Checker (see Chess & Checker).

Checkmate Prod'ns, P. O. Box 1493, Amarillo, Tex. 79105. Tel.: (806) 383-9571. Pres.: Ray Ruff.
Labels: Checkmate, Ruff.

Chelsea, 289 Third Ave., New York, N. Y. 10010. Tel.: (212) OR 9-5089. Pres.: Frank Allen.

Chelton (see Rainbow).

Cherokee, 5610 Bella Dr., Rubidoux City, Calif. 92509. Tel.: (714) OV 3-0771. Pres.: Larry Ray Duane.

Cherokee, 911 Greenbrae, Sparks, Nev. Tel.: (702) 358-8200. Owner: Jim Whitlock.

Cherokeeland, P. O. Box 502, Calhoun, Ga. 30701. Tel.: (404) 629-3950. Pres.: J. Carter; Promo. & PR: Lamar Gravitt.
Labels: Cherokeeland, Jayla, Payle, CR.

Cherry (see Fuller).

Chess & Checker, 2120 S. Michigan Ave., Chicago, Ill. 60616. Tel.: (312) 225-2770. Cable: CHES-REC. Pres.: Leonard Chess; A&R Mgr.: Billy Davis; A&R Prod'rs: Gene Barge & Sonny Thompson; Sales & Mktg. VP & Promo.: Max Cooperstein; Pub.: Bill Hegner Assoc.; Adv.: Mar-Ken Ent's.; Int'l: Marshall Chess.
Branch: Los Angeles, Calif., 1607 El Centro. Zip: 90028. Tel.: (213) 462-4950. Sales & Promo.: Paul Gayten.
Labels: Chess, Checker, Cadet (formerly Argo).
Int'l representatives: Argentina (Sicamericana), Australia (Australian Rec.), Austria (Deutsche Vogue), Belgium (Artone), Canada (Phonodisc), China (Cosdel), England (Pye), Finland (Scandia-Musik), France (Barclay), Germany (Deutsche Vogue), Holland (Artone), Italy (Durium), Japan (Cosdel), Malaysia (Cosdel), Mexico (Gamma), New Zealand (Viking), Norway (Egil Mohn Iversen), Philippines (Cosdel), South Africa (Teal), Spain (Hispanvox), Sweden, Sonet).

Chesterfield, 448 S. Hill St., Los Angeles, Calif. 90013. Tel.: (213) MA 8-7064. Pres.: V. Richmond.

Chestnut (see Don-EI).

Chevell, (see Sound Track Ent's.).

Chick Finney Assocs., 4239 Lee Ave., St. Louis, Mo. 63115. Tel.: (314) JE 1-1323 & EV 9-1712. Pres.: Chick Finney.
Label: Finney.

Chickory (see Claridge).

Children's Rec. Guild (see The Franson Corp.)

Christian Faith (see Alma).

Chroma, 7-11 E. Genesee St., Auburn, N. Y. Tel.: (315) 253-5380. Owners: Frank Mucedola, Fred G. Mammoliti.

Chuckie, P. O. Box 3, Belen, N. M. 87002. Tel.: (505) 864-7185. Pres.: Richie Johnson.

Citadelle (see Art).

Claridge, 250 W. 57 St., Suite 1528, New York, N. Y. 10019. Tel.: (212) CI 7-4985. Pres.: Frank C. Slay Jr.
Branch: Cleveland, Ohio, 4900 Euclid Ave. Zip: 44103. Tel.: (216) 431-5870. VP: Dennis J. Ganim.
Labels: Claridge, Chickory, Southern Sound, XYZ.

continued on page 32



INTERNATIONAL LABELS with WORLD-WIDE ARTISTS

RUBY JOHNSON—VOLT

SAM & DAVE—STAX

MABLE JOHN—STAX

OTIS REDDING—VOLT

MAD LADS—VOLT

CARLA THOMAS—STAX

ASTORS—STAX

RUFUS THOMAS—STAX

WILLIAM BELL—STAX

BOOKER T & THE M.G.'S—STAX

ALBERT KING—STAX

MAR-KEYS—STAX

JOHNNY TAYLOR—STAX

STAX RECORDS

926 East McLemore St.
Memphis, Tenn. (901) 946-2535

Distributed Internationally by ATLANTIC RECORDS



HANKY PANKY—Tommy James & The Shondells • SAM AND DAVE • IN ORBIT WITH DAVE "BABY" CORTEZ • POLKA MEMORIES WITH KENNY BASS • A STUDY IN TERROR (Sound Track)—John Scott Orchestra • THE EXCITERS • HONKY TONK A LA MOD—Bill Doggett • CINERAMA'S RUSSIAN ADVENTURE (Sound Track) • Tchaikovsky's THE SLEEPING BEAUTY (Sound Track) • ETTA JONES SINGS WITH JUNIOR MANCE AND KENNY BURRELL and others • CASCADING VOICES—Hugo & Luigi Chorus • JEWISH FOLK SONGS—Joey Adams and Sholom Secunda with guest stars Molly Picon, Menashe Skulnik • THE BEST OF DINAH WASHINGTON • 20 ALL TIME NUMBER ONE HITS—Various Artists • 20 ORIGINAL WINNERS OF 1964—Various Artists • THE GREATEST HITS OF LITTLE ANTHONY & THE IMPERIALS • THE HULLABALLOOS ON HULLABALLOO • FOR WOMEN ONLY—Pearl Bailey • TALES OF THE DIXIE DRIFTER • TWEETIE PIE—Dave "Baby" Cortez • SHAME AND SCANDAL IN THE FAMILY—Shawn Elliott • BOBO'S BEAT—Willie Bobo • THE GREAT REUNION OF ARMSTRONG & ELLINGTON • A NEW KIND OF LOVE—Joe Williams • THE WORLD OF COUNT BASIE • MY FAIR LADY—MY WAY—Johnny Richards • THE RETURN OF BUD POWELL • SARAH + 2—Sarah Vaughan • BILLY STRAYHORN LIVE! • EXPLORATIONS—Lalo Schifrin, Louis Bellson • LIVE FROM THE RAT FINK ROOM—Jackie Kannon • THE BEST OF JOAN BAEZ



THE CHANTELLS • WE ARE THE IMPERIALS • SERENADE --Flamingos

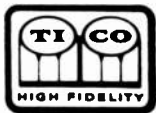

ESTAMOS HACIENDO ALGO BIEN! (WE MUST BE DOING SOMETHING RIGHT!)—Joe Cuba Sextet • CUBA Y PUERTO RICO SON—Celia Cruz, Tito Puente • PEDRITO RICO EN NEUVA YORK • TU Y MI CANCION—Dominico Acevedo con la Orquesta Panamericana de Tito Pena • EL ALMA VENEZOLANA DE LA LUPE • DESCARGAS AT THE VILLAGE GATE LIVE (LATIN JAM SESSION)—Tico All-Stars • BOBO-DO THAT THING—Willie Bobo • GUAJIRA Y GUAGUANCO—Ray Barretto • DE MI PARA TI (FROM ME TO YOU)—Tito Puente • TITO PUENTE SWINGS—THE EXCITING LUPE SINGS • AZUCAR PA TI (SUGAR FOR YOU)—Eddie Palmieri • INTIMO Y SENTIMENTAL—Graciela with Machito and Orchestra • BAILADORES—Joe Cuba Sextet • TU Y YO (YOU 'N' ME)—Tito Puente & La Lupe • MAMBO CON CONGA ES MOZAMBIQUE—Eddie Palmieri • CARNAVAL EN HARLEM—Tito Puente • BAILABLES VOL. I—Various Artists • BAILABLES VOL. II—Various Artists • HOMENAJE A RAFAEL HERNANDEZ—Tito Puente, La Lupe



THE TEENAGERS—Featuring Frankie Lymon • TEENAGE PARTY—Cletones, Wrens, Valentines, Harptones, and Crows



Y PARECE BOBO—Tito Puente and His Orchestra, Chivirico Davila • ALEGRE ALL-STARS—VOL. III • VIBES GALORE—Louie Ramirez and His Conjunto Chango • SE SOLTO (ON THE LOOSE)—Ricardo Ray • SPOTLIGHT ON PACHECO—VOL. V • LO QUE TRAIGO ES SABROSO—Eddie Palmieri • TRIBUTO A NORO MORALES—Kako After Hour Orchestra • TENGO MAQUINA Y VOY A 60—Charlie Palmieri & Orchestra • WAY OUT—VOL. IV—Alegre All-Stars



DIZ 'N' BIRD IN CONCERT—Dizzy Gillespie and Charlie Parker • THE JAZZ PIANO WORLD OF . . .—Erroll Garner, Art Tatum, Billy Taylor, Bud Powell • THE WORLD OF CHARLIE PARKER • REMINISCING—Johnny Smith • SAX EXPRESSIONS—Sonny Stitt • ARE YOU READY FOR THIS—Buddy Rich & Louis Bellson



SOLOMON BURKE • THE BEST OF MAHALIA JACKSON • COMMAND PERFORMANCE OF MAHALIA JACKSON



continued

- Clark (see Nugget).
 Classic Editions (see Music Minus One).
 Classic Clements Prod'ns (see listing under "G").
 Cloud, 200 W. 57 St., Suite 702, New York, N. Y. 10019. Tel.: (212) 757-6215. Prod'n Mgr.: Jack Goldberg; A&R: Felix Balkin.
 Clover, 315 S. Beverly Dr., Suite 211, Beverly Hills, Calif. Tel.: (213) 273-4664. Exec. Prod'r: Peter R. Brooke.
 Cloverleaf (see Tri-World).
 Clown, 1329 Pacific St., Brooklyn, N. Y. 11216. Tel.: (212) HI 3-0697. Pres.: C. A. Pruitt; A&R: Neal Tate; Sales & Mktg. & Promo.: Sam Pruitt; Pub. & Adv.: Barbara Scher.
 Int'l Representative: Canada (Quality).
 Co & Ce, 1601 Fifth Ave., Pittsburgh, Pa. 15219. Tel.: (412) 391-3973. Pres.: Herbert S. Cohen.
 Cobra (see Epstein Ent's.).
 Coda (see Spanish Music Ctr.).
 Coed, 1619 Broadway, New York, N. Y. 10019. Tel.: (212) JU 2-3050. Pres.: George Paxton; A&R: Fred Weismantel; Sales: Bob Reno; Int'l Bettye Marx.
 Coin (see Token).
 Colgems, 711 Fifth Ave., New York, N. Y. Tel.: (212) PL 1-4400. Pres.: Don Kirshner.
 Coliseum (see London).
 College, 94 State St., Northampton, Mass. Tel.: (413) 584-4431. Pres.: Raymond J. Perry.
 Colonial, P. O. Box 1170, Chapel Hill, N. C. Tel.: (919) 967-7040. Mgr.: Orville B. Campbell.
 Colonial Latin, 170 E. El Repetto Dr., Monterey Park, Calif. 91754. Tel.: (213) 283-2221. Owner: Manuel S. Acuna.
 Colosseum, P. O. Box 365, Wilton, Conn. 06897. Tel.: (203) B47-2311. Pres.: Bruno Ronty. N. Y. C. Tel.: (212) CY 5-2272.
 Colt (see CJ).
 Columbia, 51 W. 52 St., New York, N. Y. 10019. Tel.: (212) 765-4321. Cable: Colcord. Pres.: Goddard Lieberson; VP & Gen. Mgr. CBS Recs.: Clive J. Davis; VP Columbia label: William P. Gallagher; Pop A&R Dir.: Robert Mersey; Classical A&R Dir.: John McClure; VP Mds'g: Stanley J. Kavan; VP Sales: Jack Loetz; Sales Dir.: Joseph Lyons; Pub. Dir.: Robert S. Altshuler; Adv. Dir.: Alvin Goldstein; Promo. Dir.: Thomas Noonan; Int'l VP & Gen. Mgr.: Harvey L. Schein.
 Branches: Los Angeles, Calif., 6121 Sunset Blvd. Zip: 90028. Tel.: (213) HO 6-24B1. VP: Irving J. Townsend.—Chicago, Ill., 630 N. McClurg Ct. Zip: 60611. Tel.: (312) WH 4-6000.—Nashville, Tenn., 804 16 Ave. S. Tel.: (615) 242-0337.
 Contact: Don Law.
 Labels: Columbia, Ode, Epic, Harmony, Okeh.
 Int'l representatives: Argentina (CBS), Australia (Australian Rec.), Austria (CBS), Belgium (CBS), Bolivia ("Discolandia" Dueri), Brazil (CBS), Canada (Columbia), Central America: British Honduras, Costa Rica, El Salvador, Guatemala, Honduras, Nicaragua, Panama (Indica, Costa Rica), Chile (Goluboff), Colombia (CBS), Denmark (Nordisk Polyphon), Ecuador (Emporio Musical), Finland (Musik Fazer), France (Societe Art, Technique et Commerce), Germany (CBS), Greece (Music-Box), Hong Kong (Colonial Trading), Israel (CBS), Italy (CGD), Jamaica (West Indies), Japan (Nippon Columbia), Malaysia: Malaya, North Borneo, Brunei, Sarawak (Hup Hup, Malaya), Mexico (CBS), Netherlands (CBS), New Zealand (Philips), Norway (Norsk Phonogram), Peru (Sono-Radio), Philippines (Mareco), Portugal (Radio Triunfo), Singapore (Hup Hup), South Africa (Gramophone), Sweden (Philips-Sonora), Switzerland (CBS), United Kingdom (CBS), Uruguay (Sondor), Venezuela (La Discoteca). (SEE ADVERTISEMENT)
 Columbus Minuteman, 1030 Tremont St., Boston, Mass. 02162. Tel.: (617) 442-1655. VP: Barry Richards.
 Comedie Francaise (see Everest).
 Comet (see Sweco).
 Command, 1330 Ave. of the Americas, New York, N. Y. 10019. Tel.: (212) LT 1-7777. Pres.: Larry Newton; VP & Gen. Mgr.: Loren Beck; A&R Dir.: Robert Byrne; Sales Mgr.: Charles Trepel; Pub.: Tom Picardo; Int'l VP: Harry Levine.
 Labels: Command, Command Classics, Grand Award (see ABC).
 Int'l representatives: Argentina (Prodisa), Australia (Festival), Austria (Deutsche Grammophon), Belgium (Anvers Radio), Canada (Sparton), Central America (Indica), Colombia (Discos Orbe), Denmark (Deutsche Grammophon), Finland (Deutsche Grammophon), France (Pathe Marconi), Germany (Deutsche Grammophon), Holland (Deutsche Grammophon), Hong Kong (Festival), Japan (King), Mexico (Gamma), New Zealand (Festival), Norway (Deutsche Grammophon), Peru (Distribuidora Peruana), Philippines (Mareco), Singapore (Colonial Trading), South Africa (Teal), Spain (Hispanvox), Sweden (Deutsche Grammophon), Switzerland (Deutsche Grammophon).
 Command Classics (see Command).
 Compass, 1035 Quebec Terr., Suite 2, Silver Spring, Md. 20903. Pres.: Lester L. Friedman.
 Compose (see Ambassador, Newark, N. J.).
 Composers, 170 W. 74 St., New York, N. Y. 10023. Tel.: (212) TR 3-1250. Pres.: David Hall.
 Concert-Disc (see Everest).
 Congaree (see Cool Air Prod'ns).
 Congress (see Kapp).
 Conn, 1619 Broadway, New York, N. Y. 10019. Tel.: (212) CI 7-7626. Pres.: Walter Cohen.
 Connoisseur (sub. of Abbey Rec. Mfg.), 160 Passaic Ave., Kearny, N. J. Tel.: (201) WY B-B1B1. N. Y. C. Tel.: (212) LW 4-0891. Gen. Mgr.: Henry S. Rosenberg; Dir. of Creative Prods.: Ralph Stein; Sales & Mktg.: Jerome Geller. Labels: Artia, Connoisseur, MK, Panda, Parliament, Urania.
 Conrose, 1619 Broadway, New York, N. Y. 10019. Tel.: (212) CI 7-7626. Pres.: Walter Cohen.
 Console (see Supreme).
 Constellation, 1421 S. Michigan Ave., Chicago, Ill. 60605. Tel.: (312) 939-2416. Pres. & Sales: Ewart G. Abner Jr.; A&R: William E. Sheppard; Int'l: Arthur Sheridan.
 Int'l representatives: Japan, Okinawa, Korea, Taiwan, Philippines, Hong Kong, Indonesia, Laos, Cambodia, Viet Nam, Malaysia, Thailand, Macao, Guam, Burma, North Borneo (Cosdel), Scandinavia, Germany, Austria, Switzerland (Karussell), United Kingdom, Gibraltar, Iceland, Malta, Seychelles, Eire, Aden, Cyprus, Iran, Iraq, Israel, Jordan, Lebanon, Burma, India, Pakistan, Egypt, Kenya, South Africa (Trans-global).
 Contact (see Music Sales Corp.).
 Contemporary, 8481 Melrose Pl., Los Angeles, Calif. 90069. Tel.: (213) OL 3-1560. Pres.: Lester Koenig.
 Labels: California, Contemporary, Good Time Jazz, Society for Forgotten Music, Star, Stereo.
 Continental, 12 Irving St., Framingham, Mass. 01701. Tel.: (617) B79-2430. Pres.: L. Daniel Flynn.
 Labels: Continental, Cori, Salem.
 Continental, New York (see Record Corp. of New England).
 Contour (see Century 21, Charlotte, N. C.).
 Contrapoint, 850 Seventh Ave., Suite B06, New York, N. Y. 10019. Tel.: (212) LT 1-4144. Pres.: K. Sponholz.
 Conversaphone Institute, 225 W. 34 St., New York, N. Y. 10001. Tel.: (212) 695-5386. Pres.: Alfred Z. Owen.
 Cook Laboratories, 101 Second St., Stamford, Conn. 06905. Tel.: (203) 348-7578. Pres.: Emory G. Cook.
 Cookin', 1136 Columbus Ave., Boston, Mass. 02120. Tel.: (617) 445-3550. Pres.: Jack Sager.
 Cool Air Prod'ns, 1517 (B) W. Double Branch Rd., West Columbia, S. C. 29169. Tel.: (803) 794-B48B, 256-2676. Pres.: Mrs. Enola Mae Stevens; VP & Promo.: James Steward; Gen. Mgr. & Pub.: Frank Chambers Sr.; A&R: Joseph Thomas Jr.
 Branches: Columbia, S. C., 716 Wilkes Rd. Tel.: (803) 754-0328. A&R: Joseph Thomas Jr.—191B Picken St. Tel.: (803) 256-2676. A&R: John Williams Jr.—1220 Sand St. Gen. Mgr.: Frank Chambers Sr.
 Labels: Wertz, Leiby, Lakeview, Lerks, Congaree.
 Copper State, 815 E. Broadway, Tucson, Ariz. 85719. Tel.: (602) 623-0318.
 Labels: Copperstate, Santa Cruz.
 Coral, 445 Park Ave., New York, N. Y. 10022. Tel.: (212) PL 2-1600. Cable: DECCORD. Pres.: Milton R. Rackmil; Exec. VP: Leonard W. Schneider; VP: Martin P. Salkin; A&R: Milton Gabler, Harry Meyerson, Dick Jacobs, Henry Jerome, Is Horowitz, Owen Bradley, Charles B. Dant; Sales: Sydney N. Goldberg; Int'l: Hubert J. Stone. (see Decca).
 Int'l representatives: Argentina (Microfon), Australia (Festival), Belgium (Fonior), Canada (Montreal-Compo, Toronto-Apex), Chile (EMI Odeon), Denmark (Nordisk Polyphon), England (Decca), Finland (Musik Fazer), France (Societe Francaise Du Son), Germany (Teldec), Holland (Phonogram), Italy (Decca), Mexico (Audio Distribuidora), New Zealand (G. A. Wooller), Norway (Nor-Disc), Philippines (Home Indus-



- tries), Portugal (Valentim de Carvalho), Puerto Rico (Leroy Loubriel), South Africa (Gallo), Spain (Columbia), Sweden (Telefunken), Switzerland (Musikvertrieb), Venezuela (Fabrica Venezolana), West Indies (West Indies).
 Corby Rec. Prod'ns, 402 E. Las Tunas, San Gabriel, Calif. 91776. Tel.: (213) 287-4398. Pres.: Steve Waltner; VP: Douglas Cox; A&R: Dennis Hardesty & Steve Waltner; Sales, Mktg. & Nat'l Promo. Mgr.: Douglas Cox.
 Corde (see Carlson Int'l Prod'g Corp.).
 Cori (see Continental).
 Cornell Laboratory of Ornithology, 33 Sapsucker Woods Rd., Ithaca, N. Y. 14850. Tel.: (607) 275-5056. Dir.: Olin S. Pettingill Jr.
 Cornerstone (see Supreme).
 Cornuto (see Protone).
 Corona (see Rangel).
 Coronet (see Premier Albums).
 Corridor (see Hall).
 Corsair Continental, 552B N. Rosemead Blvd., Temple City, Calif. 91781. Tel.: (213) AT 7-3005. Pres.: W. R. Mac Kenzie.
 Cortina, 136 W. 52 St., New York, N. Y. 10019. Tel.: (212) JU 2-3845. Pres.: Anthony Livesey.
 Cotton Town Jubilee, P. O. Box 322, West Memphis, Ark. Tel.: (501) RE 5-6529. Pres.: Gene Williams; VP: Ness Sechrist; A&R: Johnny Duncan; Sales & Mktg.: Don McQuerten; Pub. & Adv.: Martha Williams; Promo.: Ken Burge. Branch: Jonesboro, Ark., Tel.: (501) WE 2-7125. Mgr.: Junior Bratcher.
 Labels: Big Style, Craft, Dover.
 Counterpoint (see Everest).
 Country Hit, P. O. Box 212, Henderson, Tex. 75652. Tel.: 7-6294 & 7-2531—No direct dial. Pres. & Promo. Mgr.: Lee Rose.
 Country Music Nashville, P. O. Box 701, Nashville, Tenn. 37202. Tel.: (615) 297-4967. Pres.: R. Murray Nash.
 Country Star (see Process).
 Country-Western (see Delmar Prod'ns).
 Cracked (see Sound, New Haven, Mich.).
 Craft (see Cotton Town Jubilee).
 Creative Rec. Serv., 1680 N. Vine, Rm. B14, Hollywood, Calif. 90028. Tel.: (213) 466-7379. Pres.: Ned R. Herzstam.
 Labels: Creative, Merri, Literary.
 Creative Sound Prod'ns, 9000 Sunset Blvd., Los Angeles, Calif. 90069. Tel.: (213) CR 1-4843. Pres.: Robert C. Cotterell.
 Credo (see Pathways of Sound).
 Creole (see Vandan).
- Crescendo, Los Angeles, Calif. (see GNP Crescendo).
 Crescendo, 3720 27 St., Long Island City, N. Y. 11101. Tel.: (212) RA 9-2390. Pres.: Guido Sgambellone.
 Cricket (see Pickwick Int'l).
 Critteron, 6124 Selma Ave., Hollywood, Calif. 92008. Tel.: (213) HO 9-2296. Pres.: Michael H. Golsden.
 Labels: Criterion, Tahiti.
 Crosley, 519 N. 66 St., Philadelphia, Pa. 19151. Tel.: (215) 472-4020. Pres.: Nick Busillo.
 Crossfire Rec'd & Mfg., P. O. Box 148, Lake Elsinore, Calif. 92530. Tel.: (714) 674-3636. Gen. Mgr.: C. B. Zumbach.
 Crossroads (see Epic).
 Crow, 1501 12 St., Sheffield, Ala. Tel.: (205) 381-2510. Pres.: Billy S. Crowe.
 Crown, 5810 S. Normandie Ave., Los Angeles, Calif. 90044. Tel.: (213) 753-24B1. Pres.: Saul Bihari.
 Branch: New York, N. Y., Crown East, 6 W. Broadway. Tel.: (212) DI 9-3900. Sales Mgr.: Robert K. Herrington.
 Labels: Crown, Custom, Discos Corona, Kent, Modern, Robin Hood.
 Crown V (see Singcord).
 Crusader, 6411 Hollywood Blvd., Hollywood, Calif. 90028. Tel.: (213) HO 6-3455. Pres.: Harry Maselow.
 Labels: Blue Masque, Crusader.
 Cuca, 123 Walter St., Sauk City, Wis. Pres.: Jim Kirchstien.
 Labels: Cuca, Night Owl, Polka Dot, Sara, Sounds of Wisconsin.

continued on page 34

what makes the audi plating service great?

Experience

Audio is twenty years old. We're the oldest independent processors in the business.

Facilities

At Audio we use the Audiomatic Process, our own patented system. It's so far ahead of other methods that it is used around the world by such industry leaders as RCA Victor.

Speed

We do three-step (3-step) processing overnight.

Quality control

Our process is the last word in precision, with a minimum of handling.

Personal service

Every order gets the personal attention of our top personnel. Julie Filkins has managed our customer services for 17 years. (And she's only 21!)

audi 

AUDIO MATRIX, INC., 915 Westchester Avenue, Bronx 59, New York 212 LU 9-3500

Producers of record plates and record plating equipment/Cable address: AUDIOMATIC

MUSIC of MANY LANDS

AMERICA'S LEADING
MANUFACTURER OF
INTERNATIONAL ALBUMS
OUTSTANDINGLY PACKAGED
AND DESIGNED—

Featuring:
ARABIC
AUSTRIAN
BRAZILIAN
CZECH
ESTONIAN
FRENCH
GERMAN
GREEK
GUIANIAN
GYPSY
IRISH
ISRAELI
ITALIAN
JAPANESE
JEWISH
KOREAN
LATIN
LATVIAN
LITHUANIAN
MEXICAN
POLISH
PORTUGUESE
ROUMANIAN
RUSSIAN
SCANDINAVIAN
SCOTTISH
SPANISH
TURKISH
UKRANIAN
YUGOSLAVIAN
and
WEST INDIAN

"The Finest High Fidelity
in Stereo and Monaural"

**REQUEST RECORDS
Inc.**

66 MECHANIC ST., NEW ROCHELLE, N. Y.
TELEPHONE: 914 NE 3-6059

continued

Custom, Los Angeles (see Crown).
Custom, P. O. Box 231, Tyler, Tex. 75701. Tel.: (214) LY 4-2961. Contact: Curtis Kirk & Fred Harper.
Custom Fidelity, 222 E. Glenarm, Pasadena, Calif. Tel.: (213) 441-1114. Pres.: David W. Berkus; Chief Eng.: Bob Holden.
Custom Rec. & Sound, P. O. Box 3961, Park Pl., 4 Column St., Greenville, S. C. Tel.: (803) CE 3-2252. Pres.: William E. Garrison.
Labels: Halo/Klub.
Cutt-Rite (see Franz Schubert Music).

D

D C (see Loop).
D C P (see Don Costa Prod'ns).
D G G (see listing under Deutsche Grammophon Gesellschaft).
D L V (see Falcon).
D-Town, 3040 E. Grand Blvd., Detroit, Mich. 48202. Tel.: (313) 874-3050. VP: Peter W. Hall.
Dad's, 2202 S. 88 St., Omaha, Neb. 68124. Tel.: (402) 391-3653. Owner & Adv.: Eddy Haddad; Talent Coordinator & Promo.: Gabby George.
Dade (see Atlantic).
Dana (see Jay-Gee).
Danbar, 136 W. 46 St., New York, N. Y. 10036. Tel.: (212) LT 1-0791. Pres.: Sal Salvador.
Danco (see Music Makers Network of America).
Danny (see Met Richmond Latin Rec. Sales).
Dapper, 200 Essen Dr., Lafayette, La. 70501. Tel.: (318) CE 4-8232. Owner: Roy J. Prejean.
D'Arcy, 417 W. 21 St., Norfolk, Va. 23517. Tel.: (703) 622-2111. Pres.: Warren M. Miller; Prod'n Dir.: Wayne N. Butler.
Das Alte Werke (see London).
Dasca, 16 Ridgewood Ave., Keene, N. H. 03431. Tel.: (603) 352-7131. Pres.: David S. Calef.
Date (see Columbia). Mktg. Dir.: Thomas E. Noonan.
Davis (see Beacon).
Dayon (see Horizon).
Dawn (see Seeco).
Day Dell, 1405 Locust St., Suite 803, Philadelphia, Pa. 19102. Tel.: (215) PE 5-1840. Pres.: Frank Day.
Dearborn, 13200 W. Warren, Dearborn, Mich. Tel.: (313) LU 2-5850. Pres.: Chet Kajeski.
Decca, 445 Park Ave., New York, N. Y. 10022. Tel.: (212) PL 2-1600. Cable: Deccord. Pres.: Milton R. Rackmil; Exec. VP: Leonard W. Schneider; VP: Martin P. Salkin; A&R: Milton Gabler, Harry Meyerson, Dick Jacobs, Henry Jerome, Is Horowitz, Owen Bradley, Charles B. Dant; Sales: Sydney N. Goldberg; Int'l: Hubert J. Stone.
Labels: Brunswick, Coral, Decca, Vocalion.
Int'l representatives: Argentina (EMI Odeon), Australia (Festival), Belgium (Fonior), Brazil (Som/Maior), Canada (Montreal-Compo, Toronto-Apex), Chile (EMI Odeon), Colombia (Orbe), Denmark (Nordisk Polyphon), England (Decca), Finland (Musik Fazer), France (Societe Francaise Du Son), Germany (Teldec Telefunken-Decca), Holland (Phonogram), Hong Kong (Life), Israel (Hed-Arzi), Italy (Decca), Japan (Teichiku), Malaysia (Life), Mexico (Importadora de Discos), New Zealand (G. A. Wooler), Nicaragua (Discos), Norway (Nor-Disc), Peru (El Virrey), Philippines (Home Industries), Portugal (Valentim de Carvalho), Puerto Rico (Leroy Loubriel), Singapore (Life), South Africa (Gallo), Spain (Columbia), Sweden (Telefunken), Switzerland (Musikvertrieb), Uruguay (Palacio de la Musica), Venezuela (Venezolana de Discos), West Indies (West Indies).
Deco, P. O. Box 655, Hudson, Ohio 44236. Tel.: (216) 653-8295. Pres.: Ethel P. Delaney.
Decora (see Amphora Music).
Dee-Bee, S. Camp St. Ext., Windsor, Pa. Tel.: (717) 244-5411. Owner: Stan Deppen Jr.
Dee Gee, 1953 Pontius Ave., Los Angeles, Calif. 90025. Tel.: (213) 879-1967. Pres.: Doris Gilbert.
DeeSu (see Dover, New Orleans).
Delco (see Murco).
Delwood, 10 Banta Pl., Hackensack, N. J. Pres.: Woodrow C. Gardella.
Delmar Prod'ns, P. O. Box 6023, 1506 Eighth Ave., Nashville, Tenn. Tel.: (615) 292-7549. Pres.: Dick Delmar; Gen. Mgr.: R. R. Thomas.
Labels: Country-Western, Dream Time, Voice of Calvary.
Delmark, 7 W. Grand, Chicago, Ill. 60610. Tel.: (312) 222-1467. Pres.: Robert G. Koester.
Int'l representative: England (Talent).
Delmarti, Wanderwood, Nashville, Ind. 47448. Tel.: (317) 988-2000. Pres.: Don D. Sheets.

Del Norte (see Falcon).
Del-Ray, 4 Center St., Harrington, Del. Pres.: Sam Short Jr.; A&R: Howard Vokes.
Delta Int'l, 1584 E. 31 St., Cleveland, Ohio 44114. Tel.: (216) 861-7286. Pres.: John R. Gayer.
Delta Ltd., 524 Plaster Ave. N. E., Atlanta, Ga. 30324. Tel.: (404) 874-2781. Pres.: Harold Martin.
DeLuxe (see King).
Del-Val, 1636 S. 58 St., Philadelphia, Pa. 19143. Tel.: (215) SA 7-3778. Pres.: Edward J. Kelley.
Labels: Del-Val, Pentagon.
De Marco, 3004 Beachwood Dr., Los Angeles, Calif. 90028.
Demonstration (see Vanguard).
Denver (see Big Scott).
Design (see Pickwick Int'l).
Destination, 1448 S. Michigan Ave., Chicago, Ill. 60605. Tel.: (312) 939-3698. Pres.: James Golden.
Destiny, P. O. Box 131, Lorain, Ohio. Tel.: (216) AT 8-6397. Owner: Robert W. Sellers.
Deutsche Grammophon Gesellschaft, 350 Fifth Ave., New York, N. Y. 10001. Tel.: (212) LO 4-7674. Mgr.: Claus R. Petermann (see MGM).
Labels: Archive, Deutsche Grammophon, Polydor.
De Ville, 1607 El Centro Ave., Hollywood, Calif. Tel.: (213) HO 2-0261. Pres.: Erma N. Cabot.
Dexter (see Tri-World).
Dial (see Atlantic).
Diamond, 1650 Broadway, New York, N. Y. 10019. Tel.: (212) JU 6-3876. Pres., Sales & Int'l: Joe Kolsky; A&R: Phil Kahl.
Int'l representatives: All int'l except Canada (EMI).
Diana, 210 W. 89 St., New York, N. Y. Pres.: Sidney Mills.
Dickerman Music Prod'ns, 101 First St., Utica, N. Y. 13503. Tel.: (315) 732-2172. Pres. & Treas.: Kenneth S. Hurd.
Branch: Middletown, Ohio, 3002 Manchester Rd., Zip: 45042.
Labels: Precise, Revere.
Dictation Disc, 170 Broadway, New York, N. Y. 10038. Tel.: (212) WO 2-5766. Pres.: John Visaggi.
Diplomat (see Ambassador, Newark, N. J.).
Directional Sound (see Premier Albums).
Discapon (see Apon).
Discos Columbia de Mexico (see Miami).
Discos Corona (see Crown).
Discotape Int'l (see Trend).
Disneyland, 800 Sonora Ave., Glendale, Calif. Tel.: (213) 845-3141. Pres.: James A. Johnson; A&R: Tutti Camarata; Sales: Bob Elliott.
Labels: Buena Vista, Disneyland.
Int'l representatives: Argentina (Phonogram), Australia (EMI), Brazil (RCA Victor), Canada (RCA Victor), Chile (Corporacion de Radio de Chile), Colombia (Orbe), Denmark (Skandinavisk), England (EMI), Finland (R. E. Westerlund), France (ADES), Germany (Electrola), Hong Kong (EMI), Israel (Hataklit), Italy (Carosello), Japan (Nippon Columbia), Mexico (RCA Victor), Netherlands (Bovema), New Zealand (HMV), Norway (Carl M. Iversen), Peru (El Virrey), Philippines (Dyna), South Africa (Brigadiers), Spain (Hispa-vox), Sweden (Skandinaviska), Venezuela (Vene-vox), Yugoslavia (Radio TV-Belgrad).
Di Venus, P. O. Box 1231, 164 Church, New Rochelle, N. Y. Tel.: (212) TY 2-3645. Pres.: Alfred Volpe; VP: Robert Callini; VP A&R: Anthony Sansone.
Dixie, Box 70-B Kiln Rd., Picayune, Miss. 39466. Tel.: (601) 798-2768. Owner: Fred H. Henley.
Dixie, 1020 Central Ave., Charlotte, N. C. 28204. Tel.: (704) 375-8545. Pres.: Haviland Smith; VP A&R: Howard C. Simpson.
Dixieland Jubilee (see GNP Crescendo).
Dixietone (see General American, Columbia, Mo.).
Doc, 21 College Ave., Salem, Va. Tel.: (703) DU 9-2241. Pres.: Dr. A. J. Russo.
Dode (see Ernest Prod'ns).
Dolphin, 277 Park Ave., New York, N. Y. 10017. Tel.: (212) TA 6-2000.
Dolton (see Liberty).
Dome, 3308 Eastern Ave., Baltimore, Md. 21224. Tel.: (301) 327-4861. Pres.: Ralph Johnson.
Labels: Dome, Fleet, Wedge.
Dome, P. O. Box 284, Vienna, Ohio 44473. Tel.: (216) 856-2142. Mgr.: Russ Hull.
Dominion Ent., P. O. Box 414, Eighth St., Salem, Va. 24153. Tel.: (703) 389-8339. Pres.: Earl R. Craig.
Don Costa Prod'ns, 1631 Broadway, New York, N. Y. 10019. Tel.: (212) PL 7-7630. Pres.: Don Costa.
Label: DCP.

continued on page 36

AMPARO

JOSE

ITURBI

ON

TURIA

RECORDS

IN RELEASE FALL 1966

JOSE ITURBI

CHOPIN: POLONAISE A FLAT, ETC.—
MOZART: SONATA D MAJOR—
ALBENIZ—CZERNY—DEBUSSY—
LISZT—DE FALLA, ETC.

AMPARO ITURBI

LECUONA: MALAGUENA
GRANADOS: GOYESCAS,
ETC.

TURIA RECORD CO., P.O. BOX 1917, BEVERLY HILLS, CALIF. (213) 271-4460

continued

Don-El, 2020 Ridge Ave., Philadelphia, Pa. 19121. Tel.: (215) PO 5-4889. Pres.: P. Donald White. Labels: Alpha, Chestnut, Don-El.

Don-Mar (see Casa Grande).

Dooto, 9512 S. Central Ave., Los Angeles, Calif. 90002. Tel.: (213) LO 7-2466.

Dore, 1608 N. Argyle, Rm. 108, Hollywood, Calif. 90028. Tel.: (213) HO 2-6608. Pres.: Lew Bedell.

Dot, 1507 N. Vine St., Hollywood, Calif. 90028. Tel.: (213) HO 2-3141. Pres.: Randolph C. Wood; Exec. VP: Christine Hamilton; Mdsq. & Promo. VP: Ted Rosenberg; Sales VP: George Cooper; Int'l VP: Tom Mack. Labels: Dot, Hamilton.

Int'l representatives: Argentina (Sicamericana), Australia (Festival), Belgium (Vogue), Brazil (RGE), Canada (Quality), Chile (Corporacion de Radio de Chile), Colombia (Alberto J. Verswyvel), Central America (Indica, Costa Rica), Denmark (Morks), England (Pye), France (Vogue), Germany (Vogue), Greece (Greek Phonograph Rec. House), Holland (N. V. Negram), Hong Kong (Cosdel), India (Gramophone), Italy (Saar), Japan (Cosdel), Mexico (RCA Victor), New Zealand (Pye), Norway (Arne Bendiksen), Peru (Distribuidora Peruana), Philippines (Cosdel), Portugal (Arnoldo Trinidad), Singapore (Cosdel), South Africa (Trutone), Spain (RCA), Sweden (Knappupp), Switzerland (M. J. Finsterwald), Turkey (Melodi), Venezuela (La Discoteca), West Indies (Mr. George Benson, Jamaica; West Indies).

Double H, P. O. Box 10007, Whitehorse Rd., Greenville, S. C. 29603. Tel.: (803) 246-2112. Pres.: John Hudson.

Dover, 748 Camp St., New Orleans, La. 70130. Tel.: (504) 523-7474. Exec. VP: Bob Robin. Labels: (owned) ABS, Frisco, Nola, Tailgate, White Cliffs; (distributed) DeeSu, Eight-Ball, El-Tee, Manhattan, Pitter-Pat, Tonik, Virgil. (SEE ADVERTISMENT)

Dover, 180 Varick, New York, N. Y. 10014. Tel.: (212) AL 5-3755. Pres.: Hayward Cirker.

Dover, Arkansas (see Cotton Town Jubilee).

Dream Time (see Delmar Prod'ns).

Drum-Boy (see Jay Jay).

Drumfire (see Sound City).

Drummond, 13380 Capital Ave., Oak Park (Detroit), Mich. 48237. Tel.: (313) 548-3171. Pres.: Harry Levin; Promo. Dir.: Leo Cheslak; Sales Mgr.: Al Truax.

Dual, 139 Commonwealth, Massapequa, N. Y. Tel.: (516) PY 9-4302. Pres.: Andrew A. Palatta; VP: Larry M. Palatta (see Larric).

Ducretet-Thomson (see Capitol Imports).

Duke, 2809 Erastus St., Houston, Tex. 77026. Tel.: (713) OR 3-2611, 1225. Cable: PeaDuke. Pres.: Don D. Robey; A&R: Joseph W. Scott, Gilbert G. Caple, Wilmer C. Shakesnider; Sales & Promo.: Marion Frazier & Robert Sye; Nat'l Sales: Dave Clark. Labels: Duke, Sureshot.

Int'l representatives: Australia (CBS), Austria (CBS), Benelux (Vogue), Canada (London), England (Vocalion), France (Vogue), Germany (CBS), Mexico (Gamma), New Zealand (Viking), Philippines (Mareco), Portugal (Hispavox), Spain (His-pavox), Switzerland (Vogue).

Dumont, 1040 Tremont, Boston, Mass. 02120. Tel.: (617) HI 2-0800. Pres.: Donald E. Dumont.

Dunhill (see ABC).

Dunwich (see Atco).

Duo (see Stereodiddies).

Duo Disc (see Jay-Gee).

Dynamic (see Epstein Ents.).

Dynamic Sound, 1 Woodcrest Rd., Hicksville, L. I., N. Y. Tel.: (516) WE 8-7108. Co-owners: Joe & Marty Monaco (distributed by Celtic Rec'g Prod'ns).

Dynatone (see King).

Dyno (see Gateway Rec'gs).

DynoVoice (see Genius).

E

E (see George Clements Prod'ns).

E L J, 4215 Maffitt, St. Louis, Mo. 63113. Tel.: (314) JE 5-0004. Pres.: Eddie Johnson.

E-MC (see Oakridge).

E S P-Disk, 156 Fifth Ave., New York, N. Y. 10024. Tel.: (212) 255-4800. Cable: ESPDISK. Pres.: A&R, Sales & Mktg. Int'l: Bernard Stollman; Pub. Dir.: Tim Boxer; Adv. Dir.: Howard Bernstein.

Int'l representatives: Belgium (Schott Freres), Canada (Musimart), Denmark (Dansk), England (Transatlantic), Holland (Artone), Japan (Shinsei).

Eagle (see Trend).

Eastern (see Sue).

Ebbtide (see Celtic Rec'g Prod'ns).

Ebony, 920 S. Laurel, Mishawaka, Ind. Tel.: (219) 259-3215. Owner: Juanita Henson.

Ecco, 490 University Dr., Pocatello, Idaho. Tel.: (208) 232-0966. Pres.: Rich Crowley.

Branch: Boise, Idaho, 920 S. Orchard. Tel.: (208) 343-2263. VP: Dale Rich.

Economy (see Met Richmond Latin Rec. Sales).

Eddissa (see Met Richmond Latin Rec. Sales).

Eddo, P. O. Box 12209, Atlanta, Ga. 30305. Tel.: (404) 255-5404. Pres. & A&R: Edward J. Sheahan; Prod'n Mgr.: William A. Dial; Sales Mgr. & Pub.: Mark E. Johnson.

Edit (see Tide).

Edmar, 81 Spring Valley Rd., Paramus, N. J. 07652. Tel.: (201) 489-6638. Owners: Nancy Weit & Eddy DeMello.

Branch: Bermula, Eddy DeMello, Harrington Hundreds. Labels: Edmar, Skyline.

EeZee (see Oakridge).

Eichler, 815 Broadway, New York, N. Y. 10013. Tel.: (212) OR 4-3504. Pres.: Aaron Eichler.

Eight-Ball (see Dover, New Orleans).

Elco, P. O. Box 52287, New Orleans, La. 70150. Tel.: (504) 949-9078. Pres.: Bob Cole. Labels: Elco, Rapid.

El Dorado, 755 S. Grand, Mesa, Ariz. 85201. Tel.: (602) 964-0367. Pres.: Galen Arrington; VP: Mel Williams.

Electrola, c/o Record & Tape Sales, 821 Broadway, New York, N. Y. 10003. Tel.: (212) OR 4-6400. Pres.: Robert Staub.

Elektra, 51 W. 51 St., New York, N. Y. 10019. Tel.: (212) JU 2-7711. Cable: FOLKMUSIC. Pres.: Jac Holzman; VP: W. S. Harvey; A&R: Jac Holzman & Paul Rothchild; Sales: Mel Posner; Int'l: Jac Holzman & Larry Harris. Labels: Bounty, Crestview, Elektra, Nonesuch.

Int'l representatives: Australia (Astor), Benelux (Vogue), Canada (Allied), England (Elektra), France (Vogue), Germany (Vogue), Israel (CBS), Japan (Cosdel), Mexico (CBS), New Zealand (La Gloria), Philippines (Cosdel), Scandinavia (Karussel), South Africa (Trutone), Switzerland (Vogue).

Elgin (see Brite-Star).

El-Tee (see Dover, New Orleans).

Elvitree (see Music Makers Network of America).

Emarcy, 35 E. Wacker Dr., Chicago, Ill. 60601. Tel.: (312) DE 2-5788, N.Y.C. Tel.: (212) PL 9-2727. Cable: Merrec. Pres.: Irving B. Green; Exec. VP: Irwin H. Steinberg; VP & Prod'n Mgr.: Kenny Myers; Int'l: Brice Somers.

Int'l representatives: Argentina (Phonogram), Australia (Philips), Austria (Polyphon), Belgium (Polygram), Bolivia (Philips), Brazil (Companhia Brasileira De Discos), Canada (London), Chile (Philips), Colombia (Philips), Costa Rica (Indica), Denmark (Nordisk Polyphon), Ecuador (Philips), Finland (Fintone), France (Philips), Germany (Philips), England (Philips), Greece (Helladisc), Holland (Philips), Italy (Phonogram), Japan (RCA Victor), Mexico (Dusa), New Zealand (Philips), Norway (Norsk Phonogram), Peru (El Virrey), Philippines (Home Industries), Portugal (Philips), Singapore (William Jacks), South Africa (Trutone), Spain (Fonogram), Sweden (Philips-Sonora), Switzerland (Philips), Uruguay (Philips), Venezuela (Siemens), West Indies (West Indies).

Ember, 161 W. 54 St., New York, N. Y. Tel.: (212) PL 7-2072. Cable: Saunlaw. Pres.: J. S. Kruger.

Emerald (see Philles).

Emerrod, 1653 Jonathan Ave., Cincinnati, Ohio 45207. Tel.: (513) 751-0820. Gen. Mgr.: Roosevelt Lee.

Empala, 1607 El Centro, Hollywood, Calif. 90028. Tel.: (213) 464-9819. Cable: Moonson. Pres.: John Elliott; Gen. Mgr.: Linwood Wilde. Labels: Empala, Royal Crest.

Empire, P. O. Box 743, Plattsburgh, N. Y. 12901. Tel.: (518) 563-3236. Pres.: Peter B. Guibord.

Ems, P. O. Box 86, Becket, Mass. 01223. Tel.: (413) 623-8718. Pres.: Emanuel Levenson.

End (see Roulette).

Enrichment, 246 Fifth Ave., New York, N. Y. 10001. Tel.: (212) MU 3-9600. Dir.: Martha Huddleston.

Entas, 3400 Mill St., Reno, Nev. Tel.: (702) 329-7724. Exec. Dir.: Lee Peer.

Epic, 51 W. 52 St., New York, N. Y. 10019. Tel.: (212) 765-4321. VP & Gen. Mgr.: Leonard S. Levy; Sales Dir.: Maurice Hoffman; A&R Dir.: Bob Morgan; Pop A&R: Manny Kellm & Ted Cooper; Prod'n-Classical: Paul Myers; Pub. Mgr.: Judy Lishinsky; Adv. Mgr.: Saul Saget; Mds'g Dir.: Sol Rabinowitz; Admin. Dir.: Victor Linn; Int'l Servs. Mgr.: Ettore Stratta.

Branches: Hollywood, Calif., 1777 Vine St. Tel.: (213) 466-2481. A&R Prod'r: Stu Phillips; Reg'l Sales Mgr.: John Mahan-Nashville, Tenn., 812 16 Ave. S. Tel.: (615) 255-7463. A&R Prod'r: Billy Sherrill.

Labels: Epic, Crossroads, Okeh.

Int'l representatives: Chile (Patino & Ortiz), Denmark (I.S. Dansk), Eire (Gramophone), Finland (Sonet), India (Gramophone), Italy (Ricordi), New Zealand (Peak), Norway (Arne Bendiksen), Pakistan (Gramophone), Peru (Sica Peruana), Spain (Discophon), Sweden (Sonet), United Kingdom (EMI). (see Columbia).

Epstein Ents., 735 N. General McMullen Dr., San Antonio, Tex. 78228. Tel.: (512) GE 3-1461. Owner & A&R: Abraham Epstein.

Branch: Pittsburg, Tex., 19 Cedricton. Zip: 15210. Tel.: (412) 882-7677. Promo.: Edward T. Ignaski.

Labels: Acuarela, Beckingham, Cobra, Dynamic, Jox.

Int'l representatives: Canada (Robert J. Stone Assocs.), Mexico (Capitol).

Equator, P. O. Box 1885, 216 14 Ave. S.W., Birmingham, Ala. 35211. Tel.: (205) 323-3925. Pres.: Roosevelt Harvey.

Era, 7033 Sunset Blvd., Suite 308, Hollywood, Calif. 90028. Tel.: (213) HO 6-2161. Pres.: Herb Newman. Labels: Era, Newman.

Ernst Prod'ns, 15305 Livernois Ave., Detroit, Mich. 48238. Tel.: (313) 861-5650. Pres.: G. Ernie Stratton.

Labels: Dode, Meadowbrook, Top Ten.

Erwin, 2674 Steele St., Memphis, Tenn. 38107. Tel.: (901) 257-2933. Owner: Marshall E. Ellis.

Eskee (see Amy-Mala-Bell).

Esoteric (see Everest).

Essence (see PowerTree).

Eterna (see Lyricord).

Etiquette, 4425 Sixth Ave., Tacoma, Wash. Tel.: (206) SK 2-6636. Pres.: Barrie R. Jackson.

Eugenia (see Style Wooten Prod'ns).

Euphonix Sound, 357 Leighton Dr., Ventura, Calif. Pres.: Paul E. Affeldt.

Europa (see Fiesta).

Eurotone Int'l, 130 W. 42 St., New York, N. Y. 10036. Tel.: (212) 594-9670. Pres.: George Curtiss.

Int'l Branch: Austria, Symphony Tone Prod'ns, Konzerthaus, Lothringstr. 20, Vienna. Tel.: 57-54-82. Cable: IMROSA. Pres.: Imre Rozsa.

Int'l representatives: Canada (Sparton), Portugal (Marfer), Spain (Marfer).

Eventide, P. O. Box 51, Windsor, Pa. 17366. Tel.: (717) 244-5411. Owner: Wayne Thomas.

Everest, 10920 Wilshire Blvd., Los Angeles, Calif. 90024. Tel.: (213) BR 2-4391 & GR 7-3272. Pres. & Int'l: Bernard Solomon; Pop A&R & Sales: Lee Palmer; Classical A&R: Ed Applebaum; Int'l: Bernard Solomon.

Labels: Archive of Folk Music, Arvee, Baroque, Concert-Disc, Counterpoint, Esoteric, Everest, HiFi, La Comedie Francaise, Period, Renaissance, Scala, Stradivari, Summit.

Int'l representatives: Argentina (Microfon, Trova), Australia (Transglobal, W&G, Astor), Canada (Compo, Sparton, Almada, Baroque), Denmark (Frode Herlov), England (Ember, Oriole, Associated Rec'gs), France (Societe Francaise du Son, Vox, Vogue, Barclay), Germany (Deutsche Grammophon, Deutsche Vogue), Greece (Greek Phonograph House), Hong Kong (Cosdel), Israel (Israel Rec.), Italy (CGD, Sarr), Japan (Cosdel, Nippon Grammophon), Mexico (Tizoc, Gamma), New Zealand (Transglobal), Philippines (Cosdel), Singapore (Cosdel), South Africa (Troubadour), Spain (Discophon), Sweden (Harbor), Switzerland (Eltron, John Lay), Venezuela (Discos).

Evergreen (see JJC).

Everyman (see Vanguard).

Excel, 1842 W. 11 St., Los Angeles, Calif. 90006.

Excello (see Nashboro).

Exito (see Seeco).

Experiences Anonymes (see Lyricord).

F

F G S (see Ranger).

Fabbri, 5533 Hollywood Blvd., Dept. 237, Hollywood, Calif. 90028. Tel.: (213) 463-6284. Pres.: Anthony Fabbri.

Fabor, P. O. Box 1487, Burbank, Calif. Tel.: (213) 982-1300. Pres.: Fabor Robinson.

Factor, 909 Front, Georgetown, S. C. 29440. Tel.: (803) 546-9409. Owner: Michael L. Rice.

Fairmount (see Cameo-Parkway).

Faith (see Cash Prod'ns).



RECORD PEOPLE SAY WE'RE THE WORLD'S CAPITOL.

If the record you're looking for was made in Hong Kong instead of Hollywood, or Beirut instead of New York, come to us.

We import records from all over.

Time was, you had to go directly to the source to get the record you wanted. That involved a lot of paper work, translations, customs, foreign exchange, and all that. Then, we went to work and simplified things.

Now you just come to Capitol Records International, and you get the labels you want, extra-fast, direct from New York.

(Choose from the vast catalogs of Electrola, English-Columbia, H.M.V., La Voce del Padrone, La Voix de Son Maître, Odéon and Pathé.)

So, cash in on fast-moving import sales the easy way. Contact your man at the Capitol — the Capitol Records International Corp., 1290 Avenue of the Americas, New York City 10019.



continued

Falcon, 821 N. 23 St., McAllen, Tex. Tel.: (512) MU 6-5851. Gen. Mgr.: A. Ramirez; A&R Mgr.: R. Ramirez; Sales & Mktg. Mgr.: J. Codina, Jr.; Promo. Mgr.: Fred Vela Jr.
Labels: (owned) Bronco, Del Norte, Falcon; (distributed) DLV, Orfeon.

Fame (see Atco).

Family, 64 Mechanic St., New Rochelle, N. Y. 10801. Tel.: (914) NE 2-6059. Pres.: H. J. Lengsfelder; Gen. Mgr.: R. Gamba.

Famo (see Caribbean Folk Music).

Fan, P. O. Box 2321, Santa Ana, Calif. Pres.: O. A. Swearingen.

Fanfare, P. O. Box 26393, Houston, Tex. 77032. Dir.: R. Ames.

Fanin, Rt. 1, Box 56 B, Blue Ridge, Ga. 30513. Pres., Sales & Mktg.: Edna Parker; VP, A&R (R&R), Pub., & Adv.: Jim Parker; A&R (C&W): Jimmy Smart; Promo. Mgr.: Earl Reithgeb.

Fantasy, 855 Treat Ave., San Francisco, Calif. 94103. Tel.: (415) MI 8-7750. Coordinator: John Driscoll III.
Labels: Fantasy, Galaxy, Scorpio.

Faro, 5004 Melrose Ave., Hollywood, Calif. 90038. Tel.: (213) 469-4174. Pres.: Edward L. Davis.
Labels: Faro, Linda, Rampart.

Fayette (see Swan).

Federal, 1540 Brewster, Cincinnati, Ohio 45207. Tel.: (513) 751-2211.

Felco (see Jamaka).

Festival, 318 W. 48 St., New York, N. Y. Tel.: (212) PL 7-8500. Pres.: Herb Abramson.

Festival (France), c/o Record & Tape Sales, 821 Broadway, New York, N. Y. 10003. Tel.: (212) OR 4-6400. Pres.: Robert Staub.

Fiasco (see Bandera).

Fidelity Sound, 23 Don Ct., Redwood City, Calif. Tel.: (415) EM 6-3173. Dir.: Reginald McGovern.

Fiesta, 1619 Broadway, New York, N. Y. 10019. Tel.: (212) PL 7-7760. Pres.: Jose Morand; E. Coast Sales: Irving Cherne; W. Coast Sales: Arnold Thies.
Labels: Europa, Fiesta, Grecophon. (SEE ADVERTISEMENT).

Filtro (see Met Richmond Latin Rec. Sales).

Finer Arts, 60 S. Glencoe, Denver, Colo. Tel.: (303) 355-4535. Owner: Morey Bernstein; A&R, Sales & Promo: Allan Bernstein.
Labels: Finer Arts, Transworld.

Fink Rec., 110 Pine Ave., Suite 501, Long Beach, Calif. 90802. Tel.: (213) 435-1212. Pres.: Edward N. Wood.

Fink Rec'g, 2732 Beachmont Ave., Norfolk, Va. 23504. Tel.: (703) MA 7-0957. Pres., Pub. & Adv.: Bill Johnson; A&R: Charlie Morgan; Sales & Mktg.: Jim Howard.

Chick Finney (see listing under C).

Firma (see CJ).

Flash, P. O. Box 133, Senatobia, Miss. Tel.: (601) 233-4407. Pres.: Mitchell May.

Flash, P. O. Box 231, Tyler, Tex. 75701. Tel.: (214) LY 4-2961. Contact: Curtis Kirk & Fred Harper.

Flashback (see Amy-Mala-Bell).

Fleet (see Dome).

Flip, 618 S. Ridgeley Dr., Los Angeles, Calif. 90036. Tel.: (213) 934-4033. Pres.: Max Fiertag.

Focus (see Atlantic).

Folk Promo's, Box 5007, Charleston, W.Va. Tel.: (304) 346-6428.

Folklore (see Prestige).

Folkstar (see Goldband).

Folkways, 165 W. 46 St., New York, N. Y. 10036. Tel.: (212) JU 6-7260. Dir., A&R & Int'l: Moses Asch; Sales: Lloyd Gelassen.
Labels: Folkways, Asch, Broadside, Mary.
Int'l representatives: Belgium (Schott Freres), Denmark (Dansk), England (Transatlantic), France (Le Chant du Monde), Germany (Electrola), Italy (Saar).

Fontana, 35 E. Wacker Dr., Chicago, Ill. 60601. Tel.: (312) DE 2-5788. N.Y.C. Tel.: (212) PL 9-2727. Cable: Merrec. Pres.: Irving B. Green; Exec. VP: Irwin H. Steinberg; VP & Prod'n Mgr.: Charles Fach; Promo.: Lou Dennis; Int'l: Brice Somers.
Int'l representatives: Argentina (Phonogram), Australia (Philips), Austria (Polyphon), Belgium (Polygram), Bolivia (Philips), Brazil (Compani Brasileira de Discos), Canada (London), Chile (Philips), Colombia (Philips), Costa Rica (Indica), Denmark (Nordisk Polyphon), Ecuador (Philips), England (Philips), Finland (Musik Fazer), France (Philips), Germany (Philips), Greece (Helladic), Holland (Philips), Israel (Hed-Arzi), Italy (Phonogram), Jamaica (Records), Japan (Victor), Mexico (Dusa), New Zealand (Philips), Norway (Norsk Phonogram), Peru (El Virrey), Philippines (Home Industries), Portugal (Philips), Singapore (William Jacks), South

Africa (Trutone), Spain (Fonogram), Sweden (Philips-Sonora), Switzerland (Philips), Uruguay (Philips), Venezuela (Siemens), West Indies (West Indies).

Format (see Audiofax).

Fortune, 3942 3rd Ave., Detroit, Mich. 48201. Tel.: (313) TE 3-5383. Execs: Jack & Devora Brown. Four Corners (see Kapp).

Four Sons, P. O. Box 444, Paris, Tenn. Tel.: (901) 642-9271. Pres.: C. S. Leach.

49th State Hawaii, 5810 S. Normandie Ave., Los Angeles, Calif. 90044. Tel.: (213) 750-3310. Pres.: George K. Ching.
Branch: Honolulu, Hawaii, 1218 Kaumualii St. Zip: 96817.

Fox Hall, 108 S. Main, Lake Elsinore, Calif. 92330. Tel.: (714) 674-4371. Gen. Mgr.: L. C. Saunders.

Frame (see Music Inds.).

Frank Buck, Cooperstown 26, N. Y. Tel.: (607) LH 7-8862. Pres.: Frank Lyle Buck.

Franne (see Hi Ho Prod'ns).

The Franson Corp., 100 Ave. of the Americas, New York, N. Y. 10013. Tel.: (212) WA 5-1200. Mgr.: Herman R. Singerman.
Labels: Children's Rec. Guild, Living Language Courses, Young People's Recs.

Franz Schubert Music, 425 W. Broadway, Ft. Worth, Tex. 76104. Tel.: (817) ED 2-5995. Owner & A&R: Franz Schubert.
Labels: Cuff-Rite, Franz Schubert, Unidap.

Fraternity, Sheraton Gibson Hotel, Rm. 105, Cincinnati, Ohio 45202. Tel.: (513) 381-3166.

Fred Miles Presents, 4 & 6 S. Mole St., Philadelphia, Pa. 19102. Tel.: (215) LO 8-0985.

Fredio, 2224 E. 12 St., Davenport, Iowa. Tel.: (319) 326-2841. Pres.: Fred R. Mauck.

Freeway, P. O. Box 36448, Los Angeles, Calif. 90036. Tel.: (213) WE 4-1441. Partners: H. Endemano & Norm Goodman.

Frisco (see Dover, New Orleans).

Frisky, 160 Passaic Ave., Kearny, N. J. Tel.: (201) WY 8-8181. Sales Mgr.: Jerry Geller.

Fuller, P. O. Box 10513, Tampa, Fla. 33609. Tel.: (813) 839-5471. Owner: Charles Fuller; A&R & Prod'n: John Brumage; Sales: Douglas Crutchfield; Promo: Ann Lindsay.
Labels: Fuller, CFP, Living Library, Tigertown, Cherry.
Company represents: Wellington (New Zealand).

Fun-E (see Bellaire).

Future, 1086 College, Batesville, Ark. 72501. Tel.: (501) RI 3-3553.

G

G H B (see Jazzology).

G M M, 750 Park Ave., New York, N. Y. 10021. Tel.: (212) UN 1-0843. Pres.: Charles Biderman.

G M S-Disc (see Playette).



G N P Crescendo, 9165 Sunset Blvd., Los Angeles, Calif. 90069. Tel.: (213) 275-1108. Cable: CRESREC. Pres.: Gene Norman; A&R: Billy Strange; Sales: Robin Combs; Int'l: Gene Norman.
Labels: GNP Crescendo, Dixieland Jubilee.
Int'l representatives: Benelux (Vogue), Canada (Compo), Denmark (Tono), England & Commonwealth (Vocalion & Decca), France (Vogue), Germany (Vogue), Japan (King), Mexico (Tizoc), Norway (Eilertsen), Peru: Distribuidora Peruana Sudamericana S. A., Philippines (Cosdel), South Africa (Teal), Spain (RCA), Sweden (Cupol), Switzerland (Vogue), Venezuela (El Palacio de la Musica).

G R C, 10840 Dixon Dr., Seattle, Wash. 98178. Tel.: (206) PA 5-7294. Pres.: Robert J. Wooten.

Gaiety, 6153 Lexington Ave., Suite 15, Hollywood, Calif. 90038. Tel.: (213) 469-6719. Pres.: Don Grashy.
Int'l Branch: Canada, 232 Lincoln St., Port Arthur, Ont.

Galan, 4460 W. Vernor, Detroit, Mich. 48216. Tel.: (313) 825-6110. Contact: Basil Galan.

Galaxy (see Fantasy).

Galena, 11922 E. Seventh St., Tulsa, Okla. Tel.: (918) GE 7-1700. Pres.: Leroy Duncan.

Gallery, 609 Fifth Ave., New York, N. Y. 10017. Tel.: (212) PL 2-4300. Pres.: Louis Dreyfus; A&R: John Cacavas; Promo. Mgr.: Larry Gallagher.

Gama Ent., 930 F St. N.W., Washington, D. C. 20004. Tel.: (202) DI 7-3944. Pres.: Gabriel Mantilla.
Branch: Point Marion, Pa., P. O. Box 26, Ontario Ave. Zip: 15474. Tel.: (412) 725-5318. Contact: D. B. Hoop.

Gamble, 1650 Broadway, New York, N. Y. 10019. Tel.: (212) CI 5-0620. Pres.: Kenny Gamble; Mgr. Dir.: Sam Goldner.

Garden (see Yale).

Garex (see Park Ave.).

Garlin, 11034 Blix St., North Hollywood, Calif. Tel.: (213) 769-0591. Pres.: Norm Pringle.

Gateway Rec'gs, 234 Forbes Ave., Pittsburgh, Pa. Tel.: (412) GR 1-5875. Pres.: Robert W. Schachner; Dir. of Promo.: Dave Maisle; A&R: Ron Lenhoff.
Labels: Dyno, Hunch, Leo, Scott. (SEE ADVERTISEMENT).

Gateway Recs., P. O. Box 111, 837 Los Angeles Ave., Simi, Calif. Pres.: E. E. Carlton.

Gaye (see World-Wide).

Gee (see Roulette).

General American, Lewis & Clark Bldg., 406 Turner Ave., Columbia, Mo. 65201. Tel.: (314) GI 9-7211. Pres.: James P. Mills.
Label: Dixietone.

General American, 821 N. Broad St., Philadelphia, Pa. 19123. Tel.: (215) CE 6-8408. Owners: Harry Finfer & Al Kelly.
Label: Joy-Dan.

General Int'l (see Amy-Mala-Bell).

General Lee's Confederate Recs. (see Three Star).

General Rec'g Co. (see GRC).

Genius, 1841 Broadway, New York, N. Y. Tel.: (212) CI 5-3535. Pres.: Robert S. Crewe Jr.; Exec. VP: Daniel N. Crewe.
Labels: DynoVoice, New Voice (distributed by Amy-Mala-Bell). (SEE ADVERTISEMENT)

Georden Rec. Prod'ns, 1201 Arkansas Ave., Apt. 3, Pittsburgh, Pa. 15216. Tel.: (412) 563-1109. Pres.: George W. Annesley; VP: Dennis A. Sites.
Labels: Casark, Kitten, Point, South Shore.

George Clements Prod'ns, 1598 N. "E" St., San Bernardino, Calif. 92405. Tel.: (714) TU 2-0629. Owner: George E. Clements.
Labels: E, Lane (distributed by Amy-Mala-Bell).

Getit, 114-17 145 St., Jamaica, L. I., N. Y.

Gilbert (see Southern City).

Glad-Hamp, 165 W. 46 St., New York, N. Y. Tel.: (212) PL 7-8486. Mgr.: Bill Titone.

Glenvalley, 1631 Glen Valley Dr., Irving, Tex. 75060. Tel.: (214) BL 3-7868. Pres. Sales & Mktg., Promo.: W. E. Snellings; VP & Pub.: Nelson Thornton; A&R & Adv.: Don Snellings.
Labels: Glenvalley, Texan.

Glo, Box 177, Somers, Conn. 06071.

Goal (see Laurie).

Go Go, 19 Southland Dr., Glen Cove, N. Y. Tel.: (516) OR 6-6460. Pres.: Gene Moretti.

Gold Key (see Silver Falcon).

Gold Leaf, Hotel Newhouse, Salt Lake City, Utah 84101. Tel.: (801) HU 5-0308. Pres.: Eugene Jelesnik.

Gold Token (see Vended).

Goldband, P. O. Box 1485, 313 Church St., Lake Charles, La. 70601. Tel.: (318) 439-8839. Pres.: Eddie Shuler.
Labels: Goldband, Folkstar, Luffcin, TEK, Tic Toc.

Goldust, P. O. Box 234, University Park, N. M. 88070. Tel.: (505) 524-1889. Mgr.: Ermit Brooks.

Goldwax, 2445 Chelsea Ave., Memphis, Tenn. 38108. Tel.: (901) 275-1760. VP: Quinton Claunch (distributed by Amy-Mala-Bell).

Golden (see AA).

Golden Circle Prod'ns, 10614 Valley Springs, North Hollywood, Calif.

Golden Crest, 220 Broadway, Huntington Sta., N. Y. 11748. Tel.: (516) HA 3-7090. Pres.: Clark Galehouse; Sales Mgr.: Mack Wolfson.

Golden State, 665 Harrison St., San Francisco, Calif. 94107. Tel.: (415) 781-6306. Pres. & A&R: Leo de Gar Kulka; VP Prod'ns, Sales & Mktg: Brad Miller; Pub. & Adv.: Art Ferris; Promo.: Kathy Furness.
Labels: Captain, Golden State.

Golden World, 3246 W. Davison, Detroit, Mich. 48238. Tel.: (313) 883-7843. Pres.: Joanne Jackson Bratton; Gen. Mgr. & Promo.: Irv Biegel; A&R Dir.: Andre Williams; Sales Mgr.: Al Rosner; Pub. & Promo.: Arni Zalesin.
Labels: Ric-Tic, Win Gate.

Gone (see Roulette).

Good Time Jazz (see Contemporary).

Gordon Street (see McKinnon).

Gordy (see Motown).

Gospel (see Savoy).

Gospel Corner (see Proverb/Gospel Corner).
 Gospel Prod'ns, P. O. Box 11181, Charlotte, N. C. 28209. Tel.: (704) 525-2385.
 Gospel Time (see Spar).
 Gospel Truth (see Showboat).
 Grand Award (see Command).
 Grand Prix (see Pickwick Int'l).
 Grand Staff, P. O. Box 343, 11236 Adelpia Ave., Pacoima, Calif. 91331. Tel.: (213) 896-4411, 9282. Owner & Mgr.: Harry J. Jenkins.
 Great (see Chart).
 Grecoophon (see Fiesta).
 Groove (see RCA Victor).
 Groovy, 1650 Broadway, New York, N. Y. 10019. Tel.: (212) CI 5-0620. Pres.: George Goldner; Exec. VP: Sam Goldner.
 Guest Star (see Ambassador, N. J.).
 Guillotine, P. O. Box 3086, Ogden, Utah 84403. Tel.: (801) 782-7604. Pres.: Bruce S. Unck; VP: Robert W. Collins.
 Labels: Guillotine, Stereo-Dynamics.
 Gulfstream, 5614 Taylor St., Hollywood, Fla. Tel.: (305) YU 3-6082. Pres.: Vincent Fiorino.
 Guyden (see Jamie/Guyden Dist. Corp.).
 Gypsy, 2218 Algonquin, Detroit, Mich. 48215. Tel.: (313) 822-5960. Pres.: T. Hogan & R. Carr.
 Labels: Gypsy, Hide-Out.

H

H U M C O, 313 El Tejon Ave., Oildale, Calif. 93308. Tel.: (805) 399-9028. Owner: Robert L. Horffor.
 Halifax, 4135 W. Armitage, Chicago, Ill. Tel.: (312) CA 7-3722. Owner: Hal Faktor.
 Hal n' Jean (see Southern City).
 Hall, P. O. Box 3452, 888 Pearl St., Beaumont, Tex. Tel.: (713) 832-1522. Pres. & A&R: Wm. G. Hall; Sales Mgr. & Promo. Dir.: Robert W. Webster.
 Labels: Hall, Corridor, Hall-Way.
 Int'l representatives: Australia (W&G), Canada (Compo).
 Hall-Way (see Hall).
 Halo (see One-Derful Prod'ns).
 Halo/Klub (see Custom Rec. & Sound).
 Hamilton (see Dot).
 Hanna-Barbera, 3400 W. Cahuenga Blvd., Hollywood, Calif. 90028. Tel.: (213) 466-1371. Contact: Don Bohanan.
 Int'l representative: Europe (Pye).
 Happy Hearts, 2213 Christine St., Wayne, Mich. 48184. Tel.: (313) 721-6249. Pres.: La Verne Wright; A&R: Sherman Napier; Pub. & Adv.: K. A. Jadassohn.
 Labels: Pathway, Apostle.
 Branch: New York, N. Y., Affiliated Music Ents., 1619 Broadway. Tel.: (212) JU 6-0674.
 Int'l representatives: England (Western Style), Ireland (Shamrock).
 Happy Jazz, 110 Oak Park Dr., San Antonio, Tex. 78209. Tel.: (512) TA 2-9742. Contact: Jim Cullum.
 Happy Time (see Pickwick Int'l).
 Harlequin, P. O. Box 20201, San Diego, Calif. 92120. Tel.: (714) HO 9-6352. Pres.: Richard William.
 Harmonia Mundi (see Apon).
 Harmony (see Columbia).
 Hastings, Willow Grove Rd., Stony Point, N. Y. 10980. Tel.: (914) HA 9-9831. Pres.: Ken Hastings (distributed by Celtic Rec'g Prod'ns).
 Hawk Prod'ns, 6252 1/2 S. Greenwood Ave., Chicago, Ill. 60637. Tel.: (312) 288-5381. Pres.: Robert Lee.
 Labels: Big Three, Hawk, Jerhart, Vick.
 Haydn Society, P. O. Box 2338, Hartford, Conn. Pres.: Ralph Colucci; Gen. Mgr.: Joe Girard.
 Headliner Stars, P. O. Box 411, San Fernando, Calif. 91340. Tel.: (213) DI 2-9109. Sales Rep.: Mark Raymer.
 Branch: Mehama, Ore., P. O. Box 928.
 Heart Warming, 136 Fourth Ave. N., Nashville, Tenn. 37203. Tel.: (615) CH 2-3541. Pres.: John T. Benson Jr.
 Heartbeat, 9746 Grandon, Chicago, Ill. Tel.: (312) RE 1-5716. Pres.: Seymour Schwartz.
 Heartbreak, Capitol Recs. Bldg., Suite 113, 806 16 Ave. S., Nashville, Tenn. Pres.: Don Cummings.
 Branch: Dallas, Tex., Continental Bldg., Suite 722.
 Heed (see Showboat).
 Heidi (see Atco).
 Heidi, Tex. (see Bellaire).
 High-Ho, 442 W. 57 St., New York, N. Y. 10019. Tel.: (212) 765-0674. Owner & Mgr.: Hy Fenster.
 Heliodor (see MGM).
 Hep, 2551 Aldine St., St. Paul, Minn. 55113. Tel.: (612) 633-5329. Pres.: Henry J. Auge Jr.
 Hi (see London).

Hi Ho Prod'ns, P. O. Box 8135, Chicago, Ill. 60680. Tel.: (312) 373-7072. Pres.: Frank Howard Jr.
 Labels: Franne, Hi Ho, Superbe.
 Hickory, 2510 Franklin Rd., Nashville, Tenn. 37204. Tel.: (615) 297-8558. Cable: ACUFFROSE. Owner & A&R: Wesley Rose; Sales: Lester Rose; Int'l: W. D. Kilpatrick.
 Int'l representatives: Argentina (Tonodisc), Australia (Australian Rec.), Austria (CBS), Belgium (Artone), Canada (Quality), Denmark (Morks), England (Pye), France (CBS), Germany (CBS), Holland (Artone), Japan (Cosdel), New Zealand (EMI), Philippines (Mareco), South Africa (Teal), Switzerland (CBS).
 Hide-Out (see Gypsy).
 HiFi (see Everest).
 High-Up (see Jake's Music Shop).
 Hilltop (see Pickwick Int'l).
 Hit, 1921 Rebecca Dr., Clearwater, Fla. Tel.: (813) 446-8649.
 Hit Kingdom (see McKinnon).
 Hitsuhrgh (see Southern City).
 Hob (see Scepter).
 Hodge (see Paramount).
 Holiday, 2528 Tilden Ave., Los Angeles, Calif. 90064. Tel.: (213) 473-8163 & CR 3-3700. Pres.: Dennis J. Torchia.
 Hollywood (see Starday).
 Hollywood Int'l Talents, 1607 El Centro Ave., Suites 1 & 2, Hollywood, Calif. 90028. Tel.: (213) HO 2-0261. Pres.: Lin Wilde.
 Label: Lariat.
 Holt, Rinehart & Winston, 383 Madison Ave., New York, N. Y. 10017. Tel.: (212) MU 8-9100.
 Holton, 850 Seventh Ave., New York, N. Y. 10019. Tel.: (212) 581-5120. Pres.: Fred Barr; VP: Al Carnovale; Exec. Mgr.: George Levy.
 Branch: Caldwell, N. J., 378 Bloomfield Ave.
 Labels: Holton, Patty, Security, Skyscraper.
 Holy Cross (see McKinnon).
 Hondo (see Ser-Prod'ns).
 Honey, 502 W. Roosevelt, Phoenix, Ariz. 85003. Tel.: (602) 252-2496. Pres.: Honey Hillman; A&R: Jack Miller.
 Horizon, 6290 Sunset Blvd., Hollywood, Calif. 90028. Tel.: (213) 466-4224. Cable: DAVONMUS. Pres.: David Hubert.
 Branch: New York, N. Y., Olibin, 101 W. 55 St.
 Labels: Davon, Horizon, In, Loud.

Horffor Universal Music Co. (see HUMCO).
 Hue (see Chas).
 Hull, 1595 Broadway, New York, N. Y. 10019. Tel.: (212) JU 6-5390. Pres.: Bea Kaslin.
 Labels: Hull, Sonat.
 Hunch (see Gateway Rec'gs).
 Hurd, 173 Oneida St., Chadwicks, N. Y. Tel.: (315) 724-8314. Pres.: Kenneth S. Hurd.
 Branch: New York, N. Y., 1674 Broadway, Suite 703. Tel.: (212) 245-9709.
 Hurricane, 1927 San Mateo, N.E., Albuquerque, N. M. Tel.: (505) 265-4039. Pres.: Mrs. Sanchez.
 Hussar, 3445 N. Elaine Pl., Chicago, Ill. 60657. Tel.: 248-9295. Pres.: Maria E. D'Albert.
 Hype (see Tener Ents.).

I B C, 147 Mulberry St., New York, N. Y. 10013. Tel.: (212) CA 6-8106. Pres.: Frank Tudisco.
 I N R I (see Zaraks).
 Iberia (see Met Richmond Latin Rec. Sales).
 Ideal (see Rio Grande Music).
 Ideal, Pittsburgh, Pa. (see Val).
 Iguana, 220 W. 42 St., New York, N. Y. Tel.: (212) 462-7215. VP: Rose Vee (see Universal I Ltd.).
 Image, 617 Exchange Bldg., Nashville, Tenn. Tel.: (615) 255-6376. Pres.: Kenny Marlow.
 Impact, 17111 Third Ave., Detroit, Mich. 48203. Tel.: (313) 863-2030. Pres.: Harry Baik.
 Impala-Delsey, 808 N. Broad St., Philadelphia, Pa. 19130. Tel.: (215) CE 2-5050. Pres.: Fran Williamson.
 Labels: Delsey, Impala, Mr. Genius.
 Imperial (see Liberty).
 Impex (see Tioga).
 Impire, 524 Plasters Ave. N.E., Atlanta, Ga. 30324. Tel.: (404) 874-2781. Pres.: Joe Franklin.
 Impress, 1035 Quebec Terr., Suite 2, Silver Spring, Md. Tel.: (301) 439-1629. Pres.: Lester L. Friedman.
 Impulse (see ABC).
 In (see Horizon).
 Independent, 19802 N.E. 12 Pl., North Miami Beach, Fla. Tel.: (305) 949-3033. Mgr.: Ray Meinberg.
 Industry, P. O. Box 38631, Hollywood, Calif. 90038. Tel.: (213) 763-4374. Owner: Raymon Sanders.
 Infal, 6671 Bellaire St., Commerce City, Colo. 80022.

HIT ARTISTS from JAMIE/GUYDEN
CRISPAN ST. PETERS
BARBARA MASON
TOMMY McLAIN
THE VOLCANOS
POOKIE HUDSON
KIT KATS
ANN D'ANDREA

J/G

JAMIE/GUYDEN DISTRIBUTING CO.
 PHILADELPHIA, PENNSYLVANIA 19123



**A NEW LINE OF
DRAMATIC PLAYS**
List Price \$3.98

FEATURING THE STAR OF
STAGE AND TV ("I SPY," ETC.)
ROBERT CULP

LADY WINDERMERE'S FAN by Oscar Wilde
GHOSTS by Henrik Ibsen
UNCLE VANYA by Anton Chekhov
THE RIVALRS by Richard Sheridan
DR. FAUSTUS by Christopher Marlowe
THE WAY OF THE WORLD by William
Congreve
ALL FOR LOVE or THE WORLD WELL LOST
by John Dryden
THE MASTERBUILDER by Henrik Ibsen
THE DOCTOR IN SPITE OF HIMSELF by
Moliere
SHE STOOPS TO CONQUER by Oliver
Goldsmith

**ALEXANDER KIRKLAND
ACTING GROUP**

SALOME by Oscar Wilde
THE SEA GULL by Anton Chekhov
A DOLL'S HOUSE by Henrik Ibsen
THE SCHOOL FOR SCANDAL by Richard
Sheridan

LIBRARY EDITIONS

66 Mechanic St., New Rochelle, N.Y.
Tel.: 914 NE 3-6055



WANTED

**MASTERS FOR NATIONAL
DISTRIBUTION**

**BEST PERCENTAGE DEALS
R & B ★★ POP**

**WE HANDLE PROMOTION,
SALES, PRESSING**

JIM GOLDEN

(312) 939-3698

1448 SOUTH MICHIGAN AVENUE

★★★ CHICAGO, ILL. 60605 ★★★

continued

Inner, 220 W. 42 St., New York, N. Y. Tel.: (212) 462-7215. VP: Rose (see Universal I Ltd.).
Inner-Glo, 15 S. Washington St., Emporia, Kan. 66801. Tel.: (316) DI 2-7769. Owner: Nettie M. Dawson.
Instant, P. O. Box 50650, New Orleans, La. Tel.: (504) 367-3104 (distributed by Atlanfic).
Instant Learning Series (see Pickwick Int'l).
Institute for Language Study, 24 Clinton Ave., Montclair, N. J. 07042. Tel.: (201) 746-7207. N. Y. C. Tel.: (212) JU 2-3845. Pres.: Robert E. Livesey.
International, W. 5619 Division St., Chicago, Ill. 60651. Tel.: (312) 378-4848. Chm.: Jerome V. Man; Pres. & Classical A&R: Vern Ruvalds; VP Pop A&R: Len March; Sales & Mktg.: Aina Spuris.
Island Artists (see Caribbean Folk Music).

J

J A G (see Jake's Music Shop).
J B, P. O. Box 7221, Mobile, Ala. 36607. Tel.: (504) 477-7434. Pres.: John N. Blackburn; VP: Mrs. Sara Ann Smith.
J B P (see Chanson).
J J C, 1 E. 57 St., New York, N. Y. 10022. Tel.: (212) PL 9-7470. Pres.: Joseph Csida. Labels: J J C, Evergreen.
J & T (see CBC).
Jairo, 610 S. Verdugo Rd., Suite 3, Glendale, Calif. 91205. Tel.: (213) 246-9445. Owner, Pub. & Adv.: Jairo Velasquez; A&R: Dele Ketcher; Sales & Mktg.: Adolpho Ramirez.
Jake's Music Shop, 744 N. Main St., Opelousas, La. Tel.: (318) 942-7092. Owner: Jake Graffagnino. Labels: Carl, High-Up, Jag.
Jamaka, 3621 Heath Ln., Mesquite, Tex. 75149. Tel.: (214) BR 9-5858. Owners: Jimmy Fields & George McCoy. Labels: Felco, Kick.
Jameco, 226 Flushing Ave., Brooklyn, N. Y. Tel.: (212) MA 5-2757. Pres.: Anthony Ferrante. Labels: Jameco, Blackhawk.
Int'l representatives: Benelux (Stone Assocs.), Canada (Stone Assocs.), England (Island).
Jamie (see Jamie/Guyden Dist. Corp.).
Jamie/Guyden Dist. Corp., 919 N. Broad St., Philadelphia, Pa. 19123. Tel.: (215) CE 2-8383. Pres.: Harold Lipsius; A&R: Bob Finiz; Sales & Admin.: Paul Fien. Labels: Arctic, Guyden, Jamie, Landa, MSL, Montel, Soft, Tear Drop. (SEE ADVERTISEMENT)
Janson, 559 Beach 130 St., Rockaway Park, N. Y. 11694. Tel.: (212) NE 4-2577. Pres.: Jan Bart.
Janus (see Powertree).
Jardin (see Met Richmond Latin Rec. Sales).
Jay-Gee, 318 W. 48 St., New York, N. Y. 10036. Tel.: (212) PL 7-8570. Chm. of Board: Jerry Blaine; VP: Stephen Blaine; A&R: Mickey Eichner & Robert Stephens; Sales & Mktg.: Steven Wax; Pub.: Karen Ginsberg; Promo.: Effie Smith. Labels: Blaine, B. T. Puppy, Dana, Duo Disc, Jay-Gee Int'l, Josie, Jubilee, Port, Swing.
Jay-Gee Int'l (see Jay-Gee).
Jay Jay, 2454 S. Kedzie Ave., Chicago, Ill. 60623. Tel.: (312) 762-6000. Pres.: Walter Jay. Labels: Jay Jay, Drum-Boy.
Jayla (see Cherokeeeland).
Jazz Press, 1841 Broadway, New York, N. Y. 10023. Tel.: (212) LT 1-0452. Pres.: Pauline Rivelli.
Jazzland (see Orpheum Prod'ns).
Jazzology, P. O. Box 748, Columbia, S. C. 29201. Tel.: (803) AL 2-2177. Owner: George H. Buck Jr. Labels: GHB, Jazzology.
Jerden, 2227 Fifth Ave., Seattle, Wash. 98121. Tel.: (206) MA 2-0470. Pres. & Gen. Mgr.: Jerry B. Dennon. (distributed by ABC).
Jerhart (see Hawk Prod'ns).
Jerico Road (see Bandera).

Jesse Mason Prod'ns, 6119 Potrero, El Cerrito, Calif. 94530. Tel.: (415) 235-6037. Pres.: J. W. Mason. Labels: Pam, Patricia, Pen.
Jester (see Major Mgmt.).
Jet (see Bi-Ru).
Jet Set, 519 Davis Bldg., Washington, D. C. 20006. Tel.: (202) 483-4575. Cable: JETSET. Pres.: Dimitri Villard; Exec. VP.: Caspar Davis.
Jetstar (see Abnak Music Ents.).
Jewel, P. O. Box 1832, 728 Texas, Shreveport, La. 71102. Tel.: (318) 422-7182. Pres.: Stan Lewis. Labels: Jewel, Paula, Whit.
Int'l representatives: Aden (Pye), Australia (Festival), Belgium (Show), Canada (Phonodisc), Denmark (Morks), Eire (Pye), Finland (Morks), Great Britain (Pye), Holland (Show), Jamaica (West Indies), Japan (King), Kenya (Pye), Luxembourg (Show), Malaysia (Festival), Malta (Pye), New Guinea (Festival), New Zealand (Festival), Nigeria (Pye), Norway (Morks), Philippines (Festival), South Africa (Pye), Singapore (Festival), Sweden (Morks), Switzerland (Turica-phon).
Jimbo (see Sound City).
Jin, P. O. Box 506, Villa Platte, La. 70586. Tel.: (318) 363-2138. Labels: Jin, Swallow.
Jingle (see Centaur).
Joanie, 8720 Georgia Ave., Silver Spring, Md. Tel.: (301) 589-6700. Pres.: Timothy M. O'Brien.
Jocida (see Joda).
Joda, 1733 Broadway, New York, N. Y. 10019. Tel.: (212) CI 7-3727. Pres.: Johnny Nash; VP: Danny D. Sims Jr. Labels: Jocida, Joda, Jomada.
Jody (see B-Atlas).
Jody (see Vantage).
John J. Sullivan Theatrical Ents., 80 Boylston St., Boston, Mass. 02116. Tel.: (617) HA 6-6617. Pres.: John J. Sullivan. Label: Jolar.
Johnson, 1619 Broadway, New York, N. Y. 10019. Tel.: (212) 757-2696. Prod'n Mgr. & A&R: Joey Duke; Sales Mgr.: Gil Miller; Pub. & Promo. Dir.: Jim McCarthy.
Joker (see Atco).
Jolar (see John J. Sullivan Ents.).
Jomada (see Joda).
Joni, 1122 Bardstown, Louisville, Ky. 40204. Tel.: (502) 587-0909. Pres.: Gene Snyder. Branch: Lexington, Ky., 251 Stone Ave. VP: Jerry Taylor.
Jo-Park, 100 Park Pl., Newark, N. J. 07102. Tel.: (201) MA 2-8453. Pres.: Joseph Schulman. Label: Yussels.
Jor-Dan (see General American, Philadelphia, Pa.).
Jordan (see Lantam).
Jorel, 6453 N. Sayre Ave., Chicago, Ill. 60631. Tel.: (312) 763-7328. Pres.: Earl L. Hensley.
Josie (see Jay-Gee).
Jotis (see Atco).
Jowar, 189-05 Jamaica Ave., Jamaica, N. Y. 11423. Tel.: (212) 479-3454. Pres.: J. Cosentino.
Jox (see Epstein Ents.).
Jubilee (see Jay-Gee).
Julia (see Celtic Rec'g Prod'ns).
Junior (see Kae Williams Music).

K

K M (see Klime).
K R, c/o Koppelman Rubin, 7650 Broadway, New York, N. Y. 10019. Tel.: (212) 765-2682. Pres.: Mr. Koppelman; VP: Don Rubin.
K-Town (see Soul Bros. Ents.).
Kae Williams Music, 3214 W. York St., Philadelphia, Pa. 19132. Tel.: (215) BA 3-0766 & CH 7-9376. Pres.: Kae Williams. Labels: Junior, Kaiser.
Kaiser (see Kae Williams Music).
Kalo, Rt. 3, Box 389, Kutztown, Pa. Tel.: (215) 683-3325. Owner: Robert Schwayer.
Kam, P. O. Box 15366, Orlando, Fla. 32802. Tel.: (305) CY 3-2560. Pres.: Robert P. Angel Sr.
Kama Sutra, 1650 Broadway, New York, N. Y. 10019. Tel.: (212) 765-3320. Pres.: Hy Mizrahi, Arthur Ripp & Phil Steinberg. (distributed by MGM).
Kammy (see Rollo-Marsh-Kammy).
Kangaroo, 302 E. Dewey Ave., San Gabriel, Calif. 91776. Tel.: (213) 288-5435. Owner: Les Kangas.
Kansoma (see Chartbuster).
Kanwic, 445 N. Oliver, Wichita, Kan. 67208. Tel.: (316) MU 2-7481. Pres.: Raymond Creely.
Kapla (see Recordland).



Kapp, 136 E. 57 St., New York, N. Y. 10022. Tel.: (212) PL 9-8500. Cable: KAPPRECORD. Pres.: David Kapp; Exec. VP.: Michael Kapp; VP Sales: Sidney Schaffer; A&R Dir.: Hy Grill; Int'l Sales Mgr.: Stanley Marshall.
Labels: Congress, Four Corners, Kapp.
Int'l representatives: Argentina (Sicamericana), Australia (Australian Rec.), Brazil (Rozenblit), Canada (Phonodisc), Colombia (Orbe), Costa Rica (Indica), Denmark (Morks), England (Decca House), France (Vogue), Germany (Vogue), Holland (Negram), Hong Kong (Colonial Trading), Italy (Fonit-Cetra), Jamaica (Federal), Japan (Toshiba), Mexico (Velftro), New Zealand (Australian Record), Norway (Arne Bendiksen), Philippines (Mareco), Puerto Rico (Antonio Contreras), Singapore (Hup Hup), South Africa (Gallo), Spain (Vergara), Sweden (Rueter & Rueter, Knappupp), Venezuela (Fonograma), Virgin Islands (Conrad). (SEE ADVERTISEMENT)

Karate (see Audio Fidelity).

Kardo, Bruce, Fla. 32455. Tel.: (904) 835-2916. Gen. Mgr.: Phil Carter.

Karen (see Atco).

Kash, B14 19 Ave. S., Nashville, Tenn. 37203. Pres.: J. F. Harrell.
Labels: Kash, Kippo.

Kasin (see Met Richmond Latin Rec. Sales).

Kasko (see Showboat).

Kathy, 1500 Creedmore Ave., Pittsburgh, Pa. 15226. Tel.: (412) 531-7290. Owner: James Grimes.

Kaybank, 2541 Nicollet, Minneapolis, Minn. Tel.: (612) TA 7-5441. Contact: Vern Bank.

Kay Bar Dane, 204 Cypress, Orange, Tex. Tel.: (713) TU 6-9795. Pres. & Mgr.: W. L. Thompson.

Kaye (see CLW).

Keane, 4416 Beverly Blvd., Los Angeles, Calif. 90004. Tel.: (213) 665-5257. Owner: Jane Keane.

Keepsake (see Sound, New Haven, Mich.).

Keetch (see Atlantic).

Kellmac (see One-Derful).

Kelmar, 1054 E. 71 St., Cleveland, Ohio 44103. Tel.: (216) 391-4518. Pres.: Joel Kischel.

Keltone Int'l, 7819 Noble Ave., Van Nuys, Calif. Tel.: (213) 787-0242. A&R Dir.: Fred Bonamico.

Kent (see Crown).

Kenwood (see Roulette).

Kernel, c/o Boyd Bennett, 3327 Furman Blvd., Louisville, Ky.

Kerry, 9358 James Ave. S., Minneapolis, Minn. 55431.

Keyboard (see Band Box).

Kick (see Jamaka).

Kilgore, P. O. Box 641, 805 Butler St., Leesville, La. 71446. Tel.: (318) 239-3215. Pres.: John E. Kilgore.

King, 1540 Brewster Ave., Cincinnati, Ohio 45207. Tel.: (513) 751-2211. Pres.: Sydney Nathan; VP: Saul Halper; A&R: Louis Innis; Gen. Mgr.: Johnnie Miller; Pub. & Promo.: Mrs. Dorothy Halper; Int'l: Jack Pearl, 512 Madison Ave., New York, N. Y.
Branch: Dallas, Tex., 1632 Irving Blvd. Tel.: (214) RI 8-2756. Mgr.: Phil Archer.
Labels: Audio Lab, Bethlehem, Borda, DeLuxe, Dynatone, Tartar-American.
Int'l representatives: England (Pye), France (Polydor), Germany (Deutsche Grammophon), Mexico (Orfeon-Videovox), Sweden (Sonet).

Kingdom (see Alta).

Kinor (see Audio Fidelity).

Kip, 45 W. 39 St., New York, N. Y. 10018. Tel.: (212) BR 9-3482. Pres.: Lonnie Kaufman.
Labels: Kip, Pik.

Kippo (see Kash).

Kirby, P. O. Box 3093, Lafayette, La. 70501. Tel.: (318) 234-4067. Owner: Kirby A. Boudreaux.

Kiski, P. O. Box 116, North Apollo, Pa. Tel.: (412) GR 2-7171. Pres.: G. Robert Pugh.

Kismet, 227 E. 14 St., New York, N. Y. 10003. Tel.: (212) GR 7-2891. Pres.: A. D. Kornienko.

Kismet, Penn-Sheraton Hotel, Suite 394, Pittsburgh, Pa. 15219. Tel.: (412) 281-0527. Pres.: Stanley Ediss.

Kiss Kiss, 261 Cumberland St., Brooklyn, N. Y. 11205. Tel.: (212) UL 8-2943. Pres.: Eddy Jacobs.

Kitten (see Georden Prod'ns).

Klume, 64 E. Van Buren St., Chicago, Ill. 60605. Tel.: (312) WE 9-7188. Gen. Mgr.: Ruth Kling.
Labels: KM, Klume.

Knight Education, 2406 W. Seventh St., Los Angeles, Calif. 90057. Tel.: (213) 385-2293. Pres.: Mario Piraino.
Labels: Knight Education, Learn While You Sleep, Mind Power Education.

Kristal (see Kubaney).

Kubaney, P. O. Box 2067, Hialeah, Fla. Tel.: (305) 888-7411. Gen. Mgr.: Mateo San Martin.
Labels: Kubaney, Kristal.

L

L J (see Challenge).

L M J, 408 W. 57 St., New York, N. Y. 10019. Tel.: (212) JU 2-8850. Pres.: Lee Magid.
Branch: 5750 Melrose Ave., Hollywood, Calif. 90038. Tel.: (213) HO 3-2353.
Int'l representatives: England (Ember), New Zealand (Peak).

L & Q, 2019 Shepherd Dr., Houston, Tex. 77007. Tel.: (713) UN 4-9709.

L T D Int'l (see Monument).

LaBeat, 6072 14 St., Detroit, Mich. 48208. Tel.: (313) 897-0009. Pres.: Lou Beatty Sr.

La Comedie Francaise (see Everest).

Laguna, 1056 S. St. Andrews Pl., Los Angeles, Calif. 90019. Tel.: (213) RE 2-7449. Treas.: B. H. White.

Laitini, 955 S. Magnolia Ave., Los Angeles, Calif. 90006. Tel.: (213) 383-8779. Pres.: Marvin Liblick.
Labels: Laitini, Mastersound.

Lake-Terry, 220 E. 102 St., Suite 7-E, New York, N. Y. 10029. Pres.: Ernest Kelley.

Lakeview (see Cool Air Prod'ns).

La Louisianne, 2823 Johnston St., Lafayette, La. Tel.: (318) CE 4-4118. Pres.: Carol J. Rachou.

Landa (see Jamie/Guyden Dist. Corp.).

Landmark, 2640 S. Kildare Ave., Chicago, Ill. 60623. Tel.: (312) 521-9631. Mgr.: Mrs. Jean Shemberger.

Lane (see George Clements Prod'ns).

Lanier, P. O. Box 277, Commerce, Ga. 30529. Tel.: (404) 335-4586. Partners: H. Thomas, J. Gillespie & R. Lane.

Lanor, P. O. Box 233, 583 N. Louis St., Church Point, La. Tel.: (318) 684-2176. Pres.: Lee Lavergne.

Lantam, 821 N. Broad St., Philadelphia, Pa. 19123. Tel.: (215) CE 6-8408. Owners: Harry Finfer & Al Kelly.
Labels: Jordan, Lantam.

Laredo (see Bandera).

Lariat (see Hollywood Int'l Talents).

Larric, 70-13 Caldwell Ave., Maspeth, N. Y. 11378. Pres. & Promo.: Larry M. Palatta; VP: Rocco Riccardi.
Labels: Dual, Universe.

Lasalle, 5727 S. La Salle St., Chicago, Ill. 60621. Tel.: (312) NO 7-4151. Pres. & A&R: "Jump" Jackson; VP & A&R: Oscar Jackson.

Laurie, 35 W. 45 St., New York, N. Y. 10036. Tel.: (212) JU 2-2975. Pres.: Robert M. Schwartz; Exec. VP: Oscar Faura; VP A&R: Eliot Greenberg; VP Sales: Murry Singer; VP Admin.: Gene Schwartz; Int'l: Robert Schwartz.
Labels: Abel, Audicon, Calico, Goal, Laurie, Legrand, Rust, Providence.
Int'l representatives: Argentina (EMI), Australia (Festival), Denmark (Skandinavisk Grammophon), Eire (Gramophone), England (EMI), Finland (R. E. Westerlund), France (Vogue), Germany (Ariola, Eurodisc), Greece (Columbia), Holland (Bovema), India (Gramophone), Israel (Hatak-lit), Italy (Ri-Fi), Japan (Toshiba), Mexico (Gamma), New Zealand (HMV), Norway (Iversen & Frogh), Pakistan (Pakistan, Ltd.), Peru (EMI), Philippines (Mareco), Portugal (Valentim de Carvalho), South Africa (EMI), Southern Rhodesia (Electrical Radio & Musical Industries), Spain (Hispavox), Sweden (Skandinaviska Grammophon), Venezuela (El Palacio de la Musica).

LaVal, 821 Porter St., Kalamazoo, Mich. 49007. Tel.: (616) FI 2-1936. Pres.: Vic La Val.

Lavette, 1205 Madeira S. E., Suite 124, Albuquerque, N. M. 87108. Tel.: (505) 255-3978. Pres. & A&R: Lindy Blaskey; VP: Joey Blaschke; Classical A&R: Steve Maase; Sales Mgr.: Jim Franchini; Pub. Chm.: Rose Marie Walker; Adv. Chm.: Bill Scotten; Promo. Sec.: Ann Faught.
Labels: Lavette, Lindell.
Branches: Abilene, Tex., 2600 Ivanhoe, Suite 402, Tel.: (915) OW 2-5149.—Dallas, Tex., 5920 Chalef Ct., Suite 4109, Tel.: (214) EM 9-3854. Mgr.: Joey Blaschke.

Lawn (see Swan).

Learn While You Sleep (see Knight Education).

Lebam, 2661 Clyde Ave., Los Angeles, Calif. 90016. Tel.: (213) 935-7139. Gen. Mgr.: F. J. Wedlaw.

Lebby (see Cool Air Prod'ns).

Leda (see Met Richmond Latin Rec. Sales).

Lee (see Gateway Rec'gs).

Legend (see Silver Falcon).

Legrand (see SPQR).

Tom Lehrer, P. O. Box 121, Cambridge, Mass. 02138. Tel.: (617) 523-7970. Pres.: Tom Lehrer.

The Largest Latin Budget House in the Country

MET RICHMOND

Manufacturer and National Distributor

**Presenting
an outstanding
line-up
of labels:**

- Riney • Astro • Skipper •
- Filtro • Economy • Kassim •
- Pergasso • Prominent •
- Progresso • Prospect • Ex-
plover • Columbina • Danny
• Antilano • Revancha •
- Ponce • Sono Mex • BBM • Mona • Jardin •
- BRC • Baroneza • Somar • Asa • Reli •
- Carvier • Bocar • Eddissa • Alma • Norca •
- Odessa • Encanto • Amex • Tropical • Serenata
• Colonial • Rhumba • Iberia • Quicka • Leda
• Sun Set • Que Rio.

ALL
\$1.00
RETAIL

2,000 LP's
OF DIFFERENT
TITLES
IN STOCK
AT ALL TIMES

Spanish Tapes for
sale or lease. Attractive
deals for domestic
and foreign cartridge
manufacturers.

MET RICHMOND
LATIN RECORD SALES, INC.
David Last, President

2155 Utica Ave.,
Brooklyn, N. Y.
(212) RN 3-1212

continued

Le Jazz Cool, c/o Record & Tape Sales, B21 Broadway, New York, N. Y. 10003. Tel.: (212) OR 4-6400. Pres.: Robert Staub.

L'Elegant, 110 W. 47 St., Suite 600, New York, N. Y. 10036. Tel.: (212) JU 6-0909. Mgr.: Jess Wiseman.
Int'l representative: Switzerland (Johnny Simmen).

Le Mans, P. O. Box 262, Bound Brook, N. J. 08805. Tel.: (201) 356-5343. Pres.: James B. Kemper.
Label: Sadboy.

Lemco (see Atco).

LeMonde (see Atlantic).

Leo (see Gateway Rec'gs).

Leo the Lion (see MGM).

Lerks (see Cool Air Prod'ns).

Lesley, P. O. Box 24, 3007-C Dixie Hwy., Louisville, Ky. Tel.: (502) SP 5-6030. Pres.: F. I. Brodie.

Lexington, Pleasantville, N. Y. 10570. Tel.: (914) 769-6332. Pres.: Samuel P. Puner.

Liberty, 6920 Sunset Blvd., Los Angeles, Calif. 90028. Tel.: (213) 464-8101. Cable: LIBRECORD. Pres.: A. Bennett; Exec. VP: P. Skaff; VP, A&R & Promo.: B. Skaff; A&R Admin.: D. Pell; Mktg., Adv., Mdsq.: A. LaVinger; Pub.: N. Winter; Int'l: J. Thomas.
Labels: Liberty, Dolton, Imperial, Minit, World Pacific, Pacific Jazz, Sunset, Rheims, Blue Note.
Liberty Recs. Div. (Liberty, Dolton, Rheims): Mgr.: D. Blocker; Sales Mgr.: J. Bratel; Nat'l Promo: P. Pipolo; A&R: J. Saraceno, D. Smith, N. DeCaro.
Imperial Div. (Imperial, Minit): Mgr.: K. Revercomb; Sales Mgr.: R. Frio; Nat'l Promo.: J. Musso; A&R: M. Leib, S. Turner, P. Shields; Promo. & Minit Recs.: R. Roker.
World Pacific Div. (World Pacific, Pacific Jazz): Mgr.: D. Bock; Sales Mgr. & Promo.: B. Dain.
Sunset Div.: Mgr.: E. Barsky.

Blue Note Div. (Blue Note): Gen. Mgrs.: Alfred W. Lion & Francis Wolff; Sales Mgr.: Bernie Block.
Liberty Tape Div.: Mgr.: L. Mendell.
Int'l representatives: Argentina (Odeon, Trova), Australia (EMI, Festival), Austria (Columbia), Belgium (Gramophone), Brazil (RCA, Elenco), Canada (London), Denmark (Skandinavisk (Gram-

mophon), Eire (Gramophone), England (EMI, Philips), Finland (R. E. Westerlund), France (EMI Pathe-Marconi, Philips, Polydor Deutsche Grammophon), Germany (Electrola, Philips), Greece (Columbia), Holland (Bovema, Philips), Hong Kong (Colonial Trading, EMI), India (Gramophone), Italy (La Voce del Padrone), Japan (Toshiba, Cosdel, Victor), Mexico (Pan Americana, Gamma), New Zealand (HMV), Norway (Iversen & Frog), Pakistan (Gramophone), Peru (Distribuidora Peruana), Philippines (Dyna, Cosdel), Portugal (Valentim de Carvalho), Singapore (Chiang Huat), South Africa (EMI, Teal), Southern Rhodesia (ERMI), Spain (Odeon), Sweden (Skandinaviska Gramophon), Switzerland (EMI-Verkaufs), Turkey (American Nesriyatı Buros).

Library Editions (see Request).

Lifetime, 133 North St., Rochester, N. Y. 14604. Tel.: (716) 454-1269.

Lightnin, 6311 Gulf Freeway, Houston, Tex. 77023. Contact: E. L. Cole, Sam "Lightnin" Hopkins, Charles H. Wilson.

Like Young, P. O. Box 5305, 4610 Kester, Sherman Oaks, Calif. 91403. Tel.: (213) 784-0284. Pres.: N. Young.

Limelight, 35 E. Wacker Dr., Chicago, Ill. 60601. Tel.: (312) DE 2-5788. N. Y. C. Tel.: (212) PL 9-2727. Cable: Merrec. Pres.: Irving B. Green; Exec. VP: Irwin H. Steinberg; VP & Prod'n Mgr.: Kenny Myers; Int'l: Brice Somers.
Int'l representatives: Argentina (Phonogram), Australia (Philips), Austria (Polyphon), Belgium (Polygram), Bolivia (Philips), Brazil (Brasileira de Discos), Canada (London), Chile (Philips), Colombia (Philips), Costa Rica (Indica), Denmark (Nordisk), Ecuador (Philips), England (Philips), Finland (Fintone), France (Philips), Germany (Philips), Greece (Helladisc), Holland (Philips), Italy (Phonogram), Japan (Victor), Mexico (Dusa), New Zealand (Philips), Norway (Norsk Phonogram), Peru (El Virrey), Philippines (Home Industries), Portugal (Philips), Singapore (William Jacks), South Africa (Trutone), Spain (Fonogram), Sweden (Philips, Sonora), Switzerland (Philips), Uruguay (Philips), Venezuela (Siemens), West Indies (West Indies).

Lincoln Square (see Avant Garde).
Linda (see Faro).

Lindberg, 1445 Sunset Ridge Rd., Glenview, Ill. 60025. Tel.: (312) 729-2047. Pres.: Sven Lindberg.

Lindell (see Lavette).

LinJo, 427 W. San Antonio, El Paso, Tex. 79901. Tel.: (915) 532-1434. Contact: Lindy Cash.
Branch: Englewood, N. J., 260 Speer Ave. Tel.: (201) LO 7-2323. Contact: Joan Granger.
Listen & Learn (see Decca).

Literary (see Creative Rec. Serv.).

Little Chip (see Record Corp. of New England).

Little Darlin' (see Audio Fidelity).

Little Nashville, 1610 Poinsettia Rd., Charleston, S. C. 29407. Tel.: (803) 766-9701. Pres.: Roger Hopkins; VP: G. A. Hopkins; Dir. A&R: David Jobe; Sales Dir.: Don Strange; Pub. Dir.: Matt Moser; Promo. Dir.: Boyd Cobb; Dist. Mgr.: Frank Sutton.

Labels: Little Nashville, Look, Zion.

Live, P. O. Box 663, Waxahachie, Tex. 75165. Tel.: (214) WE 7-2248. Owners: L. W. Dollar & Wayland Woodall.

Living Language Courses (see The Franson Corp.).

Living Legend, 6000 Sunset Blvd., Hollywood, Calif. 90028. Tel.: (213) HO 4-0226. Pres.: Kim Fowley.

Living Library (see Fuller).

Living Rec. Library (see Stereodiddies).

Livingston Audio Prods., 1275 Bloomfield Ave., Fairfield, N. J. Tel.: (201) 226-8300. Pres.: Darrell D. Scholten.

Loadstone, 163 Orizaba Ave., San Francisco, Calif. 94132. Tel.: (415) 334-2247. Los Angeles Tel.: (213) HO 9-2987. Pres.: Walter C. Stone.
Labels: Loadstone, Open.

Lodestar, 11224 Ewing Circle, Minneapolis, Minn. 55431. Tel.: (612) 888-2011. Owner: C. B. Brown.

L'Oiseau Lyre (see London).

Loma (see Warner Bros.).

London, 539 W. 25 St., New York, N. Y. 10001. Tel.: (212) OR 5-6060. Pres.: D. M. Toller-Bond; Admin.: Martin J. Wargo; Pop A&R: Walt Maguire; Classical A&R: Terry McEwen; Sales: Herb Goldfarb. Int'l: Mimi Trepel.
Labels: Argo, Coliseum, Das Altwerke, Hi, L'Oiseau Lyre, Palomar, Parrot, Press, phase 4, Richmond, Societe Francaise du Son, Telefunken, Tribe.

ON TOP SINCE 1894 IN CIRCULATION IN REPUTATION IN PENETRATION

No other music-trade publication gives its advertisers the global exposure, strength of editorial backing and proof of circulation claims that Billboard offers.

The nearly 70 years of international respect for Billboard's quality of journalism, scientific methods of research and high standards of business practice provide advertisers with an unmatched setting of prestige for their message.

With a world-wide circulation twice that of any other music-trade publication, only Billboard offers advertisers incontrovertible proof of circulation figures by opening its files twice every year for audit by the rigid and exacting Audit Bureau of Circulations (ABC).

Their reports detail for every Billboard advertiser just where his message goes throughout the world . . . who receives it . . . and how many receive it.

Basic Information That Every Advertiser Should Not Only Expect—But Demand!

Do You?

New York • Hollywood • Chicago • Washington
Nashville • London • Buenos Aires • Rio de Janeiro

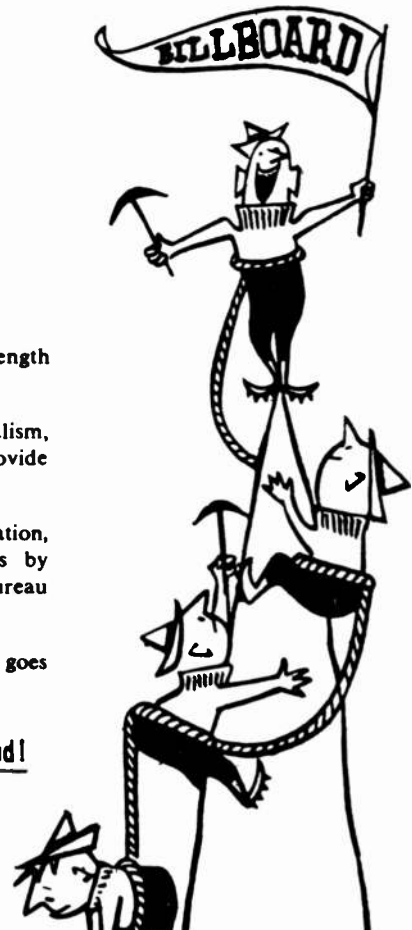

Int'l representatives: Canada (London), All others (Decca).
Longhorn, P. O. Box 17014, Dallas, Tex. 75217. Tel.: (214) AT 5-8734. Owner: Dewey Groom. Look (see Little Nashville).
Look & Listen (see Ambassador, Newark, N. J.).
Loop, 930 "F" St. N. W., Washington, D. C. 20004. Tel.: (202) 347-3944. Pres.: Lillian Claiborne. Labels: DC, Loop.
Lorelei, c/o Consolidated One-Stop, 13254 Linwood Ave., Detroit, Mich. Contacts: Tom Mutter & Joseph H. Zack.
Lorraine (see McKinnon).
Lost-Nite (see Atlantic).
Lotassco, 1634 Wakefield Dr., Houston, Tex. 77018. Tel.: (713) OV 6-1155. Contact: "Ike" Eickenhorst. Labels: Lotassco, Casual.
Loud (see Horizon).
Loyal, 5112 Scenic View Dr., Birmingham, Ala. 35210. Tel.: (205) 595-9602. Pres.: Walter Bailes.
Lucky 11 (see Cameo-Parkway).
Lucky Sounds 7 & 13 (see Shaab Prod'ns).
Luffcin (see Goldband).
Lu Green, 304 Los Reyes Dr., San Diego, Calif. 92114. Tel.: (714) 264-6070. Pres.: Tony Lujan; VP: Lawrence L. Green.
Lummtone, P. O. Box 11121, Los Angeles, Calif. 90011. Tel.: (213) RE 4-4459. Pres.: Lummie J. Fowler.
LuPine (see Atlantic).
Lutone, P. O. Box 1645, Ardmore, Okla. 73401. Tel.: (405) CA 3-1400. Pres. & Gen. Mgr.: Luton Stinson.
Lytic, P. O. Box 147, Lake Charles, La. Tel.: (318) NE 6-6727. Owner: George Khoury.
Lyrichord, 141 Perry St., New York, N. Y. 10014. Tel.: (212) WA 9-8234. Pres.: Peter Fritsch. Labels: Eterna, Experiences Anonymes, Lyrichord.

M

M F R (see Met Richmond Latin Rec. Sales).
M G M, 1540 Broadway, New York, N. Y. 10036. Tel.: (212) JU 2-2000. Cable: METROCORD. Pres.: Mort L. Nasatir; Admin. Dir.: Thomas F. White; Pop A&R: Tom Wilson; Jazz A&R: Creed Taylor; Classical A&R: Jerry Schoenbaum; Sales & Mktg.: Sol Greenberg; Pub.: Sol Handwerker; Adv.: Jack Maher; Promo: Frank Mancini; Int'l Dir.: Eric Steinmetz. Labels: DGG, Heliodor, Kama Sutra, Leo the Lion, MGM, Metro, VSP, Verve, Verve/Folkways.
Branches: Los Angeles, Calif., 2053 Venice Blvd. Tel.: (213) 733-2114.—Chicago, Ill., 1112 S. Wabash. Tel.: (312) 341-0660. Contact: Morrie Price.
Int'l representatives: Argentina (Philips), Australia (EMI), Austria (Polyphon), Belgium (Polydor), Brazil (Brasileira de Discos), Canada (Quality), Chile (Philips), Colombia (Philips), Costa Rica (Indica), Denmark (Skandinavisk Grammophon), Eire (Gramophone), England (EMI), France (Polydor), Germany (DGG), Greece (Columbia Graphophone, Music Box), Holland (Polydor), Hong Kong (EMI), India (Gramophone), Israel (Hed-Arzi), Italy (CGD), Jamaica (West Indies), Japan (Nippon Grammophon), Mexico (Dusa), New Zealand (HMV), Norway (Iversen & Frogg), Panama (Tropelco), Peru (El Virrey), Philippines (Mareco), Poland (Ars Polona), Puerto Rico (Juan Martinez Vela), Singapore (Borneo), South Africa (EMI), Spain (Fonogram), Sweden (Skandinaviska Grammophon), Switzerland (Siemens), Turkey (Grammophon), Venezuela (Siemens), Yugoslavia (Jugoton).
M I C (see Music Inds.).
M K (see Connoisseur).
M M C (see CBC Ents.).
M M O (see Music Minus One).
M R M, 156 W. Chanslor St., Richmond, Calif. Tel.: (415) 235-8109. Pres.: Dell Randle; Mgr.: Charles Franklin. Labels: Ba-By Luv, MoSound, Mustang, Shikari.
M S L (see Jamie/Guyden Dist. Corp.).
M T A, 26 W. 58 St., New York, N. Y. 10019. Tel.: (212) PL 3-5710. VP: Bob Thompson; Gen. Mgr.: Bob Mack.
M & W (see Mid-South Rec. Prod'rs).
Mace (see Scepter).
Maceo II (see TPG).
MacGregor, 729 S. Western Ave., Los Angeles, Calif. 90005. Tel.: (213) 384-4191. Owner: C. P. MacGregor; Prod'r & Dir.: R. W. McKenzie; Sales: K. M. Murray & William Stronich; Promo.: Tak Mukai.
Maestro, 5235 Cleveland, Skokee, Ill. Tel.: (312) OR 3-8632. Owner: Larry Taylor.

Magnificent, 2534 W. Pico Blvd., Los Angeles, Calif. 90006. Tel.: (213) DU 7-3276. Mgr.: Clete Moore. Labels: Magnificent, Moore.
Mainstream (see Time).
Major (see Thomas J. Valentino).
Major Mgmt., 9713 Santa Monica Blvd., Beverly Hills, Calif. 90210. Tel.: (213) 276-1018. Cable: PACSAMUSIC. Pres.: Irving Mills; Gen. Mgr.: Robert Mills. Labels: Carlo, Jester, Monte, Verdi.
Mala (see Amy-Mala-Bell).
Maloh, P. O. Box 19, Rugby Sta., Brooklyn, N. Y. 11203. Tel.: (212) NE 4-7031.
Mama, 13817 Benwoor Rd., Cleveland, Ohio. Tel.: (216) 751-4259. Pres.: Isaac Perry; VP A&R: Ike Perry; Pub.: Alfred Perry; Sales Mgr.: Eddie Banks.
Manchester (see Charbuster).
Manhattan (see Dover, New Orleans).
Map (see Music Ind.).
Maravilla (see Stereo Fi Corp. of Calif.).
Mardi Gras (see Roulette).
Margie (see McKinnon).
Margo (see Adaire).
Maria, P. O. Box 3770, Grand Central Sta., New York, N. Y. 10017. Tel.: (212) TR 2-3399. Contact: John Clark.
Marina, 870 N. Wabash Ave., Chicago, Ill. 60611. Tel.: (312) 337-2550. Pres.: Fred L. Jarm Jr.; A&R: E. "Dutch" Wenzlaff; Sec. & Dir.: James H. Nash.
Marion (see McKinnon).
Marjon, 93D Woodview Pl., Sharon, Pa. 16146. Tel.: (412) 347-4726. Owner, Sales & Mktg.: J. T. Krizancic; Pub. & Adv.: Martha Krizancic.
Mark, P. O. Box 17811, E. Atlanta Sta., Atlanta, Ga. 30316. Tel.: (404) 241-2744. Pres.: Jerry Ford.
Mark X (see Antiqua Prod'ns).
Markie (see USA).
Marlin, 557 Sharon Dr., Memphis, Tenn. Tel.: (901) 323-1519. Pres.: Marlin Grisham.
Marlo, 117 Elliott Pl., East Orange, N. J. Tel.: (201) 673-6519. Agent & Bus. Mgr.: Floyd Ketchum.
Marsh (see Rollo-Marsh-Kammy).
Marvel, 852 Elm St., Manchester, N. H. 03101. Tel.: (603) 623-9749. Cable: W&G. Pres. & Int'l: James N. Parks; Sales: Sam Goldner.
Mar-V-Lus (see One-Derful Prod'ns).
Mary (see Folkways).
Jesse Mason Prod'ns (see Listing under J).
Master Prod'ns, 832 Leona Ave., Columbus, Ohio 43201. Tel.: (214) 299-6150. Pres.: Vernon Stewart.
Masterseal (see Record Corp. of New England).
Mastersound (see Laitini).
Masters Releasing, 959 Main St., Buffalo, N. Y. 14203. Tel.: (716) 882-0427. Pres.: Steve Brodie. Branch: New York, N. Y., 330 W. 58 St. Tel.: (212) JU 6-6326. Labels: Pow, Sahara, Thunderbird. (SEE ADVERTISEMENT)
Maxwell-56, 2639 Chapline, Wheeling, W. Va. 26003. Tel.: (304) 233-1723. Pres.: Don Teachout.
Maxx (see Amy-Mala-Bell).
Mayhams Collegiate, P. O. Box 46, Morningside Sta., 12 W. 117 St., New York, N. Y. 10026. Tel.: (212) EN 9-3390. Pres. & Gen. Mgr.: N. B. Mayhams Sr.
McDowell, 828 S. Lawrence St., Montgomery, Ala. 36105. Tel.: (205) 265-3882.
McKinnon, 411 Gordon St., Reading, Pa. 19601. Tel.: (215) 376-0300. Pres., A&R, Adv.: Leonard McKinnon; Gen. Mgr., Sales & Mktg.: Beulah F. Coad. Labels: Beulah, Center City, Gordon Street, Hit Kingdom, Holy Cross, Lorraine, Margie, Marion, McKinnon, Path, Reading, Slide. Int'l representative: Canada (Allied).
Meadowbrook (see Ernst Prod'ns).
Media (see Music Inds.).
Melbourne, 852 Elm St., Manchester, N. H. Tel.: (603) 623-9749. Pres.: R. J. Gillespie; A&R: Jack Varney; Sales: George Taylor; VP Int'l: J. N. Parks.
Melody, 1912 St. Clair St., Hamilton, Ohio 45011. Tel.: (513) 895-0607. Pres.: William M. Jones. Labels: Melody, Sunrise.
Mel-O-Juke, P. O. Box 808, 1929 16 Ave. N., Meridian, Miss.
Mel-Par Prod'ns (see Mel-Tone).
Mel-Par Recs. (see Mel-Tone).
Melron, 5007 F St., Philadelphia, Pa. 19124. Tel.: (215) JE 3-8799. Pres.: Len Stark.
Mel-Tone, 2226-2228 Millburn Ave., Maplewood, N. J. 07040. Tel.: (201) 763-6866. Cable: MTC-Co. Pres.: M. Parker; A&R: E. Lucas; Sales & Promo. Dir.: B. Rytko. Branch: New York, N. Y., 520 Fifth Ave. Zip:

make the year-long reference value of the "buyer's guide" readily AVAILABLE TO EVERY MEMBER OF YOUR FIRM...

*Order extra copies NOW
Just \$1.25 per copy (prepaid)*

Billboard Buyers Guide
2160 Patterson St.
Cincinnati, Ohio 45214

Please send ... copies of Buyers Guide.
My payment for \$ is enclosed.

Name

Company

Address

City

Zone

State



YOUR DISCRIMINATING CUSTOMERS WANT

spoken arts
"LIBRARY OF LIVING LITERATURE"

Be sure your SPECIALIZED AUDIENCE finds these in your shop—Poetry ... Drama ... Shakespeare ... Children's Stories and Poems ... Belles Lettres ... Essays ... Speeches ... Foreign recordings ... Send for complete catalog and sales policy today:

spoken arts, inc.
Peter Redgrove, Sales Manager
59 Locust Ave., New Rochelle, NY 10801
Telephone (914) NE 6-5482

continued

10036. Tel.: (212) MU 2-5844.
Labels: Mel-Tone, Mel-Par Prod'ns, Mel-Par Recs.
- Me-O, 4427 S. Western Ave., Los Angeles, Calif. 90062. Tel.: (213) 235-2489. Pres.: C. M. Taylor.
- Mer-Bri, 1616 Walnut St., Philadelphia, Pa.
- Mercury, 35 E. Wacker Dr., Chicago, Ill. 60601. Tel.: (312) DE 2-5788. N. Y. C. Tel.: (212) PL 9-2727. Cable: Merrec. Pres.: Irving B. Green; Exec. VP: Irwin H. Steinberg; VP & Prod'n Mgr.: Kenny Myers; Int'l: Brice Somers.
Labels: Mercury, Mercury Wing, Fontana, Lime-light, Philips, Smash.
Int'l representatives: Argentina (Phonogram), Australia (Philips), Austria (Polyphon), Belgium (Polygram), Bolivia (Philips), Brazil (Brasileira de Discos), Canada (London), Chile (Philips), Colombia (Philips), Costa Rica (Indica), Denmark (Nordisk Polyphon), Ecuador (Industria Fonografica), England (Helladic), Finland (Fintone), France (Philips), Germany (Philips), Holland (Philips), Israel (Hed-Arzi), Italy (Phonogram), Jamaica (Records), Japan (Victor), Mexico (Dusa), New Zealand (Philips), Norway (Norsk Phonogram), Peru (El Virrey), Philippines (Home Industries), Portugal (Philips), Singapore (William Jacks), South Africa (Trutone), Spain (Fonogram), Sweden (Philips, Sonora), Switzerland (Philips), Uruguay (Philips), Venezuela (Siemens), West Indies (West Indies).
- Mercury Wing (see Mercury).
- Merlene, 2310 N. Mockingbird Ln., Abilene, Tex. 79603. Pres.: Melvin Mazy.
- Merri (see Creative Rec. Serv.).
- Merritt, 550 Radnor Rd., Oakland, Calif. 94606. Tel.: (415) 451-7787. Pres. & A&R: Tom Gericke.
- Mersey (see Process).
- Met Richmond Latin Rec. Sales, 723 E. 81 St., Brooklyn, N. Y. Tel.: (212) RN 3-1212. Pres.: David Last.
Labels: (owned) ASA, Alma, BBM, BRC, Baroneza, Bocar, Carvier, Eddissa, Jardin, Mona, Norca, Reli, Somar; (distributed) Amex, Antilano, Astro, Colonial, Columbina, Danny, Economy, Encanto, Explorer, Filtro, Iberia, Kassin, Leda, Odessa, Pergasso, Ponce, Progresso, Prominent, Prospect, Que Rio, Quicka, Revancha, Rhumba, Serenata, Skipper, Sono Mex, Sunset, Tropical. (SEE ADVERTISEMENT)
- Metro (see MGM).
- Metro, 1441 Broadway, Ann Arbor, Mich. Tel.: (313) 868-1744. Pres.: Rubin Brooks.
- Metro-Beat, P. O. Box 4447, Minneapolis, Minn. 55421. Tel.: (612) 788-9122. Pres.: Michael Jann.
- Metronome, 117 W. 48 St., New York, N. Y. 10036. Tel.: (212) JU 2-2934. Mgr.: Mrs. Brigitta Peschko.
Int'l firms represented: Metronome (Denmark, Germany, Sweden).
- Miami, 2819 N. W. Seventh Ave., Miami, Fla. 33127. Tel.: (305) NE 5-7925. Pres.: Carlos Diaz-Granados.
Branch: New York, N. Y., 157 W. 14 St. Tel.: (212) 989-3177. (SEE ADVERTISEMENT)
- Midnight, 46-23 Crane St., Long Island City, N. Y. 11101. Tel.: (212) EX 2-6442. Pres.: Robert Borchardt.
- Mid-South, P. O. Box 11522, E. Memphis Sta., Memphis, Tenn. 38111. Tel.: (901) 324-4640. Pres. & Pub.: Jim Morgan; VP Pop A&R & Adv.: Style Wooten; Classical A&R: Howard Chandler; Sales & Mktg.: Ted Walker; Promo.: Dennis Turnipseed.
Labels: M&W, Mid-South.
- Miere-View Prod'ns (see Nalasta).
- Mikalim (see Spectra).
- Fred Miles Presents (see listing under F).
- Milky Way, RR 1, Box 61, W. Ross Ln., Danville, Ill. 61835. Tel.: (217) 446-7280. Pres.: Arlyn Miller.
- Millie (see Pike).
- Minaret, 1808 West End Bldg., Penthouse, Nashville, Tenn. Tel.: (615) 244-1145. Pres.: Finley B. Duncan. (distributed by Atco).
- Mind Power Education (see Knight Education).
- Minit (see Liberty).
- Mira, 9028 Sunset Blvd., Los Angeles, Calif. 90069. Tel.: (213) 278-1125. Pres.: Randall Wood; Gen. Mgr.: Robert Demain.
Labels: Mira, Mirwood, Surrey.
- Miranda, 105 York St., Lexington, Ky. Tel.: (606) 254-1294. Pres.: H. I. Miranda.
- Miro (see Monitor).
- Mirrosonic, 502 E. 84 St., New York, N. Y. 10028. Tel.: (212) RE 7-2592. Pres.: Kenneth L. Mapes.
- Mirwood (see Mira).
- Mr. Genius (see Impala-Delsey).
- Mobile Fidelity, P. O. Box 336, Burbank, Calif. 91503. Tel.: (213) 848-5367. Pres.: Brad S. Miller.
Branch: San Francisco, Calif., 665 Harrison St. Zip: 94107. Tel.: (415) 781-6306.
- Modern (see Crown).
- Mohawk, 41 W. 86 St., New York, N. Y. 10024. Tel.: (212) TR 3-4237. Mgr.: Irving Spice.
- Mona (see Met Richmond Latin Rec. Sales).
- Money, 6232 Lyndridge Ave., Columbus, Ga. 31904. Tel.: (404) FA 3-0515.
- Monitor, 156 Fifth Ave., New York, N. Y. 10010. Tel.: (212) YU 9-2323. Cable: MONRECOIN. Pres. & A&R: Michael Stillman; Sales Mgr.: Rose N. Rubin.
Labels: Monitor, Miro.
Int'l representatives: Australia (Carinia), Belgium (Schott Freres), England (Phonodisc), Germany (Electrola), Holland (Munnikendam Groothandel), Italy (CGD).
- Monogram, 1650 Broadway, New York, N. Y. 10019. Tel.: (212) CI 7-8177. Pres.: Frances Warner.
- Monte (see Major Mgmt.).
- Montel, P. O. Box 2306, Baton Rouge, La. Tel.: (504) 342-8220. Pres.: Sam Montel. (distributed by Jamie/Guyden Corp.).
- Monticana, 4 W. 31 St., Suite 824, New York, N. Y. 10001. Tel.: (212) LA 4-7800, Ext. 824. Pres.: Dave Leonard.
Int'l Branch: Canada, 2955 Fendall St., Montreal 26, Que. Tel.: (514) 739-8935 & 737-9200.
- Montilla (see Spanish World).
- Monument, 530 W. Main St., Hendersonville, Tenn. 37075. Tel.: (615) 824-6565. Cable: Monuworld. Pres. & A&R: Fred Foster; VP & Gen. Mgr.: Jack Kirby; VP Promo.: Chuck Chellman; Mktg. Dir.: Bob Summer; Int'l Dir.: Robert B. Weiss, 9000 Sunset Blvd., Hollywood, Calif. 90069. Tel.: (213) 273-8855.
Labels: LTD Int'l, Monument, Sound Stage 7.
Branch: Hollywood, Calif., 9000 Sunset Blvd. Zip: 90069. Tel.: (213) CR 3-8855. Int'l Dir.: Bob Weiss.
Int'l representatives: Australia (EMI), Belgium (Fonio), Canada (London), Denmark (Nordisk Polyphon), France (Societe Francaise du Son), Germany (Teldec), Holland (Decca), Italy (Decca), Japan (King), Malaysia (Decca), New Zealand (HMV), South Africa (Gallo), Sweden (Telefunken), Switzerland (Musikvertrieb).
- Monumental, 2203 Maryland Ave., Baltimore, Md. 21218. Tel.: (301) BE 5-8689. Pres.: John Ahern; A&R: Joey Welz.
- Moonglow, 6359 Selma Ave., Hollywood, Calif. 90028. Tel.: (213) 469-3525. Pres.: Ray Maxwell (distributed by Atco).
- Moore (see Magnificent).
- Mor-Sun Prod'ns, 2009-11 W. 69 St., Chicago, Ill. 60636. Tel.: (312) 434-8605. Pres.: Sunny Sawyer.
Labels: Betty, New Breed.
- MoSound (see MRM).
- Mosrite, 1424 "P" St., Bakersfield, Calif. (SEE ADVERTISEMENT)
- Motivation (div. of Argosy Music), 631 Orienta Ave., Mamaroneck, N. Y. Pres.: Hy Zaref.
- Motown, 2648 W. Grand Blvd., Detroit, Mich. 48208. Tel.: (313) 871-3340. Pres.: Berry Gordy Jr.; VP: Barney Ales; A&R Dir.: William Stevenson; Mktg. Dir.: Philip Jones; Singles Sales Dir.: Al Klein; Album & Tape Sales Dir.: Ron Newman; Promo. Dir.: Larry Maxwell; Int'l: Barney Ales.
Labels: Gordy, Motown, Soul, Tamla, VIP.
Branches: Los Angeles, Calif., 6290 Sunset Blvd., Suite 804. Tel.: (213) 462-6814—New York, N. Y., 200 W. 57 St., Suite 1204. Tel.: (212) 246-0081—Dallas, Tex., 10457 Sandra Lynn Dr. Tel.: (214) 279-7068.
Int'l representatives: Argentina (Prodisa), Belgium (Artone), Canada (Phonodisc), Germany (CBS), Holland (Artone), Italy (RCA), Mexico (RCA), Spain (RCA), United Kingdom (EMI).
- Movierecord, 845 Third Ave., New York, N. Y. 10022. Tel.: (212) PL 1-6233.
Int'l representative: Spain (Sonoplay).
- Movietone (see 20th Century-Fox).
- M-Pac (see One-Derful Prod'ns).
- Murbo, 136 W. 52 St., New York, N. Y. 10019. Tel.: (212) CI 7-5500. Pres.: Mrs. B. Bourne.
- Murco, P. O. Box 105, 1842 Line Ave., Shreveport, La. Tel.: (318) 422-7376. Gen. Mgr.: Dick Martin.
Labels: Delco, Murco.
- Music City, 1866 Alcatraz Ave., Berkeley, Calif. 94703. Tel.: (415) OL 8-5344. Pres.: Ray Dobar.
- Music Guild (see Westminster).
- Music Inds., 821 19 Ave. S., Nashville, Tenn. 37203. Tel.: (615) 242-6451. Pres.: William T. Connor.
Labels: Frame, MIC, Map, Media, Racer.
- Music Library, Rt. 1, Box 545, Lakeport, Calif. 95453. Tel.: (707) 263-6029. Contact: Emile Ernest Bloch & Mrs. Vivian Faustine.
- Music Makers Network of America, 306 S. 16 St., Wilmington, N. C. 28401. Tel.: (919) 763-1007. Exec. Dir.: Samuel M. Kahn; Nat'l & Int'l Rep.: LaRain Mattocks; Exec. Prod'r: John Lewis Janco.
Labels: Danco, Elvitrue, Walton.
- Music Minus One, 43 W. 61 St., New York, N. Y. 10023. Tel.: (212) CI 5-4861. Pres.: Irv Kratka; Gen. Mgr.: James Gardner.
Labels: Classic Editions, Music Minus One.
- Music Record's Hi-Fi, P. O. Box 33393, Los Angeles, Calif. 90033. Tel.: (213) 269-2285.
- Music Research, P. O. Box 1803, Annapolis, Md. 21401. Tel.: (301) 267-5894. Pres.: Thomas B. Hoskins; Exec. VP: Mahlon K. Lea; Pop A&R: Leland M. Talbot III.
- Music Sales Corp., 33 W. 60 St., New York, N. Y. 10023. Tel.: (212) CI 6-0325. Cable: Amsonmus. Pres. & A&R: Herbert H. Wise; VP Sales & Mktg.: Robert Wise; VP Adv.: Mark Shulman.
Label: Contact.
- Music World (see Antiqua Prod'ns).
- Musica Sacra, c/o Record & Tape Sales, 821 Broadway, New York, N. Y. 10003. Tel.: (212) OR 4-6400. Pres.: Robert Staub.
- Musical Heritage Society, 1991 Broadway, New York, N. Y. 10023. Tel.: (212) TR 3-6130. Pres.: M. Naida.
- Musicland USA (see Amy-Mala-Bell).
- Musicode (see Space, Chriesman, Tex.).
- Muscor (div. of Talmadge Prod'ns), 240 W. 55 St., New York, N. Y. Tel.: (212) LT 1-4680. Cable: ARTALMADGE. Pres.: Arthur Talmadge; VP: Chris Spinosa; VP A&R (C&W): H. W. Dailey; Sales & Mktg.: Danny Fortunato; Prod'n: Bob Acerbo.
Int'l representatives: England (EMI), Italy (CGD), Venezuela (Palacio del Musica), All other (CBS).
- Mustang (see Stereo-Fi Corp. of Calif.).
- Mustang, Richmond, Calif. (see MRM).
- Mutual, 1800 N. Highland, Hollywood, Calif. 90028.

N

- Nada, RFD 1, Box 44, Lutesville, Mo.
- Nalasta, P. O. Box 1036, South Shore, Alameda, Calif. Tel.: (415) 532-7811. Pres.: W. F. Schmeltzer Jr.
- Nasco (see Nashboro).
- Nashboro, 177 Third Ave. N., Nashville, Tenn. 37203. Tel.: (615) 242-2215. Pres. & A&R: Ernest L. Young.
Labels: Excello, Nasco, Nashboro.
Nashville (see Starday).
- National, 2871 E. Ponce De Leon Ave., Decatur, Ga. 30030. Tel.: (404) 378-2379. Contact: Wendell I. Parker.
- Nebraska (see Artists Life).
- Nelber Prod'ns, 119 W. 57 St., New York, N. Y. Tel.: (212) 245-1080. Pres.: Nell Sonenberg.
- Nett, 1003 Thomas Ave., Monroe, La. 71201. Tel.: (318) 322-2291. Pres.: Mrs. Bill Nettles.
- New Breed (see Mor-Sun Prod'ns).
- New Jazz (see Prestige).
- New Voice (see Genius).
Labels: Bullfrog, Piedmont, Silverleaf, Takoma.
- Newman (see Era).
- Night Owl (see Cuca).
- Nina, 614 Eighth Ave., New York, N. Y. 10018. Tel.: (212) OX 5-7696. Pres. & Gen. Mgr.: George Valavanis; A&R, Sales & Promo.: Jim Plaven.
Int'l Branch: Greece, 2 Agiou Constantinou St., Athens 101. Tel.: 531-658. VP & Dir.: Peter Nicolaou.
Labels: Nina, Olympic. (SEE ADVERTISEMENT)
- Nola (see Dover, New Orleans).
- Nonesuch (see Elektra).
- Norala (see North Alabama Rec'g Corp.).
- Norca (see Met Richmond Latin Rec. Sales).
- Norco (see Rio Grande Music).
- Norman, 1902 Washington Ave., St. Louis, Mo. 63103. Tel.: (314) MA 1-0470. Pres.: Norman Wienstroer (distributed by Atlantic).
- North Alabama Rec'g Corp., 102 E. Second St., Sheffield, Ala. 35660. Tel.: (205) 383-2673. Pres.: Quinon R. Ivy; VP: Marlin Greene.
Labels: Quinvy, Norala.

North-American, 5114 S. Blackstone Ave., Chicago, Ill. 60615. Tel.: (312) BU 8-4686. Owner & Prod'r: George A. Tasker.

North Lake Prod'ns, Otter Lake, Mich. 48464. Tel.: (313) SW 5-5917. Pres.: Rudolph J. Koteles; Gen. Mgr.: W. Michael Williams; PR Dir.: Janette Eden; Adv. Mgr.: Randolph Curtice.

Noveline (see Carlson Int'l Prod'g Corp.).
Nowl (see Carlson Int'l Prod'g Corp.).

Nugget, P. O. Box 400, Goodlettsville, Tenn. Tel.: (615) 859-5268.
Labels: Clark, Nugget.

Nu-Mex Sound, 101 Amherst Dr. N.E., Albuquerque, N. M. 87106. Contact: Clark J. Smith.
Labels: Nu-Mex, QQ.



Oakridge, 2001 Elton Rd., Ft. Worth, Tex. 76117. Tel.: (817) TE 8-6608. Pres. & A&R: Homer Lee Sewell.
Labels: (owned) Oakridge; (distributed) E-MC, EeZee.

Ocampo, 1741 Market St., Oakland, Calif. Tel.: (415) 444-9830. Pres.: Doubose Stevenson.

Ocampo, 735 General McMullen Dr., San Antonio, Tex. 78228. Tel.: (512) GE 3-1461. Pres.: Bill Evans.
Branch: Oakland, Calif., 1741 Market St.

Oceanic, 7406 S.W. Fulton Park Blvd., Portland, Ore. 97219. Tel.: (503) 246-6728. Pres.: V. C. Jack Gilbert.

Ocono, P. O. Box 4131, Birmingham, Ala. 35206. Tel.: (205) 833-5982. Rep.: Ralph H. Compton.

Odeon (see Capitol Imports).
Offbeat (see Orpheum Prod'ns).
Ohn-J, 2011 Joliet St., Plainview, Tex. Tel.: (806) CA 4-5435. Owner: John Sands.

Okeh (see Epic).
Old Timey (see Arhoolie).
Old Town, 1697 Broadway, New York, N. Y. 10019. Tel.: (212) CI 7-2436. Pres.: Hy Weiss.

Oleander, 120 W. 45 St., New York, N. Y. 10036. Tel.: (212) JU 2-4200. Pres.: Al Donahue & Frank Walsh.

Oliver (see ABC).
Olympic (see Nina).
Olympus, c/o Record & Tape Sales, 821 Broadway, New York, N. Y. 10003. Tel.: (212) OR 4-6400. Pres.: Robert Staub.

Omen (see A&M).
One-Derful Prod'ns, 1829 S. Michigan Ave., Chicago, Ill. 60616. Tel.: (312) 225-0583. Pres.: George W. Leaner; Sales & Promo. Mgr.: Mac McKinney; PR Dir.: Anne duConge.
Labels: Halo, Kellmac, Mar-V-Lus, M-Pac, One-Derful, Toddlin Town.

Open (see Loadstone).
Orfeon (see Falcon).
Original Sound, 7120 Sunset Blvd., Hollywood, Calif. 90046. Tel.: (213) 466-6255. Pres., A&R & Int'l: Art Laboe; Sales: Fausta Ezratty.
Labels: Original Sound, Starla.
Int'l representatives: Africa (Teal), Argentina (Fermata), Brazil (Fermata), Canada (Phonodisc), Japan (Victor), Mexico (Gamma), Spain (His-pavox).

Orpheum Prod'ns, 235 W. 46 St., New York, N. Y. 10036. Tel.: (212) 765-1330. Pres.: Jack F. Doran.
Labels: Battle, Jazzland, Offbeat, Popside, Riverside, Washington, Wonderland.

Oxford (see Tioga).



P R C (see Canary).
Pacific Challenger, 1111 Garvey Blvd., El Monte, Calif. 91733. Tel.: (213) 442-6250. Owner: C. E. Whittington.

Pacific Coast, P. O. Box 38631, Hollywood, Calif. 90038. Tel.: (213) 985-2884. Owner: Raymon Sanders.

Pacific Jazz (see Liberty).
Page, 345 Second St., Conemaugh, Pa. Tel.: (814) 539-8117. Owner: Al Page.

Palette, 250 W. 57 St., New York, N. Y. 10019. Tel.: (212) JU 6-3087.

Palmer, 13401 Lyndon, Detroit, Mich. 48227. Tel.: (313) BR 3-7000.

Paloma (see Budget Sound).
Palomar (see London).
Pam (see Jesse Mason Prod'ns).

Panart Int'l, P. O. Box 423, North Miami, Fla. Tel.: (305) 751-4126.

Panda (see Connoisseur).
Parade (see Premier Albums).
Paragon Prod'ns, 1265 Broadway, New York, N. Y. 10001.
Labels: Ronnie, Record Makers.

Paramount, 1314 S. Howard St., Philadelphia, Pa. 19147. Tel.: (215) DE 6-7001. Pres.: Samuel D. Hodge.
Labels: Paramount, Hodge.

Parasonic, P. O. Box 412, Huntsville, Ala. 35804. Tel.: (205) 828-4863. Gen. Mgr.: Melvin S. Draper.

Park Avenue, 1788 S. La Cienega Blvd., Los Angeles, Calif. 90035. Tel.: (213) 870-6818. Pres.: Pete P. Gram.
Labels: Bing, Garex.

Parkway (see Cameo-Parkway).
Parliament (see Connoisseur).
Parnaso, 275 S. Second St., Brooklyn 11211. Tel.: (212) 387-1200, 5139. Pres.: Roger Lopez.
Labels: Astro, Campe, Parnaso.

Int'l representatives: Mexico (Parnaso), Puerto Rico (Allied Whsle.), Venezuela (Favedica).
Parlophone (see Capitol Imports).
Parrot (see London).

Parthenon, 815 16 Ave. S., Nashville, Tenn. 37203. Tel.: (615) 255-6535. Pres.: Benny Joy.

Path (sub. of McKinnon), 6244 Ogontz Ave., Philadelphia, Pa. 19141. Tel.: (215) 548-8960. Pres. & A&R: Leonard McKinnon; VP: Thomas Shepard; Gen. Mgr.: Martha Wooten; Sales, Mktg., Pub. & Promo. handled by McKinnon.

Pathé (see Capitol Imports).
Pathway, Wayne, Mich. (see Happy Hearts).
Pathway, 508 Maus St., Ypsilanti, Mich. Tel.: (313) 482-7317. Pres.: Marvin T. Ellis.

Pathways of Sound, 102 Mt. Auburn St., Cambridge, Mass. 02138. Tel.: (617) EL 4-6190. Pres.: Joe Berk.
Labels: Credo, Pathways of Sound.

Patmak, 320 W. 55 St., New York, N. Y. 10019. Tel.: (212) 581-9251. Pres.: Edwin D. McMullen.

Patricia (see Jesse Mason Prod'ns).
Patty (see Holton).
Paula (see Jewel).
Payle (see CherokeeLand).

Peace (see Texas Sound Studios).
Peacock, 2809 Erastus St., Houston, Tex. 77026. Tel.: (713) OR 3-2611, 1225. Cable: PeaDuke. Pres.: Don D. Robey; A&R: Joseph W. Scott, Gilbert G. Caple, Wilmer Shakesnider; Sales Rep.: Dave Clark; Sales & Promo.: Marion Frazier & Don Sapp.
Labels: Peacock, Backbeat, Songbird.
Int'l representatives: Australia (CBS), Austria

(CBS), Benelux (Vogue), British Isles (Vocalion), Canada (London), France (Vogue), Germany (CBS), Mexico (Gamma), New Zealand (Viking), Philippines (Mareco), Portugal (His-pavox), Spain (His-pavox).

Penn (see .esse Mason Prod'ns).
Pennant (see Rem).

Pentagon, 447 N. 60 St., Philadelphia, Pa. 19151. Tel.: (215) GR 4-3388. Pres.: Joseph S. Stevenson. (see Del-Val).

Peoria, 6311 Yucca St., Hollywood, Calif. 90028. Tel.: (213) HO 4-0344. Pres.: Dean L. Hall.
Perico (see Spanish World).
Period (see Everest).

Periscope, 39 Hollingsworth St., Mattapan (Boston), Mass. 02126. Tel.: (617) 298-0574. Cable: Peri-Rec. Pres. Sales & Mktg., Pub.: Edward M. Hurvitz; Adv. & Promo. Mgr.: Linda S. Berman.
Labels: Periscope, Revolution, Stroke.

Peter Pan (see Ambassador, Newark, N. J.).
Pharaoh, P. O. Box 969, McAllen, Tex. Tel.: (512) MU 6-3791. Pres.: James Nicholls.
Phase 4 (see London).
Phi-Dan (see Philips).

Philips, 35 E. Wacker Dr., Chicago, Ill. 60601. Tel.: (312) DE 2-5788. N. Y. C. Tel.: (212) PL 9-2727. Cable: Philrec. Pres.: Irving B. Green; Exec. VP: Irwin H. Steinberg; Prod'n Mgr.: Lou Simon; Int'l: Brice Somers.

Int'l representatives: Argentina (Phonogram), Australia (Philips), Austria (Polyphon), Belgium (Polygram), Bolivia (Philips), Brazil (Brasileira de Discos), Canada (London), Chile (Philips), Colombia (Philips), Costa Rica (Indica), Denmark (Nordisk Polyphon), Ecuador (Philips), England (Philips), Finland (Music Frazier), France (Philips), Germany (Philips), Greece (Helladisc), Holland (Philips), Italy (Phonogram), Japan (Victor), Mexico (Dusa), New Zealand (Philips), Norway (Norsk Phonogram), Peru (El Virrey), Philippines (Home Industries), Portugal (Philips), Singapore (William Jacks), South Africa (Tru-tone), Spain (Fonogram), Sweden (Philips, Sonora), Switzerland (Philips), Uruguay (Philips), Venezuela (Siemens), West Indies (West Indies).

Philips (France), c/o Record & Tape Sales, 821 Broadway, New York, N. Y. 10003. Tel.: (212) OR 4-6400. Pres.: Robert Staub.

The Big Sound of Arthur Lyman on HI-FI Records

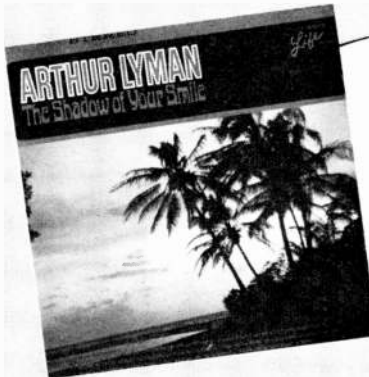

Latest Release

**"THE SHADOW
OF YOUR SMILE"**

1033 (M); SL 1033 (ST)

And Other Lyman Best Sellers

TABOO	mono 806	stereo SR 806	YELLOW BIRD	mono 1004	stereo SL 1004
HAWAIIAN SUNSET	807	SR 807	BEST OF LYMAN	1030	SL 1030
TABOO #2	822	SR 822	LYMAN '66	1031	SL 1031

We Invite Inquiries Regarding International Distribution

HI-FI RECORDS

A Division of the Everest Record Group

10920 Wilshire Blvd., LA 90024

213; BR 2-4391

continued

- Philles, 9130 Sunset Blvd., Los Angeles, Calif. 90069. Tel.: (213) 273-B661. Pres.: Phil Spector; VP & Promo. Dir.: Danny Davis; Sales Mgr.: Robert D. Kirstein.
Labels: Emerald, Phi-Dan, Philles.
Int'l distributor: London Records, New York, N. Y.
- S C Phillips Int'l (see Sun).
- Philtown Prod'ns, P. O. Box 14355, Philadelphia, Pa. 19116. Tel.: (215) OR 7-1534. VP Promo. & Prod'n: David S. Chackler. (distributed by Amy-Mala-Bell).
- Phoebe James Rhythm, P. O. Box 286, Verdugo City, Calif. 91046. Tel.: (213) 248-5472. Owner: Phoebe James.
- Phoenix, P. O. Box 643, Hollywood, Calif. 90028. Tel.: (213) NO 3-3417. Owner: Anne Upton.
- Piccolo (see Aardvark).
- Pickwick City (see Pickwick Int'l).
- Pickwick Int'l, Pickwick Bldg., B-16 43 Ave., Long Island City, N. Y. 11101. N. Y. C. Tel.: (212) EM 1-BB11. Pres.: Cy Leslie; Exec. VP: Ira L. Moss.; VP Sales: Ralph Berson.
Branches: Los Angeles, Calif. & Atlanta, Ga. Labels: Allegro, Cricket, Design, Grand Prix, Happy Time, Hill Top, Instant Learning Series, Pickwick City, Pickwick/33, Round Sound.
Int'l representatives: Canada (Ajax), England (London).
- Pickwick/33 (see Pickwick Int'l).
- Pieces of Eight, 3263 Oakdell Rd., Studio City, Calif. Tel.: (213) PO 6-1525. Pres.: Linda Hughes; VP: Rebecca Adler; Promo.: Irwin Zucker.
- Piedmont (see Music Research).
- Pik (see Kip).
- Pike, P. O. Box 1536, Bakersfield, Calif. 93302. Tel.: (805) B71-2116. Pres.: Leon Hart; VP: W. W. Wilson.
Labels: Millie, Pike, Windsor.
- Pinnacle, 5358 S. Wells St., Chicago, Ill. 60609. Tel.: (312) WA 4-2974. Pres.: Franz Jackson.
- Pirouette (see Ambassador).
- Pitter-Pat (see Dover, New Orleans).
- Plainsmen (see The Texas Plainsmen).
- Platinum, 1688 Meridian Ave., Miami Beach, Fla. 33139. Tel.: (305) 532-5475. (SEE ADVERTISE-
MENT)
- Playette, 585 Ninth Ave., New York, N. Y. 10036. Tel.: (212) BR 9-5379. Pres.: Sidney A. Evans.
Label: GMS-Disc.
- Playhouse, P. O. Box 36061, Los Angeles, Calif. Tel.: (213) WE 4-1863.
Owners: Jim Copp & Ed Brown.
- Playmates (see Ambassador, Newark N. J.).
- Pleasant Peasant (see Artists Life).
- Pliant (see Vantage).
- Plymouth (see Record Corp. of New England).
- Poetry, 475 Fifth Ave., New York, N. Y. 10017. Tel.: (212) MU 3-3421. Dir.: David Ross Jr.
- Point (see Georden Prod'ns).
- Polaris, 1232 Cambridge St., Cambridge, Mass. 02139. Tel.: (617) 547-3780. VP: Joseph F. Mahoney.
- Polka Dot (see Cuca).
- Polka-Favorites (see Artists Life).
- Polka Towne, 23 Marian Ln., Jericho, L. I., N. Y. Tel.: (516) OV 1-7356. Contact: T. Kalinowski.
- Polkaland (see Artists Life).
- Polly, 4542 Live Oak, Mesquite, Tex. 75149. Tel.: (214) BR 9-0635. Pres.: J. A. Balthrop.
- Pollyvox, 369 15 St., Norwood, N. J. 07648.
- Polydor (see Deutsche Grammophon).
- Polydor (France), c/o Record & Tape Sales, B21 Broadway, New York, N. Y. 10003. Tel.: (212) OR 4-6400. Pres.: Robert Staub.
- Popside (see Orpheum Prod'ns).
- Port (see Jay-Gee).
- Pow (see Masters Releasing).
- Powell, 1146 St. Augustine Pl. N.E., Atlanta, Ga. 30306.
- Powerfree, 144 W. 57 St., New York, N. Y. Tel.: (212) CI 5-3759. Pres.: Curtis R. Lewis.
Labels: Essence, Janus, Powerfree, Vega.
- Praise (see Prism).
- Precise (see Dickerman Music Prod'ns).
- Prelude, 7280 Caverna Dr., Hollywood, Calif. 90028. Tel.: (213) HO 6-6129. Contact: H. B. Barnum.
Premier (see Premier Albums).
- Premier Albums, 1650 Broadway, New York, N. Y. 10019. Tel.: (212) JU 6-5253. Pres.: Philip Landwehr.
Labels: Baronet, Blue Ribbon, Coronet, Directional Sound, Parade, Premier, Spin-O-Rama, Twinkle.
- Press (see London).
- Presta, 29 E. Monterey Way, Phoenix, Ariz. 85012. Tel.: (602) 264-9364. Pres.: Earl V. Perrin.
- Prestige, 203 S. Washington Ave., Bergenfield, N. J. 07621. Tel.: (201) 384-6900. Pres.: Robert S. Weinstock; A&R Dir.: Don Schlitten; Pop A&R: Cal Lampley; Sales: Jerry Field & Joe Fields; Promo.: Jerry Field; Int'l: Alan Bates, 41 Ladbroke Grove, London W. 11, England.
Branch: Pasadena, Calif., Arnold Theis, 1718 N. Los Robles.
Labels: New Jazz, Prestige, Prestige Folklore.
Int'l representatives: Argentina (Microfon), Belgium (Discobel), Eire (EMI), France (Pathe-Marconi), Holland (Artone), Hong Kong (Cosdel), India (EMI), Israel (EMI), Italy (Durium), Japan (Cosdel), Luxembourg (Discobel), Mexico (Pan Americana), New Zealand (Peak), Nigeria (EMI), Pakistan (EMI), Philippines (Cosdel), Singapore (Cosdel), Spain (EMI), Switzerland (John Lay), United Kingdom (EMI).
- Prestige Folklore (see Prestige).
- Prism, 49 Heid Ave., Dayton, Ohio 45404. Tel.: (513) 233-6904. Gen. Mgr.: Floyd Whited.
Branch: Cincinnati, Ohio, 1403 First Nat'l Bank Bldg.
Labels: Praise, Prism.
- Process, 439 Wiley Ave., Franklin, Pa. 16323. Tel.: (814) 432-4633. Mgr. & A&R: Norman Kelly.
Labels: Country Star, Mersey, Process.
- Progressive Sounds of America, 6034 Atlantic Blvd., Maywood, Calif. 90270. Tel.: (213) 5B3-5921 & 589-3880.
Branches: Kansas City, Mo.; Nashville, Tenn.; Houston, Tex.
- Protone Records & Tapes, 2534 W. Pico Blvd., Los Angeles, Calif. 90006. Tel.: (213) DU 7-3276.
Labels: Cornuto, Protone, Recotape.
- Proverb/Gospel Corner, 532B S. Central Ave., Los Angeles, Calif. 90011. Tel.: (213) AD 19261. Pres.: S. C. Henderson.
- Providence (see Laurie).
- Pulse, 300 W. 55 St., New York, N. Y. 10019. Tel.: (212) CI 6-2910. Pres.: Don Ames.
Labels: Pulse, Westerly.
- B T Puppy (see Jay-Gee).
- Purple Cow (see Springboard).
- Q**
- Q Q (see Nu-Mex).
- Que Rio (see Met Richmond Latin Rec. Sales).
- Queen City Album, 7200 Colerain Ave., Cincinnati, Ohio 45239. Tel.: (513) 931-3232. Pres.: Edward R. Bosken.
- Queen Vee (see Spivey).
- Quicka (see Met Richmond Latin Rec. Sales).
- Quint, 1035 Quebec Terr., Suite 2, Silver Spring, Md. Tel.: (301) 439-1629. Pres.: Lester L. Friedman.
- Quinvy (see North Alabama Rec'g Corp.).
- R**
- R C A Camden (see RCA Victor).
- R C A Victor, 155 E. 24 St., New York, N. Y. 10010. Tel.: (212) MU 9-7200. Cable: RCAVIC-TOR. VP: George R. Marek; Classical A&R: Roger G. Hall; Pop A&R: S. H. Sholes; Mktg. VP: H. E. Jenkins; Int'l: Dario Soria.
Branch: Hollywood, Calif. Tel.: (213) 461-9171. Mgr. & Pop A&R: Neely Plumb.—Nashville, Tenn. Tel.: (615) 255-5781. Mgr.: Chet Atkins.
Labels: RCA Victor, Camden, Groove, Victrola.
Company represents: Discophon (Finland), International Rec'g (Trinidad, BWI), RCA (Brazil), RCA Victor (Argentina, Canada, Italy, Mexico).
Int'l representatives: Argentina (RCA Victor), Australia (RCA), Austria (Musica), Belgium (Inelco), Brazil (RCA), Canada (RCA Victor), Chile (Corporacion de Radio de Chile), Colombia (Sonolux), Denmark (Hede Nielsens), Ecuador (E. Maulme), El Salvador (Dicesa), England (Decca), Finland (Discophon), France (AREA), Germany (Teldec), Greece (Greek Phonograph Rec. House), Holland (Inelco), India (Gramophone), Israel (Eastronics), Italy (RCA), Jamaica (Federal Rec. Mfg.), Japan (Victor), Lebanon (G. Haddad), Mexico (RCA Victor), New Zealand (Radio Corp. of NZ), Norway (Nera), Peru (Fabricantes Tecnicos), Philippines (Filipinas Rec. Corp.), Portugal (Telectra), South Africa (Teal), Spain (RCA), Sweden (Electra), Switzerland (Musikvertrieb), Trinidad (International Rec'g), Turkey (Melodi), UAR (Sono Cairo), Uruguay (American Prods.), Venezuela (Antor).
- R C A Victrola (see RCA Victor).
- R C P, P. O. Box 525, Mendota, Calif. Tel.: (209) 655-4630. Pres.: Ray Camacho.
- R D Truetone, 1835 Mound St., Springfield, Ohio 45505. Tel.: (513) 325-1778. Owner: Richard D. Durrant.
- R I C, 806 16 Ave. S., Suite 212, Nashville, Tenn. Tel.: (615) 244-2670. Pres.: W. L. Vanadore.
- R M P, 600 Ridgewood Ave., Brooklyn, N. Y. 11208. Tel.: (212) MI 7-9745. Owner: Stephen Benjak.
- R M T (see Reach).
- R S V P, 1650 Broadway, New York, N. Y. Tel.: (212) JU 6-6707.
- Racer (see Music Inds.).
- Rae-Ann, 6640 Gardenia Ave., Long Beach, Calif. 90805. Tel.: (213) GA 2-4890. Owner: Sarah Ann Warner.
- Raglan (see Arhoolie).
- Rainbow, 5659 Heiskell St., Philadelphia, Pa. 19144. Tel.: (215) GE B-7605. Pres.: Phil Terry; A&R: Marty Lynn; Sales & Promo.: Joe Konowol.
Labels: Chase, Chelton, Rainbow.
- Raincoat, 1112 Lillian Way, Hollywood, Calif. 90038. Tel.: (213) HO 5-9646. Owner: Ellen Marty; Pub. & Adv.: Erwin Zucker & Steve Adler.
- Rainstar (see McDowell).
- Ralbar Prod'ns, 915 Queen St., Pottstown, Pa. 19464. Tel.: (215) 323-3336. Cable: RALBAR. Pres. & Exec. Prod'r: A. Alan Botto; Gen. Mgr.: Evadna Brosius; Mktg. Mgr.: William R. Glennon.
Rama (see Roulette).
- Ramble, Rt. 2, Box 2B, Leesville, S. C. Tel.: (803) 532-4174. Pres.: William R. Watkins Jr.
- Ramco (see ARA).
- Rampart (see Faro).
- Rane/Supreme/Detroit, 677 Newbury St., Springfield, Mass. 01104. Tel.: (413) RE 4-3376. Pres.: Mark Lee Woods.
- Rangel Music, 505 W. Commerce, San Antonio, Tex. 78205. Tel.: (512) CA 6-1923. Pres.: Manuel Rangel.
Labels: Corona, Rangel.
- Ranger, 5445 Hillier Dr., Clio, Mich. 48420. Tel.: (313) 686-0189. Contact: Forrest Green.
Labels: Ranger, FGS.
- Rapid (see Elco).
- Ra-Sel, 1426 Lombard St., Philadelphia, Pa. 19146. Tel.: (215) KI 5-8970. Pres.: Raymond F. Selden.
- Rave (see Artists Life).
- Razorback of Arkansas, P. O. Box 2205, Little Rock, Ark. Tel.: (501) MO 4-5163. Pres.: Bobby Crawford.
- Reach Prod'ns, 152B Overington St., Philadelphia, Pa. 19124. Tel.: (215) PI 3-0770. Pres.: Richie Moore.
Labels: RMT, Reach.
- Reading (see McKinnon).
- Realm Ent., 310 Madison Ave., Suite 1001, New York, N. Y. Tel.: (212) TN 7-2140. Pres.: Jackson Leichter.
- Rebel, P. O. Box 246, Mt. Rainier, Md.; 540B 20 Ave., Hyattsville, Md. Tel.: (301) 927-0010. Pres.: C. R. Freeland.
Int'l Branch: Canada, Box 32, Willowdale, Ont.
- Re-Car, 3121 Nicolett Ave. S., Minneapolis, Minn. 55408. Tel.: (612) TA 4-6484. Pres.: Russ Holland.
- Recital, 4640 E. Lewis, Phoenix, Ariz. 85008. Tel.: (602) 959-2076. Owner: L. John Twiford.
- Reco-Flex (see Vantage).
- Record Corp. of New England, 30 E. 42 St., New York, N. Y. 10017. Tel.: (212) 986-6031. Pres.: Donald H. Gabor.
Labels: Continental, Little Chip, Masterseal, Plymouth, Remington, Webster.

Record Guild of America, 15 Bond St., Great Neck, L. I., N. Y. Tel.: (516) HU 2-0900. Pres.: David Shichman.

Record Makers (see Paragon Prod'ns).

Recorded Treasures (The Welte Legacy), P. O. Box 1278, North Hollywood, Calif. Tel.: (213) PO 3-3173. Pres.: Walter S. Heebner.

Recordland, 13673 Wales Ave., Oak Park, Mich. 48237. Tel.: (313) 542-2338. Pres.: Edward Kaplan; VP: Seymour Kaplan; A&R: Edward Kaplan & Daniel Schwartz; Prod'n Mgr.: Daniel Schwartz; PR & Pub.: Hershel Freeman; Adv.: Al Nawrocki.
Labels: Kapla, Recordland.

Recotape (see Protone).

Red Bird, 1619 Broadway, New York, N. Y. 10019. Tel.: (212) LT 1-3420. Pres.: George Goldner.
Labels: Blue Cat, Red Bird.

Red Fox (see Skyway).

Redda (see Atco).

Redstart, 10229 N. 15 Dr., Phoenix, Ariz. 85021. Tel.: (602) 944-7862. Owner & Promo.: Hubert C. Stotts; Sales & Mktg. Mgr.: Jimmie Spellman; A&R, Pub. & Adv.: Steve Stephens.

Regal (see Capitol Imports).

Regent (see Savoy).

Release, 1000 Rogers, Florissant, Mo. 63033. Tel.: (314) TE 7-7108. Pres.: B. J. Bax.

Reli (see Met Richmond Latin Rec. Sales).

Rello, 202 Hirst Ave., East Lansdowne, Pa. 19050. Tel.: (215) MA 6-4442. Pres.: Steven Todarello.

Rem, 2003 Liberty Rd., Lexington, Ky. 40505. Tel.: (606) 254-7858. Pres., Sales & Mktg., & Promo.: Bob Mooney; A&R (C&W): James Durham; Pub.: Kelly Bach; Adv.: Jim Voisenet.
Branches: Phoenix, Ariz., 1531 W. Peoria. Zip: 85029. Tel.: (602) 254-4161. Mgr.: Herb Sims.—Nashville, Tenn., 801 17 Ave. S. Tel.: (615) 256-0638.
Labels: Rem, Pennant, Trophy.

Remington (see Record Corp. of New England).

Renaissance (see Everest).

Renfro, 4764 Dockweiler St., Los Angeles, Calif. 90019. Tel.: (213) WE 5-5587. Pres.: Anthony C. Renfro.

Reo Tahiti (see Tiare Tahiti).

Reon, P. O. Box 11585, Oklahoma City, Okla. 73111. Tel.: (405) GA 4-2203. Pres.: Dude Rawson.

Repeat, 5782 E. Second St., Long Beach, Calif. 90803. Tel.: (213) GE 9-7785. Gen. Mgr.: B. Steidley; A&R: John Berry.
Int'l representatives: Canada (Sparton), New Zealand & Pacific Islands Area (Salem).

Reprise, 4000 Warner Blvd., Burbank, Calif. 91505. Tel.: (213) HO 9-1251. N. Y. C. Tel.: (212) CI 6-1400. Gen. Mgr.: Mo Ostin; A&R: Jimmy Bowen (see Warner Bros.).
Int'l representatives: Aden (Bhicajee Cowasjee), Argentina (Sicamericana), Australia (Australian Rec.), Austria (Musica), Belgium (Vogue), Brazil (EMI), Burma (Gramophone), Cambodia (Gramophone), Canada (Compo), Ceylon (Gramophone), Chile (Goluboff), Colombia (Columbia de Discos), Costa Rica (Indica), Denmark (Hede Neilsens), Ecuador (Industria Fonografica), England (Pye), Finland (Sankoliikkeiden), France (Vogue), Germany (Teldec), Greece (Greek Phono), Holland (Negram), Hong Kong (Cosdel), India (Gramophone), Israel (Gal Ron), Italy (CGD), Japan (Cosdel), Malaysia (E. S. Isaac), Mexico (Gamma), New Zealand (La Gloria), Norway (Arne Bendiksen), Peru (EMI), Philippines (Cosdel), Portugal (Arnaldo Trindade), Puerto Rico (Juan Martinez Vela), South Africa (Teal), Spain (Hispanovox), Sweden (Telefunken), Switzerland (Musica), Turkey (Melodi), Venezuela (Favedica), West Indies (West Indies).

Republic (see ARA).

Request, 66 Mechanic St., New Rochelle, N. Y. Tel.: (914) NE 3-6055. Mgr.: H. J. Lengsfelder.
Labels: Request, Library Editions. (SEE ADVERTISEMENT)

Rev, 12044 Chandler Blvd., North Hollywood, Calif. 91607. Tel.: (213) PO 6-9164. Owners: Maj. W. V. Thrasher & John Phillips.

Revancha (see Met Richmond Latin Rec. Sales).

Revere (see Dickerman Music Prod'ns).

Revolution (see Periscope).

Rexford, 6223 Selma Ave., Hollywood, Calif. 90028. Tel.: (213) HO 2-6088. Pres.: Donald Kahn.

Rheims (see Liberty).

**THE
INTERNATIONAL
INFLUENCE
OF BILLBOARD
GROWS
AND
GROWS**

Johnny Mercer
•
Marshall Robbins

**COMMANDER
PUBLICATIONS**

1610 N. Argyle Ave.
Hollywood 28, Calif.
469-0878

make the year-long reference value of the "buyer's guide" readily AVAILABLE TO EVERY MEMBER OF YOUR FIRM...

*Order extra copies NOW
Just \$1.25 per copy (prepaid)*

Billboard Buyers Guide
2160 Patterson St.
Cincinnati, Ohio 45214

Please send ... copies of Buyers Guide.
My payment for \$... is enclosed.

Name

Company

Address

City

Zone

State

Fiesta

#1 in the International field in the United States and Canada

REPRESENTING THE LEADING
RECORD COMPANIES
THROUGHOUT THE WORLD

FIESTA RECORD CO., INC.
1619 BROADWAY, N.Y., N.Y. 10019
212 PL 7-7760-1

M I A M I

RECORDS

2819 N. W. 7th AVENUE
MIAMI, FLORIDA 33127

DISCOS COLUMBIA

DISCOS Fuentes

THE BEST IN
LATIN AMERICAN
MUSIC

merengue

Territories still available in some States
Tel. (305) NE 5-7925 Cable Address "MIAREC"

continued

S

Rhythms Prod'ns, P. O. Box 34485, Los Angeles, Calif. 90034. Tel.: (213) 836-4678. Pres.: R. S. White.
Label: Tom Thumb.

Riba, 101 Rockaway Ave., Valley Stream, N. Y. 11580. Tel.: (516) IV 3-7766. Pres.: Richard W. Babeuf.

Ric-Tic (see Golden World).

Rice, 1531 Demonbreun St., Nashville, Tenn. 37203. Tel.: (615) 242-2461. Dir.: Jimmy Key.

Rich, 925 N. Hudson, Oklahoma City, Okla. Tel.: (405) CE 9-9512. Pres.: Jack L. Rich.

Richie, P. O. Box 961, Wilmington, Del. Tel.: (302) WY 8-9679. Pres.: Vince Rago.

Richmond (see London).

Ringstar Record Ent., 7128 S. Bennett Ave., Chicago, Ill. 60749. Tel.: (312) 684-5312. Pres.: Rollin Allison.

Rio Grande Music, P. O. Box 861, San Benito, Tex. 78586. Tel.: (512) EX 9-1471. Owner: Paco Betancourt.
Labels: Ideal, Norco.

Riverside (see Orpheum Prod'ns).

Riviera (see USA).

Robbins, P. O. Box 411, San Fernando, Calif. 91340. Tel.: (213) DI 2-9109. Sales Rep.: Mark Raymer.
Branch: Mehama, Ore., P. O. Box 928

Robbins, 713 1B Ave. S., Nashville, Tenn. 37204. Tel.: (615) AL 4-5918. Mgr.: Marty Robbins.

Roben, 102 E. Fourth, Tompkinsville, Ky. 42167. Pres.: Benny Williams.

Robin Hood (see Crown).

Rocket, 1732 E. Fourth St., Brooklyn, N. Y. 11223. Tel.: (212) ES 5-8513. Pres.: Vic Stevens.

Rockin', 1733 Carmona Ave., Los Angeles, Calif. 90019. Tel.: (213) 933-6521. Pres.: Willie H. Roquemore; Promo.: Skip Lane.
Labels: Rockin', Rockmore (distributed by SER-Prod'ns).

Rocking Horse (see Ambassador, Newark, N. J.).

Rockmore (see Rockin').

Rollo-Marsh-Kammy, 9341 Olympic Blvd., Beverly Hills, Calif. 90212. Tel.: (213) 271-6345. Pres.: Al Kavelin; VP: Bobby Lile; A&R Dir.: Frank Kavelin.

Romco, 1000 Hazel Ave., Wichita, Kan. Tel.: (316) JA 4-4033. Pres.: Richard O. Miller.

Romulus (see SPQR).

Ron (see Shaab Prod'ns).

Ron-Jac, 166 W. Washington, Chicago, Ill. 60602. Tel.: (312) 782-3053. Pres.: Jack Barthel.

Ronik Rekords, 5814 Leslie Dr., Flint, Mich. 48504. Tel.: (313) 789-2559. Pres.: Johnny Nogaj.

Ronnie (see Paragon Prod'ns).

Roper, 43-48 48 St., Long Island City, N. Y. 11104. Tel.: (212) HA 6-1190. VP: Franc Peri. (SEE ADVERTISEMENT)

Rose (see World-Wide).

Rosemarf (see Atlantic).

Brian Ross Prod'ns (see API).

Rotate (see Amy-Mala-Bell).

Roulette, 1631 Broadway, New York, N. Y. 10019. Tel.: (213) PL 7-9880. Pres.: Morris Levy; A&R: Henry Glover; Sales Mgr.: Gerri Cousins; Pub. & Promo.: Red Schwartz.
Labels: Alegre, End, Gee, Gone, Kenwood, Mardi Gras, Rama, Roulette, Satin, Squire, Tico.
Int'l representatives: Africa (Trutone), Argentina (Sicamericana), Belgium (Discobel), Brazil (Cassia Muniz), Canada (Compo, Roulette), Colombia (Fuentes), Denmark (Dansk), Dominican Republic (Gonzarena), England (EMI), France (Vogue), Greece (Helladisc), Holland (Artone), Hong Kong (Cosdel), Israel (Hatakli), Japan (Cosdel), Mexico (Gamma), New Zealand (La Gloria), Peru (Distribuidora Peruana), Philippines (Cosdel), Puerto Rico (DND), Sweden (Scandisc), Switzerland (Finsterwald & Cantacuzene), Venezuela (Palacio de la Musica). (SEE ADVERTISEMENT)

Round Sound (see Pickwick Int'l).

Roy (see Brite-Star).

Royal Crest (see Empala).

Royce, 190 E. Main St., Oblong, Ill. 62449. Tel.: (618) 1313 (no direct dial). Mgr.: Keith Dorrough.
Labels: Atom, Royce.

Ruff (see Checkmate Prod'ns).

Russell, P. O. Box 3318, 1403 Callens Rd., Ventura, Calif. 93003. Tel.: (805) 642-3555. Pres.: Ted Russell.

Rust (see Laurie).

Rustique (see Band Box).

S O A (see World-Wide).
 Tel.: (404) 874-2781. Pres.: H. H. Brooks.

S P Q R, 177 Rt. 304, New City, N. Y. Contacts: Frank Guida, Tel.: (703) 853-4041 & Pearl Frank, Tel.: (914) NE 4-5101.
Labels: Romulus, SPQR, Legrand.

S T A, P. O. Box 11372, 227 Ida, Wichita, Kan. 67211. Tel.: (316) AM 7-3275. Pres.: M. H. Jewett.

Sable, 2224 Belvedere Dr., Jackson, Miss. Tel.: (601) 354-3062. Pres. & A&R (R&B): Johnny Angle; Sales & Promo. Dir.: James Farris.

Sacred KMOF, 1347 Selby Ave., St. Paul, Minn. 55104. Tel.: (612) 645-8271. Pres.: Fred Adam.

Sacred Prod'ns, PO Box 7654, Waco, Tex. 76711. Tel.: (817) PL 6-4101. Pres.: Jarrell McCracken.

Sadboy (see LeMans).

Safice (see Atlantic).

Sage, 5653 1/2 Hollywood Blvd., Hollywood, Calif. 90028. Tel.: (213) HO 9-1527. Pres.: W. O. Fleener.
Labels: Sage, Sand.

Sahara (see Masters Releasing).

St. Paul, Arts & Science Cir., 30 E. 10 St., St. Paul, Minn. 55101. Tel.: (612) 225-6571. Pres.: John R. Stoltze.

Salem (see Continental).

Samter, 522 Lafayette St., Gretna, La. Tel.: (504) 361-9168. Pres.: Samuel C. Territo.

Sand (see Sage).

Sandrea, 12528 Buckeye Rd., Cleveland, Ohio 44120. Tel.: (216) 921-1442. Pres.: Mrs. S. Egedy.

Sansu (see Amy-Mala-Bell).

Santa Cruz (see Copper State).

Santaville, P. O. Box 146, Sugarhouse Sta., Salt Lake City, Utah 84106. Contact: Leroy Lambert.
Labels: Beehive, Santaville.

Sara (see Cuca).

Sashay, 318 Summit St., Toledo, Ohio 43604. Tel.: (419) 248-2491. Mgr.: Robert F. Thomson; A&R Dir.: Jim Wise.

Satolite, 1013 Cliff St., North Braddock, Pa. 15104. Tel.: (412) 351-1487. Pres.: Elizabeth Ray.

Sattin (see Roulette).

Savoy, 56 Ferry St., Newark, N. J. Tel.: (201) MA 3-7470. Cable: SAVREG. Pres.: Herman Lubinsky; A&R & Sales: Fred Mendelsohn.
Labels: Gospel, Regent, Savoy, Sharp, World Wide.

Saxony, P. O. Box 1771, Cincinnati, Ohio 45201. Tel.: (513) 661-0660. Mgr.: Paul Trefzger; A&R: Bud Reneau; Adv.: Jerry Humbert.

Scala (see Everest).

Scarlet (see Stereo-Fi Corp. of Calif.).

Scepter, 254 W. 54 St., New York, N. Y. 10019. Tel.: (212) CI 5-2170. Cable: SCEPTERMUS. Pres.: Florence Greenberg; VP, Sales & Mktg.: Marvin Schlachter; Pop A&R: Tommy Kay; Classical A&R: Stanley Greenberg; Promo.: Pete Garris; Int'l: Joe Zerga.
Labels: Hob, Mace, Scepter, Wand.
Int'l representatives: Australia (Festival), Canada (Quality), Denmark (Tono), England (Pye), France (Vogue), Holland (Negram), Italy (CGD), New Zealand (Festival), South Africa (Troubadour), Trinidad (National Rec'g). (SEE ADVERTISEMENT)

Franz Schubert Music (see listing under "F").

Scorpio (see Fantasy).

Scott (see Gateway Rec'gs).

Scotte, 4834 Bissell Ave., Richmond, Calif. Tel.: (415) 233-7487. Owner: W. S. Newcomb.

S C Phillips Int'l (see Sun).

Scripture (see Ambassador, Newark, N. J.).

Sea-King (see Centaur).

Sea-Mist (see CBC Ent's.).

Seagrave (see Sound City).

Seagull (see Blue Horizon).

Security (see Holton).

Seeco, 39 W. 60 St., New York, N. Y. 10023. Tel.: (212) JU 6-3620. Cable: SEECODISC. Pres.: Sidney Siegel; A&R: Sidney Siegel, Howard Roseff, VP, Sales & Prod'n: Howard Roseff; Int'l: Raymond Irizarry.
Labels: Bronjo, Dawn, Exito, Seeco, Tropical.

Semaphore (see Vantage).

Senator, P. O. Box 861, Bakersfield, Calif. Tel.: (805) 832-3010. Pres.: Jack McFadden.

Ser-Prod'ns, 6365 Selma Ave., Hollywood, Calif.
Labels: Hondo, Tempe.

Seraphim, P. O. Box 5211, Chicago, Ill. 60680. Pres.: Dr. Francois D'Albert; VP: Emmett Steele.

Sets in Order, 462 Robertson Blvd., Los Angeles, Calif. 90048. Tel.: (213) OL 2-7434. Mgr.: Jay Orem.

Shaab Prod'ns, P. O. Box 14602, Baton Rouge, La. 70808. Tel.: (504) 342-8066 & 343-2963.
 Owner: Marlene Shaab.
Branch: Philadelphia, Pa., 7613 Seminole Ave., Melrose Park, Zip: 19126.
Labels: Lucky Sounds 7 & 13, Ron, Shakespeare Rec'g Society (see Caedmon).
 Sharp (see Savoy).
 Shawmut (see Casa Grande).
 Shikari (see MRM).
 Shirley (see Triad).

Shoestring, P. O. Box 4695, 3551 Bittersweet Rd., Richmond, Va. Tel.: (703) 272-4404. Pres.: Steve Richardson; Gen. Mgr.: Jim Gemmill.
 Shout (see Bang).

Showboat (div. of Santa Claus Kastle Ent's.), P. O. Box 45, Santa Claus, Ind. 47579. Tel.: (812) 529-2622. Pres. & Gen. Mgr.: Ray F. Scrivner.
Labels: Gospel Truth, Heed, Kasko, Skoop.

Shrine, 3 Thomas Circle N.W., Washington, D. C. 20005. Tel.: (202) 628-8870. Pres.: Ray Gordy; VPs: Eddie Singleton & Stanley Ossman.
 Siemens America (see Deutsche Grammophon).

Silver Burdett, Park Ave. & Columbia Rd., Morristown, N. J. 07960. Tel.: (201) 538-0400. Cable: SILDET. Pres.: Craig T. Senft; VP: Roger E. Egan; Adv. Dir.: Francis W. Goessling; Int'l: Erroll D. Michener.
Branches: Palo Alto, Calif., 435 Middlefield Rd. Zip: 94301. Tel.: (415) 327-4081. VP & Mgr. Pacific Div.: Thomas K. Moylan—Atlanta, Ga., 3272 Peachtree Rd. N.E. Zip: 30305. Tel.: (404) 237-0382. VP & Mgr. Southeastern Div.: G. Dan Robison Jr.—Park Ridge, Ill., 460 S. Northwest Hwy. Zip: 60068. Tel.: (312) 775-5787. VP & Mgr. Central Div.: Ronald J. Layde—Dallas, Tex., 4640 Harry Hines Blvd. Zip: 75235. Tel.: (214) 631-3044. Div. Sales Mgr.: G. Harris Holmes.

Silver Cross (see Stop).

Silver Falcon, P. O. Box 204, Minot, N. D. 58701. Cable: SIL FAL. Pres. & Prod'n Dir.: William B. Lewis; Promo. Dir.: Frank Halfacre.
Branch: Baltimore, Md., 4720 Pimlico Rd.
Labels: Gold Key, Legend, Silver Falcon, Soul A Rama.

Silverleaf (see Music Research).

Simon Says (see ABC).

Sims, P. O. Box 6277, 801 17 Ave., S., Nashville, Tenn. 37203. Tel.: (615) 256-0638. Pres.: Russell Sims.
Labels: Sims, Carol.

Singcord, Sta. C, Grand Rapids, Mich. Tel.: (616) GL 6-5406. Pres.: Bernie Zondervan Jr.
Labels: Crown V, Zondervan.

Sioux, P. O. Box 223, Cambridge, Mass. 02139. Tel.: (617) 235-0234. Prop.: Anthony Dejon. Int'l representative: Canada (Sparton).

Sir, 310 Madison Ave., Suite 1001, New York, N. Y. Tel.: (212) TN 7-2140. Pres.: Jackson Lighter.

Skill, 227 E. Sterling, Pasadena, Tex. 77502.
 Skipper (see Met Richmond Latin Rec. Sales).

Skokie, 5230 W. Howard St., Skokie, Ill. 60076. Tel.: (312) OR 5-4285. Pres.: Ed. Mravik.

Skoop (see Showboat).

Skyline (see Emdar).

Skyrocket, 1739 N. Third St., Philadelphia, Pa. 19122. Tel.: (215) CE 2-5729. Contact: Rex Zario.

Skyscraper (see Holton).

Skyview, 4850 Joaquin Way, Sacramento, Calif. 95822. Tel.: (916) 457-8497. Owner & Gen. Mgr.: Wesley Strawn.

Skyway, P. O. Box 133, Hollywood, Calif. 90028. Tel.: (213) HO 3-5885. Owner: Everett L. Whenham.
Labels: Red Fox, Skyway.

Slide (see McKinnon).

Smart Set (see Trend, Hollywood, Calif.).

Smash, 35 E. Wacker, Chicago, Ill. 60601. Tel.: (312) DE 2-5788. N. Y. C. Tel.: (212) PL 9-2727. Cable: Merrec. Exec. VP: Irwin H. Steinberg; VP: Charles Fach; Promo.: Lou Dennis; Int'l: Brice Somers.
Company represents: Fontana (Holland).
Int'l representatives: Argentina (Phonogram), Australia (Philips), Austria (Polyphon), Barbados (West Indies), Belgium (Polygram), Bolivia (Philips), Brazil (Brasileira de Discos), British West Indies (Records), Canada (London), Chile (Philips), Colombia (Philips), Costa Rica (Indica), Denmark (Nordisk Polyphon), Ecuador (Philips), England (Philips), Finland (Musik Frazer), France (Philips), Germany (Philips), Greece (Helladisc), Holland (Philips), India (Philips), Israel (Hed-Arzi), Italy (Phonogram), Japan (Victor), Mexico (Discos Universales), New Zealand (Philips), Norway (Norsk Phonogram), Peru (El Virrey), Philippines (Home industries), Portugal (Philips), Singapore (Wm.

Jacks), South Africa (Trutone), Spain (Fonogram), Sweden (Philips), Switzerland (Philips), Uruguay (Philips), Venezuela (Siemens).
 Smoke, 310 Chadwick Ave., Newark, N. J. 07112. Tel.: (201) 242-6868. Owner: Kay Thomas; Pres.: George Blackwell Jr.
 Labels: Smoke, Vision.
 So Deska, 177 Beach 141 St., Belle Harbor, L. I., N. Y. 11694. Tel.: (212) GR 4-2450. Owner: Dudley Manners.
 Societe Francaise du Son (see London).
 Society for Forgotten Music (see Contemporary).
 Soft (see Jamie/Guyden Dist. Corp.).
 Solid Gold (see Bi-Ru).
 Solo, 831 Taylor Blvd., Millbrae, Calif. 94030. Tel.: (415) 692-0117. Rec'g & Prod'n: Lou Dorren; Sales & Promo.: Don O'Leary.
 Branch: San Diego, Calif., 3902 Lomaland Dr. Zip: 92106. Sales & Promo.: John Holmes.
 Soma, 7600 Wayzata Blvd., Minneapolis, Minn. 55426. Tel.: (612) 544-4201. Pres.: Amos Heilicher; VP: Daniel Heilicher; A&R: Ira Heilicher; Sales & Mktg.: Anne Allan; Promo.: Larry Bakke.
 Labels: Soma, Stereodiddies.
 Somar (see Met Richmond Latin Rec. Sales).
 Sombrero Alto, 1506 W. Bronson St., Carlsbad, N. M. Tel.: (505) TU 5-6580. Pres.: George Brazeal Jr.
 Somed, 356 Main St., Medford, Mass. 02155. Tel.: (617) 395-3373. Pres.: Robert E. Mondello.
 Somerser (see Budget Sound).
 Sommers, P. O. Box 322, Silver Spring, Md. 20907. Tel.: (301) WH 6-9039. Contact: Henry J. Sommers.
 Sommers' Song Shop, 322 Washington St., Prophets-town, Ill. Tel.: (815) 537-4721. Owner: Walt Sommers.
 Sonat (see Hull).
 Song Bird (see Peacock).
 Songs of Faith (see Spar).
 Soul (see Motown).
 Soul A Rama (see Silver Falcon).
 Soul Bros. Ents., 3436 Selma Ave., Knoxville, Tenn. Tel.: (615) 523-903. Contacts: Gary Moore, Arthur Burke.
 Label: K-Town.
 Sound, 56880 North Ave., New Haven, Mich. 48048. Tel.: (313) 749-5182. Pres.: W. Howard Walker; VP: Romeo LeDuke; A&R Prod'rs: Johnny Powers & Stan Getz; Gen. Mgr.: Lary Lick; VP Pub.: George Silvernail.
 Labels: Cracked, Keepsake, Sound, Trash, Walker.
 Sound, 240 W. Wells St., Milwaukee, Wis., 53203. Tel.: (414) 276-6422. Pres.: Stuart L. Glassman.
 Sound City, 363 Sixth St., San Francisco, Calif. 94103. Tel.: (415) EX 2-7690. Owner: James Seagrave; Mgr.: Mickey Underdahl; PR: David McDaniel.
 Branch: Kew Gardens, N. Y., 83-34 Lefferts Blvd. Tel.: (212) VI 9-2652. PR: Dick Zabe.
 Labels: Drumfire, Jimbo, Seagrave, Sound City.
 Sound Preservers, 1110 Indian St., Bellingham, Wash. 98225. Tel.: (206) 734-5621. Owner: Allen P. Giles.
 Sound Stage 7 (see Monument).
 Sound-Tex (See Texas Sound Studios).
 Sound Track Ents., PO Box 12276, Ft. Worth, Tex. 76116. Tel.: (817) PE 2-1685. Pres.: W. F. Temple; Exec. VP: N. D. Moody.
 Labels: Chevell, Sound Track.
 Sound of Atlanta (see World-Wide).
 Sound of Money (see Vantage).
 Sound of Soul (see Atlantic).
 Sounds of Wisconsin (See Cucca).
 South Shore (see Georden Prod'ns).
 Southern City, 157 Ford Ave., Gallatin, Tenn: 37066. Tel.: (615) 452-1479, 3900. Pres.: Harold Gilbert; VP: Marcus Scott; A&R: Harold Gilbert & Chico Robinson; Sales & Mktg. Mgr.: Samuel West; Pub. Dir.: Yvonne Gilbert; Adv. Mgr.: Jean Gilbert; Promo. Mgr.: Jan West; PR: Ann Goodall.
 Branch: Detroit, Mich., 18890 Keystone. Tel.: (313) TW 3-3901.
 Labels: Gilbert, Hal n' Jean, Hitsburgh.
 Southern Sound (see Claridge).
 Sovereign, 1619 Broadway, New York, N. Y. 10019. Tel.: (212) CI 7-2904. Pres.: R. Fisher.
 Spa (Society of Participating Artists), 404 Broadway, Saratoga Springs, N. Y. Tel.: (518) 584-2222. Pres.: Norman M. Fox.
 Space (see World-Wide).
 Space, 2037 Alvarado Dr. N.E., Albuquerque, N. M. 87110. Tel.: (505) 268-8405. Pres. & Gen. Mgr.: Ann Faught.
 Space, Box 132-B, Chriesman, Tex. 77838. Tel.: (713) 535-7301. Pres. & A&R: Bennie Hess; Gen. Mgr.: D. L. Collins; Pub.: D. C. Lee; Adv.: Harold Sitton.

Branch: Houston, Tex., 1009 Janbar. VP: Bob Sloan.
 Labels: Musicode, Space.
 Spanish Music Center, Belvedere Hotel, 319 W. 48 St., New York, N. Y. 10036. Tel.: (212) JU 2-4280. Mgr.: Gabriel Oller.
 Label: Coda.
 Spanish World, 115 E. 23 St., New York, N. Y. 10010. Tel.: (212) GR 5-0001. Pres.: Alfredo Garcia; VP: Marcos Garcia; Sales VP: Jose Chao.
 Labels: Montilla, Perico.
 Int'l representatives: Argentina (RCA Victor) Colombia (Ajover); Costa Rica (Indica); Dominican Republic (Salon Mozart); Mexico (CBS), Peru (MAG); South Africa (Trutone) Uruguay (RCA Victor), Venezuela (Venevox).
 Spar, 48 & Tennessee, Nashville, Tenn. 37209. Tel.: (615) 291-7883. Owners: Bill Beasley & Alan Bubis.
 Labels: Gospel Time, Songs of Faith, Spar.
 Specialty, 8300 Santa Monica Blvd., Hollywood, Calif. 90069. Tel.: (213) 656-7711. Pres.: Arthur N. Rupe.
 Spectra, 912 Stemmons Tower East, Dallas, Tex. Pres.: Wm. H. Hollingsworth; Exec. VP Sales: James E. Hollingsworth; Music Dir.: Roger B. McGaw.
 Labels: Mikalin, Spectra, Toy.
 Sphere Sound (See Amy-Mala-Bell).
 Spicy (see Band Box).
 Spin-O-Rama (see Premier Albums).
 Spindletop, 1812 Procter St., Port Arthur, Tex. 77640. Tel.: (713) YU 2-7121. Owner: Floyd J. Badeaux.
 Spinnin Square (See Style Wooten Prod'ns).
 Spiral, 875 Fifth Ave., New York, N. Y. Tel.: (212) RE 7-3304. VP, Sales, Mktg., Pub. & Promo.: Sol Abrams.
 Branch: Palisade, N. J., 780 Palisade Ave. Tel.: (201) 945-1000.
 Spivey, 65 Grand Ave., Brooklyn, N. Y. 11205. Tel.: (212) UL 7-7003. Pres.: Victoria Spivey.
 Labels: Queen Vee, Spivey.
 Spoken Arts, 59 Locust Ave., New Rochelle, N. Y. 10801. Tel.: (914) 636-5482. Pres.: Arthur Luce Klein; Sales Mgr.: Peter Redgrove; PR Dir.: Natalie Slohm. (SEE ADVERTISEMENT)
 Spoken-Word, 10 E. 39 St., New York, N. Y. 10016. Tel.: (212) MU 3-1150. Pres.: George E. Probst.
 Springboard, 2318 Coles Blvd., Norristown, Pa. 19401. Tel.: (215) 275-7420. Pres.: George Yahraes.
 Labels: Purple Cow, Springboard.
 Squire (see Roulette).
 Stadium, P. O. Box 9411, North Hollywood, Calif. 91609. Tel.: (213) 335-5931. Pres.: A. J. Minto.
 Stallion, P. O. Box 2213, Birmingham, Ala. Pres.: Cecil Price & Gustave Rosemann III.
 Standard Phono, 163 W. 23 St., New York, N. Y. 10011. Tel.: (212) CH 2-0880. Pres.: Tetos Demetriades.
 Star (see Contemporary).
 Star Artist Prod'ns, 1157 Julia St., Teaneck, N. J. Tel.: (201) 833-2431. Pres.: Ed Daniels.
 Star Prod'ns, 398 Main St., Orange, N. J. Tel.: (201) 678-3456. Dir.: Bob May.
 Starburst, 673 Oakley Pl., Oradell, N. J. Tel.: (201) 261-0871. Contacts: M. Lynch & T. Lyle.
 Branch: New York, N. Y., 541 Hudson.
 Starday, P. O. Box 115, Madison, Tenn. Tel.: (615) 228-2575. Cable: Sisco. Pres.: Don Pierce; Exec. VP: Hal Neely; VP A&R (C&W): Tommy Hill; VP Mktg.: Jim Wilson; Sales: Tina Drake.
 Labels: Hollywood, Nashville, Starday.
 Int'l representatives: Australia (Festival, Decca, W&G), Austria (Ariola, Metronome), Benelux (C. N. Rood, Dureco, Decca), England (Decca, Ember, EMI, Longhorn, Emerald, Oriole, Melodisc, Country Style), France (Artec), Germany (Ariola, Metronome, Teldec), Italy (Decca, Fonit-Cetra), Japan (King, Cosdel), New Zealand (Rank), Scandinavia (Dansk), South Africa (Trutone, Teal, Meteor, Decca), Spain (Vergara), Switzerland (Ariola, Metronome).
 Stardisc, 10337 E. Beach St., Bellflower, Calif. Tel.: (213) TO 6-4146. Owner: Mearl Ellison.
 Starfire (see Celtic Rec'g Prod'ns).
 Starla (see Original Sound).
 Startime (see Abnak Music Ents.).
 Stax, 926 E. McLemore, Memphis, Tenn. 38106. Tel.: (901) 946-2535. Pres.: Jim Stewart; VP: Estelle Axton; A&R: Steve Cropper; Promo.: Al Bell.
 Labels: Stax, Volt. (distributed by Atco & Atlantic). (SEE ADVERTISEMENT)
 Steel, 101 W. Federal St., Youngstown, Ohio. Tel.: (216) 744-4419. Pres.: William R. Ellis.

NINA

RECORDS

FEATURING

THE GREATEST PERFORMERS ON
THE GREEK & TURKISH
SCENE TODAY

TRADITIONAL FOLK DANCE

COMPLETE LINE 45'S & LP'S

NINA RECORD CO., INC.

514 8th Avenue, N.Y.C. OX 5-7696

FOR DANCING

The Dealer Who Knows, Sells

ROPER RECORDS

The Perfect Music and Rhythm
for Dancing and Easy Listening

Territories for
Distributorship
Still Available

LP & 45 Catalog
Available Upon
Request From:



roper records

43-48 48th Street
Long Island City, N.Y. 11104
Tel.: (212) NA 6-1190

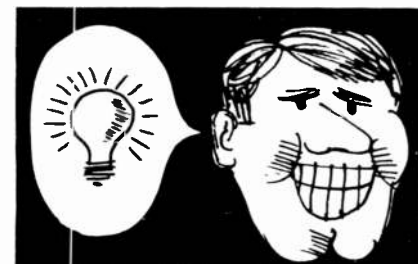

CREATIVE SOUND!!!

National Manufacturer & Distributor.

Finer quality Custom records & albums (original art or stock) Lower prices, faster personalized service—anywhere in U.S.

CREATIVE SOUND 9000 sunset boulevard
los angeles, california 90069 (213) CR 1-4843

WHERE THE INDEPENDENTS
MEET THE INDEPENDENTS

MONARCH

RECORD MFG. CO.

QUALITY & SERVICE

YOUR INDEPENDENT
RECORD PRESSING PLANT
ON THE WEST COAST

4852 W. JEFFERSON BLVD.
LOS ANGELES, CALIF. 90016
Area Code 213—732-6185

continued

- Stellar, 550 Fifth Ave., New York, N. Y. 10036. Tel.: (212) PL 7-6454. Pres.: Don S. Coyne. Stereo (see Contemporary). Stereo-Dynamics (see Guillotine). Stereo-Fi Corp. of Calif., 6277 Selma Ave., Hollywood, Calif. 90028. Tel.: (213) 463-2328. Pres.: Bob Keene; Gen. Mgr.: Ron Roessler. Labels: Bronco, Maravilla, Mustang, Scarlet. Stereo Fidelity (see Budget Sound). Stereooddities, 259 S. W. 21 Terr., Ft. Lauderdale, Fla. 33310. Tel.: (305) LU 1-7300. Pres.: Fletcher Smith; A&R: Janet P. Smith. Labels: Stereooddities, Art Sound, Bitoa, Duo, Living Rec. Library. (distributed by Soma).
- Stinson, P. O. Box 3415, Granada Hills, Calif. 91344. Tel.: (213) 735-6731. Pres.: Jack M. Kall.
- Stonel, 1531 Broadway, New York, N. Y. 10036. Tel.: (212) 265-4626. Sales: Billy Arnold.
- Stoneway, 2817 Laura Koppe, Houston, Tex. 77016. Tel.: (713) OX 7-7912. Owner: R. M. Stone. Stop, 1820 Washington St., Boston, Mass. 02118. Tel.: (617) HI 2-3830. Owner: Fred Le Blanc. Labels: Bluestown, Silver Cross, Stop, Wild.
- Story, 651 Judson St., Evansville, Ind. 47713. Tel.: (812) 422-7659. Pres.: Nathaniel E. Story.
- Stradivari (see Everest).
- Strafford, P. O. Box 599, Durham, N. H. 03824. Tel.: (603) 742-2041. A&R: Russ Hamm; Sales & Promo. Mgr.: Curt Bean.
- Strathmore, 57 Ingram Circle, Matawan, N. J. 07747. N. Y. C. Tel.: (212) PL 2-5494.
- Streetcar, c/o Iver Rec'g, 1619 Broadway, New York, N. Y. 10019. Tel.: (212) CO 5-3910. Contact: Barry Bergman, Ritchie Cordell.
- Streke (see Periscope).
- Studio, 46 Berry Rd., Houston, Tex. Tel.: (713) OX 7-8904. Pres.: Johnnie Forrer.
- Style Wooten Prod'ns, 3635 Allandale Rd., Memphis, Tenn. 38111. Tel.: (901) 324-4640. Pres.: Style Wooten; VP: Marvin Burcham; A&R: Roy Meddors & Doris Floyd; Sales & Mktg. & Promo.: Dennis Turnipseed; Pub.: Melba Knoblock; Adv.: Ann Taylor. Labels: Eugenia, Spinnin Square, Taver, Tentay, Wooten.
- Styleten, 1037 Maria, Memphis, Tenn. 38111. Pres.: Haydon Smith, VPs: June Smith & Style Wooten.
- Sue, 265 W. 54 St., New York, N. Y. 10019. Tel.: (212) PL 7-2711. Pres., A&R, Sales & Int'l: Juggy Murray. Labels: Broadway, Eastern, Sue, Symbol. Int'l representatives: Belgium (Fonior), Canada (Transworld), Denmark (Decca), Finland (Decca), France (Barclay), Germany, Holland, Sweden & Switzerland (Decca).
- Summer, P. O. Box 273, Excelsior, Minn. 55331. Tel.: (612) 474-9780. Pres.: Don Powell Summer.
- Summit (see Everest).
- Summit Sound Systems, 52 Pitman Ave., Ocean Grove, N. J. Tel.: (201) 775-4952. Pres.: William Jelley.
- Sun, 639 Madison Ave., Memphis, Tenn. Tel.: (901) 527-2614. Pres. & Int'l: Sam C. Phillips; Sales: Bill Fitzgerald; A&R: Knox Phillips. Labels: S. C. Phillips Int'l, Sun.
- Sundance (see Bee).
- Sunrise (see Melody).
- Sunset (see Liberty).
- Superbe (see Hi Ho Prod'ns).
- Supreme, 304 S. Brand, Glendale, Calif. Tel.: (213) 245-3646. Mgr.: Paul Mickelson. Labels: Console, Cornerstone, Supreme.
- Sure-Shot, 1608 N. Argyle, Hollywood, Calif. 90028. Tel.: (213) HO 5-6947. Pres.: Joseph Hoover.
- Sureshot (see Duke).
- Surrey (see Mira).
- Swallow (see Jin).
- Swan, Eighth & Fitzwater Sts., Philadelphia, Pa. 19145. Tel.: (215) MA 7-1500. Pres.: Anthony S. Mammarella; Sales: Bernard Binnick. Labels: Fayette, Lawn, Swan. Int'l representatives: Argentina (Sicamericana), Australia (EMI), Belgium (Gramophone), Canada (Quality), Chile (Corporation de Radio), Denmark (I. S. Dansk), England (EMI), France (Disc), Germany (Electrola), Holland (Verkoop-Maatschappij, Bovema), India (Gramophone), Japan (Toshiba), New Zealand (HMV), Norway (Nor-Disc), Philippines (Cosdel), Portugal (Valentim de Carvalho), South America (EMI), Spain (Odeon).
- Sweco Music, c/o Walter Hoter, 221 W. 57 St., New York, N. Y. 10019. Tel.: (212) JU 2-5030. Pres.: Jack Gale. Label: Comet, Sweco. Label: Comet, Sweco. Swing (see Jay-Gee).
- Swingline (see Celtic Rec'g Prod'ns).
- Sword (see Word).
- Sword & Shield, P. O. Box 211, 1417 E. Abram, Arlington, Tex. Tel.: (817) CR 5-4844. Pres.: Calvin Wills.
- Sylvania, 825 Madison Ave., New York, N. Y. 10021. Tel.: (212) 734-4000. Pres.: Alan Hartwell. Labels: Sylvania, Symca.
- Symbol (see Sue).
- Symca (see Sylvania).
- Sysex, c/o Sy Shaffer, 221 E. 50 St., New York, N. Y. 10022. Tel.: (212) PL 5-7160. Pres.: Sy Shaffer.

T

- T C F (see 20th Century-Fox).
- T C F-Hall (see 20th Century-Fox).
- T E K (see Goldband).
- T E O, 8307 Bronwood Rd., Richmond Va. 23229. Tel.: (703) 270-3810. Pres.: C. N. Colleran Jr.
- T M S, 3462 Midway Dr., San Diego, Calif. 92110. Tel.: (714) 224-2804. Pres.: William J. Anthony.
- T P G Rec'g, 1211 E. Main Ave., Knoxville, Tenn. Tel.: (615) 524-9516. Exec. Dir.: John H. Pembroke. Label: Maceo II.
- Tab, 1121 Market St., Galveston, Tex. 77550. Tel.: (713) SO 2-6581. Pres.: A. W. Marullo; VP: A. W. Marullo Jr.; A&R: David Yeamans; Sales & Mktg.: Steve Poncio; Pub., Adv. & Promo.: J. D. Copley. Branch: Houston, Tex., 7450 Belfort St. Tel.: (713) MI 9-0351.
- Tahiti (see Criterion).
- Tailgate (see Dover, New Orleans).
- Takoma (see Music Research).
- Tale Spinners for Children (see United Artists).
- Tally, P. O. Box 842, 2605 Nile St., Bakersfield, Calif. Tel.: (805) FA 3-9728. Owner: Charles Owen.
- Tamla (see Motown).
- Tangerine (see ABC).
- Tanner 'N' Texas, 1422 W. Poplar St., San Antonio, Tex. 78207. Tel.: (512) PE 2-8072, 8831. Pres.: R. E. (Bob) Tanner.
- Tape, 6051 Harold Way, Hollywood, Calif. 90028. Owner: George R. Nelson.
- Target (see Alvera).
- Tartar-American (see King).
- Taurus, 285 E. 49 St., Brooklyn, N. Y. 11203. Tel.: (212) PR 8-5150. Pres.: Mike Serby.
- Taver (see Style Wooten Prod'ns).
- Tear Drop (see Jamie/Guyden Dist. Corp.).
- Tee Vee (see Chanson).
- Telefunken (see London).
- Tempe (see Ser-Prod'n).
- Tener Ents., New England Bldg., Suite 480, New England Ave., Winter Park, Fla. Pres.: Eric Schabacker. Branch: New York, N. Y., 205 E. 42 St. Zip: 10017. Tel.: (212) LE 2-7711. VP: Robert Feldon. Labels: Tener, Hype.
- Tentay (see Style Wooten Prod'ns).
- Texan (see Glenvalley).
- The Texas Plainsmen, P. O. Box 4831, Midland, Tex. 79702. Tel.: (915) OX 4-3756. Contacts: Carl L. Echols Jr. & Jim O'Neill. Label: Plainsmen.
- Texas Sound Studios, 506 W. Hildebrand Ave., San Antonio, Tex. 78212. Tel.: (512) PE 3-1721. Mgr.: Jeff Smith. Labels: Anthem, Sound-Tex.
- Theatre Rec'g Society (see Caedmon).
- Three H's, 315 E. Westfield Blvd., Indianapolis, Ind. 46220. Tel.: (317) CI 1-0898. Contact: Henry Oakes.
- 3-J (see Carlson Int'l Prod'g Corp.).
- Three Rivers Prod'ns, 507 Fifth Ave., New York, N. Y. (212) OX 7-5895. Contact: Larry Della Corte.
- Three Sons, 926 Western Saving Fund Bldg., Philadelphia, Pa. 19107. Tel.: (215) PE 5-8292. Pres.: Lew Di Leo.
- Three Star, 301 Elderfield, Newark, Del. 19711. Tel.: (302) 368-1833. Pres. & Pub.: Lee Stevenson; A&R (R&R), Adv.: Eddie G. Stevenson; A&R (Country): Lee Stevenson; Sales Dir.: Lanny Walker; Promo. Mgr.: F. Lee Marden. Labels: Three Star, Blue Hen, General Lee's Confederate Recs.
- Thunderbird (see Masters Releasing).
- Tiare Tahiti, 6124 Selma Ave., Hollywood, Calif. Labels: Tiare Tahiti, Reo Tahiti.
- Tibor, 200 W. 57 St., New York, N. Y. 10019. Pres.: A. T. Halmay.
- Tic Toc (see Goldband).
- Tico (see Roulette).
- Tide, 2146 Westview St., Los Angeles, Calif. 90016. Tel.: (213) RE 3-1127. Pres.: Ruth E. Strach-borneo. Labels: Edit, Tide.
- Tiffany, 1130 Green Bay Rd., Lake Bluff, Ill. 60044. Pres.: Henry E. Doney.
- Tifton (see Ambassador).
- Tigertown (see Fuller).
- Tikva, 1650 Broadway, New York, N. Y. 10019. Tel.: (212) JU 6-4934. Mgr.: Allen B. Jacobs.
- Time, 1290 Ave. of the Americas, New York, N. Y. 10019. Tel.: (212) 247-0655. Pres. & A&R: Bob Shad; Sales: Chet Woods. Labels: Time, Mainstream. Int'l representatives: (Argentina (Dial), Belgium (Vogue), Canada (Allied), Colombia (Codiscos), England (Philips), France (Vogue), Germany (Vogue), Japan (Nippon Columbia), Mexico (Musart), Peru (Talia), South Africa (Trans-global), Spain (Vergara), Sweden (Swereco), Switzerland (Vogue), Venezuela (Plax)).
- Times Square, 55 W. 42 St., New York, N. Y. 10036. Tel.: (212) BR 9-3458. Contacts: Harold Ginsburg & Ed Gries.
- Tioga, 6620 Kindred St., Philadelphia, Pa. 19149. Tel.: (215) PI 5-5309. Gen. Mgr.: Herb Ostrow. Labels: Impex, Oxford, Tioga.
- Tip Top (see USA).
- TMP-Ting, 22 E. Huron, Chicago, Ill. Tel.: (312) 642-8461.
- Toad, 261 E. 10 St., New York, N. Y. 10003. Tel.: (212) CA 8-1930. Dir.: Marshall Dodge.
- Toad, Nashville, Tenn. (see Audiofax).
- Toddlin' Town (see One-Deerful Prod'ns).
- Token, 3303 W. Ohio Ave., Midland, Tex. 79701. Tel.: (915) OX 4-1482. Pres.: Steve Drummond. Labels: Token, Coin.
- Tom Gericke Prod'ns (see Merritt).
- Tom Thumb (see Rhythms Prod'ns).
- Tomorrow (see Atco).
- Tonik (see Dover).
- Top Dog, 9912 Taylorville Rd., Louisville, Ky. 40299. Tel.: (502) 267-5466.
- Top Fifty, 810 W. 26 St., Cheyenne, Wyo. 82001. Tel.: (307) 638-8066. Promo. Dir.: N. Margret Severson.
- Top Forty (see Chartbuster).
- Top-Hit, 5913 Gregory Ave., Hollywood, Calif. 90038. Top Ten (see Ernststrat Prod'ns).
- Topic, P. O. Box 516, Goodlettsville, Tenn. Tel.: (615) 859-2446. Pres.: Joe Wright.
- Touche, P. O. Box 96, El Cerrito, Calif.
- Tower, 1750 N. Vine St., Hollywood, Calif. Tel.: (213) HO 2-7304. Pres.: G. R. Fraser. Branch: New York, N. Y., 151 W. 46 St. Tel.: (212) 245-4510. Sales & Promo.: Vito Samela. Labels: Tower, Uptown (see Capitol).
- Toy (see Spectra).
- Tradition, 80 E. 11 St., New York, N. Y. 10003. Tel.: (212) YU 2-4422. Pres.: Patrick Clancy.
- Train, 1201 Plymouth Ave., Nashville, Tenn. 37216. Tel.: (615) CA 7-6233. Mgr.: Carl E. Thomas.
- Transworld (see Finer Arts).
- Trash (see Sound, New Haven, Mich.).
- Trend, P. O. Box 201, Smyrna, Ga.
- Trend Int'l, 816 N. Highland Ave., Hollywood, Calif. 90038. Tel.: (213) 464-8204. Pres.: Gordon Burdge. Labels: Trend, Aloha, Anzac, Arriba, Century 21, Discotape Int'l, Eagle, Smart Set, Western.
- Trepur, Rt. 3, Roanoke Rd., La Grange, Ga. Tel.: (404) 882-2391. Owner: Rupert McClendon.
- Treva, Sunset-Vine Tower, Suite 616, Hollywood, Calif. 90028. Tel.: (213) HO 9-5838. Pres.: Sonia Brandon.
- Tri-A (see AAA).
- Tri-State, 1767 Fort Henry Dr., Kingsport, Tenn. 37664. Tel.: 246-8651. Pres.: Basil J. Palmer; Gen. Mgr.: Tilford Salyer.
- Tri-World Ents., 387 Sixth St., San Francisco, Calif. 94103. Tel.: (415) YU 1-6644. Pres. & A&R: Tom Spinoso; VP: James V. Salemi; Sales Mgr.: Syd Heller; Promo. Mgr.: Sidney Greene. Branch: Hawaii, 605 Coral St., Honolulu 96813. Tel.: 502-188. Mgr.: Kenneth Kaizawa. Labels: Cavalier, Cloverleaf, Dexter, U-Mac.
- Triad Prod'ns, 6119 Potrero Ave., El Cerrito, Calif. 94530. Tel.: (415) 235-6037. Owners: Mason & Badger. Labels: Triad, Shirley (distributed by Atlantic).
- Tribe (see London).
- Trident Prod'ns, 916 Kearny, San Francisco, Calif. Tel.: (415) EX 2-8250. Prod'r: Frank Werber; Promo.: Don Graham.
- Triode, 1639 Broadway, Suite 310, New York, N. Y. 10019. Tel.: (212) 581-8179. Pres. & Mgr.: Ben Smith.
- Triumph (see Atco).

Trophy (see Rem).
Tropical (see Seeco).
Tru-Glo-Town, 1 N. Dean St., Englewood, N. J. Tel.: (201) 567-8282. Sales Mgr.: Wally Roker.
R D Truetone (see listing under "R").
Trusty, Nebo, Ky. 42411. Tel.: (502) 249-3194. Pres.: Elsie Childers; Sales Mgr.: Donald Dorris; Promo. Mgr.: Jerry Faulk; Mktg. Dir.: William Rice.
Tuff, 1697 Broadway, New York, N. Y. 10019. Tel.: (212) 757-6138. Pres.: Abner Spector.
Turia, P. O. Box 1917, Beverly Hills, Calif. Tel.: (213) 271-4460. (SEE ADVERTISEMENT)
Turnabout (see Vox).
20th Century-Fox, 444 W. 56 St., New York, N. Y. 10019. Tel.: (212) 957-5162. Cable: CENTFOX. Gen. Mgr.: Jack Benanty; A&R Dir.: Bernie Wayne; Sales Mgr.: Chris Saner; Prod'n Dir. & Int'l: Steve Morris.
Labels: 20th Century-Fox, TCF-Hall, Movietone.
Int'l representatives: Australia (Festival), Canada (Capitol), England (EMI), France (Barclay), Germany (Karl Heinz Busse), Japan (Victor), Mexico (Tizoc), South Africa (Gallo), Spain (Cantagallo).
Twilight, P. O. Box 174, Albany, Calif. 94716. Tel.: (415) 524-4939. Pres.: Clara Thompson.
Twinkle (see Premier Albums).
Twirl, 850 Seventh Ave., New York, N. Y. 10019. Tel.: (212) JU 2-4560. Pres.: Irving N. Micahnik; VP & Promo.: Rick Willard.
Int'l representatives: England (Polydor), All other (Deutsche Grammophon & affil. labels).
Ty Tex, 2109 S. Broadway, Tyler, Tex. Tel.: (214) LY 2-5271. Pres.: Eula Anton.

U

U-Mac (see Tri-World Ents.).
U N E S C O Collection, c/o Record & Tape Sales, 821 Broadway, New York, N. Y. 10003. Tel.: (212) OR 4-6400. Pres.: Robert Staub.
U S A, 7448 S. Michigan Ave., Chicago, Ill. 60605. Tel.: (312) 939-3698. Contact: James Golden.
Labels: USA, Markie, Riviera, Tip Top. (SEE ADVERTISEMENT)
Ultraphone, 69 S. Moger Ave., Mount Kisco, N. Y. Tel.: (914) MO 6-2118. Dir.: Dr. Edward T. Salvato Jr.
Unicorn, 733 15 St. N.W., Rm. 232, Washington, D. C. 20005. Tel.: (202) 783-2553. Contact: Elliot Ryan.
Unidap (see Franz Schubert Music).
United Artists, 729 Seventh Ave., New York, N. Y. 10019. Tel.: (212) CI 5-6000. Cable: UNARTISCO. Pres.: Michael Stewart; Sales: Michael Lipton & Andrew Miele; A&R: Jack Gold, Gerry Granahan, LeRoy Holmes & Kelso Herston; Creative Servs. Dir.: Lloyd Leipzig; Promo. Dir.: David Greenman; Int'l Dir.: Noel Roger, 5 Albert Gate Ct., 124 Knightsbridge, London, S.W., England. Tel.: KNI 9383.
Branch: Hollywood Calif., 1041 N. Formosa. Zip: 90046. Tel.: (213) HO 9-6161. Contact: Norman Weiser.
Labels: Ascot, Tale Spinners for Children, United Artists, Veep.
Int'l representatives: Argentina (CBS), Australia (Australian Rec.), Belgium (Artone), Canada (Compo), Chile (Philips), Colombia (Fuentes), Denmark (Nordisk Polyphon), El Salvador (Indica), England (EMI), Finland (Fintone), France (Phonographique Francaise), Germany (Deutsche Grammophon), Greece (Hellasdisc), Holland (Artone), Hong Kong (Colonial Trading), India (Gramophone), Israel (CBS), Italy (CGD), Japan (Nippon Columbia), Mexico (Gamma), New Zealand (Allied Int'l), Norway (Nor-Disc), Peru (El Virrey), Philippines (Home Industries), Portugal (Radio Triunfo), South Africa (Trutone), Spain (Hispavox), Sweden (Karusell), Switzerland (Siemens), Uruguay (Editorial Antar), Venezuela (El Palacio de la Musica), West Indies (Federal).
United Sound Associated, 633 Fifth Ave., Brooklyn, N. Y. 11215. Tel.: (212) SO 8-2885 & HY 9-4120. Pres.: Rudolph Polizzi.
United States, 1549 N. Vine St., Suite 6, Hollywood, Calif. 90028. Tel.: (213) 462-0447. Owner: Joseph Van Winkle.
Unity (see Art).
Universal, Sheraton-Lincoln Hotel, Houston, Tex. 77002. Tel.: (713) CA 5-0859. Pres.: M. Brock.
Universal I, Ltd., 485 Fifth Ave., Rm. 410, New York, N. Y. 10036. Tel.: (212) MU 7-0377. Pres.: Phil Vitale.
Labels: Inner, Iguana.
Universe (see Larric).
Uptown (see Tower).
Urania (see Connoisseur).

V
V I P (see Motown).
V S P (see MGM).
V V, 7507 Foster, Morton Grove, Ill. Tel.: (312) 965-5507. Pres.: Perry Johnson.
Labels: VV, Venus.
Val, 32 Pride St., Pittsburgh, Pa. 15219. Tel.: (412) 281-3957. Pres. & Promo.: George Goodman; VP: Auggie Bannardo.
Labels: Ideal, Val.
Thomas J. Valentino, 150 W. 46 St., New York, N. Y. 10036. Tel.: (212) CI 6-4675. Pres.: Thomas J. Valentino.
Label: Major.
Valerie (see Band Box).
Valiant, 6290 Sunset Blvd., Hollywood, Calif. 90028. Tel.: (213) 343-5807. Pres.: Billy Sherman; A&R: Barry DeVorzon; Gen. Mgr., Sales & Promo.: Budd Dolinger.
Valle, 4361 Valle Dr., La Mesa, Calif. 92041. Tel.: (714) 469-9173. Mgr.: Darlene R. G. Olson; Ass't Mgr.: David C. E. Gronseth.
Valtron, 305 Allen St., Helena, Mont. 59601. Tel.: (406) 442-0734. Owner & Mgr.: Lester L. Liedle; Sales: Roger Kingston; Pop A&R Dir.: Wally Peel; A&R (C&W) Dir.: Bob Bartmess.
Vandan, 8740 Aldwick Dr., Dallas, Tex., 75238. Tel.: (214) DI 8-9324. Pres.: Darrell A. Brown; Gen. Mgr.: Burel Merritt; Sales & Promo.: Don Brooks. Sales & Promo. Mgr.: Tom Brown.
Labels: Caprice, Creole, Vandan, Via.
Vanguard, 154 W. 14 St., New York, N. Y. Tel.: (212) AL 5-7732. Cable: VANMUSICA. Pres. & A&R: Maynard Solomon & Seymour Solomon; Sales: Herb Corsack; Int'l: Maynard Solomon.
Labels: Bach Guild, Demonstration, Everyman, Vanguard.
Int'l representatives: Argentina (Sicamericana), Australia (Radio Corp.) England (Philips), Colombia (Fonoton), Europe (Amadeo), Israel (Hed-Arzi), Japan (King), New Zealand (Philips).
Vantage, 1849 W. 107 St., Chicago, Ill. 60643. Tel.: (312) BE 8-1015. Cable: VANTAGE. Pres. & Exec. Prod'r: A. Allan Botto; VP & Gen. Mgr.: William R. Glennon; Sales: Thomas H. Bamford, Carl G. Nelson & Ronald D. Sundstrom; Int'l: A. A. Botto.

Branch: Pottstown, Pa., P. O. Box 212. Zip: 19464. Tel.: (215) 323-3336.
Labels: Jody, Pliant, Reco-Flex, Semaphore, Sound of Money, Vantage, Zouvenir.
Company represents: Eva-Tone.
Vaquero, 8275 Sunset Blvd., Hollywood, Calif. 90069. Tel.: (213) OL 6-2268. Pres.: Ellis Gold.
Variety, 51 Clifton Ave., 710 C, Newark, N. J. 07104. Owner: Stephen Janis.
Varmint, 929 14 St., Silvis, Ill. 61282. Tel.: (309) 792-3920. Pres.: V. P. Brown.
Vault (see Atco).
Veep (see United Artists).
Veevo, 54 W. 74 St., Suite 402, New York, N. Y. 10023. Tel.: (212) EN 2-2259. Pres.: Fredric Vonr.
Vega (see Powertree).
Vended, 859 N. Wilcox Ave., Hollywood, Calif. 90038. Tel.: (213) 662-4373. Owner: Larry Johnson.
Labels: Gold Token, Vended.
Venus (see VV).
Verdi (see Major Mgmt.).
Verve, 1540 Broadway, New York, N. Y. 10036. Tel.: (212) JU 2-2000. Pres.: Mort L. Nasatir; Sales: Sol Greenberg; Int'l: Eric Steinmetz. (see MGM).
Int'l representatives: Argentina (Philips), Australia (Radio Corp.), Austria (Polyphon), Belgium (Siemens), Brazil (Som/Maior), Canada (Quality), Chile (Philips), Colombia (Philips), Denmark (Nordisk Polyphon), England (EMI), Finland (Fintone), France (Polydor), Germany (Deutsche Grammophon), Holland (Polydor), Hong Kong (Jardine Matheson, EMI), Ireland (Gramophone), Israel (Hed-Arzi), Italy (CGD), Jamaica (West Indies), Japan (Nippon Gramophone), Mexico (Dusa), New Zealand (Allied Int'l), Norway (Nor-Disc), Peru (El Virrey), Philippines (Mareco), Poland (Ars Polona), Puerto Rico (Juan Martinez Vela), South Africa (Trutone), Spain (Odeon), Sweden (Karusell), Switzerland (Siemens), Venezuela (Siemens), Yugoslavia (Jugoton).
Verve/Folkways (see MGM).
Via (see Vandan).
Vick (see Hawk Prod'ns).
Victrola (see RCA Victor).
Virgil (see Dover).



THE VINCENT YOUMANS CO., INC.

Mode Music, Inc. Scope Music, Inc.

"I'M A NUT" b/w "KNIE DEEP"

Written and Recorded by
LEROY PULLINS—KAPP

From the New STEVE PERRY MGM LP "Another Rainy Day"

"POEM FOR HEATHER"

(Steve Perry)

A LITTLE RAIN

(Larry Alexander-Billy Galdenberg)

MY OWN PLACE

(Dan Mitchell-Jeanie Allen)

"I'M DROWNING"

(In an Inch and a Half of Water)

(Dan Mitchell-Jeanie Allen)

From "Gain' Tawn And Country" BILLY EDD WHEELER—KAPP

"THE MARK OF A REAL WOMAN"

(Alexander-Goldenberg-Isaacson)

JERRY ANTES—DOT

Opening in New York — Fall of 1966

The New Musical

"THE MAN WITH A LOAD OF MISCHIEF"

(Ben Tarver-Jahn Clifton)

ROBERT LISSAUER

Vice President & General Manager

157 W. 57th Street, New York 10019
CI 5-2828

MASTERS RELEASING, INC.

National Distributors of
**SAHARA
POW
THUNDERBIRD**

We Are Interested in
Leasing or Buying
Your Master

Contact:

Masters Releasing, Inc.
959 Main Street, Buffalo, N. Y.
(716) 882-0427

Watch for this Label!

Platinum
RECORDS, INC.

"The Greatest Sound Around"
starring

- Dee & Tee • The Dolls
- Jumping Jacks • Johnny Rouse
- Gay Perkins • Jimmy Hall
- Lois Foreman • Gospel Jazz Singers

Write for information
PLATINUM RECORDS, INC.
1688 Meridian Ave., Miami Beach
Fla. 33139, Phone (305) 532-5474

KING
THE NATION'S ONLY
ONE STOP
RECORD & ALBUM SERVICE

★ ★ **25** ★ ★
YEARS' EXPERIENCE
WE HOLD YOUR HAND
CUSTOM PRESSING
300 to a 1,000,000

RECORDING • PRESSING • PLATING
PRINTING • ARTWORK • PACKAGING

KING CUSTOM RECORD SERVICE
1540 BREWSTER, CINCINNATI, OHIO 45207
513 759-1910

**CARNIVAL RECORDS
CHADWICK RECORDS**

Featuring:

THE MANHATTANS
PHIL TERREL
THE METRICS
HARRY CALDWELL
THE LOVETTES
THE TOPICS

CARNIVAL RECORD CORP.
350 Chadwick Ave., Newark, N. J.
Tel.: (201) 242-6719

continued

Viscojan, 1375 Ridgeley Dr., Los Angeles, Calif. 90019. Tel.: (213) 935-9667. Pres. & Promo.: J. W. Spriggs; Gen. Mgr.: D. W. Brown; A&R Dir.: Reginald Shaw; Sales Mgr.: John T. Dudley; Pub. A. & E. Johnson.
Branch: Chicago, Ill., 7533 S. Dorchester. Zip: 60614. Tel.: (312) 493-2457. Mgr.: Nathan Griffen.

Vision (see Smoke).

Vista (see Disneyland).

Vocab, 3071 S. Broad St., Chicago, Ill. 60608. Tel.: (312) CL 4-8047. Pres.: Anthony J. Batko.

Vocalion (see Decca)

Vogue (France), c/o Record & Tape Sales, 821 Broadway, New York, N. Y. 10003. Pres.: Robert Staub.

Voice of Calvary (see Delmar Prod'ns).

Vokes, P. O. Drawer 1203, New Kensington, Pa. 15068. Tel.: (412) 828-6864. Pres. & Mgr.: Howard Vokes.

Volt (see Stax).

Vox, 211 E. 43 St., New York, N. Y. 10017. Tel.: (212) TN 7-9360. Cable: VOX PRODUCT. Pres., A&R & Int'l: George H. de Mendelssohn-Bartoldy; VP: Lawrence K. Green; Sales: Thomas Di Vita.
Labels: Vox, Turnabout.
Int'l representatives: Australia (Festival), Austria (Otto Preiser), Canada (Musimart), Chile (Victor), Colombia (Verswyvel), Denmark (Fona), England (Decca, Vox), Finland (Arne Bendiksen), France (Vox), Germany (Fono), Greece (Neodisc), Holland (Basart), Hong Kong (Cosdel), Ireland (Decca), Israel (Decca), Italy (Societa Italiana Dischi), Japan (Cosdel), Lebanon (Philosophie), Malaysia (Isaac), Mexico (Peerless), New Zealand (Wooler), Norway (Arne Bendiksen), Portugal (Oreves), South Africa (Galto), Spain (Vergara), Sweden (Decca), Switzerland (Jecklin), Uruguay (Editorial Antar), Venezuela (Venevox).

Vulcan, 812 17 Ave. S., Nashville, Tenn. Tel.: (615) 255-0624. Pres.: Henry P. Strzelecki.

W

Waikiki, 1984, Kalakaua Ave., Honolulu, Hawaii, Tel.: PH 9-4536. Pres.: Tommy Kearns.
Branch: Los Angeles, Calif. 11000 Chalon Rd. Zip: 90024.

Walker (see Sound, New Haven, Mich.).

Walton, P. O. Box 125, 428 W. Main St., Cambridge City, Ind. Tel.: 62769. Pres.: Wayman Overbay.

Walton, Wilmington, N. C. (see Music Makers Network of America).

Wand (see Scepter).

Warner Bros., 4000 Warner Blvd., Burbank, Calif. 91505. Tel.: (213) HO 9-2151. Cable: Wanewar. Pres.: J. K. (Mike) Maitland; A&R: Dick Glasser; Sales Mgr.: Gene Block; Mds'g: Joel Friedman; Promo.: Joe Smith; Int'l: Phil Rose.
Branch: New York, N. Y., 321 W. 44 St. Tel.: (212) CI 6-1700. Opts. Dir.: George Lee; A&R: Jerry Ragovoy.
Labels: Reprise, Loma, Warner Bros.
Int'l representatives: Aden (Bhicajee Cowasjee), Argentina (Sicamericana), Australia (Australian Rec.), Austria (Musica), Belgium (Vogue), Brazil (EMI Odeon), Canada (Compo), Chile (EMI Odeon), Colombia (Colombiana), Costa Rica (Indica), Denmark (Hede Nielsens), Ecuador (Industria Fonografica Ecuatoriana), England (Pye), Finland (Sahkoliikkeiden), France (Vogue), Germany (Teldec), Greece (Columbia), Holland (Negram), Hong Kong (Jardine Matheson), India (Gramophone), Israel (Gal Ron), Italy (CGD), Japan (Toshiba), Malaysia (E. S. Isaac), Mexico (Gamma), New Zealand (HMV), Norway (Arne Bendiksen), Peru (EMI), Philippines (Cosdel), Portugal (M. Arnaldo Trindade), Puerto Rico (Juan Martinez Vela), South Africa (Teal), Spain (Hispavox), Sweden (Telefunken), Switzerland Musikvertrieb), Thailand (Black & White), Turkey (Melodi), Venezuela (Venezolana de Discos), West Indies (West Indies).

Washington (see Orpheum Prod'ns).

Wax, 1755 Broadway, Oakland, Calif. Tel.: (415) 834-8340. Cable: WAX-Rex. Pres.: Sheldon Feinberg; VP & Promo.: Bob Bouchier; Sales & Mktg.: Mike Kessler.

Way Out (see Atco).

Webster (see Record Corp. of New England).

Wedge (see Dome).

Wells-DeSett, 2272 W. Adams Blvd., Los Angeles, Calif. 90018. Tel.: (213) 732-3987. Pres.: Edward G. Wells & Philip De Sett.

Wertz (see Cool Air Prod'ns).

Wesley, P. O. Box 10044, Denver, Colo. 80210. Owner: W. L. Horning.

West Wind, P. O. Box 5555, Lake St. Sta., Minneapolis, Minn. 55408. Tel.: (612) 788-9122. Pres.: Michael Jann.

Westerly (see Pulse).

Western (see Trend).

Westindy (see Caribbean Folk Music).

Westminster, 1330 Ave. of the Americas, New York, N. Y. 10019. Tel.: (212) LT 1-7777. Cable: ABPAREC. Pres.: Larry Newton; Gen. Mgr. & Sales: Marty Goldstein; Artists Relations: John Natoli; Int'l: Harry Levine.
Labels: Westminster, Music Guild, Whitehall (see ABC).

Whit (see Jewel).

White Cliffs (see Dover, New Orleans).

White Rock, 401 Wintermantle Ave., Scranton, Pa. 18505. Tel.: (717) 343-6718.

White Whale, 8490 Sunset Blvd., Los Angeles, Calif. 90069. Tel.: (213) 657-7370. Pres.: Ted Feigin.

Whitehall (see Westminster).

Wild (see Stop).

Wildwood, P. O. Box 39, Stevensville, Mich. Pres.: Jerry Kohlert; Mgr.: Lynda Kohlert.
Kae Williams Music (see listing under "K").

Windsor, Bakersfield, Calif. (see Pike).

Windsor, 5530 N. Rosemead Blvd., Temple City, Calif. 91780. Tel.: (213) 286-1167. Pres.: Edward H. Lowry.

Windy "C" (see Cameo-Parkway).

Win Gate (see Golden World).

Wine, 1500 Creedmore Ave., Pittsburgh, Pa. 15226. Tel.: (412) 531-7290. Owner: James Grimes.

Wing (see Mercury).

Wonderland (see Orpheum Prod'ns).

Wooten (see Style Wooten Prod'ns).

Word, P. O. Box 1790, Waco, Tex. 76703. Tel.: (817) PR 2-7650. Pres.: Jarrell McCracken; VP: B. M. Norcross Jr.; A&R Dir.: Kurt Kaiser; VP: Marvin Norcross; Sales Mgr.: William Jelley; Adv. & Promo. Dir.: George W. Baskin.
Labels: Canaan, Sword, World.

World Pacific (see Liberty).

World Wide, Newark, N. J. (see Savoy).

World-Wide, P. O. Box 13612, Sta. K., Atlanta, Ga. 30324. Tel.: (404) 874-2781. Pres. & Pop A&R: Johnny Brooks; Pub. & Adv.: Gaye Brooks; Classical A&R: Heinz Trutzschner; Sales & Mktg.: Hubert H. Brooks. Promo.: Doyle Taylor.
Labels: Gaye, Sounds of Atlanta (SOA), Space, World-Wide.

Wrangler, 830 Baetz Blvd., San Antonio, Tex. 78221. Tel.: (512) WA 4-1583. Pres.: John Stauffer.

Wrimus, P. O. Box 3294, San Bernardino, Calif. 92404. Owner: Neale Wrightman.

Wyncote (see Cameo-Parkway).

X

X Y Z (see Claridge).

Y

Yale, 27 Spring St., Elizabeth, N. J. 07201. Tel.: (201) EL 3-5676. Pres.: Steve Sabatino; A&R Smokey Warren.
Labels: Garden, Yale.

York (see Atco).

Young People's Recs. (see The Franson Corp.)

Yucca, 1706 College, Alamogordo, N. M. Tel.: (505) 437-4491. Owner: Calvin Boles.

Yussels (see Jo-Park).

Z

Z, Poplar Bluff, Mo. Tel.: (314) SU 5-3042. Pres.: Robert Zehm.

Zaraks, P. O. Box 5192, Washington, D. C. 20019. Pres.: Charles H. Barney Jr.
Labels: Achillean, INRI, Zaraks.

Zebra, 31 Brompton Rd., Garden City, N. Y. 11530. Tel.: (516) PI 7-3616. Pres.: Charley Ide; Gen. Mgr.: Ben Arrigo.
Branch: New York, N. Y. 157 W. 57. Zip: 10019. Tel.: (212) CO 5-6585.

Zion (see Little Nashville).

Zondervan (see Singcord).

Zone, 625 Chelsea Ave., Memphis, Tenn. 38107. Tel.: (901) 526-7826.

Zonia, 3635 Allendale, Memphis, Tenn. 38111. Tel.: (901) 324-4640. VP & A&R (C&W): Melba Knoblock.

Zouvenir (see Vantage).

Independent Record Producers

Alkon, PO Box 140, Burns, Ore. Pres.: Gary Seibert.
Branch: Canada, Klondike Rec., PO Box 561, Whitehorse, Yukon.

Aris Prod'ns, 10022 Melvin, Northridge, Calif. 91324. Tel: (213) 349-4394. Pres.: Rick Valrey.

Athens of the South Prod'ns, 815 16 Ave. S., Nashville, Tenn. 37203. Tel: (615) 255-6535. Pres.: Benny Joy.

Avenger Prod'ns, 202 Conover St., Brooklyn, N. Y. 11231. Tel: (212) 522-0525. Pres.: Joey Napoleon.
Label Credit: Verve.

Burt Bacharach & Hal David (see Blue Jac Prod'ns).
Jeff Barry Corp., 15 W. 72 St., New York, N. Y. Tel: (212) 799-4512. Contact: Jeff Barry.
Label Credits: Bang.

Bill Bellman, 958 W. Edgemont Dr., San Bernardino, Calif. 92405. Tel: (714) 882-6796.
Label Credits: Colpix, Rock-It Prod'ns, Melody House.

Blue Jac Prod'ns, 1619 Broadway, New York, N. Y. 10019. Tel: (212) PL 9-3860. Contact: Burt Bacharach & Hal David.

Brigaro Music Prod'ns, 200 W. 57 St., New York, N. Y. Tel: (212) 247-4555. Contact: Dave Brigati.

James Brown Prod'ns, 410 N. First St., Pulaski, Tenn. Tel: (615) 363-1780. Pres.: James Brown.
Label Credits: Chess, Duke, Sound Stage 7, Chanson, JBP, Tee Vee.

Calla Ent's., 1650 Broadway, New York, N. Y. 10019. Tel: (212) 246-0717. Pres.: Nate McCalla.

Cameron Prod'ns, PO Box 111, Ralston, Neb. 68051. Tel: (402) 733-4007. Prod'rs: Scott A. Cameron & Charles N. Canuso.
Label Credits: Applause, Bear, MMC, Sea-Mist.

Centaur Prod'ns Int'l, 82 Aldine St., Rochester, N. Y. 14619. Tel: (716) FA 8-4649. Prod'r: Ven Pitoni.
Label Credits: Centaur, Sea King, Warner Bros.

David S. Chackler, 10756 Heather St., Philadelphia, Pa. 19116. Tel: (215) OR 6-4930.

Channel Prod'ns, 601B Henderson St., Chicago, Ill. 60634. Tel: (312) 283-0318. Pres.: R. N. Anderson.

Cherokeeland Rec'gs, PO Box 502, Johnston Hall Clinic Bldg., Rm. 2, Calhoun, Ga. 30701. Tel: (404) 629-3950. Pres.: J. Carter.
Label Credit: Chant.

Chris Prod'ns, 300 W. 55 St., New York, N. Y. Tel: (212) 246-4982. Pres.: Bunny Jones.

George Clements Prod'ns, 159B North "E" St., San Bernardino, Calif. 92405. Tel: (714) TU 2-0629. Owner: George Clements.

Clover Rec. Prod'rs, 315 S. Beverly Dr., Beverly Hills, Calif. Tel: (213) 273-4664. Exec. Prod'r: Peter R. Brooke.

Con-Gal, 1722 Johnson St., Port Vue, McKeesport, Pa. Tel: (412) 678-5758. Pres.: Stanley Conrad.

Copper State Rec'g, 815 E. Broadway, Tucson, Ariz. 85719. Tel: (602) 623-0318. Pres.: F. S. Cayce.
Label Credits: Advanced, Brite, Brite-Star, Pulma, T-J.

Bob Crewe Prod'ns, 1841 Broadway, New York, N. Y. Tel: (212) CI 5-3535.
Label Credits: Dynovoice, Philips, Vee Jay. (SEE ADVERTISEMENT)

Custom Rec'g (div. of Custom Electronics), PO Box 755, South Bend, Ind. 46624. Tel: (219) 234-4248. Pres.: Thomas W. Zoss.

Daedalus Prod'ns, 40 W. 55 St., New York, N. Y. Tel: (212) 265-7850. Pres.: Dave Kapralik; VP: Van McCoy.
Label Credits: Date, Columbia.

Davon Music, 6290 Sunset Blvd., Hollywood, Calif. 90028. Tel: (213) 466-4224. Cable: DAVONMUS. Pres.: David Hubert.

Label Credits: CBS, Epic, Fontana, London, Mira, Mirwood, Music for Pleasure/EMI, Pickwick, Polydor, Premier, Surrey, Verve, Vogue.

Al Dexter, PO Box 71, Denton, Tex. Tel: (817) 497-2406. Mgr.: Al Dexter.
Label Credit: Dot.

Dynamite Prod'ns, 1650 Broadway, New York, N. Y. Tel: (212) 245-6344. Contact: Richard Perry.

Elray Recs., 1117 N. Main, Fremont, Neb. 68025. Tel: (403) 721-4728. Pres.: Ray Keeler.

Entertainment Unlimited, 839 E. New York Ave., DeLand, Fla. 32720. Tel: (904) 734-0384. Pres.: Raye A. Sorensen.
Label Credits: Gaynor, Shay.

Freeway Rec., PO Box 36448, Los Angeles, Calif. 90036. Tel: (213) WE 4-1441. Partners: H. Endemano & Norm Goodman.

Bob Gallo/Chris Huston, 126 W. 42 St., New York, N. Y. Tel: (212) CO 5-9659.
Label Credits: Roulette, Kapp, ABC, Cameo-Parkway, Ski-Hi, Amy-Mala, Casual, Pye.

Tim Gayle, 6376 Yucca St., Hollywood, Calif. 90028. Tel: (213) HO 3-2151 & 465-6258.
Label Credits: Decca, London, Coral, Dot, Kem, Advance, W&G, Coast.

Genius (see Bob Crewe Prod'ns).
Go Go Music, 19 Southland Dr., Glen Cove, N. Y. Tel: (516) OR 6-6460. Pres.: Gene Moretti.

Golden State Recs., 665 Harrison St., San Francisco, Calif. 94107. Tel: (415) 781-6306. Pres.: Leo de Gar Kulkka.
Label Credits: Mercury, Philips, Smash, Fontana.

H B Prod'ns, 11734 Sunshine Terr., Studio City, Calif. Tel: (213) 877-4430.

Haimes & Ashford (see Pied Piper Prod'ns).

Hawk Prod'ns, 6252 1/2 S. Greenwood Ave., Chicago, Ill. 60637. Tel: (312) 288-5381. Pres.: Robert Lee.
Label Credits: Chess, ABC, Limelight, Blue Rock.

Hi Ho Prod'ns, PO Box 8135, Chicago, Ill. 60680. Tel: (312) 373-7072. Pres.: Frank Howard Jr.

John Hill, 113 N. Church St., Moorestown, N. J. 08057. Tel: (609) 235-7962.
Label Credits: Columbia, Decca.

Holton Recs., 850 Seventh Ave., New York, N. Y. 10019. Tel: (212) 581-5120. Pres.: Fred Barr; VP: Al Carnovale; Exec. Mgr. & VP: George Levy.
Branch: Caldwell, N. J., 378 Bloomfield Ave.
Label Credits: Cameo, Holton, Laurie, Patty, Security, Skyscraper, Swan.

J D Horn, PO Box 7532, Houston, Tex. 77007.
Label Credits: Almanac, Big "D", Prestige.

Hugo & Luigi Prod'ns, 1619 Broadway, New York, N. Y. 10019. Tel: (212) 265-1626.
Label Credits: Amy-Mala-Bell, Columbia, Diamond, London, RCA Victor, Reprise, Roulette.

Independent Promos., 2540 Cambon Way, Sacramento, Calif. 95821. Tel: (916) 482-8253. Owner: C. Trumbo.
Label Credits: Dot, Ikon.

International Rec'g Co. (IRC), 5619 W. Division, Chicago, Ill. 60651. Tel: (312) 378-4848. Chm.: J. V. Mani.
Label Credits: Philips, MGM, Mercury.

J B Recs., PO Box 7221, Mobile, Ala. 36607. Tel: (504) 477-7434. Pres.: John N. Blackburn; VP: Mrs. Sara Ann Smith.

Jaclyn Ent's., 1607 El Centro, Hollywood, Calif. 90028. Tel: (213) 464-9819. Cable: MOONSON. Pres.: John Elliott; Gen. Mgr.: Linwood Wilde.

Jaysina Ent's., 143 W. 51 St., New York, N. Y. 10019. Tel: (212) CI 6-9400. Contact: Basil Bova.

Jepalana Prod'ns, 723 Seventh Ave., New York, N. Y. 10019. Tel: (212) CI 5-7640. Pres.: Nathan Schnappf.
Label Credits: Warner Bros., RCA Victor, Reprise, Tower.

Jupiter Prod'ns (see Jaysina).

K & L Ent's., 6047 Hollywood Blvd., Hollywood, Calif. 90028. Tel: (213) PO 6-6111. Pres.: Bob Klimes; VP: Hal Levy.

Kam Recs., PO Box 15366, Orlando, Fla. 32808. Tel: (305) CY 3-2560. Pres.: Robert P. Angel Sr.

Kama Sutra, 1650 Broadway, New York, N. Y. 10019. Tel: (212) 765-3320. Pres.: Hy Mizrahi, Arthur Ripp, Phil Steinberg.
Label Credits: Amy-Mala-Bell, Columbia, Kapp, Kismet, MGM, Mercury, Philips, Red Bird.

Kay-May Prod'ns, 231 Myrtle Ave., Irvington, N. J. 07111. Tel: (201) 374-5940. Pres. & A&R: Stephan Magis; Personal Mgmt.: Victor Kaply.
Label Credits: Corde, Cavalcade.

Kellmac Recs., c/o One-Derful Recs., 1829 Michigan Ave., Chicago, Ill. 60616.
Label Credits: One-Derful, Kellmac.

Kurl Recs., Rt. 2, Louisburg, Kans.

Lightnin Music, 6311 Gulf Freeway, Houston, Tex. 77023. Contacts: E. L. Cole, C. H. Wilson, Sam Lightnin Hopkins.
Label Credits: Guest Star, Vee Jay, Verve, Prestige, Fire.

Robert Lissauer, 157 W. 57 St., New York, N. Y. 1019. Tel: (212) CI 5-2828.

Madison Hall Prod'ns, 677 Newbury St. Springfield, Mass. 01104. Tel: (413) RE 4-3376. Cable: MADHAL. Pres.: Mark Lee Woods.

Malick Prod'ns, 541 Fulmer Ave., Akron, Ohio 44312. Tel: (216) 794-1304. Pres.: Ernie Malick.

Norman Malkin Prod'ns, 1549 N. Vine, Hollywood, Calif. 90028. Tel: (213) HO 5-4634.

Maverick Ent's., 424 Völker Dr., San Mateo, Calif. Prod'r: Eldon Hatfield.

Aubrey Mayhew, GPO Box 1958, New York, N. Y. 10001.
Label Credits: Parker, Hilltop, MGM.

Mack McCormick & Assocs., PO Box 13383, Houston, Tex. 77019.
Label Credits: Almanac, Candid, Prestige, Reprise.

Scotty McKay Prod'ns, Vaughn Bldg., Dallas, Tex. Tel: (214) RI 7-2174.
Branch: New York, N. Y., 250 W. 57 St., Suite 1528.
Label Credits: Dot, Ace, Philips, Claridge, Dimension, Diamond.

Huey Meaux, 227 E. Sterling, Pasadena, Tex. Tel: (713) GR 2-6947.

Ray Meinberg, c/o Warren Sound Systems, 35 N.E. 62 St., Miami, Fla. Tel: (305) PL 4-9539.

Metro-Beat Prod'ns, PO Box 4447, Minneapolis, Minn. 55421. Tel: (612) 788-9122. A&R Dir.: Michael Jann.
Label Credits: Metro-Beat, West Wind.

Earl Miles Musics (Mile/Tones Musics), PO Box 1336, 1108 Davis, Redwood City, Calif. 94403. Tel: (415) EM 9-0728.
Label Credit: Canary.

Edward M. Miller & Assocs., 518 McKay Tower, Grand Rapids, Mich. 49502. Tel: (616) GL 4-4483. Pres.: Edward M. Miller. VP: V. B. McCarthy.

Monticana Recs., 4 W. 31 St., New York, N. Y. 10001. Tel: (212) LA 4-7800, Ext. B24. Exec. Prod'r: Dave Leonard.
Int'l Branch: Canada, 2955 Fendall St., Montreal 26, Que. Tel: (514) 739-8935.
Label Credits: Bell, Columbia, London, Quality, Allied.

Morgan/Sharp Recs., 3658 S. Perry, Montgomery, Ala. 36105. Tel: (205) 265-9961. Pres.: Ed Vaughn.

Much More Music, 7507 Foster, Morton Grove, Ill. Tel: (312) 299-8222. Contact: Perry Johnson.

Jim Musil, 6202 E. Pinchot Ave., Scottsdale, Ariz. 85251. Tel: (602) 946-3640.
Label Credit: ARA.

Ostrich Prod'ns/Tony Richland, 6363 Sunset Blvd., Suite 705, Hollywood, Calif. 90028. Tel: (213) HO 7-2151.
Label Credit: Jerden.

Herb Ostrow, 260 W. 23 St., New York, N. Y. 10011. Tel: (212) AL 5-4641.
Label Credits: Columbia, Decca, Listen & Learn, MGM, RCA Victor.

Steve Falmer, 14120 N.W. Seventh Ave., Miami, Fla.
Label Credit: Date.

Past, Present & Future Prod'ns, 25 W. 56 St., New York, N. Y. 10019. Tel: (212) JU 2-8810. Pres.: Aaron Schroeder.
Label Credits: Capitol, Epic, Reprise, Smash, Vee Jay, Verve/Folkways, Warner Bros.

The Paycheck Co., GPO Box 1958, New York, N. Y. 10001. Tel: (212) UN 1-7309. Rec'g Dir.: A. Mayhew.
Branch: Nashville, Tenn., 802 18 Ave. S.
Label Credits: Audio Fidelity, Hilltop, Little Darlin'.

Pebble in the Sand Prod'ns, B Sutton Pl., Florham Park, N. J. Pres.: Bob Stone.

continued

Pied Piper Prod'ns, 1936 Butterfield, Troy, Mich. Tel: (313) 646-6693. Pres.: Shelley Haims. Label Credits: RCA Victor, Audio Fidelity, Karate, Giant.

Clay Pitts, 850 Seventh Ave., New York, N. Y. 10019. Tel: (212) LT 1-4144. Label Credits: Freeport, Roulette.

S. Polley, 116 Central Park S., New York, N. Y. 10019. Tel: (212) CI 6-3811. Mgr.: Stanley Polley. Label Credits: ABC, Colpix, Columbia, Dot, MGM, 20th-Fox, UA, Warner Bros.

Kerry Prod'ns, 9358 James Ave. S., Minneapolis, Minn. 55431. Contact: Jeff Raymond. Label Credits: Parrot, Twin Town, Studio City, Cardinal, Aesop's Label, Kerry.

Curtis Kirk/Fred Harper, PO Box 231, Tyler, Tex. 75701. Tel: (214) LY 4-2961. Label Credits: Custom, Flash.

Gus Kondas, 1405 Allen Ave., Ashtabula, Ohio 44004. Tel: (216) 964-7862.

Koppelman-Rubin, 1650 Broadway, New York, N. Y. 10019. Tel: (212) 765-2682. Pres.: Charles Koppelman; VP: Don Rubin. Label Credits: Columbia, Decca, Kama Sutra, MGM, Mercury, RCA Victor, Roulette.

Powell-Summer Assocs., PO Box 273, Excelsior, Minn. 55331. Tel: (612) 474-9780. Pres.: Don Powell Summer; VP: John Summer. Label Credits: Summer, Holton.

Professional Programming Publ'ns, 9701 SW 77 Terr., Miami, Fla. 33143. Tel: (305) 271-0839. Gen. Mgr.: Bob Harris; Prod'n Dir.: Dick Starr.

Redwood Recs., 617A S. Victor, Burbank, Calif. Tel: (213) 843-4840. Owners: C. E. Lenderman & Gordon Calcote.

Richrisand, 120 E. 56 St., New York, N. Y. Contact: Richard Adler.

Dave Rick Prod'ns, 1650 Broadway, New York, N. Y. 10019. Tel: (212) LO 4-3250. Pres.: Dave Rick. Label Credits: ABC, Herald, Jubilee, Laurie.

Risi-Thomas Prod'ns, 3163 Poplar Dr., Lynwood, Calif. 90221. Tel: (213) 639-3201. Owners: James Thomas & Nick Risi. Label Credit: Challenge.

Riverside, 915 Queen St., Pottstown, Pa. 19464. Tel: (215) 323-3336. Pres. & Exec. Prod'r: A. Alan Botto; Gen. Mgr.: Evadna Brosius.

Rostrum Recs., 153 E. 57 St., New York, N. Y. 10022. Tel: (212) 751-2740. Cable: Rostrecinc. Pres.: Louis M. Gersten.

Rowilco/World of Music, PO Box 8135, Chicago, Ill. 60680. Tel: (312) 373-7072. Exec. VP: R. C. Hillsman. Branch: Los Angeles, Calif., 4363 Lockwood Ave., Suite 2. Pres.: R. C. Wilson. Label Credits: Federal, Deluxe, King, Sta-Set.

Ray Sanders, PO Box 38631, Hollywood, Calif. 90038. Tel: (213) 763-4374. Label Credits: Buddy, Industry, Stadium.

Santa Cruz Recs., 815 E. Broadway, Tucson, Ariz. 85719. Tel: (602) 623-0318. Owner: Frank Darris.

Leonard Schwab Prod'ns, 815 Juniper St. N.W., Washington, D. C. 20012. Tel: (202) 723-0436. Cable: LENSPROD.

Scolaron Recs., 8442 Wilbur Ave., Northridge, Calif. 91325. Tel: (213) 343-8045. Pres.: David M. Seiden.

Sharastan Recs., Rt. 3, Killen, Ala. Tel: (205) 764-1781. Pres.: Jerry Day.

Shur Prod'ns, 1121 Second Ave., Columbus, Ga. 31901. Tel: (404) FA 7-4641. Owner: John Suhr. Branch: Nashville, Tenn., 815 16 Ave. S. Label Credits: Challenge, Laurie.

Singcord, Sta. C, Grand Rapids, Mich. 49506. Tel: (616) 456-5406. Pres.: Bernie Zondervan Jr. Label Credits: Zondervan, Crown V.

Sound of Gold Prod'ns, 301 E. 62 St., New York, N. Y. Contact: Jerry Goldstein.

Spectra Prod'ns, 912 Stemmons Tower E., Dallas, Tex. Tel: (214) 631-1033. Pres.: William H. Hollingsworth; VP: James E. Hollingsworth; A&R: Dale Hawkins & Roger B. McGaw.

Spice Prod'ns, 41 W. 86 St., New York, N. Y. 10024. Tel: (212) TR 3-4237. Mgr.: Irving Spice.

Standard American Prod'ns, 9155 Sunset Blvd., Hollywood, Calif. 90069. Tel: (213) 278-0522. Cable: STAMPDOD. Pres.: Marc Miller. US Branches: Miami, Fla., 12100 N.E. 16 Ave.; New York, N. Y., 136 W. 55 St. Int'l Branch: Bahamas, British Colonial, Nassau. Charles Stewart Prod'ns, PO Box 7262, Ft. Worth, Tex. Tel: (817) TE 8-9401. Prod'r: Charles Stewart. Label Credits: Hue, Mala.

Leonard Stogel & Assocs., 151 E. 55 St. Tel: (212) 755-7719. Pres.: Len Stogel.

Wesley Strawn Prod'ns, 4850 Joaquin Way, Sacramento, Calif. 95822. Tel: (916) 457-8497.

Tan-Lan Ent's, PO Box 517, Gallipolis, Ohio 45631. Tel: (614) 446-4240. Pres.: Stan Lane.

13 Prod'ns, 39 W. 55 St., Rm. 205, New York, N. Y. 10019. Tel: (212) JU 2-0234. Pres.: George Foster; VP: Bob Booker. Label Credit: Kapp.

3-8 Prod'ns, PO Box 3093, Lafayette, La. 70501. Pres.: Kirby Boudreaux; VP: Billy J. Babineaux.

Uncle John's Gang, 1457 National, Memphis, Tenn. 38122. Tel: (901) 324-5368. Contact: Terry Manning. Label Credits: Ardent, Arbet, Soul Bird, Block.

V-S Prod'ns, 832 Leona, Columbus, Ohio 43201. Tel: (614) 299-6150. Pres.: Vernon Stewart. Label Credits: Soul Town, Flame, Midtown, EKCO, Big Boy, Hitone, Stage Sound.

Vance-Pockriss Prod'ns, 1540 Broadway, New York, N. Y. Tel: (212) JU 2-2000. Contact: Paul Vance & Lee Pockriss.

Vantage Rec'g, 1849 W. 107 St. Chicago, Ill. 60643. Tel: (312) 335-1109. Cable: VANTAGE. Branch: Pottstown, Pa., PO Box 212, Zip: 19464. Tel: (215) 323-3336. Label Credits: Jody, Pliant, Reco-Flex, Semaphore, Sound of Money, Vantage, Zouvenir.

Wallen Music, 312 Harkleroad Ave. Kingsport, Tenn. 37660. Tel: (615) 245-6026. Owner & Mgr.: Ernest B. Wallen. Label Credit: Beechwood.

Willmac Recs., 60 E. 42 St., Suite 3115, New York, N. Y. 10017. Tel: (212) MU 2-1380. Pres.: William McKelvey.

Style Wooten Prod'ns, 3635 Allandale Rd., Memphis, Tenn. 38111. Tel: (901) 324-4640. Pres.: Style Wooten. Label Credits: Allandale, Style, Tentay, Burch-Io, Cotton Town Jubilee, Zonia, Calten, Spinnin Square, Wooten.

Wow Prod'ns, 39 W. 55 St., New York, N. Y. 10019. Tel: (212) 245-1270. Pres.: Ray Muscarella & Dee Anthony.

Charles Wright Agency, 124 N. Peak St., Dallas, Tex. 75226. Tel: (214) TA 7-5023.

Steve Wright Prod'ns, PO Box 626, 1608 S. Fleishel, Tyler, Tex. 75701. Tel: (214) LY 2-0591.

York-Pala, 7715 Sunset Blvd., Los Angeles, Calif. 90046. Tel: (213) 876-1360. Contacts: Charles Greene & Brian Stone. Branches: New York, N. Y., 52 Broadway; Nashville, Tenn., 1719 West End Bldg., Suite 710.

Zay-Dee Recs., Willey Bldg., Marianna, Ark. 72360. Tel: (501) CY 4-2195. Mgr.: George Whitaker.

Zenith Prod'n, 2100 Cecilia, Big Spring, Tex. 79720. Tel: (915) 264-2716. Partners: Ray B. Rush & Ted O. Groebel Jr. Branch: Houston, Tex., 1400 S. Post Oak, Suite 12.

"Repetition Builds Reputation"

Put your company's name before the entire music-record industry and keep it there—the proven, economical way.

... through consistent advertisements in Billboard's budget-priced

BUYERS & SELLERS CLASSIFIED MART

Write for rates to:
Billboard Classified Mart
188 W. Randolph St.
Chicago, Ill. 60606

disc award ltd.

METAL DISC PRESENTATION AWARDS



A LASTING MOMENTO in Appreciation for an Outstanding Performance on Record. Beautifully Framed and Mounted. A Permanent Gold Record Using Your Label.

7" — 12"

Producers • Artists • Composers • Arrangers • Writers
• Disc Jockies • Distributors

disc award ltd.



SUITE 102
6201 Santa Monica Blvd.
Los Angeles, Cal. 90038

Proclamation

whereas

CREWE GROUP LTD.

*has established a more perfect union
of its companies*

and whereas

*the following are integral units of
CREWE GROUP LTD.:*

GENIUS, INC.

SATURDAY MUSIC, INC.

GENIUS MUSIC CORP.

NEW VOICE RECORDS

DYNOVOICE RECORDS

SCC MANAGEMENT, INC.

therefore

*it is the purpose of the above mentioned
firms to present the finest in music,
recordings, performers, and production
for motion pictures, television and the stage.*

Attested to:

Robert S. Crewe, Jr.
President

Daniel N. Crewe
Executive Vice-President

June 15, 1966

1841 Broadway, New York, N. Y.

Leading U.S. Music Publishers

More than 1,000 U. S. music publishers are listed on the following pages. Information about each publisher includes licensing society affiliation, affiliated publishers, international firms which the publisher represents, and international firms which represent the publisher. Advertisers' names are in capital letters.

- A B A (BMI), 1421 S. Michigan Ave., Chicago, Ill.
A B C (ASCAP), 136 W. 52 St., New York N. Y. 10019. Tel: (212) CI 7-5500. Owner: Bonnie Bourne; Gen. Prof. Mgr.: Bernie Scherer.
Branch: Hollywood, Calif., 6381 Hollywood Blvd. Zip: 90028.
Affiliates: Bourne-Filmusic (ASCAP), Murbo (EMI), Oakland (ASCAP), Schumann (ASCAP).
Int'l firms represented: Bourne (England), Bourne-France (France).
Int'l representatives: Australia (Boosey & Hawkes), England (Filmusic), Germany (Melodie Der Welt), Holland (Basart). (SEE ADVERTISEMENT)
- A M A (ASCAP), 1650 Broadway, Rm. 301, New York, N. Y. 10019. Tel: (212) JU 6-4934. Treas.: Allen B. Jacobs.
Aardvark Ent. (ASCAP), 609 Fifth Ave., New York, N. Y. 10022. Tel: (212) PL 9-5324. Pres.: Mrs. Ramona Crehan.
Abacus (BMI), 402 E. "F" St., Ontario, Calif. Tel: (714) 983-4823. Pres. & Gen. Mgr.: G. F. Sudetta.
Abel (BMI), 507 Fifth Ave., New York, N. Y. 10017. Tel: (212) OX 7-5895.
Aberbach (BMI), see Hill & Range.
Acacia (ASCAP), Time & Life Bldg., Rockefeller Ctr., New York, N. Y. 10020. Tel: (212) CI 5-7010.
Acropole (BMI), PO Box 365, Wilton, Conn. 06897. N. Y. C. Tel: (212) CY 5-2272. Pres.: (Mrs.) Michele Ronty.
Active (ASCAP), 3170 S.W. Eighth St., C 315, Miami, Fla. 33135.
Acuff-Rose (BMI), 2510 Franklin Rd., Nashville, Tenn. 37204. Tel: (615) 297-8591. Pres.: Wesley H. Rose.
Affiliate: Fred Rose (BMI).
Adams-Ethridge (BMI), PO Box 434, 5028 Ave. N., Galveston, Tex. 77550. Tel: (713) SO 3-8344, 4146. Owners: Leon Ethridge & Gerald Adams; Gen. Prof. Mgr.: Leon Ethridge.
Branch: Houston, Tex., 8010 Weir Dr. Tel: (713) MI 5-0416.
Int'l representatives: Australia (J. Alberts & Sons), England (Belgravia, Campbell-Connelly; Francis, Day & Hunter).
Adkins (BMI), 7527 Juler Ave., Cincinnati, Ohio. 45243. Tel: (513) 561-7818. Cable: Adco Recs. Pres.: Jack Adkins.
Admiration (BMI), see Brunswick.
Advanced (ASCAP), see Music Publishers Holding Corp.
Affiliated (BMI), see Hill & Range.
Fred Ahlert (ASCAP), 15 E. 48 St., New York, N. Y. 10017. Tel: (212) PL 9-3860.
Affiliates: Ahlert-Burke (ASCAP), Blue Seas (ASCAP), Franklin Street (ASCAP), Jac (ASCAP), Knollwood (ASCAP), Sanvic (ASCAP), Thursday (BMI).
Ahlert-Burke (ASCAP), see Fred Ahlert.
Airefield (BMI), see Central Songs.
Bill Aken, 6034 Atlantic Blvd., Maywood, Calif. 90370. Tel: (213) 583-5921 & 589-3880. Dir.: John Saunders.
Alameda (BMI), see Edward B. Marks.
Alamo (ASCAP), see Hill & Range.
Alan K. (BMI) 1619 Broadway, New York, N. Y. 10019. Tel: (212) CI 5-7960.
Rene Albi (BMI), PO Box 365, Wilton, Conn. 06867. N. Y. C. Tel: (212) CY 5-2272. Mgr.: Rene Albi.
Alexis (ASCAP), 408 W. 57 St., New York, N. Y. 10019. Tel: (212) JU 2-8850. Pres.: Lee Magid.
Branch: Hollywood, Calif., 5750 Melrose. Zip: 90038. Tel: (213) 463-2353.
Affiliate: Lou-Lee (BMI), Marvelle (BMI).
Int'l firms represented: Alexis (England), Alexis (Germany), Radio Edizioni (Italy).
Alfieri, 10 W. Camden Ave., Moorestown, N. J. 08057. Tel: (609) BE 5-9699 & HO 1-6365. Pres.: Lou Alfieri.
Algonquin (BMI), 1650 Broadway, New York, N. Y. 10019. Tel: (212) PL 7-3287.
Algrove (ASCAP), 664 Schuykill Ave., Reading, Pa. Pres.: Grover A. Barbour; A&R: R. Golding.
Alki (BMI), 3514 S.W. Manning, Seattle, Wash. 98126. Tel: (206) WE 2-0084. Pres.: Don Castagna.
Allegro (ASCAP), PO Box 11371, Los Angeles, Calif. 90011. Tel: (213) FA 1-5654. Pres.: Dunlap J. Cawthron.
Allison, see Distant.
Almira, 157 W. 57 St., New York, N. Y. 10019.
Almo (ASCAP), 8255 Sunset Blvd., Hollywood, Calif. 90046. Tel: (213) 656-5330. Pres.: Jerry Moss.
Alvera (BMI), PO Box 9304, Tulsa, Okla. 74107. Tel: (918) 242-3283. Pres. & Gen. Mgr.: Al Clauser; Gen. Prof. Mgr.: Vera Clauser.
American (BMI), 9109 Sunset Blvd., Hollywood, Calif. 90069. Tel: (213) CR 1-5254. Pres.: Sylvester Cross.
Affiliate: Choice (ASCAP).
American Academy of Music (ASCAP), see Mills.
American Metropolitan Ent., 135 W. 50 St., Rm. 1920, New York, N. Y. 10019. Tel: (212) PL 7-7178.
Affiliates: Edward Arthur (BMI), Berkshire (BMI), Broadway (ASCAP), Brookdale (BMI), Conquest (ASCAP), Edward's (ASCAP), Glenbrook (ASCAP), Glow (BMI), Jay Boy (BMI), Edward Kassner (ASCAP), Kryder (BMI), Piccadilly (BMI), Pinelawn (BMI), Rush (BMI), Sid-Lee (BMI), Syndicate (ASCAP), Tideland (BMI), Town & Country (BMI), Tray (ASCAP).
Ampar (BMI), see Pamco.
Ampco (ASCAP), see Pamco.
Amphora (BMI), 1727 Division St., Davenport, Iowa 52804. Pres.: Frank L. Engel.
Anahid (BMI), 15 E. 48 St., Suite 202, New York, N. Y. 10017. Tel: (212) PL 3-0010. Owner: George Avakian.
Affiliate: Armavir (BMI).
Ananga-Ranga (BMI), see Budd.
And (BMI), 185 West End Ave., Suite 9C, New York, N. Y. Tel: (212) TR 3-1222. Pres.: Johnny Nash.
Affiliate: J&E.
Andor (ASCAP), see Sunbeam.
Andrew (ASCAP), see Frank.
Angelica, see Jasparr.
Johnny Angle (BMI), 2224 Belvedere Dr., Jackson, Miss. Tel: (601) FL 4-3062. Pres. & Gen. Mgr.: Johnny Angle; Gen. Prof. Mgr.: James E. Farris.
Angus (BMI), see Raleigh.
Anim (BMI), see A. Schroeder.
Ankerford (ASCAP), see Mills.
Ankilmor (BMI), PO Box 15366, Orlando, Fla. 32808. Tel: (305) CY 3-2560. Pres.: Robert P. Angel Sr.
Ann-Rachel (ASCAP), see Hill & Range.
Antone (ASCAP), see Donna.
Apex, 2775 Lantz Ave., San Jose, Calif. 95124. Tel: (408) 252-1580 & 377-1237. Pres.: E. F. Moss; VP: V. E. Moss; Sec.: M. M. Hogg.
Applejack (BMI), see Geld-Udell.
Applesed (ASCAP), see Sanga.
April (ASCAP), see Blackwood.
Apt (ASCAP), see Pamco.
Arc (BMI), see Regent.
Arcade (ASCAP), 2733 Kensington Ave., Philadelphia, Pa. 19134. Tel: (215) NE 4-8487. Pres. & Gen. Mgr.: Jack Howard.
Affiliate: Jack Howard (BMI).
Int'l representative: England (Burlington).
Arch (ASCAP), see A. Schroeder.
Ardell (BMI), 825 Alaska St., Memphis, Tenn. 38107. Tel: (901) 276-5256. Contact: Edward Kirby.
Arko-La-Tex (BMI), see Hill & Range.
Arko (ASCAP), see Edwin H. Morris.
Arman (BMI), 19802 N.E. 12 Pl., North Miami Beach, Fla. Tel: (305) 949-3033. Contact: June Meinberg.
Armavir (BMI), see Anahid.
Armel (BMI), see Costoma.
Arsak (BMI), PO Box 1293, Amarillo, Tex. Tel: (806) FL 6-8540. Pres.: Al Rogers.
Edward Arthur (BMI), see American Metropolitan Ent.
Artists (ASCAP), see Daywin.
Asa (ASCAP), see Metric Music Group.
Ascot-Jolen (ASCAP), 45 W. 39 St., New York, N. Y. 10018. Tel: (212) BR 9-3482. Pres.: Lonnie Kaufman.
Affiliate: Lonnie (BMI).
Ashland (BMI), see Cavalcade.
Associated (BMI), 609 Fifth Ave., New York, N. Y. 10017. Tel: (212) 752-3800. Gen. Mgr.: Benjamin V. Grasso.
Affiliate: Schroeder & Gunther (BMI).
Astron (ASCAP), 1595 Broadway, New York, N. Y. 10019. Tel: (212) JU 6-5390. Gen. Mgr.: Bea Kaslin.
Affiliates: Keel (BMI), Tona Lee (BMI).
Astronette, 2037 Alvarado N.E., Albuquerque, N.M. 87110. Tel: (505) 268-8405. Mgr.: Ann Faught.
At Last (BMI), PO Box 78191, Los Angeles, Calif. 90016. Tel: (213) 933-2269. Mgr.: Harold R. Battiste Jr.
Branch: Hollywood, Calif., 6425 Hollywood Blvd., Rm. 208. Zip: 90028. Tel: (213) HO 6-4541.
Athens of the South Prod'ns, 815 16 Ave. S. Nashville, Tenn. 37203. Tel: (615) 255-6535. Pres.: Benny Joy.
Athwarn (ASCAP), see Music Publishers Holding Corp.
Atlantic (BMI), see Criterion.
Atrium (ASCAP), 1619 Broadway, New York, N. Y. 10019. Tel: (212) 265-1626. Contact: Hugo & Luigi.
Atzal (BMI), see Hill & Range.
Audubon (ASCAP), see Frank.
Augsburg (SESAC), 426 S. Fifth St., Minneapolis, Minn. 55415. Tel: (612) FE 2-4561. Contact: W. O. Bliss.
Austin (BMI), see Criterion.
Auf (ASCAP), see Lock.
Avalon (SESAC), see Stirling.
Avaris (ASCAP), see A. Schroeder.
B & B (BMI), PO Box 7816, Detroit, Mich. 48207. Tel: (313) 832-3539. Pres.: John F. Frye.
Int'l firms represented: Bolero (Milano), Florida Music (London), Publimusic (Milano).
B L & H (ASCAP), 1650 Broadway, Suite 310, New York, N. Y. 10019. Tel: (212) JU 6-0240.
B N P (ASCAP), 1619 Broadway, New York, N. Y. 10019. Tel: (212) LT 1-6430. Mgr.: Ivan Mogull.
Branch: North Hollywood, Calif., 4030 Radford Ave. Tel: (213) 766-4151. Gen. Mgr.: Alfred Perry.
B-W (BMI), PO Box 337, Wooster, Ohio 44691. Tel: (216) 262-3571. Pres.: Quentin (Reed) Welty.
Baby Monica (BMI), see Flomar.
Balladier (BMI), see Costoma.
Bamboo (BMI), 7033 Sunset Blvd., Suite 308, Hollywood, Calif. 90028. Tel: (213) HO 6-2161.
Bandolero (BMI), 9525 Gschwind, El Paso, Tex. Tel: (915) 755-0859. Owner: Jack Hardin.
Banff (BMI), see Jasparr.
Barclay (ASCAP), see Shapiro, Bernstein.
C. L. Barnhouse (SESAC), 110 B Ave., Oskaloosa, Iowa. Tel: (515) 673-7601.
Guy Barry Ent. (ASCAP), 13 Wesley Dr., East Rockaway, N. Y. Tel: (516) FR 4-6772.
Barton (ASCAP), 116 Central Park S., Suite 3B, New York, N. Y. 10019. Tel: (212) JU 2-2205. VP: Sol Parker.
Affiliates: Ding Dong (BMI), Maraville (ASCAP), Midwood (BMI), Ritchie (ASCAP), Saga (ASCAP), San Dino (ASCAP), Sands (ASCAP), Sinatra Songs (ASCAP), Stanwood (ASCAP).
Earl Barton, Radio-TV Bldg., Springfield, Mo. Tel: (417) UN 2-4422. VP & Gen. Mgr.: Si Siman.
Affiliate: Table Rock.
Diane Basie (ASCAP), see The Big Seven.
Beaver (ASCAP), 1650 Broadway, Suite 310, New York, N. Y. 10019. Tel: (212) JU 6-0240.
Beechmont (BMI), 1650 Broadway, Suite 310, New York, N. Y. 10019. Tel: (212) JU 6-0240.
Beechwood (BMI), 1750 N. Vine St., Hollywood, Calif. 90028. Tel: (213) 462-6252.
Beehive, see Santaville.
Beekman (ASCAP), see Mercury.
Belmont (BMI), see M. M. Cole.
Benco (ASCAP), see A. Schroeder.
Bendig (BMI), see Fermata Int'l Melodies.
Benell (BMI), 318 W. 48 St., New York, N. Y. 10036. Tel: (212) PL 7-8570.
Benglo (BMI), see Notable.
Bennie Benjamin (ASCAP), see Hill & Range.
Benjon, 3707 Stanton Blvd., Louisville, Ky. 40220. Tel: (502) 452-2254. Pres.: John F. Young.

continued on page 58

The
Hallmark*
of Total
Involvement

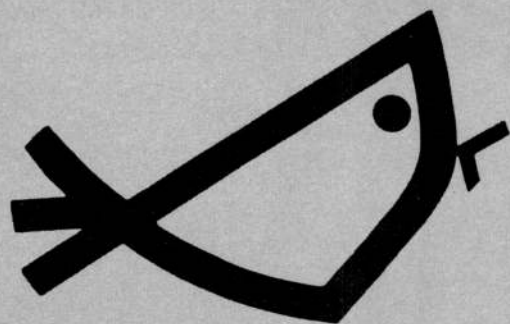

. . . In every territory throughout the world . . . in all media using music . . . signifying integrity . . . creativity . . . aggressive exploitation and complete commitment to the highest ideals of the music industry

* hall'-mark n: a mark or device placed or stamped upon an article of trade to indicate genuineness.

A. SCHROEDER
MUSIC CORPORATION

Abby Steinberg Wally Gold
January Music/Arch Music/Sea-Lark Enterprises
Aurora Records/Mainstay Management/Past,
Present & Future Productions
25 West 56th Street, New York, New York 10019
On the West Coast:
9000 Sunset Boulevard, Hollywood, California
David Mook



in England

A. Schroeder Music Publishing
Company Limited
15 Berkeley Street, London W. 1
Betty Collick Jim Smith



in Australia

A. Schroeder Music Pty Ltd.



in Italy

Catalogo A. Schroeder



in Germany

A. Schroeder Musikverlag Kg



in Holland

A. Schroeder—Basart N.V.



in France

Editions Musicales A. Schroeder



in Scandinavia

A. Schroeder Musikforlag



in Mexico

A. Schroeder Grever International S.A.



in South Africa

A. Schroeder Music Ltd.

continued

John T. Benson (ASCAP), 136 Fourth Ave. N., Nashville, Tenn. 37219. Tel: (615) CH 2-3541. Pres.: John T. Benson Jr.

Bentley (BMI), PO Box 1170, Chapel Hill, N. C. Tel: (919) 967-7040. Mgr.: Orville B. Campbell.

Berdo (BMI), PO Box 203, 159B N. "E" St., San Bernardino, Calif. 92405. Tel: (714) TU 2-0629. Pres.: George E. Clements; Gen. Mgr.: Margaret L. Clements.

Branch: Ventura, Calif., 132 S. Evergreen. Tel: (805) 643-0447.

Berkshire (BMI), see American Metropolitan Ents.

Irving Berlin (ASCAP), 1290 Ave. of the Americas, New York, N. Y. 10019. Tel: (212) CI 7-4200.

Bernice (BMI), see A. Schroeder.

Bertram (BMI), 935B James Ave. S., Minneapolis, Minn. 55431.

Betalbin (BMI), Time & Life Bldg., Rockefeller Cir., New York, N. Y. 10020. Tel: (212) CI 5-7010.

Bibo (ASCAP), 2444 Wilshire Blvd., Santa Monica, Calif. 90403. Tel: (213) UP 0-7076. Pres.: Lawrence Welk; VP & Gen. Prof. Mgr.: Paul Weirick.

Branch: New York, N. Y., 1619 Broadway. Zip: 10019. Tel: (212) LT 1-3197. Gen. Prof. Mgr.: Frank Abramson.

Affiliates: Champagne (ASCAP), Vogue (BMI), Harry Von Tilzer (ASCAP).

Big Bopper (BMI), see Tracie.

THE BIG SEVEN (BMI), 1631 Broadway, New York, N. Y. 10019. Tel: (212) JU 2-4267. Contact: Albert Peckover.

Affiliates: Diane Basie (ASCAP), Branston (BMI), CB (BMI), Cordon (BMI), Country Gentlemen (BMI), Figure (BMI), Frost (BMI), Little Dipper (BMI), Nom (BMI), Patricia (BMI), Planetary (ASCAP), Sanada (BMI), Sandra (ASCAP). (SEE ADVERTISEMENT)

The Big 3, (ASCAP), 1540 Broadway, New York, N. Y. 10036. Tel: (212) JU 2-2000. Cable: ROBMUSIC, FEISTEL, MILLERMUSE. VP & Gen. Mgr.: Arnold Maxin; Gen. Prof. Mgr.: Jay Lowy.

Branch: Hollywood, Calif., 1777 N. Vine St. Zip: 90028. Tel: (213) HO 9-5374.

Affiliates: Robbins (ASCAP), Leo Feist (ASCAP), Miller (ASCAP), Hastings (BMI).

Int'l firms represented: Curci (Italy), B. Fieldman (England), Francis, Day & Hunter (England), Hans Gerig (Germany), Reuter & Reuter (Sweden), Gordon V. Thompson (Canada).

Int'l representatives: Australia (J. Albert & Son), Austria (Weltmusik), Belgium (Francis, Day), England (B. Feldman; Francis, Day & Hunter); Robbins, France (France-Melodie, Germany (Sidemton), Holland (Trident), Italy (Curci), Japan (Eastern), Mexico (Grever), Spain (Canciones del Mundo), Sweden (Reuter & Reuter), Switzerland (Sidem).

Big Wedge (BMI), 3101 Fleet St., Baltimore 24, Md. Tel: (301) 342-3633. Contact: Ralph Johnson.

Carrie Biggs (BMI), 61 W. Third St., Xenia, Ohio 45385. Tel: (513) 372-5427. Gen. Mgr.: Ernest R. Biggs.

Bigtop (BMI), see Hill & Range.

Binh Ents. (BMI), 2321 N. Halsted St., Chicago, Ill. 60614. Tel: (312) 525-6894. Contact: Susan Larson & Edward Larson.

Bip-Bam (BMI), 950 Morris St., Cincinnati 6, Ohio. Tel: (313) 221-8495. Owner: Vincent L. Morton.

Black Gold (BMI), PO Box B033, Hollywood Sta., 625 Chelsea, Memphis, Tenn. 38108. Tel: (901) 523-1190. Pres.: Judd F. Wood.

Black Orchid (BMI), PO Box 11254, East Memphis Station, Memphis, Tenn.

BLACKWOOD (BMI), 1650 Broadway, Suite 201, New York, N. Y. 10019. Tel: (212) LT 1-9690. Gen. Mgr.: Gerald E. Teifer; Prof. Mgr.: David Rosner.

Affiliate: April (ASCAP). (SEE ADVERTISEMENT)

Jerry Blaine (BMI), 31B W. 4B St., New York, N. Y. 10036. Tel: (212) PL 7-8570.

Blasco (ASCAP), 11240 N. Oak St., Kansas City 55, Mo. Tel: (816) RE 4-2940. Mgr.: Frank Blasco.

Bloch (ASCAP), 31 W. 31 St., New York, N. Y. 10001. Tel: (212) LO 4-2040. Pres.: Edward H. Bloch.

Blockdon (BMI), 1000 Blythe, Memphis, Tenn. 38104. Tel: (901) 275-5053. Pres.: Melba Knoblock.

Bloor (see Lansdowne).

Blue Angel, 4194 Wellworth Ave., Louisville, Ky. 40216. Owner: Wesley Daugherty.

Blue Blood (BMI), see Leonard Hodess Group.

Blue Seas (ASCAP), see Fred Ahlert.

Bobby Tunes (ASCAP), see Maravilla.

Bobob (ASCAP), see Claridge.

Bobwhite (BMI) 6047 Hollywood Blvd., Hollywood, Calif. 90028. Tel: (213) PO 6-6111. Contact: Bob Klimes & Hal Levy.

Bonjour (ASCAP), see Earth.

Bouquet, 3712 N.E. 2B St., Ft. Worth, Tex. 76111. Tel: (817) TE B-2402. Pres.: Jesse Smith.

Bourne-Filmusic (ASCAP), see ABC.

Branston (BMI), see The Big Seven.

Braun (SESAC), see Music Sales Corp.

Breezy Willow (ASCAP), see Les John.

Bregman, Vocco & Conn (ASCAP), 1619 Broadway, New York, N. Y. 10019. Tel: (212) CI 7-1591. Prof. Mgr.: Jack Spatz.

Branch: Hollywood, Calif., 1610 N. Argyle Ave. Zip: 90028. Prof. Mgr.: Milton Samuels.

Affiliates: Chatham (ASCAP), Lombardo (ASCAP), Rosemeadow (ASCAP), Supreme (ASCAP), Triangle (ASCAP), Vernon (ASCAP), Welzheim (ASCAP).

Brenner (BMI), see Hill & Range.

Brent (BMI), 1290 Ave. of the Americas, New York, N. Y. 10019. Tel: (212) 247-0655. Mgr.: Bob Shad.

Brian (BMI), 7611 S. Normal Blvd., Chicago, Ill. 60620. Tel: (312) 4BB-4014. Pres.: Robert Catron; VP: Maurice Simpkins; Gen. Mgr.: Nat Engleberg.

Brigaro (BMI), 200 W. 57 St., New York, N. Y. 10019. Tel: (212) 247-4555. Contacts: Frank Scinlaro & Dave Brigati.

Bright-Tunes, c/o Seymour Barash, Esq., 1 Hanson Pl., Brooklyn, N. Y. 11217. Tel: (212) NE B-9777. Pres.: Seymour Barash.

Brittany (BMI), see Hill & Range.

Broadman Press (SESAC), 127 Ninth Ave., N., Nashville, Tenn. 37203.

Broadway (ASCAP), see American Metropolitan Ents.

Bromillo (BMI), 8740 Aldwick Dr., Dallas, Tex. 75238. Tel: (214) DI B-9324. Pres.: Don Brooks; Gen. Mgr.: Joe Jaramillo.

Bronze (SESAC), see Sure-Fire.

Brookdale (BMI), see American Metropolitan Ents.

Brot (BMI), 1413 Dutch Valley Pl. N.E., Atlanta, Ga. 30324. Tel: (404) 873-1876. VP: Don W. Tweedy.

Brown (BMI), 1650 Broadway, New York, N. Y. 10019. Tel: (212) CO 5-1063.

Brownleaf, PO Box 7221, Mobile, Ala. 36607. Tel: (504) 477-7434. Pres.: John N. Blackburn; VP: Mrs. Sara Ann Smith.

Brunswick (BMI), 2334 S. Holt, Los Angeles, Calif. 90034. Tel: (213) CR 3-0442. Owner: Lee Silver.

Affiliate: Admiration (BMI).

Bryden (BMI), 157 W. 57 St., New York, N. Y. 10019. Tel: (212) CI 5-2255. Mgr.: Lou Sprung.

Buckingham (ASCAP), see Pavanne.

Bud-Bun (BMI), 300 W. 55 St., New York, N. Y. Tel: (212) 246-4982. Pres.: Bunny Jones.

Budd (ASCAP), 1619 Broadway, Rm. 501, New York, N. Y. 10019. Tel: (212) JU 6-3090. Pres.: Buddy Kaye.

Affiliates: Ananga-Ranga (BMI), Greenleaf (BMI), Raintree (ASCAP).

Int'l firms represented: Budd, Musicville, Raintree (England).

Buffee (BMI), see Lesgor.

Bullfrog (BMI), PO Box 1803, Annapolis, Md. 21401. Tel: (301) 268-1210. Contact: Thomas B. Hoskins.

Bumar (BMI), see N. A. Busillo.

Bumarack (BMI), see N. A. Busillo.

Burchten (BMI), PO Box 11522, Memphis, Tenn. 38111. Tel: (901) 324-4640. Pres.: Marvin Burcham.

Burdett (ASCAP), 51B W. 50 St., New York, N. Y. 10019. Tel: (212) 581-4977. Mgr.: Joe Davis.

Burdge (ASCAP), B16 N. Highland Ave., Hollywood, Calif. 90038. Tel: (213) 464-B204. Pres.: Gordon Burdge.

Affiliates: Lyricon (ASCAP), Producers (ASCAP).

Burke & Van Heusen (ASCAP), 250 W. 57 St., New York, N. Y. 10019. Tel: (212) JU 6-4417. Pres.: James Van Heusen.

Affiliate: Van Heusen.

Burning Tree (BMI), see Earth.

Burnt Oak (BMI), 455 Thompson Blvd., Chickasaw, Ala. Tel: (205) GL 2-4298. Mgr.: John Bozeman.

N. A. Busillo (ASCAP), 1023 N. 67 St., Philadelphia, Pa. 19151. Tel: (215) GR 2-4020. Pres.: Nicholas A. Busillo.

Affiliates: Bumar (BMI), Bumarack (BMI), Chromatic (BMI), Clearview (ASCAP), Judith (ASCAP), Lansdale (BMI), Nicholas (ASCAP), St. George (ASCAP), Wharton (ASCAP).

Buxton Hill (ASCAP), see Chappell.

By-Nash of Nashville (BMI), PO Box 701, Nashville, Tenn. 37202. Tel: (615) 297-4967. Pres.: R. Murray Nash.

C B (BMI), see The Big Seven.

continued on page 62

Sheet Music Jobbers

ALABAMA

● HUNTSVILLE (Area Code 205)

Parasonic Music, PO Box 412. Zip: 35804. Tel: B2B-4863.

CALIFORNIA

● LOS ANGELES (Area Code 213)

Morse M. Preeman, 733 S. Spring St. Zip: 90055. Tel: 623-7211.

Ray Sanders, PO Box 38631, Hollywood. Zip: 90038. Tel: 763-4374.

● SAN FRANCISCO & BAY AREA (Area Code 415)

Pacific Coast Music, 657 Mission St. Zip: 94105.

FLORIDA

● MIAMI (Area Code 305)

Hansen Publ'ns, 1B42 West Ave., Miami Beach. Tel: 532-1791.

IDAHO

● IDAHO FALLS (Area Code 208)

Chesbro Music, 327 Broadway. Tel: 522-8691.

ILLINOIS

● CHICAGO (Area Code 312)

Carl Fischer, 306 S. Wabash Ave. Zip: 60604. Tel: HA 7-6652.

Lyon-Healy, 243 S. Wabash Ave. Zip: 60604. Tel: WA 2-7900.

MASSACHUSETTS

● BOSTON (Area Code 617)

Boston, 116 Boylston. Tel: HA 6-5100.

MISSOURI

● KANSAS CITY (Area Code 816)

Jenkins Music, 1217 Walnut St. Tel: VI 2-9430.

● ST. LOUIS (Area Code 314)

St. Louis Music Supply, 3711 W. Pine. Tel: FR 1-4522.

NEW JERSEY

● GLEN ROCK (Area Code 201)

Hansen Publ'ns, 566 Broad St. Tel: 444-0241.

NEW YORK

● NEW YORK CITY (Area Code 212)

Hansen Publ'ns, BBB Eighth Ave. Zip: 10019. Tel: 757-8950.

Walter Kane & Son, 351 W. 52 St. Zip: 10019. Tel: JU 6-4470.

Edwin H. Morris, 31 W. 54 St. Zip: 10019. Tel: JU 2-5656.

Music Dealers Serv., 426 W. 55 St. Zip: 10019. Tel: CI 7-6800.

Plymouth, 1841 Broadway, Rm. 611. Zip: 10023. Tel: CI 6-9366. Mgr.: Bernie Fisher.

Tempo, 52 W. 58 St. Zip: 10019. Tel: CI-6-3530. Pres.: Ruth Ellington.

OHIO

● CLEVELAND (Area Code 216)

Grossman Music, 127B W. Ninth St. Zip: 44113. Tel: 861-3900.

TEXAS

● FORT WORTH (Area Code 817)

Don Edgar Music, 2312 Jasper. Zip: 76106. Tel: MA 6-344B. Owner & Gen. Mgr.: D. D. Edgar.

● SAN ANTONIO (Area Code 512)

Southern Music, 1100 Broadway. Tel: CA 6-8167.

WASHINGTON

● SEATTLE (Area Code 206)

Capitol Music, 900 Terminal Sales Bldg. Tel: MA2-3380.

1965
a vintage year!



1966-A BUMPER CROP ...

25 CHART BREAKERS IN FIRST 6 MONTHS

THESE SONGS

"MY WORLD IS EMPTY WITHOUT YOU"
 "UPTIGHT (EVERYTHING'S ALRIGHT)"
 "UPTIGHT (EVERYTHING'S ALRIGHT)"
 "SHAKE ME, WAKE ME, (WHEN IT'S OVER)"
 "ONE MORE HEARTACHE"
 "GOING TO A GO GO"
 "CLEO'S MOOD"
 "LOVING YOU IS SWEETER THAN EVER"
 "DON'T LOOK BACK"
 "DON'T MESS WITH BILL"
 "THIS OLD HEART OF MINE"
 "LOVE MAKES ME DO FOOLISH THINGS"
 "HELPLESS"
 "DARLING BABY"
 "JUST A LITTLE MISUNDERSTANDING"
 "TAKE SOME TIME OUT FOR LOVE"
 "AIN'T TOO PROUD TO BEG"
 "I CAN'T BELIEVE YOU LOVE ME"
 "MY BABY LOVES ME"
 "I'M A ROAD RUNNER"
 "PUT YOURSELF IN MY PLACE"
 "GET READY"
 "TAKE THIS HEART OF MINE"
 "WHAT AM I GOING TO DO WITHOUT YOUR LOVE"
 "YOU'RE THE ONE"
 "COME ON AND SEE ME"

THESE ARTISTS

SUPREMES
 STEVIE WONDER
 JAZZ CRUSADERS
 FOUR TOPS
 MARVIN GAYE
 MIRACLES
 JR. WALKER & ALL STARS
 FOUR TOPS
 TEMPTATIONS
 MARVELETTES
 ISLEY BROTHERS
 MARTHA & VANDELLAS
 KIM WESTON
 ELGINS
 CONTOURS
 ISLEY BROTHERS
 TEMPTATIONS
 TAMMI TERRELL
 MARTHA & VANDELLAS
 JR. WALKER & ALL STARS
 ELGINS
 TEMPTATIONS
 MARVIN GAYE
 MARTHA & VANDELLAS
 MARVELETTES
 TAMMI TERRELL

THESE WRITERS

HOLLAND, DOZIER, HOLLAND
 WONDER, MOY, COSBY
 MOY WONDER, COSBY
 HOLLAND, DOZIER, HOLLAND
 WILLIAM ROBINSON
 ROBINSON, TARPLIN, MOORE, ROGERS
 WILLIE WOODS
 IVY HUNTER, STEVIE WONDER
 Wm. ROBINSON, R. WHITE
 WILLIAM ROBINSON
 HOLLAND, DOZIER, HOLLAND
 HOLLAND, DOZIER, HOLLAND
 HOLLAND, DOZIER, HOLLAND
 HOLLAND, DOZIER, HOLLAND
 L. BROADNAX, WONDER, PAUL
 ROBERT GORDY, THOMAS KEMP
 EDDIE HOLLAND, N. WHITFIELD
 FUQUA, BRISTOL
 Wm. STEVENSON, IVY HUNTER
 HOLLAND, DOZIER, HOLLAND
 HOLLAND, DOZIER, HOLLAND
 WILLIAM ROBINSON
 ROBINSON, MOORE, TARPLIN
 IVY HUNTER, SYLVIA MOY
 WILLIAM ROBINSON
 HARVEY FUQUA, J. BRISTOL

JOBETE MUSIC COMPANY, INC.

2648 W. Grand Blvd., Detroit 8, Mich.

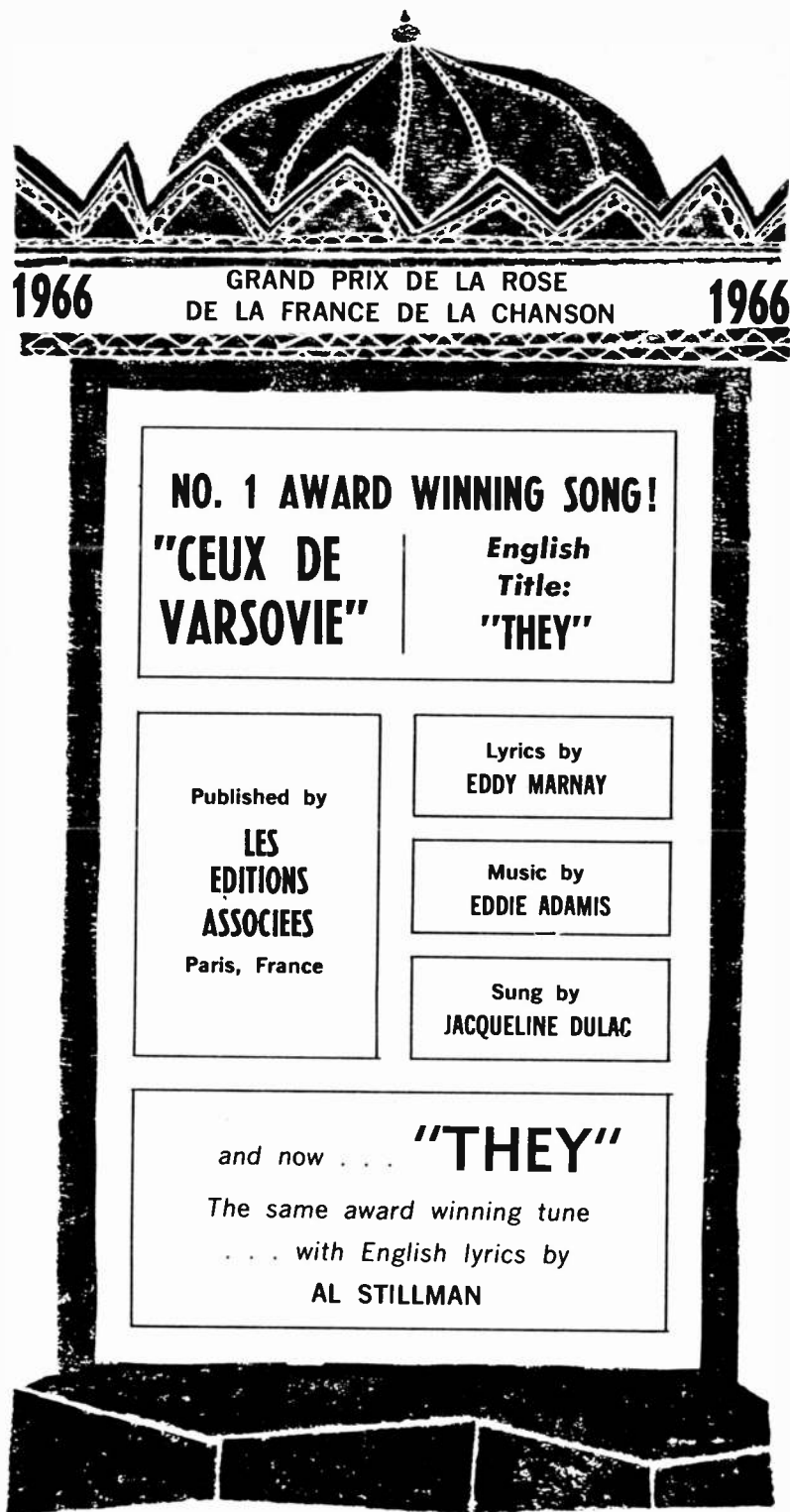

UNITED ARTISTS congratulates its Paris office—
 Les Editions Associees . . . the writers—Eddy Marnay
 and Eddie Adamis . . . and the winning recording artist
 —Jacqueline Dulac. The role of each was important
 to “Ceux De Varsovie” being chosen as the
 number one song at the competition.

Congratulations to Al Stillman are in order, too, for
 the wonderful lyrics to “They”—the English version of
 “Ceux De Varsovie.”

PUBLISHED BY UNITED ARTISTS MUSIC CO., INC.,



COMPLETE REPRESENTATION THROUGH OUR WORLD-WIDE OFFICES

United Artists Music Ltd., 5 Albert Gate Court, 124 Knightsbridge, London S.W.1, England
Editions Associees S.A.R.L., 7 Rue de la Pepiniere, Paris 8e, France
U. A. Music (Nederland) N. V., Vondelstraat 90, Amsterdam-W, Holland
Edizioni Orchestral Music, Galleria Del Corso 4, Milan, Italy
Progress Musik GMBH, Grosse Friedberger Strasse 23-27, Frankfurt a. M., Germany
Ediciones Musicales Hispavox S.A., Cta. De Santo Domingo 11-1°, No. 3, Madrid 13, Spain
United Artists Musikforlag AB, Brahegatan 24, Stockholm, Sweden
U. A. Music Latina, Inc., Moreno 2034, Buenos Aires, Argentina
Taiyo Music, Inc., Central Apartments, 90-1 Chome Onden Shibuya, Tokyo, Japan
Iramos Vitale S.A. Industria E Commercio, Rua Franca Pinto, No. 42, Sao Paulo, Brazil
Tu-Con Music Pty. Ltd., Griff House, 324 Pitt Street, Sydney, N.S.W., Australia
Mundo Musical S.A., Morro Music Division, Puebla 286, Mexica 7, D.F.

729 SEVENTH AVENUE, NEW YORK, N. Y. 10019

continued

- C L W (ASCAP), 7855 W. Colfax, Lakewood, Colo. Tel: (303) 238-3907. Pres.: Jim Ward.
- Irving Caesar (ASCAP), 1619 Broadway, New York, N. Y. 10019. Tel: (212) CO 5-7868.
- Cajun (BMI), PO Box 1130, Shreveport, La. 71102. Tel: (318) 422-8711. Mgr.: Henry B. Clay.
- Calten (BMI), 115 E. McKellar, Memphis, Tenn. Tel: (901) 324-4640. Pres.: Cecil Caldwell.
- Calumet (BMI), see M. M. Cole.
- Camarillo (BMI), see Ridgeway.
- Camelback Mountain (ASCAP), see Shapiro, Bernstein.
- Camelot (ASCAP), see General.
- Cameo-Parkway (BMI), 309 S. Broad St., Philadelphia, Pa. 19107. Tel: (215) KI 5-1140.
Branch: New York, N. Y., 1650 Broadway. Zip: 10019. Tel: (212) JU 6-3120.
- Campbell Connelly (ASCAP), 565 Fifth Ave., New York, N. Y. 10017.
- Campei (BMI), see Parnaso.
- Canford (BMI), see Hill & Range.
- Cannon Point (BMI), see Claridge.
- Cantagallo Int'l, c/o Zissu, Marcus & Stein, 292 Madison Ave., New York, N. Y. Tel: (212) MU 3-0966. Pres.: H. W. Schemke.
- Capri (BMI), 75 Channel Dr., Port Washington, N. Y. 11050. Tel: (516) 883-8860.
- Caprice (BMI), see Jasparr.
- Carlson, Sheraton Gibson Hotel, Rm. 105, Cincinnati, Ohio 45202. Tel: (513) 381-3166.
- Carlyle (ASCAP), 1650 Broadway, Suite 310, New York, N. Y. 10019. Tel: (212) JU 6-0240.
- Carmichael (ASCAP), see Frank.
- Carsan (ASCAP), PO Box 19024, Houston, Tex. 77024. Tel: (713) HO 5-6044. Pres.: Edward C. Benjamin.
- Carwin (ASCAP), (see Edwin H. Morris).
- Caslon (SESAC), 555 Kappock St., Bronx, N. Y. Tel: (212) 884-4613.
- Cavalcade (ASCAP), 136 E. 57 St., New York, N. Y. Tel: (212) PL 9-8500. Contact: Hy Grill.
Affiliates: Ashland (BMI), Highwood (BMI), Rosewood (ASCAP).
- Cave (BMI), see Raleigh.
- Cecere (BMI), PO Box 9429, Rochester, N. Y. 14604.
- Cecilian (BMI), see Jasparr.
- Cedarwood (BMI), 815 16 Ave. S., Nashville, Tenn. 37204. Tel: (615) 255-6535. Mgr.: J. Wm. Denny.
- Central Songs (BMI), 6357 Selma Ave., Hollywood, Calif. 90028. Tel: (213) 469-2239. Pres.: Clifflie Stone; Gen. Mgr.: Buzz Carleton; Gen. Prof. Mgr.: Charlie Williams.
Branches: Bakersfield, Calif., 3415 Camellia Dr., Zip: 93306. Gen. Prof. Mgr.: Dusty Rhodes.—Nashville, Tenn., 807 17 Ave. S. Zip: 37203. Tel: (615) 244-2789. Gen. Prof. Mgr.: Hapov Wilson.
Affiliates: Airefield (BMI), Century Songs (BMI), Devere (ASCAP), Freeway (BMI), Opal (BMI), Snyder (ASCAP).
- Century Songs (BMI), see Central Songs.
- Cetra (BMI), 1126 E. 59 St., Chicago, Ill. 60637. Tel: (312) HY 3-9781. Mgr.: Morton A. Kaplan.
- Champagne (ASCAP), see Bibo.
- Champion (BMI), 322 W. 48 St., New York, N. Y. 10036. Tel: (212) CI 5-1100. VPs: Salvatore T. Chiantia & Lou Levy. (see Leads).
- Channel (ASCAP), 12227 Addison St., North Hollywood, Calif. 91607. Tel: (213) 762-6442. Mgr.: Doug Cooper.
Affiliate: Cordial (BMI).
- Chappell (ASCAP), 609 Fifth Ave., New York, N. Y. 10017. Tel: (212) PL 2-4300. Prof. Mgr.: Stan Stanley.
Affiliates: Buxton Hill (ASCAP), De Sylva, Brown & Henderson (ASCAP), Gershwin (ASCAP), T. B. Harms (ASCAP), Mutual Music Society (ASCAP), Williamson (ASCAP).
- Chardon (BMI), see Faithful Virtue.
- Charlin (ASCAP), see Tunecrafters.
- Charlino (ASCAP), see Edwin H. Morris.
- Chart (SESAC), see Sammy Birchard.
- Chartbuster (BMI), 1203 2B St. N.W., Washington, D. C. Tel: (202) 333-6646. Pres. & Gen. Mgr.: Bobby Poe.
Affiliate: Kansoma (BMI).
- Chatham (ASCAP), see Bregman, Vocco & Conn.
- Checkmate: Box 1493, Amarillo, Tex. Tel: (806) 383-9571. Pres.: Ray Ruff.
- Cherie (BMI), 3621 Heath Ln., Mesquite, Tex. 75149. Tel: (214) BR 9-5858. Owners: Jimmy Fields & George McCoy.
- Chevell (BMI), PO Box 12276, Ft. Worth, Tex. 76116. Tel: (817) PE 2-1685. Pres. & Gen. Mgr.: W. F. Temple; Gen. Prof. Mor.: N. D. Moody.
Affiliate: Sound/age (BMI).
- Chickory (BMI), see Claridge.
- Choice (ASCAP), see American.
- Chrisdon (BMI), PO Box 273, Excelsior, Minn. 55331. Tel: (612) 474-9780. Pres.: Don Powell Summer; VP: John Summer.
- Chromatic (BMI), see N. A. Busillo.
- Chu-Fin, 180B West End Bldg., Penthouse, Nashville, Tenn. Tel: (615) 244-1145. Pres.: Finley B. Duncan.
- Cigma (BMI), 806 17 Ave. S., Suite 300, Nashville, Tenn. Tel: (615) 255-8578.
- Circle Dot (BMI), see Jamie.
- Claiborne (BMI), 930 F St. N.W., Washington, D. C. 20004. Tel: (202) DI 7-3944. Cable: Claiborne Music. Pres. & Owner: Lillian N. Claiborne.
- Clara (ASCAP), c/o H. Leventhal, 200 W. 57 St., Suite 1304, New York, N. Y. 10019. Tel: (212) JU 6-6553. Pres.: Harry Belafonte.
- Claridge (ASCAP), 250 W. 57 St., Suite 152B, New York, N. Y. 10019. Tel: (212) CI 7-4985. Pres.: Frank C. Slay Jr.
Affiliates: Bobob (ASCAP), Cannon Point (BMI), Chicory (BMI), Conley (ASCAP).
- Clearview (ASCAP), see N. A. Busillo.
- Clockus (BMI), see Marmor.
- Cloven Hoof (BMI), 519 Davis Bldg., Washington, D. C. 20006. Tel: (202) 483-4575. Cable: JET SET. Pres.: Dimitri Villard. Exec. VP: Caspar Davis.
- Clydene (BMI), 814 19 Ave. S., Nashville, Tenn. 37202. Tel: (615) 244-1671. VP & Gen. Mgr.: Jack B. Dixon.
Affiliate: Clyde's (SESAC).
- Clyde's (SESAC), see Clydene.
- M. M. Cole (BMI), 251 E. Grand Ave., Chicago, Ill. 60611. Tel: (312) 527-2160. Pres.: Shepard Stern.
Affiliates: Belmont (BMI), Calumet (BMI).
- Colgems (ASCAP), see Screen Gems-Columbia.
- Colonial (BMI), 163 W. 23 St., New York, N. Y. 10011. Tel: (212) CH 2-0880. Pres.: Tetos Demetriades.
- Columbia Pictures (ASCAP), see Shapiro, Bernstein.
- Columbine (BMI), see Sunbeam.
- Comet (ASCAP), c/o Walter Hofer, 221 W. 57 St., New York, N. Y. 10019. Tel: (212) JU 6-4417.
Affiliate: Sweco (BMI).
- Commander (ASCAP), 1610 N. Argyle Ave., Hollywood, Calif. 90028. Tel: (213) HO 9-0878. Mor.: Marshall Robbins.
- Concertone Songs (ASCAP), see Leonard Hodes Group.
- Conifer (ASCAP), PO Box 4131, Birmingham, Ala. 35206. Tel: (205) 833-5982. Rep.: Ralph H. Compton.
- Conley (ASCAP), see Claridge.
- Conn (BMI), 1619 Broadway, New York, N. Y. 10019. Tel: (212) CI 7-7626. Pres.: Walter Cohen.
- Reg Connelly (ASCAP), see Hill & Range.
- Conquest (ASCAP), see American Metropolitan Ents.
- Consolidated (ASCAP), see Music Sales Corp.
- Conte (BMI), 9165 Sunset Blvd., Los Angeles, Calif. Tel: (213) CR 5-5021. Pres.: Ruth Conte.
Affiliate: Etnoc (ASCAP).
- Contour (BMI), see Leonard Hodes Group.
- Cooga (BMI), see Spoonce.
- Cool Air (BMI), 1517 (B) W. Double Branch Rd., West Columbia, S. C. 29169. Tel: (803) SW 4-8488. Pres.: Mrs. Enola Mae Stevens; Gen. Mgr.: Frank Chambers Sr.; VP & Gen. Prof. Mgr.: James Steward.
Branch: Columbia, S. C., 1918 Picken St. Tel: (803) AL 6-2676. Mgr.: John Williams Jr.
- Cordial (BMI), see Channel.
- Cordon (BMI), see The Big Seven.
- Cornerstone (BMI), see Metric Music Group.
- Costoma (BMI), 6310 Cottage Grove, Chicago, Ill. 60637. Tel: (312) 363-7205. Pres.: James Bracken.
Affiliates: Armel (BMI), Balladier (BMI), Mount Royal (BMI).
- Cotillion (BMI), 1841 Broadway, New York, N. Y. 10023. Tel: (212) PL 7-6306. Pres.: Ahmet Ertegun.
Affiliates: Pronto (BMI), Walden (ASCAP).
- Country Gentlemen (BMI), see The Big Seven.
- Country Star (ASCAP), 439 Wiley Ave., Franklin, Pa. 16323.
- Cramart (BMI), 806 17 Ave. S., Suite 300, Nashville, Tenn. 37203. Tel: (615) 255-8578. Pres.: Grady Martin.
- Crazy Cajun (BMI), Tel: (215) PO 5-0300, see Jamie.
- Criterion (ASCAP), 6124 Selma Ave., Hollywood, Calif. 90028. Tel: (213) HO 9-2296.
Branch: New York, N. Y., 150 W. 55 St. Zip: 10019. Tel: (212) CI 5-7236.
Affiliates: Atlantic (BMI), Austin (BMI), E-D (BMI), Michael H. Goldsen (ASCAP), Granite (ASCAP), Peters (ASCAP), Plus-Minus (ASCAP), Tex Ritter (ASCAP), Tylerston (ASCAP).
- Crotona (BMI), 164 Church St., New Rochelle, N. Y. Partners: Alfred M. Volpe, Anthony Sansone & Robert J. Callilli.
- Crown King (BMI), 755 S. Grand, Mesa, Ariz. 85201. Tel: (602) 964-0367. Pres.: Galen Arrington. VP: Bud Isaacs.
- Cumulus (ASCAP), 200 W. 57 St., New York, N. Y. 10019. Tel: (212) 757-6215. Gen. Mgr.: Felix Balkin.
- Curton (BMI), 2203 Spruce St., Philadelphia, Pa. 19103. Tel: (215) LO 3-9035. Pres.: Curtis Mayfield.
- Cy Music, PO Box 955, Mobile, Ala.
- D A F (sub. of Amco Pictures), PO Box 4396, Chicago, Ill. 60680. Pres.: Robert L. Jones.
Affiliate: Joy De Lee.
- D & L (BMI), 6153 Lexington Ave., Suite 15, Hollywood, Calif. 90038. Tel: (213) 469-6719. Pres.: Don Grashey.
- Int'l Branch: Canada, 232 Lincoln St., Port Arthur, Ont.
- Dana (BMI), 1130 Stillwater Dr., Miami Beach, Fla. 33141. Tel: (305) UN 5-8960. Pres.: Walter Dana.
- Dandelion (BMI), Tel: (215) CE 2-8383, see Jamie.
- Charles N. Daniels (ASCAP), see Hill & Range.
- Darby (BMI), 6311 Gulf Freeway, Houston, Tex. 77023. A&R: C. H. Wilson; Promo. Mgr.: E. L. Cole.
- Darwood (ASCAP), 10 W. 74 St., New York, N. Y. 10023. Tel: (212) TR 7-2066. Mgr.: Woody Harris.
- David (BMI), 1650 Broadway, New York, N. Y. 10019. Tel: (212) CI 7-2159.
- DAVON (BMI), 6290 Sunset Blvd., Suite B23, Hollywood, Calif. 90028. Tel: (213) 466-4224. Cable: DAVONMUS. Pres.: David Hubert.
Branch: New York, N. Y., Olibin, Inc., 101 W. 55 St.
Affiliates: In (ASCAP), Lloyd (SESAC). (SEE ADVERTISEMENT)
- Dawn (ASCAP), 1416 Brooklyn Ave., Brooklyn, N. Y. 11210. Tel: (212) GE 4-3393. Mgr.: Billy Hayes.
- Dawny, see Pavanne.
- Dayshe! (BMI), see Raleigh.
- Daywin (BMI), 250 N. Canon Dr., Beverly Hills, Calif. VP: Don Genson.
Affiliate: Artists (ASCAP).
- Debmar (ASCAP), see Rambda.
- Debra (BMI), 4625 N. 50 Dr., Phoenix, Ariz., 85031. Tel: (602) YE 7-6071. Mgr.: Loy M. Clingman.
- Pietro Deiro (ASCAP), 133 Seventh Ave. S., New York, N. Y. 10014. Tel: (212) OR 5-5460. Mgr.: P. Deiro.
Affiliates: Momak (BMI), Santee (ASCAP).
- Delbryan (BMI), 1056 S. St. Andrews Pl., Los Angeles, Calif. 90019. Tel: (213) RE 2-7449. Treas.: B. H. White.
- Joy De Lee, see DAF.
- Delgay Int'l (BMI), 1584 E. 31 St., Cleveland, Ohio 44114. Tel: (216) 861-7286. Pres.: J. R. Gayer.
- Delicato (BMI), see Pavanne.
- Dick Delmar (BMI), see Delmar Prod'ns.
- Dellwood, 160 South Leswing Ave., Saddle Brook, N. J. Tel: (201) 843-3239. Pres.: Woodrow C. Garbella.
- Delmar Prod'ns (BMI), PO Box 6023, Nashville, Tenn. 37212. Tel: (615) 292-7549. Cable: Dicmar. Pres.: Dick Delmar; Gen. Prof. Mgr.: Marie C. Almon.
Affiliate: Dick Delmar (BMI).
- Den (BMI), 930 "F" St. N.W., Washington, D. C. 20004. Tel: (202) 347-3944. Contact: Lillian Claiborne.
- Dena (ASCAP), 6758 Colgate Ave., Los Angeles, Calif. 90048. Tel: (213) OL 1-3250.
- Denton & Haskins (ASCAP), PO Box 340, Radio City Sta., New York, N. Y. 10019.
- Desilu (ASCAP), see Frank.
- De Sylva, Brown & Henderson (ASCAP), see Chappell.
- Devere (ASCAP), see Central Songs.
- Dexter (ASCAP), 387 Sixth St., San Francisco, Calif. 94103. Tel: YU 1-6644. Pres.: Tom Spinosa.
- Al Dexter Songs (BMI), PO Box 71, Denton, Tex. Tel: (817) 497-2406. Mgr.: Al Dexter.
Branch: New York, N. Y., 1619 Broadway. Zip: 10019.
- Diana (ASCAP), see Sidney.
- Dickerman, 101 First St., Utica, N. Y. 13503. Tel: (315) 732-2172. Pres. & Treas.: Kenneth S. Hurd.
Branch: Middletown, Ohio, 3002 Manchester Rd. Zip: 45042.
- Dickson (ASCAP), 140 E. 56 St., New York, N. Y. 10022. Tel: (212) PL 3-6444. Pres.: Dick Manning.
- Dijon (BMI), 7165 W. Sunset Blvd., Hollywood, Calif. 90046. Tel: (213) HO 6-3311. Mgr.: Al Simms.
- Dim Light (BMI), 3163 Poplar Dr., Lynwood, Calif. 90221. Tel: (213) 639-3201. Owners: James Thomas & Nick Risi.

continued on page 64

Call us when you're in town.



AUSTRALIA
MR. JACK ARGENT
TU-COM MUSIC LTD.
GRIFF HOUSE
324 PITT STREET
SYDNEY
TEL. 61-6088

ENGLAND
MR. JACK MAGRAW
SCREEN GEMS-COLUMBIA MUSIC LTD.
28/29 ST. JAMES'S SQUARE
LONDON S. W. 1
TEL. WHITEHALL 6881

ARGENTINA
STANKO JEREBIC
MELOGRAF, S. R. L.
PARAGUAY 1583
BUENOS AIRES
TEL. 42-2867

JAPAN
MR. TATSUJI NAGASHIMA
BAIYO MUSIC, INC.
CENTRAL APT.
NO. 90, 1-CHOMU
ONDEN, SHIBUYA
TOKYO
TEL. 401-5101 EXT. 299

BELGIUM
MR. ROLAND KLUGER
EDITIONS SCREEN GEMS
COLUMBIA, S. P. R. L.
13 MADELEINE
BRUSSELS
TEL. 2578

GERMANY
MR. PETER MEISEL
PAUL SCHMIDT HRSIKVERLAG GMBH
WITTELSBACHERS'RAS'E 18
BERLIN
TEL. 91-40-57-59

ITALY
MR. LADISLAV SUGAR
EDIZIONI MUSICALI
SCREEN GEMS-COLUMBIA
GALLERIA DEL CORSO 4
MILAN
TEL. 794.841

FRANCE
MR. RUDI REVIL
EDITIONS SCREEN GEMS-COLUMBIA
71 RUE DE PROVENCE
PARIS 9E
TEL. 874 (TRI) 68.47

BRAZIL
MR. ROSSINI PINTO
EDITORIA MUNDO MUSICAL LTD. (BMI)
EDITORIA LATINO AMERICANA
DE MUSICA "ELAM" LTD. (ASCAP)
CAIXA POSTAL 1940, ZC-00
RIO DE JANEIRO GB
TEL. 31-4040

SPAIN
MR. ENRIQUE M. GAREA
EDICIONES MUSICALES
HISPAVOX SA
CAMPOMANES NUM. 8
MADRID 13
TEL. 248.6057

SCANDINAVIA
MR. STIG ANDERSSON
SCREEN GEMS
MUSIKFORLAG AB
BRAHEGATAN 24
STOCKHOLM, SWEDEN
TEL. 61-75-30

MEXICO
MR. FREDERICK REITER
MUNDO MUSICAL S. A.
PUEBLA 286
MEXICO D. F.
TEL. 25-10-42

Screen Gems/Columbia Music

Don Kirshner, President

COLUMBIA PICTURES/SCREEN GEMS TV MUSIC DIVISION
711 FIFTH AVENUE, NEW YORK / PLAZA 1 4400

continued

- Ding Dong (BMI), see Barton.
- Walt Disney (ASCAP), 800 Sonora Ave., Glendale, Calif. 91201. Tel: (213) 845-3141. Cable: DISNEY. Pres. & Gen. Prof. Mgr.: James A. Johnson; Gen. Mgr.: Rose Camereti.
- Affiliate: Wonderland (BMI).
- Int'l representatives: Argentina (Julio Korn), Australia (Chappell), Canada (Chappell), England (Walt Disney), France (Walt Disney), Germany (Chappell), Italy (Curci), Japan (Walt Disney, Shinko), Mexico (Brambila), Spain (Hispavox).
- Distant (BMI), 7514 Hollywood Blvd., Hollywood, Calif. Tel: (213) CR B-0400. Pres. & Gen. Prof. Mgr.: L. B. Jaffe; Gen. Mgr.: P. Sheeran.
- Affiliate: Allison.
- Dixiana (BMI), see Tracie.
- Dixie Pickers (BMI), PO Box 1645, Ardmore, Okla. 73401. Tel: (405) CA 3-1400. Pres. & Gen. Mgr.: Luton Stinson.
- Do Ra Me (ASCAP), 5610 Bella Dr., Rubidoux, Calif. 92509. Tel: (714) 683-0771. Pres.: L. Ray Duane; Gen. Prof. Mgr.: Andy Anderson.
- Dobo (BMI), see Metric Music Group.
- Dodie (BMI), 912 Stemmons Tower East, Dallas, Tex. Tel: (214) 631-1033. Pres.: James Hollingsworth.
- Dolfi (ASCAP), see Hill & Range.
- Doney (BMI), 1130 Green Bay Rd., Lake Bluff, Ill. Pres.: Henry E. Doney.
- Affiliate: Lake Forest (ASCAP).
- Don (BMI), 2809 Erastus St., Houston, Tex. 77026. Tel: (713) OR 3-2611. Pres.: Don D. Robey.
- Donna (BMI), 6 Carter Pl., Woburn, Mass. Tel: (617) 933-1474. Pres. & Gen. Mgr.: Frank P. Poppalardo; Gen. Prof. Mgr.: Steve Dinan.
- Affiliate: Antone (ASCAP).
- Dorsey Bros. (ASCAP), see Music Sales Corp.
- Downey (BMI), 13117 Lakewood Blvd., Downey, Calif. Tel: (213) ME 4-2928. Pres.: W. J. Wenzel.
- Dragonwyck (BMI), c/o David A. Gates, 4373 Lamp Ave., Studio City, Calif. Tel: (213) 762-9649. Pres.: David A. Gates.
- Drive-In (BMI), 7120 Sunset Blvd., Hollywood, Calif. 90046. Tel: (213) HO 6-2555. Pres.: Art Laboe.
- Drumadoone (BMI), PO Box 5305, Sherman Oaks, Calif. 91403. Tel: (213) 784-0285. Pres.: N. Young.
- Drury Lane (BMI), see Select.
- Duane (BMI), PO Box 174, Albany, Calif. Tel: (415) 524-4939. Pres.: Clara Thompson.
- Ducas, 315 S. Beverly Dr., Beverly Hills, Calif.
- Duchess (BMI), (sub. of MCA), 322 W. 48 St., New York, N. Y. 10036. Tel: (212) CI 5-1100. VP: Salvatore T. Chiantia & Lou Levy. (See Leeds).
- Dulla (BMI), 5461 Third Ave., Los Angeles, Calif. Tel: AX 2-9738.
- Dumont (BMI), 405 E. First Ave., Hialeah, Fla. 33010.
- Dundee (BMI), PO Box 926, 1321 W. Seventh St., Clovis, N. M.
- Branch: New York, N. Y. 50 W. 57 St., Zip: 10019. Tel: (212) JU 2-7569.
- Dusty (BMI), 500 Locust St., Marshall, Tex. Tel: (214) WE 5-2582. Pres.: A. T. Young.
- E-D (BMI), see Criterion.
- E D M (ASCAP), see Marmor.
- Earth (BMI), 745 Fifth Ave., Rm. 1512, New York, N. Y. 10022. Tel: (212) 421-5107. VP: Kelli Ross.
- Affiliates: Bonjour (ASCAP), Burning Tree (BMI), Jasco (BMI), Jenny (ASCAP), Lillimar (ASCAP), Pawnbroker (ASCAP), Petsilas (BMI), Sheenfeen (ASCAP).
- East (BMI), 926 E. McLemore, Memphis, Tenn. Tel: (901) 946-2535. Mgr.: Jim Stewart.
- East-West (ASCAP), see Regent.
- Eastview (BMI), PO Box 145, Hamilton, Ohio 45012. Tel: (513) 895-0607. Mor.: William M. Jones.
- Eden (BMI) 1697 Broadway, New York, N. Y. 10019. Tel: (212) LT 1-4490. Gen. Prof. Mgr.: Fred Parker.
- Don Edgar (BMI), 2312 Jasper, Ft. Worth, Tex. 76106. Tel: (817) MA 6-3448. Owner & Gen. Mgr.: D. D. Edgar.
- Edwards (ASCAP), see American Metropolitan Ents.
- Egap (BMI), see Lear.
- Elkan-Vogel (ASCAP), 1712 Sansom St., Philadelphia, Pa. 19103. Tel: (215) LO 8-7555. Pres.: Adolph Vogel; VP: Bernard Kohn.
- Int'l firms represented: Durand, Jobert, Hamelle, H. Lemoines, Philippe (all France).
- Ellipsis (ASCAP), see Jamie.
- Elvtrue (BMI), 306 S. 16 St., Wilmington, N.C. 28401. Tel: (919) 763-1007. Pres.: John Lewis Jones; Gen. Mgr.: Norberto Miguel Machiran;
- Gen. Prof. Mgrs.: Joseph Allen & Manuel A. Machiran.
- Affiliate: Miracle.
- Int'l firm represented: Tin Pan Alley (England).
- Em Ru (ASCAP), 64 E. Van Buren St., Chicago, Ill. 60605. Tel: (312) WE 9-7188. Mgrs.: Ruth Kling & Emme Mullis.
- Embassy (BMI), see Music Sales Corp.
- Emery (ASCAP), 230 W. 41 St., New York, N. Y. 10036. Tel: (212) LW 4-0132. Pres.: Emery Deutsch.
- Emperor (BMI), 1650 Broadway, Suite 310, New York, N. Y. 10019. Tel: (212) JU 6-0240.
- Empire (BMI), 3216 44 Ave. S.W., Seattle, Wash. 98116. Tel: (206) WE 5-0059.
- Empress (ASCAP), see Frank.
- Englewood (BMI), see A. Schroeder.
- Enlight (ASCAP), 451 N. Canon Dr., Beverly Hills, Calif. Tel: (213) 273-5011.
- Affiliates: Rave (BMI), Smobro (BMI), Tomard (ASCAP).
- Ensign (BMI), see Famous.
- Epitome (BMI), 7611 S. Normal Blvd., Chicago, Ill. 60620. Tel: (312) 488-4014. Pres.: Bob Catron Jr.; VP: Charles Atkins.
- Branch: Memphis Tenn., 250 Lucerne Ave. Contact: Miss Inez Catron.
- Epp's (BMI), PO Box 28123, 735 N. General McMullen Dr., San Antonio, Tex. 78228. Tel: (512) GE 3-1461. Pres.: A. Epstein; Gen. Prof. Mgr.: Milt Lance.
- Branch: San Antonio, Tex., 511 Brooklyn Ave. Zip: 78228. Tel: (512) CA 2-2947.
- Affiliate: Senisa (ASCAP).
- Ernststr (BMI), 15305 Livernois, Detroit, Mich. 48238. Tel: (313) 861-5651. Pres.: G. Ernie Stratton.
- Esteem (BMI), see United Artists.
- Etnoc (ASCAP), see Conte.
- Eureka (ASCAP), 6047 Hollywood Blvd., Hollywood, Calif. 90028. Tel: (213) FO 6-6111. Contact: Hal Levy & Bob Klimes.
- Red Evans (ASCAP), 1619 Broadway, New York, N. Y. 10019. Tel: (212) CO 5-1573.
- Affiliates: Jefferson (ASCAP), Valiant (ASCAP).
- Excellorec (BMI), 177 Third N., Nashville, Tenn. 37201.
- Fairlight, see Pavanne.
- Faithful Virtue (BMI), 1650 Broadway, New York, N. Y. 10019. Tel: (212) 765-2682. Pres.: Charles Koppelman. VP: Don Rubin.
- Affiliate: Chardon (BMI).
- Fall City (BMI), 9912 Taylorsville Rd., Louisville, Ky. 40299. Tel: (502) 267-5466. Contact: Tim Tyler.
- Affiliate: Gazebo (ASCAP).
- Fame, 603 Avalon Ave., Muscle Shoals, Ala. Tel: (205) 381-0801. Pres.: Rick Hall.
- Family (SESAC), see Sacred Songs.
- Famous (ASCAP), 1631 Broadway, New York, N. Y. 10019. Tel: (212) CI 7-8262. VP & Gen. Mgr.: Edward A. Wolpin; Prof. Mgr.: Dick Stone.
- Affiliates: Ensign (BMI), Paramount (ASCAP).
- Fann (BMI), 5533 Hollywood Blvd., Dept. 237, Hollywood, Calif. 90028. Tel: (213) 463-6284. Pres.: Anthony Fabbri.
- Favorite (ASCAP), see Hugo & Luigi.
- Favorite (ASCAP), see Pavanne.
- Fayette (BMI), 2003 Liberty Road, Lexington, Ky. 40505. Tel: (606) 254-7858. Pres. & Gen. Prof. Mgr.: Bob Mooney.
- Branches: Phoenix, Ariz., 1531 W. Peoria. Zip: B5029. Tel: (602) 254-4161. Gen. Prof. Mgr.: Herb Sims.—Nashville, Tenn., B01 17 Ave. S. Tel: (615) 256-0638. Gen. Prof. Mgr.: Bob Mooney.
- Feather (BMI), Time & Life Bldg., Rockefeller Ctr., New York, N. Y. 10020. Tel: (212) CI 5-7010.
- Fee Bee (BMI), 4517 Wainwright Ave., Pittsburgh, Pa. 15227. Tel: (412) 884-4727.
- Leo Feist (ASCAP), see The Big 3.
- Felicia (BMI), see Leonard Hodes Group.
- Fermata Int'l Melodies (ASCAP), Sunset-Vine Tower Bldg., Suite 514, 6290 Sunset Blvd., Hollywood, Calif. 90028. Tel: (213) 462-7473. Mgr.: Debora Frenkiel.
- Affiliate: Bendig (BMI).
- Fia (ASCAP), see Tuneville.
- Fideree (ASCAP), see Frank.
- Fielding (ASCAP), see Gordon.
- Fifth Avenue (ASCAP), see Five-West.
- Figure (BMI), see The Big Seven.
- Fingerlake (BMI), see Raleigh.
- Carl Fischer (ASCAP), 56-62 Cooper Sq., New York, N. Y. 10003. Tel: (212) SP 7-0900.
- Fred Fisher (ASCAP), 1619 Broadway, New York, N. Y. 10019. Tel: (212) JU 6-1504. Mgr.: Gordon Williams.
- Five-West (BMI), 7715 Sunset Blvd., Los Angeles, Calif. 90046. Tel: (213) 876-1360. Partners: Brian Stone & Charles Greene.
- Branches: New York, N. Y., 52 Broadway.—Nashville, Tenn., Suite 710, 1719 West End Bldg.
- Affiliates: Fifth Avenue (ASCAP), Ten-East (BMI).
- Flamingo (ASCAP), see Hill & Range.
- Fiat Town (BMI), PO Box 506, Ville Platte, La. 70586. Tel: (318) 363-2138.
- Flomar (BMI), 254 W. 54 St., New York, N. Y. 10019. Tel: (212) CI 5-2170. Pres. & Gen. Prof. Mgr.: Ed Silvers.
- Affiliate: Baby Monica (BMI).
- Fontain (BMI), see Jasper.
- Fontelle (BMI), 15 E. 48 St., Suite 202, New York, N. Y. 10017. Tel: (212) PL 3-0010. Owners: George Avakian & Charles Lloyd.
- Jerry Ford (BMI), PO Box 17811, East Atlanta Sta., Atlanta, Ga. 30316. Tel: (404) 241-2744. Pres.: Jerry Ford.
- Four Corners, 200 Essen Dr., Lafayette, La. 70501. Tel: (318) CE 4-8232. Owner: Roy J. Prejean.
- Four Star TV (BMI), 4030 Radford Ave., North Hollywood, Calif. Tel: (213) 766-4151. Gen. Mgr.: Alfred Perry.
- Kim Fowley (BMI), 6000 Sunset Blvd., Hollywood, Calif. 90028. Tel: (213) HO 4-0226. Pres.: Kim Fowley.
- Affiliate: Living Legend (ASCAP).
- Sam Fox (ASCAP), 1841 Broadway, New York, N. Y. 10023. Tel: (212) CI 7-3890. Pres.: Frederick Fox.
- Affiliate: Movietone (ASCAP).
- Francon (ASCAP), 161 W. 54 St., New York, N. Y. 10019. Tel: (212) JU 6-6767. Mgr.: George Scheck.
- Franden (BMI), 1426 Lombard St., Philadelphia, Pa. 19146. Tel: (215) KI 5-8970. Pres.: Raymond F. Selden.
- Frank (ASCAP), 119 W. 57 St., New York, N. Y. 10019. Tel: (212) CO 5-3600. Contact: Bert Siegelson.
- Affiliates: Andrew, Audubon, Carmichael, Desilu, Empress, Fideree, Walter Reade-Sterling, Saunders (all ASCAP).
- Franklin Street (ASCAP), see Fred Ahlert.
- Fraygrist (BMI), 600 Roosevelt Blvd., Fall Church, Va. 22044. Tel: (703) 534-3627. Pres.: H. Franklin Grist.
- Frebon (BMI), see Keltone Int'l.
- Freeway (BMI), see Central Songs.
- Frost (BMI), see The Big Seven.
- Fuddyduddy (BMI), 6363 Sunset Blvd., Suite 705, Hollywood, Calif. 90028. Tel: (213) HO 7-2151. Pres.: Tony Richland.
- Fuller (BMI), PO Box 10513, Tampa, Fla. 33609. Tel: (813) 839-5471. Pres.: Charles Fuller.
- Affiliate: Fulprod (ASCAP).
- Fulprod (ASCAP), see Fuller.
- Gallegos (ASCAP), PO Box 666, Montebello, Calif. Tel: (213) 728-7553. Pres.: Charles B. Gallegos.
- Affiliate: Sonny Boy (BMI).
- Gallery (BMI), see Ridge.
- Galli (ASCAP), see Hill & Range.
- Al Gallico (BMI), 101 W. 55 St., New York, N. Y. 10019. Tel: (212) JU 2-1368. Pres.: Al Gallico.
- Gallop (BMI), 1640 Poe Ave., Orlando, Fla. Tel: (305) 424-7746. Mgr. Dir.: William G. Woods.
- Gasto (BMI), 33 Greenwich Ave., Suite 2C, New York, N. Y. 10018. Tel: (212) 243-2498. Pres.: P. Todaro & R. Gasper.
- Gatwick (BMI), see Pavanne.
- Gaumont (ASCAP), 7830 Miami View Dr., North Bay Island, Miami Beach, Fla. 33141. Tel: (305) PL 8-6566. Pres.: George P. Hill.
- Tim Gayle Songs (ASCAP), 6376 Yucca St., Hollywood, Calif. 90028. Tel: (213) 465-6258 & 463-2151. Owner: Tim Gayle.
- Affiliates: International Songs (BMI), Hi-Fi Songs (BMI).
- Gazebo (ASCAP), see Falls City.
- Geld-Udell (ASCAP), 200 W. 57 St., New York, N. Y. 10019. Tel: (212) CO 5-2628. Mgrs.: Gary Geld & Peter Udell.
- Affiliate: Applejack (BMI).
- Gem (ASCAP), PO Box 340, Radio City Sta., New York, N. Y. 10019.
- Genelle (BMI), 138 E. Fifth St., Tifton, Ga. 31794. Tel: (912) 382-5204. Pres.: Gus P. Statiras.
- General (ASCAP), 53 E. 54 St., New York, N. Y. 10022. Tel: (212) PL 3-7340. Contact: Paul Kapp.
- Affiliates: Camelot (ASCAP), Joshua (BMI).
- General Words & Music (ASCAP), see Neil A. Kjos.

continued on page 66

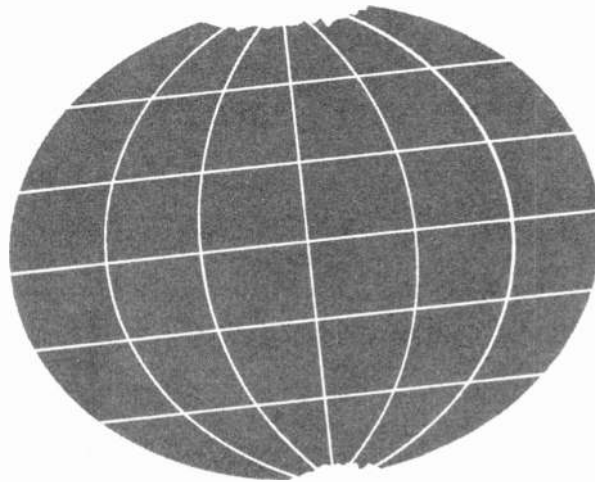

it's another world... since SESAC was founded in 1931. Today's mass communications requires a constant stream of freshly creative music. New writers, new composers and new publishers are providing SESAC licensees with an ever expanding contemporary repertory.

SESAC, one of the world's foremost music licensing organizations, eagerly continues on a course of acquisition and development of tomorrow's music today.

Past, present and future, SESAC's repertory maintains its versatility in every area of public performance.



NEW YORK: / 10 COLUMBUS CIRCLE • NEW YORK, NEW YORK 10019 • 212-586-3450
NASHVILLE: / 806 16th AVENUE, SOUTH • NASHVILLE, TENNESSEE 37203 • 615-254-5703

*trademark

continued

Genius (ASCAP), 1841 Broadway, Suite 600, New York, N.Y. 10023. Tel: (212) CI 5-3535. Pres.: Robert S. Crewe Jr.
Affiliates: Saturday (BMI), Tomorrow's Tunes (BMI).
 Gerald (BMI), 1211 Berkeley, Santa Monica, Calif. Tel: (213) 395-0227. Prof. Mgr.: Herb Swartz.
 Gershwin (ASCAP), see Chappell.
 Gideon (BMI), Time & Life Bldg., Rockefeller Ctr., New York, N.Y. 10020. Tel: (212) CI 5-7010.
 Gil (BMI), 1650 Broadway, New York, N. Y. 10019. Tel: (212) CI 5-0110. Cable: Pincusgil. Pres.: George Pincus.
Affiliates: Knightbridge (BMI), Missouri (BMI), George Pincus & Sons (ASCAP), Songfest (ASCAP), Tune Time (BMI), Unity (BMI).
Int'l firms represented: Ambassador (England).
 Glad (BMI), 316 E. 11 St., Houston, Tex. 77008. Tel: (713) UN 1-3630. Mgr.: H. W. Daily.
 Gladness (BMI), 2245 Ward St., Berkeley, Calif. 94705. Tel: (415) 845-8913. Pres.: J. Bruce Bratton.
 Gladys (ASCAP), see Hill & Range.
 Glamorous (ASCAP), see Helios.
 Glenbrook (ASCAP), see American Metropolitan Ent.
 Jonathan Glenn (BMI), see Budd Granoff Prod'n's.
 Glow (BMI), see American Metropolitan Ent.
 Gold Clef (BMI), 27 W. Chelton Rd., Parkside, Chester, Pa. Pres.: Alexander Czarenko.
 Golden Valley (SESAC), 5653 1/2 Hollywood Blvd., Hollywood, Calif. 90028. Tel: (213) HO 9-1527. Pres.: Hal Southern; Gen. Mgr.: W. O. Fleener.
 Michael H. Goldsen (ASCAP), see Criterion.
 Gomba (BMI), 17111 Third Ave., Detroit, Mich. 48203. Tel: (313) 863-2030. Pres.: Harry Balk.
 Gordon (BMI), 408 N. Rodeo Dr., Beverly Hills, Calif. 90210. Tel: (213) 275-4670. Pres.: David N. Gordon; VP: Jerry Fielding.
Affiliates: Fielding (ASCAP), Marlen (ASCAP), Tor (ASCAP).
Int'l firms represented: Curci (Italy), G. T. Folster (Japan), Peter Maurice (England).
 Gospel Quartet (SESAC), 386 N. Highland Ave., Memphis, Tenn. 38122. Tel: (901) FA 3-4206. Mgr.: J. D. Sumner.

Gowers (BMI), see Screen Gems-Columbia.
 Gramophone (SESAC), 1140 S. Robertson Blvd., Los Angeles, Calif. 90035. Tel: (213) CR 4-3129. Pres.: Oliver Berliner; Gen. Mgr.: Michelle Danielle; Gen. Prof. Mgr.: George Hernandez.
Branch: Brooklyn, N.Y., 160 Ocean Pkwy. Gen. Prof. Mgr.: Gilbert Suarez.
Affiliate: Hall of Fame (BMI).
Int'l representatives: Argentina (Danzarin), Europe (Edwin H. Morris/Chappell), Mexico (Brambila), Venezuela (Cynett).
 Grand (ASCAP), 1619 Broadway, New York, N. Y. 10019. Tel: (212) CO 5-4753.
 Grand National (BMI), 46 Berry Rd., Houston, Tex. Tel: (713) OX 7-8904. Pres.: Johnnie Forrer.
 Granite (ASCAP) see Criterion.
 Budd Granoff Prod'n's, 45 W. 56 St., New York, N. Y. 10019. Tel: (212) CI 7-7230. Mgr.: Budd Granoff.
Affiliates: Neal Hefti (ASCAP), International Korwin (ASCAP), International Pauline (ASCAP), Jonathan Glenn (BMI), Jonathan (ASCAP), Maltese (BMI), Pine Knob (BMI).
 Greenleaf (BMI), see Budd.
 Greenwich (ASCAP), 8300 Santa Monica Blvd., Hollywood, Calif. 90069. Tel: (213) 656-7711. Prof. Mgr.: Dorothy D. Rupe.
 Gretbert (BMI), see Hill & Range.
 Grosvenor House (ASCAP), PO Box 1563, Hollywood, Calif. 90028. Tel: (213) HO 3-7652 & HO 6-2466. Pres.: Art Benson.
Affiliate: Startunes (BMI).
 H & L (BMI), see Hugo & Luigi.
 Hall-Clement (BMI), see Tracie.
 Hall of Fame (BMI), PO Box 921, Beverly Hills, Calif. 90213. Tel: (213) CR 6-2726. Pres.: Oliver Berliner; Gen. Mgr.: Frank Ernest; Gen. Prof. Mgr.: John Martinez.
Branch: Brooklyn, N. Y., 160 Ocean Pkwy. Gen. Prof. Mgr.: Gilbert Suarez.
Affiliate: Gramophone.
Int'l firms represented: Bemol (Argentina), Campe (Mexico), Cynett (Venezuela), Danzarin (Argentina), Edmuvca (Venezuela), Evmi (Venezuela), Hnos. Marquez (Mexico), Musicabana (Cuba), Sprint (Argentina).
Int'l representative: Edwin H. Morris.
 Hampstead, see Pavanne.

Hancock (BMI), 202 Riverside Dr., Rm. 3C, New York, N. Y. 10025. Tel: (212) 865-3972. Pres.: Herbert J. Hancock.
 Haral Recs. (BMI), 1811 Fairmount Ave., Philadelphia, Pa. 19130. Tel: (215) PO 5-4300. VP: Harry Fink.
 Har-Bock (BMI), see Metric Music Group.
 Harms (ASCAP), see Music Publishers Holding Corp.
 T. B. Harms (ASCAP), see Chappell.
 Charles K. Harris (ASCAP), see Southern.
 Harvard (BMI), see Ivan Mogull.
 Harwin (ASCAP), see Edwin H. Morris.
 Hastings (BMI), see The Big Three.
 Hawthorne (ASCAP), see Select.
 Haymarket (BMI), 6290 Sunset Blvd., Suite 1003, Hollywood, Calif. 90028. Tel: (213) 466-4265.
 Heads Up (BMI), PO Box 105, 1842 Line Ave., Shreveport, La. 71102. Tel: (318) 422-7376. Gen. Mgr.: Dick Martin.
 Neal Hefti (ASCAP), see Budd Granoff Prod'n's.
 Heart of the Hills (BMI), 2010 52 St., Lubbock, Tex. Tel: (806) SH 4-5496. Pres.: Bill C. Crawford.
 Heid (BMI), 49 Heid Ave., Dayton, Ohio 45404. Tel: (513) 233-6904. Gen. Mgr.: Leroy Goodlander.
Branch: Cincinnati, Ohio, 6566 Montgomery Rd. & 1403 First Nat'l Bank Bldg.
 Helios (BMI), 1619 Broadway, Rm. 604, New York, N. Y. 10019. Tel: (212), LT 1-0280. Pres.: Claus Ogerman.
Affiliates: Glamorous (ASCAP), Monsapek (BMI).
 Fred Henley, Box 70-B Kiln Rd., Pica-yune, Miss. 39466. Tel: (601) 798-2768. Owner: Fred H. Henley.
 Hi-Count (BMI), Time & Life Bldg., Rockefeller Ctr., New York, N. Y. 10020. Tel: (212) CI 5-7010.
 Hi-Fi Songs (BMI), see Tim Gayle Songs.
 Hidle (BMI), 7280 Caverna Dr., Hollywood, Calif. 90028. Tel: (213) HO 6-6129.
 Highwood (BMI), see Cavalcade.
 Hill & Range (BMI), 1619 Broadway, New York, N. Y. 10019. Tel: (212) JU 6-0674. Mgr.: Freddy Bienstock.
Affiliates: Aberbach (BMI), Affiliated (BMI), Alamo (ASCAP), Anne-Rachel (ASCAP), Ark-La-Tex (BMI), Atzal (BMI), Bennie Benjamin (ASCAP), Bigtop (BMI), Brenner (BMI), Britanny (BMI), Canford (BMI), Reg Connelly (ASCAP), Charles N. Daniels (ASCAP), Dolfi (ASCAP), Flamingo (ASCAP), Galli (ASCAP), Gladys (ASCAP), Gretbert (BMI), Home Folks (BMI), Ross Jungnickel (ASCAP), Charles Emmerich Kalman (ASCAP), Kentucky (BMI), Massey (ASCAP), Johnny Mathis (ASCAP), Noma (BMI), Plan Two (ASCAP), Elvis Presley (BMI), Progressive (BMI), Quintet (BMI), Rio Grande (BMI), Rosarita (ASCAP), Rumbalero (BMI), St. Louis (BMI), Second (ASCAP), Show (BMI), Sigma (ASCAP), Silvertowne (ASCAP), Slamina (BMI), Hank Snow (BMI), Southwind (BMI), Ernest Tubb (BMI), Valley (BMI), Bob Wills (BMI).
 Hillary (BMI), see Meadowlark.
 Hillbrow (ASCAP), 161 W. 54 St., New York, N. Y. 10019. Tel: (212) PL 7-2072.
 Hilliard (BMI), 1717 N. Highland Ave., Hollywood, Calif. 90028.
 Hilo (BMI), 639 Madison Ave., Memphis, Tenn. 38103. Tel: (901) 527-2614. Mgr.: Bill Fitzgerald.
 Hitway (BMI), 925 N. Hudson, Oklahoma City, Okla. Tel: (405) CE 9-9512. Pres.: Jack L. Rich.
 Hob & Nob (BMI), 158 W. 15 St., Suite 2D, New York, N. Y. 10011. Tel: (212) AL 5-7214. Gen. Mgr.: Le Roy De Gregory.
 Leonard Hodes Group, 1780 Broadway, Suite 1200, New York, N. Y. 10019. Tel: (212) JU 6-0923, 0924. Cable: LENHODES. Contact: Leonard Hodes.
Branch: Glen Rock, N. J. Tel: (201) 444-0241.
Affiliates: Blue Blood (BMI), Concertone Songs (ASCAP), Contour (BMI), Felicia (BMI), Jaep (BMI), Dick James (BMI), MacLen (BMI), Pace-maker (BMI), Partita (BMI), Rose Hill (BMI), Spectorious (BMI).
 Hollyvale (BMI), see Moontunes.
 Home Folks (BMI), see Hill & Range.
 Robin Hood (BMI), 5531 Tuxedo Terr., Hollywood, Calif. 90028. Tel: (213) HO 5-9758. Pres.: John Marascalco.
 Hookshot (BMI), 9358 James Ave., Minneapolis, Minn. 55431. Tel: (612) 888-4459. Owner: Harley Toberman.
 Horizon (BMI), 1619 Broadway, New York, N. Y. 10019. Tel: (212) CI 7-2904. Pres.: R. Fisher.
 Hornet (BMI), see Raleigh.
 Hornsby (BMI), PO Box 7532, Houston, Tex. 77007. A&R: R. D. Courtney; Promo.: J. D. Horn.

BOURNE co.

music
publishing
with
world-wide
affiliation

136 West 52nd St., N. Y. C., N. Y.

Horttor (BMI), 313 El Tejon Ave., Oildale, Calif. 93308. Tel: (805) 399-9028. Owner: Robert L. Horttor.

Jack Howard (BMI), see Arcade.

Hugo & Luigi (ASCAP), 1619 Broadway, New York, N. Y. 10019. Tel: (212) 265-1626. Contact: Hugo & Luigi.

Affiliates: Favorite (ASCAP), H & L (BMI), Kags (BMI), Next Day (ASCAP), United (ASCAP).

Husky (BMI), 806 16 Ave. S., Nashville, Tenn. Tel: (615) 244-2428. Pres.: Ferlin Husky.

Hypo (BMI), 1020 Central Ave., Charlotte, N. C. 28204. Tel: (704) 375-8545. Pres.: Howard C. Simson; VP: Haviland Smith; Sec.-Treas.: Beuna S. Shumate.

I T C O (BMI), 423 S. 16, Quincy, Ill. 62301. Tel: (217) 223-7346. Pres.: Fred Tiekens. VP: Jack Inghram.

Charley Ide (BMI), 31 Brompton Rd., Garden City, N. Y. Tel: (516) PL 7-3616. Pres.: Charley Ide; Gen. Mgr.: Ben Arrigo; Gen. Prof. Mgr.: Marc Frederick.

Immediate (BMI), Time & Life Bldg., Rockefeller Ctr., New York, N. Y. 10020. Tel: (212) CI 5-7010.

Impromptu Tunes (BMI), 7345 Layton St., Cucamonga, Calif. 91730. Tel: (714) YU 7-1373. Pres.: Howard E. Fisher; VP & Gen. Mgr.: Joan Fisher.

In (ASCAP), see Davon.

Inner-Glo (BMI), 15 S. Washington St., Emporia, Kan. 66801. Tel: (316) DI 2-7769. Owner: Mrs. Nettie M. Dawson.

Insight (BMI), 7611 Normal Blvd., Chicago, Ill. 60620. Tel: (312) 488-4014. Pres.: Maurice Simpkins; VPs: Nat Engleberg & Robert L. Catron.

Insurance (BMI), 642 E. 64 St., Chicago Ill. 60637. Tel: (312) 752-4382.

Integrity (ASCAP), 2 W. 46 St., New York, N. Y. 10036. Tel: (212) JU 6-5577. Pres.: Jack Wolf.

Intercollegiate Syndicate (ASCAP), PO Box 340, Radio City Sta., New York, N. Y. 10019.

International Korwin (ASCAP), see Budd Granoff Prod'ns.

International Pauline (ASCAP), see Budd Granoff Prod'ns.

International Songs (BMI), see Tim Gayle Songs.

International Tunes (BMI), see Tim Gayle Songs.

Irman (BMI), 912 Clay Ave., Scranton, Pa. 18510. Tel: (717) DI 7-8429. Pres. & Gen. Mgr.: Richard A. Plotkin.

Ironmarch (BMI), see Les John.

Irving (BMI), 8255 Sunset Blvd., Los Angeles, Calif. 90046. Tel: (213) 656-5330. Pres.: Jerry Moss.

J B L & V (BMI), 1732 E. 4 St., Brooklyn, N. Y. 11223. Tel: (212) ES 5-8513. Pres.: Vic Stevens.

J & E (ASCAP), see And.

Jabber (ASCAP), 850 Seventh Ave., New York, N. Y. 10019. Tel: (212) 581-5120. Exec. Mgr.: George Levy; Proprs.: Barr & Carnovale.

Branch: Caldwell, N. J., 375 Bloomfield Ave. Jac (ASCAP), see Fred Ahlert.

Jack & Jill (BMI), 20B N. Oakhurst Dr., Beverly Hills, Calif.

Branch: Canada, Vancouver Publ'g, Vancouver, B. C.

Jaep (BMI), see Leonard Hodes Group.

Jake-Carl (BMI), 744 N. Main St., Opelousas, La. Tel: (318) 942-7092. Owner: Jake Graffagnino.

Dick James (BMI), see Leonard Hodes Group.

Jamie (BMI), 919 N. Broad St., Philadelphia, Pa. 19123. Tel: (215) CE 2-8383. Pres.: Harold B. Lipsius.

Affiliates: Circle Dot (BMI), Crazy Cajun (BMI), Dandelion (BMI), Ellipsis (ASCAP), New Keys (BMI), Nujac (BMI), Pentagon (BMI), Red Stick (BMI), Stilran (BMI).

Jamward (BMI), 7855 W. Colfax, Lakewood, Colo. Tel: (303) 238-3907. Pres.: Jim Ward.

Janon (ASCAP), see Mayhew.

January (BMI), see A. Schroeder.

Jarb (BMI), see Tune-Kel.

Jasco (BMI), see Earth.

Jaspar (BMI), 852 Elm St., Manchester, N. H. 03101. Tel: (603) 623-9749 & 624-1990.

Cable: "W&G". Mg'g Dir.: James N. Parks.

Affiliates: Angelica, Banff (BMI), Caprice (BMI), Cecilian (BMI), Fontain (BMI), Melbourne (ASCAP), Rodeo (BMI), Whitecap (BMI), Woomera.

Jatap (BMI), 9713 Santa Monica Blvd., Beverly Hills, Calif. 90210. Tel: (213) 276-1017. Cable: PACSAMUSIC. Pres.: Irving Mills; Gen. Mgr.: Robert Mills.

Javel (ASCAP), 610 S. Verdugo Rd., Suite 3, Glendale, Calif. 91205. Tel: (213) 246-9445. Cable: JAIRO. Pres. & Gen. Prof. Mgr.: Jairo Velasquez.

Jay Boy (BMI), see American Metropolitan Ents.

Jay & Cee (BMI), 1540 Brewster Ave., Cincinnati, Ohio 45207.

Jay Dee, see Pavanne.

Jay Jay (BMI), 2452 S. Kedzie Ave., Chicago, Ill. 60623. Tel: (312) RO 2-6000. Contact: Walter Jay.

Affiliate: Walters (ASCAP).

Jay Six (BMI), 1136 Columbus Ave., Boston, Mass. 02120. Tel: (617) 445-3550. Pres.: Jack Sager.

Jec (BMI), 308 Poplar Ave., Memphis, Tenn. Tel: (901) 525-6348. Contact: J. Cuoghi.

Jefferson (ASCAP), see Red Evans.

Jen-Shem (BMI), 2640 S. Kildare Ave., Chicago, Ill. 60623. Tel: (312) 521-9631. Gen. Mgr.: Mrs. Jean Shemberger.

Jenny (ASCAP), see Earth.

Jepalana (BMI), 723 Seventh Ave., New York, N. Y. 10019. Tel: (212) CI 5-7640. Pres.: Nathan Schnapp; VP: Jerry Samuels; Gen. Prof. Mgr.: Paul Friedberger.

Affiliate: Print (ASCAP).

Jerhart (BMI), 6252 1/2 S. Greenwood Ave., Chicago, Ill. 60637. Tel: (312) 288-5381. Pres.: Robert Lee.

Jerryco (ASCAP), see Edwin H. Morris.

Jetstar (BMI), 1630 Life Bldg., Dallas, Tex. 75202. Tel: (214) RI 2-7040 & RI 2-6428. Pres.: John Abdnor.

Jewel (ASCAP), see Regent.

Jimskip (BMI), see Larry Taylor.

Jitters (BMI), see Jabber.

JOBETE (BMI), 2648 W. Grand Blvd., Detroit, Mich. 48208. Tel: (313) TR 1-3340. Pres.: Berry Gordy Jr.; Gen. Mgr.: Robert L. Gordy. (SEE ADVERTISEMENT)

Les John (ASCAP), 6411 Hollywood Blvd., Hollywood, Calif. 90028. Tel: (213) HO 6-3455. Pres.: Harry Maselow.

Affiliates: Breezy Willow (ASCAP), Ironmarch (BMI), Locket (BMI), Van Winkle-Darin (BMI).

Johnstone-Montei (BMI), 1750 N. Vine St., Hollywood, Calif. 90028. Tel: (213) HO 2-6252.

Jonathan (ASCAP), see Budd Granoff Prod'ns.

Joni (BMI), 1421 S. Michigan Ave., Chicago, Ill. Pres.: Ewart G. Abner Jr.

Jordan, 4101 Boarman, Baltimore, Md. 21215. Tel: (301) 367-8560. Owner: Isadora Jordan.

Joshua (BMI), see General.

PRESENT THE FACES BEHIND THE HITS

APRIL/BLACKWOOD MUSIC PUBLISHING COMPANIES

JERRY TEIFER
General Manager
DAVID ROSNER
Professional Manager
CHIP TAYLOR
Associate Professional Manager

**WRITING EXCLUSIVELY
FOR APRIL/BLACKWOOD**



CHIP TAYLOR



ESTELLE LEVITT



VAN MCCOY



BILLY VERA



LAYNG MARTINE, JR.



AL GORGONI



WHAT'S NEW FROM CALIFORNIA...

NEW SONGS

ALONG COMES MARY
The Association (Valiant)

GREEN BACK DOLLAR
Barry McGuire (Mira/Fontana)

NEW WRITERS

EXCLUSIVE WRITERS

MASON WILLIAMS / TANDYN ALMER
DON CRAWFORD / WARREN BAKER

OTHER WRITERS

ROD McKUEEN / LIGHTNIN' HOPKINS
HOYT AXTON / JIMMY BOND / OSCAR MOORE

NEW ARTISTS

CURRENT PRODUCTION

LIGHTNIN' HOPKINS (Verve/Polydor)
DAVID LLOYD AND HIS LONDON ORCHESTRA
(Epic/CBS)

OSCAR MOORE (Surrey/Fontana)
JIMMY BOND (Mirwood/Fontana)
DON CRAWFORD (Verve/Polydor)

NEW PRODUCTIONS

PRODUCERS OF OVER 200 LP'S

FEATURING

BARRY MCGUIRE / JOHNNY PEARSON
HOYT AXTON / JIMMY WITHERSPOON
BILLY STRANGE / GLEN CAMPBELL
ANTON KARAS / SURREY STRINGS
THE BOYS CHOIR OF VIENNA
TROUBADOR SINGERS / BROWNIE & SONNY

FROM
DAVON
MUSIC CORPORATION



SUNSET & VINE TOWER
HOLLYWOOD,
CALIFORNIA 90028

466-4224
CABLE - DAVONMUS

DAVID HUBERT
President

continued

Josie (ASCAP), 318 W. 48 St., New York, N. Y. 10036. Tel: (212) PL 7-8570.
Jot (BMI), 2203 Spruce St., Philadelphia, Pa. 19103. Tel: (215) LO 3-6484. Mgr.: Irv Nahan.
Juarez (BMI), see Shan-Todd.
Judith (ASCAP), see N. A. Busillo.
Jumper (BMI), PO Box 1885, 216 14 Ave. S.W., Birmingham, Ala. 35211. Tel: (205) 323-3925. Pres.: Roosevelt Harvey.
Ross Jungnickel (ASCAP), see Hill & Range.
Just (BMI), 35 W. 45 St., New York, N. Y. 10036. Tel: (212) JU 2-2975.
Kags (BMI), see Hugo & Luigi.
Gus Kahn (ASCAP), 6223 Selma Ave., Hollywood, Calif. 90028. Tel: (213) HO 2-6088. Owner: Donald Kahn.
Affiliate: Sugarbush.
Charles Emmerich Kalman (ASCAP), see Hill & Range.
Kalmann (ASCAP), 300 Farwood Rd., Philadelphia, Pa. 19151. Tel: (215) MI 2-2980. Mgr.: Kal Mann.
Affiliate: Woodcrest (BMI).
Kama Sutra (ASCAP), 1650 Broadway, New York, N. Y. 10019. Tel: (212) 765-3320. Pres.: Hy Mizrahi, Arthur Ripp & Phil Steinberg.
Affiliate: Tender Tunes (BMI).
Les Kangas (BMI), 302 E. Dewey Ave., San Gabriel, Calif. 91776. Tel: (213) 288-5435.
Kansoma (BMI), 6418 Camrose Terr., Bethesda, Md. Tel: (301) 365-2935.
Affiliate: Chartist (BMI).
Karelo, 3215 Ave. H, Brooklyn, N. Y. 11210. Tel: (212) UL 9-8116, 9-8550. Pres.: Howard C. Klein; Exec. VP: Karen E. Klein.
Int'l representatives: Argentina (Melograf), Australia (April), Brazil (Editora Mundo Musical), France (Les Nouvelles Editions), Germany (April), Japan (Nippon Columbia Musical Ent.), Mexico (Mundo).
Edward Kassner (ASCAP), see American Metropolitan Ent.
Kathie (ASCAP), PO Box 262, Bound Brook, N. J. Tel: (201) 356-2250. Pres.: James B. Kemper.
Affiliate: Sadboy (BMI).
Keel (BMI), see Astron.
Keetch, Caesar & Oino (BMI), 1650 Broadway, Rm. 901, New York, N. Y. 10019. Tel: (212) PL 7-3287.
Kelly (BMI), 439 Wiley Ave., Franklin, Pa. 16323.
Kelton (ASCAP), 68 Mechanic St., New Rochelle, N. Y. 10801. Tel: (914) NE 3-6059. Pres. & Gen. Mgr.: H. J. Lengsfelder.
Affiliate: Pleasant (ASCAP).
Keltone Int'l (ASCAP), 7819 Noble Ave., Van Nuys, Calif. Tel: (213) 787-0242. Pres. & A&R Mgr.: Fred Bonamic; Gen. Prof. Mgr.: Frank Kelton.
Affiliate: Frebon (BMI).
Kemo (BMI), 6087 Sunset Blvd., Hollywood, Calif. 90028. Tel: (213) HO 3-8245.
Kendor (SESAC), Delevan, N. Y. 14042. Tel: (716) 492-1254. Pres.: Art Dedrick.
Kentucky (BMI), see Hill & Range.
Kenwood (BMI), 161 W. 54 St., New York, N. Y. 10019. Tel: (212) PL 7-2072. Cable: Saunlaw. Pres.: Jeffrey S. Kruger.
Affiliate: Hillbrow (ASCAP).
Int'l representatives: England (Florida Music).
Kessler (BMI), 717 Carson Ave., La Junta, Colo. 81050. Sales Rep.: Horace A. Kessler.
King John (ASCAP), 649 N. Bronson Ave., Los Angeles, Calif. 90004. Tel: (213) 462-8600. Pres.: Robert D. Summers.
Kingston Int'l (BMI), 1927 Churchill, Trenton, Mich. 48183. Gen. Mgr.: Ima Harrison; Promo.: Emo Bevan.
Int'l Branch: Kingston Int'l of Canada.
Neil A. Kjos (SESAC), 525 Busse Hwy., Park Ridge, Ill. 60068. Tel: (312) TA 5-216B. Pres.: Neil A. Kjos Sr.
Affiliates: General Words & Music (ASCAP), Loop (ASCAP), J. A. Parks (SESAC).
Kling Street (BMI), 12811 Kling St., Studio City, Calif. 91604. Tel: (213) PO 6-4985. Pres.: Fred Darian.
Branch: Hollywood, Calif., 6411 Hollywood Blvd. Zip: 90028. Tel: (213) HO 6-6817. Gen. Prof. Mgr.: Darian.
Affiliate: Red Sails (ASCAP).
Knightbridge (BMI), see Gil.
Knollwood (ASCAP), see Fred Ahlert.
Komotion (ASCAP), PO Box 39, Stevensville, Mich. Pres.: Jerry Kohlert.
Kryder (BMI), see American Metropolitan Ent.
Kuno (BMI), 850 Seventh Ave., New York, N. Y. 10019. Tel: (212) LT 1-4144. Pres.: Clay Pitts.
Lake Forest (ASCAP), see Doney.
La Lou (BMI), 2823 Johnston St., Lafayette, La. Tel: (318) CE 4-4118.

Lansdale (BMI), see N. A. Busillo.
Lansdowne (ASCAP), 1549 N. Vine, Hollywood, Calif. 90028. Tel: (213) HO 5-4634. Owner: Norman Malkin.
Affiliate: Bloor.
Lar-Bell (BMI), see A. Schroeder.
La Salle (ASCAP), see Southern.
La Salle (BMI), 5727 S. LaSalle St., Chicago, Ill. 60621. Tel: (312) 667-4151. Pres. & A&R: Jump Jackson. VP & A&R: Oscar Jackson.
Lasta (ASCAP), PO Box 20004, Sta. N., Atlanta, Ga. Laurel (ASCAP), see Sunbeam.
Lavaloran (BMI), 4405 Ventura Ave., Sherman Oaks, Calif. 91403. Tel: (213) 766-1543. Owner: Glen D. Hardin.
Law (BMI), PO Box 5777, Saraland, Ala. Tel: (205) 457-4505. Pres. & Gen. Prof. Mgr.: Lois Anne Whiting; Gen. Mgr.: Sharron Garris.
Branch: Hendersonville, Tenn., 119 Robinhood Circle. Tel: (615) B24-0234. Gen. Prof. Mgr.: Roy McElroy.
Int'l firms represented: Sparton (Canada), Woomer (Australia).
Lear (ASCAP), 555 Madison Ave., New York, N. Y. 10022. Tel: (212) PL 2-9626.
Affiliate: Egap (BMI).
Leatherneck (BMI), see Raleigh.
Le Bill (BMI), 4930 Camp Bowie, Suite A, Ft. Worth, Tex. Tel: (817) PE 8-8843. Mgr.: Bill Smith.
Affiliate: Marbill.
Fred Le Blanc (BMI), 1820 Washington St., Boston, Mass. 02118. Tel: (617) HI 2-3830.
Leeds (div. of MCA) (ASCAP), 322 W. 48 St., New York, N. Y. 10036. Tel: (212) CI 5-1100. VPs: Salvatore T. Chiantia & Lou Levy.
Affiliates: Champion (BMI), Duchess (BMI), Northern (ASCAP) Pickwick (ASCAP).
Leeway (ASCAP), see Mark Warnow.
Lee-Wayne (BMI), 2002 W. Third St., Bloomington, Ind. Tel: (317) ED 6-5666. Pres.: Fred Helms Jr.
Leivas (BMI), PO Box 189, 2037 Milton St., Riverside, Calif. 92502. Tel: (714) 686-2670. Owner: Leona Leivas.
Lemco (BMI), PO Box 8013, 2518 Southview Dr., Lexington, Ky. Tel: (606) 277-5587. VP: Cecil Jones.
Lencal (BMI), 617 S. Victor, Burbank, Calif. Tel: (213) B43-4840. Owners: C. E. Lenderman & Gordon Calcothe.
Lerita (BMI), see A. Schroeder.
Lesgor (BMI), 745 Fifth Ave., Rm. 1512, New York, N. Y. 10022. Tel: (212) 421-5107. Pres.: Lesley Gore.
Affiliate: Buffee (BMI).
Lexicon (ASCAP), see Sacred Songs.
Lexie (BMI), 1715 S. 22 St., Philadelphia, Pa. 19146. Tel: (215) DE 4-9386. Pres.: Albert Davis; VP: Ethel G. Davis.
Lingua-Musica (BMI), 11225 Ewing Circle, Minneapolis, Minn. 55431. Tel: (612) 888-2011. Owner: G. B. Brown.
Lillenas (SESAC), 2923 Troost Ave., Kansas City, Mo. 64141. Tel: (816) JE 1-4646. Mgr.: R. W. Springfield.
Lilli (ASCAP), 723 Seventh Ave., New York, N. Y. 10019. Tel: (212) CI 5-7640.
Lillimar (ASCAP), see Earth.
Limax (BMI), 618 S. Ridgely Dr., Los Angeles, Calif. 90036. Tel: (213) WE 4-4033. Pres.: Max Feirtag.
Lindell (BMI), 1205 Madeira S.E., Suite 124, Albuquerque, N. M. 87108. Tel: (505) 255-3978. Pres.: Lindy Blaskey.
Linjo (BMI), 427 W. San Antonio, El Paso, Tex. 79901. Tel: (915) 532-1434. Contact: Joey Cash.
Branch: Englewood, N. J., 260 Speer Ave. Tel: (201) LO 7-2323. Contact: Joan Granger.
Lishing (BMI), see Periscope.
Mosie Lister (SESAC), PO Box 644, Tampa, Fla. 33601. Tel: (813) 238-2641. Mgr.: Mosie Lister.
Little Dipper (BMI), see The Big Seven.
Little Guy, 1030 Tremont St., Boston, Mass. 02162. Tel: (617) 442-1655. VP: Barry Richards.
Living Legend (ASCAP), see Kim Fowley.
Livingston & Evans (ASCAP), 6290 Sunset Blvd., Suite 1003, Hollywood, Calif. 90028.
Liza (ASCAP), 150 W. 52 St., New York, N. Y. 10019. Tel: (212) JU 6-4344. VP: Jordan Remin.
Lloyd (SESAC), see Davon.
Lock (ASCAP), 6830 Pacific View Dr., Los Angeles, Calif. 90028. Tel: (213) 469-1839. Owner: Joseph Saraceno.
Affiliates: Aut (ASCAP), Wrist (BMI).
Locket (BMI), see Les John.
Lois (BMI), 1540 Brewster Ave., Cincinnati, Ohio 45207. Tel: (513) 751-8442. Contact: Gladys Knochelman.

Lola (BMI), 20 West End Ave., New York, N. Y. 10023. Tel: (212) CI 5-7933. Mgr.: Leona Apostoleris.

Lombardo (ASCAP), see Bregman, Vocco & Conn.

E. M. Long (BMI), 804 S. Highland, Memphis, Tenn. 38111. Tel: (901) 327-5641. Pres.: E. M. Long.

Lonnie (BMI), see Ascot-Jolon.

Loop (ASCAP), see Neil A. Kjos.

Loot (BMI), see Neil A. Kjos.

Lou-Lee (BMI), see Alexis.

Lovers Oak (BMI), 3811 Wylly Ave., Brunswick, Ga. 31520. Tel: (912) 265-1340. Pres.: Peggy Ann Munson.

Lowery (BMI), PO Box 9687, Atlanta, Ga. 30319. Tel: (404) 233-6703. Pres.: Bill Lowery. Affiliates: Low-Twi (BMI), Wonder (BMI).

Low-Twi (BMI), see Lowery.

Ludwig (SESAC), 557-67 E. 140 St., Cleveland, Ohio 44110. Tel: (216) 851-1150. Pres.: Carl F. W. Ludwig. VP & Treas.: E. W. Ludwig.

Luristan (ASCAP), 723 Seventh Ave., New York, N. Y. 10019. Tel: (212) CI 5-7640. Pres.: Milt Schnapf.

Lu-Tal (BMI), see Owen.

Lute (ASCAP), PO Box 1181, Hollywood, Calif. 90028. Owners: Douglas Lyon & Lloyd I. Walker.

Lyle (ASCAP), 723 Seventh Ave., New York, N. Y. 10019. Tel: (212) CI 5-7640.

Lynnstorm (ASCAP), 9713 Santa Monica Blvd., Beverly Hills, Calif. 90210. Tel: (213) 276-1017. Cable: PACSAMUSIC. Pres.: Irving Mills. Gen. Mgr.: Robert Mills.

Lyricon (ASCAP), see Burdge.

MacArthur (BMI), 1659 Sweetbrier St., Palmdale, Calif. Tel: (805) 947-4563. Pres.: Glen MacArthur.

MacXen (BMI), see Leonard Hodes Group.

Mad Hatter (BMI), see Shapiro, Bernstein.

Maggie (BMI), see Tee Pee.

Malcolm (BMI), see Shawnee Press.

Malick Prod'ns (ASCAP), 541 Fulmer Ave., Akron, Ohio 44312. Tel: (216) 794-1304. Pres. & Owner: Ernie Malick.

Maltese (BMI), see Budd Granoff Prod'ns.

Manacor, see Pavanne.

Dudley Manners (ASCAP), 177 Beach 151 St., Belle Harbor, L. I., N. Y. 11694. Tel: (212) GR 4-2450. Owner: Dudley Manners.

Mansion (ASCAP), see Edward B. Marks.

Maple Leaf (BMI), 1650 Broadway, Suite 310, New York, N. Y. 10019. Tel: (212) JU 6-0240.

Maravilla (BMI), 6277 Selma, Hollywood, Calif. 90028. Tel: (213) 463-2328. Pres.: Bob Keene; Gen. Mgr.: Ron Roessler. Affiliate: Bobby Tunes (ASCAP).

Maraville (ASCAP), see Barron.

Marbil (BMI), see Le Bill.

Marcia (BMI), see Ivan Mogull.

Margarita (ASCAP), 1650 Broadway, Suite 310, New York, N. Y. 10019. Tel: (212) JU 6-0240.

Margie (BMI), 524 Plaster Ave. N.E., Atlanta, Ga. 30324. Tel: (404) 874-2781. Pres. & Pub.: Gaye Brooks; Pop A&R: Hubert H. Brooks; Classical A&R: Heinz Trustzschler; Sales & Mktg.: Doyle Taylor. Branch: Decatur, Ga., 2640 Charles Gate Ave. Zip: 30303. Tel: (404) 289-0858.

Maricana (BMI), see Marty Robbins.

Maricopa (SESAC), see Marty Robbins.

Marielle (BMI), 119 W. 57 St., New York, N. Y. 10019. Tel: (212) JU 2-2502. Mgr.: Don Seat.

Mariposa (BMI), see Marty Robbins.

Edward B. Marks (BMI), 136 W. 52 St., New York, N. Y. 10019. Tel: (212) CI 7-7277. Affiliates: Alameda (BMI), Mansion (ASCAP), Piedmont (ASCAP).

Marlen (ASCAP), see Gordon.

Marmor (BMI), 4644 Arriba Dr., Tarzana, Calif. Tel: (213) 344-7474. Owner: Ed Marmor. Affiliates: Clockus (BMI), EDM (ASCAP).

Marson (BMI), Main, Hackleburg, Ala. 35564. Tel: (205) 935-2163. Owner: A. L. Loden.

A. W. Marullo (BMI), 1121 Market St., Galveston, Tex. 77550. Tel: (713) SO 2-6581. Pres.: A. W. Marullo Sr.; Gen. Mgr.: A. W. Marullo Jr.; Gen. Prof. Mgr.: David Yeamans. Branch: Houston, Tex., 7450 Bellford St. Tel: (713) MI 9-0351. Gen. Prof. Mgr.: David Yeamans.

Marvelle (BMI), see Alexis.

Marvin (ASCAP), 1619 Broadway, New York, N. Y. 10019. Tel: (212) JU 6-5349. Mgr.: Gordon Williams.

Mary Jane (ASCAP), 254 W. 54 St., New York, N. Y. 10019. Tel: (212) CI 5-2170.

Massey (ASCAP), see Hill & Range.

Johnny Mathis (ASCAP), see Hill & Range.

Maureen (BMI), 1697 Broadway, New York, N. Y. 10019. Tel: (212) CI 7-2436.

Peter Maurice (ASCAP), 101 W. 55 St., New York, N. Y. 10019. Tel: (212) JU 2-1368.

Ray Maxwell (BMI), 6359 Selma Ave., Hollywood, Calif. 90028. Tel: (213) 469-3525. Pres.: Ray Maxwell.

Mayfair (ASCAP), see Edwin H. Morris.

Mayhew (BMI), PO Box 1958, 221 W. 57 St., New York, N. Y. 10019. Tel: (212) 757-7111. Pres.: Aubrey Mayhew. Affiliate: Janon (ASCAP).

McClendor Ent. (BMI), Rt. 3, La Grange, Ga. Tel: (404) 882-2391. Contact: Rupert McClendon.

McDowell (BMI), 828 S. Lawrence St., Montgomery, Ala. 36105. Tel: (205) 265-3882.

McLaughlin (BMI), 1300 Arbor View, Ann Arbor, Mich. Tel: (313) 663-2059. Pres.: Ollie McLaughlin.

McLaughlin & Reilly (SESAC), 67 Kingston St., Boston, Mass. 02111. Tel: (617) 426-7367.

Meadowark (ASCAP), 1608 N. Argyle, Rm. 108, Hollywood, Calif. 90028. Pres.: Lou Bedell. Affiliate: Hillary (BMI).

Medico (BMI), 803-R Government St., Mobile, Ala. Tel: (205) HE 3-3941. Pres.: James Whiting.

Melbourne (ASCAP), see Jaspar.

Judi Mellin (ASCAP), 1650 Broadway, New York, N. Y. 10019. Tel: (212) PL 7-3287.

Melody House (BMI), 958 W. Edgemont Dr., San Bernardino, Calif. 92405. Tel: (714) 882-6796. Owner: Bill Bellman.

Melody Lane (BMI), see Southern.

Melrose (ASCAP), see Edwin H. Morris.

Mendocino (BMI), 1680 N. Vine St., Rm. 814, Hollywood, Calif. 90028. Tel: (213) 466-7379. Pres.: N. R. Herzstam.

Mercury (SESAC), 17 W. 60 St., New York, N. Y. 10023. Tel: (212) JU 2-6160. Affiliates: Beekman (ASCAP), Merrymount (BMI).

Merna (BMI), 161 W. 54 St., New York, N. Y. 10019. Tel: (212) JU 6-6767. Mgr.: George Franconero.

Merrimac (BMI), see Regent.

Merrymount (BMI), see Mercury.

Mesquite (ASCAP), see Edwin H. Morris.

Meteor (BMI), see S&R.

THE BIG 3 WORLD-WIDE MUSIC PUBLISHING ACTIVITY

With Branch Offices, Affiliates and Associates In Principal Cities

NEW YORK • HOLLYWOOD • LONDON • PARIS • MILAN • VIENNA • AMSTERDAM
BRUSSELS • COLOGNE • FRANKFURT • STOCKHOLM • MADRID • GENEVA
TORONTO • TOKYO • SYDNEY • MEXICO CITY • RIO DE JANEIRO • BUENOS AIRES



make the year-long reference value of the "buyer's guide" readily AVAILABLE TO EVERY MEMBER OF YOUR FIRM...

Order extra copies NOW Just \$1.25 per copy (prepaid)

Billboard Buyers Guide 2160 Patterson St. Cincinnati, Ohio 45214

Please send ... copies of Buyers Guide. My payment for \$... is enclosed.

Name
 Company
 Address
 City
 Zone
 State

Show me a hen
 That can write with a pen,
 And I'll bet you then
 Backed by a 'ten',
 'Tis not a hen
 But a gem!

© 1965 by HENry J. Sommers, A.S.C.A.P. Songs by Sommers Records (A.F.M.) P. O. Box 322 Silver Spring, Maryland 20907 Telephone: (301) Whitehall 6-9039

Latest releases:

- "MY LADDER OF DREAMS"**—
 Cara Stewart with Lee Hudson Drch. Advance Records =1005, 6376 Yucca St., Hollywood, Calif. 90028
- "ACTIONS SPEAK LOUDER THAN WORDS"**—
 Mary Kaye (Popular Teen Style) "B+ Smooth up-beat, a gentle pop sound." Cash Box. Lectron Record =13902, 5334 Concord, Detroit, Mich. 48211
- "OLE COUNTRY MUSIC"**—
 Rex Klingensmith (Accomp. by the Country Westerns) Received the Cash Box "BULL'S-EYE" — Process Record =103, Wiley Ave., P.D. Box 569, Franklin, Pa. 16323
- "MY LADDER OF DREAMS" c/w "ACTIONS SPEAK LOUDER THAN WORDS"**—
 Wade Holmes. A favorite with the Country-Western D.J.'s! Songs by Sommers records =2
 (For Promotional Records, write directly to the respective record company.)

continued

Meteorion (BMI), 117 W. 48 St., New York, N. Y. 10036. Tel: (212) JU 2-2934. Mgr.: Mrs. Brigitta Peschko.
 Affiliate: Multitone (ASCAP).
 Metric (BMI), see Metric Music Group.
 Metric Music Group, 1556 N. La Brea Ave., Hollywood, Calif. 90028. Tel: (213) 462-6773. Gen. Mgr.: Mike Gould; Prof. Mgr.: Ernie Farrel.
 Branch: New York, N. Y., 1650 Broadway. Tel: (212) JU 6-5085. Rep.: Al Altman.
 Affiliates: Asa (ASCAP), Cornerstone (BMI), Dobo (BMI), Har-Bock (BMI), Metric (BMI), Post (ASCAP), Travis (BMI), West Coast (ASCAP).
 Midnight Music, see Cameo-Parkway.
 Midwood (BMI), see Barton.
 Milbern (BMI), 723 Seventh Ave., New York, N. Y. 10019. Tel: (212) CI 5-7640.
 Earl Miles (BMI), PO Box 1336, 1108 Davis, Redwood City, Calif. 94403. Tel: (415) 369-0728. Owner: Earl Miles.
 Branch: Vancouver, Wash., 208 S.E. 107 Ave. Miller (ASCAP), see The Big Three.
 Mills (ASCAP), 1619 Broadway, New York, N. Y. 10019. Tel: (212) CO 5-6347. Cable: Millsmusic. Pres.: Richard L. Rosenthal; Gen. Mgr.: Warren Ling; Gen. Prof. Mgr.: Stanley Mills.
 Branches: Los Angeles, Calif., 610 S. Broadway.—Chicago, Ill., 64 E. Jackson Blvd.
 Affiliates: American Academy of Music (ASCAP), Ankerford (ASCAP).
 Int'l firms represented: H. Freeman (England), Gaillard (England), Israel Composers League (Israel), Alfred Lengnick (England), Novello (England), Quiroga (Spain), Western (Canada).
 Int'l representatives: Brazil, Canada, England, France, Germany, Holland, Mexico, Spain (all Mills).
 Minto (BMI), PO Box 9411, North Hollywood, Calif. 91609. Tel: (213) 335-9379, 5931. Dwner: A. J. Minto.
 Miracle, Concord, Tenn.
 Affiliate: Elvitruue (BMI).
 Mishawaka (BMI), 920 S. Laurel, Mishawaka, Ind. Tel: (219) 259-3215. Owner: Juanita Henson.
 Missouri (BMI), see Gil.
 Mr. Music (BMI), 92209 Sunset Blvd., Suite 328, Hollywood, Calif. 90069. Contact: Eddie Shaw.
 Affiliate: Eddie Shaw (ASCAP).
 Mitten (BMI), 2790 S. Van Dyke, Imlay City, Mich. 48444. Tel: (313) 724-5149. Pres.: W. Howard Walker.
 Modern (BMI), 5810 S. Normandie Ave., Los Angeles, Calif. 90044. Tel: (213) 753-2481. Mgr. Saul Bihari.
 IVAN MOGULL (ASCAP), 33 W. 60 St., New York, N. Y. 10023. Tel: (212) 581-6430. Dwner: Ivan Mogull.
 Affiliates: Harvard (BMI), Marcia (BMI), Viva (BMI), Zapata (BMI). (SEE ADVERTISEMENT)
 Int'l representatives: Australia, Belgium, England (Ivan Mogull), France (Ivan Mogull/ Editions Tropicales), Germany (Ivan Mogull), Greece (Ivan Mogull c/o AEPI), Holland (Ivan Mogull c/o Stemma), Israel (Ivan Mogull), Italy, (Ivan Mogull c/o Gaetano Capasso), Japan (Ivan Mogull), Spain (Ivan Mogull c/o SGAE), Sweden (Ivan Mogull/Sweden Music), Switzerland (Ivan Mogull/Musikvertrieb).
 Mojave (BMI), see Marty Robbins.
 Momak (BMI), see Pietro Deiro.
 Monarch (ASCAP), 8560 Sunet Blvd., Suite 805, Los Angeles, Calif. 90069. Tel: (213) 652-7665.
 Monoma (BMI), PO Box 111, Ralston, Neb. 68051. Tel: (402) 733-4007. Pres. & Gen. Prof. Mgr.: Scott A. Cameron.
 Monsapac (BMI), see Helios.
 Montauk (BMI), 1650 Broadway, Suite 310, New York, N. Y. 10019. Tel: (212) JU 6-0240.
 Monte Verde (BMI), 5637 Monte Verde Dr., Santa Rosa, Calif. 95405. Tel: (707) 544-2588. Gen. Mgrs.: Kathy Whitney & Frank E. Whitney.
 Montana (BMI), 4 W. 31 St., Suite 824, New York, N. Y. 10001. Tel: (212) LA 4-7800, Ext. 824. Prof. Mgr.: Dave Leonard.
 Int'l Branch: Canada, PO Box 323, Montreal, Que. Tel: (514) 739-8935, 9200.
 Mood Music (ASCAP), see Shapiro, Bernstein.
 Moon Lake (BMI), 5007 "F" St., Philadelphia, Pa. 19124. Tel: (215) JE 3-8799. Pres.: Leonard Stark.
 Moontunes (ASCAP), 1607 El Centro, Hollywood, Calif. 90028. Tel: (213) 464-9819. Cable: Moonson. Pres.: John Elliott; Gen. Mgr.: Linwood Wilde; Gen. Prof. Mgr.: Alan Block.
 Affiliate: Hollydale (BMI).
 R. Mor Music, See Listing under R.

Morgan Manor (ASCAP), 6223 Selma Ave., Hollywood, Calif. 90028. Dwner: Russ Morgan; Prof. Mgr.: Milt Stein.
 Morley (ASCAP), see Edwin H. Morris.
 Edwin H. Morris (ASCAP), 31 W. 54 St., New York, N. Y. 10019. Tel: (212) JU 2-5656.
 Affiliates: Arko, Carwin, Charling, Harwin, Jerrycio, Mayfair, Melrose, Mesquite, Morley (all ASCAP).
 Moss-Rose (BMI), 806 16 Ave. S., Nashville, Tenn. 37203. Tel: (615) 244-2428. Pres. & Gen. Mgr.: Hubert Long.
 Affiliate: Pawnee Rose (SESAC).
 Mount Lemon (BMI), 3768 Webb Ln., Tucson, Ariz. 85716. Tel: (602) 793-8830. Pres.: Rex Birmingham.
 Mount Rainier (BMI), PO Box 246, Mt. Rainier, Md. 20822. Tel: (301) 927-0010. Pres.: C. R. Freeland.
 Mount Royal (BMI), See Costoma.
 Mountaineire (BMI), PO Box 812, 101 Whitestick Rd. Beckley, W. Va. Tel: (304) 252-5161. Pres.: R. L. Ziegler.
 Movietone (ASCAP), see Sam Fox.
 Mudville (BMI), 517 Bridewell, Los Angeles, Calif. 90042. Tel: (213) 254-6525. Cable: MUMU. Owner & Mgr.: Pat H. Casey.
 Multitone (ASCAP), see Meteorion.
 Mums (BMI), 6072 14 St., Detroit, Mich. 48208. Tel: (313) 897-0009. Pres.: Lou Beatty Sr.
 Murbo (BMI), see ABC.
 Mured (BMI), 8008 Rodgers Rd., Philadelphia, Pa. 19117. Tel: (215) 635-3822. Contact: Robert A Chipez.
 Music Makers Network of America, 306 S. 16 St., Wilmington, N. C. 28403. Bus. Mgr.: Samuel Kane.
 MUSIC MUSIC MUSIC, 509 Madison Ave., New York, N. Y. 10022. Tel: (212) 421-4537. Pres.: Chet Gierlach; VP: P. Fairbanks. (SEE ADVERTISEMENT)
 Music Prod'ns (ASCAP), 6000 Sunset Blvd., Hollywood, Calif. 90028. Tel: (213) HO 3-7619. Pres.: Wayne Shanklin Sr.; Gen. Mgr.: J. R. Shanklin.
 Music Publishers Holding Corp., 488 Madison Ave., New York, N. Y. 10022. Tel: (212) PL 9-4422. Affiliates: Advanced, Athwarn, Harms, New World Nine Star, Pepammar, Remick, Shubert, Warner Bros., Weill-Brecht-Harms, Witmark (all ASCAP).
 Music Sales Corp., 33 W. 60 St., New York, N. Y. 10023. Tel: (212) CI 6-0325.
 Affiliates: Braun (SESAC), Consolidated (ASCAP), Dorsey Bros. (ASCAP), Embassy (BMI), Yorktown (ASCAP).
 MuStaff (BMI), PO Box 3322, Orlando, Fla. Tel: (305) MI 4-3853. Pres.: W. Campbell.
 Mutual Music Society (ASCAP), see Chappell.
 Myers (ASCAP), 135 W. 50 St., Rm. 1920, New York, N. Y. 10019. Tel: (212) PL 7-7178.
 Nasetan (BMI), PO Box 1485, Lake Charles, La. 70601. Pres.: Eddie Shuler.
 Nash-Beau (BMI), see Tracie.
 Nationwide Songs (ASCAP), see Pavanne.
 Nenah-Menasha (BMI), see SFD.
 Natson (ASCAP), see Ridge.
 Neches (BMI), 1812 Procter, Port Arthur, Tex.
 Nelson (ASCAP), 1717 N. Highland Ave., Hollywood, Calif. 90028.
 Neptune (BMI), 82 Aldine St., Rochester, N. Y. 14619. Tel: (716) FA 8-4649. Prof. Mgr.: Marv Steffey.
 Nettles (BMI), 1003 Thomas Ave., Monroe, La. 71201. Tel: (318) 322-2291. Pres.: Mrs. Bill Nettles.
 New Keys (BMI), Tel: (215) PD 5-0300, see Jamie.
 New World (ASCAP), see Music Publishers Holding Corp.
 Next Day (ASCAP), see Hugo & Luigi.
 Nicholas (ASCAP), see N. A. Busillo.
 Nidron Publ'r. Lyrics, 7128 S. Bennett Ave., Chicago, Ill. 60649. Tel: (312) 648-5312. Pres.: Rollin Allison; VP: Cherry Johnson; Mgr.: John Frazier.
 Nine Star (ASCAP), see Music Publishers Holding Corp.
 Nom (BMI), see The Big Seven.
 Noma (BMI), see Hill & Range.
 North & Son (ASCAP), see Shapiro, Bernstein.
 Northern (ASCAP), see Leeds.
 Northridge (ASCAP), 6290 Sunset Blvd., Suite 1003, Hollywood, Calif. 90028. Tel: (213) 466-4265.
 NorVajak (BMI), 50 W. 57 St., Rm. 711, New York, N. Y. 10019. Tel: (212) JU 2-7569. Mgr.: Norman Petty.
 Branch: Clovis, N. M., PO Box 926, 1321 W. Seventh St.

continued on page 72

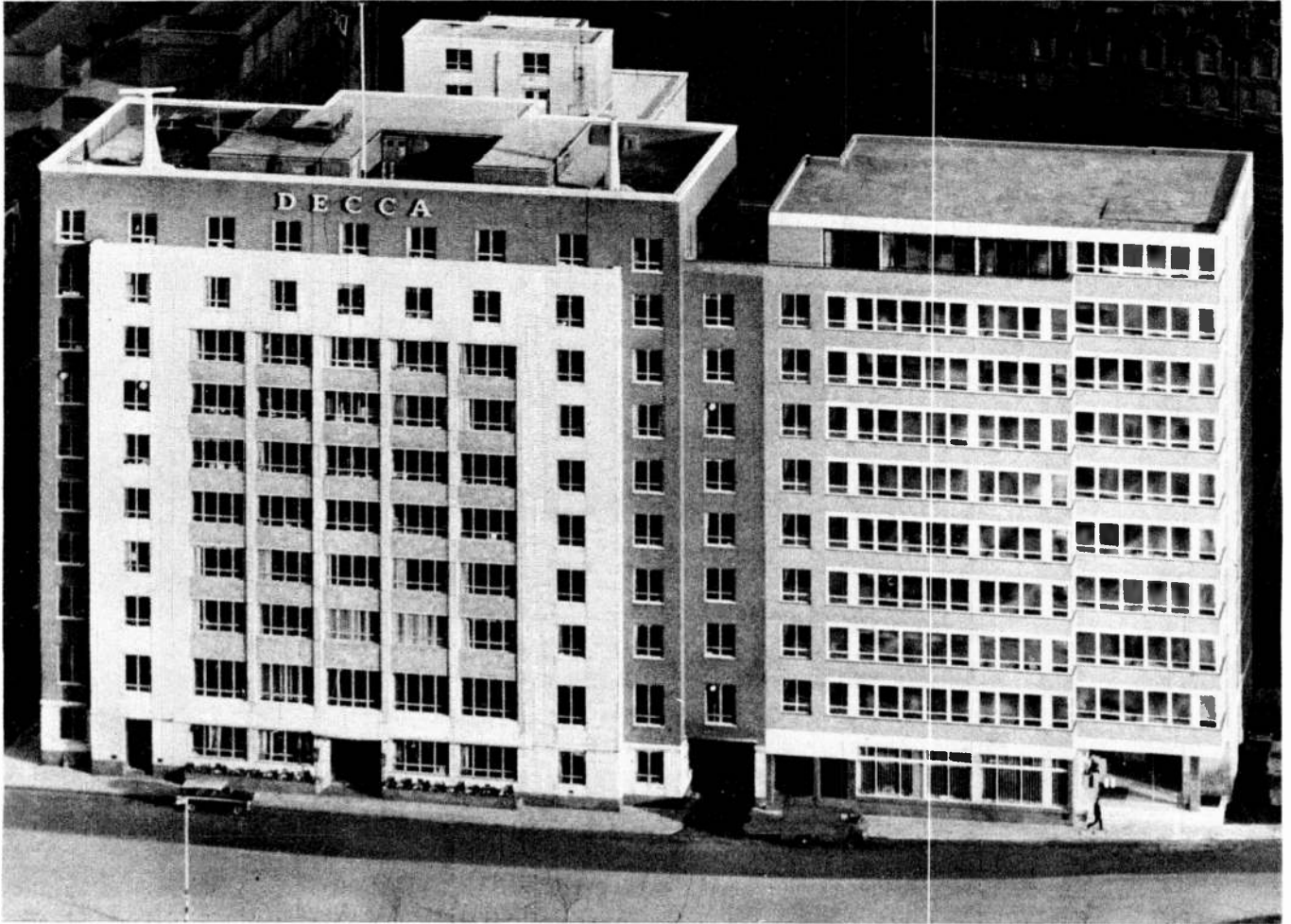

Decca offices: 9 Albert Embankment London SE1 England

The
Decca Record
Company Limited
of England
and its USA subsidiary
London Records Inc
offer American record labels a first-class
world-wide distribution service

write or call Mimi Trepel London Records Inc 539 West 25th Street New York 1 NY Oregon 5-6060

continued

Notable (ASCAP), 161 W. 54 St., New York, N. Y. 10019. Tel: (212) PL 7-9547. Pres.: Cy Coleman; Gen. Mgr.: Eric Colodne.
Affiliates: Benglo (BMI), Portable (BMI).
Int'l firms represented: Campbell Connelly (England).
 Nujac (BMI), Tel: (215) PO 5-0300, see Jamie.
 Nu-Star, c/o Kenneth Moffett, 29B Browning Rd., Nashville, Tenn. 37211. Tel: (615) 832-4761.
 Oakland (ASCAP), see ABC.
 Oakridge (BMI), 2001 Elton Rd., Fort Worth, Tex. 76117. Tel: (817) TE 8-660B. Owner & A&R: H. L. Sewell.
 Obie (BMI), 1650 Broadway, New York, N. Y. 10019.
 Ocampo, 735 General McMullen Dr., San Antonio, Tex. 78228. Tel: (512) GE 3-1461. Pres.: Bill Evans.
Branch: Oakland, Calif., 1741 Market St.
 Omni (BMI), see Tuneville.
 Opal (BMI), see Central Songs.
 Origatunes (BMI), 10337 E. Beach St., Bellflower, Calif. Tel: (213) TO 6-4146. Owner: Mearl Ellison.
 Shad O'Shea (BMI), 2570 Harrison Ave., Cincinnati, Ohio. Tel: (513) 481-6877.
 Owen (BMI), PO Box 842, Bakersfield, Calif. Tel: (805) FA 3-972B. Pres.: Charles L. Owen.
Affiliate: Lu-Tal (BMI).
 Oxford (ASCAP), see Select.
 Pacemaker (BMI), see Leonard Hodes Group.
 Pacific Coast, Box 38631, Hollywood, Calif. 90038. Tel: (213) 763-4374.
 Pacific Sound, PO Box 8244, Universal City, Calif. 91608. Pres.: Richard J. Shepp.
 Pacsa (ASCAP), 9713 Santa Monica Blvd., Beverly Hills, Calif. 90210. Tel: (213) 276-1017. Cable: Pacsamusic. Pres.: Irving Mills; Gen. Mgr.: Robert Mills.
 Painted Desert (BMI), see Shapiro, Bernstein.
 Palm Springs (ASCAP), 1601 N. Gower St., Hollywood, Calif. 90028. Tel: (213) HO 2-7321.
 Pamco (BMI), 1330 Ave. of the Americas, New York, N. Y. 10019. Tel: (212) LT 1-7777. Cable: ABPAREC. Pres.: Samuel H. Clark; VP: Larry Newton; Gen. Prof. Mgr.: Aaron (Goldie) Goldmark.
Affiliates: Ampar (BMI), Ampco (ASCAP), Apt (ASCAP), Porgie (BMI), Westpar (BMI).
 Pamper (BMI), 119 Two Mile Pk., Goodlettsville, Tenn. Tel: (615) 859-1345. Mgr.: J. Hal Smith.
 Panette (ASCAP), 320 W. 55 St., New York, N. Y. 10019. Tel: (212) 581-9251. Pres.: Edwin D. McMullen.
 Panther (ASCAP), see Southern.
 Paramount (ASCAP), see Famous.
 Parasonic (BMI), PO Box 412, Huntsville, Ala. 35804. Tel: (205) 828-4863. Gen. Mgr.: Chat Dean.
 Paris (ASCAP), see Rayven.
 J. A. Parks (SESAC), see Neil A. Kjos.
 Parnaso (BMI), 275 S. Second St., Brooklyn, N. Y. 11211. Tel: (212) EV 7-1200. Pres.: Roger Lopez.
Affiliate: Campe (BMI).
 Partita (BMI), see Leonard Hodes Group.
 Patlow (BMI), 18475 Evergreen Rd., Detroit, Mich. 48219. Tel: (313) 531-7329. Pres.: M. J. Patlow.
 Patricia (BMI), see the Big Seven.
 Pattern (ASCAP), 7033 Sunset Blvd., Suite 308, Hollywood, Calif. 90028. Tel: (213) HO 6-2161.
 Pavanne (ASCAP), 1619 Broadway, Suite 514, New York, N. Y. 10019. Tel: (212) CI 5-1249. Contact: Frank Stanton & Andy Badale.
Affiliates: Buckingham (ASCAP), Dawny, Delicato (BMI), Fairlight, Favorite (ASCAP), Gattwick (BMI), Hampstead, Jay Dee, Manacor, Nationwide Songs (ASCAP), Surrey (ASCAP), Tellaro (BMI), Winamusic.
 Pawnbroker (ASCAP), see Earth.
 Pawnee Rose (SESAC), see Moss Rose.
 George Paxton (ASCAP), 1619 Broadway, New York, N. Y. 10019. Tel: (212) JU 2-3050. Prof. Mgr.: Bob Reno.
Affiliate: Paxwin (BMI).
 Paxwin (BMI), see George Paxton.
 Peargay (BMI), 649 N. Bronson Ave., Los Angeles, Calif. 90004. Tel: (213) 462-8600. Pres.: Robert D. Summers.
 Pearl (BMI), 1619 Broadway, New York, N. Y. 10019. Tel: (212) CI 6-1990.
 Peer Int'l (BMI), see Southern.
 Peer-Southern Prod'ns (ASCAP), see Southern.
 Pentagon (BMI), see Jamie.
 Pentagrid (BMI), 1209 E 76 St., Los Angeles, Calif. 90001. Tel: (213) 585-6474. Pres.: J. L. Smith.
 Pepamar (ASCAP), see Music Publishers Holding Corp.

Pera (BMI), see Southern.
 Perfection (BMI), see Regal.
 Periscope (BMI), B9 Hollingsworth St., Mattapan (Boston), Mass. 02126. Tel: (617) 298-0574. Cable: PERI-MU. Pres. & Gen. Prof. Mgr.: Edward M. Hurvitz.
Affiliates: Lishing (BMI), Telescope (BMI).
 Peters (ASCAP), see Criterion.
 Petone (BMI), see A. Schroeder.
 Petsilas (BMI), see Earth.
 Pexam (BMI), 831 Taylor Blvd., Millbrae, Calif. 94030. Tel: (415) 692-0117. Owners: Lou Dorren, Don O'Leary.
 Piccadilly (BMI), see American Metropolitan Ent's.
 Pickering (BMI), 9713 Santa Monica Blvd., Beverly Hills, Calif. 90210. Tel: (213) 276-1017. Cable: PACSAMUSIC. Pres.: Irving Mills. Gen. Mgr.: Robert Mills.
 Pickwick (ASCAP), see Leeds.
 Piedmont (ASCAP), see Edward B. Marks.
 George Pincus & Sons (ASCAP), see Gil.
 Pine Knob (BMI), see Budd Granoff Prod'ns.
 Pinebrook (BMI), 1650 Broadway, Suite 310, New York, N. Y. 10019. Tel: (212) JU 6-0240.
 Pinelawn (BMI), see American Metropolitan Ent's.
 Pitfield (BMI), see A. Schroeder.
 Pete Pittman (BMI), S. Marvin Rd., Lyons, Ga. Tel: (912) 565-8311. Pres. & Gen. Mgr.: Pete Pittman.
 Plan Two (ASCAP), see Hill & Range.
 Planetary (ASCAP), see The Big Seven.
 Pleasant (ASCAP), see Keltan.
 Pleasant Ridge (BMI), PO Box 3961, Park Pl., Greenville, S. C. Sec.-Treas.: Robert W. Edwards.
 Plus-Minus (ASCAP), see Criterion.
 Poinsettia (BMI), 1004 Mulberry, Trumann, Ark. Tel: (501) 483-6363. Pres.: E. J. Waldrup.
 Polaris (BMI), 1936 Butterfield, Troy, Mich. Tel: (313) 646-6693. Pres.: Shelley Haims.
 Polka Towne (BMI), 23 Marian Ln., Jericho, L. I., N. Y. Tel: (516) OV 1-7356. Contact: T. Kalinowski.
 Poly Tone (ASCAP), 16027 Sunburst St., Sepulveda, Calif. 91343. Tel: (213) 892-0044. Pres.: Larry Fotine.
 Ponderosa (BMI), see Shapiro, Bernstein.
 Porgie (BMI), see Pamco.
 Portable (BMI), see Notable.
 Portage (BMI), PO Box 555, Lake St. Sta., Minneapolis, Minn. 55408. Tel: (612) B24-0820. Pres.: Larry LaPole.
 Portland (BMI), PO Box 411, San Fernando, Calif. Tel: (213) DI 2-9109. Nat'l Rep.: Mark Raymer.
 Portland (BMI), PO Box 928, Mehama, Ore.
 Post (ASCAP), see Metric Music Group.
 Premier (BMI), 1650 Broadway, New York, N. Y. 10019. Tel: (212) JU 6-5253. Pres.: Philip Landwehr.
Affiliate: West End (ASCAP).
 Premier Albums (BMI), 1650 Broadway, New York, N. Y. 10019. Tel: (212) JU 6-5253.
 Elvis Presley (BMI), see Hill & Range.
 Henri Price (BMI) see A. Schroeder.
 Pride (ASCAP), 230 W. 41 St., New York, N. Y. 10036. Tel: (212) LW 4-0131. VP: Emery Deutsch.
 Princess (ASCAP), 1650 Broadway, Suite 310, New York, N. Y. 10019. Tel: (212) JU 6-0240.
 Print (ASCAP), see Japalana.
 Prize (ASCAP), see Raleigh.
 Process (BMI), 439 Wiley, Franklin, Pa. 16323.
 Producers (ASCAP), see Burdge.
 Progressive (BMI), see Hill & Range.
 Promenade (ASCAP), see A. Schroeder.
 Pronto (BMI), see Cotillion.
 Protone (ASCAP), 2534 W. Pico Blvd., Los Angeles, Calif. 90006. Tel: (213) DU 7-3276. Owner: James Welton.
Affiliate: Welton (BMI).
 Purchase (ASCAP), 254 W. 54 St., New York, N. Y. 10019. Tel: (212) CI 5-2170.
 Quartet (ASCAP), see Trio.
 Quincy (ASCAP), 131 Farrington St., Wollaston, Mass. 02170. Owner-Pub.: Richard Miles.
 Quinlan (BMI), 870B Ruthby St., Houston, Tex. 77017. Tel: (713) MI 9-5024. Pres.: Walt Breeland.
 Quintet (BMI), see Hill & Range.
 Quinvy (BMI), 102 E. 2nd St., Sheffield, Ala. 35660. Tel: (205) 383-2673. Pres.: Quinon R. Ivy. VP & Gen. Mgr.: William Jenkins; Sec.-Treas.: Jack T. Chism.
 R F D (ASCAP), see Southern.
 R F T (BMI), see Thomas J. Valentino.
 R. Mor, 152B Overington St., Philadelphia, Pa. 19124. Tel: (215) PI 3-0770. Pres.: Richie Moore.
 Radley (BMI), see A. Schroeder.
 Ragmar (BMI), 219 W. 79 St., New York, N. Y. 10024. Tel: (212) TR 3-9821. Pres.: Jerry Ragovoy.
Affiliate: Rittenhouse (BMI).

Vince Rago (BMI), PO Box 961, Wilmington, Del. 19899. Tel: (302) WY 8-9679.
 Raintree (ASCAP), see Budd.
 Raleigh (BMI), B17 16 Ave. S., Nashville, Tenn. Pres.: Shelby S. Singleton Jr.; Gen. Prof. Mgr.: Bill O'Brien.
Affiliates: Angus (BMI), Cave (BMI), Dayshell (BMI), Fingerlake (BMI), Hornet (BMI), Leatherneck (BMI), Prize (ASCAP).
 Ramed (BMI), 116 Central Park South, New York, N. Y. 10019. Tel: (212) CI 6-3811. Mgr.: Stanley Polley.
Affiliate: Debmar (ASCAP).
 Ramitory (BMI), 3 Thomas Circle N.W., Washington, D. C. 20005. Tel: (202) 628-8870. Pres.: Ray Gordy.
 Fred Raphael (ASCAP), 6758 Colgate Ave., Los Angeles, Calif. 90048. Tel: (213) OL 1-3250. Pres.: Fred Raphael.
 Rave (BMI), see Enlight.
 Ray, 1117 N. Main, Fremont, Neb. 68025. Tel: (403) 721-4728. Pres.: Ray Keller.
 Rayster (ASCAP), see Stirling.
 Rayven, 1650 Broadway, New York, N. Y. 10019. Tel: (212) CO 5-0211. Mgr.: Duke Niles.
Affiliate: Paris (ASCAP), Showboat (BMI).
 Reach, 152B Overington St., Philadelphia, Pa. 19124. Tel: (215) PI 3-0770. Pres.: Richie Moore.
 Walter Reade-Sterling (ASCAP), see Frank.
 Red Rock (BMI), PO Box 2671, 1819 E. 31 Ave., Denver, Colo. 80201. Tel: (303) 333-8086. Pres.: James C. Scott Sr.
 Red Sails (ASCAP), see Kling Street.
 Red Stick (BMI), Tel: (215) PO 5-0300, see Jamie.
 Regal (ASCAP), 1429 Hawthorne St., Pittsburgh, Pa. 15201. Tel: (412) 781-4557. Pres.: Edward J. Moschetti.
Affiliate: Perfection (BMI).
 Regent (BMI), 1619 Broadway, New York, N. Y. 10019. Tel: (212) CI 6-1990. Prof. Mgr.: Harold Wald.
Affiliates: Arc (BMI), East-West (ASCAP), Jewel (ASCAP), Merrimac (BMI), Sunflower (ASCAP).
 Herb Reis (BMI), 1619 Broadway, New York, N. Y. 10019. Tel: (212) PL 7-9265. Mgr.: Herb Reis.
Affiliate: Summit (ASCAP).
 Reliance (ASCAP), 1619 Broadway, New York, N. Y. 10019. Tel: (212) CI 6-1397. Pres.: Norman Foley.
Affiliate: Stride (BMI).
 Remick (ASCAP), see Music Publishers Holding Corp.
 Republic (BMI), see World.
 Rex (BMI), 1650 Broadway, Suite 310, New York, N. Y. 10019. Tel: (212) JU 6-0240.
 The Richmond Organization (TRO), 10 Columbus Circle, New York, N. Y. 10019. Tel: (212) CI 6-8700. Gen. Mgr.: Al Brackman; Gen. Prof. Mgr.: Happy Goday;
Int'l representatives: Australia (Essex), Canada (Essex), England (Essex Music Group), France (Editions Essex), Germany (Essex), Holland (Les Editions Essex), Israel (The Richmond Organization), Italy (Edizioni Aromando), Japan (The Richmond Organization), Spain (Ediciones Essex), Sweden (Essex).
 Ridge (BMI), 850 Seventh Ave., New York, N. Y. 10019. Tel: (212) JU 6-2677. Pres. & Gen. Mgr.: Paul Tannen; Gen. Prof. Mgr.: Herman Dressel.
Affiliate: Natson (ASCAP).
 Ridgeway (BMI), 6087 Sunset Blvd., Hollywood, Calif. 90028. Tel: (213) 462-1366. Mgr.: Charles E. Adams.
Branch: Nashville, Tenn., 1012 17 Ave. S. Tel: (615) 255-4212. Gen. Prof. Mgr.: Carl Maynard.
Affiliates: Camarillo (BMI), Woodbury (BMI).
 Ringasel (BMI), 7280 Caverna Dr., Hollywood, Calif. 90028. Tel: (213) HO 6-6129.
 Rio Grande (BMI), see Hill & Range.
 Ritchie (ASCAP), see Barton.
 Rittenhouse (BMI), 1617 N. Broad St., Philadelphia, Pa. 19122. Tel: (215) CE 6-7300. Pres.: Bill Fox.
Branch: New York, N. Y., 219 W. 79 St. Tel: (212) TR 3-9821. Contact: Jerry Ragovoy.
Affiliate: Ragmar.
 Tex Ritter (ASCAP), see Criterion.
 Robadon (BMI), PO Box 131, Lorain, Ohio. Tel: (216) AT 8-6397. Owner: Robert W. Sellers.
 Rob-Ann (BMI), 254 W. 54 St., New York, N. Y. 10019. Tel: (212) PL 7-3181. Mgr.: Vincent Oddo.
 Robbins (ASCAP), see The Big Three.
 Marty Robbins (BMI), 713 1B Ave. S., Nashville, Tenn. 37204. Tel: (615) AL 4-5918. Mgr.: Marty Robbins.
Affiliates: Maricana (BMI), Maricopa (SESAC), Mariposa (BMI), Mojave (BMI).
 Robert (ASCAP), 1650 Broadway, New York, N. Y. 10019. Tel: (212) PL 7-3287.

Rocarneo, 624 W. 41 Dr., Los Angeles, Calif. 90037. Tel: (213) 235-2489. Pres.: R. L. Taylor.

Rock Masters (BMI), 177 Rt. 304, New City, N. Y. Contact: Frank Guida, Tel: (703) 853-4041 & Pearl Frank, Tel: (914) NE 4-5101.

Rockaway (BMI), 1631 Broadway. Tel: (212) JU 2-4267. Mgr.: Jack Hooke.

Rockmore (BMI), 1733 Carmona Ave., Los Angeles, Calif. 90019. Tel: (213) 933-6521. Owner: Willie H. Rocquemore.

Rodeo (BMI), see Jasper.

Rogelle (BMI), 35 W. 45 St., New York, N. Y. 10036. Tel: (212) JU 2-2975.

Rolling Wheels (BMI), PO Box 206, Lake Elsinore, Calif. 92330. Tel: (714) 674-3636. Gen. Mgr.: Cletus Zumbach.

Ronbeth (BMI), PO Box 14355, Philadelphia, Pa. 19116. Tel: (215) OR 7-1534. VP Promo. & Prod'n: David S. Chackler.

Roncom (ASCAP), 405 Park Ave., New York, N. Y. Tel: (212) PL 1-1480. Mgr.: Mickey Glass.

Room Seven (BMI) (div. of Seven Arts Press), 6365 Selma Ave., Hollywood, Calif. 90028. Tel: (213) 469-1095.

Roosevelt (BMI), 1650 Broadway, New York, N. Y. 10019. Tel: (212) CO 5-1053. Pres.: Hal Fein; Gen. Mgr.: Jerry Brown.

Rosarita (ASCAP), see Hill & Range.

Fred Rose (BMI), see Acuff-Rose.

Rose Hill (BMI), see Leonard Hodas Group.

Rosemeadow (ASCAP), see Bregman, Vocco & Conn.

Rosewood (ASCAP), see Cavalcade.

Rowilco (BMI), PO Box B135, Chicago, Ill. 60680. Tel: (312) 373-7072. Exec. VP: R. C. Hillsman. Branch: Los Angeles, Calif., 4363 Lockwood Ave., Suite 2. Pres.: R. C. Wilson.

Royal Flair (BMI), 870 N. Wabash, Chicago, Ill. Tel: (312) 337-2550. Pres.: Bob Williams.

Rubank (ASCAP), 5544 W. Armstrong Ave., Chicago, Ill. 60646. Tel: (312) RO 3-4646. Mgr.: Edward H. Wolske.

Rumbalero (BMI), see Hill & Range.

Rush (BMI), see American Metropolitan Ents.

Ryerson (BMI), 154 W. 14 St., New York, N. Y. 10011. Tel: (212) AL 5-7732. Pres.: Maynard Solomon.

S E S A C, 10 Columbus Circle, New York, N. Y. 10019. Tel: (212) 586-3450. Pres.: Paul Heinecke; Exec. VP: A. H. Prager. (SEE ADVERTISEMENT)

S F O (BMI), 916 Kearny, San Francisco, Calif. Tel: (415) EX 2-1886. Admin: Charlotte Larson.

S & J (ASCAP), 35 W. 45 St., New York, N. Y. 10036. Tel: (212) JU 2-2975.

S & R (ASCAP), 6533 Hollywood Blvd., Hollywood, Calif. 90028. Tel: (213) 469-1621. Pres.: Scott Seely. Affiliates: Meteor (BMI).

Sacred Songs (ASCAP), 9000 Sunset Blvd., Hollywood, Calif. 90069. Tel: (213) 275-9400. Dir.: Fred Bock. Affiliates: Family (SESAC), Lexicon (ASCAP).

Saga (ASCAP), see Barton.

Sage & Sand (SESAC), 5653 1/2 Hollywood Blvd., Hollywood, Calif. 90028. Tel: (213) HO 9-1527. Mgr.: W. O. Fleener.

Sagittarius (BMI), 265 W. 54 St., New York, N. Y. 10019. Tel: (212) PL 7-2711. Pres.: Juggy Murray. Affiliates: Saturn (BMI).

St. George (ASCAP), see N. A. Busillo.

St. Lawrence (BMI), see Sam Weiss.

St. Louis (BMI), see Hill & Range.

St. Nicholas (ASCAP), 1619 Broadway, New York, N. Y. 10019. Tel: (212) JU 2-0970. Contact: Johnny Marks.

Salute (BMI), 805 W. Main St., Robinson, Ill. 62454. Tel: (215) 544-3457. Pres.: Quentin Abraham. Gen. Mgr.: Keith Dorrough.

Samos Island (BMI), Wells-Phillips Bldg., Flora, Ill. Tel: (618) 662-2156. Branch: Nashville, Tenn., 801 16 Ave. S. Tel: (715) 256-8151.

San Dino (ASCAP), see Barton.

Sanada (BMI), see The Big Seven.

Sanavan (BMI), 350 Chadwick Ave., Newark, N. J. 07112. Tel: (201) 242-6719. Pres.: Anna Moore.

Sandman (ASCAP), RD 1, 80 Morris Ave., Montville, N. J. Tel: (201) 334-0863. Prof. Mgr.: Sandy Nelson.

Sandra (ASCAP), see The Big Seven.

Sandrea, 1252B Buckeye Rd., Cleveland, Ohio 44120. Tel: (216) 921-1442. Pres.: Mrs. S. Egedy.

Sands (ASCAP), see Barton.

John Sand's (BMI), 2011 Joliet, Plainview, Tex. 79072. Tel: (806) CA 4-5435. Pres. & Gen. Prof. Mgr.: John Sands.

Sanga (BMI), 200 W. 57 St., New York, N. Y. 10019. Tel: (212) JU 6-6553. Pres.: Harold Leventhal. Affiliates: Applesseed (ASCAP).

Santa Cruz, 815 E. Broadway, Tucson, Ariz. 85719. Tel: (602) 623-0318.

Santaville, PO Box 146, Sugarhouse Sta., Salt Lake City, Utah 84106. Affiliates: Beehive.

Santee (ASCAP), see Pietro Deiro.

Sarvic (ASCAP), see Fred Ahlert.

Sarah (ASCAP), 1650 Broadway, New York, N. Y. 10019. Tel: (212) CI 7-2159.

Sarah Ann's House of Music (ASCAP), 6640 Gardenia Ave., Long Beach, Calif. 90805. Tel: (213) GA 2-4890. Owner: Sarah Ann Warner.

Saran (BMI), PO Box 17014, Dallas, Tex. 75217. Tel: (214) AT 5-8734. Gen. Mgr.: Dewey Groom.

SATURDAY (BMI), 1841 Broadway, New York, N. Y. 10023. Tel: (212) CI 5-3535. Cable: MUSICREWE. Pres.: Robert S. Crewe Jr. (see Genius). Int'l representatives: Australia (Castle), Belgium (Ardmore & Beechwood), Brazil (Edicoes Enterpe), Denmark (Imudico), England (Ardmore & Beechwood), France (Pathe Marconi), Germany (Edition Accord), Italy (Sugar), South Africa (Ardmore & Beechwood), Spain (Canciones Del Mundo), Sweden (Edition Odeon). (SEE ADVERTISEMENT)

Saturn (BMI), see Sagittarius.

Saunders (ASCAP), see Frank.

Saxon (BMI), 135 W. 50 St., Rm. 1920, New York, N. Y. 10019. Tel: (212) PL 7-7178.

Scarsdale (ASCAP), see Shapiro, Bernstein.

Schabraf, New England Bldg., Suite 480, New England Ave., Winter Park, Fla. Pres.: Eric Schabacker.

Peter Schaeffers (BMI), see American Metropolitan Ents.

G. Schirmer (ASCAP), 609 Fifth Ave., New York, N. Y. 10017. Tel: (212) PL 2-3800. Pres.: Rudolph Tauhart.

A. P. Schmidt (SESAC), see Summy-Birchard.

Schmitt, Hall & McCreary (SESAC), 527 Park Ave., Minneapolis, Minn. 55415. Tel: (612) 336-4367. Sales Mgr.: David S. Van Fleet. Affiliates: Schmitt Music Center (ASCAP).

Schmitt Music Center (ASCAP), see Schmitt, Hall & McCreary.

A. Schroeder, 25 W. 56 St., New York, N. Y. 10019. Tel: (212) JU 2-B810. Pres.: Aaron Schroeder; Gen. Mgr.: Abby Steinberg; Gen. Prof. Mgr.: Wally Gold. Affiliates: Anim (BMI), Arch (ASCAP), Avaris (ASCAP), Benco (ASCAP), Bernice (BMI), Englewood (BMI), January (BMI), Lar-Bell (BMI), Lerita (BMI), Petone (BMI), Pitfield (BMI), Henri Price (BMI), Promenade (ASCAP), Radley (BMI), Sea-Lark (BMI), Sevaris (ASCAP), Seven Arts (BMI), Shelley (BMI), Woldox (BMI), Wolper (ASCAP).

Schroeder & Gunther (BMI), see Associated.

Franz Schubert (ASCAP), 425 W. Broadway, Fort Worth, Tex. 76104. Tel: (817) ED 2-5995. Owner: Franz Schubert.

Schumann (ASCAP), see ABC.

Schwab (BMI), 815 Juniper St. N.W., Washington, D. C. 20012. Tel: (202) 723-0436. Cable: LENSPROD. Pres.: Leonard Schwab.

Schwartz (ASCAP), 35 W. 45 St., New York, N. Y. 10036. Tel: (212) JU 2-2975.

Scope (BMI), see Vincent Youmans.

Screen Gems-Columbia (BMI), 711 Fifth Ave., New York, N. Y. 10022. Tel: (212) PL 1-4432. Affiliates: Colgems (ASCAP), Gowers (BMI). Int'l representatives: Australia (Screen Gems-Columbia), Benelux (Editions Screen Gems-Columbia), England (Screen Gems-Columbia), France (Editions Screen Gems-Columbia), Germany (Paul Schmidt), Italy (Edizioni Musicali Screen Gems-Columbia), Japan (Screen Gems-Columbia), Sweden (Screen Gems).

Seagull (BMI), PO Box 4096, 716 N. Rentz Ave., Warrington, Fla. 32507. Tel: (904) 456-2695. Pres.: Larry L. Stevens; Gen. Mgr.: Calvin Brooks; Gen. Prof. Mgr.: Edward White.

Sea-Lark (BMI), see A. Schroeder.

Second (ASCAP), see Hill & Range.

Sedco Hills (BMI), PO Box 148, Lake Elsinore, Calif. 92330. Tel: (714) 674-3636. Gen. Mgr.: L. C. Saunders.

Select (ASCAP), 1790 Broadway, New York, N. Y. 10019. Tel: (212) CI 7-4860. Pres.: George Joy; Gen. Mgr.: Ed Joy; Gen. Prof. Mgr.: Johnny Farrow. Affiliates: Drury Lane (BMI), Hawthorne (ASCAP) Oxford (ASCAP). Select (ASCAP).

Senisa (ASCAP), see Epp's.

Sentry (ASCAP), 39 W. 60 St., New York, N. Y. 10023. Tel: (212) JU 6-4144. Contact: Monroe Gumer.

Seton (ASCAP), 6072 14 St., Detroit, Mich. 48208. Tel: (313) 897-0009. Pres.: Lou Beatty Sr.



SOUTHERN MUSIC PUB. CO. INC.
PEER INTERNATIONAL CORPORATION

CHAS. K. HARRIS MUSIC PUBLISHING CO., INC.
PEER SOUTHERN PRODUCTIONS, INC.
LA. SALLE MUSIC PUBLISHERS, INC.
MELODY LANE PUBLICATIONS, INC.
PANTHER MUSIC CORP.
PERA MUSIC CORP.
R.F.D. MUSIC PUBLISHING CO. INC.
NEW YORK-CALIFORNIA TENNESSEE-FLORIDA

OFFICES IN MAJOR MUSIC CENTERS OF THE WORLD

- ARGENTINA**—Buenos Aires
- AUSTRALIA**—Sydney, N.S.W.
- AUSTRIA**—Vienna
- BELGIUM**—Brussels
- BRAZIL**—Rio de Janeiro
- CANADA**—Montreal, P.Q.
- CHILE**—Santiago de Chile
- COLOMBIA**—Bogota
- FRANCE**—Paris
- GERMANY**—Hamburg
- GREAT BRITAIN**—London
- HOLLAND**—Amsterdam
- ISRAEL**—Tel Aviv
- ITALY**—Milan
- JAPAN**—Tokyo
- MEXICO**—Mexico City
- NEW ZEALAND**—Auckland
- PUERTO RICO**—Santurce
- SOUTH AFRICA**—Johannesburg
- SPAIN**—Barcelona & Madrid
- SWEDEN**—Stockholm
- SWITZERLAND**—Zurich
- VENEZUELA**—Caracas

Mrs. RALPH PEER
President

PROFESSIONAL DIVISION
LUCKY CARLE PAUL BARRY
ROY HORTON



continued

Sevarts (ASCAP), see A. Schroeder.
 Seven Arts (BMI), see A. Schroeder.
 Seven-Eleven (BMI), see Shapiro, Bernstein.
 Shan-Todd (BMI), 22821 Hayden Rd., Farmington, Mich. Tel: (313) 474-4837. Pres.: Thomas F. Shannon; Gen. Prof. Mgr.: Carl Cisco.
Affiliate: Juarez (BMI).
 Shanaroba, PO Box 55, Portsmouth, N. H. Tel: (603) 436-9190. Pres.: Brandon Harris.
 Phil Shank, 2272 W. Adams Blvd., Los Angeles, Calif. 90018. Tel: (213) 732-3987. Pres.: Edward G. Wells & Philip De Sett.
 Shapiro, Bernstein (ASCAP), 666 Fifth Ave., New York, N. Y. 10019. Tel: (212) CI 7-3553. Cable: BERNSTEIN. Pres.: Richard M. Voltter; Exec. VP: Leon Brettler.
Affiliates: Barclay (ASCAP), Camelback Mountain (ASCAP), Columbia Pictures (ASCAP), Mad Hatter (BMI), Mood Music (ASCAP), North & Son (ASCAP), Painted Desert (BMI), Ponderosa (BMI), Scarsdale (ASCAP), Seven-Eleven (BMI), Sheffield (BMI), Skidmore (BMI).
Foreign Affiliates: Australia (Wallaby), England (Glad); Shapiro, Bernstein; Skidmore; S. B. Talent; Twangy), France (Manhattan).
 Sharastan (BMI), Rr. 3, Killen, Ala. Tel: (205) 764-1781. Pres.: Jerry Smith.
 Eddie Shaw (ASCAP), see Mr. Music.
 Shawnee Press (ASCAP), Delaware Water Gap, Pa. 18327. Tel: (717) 476-0550. Gen. Mgr.: Ernest R. Farmer.
Branch: New York, N. Y., 1776 Broadway. Zip: 10019.
Affiliates: Malcolm (BMI), Templeton (ASCAP).
 Sheenfeen (ASCAP), see Earth.
 Sheffield (BMI), see Shapiro, Bernstein.
 Shelley (BMI), see A. Schroeder.
 Sheratone Ents. (ASCAP), PO Box 3119, Pittsburgh, Pa. 15230. Tel: (412) 481-1666. Owner: Jerry Budnik.
 Sherlyn (BMI), 495 S.E. 10 Ct., Hialeah, Fla. 33011. Tel: (305) TU 7-7546. Pres.: Henry Stone; Gen. Prof. Mgr.: Bradley Shapiro.
 Sherryland (BMI), Vaughn Bldg., Dallas, Tex. Tel: (214) RI 7-2174. Contact: Scotty McKay.
Branch: 10823 Camellia.
 Sherwin (ASCAP), 1650 Broadway, New York, N. Y. 10019. Tel: (212) PL 7-3287.
 Shindig (BMI), 6290 Sunset Blvd., Suite 616, Hollywood, Calif. 90028. Tel: (213) HO 9-5838. Mgr.: George Jay.
 Show (BMI), see Hill & Range.
 Showboat (BMI), see Rayven.
 Shubert (ASCAP), see Music Publishers Holding Corp.
 Edward Shuberth (SESAC), 39 W. 60 St., New York, N. Y. 10023. Tel: (212) 757-1465.
 Sid-Lee (BMI), see American Metropolitan Ents.
 Sidney (BMI), c/o Sidney Mills, 210 W. 89 St., New York, N. Y. Pres.: Sidney Mills.
Affiliate: Diana (ASCAP).
 Sigma (ASCAP), see Hill & Range.
 Silk City (ASCAP), 422 E. 32 St., Paterson, N. J. Tel: (201) 525-3027. Pres.: Robert Block; PR: Richard Kaltz.
 Silvertowne (ASCAP), see Hill & Range.
 George Simon (ASCAP), 1619 Broadway, New York, N. Y. 10019. Tel: (212) PL 7-9266.
 Sinatra Songs (ASCAP), see Barton.
 Singpiration (SESAC), 1415 Lake Dr. S.E., Grand Rapids, Mich. 49506. Tel: (616) GL 6-5406.
 Sioux Village (BMI), PO Box 223, Cambridge, Mass. 02139. Tel: (617) 235-0234. Prop.: Anthony De Jon.
Affiliate: Sioux Warrior.

Sioux Warrior, see Sioux Village.
 Skidmore (ASCAP), see Shapiro, Bernstein.
 Skyway, PO Box 133, Hollywood, Calif. 90028. Tel: (213) HO 3-5885. Owner: Everett L. Whenham.
 Slamina (BMI), see Hill & Range.
 Slide (ASCAP), 411 Gordon St., Reading, Pa. 19601. Tel: (215) 376-0300. Pres.: Leonard McKinnon.
 Smobro (BMI), see Enlight.
 Hank Snow (BMI), see Hill & Range.
 Snyder (ASCAP), see Central Songs.
 Soli (BMI), 4741 LaDuc St., St. Louis, Mo. 63113. Tel: (314) JE 1-3482. Pres.: O. D. Washington.
 HENRY J. SOMMERS (ASCAP), PO Box 322, Silver Spring, Md. 20907. Tel: (301) WH 6-9039. (SEE ADVERTISEMENT)
 Songfest (ASCAP), see Gil.
 The Songsellers (ASCAP), 1619 Broadway, New York, N. Y. 10019. Tel: (212) CI 7-2904. Pres.: R. Fisher.
 Sonny Boy (BMI), see Gallegos.
 Son-Up (BMI), 3000 W. Third St., Odessa, Tex. Tel: (915) FE 2-7044. Contact: Jim Robinson.
 Sophisticate, 1619 Broadway, New York, N. Y. 10019. Tel: (212) PL 7-2695. Pres.: Buddy Johnson.
 Sound/age (BMI), see Chevell.
 Sounds (ASCAP), 1619 Broadway, New York, N. Y. 10019. Tel: (212) JU 2-4888. Owner: Stanley Cooper.
Affiliates: Strada (BMI), Taurus (BMI).
 Soundtown (BMI), 549 S. Yates, Memphis, Tenn. 38117. Tel: (901) 683-4661. Contact: James Luther Dickinson.
 SOUTH MOUNTAIN (BMI), 1631 Broadway, New York, N. Y. Tel: (212) PL 7-7630. Prof. Mgr.: Stan Catron. (SEE ADVERTISEMENT)
 Southdale (ASCAP), 6290 Sunset Blvd., Rm. 1003, Hollywood, Calif. 90028. Tel: (213) 466-4265. Pres.: Larry Shayne.
 Southgate (ASCAP), 1413 Dutch Valley Pl. N.E., Atlanta, Ga. 30324. Tel: (404) 873-1876. VP: Don Tweedy.
 SOUTHERN (ASCAP), 1619 Broadway, New York, N. Y. 10019. Tel: (212) CO 5-3910. Cable: SOUTH-MUSIC.
Branches: Los Angeles, Calif., 6223 Selma Ave. Zip: 90028. Tel: (213) HO 9-1667. Mgr.: William T. Walters.—Hialeah, Fla., 6095 16 Ave. Zip: 33012. Tel: (305) 821-3736. Mgr.: Ernesto Roca.—Nashville, Tenn., 806 17 Ave. S., Suite 208. Zip: 37203. Tel: (615) 256-0683. Mgr.: Archie Campbell.
Affiliates: Charles K. Harris (ASCAP), La Salle (ASCAP), Melody Lane (BMI), Panther (ASCAP), Peer Int'l (BMI), Peer-Southern Prod'ns (ASCAP), Pera (BMI), RFD (ASCAP).
 Int'l representatives: Argentina (Acorde, Edami), Australia (Sam Fox, Music Pub'g of Australia, Peer Int'l, Southern-Australasia, World), Austria (Southern), Belgium (Southern), Brazil (Embi), Canada (Sud, Peer Int'l, Southern), Chile (Southern), Colombia (Peer), England (Bluebell, Cedarwood, Iver, Jamie, Latin-American, Liber-Southern, Meridian, Meteor, Mirror, Monique, Most, South Eastern, Southern, White Lodge), France (Nouvelles Editions Meridian, Semi Vendome), Germany (Alba, Sam Fox, Marbot, Peer), Holland (Zuid-Amerikaansche), Israel (Ilan Melody Press), Italy (Fortissimo, Italcarsich, Peer, Sette Note, Southern), Japan (Southern), Mexico (Emmi, Pham), New Zealand (Southern), Puerto Rico (Peer), South Africa (Aberbach, Southern), Spain (Southern), Sweden (Iver, Southern), Switzerland (Southern), Venezuela (Peer). (SEE ADVERTISEMENT)

Southern (ASCAP), 1100 Broadway, San Antonio, Tex. 78206. Tel: (512) 226-8167. VP & Gen. Mgr.: Arthur Gurwitz.
 Southwind (BMI), see Hill & Range.
 Spanka (BMI), 200 W. 57 St., New York, N. Y. 10019. Tel: (212) JU 2-5463.
 Spectorious (BMI), see Leonard Hodes Group.
 Spencer (ASCAP), 507 Fifth Ave., New York, N. Y. 10017. Tel: (212) OX 7-5895.
 Larry Spier (ASCAP), 1650 Broadway, Suite 310, New York, N. Y. 10019. Tel: (212) JU 6-0240.
 Spivey (BMI), 65 Grand Ave., Brooklyn, N. Y. 11205. Tel: (212) UL 7-7003. Pres.: Victoria Spivey.
 Spoons (ASCAP), 9025 Wilshire Blvd., Beverly Hills, Calif. Tel: (213) CR 4-0751. Mgr.: Jack Spina.
Affiliate: Cooga (BMI).
 Stallion (BMI), 806 16 Ave. S., Nashville, Tenn. 37203. Tel: (615) 244-2428. Pres.: Bill Anderson; Gen. Mgr.: Hubert Long.
 Stanwood (ASCAP), see Barton.
 Stardust Songs (BMI), 1650 Broadway, Rm. 901, New York, N. Y. 10019. Tel: (212) PL 7-3287.
 Startunes (BMI), see Grosvenor House.
 Charles R. Stewart (BMI), PO Box 7262, Ft. Worth, Tex. 76111. Tel: (817) TE 8-9401. Gen. Mgr.: Charles Stewart.
 Stiran (BMI), Tel: (215) PO 5-0300, see Jamie.
 Stinger (BMI), PO Box 8207, Sta. C, Albuquerque, N. M. 87112. Tel: (505) 265-4036. Owner & Mgr.: Tommy Bee.
 Stirling (SESAC), 1650 Broadway, New York, N. Y. 10019. Tel: (212) CI 6-3126. Contact: Raymond Sterling.
Affiliates: Avalon (SESAC), Rayster (ASCAP).
 Roy M. Stone, 2817 Laura Koppe, Houston, Tex. 77016. Tel: (719) OX 7-7912. Owner: R. M. Stone.
 Stonebess (BMI), 163 Orizaba Ave., San Francisco, Calif. 94127. Tel: (415) DE 4-2247. Pres.: Walter C. Stone.
 Strada (BMI), see Sounds.
 Stratford (ASCAP), 609 Fifth Ave., New York, N. Y. 10017. Tel: (212) PL 2-4300. Prof. Mgr.: Gus Gabriel.
 Strathmore, 57 Ingram Circle, Matawan, N. J. 07747. N. Y. C. Tel: PL 7-5494. Gen. Prof. Mgr.: D. Clark.
 Stride (BMI), see Reliance.
 Nat Stuckey (BMI), 2903 E. Cavett, Shreveport, La. 71102. Tel: (318) 422-8711. Mgr.: Nat Stuckey.
 Style (BMI), PO Box 284, Vienna, Ohio 44473. Tel: (216) 856-2142. Mgr.: Russ Hall.
 Stylecraft (BMI), 3635 Allandale Rd., Memphis, Tenn. 38111. Tel: (901) 324-4640. Mgr.: Style Wooten
 Sugarbush, see Gus Kahn.
 Su-Ma (BMI), PO Box 1832, Shreveport, La. Tel: (318) 422-7182. Pres.: Stan Lewis.
 Summit (ASCAP), see Herb Reis.
 Summy-Birchard (ASCAP), 1834 Ridge Ave., Evanston, Ill. 60204. Tel: (312) 869-4700.
Affiliates: Chart (SESAC), A.P. Schmidt (SESAC).
 Sunbeam (BMI), 22 W. 48 St., New York, N. Y. 10036. Tel: (212) PL 7-8387. Pres.: Tommy Valando; Gen. Mgr.: Jay Morgenstern; Gen. Prof. Mgr.: Frank Military.
Branch: Los Angeles, Calif., 9220 Sunset Blvd. Tel: (213) CR 4-9026. Gen. Prof. Mgr.: Arthur Valando.
Affiliates: Andor (ASCAP), Columbine (BMI), Laurel (ASCAP), Valando (ASCAP).
Int'l firms represented: Valando (England).
 Sunday School Board of the Southern Baptist Convention (SESAC), see Broadman Press.
 Sunflower (ASCAP), see Regent.
 Sunray (BMI), PO Box 138, Chesapeake, Va. 23331. Tel: (703) 488-3001. Owner: Ouida Smith.
 Sunshine (BMI), 408 N. Rodeo Dr., Beverly Hills, Calif. 90210.
 Supreme (ASCAP), see Bregman, Vocco & Conn.
 Sure-Fire (BMI), 801 16 Ave. S., Nashville, Tenn. 37204. Tel: (615) 244-1401. Pres.: Doyle Wilburn; Gen. Mgr.: Johnny Russell.
Affiliates: Bronze (SESAC), Ten-Tex (BMI).
 Surrey (ASCAP), see Pavanne.
 Sweco (BMI), see Comet.
 Swing Lane (BMI), 429 Cooper St., Beverly, N. J. 08010. Tel: (609) DU 7-0565. Pres.: John Murphy.
 Sword & Shield (SESAC), PO Box 211, 1417 E. Abram, Arlington, Tex. Tel: (817) CR 5-4844. Pres.: Calvin Wills.
 Syndicate (ASCAP), see American Metropolitan Ents.
 T E K (BMI), see Nasetan.
 T M Music (BMI), 1619 Broadway, New York, N. Y. 10019. Tel: (212) CI 7-0700. Pres.: Bobby Darin; Exec. VP: Edgar Burton; Gen. Prof. Mgr.: Irwin Schuster.
Affiliate: Towne (ASCAP).
 T N T (BMI), 1422 W. Poplar St., San Antonio, Tex. 78207. Tel: (512) PE 2-8072. Pres.: R. E. "Bob" Tanner.



PUBLISHERS OF

"THE BALLAD OF THE GREEN BERETS"

AND

"THE A TEAM"

RECORDED BY SSGT. BARRY SADLER ON RCA VICTOR

AND THE NEW

GARY MCFARLAND ALBUM

"PROFILES"

Recorded live at Philharmonic Hall • released by Impulse Records
MusicMusicMusicInc. 509 Madison Ave. New York, N. Y. 10022

Tabitha (BMI), 204 Cypress, Orange, Tex. Tel: (713) TU 6-9795. Pres. & Mgr.: W. L. Thompson.
 Table Rock, see Earl Barton.
 Tape (ASCAP), 6051 Harold Way, Hollywood, Calif. 90028. Owner: George R. Nelson.
 Taurus (BMI), see Sounds.
 Larry Taylor (ASCAP), 165 West End Ave., 20 M, New York, N. Y. 10023. Tel: (212) SC 4-2688. Pres.: Larry Taylor.
 Affiliate: Jimskip (BMI).
 Teardrop (ASCAP), 2508 Franklin Rd., Nashville, Tenn. 37204. Tel: (615) 297-8230. Pres.: Ronnie Hayes.
 Tee Pee (ASCAP), 1650 Broadway, Rm. 715, New York, N. Y. 10019. Tel: (212) CI 5-7281. Mgr.: Teddy Powell.
 Affiliate: Maggie (BMI).
 Tejas Song Prod'ns (BMI), 124 N. Peak St., Dallas, Tex. 75226. Tel: (214) TA 7-5023. Mgr.: Charles Wright.
 Telescope (BMI), see Periscope.
 Tellaro (BMI), see Pavanne.
 Temmy (BMI), 200 W. 57 St., New York, N. Y. 10019. Tel: (212) 757-6215. Gen. Mgr.: Felix Balkin.
 Templeton (ASCAP), see Shawnee Press.
 Ten-East (BMI), see Five-West.
 Ten-Tex (BMI), see Sure-Fire.
 Tender Tunes (BMI), see Kama Sutra.
 Tex-Sound (BMI), 506 W. Hildebrand Ave., San Antonio, Tex. 78212.
 That-Kid (BMI), 4850 Joaquin Way, Sacramento, Calif. 95822. Tel: (916) 457-8497. Owner: Wesley Strawn.
 Thoroughbred (BMI), 2429 Hawthorne Ave., Louisville, Ky. 40205. Tel: (502) 454-3397. Cable: THOBRED. Pres.: James M. Owen.
 Three Bears (BMI), 8720 Georgia Ave., Silver Spring, Md. Tel: (301) 589-6700. Pres.: Timothy M. O'Brien.
 3 H's (ASCAP), 315 E. Westfield Blvd., Indianapolis, Ind. 46220. Tel: (317) CL 1-0898. Contact: Henry Oakes.
 Thrush (BMI), 2991 Ingledeale Terr., Los Angeles, Calif. 90039. Tel: (213) 662-3656. Pres.: Brian Ross.
 Thunderball (BMI), PO Box 626, 1608 S. Fleishel, Tyler, Tex. Tel: (214) LY 2-0591. Pres.: Steve Wright.
 Thursday (BMI), see Fred Ahlert.
 Tibor, 200 W. 57 St., New York, N. Y. 10019. Pres.: A. T. Halmay.
 Tideland (BMI), see American Metropolitan Ents.
 Timberland (BMI), Forest City, Iowa 50436. Tel: (515) 582-2992. Pres.: Arlo Johnson.
 Tob-Ann (BMI), 1650 Broadway, New York, N. Y. 10019. Tel: (212) JU 6-3876. Pres.: Phil Kahl.
 Toddmark (BMI), 22 E. Huron, Chicago, Ill. Tel: (312) 642-8461.
 Tomard (ASCAP), see Enlight.
 Tomaria, PO Box 3171, Columbia, S. C. Tel: (803) EL 9-6599. Contact: Charles Derrick.
 Tomich, 673 Oakley Pl., Oradell, N. J. Tel: (201) 261-0871.
 Tomorrow's Tunes (BMI), see Genius.
 Tona Lee (BMI), see Astron.
 Top-Hit (ASCAP), 5913 Gregory Ave., Hollywood, Calif. 90038. Dir.: Louis Mysels.
 Tor (ASCAP), see Gordon.
 Toulouse (BMI), PO Box 96, El Cerrito, Calif. 94530. Tel: (415) 526-3491. Pres.: Jacques Bronson.
 Town & Country (BMI), see American Metropolitan Ents.
 Towne (ASCAP), see TM.
 Tracie (ASCAP), PO Box 3452, 888 Pearl St., Beaumont, Tex. Tel: (713) TE 2-1522. Mgr.: William G. Hall.
 Affiliates: Big Bopper (BMI), Dixiana (BMI), Hall-Clement (BMI), Nash-Beau (BMI).
 Travis (BMI), see Metric Music Group.
 Tray (ASCAP), see American Metropolitan Ents.
 Tree (BMI), 905 16 Ave. S., Nashville, Tenn. Tel: (615) 254-3359. Pres.: Jack Stapp.
 Trenner (ASCAP), 408 N. Rodeo Dr., Beverly Hills, Calif. 90210.
 Triangle (ASCAP), see Bregman, Vocco & Conn.
 Tricky (ASCAP), 1631 Broadway, New York, N. Y. 10019. Tel: (212) JU 2-0820. Pres.: Jerry Leiber & Mike Stoller.
 Affiliates: Quartet (ASCAP), U. S. Songs (ASCAP).
 Triumvirate (BMI), see Tuneville.
 True Blue (ASCAP), 16027 Sunburst St., Sepulveda, Calif. 91343. Tel: (213) 892-0044. Pres.: Larry Fofine.
 Trusty (BMI), Nebo, Ky. 42441. Tel: (502) 249-3194. Pres.: Elsie Childers.

Ernest Tubb (BMI), see Hill & Range.
 Tune-Kel (BMI), PO Box 50650, New Orleans, La. 70113. Tel: (504) 367-3104. Pres.: Joseph Banashak.
 Affiliate: Jarb (BMI).
 Tune Time (BMI), see Gil.
 Tunecrafters (BMI), 1607 El Centro Ave., Hollywood, Calif. Tel: (213) HO 2-0261. Pres.: Lin Wilde.
 Affiliate: Charlin (ASCAP).
 Tuneville (BMI), 812 17 Ave. S., Nashville, Tenn. Tel: (615) 255-0624. Pres.: Henry P. Strzelecki.
 Affiliates: Fia (ASCAP), Omni (BMI), Triumvirate (BMI), Vaughn (BMI).
 Twenty Grand (BMI), 417 W. 21 St., Norfolk, Va. 23517. Tel: (703) 622-2111. Pres.: Warren M. Miller.
 Twin-Chris (ASCAP), 6290 Sunset Blvd., Suite 1003, Hollywood, Calif. 90028.
 Tyco Music (BMI), PO Box 630, Big Spring, Tex. 79721. Tel: (915) 264-2716. Partners: Ray B. Rush & Ted O. Groehl Jr.
 Tyler (BMI), PO Box 231, Tyler, Tex. 75701. Tel: (214) LY 4-2961. Contact: Curtis Kirk.
 Tylerson (ASCAP), see Criterion.
 U S Songs (ASCAP), see Trio.
 United (ASCAP), see Hugo & Luigi.
 UNITED ARTISTS (ASCAP), 729 Seventh Ave., New York, N. Y. 10019. Tel: (212) CI 5-6000. VP & Gen. Prof. Mgr.: Murray Deutch.
 Affiliate: Esteem (BMI). (SEE ADVERTISEMENT)
 Unity (BMI), see Gil.
 Up Tight (div. of Boss Prod'ns), 2104 Lake Ave., Baltimore, Md. 21218. Tel: (301) 235-1588. Pres. & Gen. Mgr.: David Harris.
 V L M (BMI), 950 Morris St., Cincinnati, Ohio 45206. Tel: (513) 281-4197. Owner: Vincent L. Morton.
 Vado (ASCAP), 2226 McDonald Ave., Brooklyn, N. Y. 11223. Tel: (212) 372-9336. A&R Dir.: Vincent Vallis; Sales: Jim Agnello.
 Valando (ASCAP), see Sunbeam.
 Thomas J. Valentino (ASCAP), 150 W. 46 St., New York, N. Y. 10036. Tel: (212) CI 6-4675. Cable: VALENTINO. Pres.: T. J. Valentino.
 Affiliate: RFT (BMI).
 Valiant (ASCAP), see Red Evans.
 Valjean (BMI), 5136 W. 41 Ave., Denver, Colo. 80212. Tel: (303) 455-4118. Pres.: Vicky Morosan.
 Valley (BMI), see Hill & Range.
 Value (BMI), Hotel Kansas Citian, Rm. 707, Kansas City, Mo. 64105. Tel: (816) HA 1-4410. Owner: W. O. (Wink) Wright.
 Branch: Henry, Ill., 713 Third St. Zip: 61537.
 Vandenburg (BMI), 8740 Aldwick Dr., Dallas, Tex. 75238. Tel: (214) DI 8-9324. Pres.: Darrell A. Brown; VP: Annie Mae Brown; Gen. Mgr.: Burel Merritt.
 Vanguard (BMI), 1750 N. Vine St., Hollywood, Calif. 90028. Tel: (213) HO 2-6252.
 Van Heusen, see Burke & Van Heusen.
 Van Winkle-Darin (BMI), see Les John.
 Vaughn (BMI), see Tuneville.
 Vault (BMI), 2525 W. Ninth St., Los Angeles, Calif. 90006. Tel: (213) 386-1821. Pres.: Jack Lewerke.
 Venice (BMI), 8300 Santa Monica Blvd., Hollywood, Calif. 90069. Tel: (213) 656-7711. Prof. Mgr.: Dorothy D. Rupe.
 Verna (ASCAP), 930 F St. N.W., Washington, D. C. 20004. Tel: (202) DI 7-3944. Cable: Claiborne. Pres. & Owner: Lillian N. Claiborne.
 Vernon (ASCAP), see Bregman, Vocco & Conn.
 Vernors (BMI), 832 Leona, Columbus, Ohio 43201. Tel: (214) 299-6150. Mgr.: Vernon Stewart.
 View (BMI), 955 S. Magnolia Ave., Los Angeles, Calif. 90006. Tel: (213) 383-8779. Pres.: Marvin M. Liblick; Gen. Mgr.: Mr. Roade.
 Vitak-Elsnic (SESAC), 4815 S. Ashland Ave., Chicago, Ill. 60609. Tel: (312) YA 7-2470. Mgr.: Henry G. Elsnic.
 Viva (BMI), see Ivan Mogull.
 Vogue (BMI), see Bibo.
 Harry Von Tilzer (ASCAP), see Bibo.
 Wal-Fran, 5112 Scenic View Dr., Birmingham, Ala. 35210. Tel: (205) 595-9602. Pres.: Walter Bailes.
 Walden (ASCAP), see Cotillion.
 Walters (ASCAP), see Jay Jay.
 Warden (BMI), PO Box 8061, Nashville, Tenn. 37207. Tel: (615) 228-3042. Mgr.: Don Warden.
 Warner Bros. (ASCAP), see Music Publishers Holding Corp.
 Mark Warnow (ASCAP), 4042 Benedict Canyon Dr., Sherman Oaks, Calif. Tel: (213) ST 4-4141. Pres.: Al Gaunaway.
 Affiliates: Leeway (ASCAP). Pres.: Hal Levy. Int'l representative: England (Essex).
 We Three (BMI), 1650 Broadway, Suite 310, New York, N. Y. 10019. Tel: (212) JU 6-0240.

continued on page 120

SOME GREAT COPYRIGHTS

"Blue Velvet"
 "Canadian Sunset"
 "Apples and Bananas"
 "I Want A Girl"
 "When My Baby Smiles At Me"
 "Row Row Row"
 "Blue Christmas"
 "Shutters and Boards"
 "Turn Back the Hands of Time"
 "You're the Reason"
 "Ko Ko Mo"
 "Pistol Packin' Mama"
 "Just the Way You Are"
 "The Wayward Wind"
 "Cinco Robles"
 "Suddenly There's A Valley"
 "Chanson D'Amour"
 "Wonderful Time Up There"
 "That's How Much I Love You"

... and many others

BIBO MUSIC PUBLISHERS, INC. VOGUE MUSIC, INC.

New York Office	California Office
Frank Abramson	Paul Weirick
1619 Broadway	2444 Wilshire Blvd.
New York, N.Y. 10019	Santa Monica, Calif.
Lt-1-3197	Upton 0-7076



(means: world-wide "Hits" and Reputable Representation)

IVAN MOGULL ASSOCIATES

33 West 60th Street
 New York

Cable: IMOGULL

EQUINOX MUSIC

Wants to thank all the Divisions of the ATTARACK CORP. for making "DIRTY WATER" and "IT'S OVER" chart hits.

Thanks to,
 GREENGRASS PROD.
 B-J ENTERPRISES
 HONEYCOMB MUSIC

Sincerely,
 ADAM ROSS
 Director of Attarack
 Publishing Firms

ALL STATE

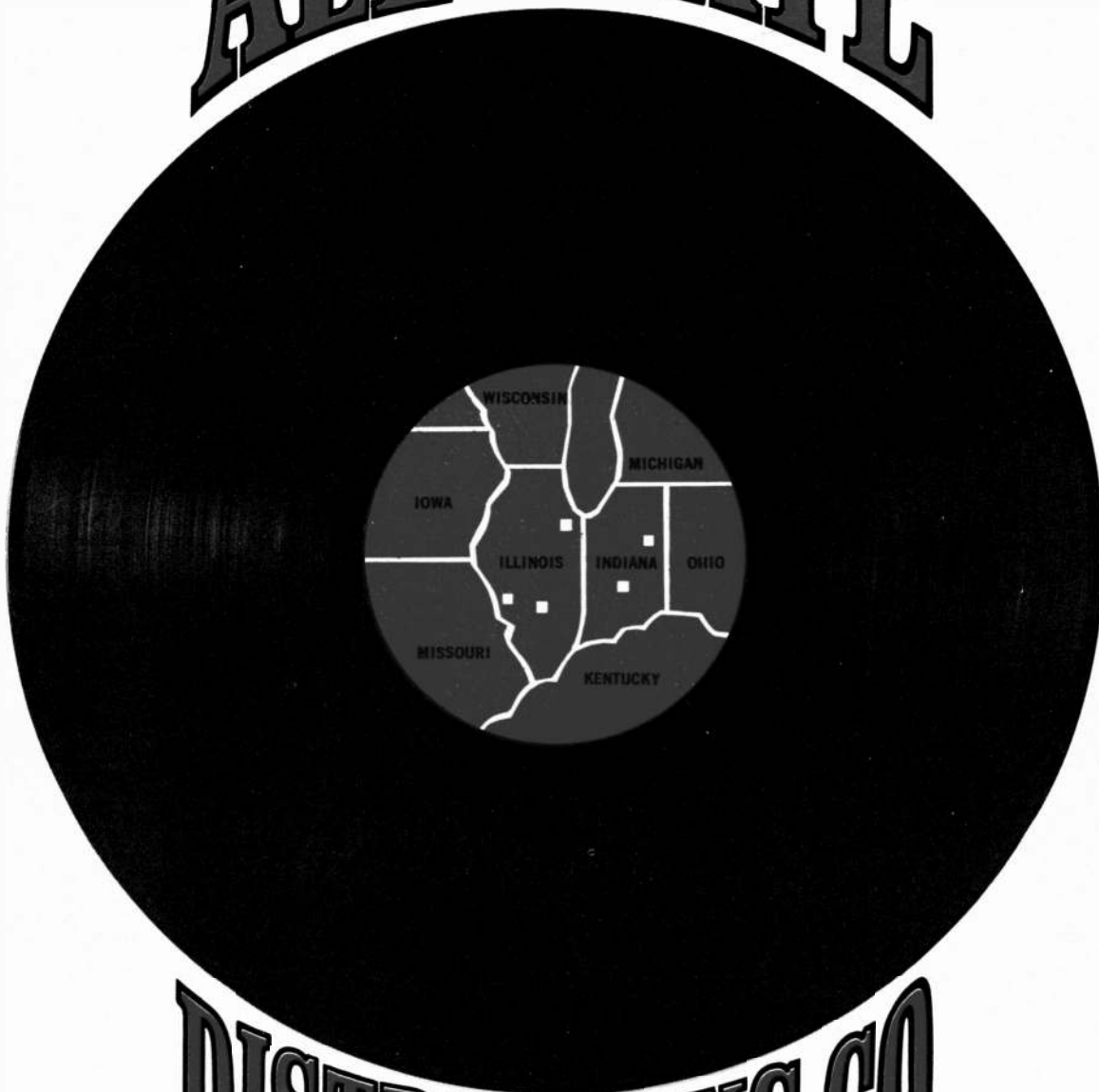

DISTRIBUTING CO

1450 SOUTH MICHIGAN AVE. • CHICAGO, ILL. 60605

PHONE (312) 939-3675

SERVING THE INDEPENDENT MANUFACTURER WITH AGGRESSIVE
PROMOTION • SALES • MERCHANDISING ON POP — R&B — C&W —
SINGLES & LP'S

LEE HOWARD • PAUL GLASS • HOWARD BEDNO & CY GOLD
Sales Manager President Promotion

ALL STATE RECORD DISTRIBUTING CO.

U.S. Record Distributors

DIRECTORY

(Including Tape, Tape Cartridge Playback Equipment & Accessories)

ALABAMA

• BIRMINGHAM (Area Code 205)

Nelson-Brantley Glass, 2213 Sixth Ave. S. Zip: 35203. Tel: 328-4370. Pres.: Larry Striplin. Labels: RCA Victor, Capitol, ITCC. Stallion Recs., PO Box 2213. Pres.: Gustave Rosemann III.

ARIZONA

• PHOENIX (Area Code 602)

Arizona, 4971 N. Central Ave. Zip: 85012. Tel: 274-9590.

Labels: ANB, Boyd, Bright Star, BT Puppy, Chalon, Chartmaker, Dore, End, Federal, Four Brothers, Impression, Jewel, Josie, Jubilee, King, La Louisianne, Mira, Mirawood, Paula, Presta, Roulette, Summit, Surrey, Tico, Whit. Arizona Sundries, 2949 N. 30 Ave. Tel: 272-2363. Contact: G. Souvall.

Tape, Cartridge: RCA Stereo 8.

M. B. Krupp, 2519 N. 16 St. Tel: 252-4013. Mgr.: Marge Grover.

Labels: ABC-Paramount, A&M, Amazon, Amy, Argo, Arvee, Atco, Atlantic, Audio Fidelity, Big Top, Boom, Cadet, Cameo, Challenge, Checker, Chess, Coed, Colpix, Command, Contemporary, Del-Fi, Diamond, Disneyland, Dooto, Duke, Dunes, Ember, Fabor, Fantasy, Folkways, GNP, Gordy, Hickory, HiFi, Impulse, Jamie, Joy, Jubilee, Kent, Laurie, Legrand, London Group, Mala, May, Minit, Motown, Old Town, Oliver, Parkway, Peacock, Phyllis, RIC, Red Bird, Sar, Scout, Serock, Starday, Stax, Sue, Swan, Talent, Tamla, Tangerine, Time, Toppa, Tower, 20th-Fox, Vista, Wand, Wilshire.

• TUCSON (Area Code 602)

Action, 815 E. Broadway. Tel: 623-0318. Mgr.: Frank Darris.

Labels: API, Copper State, Moxie, Santa Cruz.

ARKANSAS

• WEST MEMPHIS (Area Code 501)

Williams Ents., PO Box 322, 1408 Chester. Tel: RE 5-6529. Pres.: Gene Williams. Labels: Allandale, Alley, Big Style, Cotton Town Jubilee, Dover, Regent, Silver, Stardust, Style, 3H's, Tune Glow.

CALIFORNIA

• ALAMEDA (Area Code 415)

Motivestor Rec. Servs., PO Box 1036, South Shore. Contact: B. Schmeltzer. Labels: Miere-View, Nalasta, Ancath, Faygees, Dubayewe, EFE, BlueBay.

• BURBANK (Area Code 213)

Record Sales, 222 W. Orange Grove Ave. Zip: 91502. Tel: 849-4671. Pres.: Al Sherman. Labels: Alshire Presents 101 Strings, Audio Spectrum, Somerset, Stereo Fidelity.

• COSTA MESA (Area Code 714)

Stereotape, 2135 Canyon Dr. Zip: 92626. Tel: 549-2265. Gen. & Exec. VP: S. Brandt; VP Sales: G. DeRado. Tape, Reel-to-Reel: Capitol, Dot, Hamilton, Reprise, Stereotape.

• FRESNO (Area Code 209)

Calectron, 2930 Butler Ave. Tel: 268-8411. Mgr.: Merritt B. Kirk; Promo. Mgr.: Herb Tourville; Sales: Chris Crist. Branches: Sacramento, San Francisco, Calif. Labels: RCA Camden, RCA Victor. Tape, Cartridge: RCA Victor Stereo 8, ITCC, Mercury Stereo 8, MusicTapes, Aura Sonic. Tape, Reel-to-Reel: RCA Camden, RCA Victor, Ampex.

Tape Playback Equip.: RCA Victor, Borg-Warner 8 Track.

• LOS ANGELES (Area Code 213)

California, 2525 W. Ninth. Tel: 386-1821. Pres.: Ralph Kaffel.

Labels: AFM, Allegre, Argo, Arhoolie, Arvee, Audicon, Baroque, Blue Note, Bluesville, Cadet, Calico, Carnival, Checker, Chess, Concertdisc, Counterpoint, Debut, Del-Fi, Donna, Elkay, Esoteric, Everest, Fantasy, Fiesta, Fleetwood, Folklore, Galaxy, Grecophon, HiFi, Holt Language Series, Kentwood, Laurie, Legrand, Tom Lehrer, Life, Merri, Mr. Maestro, Mohawk, Monitor, Music Minus One, New Jazz, Period, Pico, Prestige Int'l, Red Bird, Roulette, Rust, Scala, Sermon, Sounds, Squire, Tuff.

Cambridge Trading, 6704 Hollywood Blvd., Hollywood. Zip: 90028. Tel: 467-3177. Pres.: Milton Levine.

Capitol, 3117 San Fernando Rd. Tel: CI 7-8224. Mgr.: Herb Whitaker.

Labels: Angel, Capitol Product.

Chapman, 2645 W. Pico Blvd. Zip: 90006. Tel: 385-3636. Mgr. & Promo.: Al Chapman.

Labels: Accent, Al Jay, Arc, Cabot Language, Cambridge, Charlie Parker, Chattahoochie, Children's Rec. Guild, Cobra, Crest, Custom Fidelity, Decima, Desto, Dixie, Ecton, Fax, Haydn Society, Happy Hours, Heb, Janson, Jox, Kem, Living Language, Milestone, Motivation, Phil's, Renfro, Riot, Rivoli, Seal, Simon Says, Spoken Arts, Stadium, Stinson, Tikva, Tondy, Way, Whirlybirds, Yardbirds, Young People's Recs.

Columbia, 1530 N. Gower St., Hollywood. Tel: HO 6-2481. Regional Sales Mgr. (Los Angeles, Denver, Honolulu, San Francisco, Seattle): Del Costello; Sales Mgr.: Robert Murphy; Promo. Mgr.: Bob Moering.

Distributes: Columbia Product.

Craig, 3410 La Cienega Blvd. Zip: 90016. Tel: WE 6-6171. VP: D. D. Carson; Adv. Mgr.: Etta Delson.

Branches: San Francisco, Calif; Denver, Colo.; Honolulu, Hawaii; Seattle, Wash.

Tape, Cartridge: Columbia, MusicTapes.

Tape, Reel-to-Reel: Audio-Spectrum, Columbia, Epic, MusicTapes, Stereotapes, Tape-Mates. Tape Playback Equip.: Craig, Columbia, Concertone.

Creative Sounds Prods. (div. of Greatest Book Inc.), 9000 Sunset Blvd. Zip: 90069. Tel: CR 1-4843. Pres.: Bob Cotterell.

Labels: Creative Sound, Surfari, Audio Bible Studies, Bible Voice, Voice of Truth.

Crest Sales, 2542 W. Pico Blvd. Zip: 90006. Tel: 386-8720. Mgr.: William Kuritzky.

Labels: Discos Columbia, Miami, Fuentes, Dela, Bego, Ideal, El Zarape, Orfeon, Maya, Dimsa, Sunglow, Teardrop, Disco Grande, Tropical, See-co, Discomoda, El Toro, MF, Musart, Montilla.

Crown, 5810 S. Normandie Ave. Tel: 753-2481. Pres.: Saul Bihari.

Decca, 6750 Santa Monica Blvd. Zip: 90038. Tel: HO 3-7126. Mgr.: Lou Verzola.

Distributes: Decca Product & Listen & Learn.

Diamond, 2990 W. Pico Blvd. Tel: RE 1-6311. Pres.: Abe Diamond.

Labels: ABC-Paramount, Apt, Berlitz, Boom, Command, DeMarco, Dunhill, Fraternity, Grand Award, Grand Prix, Impulse, Jerden, Lew Disc, Mahalo, Music Guild, Nippon, Oliver, Shad, Tangerine, Time, Waikiki, Westminster. Duplex, 2505 S. Central Ave. Tel: 746-1949. Mgr.: J. H. Higgins.

Labels: Black Hawk, Duplex, Movin', Renfro. Electronic Mdse. Corp. of Calif. (EM-CAL), 2622 S. La Cienega. Zip: 90034. Tel: 870-0401. Pres.: I. R. Stulman.

NOW MORE THAN EVER!
FOR SOLID INDEPENDENT
DISTRIBUTION
IN SAN FRANCISCO IT'S...
**INDEPENDENT
MUSIC SALES**
A DEPARTMENT OF THE H. R. BASFORD CO.

IF YOU ARE WITH INDEPENDENT
IN SAN FRANCISCO YOU HAVE...
• A HUNGRY DISTRIBUTOR
• WITH MONEY
• THE FINEST PROMOTION
• TOP SALES KNOW HOW
• EXCLUSIVELY A DISTRIBUTOR

GIVING THE INDIES THEIR BEST DISTRIBUTION ON THE WEST COAST
INDEPENDENT MUSIC SALES

SALES: PAUL McKIMMIE, PATRICK BUTLER
PROMOTION: DENNY ZEITLER, MARTY KUPPS
800 Mariposa St., San Francisco, Calif. Area 415; MA 1-8545

WORLD'S LARGEST DIXIELAND RECORD DISTRIBUTORS

New Orleans—Traditional Jazz—Blues—Foreign and U. S. ALL LABELS PLUS EXCLUSIVE U. S. DISTRIBUTORS FOR:

77 RECORDS

and
FOLKLORE

Iron Records

STORYVILLE



....(English) featuring Ken Colyer, Dominic Behan, U. S. Jazz Men recorded in Europe and re-issues of U. S. cutouts and rarities.

....(U. S.) First great original series recorded at Preservation Hall. Every famous N. O. jazzman included.

....(Denmark) world leader in European recorded jazz and American music records re-issues.

WRITE FOR FREE CATALOGS

Complete stock of all labels maintained. Representing all independent labels:

SOUTHLAND
HAPPY JAZZ BAND
DETROIT TAILGATE
RAMBLERS
RON BARTLEY (RONCO)
GHB
JAZZ CRUSADE
KING OF JAPAN (GEO. LEWIS)
GUNN (EDDIE BAYARD)
BAYOU TO BAY
(DOC SOUCHON)

SOLO (LARRY CONGER)
NOBILITY (DIXIELAND HALL)
EPITAPH
JELLY ROLL JAZZ BAND
WOODSHED
JAZZOLGY
JAZZ MUSEUM ORIGINALS
CENTER
EUPHONIC
WINDJAMMERS

NORMAN
VALON (ROY BREWER)
ALAMO CITY JAZZ BAND
PEARL
SAN JACINTO
AUDIOPHILE
RHYTHM POSSE
SOUNDS
ROSY MCHARGUE
ART (ANDY BARTHA)
JAZZ TREASURY (WALLER)

And many major label cutouts, i.e. Kapp (Kenny Ball), Verve (Geo. Lewis), Lark (Joe Darensbourg). Also limited mail distribution where there is no local distributor on Goodtime Jazz—Stinson—Argo—Monomoy—GNP—Dixieland Jubilee—JJC—Evergreen. Producer inquiries invited.

SOUTHLAND RECORDS DISTRIBUTORS

291 SPINNAKER ST. ORANGE, CALIF. 92668 Phone: (714) 537-1546

For

ACTION

in the West



BOB STERN

RON RICKLIN

REPUBLIC 5-1297

3009 WEST PICO BLVD.

RECORD SALES Inc. LOS ANGELES, CALIFORNIA 90006

THESE ARE THE PEOPLE WHO MAKE YOUR RECORDS INTO HITS . . . At RECORD MERCHANDISING . . .

Standing, left to right:
LARRY RAY, Promotion
DON GRIERSON, Promotion
DON DAVIS, Manager
MALCOM TALMADGE,
Assist. Mgr.
LENNY SALAMONE,
Promotion
Seated:
SID TALMADGE, President



RECORD MERCHANDISING CO.

2580 W. Pico Blvd, Los Angeles, Calif. 90006, Phone: A. C. 213 385-9161
P. S. WE ALSO SELL TAPE CARTRIDGES—including THE ENTIRE I.T.C.C. LINE

continued

Festival, 2769 W. Pico Blvd. Zip: 90006. Tel:

734-6220. Mgr.: John Filcich.

Branch: San Francisco, Calif.

Labels: Ace of Clubs, Alector, Amadeo, Angelicum, Apon, Avoca, B&F, Balkan, Barenreiter, Boite a Musique, Bruno, Canary & Parakeet, Cetra, Colonial, Dana, Eurotone, Gateway, Gregorian Institute, Harmonia Mundi, Helios, IMF, Kismet, Monogram, Music Library, Musica Sacra, Nina, Norsemen, Nova, Olympus, Over-tone, Period, Rainbow, Renaissance, Russell, Scala, Standard, Stradivari, Triad, Ultraphone, Vega, Venevox, Vogue.

Handleman, 1550 N. Knowles Ave. Tel: 261-0268. Contact: M. Handleman.

Tape, Cartridge: RCA Stereo 8.

Hart, 1845 S. Orchard St. Tel: 748-2281. Pres.: George D. Hartstone. Mgr.: Ross Burdick.

Affiliates: C&C Stone, San Francisco, Calif.—Mutual, Boston, Mass.—Cleve-Disc, Cleveland, Ohio.

Labels: Disneyland, London, London-American Group, Reprise, Veep, Warner Bros.

Tape, Cartridge: Muntz Stereo-Pak.

Hitsville, 2525 W. Ninth. Tel: 386-1821. Pres.: Ralph Kaffel.

Labels: Gordy, Mel-o-dy, Motown, Soul, Tamla, VIP, Workshop Jazz.

Jairo, 610 S. Verdugo Rd., Suite 3, Glendale. Tel: 246-9445. Owner: Jairo Velasquez.

Kingsway, 9000 Sunset Blvd. Zip: 90069. Tel: CR 5-4191. Pres.: Earle Williams.

Liberty, 6920 Sunset Blvd. Tel: 733-1134. Promo. Men: Julio Aiello, Len Adragna, Clyde Bak-kemo.

Distributes: Liberty Product.

Merit, 2525 W. Ninth St. Zip: 90006. Tel: 386-1821. Owner: Jack Lewerke; Promo. Men: Gene Simmons & Doug Cox.

Labels: Atco, Atlantic, Backbeat, Battle, Carla, Cash, Celeste, Clarion, Contemporary, Contact, Corby, Dial, Duke, Dunwich, Flashback, Focus, Garrett, Golden Wind, Goodtime Jazz, Instant, Jazzland, Jerk, Karen, Last Night, LuPine, Mainstream, Moonglow, Peacock, Phi-Dan, Phil-les, Pico, Riverside, Rosemart, Satellite, Soma, Songbird, Specialty, Stax, Sureshot, Triumph, Tuba, Vault, Venus, Volt, Wonderland.

METRO, 2053 Venice Blvd. Zip: 90006. Tel: 733-2114. Sales Mgr.: Mel Price. (SEE ADVERTISE-MENT)

Labels: Audio Fidelity, DGG, Golden, Heliodor, Leo the Lion, MGM, Metro, VSP, Verve, Verve/Folkways.

METRO OF CALIF., 6009 W. Pico Blvd. Zip: 90035. Tel: 931-4773. Owner: Ralph Slotnick.

Playback Equip.: Car Stereos. (SEE ADVERTISE-MENT)

Pep Rec. Sales, 3009 W. Pico Blvd. Zip: 90006. Tel: RE 5-1297. Partners: R. Stern & R. Ricklin.

Labels: Alon, Ascot, Banner, Boone, Caedmon, Canadian American, Chart, Colonial, Delmark, Dyer-Bennett, Epic, Eterna, Experiences Anon-ymes, Federal, Folk Legacy, Folkways, 49th State, King, Lyrichord, Motivation, Okeh, Pan, Ric-Tic, Sound of Nashville, Starday, Sunglow, Tahiti, Testament, Tiare Tahiti, United Artists, Vanguard, Vox.

Privilege, 2818 W. Pico. Zip: 90006. Tel: 731-3148. Pres. & Gen. Mgr.: Norman F. Goodwin.

Labels: Monument, Hanna-Barbera, GNP Cres-cendo, Tower, Original Sound, Dee Gee, Alshire Presents 101 Strings, Somerset, Stereo Fidelity, Tempo, Audio-Spectrum, Mobile Fidelity. Tape, Cartridge: ITCC, Muntz Stereo-Pak, Aural-sonic.

RCA Victor, 6051 Telegraph. Zip: 90022. Tel: 948-2771. Mgr.: D. G. Pearce. Distributes: RCA Product.

RECORD MDS'G, 2580 W. Pico Blvd. Tel: DU 5-9161. Mgr.: Sid Talmadge.

Labels: A&M, Amy, Cameo, Coed, Dimension, Dooto, Era, Elektra, Guyden, Hickory, Hilltop, Jamie, Kapp, Old Town, Parkway, SC Phillips Int'l, Savoy, Scepter, Sun, Swan, Wand, Wyn-cote. (SEE ADVERTISEMENT) Tape, Cartridge: ITCC.

Trend Int'l, 816 N. Highland Ave., Hollywood. Zip: 90038. Tel: 464-8204. Pres.: Gordon Burdge.

Labels: Trend, Discotape Int'l, Smart Set, Century 21, Eagle, Aloha, Arriba, Anzac, Western.

U T I (United Tape & Instrument), 2933 W. Pico Blvd. Tel: 733-1181. Contact: S. Ricklin.

Tape, Cartridge: RCA & Mercury Stereo 8. Tape Playback Equip.: Lear Jet Stereo 8.

United Tape, 2525 W. Ninth. Tel: 386-1821. Pres.: Ralph Kaffel.

Tape, Cartridge: Autostereo, ITCC, General, Jay Electronics, Tamla, Motown, Gordy, Soul.
Tape, Reel-to-Reel: ABC-Paramount, A&M, Atco, Atlantic, Audio Fidelity, Audio-Spectrum, Bang, Buena Vista, Cadet, Colpix, Command, Concertape, DGG, Dot, Elektra, Fantasy, Gordy, Grand Award, Hamilton, HiFi, Impulse, Kapp, Limelight, London, MGM, Mercury, Moon Glow, Motown, Nonesuch, SC Phillips Int'l, Prestige, Reprise, Smash, Soul, Starday, Tamla, 20th-Fox, UA, Vanguard, Verve, Volt, Warner Bros., Westminster, World Pacific.

Universal Assocs., 1434 Westwood Blvd., West Los Angeles. Zip: 90024. Tel: 272-6545. Pres.: C. H. Junge.

Tape, Cartridge: ITCC West Coast Office.

• **ORANGE (Area Code 714)**

Artists Life, 1211 E. Mayfair Ave. Tel: 538-4488. Pres.: H. Reynolds.

Labels: Artists Life, Bowery, Jamboree, Jay Jay, Nebraska, Pleasant Peasant, Polkaland, Rave, Soma.

Jazz Research, PO Box 141. Zip: 92666. Tel: 537-1546. Owner: Bill Bacin.

Labels: Icon, Jazzette, Jelly Roll Jazz Band, Kapp (Kenny Ball only), Mortonia, New Orleans Bandwagon, Osaka Original Dixieland, Rosy McHargue, Southland, Woodshed.

Southland, PO Box 141. Zip: 92666; 291 Spinnaker St. Zip: 92668. Tel: 537-1546. Owner: Bill Bacin.

Labels: Southland, Nobility of Dixieland Hall, Solo (Conger), Valon, Happy Jazz Band, Epitaph, Alamo City Jazz Band, Detroit Tailgate Ramblers, Icon, Jelly Roll Jazz Band, Pearl, Ron Bartley Gashouse 6, Woodshed, Kapp (Kenny Ball only), San Jacinto, GHB, Jazzology, Audiophile, Jazz Crusade, Connecticut Traditional Jazz Society, Jazz Museum Originals, Rhythm Posse, "77", Folklore, Goodtime Jazz, GNP Crescendo, Dixieland Jubilee, King, Center, Sounds, Gunn, Euphonic, Rosy McHargue, Norman, Bayou To Bay, Monomoy, Argo, Stinson, Art, Jazz Treasury, JJC, Storyville, Milneberg, Dixieland Academy, New Orleans Jazz Recorders.

• **REDWOOD CITY (Area Code 415)**

Earl Miles, PO Box 1336, 1108 Davis. Zip: 94403. Tel: EM 9-0728. Owner & Mgr.: Earl Miles.

• **SACRAMENTO (Area Code 916)**

Calctron, 330 Commerce Circle. Tel: 922-5885. Mgr.: Merritt B. Kirk; Promo. Mgr.: Herb Tourville; Sales: Chris Crist.

Branches: Fresno, San Francisco, Calif.

Labels: RCA Victor, RCA Camden.

Tape, Cartridge: RCA Victor Stereo 8, ITCC,

Mercury Stereo 8, Musictapes, Aura Sonic.

Tape, Reel-to-Reel: RCA Victor, RCA Camden, Ampex.

Tape Playback Equip.: RCA Victor, Borg-Warner B Track.

• **SAN DIEGO (Area Code 714)**

Ratners Electric, 745 Broadway. Tel: 234-3363.

• **SAN FERNANDO (Area Code 213)**

INTERNATIONAL CONSOLIDATED, PO Box 411. Rep.: Mark Raymer.

Branch: Mehama, Ore.

Labels: Robbins, Headliner Stars, Sherree Heart, Colorful. (SEE ADVERTISEMENT)

• **SAN FRANCISCO BAY AREA (Area Code 415)**

Acme Sales, PO Box 5603, 270 Sixth St. Tel: 863-6674. Mgr.: Olen Harrison.

Labels: Alto, Angeltone, Atlas, Bay-tone, Bego, Carnival, Chroma, Glad-Hamp, HiFi, LaVal, Maype, Seeco, Tropical.

H.R. Basford, PO Box 3980. Zip: 94119. Tel: MA 1-8545. Sales Mgr.: Patrik Butler; Promo. Mgr.: Chuck Gregory.

Distributes: Columbia Product.

C & C Stone, 70 Apparel Way. Tel: 647-3806. Gen. Mgr.: Ralph Parsons; Sales Mgr.: Bob Ellis. Affiliates: Hart, Los Angeles, Calif.—Mutual, Boston, Mass.—Cleve-Disc, Cleveland, Ohio.

Calctron, 33 Gough St. Zip: 94119. Tel: 621-3400. Mgr.: Merritt B. Kirk; Promo.: Chris Crist.

Branches: Fresno, Sacramento, Calif.

Labels: RCA Victor, RCA Camden.

Tape, Cartridge: RCA Victor Stereo 8, ITCC,

Mercury Stereo 8, Musictapes, Aura Sonic.

Tape, Reel-to-Reel: RCA Victor, RCA Camden,

Ampex.

Tape Playback Equip.: RCA Victor, Borg-Warner 8 Track.

INTERNATIONAL CONSOLIDATED DISTR., INC.
CONSOLIDATED ARTISTS BUREAU, INC.
PORTLAND MUSIC PUB., INC., B.M.I.
HEADLINER STARS RECORDS
ROBBINS RECORDS

Watch for current Hits of
International Recording Stars . . .
Leading Gospel Singer

★
"GINNA ANGEL"

Voted #1 Vocalist

SHERREE SCOTT

★
Introducing Headliner Star:
HUGH CAMERON
and LITTLE SHERREE

National Representation
MARK RAYMER
PROMOTIONS

D.J.'s, write for copies on Station Letterhead.
INTERNATIONAL CONSOLIDATED DISTR., INC.
P. O. Box 411, San Fernando, California
899-6422 • 342-9109



U.S. Record Distributors

PIC-A-TUNE WESTERN TAPE
DIVISION

**LARGEST STEREO 8
DISTRIBUTOR IN NORTHERN
CALIF. of the Following Lines:**

RCA VICTOR
CAMDEN
I.T.C.C.
DECCA
KAPP

TAMALA/MOTOWN
SCEPTER/WAND
MUSICAL TAPES
HEMCO LINES
LEAR JET STEREO 8

MERCURY/PHILIPS/SMASH

*We're Interested in Additional Lines
Contact:*

PIC-A-TUNE

Western Tape Division
1461 Park Ave., Emeryville 8, Calif. 94608
(415) 654-0773

PRIVILEGE
DISTRIBUTORS
INC.

2818 W. Pico Blvd.
Los Angeles, Cal. 90006
(213) 731-3148

"It is our privilege to serve you"

**WE'RE L.A.'s NEWEST
MOST AGGRESSIVE
DISTRIBUTORSHIP . . .**

. . . and we function in 3 areas—

Records:

**MONUMENT
TOWER
HANNA-BARBERA
GNP-CRESCENDO
ORIGINAL SOUND
ALSHIRE 101 STRINGS
SOMERSET STEREO FIDELITY
TEMPO
AUDIO-SPECTRUM**

London Imports:

**DAS ALTE WERK
ARGO
SOCIETE FRANCAISE DU SON
TELEFUNKEN
EDITIONS DE L'OISEAU-
LYRE**

Cartridge Tapes:

**I.T.C.C.
MUNTZ
AURA-SONIC**

**WESTERN
MERCHANDISERS**

1601 West 3rd
AMARILLO, TEXAS

-Distributors-

**LEAR JET STEREO
8 TAPE DECKS
and STEREO 8
CARTRIDGES**

I.T.C.C.

**DECCA
MERCURY**

Other Major Labels
As Available

Offices also in:

Midland, Tex.
Albuquerque, New Mex.

continued

Capitol, 475 Barnevelde Ave. Tel: VA 6-5454. Mgr.: Charles Bratnober.

Distributes: Angel & Capitol Product.
Chatton, 2517 San Pablo Ave., Oakland. Tel: 444-5677. Pres.: Bob Chatton; Sales Mgr.: Vince Cosgrave; Promo. Men: Paul August & Richard Totoian.

Labels: Atlantic, Cadet, Checker, Chess, DCP, Dore, Era, Excello, Focus, Four Corners, Fraternity, Jewel, Kapp, Legend, Living Language, Movietone, Nashboro, Panda, Parkway, Paula, Specialty, Stax, Tahiti, 20th-Fox, Wyn-cote.

Classic Sales, PO Box 229, 288 12 St., South San Francisco. Zip: 94083. Tel: 589-5874. Mgr.: Paul P. Roelofsen.

Labels: Allegro, Arhoolie, Audiophile, Audio Precision, Bysantine, Blues Classics, Baccarola, Cavalier, Cetra, County, Delmark, Electro-ladeon, Eterna, Euphonic, Experiences Anon-ymes, Eurodisc, Fidelity Sound, Folk Legacy, Folk Lyric, Fortune, GHB, Gloria, Happy Jazz, Historical Jazz, Hup, Icon, Jansco, Jazz Crusade, Jazzology, Lyricord, Melodeon, Merry Makers, Metronome, Montilla New Orleans Originals, Nobility, Norman, Old-Timey, Origin Jazz Library, Pearl, Polydor (German), Phillips (German), Piedmont, Pinnacle, Portents, Ragtime, Ragtime Soc. of Canada, Repeat, Repertoire, Ronco, San Jacinto, Spivey, Soloart, Southland, Stereodities, Tailgate, Takoma, Testament, Vulcan, Windin Ball.

Craig, 215 Littlefield.

Branches: Los Angeles, Calif.; Denver, Colo.; Honolulu, Hawaii; Seattle, Wash.

Decca, 66 Dorman Ave. Zip: 94124. Tel: VA 4-0161.

Mgr.: Bob Eggers.
Distributes: Decca Product.

Dot Dist. of Northern Calif., 2517 San Pablo Ave., Oakland. Tel: 444-5678. Pres.: Bob Chatton; Sales Mgr.: Vince Cosgrave; Promo. Men: Paul August & Richard Totoian.

Labels: Dot, Hamilton.
Eric-Mainland, 1251 Folsom St. Tel: 431-8154. Mgr.: William Wieland; Promo. Men: Grant Gibbs, Wally Messmore, Cynthia Badie.
Labels: MGM, Verve, Metro, VSP, United

Artists, Atco, Moonglow, Volt, Hanna-Barbera, Musicor, Sun, Audio Fidelity, Fiesta, Swan, Riverside, Colpix, Time, Mainstream, Folkways, Sue, Roulette, Savoy, Prestige, Wonderland, Alshire Presents 101 Strings, Desto.
Tape Cartridge: RCA, ITCC, Musical Tape Sales.

Tape Playback Equip.: Lear Jet 8 Track.
Musical Instruments: Teisco Guitars, Ddrums, Amplifiers, Organs.

Festival, 161 Turk St. Zip: 94102. Tel: PR 5-3434. Mgr.: John Filcich.

Branch: Los Angeles, Calif.
Labels: Ace of Clubs, Alector, Amadeo, Angelicum, Apon, Audio Book, Avoca, B&F, Balkan, Barenreiter, Baroque, Boite a Musique, Bruno, Cambridge, Canary, Cetra, Children's Rec. Guild, Colonial, Colosseum, Conversaphone, Dana, Dover, Dyer-Bennett, Eterna, Eurotone, Experiences Anonimes, Festival, Folk Dancer, Folkraft, Gateway, Gregorian Institute, Grinn Top Greyko, Harmonia Mundi, Haydn Society, Helios, Israel Music Foundation, Jay Jay, Kismet, Le Jazz Cool, Lyricord, Monogram, Montilla, Musica Sacra, Music Library, Nina, Norsemen, Olympic, Olympus, Overtone, Parakeet, Rainbow, Request, Russell, Sonart, Spoken Arts, Standard, Steno-Speed, Stinson, Tikva, Ultraphone, Universe, Vega, Xopo, Young People's Recs.

Field Music Sales, 1480 Howard St., Tel: 863-2258.

Pres.: Richard Field; Mgr.: Robert D. W. Chinn; Promo. Men: Bryant Ellis, Robert D. W. Chinn, & Alvaro Solorzano.

Labels: Amy, Bell, Blue Rock, Chart, Constellation, Discos Columbia, Dynovoice, Falcon, Fuentes, Goldwax, Gordy, Horten, Impression, Kent, Laurie, Mala, Maxx, Mike, Musart, Orfeon, Peerless, Sound of Nashville, Tuba, Twirl, VIP, Vee Jay, White Whale, Windsor.

Grand of Calif., 700 Independent Rd., Oakland. Tel: 569-4666. Pres.: Irving Krantzman; VPs: Max Brown & Sam Garfinkle; Mdse. Mgr.: Merle Krantzman.

Distributes: Cartridges Tapes & Cartridge Players.

INDEPENDENT Music Sales, 800 Mariposa St. Zip: 94107. Tel: 621-B545. Mgr.: Paul McKimmie; Promo. Mgr.: Denny Zeitler; Promo.: Marty Kupps.

Labels: Arctic, Backbeat, Bang, Blue Note, Calla, Co & Ce, Cameo, DGG, Duke, Everest Group, Golden, Jubilee, King, Mar-V-Lus, Mira Group, Monitor, Mustang, Motown, Omen, Old Town, Parkway, Peacock, Philles, Soul, Tamla, Uptown, Vox.
Tape, Cartridge: Motown, Gordy, Soul, Tamla. (SEE ADVERTISEMENT)

Jack's Rec. Cellar, 254 Scott St. Zip: 94117. Owner: Norman E. Pierce.

Labels: Arhoolie, Audiophile, Audio Precision, Blues Classics, Cavalier, County, Delmark, Euphonic, Folk Legacy, Folk Lyric, Folk Promotions, Fortune, GHB, Happy Jazz, Historical Jazz, Hup, Icon, Jansco, Jazz Crusade, Jazzology, Merry Makers, Melodeon, New Orleans Originals, Nobility, Norman, Old Timey, Origin Jazz Library, Pearl, Piedmont, Pinnacle, Portents, Ragtime, Ragtime Soc. of Canada, Ronco, San Jacinto, Scroll, Soloart, Sounds, Southland, Spivey, Starday, Tailgate, Takoma, Valon, Vulkan, Windin Ball.

Melody Sales, 444 Sixth St. Tel: 621-8740. Co-owners: Al Bramy & Tony Valerio; Promo.

**RECORD DISTRIBUTION
IS OUR BUSINESS**

We cover all aspects of
**SALES, PROMOTION and
SERVICE** in the Northwest:
Washington, Oregon, No. Idaho.

HUFFINE

DISTRIBUTING CO.

3131 Western Ave., Seattle, Wash.
(206) ATwater 4-8633

ANDY HUFFINE

The Northwest's newest and most promotion-minded distributor . . .

D. J. DISTRIBUTING CO.

1000 First Avenue South
Seattle, Washington 98134
MUtual 2-7188

Jerry Dennon, President

Proud to represent:

A & M	Pacific	Tower/Uptown
Dunhill	Jerden	Dover
World Pacific	Scepter/Wond	Ero
		. . . among others

Men: Walt Calloway & Pete Marino.

Labels: Caedmon, Contemporary, Crescendo, Elektra, Epic, Fantasy, Loma, Modern, None-such, Okeh, Original Sound, Pacific Jazz, Reprise, Warner Bros., World Pacific.

Music City, 1866 Alcatraz Ave., Berkeley. Tel: 658-5344. Pres.: Ray Dobard.

PIC-A-TUNE WESTERN TAPE DIV., 1461 Park Ave., Emeryville. Zip: 94608. Tel: 654-0773. Pres.: David F. Watson; Gen. Mgr.: Ted Fullmer.

Tape, Cartridge: RCA Victor, Camden, ITCC, Decca, Tamla/Motown, Mercury/Philips/Smash, Kapp, Scepter/Wand, Musical Tapes.

Tape Playback Equip.: Lear Jet Stereo 8.

Stereo Dist'g, 1161 Post St. Zip: 94109. Tel: 771-1090. Pres.: James H. Koenig.

Branch: 121 Jacoby St., San Rafael, Calif.

Tape, Cartridge: Auto Stereo, Taiko.

Tape Playback Equip.: Auto Stereo, Taiko.

Tape: (SEE ADVERTISEMENT)

• **SAN JOSE (Area Code 408)**

Discorama, 235 S. First. Tel: 286-5838. Gen. Mgr.: Art Walker.

Labels: Discos Columbia, Bego, Falcon, Fama.

• **SIMI (Area Code 805)**

M L B, PO Box 111, 837 Los Angeles Ave. Zip: 93065. Tel: 527-1326. Pres.: T. Burl Carlton;

VPs: Marlin & La Monte Carlton.

Labels: Caravan, Gateway.

COLORADO

• **DENVER (Area Code 303)**

ACTION, 1622 Federal. Zip: 80204. Tel: 222-1681. Pres.: Earl Wolf.

Labels: DGG, Fax, Fiesta, Gordy, Heliodor, Impact, Kama Sutra, Leo, MGM, M&M, Mainstream, Metro, Mira, Motown, Mustang, Original Sound, Red Bird, Soul, Tamla, Tuba, VSP, Vault, Verve, Verve/Folkways. (SEE ADVERTISEMENT)

Boyd, 1661 W. Third Ave. Tel: 222-7701. Mgr.: Joseph M. Caravana.

Distributes: Angel & Capitol Product.

Craig, 4959 Colorado Blvd. Tel: 399-0436. Mgr.: Bob Stevens.

Branches: Los Angeles, Calif.; San Francisco, Calif.; Honolulu, Hawaii; Seattle, Wash.

Distributes: Columbia Product.

Davis Sales, 3825 Newport St. Zip: 80207. Tel: FL 5-1638. Mgr.: Bill Davis.

Labels: Atco, Atlantic, Audio Book, Audio Fidelity, Backbeat, Dial, Dolton, Dot, Duke, Everest, Felsted, Fox, Garrett, Hamilton, Hanna-Barbera, Hi, Imperial, Kent, Laurie, Legrand, Liberty, London, Monument, Pacific Jazz, Peacock, Rust, Scepter, Serrock, Soma, Stereod-dities, Sunset, Time, Tower, Wand, World Pacific.

Denver, 3825 Newport. Tel: FL 5-1638. Mgr.: Bill Davis.

Labels: Amy, Challenge, Congress, Dynavoice, Happy Time, Instant Language, Mala, Mercury, New Voice, Reprise, Smash, Valiant, Warner Bros.

Latin American, 2508-10 Larimer St. Zip: 80205. Tel: 825-6893. Mgr.: Samuel Wycoff.

Labels: RCA Victor, Columbia, Musart, Orfeon, Falcon, Ideal, Colonial, Bego, Sunflow, Tear Drop, Bronco, DLV, & other major lines.

SERVING THE MOUNTAIN STATES WITH THESE MAJOR LABELS . . .

**MGM • VERVE • KAMA SUTRA • METRO
DEUTSCHE GRAMMOPHON • MOTOWN
TAMLA • GORDY • SOUL • FIESTA
MUSTANG • MIRA • MIRWOOD**

ACTION RECORD DISTRIBUTING CO.

1622 Federal Blvd.

Denver, Colorado 80204

Phone: (303) 222-1681

LOS ANGELES RECORD DISTRIBUTING COMPANY

Phone or Write Today and Get Results

- L.A.'s **NEWEST** and **YOUNGEST** phonograph record and tape cartridge distributor.
- Working with newly established and major labels, we offer advice and **A-1 SERVICE**.
- Aggressive, young promotion men to work for **YOU**.
- Tape cartridge merchandising.
- Our **SERVICE** after sales will make the difference.

Phone: 343-8045 Area Code 213

LOS ANGELES RECORD DISTRIBUTING CO.

8442 Wilbur Ave. Los Angeles, Calif. 91324

President, DAVE SEIDEN

Serving the Entire Rocky Mountain Area

Denver, Salt Lake City,
Albuquerque with the
most important labels

**DAVIS SALES CO.
DENVER RECORD
DISTRIBUTORS**

3825 Newport St.

Denver, Colorado 80207

Tel. (303) 355-1638

**THE LARGEST
PRE-RECORDED
TAPE
DISTRIBUTOR
IN SOUTHERN
CALIFORNIA**



We carry all labels—Reel to Reel, 4 Track Cartridge, 8 Track Cartridge. We offer RACK SERVICE (including Fixtures, Inventory Control, and Special Order Service).

UNITED TAPE CORP.

2525 W. 9th St., Los Angeles, Calif. 90006

Phone: 386-1821

FRANK DONOVAN, Manager

**TOPS
IN EXPERIENCE
SALES
& PROMOTION
CONN., WESTERN MASS. & VERMONT**



**RECORD
DISTRIBUTING
CORP.**

308 Tolland Street
East Hartford, Conn.
Area Code (203) 289-6424
CARL PADULA, Mgr.
GENE GOTTHELF, Pres.
**SPECIALISTS IN R&B
AND COUNTRY MUSIC**

**IN
CONNECTICUT
WESTERN MASS.
ALBANY, NEW YORK
& VERMONT**

**IT'S
TRINITY
RECORD DIST.**

and **CARTRIDGE TAPE
DISTRIBUTION**

FOR { you make em } **HITS**
{ we break em }

Call "Big Ed" Dinallo, Pres.
Jack Manus, Vice Pres.

Frank Berman } Promotion
Marcia Fox }

477 PARK AVENUE
EAST HARTFORD, CONN.

(203) 289-4349
(203) 289-4624

continued

Pan American Rec. Supply, 77 Kalamath St. Zip: 80223. Tel: 255-2021. Mgr.: Louis Oxman; Promo.: Jack Kaufman.
Labels: Argo, Blue Note, Checker, Chess, Del-Fi, Folkways, Jubilee, SC Phillips Int'l, Prestige, Roulette, Starday, Sue, Sun, Swan, Tamla, Vanguard, Vee Jay, World Artists, Young People's Recs.
Tape, Cartridge: Phyllis.
Walter Slagle, 725 S. Broadway. Zip: 80209. Tel: 777-2645. Gen. Mgr.: Grace Barger.
Labels: ABC-Paramount, A&M, Big Top, Caedmon, Coed, Command, Dunhill, Elektra, Fleetwood, Four Corners, Fraternity, Golden Crest, Grand Award, HiFi, Impulse, Kapp, Music Guild, Music Minus One, Musicor, Nonesuch, Polka Favorites, Sar, UA, Westminster.
Ward Terry, 70 Rio Grande Blvd. Tel: 266-3181. Mgr.: Robert K. Davis.
Labels: RCA Victor, RCA Camden, Disneyland, Vista.
Western Merchants Whsle., 6265 E. Evans Ave. Zip: 80237. Tel: 756-0340. Pres.: John E. Wren; VP: Sam Newton; Mgr.: Robert M. Baker.
Labels: RCA Victor, Columbia, Decca, Capitol, Golden.

CONNECTICUT

• **EAST HARTFORD (Area Code 203)**
Allied, 360 Tolland St. Tel: 289-7431. Pres.: Richard J. Godlewski; Sales Mgr.: Frank Sutter.
Labels: ABC-Paramount, Blue Note, Boom, Command, Dunhill, Fleetwood, Hickory, Hob, Impulse, Mace, Monument, Music Guild, Oliver, Phyllis, Prestige, Scepter, Sun, Tangerine, Tower, Verve, Wand, Westminster.
Associated, 360 Tolland St. Zip: 06108. Tel: 289-7431. Mgr.: Frank P. Kelley; Promo.: Robert Greenberg.
Labels: Audio Fidelity, Bert & I, Cabot, Caedmon, Canadian American, Challenge, Congress, DGG, Dana, Dauntless, Dictation Disc, Fiesta, Golden, Grecophon, Hanna-Barbera, Heliodor, Jubilee, Life, Monitor, Music Minus One, Pickwick, Reprise, Riverside, Somerset, Stereodities, Stereo Fidelity, Warner Bros., Wonderland.
Tape, Reel-to-Reel: Audio Fidelity, DGG, Stereo Fidelity.
Eastern, 360 Tolland St. Zip: 06108. Tel: 289-7431. Mgr.: Richard J. Godlewski; Promo.: Robert Greenberg.
Labels: Bang, Epic, Four Corners, Jay Jay, Kama Sutra, Kapp, Living Language, Tom Lehrer, Living Literature, Loren, MGM, MGM Children's Series, Metro, Okeh, Reprise, Swan, Vanguard, Starday.
Tape, Cartridge: ITCC, Aura-Sonics.
Tape Playback Equip.: Lear Jet 8 Track.
GLOBE, 308 Tolland St. Tel: 289-6424. Mgr.: Carl Padula.
Labels: Alon, Avin, Banshee, Black Hawk, Bunny, Cameo, Carnival, Centaur, Cimmarron, Crusader, Conduc, Dearborn, Excel, Fairmount, Fat Fish, Fortune, Freeport, Groovy, Holton, Hurd, Hype, K-Ark, Kellmac, Longhorn, Lucky 11, Mar-V-Lus, One-Derful, Patty, Rebel, Renfro, Sahara, Tener, TMP-Ting, Turnabout, Tubas, USA, Venus, Vox, Webcor, Windy C, Wise, Wheeling. (SEE ADVERTISEMENT)

Northeastern, 360 Tolland St. Zip: 06108. Tel: 289-7431. Pres.: Richard Godlewski.
Labels: ABC-Paramount, Audio Fidelity, Bert & I, Command, Congress, DGG, Epic, Fiesta, Golden, HiFi, Impulse, Kapp, Loren, MGM, Metro, Monitor, Phyllis, Reprise, Tower, Vanguard, Verve, Westminster.
Radio & Appliance, 95 Leggett St. Zip: 06108. Tel: JA 8-6581. Mgr.: Alan Sack.
Distributes: RCA Product.
SEABOARD, 275 Park Ave. Tel: 289-9361. Sales Mgr.: M. Ginsberg.
Labels: Amy, Argo, Atco, Atlantic, Bell, Cadet, Carla, Checker, Chess, Dial, Diamond, Disneyland, Dolton, DynoVoice, Elektra, End, FM, GNP-Crescendo, Goldwax, Imperial, Liberty, Limelight, Mala, Mercury, Mirwood, Moonglow, Musicland, Mustang, New Voice, Nonesuch, Original Sound, Pacific Jazz, Phillips, Roost, Roulette, Stax, Sunset, Tico, Vee Jay, Vista, Volt, White Whale, World Pacific.
Tape, Cartridge: Phillips, Mercury, Smash, Fontana, Limelight, Liberty, Dolton, Imperial, World Pacific, Pacific Jazz. (SEE ADVERTISEMENT)
TRINITY, 477 Park Ave. Tel: 289-43-49. Pres.: Big "Ed" Dinallo; VP Jack Manus.
Labels: A&M, Colonial, Colpix, Constellation, Conversaphone, Copley, DCP, Dance Along, Duke, Everest, Fantasy, Folkways, Fontana, Galaxy, Golden World, Gordy, Jamie, King, Motown, Musicor, Nashboro, Parkway, Peacock, Red Bird, Regent, Ric-Tic, Sar, Savoy, Smash, Soul, Specialty, Spoken Arts, Tamla, Tikva, Tradition, 20th-Fox, UA, VIP.
Tape, Cartridge: Musical Tape Sales, Motown Tapes. (SEE ADVERTISEMENT)
Tape Playback Equip.: Muntz, Audio Stereo.
• **HARTFORD (Area Code 203)**
Columbia, 100 Constitution Plaza, Rm. 600. Zip: 06103. Tel: 522-7151. Mgr.: Stephen J. Capone; Promo. Mgr.: Ed Hynes.
Distributes: Columbia Product.
• **WILTON (Area Code 203)**
Acropole Corp. of America, PO Box 365. Tel: 847-2311. N.Y.C. Tel: (212) CY 5-2272. Pres.: Mrs. Michele M. Ronty.
Labels: Bruno, Colosseum, Montilla.

**DISTRICT OF
COLUMBIA**

• **WASHINGTON (Area Code 202)**
Columbia, Universal Bldg. N., Suite 1113, 1875 Connecticut Ave. N.W. Zip: 20009. Tel: 332-2300. Sales Mgr.: George Deacon; Promo. Mgr.: Fred Love.
Distributes: Columbia Product.
General, 2329 Pennsylvania Ave., Baltimore, Md. Tel: (303) 669-6411. Pres.: Henry Nathanson. (See listing under Baltimore for lines handled).
SCHWARTZ BROS., 2146 24 Pl. N.E. Zip: 20017. Tel: 526-4500. Mgr.: James Schwartz; Promo. Men: John Lam, Ed Kalicka, Joe Cash, Harry Coombs.
Labels: A&M, Atco, Volt, Atlantic, Stax, Bang, Blue Note, Cadet, Challenge, Checker, Chess, Constellation, Contemporary, Crescendo, Crusader, DGG, Dolton, Elektra, Nonesuch, Golden World, Ric-Tic, Hanna-Barbera, Imperial, Jubilee,

**NO. 1 IN
PROMOTION...
SALES...
SERVICE...
TRY US AND SEE**

Hartford's oldest
independent record
distributor.
Serving Connecticut—
Western Massachusetts—
Upstate New York—Vermont

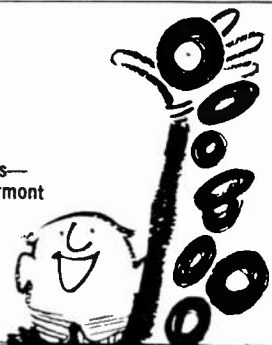

SEABOARD DISTRIBUTORS, INC.

AN AFFILIATE OF ROSKIN DISTRIBUTORS, INC.
275 Park Avenue, East Hartford, Conn. Phone: 203—289-9361
Marv Ginsburg—Sales Manager Jerry Greeberg—Promotion

Gross, BT Puppy, Kapp, Four Corners, Parrot, Mira, Monument, Motown, Tamla, Gordy, Soul, VIP, Musicor, Mustang, Pacific Jazz, Reprise, Riverside, Wonderland, Roulette, Soma, Stereodities, Starday, Sue, Symbol, UA, Ascot, Valiant, Vanguard, Vee Jay, Verve, White Whale, World Pacific, Clarion, Somerset, Stereo Fidelity, Pickwick, Hilltop, Nashville, Wyncote, VSP, Heliodor.

Tape, Cartridge: ITCC 8 Track, Motown 8 Track, Musical Accessories: All Walco accessories, 3M Blank Tape. (SEE ADVERTISEMENT)

Southern Whslers., 707 Edgewood St. N.E. Zip: 20017. Tel: 832-6400. Mgr.: George Nesline.

Walander, Rear of 2928 M St. N.W. Zip: 20007. Tel: 965-3366.

Tape, Cartridge: ITCC.

FLORIDA

• MIAMI (Area Code 305)

Antillas, 1046 N. Miami Ave. Tel: 374-4347. Pres.: Eugenio Garrote Jr.
Labels: Maype, Sirena.

Bold, 495 S.E. 10 Ct., Hialeah. Tel: 887-7546. Pres.: Henry Stone.
Labels: Kapp, Vanguard.

CAMPUS, 6751 N.W. 37 Ct. Zip: 33147. Tel: 691-3140. Mgr.: Joseph Stanzione; Promo. Men: Lou Stewart & Gary Stites.

Affiliate: Apex-Martin Rec. Sales, Newark, N. J. Labels: A&M, Challenge, Golden World, Epic, Disneyland, White Whale, Tower, Backbeat, Peacock, Ric-Tic, Prestige, Starday, Music Minus One, Impact, One-Derful, Mar-V-Lus, M-Pac, Simon Says, Mustang, Instant Language. (SEE ADVERTISEMENT)

Capitol, 80 E. 10 Ave., Hialeah. Tel: 887-4319. Mgr.: John Griffith.
Distributes: Capitol & Angel Product.

Carib, PO Box 748, Miami Springs. Zip: 33166. Tel: 885-3738. Pres.: Patricia V. Jacobs.
Labels: Carib, Famo, Island Artists, Westindy.

Columbia, 3641 N.W. 67 St. Zip: 33147. Tel: 0X 6-0033. Sales Mgr.: Bob Beasley; Promo. Mgr.: James Riggins.
Distributes: Columbia Product.

Decca, 2452 N.W. 77 Terr. Tel: 691-4816. Mgr.: Bert Jones.
Distributes: Decca Product.

Dot, 2335 N.W. Eighth Ave. Tel: 633-0643. Mgr.: Polly Reese.
Distributes: Dot Product.

Handleman, 3979 N.W. 24 St. Tel: 633-2479. Contact: J. Adams.
Tape, Cartridge: RCA Stereo 8.

Liberty, 2453 N.W. 77 Terr. Tel: 696-2010. Mgr.: Walter Gustin.
Distributes: Liberty Product.

Main Line Rec. Serv., 54 N.E. 181 St. Tel: 621-3694. Mgr.: Jack Solinger; Promo.: Gary Stites.

Labels: Crescendo, DGG, Heliodor, Kama Sutra, Leo the Lion, MGM, Musicor, VSP, Valiant, Verve, Verve/Folkways.

Tape, Cartridge: ITCC, Aura Sonic, Musical Tape Sales. Decca.

Tape Playback Equip.: Lear Jet 8.

Musical Accessories: Tape Cartridge Carrying Cases.

Merrec, 5411 N.W. 36 St., Miami Springs. Tel: 887-5661. Mgr.: Steve Brookmire.

Branches: Atlanta, Ga.; New York, N. Y.

Labels: Mercury, Philips, Smash, Limelight, Emarcy, Wine, Cumberland, Storyteller.

Distributes: Other Mercury Group Product.

Miami Recs., 2819 N.W. Seventh Ave. Zip: 33127. Tel: 635-7925. Cable: Miarec. Mgr.: Carlos Diaz-Granados V; Promo.: Carlos Diaz-Granados Jr.

Branch: New York, N. Y.

Labels: Discos Columbia, Fuentes, Merengue, Miami.

Music Sales of Florida, 2450 N.W. 77 Terr. Zip: 33147. Tel: 691-0340. Pres.: Donald C. Smith.

Labels: Allegro, After Hours, Argo, Arhoolie, Audio Lab, Audio Spectrum, Battle, Baer, Bethlehem, Blue Note, Boone, Bra, Bragg, Carol, Canaan, Chart, Crestview, Dooto, Elektra, ESP-Disc, Fantasy, Fax, Federal, Fuller, Garrett, General American, Happy Time, Hickory, Jameco, Jazzland, King, Lloyd, London, Longhorn, Mainstream, Movietone, Nonesuch, Rebel, Rich-

WEST VA. **BALTIMORE** **DEL.** **MD** **WASHINGTON DC** **RICHMOND**

SCHWARTZ BROTHERS, INC. **DISTRICT RECORDS, INC.**

Area's Largest Distributor | Area's Most Modern Merchandiser
Using Automated Systems

2146 24th Place N.E., Washington, D. C. 20018
(202) 529-5700 | (202) 832-3600

campus
record
**DISTRIBUTING
CORP.**

DEPENDABILITY—SERVICE—SALES

JOE STANZIONE, MGR.

6751 N. W. 37th Court
Miami, Fla. 33147
Phone (305) 691-3140

continued

mond, Riot, Sacred, Scorpio, Shurfine, Sims, Soma, Stereodities, Summit, Sword, Tigertown, 20th-Fox, Wonderland, Word.
Tape, Cartridge: London, Richmond, Audio Spectrum, General Recorded Tape.
Tape, Reel-to-Reel: London, Richmond, Audio Spectrum, General Recorded Tape.
Tape Playback Equip.: Norelco.
Musical Instruments: Roca Guitars, Hohner Harmonicas.
Musical Accessories: Picks, Strings, Reeds, Pitch Pipes, etc.
 Musicart, 113 N.E. First Ct., Dania. Zip: 33004. Tel: 923-5845. Mgr.: Grace P. Chew.
Labels: Bingo, Musicart.
 New State, 1055 E. 28 St., Hialeah. Tel: 691-5161. Mgr.: Morty Marks.
Tape, Cartridges: Ampex, ITCC.
Tape, Reel-to-Reel: Ampex.
 Olins Car Stereo, 3450 Biscayne Blvd. Zip: 33137. Tel: 377-2616. Pres.: William J. Kretschmar.
 Ramsa, 477 W. 27 St., Hialeah. Zip: 33010. Tel: 887-1391. Pres.: J. R. Sabat.

Sea Coast Appliance, 3575 N.W. 60 St. Zip: 33142. Tel: NE 5-0951. Mgr.: J. W. Shockey.
 Branch: Hialeah, Fla., PO Box 546. Zip: 33011.
Distributes: RCA Victor Product.
 Tone, 495 S.E. 10 Ct., Hialeah. Tel: BB7-7546.
 Pres.: Henry Stone; Prod'n Mgr.: Brad Shapiro.
Labels: ABC-Paramount, Amy-Mala-Bell, Argo, Atco, Atlantic, Bang, Boom, Cadet, Cameo, Carla, Checker, Chess, Colpix, Dade, Dial, Dunhill, Dunwich, DynoVoice, Gordy, Impulse, Kapp, Karen, Loma, Marlin, Motown, Musicland, New Voice, Oliver, Parrot, Press, Reprise, Roulette, Scepter, Soul, Stax, Sue, Swan, Tamla, Tangerine, Tribe, Triumph, UA, Vanguard, Vee Jay, Wand, Warner Bros., Westminster.

• **ORLANDO (Area Code 305)**

Kam, PO Box, 15366. Zip: 32802. Tel: CL 3-2560. Pres.: Robert P. Angel Sr.

• **PENSACOLA (Area Code 305)**

F T C Brewer, 2400 W. Hayes St. Zip: 32505. Tel: 433-7932. Owner: Frederic T. C. Brewer.
Playback Equip.: Ampex, Crown, Fairchild.

GEORGIA

• **ATLANTA (Area Code 404)**

Capitol, 1670 N.E. Expressway Access Rd. Zip: 30329. Tel: 634-5191. Mgr.: R. H. Hardy.
Distributes: Capitol & Angel Product.
Musical Instruments: Hohner Harmonicas.
 Comstock, 1323 Spring St. N.W. Zip: 30309. Tel: 876-0321. Sales Mgr.: Don Comstock; Prmo. Mgr.: M. G. King.
Distributes: Columbia Product.
 Criteria, PO Box 13612, Sta. K. Zip: 30324. Pres.: Johnny Brooks.
Labels: World-Wide, SOA, RCA Victor, Camden, Decca, Dot, Columbia.
 Decca, 156 Alexander. Zip: 30313. Tel: JA 4-8428. Dist. Mgr.: Ed Russell.
Labels: Brunswick, Caedmon, Coral, Decca, Listen & Learn, London, Richmond, Telefunken.
Distributes: Other Decca Product.
 Dixie, 1235 Techwood Dr. N.W. Tel: TR 3-2081. (See Southland.)

GODWIN, 1227 Spring St. N.W. Zip: 30309. Tel: 876-5719. Pres.: Art Godwin; Gen. Mgr.: Doyal McCollum.
Labels: A&M, Almo, Amy, Aurora, Bell, Bethlehem, Big Top, Bragg, Challenge, Co & Ce, Colpix, Command, Crestview, Dooto, Dimension, DynoVoice, Elektra, Federal, Gateway, Gem, Golden, Goldwax, Gordy, Gospel, Hickory, Hobb, Joda, King, Laurie, Loma, Mace, Mala, Motown, Musicland, New Voice, Nonesuch, Omen, Rampart, Reprise, Rust, Sacred, Savoy, Scepter, Sharp, Soul, Sphere Sound, Tamla, Thomas, Tower, 20th-Fox, Twirl, VIP, Valiant, Village Gate, Wand, Warner Bros., Word. (SEE ADVERTISEMENT)

L & F Rec. Serv., 720 14 St. N.W. Tel: 875-5565. Contact: J. Geldbart.

Tape, Cartridge: RCA Stereo 8.
 Merrec, 331 Luckie St. N. W. Tel.: 523-1961. Mgr.: Steve Brookmire.

Branches: Miami Springs, Fla.; New York, N. Y.
Labels: Mercury, Phillips, Smash, Limelight, Blue Rock, Fontana, Cumberland, Wing.
Distributes: Other Mercury Product.

R C A Victor, 1500 Marietta Blvd. N.W. Tel: 355-2960. VP: James V. C. Harter.
Distributes: RCA Victor Product.

Record Center, 2851 Piedmont Rd. N.E. Zip: 30324. Tel: 231-3336. Pres.: Robert Pattillo.

Labels: Aqua, Belco, Blue Star, Bogan, Grenn, Kalox, MacGregor, Marrbach, Rocking A, Sets in Order, Windsor.

SOUTHLAND, 1235 Techwood Dr., N.W. Zip: 30313. Tel: TR 3-2081. Pres.: Gerald Friedman.
Labels: ABC-Paramount, Artic, Ascot, Atco, Atlantic, Audio Fidelity, Bach Guild, Backbeat, Bang, Cadet, Cameo, Canaan, Canadian American, Chart, Checker, Chess, Congress, Constellation, Contemporary, Crescendo, Deutsche Gramophone, Dial, Diamond, Disneyland, Duke, Dunhill, Dunwich, Excello, Hanna-Barbera, Impulse, Jamie, Jubilee, Kama Sutra, Kapp, Kent, Living Language, London, Group, MGM, Mainstream, Mira, Monument, Moonglow, Musicor, Mustang, Nashboro, Old Town, Original Sound, Parkway, Parrot, Peacock, Philles, Pickwick/33, Prestige, Red Bird, Ric-Tic, Riverside, Roulette, Sims, Sing, Skylite, Soma, Songs of Faith, Starday, Stax, Sue, Sun, Time, Tuba, United Artists, Vanguard, Verve, Vista, Volt, Young People's Recs. (SEE ADVERTISEMENT)

• **DEMOREST (Area Code 404)**

Ralph's, PO Box 117, Hwy. 441. Zip: 30535. Tel: 723-3884. Owner: Ralph Raper. Promo.: Franklin Raper.
Labels: Bryte, Canaan, Cason, Chart, Cotton Town Jubilee, Country Gems, Country Jubilee, Country Time, Del-Ray, Dixie, Gospel Gems, Gospel Jubilee, Gospeltime, Great, Guitar, Hit, Kark, Kash, Lanier, Modern Sounds, Na-R-Co, Peach, Rains, Rally, Scripture, Sims, Songs of Atlanta, Songs of Faith, Spar, Starday, Sunlite, Tifco, Trepur, Verna, Word, Wrangler.

HAWAII

• **HONOLULU (Area Code 808)**

Craig, PO Box 377, 345 Kamakee St. Zip: 96809. Tel: 586-771. Sales Mgr. Rec. Dept.: Masao Tanaka.
Branches: Los Angeles, Calif.; San Francisco. Calif.; Denver, Colo.; Seattle, Wash.
Distributes: Columbia Product.

**WE
DELIVER
FIRST**

in the
southern
market

**BIGGER SALES
BETTER PROMOTION**

**GODWIN
Record Distributors**

Atlanta, Georgia

1227 Spring St., N.W. (404) 876-5719

#

IN THE SOUTHLAND

SOUTHLAND

RECORDS DISTRIBUTING COMPANY

1235 Techwood Drive, N.W.
 Atlanta 13, Georgia. TRinity 3-2081
 Gerald Friedman, President

Decca, 345 Kamakee St. Zip: 96814. Tel: 504-211.
Contact: L.C. Gilman.

Distributes: Decca Product.

Eric of Hawaii, 607 Coral. Tel: 511-657. Mgr.: Irv Pinensky.

Labels: ABC-Paramount, MGM, Reprise, UA, Verve, Warner Bros.

Microphone Music, 605 Coral St. Zip: 96813. Tel: 502-188. Mgr. & Promo.: Ken Kaizawa.

Labels: Atco, Atlantic, Cadet, Cameo, Challenge, Checker, Chess, Congress, Disneyland, Dot, Duke, Four Corners, Golden, Jamie, Jubilee, Kapp, Living Language, Monument, Moonglow, Parkway, Red Bird, Roulette, Riverside, Scepter, Stax, Sue, Swan, Tower, Valiant, Vault, Volt, Wand, Wyncote.

Tape, Reel-to-Reel: GRT, Musictapes.

Music Craft, PO Box 2839, 636 S. Queen St. Tel: 501-223. Pres.: Walter Kurokawa.

Labels: Amy, Blue Note, Boone, Charger, Circa, Co & Ce, Coed, Colpix, Command, Cordak, Fax, Golden World, Grand Award, Grand Prix, Hickory, Joda, King, Laurie, Legrand, Monitor, Original Sound, Prestige, Starday, Stereoddities, Storytime, Tradewinds, 20th-Fox, Vanguard.

Nylen Bros., 820 S. Beretania St. Tel: 581-171. Sales Mgr.: Ed Nielsen.

Labels: A&M, Audio Fidelity, Audio Spectrum, Aura, Caedmon, Concert-Disc, Contemporary, Dolton, Era, Everest, Fantasy, Good Time Jazz, Gordy, Imperial, Lani, Liberty, Makaha, Motown, Music Minus One, Pacific Jazz, Sunset, Tamla, Word, World Artists, World Pacific.

Radio Television, 432 Keawe St. Zip: 98613. Tel: 502-901. Mgr.: Arthur W. Kay.

Labels: Fontana, London, London American Group, Mercury Wing, RCA Camden, RCA Victor, Richmond, Smash.

Tape, Cartridge: RCA Stereo 8.

Tape, Reel-to-Reel: RCA Victor, RCA Camden 4 Track.

Surfside Hawaii, 345 Kamakee St. Tel: 513-702. Pres.: Don McDiarmid Jr.

Labels: Angel, Capitol, Hula, Mahalo.

ILLINOIS

• BERWYN (Area Code 312)

Balkan, 6917-19 W. Cermak Rd. Tel: GU 4-6436. Owner: Slavco Hlad.

Labels: Balkan, Festival, Gateway, Greyko, Polka Pal, Slovenia, Tambura.

• CHICAGO (Area Code 312)

ALL STATE, 1450 S. Michigan Ave. Zip: 60605. Tel: 939-3675. Pres.: Paul J. Glass; Promo. Men: Howard Bedno & Cy Gold.

Labels: Accent, Allegre, Atlantic, Bethlehem, Blue Note, Boone, Cadet, Camp, Charger, Checker, Chess, Cine-Voice, Co & Ce, Diamond, Doot, ESP-Disc, End, Everest (pop), Focus, GNP Crescendo, Gone, Gordy, Hanna-Barbera, HiFi, Hollywood, IRC, Jamie, Kenwood, King, Life, Montel, Motown, Movietone, Musicor, Old Town, Phillies, Red Bird, Riviera, Roost, Roulette, Specialty, Squire, Starday, Stax, Sue, Symbol, Teardrop, Tico, 20th-Fox, USA, Workshop Jazz. (SEE ADVERTISEMENT)

K. O. Asher, 7818 S. Stony Island Ave. Zip: 60649. Tel: RE 1-1741. Mgr.: K. O. Asher; Promo.: Rayburn Flerlage.

Labels: AH, Alector, Amadeo, Angelicum, Apon, Arhoolie, Asch, Audio Precision, B&F Budapest, Barenreiter, Barclay, Bartok, Berlitz, Blues Classics, Boite a Musique (BAM), Borica, Bornand, Boyes, Broadside, CMS, Caedmon, Cambridge Cantate, Cavalier, Cetra, Classic Editions, Colonial, Composers, Connoisseur, Contemporary, Conversaphone, County, Danish Odeon, Desto, Disc, Dover, Dyer-Bennett, EMS, Electrola, Elektra, Enrichment, Eterna, Euphonic, Evergreen, Experiences Anonyms, Folk-Legacy, Folk-Lyric, Folk-Promotions, Folkways, GHB, Golden Crest, Good Old Jazz, Gregorian Institute, Gryphon, Happy Jazz Band, Hargail, Harmonia Mundi, Harmony, Haydn Society, Helios, Historical Jazz, Icon, Jazz Crusade, Jazzology, LVA, Lenco, Lyricord, Melodeon, Monitor, Motivation, Music Guild, Music Library, Music Minus One, Music Sacra, Nina, Nobility, Norsemen, Oak Publ'ns, Odeon, Old Timey, Olympus, Orient, Original

Jazz, Overtone, Pathe, Pathway, Period, Piedmont, Pinnacle, Playhouse, Portent, Pro Musica, Proscenium, Qualiton, Renaissance, Rutgers Univ., Scala, Scandinavian, Science Material Center, Shakespeare Rec'g Soc., Society for Forgotten Music, Songs & Sounds of Nature, Southland, Spa, Spire, Spivey, Spoken Arts, Spoken Word, Standard, Stradivari, System for Education, Takoma, Testament, Theatre Rec'g Soc., Tradition, Turnabout, UNESCO, UTC, Ultraphone, Veritas, Vocab, Vogue, Voix de l'Auteur, Vox, Vulcan, Washington, Westminster, Windin' Ball, World Library of Sacred Music.

Car-Tapes, 2017 S. Michigan Ave. Zip: 60616. Tel: 942-6515.

Tape, Cartridge: ITCC.

Columbia Rec. Sales, 2240 N. Milwaukee Ave. Tel: HU 6-4700. Reg'l Sales Mgr. (Chicago, Minneapolis, Milwaukee): Don Van Gorp; Sales Mgr.: Norm Ziegler; Promo. Mgr.: Fred Salem. Distributes: Columbia Product.

Decca, 425 N. Michigan Ave. Tel: DE 7-1100. Mgr.: A. Weiner.

Labels: Decca, Brunswick, Coral, Listen & Learn, Vocalion.

Distributes: Other Decca Product.

Dot Rec., 1140 W. Washington. Tel: TA 9-3553. Mgr. M. Golden.

Labels: Dot, Hamilton.

GARMISA, 1700 S. Michigan Ave. Tel: 922-7455. Mgrs.: Leonard R. Garmisa, Robert M. Garmisa; Promo.: Ron Proctor.

Labels: ABC, UA, Prestige, Dunhill, Command, Asco, Band Box, Boom, Freeport, Impulse, Jerder, Tangerine, JJC, DCP, Grand Award, Jameco, Blackhawk.

Tape: Reel-to-Reel: ABC, Impulse, Command. (SEE ADVERTISEMENT)

Guess, 6911 N. Keystone, Lincolnwood. Zip: 60646. Pres.: D. C. Guess.

Handleman, 6666 Lincoln Ave., Lincolnwood. Tel: 583-0770. Contact: L. Kwiker.

Tape, Cartridge: RCA Stereo 8.

Liberty, 5251 W. North Ave. Zip: 60639. Tel: 237-7762. Mgr.: Eli Bird; Promo.: Russ Bach. Labels: Aura, Dolton, Imperial, Liberty, Minit, Pacific Jazz, World Pacific.

Distributes: Other Liberty Product.

YOU GET TOP SALES and PROMOTIONAL COVERAGE

We're distributors for

Atco
B T Puppy
Bang
Contemporary
Delmark
Dunwich
Fame
Good Time Jazz
Gross

Josie
Jubilee
Mike
Moonglow
Original Sound
Riverside
Shout
Veep
Volt

Contact:

Kent Beauchamp or Edward Yalowitz

**ROYAL DISC
DISTRIBUTING INC.**

1239 So. Michigan Ave.

Chicago, Illinois 60605 (312) 939-2661

WE AGGRESSIVELY PROMOTE AND MERCHANDISE

Check with

Irv Biegel
Rick Blackburn
Joanne Bratton
Ewart Abner
Ruth Conte
Ralph Cox
Bob Elliott
Bob Fead
Ted Feigin
Don Graham

Dewey Groom
Amos Heilicher
Mort Hoffman
Marvin Jacobs
Bob Keene
"D" Kilpatrick
Lee Lasseff
Len Levy
Joe Lucus
Jerry Moss

Larry Nunes
Sol Rabinowitz
Ron Roessler
Lester Rose
Bob Shad
Jerry Simon
Frank Slay
Slim Williamson
Chet Woods
Saul Zaentz

Two Promotion Men in Chicago

Bob Schimmel

Charles "Deek" Atkins

We represent many of the above mentioned throughout southern Ohio (Cincinnati, Columbus, Dayton) and southern Indiana. Julie Godsey handles promotion and Jim Berning is our sales representative. Both reside in the Cincinnati area and are experienced record people.

Summit Dist. welcomes the challenge of concentrating on your product in Illinois, Indiana or Ohio.

Jack White—Seymour Greenspan

Illinois & Indiana:
SUMMIT DIST., INC.
7447 North Linder Ave.
Skokie, Illinois 60076
(312) 677-1621

Ohio:
SUMMIT DIST., INC.
617 Central Trust Tower
Cincinnati, Ohio 45202
(513) 241-6361

continued

M S Dist'g, 1550 S. State St. Tel: 225-2929. Mgr.: Vic Faraci; Promo. Men: Art Smith, Bill Casady, Larry Lubliner.
 Labels: Amy, DynoVoice, Mala, New Voice; Cameo-Parkway; Challenge; Dore; Era; Fraternity; Kapp, Congress, Four Corners; Laurie; Rust; MTA; Swan; Towe; Uptown; Valiant; Warner Bros., Reprise, Loma.

J. H. MARTIN (MUSIC DIST'RS), 2419 S. Michigan Ave.: Tel: VI 2-4440. Pres.: James H. Martin. Labels: Colpix, Dimension, Hi, London, May, Monument, Jamie Guylan.
 Tape, Cartridge: ITCC 8 Track.
 Tape Playback Equip.: Lear Jet 8. (SEE ADVERTISEMENT)

Merrec, 1400 S. Michigan. Tel: 939-1425. Mgr.: Bert Loob.
 Labels: Fontana, Limelight, Mercury, MRC, Philips, Smash, Wing.
 Distributes: Other Mercury Group Product.

METRO, 1112 S. Wabash. Zip: 60605. Tel: 341-0660. Mgr.: Morris S. Price.

Labels: Audio Fidelity, DGG, Elektra, Golden, Kama Sutra, Karate, Leo the Lion, MGM, Metro, Nonesuch, Time, Verve. (SEE ADVERTISEMENT)

Musicapes, 230 N. Michigan Ave. Tel: 782-1623.

Pan American, 1344 S. Halsted. Tel: SE 3-1530. VP: M. S. Frenkel.
 Labels: Ansonia, Bego, Bronco, Colonial, Del Valle, Dimsa, Discos Columbia, Discuba, ECO, Falcon, Firma, Ideal, Maya, Montilla, Musart, Norteno, Nopal, Orfeon, Peerless, Relampago, Sombrero.

Record, 4135 W. Armitage Ave. Zip: 60639. Tel: 342-7060. Owners: Reuben Lawrence & Anthony Galgano.
 Labels: After Hours, Archive of Folk Music, Arfa, Aristophone, Arnold Palmer, Murray Banks, Baronet, Baroque, Camay, Collector's Guild, Concert-Disc, Coronet, Counterpoint, Cricket, Crown, Design, Diplomat, Esoteric, Eurotone, Everest, Fax, Fiesta, Forum, Grandisco, Grecophon, Gryphon, Guest Star, Hall of Fame, Happy Time, Helios, Labrae, La Comedie Francaise, Laughtime, Major Sound

Effects, Moppet, Earl Nightingale, Panda, Charlie Parker, Parliament, Period, Renaissance, Riot, Scala, Spin-O-Rama, Summit Sound, Surprise, Stradivari, Sutton, Virgo, Wonderland, Wyncote.

Ron-Jac, 166 W. Washington. Zip: 60602. Tel: 782-3053. Pres.: Jack Barthel.
 Labels: Fannin, MMC, Riba, Seamist, Shalamar, Trend, World Wide.

ROYAL DISC, 1239 S. Michigan Ave. Tel: 939-2661. Contacts: Edward Yalowitz & Kent Beauchamp. Labels: Ashley, Atco, Bang, Bear, Brooklyn, Canadian American, Class, Colpix, Contemporary, Cuca, Dana, Delmark, Dictation Disc, Diplomacy, Dunwich, Dyno, Enterprise, Faro, Gateway, Goal, Good Time Jazz, Gross, Hi Lite, Ideal, Jazzland, Jetis, Josie, Jubilee, K-ark, Linda, Mike, Moonglow, Original Sound, Port, Princeton, Providence, BT Puppy, Quill, Rampart, Riverside, Twirl, VIP, Volt. (SEE ADVERTISEMENT)

Santo, 64 E. Van Buren St. Tel: WE 9-7188.
 Stereorama (div. of Auto-Home Stereo), 79 St. & Southwest Hwy. Zip: 60652. Tel: 471-2345. Pres.: M. J. Quattrochi; Gen. Mgr.: Peter J. Grushi.
 Branch: New York, N. Y.
 Tape, Cartridge: ITCC, RCA Victor, Muntz Stereo Pak, Jay Electronics Encore.

SUMMIT, 7447 N. Linder Ave. Zip: 60076. Tel: 677-1621. Owners: Seymour Greenspan & Jack White.
 Branch: Cincinnati, Ohio.
 Labels: A&M, Almo, Arhoolie, Autumn, Biscayne, Bragg, Brent, Chart, Chattahoochie, Claridge, Constellation, Disneyland, Epic, Exodus, Fantasy, Fidelity Sound, Galaxy, Golden World, Great, Hickory, Longhorn, Mainstream, Mobile Fidelity, Okeh, Omen, RSVP, Ric-Tic, Satellite, Simon Says, Stereoddities, Tradition, Tuba, Vee Jay, Vista, White Whale, Wingate. (SEE ADVERTISEMENT)

UNITED, 1827 S. Michigan Ave. Zip 60616. Tel: 225-6605. Mgr.: Ernest Leaner; Promo. Men: Bill Leaner, Leroy Phillips, Mike Allen.
 Labels: Alon, Arctic, Atlas, Backbeat, Calla, Carnival, Custom, D-Town, Duke, Enjoy, Excel, Excello, 4 Bros., Groovesville, Halo, Joda, Kent, Mar-V-Lus, M-Pac, Nashboro, Nola, One-Deerful, Peacock, St. Lawrence, Savoy, Scepter, Soul, Sun, TCF (Hall), Tamla, Wand.
 Musical Instruments: Hickory Guitars. (SEE ADVERTISEMENT)

GARMISA SELLS SERVICES AND PROMOTES THE FOLLOWING LABELS IN ILLINOIS, INDIANA AND WISCONSIN

ABC Records	Dunhill	Oliver	Four (4) experienced promotion men always moving products for us.
Ascot	Grand Award	Prestige	
Boom	Impulse	Tangerine	
Command	Jerden	United Artists	
Contact	JJC	20th Century	

Call: Lennie or Bobby Garmisa

GARMISA DISTRIBUTING CO., INC. PHONE (312)
 1700 South Michigan Avenue Chicago, Illinois 922-7455

DISTRIBUTORS OF

LONDON	STEREO FIDELITY
LONDON GROUP	MONUMENT
SOMERSET	HILLTOP
VANGUARD	PICKWICK 33

Lear Jet
STEREO CAR AND HOME UNITS
 And All Brands of
 4 & 8 Track Cartridges

J. H. MARTIN (Music Distributors)
 2419 S. Michigan Avenue, Chicago, Illinois (312) VI 2-4440

For strong Sales, Promotion and Service in Chicagoland

Use our experienced promotional trio

LEROY PHILLIPS • MIKE ALLEN • BILL LEANER

Contact Ernie Leaner

UNITED RECORD DISTRIBUTORS, INC.
 1827 South Michigan Avenue Chicago, Illinois 60616
 (Area Code: 312) 225-6605

- **DES PLAINES (Area Code 312)**
 R C A Victor, 424 E. Howard St. Tel: 827-0033. Mgr.: Ralph Ergas.
 Distributes: RCA Product.
- **NILES (Area Code 312)**
 Capitol, 6401 Gross Point Rd. Zip: 60648. Tel: 647-8338. Sales Mgr.: George Gerken.
 Distributes: Angel & Capitol Product.

INDIANA

- **FORT WAYNE (Area Code 219)**
 Tri-State, 3434 Broadway. Tel: 744-5607. Mgr.: Cliff Ayers Ostermeyer.
 Labels: ABC, All Star, Alto, Angeltone, Arrawak, Art, Arvee, Atlas, Avenue, Ballad, Bandbox, Bartell, Baton, Bay Uke, Bee, Beltone, Buddy, Bullseye, C&M, Campus, Capa, Cardinal, Chattahoochee, Chroma, Cimarron, Clare, Commerce, Contour, Crescendo, Crown, Delden, Desert, Dome, Ebb, Emerald, Empire, Era, Excelsio, Fax, Film City, Flick, Flo-Jo, Ford, Golden World, Harvard, HiFi, Hit, Hudson, Hugo, Injun, Jamie, Kean, Kenco, Lincoln, Linjo, Longhorn, Lucky Four, Marvello, Mayhams, Mecca, Miracle, Moon, Motif, Motown, Nashboro, Neptune, N-Joy, Orbit, Peacock, Petal, Presta, Prima, RSVP, Rae-Cox, Ram, Rebel, Reno-Smiley, Robbins, Rondoleff, Sabine, Sabre, Sage, Sand, Serand, Shalamar, Shee, Sylvania, Sims, Spirit, Starday, Tamla, Tampa, Taylor, Twilight, Vanity, Variety, Vita, Wagner, Wedge, Wells-DeSett, Westport.
- **INDIANAPOLIS (Area Code 317)**
 Associated, 210 S. Meridian St. Tel: ME 4-2591. Mgr.: Lynne D. Jenks; Promo.: Robert Lay.
 Labels: RCA Victor, RCA Camden, Disneyland, Vista, Starday, 20th-Fox, Audio Fidelity, Vox, Living Language.
 Tape, Cartridge: RCA, ITCC.
 Tape, Reel-to-Reel: RCA Victor, Camden.
 Tape Playback Equip.: RCA Victor.

continued on page 88

NATIONAL TAPE DISTRIBUTORS

A COAST-TO-COAST HEADQUARTERS FOR SUPPLYING
YOUR EVERY TAPE AND PLAYBACK EQUIPMENT NEED FOR

CAR • HOME • BOAT • AIRPLANE



NATIONAL TAPE DISTRIBUTORS stock a complete selection of 4 and 8-track stereo cartridges, reel-to-reel and raw tape.

America's popular labels by the World's Greatest Artists.

**NATIONAL TAPE DISTRIBUTORS
PROVEN MERCHANDISING
PROGRAM INSURES EXTRA
PROFITABLE OPERATION**

*We'll Show You How to Get:
MAXIMUM TURNOVER WITH
A MINIMUM INVENTORY.*



Other features of National Tape Distributors merchandising service include:

- Personal service • Modern store fixtures and point of sale displays • Proper selection of tapes • Inventory and unit control • Packaging and pricing • 100% exchange . . . no obsolescence • Special promotions.

GET THE FULL STORY TODAY. CALL HOME OFFICE FOR YOUR NEAREST FEEDER DISTRIBUTION POINTS.

Cecil Steen
EASTERN TAPE
DISTRIBUTORS
30 Nashua St.
Woburn, Mass.
Phone (617) 933-6290

Jim Tiedjens
MIDWESTERN TAPE
DISTRIBUTORS, INC.
Box #714
5401 W. State St.
Milwaukee, Wis. 53208
Phone (414) 453-6210

Michael Daniels
WESTERN TAPE
DISTRIBUTORS, INC.
2160 Palou
San Francisco, Calif.
Phone (415) 285-2131

continued

IOWA

• DES MOINES (Area Code 515)

Jather, 515 E. Locust. Zip: 50309. Tel: 244-5157. Mgr.: John Pittman.

Branches: Minneapolis, Minn.; Omaha, Neb. Labels: A&M, Almo, Ascot, Blue Note, Chart, Conversaphone, Federal, Fidelity Sound, Hickory, Jamie, King, Living Language, Longhorn, Musicor, Specialty, Starday, Summit, Sum, Tom Lehrer, United Artists Young People's Recs. Musical Accessories: Astatic Needles, Carrying Cases.

Mid American, 1630 Locust. Tel: 288-0182. Sales Mgr.: Don Cooper.

Labels: Blue Note, Blue Rock, Bluesville, Cumberland, Dooto, Dore, Era, Fontana, International, Joy, Jubilee, King, Limelight, Little Golden, Living Language, Mercury, Monument, Moodsville, Philips, Prestige, Reprise, Smash, Somerset, Starday, Swingsville, Tru-Sound, Valiant, Warner Bros., Word.

KANSAS

• HAYS (Area Code 913)

Hays Music, 710-12 Main St. Tel: MA 4-341B.

• KANSAS CITY (Area Code 913)

R C A Victor, Fairfax & Funston Rds. Tel: AT 1-3075. VP: M. E. Kramer. Distributes: RCA Product.

• PARSONS (Area Code 316)

Music Center, 2500 Grand Ave. Zip: 67357. Tel: GA 1-2782. Owners: Mr. & Mrs. H. A. Stephens. Label: Redstart.

• WICHITA (Area Code 316)

Pioneer, 2955 S. Kansas. Zip: 67201. Tel: LY 1-3414. Label: Columbia.

KENTUCKY

• LOUISVILLE (Area Code 502)

Handleman, 4500 Louisville Ave. Tel: 361-1336. Contact: J. Powers.

Tape, Cartridge: RCA Stereo B.

Kings Rec. Supply, 240 W. Jefferson. Tel: 584-5535. Owner: Gene King.

• NICHOLASVILLE (Area Code 606)

D & G Rec. Mart, PO Box 102, North Main. Zip: 40536. Tel: 252-2155. Owner: Dudley Bonds.

• RACELAND (Area Code 606)

Reed Printing & Advertising, 546 Pond Run Rd. Zip: 41169. Tel: 836-5541. Mgr.: David Mark Reed.

Tape, Reel-to-Reel: Radio broadcast tapes from around the world.

LOUISIANA

• NEW ORLEANS (Area Code 504)

All South, 1924 Lafayette St. Zip: 70113. Tel: 525-6124. Owner and Pres.: Henry J. Hildebrand Jr.; Promo.: Stanley Chaisson.

Labels: ABC-Paramount, A&M, After Hours, Amy, Arctic, Ascot, Audio Fidelity, Backbeat, Bell, Best, Boom, Briar, Caedmon, Cam, Canadian American, Chancellor, Challenge, Childcraft, Colpix, Command, Congress, Cumberland, DCP, Diamond, Dimension, Dolton, Dooto, Duke, Dunhill, Emarcy, Entertainment, Era, Excello, Fontana, Four Corners, Garpax, Gateway, Golden, London Group, Guyden, Ha-Ha, Half & Half, Hi, Hilltop, Hob, Impulse, Instant Learning, Jamie, Jerden, Jin, Joy, Kapp, King, La Louisianne, Lanor, Laughtime, Liberty, Lime-light, London American, Mace, Mala, Mercury, Monument, Motown, Musicor, Music Guild, Nashboro, Norman, Okeh, Oliver, Original Sound, Palomar, Parrot, Peacock, Philles, Pic, Press, Pricewise, Reprise, Riot, Scepter,

Scripture, Simco, Sing, Skylite, Smash, Songs of Faith, Sonora, Sound Stage, Spark, Storyteller, Storytime, Sunset, Swallow, Tamla, Tangerine, Teardrop, United Artists, Valiant, Vanguard, Wallis, Wand, Warner Bros., Warwick, Westminster, White Whale, Wing.

Tape, Cartridge: Mercury, Limelight, Smash, Philips, A & M, Cadet, MGM, Tamla, Motown, Gordy, Soul.

Tape, Reel-to-Reel: Command, Audio Fidelity, ABC, Impulse.

Tape Playback Equip.: Mercury.

Musical Instruments: Kingston Guitars.

Columbia, John Hancock Bldg., St. Charles Ave. at Lee Circle. Zip: 70130. Tel: 524-4546. Sales Mgr.: Bill Shaler; Promo. Mgr.: Donald Burt. Distributes: Columbia Product.

Decca, 517 Canal St. Zip: 70130. Tel: JA 2-1786. VP & Mgr.: R. N. McCormick.

Labels: Decca, Coral, Brunswick, Vocalion, London, Richmond, Elektra, Listen & Learn. Distributes: Other Decca Product.

DELTA, 1023 Baronne St. Zip: 70130. Tel: 525-7104. Contact: Mgr.: Ed Walker.

Labels: Accent, Archive, Atco, Atlantic, Autumn, Bang, Big Top, Blue Note, Boone Brook-lyn, BT Puppy, Buena Vista, Cadet (formerly Argo), Calla, Cameo, Carla, Charger, Checker, Chess, Chess Sermon, Clarion, Co & Ce, Constellation, Contemporary, Custom, DGG, Destination, Dial, Dictation Disc, Disneyland, Dixieland Jubilee, Dunwich, Duo Disc, Dyno-Voice, Ember, Everest, Fabor, Fame, Fat Fish, Fraternity, GNP, Goldwax, Good Time Jazz, Gordy, Gospel, Groovy, Gross, Hanna-Barbera, Happy Jazz, Heliodor, Hickory, HiFi, Imperial, Jewel, Joda, Josie, Jubilee, Kent, Laurie, Le-grand, Life, Living Language, Mainstream, Maxx, Michelle, Minit, Mirwood, Modern, Money, Moonglow, Moonshot, Movietone, Mustang, Musicland, New Jazz, Old Town, Pacific Jazz, Charlie Parker, Parkway, Paula, Philips, Port, Prestige, Pure Soul, Red Bird, Regent, Sansu, Savoy, Sentaur, Sims, Soma, Soul, Specialty, Sphere Sound, Stax, Stereoditties, Sue, Sun, Surrey, Symbol, Thomas, Time, Tower, Tuba, Tuff, 20th-Fox, USA, Vault, Village Gate, Volt, Windy C, Whit, World Pacific (SEE ADVERTISEMENT)



ED WALKER, Gen. Mgr.
BOB SPENDLOVE, Asst. Mgr.

1023 BARONNE ST., NEW ORLEANS, LA. 70130. TELEPHONE (504) 525-7104.

Dot, 605 Baronne St. Tel: 522-3661. Mgr.: Jim Flattman; Promo.: Eric B. Kiefer.
 Labels: Dot, Hamilton, MGM, Metro, Verve.
 McDonald Sales, 5500 Jefferson Hwy. Zip: 70123.
 Tel: 733-6653. Mgr.: Milton Munch.
 Distributes: RCA Victor Product.

NEW ORLEANS, 748 Camp St. Tel: 529-2367. Contact: Bob Robbins.
 Labels: AAA (Tri A), ABS, Alto, Angeltone, DeeSu, Dover, Eight-Ball, El-Tee, Faro, Frisco, Linda, Manhattan, Nola, Pitter-Pat, Rampart, Tailgate, Tonik, Virgil, White Cliffs. (SEE ADVERTISEMENT)

• **RUSTON (Area Code 318)**

Lawson, 707-713 W. California. Tel: 255-0286.
 Tape: Cartridge: ITCC 8 Track.

• **SHREVEPORT (Area Code 318)**

Stan's Rec. Serv., 728 Texas St. Zip: 71102. Tel: 422-7182. Pres.: Stan Lewis.

Labels: ABC-Paramount, A&M, Abnak, Ace, Alamo, Alon, Amy, Ara, Argo, Arlen, Ascot, Astro, Atco, Atlantic, Aura, Autumn, BT Puppy, Backbeat, Blackwood, Blue Cat, Bofuz, Buena Vista, Cadet, Cajun, Calla, Cameo, Canadian American, Caprice, Carlton, Carnival, Celeste, Challenge, Charger, Checker, Chess, Circa, Circle, Coed, Coleman, Congress, Crazy Cajun, Crown, Crusader, D, DCP, Dart, Del-Fi, Del-Mar, Delsey, Derby, Dial, Diamond, Dimension, Diplomat, Disneyland, Dooto, Dore, D-Town, Duke, Duo-Disc, Eldo, End, Enjoy, Era, Everest, Excello, Fabor, Fame, Fantasy, Fernwood, Flip, Fraternity, Frolic, Galaxy, Goldband, Golden Crest, Golden World, Gordy, Guest Star, Guyden, Hall, Hanna-Barbera, Heritage, Hermitage, Hickory, Hi-Fi, Impala, Imperial, Interphon, Jamie, Jay Gee, Jet Star, Jet Stream, Jewel, Jin, Josie, Jovial, Joy, KT, Kent, LG, LK, La Louisianne, Lanor, Laurie, Lecam, Legend, Lyric, MGM, Mala, Marc, Michelle, Minaret, Modern, Money, Montel, Moonglow, Motown, Murco, Musicor, Mutual, Nashboro, N-Joy, Old Town, One-Derful, Original Sound, Parkway, Paula, Peacock, Philips, Philles, Prestige, Princess, RBE, Rik, Red Bird, Regina, Riverside, Rod, Ron, Rotate, Roulette, Rust, Sabra, Sand, Santo, Sar, Savoy, Scepter, Select, Shirley, Sims, Soma, Specialty, Spector, Stacy, Starday,

Stax, Sue, Sun, Swallow, Swan, Swinging, Tally, Tamla, Tangerine, Teardrop, Tollie, Town House, Tri-Fi, Tuff, 20th-Fox, Ty-Tex, Typhoon, UA, USA, Vault, Vee Jay, Verve, Vivid, Volt, Wand, Wax, Whit, World Artists, World Pacific.

• **VILLE PLATTE (Area Code 318)**

Floyd's Rec. Shop, PO Box 506. Tel: 363-2138.
 Owner: Floyd Soileau.
 Labels: Almo, Bayou, Chamo, Ciro, Dooto, Hall, Hub-City, Index, Jin, LK, La Louisianne, Lanor, Lyric, Michelle, Peter Pan, Pic-1, Princess, Shane, Sound of Nashville, Swallow, Teardrop, Viking.

MAINE

• **PORTLAND (Area Code 207)**

Commercial, 50 Diamond St. Zip: 04101. Tel: 775-5644. Mgr.: Louis W. Spear.
 Distributes: RCA Victor Product.
 Portland Rec. (sub. of Boyd Corp.), 84 W. Cove St. Tel: 772-6551. Gen. Mgr.: Mr. Rice.
 Tape, Cartridge: ITCC.
 Tape Playback Equip.: Lear Jet Stereo 8.

MARYLAND

• **BALTIMORE (Area Code 301)**

Capitol, 6910 Harford Rd. Tel: HI 4-6030. Mgr.: Bill Dawson. District Promo. Mgr.: Bill Turner; Regional Singles Promo.: Bill Jamison.
 Distributes: Capitol & Angel Product.
 D & H, 2025 Worcester St. Zip: 21230. Tel: SA 7-5100. Mgr.: Lester Pyle.
 Distributes: RCA Victor Product.
 Decca, 2921 Alexander Ave. Zip: 21215. Tel: FO 7-0710. Mgr.: Ed Keelan.
 Labels: Decca, Coral, Brunswick, Listen & Learn, Vocalion.
 Distributes: Other Decca Product.

THE
 INTERNATIONAL
 INFLUENCE
 OF
**BILLBOARD
 GROWS
 AND
 GROWS**

(Putting the NEW in NEW ORLEANS RECORD Industry!)

NEW ORLEANS DISTRIBUTING CO., INC.

748 Camp St. New Orleans, La. 70130
 504-523-7474

(Where the HITS get a head start in the Gulf South)

continued

GENERAL, 2329 Pennsylvania Ave. Tel: 669-6411.

Pres.: Henry Nathanson.

Labels: Arctic, Del-Fi, Diamond, Dore, Dot, Era, Excello, Fleetwood, Gateway, Gospel, Guyden, Hamilton, Hob, Impact, Jamie, Kent, King, M-Pac, Mace, Mobile Fidelity, Modern, Nashboro, Nola, Old Town, One-Derful, Prestige, Red Bird, Satellite, Savoy, Scepter, Status, Sun, Wand, Word. (SEE ADVERTISEMENT)

Marnel of Maryland, 5550 Newbury St. Tel: 664-8500.

Pres.: Stan Hoffman; Mgr.: George Pappafotis. Promo.: Jimmy Gordon.

Labels: Backbeat, Caedmon, Camelot, Classical, DCP, Duke, Epic, Excel, Four Bros., Golden, Kellmac, Laurie, Legrand, Living Language, Mainstream, Mike, Minuteman, Nebs, Okeh, One-Derful, Peacock, Rik, Rust, Sahara, Swan, TMP-ting, 20th-Fox, Young People's Recs.

Marshall/Mangold, 4805 Nelson Ave. Zip: 21215.

Tel: 542-7214. Mgr.: Manny Goldberg; Promo.: Fred Lewis.

Labels: Amy, Co & Ce, Colpix, Counterpoint, Disneyland, Esoteric, Everest, Fantasy, Heartwarming, Hickory, Mala, Music Minus One, Philles, Specialty, Time, Vista.

Musical Instruments: Guitars, Tambourines.

Musical Sales, 134 W. Mt. Royal Ave. Zip: 21201.

Tel: 837-5757. Pres.: Milt Bereson; Mgr.: Howard (Chic) Silvers.

Labels: Tower, Fiesta, Dance Along, Blue Cat, Joda, Jomada, Jocida, Boone, Carnival, Grecophon, Uptown, Dearborn, Wynwood, HiFi, Life, Tuba, Groovy, Avin, Webcore, Tradition.

SCHWARTZ BROS., 2146 24 Pl., Washington, D. C.

Baltimore Tel: 727-0641. Pres.: James Schwartz. (See District of Columbia for lines handled.) (SEE ADVERTISEMENT)

S-Y-R, 3123 W. North Ave. Zip: 21216. Tel: LO 6-5400.

Pres.: Ernie Burston; Promo. & Sales: Jimmy Burston.

Labels: Alto, Big Wheel, Black Hawk, Candi, City, D-Town, Deliverance, Fortune, Ge-Ge, Gospel, Jameco, Marhap, Marseilles, Nitown, St. Lawrence, Strike, Sylvia, Thomas, Turntable, Viney, Wheelsville.

Jos. M. Zamoiski, 1101 De Soto Rd. Zip: 21223.

Tel: MI 4-2900. Mgrs.: Maury Bass & Jerry Friedman; Promo. Men: John Armetta, Joe Bilello, Earl Rollison.

Labels: ABC-Paramount, Audio Fidelity, Blue Rock, Boom, Command, Cameo-Parkway, Coliseum, Cumberland, Childcraft, Dooto, Dunhill, Fontana, Grand Award, Hi, Impulse, Jerden, Leo the Lion, Lighthouse, London, Mercury, Metro, MGM, Music Guild, New Breed, Kama Sutra, Philips, Press, Richmond, Smash, Tangerine, Westminster, Wing.

Tape, Reel-to-Reel: Command, London, ABC-Paramount.

• **CHEVERLY (Area Code 202)**

Southern Whslers., 2500 Schuster Dr. Zip: 20781.

Zip: 322-3500. Mgr.: George Nesline; Promo.: Nat La Patin.

Distributes: RCA Victor Product.

• **SILVER SPRING (Area Code 301)**

L & M Rec. Assocs., 1035 Quebec Terr., Suite 2.

Zip: 20903. Pres.: Lester L. Friedman. Labels: Delta Int'l, Empire, Gaslight, Impress, Liam, Orange, Quint, Stacey, Vanguard.

MASSACHUSETTS

• **BOSTON (Area Code 617)**

Bay State, 1030 Tremont St. Zip: 02120. Tel: GA 7-5060. Pres.: Bob Levinson; Promo.: Bob Paro.

Labels: Atlantic, Bang, Caedmon, Cameo, Chess, Colonial, Dore, Duke, Elektra, Era, Fantasy, Galaxy, Mace, Music Minus One, Nonesuch, Philles, Parkway, Pathways of Sound, Peacock, Regent, Savoy, Scepter, Specialty, Stax, Standard, Starday, Vault, Wand.

Capitol, 71 Fourth Ave. Tel: HI 9-0770. Contact: Martti Takki.

Distributes: Capitol & Angel Product.

Columbia, John Hancock Bldg., 75 Third Ave., Waltham. Zip: 02154. Tel: 899-3814. Sales

Mgr.: George Ryan; Promo. Mgr.: Roy Mallomo.

Distributes: Columbia Product.

Decca, 138 Ipswich St. Zip: 02215. Tel: CO 6-5110.

Mgr.: Allan Ross; Promo.: Elgin Waters.

Labels: Brunswick, Coral, Decca, Listen & Learn, Vocalion.

Distributes: Other Decca Product.

Disc, 1136 Columbus Ave. Tel: 445-3550. Pres.: Jack Sager.

Labels: Boone, Broadway, Cookin', Crackerjack, Eastern, Enjoy, Everlast, Golden World, Gordy, Joda, Joe Jones, Lawn, Maltese, Mar-V-Lus, Mel-o-dy, Mira, Mirwood, Motown, M-Pac, One-Derful, Ric-Tic, St. Lawrence, Shrine, Soul, Sue, Swan, Symbol, Tamla, VIP, Vest, WinGate, World.

Tape, Cartridge: Tamla, Motown, Gordy, Soul.

Dumont, 1040 Tremont St. Zip: 02120. Tel: 442-0800.

Pres.: Donald Dumont; Sales Mgr.: Howard Ring; Promo.: Jerry Brenner.

Labels: Atco, Volt, Moonglow, Brook-lyn, Alector, Avoca, Bert & I, Gold Star, Blue Note, Cadet (Argo), Checker, Canadian American, Cambridge, Challenge, Clarion, Colpix, Co & Ce, Command, Grand Award, Columbus, Minuteman, Copley, Gael, Diamond, Epic, Okeh, Esp, Fiesta, Grecophon, Virgo, Europa, Fraternity, Golden, Jamie, Jubilee, Josie, BT Puppy, King, Bethlehem, Living Language, Young People's Recs., Mainstream, Time, Original Sound, Old Town, Pacific Jazz, World Pacific, Aura, Prestige, Red Bird, Blue Cat, Roulette, Roost, Squire, Tico, End, FM, Kenwood, Soma, Stereoddities, Somerset, TCF, Vee Jay, Sentaur, USA.

Tape, Reel-to-Reel: Epic, Command.

Eastern, 620 Memorial Dr., Cambridge. Tel: TR 6-4720. Sales Mgr.: A. J. Shuffer.

Distributes: RCA Victor Product.

Massachusetts Rec., 1820 Washington St. Zip: 02118. Tel: 442-3830. Pres.: Fred LeBlanc;

Gen. Mgr.: Skippy White.

Labels: Arock, Amanda, Bluestown, Casa Grande, Candlelight, Carnival, Crash, Constellation, Crown, Custom, Ditto, D-Town, Excello, Exodus, Fortune, Glowstar, Hurd, Hi-Way, Janlene, Jewel, Kent, London House, Mello, Modern, Nashboro, Oldies 45, Old Gold, Paula, Pow, Relic, Rim, Rivoli, Sahara, Score, Silver Cross, Stop, Times Square, Whit, Wild.

Music Supplier, 75 N. Beacon St. Zip: 02134. Tel: 254-1780.

Pres.: Harry Carter; VP: Gordon Dinerstein; Promo. Men: Paul Maged & Frank Falanga.

HERE'S THE SECRET TO OUR SUCCESS

Nineteen years a leading distributor in Washington, D. C.; Baltimore, Maryland, Virginia and West Virginia.

**DYNAMIC PROMOTION
AGGRESSIVE
MERCHANDISING**

Why not let the leader move your label.



General  **DISTRIBUTING CO., INC.**
HENRY NATHANSON, PRES.
2329 PENNSYLVANIA AVE. BALTIMORE 17, MD. NO. 9-6411

WE HUSTLE*

*That's because we're New England's newest and most aggressive record distributor.

WANT MORE HUSTLE ON YOUR LINE?

MASS. RECORD DISTRIBUTORS

"The distributor with soul"

1820 Washington Street, Boston, Mass. 02118
Call Skippy White at (617) 442-3830

Promotion: Bob McAlpine

Sales: Arthur Hartling

Labels: ABC-Paramount, Audio Fidelity, Boom, Deutsche-Grammophon, Dunhill, Impulse, Kapp, Laurie, MGM, Reprise, Vanguard, Verve, Vox, Warner Bros., Westminster.

Mutual, 157 Washington St., Dorchester. Zip: 02121.
Tel: 288-5700. Mgr.: Frank Heland; Promo. Men: Dave Marshall & Bruce Hatch.
Affiliates: Har, Los Angeles, Calif.—C&C Stone, San Francisco, Calif.—Cleve-Disc, Cleveland, Ohio. (SEE ADVERTISEMENT)

Labels: Academy, Amy, Artia/Parliament, Ascot, Constellation, Crusader, DCP, Disneyland, Dolton, GNP Crescendo, Hanna-Barbera, Hi, Hickory, Hill Top, IPG, Imperial, JJC, Joy, Kent, LTD, Liberty, London, London Group, Loren, Mala, Mobile Fidelity, Monument, Musicor, Mustang, Phelps, Pickwick/33, RIC, Rheims, Richmond, Sound Stage 7, Tower, 20th-Fox, Twirl, Valiant, Vista, White Whale.
Tape, Cartridge: ITCC.
Tape, Reel-to-Reel: London.
Musical Instruments: Hohner Harmonicas, Guinars.

Riverboat Ents., 12 Noyes Pl. Zip: 02113. Tel: 227-9891. Pres.: Ralph Dopmeyer.
Labels: Audiophile, Blues Classics, Cavalier, County, Delmark, Euphonic, Faier, Folk-Lyric, Folk Promotions, Historical, Icon, Melodeon, Nobility, Old-Timey, Origin Jazz, Portents, Southland, Spivey, Takoma, Testament.

Royal, 17-19 Chadwick St. Zip: 02119. Tel: 445-1411. Pres: Aaron Gross.
Labels: Artia, Parliament, Crown, Custom, Forum, Panda.

• **CHICOPEE FALLS (Area Code 413)**
Columbia, 54 Second Ave., Massachusetts Ind'l Pk. Zip: 01013. Tel: 592-5141. Regional Sales Mgr. (Boston, Hartford, Syracuse): Joseph Broderick.
Distributes: Columbia Product.

• **WOBURN (Area Code 617)**
Recordwagon, 30 Nashua St. Tel: 933-6263. Contact: C. Steen.
Tape, Cartridge: RCA Stereo 8.

Palmer, Panik, Philips, Pickwick/33, Regina, Safice, Simpson, Smash, Soma, Somerset, Stax, Stereo Fidelity, Stereo Motion, Stereoditties, Story Teller, Sue, Symbol, Tower, VSP, Vanguard, Vee Jay, Verve, Verve/Folkways, Wing. **Tape, Cartridge:** Mercury, Philips, Smash, GRT. **Tape Playback Equip.:** Mercury.
Musical Accessories: Recoton Needles.

MERIT MUSIC, 15761 Wyoming Ave. Zip: 48238.
Tel: UN 3-9119. Mgr.: John H. Schlee; Promo. Men: Gene Silverman & Al Di Noble.
Labels: A & M, Adventure, Amphora, Amy, Bell, Cadence, Colonial, Constellation, Custom, Dance Along, Dearborn, DynoVoice, Flashback, Fraternity, Golden World, Gordy, Harvey, Hickory, Mala, Maxx, Mel-o-dy, Mira, Miracle, Mirwood, Modern, Money, Monument, Musicland, Music Minus One, New Voice, Pan, Request, Ric-Tic, Sound Stage 7, Sphere, Standard, Steno-Disc, Sunglow, Surrey, Tamla, TCF, Turnabout, VIP, Valiant, Vox, White Whale, WinGate.
Tape, Cartridge: Tamla, Gordy, Motown, Soul. **Tape, Reel-to-Reel:** Ampex. (SEE ADVERTISEMENT)

Merle, 15365 Livernois. Tel: 342-8777. Pres.: Merle Schneider.
Labels: Battle, Blue Note, Coronet, Cosmo, Crown, Design, Diplomat, ESP-Disc, Golden, Gospel Corner, Grand Prix, Guest Star, Harmony, Palace, Peter Pan, Pickwick/33, Proverb, Riverside, Simon Says, Time, Wonderland.

Michigan Mobile Radio, 20232 Livernois Ave. Zip: 48221. Tel: 863-7163. Pres.: Jack Frankford.
Tape, Cartridge: Motown, Muntz Stereo Pak, ITCC, Mercury.
Tape Playback Equip.: Muntz.

MUSIC MERCHANTS, 3731 Woodward Ave. Zip: 48201. Tel: TE 2-0870. Gen. Mgr.: Marvin M. Jacobs; Sales Mgr.: Joe Goleski; Promo. Mgr.: Ed Berson; Promo.: Al Valente.
Labels: Argo, Atco, Blue Cat, Caedmon, Carla, Checker, Chess, Colpix, Con-Lo, DCP, Dana, Dimension, Dunwich, Enjoy, Epic, Era, Everest, Faber, Fantasy, Folkways, Gateway, Jewel, Josie, Jubilee, Karen, Life, Limelight, Mainstream, Moonglow, Okeh, Old Town, One-Derful, Port, Prestige, Red Bird, St. Lawrence, Satellite, Sentaur, Tuba, USA, Veep, Volt. (SEE ADVERTISEMENT)

RCA Victor, 7400 Intervale Ave. Zip: 48238. Tel: TE 4-3500. VP: Reid Donaldson.
Distributes: RCA Victor Product.

Radio, 15-470 Schaefer Hwy. Zip: 48227. Tel: 273-6740. Mgr.: George MacDuff.
Labels: London, Richmond, Coliseum, Press, Palomar, Audio Book.
Musical Accessories: Amberg Carrying Cases, Astatic Cartridges, Cascraft Carrying Cases, Chicago Album Storage Albums, Cohoes Green Stock Envelopes, All 45 rpm Spindles, Duotone Blank Recording Discs, Fidelitone Needles, Genuine Diamond Needles, LeBo Products, Lu-Van Record Cabinets, 3M Blank Tape, Prevue Racks & Stands, Robins Phono & Tape Accessories, Rotographic LP Savers, Seebro Racks & Cass, Shelfmaker Platter-Poles, Walco Staticlean and Wall Racks & Stands.

Record Dis. Corp. of Mich., 14344 Fenkell Ave. Tel: 335-3790. Mgr.: Armen Boladian.
Labels: Arctic, Backbeat, Conversaphone, Duke, Elektra, Eurotone, Exello, Gospel, Hob, Linda, Mace, Nashboro, Nina, Nonesuch, Peacock, Rampart, Regent, Ring, Savoy, Scepter, Sharp, Songbird, Sureshot, Thelma, Wand, Wild Dece, World Wide.

Rissi Electronic Supply, 14405 Wyoming Ave. Branch: Grand Rapids, Radio Electronic Supply.
Tape, Cartridge: ITCC.
Tape Playback Equip.: Lear Jet Stereo 8.

• **GRAND RAPIDS (Area Code 616)**
Radio Electronic Supply, 505 Jefferson Ave. S.E. Branch: Detroit, Rissi Electronic Supply.
Tape, Cartridge: ITCC.
Tape Playback Equip.: Lear Jet Stereo 8.

• **KALAMAZOO (Area Code 616)**
Laval, 821 Porter St. Tel: FL 2-1936. Pres.: Vic La Var.
Labels: Adell, Anika, Ballad, Bay Tone, Ball, Boss, Cardinal, Danae, Gedinsons, Gospel, La Val, Luck, Regal, Skylight, Pammar.

• **NEW HAVEN (Area Code 313)**
Music City, 56880 North Ave. Tel: 749-5182. Pres.: W. Howard Walker.
Labels: Cracked, Keepsake, Sound, Trash, Walker.

MICHIGAN

• **DETROIT (Area Code 313)**
Arc, 13415 Lyndon. Tel: BR 2-4872. Mgr.: Henry Droz.
Labels: ABC-Paramount, Audio Fidelity, Calla, Cameo, Chancellor, Coed, Command, Congress, Crescendo, Diamond, End, Enterprise, Fiesta, Gone, Grand Award, Guymen, Hi, Imperial, Impulse, Jamie, Jay Jay, Kapp, King, Laurie, Legrand, Living Language, Loma, London Group, Music Guild, Musicor, Motown, Oliver, Original Sound, Parkway, Parrot, Philles, RIC, Reprise, Roulette, Rust, Soul, Starday, Swan, Tangerine, Tollie, 20th-Fox, Warner Bros., Westminster.

Cadet, 13380 Capital Ave., Oak Park. Zip: 48237. Tel: 548-3171. Pres.: Harry Levin. Promo.: Leo Cheslak.
Labels: Aura, Avant Garde, Budapest, Challenge, Chattanooga, Contemporary, Dee Gee, Derry, Disneyland, Dolton, Dooto, Drummond, Freepport, Good Time Jazz, Hanna-Barbera, Liberty, Monitor, Pacific Jazz, SVR, Specialty, Star, Sun, Sunset, Universe, Vista, World Pacific.

Capitol, 18921 Wyoming Ave. Tel: UN 4-5001. Opts. Mgr.: Hersey Bryant.
Distributes: Angel & Capitol Product.
Musical Instruments: Hohner Harmonicas, Capitol Stereo Phonographs.

Columbia, 16141 W. Eight Mile Rd. Zip: 48235. Tel: 273-8616. Sales Mgr.: Larry Owens; Promo. Mgr.: Russ Yerge.
Distributes: Columbia Product.

Decca, 12730 Puritan. Zip: 48227. Tel: 341-6040. Mgr.: Mario De Filippo; Promo.: Pete Gidion.
Labels: Decca, Coral, Brunswick, Vocalion, Listen & Learn.
Distributes: Other Decca Product.

Handleman, 670 E. Woodbridge St. Zip: 48226. Tel: 961-9565. Contact: D. Strome.
Tape, Cartridge: RCA Stereo 8.

Jay-Kay, 13401 Lyndon Ave. Zip: 48227. Tel: BR 3-7000. Gen. Mgr.: John S. Kaplan; Sales & Promo. Mgr.: Tom Schlesinger; Promo. Men: Larry Benjamin, Rick Drapkin, Bob Hankins & Cliff Gorov.
Labels: ARA, Ashley, Atlantic, Audio-Spectrum, Bang, Clarion, Cumberland, Dial, Dot, Eastern, Everyman, Focus, Fontana, Garrett, Golden Ring, Hamilton, Heliodor, Hilltop, Kama Sutra, Kent, Leo the Lion, MGM, Mercury, Metro,



**We Are From Detroit
We Are Now 4 Years Old
We Are Now Representing:**

A&M • ALMO • AMY-MALA-BELL • COLONIAL •
CONSTELLATION • DEARBORN • DYNVOICE • EXODUS • GOLDEN WORLD • GORDY
• HICKORY • MIRA • MODERN MONUMENT • MUSIC MINUS ONE • NEW VOICE •
REQUEST • RIC-TIC • TAMLA • TCF • VALIANT • VIP • WHITE WHALE • WINGATE

WON'T YOU JOIN US!
NEXT YEAR WE WILL BE 5 YEARS OLD

MERIT MUSIC DISTRIBUTORS, INC.

15761 Wyoming Avenue Detroit 38, Michigan (313) UN 3-9119

The Fanfare is for . . . Our Sixth Anniversary

music merchants, inc.

3731 Woodward Ave., Detroit 1, Mich. TE 2-0870



WE BREAK RECORDS
(sometimes just for fun)
WE MOVE PRODUCT
(the way it should be done)

Marvin M. Jacobs Pres. and Gen. Mgr.	Joe Goleski Sales Mgr.	Edward Berson Promo. Mgr.
--	----------------------------------	-------------------------------------

continued

MINNESOTA

• MINNEAPOLIS (Area Code 612)

Columbia, 9220 James Ave. S. Zip: 55431. Tel: 888-9551. Sales Mgr.: Mert Paul; Promo. Mgr.: Ronald D. Lynne.

Distributes: Columbia Product.

Decca, 17-19 E. Hennepin Ave. Zip: 55401. Tel: FE 5-7681. Mgr.: Ozzie Lowe.

Distributes: Decca Product.

F. C. Hayer, 250 Third Ave. N. Zip: 55401. Tel: 339-0201. Mgr.: Arthur R. Patch.

Distributes: RCA Victor Product.

Heilicher Bros., 7600 Wayzata Blvd. Zip: 55426. Tel: 544-4201. Pres.: Amos Heilicher; VP: Dan Heilicher.

Labels: ABC-Paramount, Academy, Accent, Amy, Arwin, Atco, Atlantic, Audio Fidelity, Audio-ophile, Audio-Spectrum, Aura, Aurora, Backbeat, Bell, Big Hill, Boom, BT Puppy, Cadet, Caedmon, Canadian American, Carla, Challenge, Charger, Checker, Chess, Childcraft, Co & Ce, Colonial, Colpix, Command Concert Disc, Constellation, Counterpoint, Crescendo, Crestview, Crusader, Cumberland, Dial, Diamond, Disneyland, Dolton, Dore, Drum Boy, Duke, Dunhill, Dunwich, DynoVoice, Elektra, Emarcy, Epic, Era, Everest, Excello, Fame, Fiesta, Focus, Folkways, Fontana, GNP, Gateway, Golden, Golden Crest, Golden Ring, Gordy, Gregmark, Hall, Hanna-Barbera, HiFi, Horizon, IRC, Imperial, Impulse, Interphon, Jay Jay, Jerden, Josie, Jubilee, Karate, Kenwood, Laurie, Liberty, Life, Limelight, Loma, Mainstream, Mala, Mercury, Minit, Mirwood, Mobile Fidelity, Money, Monogram, Moonglow, Motown, Musicland USA, Music Minus One, Mustang, New Voice, Nonesuch, Okeh, Original Sound, Pacific Jazz, Palmer, Paula, Period, Philips, Playcraft, Pricewise, Pure Soul, Rampart, Red Bird, Reprise, Riot, Rosemart, Scepter, Sentaur, Sermon, Sims, Smash, Soma, Somerset, Soul, Sphere, Sound, Standard, Stax, Stereoddities, Story Teller; Sue, Sun glow, Symbol, Tamla,

Time, Tollie, Triumph, 20th-Fox, Twirl, VIP, Vault, Vee Jay, Vista, Volt, Wand, Warner Bros., Westminster, White Whale, Wing, World Pacific.

Tape, Cartridge: All Lines.

Tape Playback Equip.: Voice of Music, Roberts, Lear-Jet.

Musical Instruments: String Instruments, Drums. Musical Accessories: Hohner Harmonicas, Sheet Music, Music Books, Miscellaneous Drum and String Accessories.

Jather, 730 Lyndale Ave. N. Zip: 55411. Tel: 374-3420. Mgr.: Jack Taylor. Promo.: Walter (Bud) Fritz.

Branches: Des Moines, Iowa; Omaha, Nebraska. Labels: A&M, Almo, Ascot, Blue Note, Chart, Conversaphone, Federal, Fidelity Sound, Hickory, Jamie, King, Living Language, Longhorn, Musicor Specialty, Starday, Sum, Summit, Tom Lehrer, United Artists, Young People's Recs. Musical Accessories: Astatic Needles, Carrying Cases.

Harold N. Lieberman, 257 Plymouth N., Zip: 55411. Tel: 332-7131. Mgr.: Allen Abrams; Promo. Men: John Knodie & Tommy Gee.

Labels: Bach Guild, Bang, Bear, Best, Chairman, Coliseum, Dot, Felsted, Folk Sing, Four Corners, Garpax, Golden World, Group, Hamilton, Heliodor, Hi, Kapp, Leo the Lion, London, Louis, MGM, MOC, Medway, Metro, Monument, Parkway, Parrot, Philles, Press, Richmond, Ric-Tic, Seville, Sierra, Sound Stage 7, SPQR, Swan, Telefunken, Tower, Tribe, VSP, Valiant, Vanguard, Verve, Verve/Folkways. Tape, Reel-to-Reel: Concord Aiwa. Tape Playback Equip.: Concord Aiwa. Musical Instruments: Guitars, Drums.

MISSOURI

• KANSAS CITY (Area Code 816)

Capitol, 701 E. Linwood. Tel: JE 1-0435. Dist. Sales Mgr.: John Swenson; Territory Mgr.: Kurt Orosz.

Distributes: Capitol & Angel Product.

Choice, 321 1/2 Southwest Blvd. Tel: HA 1-2540. Mgr.: Harold Hassler.

Labels: Boone, Chart, Down Home, ESP-Disc, Gateway, Golden World, Hickory, Hilltop, Jewel, Nola, Paula, RIC, Ric-Tic, Scepter, Simms, Sound of Nashville Group, Starday, Sun, Wand, Whit, WinGate.

Commercial Music, 3230 Roanoke Rd. Tel: JE 1-1317.

Decca, 2729 Gilham Rd. Zip: 64108. Tel: GR 1-4030. Mgr.: Carl Wayne.

Distributes: Decca Product.

• ST. LOUIS (Area Code 314)

Columbia, 2151 59 St. Zip: 63110. Tel: MI 7-5101. Sales Mgr.: Bob Van Metre; Promo. Mgr.: Eugene Denonovich.

Distributes: Columbia Product.

Commercial Music, 2721 Pine. Tel: JE 5-1515. Pres.: Bud Lampe.

Labels: Colpix, Contemporary, Conversaphone, Epic, Living Language, Mercury, Reprise, Roulette, Sun, Swan, UA, Warner Bros., World Pacific.

Decca, 1923 Delmar Blvd. Zip: 53103. Tel: CE 1-6600. Mgr.: Max Melton.

Distributes: Decca Product.

Dot, 2721 Pine. Tel: JE 3-8390.

Labels: Dot, Hamilton.

Dynamic Devices, 7831 Olive Blvd. Zip: 63130. Tel: PA 6-1081. Pres.: Mort Ross.

Distributes: Tape Cartridge, 4 & 8 track; Reel-to-Reel Tape & Playback equip.

Europa Ctr. (see Mayer Ents.).

Interstate Supply, 1153 Gustine Ave. Zip: 63116. Tel: B32-6000. Mgr.: R. N. Decker.

Distributes: RCA Victor Product.

Liberty, 1905 Washington Ave. Zip: 63103. Tel: GA 1-3326. Mgr.: James Saltzman; Promo.: Don Miller.

Distributes: Liberty Product.

Mayer Ents. & Europa Ctr., 5031 Gravois. Zip: 63116. Tel: VE 2-9659. Mgr.: Anton Mayer. Labels: Ariola, Baccarola, Brilliant, Gloria, Polydor, Telefunken.

Mid-State, 2549 Sullivan. Tel: GA 1-6878.

Labels: ABC-Paramount, Boom, Impulse, Oliver, Simon Says, Tangerine.

Mr. Manufacturer

When it Comes to Your Records

O-O-O-O-O-O-O-O-O

Do We Worry

WENDY DISTRIBUTORS

37 WILLIAM ST., NEWARK, N. J. 07102

Jerry Winston, Pres. (201) 623-5845

CELEBRATING 1st ANNIVERSARY

DISTRIBUTING IN THE

MARYLAND, WASHINGTON, D. C., VIRGINIA and
W. VIRGINIA AREAS

Y-R-S DISTRIBUTORS, INC.

3123 W. North Avenue

Baltimore, Md. 21216

Ernie Burston—Pres.

Jimmy Burston—Promotion & Sales

(301) LO 6-5400/01

DEALERS! CALL US FOR ANYTHING IN
4 TRACK & 8 TRACK

AUTO STEREO

- All Famous Label TAPE CARTRIDGES
 - Largest Stock of TAPE PLAYERS in the East
 - Installation & Service
- 100% EXCHANGE PRIVILEGE
ON TAPES

J & J CORPORATION

232 So. Orange Ave., Newark, N. J. 07103
Phone (201) 642-6000

OVER 1.5 MILLION
CARTRIDGE PLAYERS
NOW IN USE!

... and the market is expanding daily. Don't miss your opportunity to share in the profits. TAPE TOWN franchises available

for details contact

TAPE TOWN

222 W. 37th Street, New York
Phone: 212-279-9777

Roberts, 1906 Washington Ave. Tel: MA 1-0470.
 Pres.: Robert Hausfater.
 Labels: Amy, Argo, Atlantic, Backbeat, Blue Note, Boone, Cadet, Cameo, Canadian American, Challenge, Checker, Chess, Co & Ce, Congress, Constellation, DGG, Disneyland, Dooto, Em-er, Era, Excello, Four Corners, Fraternity, GNP Crescendo, Golden, Hanna-Barbera, Herald, Hi, HiFi, Jamie, Jubilee, Kama Sutra, Kapp, King, Laurie, Legrand, Life, London, MGM, Mainstream, Mala, Metro, Mirwood, Modern, Monument, New Voice, Norman, Parkway, Parrot, Peacock, Prestige, Red Bird, Ric-Tic, Starday, Stax, Time, Tower, VSP, Vee Jay, Verve, Vista, Volt.

MONTANA

• BILLINGS (Area Code 406)

Billings Hardware, 501 N. Broadway. Zip: 59101.
 Tel: 245-3066. Pres.: Ralph Johnson; Rec. Mgr.: Marion Massick.
 Labels: Angel, Capitol, Disneyland, Golden, Vista.

Interstate, PO Box 2523. Zip: 59101; 457 Daniels. Zip: 59102. Tel: 245-5141. Pres.: James A. Whitson.
 Distributes: RCA Victor Product.

• GREAT FALLS (Area Code 406)

Music Serv., PO Box 2487, 318 Sixth St. Tel: 761-2420. Pres.: R. E. Holm.
 Labels: A&M, Best, Boone, Challenge, Colpix, Cricket, Cumberland, Design, Dolton, Dot, Epic, Everest, Fabor, Fontana, Hamilton, Hi, Hilltop, Imperial, Instant Language, Jubilee, Kama Sutra, Laurie, Liberty, London, MGM, Mercury, Monument, Nashville, Okeh, Palomar, Parrot, Philips, Phyllis, Reprise, Richmond, SPQR, Seville, Smash, Sound Stage 7, Starday, Stereodities, Sun, Tribe, Vanguard, Verve, Warner Bros.

NEBRASKA

• OMAHA (Area Code 402)

Jather, 2500 Harney. Zip: 68131. Tel: 342-1545.
 Mgr.: George Shearer.
 Branches: Des Moines, Iowa; Minneapolis, Minn.
 Labels: A&M, Almo, Ascot, Blue Note, Chart, Conversaphone, Federal, Fidelity Sound, Hickory, Jamie, King, Living Language, Longhorn, Musicor, Specialty, Starday, Sum, Summit, Tom Lehrer, United Artists, Young People's Recs.
 Sidles, 7302 Pacific St. Zip: 68101. Tel: 393-2233.
 Mgr.: Ralph Woodward.
 Distributes: RCA Victor Product.
 T D C Electronics, 1121 Farnam St. Tel: 342-1538.
 Contact: Leo Colvin.
 Tape, Cartridge: Music-Tapes.
 Tape, Reel-to-Reel: Music-Tapes.

NEW JERSEY

• ATLANTIC CITY (Area Code 609)

Rockin' Recs., c/o Ed Marcus, Runnymede Hotel, Park Pl.
 Branches: Perth Amboy, N.J.; Philadelphia, Pa.
 Distributes: Oldies But Goodies.

• CAMDEN (Area Code 609)

Decca, 1722 Federal St. Tel: 966-7111. Philadelphia Tel: (215) WA 2-5659. Mgr.: Sam Passamano.
 Distributes: Decca Product.

• NEWARK (Area Code 201)

ALL-STATE NEW JERSEY, 321 Sherman Ave. Tel: 242-6500. Pres.: Mel Koenig; VP: Irwin Fink.
 Labels: Ascot, Atco, Brook-lyn, Carla, Class, Colosseum, Congress, Dunwich, Fame, Felsted, Four Corners, Garrett, Heidi, Hi, Kapp, Karen, London, Monument, Moonglow, Musicor, Palmer, Palomar, Parrot, Richmond, Select, Seville, Sound Stage 7, Telefunken, Tivoli, Tomorrow, Tribe, UA, Volt. (SEE ADVERTISEMENT)

LAREDY
HAS COMPLETED
11 SUCCESSFUL YEARS
BECAUSE OF
REPUTATION, SERVICE,
PROMOTION & SALES.

LAREDY
RECORD
DIST.
CORP.

46 Green Street
Newark, New Jersey
(201) MA 3-5984

U.S. Record Distributors

IN NEW JERSEY

You will get the strong sales coverage and merchandising know-how of our professional staff

ALL-STATE

MEL KOENIG Pres. • **SHERMAN KOENIG** Treas. • **IRWIN FINK** Vice Pres.

Promotion: Milt Eidelman

HARD-HITTING HUNGRY SALESMEN

ALL-STATE, N.J., INC., 321 SHERMAN AVE., NEWARK, N.J.
(201) 242-6500

continued

APEX-MARTIN REC. SALES, 175 Clinton Pl. Zip: 07112. Tel: 923-7474. Mgrs.: Joe Martin & Jerry Cohen.

Affiliate: Miami, Fla., Campus Rec.

Labels: Epic, Okeh, A&M, Tamla, Motown, Gordy, Soul, VIP, Almo, Omen, New Voice, DynoVoice, Amy, Mala, Bell, Musicland, White Whale, Mustang, Arctic, Bang, Big Hill, Broadway, Eastern, Sue, Symbol, Calla, Windy C, Moonshot, Attack, Kent, Modern, Fantasy, Galaxy, Scorpio, Jay Jay, Starday, One-Derful, Relic, Tuba, D-Town, Sentaur, Gateway, Aurora, Carnival, TCF-Hall, Renfro, Faro, Linda, Chaffahoochee, Catamount, Choice, Crown, DW Marton, Holly, Jamie, Guyden, Halo, HiWay, Kay-O, Nashville, Phillies, Phi-Dan, Orbit, Lost Nite, Times Square, Somerset, Stereo Fidelity, Everest, Music Minus One, Sphere Sound, USA, Satellite, St. Lawrence, Shrine, Rim, Kevin, Academy, Thomas, Goldwax.

Tape, Cartridge: Motown, Tamla, Gordy, Soul, Aura Sonic, Epic, Okeh.

Tape, Reel-to-Reel: Epic, A&M, Audio-Spectrum.

Musical Accessories: Walco Strings, Needles & Accessories; Red Rope & Cascraft Carrying Cases. (SEE ADVERTISEMENT)

Bravo Rec., 356 Washington St. Zip: 07102. Tel: 642-2604. Pres.: David King.

Labels: Ajax, Benja, Casa Grande, Conrose, Coulee, Deblyn, Debut, GCP, Guillotine, Holiday, Impression, IRC, Jor-Dan, Kondas, Lantam, Mama, Maria, Melron, Parnaso, Summer, Tru-tone.

Tape, Cartridge: Rac Auto Tape, Sonocar Stereo.

Tape Playback Equip.: Rac.

Dance, 1161 Broad St. Zip: 07114. Tel: 622-0024.

Labels: MacGregor, Sets in Order, Windsor.

Essex, 10 Fenwick St. Zip: 07114. Tel: 243-7700.

Pres.: Joseph Cohen; **Promo.:** Harold Ladell.

Labels: ABC-Paramount, Allegre, Argo, Avin, Atlantic, Backbeat, Blue Cat, Blue Note, Boom, BT Puppy, Checker, Chess, Co & Ce, Coed, Colonial, Constellation, Copley, Dana, Dial, Diamond, Diplomat, Dooto, Double L, Dunhill, Duke, End, Excello, Fleetwood, Gee, Golden, Golden World, Gone, Gospel, Groovesville, Halo, Impulse, Jerden, Jewel, Josie, Jubilee, Kellmac, Laurie, Legrand, LuPine, Mace, Mira,

Mirwood, Money, Nashboro, Oldies, Old Town, One-Derful, Original Sound, Paula, Peacock, Pelnor, Peter Pan, Pure Soul, Red Bird, Ric-Tic, Roulette, Sar, Savoy, Scepter, Sew City, Sharp, Simpson, Song Bird, Specialty, Standard, Stax, Stella, Sun, Sureshot, Swan, Sylvia, Tangerine, Tico, Tiger, Tower, Uptown, Vee Jay, Wand, Whit, Win Gate.

IDEAL, 357 Lyons Ave. Tel: WA 3-6333. Pres.: Samuel Keenholtz.

Labels: Alector, Brent, Bruno, Caedmon, Cook, Fargo, Fiesta, Gold Star, Golden Crest, Headline, Helios, Simon Says, Time, Vesuvius.

J & J, 232 S. Orange Ave. Zip: 07103. Tel: 642-6000. Pres.: Irwin Jennis; Gen. Mgr.: Jay Jennis.

Tape, Cartridge: ITCC, Muntz Stereo-Pak, RCA Victor, Mercury, Motown.

Tape Playback Equip.: Norelco, Muntz, Lear Jet. (SEE ADVERTISEMENT)

Krich-New Jersey, 428 Elizabeth Ave. Tel: 81 8-7400. Pres.: F. M. Comins.

Distributes: RCA Victor Product.

LAREDY, 46 Green St. Zip: 07101. Tel: MA 3-5984. Pres.: Joseph Fechner.

Labels: Betty White Dance Recs., Challenge, Command, Contact, Conversaphone, DCP, Dee Gee, Disneyland, Evergreen, Grand Award, Hilltop, Living Language, Loma, Pickwick, Reprise, Sure, Tradition, Vista, Warner Bros., Young People's Recs. (SEE ADVERTISEMENT)

Steejay, 457 Chancellor Ave. Tel: WA 3-4900, N.Y.C. Tel: (212) CI 5-3800. Contact: Joel Koenig.

Tape, Cartridge: ITCC Stereo 8.

Tape Playback Equip.: Lear Jet Stereo 8.

• **TRENTON (Area Code 609)**

Schenk Electronics, 218 Fourth St. Tel: 882-1660. Sales Mgr.: Mike Wyatt.

Tape, Cartridge: ITCC.

WENDY, 37 William St. Tel: MA 3-5845. Pres.: Jerry Winston.

Labels: Arvee, Audio Fidelity, Boone, Cameo, Canadian American, Colpix, Congress, Contemporary, Dolton, Elektra, Era, Excel, GNP Crescendo, Hanna-Barbera, Hickory, HiFi, Imperial, Joda, Karate, K-ark, King, Liberty, Life, Mainstream, Mardi Gras, Nonesuch, Parkway, Prestige, RSVP, 20th-Fox, Vanguard, World Pacific, Wyncote. (SEE ADVERTISEMENT)

• **OCEAN CITY (Area Code 609)**

Neptune, PO Box 569, 1217 Simpson Ave. Zip: 08226. Tel: 399-0446. Gen. Mgr.: Milton Katz. **Distributes:** Low-cost promotional records & record accessories.

• **PENNSAUKEN (Area Code 609)**

Handleman, 7135 Colonial Ln. Tel: 665-5460. Contact: V. Chesslar.

Tape, Cartridge: RCA Stereo 8.

• **PERTH AMBOY (Area Code 201)**

Rockin' Recs., 169 High St. Zip: 08861. Tel: 442-1021. Gen. Mgr.: Edward Marcus.

Branches: Atlantic City, N. J.; Philadelphia, Pa. **Distributes:** Oldies But Goodies.

NEW MEXICO

• **ALBUQUERQUE (Area Code 505)**

Linden, 1205 Madeira S.E., Suite 124. Zip: 87108. Tel: 255-3978. Pres.: Lindy Blaskey.

Labels: ABC-Paramount, Capitol, Columbia, Decca, Dot, LaVette, Philips, RCA Victor, Reprise, Scepter, Space.

NEW YORK

• **ALBANY (Area Code 518)**

Delta, 1260 Broadway. Zip: 12204. Tel: 462-6653. Pres.: Robert E. Devere.

Labels: A&M, Amy, Audio Fidelity, Autumn, BT Puppy, Bell, Blue Note, Calla, Cameo-Parkway, Carnival, Challenge, Chaffahoochee, Co & Ce, Coed, Colpix, Connoisseur, Crescendo, Data, Dimension, Diplomacy, Devine, Double L, D-Town, Duke, Duo-Disc, DynoVoice, Era, Enjoy, Fleetwood, Four Brothers, Gateway, Goal, Golden World, Goldwax, Gordy, Hanna-Barbera, Hickory, Holton, Jay Gee, Jewel, Joda, Jubilee, Karate, Kent, King, Laurie, Mala, Motown, Music Sales, Musicor, Nashboro, New Voice,

continued on page 96



APEX MARTIN

RECORD SALES, INC.

175 CLINTON PLACE, NEWARK, N.J. 07112 (201) 923-7474 • JERRY COHEN, Gen. Mgr. • JOE MARTIN, Pres.

THE BIG
Roarrrrr!!!

GET A
LION
SHARE
AT...



BETA DISTRIBUTORS

Top Promotion (2 Men) — Top Service — Top Sales (Mgr & 4 salesmen)

plus

OUR NEW BIG LATIN DIVISION

*Johnny
Halonka*

BETA RECORD DISTRIBUTORS

599 10th Avenue (Phone CH 4-3744) New York, N. Y.

continued

Old Town, Omen, One-Derful, Original Sound, Peacock, Philles, Pioneer, Prestige, Pure Soul, RIC, Rampart, Rust, Savoy, Scepter, Sims, Soma, Soul, Stereodiddies, Sue, Swan, Swinging, Tamla, Time, Tower, Tradition, 20th-Fox Group, VIP, Valiant, Wand, Whit.

J-S, 98 Everett Rd. Zip: 12205. Tel: 489-5446. Owner: Joseph E. Spence Sr.; Gen. Mgr.: Tom Ryan.

Labels: Ajax, Alon, Big Bunny, Bragg, Bright Star, Canadian American, Carnival, Chart, Dearborn, DeeSu, Dooto, Dore, Elbam, Fatfish, Four Bros., Fraternity, Gamble, Gayland, Groovy, Hollywood, Holton, Hurd, Impact, Jameco, Jerand, Jessica, K-ark, Kell-Mac, Mar-V-Lus, Melic, Mustang, Nola, Pow, Rainbow, Renfro, Sahara, Scarlet, Sims, Sounds of Nashville, Starday, Stereo-Fi, Surfline, Toddlin' Town, Tomorrow, Tuba, Twirl, Vault, Venus.

Northeastern Rec., 360 Tolland St., East Hartford, Conn. 06108. Tel: (203) 289-7431. Mgr.: Frank Sutter.

Labels distributed in Albany area: ABC-Paramount, Bach Guild, Bang, Command, Dunhill, Epic, Eurotone, Haydn Society, Impulse, Jay Jay, Kama Sutra, Kapp, Living Language, MGM, Metro, Music Guild, Okeh, Pickwick, Prestige, Tangerine, Vanguard, Verve, Verve/Folkways, Westminster.

R T A, 991 Broadway. Zip: 12204. Tel: 465-7346. Rec. Mgr.: Joseph Paone.

Trinity, 477 Park Ave., East Hartford, Conn. Tel: (203) 289-4349.

Distributes: in Albany area.

• **BUFFALO (Area Code 716)**

Decca, 284 Delaware Ave. Tel: TL 2-8318. Mgr.: Maury Bloom.

Labels: Brunswick, Caedmon, Coral, Decca, Listen & Learn, London, Vocalion.

Distributes: Other Decca Product.

Gold, 959 Main St. Zip: 14203. Tel: 882-0427. Mgr.: Oavid Colson; Promo.: Neil Sawyer.

Labels: ABC-Paramount, Atlantic, Autumn, Blue Note, Cadet, Chess, Checker, Colpix, Constellation, Dial, Dooto, Fiesta, Hi Fidelity, Impulse, Mirwood, Sahara, Swan, Tuff, Universe, Westminster.

For Manufacturers Who Want

- The Best in Merchandising
- The Best in Promotion
- The Best in Service

IN NEW YORK IT'S

MALVERNE

DISTRIBUTORS INC.

601 West 50th St.
N.Y., N.Y. 10019 (212) PL 7-0070

AL HIRSCH, Pres.

**POLKA
TOWNE
MUSIC**

**FIRST IN
POLKA
AND
INTERNATIONAL
RECORD
DISTRIBUTION**

23 Marian Lane, Jericho, L. I., N. Y.
Area Code (516) OV 1-7356

Jet Electronics (div. of Jet TV), 331 Franklin St. Zip: 14202. Tel: 853-7244. Sales Mgr.: M. Lebovitz.

Tape, Cartridge: Aura Sonic, ITCC.

Tape Playback Equip.: Lear Jet Stereo 8.

• **COHOES (Area Code 518)**

Decca, Vliet & Mohawk Sts. Zip: 12047. Tel: CE 7-9000. Warehouse Mgr.: Leo Refice.

Distributes: Decca Product.

• **EAST ROCKAWAY, L. I. (Area Code 516)**

Guy Barry Ent's., 13 Wesley Dr. Tel: FR 4-6772. Pres.: Guy Barry.

Labels: Latin American, Int'l Imports—Europe, Central & South America.

• **GARDEN CITY, L. I. (Area Code 516)**

Melody, 750 Stewart Ave. Tel: CH 8-7140. VP: Morty Kline.

Labels: Conversaphone, Cricket, Disneyland, Golden, Hanna-Barbera, Learn in Record Time, Motivation, Music Minus One, Pickwick/33, RCA Camden, Berlitz.

Tape, Reel-to-Reel: GRT, Dot, Reprise, Camden.

• **HICKSVILLE, L. I. (Area Code 516)**

Gemini Whsle, 314 N. Broadway.

Branches: Levittown, L.I., N.Y.; New York, N.Y.

Jay Electronics, 52 Bethpage Rd. Zip: 11801. Tel: WE 5-8181. Pres.: Sanford Jay.

• **JERICHO, L. I. (Area Code 516)**

Polka Towne Music, 23 Marian Ln. Zip: 11753. Tel: OV 1-7356. Pres.: Teresa Kalinowski.

Labels: Ampol, Bel-Aire, Cardinal, Chicago, Delta Int'l, Dyno, Eurotone, Family, Gateway, Glo, Jay Jay, Lush, PASA, Pan, Rave, Request, Rex, Ridgemoor, Silverbell, Steljo, Sun glow, USA.

• **LATHAM (Area Code 518)**

Bee Gee, 10 Northway Ln. N. Tel: 785-1350. Mgr.: Leonard Smith; Promo.: Tom Markoski.

• **LEVITTOWN (Area Code 516)**

Gemini Whsle., 2950 Hempstead Tpke. Zip: 11756. Tel: PY 6-2332. Pres.: Samuel Gower.

Branches: Hicksville, L. I., N. Y.; New York, N. Y.

• **LONG ISLAND CITY (See New York City)**

• **NEW YORK CITY (Area Code 212)**

ALPHA, 20 West End Ave. Tel: 245-7933. Promo.: Jerry Love.

Labels: Accent, Admiral, Adventure, Alector, Almo, Amy, Ansonia, Aravel, Ascot, Autumn, Avoca, Baroque, Bell, Big Top, Buena Vista, Carney, Challenge, Checker, Chess, Colonial, Concert-Disc, Counterpoint, DCP, Disneyland, DynoVoice, Esoteric, Eurotone, Everest, Flashback, Fleetwood, Freepport, GNP Crescendo, Goldwax, Hickory, HiFi, Hull, Humor Int'l, Italdisc, JJC, Jay, Jewel, KFM, Loma, Mala, Maxx, Mona-Lee, Monument, Motown, Movie-tone, Musicland USA, Nam, Nashville, New Voice, Nina, Omen, Panart, Period, Red Fox, Reprise, Request, Rotate, San Su, Soma, Sphere, Standard, Starday, Stella, Stereodiddies, Streetcar, Sun, Tamla, 20th-Fox, UA, Valiant, Veep, Village Gate, Warner Bros., Whit, White Whale. (SEE ADVERTISEMENT)

Apon, PO Box 131, Grand Central Sta., 1541 First Ave. Zip: 10017. Tel: YU 8-0450. Pres.: Andrej Poncic.

Labels: Amadeo, Angelicum, Apon, Harmonia Mundi.

Argus, 160 W. 46 St. Zip: 10036. Tel: 765-2585 & TE 2-9314. Pres. & Mgr.: Rose Saggio.

Labels: Agon, Ajax, Book, Cotillion, Criterion, Dapt, Dragon, Goodway, Golden Beam, Gospel Rec'g, Iguana, Inner, Jerand, Johnson, Kevin, Knox, Monmouth, Prince, Riccio, Rojac, Ron, Shell, Van.

Tape, Cartridge: Tucker.

BETA, 599 10 Ave. Zip: 10036. Tel: CH 4-3744. Mgr.: John Halonka; Promo. Men: Joseph Senkiewicz & Matty Mathews.

Labels: Artia, Blue Cat, Co & Ce, Colpix, Dance Along, Diamond, Dimension, Distinguished, Duke, Excello, Fantasy, Golden Crest, Gordy, Hob, Jamie/Guyden, Jazzland, Kent, King, Laurie, Legrand, Mace, Musicor, Mustang, Nashboro, Old Town, Parliament, Peacock, Red Bird, Riverside, Rust, Scepter, Simco, Soul, Speciality, Sue, Sureshot, Symbol, TCF Group, Wand, Wonderland. Tape, Cartridge: Musical Tape Sales. (SEE ADVERTISEMENT)

Bruno-New York, 460 W. 34 St. Zip: 10001. Tel: 564-3062. Mgr.: Phil Silverman; Promo.: Mike Borrello.

Distributes: RCA Victor Product.

Capitol, 317 W. 44 St. Tel: CI 5-3400. Mgr.: Ben Savoia.

Distributes: Capitol, Angel Product.

Musical Instruments: Hohner Harmonicas.

Musical Accessories: Duetone Needles & Accessories.

Cetra, 97 Chambers St. Zip: 10007. Tel: BE 3-6280. Pres.: Martin Silvers.

Cole & Gale, c/o W. Hofer, Esq., 221 W. 57 St. Tel: JU 2-5030.

Columbia, 545 Madison Ave. Zip: 10022. Tel.: HA 1-4700. Mgr.: Don England; Promo. Men: Nick Cortale & Frank Campana.

Distributes: Columbia Product.

Conlas, 324 W. 49 St. Tel: LT 1-9436. Pres.: L. A. Sorrentino.

Labels: Panart, Peerless.

Cosnat, 315 W. 47 St. Zip: 10019. Tel.: PL 7-8140. Mgr.: Elliot Blaine.

Labels: Jubilee, Monogram, Satellite, Riot, Josie, D-Town, Borderline, National, Port, Custom, Lew Disc, Jameco, Dana, Afro, BT Puppy, St. Lawrence, Dictation Disc, Saint, Duo Disc.

Decca, 445 Park Ave. Zip: 10022. Tel: PL 2-1600. Mgr.: J. McDonald.

Distributes: Decca Product.

Eastern Rec. Sales, 666 10 Ave. Zip: 10036. Tel: CI 5-9469. Mgr.: Murray Lefkoff.

Labels: Astro-Greek, Bear.

Educational Rec. Sales, 157 Chambers. Tel.: CO 7-7437. Mgr.: Norman Kaplan.

Labels: Bowmar, Caedmon, Capitol, Columbia, Decca, Enrichment, Folkways, Pathways of Sound, Poetry, RCA Victor, Spoken Arts.

Fine-Tone Audio Prods, 7111 20 Ave., Brooklyn, N.Y. Zip: 11204. Tel: CL 6-7876. Pres.: Leonard Finkel; Gen. Mgr.: Stuart Mont.

Tape, Cartridge: Music Tapes.

Tape, Reel-to-Reel: ABC, Ampex, Audio Spectrum, Capitol, Columbia, Command, Decca, Dot, Epic, Liberty, Music Tapes, RCA Victor, Reprise, United Artists.

Folk Dancer, 108 W. 16 St. Tel: WA 9-0644. Mgr.: Michael Herman.

Labels: Folk Dancer, MacGregor.

Folkways, 165 W. 46 St. Zip: 10036. Tel: JU 6-7260. Dir.: Moses Asch.

Gemini Whsle, 231 Front St., Brooklyn.

Branches: Hicksville, L.I., N.Y.; Levittown, N.Y.

German News, 200 E. 86 St. Zip: 10028. Tel: BU 8-5500. Mgr.: Walter Buhrmann.

Labels: Elite-Austron, Eurodisc, Polydor.

Hager, 711 Crown St., Brooklyn. Zip: 11213. Tel: HY 3-8131. Pres.: Isaac Hager.

Labels: Fran, Neginah, Yeled, Rone, Tivell, Greater Rec'g, Famous.

Hector, 49 W. 22 St. Zip: 10010. Tel: 242-1989. Mgr.: Frank Warren.

Labels: Academy, Aeolian-Skinner, Audiophile, Austin, Bert & I, Blues Classics, Boston, Cook, Distinguished, Dorian, Educo, Evergreen, Fidelity Sound, GHB, Gold Star, Haydn Society, Internos, JJC, Jazz Crusade, Jazzology, Lexington, Louisville, MEA, Mobile Fidelity, Murril, Music Library, Origin Jazz Library, Overtone, RIC, Rocco, SPA, Southland, Stinson, Storytime, Sure, Toad, VLR, Word.

The Hellenic, 365-367 W. 34 St. Zip: 10001. Tel: LO 3-2831. Pres.: Ted Starke.

Labels: Alector, Orient Int'l, Parkmount.

Ideal, 171-07 Jamaica Ave., Jamaica. Zip: 11432. Tel: AX 1-8700. Pres.: Samuel Keenholz.

Labels: Distinguished, Gold Star, Tom Lehrer.

Interstate, 15 W. 20 St. Tel: 989-2255. Pres.: Manny G. Wells.

Jay-Gee Jubilee, 318 W. 48 St. Tel: PL 7-8570.

Labels: Jubilee, Josie, Port, Blaine, BT Puppy, Duo Disc.

Jet, 4011 Skillman Ave., Long Island City. Zip: 11104. Tel: ST 6-0677. Gen. Mgr.: Walter Lam.

Labels: ABC-Paramount, Award Artists, Boom, Command, Contact, Dunhill, Grand Award, Impulse, Jerden, Menotti, Oliver, Relic, Simon Says, Tangerine, Times Square.

Jody, 2226 McDonald Ave., Brooklyn. Zip: 11223. Tel: 372-9336. Sales Mgr.: Vince Vallis.

Labels: Solar, Lifetime, Variety, Goldust, Saugus, Tudorline, Arnold, Sonora, Getit, Di Venus, B-Atlas, Jody.

Kartridge Audio Centre, 3536 Hull Ave. Zip: 10467. Tel: (914) 337-5844. Pres.: Kenneth A. Chesney.

Tape, Cartridge: GRT, Muntz Stereo Pak, Auto-stereo, Tucker Prod'ns.

Tape Playback Equip.: Automatic Radio.

continued on page 98



WHAT AILS YOUR SALES!

**FINE-TONE CAN RENDER THE
PRESCRIPTION YOUR STORE NEEDS
FOR THOSE SICK SLOW MONTHS AND
HELP MAKE THE GOOD MONTHS REALLY GREAT**

*The Record Shops Big Profits Are in
Accessories and Tapes*

● PRE-RECORDED TAPES

Open Reel All Labels
4-Track Stereo & 2-Track
Discounts to 50 & 10% Off
Send for Catalog

● TAPE CARTRIDGES

Stereo 4 & 8 Track
3M Tape Cartridges
Norelco Tape Cartridges

● RECORD CARRYING CASES

20 FIBERBOARD MODELS
#521-12 With Index for 50-45's 68c*
Packed 24 Assorted Per Carton

10 WOOD MODELS
#70-12" for 50 LP's \$3.75*
Packed 6 Assorted Per Carton

8 METAL MODELS
#C7 With Index for 60-45's \$2.10*
Packed 6 Assorted Per Carton

4 LEATHER TYPE MODELS
#LC12 for 30 LP's \$2.99*
Packed 6 Assorted Per Carton

● DIAMOND NEEDLES

Recoton • Ronette • Walco
Ronette Open End Mono & Stereo 69c*
All Recoton Diamonds \$1.25 ea. Plus a
Ronette Mono or Stereo Sapphire FREE*

● PHONO CARTRIDGES

Astatic • Electro-Voice • G.E. • BSR •
Acos • Shure • Vaco • Sonotone •
Pickering • Audio Empire • Euphonics •
Norelco • R.C.A. • Zenith, Etc.
#13 T Astatic or EV #13 \$2.25*

● 45 R.P.M. SPINDLES

From Admiral to Zenith
48 Different Models
BSR Short 59c*

● CONCORD TAPE RECORDS

Portable • Monaural • Stereo
Automatic & Professional
Model #F20 as Low as \$14.97

● MICROPHONES

Astatic • Electro-Voice •
Shure • Sonotone & Japanese
Model #MC105 Lapel Type 69c*

● MICROPHONE ACCESSORIES

Atlas & Japanese Mike Stands •
Jacks • Plugs • Cords, Etc.

● GUITAR ACCESSORIES

Strings • Picks • Amplifiers •
Bags, Etc.
Goya • La Bella • Herco, Etc.

● BATTERIES

Eveready & Maxcel—Discounted
#216 Eveready 9 Volt 31c*

● RECORD CHANGERS

BSR • GARRARD • VM, ETC.

● PHONOGRAPHS

Acoustic to Stereo
#PH500 Transistor, Battery Operated,
2-Tone Case, with Battery \$14.95

● RADIOS

6 to 15 Transistors
Portable & Table Models

● KIDDY RECORDS

7"—45's & 78's
12"—LP's & Budget Records

● BLANK RECORDING TAPES

American • Fine-Tone • R. C. A. •
Reeves & Scotch
150' Mylar Fine-Tone 3" Reel 19c*
600' Mylar Fine-Tone 5" Reel 59c*
1200' Mylar Fine-Tone 7" Reel 79c*

● TAPE ACCESSORIES

Splicing Tape • Leader Tape • Labels •
Tape Splicers • Head Cleaners •
Demagnetizers • Tape Clips • Case &
Rack's. Empty Reels 3", 5" & 7"
Bulk 3"—06c • 5"—12c • 7"—16c*

● RECORD RACKS—BLACK & BRASS

10—TABLE TOP MODELS
#60E Holds 60 LP's or 120-45's 69c*
Packed 12 Per Carton

20—Two Tier Floor Models
#R53 Holds 130 LP's \$2.25*
Packed 4 Per Bundle

10—PHONO & RECORD TABLES
In Black • Brass & Wood Combinations

5—WOOD RECORD CABINETS
Top Quality 5 Different Wood Finishes

● RECORD ACCESSORIES

Insert—Plastic & Metal • Centers •
Domes • Turntable Pads • Brushes •
Brush + Lift.
Cloths • Cloth & Brush • Spray Cans •
Spray Kits • Polyethylene Sleeves •
Disk Whisk •
Lektrostat • Browser Divider Cards &
Boxes •
Record Albums • Green Stock Envelopes
Cloth \$1.00 List, 10c, Min 25 Pcs.
Brushes \$1.00 List, 12c, Min 25 Pcs.

* OPENING ORDERS ONLY

All prices quoted f.o.b. Brooklyn. Terms:
net 30 days to rated accounts. Prices sub-
ject to change without notice.



FINE-TONE AUDIO PRODUCTS CO., INC.

7111—20th Avenue, Brooklyn, N. Y. 11204

Telephone (212) CL 6-7875

continued

Liberty, 524 W. 43 St. Tel: LW 4-0491. Mgr.: Bernie Block; Promo. Men: Jim Brown & Tim Lane.
Labels: Liberty, Blue Note, Dolton, Premier, Imperial, Mini, World Pacific, Pacific Jazz, Sunset.
Tape, Cartridge: 4 & 8 Track Stereo.
 London, 521 W. 25 St. Zip: 10001. Tel: AL 5-8350. Mgr.: Philip Wesen.
Labels: All Boy, Beltone, Circle, Coliseum, Congress, Deaux, Dover, Felsted, Four Corners, Hi, Kapp, L'Oiseau-Lyre, London, London Int'l, Palomar, Parrot, President, Press, Richmond, SPQR, Seville, Shell, Spark, Telefunken, Terrace, Tribe.
 MALVERNE, 601 W. 50 St. Zip: 10019. Tel: PL 7-0070. Owner: Al Hirsch; Sales Mgr.: Joe Grippo.
Labels: Atco, Atlantic, Blue Note, Brook-lyn, Cameo, Carla, Carnival, Class, Cook, Delmark, Dial, Dore, Dunwich, Era, Fame, Focus, Gospel, Hanna-Barbera, Headline, Joda, Kellmac, Moon-glow, New Art, Okeh, One-Derful, Parkway, Prestige, Roost, Savoy, Stax, Testament, Vault, Volt. (SEE ADVERTISEMENT)
 Merrec, 524 W. 43 St. Tel: LA 4-6666. Mgr.: Stan Drayson.
Branches: Miami Springs, Fla.; Atlanta, Ga.
Labels: Cumberland, Fontana, Limelight, Mercury, New Breed, Philips, Smash, Wing.
Distributes: Other Mercury Product.
 MET RICHMOND LATIN REC., 2155 Utica Ave., Brook-lyn. Tel: RN 3-1212.
Labels: Alma, BBM, Carvier, Baroneza, Bocar, BRC, ASA, Eddezza, Encanto, Amex, Norca, Mona, Jardin, Reli, Somar, Riney, Astro, Skip-ker, Filtro, Economy, Kasin, Pergasso, Promi-nent, Progresso, Prospect, Explorer, Columbi-na, Danny, Antilano, Revancha, Ponce, Sono Mex, Jardin, Odessa, Tropical, Serenata, Colonnia, Rhumba, Iberia. (SEE ADVERTISEMENT)
 METRO, 547 W. 52 St. Zip: 10036. Tel: CO 5-1871. Mgr.: Dave Seidman.
Labels: Audio Fidelity, Contemporary, DGG, Elektra, Good Time Jazz, Heliodor, Kama Sutra, Leo the Lion, Living Language, MGM, Mardi Gras, Metro, Mira, Nonesuch, Surrey, Swan, VSP, Vee Jay, Verve, Verve/Folkways.
Tape, Cartridge: ITCC. (SEE ADVERTISEMENT)
 Miami, 157 W. 14 St. Tel: 989-3177. Mgr.: Antonio Bustillo; Promo.: Carlos Franco.
Branch: Miami, Fla.
Labels: Discos Columbia, Fuentes, Merengue, Miami.
 Olympia, 239 W. 18 St. Zip: 10011. Tel.: 989-7200. Pres.: Ervin Litkei.
Labels: Ambassador, B&F, Bible Stories, Buda-pest, Design, Diplomat, Disque D'O, Galiko, Golden, Grand Prix, Guest Star, Hilltop, Instant Language Series, Kelif, Pickwick/33, Prima, Magnagroove, Request, Somerset, Sonart, Stadium, Tiffon.
 Playette, 585 Ninth Ave. Zip: 10036. Tel: BR 9-5379. Pres.: Sidney A. Evans.
Labels: Amadeo Literature Series, Ades Series, Barclay, Cetra, Chant du Monde, DGG, Litera-ture Series, Festival, GMS-Disc, Hispavox, Lum-en, Nuova Accademia, Pleiade, RTF, Visa-phon, Vogue.
 R A C ELECTRONICS (Tape Town), 222 W. 37 St. Tel: 279-7980. Pres.: Robert Berger; VP: Arthur Halbreich.
Tape, Cartridge: ABC-Paramount, A&M, Audio Spectrum, Audiophile, Checker, Chess, Command, Concertapes, Crescendo, Elektra, Everest, Hori-zon, Liberty, MGM, Mahalo, Mercury, Monitor, Musicor, Musicapes, Prestige, Reprise, Sea-fair, Starday, Tempo, Vee Jay, Verve, Warner Bros.
Tape, Playback Equip.: RAC, Craig. (SEE AD-VERTISEMENT)
 Record & Tape Sales, 821 Broadway. Zip: 10003. Tel.: OR 4-6400. Contact: Robert Staub.
Labels: Barclay, Festival, Philips, Polydor, Vogue (all France).
 Sherman Sales, 1776 Broadway. Tel.: PL 7-6081. Gen. Mgr.: Larry Uttal.
 Spectrum Ents., GPO Box 1785. Zip: 10001.
 Stanley-Lewis, 534 W. 58 St. Zip: 10019. Tel.: CO 5-7955. Mgr.: Harry Lew.
Labels: Archive, Avakian, Bach Guild, Baren-reiter, Bartok, Boite a Musique (BAM), Broad-side (Folkways), CMS (Children's Records), Caedmon, Cambridge, Cetra, Classic Editions, Composers Rec'gs (CRI), Connoisseur Society, Credo, Cricket, Cum Laude, Desto, Deutsche Grammophon (DGG), Dover (Classics), Dyer-Ben-nett, EMS, Enrichment, Eterna, Experiences

Anonyms (EA), Ficker, Folkways, Gregorian Inst., Haydn Society, Instant Language, Lex-ington, Lyricord, Monitor, Montilla, Motiva-tion, Musica Sacra (AMS), Music Guild, Music Minus One (MMO), Oak Publications, Olympus, Pathways of Sound (POS), Poetry, Proscenium, Quote, Rainbow, Rutgers Music Dictation, Spa, Spoken Word, Spoken Art, Tradition, Turnabout, UTC, Vanguard, Voix de l'Auteur (LVA), Vox, Westminster.
 States, 45-18 Court Sq., Long Island City. Zip: 11101. Tel: 786-9369. Principals: Lou Klaymin & Al Levine; Mgr.: Morris Weissman; Promo.: Sam Vargas.
Labels: Bang, Mainstream, Somerset, Stereo Fidelity, Time, Tower.
Tape, Cartridge: Audio-Spectrum.
 Stereorama (div. of Auto Home Stereo), 33 W. 42 St. Tel: LO 5-5561. Pres.: M. J. Quattrochi; Gen. Mgr.: Peter Gushi.
Branch: Chicago, Ill.
Tape, Cartridge: ITCC, RCA Victor, Muntz Stereo Pak, Jay Electronics, Encore.
 Triode, 1639 Broadway, Suite 310. Zip: 10019. Tel: 581-8179. Pres. & Mgr.: Ben Smith.
Labels: All Church, Tarx, Trax, Tra-X, Triode, X-Tra.
 U. S. Premium, 1 E. 42 St. Tel: 867-1891. Pres.: Ed Krass.
Labels: Pickwick Int'l & Decca.
 Wally's Stereo Tape City, 550 W. 54 St. Zip: 10019. Tel: JU 2-6118. Pres.: Harry Wally.
Tape, Cartridge: Autostereo, ITCC, Muntz Stereo Pak, Aura Sonic.
 • **OCEANSIDE, L. I. (Area Code 516)**
 National Mercantile, 3580 Oceanside Rd. Tel: 678-6770. Pres.: Jesse Selter.
 • **RAVENA (Area Code 518)**
 R & J Rec. Promo. Ctr., 9 Wendell St. Zip: 12143. Tel: 751-5152. Contact: Jay Polverelli.
Labels: Parrot, Kapp.
 • **ROCHESTER (Area Code 716)**
 Lifetime Rec'gs, 133 North St. Zip: 14604. Tel: 454-1269.
Labels: Archives, Arhoolie, Artia, Audio-Spec-trum, Avoca, Baronet, Baroque, Battle, Blue Ribbon, Broadside, Celebrity, Colonial, Concert Disc, Conversaphone, Cook, Coronet, Counter-point, Dana, Desto, Dimensional Sound, Disc, Esoteric, Eterna, Eurotone, Everest, Evergreen, Fax, Fiesta, Fleetwood, Folkways, Golden Crest, HiFi, Jazzland, Kismet, Lifetime, Longhorn, Lyricord, MK, Mirrosomic, Monitor, Nashville, Parliament, Period, Pickwick, Premier, Rain-bow, Riverside, Scala, Standard, Starday, Stereo Fidelity, Time, Wonderland.
Tape, Cartridge: Encore.
Tape, Reel-to-Reel: Audio-Spectrum, Dot, Re-prise, Concertapes, Everest, Pickwick, Encore.
 • **SYRACUSE (Area Code 315)**
 Columbia, 218 Harrison St. Zip: 13202. Tel: 474-2901. Sales Mgr.: Irv Medway; Promo. Mgr.: John Perry.
Distributes: Columbia Product.
 Morris, 1153 W. Fayette St. Zip: 13201. Tel: GR 5-6531. Mgr.: Oscar Dachs.
Distributes: RCA Victor Product.

NORTH CAROLINA

• **CHARLOTTE (Area Code 704)**
 Arnold, PO Box 1126, 2704 Freedom Dr. Tel: 399-9741.
Labels: ABC-Paramount, Atco, Aurora, Bang, Blue Rock, Boom, Calla, Cameo, Carla, Carnival, Challenge, Class, Custom, Dooto, Dunhill, Dyno-Voice, Eastern Elektra, Hull, Impulse, Jerden, Joda, Loma, Moonglow, Musicor, Mustang, Nonesuch, Parkway, Reprise, Sue, Symbol, Tan-gerine, Vault, Volt, Warner Bros., Wynco-te.
 Bertos Sales, 2214 W. Morehead St. Zip: 28208. Tel: 375-2517. Mgr.: Phil Goldberg; Promo.: Mickey Beheler.
Labels: Afco, Ascot, Blue Cat, Boone, BT Pappy, Cadet, Command, Chess, Checker, Constellation, Colpix, Crusader, Cumberland, Dolton, Epic, Excello, Fontana, Fraternity, Gordy, Groovy, Gross, Hilltop, Josie, Jubilee, Kellmac, Liberty, Mirwood, Motown, Nashboro, Nashville, Okeh, One-Derful, Pacific Jazz, Pickwick, Port, Pure Soul, Red Bird, Smash, Soul, Starday, Surrey, Sims, Soma, TCF, Tamla, UA, VIP, Valiant, Vee Jay, Verve, Verve/Folkways, World Pacific.
Tape, Cartridge: Tamla, Motown, Gordy.
Tape, Reel-to-Reel: Epic, Command.

C & M, 100 Southside Dr. Tel: 525-1971. Exec VP: T. L. Conder.
Labels: Capitol, Columbia, RCA Victor.
 Carol, 124 W. Morehead St. Zip: 28209. Tel: ED 3-9457. Contact: Joseph Voynow.
Distributes: Decca Product.
 F & F Ents., PO Box 1126, 2704 Freedom Dr. Tel: EX 9-9741. Contact: Bert Fleishman.
Labels: A&M, Almo, Arctic, Atlantic, Backbeat, Blue Note, Canaan, Clarion, Dial, Diamond, Duke, Emarcy, End, Fabor, Focus, Golden, Guy-den, Hanna-Barbera, Jamie, Kenwood, Laurie, Legrand, Limelight, Mercury, Montel, Old Town, Omen, Original Sound, Peacock, Philles, Roost, Roulette, Rust, Songbird, Stax, Vanguard, Westminster.
 Mangold, 2212 W. Morehead. Tel: 334-0866. Mgr.: Herb Weisman; Promo.: Dub Plyler.
Labels: Amy, Crescendo, DCP, Disneyland, Gold-en World, Hickory, Imperial, Kapp, Kent, Lon-don, MGM, Mala, Monument, Phillips, Savoy, 20th-Fox.
Musical Accessories: Walco Prods.
 Southern Radio, 1625 W. Morehead. Zip: 28208. Tel: 376-4461. Pres.: James R. McMillan.
Distributes: RCA Victor Product.
 • **GREENSBORO (Area Code 919)**
 Southland Musical Mds., 826 Winston. Tel: 272-5123. Pres.: Harry Greenberg.
Labels: Audio, CRG, Conversaphone, Golden, Heartwarming, Living Language, Music Minus One, Peter Pan, Sacred Word, Young People's Recs.
 • **GREENVILLE (Area Code 919)**
 Carolina Sales, PO Box 404. Zip: 27934. Tel: 752-3143.
Tape, Cartridge: ITCC.
Tape Playback Equip.: Lear Jet Stereo B.

OHIO

• **AKRON (Area Code 216)**
 Twelgrenn, 2775 Yellow Creek Rd. Tel: TE 6-5591. Pres.: J. Hugh Macey.
Labels: ABC (school), ASP, Aqua, Artists Life, Balance, Balkan, Belco, Bel-Mar, Big J, Black Mountain, Blue Star, Bogan, Bowery, CEM, Country Dance Society, Dance Along, Danro, Dash, Family Squares, Fiesta, Flip, Folk Dancer, Folk Arts Bazaar, Folkraft, Fun 'N Frolic, Go, Grenn, Hi Hat, Hoctor, Honor Your Partner, Israeli, J. Bar, Jewel, Kalox, Keeno, Longhorn, Lore, MacGregor, Magic, Mayflower, Mibs, Mustang, Old Timer, Panpiper, Prairie, Rainbow, Rockin' A, Roper, Russell, SMC, SNR, Sashay, Sets in Order, Lloyd Shaw, Square L, Sunny Hills, Swinging Square, TNT, Top, Wagon Wheel, Western Jubilee, Windsor, World of Fun.
 • **CINCINNATI (Area Code 513)**
 A & I, 1000 Broadway. Zip: 54202. Tel: 241-7644. Gen. Mgr.: Joe Nathan.
Labels: Arctic, Atco, Bang, Bluesville, Boom, Cabot, Challenge, Co & Ce, Constellation, Con-versaphone, Crusader, Diamond, Dore, Enjoy, Era, Four Saint's, Garrett, Guyden, Hanna-Barbera, HiFi, Hob, Jamie, Jocida, Joda, Josie, Joy, Jubilee, Kent, Mira, Modern, Moodsville, Nashboro, Ohio State Band, Old Town, New Jazz, Philips, Prestige, Red Bird, Reprise, Rou-lette, Roost, Savoy, Scepter, Simpson, Soma, Somerset, Stereo Fidelity, Surrey, Stereoditties, Swan, Swingsville, Tower, 20th-Fox, Valiant, Vee Jay, Volt, Wand, Warner Bros.
 Capitol, Executive Bldg., Suite 612, 35 E. Seventh St. Zip: 45202. Tel: 721-5616. Contact: John Leffler.
Distributes: Capitol & Angel Product.
 Columbia, Carew Tower, Suites 444-447. Zip: 45202. Tel: 241-4088. Sales Mgr.: William Kelly; Promo. Mgr.: Charles B. Moore.
Distributes: Columbia Product.
 Custom Recs., 1410 Corvallis. Zip: 45327. Tel: 761-9061. Sales Mgr.: Marvin Jacobs.
 Decca, E. Sixth & Court Sts. Zip: 45202. Tel: 721-4210. Mgr.: C. W. Doherty; Promo.: Herb Shucher.
Labels: Brunswick, Coral, Decca, London, Listen & Learn.
Distributes: Other Decca Product.
 Hit, 659 E. Sixth St. Zip: 45202. Tel.: 241-2887. Mgr.: Vern Hawk; Promo.: Charles Royal.
Labels: ABC-Paramount, Impulse, Tangerine, Dunhill, Jerden, Golden Children's, Command, Grand Award, Audio Fidelity, Karate, Colpix,
 continued on page 100

**THE MOST DEPENDABLE
INDEPENDENT DISTRIBUTOR IN . . .**

**NEW YORK
and the
METROPOLITAN
AREAS**



ALPHA

DISTRIBUTING CORP.

**HARRY N. APOSTOLERIS
20 West End Ave., N. Y. C. 19, N. Y.
(212) CI 5-7933**

★ AGGRESSIVE PROMOTION

★ DYNAMIC SALES STAFF

★ TOP-RATE DIRECTION

★ FINEST FACILITIES



DAVID ROSEN inc.

855 N. BROAD ST. • PHILADELPHIA, PA. 19123

HARRY ROSEN
* Vice-President

(215) CE 2-2900

FOR DISTRIBUTION IN
PHILADELPHIA

You can't match
Chips

CHIPS DISTRIBUTING CORP.

2750 NORTH BROAD STREET PHILADELPHIA, PA. 19132
(215) BA 6-4600

Ernie Santono, Gen. Mgr.



IN PHILADELPHIA
Promotion In Motion Merchandising
Volume Sales

Universal

LEN RADCLIFF, Gen. Mgr.
record distributing corporation
919 N. Broad St. Philadelphia 23, Pa.
Center 2-3333

continued

Cameo-Parkway, Duke, Peacock, Backbeat, Sure-shot, Everest, Esoteric, Concert Disc, Counterpoint, Baroque, Tom Lehrer, London Group, Parrot, Press, Tribe, Hi, Riverside, Jazzland, Battle, Wonderland, Pickwick, Hilltop, UA, DCP, Ascot, Vanguard, Bach Guild, Word, Sacred, Summit, Canaan, Sun, Living Language, Thomas, St. Lawrence, Sattelite, Chi-Town, Star, Crescendo.

Musical Instruments: Guitars.

Main Line, 3108 Westbrook Dr. Zip: 45202. Tel: 481-3013. Sales: Terry Cox.

Ohio Appliances, 7624 Reinhold Dr. Zip: 45237.

Tel: 821-6414. Mgr.: Jerry Weiner.

Labels: Disneyland, Fraternity, RCA Victor.

Tape, Cartridge: ITCC & RCA Stereo 8.

Tape, Reel-to-Reel: RCA Victor.

Summit, 617 Central Trust Tower. Zip: 45202. Tel:

241-6361. Sales Mgr.: Jack White.

Branch: Chicago, Ill.

Labels: Bragg, Brent, Bronco, Claridge, Epic,

Exodus, Kelmac, Mainstream, Mustang, Okeh,

One-Derful, RSVP, Satellite, Tuba, Win Gate.

Supreme, 1000 Broadway at Court. Tel: 421-0747.

Mgr.: Al Klayman.

Labels: Amy, Atlantic, Blue Note, Blue Rock,

Caedmon, Chart, Contemporary, Cumberland,

Dial, Dimension, Fabor, Fantasy, Fiesta, Fon-

tana, Galaxy, Gaylord, Good Time Jazz, Heart-

warming, Hickory, Limelight, Mala, Mercury,

Monument, Musicor, Philles, Rem, Sing, Sky-

light, Smash, Songs of Faith, Sound Stage 7,

Starday, Stax, Wing.

Wego, 6566 Montgomery Rd. Tel.: 731-7051. VP:

Charles Weiner.

Labels: Fax, Prism, Solar, Sound Spectrum, Tip.

● **CLEVELAND (Area Code 216)**

B & F, 3046 E. 123 St. Tel: LO 1-5524. Pres.:

Frank Szappanos.

Buckeye Nat'l Sales, 6313 St. Clair Ave. Zip: 44103.

Tel: 431-1155. Pres.: Harvey Korman.

Labels: A&M, American Artist, Armour, Bang,

Barbizon, Canary, Capa, Chart, Chevelle, Circa,

Clark, Curley, Dapper, Daralena, Down Home,

Forest, Gordy, JCP, Jo Mar, Lloyd, Longhorn,

MGM, Nugget, Peach, Pocano, Post, Prism,

Progress, Re Von, Rice, Tamlal, Tim, Token,

Train, Songs of Faith, Sound, Sound of Nash-

ville, Sound Spectrum, Vulcan, Wise, Wolf,

Capitol, 2800 Euclid, Rm. 225. Tel: 861-9187.

Territorial Mgr.: Jim Johnson.

Distributes: Capitol & Angel Product.

Cleve-Disc, 1550 E. 33 St. Tel: 391-1320. Gen.

Mgr.: Godfrey Dickey.

Affiliates: C&C Stone, San Francisco, Calif.—

Hart, Los Angeles, Calif.—Mutual, Boston, Mass.

Labels: ABC-Paramount, Atco, Co & Ce, Colpix,

Dunhill, Epic, Fiesta, Impulse, London Group,

Monument, Reprise, Tower, 20th-Fox, Warner

Bros., Westminster.

Columbia, 3510 Chester Ave. Zip: 44114. Tel: 431-

6300. Regional Sales Mgr. (Cleveland, Detroit,

Pittsburgh, Cincinnati): Tony Martell; Sales

Mgr.: Gene Settler; Promo.: Robert Fluke.

Distributes: Columbia Product.

Concord-Benart, 620 Frankfort Ave. Zip: 44113. Tel:

MA 1-7274. Pres.: Arthur Freeman.

Labels: Alpha, Arctic, Arrawak, Associated

Artist, Atila, Audio Fidelity, Bing, Blue Note,

Bonanza, Boyd, Broadway, Cadet, Carney, Chat-

tahoochee, Checker, Chess, Class, Clock, Con-

temporary, Coun-Tree, Crusader, Current, Dance

Along, Destination, Diplomacy, Disneyland,

Dooto, Downey, D-Town, Dyno, Era, Exodus,

Fantasy, Faro, Gemini, Good Time Jazz, Gospel,

Hall, Jamie, Jell, Jewel, Junior, Landa, Mag-

num, Montel, Moonglow, Paula, Phi-Dan, Philles,

Prism, Rampart, Red Fox, Regent, Riviera, Sa-

voy, Sharp, Soft, Sonar, Specialty, Stella, Sun,

Supreme, Sur-Speed, TCF, Tally, Teardrop, Tip

Top, USA, VIP, Verann, Vista, Ware, Wheel

City, Whit.

Decca, 746 W. Superior Ave. Zip: 44113. Tel:

621-9770. Mgr.: Bill Green.

Distributes: Decca Product.

Handleman, 6116 Broadway. Tel: 641-5989.

Contact: R. Cipriani.

Tape, Cartridge: RCA Stereo 8.

Liberty, 7002 Euclid Ave. Tel: 881-5050. Contacts:

Joe Simone, Ron Iafornaro, Marv Dorfman.

Distributes: Liberty Product.

Main Line, 1260 E. 38 St. Zip: 44114. Tel: 391-

1800. Exec. VP: Jim Shipley; VP & Gen. Mgr.:

Mike Spence; Mgr. RCA Div.: Carl Lombardo;

Mgr. Independent Div.: Ed Rosenblatt.

Labels: RCA Victor, RCA Camden, A&M, Amy,

Autumn, Cadet, Cameo, Checker, Chess, Congress,

continued on page 102



FOR THE LION'S SHARE OF THE MARKET IT'S METRO DISTRIBUTORS

Branches In Three Major Markets

NEW YORK

Metro Distributors
547 West 52nd Street
New York, N.Y.
Dave Seidman, Branch Manager

Handling:

Audio Fidelity
DGG
Elektra
Golden World
Heliodor
Kama Sutra
Leo the Lion
Living Language
Lost Night
MGM
MTA
Metro
Mira
Nonesuch
Original Sound
Saharo
Sew City
Surrey
Swan
VSP
VeeJay
Verve
Verve/Folkways

CHICAGO

Metro Distributors
1112 South Wabash Avenue
Chicago, Illinois
Morrie Price, Branch Manager

Handling:

Banner
DGG
Elektra
Golden
Heliodor
Kama Sutra
Karate
Leo the Lion
Living Language
MGM
Metro
Mira
Mirrowood
Nonesuch
Surrey
Time
VSP
Verve
Verve/Folkways

LOS ANGELES

Metro Distributors
2053 Venice Blvd.
Los Angeles, Calif.
Mel Price, Branch Manager

Handling:

Audio Fidelity
Black Rock
Double L
DGG
Golden
Heliodor
Kama Sutra
Leo The Lion
MGM
Metro
MTA
Original Sound
VSP
Verve
Verve/Folkways



The WINNER

The Most Aggressive
Independent
Distribution in
Pennsylvania,
New Jersey
and Delaware.

BEST IN SERVICE
BEST IN SALES
BEST IN PROMOTION

OUR BEST ENDORSEMENT
IS OUR SATISFIED
MANUFACTURERS

You're a Winner when you
call:

AL MELNICK

A&L

DISTRIBUTORS, INC.

1811 Fairmount Ave.
Philadelphia, Pa.
(215) POplar 5-4300

continued

Deutsche Grammophon, Duke, Elektra, Fraternity, Gordy, Kapp, King, Laurie, MGM, Mala, Motown, Nonesuch, Parkway, Peacock, Prestige, Red Bird, Sue, Starday, Tamla, Verve, Vanguard.

Tape, Cartridge: RCA Victor, ITCC, Motown, Aura Sonic.

Tape, Reel-to-Reel: RCA Victor, RCA Camden.

Tape Playback Equip.: RCA Victor, Lear Jef.

Mobile Stereo of Ohio, 5141 Pearl Rd. Zip: 44129. Tel: 741-3134. Pres.: C. J. Lombardo; Mgr.: R. C. Smith.

Tape, Cartridge: ITCC.

Tape Playback Equip.: Craig.

Seaway, 3142 Prospect Ave. Tel: EX 1-7300. Pres.: John Cohen; Promo.: Mike Dragas.

Labels: Atlantic, Blue Horizon, Bo-Mar, Diamond, Disneyland, Dot, Everest, Golden, Mainstream, Scepter, Time, Wand.

• COLUMBUS (Area Code 614)

Handleman, 1977 McAllister Ave. Tel: 258-8419. Contact: J. Glaser.

Tape, Cartridge: RCA Stereo 8.

United Assocs., 832 Leona Ave. Zip: 43201. Tel: 299-6150. Mgr.: Vernon Stewart; Promo. Men: Ben Segal, George E. Sagold & Bobby Clark. **Labels:** Ekco, Four-L, Hi, Hitone, Hi-Top, Song-dial, Stardisc, Verne.

• SPRINGFIELD (Area Code 513)

Buckeye Ents., 5 E. Main St. Zip: 45502. Tel: 325-7686. Pres.: Asen Kristoff; VP: Steve Kristoff.

Labels: Design, Dooto, Little Golden.

OKLAHOMA

• OKLAHOMA CITY (Area Code 405)

B & K, 129 N.W. 23 St. Zip: 73103. Tel: 525-7509. Owner: Cliff Keeton & Bill Burton; Sales: Bill Runge.

Labels: AAA, ABC-Paramount, Atco, Autumn, Backbeat, Bang, Blue Horizon, Bo-Mar, Boom, Cameo, Command, Diamond, Disneyland, Dolton, Dunhill, Faro, Hanna-Barbera, Imperial, Impulse, Jamie/Guyden, Kapp, Liberty, Linda, Loadstone, Oliver, Open, Parkway, Phyllis, Rampart, Roulette, Sound of Nashville, Sunset, Tangerine.

Dulaney, 100 N.W. 44 St. Zip: 73118. Tel: JA 5-1511. Pres.: L. T. Dulaney.

Labels: Atlantic, Colpix, Fraternity, RCA Camden, RCA Victor.

OREGON

• MEHAMA (Area Code 503)

International Consolidated, PO Box 928. Nat'l Rep.: Mark Raymer; Promo.: Sherree Scott. Branch: San Fernando, Calif.

Labels: Robbins, Headliner Stars, Sherree Heart, Colorful, Atlas, Angeltone.

• PORTLAND (Area Code 503)

North Pacific, 2950 N.W. 29 Ave. Zip: 97210. Tel: 228-9576. Mgr.: Harry Salvus.

Labels: RCA Camden, RCA Victor.

Tape-Tronics (div. of Seattle Rec. One Stop), 21 N.E. Seventh Ave. Zip: 97232. Tel: 234-0965. Sales: Jerry Coats.

Tape, Cartridge: ITCC.

PENNSYLVANIA

• BETHLEHEM (Area Code 215)

Rave, 938 Sullivan St. Tel: 868-9315. Mgr.: Joe Timmer.

Labels: Ampol, Apon, Artists' Life, B&F, Chicago, Dala, Dyno, Edelweiss, Glo, Hazam, Jay Jay, Pageant, Rave, Request, Rex, Stella, Turul, Universe.

• BROOMALL (Area Code 215)

Lesco, 2205 Mary Ln. Zip: 19008. Tel: EL 6-1887. Pres.: Edward Cohn.

Labels: Canary Bird, Cetra, Dance Along, Datus, Eterna, Experiences Anonyms, Hot Rod, Key, Lesco, Lyrichord, Major, Parakeet, Peter Pan, Plaza, Rainbow, Rosemont.

• HARRISBURG (Area Code 717)

D & H, 2525 N. Seventh St. Tel: 236-8001. Mgr.: David Press.

• JOHNSTOWN (Area Code 814)

Page Rec'g, 345 Second St. Zip: 15909. Tel: 539-8117. Mgr.: Al Page; Promo. Men: Al Page (East Coast); Ernie Page (West Coast).

Labels: ARC, Apon, Camay, Coronet, Crown, Disneyland, Greyko, HBR, Jay Jay, Labrea, Marion, Page, Rave, Seaway, Silverbell, Somerset, Spin-O-Rama, Tambura, Wyncote.

Tape, Cartridge: ITCC.

• NEW KENSINGTON (Area Code 412)

Vokes Music, Drawer 1203. Zip: 15068. Tel: 828-6864. Pres. & Mgr.: Howard Vokes; Promo. Men: Howard Vokes & Bob Rose.

Labels: Blue Hen, Del-Ray, Vokes.

• PHILADELPHIA (Area Code 215)

A & L, 1811 Fairmount Ave. Zip: 19130. Tel: PO 5-4300. Owner: Albert Melnick; Mgr.: Harry Fink; Promo.: Barry Abrams.

Labels: Academy, Adventure, Afro, Amy, Arhoolie, Audio Fidelity, Aurora, Backbeat, Bell, Big Hill, Big Top, Bounty, Bragg, Cambridge, Charlie Parker, Constellation, Conversaphone-Betty White Dance Series, Language Courses-Steno-Speed Courses, Colonial, Dearborn, Double L, D-Town, Duke, DynoVoice, Elektra, End, ESP-Disc, Excello, Fantasy, Flashback, Folkways, Galaxy, Gee, Glad Hamp, Golden Crest, Goldwax, Happy Time, Headline, Hull, Kenwood, Mala, Maxx, Melodian, Mobile Fidelity, Monitor, Mr. Maestro, Murnil, Music Minus One, Nashboro, New Voice, Nina, Nonesuch, Peacock, Request, Richard Dyer-Bennett, Riot, Rittenhouse, Rivoli, Roulette, Roost, St. Lawrence, Satellite, Song Bird, Sphere Sound, Spoken Arts, Squire, Standard, Summit, Sure Shot, Tico, Tikva, Tradition, Turntable, 20th-Fox, Win Gate.

Tape Playback Equip.: Claricon, Crown, Webcor.

Musical Instruments: Guitars.

Musical Accessories: Amplifiers, Crown Products.

American Rec. Sales, 1242 W. Girard Ave. Zip: 19123. Tel: PO 9-3900. Pres.: Bill Buster; VP: Ed Balbier.

Labels: Oldies But Goodies, Back Number 45.

Capitol, 2629 N. 15 St. Tel: BA 6-1550. Mgr.: Howard Aronson.

Distributes: Capitol & Angel Product.

CHIPS, 2750 N. Broad. Zip: 19132. Tel: PO 9-5000. Gen. Mgr.: Ernie Santone.

Labels: Artia, Cameo, Carnival, Claridge, Diamond, Disneyland, Dore, Era, Fleetwood, Fraternity, GNP, Gateway, Gordy, Hickory, JJC, Mira, Mirwood, Motown, Parkway, Parliament, Soul, Surrey, Swan, TCF, Tamla, VIP, Vee Jay, Vista, Vox, Wyncote. (SEE ADVERTISEMENT)

Columbia Rec. Sales, 4 Penn Ctr. Plaza, Suite 224. Zip: 19103. Tel: LO 8-4445. Mgr.: Edward Masterson; Promo. Mgr.: Ted Kellem; Reg'l Sales Mgr. (Philadelphia, Washington, Miami, Atlanta): Jack Craig.

Distributes: Columbia Product.

Dot, 919 N. Broad St. Tel: CE 6-7711.

Labels: Dot, Hamilton.

Hamilton Sales, 22 St. & Parkway. Zip: 19130. Tel: LO 3-4679. Owner: Bill Hamilton.

Labels: (All label closeouts, 45's & LP's).

Jamie/Guyden, 919 N. Broad St. Zip: 19123. Tel: CE 2-8383. Pres.: Harold Lipsius.

Labels: Arctic, Guyden, Jamie, Landa, MLS, Montel, Soft, Teardrop.

Marnel, 2512 N. Broad St. Tel: BA 6-1222. Mgr.: Marshall Verbit.

Labels: Ascot, Atlantic, Bach Guild, Bang, Blue Note, Caedman, Choice, Colpix, Concert-Disc, Counterpoint, Dana, Dial, Dolton, Dooto, Everest, Fiesta, Gospel, Grecophon, Hanna-Barbera, HiFi, Jubilee, Laurie, Legrand, Liberty, Living Language, Lost-Nite, Mainstream, Pacific Jazz, Prestige, Regent, Riverside, Rust, Savoy, Sharp, Speciality, Starday, Status, Stax, Stereoaddies, Sun, Time, Tower, UA, Uptown, Valiant, Vanguard, World Pacific.

Robert Nash, 207 Tulpehocken Ave., Elkins Park. Tel.: WA 7-6100. Pres.: Robert Nash.

Distributes: Cartridge Tape.

Quaker City, 821 N. Broad St. Zip: 19123. Tel: CE 6-8406. Mgrs. & Promo. Men: Al Kelly & Harry Finfer.

Labels: Arlen, Ashley, Bluestone, Capa, Capco, Chalton, Chart, Clown, Cobra, Deblynn, Embers, Eurotone, Fabor, Faro, Gallio, Gem, General American, German News, Holton, Inner, Joed,

Jordan, Kevin, Linda, Longhorn, La Louisianne, Lantam, Lumtome, Magnum, Moonglow, Patty, Polydor, Rampart, Rebel, Rockin, Sage, Samron, Sand, Security, Sincere, Skyscraper, Sounds of Nashville, Stop, Summer, Tabb, Tiara, Topic, Tressure, Wheeling.

Rockin' Recs., 51D1 N. 12 St.

Branches: Atlantic City, Perth Amboy, N. J.
Labels: Oldies But Goodies.

DAVID ROSEN, B51-53-55 N. Broad St. Zip: 19123.

Tel: CE 2-2900. Mgr.: Harry Rosen; Promo. Men: Matty Singer, Herb Gordon, Ronnie Singer, Richard Salvador.

Labels: ABC-Paramount, Apt, Arwin, Award Artists, Banner, Bethlehem, Blue Cat, Boom, Cadet, Checker, Chess, Command, Congress, DCP, Debut, Dee Gee, DeLuxe, Dunhill, Four Corners, Freeport, Golden, Grand Award, Hilltop, Imperial, Impulse, Jaguar, Jerden, Junior, Kapp, Kee, King, King Karol, LTD, Loma, Modern, Monument, Music Guild, Musicor, Palmer, Pickwick, Post, Reach, Red Bird, Reprise, Soma, Sure, Tangerine, Tuff, Warner, Westminster.

Tape, Reel-to-Reel: ABC-Paramount, Command, Impulse, Westminster.

Musical Accessories: Recoton, Astatic, Pickering, Mercury Players, Le Bo Prods., Gavin. (SEE ADVERTISEMENT)

Raymond Rosen, Parkside Ave. at 51 St. Tel: TR B-2200. Mgr.: Paul Knowles.

Labels: RCA Victor, RCA Camden, RCA Victrola, London, London phase 4, London Int'l, Richmond, MGM, Verve, Metro, Kama Sutra, Coliseum, Heliodor, VSP, Leo the Lion, Verve/Folkways.

Tape, Cartridge: RCA Stereo B.

Tape, Reel-to-Reel: RCA Victor & Camden 4 Track.

UNIVERSAL, 919 N. Broad St. Zip: 19123. Tel: CE 2-3333. Mgr.: Leonard Radcliff; Promo. Men: Gunter Haver & Bill Harper.

Labels: A&M, Atco, Challenge, Contemporary, Epic, London Group, Mustang, Old Town, Original Sound, Philles, Scepter, Wand, White Whale.

Tape, Reel-to-Reel: Epic. (SEE ADVERTISEMENT)

• PITTSBURGH (Area Code 412)

Capitol, 110 St. Joseph St. Tel: 431-5803. Mgr.: Dennis Letzler.

Distributes: Angel & Capitol Product.

Columbia Rec. Sales, 220 Porter Bldg. Zip: 15219.

Tel: 261-2844. Sales Mgr.: James K. Winston;

Promo.: "Solly" Solomon.

Distributes: Columbia Product.

East Coast, 633 Liberty Ave. Tel: 281-6344. Mgr.:

Nicholas Lomakin.

Labels: Argos, Audiotape, Borderline, Commodore, Dictation Disc, Dootone, Fax, Golden Crest, Humorsonic, K&H, Russell Dance, Switchcraft.

Fair-Shake, 32 Pride St. Zip: 15232. Tel: 281-3956.

Mgr. & Promo.: George Goodman.

Fenway, 1601 Fifth Ave. Tel: 391-3973. Pres.:

Herbert Cohen.

Labels: Ama-Mala-Bell Group, Argo, Atlantic, Blue Cat, Checker, Chess, Co & Ce, Diamond, Everest, Golden Crest, Golden World, Gordy, Guyden, Hickory, Jay Jay, Kapp, London Group, Markie, Motown, Music Note, Old Town, Red Bird, Roulette, Scepter, Tamla, Time, 20th-Fox, UA, Wand.

Hamburg Bros., 24 St. & AVRR. Zip: 15222. Tel:

471-0808. Gen. Mgr.: Morton J. Locker; Promo.:

Jay Conniff.

Labels: ABC-Paramount, A&M, Almo, Apt, Audio Fidelity, Aura, Bach Guild, BT Puppy, Camden, Dana, Dolton, Dunhill, Eurotone, Fortune, Fraternity, Golden, Hanna-Barbera, Impulse, Josie, Jubilee, Karate, K-Ark, Liberty, Living Language, Mira, Mirwood, Monument, Music Guild, Nashville, Pacific Jazz, Pickwick/33, Port, RCA Camden, RCA Victor, RCA Victrola, Savoy, Sound Stage 7, Starday, Surrey, Tangerine, Tower, Vanguard, Westminster, World Pacific, Young People's Recs.

Tape, Cartridge: RCA Stereo B, Liberty, ITCC.

Tape, Reel-to-Reel: RCA Victor, RCA Camden, ABC, Impulse, A&M.

Handleman, 3109 Forbes St. Tel: 681-4790. Con-

tact: Vera Powell.

Tape, Cartridge: RCA Stereo B.

make the year-long reference value of the "buyer's guide" readily

AVAILABLE TO EVERY MEMBER OF YOUR FIRM...

Order extra copies NOW
Jus: \$1.25 per copy (prepaid)

Billboard Buyers Guide
2160 Patterson St.
Cincinnati, Ohio 45214

Please send ... copies of Buyers Guide.
My payment for \$... is enclosed.

Name
Company
Address
City
Zone
State

U.S. Record Distributors

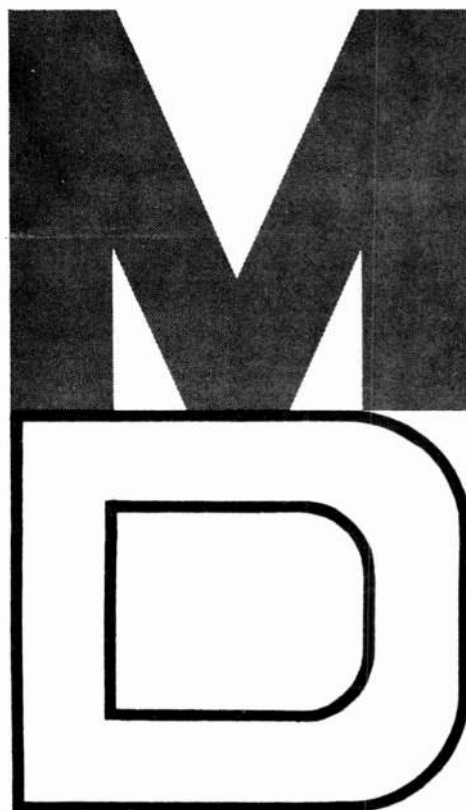

MEMPHIS
-DELTA
DISTRIBUTING CO.

596 Lane Avenue
Memphis, Tennessee
(901) 525-0756

Ewell Roussell, Mgr.
Representing the Independent
Manufacturer with effective
sales promotion, merchandising
know-how and fast service.

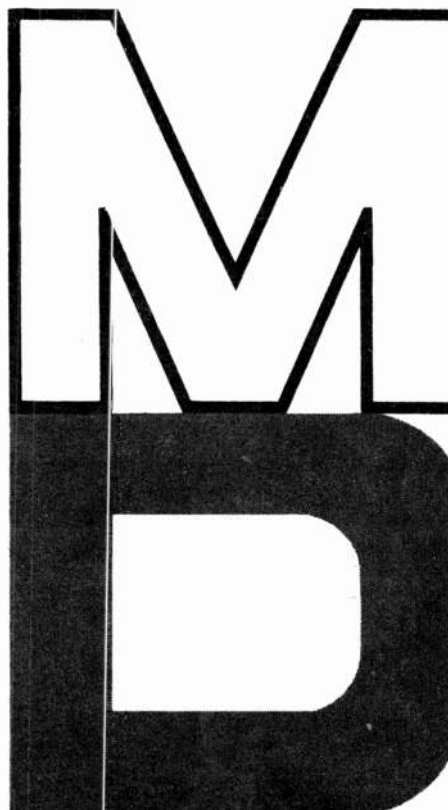

continued

Klein's Logan Variety Store, 2111 Centre Ave. Tel: 261-6176. Pres.: Isadore Klein.
Labels: AngelTone, Atlas, Aura, Backbeat, Baronet, Bluesville, Brent, Candlelight, Carnival, Circa, Cobra, Cortland, Dana, Don-EI, Dooto, Dore, D-Town, Duke, Eastern, Excello, Fortune, Gina, Golden World, Goldie, Goldisc, Hull, Impact, Itzy, Jimo, Jox, Junior, Lola, Milestone, Musicnote, Music World, Nashboro, Nola, Peacock, Prestige, Ran-Dee, Relic, Ric-Tic, Swingin', Time, Travis, V-Tone, Win Gate, Witch.
 Jack H. Samuels, 4917 Baum Blvd. Zip: 15213. Tel: 621-1816.
Tape, Cartridge: Decca, ITCC, Mercury, Mowtown, Muntz Stereo Pak, RCA Victor.
Tape Playback Equip.: Lear Jet Stereo B.
 Standard, 1601 Fifth Ave. Tel: 391-3973. Mgr.: Nich Cenci.
Labels: Atco, Challenge, Command, Era, Flip, Gateway, Grand Award, Hilltop, Imperial, Kent, Laurie, Modern, Original Sound, Parkway, Phillies, Phillips Int'l, Regina, Reprise, Swan, Vee Jay, Warner Bros.

• **READING (Area Code 215)**

McKinnon, 411 Gordon St. Zip: 19601. Tel: 376-0300. Pres.: Leonard McKinnon; Gen. Mgr.: Beulah F. Coad.
Labels: Beulah, Center City, Gordon Street, Hit Kingdom, Holy Cross, Lorraine, Margie, Marion, McKinnon, Path, Reading, Slide.

• **SCRANTON (Area Code 717)**

Bellnash, 912 Clay Ave. Zip: 18510. Tel: 347-8429. Mgr. & Promo.: Dick Plorkin.
Labels: Abadel, Beret, Debra, Gina, Little Gents Children's Recs., Marla, Midtown, Seaway, Shalomar, Tala.
Musical Accessories: Pageant.

• **SHARON (Area Code 412)**

Marjon, 930 Woodview Pl. Zip: 16146. Tel: 347-4726. Mgr: John T. Krizancic.
Labels: Balkan, Marjon, Tamart, Tambura, Yadran.

RHODE ISLAND

• **PROVIDENCE (Area Code 401)**

Beacon., 752 Branch Ave. Tel: UN 1-7500. Pres.: Milton Israeloff.
Labels: Buckingham, Coronet, Crown, Design, Grand Prix, Hilltop, Hurrah, Mercury Wing, Pickwick/33, RCA Camden, Somerset, Zondervan.
Tape, Cartridge: Mercury & ITCC B Track.

TENNESSEE

• **GALLATIN (Area Code 615)**

Randy's Rec. Shop, 321 W. Main St. Zip: 37066. Tel: 452-4696. Pres.: Gilbert Brown.

• **KNOXVILLE (Area Code 615)**

McClung Appliances, 310 Georgia St. Zip: 37917. Tel: 524-1811. Mgr.: Albert Smith.
Labels: RCA Victor, RCA Camden, Peter Pan, Heartwarming, Pickwick Int'l.
Tape, Cartridge: RCA & ITCC Stereo B.
Playback Equip.: Lear Jet.

• **MEMPHIS (Area Code 901)**

Blackwood Bros., 209 N. Lauderdale. Tel: JA 7-4349. Pres.: James Blackwood.
Labels: Audio Books, Capitol, Choice, Christian Faith, Columbia, Comfort, Decca, Heartwarming, Inspiration, RCA Victor, Sing, Skylite, Songs of Faith, Supreme, Zondervan.
 Decca, 741 Galloway Ave. Zip: 38105. Tel: 527-4539. Mgr.: Jack Brown.
Distributes: Decca Product.

McDonald Bros., 994 S. Bellevue. Zip: 38102. Tel: WH 8-2771. Mgr.: Charles F. Smith.
Labels: RCA Victor, Atlantic, Atco, Smash, Stax, Mercury, Volt.
Distributes: Other RCA Product.

MEMPHIS-DELTA, 596 Lane St. Zip: 38105. Pres.: Ewell Russell.
Labels: Bang, Boone, Bright Star, BT Puppy, Cadet, Cameo-Parkway, Canaan, Checker, Chess, Co & Ce, Colpix, Everest, Four Brothers, GNP Crescendo, Golden World, Hanna-Barbera, Hick-

ory, HiFi, Impact, Joda, Josie, Jubilee, La Louisiane, Living Language, Mainstream, Nola, Old Town, One-Derful, Phillies, Phillips, Ric-Tic, Saxoy, Sentaur, Sims, Starday, Sun, Time, USA. (SEE ADVERTISEMENT)

Record Sales, 311 Exchange Ave. Tel: 526-7361. Gen. Mgr.: Stanley Terry.

Labels: ABC-Paramount, Amy, Ascot, Autumn, Backbeat, Blue Cat, Command, Congress, Crown, DCP, Diamond, Duke, Dunhill, DynoVoice, Eastern, Era, Excello, Fame, Goldwax, Hi, Imperial, Impulse, Interphon, Jewel, Joy, Kent, King, Liberty, Mala, Modern, Money, Monument, Musicland USA, Nashboro, New Voice, Original Sound, Parrott, Paula, Peacock, Press, Red Bird, Reprise, Scepter, Statue, Sue, Tally, Teardrop, Tollie, Tribe, 20th-Fox, UA, Vee Jay, Wand, Warner Bros., World Artists, Young People's Records.

Tri-State, 3635 Allendale. Tel: 324-4640. Mgr.: Pete Edwards.

Labels: Allendale, Burch-lo, Calten, Express, Jenny-Lynn, Mid-South, STZ, Spinnin' Square, Style, Styleten, Taver, Tentay, Tover, Wooten, Zonia.

• **NASHVILLE (Area Code 615)**

Country Music Nashville, PO Box 701. Tel: 297-4967. Pres.: R. Murray Nash.

Dot, 535 Fourth Ave. S. Tel: 255-5451. Mgr.: Jim Wardlaw.

Labels: Dot, Hamilton, Planetary.
 Hermitage, 569 Chestnut St. Tel: 244-1790.

Music City, 127 Lafayette St. Zip: 37202. Tel: 255-7315. Mgr.: Hutch Carlock; Promo.: Mrs. Rae Bundy.

Labels: ABC-Paramount, ARA, Atco, Atlantic, Audio Book, Bang, Bethany, Bethlehem, Blue Rock, BT Puppy, Calla, Cameo, Carla, Carnival, Celeste, Chart, Chattahoochee, Clarion, Courier, Charter, Co & Ce, Dial, D-Town, Dunhill, Eastern, Enjoy, Epic, Era, Excello, Fabor, Fantasy, Federal, Fontana, Four Bros., Fraternity, Galaxy, Garpax, Gross, Hanna-Barbara, Hi, HiFi, Hob, Jorden, Jubilee, Joda, Kapp, Kent, King, La Louisiane, Laurie, Limelight, Longhorn, Lupine, MOC, Mar-V-lus, Mercury, Mercury-Wing-Childcraft-Playcraft, Mirwood, Money, Monument, Moonglow, M-Pac, Music Guild, Nasco, Nashboro, Nashville, Okeh, One-Derful, Original Sound, Parkway, Parrot, Phillies, SC Phillips Int'l, Press, Price-Wise, Pure Soul, Rampart, Rem, SPQR, Safice, Scepter, Serock, Simco, Sims, Smash, Sound of Nashville, Sound Stage 7, Spokane, Specialty, Starday, Stax, Sue, Sun, Swan, Swingin', Thelma, Tribe, 20th-Fox, Vanguard, Vault, Volt, Wand, Watch.
Tape, Reel-to-Reel: ABC-Paramount.
Tape Playback Equip.: Mercury.
Musical Accessories: Fidelitone Needles & Accessories, Freedman Artcraft Rack.

Southern, 467 Chestnut St. Tel: 254-1991. Pres.: Howard Allison.

Labels: A&M, Age, Amy, Argo, Aura, Backbeat, Bell, Blue Cat, Blue Note, Bragg, Canadian American, Challenge, Champion, Checker, Chess, Colpix, Congress, Constellation, Crescendo, Crusader, DCP, DGG, Diamond, Dimension, Doyton, Domain, Dooto, Dore, Duke, Dunhill, DynoVoice, End, Everest, Gateway, General Arts, Golden World, Goldwax, Gordy, Guyden, Hickory, Imperial, Jamie, Jet Stream, Jewel, Josie, Kenwood, Landa, Liberty, Little Golden, MGM, Mala, Maxx, Mel-o-dy, Michele, Motown, Musicor, Old Town, Paula, Peacock, Phillips, Prestige, Red Bird, Roulette, Savoy, Soma, Soul, Squire, Sunset, Sureshot, Talley, Tamla, Teardrop, Tico, Tolley, Tower, 20th-Fox, UA, USA, Vee Jay, Veep, Verve, World Artists, World Pacific, XL.

TEXAS

• **AMARILLO (Area Code 806)**

Western Mdtrs., 1601 W. Third.
Tape, Cartridge: Decca, ITCC, Mercury.
Tape Playback Equip.: Lear Jet Stereo B.

• **DALLAS (Area Code 214)**

Adleta, 1914 Cedar Springs. Tel: RI 1-3151. Gen. Mgr.: E. P. Miles; Mgr. Rec. Dept.: David Eisenlohr; Adv. & Sales Promo. Mgr.: G. E. Stone Jr.

Distributes: RCA Product.
 B & K, 2512 Irving Blvd. Tel: ME 7-1920. Contact: Bill Burton.
Labels: Ascot, DCP, DGG, Disneyland, Enjoy, Everest, Heliodor, Hickory, Life, MGM, Metro,

Prestige, Reprise, Riverside, Starday, Stereo Fidelity, UA, VSP, Verve, Vista, Warner Bros. Big State, 1337 Chemical St. Tel: ME 1-1100. Mgr.: Bill Emerson.

Labels: A&M, Argo, Atco, Atlantic, Autumn, Blue Note, Cameo, Challenge, Chancellor, Checker, Chess, Coed, Colpix, Del-Fi, Dore, Duke, Ember, Fabor, Fantasy, Fraternity, Gordy, Guyden, Imperial, Jamie, Jubilee, Kent, Laurie, Liberty, London, Montel, Monument, Motown, Musicor, Nashboro, Parkway, Peacock, Red Bird, Richmond, Roulette, Scepter, Specialty, Sun, 20th-Fox, Tamla, Vanguard, Vee Jay, Wand, Young People's Recs.

Capitol, 5105 Lakawana. Tel: ME 7-0710. Mgr.: Roger Moore; Sales: Marvin Beisel.
Distributes: Angel & Capitol Product.

Columbia, 8808 Empress Row. Zip: 75247. Tel: ME 1-5680. Regional Sales Mgr. (Dallas, New Orleans, St. Louis): Bud Rieland; Sales Mgr.: Tom Cade; Promo. Mgr.: Harold Bakke Jr.

Distributes: Columbia Product.
 Decca, 139 Cole St. Tel: RI 2-3739. Mgr.: C. E. McNabb. Zip: 75207.

Labels: Brunswick, Coral, Decca, Elektra, Listen & Learn.
Distributes: Other Decca Product.

Dot, 1347 Chemical St. Tel: 631-0630. VP: John P. Vescovo.

Labels: Dot, Hamilton.
 Handleman, 2260 Monitor St. Tel: 631-2943. Contact: G. Braun.

Tape, Cartridge: RCA Stereo B.

Jay Kay, 2931 Irving Blvd., Suite 105. Tel: 637-2440. Zip: 75207. Mgr.: Tom Hainey; Sales: Ray Goff.

Labels: AA, ABC-Paramount, Audio Fidelity, Boom, Canaan, Crown, Custom, GNP Crescendo, Gordy, Impulse, Kapp, Mainstream, Mira, Motown, Oliver, Pickwick/33, Soul, Tamla, Tangerine, Time, Tower, Word.

King, 1107-A Lagoon Dr. Zip: 75207. Tel: ME 1-3080. Contact: Phil Archer.

Labels: Bethlehem, Federal, King.
 Merrec, 814 Stemmons, Tower South. Zip: 75207. Tel: ME 1-3531. Mgr.: Tom Colley.

Labels: Childcraft, Emarcy, Fontana, Limelight, Mercury, Mod, New Breed, Phillips, Playcraft, Smash, Storyteller, Wing.
Distributes: Other Mercury Product.

• **EL PASO (Area Code 915)**

M B Krupp, 311 S. Santa Fe St. Tel: 532-4961. Mgr.: M. B. Krupp.

Labels: A&M, Argo, Atco, Atlantic, Audio Fidelity, Blue Cat, Cameo, Challenge, Checker, Chess, Colonial, Colpix, Constellation, Coronado, Del Valle, Dial, Dootone, Dore, Duke, Ember, Era, Everest, Falcon, Fantasy, Gordy, Guyden, Hickory, HiFi, Ideal, Jamie, Jubilee, Kent, Landa, Laurie, Legrand, Miami, Modern, Monogram, Moonglow, Motown, Parkway, Peacock, Project, Red Bird, Roulette, Scepter, Soul, Starday, Sue, Sun, Swan, Tamla, Tom Lehrer, 20th-Fox, Wand, World Artists, Yucca.

Lindy, 427 W. San Antonio St. Zip: 79901. Tel: 532-1434. Pres.: Lindy Cash; Mgr.: Joey Cash; Promo. Men: Ray Martin & Rick Rivera.

Labels: Beckingham, Cobra, Conversaphone, Crown, Del-Fi, Donna, Eco, El Zarape, Jima, Jox, LinJo, Mira, Mirwood, Mustang, Prestige, Surrey, Tomi.
Tape Cartridge: Ampex, Columbia, Capitol, RCA, 3M.
Tape, Reel-to-Reel: Ampex, Columbia, Capitol, RCA.

Tape Playback Equip.: Hitachi.
Musical Accessories: Walco Guitar Strings, Needles & Record Accessories, Amfile Carrying Cases, Lyric Rec. Racks.

Sunland, 2227 Texas Ave. Zip: 79949. Tel: 533-5901. Pres.: William Shapiro; Promo.: Richard Kalina.

Labels: Artia, Audio, Bruno, Caedmon, Children's Rec. Guild, Cricket, Cumberland, DGG, Folkways, Hi, King Group, Living Language, London Group, Monitor, Monument, Musart, Original Sound, Parliament, Specialty, Urania, Vanguard, Vox, Young People's Recs.

Tape, Cartridge: All available on the above labels.
Tape Playback Equip.: Emerson, Viking, BSR, Taiko, Portatape, Aiwa.
Musical Instruments: Teisco, WMI.

• **FORT WORTH (Area Code 817)**

Advanced Stereo Systems, 1413 S. University. Tel: ED 2-9205.

Distributes: Tape Cartridge Equipment.

Oakridge, 2001 Elton Rd. Zip: 76117. Tel: TE 8-6608.

Labels: E-MC, Eegeg, Oakridge.

• **HOUSTON (Area Code 713)**

A R S, 2702 Polk Ave. Zip: 77003. Tel: CA 7-2316.
 Pres.: Ben Baker.
 Labels: (U.S.) HiFi, Everest, ConcertDisc, Baroque, Archive of Folk Music, Living Language, Sue/Symbol/Broadway/Eastern, Longhorn, Bragg, Chart, K-Ark, Topic, Picture, Acclaim, Request, Heartwarming, Down Home; (Int'l) Musart, Orfeon, Music-Disc, Peerless/Eco, Nina/Olympic, Tropical, Velvet, Disco-Rico, Zafiro, Kubaney.
 Tape, Cartridge: A&M, Atco, Atlantic, Audio Spectrum (Aura Sonic), Bang, Cadet, Command, Concertapes, Crescendo, Everest, Elektra, GNP, Gordy, Horizon, Liberty, MGM, Mahalo, Monitor, Moonglow, Motown, Musicor, Music Guild, Musictapes, Prestige, Roulette, Seafair, Starday, Tamla, Tempo, Turnpike, Vee Jay, Verve, Volt, Westminster.
 Tape, Reel-to-Reel: Atco, Atlantic, Audio Spectrum (Aura Sonic), Bang, Cadet, Command, Concertapes, Crescendo, Discovery, Dot, Everest, Elektra, GNP, Grand Award, Hamilton, HiFi, Liberty, Mahalo, Moonglow, Music Guild, Musicor, Musictapes, Nonesuch, Prestige, Purist, Reprise, Seafair, Starday, Tapemates, Turnpike, United Artists, Vee Jay, Volt, Westminster.
 Tape Playback Equip.: Instamount 603M, Trans-World, Tele-Pro, ARS 101.
 Musical Accessories: Blank Tape.
 H W Daily, PO Box 7473, 314 11 Ave. Tel: UN 1-6868. Owners: Bud & Don Daily.
 Labels: Amy, Big Hill, BT Puppy, Cameo, Canadian American, Challenge, Constellation, Diamond, Era, Excello, Fantasy, Galaxy, Hi, Imperial, Josie, Jox, Jubilee, Laurie, London, Mainstream, Mala, Maxx, Money, Musicor, Nasco, Nashboro, Oldies, Old Town, Original Sound, Palomar, Parkway, Parrot, Phyllis, Rust, Soma, Sunglow, 20th-Fox, Vee Jay.
 Tape, Cartridge: Musical Tape Sales.
 Musical Accessories: Fidelitone, Walco, LeBo.
 Gulf, 715 Francis. Zip: 77002. Tel: JA B-2011.
 Tape, Cartridge: ITCC.
 Houston Air Center, PO Box 60396, 7700 Airport Blvd. Tel: MI 4-1701.
 Tape, Cartridge: ITCC.
 Tape Playback Equip.: Lear Jet Stereo 8.
 Art Jones, PO Box 27, 4301 Gulf Freeway. Zip: 77001. Tel: 223-4281. Mgr.: W. Whitehead.
 Distributes: RCA Victor Product.
 Lotasco, 1634 Wakefield Dr. Zip: 77018. Tel: OV 6-1155. Owners: Albert & Maxine Eickenhorst.
 Labels: Dot, Hamilton, Word, Canaan, Summit, Sword, Sacred; Diplomat, Guest Star, Peter Pan, Playmates, Rocking Horse, Sunset Strings, Embajador Discos, Scripture, Super Long Play; Coronet, Spin-O-Rama, Twinkle, Blue Ribbon, Premier, Baronet; Wyncote, Cameo, Parkway; Wrangler, Panda, Avon Forum; Somerset, 101 Strings, Tempo, Audio Spectrum, La Poloma, Mopet; Crown, Discos Corona, Crown Mexican, Custom, Robin Hood; Pickwick/33, Hilltop, Bible Series, Allegro, Design, Grand Prix, Grandisco, Happy Time; Humorsonic, Clarion; Time; Lotasco, Casual.
 Merrbach Rec. Serv., 323 W. 14 St. Tel: UN 2-7077.
 Owner: N. F. Merrbach.
 Record Dist'r, 901 Commerce. Tel: 227-4221. Contact: L. Rosmarin.
 Tape, Cartridge: RCA Stereo B.
 United, 1613 St. Emanuel St. Zip: 77003. Tel: 228-8151. Mgr.: Steve Poncio.
 Labels: A&M, ARA, Arbee, Arctic, Argo, Ark, Ascot, Astro, Atco, Atlantic, Atlantic Jazz, Aura, Autumn, Backbeat, Bellaire, Berlitz, Bethlehem, Big Thunder, Blue Cat, Blue Note, Boone, Brooklyn, Caddo, Cadet, Cadette, Calla, Camp Clambaker, Campus Song, Cams, Canjo, Capitol, Capri, Carney, Carla, Carsan, Cee-Jan, Celeste, Chalice, Checker, Chess, Clarion, Climax, Colpix, Copa, Coun-Tree, Crazy Cajun, Cyclone, DCP, Dade, Dante, Delca, Destination, Dial, Dimension, Dolton, Dooto, Duke, ESP-Disc, Eldo, Ember, Enjoy, Eric, Fabor, Fairyland, Fame, Federal, Focus, Four Brothers, Frisco, Frolic, Fury, Gadget, Gen, Gold Band, Golden Eagle, Golden World, Gospel, Groovy, Guyden, Heidi, Herald, Hermitage, Hob, Hub-City, Interlude, L&K, La Louisianne, Lew, Liberty, Loma, Lori, Lost-Nite, LuPine, Lyric, Jamie, J-Beck, Jell, Jemal, Jet-Stream, Jewel, Jin, Jocida, Joda, Joed, Joker, Jomada, Jotis, Joy, Junior, Kent, King, Kirk, Kontic, Levee, Mace, Marvel, Matrix, Michelle, Midtown, Modern, Montel, Monument, Moonglow, Music-City, Musicode, Neal, Nola, Omen, Pacemaker, Pacific Jazz, Pam, Paradise, Paula, Peacock, Pic T, Plaboy, Praise, Prestige, Price Wise, Princess, Project, Rampart, Red Bird, Regent, Renfro,

Renner, Reprise, Rheims, Rhythmaires, Rit-Tic, Riviera, Roscoe, Rosemart, Roulette, Sabra, Safice, Sansu, Sar, Sarg, Satellite, Savoy, Scepter, Seafair Bolo, Select, Sermon, Shane, Sharp, Shaw, Shazam, Simco, Sims, Sincere, Sing Song, Songbird, Sonore, Soul Sound, Sound Stage 7, Spade, Spokane, Specialty, Spinner, Stax, Stone Way, Suave, Sully, Sun, Sunburst, Sunshine, Sure Shot, Swallow, Swan, Symbol, TCF-Hall, TNT, Tamm, Teardrop, Texan, Tico, Tomorrow, Tower, Trey, Triumph, Tuff, Turntable, Twirl, Typhoon, USA, UT Talent, United Artists, Uptown, Van, Vault, Venture, Verna, Volt, Wand, Warner Bros., Way Out, Word, World Pacific, Win Gate.

• **LUBBOCK (Area Code 806)**

Crawford, 2010 52 St. Tel: SH 4-5496. Pres.: Bill C. Crawford.

• **PORT ARTHUR (Area Code 713)**

Hurricane, 1812 Procter St. Zip: 77640. Tel: YU 2-7121. Mgr.: Floyd J. Badeaux.
 Labels: Debonair, Fabor, Glenn, Jo-Mar, Kash, Loadstone, Netra, Open, Pitch, Rosie, Spec, Spindletop, Twin Town.

• **SAN ANTONIO (Area Code 512)**

Epstein Ents., PO Box 28123, 735 N. General McMullen Dr. Zip: 78228. Tel: GE 3-1461.
 Owner-Mgr.: A. Epstein. Promo. Men: Bill Evans, Crosby A. Brown, Kenny Thompson.
 Labels: Ballad, Busy Bee, Beckingham, Champ, Cobra, Dynamic, Frisco, Gallio, Groovy, Impression, Jox, Magic Touch, Nola, Selsom, Solo, World Wide.
 Rangel Music, 505 W. Commerce. Zip: 78205. Tel: CA 6-1923. Pres.: Manuel Rangel.
 Labels: Corona, Mexican Columbia, Orfeon, Ideal.

Santone Sales, 121 Navarro. Tel: CA 7-5181. Contact: Louis Jamail.

Perry Shankle, 1801 S. Flores. Zip: 78206. Tel: CA 3-1801. Mgr.: J. J. Schneider.

Sales & Promo.: James Alston & John Sobieski.
 Labels: RCA Victor, RCA Camden, RCA Victor Mexicana, Liberty, A&M, Disneyland, Cameo-Parkway, Pickwick/33.

Tape, Cartridge: RCA Stereo 8.
 Tape, Reel-to-Reel: RCA Victor, Camden, A&M.
 Tape Playback Equip.: RCA Victor, Lear Jet.

Tanner 'N' Texas Sales, 1414 W. Poplar St. Zip: 78207. Tel: PE 2-8831. Pres.: R. E. Tanner; Mgr.: Charles Cole; Promo.: Mel Moran.
 Labels: Disco Grande, Pan Am, El Toro, Falcon, Bronco, DLV, Teardrop, Bego, Musart, Columbia, Rosina, Cometa, Valmon, Sunglow, El Zarape.

• **SAN BENITO (Area Code 512)**

Rio Grande Music, PO Box 861, 119 S. Sam Houston Blvd. Zip: 78586. Tel: EX 9-1471. Pres.: Paco Betancourt; Promo.: John F. Phillips.

Labels: Ideal, Alfa, Norco, Bego, Bronco, Columbia, Coast, Cobra, Cima, Corona, Colonial, Cometa, Chemiro, Dela, Del Valle, DLV, Fama, Falcon, Firma, Gabe, Gapoca, Grande, Jox, Lira, Nopal, Norteno, Oro, Orfeon, Popular, Relampago, Rosina, Rio, Sombrero, Sunglow, Teardrop, Tomi, Valmon, El Zarape.
 Tape, Cartridge: RCA Victor, Camden.
 Tape Playback Equip.: RCA Victor, Voice of Music, Webcor, Masterwork.

Musical Instruments: Fender, Alamo, Rogers, Lyra, Kent, Gibson.
 Musical Accessories: Foot Pedals (Fender), Cords (Fender), Cymbals (Maxiton-Zildgen), Drum Sticks (Pro-Mark), Strings (Fender-Black, Diamond-Gibson), Blank Tape (Scotch).

• **WACO (Area Code 817)**

Word, PO Box 1790. Zip: 76703. Tel: PR 2-7650.
 Pres.: Jarrell F. McCracken; Nat'l Sales Mgr.: William Jelley; Dir. Promo./Adv.: George W. Baskin.

Labels: Canaan, Sacred, Sword, Word.
 Tape, Cartridge: Canaan, Word.

UTAH

• **SALT LAKE CITY (Area Code 801)**

Billinis, 3575 South-700 West. Tel: 266-3540, 3548.
 Pres.: John Billinis.
 Labels: A&M, Argo, Buena Vista, Checker, Chess, Disneyland, Gordy, MGM, Motown, Musicor, Phyllis, Tamla, Starday, UA.
 Tape Cartridge: RCA Stereo B, ITCCO
 Tape Playback Equip.: Lear Jet 8.

Billinis 
 DISTRIBUTING CO.
 3575 SOUTH 700 WEST
 SALT LAKE CITY, UTAH 84119
 Phone: 266-3548. Area Code 1-801

Distributors & Merchandisers of Phonograph Records & Stereo 8 Cartridges.
Distributors of Lear Stereo 8 Equipment for Cars—Boats—Homes.
Complete ONE-STOP Service for Juke Box Operators & Music Dealers
Serving the Intermountain West for over 10 years.
WHOLESALE ONLY

For Records In SEATTLE It's . . .
FIDELITY
 Electric Co. 
RECORD DISTRIBUTORS
 ★ **Quality**
 ★ **Service**
 ★ **Promotion**
WALLIS J. TOLLES,
 Vice-President
 5301 Shilshole Ave., N.W.
 Seattle, Wash. 206-504-9100

continued

Cordova's Importers, PO Box 16065, 543 W. Third N. Tel: 355-0642. Owner: Carl Cordova.
Labels: Bego, Bravo, Bronco, Colonial, Columbia-Mexican, Cometa, Corona, DLV, Del Norte, Del Valle, Del West, Dela, Discos Grande, Eco, El Toro, El Zarape, Falcon, Ideal, Infal, Lira, Musart, Nopal, Norteno, Orfeon, Pan Am, Peerless, Relampago, Rosina, Sombrero, Sun-glow, Teardrop, Valmon.

Huish, 2525 S. Eighth W. Zip: 84115. Tel: 486-7611. Mgr.: Ross Davis.
Labels: Cameo, Parkway, Philips, RCA Camden, RCA Victor, Vanguard, Wyncote.
Tape, Cartridge: RCA Stereo 8.
Tape, Reel-to-Reel: RCA Victor & Camden 4 Track.

VIRGINIA

• **McLEAN (Area Code 703)**
 Dance, 1438 Springvale Ave. Zip: 22101. Tel: 356-4602. Prop.: Richard Mason.

• **RICHMOND (Area Code 703)**
 Allen, 3409 W. Leigh St.

WASHINGTON

• **SEATTLE (Area Code 206)**
 C & C, 1000 First Ave. S. Tel: MU 2-7188. Pres.: Lou Lavinthal.
Labels: Atlantic, Cadet, Checker, Chess, Dol-ton, Jubilee, Liberty, MGM, Roulette, Sunset, TCF, Verve.
 Capitol, 1920 Terry. Tel: MA 3-1920. Mgr.: Marge Sires. Promo.: Jay Swint.
Distributes: Angel & Capitol Product.
Musical Instruments: Hohner Harmonicas.
Musical Accessories: Hohner Harmonica Acces-sories, Duotone Needles.

Craig (Independent Rec. Sales Div.), 540 S. Front St. Zip: 98108. Tel: PA 2-9186. Promo.: Dan Niles.
Branches: Los Angeles, Calif.; San Francisco, Calif.; Denver, Colo.; Honolulu, Hawaii.
Labels: Almo Int'l, Aura, Ban, Co & Ce, Chart, Congress, Constellation, Counterpoint, Dore, Ember, Epic, Everest, Folk Art, Four Corners, Fraternity, Groovey, Hall, Hall-way, Herald, Hob, Impact, Kellmac, King, Long-horn, MTA, Mace, Mar-V-Lus, Mira, Mirwood, Mintueman, Mobile-Fidelity, Money, Monogram, M-Pac, Mutual, Okah, One-Derful, Original Sound, Phi-Dan, Philles, Prestige, RSVP, Re-quest, Simon Says, Sound of Nashville lines, Specialty, Status, TCF, Teardrop.
 D J, 1000 First Ave. S. Tel: MU 2-7188. Pres. & Gen. Mgr.: Jerry Dennon.
Labels: A&M, Dunhill, Era, Jerden, Omen, Panorama, Scepter/Wand, Tower/Uptown, World Pacific/Pacific Jazz.

Decca, 3131 Western Ave. Zip: 98101. Tel: AT 4-8060. Mgr.: Mel Nimon.
Labels: Brunswick, Coral, Decca, Listen & Learn.
Distributes: Other Decca Product.

FIDELITY ELECTRIC, 5301 Shilshole Ave. N.W. Zip: 98107. Tel: SU 4-9100. VP: W. J. Tolles.
Labels: Artia, Arvee, Attack, Blue Note, Calla, Cameo, 49th State, HiFi, JJC, Kapp, Living Language, Lucky 11, Mustang, Oldies "45", Pageant, Parkway, Parliament, Philips, RCA Camden, RCA Victor, Tollie, Vault, Venus, Vox, White Whale.
Tape, Cartridge: RCA Stereo 8.
Tape, Reel-to-Reel: RCA Victor & Camden 4 Track. (SEE ADVERTISEMENT)

Gordon Sales, 1000 First Avenue S. Tel: MU 2-7188. Mgr.: Stan Jaffee.
Labels: Columbia, Capitol, Decca, Dot, Liberty, Atco.
Tape, Cartridge: RCA Stereo 8.

HUFFINE, 8131 Western Ave. Tel: AT 4-8633. Pres.: Andy Huffine.
Labels: Amy, Audio Fidelity, Cabot, Colpix, Di-mension, Europa, Fiesta, GNP Crescendo, Gate-way, Golden Crest, Gordy, Hickory, Mala, Monitor, Motown, Music Minus One, Tamla, Westminster, Workshop Jazz. (SEE ADVER-TISEMENT)

Music Dist., 1000 First Ave. S. Tel: MU 2-7188. Pres.: Stan Sulman; Promo.: Ron Saul.
Labels: Command, Elektra, Folkways, Imperial, Mercury, Musicor, Smash, Starday, UA, Van-guard.
 Stanley, 1000 First Ave. S. Tel: MU 2-7188. Pres.: Stan Jaffe.
Labels: ABC-Paramount, Atco, Canadian Ameri-can, Disneyland, Fantasy, London, Reprise, Tangerine, Warner Bros.
 Tape-Tronics (div. of Seattle Rec. One Stop), 127 First Ave. N. Zip: 98109. Tel: 284-8991. Sales Mgr.: Roy Rumery.
Tape, Cartridge: ITCC.
 WCRD, 100 First Ave. S. Zip: 98134. Pres.: V. C. Jack Gilbert.

WEST VIRGINIA

• **CHARLESTON (Area Code 304)**
 Handleman, 5606 MacCorkl, S.E. Tel: 925-2145. Contact: W. Hanson.
Tape, Cartridge: RCA Stereo 8.

WISCONSIN

• **MADISON (Area Code 608)**
 Tell Music, 1017 Jonathan Dr. Tel: 257-4667. Pres.: Rolf V. Voegelin.
Labels: A&M, Challenge, Crescendo, Dearborn, Disneyland, Elektra, Epic, Fantasy, Fidelity Sound, Galaxy, Golden, Mainstream, Mustang, Nonesuch, Okeh, Pageant, Pleasant Peasant, Reprise, Simon Says, Sims, Soma, Starday, United Artists, Vista, Warner Bros., White Whale.
 • **MEQUON (Area Code 414)**
 Mid-West Tape, 1908 Bonniwell Rd., 136 North. Pres.: Jim Tiedjens.

• **MILWAUKEE (Area Code 414)**
 Capitol, PO Box 3656. Zip: 53217. Tel: 272-3883.
Distributes: Angel & Capitol Product.
 Gemini, 423 N. Third St. Zip: 53203. Tel: 271-1730. Pres.: Robert Kratky; Promo.: John Heidner.
Labels: Amy, Bang, Bell, Constellation, Dyno-Voice, Goldwax, Kent, Mace, Mala, Maxx, Mira, Mirwood, Modern, Musicland, New Voice, Scepter, Vee Jay, Wand.
 Midwestern Tape, 5401 W. State St. Zip: 53028. Tel: 453-6210. Pres.: James J. Tiedjens.
Tape, Cartridge: ABC-Paramount, Ampex, Aura Sonic, Command, Decca, Dot, Fontana, Gordy, ITCC, Liberty, Mercury, Motown, Musictapes, Philips, RCA Camden, RCA Victor, Reprise, Smash, Soul, Tamla.
Tape, Reel-to-Reel: Ampex, Audio-Spectrum, Capitol, Columbia, Command, Decca, GRT, Musictapes, RCA Victor, Tape Mates.
Tape Playback Equip.: Borge-Warner, Craig Panorama.
Accessories: Full line of tape accessories.
 Morley-Murphy, 5151 W. State St. Zip: 53208. Tel: 453-7200. Mgr.: H. F. Aubuchon; Promo.: Gordon Krahn.
Distributes: Columbia Product.
Tape Playback Equip.: Masterwork, Craig, Vista.

JOHN O'BRIEN, 2830 W. Vliet St. Zip: 53208. Tel: 344-3560. Pres.: John F. O'Brien.
Labels: Atco (Volt, Vault, Moonglow, Brook-yn), Atlantic (Stax, Focus), Blue Note, Cadet (Polka's), Cadet (formerly Argo), Chess, Check-er, Clarion, Co & Ce, Colpix, Dana, Del-Fi, Diamond, Donna, Dunwich, End, Emarcy, Ever-est, Fabor, Fox, Gee, Gordy, Gross, HiFi, IRC, Jamie-Guyden-Arctic, Josie, Jubilee, King, Life, Limelight, Mainstream, Montel, Motown, Musi-cor, Old Town, Philles, Polkaland, Red Bird, Riviera, Roulette, Roost, Soul, Specialty, Tamla, Tear Drop, Tico, USA (Dyno). (SEE ADVERTISE-MENT)
 Taylor Electric, 4080 N. Port Washington Rd. Zip: 53212. Tel: 964-4321. Pres.: J. A. Taylor. Rec. Dept. Mgr.: Peter D. Stocke.
Labels: Allegro, Cricket, Cuca, Happy Time, Hickory, Hilltop, Pickwick/33, RCA Camden, RCA Victor.
Tape, Cartridge: ITCC, Motown, RCA Victor, RCA Camden (Stereo 8).
Tape, Reel-to-Reel: RCA Victor, RCA Camden.
Tape Playback Equip.: Roberts, Lear Jet.
 Volume Rec. Sales, 2830 Vliet St. Zip: 53208. Tel: 344-3738. Pres.: John F. O'Brien. Promo.: Helen B. Beiffuss & Bruce Bennett.
Labels: Childcraft, Cumberland, Fontana, Mer-cury, Philips, Smash, Wing.



JOHN 'BRIEN

DISTRIBUTING, INC.

SALES
PROMOTION
SERVICE

2830 WEST VLIET STREET • MILWAUKEE, WISCONSIN 53208

(414) 344-3560



JOHN 'BRIEN

DISTRIBUTING, INC.

U.S. Rack Jobber Directory

ALABAMA

- **BIRMINGHAM** (Area Code 205)
Music Center, 416 N. 19 St. Tel: 251-8252. Mgr.: Virgil Lugar.
- **GADSDEN** (Area Code 205)
Reliable Rec., 1018 Christopher. Zip: 35901. Tel: 546-2591. Owner: C. R. O'Neal.
- **MOBILE** (Area Code 205)
Oixie Rec. Serv., 700 N. Conception St. Tel: 432-1858. Pres.: W. H. Chamblis; Mgr.: E. Allsup. Buyer: Singles & Albums, E. M. Farver.
Music City Rec. Serv., 400B Dauphin Island Pkwy. Tel: 471-2437. Pres.: Al Pardo.

ARIZONA

- **PHOENIX** (Area Code 602)
Arizona Sundries, 2949 N. 30 Ave. Pres.: George Souvall.
Record Serv., 3036 N. 30 Ave. Zip: 85017. Tel: 278-1025. Pres.: Larry Nunes; Mgr.: Jack Sharpe. Buyer: Singles, Ken Wynn; Albums, Jack Sharpe.

ARKANSAS

- **LITTLE ROCK** (Area Code 501)
Siebert News Agency, 6301 Forbing Rd. Tel: LO 5-8471. Owner: Sieg Siebert; Mgr.: David A. Siebert. Buyer: Singles & Albums, David A. Siebert.

CALIFORNIA

- **ANAHEIM** (Area Code 714)
National Rec. Serv., 1081 N. Harbor. Tel: 776-8610. Pres.: Wally Hill.
Branches: Los Angeles, Calif., Cal Raks—San Francisco, Calif., Nor-Cal Rec. Serv.—Dorchester, Mass., Record Whslers. of New England.
Rapid Mds'g, 1802 American St. Tel: 879-4070. Mgr.: Larry Roe.
Home office: Minneapolis, Minn.
- **BAKERSFIELD** (Area Code 805)
Record Serv., 116 Goodman St. Tel: 323-4150. Pres.: Larry Nunes.
- **BUENA PARK** (Area Code 714)
JULIAN BROWN ENTS., 7425-A Orangethorpe Ave. Zip: 90620. (SEE ADVERTISEMENT)
- **DANVILLE** (Area Code 415)
M. & M Recs., PO Box 787, 295 N. Hartz Ave. Tel: 837-6922. Contact: Gordon C. George.
- **FRESNO** (Area Code 209)
Pic-A-Tune, 4453 E. Buckingham Way. Zip 93726. Tel: 229-1400. Mgr.: Gil Mondonado.
Branches: Sacramento, San Francisco, San Jose, Calif.; Reno, Nev.
Tip Top Music, 2180 E. McKinley Dr. Tel: 268-7336. Pres.: Monroe Goodman; Mgr.: Alex Morales. Buyer: Singles & Albums, Jack Hall.
- **LOS ANGELES** (Area Code 213)
Bertel Dist., 5415 W. Washington Blvd. Tel: WE 7-1223. Pres.: Herbert Seigel.
Cal Raks, 1499 W. Washington. Tel: 748-2281. Mgr.: Ben Bartell.
Branches: Anaheim, Calif., Nat'l Rec. Serv.—San Francisco, Calif., Nor-Cal Rec. Serv.—Dorchester, Mass., Record Whslers. of New England.
Electronic Mdse. (EM-CAL), 2622 S. LaCienega. Zip: 90034. Tel: 870-0401. Pres.: I. R. Stulman.
Handleman, 1550 N. Knowles Ave. Zip: 90063. Tel: 261-0268. Contact: M. Handleman.
Ivy Hill Litho, 1921 E. 51 St. Tel: LU 3-8977.
Leader Sales, 3416 W. Pico Blvd. Zip: 90019. Tel: 731-3119. Pres.: Leonard Silver.
Music City Rec. Racks, 10711 W. Venice Blvd. Zip: 90034. Tel: 839-4306. Exec. VP: Glen C. Becker.
New Deal Rec. Serv., 3660 W. Pico Blvd. Tel: 431-9313. Mgr.: Rick Susser.
Branches: Chicago, Ill.; Baltimore, Md.; Detroit, Mich.; Long Island City, N. Y.
Record Rack Serv., 5873 Rodeo Rd. Tel: UP 0-0246. Owner: Ed Mason; Mgr.: Martin Shaw. Buyer: Singles & Albums, Freda G. Holly.
RECORD SERV., 911 E. 59 St. Tel: 232-3161. Pres.: Larry Nunes. (SEE ADVERTISEMENT)
- **MODESTO** (Area Code 209)
Westrad Dist., 131 Phoenix Ave. Tel: 529-3265. Contact: Jim Petros Jr.

- **PASADENA** (Area Code 213)
Canterbury Rec., 805 E. Colorado St. Tel: 792-7184. Gen. Mgr.: Eddy Allen.
- **SACRAMENTO** (Area Code 916)
Pic-A-Tune, 2147 Barstow St., Bldg. B. Zip: 95815. Tel: 927-1256. Owner: David Watson; Mgr.: John A. LeCompte.
Branches: Fresno, San Francisco, San Jose, Calif.; Reno, Nev.
Tip Top Music, 1224 N. "B" St. Tel: HI 7-3074. Pres.: Monroe Goodman; Mgr.: Bob Ferrero.
- **SAN DIEGO** (Area Code 714)
Dial Dist., 1859 Fifth Ave. Tel: 239-4095. Mgr.: Mike Millsap.
Discount Rec. Serv., 5431 Hanna St. Tel: 286-3334. Contacts: Mill Levine & Chuck Bush.
Record Serv., 3736 University Tel: 283-8112. Pres.: Larry Nunes; Mgr.: Bob Jones. Buyer: Singles & Albums, J. Eggert.
San Diego Rec. Rack Serv., 1340 "E" St. Tel: BE 9-0631.
- **SAN FRANCISCO & BAY AREA** (Area Code 415)
Mars Music, 2450 Teagarden, San Leandro. Contact: Morey Alexander.
Nor-Cal Rec. Serv., 2035 Newcomb Ave. Tel: 285-4282. Sales Mgr.: Craig Simpson.
Branches: Anaheim, Calif., Nat'l Rec. Serv.—Los Angeles, Calif., Cal Raks—Dorchester, Mass., Record Whslers. of New England.
PIC-A-TUNE, 1461 Park Ave., Emeryville. Tel: 654-0773. Pres.: D. F. Watson; Mgr.: John Edgerton. (SEE ADVERTISEMENT)
Branches: Fresno, Sacramento, San Jose, Calif.; Reno, Nev.
Record Whslers., 2000 Oakdale Ave. Tel: MI 8-8505. Pres. & Mgr.: Don Ayers. Buyers: Singles, Fred Pollastrini; Albums, Don Ayers.
TIP TOP MUSIC, 900 Minnesota St. Tel: 285-1400. Pres.: Monroe Goodman; Mgr.: William A. Hall. Buyers: Singles, John Padden; Albums, Jack Hall. (SEE ADVERTISEMENT)
- **SAN JOSE** (Area Code 408)
Pic-A-Tune, 2096 Orlando Or. Zip: 95122. Tel: 259-1237. Mgr.: Tony Changco.
Branches: Fresno, Sacramento, San Francisco, Calif.; Reno, Nev.
Tip Top Music, 2855 Florence Ave. Tel: 259-7334. Pres.: Monroe Goodman; Mgr.: Ed Hartman.

COLORADO

- **DENVER** (Area Code 303)
J & L Racks, 77 Kalamath. Zip 80223. Tel: 255-2021. Mgr.: Louis Oxman.
Mershaw Midwest, 3990 Grape St. Tel: 399-2320. Mgr.: Paul Marcus. Buyer: Singles & Albums, Paul Marcus.
Branches: Miami, Fla.; Albuquerque, N. M.; Albany, N. Y.; Dallas, Tex.
Music Merchandisers of Denver, 3825 Newport. Tel: 355-1638.
Tip Top Music, 817 Broadway. Tel: 244-5692. Pres.: Monroe Goodman; Mgr.: Dale Williams.
Western Merchants Whsle., 6265 E. Evans. Tel: 756-0340. Mgr.: R. M. Baker.

CONNECTICUT

- **EAST HARTFORD** (Area Code 203)
Park Rec., 275 Park Ave. Tel: 289-9361. Mgr.: Edward E. Stein. Buyers: Singles, Robert Hoyt; Albums, Edward E. Stein.
- **NEW BRITAIN** (Area Code 203)
Central Connecticut Dist., 381 Main St. Tel: 225-4558.
- **NEW HAVEN** (Area Code 203)
State Drug Rack, 771-773 Grand Ave. Tel: 787-0911. Pres.: S. S. Epstein.
- **WILTON** (Area Code 203)
Acropole Corp. of America, PO Box 365. Tel: B47-2311. N. Y. C. Tel: (212) CY 5-2272. Pres.: Michele Ronty.

RECORD SERVICE, INC.

911 E. 59th St., Los Angeles, Calif.
90001 213-232-3161

TIP TOP MUSIC CO., Inc.

900 Minnesota St., San Francisco,
Calif. 94117 415-AT 5-1400

SERVICE IS OUR BUSINESS

**CREATIVE
MERCHANDISING
PLUS CUSTOMIZED SERVICE**

**THE LARGEST RECORD RACK
MERCHANDISERS IN THE WEST
NOW ALSO SERVING THE
MID-WEST AND SOUTH-EAST**

- Always First With Latest "Hits"
- Complete Record Inventory in Depth
- Fantastic Record Promotions
- Specialists in Auto Stereo Tapes
- "VICTORIA" Guitars and Accessories

Branches in:

SEATTLE, WASH. 2213 15th Ave. 206-AT 4-8910	BAKERSFIELD, CALIF. 116 Goodman St. 805-323-4150
SPokane, WASH. 431 E. Sprague 509-MA 4-6363	SAN DIEGO, CALIF. 3736 University Ave. 714-283-8112
PORTLAND, ORE. 4616 No. Albina St. 503-287-0534	PHOENIX, ARIZ. 3036 No. 30th Ave. 602-278-1025
MEJFORD, ORE. 825 Beekman 503-779-1009	LAS VEGAS, NEV. 3127 Industrial Rd. 702-735-0394
DENVER, COLO. 817 Broadway 303-244-5692	ALBUQUERQUE, N. M. 2041 Farrington Rd. 505-265-7404
SACRAMENTO, CALIF. 1224 "B" St. 916-HI 7-3074	DALLAS, TEX. 2041 Farrington 214-RI 7-2254
FRESNO, CALIF. 2110 E. McKinley Dr. 209-268-7336	ATLANTA, GA. 442 Cain St. NE 404-577-2767
SAN JOSE, CALIF. 2815 Florence Ave. 408-259-7334	KANSAS CITY, MO. (Now Opening)

continued

DISTRICT OF COLUMBIA

- **WASHINGTON (Area Code 202)**
District Recs., 2146 24 Pl. N.E. Tel: 526-2086.
Contact: Jay R. Jacobs.
National Mds'g Serv., 4620 Wisconsin Ave. N. W.
Tel: EM 2-0511.

FLORIDA

- **JACKSONVILLE (Area Code 904)**
Sav-A-Stop, 7660 Gainesville Ave. Tel: 768-3411.
- **MIAMI (Area Code 305)**
Goldstate Rec. Dist., 4500 N. W. 36 Ave. Tel: 635-2428. Owners & Mgrs.: Allan Wolk & Marvin Lieber. Buyer: Singles & Albums, Allan Wolk. Handelman, 3979 N.W. 24 St. Tel: 633-2479. Contact: J. Adams.
International Rack, 4500 N. W. 36 Ave. Tel: 635-2428. Owners & Mgrs.: Allan Wolk & Marvin Lieber. Buyer: Singles & Albums, Marvin Lieber. Mershaw, 8160 N. W. 36 Ave. Zip: 33147. Tel: 696-6261, 6263. Mgr.: Edward Chapman. Buyer: Singles & Albums: Edward Chapman.
Branches: Denver, Colo.; Albuquerque, N. M.; Albany, N. Y.; Dallas, Tex.
Record Supply Co. of Miami, 495 S. E. 10 Ct., Hialeah. Pres.: R. N. Stultz.
Branch: Orlando.
- **ORLANDO (Area Code 305)**
Record Supply, 2634 Taft Ave. Tel: 424-6396.
Pres.: R. N. Stultz.
Branch: Miami, Fla.

GEORGIA

- **ATLANTA (Area Code 404)**
Criteria Dist., PO Box 13612, Sta. K. Zip: 30324.
Pres.: Johnny Brooks.
Eastern Rec. Serv., 442 N. E. Cain St. Tel: 577-2767. Mgr.: Charles Peter.
GATE CITY REC. SERV., 1231-D Collier Rd. N.W. Tel: 351-4821. Owner: Gerald Friedman. (SEE ADVERTISEMENT)
L & F Rec. Serv., 720 14 St. N. W. Zip: 3031B. Tel: TR 5-5565. Owner & Mgr.: Jack Goldbart. Buyers: Singles, Herman Watkins; Albums, Alan Levenson.
- **CLARKSVILLE (Area Code 404)**
Clarksville Rec. Sales, Washington St. Zip: 30523. Tel: 754-2517. Owner: Peter J. Rosetty; Mgr.: Stanley J. Jones.
- **DEMOREST (Area Code 404)**
Ralph's Radio Music, PO Box 117, Hwy. 441. Tel: 723-3884. Owner: Ralph Raper.
- **TIFTON (Area Code 912)**
Southwest Rec. Sales, 138 E. Fifth St. Zip: 31794. Tel: 382-5204. Owner: Gus P. Statiras; Mgr.: Mrs. Ann Rysdorph. Buyer: Singles & Albums, Gus P. Statiras.

ILLINOIS

- **CHICAGO (Area Code 312)**
All Rec. Serv., 3006 N. Elston Ave. Tel: 478-4130.
ALL TAPES DIST'G, 1239 S. Michigan Ave. Tel: 939-2663. Contacts: Kent Beauchamp & Eddie Yalowitz. (SEE ADVERTISEMENT)
Hit Record (div. of Charles N. Stephens Co.), 10614 S. Mackinaw Ave. Zip: 60617. Tel: 734-2244. Owner: Charles N. Stephens; Mgr.: Earl Phillips. Buyer: Albums, Earl Phillips.
Mid-America Specialty Dist., 752 N. Milwaukee Ave. Tel: 243-0919. Owner: Howard M. Rosen; Mgr.: Robert W. Duggan. Buyer: Albums, Wayne Juhlin.
Branch: Youngstown, Ohio.
Musical Isle, 1550 S. State St. Tel: 225-2929. Milwaukee, Wis. Tel: (414) 264-4380. Owner: Milt Salstone; Mgr.: John Kotecki. Buyer: Albums, Bob Fleck.
New Deal, 1414 S. Michigan. Tel: 922-6245. Mgr.: Irving Rothblatt.
Branches: Los Angeles, Calif.; Baltimore, Md.; Detroit, Mich.; Long Island City, N. Y.
Profit Vendors, 3216 W. Lawrence Ave. Tel: 478-1441. Pres.: Albert L. Temaner.
R & R Rec. Dist., 7059 W. Addison St. Zip: 60634. Tel: 282-5454. Contact: Robert Kennedy.
- **DECATUR (Area Code 217)**
Decatur Rak Sales, 312 N. Water. Tel: 428-6653. Pres.: Bud Lampe; Mgr.: William Chrysler.
Branches: Kansas City, St. Louis, Mo.
- **EAST PEORIA (Area Code 309)**
Paul Allen Rack Sales, 111 Sun Valley Ct. Zip: 61614. Tel: 699-1541. Mgr.: Paul Allen.
- **HIGHLAND PARK (Area Code 312)**
L. S. Gilbert, 1667 Northland Ave. Tel: 432-6895. Pres.: Louis S. Gilbert.

- **LINCOLNWOOD (Area Code 312)**
Handelman, 6666 N. Lincoln Ave. Tel: 583-0770. Mgr.: Louis A. Kwiker. Buyers: Singles, Ray Sanchez; Albums, Louis A. Kwiker.
- **PEORIA (Area Code 309)**
Sell-Rite Sales, 1215 W. Glen. Mgr.: R. Pritzker.
- **SKOKIE (Area Code 312)**
Arthur Bryant, 3918 Isabel. Mgr.: Arthur Bryant.

INDIANA

- **FORT WAYNE (Area Code 219)**
Midwest Dist., 123 McKinnie. Tel: 744-5656. Owner: Walt Ostermeyer; Mgr.: Dolores Harker. Buyers: Singles, Dolores Harker; Albums, Walt Ostermeyer.
- **GARY (Area Code 219)**
Woodward Recs., 2011 Madison St. Zip: 46407. Tel: 885-190B. Owner: D. W. Woodward.
- **INDIANAPOLIS (Area Code 317)**
Associated Dist., 210 S. Meridian St. Tel: ME 4-2591. Owner: L. E. Randle; Mgr.: Lynne Jenks. Buyers: Singles, James Coffin; Albums, Robert Lay.
- **MARTINSVILLE (Area Code 317)**
Mid-State Dist., 190 N. Main St. Tel: 342-4276, 8427. Owner & Mgr.: Robert E. Liese. Buyer: Singles & Albums, Virginia Rose Liese.

IOWA

- **DES MOINES (Area Code 515)**
Major Rec., 1212 Grand Ave. Zip: 40309. Tel: 288-0271. Owner: Jack Silverman; Mgr.: Robert Pockrandt.
Quality Rec. Serv., 1234 Harding Rd. Tel: AT 8-1993. Pres.: Ralph T. Anderson. Buyer: Singles & Albums, Ralph T. Anderson.

KANSAS

- **WICHITA (Area Code 316)**
Pioneer Dist. Co. of Kansas, 2955 S. Kansas. Tel: LY 1-3414. Pres.: Al Driscoll. Buyers: Singles, Norma Merideth; Albums, Norma Merideth & Al Driscoll.
Reco-Rak Dist., 221 E. William. Tel: AM 5-750B. Owner: I. Albert.

KENTUCKY

- **CAMPBELLSVILLE (Area Code 502)**
Central Electronics, PO Box 35, 113 N. Central Ave. Tel: 465-4147. Owner: Randall B. Herron. Buyer: Singles & Albums, Randall B. Herron.
- **LOUISVILLE (Area Code 502)**
Handelman, 4500 Louisville Ave. Mgr.: James E. Powers. Buyers: Singles, Barbara Schmeing; Albums, James E. Powers.
Vine Rec., 560 S. Fourth St. Tel: 583-2092. Pres.: Helen T. Vine; Mgr.: Ken Vine. Buyer: Singles & Albums, Ken Vine.
- **NICHOLASVILLE (Area Code 606)**
D & G Rec. Mart, PO Box 102, N. Main. Zip: 40536. Tel: 252-2155. Owner: Dudley Bonds.
- **OWENSBORO (Area Code 502)**
W W Rec. Sales, 320 Washington Ave. Tel: 683-1585. Contact: Leroy Woodward.

LOUISIANA

- **LAFAYETTE (Area Code 318)**
Modern Rec. Serv., PO Box 3727. Tel: CE 4-3291. Pres.: J. R. Chachere; Gen. Mgr.: George Berry. Branch: New Orleans.
- **NEW ORLEANS (Area Code 504)**
Modern Rec. Serv., 757 Central Ave. Tel: VE 3-3735. Pres.: J. R. Chachere; Gen. Mgr.: George Berry. Branch: Lafayette.

MAINE

- **BANGOR (Area Code 207)**
Viner's Music, 20-24 Broad St. Tel: 945-9494. Owners: Sam & Ben Viner. Mgr.: Ben Viner. Buyer: Singles & Albums, Ben Viner.
- **KENNEBUNK (Area Code 207)**
Thor Music, 19 Cat Mousam Rd. Tel: 985-2556. Gen. Mgr.: David W. Flannery.
- **PORTLAND (Area Code 207)**
Diamond, 212 Anderson St. Mgr.: Louis W. Spear. Portland Rec. (div. of Boyd Corp.), 84 W. Cove St. Tel: 772-6551.
Unity Sales, 60 York St. Tel: SP 2-6547. Pres.: Bernard Troubh.

MARYLAND

- **BALTIMORE (Area Code 301)**
New Deal Rec., 1601 Guilford Ave. Tel: 837-2774. Mgr.: Ronald Bolton.
Branches: Los Angeles, Calif.; Chicago, Ill.; Detroit, Mich.; Long Island City, N. Y.
Stacey Dist., 3004 Mary Ave. Tel: 426-1182.

- **HYATTSVILLE (Area Code 301)**
Shawn Rec. Dist., 5408 20 Ave. Tel: 927-0010. Partner: C. R. Freeland.
- **LAUREL (Area Code 301)**
Edge, 9914 Rhode Island Ave. Tel: 935-5800. Mgr.: Lawrence M. Goldberg.
- **PIKESVILLE (Area Code 301)**
Coronet Music, 4724 Bonnie Brae Rd. Zip: 21208. Tel: 655-5145, 4031. Pres.: Sam Anoff.

MASSACHUSETTS

- **BOSTON (Area Code 617)**
Boston Mdse., 150 Vernon St. Tel: HI 2-2345. Mgr.: Jerry Flatto.
Boston Rec. Dist., 150 Vernon St. Tel: HI 2-2345. Pres.: Jerry Flatto.
Disco, 141 Milk St. Tel: 423-4840. Mgr.: Fred Traub.
Malden Mop & Brush, 7-27 E. Eden St. Zip: 02129. Massachusetts Rack, 256 Blue Hill Ave., Roxbury. Tel: 442-6711. Mgr.: A. Redmund.
Record Whslers. of New England, 157 Washington St., Dorchester. Tel: 288-5700. Sales Mgr.: Fred Furfey.
Branches: Anaheim, Calif., Nat'l Rec. Serv.—Los Angeles, Calif., Cal Raks—San Francisco, Calif., Nor-Cal Rec. Serv.
Temple Sales, 4 Gordon St. Tel: JA 4-5450. Owner & Mgr.: Myer Tenenbaum. Buyers: Singles, Michael Driscoll; Albums, Myer Tenenbaum.
- **EAST BRIDGEWATER (Area Code 617)**
Whitmarsh Music, 41 Bedford St. Zip: 02333. Tel: 378-3575. Owner & Mgr.: Richard Whitmarsh. Buyer: Singles & Albums, Richard Whitmarsh.
- **FALL RIVER (Area Code 617)**
Somerset, 203 Plymouth Ave. Tel: 678-8336. Mgr.: William Greenblatt.
- **SOMERSET (Area Code 617)**
United States Rec. Rack, 185 Riverside Ave. Tel: 674-4688. Pres.: Danny Gittelman.
- **WEBSTER (Area Code 617)**
Alan Sales, 45 Stoughton Ave. Zip: 01570. Tel: 943-5962, 3527. Contact: John Stolarczyk.
- **WOBURN (Area Code 617)**
Edge, 30 Nashua St. Tel: 933-6290. Pres.: Cecil Steen. Buyers: Singles, Lee Bonfilio; Albums, Cecil Steen.
Recordwagon, 30 Nashua St. Tel: 933-6290. Pres.: Cecil Steen. Buyers: Singles, Lee Bonfilio; Albums, Cecil Steen.

MICHIGAN

- **DETROIT (Area Code 313)**
Cornell Rec., 13380 Capital Ave., Oak Park. Zip: 48237. Tel: 548-3171. Pres.: Harry Levin. Buyers: Singles, Leo Cheslak; Albums, Al Truax. Handelman, 670 E. Woodbridge St. Zip: 48226. Tel: 961-9563. Contact: D. Strome.
Mar-Ed Dist., 12800 Joy Rd. Tel: 834-2221. Mgr.: Edmond J. Doherty. Buyer: Singles & Albums, Edmond J. Doherty.
New Deal Rec. Serv., 15333 Livernois. Tel: 863-2225. Owners: Al Levine & Lou Klayman; Mgr.: Dave Lasher. Buyers: Singles, Ken Corbielle; Albums, Dave Lasher.
Branches: Los Angeles, Calif.; Chicago, Ill.; Baltimore, Md.; Long Island City, N. Y.
Rapid Sales, 15365 Livernois. Zip: 48238. Tel: 342-8777. Pres.: Merle Schneider; Mgr.: Samuel J. Corrado.
Trico Dist., 13400 Fenkell Ave. Tel: 835-7425. Owner: John J. Genna; Mgr.: William Merritt. Buyer: Singles & Albums, John J. Genna.
- **GRAND RAPIDS (Area Code 616)**
Monroe, 100 Hall S. W. Tel: CH 5-3629. Pres.: Herman Rubin.
- **LANSING (Area Code 517)**
Canfield Supply Serv., 210 Mill St. Tel: 485-9593. Pres.: Robert Canfield. Buyer: Singles & Albums, Jack Shue.
Branch: Cincinnati, Ohio.
Handelman, 4604 N. East St. Tel: 484-1386. Mgr.: Donald DeKoninck.
- **TWIN LAKE (Area Code 616)**
Allstate, 3625 Michilinda. Zip: 49457. Tel: 828-6329. Pres.: David A. Touzel.

MINNESOTA

- **MINNEAPOLIS (Area Code 612)**
Acme Music Serv., 321 Plymouth Ave. N. Tel: 332-7131. Contact: Hy Sandler. (Rapid)
Branch: Anaheim, Calif.
J. L. Marsh, 7600 Wayzata Blvd. Tel: 544-4201. VP: Daniel Heilicher; Mgr.: Manuel Swaiez. Buyers: Singles, Marvin Sanderson; Albums, Robert Dahle.

Rapid Mds'g, 8175 Lewis Rd. Tel: 544-3561. Pres.: Herbert N. Sandel. Buyers: Singles, W. H. Taylor Jr.; Albums, Noel Korengold.
Sam Sales, 321 Plymouth Ave. N. Tel: 332-7131. Contact: Hy Sandler.

MISSOURI

• **KANSAS CITY (Area Code 816)**
K C Rak Sales, 3230 Roanoke Rd. Tel: LO 1-4610. Pres.: S. Goldman.
Branches: Decatur, Ill.; St. Louis, Mo.

• **ST. LOUIS (Area Code 314)**
Missouri Discs, 1906 Washington Ave. Tel: MA 1-2874. Contact: Robert L. Hausfater.
Rak Sales, 2549 Sullivan. Tel: CH 1-8486. Pres.: Sanford Goldman.
Branches: Decatur, Ill.; Kansas City, Mo.

• **UNIVERSITY CITY (Area Code 314)**
Top Notch Rec., 1255 North & South Rd. Owner & Mgr.: Robert I. Recht. Buyer: Singles & Albums, Robert I. Recht.

MONTANA

• **HELENA (Area Code 406)**
Playhouse Div., Sundry Shops, 1015 Popular. Tel: 442-6345. Mgr.: Ben B. Hopkins.

NEVADA

• **LAS VEGAS (Area Code 702)**
Music City Rec. Racks of Nev., 5409 Gipsy Ave. Tel: 870-4969. Owners: Alex & Betty Fox.
Record Serv., 3127 Industrial Rd. Tel: 735-0394. Pres.: Larry Nunes; Mgr.: Gene Hotchkins.

• **RENO (Area Code 702)**
Pic-A-Tune, 1522 Matly Ln. Tel: 329-0010. Mgr.: Darwin Jones.
Branches: Fresno, Sacramento, San Francisco, San Jose, Calif.

NEW JERSEY

• **LINDEN (Area Code 201)**
Supermarket Serv., 1601 W. Edgar Rd. Tel: 925-5950. Mgr.: E. Spitaletta. Buyer: Singles & Albums, C. McAllister.

• **MEDFORD (Area Code 609)**
National Mds'g Serv., Stokes Rd. Tel: OL 4-4990. Pres.: L. L. Goughan.

• **NEWARK (Area Code 201)**
Service One Stop Dist., 16 Fenwick St. Tel: BI 3-8700. Owner: Irv Cohen; Mgr.: Ralph Schechtman. Buyers: Singles, R. Schechtman; Albums, Frank Di Marsico.
Branch: Springfield.

• **NUTLEY (Area Code 201)**
"Tiny" Fairbanks, 449 Kingsland St. Zip: 07110. Tel: 667-3767. Pres.: A. L. "Tiny" Fairbanks.

• **PENNSAUKEN (Area Code 609)**
Handleman, 7135 Colonial Ln. Tel: 665-5460. Contact: V. Chesslar.

• **ROCHELLE PARK (Area Code 201)**
Garden State Rec. Dist. (div. of Interstate Rec. Dists.), 68 W. Passaic St. Tel: 843-2670. Mgr.: Stan Sterling.

• **SPRINGFIELD (Area Code 201)**
Service One Stop Dist., Rt. 22, Fadem Rd., Runyon Bldg. Tel: DR 6-7666.
Branch: Newark.

NEW MEXICO

• **ALBUQUERQUE (Area Code 505)**
Linden, 1205 Madeira S.E., Suite 124. Zip: 87108. Tel: 255-3978. Pres.: Lindy Blaskey.
Mershaw Midwest, 4115 Silver S. E. Zip: 87108. Tel: 268-1902. Buyer: Sandy Kahn.
Branches: Denver, Colo.; Miami, Fla.; Albany, N. Y.; Dallas, Tex.

Record Serv., 828 San Mateo S. E. Tel: 265-7404. Pres.: Larry Nunes; Mgr.: E. D. Shaffer. Buyer: Singles & Albums, E. D. Shaffer.
Sandy's Rec. Sales, 4115 Silver S.E. Tel: 268-3857. Contact: Sandy Kohn.

• **SANTA FE (Area Code 505)**
Old Trail News Agency. Tel: 983-4951.

NEW YORK

• **ALBANY (Area Code 518)**
Mershaw of New York, 100 Watervliet Ave. Zip: 12206. Tel: 438-3571. Pres.: Charles H. Schlang; Sales Mgr.: Joseph Dean. Buyer: Stanley W. Eno.
Branches: Albuquerque, N. M.; Dallas, Tex.; Denver, Colo.; Miami, Fla.

• **AMSTERDAM (Area Code 518)**
Almor Playtime, PO Box 111, Wallins Corners Rd. Tel: 842-2500. Contact: Albert Hyman.

• **BUFFALO (Area Code 716)**
Disceries, 863 Washington St. Tel: TL 6-8477. Owner: Carl Glaser; Mgr.: Robert Arent. Buyers: Singles, F. Bachmeier; Albums, Jerald Glaser.
Porter Electronics, 85 Ledger St. Zip: 14216. Tel: 875-1908. Pres.: Ed Lyons. Buyer: Singles & Albums, Bob Desbecker.

• **DEER PARK, L. I. (Area Code 516)**
Bocar Sales, 124 W. 10 St.
United Sterling, 1870 Deer Park Ave.

• **EAST ROCKAWAY, L. I. (Area Code 516)**
Guy Barry Dist. (see Hemisphere Ent.).
Hemisphere Ent., 13 Wesley Dr. Tel: FR 4-6772. Owner: Guy Barry.

• **GARDEN CITY, L. I. (Area Code 516)**
Merco Ent., 750 Stewart Ave. Tel: CH 8-7140. Pres.: Jack Grossman.

• **GREAT NECK, L. I. (Area Code 516)**
Record Guild of America (see Variety Rec. Dist.).
Variety Rec. Dist., 15 Bond St. Tel: HU 2-0900. Owner & Mgr.: David Shichman; Buyer: Singles & Albums, David Shichman.

• **HICKSVILLE, L. I. (Area Code 516)**
Wilmi Sales, 3 Westermorland Rd. Tel: GE 3-0337.

• **LATHAM (Area Code 518)**
Bee Gee Dist., 10 Northway Ln. N. Tel: 785-1350. Pres.: Leonard Smith.

• **LONG ISLAND CITY (See New York City)**

• **MOUNT VERNON (Area Code 914)**
Steadman One Stop, 140 E. Third St. Tel: OW 9-3166. Pres.: Leonard Book.

• **NEW YORK CITY (Area Code 212)**
Arovax Rec., 243 W. 18 St. Tel: 989-7200. VP: David Weg.
Arrow Rec. Serv., PO Box 316, Times Sq. Sta. Zip: 10036. Tel: JU 6-5266.
Candy Stripe Rec., 674 Midwood St., Brooklyn. Zip: 11203. Tel: IN 7-1559. Pres.: Bernard Keil.
Consolidated One Stop of New York, 315 W. 47 St. Zip: 10019. Tel: PL 7-8140. Mgr.: Elliot Blaine.
Eastern Rec. Sales & Dist., 666 10 Ave. Zip: 10036. Tel: CI 5-9469. Owner & Mgr.: Murray Lefkoff; Buyer: Singles & Albums, Murray Lefkoff.
Independent Rec. Promo., 258 W. 18 St. Zip: 10011. Tel: YU 9-8644. Pres.: Larry Guttentplan.
Kaco Ent., 3911 Monticello Ave., Bronx. Zip: 10466. Owner: Bruce Kravis.
Met Richmond Rec. Racks, 723 E. 81 St., Brooklyn. Zip: 11236. Tel: RN 3-1212. Mgr.: David Last.
New Deal Rec. Serv., 45-18 Court Sq., Long Island City. Tel: 786-4263. Pres.: Al Levine; VP: Lou Klaysman.
Branches: Los Angeles, Calif.; Chicago, Ill.; Baltimore, Md.; Detroit, Mich.
New York Rec. Dists, 15 W. 20 St. Zip: 10011. Tel: YU 9-2255. Mgr.: Manny Wells.
R O C, 1309 Ed. L. Grant Hwy., Bronx. Zip: 10452. Tel: GR 7-3521. Owner: S. Sahler.
Branch: South Fallsburg, N. Y.

Raymar Sales, 170-21 Jamaica Ave., Jamaica. Tel: OL 8-4012.
Record Mart, 1470 Broadway. Zip: 10036. Tel: AL 4-4024. Owner: Robert Stack; Mgr.: Jesse Moskowitz. Buyer: Singles & Albums, J. Moskowitz.
Richmark Sales, 110 E. 23 St. Zip: 10010. Tel: 673-3070. Mgr.: Bernie Ashkinazy.
Spectrum Ent., GPO Box 1785. Zip: 10001. Owner: L. Dodge; Mgr.: K. Hooper; Buyer: Singles & Albums, K. Hooper.
Win Rec., 858 Ninth Ave. Tel: JU 2-0130. Owner: Sam Weiss; Mgr.: George Weiss. Buyer: Singles & Albums, George Weiss.

• **OCEANSIDE, L. I. (Area Code 516)**
Scott Dist., 3580 Oceanside Rd. Tel: OR 8-6580. Pres.: Sidney Kruglick; Sales Mgr.: Harvey Lefkowitz. Buyer: Singles & Albums, Harvey Lefkowitz.

• **PALMYRA (Area Code 315)**
Canaltown Rec. & Tape Sales, Walton Rd. Tel: LY 7-5003. Owner & Mgr.: G. L. Griffin.

• **POUGHKEEPSIE (Area Code 914)**
Toy House of Hudson Valley, Manchester Rd. Tel: GR 1-2740. Pres.: Lou J. Kustas.

• **SOUTH FALLSBURG (Area Code 914)**
R O C. Owner: S. Sahler.
Branch: New York, N. Y.

NORTH CAROLINA

• **ASHEVILLE (Area Code 704)**
Alexander News, 25 Carolina Ln. Zip: 28801. Tel: AL 3-2631. Owner: W. G. Alexander; Mgr.: C. N. Suttle. Buyer: Singles & Albums, C. N. Suttle.

• **CHARLOTTE (Area Code 704)**
Dixie News, 2100 Freedom Dr. Tel: 334-8614. Gen. Mgr.: Tim Brasswell.
Southeastern Rec. Mdsrs., 2706 Freedom Dr. Tel: 399-5633. Sales: Charles Hartley.

• **ROCKY MOUNT (Area Code 919)**
Rocky Mount News, 1700 S. Franklin St. Tel: 446-6812. Mgr.: Bill McCarver. Buyer: Singles & Albums, Bill McCarver.

• **WINSTON-SALEM (Area Code 919)**
J. B. Armstrong News Agency, 601 S. Broad St. Zip: 27101. Tel: 722-8586. Pres.: J. B. Armstrong; Mgr.: Earle C. Martin. Buyer: Singles & Albums, John Mayes.



COMPLETE SO. CALIFORNIA RACK JOBBER SERVICE

After

17 YEARS

In the same location
we're moving to
Bigger and
Better Quarters

NEW ADDRESS:

7425-A Orangethorpe Avenue
Buena Park, California 90620
Phone: (714) 522-8351

YOU GET SUPER SERVICE on REEL-TO-REEL and CARTRIDGE TAPES WHEN YOU DEAL WITH US

We handle all lines

Capitol	Mercury Stereo
Columbia	Tapes
Decca	Music Tapes
GRT	Orisonic
ITCC	RCA Victor
	Tamla-Motown

First and most experienced jobber and one-stop of tape in the Midwest.

Contact:
Kent Beauchamp or Edward Yalowitz

ALL TAPES DISTRIBUTING INC.

1239 S. Michigan Ave.
Chicago, Illinois (312) 939-2661

continued

OHIO

- **CINCINNATI (Area Code 513)**
Album Rec. Sales of America, 6566 Montgomery Rd. Tel: 731-7051. Pres. & Mgr.: LeRoy R. Goodlander. Buyers: Singles & Albums, L. R. Goodlander.
- Canfield Supply Serv., 8100 Reading Rd. Tel: 821-0361. Owner: Robert Canfield. Branch: Lansing, Mich.
- K C Dist. (div. of Mulane Taffy), 4108 Spring Grove Ave. Tel: 542-4573 & 271-3887. Dir.: Marilu Case; Serv. Mgr.: Tom Case.
- **CLEVELAND (Area Code 216)**
All Label Rec. Serv., 1464 W. Ninth St. Zip: 44113. Tel: 861-2578. Contact: Harry H. Budin. Handleman, 6116 Broadway. Tel: 641-5989. Contact: R. Cipriani.
- Inland Rec. Sales, 3142 Prospect. Tel: 621-6742. Owner: John Cohen; Mgr.: Dan Connors. Buyer: Singles & Albums, Dan Connors.
- Main Line Rec. Serv., 1260 E. 38 St. Zip: 44114. Tel: 391-9616. Pres.: Ross Halamay. Buyer: Singles & Albums, E. W. Halamay.
- Modern Rec. Serv., 1958 E. 105 St. Tel: 795-5225. Pres.: J. W. Burke.
- Stark Rec. Serv., 2797 Hamilton. Tel: 621-1119. Contact: Charles E. Murray. Branch: Massillon, Ohio.
- **COLUMBUS (Area Code 614)**
Disco Rec. Dist., 2052 Cleveland. Zip: 43211. Tel: 876-6702.
- Handleman, 1977 McAllister Ave. Tel: 258-8419. Mgr.: Joe Glaser. Buyer: Albums, Joe Glaser.
- **DAYTON (Area Code 513)**
Dayton Rec. Serv., 2223 Springboro Rd. Tel: 399-0981. Mgr.: Maurice Leach. Branch: Portsmouth.
- **HAMILTON (Area Code 513)**
Oon E. Nevin Sales, 610 Central Ave. Tel: 894-8948. Partner & Gen. Mgr.: Don Nevin; Sales Mgr.: Dave Rosenfield. Buyer: Singles & Albums, Don Nevin.
- **MASSILLON (Area Code 216)**
Stark Rec. Serv., 1226 Duncan S.W. Tel: 832-1565. Contact: Paul David. Branch: Cleveland, Ohio.
- **PORTSMOUTH (Area Code 614)**
Dayton Rec. Serv., 24 Union St. Tel: EL 4-3188. Pres.: W. A. Carrington. Branch: Dayton.
- **SPRINGFIELD (Area Code 513)**
Buckeye Ents, 5 E. Main St. Zip: 45502. Tel: 325-7686. Pres.: Asen Kristoff; VP: Steve Kristoff.
- **TOLEDO (Area Code 419)**
Bartley, 1001 Brown. Tel: 244-3011. Contact: Dick Bernard.
- Buckeye Specialties, 1102 Summit St. Tel: 243-4166. Contact: Ruth Redfox.
- Northwestern Dist., 1018-20 Sylvania Ave. Zip: 43612. Tel: 479-5241. Pres.: George LaCourse.
- **YOUNGSTOWN (Area Code 216)**
Mid-America Specialty Dist., 1028 Rayen St. Owner: Howard M. Rosen. Branch: Chicago, Ill.

OKLAHOMA

- **OKLAHOMA CITY (Area Code 405)**
Mid-Continent News, 7001 N. Broadway Expressway. Tel: VI 3-9383. Contact: Don Byers. Southwest Dist., 1159 E. Madison Ave. Tel: GA 7-3225. Pres.: K. D. Hensley.

- **TULSA (Area Code 918)**
Broadcast Rec. Dist., PO Box 223. Owner: Ken Green. Oklahoma News, 909 W. 23 St. Tel: LU 4-4754. Contact: Stanley E. White.

OREGON

- **MEDFORD (Area Code 503)**
Tip Top Music, 825 Beekman. Tel: 772-9966. Pres.: Monroe Goodman; Mgr.: Dave Urban.
- **PORTLAND (Area Code 503)**
Austin Bros., 9300 N. E. Multnomah St. Mgr.: Ross Whisman. Wm. G. Blackburn, 105 N. E. 62 Ave. Zip: 97213. Tel: BE 2-5750. Owner: Bill Blackburn. Tip Top Music, 4616 N. Albina St. Tel: 287-0534. Pres.: Monroe Goodman; Mgr.: Al Zangrillo. Buyer: Singles & Albums, Al Zangrillo.
- **ROSEBURG (Area Code 503)**
Paul Jackson Whsle. Tel: 672-4262. Contact: Bob Logan.

PENNSYLVANIA

- **CONEMAUGH (Area Code 814)**
Page Rec'g, 345 Second St. Tel: 539-8117. Owner & Mgr.: Al Page. Buyer: Singles & Albums, Al Page.
- **EAST LANSDOWNE (Area Code 215)**
Rec-O-Rac Dist., 1011 Baltimore Ave. Tel: MA 6-2177. Owner & Mgr.: Harry Blaufeld. Buyer: Singles & Albums, Harry Blaufeld. Branch: Havertown.
- **HARRISBURG (Area Code 717)**
O & H Dist'g, 2525 N. Seventh St. Tel: 236-8001. Contacts: David Press & Endo Corsetti.
- **HAVERTOWN (Area Code 215)**
Rec-O-Rac Dist., 100 Ellis Rd. Tel: HI 9-3336. Owner & Mgr.: Harry Blaufeld. Buyer: Singles & Albums, H. Blaufeld. Branch: East Landsdowne.
- **IRWIN (Area Code 412)**
Richmark Sales, 1072 Lincoln Hwy. W. Tel: 351-1107. Owner: A. Ackerman; Mgr.: J. T. Walker. Buyer: Singles & Albums, J. T. Walker.
- **PHILADELPHIA (Area Code 215)**
Bandstand, 2522 N. Broad St. Zip: 19132. Tel: BA 9-9110. Owner: Gerald Rappaport. I. J. Morgan, 511 N. Broad St. Tel: WA 5-7535. Owner: Irv Perlman; Mgr.: Joe Masci. Buyers: Singles, Mary Picano; Albums, Art Pernie.
- **PITTSBURGH (Area Code 412)**
All Brands, 24 & AVRR. Tel: 281-9555. Mgr.: Robert C. Roche. East Coast Dist., 633 Liberty Ave. Tel: 281-6344. Mgr.: Nicholas Lomakin. Handleman, 3109 Forbes St. Tel: 681-4790. Contact: Vera Powell. One Stop Rack Serv., 1704 Fifth Ave. Zip: 15219. Tel: 261-3340. Owner: Bill Lawrence; Mgr.: Dick Zimmer. Buyer: Singles & Albums, Dick Zimmer. Star Title Strip, 842 Western Ave. Tel: 231-4314. Mgr.: N. W. Morgan.
- **WILLIAMSPORT (Area Code 717)**
Mid Penn Magazine Agency, 100 Eck Circle. Owner: D. Demel; Mgr.: Bob Edler. Buyer: Singles & Albums, D. Demel.

RHODE ISLAND

- **EAST PROVIDENCE (Area Code 401)**
H. V. Papazian, 803 Broadway. Tel: 434-7212. Owner: H. V. Papazian; Mgr.: John Wolohojian. Buyers: Singles, Charles Ryan; Albums, H. V. Papazian.

- **PROVIDENCE (Area Code 501)**
Beacon Rec. Dist., 725 Branch Ave. Zip: 02904. Tel: UN 1-7500. Pres.: Milton Israeloff; Mgr.: Rubin Zeidman. Buyers: Singles, Chris Howe; Albums, Rubin Zeidman.

SOUTH CAROLINA

- **ABBEVILLE (Area Code 803)**
Savitz Rec. Cir., 115 Public Sq. Tel: 459-2143. Owner: Allen Savitz; Mgr.: Cregg Booth. Buyer: Singles & Albums, Susan Hagen.
- **COLUMBIA (Area Code 803)**
Brown Sales, 1423 Ellerbe St. Tel: 787-3401. Owner & Mgr.: H. G. Brown Jr. Buyer: Singles & Albums, H. G. Brown Jr.

TENNESSEE

- **COOKEVILLE (Area Code 615)**
Rack Ent., 141 Shipley. Tel: 526-5148. Owner: Bill H. Amonette.
- **KNOXVILLE (Area Code 615)**
Knox Rec. Rack, PO Box 4045, 2000 Western Ave. Tel: 525-0445. Owner: Sam Morrison. Tucker's Rec. Shop, 22 1/2 Market St., On the Mall. Tel: 522-9300. Owner: Martin T. Robertson; Mgr.: Dale Clark.
- **NASHVILLE (Area Code 615)**
Nashville Rec. Serv., PO Box 7310, 618 Ewing Ave. Zip: 37203. Tel: 242-8208. Pres.: Albert E. Martin. Volunteer Dist., 435 37 Ave. N. Tel: 297-0055. Owner: Webber Parrish.

TEXAS

- **AMARILLO (Area Code 806)**
Western Mdsrs., 1601 W. Third Ave. Tel: DR 6-6251. Owner: Sam Marmaduke; Mgr.: Dick Williamson. Buyer: Singles & Albums, Ed Perry.
 - **CARROLLTON (Area Code 214)**
D J Rec. Sales, 2315 Briarwood Ln. Tel: CH 2-3698. Owner & Mgr.: Don Bresler. Buyer: Singles & Albums, Don Bresler.
 - **DALLAS (Area Code 214)**
Handleman, 2260 Monitor St. Tel: 631-2943. Contact: G. Braun. Mershaw of America, 1327 Chemical St. Zip: 75207. Tel: ME 7-0552. Mgr.: Kerry B. Charlton. Buyer: Singles & Albums, Kerry B. Charlton. Branches: Denver, Colo.; Miami, Fla.; Albuquerque, N. M.; Albany, N. Y. Records of Dallas, 1345 Chemical St. Tel: ME 1-7263. Mgr.: Doug Martin. Record Serv., 3815 Pictureline. Tel: FE 7-2847. Mgr.: Bruce Masterton. Branch: 2041 Farrington. Tel: RI 7-2254.
 - **EL PASO (Area Code 915)**
B & C Rec. Sales, 427 W. San Antonio St. Tel: KE 2-1434. Pres.: Mrs. Lindy Cash; Mgr.: Joey Cash. Buyers: Singles, Lupi Arci; Albums, Joey Cash. Sunland Supply, 2227 Texas Ave. Tel: 533-5901. Contact: Bill Shapiro.
 - **HOUSTON (Area Code 713)**
Lotasco, 1634 Wakefield Dr. Zip: 77018. Tel: OV 6-1155. Owners: Maxine & Albert Eickenhorst. Record Dist., 901 Commerce Ave. Tel: CA 7-6961. Owner: Larry M. Rosmarin; Mgr.: Al Acuna. Buyers: Singles, Mary Ann Martinez; Albums, Larry M. Rosmarin. Records of Houston, 316 E. 11 Ave. Zip: 77008. Tel: UN 1-6868. Mgr.: Roy E. Buckner.
 - **LUBBOCK (Area Code 806)**
Recordland USA, 3819 Ave. A. Tel: SH 7-4443. Owner: Allan Rosen; Mgr.: Bob Iseral. Buyer: Singles & Albums, Bob Iseral. Rosen Whsle., 619-21 Broadway. Tel: PO 3-4435. Contacts: Allan Rosen & Bob Iseral.
 - **SAN ANGELO (Area Code 915)**
Parks Dist., PO Box 3051. Tel: 949-6055. Owner: Ira Parks Jr.
- UTAH**
- **SALT LAKE CITY (Area Code 801)**
Billinis Dist., 3575 South 700 West. Tel: 266-3540, 3548. Pres. & Mgr.: John Billinis. Buyers: Singles, Ray Peterson; Albums, John Billinis. Grover Dist., 774 E. Eighth S. Tel: 355-4710. Contact: Lynn Grover. Mountain West Dist., 2295 S. W. Temple. Tel: 467-0202. Contact: Dick Brewer.
- VERMONT**
- **ST. JOHNSBURY (Area Code 802)**
St. Johnsbury Rec. Dist., Railroad St. & Eastern Ave. Zip: 05819. Tel: 748-2475. Pres.: Loren Phelps; Mgr.: Reginald Sevigny. Buyer: Singles & Albums, L. Phelps.

continued on page 120

A SERVICE FOR THE

RACK JOBBERS

☆☆☆

All Types of INDEX STRIPS and PRICE LABELS

"TAILOR MADE" for your needs.

SEND FOR A COMPLETE BROCHURE TODAY.

★

STAR TITLE STRIP COMPANY, INC.

842 Western Avenue Area Code 412 231-4314 Pittsburgh, Pa. 15233

U.S. One-Stop Directory

ALABAMA

- **BIRMINGHAM (Area Code 205)**
Music Center, 416 N. 19 St. Zip: 35204. Tel: 251-8252. Mgr.: Virgil Lugar.
Victory Rec. Serv., 1028 First Ave. N. Tel: 324-9505. Mgr.: Morris S. Corona.

ARIZONA

- **PHOENIX (Area Code 602)**
Arizona M.B. Krupp, 2519 N. 16 St. Tel: 252-4013. Mgr.: Margo Grover.
Flash Dist., 3121 E. McDowell. Tel: 273-7346. Pres.: Joe English.

ARKANSAS

- **LITTLE ROCK (Area Code 501)**
Moses Melody, 505 Main St. Tel: FR 5-0105. Pres.: Jim Moses.

CALIFORNIA

- **LA MESA (Area Code 714)**
Hit Line Rec. Sales, PO Box 781. Zip: 92041. Tel: 463-4818. Owner: Frank Metzker.
- **LOS ANGELES (Area Code 213)**
CALIFORNIA MUSIC, 2933 W. Pico Blvd. Zip: 90066. Tel: 733-1181. Owner: Sam Ricklin; Mgr.: Buddy Robinson. Buyers: Singles, Jerry Barish; Albums, Raoul Montano. (SEE ADVERTISEMENT)
Luenhagen, 2277 W. Pico Blvd. Tel: DU 4-4134. Mgr.: Mary Solla.
New Deal, 3660 W. Pico Blvd. Mgr.: Rick Susser. Branches: Chicago, Ill.; Baltimore, Md.; Detroit, Mich.; Long Island City, N.Y.
Norty's, 436 N. Fairfax Ave. Tel: WE 8-2758. Owner: Norton Beckman.
Op's 1 Stop, 2647 W. Pico Blvd. Tel: RE 2-6737. Pres.: Charles F. Pearce.
Sun State Music Dist., 2669 W. Pico Blvd. Tel: 383-4137. Owner: Al Latauska.

- **MODESTO (Area Code 209)**
Westrad, 131 Phoenix Ave. Zip: 95351. Tel: 529-3265. Mgr.: Jim Petros Jr.

- **SAN BERNARDINO (Area Code 714)**
Braviuro Piano & Music, 1170 "E" St. Tel: TU 9-8596. Owner: Harvey Braviuroff.

- **SAN DIEGO (Area Code 714)**
Ratner Electric, 745 Broadway. Tel: 234-3363.

- **SAN FRANCISCO & BAY AREA (Area Code 415)**
Nor-Cal, 1175 Howard St. Tel: 621-1837. Owner: Leon Hartstone; Gen. Mgr.: Larry Reed. Buyers: Singles, Mike Kessler; Albums, A. L. Reed. Branch: Dorchester, Mass., Record Wholesalers of New England.
Western, 224 Sixth St. Tel: HE 1-3367. Owner: David Watson; Mgr.: Bob Davenport. Buyer: Singles & Albums, Bob Davenport. Branch: 1461 Park Ave., Emeryville. Zip: 94608. Tel: 654-5110. Mgr.: Ted Fullmer. Buyers: Singles, Hal Furtney; Albums, Dick Hanhoe.

- **SAN JOSE (Area Code 408)**
Discorama, 235 S. First St. Tel: 286-5838. Gen. Mgr.: Art Walker.

COLORADO

- **DENVER (Area Code 303)**
A & N, PO Box 2671. Zip: 80201. Owner & Gen. Mgr.: James C. Scott Sr.
Mile Hi, 77 Kalamath St. Zip: 80223. Tel: 255-2021. Owner: Louis & Joe Oxman; Mgr.: Louis Oxman. Buyers: Singles, Manny Martinez; Albums, Bob King.
Mountain Dist., 3630 Downing St. Tel: 222-8518. Owner: Peter J. Geritz.

- **PUEBLO (Area Code 303)**
Morton Rec., 945 E. Evans Ave. Tel: 543-0928.

CONNECTICUT

- **EAST HARTFORD (Area Code 203)**
Central Rec. Serv. (div. of Trinity Rec. Dist.), 477 Park Ave. Tel: 289-5339. Mgr.: John Rocanello. Dave's, 171 Park Ave. Zip: 06108. Tel: 289-6122. Owner: Dave Bratter; Mgr.: Dave Demers. Globe, 308 Tolland St. Tel: 289-6424. Owner: Gene Gotthelf; Mgr.: Wayne Marshall. Buyers: Singles, Anthony Galeota; Albums, Wayne Marshall.

- **NEW HAVEN (Area Code 203)**
Cutlers, 33 Broadway. Tel: 777-6271.

DISTRICT OF COLUMBIA

- **WASHINGTON (Area Code 202)**
Quality Music, 1836 Seventh St. N.W. Tel: DU 7-1033. Owners: Max Silverman, Gene Levy, Herb Cohen. Buyer: Singles & Albums, Gene Levy. Branch: 721 H St. N.E. Tel: 543-2134-5807 Eastern Ave. N.E.
Super Music City, 1110 Seventh St. N.W. Tel: NO 7-1049. Owners: Phil Levine & Herb Fribush; Mgr.: Phil Levine. Buyer: Singles & Albums, Phil Levine.

FLORIDA

- **JACKSONVILLE (Area Code 305)**
Budisco, 60 Riverside Ave. Tel: 355-6443. Mgr.: Mrs. Carol Sanford.
- **MIAMI (Area Code 305)**
Budisco Int'l, 286 N.W. 29 St. Tel: 633-6033. Gen. Mgr.: Raoul Shapiro. Buyer: Singles & Albums, Raoul Shapiro.
Jet, 4928 N.W. Seventh Ave. Tel: 751-2473. Owner: Fred Maroon; Mgr.: Paul Yoss. Buyer: Singles & Albums: Paul Yoss.
Ernest C. Reyer, 2815 S.W. 63 Ave. Tel: MO 1-1524. Owner: Ernest C. Reyer.
Southern Rec. Serv., Hialeah. 1020 E. 14 St. Tel: 885-4625. Pres.: Dave Shedd.
- **ORLANDO (Area Code 305)**
Record Supply, 2634 Taft Ave. Tel: 424-6396.
- **TAMPA (Area Code 813)**
Budisco Rec. Serv., 1723 W. Cypress. Tel: 251-1205. Florida Electronics, 2106 Main St. Zip: 33607. Tel: 251-3169. Pres.: Linda L. Santos.

GEORGIA

- **ATLANTA (Area Code 404)**
All Purpose Serv., 1456 Northside Dr. N.W. Tel: 351-3841.
GATE CITY REC. SERV., 1231-D Collier Rd. Tel: 351-4821. Owner: Gerald Friedman; Mgr.: Richard Atkinson. Buyers: Singles, Elaine Steiner; Albums, Richard Atkinson. (SEE ADVERTISEMENT)
- **CLARKSVILLE (Area Code 404)**
Clarksville Rec. Sales, 608 N. Washington St. Zip: 30523. Tel: 754-2517. Owner: Peter J. Rosetty; Mgr.: Stanley J. Jones. Buyers: Singles, Stanley Jones; Albums, Peter J. Rosetty.
- **DEMOREST (Area Code 404)**
Ralph's Radio Music, PO Box 117, Hwy. 441. Zip: 30535. Tel: 723-3884. Owner: Ralph Raper.
- **MABLETON (Area Code 404)**
Best Music, 1659 Bankhead Hwy. Zip: 30059. Tel: 948-7711. Owner: L. E. Jenkins.
- **TIFTON (Area Code 912)**
Southeast Rec. Sales, 138 E. Fifth St. Zip: 31794. Tel: 382-5204. Owner & Mgr.: Gus P. Statiras. Buyer: Singles & Albums, Gus P. Statiras.

ILLINOIS

- **CHICAGO (Area Code 312)**
A B C O, 3313 N. Springfield Ave. Tel: KE 9-7378. Pres.: T. H. Gorman.
BARNEY'S, 3234 W. Roosevelt Rd. Tel: 826-1828. (SEE ADVERTISEMENT)
LITTLE AL'S, 3216 W. Lawrence Ave. Zip: 60625. Tel: IR 8-6114. Contact: Al Temaner. (SEE ADVERTISEMENT)
Lormar Dist'g, 2311 N. Western Ave. Tel: BR 8-8300.
Marquette, 3215 W. 63 St. Zip: 60629. Tel: 434-3737. Mgr.: James S. O'Dwyer. Buyer: Singles & Albums, James S. O'Dwyer.
Mid-America Specialty Dist., 752 N. Milwaukee. Tel: 243-0919.
Music Box, 1301 W. 78 St. Tel: 224-3600. Pres.: Harold N. Lieberman; Mgr.: Harry S. Losk. Buyers: Singles, John H. Kelly; Albums, Paul Beutell.
New Deal Rec. Dist., 1414 S. Michigan Ave. Tel: 922-6245. Mgr.: Irv Rothblatt.
Branches: Los Angeles, Calif.; Baltimore, Md.; Detroit, Mich.; Long Island City, N.Y.
Pan-American, 1344 S. Halsted St. Tel: SE 3-1530. VP: M. S. Frenkel.
R & R Rec. Dist., 7059 W. Addison. Tel: 282-5454. Singer, 1812 W. Chicago Ave. Tel: HU 6-7400. Pres.: Fred Sipora.
Susan Dist., 1410 S. Michigan Ave. Tel: 922-2517. Mgr.: Harry Losk.

- World Rec. Dist., 2021 S. Michigan Ave. Zip: 60616. Tel: 842-4307. Owner: Morris Goldstein & Joe Weiss; Mgr.: Charles Zoia. Buyers: Singles, Edey Carter; Albums, Joe Weiss.

- **DECATUR (Area Code 217)**
Decatur Rak Sales, 312 N. Water. Tel: 428-6653. Mgr.: Bill Chrysler.
ORIGINAL ONE STOP REC. SERV., 312 N. Water. Tel: 428-6653. Mgr.: William Chrysler. Branches: Kansas City, Mo.; St. Louis, Mo. (SEE ADVERTISEMENT)

- **PEORIA (Area Code 309)**
Hi Fi, 804 N. Main St. Tel: 674-1383.
S & G Music Store, 403 S. Adams. Tel: 676-5112. VP: Paul Duncan.

- **ROCK ISLAND (Area Code 309)**
Van Goor Music City, 1715 Second Ave. Tel: 788-3401. Mgr.: Don Larson.

- **SPRINGFIELD (Area Code 217)**
The Pfaffler, Fourth & Adams St. Tel: 528-0455.

INDIANA

- **INDIANAPOLIS (Area Code 317)**
Associated Dist., 210 S. Meridian St. Tel: ME 4-2591. Mgr.: Lynne D. Jenks.
C C Rec. Co. of Indiana, 1312 N. Capitol Ave. Tel: ME 2-7554. Owner: Charles Collier.

IOWA

- **DES MOINES (Area Code 515)**
Dart Rec., 515 E. Locust. Tel: 244-5157. Owner: Jack A. Taylor; Mgr.: John Pittman. Buyer: Singles & Albums, John Pittman. Branches: Minneapolis, Minn.; Omaha, Neb.
Lieberman Iowa One Stop, 1406 E. Grand Ave. Tel: 262-8211. Mgr.: L. A. Hummel. Buyer: Singles & Albums, Ray Munson.
Mars Sales, 1630 Locust. Tel: 282-0429. Gen. Mgr.: Jack Mishler. Buyers: Singles, Ed Dunker; Albums, Chuck Taylor.

KANSAS

- **WICHITA (Area Code 316)**
Davidson's, 1719 S. Hillside. Tel: MU 6-6648. Owner: M. S. Davidson; Mgr.: Evelyn Oakes. Buyer: Singles & Albums, Evelyn Oakes. Branch: Kansas City, Mo.; Omaha, Neb.
Giant, 221 E. William. Tel: AM 5-5708. Owner: I. Alsert.
Pioneer Dist., 2955 S. Kansas Ave. Tel: LY 1-3414. Pres. & Gen. Mgr.: Al Driscoll. Buyers: Singles, Norma Merideth; Albums, Norma Merideth & Al Driscoll.

KENTUCKY

- **CAMPBELLSVILLE (Area Code 502)**
Central Electronics, 113 N. Central Ave. Tel: 465-4147. Owner: Randall Herron.
- **LOUISVILLE (Area Code 502)**
Kings Rec. Shop, 240 W. Jefferson St. Tel: 584-5535. Owner: Gene King.
Shivley, 4464 Dixie Hwy. Tel: 447-4951. Owner: A. K. Brown.
Variety, 645 S. Fourth St. Zip: 40202. Tel: 587-8311. Owner & Mgr.: Larry King. Buyer: Singles & Albums, Larry King.
Vine, 560 S. Fourth St. Zip: 40202. Tel: 585-4750. Pres.: Helen Vine; Mgr.: Ken Vine. Buyer: Singles, Helen Vine.

- **NICHOLASVILLE (Area Code 606)**
D & G Rec. Mart, PO Box 102, N. Main. Zip: 40536. Tel: 252-2155. Owner: Dudley Bonds.

- **OWENSBORO (Area Code 502)**
Wax Works Rec. Shop, 320 Washington Ave. Tel: 683-1585. Contact: Leroy Woodward.

LOUISIANA

- **LA FAYETTE (Area Code 318)**
Stagg's Music Shoppes, 503 N. University. Zip: 70501. Tel: CE 2-1575. Owner: L. R. Stagg; Mgr.: Mrs. L. B. Stagg. Buyers: Singles, Mrs. Denra Lormand; Albums, Mrs. L. B. Stagg. Branch: New Iberia, La.
- **LAKE CHARLES (Area Code 318)**
Lyric-Khoury's Rec'g, PO Box 147.
- **NEW IBERIA (Area Code 318)**
Stagg's Music Shoppes, 204 E. Main St. Tel: 364-5941. Owner: L. R. Stagg; Mgr.: Mrs. L. B. Stagg. Buyers: Singles, Mrs. Denora Lormand; Albums, Mrs. L. B. Stagg. Branch: Lafayette, La.

ON-THE-GO COAST TO COAST

NEW DEAL RECORD SERVICE CORP.

Al Levine, Lou Klayman

MOBILE ONE STOP ALL LABEL RECORD SERVICE

The Most Complete, Versatile Distribution Network.
Rack Jobbing • Servicing
Promotion Planning • One-Stop Service
Prompt-As-Promised Delivery
Check the New Deal Office nearest you

NEW DEAL RECORD SERVICE CORP.
45-18 COURT SQUARE
LONG ISLAND CITY, N.Y.
212-786-4263
Morris Weissman
Peter Hyman

NEW DEAL RECORD SERVICE CORP.
1414 SOUTH MICHIGAN
CHICAGO, ILLINOIS
312-922-6245
Irv Rothblatt

NEW DEAL RECORD SERVICE CORP.
1601 GUILFORD AVENUE
BALTIMORE, MARYLAND
301-837-2773
Ronny Bollin

NEW DEAL RECORD SERVICE CORP.
15329 LIVERNOIS AVENUE
DETROIT, MICHIGAN
313-863-2226
Dave Lasher

NEW DEAL RECORD SERVICE CORP.
c/o DON FAERBER
3449a MORGANFORD
ST. LOUIS, MO.
314-865-0482
Dan Faerber

NEW DEAL RECORD SERVICE CORP.
3660 W. PICO BLVD.
LOS ANGELES, CALIFORNIA
213-731-9313
Rich Susser

NEW DEAL RECORD SERVICE CORP.
c/o ED McKEON
13655 PHILMOUNT AVENUE
PHILADELPHIA, PA.
215-673-8041

STATE RECORD DIST. CORP.
45-18 COURT SQUARE
LONG ISLAND CITY, N.Y.
212-786-9369
Morris Weissman
Peter Hyman

continued

- **NEW ORLEANS (Area Code 504)**
One Stop Rec. Shop, 350 S. Rampart St. Tel: 524-3372. Owner: Joe Assunto.
Operators, 4006 Eden St. Zip: 70125. Tel: 822-4332, 1418. Owner & Mgr.: Jack Bernard. Buyer: Singles & Albums, Jack Bernard.
- **SHREVEPORT (Area Code 318)**
STAN'S REC. SERV., 728 Texas St. Tel: 422-7182. Owner: Stanley J. Lewis; Mgr.: Ronnie Lewis. Buyers: Singles & Albums, Ronnie Lewis, Pete Pizzaloto, Max Walker. (SEE ADVERTISEMENT)
- **VILLE PLATTE (Area Code 318)**
Floyd's Rec. Shop, PO Box 506. Zip: 70586. Tel: 363-2138. Owner & Mgr.: Floyd Soileau. Buyers: Singles, Floyd Soileau; Albums, Ray Lafleur.

MAINE

- **PORTLAND (Area Code 207)**
New England Rec., 212 Anderson St. Tel: 774-5362. Mgr.: Louis W. Spear.
Portland Rec., 84 W. Cove. Tel: 772-6551. Pres.: J. C. Boyd; Mgr.: C. Roy Rice. Buyer: Singles & Albums, C. Roy Rice.

MARYLAND

- **BALTIMORE (Area Code 301)**
Ellis Dist., 5216 Fairlawn Ave. Zip: 21215. Tel: 367-0700, 0701. Pres.: Edgar H. Ellis.
Musical Sales, 134 W. Mt. Royal Ave. Zip: 21201. Tel: VE 7-5757. Owner: Milt Bereson; Mgr., Joe Sadler. Buyers: Singles, Joe Sadler; Albums, Milt Bereson.
New Deal, 1601 Guilford Ave. Tel: 837-2774. Mgr.: Ronald Bollon.
Branches: Los Angeles, Calif.; Chicago, Ill.; Detroit, Mich.; Long Island City, N.Y.
One Stop Rec. Serv., 2580 McCulloh St. Tel: NO 9-6100. Mgr.: Nathan Barnett.
REDISCO, 1815 Guilford Ave. Tel: 727-6420. Mgr.: Oscar Buchman. (SEE ADVERTISEMENT)
Wollman Music Store, 233 S. Broadway. Tel: OR 5-7990.
Your Super Music, 570 N. Gay St. Zip: 21202. Tel: BR 6-3770.
- **PIKESVILLE (Area Code 301)**
Coronet Music, 4724 Bonnie Brae Rd. Zip: 21208. Tel: 655-5145, 4031. Pres.: Sam Anoff.

MASSACHUSETTS

- **BOSTON (Area Code 617)**
Boston Rec. Dist., 150 Vernon St. Tel: 442-2345, 2346. Owner: Jerry Flatto. Buyers: Singles, Tim Melanson; Albums, Jerry Flatto.
Circle Dist., 75 N. Beacon St. Zip: 02134. Tel: 782-8800.
Dick's Rec., 1355A Washington St. Zip: 02118. Tel: LI 2-8380. Owner: Richard L. Mitchell; Mgr.: Richard Peach. Buyer: Singles & Albums, R. Peach.
Disco, 37 Fremont St., Somerville. Tel: 625-8985. Mgr.: Ken Stevens. Buyers: Singles, Gabriel Margolis; Albums, Fred Traub.
Branch: 141 Milk St. Tel: 423-4840. Mgr.: Fred Traub.

Record Wholesalers of New England, 157 Washington St., Dorchester. Tel: 288-5700. Sales Mgr.: Fred Furphy.

Branch: San Francisco, Calif., Nor-Cal One Stop. W S Music Dist., 126 Lincoln St., Brighton. Tel: 254-4040. Owner: William Schwartz; Mgr.: Elliot E. Stone. Buyer: Singles & Albums, Elliot Stone.

• **FALL RIVER (Area Code 617)**
Somerset, 203 Plymouth Ave. Tel: 678-8336. Owner: Louis Freedman; Mgr.: William Greenblatt. Buyer: Singles & Albums, Louis Freedman.

• **NEEDHAM HEIGHTS (Area Code 617)**
Lesley Sales, 330 Reservoir St. Zip: 02194. Tel: HI 4-3803. Owner: A. L. Levine.

• **WOBURN (Area Code 617)**
One Stop, 30 Nashua St. Tel: 933-6290.

MICHIGAN

• **BAY CITY (Area Code 517)**
Lucky's Rec. Shop, 713 E. Midland St. Zip: 48707. Tel: TW 2-0116. Owner: Frank J. Pepp.

• **CHARLOTTE (Area Code 517)**
Martens Mobile Rec. Serv., 2256 W. Lawrence. Zip: 48813. Tel: 543-3313. Owner: Charles Martens.

• **DEARBORN (Area Code 313)**
MARTIN & SNYDER, 13200 W. Warren Ave. Tel: LU 2-5850. Mgr.: Chet Kajeski. (SEE ADVERTISEMENT)

• **DETROIT (Area Code 313)**
Angott Sales, 2616 Puritan. Tel: UN 4-0773. Mgr.: Ron Rogers.

Cadet Dist., 13380 Capital Ave., Oak Park. Zip: 48237. Tel: 548-3171. Pres.: Harry Levin. Buyers: Singles, Leo Cheslak; Albums, Al Truax.

continued on page 114

Consolidated One Stop OF N.Y.

- Complete One-Stop Operation Specializing in Latin-American Records
- Operating a Rack Division with Inventory Control—Pre-Ticketing
- Largest Selection of Best Selling Latin-American Records of all Companies
- Imprinted "Hit Parade" Sheets & Streamers
- 19 Years of Record Know-How
- Experienced in Servicing Department Stores and Record Dealers

We Invite Your Inquiries!

Write, Wire or Phone

Consolidated One Stop OF N.Y.

315 West 47th Street, New York, N.Y. 10036

JU 2-2388

A Division of The Cosnat Corp. (Jubilee Industries Inc.)

EIGHTEEN YEARS

of Satisfying Service to thousands of customers thru the 50 States with our FAST one-day mail-order service via our nightly shows on:

KWKH, Shreveport
(50,000 watts)

KEEL, Shreveport
(50,000 watts)

KAAY, Little Rock
(50,000 watts)

YOU GET THE ACTION YOU WANT FROM:

• • • **STAN THE RECORD MAN** • • •
(HITMAKER OF THE SOUTH)

ONE-STOP SERVICE TO STORES AND OPERATORS

★ Best Prices ★

- Expert Service & Advice • Complete Stock of Singles • LP's—Little LP's • Gold Standard Catalogue • Oldies But Goodies • Spirituals
- R&B-Pop-C&W • Juke Box Standards • Free Title Strips

So—No matter what your need may be—**STAN THE RECORD MAN** has it in stock and can give you **ONE DAY SERVICE**. (Orders Shipped Same Day Received).

Phone (318) 422-7182

STAN'S RECORD SERVICE
728 TEXAS STREET SHREVEPORT, LOUISIANA

MARTIN & SNYDER ONE-STOP

The Complete One Stop

IF IT'S A RECORD WE HAVE IT!!!

Servicing Entire State of Michigan & Northern Ohio

COMPLETE LINE OF STANDARDS & FOREIGN RECORDS

13200 W. Warren

Dearborn, Michigan

(313) LU 2-5850. Chet Kajeski, President.

GATE CITY RECORD SERVICE CO.

THE SOUTHEAST'S MOST COMPLETE RECORD AND ALBUM SERVICE

FAST SAME DAY SERVICE
FREE STRIPS TO OPERATORS
ALL 45's @ 58¢

1231D Collier Rd., N.W.
Atlanta, Georgia
Telephone (404) 351-4821
Richard Atkinson—Mgr.

ONE-STOP RECORD SERVICE

Complete line of Spirituals R & B and big selection of low end LP's.

Write to be placed on our national mailing list.

We ship C.O.D. in the U.S.

Check must accompany order from all international accounts.

Barney's One-Stop

3234 Roosevelt, Chicago, Ill. 60624
PHONE: (312) VA 6-1828

continued

CONSOLIDATED, 13254 Linwood Ave. Tel: TO 5-8666. Gen. Mgr.: Thomas Mutter. (SEE ADVERTISEMENT)

New Deal Rec. Serv., 15329 Livernois Ave. Tel: 863-2225. Owner: Al Levine & Lou Klayman; Mgr.: Dave Lasher. Buyers: Singles, Ken Corbielle; Albums, Dave Lasher.

Branches: Los Angeles, Calif.; Chicago, Ill.; Baltimore, Md.; Long Island City, N.Y.
State Song Shop, 3419 Chrysler. Tel: TE 3-5299.

• **ESCANABA (Area Code 906)**
S & G Dist'g, 1111 N. 16 St. Zip: 49829. Tel: 786-1111. Owner: Sam B. Mills.

• **GRAND RAPIDS (Area Code 616)**
Record City, 41 S. Division. Tel: 459-4549. Owner: Gordon Darrah.

MINNESOTA

• **MINNEAPOLIS (Area Code 612)**
Acme Music Serv., 321 Plymouth Ave. N. Zip: 55411. Tel: 333-7221. Opns. Mgr.: L. Ruegemer. Buyers: Singles, Bill Williams; Albums, S. M. Vanyo.

All Rec., 7600 Wayzata Blvd. Tel: 332-8026. Mgr.: Sandy Sanderson.

Brown Bros., 2321 Washington Ave. N. Zip: 55411. Tel: 522-6648. Owner: Ray Brown.

Dart Rec., 730 Lyndale Ave. N. Tel: 374-3422. Owner: Jack A. Taylor; Mgr.: Richard J. Daly. Buyers: Singles, Irv Gorsen; Albums, Dick Daly. Branches: Des Moines, Iowa; Omaha, Neb.

Sam Sales, 321 Plymouth Ave. N. Tel: 332-7131. Ext. 261. Opns. Mgr.: L. Ruegemer. Buyers: Singles, Bill Williams; Albums, S. M. Vanyo.

• **ST. PAUL (Area Code 612)**
Soul City Rec. Shop, Selby & Doll. Tel: 227-3414.

MISSOURI

• **KANSAS CITY (Area Code 816)**
Davidson's, 321 Southwest Blvd. Tel: VI 2-5220. Owner & Mgr.: M. S. Davidson. Buyers: Singles, H. Hassler; Albums, B. Dysart.

Branch: Wichita, Kan.; Omaha, Neb.
ORIGINAL ONE STOP REC. SERV., 3230 Roanoke Rd. Tel: LO 1-8076. Pres.: Ed Ockel; Mgr.: Neva Cessnun.

Branches: Decatur, Ill.; St. Louis, Mo. (SEE ADVERTISEMENT)

• **ST. LOUIS (Area Code 314)**
L & R Dist'g, 1901 Delmar Blvd. Zip: 63103. Tel: GA 1-5633. Owner: Lew Ruben; Mgr.: Rick Elliot. ORIGINAL ONE STOP REC. SERV., 2721 Pine St. Zip: 63103. Tel: JE 5-4172. Contact: Lee Davis. Branches: Decatur, Ill.; Kansas City, Mo. (SEE ADVERTISEMENT)

Pat's One Stop Rec. Serv., 1911 Washington. Zip: 63103. Tel: CE 1-2074. Mgr.: Pat Blunda.

Record Van Original Mobile, PO Box 6391, 2025 E. Grand. Zip: 63107. Tel: CH 1-5976. Pres.: Don Ruehman.

Uptown Music, 617 N. Kings Hwy. Tel: FO 7-2602. Pres.: Harry Brockman.

NEBRASKA

• **OMAHA (Area Code 402)**
Dart Rec., 2500 Harney St. Tel: 342-1545. Owner: Jack A. Taylor; Mgr.: George Shearer. Buyer: Singles & Albums, George Shearer.

Branches: Des Moines, Iowa; Minneapolis, Minn. Davidson's, 1214 Farnam. Tel: 341-4088. Owner: M. S. Davidson; Mgr.: Pete G. Poulos. Buyer: Singles & Albums, Pete Poulos.

Branches: Wichita, Kan.; Kansas City, Mo. Lieberman's, 809 S. 26 St. Tel: 341-3056. Mgr.: Evelyn Dalrymple.

NEVADA

• **RENO (Area Code 702)**
Ranchito Dist'g, 1522 Matley Ln. Zip: 89502. Tel: 329-0010. Owner & Mgr.: Darwin Jones. Buyer: Singles & Albums, Darwin Jones.

NEW HAMPSHIRE

• **MANCHESTER (Area Code 603)**
Manchester Music, 62 Lowell St. Tel: 669-5320. Owner: Irving Taube; Mgr.: Alfred Bergeron. Buyer: Singles & Albums, Ruth Demers.

NEW JERSEY

• **ELIZABETH (Area Code 201)**
Able Rec. Sales, 730 Division St., Seeburg Bldg. Tel: 351-6660. Mgr.: Anthony Villanova. Melody Shop, 1172 Elizabeth Ave. Tel: EL 3-0308.

• **HACKENSACK (Area Code 201)**
"Oldies Unlimited," 304 Main St. Zip: 07601. Tel: DI 3-8285. Pres.: Karl M. Olsen. Relic Rack, 136 Main St. Tel: 342-4848. Owner: Ed Gries; Mgr.: Wayne Stierle. Buyers: Ed Gries & Wayne Stierle.

- **NEWARK (Area Code 201)**
Belmont Rec., 268 15 Ave. Zip: 07103. Tel: MA 2-1936. Prop.: Frank Gottlieb.
Ideal Rec. Prods.-Ramar Sales, 357 Lyons Ave. Tel: WA 3-6333. Pres.: Samuel Kennholtz.
NEW JERSEY, 175 Clinton Pl. Tel: 923-6472. Owner: Joe Martin; Mgr.: Angela Pompeo. Buyer: Singles & Albums, Ed Gries. (SEE ADVERTISEMENT)
Red Top, 261 S. Orange Ave. Tel: MI 3-9807. Pres.: Ralph Giacobbe.
SERVICE ONE STOP DIST., 16 Fenwick St. Tel: 243-8700. Owner: Irv Cohen; Mgr.: Ralph Schechtman. Buyers: Singles, Ralph Schechtman; Albums, Frank Di Marsico.
Branch: Springfield, N.J. (SEE ADVERTISEMENT)
- **ROCHELLE PARK (Area Code 201)**
Garden State Rec. Dist. (div. of Interstate Rec. Dist.), 6B W. Passaic St. Tel: 843-2670. Owner: M. G. Wells. Buyers: Singles B. Kobrin; Albums, Stan Sterling.
Branch: New York, N. Y., New York Rec. Dist.
- **SPRINGFIELD (Area Code 201)**
SERVICE ONE STOP DIST., Rt. 22, Fadem Rd., Runyon Bldg. Tel: DR 6-7666. Mgr.: Paul Reilly.
Branch: Newark, N. J. (SEE ADVERTISEMENT)
- **ALBUQUERQUE (Area Code 505)**
Linden, 1205 Madeira S.E., Suite 124. Zip: 87108. Tel: 255-3978. Pres.: Linda Blaskey.

NEW YORK

- **ALBANY (Area Code 518)**
Harpers, 97 N. Pearl St. Tel: HE 4-2021. Owner: Abraham Lower.
J-S Rec. Dist'rs, 98 Everett Rd. Zip: 12205. Tel: 489-5446. Owner: Joe Spence; Gen. Mgr.: Tom Ryan.
- **AMSTERDAM (Area Code 518)**
Almor Playtime, Wallins Corners Rd. Tel: VI 2-2500. VP: Albert A. Hyman.
- **BUFFALO (Area Code 716)**
Buffalo, 959 Main St. Tel: TT 2-0427. Owner: Steve Brodie.
Florence, 875 Main St. Tel: TT 4-5220. Pres.: Florence Bloom.
- **FREEPORT, L. I. (Area Code 516)**
DOUBLE B., 240 E. Merrick Rd. Tel: FR 8-2222. Pres.: Bernie Boorstein. (SEE ADVERTISEMENT)
- **GREAT NECK, L. I. (Area Code 516)**
Variety Rec. Dist., 15 Bond St. Tel: HU 2-0900. Owner & Mgr.: David Shichman. Buyer: Singles & Albums, David Shichman.
- **LATHAM (Area Code 518)**
Bee Gee, 10 Northway Ln. N. Tel.: 785-1350. Pres.: Leonard Smith.
L & L Dist., 10 Northway Ln. N. Tel: 785-1350.
- **LONG ISLAND CITY (See New York City)**
- **MOUNT VERNON (Area Code 914)**
Steadman, 140 E. Third St. Tel: OW 9-3166. Pres.: Leonard Book.
- **NEW YORK CITY (Area Code 212)**
A-1 REC. SALES, 659 10 Ave. Zip: 10036. Tel: CI 6-1234. (SEE ADVERTISEMENT)
Comas, 324 W. 49 St. Tel: LI 1-9436. Pres.: L. A. Sorrentino.
CONSOLIDATED ONE-STOP OF NEW YORK, 315 W. 47 St. Zip: 10019. Tel: PL 7-8140. Mgr.: Elliot Blaine. (SEE ADVERTISEMENT)
Eastern Rec. Sales, 666 10th Ave. Zip: 10036. Tel: CI 5-9469. Mgr.: Murray Lefkoff.
Gen-Mar Dist., PO Box L, Old Chelsea Sta. Pres.: L. Guttenplan.
Hector, 48 W. 22 St. Zip: 10010. Tel: CH 2-1989. Sales Mgr.: Stan Cumberpatch.
Independent Rec. Promos., 258 W. 18 St. Zip: 10011. Tel: YU 9-8644. Pres.: Larry Guttenplan.
King Karol, 444 W. 42 St. Tel: BR 9-2342. Owner: Ben Karol.
New Deal, 45-18 Court Sq., Long Island City. Tel: ST 6-4263. Mgrs.: Al Levine & Lou Klayman; Nat'l Sales Mgr.: Pete Hyman; Gen. Mgr.: Morris Weissman.
Branches: Los Angeles, Calif.; Chicago, Ill.; Baltimore Md.; Detroit, Mich.
New York Rec. Dist. (div. of Interstate Rec. Dist.), 15 W. 20 St. Zip: 10011. Tel: YU 9-2255. Owner: Manny G. Wells; Mgr.: Mac Goldstein.
Branch: Rochelle Park, N. J., Garden State Rec. Dist.
One-Stop Serv., 133 E. 84 St. Tel: 288-4338.
Raymar Sales, 170-21 Jamaica Ave., Jamaica. Tel: OL 8-4012.
Record Shack, 2132 Second Ave. Tel: EN 9-8600. Mgr.: Edward Portnoy. Buyer: Albums, Larry Sonin.
Schony's, 2602 Hilden Ave., Brooklyn. Tel: BU 7-3576. Partner: L. Schonberger.
Stratford Dist., 179-01 Jamaica Ave., Jamaica. Tel: OL 7-5080.

OLDEST & LARGEST ONE STOP IN THE MIDWEST

"The Original" ONE STOP RECORD SERVICE, INC.
Now 3 Cities to serve you

- Complete Single and L.P. Inventory
- Regular Wholesale Prices
- Orders Shipped Same Day Received (P. P., U. P., Bus, Train, Etc.)
- Free Title Strips
- We Ship Anywhere

"The Original" ONE STOP RECORD SERVICE, INC.

2721 Pine Street, St. Louis 3, Mo. Jefferson 5-4172
3230 Roanoke Rd., Kansas City 11, Mo. Logan 1-8076
312 N. Water, Decatur, Ill. 428-6653

Write or Call for Details

SAVE TIME—SAVE MONEY—USE ONE STOP SERVICE

CONSOLIDATED ONE STOP, INC.

13254 Linwood Ave. Detroit, Mich. 48238

- ★ MOST COMPLETE L. P. STOCK IN MICHIGAN
- ★ COMPLETE STOCK OF CURRENT & STANDARD 45's
- ★ 24 HR. DELIVERY SERVICE
- ★ PERSONAL SERVICE IN JUKE BOX PROGRAMING
- ★ WE SPECIAL ORDER

MEMBER OF ROSA PHONE TO 5-8665

The Most EXPERIENCED... AGGRESSIVE

ONE-STOP

furnish STAR PRINTED TITLE STRIPS

☆☆☆

MR. OPERATOR—Check with your local One-Stop today or write to us for the name and address of a "STAR SUPPLIED" One-Stop near you.

★

STAR TITLE STRIP COMPANY, INC.

842 Western Avenue Area Code 412 231-4314 Pittsburgh, Pa. 15233

**NEW YORK'S LEADING
WHOLESALE PHONOGRAPH
RECORD DISTRIBUTOR...
DISTRIBUTING
ALL LABELS**

**WIN
RECORDS
INC.**

**CONTACT US FOR
INCREASE IN PROFIT
THROUGH OUR RACK
MERCHANDISING PLAN . . .**

**CALL — WIRE — WRITE
SAM WEISS and GEORGE WEISS**

WIN RECORDS, INC.

**858 Ninth Ave., New York, N. Y.
JU 2-0130**

13

**Years Of Proven Success. Become
Part Of Our Profitable Picture. We
Feature Complete Rack Service, Chain
Stores And Discount Stores Our Specialty...**

STEADMAN SALES, INC.

**140 East 3rd Street Mount Vernon, N. Y.
(914) OW 9-3166**

DEALERS and OPERATORS

For PROMPT, EFFICIENT Service

Try Our COMPLETE ONE-STOP Facilities

2 Locations to Serve You

AM BAT RECORDS, INC.

**1667-71 Central Parkway, Cincinnati, Ohio 45214
Phone (513) 621-3252**

and

**1336 Xenia Avenue, Dayton 10, Ohio
Phone (513) 256-4212**

continued

TOWN HALL, 9131 Bedell Ln., Brooklyn. Tel: BR 2-9702. Pres.: Ben Reminick. (SEE ADVERTISEMENT)

Win Rec., 858 Ninth Ave. Tel: JU 2-0130. Mgr.: George Weiss.

• **PALMYRA (Area Code 315)**
Canaltown Rec. & Tape Sales, Walton Rd. Tel: LY 7-5003. Owner & Mgr.: G. L. Griffin.

• **PORT CHESTER (Area Code 914)**
Bandstand Rec., 15½ N. Main St. Tel: WE 7-4092. Owner: Leonard Cooper.

• **POUGHKEEPSIE (Area Code 914)**
Toy House of Hudson Valley, Manchester Rd. Tel: GR 1-2740. Mgr.: Lou J. Kustas. Buyer: Singles & Albums, Lou Kustas.

• **ROCHESTER (Area Code 716)**
Rochester (div. of Transcontinental Rec. Sales), 213 Monroe Ave. Zip: 14607. Tel: 454-6968. Owner: Leonard Silver; Mgr.: Philip P. Martin. Buyer: Singles & Albums, Philip P. Martin.

Star, 17 Clinton Ave. N. Tel: 454-4635. Owner & Mgr.: John Schreiber. Buyer: Singles & Albums, John Schreiber.

• **SYRACUSE (Area Code 315)**
Syracuse, 333 W. Fayette St. Tel: GR 6-4019. Owner & Mgr.: Ralph La Rosa. Buyer: Singles & Albums, Ralph La Rosa.

• **WILLISTON PARK, L. I. (Area Code 516)**
All Rec. Dist., 67 Hillside Ave. Tel: PI 7-0584. Mgr.: Stanley Schneider. Buyers: Singles, Thomas Hoffman; Albums, John Riccoboni.

NORTH CAROLINA

• **CHARLOTTE (Area Code 704)**
Bib Dist., 126 W. Morehead. Tel: 372-2032. Contact: Joe Voynow.
Southeastern Rec. Mdsrs., 2706 Freedom Dr. Tel: 399-5633. Sales: Charles Hartley.

OHIO

• **CINCINNATI (Area Code 513)**
AM-BAT, 1667 Central Pkwy. Zip: 45214. Tel: 621-3252. Pres.: Vern Hawk.
Branch: Dayton, Ohio. (SEE ADVERTISEMENT)
Royal Dist., 1210 Glendale-Milford Rd. Tel.: 771-4256. VP: Jack D. Pierce.

• **CLEVELAND (Area Code 216)**
Inland, 3142 Prospect. Tel: 431-5300. Owner: John Cohen; Gen. Mgr.: Danny Connors.
Mobile Rec. Serv., 2701 St. Clair. Tel: 861-3620. Mgr.: Brud Oseroff, Pittsburgh, Pa. Tel: (214) 471-3566.

Northern Rec. Sales, 2006 Prospect Ave. Tel: 781-7080. Pres.: J. George Freeman.
Stark Rec., 2797 Hamilton Ave. Zip: 44114. Tel: 621-1119. VP: Charles Murray.

• **COLUMBUS (Area Code 614)**
Century Rec. Sales, 849 N. High. Tel: 299-5700. Owner: Arthur Freeman; Mgr.: Paul Lang. Buyer: Singles & Albums, Paul Lang.

• **DAYTON (Area Code 513)**
AM-BAT, 1336 Xenia Ave. Tel: 256-4212. Pres.: Vern Hawk; Mgr.: Martha Baker.
Branch: Cincinnati, Ohio. (SEE ADVERTISEMENT)

• **MASSILLON (Area Code 216)**
Stark, 1226 Duncan Ave. S.W. Tel: TE 2-1565. Owner: Paul David; Mgr.: Phil Shannon. Buyer: Singles & Albums, Phil Shannon.

• **SPRINGFIELD (Area Code 513)**
Buckeye Ents., 5 E. Main St. Zip: 45502. Tel: 325-7686. Pres.: Asen Kristoff; VP: Steve Kristoff.

• **YOUNGSTOWN (Area Code 216)**
Plaza Rec., 309 Boardman Plaza. Tel: SK 8-5795. Owners: Frank Valicenti & Jack Smith; Mgr.: Tom Temelkoff.
Branch: 37 Liberty Plaza. Tel: 759-1800.

OKLAHOMA

• **OKLAHOMA CITY (Area Code 405)**
Advanced, 129 N.W. 23. Zip: 73103. Tel: JA 5-9041. Contact: Cliff Kelton & Ron Waters.

All Rec. Dist., 520-522 Classen Blvd. Zip: 73106. Tel: CE 5-3381. Mgr.: Bill Hill. Buyer: Singles & Albums, Bill Hill.

Phil's, 705 N.W. Fourth St. Tel: CE 5-0771. Pres.: Phil Burlingame.

• **TULSA (Area Code 918)**
Bill's, "T" Rec. Shop, 213 E. Sixth St. Tel: LU 2-5218. Owner: Al Horn.

Broadcast Rec. Dist., PO Box 223. Tel: LU 4-3823. Owner: Kenneth A. Green.
Tops, 213 E. Sixth St. Tel: LU 2-5218. Owner: Kenneth A. Horn; Mgr.: Connie Moore.

OREGON

• EUGENE (Area Code 503)

Thompson, 62 W. Broadway. Tel: 343-9273. Partners: R. B., T. F., J. M. & F. H. Thompson; Mgr.: J. M. Thompson. Buyers: Singles, J. Hogan; Albums, B. Woods.

• PORTLAND (Area Code 503)

Portland, 511 S.W. Sixth. Tel: CA 6-3656. Pres.: M. C. McMahon.

Sea-Port Rec., 21 N.E. Seventh Ave. Zip: 97232. Tel: 234-0965. Mgr.: Dave Smith. Branch: Seattle, Wash., Seattle Rec.

Sixth Ave. Rec. & Hi Fi, 511 S.W. Sixth Ave. Zip: 97204. Tel: CA 6-3656.

PENNSYLVANIA

• HARRISBURG (Area Code 717)

D & H, 2525 N. Seventh St. Tel: 236-8001. Mgr.: David Press. Buyer: Singles & Albums, Endo Corsetti.

• LEHIGHTON (Area Code 215)

Green's Recs., 127 S. First St. Zip: 18235. Tel: 377-1854. Mgr.: George Hunsicker.

• PHILADELPHIA (Area Code 215)

AMERICAN REC. SALES, 1242 W. Girard Ave. Zip: 19123. Tel: PO 9-3900. Pres.: W. R. Buster Jr. (SEE ADVERTISEMENT)

Eastern, 334 N. Broad. Zip: 19102. Tel: LO 4-4415. Mgr.: Ray Pettola.

I. J. Morgan, 511 N. Broad. Tel: WA 5-7535. Owners: Irv Perlman & Jerry Rosen; Mgr.: Joe Masci. Buyers: Singles, Mary Picano; Albums, Art Pernie.

Oldies But Goodies Land, PO Box 2902. Zip: 19126. Tel: WA 7-0253. Pres.: M. Adler.

Williams, B17 N. Broad St. Tel: CE 2-2020. Owner: Sid Williams.

• PITTSBURGH (Area Code 412)

All Brands Dist., 1901 Fifth Ave. Tel: AT 1-0131. East Coast, 633 Liberty Ave. Tel: 281-6344. Owner: Nicholas Lomakin.

Empire Dist'g, 4610 Liberty Ave. Zip: 15224. Tel: 682-8437. Pres.: S. R. Canterman. (promotional albums)

Klein's Logan Variety Store, 2111 Centre Ave. Tel: 261-6176. Pres.: Isadore Klein.

Mobile Rec. Serv. Tel: 471-3566. (See Cleveland, Ohio.)

One Stop Rack Serv., 1704 Fifth Ave. Tel: 261-3340. Regal Rec., 1601 Fifth Ave. Zip: 15219. Tel: 471-6770. Owner: Herbert S. Cohen; Mgr.: Don Bray.

• READING (Area Code 215)

McKinnon, 411 Gordon St. Zip: 19601. Tel: 376-0300. Pres.: Leonard McKinnon; Gen. Mgr.: Beulah F. Coad.

• STROUDSBURG (Area Code 717)

Dee Jay, 528 Main St. Tel: 421-3211.

• SUMMIT HILL (Area Code 717)

Barnes Rec. Dist., 13 W. White St. Tel: 645-2321. Prop: William Barnes.

RHODE ISLAND

• PROVIDENCE (Area Code 401)

Beacon, 821 N. Main. Tel: B61-7500. Pres.: Milton Israeloff.

SOUTH CAROLINA

• ABBEVILLE (Area Code 803)

Savitz, 115 Public Sq. Tel: 459-2143. Owner: Allen Savitz; Mgr.: Cregg Booth. Buyer: Singles & Albums, Susan Hagen.

South Carolina, 115 Public Sq. Tel: 459-2143. Owner: Allen Savitz; Mgr.: Cregg Booth. Buyer: Singles & Albums, Susan Hagen.

• CHARLESTON (Area Code 803)

Fox, 537 King St. Tel: 722-0511. Owner & Mgr.: Harold I. Fox. Buyer: Singles & Albums, Harold I. Fox.

TENNESSEE

• CHATTANOOGA (Area Code 615)

Jack's Music Shop, 906 Market St. Tel: 266-8554. Owner: Lucille Huffaker.

• KNOXVILLE (Area Code 615)

Tucker's Rec. Shop, 22½ Market St., On the Mall. Tel: 522-9300. Owner: Martin T. Robertson; Mgr.: Dale Clark.

WE SUPPLY AND SERVICE

Discount Centers
Appliance Shops
Department Stores
Drug Stores
Variety Shops
Advertising Agencies
Schools and Studios
TV Repair Shops
Your Needs

45 r.p.m. Records58¢ ea.

**One Delivery, One Invoice,
Guaranteed Sale—
Guarantees Profit**

CALL, WRITE OR PHONE

LITTLE AL'S

**3216 W. Lawrence Ave.
Chicago 25, Illinois
(Phone: IR 8-6114)**



**“GOOD MORNING
NEW JERSEY
ONE STOP”**

**WE CARRY ALL LABELS AND
SPECIALIZE IN HARD-TO-GET RECORDS**

**Free Strips—Special Orders—Open 6
Days a Week.**

**For Fast Service, Shipped the Same Day,
Please Call:**

NEW JERSEY ONE STOP CORP.

**175 Clinton Place Newark, N. J. 07112
Telephone (201) 923-6472**

DOUBLE B RECORDS CORP.
A singular sales service for all.

LP's — 45's — One Stop to the Trade

Complete Line of 4 & 8 Track
 Stereo Cartridge Tapes

Catalogs & Prices on Request

Bernard Boorstein
 Donato Liberatore

240 E. Merrick Rd., Freeport, N.Y. 11520
 FReeport 8-2222

**A-1
 RECORD
 SALES**

659 Tenth Ave., (212) Circle 6-1234, New York City 36

**EXCLUSIVE SPECIALISTS FOR
 THE JUKE BOX OPERATORS**

The One-Stop with a complete selection of Singles, LP's, Standards and Background Music.

FREE TITLE STRIPS

Immediate Delivery
 Mail Orders Our Specialty

OTTO WILKINSON
 General Manager

continued

• **MEMPHIS (Area Code 901)**

Home of the Blues, 107 Beale St. Tel: JA 5-6303.
 Owner: Ruben Cherry. Buyer: Singles & Albums, Ruben Cherry.

Poplar Tunes, 308 Poplar St. Tel: (901) 525-6348.
 Owner: Joe Cuoghi; Mgr.: Frank Berretta.

• **NASHVILLE (Area Code 615)**

Ernie's 179 Third Ave. N. Tel: 256-2916. Buyer: Singles & Albums, Shannon Williams.

Hermitage Music, 467 Chestnut St. Tel: 244-1790.

Volunteer, 435 37 Ave. N. Tel: 297-0055. Owner: Webber Parrish. Buyers: Singles, R. Crick; Albums, H. Kilgore.

TEXAS

• **AMARILLO (Area Code 806)**

Western Merchandisers, 1601 W. Third Ave. Tel: DR 6-6251. Owner: Sam Marmaduke; Mgr.: Dick Williamson. Buyer: Singles & Albums, Ed Perry.

• **CARROLLTON (Area Code 214)**

D J, 2315 Briarwood Ln. Tel: CH 2-3698. Owner & Mgr.: Don Bresler. Buyer: Singles & Albums, Don Bresler.

• **DALLAS (Area Code 214)**

Big State, 1337 Chemical St. Tel: ME 1-1100.
 Mgr.: Bill Emerson.

Westex Rec. Serv., 1327 Crampton. Tel: ME 7-1810.
 Pres.: Bruce Switzer.

• **EL PASO (Area Code 915)**

B & C Rec. Sales, 427 W. San Antonio St. Tel: KE 2-1434. Mgr.: Joey Cash. Buyers: Singles, Lupe Arce; Albums, Joey Cash.

M. B. Krupp Dist., 311 S. Santa Fe. Tel: 532-4961.
 Pres.: M. B. Krupp.

Star Discos, 100-102 Texas Ave. Zip: 79946. Tel: 533-7282. Owner: Joseph Gillman.

Sunland, 2227 Texas Ave. Tel: KE 3-5901. Owner: William Shapiro.

• **HOUSTON (Area Code 713)**

Central Sales, 2104 Leeland St. Tel: CA 4-2626.
 Mgr.: George Jamail.

If you are in the MUSIC business you are in the HIT business. HIT records are RATED and IDENTIFIED on HIT STRIPS. Music ops who want EXTRA PLAYS should insist on HIT STRIPS from their record source.

WRITE FOR BROCHURE

STERLING TITLE STRIP COMPANY, INC.
 1175 BROAD ST. 201-243-0222 NEWARK, N. J. 07114

**SERVICE
 ONE-STOP
 DISTRIBUTORS**

ONE OF
 THE NATION'S
 LEADING

**ONE
 STOPS**

16 Fenwick St.
 Newark, N. J.
 (201) 243-8700

(Branch Office)

Route 22 (Runyon Bldg.)
 Springfield, N. J.
 (201) DRexel 6-7666

ONE-STOP

OLDIES = EXTRA DOLLARS!
 (Where else can you still make \$400%?)

LARGEST FULL-LINE
 OLDIES ONE-STOP!
 ALL LABELS

WRITE TODAY FOR
 LATEST COMPLETE
 LISTINGS

AMERICAN RECORD SALES INC.
 1242 W. GIRARD AVE., PHILADELPHIA, PA 19123 — (215) PO 9-3900

"THAR'S GOLD IN THEM THAR OLDIES"

H. W. Daily, 314 E. 11 Ave. Tel: UN 1-6868.
 Owners & Mgrs.: Bud & Don Daily. Buyers:
 Singles & Albums, Bud & Don Daily.

Merrbach Rec. Serv., 323 W. 14 St. Tel: UN 2-7077.
 Owner: N. F. Merrbach.

Record Serv., 614 Dennis St. Tel: JH 3-2269, 6781.
 Mgr.: J. R. (Russ) Reeder.

United Rec. Dist., 1613 St. Emanuel St. Tel: CA
 8-8151.

• **LUBBOCK (Area Code 806)**

Recordland USA, 3819 Ave. A. Tel: SH 7-4443.
 Owner: Allan Rosen; Mgr.: Bob Iseral. Buyer:
 Singles & Albums, Bob Iseral.

• **SAN ANTONIO (Area Code 512)**

E & R, 911 E. Houston St. Tel: CA 2-0911. Owner
 & Mgr.: Russell Schram.

Phil's, 224 S. Flores. Tel: CA 6-4052. Owner &
 Mgr.: Russell Burlingame. Buyers: Singles &
 Albums, Mattie Johnson.

Santone Sales, 121 Navarro. Tel: CA 7-5181.
 Contact: Louis Jamail.

Perry Shankle, 1801 S. Flores. Tel: CA 3-1801.
 Mgr.: J. J. Schneider.

Tanner 'N' Texas, 1414 W. Poplar. Zip: 78207.
 Tel: PE 2-8831, 5841. Mgr.: Charles Cole.

• **SAN BENITO (Area Code 512)**

Rio Grande Music, PO Box 861, 119 S. Sam Houston
 Blvd. Zip: 78586. Tel: EX 9-1471. Owner: Paco
 Befancourt.

UTAH

• **SALT LAKE CITY (Area Code 801)**

Billinis Dist., 3575 South-700 West. Tel: 266-3540,
 3548. Owner & Mgr.: John Billinis. Buyers:
 Singles, Ray Peterson; Albums, John Billinis.

Records Express, 209 E. Ninth St. Zip: 84111. Tel:
 328-3135. Mgr.: Dick La Duke.

VIRGINIA

• **FALLS CHURCH (Area Code 703)**

Giant Music, 110 W. Broad St. Tel: 534-0930. Pres.:
 Jack Shaver. Buyer: Singles, D. Blackburn.

• **RICHMOND (Area Code 703)**

PAT'S, First & Canal. Tel: MI 8-4791. Pres.: Pat
 Cohen. (SEE ADVERTISEMENT)

WASHINGTON

• **SEATTLE (Area Code 703)**

Disc City, 410 Elliott W. Tel: AT 2-7555. Mgr.:
 Larry Dolgoff.

Seattle Rec., 125 First Ave. N. Zip: 98109. Tel:
 AT 4-8990. Contact: Lew Choate.

Branch: Portland, Ore., Sea-Port Rec.

• **SPOKANE (Area Code 509)**

Music Box, 417 W. Riverside Ave. Tel: MA 4-9123.

WEST VIRGINIA

• **CHARLESTON (Area Code 304)**

Elkins, 160 Court St. Tel: 343-7833. Owner &
 Mgr.: M. Z. (Red) Elkins. Buyer: M. Z. Elkins.

• **HUNTINGTON (Area Code 304)**

Music Man, 803 Eighth Ave. Tel: 522-7551. Pres.:
 & Mgr. F. J. McGlynn. Buyers: Singles, C. L.
 Blankenship; Albums, F. J. McGlynn.

WISCONSIN

• **BURLINGTON (Area Code 414)**

Music Mar., 164 E. Washington St. Tel: 763-3361.
 Pres: Robert Ruedebusch.

• **KENOSHA (Area Code 414)**

Hoffman's, 5707 Sixth Ave. Tel: OL 7-7858. Owner:
 Joseph Hoffman; Mgr.: S. C. Hoffman. Buyers:
 Singles & Albums, S. C. Hoffman.

• **MILWAUKEE (Area Code 414)**

Radio Doctors, 240 W. Wells St. Tel: 276-6422.
 Owner: L. M. Glassman; Mgr.: M. Mowers. Buyer:
 Singles & Albums, M. Mowers.
 Branch: 2152 N. Third St. Tel: LO 2-7607.

Record City, 5600 W. North Ave. Tel: 871-0460.
 Mgr.: K. E. Rietz; Buyers: Singles, Gordon
 Pelzek; Albums, Dave Wulfsohn.

• **RACINE (Area Code 414)**

Soulville, 507 Main St. Tel: 634-9633. Prop.: J.
 Huennkens.

HERMITAGE MUSIC CO.

ONE OF THE SOUTH'S
 LARGEST
 ONE STOP RECORD SUPPLIERS

469 Chestnut St.

Nashville, Tenn.

(615) 244-1790

THE WISE DEALER IS THE ONE WHO REALIZES THAT HE CANNOT AFFORD TO DEAL
 WITH ANYTHING LESS THAN THE BEST RECORD SUPPLY SERVICE AVAILABLE—THAT
 HE DOES HIMSELF AND HIS BUSINESS AN IRREPARABLE DISSERVICE IN SETTLING
 FOR A MEDIOCRE SUPPLY SERVICE, WHEN A SUPERIOR SERVICE IS AVAILABLE.



...RIGHT HERE FOR THE BEST IN ONE-STOP RECORD SERVICE

Now celebrating our 20th and greatest year serving dealers in all of the 50 United States.

Let us help you make extra sales, more customers and greater profits with our reliable, efficient service
 and our unbeatable fill of your orders.

—Try us and convince yourself—

WE GUARANTEE:

- Most complete fill of your orders
 (We invite you to try us on the items that your present
 suppliers have been unable to fill)
- Reliable, efficient, same-day service
- Competitive prices

We carry the most complete stock of "oldie" 45's in
 the country, write for our new giant "oldies" catalog
 listing 3000 best selling "Golden Oldies."

NOW IN STOCK

- Best selling automobile stereo-8 cartridge tape player
 at low dealer prices.
- Best selling home stereo-8 cartridge tape player
- Complete inventory of stereo-8 tape cartridges

Get your share of this fast growing, "Extra" Business.

Write! Wire! Phone! For Details—Now!

TOWN HALL RECORD ONE-STOP

9131 BEDELL LANE, BROOKLYN, N. Y. (212) BR 2-9702

Make a most important move
 to improve your business.

LEADING MUSIC PUBLISHERS

Continued from page 75

Web IV (BMI), 1650 Broadway, New York, N. Y. 10019. Tel.: (212) LT 1-3740. Pres.: Bert Berns.
 Weill-Brecht-Harms (ASCAP), see Music Publishers Holding Corp.
 Sam Weiss (ASCAP), 6087 Sunset Blvd., Hollywood, Calif. 90028. Tel.: (213) 464-9251.
 Affiliate: St. Lawrence (BMI).
 Welton (BMI), see Protone.
 Welzheim (ASCAP), see Bregman, Vocco & Conn.
 Wemar (BMI), 1619 Broadway, New York, N. Y. 10019. Tel.: (212) CO 5-4753.
 Bobe Wes (BMI), 4542 Live Oak, Mesquite, Tex. 75149. Tel.: (214) BR 9-0635. Pres.: Bobe Wes.
 West Coast (ASCAP), see Metric Music Group.
 West End (ASCAP), see Premier.
 Westpar (BMI), see Pamco.
 Wharton (ASCAP), see N. A. Busillo.
 White Cliffs (BMI), 748 Camp St., New Orleans, La. 70130. Tel.: (504) 523-7474.
 White Mountain (ASCAP), 164 Church St., New Rochelle, N. Y. Partners: A. Volpe, R. Calilli & A. Sansone.
 Whitecap (BMI), see Jaspur.
 Whitlock (BMI), 911 Greenbrae, Sparks, Nev. Tel.: (702) 358-8200. Owner: Jim Whitlock.
 Kae Williams (BMI), 3214 W. York St., Philadelphia, Pa. 19132. Tel.: (215) BA 3-0766. Pres.: Kae Williams.
 Williamson (ASCAP), see Chappell.
 Bob Wills (BMI), see Hill & Range.
 Winamusic, see Pavanne.
 Window (BMI), 809 18 Ave. S., Nashville, Tenn. Tel.: (615) 255-8388. Pres.: Pete Drake.
 Winner (BMI), 1619 W. Division, Chicago, Ill. 60651. Tel.: (312) 378-4848. Chm.: J. V. Man.
 Witmark (ASCAP), see Music Publishers Holding Corp.
 Woldox (BMI), see A. Schroeder.
 Wolper (ASCAP), see A. Schroeder.
 Wonder (BMI), see Lowery.
 Wonderland (BMI), see Walt Disney.
 Woodbury (BMI), see Ridgeway.
 Woodcrest (BMI), see Kalmann.
 Woomera, see Jaspur.

R. J. Wooten, 10840 Dixon Dr. S., Seattle, Wash. 98178. Tel.: (206) PA 5-7294. Pres.: Robert J. Wooten.
 Word & Music (ASCAP), 1841 Broadway, New York, N. Y. 10023. Tel.: (212) CI 6-9366.
 World (ASCAP), 18 E. 4B St., New York, N. Y. 10017. Tel.: (212) 688-6230. Pres.: Sammy Kaye.
 Affiliate: Republic (BMI).
 Wrismus (BMI), PO Box 3294, San Bernardino, Calif. Owner: Neale Wrightman.
 Wrist (BMI), see Lock.
 Wyncote (ASCAP), 309 S. Broad St., Philadelphia, Pa. 19107. Tel.: (215) KI 5-1140.
 Wyoming Music Ents., PO Box 104, 707 N. 10 St., Worland, Wyo. B2401. Tel.: (307) 347-3872. Pres.: Ray Pendergraft.
 Yardley, 2499 Cottle Ave., San Jose, Calif. 95125. Tel.: (408) 269-6011. Owners: David M. Nye & Scott Owen.
 Ybarra (ASCAP), PO Box 665, Lemon Grove, Calif. 92045. Tel.: (714) HO 9-6352. Owner: R. William.
 Yorktown (ASCAP), see Music Sales Corp.
 VINCENT YOUMANS (ASCAP), 157 W. 57 St., Rm. 404, New York, N. Y. 10019. Tel.: (212) CI 5-282B. VP & Gen. Mgr.: Robert Lissauer.
 Affiliate: Scope (BMI). (SEE ADVERTISEMENT)
 Zanetis (BMI), Tigo Bldg., Flora, Ill. Tel.: (618) 662-2156. Pres.: Alexander Zanetis.
 Branch: Nashville, Tenn., B01 16 Ave. S. Tel.: (615) 256-B151.
 Zap (BMI), PO Box 246, Mt. Rainier, Md. 20822. Tel.: (301) 927-0010. Pres.: C. R. Freeland.
 Zapata (BMI), see Ivan Mogull.
 Rex Zario (BMI), 1739 N. Third St., Philadelphia, Pa. 19122. Tel.: (215) RE 9-6970. Pres.: Rosario Lefavi.
 Zebra Recs. (BMI), 31 Brompton Rd., Garden City, L.I., N. Y. 11530. Tel.: (516) PI 7-3616. Pres.: Charley Ide; Gen. Mgr.: Ben Arrigo; Gen. Prof. Mgr.: Marc Frederick.
 Branch: New York, N. Y. 157 W. 57 St. Zip: 10019. Tel.: (212) CO 5-6585.
 Zelda Presents (BMI), Hollywood, Calif. 90046. Tel.: (213) HO 4-2020. Pres.: Zelda Samuels.
 Zoeller (BMI), 7507 De Soto Ave., Canoga Park, Calif. Owner: Lou E. Zoeller.

U. S. RACK JOBBERS

Continued from page 110

VIRGINIA

● **ROANOKE (Area Code 703)**
 Turner Candy, 516 Rorer Ave. S.W. Tel.: 342-0500.
 Pres.: A. L. Turner Jr.
 ● **VIRGINIA BEACH (Area Code 703)**
 Edge, PO Box 5043. Zip: 23455. Tel.: 464-6051.
 Mgr.: Ed Cook.

WASHINGTON

● **SEATTLE (Area Code 206)**
 General Rec. Serv., 40B S. River. Tel.: PA 5-6423.
 Contact: Paul Porretucus.
 Gordon Sales, 1000 First Ave. S. Zip: 98134. Tel.: MU 2-718B. Mgr.: Stan H. Jaffe. Buyer: Singles, R. A. Harlan; Albums, Chuck Blacksmith.
 Tip Top Music, 2213 15th Ave. W. Tel.: AT 4-8910. Pres.: Monroe Goodman; Mgr.: Frank McAllister.
 ● **SPOKANE (Area Code 509)**
 Tip Top Music, 431 Sprague Ave. E. Tel.: MA 4-6363.
 Mgr.: Fred Stewart.
 ● **YAKIMA (Area Code 509)**
 Ring Mdse. Dist., 1011 Pitcher St. Tel.: GL 7-5483.
 Sales: William Ring.

WEST VIRGINIA

● **CHARLESTON (Area Code 304)**
 Handleman, 5606 McCorkle Ave. S.E. Tel.: 925-2145.
 Mgr.: W. D. Hanson.

WISCONSIN

● **EAU CLAIRE (Area Code 715)**
 Arrow Racks, 1609 Laurel Ave. Tel.: 832-2533.
 Owner: R. W. Meyer.
 ● **MADISON (Area Code 608)**
 Rapid Sales, 1017 Jonathon Dr. Tel.: 257-308B. Pres.: Rolf V. Voegelin. Buyers: Singles, Lowell Grass; Albums, Donald C. Smith.
 ● **MILWAUKEE (Area Code 414)**
 Modern Rack Sales, 2715 W. Lisbon Ave. Tel.: 933-1244. Contact: Arnold Skieba.
 Musical Isle, Tel.: 264-4380. Chicago office: 1550 S. State St. Tel.: (312) 225-2929. Owner: Milt Salstone.
 Record City, 5600 W. North Ave. Tel.: 871-0460.
 Contact: Harold E. Rietz.

NEW ENGLAND'S LARGEST RECORD AND CARTRIDGE TAPE DISTRIBUTORS

Serving

**CONNECTICUT, WESTERN MASSACHUSETTS
 MAINE, VERMONT, ALBANY, N.Y.**

OUR BEST REFERENCES ARE

manufacturers we represent and our customers

**EXCLUSIVE LEAR JET DISTRIBUTION IN
 Connecticut and Western Massachusetts**

EASTERN—ALLIED—ASSOCIATED RECORD DISTRIBUTORS

360 Tolland Street—East Hartford, Conn.
 Phone 289-7431 Area Code 203

**IT PAYS OFF
 TO DEAL
 WITH**

**PAT'S
 ONE STOP**

WE CARRY ALL LABELS—
 INDIES & MAJORS—L.P.'s
 — ACCESSORIES — BAGS
 — BUDGET L.P.'s — CUT
 OUTS.

45 RPM's 60c
 FREE TITLE STRIPS
 SAME DAY SERVICE

PAT'S ONE STOP
 First & Canal Street, Richmond 19, Va.
 Phone (703) 648-4791

U.S. Importer - Exporter Directory

CALIFORNIA

• LOS ANGELES (Area Code 213)

CALIFORNIA MUSIC EXPORT, 2933 W. Pico Blvd.
Tel: 733-1181. Cable: CALMUSEX. Pres.: Sam
Ricklin. (SEE ADVERTISEMENT)

Cambridge Trading, 6704 Hollywood Blvd. Zip:
90028. Tel: 467-3177. Pres.: Milton Levine.

Gateway Mercantile, 107 N. Virgil. Tel: 381-5874.

Horizon Int'l, 6290 Sunset Blvd., Hollywood. Zip:
90028. Tel: 466-4224. Cable DAVONMUS. Pres.:
David Hubert.
Branch: New York, N. Y., Olibin, 101 W. 55 St.

• SAN FRANCISCO (Area Code 415)

Festival Rec. Dist., 161 Turk. Zip: 94102. Tel:
PR 5-3434. Mgr.: John Filcich.

• SANTA ANA (Area Code 714)

Rantra Rec., 1136 S. Arapahoe Dr. Tel: 546-1876.
Pres.: Stewart Douglas.

CONNECTICUT

• WILTON (Area Code 203)

Acropole (see New York City listing).

FLORIDA

• MIAMI (Area Code 305)

Budisco Int'l, 286 N.W. 29 St. Tel: 633-6033. Gen.
Mgr.: Raoul Shapiro.

Carib, PO Box 748, Miami Springs. Zip: 33166.
Tel: 885-3738. Pres.: Patricia V. Jacobs.

Inter-Alliance Trading, 251 S.W. First Ct.

Panart Int'l, PO Box 423, North Miami. Zip: 33161.
Tel: 751-4126. Pres.: Ramon S. Sabat.

• PRINCETON (Area Code 305)

Buhl Int'l Rec. Sales, PO Box 34. Zip: 33171.
Owner: Frank Buhl.

• WEST PALM BEACH (Area Code 305)

Stratford, PO Box 887. Tel: 844-1680. Pres.: Reno
B. Swails.

HAWAII

• HONOLULU

Microphone Music, 605 Coral St. Tel: 502-188.
Pres.: Ken Kaizawa.

ILLINOIS

• CHICAGO (Area Code 312)

Gaelic Imports, 5931 W. Chicago Ave. Zip: 60651.
Tel: 261-6144. Pres.: George Hudson.

Gale Prods., 5249 N. Virginia Ave. Tel: ED 4-2565.
Pres.: Joseph S. Gale.

Pan-American Rec., 1344 S. Halsted. Tel: SE
3-1530. VP: M. S. Frenkel.

KENTUCKY

• LOUISVILLE (Area Code 502)

Orbit Radio, PO Box 1644, 1863 Arlington St. Zip:
40201. Tel: 895-1143. Pres.: Stephen A. Cisler.

MASSACHUSETTS

• WORCESTER (Area Code 617)

J. K. Ogasian & Sons, 179 Belmont St. Tel: PL
2-9844. Pres.: J. K. Ogasian.

MISSOURI

• ST. LOUIS (Area Code 314)

Original One Stop Rec. Serv., 2721 Pine St. Tel:
JE 5-4172. Pres.: Ed Ockel.

NEW YORK

• ARMONK (Area Code 914)

Zerga, 4 Mill Ln., Rt. 2. Zip: 10504. Tel: AR
3-9529.

• NEW YORK CITY (Area Code 212)

Acropole, PO Box 365, Wilton, Conn. N.Y.C. Tel:
CY 5-2272. Pres.: Michele M. Ronty.

Airdisc USA, PO Box 545, Radio City Sta. Zip:
10019. Contact: Heinz I. Krohn.

Alector Rec., c/o Hellenic, 367 W. 34 St. Zip:
10001. Tel: LO 3-2831. Pres.: Ted Starke.

**ATTENTION: OVERSEAS
RECORD & STEREO
EQUIPMENT DEALERS**

**RECORDS
FOR EXPORT**

All Labels Phonograph Records
Low Prices
Shipments Consolidated
to Cut Your Costs
Speedy Service

**TAPES
FOR EXPORT**

4-Track Stereo Tapes, All Makes
Popular, Classical & Sound Tracks

**EQUIPMENT
FOR EXPORT**

Cartridges, Stereo Components,
Tape Recorders, Etc.
Catalogues on All Above Lines
Will Be Furnished Upon Request.

**SALIENT
Export
Agencies, Inc.**

1265 Broadway, New York 1, N.Y.
Cable: Saliexa, N. Y. (Tel.) LE 2-2283

FOR RECORDS AND TAPES
California Music Export Co.

(A division of Calif. Music Co.)
**LARGEST RECORD EXPORTER ON
THE U. S. WEST COAST**
— Since 1935 —

FASTEST SERVICE

To overseas buyers in the far east . . .

Pacific Countries, Hawaii, Alaska, Mexico, Central America and
South American Countries.

- **COMPLETE INVENTORY** on all labels, LP & 45—
including low-price merchandise.
- **PROMPT SERVICE** and **FREE Title Strips** to
Juke Box Operators.
- **8 TRACK Cartridge Tape.**
- **4 TRACK Reel to Reel Tape.**

— Write for prices and information —

CALIF. MUSIC EXPORT CO.

2933 W. Pico Blvd., Los Angeles 90006
California, U.S.A.

Telephone: 733-1181
Cable Address: CALMUSEX

FOR EXPORT ONLY:
AMERICAN GRAMOPHONE
RECORDS
 AND
TAPES
ALBERT SCHULTZ, INC.
 116 West 14th St.
 NEW YORK, N. Y. 10011, U.S.A.

Export: Records & Tapes
ALL AMERICAN
BRANDS COMBINED IN
ONE SHIPMENT
ELTRON
EXPORT
COMPANY
 122 Broad St., New York 4, N. Y.
 cable: ELTRONCOMP

ALL American Records
 ALL Imported Records
 ALL Pre-recorded Tapes
 ALL Car Tapes
 ALL Your Needs In One Shipment
 AT LOW, LOW PRICES
Free Catalogues on Request
DAVID ESKIN
INTERNATIONAL SALES
 400 Riverside Drive
 New York 10025 U.S.A.

RECORDS
For Export
 All American Labels,
 Extremely Attractive Prices
 and
 Speedy Service
CARDINAL
EXPORT CORP.
 135 West 29th St.
 New York, N.Y. 10001

TAPES FOR EXPORT
 ALL BRANDS REEL TO REEL.
 ALL BRANDS STEREO 8 CARTRIDGES.
LP RECORDS for EXPORT
 SPECIALISTS IN LOW-PRICED LABELS,
 BLUES, JAZZ AND FOLK LINES.
 Write to us for up-to-date Catalogs
 and our CIF price schedule.
HARBOR RECORD EXPORT
 8621 3rd Avenue Brooklyn, N. Y.

FAMOUS BRITISH AND
GERMAN DANCE
ORCHESTRAS
 on singles, EP's, LP's
Joe Loss
Victor Silvester
Phil Tate
John Warren
Willy Berking
Max Greger
Bela Sanders
Horst Wende
 Used in Leading U. S. Dance Studios.
 Free Wholesale Catalog.
DANCE RECORDS
 1438 Springvale Ave. McLean, Va.

RECORDS FOR EXPORT
 ALL BRANDS
 CONSOLIDATED INTO
 SINGLE SHIPMENTS
ALSCAP, INC.
 19 W. 34th STREET
 NEW YORK, N.Y. 10001
 WE PURCHASE JOBS CUT-
 OUTS OF LPs, EPs, 45s

THE
INTERNATIONAL
INFLUENCE
OF BILLBOARD
GROWS
AND
GROWS

continued

ALSCAP, 19 W. 34 St. Tel: CH 4-1195. Mgr.: B. ... (SEE ADVERTISEMENT)
 Apon Rec., PO Box 131, Grand Central Sta., 1541 First Ave. Tel: YU 8-0450. Pres.: Andrej Poncic.
 Baronet-Coronet, 8621 Third Ave., Brooklyn. Zip: 11209. Tel: SH 8-5307. Pres.: J. Hornig.
 CARDINAL EXPORT, 135 W. 29 St. Tel: PE 6-5855. Pres.: Arthur Lerner. (SEE ADVERTISEMENT)
 Cetra Rec. Dist., 97 Chambers St. Zip: 10007. Tel: BE 3-6280. Pres.: Martin Silvers.
 Daro Exports, 424 Madison Ave. Zip: 10017. Tel: PL 5-1753. Pres.: J. R. Weinberg.
 Discount Rec., 15 E. 53 St. Tel: HA 1-0290. Owners: M. G. Saines & J. Widoff.
 ELTRON EXPORTS, 122 Broad St. Zip: 10004. Tel: WH 4-7636. Pres.: Werner T. Glaeser. (SEE ADVERTISEMENT)
 DAVID ESKIN, 400 Riverside Dr. Tel: RI 9-4257. Pres.: David Eskin. (SEE ADVERTISEMENT)
 HARBOR REC. EXPORT, 8621 Third Ave., Brooklyn. Zip: 11209. Tel: BR 9-5307. Pres.: Jerome Hornig. (SEE ADVERTISEMENT)
 Hellenic, 365-367 W. 34 St. Zip: 10001. Tel: LO 3-2831. Pres.: Ted Starke.

INTERNATIONAL EXPORT AGENCIES, INC.
RECORDS—EXPORT ONLY
 Economical Consolidated Shipments
 and
 Rapid Deliveries
 394 Broadway, New York, N. Y. 10013

INT'L EXPORT AGENCIES (div of Sigmund Gold), 394 Broadway. Zip: 10013. Tel: CA 6-1056. (SEE ADVERTISEMENT)
 Music-By-Mail, 50 Broadway. Zip: 10004. Tel: WH 4-0852. Pres.: A. Edward Lowe.
 Playette, 585 Ninth Ave. Zip: 10036. Tel: BR 9-5379. Pres.: Sidney A. Evans.
 Record & Tape Sales, 821 Broadway. Zip: 10003. Tel: OR 4-6400. Pres.: Robert Staub.
 Record Hunter, 507 Fifth Ave. Tel: OX 7-8970. Gen. Mgr.: Jerome Maggid.
 Alex S. Roberts Assocs., 35 Bleecker St. Zip: 10012. Tel: 533-3840. Pres.: Alex S. Roberts.
 SALIENT, 1265 Broadway. Tel: LE 2-2283. Pres.: Morris Cohen. (SEE ADVERTISEMENT)
 ALBERT SCHULTZ, 116 W. 14 St. Zip: 10011. Tel: WA 4-1122. Cable: Albyrep. Pres.: Albert Schultz; VP: Stanley Atsidis. (SEE ADVERTISEMENT)

• **OCEANSIDE, L. I. (Area Code 516)**
 Scott Dist., 3580 Oceanside Rd. Tel: OR 8-6580. Pres.: Sidney Kruglick. Sales Mgr.: Harvey Lefkowitz.

PENNSYLVANIA
 • **PHILADELPHIA (Area Code 215)**
 American Rec. Sales, 1242 W. Girard Ave. Zip: 19123. Tel: PO 9-3900. Pres.: W. R. Buster.

SOUTH CAROLINA
 • **CHARLESTON (Area Code 803)**
 B & R Imports, 354 Grove St. Zip: 29403. Tel: 723-7766. Gen. Mgr.: Keith E. Robin.

VIRGINIA
 • **McLEAN (Area Code 703)**
 Dance Rec., 1438 Springvale Ave. Zip: 22101. Tel: 356-4602. Prop.: Richard Mason.

Services & Supplies

DESIGN & ARTWORK

CALIFORNIA

- **ALAMEDA (Area Code 415)**
Motivestor Rec. Serv., PO Box 1036, South Shore.
Tel: 532-7811.
- **LOS ANGELES (Area Code 213)**
BERT-CO ENTS., 1855 Glendale Blvd. Tel: 665-5137.
(SEE ADVERTISEMENT)
Cadet Rec., 5810 S. Normandie Ave.
Container-Kraft, 721 E. 61 St. Tel: 232-3281.
Creative Sound Prod'ns, 9000 Sunset Blvd. Zip:
90069. Tel: CR 1-4843. Pres.: Bob Cotterell.
Custom Rec. Mfg., 5810 S. Normandie Ave. Tel: PL
0-3310.
Evans Creative Designers, 1412 W. Glenoaks, Glen-
dale. Zip: 91201. Tel: 243-8747.
Golden State Graphics, 615 S. Flower St. Zip:
90017. Tel: 627-6396.
Record Labels, 6211 Santa Monica Blvd. Tel: 466-
1307.
Szarko Organization, California Federal Bldg., 10680
W. Pico, Suite 220. Tel: 839-4343. Pres.: John
C. Szarko.
- **PASADENA (Area Code 213)**
Custom Fidelity, 222 E. Glenarm St. Tel: 441-
1114.

DISTRICT OF COLUMBIA

- **WASHINGTON (Area Code 202)**
Menick & Sadel, 143 Kennedy St. N.W. Tel: RA
3-4215.

FLORIDA

- **MIAMI (Area Code 305)**
ADRIAN ASSOCS., The General Bldg., 6660 Biscayne
Blvd. Zip: 33138. Tel: 757-1626. (SEE AD-
VERTISEMENT)

ILLINOIS

- **CHICAGO (Area Code 312)**
Don Bronstein, 44 E. Superior. Tel: WH 3-5464.
International Rec'g Co. (IRC), 5619 W. Division St.
Zip: 60651. Tel: 378-4848.
Joseph Sugarman & Assocs., 4501 S. Western Blvd.
Zip: 60609. Tel: 523-7800. Pres.: Joseph
Sugarman.

INDIANA

- **TERRE HAUTE (No Area Code)**
Woodburn Printing, 25 S. Sixth St. Tel: C-0164 (no
direct dial).

LOUISIANA

- **NEW ORLEANS (Area Code 504)**
Andates-Basand, 2627 Leonidas. Zip: 70118. Tel:
861-7494.
Cosimo Rec'g Studios, 748 Camp St. Zip: 70130.
Tel: 523-7474. Contact: Miss Barbara Ann
Richardson.
Superior Plastics, 748 Camp St. Zip: 70130. Tel:
523-7474. Contact: Miss Barbara Ann Richard-
son.

MARYLAND

- **BALTIMORE (Area Code 301)**
RECORDINGS, INC., 1130 E. Cold Spring Ln. Tel:
433-0701. (SEE ADVERTISEMENT)

MASSACHUSETTS

- **CHICOPEE (Area Code 413)**
Glo Recs., 40 Marion. Zip: 01013. Tel: 592-1789.
Pres.: Al Soyka.

MICHIGAN

- **GROSSE POINTE PARK (Area Code 313)**
R A Carrier Music, 791 Harcourt. Zip: 48230. Tel:
821-0357 & TU 2-6300. Owner: R. A. Carrier.

MINNESOTA

- **DULUTH (Area Code 218)**
Z T S, 1615 London Rd. Zip: 55812. Tel: 728-4208.
- **MINNEAPOLIS (Area Code 554)**
Kaybank, 2541 Nicollet. Zip: 55404. Tel: TA 7-5441.

NEW YORK

- **GREAT NECK, L. I. (Area Code 516)**
IVY HILL LITHO., Community Dr. Tel: HU 7-0200.
(SEE ADVERTISEMENT)
- **HAUPPAUGE, L. I. (Area Code 516)**
Globe Albums, Cardinal Ind'l Park. Tel: 291-7600.

LONG ISLAND CITY (See New York City)

- **NEW YORK CITY (Area Code 212)**
Artwork: Plain & Fancy, 825 Madison Ave. Zip:
10021. Tel: 734-4000. Pres.: Alan Hartwell.
Associated Design, 660 Madison Ave. Tel: PL
9-7570. Art Dir.: Rene Vidmer.
Stephen P. Haas, 117 W. 48 St. Tel: JU 6-7528.
Lee-Myles Assocs., 40 W. 57 St. Zip: 10019. Tel:
PL 7-6630.

- LONGMARK PRODS., 1674 Broadway, Suite 703. Tel:
245-9709 (see Utica, N.Y.) (SEE ADVERTISE-
MENT)

- ONE STOP SERV., 133 E. 84 St. Zip: 10028. Tel:
288-4338. Mgr.: Adam Gray. (SEE ADVERTISE-
MENT)

- Profile Press, 151 W. 25 St. Tel: OR 5-1220.
Queens Litho., 52-35 Barnett Ave., Long Island City.
Zip: 11104. Tel: IL 7-7700.

- **UTICA (Area Code 515)**
LONGMARK PRODS., 814 Jay St. Tel: 724-3464 (see
N.Y.C.). (SEE ADVERTISEMENT)

NORTH CAROLINA

- **WINSTON-SALEM (Area Code 919)**
SNYDER ALBUMS, 3083 Indiana Ave. Zip: 27105.
Tel: 722-6768. (SEE ADVERTISEMENT)

OHIO

- **CINCINNATI (Area Code 513)**
King Custom Rec. Serv., 1540 Brewster Ave. Tel:
751-1910.

- Queen City Album, 7200 Colerain Ave. Tel: 931-
3232.

- Rite Rec. Prods., 9745 Lockland Rd. Tel: 761-8844.

- **CLEVELAND (Area Code 216)**
Pama, 4991 Osborn Rd. Tel: 581-0661.

PENNSYLVANIA

- **PHILADELPHIA (Area Code 215)**
Jack Howard Promos., 2733 Kensington Ave. Tel:
NE 4-8487.

- **PITTSBURGH (Area Code 412)**
Gateway, 234 Forbes. Tel: 471-5875.

- **SHARON (Area Code 412)**
Marjon, 930 Woodview Pl. Tel: DI 7-4726.

SOUTH CAROLINA

- **GEORGETOWN (Area Code 803)**
Factor Prods., 909 Front St. Tel: 546-9409.

TENNESSEE

- **MEMPHIS (Area Code 901)**
Pata-Prod., 1457 National. Zip: 38122. Tel: 323-
5368. Art Consultant: Richard Gatlin.

TEXAS

- **SAN ANTONIO (Area Code 512)**
Tanner 'N' Texas, 1422 W. Poplar. Tel: PE 2-8072.

- **WACO (Area Code 817)**
Alco Engraving, PO Box 294, 2015 Franklin Ave.
Tel: PL 6-2736.

UTAH

- **SALT LAKE CITY (Area Code 801)**
J W Platt, 2006 Arbor Ln. Zip: 84117. Tel: 278-
4305. Owner: James W. Platt.

DIRECT MAIL

CALIFORNIA

- **ALAMEDA (Area Code 415)**
Motivestor Rec. Serv., PO Box 1036, South Shore.
Tel: 532-7811.

- **LA MESA (Area Code 714)**
Hit Line Rec. Sales, PO Box 781. Zip: 92041.

- **LOS ANGELES (Area Code 213)**
Allied Rec., 2437 E. 57 St. Zip: 90058. Tel:
582-0841.

- Golden State Graphics, 615 S. Flower. Zip: 90017.
Tel: 627-6396. VP: Guy S. Wolff.
Szarko Organization, California Federal Bldg., 10680
W. Pico, Suite 220. Tel: 839-4343. Pres.: John
C. Szarko.

- **SAN FERNANDO (Area Code 213)**
Consolidated Artists Bureau, PO Box 411. Tel: DI
2-9109.

CONNECTICUT

- **UNCASVILLE (Area Code 203)**
Steljo, 37 Park Ave.

DISTRICT OF COLUMBIA

- **WASHINGTON (Area Code 202)**
Menick & Sadel, 143 Kennedy St. N.W. Tel: RA
3-4215.

ILLINOIS

- **EVANSTON (Area Code 312)**
Merchandise Dist., PO Box 1339. Zip: 60602. Tel:
475-5510. Mgr.: Glenn Cardott.

MISSOURI

- **CAPE GIRARDEAU (Area Code 314)**
James Floyd Ford, PO Drawer 839. Zip: 63701. Tel:
334-5772. Pres.: James Floyd Ford.

MONTANA

- **MISSOULA (Area Code 406)**
Blue Angel Promo. Agency, 1401 Sherwood St. Tel:
549-606.

NEW YORK

- **NEW YORK CITY (Area Code 212)**
Accurate List Letter Serv., 112-15 Northern Blvd.,
Flushing. Zip: 11368. Tel: IL 7-5130.

- R D Cortina, 136 W. 52 St. Tel: JU 2-3845.

MUSIC INDUSTRIES PROMOTIONS

10,000 ACTIVE RECORD DEALERS
Up-to-date list now available by State or
sector Guaranteed accurate listings . . .
updated monthly. For information contact:
L. J. MORTIN
Music Industries Promotions
200 W. 57 St., New York, N. Y. 10019

- Music Irco. Promo. Serv., 200 W. 57 St. Tel: CO
5-4300.

- Spectrum Ent., GPO Box 1785. Zip: 10001.

OHIO

- **CINCINNATI (Area Code 513)**
Shad O'Shea, 2570 Harrison Ave. Tel: 481-6877.

PENNSYLVANIA

- **PHILADELPHIA (Area Code 215)**
Ed Cotlar, 2030 Brandywine St. Zip: 19130. Tel:
LO 4-3081.

- **SCRANTON (Area Code 717)**
Ladd Music, 401 Wintermantle Ave. Tel: 343-6718.

SOUTH CAROLINA

- **GEORGETOWN (Area Code 803)**
Factor Prods., 909 Front. Tel: 546-9409.

TENNESSEE

- **NASHVILLE (Area Code 615)**
Atlantic Envelope, PO Box 888. Zip: 37202.

ENVELOPES & MAILERS

CALIFORNIA

- **LOS ANGELES (Area Code 213)**
Allied Rec., 2437 E. 57 St. Zip: 90058. Tel: 582-
0841.

- BERT-CO ENTS., 1855 Glendale Blvd. Tel: 665-5137.
(SEE ADVERTISEMENT)

- Container-Kraft, 721 E. 61 St. Tel: 232-3281.

- Golden State Graphics, 615 S. Flower. Zip: 90017.
Tel: 627-6396. VP: Guy S. Wolff.

- Szarko Organization, California Federal Bldg., 10680
W. Pico, Suite 220. Tel: 839-4343. Pres.: John
C. Szarko.

- **SAN FERNANDO (Area Code 213)**
Consolidated Artists Bureau, PO Box 411. Tel: DI
2-9109.

- **SAN FRANCISCO & BAY AREA**
(Area Code 415)
Gopher Prods., PO Box 812, Berkeley. Tel: 843-5836.

DISTRICT OF CALIFORNIA

- **WASHINGTON (Area Code 202)**
Record Safe Mailers, 4915 Earliston Dr. Zip: 20016.
Tel: (301) OL 4-3739. Pres.: George Y. Wor-
thington.

MASSACHUSETTS

- **SPRINGFIELD (Area Code 413)**
U S Envelope, 21 Cypress St. Zip: 01101. Tel:
736-7211.



**CUSTOM PRESSING • PLATING
MASTERING • LABEL PRINTING
SHIPPING • WAREHOUSING**

ALL SIZES—ALL SPEEDS

Specialists

IN LITTLE L. P.'s

OVER 30 YEARS' SERVICE TO THE RECORD INDUSTRY

Phone: 582-0841

2437 E. 57th Street

Cable: ALIRECORD

Los Angeles, Calif. 90056

continued

NEW YORK

- **HICKSVILLE, L. I.** (Area Code 516)
ANDREWS-MUNNERY, 205 Park Ave. Tel: WE 1-6500.
(SEE ADVERTISEMENT)
- **NEW YORK CITY** (Area Code 212)
ONE STOP SERV., 133 E. 84 St. Zip: 10028. Tel:
288-4338. Mgr.: Adam Gray. (SEE ADVER-
TISEMENT)
- Queens Envelope, 52-35 Barnett Ave., Long Island
City. Zip: 11104. Tel: IL 7-7700.
- EDWARD R. WHITE, 342 Madison Ave. Tel: MU
7-2167. (SEE ADVERTISEMENT)

OHIO

- **TOLEDO** (Area Code 419)
Pioneer Inds., PO Box 38, Sta. F. Tel: 691-2065.

TENNESSEE

- **NASHVILLE** (Area Code 615)
Atlantic Envelope, PO Box 888. Zip: 37202.

JACKET MANUFACTURERS

CALIFORNIA

- **BURBANK** (Area Code 213)
Location Rec'g Serv., 2201 W. Burbank Blvd. Zip:
91506. Tel: 849-1321. Partners: Allen J. Frai-
berg & Steven A. Guy.
- **LOS ANGELES** (Area Code 213)
Advance Paper Box, 1900 W. 62 St. Tel: PL 1-4141.
BERT-CO ENTS., 1855 Glendale Blvd. Tel: 665-5137.
(SEE ADVERTISEMENT)
- Container-Kraft, 721 E. 61 St. Tel: 232-3281.
CREATIVE SOUND PROD'NS, 9000 Sunset Blvd. Zip:
90059. Tel: CR 1-4843. (SEE ADVERTISEMENT)
- Custom Rec. Mfg., 5810 S. Normandie Ave. Tel: PL
0-3310.

FLORIDA

- **MIAMI** (Area Code 305)
ADRIAN ASSOCS., The General Bldg., 6660 Biscayne
Blvd. Zip: 33138. Tel: 757-1626. (SEE AD-
VERTISEMENT)
- Flamingo Rec. Album, 150 W. 29 St. Hialeah. Tel:
Tel: 888-7411.

GEORGIA

- **CALHOUN** (Area Code 404)
Cherokeeland Rec'gs, PO Box 502, Rm. 2, Johnston-
Hall Clinic Bldg. Zip: 30701. Tel: 629-3950.
Pres.: J. Carter.

ILLINOIS

- **CHICAGO** (Area Code 312)
Chicago Album & Specialty, 426 S. Clinton. Tel:
HA 7-0113.
- M M Cole, 251 E. Grand Ave. Tel: 257-2160.
- R. Royce, 825 S. Wabash. Tel: WE 9-3773.
- Weyerhaeuser Packaging Group, 100 S. Wacker Dr.
Zip: 60606. Tel: 346-6364.

INDIANA

- **RICHMOND** (Area Code 317)
Mercury Rec. Mfg., 301 S. First St. Tel: 962-9511.
- **TERRE HAUTE** (No Area Code)
Modern Albums of Indiana, 1299 Voorhees St. Tel:
L-6001 (no direct dial).
- Woodburn Printing, 25 S. Sixth St. Tel: C-0164 (no
direct dial).

LOUISIANA

- **NEW ORLEANS** (Area Code 504)
Cosimo Rec'g Studios, 748 Camp St. Zip: 70130.
Tel: 523-7474. Contact: Miss Barbara Ann
Richardson.
- Superior Plastics, 748 Camp St. Zip: 70130. Tel:
523-7474. Contact: Miss Barbara Ann Richard-
son.

MARYLAND

- **BALTIMORE** (Area Code 301)
RECORDINGS, INC., 1130 E. Cold Spring Ln. Tel:
433-0701. (SEE ADVERTISEMENT)

MASSACHUSETTS

- **SPRINGFIELD** (Area Code 413)
U S Envelope, 21 Cypress St. Zip: 01101. Tel:
736-7211.

MINNESOTA

- **MINNEAPOLIS** (Area Code 612)
Kaybank, 2541 Nicollet. Zip: 55404. Tel: TA 7-5441.

continued on page 126



**OUR SERVICE IS
THE FINEST
AND INCLUDES...**

- PRESSING
- LABELS
- MASTERING
- WAREHOUSING
- DROP SHIPPING

Ideally located to serve the Midwest, South and Southwest



Manufacturers of Plastic Products

**1746 Chelsea Ave., Memphis 7, Tennessee. BR 6-7160.
Plant and Sales Office—Area Code 601-622-4341**

EGAR

Compounder - Preplasticizer SAVES PRESSING COSTS 6 IMPORTANT WAYS

USING DRY BLEND, PELLET OR REGRIND

1. Pressing output increased by 300 to 400 net good records per 7½ hour day over Pellet Warmer or other methods.
2. Cost of material using vinyl dry blend brings considerable savings per pound vs. pellet or biscuit material.
3. Flash & rejects can be reused for first quality material. Production reject rate drops at least 50%.
4. Stamper life increased 300% plus complete elimination of damage due to contaminants.
5. Inspection procedures substantially reduced.
6. The molding quality as well as the overall quality of the recording is improved.



THE
STANDARD
OF THE
INDUSTRY
ALL OVER
THE WORLD

EGAR 30:1 SUPER SENIOR

Delivers 185 grams in 7 seconds of uniformly heated, exactly weighed and perfectly compounded material from dry blend in a patty with or without a hole. Feeds 4 or more 12" presses in extremely rapid cycles. Base 24" x 25".



EGAR 30:1 SENIOR

Delivers 185 grams in 10 seconds of uniformly heated, exactly weighed and perfectly compounded material from any dry blend in a patty with or without a hole. Feeds two or more 12" presses at extremely rapid cycles. Base 20" x 24".



EGAR 30:1 STANDARD

Delivers 185 grams in 15 seconds of uniformly heated, exactly weighed and perfectly compounded material from any dry blend in a patty with or without a hole. Feeds two 12" presses. Base 18" x 20".



EGAR 30:1 PORTABLE

Delivers 185 grams in 24 seconds of uniformly heated, exactly weighed and perfectly compounded material from any dry blend in a patty with or without a hole. Feeds two 7", two 10" or one 12" press. Base 15" x 16".

IN USE WITH EVERY MAJOR RECORD COMPANY IN THE WORLD

Contact us today for information concerning prices and delivery on the New Model E Eggar Compounder/Preplasticizer (shown here). Most sizes now in stock for immediate delivery.

Full Refund After 90 Days Use
in Your Factory if Not Entirely Satisfied



ARAGON
PRODUCTS, INC.

72 Concord Street, Newark, New Jersey 07114
Area Code (201) 243-1549

639 Island View Drive, Santa Barbara, Calif.
966-5631

continued

NEW JERSEY

• **NEWARK** (Area Code 201)
Modern Album of New Jersey, 145 N. 13 St. Tel: HU 4-8330.

NEW YORK

• **GREAT NECK, L. I.** (Area Code 516)
IVY HILL LITHO., Community Dr., Tel: HU 7-0200. (SEE ADVERTISEMENT)

• **HAUPPAUGE, L. I.** (Area Code 516)
Alema, Cardinal Ind'l Park. Tel: 291-7600.
Globe Albums, Cardinal Ind'l Park. Tel: 291-7600.

• **MOUNT VERNON** (Area Code 914)
County Box & Album, 201 S. Second Ave. Tel: MO 8-7862. N.Y.C. Tel: (212) SY 2-9080.

• **NEW YORK CITY** (Area Code 212)
Jewel Albums, 1119 Worthen St., Bronx. Zip: 10459. Tel: LU 9-0954.

Lee-Myles Assocs., 40 W. 57 St. Zip: 10019. Tel: PL 7-6630.

LONGMARK PRODS., 1674 Broadway, Suite 703. Zip: 10019. Tel: 245-9709 (see Utica, N. Y.). (SEE ADVERTISEMENT)

MacMurray Press, 22 Jones St. Tel: WA 4-1530.
Modern Album, 119-01 22 Ave., College Point. Tel: FL 3-5701.

ONE STOP SERV., 133 E. 84 St. Zip: 10028. Tel: 288-4338. Mgr.: Adam Gray. (SEE ADVERTISEMENT)

Profile Press, 151 W. 25 St. Zip: 10001. Tel: OR 5-1220.

Progressive Label, 286 Stanhope, Brooklyn. Tel: HY 7-2320.

Record Albums, 286 Stanhope St., Brooklyn. Tel: EM 6-8171.

Record Promo., 130 W. 42 St. Tel: PE 6-0936.

Standard Paper Box, 476 Broome St. Tel: WA 5-9818.

Tee Packaging, 22 Jones St. Tel: WA 4-1530.

UTICA (Area Code 315)
LONGMARK PRODS., 814 Jay St. Tel: 724-3464. (see N.Y.C.). (SEE ADVERTISEMENT)

NORTH CAROLINA

• **WINSTON-SALEM** (Area Code 919)
Snyder Album, 3083 Indiana Ave. Zip: 27105. Tel: 722-6768.

OHIO

• **CINCINNATI** (Area Code 513)
King Custom Rec. Serv., 1540 Brewster Ave. Tel: 751-1910.

Queen City Album, 7200 Colerain Ave. Tel: 931-3232.
Rite Rec. Prod., 9745 Lockland Rd. Tel: 761-8844.

• **CLEVELAND** (Area Code 216)
KELMAR, 1054 E. 71 St. Zip: 44103. Tel: 391-4518. Pres.: Joel Kischel. (SEE ADVERTISEMENT)

Pama, 4991 Osborn Rd. Tel: 581-0661.

• **DAYTON** (Area Code 513)
Mega City Music, 126 Davis Ave. Zip: 45403. Tel: 256-6931, 6557.

Southern-Aires Quartet Album & Music, 5981 Echo Hill Ln. Zip: 45430. Tel: 426-0310. Pres.: Dall H. Miller.

PENNSYLVANIA

• **ALLENTOWN** (Area Code 215)
Allentown Rec., 10 & Walnut Sts. Tel: 433-7405.

• **PHILADELPHIA** (Area Code 215)
Allstate Printing, 1021 S. Ninth St. Zip: 19147. Tel: WA 5-6685.

Crown Associated Prods., 2925 N. Broad St. Zip: 19132. Tel: BA 9-8986. VP: M. Grossman.

Diskmakers, 925 N. Third St. Zip: 19123. Tel: MA 7-2277.

Jack Howard Promos., 2733 Kensington Ave. Tel: NE 4-8487.

H. Royer Smith, 10 & Walnut Sts. Zip: 19107. Tel: WA 2-2023.

• **SHARON** (Area Code 412)
Marjon, 930 Woodview Pl. Tel: DI 7-4726.

SOUTH CAROLINA

• **GEORGETOWN** (Area Code 803)
Factor Prods., 909 Front St. Tel: 546-9409.

TENNESSEE

• **NASHVILLE** (Area Code 615)
Atlantic Envelope, PO Box 888. Zip: 37202. Music City Album, 219 Russell St.

TEXAS

• **SAN ANTONIO** (Area Code 512)
Tanner 'N' Texas, 1422 W. Poplar. Tel: PE 2-8072. Texas Sound, 506 W. Hildebrand Ave. Tel: PE 3-1721.

• **WACO** (Area Code 817)
Alco Engraving, PO Box 294, 2015 Franklin Ave. Tel: PL 6-2736.

LABEL MANUFACTURERS

CALIFORNIA

• **BURBANK** (Area Code 213)
Location Rec'g Serv., 2201 W. Burbank Blvd. Zip: 91506. Tel: 849-1321. Partners: Allen J. Fraiberg & Steven A. Guy.

• **LOS ANGELES** (Area Code 213)
Alco, 6201 Santa Monica Blvd., Hollywood. Zip: 90038. Tel: HO 6-1101.

Allied Rec., 2437 E. 57 St. Zip: 90058. Tel: 582-0B41. Pres.: Daken K. Broadhead; VP: John F. Wegner.

Bert-Co Ents., 1855 Glendale Blvd. Tel: 665-5137. Container-Kraft, 721 E. 61 St. Tel: 232-3281.

CREATIVE SOUND PROD'NS, 9000 Sunset Blvd. Zip: 90069. Tel: CR 1-4843. (SEE ADVERTISEMENT)

Custom Rec. Mfg., 5810 S. Normandie Ave. Tel: PL 0-3310.

Monarch, 4852-56 W. Jefferson Blvd. Tel: RE 2-6185. Rainbo, 1041 N. Las Palmas, Hollywood. Tel: HO 6-7516.

Record Labels, 6211 Santa Monica Blvd. Tel: 466-1307.

• **SAN FERNANDO** (Area Code 213)
Consolidated Artists Bureau, PO Box 411. Tel: DI 2-9109.

FLORIDA

• **MIAMI** (Area Code 305)
ADRIAN ASSOCS., The General Bldg., 6660 Biscayne Blvd. Zip: 33138. Tel: 757-1626. (SEE ADVERTISEMENT)

finebit

Serving the Sound Industry

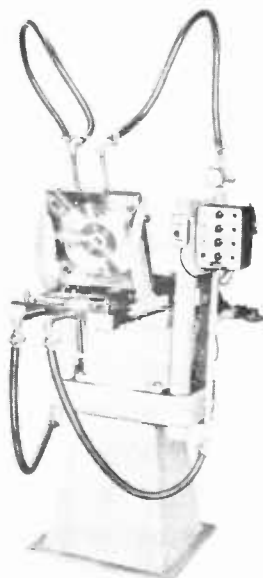

RECORD PRESSING PLANTS

- PRESSES
- AUTOMATIC CONTROLS
- RECORD MOLDS
- TRIMMERS
- EXTRUDERS
- COMPRESSORS
- BOILERS
- MATRIX EQUIPMENT
- PRINTING PRESSES
- RECORDING EQUIPMENT
- SEALING MACHINES
- SHRINK TUNNELS

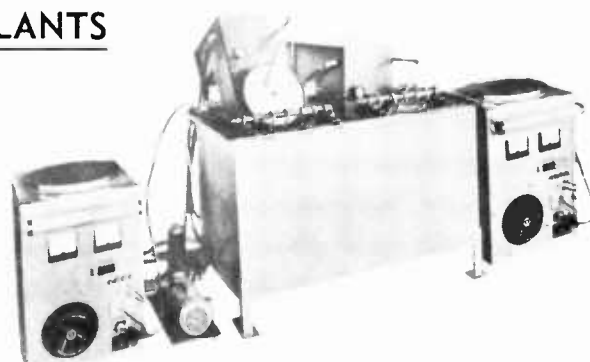

SUPPLIES

- RECORD COMPOUNDS
- LABEL PAPER
- SHRINK FILM
- PROCESSING

INDIANA

- **INDIANAPOLIS** (Area Code 317)
R C A Victor, 501 N. LaSalle. Tel: ME 6-5321.
- **RICHMOND** (Area Code 317)
Mercury Rec. Mfg., 300 S. First St. Tel: 962-9511.
- **TERRE HAUTE** (No Area Code)
Woodburn Printing, 25 S. Sixth St. Tel: C-D164
(no direct dial).

LOUISIANA

- **GRETNA** (Area Code 504)
PHONO REC. PRESSING, 95 First St. Tel: 367-8822.
Contact: Ralph Pate. (SEE ADVERTISEMENT)
- **NEW ORLEANS** (Area Code 504)
Cosimo Rec'g Studios, 748 Camp St. Zip: 70130.
Tel: 523-7474. Contact: Miss Barbara Ann Richardson.
Superior Plastics, 748 Camp St. Zip: 70130. Tel:
523-7474. Contact: Miss Barbara Ann Richardson.

MARYLAND

- **BALTIMORE** (Area Code 301)
RECORDINGS, INC., 1130 E. Cold Spring Ln. Tel:
433-0701. (SEE ADVERTISEMENT)

MINNESOTA

- **MINNEAPOLIS** (Area Code 612)
Kaybank, 2541 Nicollet. Zip: 55404. Tel: TA 7-5441.

NEW JERSEY

- **NEWARK** (Area Code 201)
Sun Plastics, 900 Passaic Ave., East Newark.

NEW YORK

- **FARMINGDALE, L. I.** (Area Code 516)
Pressure Sensitive Labels, 135 Schmitt Blvd. Tel:
293-7300.
- **GREAT NECK, L. I.** (Area Code 516)
Ivy Hill Litho., Community Dr. Tel: HU 7-0200.
- **HAUPPAUGE, L. I.** (Area Code 516)
Alemo, Cardinal Ind'l Park. Tel: 291-7600.
Globe Albums, Cardinal Ind'l Park. Tel: 291-7600.
- **LONG ISLAND CITY** (See New York City)
- **NEW YORK CITY** (Area Code 212)
Kaltman Press, 52-35 Barnett Ave., Long Island
City. Tel: LI 7-7700.

PROMOTIONAL 45 R.P.M. RECORD MAILING ENVELOPES
12" LP RECORD MAILING SYSTEM

Unique Record Mailers—For 1 to 2 LP's
Variable Record Folders—For 3 to 15 LP's
7"—10"—12" ENVELOPES & BOARDS



Edward R. White INC.

342 MADISON AVE., NEW YORK 17, N. Y.
MUrray Hill 7-2167

Services & Supplies



SILVER PLASTICS
INCORPORATED

SPECIALIZING IN SERVICE & DEPENDABILITY
FOR LEADING INDIE RECORD COMPANIES

SILVER PLASTICS, INC.

A division of Cameo/Parkway

SOUTHAMPTON INDUSTRIAL HIGHWAY
SOUTHAMPTON, PA. 18966
(215) 357-1175, HObart 4-3270

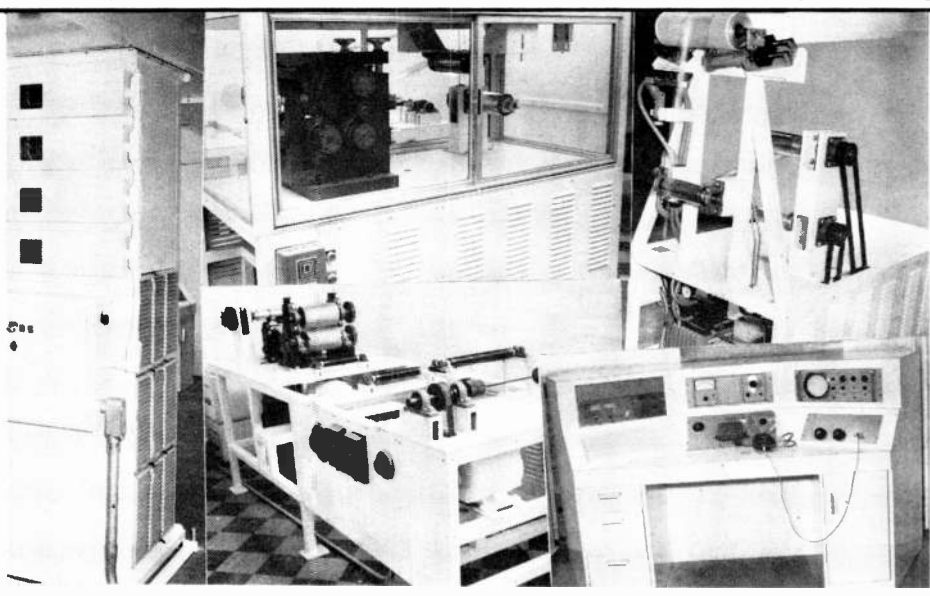

MAGNETIC TAPE DUPLICATING INSTALLATIONS

- MASTERING EQUIPMENT
- MASTERS
- SLAVES
- TRANSPORTS
- SUPPLIES

SUPPLIES

- COATING MATERIAL
- REELS
- BASE MATERIAL
- SOLVENTS

MAGNETIC SOUND RECORDING TAPE PLANTS

- | | | |
|----------------|---------------------|---------------------|
| ● TAPE COATERS | ● WEBGUIDES | ● DEGAUSSERS |
| ● SLITTERS | ● SUPPLY TANKS | ● TESTING EQUIPMENT |
| ● REWINDERS | ● CIRCULATION PUMPS | |

FINEBILT MANUFACTURING CO. 931 No. Citrus Ave., Hollywood, Cal. 90038

Export Division: Coast Export Company, Inc. CODE: COEXPORT. Phone: HOLLYWOOD 6-9511
FINEBILT has been awarded the Presidential "E" for excellence in Export

DON'T CALL US
For Record Pressing
UNLESS
You Want Quality
and Service
That's Unbeatable
Anywhere!
 ALL SPEEDS
KAY RECORDS, INC.
 110 Bergen Pike, Little Ferry, N. J.
 Diamond 3-5721-2

 **Kelmar**
RECORD MANUFACTURING
"Your complete manufacturing plant."

- RECORDING
- MASTERING
- PLATING
- PRESSING
- ALBUM JACKETS
- LABEL PRINTING

CALL
216 • 391-4518

1054 EAST 71st STREET
 CLEVELAND, OHIO 44103

Snyder 
ALBUM CO.

PRICE LIST & BROCHURE
 ON REQUEST

- ★ FABRICATORS
- ★ PRINTING
- ★ CUSTOM DESIGNING
- ★ 7", 10" & 12" Size

722-6768
 3083 Indiana Avenue
 WINSTON-SALEM, N. C. 27105

- RECORD ENVELOPES, all sizes
- CORRUGATED BOARDS AND RECORD MAILERS
- STOCK LEGAL CONTRACTS for Music Publishers and Record Companies
- PRESSURE-SENSITIVE LABELS (for Recording Studios)
- FAN CLUB PHOTO CARDS

Sleeves — Stationery — Album Jackets
 Invoices — Business Cards
 Offset and Letterpress Printing
 Custom Designed for the Music Industry
 Price Lists Available Upon Request

ONE STOP SERVICE, INC.
 133 E. 84th St., New York, N.Y. 10028
 288-4338 — Adam Gary

continued

Linear Prods., 45 W. 20 St. Zip: 10011. Tel: AI 5-2917.
 LONGMARK PRODS., 1674 Broadway, Suite 703. Zip: 10019. Tel: 245-9709. (see Utica, N. Y.). (SEE ADVERTISEMENT)
 MacMurray Press, 22 Jones St. Tel: WA 4-1530.
 ONE STOP SERV., 133 E. 84 St. Zip: 10028. Tel: 288-4338. Mgr.: Adam Gray. (SEE ADVERTISEMENT)
 Progressive Label, 286 Stanhope, Brooklyn. Tel: HY 7-2300.
 Record Promo., 130 W. 42 St. Tel: PE 6-0936.

● **UTICA** (Area Code 315)
 LONGMARK PRODS., 814 Jay St. Tel: 724-3464. (see N.Y.C.). (SEE ADVERTISEMENT)

OHIO
 ● **CINCINNATI** (Area Code 513)
 King Custom Rec. Serv., 1540 Brewster Ave. Tel: 751-1910.
 Queen City Album, 7200 Colerain Ave. Tel: 931-3232.
 Rite Rec. Prod., 9745 Lockland Rd. Tel: 761-8844.

● **CLEVELAND** (Area Code 216)
 KELMAR, 1054 E. 71 St. Zip: 44103. Tel: 391-4518. Pres.: Joel Kischel. (SEE ADVERTISEMENT)
 Pama, 4991 Osborn Rd. Tel: 581-0661.

PENNSYLVANIA
 ● **ALLENTOWN** (Area Code 215)
 Allentown Rec., 10 & Walnut Sts. Tel: 433-7405.
 ● **PHILADELPHIA** (Area Code 215)
 Allstate Printing, 1021 S. Ninth St. Zip: 19147. Tel: WA 5-6685.
 Community Press, 6047-9 Woodland Ave. Tel: SA 9-4655.
 Diskmakers, 925 N. Third St. Zip: 19123. Tel: MA 7-2277.
 Fenton Label, Coral & Buckius Sts. Zip: 19124. Tel: CU 8-2910.

● **SHARON** (Area Code 412)
 Marjon, 930 Woodview Pl. Tel: DI 7-4726.

SOUTH CAROLINA
 ● **GEORGETOWN** (Area Code 803)
 Factor Prods., 909 Front St. Tel: 546-9409.

NICKEL MATRIX PLATING

Individual Attention Given Each Order
 Fast Service—Stampers Cut to Any Size
 Satisfaction Guaranteed
 We Ship Stampers Anywhere
 Send Us Your Tapes for Dependable Nickel Stampers

S.J. Shaw Plating Corp.
 P. O. Box 19259 Cincinnati, Ohio 45219

SPECIALTY RECORDS CORP.
 for
PERSONALIZED SERVICE ON QUALITY
7", 10", 12" RECORDS
 Phone (717) 489-4717
 TWX (717) 371-3662
 210 N. Valley Ave.
 Olyphant, Penna. 18447

TEXAS
 ● **SAN ANTONIO** (Area Code 512)
 Tanner 'N' Texas, 1422 W. Poplar. Tel: PE 2-8072.

WISCONSIN
 ● **ELKHART LAKE** (Area Code 414)
 Sohn Mfg. Zip: 53020. Tel: 876-3361.

LICENSORS, TAPE & RECORD

CALIFORNIA
 ● **LOS ANGELES** (Area Code 213)
 National Rec. Library, 9278 Santa Monica Blvd. Tel: 931-1381. Pres.: R. Kopelman.

CONNECTICUT
 ● **WILTON** (Area Code 203)
 Acropole Corp. of America, PO Box 365. Zip: 06897. N. Y. C. Tel: (212) CY 5-2272. Pres.: Michele M. Ronty.

FLORIDA
 ● **MIAMI** (Area Code 305)
 Active Music, 3170 S.W. Eighth St. Zip: 33135.

ILLINOIS
 ● **CHICAGO** (Area Code 312)
 Shepard Stern, 251 E. Grand Ave. Zip: 60611. Tel: 257-2160.

LOUISIANA
 ● **NEW ORLEANS** (Area Code 504)
 Cosimo Rec'g Studios, 748 Camp St. Zip: 70130. Tel: 523-7474. contact: Barbara Ann Rnchardson.
 White Cliffs Publ'g, 748 Camp St. Zip: 70130. Tel: 523-7474. Contact: Barbara Ann Richardson.

NEW YORK
 ● **NEW YORK CITY** (Area Code 212)
 Associated, c/o Milt Schnapf, 723 Seventh Ave. Tel: CI 5-7640.
 R D Cortina, 136 W. 52 St. Tel: JU 2-3845.
 Olibin, 101 W. 55 St. Tel: 246-2220. Cable: Olibino.
 Transglobal, 130 W. 57 St. Zip: 10019. Tel: JU 2-3550. Gen. Mgr.: James Krueger.

OHIO
 ● **CINCINNATI** (Area Code 513)
 King Custom Rec. Serv., 1540 Brewster Ave. Tel: 751-1910.
 Shad O'Shea, 2570 Harrison Ave. Tel: 481-6877.

PENNSYLVANIA
 ● **PITTSBURGH** (Area Code 412)
 Gateway, 234 Forbes. Tel: 471-5875.
 ● **SCRANTON** (Area Code 717)
 Ladd Music, 401 Wintermantle Ave. Tel: 343-6718.

MACHINE SHOPS

CALIFORNIA
 ● **GARDENA** (Area Code 213)
 Johnson Machine & Tool, 1722 W. 134 St.
 ● **LOS ANGELES** (Area Code 213)
 ALLIED REC., 2437 E. 57 St. Zip: 90058. Tel: 582-0841. (SEE ADVERTISEMENT)
 Eckstein Prods., 1023 W. First St. Zip: 90012. Tel: 624-9933.
 Finebilt Mfg., 913 N. Citrus Ave. Tel: HO 6-9511.
 R C A Victor, 1016 N. Sycamore St., Hollywood. Tel: HO 1-9171.
 World Export Mfg., 1248 S. Berendo St. Zip: 90006. Tel: 388-9669.

● **SANTA BARBARA** (Area Code 805)
 Aragon Prods., 639 Island View Dr. Tel: WO 6-5631.

INDIANA
 ● **INDIANAPOLIS** (Area Code 317)
 Indus, 1815 Madison Ave. Tel: ME 9-5281.
 R C A Victor, 501 N. LaSalle St. Tel: ME 6-5311.

NEW JERSEY
 ● **ELIZABETH** (Area Code 201)
 Tools Mfg, 701 Spring St. Zip: 07201. Tel: 289-6181.
 ● **LYNDHURST** (Area Code 201)
 Standard Tool & Mfg., 738 Schuyler. Tel: WE 9-5500.
 ● **MORRIS PLAINS** (Area Code 201)
 Schiff Machine, 28 E. Hanover Ave. Zip: 07950. Tel: 539-5100.

continued on page 130

YOUR TIME IS OUR TIME.



Eastern

3 factories in Pitman, New Jersey, Terre Haute, Indiana and Santa Maria, California operate around the clock to provide the total operation that Columbia Record Productions' custom record clients have come to expect...and get!



Central



Pacific

And now we're equipped to custom-duplicate your 8-track stereo cartridges. Another timely service from America's largest custom record manufacturer.

Columbia Record Productions

A Service of Columbia Records 51 West 52 Street, New York, New York 10019 (212) 765-4321 / 804 16th Avenue South, Nashville, Tennessee 37203 (615) 242-0337 / 2990 West Grand Boulevard, Detroit, Michigan 48202 (313) TR 1-6100 / 630 North McClurg Court, Chicago, Illinois 60611 (312) WH 4-6000 / 6121 Sunset Boulevard, Hollywood, California 90028 (213) 466-2481

Factories: Pitman, New Jersey; Terre Haute, Indiana; Santa Maria, California

A Great Name in a Great Industry

For over 40 years
the prime supplier
to the record industry

- Sleeves and Mailers
- 7" — 10" — 12"
white, brown, green
plain or printed
- 16" Transcription Sleeves
Available

ANDREWS NUNNERY

ENVELOPE AND PAPER CORP.

205 Park Ave. Hicksville, L. I., N. Y.
Area 516 WE 1-6500

continued

• **NEWARK (Area Code 201)**
ARAGON PRODS., 72 Concord St. Tel: BI 3-1549.
(SEE ADVERTISEMENT)

• **ROCKAWAY (Area Code 201)**
R C A Victor, Rt. 46, Franklin Ave. Tel: OA 7-2401.

NEW YORK

• **NEW YORK CITY (Area Code 212)**
Audio Matrix, 915 Westchester Ave., Bronx. Zip:
10459. Tel: LU 9-3500.
Audiomatic, 915 Westchester Ave., Bronx. Zip:
10459. Tel: LU 9-3500.
Don Gabor Ents., 30 E. 42 St. Zip: 10017. Tel:
986-6031. Pres.: Donald H. Gabor.
R C A Victor, 155 E. 24 St. Tel: MU 9-7200.

OHIO

• **CINCINNATI (Area Code 513)**
King Custom Rec. Serv., 1540 Brewster Ave. Tel:
751-1910.

MATERIALS MILLING PLANTS

CALIFORNIA

• **LOS ANGELES (Area Code 213)**
Custom Rec., 5810 S. Normandie. Tel: PL 0-3310.
Lewis Rec. Mfg., 307 E. Beach St., Inglewood.
Zip: 90302.
Research Craft, 1011 N. Fuller. Tel: 876-3440.
World Export Mfg., 1248 S. Berendo St. Zip: 90006.
Tel: 388-9669.

• **PARAMOUNT (Area Code 213)**
Collins, Caldwell & Dague, 1616 Garfield Ave. Zip:
90723. Tel: NE 6-7111.

• **SANTA BARBARA (Area Code 805)**
Aragon Prods., 639 Island View Dr. Tel: WO 6-6631.

CONNECTICUT

• **STAMFORD (Area Code 203)**
Cook Labs., 351 Courtland Ave., Glenbrook. Zip:
06906. Tel: 348-7578.

INDIANA

• **RICHMOND (Area Code 317)**
Mercury Rec. Mfg., 300 S. First St. Tel: 962-9511.

NEW JERSEY

• **NEWARK (Area Code 201)**
Aragon Prods., 72 Concord St. Tel: BI 3-1549.

• **PLAINFIELD (Area Code 201)**
PlastyLite, 333 North Dr., North Plainfield. Tel:
755-7000.

NEW YORK

• **NEW YORK CITY (Area Code 212)**
AUDIOMATIC, 915 Westchester Ave., Bronx. Zip:
10459. Tel: LU 9-3500. (SEE ADVERTISEMENT)
Don Gabor Ents., 30 E. 42 St. Zip: 10017. Tel:
986-6031. Pres.: Donald H. Gabor.
R C A Custom Recs., 155 E. 24 St. Tel: MU 9-7200.

OHIO

• **CINCINNATI (Area Code 513)**
King Custom Rec. Serv., 1540 Brewster Ave. Tel:
751-1910.

PENNSYLVANIA

• **PHILADELPHIA (Area Code 215)**
Marco Prods., Yerkes Rd., Bridgeport. Tel: 265-2330.

• **STOCKERTOWN (Area Code 215)**
Holland-Suco Color. Zip: 18083. Tel: 759-3690.

MUSIC LICENSING ORGANIZATIONS

Affiliated Music Enterprises, 1619 Broadway, New
York, N. Y. 10019. Tel: (212) JU 6-0674.
American Composers Alliance (ACA), 170 W. 74 St.,
New York, N. Y. 10023. Tel: (212) TR 3-1250.
American Mechanical Rights Agency (AMRA), 250 W.
57 St., New York, N. Y. 10019. Tel: (212)
CI 6-4077.
American Society of Composers, Authors & Publish-
ers (ASCAP), 575 Madison Ave., New York,
N. Y. 10022. Tel: (212) MU 8-BB00.
Broadcast Music, Inc. (BMI), 589 Fifth Ave., New
York, N. Y. 10017. Tel: (212) PL 9-1500.

continued on page 132

NOBODY CAN MATCH BESTWAY'S SERVICE

BESTWAY feels that a promise is something special and has to be kept. Maybe that's what accounts for our reputation.

BESTWAY DELIVERS WHAT YOU WANT . . . WHEN YOU WANT IT (if not sooner)

Specializing in: **CUSTOM PRESSING . . .
FROM PLATE TO COMPLETED PRODUCT . . .
LABELS . . . WAREHOUSING . . .
DROP SHIPPING . . .**



BESTWAY PRODUCTS

MOUNTAINSIDE, NEW JERSEY (201) ADAMS 2-8383



Can a big outfit like Capitol actually underbid everyone else on a custom order?

Most of the time we can.

Do business with us at Capitol, and you'll get more than our fanatically high standard of quality and service.

You'll probably save money.

Our kind of fanaticism breeds efficiency. And efficiency breeds savings. So, check with us about your next record order.

You can't lose.

Capitol Custom Services



1750 N. Vine Street, Hollywood 28, California Hollywood 2-6252

151 West 46th Street, New York 19, New York Judson 2-8040



PRESSING COMPANY

COMPLETE
CUSTOM RECORD
PRESSING SERVICE
FROM RECORDING
TO NATIONAL
DISTRIBUTION

ALL SPEEDS

LABELS
PLATING
PRESSING
SHIPPING

Fastest Service

CONTACT: CHARLIE ROMAGOS
NEW ORLEANS (509) 367-8822
91 1ST STREET, GRETN, LA.



PRESSING COMPANY

continued

John Brumage (Agent and Trustee), PO Box 14422, Tampa, Fla. 33609.
Franco Colombo, 16 W. 61 St., New York, N. Y. 10023. Tel: (212) JU 2-5300.
Cosimo Rec'g Studios, 748 Camp St., New Orleans, La. 70130. Tel: 523-7474. Contact: Miss Barbara Ann Richardson.
Harry Fox, 460 Park Ave., New York, N. Y. 10022. Tel: (212) PL 1-1930.
S E S A C, 10 Columbus Circle, New York, N. Y. 10019. Tel: (212) 586-3450.

PLATING PLANTS

ARIZONA

● **PHOENIX (Area Code 602)**
WAKEFIELD MFG., PO Box 6037, 1836 W. Moreland St. Tel: 252-5644. (SEE ADVERTISEMENT)

CALIFORNIA

● **HAWTHORNE (Area Code 213)**
Fidelatone Mfg., 12848 Weber Way.
● **LOS ANGELES (Area Code 213)**
A F M Eng., 6209 Santa Monica Blvd. Tel: 466-9291.
Audio Plating, 1037 N. Sycamore.
Cadet Rec., 5810 S. Normandie Ave.
Capitol (Exec. Offices), 1750 N. Vine St. Tel: HO 2-6252.
Custom Rec. Mfg., 5810 S. Normandie Ave. Tel: PL 0-3310.
Finebilt Mfg., 931 N. Citrus Ave. Tel: HO 6-9511.
Lewis Rec. Mfg., 307 E. Beach St., Inglewood. Zip: 90302.
Monarch, 4852-56 W. Jefferson Blvd. Tel: RE 2-6185.
Rainbo, 1041 N. Las Palmas, Hollywood. Tel: HO 6-7516.
Research Craft, 1011 N. Fuller. Tel: 876-3440.
World Export Mfg., 1248 S. Berendo St. Zip: 90006. Tel: 388-9669.
● **SAN MARCOS (Area Code 714)**
Record Broadcast, 237 S. Bent Ave. Tel: 744-0633.
● **SANTA MARIA (Area Code 805)**
Customatrix, 900 E. Stowell Rd. Tel: WA 2-4511.

CONNECTICUT

● **STAMFORD (Area Code 203)**
Cook Labs., 351 Courtland Ave., Glenbrook. Zip: 06906. Tel: 348-7578.

FLORIDA

● **MIAMI (Area Code 305)**
Southeastern Rec. Mfg., 150 W. 29 St., Hialeah. Tel: 888-7411.

INDIANA

● **RICHMOND (Area Code 317)**
Mercury Rec. Mfg., 300 S. First St. Tel: 962-9511.
● **TERRE HAUTE (No Area Code)**
Customatrix, 1400 Fruitridge Ave. Tel: NO 4231 (no direct dial).

LOUISIANA

● **GRETN (Area Code 504)**
PHONO REC. PRESSING, 95 First St. Tel: 367-8822.
Contact: Ralph Pate. (SEE ADVERTISEMENT)

MARYLAND

● **BALTIMORE (Area Code 301)**
RECORDINGS, INC., 1130 E. Cold Spring Ln. Tel: 433-0701. (SEE ADVERTISEMENT)

MICHIGAN

● **DETROIT (Area Code 313)**
Customatrix, 2990 W. Grand Blvd. Tel: 871-6100.
● **NEW HAVEN (Area Code 313)**
Sound, Inc., 56880 North Ave. Tel: 749-3225.

MINNESOTA

● **MINNEAPOLIS (Area Code 612)**
Kaybank, 2541 Nicollet. Zip: 55404. Tel: TA 7-5441.

NEW JERSEY

● **PITMAN (Area Code 609)**
Customatrix, Lams & Woodbury Rd. Tel: LU 9-8000.

NEW YORK

● **HICKSVILLE, L. I. (Area Code 516)**
Sonic Rec'g Prods., 27 Ludy St. Tel: WE 8-2600.
● **NEW YORK CITY (Area Code 212)**
AUDIO MATRIX, 915 Westchester Ave., Bronx. Zip: 10459. Tel: LU 9-3500. (SEE ADVERTISEMENT)

continued on page 134

BERT·CO



★ **tape boxes**



★ **shipping labels**



★ **box and film can labels**



★ **complete design and manufacturing facilities**

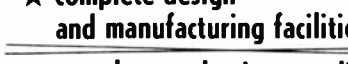

★ **complete packaging supplies**

mailing cartons shipping cartons packing pads dust jackets mailing envelopes record envelopes



★ **record jackets**

★ **phonograph record labels**

★ **color printing of jacket covers and liners**

★ **printed paper sleeves**
7" & 12" 1 to 4 colors

★ **transcription labels**



THE BERT·CO ENTERPRISES
THE BERT·CO PRESS • THE BERT·CO ALBUM CO. • THE BERT·CO PACKAGING CO.
1855 GLENDALE BLVD.
LOS ANGELES, CALIFORNIA 90026
PHONE 685-5137

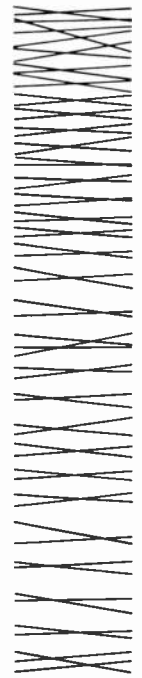

4,000 hours of music

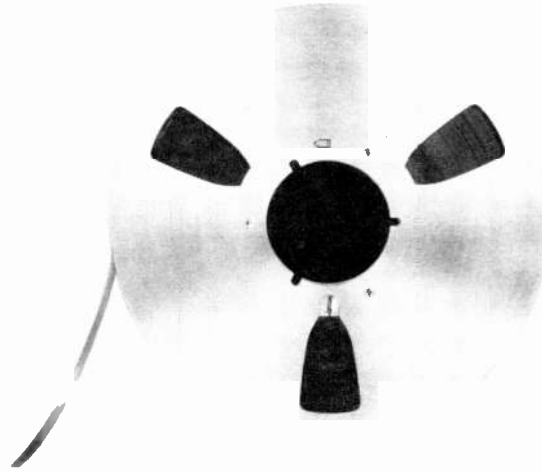

for license.

Licensors for Tapes and Records: Available for license to every country in the world—music for records, pre-recorded tapes, 4 and 8-track cartridges and background music. An exceptional library of over 4,000 hours of over 15,000 selections from the finest recorded music.

Music for Every Need: Classical popular, Jazz, Latin, International, kiddies, dance music, Big Bands, Country and Western, Folk, etc.

Famous Artists: Such outstanding performers as Bela Bartok, Villa-Lobos, George Enesco, Oscar Strauss, Sarah Vaughn, Carlos Montoya, Astrid Varnay, Rias

Symphony, Rome Opera and many others.

Engineering Services: We also have an unexcelled engineering department to install pressing and complete record plants using our newest patented machines, making up to 1600 LP records per day—for immediate delivery. We have installed many plants throughout the world.

Trademarks available. Negatives for full color artwork can be supplied. Write for information on catalog and low royalty rates.

Wanted: We also buy or lease your catalog.

Don Gabor Enterprises

Owners of America's oldest and largest independent record manufacturer.

4645 DELAFIELD AVENUE, RIVERDALE, NEW YORK Phone 212/549-3230

continued

Don Gabor Ents., 30 E. 42 St. Zip: 10017. Tel: 986-6031. Pres.: Donald H. Gabor.
 Mastercraft Rec. Plating, 619 W. 54 St. Tel: CO 5-6040.
 R C A Custom Recs., 155 E. 24 St. Tel: MU 9-7200.
 ● **ROCHESTER** (Area Code 716)
 Good Music Promo./Prods., PO Box 291, East Rochester. Tel: 381-4095.

OHIO

● **CINCINNATI** (Area Code 513)
 King Custom Rec. Serv., 1540 Brewster Ave. Tel: 751-1910.
 Rite Rec. Prods., 9745 Lockland Rd. Tel: 761-8844.
 S J SHAW PLATING, 2604 Glendora Ave. Zip: 45219. Tel: 961-3058. (SEE ADVERTISEMENT)
 ● **CLEVELAND** (Area Code 216)
 KELMAR, 1054 E. 71 St. Zip: 44103. Tel: 391-4518. Pres.: Joel Kischel. (SEE ADVERTISEMENT)
 Pama, 4991 Osborn Rd. Tel: 581-0661.

PENNSYLVANIA

● **ALLENTOWN** (Area Code 215)
 Allentown Rec., 10 & Walnut Sts. Tel: 433-7405.

RHODE ISLAND

● **PAWTUCKET** (Area Code 401)
 Johnston Sound Serv., 111 Sweet Ave. Tel: 723-7773.

SOUTH CAROLINA

● **DUNCAN** (Area Code 803)
 Cryovac (div. of W. R. Grace). Tel: 439-4121.

TEXAS

● **SAN ANTONIO** (Area Code 512)
 Tanner 'N' Texas, 1422 W. Poplar. Tel: PE 2-8072.

POLYETHYLENE BAGS

CALIFORNIA

● **LOS ANGELES** (Area Code 213)
 Container-Kraft, 721 E. 61 St. Tel: 232-3281.

FLORIDA

● **MIAMI** (Area Code 305)
 Duotone, 6875 S.W. 81 St., South Miami. Tel: 665-1121.

ILLINOIS

● **CHICAGO** (Area Code 312)
 Diamond Cellophane, 1736 S. Michigan Ave. Tel: 427-7038.

MINNESOTA

● **MINNEAPOLIS** (Area Code 612)
 Kaybank, 2541 Nicollet. Zip: 55404. Tel: TA 7-5441.

NEW YORK

● **NEW YORK CITY** (Area Code 212)
 Equitable Paper Bag, 45-50 Van Dam St., Long Island City. Zip: 11101. Tel: ST 6-0620.
 Fine-Tone Audio Prods., 7111 20 Ave., Brooklyn. Tel: CL 6-7876.
 Kirsch Music, 15-28 127 St., Flushing. Zip: 11356. Tel: HI 5-7200.
 Le-Bo, 33-59 Vernon Blvd., Long Island City. Zip: 11106. Tel: RA 1-8504.

OHIO

● **CINCINNATI** (Area Code 513)
 King Custom Rec. Serv., 1540 Brewster Ave. Tel: 751-1910.
 Mehl Mfg., 2057 Reading Rd. Tel: 241-6430.

PENNSYLVANIA

● **BROOMALL** (Area Code 215)
 Lesco Dist., 2205 Mary Ln. Zip: 19008. Tel: EL 6-1887.

TENNESSEE

● **NASHVILLE** (Area Code 615)
 Atlantic Envelope, PO Box 888. Zip: 37202.

PRESSING PLANTS

ARIZONA

● **PHOENIX** (Area Code 602)
 WAKEFIELD MFG., PO Box 6037, 1836 W. Moreland St. Tel: 252-5644. (SEE ADVERTISEMENT)

CALIFORNIA

● **BURBANK** (Area Code 213)
 H B Wadell, 231 W. Olive.
 ● **GARDENA** (Area Code 213)
 Record Pressings, 145-151 W. 154 St. Tel: FA 1-1446.
 ● **HAWTHORNE** (Area Code 213)
 Fidelatone Mfg., 12848 Weber Way.
 ● **LOS ANGELES** (Area Code 213)
 Alco, 6201 Santa Monica Blvd., Hollywood. Zip: 90038. Tel: HO 6-1101.
 ALLIEU REC., 2437 E. 57 St. Zip: 90058. Tel: 582-0841. (SEE ADVERTISEMENT)
 Cadet Rec., 5810 S. Normandie Ave.
 Capitol, 3061 Fletcher Dr.
 Columbia Rec. Prod'ns, 6121 Sunset Blvd., Hollywood Zip: 90028. Tel: 466-2481.
 CREATIVE SOUND PROD'NS, 9000 Sunset Blvd. Zip: 90069. Tel: CR 1-4843. Pres.: Bob Cotterell. (SEE ADVERTISEMENT)
 Custom Rec. Mfg., 5810 S. Normandie Ave. Tel: 753-2481.
 FINEBILT MFG., 931 N. Citrus Ave. Tel: HO 6-9511. (SEE ADVERTISEMENT)
 Lewis Rec. Mfg., 307 E. Beach St., Inglewood. Zip: 90302.
 Monarch, 4852-56 W. Jefferson Blvd. Tel: RE 2-6185.
 R C A Custom Rec. Sales, 6363 Sunset Blvd., Hollywood. Tel: HO 1-9171.
 Rainbo, 1041 N. Las Palmas, Hollywood. Tel: HO 6-7516.
 Record Broadcast, 237 S. Bent Ave. Tel: 744-0633.
 Research Craft, 1011 N. Fuller Ave. Tel: 876-3440.
 WORLD EXPORT MFG., 1248 S. Berendo St. Zip: 90006. Tel: 388-9669. (SEE ADVERTISEMENT)
 ● **SANTA BARBARA** (Area Code 805)
 Aragon Prods., 639 Island View Dr. Tel: WO 6-5631.
 ● **SANTA MARIA** (Area Code 805)
 Customatrix, 900 E. Stowell Rd. Tel: WA 2-4511.
 ● **SAUGUS** (Area Code 805)
 Century, 26000 Bouquet Canyon Dr. Tel: 259-2360.
 Keycor Chemical, PO Box 338, 26000 Springbrook Rd. Tel: 259-2360.

continued on page 137

WORLDDEX



For The Phonograph Record Industry

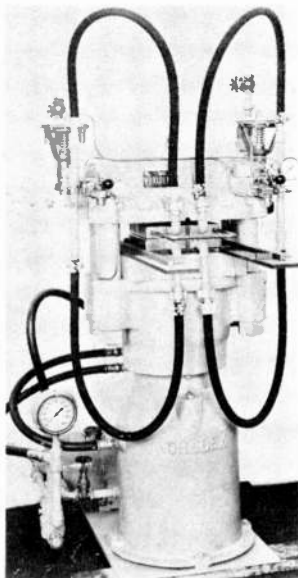

Self-contained Record Press—ready to work.

WORLDDEX Phonograph Record Equipment & Supplies

- Automatic Press Controls
- Record Molds
- Edging Machines
- Steam Boilers
- Record Materials
-
- Recording Equipment
- Acetates & Tape
-
- D. C. Rectifiers
- Mastering Stamper Service

Our most detailed Nickel Electroplating Manual in English with each Plating Plant.

Write for catalog and prices.

12-position plating tank. 1/8" seamless lining over steel, with overflow tank.

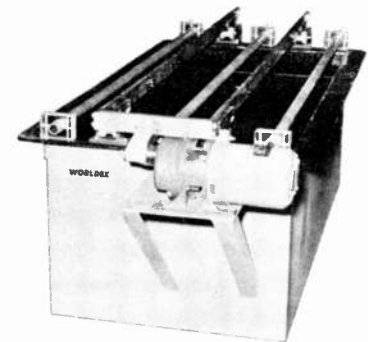

Nickel sulfamate Stamper plants.

WORLD EXPORT MFG. CO., LTD.

1248 SOUTH BERENDO STREET
 LOS ANGELES, CALIF. 90006, U. S. A.

Cable: WORLDDEX

When Quality Counts...
and Time is of the Essence

call on...

ALLENTOWN RECORDS

for all your Record
Pressing Needs



**ALLENTOWN
RECORD
COMPANY, INC.**

*Independent Custom
Molders for the
Phonograph Industry
10th and Walnut Streets
Allentown, Penna.*

Top
Quality
Jobs are
a "Snap" at

ALLENTOWN RECORDS

DE-TICKING THE METAL MATRIX...
one of the many quality control
checkpoints included with the
"in-plant" functions of
Allentown Records

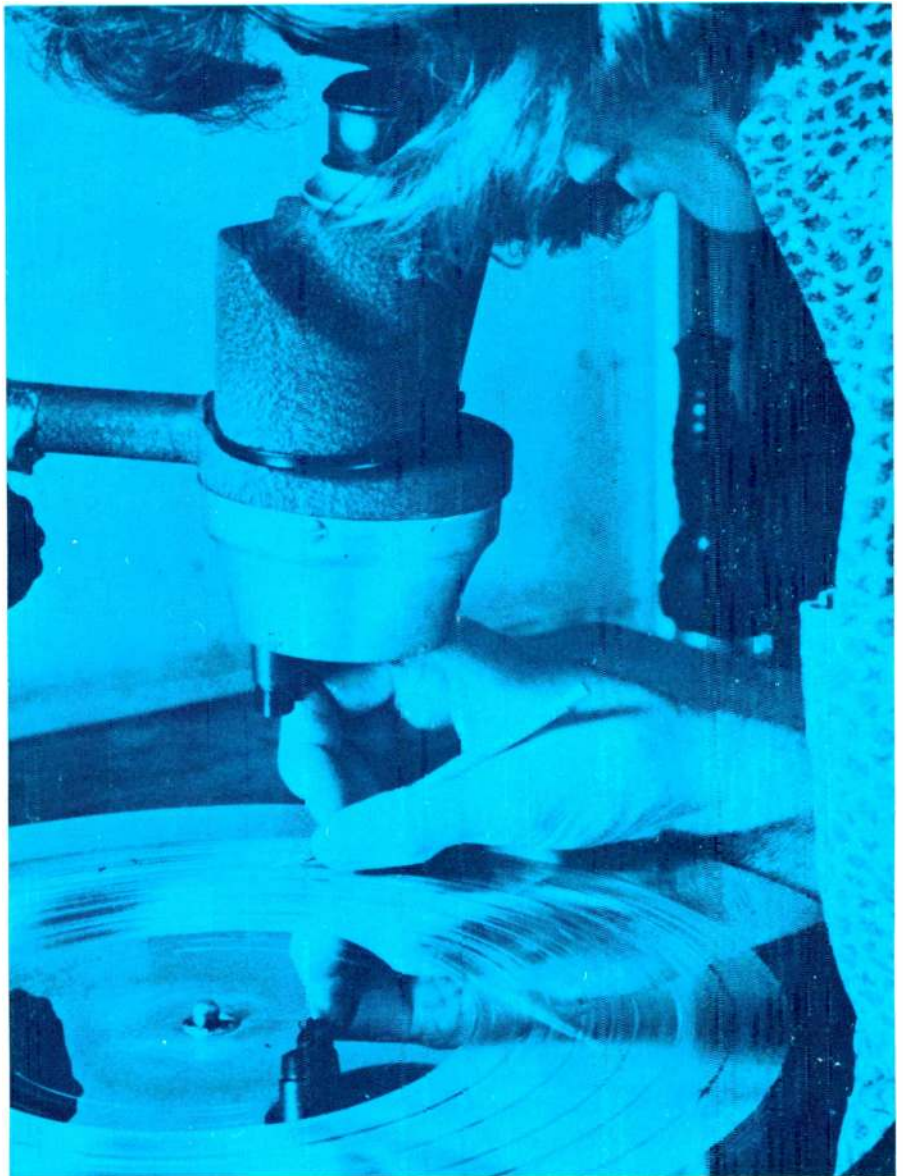

We do the "whole" job

Printing too?...*OF COURSE* ■ Jacket fabricating too?...*OF COURSE* ■
Labels too?...*OF COURSE* ■ Dubbing and pseudo stereo too?...*OF COURSE* ■
Metal processing too?...*OF COURSE* ■ Warehousing, Drop shipping,
DJ mailings too?...*OF COURSE*.

All of the above functions are accomplished on the premises of **Allentown Record Co.**
Subcontracting of specific functions is just not done at **Allentown Record Co.**

Remember! We do not have a proprietary product. Therefore our undivided efforts are for **YOU**.

Call Sandy Wartell or Dick Dickerman today—215-433-7405.

ALLENTOWN RECORD COMPANY, INC. / 10TH & WALNUT STREETS / ALLENTOWN, PENNSYLVANIA

World Radio History

continued

CONNECTICUT

● **STAMFORD** (Area Code 202)
Cook Labs., 351 Courtland Ave., Glenbrook. Zip: 06906. Tel: 348-7578.

FLORIDA

● **JACKSONVILLE** (Area Code 904)
Capitol, PO Box 385. Zip: 62650. Contact: Harold Walker.

● **MIAMI** (Area Code 305)
ADRIAN ASSOCS., The General Bldg., 6660 Biscayne Blvd. Zip: 33128. Tel: 757-1626. (SEE ADVERTISEMENT)
ARTREC, 1688 Meridian Ave., Miami Beach. Zip: 33139. Tel: 532-5474. (SEE ADVERTISEMENT)
Miami Rec., 2819 N.W. Seventh. Zip: 33127. Tel: NE 5-7925.
Southeastern Rec. Mfg., 150 W. 29 St., Hialeah. Tel: 888-7411.

● **TAMPA** (Area Code 813)
Fuller Recs. (div. Charles Fuller Prod'ns), PO Box 10513. Zip: 33609. Tel: 839-5471. Contact: John Brumage.

GEORGIA

● **DECATUR** (Area Code 404)
National Rec'g, 2871 E. Ponce de Leon Ave. Tel: 378-2379.

ILLINOIS

● **CHICAGO** (Area Code 312)
Apex Rec., 2009 W. 69 St. Zip: 60636. Owner: Sunny Sawyer.
Columbia Rec. Prod'ns, 630 N. McClurg Ct. Zip: 60611. Tel: WH 4-6000.
International Rec'g Co. (IRC), 5619 Division St. Zip: 60651. Tel: 378-4848.
MIDWEST, 7007 S. Wentworth Ave. Tel: ST 3-4150. (SEE ADVERTISEMENT)
Musical Prods., 521 W. 26 St. Tel: 326-1052.
R C A Custom Rec. Sales, 445 N. Lake Shore Dr. Zip: 60611. Tel: WH 4-3215.

● **PICKNEYVILLE** (Area Code 618)
Decca Mfg.

INDIANA

● **INDIANAPOLIS** (Area Code 317)
R C A Custom Rec. Sales, 501 N. La Salle St. Tel: ME 5-9000.
● **RICHMOND** (Area Code 317)
Mercury Rec. Mfg., 300 S. First St. Tel: 962-9511.
● **TERRE HAUTE** (No Area Code)
Customatrix, 1400 Fruitridge Ave. Tel: NO 4231 (no direct dial).
PHONO REC. PRESSING, 95 First St. Tel: 367-8822. Contact: Ralph Pate. (SEE ADVERTISEMENT)

LOUISIANA

● **NEW ORLEANS** (Area Code 504)
Andates-Basand, 2627 Leonidas. Zip: 70118. Tel: 861-7494.
Cosimo Rec'g Studios, 748 Camp St. Zip: 70130. Tel: 523-7474. Contact: Barbara Ann Richardson.
SUPERIOR PLASTICS, 748 Camp St. Zip: 70130. Tel: 523-7474. Contact: Barbara Ann Richardson. (SEE ADVERTISEMENT)

MARYLAND

● **BALTIMORE** (Area Code 301)
RECORDINGS, INC., 1130 E. Cold Spring Ln. Tel: 433-0701. (SEE ADVERTISEMENT)

MICHIGAN

DETROIT (Area Code 313)
Archer Rec. Pressing, 6552 E. Davison. Zip: 48212. Tel: 366-5475.
Columbia Rec. Prod'ns, 2990 W. Grand Blvd. Zip: 48202. Tel: TR 1-6100.
● **NEW HAVEN** (Area Code 313)
Sound, Inc., 56800 North Ave. Tel: 749-3225.
● **OWOSSO** (Area Code 517)
AMERICAN REC. PRESSING, 1810 W. King St. Tel: 725-8176. (SEE ADVERTISEMENT)

MINNESOTA

● **MINNEAPOLIS** (Area Code 612)
Kaybank, 254 Nicollet. Zip: 55404. Tel: TA 7-5441.

NEW HAMPSHIRE

● **MANCHESTER** (Area Code 603)
W & G Rec. Processing, 852 Elm St. Tel: 623-9749.

NEW JERSEY

● **ANCORA** (Area Code 609)
Presswell, White Horse Pike. Tel: 561-5250.

Billboard 1966-1967 International Music-Record Directory

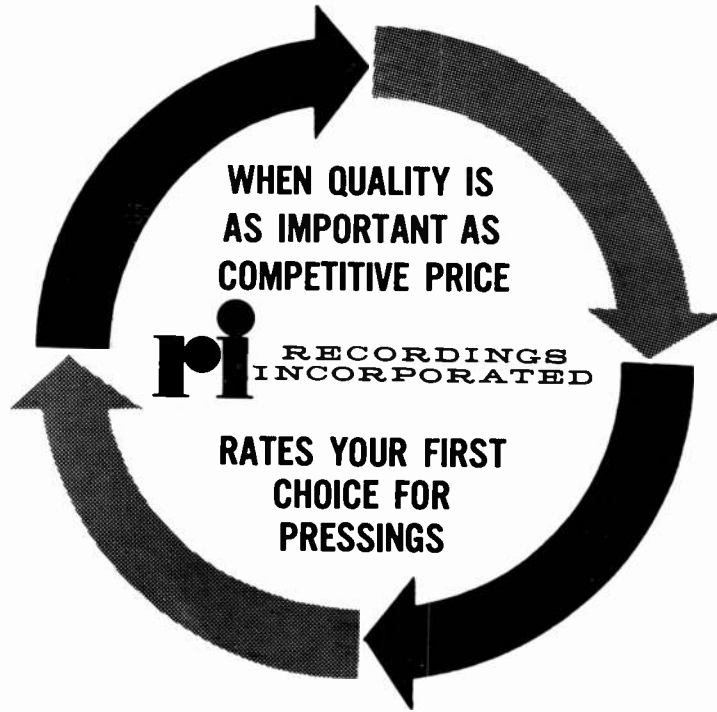

Quality that cannot be surpassed In every step of manufacture Recordings Incorporated uses only the most modern and the finest equipment available. As just one example, the recording head which cuts your master disc is a Neumann ES-59; it cost \$4000 and its fidelity is incredible. Every other machine and facility is of similar quality. And just as important to you, our technicians are every bit as good as their equipment. Each of them is a member of the Audio Engineering Society.

When you touch the needle down on the finished product you can instantly recognize the exceptional tonal qualities that only superb equipment and talented, painstaking technicians can produce.

In addition, Recordings Inc., has complete studio and sound facilities, manned by creative recording engineers. Your original tape can be edited, levels re-balanced, reverb added, equalization adjusted: virtually any change you want made.

Highly competitive prices The price per disc among the major record pressors varies only in pennies. Recordings Inc., can meet or beat any legitimate price offer you get. And you gain three other distinct advantages: prompt, personal attention; quality that cannot be surpassed; and the security of knowing that your material gets confidential treatment.

Lower shipping costs Baltimore has historically enjoyed the benefits of lower freight rates to the South and the Midwest. Shipping costs are often the difference between profit and loss for record producers.

In addition to the savings on freight, Recordings Incorporated will make drop shipments for you, and provide warehousing at no extra charge.

Any Size, Any Speed, Any Quantity, Mono Or Stereo

Exclusive franchises available for select areas

FREE DEMO DISC!
Hear on your own turntable the superior quality—both technical and artistic—that Recordings Incorporated can give to your pressings. Write or phone today for this valuable reference disc.



TELEPHONE 301-433-0701

Studio: Louis R. Mills

Pressings: Burgess Macneal

continued

- **CLIFTON (Area Code 201)**
Premier Albums of New Jersey, 140 Delawanna Ave.
Zip: 07014. Tel: GR 3-721B.
- **KEARNY (Area Code 201)**
Abbey Rec. Mfg., 160 Passaic Ave. Tel: WY B-8181
(see N.Y.C.).
- **LITTLE FERRY (Area Code 201)**
KAY REC., 110 Bergen Pike. Zip: 07643. Tel: DI
3-5721. (SEE ADVERTISEMENT)
- **MOUNTAINSIDE (Area Code 201)**
BESTWAY PRODS., Globe Ave. Tel: AD 2-8383.
Pres.: Al Massler. (SEE ADVERTISEMENT)
- **NEWARK (Area Code 201)**
Dynamic LP, 900 Passaic Ave., East Newark.
Sun Plastics, 900 Passaic Ave., East Newark.
United, 111 New Jersey Railroad Ave. (see N.Y.C.).
- **PITMAN (Area Code 609)**
Customatrix, Lams & Woodbury Rds. Tel: LU
9-8000.

- **PLAINFIELD (Area Code 201)**
Plastylite, 333 North Dr., North Plainfield. Tel:
755-7000.
- **ROCKAWAY (Area Code 201)**
R C A Custom Rec. Sales, Rt. 46 & Greenpond Rd.
Tel: OA 7-2400.
- **ROSELLE (Area Code 201)**
All Disc Rec. 625 W. First Ave. Tel: CH 5-7415.
N.Y.C. Tel: (212) CO 7-1523.

NEW YORK

- **FRANKLIN SQUARE, L. I. (Area Code 516)**
Audio Rec'g & Mfg., 4 New Hyde Park Rd. Zip:
11010. Tel: GE 7-6200.
- **GLOVERSVILLE (Area Code 518)**
Decca Mfg., Rt. 30A. Zip: 12078.
- **HICKSVILLE, N. J. (Area Code 516)**
Sonic Rec'g Prods., 27 Ludy St. Tel: WE 8-2600.
- **NEW YORK CITY (Area Code 212)**
Abbey Rec. Mfg., 370 Seventh Ave. Tel: LW 4-0891
(see Kearny, N. J.).
- **Allied Creative Serv., 537 W. 53 St. Zip: 10019.
Tel: PL 7-6556.**

- Capitol, 151 W. 46 St. Tel: JU 2-8040.
- COLUMBIA REC. PROD'NS, 51 W. 52 St. Zip: 10019.
Tel: 765-4321. (SEE ADVERTISEMENT)**
- Decca, 619 W. 54 St. Zip: 10019. Tel: PL 7-2000.
- Empire, 800 E. 141 St., Bronx. Tel: LU 5-2222.
- Don Gabor Ents., 30 E. 42 St. Zip: 10017. Tel:
986-6031. Pres.: Donald H. Gabor.
- House of Wax, 1650 Broadway. Tel: CI 7-2159.
- LONGMARK PRODS., 1674 Broadway, Suite 703. Zip:
10019. Tel: 245-9709 (see Utica, N. Y.). (SEE
ADVERTISEMENT)**
- Oasis Rec. Pressing, 275 S. Second St., Brooklyn.
Zip: 11211. Tel: EV 7-1200. Pres.: Roger Lopez.
- R C A Custom Rec. Sales, 155 E. 24 St. Tel: MU
9-7200.
- Record Promo., 130 W. 42 St. Tel: PE 6-0936.
- Romaba, 33 34 St., Brooklyn. Tel: HY 9-3060.
- United, 1650 Broadway. Tel: CI 5-0022 (see Newark,
N. J.).
- **ROCHESTER (Area Code 716)**
Good Music Promo./Prods., PO Box 291, East Roch-
ester. Tel: 381-4095.
- Star Artist Rec'g, 67 Chestnut St., Suite 710. Tel:
546-6780, Ext. 710. Pres.: Donnie Lee Bailes;
VP: Tony Powlowski.
- **UTICA (Area Code 315)**
LONGMARK PRODS., 814 Jay St. Tel: 724-3464 (see
N. Y. C.). (SEE ADVERTISEMENT)

NORTH CAROLINA

- **CHARLOTTE (Area Code 704)**
Arthur Smith, PO Box 17551, 5457 Old Monroe Rd.
Tel: 536-0424.

OHIO

- **CINCINNATI (Area Code 513)**
KING CUSTOM REC. SERV., 1540 Brewster Ave. Tel:
751-1910. (SEE ADVERTISEMENT)
- Queen City Album, 7200 Colerain Ave. Tel: 931-
3232.
- Rite Rec. Prods., 9745 Lockland Rd. Tel: 761-8844.
- **CLEVELAND (Area Code 216)**
KELMAR, 1054 E. 71 St. Zip: 44103. Tel: 391-451B.
Pres.: Joel Kischel. (SEE ADVERTISEMENT)
- Pama, 4991 Osborn Rd. Tel: 581-0661.
- **COLUMBUS (Area Code 614)**
Magnetic Studios, 1670 W. First Ave. Tel: 486-2469.

PENNSYLVANIA

- **ALLENTOWN (Area Code 215)**
ALLENTOWN REC., 10 & Walnut St. Tel: 433-7405.
(SEE ADVERTISEMENT)
- **OLYPHANT (Area Code 717)**
SPECIALTY REC., 210 N. Valley Ave. Zip: 18447.
Tel: 489-4717. (SEE ADVERTISEMENT)
- **PHILADELPHIA (Area Code 215)**
Clarion Rec., 1021 Ridge Ave. Tel: CE 6-5252.
- Diskmakers, 925 N. Third St. Zip: 19123. Tel: MA
7-2277.
- Hodge Rec., 1314-24 S. Howard St. Zip: 19147.
Tel: DE 6-7001.
- **PITTSBURGH (Area Code 412)**
Gateway, 234 Forbes. Tel: 471-5875.
- **SCRANTON (Area Code 717)**
Capitol, 300 Brook St. Contact: Bob Stearns.
- **SHARON (Area Code 412)**
Marjon, 930 Woodview Pl. Tel: DI 7-4726.
- **SOUTHAMPTON (Area Code 215)**
SILVER PLASTICS, Southampton Ind'l Park. Zip:
18966. Tel: EL 7-1175. (SEE ADVERTISEMENT)
- **WINDSOR (Area Code 717)**
Dee-Bee Rec'g Serv., S. Camp St. Ext. Zip: 17366.
Tel: 244-5411. Owner: Stan Deppen Jr.

RHODE ISLAND

- **PAWTUCKET (Area Code 401)**
Johnston Sound Serv., 111 Sweet Ave. Tel: 723-
7773.

SOUTH CAROLINA

- **GEORGETOWN (Area Code 803)**
Factor Prods., 909 Front St. Tel: 546-9409.

TENNESSEE

- **MEMPHIS (Area Code 901)**
Memphis, 3635 Allandale Rd. Zip: 38111. Tel:
324-4640. Mgr.: Style Wooten.
- Plastic Prods., 1746 Chelsea Ave. Tel: BR 6-7160.
- **NASHVILLE (Area Code 615)**
Columbia Rec. Prod'ns, 804 16 Ave. S. Tel: 255-0371.
Acct. Exec.: Cecil Scaife.
- R C A Custom Rec. Sales, 800 17 Ave. S. Tel:
AL 5-5781.
- Sound of Nashville, 160 Second Ave. S. Tel: 244-
1124.
- Southern Plastics, 453 Chestnut St. Tel: 244-1293.
- Standard Rec. Pressing, 415 Fourth Ave. S. Tel:
244-1867.

For QUALITY and SERVICE in the MIDWEST and EAST

The American Record Pressing Co.

1810 W. King St., Owosso, Michigan Area Code 517—725-8176

Complete, Quick Service

PROCESSING • LABELS PRESSINGS • DROP SHIPMENTS

Centrally located for custom work at economy prices

MIDWEST RECORD PRESSING, INC.

7007 S. WENTWORTH AVE. PHONE: (312) ST 3-4150 CHICAGO, ILLINOIS 60621

Sidney J. Wakefield

CUSTOM RECORD PRESSING

★ PRECISION ★ RAPID
PRODUCT SERVICE

★ COMPETITIVE
PRICES
7" - 10" - 12"

TRY US and join our
Family of Satisfied Clients

P.O. Box 6037
Ph. (602) 252-5644
Phoenix, Arizona 85005

TEXAS

- **ARLINGTON** (Area Code 817)
Rec-O-Press, 3500 S. Cooper. Zip: 76010. Tel: CR 5-6862.
- **HOUSTON** (Area Code 713)
Houston Rec., 3300 Jensen Dr. Tel: 323-5971.
- **SAN ANTONIO** (Area Code 512)
Tanner'N' Texas, 1422 W. Poplar. Tel: PE 2-8072.
- **SAN BENITO** (Area Code 512)
Betancourt Ent's., PO Box 861, 119 S. Sam Houston Blvd. Zip: 78586. Tel: EX 9-1471. Owner: Paco Betancourt; Mgr.: John F. Phillips.

PRINTERS & LITHOGRAPHERS

CALIFORNIA

- **ALAMEDA** (Area Code 415)
Motivester Rec. Serv., PO Box 1036, South Shore. Tel: 532-7811.
- **BURBANK** (Area Code 213)
Location Rec'g Serv., 2201 W. Burbank Blvd. Zip: 91506. Tel: 849-1321. Partners: Allen J. Fraiberg & Steven A. Guy.
- **LOS ANGELES** (Area Code 213)
BERT-CO ENTS., 1855 Glendale Blvd. Tel: 665-5137. (SEE ADVERTISEMENT)
Cadet Rec., 5810 S. Normandie Ave.
Container-Kraft, 721 E. 61 St. Tel: 232-3281.
Custom Rec. Mfg., 5810 S. Normandie Ave. Tel: PL 0-3310.
Golden State Graphics, 615 S. Flower St. Zip: 90017. Tel: 627-6396.
Record Labels, 6211 Santa Monica Blvd. Tel: 466-1307.
- **SAN FRANCISCO & BAY AREA** (Area Code 415)
Gopher Prods., PO Box 812, Berkeley. Tel: 843-5836.
- **CONNECTICUT**
- **BRIDGEPORT** (Area Code 203)
Lithographic Corp., 1501 State St. Tel: WO 6-4353.

FLORIDA

- **MIAMI** (Area Code 305)
ADRIAN ASSOCS., The General Bldg., 6660 Biscayne Blvd. Zip: 33138. (SEE ADVERTISEMENT)

ILLINOIS

- **CHICAGO** (Area Code 312)
Weyerhaeuser Packaging Group, 100 S. Wacker Dr. Zip: 60606. Tel: 346-6364.

INDIANA

- **RICHMOND** (Area Code 317)
Mercury Rec. Mfg., 301 S. First St. Tel: 962-9511.
- **TERRE HAUTE** (No Area Code)
Woodburn Printing, 25 S. Sixth St. Tel: C-0164 (no direct dial).

MARYLAND

- **BALTIMORE** (Area Code 301)
RECORDINGS, INC., 1130 E. Cold Spring Ln. Tel: 433-0701. (SEE ADVERTISEMENT)

MICHIGAN

- **NEW HAVEN** (Area Code 313)
Sound, Inc., 56880 North Ave. Tel: 749-3225.

MISSOURI

- **CAPE GIRARDEAU** (Area Code 314)
James Floyd Ford, PO Drawer 839. Zip: 63701. Tel: 334-5772. Pres.: James Floyd Ford.

NEW YORK

- **GREAT NECK, L. I.** (Area Code 516)
IVY HILL LITHO., Community Dr. Tel: HU 7-0200. (SEE ADVERTISEMENT)
- **HAUPPAUGE, L. I.** (Area Code 516)
Alemo, Cardinal Ind'l Park. Tel: 291-7600.
Globe Albums, Cardinal Ind'l Park. Tel: 291-7600.
- **NEW YORK CITY** (Area Code 212)
Jewel Albums, 1119 Worthen St., Bronx. Zip: 10459. Tel: LU 9-0954.
Lee-Myles Assocs., 40 W. 57 St. Zip: 10019. Tel: PL 7-6630.
MacMurray Press, 22 Jones St. Tel: WA 4-1530.
Majestic Printing, 251 W. 19 St. Tel: AL 5-0350.
ONE STOP SERV., 133 E. 84 St. Zip: 10028. Tel: 288-4338. Mgr.: Adam Gary. (SEE ADVERTISEMENT)
Progressive Label, 286 Stanhope, Brooklyn. Tel: HY 7-2320.

Queens Litho., 52-35 Barnett Ave., Long Island City. Zip: 11104. Tel: IL 7-7700.

Radom & Neidorff, 438 W. 37 St. Tel: BR 9-1591.
Record Promo., 130 W. 42 St. Tel: PE 6-0936.
Supreme Printing, 147 W. 15 St. Zip: 10011. Tel: AL 5-0600.

NORTH CAROLINA

- **WINSTON-SALEM** (Area Code 919)
SNYDER ALBUM, 3083 Indiana Ave. Zip: 27105. Tel: 722-6768. (SEE ADVERTISEMENT)

OHIO

- **CINCINNATI** (Area Code 513)
KING CUSTOM REC. SERV., 1540 Brewster Ave. Tel: 751-1910. (SEE ADVERTISEMENT)
Queen City Album, 7200 Colerain Ave. Tel: 931-3232.
Rite Rec. Prods., 9745 Lockland Rd. Tel: 761-8844.
- **CLEVELAND** (Area Code 216)
KELMAR, 1054 E. 71 St. Zip: 44103. Tel: 391-4518. Pres.: Joel Kischel. (SEE ADVERTISEMENT)

● **TOLEDO** (Area Code 419)

Pioneer Inds., PO Box 38, Sta. F. Tel: 691-2065.

PENNSYLVANIA

- **PHILADELPHIA** (Area Code 215)
Allstate Printing, 1021 S. Ninth St. Zip: 19147. Tel: WA 5-6685.
Harrison Color Process, 2032 N. 16 St. Tel: CE 6-9300.
Jack Howard Promos., 2733 Kensington Ave. Tel: NE 4-8487.

● **SHARON** (Area Code 412)

Marjon, 930 Woodview Pl. Tel: DI 7-4726.

SOUTH CAROLINA

- **GEORGETOWN** (Area Code 803)
Factor Prods., 909 Front St. Tel: 546-9409.

TENNESSEE

- **NASHVILLE** (Area Code 615)
Atlantic Envelope, PO Box 888. Zip: 37202.

TEXAS

- **SAN ANTONIO** (Area Code 512)
Tanner 'N' Texas, 1422 W. Poplar. Tel: PE 2-8072.
- **WACO** (Area Code 817)
Alco Engraving, PO Box 294, 2015 Franklin Ave. Tel: PL 6-2736.

★ **MODERN PRESSING PLANT**
★ **EXPERIENCED PERSONNEL**
★ **TOP QUALITY**
★ **FAST SERVICE**

WE CAME UP WITH A FORMULA THAT OFFERS THE BEST IN RECORD PRESSING.



SUPERIOR PLASTICS INC.

RALPH PATE, PLANT MANAGER
PLANT: 340 BROOKLYN AVENUE
NEW ORLEANS, LA. 70121
OFFICE: 748 CAMP STREET
NEW ORLEANS, LA. 70130 (504) 523-7474

continued

WISCONSIN

- **MILWAUKEE** (Area Code 414)
New Printing Serv., 761 N. 29 St. Tel: 344-3925.

PROCESSING PLANTS

ARIZONA

- **PHOENIX** (Area Code 602)
Wakefield Mfg., PO Box 6037, 1836 W. Moreland St. Tel: 252-5644.

CALIFORNIA

- **LOS ANGELES** (Area Code 213)
Allied Rec., 2437 E. 57th St. Zip: 90058. Tel: 582-0841.

Capitol, 3061 Fletcher Dr.
Rainbo, 1041 N. Las Palmas, Hollywood: Tel: HO 6-7516.

WORLD EXPORT MFG., 1248 S. Berendo St. Zip: 90006. Tel: 388-9669. (SEE ADVERTISEMENT)

- **SAN MARCOS** (Area Code 714)
Record Broadcast, 237 S. Bent Ave. Tel: 744-0633.

CONNECTICUT

- **STAMFORD** (Area Code 203)
Cook Labs., 351 Courland Ave., Glenbrook. Zip: 06906. Tel: 348-7578.

ILLINOIS

- **CHICAGO** (Area Code 312)
International Rec'g Co. (IRC), 5619 W. Division St. Zip: 60651. Tel: 378-4848.

MICHIGAN

- **NEW HAVEN** (Area Code 313)
Sound, Inc., 56880 North Ave. Tel: 749-3225.

MINNESOTA

- **MINNEAPOLIS** (Area Code 612)
Kaybank, 2541 Nicollet. Zip: 55404. Tel: TA 7-5441.

NEW HAMPSHIRE

- **MANCHESTER** (Area Code 603)
W & G Rec. Processing, 852 Elm St. Tel: 623-9749.

NEW YORK

- **NEW YORK CITY** (Area Code 212)
AUDIO MATRIX, 915 Westchester Ave., Bronx. Zip: 10459. Tel: LU 9-3500. (SEE ADVERTISEMENT)
Longmark Prods., 1674 Broadway, Suite 703. Zip: 10009. Tel: 245-9709 (see Utica, N. Y.).

- **UTICA** (Area Code 315)
Longmark Prods., 814 Jay St. Tel: 724-3464 (see N. Y. C.).

OHIO

- **CLEVELAND** (Area Code 216)
Kelmar, 1054 E. 71 St. Zip: 44103. Tel: 391-4518.
Pres.: Joel Kischel.
Pama, 4991 Osborn Rd. Tel: 581-0661.

PENNSYLVANIA

- **ALLENTOWN** (Area Code 215)
Allentown Rec., 10 & Walnut Sts. Tel: 433-7405.

- **SCRANTON** (Area Code 717)
Capitol, 300 Brook St.

RHODE ISLAND

- **PAWTUCKET** (Area Code 401)
Johnston Sound Serv., 111 Sweet Ave. Tel: 723-7773.

SOUTH CAROLINA

- **GEORGETOWN** (Area Code 803)
Factor Prods., 909 Front St. Tel: 546-9409.

TEXAS

- **SAN ANTONIO** (Area Code 512)
Tanner 'N' Texas, 1422 W. Poplar. Tel: PE 2-8072.

PROMOTION & PUBLICITY

ALABAMA

- **HUNTSVILLE** (Area Code 205)
Parasonic, PO Box 412. Zip: 35804. Tel: 828-4863.
Gen. Mgr.: Melvin S. Draper.

ARIZONA

- **TUCSON** (Area Code 602)
Action, 815 E. Broadway. Tel: 623-0318. Pres.: Frank Darris.
Copper State Rec'g, 815 E. Broadway. Zip: 85719. Tel: 623-0318.

CALIFORNIA

- **ALAMEDA** (Area Code 415)
Motivator Rec. Serv., PO Box 1036, South Shore. Tel: 532-7811.

- **BAKERSFIELD** (Area Code 805)
Jon Badaux Prod'ns, PO Box 6128. Pres.: Jon Badaux; Exec. Prod'r: George E. Clements (see San Bernardino, Calif.).

- **FRESNO** (Area Code 209)
California Artists, 2194 Maud No. 54. Tel: 266-9570.

- **GARDENA** (Area Code 213)
Audio Magnetics Corp., 1604 W. 139 St. Tel: 321-6841. Pres.: Irving Katz.

- **LA MESA** (Area Code 714)
Hit Line Rec. Sales, PO Box 781. Zip: 92041.

- **LOS ANGELES** (Area Code 213)
Allied Rec., 2437 E. 57 St. Zip: 90058 Tel: 582-0841

Art Benson, PO Box 1563, Hollywood. Zip: 90028. Tel: HO 3-7652 & HO 6-2466.

Creative Sound Prod'ns, 9000 Sunset Blvd. Zip: 90069. Tel: CR 1-4843. Pres.: Bob Cotterell.

TIM GAYLE & ASSOCS., 6376 Yucca St., Hollywood. Zip: 90028. Tel: 465-6258, 463-2151. Owner: Tim Gayle. (SEE ADVERTISEMENT)

H I T, 1607 El Centro Ave., Suites 1 & 2, Hollywood. Tel: HO 4-2164.

George Jay Assocs., Sunset-Vine Tower, Hollywood. Zip: 90028. Tel: HO 9-5838.

Kragen/Fritz, 451 N. Canon Dr., Beverly Hills. Tel: 273-5011.

Merrick, 9000 Sunset Blvd. Zip: 90069. Tel: CR 8-1211 (see N. Y. C.).

Mexican Rec., 3320 Barham Blvd., Hollywood. Zip: 90028. Tel: HO 4-3653.

Stan Pat, 6269 Selma Ave., Hollywood. Zip: 90028. Tel: HO 6-4439.

Record Promos., 6367 Selma Ave., Hollywood. Zip: 90028. Tel: HO 5-6121. Mgr.: Tom Sawyer.

Tony Richland Promo., 6363 Sunset Blvd., Suite 705, Hollywood. Zip: 90028. Tel: HO 7-2151. Pres.: Tony Richland.

Ray Sanders, PO Box 38631, Hollywood. Zip: 90038. Tel: 763-4374.

Studio City Adv., 2559 W. Pico Blvd. Tel: 388-3251.

Szarko, California Federal Bldg., 10680 W. Pico Blvd., Suite 220. Zip: 90064. Tel: 839-4343.

Guy Ward, 9601 Wilshire Blvd., Suite 14, Beverly Hills. Tel: CR 4-7551.

Norman Winter & Assocs., 1560 N. La Brea, Hollywood. Zip: 90028. Tel: HO 4-7129.

Irwin Zucker, 6515 Sunset Blvd., Hollywood. Tel: HO 6-9594.

- **MAYWOOD** (Area Code 213)
Progressive Sounds of America, 6034 Atlanta Blvd. Zip: 90370. Tel: 583-5921 & 589-3880. Dir.: John Saunders.

- **MENDOTA** (Area Code 209)
California Rec., PO Box 525. Tel: 655-4630.

- **NORTHRIDGE** (Area Code 213)
Rick Valrey Assocs., 10022 Melvin. Zip: 91324. Tel: 349-4394. Pres.: Rick Valrey.

- **SACRAMENTO** (Area Code 916)
Frederick Vail Prod'ns, PO Box 4864, 4104 Winding Creek Rd. Zip: 95825. Tel: 489-3355. Pres.: Frederick Vail.

- **SAN BERNARDINO** (Area Code 714)
Jon Badaux Prod'ns, PO Box 3211, 25991-A East 20. Zip: 92404. Tel: TU 2-0629. Pres.: Jon Badaux; Exec. Prod'r: George E. Clements. (see Bakersfield, Calif.).

- **SAN FERNANDO** (Area Code 213)
American Talent Agency, PO Box 411. Tel: DI 2-9109.

- Consolidated Artists Bureau, PO Box 411. Tel: DI 2-9109.

- Mark Raymer, PO Box 411. Tel: DI 2-9109.

- **SAN FRANCISCO & BAY AREA** (Area Code 415)
Bronson Ent's., PO Box 96, El Cerrito. Tel: 526-3491.
Cathy Furniss, 703 Market St. Tel: DO 2-0106.

Ted Ponseti, 221 Knight Dr., San Rafael. Tel: 453-4388.

T M P, 2482 Tea Garden St., San Leandro. Tel: 351-7907.

Sylvia White, 2383 Union St. No. 4. Tel: 567-6935.

Quality First!
at
Queen City
ALBUM COMPANY

A COMPLETE PRESTIGE RECORD PACKAGE

- Mastering ● Plating ● Labels ● Art-Design
- Record Pressing ● Printing and Fabricating of Jackets ● Quality Controlled at each Process

Large Selection of Stock Jackets
Write for complete illustrated catalog of prices and designs

QUEEN CITY ALBUM CO. — 2832 Spring Grove Ave.
Phone 513 - 681-8400 Cincinnati, Ohio 45225

COLORADO

• **DENVER** (Area Code 303)
Heather Pub., 3285 S. Wadsworth Blvd. Tel: 985-7437.

CONNECTICUT

• **UNCASVILLE** (Area Code 203)
Steljo, 37 Park Ave.

DISTRICT OF COLUMBIA

• **WASHINGTON** (Area Code 202)
H & H Ents., 930 F St. N.W. Zip: 20004. Tel: DI 7-3944 (see Point Marion, Pa.).
Menick & Sadel, 143 Kennedy St. N.W. Tel: RA 3-4215.
Elliot Ryan, 733 15 St. N.W., Rm. 232. Zip: 20005. Tel: 783-2553.
Suite 54 Promos., 1745 K St. N.W. Zip: 20006. Tel: 659-1673. Owner: Frank Grist.
UNICORN PROD'NS, 232 Woodward Bldg. Tel: 783-2553. (SEE ADVERTISEMENT)

FLORIDA

• **MIAMI** (Area Code 305)
ADRIAN ASSOCS., The General Bldg., 6660 Biscayne Blvd. Zip: 33138. Tel: 757-1626. (SEE ADVERTISEMENT)
RAY MINER, 19802 N.E. 12 Pl., North Miami Beach. Tel: 949-3033. (SEE ADVERTISEMENT)
Professional Programming Publications, 9701 S.W. 77 Terr. Zip: 33143. Tel: 271-0839. Gen. Mgr.: Bob Harris; Prod'n Mgr.: Dick Starr.
• **ORLANDO** (Area Code 305)
Whiteholme Sounds, 620 Gatlin Ave. Zip: 32806. Tel: 422-2374. Pres.: Robert C. Benzning.

GEORGIA

• **CALHOUN** (Area Code 404)
Cherokeeland Rec'gs, PO Box 502, Rm. 2, Johnston-Hall Clinic Bldg. Zip: 30701. Tel: 629-3950. Pres.: J. Carter.
• **DECATUR** (Area Code 404)
National Rec'g, 2871 E. Ponce De Leon Ave. Tel: 378-2379.
• **STATESBORO** (Area Code 912)
Len Latimer Promos., PO Box 961. Tel: 764-4892. Pres.: Len Latimer. Cable LATPRO.

ILLINOIS

• **CHICAGO** (Area Code 312)
Ad-vertising Unlimited, PO Box 8135. Zip: 60680. Tel: 373-3072. VP & Acct. Exec.: R. C. Hillman.
American Music Promos., 870 N. Wabash. Zip: 60611. Tel: 337-2550. Pres.: Fred L. Jarm Jr.; A&R: "Dutch" Wenzloff; Dir.: James H. Nash.
Paul Gallis, 632 N. Dearborn St. Zip: 60610. Tel: WH 4-2759
Marsteller, 1 E. Wacker Dr. Zip: 60601. Tel: 329-1100.
Newsmakers, 952 N. Michigan Ave. Zip: 60611. Tel: 944-5545. Pres.: Eva Dolin.
PROMOTIONS, 1770 Winthrop Rd., Highland Park. Zip: 60035. Tel: 831-4466. Contact: Earl Glicken. (SEE ADVERTISEMENT)
H. R. SCHWAB ASSOCS., 1525 E. 53 St., Suite 425. Tel: 324-7300. (SEE ADVERTISEMENT)
Shepard Stern, 251 E. Grand Ave. Zip: 60611. Tel: 257-2160.
TALENT MGMT. & PROMO., 22 E. Huron. Tel: 642-8461. Pres.: Morey Alexander. (SEE ADVERTISEMENT)
Peter H. Wright Assocs., 185 N. Wabash Ave. Zip: 60601. Tel: 236-6185.

• **MORTON GROVE** (Area Code 312)
Perry Johnson, 7507 Foster. Tel: 299-8222.

INDIANA

• **FORT WAYNE** (Area Code 812)
Tri-State Serv., 3434 Broadway.
• **INDIANAPOLIS** (Area Code 317)
Bill Rucker Ents., 4923 University Ave. Zip: 46201. Tel: 359-0462. Pres.: Bill Rucker.
Variety Pub. Assocs., PO Box 940. Zip: 46206. Mg'g Dir.: Jerry D. Allen.

KANSAS

• **LOUISBURG** (No Area Code)
Kurl, Rt. 2. Zip: 66053.

KENTUCKY

• **LOUISVILLE** (Area Code 502)
Orbit Radio, PO Box 1644, 1863 Arlington St. Tel: 895-1143.

RECORD PROMOTION & PUBLICITY

Complete disc jockey coverage . . . Trade paper publicity.

CONSULTATION

All questions answered . . . Distribution, Pricing, Recording, Union Rules, Music Publishing.

PRESSING

No job too small.

DISTRIBUTION ARRANGED



MORTY WAX PROMOTIONS

1650 B'WAY • N.Y. 19, N.Y. • CI 7-2159

So You Wanna Be a Star . . .

In the Midwest See

MOREY ALEXANDER
at

Talent Management Promotions, Inc.

22 East Huron St., Chicago, Ill.
(312) 642-8461

Divisions:

TMP-TING RECORDS
TODD-MARK PUBL. CO. (BMI)
RECORD PRODUCERS MANAGEMENT

FOR BOSTON-NEW ENGLAND MUSIC PROMOTION

Ed Penney

because . . .

NEW LOCATION: 8 CARTER DRIVE, FRAMINGHAM, MASSACHUSETTS (617) 877-4455

A NEW IDEA
in Public Relations for

Musicians and Performers

We Will Promote Your Image

- by advance exposure of your appearance anywhere in the United States and Canada thru daily papers, trade and consumer magazines, neighborhood papers, TV and radio.
- by Free mailing of promotional pictures and biographical brochures (as this sample) to DJ's, columnists, entertainment editors, etc.
- by giving you Free public relations advice.
- by personal representation if requested.

All this is included in an average monthly fee of \$50.00.

BROCHURE INCLUDES:

- Biographical Notes
- Major Past Appearances
- Excerpts From Reviews
- Discography
- Photographs

You can't afford to be without this service. For additional information write or call us today. It may cost NOTHING with our help your earnings should increase considerably.

H. R. SCHWAB/ASSOCIATES

1525 E. 53rd, Chicago, Ill. 60615
Phone: (312) 324-7300

CPR

Contemporary
Public Relations
Record Promotion

Beverly Noga—Bobbi Cowan

9100 Sunset Blvd., Suite 250
Los Angeles, Calif. 90069
Area Code 213—273-8430

**GATEWAY TO MORE
BUSINESS FOR YOUR
PHONOGRAPH RECORDS**



★
**RAY
LAWRENCE Ltd.**
1511 N. Laurel Canyon Blvd.
Hollywood, Calif. 90046
654-4410

**MARKETING
MERCHANDISING
PROMOTION**

continued

MAINE

- **BATH (Area Code 207)**
Critique Music Promos., 20 Spring. Zip: 04530.
Tel: 443-3751. Gen. Mgr.: Carl Strube.

MARYLAND

- **ACCOKEEK (Area Code 301)**
Ray Vernon Prod'ns, PO Box 6.
- **SILVER SPRING (Area Code 301)**
L & M Rec. Assocs., 1035 Quebec Terr., Suite 2.
Zip: 20903.

MASSACHUSETTS

- **BOSTON (Area Code 617)**
Ed Hurvitz Music, 89 Hollingsworth St., Mattapan.
Zip: 02126. Tel: 298-0574.
- New England Rec. Promo., 760 Cummings Hwy.,
Mattapan. Zip: 02126. Tel: 296-3979.
- ED PENNEY & ASSOCS., 645 Beacon St. Tel: CO
6-0060. (SEE ADVERTISEMENT)

MICHIGAN

- **DETROIT (Area Code 313)**
Sam Kaplan, Northland Towers, Suite 106, South-
field. Tel: 442-5938.
- Kay Ent's., 13673 Wales. Zip: 48237. Tel: LI 2-2338.

- **NEW HAVEN (Area Code 313)**

Sound, Inc., 56880 North Ave. Tel: 749-3225.

MISSISSIPPI

- **GULFPORT (Area Code 601)**
Andates-Basand, PO Box 2213, Evergreen Sta. Zip:
39503. Tel: 861-7494.

MONTANA

- **MISSOULA (Area Code 406)**
Blue Angel Promotional Agency, 1401 Sherwood St.
Zip: 59801. Tel: 549-1606.

NEVADA

- **LAS VEGAS (Area Code 702)**
Personality Prod'ns, PO Box 5697, Garside Sta.
Zip: 89102. Tel: 385-4656.

NEW HAMPSHIRE

- **KEENE (Area Code 603)**
Vanguard, 16 Ridgewood Ave. Zip: 03431. Tel:
352-7131.

NEW JERSEY

- **SECAUCUS (Area Code 201)**
Personality Prod'ns, 80 Central Ln. N. Y. C. Tel:
(212) CO 5-3413. N. Y. Rep.: Frieda Gillis.

NEW MEXICO

- **ALBUQUERQUE (Area Code 505)**
LaVetta, 1205 Madeira S.E., Suite 124. Zip: 87108.
Tel: 255-3978. Pres.: Lindy Blaskey.
- W E B Ent's., 3504 Carlisle N.E. Tel: 344-6261.

- **BELEN (Area Code 505)**
Little Ritchie Johnson, PO Box 3.

NEW YORK

- **BUFFALO (Area Code 716)**
Entertainment Ent's., 31-35 Janice St. Zip: 14207.
Tel: 877-0476.
- Edwin A. Hewson, 31-35 Janice St. Zip: 14207.
Tel: 877-0476.

- **HURLEY (Area Code 914)**
Empire Ent's., PO Box 158. Zip: 12443. Tel: 331-
7314. Pres.: Robert M. Kershaw.

- **NEW YORK CITY (Area Code 212)**
A D Adams Adv., 145 E. 52 St. Tel: PL 5-0845.
- Sidney Ascher & Assocs., 1545 Broadway, Zip:
10036. Tel: LT 1-2287.

- Buddy Basch, 25 W. 45 St. Zip: 10036. Tel: JU
6-7570.
- Barry Bergman, 2800 Ocean Ave. Brooklyn. Tel:
DE 2-8500.

- Ivan Black, 900 W. 190 St. Tel: LO 8-2724.
- Tim Boxer, 155 W. 46 St. Zip: 10036. Tel: PL
7-3995.

- Mal Braveman, 15 E. 48 St. Tel: EL 5-7752.
- Brite Star Nat'l Rec. Promos., 525 Lexington Ave.,
Suite 427. (see Newbury, Ohio).

- Paul Brown, 507 Fifth Ave. Tel: MU 7-3072.
- George Clark II—Int'l Press, Pan Am Bldg., 200
Park Ave., Suite 303 East. Zip: 10017. Tel:
YU 6-2515. Exec. Admin'r: Geroge Clark II.

- Liz Creighton, 325 W. 45.
- Marvin Drager, 424 Madison Ave. Tel: MU 8-1078.
- Richard Gersh Assocs., 200 W. 57 St. Zip: 10019.
Tel: CI 7-4161.

- Glen Prod'ns, 157 W. 57 St. Tel: CO 5-6585. Con-
tact: Ben Arrigo.

Ethel Gould, 23 W. 73 St. Zip: 10023. Tel: TR
3-5668.

Budd Hellawell-Budd Prod'ns, 157 W. 57 St. Tel:
CI 7-4896.

Mike Merrick, 1B E. 4B St. Zip: 10017. Tel:
PL 2-4111 (see Los Angeles, Calif.).

Music Makers Promo. Network, Shelton Towers,
49 St. & Lexington Ave. Zip: 10017. Tel:
PL 3-4951. Pres.: Joey Sasso.

Henry Okun, 157 W. 47 St.
David Platt Prod'ns, 325 W. 45 St.

R S V P, 1650 Broadway. Tel: JU 6-6707.

Dorothy Ross-Richard O'Brien Assocs., 300 W. 55
St. Zip: 10019. Tel: 247-5560.

William Kermit Smith, 1841 Broadway. Zip: 10023.
Tel: 757-2039.

Spectrum Ent's., GPO Box 1785. Zip: 10001.

Bill Spitalsky, 40 W. 57 St. Tel: 246-4280.

MORTY WAX, 1650 Broadway. Tel: CI 7-2159. (SEE
ADVERTISEMENT)

Worldwide Prod'ns, 200 W. 57 St. Tel: CO 5-4300.

- **PELHAM (Area Code 914)**
William Kermit Smith, PO Box 155. Zip: 10803.
Tel: 738-9862. Cable WKS. Pres.: Billy Smith.

- **ROCHESTER (Area Code 816)**
A R C, PO Box 9429. Zip: 14604.

NORTH CAROLINA

- **WILMINGTON (Area Code 919)**
Elvitru, 306 S. 16 St. Zip: 28401. Tel: 763-1007.
Music Makers Network of America, 306 S. 16 St.
Zip: 28401. Tel: 763-1007.

OHIO

- **CINCINNATI (Area Code 513)**
Julie Godsey Summit Dist., 265 Jupiter Dr. Tel:
921-8722.

Shad O'Shea, 2570 Harrison Ave. Tel: 481-6877.

- **CLEVELAND (Area Code 216)**
Helper & Stevens Ent's., 2208 Edgerton Rd. Zip:
44118. Tel: 321-0641 & 449-5635. Contacts:
Marv Helper & Perry Stevens.

- **COLUMBUS (Area Code 614)**
Dave Segel, 1049 Oakwood Ave. Zip: 43206. Tel:
252-5839.

United Network, 832 Leona Ave. Zip: 43201. Tel:
299-6150. Promo. Mgr.: Vernon Stewart.

- **NEWBURY (Area Code 216)**

BRITE STAR RECORD PROMOTIONS

National Promotion — Distribution Ar-
ranged — Label Contacts — TV-Radio
Coverage—Booking Agents Contracts—
Newspaper Publicity, Etc.

Brite Star, Newbury, Ohio 44065
Call CLEVELAND 216—JO 4-2211

BRITE STAR NAT'L REC. PROMOS., 14881 Overlook
Dr. Zip: 44065. Tel: JO 4-2211. Mgr.: Tex
Clark. (See N.Y.C.). (SEE ADVERTISEMENT)

- **VAN WERT (Area Code 419)**
Tom Smith Promos., PO Box 344. Tel: 233-9262.

OKLAHOMA

- **OKLAHOMA CITY (Area Code 405)**
Henley Newsfeatures, 1120 W. Park Pl. Tel: CE
6-3213.

PENNSYLVANIA

- **FRANKLIN (Area Code 814)**
Country Star Prod'ns, 439 Wiley Ave.

- **PHILADELPHIA (Area Code 215)**
David S. Chackler, 10756 Heather. Zip: 19116.
Tel: OR 6-4930.

Ed Cotlar, 2030 Brandywine St. Zip: 19130. Tel:
LO 4-3081.

Buzz Curtis, 2201 Bryn Mawr Ave. Zip: 19131. Tel:
GR 3-4030.

Gospel News Journal, PO Box 1801. Zip: 19105.
Tel: PO 9-3744. Contact: Marvin Bunton.

Jack Howard Promos., 2733 Kensington Ave. Tel:
NE 4-8487.

Al Kelly, 821 N. Broad St. Zip: 19123 (see Upper
Darby, Pa.).

Sam Rabinowitz (KSJ Ent.), 525 W. Eleanor, 2 Fl.,
Tel: 455-6703.

- **PITTSBURGH (Area Code 412)**
Barbeerecord Promo., 43 Cedricton St. Tel: 882-
2658. Pres.: Gerald F. Smith.

- **POINT MARION (Area Code 412)**
H & H Ent's., PO Box 26, Ontario Ave. Zip: 15474.
Tel: 725-5318. Nat'l Promo. Mgr.: David B.
Hoop (see Washington, D. C.).

● **READING (Area Code 215)**
Keystone Badge, 832 Franklin St. Zip: 19602. Tel: 373-1179. Gen. Mgr.: R. Ziegler.
McKinnon, 411 Gordon. Zip: 19601. Tel: 376-0300.
Promo. Dir.: Leonard McKinnon.
United Sales, 810 Franklin St. Zip: 19602. Tel: 374-5700. Gen. Mgr.: Jouis J. Fruchter.
United Serv., 104 S. Fourth St. Tel: 374-5700.

● **SCRANTON (Area Code 717)**
Bell-Nash, 912 Clay Ave. Zip: 18510. Tel: 347-8429.
Ladd Music, 401 Wintermantle Ave. Tel: 343-6718.

● **UPPER DARBY (Area Code 215)**
Al Kelly, 255 Long Ln. Zip: 19023. Tel: FL 2-2793
(see Philadelphia, Pa.).

● **WARRINGTON (Area Code 215)**
J B Artist & Rec. Promos., PO Box 222. Zip: 18976. Tel: 723-5052. Pres.: John Braithwaite.

● **WENDEL (Area Code 412)**
Ben Palien Rec. Promos., 71 Elm St. Zip: 15691.
Tel: 863-7377. Pres.: Ben Palien.

TENNESSEE

● **MEMPHIS (Area Code 901)**
Mid-South Promos., PO Box 11522. Zip: 38111.
Tel: 324-4640. Mgr.: Dennis Turnipseed.

● **NASHVILLE (Area Code 615)**
Cummings & Cummings, Suite 113 Capitol Recs.
Bldg., 806 16 Ave. S.

TEXAS

● **BEAUMONT (Area Code 713)**
Big Bopper, 888 Pearl St. Tel: TE 2-1522.

● **DALLAS (Area Code 214)**
Bob Lawler & Assocs., 3201 Turtle Creek Blvd.
Zip: 75219. Tel: LA 1-0450. Pres.: Bob Lawler.
Chas. Wright Agency, 124 N. Peak St. Zip: 75226.
Tel: TA 7-5023.

● **EL PASO (Area Code 915)**
Star Recs. Promos., 102 Texas Ave. Zip: 79946.
Tel: 533-7282. Owner: Joseph Gillman.

● **HOUSTON (Area Code 713)**
Radio y Television, 3810 Westheimer, Suite 426.
Zip: 77027. Tel: 664-3016.

● **SAN ANTONIO (Area Code 512)**
Epstein Ents., PO Box 28123, 735 N. General Mc-
Mullen Dr. Zip: 78228. Tel: GE 3-1461.
Wrangler Country, 830 Baetz Blvd. Tel: WA 4-1583.

● **TYLER (Area Code 214)**
Custom Prod'ns, PO Box 231. Zip: 75701. Tel: LY
4-2961. Mgr.: Curtis Kirk; Promo. Mgr.: Fred
Harper.

VERMONT

● **SPRINGFIELD (Area Code 802)**
Ficara Ents., 40 Clinton. Zip: 05156. Tel: 885-3820.
Mgr.: Greg Ficara.

VIRGINIA

● **CHARLOTTESVILLE (Area Code 703)**
Bee-Gee Prod'ns, 104 Fourth St. N.E. Tel: 296-6177.

● **LURAY (Area Code 703)**
Earl Rothgeb, PO Box 208, 111 N. Hawksbill St.
Tel: 743-5394.

● **NORFOLK (Area Code 703)**
Glamour Topper Promos., 702 Church St. Zip: 23501.
Tel: MA 5-4677 & KI 5-3687. Pres.: Leroy
Little.
Warren M. Miller & Assocs., 417 W. 21 St. Zip:
23517. Tel: 622-2111.

● **RICHMOND (Area Code 703)**
International Promo., 5906 Kensington Ave. Zip:
23226. Tel: 282-8835.

WEST VIRGINIA

● **CHARLESTON (Area Code 304)**
Bill McDowell Prod'ns, 3 Atkinson Ct. Zip: 25302.
Tel: 343-7744.

WISCONSIN

● **RACINE (Area Code 414)**
ENTERPRISE THIRTEEN, 523 Main St., Suite 529.
Zip: 53403. Tel: 637-8600. Owner: John J.
Braun. (SEE ADVERTISEMENT)

RECORDING STUDIOS

ALABAMA

● **HUNTSVILLE (Area Code 205)**
Parasonic, PO Box 412. Zip: 35804. Tel: 828-4863.

● **MOBILE (Area Code 205)**
Audio Master, 803-R Government St. Tel: 433-3941.

● **MONTGOMERY (Area Code 205)**
Hill-Vaughn, 3658 S. Perry St. Zip: 36105. Tel:
265-9961. Pres.: M. E. Vaughn.



IN
WASHINGTON, D.C.
BALTIMORE, MD.
RICHMOND, VA.

**REPRESENTATION
PUBLICITY
PROMOTION
DISTRIBUTION**

**&
SUPERVISION
STUDIO RECORDING
PRESSING**

TELEPHONE
ELLIOT A. RYAN
AC 202 783-2553

**UNICORN
PRODUCTIONS**

MAIN OFFICE
733 15th St. N.W., Washington, D.C. 20005

Chicago has only 1 independent promotion man . . .

EARL GLICKEN

P.S. We make the hits because we click with Glick

PROMOTIONS, LTD.

1770 Winthrop Road

Highland Park, Illinois 60035

(312) 831-4466

'CONSULTANT'

Recording
Organize Record Company
Music Publishing
Pressing
National Distribution
National Promotion

15 Years' actual experience
heading top firms with
top artists

RAY MINER

19802 N.E. 12th Pl., N. Miami Beach, Fla.
(305) 949-3033

On the West Coast . . .

**TONY
RICHLAND**

. . . Record Promotion
Artist-Publisher Representation

HO 7-2151

6363 Sunset Blvd.

Hollywood, Calif. 90028

continued

● **SHEFFIELD (Area Code 205)**
North Alabama Rec'g, 102 E. Second St. Zip: 35660. Tel: 383-2673. Pres.: Quinon R. Ivy; VP: Marlin Greene.

ARIZONA

● **PHOENIX (Area Code 602)**
Audio Recorders, 3830 N. Seventh St. Zip: 85014. Tel: CR 7-4723.

● **TUCSON (Area Code 602)**
Copper State, 815 E. Broadway. Tel: 623-0318. Pres.: Foster S. Casey.

ARKANSAS

● **HOT SPRINGS (Area Code 501)**
Rogers Rec'gs, 617 Third St. Zip: 71901. Tel: NA 3-8261. Owner-Mgr.: Patricia T. Rogers.

CALIFORNIA

● **BAKERSFIELD (Area Code 805)**
Jon Badaeux Prod'ns, PO Box 6128. (See San Bernardino).
David Welch, 1227 Brundage Ln. Zip: 93304. Tel: 831-8581.

● **BURBANK (Area Code 213)**
Location Rec'g Serv., 2201 W. Burbank Blvd. Zip: 91506. Tel: 849-1321.

● **DOWNEY (Area Code 213)**
Downey Recs., 13117 Lakewood Blvd. Tel: ME 4-2928.

● **EL MONTE (Area Code 213)**
Pacific Challenger, 11111 Garvey Blvd. Zip: 91733. Tel: 442-6250. Mgr.: R. L. Mahoney.

● **LODI (Area Code 209)**
Soundtronic Studio, PO Box 831, 880 E. Pine St. Zip: 95240. Tel: 369-5307. Studio Mgr.: Leroy Bain.

● **LOS ANGELES (Area Code 213)**
Alto Fonic, 6362 Hollywood Blvd., Hollywood. Tel: 466-9261.

● **Cadet Rec., 5810 S. Normandie Ave.**
Custom Rec. Mfg., 5810 S. Normandie Ave. Tel: PL 0-3310.

● **Electro-Vox, 5546 Melrose Ave., Hollywood. Zip: 90028. Tel: 466-2189.**

Fidelity, 6315 Yucca, Hollywood. Zip: 90028. Tel: HO 4-6277.

● **Gold Star, 6252 Santa Monica Blvd., Hollywood. Zip: 90028. Tel: 469-1173.**

● **Wally Heider, 6373 Selma Ave., Hollywood. Tel: 466-5474.**

● **Horizon, Sunset & Vine Tower, Hollywood. Zip: 90028. Tel: 466-4224. Cable: DAVONMUS. Pres.: David Hubert.**

● **Lewis Rec. Mfg., 307 E. Beach St., Inglewood. Zip: 90302.**

● **M T D (Magnetic Tape Duplicators), 7925 Santa Monica Blvd., Hollywood. Zip: 90046. Tel: OL 4-6900.**

● **C P MacGregor, 729 S. Western Ave. Tel: DU 4-4191. R C A Custom Rec. Sales, 6363 Sunset Blvd., Hollywood. Tel: HO 1-9171.**

● **R J Recorders, 6359 Selma Ave., Hollywood. Zip: 90028. Tel: 469-3527. Chief Eng.: Phil Yeend. Spectra-Sound, 6110 Santa Monica Blvd., Hollywood. Tel: HO 2-6981.**

● **United, 6050 Sunset Blvd., Hollywood. Tel: HO 9-3983.**

● **Universal Associated Studios, 5539 Sunset Blvd. Zip: 90028. Tel: HO 9-5161.**

● **Western, 6000 Sunset Blvd., Hollywood. Tel: 463-6811.**

● **WHITNEY REC., 1516 W. Glenoaks Blvd., Glendale. Tel: 245-5668. (SEE ADVERTISEMENT)**

● **PASADENA (Area Code 213)**
Custom Fidelity, 222 E. Glenarm St. Tel: 441-1114.

● **RIVERSIDE (Area Code 714)**
William Lucy Sound Studio, 8207 Arlington. Zip: 92503. Tel: 689-0411. Mgr.: Dan Yoder.

● **SAN BERNARDINO (Area Code 714)**
Jon Badaeux Prod'ns, PO Box 3211, 25991-A East 20. Zip: 92404. Tel: TU 2-0629. Pres.: Jon Badaeux; Exec. Prod'r: George E. Clements. (see Bakersfield, Calif.).

● **SAN FRANCISCO & BAY AREA (Area Code 415)**
Coast Recorders, 960 Bush St. Tel: PR 5-3900.

● **Golden State Recorders, 665 Harrison St. Zip: 94107. Tel: 781-6306.**

● **Sierra Sound, 1741 Alcatraz Ave., Berkeley. Tel: 655-7636.**

● **Sound City, 363 Sixth St. Tel: EX 2-7690. Owner: James Seagrave.**

● **SAN JOSE (Area Code 408)**
M N O Rec's, 2558 Westgate Ave. Zip: 95125. Tel: 269-2113. Gen. Mgr.: F. David Niederauer.

● **SAN MARCOS (Area Code 714)**
Record Broadcast, 237 S. Bent Ave. Tel: 744-0633.

● **VISTA (Area Code 714)**
Cook Recorders, PO Box 1508. Zip: 92083.

COLORADO

● **COMMERCE CITY (Area Code 303)**
Hernandez Rec'g, 6671 Bellaire St. Zip: 80022. Tel: 288-3003. Contact: Victor M. Hernandez.

● **DENVER (Area Code 303)**
Band Box, 5136 W. 41 Ave. Tel: 455-4118.
Delft, 5201 W. Mexico Ave. Tel: 922-0356.
Western Cine, 312 S. Pearl. Tel: 744-1017.

CONNECTICUT

● **HARTFORD (Area Code 203)**
M T R (Music Town Rec'g.), 7 S. Main St., West Hartford. Tel: 236-4439. Pres.: Irv Jeffries.

● **UNCASVILLE (Area Code 203)**
Steljo, 37 Park Ave.

FLORIDA

● **MIAMI (Area Code 305)**
Adrian Assocs., The General Bldg., 6660 Biscayne Blvd. Zip: 33138. Tel: 757-1626.

● **Artrec, 1688 Meridian Ave., Miami Beach. Zip: 33139. Tel: 532-5474.**

● **Criteria, 1755 N.E. 149 St. Zip: 33161. Tel: 947-5611. Pres.: M. L. Emerman.**

● **Warren Sound Systems, 35 N.E. 61 St. Tel: PL 4-9539. Dir.: Ray Meinberg.**

● **ORLANDO (Area Code 305)**
Whiteholme Sounds, 620 Gatlin. Zip: 32806. Tel: 422-2374. Pres.: Robert C. Benzing.

● **TAMPA (Area Code 813)**
Charles Fuller Prod'ns, Studio A, 3013 Granada St.; Studio B & Film Studio, PO Box 10513, 2722 S. Macdill. Zip: 33609. Tel: 839-5471; Night No.: 839-4880.

GEORGIA

● **ATLANTA (Area Code 404)**
LeFevre Sound Studios, 1314 Ellsworth Ind'l Dr. N.W. Zip: 30318. Tel: 355-8680.

● **CALHOUN (Area Code 404)**
Cherokeeland Rec'gs, PO Box 502, Rm. 2, Johnston-Hall Clinic Bldg. Zip: 30701. Tel: 629-3950. Pres.: J. Carter.

● **DECATUR (Area Code 404)**
National Rec'g, 2871 E. Ponce De Leon Ave. Tel: 378-2379.

ILLINOIS

● **CHICAGO (Area Code 312)**
Argus Audio, 3505 N. Ashland. Tel: EA 7-8989.
Audio-Craft, 11359 S. Lohair. Tel: BE 3-4717.
Audio Spectrum (div. of Transit Play), 777 S. Tripp. Tel: 826-4813.

● **Balkan, 6917 W. Cermak Rd., Berwyn. Boulevard, 632 N. Dearborn St. Tel: WH 4-2752. C & L, 4140 W. 56 Pl. Tel: LU 5-3340.**

● **Century Rec., 303 Pine Prospect Heights. Tel: 392-0919.**

● **Chess Rec., 2120 S. Michigan. Tel: CA 5-2770. Chicago Sound Studios, 4849 N. Western. Tel: 728-2966.**

● **Columbia Rec. Prod'ns, 630 N. McClurg Ct. Zip: 60611. Tel: WH 4-6000.**

● **Concertapes Studios, 1010 Central Wilmette. Tel: AL 6-0680.**

● **Crystal Studios, 36 W. Randolph. Tel: DE 2-2065. Delta Recs., 4304 W. Fullerton. Tel: DI 2-7337.**

● **Filmack Studios, 1327 S. Wabash. Tel: HA 7-4855. Globe, 230 N. Michigan. Tel: RA 6-0126. Mgr.: Don Lavery.**

● **International Rec'g Co. (IRC), 5619 W. Division St. Zip: 60651. Tel: 378-4848.**

● **Jay Jay, 2454 S. Kedzie Ave. Tel: 762-6000. Joy, 111 E. Ontario. Tel: 337-8055.**

● **M B S, 228 S. Wabash. Tel: WE 9-0866. Morrison Sound Studio, 2011 W. 69. Tel: 925-6810.**

● **Norelco-Audio Video Prods., 1043 E. 95. Tel: 731-4404.**

● **Parliament, 3547 W. Madison. Tel: 638-6851. R C A Custom Rec. Sales, 445 N. Lake Shore Dr. Tel: WH 4-3215.**

● **Rapid Recs., 410 S. Michigan. Tel: WA 2-0079. Recordings Unlimited, 64 E. VanBurn. Tel: 922-2340.**

● **Sheldon, 1725 N. Wells. Tel: 664-7734. Sonic Film, 1230 W. Washington. Tel: CH 3-2600.**

● **Sound Studios, 230 N. Michigan. Tel: 236-4814. Stereo-Sonic, 226 S. Wabash. Tel: 922-0132.**

● **Tono-Tape Duplicating, 46 E. Walton. Tel: 642-6465. Universal, 46 E. Walton. Tel: MI-2-6465.**

● **Vantage, 1849 W. 107 St. Zip: 60643. Tel: 335-1109. Cable: VANTAGE.**

● **Webb, 812 N. Dearborn. Tel: 664-0705. Zenith Cinema Serv., 3252 W. Foster. Tel: 478-2103.**

● **QUINCY (Area Code 217)**
I T, 423 S. 16. Zip: 62301. Tel: 223-7346.

INDIANA

● **SOUTH BEND (Area Code 219)**
Custom, PO Box 755. Zip: 46624. Tel: 234-4248. Pres.: Thomas W. Zoss.

KANSAS

● **LOUISBURG (Area Code 913)**
Kurl, Rt. 2.

● **WICHITA (Area Code 316)**
High Fidelity, 445 N. Oliver. Zip: 67208. Tel: MU 2-7481. Pres.: Raymond Creely.

● **S T A, 227 15a, PO Box 11372. Zip: 67211. Tel: AM 7-3275.**

KENTUCKY

● **LOUISVILLE (Area Code 502)**
Orbit Radio, PO Box 1644, 1863 Arlington. Zip: 40201. Tel: 895-1143.

● **Sambo Sound Studio, 9912 Taylorsville Rd. Zip: 40299. Tel: 267-5466. Contact: Tim Tyler.**

LOUISIANA

● **BATON ROUGE (Area Code 504)**
Apollo, PO Box 1564, 307 N. Blvd. Zip: 70801. Tel: 342-3209. Pres.: Al Michael; Exc. VP & Sec.-Treas.: Ted Hart.

● **LAFAYETTE (Area Code 318)**
La Louisianne, 711 Stevenson St.; Bus. Office: 2823 Johnston St. Tel: 234-4118.

● **NEW ORLEANS (Area Code 504)**
Andates-Basand, 2627 Leonidas. Zip: 70118. Tel: 861-7494.

● **Cosimo, 748 Camp St. Zip: 70130. Tel: 523-7474. Superior Plastics, 748 Camp St. Zip: 70130. Tel: 523-7474. Contact: Miss Barbara Ann Richardson.**

MARYLAND

● **ACCOKEEK (Area Code 301)**
Ray Vernon Prod'ns, PO Box 6.

● **BALTIMORE (Area Code 301)**
RECORDINGS, INC., 1130 E. Cold Spring Ln. Tel: 433-0701. (SEE ADVERTISEMENT)

Attention, Distributors
ENTERPRISE THIRTEEN
Presents
"The Sultans Five"
Miss Beverly Pitts
Miss Dorothy Fisher
on 45's
Albums Available after
September 13, 1966
Order Today from
ENTERPRISE THIRTEEN
523 Main Street, Suite 529
Racine, Wisconsin 53403

Representing the
top artists in the
world of music

■

BRAVERMAN-MIRISCH
Advertising/Public Relations
9255 Sunset Boulevard
BRadshaw 2-8608
MILLICENT BRAVERMAN

●

Los Angeles, California
CRestview 5-5169
DAVID MIRISCH

MASSACHUSETTS

- **FRAMINGHAM** (Area Code 617)
Continental, 12 Irving St. Zip: 01701. Tel: 879-2430. Pres.: L. Daniel Flynn.
- **SPRINGFIELD** (Area Code 413)
Universal, 26 Colton Ave., West Springfield. Tel: RE 6-7727.

MICHIGAN

- **DETROIT** (Area Code 313)
Centaur-Anton, 15336 Robson. Zip: 48227. Tel: 835-7227. Pres.: J. C. Malamis.
- Ernstrat Prod'ns, 15305 Livernois. Zip: 48238. Tel: 861-5651.
- GOLDEN WORLD**, 3246 Davison W. Tel: 833-7843. (SEE ADVERTISEMENT)
- Master, 8325 Joy Rd. Tel: 935-9709.
- Recordland, 13673 Wales. Zip: 48237. Tel: LI 2-2338.
- Tri-Sounds, 11825 Hamilton, Highland Park. VP: Major Reynolds.

- **NEW HAVEN** (Area Code 313)
Sound, Inc., 56880 North Ave. Tel: 749-3225.

- **STEVENSVILLE** (Area Code 616)
Wildwood, PO Box 39. Pres.: Jerry Kohlert.

MINNESOTA

- **DULUTH** (Area Code 218)
Star, 1615 London Rd. Zip: 55812. Tel: 728-4208.
- **MINNEAPOLIS** (Area Code 612)
Dove, 9358 James Ave. S. Zip: 55431. Tel: 888-4459. Pres. & Gen. Mgr.: Donald H. Peterson.
- Kaybank, 2541 Nicollet. Zip: 55404. Tel: TA 7-5441.

- **ST. PAUL** (Area Code 612)
E M C, 180 E. Sixth St. Zip: 55101. Tel: 227-7366.

MISSISSIPPI

- **JACKSON** (Area Code 601)
Mac, 328 O'Ferrall Ave. Zip: 39209. Tel: 355-9450 & 354-3127.

- **LONG BEACH** (Area Code 601)
Sonovue, PO Box 104. Tel: 864-8911. Co-owners: John N. Blackburn & Pewee Maddux.

MISSOURI

- **KANSAS CITY** (Area Code 816)
Fremmerman, 3706 Broadway. Tel: PL 3-686B.

MONTANA

- **HELENA** (Area Code 406)
Valtron, 305 Allen St. Zip: 59601. Tel: 442-0734.

NEBRASKA

- **LINCOLN** (Area Code 402)
Williams Rec. Serv., 2650 N. 48 St. Zip: 68504. Tel: 434-4745.

NEVADA

- **LAS VEGAS** (Area Code 702)
United, 3143 Industrial Rd. Tel: 735-7131.

NEW HAMPSHIRE

- **DURHAM** (Area Code 603)
Strafford Rec., PO Box 599. Zip: 03824. Tel: 742-2041. A&R: Russ Hamm; Sales Mgr.: Curt Bean.

- **KEENE** (Area Code 603)
Vanguard Prod'ns, 16 Ridgewood Ave. Zip: 03431. Tel: 352-7131.

NEW JERSEY

- **BERGENFIELD** (Area Code 201)
Double Echo, 14 Magnolia St.

- **CAMDEN** (Area Code 609)
Recorded Publ'ns Labs. (div. of Recorded Publ'ns Mfg.), 1558-1570 Pierce Ave. Zip: 08105. Tel: 963-3000. VP & Sales: David H. Goodman.

- **TOTOWA BOROUGH** (Area Code 201)
Sim-O-Rama Sound Serv., 572 Union Blvd. Zip: 07512. Tel: 274-6772. Owner: Tony Simonetti.

NEW MEXICO

- **ALBUQUERQUE** (Area Code 505)
Count, 227 Sierra S.E. Zip: 87109. Tel: 255-8425. Mgr.: John Wagner.
- LaVetta, 2037 Alvarado N.E. Zip: 87110. Tel: 268-8405. Mgr.: Lindy Blaskey.

NEW YORK

- **BINGHAMTON** (Area Code 607)
K M Studios, Palmer Hill Rd., RD 1, Port Crane. Zip: 13833. Tel: 648-5194.

- **BUFFALO** (Area Code 716)
Howell, 2703 Delaware Ave. Tel: 876-9800.

- **FRANKLIN SQUARE, L. I.** (Area Code 516)
Audio Rec'g & Mfg., 4 New Hyde Park Rd. Zip: 11010. Tel: GE 7-6200.

- **HEMPSTEAD, L. I.** (Area Code 516)
Ultra-Sonic, 149 N. Franklin St. Tel: IV 5-5066.

- **ITHACA** (Area Code 607)
Alcor, 215 S. Tioga St. Tel: AR 3-4242.

- **NEW YORK CITY** (Area Code 212)
A-1 Sound, 234 56 St. Zip: 10019. Tel: CI 6-3594.
- A & R, 112 W. 48th St. Tel: JU 2-1070. (SEE ADVERTISEMENT)

- Ality, 5914 Fifth Ave., Brooklyn. Zip: 11220. Tel: HY 2-7771.

- Allegro Sound, 1650 Broadway.
- Artcraft, 285 E. 49 St., Brooklyn. Tel: PR 8-5150.
- Associated, 723 Seventh Ave. Tel: CI 5-7640.

- Bell Sound, 237 W. 54 St. Zip: 10019. Tel: JU 2-4812.

- BelTone, 4 W. 31 St. Tel: OX 5-1055.
- Capitol, 151 W. 46 St. Tel: JU 2-8040.

- Dick Charles Rec'g Serv., 729 Seventh Ave. Tel: JU 2-7920.

- R D Cortina, 136 W. 52 St. Tel: JU 2-3845.
- Cue, 117 W. 46 St. Tel: PL 7-3641.

- Fine, 118 W. 57 St. Tel: CI 5-6969.
- International, 264 W. 35 St. Tel: CH 2-1455.

- Jaysina, 143 W. 51 St. Zip: 10009. Tel: CI 6-9400.
- Knickerbocker Sound, 146 W. 47th St. Tel: LT 1-9270.

- LONGMARK PROD'NS, 1674 Broadway, Suite 703. Zip: 10019. Tel: 245-9709. (see Utica, N. Y.). (SEE ADVERTISEMENT)

- Madison Sound, 12 E. 44 St. Tel: YU 6-3970.

- Mastertone, 130 W. 42 St. Tel: WI 7-2940.
- Nola, 111 W. 57 St. Tel: JU 2-1417 & JU 6-0040.

- Olmsted, 1 E. 54 St. Tel: PL 1-0890.
- R C A Custom Rec. Sales, 155 E. 24 St. Tel: MU 9-7200.

- Recording Studios, 1639 Broadway. Tel: PL 7-8855.
- Regent, 25 W. 56 St. Tel: CI 5-2630.

- Richcraft, 1706 Flatbush Ave., Brooklyn. Zip: 11210. Tel: ES 7-1664.

- Stereo Sound, 238 E. 26th St. Tel: MU 3-5240.
- Studio 76, 1650 Broadway. Tel: CI 7-6010.

- Talentmasters, 126 W. 42 St. Zip: 10036. Tel: LO 5-9524.

- True Tone, 160 W. 73 St. Tel: TR 4-2015.



Offering the finest in Stereo 4-track recording—complete dub and mastering facilities. The latest European equipment.

"THE BEST IN THE MIDWEST"

GOLDEN WORLD RECORDING STUDIOS

3246 Davison West, Detroit 38, Mich. Tel. (313) 833-7844

continued

Variety Sound, 225 W. 46 St. Zip: 10036. Tel: JU 6-7947.

- **ROCHESTER (Area Code 716)**
Audition, PO Box 9429. Zip: 14604.
Lifetime, 133 North St. Zip: 14604. Tel: 454-1269.
Star Artist, 67 Chestnut St., Suite 710. Tel: 546-6780, Ext. 710. Pres.: Donnie Lee Bailes.
- **UTICA (Area Code 315)**
LONGMARK PROD'NS, 814 Jay St. Tel: 724-3464. (see N.Y.C.). (SEE ADVERTISEMENT)
- **VALLEY STREAM, L. I. (Area Code 516)**
Sound Unlimited, 906 Lynn Dr. Tel: LO 1-7515.

NORTH CAROLINA

- **CHARLOTTE (Area Code 704)**
Arthur Smith, PO Box 17551, 5457 Old Monroe Rd. Tel: 536-0424.
Haviland Smith, 1020 Central Ave. Zip: 28204. Tel: ED 2-8331.
- **GREENSBORO (Area Code 919)**
Copeland Sound, PO Box 6104. Tel: 275-0434.
- **WASHINGTON (Area Code 919)**
Prince, Bank of Washington Bldg. Tel: 946-2569, 6101. Pres.: Barney L. Conway Jr.

OHIO

- **CINCINNATI (Area Code 513)**
A D C O, 7527 Juler Ave. Zip: 45243. Tel: 561-7818.
Finch, 3250 Harvey Ave. Zip: 45229.
King Custom Rec. Serv., 1540 Brewster Ave. Tel: 751-1910.
Mega-Sound, 1403 First Nat'l Bank Bldg. (see Dayton, Ohio.)
Shad O'Shea, 2570 Harrison Ave. Tel: 481-6877.
Rite Rec. Prod'ns, 9745 Lockland Rd. Tel: 761-8844.
Saxony, 3014 Woodburn. Zip: 45206. Tel: 861-7554
- **CLEVELAND (Area Code 216)**
Boddie, 12202 Union Ave. Zip: 44105. Tel: 752-3440. Contact: Mr. Boddie.
CLEVELAND, 1515 Euclid Ave. Zip: 44115. Tel: 621-9362. Pres: Frederick C. Wolf; VP: Kenneth R. Hamann. (SEE ADVERTISEMENT)
- KELMAR, 1054 E. 71 St. Zip: 44103. Tel: 391-4518. Pres.: Joel Kischel. (SEE ADVERTISEMENT)

- Pama, 4991 Osborn Rd. Tel: 581-0661.
Szappanos, 3046 E. 123 St. Zip: 44120. Tel: 561-5524.
- W B K R, 1169 Sylvania Rd. Tel: 382-0900.
Way-out, 1850 E. 55 St. Zip: 44104. Tel: EN 1-7918.
- **COLUMBUS (Area Code 614)**
Magnetic Studios, 1670 W. First Ave. Tel: 486-2469.
- **DAYTON (Area Code 513)**
Mega City Music, 126 Davis Ave. Zip: 45403. Tel: 256-6931, 6557.
Mega-Sound, 49 Heid Ave. Zip: 45404. Tel: 233-6904. Gen. Mgr.: Floyd Whited (see Cincinnati, Ohio).
- **HAMILTON (Area Code 513)**
Melody, 1912 St. Clair St. Zip: 45011. Tel: 895-0607. Pres.: William M. Jones.
- **TOLEDO (Area Code 419)**
A & T Prod'ns, 318 Summit St. Zip: 43604. Tel: 248-2491. Pres.: James Thomson.
- **YOUNGSTOWN (Area Code 216)**
W A M, 10 Ellenwood. Tel: 744-5819.

PENNSYLVANIA

- **ALLENTOWN (Area Code 215)**
Allentown Rec., 10 & Walnut Sts. Tel: 433-7405.
- **FRANKLIN (Area Code 814)**
Process Rec., 439 Wiley Ave. Zip: 16323. Tel: 432-4633.
- **PHILADELPHIA (Area Code 215)**
Abundant Sounds, 4 & 6 S. Mole St. Zip: 19102. Tel: LO 8-0985.
Impact, 7102 1/2 Castor Ave. Zip: 19149. Tel: FI 2-8760. Pres.: Anthony Schmidt.
Virtue, 1618 N. Broad St. Zip: 19121. Tel: PO 9-9479. Pres.: Frank Virtue.
- **PITTSBURGH (Area Code 412)**
GATEWAY, 234 Forbes. Tel: 471-5875. (SEE ADVERTISEMENT)
United Rec. Serv., 2724 Penn Ave. Zip: 15222. Tel: AT 1-9898.
- **POTTSTOWN (Area Code 215)**
Vantage, PO Box 212. Zip: 19464. Tel: 323-3336.
- **SHARON (Area Code 412)**
Marjon, 930 Woodview Pl. Tel: DI 7-4726.

RHODE ISLAND

- **PAWTUCKET (Area Code 401)**
Johnston Sound Serv., 111 Sweet Ave. Tel: 723-7773.

SOUTH CAROLINA

- **GEORGETOWN (Area Code 803)**
Factor Prods., 909 Front St. Tel: 546-9409.
- **GREENVILLE (Area Code 803)**
Custom Rec'g & Sound, PO Box 3961, Park Pl. Zip: 29608. Tel: CE 3-2252.

TENNESSEE

- **HENDERSONVILLE (Area Code 615)**
Fred Foster, 530 W. Main St. Zip: 37075. Tel: 824-6565.
- **MADISON (Area Code 615)**
Starday Sound & Film Studio, PO Box 115, Dickerson Rd. at Due West. Tel: 228-2575.
- **MEMPHIS (Area Code 901)**
Arden, 1457 National. Zip: 38122. Tel: 324-5368. Mgr.: John Fry.
- **NASHVILLE (Area Code 615)**
Audiofax, 821 19 Ave. S. Zip: 37203. Tel: 242-5585.
Globe, 420 Broad St. Tel: AL 5-7645.
Music City Recorders, 821 19 Ave. S. Zip: 37203. Tel: 242-5585.
Nashville-West, 5505 Melrose. Pres.: Charles Underwood.
R C A Custom Rec. Sales, 800 17 Ave. S. Tel: AL 5-5781.

TEXAS

- **AMARILLO (Area Code 806)**
Demand Rec. Organization, 2027 S. Bonham St. Tel: 356-4806.
- **DALLAS (Area Code 214)**
Pams Prod'ns, 4141 Office Pkwy. Tel: TA 7-0901.
Sellers, 2102 Jackson. Tel: RI 1-5836.
- **EL PASO (Area Code 915)**
Star, 102 Texas at Oregon. Tel: 533-7282. Contact: Joe Gillman.
- **FORT WORTH (Area Code 817)**
Bo-Kay, 3712 N.E. 28 St. Zip: 76111. TE 8-2402. Pres.: Jesse Smith.
Delta Rec'g Ctr., PO Box 9428, 910 Currie St. Zip: 76107. Tel: ED 2-3821.
Oakridge, 2001 Elton Rd. Tel: TE 8-6608.
Sound City, 1705 W. Seventh St. Tel: ED 5-9511.
- **HOUSTON (Area Code 713)**
Ferrer, 46 Berry Rd. Tel: OX 7-8904.
- **McALLEN (Area Code 512)**
Pharaoh, PO Box 969. Tel: MU 6-0791.
- **ODESSA (Area Code 915)**
Tommy Allsup, PO Box 6406, 5600 E. County Rd. Zip: 79762. Tel: EM 2-1512. Partners: Tommy Allsup & Gorman Maxwell.
- **PORT ARTHUR (Area Code 713)**
L & F, 1812 Procter St. Zip: 77640. Tel: YU 2-7121.
- **SAN ANTONIO (Area Code 512)**
Epstein Ents., PO Box 28123, 735 N. General McMullen Dr. Zip: 78228. Tel: GE 3-1461.
Southern Rec. Serv., 506 W. Hildebrand Ave. Tel: PE 3-1721. Mgr.: Jack Bond.
Tanner 'N' Texas, 1422 W. Poplar. Tel: PE 2-8072.
Texas Sound, 506 W. Hildebrand Ave. Tel: PE 3-1721.
- **SAN BENITO (Area Code 512)**
Ideal, 119 S. Sam Houston Blvd. Zip: 78586. Tel: EX 9-1471.
Rio Grande Music, 119 S. Sam Houston Blvd. Zip: 78586. Tel: EX 9-1471.
- **TYLER (Area Code 214)**
Custom Sound, PO Box 231. Zip: 75702. Tel: LY 4-2961. Mgr.: Curtis Kirk.
Steve Wright, PO Box 626, 1608 S. Fleishel. Zip: 75701. Tel: LY 2-0591. Pres.: Steve Wright.

VIRGINIA

- **FALLS CHURCH (Area Code 703)**
Wynwood, 102 E. Fairfax St. Tel: 532-9597.
- **NORFOLK (Area Code 703)**
D'Arcy Sound, 417 W. 21 St. Zip: 23517. Tel: 622-2111.

WASHINGTON

- **BELLINGHAM (Area Code 206)**
Sound Preservers, 1110 Indian St. Zip: 98225. Tel: 734-5621. Owner: Allen P. Giles.

WEST VIRGINIA

- **BECKLEY (Area Code 304)**
Magna Recs., PO Box 812, 101 Whitestick Rd. Tel: 252-5161. Pres.: R. L. Zeigler.

Gateway Recordings, Inc.

HOME OF GATEWAY & DYNO RECORDS
COMPLETE RECORDING FACILITIES
FOR 45 AND LP RECORDS
MONO/STEREO

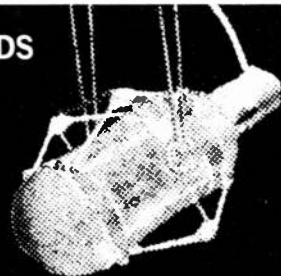

Scully 4-Track Recorder and Mastering Lathes

Ampex Mono and Stereo Recorders

MASTERING • PRESSING • ART DEPARTMENT

Recorded At Gateway

- | | |
|-----------------|----------------|
| Louis Armstrong | The Vogues |
| Jack Jones | Harold Betters |
| The Four Coins | Marion Lush |



GATEWAY RECORDINGS, INC.
234 FORBES AVENUE
PITTSBURGH, PA. 15222
PHONE 471-5875

WISCONSIN

● **RHINELANDER** (Area Code 715)
Audio Unlimited, 1418 N. Stevens St. Zip: 54501.
Tel: 362-2059. Owner & Mgr.: M. Kuehl.

WYOMING

● **WORLAND** (Area Code 307)
Wyoming Music Ent's., PO Box 104, 707 N. 10.
Zip: 82401. Tel: 347-3872. Pres.: Ray Pendergast.

RECORDING STUDIOS— EQUIPMENT

Altec Lansing, 1515 S. Manchester Ave., Anaheim, Calif. 92803. Tel: (714) PR 4-2900. Sales: H. S. Morris.

Chief products: General audio equip.

Ampex, 401 Broadway, Redwood City, Calif. 94063. Tel: (415) 367-2911. Sales Mgr.: R. Owens.

Chief products: Tape recorders, duplicators, accessories.

Audio Devices, 235 E. 42 St., New York, N. Y. 10017. Tel: (212) MU 7-0800. Sales Mgr.: H. Kornbrodt.

Chief products: Discs, needles, tape, cartridges.

Ballantine Labs., PO Box 97, Fanny Rd., Boonton, N. J. 07005. Sales Mgr.: F. Zayac.

Chief products: Voltmeters & other electronic measuring instruments.

R T Bozak, PO Box 1166, Darien, Conn.; 587 Connecticut, Norwalk, Conn. Tel: (203) 838-6521.

Chief products: Speakers.

C B S Labs., 227 High Ridge Rd., Stamford, Conn. 06905. Tel: (203) 325-4321. Pres.: P. Goldmark.

Chief products: General audio equip.

Cinema, 1100 Chestnut St., Burbank, Calif. 91503. Tel: (213) 849-5511. Sales Mgr.: P. Hotchkiss.

Chief products: General audio equip.

Concertone, 9731 Factorial Way, South El Monte, Calif. 91733. Tel: (213) GI 3-3211. Sales: Bernard Kaufman.

Chief products: Tape recorders.

Concord Electronic, 1935 Armacost Ave., West Los Angeles, Calif. 90025. Tel: (213) 478-2541.

Chief products: Tape recorders.

Daven, 53 W. Point Pleasant Ave., Livingstone, N. J. 07039. Tel: (201) 992-4300. Sales Mgr.: G. McKenna.

Chief products: Networks, alternators, switches.

Dynaco, 3912 Powelton Ave., Philadelphia, Pa. 19104. Tel: (215) EV 6-9405. Sales Mgr.: R. Tucker.

Chief products: Amplifiers.

E M I (see Scope).

Electro Voice, Cecil & Carroll Sts., Buchanan, Mich. 49107. Tel: (616) 695-6831. Pres.: A. Kahn.

Chief products: Microphones, speakers.

Fairchild Rec'g Equip., 10-40 45 Ave., Long Island City, N. Y. 11101. Tel: (212) ST 4-6163. Sales Admin'r: M. P. McLaughlin.

Chief products: General audio equip.

Fisher Radio, 11-40 45 Rd., Long Island City, N. Y. 11101. Tel: (212) 937-2100. Sales Mgr.: Harry Norman.

Chief products: Amplifiers, tuners, speaker systems.

General Electric (admin. offices), 570 Lexington Ave., New York, N. Y. 10022. Tel: (212) PL 1-1311.

Consumer Electronics Div., Television Receiver Dept., Electronics Park, Syracuse, N. Y. 13201.

Tel: (315) 456-0123. Mktg. Mgr.: Steven R. Mihalic.

Radio Receiver Dept., 1001 Broad St., Utica, N. Y. 13501. Tel: (315) SW 7-0750. Mktg. Mgr.: John S. Chamberlin.

Audio Products Dept., 2200 N. 22 St., Decatur, Ill. 62525. Tel: (217) 428-4311. Mktg. Mgr.: Jack L. Hunter.

Chief products: General audio equip.

General Radio, 22 Baker Ave., West Concord, Mass. 01780. Tel: (617) EM 9-4400. Sales Mgr.: W. Saylor.

Chief products: Test equip.

Harvey Radio, 103 W. 43 St., New York, N. Y. 10036. Tel: (212) JU 2-1500. Sales Mgr.: Ronald Coll.

Chief products: Recording consoles.

Hewlett-Packard, 1501 Page Mill Rd., Palo Alto, Calif. 94304. Pres.: D. Packard.

Chief products: Electronic test instruments.

I T T Cannon, 3208 Humbolt St., Los Angeles, Calif. 90031. Tel: (213) 225-1251. Pres.: J. Yunker.

Chief products: Plugs, accessories.

K L H Research & Development, 30 Cross St., Cambridge, Mass. 02139. Tel: (617) 547-3815. Sales Mgr.: S. Pressman.

Chief products: Speakers, phonographs.

Koss Electronics (Rek-o-Kut), 2227 N. 31 St., Milwaukee, Wis. 53208. Tel: (414) 444-9442. Sales Mgr.: G. Cornehl.

Chief products: Turntables, headphones.

Lane Electronics, 507 Fifth Ave., New York, N.Y. 10017. Tel: MU 2-7147. Pres.: Lon Lang.

Chief products: Tape duplicating systems.

Langevin, 503 S. Grand Ave., Santa Ana, Calif. Tel: (714) 546-8830. Sales Mgr.: R. Kuri.

Chief products: General audio equip.

James B. Lansing Sound, 3249 Casitas Ave., Los Angeles, Calif. 90039. Tel: (213) NO 5-4101. Pres.: W. Thomas.

Chief products: Speakers, amplifiers.

Magnecord (see Midwestern Instrument).
McIntosh Lab., 2 Chambers St., Binghamton, N. Y. 13903. Tel: (607) 723-5491. Sales Mgr.: G. Gow.

Chief products: Amplifiers, receivers.
Midwestern Instrument (Magnecord), PO Box 7509, 41 St. & Sheridan Rd., Tulsa, Okla. 74105. Tel: (918) NA 7-1111. Sales Mgr.: James Arrington.

Chief products: Tape recorders.

Norelco, Prof. Sound Prods. Div., 100 E. 42 St., New York, N.Y. 10017. Tel: OX 7-3600.

Chief products: Microphones.

Pickering, 101 Sunnyside Blvd., Plainview, L. I., N. Y. 11803. Tel: (516) OV 1-0200. Sales Mgr.: C. Bennett.

Chief products: Stylus cartridges.

Pultec (Pulse Techniques), 1411 Palisades Ave., West Englewood, N. J. Tel: (201) TE 7-2575.

Chief products: General audio equip.

Radio Corp. of America (RCA), Front & Cooper Sts., Camden, N. J. Tel: (609) WO 3-8000. Sales Mgr.: E. Tracy.

Chief products: General electronic equip.

Reeves Soundcraft, Great Pasture Rd., Danbury, Conn. 06810. Tel: (203) 743-7601. Sales: George Petetin.

Chief products: Tapes, discs.

Reevesound, 35-54 36 St., Long Island City, N. Y. Tel: (212) 729-5100. Sales Mgr.: Adolph Schuster.

Chief products: Magnetic recording studio equip.

UA → the answer

to all your needs for—

**STUDIO RECORDING EQUIPMENT
PRESSING EQUIPMENT
MATRIX EQUIPMENT**

**WE SELL AND INSTALL WORLD-FAMOUS PLATING EQUIPMENT THAT
MAKES STAMPERS IN 50 MINUTES OR LESS . . . CLEAN ENOUGH TO INSTALL
ANYWHERE . . . SIMPLE TO OPERATE . . . AND COMPLETELY FOOL-PROOF TO USE.**

UNIVERSAL AUDIO SALES CORPORATION

JOHN A. MICHAELSON, PRESIDENT

2451 NICOLLET AVENUE • MINNEAPOLIS, MINNESOTA • (612) 827-5443

CREATIVE DESIGN

◆ ◆ ◆

PRINTING & PACKAGING

● ● ●

RECORDING AND RECORD MANUFACTURING

● ● ●

NOW IN MIAMI →

NEW OFFICE
ADRIAN ASSOCIATES

6660 Biscayne Boulevard, Miami, Fla. 33138
(305) 757-1626-7

RECORD PRESSING SPECIAL
Finest Quality Fast Service

Quantity	45 rpm Mono.	12" 33 1/3 Mono.
100	45.00	100.00
300	64.00	170.00
500	85.00	215.00
1000	125.00	350.00

This price includes mastering, processing, any color label, and plain sleeve. Inquire about our demo work, national promotion and distribution. Records shipped in 5 days after order is received. Reorders shipped same day we receive them.

Longmark Productions Incorporated
P.O. Box 116, Dept. B
New York Mills, New York
Phone 315-724-3464 or 315-737-7341

continued

Scope Electronics (EMI), 470 Park Ave. S., New York, N. Y. 10016. Tel: (212) 889-6800. Sales Mgr.: Murry Rosenberg.
Chief products: Recorders, speakers, amplifiers.

H H Scott, 111 Powder Mill Rd., Maynard, Mass. Tel: (617) 897-8801. Sales Mgr.: E. Dyett Jr.
Chief products: Amplifiers, speakers, receivers.

Scully Rec'g Instruments, 480 Bunnell, Bridgeport, Conn. Tel: (203) 335-5146. Contact: Lawrence J. Scully.
Chief products: Recording instruments & lathes, tape machines.

Sennheiser Electronic, 500 Fifth Ave., New York, N. Y. 10036. Tel: (212) LO 4-0433. Pres.: Thomas Schillinger.
Chief products: Microphones, transformers.

Sherwood Electronic Labs., 4300 N. California Ave., Chicago, Ill. 60618. Tel: (312) IR 8-7300. Sales Mgr.: A. Fields.
Chief products: Amplifiers.

Shure Bros., 222 Hartrey Ave., Evanston, Ill. 60204. Tel: (312) DA 8-9000.
Chief products: Headphones, playback cartridges, microphones, preamplifiers.

Sony (see Superscope).

Stanton Magnetics, Terminal Dr., Plainview, L. I., N. Y. Tel: (516) 681-0200. N.Y.C. Tel: (212) HI 5-0063. Sales Mgr.: Tom Donohue.
Chief products: Stylus cartridges, tone arms, turntables.

Superscope (Sony), 8150 Vineland Ave., Sun Valley, Calif. 91353. Tel: (213) 875-0810. Sales Mgr.: Fred Tushinsky.
Branch: Woodside, Queens, N. Y. 37-09 56 St. Zip: 11377. Tel: (212) 446-7227. VP Sales: Ellis G. Rosen.
Chief products: Recorders, tapes, microphones.

3 M, 2501 Hudson Rd., St. Paul, Minn. 55119. Tel: (612) 733-1110.
Chief products: Tapes, recorders.

United Transformer, 150 Varick St., New York, N. Y. Tel: (212) AL 5-3500. Sales Mgr.: H. Russell.
Sound Div., 809 Stewart Ave., Garden City, L. I., N. Y. 11533. Tel: (516) CH 8-6404. Sales Mgr.: P. Bert Groveman.
Chief products: Transformers, speakers.

Vinco Electronics, 1500 Dixwell Ave. Hamden, Conn. 06514. Tel: 248-0914. Gen. Mgr.: Vincent Esposito.
Chief products: Sound systems.

Weston Instruments, 614 Frelinghuysen Ave., Newark, N. J. Tel: (201) 243-4700. Sales Mgr.: E. Brown.
Chief products: Electronic test equip.

Westrex, 1 Lefevre Ln., New Rochelle, N. Y. Tel: (914) NE 6-1620.
Chief products: Cutting heads, amplifiers.

SHIPPING SERVICES

CALIFORNIA

● **LOS ANGELES (Area Code 213)**
Allied Rec., 2437 E. 57 St. Zip: 90058. Tel: 582-0841.
Cadet Rec., 5810 S. Normandie Ave.
Container-Kraft, 721 E. 61 St. Tel: 232-3281.
Monarch, 4852-56 W. Jefferson Blvd. Tel: RE 2-6185
Rainbo, 1041 N. Las Palmas, Hollywood. Tel: HO 6-7516.

● **SAN FERNANDO (Area Code 213)**
Consolidated Artists Bureau, PO Box 411. Tel: DI 2-9109.

CONNECTICUT

● **UNCASVILLE (Area Code 203)**
Steljo, 37 Park Ave.

GEORGIA

● **DECATUR (Area Code 404)**
National Rec'g, 2871 E. Ponce De Leon Ave. Tel: 378-2379.

LOUISIANA

● **GRETTA (Area Code 504)**
PHONO REC. PRESSING, 95 First St. Tel: 367-8822.
Contact: Ralph Pate. (SEE ADVERTISEMENT)

● **NEW ORLEANS (Area Code 504)**
Andates-Basand, 2627 Leonidas. Zip: 70118. Tel: 861-7494.



A & R RECORDING, INC.

is Proud to Announce

Acquisition of

Additional Recording Studios

799 Seventh Avenue

(Currently Occupied by Columbia Records)

Occupancy is Anticipated January, 1967

A & R RECORDING, INC., 112 W. 48th St., New York 36, N. Y. JUdson 2-1070

Arthur D. Ward
President

Phil Ramone
Exec. Vice President

Don Frey
Vice President



CAPTURE ALL THE SOUND!!!

Finer quality Custom records & albums (original art or stock) Lower prices, faster personalized service—anywhere in U. S.
National Manufacturer & Distributor.

**CREATIVE SOUND 9000 sunset boulevard
los angeles, california 90069 (213) CR 1-4843**

WHITNEY RECORDING STUDIO

Complete Studio Facilities

Air Conditioned

Day & Night by Appointment

Mono. & Stereo Mastering

TAPE DUPLICATORS

Professional or Personal

Specialists in Recording & Tape Duplicating

STEREOPHONIC RECORDING

● 4 M PIPE ORGAN ● NEUMAN DISC
● HAMMOND ORGAN ● CONTROL LATHE
● STEINWAY PIANO ● AMPEX RECORDERS
● ECHO CHAMBER AND DUPLICATORS

1516 W. Glenoaks, Glendale, Calif.
Phone: (213) 245-5668 • 245-6801
Free Parking

MARYLAND

• **BALTIMORE** (Area Code 301)
RECORDINGS, INC., 1130 E. Cold Spring Ln. Tel: 433-0701. (SEE ADVERTISEMENT)

MINNESOTA

• **MINNEAPOLIS** (Area Code 612)
Kaybank, 2541 Nicollet. Zip: 55404. Tel: TA 7-5441.

MISSOURI

• **CAPE GIRARDEAU** (Area Code 314)
James Floyd Ford, PO Drawer 839. Zip: 63701. Tel: 334-5772.

MONTANA

• **MISSOULA** (Area Code 406)
Blue Angel Promo. Agency, 1401 Sherwood St. Tel: 549-1606.

NEW YORK

• **NEW YORK CITY** (Area Code 212)
R D Cortina, 136 W. 52 St. Tel: JU 2-3845.
Schoenfelds Exp., 538 W. 35 St. Zip: 10001. Tel: BR 9-7730. Pres.: David Schoenfeld.

OHIO

• **CINCINNATI** (Area Code 513)
KING CUSTOM REC. SERV., 1540 Brewster Ave. Tel: 751-1910. (SEE ADVERTISEMENT)

PENNSYLVANIA

• **PHILADELPHIA** (Area Code 215)
Diskmakers, 925 N. Third St. Zip: 19123. Tel: MA 7-2277.

TENNESSEE

• **NASHVILLE** (Area Code 615)
Sound of Nashville, 160 Second Ave. S. Tel: 244-1124.

TEXAS

• **SAN ANTONIO** (Area Code 512)
Tanner 'N' Texas, 1422 W. Poplar. Tel: PE 2-8072.

SLEEVES

CALIFORNIA

• **LOS ANGELES** (Area Code 213)
Allied Rec., 2437 E. 57 St. Zip: 90058. Tel: 582-0841.
BERT-CO ENTS., 1855 Glendale Blvd. Tel: 665-5137. (SEE ADVERTISEMENT)
Container-Kraff, 721 E. 61 St. Tel: 232-3281.
Lewis Rec. Mfg., 307 E. Beach St., Inglewood. Zip: 90302.

ILLINOIS

• **CHICAGO** (Area Code 312)
M M Cole, 251 E. Grand Ave. Tel: 257-2160.

INDIANA

• **TERRE HAUTE** (No Area Code)
Woodburn Printing, 25 S. Sixth St. Tel: C-0164 (no direct dial).

MASSACHUSETTS

• **SPRINGFIELD** (Area Code 413)
U S Envelope, 21 Cypress St. Zip: 01101. Tel: 736-7211.

MINNESOTA

• **MINNEAPOLIS** (Area Code 612)
Kaybank, 2541 Nicollet. Zip: 55404. Tel: TA 7-5441.

NEW YORK

• **GREAT NECK, L. I.** (Area Code 516)
IVY HILL LITHO., Community Dr. Tel: HU 7-0200. (SEE ADVERTISEMENT)

• **HAUPPAUGE, L. I.** (Area Code 516)
Globe Albums, Cardinal Ind'l Park. Tel: 291-7600.

• **HICKSVILLE, L. I.** (Area Code 516)
ANDREWS-NUNNERY, 205 Park Ave. Tel: WE 1-6500. (SEE ADVERTISEMENT)

• **NEW YORK CITY** (Area Code 212)
Equitable Paper Bag, 45-50 Van Dam St., Long Island City. Zip: 11101. Tel: ST 6-0620
Fine-Tone Audio Prods., 7111 20 Ave., Brooklyn. Tel: CL 6-7876.
LE-80, 33-59 Vernon Blvd., Long Island City. Zip: 11106. Tel: RA 1-8504. (SEE ADVERTISEMENT)
Lee-Myles Assocs., 40 W. 57 St. Zip: 10019. Tel: PL 7-6630.

ONE STOP SERV., 133 E. 84 St. Zip: 10028. Tel: 288-4338. Mgr.: Adam Gary. (SEE ADVERTISEMENT)

Queens Litho., 52-35 Barnett Ave., Long Island City. Zip: 11104. Tel: IL 7-7700.
Standard Machine, 476 Broome St. Tel: WA 5-9818.
EDWARD R. WHITE, 342 Madison Ave. Tel: MU 7-2167. (SEE ADVERTISEMENT)

NORTH CAROLINA

• **WINSTON-SALEM** (Area Code 919)
SNYDER ALBUM, 3083 Indiana Ave. Zip: 27105. Tel: 722-6768. (SEE ADVERTISEMENT)

OHIO

• **CINCINNATI** (Area Code 513)
KING CUSTOM REC. SERV., 1540 Brewster Ave. Tel: 751-1910. (SEE ADVERTISEMENT)
Queen City Album, 7200 Colerain Ave. Tel: 931-3232.
Rite Rec. Prod'ns, 9745 Lockland Rd. Tel: 761-8844.

PENNSYLVANIA

• **PHILADELPHIA** (Area Code 215)
Allstate Printing, 1021 S. Ninth St. Zip: 19147. Tel: WA 5-6685.
H. Royer Smith, 10 & Walnut Sts. Zip: 19107. Tel: WA 2-2023.

TENNESSEE

• **NASHVILLE** (Area Code 615)
Atlantic Envelope, PO Box 888. Zip: 37202.

TRADE ASSOCIATIONS

American Guild of Authors and Composers (AGAC), 50 W. 57 St., New York, N.Y. 10019. Tel: (212) PL 7-8833.
Branch: Hollywood, Calif., 6331 Hollywood Blvd.
Membership: Any lyricist or composer.

American Guild of Musical Artists, 1841 Broadway, New York, N.Y. 10023. Tel: (212) CO 5-3687. Pres.: John Brownlee.

Country Music Assn. (CMA), 801 16 Ave. S., Nashville, Tenn. 37203. Tel: (615) 244-2840. Pres.: J. William Denny; Chm. of Bd.: Hal B. Cook.
Membership: All those interested in advancing the cause of country music.

Electronic Inds. Assn. (EIA), 2001 Eye St. N.W., Washington, D. C. Tel: (202) 659-2200. Exec. VP: James D. Secrest.
Membership: American manufacturers of tape recording and playback equipment and producers of raw and prerecorded tape.

Institute of High Fidelity (IHF), 516 Fifth Ave., Rm. 1402, New York, N. Y. 10036. Tel: (212) MU 2-5131. Pres.: Walter O. Stanton.
Membership: Manufacturers of high-fidelity components.

International Rhythm & Blues Assn., 642 E. 64 St., Chicago, Ill. 60637. Tel: (312) 752-4382. Pres.: William C. Tyson.

Music Operators of America (MOA), 228 N. La Salle St., Chicago, Ill. 60601. Tel: (312) RA 6-2810. Exec. VP: Frederick M. Granger Jr.
Membership: Coin-operated music and amusement machine operators.

moving up the charts fast!

CLEVELAND RECORDING COMPANY, INC.

one of America's oldest independent recording studios

8 Track — 1 inch Studer
4 Track — 1 inch Studer
3 Track — 1/2 inch Ampex
2 Track — 1/4 inch Scully

Two large studios—Complete Neumann mastering and dubbing service—Stereo and monaural—High speed tape duplicating system—

plus
Custom design and construction of Professional recording consoles.



CLEVELAND RECORDING COMPANY, INC.

1515 Euclid Ave.
Cleveland, Ohio—(216) 621-9362
(Established 1934)

For a "GREAT NEW SOUND" for today's market at LOW PRICES try Hollywood's fastest growing recording studio.

R. J. RECORDERS

6359 Selmo Ave., Hollywood, Calif.
(213) 465-3527
Engineering by Phil Yeend
1-2-3-4 Tracks

Complete Facilities for:

LABELS — PRESSING — MATRIX

• since 1943 •

ALCO RESEARCH & ENGINEERING, INC.

6201 Santa Monica Blvd.
Hollywood, Calif. 90038

for prompt service phone General Manager
Jim Stevenson at 213-466-1101

If you're a distributor looking for accounts . . . an operator selling used coin equipment . . . or a record company looking for a sales manager . . . YOU'LL GET TOP RESULTS AND PEAK EXPOSURE

**IN BILLBOARD'S
Buyers & Sellers**

CLASSIFIED MART

The special low price structure of the Classified Mart offers new and growing businesses the opportunity for more frequent advertising and consistent exposure . . . and for new products and services—this market place of the music-record industry is the perfect setting to announce the good news.

**PROVEN
RESULTS**

**PEAK
ECONOMY**

CLASSIFIED RATES

REGULAR CLASSIFIED AD: 25c a word. Minimum \$5. First line set all caps.

DISPLAY CLASSIFIED AD: 1 inch—\$20. 2 inches—\$35. Each additional inch \$15. Box rule around all ads. 3 consecutive insertions of same ad, 5% discount; 6 insertions, 10%; 13 or more insertions, 15%.

PAYMENT MUST ACCOMPANY ALL ORDERS

Include 50c additional, per insertion, to cover cost of handling and forwarding box number mail. If box number is used allow 10 words for number and address.

All classified ads must be received 11 days prior to date of issue

**Classified Advertising Department
BILLBOARD MAGAZINE**
188 W. Randolph St.
Chicago, Ill. 60601

Please run the classified ad copy shown below (or enclosed separately) in the following issues:

Type of ad desired—check one

REGULAR CLASSIFIED DISPLAY CLASSIFIED

- | | |
|---|--|
| <input type="checkbox"/> DISTRIBUTING SERVICES | <input type="checkbox"/> RECORD PROMOTION AND PUBLICITY |
| <input type="checkbox"/> HELP WANTED | <input type="checkbox"/> SITUATIONS WANTED |
| <input type="checkbox"/> MISCELLANEOUS | <input type="checkbox"/> USED COIN MACHINE EQUIPMENT, PARTS AND SUPPLIES |
| <input type="checkbox"/> RECORD MFG. SERVICES, SUPPLIES AND EQUIPMENT | |

Check heading under which ad is to be placed

AD COPY

Please type or print legibly

FULL PAYMENT MUST ACCOMPANY ORDER

Business Name _____ Authorized By _____

Address _____

City _____ State and Zip Code _____

Enclose in envelope and mail with payment to address shown at top of this order form.

continued

Music Publishers Protective Assn. (MPPA), 460 Park Ave., New York, N. Y. 10022. Tel: (212) PL 1-1930. Exec. Sec.: Leonard Feist.

National Academy of Recording Arts & Sciences (NARAS), 21 W. 58 St., New York, N. Y. 10019. Tel: (212) PL 5-1535.

Branches: Hollywood, Calif., 1741 Ivar Ave. Zip: 90028. Tel: (213) HO 5-2124—Chicago, Ill., 46 E. Walton St. Zip: 60611. Tel: (312) MI 2-6465—Nashville, Tenn., 1609 Hawkins St. Membership: Vocalists, conductors, songwriters, musicians, A&R men, engineers, arrangers, art directors, annotators, others meeting voting membership requirements. Associate (non-voting) memberships are also available.

National Assn. of Music Merchants (NAMM), 222 W. Adams St., Chicago, Ill. 60606. Tel: (312) AN 3-0679. Exec. VP: William R. Gard.

Membership: Retailers in any facet of music business.

National Assn. of Radio Announcers, 850 Seventh Ave., New York, N.Y.

National Assn. of Record Merchandisers (NARM), Trianon Bldg., Suite 703, 20 Conshohocken State Rd., Bala Cynwyd, Pa. 19004. Tel: (215) TE 9-7900.

Membership: Rack jobbers of records and tapes, record and tape manufacturers, distributors, packaging and display products manufacturers. Companies in business allied or related to the record industry may become Associate Members.

National Assn. of Retail Record Dealers (NARRD), 327 Jackson Ave., Jersey City, N. J. Tel: (201) 432-3570. Pres.: Lou Shapiro.

Membership: Retail record dealers.

Record Industry Assn. of America (RIAA), 1 E. 57 St., New York, N. Y. 10022. Tel: (212) MU 8-3778. Exec. Sec.: Henry Brief.

Membership: Record manufacturers.

Record One-Stop Assn. (ROSA), 511 N. Broad St., Philadelphia, Pa. 19123. Tel: (215) WA 5-7278. Pres.: Irv Perlman.

Membership: One-Stops.



ESTABLISHED 1939

1041 N. LAS PALMAS HO. 6-7516
HOLLYWOOD 38, CALIF.

The largest independent pressing plant in Hollywood.

Matrix — Labels — Albums — D.J.
Mailings — Drop Shipments—
Warehousing — Immediate
Service — Competitive Prices.



**RECORD PRESSING
COMPANY, INC.**

AREA CODE 615; 244-1867

Your Standard
of Comparison

415 Fourth Ave. So. Nashville, Tenn.

wherever you are...

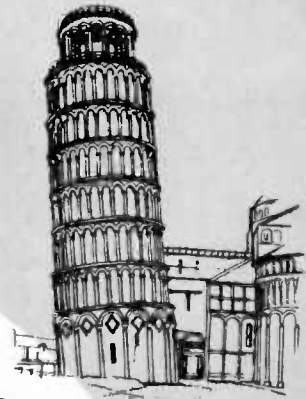

Billboard

will reach you by "jet" in every part of the world!

**NEWS! MARKETS!
PRODUCTS! IDEAS!
SALES CHARTS!**

All still HOT when you get them via Billboard's globe-spanning air-jet delivery to its more than 24,000 readers.

All the vital news, sales and marketing information needed for tomorrow's decisions . . . in your hands just hours after it comes off the press!

Just one of the many services designed expressly to make Billboard "work for YOU" . . . fast and often!



Mail subscription order today 

BILLBOARD

165 W. 46th St., New York, N. Y., 10036

Please enter my subscription to Billboard for

1 YEAR \$20 3 YEARS \$45 New Renew

Payment enclosed 2 EXTRA issues for cash

Bill me later

Above subscription rates are for U. S. and Canada.
Europe: \$40 per year by air. ww

Other overseas rates on request.

Company

Name

Address

City

State

Zip

Type of Business

Title

TAPE SECTION

Major development in the music industry in 1966 was the emergence of the tape CARtridge, used primarily in automobiles and now promising to go into the home as a force to be reckoned with. This year's Tape Section includes both reel-to-reel and tape cartridge players and product. Whenever possible, distinctions are made between tape cartridge and open reel. In the case of sources of supply, such as raw tape, no distinction need be made.

CARTRIDGE CASE MANUFACTURERS

- Amerline, 1800 W. Fullerton Ave., Chicago, Ill. 60614. Tel: (312) 348-4300. Pres.: Charles E. Caestecker; VP: Arnold Hultgren; Mktg. Eng.: Frank O. Glaubitz.
- Audio Devices, 235 E. 42 St., New York, N. Y. 10017. Tel: (212) MU 7-0800. Sales Mgr.: H. Kornbrodt.
- Fidelipac c/o TelePro, Cherry Hill Ind'l Ctr., Cherry Hill, N. J. 08034. Tel: (609) 424-1234. Pres.: Bill Mulcahy; Mktg. Dir.: Howard Gross; Sales Mgr.: J. McHugh.
- Lear Jet, 13131 Lyndon Ave., Detroit, Mich. 48227. Tel: (313) 272-0730. Pres.: William Lear; Gen. Mgr.: Kenneth Miller; Mktg. Dir.: James R. Gall.
- Norelco (North American Philips), 100 E. 42d St., New York, N. Y. 10017. Tel: (212) OX 7-3600. Mgr. High Fidelity Prods. Dept.: Wybo Semelink.
- Orrtronic, PO Box 864, Toledo, Ohio; 30335 Oregon Rd., Perryburg, Ohio. Tel: (419) 693-D641. Pres.: Keith Wilson; Mgr.: Joseph Meidt.
- Playtape, 1115 Broadway, New York, N. Y. 10010. Tel: (212) OR 5-8000. Pres.: Frank Stanton.

RAW TAPE MANUFACTURERS

- American (see Greentree Electronics)
- Ampex, 2201 Landmeier Rd., Elk Grove Village, Ill. 60007. Tel: (312) 437-5800. Pres.: William E. Roberts; Gen. Mgr.: John N. Latter.
- Audio Devices, 235 E. 42 St., New York, N. Y. Tel: (212) 687-0800.
- AUDIO MAGNETICS Corp. (AMC), 1604 W. 139 St., Gardena, Calif. Tel: (213) 321-6841. Cable: Mag Tape. Pres.: Irving Katz; Gen. Mgr.: Russ Malloy; Gen. Sales Mgr.: Sam Schobel. (SEE ADVERTISEMENT)
- Burgess Battery, Freeport, Ill. Tel: (815) 232-2161.
- Eastman Kodak, 343 State St., Dept. 940, Rochester, N. Y. 14650. Tel: (716) 325-2000.
- Ferrodynamics Tape Div. (see Robins Inds.)
- Fine-Tone Audio Prods., 7111 20 Ave., Brooklyn, N. Y. Tel: (212) CL 6-7876.
- GREENTREE ELECTRONICS, 2135 Canyon Dr., Costa Mesa, Calif. Tel: (714) 549-2265. (SEE ADVERTISEMENT)
- Irish Magnetic, 458 Broadway, New York, N. Y. 10013.
- Magnetic Stereo Cartridge (see Audio Magnetics Corp.).
- Morhan Nat'l Sales, 458 Broadway, New York, N. Y. 10013. Tel: (212) WA 5-1257. Cable: MORHANEX. Pres.: M. Zigman; VP: S. Zigman; Sales Mgr.: G. Kaplan.
- MusicTapes, 230 N. Michigan Ave., Chicago, Ill. Tel: (312) 782-1623.
- Mylar c/o Dupont Film Dept., Wilmington, Del. Tel: 774-3549. Contact: C. K. Enderle.
- Pfantsiehl, 104 Lake View Ave., Waukegan, Ill. Tel: (312) 623-1360.
- R C A Victor Rec. Div. (Magnetic Tape Prods.), 155 E. 24 St., New York, N. Y. Tel: (212) MU 9-7200.
- Branches: Hollywood, Calif., 6363 Sunset Blvd. Tel: (213) HO 1-9171. Chicago, Ill., 445 North Lake Shore Dr. Tel: 222-1550.
- Recoton, 46-23 Crane St., Long Island City, N. Y. 11101. Tel: (212) EX 2-6442.
- Branch: Los Angeles, Calif., c/o Marshank Sales, 7422 Melrose Ave.
- Robins Inds., 15-58 127 St., Flushing, N. Y. 11356. Tel: (212) 445-7200. Prod. Mgr.: Daniel Schwartz.
- Reeves Soundcraft, Great Pasture Rd., Danbury, Conn. Tel: (203) 743-7601.
- Scotch (see 3M).

3 M (Minnesota Mining & Mfg.), 2501 Hudson Rd., St. Paul, Minn. 55119. Tel: (612) 733-1110.

United Inds., 334 36 St., Brooklyn, N. Y. Tel: (212) SO 8-0657, 0507.

TAPE CARTRIDGE AND REEL-TO-REEL MANUFACTURERS & LICENSED DUPLICATORS/DISTRIBUTORS

- Ampex, 2201 Lunt Rd., Elk Grove Village, Ill. Tel: 439-4600 & 438-8700. Pres.: William E. Roberts; Regional PR Mgr.: John Hatch; Stereo Tape Mgr.: P. E. Larmer.
- Cartridge: 8-track.
- Label: London.
- Reel-to-Reel: 4-track.
- Labels: ABC, A&M, Aeolian-Skinner, Archive, Atlantic, Atco, Audio Fidelity, Buena Vista, Colpix, Command, Coliseum, DGG, Fantasy, Fontana, Four Corners, Gordy, Hi, Impulse, Institute of Language, Kama Sutra, Kapp, Limelight, L'Oiseau Lyre, London, MGM, Mercury, Motown, Parrot, Philips, Richmond, Smash, Tamla, 20th-Fox, United Artists, Vanguard, Verve, Warner Bros., Westminster, Wing, World Pacific.
- AURA SONIC, Dept. HF56, Runnemed, N. J. Tel: (609) 931-7242.
- Cartridge: 4 & 8-track Stereo, 4-track Mono.
- Labels: ABC-Paramount, Audio Spectrum, Grand Award, Impulse, Roulette, Somerset, Stereo Fidelity, Starday, Tico, Westminster. (SEE ADVERTISEMENT)
- Autostereo, 14617 Keswick St., Van Nuys, Calif. 91405. Tel: (213) 781-8920. Pres.: Richard E. Danielson Jr.; Music Dir.: Walt Heebner.
- Cartridge: 4-track; 3 $\frac{3}{4}$ ips.
- Labels: ABC, A&M, Atlantic, Audio Fidelity, Autostereo, Bel Canto, Counterpoint, Crescendo, Disco Cisse, Dot, Elektra, Everest, Good Time Jazz, Grand Award, Impulse, King, MGM, 20th-Fox, Verve.
- BIBLE VOICE, PO Box 3521, Valley Federal Towers Bldg., 6842 Van Nuys Blvd., Suite 406, Van Nuys, Calif. 91407. Tel: (213) ST 7-5600. Pres.: George Otis.
- Branch: Plainfield, N. J., 185 North Ave. Zip: 07060. Tel: (201) 754-0745.
- Label: Bible Voice. (SEE ADVERTISEMENT)
- Cartridge: 4 & 8-track Stereo.
- Reel-to-Reel: 2-track; 1 $\frac{7}{8}$ & 3 $\frac{3}{4}$ ips.
- Capitol, 1750 N. Vine St., Hollywood, Calif. 90028. Tel: (213) 462-6252. Pres.: Alan W. Livingston; Special Prods. Mgr.: Oris W. Beucler.
- Branch: New York, N. Y., 1290 Ave. of the Americas, Rm. 3214. Zip: 10019. Tel: (212) PL 7-7470.
- Labels: Capitol, Angel.
- Cartridge: Lear 8-track Stereo.
- Reel-to-Reel: 4-track Stereo; 3 $\frac{3}{4}$ & 7 $\frac{1}{2}$ ips.
- Type of distribution: Capitol record distributors.
- Columbia, 51 W. 52 St., New York, N. Y. 10019. Tel: (212) 765-4321. Pres.: Goddard Lieberson.
- Labels: Columbia, Epic.
- Cartridge: 8-track Stereo.
- Reel-to-Reel: 4-track; 3 $\frac{3}{4}$, 7 $\frac{1}{2}$ ips.
- Decca, 445 Park Ave., New York, N. Y. 10022. Tel: (212) PL 2-1600. Pres.: Milton R. Rackmil; Gen. Mgr.: Vern Cupples.
- Labels: Decca, Coral, Brunswick.
- Cartridge: Lear 8-track Stereo.
- Reel-to-Reel: 4-track; 7 $\frac{1}{2}$ ips.
- Type of Distribution: Decca branches.
- General Recorded Tape (GRT), 1262 Lawrence Station Rd., Sunnyvale, Calif. 94086. Tel: (408) 738-2660. Pres.: Alan Bayley; VP: John Spellman; Sales: H. B. Hershfield.
- Branch: Bloomfield, N. J. 39 Broad St. Zip:

07003. Tel: (201) 748-6654. N. Y. C. Tel: (212) 267-6875.

Cartridge: 4 & 8-track Stereo.

Labels: ABC-Paramount, Amy, Atco, Atlantic, Bang, Bell, Boom, Command, Dunhill, DynoVoice, Grand Award, Impulse, Mala, Moonglow, Music Guild, Musicland, New Voice, Oliver, Purist, Scepter, Starday, Stax, Tangerine, Vault, Volt, Wand, Westminster.

Reel-to-Reel: 4-track Stereo; 3 $\frac{3}{4}$ & 7 $\frac{1}{2}$ ips.

Labels: Amy, Atco, Atlantic, Bang, Bell, Command, DynoVoice, Grand Award, Mala, Moonglow, Music Guild, Musicland, New Voice, Purist, Scepter, Starday, Stax, Vault, Volt, Wand, Westminster.

Type of distribution: Record and photographic distributors & automotive outlets.

Greentree Electronics (see Stereotape).

INTERNATIONAL TAPE CARTRIDGE CORP. (ITTC), 1290

Ave. of the Americas, New York, N. Y. 10019.

Tel: (212) 581-1040. Pres.: Larry Finley;

Ass't. to Pres.: Jack L. Lewis; Customer Relations

Dir.: Billie Dobson.

Branch: Los Angeles, Calif., 1434 Westwood

Bldv. Tel: (213) 272-6546.

Cartridge: Lear & Orrtronic 8-track Stereo;

Fidelipac & Audio Devices 4-track; DeJure

2-track.

Labels: ABC-Paramount, A&M, Atco, Atlantic, Audio Fidelity, Brasilerio, Colpix, Command, Crescendo, Dana, Dextra, Dot, Dunhill, Elektra, Ember (England), Focus, Folklorico, Fontana, Glad-Hamp, Grand Award, Hanna-Barbera, Horizon, Impulse, International, Josie, Jubilee, Kapp, Kendall, Laurie, Lime-light, MGM, Mainstream, Melodyca, Mercury, Mira, Mirwood, Mobile Fidelity, Moonglow, Musicor, Nonesuch, Nueva Ola, Philips, Prima, Roulette, Seeco, Sesac, Smash, Spoken Arts, Starday, Stax, Surrey, Tango, Tico, 20th-Fox, Tropical, Vault, Vee Jay, Verve, Volt, Westminster. (SEE ADVERTISEMENT)

Liberty, 6920 Sunset Blvd., Los Angeles, Calif.

90028. Tel: (213) 464-8101. Cable: LIBRECORD.

Pres.: A. Bennett; Mgr.: Lee Mendell; Sales

Mgr.: Mike Elliot.

Cartridge: Lear 8-track Stereo; Fidelipac 4 &

8-track.

Labels: Liberty Stereo Tape.

Tape Reel-to-Reel: (licensed to MusicTapes).

Type of distribution: Liberty record distributors

& auto stores.

Mercury, 35 E. Wacker Dr., Chicago, Ill. 60601.

Tel: (312) DE 2-5788. N. Y. C. Tel: (212) PL

9-2727. Cable: Merrec. Pres.: Irving B. Green;

Gen. Mgr.: Tom Bonetti.

Labels: Mercury, Philips, Smash, Fontana,

Limelight.

Cartridge: Lear 8-track Stereo; Fidelipac 4-

track; Philips reel-to-reel cartridge (1 $\frac{7}{8}$ ips).

Reel-to-Reel: 4-track Stereo; 3 $\frac{3}{4}$ & 7 $\frac{1}{2}$

ips. (licensed to Ampex).

Type of distribution: Record distributors, Rack

Jobbers, electronic & automotive distributors.

Metra Electric, 660 McDonald Ave., Brooklyn 11218.

Tel: (212) TR 1-4100. Pres.: Charles R. Fox;

VP: Michael Somma; Sales Mgr.: Bill Koehler.

Cartridge: 4 & 8-track.

Motown, 2648 W. Grand Blvd., Detroit, Mich. Tel:

(313) TR 1-3414. Pres.: Berry Gordy Jr.; Sales

Dir.: Ron Newman.

Labels: Motown, Tamla, Gordy, Soul.

Cartridge: 8-track Stereo.

Reel-to-Reel: (licensed to Ampex).

MUNTZ STEREO-PAK, 7715 Densmore Ave., Van Nuys,

Calif. Tel: (213) 787-7700. Cable: MUNTZPAK.

Pres.: Earl Muntz; Music Dept. Head: Ed

Michel.

Cartridge: 4 & 8-track Stereo.

Labels: ABC, Arvee, Atco, Atlantic, Audrea,

Auto Learning, Ava, Cadet, Cameo, Charger,

Charlie Parker, Charter, Checker, Chess, Com-

mand, Coro, Crescendo, Crusader, Dot, Dunhill,

continued on page 155

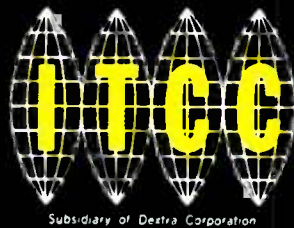

The World's Largest Source of Four and Eight-track Stereo Tape Cartridges...

FEATURING A CHOICE OF OVER 63 FAMOUS RECORD LABELS . . . MORE THAN 1,800 CURRENT AND STANDARD BEST SELLERS . . . AND OVER 300 FAVORITE ARTISTS.

INTERNATIONAL TAPE CARTRIDGE CORPORATION HAS THE PRODUCT AND SALES AIDS TO HELP YOU CASH IN ON THE BOOMING TAPE CARTRIDGE INDUSTRY.

Write for details today!

INTERNATIONAL TAPE CARTRIDGE CORPORATION

1290 Avenue of the Americas, New York, N. Y. 10019 Phone: (212) 581-1040

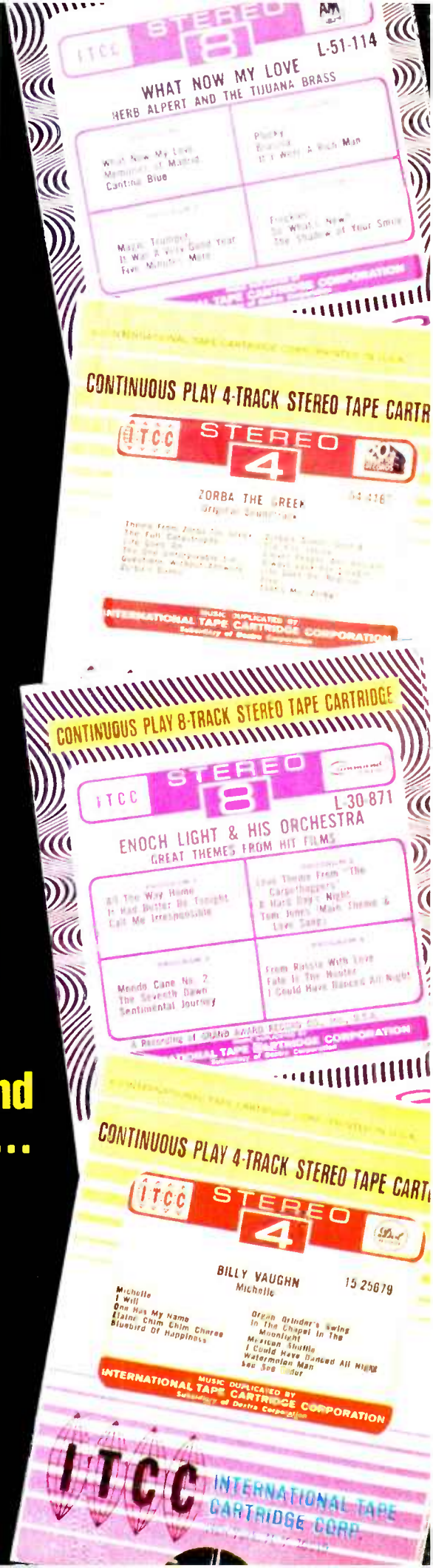

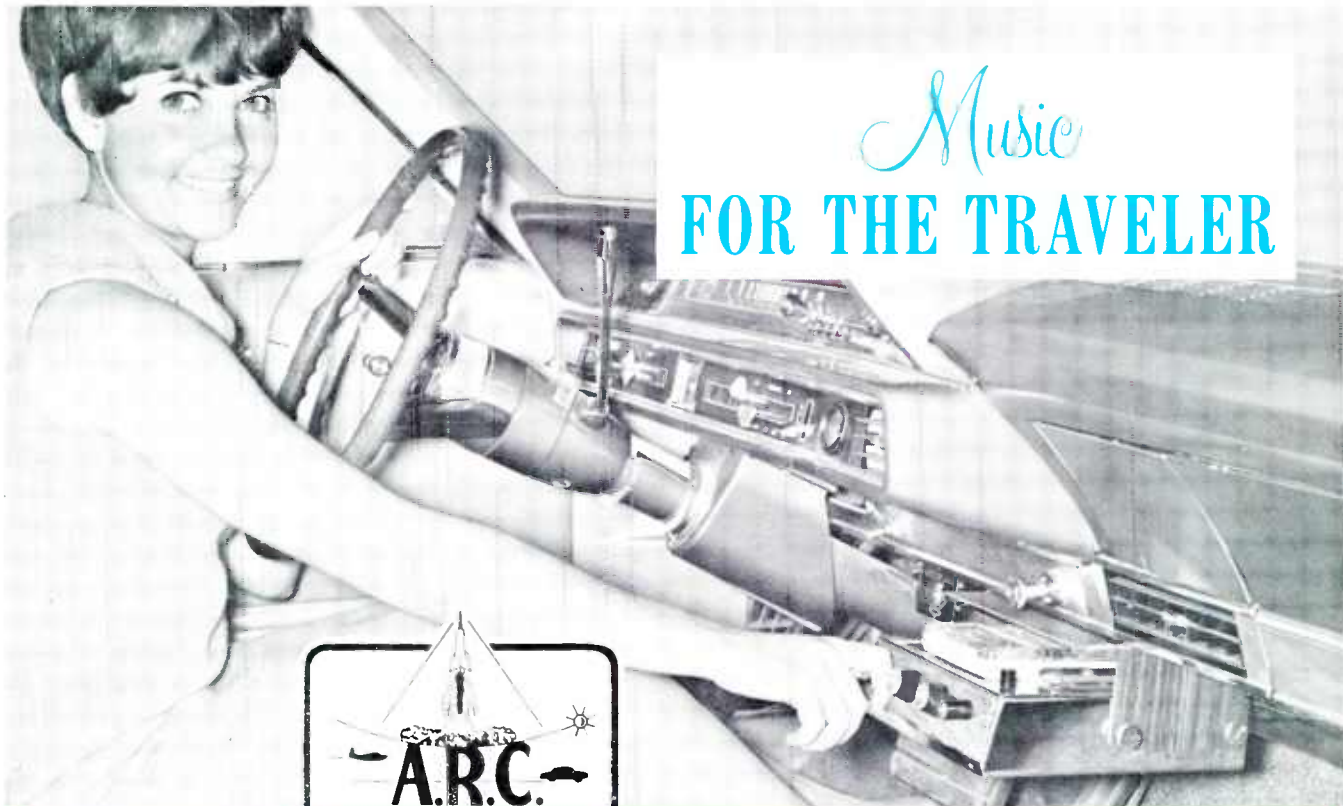

Music
FOR THE TRAVELER



STEREO TAPE DECK

The fully automatic, solid state, 13 transistor "880" Stereo Tape Deck assures the finest in full fidelity reproduction. Features balanced channels, filtered music (engine noise filtered out), 10½ music watts per channel, and plays up to two full hours of tape. A continuous-play, four-track cartridge produces two completely separate stereophonic selections per side. A simple flip of a switch changes programs. Easy to change tapes while driving... music begins with insertion of the cartridge! Available in 12-Volt Positive or Negative ground.

Included with Tape Deck is the SKS-525 Speaker Kit, 2 grill assemblies, 2 8-OHM 5½" speakers, wire and mounting hardware. Simple detailed instructions furnished. (Made and assembled in the U.S.A.)

SUGGESTED LIST \$119.88 incl. speaker kit



AUTOMATIC RECoRD CHANGER

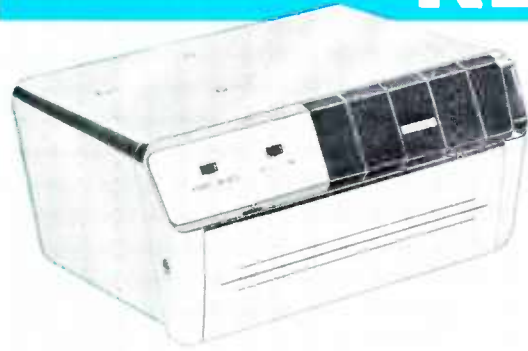

≈2500 (pictured) The Original Auto Record Changer Plays and rejects up to 12 45's automatically. Fits all cars and needs no technician to install. Economical to operate with "45" records available everywhere.

SUGGESTED LIST \$68.88

≈3000 Has all the above features and will play either 45 or 33½ 7-inch records with the large center hole... one kind at a time, or mix them. A flip of the switch changes speeds. The 33½ 7-inch records needed are available from A.R.C. Electronics, Inc. or its dealers.

SUGGESTED LIST \$78.88

≈660 Incorporates the features of both the ≈2500 and ≈3000. In addition, its consistent, high-quality sound reproduction is assured because no car radio is necessary for operation. Three knobs - (1) Off-On/Volume, (2) Balance, and (3) Tone, offer finer tuning. Two 5½" speakers and kit are included.

SUGGESTED LIST \$98.88

TAPE HOLDER & FLOOR CONSOLE FOR CARS

All-metal die casting custom Chrome-plated in keeping with fine car styling. Sturdy, spring-loaded cover. Closed provides convenient flat surface at the fingertips. Simple to install and designed for removal to another car without leaving damage. SUGGESTED LIST... \$19.88

SEND FOR INFORMATION

A.R.C. ELECTRONICS, INC.

15302-L Illinois Ave. • Paramount, California 90723

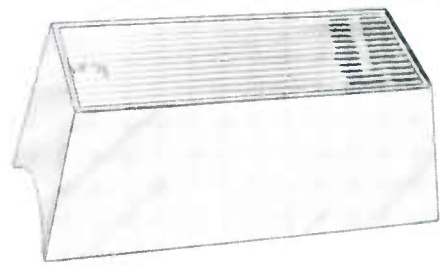

continued

Dunwich, Echo, Eurotone, Everest, Fat Fish, Fermata, 49th State, General Music, Grand Award, Hamilton, Hanna-Barbera, HiFi, Impulse, Kiddy Go, Lancelot, Life, MGM, Maze, Mel, Monument, Moonglow, Musicor, Omega, Parkway, Phyllis, RGE, Raynet, Reprise, Starday, Triumph, Valiant, Vault, Verve, Volt, Waikiki, Warner Bros., Westminster. (SEE ADVERTISEMENT)

MusicTapes, 230 N. Michigan Ave., Chicago, Ill. 60601. Tel: (312) 782-1623.

Cartridge: 4 & 8-track Stereo.

Labels: Caedmon, Cadet, Checker, Chess, Discovery, Elektra, GNP Crescendo, Mahalo, Monitor, Musicor, MusicTapes, Nonesuch, Prestige, Starday, Vee-Jay.

Reel-to-Reel: 4 & 8-track; 3¾, 7½ ips.

Labels: Caedmon, Cadet, Checker, Chess, Discovery, Elektra, GNP Crescendo, HiFi, Liberty, Mahalo, Monitor, Musicor, MusicTapes, Nonesuch, Prestige, Starday, Vee Jay.

Playtape, 1115 Broadway, New York, N. Y. 10010. Tel: (212) OR 5-8000. Pres.: Frank Stanton.

Cartridge: 2-track.

Labels: ABC, Cameo-Parkway, MGM, Playtape.

R C A Victor, 155 E. 24 St., New York, N. Y. Tel: (212) MU 9-7200. VP: George R. Marek; Sales: Ed Welker.

Cartridge: Lear 8-track Stereo.

Labels: RCA Victor, RCA Camden, Kapp, Scepter, Wand.

Reel-to-Reel: 4-track; 7½ ips.

Labels: RCA Victor, RCA Camden.

Record Corp. of New England, 30 E. 42 St., New York, N. Y. 10017. Tel: 986-6031. Pres.: Donald H. Gabor.

Cartridge: 4 & 8-track.

Labels: Continental, Little Chip, Maple Leaf, Masterseal, Remington.

STEREOTAPE (div. of Greentree Electronics), PO Box 1469, 2135 Canyon Dr., Costa Mesa, Calif. 92626. Tel: (714) 549-2265. Pres.: Burt Harris; Exec. VP & Gen. Mgr.: Sidney Brandt; Sales Mgr.: Jim Neiger.

Labels: Angel, Capitol, Dot, Hamilton, Reprise. (SEE ADVERTISEMENT UNDER GREENTREE)

Reel-to-Reel: 2 & 4-track; 3¾, 7½ ips.

3 M (Minnesota Mining & Manufacturing), 2501 Hudson Rd. Tel: (612) 733-1110. Cable: MIMACO.

Cartridge: 2-track Stereo.

Labels: ABC-Paramount, Columbia, Command, GNP Crescendo, Discovery Rec'gs, Dot, Elektra, Everest, Grand Award, Impulse, Kapp, Limelight, Mahalo, Mercury, Monitor, MusicTapes, Philips, Purist, Reprise, Roulette, United Artists, Vanguard, Warner Bros., Westminster.

Tucker Prod'ns, 157 W. 57 St., New York, N. Y. 10019. Tel: (212) CO 5-0408. Pres.: George Tucker.

Labels: Amy, Audio Fidelity, Bell, Golden, Mala, & 30 language courses.

Cartridge: 4-track Stereo & Mono.

Reel-to-Reel: 4-track Stereo; 3¾ & 7½ ips.

TAPE CARTRIDGE AND REEL-TO-REEL PLAYBACK MANUFACTURERS

A R C ELECTRONICS, 15302 S. Illinois Ave., Paramount, Calif. Tel: (213) 636-9171. Pres.: Robert B. Tibbetts; V-P: Arthur Rickrode; Sales Dir.: Tony Antony.

Cartridge: 1 4-track Stereo model. Price: \$109.88. (SEE ADVERTISEMENT)

Aiwa (see Selectron Int'l).

All American (see Soundex Radio).

Ampex, 1212 Ave. of the Americas, Suite 2305, New York, N. Y. 10036. Tel: (212) 765-0730.

Pres.: William E. Roberts; VP & Gen. Mgr. Consumer & Educational Prods. Div.: John Latter; Mktg. Mgr.: John Trux.

Branch: Elk Grove Village, Ill., 2201 Landmeier Rd. Zip: 60007.

Reel-to-Reel: 10 Stereo models; 1⅞, 3¾, 7½ ips. Price range: \$299.95-\$599.95.

AUDIO SPECTRUM, 901 E. Clements Bridge Rd., Rummelmeade, N. J. Tel: (609) 931-7242. Pres.: H. S. Lenahan; Sales: J. R. Bott.

Cartridge: 1 4-track Mono. model. Price: \$69.50. (SEE ADVERTISEMENT)

Audiosphere (see Livingston Audio Prods.).

Audio/Stereo (see Muntz Stereo-Pak).

Audio/Stereo (see Muntz Stereo-Pak).

Audio/Stereo (see Muntz Stereo-Pak).

Audio/Stereo (see Muntz Stereo-Pak).

Audio/Stereo (see Muntz Stereo-Pak).

Audio/Stereo (see Muntz Stereo-Pak).

Audio/Stereo (see Muntz Stereo-Pak).

THE OTHER DAY WE RECEIVED THIS MEMO FROM OUR AD MANAGER:

MEMO:

5/11/66

Writing down all the reasons for coming to us for magnetic tape duplicating or stereo cartridges takes a bigger ad than our budget now allows. Either raise prices to increase my budget or stop coming up with so many new products and services.

Russ Molloy

what do you think we did about it?

NOTHING!

that's why this ad is so small and our prices are still so low

**MAGNETIC TAPE—standard & lubricated
HIGH SPEED DUPLICATING—Mono, 2, 4 & 8 track
CONTINUOUS LOOP CARTRIDGES—Lear Jet,
Fidelipak, Audiopac, Telepro, Orrtronic, Gates,
Viking, Norelco/REEL TO REEL/MERCHANDISING
DISTRIBUTION/MASTERING AND
DROP SHIPMENT FACILITIES.**

AUDIO MAGNETICS CORP.

**1604 West 139th St., Gardena, Calif.
Phone: (213) 321-6841 Cable: MAGTAPE**

continued

Automatic Radio, 2 Main St., Melrose, Mass. 02176. Tel: (617) 321-2300. Pres.: David Housman; Sales Mgr.: David Nager.
Cartridge: 3 car & 4 home models; 2, 4 & 8-track Stereo. Price range: \$69.95-\$129.95. (All car cartridge models adaptable for home use).
Brand name: TapeDek.

Austostereo, 14617 Keswick St., Van Nuys, Calif. 91405. Tel: (213) 781-8920. Pres.: Richard E. Danielson Jr.
Cartridge: 1 lb. 8-track tape deck.
track Stereo home models. Price range: \$89-\$159. Dne 4-track Marine Stereo model. Price: \$189.

B S R (USA) Ltd., Rt. 303, Blauvelt, N. Y. 10913. Tel: (914) 358-6060. VP & Gen. Mgr.: John H. Hollins; Sales Mgr.: David Feir.
Cartridge: 1 8-track tape deck.
Reel-to-Reel: 2 Stereo models.
Note: Manufactures for Westinghouse, General Electric, Emerson (does not make finished product).

Bible Voice, PO Box 3521, 6842 Van Nuys Blvd., Van Nuys, Calif. 91407.
Reel-to-Reel: 1 2-track Mono model; 1 7/8 & 3 3/4 ips.

Borg-Warner (Spring Division), 25 St. & Madison, Bellwood, Ill. 60104. Tel: (312) 544-2600. Pres. & Gen. Mgr.: Arthur J. Welch; Mgr. of Consumer Prod. Sales: Vincent R. Vecchione; Asst. Gen. Mgr.: James F. Niblick.
Cartridge: 1 8-track Stereo car model. Price: \$119.95.

Capitol, 1750 N. Vine St., Hollywood, Calif. Tel: (213) HO 2-6252. Cable: Caprecords. Pres.: Alan W. Livingston; Gen. Mgr.: Oris Beucler.
Branch: New York, N. Y., 1290 Ave. of the Americas, Rm. 3214. Zip: 10019. Tel: (212) PL 7-747D. Special Prods. Mgr.: Paul Adams.
Cartridge: 1 8-track car Stereo. Price: \$89.95.

Columbia, 51 W. 52 St., New York, N. Y. 10019. Tel: (212) 765-4321. Cable: Colcord. Pres.: Goddard Lieberston.
Cartridge: 8-track Stereo.
Reel-to-Reel: 1 Stereo & 4 Mono models. Price range: \$39.59-\$129. *
 Concertone (div. of Astro Science Corp.), 9700 Fac-

torial Way, S. El Monte, Calif. Tel: (213) GI 3-3211. VP & Div. Mgr.: A. Barsimanto; Chief Engineer: Arne Berg.
Reel-to-Reel: 7 4-track Stereo models. Price range: \$239.95-\$2,000.

Concord Electronics, 1935 Armacost Ave., Los Angeles, Calif. 90025. Tel: (213) 478-2541 & 879-1680. Cable: CDNCORLEC. Pres.: Howard P. Ladd; Gen. Mgr.: Robert L. Halpern; Sales Mgr.: John J. Pacconi.
Cartridge: 1 2-track Mono home model. Price: \$79.95.
Reel-to-Reel: 5 Stereo & 9 Mono models. Price range: \$19.95-\$349.95. 1 video tape.

Craig Panorama, 2302 E. 15 St., Los Angeles, Calif. 90021. Tel: (213) 623-2421. Pres.: Ed Motokani; Sales Mgr.: Jack Baker.
Cartridge: 2 car & 1 home model; 4-track Stereo. Price range: \$40-\$180.
Reel-to-Reel: 5 models—1 Stereo, 4 Mono; 1 7/8 3 3/4, 7 1/2 ips.
Brand name: Vista.

DeJur Amsco, 4501 Northern Blvd., Long Island City, N. Y. Tel: (212) PL 1-2820. Exec VP: Lee Friend.
Cartridge: 1 2-track Mono model. Price: \$129.95.
Brand name: DeJur Grungig.

Delmonico Int'l., 50-35 56th Rd., Maspeth, N. Y. 11378. Tel: (212) EX 2-7100. Pres.: Herbert Kabat; Exec. VP: Raymond Gincavage; Sales Mgr.: Sy Lipper.
Reel-to-Reel: 3 4-track Stereo models—1 portable & 2 console; 3 3/4, 7 1/2 ips. Price range: \$169.95-\$289.95.

Emerson Radio, 680 Fifth Ave., New York, N. Y. Tel: (212) 757-5885. Cable: ERPCO. Pres.: Benjamin Abrams; V-P Sales: A. Barshop.
Reel-to-Reel: 10 models—3 Stereo, 7 Mono. 15/16, 1 7/8, 3 3/4, 7 1/2 ips. Price range: \$49.95-\$229.95.

General Electric Co. (Audio Product Dept.), 2200 N. 22 St., Decatur, Ill. Tel: (217) 428-4311. Gen. Mgr.: H. B. Waldron; Mktg. Mgr.: J. L. Hunter.
Branch: Utica, N. Y., 831 Broad St. Tel: (315) 798-7D11. Mgr. Tape Prods.: J. S. Chamberlin.

Hitachi, 666 Fifth Ave., New York, N. Y. 10019. Tel: (212) LT 1-8844. Pres.: E. Matsumura; Sales Mgr.: P. R. O'Connell.

Cartridge: 1 Mono home model. Price: \$6D.
Reel-to-Reel: 3 Mono models; 1 7/8, 3 3/4 ips. Price range: \$49.95-\$89.95.

Hoffman Electronics, 5550 Harbok St., City of Commerce, Los Angeles, Calif. 90022. Tel: (213) 442-0123. Gen. Mgr.: R. L. Jablonski.
Cartridge: 1 Stereo 8-track car model. Price: \$69.95. (Unit can be added to any '66 or '67 Hoffman Stereo console.)

Jay Electronics, 52 Bethpage Rd., Hicksville, L. I., N. Y. Tel: (516) WE 5-8181. Pres.: Sanford Jay; VP Sales: J. Ehrenzweig; Gen. Mgr.: M. R. Rabin.
Cartridge: 1 Stereo 4 & 8-track compatible car model. Price: \$119.95.
Reel-to-Reel: 1 Stereo 4 & 8-track compatible home model. Price: under \$100.

Kinemafix, 2040 W. Washington Blvd., Chicago, Ill. 60612. Tel: (312) 666-0066. Pres.: Leonard Fish; Sales: Martin Santo.
Cartridge: 2 car & 2 home models; 4 & 8-track Stereo. Price range: \$70-\$130.

Lafayette Radic Electronics, 111 Jerico Turnpike, Syosset, L. I., N. Y. 11791. Tel: (212) 921-7700. Cable: LAFRAMELEC. Pres.: Abraham Pletman; Sales Mgr.: G. Russell.
Reel-to-Reel: 7 Stereo & 3 Mono models. Price range: \$39.95-\$249.

Lear Jet, Stereo Div., 13131 Lyndon Ave., Detroit, Mich. 48227. Tel: (313) 272-0730. Pres.: William Lear; Gen. Mgr.: Kenneth Miller; Mktg. Dir.: James R. Gall; Mgr. of Dist'n.: Joel Rowley; Dir. of Adv.: George Bechtel.
Cartridge: 3 car & 1 home model; 8-track Stereo. Price range: \$80-\$175.
Brand names: Mopar, Stereo 8, Lear Jet, Sears.

Livingston Audio Prods., 1275 Bloomfield Ave., Fairfield, N. J. Tel: (201) 226-8300. Pres. & Sales: Darrell Scholten.
Cartridge: 1 compatible 4 & 8-track car stereo. Price: \$139.50.
Brand name: Audiosphere.

Magnecord (Div. of Telex Corp.), PO Box 1526, 41 St. & Sheridan Rd., Tulsa, Okla. 74101. Tel: (918) NA 7-1111. Gen. Mgr.: James S. Arrington; Prod. Mgr.: Paul R. Bunker.
Reel-to-Reel: 1 Stereo & 4 Mono 2-speed models. Price range: \$570-\$1,200.

continued on page 158

The Biggest Recording Stars in Show Business

exclusively on

STEREO TAPE!

A Division of GREENTREE ELECTRONICS
 Costa Mesa, California
 Manufacturers of
 American Recording Tape



WOULD YOU BELIEVE . . .

These Two Have Something in Common?

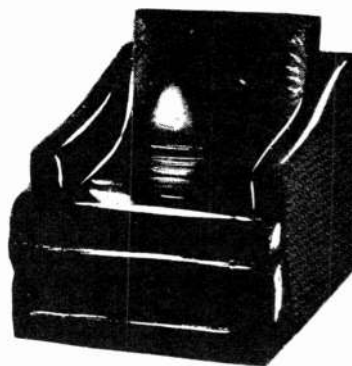

**A LISTENER . . . HEARING THE FINEST IN TAPE
CARTRIDGE REPRODUCTION**

Now for the FIRST TIME, whether through the limited Stereo Sound System of your automobile or through the unlimited Stereo Sound System of your home, you'll hear THE ULTIMATE in Clean Recording.

Reproduced FOUR TIMES FASTER with UNSURPASSED QUALITY and the SIMPLICITY of . . .

- GAUSS'** G11 A **MASTERING RECORDER**
G12 B* **ULTRA HIGH SPEED DUPLICATING MASTER**
G12 C* **ULTRA HIGH SPEED SLAVE**



GAUSS ELECTROPHYSICS, INC.

1850 WESTWOOD BOULEVARD
WEST LOS ANGELES, CA 90025
(213) 474-2212 OR 272-1581

***SOLD EXCLUSIVELY BY
CAPITOL RECORDS**

CAPITOL RECORD, INC.
Engineering Dept.
1750 N. Vine St.
Hollywood, Calif. 90028
(213) 462-6252



YOUR BRAIN TRUST
for
ALL TAPE
CARTRIDGE DEVICES

*From Prototype
to Production*

- ★ PRIVATE LABEL
- ★ OEM
- ★ COMPLETE MANUFACTURING FACILITIES

*FROM CONCEPT
TO COMPLETION*

**APPLICATIONS
ENGINEERING**

from the marketing man's viewpoint assures all products are designed to meet the most crucial industrial and commercial specifications—with special features desired for every need.

**ELECTRO MECHANICAL
&
AUDIO ENGINEERING**

Based on the most advanced technology in the state of the art.

RECORDERS-PLAYERS
*in 4-8-? Track
Configuration*



CORPORATION

7660 Gloria Avenue
Van Nuys, California

continued

Martel Electronics, 2339 S. Cotner, Los Angeles, Calif. 90064. Tel: (213) 479-4491. Pres.: David Krechman; Sales Mgr.: George A. Rose.
Cartridge: See SJB.
Reel-to-Reel: 3 Stereo & 3 Mono models. Price range: \$160-\$440.
Brand name: Uher.

Matsushita Electric Corp. (see Panasonic).

Mercury, 35 E. Wacker Dr., Chicago, Ill. 60601. Tel: (312) DE 2-5788. Cable: Merrec. Pres.: Irving B. Green; Prod. Mgr.: Perry Winokur.
Cartridge: 1 4-track Stereo car model & 1 4-track Stereo home model. Price range: \$100.

Metra, 660 McDonald Ave., Brooklyn, N. Y. 11218. Tel: (212) TR 1-4100. Pres.: Charles R. Fox; VP: Michael Somma; Sales Mgr.: Bill Koehler.
Cartridge: 3 4-track Stereo car models. Price range: \$79.95-\$169.95. Two 4-track Stereo home models. Price range: \$119.95-\$239.95.

Midland Int'l., 1909 Vernon St., North Kansas City, Mo. Tel: (816) VI 2-0511. Pres.: Ed Benson; Gen. Mgr.: Jack M. Lose.
Cartridge: 1 4-track car Stereo. Price: \$69.

Mopar (see Lear Jet).

Motorola Consumer Prods., 9401 W. Grand Ave., Franklin Park, Ill. Tel: (312) NA 5-6000. Gen. Mgr. Consumers Prods. Div.: Arthur Reese; Gen. Prods. Mgr.: C. V. Phillips.
Cartridge: 2 car & 1 home 8-track Stereo models.
Reel-to-Reel: 1 Stereo model; 1 7/8, 3 3/4 & 7 1/2 ips. Price: \$599.95.
Note: Makes playback equip. for RCA Victor, Philco, Packard-Bell.

MUNTZ STEREO-PAK, 7715 Densmore, Van Nuys, Calif. Tel: (213) 989-5000. Pres.: Earl Muntz; Sales Mgr.: James LeVitus.
Cartridge: 6 car Stereo models, 4 & 8-track; 2 4-track Stereo home model's. Price range: \$35-\$420.
Brand Name: Audio/Stereo. (SEE ADVERTISEMENT)

MUSICPET OF CALIFORNIA, 1315 S. Los Angeles St., Los Angeles, Calif. 90015. Tel: (213) 747-5661. Pres.: Murray Epstein; VP: Gerald Moss; Sec.-Treas.: Boris Laskin.
Cartridge: 5 4-track Stereo car models. One 4 & 8-track compatible Stereo home model. Price range: \$69-\$129. (SEE ADVERTISEMENT)

New-Tronics Corp., 3455 Vega Ave., Cleveland, Ohio. Tel: (216) 631-6660. Pres.: John Allmayer; Sales Mgr.: J. L. Taylor.
Cartridge: 1 4-track Stereo car model. Price: \$99.90.

Norelco (North American Philips), 100 E. 42 St., New York, N. Y. 10017. Tel: (212) OX 7-3600. Mgr. High Fidelity Prods. Dept.: Wybo Semmelink.
Cartridge: 1 car & 1 home Mono models. Uses Norelco cassette, 1 7/8 ips.
Reel-to-Reel: 2 Stereo & 2 Mono models, 1 7/8, 3 3/4, 7 1/2 ips.

Orrtronic, PO Box 864, Toledo, Ohio; 30335 Oregon Rd., Perrysburg, Ohio. Tel: (419) 693-0641. Pres.: Keith Wilson; Mgr.: Joseph Meidt.
Cartridge: 2 car models, 1 Stereo 8-track & 1 Mono 4-track; 1 Stereo 8-track home model. Price range: \$80-\$110.
Brand names: Grant, Orrtronic, Sears, White Truck.

Packard-Bell, 12333 W. Olympic Blvd., Los Angeles, Calif. 90025. Tel: (213) 272-6141. Pres.: Robert Bell; Sales Mgr.: Ted Flynn.
Cartridge: 2 Stereo 8-track home models. Price range: \$89-\$500 (approx.).

Panasonic (Matsushita Electric), 200 Park Ave., New York, N. Y. 10017. Tel: (212) 973-5700. Pres.: K. Isomura; VP Consumer Sales: Raymond Gates.
Cartridge: 1 2-track Mono portable car/home model. Price: \$79.95.
Reel-to-Reel: 4 Stereo & 8 Mono models. Price range: \$39.95-\$699.95.

Philco, Tioga & "C" St., Philadelphia, Pa. 19134. Tel: (215) 443-5967. Sales Dir.: John A. O'Hara.
Cartridge: 1 8-track Stereo model. Price: \$379.95.
Reel-to-Reel: 1 4-track Stereo model. Price: \$900.

Playtape, 1115 Broadway, New York, N. Y. 10010. Tel: (212) OR 5-8000. Pres.: Frank Stanton.
Cartridge: 1 2-track Mono portable car/home model.

Porta-Tape (see TelePro).

R A C, 222 W. 37 St., New York, N. Y. Tel: (212) 279-7980. Pres.: Robert Gerger; VP & Mgr.: Arthur Halbreich; Sales Mgr.: Donald Avrut.
Cartridge: 3 4-track Stereo car models & 1 4-track Mono car model. Price range: \$69.95-

\$160. 1 4-track Stereo home model. Price: \$250.

R C A Sales Corp., 600 N. Sherman, Indianapolis, Ind. Tel: (317) 635-9000. Pres.: Bryce Durand; Mfg. Mgr.: J. Dee Mott.
Cartridge: 8-track home Stereo.
Reel-to-Reel: 4-track Stereo; 4-track Mono.

Roberts Electronics (Rheem Califone Roberts Electronics), 5922 Bowcroft St., Los Angeles, Calif. 90016. Tel: (213) 870-9631. VP & Gen. Mgr.: O. X. Pitney; Sales Mgr.: Milton Philipson.
Cartridge: 1 Stereo 4 & 8-track compatible home model. Price: \$99.95.
Reel-to-Reel: 13 Stereo & 4 Mono models. Price range: \$159.95-\$800.
Note: 1 unit with 8-track cartridge & 4-track Reel-to-Reel. 1 video recorder.

S J B (automotive div. of Martel), 2339 S. Cotner, Los Angeles, Calif. 90064. Tel: (213) 479-4491. Cable: ESSJAYBE. Pres.: Sheldon Krechman; Sales Mgr.: George Bozanic.
Cartridge: 12 Stereo car models—8 4-track, 2 8-track, 2 4 & 8-track compatible. 2 4-track Stereo home models. (SEE ADVERTISEMENT)

Satellite (see TelePro).

Selection Int'l, 4215 W. 45 St., Chicago, Ill. Tel: (312) 254-7900. Pres.: Nicholas Milouac; Sales Mgr.: Bernard Buchwald.
Cartridge: 1 portable 2-track Mono car/home model. Price: \$64.95.
Reel-to-Reel: 14 2-speed models—2 stereo, 12 Mono. Price range: \$14.95-\$229.95.
Brand name: Aiwa.

Skytone (see Taiko).

Smith (Stereo Tape Player div.), 2301 University Ave., S.E., Minneapolis, Minn. 55414. Tel: (612) FE 9-7766. Pres.: Don Smith; Mgr.: Leon Niles.
Cartridge: 1 car, 1 home, 1 school bus model (with PA system), 4-track Stereo. Price range: \$125-\$200.

Sonocar (Belmar Prods.), 33 W. 42 St., New York, N. Y. 10036. Tel: (212) 565-5561. Pres.: J. Cerritelli.
Cartridge: 1 4-track Stereo model.

Sony-Superscope, 8150 Vineland Ave., Sun Valley, Calif. 91353. Tel: (213) 875-0810. Pres.: Joseph Tushinsky; VP & Dir. of Sales: Fred Tushinsky.
Branch: Woodside, L. I., N. Y., Superscope, 37-09 56 St. Tel: (212) LT 1-0100.
Reel-to-Reel: 7 Stereo & 5 Mono models. Price range: \$39.50-\$695.

Soundex Radio, 146 Court, Brockton, Mass. 02403. Tel: (617) 586-2468. Pres.: William Sandler; Mgr.: John Stawicki.
Cartridge: 2 car & 3 home 8-track Stereo models. Price range: \$80-\$130.
Brand names: Soundex, All American.

Standard Radio, 410 E. 62 St., New York, N. Y. 10021. Tel: (212) TE 8-4040. Pres.: Mitsuyuki Nagatome; Sales Mgr.: M. J. Kaplan.
Cartridge: 1 2-track Mono home model. Price: \$59.95.

Symphonic Radio & Electronic, 470 Park Ave., South, New York, N. Y., 10016. Tel: (212) 889-6800. Cable: Sympholec. Sales Mgr.: A. Wellington.
Reel-to-Reel: 4 Stereo & 2 Mono models. Price range: \$89.95-\$549.95.

T P I (see TelePro).

TAIKO, 15164 1/2 Stagg St., Van Nuys, Calif. Tel: (213) 787-5420 & 873-5840. Pres.: Sol Zamek; Sales: John Anderson.
Cartridge: 3 car models, 4 & 8-track; 1 home model, 4-track Stereo. Price range: \$119-\$150.
Brand names: Skytone, Taiko, Universal (SEE ADVERTISEMENT)

Tandberg, 8 Third Ave., Pelham, N. Y. Tel: (914) PE 8-0772. Cable: REEVESQUIP. Pres.: Eric Darmstaedter; Sales Mgr.: Robert Bowman.
Reel-to-Reel: 3 Stereo models & 6 Mono models. Price range: \$199.50-\$498.

TapeDek (see Automatic Radio).

Telectro, 100 Electro Ln., Yonkers, N. Y., Tel: (914) BE 7-7700. Pres.: Morris Sobin; Engineering VP: Harry Sussman.
Reel-to-Reel: 5 Stereo & 5 Mono models. Price range: \$79.95-\$249.95.

Telefunken, c/o American Elite Corp., 48-50 34 St., Long Island City, N. Y. Tel: (212) ST 6-8913. Exec. VP: E. Zwarg; Sales Mgr.: Charles Bock.
Reel-to-Reel: 2 Stereo & 4 Mono models. Price range: \$139.95-\$329.

TelePro, Cherry Hill Ind'l Ctr., Cherry Hill, N. J. 08034 Tel: (609) 424-1234. Pres.: Bill Mulcahy; Mktg. Dir.: Howard Gross.
Cartridge: 3 models—2 car models, 1 Stereo & 1 Mono, 4-track; 1 home model, 4-track Stereo. Price range: \$70-\$90. (Marine Porta-Tape,

continued on page 160



AURA SONIC . . . quality leader in the tape cartridge field . . . proudly presents the newest and best in classical, popular and "spoken word" releases . . . all at sensible prices!

YOUR CAR'S A CONCERT HALL WITH AURA SONIC'S 50 NEW STEREO CLASSICS CARTRIDGES!

THE GREAT COMPOSERS . . . *Bach, Beethoven, Brahms, Dvorak, Grieg, Handel, Liszt, Mozart, Rachmaninoff, Ravel, Shubert, Tchaikovsky, Vivaldi*
 INTERPRETED BY
 THE GREAT ORCHESTRAS
 OF THE WORLD! *The London Philharmonic, Sir Adrian Boult; The Hungarian Philharmonic, Miltiades Caridis; The Hamburg Orchestra, Wilhelm Bruckner-Ruggelbert*

\$5⁹⁵
ea.

TWIN PAK TWO-HOUR CARTRIDGES . . . just \$7⁹⁵ ea.

Listen To Your Favorite Popular Music While Driving, With Aura Sonic Stereo or Monaural Tapes!

POP, FOLK, ROCK, JAZZ, MOVIE THEMES, SHOW TUNES, LIGHT CLASSICS, COUNTRY AND WESTERN!

By Top Artists Like Ray Charles, Ferrante & Teicher, Steve Lawrence, Edie Gorme, Roger Miller, Tony Bennett, Joan Baez, Count Basie

\$4⁹⁵
to
\$6⁹⁵
ea.

SPECIAL! "BEST OF 101 STRINGS" . . . just \$2⁹⁵ ea.



Now! Enjoy Caedmon "Spoken Word" Performances Exclusively On Aura Sonic Tape Cartridges!

The great classics of Literature . . . Books, Plays, Poetry . . . from the Bible to the Present!

Author Readings by T. S. Eliot, William Faulkner, Robert Frost, Ernest Hemingway, Sean O'Casey, Dylan Thomas, Etc.

Performances by Ingrid Bergman, Richard Burton, Montgomery Clift, John Gielgud, Julie Harris, Rex Harrison, Laurence Olivier, Bea Lillie, Etc.

\$7⁹⁵
each
1-hour
Cartridge

PRODUCED BY THE SHAKESPEARE RECORDING SOCIETY

"101 Strings" Cartridges Exclusively On
AMERICA'S FASTEST SELLING CARTRIDGES!

Write For Free Catalog!

Mfd. by AURA SONIC CORPORATION, DEPARTMENT B-76, RUNNEMEDE, N.J.



AT LAST!

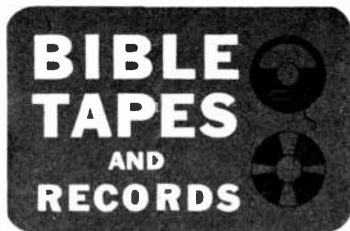

The Complete	TAPE (17 1/8 speed)	RECORDS (16 rpm)
NEW TESTAMENT	\$33.95°	\$29.95
OLD TESTAMENT	\$96.95	\$89.95
PSALMS	\$11.95°	\$11.95
SACRED MUSIC	\$ 8.95 (3 3/4 speed)	

*Available on 3 1/4" reels. Also at 3 3/4 speed on 7" reels slightly extra. Write for prices, Bible in cartridges.

SPECIAL OFFER:

Entire New Testament plus BIBLE VOICE de luxe portable tape recorder — only — \$99.50 complete. Prices F.O.B. Los Angeles.

FREE

... set of stetho earphones with \$50 order. Merchandise may be returned within 10 days for refund if not completely satisfied.



continued

4-track Stereo, adapted for marine craft. Price: \$99.95.)
Brand names: Satellite, Porta-Tape, TPI.
 Tenna, 19201 Cranwood Pkwy., Warrensville Heights, Cleveland, Ohio 44128. Tel: (216) 475-1400
 Pres.: R Mendes; Sales Prod'n Mgr.: Don Slack; Sales VP: Stan Goss.
Cartridge: 1 compatible 4 & 8-track Stereo car model. Price: \$129.95. 2 compatible 4 & 8-track Stereo home models.
 Trans-World, PO Box 482, 717 Elise Ave., Metairie, La. Tel: (504) 834-9097. Pres.: Edward Conrad; Sales Mgr.: F. Davila.
Cartridge: 3 car Stereo models, 4-track, 8-track & 4 & 8-track compatible; 2 home models, 4 & 8-track Stereo. Price range: \$60-\$120.
 Universal (see Taiko).
 UNIVERSAL TAPEDEX CORP., 7660 Gloria Ave., Van Nuys, Calif. Tel: (213) 989-3370. Pres.: Jack Cummings; Exec. VP: Richard G. Paxson.
Cartridge: 2, 4 & 8-track compatible home Stereo units.
 Note: Research & development corp. for manufacturers. (SEE ADVERTISEMENT)
 V-M (Voice of Music), PO Box 659, 305 Territorial Rd., Benton Harbor, Mich. 49023. Pres.: Victor Miller; Mktg. Mgr.: M. B. Cain.
 Reel-to-Reel: 4 Stereo & 5 Mono models. Price range: \$99.95-\$469.95.
 Viking of Minneapolis, 9600 Aldrich Ave. S., Minneapolis, Minn. 55420. Tel: (612) 881-2636. Pres.: Frank Garay.
Cartridge: 2 car & 1 home model, 4-track Stereo.
 Reel-to-Reel: 11 models, 2 & 4-track Stereo & Mono.
 Vista (see Craig Panorama).
 Webcor, 2400 N. Wolcott Ave., Chicago, Ill. 60614. Tel: (312) MO 4-6400. Pres.: Titus Haffa; Pres. Sales: George Pyre.
 Reel-to-Reel: 10 Stereo & Mono models; 1 7/8, 3 3/34, 7 1/2 ips. Price range: \$60-\$400.
 Wollensak (3M), 2501 Hudson Rd., St. Paul, Minn. 55119. Tel: (612) 733-1110.
Cartridge: 3 home & 1 cordless Mono tape recorder (uses Norelco cartridge 1 7/8 ips). Price range: \$100-\$460.

Reel-to-Reel: 5 Stereo & 2 Mono models; 1 7/8, 3 3/4, 7 1/2 ips.

TAPE DUPLICATION

ARIZONA

• **PHOENIX (Area Code 602)**
 Audio Recorders, 3830 N. Seventh St. Zip: 85014. Tel: CR 7-4723.

CALIFORNIA

• **COSTA MESA (Area Code 714)**
 Greentree Electronics, 2135 Canyon Dr. Tel: 549-2265.
 • **GARDENA (Area Code 213)**
 AUDIO MAGNETICS (see Magnetic Stereo Cartridge. (SEE ADVERTISEMENT)
 MAGNETIC STEREO CARTRIDGE, 1604 W. 139 St. Tel: 321-6841. Cable: Mag Tape. Pres.: Irving Katz; Gen. Mgr.: Russ Malloy. (SEE ADVERTISEMENT UNDER AUDIO MAGNETICS)
 • **LOS ANGELES (Area Code 213)**
 Alto Fonic, 6362 Hollywood Blvd., Hollywood. Tel: 466-9261.
 Capitol, 1750 N. Vine St., Hollywood. Tel: HO 2-6252.
 Columbia Rec. Prod'ns, 6121 Sunset Blvd., Tel: 466-2481.
 E M C, 7000 Santa Monica Blvd., Hollywood. Tel: HO 3-3282.
 FINEBILT MFG., 931 N. Citrus Ave., Hollywood. Tel: HO 6-9511. (SEE ADVERTISEMENT)
 MAGNETIC TAPE DUPLICATORS, 7925 Santa Monica Blvd., Hollywood. Zip: 90046. Tel: OL 4-6900. (SEE ADVERTISEMENT)
 Merrimac Music Ind., 9278 Santa Monica Blvd. Tel: 272-1615. Pres.: R. Kopelman.
 National Rec. Library, 9278 Santa Monica Blvd. Tel: 931-1381. Pres.: R. Kopelman.
 R C A Custom Rec. Sales, 6363 Sunset Blvd., Hollywood. Tel: HO 1-9171.
 WHITNEY REC., 1516 W. Glenoaks Blvd., Glendale. Tel: 245-5668. (SEE ADVERTISEMENT)
 • **SAN FRANCISCO & BAY AREA (Area Code 415)**
 Sierra Sound, 1741 Alcatraz Ave., Berkeley. Tel: 655-7636.
 • **SAN MARCOS (Area Code 714)**
 Record Broadcast, 237 S. Bent Ave. Tel: 744-0633.
 • **VAN NUYS (Area Code 213)**
 Audio Publ'g, 6842 Van Nuys Blvd. Zip: 91405. Tel: ST 7-5600.

COLORADO

• **DENVER (Area Code 303)**
 Delft, 5201 W. Mexico Ave. Tel: 922-0356.

FLORIDA

• **MIAMI (Area Code 305)**
 Adrian Assocs., The General Bldg., 6660 Biscayne Blvd. Zip: 33138. Tel: 757-1626.
 • **PENSACOLA (Area Code 904)**
 F T C Brewer, 2400 W. Hayes St. Zip: 32505. Tel: 433-7932. Owner: Frederic T. C. Brewer.
 • **TAMPA (Area Code 813)**
 Charles Fuller Prod'ns, PO Box 10513, 2722 S. Macdill Ave. Zip: 33609. Tel: 839-5471.

ILLINOIS

• **CHICAGO (Area Code 312)**
 Columbia Rec. Prod'ns, 630 N. McClurg Ct. Zip: 60611. Tel: WH 4-6000.
 International Rec'g Co. (IRC), 5619 W. Division St. Zip: 60651. Tel: 378-4848.
 R C A Custom Rec. Sales, 445 N. Lake Shore Dr. Tel: WH 4-3215.
 Universal Rec'g, 46 E. Walton. Tel: MI 2-6465. Pres.: Bernie Clapper.
 • **ELK GROVE (Area Code 312)**
 Ampex, 2201 Landmeier Rr. Tel: 439-5800.

IOWA

• **COUNCIL BLUFFS (Area Code 712)**
 Moss Rec'g Serv., 708 W. Broadway. Zip: 51504.

KANSAS

• **WICHITA (Area Code 316)**
 High Fidelity, 445 N. Oliver. Zip: 67208. Tel: MU 2-7481. Pres.: Raymond Creely.

KENTUCKY

• **LOUISVILLE (Area Code 502)**
 Orbit Radio, PO Box 1644, 1863 Arlington. Tel: 895-1143.

ANOTHER GOPHER FIRST!



Want to lock your Tape Display Case, and index your tapes too? Here is a NEW DIVIDER CARD to go with the new cabinet, Remember - if it's a divider card - Gopher Products always has it first.

AND, you might try us for a DISPLAY CASE too.



M.T.D. HOLLYWOOD

World's largest and most experienced tape duplicators.

Complete facilities including "BIASONIC"

Exclusive duplicating process for 2-4-8-track tapes.

160' assembly line for Cartridge loading.

Expert quality control.

7925 Santa Monica Blvd. Hollywood 46, California

TWO NEW PRODUCTS FROM SEAWAY

SEAWAY® PAC 4 & 8-TRACK CARTRIDGE UNIT.

Ready for immediate loading. Shipped ready to load with your 4 or 8-track tape. Available in colors. Immediate shipment.

SEAWAY® AUTOSTEREO TAPE DISPENSER. Holds 6 four or 8-track cartridges. Mounts quickly . . . right under the dash. Easy access to driver or passenger. Simple installation. Brackets and hardware included. Manufactured from durable polystyrene material . . . safety tested. **\$2.98**
 Retailers at

Write for details and prices. Distributorships available.

SEAWAY STEREO, INC.

833 W. Huron Street, Pontiac, Mich. 48053 (313) 335-8131

LOUISIANA

• **NEW ORLEANS (Area Code 504)**
Andates-Basand, 2627 Leonidas. Zip: 70118. Tel: 861-7494.
Cosimo Rec'g Studios, 748 Camp St. Zip: 70130.
Tel: 523-7474. Contact: Miss Barbara Ann Richardson.

MARYLAND

• **BALTIMORE (Area Code 301)**
Recordings, Inc., 1130 E. Cold Spring Ln. Tel: 433-0701.

MICHIGAN

• **DETROIT (Area Code 313)**
Columbia Rec. Prod'ns, 932 Fisher Bldg. Zip: 48202. Tel: 871-6100.
• **ROYAL OAK (Area Code 313)**
Rael Sound, 4413 Fernlee St. Tel: 549-2930. Pres.: Richard Krause.

MINNESOTA

• **MINNEAPOLIS (Area Code 612)**
Kaybank, 2541 Nicollet. Zip: 55404. Tel: TA 7-5441.
• **ST. PAUL (Area Code 612)**
E M C, 180 E. Sixth St. Zip: 55101. Tel: 227-7366.

MISSOURI

• **KANSAS CITY (Area Code 816)**
Fremerman, 3706 Broadway. Tel: PL 3-6868.
K L S Program Serv., PO Box 10001, Westport Sta. Zip: 64141.

MONTANA

• **HELENA (Area Code 406)**
Valtron, 305 Allen St. Zip: 59601. Tel: 442-0734.

NEBRASKA

• **LINCOLN (Area Code 402)**
Williams Rec. Serv., 2650 N. 48 St. Zip: 68504. Tel: 434-4745.
• **OMAHA (Area Code 402)**
TDC Electronics, 1121 Farnam St. Tel: 342-1538. Contact: Leo Colvin.

NEW HAMPSHIRE

• **KEENE (Area Code 603)**
Vanguard Prod'ns, 16 Ridgewood Ave. Zip: 03431. Tel: 352-7131.

NEW JERSEY

• **CAMDEN (Area Code 609)**
Recorded Publ'ns Labs., 1558 Pierce Ave. Zip: 08105. Tel: 963-3000. Sales Mgr.: David H. Goodman.
• **FAIRFIELD (Area Code 201)**
Tape Handling Prods., 1275 Bloomfield Ave. Zip: 07007. Pres.: Frank X. Brennan.
• **PARSIPPANY (Area Code 201)**
National Tape Serv., 1259 Hwy. 46. Tel: 335-0660. N.Y.C. Tel: (212) 732-5054.

NEW YORK

• **BUFFALO (Area Code 716)**
Howell, 2703 Delaware Ave. Tel: 876-9800.
• **FRANKLIN SQUARE, L. I. (Area Code 516)**
Audio Rec'g & Mfg., 4 New Hyde Park Rd. Zip: 11010. Tel: GE 7-6200.
• **HEWLETT, L. I. (Area Code 516)**
Dubbings Electronics, 226 Franklin Ave. Zip: 11557. Tel: FR 4-6600. Pres.: Julius Konins.
• **HICKSVILLE, L. I. (Area Code 516)**
Jay Electronics, 52 Bethpage Rd. Tel: WE 5-8181. Pres.: Sandford Jay. Gen. Mgr.: Jerry Ehrenzweig.
• **ITHACA (Area Code 607)**
Alcor, 215 S. Tioga. Tel: AR 3-4242.
• **NEW YORK CITY (Area Code 212)**
A & B, 237 W. 54 St. Tel: JU 2-4812. Pres.: Al Weintraub.
Associated, 723 Seventh Ave. Tel: CI 5-7640.
Audio Magnetics, 915 Westchester Ave., Bronx. Zip: 10459. Tel: LU 9-3500. Contact: Milton Gelfand.
Columbia Rec. Prod'ns, 51 W. 52 St. Tel: 765-4321.
Decca, 619 W. 54 St. Zip: 10019. Tel: PL 7-2000.
LONGMARK PROD'NS, 1674 Broadway, Suite 703. Zip: 10019. Tel: 245-9709. (See Utica, N. Y.)
(SEE ADVERTISEMENT)
Olmstead, 1 E. 54 St. Tel: PL 1-0890.
R C A Custom Rec. Sales, 155 E. 24 St. Tel: MU 9-7200.
• **UTICA (Area Code 315)**
LONGMARK PROD'NS, 814 Jay St. Tel: 724-3464. (See New York, N. Y.) (SEE ADVERTISEMENT)

continued on page 204

IF YOU'RE LOOKING FOR A RELIABLE DISTRIBUTOR OF PRE-RECORDED TAPES, YOU'VE JUST FOUND ONE! THE BEST ONE!

PRE-RECORDED TAPES:

- 4 TRACK REEL-TO-REEL**
- 4 TRACK CARTRIDGES**
- 8 TRACK CARTRIDGES**



CALECTRON

TAPE DIVISION
33 GOUGH ST.
SAN FRANCISCO, CALIF. 94119
PHONE: (415) 621-3400
 BRANCHES IN SACRAMENTO & FRESNO

**Prestige
 or Prostitution?**

- 4 and 8 track stereo cartridge libraries of all the major record manufacturers.
- Fully computerized inventory system, guaranteed maximum sales and profits.
- Manufacturing facilities which enable us to design "Pilfer-Proof" displays.
- Efficient, uniformed driver salesmen.
- Best price prevailing plan.

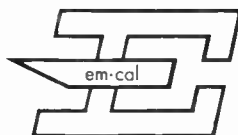

A division of
**ELECTRONIC MERCHANDISE
 CORPORATION OF CALIFORNIA**

2622 So. La Cienega Boulevard, Los Angeles, California 90034
Phone: UP 0-0401

Are you missing orders by not selling our full line ?

Amfile as your one source for all carrying case lines makes good business sense. Why settle for only some of the available orders when, with complete Amfile lines, you can supply any retailer, from auto accessory store to variety chain, and reach the whole market, from pre-teen kid to classical collector?

Platterpak record carrying cases come in 7 shapes, 15 colors, 6 capacities and 7 prices. With or without pop displays. Backed up with mats, photos, catalog sheets, trade ads. New this fall: 3 colors, 4 designs, 4 items.

Ampak cartridge tape carrying cases now come in 2 models, 6 colors, 2 designs and 2 prices. Pop tags on all items, catalog sheets, photos, mats, trade ads. New for fall: Ampak

Deluxe, quality top of the line cartridge tape case - beautiful styling, deluxe packaging.

We're a "teen" outfit on private brands, too. Our Custom Department styles the sell into the case that fits your budget.

Reach the whole carrying case market with Amfile lines - Platterpak record cases, Ampak cartridge tape cases.

Some distributorships still available



Kankakee, Illinois 60901 • 815/933-3351

Record Dealer Accessories & Supplies

BROWSER BOXES

CALIFORNIA

- LOS ANGELES (Area Code 213)
Container-Kraft, 721 E. 61 St. Tel: 232-3281.

ILLINOIS

- CHICAGO (Area Code 312)
Seebro, 2019 S. Michigan Ave. Tel: VI 2-8221.

- KANKAKEE (Area Code 815)

AMBERG FILE & INDEX, 1625 E. Duane. Tel: WE 3-3351. (SEE ADVERTISEMENT)

MICHIGAN

- CHARLEVOIX (Area Code 618)
Freeman Artcraft, PO Box 228. Tel: 547-6501.

NEW JERSEY

- NEWARK (Area Code 201)
Art-Phyl, 508 Frelinghuysen Ave. N.Y.C. Tel: (212) WO 4-2565.

NEW YORK

- NEW YORK CITY (Area Code 212)
Fine-Tone Audio Prods., 7111 20 Ave., Brooklyn. Tel: CL 6-7876.

CARRYING CASES— RECORD & TAPE

CALIFORNIA

- LOS ANGELES (Area Code 213)
Advance Paper Box, 1900 W. 62 St. Tel: PL 1-4141.
Capitol Rec., 3117 San Fernando Rd. Tel: CI 7-8224.
Paramount Wire Prods., 5164 Alcoa Ave. Tel: LU 9-5721.
Raynor Sales, 2663 W. Pico Blvd. Zip: 90006. Tel: 386-3011. Owner: Ray Abrams.

- SAN FRANCISCO & BAY AREA (Area Code 415)

Gopher Prods., PO Box 812, Berkeley. Tel: 843-5836.

ILLINOIS

- CHICAGO (Area Code 312)
M M Cole, 251 E. Grand Ave. Tel: 257-2160.
Lyric-Replogle, 1901 N. Narragansett Ave. Tel: NA 2-5500.
Seebro, 2019 S. Michigan Ave. Tel: VI 2-8221.

- KANKAKEE (Area Code 815)

AMBERG FILE & INDEX, 1625 E. Duane. Tel: WE 3-3351. (SEE ADVERTISEMENT)

MICHIGAN

- PONTIAC (Area Code 313)
SEAWAY STEREO, 833 W. Huron St. Zip: 48053. Tel: 335-8131. VP: George Ivankovics. (SEE ADVERTISEMENT)

NEW JERSEY

- NEWARK (Area Code 201)
Art-Phyl, 508 Frelinghuysen Ave. N.Y.C. Tel: (212) WO 4-2565.

- PERTH AMBOY (Area Code 201)

CHARTER INDS., 224 Washington St. Zip: 08862. N.Y.C. Tel: (212) 753-2157. (SEE ADVERTISEMENT)

- PLAINFIELD (Area Code 201)

Standard Plastic, 450 Oak Tree Ave., South Plainfield.

NEW YORK

- NEW YORK CITY (Area Code 212)
Coast Mfg., 22-45 Pitkin Ave., Brooklyn. Tel: HY 8-2330.

Decca, 619 W. 54 St. Zip: 10019. Tel: PL 7-2000.
Fine-Tone Audio Prods., 7111 20 Ave., Brooklyn. Tel: CL 6-7876.

LE-BO, 33-59 Vernon Blvd., Long Island City. Zip: 11106. Tel: RA 1-8504. (SEE ADVERTISEMENT)

OHIO

- AKRON (Area Code 216)
CAR STEREO, 72 W. Market St. Tel: 434-6666. Pres.: B. J. Liberman. (SEE ADVERTISEMENT)

CATALOG SERVICES

CALIFORNIA

- LOS ANGELES (Area Code 213)
List-O-Tapes, 2720 Beverly Blvd. Zip: 90057. Tel: 385-4211.

Phonolog, 2720 Beverly Blvd. Zip: 90057. Tel: 385-4211.

Tape Parade, 2720 Beverly Blvd. Zip: 90057. Tel: 385-4211.

ILLINOIS

- MOUNT PROSPECT (Area Code 312)
One-Spot, 701 E. Prospect Ave. Tel: 392-1720.

MASSACHUSETTS

- BOSTON (Area Code 617)
Schwann Rec. Catalog, 137 Newbury St. Tel: CO 6-6211.

NEW JERSEY

- HACKENSACK (Area Code 201)
Olsen Catalog of Golden Oldies, 304 Main St. Zip: 07601. Tel: DI 3-8285.

NEW YORK

- NEW YORK CITY (Area Code 212)
Art & Industry, 11 W. 30 St. Tel: WI 7-7979.
Decca, 619 W. 54 St. Zip: 10019. Tel: PL 7-2000.
Harrison Catalog of Stereophonic Tapes, 274 Madison Ave. Tel: MU 5-5383.
Queens Litho., 52-35 Barnett Ave., Long Island City. Zip: 11104. Tel: IL 7-7700.

PENNSYLVANIA

- PHILADELPHIA (Area Code 215)
Recordaid, PO Box 5765. Zip: 19120. Tel: 924-7730.

CLEANERS, CLOTHS, BRUSHES

CALIFORNIA

- LOS ANGELES (Area Code 213)
Capitol Rec., 3117 San Fernando Rd. (see local distributor.)
Recoton, c/o Marshank Sales, 7422 Melrose Ave.



YOUR #1 SOURCE FOR:

- RECORD RACKS ■ RECORD ACCESSORIES ■
- GUITAR ACCESSORIES ■ TAPE ACCESSORIES ■
- BROWSER DIVIDER CARDS — White & Black Plastic ■
- PEGBOARD POCKETS



#127



#75



#45RR



#750

For all your needs,
come to LE-BO first!
We have the most extensive
line of accessories.

For full information, contact —
LE-BO PRODUCTS CO., INC. 33-59 Vernon Blvd.
Long Island City, N. Y. 11106 212-721-8504

STOCK AND SELL FAMOUS WALCO PRODUCTS

WALCO PHONOGRAPH NEEDLES

THE MOST
WANTED
BRAND IN
THE WORLD



... AND WALCO RECORD
ACCESSORIES THE FINEST
AND MOST COMPLETE LINE.

WALCO Stati-Clean

The country's best selling, most popular anti-static record cleaner. Handy aerosol can.

WALCO Discovers

Package of 12 contoured clear polyethylene sleeves to protect records in storage. 12" size.

WALCO Discloth

Chamois-soft yellow record cleaning cloth with rich anti-static impregnate. Lasts for months.

WALCO Stereo/HiFi DisCleaner Kit

World's most effective anti-static record cleaning solution and two deep pile applicators. For stereo and microgroove.

WALCO DiscOdaptors

Card with 10 plastic inserts for 45 rpm records—adapts discs for narrow sprinkle of 3 speed changer.

AND NOW! WALCO MUSIC STRINGS AND ACCESSORIES -

Here is a new top-quality line of guitar, banjo and ukulele strings, precision-made for superior performance... plus in-demand accessories including pitch pipes, polishing cloths, picks, coil cords, books, etc. Attractively, colorfully packaged to be a "hit" on sight, Walco Guitar Strings & Accessories can be yours in your own complete department—easily. Just select from among four handsome, hard-selling Walco displays: counter type, floor type, rotating type and book rack... racks free with each deal.



For Highest Profits, Fastest
Turnover, Sell Walco

SEE YOUR DISTRIBUTOR OR WRITE

Walco Electronics Div.

WALCO-LINCK CORP.

1234 State Highway 46, Clifton, New Jersey

continued

● SAN FRANCISCO & BAY AREA (Area Code 415)

Corey of California, 930 Linden Ave. Tel: 761-0447.

FLORIDA

● MIAMI (Area Code 305)

Duotone, 6875 S.W. 81 St., South Miami. Tel: 665-1121.

ILLINOIS

● CHICAGO (Area Code 312)

M M Cole, 251 E. Grand Ave. Tel: 257-2160.
Fidelitone, 6415 Ravenswood Ave. Tel: BR 4-0075.
Seebro, 2019 S. Michigan Ave. Tel: VI 2-8221.

● ROCKFORD (Area Code 815)

Audiotex, 400 S. Wyman. Tel: 968-9661.

● WAUKEGAN (Area Code 312)

Pfanstiehl, 104 Lake View Ave. Tel: 623-1360.

MASSACHUSETTS

● ATTLEBORO (Area Code 617)

Transcriber, PO Box 478, County St. Tel: CA 2-3525.

NEW JERSEY

● CLIFTON (Area Code 201)

WALCO-LINCK, 1234 State Hwy. 46. Tel: 471-1070.
(SEE ADVERTISEMENT)

● NEWARK (Area Code 201)

Art-Phyl, 508 Frelinghuysen Ave. N.Y.C. Tel: (212)
WO 4-2565.

NEW YORK

● NEW YORK CITY (Area Code 212)

Fine-Tone Audio Prods., 7111 20 Ave., Brooklyn.
Tel: EL 6-7876.

Kirsch Music, 15-28 127 St., Flushing. Zip: 11356.
Tel: HI 5-7200.

MANUFACTURER TO YOU
FOR LOW PRICE and
BIG PROFIT

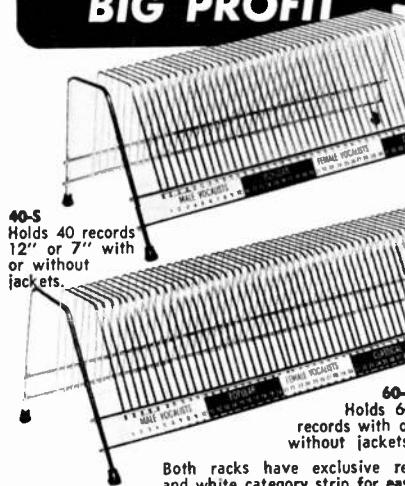

40-S
Holds 40 records
12" or 7" with
or without
jackets.

60-S
Holds 60
records with or
without jackets.

Both racks have exclusive red
and white category strip for easy
filing and selection. Gleaming brass finish.

Record racks—display racks

Over 20 models to choose from

Pegboard units & accessories—Pegboard Hooks

The complete line 89c to \$9.98 retail

Art-Phyl eliminates the middleman to give you
bigger profits.

For more information & literature, call or write

ART-PHYL Creations

508 frelinghuysen avenue, newark, new jersey
bigelow 8-5100 • worth 4-2565

LE-80, 33-59 Vernon Blvd., Long Island City. Zip:
11106. Tel: RA 1-8504. (SEE ADVERTISEMENT)

Lektrostat, 845 Edgewater Rd. Tel: 323-7700.

Le Mire Prods., 204 W. 55 St. Zip: 10019. Tel:
CL 7-3818.

Olympia Mfg. 239 W. 18 St. Tel: 989-7200.

Recoton, 46-23 Crane St., Long Island City. Zip:
11101. Tel: EX 2-6442.

● WYANDANCH, L. I. (Area Code 516)

Tone-King, 354 Long Island Ave. Zip: 11798. Tel:
MI 3-8333.

OHIO

● CONNEAUT (Area Code 216)

Astatic, Harbor & Jackson Sts. Tel: 599-6916.

PENNSYLVANIA

● BROOMALL (Area Code 215)

Lesco Dist., 2205 Mary Ln. Zip: 19008. Tel: EL
6-1887.

NEEDLES

CALIFORNIA

● LOS ANGELES (Area Code 213)

Capitol, 3117 San Fernando Rd. (see local dis-
tributor.)

Recoton, c/o Marshank Sales, 7422 Melrose Ave.

FLORIDA

● MIAMI (Area Code 305)

Duotone, 6875 S.W. 81 St., South Miami. Tel:
665-1121.

ILLINOIS

● CHICAGO (Area Code 312)

Fidelitone, 6415 N. Ravenswood Ave. Tel: BR 4-0075.
Seebro, 2019 S. Michigan Ave. Tel: VI 2-8221.

Shepard Stern, 251 E. Grand Ave. Zip: 60611. Tel:
257-2160.

Zenith, 1900 N. Austin Ave. Zip: 60639. Tel:
745-2000.

● WAUKEGAN (Area Code 312)

Pfanstiehl, 104 Lake View Ave. Tel: 623-1360.

MASSACHUSETTS

● ATTLEBORO (Area Code 617)

Transcriber, PO Box 478, County St. Tel: CA 2-3525.

MICHIGAN

● BUCHANAN (Area Code 616)

Electro-Voice, 600 Cecil St., Dept. W. Zip: 49107.
Tel: 695-6831.

NEW JERSEY

● CLIFTON (Area Code 201)

WALCO-LINCK, 1234 State Hwy. 46. Tel: 471-1070.
(SEE ADVERTISEMENT)

NEW YORK

● NEW YORK CITY (Area Code 212)

American Laubscher, 250 W. 57 St. Tel: JU 6-7474.
Decca, 619 W. 54 St. Zip: 10019. Tel: PL 7-2000.

Fine-Tone Audio Prods. 7111 20 Ave., Brooklyn.
Tel: CL 6-7876.

LE-80, 33-59 Vernon Blvd., Long Island City. Zip:
11106. Tel: RA 1-8504. (SEE ADVERTISEMENT)

Olympia Mfg., 239 W. 18 St. Tel: 989-7200.

RECOTON, 46-23 Crane St., Long Island City. Zip:
11101. Tel: EX 2-6442. (SEE ADVERTISEMENT)

● TUCKAHOE (Area Code 914)

Aldshir Mfg., 111 Lake Ave. Tel: SP 9-1297.

● WYANDANCH, L. I. (Area Code 516)

Tone-King, 354 Long Island Ave. Zip: 11798. Tel:
MI 3-8333.

OHIO

● CONNEAUT (Area Code 216)

Astatic, Harbor & Jackson Sts. Tel: 599-6916.

The official record carrying case of the stars



DISK·GO·CASE ^{T.M.}

Records lie flat — won't scratch or warp • Holds 60 records • Unbreakable in normal use • Sure-lock carrying handle • Dust repellent • Produced in a variety of today's fashion colors • **Backed by TV and radio exposure, artists endorsements, and strong sales promotion** • Sold by the nation's leading record distributors, rack jobbers, and retailers

Manufacturer's suggested list price \$3.98

Write us for literature and sample:

Product of Charter Industries Incorporated, 224 Washington Street, Perth Amboy, New Jersey 08862. Patent No. 3,224,655. Other patents pending in U.S.A. and foreign countries. All rights reserved. © 1966 Charter Industries Incorporated.

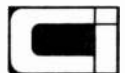

a
must

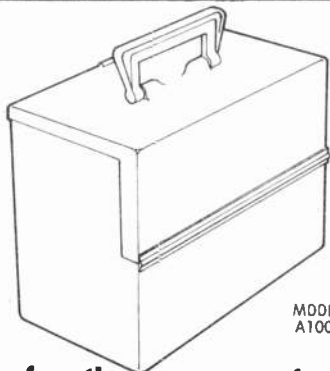

MODEL
A1000

for the owners of
car stereo players!
—AND—

YOUR
'66 PROFIT PICTURE!

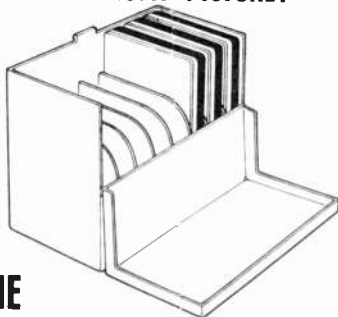

**THE
TAPE TRAVELER**

- HIGH PROFITS ON THIS "MUST" NEW PRODUCT!!
- MADE FROM POLYPROPYLENE (LIKE FINE LUGGAGE)
- LEATHER GRAIN SADDLE-TAN FINISH
- NO SEAMS, ONE PIECE CONSTRUCTION
- "LIVING HINGE" IS GUARANTEED FOR 1 MILLION CLOSINGS
- HOLDS 8 FOUR OR EIGHT TRACK TAPES IN INDIVIDUAL COMPARTMENTS
- PATENTED DESIGN
- SEALS OUT DUST AND DIRT

For Dealer Information on Prices
and Available Distributorships

CALL—WRITE—WIRE

**STEREO PRODUCTS
MANUFACTURING CO.**

72 W. MARKET ST.
AKRON, OHIO 44308
A.C. 216 434-8666

continued

PENNSYLVANIA

- BROOMALL (Area Code 215)
Lesco Dist., 2205 Mary Ln. Zip: 19008. Tel: EL 6-1887.

RACK MANUFACTURERS

CALIFORNIA

- LOS ANGELES (Area Code 213)
Custom Rec. Mfg., 5810 S. Normandie. Tel: PL 0-3310.
Paramount Wire Prods., 5164 Alcoa Ave. Tel: LU 9-5721.

- SAN FRANCISCO & BAY AREA (Area Code 415)

Gopher Prods., PO Box 812, Berkeley. Tel: 843-5836.

ILLINOIS

- CHICAGO (Area Code 312)
Lyric-Replogle, 1901 N. Narragansett Ave. Tel: NA 2-5500.
Seebro, 2019 S. Michigan Ave. Tel: VI 2-8221.

MICHIGAN

- CHARLEVOIX (Area Code 618)
Freedman Artcraft, PO Box 228. Tel: 547-6501.

NEW JERSEY

- NEWARK (Area Code 201)
ART-PHYL, 508 Frelinghuysen Ave. N.Y.C. Tel: (212) WD 4-2565. (SEE ADVERTISEMENT)

NEW YORK

- NEW YORK CITY (Area Code 212)
Art & Industry, 11 W. 30 St. Tel: WI 7-7979.
Fine-Tone Audio Prods., 7111 20 Ave., Brooklyn. Tel: CL 6-7876.

- LE-BO, 33-59 Vernon Blvd., Long Island City. Zip: 11106. Tel: RA 1-8504. (SEE ADVERTISEMENT)
- RECOTON, 46-23 Crane St., Long Island City. Zip: 11101. Tel: EX 2-6442. (SEE ADVERTISEMENT)

TITLE STRIPS

CALIFORNIA

- LOS ANGELES (Area Code 213)
Bert-Co Ents., 1855 Glendale Blvd. Tel: 665-5137.

ILLINOIS

- SKOKIE (Area Code 312)
Merchandising Serv., PO Box 613. Zip: 60076. Tel: 676-3270. Gen. Mgr.: J. McDonald.

MICHIGAN

- NEW HAVEN (Area Code 313)
Sound, Inc., 56880 North Ave. Tel: 749-3225.

NEW JERSEY

- NEWARK (Area Code 201)
Art-Phyl, 508 Frelinghuysen Ave. N.Y.C. Tel: (212) WD 4-2565.
Hit Program Serv., 1175 Broad St. Zip: 07114. Tel: BI 3-0222.
STERLING, 1175 Broad St. Tel: BI 3-0222. N.Y.C. Tel: (212) MU 2-7783. (SEE ADVERTISEMENT)

NEW YORK

- HAUPPAUGE, L. I. (Area Code 516)
Globe Albums, Cardinal Ind'l Park. Tel: 291-7600.

PENNSYLVANIA

- PITTSBURGH (Area Code 412)
STAR, 842 Western Ave. Tel: 231-4314. (SEE ADVERTISEMENT)

ZOWIE!!

Always **NEW** Attractive
Products from the
BIG R

**HOLY
HARMONICA!**

Blister Pack Harmonicas
Ultra-Modern Packaging

BOFF! FREE DISPLAYS

GUITAR ACCESSORIES... COMPLETE LINE

WOW!

- Strings ● Straps
- Picks ● Pitch-pipes
- Cords ● Capos
- Microphones
- Stringwinders
- Instruction Books
- Polishing Kits



Colorful
Blister-
Pack
Pilfer-
Proof

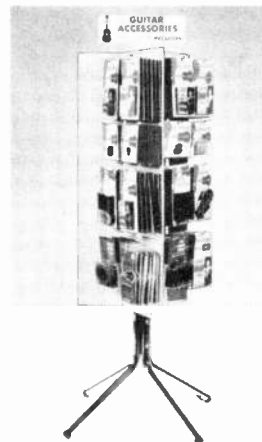

ZONK!

Auto-Tape Cartridge Maintenance
Kit-A Must for all Machines

Write for Information to: RECOTON CORP.
46-23 Crane St., Long Island City, N. Y. 11101
or call us collect 212 EX 2-6442

One best manufacturing
source for Diamond Needles,
Recording Accessories, Tape
Accessories, Recording Tape,
Spindles

from **Billboard**

... THE MOST ALL-ENCOMPASSING REFERENCE LIBRARY OF SERVICE EDITIONS PUBLISHED ANYWHERE FOR ANY INDUSTRY

Now six major 8½ x 11 annual reference issues, providing comprehensive, authoritative information on six specific segments of the music-record industry.

*All distributed without extra charge to Billboard's entire roster of over 21,000 Paid subscribers throughout the world.

THE
ANNUAL
REFERENCE
"LIBRARY"
OF
SPECIALIZED
BUSINESS
INFORMATION



MUSIC ON CAMPUS/The College Market for Records and Talent

On the scene reports from colleges throughout the nation. Contact information and Directory of Artists for use by colleges, and Directory of Colleges (enrollment, auditorium facilities, etc.) for use by artists and booking managers. Winner of the 1964 Jesse H. Neal Award as Best Single Issue published by the American business press.

INTERNATIONAL COIN MACHINE DIRECTORY & Who's Who in the Coin Machine World

*Circulated to members of the coin machine industry only. Complete name and address directories of all firms dealing in the manufacture, distribution or maintenance of coin-operated equipment. Thumbnail biographies and photo gallery of leading coin machine men throughout the world.

THE WORLD OF COUNTRY MUSIC

For the music industry and music fan alike, the most complete and authoritative annual report published for the country music field. Feature articles by leading country music personalities. Complete coverage of the Nashville scene. Directories of Country Artists and Managers. Winner of a 1963 Jesse H. Neal Editorial Achievement Award.

THE INTERNATIONAL BUYERS GUIDE OF THE MUSIC-RECORD INDUSTRY

The most internationally known and referred to directory in the Billboard Library — complete name, address, phone, products, affiliates and branch office listings for everyone providing a product, service or facility available to the music-record industry (domestic and foreign).

THE INTERNATIONAL RECORD TALENT SHOWCASE Who's Who in the World of Music

A comprehensive booker's directory of national and international recording artists. Separate directories, photo galleries and show case sections on the year's top artists in every major musical category.

THE WORLD OF RELIGIOUS MUSIC

The newest addition to Billboard's roster of industry-service annuals . . . providing an in-depth study of the various forms of religious music (gospel, sacred, spiritual) which have grown to be a major force in record industry. Listings of artists, publishers and record manufacturers specializing in religious music.

ANOTHER MAJOR INDUSTRY SERVICE FOR BILLBOARD SUBSCRIBERS

U.S. Phonograph Manufacturers

A M C (see Wells-Gardner Electronics).

Admiral, 3800 W. Cortland St., Chicago, Ill. 60647. Tel: (312) 772-0100. Chm.: R. D. Siragusa; pres.: Vincent Barreca; VP Mktg. & Sales: R. D. Siragusa Jr.; Pres. Int'l: Norman E. Johnson. Int'l Branches: Canada Canadian Admiral, 501 Lakeshore Rd., Port Credit, Ontario. Tel: (416) CR 8-5561. Pres.: Stuart Brownlee. VP: Ed Whittaker.—Mexico, Admiral de Mexico, S.A. de C.V., Apartado Postal 23065, Mexico City 9. Exec. VP: Anthony Farina.

Airline (see Wells-Gardner Electronics).

Aiwa (see Selectron Int'l)

Allied, 2437 E. 57 St., Los Angeles, Calif. 90058. Tel: (213) 582-0841. Pres.: Daken K. Broadhead; VP: John F. Wegner.

Andrea Radio, 27-01 Bridge Plaza N., Long Island City, N.Y. Tel: (212) ST 4-5411. Chm. & Pres.: Frank A. D. Andrea Jr.; Exec. VP: Anthony S. Abbene; Sales VP: Peter J. Morahan.

Arvin, 1531 13 St., Columbus, Ind. 47201. Tel: (812) 372-7271. Pres.: E. H. Stonecipher; VP & Gen. Mgr.: H. J. Seigle.

Audio-Master, 17 E. 45 St., New York, N.Y. 10017. Tel: (212) OX 7-0725. Contact: Herbert Rosen.

Automatic Radio, 2 Main St., Melrose, Mass. 02176. Tel: (617) 321-2300. Pres.: David Housman; VP: E. L. Housman; Consumer Prods. Div. Sales Mgr.: David Nager; Adv. Mgr.: Bob Tegen; Mktg. Dir.: Bert Housman; Exp. Mgr.: Walter Semonoff. Int'l Branch: Canada, Automatic Radio of Canada, Ltd., 25 Bermondsey Rd., Toronto, Ont. Contact: Al McLeod.

Bradford (see Wells-Gardner Electronics).

Bulova, Exec. Offices, 630 Fifth Ave., New York, N. Y. Tel: (212) LT 1-0400.

Capitol, Hollywood & Vine, Hollywood, Calif. 90028. Tel: (213) 462-6252. Chm. & Exec. Off.: Glenn E. Wallichs; Pres. Capitol Rec.: Alan W. Livingston; Pres. Capitol Rec. Dist.: Stanley M. Gortikov; Int'l Pres.: Lloyd W. Dunn. **US Branches:** Los Angeles, Calif., 3117 San Fernando Rd. Zip: 90065. Tel: (213) CL 7-8224. Sales Mgr.: Herb Whitaker.—San Francisco, Calif., 475 Barneveld. Zip: 94124. Tel: (415) VA 6-5454. Sales Mgr.: Charles Bratnober.—Atlanta, Ga., 1670 Northeast Freeway Access Rd. Zip: 30329. Tel: (404) 634-5191. Sales Mgr.: Tom Beckwith.—Niles (Chicago) Ill., 6401 Gross Pointe Rd. Zip: 60648. Tel: (312) 647-8338. Sales Mgr.: George Gerken.—Kansas City, Kan., 4055 Broadway. Zip: 64111. Tel: (913) JE 10435. Sales Mgr.: John Swenson.—Baltimore, Md., 6910 Harford Rd. Zip: 21234. Tel: (301) HI 4-6030. Sales Mgr.: Bill Dawson.—Boston, Mass., 71 Fourth Ave., Needham Hts. Zip: 02194. Tel: (617) HI 9-0770. Sales Mgr.: Martti Takki.—Detroit, Mich., 18921 Wyoming Ave. Zip: 48221. Tel: (313) UN 4-5001. Sales Mgr.: Arnold Orleans.—New York, N.Y., 317 W. 44 St. Zip: 10036. Tel: (212) PL 4-7470. Sales Mgr.: Ben Savoia.—Cincinnati, Ohio, 35 E. Seventh St., Suite 612. Zip: 45202. Tel: (513) 721-5616. Sales Mgr.: John Leffler.—Philadelphia, Pa., 2629 N. 15 St. Zip: 19132. Tel: (215) BA 6-1550. Sales Mgr.: Howard Aronson.—Pittsburgh, Pa., 110-120 San Joseph St. Zip: 15210. Tel: (412) HE 1-5803. Sales Mgr.: Arnold Orleans.—Dallas, Tex., 5105 Lakawana St. Zip: 75247. Tel: (214) ME 7-0710. Sales Mgr.: Marvin Beisel.—Seattle, Wash., 1920 Terry Ave. Zip: 98101. Tel: (206) MA 3-1920. Sales Mgr.: Charles Bratnober.

Channel Master, Ellenville, N. Y. 12428. Tel: (914) 647-5000. Sales Mgr.: Sam Schlusset.

Columbia Masterwork Audio Prods., 51 W. 52 St., New York, N.Y. 10019. Gen. Mgr.: J. J. Harris. **US Branches:** Hollywood, Calif., Columbia Recs. Sales, 1530 N. Gower St. Tel: (213) HO 6-2481. Sales Mgr.: Robert Murphy.—Denver, Colo., Craig Corp., 4959 Colorado Blvd. Tel: (303) 399-0434. Sales Mgr.: Al Bergamo.—Hartford, Conn., Columbia Recs. Sales, 100 Constitution Plaza, Rm. 600. Tel: (203) 522-7151. Sales Mgr.: Stephen Capone.—Washington, D. C.,

Columbia Recs. Sales, Universal Bldg., Suite 1113, 1875 Connecticut Ave. N.W. Tel: (202) 332-2300. Sales Mgr.: George Deacon.—Miami, Fla., Columbia Recs. Sales, 3641 N.W. 67 St. Tel: (305) OX 6-0033. Sales Mgr.: Robert Beasley.—Atlanta, Ga., Comstock Dist'g, 1323 Spring St. N.W. Tel: (404) 876-0321. Sales Mgr.: Donald Comstock.—Honolulu, Hawaii, Craig Corp., 345 Kamakee St. Tel: (808) 586-7171. Sales Mgr.: Masao Tanaka.—Chicago, Ill. Columbia Recs. Sales, 2240 N. Milwaukee Ave. Tel: (312) HU 6-4700. Sales Mgr.: Norman Ziegler.—Des Moines, Iowa, Mid America Dist's., 1630 Locust. Tel: (515) 282-0429. Sales Mgr.: Donald Cooper.—New Orleans, La., Columbia Recs. Sales, John Hancock Bldg., St. Charles Ave. at Lee Circle. Tel: (504) 524-4546. Sales Mgr.: William Shaler.—Portland, Me., Boyd Corp., 84 W. Cove St. Tel: (207) SP 4-0326. Sales Mgr.: Roy Rice.—Waltham, Mass., Columbia Recs. Sales, John Hancock Bldg., 75 Third Ave. Tel: (617) 899-3814. Sales Mgr.: George Ryan.—Detroit, Mich., Columbia Recs. Sales, 16141 W. Eight Mile Rd. Tel: (313) 273-8616. Sales Mgr.: Lawrence Owens.—Minneapolis, Minn., Columbia Recs. Sales, F & M Bank Bldg., Suite 610, 88 S. Sixth St. Tel: (612) 338-7001. Sales Mgr.: Merton Paul.—St. Louis, Mo., Columbia Recs. Sales, 2151 59 St. Tel: (314) MI 7-5101. Sales Mgr.: Robert Van Metre.—New York, N. Y., Columbia Recs. Sales, 545 Madison Ave. Tel: (212) HA 1-4700. Sales Mgr.: Donald England.—Syracuse, N. Y., Columbia Recs. Sales, 218 Harrison St. Tel: (315) 474-2901. Sales Mgr.: Irwin Medway.—Cincinnati, Ohio, Columbia Recs. Sales, Carew Tower, Suite 444-47. Tel: (513) 241-4088. Sales Mgr.: William Kelly.—Cleveland, Ohio, Columbia Recs. Sales, 3510 Chester Ave. Tel: (216) 431-6300. Sales Mgr.: Eugene Settler.—Philadelphia, Pa., Columbia Recs. Sales, 4 Penn Ctr. Plaza, Suite 224. Tel: (215) LO 8-4445. Sales Mgr.: Edward Masterson.—Pittsburgh, Pa., Columbia Recs. Sales, Porter Bldg., Sixth & Grant Sts. Tel: (412) 261-2844. Sales Mgr.: James Winston.—Memphis, Tenn., Stratton Warren Hardware, 37 E. Carolina Ave. Tel: (901) JA 5-7741. Sales Mgr.: James Lewis.—Dallas, Tex., Columbia Recs. Sales, 8808 Empress Row. Tel: (214) ME 1-5680. Sales Mgr.: Thomas Cade.—Seattle, Wash., Craig Corp., 540 S. Front St. Tel: (206) EA 4-2701. Sales Mgr.: Lauren Davies.—Milwaukee, Wis., Morley Murphy, 5151 W. State St. Tel: (414) GL 3-7200. Sales Mgr.: Henry Aubuchon.

Coronado (see Wells-Gardner Electronics).

Crestmark (see Gotham).

Curtis-Mathes, 2220 Young St., Dallas, Tex. Tel: (214) RI 8-8311. Pres.: Charles R. Mathes; Sec.-Treas.: R. C. Owens Jr.

Decca, 445 Park Ave., New York, N. Y. 10022. Tel: (212) PL 2-1600. Pres.: Milton R. Rackmil; Exec. VP: Leonard W. Schneider; VP Sales: Sydney N. Goldberg; Asst. Gen. Mgr. Int'l Sales: Hubert J. Stone.

US Branches: Los Angeles, Calif., 6750 Santa Monica Blvd. Zip: 90038. Tel: (213) HO 3-7126. Dist. & Branch Mgr.: Lou Verzola.—San Francisco, Calif., 66 Dorman Ave. Zip: 94123. Tel: (415) VA 4-0161. Mgr.: Bob Eggers.—Miami, Fla., 2452 N. W. 77 Terr. Zip: 33147. Tel: (305) 691-4816. Mgr.: Bert Jones.—Atlanta, Ga., 156 Alexander St. N. W. Zip: 30313. Tel: (404) JA 4-8428. Mgr.: Ed Russell.—Honolulu, Hawaii, 345 Kamakee St. Zip: 96814. Tel: (808) 504-2111. VP: L. C. Gilman.—Chicago, Ill., 425 N. Michigan Ave., The Mandel-Lear Bldg. Zip: 60611. Tel: (312) DE 7-1100. VP: S. C. Schulz; Mgr.: A. Weiner.—New Orleans, La., 517 Canal St. Zip: 70130. Tel: (504) JA 2-1786. VP: R. N. McCormick.—Baltimore, Md., 2921 Alexander Ave. Zip: 21215. Tel: (301) FO 7-0710. Mgr.: Edward Keelan.—Boston, Mass., 138 Ipswich St. Zip: 02215. Tel: (617) CO 6-5110. Mgr.: Allan Ross.—Detroit, Mich., 12730 Puritan Ave. Zip: 48227. Tel: (313) DI 1-6040. Mgr.: Mario DeFilippo.—Minneapolis, Minn., 17-19 E. Hennepin Ave. Zip: 55401. Tel: (612) FE 5-7681. Mgr.: Ozzie Lowe.—Kansas City, Mo., 2729 Gillham Rd. Zip: 64108. Tel: (816) GR 1-4030. Mgr.: Carl Wayne.—St. Louis, Mo., 1905 Delmar Blvd.

Zip: 63103. Tel: (314) CE 1-6600. Mgr.: Max Melton.—Camden, N. J., 1722 Federal St. Tel: (609) 966-7111. Mgr.: Sam Passamano.—Cohoes, N. Y., Vliet & Mohawk Sls. Zip: 12047. Tel: (518) CE 7-9000. Mgr.: Leo Refice.—Cincinnati, Ohio, Daylight Bldg., Sixth & Court. Zip: 45202. Tel: (513) PA 1-4210. Mgr.: C. W. Doherty.—Cleveland, Ohio, 746 W. Superior Ave. Zip: 44113. Tel: (216) 621-9770. VP: William Glaseman; Mgr.: Bill Green.—Memphis, Tenn., 741 Galloway Ave. Zip: 38105. Tel: (901) 527-4539. Mgr.: Jack Brown.—Dallas, Tex., 139 Cole St. Zip: 75207. Tel: (214) RI 2-3739. Mgr.: C. E. McNabb.—Seattle, Wash., 3131 Western Ave. Zip: 98121. Tel: (206) AT 4-8060. Mgr.: Mel Nimon.

Dormeyer (see Webcor).

Dumont (see Emerson).

Dynavox Electronics, 40-05 21 St., Long Island City, N. Y. 11101. Tel: (212) ST 6-3770. Pres.: Joseph Dworcen.

Electron Ents., 6727 Stanley Ave., Berwyn, Ill. Tel: (312) BI 2-2636. Pres.: J. Cimfe; VP: R. Stauber; Sales: J. R. Cimfe.

Emerson Radio, 680 Fifth Ave., New York, N. Y. 10019. Tel: (212) 757-5885. Pres.: C. Russell Feldmann; VP Mktg.: George Cohen; VP Sales, Emerson Div.: Leo Hahn; VP Sales, Dumont Div.: George Hakim.

Fanon Electronic Ind., 439 Frelinghuysen Ave., Newark, N. J. Tel: (201) BI 3-1020. Pres.: Salo Nachtigall; Exec. VP: Walter Nachtigall; VP Sales: Murray Trotiner. Int'l Branch: Canada, 489 King St., W., Toronto, Ont. Contact: Harold Rosen.

Fisher Radio, 11-40 45 Rd., Long Island City, N. Y. 11101. Tel: (212) EX 2-8900. Pres.: Avery Fisher; Exec. VP: Harold J. Schulman; Sales Mgr. Console Div.: James J. Carroll; Sales Mgr. Component Div.: Harry Norman; Int'l: Ben Buxton.

General Electric, Radio Receiver Dept.: 1001 Broad St., Utica, N. Y. Tel: (315) SW 7-1000. Mktg. Mgr.: John S. Chamberlin; Mgr. Mfg.: D. E. Garrett.

Main Branch for Audio Prods.: Decatur, Ill., 2200 N. 22 St. Zip: 62525. Tel: (217) 428-4311. Gen. Mgr.: H. B. Waldron; Mktg. Mgr.: J. L. Hunter; Sales/Consoles: J. E. Wiegel; Sales/Portables: J. P. Enggaard.

Gotham-Crestmark, 170 Michael Dr., Syosset, N. Y. 11791. Tel: (516) WA 1-4500. Pres.: Marvin J. Frank; VP: Stanley Cohen; Sales Mgr.: Irv Kaplan.

Guild Radio & Television, 460 N. Eucalyptus Ave., Inglewood, Calif. 90302. Tel: (213) OR 8-7771. Pres. & Sales Mgr.: Lou Dolgin.

Hoffman Electronics, 4501 N. Arden Dr., El Monte, Calif. 91734. Tel: (213) 686-0123. Pres. & Chm. of Bd.: H. Leslie Hoffman; VP Consumer Prods.: R. B. Cox; Gen. Mgr.: R. L. Jablonski; Adv. Dir.: E. A. Tischler. **US Branches:** Los Angeles, Calif., 55550 Harbor St., City of Commerce. Zip: 90022. Tel: (213) 685-5363.—Chicago, Ill., 571 W. Jackson. Zip: 60606. Tel: (312) 427-9151.

M P Engineering, Fairfield, Conn. 06430. Tel: (203) 268-2385. Contact: M. Paneyko.

Magnavox, Exec. Offices, 270 Park Ave., New York, N. Y. Tel: (212) YU 6-0055. Pres.: Frank Freimann; VP & Sales Mgr.: George H. Fezell. **Corporate Offices:** Ft. Wayne, Ind., 2131 Bueter Rd. Tel: (219) 743-9721.

Major Electronics, 1776 Eastern Parkway, Brooklyn, N. Y. Tel: (212) HY 8-7200. Pres.: M. V. Lane; VPs: Steve Lane & Bill Lane; Gen. Mgr.: S. Smolen.

Majorette, 2124 Bergen St., Brooklyn, N. Y. (see Major).

Masco (see Fanon Electronic Ind.)

Mercury, 35 E. Wacker Dr., Chicago, Ill. 60601. Tel: (312) DE 2-5788. Contact: Perry Winnokur.

Midland Int'l, 1909 Vernon St., North Kansas City, Mo. 64116. Tel: (816) VI 2-0511. Pres.: Edward L. Benson; Mktg. Mgr.: James Love.

Motorola Consumer Prods., 9401 W. Grand, Franklin Park, Ill. Tel: (312) NA 5-6000. Pres.: S. R. Herkes; VPs: J. F. Haley & C. V. Phillips; Gen. Mgr.: A. L. Reese; Dir. of Adv.: R. G. Farris.

Olympic Radio & Television Sales, div. of Lear Siegler, Inc., 34-D1 38 Ave., Long Island City, N. Y. 11101. Tel.: (212) EX 2-5200. Pres.: Morton M. Schwartz; Exp. Mgr.: Jack Goldman.
US Branches: Los Angeles, Calif., 4341 District Blvd. Tel: (213) LU 9-5246. Contact: William Briggs.—San Francisco, Calif., 2041 Evans Ave. Tel: (415) 824-9511. Contact: Dore Schwab.—Hartford, Conn., 175 Locust St. Tel: (203) 249-7721. Contact: Ted Bloom.—Chicago, Ill., 1447 Diversey Pkwy. Tel: (312) WE 5-6421. Contact: Bob Schwartz.—Baltimore, Md., 6700 White Stone Rd. Tel: (301) 944-4900. Contact: George Rosen.—Roxbury, Mass., 7 Westminster Ave. Tel: (617) GA 7-7047. Contact: Sam Chiacchia.—Detroit, Mich., 7460 Intervale Ave. Tel: (313) TE 4-6720. Contact: Max Lipin.—Minneapolis, Minn., 4906 W. 35 St. Tel: (612) 927-6511. Contact: Dan McKinnon.—St. Louis, Mo., 7155 Manchester Ave. Tel: (314) MI 7-1155. Contact: Tom Cutler.—Albany, N. Y., 18 Interstate Ave. Tel: (518) HE 8-3587. Contact: Charles Corman.—Buffalo, N. Y., 94 Pearl St. Tel: (716) TL 6-2651. Contact: Bob Whitelaw.—Glendale, N. Y., 89-89 Union Turnpike. Tel: (212) HI 1-6400. Contact: Bill Goldberg.—Syracuse, N. Y., 845 Hiawatha Blvd. W. Tel: (315) 474-3396. Contact: Glenn Sheldon.—Cleveland, Ohio, 2625 St. Clair Ave. Tel: (216) MA 1-4136. Contact: Ted King.—Folcroft, Pa., 1776 Delmar Dr. Tel: (215) LU 3-6600. Contact: Ed Beetem.—Pittsburgh, Pa., 2930 Liberty Ave. Tel: (412) GR 1-4081. Contact: Harold Gold.—Dallas, Tex., 9001 Diplomacy Row. Tel: (214) ME 7-0790. Contact: Earl Kittleson.—Houston, Tex., 2210 Edwards St. Tel: (713) UN 9-4677. Contact: K. P. Roberts.—Seattle, Wash., 825 S. Stacy St. Tel: (206) MA 3-8650. Contact: George Shipman.

Packard-Bell Electronics, 12333 W. Olympic Blvd.,

Los Angeles, Calif. 90025. Tel: (213) 272-6141. Chm.: R. S. Bell; Pres.: W. B. Sell; Pres. Sales & Int'l: K. R. Johnson.

Philco, a subsidiary of Ford Motor Co., "C" & Tioga Sts., Philadelphia, Pa. 19134. Tel: (215) 443-6000. Pres.: Robert D. Fickes; VP Int'l Div.: W. S. Bopp.
 Int'l Branches: Argentina, Philco Argentina, S.A., Canada de Gomez 5567, Buenos Aires. Tel: 60-2061. Gen. Mgr.: W. S. Rolston.—Brazil, Philco Radio & Televisao Ltda., Virginia 299 (Tatuape), Sao Paulo. Tel: 93-6193. Mgt'g Dir.: F. L. Sherman.—Canada, Philco Corp. of Canada, Ltd., 900 Don Mills Rd., Toronto, Ont. Tel: (416) 444-2541. VP & Gen. Mgr.: R. A. MacDonald.—Italy, Philco Italiana S.p.A., Via G. Marconi 14-22, Ponte San Pietro, Bergamo. Tel: 611-560. Pres. & Gen. Mgr.: R. DiPiramo.—Mexico, Philco S.A. de C.V., Clavel 157, Mexico D. F. Tel: 47-46-00. Pres. & Gen. Mgr.: H. L. Cummings.

Phonola (see Waters-Conley).

Pilot Radio, 100 Electra Ln., Yonkers, N. Y. 10704. Tel: (914) BE 7-7700. Pres.: Morris Sobin; Nat'l Sales Mgr.: William O'Boyle.

RCA Sales, 600 N. Sherman Dr., Indianapolis, Ind. 46201. Tel: (317) ME 6-5311. Pres.: Bryce S. Durant; VP Prod. Planning: Jack K. Sauter; VP Adv. & Sales Promo.: Jack M. Williams; VP Sales: Joseph P. Bannon; VP Distributor Dpns. Servs.: J. L. Albers.

Rheem Califone-Roberts Electronics, div. of Rheem Mfg., 5922 Bowcroft St., Los Angeles, Calif. 90016. Tel: (213) 870-9631. VP & Gen. Mgr.: O. X. Pitney; VP Mktg.: J. F. White.

Roberts Electronics (see Rheem Califone).

Selectron Int'l, 4215 W. 45th St., Chicago, Ill. 60632. Tel: (312) 254-7900. Pres.: N. Milovac; Sales Mgr.: Bernard Buchwald.

Silvertone (see Warwick Electronics).

Sylvania Electric Prods., 730 Third Ave., New York, N. Y. 10017. Tel: (212) 551-1409. Pres.: Gene K. Beare. Contact: Richard L. Graves.
 US Branches: Bedford, Mass., Commercial Electronics Div., PO Box 268, Burlington Rd.—

Waltham, Mass., Sylvania Electronic Systems Div., 40 Sylvan Rd.—Batavia, N. Y., Sylvania Home Entertainment Electronics, 700 Ellicott Ave.—Hicksville, L. I., N. Y., Sylcor, Cantiague Rd.

Symphonic Radio & Electronic, 470 Park Ave. S., New York, N. Y. 10016. Tel: (212) 889-6800. Pres.: Max J. Zimmer; Nat'l Sales Mgr.: A. Wellington; Int'l Sales: H. A. Jacobs.

Truetone (see Wells-Gardner Electronics).

V-M Corp., 305 Territorial Rd., Benton Harbor, Mich. 49023. Tel: (616) 925-8841. Pres.: Victor A. Miller; Mktg. Mgr.: M. B. Cain; Exp. Sales Mgr.: Merce Fisher.

Victrola (see RCA Sales).

Warwick Electronics, 7400 N. Lehigh, Chicago, Ill. 60648. Tel: (312) 774-6400. Contact: A. W. Travers.

Waters-Conley, 645 N. Michigan Ave., Chicago, Ill. 60611. Tel: (312) 944-5125. Pres.: H. M. Greenspon; Nat'l Sales Mgr. Phonola Div.: Edward Boba; Sales Mgr. Private Label Div.: Martin W. Krenzke.

US Branch: Rochester, Minn., 501 First Ave. N. W. Zip: 55902. Tel: (507) 289-1681. VP Mfg.: Richard Huber.

Webcor/Dormeyer, 700 N. Kingsbury St., Chicago, Ill. 60610. Tel: (312) MO 4-6400. Pres. & Chm.: Titus Haffa; Exec. VP: Richard J. Cole; Mfg. VP: George J. Pyre; VP Mktg. & Sales: William Chapman; Sec.: Charles Blake; Pres. Webcor Sales: George J. Pyre; Pres. Dormeyer: George J. Pyre.

Wells-Gardner Electronics, 2701 N. Kildare Ave., Chicago, Ill. 60639. Tel: (312) AL 2-8220. Pres.: Grant Gardner; Exec. VP & Gen. Mgr.: A. J. Wells Jr.; Sales VP: Allan Gardner.

Westinghouse Electric, TV-Radio-Phono. Div., Rt. 27, Vineyard Rd., Metuchen, N. J. Tel: (201) LI 8-5000. Gen. Mgr.: W. M. Day; Prod. Plan'g Mgr.: H. Paxinos.

Zenith Radio, 1900 N. Austin Ave., Chicago, Ill. 60639. Tel: (312) 745-2000. Pres.: J. S. Wright; Exec. VP Sales: L. C. Truesdell; VP Exp.: J. A. Miguel.

*It's been a wonderful first year!!
 Our thanks to people in the industry... all over the world!*

Mira
 RECORDS

Mirwood
 RECORDS

SURREY
 RECORDS

International licensees:

DISCHI RICORDI (Italy)/SPARTON of CANADA, LTD (Canada)/PHILIPS PHONOGRAPHIC INDUSTRIES (all other countries)

MIRA PRODUCTIONS, INC./ 9028 Sunset Blvd., Los Angeles, California 90069
 PHONE (212) 278-1125
 Cable: Mirarec

ATLANTIC RECORDS THROUGHOUT THE WORLD

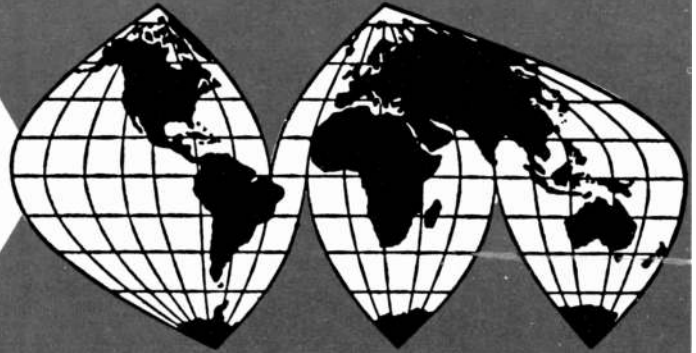

Atlantic Foreign Licensees and Distributors:

ARGENTINA:

SURCO INDUSTRIAS MUSICALES
Tucuman 439
Buenos Aires, Argentina
Mr. Enrique Iriberrí
Phone: 32-0123

AUSTRALIA:

FESTIVAL RECORDS PTY. LTD.
223-229 Harris Street
Pyrmont, N.S.W., Australia
Mr. Frederick C. Marks
Phone: 68-4021

BELGIUM:

**COMPAGNIE PHONOGRAPHIQUE
FRANCO-BELGE, BARCLAY**
31, rue du Lombard
Brussels 1, Belgium
Mr. V. Bral
Phone: 11 81 97

CANADA:

QUALITY RECORDS LIMITED
380 Birchmount Road
Scarborough, Ontario, Canada
Mr. George L. Keane
Phone: OX 8-5511

DENMARK:

METRANOME RECORDS A/S
31 Vibevej
Copenhagen, Denmark
Mr. Bent Fabricius-Bjerre
Phone: Aegir 8112

ENGLAND:

POLYDOR RECORDS LIMITED
17-19 Stratford Place
Oxford Street
London, W. 1, England
Mr. Roland Rennie
Phone: Hyde Park 7401

FRANCE:

DISQUES BARCLAY
143, Avenue de Nevilly
Neuilly sur Seine, France
Mr. Eddie Barclay
Phone: 722-60-30

GERMANY:

METRANOME RECORDS GMBH
Heidenkampsweg 76B
Hamburg, Germany
Mr. Leif Kraul
Phone: 24 12 61

GREECE:

DIONYSOS GENERAL PUB. CO. LTD.
11, Kriezotou Street
Athens 134, Greece
Mr. Alexander Patsifas
Phone: 616 716

HOLLAND:

POLYDOR NEDERLAND N.V.
Piet Heinplein 5
Den Haag
Mr. E. Garretsen
Phone: 63 49 55

HONG KONG:

COSDEL (HONG KONG) LTD.
1331-2 Prince's Building
Hong Kong, B.C.C.
Mr. T. K. Whang
Phone: 240823

ITALY:

SAAR, S.R.L.
Viale Porta Vercellina, 14
Milan, Italy
Mr. Walter Guertler
Phone: 4696251

JAPAN:

COSDEL RECORDS (JAPAN) LTD.
The Nikkatsu International Building
No. 1, 1-chome, Yuraku-cho, Chiyoda-ku
Tokyo, Japan
Mr. Kenneth L. Cole
Phone: 271-5862

MEXICO:

RCA VICTOR MEXICANA, S.A. de C.V.
Av. Cuiclahuac 2519
Mexico 16, D.F.
Mr. E. Gutierrez Zamora
Phone: 27-60-20

PHILIPPINES:

MARECO, INC.
131 Del Monte Avenue
Quezon City, Philippines
Mr. Luis Villar
Phone: 7 87 94

SINGAPORE:

COSDEL (SINGAPORE) LTD.
50E, Armenian Street
Singapore 6
Mr. S. P. Sim
Phone: 35047

SOUTH AFRICA:

GALLO AFRICA LIMITED
161 President Street
Johannesburg, South Africa
Mr. Alec Delmont
Phone: 23-2111

SPAIN:

DISCOS BELTER S.A.
Gomis, 1
Barcelona, Spain
Mr. J. Alfonso
Phone: 248 17 53

SWEDEN:

METRANOME RECORDS AB
Storangsvagen 27
Stockholm, Sweden
Mr. Borje Ekberg
Phone: 610616

TURKEY:

GRAMOFON LİMİTET SİRKETİ
Halkali Caddesi 85
Yesilkoy-Istanbul
Mr. Alan Campbell
Phone: 73-89-76



ATLANTIC RECORDS, 1841 Broadway, New York, N.Y. 10023 • (212) PL. 7-6306

International Market Report

Argentina
Australia
Austria
Bahamas
Belgium
Bermuda
Bolivia
Brazil
Bulgaria
Canada
Chile
China, Republic of
Colombia
Costa Rica
Czechoslovakia

Denmark
Dominican Republic
Ecuador
Eire
El Salvador
England (See United Kingdom)
Finland
France
Germany, East
Germany, West
Greece
Guatemala
Guyana
Honduras

Hong Kong
Hungary
Iceland
India
Indonesia
Israel
Italy
Jamaica
Japan
Kenya
Lebanon
Malaysia
Mexico
Morocco
Netherlands

Netherlands Antilles
New Zealand
Nicaragua
Nigeria
Norway
Pakistan
Panama
Paraguay
Peru
Philippines
Poland
Portugal
Puerto Rico
Singapore
South Africa, Republic of

South Korea
South Vietnam
Spain
Sweden
Switzerland
Thailand
Trinidad & Tobago
Turkey
United Arab Republic
United Kingdom
Uruguay
U.S.S.R.
Venezuela
Virgin Islands (U. S.)
Yugoslavia

ARGENTINA

Population: 21,416,000.
Official rate of exchange: \$1 (US) = 134.70 pesos.
Per capita income: \$80.
Records exported to US (factory value): 1964—\$2,494.
Records imported from US: None.
Average retail price: LP's—\$4.50; EP's—\$1.75; Singles—\$1.15.
Record distribution system: Manufacturer to dealer.
Discounting: Occasional.
Record club sales: 1%.
Jukeboxes: 1,000.
Radio stations: 70.
Television stations: 20. Ruben Machado

● record manufacturers

Belter, Rodriguez Pena 36, 70-D, Buenos Aires. Tel: 46-5827. Cable: LATINA. Pres.: Jose Navas; Gen. Prof. Mgr.: Ricardo Romero.

C B S, Paraguay 1583, Buenos Aires. Tel: 42-4307. Cable: COLRECORD. VP: John Truden; Gen. Mgr.: Armando di Guglielmo; Mgr.: Douglas Taylor; Pop. A&R Mgr.: John Lear; Classical A&R Mgr.: Alberto Caldeiro; Sales Mgr.: Luis Aguado; Pub. & Adv. Mgr.: Orlando Rosenberg; Promo. Mgr.: Ricardo Pereira.
Labels: CBS, Orfeo.
This company represents: Columbia (USA), Plaza (Brazil), Ricordi (Italy), United Artists (USA).

Dial, Pasteur 341, Buenos Aires. Tel: 47-0145. Gen. Mgr.: C. L. Tealdo Alizieri; Mgr.: Cesar A. Divaga; Adv. & Promo. Mgr.: Pablo Rossi.
Label: Dial.
This company represents: Fantasy, GNP Crescendo, Mainstream, Time (all USA).

Disc Jockey, Pedro Goyena 70-72, Buenos Aires. Tel: 72-9090. Pres.: Manuel Rodriguez Luge; VP: Eduardo Piovano; Sales Mgr.: Ricardo Portela; Pub. Mgr.: Roberto Quirno.
Label: Disk Jockey.
This company represents: Barclay (France), Carosello (Italy), Chantecler (Peru), Continental (Brazil), Italdisc (Italy), Palette (Belgium), Sonoradio (Peru), El Virrey (Peru).

Famous, Peru 151, Buenos Aires. Tel: 26-3298. Gen. Mgr.: I. W. Morris; Mgr.: Mike Davis.
Label: Ariel.
This company represents: ABC-Paramount (USA), EMI (England), Fonograma (Venezuela), Musidisc (Brazil), Tropical (Colombia), Versailles (France).

Fermata, San Martin 640, Buenos Aires. Tel: 31-9330, 9377. Cable: Fermata. Pres.: Enrique Lebendig & Mauricio Brenner; Mgr.: Gerardo Grassi.
Label: Fermata.
This company represents: A&M (USA), AZ (France), Cameo-Parkway (USA), Clan (Italy), Class (Uruguay), Ferbra (Brazil), Fonit-Cetra (Italy), Jaguar (Italy), Jolly (Italy), Momo (Brazil), Prosadis (France), Red Bird (USA), RGE (Brazil), Style (Italy).

Industrias Electricas y Musicales Odeon (EMI), Corrientes 485, Buenos Aires. Tel: 49-6651. Cable: TURNTABLE. Gen. Mgr.: Philip Brodie; Mgr.: George W. Ferguson; Pop A&R Mgr.: Jose Angel Rota; Classical A&R Mgr.: Federico Clappenbach; Sales Mgr.: Roberto A. Abatte; Pub. & Adv. Mgr.: Domingo A. Ramos; Promo. Mgr.: Juan Carlos Menna; Mgr. Int'l A&R: Miguel Scaglia.

Branches: Cordoba 669. Tel: 31-6017. Contact: Jose Cortez.—Lavalle 465. Tel: 32-6296. Contact: Aida Verdi.—Mendoza 2150. Tel: 76-2347. Contact: Enrique Lynch.
Labels: Odeon, Odeon "Pops."
This company represents: Capitol (USA), Carish (Italy), Columbia (Italy), Cubartimpex (Cuba), Decca (USA), EMI (England), Ember (USA), Imperial (USA), Liberty (USA), London (England), Musart (Mexico), Parlophone (Italy), Pathe-Marconi (France), Toshiba (Japan), La Voce Del Padrone (Italy).

Microfon, Lavalle 1759, Buenos Aires. Tel: 49-6128. Gen. Mgr.: Mario R. Kaminsky; Mgr.: Norberto Kaminsky; Pop A&R Mgr.: Horacio Malvicino; Promo. Mgr.: Osvaldo Guerra.
Label: Microfon.
This company represents: Audio Fidelity (USA), Bang (USA), Brunswick (USA), Coral (USA), Joda (USA), Karate (USA), Prestige (USA), Som/Major (Brazil).

Ala Nicky, Alsina 1535, Buenos Aires. Tel: 40-8210. Gen. Mgr.: Jose Bragato.
Label: Ala Nicky.
This company represents: Meazzi (Italy).

Phonogram, Cordoba 1351, Buenos Aires. Tel: 41-0048. Cable: PHONOGRAM. Gen. Mgr.: Hugo A. J. Persichini; Pop A&R Mgr.: Santo Lipesker; Sales Mgr.: Americo Severini; Pub. & Adv. Mgr.: Arturo J. Martinez; Promo. Mgr.: Alfredo Leutgebeweger.
Label: Philips.
This company represents: Archive (Germany), Deutsche Grammophon (Germany), Disneyland (USA), MGM (USA), Mercury (USA), Polydor (Germany), Verve (USA).

Prodisa, Thames 2472, Buenos Aires. Tel: 72-1862. Gen. Mgr.: Jorge Cesar Esperon; Sales Mgr.: Facundo Martinez; Promo. Mgr.: Horacio Tanturi; Country Sales Mgr.: Luis Pissolito.
Label: Tonodisc.
This company represents: Grand Award (USA), Tamla-Motown (USA), Westminster (USA).

RCA, Paroissien 3960, Buenos Aires. Tel: 70-4171. Pres.: Robert F. Cook; Gen. Mgr.: Bruno Grupp; Pop A&R Mgr.: Johnnie Camacho; Classical A&R Mgr.: Aquiles Iacometti; Sales Mgr.: Adolfo Pino; Pub. & Adv. Mgr.: Juan Piccin; Promo Mgr.: Francisco Azzaritto.
Labels: RCA Camden, RCA Victor, RCA Victrola, VIX "X."
This company represents: Dunhill (USA), Montilla (USA).

Sicamericana, Jose E. Uriburo 40, Buenos Aires. Tel: 46-9807. Cable: SICAMERICANA. Pres.: Nestor Selasco; VP: Luis Calvo; Pop A&R Mgr.: Hector Milliano; Sales Mgr.: Ricardo Taverna; Pub. & Adv. Mgr.: Jorge Montez; Promo. Mgr.: Elsa Ferreyra; Prod'n Mgr.: Juan Kregar.
Label: Music Hall.
This company represents: CGD (Italy), Copacabana (Brazil), Demon (Chile), Dot (USA), Fuentes Colombia, Gamma (Mexico), Kapp (USA), Orfeon Peerless (Mexico), Pye (England), Reprise (USA), Roulette (USA), Seeco (USA), Vanguard (USA).

Surco, Tucuman 439, Buenos Aires. Tel: 32-0123. Gen. Mgr. & Pop A&R Mgr.: Enrique Iriberrri; Sales Mgr.: Atilio Suva; Promo. Mgr.: Martin Lauterer.
Labels: Calesita, Opus.
This company represents: Atlantic (USA), Elite Spezial (Switzerland), President (France), Telefunken (Germany).

Tonodisc, 15 de Noviembre 1287, Buenos Aires. Tel: 23-7724. Pres.: Jorge Cesar Esperon.
This company represents: Artone (Holland), Command (USA), Tamla-Motown (USA), Westminster (USA).

Trova, Corrientes 2434, Buenos Aires. Tel: 49-9996. Gen. Mgr.: Jorge Calandra; Mgr.: Alfredo Silvernstein; Pop A&R Mgr.: Alfredo Radoszynski.
Label: Trova.
This company represents: Concertdisc (USA), Contemporary (USA), Counterpoint-Esoteric (USA), Elenco (Brazil), Folkways (USA), Good Time Jazz (USA), World Pacific (USA).

● music publishers

Canciones Del Mundo (see Editorial Julio Korn).
Connelly Argentina (see Editorial Julio Korn).
Edami (Editorial Argentina de Musica Internacional) (SADAIC), Lavalle 1494, Buenos Aires. Tel: 40-1613, 8853. Gen. Mgr.: Alberto Martinez; Gen. Prof. Mgr.: Juan Carlos Protocchini.
Affiliate: Ediciones Musicales Acorde.
This company represents: EMI (Mexico), Edizione Southern (Italy), Musica Del Mundo (Spain), Peer Int'l (USA), Societe D'Edizione Musicales (France), Southern (England, USA).

Ediciones Internacionales Fermata (SADAIC), San Martin 640, Buenos Aires. Tel: 31-9330, 9377. Pres.: Enrique Lebendig & Mauricio Brenner; Gen. Mgr.: Gerardo Grassi.
This company represents: Fermata (Brazil, Chile, Mexico, Paraguay, Uruguay).

Ediciones Musicales Acorde (see Edami).
Editorial Esuropa (see Editorial Julio Korn).
Editorial Julio Korn (SADAIC), Moreno 2038, Buenos Aires. Tel: 47-3622. Pres. & Gen. Mgr.: Ricardo I. Korn; Gen. Prof. Mgr.: Felix Lipesker.
Affiliates: Canciones Del Mundo, Connelly Argentina, Editorial Esuropa, Latin, Vitale Argentina.
This company represents: Acuff-Rose (USA), Arc (USA), Branbilla (Mexico), Morro (USA), United Artists (USA), Walt Disney (USA).

Editorial Musical Pirovano (SADAIC), Pasco 1267, Buenos Aires. Tel: 23-0275. Pres.: Laura C. Pirovano.

Lagos (SADAIC), Talcahuano 63B, Buenos Aires. Tel: 40-3746. Gen. Mgr.: G. Lagos.

Latin (see Editorial Julio Korn).
Melograf, Paraguay 1583, Buenos Aires. Tel: 42-2867. Contact: Stanko Jerebic.
Neumann (SADAIC), Maipu 235, Buenos Aires. Tel: 46-5343. Gen. Mgr.: Carlos Di Liscia.
Ricordi America (SADAIC), Cangallo 1558, Buenos Aires. Tel: 40-9841. Gen. Mgr.: Renzo Valcarenci.
Sprint (SADAIC), Lavalle 560, Buenos Aires. Tel: 32-8936. Gen. Mgr.: Jose Russo.
Vitale Argentina (see Editorial Julio Korn).

● supplies & services

PRESSING PLANTS

C B S Columbia, Victor Martinez 1824, Buenos Aires.
Galvadis, 11 de Setiembre 481, Ciudadela.
H & R Maluf, Francisco Bilbao 2248, Buenos Aires. Tel: 63-6534.
Phonogress, Perito Moreno 235, Temperley.
R C A Victor, Paroissien 3960, Buenos Aires. Tel: 70-4171.

continued

RECORDING STUDIOS

C B S Columbia, Paraguay 1583, Buenos Aires.
 Constelacion, Belgrano 1666, Buenos Aires.
 Ion, Hipolito Irigoyen 2512, Buenos Aires.
 Music Hall, Jose E. Uriburu 40, Buenos Aires.
 Odeon, Cordoba 669, Buenos Aires.
 Philips, Cordoba 1351, Buenos Aires.
 R C A Victor, Paroissien 3960, Buenos Aires.
 San Martin, Tucuman 451, Buenos Aires.

TRADE ORGANIZATIONS

Asociacion de Directores de Orquesta.
 Asociacion de Profesorado Orquestal (APO).
 Sindicatos de Musicos.

AUSTRALIA

Population: 1961 census—10,508,186; latest official estimate Dec. 31, 1965—11,478,703.
 Official rate of exchange: \$1 (US) = .45 Australian pounds.
 Records produced domestically: 1964-65—10,131,299; 1963-64—9,084,349; 1962-63—8,187,130.
 Records unit breakdown: 1964-65—LP's (10" & 12"): 4,459,737; EP's: 1,473,755; Singles (78 & 45 rpm): 4,197,807.
 Stereo (percentage of total production): 15%.
 Records imported from US (factory value): 1964—\$267,295.
 Discounting: Rare.
 Record Club sales: 10% of total sales (approx.).
 George Hilder

● **record manufacturers**

A T A, 22 Alford St., Milson Point, Sydney, N.S.W. (distributed by Festival).
 Astor Electronics, Astor House, 161-173 Sturt St., South Melbourne, Victoria. Tel: 69-0300.
 This company represents: Astor, Audio Fidelity, Autumn, Charger, Colpix, Crusader, Elektra, Go, Hanna-Barbera, HiFi, Kama Sutra, Pye, Red Rird, Somerset, Vanguard, Verve, Verve/Folkways.

Australian, 11-19 Hargrave St., East Sydney, N.S.W. Tel: 31-4111. Cable: COLRECORD. PO Box 267, Darlinghurst, N.S.W. Mg'g Dir.: A. W. T. Smith; Gen. Mgr.: A. H. Watts; Sales Mgr.: R. C. Bull; A&R Mgr.: S. E. Libaek; Creative Servs. Mgr.: K. N. Anderson; Rec. Club Mgr.: W. J. Hagan.

Label: CBS.

This company represents (including all subsidiaries): Columbia, Aristocrat, Epic, Hickory, Kapp, Musicor, Palette, Reprise, Sue, United Artists, Warner Bros.

Boosey & Hawkes, National Bldg., 250 Pitt St., Sydney, N.S.W. Tel: 61-9046. Mg'g Dir.: George S. Cooper.

Labels: Boosey & Hawkes, Bosworth, Major.

Carinia, Daking House, Rawson Pl., Sydney, N.S.W. Tel: 61-3234 & 211-3193. Mgr.: M. Kulakowski.

Label: Carinia.

This company represents: Elite Special, Ricordi, Telefunken, Monitor, Jugotan.

E M I, Emitron House, 301 Castlereagh St., Sydney, N. S. W. Tel: 2-0912. Cable: Emitron. Chm. & Mg'g Dir.: J. M. Burnett, CBE.

This company represents: Ace of Clubs, Ace of Diamonds, Adaire, Admiral, Alan Kelley, Alladin, All Boy, Alley, Allwood, Amy, Angel, Antler, Apache, Arien, Auburn, Aurora, Ava, Avanti, Bandstand, Bang, Bat, Beacon, Bell, Beltona, Best, Big Top, Blackhawk, Bobbin, Buckley, Buena Vista, Cadette, Cameo, Cannon, Capitol, Century, Chairman, Challenge, Charter, Coed, Collier, Colonial, Columbia (England), Concert-Disc, Contemporary, Constellation, Cotton Town Jubilee, Counterpoint, Courtney, Cover, Crescendo, D-L, Dale, Decca (England), Delaware Valley, Del-Fi, Delyse, Dial, Diamond, Discomoda, Disneyland, Divinity, Do-Re-Mi, Dunes, Dynovox, Ebb Tide, Eclipse, Edit, Electro, Emerson, Era, Eric, Esoteric, Everest, Excello, Fantasy, Fayette, Felsted, Fire, Folklore, Fury, GNP, Garpax, Garrett, Genius, Gold Town, Good Time Jazz, Gordy, Gramercy, Gulf, Gusto, HMV, Harmon, Hart-Vann, Hi, Highlane, Hollywood, Imperial, In, Irish, Jackpot, Jameco, Joda, Judo, Kama, Kellmac, Keith, Lancer, Lawn, Lemay, Liberty, Liberty Bell, Lively Art, Logo, London, Louis, Ludix, Lyco, M&H, Mar-V-Lus, Mala, Martay, Maxx, Mel-o-dy,

Metro, Metronome (Sweden), Monogram, Monument, Motown, Music Clef, Musicnote, Music-tone, Nashboro, Neale, Near East, Newjazz, New Voice, Odeon, One-Derful, Parkway, Parlophone, Pathe, Pear, Philles, Pike, Plaza, Post, Premiere, Premier, President, Press, RGE, Ray, Regina, Romac, Roulette, Sanro, Seville, Shar-Dee, Shell, Soma, Soul, Soundstage, Spark, Speciality, Splash, Stage, Stan, Starday, Starfire, Sultan, Sun, Sunland, Swan, Tahoe, Take Ten, Talent, Tama, Tarwee, Tilt, Titanic, Toshiba, Transatlantic, Tru-Sound, Unical, Unison, Unity, VIP, Vault, Viking, Viscount, Vocalion, Warrior, Waverley, Wedge, Whippet, Workshop, Zeida.

Europa, Adams Chambers, 4th Fl., 484 George St., Sydney, N.S.W. Tel: 26-2635. Mgr.: Albert Yacoel.

Labels: Secco, Europa-Teppaz.

Festival, PO Box 16, 223 Harris St., Pyrmont, N.S.W. Tel: 68-4021. Cable: FESTIVAL, Sydney. Exec. Dir.: F. C. Marks; Sales Mgr.: N. W. Brown; Prod'n Mgr.: C. H. Beavis; Adv. Mgr.: R. Atkinson; PR Mgr.: R. Barlow; A&R Prod'r: Joe Halford.

Labels: Festival, Leedon, Sunshine, Spin, Komotion.

This company represents: Decca, Coral, Brunswick (USA), ABC-Paramount, Command, Impulse, Grand Award, Westminster (USA), Dot, Hamilton (USA), A&M (USA), Atlantic, Atco (USA), 20th Century-Fox (USA), King (Japan), King (USA), Scepter, Wand (USA), World Pacific, Pacific Jazz (USA), Jubilee, Jay Gee (USA), White Whale (USA), Laurie, Rust (USA), Chatahoochie (USA), Accent (USA), Lantern (England), Island (England), Ember (England), Elite Special (Switzerland).

Int'l representative: New Zealand (G. A. Wooler).

Jewel, 29 Bligh St., Sydney, N.S.W. Mg'g Dir.: D. B. Lockyer.

Labels: Jewel, Talent.

Kommotion (see Festival).

Leedon (see Festival).

Minstrel, 467 Parramatta Rd., Leichhardt. Tel: 56-4383. Mgr.: A. D'Ambr.

Label: Minstrel.

This company represents: Cetra, Fonit, CGD, Vis, Jukebox (JB).

Philips, 69-79 Clarence St., Sydney, N.S.W.

This company represents: Philips, Polydor, Deutsche Grammophon, Fontana, Mercury, Zodiac.

R C A, 221 Elizabeth St., Sydney, N.S.W. Tel: 61-8541. Mg'g Dir.: K. F. Fidden; Gen. Mgr. (Recs. Div.): W. J. Walsh; Mgr. & A&R: Ron Wills.

This company represents: RCA, Camden, Victrola, Vik, Bluebird, Contemporary, Good Time Jazz.

Recording Society of Australia, GPO Box 572, Sydney, N.S.W. Pres.: Prof. Donald Peart (non-profit organization).

Simcol Rec. Agency, 9 Everard St., Hunters Hill, Sydney, N.S.W. Tel: 89-4205. Dir. & Sales: N. Coleman; A&R: Elizabeth M. Sim.

Label: Pedigree.

Spin (see Festival).

Sunshine (see Festival).

W & G, 185-187 a'Beckett St., Melbourne, Victoria. Tel: 329-7255. Dir.: E. A. White; Gen. Sales Mgr.: M. D. Angus.

Label: W&G.

This company represents: Gem, Diaphon, In, CGD, Carish, Jaguar, Cemea Carosello, Marvel, Jerden, Spoken Arts, Music Minus One, Ar-tone, Chapel, Everest, Prima, Fraternity, Ambassador, Pickwick, Melbourne, Banff, Rodeo, TCF-Hall, Gaiety, Rampart, Quality, Paxton, Mozart, Robert Stone Assocs. Master Releasing. (SEE ADVERTISEMENT)

Wattle, 1 Arundel St., Glebe, N.S.W. Tel: 68-4821. Mg'g Dir.: Peter Hamilton.

● **music publishers**

Accolade, 255 Sailors Bay Rd., Northridge, N.S.W. Contact: D. Harper.

J. Albert & Son, 137 King St., Sydney, N.S.W. Contact: A. F. Albert.

Allans, GPO Box 513 J., Melbourne, Victoria. Contact: R. E. Bare.

Apollo, Astor House, 121 Sturt St., South Melbourne, Victoria. Contact: Neville Smith.

April/Blackwood, c/o Australian Rec., 11-19 Hargrave St., East Sydney, N.S.W. Tel: 31-4111. Mgr.: S. Libaek.

Belinda, Third Fl., MacDonell House, 321 Pitt St., Sydney, N.S.W. Mg'g Dir.: N. Whiteley.

Boosey & Hawkes, 250 Pitt St., Sydney, N.S.W. Contact: G. S. Cooper.



Distributing and

Manufacturing

**AMERICA'S TOP HITS
 IN AUSTRALIA & NEW ZEALAND**

If you are looking to find strong distribution and top notch representation for your record line, you are making a wise choice in selecting **W & G RECORD PROCESSING COMPANY PTY. LTD.**, to handle your line in Australia.

W & G is **AUSTRALIA'S LARGEST INDEPENDENT-MAJOR COMPANY** with its own processing plants and distributors.

Come! join our happy family of American and foreign labels we already handle.

Look to W & G for the Australian trend shaping up World-Wide in 1966. W & G leads the way with original product from Australia.

"IN AUSTRALIA IT'S W & G ALL THE WAY"

American Office
JAMES N. PARKS

Australian Office
RON J. GILLESPIE

**W & G RECORD PROCESSING COMPANY,
 PTY. LTD.**

852 Elm Street
 Manchester, N. H., U.S.A.
 Tel. 603; 623-9749

185-187 a'Beckett Street
 Melbourne Cl., Australia
 Tel. 329-7255

PAR AMOUR POUR TOI
(A LOVER'S CONCERTO)
Sandy LINZER & Denny RANDELL

WALKIN' MY CAT NAMED DOG
NORMA TANEGA

**MUSIC IS THE
INTERNATIONAL LANGUAGE**

AND IN ANY LANGUAGE

SATURDAY MUSIC, INC.

SPELLS HIT!

SATURDAY MUSIC'S RECENT INTERNATIONAL HITS

PAR AMOUR POUR TOI
(A LOVER'S CONCERTO)

"THE SUN AIN'T GONNA SHINE ANYMORE"
(BOB CREWE—BOB GAUDIO)

"DENNY TAKE A RIDE"
(BOB CREWE—BOB GAUDIO)

"A LOVER'S CONCERTO"
(SANDY LINZER—DENNY RANDELL)

"ATTACK"
(SANDY LINZER—DENNY RANDELL)

"LET'S HANG ON"
(BOB CREWE—SANDY LINZER—DENNY RANDELL)

"BYE, BYE BABY" (BABY GOODBYE)
(BOB CREWE—BOB GAUDIO)

"WORKING MY WAY BACK TO YOU"
(SANDY LINZER—DENNY RANDELL)

"CONCRETE AND CLAY"
(T. MOELLER—B. PARKER)

"WALKING MY CAT NAMED DOG"
(NORMA TANEGA)

"RAG DOLL"
(BOB CREWE—BOB GAUDIO)

LIST OF INTERNATIONAL AFFILIATES

AUSTRALIA

CASTLE MUSIC, LTD.
299/301 CASTLEREAGH STREET
SYDNEY, AUSTRALIA

ENGLAND

ARDMORE & BEECHWOOD, LTD.
30/34 LANGHAM STREET
LONDON W.1, ENGLAND

SOUTH AFRICA

ARDMORE & BEECHWOOD S. AFRICA
P.O. BOX 11254
JOHANNESBURG
TRANSVAAL, SOUTH AFRICA

BELGIUM

ARDMORE & BEECHWOOD BELGIUM
72, QUAI DES CHARBONNAGES
BRUSSELS, BELGIUM

FRANCE

PATHE MARCONI
22 AVENUE DE LA GRANDE ARMEE
PARIS 17e, FRANCE

SPAIN

CANCIONES DEL MUNDO
CARMEN 20,
MADRID, SPAIN

BRAZIL

EDICOES ENTERPE LTDA
AV RIO BRANCO 108-2 and S/204/6
RIO DE JANEIRO, BRAZIL

GERMANY

EDITION ACCORD
HOHENSTAUFRING 63/1
KOLN 52 GERMANY

SWEDEN

EDITION ODEON
SANDHAMNAGTEN 39
STOCKHOLM, SWEDEN

DENMARK

IMUDICO
COLBJORNSENSGADE 19
COPENHAGEN V, DENMARK

ITALY

SUGAR MUSIC, EDIZIONI MUSICALI
SUVINI ZERBONI
GALLERIA DEL CORSO, 4
MILAN, ITALY

SATURDAY MUSIC, INC.

1841 Broadway, New York, N. Y. 10023
212 CI 5-3535 Cable: MUSICREWE

continued

Castle, PO Box 352, Haymarket, Sydney; 299 Castlereagh St., N.S.W. Mgr.: Phillip Mathews.

Chappell, GPO Box 1486, 68-70 Clarence St., Sydney, N.S.W. Tel: 29-4681. Cable: Symphony. Mgr.: W. B. Ahrens

Reg Connelly, 21 Elliott St., Belmain, N.S.W.

Cricket (see Leeds).

Crown, c/o Festival, PO Box 16, 223 Harris St., Pyrmont, N.S.W. Tel: 68-4021.

Essex, Griff House, 324 Pitt St., Sydney, N.S.W. Tel: 61-8523. Cable: Semus. Gen. Mgr.: Barry Kimberley.

Sam Fox (see Southern).

Joye, 22 Alford St., Milson Point, Sydney, N.S.W. Leeds, 324 Pitt St., Sydney, N.S.W. Tel: 61-6088/9. Cable: Leedsmusic. Mgr'g Dir.: Jack H. Argent.

Maxana (see Leeds).

Mogull, Ivan, 301 Castlereagh St., Sydney, N.S.W. Pres.: Ivan Mogull.

Music Houses of Australia, 416 George St., Sydney, N.S.W. Contact: B. Grant.

Music Publishing of Australia (see Southern).

Peer Int'l (see Southern).

Pincus-Gil (see Leeds).

G. Ricordi, 164 Pitt St., Sydney, N.S.W. Mgr.: D. James.

Sandy, 27 O'Connell St., Suite 533, Sydney, N.S.W. Seven Seas, 27 O'Connell St., Suite 533, Sydney, N.S.W.

South Mountain (see Leeds).

Southern, Carleton House, 40 York St., Sydney, N.S.W. Tel: 29-2547. Cable: SOUTHMUSIC. Mgr'g Dir.: C. Vaughan-Smith.

Spanka Music, 185 a'Beckett St., Melbourne, Victoria. Mgr.: C. C. Bruce.

Spoone (see Leeds).

Tangerine (see Leeds).

TU-Con (see Leeds).

Victoria (see Leeds).

Woomera, 185 a'Beckett St., Melbourne, Victoria. Mgr.: C. C. Bruce.

World (see Southern).

● independent record producers

Maverick Ents., Sydney, N.S.W. Cable: Maverick.

● record distributors

Australian Rec., 11-19 Hargrave St., East Sydney, N.S.W.

Outlets: Newmarket, Queensland, Colin Hopgood, 309 Enoggera Rd.—Adelaide, S.A., 244 Gilbert St.—Launceston, Tasmania, K. W. McCulloch, 109 York St.—South Yarra, Victoria, 7 Claremont St.—Perth, W.A., Athol M. Hill, 613 Wellington St.

Julius Cohn, 31 Gilles St., Adelaide, S.A.

Farleighs, 26-28 Helen St., The Valley, Brisbane, Queensland.

Athol M. Hill (see Australian Rec.).

Colin Hopgood (see Australian Rec.).

K. W. McCulloch (see Australian Rec.).

Michaelis, Hallenstein & Co., 150 Buckhurst St., South Melbourne, Victoria.

Branches: Launceston, Tasmania, 143 Wellington St.—Hobart, Tasmania, 118-124 Bathurst St. Musical Whistle. Supplies, 416 George St., Sydney, N.S.W.

Rosenstamm, 61-65 King St., Perth, W.A.

● importers & exporters

Allen, 276 Collins St., Melbourne, Victoria.

Edels, 88 King St., Sydney, N.S.W.

Scala Rec., Alderson Bldg., 504-520 Pacific Highway, St. Leonards, N.S.W. Tel: 43-0243. Dir.: G. Polgar.

● record clubs

World, 330 Flinders Ln., Melbourne C.1, Victoria.

● supplies & services

MUSIC LICENSING ORGANIZATIONS

Australasian Performing Right Assn., 66 Pitt St., Sydney, N.S.W.

J. McFadden, 67 York St., Sydney, N.S.W.

PRESSING PLANTS

Astor Electronics, Astor House, 161 Sturt St., South Melbourne, Victoria.

Australian, 11-19 Hargrave St., East Sydney, N.S.W.

E M I, 301 Castlereagh St., Sydney, N.S.W.

Festival, 223 Harris St., Pyrmont, Sydney, N.S.W.

Peter Mann, 3 Estella St., Melbourne, S.E. 6, Victoria.

R C A, 221 Elizabeth St., Sydney, N.S.W.

W & G Rec. Processing, 185 a'Beckett, Melbourne, Victoria.

PROMOTION & PUBLICITY

Continental, 29 Bligh St., Sydney, N.S.W. Mgr'g Dir.: S. Turocz.

RECORDING STUDIOS

Amalgamated Wireless, 167 Queen St., Melbourne, Victoria.

Branch: 47 York St., Sydney, N.S.W.

Australian, 11 Hargrave St., East Sydney, N.S.W.

Clark Martin, 28 Bay View Terr., Mosman Park, Perth, W.A.

E M I, 301 Castlereagh St., Sydney, N.S.W.

Earway, 15 Mary St., Brisbane, Queensland.

Festival, 223 Harris St., Pyrmont, N.S.W.

Gale Sound, 576 Hay St., Perth, W.A.

Harmony House, 177 George St., Sydney, N.S.W.

Sonic & Television Engineers, 233 Rundle St., Adelaide, S.A.

W & G, 185 a'Beckett St., Melbourne, Victoria.

AUSTRIA

Population: 7,100,000.

Official rate of exchange: \$1 (US) = 26 schillings.

Number of record players in homes: 400,000.

Records imported from US (factory value): 1964—\$32,430; 1963—\$25,500.

Records exported to US (factory value): 1964—\$5,097.

Average retail prices: Austrian prices are equal in Mono or Stereo. 12-inch LP's, 150 Austrian schillings (\$6); 10-inch LP's, 105 Austrian schillings (\$4); 7-inch EP's 55 Austrian schillings (\$2.20); Singles, 33 Austrian schillings (\$1.25).

Record club sales: 12% of all sales.

Stereo sales: 33% of all sales.

Medium wave radio: Oesterreichischer Rundfunk with main studio at Argentinierstrasse 30A, Vienna IV. Has six additional studios in Linz, Graz, Salzburg, Klagenfurt, Innesbruck, Dornbirn. Office Address: Schellinggasse, Vienna 1. Same company operates TV broadcasting network.

● record manufacturers

Amadeo, Untere Donaustr., Vienna 2. Tel: 24-35-98. Cable: Amadeodisc. Gen. Mgr.: Stephan Von Friedberg; Pop A&R, Pub., Promo. & Adv.: Walter Praxl; Classical A&R: Rudolf Mraz. Label: Amadeo.

This company represents: Ariston (Italy), Artone (Holland), Barclay (France), Cadet (USA), Checker (USA), Chess (USA), Christophorus (Germany), Ember (England), Funckler (Holland), Hipavox (Spain), Palette (Belgium), Phonag (Switzerland), Ricordi (Italy), Ri-Fi (Italy), Riviera (France), Vanguard (USA).

Int'l representatives: Belgium (Inelco), Denmark (Tono), Finland (Fazer), France (La Compagnie Europeenne du Disque), Germany (Philips), Italy (Recordi), Japan (Nippon Columbia), Norway (Norsk Phonogram), Spain (Hisvavox), Sweden (Philips Sonora), Switzerland (Phonag), USA (Apon).

Ariola, Rotenturmstr. 5-9, Vienna 1. Tel: 63-55-97. Mgr. Dir.: Egmont Luftner.

This company represents: Ariola, Atlantic, Eurodisc, Italia Int'l, Metronome.

Musica, PO Box 132, Neustiftgasse 3, Vienna 7/62. Cable: MUSICA. Tel: 93-65-48. Contact: Franz Hochner.

Oesterreichische Columbia, 2 Fuehrichgasse, Vienna 1. Tel: 52-36-75. Cable: Colpho. Gen. Mgr.: Frank W. Beh; Mgr. Sales, Promo & A&R: Erich Chobot; Admin. Mgr.: Walter Zulinski.

Branches: Sigmundspalitz 2, Salzburg. Tel: 83-2-15. Mgr.: Edmond Pichler.—Kaerntnerstr. 30, Vienna 1. Tel: 52-36-75. Mgr.: Karl Pfeiffer.

This company represents: Angel, Capitol, Columbia, Concert-Classico, Electrola, Encore, English by Radio, Erato, Gloria, HMV, Hoer Zu, Imperial, Liberty, Magic Notes, Monitor, Musica Sacra, Odeon, PaperBack-Classics, Parlophone, Pathe, Regal, Stateside, Tower, Voce del Padrone, Voix de son Maître.

Polyphon, Mariahilferstr. 127, 1060 Vienna. Tel: 65-35-06. Cable: POLYPHON. Pres.: Gerhard Gebhard; Prod'r: Frank Pippal; Sales Mgr.: Wolfgang Arming; Sales Mgr.: Hans Joachim Gaede.

This company represents: ABC-Paramount,

Archiv, Brunswick, Caedmon, Command, Deutsche Grammophon, Fontana, Interdisc, Kama Sutra, MGM, Mercury, Philips, Polydor, Riverside, UA, Verve.

● music publishers

Bosworth, Dr.-Karl-Luegerplatz 2, Vienna 1.

DaCapo, Mahlerstr. 11, Vienna 1.

Deutscher Volksgesangsverein, Reindorfsgasse 42, Vienna 15. Prop.: Ludwig Krenn.

Ludwig Doblinger, Dorotheergasse 10, Vienna 1.

Gloria, Gluckgasse 1, Vienna 1.

Josef Hochmuth, Seilergasse 12, Vienna 1.

Friedr. Hofmeister-Figaro, Seilergasse 12, Vienna 1. Tel: 52-49-77

Imperial, Gluckgasse 1, Vienna 1.

Johnny, Gluckgasse 1, Vienna 1.

Jungbrunnen, Rauhensteingasse 5, Vienna 1.

Kosmos, Neuterchenfelderstr. 8, Vienna 17.

Mayer, Ottakringerstr. 109, Vienna 16. Tel: 66-23-34. Prop.: Edea Margaritella.

Mayrische, Theatregasse 4, Salzburg.

Mozart, Sigmund Hafnergasse 18, Salzburg.

Musikverlag V. Hladky, Brounbadgasse 13, Vienna 9.

Papageno, Linke Wienzeile 6, Vienna 6.

Hermann Schneider, Gluckgasse 1, Vienna 1.

Southern, Seilergasse 12, Vienna 1. Tel: 52-27-51. Cable: SOUTHMUSIC.

Stanberg, Joanneum Ring 12, Graz Styria.

Symphonia, Lothringstr. 20, Vienna 3.

Josef Weinberger, Mahlerstr. 11, Vienna 1.

Weltmusik (Josef Hochmuth), Seilergasse 12, Vienna 1. Tel: 52-27-51.

Ludmilla Weselka, Mariahilferstr. 55, Vienna 6.

Wiener Verlagsanstalt, Johannesgasse 12, Vienna 1.

● record wholesalers

IMPORTERS & EXPORTERS

Amadeo, Untere Donaustr. 17, Vienna 2. Tel: 24-35-98. Cable: Amadeodisc.

Audio Haus, Lothingerstr 20, Vienna 3. Contact: George W. Hamilton.

Centrocord, Johannesgasse 4/6, Vienna 1. Tel: 52-99-55. Cable: CENTROCORDER. Gen Mgr.: Helmut Bischof.

This company represents: Accordia, Blue Note, Dot, Durium, Elite, Special, Kapp, Mode, Pacific, Popular, Saba Sonet, Storyville, Tempo, Triola, Vogue, Vogue-Pye.

E. Kratochwil, Taborstr. 52 A, Vienna 2.

Schaettle, Dkfm. O. Schattler, Webgasse 43, Vienna 6. Tel: 56-56-795.

Terraphone, Fridrich Schiegl Goldgasse 2, Vienna 4.

Roland Teuchter, Schottengasse 30, Vienna 1.

A. Weiner, Karl Schweighofergasse 12, Vienna 7.

Yank Rec., Webgasse 43, Vienna 6. Tel: 56-56-795.

RECORD DISTRIBUTORS

Austro-Mechana, 2 Ungargasse, Vienna 3.

Centrocord, Johannesgasse, 4/6, Vienna 1.

Musica, PO Box 132, Neustiftgasse 3, Vienna 7/62. Tel: 93-65-48. Dir.: Rudolf Friedman.

● supplies & services

RECORDING & TAPE DUP. STUDIOS

Austrophon, Konzerthaus, Vienna 3.

Musik Produktion Sued, Konzerthaus, Vienna 3.

Symphonia, Konzerthaus, 1030 Vienna 3.

Tonstudio-Kaerntner-Strasse, 51 Kaerntnerstr., Vienna 1. Tel: 52-27-56.

Veritas, 26 Singerstr., Vienna 1.

TRADE ORGANIZATIONS

Austro-Mechana, PO Box 341, Vienna 111/40.

BAHAMAS

Population: 138,640.

Official rate of exchange: \$1 (US)=\$1.02 Bahaman dollars.

Number of homes with record players: 20,000 (approx.).

Records imported from US (factory value): \$100,000 (US) retail value—\$200,000 (US).

Records imported from countries other than US (factory value): \$10,000 (US); retail value—\$20,000 (US).

Records manufactured (factory value): LP's—40,000 units, \$80,000 (US); Singles — 20,000 units, \$10,000 (US).

Average retail price per record: LP's—\$5.06 (US); EP's—\$2.05 (US); Singles—\$1.20 (US).

Stereo sales: 50% of total sales.

Discounting: Never.

Type of record distribution: Manufacturer to wholesaler to retailer; rarely, manufacturer to retailer.

Number of jukeboxes: 500 (approx.).

Radio stations: AM-2, combined government and commercial; FM-2 experimental.

Import regulations: 27 1/2% import duty on goods from US; 17 1/2% duty on goods from UK. Little exportation. No copyright on records.

● **record manufacturers**

Bahama Recs., PO Box 942, Nassau. Tel: 2-2201.
Caribbean Folk Music, PO Box 174, Nassau. Tel: 2-8784. Cable: Tropical. Pres. & A&R: Tom Jacobs; Sales & Mktg.: Patricia Jacobs.
Labels: Carib, Famo, Island Artists, Westindy.
Int'l representative: England (EMI).

John S. George (Electric), PO Box 287, Palmdale, Nassau. Tel: 2-8429.

Penny Farthing, PO Box 5668, Nassau. Tel: 2-8986.
U-C, PO Box 1671, Nassau.

● **record wholesalers**

RECORD DISTRIBUTORS

Bahama Recs., PO Box 942, Nassau. Tel: 2-2201.
Carter's Rec. & Juke Box Dist'rs, PO Box 934, Nassau. Tel: 2-3626.

Penny Farthing, PO Box 5668, Nassau. Tel: 2-8986.

IMPORTERS

Bahama Recs., PO Box 942, Nassau. Tel: 2-2201.
Carter's Rec. & Juke Box Dist'rs, PO Box 934, Nassau. Tel: 2-3626.

John S. George (Electric), PO Box 287, Palmdale, Nassau. Tel: 2-8429.

Frank J. Hazlewood/John Bull, PO Box 737, Nassau. Tel: 2-2657.

George Moxey Jr., Wulff Rd., Nassau.
Penny Farthing, PO Box 5668, Nassau. Tel: 2-8986.
U-C, PO Box 1671, Nassau.

BELGIUM

Population: 9,500,000.

Official rate of exchange: \$1 (US)=50 Belgian francs.

Record sales, 1965: LP's—\$20,000; EP's—\$500,000; Singles \$3,000,000.

Records imported from US: \$100,000.

Records exported to US: Practically none.

Number of juke boxes: 29,000.

Mimi Smith

● **record manufacturers**

Anvers Radio, 10 place de l'Yser, Brussels 1. Tel: 18.74.00. Top Exec.: Mr. Goldschmidt; Sales: Mr. Janty.

This company represents: ABC-Paramount, Audio-Fidelity, Command, Ducretet-Thomson, Durium, Elite, Ember, Hebra, Impulse, Karate, Telefunken, Telear.

Artone, 20-21 Blvd. Baudouin, Brussels 1. Tel: 19.11.70.

This company represents: Apex (Canada), Argo (USA), Artone (Holland), Ascot (USA), Baerenreiter-Musicaphon (Germany), Cameo-Parkway (USA), Checker (USA), Cheltenham (USA), Chess (USA), Colpix (USA), Compo (Canada), Congress (USA), DCP Int'l (USA), Dimension (USA), Epic (USA), Funckler (USA), Gordy (USA), Hickory (USA), Joy (USA), MRC (Italy), Melody (USA), Motown (USA), Okeh (USA), Palette (Belgium), Pop (USA), Prima (USA), Pythia (Holland), Ricordi (Italy), Select (USA), Soul (USA), Specialty (USA), Supraphon (Czechoslovakia), Tama (USA), United Artists (USA), VIP (USA), Veep (USA), Westminster (USA), Wyncote (USA).

Barclay, rue de Lombard 31, Brussels 1. Tel: 11.81.87.

This company represents: Atco, Atlantic, Barclay, Hispavox, Rigolo, 20th-Fox.

Brauer, 30 rue St. Christophe, Brussels 1. Tel: 12.93.75. Top Exec.: Mme. Brauer.

This company represents: Blue Jeans, Carish, Hebra, Jaguar, Meteor, Mi-Re, NMC.

C B S, 20-21 Blvd. Baudouin, 6th Fl., Brussels. Tel: 18.64.00. Cable: Colrecord. Mg'g Partners: Bill C. Slinger & Casper D. Slinger; Sales Mgr.: Pascal Robiefroid.

Labels: Int'l and domestic products are released on the CBS label, a division of Columbia Broadcasting System.

THE MUSIC PUBLISHERS OF THE

WORLD MUSIC GROUP



IN BELGIUM • HOLLAND • LUXEMBURG

ACUFF-ROSE

- I FOUGHT THE LAW BOBBY FULLER
- TWINKLE TOES ROY ORBISON
- SHAKE HANDS THE NEW BEATS
- HISTORY REPEATS ITSELF BUDDY STARCHER

AUDEO VIDEO

- EARLY BIRD
- THE KID ANDRE BRASSEUR
- HOLIDAY

BEL MUSIC—ED. J. KLUGER

- CIAO, ADIEU, BYE, BYE WILL TURA
- HEIMWEE NAAR HUIS

RAOUL BRETON

- LE PETIT OISEAU DE TOUTES LES COULEURS
- SEUL SUR SON ETOILE GILBERT BECAUD

VITALE MUSIC

- QUERO QUE VA TUDO PRO INFARNO R. CARLOS

ITALMUSIC

- DIO, COME TI AMO CELENTANO—GIGIOLA CINQUETTI
- LA MAISON OU J'AI GRANDI FRANCOISE HARDY
- THE STORY OF A COUNTRY BOY THE COUSINS
- NESSUNO MI PUO GIUDICARE GENE PITNEY
- BAISSA UN PEU LA RADIO DALIDA
- MAI, MAI VALENTINO RICARDO
- BYE, BYE, BYE MOI JE RESTE LUCKY BLONDO

PETER MAURICE MUSIC

- DUM-DE-DA BOBBY VINTON

SCREEN GEMS

- THE GAMMA GOOCHEE GAMMA GOOCHEE
- SOUL AND INSPIRATION THE RIGHTEOUS BROTHERS
- KICKS PAUL REVERE AND THE RAIDERS
- A GROOVY KIND OF LOVE THE MINDBENDERS
- LES CRAYONS DE COULEUR HUGHES AUFRAY

SOUTHERN MUSIC

- LA POUPEE QUI FAIT NON MICHEL POLNAREFF
- LOVE ME WITH ALL YOUR HEART THE BACHELORS

TOP MUSIC

- LA PLAYA LOS MAYAS—MARIE-LAFORET—
CLAUDE CIARI—ACKER BILK

For a Concentrated Action in Benelux
WORLD MUSIC COMPANY—BRUSSELS
INTERNATIONAL MUZIEK COMPANY—AMSTERDAM
LUXEMBOURG MUSIC COMPANY—LUXEMBURG
 The Largest Organisation with 100% Exploitation
 Call, Cable or Write—WORLD MUSIC, 13, MADELEINE—BRUSSELS
 Phones: 11.51.20—12.40.04—Cables: WORLDMUSIC—BRUSSELS

continued

Candle, Bolwerklaan 19, Brussels 1. Top Exec.: Mr. Saey & Mr. Moescoop.
This company represents: Bobbejaan, Candle.
 Cardinal, Belgielei 143, Antwerp. Tel: 30.49.42.
 Top Execs.: Rocco Granata & John Craeynest.
This company represents: Arcade, CNR, Cardinal.
 Cobedi, 32 rue St. Christophe, Brussels 1. Tel: 11.20.61. Cable: Cobedi. Top Exec.: Fernand Jansens; A&R: Frans Verbeeck; Sales: Mme. Jansens.
This company represents: Newton, Novelty, Olympia.
 Discobel, 31 rue de Lombard, Brussels 1. Tel: 13.39.45. Top Exec.: Van de Walle & Penninck.
This company represents: Ariola, Baccarola, CNR, Cantate, Discosart, Erato, Eurodisc, Imperial, Lumen, Prestige, Riviera, Roulette, Studio SM, Sonet, Storyville.
 Fonior, 26-28 Quai des Charbonnages, Brussels B. Tel: 25.40.10. Top Exec.: Pelgrims de Bigard. A&R: A. Palmans; Sales: Mr. De Reuck.
This company represents: A&M, Arc, Box, Brunswick, Cetra, Cid, Coral, Decca, Discophone, Dureco, Egmont, Everett, Fonit, Geminal, London, Mecca, National, Omega, Opus, Orly, President, Saga, Sociely, Sunderland, Symco, Tedeum, Telstar, Valmy, Vega, Victory, Viking, Vocalion, Weekend.
 Gramophone, 171 Blvd. M. Lemonnier, Brussels 1. Tel: 12.98.15. Cable: Gramophone. Top Exec.: John Kirsch; Sales: Emile Garin; A&R: Jeff De Boeck.
This company represents: Angel, Capitol, Charlin, Columbia, Electrola, Encore, Gloria, HMV, Liberty, Markal, Odeon, Parlophone, Pathe, Stateside, Trianon, Voix de son Maitre.
 Inelco, 20-24 rue de l'Hopital, Brussels 1. Tel: 11.22.20. Top Exec.: Pierre Jean Gommaere; A&R: Yvon De Bie; Sales: Willy Roelans.
This company represents: Amadeo, President, RCA Camden, RCA Victor, Victrola, Vik.
 Intervox, Boomsstew. 376, Wilrijk. Tel: 38.86.00 & 38.16.16. Contact: L. J. Van Rymentant.
This company represents: Arcade, Cannon, Dino, Fonodisc.
 Leman & Gorle, 52 Av. N.D. de Lourdes, Brussels 9. Tel: 27.33.72. Top Exec.: Pierre Gorle.
This company represents: Alpha, Argo, Boite a Musique, Cantate, Classics, Club National du Disque, Discophiles Francais, Emerald, Oiseau Lyre.
 Polydor, 116 chaussee de Charleroi, Brussels 6. Tel: 37.31.00 & 38.60.80. Cable: SIEMENS. Top Exec.: Mr. Holzapfel.
 Label: Polydor.
This company represents: Adria, Archiv, Deutsche Grammophon, Kama Sutra, MGM, Metronome, Roover, Saba, Verve, Verve/Folkways.
 Polygram, 3 rue d'Anderdecht, Brussels 1. Tel: 13.44.44. Top Exec.: P. Lebbink; A&R: H. Van Baaren.
This company represents: Arvee, Audio Fidelity, Battle, Beat, Bluesville, Caedmon, Cygnus, Fontana, Good Time Jazz, Hi-Fi, Jazzland, J.V.B. Gospels, Mercury, Off-Beat, Pacific Jazz, Pergola, Philips, Pop Side, Riverside, Smash, Swingsville, Washington, Wonderland, World Pacific, Yet, Critere, Oiseau Lyre, Star-Club, Vee Jay.
 Ranch, 90 rue Gallait, Brussels 3. Tel: 41.22.80 & 41.22.87. Dir.: Janine Bosmans; A&R: Harry Frekin.
 Label: Ranch.

Schott Freres, 30 rue St. Jean, Brussels 1. Tel: 12.39.80. Top Exec.: J. J. Junne.
This company represents: Angelicum, Blue Note, Classics, CND, Commodore, Concert Disc, Directional Sound, Eterna, Everest, Folkways, Harmonia Mundi, Jazz Tone, Mainstream, Monitor, Music Minus One, Musique pour les temps, Nonesuch, Period, Regent, Savoy, Scala, Schola Rhythm, Stinson, Stradivari, Time, Universal, Urania, Valois.
 Selection, 41 Blvd. de l'Abattoir, Brussels. Tel: 11.03.19. Contact: Pierre Pletinckx.
 Siemens (see Polydor).
 Sobedi, Societe Belge Du Disque, 20 Blvd. M. Lemonnier, Brussels. Tel.: 13.13.07.
 Sonobel, Sonobel Bldg., 15 Place Rouppe, Brussels. Tel: 12.09.28 & 12.54.72. Top Exec.: Pierre Borzee.
This company represents: Anbassador, Angelicum, Chant du Monde, Lyrichord, Musidisc, Fickwick, Vergara, Vox.
 Teenager Club, 41 Blvd. de l'Abattoir, Brussels. Tel: 11.03.19. Contact: Pierre Pletinckx.
 Voque, 35 Blvd. Barthelemy, Brussels 1. Tel: 11.97.91. Top Exec.: Leon Cabat; Contact: R. Meylemans.
This company represents: AZ, Belter, Deutsche Vogue, Dot, GNP Crescendo, Kapp, Mainstream, Mode, Orfeu, Pacific, Pye, Reprise, Scepter, Time, Vogue, Warner Bros.
 Will, 41 Blvd. de l'Abattoir, Brussels. Tel: 11.03.19. Contact: Pierre Pletinckx.

● music publishers

Ardmore & Beechwood, 72 Quai des Charbonnages, Brussels. Tel: 27.43.90. Contact: Jeff De Boeck.
 Belga, Steenweg op Diest 69, Aarschot. Tel: 016.669.99. Pres.: Jules Nijs.
 Belinda-Dolfi, 155 Blvd. Anspach, Brussels. Tel: 11.83.13. Contact: Edgard Plumart.
 Bens, 90 rue Gallait, Brussels 3. Tel: 41.22.87 & 41.22.80. Gen. Dir.: J. Bosmans.
 H. Brauer, 30 rue St. Christophe, Brussels 30. Tel: 12.93.75.
 DISCO, Dascottelet 34, Deurne, Antwerp. Tel: 36.75.97. Contact: Werner Huys. (SEE ADVERTISEMENT)
 Editions Francis-Day, 25 Place Saint-Gery, Brussels. Cable: SABAM. Contact: Mme. H. Dulieu.
This company represents: The Big 3 (USA).
 Editions Screen Gems/Columbia, 13 Madeleine, Brussels. Tel: 2578.
 Eurovox (see Intervox).
 Fonior, 24 Quai des Charbonnages, Brussels. Tel: 25.40.10. A&R: A. Palmans.
 Fonogram, 20 Blvd. Maurice Lemonnier, Brussels. Tel: 13.13.06. Contact: Fernand Jansens.
 Granata Music, Be'werklaan 143, Antwerp. Tel: 30.49.42. Top Execs.: Rocco Granata & John Graeynest.
 Intervox, Boomsstew. 376, Wilrijk. Tel: 38.86.00 & 38.16.16. Contact: L. J. Van Rymentant.

EDITIONS

JEAN KLUGER
 Galeries du Centre
 Bloc. 3, Appt. 339
 BRUSSELS
 Tel.: 12-92-38

JEAN KLUGER, Bloc 3, Apt. 339, Galeries du Centre, Brussels. Tel: 12.92.38. (SEE ADVERTISEMENT)
 Ivan Mogull, c/o Sabam, 61 rue de la Loi, Brussels. New Music (see Brauer).
 Overseas (see Voix du Rhythme).
 Passe-Partout, Kwadenplasstr. 7, Heist o/d Berg. Tel: 216.25. Foreign correspondence to: Hermans Frank, Vroenhofstr., 13, Deurne, Antwerp.
 Peter Plum, 18 rue des Teinturiers, Brussels 1. Tel: 11.47.43 & 11.52.29.
 Primavera, 22 Blvd. M. Lemonnier, Brussels. Tel: 13.37.89. Contact: L. Van Hout.
 Radio Tele Music, Ave. Lloyd Georges, Brussels 5. Dir.: Hubert Terheggen.
 Sab (see Voix du Rhythme).
 Southern Music, 13 Rue de la Madeleine, Brussels. Tel: 11.51.20. Cable: SOUTHMUSIC. Mgr.: Felix Faecq.
 Vogue Int'l, 35 Av. Barthelemy, Brussels. Tel: 11.79.73. Contact: Guy Khavessian.
 Voix du Rhythme, 41 Blvd. de l'Abattoir, Brussels 1. Tel: 32.56.75 & 32.50.50. A&R: Georges Legrand.

WORLD, 13 rue de la Madeleine, Brussels. Tel: 11.51.20. (SEE ADVERTISEMENT)

● record wholesalers

RECORD DISTRIBUTORS

Biblos, Sint-Jacobsmarkt 6, Antwerp 1. Owner: M. A. van den Bosch.

IMPORTERS & EXPORTERS

Fabeldis, 8 rue Sainte Marie, Brussels B.

● supplies & services

PRESSING PLANTS.

Discopress, BB rue Gallait, Brussels.
 Sobedi, 20 Blvd. M. Lemonnier, Brussels.

RECORDING & TAPE DUP. STUDIOS

Discopress, BB rue Gallait, Brussels.
 Fonior, 26-28 Quai des Charbonnages, Brussels.
 Sobedi, 20 Blvd. M. Lemonnier, Brussels.

TRADE ORGANIZATIONS

Chambre Syndicate de l'Industrie de la Musique Enregistree, 410 Centre Rogier, Brussels.
 Sabam, 61 rue de la Loi, Brussels.
 U B A, 228 rue T. Verhaegen, Brussels 6. Tel: 38.43.14. Nat'l Pres.: Henri de Vroey; Gen. Dir.: Omer de Munck.

BERMUDA

Population: 45,921.
 Official rate of exchange: \$1 (US) = 1 sterling pound.
 Records imported from US (factory value): 1964—\$111,011; 1963—\$165,000.

● record manufacturers

Bermuda Rec., PO Box 452, Hamilton. Tel: 2-1122. Pres.: Walt Staskow.
 Branch: I.S.L., 20 E. 46 St., New York, N. Y.
 Masters, Front St., Hamilton. Tel: 2-3000. Cable: Mastand. Pres. & Gen. Mgr.: W. H. Freisenbruch.

● music publishers

Pembroke (BIEM), PO Box 452, Hamilton. Tel: 2-1122. Dir.: Kenny Harris.

● record wholesalers

IMPORTERS & EXPORTERS

Bandstand, Queen St., Hamilton. Tel: 1-2972. Mg'g Dir.: John W. McNamara.
 Masters, Front St., Hamilton. Tel: 2-3000. Cable: Mastand. Pres. & Gen. Mgr.: W. H. Freisenbruch.

RECORD DISTRIBUTORS

Bandstand: Queen St., Hamilton. Tel: 1-2972. Mg'g Dir.: John W. McNamara.

● service & supplies

RECORDING STUDIOS

Z B M, PO Box 452, Hamilton. Tel: 2-1122. Dir.: Bryan Lodge.

BOLIVIA

Population: 3,604,000.
 Official rate of exchange: \$1 (US)=1 peso.
 Records imported from US (factory value): 1964—\$12,565.
 Radio stations: 1.

● record manufacturers

"Discolandia" Dueri, Evaristo Valle 239, La Paz. Tel: 8685. Pres.: Miguel A. Dueri.
This company represents: Columbia.
 Philips Sudamericana, Cajon Postal 2964, La Paz. **This company represents:** Philips.
 Enrique Aires Rocha, Casilla 615, Ave. 6 de Octubre 1539, Oruro.

LOOKING FOR ACTION!

**LET US PUBLISH
 YOUR MUSIC!**

DISCO-MUSIC

**Dascottelei, 34
 Deurne/Antwerp**

Phone: 03/36.75.97

Our Specialty:

**HEAVY PLUGS ON YOUR
 ORIGINAL RECORDINGS**

BRAZIL

Population: 83,000,000.
Per capita income: \$300 annually.
Official rate of exchange: \$1 (US) = 2,200 cruzeiros.

Records sold domestically: 1965—6,933,078; 1964—4,961,039; 1963—6,133,822.

Record unit breakdown—1965: LP's 3,303,293; EP's: 1,059,543; Singles: 2,556,028. No longer presses 45's.

Stereo sales: 6% of total sales.

Average retail price: LP's: \$3.50; EP's: \$1.50; Singles: \$1.

Discounting: Rare.

Type of record distribution: Manufacturer to retailer only.

Origin of music on Pop records: Domestic—40%; US—15%; England—10%; Other—35%.

Radio stations: B25 medium wave; 95 short wave. Of these, 65 are FM.

Television stations: 41 channels.

Sylvio Tullio Cardoso.

● record manufacturers

Albatroz, Av. Rio Branco 277, Rio de Janeiro. Tel: 42-5467. Pres.: Flora Matos.

C B S, Rua Visconde do Rio Branco 53, Rio de Janeiro. Tel: 52-9673. Cable: Colcord. Pres.: Dr. Terencio P. Caply; V-P: Evandro Ribeiro. Labels: CBS, Entre.

This company represents: Columbia (USA), Epic (USA), Harmony (USA), Hispavox (Spain), Musicor (USA), Okeh (USA), Orfeo (Argentina), Sono-Radio (Peru).

Int'l representatives: Argentina (Orfeo), Japan (Nippon), Peru (Sono-Radio), Spain (Hispavox), USA (Columbia).

Chantecler, Rua Aurora 1011, Sao Paulo. Tel: 34-7141. Pres.: Helio Muniz de Souza; Gen. Dir.: Joao Rhamy.

Branch: sala 223, Av. Rio Branco 185, Rio de Janeiro.

Labels: Chantecler, Rosicler, Sertanejo.

This company represents: Brunswick (USA), Coral (USA), Decca (USA), Fuentes (Columbia), Peerless (Mexico), Ricordi (Italy), Roulette (USA).

Companhia Brasileira de Discos, Av. Rio Branco 311, 4 andar, Rio de Janeiro. Tel: 42-0964. Cable: Discosinter. Pres.: Alberto Pittigliani; V-P: Rodolfo Beicht; Exec. Dir.: Alain Trossat; Sales: Joaquim Lima.

Labels: Fantasia, Philips, Polydor.

This company represents: MGM (USA), Mercury (USA), Philips (Holland), Polydor (Germany).

Int'l representatives: Argentina (Philips), Bolivia (Philips), Chile (Philips), Colombia (Philips, Fonoton), France (Philips, Polydor), Germany (Philips, DGG), Holland (Philips), Italy (Fonit), Japan (Nippon Victor), Mexico (Peerless), Peru (El Virrey), Portugal (Philips), Venezuela (Siemens), Uruguay (Philips), USA (Mercury).

Discos Som/Maior, Rua Rego Freitas 354, Sao Paulo. Tel: 35-0665. Pres.: Sebastiao Dos Reis Bastos; Mgr.: Fernando De Araujo Neves.

Label: Som/Maior.

This company represents: Audio Fidelity (USA), Decca (USA), Brunswick (USA), Coral (USA).

Elenco, 125 Visconde da Gavea, Rio de Janeiro. Exec. Dir. & A&R: Aloysio de Oliveira; Ass't Dir.: Jose Delphino.

Label: Elenco.

This company represents: Pacific Jazz (USA).

Equipe, Av. Rio Branco 165, sobreloja, Rio de Janeiro. Exec. Dir. & A&R: Osvaldo Cadaxo.

Label: Equipe.

Fermata do Brazil, Av. Ipiranga 1123, Sao Paulo. Tel: 35-2832. Pres.: Enrique Lebendiger.

This company represents: A&M (USA), EMI (England).

Festa, Av. Franklin Roosevelt 84, Rio de Janeiro. Tel: 52-4460. Pres.: Irineu Garcia.

Forma, 1319 Av. Copacabana, sala 802, Rio de Janeiro. Exec. Dir. & A&R: Roberto Quartin; Commercial Dir.: Wadi Gebara Neto; Promo.: Lourdes May.

Label: Forma.

Gravacoes Eletricas, Av. do Estado 4667, Sao Paulo. Tel: 37-5439. Cable: Contaldiscos. Pres.: Alberto Jackson Byington Neto; Exec. Sec.: Jose Augusto MacDowell Leite de Castro; Exec. Mgr.: Braulio Bonadiu; Sales Mgr.: Romeo Nunes; Promo.: Ricardo Galeno.

Branch: Rua Pedro Lessa, 35, 7 andar, Rio de Janeiro. Tel: 32-3141.

Labels: Cabloco, Continental, Disquinho-Historias.

This company represents: Alvorada (Portugal), Colpix (USA), Disc Jockey (Argentina), Duret-Thomson (France), King (Japan), Telefunken (Germany).

Imperial do Brazil, Av. Rio Branco 99, Rio de Janeiro. Tel: 23-8050. Dir.: Luis Alencar Amaral; Ass't: Mauricio Marconi.

Label: Imperial.

Industrias Electricas e Musicas Fabrica Odeon (EMI), Av. Rio Branco 99, 15 andar, Rio de Janeiro. Tel: 24-8050. Cable: Turntable. Pres.: Joao Pedro Vieira de Gouveia; Supt.: H. E. Morris (EMI Head for S.A.); Int'l A&R: Jose de Sa; PR: Mauricio Quadrio; Promo.: Alayde Araujo. Labels: Angel, Capitol, Odeon, Parlofon.

This company represents: London (England), Reprise (USA), Warner Bros. (USA) and Int'l labels of EMI group.

Musidisc, Rua da Lapa 120, 12 andar, Rio de Janeiro. Tel: 52-0474. Cable: Musidisc. Pres.: Nilo Santos Pinto.

Branch: Rua dos Gusmos 662, Sao Paulo. Labels: Masterpiece, Musidisc, Nilser.

R C A Electronica Brasileira, Av. Ipiranga 1097, Sao Paulo. Tel: 35-0178. Cable: Radiointer. Branch: Rua Visconde da Gavea 125, Rio de Janeiro. Pres.: Douglas J. M. Reid; V-P: R. D. Penna; Exec. Dir.: Eric Skinner.

Labels: RCA Camden, RCA Victor.

This company represents: Audio Fidelity (USA), Disneyland (USA), Elenco (Brazil), Fermata (Brazil), Liberty (USA), Musidisc (Brazil), RGE (Brazil).

R G E, Rua Paula Souza 181, Sao Paulo. Tel: 35-1452. Cable: Rgediscos. Owner & Pres.: Enrique Lebendiger. A&R: Rubens Perez & Benil Santos; Int'l: Marcos Mobil.

This company represents: Barclay (France), Dot (USA).

Int'l representatives: Argentina (Fermata), Mexico (Orfeo), USA (Dot), Venezuela (Sonodisco).

Rozenblit, Estrada dos Remedios, 855 Recife, Pernambuco. Cable: Mocambodiscos. Top Exec.: Jose Rozenblit; Sales: Isaac & Adolfo Rozenblit; Promo: Zelia Camara; A&R: Jonas Silva; Int'l: Kurt Sondermann.

Label: Mocambo.

This company represents: Kapp (USA), Mainstream (USA), Time (USA), Vogue (France).

Som, Rua Franca Pinto 70 & Av. Casper Libero 58, Sao Paulo. Tel: 35-8197. Cable: Somdiscos. Pres.: Pedro de Souza Rezende.

Branch: Av. Rio Branco 47 & Av. Nelson Cardoso 627, Rio de Janeiro. Tel: 42-8021. Labels: Copacabana, Sabia, Sacy, Som.

This company represents: Gema (Italy), HiFi (USA), Montilla (USA), Music Hall (England), Pacific (France), Palette (Belgium), Period, Sabrina, Verve (USA).

● music publishers

Aquarela do Brazil, Rua Buenos Aires 58, Rio de Janeiro. Tel.: 37-3566. Dir.: Ary Barroso.

Bandeirante, Rua do Seminario 165, Sao Paulo. Mgr.: A. A. Lentino.

Brasileira, Rua Santa Luzia 799, Rio de Janeiro. Tel: TT-3642. Mgr.: Dalvo Mendes.

Brasileiras Interacionais, Av. Almirante Barroso 91, Rio de Janeiro. Tel: 22-0098. Mgr.: A. A. Lentino.

Brasilrithmos Vitale, Av. Rio Branco 25, Rio de Janeiro. Tel: 42-8021. Mgr.: Emilio Vitale.

Brazano, Rua Visconde Inhauma 134, Rio de Janeiro. Mgr.: Djalma Mafra.

Cooperativa dos Autores Musicais, Rua Sete de Setembro 81, Rio de Janeiro.

Copacabana, Av. Rio Branco 277, Rio de Janeiro. Mgr.: Jose Batista de Costa.

Corcovado, Av. Rio Branco 277, Rio de Janeiro. Mgr.: Renato Araujo.

Cruzeiro Musical, Rua Visconde Inhauma 134, Rio de Janeiro. Mgr.: Milton Bittencourt.

E L A M, Rua Visconde do Rio Branco 53, Rio de Janeiro. Tel: 52-1221. Mgr.: Evandro Ribeiro.

Editora de Musica Brasileira E Internacional, Av. Almirante Barroso 91, Group 401, Rio de Janeiro. Tel: 22-0098 & 32-9401. Cable: Embisa. Mgr.: Sr. Antonio A. Lentino.

Editora Musical Mills, Av. Ipiranga 1123, Sao Paulo. Mgr.: Enrique Lebendiger.

Euterpe, Av. Rio Branco 10B, Rio de Janeiro. Tel: 32-0074. Pres.: Vicente Mangione.

Fermata do Brazil, Av. Ipiranga 1123, Sao Paulo. Tel: 35-2832. Pres.: Enrique Lebendiger.

Latin America's BIGGEST HITS

of YESTERDAY & TODAY

Now Available for PUBLISHING and/or RECORDING

in the United States and Canada

WRITE—WIRE—PHONE FERMATA INT'L MELODIES, ASCAP BENDIG MUSIC, BMI

c/o D. Frenkiel

6290 Sunset Blvd., Hollywood, Calif. 90028

PHONE: (213) 462-7473

THE INTERNATIONAL INFLUENCE OF BILLBOARD GROWS AND GROWS

continued

Frevo, Rua dos Palmares 174, Recife, Pernambuco. Mgr.: Nelson Ferreira.
 Carlos Gomes, Rua Barao de Itapetinga 255, Sao Paulo.
 Viuva Guerreiro, Rua Sete de Setembro 169, Rio de Janeiro. Tel: 43-3070. Mgr.: Fileto Moura.
 Ilha Bela, Rua Barao de Itapetinga 255, Sao Paulo. Mgr.: Herivelto Martins.
 Irmaos Vitale, Av. Rio Branco 25, Rio de Janeiro. Tel: 42-8021. Mgr.: Vitale Emilio.
 M R, Rua Visconde de Inhauma 134, Rio de Janeiro. Mgr.: Arlindo Marques.
 Mangione, Av. Treze de Maio 13, Rio de Janeiro. Tel: 42-3223. Pres.: Estevo Mangione.
 Maua, Rua Visconde Inhauma 134, Rio de Janeiro. Mgr.: Mario Morais.
 Mundo Musical, Rua Visconde do Rio Branco 53, Rio de Janeiro. Tel: 52-1221. Mgr.: Evandro Ribeiro.
 Nossa Terra, Rua Visconde Inhauma 134, Rio de Janeiro. Mgr.: Alcir Pires Vermelho.
 Planalto, Praca Mahatma Gandhi 2, Rio de Janeiro. Mgr.: B. Gomes.
 Reunidas, Av. Casper Libero 5B, Sao Paulo. Tel: 36-8229.
 Ricordi Brasileira, Alameda Barao de Limeira 331, Sao Paulo. Tel: 33-5572. Mgr.: Romiglio Giacompoli.
 Rio Musical, Rua Visconde Inhauma 134, Rio de Janeiro. Mgr.: Roberto Martins.
 Romance, Rua Visconde Inhauma 134, Rio de Janeiro. Mgr.: Milton Bittencourt.
 Samba, Rua Gal. Gustavo Cordeiro Farias 573, Rio de Janeiro. Tel: 34-8105. Mgr.: Fernando Cesar.
 Santos Dumont, Rua 24 de Maio 276, Sao Paulo. Mgr.: Mario Zandomenighi.
 Sao Jorge, Rua Visconde Inhauma 134, Rio de Janeiro. Mgr.: Ary Monteiro.
 Todamerica, Rua Santa Luzia 799, Rio de Janeiro. Tel: 22-3642. Pres.: Oswaldo Santiago.
 Walter Tourinho, Rua Visconde Inhauma 134, Rio de Janeiro. Mgr.: Walter Tourinho.

● **supplies & services**

MUSIC LICENSING & TRADE ORGANIZATIONS

A D D A F, Rua Visconde Inhauma 167, Rio de Janeiro. Tel: 23-1693. Pres.: Ataulpho Alves.

B I E M, Rua Evaristo da Veiga 35, Rio de Janeiro. Tel: 22-7219. Mgr.: Umberto Marconi.
 S A D E M B R A, Rua Buenos Aires 5B-A, Rio de Janeiro. Tel: 52-9630. Mgr.: Cesar do Prado.
 S B A C E M, Rua Buenos Aires 5B-A, Rio de Janeiro. Tel: 23-1935. Pres.: Marino Pinto.
 S B A T, Rua Buenos Aires 5B-A, Rio de Janeiro. Tel: 42-5452. Pres.: Juracy Camargo.
 U B C, Rua Visconde Inhauma 134, Rio de Janeiro. Tel: 23-1693. Pres.: Oswaldo Santiago.

PRESSING PLANTS

Companhia Brasileira de Discos, Estrada das Furnas 1467, Rio de Janeiro.
 Companhia Industrial de Discos, Rua 29 de Julho 1507, Rio de Janeiro.
 Gravacoes Eletricas, Av. do Estado 4755, Sao Paulo. Industrias Electricas e Musicais Fabrica Odeon, Rua "6", Sao Bernardo do Campo, E. de Sao Paulo.
 Musidisc, Rua Quissama, 910, Petropolis, Est. do Rio.
 R C A Eletronica Brasileira, Av. Engenheiro Billings 2299, Sao Paulo.
 Rozenblit, Estrada dos Remedios 855, Recife, Pernambuco.
 Som, Av. Nelson Cardoso 627, Rio de Janeiro.

RECORDING STUDIOS

C B S, Rua Visconde do Rio Branco 53, Rio de Janeiro.
 Chantecler, Rua Aurora 1011, Sao Paulo.
 Companhia Brasileira de Discos, Av. Rio Branco 181, Rio de Janeiro.
 Gravacoes Eletricas, Av. Rio Branco 47, Rio de Janeiro.
 Gravodisc, Rua General Osorio 707, Sao Paulo. Industrias Electricas e Musicais Fabrica Odeon, Av. Rio Branco 277, Rio de Janeiro.
 Musidisc, Rua da Lapa 120, Rio de Janeiro.
 Promotion Studio, Av. Marechal Camara 271, Rio de Janeiro.
 Publi-Son, Rua Santa Luzia 799, Rio de Janeiro.
 R C A Eletronica Brasileira, Rua Visconde de Gavea 125, Rio de Janeiro.
 Rio Som, Rua do Senado 185-187, Rio de Janeiro.
 Rozenblit, Estrada dos Remedios 855, Recife, Pernambuco.
 Som, Av. Rio Branco 47, Rio de Janeiro.

BULGARIA

Population: 8,226,564.
 Official rate of exchange: \$1 (US)=1.17 leva.
 Records exported to U. S. (retail value): \$3,000.
 Records imported from countries other than US (retail value): \$160,000.
 Records exported to countries other than US (retail value): \$460,000.
 Records manufactured for domestic & export sale: LP's—1,694,964 units; EP's—976,400 units; Singles—210,636 units.
 Average retail price per record: LP's—88 cents; EP's—53 cents; Singles—26 cents.
 Radio stations: 14 government controlled.
 Television: 1 government controlled.

● **record manufacturers**

Balkanton, 6 Hayduska Poljana Str., Sofia 12. Tel: 55451.
 Radioprom, Chajduska Poljana 2, Sofia.

● **supplies & services**

PRESSING PLANT

Balkanton, 6 Hayduska Poljana Str., Sofia 12. Tel: 55451.

CANADA

Population: 19,785,000.
 Official rate of exchange: \$1 (US) = \$1.07½ Canadian.
 Per capita income: 1965—\$1,922.
 Number of homes with record players: 2,868,000 (59% of households).
 Records sold domestically: 1965—28,116,820 units, \$27,609,213; 1964—26,184,609 units, \$24,629,431; 1963—23,271,289 units, \$20,755,915. (Distributor's net selling price, in Canadian currency).
 Records manufactured for domestic and export sale: 33,622,252 units, \$27,676,020 (Canadian).
 Records imported from US: 1965—\$1,566,030 (Canadian).
 Records exported to the US: 1965—\$56,114 (Canadian).
 Records imported from countries other than US: 1965—\$727,037 (Canadian).
 Records exported to countries other than US: 1965—\$10,693 (Canadian).
 Average retail price per record: LP's—pop mono, \$4.20; pop stereo, \$5.20; classical mono, \$5.20; classical stereo, \$5.98. Budget, \$1.98, \$2.49, \$2.98. Singles, 99 cents (all Canadian currency).
 Discounting: Frequent in some major markets.
 Stereo sales: 28% of total sales.
 Record club sales: 12% of total sales.
 Type of record distribution: Manufacturer to wholesaler to retailer.
 Import-export regulations: Import customs tariff—20%; sales tax—11%, plus provincial sales tax (varies 3-5%).
 Radio stations: AM—266: 30 government & 236 commercial; programming: recorded music predominates government programs; talks, drama, documentaries. FM—56: 5 government & 51 commercial; programming by regulation: 20% arts, letters & sciences, rest mainly recorded music.
 Television stations: 71 channels (plus 137 rebroadcasting stations): 14 government & 57 commercial; programming: minimum 55% Canadian content; rest US and UK shows. Kit Morgan

● **record manufacturers**

Acadia Recs. of Canada, Box 400, Sta. T, Toronto 19, Ont. Tel: (416) RU 2-5645. Gen. Mgr.: Fred Roy; A&R (C&W): Russ Wheeler.
 Labels: Acadia, Mountain.
 ALLIED, 110 Barbados Blvd., Toronto, Ont. Tel: (416) 267-1584. Pres.: Bruce T. Beatty; Gen. Sales Mgr.: Jack Boswell.
 Branch: Montreal, Que., 124 Ronald Dr. Tel: (514) 489-9729. Sales Mgr.: Bill Fisher.
 This company represents: Allied, Bang, Elektra, Joda, Nonesuch, Pye, Recoton, Roulette, Tartan, Time. (SEE ADVERTISEMENT)
 Alouette (see Archambault).
 Aragon Ents., 615 W. Hastings St., Vancouver 2, B.C. Tel: (604) 685-5423. Pres. & Gen. Mgr.: Al Reusch; Sec. & Office Mgr.: Dorothea Reusch.
 Label: Arrex.



RECORD CORPORATION

EXCLUSIVE CANADIAN DISTRIBUTOR OF THE FOLLOWING MAJOR LABELS

**PYE • ROULETTE • ELEKTRA
NONESUCH • TIME • BANG**

and

RECOTON PHONEEDLES AND ACCESSORIES

HEAD OFFICE—110 BARBADOS BLVD.
SCARBOROUGH, ONTARIO
TELEPHONE (416) 267-4460

BRUCE BEATTY—PRESIDENT
JACK BOSWELL—GENERAL
MANAGER

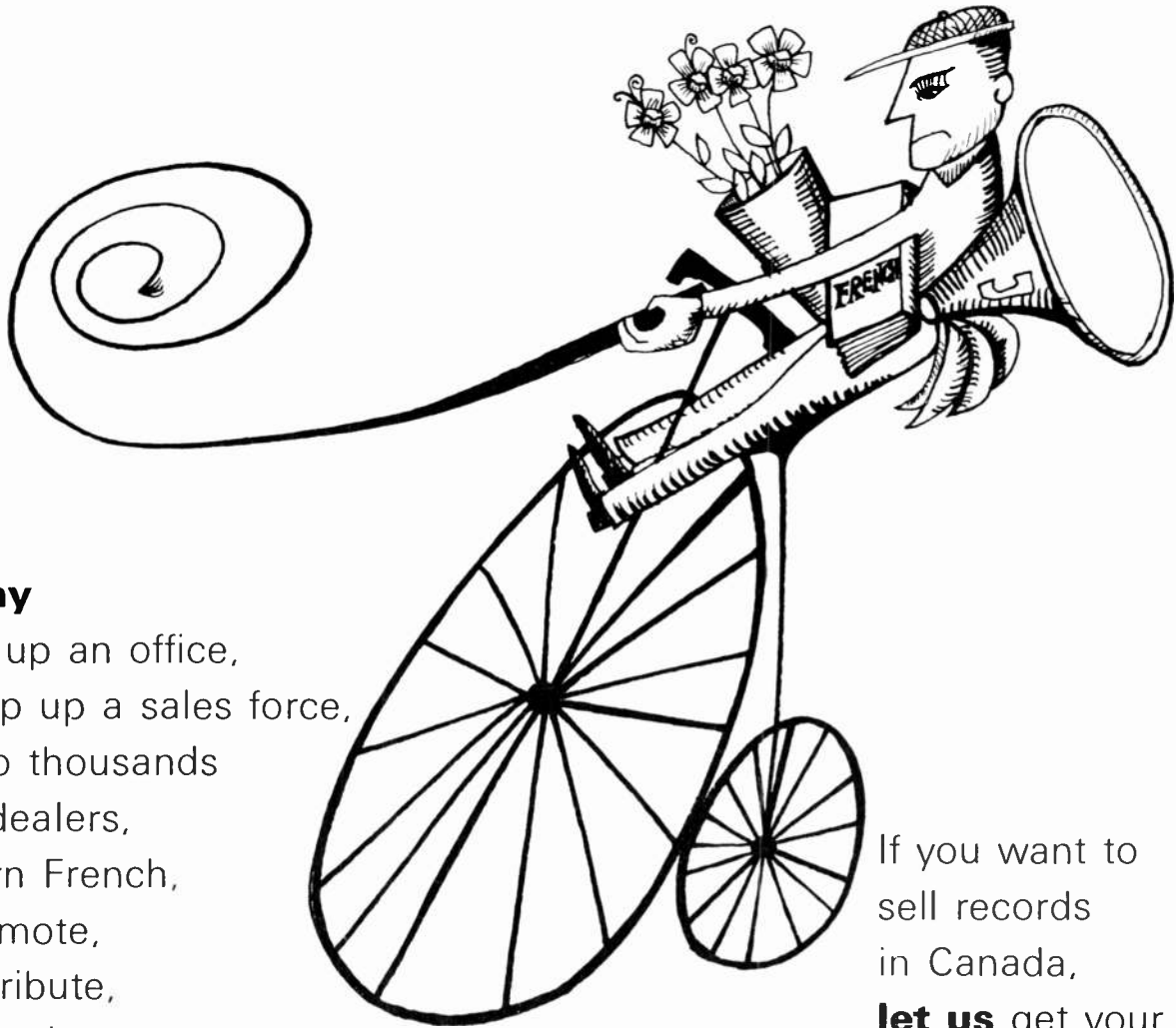

Why

set up an office,
whip up a sales force,
woo thousands
of dealers,
learn French,
promote,
distribute,
advertise—
why bother
to manufacture?

If you want to
sell records
in Canada,
let us get your
ulcers
for you.

**Only RCA Victor has COMPLETE
facilities for manufacturing and
marketing records in Canada.**

RCA VICTOR COMPANY, LTD. 1001 Lenoir St., Montreal, Canada
514-933-7551

BMI CANADA LIMITED

is proud
to have had Canadian songs
recorded by the following
artists during the year.

Popular

Les Atomes
The Brian Browne Trio
Johnny Cowell
Doug Crossley
Jack Davis
Dee & The Yeomen
The Ducats
The Esquires
Bob Goulet
The Guess Who
Ina & Al Harris
Al Hirt
Lonnie Johnson
Richie Knight &
The Mid-Knights
Moe Koffman
Mike Luvzit
Race Marbles
Jerry Martin
The Smart Set
The Staccatos
The Townsman

Country

Al Cherny
Max Falcon
Stonewall Jackson
Bob King
Diane Leigh
Orval Prophet
Bud Roberts
Mac Wiseman

Folk

The Jubilation
Singers
Malka & Joso
Seaway Singers

INTERNATIONAL HITS
FROM
BMI CANADA LIMITED
16 GOULD ST.
TORONTO 2, ONTARIO

continued

ARC SOUND, 2D Cranfield Rd., Toronto 16, Ont. Tel: (416) 751-1613. Cable: Arcsound. Pres.: Phil G. Anderson; VP & Sales & Mktg.: W. R. (Bill) Gilliland; A&R: Tony Di Maria; Pub.: Ken Warriner.
Branch: Winnipeg 4, Man., 1436 Erin St. Tel: (204) 774-105D. Sales Mgr.: Tom Burney.
This company represents: Arc, Arc Int'l, Audio-Spectrum, Golden Hanna-Barbera, International Artists, Somerset. (SEE ADVERTISEMENT)

ARCHAMBAULT, 500 St. Catherine St. E., Montreal, Que. Tel: (514) 849-6201. Cable: ARCHMUSIC. Co-Props.: Rosaire Archambault & Edmond Archambault; A&R Mgr.: John Damont; Promo. Mgr.: Claude Gagnon.
Branch: Montreal, Que., 1201 Notre-Dame de Lourdes. Tel: (514) 849-6201.
Labels: Alouette, Select.
This company represents: Ades, Assimil, Boite a Musique, Canetti, Chant du Monde, Charlin, Critere, Cycnus, Erato, Festival, Jericho, Lumen, Musidisc, Pleiade, Trianon, Valois. (SEE ADVERTISEMENT)

Arrex (see Aragon Ents.).

Baroque Rec. of Canada, 11432 Tardivel St., Montreal 12, Que. Tel: (514) 334-1544. Cable: BAROCCORDS. Pres. & A&R: Gideon Cornfield; Sales: G. Dagan.
Labels: Baroque, Janus.

Bettini of Canada (see Video Audio Prod'ns).

Bravo Recs. & Music, 58 Advance Rd., Toronto 18, Ont. Tel: (416) 239-2361. Pres.: Johnny Lombardi; Sec.-Treas.: T. S. St. Clair Low.
Labels: Bravo, Vis.

CANADIAN MUSIC SALES, 58 Advance Rd., Toronto 18, Ont. Tel: (416) 239-2361. Cable: Music. Pres.: T. St. Clair Low; Sales Mgr.: T. P. Regan; Adv.: Harold Cluff.
Branch: Montreal, Que., 3431 Ontario St. E. Tel: (514) 526-1233. Contact: Adelard Laurendeau.
This company represents: Alma, Apon, Ariola, Bruno, Budapest, Cetra, Collectors' Guild, Colonial, Educo, 49th State, Hazam, MMO, Standard, Turul, Universe, and all square dance labels. (SEE ADVERTISEMENT)

Capitol, 635 Queen St. E., Toronto 8, Ont. Tel: (416) 461-0391. Cable: Capitolrec. Exec. VP & Gen. Mgr.: G. Edward Leetham; VP & Sales Dir.: E. Taylor Campbell; A&R Dir. & Adv. Mgr.: Paul White.
Branch: Montreal, Que., 155 Port Royal W. Tel: (514) DU 9-3588. Sales Mgr.: R. Riendeau.
Labels: Capitol, Angel.
This company represents: Aventures, Cavalier, Cricket, Electrola, Gamma, Hawk, Hilltop, Movietone, Odeon, Parlophone, Pathe, Pickwick, 20th-Fox, Voce del Padrone.

Centennial, 10534 109 St., Edmonton, Alta. Tel: (403) 424-7786. Pres.: Ray Schwartz.

Columbia Recs. of Canada, 1121 Leslie St., Don Mills, Ont. Tel: (416) 447-3311. Mg'g Dir.: Robert R. Pampe; Sales & Mfg. VP: Frederick T. Wilmot; A&R Mgr.: P. S. Westwood; Distributor Sales Mgr.: J. Robertson; Sales, Promo. & Adv. Mgr.: R. L. Martin.
Branch: Montreal, Que., 1168 Montee de Liesse. Tel: (514) 748-9648. Mgr.: John Williams.
Labels: Columbia, Date, Epic, Okeh.
This company represents: Barclay, Dorval, Musicor, Oldtown.

COMPO, 2377 Remembrance St., Lachine, Que. Tel: (514) 637-2561. Cable: COMPOCO. VP & Gen. Mgr.: R. A. Chislett; VP & Sales Mgr.: S. D. Roberts; A&R: Lee Armstrong; Sales, Mktg. & Adv. (Decca div.): S. D. Roberts; (Apex div.): Lee Armstrong; Pub. & Promo.: Roy Smith.
This company represents: (Decca div.): Decca, Coral, Brunswick, Vocalion, Caedmon. (Apex div.): Accent, Apex, Carnaval, Challenge, Colpix, Cresendo, Diamond, Everest, Hall, Lero, Point, Reprise, Soma, United Artists, Valiant, Warner Bros. (SEE ADVERTISEMENT)

Disques Gamma, 389 St. Paul St. W., Montreal, Que. Tel: (514) 288-1592. Pres.: Jack Lazare; Sec.: Dan Lazare; VP, Sales & Mktg.: Christian Larsen.
Int'l representatives: Belgium, France (CBS).

Disques Jupiter (Les), 4824 Cote des Neiges, Suite 44, Montreal, Que. Tel: (514) 733-9673. Pres. & A&R: Yvan Dufresne.
Label: Jupiter.
This company represents: Ranch (Belgium).

Eagle, Box 3539, Winnipeg 4, Man. Tel: (204) 582-5287. Pres.: R. W. Nowosad; Treas.: C. D. Ward.
Labels: Eagle, Ruler.

Fireside, Box 181, Ft. William, Ont. Tel: (807) 623-1880. Pres.: Edwin W. Kukkee.

Frontier, Box 489, Waterloo, Que. Tel: (514) 539-1322, 0922. Dwner: B. R. (Scotty) Gibbs.

Gaiety, 232 Lincoln St., Port Arthur, Ont.

Hawk, 331 Yonge St., Toronto 1, Ont. Tel: (416) 364-1681. Pres.: Ronnie Hawkins; VP: Wanda Hawkins.

Janus (see Baroque).

Joseph Lipari Dist., 7111 St. Denis, Montreal, Que. Tel: (514) 274-2457. VP: Mario Lipari.
Label: Lipari.
This company represents: Ariston, Carosello, Durium, Fonit, Phonocolor, Pin-Kar, Primavera, Style, (all Italy).

London Recs. of Canada, 190 Graveline St., St. Laurent, Montreal, Que. Tel: (514) 631-2061. Cable: FULLRANGE. Gen. Mgr.: F. C. Jamieson; Asst. Gen. Mgr.: Miss Alice Koury; Sales Admin.: Giles Aubin.
Branches: Calgary, Alta., 628 11 Ave. S.W. Tel: (403) 244-6133. Mgr.: Miss Fran Tochor.
Vancouver, B. C., 3166 Lake City Way. Tel: (604) CY 8-6471. Mgr.: Drmond L. Jones.—
Winnipeg, Man., 654 King Edward. Tel: (204) 772-4305. Mgr.: Mark Anderson—**St. Laurent, Que.,** 180 Graveline St. Tel: (514) 631-2061. Mgr.: Mr. Jean Desrosiers.
This company represents: Ace of Clubs, Ace of Diamonds, Aragon, Argo, Aura, Backbeat, Banff, Belair, Beltona, Blue Rock, Caprice, Celtic, Click, Coliseum, Das Alte Werke, Dolton, Duke, Durium, Elysee, Emarcy, Era, Etiquette, Europa, Fontana, France-Canada, Hi, Imperial, Jamie, Jupiter, Liberty, Lighthouse, London, Marjon, Melbourne, Mercury, Mobile Fidelity, Monument, Oiseau Lyre, Pacific Jazz, Parrot, Peacock, Pergola, Philips, Philles, Press, Rheims, Rodeo, Rusticana, Smash, Societe Francaise du Son, Sun, Sunset, Telefunken, Tribe, Venus, Wing, World-Pacific.

Masterseal, 1244 Dufferin St., Toronto, Ont. Tel: (416) 531-5753. Pres.: Donald H. Gabor.
Labels: Continental, Little Chip, Maple Leaf, Masterseal, Remington.

Match Music, 6 Wellington St. S., Sherbrooke, Que. Tel: (819) 569-6314. Gen. Mgr.: Russell M. Marois.
Labels: Meteor, Worth.

Meteor (see Match Music).

Monticana, 2955 Fendall, Montreal 26, Que. Tel: (514) 739-8935 & 737-9200. Pres.: Dave Leonard.
Int'l branch: USA, New York, N. Y.

Mountain (see Acadia Recs. of Canada).

Musimart, 970 McEachran Ave., Montreal B, Que. Tel: (514) 273-8354. Pres.: George E. Erlick; Sales Mgr.: Rudy Assaly.
This company represents: Arka, Artia, Bach Guild, Betty White, Blue Note, Cavalier, Compose, Conversaphone, Copley, Dana, Diplomat, Dyer-Bennett, ESP-Disk, Everyman, Guest Star, Lyricord, Magic Violins, Melodia, Panda, Parliament, Peter Pan, Pierrot, Planet, Playmate, Polydor, Prestige, Spoken Word, Tikva, Tip, Tradition, Turnabout, Vanguard, Virtuoso.

New Syndrome, 4772 Harvaez Dr., Vancouver, B. C. Tel: (604) 682-4869. Gen. Mgr.: Jack Herschorn.

Pace, 13907 Buena Vista Rd., Edmonton, Alta. Tel: (403) 482-1187. Pres.: Ray Schwartz.

Perception (see Video Audio Prod'ns).

Phonodisc, 355 King St. W., Toronto, Ont. Tel: (416) 366-8744. Pres.: Don McKim; Sales Mgr.: Hal Ross.
Branches: Winnipeg, Man., 3-47 Carlton Pl. Tel: (204) 453-8955. Sales Mgr.: Mrs. Corinne Burke.—**Montreal, Que.,** 4640 Decarie Blvd. Tel: (514) 482-3060. Sales Mgr.: Jim Corbett.
This company represents: Audio Fidelity, Cadet, Checker, Chess, Congress, Del-Fi, Delta, Gordy, Kapp, King, Motown, Paula, Phonodisque, Regency, Soul, Tamla, VIP, Whit.

Polydor Recs. of Canada, 407 McGill St., Suite 7D9, Montreal 1, Que. Tel: 849-5783. Mg'g Dir.: Fred Exon.

Profound (see Video Audio Prod'ns).

QUALITY, 38D Birchmount Rd., Scarborough, Ont. Tel: (416) 698-5511. VP & Mg'g Dir.: George L. Keane; Sales Mgr.: Lee W. Farley; Prom'n Co-ordinator: George R. Struth; Sales & Promo. Co-ordinator: Harold Winslow.
Branches: Winnipeg, Man., Galt Bldg., 4th Floor. Tel: (204) WH 3-6563. Mgr.: Reg Ayres.—**Toronto, Ont.,** 130 Mack Ave. Tel: (416) 698-5643. Mgr.: Harold Gallant.—**Montreal, Que.,** 2215 Beaconsfield Ave., Rm. 4. Tel: (514) HU 1-1167. Mgr.: Clyde McGregor.
Int'l Branch: USA, c/o Marshall & Vigoda, 130 W. 57 St., New York, N. Y. Tel: (212) 582-1122. Contact: Paul G. Marshall.
This company represents: Atco, Atlantic, Barry, Cameo, DGG, Dot, Hickory, Jubilee, Kama Surtra,



Head Office: 1940 YONGE ST., TORONTO 7, ONTARIO, CANADA PHONE (416) 487-3466

We at Bigland Are Proud to be the
Number One Booking Agency in Canada,
But We Are Even More Proud of:

BARRY ALLEN—CAPITOL RECORDS

THE ASSOCIATES

THE BIG TOWN BOYS—BELL RECORDS

WES DAKUS AND THE REBELS—CAPITOL RECORDS

DEE AND THE YEOMEN—BELL RECORDS

JAMES AND THE BONDSMEN—CAPITOL RECORDS

BOBBY KRIS AND THE IMPERIALS—COLUMBIA RECORDS

LITTLE CAESAR AND THE CONSULS—BELL RECORDS

THE 5 RISING SONS—YORK TOWN RECORDS

THE SECRETS—ARC RECORDS

STITCH 'N TYME—ARC RECORDS

THE UGLY DUCKLINGS—YORK TOWN RECORDS

Exclusive Publicity & Promotion:
FRED WHITE PUBLICITY AND PROMOTION,
SUITES 1 & 2,
1940 YONGE STREET,
TORONTO 7, ONTARIO
PHONE (416) 487-3466

Write or Phone Today
To Request Free Pictures
And Catalogue of
Attractions

ROBERT J. STONE ASSOCIATES

post office box 703 / oshawa / canada

Leave Canada and the world markets

to us . . . record distribution, music

publishing, creative art, promotion

and publicity, talent, are only a few

of the services we have to offer.



telegrams. "MUSICCAN" Oshawa, Canada

continued

Laurie, MGM, Quality, Reo, Scepter, Verve. (SEE ADVERTISEMENT)

RCA VICTOR, 1001 Lenoir St., Montreal, Que. Tel: (514) 933-7551. Cable: Victoradio. VP & Gen. Mgr. (Rec. Div.): G. I. Harrison; A&R Dir.: W. A. Gillmeister; Mgr. Comm'l Rec. Sales: K. Coupland; Pub.: Mrs. M. Danies; Int'l Mgr.: S. Kulin.

Branches: Calgary, Alta., 4120 6 St. S.E., Tel: (403) CH 3-4661. Contact: A. Bell.—Vancouver, B. C., 2876 Rupert St. at Grandview Hwy. Tel: (604) 433-6881. Contact: C. Smith.—Winnipeg, Man., 2070 Notre Dame Ave., St. James 21. Tel: (204) 772-0481. Contact: R. T. Nugent.—Halifax, N. S., 3611-3619 Commission St. Tel: (902) 455-7247. Contact: H. Josey.—Toronto, Ont., 1450 Castlefield Ave. Tel: (416) 762-7311. Contact: J. R. Feeney.—Montreal, Que., 5575 Royalmount Ave. Tel: (514) RE 1-3411. Contact: J. G. Bergeron.

Label: RCA Victor.

This company represents: Buena Vista, Disneyland, Dunhill, Elite, Request. (SEE ADVERTISEMENT)

Rebel, Box 32, Willowdale, Ont. Pres.: C. R. Freeland.

Red Leaf (see Tamarac).

Rodeo, 4824 Cote des Neiges Rd., Montreal 26, Que. Tel: (514) 731-0889. Pres.: George Taylor; VP: Frank W. McKnight; Int'l: James N. Parks, 852 Elm St., Manchester, N. H., USA. Tel: (603) 623-9749.

Label: Rodeo Int'l.

This company represents: Banff, Campus, Caprice, Celtic, Europa, Melbourne.

Int'l representatives: Australia (W&G), England (Phonodisc), France (Janeret), New Zealand (W&G).

Select (see Archambault).

SPARTON OF CANADA (Rec. Div.), Box 2125, London, Ont. Tel: (519) 455-6320. Gen. Mgr.: Harold E. Pounds; VP: W. Larry Page.

Label: Sparton.

This company represents: ABC-Paramount, Boom, Boone, Bragg, Coloritone, Command, Contemporary, Eurotone, Grand Award, Good Time Jazz, HiFi, Impulse, Longhorn, Mira, Mirwood, Nashville, Oliver, Starday, Summit, Supraphon, Surrey, Tangerine, Westminster, Whitehall. (SEE ADVERTISEMENT)

Spotlight, PO Box 217, Ottawa, Ont. Tel: (613) 235-2944. Owner: Gilbert "Gib" Kerr; Sales Consultant: Harold Smith.

ROBERT J. STONE ASSOCS., Box 703, Oshawa, Ont. Tel: (416) 723-0898. Cable: Musiccan. Pres.: Robert J. Stone; Gen. Mgr.: J. C. Devlin; Sales Mgr.: Daniel Glanfield; Promo. & Pub. Dir.: Bob James; Int'l Rep.: Herb Ostrow, 200 W. 57 St., Suite 702, New York, N. Y. 10019, USA. Tel: (212) 757-6215.

This company represents: Artia, Associated Artists, Ballad, Big C, Bo-Mar, Cloud, Cordy, Impression, Jameco, Listen & Learn, Murbo, Process, Supraphon. (SEE ADVERTISEMENT)

Tamarac, 1940 Yonge St., Toronto 7, Ont. Tel: (416) 487-3466. Pres.: Stan Klees.

Label: Red Leaf.

TRANS-CANADA, 189 Rockland Rd., Ville Mont Royal, Montreal, Que. Tel: (514) 731-8571. Pres.: Jean-Paul Rickner.

This company represents: AZ, Blue Jean, Citation, Decouverte, Dominion, Fantastic, Miracle, Music Hall, Pacific, Prestige, Teledisc, Trans-Canada, Triomphe, Tournesol, Vedette, Vogue. (SEE ADVERTISEMENT)

Trans-World, 1180 St. Antoine St., Montreal, Que. Tel: (514) 866-2884. Pres.: Art Young; Sec., Sales & Mktg.: Sam Rubin; Pub., Adv. & Promo.: Al Garner.

Branches: Winnipeg, Man., 1299 Strathcona Ave. Tel: (204) SU 3-0436.—Scarborough, Ont., 390 Progress Rd. Tel: (416) 293-9389. Mgr.: Frank Swain.

This company represents: Battle, Blanche-Neige, Capri, Dance Along, Dover Classical, Elegante, Excello, Fantasy, Fiesta, Folkways, Gateway, Grecophon, Jazzland, Mainstream, Oak Publ'ns, Riverside, Sue, Trans-World, Verve/Folkways, Wonderland.

Transcend (see Video Audio Prod'ns).

V A P Specialty Series (see Video Audio Prod'ns). Video Audio Prod'ns, 2804 26 St. S.W., Calgary, Alta. Tel: (403) 249-1507. Pres.: Miss L. D. McMurphy; Prod'n Supervisor & Sales & Mktg.: Brian E. Sullivan.

Labels: Bettini of Canada, Perception, Profound, Transcend, VAP Specialty Series.

Vis (see Bravo Recs. & Music).

Worth (see Match Music).

CARAVAN RECORD SALES LIMITED

390 Progress Avenue
Scarborough, Ontario
Tel. (416) 293-2153

FRANK P. SWAIN, President

ONTARIO DISTRIBUTORS OF THE FOLLOWING LINES

TIME
FIESTA
RED LEAF
WALCO NEEDLES & ACCESSORIES
V RECORDS
DR. MURRAY BANKS
DESIGN
ITAL RECORDS
CHARLIE PARKER

FOR TRANS-CANADA
VOGUE—MODE—CARIBE—ETC.

MS
MUSIQUE SERVICE INC.

Phone RE 1-3462

CANADA'S
LARGEST ONE-STOP

ALL LABELS

189 Rockland Rd., T.M.R., Montreal 16, Quebec

TRANS-CANADA

TC

DISQUES INC.

Phone RE 1-8571
EXCLUSIVE DISTRIBUTOR
FRENCH RECORDS

Jeunesse-Franco—Fantastic
Tournesol—Tele disc—
Trans-Canada—Vogue—
A-Z

Zoria, 11335 84 St., Edmonton, Alta. Tel: (403) 479-2395. Contact: William Barabash.

• music publishers

Anglo-Canadian (CAPAC) (see Canadian Music Sales).
 B + 3 (see Montana).
 Banff (BMI), c/o Leeds (Canada), 215 Victoria St., Toronto, Ont. Tel: (416) 362-1403. Pres.: George Taylor; Gen. Mgr.: Bailey Bird.
 Branch: Montreal, Que., 4824 Cote des Neiges Rd. Tel: (514) 731-0889. Gen. Prof. Mgr.: George Taylor.
 Barabash (BMI), 11335 84 St., Edmonton, Alta. Tel: (403) 479-2395. Pres.: William Barabash.
 Bay (BMI), 5 Waterman Ave., Toronto 16, Ont. Tel: (416) 751-2233. Gen. Mgr.: Phil G. Anderson; Gen. Prof. Mgr.: Ralph Harding.
 Belafonte (see Chappell).
 Ben-Art (CAPAC) (see Elegante).
 Irving Berlin (see Chappell).
 Betanec (CAPAC), 4824 Cote des Neiges Rd., Suite 3B, Montreal, Que. Tel: (514) 739-4774. Pres. & Gen. Prof. Mgr.: Ben Kaye; Gen. Mgr.: George Kushnir.
 Bigland (CAPAC), 1940 Yonge St., Toronto 7, Ont. Tel: (416) 487-3466. Pres.: Stan Klees.
 Boosey & Hawkes (CAPAC), 209 Victoria St., Toronto 2, Ont. Tel: (416) 368-1874. Cable: SONOROUS. Pres.: K. Pool; Gen. Prof. Mgr.: W. Croombs.
 This company represents: Artia (Czechoslovakia), Edwin Ashdown (England), Boosey & Hawkes (England, USA), J. Curwen & Sons (England), Israel Music Inst. (Israel), Kultura (Hungary), Luverne (USA).
 Bregman, Vocco & Conn (see Chappell).
 Ray Brown (BMI), 40 Park Rd., Suite 503, Toronto, Ont. Tel: (416) 923-6380. Pres.: Ray Brown; VP: Maurice Kessler.
 Burlington (CAPAC), 190 Graveline St., St. Laurent, Montreal, Que. Tel: (514) 631-2061. Mgr.: Brian Chater.
 This company represents: Burlington/Palace Group (United Kingdom), International Music (Belgium).
 Int'l representative: England (Burlington/Palace).
 CANADIAN MUSIC SALES (CAPAC), 58 Advance Rd., Toronto 1B, Ont. Tel: (416) 239-2361. Cable:

Music. Pres.: T. St. Clair Low.
 Branch: Montreal, Que., 3431 Ontario St. E. Tel: (514) 526-1233.
 Affiliates: Anglo-Canadian (CAPAC).
 This company represents: Alfred, Hill & Range Songs. Music Publishers Holding Corp. (all USA). (SEE ADVERTISEMENT)
 Canint (CAPAC), 20 Cranfield Rd., Toronto 16, Ont. Tel: (416) 751-1113. Gen. Mgr.: W. R. Gilliland; Gen. Prof. Mgr.: Ralph Harding.
 Chappell, 14 Birch Ave., Toronto 7, Ont. Tel: (416) 922-2159, 2150. Cable: Symphony. Gen. Mgr.: C. C. Devereux.
 Affiliates: Belafonte, Irving Berlin; Bregman, Vocco & Conn; Compass, Famous-Chappell, Five Continents Chappell, Frank, Edwin H. Morris, Paxwin, Sheldon, Valando.
 Chateaugay (BMI), 1180 St. Antoine St., Suite 401, Montreal, Que. Tel: (514) 866-2884. Pres.: Arthur Young; Gen. Mgr.: Sam Rubin.
 Chinguacousy (BMI), PO Box 703, Oshawa, Ont. Tel: (416) 723-089B. Cable: Musiccan. Pres.: Robert J. Stone; Gen. Mgr.: Jack Devlin.
 Chrisong-Arrowig (BMI), 44 Douglas Crescent, Toronto 5, Ont. Tel: (516) WA 1-4443. Owners: Chris Wittigins, Matie Molinaro.
 Colonel Hall (BMI), 1940 Yonge St., Toronto 7, Ont. Tel: (416) 487-3466. Pres.: Stan Klees. Compass (see Chappell).
 Cross Canada (BMI), 2420 Benny Crescent, Suite 410, Montreal 2B, Que. Tel: (514) 482-8714. Pres.: Johnny Clark.
 D & L, 232 Lincoln St., Port Arthur, Ont.
 Duffer Publ'ns (BMI), 234 Davenport Rd., Toronto, Ont. Tel: (416) 927-3275. Pres.: David Mostoway.
 EDITIONS ARCHAMBAULT (CAPAC-BIEM), 500 St. Catherine St. E., Montreal, Que. Tel: (514) 849-6201. Cable: ARCHMUSIC. Pres.: Rosaire Archambault.
 This company represents: Editions Primavera (Belgium), Editions Tutti (France). (SEE ADVERTISEMENT)
 Editions Cybele (BMI), 4824 Cote des Neiges Rd., Suite 44, Montreal, Que. Tel: (514) 733-9673. Pres.: Yvan Dufresne.
 Editions Dulau (CAPAC), 4824 Cote des Neiges Rd., Suite 44, Montreal, Que. Tel: (514) 733-9673. Pres.: Yvan Dufresne.

Editions de L'etoile (CAPAC), 8359 Place Chanceaux, Ville d'Anjou, Montreal, Que. Tel: (514) 352-5863. Pres.: Lucien Brien.
 Editions Jerome, 6341 Goncourt, Ville d'Anjou, Montreal, Que. Tel: (514) 352-9141. Gen. Mgr.: Jerome Lemay.
 This company represents: Alleluia, Caroussel (France).
 Editions du Passe-Temps (BMI), Box 906, Sta. B, Montreal, Que. Tel: (514) 849-2692. Pres. & Gen. Prof. Mgr.: Eddy Prevost.
 Editions Purlenne (CAPAC), CP 72, Sta. De Lorimier, Montreal 34, Que. Pres.: Paul-Marcel Gauthier.
 Editions Andre Roussel (see Match Music).
 Editions Rusois (see Match Music).
 Editions Sud (see Southern).
 Editions Tact (CAPAC), B437 rue Bretagne, St. Leonard, Montreal 38, Que. Tel: (514) 728-6160. Pres.: Roger Beaulne.
 Eko-Phon (BMI), Bield, Man. Tel: Roblin 337-5. Gen. Mgr.: Harry Holunga.
 Elegante (CAPAC), 1180 St. Antoine St., Suite 401, Montreal, Que. Tel: (514) 866-2884. Pres.: Arthur Young; Gen. Mgr.: Sam Rubin.
 Affiliates: Ben-Art (CAPAC), W.A.A. (CAPAC).
 Empire (BMI), 934 12 St., New Westminster, B.C. Tel: (604) LA 2-6232. Cable: EMPMUSIC. Pres.: Karle Hodsing; Gen. Prof. Mgr.: Will Verra.
 Int'l Branch: USA, Seattle, Wash.
 Falcon (BMI), Enderby, B. C.
 Famous (see Chappell).
 Felsted (BMI), 190 Graveline St., St. Laurent, Montreal, Que. Tel: (514) 631-2061. Mgr.: Brian Chater.
 Fireside (CAPAC), Box 181, Ft. William, Ont. Tel: (807) 623-1880. Pres.: Ed Kukkee.
 Five Continents Chappell Canada (see Chappell).
 Forwill Prod'ns., 10534 109 St., Edmonton, Alta. Tel: (403) 424-9394. Pres.: J. C. Williams.
 Frank (see Chappell).
 Frontier (BMI), Box 400, Sta. T, Toronto 19, Ont. Tel: (416) 782-5645. Pres. & Gen. Mgr.: Fred Roy.
 Gaudan (CAPAC), 389 St. Paul St. W., Montreal, Que. Tel: (514) AV 8-1592. Pres.: Jack Lazare; Gen. Mgr.: Christian Larsen.
 GROUPE EDITORIAL FRANCO, 189 Rockland Rd., Montreal, Que. Tel: (514) 731-2741. Dir.: Tony Cattichio. (SEE ADVERTISEMENT)

**WHO'S THE MOST
POPULAR MAN
IN CANADA?**



**COLUMBIA • MUSICOR • BARCLAY • EPIC
DATE • OKEH • HARMONIE • CBS INTERNATIONAL SERIES**

DISTRIBUTED THROUGH

Columbia Records Distributors of Canada, Ltd.

1113 Leslie Street Don Mills 5, Ontario
(416) 444-6651

Columbia Records Distributors of Canada, Ltd.

1168 Montée de Liesse Montreal 9, Quebec
(514) 748-9648

Van Horne Electric Supply Co.

550 Cambie Street Vancouver, British Columbia
(604) MU 4-2231

Canadian Electronics, Ltd.

10552-A-114th Street Edmonton, Alberta
(403) 424-3988

The COLUMBIA RECORDS Salesman . . . That's who!



**Key^{ed} to
FAST,
EFFICIENT
COAST TO
COAST
DISTRIBUTION**



QUALITY RECORDS LIMITED
380 BIRCHMOUNT ROAD,
TORONTO, ONTARIO CANADA
Phone OX-8-5511

U.S. OFFICE
130 WEST 57TH ST.
NEW YORK, NEW YORK

c/o MARSHALL & VIGODA
Phone JU-2-1122

continued

Halben (CAPAC), 4824 Cote des Neiges Rd., Montreal 26, Que. Tel: (514) 739-4774. Pres. & Gen. Prof. Mgr.: Ben Kaye; Gen. Mgr.: Hal Stanley.

Frederick Harris (CAPAC), 529 Speers Rd., Oakville, Toronto, Ont. Tel: (416) 845-2391. Gen. Mgr.: R. G. Fred Collier; Sales Mgr.: W. Ray Stephens.

This company represents: Allans (Australia), Ascherberg, Hopwood & Crew (England), Banks (England), Brodt (USA), Alfred Lengnick (England), Novello (England), Simrock (England).

Hawk, 331 Yonge St., Toronto 1, Ont. Tel: (416) 364-1681. Pres.: Ronnie Hawkins; Gen. Mgr.: Edward Nagurski.

Jendale (CAPAC), 6321 10 Ave., Rosemount, Montreal, Que. Tel: (514) 722-0401. Pres.: Jerry Hrynaych; Gen. Mgr.: Ken Ayoub.

Kalamalka Music Sales (BMI), 2505 27 St., Vernon, B. C. Tel: (604) 542-4745. Gen. Mgr.: Eric J. Hopkins.

Kustor (BMI), 4824 Cote des Neiges Rd., Montreal 26, Que. Tel: (514) 739-4774. Pres.: Ben Kaye; Gen. Mgr.: Hal Stanley.

La Sol, (CAPAC), 2085 Scott St., Ville St. Laurent, Montreal 9, Que. Tel: (514) 744-0956. Pres.: Adam Gutman.

Leeds (div. of Music Corp. of America) (CAPAC), 215 Victoria St., Toronto, Ont. Tel: (416) 362-1403. Mg'g. Dir.: Bailey Bird; Gen. Prof. Mgr.: Al Allbutt.

Affiliates: Banff (BMI), Melbourne (CAPAC). **This company represents:** Champion (USA), Duchess (USA), MCA (USA), Northern (USA), Pickwick (USA), Sim (France), Welbeck (England).

M J S (BMI), 2327 Richmond Rd. S.W., Calgary, Alta. Tel: (403) 242-1277. Pres.: Mel Shaw.

Manitou (div. of Revue Studios) (BMI), 215 Victoria St., Toronto, Ont. Tel: (416) 362-1403. Cable: Leeds Music. Mg'g. Dir.: Bailey Bird; Gen. Prof. Mgr.: Al Allbutt.

Match, 6 Wellington St. S., Suite 301, Sherbrooke, Que. Tel: (819) 569-6314. Pres.: R. M. Marois. **Affiliates:** Editions Andre Roussel, Editions Rusois.

Melbourne (CAPAC), c/o Leeds, 215 Victoria St., Toronto, Ont. Tel: (416) 362-1403. Pres.: George Taylor; Gen. Mgr.: Bailey Bird. **Branch: Montreal, Que., 4824 Cote des Neiges Rd. Tel: (514) 731-0889. Gen. Prof. Mgr.: George Taylor.**

Mello-Music (BMI), 988 Waterford Ave., Winnipeg 19, Man. Tel: (204) GL 2-8695. Owner & Mgr.: Allan Caron.

Mills (CAPAC), 44 Victoria St., Toronto, Ont. Gen. Mgr.: Warren Ling.

Mohican (BMI), 100 Rideau St., Ottawa 2, Ont. Tel: (613) 232-5775. Pres.: Russell Kronick; Gen. Mgr.: Mark Max.

Montina (BMI), PO Box 323, Montreal, Que. Tel: (514) 739-8935 & 737-9200. Pres. & Gen. Prof. Mgr.: Dave Leonard.

Int'l branch: USA, New York, N. Y. **Affiliate:** B + 3.

Edwin H. Morris (see Chappell).

Muir (BMI), 888 Yonge St., Toronto, Ont. Tel: (416) WA 1-9701. Pres. & Gen. Prof. Mgr.: Norm Muir; Gen. Mgr.: Barbara Lomoro.

Nowar (BMI), 475 Selkirk Ave., Winnipeg 4, Man. Tel: (204) 582-5287. Pres.: R. W. Nowosad; Gen. Mgr.: C. D. Ward.

Paxwin (see Chappell).

Peer Int'l (BMI) (see Southern).

Power (BMI), 150 Overbrook Pl., Toronto, Ont. Tel: (416) ME 3-4421. Pres.: Larry Wiener.

Rudy's Song Publ'ns (BMI), 3 Red Creek Rd., Grasmere, B. C. Tel: (604) 351-0346. Pres.: Rudolph Hallwas.

Shefford (BMI), Box 489, Waterloo, Que. Tel: (514) 539-1322, 0922. Pres.: Scotty B. R. Gibbs.

Sheldon (see Chappell).

Southern (CAPAC), 1405 Bishop St., Montreal, Que. Tel: (514) AV 8-9410. Cable: SOUTHMUSIC. Gen. Mgr.: Matt Heft. **Affiliate:** Peer Int'l.

Spellbinder (BMI), 223 Joicey Blvd., Toronto 12, Ont. Tel: (416) 485-3798. Pres.: Edwin J. Feeny; Musical Dir.: C. J. Feeny.

A & B Syme (BMI), Box 383, Salmon Arm, B. C. Tel: (604) 832-2530. Pres.: A. Syme; Gen. Mgr.: B. Syme.

Adolphe Taigi (CAPAC), 2161 Jolicoeur, Montreal 20, Que. Tel: (514) 766-5415. Cable: Dolgi. Pres.: Adolphe R. LaPointe; Gen. Mgr.: Robert J. LaPointe; Gen. Prof. Mgr.: Parnelia LaPointe.

Gordon V. Thompson (CAPAC), 32 Alcorn Ave., Toronto 7, Ont. Tel: (416) 923-7329. Cable: Gor-

thom. Pres. & Gen. Mgr.: John C. Bird; Gen. Prof. Mgr.: Phil Moore.

This company represents: Barton, Big 7, Big 3 (Robbins, Feist, Miller), Bourne, Eastman, Essex, Fred Fisher, Forster, Sam Fox, Mansion, Milene, George Pincus & Sons, Plymouth, St. Nicholas, Shapiro-Bernstein, The Richmond Organization.

Tomi (BMI), 40 Park Rd., Suite 503, Toronto, Ont. Tel: (416) 923-6380. Gen. Mgr.: Oscar Peterson.

Troika (BMI), 190 Adelaide St. W., Toronto, Ont. Tel: (416) 535-3020. Pres.: Paul Neary; Gen. Mgr.: Hushy Sherman; Gen. Prof. Mgr.: Art Snider.

Valando (see Chappell).

Vancouver Publ'g (BMI), 4772 Narvaez Dr., Vancouver, B. C. Tel: (604) 682-4869. Mgr.: Tom Northcott.

Branch: USA, Jack & Jill, Beverly Hills, Calif. W. A. A. (see Elegante).

Waterloo, 3 Regina St. N., Waterloo, Ont. Tel: (519) SH 3-4388. Pres.: F. C. Moogk. **Branch: Ottawa, Ont., 913 Carling Ave. Tel: (613) 728-2084. Gen. Prof. Mgr.: H. J. Heath.**

Wentworth (BMI), 22 Woodland Ave., St. Catharines, Ont. Tel: (416) 682-0051. Pres.: Jack Kingston.

Whaley, Royce (CAPAC), 310 Yonge St., Toronto, Ont. Tel: (416) 362-6778. Dirs.: E. G. Hough & F. W. Lewis.

This company represents: Bayley & Ferguson (Glasgow, United Kingdom), Magnamusic (USA), Musicord (USA).

● **independent record producers**

Company of Broadcast Prod'rs, 55 Isabella St., Suite 1108, Toronto, Ont. Tel: (416) 922-6353. Cable: COMPROD. Pres. & Exec. Prod'r.: Marshall F. Shapiro; VP & Dir. of Sales & Promo.: M. H. Richardson; Arranger & Musical Dir.: Len Moss.

Int'l representatives: (USA), Fred E. Ahlert, 15 E. 48 St., New York, N. Y. 10007. Tel: (212) PL 9-3860.

Dasanda Prod'ns, Box 4182, Sta. E., Ottawa, Ont. Tel: (613) 235-7382. Dir.: Leonard Alexander; A&R & Adv.: Sandy Gardiner; Pub. & Promo.: Vern Craig.

Eko-Phon, Bield, Man. Tel: Roblin 337-5. Mgr.: Harry Holunga. **Label:** Bield.

Forwill Prod'ns, 10534 109 St., Edmonton, Alta. Tel: (403) 424-9394. Pres.: J. C. Williams.

Franco-Disque, 189 Rockland Rd., Ville Mont Royal, Montreal, Que. Tel: (514) 731-2741. Pres.: Gilles Lecuyer; Promo. Dir.: Michel Constantineau.

Hi-Fi Rec'g Servs., 214 Ave. B. S., Saskatoon, Sask. Tel: 242-7866. Gen. Mgr.: R. Heineke. **Label:** Barb.

J C Ents., 2420 Benny Crescent, Suite 410, Montreal 28, Que. Tel: (514) 482-8714. Pres.: Johnny Clark.

Alan Johnson, 10534 109 St., Edmonton, Alta. Tel: (403) 482-1187. Pres.: Alan Johnson.

Ben Kay Assocs., 4824 Cote des Neiges Rd., Suite 38, Montreal, Que. Tel: (514) 739-4774. Pres. & Prof. A&R Mgr.: Ben Kaye; VP: George Kushnir.

Stan Klees Prod'ns, 1940 Yonge St., Toronto 7, Ont. Tel: (416) 487-3466. Pres.: Stan Klees.

Markle Prod'ns, PO Box 209, Newmarket, Ont. Tel: 895-4950. Co-partners: Dennis Day, John E. Markle & Milton Roher.

Monticana Recs. & Ents., Box 323, Montreal 3, Que. Tel: (514) 739-8935 & 737-9200. Pres.: Dave Leonard.

Int'l Branch: USA, New York, N. Y.

David Mostoway Prod'ns, 234 Davenport Rd., Toronto, Ont. Tel: (416) 927-3275. Pres.: David Mostoway. **Label:** Roman.

Music World Creations, 2327 Richmond Rd. S.W., Calgary, Alta. Tel: (403) 242-1277. Pres.: Mel Shaw.

Orchard Rec'gs, 3726 First St. N.W., Calgary, Alta. Tel: (403) 277-1361. Prod'n. Mgr.: M. C. Orchard.

Ray Schwartz, 10534 109 St., Edmonton, Alta. Tel: (403) 482-1187. Pres.: Ray Schwartz.

Marshall F. Shapiro, 55 Isabella St., Toronto 5, Ont. Tel: (416) 922-6353. Cable: COMPROD. Pres.: Marshall F. Shapiro. **Label credits:** RCA Victor, Reo, Quality. **Int'l Branch:** London, England, c/o Commercial Radio.

Troika Prod'ns, 190 Adelaide St. W., Toronto, Ont. Tel: (416) 535-3020. Pres.: Paul Neary; Sales Dir.: Hushy Sherman; Musical Dir.: Art Snider.

● **record clubs**

Capitol, 635 Queen St. E., Toronto, Ont.
 Cumbia, 111 Leslie St., Don Mills 5, Ont. Tel:
 (416) 447-3311. VP & Mg'g Dir.: R. R. Pampe;
 Fulfillment Mgr.: Frederick Rich; Adv. Mgr.:
 Peter Westwood.

R C A, 3333 Cavendish Blvd., Montreal 28, Que.
 Tel: (514) 482-9912. Mgr.: K. N. Middleton.

● **record distributors**

Alberta

● **CALGARY (Area Code 403)**

Acklands, 4124 Ninth St. S.E. Tel: 243-4291. Mgr.:
 Wayne Langton.

Labels: (Decca div.) Brunswick, Caedmon, Coral,
 Decca, Vocalion; (Apex div.) Accent, Apex,
 Carnival, Challenge, Colpix, Crescendo, Dia-
 mond, Everest, Hall, Lero, Point, Reprise,
 Soma, United Artists, Valiant, Warner Bros.

Central Rec., 3631 Blackburn Rd. Tel: 243-2586.
 Pres.: Dave Jones.

Labels: All labels of Arc Sound, Canadian
 Music Sales, Phonodisc, Tartan.

London, 628 11 Ave. S.W. Tel: 244-6136. Cable:
 FULLRANGE. Mgr.: Miss Fran Tocher.

Labels: Liberty/Imperial, London & London
 Group, Philips/Mercury Group.

RCA Victor, 4120 Sixth St. S.E. Tel: CH 3-4661.
 Contact: A. Bell.

Labels: Buena Vista, Disneyland, Dunhill, Elite,
 RCA Victor, Request.

Taylor, Pearson & Carson (div. of Prairie Pacific
 Western), 4340 Fourth St. S.E. Tel: 262-6911.
 Mgr.: John Watson.

Labels: Atco, Atlantic, Barry, Cameo, DGG, Dot,
 Hickory, Jubilee, Kama Sutra, Laurie, MGM,
 Quality, Reo, Scepter, Verve.

● **EDMONTON (Area Code 403)**

Acklands, 10304 108 St., Tel: 429-1781. Mgr.:
 Wayne Langton; Rep.: Jack Williams.

Labels: (Decca div.) Brunswick, Caedmon, Coral,
 Decca, Vocalion; (Apex div.) Accent, Apex,
 Carnival, Challenge, Colpix, Crescendo, Dia-
 mond, Everest, Hall, Lero, Point, Reprise,
 Soma, United Artists, Valiant, Warner Bros.

Van Dusen Bros., 10528 123 St. Tel: 488-0440.
 Cable: Sunco. Pres.: W. Van Dusen; VP: F. L.
 Hardy.

Labels: Adventures, Angel, Capitol, Cavalier,
 Cricket, Gamma, Electrola, Hawk, Hilltop,
 Movietone, Odeon, Parlophone, Pathe, Pick-
 wick, Roman, 20th-Fox, Voce del Padrone.

British Columbia

● **KAMLOOPS (Area code 604)**

Pacific Electronics, 605 Victoria St. Tel: 372-2558.
 Pres.: J. S. Baxter.

Labels: Audio Fidelity, Audio Rarities, Cadet,
 Checker, Chess, Del-Fi, Design, Gordy, Grand
 Prix, Happy Time, Kapp, King, Motown, New
 Syndrome, Sue, Tamla.

● **PRINCE GEORGE (Area Code 604)**

Van Horne Electric Supply, 1750 Quinn St. Tel:
 564-8817. Mgr.: Cliff Currie.

Labels: Barclay, Columbia, Epic, Harmony,
 Musicor.

● **VANCOUVER (Area Code 604)**

Johnston Appliances, 5239 Victoria Dr. Zone 16.
 Tel: FA 5-3261. Mgr.: Miss Pat van Kleeck.

Labels: (Decca div.) Brunswick, Caedmon,
 Coral, Decca, Vocalion; (Apex div.) Accent,
 Apex, Carnival, Challenge, Colpix, Crescendo,
 Diamond, Everest, Hall, Lero, Point, Reprise,
 Soma, United Artists, Valiant, Warner Bros.

London, 3166 Lake City Way. Tel: CY 8-6471.
 Cable: FULLRANGE. Mgr.: Ormond L. Jones.

Labels: Liberty/Imperial Group; London &
 London Group; Philips/Mercury Group.

Pacific Electronics, 1641 W. Second Ave. Zone 9.
 Tel: RE 1-8131. Pres.: J. S. Baxter; Sec-
 Treas.: G. D. McRae.

Labels: Audio Fidelity, Audio Rarities, Cadet,
 Checker, Chess, Del-Fi, Design, Gordy, Grand
 Prix, Happy Time, Kapp, King, Motown, New
 Syndrome, Sue, Tamla.

RCA Victor, 2876 Rupert St. at Grandview Hwy.
 Tel: 433-6881. Contact: C. Smith.

Labels: Buena Vista, Disneyland, Dunhill,
 Elite, RCA Victor, Request.

Select, 1803 Commercial Dr. Tel: 255-3101. VP:
 A. Folliot; Sales Mgr.: W. Kiss.

Labels: Adventures, Angel, Capitol, Cavalier,

Cricket, Electrola, Gamma, Hawk, Hilltop,
 Movietone, Odeon, Parlophone, Pathe, Pick-
 wick, Roman, 20th-Fox, Voce del Padrone.

Square & Round Dance Whse., 455 W. Broadway.
 Tel: TR 9-2822. Owner: Gladys Neustaedter;
 Mgr.: Marg McPherson.

Labels: Aqua, Belco, Blue Star, Bogan, Family
 Squares, Flip, Go, Grenn, Hi Hat, Jewel, Kalox,
 Keeno, Longhorn, Lore, MacGregor, Mustang,
 Old Timer, Prairie, Rockin "A", Sets in Order,
 Lloyd Shaw, Square L, Swingin Squares, Top,
 Wagon Wheel, Windsor.

Taylor, Pearson & Carson (div. of Prairie Pacific
 Western), 1100 Venables St. Tel: 253-1533.
 Mgr.: Ken Welsh.

Labels: Atco, Atlantic, Barry, Cameo, DGG,
 Dot, Hickory, Jubilee, Kama Sutra, Laurie,
 MGM, Quality, Reo, Scepter, Verve.

Van Horne Electric Supply, 550 Cambie St. Tel:
 MU 4-3321. Pres.: E. R. Gordon; Opns. Mgr.:
 A. Eason.

Labels: Barclay, Columbia, Epic, Harmony,
 Musicor.

Wholesale Appliances, 8401 Fraser St. Zone 15.
 Tel: 325-3281. Gen. Sales Mgr.: D. C. Main-
 waring; Rec. Dept. Mgr.: H. A. Miller.

Labels: (Sparton div.) ABC-Paramount, Award
 Artist, Colortone, Command, Contemporary,
 Eurotone, Good Time Jazz, Grand Award, HiFi,
 Hollywood, Impulse, Life, Mira, Music Guild,
 Nashville, Shasta, Sparton, Starday, Summit,
 Tangerine, Tiffany, Surrey, Waldorf, Westmin-
 ster, Whitehall; (Other) Acapella, After Hours,
 Almor, Apon, Belle Barth, Battle, Broadside
 (Folkways), CRB Series, Conversaphone, Dance
 Along, Dover, Elektra, Etiquette, Europa, Fan-
 tasy, Fax, Fiesta, Folkways, Galaxy (Fantasy),
 Golden Crest, Golden Guinea Classic, Grecophon,
 Jazzland, Tom Lehrer, Listen & Learn, Lumby,
 Mainstream, Mirwood, Murlin, Nonesuch, Oak
 Publ'ns, Pye, Repeat, Riot, Riverside, Roost,
 Roulette, Simon Says, Steno Speed, Surprise,
 Tartan, Time, Turul, Verve/Folkways, Warwick,
 Wonderland, World Artist.

● **VICTORIA (Area Code 604)**

Van Horne Electric Supply, 630 John St. Tel: 386-
 1474. Mgr.: Reg Byron.

Labels: Barclay, Columbia, Epic, Harmony,
 Musicor.

**Top Distribution
 and representation
 to the major independents**



**Synonymous with the best in manufacturing,
 distribution and promotion - coast-to-coast in Canada**

APEX DIVISION - THE COMPO COMPANY LTD.

2377 REMEMBRANCE STREET, LACHINE, MONTREAL, QUEBEC • 514-637-2561

Telex: 01-20122

TWX: 610-422-3064

Bob Chislett, General Manager

Lee Armstrong, Sales Manager



*the oldest
and largest
front cover
printers and
jacket makers
in
CANADA*

- WE guarantee our quality
- WE are FAST and EFFICIENT
- WE are economy-minded
- WE offer a complete service

From: COVER CONCEPT
To: FINISHED JACKET

**SHIPPED DIRECT TO
RECORD MANUFACTURERS**

**PARR'S PRINT
AND LITHO LTD**
625 YONGE STREET
TORONTO, ONTARIO
TELEPHONE 925-5166

In co-operation with
MODERN ALBUM LIMITED
1244 DUFFERIN STREET
TORONTO 4, ONTARIO
TELEPHONE 534-7951

continued

Manitoba

• WINNIPEG (Area Code 204)

Arc Sound, 1436 Erin St. Tel: 774-1050. Cable: Arcsound. Mgr.: Garnet Armstrong; Sales Mgr.: Tom Burney.

Labels: Arc, Arc Int'l., Audio-Spectrum, Golden, Hanna-Barbera, International Artists, Somerset.

Electrical Supplies, 312 William Ave. Zone 2. Tel: WH 3-8491. Pres.: E. H. Oliver; Mgr. Rec. Dept.: W. L. Bright.

Labels: Angel, Aventures, Capitol, Cavalier, Cricket, Electrola, Gamma, Hawk, Hilltop, Movietone, Odeon, Parlophone, Pathe, Pickwick, Roman, 20th-Fox, Voce del Padrone.

Laurel, PO Box 1021, 1299 Strathcona St. Tel: 783-0436. Prop.: W. V. Sokulsky; Mgr.: R. D. Kendrick.

Labels: Bravo, Bruno, Classic Editions, Colonial, Dance Along, Dominion, Dover, Everest, Fax, Folkways, Jay Jay, Mainstream, Monitor, Music Minus One, Oak Publ'ns, Riverside, Rusalka, Standard, Tartan, Trans-World, Verve/Folkways, Wonderland.

Musical accessories: Recoton.
London, 654 King Edward Trl. 777-4305. Cable: FULLRANGE. Mgr.: Mark Anderson.

Labels: Liberty/Imperial Group, London & London Group, Philips/Mercury.

Phonodisc, 3-47 Carlton Pl. Tel: 453-8955. Sales Mgr.: Mrs. Corinne Burke.

Labels: Audio Fidelity, Cadet, Checker, Chess, Congress, Del-Fi, Delta, Gordy, Kapp, King, Motown, Paula, Phonodisque, Regency, Soul, Tamla, VIP, Whit.

Quality Recs., Galt Bldg., 4th Floor. Tel: 943-6563. Mgr.: Reg Ayres.

Labels: Atco, Atlantic, Barry, Cameo, DGG, Dot, Hickory, Jubilee, Kama Sutra, Laurie, MGM, Quality, Reo, Scepter, Verve.

R C A Victor, 2070 Notre Dame Ave., St. James 21. Tel: 772-0481. Contact: R. T. Nugent.

Labels: Buena Vista, Disneyland, Dunhill, Elite, RCA Victor, Request.

Thomas Rathwell, 575 Roseberry St., St. James. Tel: SP 4-4561. Pres.: Thomas Rathwell.

Labels: (Apex div.) Accent, Apex, Carnaval,

Challenge, Colpix, Crescendo, Diamond, Everest, Hall, Lero, Point, Reprise, Soma, United Artists, Valiant, Warner Bros. (Decca div.) Decca, Coral, Brunswick, Vocalion, Caedmon.

Nova Scotia

• AMHERST (Area Code 902)

Canadian Assemblies, Station St. Tel: 667-3308. Mgr.: William Daley.

Labels: Atco, Atlantic, Barry, Cameo, DGG, Dot, Hickory, Jubilee, Kama Sutra, Laurie, MGM, Quality, Reo, Scepter, Verve.

Waldale, Station St. Tel: 667-3308. Pres.: W. S. A. Daley.

Labels: (Apex div.) Accent, Apex, Carnaval, Challenge, Colpix, Crescendo, Diamond, Everest, Hall, Lero, Point, Reprise, Soma, United Artists, Valiant, Warner Bros. (Decca div.) Decca, Coral, Brunswick, Vocalion, Caedmon.

• FAIRVIEW (Area Code 902)

Allied, 58 Convoy Ave. Tel: 455-0961. Sales Mgr.: George Spencer.

Labels: Allied, Bang, Elektra, Joda, Nonesuch, Pye, Roulette, Tartan, Time.

• HALIFAX (Area Code 902)

R C A Victor, 3611-3619 Commission St. Tel: 455-7247. Contact: H. Josey.

Labels: Buena Vista, Disneyland, Dunhill, Elite, RCA Victor, Request.

Ontario

• DON MILLS (Area Code 416)

COLUMBIA, 1121 Leslie St. Zone 5. Tel: 447-3311.

Mg'g Dir.: R. R. Pampe; Sales & Mfg. VP: F. T. Wilmot.—1113 Leslie St. Mgr.: W. Eaton. Labels: Barclay, Columbia, Date, Dorval, Musicor, Okeh, Old Town. (SEE ADVERTISEMENT)

• LONDON (Area Code 519)

SPARTON OF CANADA (Rec. div.), Box 2125. Tel: 455-6320. Gen. Mgr.: Harold E. Pounds; VP: Larry Page.

Labels: ABC-Paramount, Boone, Bragg, Color-tone, Command, Contemporary, Eurotone, Grand Award, Good Time Jazz, HiFi, Impulse, Longhorn, Mira, Mirwood, Nashville, Surrey, Star-day, Sparton, Summit, Supraphon, Westminster, Whitehall. (SEE ADVERTISEMENT)

• SCARBOROUGH (Area Code 416)

CARAVAN REC. SALES, 390 Progress Ave. Tel: 293-2153. Pres.: Frank P. Swain; Sales Mgr.: Paul Clark.

Labels: Cricket 45's, Design, Dictation Disc, Fiesta, Ital, Javelin Inserts, Mark III, Murray Banks, Red Leaf, Time, V.

Musical accessories: Walco needles & accessories. (SEE ADVERTISEMENT)

QUALITY RECS., 380 Birchmount Rd. Tel: 698-5511. VP & Mg'g Dir.: George L. Keane.—130 Mack Ave. Tel: 698-5643. Mgr.: L. W. Farley.

Labels: Atco, Atlantic, Barry, Cameo, DGG, Dot, Hickory, Jubilee, Kama Sutra, Laurie, MGM, Quality, Reo, Scepter, Verve. (SEE ADVERTISEMENT)

Raleigh Rec. Sales, 390 Progress Ave. Tel: 293-2740. Pres.: D. R. Pugh.

Labels: Avoca, Eagle, Fleetwood, Hallmark. Trans World Rec., 390 Progress. Tel: 293-9389. Gen. Mgr.: Frank Swain.

Labels: Battle, Blanche-Neige, Capri, Dover Classical, Dance Along, Elegante, Excello, Fiesta, Grecophon, Fantasy, Folkways, Gateway, Jazzland, Mainstream, Oak Publ'ns, River-sue, Sue, Trans-World, Verve/Folkways, Wonderland.

• TORONTO & AREA (Area Code 416)

ALLIED, 110 Barbados Blvd. Tel: 267-1584. Pres.: Bruce T. Beatty; Gen. Sales Mgr.: Jack Boswell.

Labels: Allied, Bang, Elektra, Joda, Nonesuch, Pye, Roulette, Tartan, Time.

Musical accessories: Recoton. (SEE ADVERTISEMENT)

Apex, 76 Colville Rd. Zone: 15. Tel: 249-7551. Mgr.: George Offer.

Labels: (Apex div.) Accent, Apex, Carnaval, Challenge, Colpix, Crescendo, Diamond, Everest, Hall, Lero, Point, Reprise, Soma, United Artists, Valiant, Warner Bros. (Decca div.) Decca, Coral, Brunswick, Vocalion, Caedmon.

ARC SOUND, 20 Cranfield Rd. Zone 16. Tel: 751-1613. Pres.: Phil G. Anderson; VP: W. R. (Bill) Gilliland.

Labels: Arc, Arc Int'l., Audio-Spectrum, Golden,

CANADA



**AGGRESSIVE
DISTRIBUTION
MERCHANDISING
AND
PROMOTION
FROM
COAST TO COAST**

**CONTACT:
PHIL ANDERSON
or
BILL GILLILAND**

ARC SOUND LTD.
20 CRANFIELD RD.,
TORONTO 16
PHONE—(416) 751-1613
CABLE—ARCSOUND

Sound planning in Canada requires RCA VICTOR Recording Services.

Advanced acoustical equipment, technically the finest recording facilities custom-tailored to your needs. Unexcelled engineering, pressing and mastering skills. 3 and 4 track equipment, studios of all sizes. Complete services: mastering studio tapes, or your own tapes, tape duplication, remotes, recording, record

manufacturing, record jackets, creation of premium records. Just name it.



Montreal:
1241 Guy Street,
931-1871

Toronto:
225 Mutual Street,
363-3443

make the year-long reference value of the "buyer's guide" readily AVAILABLE TO EVERY MEMBER OF YOUR FIRM...

Order extra copies NOW
Just \$1.25 per copy (prepaid)

Billboard Buyers Guide
2160 Patterson St.
Cincinnati, Ohio 45214

Please send ... copies of Buyers Guide.
My payment for \$ is enclosed.

Name

Company

Address

City
Zone
State

Ed. Archambault INC

500 St. Catherine St. E.
Montreal 24, Canada
849-6201

RECORD MANUFACTURERS

- SELECT
The largest independent Canadian Label

- ALOUETTE

RECORD DISTRIBUTORS

- Classical, Religious, Literary and Popular Records imported from France
- Language Courses (Books and Records)

MUSIC PUBLISHERS

DEALERS AND IMPORTERS

Sheet Music
Records
Pianos
Organs
Band & Orchestra Instruments

continued

Labels: Audio Fidelity, Cadet, Checker, Chess, Congress, Del-Fi, Delta, Gordy, Kapp, King, Motown, Paula, Phonodisque, Regency, Soul, Tamla, VIP, Whit.

Quality Recs., 2215 Beaconsfield Ave., Suite 4, Zone 28. Tel: 481-1167. Mgr.: Clyde McGregor. Labels: Atco, Atlantic, Barry, Cameo, DGG, Dot, Hickory, Jubilee, Kama Sutra, Laurie, MGM, Quality, Reo, Scepter, Verve.

R C A Victor, 5575 Royalmount Ave. Tel: RE 1-3411. Contact: J. G. Bergeron. Labels: Buena Vista, Disneyland, Dunhill, Elite, RCA Victor, Request. (SEE ADVERTISEMENT)

R M P Rec. Sales, 183 Bates Rd., Town of Mt. Royal. Tel: RE 9-5662, 8988. Pres.: Leslie Faludi. Label: Arc Sound Prods.

TRANS-CANADA, 189 Rockland Rd., Ville Mont Royal. Tel: 731-8571. Pres.: Jean-Paul Rickner. Labels: AZ, Blue Jean, Citation, Decouverte, Dominion, Fantastic, Miracle, Music-Hall, Pacific, Prestige, Teledisc, Tournesol, Trans-Canada, Triomphe, Vedette, Vogue. (SEE ADVERTISEMENT)

Trans-World Rec., 1180 St. Antoine St. Tel: 866-2884. Pres.: Art Young.

Labels: Battle, Blanche-Neige, Capri, Dover Classical, Dance Along, Elegante, Excello, Fantasy, Fiesta, Folkways, Gateway, Grecophon, Jazzland, Mainstream, Oak Publ'ns, Riverside, Trans-World, Sue, Verve/Folkways, Wonderland.

• QUEBEC CITY (Area Code 418)

Laval, 383 Second St. Labels: Baronnet, Beaumont, Canusa, Choc, Design, Happy Time, Ideal, Kebec, Laval, MCA, Meteor, Niagara, Play Boy, Plaza, Premiere, Stop, Twinkle.

Trans-Canada Rec., 315 St. Paul. Tel: 524-4671. Pres.: Jean-Paul Rickner.

Labels: AZ, Blue Jean, Citation, Decouverte, Dominion, Fantastic, Miracle, Music-Hall, Pacific, Prestige, Teledisc, Tournesol, Trans-Canada, Triomphe, Vedette, Vogue.

• RIMOUSKI (Area Code 418)

W. Ouellet & Fils, 151 Rue St. Germain. Mgr.: P. Ouellet. Labels: Buena Vista, Disneyland, Dunhill, Elite, RCA Victor, Request.

Saskatchewan

• REGINA (Area Code 306)

Grosvenor, 1374 Broad St. Tel: 568-1553. Mgr.: M. Stech.

Labels: Angel, Aventures, Capitol, Cavalier, Cricket, Electrola, Gamma, Hawk, Hilltop, Movietone, Odeon, Parlophone, Pathe, Pickwick, Roman, 20th-Fox, Voce del Padrone.

A A Murphy & Sons, 2506 Dewdney Ave. Tel: JO B-1333.

Labels: Buena Vista, Disneyland, Dunhill, Elite, RCA Victor, Request.

• SASKATOON (Area Code 306)

Gerry Hawley, 34 Norman Crescent.

A A Murphy & Sons, 216 First Ave. N. Tel: 242-6611. Pres.: W. A. Murphy; Whlse. Mgr.: I. A. Burlingham.

Labels: Buena Vista, Disneyland, Dunhill, Elite, RCA Victor, Request.

• importers & exporters

Manitoba

• WINNIPEG (Area Code 204)

Dominion Specialties, 35 Scotia St. Tel: WH 2-1913. Cable: Dominico. Gen. Sales Mgr.: Hy Herman.

Ontario

• OTTAWA (Area Code 613)

Sherman Ents., 29 Bayswater Ave. Tel: 729-1421. Pres.: Alex Sherman.

• TORONTO (Area Code 416)

Taylor's Rec. Sales, 66 Industry St. Tel: 766-6801. Pres.: H. Taylor Sr.; VP: H. Taylor Jr.

Quebec

• MONTREAL (Area Code 514)

Joseph Lipari, 7111 St. Denis. Tel: 274-2457. VP.: Mario Lipari.

• WATERLOO (Area Code 514)

B R Gibbs, Box 489. Tel: 539-1322, 0922.

Saskatchewan

● **REGINA (Area Code 306)**
Solaray, 2300 11 Ave. Tel: 523-1B3B. Sales Mgr.: G. L. Hammond.

● one-stops

Ontario

● **OTTAWA (Area Code 613)**
Sherman Ent's., 29 Bayswater Ave. Zone 3. Tel: 729-1421. Pres.: Alex Sherman.

● **TORONTO (Area Code 416)**
Alldisc, 146 Neville Park Blvd. Zone. 13. Tel: 691-994B. Mgr.: Anthony Frank.
Canada Rec. Sales, 355 King St. W. Tel: 363-1019. Pres.: H. Berne.

Taylor's Rec. Sales, 66 Industry St. Tel: 766-6801. Pres.: H. Taylor Sr.; VP: H. Taylor Jr.

Quebec

● **MONTREAL (Area Code 514)**
Musique Serv. Music, 189 Rockland Rd., Ville Mont Royal 16, Tel: 731-3462. Pres.: Rene Girard.
R M P Rec. Sales, 183 Bates Rd., Town of Mt. Royal. Tel: RE 9-5662, B98B. Pres.: Leslie Faludi.

TRANS-CANADA, 189 Rockland Rd., Ville Mont Royal. Tel: 731-8571. Pres.: Jean-Paul Rickner. (SEE ADVERTISEMENT)

● rack jobbers

Alberta

● **CALGARY (Area Code 403)**
Record Dists., 73B 11 Ave. S.W. Tel: 266-8996. Contact: Neil Courtney.

● **EDMONTON (Area Code 403)**
Record Dists, 1052B 123 St. Tel: 482-4B71. Contact: Bud Thompson.

British Columbia

● **VANCOUVER**
Western Rack Serv., 120 W. Hasting St. Tel: 683-7501. Mgr.: Jack MacMillan.

Ontario

● **KINGSTON (Area Code 613)**
Jack Slumkoski, 257 Avenue Rd. Tel: 548-4105. Owner: Jack Slumkoski.

● **OTTAWA (Area Code 613)**
Sherman Ent's., 29 Bayswater Ave. Zone 3. Tel: 729-1421. Pres.: Alex Sherman; Sec.-Treas.: Arnold Gosewich.

● **SCARBOROUGH (Area Code 416)**
Handleman, 132 Manville Rd. Tel: 759-1166. Pres.: J. Handleman; Gen. Mgr.: R. Perini.
Manor Dist'g, 446 Birchmount Rd. Tel: 699-7175. Contact: John Norris.

● **TORONTO (Area Code 416)**
Canada Rec. Sales, 355 King St. W. Tel: 363-1019. Pres.: H. Berne; Exec. Ass't: Mrs. B. Bernadetti.

ELECTRIC & MUSICAL INDUSTRIES (EMI), B King St. E., Suite 607. Tel: 363-240B. Exec. VP: Geoffrey F. Racine. (SEE ADVERTISEMENT)

Mr. Music, 20 Cranfield Rd. Zone 16. Tel: 751-1613. Gen. Mgr.: Phil G. Anderson; Sales Mgr.: W. R. (Bill) Gilliland.

Taylor's, 66 Industry St. Tel: 766-6801. Pres.: H. Taylor Sr.; VP: H. Taylor Jr.

Quebec

● **MONTREAL (Area Code 514)**
International Business Mart, 183 Bates Rd., Zone 16. RE 9-B98B. Pres.: Leslie Faludi.

Saskatchewan

● **REGINA (Area Code 306)**
Kensington, 1374 Broad St. Tel: 569-608B. Contact: Jack Hewer.

● services & supplies

JACKET MANUFACTURERS

Ontario

● **OSHAWA (Area Code 416)**
Studio Thirteen Creations, Box 703. Tel: 723-0B9B. Cable: Musiccan. Contact: Robert J. Stone.

● SCARBOROUGH (Area Code 416)

Telfer Paper Box, 1845 Birchmount Rd. Tel: 291-1161. Pres. & Gen. Mgr.: J. A. Northey Jr.; VP & Treas.: J. P. Williams.

● TORONTO (Area Code 416)

Art Bookbinding & Novelty, 135 Bentworth Ave. Tel: 787-0241. Sales Mgr.: Don Bader; Designer: Bob Bader.

Modern Album, 1244 Dufferin St., Bldg. 2. Tel: 534-7951. Pres.: R. A. Froehlig.

Parr's Print & Litho, 625 Yonge St. Zone. 5. Tel: 925-5166. Pres.: Victor W. Parr; Sales Mgr.: R. J. Humphreys.

Quebec

● MONTREAL (Area Code 514)

Imperial Sample Card, 9775 Meilleur St. Tel: 384-0130. Gen. Mgr.: T. Tubie.

MUSIC LICENSING ORGANIZATIONS

BMI Canada Ltd., 16 Gould St., Toronto, Ont. Tel: (416) 364-0317. Gen. Mgr.: Harold Moon.

Branch: Montreal, Que., 1500 St. Catherine St. W. Zone 5. Tel: 935-2552. Mgr.: Clyde Moon.

Composers, Authors & Publishers Ass'n of Canada (CAPAC), 1263 Bay St., Toronto, Ont. Tel: (416) 924-4427. Gen. Mgr.: W. St. Clair Low. Branch: Montreal, Que., 1155 Dorchester Blvd. W., Rm. 614. Zone 2. Tel: (514) UN 6-7266.

PRESSING & PLATING PLANTS

Ontario

● CORNWALL (Area Code 613)

Compo, 3400 Montreal Rd. Tel.: WE 3-0450. VP & Gen. Mgr.: R. A. Chislett; Factory Mgr.: A. L. Fitzharris.

● LONDON (Area Code 519)

SPARTON (Rec. Div.), Box 2125. Tel: 455-6320. Cable: Sparton. Gen. Mgr.: Harold E. Pounds; VP: W. Larry Page. (SEE ADVERTISEMENT)

**CANADA'S MOST
PROGRESSIVE
AND
DEPENDABLE
DISTRIBUTOR**

LONDON
RECORDS

**FAST
AGGRESSIVE
EFFICIENT
PROMOTION**

**COAST TO COAST
DISTRIBUTION**

LONDON RECORDS OF CANADA LTD.

190 GRAVELINE RD. PHONE: 631-2061
ST.-LAURENT, QUE. TELEX: 01-2384

"No serious student of jazz improvisation can afford to miss reading this important and valuable work."

—*Music Educators Journal*



Jazz
Improvisation: 4

Contemporary Piano Styles

By John Mehegan

Introduction by Bill Evans/Preface by
Tom Glazer

Here is an important new book on jazz that deals with the full range of piano styles of the 1950's and 1960's and shows the reader how to apply them to his own musical training and playing. Filled with a wealth of musical material that would take months and sums of money to acquire, this remarkable work delineates contemporary jazz styles of such greats as Oscar Peterson, Les McCann, Bill Evans, Horace Silver, and many others. Hit songs are paraphrased so that students, teachers, professionals, and amateurs can apply the fundamental concepts of jazz improvisation to their own playing. *Contemporary Piano Styles* enriches and extends the musical understanding of every musician and serious jazz student. **SEND FOR IT NOW! 288 pages.**

88½ x 11. Fully concealed wire-o-binding.
\$15.00

Also available: *JAZZ IMPROVISATION* by
John Mehegan

Vol. I: Tonal & Rhythmic Principles, \$15.00

Vol. II: Jazz Rhythm & The Improvised
Line, \$12.50

Vol. III: Swing & Early Progressive Piano
Styles, \$12.50

Order Now. Clip this coupon.

Watson-Guption Publications, Dept. 1322
2160 Patterson St., Cincinnati, Ohio 45214

Send me *Jazz Improvisation* (Check)

Vol. IV Vol. I
 Vol. II Vol. III

I may return my order within ten days
of receipt for full credit or refund if I
am not satisfied. (USA only)

I enclose \$ _____

Name _____ (Please print)

Street _____

City, State & Zip _____

Add sales tax where applicable. For NYC
add 5%; for Calif., add 4%. Send check
or M. O. only.

continued

• SCARBOROUGH (Area Code 416)

QUALITY RECS., 380 Birchmount Rd. Tel: 698-5511.
VP & Mgt Dir.: George L. Keane. (SEE ADVERTISE-
MENT)

• SMITHS FALLS (Area Code 613)

R C A VICTOR, Hannibal St. Tel: 283-4010. Plant
Mgr.: J. P. Supple. (SEE ADVERTISEMENT)

• TORONTO (Area Code 416)

ARC SOUND, 20 Cranfield Rd. Zone: 16. Tel: 751-
1613. Pres.: Phil G. Anderson; VP & Sales
& Mktg.: W. R. Gilliland. (SEE ADVERTISEMENT)

Masterseal Recs., 1244 Dufferin St. Tel: (416) 531-
5753. Pres.: Donald H. Gabor.
Precision Rec. Prod'ns, 1 Waterman. Tel: 751-1616.
Gen. Mgr.: Jack C. Anderson.

Quebec

• LACHINE (Area Code 514)

COMPO, 2377 Remembrance St. Tel: 637-2561.
Cable: COMPOCO. VP & Gen. Mgr.: R. A. Chis-
lett; Factory Mgr.: A. L. Fitzharris. (SEE
ADVERTISEMENT)

PROMOTION & PUBLICITY

Alberta

• CALGARY (Area Code 403)

Mel Shaw Ents., 2327 Richmond Rd. S.W. Tel: 242-
1277. Pres.: Mel Shaw.

Ontario

• OSHAWA (Area Code 416)

Robert J. Stone Assocs., Box 703. Tel: 723-0898.
Cable: Musiccan. Contact: Robert J. Stone.

• TORONTO (Area Code 416)

FRED WHITE PUB. & PROMO., 1940 Yonge. Zone 7.
Tel: 487-3466. Pres.: Fred White. (SEE ADVER-
TISEMENT)

Quebec

• MONTREAL (Area Code 514)

Monticana Ents., Box 323. Tel: 739-8935 & 737-
9200. Pres.: Dave Leonard.

RECORDING STUDIOS

Alberta

• CALGARY (Area Code 403)

Orchard, 3726 First St. N.W. Tel: 277-1361. Prod'n
Mgr.: M. C. Orchard.

• EDMONTON (Area Code 403)

Downtown Sound Studio, 10534 109 St. Tel: 424-
9394. Pres.: Ray Schwartz.

British Columbia

• VANCOUVER (Area Code 604)

Aragon Ents., 615 W. Hastings St. Zone 2. Tel:
685-5423. Pres. & Gen. Mgr.: Al Reusch.

Manitoba

• BIELD (Area Code 204)

Eko-Phon. Tel: Roblin 337-5. Mgr.: Harry Holunga.

Ontario

• TORONTO (Area Code 416)

Bay Music, 5 Waterman Ave. Zone 16. Tel: 751-
2233. Gen. Mgr.: Phil G. Anderson; Studio
Mgr.: Ralph Harding.

Hallmark Studios, 22 Sackville St. Zone 2. Tel:
362-7707. Pres.: D. M. Sanderson.

R C A, 225 Mutual St. Tel: 363-3443. Mgr.: R. A.
Gray.

Quebec

• MONTREAL (Area Code 514)

R C A, 1241 Guy St. Tel: 931-1871. Mgr.: E. Tray-
nor. (SEE ADVERTISEMENT)

Stereo Sound, 4824 Cote des Neiges Rd. Tel: 735-
3266. Contacts: Maurice Bougie & Jack Raskin.

CANADA'S ONLY NATION-WIDE SUB-DISTRIBUTOR ORGANIZATION

WEST

KENSINGTON DISTRIBUTORS LTD.

Branches at Vancouver, Edmonton, Calgary, Regina and Winnipeg

EAST

MANOR DISTRIBUTING LTD.

(LE MANOIR DISTRIBUTION LTEE)

Branches at Toronto, Montreal and Moncton

NO FREIGHT—NO WAIT

HEAD OFFICE:

Suite 607, 8 King St. E., Toronto, Ontario

Telephone: (416) 363-2408

GET Groupe Editorial Franco

FRENCH CANADA'S MOST ACTIVE
PUBLISHER AND SUB-PUBLISHER

Representing

ALPHA • CARROUSEL

FRANCO • LYRA • METRO

TOURNESOL • VOGUE INTERNATIONAL

189 ROCKLAND RD.

T. M. R. MONTREAL 16

TEL. 731-0213

U. S. DEALERS ATTENTION

Write for free listings

DOMINION LABEL

(12" LP's plus some 7" EP's and singles)

- * Scottish records (featuring artists from all the touring Scottish concerts)
- * Welsh records (featuring many lovely Welsh choirs)
- * Irish records (at low Canadian list price of \$1.98)
- * French Canadian records (folk music from Quebec)

CANADIAN MUSIC SALES CORPORATION LIMITED

58 Advance Road, Toronto, 18, Ontario, Canada

Saskatchewan

● **SASKATOON (Area Code 306)**
Hi-Fi, 214 Ave. "B." S. Tel: 242-7866. Gen. Mgr.: R. Heineke.

TRADE ASSOCIATIONS

American Federation of Musicians of the U. S. & Canada, 101 Thorncliff Park Dr., Toronto 17, Ont. Tel: (416) 425-1831. Exec. Officer for Canada: J. Alan Wood.

Canadian Music Publishers Assn., Board of Trade Bldg., 11 Adelaide St. W., Toronto, Ont. Chm.: Ronald Napier.

Canadian Record Manufacturers Assn., c/o CRMA Pres., Geo. I. Harrison, RCA Victor Recs., 1001 Lenoir St., Montreal, Que. Tel: (514) WE 3-7551.

● tape cartridge

PLAYBACK UNIT MANUFACTURERS

Automatic Radio, 25 Bermondsey Rd., Toronto 16, Ont. Tel: (416) 757-8771. VP: Allan B. McLeod; Mktg. Mgr.: George Lyall.
Brand name: TapeDek.

TelePro Ind. (expect to be manufacturing in Canada late in 1966), 121 Richmond St. W., Penthouse, Toronto, Ont. Tel: (416) 364-9471. Pres. & Gen. Mgr.: Norton Cooper; Exec. VP: Albert A. Shelman.
Brand names: Autostereo, Porta-Tape.

TAPE IMPORTERS & DISTRIBUTORS

Continuous Stereo, 700 Bay St., Toronto, Ont. Tel: (416) 368-4096. Contact: Howard Ray.
Tape, Cartridge: ITCC.

Tape Playback Equip.: Autostereo, Porta-Tape.
Muntz Stereo-Pak, 21 Sanford St. N., Hamilton, Ont. Tel: (416) 525-0268. Pres.: David Hoffman; Gen. Mgr.: Douglas Martyniuk.

Tape, Cartridge: Muntz.
Tape Playback Equip.: Muntz Stereo-Pak.
R C A Victor, 1001 Lenoir St., Montreal, Que. Tel: (514) WE 3-7551. VP & Gen. Mgr.: George I. Harrison; Sales Mgr.: Knox Coupland.

Tape, Cartridge: RCA Stereo 8.
Tape Playback Equip.: Lear Jet.
Solaray, 2300 11 Ave., Regina, Sask. Tel: (306) 523-1838. Sales Mgr.: G. L. Hammond.
Tape: ITCC, Autostereo, Omaha.
Playback Equip.: Autostereo, Craig, Taiko.

CHILE

Population: Latest official estimate—8,500,000.
Official rate of exchange: \$1 (US) = 5 escudos.
Per capita income: \$300 annually.
Record players: 500,000 (approx.).
Record sales: \$8,000,000.
Stereo sales: 20% of LP's.
Retail record prices: Up 13% from 1965.
Average retail price per record: LP's \$5; EP's \$1.80; Singles \$1.20.
Discounting: Frequent.
Type of record distribution: Manufacturer to retailer.
Number of jukeboxes: 4,000 (approx.).
Radio stations: AM—122 (recorded music, disk jockey, shows, news); FM—15 (recorded music only).
TV stations: 2 channels (non-commercial, controlled by the two most important universities: Channel 13 belongs to Catholic University; Channel 9 belongs to University of Chile).
Important regulations: Record importation is forbidden; all records are pressed locally on license from the originating company. Ricardo Garcia

● record manufacturers

Caracol, San Antonio 551, 1er. piso, Santiago. Owner & Dir.: Antonio Contreras (pressed by Odeon).
Corporacion de Radio de Chile (RCA), Casilla 1407, Av. Vicuna Mackenna 3333, Santiago. Tel: 5-0081. Sales Mgr.: Hector Urbina; Mgr. Rec. Dept.: Jorge Rencoret; A&R: Hernan Serrano; Promo.: Osvaldo Flores.
This company represents: Disneyland (USA), Fermata (Argentina), Hispavox (Spain), Sonolux (Colombia), Telefunken (Germany).
Demon, Estado 215, of. 804, Santiago. Tel: 38-0395. Owner & Dir.: Camilo Fernandez Leiva (pressed by RCA Victor).

Ediciones L. R. Ortiz, Union Central 1050, Santiago. Owner & Mgr.: L. R. Ortiz.
This company represents: Folkways (USA).
Goluboff Industrias Fonograficas, Miraflores 113, Santiago. Tel: 38-1952. Cable: Godav. Owner & Gen. Mgr.: Diego Goluboff; Sales Mgr.: Enrique Pallerano; A&R & Promo.: Scottie Scott.
Label: Vivart.
This company represents: CBS (USA), Liberty (USA), Reprise (USA), Ricordi (Italy), Sono Radio (Peru), Verve (USA).
Industrias Electricas y Musicales Odeon (EMI), Casilla 186 D, Compania 2045, Santiago. Tel: 8-5545. Cable: Turntable. Gen. Mgr.: Enrique Epple; A&R Dir.: Ruben Nouzeilles; Promo.: Jorge Onate.
This company represents: Angel (USA), BBC (England), Capitol (USA), Coral (USA), Decca (USA), London (England), Warner Bros. (USA).
Orpal (Editora Chilena de Discos), Av. Irarrazaval 3349, Santiago. Owner & Mgr.: Carlos Patino.
This company represents: Epic (USA), Microfon Argentina.
Philips Chilena, Casilla 2687, Av. Santa Maria 0760, Santiago. Tel: 3-5081. Cable: PHILCHASI. Mgrs.: A. M. Brakema & Jorge Rosso; A&R Dir.: Sauf San Martin; Promo.: Hugo Cordova & Alfredo Barra.
This company represents: Archiv (Germany), DGG (Germany), MGM (USA), Mercury (USA), Peerless (Mexico), Polydor (Germany), Seeco (USA), United Artists (USA).
Polydor (see Philips Chilena).
Vox, Huerfanos 878, Santiago. Tel: 3-3152. Owner & Mgr.: Arnoldo Vera B.
This company represents: Music Hall (Argentina).

● music publishers

Fermata, Los Alpes 916, Santiago.
Southern Music Int'l, Los Lirios 273, Santiago. Tel: 8-4588. Cable: SOUTHMUSIC. Mgr.: Alfredo Burgess.

● supplies & services

PRESSING PLANTS

Goluboff, Miraflores 113, Santiago. Tel: 38-1952.
Corporacion de Radio de Chile (RCA), Av. Vicuna Mackenna 3333, Santiago. Tel: 5-0081.



**Over 25 Years
of Profitable
Canadian
Distribution**

**ABC RECORDS
ARWIN
BOONE
COMMAND
GOLD AWARD
COLORTONE
CONTEMPORARY
EUROTONE
GOOD TIME JAZZ
HI-FI RECORDS
IMPULSE
LONGHORN
MIRA
M.T.A. RECORDS
NASHVILLE
TIFFANY
SPARTON
STARDAY
SUPRAPHON
SUMMIT
SURREY
STONE
WESTMINSTER
WHITEHALL**

SPARTON OF CANADA LIMITED—LONDON • TORONTO • MONTREAL

HEAD OFFICE, P.O. BOX 2125, LONDON, CANADA

continued

Industrias Electricas y Musicales Odeon (EMI),
Compania 2045, Santiago. Tel: 8-5545.

RECORDING STUDIOS

Splendid, Catedral 1029, Santiago. Top Exec.: Sergio Maldonado.

TRADE ORGANIZATIONS

Sindicato Profesional de Actores, San Diego 246,
Santiago. Tel: 8-5268.
Sindicato Profesional de Folkloristas, Compania
1361, Santiago. Tel: 6-4501.
Sindicato Profesional Orquestal, Bandera 206, Santi-
ago. Tel: 6-4357.

MUSIC ASSOCIATIONS

Codayco (Corporacion de Autores y Compositores),
San Antonio 427, Santiago.
Departamento del Derecho de Autor, San Antonio
427, 2o. piso, Santiago.
Sociedad Autores Teatrales, San Diego 246, Santiago.

CHINA, REPUBLIC OF

Population: 12,454,302.
Official rate of exchange: \$1 (US) = NT \$40.
Per capita income: \$174 US.
Average retail price per record: LP's 40 cents. (No
market on EP's and Singles.)
Type of record distribution: Manufacturer to whole-
saler to retailer; manufacturer to retailer—Rare.
Radio stations: AM 69—Government 37, Commercial
32. FM none.
Television stations: 2 Channels—1 Government, 1
Commercial.
Important record import-export regulations: Export
of reproductions of foreign records is pro-
hibited. Foreign music recordings can be imported
only with the permission of the Ministry of In-
terior. Foreign instructional recordings can be
imported with the permission of the Foreign Ex-
change & Trade Commission.

● **record manufacturers**

Asia Rec., 59 Chien Kong Rd., Tainan, Taiwan.
Pres.: W. H. Tsai.
Bell Echo Rec., 83 Chung Hsin Rd., San Chung City,
Taipei Hsien, Taiwan. Pres.: S. C. Chow.
Black Cat Rec. Works, Ken Ting St., San Chung
City, Taipei Hsien, Taiwan. Pres.: C. T. Lee.
Cheng Sheng Rec., 10 Lane 490, Taichung Rd.,
Taichung, Taiwan. Pres.: M. C. Tsai.
China Rec., 103 Kan Yuan Li, Shu Lin Chen, Taipei
Hsien, Taiwan. Pres.: C. M. Chen.
Chung Shen Rec., 3 Lane 27, San Ming Rd., Sec. 1,
Taichung, Taiwan. Tel: 2558. Pres.: C. T. Chen.
Four Seas Rec. Publ'g., 11 O'mei St., Taipei,
Taiwan. Tel: 33721. Pres.: C. Y. Liao.
Fox Rec., 1 Lane 344, Nanking W. Rd., Taipei,
Taiwan. Tel: 404-6200. Pres.: H. C. Huan
(export available).
Hai Shan Rec., 11 Pi Lin, Tu Chen, Pan Chiao
Chen, Taipei Hsien, Taiwan. Pres.: C. K. Chen.
Hsin Ya Rec. Factory, 2-4 Tien Liao, Nan Chu,
Tainan, Taiwan. Pres.: Tsai Ming.
Kinmen Rec., 268 Chen Yi N. Rd., San Chung City,
Taipei Hsien, Taiwan. Tel: 99-2793. Pres.: Shye
Syone, Lee.
Mien-Phone Rec., PO Box 346, 150 Ho Pien N.
St., San Chung City, Taipei Hsien, Taiwan. Tel:
2324. Pres.: C. P. Fan.
New Voice Rec., 3 Min Chuan Rd., Lukong,
Changhwa, Taiwan. Cable: NEWVOICE. Tel: 318.
Pres.: C. C. Wong.
Queen Rec., 70 Fu-teh S. Rd., San Chung City,
Taipei Hsien, Taiwan. Tel: 126. Pres.: C. Y.
Wu.
Song Jwu Rec., 19-7 Chung Hua 2nd Rd., San
Ming Chu, Kaohsiung, Taiwan. Tel: 21753.
Pres.: S. T. Lu.
Tong Pau Rec. Factory, 25-9 Pu Chien Li, Pan Chiao
Chen, Taipei Hsien, Taiwan. Pres.: Yang
Tung-mei.
Universal Rec., 256 Hsi Yuan Rd., Sec. 2, Taipei,
Taiwan. Tel: 33993. Pres.: H. L. Huang.
Wu Chou Rec., 121 Nai Chiang St., Taipei, Taiwan.
Tel: 34250. Pres.: H. C. Liu.

● **importer-exporter**

Fox Rec., 1 Lane 344, Nanking W. Rd., Taipei,
Taiwan. Tel: 404-6200. Pres.: H. C. Huan.
Hai-Ti Industrial, PO Box 1012, Taipei, Taiwan.
Pres.: C. Y. Tan.

● **supplies & services**

PRESSING PLANTS

Asia, 59 Chien Kong Rd., Tainan, Taipei, Taiwan.
Chung Hwa, 5 Lane 2, Chung Ho Rd., Yung Ho Chen,
Taipei Hsien, Taiwan.
Echo, 113 Chungking S. Rd., Sec. 1, Taipei, Taiwan.
Five Continents, 121 Lei Chian St., Taipei, Taiwan.
Four Seas, 11 O'mei St., Taipei, Taiwan. Pres.:
C. Y. Liao.
Globe, 256 Hsi Yuan Rd., Sec. 2, Taipei, Taiwan.
Great King, 90 Ho Pien N. St., San Chung City,
Taipei Hsien, Taiwan.
Kolo, 3 Lane 302, Nanking W. Rd., Taipei, Taiwan.
Lico, 60 Yen Ping N. Rd., Sec. 1, Taipei, Taiwan.
Ming Feng, 150 Ho Pien N. St., San Chung City,
Taipei Hsien, Taiwan.
New Voice, 3 Min Chuan Rd., Lukong, Changhwa,
Taiwan.
Queen, 70 Fu-teh S. Rd., San Chung City, Tapei
Hsien, Taiwan.

COLOMBIA

Population: 17,482,420.
Official rate of exchange: \$1 (US) = 10 pesos.
Per capita income: \$480.
Records imported from US (factory value): \$4,094
(1964).
Records exported to US (factory value): \$7,242
(1964).
Records imported from countries other than US
(factory value): \$783 (1964).
Records exported to countries other than US: \$114,
689 (1964).
Records manufactured for domestic and export sale:
LP's—8,151,340 units (1963).
Radio stations: AM—185, 2 government, 183 com-
mercial.
Television station: 1 government (2 channels).
Import-Export regulations: Pressed records illegal;
master importation only.

● **record manufacturers**

Colombiana de Discos, Aptdo. Aereo 1428, Medellin.
Tel: 61-922. Cable: Codiscos. Gen. Mgr.: Alfredo
Diez; A&R: Alvaro Arango & Guillermo Diez;
Int'l: Guillermo Diez.
Label: Zeida.
This company represents: Angel (USA), CAM
(Italy), Capitol (Mexico, USA), Discuba (USA),
Musart (Mexico), Odeon (Argentina, Brazil,
Chile), Regal (France, Italy, Spain), Sono-Radio
(Peru), Warner Bros. (USA).
Daro Internacional, Aptdo. Aereo 4578, Bogota. Tel:
43-36-66. Cable: Impodaro. Pres.: Simon Daro;
Gen. Mgr., A&R, Sales & Int'l: Bernard Forman.
This company represents: Cameo-Parkway (USA)
Colpix (USA), London (USA), Miller Int'l (USA),
Surco (Argentina).
Int'l representatives: Chile (Odeon), USA (Daro
Int'l).
Discos CBS, Apartado Aereo 15756, Bogota. Tel:
47-13-41. Cable: COLRECORD. M'g'r Dir.: Stefan
Reiss.
Discos Fuentes, Aptdo. Aereo 1960, Medellin. Tel:
46-08-60. Cable: Oisfuentes. Pres.: Antonio
J. Fuentes; A&R: Pedro A. Fuentes; Int'l:
Jose Ma. Fuentes.
This company represents: Chantecler (Brazil),
Eurodisc (Germany), Music Hall (Argentina),
Palacio (Venezuela), Panart (Cuba), Peerless
(Mexico), Ricovox (Puerto Rico), Rondador (Ecu-
ador), Roulette (USA), Seeco (USA), Sonus
(Venezuela), United Artists (USA).
Int'l representatives: Argentina (Music Hall),
Brazil (Chantecler), Central America (Oicosa),
Ecuador (Rondador), Mexico (Peerless), USA
(Miami), Venezuela (Oiscos Fuentes).
Discos Orbe, Apartado Aereo 4911, Calle 19, 14-40,
Bogota. Cable: AJOVER. Contact: Luis Angel
Restrepo.
Emilio Fortou P., Apartado Aereo 793, Barranquilla.
Tel: 16-509. Cable: RADIAG. Pres.: Emilio
Fortou P.
Esper, Antonio Carrera 40, Esquina Calle 37, Jesus-
La Paz, Barranquilla.
Fabricantes de Discos Fonograficos, Carrera 4a,
No. 22-29, Pereira, Caldas.
Industria Electro Sonora (Sonolux), Calle 29, 43 A 5,
Aptdo. Aereo 640, Apartado Nal. 432, Medellin.
Mgr.: Guillermo de Bedout Moreno.
Industrias Fonograficas Victoria, Calle 12, No. 8-85,
Cali. Mgr.: Mario Mendez.
Industrias Fonoton, Apartado Aereo 12330, Bogota.
This company represents: Ansonia, Archiv (Ger-

many), Deutsche Grammophon, Fonoton, MGM,
Mercury, Philips, Polydor, Verve.
Ondina Fonografica Colombiana, Apartado Aereo
915, Apartado Nacional 270 & 469, Medellin.
Tel: 44-10-00 & 44-33-33. Cable: ONDINA.
Mgr.: Rafael Acosta Salinas.
Philips Colombiana, Apartado Aereo 42B2, Bogota.
Sociedad Nacional de Musica (Sonomusica), Apartado
Aereo 1263, Medellin. Mgr.: Orlando Posada
Gonzalez.
Suramericana de Grabaciones, Aptdo. Aereo 5B-37,
Bogota.

● **music publishers**

Peer de Colombia, PO Box 8665, Edificio Bristol,
Calle 18, 6-31. Oficina 406, Bogota. Tel: 41-
98-64. Cable: PEERCO.

● **importers & exporters**

Colombiana de Discos, Apartado Aereo 1428,
Medellin.
Daro Int'l, Aptdo. Aereo 4578, Bogota.

● **supplies & services**

PRESSING PLANTS

Colombiana de Discos, Apartado Aereo 1428,
Medellin.
Discos Silver, Calle 41 K-48, No. 46-55, Medellin.
Discos Tropical, Apartado Aereo 793, Barranquilla.
Pres.: Emilio Fortou P.
Fabrica de Discos Curro, Apartado 1344, Cartagena.
Fabrica de Discos Fuentes, Apartado 1960, Medellin.
Industrias Fonograficas del Caribe, Carrera 40,
No. 4133, Barranquilla.
Industrias Fonograficas "Lusar," Calle 25 No. 4C-
61, Apartado 679, Ibague.
Industrias Fonograficas Victoria, Apartado 2264,
Cali.
Industrias Fonoton, Apartado 7080, Bogota.
Manufacturas Ajover, Apartado 4911, Bogota.
Ondina Fonografica Colombiana, Calle 67-A, No.
51-D-33, Apartado 915, Medellin.
Sello Vergara, Apartado 3587, Bogota.
Sonolux, Apartado 640, Medellin.

RECORDING STUDIOS

Daro, Aptdo. Aereo 4578, Bogota.
Colombiano de Discos, Aptdo. Aereo 1428, Medellin.
Industrias Fonoton, Aptdo. Aereo 12330, Bogota.
Suramericana de Grabaciones, Carrera 8, No. 18-27,
Bogota.

COSTA RICA

Population: 14,058,000.
Rate of exchange: \$1 (US)=6.63 colons.
Records imported from US (factory value): 1964—
\$20,456; 1963—\$41,100.
Radio Stations: 5.

● **record manufacturers**

Almacen Filco, Avenida central calles AV/1, San
Jose.
Oiscolandia Reuben, Calle 1, avenida 1/3, San Jose.
Emporio R. Castro, Calle 4 avenida 2, San Jose.
Industria de Discos Centroamericana (INOICA), PO
Box 4093, avenida 8 calles 11/13, San Jose.
Tel.: 1931. Cable: Indica. Pres.: Oscar Stupp;
Gen. Mgr.: T. A. Reuben.
Label: Indica.
This company represents: Columbia, EMI Group,
Deutsche Grammophon, Oot, Kapp, MGM,
Philips Group.
Note: The Central American Common Market
is serviced through INOICA (British Honduras,
Costa Rica, El Salvador, Guatemala, Honduras,
Nicaragua, Panama).
Libreria Universal, Carlos Federspiel, calle AV/1
avenida FG, San Jose.

● **importers & exporters**

Almacen Filco, Avenida central calles AV/1, San
Jose.
Oiscolandia Reuben, Calle 1, avenida 1/3, San Jose.
Impo-Discos, Apartado No. 1645, San Jose. Contact:
Sr. Oscar Stupp.

● **services & supplies**

**PLATING PLANT
PRESSING PLANT
PROMOTION & PUBLICITY
RECORDING STUDIO**

Industria de Discos Centroamericana, PO Box 4093,
avenida 8 calles 11/13, San Jose. Tel: 1931.
Cable: Indica. Pres.: Oscar Stupp.

CZECHOSLOVAKIA

Population: 1964 census—14,108,000.
Rate of exchange: \$1 (US) = 7.20 koruny.
Records imported from US: 1965—\$2,829; 1964—\$8,908.
Records exported to US: 1965—\$1,393; 1964—\$1,981.

● record manufacturers

State Publishing House of Music, N.E. (Statni hudebni vydavatelstvi n.p.). Palackeho 1, Prague 1. Tel: 24-92-51.
Supraphon, Lodenice Uberouna.

● music publishers

Panton, Publishers for the Guild of Czechoslovakian Composers (Panton, nakladatelstvi Svazu csl. spisovatelu), Besedni 3, Prague 1. Tel: 533-784.
State Publishing House of Music, N.E. (Statni hudebni vydavatelstvi n.p.). Palackeho 1, Prague 1. Tel: 24-92-51.

● importers & exporters

Artia, Foreign Trade Corporation for the Import & Export of Cultural Commodities, Ve Smeckach 30, Prague 1. Tel: 24-62-84 & 24-63-92.

DENMARK

Population: 4,684,000.
Official rate of exchange: \$1 (US) = 6.90 kroner.
Per capita income: \$2,250 annually.
Number of homes with record players: Approx. 13%.
Records exported to US (factory value): 1964—\$3,573.
Records imported from US (factory value): 1964—\$67,718.
Origin of records sold: Domestic 25%, USA 5%.
Other foreign: 70%.
Discounting: None.
Average retail price: LP's—\$5; EP's—\$2; Singles—\$1.30.
Record club sales: Approx. 9% of total sales.
Jukeboxes: About 850.
Stereo sales: 15% of total; 40% of LP sales.
Import-Export regulations: Increase of tax duties from 13% to 17% of retail price; NCB copyrights still 8% of retail price; artist royalty 4% of retail price.

● record manufacturers

I. S. Dansk, 39 Dortheavej, Copenhagen. Tel: Taga 8505. Cable: Danrecord. Mg'g Dir.: Karl Emil Knudsen; A&R: Gustav Winckler.
Labels: Sonet, Mascot, Storyville, Life.
This company represents: Argo, Blue, Note, Chancellor, Checker, Chess, Colpix, Ecco, Folkways, Gazell, Palette, Roulette, Savoy, Scan-Disc.

Metronome, 31 Vibevej, Copenhagen. Tel: Aegir 8112. Mg'g Dir.: Bent Fabricius-Bjerre; Classical & Pop. A&R: Olav Bennike.

Labels: ABC, Anders And, Ariola, Athena, Atco, Atlantic, Baccarola, Bang, Cameo-Parkway, Carla, Clarion, Dial, Debut, Dunwich, Elektra, Eurodisc, Hansa, Impulse, Joker, Metronome, Midnight Sun, Music, Nonesuch, Snurr, Stax, Swe-disc, Troubadour, Volt, Westminster.

Moerks Musik, Vesterport 247, Copenhagen V. Tel: PA 11 5000. Gen. Mgr.: Sales & Int'l: K. Moerk; A&R: J. Windfeldt.
Label: Triola.

This company represents: Austraton & Elite (Germany), CGD (Italy), Pye (England), California (USA), Dot (USA), Hickory (USA), Kapp (USA).

Hede Nielsens, Grundtvigsvej 10A, Copenhagen. Tel: Eva 4120. Cable: HENIGRAM. Gen. Mgr.: Leif Risell.

Labels: RCA Victor, Reprise, Warner Bros.
This company represents: RCA Victor (USA), Reprise (USA), Warner Bros. (USA).

Nordisk Polyphon, Emdrupvej 115, Copenhagen NV. Tel: 692522. Cable: Polyphon. Gen. Mgr. & Int'l: W. E. Hamburger; A&R: Bruno Henriksen.
Labels: Polyphon, Polydor, Philips.

This company represents: Ace of Clubs/Diamonds (England), Ace of Hearts (USA), Archiv (Germany), Argo (England), Beltona (England), Brunswick, CBS (USA), Caedmon (USA), Com-

mand (USA), Coral (USA), Decca (England), Deutsche Grammophon (Germany), Fontana (Holland), Heliodor (Germany), Jazzland (USA), Kama Sutra (USA), L'Oiseau Lyre (France), London (USA), Louisiana (Denmark), Melody (Denmark), Mercury (USA), Orpheus (Holland), Pergola (France), Philips (Holland), Polar (Sweden), Polydor (Germany, Denmark), Polyphon (Denmark), Rex (England), Riverside (USA), Sonata (Sweden), Sonora (Sweden), Star Club (Germany), UA (USA), Vee-Jay (USA), Verve (USA), Vocalion (USA).

Int'l representatives: Associates and branches of Philips, CBS, Decca, DGG and sub-labels.

Skandinavisk Gramophon, Hoffdingsvej 1B, Copenhagen, Valby. Tel: 306711. Cable: Gramophon. Top Exec.: S. L. G. Gottlieb; Sales & Int'l: K. Hviid Mikkelsen.

Labels: Columbia, HMV, Odeon.

This company represents: Capitol (USA), Columbia (USA), Dolton (USA), Electrola (Germany), Ember (USA), Encore (England), Gloria (Germany), HMV (England), Imperial (Germany), Laurie (USA), Liberty (USA), MGM (USA), Motown (USA), Odeon (France), Parlophone (England), Pathe (France), Regal-Zonophone, State-side (USA), Tamla (USA).

Int'l representatives: All EMI branches and associates.

TONO, Dortheavej 1, Copenhagen. Tel: Aegir 9680. Cable: TONORECORDS. Mg'g Dir.: Harry Larsen; A&R Pop & Classical: E. Ollgaard; A&R & Sales & Mktg.: Svend Hansen; Pub.: H. Frederiksen.

Labels: Tono, Teenor.

This company represents: Amadeo, Audio Fidelity, Barclay, Contemporary, Durium, Fidelio, Fonit, GNP Crescendo, Jay-Gee, Majestic, Mainstream, Request, Time, 20th-Fox, Vogue. (SEE ADVERTISEMENT)

● music publishers

Cantagallo, Veldemargade 12, Horsens.

D F G Music (see Winckler Music).

Dacapo, Pilestraede 2, Copenhagen. Tel: CE 159549. Cable: DACAPOMUSIC. Gen. Mgr.: Henry Andersen.

Branch: Madvigsalle 11, Copenhagen. Gen. Prof. Mgr.: Henry Andersen.

Wilhelm Hansen, Gothersgade 9, Copenhagen K. Tel: MI 7888. Contact: A. Spliid.

Imudico, Colbjørnsensgade 19, Copenhagen V. Tel: HI 5625. Contact: A. Kleinert.

Internorthern, Chr. 9 Gade 6, Copenhagen K.

Moerks, Vesterport 247, Copenhagen V. Tel: PA 5000. Contact: K. Moerk.

Multitone, Vibevej 31, Copenhagen NV. Tel: Aegir 8112. Cable: Multitone. Pres.: Harry Jensen.

Winckler, Dortheavej 39, Copenhagen NV. Tel: TA 2282. Cable: Wincklermusic. Pres.: Gustav Winckler; Gen. Mgr.: K. E. Knudsen.

Affiliates: Stockholms Musikproduktion, Sweden Music.

This company represents: Aberbach (Germany), Criterion (USA), Gehrman (Sweden), Minerva (Germany), Oak (USA), Alfred Schact (Germany), Hans Sikorski (Germany), Southern (Sweden).

● importers & exporters

Frode Herlov, 14 Borgergade, Copenhagen K. Tel: 149850. Cable: SELECTAHERLOEV.

● supplies & services

MUSIC LICENSING ORGANIZATIONS

Gramex (Affiliate of Koda-record royalties, etc.), Kronprinsessegade 26, Copenhagen. Tel: CE 2276.

Koda (Counterpart of ASCAP), Kronprinsessegade 26, Copenhagen. Tel: 142277.

Nordisk Copyright Bureau, Upsalagade 24, Copenhagen. Tel: TR 3660. Pres.: S. T. Wilson; Mg'g Dir.: K. Nielsen.

POLYETHYLENE BAGS

Norlip, Prinsessegade 29A, Copenhagen B. Pres.: H. S. Philipsen.

PRESSING PLANTS

Plastica, Dortheavej 1, Copenhagen NV. Tel: Aegir 9680.

Skandinavisk Bakelite, Proevensvej 35, Copenhagen V. Tel: 701521.

Skandinavisk Gramophon, Hoffdingsvej 1B, Copenhagen. Tel: 306711.

PROMOTION & PUBLICITY

Popic Prod'ns, PO Box 1218, Copenhagen S. Tel: 583539. Mgr.: O. Trosborg.

RECORDING STUDIOS

Metronome, Vibevej 31, Copenhagen. Tel: Aegir 8112. Contact: Birger Svan.

Polyphon, Emdrupvej 115, Copenhagen. Tel: 692522. Cable: Polyphon.

Skandinavisk Gramophon, Hoffdingsvej 1B, Copenhagen. Tel: 306711. Contact: S. L. G. Gottlieb.

Tono, Dortheavej 1, Copenhagen. Tel: Aegir 9680.

TRADE ORGANIZATIONS

Den Danske Gruppe af Grammfonindustriens, Internationale Federation, Sankt Anna Plads 11, Copenhagen K. Tel: 144401. Sec.: Otto Lassen.

DOMINICAN REPUBLIC

Population: 3,500,000.

Official rate of exchange: \$1 (US) = 1 peso.

Average retail price per record: LP's: \$4.95 local manufacture, \$7.00 imported; EP's: not sold; Singles: \$1.50 local manufacture, \$2.00 imported. Stereo sales: 5% of total sales.

Discounting: Rare.

Record club sales: None.

Type of record distribution: Manufacturer to wholesaler to retailer and manufacturer to retailer.

Number of jukeboxes: 4,500. Two thirds local owned & one third on commission.

Radio stations: 75 (approx.) including Government stations.

Television: Two channels—Television Dominicana (Government), HIN (private).

Note: Due to conditions in this country during 1965 it is impossible to obtain, at this time, figures on sales, importation and manufacture of records. Owing to the high customs duties on imported records, this country pays about the highest price for records anywhere and has one of the lowest per capita incomes in the Caribbean area. Antonio Contreras

● record manufacturers

Federacion Dominicana de Discos (Government).

Industria Sonora Dominicana, Santo Domingo.

Salon Mozart C. por A., El Conde 106, Santo Domingo.

● music publishers

Salon Mozart, El Conde 106, Santo Domingo.

● record importers, exporters and wholesalers

Amaro Discos, Santo Domingo.

Discolandia, Ravelo 92, Santo Domingo.

Distribuidora Dom de Discos, Edificio Jarr, Santo Domingo.

Guarachita, El Conde 108, Santo Domingo.

Bartolo Pr mero, Ave. Mella 156, Santo Domingo.

Julio Tono., Apartado 364, Santo Domingo.

● record distributors rack jobbers

Distribuidora Dom. de Discos, Edificio Jarr, Santo Domingo.



TONO

for more than 25 years biggest independent company in Denmark

*
own studio
*
own processing and pressing plant
*
guarantee your label
an efficient and nation-wide distribution in Denmark

TONO, Copenhagen NV.
1 Dortheavej, Phone: Aegir 9680

continued

● supplies & services

PRESSING PLANTS

See Record Manufacturers.

RECORDING STUDIOS

Most local recording done at radio and television studios.

ECUADOR

Population: 4,700,000 million.

Official rate of exchange: \$1 (US)=18.60 sucres.
Records imported from U. S. (factory value): 1964-\$10,704.

● record manufacturers

Emporio Musical, Casilla 1276, Guayaquil. Tel: 14174. Cable: EMPORMUSIC. Mgr.: Carlos Pino Plaza.

This company represents: Columbia (USA).

Industrial Fonografica Ecuatoriana (CAIFE), PO Box 84, Venezuela 703, Quito. Tel: 11919. Pres.: Pablo Molina S.; Mgr.: Carlos Rota-M; A&R: Raul Emiliani.

E. Maulme (div. of Discos RCA Victor), Calle Calicuchima y Rumichaca, Aptdo. 3885, Guayaquil. Tel: 14102. Mgr.: Luis Pino Y.

This company represents: RCA Victor (USA).

Philips Ecuador, Casilla 343, Quito.
This company represents: Philips.

● music publishers

S A D R A M (Sociedad De Representaciones y Administraciones Musicales), PO Box 3456, Guayaquil.

● importers & exporters

Almacenes de Musica, J. D. Feraud Guzman, Aptdo. 856, Guayaquil. Tel: 13932.

● supplies & services

PRESSING PLANTS

Importadora Velaga, Casilla 318, Ambato.

Industrial Fonografica Ecuatoriana, Aptdo. 3885, Guayaquil.

Branch: PO Box 84, Quito. Tel: 11919.

EIRE

Population: 1961 census-2,818,341; latest official estimate-2,849,000.

Official rate of exchange: \$2.80 (US)=1 Irish pound.

Per capita income: Approx. \$750 annually.

Records imported from U. S. (factory value): 1964-\$49,814; 1963-\$70,500; 1962-\$60,500.

Records exported to U. S. (factory value): 1964-\$360.

Average retail price: LP's-\$4.50; EP's-\$1.40; Singles-90 cents.

Discounting: Occasional.

Record club sales: Approx. 11% of all sales.

Stereo sales: Approx. 3% of all sales.

Medium-wave radio stations: 1 (Radio Eireann).

Television stations: 1 (Telefis Eireann).

Number of juke boxes: Approx. 550.

Type of record distribution: Manufacturer to wholesaler to dealer.

Important regulation: Import duty of 15% or 14 cents per single record, whichever is greater.

● record manufacturers

F M I (Eire), 23 Lower Dominick St., Dublin 1. Tel: 46108. Dir.: H.D. Christmas.

Gramophone, 23 Lower Dominick St., Dublin 1. Tel: 46108. Cable: JABBERMENT. Dir.: Harry Christmas; Gen. Mgr.: Joe McCabe.

Labels: Delyse, Glenside, all EMI group.

Pye Rec. Sales, 24 Mountjoy Sq., Dublin 1. Tel: 45441. Mgr.: John Woods.

Label: Checker (Ireland).

Silver, 27 Molesworth St., Dublin. Tel: 63994. Prod'r: Tony Boland.

Label: Tempo.

Int'l representative: USA (Jerden).

● music publishers

Flude (M.C.P.S., P.R.S.), 38 Lower Mountpleasant Ave., Dublin 6. Tel: BOYLE 156. Pres.: T. McEniry; Gen. Mgr.: William B. Devine; Gen. Prof. Mgr.: Gay McKeon.

Montrose (M.C.P.S.), 27 Molesworth St., Dublin. Tel: 63994. Pres.: Tony Boland.

Pigott, 112 Grafton St., Dublin 2. Tel: 73161. Mgr'g Dir.: J.G. Lyons.

Branch: 117 Patrick St., Cork. Tel: 20592. Mgr.: T.P. McAlpine

Segway, 4/7 Cathal Brugha St., Dublin. Tel: 49643. Gen. Mgr.: Vincent Nordell.

Walton's Musical Galleries, 2 N. Frederick St., Dublin. Tel: 47041. Mgr'g Dir.: Martin Walton.

● importers & exporters

Connoisseur Recs., 5 Cope St., Dublin 2.

Dolphin Discs, 164 Capel St., Dublin. Tel: 72187. Branch: 58 Stephen's St., Dublin. Tel: 53198.

Dolphin-Seal, 22 Marlboro's St., Dublin. Tel: 46525. Prop.: Joseph P. O'Reilly.

Gael-Linn, 54 Sraid Grafton, Dublin.

Pye Rec. Sales, 24 Mountjoy Sq., Dublin 1. Tel: 45441. Mgr.: John Woods.

Siemens-Schuckert, 49 Middle Abbey St., Dublin.

Solomon & Peres, 2 Dame Ln., Trinity St., Dublin.

● supplies & services

PRESSING PLANTS

Carlton Prod'ns, Drimnagh Ind'l Estate, Long Mile Rd., Dublin 12. Tel: 505773. Mgr.: Robert McGrattan.

E M I, Ferrybank, Waterford. Tel: 4195. Mgr.: Thomas Boylan.

RECORDING & TAPE DUP. STUDIOS

An Comhlacht Taifeadadh, 2 & 26 Upper Mount St., Dublin 2. Tel: 63330.

Eamonn Andrews, 4 Henry St., Dublin. Tel: 49191. Dir.s.: Eamonn Andrews, Dermot Cafferky, Lorcán Bourke, Fred O'Donovan.

Peter Hunt, 130 St. Stephen's Green, Dublin.

Silverpine, Bray, County Wicklow.

DISTRIBUTORS

Associated Rec'gs, Broombridge Rd., Finglas, Dublin 11. Tel: 488971.

Dolphin Whsle. Discs, 164 Capel St., Dublin.

Irish Rec. Factors, 34 Parnell Sq. W., Dublin. Tel: 43112 & 43475. Cable: IREFACTS. Gen. Mgr.: M.H. Geoghegan; Pub.: Miss Phyl Mitton.

Labels: (distributed) Ace of Hearts, Argo, Avoca, CBS, Chamber, Coral, Elektra, Emerald, Folkways, Globe, Immediate, King, London, Philips, Planet, RCA Italiana, RCA Victor, Rex, Shamrock, Strike, Topic, Turnabout, Transatlantic, Vocalion.

EL SALVADOR

Population: 2,850,000.

Official rate of exchange: \$1 (US)=2.50 colones.

Records imported from US (factory value): 1964 \$106,605; 1963 \$137,500.

Records exported to US (factory value): 1964 \$285.

Radio stations: 10.

Television stations: 1.

● record manufacturers

Discos Centroamericanos S.A. (DICESA), Blvd. de El Ejercito Nacional, Km. 4, Aptdo. Postal 847, San Salvador. Tel: 12-20, Ext. 6B. Cable: DICESA. Mgr.: Mrs. Maria Rodriguez de Boet. This company represents: RCA Victor (USA), United Artists (USA).

Lesser, Apartado 104, San Salvador.

● importers & exporters

Casa de la Musica, L. Garay & Cia, Apartado No. 142, San Salvador.

Casa Kismet, 4a Ave. Sur No. 36, San Salvador.

Casa Rivas, Calle Ruben Dario No. 708, San Salvador.

Dada Dada, Apartado No. 274, San Salvador.

Roberto Orantes Penate, 3a Calle Poniente No. 4, Santa Ana.

Radio Electrica, 4a Ave Sur No. 228, San Salvador. Tel.: 5609 & 3967. Contact: Ricardo Dutriz.

FINLAND

Population: 1965-4,626,000.

Official rate of exchange: \$1 (US) = 3.20 Finnish markka.

Per capita income: 1965-\$1,406.

Number of homes with record players: 250,000.

Records sold domestically: 1965-LP's, 170,000 units; EP's, 130,000 units; Singles, 580,000 units.

Records imported from US (import value): \$37,346.

Records exported to US (export value): \$5,361.

Records imported from countries other than US (import value): \$532,910.

Records exported to countries other than US (export value): \$18,985.

Records manufactured for domestic and export sale: 1965-LP's, 27,000 units; EP's, 60,000 units; Singles, 330,000 units.

Stereo sales: 5% of LP sales.

Average retail price per record: LP's: \$6.25; EP's: \$3; Singles: \$2.

Discounting: Rare.

Record club sales: 70,000 units annually.

Type of record distribution: Manufacturer to retailer; rarely manufacturer to wholesaler to retailer.

Number of jukeboxes: 2,000.

Radio stations: One government broadcasting company with 90 transmitters.

Television stations: One government TV company. Channels: VHF area, 10 in use; UHF area, 2 in use; 40 possibilities. Harry Aaltonen

● record manufacturers

Akkuteollisuus Neitsytpolku 1B, Helsinki. Tel: 11912. Contact: Matti Sarapalio.

Discophon, Takomantie 3, Helsinki 37. Tel: 451627. Cable: DISCOY. Top Exec.: Bengt G. Liljerth; A&R, Sales, Int'l: Johan Vikstedt.

Label: RCA.

This company represents: RCA (USA).

Fazer Musikhandel, Alexandersgaten 11, Helsinki O. Finndisc, Simonkatu 10B, Helsinki. Tel: 644877.

Dir.: Rolf Kronqvist; Sales: Erik Lindstrom.

Labels: Blue Note, Nashville, Safir.

Fintone, Munkkisaarekatu 2, Helsinki 15. Tel: 15533. Cable: Fintone. Top Exec. & A&R: Henrik Denfer.

This company represents: ABC-Paramount (USA), Adria (France), Archiv (Germany), Brunswick, Cameo (USA), Command (USA), DGG (Germany), Elektra (USA), Heliodor (Germany), Impulse (USA), Joker (Sweden), Kama Sutra (USA), Karusell (Sweden), Mercury (Holland), Nonesuch (USA), Olga (Sweden), Parkway (USA), Polydor (Germany), Primula (Sweden), Riverside (Holland), Swe-Disc (Sweden), United Artists (USA), Vee Jay (USA), Verve (USA), Westminster (USA), Whitehall (USA).

Levytkku, Fredrikinkatu 45, Helsinki 10. Tel: 659581. Top Exec.: N. E. Saarikko.

Labels: Broadway, Manhattan, Triola.

This company represents: Triola.

Musik Fazer, Aleksanterinkatu 11, Helsinki. Tel: 10751. Cable Musikfazer. Mgr'g Dir.: Roger Lindberg; A&R: Toivo Karki; Sales: Osmo Ruuskanen.

Labels: Coral, Decca, Fontana, Philips, Rylmi.

This company represents: Amadeo (Austria), Barclay (France), CBS (USA), Coral (USA), Decca (England, USA), Fontana (Holland), London (England), Palette (Belgium), Philips (Holland), Pye (England), Sonora (Sweden).

Pohjoismainen Sähkö, Vuorikatu 14, Helsinki. Tel: 12651. Music Dept. Mgr.: Mortti Pihö.

This company represents: EMI's trademarks (Columbia, Parlophone, Odeon, MGM, Gloria, Encore); Blue Master, Elite Spezial, Finlandia, Le Chant du Monde, Music Minus One, Regal.

Sihkoliikkeiden, Satamakatu 4, Helsinki 10. Tel: 454401. Cable: SLOY. Top Exec.: Eino Hietanen; A&R, Sales, Int'l: Johan Vikstedt.

Label: Telefunken.

This company represents: Reprise (USA), Telefunken (Germany), Warner Bros. (USA).

Scandia-Musiikki, Hietalahdenranta 11A, Helsinki. Tel: 642005. Cable: Scandiamusic. Gen. Mgr.: Harry Orvoma; A&R: Jaakko Salo; Sales: Paavo Einio; Int'l: Antti Einio.

Label: Scandia.

This company represents: Ariola, Atlantic, Cadet, Checker, Chess, Ember, Epic, Eurodisc, Gazell, Hansa, Kapp, Knappupp, Mainstream, Metronome, Prestige, Red Bird, Roulette, Scandia, Scan-Disc, Sonet, Storyville.

R E Westerlund, N. Esplanad 37, Helsinki. Tel: 10396. Cable: Pianowesterlund. Pres.: Robert Westerlund; A&R: Reino Backman.
Label: Westerlund.
This company represents: Angel, Buena Vista, Capitol, Disneyland, Dolton, Electrola, HMV, Imperial, Liberty, Motown, Pathe, Star, State-side, Tamla, Video.

● music publishers

CODA, Edition, Ritokalliontie B-16P, Helsinki. Mgr.: Johan Vikstedt. (SEE ADVERTISEMENT)
 Commandittiyhtio Libito, Fredrikinkatu 32A, Helsinki 14.
 Finndisc, Simonkatu 10B, Helsinki. Tel: 644877. Dir.: Rolf Kronqvist.
 Levysavel, Vuorikatu 14, Helsinki. Tel: 12651. Contact: Mortti Pihö.
 Levyttukku, Fredrikinkatu 45A, Helsinki 10. Tel: 659581. Contact: N. E. Saarikko.
 Musik Fazer, Aleksanterinkatu 11, Helsinki. Tel: 10751. Cable: Musicfazer. Mg'g Dir.: Roger Lindberg.
 Scandia-Musiikki, Hietalahdenranta 11A, Helsinki. Tel: 642005. Cable: Scandiamusic. Gen. Mgr.: Harry Orvoma.
 R E Westerlund, N. Esplanad 37, Helsinki. Tel: 10396. Cable: Pianowesterlund. Pres.: Robert Westerlund; Promo. Mgr.: Jorma Pukkila.
 X-Savel, Humalistonkatu 17A, Helsinki 5.

● importers & exporters

Akkuteollisuus, Neitsypolku 1, Helsinki.
 Discophon, Takomontie 3, Helsinki 37. Tel: 451627. Cable: DISCOVY.
 Finnone, Munkkisaarenpolku 2, Helsinki.
 Kansankulttuuri, Simonkatu 8, Helsinki 10.
 Levyttukku, Fredrikinkatu 45, Helsinki 10. Tel: 659581.
 Musik Fazer, Aleksanterinkatu 11, Helsinki. Tel: 10751. Mg'g Dir.: Roger Lindberg.
 Pohjoismainen Sahko, Vuorikatu 14, Helsinki.
 Sahkoliiikkeiden, Takomontie 3, Helsinki.
 Scandia-Musiikki, Hietalahdenranta 11A, Helsinki. Tel: 642005. Cable: Scandiamusic.
 R E Westerlund, N. Esplanad 37, Helsinki. Tel: 10396.

● supplies & services

MUSIC LICENSING ORGANIZATIONS

Saveltajain Tekijanoikeustoimisto Teosto r.y., Hietaniemenkatu 2, Helsinki.

RECORDING STUDIOS

Aanitoisto, Mechelinink 19B, Helsinki 10. Tel: 494111.
 Elektrovox (Akkuteollisuus), Neitsypolku 1, Helsinki.
 Filmi-aani, Film Sound Ltd., Annankatu 16, Helsinki.
 Finnvox, Arinantie 8, Pitäjänmäki. Tel: 454523.
 Levyttukku, Kirjatyöntekijänkatu 10, Helsinki. (Also tape duplication, record distribution, independent record production from offices at Fredrikinkatu 45A, Helsinki 10).
 Scandia, Sturenk 4, Helsinki.
 R E Westerlund, Sturenk 4, Helsinki.

TRADE ORGANIZATIONS

Suomen Automaattiyhdistys r.y., It. Puistotie 6B, Helsinki 14. Tel: 61169. Cable: Automaatti. Pres.: Tuomas Tapala.
 Suomen Musiikkikauppiaaliitto r.y., Kluuvantie 6 H 72, Helsinki 91.
 Suomen Soittinalan Tuottajaliitto, Mikonkatu 13A, Helsinki 19.

FRANCE

Population: 49,157,200 (Inst. National des Statistiques).
 Official rate of exchange: \$1 (US) = 5 francs.
 Per capita income: \$2,025 annually.
 Number of homes with record players: 4,000,000.
 Records sold domestically: 1964 \$40,400,000 for 44,000,000 units; 1965—approx. the same.
 Stereo sales: 5% of total sales.
 Records imported from the US (retail value): \$221,800.
 Records exported to the US (retail value): \$202,200.
 Average retail price: LP's—\$5; EP's—\$2.
 Discounting: 15% discount obtainable in Paris; none in provinces.
 Record club sales: 5% of total sales.

Billboard 1966-1967 International Music-Record Directory

Type of record distribution: Manufacturer to dealer.
Number of jukeboxes: 30,000.
Radio stations: 4 channels State controlled & 3 nation-wide commercial stations—Europe 1, Radio Luxembourg & Radio Monte Carlo.
Television stations: 2 channels, State controlled.
Import-export regulations: 20% tax.

Mike Hennessey

● record manufacturers

A D E S, 141 rue La Fayette, Paris 10. Tel: TRU. 72.92. Contact: Lucien Ades.
 A R E A (Les Applications & Realisations Electriques & Acoustiques), 52 Av. Hoche, Paris B. Tel: WAG. 33.60. Cable: AREADIS. Pres.: M. H. Froment; Admin. Dir.: Mme. Helyett de Rieux; A&R: J. P. Hebrard, Guy Lafarge, D. Filipacchi; Sales: J. Buche; Pub.: Mlle M. Buret.
Label: RCA.
This company represents: RCA Victor (USA).
 A Z (see Vogue).
 Ange (see Vogue).
 Anthologie Sonore, 42 rue de Paradis, Paris 10. Tel: TAI 93.20.
 B A M (Editions de la "Boite a Musique"), 133 Blvd. Raspail, Paris 6. Tel: LIT 16.12. Pres.: A. Levi Alvarez.
 BARCLAY, 143 Av. de Neuilly, Neuilly (Seine). Tel: SAB. 60.30. Cable: Barclaydisc. Pres.: Eddie Barclay; Ass't Dir.: Hubert Ballay; Sales Dir.: Jo Milgrand.
Label: Barclay.
This company represents: Ariston (Italy), Atlantic (USA), Bang (USA), Big-Top (USA), Cadet (USA), Chess/Checker (USA), Colpix (USA), Elenco (Brazil), HiFi (USA), Hispavox (Spain), Kent (USA), Lena Forma (Brazil), Jazz-Press (USA), Musidisc (Brazil), Rifi (Italy), Sue (USA), 20th-Fox (USA), UA (USA), Valiant (USA). (SEE ADVERTISEMENT)
 Bel-Air, 79 rue Traversiere, Courbevoile (Seme). Tel: DEF. 59.49. Pres.: Mme. Nicole Barclay; A&R: Dany Kane; Int'l: Jean-Louis Ginibre.
This company represents: Atlantic (USA), Time (USA).
 Pierre Berjot Prod'n, 3 rue du Bois de Boulogne, Paris 16. Tel: PAS. 80.09. Pres. & A&R: Pierre Berjot.
Label: Ely.
 C B S-Arteco, 42 rue de Paradis, Paris 10. Tel: 824.93.20. Cable: Berntaylor. Pres.: Jacques Souplet; Sales: Jacques Vatinet; Promo.: Christian Daffes; Int'l: Henri Renaud & Jacques Plait.
Label: CBS.
This company represents: Blue Note, Epic, Karate (all USA).
 Century, 13 rue des Francs-Tireurs, La Courneuve (Seine). Tel: FLA. 27.71. Pres.: Lucien Pierlot; A&R Int'l: Lucien Philippe.
 Chant du Monde, 32 rue Beaujon, Paris 8. Tel: WAG. 67.73.
 Cid (see Societe Francaise du Son).
 Cochon d'Inde (see Vogue).
 Compagnie Phonographique Francaise, 143 Av. de Neuilly, Neuilly (Seine). Contact: Patrick Viaret.
 Contrepoint (see Vogue).
 Diapason-Microsillon, 61 rue La Fontaine, Paris 16. Branch: 39 rue des Perchamps, Paris 16. Tel: MIR. 58.50.
 Disco-France, 124 Av. de Wagram, Paris 17.
 Discophiles Francais (Les) (see Pathe-Marconi).
 Disques de France, 3 rue de Gramont, Paris 2. Tel: 742.96.10.
 Ducretet-Thomson (see Pathe-Marconi).
 E N (see Vogue).
 Erato, 60 Chaussees d'Antin, Paris 9. Tel: TRI. 78.71. Cable: Costerat.
 Fashion (see Vogue).
 FESTIVAL, Les Disques de France, 3 rue de Gramont, Paris 2. Tel: RIC 94.61. Pres.: P. G. Duprat; Gen. Dir.: Andre Chagneau; Sales Dir.: J. L. Dasque; Performance Mgrs.: Roger Maruani & Pierre Brunet. (SEE ADVERTISEMENT)
 Fontana (see Philips).
 Holiday-Hohner, 19-21 rue Van-Loe, Paris 16. Tel: BAG. 63.50. A&R: M. Coulon.
 Horizon (see Vogue).
 Iramac France, 36 rue Ernest Renan, 92-Issy les Moulinaux. Tel: 642.21.93. Pres. & Sales: A. Samama; A&R: B. Duvernay.
Labels: Iramac, Relax.
 Juniors (see Vogue).
 Kangourou (see Vogue).
 Loisirs (see Vogue).
 Lou (see Vogue).
 Lumen, 3 rue Garanciere, Paris 6. Tel: MED. 29.30. Contact: Bloud & Gay.

M G M 37 rue Condorcet, Paris. Tel: TRU. 78.00. Cable: METROFILMS. Contact: John E. Nathan.
Labels: MGM, Verve.

May (see Vogue).
 Mercury (see Philips).
 Michel (see Vogue).
 Mode (see Vogue).
 Monestier, 19 rue du Palais-Gallien, Bordeaux. Tel: 4B.12.80.
Label: Black & Blue.

Monte-Carlo (see Vogue).
 Musique (see OCD).
 Number One Rec. & Disques Line, 5 rue du Bois de Boulogne, Paris 16. Tel: 7D4. 53.53. Contact: Loulou Gaste, Line Renaud.

O C D (Office Catholique du Disque), 31 rue de Fleuris, Paris 6. Tel: LIT. 49.95. Contact: Roger Payen.

Labels: Musique, Pastorale, Unidisc.
 Odeon (Societe Art, Technique & Commerce), 42 rue de Paradis, Paris 10. Tel: 824.93.20. Pres.-Gen. Mgr.: Jacques Souplet.

Oiseau-Lyre, Les Remparts, Monaco.
 Orly, 33 rue du Faubourg St.-Martin, Paris 10. Tel: NOR. 89.05.

Orpheo (see Vogue).
 Pacific (see Vogue).
 Palmares (see Vogue).
 Pastorale (see OCD).

Pathe-Marconi, 19 rue Lord Byron, Paris 8. Tel: BAL. 53.00. Cable: Gramophone. Pres.: G. E. Cross; VP: Pierre Rouzies; Sales Dir.: Georges Mealle; Int'l: J. J. Timmel.

Labels: Pathe, La Voix de Son Maitre, Columbia, Ducretet-Thomson, Les Discophiles Francais.
This company represents: A&M (USA), Band Box (USA), Bell Group (Admiral, Amy, Bell, DynoVoice, Dynovox, Eskee, Fanso, General Int'l, Goldwax, Logo, Mala, Maxx, Musicland, New Voice, Rotafte, Village Gate—USA), Capitol (USA), Command (USA), Diamond (USA), Discomoda (Venezuela), Ember (England), EMI (England), Liberty (USA), One-Derful (USA), Prestige (USA), Regina (USA), Select (Canada), Soma (USA), Sonet (Sweden), Tamla-Motown (USA), Telefunken (Germany), Toshiba (Japan), World Artist (USA), Zeida (Colombia).
 Pergola (see Philips).

PHILLIPS, 6 & 8 rue Jenner, Paris 13. Tel: POR. 75.28. Cable: Phildisc. Pres.: Georges Meyer-

**No matter how
you spell it:**

LETKISS

**Let's Kiss
Jenka
Schon, Schon
La Lecon de Letkiss
De Kus-Kus Letkiss
Lecion de Besos**

it's a **HIT**
HIT
HIT

EDITION

coda

from

**Ritokalliontie 8-16 P
Helsinki • Finland**

continued

stein; Ass't Dir.: Louis Hazan; A&R: Jacques Caillart; Sales: Godefroy de Noaillet.
Labels: Philips, Fontana, Mercury, Pergola.
This company represents: Arhoolie, Aura, Jazzland, Mercury (Limelight, Smash), Mira (Mirwood, Surrey), Offbeat, Pacific Jazz, Riverside, Tollie, Vee Jay, Washington, Wing, World Pacific (all USA); Oebut (Denmark). (SEE ADVERTISEMENT).

Pingoin (see Vogue).

Polydor, 2 rue Cavalotti, Paris 18. Tel: LAB. 05.39. Cable: Polydor Disc. Pres.: Marcel Frange; Dir.: Mr. Kerner; A&R: Jacques Bedos; Int'l: Andre Poulain; Sales Dir.: Mr. Mangin; Export: Jean Jadin.
Label: Polydor.

Tape, Cartridge: 2-track.

This company represents: Archive (Germany), Archives Litteraires (France), Jacques Canetti (France), OGG (Germany), Excello (USA), Imperial (USA), Kama Sutra (USA), King (USA), MGM (USA), Polydor (Germany), Ranch (Belgium), Saba (Germany), Verve (USA).

Pop. 4 (see Vogue).

Pop. 12 (see Vogue).

President, 30 rue Pierre Semard, Paris 9. Tel: LAM 49.20. Contact: Ted Moura.
RCA (see AREA).

R G M, 16 rue Latour-d'Auvergne. Tel: 526.42.66.
R O G, 7 rue St. Lazare, Paris 9. Tel: 878.76.96.
Sales: Airaut Roger; Int'l: M. d'Anella.

Relax (see Iramac).

Saphir, 22 rue Jean-Jacques Rousseau, Paris 1. Tel: 236.04.47.

Sinfonia, 68 Av. des Champs Elysees, Paris 8. Tel: ELY. 53.60. Contact: J. F. Lion.

SOCIETE FRANCAISE OU SON (La), 30 rue Beaujon, Paris B. Tel: 924.19.01. Cable: Occadis. Pres.: Henri Froment; Dir.: Mme. de Rieux; A&R: Jacques Bec, A. Evans, Gerard Hugel; Sales Dir.: C. Gagniere; Pub.: Mlle M. Burlet.
Labels: Cid, La Societe Francaise du Son.
This company represents: Ace of Hearts (USA), Brunswick (USA), Decca (Britain), London (USA). (SEE ADVERTISEMENT)

Teppaz, 170 Blvd. de la Croix Rousee, Lyon. Tel: 28.56.75.

Typic, 13 rue de l'Echiquier, Paris 10. Tel: PRO. 39.15. Contact: Julio Garzon.

Unidisc (see OCO).

Valois, 19bis, rue de Vanve, Boulogne (Seine). Tel: VAL. 99.99. Contact: Michel Bernstein.

Vega, 49 Av. Hoche, Paris B. Tel: CAR. 19.92 & 16.34. Contact: Henri Froment.

This company represents: ABC-Paramount (USA), Impulse (USA).

Visage de France (see Vogue).

Visage du Monde (see Vogue).

VOGUE, 82 rue Maurice Grandcoing, Villetaneuse (Seine). Tel: 752.73.00. Cable: VOGOISC. Pres.: Leon Cabat; A&R: Jacques Wolfsohn, Christian Fechner, Pierre Lefevre, Andre Clergeat, Michel Guillaneuf, Jean-Pierre Recazin, Albert Ferreri.
Labels: (owned) Ange, Cochon d'Inde, Contrepoint, ENF (children albums), Fashion, Horizon, Juniors, Kangourou, Loisirs, Michel, Mode, Orpheu, Pacific, Pingoin, Pop. 4, Pop. 12, Visage de France, Visage du Monde. (distributed) AZ, Lou, May, Monte-Carlo, Number One, Palmares.

This company represents: Rozenblit (Brazil), Franco-Oisques (Canada), Marquee London, Pye, Stevie Prod'ns (England); Scandia Music (Finland); Deutsche Vogue (Germany); Negram (Holland); Clan Celentano, Ourium, Jolly, SAAR, Sprint (Italy); Teichiku (Japan); Orfeu (Portugal); Belter, Hispavox (Spain); Turicaphon (Switzerland); Autumn, Bounty, Budget Sound, Chattahoochee, Davon, Oot, Ouke, Elektra, Everest, Glad-Hamp, GNP Crescendo, Guardian Inds., Jay Gee, Joda, Jubilee, Kapp, Laurie, Mainstream, Peacock, Premier, Red Bird, Reprise, Roost, Roulette, Scepter, Time, Warner Bros. (USA); Jugaton (Yugoslavia). (SEE ADVERTISEMENT)

Voix de son Maitre (La) (see Pathe-Marconi).

● music publishers

Leon Agel, 96 rue Rene-Boulangier, Paris 10. Tel: BOT. 17.77.

Alpha, 54 rue d'Hauteville, Paris 10. Tel: TAI. 93.82.

Amour, 24 rue Pierre Semard, Paris 9. Tel: TRU. 56.39. Contact: Ted Moura.

Amphion, 5 rue Jean-Ferrandi, Paris 6. Tel: ANJ. 94.15.

Branch: 3 rue Roquepine, Paris 8.

Armagnac-Music, 12 Blvd. Poissonniere, Paris 9. Tel: PRO. 25.02.

Atlantic, 60 Blvd. de Clichy, Paris 9. Tel: MON. 56.47.

Charles Aznavour, 124 rue La Boetie, Paris B. Tel: 225.80.30.

Baerenreiter, 19 bis due de Vanve, Boulogne (Seine). Tel: VAL. 99.99. Contact: Mme. Bernstein.

P. Baetz, 52 rue du Faubourg-St.-Martin, Paris 10. Tel: NOR. 45.91.

Bagatelle, 10 rue Washington, Paris B. Tel: ALM. 17.99.

Bals de France, 82 rue du Faubourg-St.-Martin, Paris 10. Tel: NOR. 45.91.

Eddie Barclay, 2 Av. de Messine, Paris B. Tel: LAB. 06.03.

Irving Berlin, 4 rue d'Argenson, Paris 8. Tel: ANJ. 56.05.

Paul Beuscher, 27 Blvd. Beaumarchais, Paris 4. Tel: TUR. 18.98.

Boosey & Hawkes, 4 rue Orouot, Paris 9. Tel: PRO. 73.44.

S. Bornemann & Editions P. Decourcelle, 15 rue de Tournon, Paris 6. Tel: OAN. 05.88.

Bourrellet, 55 rue St.-Placide, Paris 6. Tel: BAB. 23.59.

H. Bourtayre, 56 rue Bassano, Paris B. Tel: ELY. 29.29.

R. Breton, 3 rue Rossini, Paris 9. Tel: TAI. 53.64.
Maurice Brun, 41 bis rue Vandrezanne, Paris 13. Tel: GOB 75.85.

C E M C O M E S, 50 Faubourg-de-Trois-Maisons, Nancy (Meurthe-et-Moselle).

C I P E M, 60 Blvd. de Clichy, Paris 18. Tel: MON. 56.47.

Gerard Calvi, 54 rue d'Hauteville, Paris 10. Tel: TAI. 93.84.

Camia, 80 rue Rene-Boulangier, Paris 10. Tel: NOR. 06.54.

Caravelle, 3 Blvd. Malesherbes, Paris B. Tel: 265.08.93.

Emile Carrara, Prod'ns du Club, 86 Faubourg-St.-Martin, Paris 10. Tel: LAM. 63.37.

M. Cayla, 33 Faubourg-St.-Martin, Paris 10. Tel: BOT. 91.66.

A. T. Cekow, 11 rue Mansart, Paris 9. Tel: FIG. 64.11.

Centre d'Art National Francais (Paris-Toulouse). B.P. 98 RP, Toulouse (Hte.-Garonne). Tel: 52.86.71.

J. M. Champel, B.P. 2, Neuville-sur-Ain (Ain). Tel: 17.

Champs-Elysees 5 Ave. de l'Opera, Paris 1. Tel: OPE. 37.37.

Chant du Monde, 32 rue Beaujon, Paris B. Tel: WAG. 67.73.

Chappell, 4 rue d'Argenson, Paris B. Tel: ANJ. 56.05.
Comete, 80 rue Rene-Boulangier, Paris 10. Tel: LAM. 69.74.

Comtesse, 44 rue de Miromesnil, Paris B. Tel: 265.87.80.

Comufra, 252 Faubourg-St.-Honore, Paris 8. Tel: MAC. 50.16.

Consortium Musical Berger, 24 Blvd. Poissonniere, Paris 9. Tel: PRO. 21.22.

O M F, B rue Caumartin, Paris 9. Tel: RIC. 51.83, 51.84.

M. O'Anelia, 118 rue Legendre, Paris 17.
Dauphine, 44 rue de Miromesnil, Paris B. Tel: 265.87.80.

De Clercq, 44 rue du Colisee, Paris B. Tel: BAL. 69.84.

Oecluck, 61 Ave. Ray-Poincare, Paris 16. Tel: PAS. 69.69.

G. Oelrieu, 45 Av. de la Victoire, Nice (Alpes-Maritimes). Tel: B61.96.

Oeprince, 31 Faubourg-St.-Martin, Paris 10.
Oicado, 1 Sq. de la Mayenne, Paris 17. Tel: 380.68.25, 19.79.

L. Oigoude-Oiodet, 39 Faubourg-St.-Martin, Paris 10. Tel: BOT. 28.61.

Walt Disney, 4 rue d'Argenson, Paris 8. Tel: ANJ. 56.05.

Jean Orejac, 60 rue Francois 1er, Paris B. Tel: ELY. 62.36.

Ourand, 4 Pl. de la Madeleine, Paris 8. Tel: OPE. 45.74.

Eco, 33 rue Le Peletier, Paris 9. Tel: PRO. 08.53.
Edisonor, 14 rue des Messageries, Paris 10. Tel: PRO. 89.78.

Editions Billaudot, 14 rue de l'Echiquier, Paris 10. Tel: PRO. 13.77.

Editions Bonita, 252 Faubourg-St.-Honore, Paris B. Tel: 622.50.16.

Editions Carrousel, 54 rue d'Hauteville, Paris 10. Tel: TAI. 93.82.

Editions Chaillot, 13 rue de Washington, Paris 8. Tel: 359.34.35 & 704.19.80.

TUTTI,

in Paris, is PHILIPS' publishing company but we are also the most independent publisher. Your song will go to the best artist whatever his label may be. Ask for our monthly best-sellers list and check for yourself.

We are very proud of our A & R and Promotion team. They will plug your song all over France and get the top TV shows.

THE BEST . . .

THE SAFEST . . .

THE MOST ACTIVE IN PARIS

General Manager:
International Manager:
Copyright Manager:
Manager A & R department
A & R:
A & R:
Head Promotion Department.

Jean PIERARD
Claude PASCAL
Georges AUTHIER
Bob LUMBROSA
Maurice BOUCHOUX
Max AMPHOUX
Katia BABL
Catherine CLEMENT

TUTTI-PHILIPS

15, Rue Saussier-Leroy
PARIS 17

PHILIPS FRANCE *is proud to record*

**THE "SOUND" OF
Paul MAURIAT
FRENCH BIG ORCHESTRA**

All the top french and foreign titles written with his "spécial" and "personnal" touch

You must listen to it!!!



mono 77.275 stéréo 842.120



mono 70.309 stéréo 842.126



mono 70.328 stéréo 842.134



"Special issue"
**All the russian
evergreens
the most romantic
LP!!!**



Société Phonographique **PHILIPS** 6 et 8 Rue Jenner **PARIS**

continued

Editions Choudens, 38 rue Jean-Mermoz, Paris 8. Tel: BAL. 17.21 & ELY. 3151.
 Editions Concorde, 252 Faubourg-St.-Honore, Paris 8. Tel: MAC. 50.16.
 Editions Continental, 17 rue Monsigny, Paris 2. Tel: 742.49.18 & 742.61.83.
 Editions Coquelicot, 6 rue Francoeur, Paris 18. Contact: Roland de Cande.
 Editions Essex, 28 Blvd. Poissoniere, Paris 9. Mgr.: Ellen Nathan; Prof. Mgr.: Jack Robinson.
 Editions Fernando, 29 rue Ste.-Marthe, Paris 10. Tel: NOR. 39.42.
 Editions Francaises de Musique, 26 rue Beaujon, Paris 8. Tel: CAR. 77.90.
 Editions Internationales Arlequin, 82 rue du Faubourg-St.-Martin, Paris 10. Tel: BOT. 76.83.
 Editions Magali, 33 rue de la Rochefoucauld, Paris 9. Tel: FIG. 77.35.
 Editions Marguerita, Schoenaers, Millereau Reunis, 29 Blvd. Malesherbes, Paris 8. Tel: ANJ. 90.12.
 Editions Marine, 153 Av. de Neuilly, Paris 16. Tel: 624.07.40.
 Editions Mellottee, 48 rue Monsieur-le-Prince, Paris 6. Tel: DAN. 03.87.
 Editions Metropolitan, 3 rue Rossini, Paris 9. Tel: PRO. 21.78.
 Editions Micro, 14 rue Washington, Paris 8. Tel: BAL. 43.03.
 Editions Montmartre, 28 Blvd. Poissoniere, Paris 9. Tel: TAI. 86.89, 52.17.
 Editions Musicales Arpege, 25 Blvd. Beaumarchais, Paris 4. Tel: ARC. 51.28.
 Editions Musicales Hortensia, 46 rue de Douai, Paris 9. Tel: TRI. 52.64.
 Editions Musicales de Morville, 14 Av. Hoche, Paris 8. Tel: WAG. 01.46.
 Editions Musicales Schola Cantorum et de la Procure Generale de Musique, 76 bis rue des Sts.-Peres, Paris 7. Tel: LIT. 70.50.
 Editions de l'Ours, 56 rue de l'Universite, Paris 7. Tel: LIT. 26.17. Contact: Mlle. Jacqueline Carnet.
 Editions Paris-Inter, 7 rue St.-Lazare, Paris 9. Tel: 878.76.96. Dir.: M. d'Anella.
 Editions Petit Duc, 22 rue de l'Echiquier, Paris 10. Tel: PRO. 80.57.
 Editions Pigalle, 89 rue La Boetie, Paris 8. Tel: ELY. 76.54.

Editions Salabert, 22 rue Chauchat, Paris 9. Tel: TAI. 55.60.
 Editions Screen Gems/Columbia, 71 rue de Provence, Paris 9. Tel: 874 68.47. Contact: Rudi Revil.
 Editions Theven, 34 rue Pigalle, Paris 9. Tel: TRI. 41.18.
 Editions Transatlantiques, 14 Av. Hoche, Paris 8. Tel: WAG. 01.13.
 Editions Tropicales, 28 Blvd. Poissoniere, Paris 9. Tel: PRO. 25.28.
 Editions Trois Balances, 19 rue J-J-Rousseau, Paris 1. Tel: CEN. 17.70.
 Editions Universelles, 52 rue du Faubourg-St.-Martin, Paris 10. Tel: NOR. 45.91.
 Enoch, 27 Blvd. des Italiens, Paris 2. Tel: RIC. 69.95.
 Epis (Les), 14 Blvd. des Filles-du-Calvaire, Paris 11. Tel: ROQ. 36.58.
 M. Eschig, 48 rue de Rome, Paris 8. Tel: LAB. 66.64.
 F R A N C E, 16 rue Santerre, Paris 12. Tel: NAT. 47.21 & BOT. 76.83.
 Fantasia, 3 rue de Gramont, Paris 2. Tel: RIC. 96.10.
 Fortin, 4 cite Chaptal, Paris 9. Tel: TRI. 58.34.
 Sam Fox, 46 rue Laffite, Paris 9. Tel: TRU. 07.79.
 France Continentale, 80 rue Rene-Boulanger, Paris 10. Tel: NOR. 06.54.
 France Melodie, 5 Av. de l'Opera, Paris 1. Tel: OPE. 37.37, 33.11.
 France Vedettes, 44 rue du Colisee, Paris 8. Tel: BAL. 69.83.
 Francis-Day, 5 Av. de l'Opera, Paris 1. Tel: OPE. 37.37.
 French Music, 124 rue La Boetie, Paris 8. Tel: BAL. 80.30.
 Rose Frizza, 56 rue de Paradis, Paris 10. Tel: PRO. 19.64.
 Julio Garzon, 13 rue de l'Echiquier, Paris 10. Tel: PRO. 39.15.
 Louis Gaste, 5 rue du Bois-de-Boulogne, Paris 16. Tel: POI. 53.53.
 Gedalge, 75 rue des Sts.-Peres, Paris 6. Tel: LIT. 53.79.
 Golf, 10 Av. Frochet, Paris 9. Tel: 878.53.03.
 Grandes Editions Musicales, 4 rue Drouot, Paris 9. Tel: PRO. 73.44.
 J. Hamelle, 22 Blvd. Malesherbes, Paris 8. Tel: ANJ. 36.39.
 Michel Havanair, 7 rue de Tretaigne, Paris 18. Tel: CLI. 17.39.

Heugel, 2 bis rue Vivienne, Paris 2. Tel: GUT. 43.53.
 Homere (Union des Auteurs et Musiciens Aveugles), 26 rue de Charenton, Paris 12. Tel: 628.61.79.
 Imperia Editions Musicales, 8 rue Caumartin, Paris 9. Tel: RIC. 51.81 & OPE. 59.46.
 J. Jobert, 44 rue du Colisee, Paris 8. Tel: ELY. 26.82.
 Joker, 17 rue St.-Florentin, Paris 8. Tel: 742.88.99 & 265.85.57.
 Joubert, 25 rue d'Hauteville, Paris 10. Tel: PRO. 15.73.
 L Y S, 50 rue Croix-des-Petits-Champs, Paris 1. Tel: 488.45.16.
 Branch: 17 rue St.-Florentin, Paris 8.
 Albert Lasry, 62 Blvd. de Clichy, Paris 18. Tel: MON. 53.00.
 G. Leblanc, 70 rue des Rigoles, Paris 20. Tel: MEN. 59.52.
 A. Leduc, 175 rue St.-Honore, Paris 1. Tel: OPE. 12.80.
 R. Legoux, 4 rue Chauveau-Lagarde, Paris 8. Tel: ANJ. 36.78.
 H. Lemoine, 17 rue de Pigalle, Paris 9. Tel: TRI. 89.25.
 Limousine Edition (Segurel), Chaumeil (Correze). Tel: 4.
 Francis Lopez, 5 rue Lincoln, Paris 8. Tel: ELY. 10.81, 50.90.
 Pepe Luiz, 14 rue Chaptal, Paris 9. Tel: FIG. 24.03.
 Majestic-Lucienne Canetti, 252 Faubourg-St.-Honore, Paris 8. Tel: 924.69.70.
 Manege, 4 Av. de Clichy, Paris 17. Tel: 522.54.50.
 Marcus, 33 Faubourg-St.-Martin, Paris 10. Tel: NOR. 89.05.
 R. Martin, 106 La Coupee, Charnay-les-Macon, (Saone-et-Loire).
 Masspacher, 39 Passage du Grand-Cerf, Paris 2. Tel: GUT. 02.02.
 Mediterranee, 252 Faubourg-St.-Honore, Paris 8. Tel: MAC. 50.16.
 Robert Mellin, 74 Blvd. de la Gare, Paris 13.
 Meridian, 5 rue Lincoln, Paris 8. Tel: ELY. 10.81, 50.90.
 Mills, 67 rue Provence, Paris. Cable: SACEM. Mgr.: Gerard Tournier.
 Monde-Melody, 6 rue Vivienne, Paris 2. Tel: CEN. 71.75.
 R. Monis, 26 rue du Chateau-d'Eau, Paris 10. Tel: 807. 28.85.

LOOKING FOR FRENCH HITS FESTIVAL'S GOT THEM



**MARIE LAFORET
 GIGLIOLA CINQUETTI
 LES SURFS
 BOBBY SOLO
 ANDRE VERCHUREN
 PIA COLOMBO
 NINA & FREDERIK
 MICHEL DELPECH
 LEE CHAMBERLIN
 ACKER BILK**



LOOKING FOR HITS PROMOTION FESTIVAL'S GOT IT

50 000 000 FRENCHMEN

CAN'T BE WRONG
*
IN NAMING



FRANCE'S N°1 LABEL

HUGUES AUFRAY * CHARLES AZNAVOUR * ALAIN
BARRIERE * JACQUES BREL * DALIDA * MAURICE
FANON * JEAN FERRAT * LÉO FERRÉ * MIREILLE
* MATHIEU * EDDY MITCHELL * MONTY *
* CHARLES TRÉNET *

DISTRIBUTION
*



CHESS



THESE 50 000 000 FRENCHMEN DO NOT INCLUDE 10 000 000 BELGIANS,
12 000 000 DUTCH AND 6 000 000 SWISS.
WHO AGREE 100 % WITH THE ABOVE STATEMENT.

IN FRANCE

COMPAGNIE PHONOGRAPHIQUE FRANÇAISE *
143, AVENUE DE NEUILLY, NEUILLY-SUR-SEINE

IN BELGIUM

COMPAGNIE PHONOGRAPHIQUE FRANCO-BELGE BARCLAY *
31, RUE DU LOMBARDO · BRUXELLES

IN HOLLAND

BARCLAY NEDERLAND *
SINGEL 104 · AMSTERDAM

THEODIE

"Turner was the greatest watercolorist of his era . . . he had an enormous influence on Impressionism and even on the advanced art of the 20th century."—Robert Beverly Hale, Curator of American Paintings and Sculpture at the Metropolitan Museum of Art."

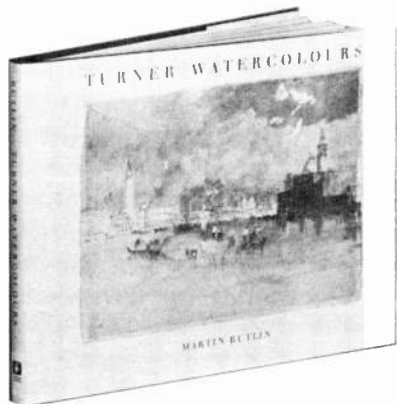

TURNER WATERCOLOURS

By MARTIN BUTLIN
Assistant Keeper, Tate Gallery

This is the year that Turner is *in!* For everyone who has discovered the greatness of Turner, here is a beautiful art book that faithfully reproduces 32 of his finest watercolors and traces the artist's growth from a conventional landscape painter to one of the great precursors of modern art. "The great importance of Turner as a watercolorist, the high quality of the reproductions, and Mr. Butlin's scholarly and eloquent commentaries make this book a major contribution to the literature of art."—William C. Seitz, Curator of Painting and Sculpture Exhibitions at the Museum of Modern Art. "Turner's work represents the highest point of the watercolorist's art and these color plates are so faithful the reader seems to be watching the master at work."—H. Lester Cooke, Curator of Painting at The National Gallery of Art. "A book that approaches perfection."—Eric Newton, *The Guardian*.

84 pages. 12 $\frac{3}{8}$ x 9 $\frac{3}{4}$. 32 color plates.
\$15.00

Order Now. Clip this coupon.

Watson-Guption Publications, Dept. 1321
2160 Patterson St., Cincinnati, Ohio 45214

Send me
(Check)

Turner Watercolours

I may return my order within ten days
of receipt for full credit or refund if
I am not satisfied. (USA only)

I enclose \$ _____

Name (Please print) _____

Street _____

City, State & Zip _____

Add sales tax where applicable. For NYC
add 5%; for Calif. add 4%. Send check
or M.O. only.

continued

- Edwin J. Morris, 4 rue d'Argenson, Paris B. Tel: ANJ. 56.05.
Musica Films, 15 rue Montjuret, Clarmont-Ferrand (Puy-de-Dome). Tel: 37.68.
Jean Naudin (Fils), Fontaine-Chandon, Amboise (Indre-et-Loire).
P. Noel, 24 Blvd. Poissonniere, Paris 9. Tel: PRO. 21.22.
Nuances, 3 rue Roquepine, Paris B. Tel: ANJ. 51.47.
L'Oiseau Lyre, 122 rue de Grenelle, Paris 7. Tel: INV. 51.73.
Ouvrieres, 12 Av. Soeur-Rosalie, Paris 13. Tel: GOB. 86.23.
H. Panella, 1 bis rue Bleue, Paris 9. Tel: TAI. 45.31.
Paris-Centre Accordeon, Masseret (Correze). Tel: 37.
Paris Hollywood, 38 rue Jean-Mermoz, Paris B. Tel: BAL. 17.21.
Paris Melodie, 76 Champs Elysees, Paris 8. Tel: BAL. 49.80.
Pathe Marconi, 22 Av. de la Grande-Armee, Paris 17. Tel: 425.29.94.
Peter Maurice, 14 Av. Hoche, Paris 8. Tel: WAG. 01.13, 01.46.
Philippe Pares Editions, 46 rue Laffitte, Paris 9. Tel: TRU. 07.79.
Philippo, 24 Blvd. Poissonniere, Paris 9. Tel: TRI. 89.24.
Picot, 50 Blvd. de Strasbourg, Paris 10. Tel: COM. 94.53.
Jacques Plante, 35 Blvd. Malesherbes, Paris B. Tel: ANJ. 08.93.
Pleins Feux (George Berard), 12 Blvd. Poissonniere, Paris 9. Tel: PRO. 86.04.
Ploix Musicque, 48 rue St-Placide, Paris 5. Tel: LIT. 82.25.
Premiere, 44 rue de Miromesnil, Paris B. Tel: 265.87.80.
Presence, 33 Faubourg-St.-Martin, Paris 10. Tel: NOR. 89.05.
Prisma Music, 40 rue du Faubourg-Poissonniere, Paris 10. Tel: PRO. 53.01.
Productions Allouia-Gerard Meys, 252 Faubourg-St.-Honore, Paris 8. Tel: MAC. 50.16.
Productions Michel Legrand, 252 Faubourg-St.-Honore, Paris B. Tel: MAC. 50.16.
Productions Francis Lemarque, 121 Blvd. de la Marne, La Varenne-St.-Maur (Seine). Tel: GRA. 34.21.
Prosadis, 14 Av. Hoche, Paris B. Tel: 924.81.93.
Ricordi, 3 rue Roquepine, Paris B. Tel: ANJ. 94.15.
Royalti, 25 rue d'Hauteville, Paris 10. Tel: PRO. 67.26.
Rythmes Nouveaux (Les), 3 rue Gustave-Goublier, Paris 10. Tel: BOT. 21.94.
S D M, 20 rue du Croissant, Paris 2. Tel: 236.48.97.
S E M I (Societe d'Editions Musicales Internationales), 5 rue Lincoln, Paris 8. Tel: ELY. 50.90, 10.81.
S I M, 56 rue Bassano, Paris B. Tel: ELY. 28.52.
R. Salvat, 89 rue la Boetie, Paris 8. Tel: ELY. 76.54.
Sandra Music, 17 rue Monsigny, Paris 2. Tel: 742.05.23.
Spanka, 44 rue de Miromesnil, Paris 8. Tel: 265.-87.80.
F. Sudre, 17 Av. Trudaine, Paris 9. Tel: TRU. 72.23.
Sylva, 4 rue d'Argenson, Paris B. Tel: ANJ. 56.05.
Tournesol, 6B & 70 rue Lhomond, Paris 5. Tel: POR. 25.81.
Train Bleu, 12 rue de Magellan, Paris B. Tel: 225.96.60.
TUTTI, 46 rue Laffitte, Paris 9. Tel: LAM. 40.42. (SEE ADVERTISEMENT)
Vendome, 5 rue Lincoln, Paris B. Tel: ELY. 50.90, 10.81.
Ray Ventura, Tel: WAG. 01.46, 01.13.
Vianelly, 3 rue Rossini, Paris 9. Tel: TAI. 53.64.
Williams, 62 rue d'Orsel, Paris 18. Tel: ORN. 19.04.
A. Zurluh, 73 Blvd. Raspail, Paris 6. Tel: LIT. 68.60.

● supplies & services

JACKET MANUFACTURERS

Garrod & Lofthouse, 2 rue Emile, Chatou, Paris.
Tel: Chatou 9664990 & Balzac 0065.

PRESSING PLANTS

- Disco-France, 180 rue Lafayette, Paris 10. Tel: NOR. 95.34.
Pathe-Marconi, 19 rue Lord Byron, Paris B. Tel: BAL. 53.00.
Phillips, 6 rue Jenner, Paris 13. Tel: GOB. 48.90.
Societe de Faconnage Industriel, 21 rue Pierre Vallette, Malakoff 92. Tel: ALE. 62.69.
Societe Francaise d'Enregistrements Sonores, 18 rue Pigalle, Paris 9. Tel: FIG. 25.93.
Societe Francaise de Presse, 51 Av. de la Division Leclerc, 93 Villetaneuse. Tel: PLA. 75.95.

- Societe Francaise de Technique Sonore, 14 rue des Flandres, 94 Vitry-sur-Seine. Tel: ITA. 77.05.
Societe Francaise du Son, 30 rue Beaujon, Paris B. Tel: WAG. 19.01.
Vogue, 82 rue Maurice Grandcoing, Villetaneuse, Seine. Tel: PLA. 73.00.

RECORDING & TAPE DUP. STUDIOS

- Agence Generale d'Enregistrement Sonore, 16 Place Vendome, Paris 1. Tel: 073.96.45.
Air-Production, 134 Blvd. Haussmann, Paris B. Tel: 277.12.17.
Auditorium (P.B.), 11 rue Scholcher, Paris 14. Tel: 326.55.61.
Barclay-Hoche, 9 Av. Hoche, Paris B.
Century, 13 rue des Francs-Tireurs, La Courneuve (Seine), Paris. Tel: FLA. 27.71.
Comedie des Champs Elysees, 15 Av. Montaigne, Paris B. Tel: BAL. 05.06.
Diffusion Magnetique Sonore, 15 rue Saussier-Leroy, Paris 17. Tel: 924.40.55.
Enregistrements A D M (Les), 23 rue Palestro, Paris 2. Tel: 236.75.60.
Europa-Sonor (Studio A), 15 rue Charcot, Paris 15. Tel: JUS. 33.33 & (Studio B), 2-B rue de la Gaite, Paris 15.
Europ-Union, 5 rue Montholon, Paris 9.
Louis Gaste, 5 rue du Bois de Boulogne, Paris 16. Tel: 704.53.53.
Genex, 6 rue Jouvenet, Paris 16.
General Prod'ns, 26 rue Marbeuf, Paris 8. Tel: 359.00.18.
Images de France, 29 rue Vernet, Paris B. Tel: 359.53.17.
Intersonor, 55 rue de la Croix Nivert, Paris 15.
Magali, 33 rue de la Rochefoucauld, Paris 9. Tel: 744.77.35.
Marignan, 15 rue Forest, Paris 18. Tel: 522.58.32.
Moureaux-Nery, 73 Blvd. Cdt-Charcot, Neuilly. Tel: 722.41.30.
Pathe Marconi, rue de Sevres, Boulogne (Seine).
Polydor, 44 rue des Dames, Paris 17.
Poste Parisien, 116 bis Av. des Champs Elysees, Paris 8.
Sarc (Sonorisation Artistique Radiophonique & Cinematographique), 31 Blvd. Port-Royal, Paris 13. Tel: 707.04.26.
Sem (Societe Enregistrement Montmartre), 19 rue Burq, Paris 18. Tel: 076.09.44.
Sergent Lucien Pere, 34 rue du Colisee, Paris B. Tel: 359.83.81.
Societe Industrielle de Sonorisation (S.I.S.), 22 Av. de la Porte de Champerret, Paris 17. Tel: GAL. 96.11. Pres.: J. Guevel; Mgr.: M. Brunet.
Branch: 10 rue du Chateau, La Garenne-Colombes. Tel: CHA. 63.89.
Societe Phonographique Philips, 94 Blvd. Auguste-Bianqui, Paris 13. Tel: 535.00.88.
Studios des Victoires, 50 rue Croix des Petits Champs, Paris 1.
Technisonor, 12 rue Magellan, Paris 8. Tel: 225.-96.60.
Voxgrave, Steinway Hall, 6 rue de Lisbonne, Paris 8.

MUSIC LICENSING ORGANIZATIONS

- B I E M (Bureau International de l'Édition Mécanique), 12 rue Ballu, Paris 9. Tel: TRI. 20.11.
Cable: Biemusico-Paris, 84.
S A C E M (Societe des Auteurs, Compositeurs et Editeurs de Musique), 10 rue Chaptal, Paris 9. Tel: FIG. 85.25.

● tape

TAPE MANUFACTURERS

- Kodak, 37 Av. Montaigne, Paris 8. Tel: ALM. 48.11.
Minnesota de France, 135 Blvd. Serurier, Paris 19. Tel: BOL. 71.19.
Pyrat, 47 rue de l'Echat, 94 Creteil. Tel: 207.48.90.
Sonocol, 35 Quai de la Baronnie, 94 Ablon. Tel: 922.30.04.

CARTRIDGE TAPE MANUFACTURERS

Philips ELA, 162 rue St. Charles, Paris 15. Tel: LEC. 21.29.

GERMANY, EAST

Population: 1964 census—17,011,931.
(No other statistics available)

● record manufacturers

- Deutsche Schallplatten (VEB), Reichstagufer 4-5, Berlin 108.
Record Playing, Kurt Ehrlich, Otto Gedlichstr. 25, Pirna Copitz.

● music publishers

Breitkopf & Haertel (VEB), PO Box 147, Karlsstr. 10, 701 Leipzig.

Deutscher Verlag Fuer Musik (VEB), PO Box 147, Karlsstr. 10, 701 Leipzig.

Harth, Karl-Liebkechtstr. 12, 701 Leipzig. Tel: 32612. Cable: MUSICA. Pres.: Curt Clauss.

Friedrich Hofmeister, PO Box 147, Karlsstr. 10, 701 Leipzig.

Lied der Zeit (VEB), PO Box 1515, Hankestr. 3, 102 Berlin. Tel: 425081. Cable: Lied der Zeit.

Pro Musica, Karl-Liebkechtstr. 12, 701 Leipzig. Tel: 32612. Cable: MUSICA. Pres.: Curt Clauss.

IMPORTER & EXPORTER

Deutscher Buchexport & Import, Leninstr. 16, 701 Leipzig.

GERMANY, WEST

Population: 55,214,400.

Official rate of exchange: \$1 (US) = 4 D.M. (German marks).

Per capita income: \$181 monthly.

Records imported from U.S.: 1956—\$709,569. (figure includes recordings, record blanks & pre-recorded tapes).

Records exported to U.S.: 1965—\$965,392; 1964—\$1,000,427.

Stereo sales: 11% of all LP's.

Percentage record sales of pop music: Approx. 86.5% of all records.

Average retail price: 12-inch LP's—\$4.50; 10-inch LP's—\$3.75; EP's—\$2; Singles—\$1.19.

Record club sales: Approx. 14% of all sales.

Discounting: Occasional.

Retail record dealers: About 7,000.

Medium wave radio stations: 14.

FM stations: 12.

Television stations: 9.

Number of jukeboxes: About 60,000.

Record distributing system: From manufacturer to dealer through own distribution organization. Also, from manufacturer to wholesaler to dealer.

Important regulations: Duty value—13.2% of list

price. When imported from Common Market countries—7%. In both cases, 6% purchase tax must be paid. GEMA, the German Performing Rights Society, gets 8% of retail selling price for singles.

● record manufacturers

Ariola-Eurodisc, Friedrichsdorferstr. 75, 483 Gutersloh. Tel: 3427. Dir.: Dr. Werner Vogelsang; Sales: Friedrich Schmidt; Pop A&R: Egmont Luftner, Landwehrstr. 33, B Munich 15. Tel: (08 11) 59 1021; Classical A&R: Fritz Ganss, Viktoria-Luise-Platz 7, 1 Berlin 30. Tel: (03 11) 24 42 92.

Labels: Ariola, Ariola-Athena, Baccarola, Cantagallo, Eurodisc, Hansa, Karate, Melodia-Eurodisc, Ufa.

This company represents: Embassy (England), Fonit-Cetra (Italy), Ha-Voc (Holland), Laurie (USA), Negram (Holland), Oriole (England), Vega (France), Vergara (Spain), World Record Club (England).

Int'l representatives: Australia (W & G), Austria (Ariola), Belgium (Discobell), Canada (Canadian Music Sales), Denmark (Metronome), Finland (Scandia), France (Vega), Holland (Negram), Israel (Russcol), Italy (Fonit-Cetra), Norway (Nor-Disc), South Africa (Teal), Sweden (Cupol), Switzerland (Musikvertrieb), United Kingdom (Oriole), USA (German News).

Baerenreiter, Heinrich-Schuetz-Allee 29-37, Kassel-Wilhelmshohe. Tel: 3 00 11. Contact: Dr. h.c. Karl Voetterle.

Labels: Baerenreiter-Musicaphon, Cantate.

C B S, Palmengartenstr. 4, 6 Frankfurt/Main. Tel: 77 08 61. Cable: Colrecord. Mg'g Dir.: Bernhard Mikulski; Admin. Dir.: Helmut Hecht; A&R Mgr.: Joachim Lehmann; Pop. A&R: Jurgen Kramer; Classical A&R: Hans-Richard Stracke; Mktg. Dir.: Herbert Giesewetter; Pub. & Promo.: Dietlind Rieth; Adv.: Anton Simmert.

Branches: Fassenstr. 44, Berlin-Wilmersdorf. Tel: 902B52.—Sternstr. 67, Dusseldorf. Tel: 483685.—Hagedornstr. 6, Hamburg 13. Tel: 457400.—Fliegenstr. 4, Munich. Tel: 551915.

This company represents: Blue Note, CBS, Epic, Funckler, Gordy, Hickory, Musicor, Regina, Tamla-Motown, Westminster.

Camerata, Hoffman-von-Fallerlebenstr. B, Wolfenbuttel. Tel: 22684. Owner: Karl-Heinrich Moeseler.

Cantagallo, Sonnenstr. 20, Munich 15. Tel: 55 80 51. Pres.: Dr. Karl Heinz Busse; Int'l: H. W. Schiemke.

Deutsche Austrophon, PO Box 187, 284 Diepholz/Hannover. Tel: (05 441) 344. Cable: Austrophon. Dir.: Rolf Neumann Jr.; Sales: Ulrich Wilke.

This company represents: Camerata, Christophorus, Da Camera, Elite Special, Hippo, Jupiter, MCE, Pelka, Ricordi, Swiss Jazz, Triola.

DEUTSCHE GRAMMOPHON, Harvestehuderweg 1-4, Hamburg 13. Tel: 44 14 21. Cable: Grammophon. Dirs.: Helmut Haertel, J. van der Velden, C. Solleveld, Dr. Hans-Werner Steinhäuser; A&R: Otto Gerdes, Guenther Ilgner, Heinz Voigt; Sales: Kurt Kinkele.

Labels: Archive, Brunswick, Deutsche Grammophon, Polydor, Heliodor.

This company represents: Ava (USA), Big Top (USA), Brunswick, Charlie Parker (USA), Command (USA), Fiesta (USA), Grand Award (USA), Italdisc (Italy), Kama Sutra (USA), MGM (USA), Palacio (Venezuela), Peerless (Mexico), United Artists (USA), Verve (USA).

Int'l representatives: Afghanistan (Siemens), Algeria (Siemens), Argentina (Philips), Austria (Polyphon), Australia (Philips), Belgium (Polydor), Brazil (Brasileira), Canada (Compo, Quality), Costa Rica (Siemens), Chile (Philips), Colombia (Philips), Denmark (Nordisk Polyphon), Eire (Siemens), El Salvador (Kismet), Finland (Fintone), France (Polydor), England (DGG), Greece (Helladisc), Hong Kong (Companion), Iran (Alfi & Cohen), Italy (Phonogram), Japan (Nippon Grammophon), Lebanon (Maison Succes), Luxembourg (Polydor), Morocco (Siemens), Mexico (Discos Universales), Netherlands (Polydor), New Zealand (Philips), Norway (Nordisc), Peru (El Virrey), Portugal (Philips), Malaysia (The Cycle & Carriage), South Africa (Gallo), Spain (Fonogram), Sweden (Karusell), Switzerland (Siemens), Uruguay (Philips), USA (MGM, Decca), Venezuela (Siemens), Yugoslavia (Jugoton). (SEE ADVERTISEMENT)

Deutsche Overseas Recs., Muntpratstr. 1B, Konstanz. Gen. Mgr.: Michel Liber.

This company represents: Athene (Greece),



ERIC CHARDEN

Claudie

pas question
va-t'en
de ma vie
s'il fallait
460.974



une chanson "Claudie" sélectionnée pour la "Rose de France 1966", 2 chansons que vont enregistrer les Moody Blues, Eric se révèle brusquement comme un auteur-compositeur-interprète "dans le vent de demain"

PUSSY CAT



The new
teenage
idol
in France

ce n'est pas une vie
(sha-la-la-la-lee)
stop!
les temps ont changé
mais pourquoi...

86.148



continued

Clan Celentano (Italy), Ciao Ragazzi (Italy), Fantasy (Italy), Maietti (Italy), Marfer (Spain), Melody (Greece), Melodi (Turkey), Primary (Italy), PIG (Italy), Ribalta (Italy), Ri-Fi (Italy), Rondo (Germany), Said (Italy), Sir (Italy), Silver Record (Italy), Sunstar (Italy), Togo (Italy), Variety (Italy), Zephyr (Italy).

Deutscher Schallplattenclub, Libanonstr. 3-5, 7 Stuttgart 13. Tel: (0711) 4 53 41. Cable: Stuttgartbuch. Contact: G. von Holtzbrinck, W. Schoenicke, Dr. U. Unger.

Labels: Deutscher Schallplattenclub, Eurocord. Deutsche Vogue, Zur Muhle 2, 5021 Grosskoenigsdorf, Cologne. Tel: (02234) 3961. Cable: DEUVOG. Mg'g Dir.: J. J. Finsterwald; Gen. Mgr.: R. Lilla; Sales Mgr.: H. Juergens; Int'l Mgr.: L. Yaskiel; Exp. Mgr.: R. Roemer.

This company represents: AZ, Autumn, Blue Car, Cadet, Caramba, Cellograf Simp, Celson, Checker, Chess, Collection du Chat Botte, Collection du Musee de l'Homme, Congress, Contrepoint, Conversaphone, Deutsche Vogue, Dixieland Jubilee, Dot, Durium, Everest, Four Corners, GNP Crescendo, Hamilton, Hispavox, Hitton, Horizons, Jazz Selection, Jolly, Josie, Jubilee, Kapp, Line, MK, Michel-Ange, Mode Int'l, Musette Club, Music, Orpheo, PC, Pacific, Pacific Junior, Palette, Phonocolor, Picadilly, Pinguin, Pop, Premier, Primavera, Puppy, Pye, Red Bird, Roulette, SP, Saar, Scepter, Stella, Strike, Style, Swing, Tico, Time, Transatlantic, Visages de France, Visages du Monde, Vogue, Vogue Contrepoint, Vogue France, Vogue Pye, Wand, Xtra, Zafira.

Int'l representatives: France & Switzerland (both Vogue).

Electrola, Maarweg 149, 5 Cologne/Braunsfeld. Tel: (0221) 49 31 31. Dir.: Dr. Ladislav Veder; Pop. A&R: Heinz Villmann; Classical A&R: Dr. Helmut Storchhann; Sales: Wilfried Jung; Pub. Mgr.: Herfrid Kiar; Adv. Mgr.: Heinz Intveen; Artist Promo.: Walter Friedrich; Exp. Mgr.: August Batzem.

Labels: Capitol, Columbia, Electrola, Hoer zu, Liberty, Odeon.

This company represents: Amy (USA), Angel (USA), Appollon (Greece), Armonia (Greece), Athenee (Greece), Avlon (Greece), Baidaphon, BAM (France), Baronet (USA), Bell (USA), Buena Vista (USA), Cairophon, Capitol (Mexico), Carisch (Italy), Chrisso Mikrophone (Greece), Classic Editions (USA), Cortina (Greece), Dede (Liberia), Desto (USA), Diamond (USA), Directional Sound (USA), Discophiles Francais (France), Discophon (Greece), Disneyland (USA), Dolton (USA), Dore (Greece), DynoVoice (USA), Ember (Britain), Encore (Britain), Erato (France), Esengo, Favorit (Austria), Folkways (USA), Greek Voice (Greece), His Master's Voice, Hoer zu (Germany), Imperial (Holland), Imperial (USA), Kabarett aus Wien (Austria), Keravnophone (Greece), Lawn (USA), Lebendiges Wort (Austria), Liberty (USA), Lilly (Greece), Logo (USA), Lyra (Greece), MMO (USA), Mala (USA), Ma. Miranda M. (Greece), Melody (Greece), Mocambo (Brazil), Monitor (USA), Musart (Mexico), Music (Austria), Music Box (Greece), Musicland (USA), Muza (Poland), Nashboro (USA), New Voice (USA), Odeon, Olutone, Oskar (Greece), Pan-Vox (Greece), Parlophone, Pathe (France), Phoenix (Greece), Polyphone (Greece), Popular (Greece), Preiser-Recs. (Austria), Premier (USA), Die Prominente Stimme (Austria), Pronit (Poland), Regal, Regal-Zonophone, Rhythmophone (Greece), Rogie, Sahibinin Sesi (Turkey), Salonica (Greece), Simonetta (Greece), Sout-Elphan, Souvenir (Austria), Stateside, Stella (Greece), Sun-Sing (Hong Kong), Swan (USA), Tina (Greece), Toshiba (Japan), Tower (USA), Trianon (France), Unikum (Austria), Uptown (USA), Voce del Padrone (Italy), Voix de l'Islam, Voix de l'Orient, Voix de son Maitre (France), Voix du Liban, La Voz de su Amo (Spain), A Voz do Dono (Portugal), Waverly (Britain), Zeida (Columbia).

Eriksound Prod'ns, Schubertstr. 30, Osterath. Tel: 4935-4B35. Cable: Eriksound. Gen. Mgr. & Promo.: Erik Schoenland; Pop. A&R: Ed Holland; Classical A&R: Toni Hedderich; Pub.: B. van Tienhoven.

Eurodisc-Musikproduktion, Landwehrstr. 33, B Munich 15. Tel: 591021. Cable: Eurodisc. Mg'g Dir.: Egmont Luftner; Pop. A&R: Alisch, Fehring, Milko, Schmidt-Norden; Classical A&R: Ganss; Int'l: Varenholz.

Labels: Ariola, Ariola-Athena, Baccarola, Eurodisc.

Int'l representatives: Australia (WRC), Austria (Ariola), Belgium (Discobel), Canada (Canadian Music Sales), England (Oriole, World Rec. Club), Finland (Nor-Disc), France (Vega), Holland

(Negram), Italy (Fonit-Cetra), Japan (King), Mexico (RCA Mexico), Norway (Nor-Disc), South Africa (Teal), Spain (Almapres, Circulo de Lectores), Switzerland (Musikvertrieb), USA (Fiesta, Kapp, RCA Victor).

Golden 12, Papenhuderstr. 42, Hamburg 22. Tel: 24 69 54. Contact: Reinhard Streit.

Hansa, Wittelsbacher 18, 1000 Berlin 31. Tel: 90 23 45. Contact: Peter Meisel.

Hippo, Haumkamp 45, 2 Hamburg 39. Tel: 51 64 74. Cable: HIPPORECORDS. Mg'g Dir.: Frank Valdor. Label: Hippo.

Int'l representative: Switzerland (Pick).

Hitsville, PO Box 64, 21 Im Leimen, 61 Darmstadt-Arheilgen. Dir.: Karl L. Schneider; A&R & Int'l: Gangolf K. Zimmermann.

Labels: Century 21, Hitsville, Spectrum.

Wolf Hoehc, PO Box 706, Parkstr. 21, 75 Karlsruhe. Tel: 62185. Contact: Wolf Hoehc.

International, Sonnenstr. 20, Munich 15. Tel: 55 80 51. Pres.: Dr. Karl Heinz Busse; Int'l: H. W. Schemke.

Iramac, Josefskirchplatz 5, 4400-Muenster. Tel: 40217. Pres.: H. Brockhoff; A&R: S. S. A. Samama.

Labels: Iramac, Relax.

Italia, Sonnenstr. 20, Munich 15. Tel: 55 80 51. Pres.: Dr. Karl Heinz Busse; Int'l: H. W. Schemke.

This company represents: CGD, Meazzi, Ricordi.

Jupiter (see Stellina).

Metronome, Heidenkampsweg 76 B, 2 Hamburg 1. Tel: (0411) 24 12 61. Cable: METRONOME. Dir. & A&R: Leif E. Kraul; Sales & A&R: Reinhard Streit.

Label: Metronome.

This company represents: Atco (USA), Atlantic (USA), Bang (USA), Barclay (France), Belter (Spain), Golden 12 (Germany), Italia (Germany), International (Germany), Metronome (Denmark), Metronome (Sweden), Riviera (France), Sonet (Denmark), Storyville (Denmark), Supraphon (Czechoslovakia).

Int'l representatives: Austria (Ariola), England (EMI), Denmark (Metronome), Finland (Scandia-Musikkii), France (Festival, Sopholest), Holland (Dureco, Metronome), Norway (Nor-Disc), Spain (Belter), Sweden (Metronome), Switzerland (Jecklin), USA (Atlantic, Metronome).

Monopol, c/o Will Meisel Verlage, Wittelsbacherstr. 1B, 1 Berlin 31. Tel: BB3 23 45.

Philipston, Moenckbergstr. 7, 2 Hamburg 1. Tel: 33 92 21. Cable: Pihag. Dir.: Hans Schrade; Sales: Georg Augustin; A&R: Wolfgang Kretzschmar.

Labels: Chestland, Dixieland, Fontana, Good Time Jazz, HiFi, HiFi Jazz, Pergola, Philips.

This company represents: ABC (USA), Amadeo (Austria), Debut (Denmark), Emarcy (USA), HiFi (USA), Impulse (USA), Mercury (USA), Mira (USA), Mirwood (USA), Pacific Jazz (USA), Riverside (USA), Smash (USA), Star Club (Germany), Surrey (USA), Vee (USA), Wing (USA), World Pacific (USA).

Int'l representatives: Argentina (Philips), Australia (Philips), Belgium (Phonogram), Brazil (Companhia Brasileira de Discos), England (Fontana, Philips), Colombia (Phonoton, Philips), Chile (Philips), Denmark (Nordisc, Polyphon), Egypt (Philips Orient), Ecuador (Philips), Finland (Philips Facers), France (Philips, Interdisc), Greece (Heladisc), Holland (Phonogram, Philips, Fontana), Italy (Philips, Phonogram), Ireland (Philips), Iran (Philips Teheran), India (Philips Indien), Japan (Nippon Victor), Lebanon (Philips Libanon), Mexico (Philips), New Zealand (Philips), Norway (Norsk Phonogram), Paraguay (Philips), Portugal (Philips), Pakistan (Philips), South Africa (Grammophon), Spain (Philips), Syria (Philips Orient), Sweden (Philips), Switzerland (Philips), Turkey (Philips), USA (Philips, Mercury), Uruguay (Philips), Venezuela (Siemenes Renzola), Yugoslavia (Philips).

L. Schwann, PO Box 7640, 4 Dusseldorf 1. Tel: 35581.

Stellina, Am Biederstein, 7 Munich 23. Tel: 34 70 11. Cable: Siegelmusik. Pres.: Ralph Maria Siegel.

Labels: Stellina, Jupiter.

Sud, Nymphenburgerstr. 139/1, B Munich 2. Tel: 5169771.

Supertone, Melcherstr. 2a, Munich 19. Tel: 514 44 29. Pres.: Dr. Heinz Stein; Promo: Waldemar Simon.

Branch: Quint-Musikverlag, Munich 19. Tel: 55 06 85.—Nymphenburgerstr. 3B, Munich 19. Tel: 55 06 85.

Labels: Amati, Starlet, Supertone.

Int'l representative: Switzerland (Layola).

TELDEC (Telefunken-Decca), Heussweg 25, Hamburg 19. Tel: 40191. Pres.: Hans Lieber; VPs: Artur Waizenegger, Kurt Richter; Classical A&R: Dr.

Gerhard Slavik; Pop. A&R: Gunther H. Borchert. Labels: Coral, Decca, Decca (US Group), Hoer zu, London, RCA Victor, Reprise, Telefunken, Warner Bros.

This company represents: Telefunken (Germany), Decca (England), Decca (American series), Coral (USA), London (USA), RCA (USA), Reprise (USA), Warner Bros. (USA). (SEE ADVERTISEMENT)

Tip, 5B Adolfstr., Hamburg 22. Tel: 23 39 48. Pres.: H. J. Fruechticht.

Tonbild, Rosenbuschstr. 6, Munich 22. Tel: (0811) 22 01 86. Dirs.: Michael Ingerl, Joachim Brandenburger; Pub.: Freiherr Von Ruxleben; Adv.: Hans-Alexander.

Branch: Herxheim B. Landau. Tel: 06342B-113.

● music publishers

ABERBACH, Warburgstr. 22, Hamburg 36. Tel: 44 20 02. Cable: Abermusik. Pres.: Jean Aberbach; Gen. Mgr.: Dr. Rudolph Bollow; Gen. Prof. Mgr.: Rudolf Slezak.

Affiliates: Bella-Ton, Colby, Fein, Musikverlag Benday, Musikverlag Lark, Musikverlag Progressive, T.M. (SEE ADVERTISEMENT)

Alba (see Southern).

Alkor, Heinrich-Schuetz-Allee 29, Kassel-Wilhelmshoehe. Tel: 30014. Contact: Dr. Oeser.

Allegro-Theatreverlag (see Oktave).

Paul C. R. Arends, PO Box 20, Hoehenweg 22, B211 Rimsing. Tel: (08051) 634 & 2385. Cable: Arendsmusic. Pres. & Gen. Mgr.: Mrs. Gerda Arends; Gen. Prof. Mgr.: Michael Arends. Affiliates: Edition Trumpf, Burlington.

This company represents: Burlington, Good, Palace (Great Britain); Acclaim, Blue Crest, Cireco, Four Star Sales, Glad, Jack, Jec, Sagittarius, Tree, Tuckahoe, Zodiac (USA).

Ralf Arnie (GEMA), Wrangelstr. 5, 2 Hamburg 20. Tel: 46 40 41. Pres.: Ralf Arnie.

Affiliate: Star-Musikproduktion.

Atrium, Rothenbaumchausee 191, 2 Hamburg 13. Tel: 44 7B 10. Contact: Felix Stahl.

Automaten-Service Kretz, Sofienstr. 179, 75 Karlsruhe.

Baerenreiter, Heinrich-Schuetz-Allee 29-37, Kassel-Wilhelmshoehe. Tel: 30011/16. Contact: Dr. h. c. Karl Voetterle.

Bavariaton (see Musik-Edition Discoton).

Beco (see Oktave).

Bella-Ton (see Aberbach).

Belmont, Zur Muhle 2, 5021 Grosskoenigsdorf/Cologne. Tel: (02234) 3961 & 2025. Mg'g Dir.: J. J. Finsterwald; Int'l: Lawrence Yaskiel.

Richard Birnbach, Durerstr. 28 a, Berlin-Lichterfelde 1. Tel: 73 13 71. Contact: Joh. Birnbach.

Eduard Bloch, Hilperstr. 9, Darmstadt. Tel: 74120.

Contact: Hans Manfred Otto.

Gustav Bosse, Landshuterstr. 14 a, Regensburg. Tel: (55455) 7173. Pres.: Bernhard Bosse.

Bosworth, Hoehstr. 133, 5 Cologne. Tel: 21 14 79. Pres.: Maud Sinclair; Gen. Prof. Mgr.: Fritz Hartmann.

Bote & Bock, Hardenbergstr. 9 a, Berlin 12. Tel: 32 39 B1.

Georg Bratfisch, Treudelstr. 5, 865 Kulmbach. Tel: (09221) 4800. Pres.: Edithe Bratfisch; Gen. Prof. Mgr.: Heinz Bratfisch.

Braun-Peretti, Hahnchen passage, 53 Bonn. Tel: 3459B. Pres.: Jakob & Konrad Christ.

Brilliant (see Musikverlage Hans Gerig).

Rolf Budde, Hohenzollerndamm 54 A, 1 Berlin 33. Tel: 886 50 51. Cable: BUDEMUSIC. Pres.: Rolf Budde.

This company represents: Dick James (England), Northern Songs (England), Music Publishers Holding Corp. (USA).

Burlington (see Paul C. R. Arends).

Busse, Sonnenstr. 20, Munich 15. Tel: 55 80 51. Contact: Dr. Karl Heinz Busse.

Affiliates: Edition ABC Musikhaus, Edition Bellevue, Edition Cantagallo.

Camerate, PO Box 460, Wolfenbuttel. Tel: 22684.

Capriccio, Monckbergstr. 5, Hamburg. Tel: 33 40 96. Mgr.: Peter Lach.

Carlton (see Musikverlage Hans Gerig).

Chappell, 10 Sendlinger Tor, Platz, Munich 2. Tel: 59 6B 2B.

Christophorus, Hermann-Herderstr. 4, Freiburg/Breisgau. Tel: 31240.

Colby-Hamburg (see Aberbach).

Deutsche Austrophon, PO Box 187, 284 Diepholz/Hann. Tel: (05441) 344. Cable: AUSTRUPHON.

Dreiklang-Dreimasken, Sonnenstr. 19, Munich 15. Tel: 55 79 57. Cable: Dreiklang.

Drei Ringe, Hohenzollerndamm 54 A, 1 Berlin 33. Tel: 886 50 51. Cable: Buddemusic. Pres.: Rolf Budde.

Gerhard Ebeler (see Musikverlage Hans Gerig). Edition ABC Musikhaus (see Busse).

TELDEC

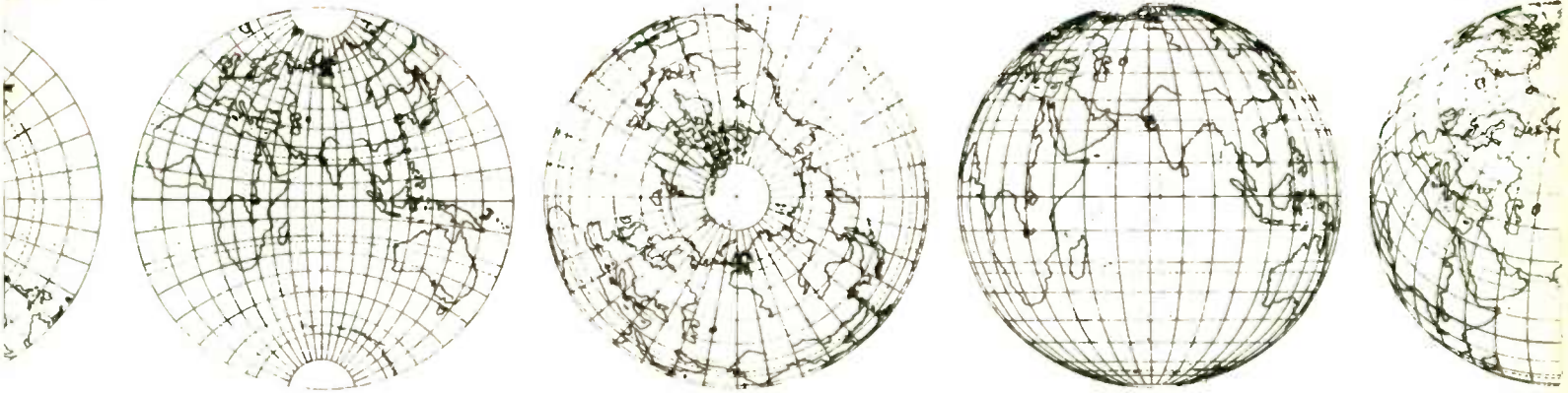

REPRESENTING THE WORLD'S MOST IMPORTANT RECORD LABELS AND INTERNATIONALLY FAMOUS ARTISTS IN GERMANY

		Drafi Deutscher	(Decca)		
		Hildegard Neff	(Decca)		
		(Hildegard Knef)			
		Len Barry	(Decca)	Chet Atkins	(RCA-Victor)
		Don Kosaken	(Decca)	Bobby Bare	(RCA-Victor)
		Buddy Holly	(Coral)	Jim Reeves	(RCA-Victor)
		Kingston Trio	(Decca)	Rita Pavone	(RCA-Victor)
		Milch Miller	(Decca)	Mario Lanza	(RCA-Victor)
		Brenda Lee	(Decca)	Eartha Kitt	(RCA-Victor)
		Manuela	(Telefunken)	Roy Orbison	(London)
		Ronny	(Telefunken)	Tijuana Brass	(A & M)
		Egerländer Musikanten	(Telefunken)	Peter, Paul & Mary	(Warner Bros.)
		Oberkrainer Quintett	(Telefunken)	Everly Bros.	(Warner Bros.)
		Willy Schneider	(Telefunken)	Count Basie	(Reprise)
		Harry Belafonte	(RCA-Victor)	Sammy Davis Jr.	(Reprise)
		Al Hirt	(RCA-Victor)	Duke Ellington	(Reprise)
		Elvis Presley	(RCA-Victor)	Frank Sinatra	(Reprise)
		Peggy March	(RCA-Victor)	Dean Martin	(Reprise)
		Paul Anka	(RCA-Victor)	Nelson Riddle	(Reprise)
		Floyd Cramer	(RCA-Victor)	Nancy Sinatra	(Reprise)
		Glenn Miller	(RCA-Victor)	Trini Lopez	(Reprise)
The Rolling Stones	(Decca)				
Caterina Valente	(Decca)				
Will Glahé	(Decca)				
Werner Müller	(Decca)				
Mantovani	(Decca)				
Ted Heath	(Decca)				
Edmund Ros	(Decca)				
Los Machucambos	(Decca)				



DECCA



RCA VICTOR

LONDON

reprise:



CORAL

TELDEC Schallplatten-Gesellschaft mbH. Hamburg/Germany

World Radio History

SURE, IN GERMANY

IT'S



ABERBACH

YOUR PUBLISHER TO DEAL

WITH!

2 HAMBURG 36
WARBURGSTR. 22
TEL. 442002/04

LOOKING FOR . . .

a new "Sound" to replace some band your catalog may be loosing? Playbacks for a Musical or Opera you'd like to produce at low cost?

Program Material for: an Esoteric Line?
a Classical Line?
a Budget Line? a Pop Line?
or perhaps Films, Backgrounds,
Cartridges or Tapes?

THEN ASK FOR OUR

"LIBRARY OF RECORDED MUSIC"

General Catalog, or Contact

ARTISTS FILMS, INC.

c/o Paul Lazare,
2 HAMBURG 22,
Muehlendamm 41,

West Germany Phone: 22-58-66

Or any one of our representatives:

WIM BOSHECK
Hemsterhuisstraat 241,
AMSTERDAM, 1B, HOLLAND 15-46-89

O. van ERDEN-REPPERT
Via Padre Semeria 13,
GENOA, Italy 20-52-21

Roy Kohn
Southern Library of Recorded Music
1619 Broadway
New York, N.Y. 10019 CO 5-3910

JEAN ZIEGLER
10, Rue Stanislas
PARIS, 6me, France LIT 5162

continued

Edition Accord, Hohenstaufenring 63, 5 Cologne. Tel: 23 80 67. Contact: Otto Demler.
Edition Bellevue (see Busse).
Edition Cantagallo (see Busse).
Edition Canzonetta, Petzowerstr. 13, Berlin 39. Tel: 809 17 40. Cable: CANZONETTA. Pres. & Gen. Mgr.: Francisca Bochmann.
Edition Capella (see Musikverlage Hans Gerig).
Edition Esplanade, Rathenastr. 25, 2 Hamburg 39. Tel: 51 51 87 & 51 82 11. Pres.: Lotar Olias; Gen. Mgr.: Harold Frahm.
Edition Excelsior (see Musikverlage Hans Gerig).
Edition Intro Gebr. Meisel, Wittelsbacherstr. 18, 1 Berlin 31. Tel: 91 40 57. Cable: INTROMUSIK. Pres.: Peter & Thomas Meisel; Gen. Mgr.: Irmtrud Sennert; Gen. Prof. Mgrs.: Peter & Thomas Meisel.
Affiliates: Nero Musikverlag Gerhard Hammerling, Hansa Musik Produktion.
Edition Majestic, Helmstedterstr. 27, 1 Berlin 31, Wilmersdorf. Tel: 87 48 44. Contact: Erwin Paesike.
Editions Melodia (see Musikverlage Hans Gerig).
Editions Meteorion (see Oktave).
Edition Montana, Neuhauserstr. 3, 8 Munich 2. Tel: 26 10 96. Cable: Montanamusic. Pres.: Hans R. Beierlein.
Edition Rialto (see Musikverlage Hans Gerig).
Edition 63 (see Musikverlage Hans Gerig).
Edition Supra (see Musikverlage Hans Gerig).
Edition Titania (see Musikverlage Hans Gerig).
Editions Trumpf (see Paul C. R. Arends).
Essex (see Musikverlage Hans Gerig).
Eurocord, Aichelestr. 7, 7 Stuttgart/Plieningen. Tel: 25 46 77. Contact: Dr. Udo Unger.
Fein-Hamburg (see Aberbach).
Kurt Fletz, Drususgasse 7-11, Cologne. Tel: 21 57 23.
Sam Fox (see Southern).
Francis, Day & Hunter (see Melodie Der Welt).
Friedrich Wilhelm Froehlich, Ansbacherstr. 52, Berlin 30. Tel: 24 13 77. Contact: Hilda Froehlich.
Goodman Music (see Musikverlage Hans Gerig).
Hansa Musik Produktion (see Edition Intro Gebr. Meisel).
Hanssler, Hattenbachweg 16, 7 Stuttgart/Hohenheim. Tel: 25 31 B4. Pres. & Gen. Prof. Mgr.: Friedrich Hanssler.
Branch: Echterdingerstr. 3, 7 Stuttgart/Plieningen. Tel: 25 48 78. Gen. Prof. Mgr.: Elsa Schwermer.

Max Hieber, Kaufingerstr. 23, Munich. Tel: 22 72 12. Owner: Adolf Hieber.
Michael Jary Produktion (see Melodie der Welt).
Otto Junne, Sendlinger-Torplatz 10, Munich. Contact: Harry Schultz-Bielefeld.
C. F. Kahnt, in der Hofstatt, Lindau/Bodensee. Tel: (08382) 2283.
Leeds (see Musikverlage Hans Gerig).
F. E. C. Leuckart, Boecklinstr. 1, Munich 19. Tel: (0811) 516 26 33. Cable: Leuckartverlag. Pres.: Erich Sander; Gen. Mgr.: Dr. Dietrich Sasse; Gen. Prof. Mgr.: Marco Sander.
Branch: Anhalterstr. 4, Leipzig 21. Gen. Prof. Mgr.: Kurt Bruckner.
Affiliate: Tischer & Jagenberg.
Will Meisel, Wittelsbacherstr. 18, 1 Berlin 31. Tel: 883 23 45.
MELODIE DER WELT, Grosse Friedbergerstr. 23-27, 6. Frankfurt/Main. Tel: 28 78 47. Contact: Johann Michel.
Affiliates: Francis, Day & Hunter; Michael Jary Produktion; Progress. (SEE ADVERTISEMENT)
Meteorion (see Oktave).
Mills, Hohenzollernndamm 54 A, 1 Berlin 33. Tel: 886 50 51. Cable: Buddemusic. Pres.: Rolf Budde.
Ivan Mogull, Kurfurstendamm 103, 1 Berlin 31.
K. H. Moseler, PO Box 460, Wolfenbittel. Tel: 22684. Cable: Moselerverlag. Owner: Karl-Heinrich Moseler.
Mozart, Wittelsbacherstr. 823, Bad Reichenhall. Tel: 3219. Contact: Gustav Zagler.
Musik-Edition Discoton, Sonnenstr. 19, 8 Munich 15. Tel: 55 79 57. Cable: Ufaton.
Affiliates: Bavariaton, Ufaton, Wiener Boheme.
Musikverlag Benday (see Aberbach).
Musikverlag Carl Engels, Bulowstr. 44, 433 Mulheim-Ruhr. Tel: 52592. Pres.: Caroline Engels.
Musikverlag Lark (see Aberbach).
Musikverlag Progressive (see Aberbach).
MUSIKVERLAGE HANS GERIG, Drususgasse 7/11, Cologne/Rhein. Tel: 23 48 33. Cable: Gerigverlage. Pres.: Dr. Hans Gerig; Gen. Mgr.: Erwin Boche; Gen. Prof. Mgr.: Heinz Korn.
Affiliates: Brilliant, Carlton, Gerhard Ebeler, Edition Capella, Edition Excelsior, Edition Melodia, Edition Rialto, Edition 63, Edition Supra, Edition Titania, Essex, Goodman, Leeds, Willi Ostermann, Polyphon, Jupp Schmitz, August Schnorrenberg, Sidemton. (SEE ADVERTISEMENT)
Nero Musikverlag Gerhard Hammerling (see Edition Intro Gebr. Meisel).
Johannes Oertel, Prinzregentenstr. 64, Munich. Tel: 44 13 94. Contact: Marianne Schorkoff.
Oktave, Heinrich Barthstr. 13, 2 Hamburg 13. Tel: (0411) 44 53 23. Pres.: Alfred K. Schacht; Gen. Prof. Mgr.: Peter Majewski.
Affiliates: Allegro Theaterverlag, Beco, Meteorion, Schacht, Tonika.
Orlando, Dachauerstr. 173, 8 Munich 2. Tel: 516 26 39. Contact: Richard Gartenmaier.
Willi Ostermann (see Musikverlage Hans Gerig).
Peer (see Southern).
Polyphon (see Musikverlage Hans Gerig).
Josef Preissler, Brauhausstr. 8, 8000 Munich 2. Tel: 22 40 51. Pres.: Josef Preissler & Inge Preissler; Gen. Mgr.: Gernot Rosin.
Progress Musik (see Melodie Der Welt).
Schacht (see Oktave).
Paul Schmidt, Wittelsbacherstr. 18, Berlin. Tel: 91 40 57. Contact: Peter Meisel.
Jupp Schmitz (see Musikverlage Hans Gerig).
August Schnorrenberg (see Musikverlage Hans Gerig).
B. Schott's Soehne, Weihergarten 5, Mainz. Tel: 24341.
L. Schwann, PO Box 7640, 4 Dusseldorf 1. Tel: 35581.
AUGUST SEITH, 10 Sendlinger Tor. Platz, Munich 2. Tel: 59 68 28. (SEE ADVERTISEMENT)
777, im Kirling 11, 414 Rheinhausen. Tel: 777. Cable: Acorn. Pres. & Gen. Mgr.: Lambertus B. de Jonge.
Ralph Maria Siegel, Biederstein 7, Munich 23. Tel: 34 70 11. Cable: Siegelmusik. Pres.: Ralph Maria Siegel.
Sirius, Wiciefstr. 67, Berlin 21. Tel: 35 41 33. Pres.: Margarita Katz.
Sidemton (see Musikverlage Hans Gerig).
Southern, Klaerchenstr. 11, 2000 Hamburg 39. Tel: 48 86 45. Cable: SOUTHMUSIC. Gen. Mgr.: Theodor O. Seeger; Asst. Mgr.: Mrs. G. Seeger.
Affiliates: Alba, Sam Fox, Peer.
Spanka, Hohenzollernndamm 54 A, 1 Berlin 33. Tel: 886 50 51. Cable: Buddemusic. Pres.: Rolf Budde.
Stamm, Goldammerweg 16, 43 Essen-Stadtwald.
Star-Musik Produktion (see Ralf Arnie Musikedition).
Stella, PO Box 460, Wolfenbittel. Tel: 22684. Gen. Prof. Mgr.: Karl-Heinrich Moseler.

TAPE CARTRIDGE

continued from page 161

NORTH CAROLINA

• **CHARLOTTE** (Area Code 704)
Arthur Smith, PO Box 17551, 5457 Old Monroe Rd. Tel: 536-0424.
• **GREENSBORO** (Area Code 919)
Copeland Sound, PO Box 6104. Tel: 275-0434.

OHIO

• **CLEVELAND** (Area Code 216)
Cleveland Rec., 1515 Euclid Ave. Zip: 44115. Tel: 621-9362. Pres.: Frederick C. Wolf; VP: Kenneth R. Hamann.
W B K R Broadcast Serv., 1169 Sylvania Rd. Tel: 382-0900.

• **COLUMBUS** (Area Code 614)
Magnetic Studios, 1670 W. First Ave. Tel: 486-2469.
• **DAYTON** (Area Code 513)
Mega-City Music, 126 Davis Ave. Zip: 45403. Tel: 256-6931 & 256-6557.

PENNSYLVANIA

• **FRANKLIN** (Area Code 814)
Process Rec., 439 Wiley Ave. Zip: 16323. Tel: 432-4633.
• **SHARON** (Area Code 412)
Marjon, 930 Woodview Pl. Tel: DI 7-4726.

RHODE ISLAND

• **PAWTUCKET** (Area Code 401)
Johnston Sound Serv., 111 Sweet Ave. Tel: 723-7773.

TENNESSEE

• **NASHVILLE** (Area Code 615)
Columbia Rec. Prod'ns, 804 16 Ave., S. Tel: 255-0371.
Globe, 420 Broad St. Tel: AL 5-7645.
R C A Custom Rec. Sales, 800 17 Ave., S. Tel: AL 5-5781.

TEXAS

• **AMARILLO** (Area Code 806)
Demand Rec. Org., 2027 S. Bonham St. Tel: 356-4806.
• **FORT WORTH** (Area Code 817)
Oakridge, 2001 Elton Rd. Tel: TE 8-660B.

T M (see Aberbach).
 Otto Teich, Hilpertstr. 9, 61 Darmstadt. Tel: 74120.
 Contact: Claus Manfred Otto.
 Tischer & Jagenberg (see F. E. C. Leuckart).
 P. J. Tonger, Bergstr. 10, 503B Rodenkirchen/Rhein.
 Tel: Cologne (0221) 30 15 0B.
 Tonika (see Oktave).
 Tonos, Ahastr. 7, 61 Darmstadt. Tel: 76347. Contact:
 Franz Koenig.
 Ufaton (see Musik-Edition Discoton).
 Ugrino, Elbchausee 499a, 2 Hamburg 55, Tel:
 B6 01 73. Contact: Signe Jahnn.
 Chr. Friedrich Vieweg, Limonenstr. 10, Berlin 45,
 Lichterfelde. Tel: 76 65 51. Contact: Horst
 Koppe.
 VIKTORIA, Werner Scharfenberger K.G., Dachauerstr.
 16, B Munich 2. Tel: 59 21 93. Mgr.: Hanns
 Huber. (SEE ADVERTISEMENT)
 Wiener Boheme (see Musik-Edition Discoton).
 Josef Weinberger, Oederweg 26, Frankfurt/Main.
 Contact: Johann Michel. Tel: 59 03 19. Cable:
 Weinjos.
 Paul Woitschach, Artuswall 4B, 1 Berlin 2B. Pres.:
 Paul Woitschach.
 Wilhelm Zimmermann, Zeppelinallee 21, Frankfurt/
 Main. Tel: 77 24 60. Contact: Edith Zimmer-
 mann.

● **independent record producers**

Viktoria Musikproduktion, Werner Scharfenberger,
 Dachauerstr. 16, B Munich 2. Tel: 59 21 93.
 Mgr.: Hanns Huber.

● **record wholesalers**

DISTRIBUTORS

Top Hit, Sonnenstr. 20, Munich 15. Tel: 55 80 51.
 Pres.: Dr. Karl Heinz Busse.

IMPORTERS & EXPORTERS

Action, Inc. (British-American Rec. Club), PO Box
 64, 21 Im Leimen, 61 Darmstadt-Arheilgen.
 Mgr.: Gangolf Zimmermann.
 Ariola-Eurodisc, Friedrichsdorferstr. 75, Guetersloh.
 Tel: 3427.
 Deutsche Vogue, 5021 Grosskoenigsdorf. Cable:
 Deuvog.

PAUL LAZARE, Muhlendamm 41, Hamburg 22. Tel:
 22 58 66. (SEE ADVERTISEMENT)
 Platten-Bussee, Sonnenstr. 21, Munich 15. Contact:
 Dr. Karl Heinz Busse.
 Karl L. Schneider, PO Box 64, 61 Darmstadt-
 Arheilgen

● **record club**

Action, Inc. (British-American Rhythm & Blues Rec.
 Club), PO Box 64, 21 Im Leimen, 61 Darmstadt-
 Arheilgen. Pres.: Karl L. Schneider; Sales Mgr.:
 Gangolf K. Zimmermann.

● **supplies & services**

MUSIC LICENSING ASSOCIATIONS

G E M A (Gesellschaft fuer musikalische Auffue-
 hrungs-und mechanische Vielfaeltigungs-
 rechte), Herzog-Wilhelm-Str. 2B, B Munich 2.
 Tel: 55 79 01.
 Branch: Bayreutherstr. 37-3B, 1 Berlin 30.
 Tel: 24 99 51.
 Gesellschaft zur Verwertung von Leistungsschutz-
 rechten, Spichernstr. 55, Cologne.

PRESSING PLANTS

Ariola-Eurodisc, Friedrichsdorferstr. 75, Guetersloh.
 Tel: 3427.
 Electrola, Maarweg 149, Cologne-Braunsfeld. Con-
 tact: Carl Lindstrom.
 Teldec, Niedernstr., Nortorf. Tel: 911.

RECORDING & TAPE DUP. STUDIOS

Ariola-Eurodisc, Friedrichsdorferstr. 75, 483 Gueters-
 loh. Tel: 3427.
 Rolf Bauer, 46 Markgroeningestr., 714 Ludwigs-
 burg-Egloshein. Tel: 343B.
 Berliner Union-Film, Oberlandstr. 26-35, 1 Berlin
 42 (Tempelhof). Tel: 70 00 11.
 Branch: Viktoriastr. 13-1B, 1 Berlin 42. Tel:
 75 04 61.
 Deutsche Grammophon, Podbielskistr. 164, Han-
 over 3.
 Electrola, Maarweg 149, Cologne-Braunsfeld.
 Europa, Goethestr. 5, Stuttgart N. Tel: 29161.
 Hadeko, graf Landsbergstr. 2-4, Neuss/Rhein. Tel:
 25051.
 Paul Lazare, Muhlendamm 41, Hamburg 22. Tel:
 22 58 66.

Kurt Linnebach, Kepelerstr. 1B, Munich 27.
 Robert Nettekoven, Eschersheimer Landstr. 33,
 Frankfurt/Main.
 Branch: Wolfganstr. 41, 6 Frankfurt/Main.
 Tel: 55 67 32.
 Riva, B043 Unterfoehring, Munich. Tel: 32 60 11.
 777, Rheinhausen 414, Im Kirling. Tel: 777.
 Stellina, Am Biederstein 7, Munich 23.
 Studio Hamburg, PO Box 13107 Tonndorfer Hauptstr.
 90, 2000 Hamburg-Wandsbek. Tel: 66BB1.
 Sudwest, Lortzingstr. (Liederkrantzalle), 7 Stuttgart-
 Botnang. Contact: H. Jansen.
 Teldec, Osterstr. 124, Hamburg 19.
 Branch: AEG-House, Am Steubenplatz, Munich.
 Tel: 6155B.-Finkensteinallee 3B-40, Berlin-
 Lichterfelde. Tel: 73 01 36.-Niedernstr., Nor-
 tort.
 E. Thienhaus & G. Loos, Elbchausee 499, Hamburg-
 Blankenese. Tel: B6 32 69 & B6 33 44.
 Tonbild-Werbung, Rosenbuschstr. 6, Munich 22.

TAPE LICENSORS

Artist Films, c/o Paul Lazare, Muhlendamm 41, 2
 Hamburg 41. Tel: 22 58 66.

TRADE ORGANIZATIONS

Automaten-verband Niedersachsen, 1 Alte Dohrenerstr.,
 Hanover 12.
 Automaten-Verband Rheinland-Pfalz, 153 Kaiserstr.,
 Karlsruhe.
 Automaten-Verband des Saarlandes, Bliesmuhle,
 Neunkirchen.
 Bayerischer Automaten-Verband, Neuhauserstr. 34,
 Munich 2.
 Berliner Automaten-Verband (BAV), Emserstr. 45, 1
 Berlin 15. Tel: BB3 49 35.
 Bundesverband der Phonographischen Wirtschaft,
 Museumstr. 31, Hamburg-Altona.
 Deutscher Automaten-Groshandels-Verband, 3 Grosse
 Backerstr., Hamburg 1.
 Deutscher Automaten-Verband (DAV), 6-B Kaiser-
 Wilhelm-Ring, Cologne.
 Deutscher Komponisten-Verband, Lagardestr. 2B, Ber-
 lin 38 (Schlachtensee).
 Deutscher Musikalien-Wirtschaftsverband, 1 Dreick,
 Bonn.
 Deutscher Musikverleger-Verband 1 Dreick, Bonn.
 Deutscher Sangerbund, Bemhardstr. 166, 5 Cologne-
 Bayenthal. Tel: 38 60 01.

ASK

the professional music man!

*ASK him which music publisher is the best
 in the German music business!*

He'd tell you

GERIG

So, when you think of Germany, think of

GERIG MUSIKVERLAGE

COLOGNE, DRUSUSGASSE 7—11

ALWAYS IN THE SPOTLIGHT



MELODIE DER WELT

J. Michel KG.

**AND READY
FOR BUSINESS IN
OUR NEW OFFICES**



FRANCIS, DAY & HUNTER

G.M.B.H.

FRANKFURT/MAIN

6 FRIEDBERGER STR. 23-27 Tel.: 28 78 47

AUGUST SEITH

Germany's Leading Music Publisher

•
Exclusive Wholesale Sheet Music Distribution
for Leading International Publishers

•
Sendlinger-Tor-Platz 10, Munich 2, Germany

IN GERMANY

A YOUNG and VERY ACTIVE COMPANY

VIKTORIA MUSIKVERLAG

and

VIKTORIA MUSIKPRODUKTION

**Werner Scharfenberger K.G.,
Dachauer Strasse 16, 8 Munich 2
Tele: 59 21 93**

continued

Gemeinschaft Deutscher Musikverbände, Dahlmannstr. 20, Bonn. Tel: 22 03 04.
Gesellschaft zur Verwertung von Leistungsschutzrechten, Spichernstr. 55, Cologne.
Landesverband Baden-Württemberg des Automaten-Aufstellgewerbes, Knoedelstr. 6, Stuttgart-Ost.
Nordwestdeutscher Automaten-Verband, 76 Sogestr., Ecke Wall, Bremen.
Verband des Automaten-Gewerbes Schleswig-Holstein, Holsteinstr. 88/90, Kiel.
Verband der Deutschen, Automaten Industrie (VDAl), 199 Aachenerstr., Cologne-Lindenthal.
Verband Hessischer Automaten-Aufsteller Gluckstr. 7, Frankfurt/Main.
Verband des Norddeutschen Automaten-Gewerbes, 58 Ahrensburgerstr., Hamburg-Wandsbeck.
Zentralverband der Elektrotechnischen Industrie, 19 Siressemannallee, Frankfurt/Main.
Zentralverband der Organisationen des Deutschen Automaten-Aufstellgewerbes (ZOA), Kaiser-Wilhelm-Ring 6-8, Cologne 5.

GREECE

Population: 1961 census—8,387,201; latest official estimate—8,492,000.
Official rate of exchange: \$1 (US)=30 drachmas.
Records imported from US (factory value & in tons): 1964—\$123,400 (211); 1963—\$93,500 (151).
Records exported to US (factory value): 1964—\$90,670.
Records manufactured for domestic and export sale (factory value): 1964—\$1,400,000 (4.2 million units); 1963—\$1,296,500 (3.6 million units).

● **record manufacturers**

General Publishing Co., Kriezotou 11, Athens. Tel: 616-716. Cable: LYRAHELLAS. Top exec.: Alexander Patsifas.
Labels: Lyra, Dionysus.
This company represents: Atlantic (USA), Cetra (Italy), Ducretet-Thomson (France), Vedette (France).
Greek Phonograph Rec. House, 3 Platia Kolocotroni, Athens. Tel: 233-069. Cable: GEORPH. Prop.: Georgios Orphanidis.
Labels: RCA Victor, Melophone, Olympic.
This company represents: CGD (Italy), Carisch (Italy), Dot (USA), Everest (USA), Fonit (Italy), Galleria del Corso (Italy), Juke Box (Italy), Melophone (Greece), Olympic (Greece), Pathe (France), RCA Victor (USA), Reprise (USA), Telefunken (Germany).
Helladisc, Hermou 8, Athens. Tel: 238-291. Cable: Helladisc. Mg'g Dir.: Nikolas Antipapas.
Labels: Fidelity, Philips, Polydor.
This company represents: Archiv (Germany), Ariston (Italy), Atco (USA), Atlantic (USA), Audio Fidelity (USA), Barclay (France), Brunswick, Cameo-Parkway (USA), Coral (USA), Deutsche Grammophon (Int'l), Fontana (Holland), Heliodor (Germany), Jolly (Italy), Kama Sutra, Mercury (USA), Philips (Int'l), Riffi (Italy), Riverside (USA), Roulette (USA), Scepter (USA), Smash (USA), United Artists (USA), Vee Jay (USA), Wand (USA).
Lambropoulos Bros., Stadiou & Eolou Sts. 99, Athens. Tel: 539-811. Cable: ADELAMBRO. Top Exec.: Them. Lambropoulos.
Labels: Columbia, HMV.
This company represents: ABC - Paramount (USA), Capitol (USA), Impulse (USA), Verve (USA), Regal.
Melody, 4 Sparti 3is Septemvriou 13, Athens. Tel: 227-329 & 527-472. Pres.: Anthony Plomaritis & Evans Plomaritis.
Labels: Melody, Athenee, Popular, Lucky.
This company represents: Blue Bell, Combo, Festival (France), Meazzi (Italy), Pacific (USA), Ricordi (Italy), Soutelphan, Voix de l'Orient.
M. Matsas & Son, Stadiou 4B, Athens. Tel: 318-091. Top Exec.: Minos Matsas.
Labels: Odeon, Parlophone.
This company represents: Jaguar, Odeon (France), Parlophone, Tamla Motown (USA), Warner Bros.
Music-Box, Nikis 2, Athens 126. Tel: 221-574. Cable: THOMS. Top Exec.: Martin Gesar.
This company represents: Amy (USA), Ariola (Germany), Bel Air (France), Bell (USA), CBS (USA), Chancellor (USA), Colpix (USA), Decca (USA), Durium (Italy), Epic (USA), Fraternity (USA), Garrett (USA), Kapp (USA), London (USA), Okeh (USA), Palette (USA), Pye (England),

State Side (USA), Swan (USA), Vogue (Germany), Markal.
 Nina, Hellas, 2 Agiou Constantinou St., Athens 101.
 Tel: 531-658. VP & Dir.: Peter Nicolaou.
 Label: Nina.
 Philips Hellenique, PO Box 153, Athens.
 Polydisc, 7 Stadiou St., Athens.
 Yannis & Navrogorato, Rongoti 5, Thessaloniki.

● music publishers

Arion, PO Box 287, Athens. Tel: 880-371. Cable: COLGRAPH. Mgr.: Robert Mackenzie.
 Grecophon, 3 Karagiorgi Servias St., Athens.
 Icaros, 4 Vouliis St., Athens.
 Lucky, 14 St Constantinos, Athens. Tel: 527-472.
 Contact: G. Plomaritis.
 Ivan Mogull, 7 Botassi St., Athens.

● supplies & services

MUSIC LICENSING ORGANIZATION
 Societe Anon. Hellenique pour la Protection de la Propriete Intellectuelle (AEPI), 7 Botassi St., Athens. Mgr.: C. Macris. Tel: 610-322.

PRESSING PLANTS

Columbia Graphophone Co. of Greece, PO Box 287, Athens. Tel: 880-371. Cable: COLGRAPH. Mg'g Dir.: R. Mackenzie; Admin. Mgr.: B. Toumbakaris; Technical Mgr.: E. Areteos; Commercial Mgr.: E. J. Jones; Export: G. Giras.
This company represents (for processing bulk supplies to licensees and record companies as hereunder and for export): Columbia, HMV, Capitol, Odeon, Parlophone, Stateside, MGM, Liberty, Verve, Regal, Sobedi, Imperial, Tamla-Motown, Pathe, Ducretet-Thomson, Ember, Moonglow, Swan, Garrett, Fraternity, Laurie, Rust, Amy, Bell, Diamond, Hispavox, Gamma, Voix de l'Orient, Soutelphan, Cetra, Markal.

GUATEMALA

Population: 4,437,871.
 Official rate of exchange: \$1 (US)=1 quetzal.
 Per capita income: 249.6 (1963).
Records manufactured for domestic and export sales: LP's—40,000 units, \$80,000; Singles—40,000 units, \$20,000.
Average retail price per record: LP's—\$5; EP's—\$1.50; Singles—\$1.
Stereo sales: 25% of total sales.
Type of record distribution: Manufacturer to wholesaler to retailer and manufacturer to retailer.
Radio stations: AM—71, 7 government, 64 commercial, recorded music & newscasts; FM—28, 3 government, 25 commercial, recorded music & newscasts. Import-Export regulations: Import duties on jukeboxes. \$2 gross kilo and 25% ad valorem. Import duties on amusement machines, \$5 gross kilo and 20% ad valorem.

● record manufacturers

Discos de Centroamerica, 12 Calle 3-23, Zona 1, Guatemala. Tel: 20442.
 St. Manuel Antonio Catalan, Casa Diana, 6a Ave. 15-35, Guatemala.

● music publishers

Hits Musicales, 4a Ave. No. 16-02, Zona 1, Guatemala.
 Musical, Ing. M.G. Wunderlich, 13 Calle 9-62, Zona 1, Guatemala.

● importers & exporters

Salvador Avelar, "Casa Avelar," 18 C.P. No. 3-60, Zona 1, Guatemala.
 Haroldo Castillo, 6a Ave. 12-15, Zona 1, Guatemala.
 Distribuidora Electro Musical, 7a Ave. No. 20-06, Zona 1, Guatemala.
 Hits Musicales, 4a Ave. No. 16-20, Zona 1, Guatemala.
 Instrumentos Musicales, Apartado Postal No. 345, Guatemala.
 M.A. Mena, Cadena Philco, 11 Calle 6-38, Zona 1, Guatemala.
 Musical, Ing. M.G. Wunderlich, 13 Calle 9-62, Zona 1, Guatemala.

● supplies & services

DISTRIBUTOR
 Distribuidora Electro Musical, 7a Ave. No. 20-06 Zona 1, Guatemala.

Billboard 1966-1967 International Music-Record Directory

TRADE ORGANIZATIONS

AGAYC, Asociacion Guatemalteca de Autor:s y Compositores, 14 Calle 11-42, Zona 1, Guatemala.
 Sociedad Filarmonica de Guatemala, Conservatorio Nacional de Musica y Artes Escenicas 3a. Ave. y 5a Calle, Zona 1, Guatemala.

GUYANA

Population: 636,000.
 Official rate of exchange: \$1 (US) = \$1.7143 British West Indian dollars.
 Per capita income: \$406.
Records imported from US (CIF): \$22,269.
Records imported from countries other than US (CIF): \$62,466.
Records exported to countries other than US (CIF): \$50.
Radio stations: 2 commercial.

● distributors

Ace Rec. Club, 34 Robb & King Sts., Georgetown. Tel: 2742.
 Alphonso's Modern Rec. Store, 64 King St., Georgetown. Tel: 3114.
 Auto Supplies, 30 Hadfield St., Georgetown. Tel: 2406.
 D. M. Fernandes, 26 Main St., Georgetown. Tel: 62021.
 William Fogarty, 34-37 Water St., Georgetown. Tel: 62111.
 Indian Musical, 13H Water St., Georgetown. Tel: 15000.
 International Musical House, Lombard & De Roy Sts., Georgetown.
 Sandbach Parker, 43-46 Water St., Georgetown. Tel: 62051.

HONDURAS

Population: 2,130,000.
 Official rate of exchange: \$1 (US) = 2 lempira.
 Per capita income: \$203.
Records sold domestically (factory value): 1964—\$128,624.
Records imported from US: \$23,756.
Records imported from countries other than US (factory value): \$104,868.
Records exported: None.
Radio stations: 1 commercial.
Television stations: 3 commercial channels

● importers & exporters

Alfredo Campos Marco, Apartado No. 26. Tegucigalpa, D.C.
 Casa Carlos a Zuniga, Tegucigalpa, D.C.
 Isolina de Arellano, Aereopuerto de Toncontin, Tegucigalpa, D.C.
 Francisco J. Yones, Ave. Paz Barahona, Tegucigalpa, D.C.

HONG KONG

Population: 3,800,000.
 Official rate of exchange: \$1. (US)=5.68 Hong Kong dollars.
Records imported from US (factory value): 1965—\$317,065; 1964—\$342,261; 1963—\$333,147.
Records imported from countries other than US (factory value): 1965—\$913,695; 1964—\$935,621; 1963—\$679,270.
Records exported to countries other than US (factory value): \$61,864.
Average retail price per record: LP's: \$3.80; EP's: \$1.14; Singles: \$0.70.
Stereo sales: 50% of total sales.
Type of record distribution: Manufacturer to wholesaler to retailer.
Medium wave radio stations: Radio Hong Kong (government-owned) and the Hong Kong Commercial Broadcasting Co. Also a wired sound system, Rediffusion (HK) Ltd. Programming includes recorded music & disk jockey shows.
Television stations: One (government-owned).
Import-Export regulations: Free port.

● record manufacturers

Colonial Trading, PO Box 950, Queen's Theater Bldg., Hong Kong. Tel: 221109. Cable: Coltraco.
 Mg'g Dir.: R. A. da Silva; A&R: Mrs. Frances da Silva Kirk.
 Label: Diamond.
This company represents: CBS (USA), Cameo (USA), Canadian American (USA), Congress (USA), Decca (England), Dolton (USA), Kapp (USA), Liberty (USA), Parkway (USA), United Artists (USA).

Int'l representatives: Diamond Music (Singapore).
 Diamond Music, Queen's Theater Bldg., Central Hong Kong. Tel: 221109 & 233370. Mg'g Dir.: R. A. da Silva.

E M I, 305 Chartered Bank Bldg., Hong Kong. Tel: 223081. Cable: Emitron. Mg'g Dir.: E. Inslay; A&R: Mirian Wang & Vic Cristobal; Sales & Int'l: K. F. Bruce.
 Labels: Angel, Columbia, Parlophone, Pathe, Regal.

This company represents: Audio Fidelity (USA), Capitol (USA), Columbia (England), Disneyland (USA), Encore (England), Epic (USA), Imperial (USA), King (USA), Laurie (USA), MGM (USA), Odeon (England), Parlophone (England, Australia, India), Stateside (USA), Verve (USA), Vista (USA).
Int'l representatives: England (EMI), France (Pathe Marconi), India (Gramophone), Macao (Universal Agencies), Malaysia (Borneo), Philippines (Oyna), Thailand (Kamol Sukosol), Capitol (USA).

The Life Rec., 202 A, Princess Theatre Bldg., Kowloon. Tel: 65986. Mg'g Dir.: Ng Lian Chin.
This company represents: Decca.

● music publisher

E M I, 305 Chartered Bank Bldg., Hong Kong. Tel: 223081. Contact: K. F. Bruce.

● importers & exporters

Cosdel, 1331 Prince's Bldg., Hong Kong. Tel: 240833.
 Mg'g Dir.: T. K. Whang.
 Labels: Amber (England), Aristocrat, Atco, Atlantic, Big Top, Cadet, Candid, Carlton, Checker, Chess, Dot (USA), Durium (Italy), Elektra, Everest, Hickory, Jubilee, Motown-Tamla-Gordy, (USA), Pye (England), Reprise, Roulette, Seeco (USA), Voque (France), Vox, Westminster (USA).
 Diamond Music, Queen's Theater Bldg., Central Hong Kong. Tel: 221109 & 233370.
 E M I, 305 Chartered Bank Bldg., Hong Kong. Tel: 223081.
 Livingston Gibb, PO Box 55, 11th Fl., Hang Seng Bank Bldg., Hong Kong. Tel: 234161. Mgr.: W. J. Rodger; Asst. Mgr.: J. L. DeSousa.
This company represents: RCA Victor.
 Jardine Matheson, Jardine House, Hong Kong.
 Moutrie, Alexander House, 7 Des Voeux Rd. C., Hong Kong. Tel: 226059.
 Orbit Rec., Rm. 2537, H. K. Hilton, Hong Kong. Tel: 233111. Cable: Orbitdisc. Mgr.: Igo Fisher; Prom. Mgr.: Gery Scott.
This company represents: Pye, Picadilly, Scepter.
 T. K. Whang, Man Yee Bldg., Hong Kong.

● supplies & services

PRESSING PLANTS
 Colonial Trading, PO Box 950, Queen's Theater Bldg., Hong Kong. Tel: 221109.
 Diamond Music, Queen's Theater Bldg., Central Hong Kong. Tel: 221109 & 233370.

RECORDING & TAPE DUP. STUDIOS

Diamond Music, Queen's Theater Bldg., Central Hong Kong. Tel: 221109.
 E M I, Embassy Court Basement, Causeway Bay, Hong Kong.

HUNGARY

Population: 10,168,000.
 Official rate of exchange: \$1 (US) = 11.74 forints.
 Per capita income: \$89 monthly, industrial worker; \$133.50 monthly, miners.
Number of homes with record players: 210,000.
Records exported to U. S. (factory value): 1964—\$4,660.
Average retail price: 12-inch LP's—\$2.60; 10-inch LP's—\$1.90; EP's—\$1.17; 45 rpm Singles—87 cents; record postcards, 52 cents.
Discounting: None.

continued

Record clubs: Under consideration by the Hungarian Musical Fund.

Stereo: 1% of LP's.

Import-Export regulations: Import duty on records sent as presents to private individuals via parcel post from western sources is 60% of inland commercial sales value; i.e.: \$5.22 on 12-inch LP with sales value of 200 forint (\$8.70); \$3.90 on 10-inch LP with sales value of 150 forint (\$6.50); \$1.30 on EP with sales value of 50 forint (\$2.17); and 78 cents on single with sales value of 30 forint (\$1.30). Travelers coming to Hungary (also Hungarian tourists) may import free of duty five 12-inch and ten 10-inch LP's. Contact with manufacturers and publishers should be made through Kultúra (see Importers-Exporters) as all dealings with foreign countries are controlled through this firm.

Mechanical license for records manufactured in Hungary: According to general contract of BIEM, Paris—7.48% of retail price on all LP's and EP's, 3.2% on record postcards.

Best occasion for commercial contact with Hungary is the Budapest International Fair, held every year in May in Budapest, attended by 32 nations in 1964. Paul Gyongy

● record manufacturer

Magyar Hanglemegyzarto Vallalat, Semmelweisutca 1-3 Budapest V. Tel: 187-990, ext. 189. Dir.: Jenő Bors. Label: Qualiton.

● music publisher

Zenemukiado Vallalat, Editio Musica, Semmelweisutca 1-3, Budapest V. Tel: 187-990, ext. 123. Dir.: Bela Tardos.

● importer & exporter

Kultúra, PO Box 149, Budapest 62. Tel: 159-450. Dir.: Marton Vertes.

● supplies & services

MUSIC LICENSING ORGANIZATION

Szerzoi Jogvedo Hivatal, (Artisjus, Bureau Hongrois pour la Protection des Droits d' Auteurs). Nyar utca 6, Budapest VII. Tel: 187-057 & 185-672. Cable: ARTISJUS.

PRESSING PLANT

Villamoszigetelo es Muanyaggyar, Fehervariut 120, Budapest XI.

RECORDING & TAPE DUP. STUDIO

Magyar Hanglemegyzarto Vallalat, Rottenbillerutca 47, Budapest VII.

ICELAND

Population: 194,000.

Official rate of exchange: \$1 (US)=43 krona.

Per capita income: \$1,800.

Records imported from US (CIF): \$25,500.

Records imported from countries other than US: (CIF): \$86,300.

Records exported: Few.

Records manufactured for domestic sale: EP's & Singles—\$19,500.

Average retail price: LP's—\$5.81 to \$6.97; EP's—\$2.91; Singles—\$1.60.

Stereo Sales: No statistics available but popularity of stereo recordings is increasing.

Discounting: Rare.

Record club sales: None.

Type of record distribution: Manufacturer to wholesaler to retailer on imports and manufacturer to retailer on domestic product.

Number of jukeboxes: 10 to 20 (all outside the capital).

Radio stations: 1 government station programming primarily recorded music.

Television stations: The first Icelandic station will start telecasting in Sept. 1966.

Import-Export regulations: Import is free. Duty on Icelandic records pressed abroad is 30% of CIF value. Duty on foreign records amounts to 80% of CIF value. Duty on foreign records amounts to 80% of CIF value.

Note: Local manufacture consists solely of records pressed abroad (the music sometimes taped in Iceland) and distributed almost exclusively on the

Icelandic market. Music publishing houses are not to be found. Composers privately finance the publishing of their music.

● record manufacturers

Falkinn H/F, Laugaveg 24, Reykjavik. Mg'g Dir.: H. V. Olafsson. Cable: Falkinn.

Hjiodfaeverzlun Sigridur Hedgadóttur, Vesturveri, Reykjavik.

S G Rec., Skafthlid 13, Reykjavik. Tel: 16414. Pres.: Svavar Gestis.

Stal, PO Box 737, Reykjavik.

Islenzkir Tonar, The Icelandic Rec. Co., c/o Drangey, Laugaveg 5B. Tel: 13311.

Verzlunin Drangey, Laugaveg 5B, Reykjavik.

● music publishers

Verzlunin Drangey, Laugaveg 5B, Reykjavik.

R. E. Westerlund, Pohjoinen.

Kattan Bros., PO Box 2594, Bechara Khoury Ave., Beirut. Tel: 239073. Mgr. & Int'l: Robert S. Kattan; Sales: William S. Kattan.

● supplies & services

MUSIC LICENSING

S T E F, Freyjugata 3, Reykjavik.

INDIA

Population: 461,300,000.

Official rate of exchange: \$1. (US)=4.76 rupees.

Records exported to US (factory value): 1964—\$9,575.

Records imported from US (factory value): 1964—\$1,252.

● record manufacturers

The Gramophone Co. of India, PO Box 699, 33 Jessore Rd., Dum Dum, Calcutta 2B. Tel: 57-24-31. Cable: EMITRON. Mg'g Dir. & Int'l: Bhaskar Menon.

Philips India, Philips House, 7 Justice Chandra Madhab Rd., Calcutta 20.

INDONESIA

Population: 104,366,000.

Official rate of exchange: \$1 (US) = 36 rupiahs.

Records imported from US (factory value): 1964—\$25,420.

(No other current statistics available.)

● record manufacturers

Dimita Moulding, Bandengan Utara, 40 B, Djakarta. Tel: 21180. Dir.: M. S. Tamimi.

Indonesian Music, Irama, Tjikini Raya 7B, Djakarta. Tel: 1892. Cable: Irama. Pres.: R. Soejoso.

P. N. Lokananta, Terusan 21, Surakarta. Tel: 3230. Cable: Lokananta. Dir.: Oetoyo Soemowidjojo.

Republic Manufacturing, Tanah Pasir, (Gedong Pandjang), PO Box 605/DAK., Djakarta-Kota. Tel: OK 23432. Cable: Remaco. Dir.: Raden M. Moestari.

● music publisher

Indonesian Music, 7B Tjikini Raya, Djakarta. Tel: 1892.

● supplies & services

PRESSING PLANTS

Dimita Moulding Ind., Bandengan Utara 40 B, Djakarta-Kota.

Indonesian Music, Irama, Tjikini Raya 7B, Djakarta. P. N. Lokananta, (Government Enterprise), Djalan Terusan, Surakarta.

Republic Manufacturing, Tanah Pasir (Gedong Pandjang), PO Box 605/DAK., Djakarta-Kota. Tel: OK 23432.

RECORDING STUDIOS

Indonesian Music, Irama, Tjikini Raya 7B, Djakarta. Tel: 1892.

R R I (Government's Radio Republic Indonesia), Djakarta.

Republic Manufacturing, Tanah Pasir (Gedong Pandjang), PO Box 605/DAK., Djakarta-Kota. Tel: OK 23432.

ISRAEL

Population: 1965—2,530,000.

Official rate of exchange: \$1 (US)=1.3 Israeli pounds.

Records imported from U. S. (factory value): 1964—\$24,655; 1963—\$12,700; 1962—\$9,300.

Records exported to U. S. (factory value): 1964—\$2,574.

Average retail price, domestic records: 12-inch LP's—\$5.50; 10-inch LP's—\$4.12; EP's—\$2; Singles—\$1.35.

Discounting: For "regular buyers," between 10 to 20%.

Type of record distribution: Manufacturer to retailer.

Medium wave radio stations: 2.

Juke boxes: Prohibited by law.

Other important regulations: General and complete liberalization of the trade now permits free import of records from any country without limitations. The only exception is the barter arrangement rigidly adhered to as far as records from behind the Iron Curtain are concerned. An exchange of records would be allowed only if the country would accept Israeli records in trade. There also has been a liberalization of import rules for record players, which brought in automatic record changers and such brands as Garrard and Philips.

● record manufacturers

C B S, PO Box 6B1, Tel Aviv. Tel: B40191. Cable: COLRECORD. Mg'g Dir.: Simon Schmidt.

Eastronics (RCA), PO Box 21029, 75 Haifa Rd., Tel Aviv. Tel: 446060. Cable: Eastronix. Mg'g Dirs.: T. Kenny, Dov Peleg.

This company represents: RCA Victor.

Hataklit, 20 Haneviim St., Haifa. Tel: 69950. Cable: RECOMUSIC. Pres.: Dov Zeira; Gen. Prof. Mgr.: Y. Shapira.

This company represents: Collectors Guild (USA), Walt Disney (USA), Durium (Italy), Meazzi (Italy), Picadilly (England), Roulette (USA), Vogue (France).

Hed Arzi, 4 Hilazon St., Ramat Gan. Tel: 722003 & 723605. Dir. & Sales: Joseph Grossman; Dir. & Int'l: Zeev Lewin; A&R Mgr. & Pub.: Dan Fainaru.

This company represents: ABC-Paramount (USA), Barclay (France), Cetra (Italy), Decca (USA), Grand Award (USA), MGM (USA), Mercury (USA), Vanguard (USA), Verve (USA), Westminster (USA).

Israel Rec., Opposite subdivision Tamar, Block 6667. Herzilya, By the Sea. Contact: Avrum M. Hirsch.

Israphon, Industrial "B" Zone Azor, Tel Aviv. Tel: 86542. Dir., A&R & Int'l: Naftaly Alsheich; Sales: Jacques Alsheich.

Labels: Israphon, Israelectra, Literaton.

Makolit, 15 Hamanor St., Tel Aviv. Tel: B1694. Dir. Sales & Int'l: Daniel Antanir; A&R: Sh. Peer.

Labels: Makolit, Carlophon, Olympia, Hindustan. **This company represents:** Dot (USA), WMC (Belgium), Embassy (England), Fonit (Italy), Hispavox (Spain), Oriole (England). **Int'l representatives:** England (Oriole), USA (Fiesta).

Palestine Orient, PO Box 230, 4 Herzl St., Tel Aviv. Mg'g Dir.: Y. Kimchi.

Studio Rec'gs, 33 Allenby Rd., Tel Aviv. Dir. Sales & Int'l: Herbert Russcol. Label: Studio Recordings.

This company represents: Tiqua (USA) and a full line of Israeli folk music & children's records in Hebrew.

● music publishers

Edition "Negen," 63 Allenby Rd., Tel Aviv. Tel: 621457. Mgr.: Yoel Schreiber.

Illan Melody Press (ACUM) (see Israeli Music Publ'ns.)

Israeli Music Ivan Mogull (ACUM), 20 Haneviim St., Haifa. Tel: 440395. Cable: RECOMUSIC. Pres.: Ivan Mogull; Gen. Mgr.: Dov Zeira.

Int'l Branch: USA, New York, New York.

Israeli Music Publ'ns (ACUM), PO Box 6011, 59 Rehov Ben Yehuda, Tel Aviv. Tel: 232078. Cable: ISMUSICA. Pres.: Dr. Peter Gradenwitz. **Affiliate:** Illan Melody Press.

This company represents: Broekmans & van Poppel (Holland), Carisch (Italy), J&W Chester (England), Ed. Gruppo Curci (Italy), Faber & Faber (England), Impero-Verlag (Germany), E. B. Marks (USA), Meridian (France), Oxford University Press (England), Peer (Germany, USA), SEMI (France), Schott (Germany, England), Southern (England, Italy, USA), David Toff (England).

Int'l representatives: England (J & W Chester), Germany (Impero-Verlag), Holland (Broekmans & van Poppel), Italy (Carisch), Switzerland (Hug), USA (Southern).

Israzemer, 20 Haneviim St., Haifa. Tel: 69950. Cable: RECOMUSIC.

Musicor, PO Box 21029, 75 Haifa Rd., Tel Aviv. Tel: 446060. Mg'g Dirs.: T. Kenny, Dov Peleg
The Richmond Organization, 1 Any Ma'amin St., Ramat-Hasharon, Israel.

Subar, 1 Ani Ma'amin St., Ramat Hasharon. Tel. 931323. Dir.: Dr. O. Bar-Elan.

● importers & exporters

Eastronics (RCA), PO Box 21029, 75 Haifa Rd., Tel Aviv. Tel: 446060. Cable: Eastronix.

Hed Arzi, 4 Hilazon St., Ramat Gan. Tel: 722003.

Israelectra (Philips), PO Box 1608. Tel: 526231.

Israphon, Industrial "B" Zone Azor, Tel Aviv. Tel: 86542.

● supplies & services

PRESSING, PLATING & PROCESSING PLANTS

Hed Arzi, 4 Hilazon St., Ramat Gan. Tel: 722003.
Israphon, Industrial "B" Zone Azor, Tel Aviv. Tel: 86542.

Makolit, 15 Hamanor St., Tel Aviv. Tel: B1694.

RECORDING STUDIOS

Hed Arzi, 4 Hilazon St., Ramat Gan. Tel: 722003.
Makolit, 15 Hamanor St., Tel Aviv. Tel: B1694.

TRADE ORGANIZATION

League of Composers in Israel, PO Box 11180, 17 Har Nevo St., Tel Aviv. Tel: 440395. Sec.-Gen.: B. Bar-Am.

ITALY

Population: 1961 census: 49,876,790. Latest estimate: 52,596,000.

Official rate of exchange: \$1 (US) = 622 lira.

Per capita income: \$730 annually.

Number of homes with record players: 7 million.

Records sold domestically: 1965-22 million units, \$22,000,000; 1964-23 million units, \$25,000,000; 1963-24 million units, \$28,000,000.

Records imported from the US (factory value): 1964-\$196,437.

Records exported to the US (factory value): 1964-\$104,915.

Records manufactured for domestic and export sale: LP's-5 million units; EP's-200,000 units; Singles-18,800,000 units.

Average retail price per record: LP's-\$4; EP's-\$1.60; Singles-\$1.12.

Stereo sales: Minimal.

Discounting: Frequent.

Record club sales: 5% of total sales.

Type of record distribution: Manufacturer to wholesaler to retailer-25%; manufacturer to retailer-75%.

Number of jukeboxes: 20,000.

Radio stations: RAI-TV: 1 State company, 3 channels.

Television stations: RAI-TV: 1 State company, 2 government channels.

Import-Export regulations: Regular customs duties plus special 10% tax as luxury article.

Germano Ruscitto

● record manufacturers

Angelicum (AFI), Piazza San Angelo 2, Milan. Tel: 654.610. Gen. Mgr. & Int'l: Mr. Allorto.

Labels: Angelicum, Giax, Originalrecord. (Distributed through Dischi Ricordi.)

Ariston (AFI), Piazzetta Pattari 1/3, Milan. Tel: B97.745. Pres.: Alfredo Rossi; VP & Int'l: Giampiero Simontacchi; Pop A&R: Giorgio Guarnieri; Pub.: Aridzzone.

Labels: Ariston, Picnic.

This company represents: Copacabana, Leon-

solco, Sabrina.

Bluebell (AFI), Via Tarchetti 1, Milan. Tel: 650.675.

Gen. Mgr.: Antonio Casetta; A&R: Federico Monti Arduini; Promo.: Fritz Altman; Int'l: Antonio Casetta & Franca De Marchi.

Label: Bluebell.

This company represents: Canadian-American, Colpix, Hanna-Barbera, Somerset.

C A M (AFI), Via Virgilio B, Rome. Tel: 314.341. Pres. & Int'l: Luigi Campi; Sales Mgr.: Giacchi; Promo. & Pub.: Jannino.

Label: CAM (Distributed through Dischi Ricordi).

CGD, COMPAGNIA GENERAL DEL DISCO (AFI), Galleria del Corso 4, Milan. Tel: 79.4B.41 & 70.25.63.

Cable: COMGEDISC. Adms.: Ladislao & Piero Sugar; Mgrs.: Giuseppe Giannini, Franco Cre-

pax, Sandro Delor; Pop A&R: Franco Monaldi, Renato Angiolini; Promo. & Pub. & Int'l: Johnny Porta.

Branch: Via delle Carrozze 3, Rome. Tel: 6B.16.1B. Mgr.: Francesco de Crescenzo.

Labels: CGD. Derby. (Sales/distribution through Messaggerie Musicali).

This company represents: A&M (USA), Audio Fidelity (USA), Cameo (USA), GNP Crescendo (USA), Festival (France), Joda (USA), Musicor (USA), Palette (Belgium), Reprise (USA), Riviera (France), Scepter (USA), Warner Bros. (USA).

Int'l representatives: Argentina (Sicamericana), Australia (W&G), Brazil (RGE), Denmark (Morks), Ecuador (Emporio), France (Festival), Great Britain (Decca), Israel (CBS), Greece (Melophone), Japan (King), Lebanon (SLD), Mexico (Gamma), New Zealand (Manufacturers Dist.), Portugal (Radio Triunfo), South Africa (Meteor), Spain (Hispanovox), Switzerland (Jek-

lin), Turkey (Elia Aluf Medina), USA (CBS), Uruguay (CBS), Yugoslavia (RTB). (SEE ADVERTISEMENT)

Carisch (AFI), Via General Fara 39, Milan. Tel: 650.741. Mgr. & Int'l: Galli; A&R: Mazzocchi.

Labels: Carisch, Odeon, Parlophon.

Cellograph-Simp (AFI), Via Maffucci 1B, Milan. Tel: 371.130. Pres.: Ugo Sciascia; Gen. Mgr. & Int'l: Rofa; Sales: Albani.

Labels: Big Ben, Oscar, Phonocolor, Primavera, Style.

CEMED-CAROSELLO (AFI), Via Beccaria 5, Milan. Tel: 794.746. Cable: Curcimusic. Pres.: Giuseppe Grammito Ricci; VP: Theo Treppiedi; Gen. Mgr. & Int'l: Davide Matalon; Pop A&R: Mario

CURCI

PUBLISHING GROUP—GALLERIA
DEL CORSO 4 MILANO TEL. 794746

CURCI—D'ANZI—ACCORDO—ITALCANTO—
CERVINO—SPANKA ITALIANA—ARIETE—MUSIC
UNION—ITALIAN YANK—DUCALE—ORCHESTRAL-
MUSIC—IZZO—RTV—FAST

Publisher of the winner of the FESTIVAL of SAN REMO 1966

DIO COME TI AMO

Recorded by DOMENICO MODUGNO for our sister firm

CAROSELLO CEMED s.r.l. Via BECCARIA
5 MILANO

OTHER ORIGINAL HITS:

I FRATELLI DEL FAR WEST—1° prize Zecchino d'oro 1966

IO CHE NON VIVO SENZA TE
IL RAGAZZO DELLA VIA GLUCK
IL GEGHEGE

SURF DELL'AMORE
UNA CASA IN CIMA AL MONDO
IO TI DARO' DI PIU'
LA NOTTE DELL'ADDIO

continued

- Magenta; Classical A&R: Luigi Spaggiari; Pub.: Claudio Occhiena.
Labels: Ariete, Carosello, Costanza, Curci, Italian Yank, Paperino, Topolino (Distributed through "C & C").
This company represents: Buena Vista, Curci-Erato, Disneyland, Triola.
Int'l representatives: Argentina (Disc Jockey), Australia (W&G), Brazil (Rozenblit), France (Disques AZ), Germany (DGG), Greece (Melody), Mexico (Gamma), Spain (Belter), South Africa (Gallo Africa), United States (SM). (SEE ADVERTISEMENT)
- Cinevox (AFI), Via Veneto 108, Rome. Tel: 470.764 & 461.614. Admin.: C. A. Bixio; A&R: Carlo Bixio; Sales Mgr.: Franco Rizzi; Int'l: Carlo Bixio & L. M. Boxco.
Branch: Via Borgogna 7, Milan. Tel: 701.107.
Mgr.: Pasquale Bixio.
Labels: Cinevox, Rang.
- Clan (AFI), Corso Europa 5, Milan. Tel: 782.652 & 781.820. Gen. Mgr. & Int'l: Alessandro Celenzano; Dir.: Vincenzo Gilardi; Co-ordination Mgr.: Alessandro Colombini; Pop A&R: Detto Mariano; Pub.: Daniele Usellini.
Labels: Clan, Ciao Ragazzi (Sales/distribution through "C & C").
Int'l representatives: Canada (Johnny Lombardi), France (Vogue), Japan (Nippon Columbia), Middle East (SLD), South Africa (Troubadour), South America (Fermata), Holland (Artone), Spain (Vergara), Turkey (Senses), Greece (Music Box).
- Company Discografica Italiana (APDI), Via Balilla 36, Milan. Tel: 8472672. Pres. & Int'l: Pier Quinto Cariaggi; VPs: Alberto Cariaggi & Antonio Cariaggi; Sales Mgr.: Armando Cortesi.
Labels: CDI, California Song, Discolino, Discomec, PCD.
Int'l representatives: Spain (Belter), Sweden (Karousel), rest of world (Philips).
- Decca Dischi Italia (AFI), Via Brisa 3, Milan. Tel: 891.648 & 874.048. Cable: Deccital. Gen. Mgr.: Romano Bacchini; Mgr. & A&R Int'l: Paolo Tosi; Sales: Roberto Negro.
Labels: (affiliated) Ace of Clubs, Ace of Hearts, Decca, Decca American series, Decca Asso di Quadri Stereo, London; (distributed) Edig, Jaguar, MRC
This company represents: Argo (Great Britain), Brunswick (USA), Coral (USA), Oiseau Lyre (France), Telefunken (Germany), Vega (France).
Int'l representatives: Decca companies.
- Ducal Italdisc (AFI), Via Beccaria 5, Milan. Tel: 702.402. Cable: FONORECORD. Admin., Gen. Mgr. & Int'l: Davide Matalon; Pub. & Promo.: Renzo Gramegna.
Labels: Italdisc, Broadway. (Sales & distribution through Didea.)
This company represents: Discophon (Spain).
Int'l representatives: Argentina (Disc Jockey), Australia (Phonovox), Brazil (Rozenblit), Germany (Cantagallo), Japan (Nippon Columbia), Spain (Cantagallo), Switzerland (Siemens).
- DURIUM (AFI), Via Manzoni 40/42, Milan. Tel: 70.10.03 & 70.17.05 & 70.17.03. Cable: Durium. Pres. & Oir. of Board: Krikor Mintangian; Mgr's Dir.: Franco Martinengo; Exp. Mgr.: Elisabetta Mintangian; Prod'rs: Aurelio Airolidi, Giampiero Scussel & Felice Piccaredda; A&R & Publ'r: Franco Cassano; Sales: Pino Paschetto; Int'l: Elisabetta Mintangian, Giampiero Scussel & Felice Piccaredda.
Branch: Via San Martino della Battaglia 3, Rome.
Labels: (owned) Circus, Durium, Sprint, Royal; (distributed) Hockey, Jojo, Tiffany.
This company represents: Cadet, Checker, Chess, King, Motown, Prestige, Tamla.
Int'l representatives: Austria (Centrocord), England (Pye), France (Vogue), Germany (Hansa), Holland (Stibbe). (SEE ADVERTISEMENT)
- Ecco (APDI), Via San Antonio 5, Milan. Tel: 802.301. Gen. Mgr. & Int'l: Eugenio Consonni.
Labels: Eco, Gulliver.
This company represents: Studio SM (France).
- Editrice Italiana Audiovisivi (AFI), Via Alpi 9, Rome. Tel: 859.201. Mgr's Dir. & Int'l: Nino Sangioanni.
This company represents: Pleiade (France), Jupiter (Great Britain), Hachette (France).
- Fonit-Cetra (AFI), Via Bertola 34, Turin. Tel: 57.77. Cable: Cetra. Pres.: Enrico Carrara; Sales Mgr.: Luigi Arduino; Pub.: Robba; A&R: Mario Zanolletti; Int'l: Maurizio Golla (export manager).
Branch: Via Gonzaga 4, Milan.
Labels: Cetra, Cricket, Excelsius, Fonit, International.
This company represents: Ariola (Germany), Kapp (USA).
- Fonocrom (AFI), Via Martiri della Libertà, Bellano (Como). Mgr's Dir. & Int'l: Tommaso Grossi.
Labels: Best, Ciak, Fonocrom, Interdisca, Tiger.
- Fonola (AFI), Via Leopardi 25, Milan. Tel: 872.882. Mgr's Dir.: Mr. Braga.
Labels: Fonola, Melody, Phonophon, Souvenir.
- G T A, Galleria del Corso 2, Milan. Tel: 79.88.45. Cable: GTARECORDS. Mgr's Dir.: Gigi Cichellero; A&R: Giulio Libano; Sales Mgr.: Giuliano Tiesi; Pub. & Promo.: Fatma Ruffini.
Branch: Piazza Campo Marzio 3, Rome. Mgr.: Aldo Tirone.
Label: GTA.
- Italmusica (AFI), Corso Genova 22, Milan. Tel: 854.641. Mgr's Dir. & Int'l: Luigi Pigini.
Labels: Embassy, IPM, Mondial, Pig, Silver, Sir, Jaguar, Galleria Passarella 1, Milan. Tel: 782.337. Mgr's Dir. & Int'l: Benito Vassura.
Label: Jaguar.
- Juke Boxe (AFI), Galleria del Corso 2, Milan. Tel: 780.762 & 795.353. Mgr's Dir.: Carlo Alberto Rossi; Int'l: Alma Pozzati.
Label: Juke Boxe (distribution/sales through Messaggerie Musicali).
- Kansas, Galleria del Corso 4, Milan. Tel: 79.49.95. Mgr's Dir.: Miki Del Prete & Domenico Serengaj.
Label: Kansas (sales & distribution through C&C).
- Karim, Via G. A. Guattani 8, Rome. Tel: 865.698. Mgr's Dir. & Int'l: Fischietti.
Label: Karim (sales & distribution through Pulvirenti-Rome).
This company represents: Barenreiter, Bruno, Cantate, Comedie Francaise, HiFi, Musiaphone, Musicart, New Jazz, Period, Scala, Show Case, Thrift Edition, Valois.
- King Universal (APDI), Corso A. Lucci 13, Naples. Tel: 515.684. Mgr's Dir. & Int'l: Aurelio Fierro.
Labels: Capri, King Universal, Paperino Star.
- Las Vegas, Piazzetta Pattari 4, Milan 2/5. Tel: 804.818. Mgr's Dir. & Int'l: Emilio Daniele; Gen. Mgrs.: Emanuele & Roberto Daniele; Pop A&R: Mario Mellier; Promo. & Pub: Luciana Medini.
Labels: Italia, Las Vegas, Radio (sales & distribution through Saar).
Int'l representative: Japan (Victor).
- Meazzi, Ed. (AFI), Via Piatti 4/6, Milan. Tel: 867.361. Cable: MEFRONO. Mgr's Dir. & Int'l: Enrico Meazzi.
Labels: Arpeggio, Astraphon, Baby Popular, Baby, GBC, Hollywood, Meazzi, Meazzi Classica, Music Scores (sales & distribution through C&C).
- Milano (AFI), Piazzetta Pattari 2, Milan. Tel: 896.622. Gen. Mgr. & Int'l: Piero Gallotti.
Labels: MRCA, Giovane (sales & distribution through Decca (MRC) and Ri-Fi (Giovane)).
- Phonogram (AFI), Via Benadir 14, Milan. Tel: 28.26.241. Cable: COMINFON. Pres. & Int'l: Paul Lebbink; Mgr's Dir.: Manlio Baron; Sales Mgr.: Enrico Navarra; A&R: Gianfranco Intra; Promo. & Pub.: Tommaso Biggiero, DGG label chief: Mr. Ebnat; Philips label chief: Mr. Koen.
Labels: Adria, Archiv, Critere, Cycnus, DGG, Fontana, Heliodor, Jazzland, Melodicon, Mercury, Philips, Polydor.
Int'l representatives: world-wide (Philips and DGG).
- R C A ITALIANA (AFI), Via Tiburtina Km. 12, Rome. Tel: 41.60.41. Cable: Radiointer. Mgr's Dir.: Giuseppe Ornato; Ass't Gen. Mgr.: Ennio Melis; A&R Mgr.: Ettore Zeppegno; Pub. Mgr.: Giacomo Peroni; Distribution Mgr.: Luciano Bernacci; Int'l: Francesco L. Fantì.
Branches: Bari, Bologna, Cagliari, Catania, Florence, Genoa, Milan, Naples, Padua, Pescara, Rome, Turin.
Labels: RCA Victor, RCA Italiana, Arc, Victrola, Vik.
This company represents: Barclay (France), Ducretet-Thomson (France), Discophiles Francais (France), Pye (England).
Int'l representatives: RCA Int'l affiliates. (SEE ADVERTISEMENT)
- RICORDI (AFI), Via Berchet 2, Milan. Tel: 89.33.66. Cable: Ricordisc. Mgr's Dir. & Int'l: Guido Rignano; Domestic A&R: Iller Pattacini; Int'l A&R: Paolo Ruggieri; Promo. Mgr.: Lucio Salvini; Sales: Renzo Benini.
Labels: (owned) Ricordi, Ricordi Int'l, I Classici della Musica Classica, I Classici della Musica Leggera, Club, Tavola Rotonda; (distributed) CAM, Edibi.
This company represents: Amadeo-Vanguard, Epic, Hickory, Mirwood. (SEE ADVERTISEMENT)
- Ri-Fi (AFI), Corso Buenos Aires 77, Milan. Tel: 27.36.41. Cable: Rificordrec. Pres.: Giampiero Rossi; Mgr's Dir.: Giovanbattista Ansoldi; Prod'n Mgr.: Antonio Ansoldi; Pop. A&R:
- Giordano Bruno Martelli; Classical A&R: Rachele Hein Campodonico; Sales: Giorgio Termignoni & Piero La Falce; Pub. & Promo. Mgr.: Wladimiro Albers; Int'l: Giuseppe Velona; Business Agent: Richard H. Roemer, 400 Madison Ave., New York, N. Y., USA.
Labels: (owned) Antoniano, Pop, Primary, Publicisco, Rifi, Variety; (distributed) DNG, S-Giovane.
This company represents: Apex, Time, Westminster.
Int'l representatives: Australia (United Artists), Austria (Amadeo), Benelux (Barclay), French Canada (Kosmophon), English Canada (United Artists), Great Britain (United Artists), France (Barclay), Germany (Overseas), Japan (Philips), Mexico & S. America (Philips), Greece (Philips), Middle East (SLD), New Zealand (United Artists), Portugal & Spain (Belter), Turkey (Melody), USA (United Artists), Union of S. Africa (Trutone), Switzerland (Oversea). (SEE ADVERTISEMENT)
- Saar Ed. (AFI), Viale di Porta Vercellina 14, Milan. Tel: 46.96.251. Cable: Saar. Mgr's Dir.: Walter Gurtler; Gen. Mgr.: Italo Prandin; Sales Mgr. & Promo.: Sergio Balloni; Prod'n Mgr. & Int'l: Giuseppe De Gioia.
Labels: (owned) Jolly, Music, Stella; (distributed) Cooper, Equipe, Radio.
This company represents: AZ (France), Atlantic (USA), Concert-Disc (USA), Contact (USA), Contrepoint (USA), Dot (USA), Everest (USA), Folkways (USA), Mode (France), Red Bird (USA), Roulette (USA), Vogue (France).
- Societa Trevisan Combo (AFI), Corso Europa 16, Milan. Tel: 799.158. Cable: Trevisancombo. Mgr's Dir. Int'l: Mario Trevisan.
Labels: Combo, Humor, RT Club.
Int'l representatives: Australia (Minstrel), Canada (Leon Vellone), Spain (Marfer), Switzerland (A. Rothlisberger), USA (Carosello).
- Sviluppo Discografico Del Mezzogiorno (EDIBI), Via Morgantini 3, Naples. Mgr's Dir.: Luciano Vilevle Bideri.
Branch: Via Teulada 52, Rome. Tel: 380.700.
Label: Edibi (sales & distribution through Ricordi).
- VEDETTE-EMBER (AFI), Via San Paolo 15, Milan. Tel: 89.82.48 & 87.78.31. Pres.: Armando Sciascia; Pop A&R: Francesco Anselmo; Classical A&R: Armando Sciascia & Aliki Andris; Sales Mgr.: Sergio Sciascia; Pub.: Aliki Andris; Int'l: Aliki Andris-Michalaros.
Branches: Via dei Mille 27/a, Rome.—Piazza Garibaldi 73, Naples.
Labels: (owned) Corsair, Tempo, Vedette; (distributed) Fox.
This company represents: Ember (Great Britain), Lyra (Greece), Starday (USA).
Int'l representatives: Great Britain (Ember), Greece (Lyra), Japan (Philips), Switzerland (J.Lay). (SEE ADVERTISEMENT)
- Visradio (AFI), Corso Umberto I 132, Naples. Tel: 322.705. Cable: Visradio. Mgr's Dir. & Sales & Int'l: Aldo Scoppa; Pop A&R: Gino Conte.
Branches: Via Larga 11, Milan. Tel: 860.422.
Contact: Gennaro Senatore—Via Flavia 72, Rome. Tel: 471.618. **Contact:** Carlo Santoro.
Labels: Vis Radio, Dominator.
Int'l representatives: Canada (Bravo), USA (Italdisc), Venezuela (Radio Capri).
- Voce del Padrone (AFI), Via Domenichino 14, Milan. Tel: 43.40.41. Cable: Vicem. Mgr's Dir.: Francois Minchin; A&R: John Lee; Sales & Int'l: Carlo Barbareschi; Pub. & Promo.: Eraldo Di Vita.
Label: Voce del Padrone.
This company represents: ABC (USA), Angel (USA), Capitol (USA), Columbia (England), HMV (England), Imperial (Germany), Impulse (USA), Liberty (USA), Pathe (France), Stateside (USA).

• music publishers

- Aberbach (BIEM-SEDRIM) (UNEMI), Via Lazio 9, Rome. Tel: 48.58.53 & 47.08.81. Cable: Aberoma. Mgr's Dirs.: Joachim J. Aberbach & Julian J. Aberbach; Gen. Mgr.: Fulvio Corradini.
Affiliates: Edizioni Progressive, Edizioni Roosevelt.
This company represents: Hill & Range Songs, Jobete, Starday, Lark, Living Music, Spectacular.
Int'l representatives: Hill & Range Songs and their American and foreign affiliates.
 Accademia (see Ariston).
 Accordo (see Curci).
 Alfa (see Leonardi Gruppo).
 Alfieri-Esdrà, Piazzetta Pattari 2, Milan. Prof. Mgr.: Mr. Litz.
Int'l representatives: Philips affiliated publishing companies.

GTA Records HITS

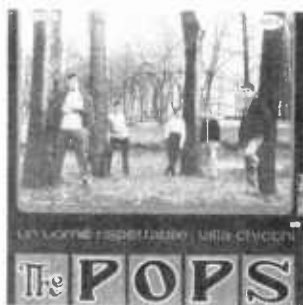

continued

Abramo Allione Editore (BIEM-SEDRIM) (AIDEM), Via Borgogna 3, Milan. Tel: 700.221. Prof. Mgr.: Mr. Allione.

Ambrosiana (see Nazionalmusic).

Applauso (see Southern).

Ariete (see Curci).

Ariston, Piazzetta Pattari 1/3, Milan. Tel: 88.77.45. Pres.: Alfredo Rossi; Prof. Mgr.: Giorgio Guarnieri.

Affiliates: Accademia, First Music, Formidable Music, La Bussola, Mec, Palace, Pettiroso, Piper Club, Regent, Santa Cecilia.

Bella Ciao, Via Cernaia 5, Milan. Tel: 65.34.13 & 63.70.80. Mg'g Dirs.: Carlo Emanuele Ricordi & Dante Bellamio; Gen. Prof. Mgr.: C. E. Ricordi.

Affiliates: Edizioni Delgallo, Ed. Mus. Redi.

Bixio C E M S A (BIEM-SEDRIM) (UNEMI), Via Borgogna 7, Milan. Tel: 701.107. Gen. Mgr.: Cesare Andrea Bixio; Prof. Gen. Mgr.: Pasquale Calimban.

Branch: Via Veneto 108, Rome. Tel: 47.07.64.

Affiliates: "Grandi Firme della Canzone," Edizioni Musicali Allegro.

C A M (see Edizioni Campi).

Caesar (see Nazionalmusic).

California (see Rossi).

Campi Editore (see Edizioni Campi).

Cantanapoli (see Leonardi Gruppo).

Casa Editrice Musicale Gustavo Gori (see Francis-Day).

Casiroli (see Leonardi Gruppo).

Cervino (see Curci).

Chant du Monde (see Nazionalmusic).

Chiappo (see Nazionalmusic).

Gigi Cichellero (see GTA).

Cielo-Video (BIEM-SEDRIM) (UNEMI), Galleria del Corso 2, Milan. Tel: 705.231. Pres.: Virgilio Panzuti; Gen. Prof. Mgr.: Dante Panzuti.

Clan Gruppo, Corso Europa 5, Milan. Tel: 78.26.12. Pres.: Alessandro Celentano; Gen. Prof. Mgr.: Giusta Spotti.

Affiliates: Edizioni Blue Sky, Edizioni Clan, Edizioni Star.

Curci (SEDRIM-BIEM), Galleria del Corso 4, Milan. Tel: 79.14.40. Pres. & Gen. Mgr.: Giuseppe Gramitto Ricci; Gen. Prof. Mgr.: Theo Trepiedi.

Affiliates: Accordo, Ariete, Cervino, D'Anzi,

Dea, Fast, Fortuna, Italcanto, Italian Yank, Izzo, Music Union, Orchestral Music, RTV, Spanka Italiana.

Daniele (see Sidet).

D'Anzi (see Curci).

Dea (see Curci).

Diamante (see Sidet).

Donnarumma (see Edizioni Bideri).

Ducale, Via Beccaria 5, Milan. Tel: 702.402. Pres. & Gen. Mgr.: Davide Matalon.

Duomo (see Durium Gruppo).

DURIUM GRUPPO (BIEM-SEDRIM) (AIDEM), Via Manzoni 40/42, Milan. Tel: 70.10.08 & 70.17.05. Cable: Durium. Pres.: Krikor Mintangian; Gen. Prof. Mgr.: Franco Cassano; Int'l Mgr.: Elisabel Mintangian.

Branch: Edizioni Durium-Sprint, Via San Martino della Battaglia 3, Rome. Tel: 490.095.

Mgr.: D. Caruana.

Affiliates: Duomo, Sprint.

Int'l representatives: Welbeck (Great Britain), Laetrec (S. Africa). (SEE ADVERTISEMENT)

Ear (see Nazionalmusic).

Ebe (see Nazionalmusic).

Eden (see Nazionalmusic).

Edicom (see Guerrini Gruppo).

Edir (see Ricordi).

Edizioni Bideri (BIEM-SEDRIM) (UNEMI), Via S. Pietro a Majella 17, Naples. Tel: 210.325 & 343.917. Cable: BIDERI. Pres.: Maria Flavia Bideri; Gen. Mgr.: Luciano Villevielle Bideri.

Branch: Via Teulada 52, Rome. Tel: 380.700 & 385.200.

Affiliates: Donnarumma, E. Gennarelli, Santa Lucia, Santojanni, Scia.

Edizioni Blue Sky (see Clan Gruppo).

Edizioni Campi, Via Virgilio B, Rome. Tel: 31.43.41. Mg'g Dir.: Luigi Campi.

Affiliates: CAM, Campi Editore, Fulginea, Gong, Sorrisi & Canzoni, Tank.

Edizioni M. Cicogna, Via Morozzo della Rocca 6, Milan. Tel: 468.614. Gen. Prof. Mgr.: Mr. De Bellis.

Edizioni Clan (see Clan Gruppo).

Edizioni La Canzone (see Edizioni Musicali "Connolly").

Edizioni Mediolana (see Edizioni Musicali "Connolly").

Edizioni Progressive (see Aberbach).

Edizioni Roosevelt (see Aberbach).

Edizioni Star (see Clan Gruppo).

Edizioni Musicali Allegro (see Bixio).

Edizioni Musicali Bridge (BIEM-SEDRIM), Galleria del Corso 4, Milan. Tel: 790.633. Gen. Mgr.: Lidia Testoni.

Affiliates: Edizioni Musicali Flag.

Edizioni Musicali "Club" (BIEM-SEDRIM) (AIOEM), Via Luchino del Maino 12, Milan. Tel: 49.68.12. Pres. & Gen. Prof. Mgr.: Claudio Gambarelli.

Edizioni Musicali "Connolly" (AIDEM), Galleria del Corso 2, Milan. Tel: 709.491. Mg'g Dir. & Gen. Prof. Mgr.: Gabriele Gaspare Abbate.

Affiliates: Edizioni La Canzone, Edizioni Mediolana.

This company represents: Campbell, Connolly (Great Britain), Berry (Great Britain), Cinephonic (Great Britain), Picturetone (USA), American (USA), Central Songs (USA).

Edizioni Musicali Flag (see Edizioni Musicali Bridge).

Edizioni Musicali Dott. Gallazzi (see Francis-Day).

Eldorado (see Guerrini Gruppo).

Elite (see Leonardi Gruppo).

Eurasia (see Nazionalmusic).

Everest (see Vis).

FP4, Galleria del Corso 2, Milan. Gen. Prof. Mgr.: Aldo Pagani.

Branch: Milrom, Rodriguez Pena 36, Buenos Aires. Mgr.: Lucio Milena.

Fama (see Ricordi).

Fantuzzi (see Nazionalmusic).

Fast (see Curci).

Film Melodia (see Nazionalmusic).

Film Ricordi (see Ricordi).

Filmusic (see Nazionalmusic).

First Music (see Ariston).

Fono (see Ricordi).

Fonocine (SEDRIM-BIEM) (AIDEM), Via San Paolo 15, Milan. Tel: 86.44.60. Owner & Gen. Prof. Mgr.: Pericle Boschetti.

Formidable (see Ariston).

Fortissimo (see Southern).

Fortuna (see Curci).

Fox (see Southern).

Francis-Day (AIDEM), Piazza del Liberty 2, Milan. Tel: 78.00.36. Cable: Arpeggio. Pres.: Frederick E. M. Day; Mg'g Dir.: Giuseppe Gallazzi.

Affiliates: Casa Editrice Musicale Gustavo Gori, Edizioni Musicali Dott. Gallazzi.

This company represents: Bibo (USA), Canciones del Mundo (Spain), Francis, Day (France), Fran-



COMPAGNIA GENERALE DEL DISCO

EXCLUSIVE DISTRIBUTOR FOR ITALY OF WORLD FAMOUS LABELS



DISTRIBUTES IN ITALY ON ITS "DERBY" LABEL
A & M - CRESCENDO - JODA AND OTHER INDIE MASTERS

COMPAGNIA GENERALE DEL DISCO
GALLERIA DEL CORSO 4, MILAN (ITALY) - PHONE 794841 - CABLE: COMGEDISC, MILAN

The major italian sound-tracks, such as:

FELLINI 8^{1/2}
THE LIOPARD
EL GRECO
SODOMAH and GOMORRAH
FOR A HANDFUL OF DOLLARS
THE GOSPEL ACCORDING TO ST. MATTHEW
JULIET OF THE SPIRITS
THE BIBLE
AFRICA ADDIO

were recorded at RCA italiana rome recording studios;

the most outstanding and modern operatic recordings, such as:

MADAMA BUTTERFLY with Price, Tucker, Elias, Leinsdorf
RIGOLETTO with Merrill, Moffo, Kraus, Solti
FALSTAFF with Evans, Merrill, Simionato, Freni, Solti
LUISA MILLER with Moffo, Bergonzi, Verrett, Tozzi, Cleve
THE FORCE OF DESTINY with Price, Tucker, Merrill, Schippers
LUCIA DI LAMERMOOR with Moffo, Bergonzi, Flagello, Prêtre
A MASKED BALL with Price, Bergonzi, Flagello, Leinsdorf

were recorded at RCA italiana rome recording studios;

and also the two major italian pop-recording artists:

**GIANNI
MORANDI
RITA
PAVONE**



have recorded their many hits at
**RCA ITALIANA ROME
RECORDING STUDIOS**

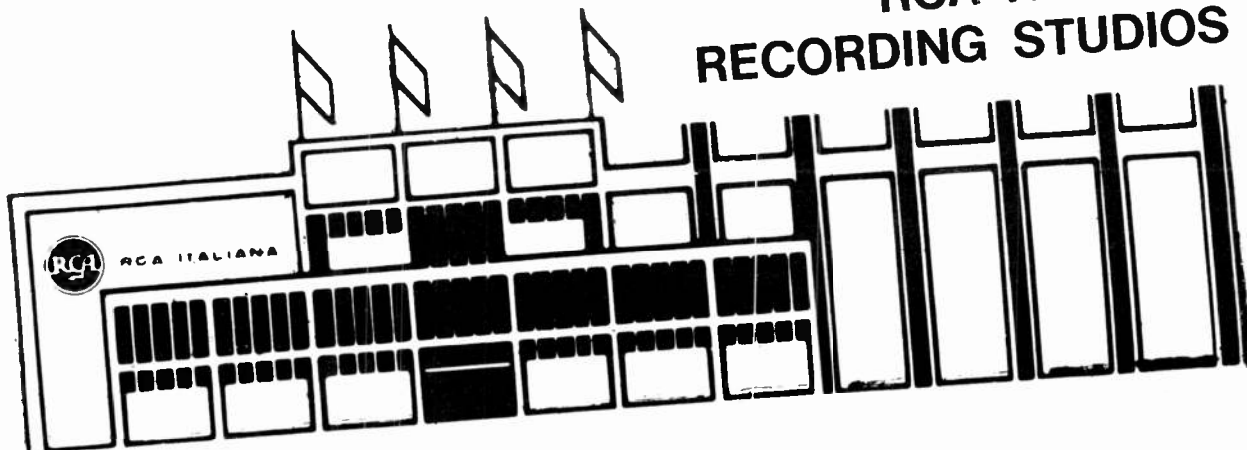

continued

cis, Day & Hunter (Great Britain), Lawrence Wright (Great Britain).
 Gulginea (see Edizioni Campi).
G T A (SEDRIM-BIEM (UNEMI), Galleria del Corso 2, Milan. Tel: 79.88.45. Cable: GTAMUSIC. Gen. Prof. Mgr.: Gigi Cichellero. Affiliates: Gigi Cichellero, Olona, Orsa Maggiore, Portofino, Sagittario, San Paolo, Selemusica, Sistro. (SEE ADVERTISEMENT)
E. Gennarelli (see Edizioni Bideri).
Gong (see Edizioni Campi).
Grandi Firme della Canzone (see Bixio).
Guerrini Gruppo (SEDRIM-BIEM) (UNEMI), Galleria del Corso 2, Milan. Tel: 780.103. Pres.: Gualtiero Guerrini; Gen. Mgr.: Maria Luisa Nobile. Affiliates: Edicom, Eldorado, Rampoldi, San Giusto, Zig Zag.
I M I (Int'l Music of Italy), Via San Paola 15, Milan. Tel: 89.82.48. Dirs.: Pres.: Armando Sciascia; Int'l: Aiki A. Michalaros.
International, Via San Paolo 15, Milan. Tel: 89.82.48.
Italcanto (see Curci).
Italcarisch (see Southern).
Italian Yank (see Curci).
Italmusica, Corso Genova 22, Milan. Tel: 85.46.41. Contact: Mr. Pignini.
Izzo (see Curci).
Kansas (SEDRIM-BIEM), Galleria del Corso 4, Milan. Tel: 79.49.95. Gen. Prof. Mgrs.: Miki Del Prete & Domenico Serengaj.
Edward Kessner (see Nazionalmusic).
Kramer (see Southern).
La Bussola (see Ariston).
Leon (see Leonardi Gruppo).
Leonardi Gruppo (SEDRIM-BIEM), Corso Europa 5, Milan. Tel: 70.20.94. Pres.: Fritz Leonardi; Gen. Prof. Mgr.: Giuseppe Coreca; Int'l Mgr.: Giuseppe Dell'Acqua. Affiliates: Alfa, Cantanapoli, Casiroli, Elite, Leon, Luisiana, Musical Film, Souvenir.
Les Copains (SEDRIM-BIEM), Piazza del Liberty 2, Milan. Tel: 700.964. Gen. Mgr.: Christine Leroux. This company represents: Dauphine (France), Nouvelles Editions Barclay (France), Editions 707 (France), Marine (France).
Luisiana (see Leonardi Gruppo).

Mas (SEDRIM-BIEM), Via San Vittore 40/42, Milan. Tel: 46.29.09. Gen. Prof. Mgr.: Pierangelo Codevilla. Affiliate: Saar.
Mascotte (SEDRIM-BIEM) (AIDEM), Galleria del Corso 2, Milan. Tel: 793.601. Pres.: Eloisa Spaziani; Gen. Prof. Mgr.: Eros Sciorilli.
Mec (see Ariston).
Millenote (see Sidet).
Music Union (see Curci).
Musical Film (see Leonardi Gruppo).
Nazionale (see Nazionalmusic).
Nazionalmusic, Corso Vittorio Emanuele 30, Milan. Affiliates: Ambrosiana, Caesar, Chant du Monde, Chiappo, Ear, Ebe, Eden, Eurasia, Fantuzzi, Film Melodia, Filmusic, Edward Kessner, Nazionale, Sonofilm.
Olona (see GTA).
Orchestral Music (see Curci).
Orsa Maggiore (see GTA).
Palace (see Ariston).
Peer Italiana (see Southern).
Pettiroso (see Ariston).
Piper Club (see Ariston).
Portofino (see GTA).
R C A Italiana (BIEM-SEDRIM), Via Tiburtina Km. 12 Rome. Tel: 41.60.41. Cable: Radiointer. Gen. Mgr.: Giuseppe Ornato; Ass't Mgr.: Ennio Melis; Gen. Prof. Mgr.: Mario Cantini. Branch: Galleria del Corso 4, Milan. Tel: 78.07.07. This company represents: Ediciones Musicales RCA Espanola (Spain), Ediciones Musicales Relay (Argentina), Edicoes Musicales Victor (Brazil), Editorial RCA Victor (Mexico), Elmwin (USA), Millwick (Great Britain), Pipdon (Great Britain).
R T V (see Curci).
Radio (see Sidet).
Radio Record Ricordi (see Ricordi).
Rampoldi (see Guerrini Gruppo).
Regent (see Ariston).
Ricordi (SEDRIM-BIEM), Galleria del Corso 2, Milan. Gen. Mgr.: Mariano Rapetti. Affiliates: Edir, Fama, Film Ricordi, Fono, Radio Record Ricordi, Ritmi e Canzoni.
Rimi (SEDRIM-BIEM), Galleria del Corso 2, Milan. Tel: 79.38.96. Cable: MARIART. Owner & Mg'g Dir.: Anna Scocca; Gen. Prof. Mgr.: Maurizia Foladore.
Ritmi e Canzoni (see Ricordi).

C A Rossi, Galleria del Corso 2, Milan. Tel: 79.53.53. Pres. & Gen. Mgr.: C. A. Rossi; Int'l Mgr.: Alma Pozzati. Affiliates: California, Stradivarius, Tre Stelle. Saar (see Mas). Sacha (see Southern). Sagittario (see GTA). San Giusto (see Guerrini Gruppo). San Paolo (see GTA). Santa Cecilia (see Ariston). Santa Lucia (see Edizioni Bideri). Santojanni (see Edizioni Bideri). Scia (see Edizioni Bideri). Sciascia (BIEM-SEDRIM), Via San Paolo 15, Milan. Tel: 89.82.48. Pres. & Gen. Mgr.: Armando Sciascia. This company represents: Ember Mood Music Library. Int'l representatives: Worldwide (Ember Mood Music Library). Selemusica (see GTA). Sette Note (see Southern). Sidet (BIEM-SEDRIM) (AIDEM), Piazzetta Pattari 4, Milan. Tel: 804.818 & 861.165. Pres. & Mg'g Dir.: Emilio Daniele; Gen. Mgr.: Emanuele Daniele. Branch: Via Teulada 52, Rome. Affiliates: Daniele, Diamante, Millenote, Radio, Tornado. This company represents: Alexis (USA), Edition Raphaelae (Germany), Eurovarietes (France), Marvelle (USA), Mozart Edition (Great Britain), Mozart Music (Germany). Int'l representatives: Japan (Victor Publ'g). Sistro (see GTA). Sonofilm (see Nazionalmusic). Sorrisi & Canzoni (see Edizioni Campi). Southern, Piazzetta Pattari 2, Milan. Tel: 896.622 & 896.709. Cable: Southmusic. Mg'g Dir.: Alberto Carisch. Affiliates: Applauso, Fortissimo, Fox, Italcarisch, Kramer, Peer Italiana, Sacha Italiana, Sette Note. Souvenir (see Leonardi Gruppo). Spanka Italiana (see Curci). Sprint (see Durium Gruppo). Stradivarius (see C. A. Rossi). Sugar, Gruppo Editoriale (BIEM-SEDRIM), (UNEMI), Galleria del Corso 4, Milan. Tel: 79.48.41. Mg'g Dirs.: Ladislao Sugar & Piero Sugar; Gen.

our cigarettes Produce smoke...

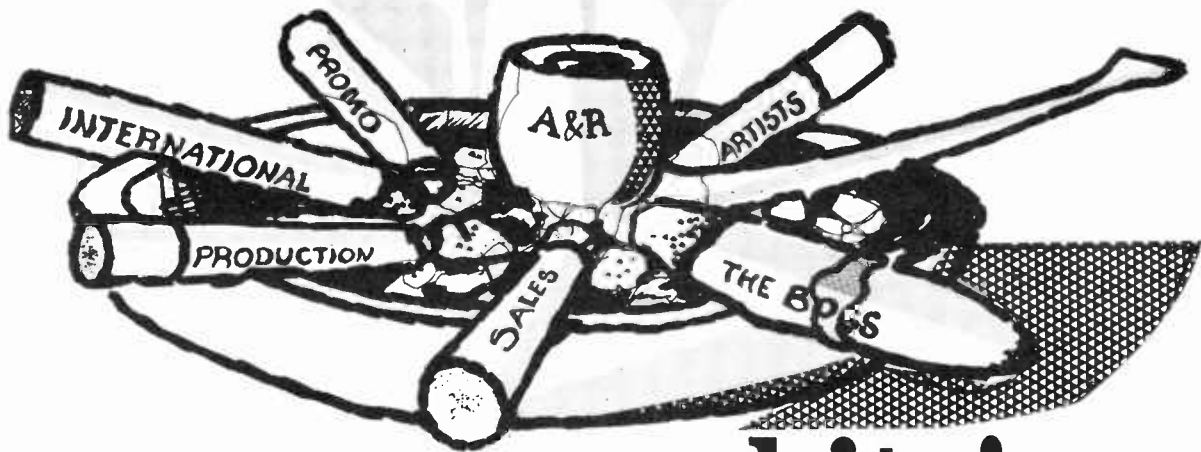

.....but we produce hits!

RIE ITALY
 RECORD COMPANY MILANO CORSO BUENOS AIRES, 77

USA
 400 MADISON AVENUE - NEW YORK

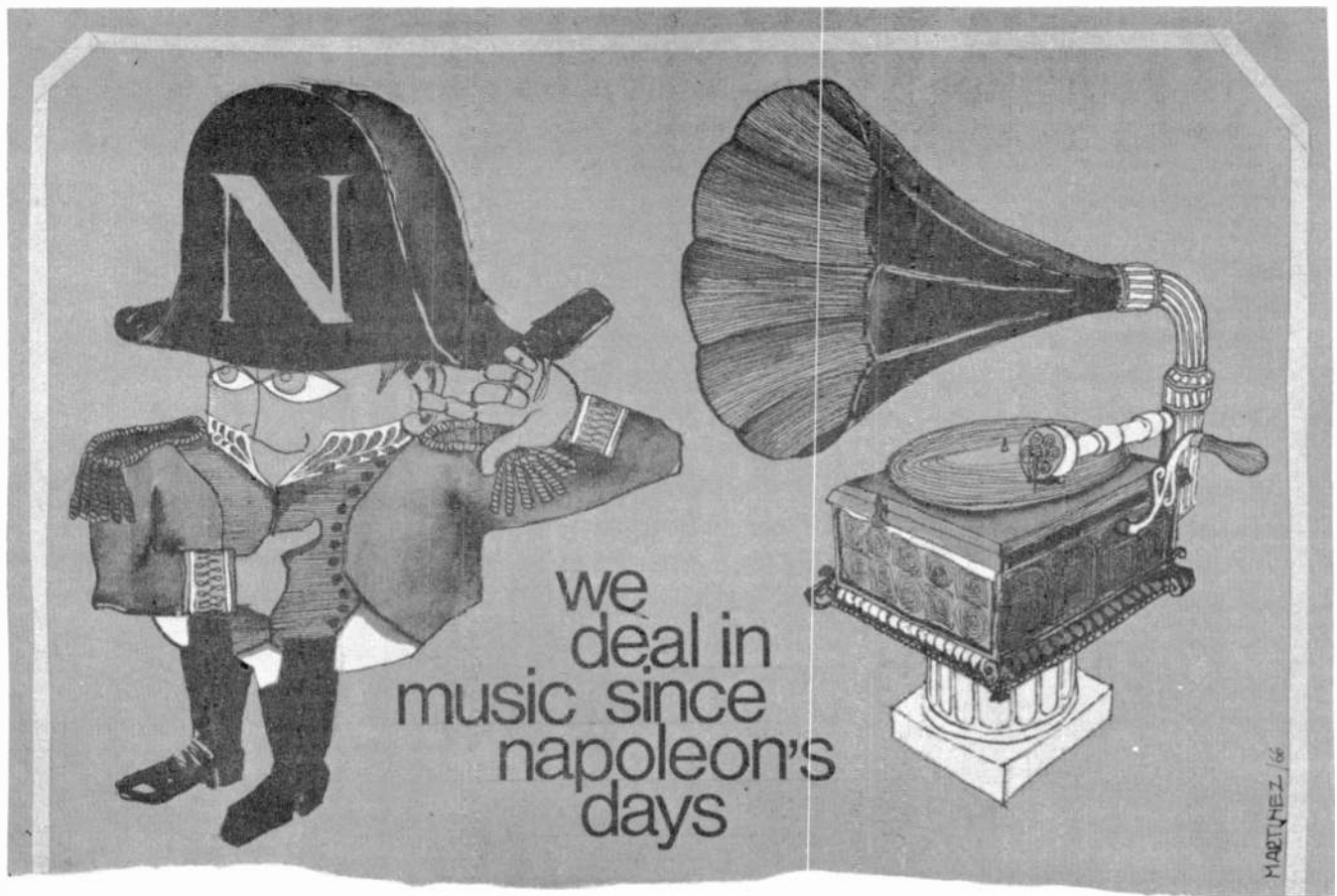

The young companies with an old tradition



DISCHI RICORDI S.p.A. - Via Berchet, 2 - Milano (Italy)



international.

ITALIAN & INTERNATIONAL ARTISTS ON RICORDI LABELS

Lucio Battisti • The Bachelors • Chet Baker • Patrizia Borgatti • Lee Chamberlin • I Dik Dik • Equipe 84 • Lando Fiorini • Ricky Gianco • Gino • Wilma Goich • The Immigrants • The Ingoes • The Leaves • Jackie Lee • Bob Lind • Andrea Lo Vecchio • The McCoys • Alberto Minardi • I Pop Seven • Rosy • I Satelliti • Bud Shank • Bobby Solo • Catherine Spaak • The Strangeloves • The Troggs • Ornella Vanoni • The Yardbirds

GRUPPO RICORDI MUSICA LEGGERA - Galleria del Corso, 2 - Milano (Italy)

ITALIAN & INTERNATIONAL HITS

La mamma • Per questa volta (Too late to worry) • Se piangi se ridi • Le colline sono in fiore (The river)
 L'uomo che non sapeva amare (Monica) • Com'è triste Venezia (Que c'est triste Venise) • Ho capito che ti amo • L'esercito del surf • Tanto so che poi mi passa (Every day I have to cry) • Io sono così (The love of a boy) • In un fiore (Sweet love) • Mister Tamburino (Mr. Tambourine man) • La Bohème • Bambina, non sono io (It ain't me, babe) • Resta (Stay) • E allora vai (It's all over now baby blue) • Io ho in mente te (You were on my mind) • L'uomo di ieri (Yesterday man) • Rimpiangerai, rimpingerai • Le avventure e gli amori di Moll Flanders (Lovely is she) • Non so più che santo pregare (Oh, rock my soul) • Sforisci bel fiore • Al primo quarto di luna (Theme for young lovers) • Splendore nell'erba (Splendour in the grass) • La mia voce / C'è una strana espressione nei tuoi occhi (When you walk in the room) • Che colpa abbiamo noi (Cheryl's goin' home) • Apro gli occhi per non vederti (A house is not a home) • Come una pietra che rotola (Like a rolling stone) • La risposta (è caduta nel vento) (Blowin' in the wind) • Sognando la California (California dreamin')

subsidiaries of **G. RICORDI & C. S.p.A.** established in 1808

For the most complete representation in Italy

VEDETTA RECORDS offers

- TOTAL NATIONAL DISTRIBUTION**
- DYNAMIC & SECURE ORGANIZATION**
- POWERFUL PUBLICITY & PROMOTION**
- CONCENTRATED & PERSONALIZED SERVICE**

Our company has the most active distributional organization in Italy, equipped to deal with any kind repertoire. Let us handle your material for the results you want!



Via S. Paolo, 15 - MILANO ITALIA

make the year-long reference value of the "buyer's guide" readily AVAILABLE TO EVERY MEMBER OF YOUR FIRM...

*Order extra copies NOW
Just \$1.25 per copy (prepaid)*

Billboard Buyers Guide
2160 Patterson St.
Cincinnati, Ohio 45214

Please send ... copies of Buyers Guide.
My payment for \$ is enclosed.

Name

Company

Address

City

Zone

State

continued

Mgr.: Ettore Carrera.
Branch: Via delle Carrozze 3, Rome. Tel: 68.16.18.
Affiliates: Acuff-Rose, Adriatica, Amazona, Apollo, Araldo, Arianna, Arion, Aromando, Bama, Canzoni, Moderne, Cobra, Colby, Di Lazzaro, Fantasia, Fiera, Flaminia, Frank, Gea, Ivana, La Cicala, La Falena, Liberty, Mascheroni, Melodi, Menestrello, Peter Maurice, Pickwick, Polaris, Rascel, Resolute, Sofia, Successo, Supersonic, Suvini Zerboni, Tevere, Tiber, Verve.

This company represents: Annis House (USA), Argo (USA), B&F (USA), Raul Breton (France), Charles Brull (England), Editorial Julio Korn (Argentina), Frederick (USA), Genius (USA), Gleam (USA), Gopam Ent. (USA), Harmonic Recs. (England), Newroad (USA), The Richmond Organization (USA), River (USA), Sparta (England), Symbol (USA), Taggie (USA), UPAM (USA), Vincent (USA), Web IV (USA).

Int'l representatives: Argentina (Editorial Latin), Belgium (Italmusic), France (Sugarmusic), Germany (Solami).

Susy (AIDEM), Via Piatti 4, Milan. Tel: 86.73.61. Mg'g Dir.: Enrico Meazzi.

Tank (see Edizioni Campi).
Telstar (BIEM-SEDRIM), Via Turati B, Milan. Tel: 650.677. Mg'g Dir.: Antonio Casetta; Gen. Prof. Mgr.: Federico Monti Arduini.

Tornado (see Sidel).
Tre Stelle (see C. A. Rossi).
Usignolo (Fonit-Cetra), Via Gonzaga 4, Milan. Tel: 80.80.06.

Vis (BIEM-SEDRIM) (UNEMI), Corso Re Umberto I 132, Naples. Tel: 313.764. Cable: Visradio. Pres. & Gen. Mgr.: Aldo Scoppa; Prof. Mgr.: Luigi Ricciardi.
Affiliate: Everest.

Voce del Padrone, Galleria del Corso 4, Milan. Tel: 79.11.22. Gen. Mgr.: John Lee.

● independent record producers

FP4 (Aldo Pagani), Galleria del Corso 2, Milan. Tel: 70.50.05.

Reno Teddy, Ariccia, Rome.
Reverberi G. & G. (Pro-Nas) (Gianpiero Reverberi & Giorgio Guglieri), Via Sturlia 24, Genova. Tel: 36.07.66.

Ricordi Nanni (Produzioni NR), Via Cernaia 5, Milan. Tel: 63.70.80.

● record wholesalers IMPORTERS & EXPORTERS

Messaggerie Musicali, Galleria del Corso 4, Milan. Cable: Messmusic. Gen. Mgrs.: Edmondo Besnio, Antonino Alati.

Orlandini Dischi, Piazza Soziglia 11, Genoa. Tel: 296.866.

A. Ronchini, Via B. Longhi 6, Parma.
Ludwig Wagner, Viale Duca D'Aosta B2, Bolzano.

DISTRIBUTORS

C & C (Clan & Curci), Corso Europa 5, Milan. Mgr.: Romeo Frumento.

Labels: Buena Vista, Cemed-Carosello, Cio Ragazzi, Clan Celentano, Curci, Kansas, Meazzi. D D R, Corso Vittorio Emanuele I, Milan.

Didea, Via Moncalvo 52, Milan.
Messaggerie Musicali, Galleria del Corso 4, Milan.

Labels: Distributes CGD product.
Pulvirenti, Via Morgagni 29, Rome.
Labels: Ariel & Karims product.

● supplies & services

MUSIC LICENSING ORGANIZATIONS

Editori Indipendenti, c/o Sandro Fumagalli, Via Besana 2, Milan. Tel: 79.00.40.

Francis-Day, Piazzeta del Liberty 2, Milan.
Sandro Fumagalli, Via Besana 2, Milan. Tel: 79.00.40.

S E O R I M (BIEM), Via Bordonì 32, Milan.
S I A E, Via E. Gianfurco 2, Rome.
Southern Music, Piazzetta Pattari 2, Milan.

PRESSING PLANTS

Bideri, Via San Pietro a Majella 17, Naples.
C G D, Compagnia Generale Del Disco, Via Moretto 9, Milan.

C I F, Via Benadir 14, Milan.
Cellograph-Simp, Via Maffucci 18, Milan.
Durium, Viale Trieste, Erba (Como).
Fonit-Cetra, Via Meda 45, Milan.

Fonocrom, Via Martiri della Libertà, Bellano (Como).
I F I (Ariston), Via Bordighera 6, Milan.
Industrie Riunite Italiane (RI-FI), Via Vespolate 22, Confienza, Pavia. Tel: 64.054.

Italmusica, Ripa Ticinese 75, Milan.
Leonsolco, Via Caterina Bianchi 22, San Colombano al Lambro (Milan).

Ma-Plast, Via Teocrito 23, Milan. Tel: 25.76.586.
Microwatt, Via Principato 2, Vimercate. Tel: 62.209.
R C A Italiana, Via Tiburtina Km. 12, Rome. Tel: 41.60.41. Cable: Radiointer.

Record Self Service, Via Pezzotti 22, Milan.
Rossi Materia Plastiche (RI-FI), Via Quintino Sella, 91/A, Busto Arsizio (Varese). Tel: 34.161.

Saar, Via Gramsci 20, Pero (Milan).
Voce del Padrone, Via Domenichino 14, Milan.

RECORDING & TAPE DUP. STUDIOS

Angelicum, Piazza San Angelo 2, Milan. Tel: 65.46.10. Mg'g Dir.: Riccardo Allorto; Prof. Gen. Mgr.: Thomas Gallia.

Bideri, Via San Pietro a Majella 17, Naples. Tel: 21.03.25.

Cinevox, Via Gregoriana 16, Rome. Tel: 68.34.86.
Durium, Via Carlo Troja 7/a, Milan.

Fonit-Cetra, Via Meda 45, Milan.
Branches: Via Nicolade Cesarini 3 Rome; Via Bertola 3, Turin.

Fonorama (C. A. Rossi), Via Barletta 11, Milan.
International Rec'g, Via Urbana 172, Rome. Tel: 480.667. Cable: Recording. Owner & Pres.: G. A. Biondo.

Microphone, Via Mantova 10, Milan.
Phonogram, Piazza Cavour, Milan.

R C A Italiana, Via Tiburtina Km. 12, Rome. Tel: 41.60.41. Cable: Radiointer.

Regson, Via Ludovico il Moro 57, Milan. Tel: 422.46.20.

Ricordi, Via dei Cinquecento 1, Milan. Tel: 53.03.94.
Saar, Via Gramsci 20, Pero (Milan). Tel: 35.30.564 & 35.30.573. Cable: Saar.

Sax, Via P. Borsieri 41, Milan. Tel: 688.44.23. Mgr.: Luigi Ambrosini.

Stereo, Via Stromboli 1B, Milan. Tel: 46.39.00 & 46.32.57.

Studio 7, Corso Venezia 7, Milan.
Vis Radio, Via Cupa Cajafa 36, Naples. Tel: 38.61.84. Cable: Visradio.

Voce Del Padrone, Via S. Eufemia 25, Milan.

TRADE ORGANIZATIONS

A F I (Assn. of the Italian Rec. Companies), affiliated to IFPI (International Federation of the Phonographic Industry), Via Palagi 10, Milan. Tel: 22.59.66. Gen. Sec.: R. A. Fracchetti.

A I D E M (Italian Assn. of the Music Publ'rs), Piazza del Liberty 2, Milan. Tel: 78.00.35. Sec.: Gabriele Abbate.

A P D I (Assn. of the Independent Rec. Companies), Via G. B. Morgagni 5, Milan.

L A C O I M (Indie Assn. of Singers & Orchestras), PO Box 736, Milan.

U N E M I (Union of Italian Music Publ'rs), Via Francesco Sforza 1, Milan. Tel: 79.26.69.

● tape cartridge

Durema, Via Marsala 7, Milan. Tel: 66.41.61. Mg'g Dir.: Claudio Occhiena; Gen. Prof. Mgr.: Alberto Angelini.

Cartridge duplication.
Ecofina, Via Boccaccio 24, Milan. Tel: 869.01.21.

Mg'g Dir.: Sabet Mourad.

Importers of stereo tape cartridge players and stereo tape cartridges. Producers of stereo tape cartridges.

JAMAICA

Population: 1,672,426.
Official rate of exchange: \$2.80 (US)=1 Jamaican pound.

Average retail price: LP's—\$5. (domestic), \$6 (imported); EP's—\$1.80; Singles—\$1 (domestic), \$1.50 (imported).

Type of record distribution: Manufacturer to dealer.

● record manufacturers

Federal, PO Box 27, Hagley Park Post Office; 220 Marcus Garvey Dr., Kingston 11. Tel: 3B-817. Cable: FEDERREC. Mg'g Dir.: Kenneth Khouri.

This company represents: Kapp, Philips, RCA Victor, United Artists.

The Gloken, PO Box 27, Hagley Park Post Office, Kingston.

Stanley Motta, 109 Harbour St. Tel: 25416.

DURIUM RECORDS

VIA MANZONI, 40/42
MILANO · (ITALIA)

PUBLISHING
FIRM:

GRUPPO EDITORIALE DURIUM
DURIUM · DUOMO
SPRINT
MANAGER: FRANCO CASSANO
FOREIGN CONTACT:
ELISABEL MINTANGIAN



7010 08
7017 05
7017 03
7018 72
7018 71

BRANCH OFFICE:
VIA SAN MARTINO
DELLA BATTAGLIA, 3
ROMA

CABLE:
DURIUM
MILANO

**LABELS REPRESENTED &
DISTRIBUTED IN ITALY:**
PRESTIGE · CHESS · CADET
CHECKER · KING · SPRINT
ROYAL · CIRCUS · TIFFANY

DISTRIBUTION WITH
DEPOT IN: **ROME** (LOMBARDY IS
MILAN · RAVENNA SERVICED BY
PALERMO · TURIN TRAVELLING
NAPLES · FLORENCE SALESMEN)
BARI

PLANT
VIALE TRIESTE
ERBA · (COMO)

RECORDING
STUDIO
VIA C. TROJA, 7A
MILANO

**MOST
MODERN
EQUIPMENT**

30 PRESSES

**PRESIDENT
KRIKOR
MINTANGIAN**

ADMINISTRATION
**FRANCO
MARTINENGO**

A&R
**AURELIO
AJROLDI**

EXPORT DEP.
**ELISABEL
MINTANGIAN**

FOREIGN DISTRIBUTION IN ALL THE
WORLD

PYE RECORDS · VOGUE
DISCOS VERGARA
HANSA Schallplatten
CODEL Records Inc.
LONDON RECORDS OF CANADA **CBS**

**DURIUM
MEANS FAST
AND BEST
SERVICE!**

HITS
IL SILENZIO
SEI DIVENTATA NERA
LA BALLATA DELLA TROMBA
SONO TANTO INNAMORATA
ANGELITA DI ANZIO
QUANDO VEDRAI LA MIA
RAGAZZA
HOLIDAYS IN ATHENS (SIRTAKI)



continued

Paradisc, 220 Foreshore Rd., Kingston.
This company represents: ABC (USA), Impulse (USA).
Randy's Rec. Mart, 17 N. Parade, Kingston. Mgr.: Vincent Chin.
Tropical, Edw. S. Shoucair, 40 Port Royal St., Kingston.
This company represents: Chancellor (USA).
West Indies, 13 Bell Rd., Industrial Estate, Kingston 11. Tel: 37340. Cable: WIRL. Dir.: Clifford Rae.
This company represents: Columbia, Coral, Decca, Dot, MGM, Verve.

● supplies & services

MUSIC LICENSING ORGANIZATIONS

International Federation of Phonograph Industries.

PRESSING PLANTS

Caribbean Rec. 1 Geffard Pl., Kingston.
Federal, 220 Foreshore Rd., Kingston.
West Indies, 13 Bell Rd., Industrial Estate, Kingston.

JAPAN

Population: 98,280,000.
Official rate of exchange: \$1 (US) = 360 yen.
Per capita income: \$608.33 (US).
Number of record players in use: 5,000,000.
Records sold domestically: 1965—\$81,648,223; 1964—\$69,972,660; 1963—\$58,107,816.
Records imported from US (Customs declared amount): \$374,525.
Records exported to US (Customs declared amount): \$91,641.
Records imported from countries other than US (Customs declared amount): \$1,055,097.
Records exported to countries other than US (Customs declared amount): \$483,797.
Records manufactured for domestic and export sale: LP's—29,047,109 units, \$41,847,490; EP's—684,016 units, \$3,334,488; Singles—61,202,646, \$34,547,643.
Average retail price per record: LP's—\$5; EP's—\$1.38; Singles—92 cents.
Stereo Production: 76% of total production.
Discounting: Frequent.
Type of record distribution: Manufacturer to wholesaler to retailer, but only a few distributors operating; and manufacturer to retailer.
Number of jukeboxes: 7,600.
Radio stations: 48 AM—2 semi-government networks with 170 stations; 46 commercial stations. 2 FM—1 semi-government network with 80 stations; 1 commercial station.
Television stations: 48 channels—2 semi-government networks with 406 stations, 46 commercial.
Import-export regulations: Free, effective Oct. 1, 1962.

J. Fukunishi

● record manufacturers

Cosdel, Nikkatsu Int'l Bldg., Rm. 525, 1-1 Chome, Yuraku-cho, Chiyoda-ku, Tokyo. Tel: (271) 5861/2. Pres.: Kenneth L. Cole.
King, 1 Otoha-cho 2-Chome, Bunkyo-ku, Tokyo. Tel: (941) 3111. Cable: Kingrecord. Pres.: K. Machijiri; A&R: K. Ikeno; Sales: M. Suzuki; Int'l: M. Suzuki; Pub. & Adv.: T. Osawa.
This company represents: ABC (USA), Command (USA), London (UK), Telefunken (Germany), Vanguard (USA), Westminster (USA), Seven Seas (Japan) consisting of Alborada (Portugal), Ariola-Eurodisc (Germany), Argo (UK), CGD (Italy), Cetra (Italy), Compagnie Phonographique Francaise (France), Discomoda (Venezuela), Disk Jockey (Argentina), Festival (Australia), Gurtler (Italy), Jolly (Italy), Music Hall (Argentina), Ricordi (Italy), Sobeide (Belgium), Storyville (Sweden), Vault (USA), Waikiki (USA).
NIPPON COLUMBIA, 17 Tango-cho, Akasaka, Minato-ku, Tokyo. Tel: (582)-811. Cable: Nippon-columbia. Pres.: T. Kanzaki; A&R: H. Kaneko; Sales: K. Terajima; Int'l: H. Terajima; Pub. & Adv.: E. Kojima.
This company represents: Audio Fidelity (USA), CBS (USA), Disneyland (USA), Epic (USA), Festival (France), Hula (USA), Mainstream (USA), Pye (UK), Supraphon (Czechoslovakia), Time (USA), United Artists (USA), Vee Jay (USA), Columbia International consisting of Amadeo (Austria), Bam (France), Celentano (Italy), Europaischer Operaklub (Germany), Mahalo (USA), Melodia (USSR), Monitor (USA), Muza

(Poland), Palette (Belgium), Symphony Tone (Austria), Turicaphon (Switzerland), Valois (France), Viking (New Zealand). (SEE ADVERTISEMENT)

Nippon Crown, 1 Tamachi 7-Chome, Akasaka, Minato-ku, Tokyo. Tel: (503)-8941/5. Pres.: K. Arita; A&R: N. Saito; Int'l: T. Kamei; Sales: Y. Yoshida; Pub. & Adv.: K. Meguro.
Label: Crown.
Nippon Grammophon, 57 Aoyama Kita-machi 6-Chome, Minato-ku, Tokyo. Tel: (401)-4131/3. Cable: Gramocord. Pres.: S. Izawa; A&R: T. Hino; Sales: M. Tachikawa; Int'l: G. H. Hellgardt; Pub. & Adv.: T. Ito.
This company represents: Archiv (Germany), Deutsche Grammophon (Germany), MGM (USA), Verve (USA), and Polydor which consists of Ansonia (USA), Discos Universales (Mexico), Virrey (Mexico), Hi-Fi (USA), Karousel (Sweden), Fiesta (USA), Microphon (Argentina), Phonogram (Argentina & Italy), Palacio (Venezuela), Sound of Hawaii (USA).
Nippon Westminster, Shirakawa Bldg., 6 Tamura-cho 6-Chome, Shiba, Minato-ku, Tokyo. Tel: (431)-1348. Cable: Westrecording. Rep. Dir.: M. Kanishi.
This company represents: Erato (France), Hispavox (Spain) which are pressed and distributed by Nippon Columbia.
Nitchiku Industrial, c/o Nippon Columbia, 17 Tango-cho, Akasaka, Minato-ku, Tokyo. Tel: (584)-8111. Rep.: J. Takagi.
This company represents: Stereo Fidelity (USA) and Somerset (USA) which are pressed and distributed by Nippon Columbia.
Shinsekai, Saiwai Bldg., 3 Uchisaiwai-cho 2-Chome, Chiyoda-ku, Tokyo. Tel: (591)-0968. Cable: Shinseka. Pres.: K. Hoashi; Int'l: Y. Tanabe.
This company represents: Mezhkniga (USSR) which is pressed and distributed by Victor of Japan.
Teichiku, 1 Nishi-Shimbashi 2-Chome, Minato-ku, Tokyo. Tel: (502)-6651/8. Cable: Teichiku. Pres.: T. Nanko; A&R & Int'l: I. Kinouye; Sales: K. Kawasaki; Pub. & Adv.: T. Yoshiro.
This company represents: Decca (USA), Vogue (France), Union (Japan) consisting of Artone (Holland), Continental (Brazil), Meazzi (Italy), Metronome (Sweden), Ronnex (Belgium), Riviera (France), Tono (Denmark), World (Australia).
Toshiba, 30 Akasaka Tameike, Minato-ku, Tokyo. Tel: (583)-1111. Cable: Toshibamusical. Chm.: M. Kuno; A&R: S. Asawa; Int'l: N. Ishizaka; Sales: T. Sakai; Pub. & Adv.: H. Nozaka.
This company represents: Angel (UK), Capitol (USA), Kapp (USA), Liberty (USA), Odeon (UK), Stateside (USA), Warner Bros. (USA).
Victor of Japan, 1 Hon-cho 4-Chome, Nihombashi, Chuo-ku, Tokyo. Tel: (241)-7811. Cable: Vic. Pres.: H. Momose; A&R S Sales: S. Iino (RCA Victor), H. Machida (World Group), N. Ito (Philips); Int'l: T. Yagisawa; Pub. & Adv.: Y. Kumakura.
This company represents: Atlantic (USA), Big (USA), Camden (USA), Colpix (USA), Cameo (USA), Cam (Italy), Critere (France), Cynsus (France), Dot (USA), Elektra (USA), Fontana (Holland), Hickory (USA), Imperial (USA), Limelight (USA), Milano (Italy), Mercury (USA), Motown (USA), Oiseau Lyre (UK), Pacific Jazz (USA), Parkway (USA), Philips (Holland), Prestige (USA), Purist (USA), RCA (USA), Red Bird (USA), Reprise (USA), Ri-Fi, (Italy), Riverside (USA), Roost (USA), Roulette (USA), Seeco (USA), Smash (USA), Tico (USA) 20-Fox (USA), Victrola (USA), Vox (USA), World-Pacific (USA), World Group (Japan) consisting of Aristocrat (USA), Avenue (USA), Argo (USA), Bandbox (USA), Bornand (USA), Checker (USA), Chess (USA), Conquest (USA), Cucca (USA), Dart (USA), Durium (Italy), Ember (USA), Everest (USA), Fraternity (USA), Sidet (Philippines).

● music publishers

Aberbach Tokyo, Zenkyoren Bldg., 7 Hirakawacho 2-Chome, Chuo-ku, Tokyo. Tel: (265)-3291/9. Pres.: T. Ishikawa.
Crown, Shinwa Bldg., 1 Tamachi 7-Chome, Akasaka, Minatoku, Tokyo. Tel: (582)-4741/5. Dir.: T. Kamei.
Eastern, Kyowa Bldg., 34 Kotohiracho, Shiba, Minatoku, Tokyo. Tel: (501)-0344/5. Pres.: M. Isomura.
FRIENDSHIP MUSIC, 17-7, 7-Chome, Tsukiji, Chuo-ku, Tokyo. Tel: 541-7828. Pres.: K. Murakami & H. Sugiura. Liaison office: First Phoenix Mansion, Rm. B/5, 12 Takagi-cho, Akasaka, Minato-ku, Tokyo. Tel: 400-9773. (SEE ADVERTISEMENT)

International, Mansui Bldg., 14 Ogawamachi 3-Chome, Kanda, Chiyodaku, Tokyo. Tel: (201)-2317. Pres.: Y. Kitagawa.

International Music Co. & Music Publ'rs, Fuku-shima Bldg., Suite 402, 116, 1-Chome, Nishio-saki, Shinagawa-ku, Tokyo. Tel: 491-0667, 1628. Pres.: Jay H. Prager.
Japan Music, Kosokudoro Bldg., 2 Ginza Nishi 1-Chome, Chuo-ku, Tokyo. Tel: (535)-5851/9. Pres.: S. Akimoto.
Kanai Music, Dai 3 Tokyo Bldg., 4 Marunouchi 3-Chome, Chiyoda-ku, Tokyo. Tel: (211)-7826/9. Pres.: I. Hara.
Kawai Gakufu, 321 Komagome 2-Chome, Toshima-ku, Tokyo. Tel: (983)-7428. Pres.: O. Shimidzu.
Kusano, Awaji Bldg., 6 Awajicho 2-Chome, Kanda, Chiyodaku, Tokyo. Tel: (253)-0662. Pres.: S. Kusano.
Ivan Agajili Music of Japan, Awaji Bldg., 2-Chome, Awajicho, Chiyodaku, Tokyo. Pres.: Ivan Mogull.
New Orient, Sanyo Bldg., 5-17 Hongo 1-Chome, Bunkyo-ku, Tokyo. Tel: (812)-7867. Pres.: S. Itoh.
Nippon Columbia Musical Ent. (Publishing Div.), 17 Tangocho, Akasaka, Minatoku, Tokyo. Tel: (582)-8111. Dir.: J. Imahori.
Ongakunotomo Sha, 30 Kagurazaka 6-Chome, Shinjuku-ku, Tokyo. Tel: (268)-6151. Pres.: S. Meguro.
Overseas, 25 Higashi-Gokencho, Shinjuku-ku, Tokyo. Tel: (269)-0121/7. Pres.: E. Shimada.
Pacific Music, c/o Nippon Huhsu, Togyo Kaikan Bldg., 1 Yuraku-cho 7-Chome, Chiyoda-ku. Tel: (281)-5257. Pres.: T. Ishida; Int'l: Johnny Takasaki.
The Richmond Organization, 32 Ryogoku-Nihonbashi, Chuo-ku, Tokyo.
Seven Seas, King Rec., 1 Otohacho 2-Chome, Bunkyo-ku, Tokyo. Tel: (941)-3111. Pres.: K. Machijiri.
Shinko, Awaji Bldg., 6 Awajicho 6-Chome, Kanda, Chiyodaku, Tokyo. Tel: (253)-2662. Pres.: T. Kusano.
Southern, 423 Nikkatsu Int'l Bldg., 1-1 Chome, Yurakucho, Chiyoda-ku, Tokyo. Tel: (271)-9866. Cable: Southmusic.
Suisei-Sha, c/o Ongakunotomo Sha, 30 Kagurazaka 6-Chome, Shinjuku-ku, Tokyo. Tel: (268)-6151. Pres.: S. Meguro.
Taiyo, Central Apartment, 90 Onden 1-Chome, Shibuyaku, Tokyo. Tel: (403)-3763. Pres.: T. Nagashima.
Toa, c/o Ongakunotomo Sha, 30 Kagurazaka 6-Chome, Shinjuku-ku, Tokyo. Tel: (268)-6151. Pres.: S. Asaka.
Tokyo Music, Kotani Bldg., 1 Yuraku-cho 4-Chome, Chiyoda-ku, Tokyo. Tel: (501)-7737. Rep.: D. Joppe.
Tone, Dai-San Mori Bldg., 4-10, 1-Chome, Nishi Shimbashi Minato-ku, Tokyo. Tel: (502)-8214. Dir.: Katsuma Kato.
Toshiba, 34 Akasaka Tameike, Minatoku, Tokyo. Tel: (583)-1131/3. Pres.: N. Ishizaka.
Victor, 13 Misakicho 2-Chome, Kanda, Chiyodaku, Tokyo. Tel: (262)-1320. Pres.: K. Imamura.
Watanabe, Matsui Bldg., 4 Yurakucho 1-Chome, Chiyodaku, Tokyo. Tel: (502)-1966, 0038. Pres.: Mrs. M. Watanabe.
Zen-On, 25 Higashi Gokencho, Shinjuku, Tokyo. Tel: (269)-0121/7. Pres.: T. Shimada.

● record clubs

Concert Hall Society, 333 Kita-Shinagawa 3-Chome, Shinagawa-ku, Tokyo. Tel: (443)-9131. Pres.: Samuel Josepowitz.
Nippon Reader's Digest, 79 Sakuradacho, Azabu, Minato-ku, Tokyo. Tel: (402)-7301.
Time-Life Int'l, Asahi Bldg., 3 Ginza-Nishi 6-Chome, Chuo-ku, Tokyo. Tel: (572)-8511.
World Record Club, New Toyo Bldg., 14 Demma-cho 1-Chome, Akazaka, Minato-ku, Tokyo. Tel: (404)-6771/3. Pres.: S. Saito.

● supplies & services

MUSIC LICENSING ORGANIZATIONS

Mrs. Folster & Assoc., Nikkatsu International Bldg., 1 Yurakucho 1-Chome, Chiyodaku, Tokyo. Tel: (271)-6084. Pres.: Mrs. G. T. Folster.
J A S R A C (Japanese Society of Rights of Authors & Composers), agents for ASCAP, BMI, BIEM, Fox, GEMA and others. 30 Akasaka Tameikecho, Minatoku, Tokyo. Tel: (582)-0231. Pres.: S. Saijo.
Suisei-Sha (BIEM sub-agent), c/o Ongakunotomo Sha, 30 Kagurazaka 6-Chome, Shinjuku-ku, Tokyo. Tel: (268)-6151. Pres.: S. Meguro.

IN
JAPAN
&
FAR EAST



assures the maximum income from your copyrights
let's show it with results!

*Friendship**

Friendship Music, Inc.

MAILING ADDRESS 17-7, 7-CHOME, TSUKIJI, CHUO-KU, TOKYO

ADMINISTRATIVE OFFICE

PHOENIX MANSION B-5 • 12 AOYAMA-TAKAGI-CHO, AKASAKA, MINATO-KU, TOKYO

*OWNED BY KENJI MURAKAMI & HIKARU SUGIURA

continued

PRESSING & PLATING PLANTS

Athena Rec. Industry, 675 Miyahatake, Katase, Fujisawa City, Kanagawaken.
 Canary Rec. Industry, 1166 Ichibacho, Tsurumiku, Yokohama.
 King Rec., 44 Okucho 6-Chome, Arakawaku, Tokyo.
 Nippon Columbia, 125 Minatocho, Kawasaki.
 Nippon Grammophon, 1333 Kami-Kotanaka, Kawasaki.
 Teichiku Rec., 148 Hijitsukacho, Nara.
 Toshiha Rec., 5000-2 Ryokacho, Kawaguchi.
 Toyo Kasei, 1163 Ichibacho, Tsurumiku, Yokohama.
 Victor of Japan, 3-12 Moriyacho, Kanagawaku, Yokohama.

RECORDING STUDIOS

Abako, 22 Midorigaokacho, Shibuyaku, Tokyo.
 Aoi, 1-1 Jubancho, Azabu, Minatoku, Tokyo.
 Bancho, 12 Nibancho, Chiyodaku, Tokyo.
 Chuo Rokuon, Hideyoshi Bldg., 5 Ginza Nishi 5-Chome, Chuoku, Tokyo.
 Hikokan, 3 Tamuracho 1-Chome, Shiba, Minatoku, Tokyo.
 Kojimachi, 2 Hirakawacho 1-Chome, Kojimachi, Chiyodaku, Tokyo.
 Kokusai Radio Center, 13 Shinsakacho, Akasaka, Minatoku, Tokyo.

TRADE ORGANIZATIONS

Japan Phonograph and Record Assoc., 20 Tsukiji 1-Chome, Chuoku, Tokyo.
 National Record Dealers Union, Kakyo Bldg., 6 Tsukiji 3-Chome, Chuoku, Tokyo.

TAPE PLAYBACK EQUIPMENT

Aiwa, 2-3, 5-Chome, Sotokanda, Chiyoda-ku, Tokyo.
 Type: 2 track mono.
 Crown Radio, 17-4 3-Chome, Ueno, Taito-ku, Tokyo.
 Type: 4 track.
 Funai Electric, 20, 3-Chome, Ikaino, Ikuno-ku, Osaka.
 Hayakawa Electric, 1-232, Nishi Tanabe Cho, Abeno-ku, Osaka.
 Type: Philips type portable machine & 8-track
 Hitachi, 1-4, Marunouchi, Chiyoda-ku, Tokyo.
 Type: Non-compatible, reel-to-reel, mono.
 Maruwa Electronic & Chemical, 16-1, Nishiura Cho, Higashi-ku, Nagoya.
 Type: 4 track.

Matsushita Electric Ind'l, 1006, Oaza Kadoma, Kadoma-Shi, Osaka.
 Nippon Columbia, 17, Akasaka Tango Cho, Minatoku, Tokyo.
 Type: 4 track, non-compatible. Some experimental 8 track.
 Pioneer Electric, 5, 4-15, Omori Nishi, Ota-Ku, Tokyo.
 Type: 4 track.
 Sanai Kogyo, 843, Karasuyama, Ota Shi, Gunma Pref.
 Type: 4 track.
 Sanyo Electric, 2-18, Keihan Hon-dori, Moriguchi Shi, Osaka.
 Type: Reel-to-reel cartridge.
 Taiko Electric Works, 13-10, 6 Nakanobu, Shinagawa-ku, Tokyo.
 Type: 4 track.
 Teikoku Dempa, Sakurai Bldg., 4-5 Kojimachi, Chiyoda-ku, Tokyo.
 Type: 4 track.
 Victor of Japan, 3-12, Moriya Cho, Kanagawa-Ku, Yokohama.
 Type: 2 track, not compatible with any other system.

● **record manufacturers**

Flex Sal, PO Box 4070, Dsouki Bldg., Hoyek St., Beirut.
 G. Haddad, Cinema Empire, PO Box 4680, Beirut. Tel: 252222. Cable: CINEMPIRE.
 Kattan Bros., PO Box 2594, Bechara Khoury Ave., Beirut. Tel: 239073. Mgr. & Int'l: Robert S. Kattan; Sales: William S. Kattan.
 Label: Ruby.
 Lebanese, PO Box 4872, Beit Meri Rd., Sin El-Fil, Beirut.
 Philips Liban, PO Box 670, rue Verdun, Beirut.

● **supplies & services**

PRESSING PLANTS

Kattan Bros., PO Box 2594, Bechara Khoury Ave., Beirut Tel: 239073.

RECORDING & TAPE DUP. STUDIOS

Baalbeck Studios, PO Box 4665, Sin El-Fil, Beirut. Tel: 260150 & 260152. Cable: STUBAAL.
 Near East Sound, PO Box 4627, Beirut.

KENYA

Population: 9,365,000.
 Official rate of exchange: \$1 (US)=7 shillings; 20 shillings=1 pound.
 Records imported: 1965-112,752 units, value 46,769 pounds; 1964-76,634 units, value 29,040 pounds; 1963-83,528 units, value 36,047 pounds.
 Records imported from US: 1798 pounds (CIF).
 Records exported to US: Figures not available.
 Records imported from countries other than US: 44,971 pounds (CIF).
 Records exported to countries other than US: 7,056 pounds (FOB).
 Average retail price: LP's-\$3.60 (US); EP's-\$1.15 (US); Singles-86 cents (US).
 Stereo sales: 10% of total sales.
 Discounting: Rare.
 Type of record distribution: Manufacturer to wholesaler to retailer & manufacturer to retailer.
 Number of jukeboxes: 500.
 Radio stations: 1 AM government-controlled station; no FM.
 Television stations: 1 government-controlled station.
 Import-export regulations: Importation of records allowed freely. Duty-33 1/3% ad valorem.

● **record manufacturers**

East African Recs., PO Box 30256, Nairobi. Tel: 58088. Cable: Topten. Mgr.: J. F. Steindel.

● **record wholesalers**

IMPORTERS

African Mercantile (overseas), PO Box 30010, Nairobi. Tel: 26481.
 Assanand & Sons, PO Box 377, Bazaar Rd., Nairobi. Tel: 23809.
 East African Music Stores, PO Box 578, Nairobi. Tel: 20935.

Music Corner, PO Box 674, Nairobi.
 Shankardass & Sons, PO Box 486, Mombasa.
 Supermarket, PO Box 971, Nairobi.

EXPORTERS

East African Recs., PO Box 30256, Nairobi. Tel: 58088. Cable: Topten. Mgr.: J.F. Steindel.

● **supplies & services**

PRESSING PLANTS

East African Recs., PO Box 30256, Nairobi. Tel: 58088. Cable: Topten. Mgr.: J. F. Steindel.

RECORDING & TAPE DUP. STUDIOS

East African Recs., PO Box 30256, Nairobi. Tel: 58088. Cable: Topten. Mgr.: J. F. Steindel.

LEBANON

Population: 2,152,000.
 Official rate of exchange: \$1 (US) = 3 Lebanese pounds.
 Records imported from US (factory value): 1964-\$14,599; 1963-\$15,500; 1962-\$7,500; 1961-\$16,200.

MALAYSIA

Population (Malaya, Sabah, Sarawak): Latest official estimate-8,780,000.

Over-all income: \$8,166,000,000.

Per capita income: \$932 annually.

Official rate of exchange: \$1 (US) = 3 Malaysian dollars (approx.).

Number of homes with record players: 220,000.

Records imported from the US (factory value): \$37,271 (US); (retail value): \$75,561 (US), (including 20% import duty).

Records imported from countries other than the US (factory value): \$211,742 (US); (retail value): \$75,561 (US) (including 20% import duty).

Records exported to countries other than the US (factory value): \$138,140 (US); (retail value): \$346,376 (US), (including 20% import duty).

Average retail price per record: LP's: \$4.25 (US); EP's: \$1.50 (US); Singles: 80 cents (US).

Stereo sales: 70% of total sales.

Discounting: Frequent.

Type of record distribution: Manufacturer to wholesaler to retailer, rarely manufacturer to retailer.
 Number of jukeboxes: None (prohibited by Government).

Radio stations: AM: One Government-owned radio situated centrally in the Malaysian capital, Kuala Lumpur, with sub-stations in Penang, Malacca, Ipoh, Kota Bahru in the States of Malaya. Sabah and Sarawak operate their own radio stations. Rediffusion Ltd. operates in the States of Malaya, providing a wired service to listeners with programs comprised mainly of commercials and entertainment value.

Television stations: FM: One Government-owned television station in the Malaysian capital, Kuala Lumpur, broadcasting simultaneously on six channels to various States of Malaya only. Sabah and Sarawak do not have any television service as yet.

Important record import-export regulations: Import duty of 20% on all goods direct from manufacturers into Malaysia. Imports via Singapore are charged 25% tax. The object is to encourage direct imports into Malaysia.

Wally Chan

● **record manufacturers**

Borneo, PO Box 151, Kuala Lumpur. Cable: Borneo. Branches: Maxwell Rd., Ipoh.-6-A Weld Quay, Penang.

Hup Hup, 61 Bukit Bintang, Kuala Lumpur. Tel: 87809.

Branches: 5 Jalan 13/2 Petaling Jaya, Kuala Lumpur. Tel: 53213.-10 Lemon St., Seremban. Tel: 4356.-25 Green Hill Dr., Ipoh. Tel: 4299.-11-11 Yau Tet Shin Market, Ipoh. Tel: 2300.

The Life Recs., c/o King Musical Inds., 5 Jalan 13/2 Petaling Jaya, Kuala Lumpur. Tel: 52118 & 52119. Cable: Discking. Mgr's Dir.: NG Lian Chin.

● **importers & exporters**

Borneo, PO Box 151, Kuala Lumpur. Cable: Borneo. Branches: Maxwell Rd., Ipoh.-6-A Weld Quay, Penang.

This company represents: Capitol (USA), Co-

THE
 INTERNATIONAL
 INFLUENCE
 OF
**BILLBOARD
 GROWS
 AND
 GROWS**

WONDERFUL ACCEPTANCE IN JAPAN

thanks to the world-wide co-operation with NIPPON COLUMBIA,
having proud of 56 years history in the music world

CBS RECORDS
EPIC
UNITED ARTISTS
DISNEYLAND
AUDIO FIDELITY
MAIN STREAM
TIME
VEE-JAY
MONITOR
BUDGET SOUND
PYE
ERATO
FESTIVAL
VALOIS
DISQUES BAM
HISPAVOX

AMADEO
SYMPHONY TONE
ELITE SPECIAL
EURODISC
VIKING
BARENREITER
HULA
ITALDISC
PALETTE
MUSICA ET LITERA
CLAN CELESTANO
SUPRAPHON
MELODIA
MUZA

WHOLE CATEGORY JAPANESE LOCAL

AN ALSHIRE PRODUCTION

NIPPON COLUMBIA CO., LTD.

4-14 AKASAKA MINATO-KU TOKYO

ONE OF THE MOST IMPORTANT CLASSICAL AND POPULAR RECORD CATALOGUES IN THE WORLD



LONDON RICHMOND



Exclusive Distributor: PEERLESS DE MEXICO, S. A. APDO. 1657 MEXICO, D. F.

continued

lumbia (USA), MGM (USA), Parlophone (USA), EMI (England), Pathe (France & Hong Kong), Angel (India).

Cosdel, 1014 Jalan Tun Tjih, Selango Mansion, Kuala Lumpur. Tel: 24366.
This company represents: Pye (England), Dot (USA), Motown (USA), Tama (USA), Gordy (USA), Roulette (USA), Hamilton (USA), Chess (USA), Checker (USA), Argo (USA), Hickory (USA), Ember (England).

Decca, 241-A Victoria St., Penang. Tel: 60671.
Branch: 141 Jalan Bandar, Kuala Lumpur. Tel: 23B10.
This company represents: Decca (England), London (England), Ace of Clubs (England), Ace of Diamonds (England), Argo (England).

Edward Eu, 193 Jalan Imbi, Kuala Lumpur. Tel: 22261.
Branch: 35 Penang St., Penang. Tel: 23273.
This company represents: RCA (international).

Hup Hup, 61 Bukit Bintang, Kuala Lumpur. Tel: 87809.
Branches: 5 Jalan 13/2 Petaling Jaya, Kuala Lumpur. Tel: 53213.—10 Lemon St., Seremban. Tel: 4356.—Green Hill Dr., Ipoh. Tel: 4299.—11-11 Yau Tet Shin Market, Ipoh. Tel: 2300.
This company represents: CBS (USA).

E. S. Isaac, 205 Jalan Tunku Abdul Rahman, Kuala Lumpur. Tel: B0637. Cable: Isaanco.
This company represents: Warner Bros. (USA), Reprise (USA), Vogue (France).

William Jacks, Chartered Bank Bldg., Jalan Ampang, Kuala Lumpur. Tel: 25431.
Branches: Eastern Bank Bldg., 2 Benteng, Kuala Lumpur. Tel: 23161.—94 Brewster Rd., Ipoh. Tel: 2616.—2-0 Chartered Bank Chambers, Penang. Tel: 64731.
This company represents: Philips (Holland), Fontana (England), Smash (USA), Mercury (USA).

Music City, 61 Jalan Bukit Bintang, Kuala Lumpur. Tel: 87809.
Branch: 10 Lemon St., Seremban. Tel: 4356.

Music House Rec., 57/61 Leech St., Ipoh. Tel: 3117.

MEXICO

Population: 1960 census—34,923,129; latest official estimate: 42,000,000.

Official rate of exchange: \$1 (US) = 12.50 Mexican pesos.

Per capita income: \$255 annually.

Number of homes with record players: About 500,000, up from 450,000 in 1964.

Records sold, 1965 (domestic production at wholesale): LP's—\$12 million (20% up from 1964); EP's—\$1.7 million (about 35% up from 1964); Singles—\$2.8 million (about the same as in 1964). Total: About \$16.5 million (up from \$14 million in 1964), over 200 million Mexican pesos.

Records imported from US (factory value): 1965—\$350,000.

Records exported to US: 1965—350,000 units (factory value \$240,000).

Origin of music on pop records: Domestic—60% (down 15%); U. S.—25% (up 10%); other—15% (up 5%).

Average retail prices: LP's—\$4; EP's—\$1.20; Singles—72 cents.

Discounting: 15% to 22% is common, the same as in 1964 (up from 10% in 1961).

Record club and package sales: 12% (in value) of total sales (the same as in 1964).

Stereo: 10% of LP's.

Radio stations: 517.

TV stations: 21.

Juke boxes: About 35,000.

Important regulations: Export taxes abroad from Mexico: 3%. Import taxes: 40% ad valorem plus \$1.20 per kilo, with lowest minimum tax \$6.40 per kilo. Sales tax in Mexico, 3%. Royalties to composers and authors: 8% on wholesale price of record. Otto Mayer-Serra

● record manufacturers

C B S, San Bartolo, Naucalpan, Estado de Mexico. Tel: 27-62-20. Cable: Colrecord. VP & Gen. Mgr.: Armando de Llano; A&R: Felipe Valdez Leal; Sales: Raul Bejarano.
Labels: CBS, Harmony, Okeh.
This company represents: Columbia (USA) and

all CBS affiliates; Montilla (USA).
Int'l representatives: USA (Columbia) and all CBS affiliates.

CAPITOL DE MEXICO, Ayuntamiento 54, Mexico 1, D.F. Tel: 18-13-20. Cable: Caprecord. Pres.: Emilio Azcarraga Jr.; Gen. Mgr.: Andre Midani; A&R: Rafael de Paz; Sales Mgr.: Arturo Valdes; Pub. Mgr.: Rene Flores.
Labels: Capitol, Odeon.
This company represents: Capitol and all EMI affiliates.
Int'l representative: Via Capitol and EMI. (SEE ADVERTISEMENT)

Co-Ro, Bahia de Perula 80, Mexico 17, D.F. Gen. Mgr. & Int'l: Federico Rojas.
Labels: Co-Ro, Lyra, Corito.

Discos Cisne, Caracci 64, Mexico 19, D.F. Tel: 24-57-53, 24-52-11. Pres.: Rafael Ficachi; Gen. Mgr.: Guillermo Buerckle.
Labels: Cisne, E.R.

Discos Exclusivos, Hamburgo 214, Mexico 6, D.F. Tel: 25-61-44. Gen. Mgr.: Jose I. Morales; Admin. Mgr.: Bernardo Gonzalez.
Label: Son-Art.

DISCOS GREVER INT'L, Londres 179, Mexico 6, D.F. Tel: 14-18-28. Mgr.: Teodoro A. Dehesa. (SEE ADVERTISEMENT)

DISCOS MUSART, Aptdo. 17503, Tacuba, Mexico, D.F. Tel: 27-00-20. Cable: Musart. Pres.: Eduardo L. Baptista; Treas.: Luis Gil; Sales Mgr.: Jose Luengo; A&R: Guillermo Acosta; Pub.: Jose Valdivia.
Label: Musart.
This company represents: Fonograma (Venezuela), Liberty (USA), Mainstream (USA), Musidisc (Brazil), Tempo (USA), Tico (USA), Time (USA), Pacific Jazz (USA), Prestige (USA), RGE (Brazil), Roulette (USA), World Pacific (USA), Zafiro (Spain), Zeida (Columbia).
Int'l representatives: Bolivia (Discolandia), Brazil (RGE), Central America (Dideca, Guatemala), Chile (Odeon), Colombia (Co-Discos), Ecuador (Ifesa), Peru (Iemosa), Spain (Zafiro), Uruguay (Palacio de la Musica), USA (Rec. Dist're of America), Venezuela (La Discoteca). (SEE ADVERTISEMENT)

DISCOS TIZOC, PO Box 11620, Mexico 11, D.F.; Division del Norte 31, Mexico 12, D. F. Tel: 43-72-41. Cable: Discizoc. Pres.: Mario Freidberg; A&R: M. Angel Sarraile.
Label: Tizoc.
This company represents: A&M (USA), Challenge (USA), Clan (Italy), Colpix (USA), Contemporary (USA), Disc Jockey (Argentina), Elektra (USA), Ember (England), Fantasy (USA), Fermata (Argentina, Brazil), Folkways (USA), Fuentes (Colombia), GNP (USA), HiFi (USA), Phonocolor (Italy), Prosadis (France), Nilser (Brazil), Vault (USA), W&G (Australia).
Int'l representatives: Argentina (Disc Jockey), Colombia (Fuentes), New Zealand (Viking). (SEE ADVERTISEMENT)

Discos Universales (DUSA), Tiber 5B, Mexico 5, D.F. Tel: 11-72-42, 25-29-89. Cable: Grammophon. Gen. Mgr.: Constantin Th. Metaxas; Sales: Fritz Hentschel.
Labels: Polydor, Philips, Belart, Heliodor, Velvet, Sonvel.
This company represents: Ansonia (USA), Archiv (Germany), DGG (Germany), Elite (Switzerland), Fontana (Holland), Kubaney (USA), MGM (USA), Mercury (USA), Philips (Holland), Polydor (Germany), Ri-Fi (Italy), Riverside (USA), Saar (Italy), Velvet (USA), Verve (USA).
Int'l representatives: Via Polydor and Philips.

Gamma, PO Box 7762, Mexico 1, D.F.; Ejercito Nacional 167, Mexico 5, D. F. Tel: 45-73-60. Gen. Dir.: Tomas Munoz.
Labels: Gamma, Diana
This company represents: ABC Paramount (USA), Alvorada (Portugal), Amadeo (Austria), Cameo-Parkway (USA), Canadian-American (Canada), Chess, Checker, Cadet (USA), CGD (Italy), Command (USA), Ducretet-Thomson (France), Erato (France), Everest (USA), Festival (France), Hispavox (Spain), Imperial (USA), Laurie (USA), Le Chant du Monde (France), Metronome (Denmark), Reprise (USA), Supraphon (Czechoslovakia), United Artists (USA), Vanguard (USA), Vogue (France), Warner Bros. (USA).
Int'l representatives: Via Hispavox (Spain) and its affiliates.

Importadora de Discos, Tenayuca 475-F, Mexico 13, D.F. Tel: 24-46-79. Mgr.: Gabriel Mendoza;

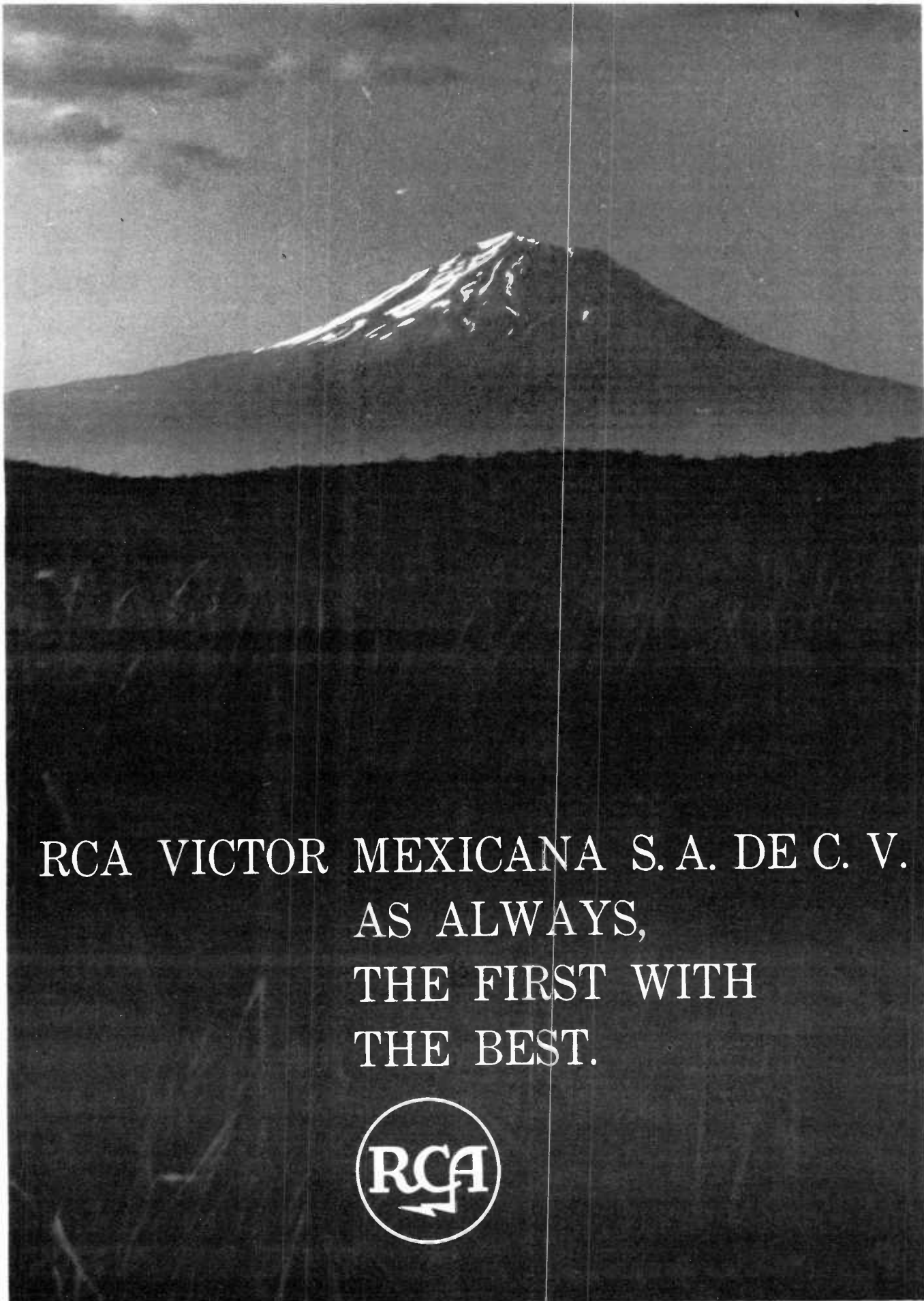

RCA VICTOR MEXICANA S. A. DE C. V.
AS ALWAYS,
THE FIRST WITH
THE BEST.





BEST artists
sellers
quality



ALBERTO VAZQUEZ



GLORIA LASSO



LOS ARAGON



ANGELICA MARIA



MANOLO MUÑOZ



FLOR SILVESTRE

U. S. A. distributor:

Records Distributors of America Inc.
P. O. Box 75 Tel. 887-2638
Hialeah, Fla.

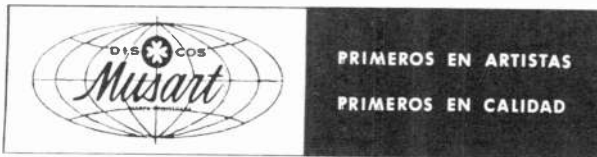

DISCOS MUSART S. A.

Av. Cuitláhuac 2327 Atzacapozalco 16, D. F. México
 Cable Musart Tel. 27-00-20



ANTONIO AGUILAR



MIKE LAURE



LUCHA VILLA



CARLOS CAMPOS



LOS YORSY'S

distributors in:

- CENTRAL AMERICA
- PUERTO RICO
- COLOMBIA
- ECUADOR
- PERU
- CHILE
- BRASIL
- VENEZUELA
- ARGENTINA
- DOMINICANA
- BOLIVIA
- URUGUAY
- SPAIN



OLGA GUILLOT



LENA Y LOLA

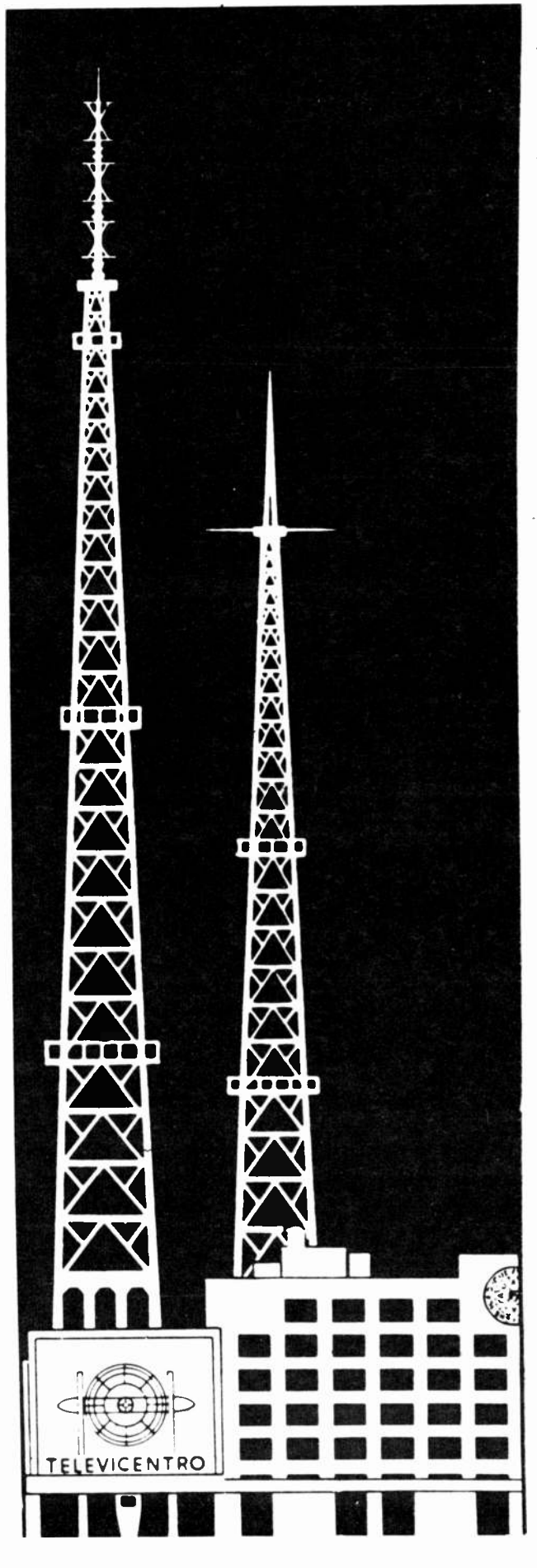

Mexico's private enterprise television produces 171 hours of live on tape and live entertainment weekly. Three channels (2, 1 and 5) broadcast from the Telesistema Mexicano, S. A. "Televiscentro" central service complex, in Mexico City, sending programs by microwave to seventeen states surrounding the nation's capital. Although the three channels are separate, they operate from common facilities, reaching 11 owned stations on the nets (3 are repeaters) and shipping videotapes and films to an additional 15 independently owned affiliates throughout the country.

Telesistema exports Mexico-produced programs to Central and South America and to affiliates in Los Angeles, California (Channel 31) and San Antonio, Texas (Channel 11). Throughout Latin America, Mexican programs have earned enviable popularity competing with film products. In Mexico, local shows maintain 8 of the top 10 popularity positions in rating polls conducted continually.

Today, Mexican viewers select from local productions and fifty American programs, dubbed into Spanish. Remote controls from five units cover every important event in the country, such as boxing, baseball, bullfights, soccer, basketball, tennis and important government activities. As many as six remote controls are handled on an average Sunday. News, produced independently, informs the nation of world events through films and major wire services received daily by the 3 leading newspapers which produce TV news programs. Cultural and educational programming is offered in prime time. Children's shows form a major part of Channel 5's daily programming.



olympics

1 9 6 8

TELESISTEMA MEXICANO, S. A.

TELEVICENTRO

Avenida Chapultepec numero 18

MEXICO 1, D.F. • MEXICO

Discos
Capitol
de 
Mexico, s.a.

A NEW VOICE IN *méxico* the finest sound in today's
world of Mexican Music.



MARIA BRAVO
MANUEL CORREA
EVA MARIA
GABRIELA
ADOLFO GARZA
LUCHO GATICA
LAS CASTILLON

LOS YAKI
MARIACHI ORO Y PLATA
NACHO MENDEZ
NADIA MILTON
FRANCISCO OSEGUERA
MARIO PATRON
JOAQUIN PRIETO

continued

A&R: Francisco Corchado.
Labels: Decca, AudioMex.
This company represents: Decca (USA).

ORFEON-VIDEO VOX, Av. Universidad 1273 Mexico 12, D.F. Tel: 24-25-00. Cable: Dismexsa. Pres.: Rogelio Azcarraga; Gen. Dir.: Alejandro Siegrist; Mgr.: Jorge Audiffred; A&R: Porfirio Reyna & Paco de la Barrera.

Labels: Orfeon, Dimsa, Maya, Ariel.
This company represents: Copacabana (Brazil), Columbia (Spain), King (Japan), King (USA), Somerset (USA), Westminster (USA), Whitehall (USA).

Int'l representatives: Argentina (Sicamericana), Brazil (Copacabana), Colombia (Sonolux), Ecuador (Emporio Musical), France (Vogue), Japan (King), USA (Ansonia, Arv Music, Crest Sales, Velvet), Venezuela (Antor). (SEE ADVERTISEMENT)

PEERLESS, Laguna Mayran 232, Mexico 17, D.F. Tel: 45-63-40. Cable: Peerless. Pres.: Heinz Klinckwort; Gen. Mgr.: Leo Porias; Ass't Gen. Mgr.: Alejandro Zaldivar; A&R: Gustavo Cervantes; Sales: Bruno Vogt; Int'l: Rene Vera Sanchez. Labels: Peerless, Eco.

This company represents: Decca (England), Del Norte (USA), Falcon (USA), Fuentes (Colombia, Ecuador), London (USA), Richmond (USA), Seeco (USA), Telefunken (Germany), Vox (USA).

Int'l representatives: Argentina (Sicamericana), Brazil (Cassio Muniz), Chile (Philips), Colombia (Fuentes), Paraguay (Antar), Peru (Virrey), Puerto Rico (P.R. Recs.), Spain (Hispanovox), Uruguay (Antar), USA (S&R), Venezuela (Palacio de la Musica). (SEE ADVERTISEMENT)

R C A Victor Mexicana, Ave. Cuiclahuac 2519, Mexico 16, D.F. Tel: 27-60-20. Cable: Radiointer. Pres.: Louis Couffolenc Jr.; Gen. Sales Mgr.: Guillermo Infante; A&R: Ruben Fuentes; Pub.: Juan Calderon.

Labels: RCA Victor, Camden, Victrola.
This company represents: Atlantic (USA), Disneyland (USA), Dot (USA), Elenco (Brazil), Motown (USA), RCA affiliates.

Int'l representatives: Via RCA International. (SEE ADVERTISEMENT)

● music publishers

BRAMBILA MUSICAL MEXICO, S. A.

Editora de los exitos:
TIBURON A LA VISTA
RENUNCIACION
LA ENRAMADA
ESCLAVO Y AMO
ANSIEDAD
ETC.

Representante de:
WALT DISNEY MUSIC CO.

EDWIN H. MORRIS & CO. INC.
Julio Korn

Sub-editora de los exitos:
ACOMPANAME
SOMBRA
UNA PROBABITA DE MIEL
SOY ENRIQUE VIII
CELOSA
ETC.

Brambila Musical Mexico, Av. Cuiclahuac 2305, Mexico 17, D.F. Tel: 27-66-67. Mgr.: Rogelio Brambila.

Campei, Av. Cumbres de Maltrata 375-A, Mexico 12, D.F. Tel: 43-71-40.

Compas, Av. Cumbres De Maltrata 375-A, Mexico 12, D.F. Tel: 43-71-40.

Editorial Mexicana de Musica Internacional (EMMI), Dr. Valenzuela 10, Mexico 7, D.F. Tel: 12-62-39. Mgr.: Mario Alvarez.

Emroth, Av. Cumbres De Maltrata 375-A, Mexico 12, D.F. Tel: 43-71-40.

Fermata Mexicana, Division del Norte 31, Mexico 12, D.F. Tel: 43-72-40. Mgr.: Mario Freidberg.

Grever Int'l, Londres 179, Mexico 6, D.F. Tel: 11-51-16 & 11-52-75. Pres.: Carlos E. Grever; Mgr.: Enrique Marquez.

Juventa, Tonalá 194-6, Mexico 7, D.F. Tel: 11-80-09. Mgr.: Rosa Maria Gonzalez.

Marques, Hnos, Av. Chapultepec 43, Mexico 1, D.F. Tel: 12-02-28. Mgr.: Ramon Carrillo.

Mexicanas de Musica, Av. Juarez 18-206, Mexico 1, D.F. Tel: 21-58-55. Mgr.: Rodolfo Halffter.

Mexicomusic, Division del Norte 31, Mexico 12, D.F. Tel: 43-72-40. Mgr.: Mario Freidberg.

**CAMPEI S.A. PUBLISHING
ADMINISTRATION IN MEXICO FOR:**

- COMPAS
- EMROTH PUBLISHERS CO.
- MILLS MUSIC DE MEXICO
- PAMPER MUSIC DE MEXICO
- PROMOTORA MUSICAL MIGUEL PRADO

**AVENIDA CUMBRES DE MALTRATA
375-A. TELEFONO 43-71-40**

Mills Music de Mexico, Cumbres de Maltrata 375-A, Mexico 112, D.F. Tel: 43-71-40. Mgr.: Alfredo Gil.

Mundo Musical, Puebla 286, Mexico 7, D.F. Tel: 25-10-42. Mgr.: Jose Vaca Flores.

Pamper (see Mills Music de Mexico).
Promotora Hispano-Americana de Musica (PHAM), Dr. Valenzuela 10, Mexico 7, D.F. Tel: 12-96-50. Mgr.: Luis Martinez Serrano.

Promotora Musical Miguel Prado, Av. Cumbres de Maltrata 375-A, Mexico 12, D.F. Tel: 43-71-40.

Ricordi de Mexico, P. de la Reforma 481-A, Mexico 5, D.F. Tel: 25-57-22. Mgr.: Mario Balestrini.

Teocali, Division del Norte 31, Mexico 12, D.F. Tel: 43-72-40. Mgr.: Mario Freidberg.

Trebol, Rio de la Loza B4-105, Mexico 13, D.F. Tel: 12-63-66. Mgr.: Jose Martin Hernandez.

● importers & exporters

Exportadora Centroamericana, Av. Juarez 127-40B, Mexico 1, D.F.

Intercambio Mercantil, Marsella 6B, Mexico 6, D.F.

● supplies & services

RECORDING & TAPE DUP. STUDIOS

C B S, San Bartolo Naucalpan, Estado de Mexico. Tel: 27-62-20.

Pan Americana de Discos, Apdo. 3, Tacuba, Mexico 17, D.F.

Peerless de Mexico, Apdo. 1657, Mexico 1, D.F.

R C A Victor Mexicana, Av. Cuiclahuac 2519, Mexico 16, D.F.

MUSIC LICENSING ORGANIZATIONS

Sociedad de Autores y Compositores de Mexico, Ponciano Arriaga 17, Mexico 1, D.F. Tel: 46-91-67. Gen. Dir.: Carlos Gomez Barrera.

TOP IN DISTRIBUTION
MORE THAN 500 DEALERS

TOP IN FACILITIES
THREE RECORDING STUDIOS
Three, Two Or Monaural Recording Using Up To 12 Microphones.

MASTERING
Stereo Or Monaural
PLATING
8 Hrs. Service, Direct Stamper
24 Hrs. 3 Step Process
PRESSING
16 Automatic Presses

JACKET MANUFACTURE
With Own Color Separation And Printing Facilities

ORFEON VIDEOVOX, S.A.
Av. de la Universidad 1273 - Mexico 12, D.F.



make the year-long reference value of the "buyer's guide" readily AVAILABLE TO EVERY MEMBER OF YOUR FIRM...

*Order extra copies NOW
Just \$1.25 per copy (prepaid)*

Billboard Buyers Guide
2160 Patterson St.
Cincinnati, Ohio 45214

Please send ... copies of Buyers Guide.
My payment for \$ is enclosed.

Name

Company

Address

City

Zone

State

GREVER INTERNATIONAL S.A.
WISHES TO THANK
ITS MANY REPRESENTATIVES
ALL OVER THE WORLD
GREVER INTERNATIONAL S.A.
LONDRES 179, MEXICO 6, D.F.



in **MEXICO**

We sell your records in Mexico and Central America through the best distribution and advertising. Send us your records and receive pesos from

DISCOS TIZOC, S.A.

Division del Norte 31, Mexico 12, D.F., Mexico — Phone: 43-72-40

MUCHAS GRACIAS TO ALL OUR AFFILIATES THRU THE YEARS

Hi-Fi	Folkways	GNP-Crescendo
Monitor	Everest	Fantasy
	Challenge	

AND WELCOME TO THE NEW ONES

A & M

Specialty	20th Cent. Fox	Pickwick	Valiant
-----------	----------------	----------	---------

FOR BEST PUBLISHING & COLLECTING IN MEXICO

MEXIMUSIC, S.A. — FERMATA MEXICANA, S.A. — EDITORIAL TEOCALI, S.A.

we represent some of the world's leading publishers in Mexico & Central America including:

The Beatles Publishing Companies; Fermata Music; Venice Music; Almo & Irving Music; Burlington Music; Clan Music; Leonardi Music and Aznavour's Publishing Companies.

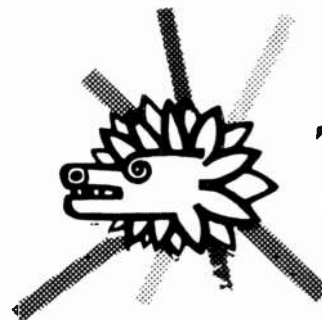

TIZOC
RECORDS

continued

PRESSING PLANTS

C B S, San Bartolo Naucalpan, Estado de Mexico.
Co-Ro, Bahia de Perula 80, Mexico 17, D.F.
Discos Cisne, Caracci 64, Mexico 19, D.F.
Gamma, PO Box 7762, Mexico 1, D.F.
Orfeon-Video Vox, Av. Universidad 1273, Mexico 12, D.F.
Pan Americana de Discos, Apdo. 3. Tacuba, Mexico 17, D.F.
Peerless, Apdo. 1657, Mexico 1, D.F.
R C A Victor Mexicana, Apdo. 28570, Mexico 16, D.F.

MOROCCO

Population: 12,600,000.
Official rate of exchange: \$1 (US) = 5.06 dirhams.

● **record manufacturers and/or wholesalers**

Auclair-Salemi, 26 rue Nationale, Casablanca. Tel: 22381.
Jean Brunot, 8-10 rue de la Somme, Casablanca. Tel: 25378.
Casa Rox, 8 Blvd. Pasteur, Tangiers. Tel: 15225.
Chellsons, 50 rue des Chretiens, Tangiers. Tel: 18795.
Henri Cometta 67 rue Nationale, Casablanca. Tel: 68231.
Comptoir des Produits Parlants, 2 rue Ch. Valdrome, Casablanca. Tel: 22184.
Disco-Maghreb, 21 rue du Soldat-Roch, Casablanca. Tel: 41450.
Herma, 33 rue Fernando de Portugal, Tangiers. Tel: 19072.
Radelec, 10 rue Pegoud, Casablanca. Tel: 29493.
Radio-Vox 24-26 rue Clemenceau, Casablanca. Tel: 23511.
S O D I C, ang., rue J. Cartier & Blvd. Girardot, Casablanca. Tel: 65689.

Societe Africaine de Telecommunications "SAFTEL," Immeuble Liberte, Casablanca. Tel: 28975.
Somidex, 81 Av. Moulay Hassan 1, Casablanca. Tel: 71799 & 72798.
Vadrot, 45 rue Clemenceau, Casablanca. Tel: 65-382.

● **importers**

Atlas Dist'g, 31 rue de Charmes, Casablanca.

NETHERLANDS

Population: 1965 estimate—12,974,000.
Per capita income: \$740 annually.
Record sales: 1965—22,000,000.
Records imported from US (factory value): 1965—\$174,543; 1964—\$163,409; 1963—\$199,700.
Average retail price: LP's—\$5; EP's—\$1.75; Singles—\$1.20.

Discounting: None.
Record club sales: 2.8% of all records.
Stereo sales: 39% of all LP's.
Record distribution: Manufacturer to dealer.
Medium-wave radio stations: 4 channels.
Television stations: 6 channels.
Number of jukeboxes: 4,500 (approx.).
Import-export regulations: Turnover tax on rights: 4%. Import tariff from EEC Common Market countries—8.4% plus 5/95 turnover tax invoice amount. Tax on imports from other nations—13.6% plus 5/95 turnover tax invoice amount. In case of imports from US add copyright to the invoice amount, import tariff and turnover tax. All other nations as members of the Berne convention have import and export rights paid by the receiving countries. **Bas Hageman**

● **record manufacturers**

Artone Gramophone, Artone Bldg., 8-10 Kruisstr., Haarlem. Tel: 17476. Pres. Mfg. & Dom.: Casper D. Slinger; Dir. Sales: John J. Vis; Pres. Int'l: Bill C. Slinger.
This company represents: ABC, Cameo-Parkway, Command, Festival, Hickory, Impulse, Oriole, Ricordi, Specialty, United Artists, Westminster.

Barclay-Nederland, 104 Singel, Amsterdam. Tel: 223461. Pres. Mg'g.: B. R. Maassen.
This company represents: Barclay, Erato, Hispavox, Riviera, 20th-Fox.
Cartridge: Barclay fits Philips-system.

BASART, 20 Houtmankade, Amsterdam. Tel: 222192/63209/241260.

Branch: Leidsegracht 11, Amsterdam. Tel: 222-626. Cable: Editoras. Dir.: Guus Jansen Jr. & Frans Basart; A&R & Int'l: Guus Jansen Jr.
Labels: Europhon-Basart, Whamm.

This company represents: Alpha, CND, Camerata, Christophorus, Gotta, Delyse, Discophiles Francais, Durium, Experiences Anonymes, Folkways, Hebra, Kniga, Orchestrola, President, Saba, Savoy, Trianon, Vox, Walt Disney. (SEE ADVERTISEMENT)

Bosheck, 241 XII Hemsterhuisstraat, Amsterdam. Tel: 154684. Pres.: Mr. W. W. E. Bosheck.

This company represents: Da Camera, Phonoband, Tell-Alpha, Startlet, Weltmelodie, Superstone, Combo-Krysta, Kritos, Alpina, Amati, Clartes, Pastorale & Musique, Unidisc, Ancore.

BOVEMA, 49 Bronsteeweg, Heemstede. Tel: 80750. Pres.: G. M. Oord.

This company represents: Angel, Capitol, CUB, Columbia (England), Disneyland, Gloria, HMV, Imperial, Jupiter, Keen, Laurie, Legrand, Liberty, Pathe, Pret, Regal, Stateside, Studio SM, World Production, Ember, Parlophone-Odeon, Volt, Stax, Dial, Playboy, Encore, Focus, Liberty, Dolton, BBC. (SEE ADVERTISEMENT)

C B S, Jansstraat 14, Haarlem. Tel: 17476.

Cable: Colrecord. Mg'g Partners: Bill C. Slinger & Casper D. Slinger; Sales Mgr.: Hemmy Wapperom.

This company represents: All USA, International & Domestic products released on the CBS label.

C N R, 40 Gevers Deynootplein, Scheveningen. Tel: 559500 Cable: Cener, The Hague. Mgr.: Hans van Zeeland; Promo. Dept.: Gerrit van der Meent; A&R: Addy Kleingeld; A&R Int'l: Wim den Daas.

Labels: CNR, Jubilate.
This company represents: Telefunken, Cantate, Cetra, Harmonia Mundi, Storyville, Audio Fidelity, CGD, Trans Atlantic, Tania Exclusive, Muziek Expres.

Int'l representatives: Belgium (Discobell), France (Pathe-Marconi), Germany (Teldec),

IN HOLLAND



records for

COMPLETE NATIONAL REPRESENTATION

N.V. Grammofoonplatenmaatschappij CNR
postbox 5075 - Scheveningen - Holland
OWN PRESSINGPLANT

Italy (Fonit), Scandinavia (Dans Gramofonplade), Spain (Belter). (SEE ADVERTISEMENT)
 Cinerec Supraphon Holland, 14 Vaartweg, Hilversum. Tel: 15353. Pres.: Peter M. Bronkhorst; Mg'g Dir.: Miss Francis Holdert.
This company represents: Supraphon, Musica Sacra, Musica Mundi.
 Dureco, 21 Beursstraat, Amsterdam. Tel: 2422BB. Cable: Recmus. Pres. & A&R: J. D. Timman; Sales: Ch. P. Noordendorp.
Labels: Cid, Omega, Metronome, Te Deum, Telstar, Vega, Dureco, Weekend, Zafiro, Ojee.
This company represents: Omega-Cid (Belgium, France), Saga (England), Stella (France), Vega (France), Weekend (France), Wonderland.
Int'l representatives: Belgium (Omega), Germany, Scandinavia (Metronome).
 Exclusive, L. Pasteurstraat 74, Haarlem. Tel: 12B46. Pres.: G.A.S. Grit.
Labels: Tania, Exclusive.
 Funckler (div. of Artone), Artone Bldg., B-10 Kruisstraat, Haarlem. Exec. mgr.: Pete Felleman.
This company represents: Barenreiter, Epic, Chess-Int'l, Colpix, Hickory, Tamla-Motown, Pallette, Prestige, Roulette, Tico, High Fidelity.
 Hollandse Decca, Singel 170-172, Amsterdam-C. Mg'g Dir.: R. H. Klaassen.
 I F O (Independent Rec. Prods.), PO Box 3524, 39 Middenweg, Amsterdam. Tel: 59625/943618. Mg'g Dir.: P. Rensen; A&R Mgr.: J. Akkerman; PR & Int'l Sales Mgr.: R. Faber.
 Inelco, Holland, 801 Arent Janszoon Ernststraat, Amsterdam, Z-2. Tel: 421722. Cable: Intelect. Mg'g Dir.: W. Brandsteder; A&R: C. Koelman Jr.; Sales: J. Beutler; PR & Int'l: A. N. Prins; Pub.: P.F.J. Dam.
Labels: RCA Victor, RCA Victrola, RCA Camden.
This company represents: RCA Victor (USA), Amadeo (Austria), Elite Special (Switzerland).
 Iramac, Brediusweg 43, Bussum. Tel: 02959 & 18285. Pres.: S. S. A. Samama; A&R: W. Duys; Sales: H. C. Majoor.
Labels: Iramac, Relax.
 Munnikendam, Fa. B., Kromme Waal 18, Amsterdam. Tel: 248994. Pres.: B. Munnikendam.
This company represents: Ansonia, Blue Note, Mainstream, Monitor, Seeco (USA), Acropole, Musidisc, Typic (France), Arc, Fidelity, Presto, Society, Selection-Collector (England).

Muzikale Meesterwerken Serie, 12 Paulus Potterstraat, Amsterdam. Tel: 734911 (Record Sales Club).
 NEGRAM-DELTA, Zijlweg 286, Haarlem. Tel: 17543/B1400/B6659. Mg'g Dirs.: R. Oeges & H. I. Kellerman; Pub. Mgr.: Cor Aaftink.
This company represents: Reprise, Warner Bros., Kapp, Congress, Dot, Red Bird, Duke, Everest, Elektra (USA), Vogue (France), A Z, Pye, Piccadilly (England), Ariola, Eurodisc, Melodia-Eurodisc, Baccarola (Germany), Jolly (Italy), Scepter, Delta, Vergara, Hilltop, Design, Sonet, Clan, Olympia. Tel: Picketino. (SEE ADVERTISEMENT)
 PHILIPS PHONOGRAPHIC INDUSTRIES, Gerrit v.d. Veenlaan 4, Baarn. Tel: 3551. Pres.: Mr. C. Solleveld; Mg'g Dirs.: Dr. J. van der Velden, Dr. H. Haertle, Dr. H. W. Steinhuisen; Deputy Dirs.: T. van de Haar, Ir. J. C. van Houten; PR Mgr.: A. L. Bouma; Adv. Mgr.: H. J. van Ramshorst. (SEE ADVERTISEMENT)
 Phonogram, 170-172 Singel, Amsterdam. Tel: 245588. Cable: Phonogram. Mg'g Dir.: J. Haslinghuis; Dept. Mgr.: R. H. Klaassen.
This company represents: A&M, Ace of Hearts, Almo, Brunswick, Coliseum, Coral, Decca, Hi, Hollywood, Mira, Mirwood, Monument, Parrot, Philles, Planet, Starday, Sue, Symbol, Tribe, Vee-Jay, Vocalion.
 Polydor, Piet Heinplein 5, Den Haag. Tel: 634955. Cable: Polned. Sales: T. A. van Holten; Int'l: Drs. J. van Bart, Fred Haayen.
Labels: Polydor, Polydor Int'l, MGM, Verve, Atlantic.
This company represents: Archiv (Germany), Command (USA), Deutsche Grammophon (Germany), Kama Sutra (USA), MGM (USA), Polydor (Germany), Verve (USA).
 Telstar, St. Maartenslaan 1-3, Weert. Tel: 2620/4269. Pres. & Owner: Johnny Hoes; A&R & Int'l: Mrs. Jacqueline Linnartz-Hoes.
Labels: Telstar, Ojee.

ALTONA "Symphony House," Vondelstraat 90, Amsterdam. Tel: 020-1B6324. Pres.: Wim van Vught. (SEE ADVERTISEMENT)
 ANAGON, Heemsteede Dreef 287, Heemsted. Tel: 02500-B3654. Pres.: J. van Schalkwijk. (SEE ADVERTISEMENT)
 Ars Nova, Oostsingel 92, Goes.
 Aura, Oude Gracht 305, Utrecht. Tel: 030-12051.
 Annie Bank, Anna Vondelstraat 13, Amsterdam. Tel: 020-B5483.
 BASART, Leidsegracht 11, Amsterdam. Tel: 020-222626. Haarlem Tel: 02500-41767. Pres.: & Mg'g Dir.: H. Ch. Gomperts; Dir.: G. Jansen Jr.
Affiliates: Aberbach-Concern; Accent-Music; Allegretto Music; G. Alsbach & Co.; Anglo-Continental Music; Ars Poiona; Astra Music; Bella Musica L.C.; Capitol Music; Campbell Connelly; Centraal Music/Langerak Serie; Continental Music; Cosmopolitan Music; Dekeling & Swart; Delta Music; Dreiklang-Dreimasken-Verlag; A. Dreissen Harmonie & Fanfare; Dutchess Music (Pia Beck); Editions A. v.d. Kleyn; Essex/How Richmond; v. Esso & Co. L.C.; Fonds Albersen & Co.; Fonde Feike Asma; Fonds Ph. Hakkert Jr.; Fonds Kessels Harmonie & Fanfare; Fonds A. Malando; Fonds J. Philip Kruseman; Fonds H. Rahr Anno 1837; Fonds J. H. Speenhof; Goodman/Basart L. C.; Gramac Music; Jac. Mils-Holland L. C.; Maestro Music; Magnet Verlag; Mondial Music; Music Smith; Musiccomp. Kralingen-Ode Vaal; Operettefonds; J. J. Lispet; Peter Schaeffers/Basart L. C.; Pickwick Music; Podium Music; Progressive Music; Rhythme Music; Scala Editions; Supertune; United Artists; World Hits.
 All the subsidiary holding companies have the same telephone number. (SEE ADVERTISEMENT)
 Belinda (see Aberbach).
 Benelux Musir, St. Maartenslaan 1-3, Weert L. Tel: 04950-2620. Pres.: Johnny Hoes.
 Broekmans & van Poppel, Van Baerlestraat 92-94, Amsterdam-Z. Tel: 020-796126.
 Capriole, (see Anagon).
 Chappell, Weteringschans 35, Amsterdam. Tel: 64664/64790.
 Coolsma Solo, Oude Gracht 305, Utrecht. Tel: 030-12051.

● music publishers

ABERBACH, Leidsegracht 1, Amsterdam. Tel: 220162. Mgr.: Elbert van Zoeren.
 Alsbach & Doyer, Raamgracht 10, Amsterdam. Tel: 020-244009.

neGram HOLLAND neGram HOLLAND neGram HOLLAND neGram HOLLAND

you like our cheese but we like your records

N.V. NEGRAM
 ZIJLWEG 286
 HAARLEM-HOLLAND
 PHONE 02500-17543

HANS I. KELLEMAN
 BOB OEGES

neGram HOLLAND neGram HOLLAND neGram HOLLAND neGram HOLLAND

For all those with a Sound to offer the World

If you have a sound to put on record, you turn to Philips. In every one of 64 countries there is a Philips man who provides you with personal service. He appreciates *your* needs, *your* difficulties, *your* problems. He understands a hundred-and-one things about local market conditions that no outsider could even begin to know. He can advise more effectively, act more efficiently.....

He is part of an international network made up of men like him. All these men are specialists in the fields of recording, pressing, selling, distribution and promotion. By working in smooth co-operation, they can make sure that the sound you hand to Philips becomes a top-rate quality record which can be heard anywhere or everywhere in the world.

These are a few reasons why

Trust

There is a Philips record-man in:

EUROPE

AUSTRIA
Polyphon
Schallplatten G m b H
Mariahilferstrasse 127
Vienna 6

BELGIUM
N V Polygram
Anderslichtstraat 17
Brussels

CYPRUS
Messrs D Quizonian
M Sultanan & Co
P.O. Box 1175
Nicosia

DENMARK
Nordisk Polyphon A S
Emdrupvej 115
Copenhagen

FINLAND
Music Fazim
P.O. Box 760
Helsinki
Fintone Oy
Munkkisaarekatu 2
Helsinki

FRANCE
Societe Phonographique
Philips
6 B Rue Jenner
Paris 13e

GERMANY
Philips
Ton Gesellschaft G m b H
Morckebergstrasse 7
Hamburg 1

**GREAT BRITAIN and
NORTHERN IRELAND**
Philips Records Limited
Stanhope House
Stanhope Place
London W 2

GREECE
Hellasdisc S A
8 Hermes Street
Athens

ICELAND
Stal Ltd
P.O. Box 131
Reykjavik

IRELAND
Irish Record Factors
34 Parnell Square West
Dublin

ITALY
Phonogram S p A
14 Via Benadir
Milan

THE NETHERLANDS
N V Phonogram
Singel 170 172
Amsterdam

NORWAY
Norsk Phonogram A S
Kirkeveien 64 IV
Oslo 3

PORTUGAL
Philips
Portugesa S A R L
Rua Joaquim Antonio de Aguiar 66
Lisbon

SPAIN
Fonogram S A
P.O. Box 35019
Madrid 17

SWEDEN
A B Philips Sontun
Kommandorsgatan 26
Stockholm

SWITZERLAND
Philips A G
Edenstrasse 20
Zurich

TURKEY
Grunberg Ticaret A S
P.O. Box 533
Istanbul

NORTH AMERICA

CANADA
London Records
of Canada Ltd
190 Graveline Street
St Laurent P.Q.

U.S.A.
Philips Records
35 East Wacker Drive
Chicago 1 Illinois 60601

CENTRAL AMERICA

BARBADOS
Messrs Manning & Co
P.O. Box 176
Bridgetown

COSTA RICA
Indica Industria de Discos
Centroamericana S A
Apartado 4093
San Jose

JAMAICA
Federal Record Company Ltd
P.O. Box 417
Kingston

MEXICO
Dusa Discos Universales S A
Rio Tiber 58
Mexico, 5 D F

NETHERLANDS ANTILLES
Philips Antillana N V
P.O. Box 523
Willemstad - Curaçao

PANAMA
Messrs
Motta Internacional S A
P.O. Box 417
Colon

SURINAME
C Kersten & Co N V
P.O. Box 1808
Paramaribo

SOUTH AMERICA

ARGENTINA
Phonogram S A I C
Cordoba 1351 9 piso
Buenos Aires

BOLIVIA
Philips Sudamericana S A
Cajon Postal 2964
La Paz

BRAZIL
Companhia
Brasileira de Discos
Caixa Postal No 93
Rio de Janeiro ZC 06

CHILE
Philips Chilena S A
Casilla 2687
Santiago de Chile

COLUMBIA
Division Discos
Apartado Aereo 6393
Bogota

ECUADOR
Philips Ecuador C A
Casilla 343
Quito

PARAGUAY
Philips del Paraguay S A
Casilla Correo 605
Asuncion

PERU
"El Virrey" Industrias
Musicales S A
Av Méjico, 238
Lima

URUGUAY
Philips del Uruguay S A
Avenida Uruguay 1287
Montevideo

VENEZUELA
Siemens Venezolana S A
Apartado Postal 3616
Caracas

MIDDLE EAST

**THE HASHEMITE
KINGDOM OF JORDAN**
Transjordan Engineering Co Ltd
P.O. Box 1
Amman

ADEN
c/o Messrs
Besse & Co (Aden) Ltd

ARABIA
Messrs Yusuf A Alghanim
P.O. Box 223
Kuwait

SAUDI ARABIA
Messrs
A Rajab & A Salsilah
P.O. Box 203
Jeddah

SYRIA
Ets Chanine & Fils
Rue du Parlement
Damas

FAR EAST

CEYLON
Messrs Maurice Roche Ltd
P.O. Box 61
Colombo

HONG KONG
Messrs Moutrie & Co Ltd
Alexandra House
7, Des Voeux Road C

INDIA
Philips India Limited
Philips House
7, Justice Chandra Madhab Road
Calcutta 20

JAPAN
Victor Co of Japan Ltd
13, 2-chome, Tsukiji, Chuo Ku
Tokyo

PHILIPS



in Philips is world-wide

MALAYSIA
Messrs
William Jacks & Co (M) Ltd
P.O. Box 286
Kuala Lumpur

PHILIPPINES
Home Industries Inc
P.O. Box 170
Quezon City

SINGAPORE
William Jacks & Co Ltd
P.O. Box 2150
Singapore 9

THAILAND
Philips Electrical Co
of Thailand Ltd
282 Silom Road
Bangkok

VIET NAM
Messrs Tan Viet Nam Thuong Xu
183 Rue Tu Do
Saigon

AFRICA

CONGO
Philips Congo S.C.H.I.
137, Boulevard du 30 Juin
P.O. Box 1798
Leopoldville

EAST AFRICA
Associated Sound
(East Africa) Ltd
P.O. Box 3895
Nairobi

ETHIOPIA
Philips Ethiopia
(Pty) Ltd (S.A.)
P.O. Box 1099
Addis Ababa

GHANA
Messrs
Philips (Ghana) Ltd
P.O. Box M 14
Accra

LIBERIA
Messrs
Oost Afrikaanse Compagnie
P.O. Box 281
Monrovia

LIBYA
Messrs
W. Buzaeik Radio House
P.O. Box 156
Benghazi

NIGERIA
Philips (West African)
Records Ltd
P.O. Box 2997
Lagos

SIERRA LEONE
Messrs
Freetown Cold Storage Ltd
P.O. Box 99
Freetown

SOUTH AFRICA
Trutone (Pty) Ltd
P.O. Box 9299
Ophirton

SUDAN
Messrs. Electrohouse
P.O. Box 823
Khartoum

OCEANIA

AUSTRALIA
Philips Electrical
Industries Pty Ltd
Philips House
Box 2703 G.P.O.
Sydney

NEW ZEALAND
Philips Records
(New Zealand) Ltd
Philips House
P.O. Box 3517
Wellington



Address all general enquiries to Philips' Phonographic Industries
Central offices: Baarn, The Netherlands.

continued

Creyghton, Musicology-Musica Antiqua, 45 Las-
suslaan, Bilthoven.
De Eerste Muziekcentrale, Raamgracht 10, Amster-
dam. Tel: 020-246933/65256.
"De Toorts," Afdeling Grafische Industrie,
Nijverheidweg 1, Haarlem. Tel: 02500-15238.
Pres.: C. Hesseling & J. H. Schnabel.
Dreissen, Muziekuitgave, 11 Leidsegracht, Amster-
dam. Tel: 222626.
Dutch Rec. Centre, "In de Blockfluyt," Oude Gracht
305, Utrecht. Tel: 030-12051.
Harmonia Uitgave, Roeltjesweg 23, Hilversum. Tel:
02950-14318.
Harp, Muziekfonds De (F. Pijlman), 1 Helmerstr. 94,
Amsterdam. Tel: 020-86691.
Joh de Heer, Jensusstr. 56. Rotterdam. Tel:
010-241871.
Hees, Choorstr. 1-3, Delft. Tel: 01730-23183.
Heinrichshoten-Edition, Raamgracht 10, Amsterdam.
Tel: 020-246933.
Holland Music, Singel 500, Amsterdam 1. Tel:
020-231163. Cable: SOUTHMUSIC. Contact: J.
Han Dunk.
I F O, PO Box 3524, Amsterdam. Tel: 020-59625.
M'g'g Dir.: Peter Rensen.
Michael Jary-Production (see Nagel).
Klavarskribo, Ringdijk, Slikkerveer. Tel: 01896-2339.
Prop.: C. Pot.
Konefa Muziekuitgaven, Jensusstr. 54, Rotterdam
11. Tel: 010-241871.
Krips Muziek, Thorbeckelaan 71, The Hague. Tel:
070-330550.
deKruyff, PO Box 12, Rijksstraatweg 115, Gaander-
en, Doetinchem. Tel: 08350-4181.
A. van Leest, Herm. Boexstr. 12-14, Eindhoven.
Tel: 04900-65859.
W. F. Lichtenauer, Korte Lijnbaan 26, Rotterdam.
Tel: 010-118235.
Lions Music (see Anagon).
J. J. Lisset, P. C. Hooftweg 18, Hilversum. Tel:
02950-47016.
Marange Music (see Anagon).
Mills, Leidsegracht 11, Amsterdam. Mgr.: Hans
Gompers.
Mix Music (see Aberbach).
Mogull, Ivan, c/o Stemma, Marius Bauerstr. 30,
Amsterdam 17.
Molen Muziek Holland (see Aberbach).

Molenaar, PO Box 19, Wormerveer. Tel: 02980-
82013.
Montana (see Anagon).
Morotone (see Anagon).
Muziekgravure Diligentia, Stationsstr. 11, Maasland.
Tel: 01899-2613.
Nagel, Weteringschans 35, Amsterdam. Tel: 64664-
64790.
J. Nauta, Looxmagracht 18, Sneek. Tel: 05150-
3127.
J. Portengen, Kruisstr. 8-10, Haarlem. Tel: 02500-
12277.
Progressive (see Aberbach).
Roniepers, 's-Gravendijkwal 165 B, Rotterdam. Tel:
010-252427.
Schalltone (see Anagon).
S. Spiero, Kerkr. 19, 's-Hertogenbosch.
Stichting Donemus, Jacob Obrechstr. 51, Amsterdam.
Tel: 020-722432.
Stichting Zingende Stemmen, 1 Jacob van Cam-
penstr. 59, Amsterdam.
Sunrise Muziek (see Aberbach).
Tierloff Muziekcentrale, Markt 92, Roosendaal.
Tel: 01650-4551.
Trident, Amstel 52, Amsterdam. Contact: Cor Smit.
Trio-Music, Singel 262, Amsterdam. Tel: 020-
238728.
Universal Songs, 801 A. J. Ernststr., Amsterdam-Z.
2. Tel: 421722. M'g'g Dir.: W. Brandsteder;
A&R: C. Koelman Jr.
Van't Hoens Periodieke Pers, 's-Gravendijkwal 165
B, Rotterdam. Tel: 010-252427.
Victoria Muziek, (see Aberbach).
Vita Nuova (Daan van Teeseling), van Broeckhuys-
senstr. 7, Nijmegen. Tel: 08300-23076.
Wed. J. R. Van Rossum, Korte Minnebroederstr. 1-3,
Utrecht.

● importers & exporters

BASART, Houtmankade 20, Amsterdam. Tel: 020-
222192/63209-241260. (SEE ADVERTISEMENT)
BOVEMA Gramophonenhouse, Bronsleeweg 49, Heem-
stede. Tel: 02500-80750. (SEE ADVERTISEMENT)
C N R (Rood), Gevers Deynootplein 40, Scheven-
ingen. Tel: 070-559500. (SEE ADVERTISEMENT)
Cinerec Supraphon-Holland, Vaartweg 14, Hilversum.
Tel: 02950-15353.
Delta, Zijlweg 286, Haarlem. Tel: 02500-17543.

DURECO, 21 Beursstraat, Amsterdam. Tel: 020-
242288. (SEE ADVERTISEMENT)
Disco Dump, PO Box 1769, Blauwburgwal 5,
Amsterdam. Tel: 020-237598. Gen. Mgr.: Ed
vander Rest.
Europese Fono Club, 262 Singel, Amsterdam. Tel:
020-238728.
I F O, 39 Middenweg, Amsterdam. Tel: 020-59625.
Inelco-Holland, A. J. Ernststraat 801, Amsterdam,
Z.2. Tel: 421722.
B. Munnikendam, 18-19 Kromme Waal, Amsterdam.
Tel: 020-246994.
Muzikale Meesterwerken Serie (MMS), Paulus Pot-
terstraat 12, Amsterdam. Tel: 020-734911.
Negram, Zijlweg 286, Haarlem. Tel: 02500-17543;
PHILIPS Phonographic Industries, Gerrit v.d. Veen-
laan 4, Baarn. Tel: 02954-3551. (SEE AD-
VERTISEMENT)
Phonogram L. C., Singel 170-172, Amsterdam. Tel:
020-245588.
Polydor, Piet Heiplein 5, The Hague. Tel: 070-
634955.
Rhythm & Blues Studio, Pieter Langendijkstraat 38,
The Hague 14. Tel: 070-614061.

● supplies & services

MUSIC LICENSING ORGANIZATIONS
Bureau STEMRA, Marius Bauerstr. 30, Amsterdam
17. Tel: 020-156822.
Rhythm & Blues Studio, Pieter Langendijkstraat 38,
The Hague 14. Tel: 070-614061.

PRESSING PLANTS

Argram Phonographic Industry, Nijverheidsweg 34,
Haarlem.
C N R (Rood), Gevers Deynootplein 40, Scheven-
ingen. (SEE ADVERTISEMENT)
Fugram Phonographic Industry, Noorderduinweg 54,
Zandvoort.

PHILIP Phonographic Industries, Gerrit v.d. Veen-
laan 4, Baarn. (SEE ADVERTISEMENT)

PRINTING PLANTS

Arprint, Stephensonstr. 44, Haarlem.

RECORDING STUDIOS

BOVEMA, L.C. Bleekersvaartweg 45, Heemstede.
(SEE ADVERTISEMENT)
PHILIPS PHONOGRAPHIC INDUSTRIES, Gerrit v.d.
Veenlaan 4, Baarn. (SEE ADVERTISEMENT)

TRADE ORGANIZATIONS

Nederlandse Vereniging van Grammofoonplaten
Detailhandelaren (N.V.G.D.), Nieuwe Binnenweg
132, Rotterdam.
Nederlandse Vereniging voor Grammofoonplaten
Importeurs en Fabrikanten (N.V.G.I.), Singel
170-172, Amsterdam.

NETHERLANDS ANTILLES

Population (including islands of Aruba, Bonaire,
Curacao, Saba, St. Eustatius and part of St.
Martin): 199,607.
Official rate of exchange: \$1 (US) = 1.89 gulden.
Records imported from US (factory value): 1964-
\$56,161.
Jukeboxes: 110, approx. (Aruba).

YOUR MAN IN AMSTERDAM-HOLLAND

is looking after your interests and is ready to *promote* and *plug* your material.
Our specialty is obtaining local cover records with prominent Dutch artists.

Contact:

EDITIONS ALTONA-'SYMPHONY HOUSE'

Vondelstraat 90 — AMSTERDAM-W.

MANAGER: Wim van Vught Phones: 18 63 24 — 18 63 25

Our organization also handles:

PALACE MUSIC HOLLAND • U. A. MUSIC NEDERLAND
KASSNER ALTONA

**YOUR CONTACT
IN BENELUX IS
ANAGON
SCHALSTONE**
*Music Publishers
Recording
Productions*
PRESIDENT: JAN VAN SCHALKWIJK
MELODY HOUSE - HEEMSTED
HOLLAND
PHONE 81445
PHONE STUDIO
83654

BASART

in
BENELUX

The Number One
publisher!

Leidsegracht 11,
Amsterdam -C.

Radio stations: Radio Curon, Curacao; Radio Caribe, Curacao; Radio Hoyer, Curacao; Radio Kelkboom, Aruba; Radio Voz di Aruba, Albert M. Arends, Prop., PO Box 19, Aruba.

Dutch, English, Spanish and Papiamentu (a unique blend of four languages) are spoken in these islands. Therefore the taste in recorded music can also be quite varied.

A big promotion, in connection with the recent decision of the US Government to expand exports, will no doubt improve importation of records by the Netherlands Antilles. The Government of the Commonwealth of Puerto Rico (less than two hours by plane to Aruba-Curacao) is also planning a number of ways to greatly facilitate exports from Puerto Rico to both Aruba and Curacao.

Many of the products, records included, produced by Government-sponsored factories in Puerto Rico find easy markets in the Netherlands Antilles.

● dealers and importers

Benar Sales, PO Box 600, Curacao. (Also juke operators & dealers).

A. R. Capello, Bredestraat 35, Curacao.

Chez Gomez, Bredestraat 33A, Curacao.

Angel H. Job, PO Box 367, Curacao.

Music & Sport Store, PO Box 462, Curacao.

Neme Import-Export, PO Box 11, Aruba.

Boekhandel Salas, PO Box 44, Curacao.

Valen Gift Shop, Main St., Aruba.

NEW ZEALAND

Population: 2,611,020.

Official rate of exchange: \$1 (US) = 7.25 shillings.

Per capita income: \$2,355 annually.

Records sold domestically: 1965—2,871,000 units, \$9,842,000; 1964—2,880,000 units, \$9,894,000; 1963—2,881,000 units, \$9,643,000.

Records imported & exported from US: Figures unobtainable.

Records imported from countries other than US: Factory value—\$90,445, retail value—\$160,992.

Records exported to countries other than US: Factory value—\$56,108; retail value—\$110,811.

Records manufactured for domestic & export sale: LP's—1,260,000 units; EP's—291,000 units; Singles—1,591,000 units.

Average retail price: LP's—\$5.44; EP's—\$1.86; Singles—\$1.35.

Stereo sales: 27% of total sales.

Record club sales: 23-25% of total sales.

Discounting: Rare.

Type of record distribution: Mainly manufacturer to wholesaler to retailer, but there is considerable amount of manufacturer to record club for members.

Number of jukeboxes: 285.

Radio stations: The New Zealand Broadcasting Corp. (NZBC)—a financially self-supporting statutory body controlling both sound and television broadcasting in New Zealand—is one of the largest advertising bodies in New Zealand and, like any other large trading organization, pays income tax on its commercial activities. The NZBC operates throughout the country 42 medium-wave stations which broadcast commercial, semi-commercial and non-commercial programs. There is only one privately owned station in New Zealand and this is subsidized by the Corporation. The Corporation's two short-wave transmitters broadcast non-commercial programs to the Pacific Islands, the Ross Dependency and Australia.

Television stations: The NZBC operates four main television stations—at Auckland (AKTV-2), Wellington (WNTV-1), Christchurch (CHTV-3) and Dunedin (DNTV-2). Each broadcasts for a total of 50 hours a week, during the evenings and on Saturday and Sunday afternoons. There are no privately owned television stations in New Zealand. The Corporation is the sole purchasing authority of television programs and there are no program contractors involved in the commercial transmissions. It also runs six television repeater stations which relay the programs of the nearest main station to viewers in regions farther afield. Several more stations are planned as part of the NZBC's plan to develop television coverage over the whole country. Viewers in many regions so far not covered by NZBC transmitting equipment are served by smaller transmitters owned and operated by private societies under license from and subsidized by the Corporation.

Important regulations: All records sold in New Zealand irrespective of origin bear sales tax; sales tax is levied at 20% of wholesale (distributor) value. Gramophone records, magnetic re-

cordings of sound or other phenomena, matrices for production of records, prepared record blanks, film for mechanical sound recording, prepared tapes, wires, strips, and like articles of a kind commonly used for magnetic recording, blank tapes and recorded discs, are all subject to import licensing. Licenses for the 1965-1966 licensing period are based on 100% for 1964 of licenses issued. Import licenses issued for 1964 amounted to 78,613 NZ pounds. Import duty is charged on the basis of current domestic value. No duty is incurred under the British Preferential Tariff; a duty of 20% is applied to the import from countries entitled to M.F.N. (most favored nation) treatment, while imports from other sources incur a duty of 30%.

J. P. Monaghan

● record manufacturers

Action (see New Zealand Musical Inds.).

Fusion (see New Zealand Musical Inds.).

Green & Hall, Taia Hall, Bay Rd., Wellington, E.3.

H M V, PO Box 296, 162-172 Wakefield St., Wellington C.I. Tel: 54.89D. Cable: Gramophone. Sales: E. B. Feasey.

Label: HMV.

This company represents: Ad-Lib, Beltone, Capitol, Columbia (England), Contemporary, Decca (England), Diamond, Disneyland, Dalton, Dore, Dunes, East West, Eclipse, Epic, Era, Essex, Fantasy, Felsted, Freedom, Fury, GNP Crescendo, Genius, Gold-Tone, Guaranteed, Gulf, Guyden, Hamilton, Hi, Hickory, Imperial, Jackpot, Jamie, Jubilee, Judd, Laurie, Leader, Liberty, MGM, Medallion, Media, Metronome, Monument, Nashboro, National Rec'g, One-Derful, Pacific Jazz, Parlophone, Philips Int'l, Plaza, Past, Ray, Romac, Roost, Santo, Sar, Scarlet, Seville, Shar-dee, Shell, Somerset, Spark, Specialty, Star, Sue, Swan, Till, Trend, Trey, Todd, Unison, Viscount, Vista, Warner Bros., Warrior, Worldwide, XYZ.

Levin Rec'g Studios, 377 Oxford St., Levin. Tel: 5879. Owner: W. L. Clark.

Labels: Tala, Mark, Minex. This company represents: Singspiration, Zonder-van.

Manufacturers Dist., PO Box 2560, 144 Kilmore St., Christchurch, C.I. Tel: 65.433. Cable: Mandisco. Mgr.: Austin Hadler; Sales: H. Hughes. Branches: PO Box 8753, Auckland. Tel: 16.123—PO Box 6454, Wellington. Tel: 52.405.

Label: Spin-O-Rama.

This company represents: (Crown USA), Diplo-mat (USA), Peter Pan (USA).

New Zealand Musical Inds., CPO Box 2144, Christchurch. Music Dir.: James R. Tomlin; Int'l Dir.: Paul M. Marks; Int'l: Rod Spence & David Foster. Label: Action.

Peak, Box 1757, 76 Chester St., Christchurch. Tel: 65-982. Cable: HITDISC. Mg'g Dir.: Jack Urlwin; Promo. Mgr.: Jacqueline Clegg. Label: Peak.

This company represents: Artone (Holland), Bel-laire (USA), Centaur (USA), Circa (USA), Clar-idge (USA), Columbia (USA), Delta (USA), Don Ray (USA), Downey (USA), Durium (Italy), Ember (England), Epic (USA), Ford (USA), GTA (Italy), Joda (USA), Kent (USA), King (USA), Lee Magid (USA), Modern (USA), North Lake Prod'ns (USA), CBS/Oriole (England), Okeh (USA) Prestige (USA), Prima Magnagrove (USA), Saga (USA), So Deska (USA), Turicaphon (Switzerland).

Philips, PD Box 3517, Philips House, 181-195 Wakefield St., Wellington, C.3. Tel: 57.250. Cable: Argenta. Gen. Mgr.: G. Broughton; A&R & Sales: W. Morton. Label: Philips.

This company represents: Blue Note (USA), CBS (USA), Caedmon (USA), Fontana (Holland), Kapp (USA), Kapp-Medallion (USA), Mercury (USA), Musicor (USA), Pacific Jazz (USA), Philips (Holland), Polydor (Germany), Van-guard (USA), World Pacific (USA).

Pye, PO Box 2839, Auckland. Tel: 21.949. Cable: Pyrad. Label: Pye.

This company represents: Goldengroove, Pye (England).

Radio Corp. of New Zealand, PO Box 696, Wellington. Tel: 55.020.

Branch: PO Box 3044, NIMU Bldg., Chancery St., Auckland, C.I. Tel: 21-949. Cable: MARK-SLIM.

This company represents: RCA Victor (USA), RCA Camden (USA).

Salem, 7 Clifton Terr., Wellington. Tel: 42412. Cable: SALEMCO. Dir.: Peter Caithness, Dennis Bailey & Charles Harley.

Labels: Academy of Dancing, Armar, Astor, Carinia, Go, Repeat, Royal, Salem, Spin.

Viking/La Gloria, PO Box 1431, Wellington. Tel: 52.319. Cable: Viking. Mg'g Dir.: Murdock Riley; Int'l: Ron Dalton.

This company represents: Backbeat (USA), Briar (USA), Cadet (USA), Cameo (USA), Checker (USA), Duke (USA), Elektra (USA), Meazzi (Italy), PPX (USA), Palette (Belgium), Parkway (USA), Peacock (USA), Quality (Canada), Reprise (USA), CN Rood (Holland), Roulette, (USA), Schofield Prod'ns (England), Tahiti (Tahiti), Tartan (Canada), Waverly (Scotland). Int'l representatives: Australia (Viking), Canada (Quality), England (EMI), France (EMI), South Africa (Troubadour).

● music publishers

J. Albert & Sons, 2-4 Willis St., Wellington.

Charles Begg, PO Box 889, 19-21 Manners St., Wellington.

Bell-Cast, c/o HMV, Hutt Rd., Lower Hutt.

Chappell, 39 Lower Cuba St., Wellington.

Seven Seas, 57 Tory St., Wellington.

Southern, 12 Security Bldg., 198 Queen St., Auckland. Tel: 23-851. Cable: Southmusic.

● independent record producers

Levin Rec'g Studios, 377 Oxford St., Levin. Tel: 5879. Owner: W. L. Clark.

Maverick Ent's, New Zealand, Box 1837, Auckland. Exec. Prod'r: Antonio Santa Maria-Fernandez; Asst. Prod'rs: John Bridson & Eidon H. Hatfield.

● record wholesalers

RECORD DISTRIBUTORS

Allied Int'l, PO Box 3043, Auckland, C.I. Tel: 21.949. Cable: Groove. Contact: Mr. Pulham.

This company distributes: United Artists (USA), Verve (USA).

Astor Rec. T.V. Studios, Grafton Rd., Auckland.

Delta Trading, PO Box 1617, Wellington. Tel: 43.388. Cable: Pickup. Contact: Mr. Irwin.

Green & Hall, Taia Hall, Bay Rd., Wellington, E.3. Tel: 73.173. Contact: Mr. Greene.

H M V, PO Box 296, Wellington. Tel: 54.890. Cable: Gramophone. Contact: Mr. Smith.

Manufacturers Dist., PO Box 2560, 144 Kilmore St., Christchurch, C.I. Tel: 65.433. Cable: Mandisco. Mgr.: A. Hadler; Sales: H. Hughes. Branches: PO Box 8735, Auckland. Tel: 16.123—PO Box 6454, Wellington. Tel: 52.405.

This company distributes: Blue Note, CBS, Crown, Ember, ERW, Fontana, Kapp, King, Kingsway, Mercury, Octagon, Peak, Peter Pan, Philips, Polydor, Riverside, Robbins, Spin-O-Rama, Word.

New Zealand Musical Inds., CPO Box 2144, Christchurch. Music Dir.: James R. Tomlin; Int'l: Rod Spence.

Philips, PO Box 3517, Wellington. Tel: 57.250. Cable: Argenta. Contact: Mr. Broughton.

Radio Corp. of New Zealand, PO Box 696, Wellington. Tel: 55.020.

Record Dist'g Co. of New Zealand, PO Box 86, 377 Oxford St., Levin. Dir.: W. L. Clark.

Labels: Mark, Minex, Tala, Singspiration, Zonder-van.

A.H. & A.W. Reed, PD Box 6002, Te Aro, Wellington. Tel: 57.900. Contact: Mr. Vercoe.

Sacred, PO Box 275, Levin. Tel: 1423. Cable: Sacreds. Contact: Mr. Harris.

Stebbing, 7 Saratoga Ave., Herne Bay, Auckland, W.I. Tel: 12.426. Contact: E. C. Stebbing.

Viking, PO Box 1431, Wellington. Tel: 51.090. Cable: Viking. Contact: Ron Dalton.

G. A. Wooler, PO Box 2167, Auckland. Tel: 21.949. Cable: Fivestar.

This company distributes: ABC-Paramount (USA), Brunswick (USA), Coral (USA), Decca (USA) through Australia, Festival (Australia, including Leedon, Command), Vox (USA).

IMPORTERS & EXPORTERS

Allied Int'l, PO Box 3043, Auckland.

Gem, 12-14 Kitchener St., Auckland.

H M V, PO Box 296, Wellington.

La Gloria, PO Box 3534, 12 O'Connell St., Auckland. Manufacturers Dist., PO Box 2560, 144 Kilmore St., Christchurch, C.I.

Peak, PO Box 1757, Christchurch.

Philips, PO Box 3517, Wellington.

Pye, PD Box 2839, Auckland.



LOTSA SHOWBIZ UNDER ONE HAT

(in fact the biggest independent hat in Norway)

Looking for a good connection in Scandinavia? May we offer you our services: record dept. (the definite leading on locally produced single hits), concert agency, background music, publishing, sound equipment, recording facilities.

Local recording on Triola- and Sonet-label (constantly on the charts).

Distribution: Argo — Bel Air — Blue Note — Candid — Cash Productions — Checker — Chess — Colpix — Dimension — Debut — Dot — Elite Special — Ember — Epic — Funkler — Gazell — Hickory — Joy — Kapp — Knappupp — Loma — MK — Omega — Palette — Prima — Red Bird — Reprise — Ric — Rifi — Roulette — Scandisc — Select — Show — Sonet — Specialty Records — Storyville — Sue — Symbol — Tiger — Tip — Transatlantic — Triola — Valiant — Vox — Warner — Vogue



**ARNE BENDIKSEN AS
NORSK
MUSIKK
PRODUKSJON**
Grammofonplateavd./
record dept.
OSTERDALS GT. 1, OSLO
TLF. 67 67 90, CABLEADR.:
"BENDIKMUSIC"

— the progressive and trusted firm that's setting the trend in Scandinavian showbiz.

continued

Radio Corp. of New Zealand, PO Box 696, Wellington.

Viking, PO Box 1431, Wellington.
G. A. Wooler, PO Box 2167, Auckland.
World, Farish St., Wellington.

● supplies & services

JACKET MANUFACTURER

Levin Rec'g Studios, 377 Oxford St., Levin. Tel: 5879. Owner: W. L. Clark.

MUSIC LICENSING ORGANIZATIONS

Australian Performing Rights Assn, Ltd, Conference Chambers, Corner Wakefield & Farish Sts., Wellington.

Attorneys & Trustees for Composers & Authors & Publishers of Music.

PRESSING PLANTS

Green & Hall, Taia Hall, Bay Rd., Wellington, E.3.
Branch: 72 Surrey Crescent, Auckland.

H M V, PO Box 296, Hutt Rd., Lower Hutt, Wellington, C1.

Radio Corp. of New Zealand, PO Box 696, Paeroa, Wellington.

PROMOTION & PUBLICITY

New Zealand Musical Inds., CPO Box 2144, Christchurch.

RECORD CLUBS

Gem, 12-14 Kitchener St., Auckland.
Philips, PO Box 3517, Wellington.
World, Farish St., Wellington.

RECORDING STUDIOS

Astor, 48 Shortland St., Auckland.
H M V, PO Box 296, Wellington.
Levin, 377 Oxford St., Levin. Tel: 5879. Owner: W. L. Clark.

New Zealand Musical Inds., CPO Box 2144, Christchurch.

Stebbing, 7 Saratoga Ave., Herne Bay, Auckland, W.1.

TRADE ORGANIZATIONS

N.Z. Federation of the Phonographic Industry, PO Box 2885, Wellington.

N.Z. Radio & Television Manufacturers' Federation, PO Box 1605, Wellington.

NICARAGUA

Population: 1,597,000.

Official rate of exchange: \$1 (US) = 7 cordobas.
Records imported from US (factory value): 1964—\$33,141; 1963—\$32,700; 1962—\$30,100; 1961—\$26,200.

● record manufacturers

Miguel G. Hernandez, 5a Calle S.E. 504, Managua. Tel: 2038.

● importers & exporters

Elias Argenal, Apartado No. 555, Managua.
Discolandia, Ave. Roosevelt 110, Aptdo. 24, Managua. Tel: 3596 & 71530. Contact: Edmund Tefel.

Discos (Central America), Aptdo. 749, Managua. Tel: 20-35. Cable: DISCOSA. Pres.: William Arguello; Sales Mgr.: Juan J. Mourra.

Discoteca Universal, Calle 15 de Sept. 301, Managua. Contact: Jaime Argenal.

Miguel G. Hernandez, 5a Calle S.E. 504, Managua. Tel: 2038.

Solorzano Villa Pereira Comercial, Aptdo. 481, Managua. Tel: 3501/2/3. Mgr.: Enrique Vanegas.

NIGERIA

Population: 55,653,821.

Official rate of exchange: \$2.80 (US)=1 pound sterling.

Records imported from US (factory value): 1964—\$10,554.

● record manufacturers

E M I, 44-46 Queen Elizabeth Way, Jos. Tel: 2094.
Cable: EMITRON. Mg'g Dir.: P.S. Homewood.
Labels: Columbia, HMV, Parlophone.
This company represents: All EMI labels available to Nigeria.
Philips, PO Box 2997, Lagos.

NORWAY

Population: 3,700,000.

Official rate of exchange: \$1 (US) = 7.15 Norwegian kroner.

Pep capita income: \$900 (US).

Records sold domestically: 1965—2,427,000 units, \$2.5 million; 1964—2,140,000 units, \$2 million; 1963—1,878,000 units, \$1.7 million.

Records imported from US Factory value—\$10,000; retail value—\$85,000.

Records imported from countries other than US: Factory value—\$300,000; retail value—\$2.1 million.

Records manufactured for domestic & export sale: LP's—150,000 units, \$65,000; EP's—380,000 units, \$90,000; Singles—1.5 million units, \$210,000.

Average retail price: LP's—\$4.50, EP's—\$2, Singles—\$1.

Stereo sales: 55% of total sales.

Record club sales: 12% of total sales.

Type of record distribution: Manufacturer to retailer—90%; manufacturer to consumer—10%.

Number of jukeboxes: 800.

Radio stations: 1 government network.

Television stations: 1 government network operating 2 hours per day. Borre Bentsen

● record manufacturers

Ansgar, Møllergaten 26, Oslo 1. Tel: 420747. Dir.: T. Torgussen.

ARNE BENDIKSEN, Osterdalsveien 1, Oslo 6. Tel: 676790. Cable: Bendiksmusic. Dir. & A&R: Arne Bendiksen; Sales & Mktg.: Borre Berntsen; Promo. & Pub.: Eli Thorsen.

Label: Triola.

This company represents: Argo (USA), Bel Air (France), Blue Note (USA), Candid (USA), Cash Prod'ns (USA), Checker (USA), Chess (USA), Colpix (USA), Debut (USA), Dimension (USA), Dot (USA), Elite Special (Germany), Ember (England), Epic (USA), Funkler, Gazell (Sweden), Hickory (USA), Joy (USA), Kapp (USA), Knappupp (Sweden), Loma, MK (USSR), Megafon (Sweden), Omega, Palette (Belgium, USA), Prima, Red Bird (USA), Reprise (USA), Ri-Fi (Italy), Roulette (USA), Scandisc (Sweden), Show, Sonet (Denmark, Sweden, USA), Specialty, Storyville (Denmark), Sue (USA), Symbol, Tempo (Germany), Tiger, Tip, Transatlantic (England), Triola (Denmark, Sweden), Vogue (France), Vox (France), Warner Bros. (USA).

Int'l representatives: Denmark (Triola), Sweden (Triola), USA (Reprise, Warner Bros.). (SEE ADVERTISEMENT)

Jorg Ellertsen, Jernbanetorget 4, Oslo 1. Tel: 412609. Top Exec.: Jorg-Fr. Ellertsen; A&R: Ivar Thorstensen.

Labels: Troll, Kristne Toner (religious).

This company represents: Crescendo (USA).

Eurotron, Prinsensgate 5, Oslo 1. Tel: 411805. Cable: Eurotron. Top Exec.: Erwin J. Kast.

This company represents: Allegro (England), Discos (Denmark), Fidelio (England), Fidelity (England), Forum (USA), Jaro (Sweden), Metro (USA), Society (England), Starday (USA), Tempo (Germany).

Filadelfia, St. Olavsgate 24, Oslo 1. Tel: 336127. Top Exec.: M. Ruud.

Carl M. Iversen, Youngsgaten 1, Oslo 1. Tel: 413867 & 413960. Cable: Planoreflex. Top Exec.: Hans Ro; A&R & Pub.: Rolf Syversen; Sales: Rolf Ruud.

Labels: Columbia, Odeon, HMV.

This company represents: Capitol (USA), Columbia (England), Electrola (Germany), HMV (England, Germany), Imperial (Germany), Liberty (USA), MGM (USA), Metrojazz (USA), Odeon (Denmark, France, Germany, Sweden), Parlophone (England), Pathe (France), Regal (England), Stateside (England), Svensk-American (Sweden), Tamla-Motown (USA).

Kaare Korneliusen, Mjondalen. Tel: 848271 & 848722 (also when telephoned from Oslo). Top Exec.: Kaare Korneliusen.

Label: Aksept.

Manu, Tollbodgaten 12, Oslo 1. Tel: 427212. Top Exec.: Per Gunnar Jensen.
Labels: Manu, Emanuel (religious).

Nera Grammophone Dept., Pilestredet 75 C, Oslo 3. Tel: 461950. Cable: Musica. Top Exec.: Eilif Meyer; A&R & Pub.: John Johanson.
Label: RCA Victor.

This company represents: Camden (USA), Comodore (USA), Cupol (Sweden), Mainstream (USA), Olga (Sweden), RCA (USA), Telefunken (Germany), Telestar (Germany).

Nor-Disc, Rosenborggaten 19, Oslo 3. Tel: 463952. Top Exec.: Totto Johannessen; A&R: Sverre Dahl; Pub.: Kari Neegaard.

Labels: Nor-Disc, Polydor, Decca, Karusell.
This company represents: ABC (USA), Ace of Clubs, Ace of Diamonds, Ace of Hearts (UK), Archiv (Germany), Ariola (Germany), Argo (UK), Atlantic (USA), A&M (USA), Barclay (France), Brunswick (Germany, UK), Command (USA), Decca (UK), DGG (Germany) Elektra (USA), Impulse (USA), Joker (Sweden), Kama Sutra (USA), Karusell (Sweden), London (England), Oiseau Lyre (UK), Metronome (Denmark), None-such (USA), Polydor (Germany), United Artists (USA) Verve (USA), Westminster (USA), Whitehall (USA).

Norsk Grammofonkompani, Wergelandsveien 1, Oslo 1. Tel: 334018. Cable: Nograko. Top Exec.: Odd Knudsen.

Labels: Harmoni, Barneplaten.
This company represents: Diplomat (USA), Embassy (G.B.), Guest Star (USA), Music Minus One (USA), Pickwick (USA).

Norsk Phonogram, Kirkeveien 64, Oslo 3. Tel: 695902. Cable: Phonogram. Top Exec. & A&R: Classical: Haakon Tveten; A&R Pop: Per W. Kilde; Sales & Mktg., Adv., Pub., Promo.: Oivind Lyng-Jorgensen & Erik Roed.

Labels: Philips, Fontana.
This company represents: CBS (USA), Fontana (Holland), Mercury (USA), Philips (Holland), Riverside (USA), Sonora (Sweden), Pye (UK), Amadeo (Austria), Tono (Denmark), Polar (Sweden), Vanguard (USA).

● **music publishers**

ARNE BENDIKSEN, Osterdalsveien 1, Oslo 6. Tel: 676790. (SEE ADVERTISEMENT)

Disco, Pilestredet 75c, Oslo 3. Tel: 461950. Cable: Musica.

Jorg-Fr. Ellertsen, Jernbanetorget 4, Oslo. Tel: 412609 & 410961. Dir.: Jorg-Fr. Ellertsen.

Carl M. Iversen, Youngsgaten 1, Oslo. Tel: 413867. Contact: A. Iversen.

Harold Lyche, Kongensgate 2, Oslo. Tel: 413461. Contact: P. Kroemer.

Manu, Tollbodgaten, Oslo. Tel: 427212.

Musikk-Huset, Karl Johansgate 45, Oslo. Tel: 421703. Contact: S. Kielland.

Nor-Disc, Rosenborggaten 19, Oslo 3. Tel: 463952.

Norsk Komponistforenings Internasjonale Musikkbyra, Klingenbergsgaten 5, Oslo. Tel: 421808. Contact: R. Kierulf.

Norsk Musikkforlag, Karl Johansgate 39, Oslo. Tel: 410574. Contact: Backer Groendahl.

● **record clubs**

Cappelens Plateklubb, Kirkegaten 15, Oslo 1. Tel: 413660.

Concert Hall Society, Aslakveien 20, Oslo 7. Tel: 245190.

● **supplies & services**

MUSIC LICENSING ORGANIZATIONS
Tono, Norsk Komponistforenings Internasjonale Musikkbyra.
Klingenbergsgaten 5, Oslo 1. Tel: 421808. Dir.: Knut Tvedt.

PRESSING PLANTS

Heger Plastics, Kjelsasveien 141/143, Oslo 4. Tel: 217217.

Norsk Grammofonkompani, Wergelandsveien 1, Oslo 1. Tel: 334018.

Norsk Teknisk Porselensfabrikk, Seiersborg, Fredrikstad.

Radio Industri, Sandakerveien 16, Oslo 4. Tel: 375680.

Ulf Corneliusen, Steinsfjaeringen pr., Honefoss. Tel: (067) 39208.

RECORDING STUDIOS

Roger Arnhoff Lydstudio, St. Olavsgate 26, Oslo 1. Tel: 200923.

Arne Bendiksen, Osterdalsveien 1, Oslo 6. Tel: 676790.

Carl M. Iversen, Youngsgaten 1, Oslo 1. Tel: 413867.

Norsk Grammofonkompani, Wergelandsveien 1, Oslo 1. Tel: 334018.

TRADE ORGANIZATIONS

Grammofonplategrossistene Forening, (record wholesalers' organization) N. Slottsgate 11, Oslo. Tel: 420993. Contact: Brodrene Johnsen.

Norges Musikkhandlerforbund (record dealers' organization), Meltzergate 4, Oslo. Tel: 562295. Dir.: Per Oldeman Isaksen.

Norsk Musikerforbund (Musicians Union), Stortingsgaten 28, Oslo 1. Tel: 425521. Dir.: Sigurd Lonseth.

PAKISTAN

Population: 98,612,000.

Official rate of exchange: \$1 (US) = 4.76 Pakistan rupees.

Records imported from US (factory value): 1964-\$4,667.

● **record manufacturer**

Grammophone Co. of Pakistan, PO Box 451, Mauripur, Karachi 13. Tel: 79149 & 79566. Cable: Jabberment. Mg'g Dir.: W. J. Richmond; Comm. Dir.: Mujib-Ur-Rahman.

This company represents: Capitol (USA), Columbia (England), HMV (England), Liberty (USA), Mercury (USA), MGM (USA), Parlophone (England).

Int'l representatives: Africa (EMI), England (EMI), Middle East (EMI).

PANAMA

Population: 1,245,900.

Official rate of exchange: \$1 (US)=1 balboa.

Per capita income: 1964-\$398.

Records imported from US: \$134,232 (FOB).
Records imported from countries other than US: \$129,818 (FOB).

Records exported: None.
Radio stations: AM-65 commercial; FM-19 commercial.

Import & Export regulations: 12.5% ad-valorem tax on bulk importations.

● **importers**

Ar'elec, Ave. Central y Calle 34, Panama.
Cynos, Ave. Jose Francisco de la Ossa 24-21, Aptdo. 976, Panama.

Dyscolandia, Via Espana y Calle 37, Edificio Espana, Panama.

Almacen Grecha, Ave. Central 18-81, Aptdo. 7344, Panama.

Motta Internacional, PO Box 417, Colon.
This company represents: Philips.
Panama Racio Corp., Plaza 5 de Mayo, Panama. Tel: 2.0880. Gen. Mgr.: Donald Halman.

Radio Centro Panama, Ave. Jose Francisco de la Ossa, Aptdo. 6928, Panama.

Tropelco, Via Espana, Panama. Tel: 3.1285.

PARAGUAY

Population: Latest official estimate-2,000,000.

Official rate of exchange: \$1 (US) = 126 guarani.

Per capita income: \$600 annually.

Number of homes with record players: 15,000.

Average retail price: LP's \$4.65, EP's \$1.65.

Records imported from US: None.

Origin of music (pop): Domestic 50%; Tropical 30%; US and other 20%.

Radio stations: 7 long-wave.

Television station: 1 (Cerro Cora, Channel 9).
Alberto Maravi

● **record manufacturers**

Guarana, Industrias Fonoelectronicas, Antequera 662, Asuncion. Tel: 1241. Gen. Mgr.: Jorge Urdapilleta.

Label: Guarania.

"the latest hits are always at"

IN

PERU



VIRREY

INDUSTRIAS MUSICALES S. A.

Av Panamericana 3551-3553 LIMA-PERU

**NEW PERUVIAN'S
COMPANY IN THE
RECORD BUSINESS**

DOREMI

RECORDS

TOP PROMOTION

TOP SERVICES

TOP SALES

EQUALS

"TOP HITS"

PERUDISCOS S. A.

Gen. Mgr.: Alberto Maravi

Horacio Urteaga 1144—Jesús María

Tel.: 36398—Cable: Almadisc

LIMA — PERU

**"IN PERU"
DISCOMETRO MUNDIAL
AND
"MUSICASHOW-TV"
"The Most Constant Hitmakers"
IN
RADIO — TELEVISION —
MAGAZINE**

FOR PROMOTION AND THE RECORD
BUSINESS IN PERU WRITE:

ALBERTO MARAVI

Horacio Urteaga 1144—Jesús María

Tel.: 36398—Cable: Almadisc
LIMA, PERU

DYNA PRODUCTS, INC.

135-2nd Avenue Corner D.
Aquino Street

Grace Park, Caloocan City,
Philippines

Cable Address: "DYPRO" Manila

Licensee, Manufacturer and Dis-
tributor of E.M.I. Records, Liberty
& Dolton Records, Inc.; Pye Rec-
ords, Ltd., and Dyna Records.

Marpur, Cerro Cora, Casi Tacuari, Asuncion. Tel:
6551. Gen. Mgr.: Marcelino Paredes; Mgr.:
Miguel Benites.

Label: Marpar.

Philips del Paraguay, Casilla Correo 605, Asuncion.

● **music publishers**

Fermata, Estrella 151 altos, Asuncion.

● **recording studio**

Guarania, Antequera 662, Asuncion.

PERU

Population: Latest official estimate—12,000,000.

Official rate of exchange: \$1 (US) = 2.7 sols.

Per capita income: \$672 annually.

Number of homes with record players: 250,000.

Average retail price: LP's \$4.50; EP's \$1.50; Sin-
gles 88 cents.

Records imported from US (factory value): 1965—
\$100,000.

Origin of music (pop): Domestic 55%; Tropical 30%;
US, European and other 15%.

Stereo sales: 20%.

Type of distribution: Manufacturer to retailer, with
a 30% mark-up.

Jukeboxes: 10,000.

Radio stations: (medium wave): 100 plus 3 FM
(Lima: 32 stations, 1 stereo).

TV stations: 12 (Lima: 2, 4, 5, 7, and 9 Channels).

Important regulations: Popular records pay high
duties of approx. \$4 per record. Classical records
may be imported duty-free. Alberto Maravi

● **record manufacturers**

Decibel, Moquegua 182, Of. 306, Lima. Mgr.:
Mauricio Santa María.

Labels: Oecibel, Fermata.

This company represents: A&M (USA), Fermata
(Brazil), Orfeon (Mexico), RGE (Brazil).

Discofom, Moquegua 270, Of. 402, Lima. Tel:
77995. Cable: Discofom. Gen. Mgr.: Alberto
Salaverry.

Label: Discofom.

This company represents: Ducretet-Thomson
(France), Kapp (USA), Les Discophiles Francaises
(France), Fonograma (Venezuela), Pickwick
(USA).

Discos Smith, Parque Chicama 1425, Balconcillo,
Lima. Tel: 32851. Mgr.: Manville Smith.

Label: Smith.

Distribuidora Musical, Paeo Colon 299, Lima. Mgr.:
Alejandro Parodi.

Label: Corona.

This company represents: Quality (Canada),
Vergara (Spain).

Distribuidora Peruana Sudamericana, Jiron Miro
Quesada 309, Of. 210, Lima. Tel: 73624. Cable:

Jososal. Gen. Mgr.: Jose L. Salazar; Mgr.:

Jaime Guzinsky; Sales: Javier L. de Mola.

Label: Disperu.

This company represents: Atco (USA), Atlantic
(USA), Command (USA), Co-Ro (Mexico), Dot
(USA), Gema (USA), Music Hall (Argentina),

Musidisc (Brazil), Nilsen (Brazil), Routlette (USA),

Tico (USA), Vee Jay (USA).

Fabricantes Tecnicos Asociados, PO Box 3662, Km. 6
Autopista Ancon, Lima. Tel: 4701B, 42050.

Cable: FTA. Gen. Mgr.: Nilo Marchant; Sales:

O. Vazquez.

Labels: FTA, Varv-Bo, Gaviota.

This company represents: RCA (Int'l), Ala

Nicky (Argentina), Demon (Chile), Sonolux (Co-

lombia), FTA.

Imperial del Peru, Carabaya 685, Of. 310, Lima.
Tel: 7090B. Mgr.: Eduardo Salazar; Sales:

Oscar Bata.

Label: Imperial.

This company represents: Imperial (Brazil).

Industrial Sono Radio, Av. Republica de Panama
1427, Lima. Tel: 31854. Cable: Sonoradio.

Pres.: Luis A. Aubry; Mgr. and Sales: Carlos

Zavala; A&R: Mario Cavagnaro; Int'l: Carolina

Coloma.

Labels: SonoRadio & Corona.

This company represents: CBS (Int'l), Onix

Ecuador, Ricordi (Italy).

Industrias Electricas y Musicales, Jiron Miro Quesada
260, Of. 610, Lima. Tel: 77399. Cable: Itempa.

Gen. Mgr.: Augusto Sarria; A&R: Eulogio

Molina; Sales: Gilberto Cuevas; Int'l: Nora

Catanzaro.

Label: Odeon.

This company represents: Angel (USA), Capitol

(USA), Discomoda (Venezuela), Itsmo (Nica-
ragua), La Voce del Padrone (Italy), La Voz de
su Amo (Spain), London (England), Musart
(Mexico), Odeon (Argentina, Brazil, Chile), Pathe-
Marconi (France), Reprise (USA), Seeco (USA),
Warner Bros. (USA).

Industrias Fonograficas el Inca, Jiron Miro Quesada
309, Of. 510, Lima. Gen. Mgr.: Jose L. Salazar;
Sales: Jose Hernandez.

Labels: Riko, El Inca.

This company represents: Crescendo (USA),
Hamilton (USA), Paradise (USA).

Perudiscos, Horacio Urteaga 1144, Jesus Maria,
Lima. Tel: 36398. Cable: Almadisc. Gen. Mgr.:

Alberto Maravi.

Label: Doremi.

Philips Peruana, Edificio Philips, Aptdo. 1841, Avda.
Alf. Ugarte 1268, Lima. Mg'g Dir.: Robert E.
Delmas.

Sica Peruana, PO Box 3102, Oroya 224, Lima. Tel:
36371 & 37559. Cable: Sica. Gen. Mgr.: Man-
uel Guerrero; Int'l: Angelica Roman; A&R:

Javier Chaves; Sales: Alfonso Bueno.

Label: Mag.

This company represents: Audio Fidelity (USA),
Alegre (USA), Carisch (Italy), Epic (USA), Fiesta
(USA), Montilla (USA), Panart (USA).

Talia Imdisa, Av. Canada 200, Balconcillo, Lima.
Tel: 46810. Cable: Distalia. Pres.: Gino San-

galli; Sales: Dante Capella.

Label: Talia.

This company represents: Caife (Ecuador), Em-
ber (England), Time (USA), Vogue (France).

Vogue (France).

VIRREY INDUSTRIAS MUSICALES, Av. Mejico 23B,
Balconcillo, Lima. Gen. Mgr.: Polidoro Garcia;

Mgr.: Enrique Brenner; Sales: E. Maluenda;
A&R: Raul del Mar; Int'l: Virginia Canepa.

Label: Virrey.

This company represents: Barclay (France),
Buena Vista (USA), CGD (Italy), Coral (USA),

OGG (Germany), Decca (USA), Disc Jockey
(Argentina), Discos Ecuatorianos (Ecuador), Dis-

cuba (USA), Disneyland (USA), Durium (Italy),
Eco (Mexico), Fuentes (Colombia), Hispavox

(Spain), Kubaney (USA), MGM (USA), Mercury
(USA), Maype (USA), Nuria (USA), Polydor

(Int'l), Philips (Int'l), Peerless (Mexico), Ronde
(Venezuela), Sonus (Venezuela), United Artists

(USA), Verve (USA), Velvet (Venezuela), Zafiro
(Spain). (SEE ADVERTISEMENT)

● **music publishers**

Ediciones Internacionales Perumusica, Moquegua
270, Lima. Cable: Perumusica. Dir.: Ruben

Alberto Salaverry.

Edimusa (Sono. Radio), Av. Republica de Panama
1427, Lima.

Impresora y Editorial Luz (Virrey), Av. Panamericana
3551.

La Rosa Hnos., Cailloma 125, Lima.

Universal (FTA), Km. 6 Autopista Ancon, Lima.

● **music licensing
organizations**

Asociacion Peruana de Autores y Compositores
(APDAYC), Wilson 1112, Lima. Tel: 30954.

Pres.: Pedro Espinel; Mgr.: Hector Sapelli.

● **services & supplies**

PRESSING PLANTS

Discos Smith, Parque Chicama 1427, Balconcillo,
Lima. Tel: 32851.

Fabricantes Tecnicos Asociados, Km. 6 Autopista
Ancon, Lima. Tel: 4701B.

Industrias Electricas y Musicales, Casilla 64. Pro-
longacion San Martin 1247, Lima. Tel: 39139 &
36494.

Sica Peruana, PO Box 3102, Oroya 224, Lima. Tel:
36371 & 37559.

Sono-Radio, Av. Republica de Panama 1427, Lima.
Tel: 31854. (Also plating and processing.)

Virrey Industrias Musicales, Av. Mejico 23B, Bal-
concillo, Lima.

PRINTERS & LITHOGRAPHERS

Sono-Radio, Av. Republica de Panama 1427, Lima.
Tel: 31854. (Also design & artwork, jacket &
label manufacturing.)

PROMOTION & PUBLICITY

Sono-Radio, Av. Republica de Panama 1427, Lima.
Tel: 31854.

RECORDING STUDIOS

I.E.P.S.A., Prolongacion San Martin 1427, Lima.
Tel: 39139.

Mag (Sica), PO Box 3102, Oroya 224, Lima. Tel: 36371 & 37559.
 Sono-Radio, Av. Republica de Panama 1427, Lima. Tel: 31854.
 Virrey, Av. Mejico 238, Balconcillo, Lima.

SHIPPING SERVICES

Sono-Radio, Av. Republica de Panama 1427, Lima. Tel: 31854.

PHILIPPINES

Population: 32,583,000.
 Official rate of exchange: \$1 (US)=3.95 pesos.
 Per capita income: \$46.25.
 Number of homes with record players: 50,088.
 Records sold domestically: 1965-\$184,047; 1964-\$143,614; 1963-\$104,195.
 Records imported from the US (factory value): \$2,340; (retail value): \$2,808.
 Records exported to the US (factory value): \$6,223; (retail value): \$7,467.
 Records imported from countries other than US: None.
 Records exported to countries other than US: None.
 Records manufactured: LP's-\$8,090; EP's-\$650; Singles-\$1,220.
 Stereo sales: 40% of total sales.
 Average retail price per record: LP's-\$3.60; EP's-\$1.25; Singles-50 cents.
 Discounting: Rare.
 Record club sales: None.
 Origin of music on pop records: Domestic-30%; US-70%.
 Type of record distribution: Manufacturer to wholesaler to retailer; rarely from manufacturer to retailer.
 Number of jukeboxes: 6,000 (total in operation); 400 (importation, 1965).
 Radio stations: AM-8 government, 146 commercial (disk jockey & recorded music programs); FM-1 government, 6 commercial (disk jockey & recorded music programs).
 Television stations: 6 commercial channels (canned and live shows).
 Import-export regulations: 30% tax on records.

● **record manufacturers**

Cosdel, PO Box 170, Republic Super Market Bldg., Suites 234-238, Rizal Ave., Manila. Tel: 3-52-07.
 This company represents: Ace, Admiral, Arcede, Ardent, Argo, Bigtop, Bluesville, Candid, Cash, Checker, Chess, Dawn, Dot, Durium, Everest, Folkways, Flat-Git-It, Gallant, Gee, Glove, Horizon, Imperial, K&H, Lee, Moodsville, Prestige, Rama, Reprise, Rhythm, Roost, Roulette, Scepter, Secco, Swingsville, Tico, Vee Jay, Vox, Warner Bros., World Pacific.
 DYNA PRODS., PO Box 4591, 135 Second Ave. at D. Aquino St., Grace Park, Caloocan City. Tel: 4-64-23 & 2-29-74. Cable: DYPRO. Pres.: Albert Tan; VP: James Dy; Gen. Mgr.: Tan Huy Bin; Int'l: Albert Tan & James G. Dy.
 Label: Dyna.
 This company represents: Cadence, Cameo-Parkway, Chancellor, Disneyland, Dolton, Gordy, Liberty, Motown, Parlophone, Pye, Sue, Tamla. (SEE ADVERTISEMENT)
 Filipinas, 131 Del Monte Ave., Quezon City. Tel: 6-27-60. Cable: FILRECO. Pres. & Sales: Manuel Villar.
 This company represents: RCA Victor (USA).
 Home Industries Development, PO Box 34, Republic Super Market Bldg., Suites 234-238, Rizal Ave., Manila. Tel: 3-52-07. Cable: HIDCOR. Pres.: Alfredo M. Lustre.
 This company represents: Brunswick, Coral, Decca, Philips, United Artists.
 Manila Importing (MICO), 667 St., Quiapo, Manila. Tel: 3-82-30. Cable: Mico. Mar., A&R & Int'l: Eusebio Contreñas; Sales: Elena Macaraeg. Label: Mico.
 This company represents: Crown, Kent, Pickwick.
 Mareco, 131 Del Monte Ave., Quezon City. Tel: 7-87-94 & 6-27-60. Cable: VILMARECO. Gen. Mgr. & Int'l: Luis Villar; Sales: Jose Villar.
 Labels: Mabuhay, Villar.
 This company represents: ABC-Paramount, Artone, Atco, Atlantic, Backbeat, CBS, Capitol, Command, Duke, Embassy, Epic, Hispavox, Joy, Kama Sutra, Kapp, Laurie, MGM, Medalion, Musicor, Peacock, Select, Tower, 20th-Fox, Valiant, Verve.

Super, 252 Escolta St., Manila. Tel: 3-85-83 & 3-73-22. Cable: SUPER. Gen. Mgr. & Int'l: Sian Yok Cheng; A&R & Sales: Ignacio Jose.
 This company represents: London, Mercury, Smash.

● **music publishers**

Mareco, 131 Del Monte Ave., Quezon City.

● **supplies & services**

PRESSING PLANTS

Dyna Prods., 135 Second Ave. at D. Aquino St., Grace Park, Caloocan City.
 Hidcor, Republic Super Market Bldg., Suite 234-238, Rizal Ave., Manila. Tel: 3-52-07.
 Mareco, 131 Del Monte Ave., Quezon City. Tel: 7-87-94 & 6-27-60.
 Mico, 667 Sales St., Manila. Tel: 3-82-30.
 Super, 252 Escolta, Manila. Tel: 3-85-83 & 3-73-22.

RECORDING STUDIO

Mareco, Muelle del Banco Nacional, Manila. Tel: 3-11-83 & 4-10-81.

POLAND

Population: 31,000,000.
 Official rate of exchange: \$1 (US) = 24 zloty.
 Records imported from US: \$35,000.
 Records exported to US: \$31,000.

● **record manufacturers**

P. P. Polskie Nagrania, Długa 5, Warsaw. Tel: 313231. Dir.: Pawel Kruk.
 Labels: Muza, Pronit, Veriton.

● **music publishers**

Polskie Wydawnictwa Muzyczne, Al. Krasinskiego 11 a, Krakow. Tel: 252-10. Dir.: M. Tomaszewski.
 Waf Synkopa, Krakowskie Przed. 21, Warsaw. Dir.: St. Kisielewski.

● **importers & exporters**

Ars Polona, Krakowskie Przed. 7, Warsaw. Rec. a, Krakow. Tel: 252-10. Dir.: M. Tomaszewski.

PORTUGAL

Population: 9,140,000.
 Official rate of exchange: \$1 (US)=28.5 escudos.
 Per capita income: \$400 annually.
 Records imported from US (factory value): 1964-\$8,668.
 Records exported to US (factory value): 1964-\$14,111.
 Radio stations: 19.
 Television stations: 1.

● **record manufacturers**

Discos Belter, Avda. Defensores de Chaves 3-2, Lisbon. Tel: 59026. Cable: BELTERDISC. Pres.: Cassiano Goncalves de Azevedo; Dir.: C. Goncalves de Azevedo; Gen. Prof. Mgr.: Mello Pereira.
 Branch: Entreparedes 74, Porto. Tel: 25859. Cable: BELTERDISC.
 This company represents: ACM (Great Britain), Atco (USA), Atlantic (USA), Belter (Argentina & Spain), CNR (Holland), Cantagallo (Germany), Carosello-Curci (Italy), MRC (Italy), Meazzi (Italy), Metronome (Denmark, Germany, Sweden, USA), Palette (Belgium), Ri-Fi (Italy), Serfaty (Venezuela), Vox (USA).
 Valentim de Carvalho, Rua Nova do Almada, 95-99, Lisbon. Tel: 367051/2/3/4. Cable: TIM. Exec. Dirs.: Dr. M. Graca B. Carvalho & Rui Valentim Carvalho; A&R Pop: Merio Martins; A&R Classical: Julio Cunha; Sales & Mktg. Mgr.: Abelha dos Santos; Pub. Mgr.: Helder Pereira; Adv. Mgr.: M. Virgínia Posal Domingues; Promo. Mgr.: J. Belchior Viegas.
 Labels: Columbia, Capitol, Decca, HMV, London, Liberty, Odeon, Parlophone, Pathe, Stateside.
 Int'l representative: EMI (England).
 Philips Portuguesa, Rua Joaquim Antonio de Aguiar 66, Lisbon. Tel: 683120. Cable: PHILAMP. Admin.: J.J. Van de Panne; A&R, Sales &

Mktg. & Promo.: Antonio Manuel Coelho Ribeiro; Pub. & Adv.: Joaquim Rodrigues Faisca.
 This company represents: Archiv (Germany), Chave (Portugal), Critere, Cycnus (France), DGG (Germany), Fontana (World-Wide), Jolly (Italy), Kama Sutra (USA), Mercury (USA), Music (Italy), Octave (USA), Philips (Int'l), Polydor (Germany & France), Riverside (USA), Sinter (Brazil), Scepter (USA), Stella (Italy), Tecla (Portugal).
 Int'l representatives: Associates and branches of Philips.

Radio Triunfo, Praca do Municipio 309, Porto. Tel: 21445.
 Labels: Alvorada, Melodia.

This company represents: Amadeo (Austria), Barclay (France), Bel-Air (France), Chantecler (Brazil), CBS (Int'l), Carisch (Italy), Carioca (Brazil), CGD (Italy), Continental (Brazil), Copacabana (Brazil), Ducretet-Thomson (France), Epic (USA), Erato (France), Festival (France), Hickory (USA), Hispavox (Spain), King (Japan), Musicor (USA), Oriole (England), Peerless (Mexico), Style (Italy), Venevox (Venezuela), Gamma, S.A. (Mexico), United Artists (USA).

Tecla, R. Tristao Vaz 20-3, Lisbon. Tel: 613028.
 Telectra Empress Tecnica, R. Rodrigo de Fonseca 103, Lisbon.

● **music publishers**

Valentim de Carvalho, Rua Nova do Almada 95-99, Lisbon. Tel: 367051/2/3/4. Cable: TIM. Pres.: Dr. M. Graca B. Carvalho; Gen. Mgr.: Antero Pita.
 Costa Pinto, R. Tristao Vaz 20-3, Lisbon. Tel: 613028. Pres.: Jorge Costa Pinto.
 Edicoes Musicais Triunfo, Praca do Municipio 309, Porto. Tel: 21445.
 S E C T P, Avenida Duque, De Louie 111, Lisbon 1.

● **importers & exporters**

Philips Portuguesa, R. Joaquim Antonio de Aguiar 66, Lisbon 1.
 Radio Triunfo, Praca do Municipio 309, Porto. Tel: 21445.
 Telectra, R. Rodrigo de Fonesca 103, Lisbon.
 Arnaldo Teindade, Rua de Santa Catarina 117, Porto.

● **supplies & services**

PRESSING PLANTS

Radio Triunfo, Praca do Municipio 309, Porto. Tel: 21445.

PUERTO RICO

Population: 2,644,000.
 Currency: Same as US.
 Per capita income: \$900.
 Number of homes with record players: 75% in San Juan area, 30-50% elsewhere.
 Records sold domestically: 1965-\$2,500,000; 1964-\$2,100,000; 1963-\$2,000,000.
 Records imported from US (factory value): \$1,785,809.
 Records exported to countries other than US: To US Virgin Islands-\$68,652 (approx.); others-\$35,234.
 Average retail price per record: LP's-\$2.75; EP's \$1.50; Singles-85 cents.
 Stereo sales: 15% of total sales.
 Discounting (Retail sales below list price): Frequent.
 Record club sales: 15% of total sales.
 Type of record distribution: Manufacturer to wholesaler to retailer; manufacturer to consumer through record clubs.
 Number of jukeboxes: 10,000.
 Radio stations: 48 AM-2 government, 44 commercial, 2 armed forces; 8 FM-2 government, 6 commercial. 80% of all radio programming is made up of recorded music with disk jockey. Live programming 12 noon to 2 p.m.
 Television stations: 7 channels-2 government, 5 commercial. Live programming includes soap operas in Spanish, noontime spot, three variety shows. Taped programs such as "Bonanza" and "Bronco" dubbed in Spanish. There are 350,000 TV sets covering roughly one-third of the island population.
 Important regulations: Since Puerto Rico is governed by the same regulations that apply to the U.S., there is no custom duty or local tax on records coming from U.S. On records coming from foreign sources, the federal custom rate of about 15% ad valorem applies. Parcel Post ship-

continued

ments: Records can be shipped from any point in the U.S. to Puerto Rico, under the classification "Special fourth class rate—Sound recordings" and at the same rates that apply Stateside. Postage rates and currency are the same in Puerto Rico as Stateside. Many Stateside banks have branch offices here. Likewise, many Puerto Rican banks have branches in New York City. Checks drawn by firms or individuals on Puerto Rican banks, clear through Stateside banks without any charges or red tape.

Antonio Contreras

● record manufacturers

LOCAL MANUFACTURERS

- Alcazar, PO Box 292, San Juan. Pres.: Arturo Somohano.
- Balseiro, PO Box 4805, San Juan. Tel: 785-2072. Pres.: J. R. Balseiro.
- Borinquen, 606 Cerra St., Santurce. Tel: 724-4964. Pres.: Dario Gonzalez.
- Dilo, 655 Ponce de Leon Ave., Hato Rey. Tel: 766-511B. Pres.: Charles Tarrab.
- Fragoso (Casa), PO Box 2774, San Juan. Tel: 723-0505. Pres.: Iino Fragoso.
- Fuentes-Montilla (Ultra Recs.), 1859 Fernandez Juncos Ave. Tel: 725-1140. Pres.: Oscar Rodriguez.
- Gema, 154 Tres Hermanos St., Santurce. Tel: 723-7187. Pres.: Rafael Alvarez Guedes.
- Jenny, L-13 Ext. Los Angeles, Isla Verde. Tel: 791-1604. Pres.: A. L. Pizarro.
- Marilu, 2020 Espana St., Santurce. Tel: 722-3441. Pres.: Antonio Contreras.
- Marvela, PO Box 2027, San Juan. Tel: 722-5171. Pres.: J. C. Julia.
- Musart, 264-A Ave. Central, University Gardens, Rio Piedras. Zip: 0092B. Rep.: Ernesto Lopez.
- RCA Victor, PO Box 2625, Rio Piedras. Zip: 0092B. Tel: 767-0027. Pres.: Carlos Ron.
- Rico-Vox, 607 Lloveras St., Santurce. Tel: 724-0486. Pres.: B. Herger.
- Riney, Calle Caceres 30B, Urb. Valencia, Rio Piedras. Tel: 767-63B1. Pres.: Ney Rivera.
- Showtime, PO Box 12124, Santurce. Tel: 722-6429. Pres.: C. Harman.

NEW YORK MANUFACTURERS FOR PUERTO RICAN SALE

- America, 151 E. 116 St., New York, N. Y.
- Ansonia, 922 Columbus Ave., New York, N. Y.
- Gema, 693 10 Ave., New York, N. Y.
- Miami, 643 10 Ave., New York, N. Y.
- Panart, 324 W. 49 St., New York, N. Y.
- Remo, 664 10 Ave., New York, N. Y.
- Rival, 151 E. 116 St., New York, N. Y.
- S M C, 319 W. 4B St., New York, N. Y.
- Seeco, 39 W. 60 St., New York, N. Y.
- Spanoramic, 106 Rivington St., New York, N. Y.
- Suaritos, 155 E. 116 St., New York, N. Y.
- Tropical, 39 W. 60 St., New York, N. Y.

● music importers

- Bazar Andreu, 157 Tetuan St., San Juan.
- Giusti, 202 Fortalexa St., San Juan.
- Mendez Music, 1460 Ponce de Leon Ave., Santurce.
- Peer Int'l, PO Box 10192, Edificio Banco de Ponce, Ponce de Leon Ave. 1250, Oficina 705, Santurce. Tel: 725-2380. Cable: SOUTHMUSIC.

● record distributors

- Antonio Contreras, 2020 Espana St., Santurce.
- Labels: Bronjo, Dot, Kapp, Seeco, Tropical.
- Casa Fragoso, PO Box 2774, San Juan.
- Labels: Audio Fidelity, Billo, Fonograma.
- Discorico, 653 Carrion Maduro St., Santurce.
- Labels: Belter, Kubaney, Kristal, Zafiro.
- Distribuidora Nacional, 606 Cerra St., Santurce.
- Labels: Liberty, Roulette, Tico, Velvet.
- Island Tours, 607 Lloveras St., Stop 21. Promo.: Bernardo Herger.
- Kelvinator Sales, 1193 Ponce de Leon, Rio Piedras. Tel: 767-5265. Cable: ELREF. Gen Mgr.: Carlos Rom; Rec. Mgr.: Ignacio Mena.
- Mariel, 604 Cerra St., Santurce.
- Label: Spanoramic.
- Splendid, PO Box 4568, San Juan.
- Ultra Recs., 1859 Fernandez Juncos Ave., Santurce.
- Labels: CBS, Fuentes, Montilla.
- J. Martinez Vela, PO Box 2027, San Juan.
- Labels: Command, EMI, MGM, Reprise, UA, Verve, Warner Bros., Peerless (Mexico), Zeida (Colombia).

● services & supplies

MUSIC LICENSING ASSOCIATIONS

Peer Int'l, PO Box 10192, Santurce.
SPACEM (ASCAP), 1105 Ponce de Leon Ave., Santurce.

PRESSING PLANTS

Master Rec. Syndicate, PO Box 2B56, Rio Piedras. Montilla, Canovanas.
Puerto Rico Recs., PO Box 2027, San Juan.
San Juan Recs., 911 Refugio St., Santurce.

RECORDING & TAPE DUP. STUDIOS

Avilea, 401 Ponce de Leon Ave., Santurce.
Montilla, Canovanas.
Ochoa, 1105 Fernandez Juncos Ave., Santurce.
Puerto Rico, PO Box 2027, San Juan.
Soni-Lab, 1679 Ponce de Leon Ave., Santurce.

TRADE ORGANIZATIONS

Federation of Musicians, Local 46B, 255 Canal St., Santurce.
Music Assocs., 1705 Loiza St., Santurce.

SINGAPORE

Population: 1960 estimate-1,600,000; latest official estimate-1,864,900.
Official rate of exchange: \$1 (US) = \$3 Malaysian (approx.).
Over-all income: \$2,980,000,000.
Per capita income: \$1,500 annually (average).
Number of homes with record players: 160,000.
Records imported from the US (factory value): \$261,862 (US); (retail value): \$527,391 (US).
Records imported from countries other than the US (factory value): \$1,202,735 (US); (retail value): \$2,072,473 (US).
Records exported to countries other than the US (factory value): \$972,461 (US); (retail value): \$1,884,922 (US).
Average retail price per record: LP's: \$3.50 (US); EP's: \$1.25 (US); Singles: 65 cents (US).
Discounting: Frequent.
Stereo sales: 70% of total sales.
Type of record distribution: Manufacturer to wholesaler to retailer; rarely manufacturer to retailer.
Number of jukeboxes: None (prohibited by government).

Radio stations: AM: One government-owned station which broadcasts in four languages—English, Malay, Chinese and Tamil—from 6 a.m. to 12 midnight daily, on both the Medium Wave Band and the Short Wave Band. Transmissions are over four channels and the total number of hours over the air average 504 hours per week, of which approximately 251 are occupied by commercials in the four language streams. About 50% of the remainder of the programming is devoted to entertainment, of which recorded music, disk jockey and recorded plays comprise about 70% of the daily programming. Rediffusion, Ltd., broadcasts a wired service, mainly commercials and entertainment programs.

Television stations: FM: One government-owned television station transmitting daily on two channels from 6 p.m. to 11:30 p.m. (earlier start on holidays). The total number of hours over the air average 75 hours per week with extra five hours on holidays. All broadcasts are in four languages—English, Malay, Chinese and Tamil. Commercials take up about 20% of broadcasting time.

Important record import-export regulations: No tax on all imports or exports. Imports intended for Malaysia are liable to 25% tax on arrival at any center in Malaysia, whether opened or unopened in Singapore.

Wally Chan

● record manufacturers

- Borneo, 71 Robinson Rd., Singapore 1. Tel: 761B1. Cable: Borneo.
- Gramophone, 302 Orchard Rd., Singapore 9. Tel: 32003.
- Hup Hup, 232 Serangoon Rd., Singapore B. Tel: 31B73.
- William Jacks, PO Box 2150, Clemenceau House, Clemenceau Ave., Singapore 9. Tel: 26470. Cable: Expanded.

● importers & exporters

- Borneo, 71 Robinson Rd., Singapore 1. Tel: 761B1. Cable: Borneo.

This company represents: Capitol (USA), Columbia (USA), MGM (USA), Parlophone (USA), EMI (England), HMV (England), Pathe (France & Hong Kong), Angel (India).

Chiang Huat, 164 S. Bridge Rd., Singapore 1. Tel: 74144. Mgr.: T. Quek.

This company represents: Liberty (USA).

Cosdel, 50-E Armenian St., Will's Clinic, 2nd Floor. Singapore 6. Tel: 35047. Mg'g Dir.: S. P. Sim. Cable: Cosdel.

This company represents: Pye (England), Dot (USA), Motown (USA), Tamla (USA), Gordy (USA), Roulette (USA), Hamilton (USA), Chess (USA), Checker (USA), Argo (USA), Hickory (USA), Ember (England).

Cycle & Carriage, PO Box 142, 41-43 Orchard Rd., Singapore 9. Tel: 393B1. Cable: Cyclecarri. Gen. Mgr.: Chuna Boon Peng.

This company represents: Polydor (Int'l).

Decca, E-6 MacDonald House, Orchard Rd., Singapore 9. Tel: 20537. Mgr.: D. J. Coupland. This company represents: Decca (England), London (England), Ace of Clubs (England), Ace of Diamonds (England), Argo (England).

Diamond Music, 7 Jalan Kayu Manis, Mt. Elizabeth, Singapore 9. Tel: 39636.

This company represents: Diamond (Hong Kong).

Ee Thye, 72-A Chulia St., Singapore 1. Tel: 9261B. Cable: Eethyco. Sole prop.: Tay Tian Song.

Edward Eu, 1 Orchard Rd., Singapore 9. Tel: 2544B. Cable: Eutronic. Gen. Mgr.: Edward Eu.

This company represents: RCA (England, USA, Australia).

Hup Hup, 232 Serangoon Rd., Singapore B. Tel: 31B73.

This company represents: CBS (USA).

E. S. Isaac, 168-A Cecil St., Singapore 1. Tel: 7B460. Cable: Isaacncn.

This company represents: Warner Bros. (USA), Reprise (USA), Vogue (France).

William Jacks, PO Box 2150, Clemenceau House, Clemenceau Ave., Singapore 9. Tel: 26470.

This company represents: Philips (Holland), Fontana (England), Smash (USA), Mercury (USA).

Kwang Sia, 104 Hill St., Singapore 6. Tel: 34501.

Music City, 61-63 High St., Singapore 6. Tel: 30283.

Victory Rec., 487 N. Bridge Rd., Singapore 7. Tel: 23932.

● supplies & services

PRESSING PLANTS

- Kinetex, 9 Wan Tho Ave., Singapore 13. Tel: 86209.
- Ruby Rec. Ind., 92 Koon Seng Rd., Singapore 15. Tel: 43670.

RECORDING & TAPE DUP. STUDIOS

- H M V, MacDonald House, Orchard Rd., Singapore 9. Tel: 32002.
- Kinetex, 9 Wan Tho Ave., Singapore 13. Tel: 86209.
- H. A. O'Connor, PO Box 11, Maxwell Rd. Post Office; Maybank House, 124/126 Robinson Rd., Singapore 1. Tel: 771B1. Cable: Oconoco.
- Rediffusion, 182 Clemenceau Ave., Singapore 9. Tel: 25011.

● cartridge tape

IMPORTERS & EXPORTERS

- Singapore Motors, 315/319 Orchard Rd., Singapore 9. Tel: 2B291. Cable: Singmotors. Mgr.: Quek Seng Kee.
- Sole importers of Taiko CarStereo from Japan. Complete set available only in 12 volt, positive and negative ground. Also available, tapes pre-recorded.
- Set costs \$300 each in Singapore and Penang, Malaysia. Other States of Malaysia, add 25% import duty.
- Tapes at \$25 for 300 feet (half hour); and \$40 for 600 feet (one hour).
- NOTE: Car stereo sets are still new to local motorists and 99% of car owners are not aware of this new entertainment medium.

SOUTH AFRICA, REPUBLIC OF

Population: Latest official estimate: 18,000,000; whites: 80%; non-whites: 55-60%.
Official rate of exchange: \$1 (US)=71 rand (approx.).
Per capita income: Whites: \$1,450 annually; Non-whites: \$350 annually.
Record sold domestically: 1963: 500,000 units. An increase of 5% annually is estimated.

Records imported from the US: 1963 - \$48,300 (FOB).

Records exported to the US: None.

Records imported from countries other than US: \$195,300 (FOB).

Records exported to countries other than US (factory value): \$159,600.

Average retail price per record: LP's—\$5; EP's—\$2; Singles—75 cents.

Stereo sales: 5.6% of total sales.

Discounting: Rare.

Record club sales: 5 to 6% of total sales.

Type of record distribution: Manufacturer to retailer; rarely from manufacturer to wholesaler to retailer or from manufacturer to consumer.

Number of jukeboxes: 1,550.

Radio stations: 15 AM, 3 FM.

Television stations: None.

Import-Export regulations: Permits must be obtained by South Africans desirous of importing.

● record manufacturers

Brigadiers, 20 De Beer St., Braamfontein, Johannesburg. Cable: Brigadiers. Contact: Mr. Albie Venter.

E M I, 23 Steele St., Steeple, Johannesburg. Tel: 869-2661. Cable: Soundbox. Chm.: W. J. Richmond; Dir. & Gen. Mgr.: J. A. Bailes; A&R and Sales Promo.: J. Nofat; Sales: M. Plumley. Labels: Columbia, HMV, Parlophone.

This company represents: Barclay (France), Capitol (USA), Columbia (England), HMV (England), Liberty (USA), MGM (USA), Parlophone (England), Stateside (USA), Tamla-Motown (USA), Time-Mainstream (USA), Transglobal (USA).

Gallo, Box 6216 Johannesburg. Tel: 23-2111. Cable: Gallotone. Dir. & Int'l: Alexander Delmont. Labels: Continental, Fakkell, Gallotone, New Sound, Welkom.

This company represents: Atlantic (USA), Argo (USA), Audio Fidelity (USA), Brunswick (USA), Buena Vista (USA), Cameo-Parkway (USA), Coral (USA), Decca (England, France & USA), Disneyland (USA), DGG (Germany), Ourium (Italy), Ember (USA), Hickory (USA), Kapp (USA), Medallion, London (USA), Palacio (Venezuela), Polydor (Germany), Somerset (USA), Telefunken (Germany), Vogue (UK), Vox (USA).

Gramophone, Fox & Gold Sts., Johannesburg. Tel: 23-0546. Cable: Africord. Mg'g Dir.: Arnold Golembó; A&R: Ivor Golembó; Sales: D. Bome & M. Mann; Int'l: A. Gewer.

Labels: Unika, Zonk, Kiddie Sound.

This company represents: CBS (International).

Meteor, PO Box 6640, Johannesburg. Tel: 22-6403. Cable: Meteorisc. Mg'g Dir.: R. R. Moskovitz.

Labels: Meteor, Kristal, Saffier, Big Beat, Meritone, Galaxie.

This company represents: Design, Period, Pickwick, Scala, Tikva (USA); CGD (Italy); Hispavox (Spain).

Teal, 124 President St., Johannesburg. Tel: 22-0355. Cable: Tealrec. Chm. & Int'l: A. G. J. McGrath;

A&R: C. Ford & D. Hannan; Mdse. Mgr.: H. R. Friedman; Sales: A. Marshall.

Labels: Drum, Kalahari, President, Teal. This company represents: ABC (USA), Cadet (USA), Checker (USA), Chess (USA), Command (USA), Delyse (England), Durium (Italy), Golden (USA), Grand Award (USA), Hanna-Barbera (USA), Imperial (USA), Impulse (USA), Pacific Jazz (USA), Palette (Belgium), Pye (England), RCA Victor (USA), Red Bird (USA), Reprise (USA), Sue (USA), Starday (USA), Vogue (France), Warner Bros. (USA), Westminster (USA), World Pacific (USA).

Int'l representatives: Central African Federation (ERMI).

Troubadour, 3-5 Browning St., Johannesburg. Tel: 24-9157. Cable: Troubadour Jeppetown. Dir. & Sales: Israel Katz.

Labels: Church, Colpix, FM, Goli, Hit, Manzini, Scepter, Troubadour. This company represents: Amadeo (Austria), Canadian American (USA), Carisch (Italy), Clan (Italy), Colpix (USA), Elite Special (Switzerland), Horizon (USA), Ricordi (Italy), Scepter (USA), Viking (New Zealand), W&G (Australia).

Trutone, PO Box 9299, Bosman Rd., Ophirton, Johannesburg. Tel: 834-6311. Cable: Trutone. Mg'g Dir.: David G. Fine; A&R: Art Heatlie; Sales: Theo Rosengarten.

Labels: Envee, Juweel, Perel, Quality, Rave, Renown, Winner. This company represents: Dot, Elektra, Folkways, Mercury, Philips, Roulette, UA, Vanguard, Verve, (USA); Vox (France).

● music publishers

Ardmore & Beachwood, 32 Steele St., Steeple, Johannesburg. Tel: 869-2661. Cable: Abeemusic. Dir.: W. F. Fraser. Branch: Beechwood, 1750 N. Vine St., Hollywood, Calif., USA.

Arwin, PO Box 6216, Johannesburg. Tel: 23-2111. Mgr.: Ralph Trehwela.

Belinda, 304/5 His Majesty's Bldg., Eloff St., Johannesburg. Tel: 834-8208. Gen. Mgr.: Ray Walter.

Brownhut, 3-5 Browning St., Johannesburg. Tel: 24-9157 (see Troubadour Rec.).

Carstens-de, PO Box 9973, Johannesburg. Tel: 22-8146. Mg'g Dir.: Anton de Waal.

De Jay, PO Box 9973, Johannesburg. Tel: 22-8246. Mg'g Dir.: Louis Combrinck.

Good Music Africa, PO Box 6216, Johannesburg. Tel: 23-2111. Mgr.: Ralph Trehwela.

Impala, PO Box 9973, Johannesburg. Tel: 22-8146. Mg'g Dir.: Anton de Waal.

Laetrec (Ivan Mogull), 304 His Majesty's Bldg. (East), Eloff St., Johannesburg. Pres.: Ivan Mogull.

Robert Mellin, PO Box 7447, Johannesburg. Tel: 33-9314. Mg'g Dir.: Arthur D. Harris.

Melody, PO Box 6216, Johannesburg. Tel: 23-2111. Mg'g Dir.: A. Delmont.

Meritone, PO Box 6640, Johannesburg. Music Pub. Co. of Africa, PO Box 6216, 161 President St., Johannesburg. Tel: 23-2111. Cable: Musipub. Dir.: A. Delmount & R. H. Trehwela.

Planetary-Nom Africa, PO Box 6216, Johannesburg. Tel: 23-2111. Mgr.: Ralph Trehwela.

Southern, 601/603 Silbro House, 225 Jeppe St., Johannesburg. Tel: 23-6222. Cable: SOUTHMUSIC.

Mg'g Dir.: Glyn Taylor.

Sun-Pacific, PO Box 17004, Hillbrow, Johannesburg. Tel: 724-8278. Cable: Reklama. Dir.: Gilbert Gibson.

● independent record producers

Golden Sound Promos., PO Box 7186, Johannesburg. Tel: 22-8146. Mg'g Dir.: Louis Combrinck & Anton de Waal.

Reklama, 608 Hunstanton Twist St., Hillbrow, Johannesburg. Tel: 724-8278. Mg'g Dir.: Gilbert Gibson.

Label Credits: CBS, Continental, Gallotone, HMV, Sun-Pacific, Unika.

● importers & exporters

Galo, PO Box 6216, Johannesburg. Tel: 23-2111. Grammophone, PO Box 2445, Corner Fox & Gold Sts. Johannesburg. Tel: 23-0546. Cable: Africord.

Meteor, PO Box 6640, Johannesburg. Tel: 22-6403. Cable: Meteorisc.

Teal, 124 President St., Johannesburg. Tel: 22-0355.

Troubadour, 3-5 Browning St., Johannesburg. Tel: 24-9157.

Trutone, PO Box 9299, Johannesburg. Tel: 834-6311.

● supplies & services

PLATING & PRESSING PLANTS

Audio Inds., 109 Smit St., Braamfontein, Johannesburg. Tel: 724-4847. Mg'g Dir.: P. J. Lombard.

Gallo, PO Box 6216, Johannesburg. Tel: 23-2111.

Meteor Rec., 109 Smit St., Braamfontein, Johannesburg.

South African Broadcasting, PO Box 8606, Johannesburg.

Troubadour Rec., 3-5 Browning St., Johannesburg. Tel: 24-9157.

Trutone, PO Box 9299, Johannesburg. Tel: 834-6311.

RECORDING STUDIOS

E M I, Music Centre, Troye & President Sts., Johannesburg.

Gallo, PO Box 6216, Johannesburg. Tel: 23-2111.

Meteor Rec., 109 Smit St., Braamfontein, Johannesburg.

Troubadour, 3-5 Browning St., Johannesburg. Tel: 24-9157.

TRADE ORGANIZATIONS

Association of the Southern African Phonographic Industry, P.O. Box 5411, Johannesburg. Sec.-Treas.: W. F. Fraser.

Southern African Record Manufacturers and Distributors Assn., P.O. Box 8213, Johannesburg. Sec.-Treas.: W. F. Fraser.

MUSIC LICENSING ORGANIZATIONS

South African Society of Composers, Authors and Music Publishers, PO Box 9292, Johannesburg. Tel: 23-4025. Mg'g Dir.: Gideon Roos.

South African Recording Rights Assn., PO Box 4301, Johannesburg.

SOUTH KOREA

Population: 28,024,000.

Official rate of exchange: \$1 (US) = 273 wons.

Records imported from US (factory value): 1964—\$7,945; 1963—\$15,000; 1962—\$15,100.

(No other current statistics available.)

● record manufacturer

Dong-Ah Rec., 40 Second St., Kwangbok-Dong, Pusan.

● supplies & services

PRESSING PLANTS

Oasis Rec., 133, 2-Ka, Taeyong-Ro, Chung-Ku, Seoul.

Yung Chang Ind., 99 Ta-Dong, Chung-Ku, Seoul.

SOUTH VIETNAM

Population: 15,715,000.

Official rate of exchange: \$1 (US) = 35.35 piastres.

Records imported from US (factory value): 1964—\$10,296.

● record manufacturers

Asia Disques, 626 Ben Ham-Tu, Cholon. Mgr.: Ngo Van Duc.

Messrs. Tan, Viet-Nam Thuong-Xa, 183 rue Tu Do, Saigon.

THE AUTHENTIC AND TRUE SPANISH MUSIC

Guitar, Orchestra, Castanets, Flamenco
AND ALL KINDS OF SPANISH FOLKLORE MUSIC

At 45 rpm. EP-33 1/3 rpm. LP records

IN ATTRACTIVE ALBUMS WITH BEAUTIFUL ILLUSTRATIONS

Special prices for export

Catalogues and samples can be obtained from:

Discophon

Valencia, 288 - BARCELONA 7, SPAIN

continued

● supplies & services

PRESSING PLANTS

Asia Disques, 626 Ben Ham-Tu, Cholon. Mgr.: Ngo Van Duc.
 Xuong To Van Ngoc, 49 Pasteru St., Saigon.

SPAIN

Population: 32,000,000.

Official rate of exchange: \$1 (US) = 60 pesetas.
 Per capita income: \$570 annually.

Records imported from the US (factory value):
 1965—\$21,000; 1964—\$17,000; 1963—\$19,350.

Records exported to US (factory value): 1965—
 \$5,400; 1964—\$4,873.

Average retail price per record: LP's—\$4.50; EP's
 \$1.50; Singles—\$1.

Stereo sales: 9% of total sales.

Discounting: 25%.

Number of jukeboxes: 30,000.

Television stations: 2—Madrid & Barcelona.

Carlos Marimon

● record manufacturers

Canciones Del Mundo, Carmen 20, Madrid 13. Tel:
 221 6450. Gen. Mgr.: Augusto Alguero.

Cantagallo, Edificio Espana, Madrid. Tel: 248 7487.
 Pres.: H. W. Schemke.

Carrillon, Alfonso Rodriguez Santamaria 2B, Ma-
 drid. Gen. Mgr.: Mr. Kraus.

Columbia, Libertad 24, Madrid 4. Tel: 221 1095.
 Cable: DISCOLUMBIA. Sales: Francisco Flores;
 Int'l: E. Inurrieta.

Branch: Gerona 176, Barcelona. Tel: 257 4572.
 Gen. Mgr.: Juan Arnau.

Labels: Alhambra, Columbia, Iberia.
 This company represents: Barclay (France),
 Decca (England, France), Fonior (Belgium),
 London (USA).

Int'l representatives: Europe (British Decca),
 USA (London), Venezuela (Venevox), Mexico
 (Orfeon-Videvox).

Compania del Gramofono—Odeon, Urgel 234, Barce-
 lona. Tel: 230 2205. Cable: Gramofono. Pres.:
 George C. Alexander; Dir.: Antonio Alberich;
 Gen. Mgr.: Werner Raehse.

Branch: Arenal 9, Madrid. Tel: 231 1997.
 This company represents: Capitol, Diamond,
 Dolton, DynoVoice, Imperial, Liberty, New
 Voice, Tamla-Motown, Uptown, Verve (USA)
 & all EMI affiliates.

Int'l representatives: EMI licensees.
 DISCOPHON VALENCIA 2BB, Barcelona 4. Tel:
 215 1370. Cable: DISCOPHON. Mgr. & A&R:
 Francisco S. Ortega; Mgr. & Sales: Manuel
 Alavedra.

Labels: Colpix, Discophon, Epic, Seeco.
 This company represents: Blue Bell (Italy),
 Canadian-American (USA), Colpix (USA), Everest
 (USA), Gazell (Sweden), Italdisc (Italy), Karusell
 (Sweden), President (France), Ronnex (Belgium),
 Seeco (USA), Sonet (Sweden), Supraphon
 (Czechoslovakia), Triola (Denmark), Vee Jay
 (USA), Versailles (France). (SEE ADVERTISE-
 MENT).

Discos Belter, Gomis 1, Barcelona 6. Tel: 248 1753.
 Cable: BELTERDISC. Pres. & Dir.: J. R. Batalla;
 Gen. Mgr.: J. Alfonso.
 Branch: Salud 17, Madrid 13. Tel: 231 2860.
 Cable: BELDISC. Gen. Mgr.: J. Turull.
 Label: Belter.

This company represents: ACM (Great Brit-
 ain), Atco (USA), Atlantic (USA), Belter
 (Argentina & Portugal), CNR (Holland), Canta-
 galo (Germany), Carosello Curci (Italy),
 Deutsche Vogue (Germany), MRC (Italy),
 Meazzi (Italy), Metronome (Denmark, Germany,
 Sweden, USA), Pacific (France), Palette (Bel-
 gium), Ri-Fi (Italy), Serfaty (Venezuela), Vox
 (France & USA).

Int'l representatives: Argentina (Belter), Bene-
 lux (Vogue, Belgium), France (Vogue), Ger-
 many (Metronome), Morocco (Somidex), Por-
 tugal (Belter), Puerto Rico (South Eastern),
 Sweden (Metronome), Switzerland (Finsterwald,
 Cantacuzene), Venezuela (Serfaty), W. Indies
 (South Eastern).

Discos Tempo, Campomanes B-2 D, Madrid. Tel:
 247 1267. Dir.: Alfredo Garcia Segura; Gen.
 Mgr.: Gregorio Garcia Sagura.
 Branch: Canuda 45, Barcelona. Tel: 231 0886.
 Gen. Mgr.: Jose Cruells Solbes.

This company represents: Exito (Germany), In-
 errecord (Italy), Jugoton (Yugoslavia), Quali-
 ton (Hungary), 20th-Fox (USA).

Discos Vergara, Paseo General Mola 4, Barcelona
 9. Tel: 257 1200. Cable: VERGARASA. Pres.:
 Nicolas Suris; Dir.: Alberto Serra.
 Branch: Arcipreste de Hita 14, Madrid 15. Tel:
 244 1257.

This company represents: Angelicum (Italy),
 Ariola-Eurodisc (Germany), Ariston (Italy), Bam
 (France), Cetra (Italy), Clan Celentano (Italy),
 Club Francais du Disque (France), Durium
 (Italy), Harmonica Mundi (France), Kapp (USA),
 Ricordi (Italy), Schwann-Musica Sacra (Ger-
 many), Studio SM (France), Time (USA), Vox
 (France).

Expinter, Zurbano 67, Madrid. Gen. Mgr.: Mr.
 Cabrera.

Fonogram, Av. America Hernandez Tejada, Madrid
 17. Tel: 267 4200. Cable: Fonogram. Mgr'g
 Dir.: J. Sampedro; A&R: R.F. de la Torre, R.
 Niederleytner, L. Regatero; Sales & Int'l: S.
 Tagarro.

Branch: Plaza Narciso Oller 9, Barcelona. Tel:
 228 1013. Gen. Mgr.: Ruperto Castro.
 This company represents: Archiv (Germany),
 Contemporary (USA), DGG (Germany), Fontana
 (world-wide), MGM (USA), Mercury (USA),
 Philips (world-wide), Polydor (Germany), River-
 side (USA).

Int'l representatives: Argentina (Phonogram),
 Austria (Polyphon), Australia (Philips), Belgium
 (Polygram), Brazil (Companhia Brasileira), Chile
 (Philips), Colombia (Philips), Denmark (Nordisk
 Polyphon), England (Philips), France (Philips),
 Germany (Philips), Greece (Helladisc), Holland
 (Phonogram), Italy (Phonogram), Japan (Victor),
 Mexico (Discos Universales), Norway (Norsk
 Phonogram), Peru (El Virrey), Portugal (Philips),
 Sweden (Philips Sonora), Switzerland (Philips),
 South Africa (Gramophone Rec.), Uruguay
 (Philips), USA (Philips), Venezuela (Siemens).

Fonopolis, Ibiza 52, Madrid 9. Tel: 273 9000.
 Cable: Fonopolis. Gen. Mgr.: Luis Sanchez
 Caballero Estevez; Sales: Miguel Gil Fernandes;
 A&R Dir.: Guillermo Rancez Parra.

Int'l representatives: Discofrance (France), Ron-
 de (Venezuela), Selection, Will (Belgium), Casa
 Musicales, Eco (Italy).

H A G S A (Concentric), Notariado 3, Barcelona.
 Tel: 221 8170. Pres.: Jose Ma. Espinas Masip;
 Dir.: Francisco Borrull; Gen. Mgr.: Roser
 Domingo.

Hispavox, Torrelaguna 102, Madrid 17. Tel: 215
 2304. Cable: VOX. Gen. Mgr.: Jose Manuel
 Vidal; Sales Mgr.: Luis Vidal; A&R: Roberto
 Pla & Rafael Trabuchelli; Int'l: Luis Calvo.
 Branch: Corcega 516, Barcelona 4. Tel: 236
 6B19. Gen. Prof. Mgr.: Eusebio Secanell.

This company represents: ABC (USA), A&M
 (USA), AZ (France), Alvorada (Portugal), Amadeo
 (Austria), Ansonia (USA), Buena Vista (USA),
 CGD (Italy), Cameo-Parkway (USA), Carisch
 (Italy), Le Chant du Monde (France), Chess
 (USA), DCP (USA), Discophiles Francais (France),
 Disneyland (USA), Erato (France), Festival
 (France), Impulse (USA), Juke Box (Italy),
 Moonglow (Belgium), Peerless (Mexico), Reprise
 (USA), Sicomerciana (Argentina), United Artists
 (USA), Vogue (France), Warner Bros. (USA),
 Westminster (USA).

Int'l representatives: Australia (Australian),
 Benelux (Barclay), Colombia (Tropical), Ecuador
 (Ifesa), England (PAY), France (Barclay), Ger-
 many (Vogue), Greece (Columbia), Ireland (PAY),
 Italy (CGD), Japan (Nippon Columbia), Mexico
 (Gamma), Peru (El Virrey), Portugal (Radio
 Triunfo), Puerto Rico (Island), Scandinavia
 (PAY), South Africa (Meteor), Switzerland
 (Barclay), Turkey (Elia Alf Medina), USA
 (Columbia), Venezuela (Discoteca).

International Rec., Edificio Espana, Madrid. Gen.
 Mgr.: H.W. Schemke.

Marfer, P. Alto de la Virgen del Puerto 7, Madrid.
 Pres.: D. Enrique Moles; Dir.: D. Emilio Fer-
 nandez Fernandez; Gen. Mgr.: D. Antonio
 Martinez Rodriguez.

This company represents: Araenplast (Argentina),
 Artone (Holland), Combo (Italy), Emporio Mu-
 sical (Ecuador), Monitor (USA), Musidisc-
 Europe (France), Palacio de la Musica (Vene-
 zuela), Pickwick (USA), Turicaphon (Switzerland),
 Vega (France).

Pax, Vallehermoso 3B, Madrid. Gen. Mgr.: Mr.
 Boeta.

R C A Espanola, Princesa 1, Torre Madrid, Planta
 7, Oficinas B-9 & Planta 5, Oficina 19. Tel:
 248 4913. Cable: RCASPAIN. Mgr'g Dir.:
 Guillermo Caram.

Branch: Diputacion 251, Barcelona 7. Tel: 232

401B. Cable: RCASPAIN. Mgr.: Antonio Perez
 Font.

This company represents: Dot (USA), Telefunken
 (Germany).

Int'l representatives: RCA licensees.

SONOPLAY

"Don't do anything about your
 Record needs before contacting . . .
 SONOPLAY . . ."

Sonoplay, Serano 164-2, Madrid. Tel: 261 466B.
 Cable: Sonoplay. Dir.: Adolfo Waltzman; Execs.:
 Santiago Moro, Alfredo Pla.

Int'l representative: USA (Movierecord).

Zafiro, Campomanes 10-1, Madrid. Tel: 241 5004.
 Cable: ZAFIRO. Pres.: Francisco Ledesma; Dir.:
 Esteban Garcia Morencos.

Branch: Fernando Agullo 24, Barcelona. Tel:
 228 256B. Gen. Mgr.: Fernando Castano.

This company represents: Fonit (Italy), Montilla
 (USA), Musart (Mexico), Saar (Italy).

● music publishers

Aberbach, Carmen 20, Madrid.

Alvarez y Perez, Editorial Summa, Claudio Coello
 90, Madrid 6. Cable: SUMMARUM. Tel: 226
 6695. Gen. Mgr.: Juan Antonio Tamayo y
 Rubio.

Arlequin, Aragon 217, Barcelona.

Barna, Via Layetana 15B, Bajos, Barcelona 9. Tel:
 228 6967. Gen. Mgr.: Manuel Riera Cleville.

Tomas Aldas Conesa, Avellanias 7, Valencia. Tel:
 21 8213.

C S I C (Consejo Superior Investigaciones Cientificas)
 Vitrubio 17, Madrid 6. Tel: 259 2455.

Canciones del Mundo, Carmen 20, Madrid 13. Tel:
 221 6450. Pres. & Gen. Mgr.: Augusto Alguero
 Alguero; Gen. Prof. Mgr.: Augusto Alguero
 Dasca.

Branch: Bruch 136, Barcelona. Tel: 258 1807.
 Gen. Prof. Mgr.: Rosa Alguero.

This company represents: B. Feldman (London),
 Julio Korn (Argentina), Francis-Day (France),
 Peter Maurice (London), Robbins (USA).

Cantagallo, Edificio Espana, Madrid. Tel: 248 7487.
 El Carmen, Paseo de la Senda 5, Vitoria. Tel: 1499.

Casulleras, Via Layetana 95, Barcelona 10. Tel:
 221 3634. Gen. Mgr.: Rafael Casulleras
 Grabulosa.

Cisneros, San Buenaventura 1, Madrid 5. Tel: 239
 2007. Gen. Mgr.: P.P. Franciscanos.

Coculsa (Editorial y Libreria Comercial Cultural),
 Victor Pradera 65, Madrid B. Cable: COCULSA.
 Tel: 248 5638.

Daimon, Provensa 2B4, Barcelona B. Cable:
 EDIDAIFON. Tel: 228 992B. Gen. Mgr.: Manuel
 Tamayo Benito.

Alberto Bernaldo Duarte, Plaza del Monasterio 6,
 Barcelona 17.

E P E S A (Ediciones y Publicaciones Easoanola),
 Pizarro 19, Madrid 13. Cable: ASEPE. Tel:
 222 2100. Gen. Mgr.: Joaquin Ruiz-Jimenez.

Ediciones Armonico, Ramba de Cataluna 10, Barce-
 lona 7. Tel: 222 1B47. Cable: ARMONICO.
 Pres.: Nicolas Suris Palome; Gen. Mgr.: Julio
 Guiu Clara; Gen. Prof. Mgr.: Francisco Vinuesa
 Gimenez.

Branch: c/o Jacometrezo 7-2, Madrid 13.
 Tel: 248 6113. Gen. Prof. Mgr.: Luis Caceres
 Garcia.

Affiliates: Radio Record Iberica.

This company represents: Arc Espanola, Ariston
 Espanola, Clan Espanola, Ediciones Connelly.

Ediciones Essex Espanola (SGAE), Hortaleta 1B,
 Madrid. Tel: 221 3650. Cable: SEXMUS. Pres.:
 Howard S. Richmond; Gen. Mgr.: Manuel G.
 Salinger; Gen. Prof. Mgr.: Antonio Barta.

Branch: Diputacion 337, Barcelona 9. Tel: 225
 B489.

Affiliate: The Richmond Organization.

Ediciones Gramofono-Odeon, Urgel 234, Barcelona.
 Tel: 230 2205. Cable: GRAMOFONO. Pres.:
 George C. Alexander; Gen. Mgr.: Francisco
 Ribe.

Branch: Arenal 9, Madrid. Tel: 231 9246. Gen.
 Prof. Mgr.: Carlos Rico.

This company represents: Ardmore (USA), Ard-
 more & Beechwood (Great Britain), Beechwood
 (USA), Jaep (Great Britain), Dick James (Great
 Britain), Ivan Mogull (USA), Northern Songs
 (Great Britain), Pacer (Great Britain), PhotoPlay
 (Great Britain), REIMSA (Mexico), and companies
 of the EMI group (world wide).

Ediciones Hispania, Av. de Jose Antonio 31, Madrid 13. Tel: 231 2633. Cable: EDISPANIA. Pres. & Gen. Mgr.: J. Mario Suarez; Gen. Prof. Mgr.: Julian S. Ruiz.

Branch: Ediciones Hispania, Barcelona 4. Tel: 241 6673. Gen. Prof. Mgr.: Luis G. Thomas.

Affiliate: Kassner Music Espanola.

This company represents: American Metropolitan Enters., Davon (USA).

Ediciones IFI, Marques del Duero 106, Barcelona 15. Ediciones Orue, Irala-Barri Av. Pral. 6, Bilbao. Tel: 3 0810. Gen. Mgr.: Juan de Orue Matia.

Ediciones Quiroga (SGAE), Alcala 70, Madrid. Tel: 276 3966. Cable: QUIROGAMUSIC. Pres.: Manuel Lopez-Quiroga Miguel; Dir. & Gen. Prof. Mgr.: Carlos Perez Cancio.

Branch: Canuda 45, Barcelona. Tel: 231 0886. Gen. Prof. Mgr.: Jose Cruells Solbes.

Affiliates: Ediciones Musicales Calypso, Ediciones Musicales Clave, Ediciones Musicales Puerta del Sol.

This company represents: Dorabet (USA), Sam Fox (USA), Edward B. Marks (USA), Mills (England, USA), Palisades (USA).

Ediciones Ritma y Melodia, Villarroel 18, 2-3, Barcelona 11. Gen. Mgr.: D.F. Sanchez.

Ediciones Musicales Calypso (see Ediciones Quiroga). Ediciones Musicales Clave (see Ediciones Quiroga). Ediciones Musicales Hispavox, Campomanes 8 & Cuesta de Santo Domingo 11, Madrid. Tel: 248 6057. Cable: EDIVOX. Pres.: Enrique Maria Peral Buesa; Gen. Mgr.: Enrique Martin Garea.

Branch: Balmes 2-4-2, Barcelona. Tel: 231 5135.

This company represents: Acuff-Rose (USA), Argo (USA), Brandom (USA), Edizioni Colorado (Italy), Morro (USA), Mundo (Mexico), Screen Gems-Columbia (USA), Spanka (USA), UA (USA), Walt Disney (USA).

Ediciones Musicales Luis Araque, Av. Aster 17, Ap. Correos 3.042, Madrid 16. Tel: 246 0269 & 233 9832. Gen. Mgr.: Luis Araque Sancho.

Ediciones Musicales Madrid, Mayor 27, Madrid 13. Gen. Mgr.: Federico Moreno Torroba.

Ediciones Musicales Ortegal, Ap. Correos 19, Ortigueira.

Ediciones Musicales Puerta del Sol (see Ediciones Quiroga).

Ediciones Musicales RCA Espanola, Torre Madrid, Planta 7, Oficina 8-9. Tel: 248-4913. Cable: RCASPAIN. Mgr.: Antonio Martinez.

This company represents: RCA Victor Mexicana (Mexico), Relay (Argentina), Trousdale (USA).

Ediciones Musicales Sirius, Av. Jose Antonio 572, Pral 2, Ap. Correos 792, Barcelona 11. Tel: 223 4907. Gen. Mgr.: Mariano Farre Pujol.

Editora General (EDIGSA), Av. Jose Antonio 654, Barcelona. Tel: 232 3501. Pres.: Salvador Casanovas; Dir.: Josep M. Macip; Gen. Prof. Mgr.: Antonio Serra.

Editora Nacional, Av. Jose Antonio 62, Madrid 13. Tel: 247-3912, 2146. Gen. Mgr.: Santiago Galindo Herrero.

Editorial Balmes, Duran y Bas 9, Barcelona 2. Tel: 221 5050. Gen. Mgr.: Rdo. Eudaldo Serra.

Editorial Escuela Espanola, Mayor 4, Ap. Correos 14.540, Madrid 13. Gen. Mgr.: Joaquin Solana San Martin.

Editorial Mills Music Espanola, Alcala 70, Madrid. Mgr.: Carlos P. Cancio.

Editorial de Musica, Tuset 15, Barcelona 6. Tel: 237 4751. Gen. Mgr.: J. Garzon.

Editorial de Musica Boileau, Provenza 287, Barcelona 9. Tel: 227 5136. Gen. Mgr.: R. Boileau.

Erviti, San Martin 28, Ap. Correos 41, San Sebastian. Gen. Mgr.: Jose Manuel Garate Erviti.

Fiesta en Triana, Adriano 40, Ap. Correos 493, Seville. Gen. Mgr.: Juan Valenzuela Mostazo.

Fonopolis, Ibiza 52, Madrid. Tel: 273 9000. Gen. Mgr.: D. Luis Sanchez Caballero.

Joya, Concepcion Arenal 5, Ap. Correos 14.435, Madrid 13. Gen. Mgr.: Emilio Martinez Lluna.

Kassner Music Espanola (see Ediciones Hispania).

Melodias del Universo, Poetas 16, Madrid 12. Tel: 231 0625. Gen. Mgr.: Francisco Prada Blasco.

Robert Mellin, Carmen 20, Madrid.

El Mensajero del Corazon de Jesus, Av. Universidades 13, Bilbao. Tel: 1 8756 & 1 3755. Cable: MENSAJERO. Gen. Mgr.: Gregorio Arrate Martinez.

El Momento Musical, Horno de la Mata 3, Madrid 13. Tel: 222 6674. Gen. Mgr.: Genaro Monreal Lacosta.

Musica de Espana, General Mola 258, Madrid 16. Tel: 253 1552. Gen. Mgr.: Manuel Gordillo.

Musica de Hoy, Cuesta de Santo Domingo 11, Madrid. Tel: 247 0728.

Musica Modern, Marques de Cubas 6, Madrid 14. Tel: 211 5593. Gen. Mgr.: Antonio Carmona Reverte.

Musical Emporium, Rambla Canaletas 129, Barcelona 2. Gen. Mgr.: I. Llobet.

the sonet group

OF INDEPENDENT
RECORD COMPANIES
OF SCANDINAVIA

10th anniversary



SWEDEN

Sonet Grammofon AB

Artemisgatan 8 Stockholm No

NORWAY

Arne Bendiksen ALS

Österdalsgaten 1 Oslo 6

DENMARK

Dansk Grammofonpladeforlag

Dortheavej 39 Copenhagen

FINLAND

Scandia Musiikki

Hietalahdenranta 11 Helsingfors

continued

Nova Terra, Banos Nuevos 12, Barcelona 2. Tel: 231 0263. Gen. Mgr.: Jose Verdura.
Peer Southern (see Southern Music Espanola).
El Perpetuo Socorro, Covarrubias 19, Madrid 10. Tel: 223 0298. Gen. Mgr.: Dionisio Barriuso.
Radio Record Iberica (see Ediciones Armonico).
The Richmond Organization (see Ediciones Essex Espanola).
Sonoplay, Serano 164-2, Madrid 2. Tel: 261 4668. Dir.: Adolfo Waltzman.
Southern Music Espanola (SGAE), PO Box 5447, 337 Diputacion, Barcelona 9. Tel: 225 6197, B489. Cable: SOUTHMUSIC. Pres.: D. Juan Burbano Barguno; Gen. Mgr.: Manuel G. Salinger.
Branch: Hortaleza 18, Madrid 4. Tel: 231 0661, 3650. Gen. Prof. Mgr.: Antonio Baria.—Arzobispo Melo 3, Valencia 5. Tel: 33 1935. Gen. Prof. Mgr.: Enrique Piedra Albis.
Affiliate: Southern-Peer (world-wide organization).
This company represents: All firms of Southern Peer organization.
Union Musical Espanola, Carrera de San Jeronimo 26, Ap. Correos 177, Madrid 14. Cable: MUSICA. Gen. Mgr.: Javier Chapa Bermejillo.
World Music Espanola (SGAE), Diputacion 337, Barcelona 9. Tel: 225 6197. Cable: WORLDMUSIC. Pres.: Felix Faecq; Gen. Mgr.: Manuel G. Salinger; Gen. Prof. Mgr.: Antonio Baria.
Branch: Hortaleza 18, Madrid. Tel: 231 0661.
This company represents: Worldmusic organization & affiliated firms & branches.

● record club

Circulo de Lectores, Calle Padilla 327, Barcelona 13. Tel: 236-1400. Rec. Div.: N.E. Varenholz. Label: Orlador.

● supplies & services

JACKET MANUFACTURERS

Graficas Aragon Martin de Vargas 14, Madrid.
Graficas Martin, Antonio Lopez 166, Madrid.

LABEL MANUFACTURERS

A L G, Madrid.
Bosch, Barcelona.
Columbia, General Zumalacarreui 3, San Sebastian.
Graficas Espejo, Tomas Bregon 51, Madrid.
Huecograbado Imago, San Bernardo 25 & 26, Madrid.
L I M, J. Corrales 32, Esplugas Llobregat, Barcelona.
Pentacrom, Madrid.
Philips Iberica, Delicias 65, Madrid.
Pueche, Madrid.
Quintilla & Cardona, Barcelona.
Topografiahostench, Barcelona.

MATERIALS MILLING PLANTS

Etemo-Quimica, Paris 136, Barcelona.

MUSIC LICENSING ORGANIZATIONS

Sociedad General de Autores de Espana, Fernando VI 4, Madrid.

PRESSING PLANTS

Belter, Tamarit, 72, Barcelona 4.
Columbia, General Zumalacarreui 3, San Sebastian.
Cranvox, Jovellanos 3, Madrid.
Fonogram, Av de America, Madrid.
Fonopolis, Ibiza 52, Madrid.
Hisvapox, Torrelaguna 102, Madrid.
Odeon, Urgel 234, Barcelona.
Philips, Delicias 65, Madrid.
R C A, Av. de America y Hernandez Tejada, Madrid.
S E L E Z, Jose Antonio 324, Barcelona.

RECORDING STUDIOS

Belter, Gomis 1, Barcelona 6.
Columbia, General Zumalacarreui 3, San Sebastian.
Fonogram, Delicias 65, Madrid.
Fonopolis, Ibiza 52, Madrid 9. Tel: 273-90-00.
Hisvapox, Torrelaguna 102, Madrid.
Odeon, Urgel 234, Barcelona.
Philips, Delicias 65, Madrid.
R C A, Av. de America y Hernandez Tejada, Madrid.
Sonoplay, Serano, 164-2, Madrid 2. Tel: 261 4668.

TAPE DUPLICATION

Adams, Sagasta 23, Madrid.
Celada, Av. de America 22, Madrid 2. Tel: 245-4600. Dir.: Juan Alonso de Celada.
Dyrasa, Jose Antonio 55, Madrid.
Fonopolis, Ibiza 52, Madrid.
Sonoplay, Serano, 164-2, Madrid 2.
Sonomax, Santo Domingo 11, Madrid.

TRADE ORGANIZATIONS

Sinfonola, Camino Valderribas (Puente Vallecas), Madrid.

SWEDEN

Population: 7,680,531.
Official rate of exchange: \$1 (US) = 5.17 krona.
Records imported from US (factory value): 1964—\$136,817.
Records exported to US (factory value): 1964—\$381.
Average retail price: LP's—\$4; EP's—\$2; Singles—\$1.25.
Discounting: Occasional.
Type of record distribution: Manufacturer to dealer.
Radio stations: 1 (with 3 channels).
Television stations: 1.

Bjorn Fremer

● record manufacturers

Arkens Rundradio, c/o Ljusterdal, Murargatan 2C, Uppsala. Tel: 11 62 60. Pres.: Ake Ljusterdal, Stig Holtzberg & Gunnar Olsson.
Label: Arr (distributed by GDC).
Arne Bill Production, PO Box 953, Blommensbergsvagen 140, Hagersten 9. Tel: Stockholm 1B 18 44. Pres.: Arne Bill.
Label: Bill. (distributed by GDC).
Bokforlaget Libris, PO Box 330, Skolgatan 11, Orebro 1. Tel: (019) 11 93 60. Cable: ORE-BROMMISSIONEN. Mgr.: Wimar Hansson.
Label: Jubilate.
Clavicord, Post Box 35, Bollnas 1. Tel: 52 122. Pres.: Evald Sonefors.
Label: Clavicord. (distributed by GDC).
Cupol Grammofon & Musik, Katarina Bangata 17, Stockholm So. Tel: 23 30 55. Cable: CUPOL. Pres.: Helge Roundqvist.
Labels: Cupol, Nashville, Reprise, Toni.
This company represents: Ariola, Big Top, Cetra, Crescendo, Dollar, Efel, Embassy, Eurodisc, Europa, Hansa, Kent, Music Minus One, Muza, Oriole, Palette, Pronit, Qualiton, Sveriges Radio, Swe-Tone, Time, Triola (Finland), Vega, Veriton.
Dollar Music, Folkungagatan 136, Stockholm So. Tel: 43 90 93. Pres.: Ake Sohr.
Label: Dollar (distributed by Cupol).
Europa-Produktion, Droffningatan 65, Stockholm C. Tel: 11 62 40. Cable: EUROPASONG. Pres.: Ake Gerhard-Larsson.
Labels: Efel, Europa, Olga (distributed by Cupol).
Fralsningsarmens, PO Box 5090, Stockholm 5, Ostermalmsgatan 71, Stockholm O. Tel: 63 17 00. Cable: FRALSNING. Mgr.: Harry Floby.
Label: Festival.
This company represents: Regal.
Forlaget Filadelfia, PO Box 6082, Stockholm 6; Dobelmsgatan 52, Stockholm Va. Tel: 34-93-80. Cable: PINGSTKYRKAN. Pres.: Sven Lindahl.
Label: Hammets Harold.
Grammofon Electra, PO Box 1178, Ankdammsgatan 5G, Solna 1. Tel: Stockholm B2 04 80. Cable: Tefunk. Pres.: Sixten Eriksson; A&R: Mats Olsson.
Label: RCA Victor.
This company represents: RCA Victor, RCA Camden, RCA Victrola.
Hellberg-Perlitz Production, Lilla Nygatan 16, Stockholm C. Tel: 11 42 84. Pres.: Franklin Perlitz.
Label: Rasp. (distributed by Skandinaviska Grammophon).
IBRA Radio, PO Box B21, Stockholm 1, Sveavagen 34, Stockholm C. Tel: 24 01 30. Pres.: Hans Carlsson.
Label: Ibra.
Jazz, Nynasvagen 333, Enskede. Tel: Stockholm 39 29 88. Pres.: Gunnar Lindqvist.
Label: Jazz.
Jet, PO Box 14068, Stockholm 14; Grevgatan 3, Stockholm O. Tel: 60 61 50. Pres.: Ove Sloor.
Label: Jet (distributed by GDC).
Karusell Grammofon, Post Box, Frammasbacken 4B, Solna 1. Tel: Stockholm 27 26 70. Cable: KARUSELL. Pres.: Simon Brehm.
Labels: Joker, Karusell, Polydor, Primula.
This company represents: ABC-Paramount, Archiv-Produktion, Ascot, Cameo-Parkway, Command, Deutsche Grammophon, Elektra, Heliodor, Impulse, Kama Sutra, Swe-Disc, United Artists, Vault, Vee Jay, Verve, Westminster. (distributed by GDC).
Kaskad, PO Box 3134, Stockholm 3, Solvagen B, Trollbacken. Tel: 44 40 87. Pres.: Lennart Broberg.
Label: Kaskad.
Kewe Music, Vikingavagen 15, Danderyd. Tel: Stockholm 55 78 99. Pres.: Kewe Wickman.
Label: Wide World.

Knappupp, PO Box 3073, Stockholm 3, Kungsgatan 19, Stockholm C. Tel: 24 07 20. Cable: RALVOPRO. Pres.: Felix Alvo.
Labels: Knappupp, Triola.
This company represents: Argo, California (Imperial of USA), CGD, Derby, Dot, Hickory, Kapp, Medallion (distributed by GDC).
Lidoproduktion, Fack 131, Lidköping. Tel: 23 125. Pres.: Einar Svensson.
Label: Anette. (distributed by GDC).
Megafon, Goteborgsvagen 28, Gothenburg C. Tel: 20 60 96. Pres.: Lars-Gunnar Andersson.
Label: Megafon (distributed by GDC).
Metronome, Storaingsvagen 27, Stockholm No. Tel: 61 06 16. Cable: METROREC. Pres.: Mats Bjerke; Exp. Mgr.: Borje Ekberg.
Labels: Metronome, Snurskivan.
This company represents: Atco, Atlantic, Barclay, Belter, Stax, Volt. (distributed by GDC).
Moonlight Music, Vackravagen 14, Sundbyberg. Tel: Stockholm 29 15 36. Pres.: Ake Oquist.
Label: Midnight Sun. (distributed by GDC).
Morgonstjarnans, Kungsholmsgatan 20, Stockholm K. Tel: 51 63 87. Cable: Ahlinmusic. Pres.: Mrs. Marta Ahlin.
Label: Morgonstjarnan.
This company represents: Ansgar.
Nordiska Musikforlaget, PO Box B, Stockholm Tull, Pipersgatan 19, Stockholm K. Tel: 54 19 00. Cable: MUSICALIA. Pres.: Leif Kronlund.
Labels: Artist, Barnparaden. (distributed by Skandinaviska Grammophon).
N Y A Bokforlags, PO Box 5020, Stockholm 5; Sibyllegatan 18, Stockholm O. Tel: 67-01 55. Pres.: Karl-Erik Hellberg.
Label: Angelica.
Philips-Sonora: PO Box 5153, Stockholm 5; Kommandorsgatan 26, Stockholm O. Tel: 63 54 00. Cable: SONORA. Pres.: Eddie Landqvist.
Labels: Concerton, Dux, Fontana, Oktav, Padorec, Philips, Sonata, Sonora, Svenska, Ljud.
This company represents: Amadeo, CBS, Date, Golden Guinea, Harmony, Limelight, Marble Arch, Mercury, Mira, Musicor, Piccadilly, Pye, Riverside, Smash, Vanguard, World Pacific. (distributed by CGD).
Polar Music, Brahegatan 24, Stockholm O. Tel: 63 79 70. Cable: SWEDENMUSIC. Pres.: Bengt Bernhag.
Labels: Polar, Septima. (distributed by GDC).
Popular Melodi, Norrbackagatan 5, 1—Stockholm Va. Tel: 30 16 96. Pres.: Allan Ehwert.
Label: Pop.
Record-Materiel, Norrbackagatan 1, Stockholm Va. Tel: 23 42 15. Cable: RECOMPRESS. Pres.: Knut Vestman.
Label: Onskesagan.
Scan-Disc, Grevturegatan 3B, Stockholm O. Tel: 67 99 14. Cable: SCANDISCO. Pres.: Ronald Sjogren.
Labels: Polka, Scan-Disc.
This company represents: Roost, Roulette, Tono (distributed by GDC).
Septima (see Polar Music).
Skandinaviska Grammophon, PO Box 27053, Stockholm 27; Sandhammsgatan 39, Stockholm No. Tel: 22 45 80. Cable: GRAMMOPHON. Pres.: Anders Holmstedt. A&R: Ivan Nordstrom.
Labels: Columbia, HMV, Odeon, Sakral, Svensk-American.
This company represents: Amy, Angel, Artist, Barnparaden, Biophon, Bell, Blue Note, Buena Vista, Capitol, Delyse, Disneyland, Dolton, DynoVoice, Electrola, Ember, Encore, Imperial, Kurre Smack, Laurie, Liberty, MGM, Mala, Metro, New Voice, Parlophone, Pathe, Rasp, Regal, Stateside, Tamla/Motown, Tower, Uptown, Waverly.
SONET GRAMMOPHON, PO Box 39062, Stockholm 39; Artemisgatan B, Stockholm No. Tel: 67 05 40. Cable: SONETMUSIC. Pres.: Gunnar Bergstrom. Int'l & Sales Mgr.: Dag Haggqvist.
Labels: Gazell, Sonet, Storyville.
This company represents: Bel Air, Cadet, Checker, Chess, Colpix, Durium, Epic, King, Okeh, Pickwick/33, Red Bird, Riviera, Scepter, Starday, Supraphon, Transatlantic, Xtra. (distributed by GDC). (SEE ADVERTISEMENT)
Sunset, PO Box 40139, Stockholm 40. Tel: Uppsala 13 50 50. Pres.: Thomas Nordlund.
Label: Sunset. (distributed by GDC).
Svenska Manu-Music, Blekingegatan 61, Stockholm So. Tel: 43 07 55. Pres.: Per Nystrom.
Label: Manu.
This company represents: Junior. (distributed by GDC).
Svenska Missionsforbundets, Tegnergatan 8, Stockholm Va. Tel: 34 96 80. Cable: FORBUNDET. Pres.: Bertil Johansson.
Labels: Sirius, Solist. (distributed by GDC).

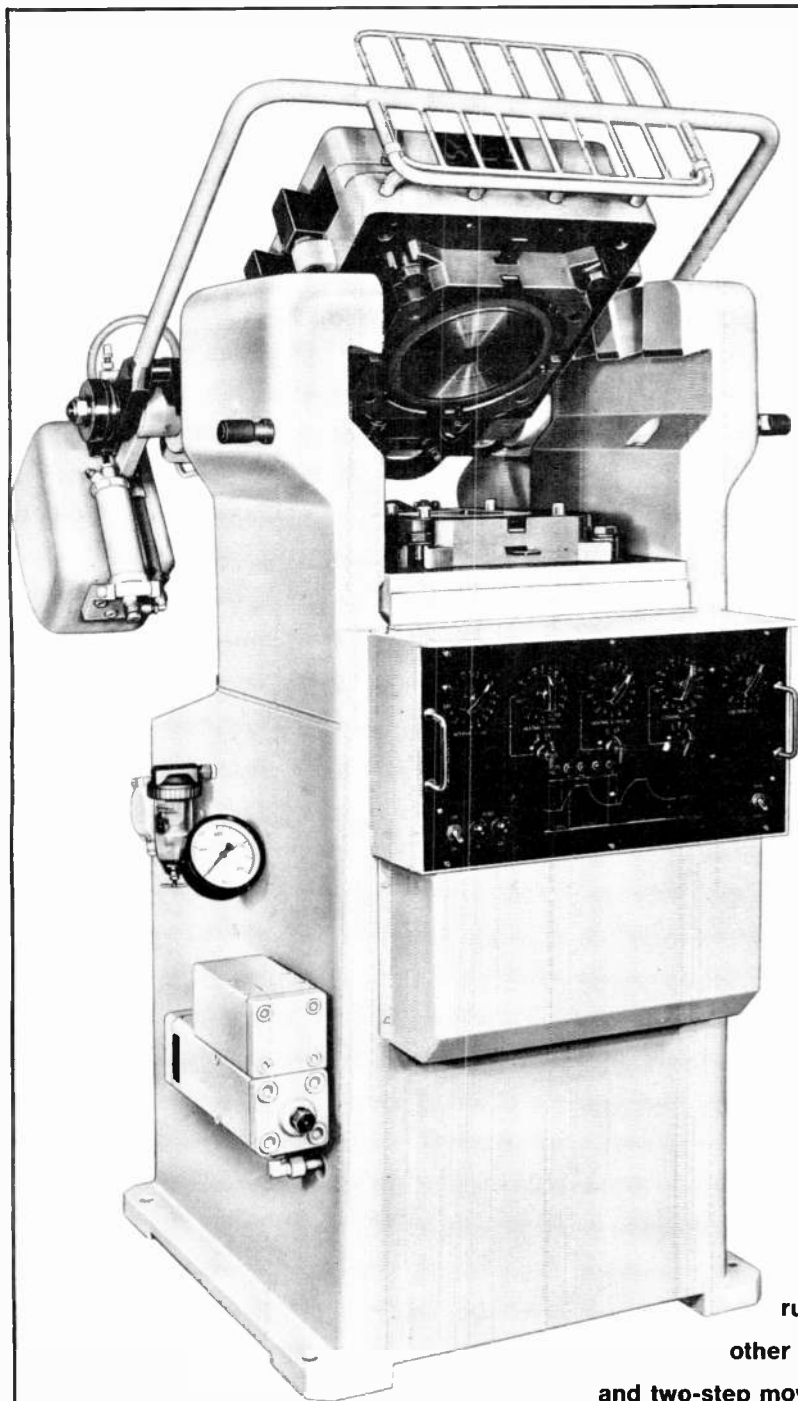

ALPHA **AUTOMATIC** **100** **TON** **GRAMOPHONE** **RECORD** **PRESS**

OUTSTANDING FEATURES OF THE ALPHA PRESS 10 H 537

Simple design giving highest reliability in running • Rapid mechanic function with, among other things, hydraulic retarding of the upper platen and two-step movement of the main ram • Electronically controlled automation • Automatic temperature cycle control • Patented hydraulic pressure control • Patented high speed heating system • Double action safety device preventing any misclosing of the press • Material and machine work of highest Swedish quality



AB ALPHA

SUNDBYBERG • SWEDEN
Cables: AKTIALPHA • STOCKHOLM
Telephone: STOCKHOLM 28 26 00
Telex: 10082 AKTIALPHA

continued

Sveriges Radio, PO Box 955, Stockholm 1; Oxenstiernsgatan 2, Stockholm No. Tel: 63 10 00. Cable: BROADCAST. Rec. dept. mgr.: Manne Ginsburg.
Label: Sveriges Radio (distributed by Cupol & Scandinaviska Grammophon).
 Swe-Disc Grammofon, Islandsorget, Bromma. Tel: Stockholm 87 33 00. Cable: SWEDISC Islandsorget. Pres.: Roland Ferneberg & Sture Wahlberg.
Label: Swe-Disc (distributed by GDC).
 Swereco, Post Box, Huvudskarsvagen 16, Johannes-hov. Tel: Stockholm 39 32 00. Pres.: Arne Setterwall.
This company represents: AZ, Crown, Eros, MK, Mode, Monitor, Pop, Saga, Sidney Bechet, Vogue.
 Swe-Tone, c/o Pergeman, Snickarvagen 25, Bro. Tel: Staket 40 553. Pres.: Alf Pergeman.
Label: Swe-Tone (distributed by Cupol).
 Telefunken, PO Box 1178, Ankdammsgatan 5G, Solna 1. Tel: Stockholm 82 04 80. Cable: TEFUNK. Pres.: Sixten Eriksson; Musical Dir.: Mats Olsson; A&R: Sven Agren.
Labels: Decca, Reprise, Sagoton, Swedish Society Discofil, Telefunken, Warner Bros.
This company represents: Ace of Clubs, Ace of Diamonds, Ace of Hearts, Argo, Brunswick, Coral, London, L'Oiseau-Lyre, Telestar, Turnabout.
 Ernst Westerbergs, Post Box, Stockholm 6; Norrtullsgatan 10, Stockholm Va. Tel: 24 16 50. Cable: BAPTIST. Pres.: Zeth Abrahamsson.
Label: Cantus.
 Williams, PO Box 315, Bromma 3; Holbergsgatan 95, Bromma. Tel: Stockholm 37 27 40. Cable: ILLKASS. Pres.: 80 All.
Label: Kurre Smack (distributed by Skandinaviska Grammophon).

● **music publishers**

Ahlins, Kungsholmsgatan 20, Stockholm K. Tel: 51 63 86. Cable: AHLINMUSIK. Pres.: Ernfrid Ahlin.
 American Songs, Drottninggatan 55, Stockholm C. Tel: 21 69 97. Cable: STOCKHOLMSMUSIK. Pres.: Felix Stahl.
 Anderssons, Sodra Forstadsgran 6, Malmo C. Tel: 23 659. Pres.: Ake Andersson.
 Barton (Scandinavia), Drottninggatan 65, Stockholm C. Tel: 11 62 40. Pres.: Ake Gerhard-Larsson.
 Belinda (Scandinavia), Drottninggatan 65, Stockholm C. Tel: 11 62 40. Cable: BELINDSONG. Pres.: Ake Gerhard-Larsson.
 Bens (see Sweden).
 Broadway (see Sweden).
 Cedarwood (Scandinavia), Drottninggatan 65, Stockholm C. Tel: 11 62 40. Pres.: Ake Gerhard-Larsson.
 Dominion, Storangsvagen 27, Stockholm No. Tel: 61 13 16. Cable: MULTITONE. Pres.: 80 Goran Edling.
 Edition City, Drottninggatan 65, Stockholm C. Tel: 11 62 40. Pres.: Ake Gerhard-Larsson.
 Edition Liberty, PO Box 1178; Ankdammsgatan 5G, Solna 1. Tel: Stockholm 82 04 80. Cable: TEFUNK. Pres.: Sixten Eriksson; Prof. Mgr.: Hans Englund.
 Edition Lunden, Bromsvagen 25, Alvsjo. Tel: 47 35 46. Pres.: Walter Cohn.
 Edition Odeon, Oxenstiernsgatan 37, Stockholm No. Tel: 60 53 53 & 22 45 80. Cable: TURNTABLE. Pres.: Ivan Nordstrom & Bengt Sundstrom.

Edition Sylvain, Linnegatan 9-11, Stockholm O. Tel: 62 05 30. Cable: EHRLINGMUSIK. Pres.: Thore Ehrling.
 Ehrling & Lofvenholm, PO Box 8, Stockholm Tull; Pipersgatan 29, Stockholm K. Tel: 54 32 13. Cable: KAYTONE. Pres.: Leif Kronlund.
 Ehrlingforlagen, Linnegatan 9-11, Stockholm O. (A concern of music publishers. For information see: Edition Sylvain, Nils-Georgs, Thore Ehrling).
 Europa-Produktion, Drottninggatan 65, Stockholm C. Tel: 11 62 40. Cable: EUROPASONG. Pres.: Ake Gerhard-Larsson.
 Flamingo, Bergslagsvagen 260, Bromma. Tel: 87 33 00. Pres.: Roland Ferneberg & Sture Wahlberg.
 Forlaget Filadelfia, PO Box 6082, Stockholm 6; Dobelngsgatan 52, Stockholm Va. Tel: 34 93 80. Cable: PINGSTYRKAN. Mgr.: Sven Lindahl.
 Forlaget Visor & Latar, PO Box 194, Aerla; Olstorp-Aerla. Tel: Eskilstuna (016) 700 16. Pres.: Gunnar Olsson.
 Gavotte Music, PO Box 27199; Invernessvagen 16, Stockholm 27. Tel: 85 50 50. Pres.: Pierre Westerman.
 Gehrmans, PO Box 505, Stockholm 1; Vasagatan 46, Stockholm C. Tel: 10 09 52. Cable: MUSIK-GEHRMAN. Pres.: Lennart Bagger-Sjback; Prof. Mgr.: Bernt Baune.
 Globe Music, PO Box 40139, Stockholm 14. Tel: Uppsala 13 50 50. Pres.: Thomas Nordlund.
 Gronstedts, Borgargatan 4, Stockholm Sv. Tel: 69 22 07. Pres.: Karl Gronstedt.
 Karin, Storangsvagen 27, Stockholm No. Tel: 61 13 16. Cable: MULTITONE. Pres.: 80 Goran Edling.
 Kassner, Drottninggatan 55, Stockholm C. Tel: 21 69 97. Cable: STOCKHOLMSMUSIK. Pres.: Felix Stahl.
 Kewe, Vikingavagen 15, Danderyd. Tel: Stockholm 755 78 89. Pres.: Kewe Wickman.
 Lani, Hantverkargatan 54, Stockholm K. Tel: 53 53 00. Pres.: Yngve Stoor.
 Lois (Scandinavia), Drottninggatan 65, Stockholm C. Tel: 11 62 40. Pres.: Ake Gerhard-Larsson.
 A 8 R Lundquist, Surbrunnsgatan 30, Stockholm a. Tel: 34 55 20. Pres.: Einar Hylin.
 Robert Mellin (Scandinavia), Drottninggatan 65, Stockholm C. Tel: 11 62 40. Pres.: Ake Gerhard-Larsson.
 Modern, Valhallavagen 16, Stockholm O. Tel: 30 20 36. Dir.: Felix Stahl.
 Mogull (see Sweden).
 Moonlight, Vackravagen 14, Sundbyberg. Tel: Stockholm 29 15 36. Pres.: Ake Oquist.
 Morgonstjarnans, Kungsholmsgatan 20, Stockholm K. Tel: 51 63 87. Cable: AHLINMUSIK. Pres.: Mrs. Marta Ahlin.
 Multitone, Storangsvagen 27, Stockholm No. Tel: 61 13 16. Cable: MULTITONE. Pres.: 80 Goran Edling.
 Musikaliska Knuten, PO Box 733, Stockholm 1; Idrottsvagen 52, Norrviken. Tel: 714 06 77. Pres.: Uno Ullven.
 Musikaliska Magazinet, Drottninggatan 65, Stockholm C. Tel: 11 62 40. Pres.: Ake Gerhard-Larsson.
 Musikforlaget Essex, Regeringsgatan 45, Stockholm C. Tel: 23 49 85. Cable: NOMECCO. Pres.: Lennart Reuterskiold.
 Der Musikus, Farkostvagen 8, Lidingo 1. Tel: Stockholm 765 12 30. Pres.: Hans Busch.
 Nils-Georgs, Linnegatan 9-11, Stockholm O. Tel: 62 05 30. Cable: NILS-GEORGMUSIK. Pres.: Thore Ehrling.

Nordiska, PO Box 8, Stockholm Tull; Pipersgatan 29, Stockholm K. Tel: 54 19 00. Cable: MUSICALIA. Pres.: Leif Kronlund.
 Palace (see Sweden).
 Platina c/o Edition Odeon, Oxenstiernsgatan 37, Stockholm No. Tel: 60 53 53. Cable: TURNTABLE. Pres.: Bengt Sundstrom & Ivan Nordstrom.
 Polar (see Sweden).
 Progressive, Storangsvagen 27, Stockholm No. Tel: 61 13 16. Cable: MULTITONE. Pres.: 80 Goran Edling.
 Reuter & Reuter, Regeringsgatan 45, Stockholm C. Tel: 23 49 85. Cable: NOMECCO. Pres.: Lennart Reuterskiold.
 RYMUS, Kungsgatan 56, Stockholm C. Tel: 20 06 97. Pres.: Henry Fox.
 SCALA, Regeringsgatan 45, Stockholm C. Tel: 23 49 85. Cable: NOMECCO. Pres.: Lennart Reuterskiold.
 Schlagerforlaget, Hantverkargatan 62, Stockholm K. Tel: 53 53 00. Pres.: Yngve Stoor.
 A. Schroeder, Brahegatan 24, Stockholm O. Tel: 61 75 30. Cable: SWEDENMUSIC. Pres.: Stig Anderson.
 Screen Gems (see Sweden).
 Seven Brothers, c/o Edition Odeon, Oxenstiernsgatan 37, Stockholm No. Tel: 60 53 53. Cable: TURNTABLE. Pres.: Ivan Nordstrom & Bengt Sundstrom.
 The Shadows (Scandinavia), Drottninggatan 65, Stockholm C. Tel: 11 62 40. Pres.: Ake Gerhard-Larsson.
 Sonet, PO Box 39062, Stockholm 139; Artemisgatan 8, Stockholm No. Tel: 67 05 40. Cable: SCANDICORD. Pres.: Rune Ofwerman.
 Sonora, PO Box 5153, Stockholm 5; Kommendorgatan 26, Stockholm O. Tel: 63 54 00. Cable: SONORA. Pres.: Eddie Landqvist. Prof. Mgr.: Sture Borgedahl.
 Southern, Grevturegatan 38, Stockholm O. Tel: 67 99 10. Cable: SOUNDMUSIC. Pres.: Ronald Sjogren.
 Spanka (see Sweden).
 Starton, Bondegatan 4, Stockholm So. Tel: 23 30 55. Pres.: Helge Roundqvist.
 Stockholms Musikproduktion, Drottninggatan 55, Stockholm C. Tel: 21 69 97. Cable: STOCKHOLMSMUSIK. Pres.: Mrs. Felix Stahl.
 Succemelodier, Drottninggatan 55, Stockholm C. Tel: 21 69 97. Cable: STOCKHOLMSMUSIK. Pres.: Felix Stahl.
 Svenska Manu-Music, Blekingegatan 61, Stockholm So. Tel: 43 80 12. Pres.: Per Nystrom.
 SWEDEN, Brahegatan 24, Stockholm O. Tel: 61 75 30. Cable: SWEDENMUSIC. Pres.: Stig Anderson.
This company represents: Bens, Broadway, Mogull, Palace, Polar, Screen Gems, Spanka. (SEE ADVERTISEMENT)
 Tagemusik, c/o Edition Odeon, Oxenstiernsgatan 37, Stockholm No. Tel: 60 53 53. Cable: TURNTABLE. Pres.: Ivan Nordstrom & Bengt Sundstrom.
 Thore Ehrling, Linnegatan 9-11, Stockholm O. Tel: 62 05 30. Cable: EHRLINGMUSIK. Pres.: Thore Ehrling.
 United Artists, Brahegatan 24, Stockholm O. Tel: 61 75 30. Cable: SWEDENMUSIC. Pres.: Stig Anderson.
 Wessman & Pettersson, Adelsgatan 5, Visby. Tel: 101 11. Pres.: Hans Pettersson.

● **record distributors**

Cupol, Katarina Bangata 17, Stockholm So. Tel: 23 30 55. Cable: CUPOL. Pres.: Helge Roundqvist.
Distributes the products of: Cupol Grammofon & Musik, Dollar Music, Europa-Produktion, Sveriges Radio, Swe-Tone.
 G D C (Grammofonbolagens Distributioncentral) PO Box 5153, Stockholm 5; Jungfrugatan 19, Stockholm O. Tel: 63 54 00. Pres.: Eddie Landqvist.
Distributes the products of: Arkens Rundradio, Arne Bill Produktion, Clavicord, Jet Records, Karusell Grammofon, Knappupp, Lidoproduktion, Megafon, Metronome, Moonlight Music, Pan, Philips-Sonora, Polar Music, Scan-Disc, Septima, Sonet Grammofon, Sunset, Svenska Manu-Music, Svenska Missionsforbundets, Swe-Disc Grammofon.
 Skandinaviska Grammophon, PO Box 27053, Stockholm 27; Sandhamngsgatan 39, Stockholm No. Tel: 22 45 80. Cable: GRAMMOPHON. Pres.: Anders Holmstedt.
Distributes the products of: Hellberg-Perlitz Produktion, Jazz Records, Nordiska Musikforlaget, Skandinaviska Grammophon, Sveriges Radio, & Williams.

**SWEDEN
MUSIC AB**

Brahegatan 24
STOCKHOLM • SWEDEN
 Cableaddress:
SWEDEN MUSIC • STOCKHOLM
 Phone:
61 75 30 • 60 22 87 • 63 79 70

STIG ANDERSON

The centre of the
Record Industry is

MUSIKVERTRIEB AG ZURICH

Distributing the Top Labels
in the World of Music



Ariola



ELITE



FESTIVAL



L'OISEAU
LYRE



RCA VICTOR



BADENERSTRASSE 555
8040 ZURICH

SWITZERLAND

Telephone: 051/54.97.54
Cable: Musikvertrieb Zurich

continued

● supplies & services

MUSIC LICENSING ORGANIZATIONS

S T I M, Tegnerlunden 3, Stockholm C. Tel: 24 29 50. Cable: STIM. Pres.: Sven Wilson. The Swedish Performing Rights Society.

PRESSING PLANTS

ALPHA, PO Box; Esplanaden 10, Sundbyberg. Tel: Stockholm 28 26 00. Cable: AKTIEALPHA. Pres.: S. Jacobsson (SEE ADVERTISEMENT)

Champion Radio, PO Box 21028, Stockholm 21; Rorstrandsgatan 37 Stockholm Va. Tel: 22 78 20. Cable: CHAMPIONRADIO. Pres.: Olof Bengtsson.

Mekaniska Verkstaden Rekord, Norrbackagatan 1, Stockholm Va. Tel: 23 42 15. Cable: Recopress. Pres.: Knut Vestman.

Svensk Grammofonindustri, Sveavagen 17, Stockholm C. Tel: 10 63 67. Pres.: Tage Andersson.

RECORDING STUDIOS

Como Studios, Karlbergsvagen 57, Stockholm Va. Tel: 30 96 00. Cable: METROREC. Mgr.: Rune Persson.

Europa Film, Annedalsvagen 29, Sundbyberg. Tel: Stockholm 28 28 00. Cable: EUROPAPILM. Mgr.: Bjorn Bergqvist.

Svenska Philips, PO Box, Stockholm 27; Lidingsvagen 50, Stockholm No. Tel: 63 50 00. Cable: PHILAMP. Mgr.: Dag Secher.

Sela Studio, Skiltorget 5, Stockholm C. Tel: 10 31 34. Pres.: Lennart Ljungberg; Mgr.: Sten Hagberg.

SWITZERLAND

Population: 6,080,000.

Official rate of exchange: \$1 (US)=4.29 francs.

Records imported from US (factory value): 1964—\$190,328.

Records exported to US (factory value): 1964—\$3,287.

Origin of pop record music: Domestic—2%; USA—42%; European (Common Market)—56%.

Stereo record sales: 15% of all records.

Discounting: None.

Record club sales: 5%.

Important regulations: 5.4% tax on wholesale price, plus 8 for SUIISA (mechanical copyright royalties)—both added to retail price.

● record manufacturers

C B S, PO Box 66, Winterthur. Tel: 6.62.31. Cable: COLRECORD. Gen. Mgr.: Helmut Bischof. Label: Columbia.

Disques Office, 188 rue Pierre Aebly, 1700 Fribourg. Tel: (037) 2.62.61.

This company represents: Ades-Petit Menestrel (France), Alpha (Belgium), Baroque (Canada), BAM (France), Discophile Francais (France), Musidisc, Ocora, Pleiade (France), President (France), Supraphon (Czechoslovakia), Supradidac (Belgium), Vergara, (Spain), Vista (USA).

E M I, Bahnhofstr. 28, 6300 Zug, Switzerland. Cable: EMISPHER.

Electromusic, Nauenstr. 71, Basel. Tel: 34.92.50. Cable: ELMUBA. Gen. Mgr.: Fritz Voegelin; Vice-Mgr.: Max Blattner.

Labels: Alpha, Alpina, Tell. This company represents: Cetra (Italy), Discophon (Spain), Juke Box (Italy), Sabrina (Italy), 777 (Germany), Sunset (Italy), Tempo-Osca (Germany).

Ex Libris, PO Box 8023, Hermetschloostr. 77, Zurich. Tel: 62.51.00.

Finsterwald & Cantacuzene, 70 Av. des Alpes, 1820 Montreux. Tel: 62.45.55.

This company represents: AZ (France), Adventure (Italy), Arlequin (Spain), Artone (Holland), Autumn (USA), Belter (Spain), Calig (Germany), Charlin (France), Christophorus (Germany), Circus (Italy), Clarte (France), Collector Recs. (England), Contrepoint (France), Crescendo (USA), Critere (France), Davon Music (USA), Deutsche Vogue (Germany), Dot (USA), Durium (Italy), Erato (France), Everest (USA), Fiori Musicali (France), Funkler (Holland), GNP Crescendo (USA), Golden Guinea (England), Hispavox (Spain), Jay Gee (USA), Jericho (France), Jolly (Italy), Josie (USA), Jubilee (USA), Kapp (USA), Laurie (USA), Lumen (France), MK (USSR), Mainstream (USA), Marble Arch (England), Markal (Belgium), Marquee

(USA), Mode (France), Music (Italy), Negrin (Holland), Nixa (England), Orfeon (Mexico), Pacific (France), Palette (Belgium), Pastorale & Musique (France), Piccadilly (England), Pop (France), Peacock (USA), Premier (USA), Pye (England), Red Bird (USA), Roulette (USA), Royal (Italy), Scepter (USA), Somerset (Germany), Sonet (Sweden), Spoken Arts (USA), Sprint (Italy), Stella (Italy), Stevie (England), Storyville (Denmark), Strike (England), Studio SM (France), Swing (France), Tico (USA), Titanus (Italy), Tono (Denmark), Transatlantic (England), Typic (France), Unidisc (France), Vogue (France), Zafiro (Spain).

Hug, Lindenhofstr. 16, Basel. Tel: (061) 35.10.77.

This company represents: HMV, Electrola, Angel, Encore, Trianon, Liberty, Jupiter, L'Encyclopedie Sonore (Hachette), Bartok, Monitor, Musidisc, Qualiton.

Interdisc, PO Box 34, V.d. Scuole 10, Cassarate-Lugano. Tel: 3.20.93. Dir.: Aldo Libanione.

Iramac, Burgerstr. 17, 6000 Luzerne. Pres.: S. S. A. Samama.

Labels: Iramac & Relax.

Jecklin, Ramistr. 42, 8024 Zurich. Tel: (051) 24.39.41.

This company represents: Angel (England), Atco (USA), Atlantic (USA), CGD (Italy), Carisch (Italy), Choir (USA), Columbia (England), Contemporary (USA), Derby (Italy), Favorite (Austria), Gloria (Germany), Golden 12 (Germany), Good Time Jazz (USA), Harmonia Mundi (Germany), Imperial (Germany), International (Germany), Italia (Germany), Kabarett Aus Wien (Austria), Lebendiges Wort (Austria), Metro-nome (Germany), Musica Sacra (Germany), Odeon-Parlophon (England), Pathe (England), Patmos (Germany), Regal (England), Stateside (England), Super Majestic (France), Tamlamotown (USA), Unikum (Austria), Vox (USA, France).

Mercury, 5 Quai du Mont Blanc, Geneva. Tel: 32.87.10. Cable: Merrecord. Dir. Int'l: Brice Somers.

MUSIKVERTRIEB, PO Box 8040, Badenerstr. 555, Zurich. Tel: (051) 54.97.54. Cable: MUSIKVERTRIEB. Pres.: M. A. Rosengarten; Sales: L. Schmucki.

This company represents: Ace of Clubs (England), Ace of Hearts (England), Ariola (Germany), Argo (Europe), Baccarola (Germany), Parclay (France), Bel Air (France), Capitol (USA), Coral (USA), Decca (England), Ducretet-Thomson (France), Elite Special (Switzerland), Eurodisc (Germany), Festival (France), Hansa (Germany), Hed-Arzi (Israel), Hispavox (Spain), Jaguar (Italy), Karate (USA), London (England), L'Oiseau Lyre (France), Monument (USA), RCA Victor (USA), RCA Italiana (Italy), Reprise (USA), Ricordi (Italy), Rigolo (France), Riviera (France), Telefunken (Germany), Triola (Denmark), 20th Century-Fox (USA), Vega (France), Warner Bros. (USA). (SEE ADVERTISEMENT)

Oversea, Alte Zurcherstr., 8154 Oberglatt, Zurich. Tel: (051) 94.71.50. Gen. Mgr.: Michel Liber. Label: Oversea.

This company represents: Carosello (Italy), Clan Celentano, (Italy), Curci (Italy), Delta (England), Fidelio (England), IPM (Italy), Italmusica, (Italy), Jazz Club (France), Kansas (Italy), Maietti (Italy), Meazzi (Italy), Ole (Italy), Palette (USA), Panorama (France), Pig (Italy), President (France), Primary (Italy), Ri Fi (Italy), Ribalta (Italy), Rondo (Germany), Said (Italy), Sir (Italy), Silver (Italy), Sonor (Italy), Sunstar (Italy), Togo (Italy), Variety, Vergara (Spain), Zephyr (Italy).

Philips, Edenstr. 20, 8027 Zurich. Tel: (051) 25.86.10. Cable: ARGENTA. Gen. Mgr.: Dr. J. J. Schwenzer; Sales: A. Duchable.

Labels: Philips, Fontana, Mercury, Caedmon, Orpheus, Pergola.

This company represents: Audio-Fidelity (USA), Battle (USA), Caedmon (USA), Caravel (Italy), Critere (France), Fidelity (Greece), Fontana, Jazzland (USA), Mercury (USA), Melodicon (Italy), Pacific Jazz (USA), King Universal (Italy), Philips (USA), Riverside (USA), Star Club (Germany), Vee Jay (USA), World Pacific (USA).

Phonag, PO Box 66, Stadthausstr. 69, 8400 Winterthur. Tel: (052) 6.62.31.

Label: Phonag.

This company represents: Amadeo (Austria), Blue Note (USA), Saba (Germany), CBS (USA), Epic (USA), Okeh (USA), Phonocolor (Italy), Style (Italy), Vanguard (USA).

Pick, Brunnwiesenstr. 26, CH 8049 Zurich. Tel: 56.70.60 & 56.44.40. Cable: MUSIKCENTER. Pres.: Anton Peterer; Int'l: Jane Peterer; Mgr.:

Ernest Niedermann.

Labels: Regina, Hippo.

RCA Overseas (European Liaison Office), 31 Blvd. Helvetique, Geneva. VP & Mg'g Dir.: Peter F. Baumberger.

Siemens, Lowenstr. 35, 8001 Zurich. Tel: (051) 25.36.00. Gen. Mgr.: Eugen Vogler.

This company represents: Adria (France), Archiv (Germany), Ascot (USA), Brunswick (Germany), Command (USA), Cricket (Italy), DCP-International (USA), DGG (Germany), Disques Jacques Canetti (France), Fonit (Italy), Heliodor (Germany), Hit House (Germany), Polydor (Germany), Italdisc (Italy), Kama Sutra (USA), Langenscheidt (Germany), MGM (USA), Polydor (Germany), Tip (Germany), UA (USA), Verve (USA), Verve/Folkways (USA), VSP (USA).

Turicaphon, 8611 Riedikon/Uster, Zurich. Tel: (051) 87.43.11. Gen. Mgr.: Hans Oestreich Sr.; Sales & Promo.: Hans Oestreich Jr. Label: Elite Special.

This company represents: Asmahan, Ricordi, Triola, Phonocolor, Vogue (see Finsterwald & Cantacuzene).

Vogue, Av. des Alpes 70, Montreux.

● music publishers

De Belmont, 70 Av. des Alpes, 1820 Montreux. Tel: (021) 62.45.55.

Cadenza, 8 rue de Hesse, Geneva. Tel: 25.59.55. Gen. Mgr.: Heinz Liechti.

Affiliate: Editions Sidem, Mondiamusic.

This company represents: Big 3.

Chappell (see Helbling).

Edifo, Badenerstr. 332, 8000 Zurich 4. Tel: 54.64.77.

Edition Annabella (see Musikus).

Edition Coda, Brunnwiesenstr. 26, CH 8049 Zurich. Tel: 56.70.60 & 56.44.40. Cable: MUSIKCENTER. Gen. Mgr.: Anton Peterer.

Affiliate: Melodie.

This company represents: Ralph Arnie (Germany), Edition Montana (Germany), Francis-Day (France), Peter Meisel (Germany), UFA (Germany).

Edition Turicaphon, 8611 Riedikon/Uster, Zurich. Tel: (051) 87.43.11. Cable: TURICAPHON RIEDIKON. Pres.: Hans Oestreich Sr.

Editions Sidem (see Cadenza).

Flora (see Musikus).

Helbling, Haus Melodie, 8604 Voketswil, Zurich. Tel: (051) 86.43.93.

This company represents: Chappell, Modern, Nova, Southern.

Impact, V.d. Scuole 10, 6900 Cassarate-Lugano. Tel: 3.20.93. Dir.: Aldo Libanione.

Intervox, Pfauen-Ramistr. 42, Zurich 1/24. Tel: 24.16.73.

Maietti (see Oversea).

Me'odie (see Edition Coda).

Ivan Mogull (see Musikvertrieb).

Mondiamusic (see Cadenza).

Musikus, Weidstr. 11, 8610 Uster/Zurich. Tel: 87.30.72. Pres.: Hans Oestreich Sr.

Affiliates: Flora, Edition Annabella.

MUSIKVERTRIEB, Badenerstr. 555, 8040 Zurich.

This company represents: Ivan Mogull. (SEE ADVERTISEMENT)

Oversea Rec., 8154 Oberglatt, Zurich.

Sonographic, PO Box 2, 8952 Schlieren.

Southern (see Helbling).

Vescovi (see Oversea).

● distributors

Jecklin, Ramistr. 42, 8024 Zurich. Tel: (051) 24.39.41.

MUSIKVERTRIEB, Badenerstr., 555, Zurich 9/48. Contact: Alex Reichstadt. (SEE ADVERTISEMENT)

Pick, Brunnwiesenstr. 26, 8049 Zurich. Tel: 56.70.60 & 56.44.40. Mg'g Dir.: Anton Peterer.

● supplies & services

MUSIC LICENSING ASSOCIATIONS

S U I S A (Societe Suisse des Auteurs et Editeurs), General Guisan Quai 38, 8027 Zurich. Tel: (051) 25.77.00.

PRESSING PLANT

Turicaphon, 8611 Riedikon/Uster, Zurich. Tel: 87.43.11.

RECORDING & TAPE DUP. STUDIOS

Hug, Fusslistr. 4, 8000 Zurich 1.

Max Lussi, Leimenstr. 76, 4000 Basel.

Oversea, 8154 Oberglatt, Zurich.

Sonographic, PO Box 2, 8952 Schlieren.

THAILAND

Population: 29,700,000.

Official rate of exchange: \$1 (US) = 20.80 baht.

Records imported from US (factory value): 1964—\$125,516; 1963—\$120,700; 1962—\$131,100; 1961—\$102,300.

● record manufacturers

Black & White, 708 Mahachai Rd., Bangkok. Tel: 23002.

Cathay, Charoenkrung Rd., Bangkok.

T. Ngeck Chuan, 96 Phrasumeru Rd., Bangkok. Tel: 20560.

Kamol Sukosol, PO Box 178, Bangkok.

Sri Krung Film Co., 129 Bangkokpi, Bangkok. Tel: 57133.

Philips Electrical Co. of Thailand, 282 Silom Rd., Bangkok.

● importers & exporters

T. Ngeck Chuan, 96 Phrasumeru Rd., Bangkok. Tel: 20560.

Kamol Sukosol, PO Box 178, Bangkok.

● supplies & services

PRESSING PLANTS

Sri Krung Film Co., 129 Bangkokpi, Bangkok. Tel: 57133.

Virulhhatthakich, c/o Kamol Sukosol, PO Box 178, Bangkok.

RECORDING STUDIO

Kamol Sukosol, PO Box 178, Bangkok.

TRINIDAD & TOBAGO

Population: 969,380.

Official rate of exchange: \$1 (US) = 1.714 West Indian dollars.

Per capita income: \$863 (1964).

Records imported from the US (CIF value): 7" and under—\$40,774; 7" to 10"—\$2,717; over 10"—\$60,074 (1964).

Records exported to US (FOB value): 7" and under—\$77; over 10"—\$181 (1964).

Total record imports (CIF value): 7" and under—\$59,194; 7" to 10"—\$30,804; over 10"—\$97,812 (1964).

Total record exports (FOB value): 7" and under—\$70,748; 7" to 10"—\$903; over 10"—\$42,259.

Radio stations: 2 (Radio Trinidad & Radio Guardian).

Television station: 1 (Trinidad & Tobago).

● record manufacturers

International Rec'g, 8 Dundonald St., Port-of-Spain.

Tel: 52337. Cable: Interrecord. Mg'g Dir., A&R & Sales: Leslie C. D. Lucky-Samaroo.

Label: Tropic.

This company represents: RCA Camden, RCA Victor, Ultra Audio, United Artists.

National Rec'g, Simeon Rd., Petit Valley, Diego Martin, Trinidad. Contact: Slinger Francisco.

Telco Rec'g Div., Corner Gordon & Maingot Sts., Mt. Hope, Port-of-Spain. Tel: 638-3354.

Trinidad Rec'g House (TRH) (West Indies), 131 Long Circular Rd., Port-of-Spain. Tel: 22335.

● supplies & services

PRESSING PLANTS

International Rec'g, PO Box 517, Port-of-Spain.

National Rec., PO Box 631, Port-of-Spain.

Trinidad Rec'g House (TRH) (West Indies), 131 Long Circular Rd., Port-of-Spain. Tel.: 22335.

West Indies Telecommunications & Electronics, PO Box 890, Port-of-Spain. Tel: 638-3354.

TURKEY

Population: 31,300,000.

Official rate of exchange: \$1 (US) = 9 Turkish pounds.

Per capita income: \$216.

Imports: 1965—Gramophone records—\$38,011; Blanks—\$1,024; Matrices of gramophone records—\$11,448.

Exports: 1965—Gramophone records—\$24,444.

Average retail price: LP's—\$11.00; EP's—\$2.20; Singles—\$1.60.

Type of record distribution: Manufacturer to wholesaler to retailer and manufacturer to retailer.

Import-Export regulations: Records are imported through quotas, there is no regulation for export. Radio stations: There are 15 radio stations, not including school radios. For example, Istanbul Technical University operates two studios; one is broadcasting on FM and AM and the other is a small circuit studio.

● record manufacturers

Cramofon Limitet Sirketi, Halkali Cad. 85, Yesilkoy, Istanbul. Tel: 738976. Cable: Gramoturk. Mg'g Dir.: Alan A. Campbell.

Labels: EMI, HMV, Columbia, Odeon, Pathe, Capitol.

This company represents: Capitol (USA), Columbia (England), HMV (England), Pathe (France), Parlophone (England), Stateside (England), Warner Bros. (USA).

Int'l representative: EMI (Int'l).

Melodi, Istiklal Cad. 387, Istanbul. Tel: 442636.

Pres.: Kayihan Caglayan; Sales: Salim Kabar; Int'l: Nuran Ucuu.

This company represents: Decca, Imperial, Italdisc, Liberty, London, RCA, Reprise, Ricordi, Ri-Fi, Teldec, Warner Bros.

EUROPE'S TOP PUBLISHERS

FRANCIS, DAY & HUNTER LTD.

LONDON, ENGLAND
Francis, Day & Hunter Ltd.
138 Charing Cross Road, W.C.2

MILAN, ITALY
Edizioni Musicali Francis-Day
S.R.L.
Piazza Del Liberty 2

ZURICH, SWITZERLAND
Francis-Day Produktion
der Edition Coda
Brunnwiesenstrasse 26

PARIS, FRANCE
Publications Francis-Day
S. A.
5, Avenue de L'Opera, 1 ER

BRUSSELS, BELGIUM
Editions Francis-Day, S.A.
25, Place Saint-Gery

MADRID, SPAIN
Canciones Francis-Day
Carmen 20

FRANKFURT/MAIN
W. GERMANY
Francis, Day & Hunter G.M.B.H.
Grosse Friedberger Strasse 23-27

AMSTERDAM, HOLLAND
Francis-Day
Muziekuitgevers, N.V.
Amstel 52

COPENHAGEN, DENMARK
Francis, Day & Hunter Scandinavia A/S
Gothersgade 9-11

B. FELDMAN & CO. LTD.

LONDON, ENGLAND
B. Feldman & Co. Ltd.
64 Dean Street, W.1.

PARIS, FRANCE
Editions Feldman S.A.
5, Avenue de L'Opera, 1 ER

ROBBINS MUSIC CORPORATION LTD.

LONDON, ENGLAND
Robbins Music Corporation Ltd.
35 Soho Square, W.1.

PARIS, FRANCE
Editions France-Melodie S.A.
5 Avenue de L'Opera, 1 ER.

continued

UNITED ARAB REPUBLIC

Population: 28,359,000.
 Records imported from US: 1965—\$344,842.
 Records exported to US: 1965—\$2,693.

● record manufacturers

Sono Cairo, PO Box 2017, 18 Borsa St. Tewfikieh, Cairo. Tel: 40-897. Gen. Dir.: Taha Nasr.
 This company represents: RCA Victor.
 Michael Yacoumopoulos, PO Box 1904, Alexandria. Tel: 30934. Cable: Yalos.

UNITED KINGDOM

Population: (England, Northern Ireland, Scotland, Wales): Latest official estimate—54,285,700.
 Official rate of exchange: One pound sterling = \$2.80.

Per capita income: \$2,200 annually.
 Number of homes with record players: 8,000,000.
 Records sold domestically (factory value): 1965—\$61.9 million; 1964—\$63.4 million; 1963—\$53.7 million.
 Records imported from the US (factory value): \$356,585.
 Records exported to the US (factory value): \$1,847,664.
 Records imported from countries other than US (factory value): \$1,409,422.
 Records exported to countries other than US (factory value): \$6,652,551.
 Records manufactured for domestic and export sales: LP's—31.5 million units at \$53.8 million, EP's & singles—62.2 million units at \$17.4 million.
 Average retail price per record: LP's—\$4.50; EP's—\$1.77; Singles—\$1.01.
 Stereo Sales: 24%.
 Discounting: Never

Record club sales: 6% of total sales.
 Type of record distribution: Manufacturer to retailer, rare from manufacturer to wholesaler to retailer.

Number of jukeboxes: 24,000.
 Radio stations: BBC monopoly.
 Television stations: 2 government; 1 commercial. Extensive musical programming.

Import-export regulations: All records sold in Britain, irrespective of origin, bear a purchase tax. On domestic products it is levied at 25% of the wholesale (distributor) value. There is no purchase tax on pre-recorded tapes or matrices. On imported disks the 25% tax is payable at point of entry on the assessed value after import duty has been paid.

Import duty is charged on the value assessed at cost, insurance and freight charges in addition to 25% purchase tax. For gramophone records the duty is: from Commonwealth countries—10%; EFTA countries—3%; other countries—15%. On pre-recorded magnetic tapes import duty is: from Commonwealth countries—16½%; EFTA countries—6½%; other countries—25%.

No import licenses are needed for disks, tapes or matrices apart from Communist Bloc countries. Current legislation provides that entry be denied to unauthorized copies of copyright works. Approval must be obtained from the copyright holder or his agent.

In most cases the agent in Britain is the Mechanical Copyright Protection Society. Where the copyright has not been cleared for import into Britain in the country of origin, royalties must be paid in advance. There is a special royalty for imports. This varies from 14 cents per title per record, for small quantities, to 5 cents per title per record for larger numbers. Not all copyright holders are members of MCPS. Some publishing houses act independently. Many continental copyrights which belong to BIEM firms are the responsibility of the British Copyright Protection Association.

Chris Hutchins

● record manufacturers

A R C, 326 Kensal Rd., London W.10. Tel: LAO 6651. Cable: MUSICALITY.
 Branches: 42 Broughton St., Manchester 8.

Tel: Deansgate 2355. Scotland, 669 Gallowgate, Glasgow S.E. Tel: Bridgeton 0235.

Labels: Coda, Dandy, Eros, Festival, Fidelity, Heritage, Lyrique, Lyro, Octave, Opera Society, Presto, Saga, Silver Dollar, Society, Trumps.
 Int'l representatives: Australia (Festival), Belgium (Decca), Canada (Eldon), Germany (Fidelity), Holland (Dureco, Munnickendam), Italy (Interexchange), New Zealand (HMV), Norway (Cappelens), South Africa (Gallo), Sweden (Swereco), Switzerland (Classic Rec.).

Abbey, 2 Abbey St., Eynsham, Oxford. Tel: Eynsham 388 & Oxford 4-1356. Mg'g Dir.: H. F. Mudd; A&R Dir.: David Lumsden.

ARGO, 113 Fulham Rd., London S.W.3. (SEE ADVERTISEMENT)

Ariola (see CBS).

Associated Rec'gs Co. (see ARC).

C B S, 28-30 Theobalds Rd., London W.C.1. Tel: CHA 9000. Cable: Colcord. Mg'g Dir.: Ken Glancy; Ass't Mg'g Dir.: George Shestopal & Maurice Oberstein; A&R: Reg Warburton; Classical Promo.: Miss Quita Chavez; Mk'tg. Mgr.: Olav Wyper; Sales Mgr.: Walter Sparksmann; Promo. & Pub. Mgr.: Roger Easterby; Adv. Mgr.: Peter Lamb.

Labels: Ariola, CBS, CBS-Realm, Date, Embassy, Euro-Disc, Oriole, Savoy (SEE ADVERTISEMENT)

C B S Ream (See CBS).

Cannon (see Crossbow).

Coda (see ARC).

Concert Hall, Concert Hall House, London S.W. 18. Tel: VAN 0441. Cable: Cohallclub. Gen. Mgr. & Sales: Leonard Joseph; A&R: Jean Goehr; Int'l: Lionel Phillips.

Labels: Children's Corner, Concert Hall, Introduction to Music.

Crossbow, 47 Dean St., London W.1. Tel: REG 7451. Cable: Ayceemusic. Mg'g Dir., A&R, Sales & Int'l: Allan Crawford.

Labels: Acclaim, Cannon, Carnival, Crossbow, Flair, Rocket, Sabre.

Int'l representatives: Various in Australia, Denmark, Finland, Italy, New Zealand, Norway, Sweden, U.S.A.

Dandy (see ARC).

Date (see CBS).

DECCA, 9 Albert Embankment, London S.E.1. Tel: REL 8111. Cable: Deccord. Chm.: Sir Edward Lewis; A&R: John Culshaw & Oick Rowe;

Page 2—MELODY MAKER, February 26, 1966

Rank	Artist	Record Title	Label
1	(1)	19TH NERVOUS BREAKDOWN	Rolling Stones, Decca
* 2	(2)	THESE BOOTS ARE MADE FOR WALKIN'	Nancy Sinatra, Reprise
3	(3)	MY LOVE	Petula Clark, Pye
4	(4)	A GROOVY KIND OF LOVE	Mindbenders, Fontana
5	(5)	YOU WERE ON MY MIND	Crispian St. Peters, Decca
* 6	(6)	SPANISH FLEA	Herb Alpert, Pye
7	(7)	SHA-LA LA LEE	Small Faces, Decca
* 8	(8)	MICHELLE	Overlanders, Pye
* 9	(9)	TOMORROW	Sandie Shaw, Pye
10	(10)	LOVE'S JUST A BROKEN HEART	Cilla Black, Parlophone
11	(11)	BARBARA ANN	Beach Boys, Capitol
12	(12)	INSIDE LOOKING OUT	Animals, Decca
13	(13)		Decca

NEED WE SAY MORE?

PE PYE RECORDS ATV HOUSE, GREAT CUMBERLAND PLACE, LONDON, W.1
 TELEPHONE: AMBASSADOR 5502
 AMERICAN REPRESENTATIVE: IRVING CHEZAR 555 MADISON AVENUE, NEW YORK CITY 22
 TELEPHONE: PLAZA 5-2100

LIBERTY ENTERTAINMENT IS



FOR EVERYONE... WORLD WIDE!

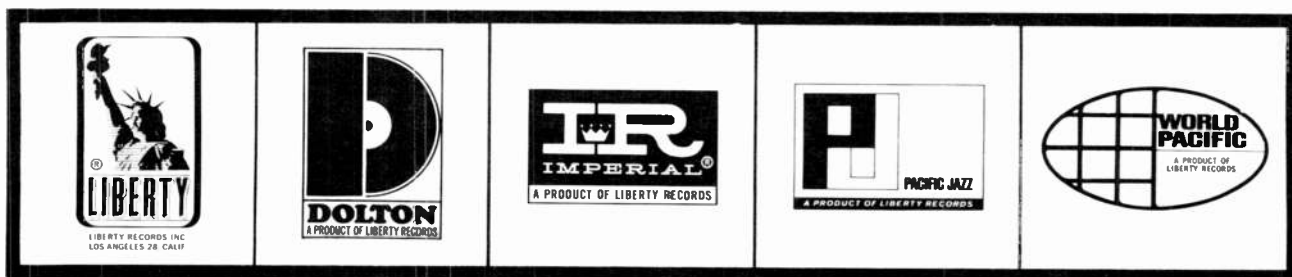

THE METRIC MUSIC PUBLISHING GROUP

Aladdin Music Publications Alan Edwards, Inc. A.Q.V. Music Corporation Asa Music Co. Commodore Music Co. Cornerstone Publishing Co. D. and M. Music Publications Dobo Music Inc. Fairway Music Co. Geronimo Music Corp. Golden River Publishing Co. Har-bock Publishing Co. Intro Music, Inc. Kline Music Publishing Corp. Lamp Music Publications M. and M. Music Publications Malabar Music, Inc. Marquis Music Inc. Metric Music Co. Minit Music Co. Portrait Music Corp. Post Music, Inc. Reeve Music Co., Inc. Royalty Music Ltd. Salmin Music Corp. Sequence Music, Inc. 7-11 Music Publications. Shalimar Music Corp. Sharron Music, Inc. Sheldon Music Co. Springfield Music, Inc. Stratton Music, Inc. Travis Music Co. West Coast Music Publishers Co.

... ALL PRODUCTS OF LIBERTY RECORDS INC.

continued

Sales: S. A. Beecher-Stevens; Pub.: E. M. Roach; Int'l: Hilary Watson.

Labels: Ace of Clubs, Ace of Diamonds, Argo, Beltona, Decca, Emerald, Rex, Vocalion.

This company represents: L'Diseau Lyre (France), Telefunken (Germany), Ara, Ava, Backbeat, Bethlehem, Brunswick, Bighill, Bigtop, Camden, Challenge, Coed, Congress, Contemporary, Coral, Crescendo, Debut, Decca, Dial, Duke, Era, Everest, Fantasy, Federal, Focus, Four Corners, GNP, Galaxy, Good Time Jazz, Heidi, HiFi, Kapp, Keetch, King, Link, Monument, Peacock, Philles, RCA Victor, Rosemart, Safiche, Song Bird, Sound Stage 7, Specially, Starday, Stax, Sue, Sun, Victrola, Volt (USA), Vox.

International representatives: Aden (Bhicajee Cowasjee), Antigua (Joseph Dew), Arabian Gulf (Modern Art Studio; Morad Yousuf Behbehani & Jashanmal & Sons, Kuwait; Ahmad Aluthman & Bros., Doha, Quater; Vithaldas V. & Bros., Dubai, Trucial States), Argentina (Odeon) Australia (EMI, Argo, Scala), Austria (Musica Schallplatten), Bahamas (John S. George), Belgium (Fonior), Bermuda (Masters), Brazil (Odeon), British Guiana (Affonso's Modern Record Store), Burma (Sum Hin), Canada (London), Ceylon (Lewis Brown), Chile (Odeon), Columbia (Daro), Costa Rica (London), Cyprus (Papasian), Denmark (Nordisk Polyphon), East Africa (Gallo), Ecuador (London), Egypt (Aristote Tzoulakis), Eire (Solomon & Peres; Irish Record Factors), Ethiopia & Eritrea (Luke Thomas), Falkland Islands (Falkland Islands Co.), Fiji (Morris Hedstrom), Finland (Fazer), France (Societe Francaise du Son), Germany (Teldec, Telefunken), Ghana (Records & Musical Co.), Gibraltar (S. Teuma), Greece (Music Box), Guatemala (London), Holland (Phonogram), Honduras (London), Hong Kong (Moutrie), Iran (Alfi & Cohen), Iraq (Leon Kouyoumdjian), Israel (Symphonia), Italy (Decca Dischi Italia), Jamaica (Stanley Motta; The Times Stores; Wonards Radio), Japan (King Rec.), Jordan (Joseph I. Bahous), Lebanon (Mitri Murr & Fils), Liberia (Electronic-George Wehbe), Macao (Johnson Radio & Electric Service; Universal Agencies), Malta (P. Carabott; R. Brizzi; Anthony D'Amato), Mexico (Peerless), Mauritius (Hendy Bros.), Morocco

(Atlas), New Guinea (Tropical Radio; Rabaul Sports & Music Stores), Nicaragua (London), Nigeria (Decca), North Borneo (Isaac & Co.), Northern & Southern Rhodesia & Nyasaland (Gallo), New Zealand (HMV), Norway (Nor-Disc), Panama (London), Philippines (Super), Portugal (Valentim de Carvalho), Peru (London), St. Helena (Solomon), St. Lucia (Minvielle & Chastanet), Salvador (London), Sierra Leone (Henry Duck), Singapore (Decca), South Africa (Gallo), Spain (Fabrica de Discos Columbia), Sudan (Electro-house), Sweden (Telefunken), Switzerland (Musikvertrieb), Syria (George Murr Hreike), Taiwan (Linfair Engineering & Trading), Thailand (Kamol Sukosol), Trinidad (Sports & Games; Leon H. Ache; William Fogarty), Turkey (Melodi), Uruguay (Clave), Venezuela (London), Vietnam (Georges Bonnet), USA (London), Yugoslavia (Jugoton). (SEE ADVERTISEMENT)

ELYSE, 25/27 Marylebone Rd., London N.W1. Tel: HUN 4266. Mg'g Dir. & A&R: Isabella M. Wallich; Sales and Int'l: R. C. Young.

Labels: Delyse, Envoy.

Int'l representatives: Argentina (Odeon), Australia (EMI), Benelux (Electrola), Canada (Canadian Music Sales), Eire (Gramophone), France (Ricordi, Pathe-Marconi), Germany (Electrola), Holland (Bovema), India (Gramophone), New Zealand (HMV), South Africa (Teal) South America (EMI Odeon), USA (London Decca). (SEE ADVERTISEMENT)

Disc Imports, 16 John Dalton St., Manchester 2. Tel: BLA 7292. Cable: Imdisc. Mg'g Dir.: I. T. Wilson.

Labels: Campion, Euroson.

This company represents: Carisch (Italy), Monodiophone (France), Musica Mundi (Germany), Musica Sacra (Germany), SFP (France), Valois (France), Vogue (Germany).

Dobell's Jazz Rec. Shop, 77 Charing Cross Rd., London W.C.2. Tel: GER 4197. Mg'g Dir.: D. A. Dobell.

Labels: "77," Folklore.

EMI 1, EMI House, 20 Manchester Sq., London W.1. Tel: HUN 44BB. Cable: Emirecord, Wesdo. Exec-Vice-Chm.: L. G. Wood; Mg'g Dir.: G. N. Bridge; Deputy Mg'g Dir.: J. B. Stevenson; Int'l: A. M. Smith; Gen. Mgr. Pop Prod. Group, U.S. & Independent Sources: Rex Oldfield; Gen. Mgr. EMI Produced Repertoire: Norrie Paramor;

Mktg. Servs.: Ron White.

Labels: Capitol, Columbia, Encore, HMV, Liberty, MGM, Motown, Parlophone, Regal-Zonophone, Stateside, Tamla, UA, Verve, Waverley. This company represents: ABC-Paramount, Amy-Mala, Apollo, Ascot, Buena Vista, DCP, Disneyland, Diamond, Dolton, Epic, Global, Imperial, Impulse, Institute for Language Study, Laurie, Metronome, Musicor, Okeh, Prestige, Swan, Tower, 2Dth-Fox, Westminster (USA).

Int'l representatives: All major territories principally through EMI Ltd. subsidiary companies. (SEE ADVERTISEMENT)

E'ektra, 7 Poland St., London W.1. Tel: REG 6466. Contacts: Don Johnston & Joseph Boyd.

Embassy (see CBS).

Ember, York House, Empire Way, Wembley, Middlesex. Tel: DIL 1077. Cable: Krugent. Mg'g Dir.: Jeffrey S. Kruger.

Int'l representatives: Aden (Bhicajee Cowasjee), Arabian Gulf (Jashanmal & Sons, Ambassador Stores), Argentina (Sicamericana), Australia (Festival), Austria (Amadeo), Belgium (Anvers Radio), Brazil (EMI Odeon), Canada (Capitol, Quality), Canary Islands (Adolfo Rivera Canals), Cyprus (J.A. Cabras & Bros.), Denmark (Skandinavisk Grammophon), Eire (Solomon & Peres), Finland (Scandi-Musiikki), France (Pathe-Marconi), Germany (Electrola, H. Marcuse), Greece (Columbia Gramophone), Holland (Bovema), Hong Kong (Cosdel), India (Gramophone), Italy (Vedette), Japan (Cosdel), Lebanon (Wattar Freres), Malta (Anthony D'Amato & R. Brizzi), Mexico (Capitol), New Zealand (Peak), Nigeria (EMI), Norway (Arne Bendiksen), Peru (Distribuidora Peruana, Talia), Portugal (Discophon), Rhodesia (Electrical Radio Musical Inds.), Singapore (Cosdel), South Africa (EMI), Spain (Discophon), Sweden (Skandinaviska Grammophon), Switzerland (Finsterwald & Cantacuzene), Turkey (Sirkeci), USA (Ember).

Emerald, 67/69 Ann St., Belfast, Ireland. Tel: 3616. Mg'g Dir. & Adv.: Mervyn Solomon; Dir.: Maurice Solomon; A & R: Mervyn Solomon & Tommy Scott; Sales & Mktg.: Maureen McNamee; Pub.: Louis Solomon; Promo. Dir.: Philip Solomon. Branch: 73/75 New Oxford St., London. Tel: TEM 5941. Dir.: Phil Solomon. Label: Emerald.

ATLANTIC

NOW BEING DISTRIBUTED IN GREAT BRITAIN BY: POLYDOR RECORDS LTD. LONDON

THE WONDROUS WORLD OF SONNY & CHER

Sonny & Cher
Stereo 588 006 Mono 587 006

LAND OF 1,000 DANCES

Chris Kenner
Mono 587 008

OVER THE RAINBOW

Patti LaBelle & Her Belles
Stereo 588 001 Mono 587 001

THE AVANT-GARDE

John Coltrane & Don Cherry
Stereo 588 004 Mono 587 004

MOSE ALIVE!

Mose Allison
Stereo 588 007 Mono 587 007

MONDAY NIGHT AT THE VILLAGE GATE

Herbie Mann
Stereo 588 003 Mono 587 003

IT'S MAGIC

Barbara Lewis
Stereo 588 002 Mono 587 002

JAZZ FOR THE JET SET

Dave Pike
Stereo 588 005 Mono 587 005

FROM

LONDON ENGLAND

COME THE WORLDS

GREATEST HITS!

CREATED BY

NORTHERN SONGS LIMITED • JAEP MUSIC LIMITED

MARIBUS MUSIC LIMITED • GRALTO MUSIC LIMITED

NUOVA MUSIC LIMITED • LORDS MUSIC CO. LIMITED • PACERMUSIC LIMITED

DICK JAMES MUSIC LIMITED • METRO MUSIC LIMITED • PAGE ONE RECORDS LIMITED

For U.S.A., CANADA, MEXICO & THE PHILIPPINES
Administration Management: Walter Hofer, 221, West 57th Street, New York, N.Y. 10019
Music Management: Leonard Hodes, 1780, Broadway, New York, N.Y. 10019

The World-Wide Organisation of

DICK JAMES MUSIC LIMITED

JAMES HOUSE, 71-75 NEW OXFORD STREET, LONDON, W.C.1
Cables: DEJAMUS, LONDON, W.C.1
Telex: 27135





**CBS is proud to
announce their
CUSTOM PRESSING
and
STUDIO SERVICES
in England**

*

CUSTOM PRESSING

All sizes and speeds.
Finest quality
Processing and Pressing

*

STUDIOS

The most up-to-date
in England
1, 2, 3 & 4-Tracks
STUDER and AMPEX
machines
AKG and NEUMANN
microphones
Full Echo and
Equalisation facilities

*

MASTERING

ORTOFON and NEUMANN
systems—Mono & Stereo

*

Inquiries welcomed at
CBS RECORDS LTD.
28-30 Theobalds Road,
London, W.C.1
Telephone: CHAncery 9000
Telex: 263349 CBSR London
Cables: Colrecord London, W.C.1

continued

This company represents: Chart-Peach (USA), Festival (Australia), Skylite (USA).
Int'l representatives: Australia (Festival, W&G), Canada (London), South Africa (Gallo), USA (London).
Eros (see ARC).
Esquire, 76 Bedford Ct. Mansions, Bedford Ave., London W.C.1. Tel: MUS 1810. Dir.: Carlo Krahrmer.
Labels: Esquire, Faith, Starlite.
Euro-disc (see CBS).
Evangelical Rec'g, 2 Lavender Gardens, London S.W.11. Tel: 228 0130. Gen. Mgr.: A. Hogbin.
Faith (see Esquire).
Festival (see ARC).
Fidelity (see ARC).
Folklore (see Dobell's Jazz Rec. Shop).
Heritage (See ARC).
Immediate, 138/147 Ivor Ct., Gloucester Pl., London N.W.1. Tel: AMB 2701, 1811. Dirs.: Tony Calder & Andrew Oldham.
Iramac Britain, 167 Burwood Rd., Walton on Thames. Tel: 28473. Pres.: S.S.A. Samama; A&R: D. M. Meacock; Sales: Keith, Prowse & Co., 6 Woodstock St., London W.1. Tel: HYD 5031.
Labels: Iramac, Relax.
ISLAND, 155-157 Oxford St., London W.1. Tel: REG 6228. Cable: ACKEE. Mg'g. Dir. & Int'l: Chris Blackwell; A&R: Blackwell & Stevens; Sales: David Betteridge.
This company represents: Ace (USA), National Rec'gs (Trinidad), Surprise (USA), Telco (Trinidad).
Int'l representatives: Jamaica (Black Swan), Trinidad (National, Telco). (SEE ADVERTISEMENT)
Jupiter, 140 Kensington Church St., London W.8. Tel: BAY 9531. Top Exec.: V. C. Clinton-Baddeley & T. W. Southam.
Int'l representatives: Belgium (Audi vox), France (Pleiade), Germany (Polygotte), Holland (Audi-vox), New Zealand (Delta), South Africa (Recorded Music Specialists), USA (Folkways).
Leomark, 77 London Wall, London E.C.2. Dir., A&R & Int'l: F. W. Bradshaw; Sec. & Gen. Mgr.: Derek Thackray.

<p>ENGLAND'S YOUNGEST and most vital Record Company Smashed The World's Charts with its First release "THAT'S NICE" by NEIL CHRISTIAN</p>	<p>STRIKE!</p>
<p>Other Artists Include:— JIMMY POWELL, MIKI DALLOM, THE JEEPS, JACKI BOND, ROY HARPER, THE IDES OF MARCH, ALEX WELSE, KEN WOODMAN, etc. etc.</p>	<p>STRIKE!!</p>
<p>STRIKE RECORDS LTD. Directors Lionel Segal and Jack Heath, P.R. enquiries Andrew Heath Suite 15, 43 Upper Berkeley St., London W.1. AMB. 0563, 3588.</p>	<p>STRIKE!!!</p>

Int'l representatives: New Zealand (Delta), South Africa (Gallo), USA (Word, Texas).
Livingston, 32a E. Barnet Rd., New Barnet, Herts. Tel: HAD 161 Mg'g Dir.: W. T. Hamilton.
Label: Herald.
Lyrique (see ARC).
Lyro (see ARC).
Melodisc, 12 Earlham St., London W.C.2. Tel: COV 2848. Cable: Melodisc. Mg'g Dir.: Emil Shalit; A&R, Sales & Int'l: Ziggy Jackson.
Labels: Bluebeat, Dice, Kalyppo, Melodisc.
Int'l representatives: Australia (Festival), Germany (Electrola), Italy (Combo), USA (Paramount).
Octave (see ARC).
Olympus, 5 Laurence Pountney Hill, London E.C.4. Tel: MIN 6610. Gen. Mgr.: L. B. Churchfield.
Opera Society (see ARC).
Oriole (see CBS).
Pan, 271 Gallowgate, Glasgow C.4., Scotland.
W. Paxton, 36-38 Dean St., London W.1. Tel: GER 4801. Cable: PAXTOMUSIC. Mg'g Dir.: Leslie Neil; Sales: C. Warsaw.
PHILIPS, Stanhope House, Stanhope Pl., London W.2. Tel: AMB 7788. Cable: Philrecord. Mg'g Dir.: L. Gould; A&R: J. Franz, J. Baverstock, H. Hawker, J. Humphries; MKTg: D. J. Glover; Sales: G. Hannington; Int'l: C. Voute.
Labels: Caedmon, Fontana, Limelight, Mercury, Philips, Riverside, Wing.
This company represents: Amadeo (Austria), Barclay (France), Caedmon (USA), Mainstream (USA), Mercury (USA), Pacific Jazz (USA), Riverside (USA), Smash (USA), Vanguard (USA), Vee Jay (USA), World Pacific (USA).
Int'l representatives: World-Wide (Philips, Fontana, Mercury). (SEE ADVERTISEMENT)
Pickwick Int'l, Victoria Works, Edgware Rd., London N.W.2. Tel: Dollis Hill 7746. Mg'g Dir: Monty Lewis.
Labels: Allegro, Bravo, Happy Time, Pickwick Int'l.
This company represents: Pickwick (USA).
POLYDOR, 17-21 Stratford Pl., London, W.1. Tel: HYD 7401. Cable: GRAMDISC. Mg'g Dir.: R. Rennie; Dir.: W. Riemer; Gen. Mktg. Mgr.: D. Johnston.
Labels: Archive Prod'n, Deutsche Grammophon, Heliodor, Polydor. (SEE ADVERTISEMENT)
This company represents: Archive (Germany), Atco (USA), Atlantic (USA), Deutsche Grammophon (Germany), Heliodor (Germany), Polydor (Germany)
Prestige, 41 Ladbroke Grove, London W.11. Fieldman: Alan Bates.
Presto (see ARC).
PYE, A.T.V. House, 17 Great Cumberland Pl., London W.1. Tel: AMB 5502. Cable: PYREC. Mg'g Dir.: Louis Benjamin; Sec. & Controller: George Margrave; A&R: Les Cocks; Sales Controller: Tom Grantham; Sales Mgr.: Roy O'Dwyer; Press Officer: Patricia A. Pretty; Adv. Mgr.: Len Bickel; Promo. Mgr.: John Wise.
Labels: Cameo-Parkway, Century 21, Chess, Colpix, Durium, Golden Guinea, Hanna-Barbera, Hickory, Hispavox, Kama Sutra, Marble Arch, Piccadilly, Pye, Pye Command, Pye Int'l, Pye Sacred, Pye Jazz, Red Bird, Reprise, Vogue, Warner Bros.
This company represents: A&M (USA), Almo (USA), Alshire Presents (USA), Audio Fidelity (USA), Blue Cat (USA), Bounty (USA), Cadet (USA), Charger (USA), Checker (USA), Crusade (USA), Daisy, Deutsche Vogue (Germany), Dimension (USA), Grand Award (USA), Jerden (USA), Jewel (USA), Joda (USA), Hamilton (USA), King (USA), Loma (USA), Omen (USA), Mace (USA), Mode (France), Palette (Belgium), Paula (USA), Panorama (USA), Scepter (USA), Somerset (USA), Tiger (USA), Try, Wand (USA), Wyncote (USA).
Int'l representatives: Argentina (Sicamericana), Australia (Astor Electronics), Belgium (Vogue), Canada (Allied), Denmark (Morks), Eire (Pye), Finland (Musik Fazer), France (Vogue), Germany (Deutsche Vogue), Greece (Music Box), Holland (Negram), Hong Kong (Cosdel), Italy (RCA), Japan (Nippon Columbia), Luxembourg (Vogue), Mexico (Gamma), New Zealand (Pye), Nigeria (Philips—West Africa), Norway (Norsk Phonogram), Philippines (Dyna Prods.), Rhodesia (Kemsley & Dawes), Singapore (Cosdel), South Africa (Teal), Spain (Hispavox), Sweden (Philips-Sonora), Switzerland (Vogue). (SEE ADVERTISEMENT)
R & B. 282b Stamford Hill, London N.16. Tel.: STA. 4127, 2988. Cable: Randbee. Mg'g Dir.: R. Isen; Dirs.: B. Isen, M Hitches; Sales Mgr.: D. Jamieson.
Labels: King, Prima, R&B, Ska Beat.
This company represents: Buhl Int'l (USA), Capa

MR. HERB HENDLER
BEECHWOOD MUSIC CORP.
1750 VINE STREET,
HOLLYWOOD 28,
CALIFORNIA, U.S.A.

MR. OTTO DEMLER
EDITION ACCORD
HOHENSTAUFENRING 63/1,
KOLN 5,
GERMANY

MR. IVAN NORDSTROM
EDITION ODEON
OXENSTIERNSGATAN 37
STOCKHOLM, N.O.
SWEDEN

MR. JOE HALFORD
CASTLE MUSIC (PTY) LTD.
EMITRON HOUSE,
299/301 CASTLEREAGH ST.,
SYDNEY, AUSTRALIA

MR. JOHN RASMUSSEN
IMUDICO
COLBJORNSENSGADE 19,
COPENHAGEN V,
DENMARK

MR. GEORGE ALEXANDER
EDICIONES GRAMOFONO ODEON
APARTADO 588,
BARCELONA,
SPAIN

SEN. ING. ROGELIO BRAMBILA PELAYO
BRAMBILA MUSICAL MEXICO S.A.
AV. CUITLAHUAC 2305,
MEXICO 16, D.F.

ARDMORE & BEECHWOOD LTD
30-34 LANGHAM ST.
LONDON. W.1.
ENGLAND

MR. EMLYN JONES
ARION GREEK MUSIC CO., LTD.
P. O. BOX 287,
ATHENS,
GREECE

MR. HENRI MARCHAL
PATHE MARCONI
22 AVENUE DE LA GRANDE
ARMEE,
PARIS 17e,
FRANCE

MR. RICARDO I KORN
EDITORIAL MUSICAL ODEON
MORENO 2034,
BUENOS AIRES,
REP ARGENTINA

MR. JOHN LEE
LA VOCE DEL PADRONE
GALLERIA DEL CORSO 4,
MILAN,
ITALY

MR. JEFF DE BOECK
ARDMORE & BEECHWOOD
BELGIUM
72 QUAI DES CHARBONNAGES,
BRUSSELS,
BELGIUM

MR. BILL FRASER
ARDMORE & BEECHWOOD
S. AFRICA
P. O. BOX 11254,
JOHANNESBURG,
TRANSVAAL,
S. AFRICA

MR. N. ISHIZAKA
TOSHIBA MUSIC CO., LTD.
30, TAMEIKE-CHO,
AKASAKA,
MINATO-KU,
TOKYO, JAPAN

continued

(USA), Caribou (Jamaica), Downey (USA), Kent (USA), Premore (USA), Prima (USA).
R C A Great Britain (Rec. Div.), Berger House, 36 Berkeley Sq., London W.1. Tel: MAY B541. Cable: IRCAVICTOR.
Regina, 156 Strand, London W.C.2. Tel: TEM B377, 2294.
Relax (see Iramac).
Saga (see ARC).
Savoy (see CBS).
Stanley Schofield, 6-B Old Bond St., London W.1. Tel: MAY 4642. Cable: Eskofilms. Dir.: Stanley Schofield.
Label: Sound Stories.
Int'l representatives: Aden (Bhicajee Cowasjee), Australia (Colin Ryrrie), Canada (E. J. Piggott), Germany (Motor Press), Holland (EMAP Hugo de Grootplein; G. L. Van Lennep), New Zealand (Viking), South Africa (Recorded Music), Sweden (MC Nytt; Illustrerad Motor Sport), USA (E. J. Piggott Entls.).
Selection, 39 Greenford Gardens, Greenford, Middlesex. Tel: WAX 1545. Mg'g Dir., A&R, Sales & Int'l: Colin Pomroy.
Labels: Collector, Jazz Collector, Range.
This company represents: Cetra (Sweden), Folk Lyric (USA), Oktav (Sweden), Vogue (France).
Int'l representatives: Argentina (Microfon), France (Vogue), Italy (Celson), Sweden (Cetra), USA (Folk Lyric).
 "77" Rec. (see Dobell's Jazz Rec. Shop).
Silver Dollar (see ARC).
Society (see ARC).
Sound Stories (see Stanley Schofield).
Starlite (see Esquire).
Talent, 76 Bedford Ct. Mansions, Bedford Ave., London W.C.1. Tel: MUS 1B10. Dir.: C. Kraher.
Label: Delmark.
Topic, 27 Nassington Rd., London N.W.3. Tel: HAM 9983. Mg'g Dir.: Gerry Sharp.
Transatlantic, 120/122 Marylebone Ln., London W.1. Tel: HUN 4353. Mg'g Dir.: Nathan Joseph; Gen. Mgr.: Paul Ellis.
Labels: Transatlantic, Xtra.
This company represents: Audio Fidelity (USA), Conversaphone (USA), Folkways (USA), MK (USSR), Storyville (Denmark).
Trumps (see ARC).

UNITED ARTISTS, 5 Albert Gate Ct., 124 Knightsbridge, London S.W. Tel: KNI 9383. Dir.: Noel Rogers. (SEE ADVERTISEMENT)
Vogue, Decca House, 9 Albert Embankment, London S.E.1. Tel: REL B111. Gen. Mgr.: Sales & Int'l: E. J. Mills; A&R: John Taylor.
Labels: Contemporary, Emerald, Good Time Jazz, Vocalion.
This company represents: Contemporary (USA), Fantasy (USA), GNP Crescendo (USA), Good Time Jazz (USA), HiFi (USA).
Int'l representatives: Same as British Decca.
Vox Prods., 231 Oxford St., London W.1. Tel: GER 7482. Cable: Voxrecords. Chm.: George H. de Mendelssohn-Bartholdy; Sales & Int'l: Paul Fejer.
This company represents: Vox (USA).
Int'l representatives: USA (Vox).
World Rec. Club, Parkbridge House, Little Green, Richmond, Surrey. Tel: RIC 3646. Cable: Disclub. Chm.: Norman J. Lonsdale; A&R: A. C. Griffith; Int'l: B. Gilbert.
Labels: World Rec. Club, Recorded Music Circle, Conquest.
This company represents: Subsidiary of EMI.
Int'l representatives: Australia & New Zealand (World Rec. Club).
Zodiac, 13 Gerrard St., London W.1. Tel: GER 6729, 3402. Dir.: Herbert Wilcox.

● **music publishers**

Aberbach (see Belinda).
Acuff-Rose, 15 St. George St., London W.1. Tel: MAY 7600. Mg'g Dir.: Nick Firth.
Airborne, 26 D'Arblay St., London W.1. Tel: GER 3745. Mg'g Dir.: Noel Brown.
Ambassador, 23-24 Greek St., London W.1. Tel: GER 7053. Mgr.: Lee Pincus.
Int'l representative: USA (Unity Music).
Andes (see Mirage).
Angel (see Ember).
Anglo-Soviet Music Press (see Boosey & Hawkes).
Apex, 33 D'Arblay St., London W.1. Tel: MAY 0686. Mg'g Dir.: Harry Mann.
Apollo, 164 Shaftesbury Ave., London W.C.2. Tel: TEM 0022. Gen. Mgr.: Leslie Paul.
April, 104 New Bond St., London W.1. Tel: GRO 5301. Cable: Aprimusic. Admin. Exec.: Barbara Hayes.
Int'l representatives: USA (April, Blackwood).
Arcadia, 10 Sherlock Mews, Baker St., London W.1. Tel: WEL 5469. Mg'g Dir.: W. J. Wallington.
ARMDRE & BEECHWOOD, 3D/34 Langham St., London W.1. Tel: MUS 6766. (SEE ADVERTISEMENT)
Ascherberg, Hopwood & Crew, 16 Mortimer St., London W.1. Tel: MUS 3562. Mg'g Dir.: N. Johnson.
Edwin Ashdown, PO Box 4, 19 Hanover Sq., London W.1. Tel: MAY 11B4. Mg'g Dir.: Francis S. Ashdown.
Ashley Sinclair Theatrical Entls., 23 Denmark St., London W.C.2. Tel: COV 1729. Dir.: Harold H. Ashley.
Associated Board of the Royal Schools of Music (Publ'ns dept.), 14 Bedford Sq., London W.C.1. Tel: MUS 6919. Cable: MUSEXAM.
Stanley Barnett, 4 Golden Sq., London W.1. Tel: GER D292.
Belinda, 17 Savile Row, London W.1. Tel: REG 3251. Mg'g Dir.: Franklin Boyd.
Affiliates: Aberbach, Kenny Lynch, Shadam.
Irving Berlin, 15 St. George St., London W.1. Tel: MAY 7600. Mg'g Dir.: Louis Dreyfus.
Blossom (see Leeds).
Blue Blood (see Freddie Poser).
Bluebell (see Southern).
Boosey & Hawkes, 295 Regent St., London W.1. Tel: LAN 2060. Mg'g Dir.: D. S. Adams.
Bosworth, 14-1B Heddon St., London W.1. Tel: REG 4961. Dir.: A. P. Dickin.
Bourne, 34/36 Maddox St., London W.1. Tel: HYD 6412. Gen. Mgr.: Len Taylor.
Box & Cox, 7 Denmark St., London W.C.2. Tel: TEM B309. Mg'g Dir.: H. E. Box.
Bron Assoc'd, 29/31 Oxford St., London W.1. Tel: GER 5063. Mg'g Dir.: Sydney Bron; Prod'n & Exec. Dir.: Gerry Bron.
Budd (see KPM).
BURLINGTON, 9 Albert Embankment, London S.E.1. Tel: REL 2692 & MAL 7507. Dir.: J. F. Axtmann; Gen. Mgr.: John Nice. (SEE ADVERTISEMENT)
Tony Calder, 13B/14/ Ivor Ct., Gloucester Pl., London N.W.1. Tel: AMB 2701, 1B11. Dirs.: Tony Calder & Andrew Dldham.
Campbell-Connelly, 10 Denmark St., London W.C.2. Tel: TEM 1653. Mg'g Dir.: Roy Berry.
Cavendish (see Boosey & Hawkes).
Cedarwood (see Southern).



RAPIDLY becoming the most exciting international label

Singles and Albums on release by . . .

SHIRLEY BASSEY
BOBBY GOLDSBORO
LENA HORNE
JAY AND THE AMERICANS
FERRANTE & TEICHER
LITTLE ANTHONY & THE IMPERIALS
JORDAN CHRISTOPHER
LONG JOHN BALDRY
CHARLES BLACKWELL
SAMANTHA JONES
MINA
RAPHAEL
PETER SELLERS & THE HOLLIES

Sound Track Albums:

- KHARTOUM
- AFTER THE FOX
- A FUNNY THING HAPPENED ON THE WAY TO THE FORUM
- CAST A GIANT SHADOW
- RETURN OF THE SEVEN
- A RIVER OF DOLLARS
- HAWAII

UNITED ARTISTS RECORDS

5 Albert Gate Court, 124 Knightsbridge, London, S.W.1.
 a division of United Artists Records, Inc., N. Y.

SUCCESS STORY OF 1966

THIS YEAR PHILIPS AND FONTANA ARTISTS DOMINATE THE BRITISH CHARTS...

DUSTY SPRINGFIELD

PHILIPS THE MINDBENDERS 

WALKER BROTHERS

PHILIPS THE MERSEYS 

SPENCER DAVIS GROUP

 FOUR SEASONS PHILIPS

BOB LIND

 ROGER MILLER PHILIPS

DAVE DEE, DOZY, BEAKY, MICK & TICH 

THE TROGGS 

WAYNE FONTANA

 FOUR PENNIES PHILIPS

PRETTY THINGS

 JOAN BAEZ 

.... AND WILL CONTINUE TO DO SO



PHILIPS GROUP RECORDS LONDON

International Representation Through THE BURLINGTON—PALACE MUSIC GROUP

(The World's fastest growing Publishing Organisation)

BRITISH ISLES

BURLINGTON MUSIC CO. LTD.
9 Albert Embankment,
London. S.E.1.

U.S.A.

BURLINGTON MUSIC CORPORATION
539 West 25th Street,
New York 1, N.Y.

CANADA

BURLINGTON MUSIC OF CANADA LTD.
190 Graveline Road,
St. Laurent, P.Q.

AUSTRALASIA

PALACE MUSIC (PTY) LIMITED
299-301 Castlereagh Street
Sydney, N.S.W.

BENELUX COUNTRIES

N.V. PALACE MUSIC HOLLAND
Vondelstraat 90
Amsterdam-W.

SCANDINAVIA

PALACE MUSIC (SWEDEN) A/B.
Brahegatan 24,
Stockholm O.

ITALY

EDIZIONI MUSICALI PALACE Srl.
Piazzetta Pattari 1/3,
Milano.

PALACE MUSIC CO. LTD.
9 Albert Embankment,
London, S.E.1.

FELSTED MUSIC CORPORATION
539 West 25th Street,
New York 1, N.Y.

FELSTED MUSIC OF CANADA LTD.
190 Graveline Road,
St. Laurent, P.Q.

SOUTH AFRICA

BURLINGTON MUSIC (AFRICA)
a division of:
MUSIC PUBLISHING CO. OF AFRICA
(PTY) LIMITED

161 President Street,
Johannesburg.

GERMANY & AUSTRIA

BURLINGTON MUSIKVERLAG GmbH.
Hoehenweg 22,
8211 Rimsting (Chiemsee),
Bavaria, Germany.

FRANCE & FRENCH UNION

EDITIONS MUSICALES PALACE Srl.
14 Avenue Hoche,
Paris VIII.

ARGO

the best in choral records

Selection from our extensive list:

THE CHOIR OF KING'S COLLEGE CAMBRIDGE

Handel—Chandos Anthems
Tallis—40 Part Motet
Gibbons—Music for Evensong

THE CHOIR OF ST. JOHN'S COLLEGE CAMBRIDGE

Haydn—Theresa Mass
Purcell—Music for the Chapel Royal
20th Century Church Music

THE ELIZABETHAN SINGERS

Britten Part Songs
I Love My Love—an Anthology of English Songs

ARGO IS DISTRIBUTED IN THE USA BY LONDON RECORDS

A Division of the Decca Group



113 Fulham Road, London S W 3.

continued

Chappell, 50 New Bond St., W.1. Tel: MAY 7600.
Dir.: Louis Dreyfus.

J. & W. Chester, 11 Great Marlborough St., London
W.1. Tel: GER 9546. Mg'g Dir.: R. D. Gibson.

Cinderella (see Lorna).

Clifford, 271 Gallowgate, Glasgow C.4., Scotland.
Tel: BELL 3187.

Clinton (see KPM).

Cooper (see KPM).

Edward Cox, 142 Charing Cross Rd., London W.C.2.
Tel: TEM 3917. Mg'g Dir.: Edward Cox.

J. B. Cramer, 99 St. Martin's Ln., London W.C.2.
Tel: COV 1612. Mg'g Dir.: L. J. Savile.

Cranz, Aldermans House, Aldermans Walk, London
E.C.2. Tel: AVE 4266. Sec.: R. J. Martin.

J. Curwen & Sons, 29 Maiden Ln., London W.C.2.
Tel: COV 1666. Chm.: Maurice Jacobson.

Damon, 35 Forest Side, Worcester Park, Surrey. Tel:
DER 1159. Prop.: Denny Boyce.

Walt Disney (see Chappell).

Dominion, 5 Albert Gate Ct., 124 Knightsbridge,
London S.W.1. Tel: KNI 9383. Mg'g Dir.:
Noel Rogers & John Spalding.

Dunraven, 28-30 Market Pl., London W.1. Tel: LAN
9694. Chm.: Eric Robinson, G. Clouston.

Editions A. Gutheil (see Boosey & Hawkes).

Essex Music Group, Dumbarton House, 6B Oxford
St., London W.1. Mg'g Dir.: David Platz.

Ernest Eulenburg, 48 Great Marlborough St., Lon-
don W.1. Tel: GER 1246. Mg'g Dir.: P. W.
Makings.

Famous-Chappell (see Chappell).

Fanfare (see Tin Pan Alley).

B. Feldman, 64 Dean St., London W.1. Tel: GER
9336. Gen. Mgr.: B. Nisbet.

Filmusic, 110 New Bond St., London W.1. Tel: HYD
7633. Contact: Harold Shampian.

Flamingo, Stanhope House, Stanhope Pl., London
W.2. Tel: AMB 778B. Mg'g Dir.: L. Gould, J.
Franz; Mgr.: D. Carey.

Florida (see Ember Recs.).

Sam Fox (see KPM).

FRANCIS, DAY & HUNTER, 138-140 Charing Cross
Rd., London W.C.2. Tel: TEM 9351. Dirs.: Eddie
Day & David Day. (SEE ADVERTISEMENT)

Furstner, 40 Hyde Park Gate, Flat 6, London S.W.7.
Tel: KEN 4383. Oir.: Ursula Furstner.

Galliard, 14B Charing Cross Rd., London W.C.2.
Tel: TEM 9364. Mg'g Dir.: Bernard A. Braley.

Gallico (see KPM).

Garnett (see KPM).

Noel Gay, 24 Denmark St., London W.C.2. Tel: TEM
3941. Mg'g Oir.: R. N. M. Armitage; Oir. &
Sec.: R. Walker.

Glad (see Shapiro-Bernstein).

Glissando (see Freddie Poser).

Gloucester (see Ember Recs.).

Gratto (see Dick James).

Fred Hartley, 45 Queen's Grove, London N.W.B.
Tel: PRI 1943. Oir.: Fred Hartley.

Hawkes & Son (see Boosey & Hawkes).

Heathside, 120/122 Marylebone Ln., London W.1.
Tel: HUN 4353. Mg'g Dir.: Nathan Joseph.

Hill & Range Songs (see Belinda).

Hinrichsen, 10-12 Baches St., London N.1. Tel: CLE
1638. Mg'g Dir.: C. Hinrichsen.

Hohner Concessionaires, 11-13 Farringdon Rd.,
London E.C.1. Tel: HOL 3056. Mgr.: J. Mus-
grave.

Immediate (see Tony Calder).

Imperia (see KPM).

Independent Rec. Prod'ns, 21 Denmark St., London
W.C.2. Tel: TEM 3856. Mg'g Dir.: J. J. Phillips.

intertone, 46 Maddox, London W.1. Tel: MAY 1735.

Island Music, 155-157 Oxford St., London W.1. Tel:
REG 6228. Cable: ACKEE. Mg'g Dir.: Chris
Blackwell; A&R: Blackwell & Stevens; Sales:
David Betteridge.

Int'l representative: Essex Music Group.

Iver Rec'g (see Southern).

Jaep (see Dick James).

DICK JAMES, James House, 71-75 New Oxford St.,
London W.C.1. Tel: TEM 4864. Cable: DE-
JAMUS. Dir.: Richard L. James. (SEE ADVER-
TISEMENT)

Jamie (see Southern).

Joanline (see Belinda).

KPM, 21 Denmark St., London W.C.2. Tel: TEM
3856. Cable: Mauritunes. Mg'g Dir.: J. Phillips.
(SEE ADVERTISEMENT)

Edward Kassner, 25 Denmark St., London W.C.2.
Tel: COV 3026. Mg'g Dir.: E. Kassner.

Key (see Essex Music Group).

J R Lafleur (see Boosey & Hawkes).

Latin-American (see Southern).

Laurel (see Lorna).

Leeds, 25 Denmark St., London W.C.2. Tel: COV
2962. Mg'g Dir.: Cyril Simons.

A. Lengnick, Purley Oaks Studios, 421 A Brighton Rd., South Croydon, Surrey. Tel: UPL 7646. Mg'g Dir.: C. R. L. Avenel.
 Liber-Southern (see Southern).
 Lords (see Dick James).
 Lorna, 5 Denmark St., London W.C.2. Tel: TEM 4741. Cable: LORNAMUSIC. Mg'g Dir.: Alan Paramor.
 Kenny Lynch (see Belinda).
 Lynn, 142 Charing Cross Rd., London W.C.2. Mg'g Dir.: Edwin Morris.
 Mac Melodies (see KPM).
 Maestro, 7 & 8 Norfolk St., London W.C. 2. Tel: TEM 8570. Mg'g Dir.: Norman Gledhill & Malcolm Lockyer.
 Maribus (see Dick James).
 Mark (see Ember Recs).
 Marlboro (see KPM).
 Marquis, 37 Sohio Sq., London W.1., GER 9405. Mg'g Dirs.: J. Roncoroni, K. Jones.
 Marvel (see Freddie Poser).
 Peter Maurice (see KPM).
 Melcher (see Dick James).
 Robert Mellin, 64 New Bond St., London W.1. Tel: MAY 3272. Mg'g Dir.: Robert Mellin.
 Meridian (see Southern).
 Meteor (see Southern).
 Metro (see Dick James).
 Metropole (see Ember Recs.).
 Mills, 20 Denmark St., London W.C.2. Tel: COV 1745. Mg'g Dir.: Cyril Gee.
 Mirage, 138/147 Ivor Ct., Gloucester Pl., London N.W.1. Tel: AMB 2701,1881. Dir.: Andrew Oldham.
 Mirror (see Southern).
 Ivan Mogull, Dumbarton House, 68 Oxford St., London W.1. Tel: MUS 7906.
 Monique (see Southern).
 Monshana (see Ember Recs.).
 Mood (see Ember Recs.).
 Morris Music, 115 Shastisbury Ave., London W.C.2. Mg'g Dir.: Edwin Morris.
 Moss-Rose (see KPM).
 Most (see Southern).
 Mozart Edition, 10 Sherlock Mews, Baker St., London W.1. Tel: WEL 2929. Mg'g Dir.: Joe Cohen.
 Munny (see Freddie Poser).
 Musicall, 46 Old Bond St., London W.1. Tel: PRI 9027. Dir.: E. A. Agoult.

BRITAIN'S FASTEST GROWING INDIE COMPANY

ISLAND
MUSIC



WEST END
PROMOTIONS

Management, Promotion, Record Production for

THE SPENCER DAVIS GROUP
MILLIE SMALL
JACKIE EDWARDS
THE V.I.P.s

Chris Blackwell—Sue Records—Surprise Records—Chris Peers

ISLAND RECORDS LTD.

155-157 Oxford Street, London W. 1.

THE TOP GROUP IN INTERNATIONAL MUSIC PUBLISHING

THE PEER-SOUTHERN-ORGANIZATION

ITS TOP MEN IN EUROPE

ALBERT BRUNNER	(SOUTHERN MUSIC, ZURICH)
ALBERTO CARISCH	(SOUTHERN MUSIC, MILAN, and associates)
HAN DUNK	(HOLLAND MUSIC, AMSTERDAM)
FELIX FAECQ	(SOUTHERN MUSIC, BRUSSELS)
JOSEF HOCHMUTH	(SOUTHERN MUSIC, VIENNA)
BOB KINGSTON	(SOUTHERN MUSIC, LONDON, and associates)
ROLF MARBOT	(S.E.M.I. and MERIDIAN, PARIS)
MANUEL SALINGER	(SOUTHERN MUSIC, BARCELONA and MADRID)
THEO SEEGER	(PEER, HAMBURG and subsidiaries)
RONI SJÖGREN	(SOUTHERN MUSIC, STOCKHOLM)
... and a WOMAN	
ERNI BILKENROTH	(EDITION MARBOT, HAMBURG)
... and in AFRICA	
GLYN TAYLOR	(SOUTHERN MUSIC, JOHANNESBURG)
... and the CO-ORDINATORS	
TOMMY and TOM WARD	(8 DENMARK STREET, LONDON, W.C.2.)

also in SYDNEY, AUCKLAND, TOKYO, TEL AVIV and
throughout NORTH, CENTRAL, and SOUTH AMERICA

The
most famous
name for
LP JACKETS
in Europe
is
**GARROD &
LOFTHOUSE**

LIMITED

... because

THEY
give the quickest service

THEY
have the largest capacity

THEY
print the highest quality

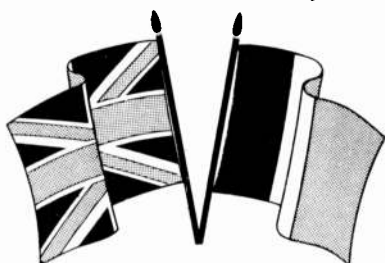

ADDRESSES:

6 LANGLEY STREET, LONDON, W.C.2
Telephone: Covent Garden 3322

IDN

2 RUE EMILE. CHATOU. PARIS
Telephones: Chatou 9664990
Balzac 0065

continued

Musicus, 47 Dean St., London W.1. Tel: GER 5708.
Mg'g Dir.: Edward White.
Musicville (see KPM).
New Town Sound, 326 Kensal Rd., London W.10.
Tel: LAD 6651. Mg'g Dir.: Marcel Rodd.
Nicolson (see Tony Calder).
Northern Songs (see Dick James).
Novello, Borough Green, Sevenoaks, Kent. Tel: BOR 3261.
Nuova (see Dick James).
One Four Two Music, 73-75 New Oxford St., London W.C.1. Tel: TEM 1801. Mg'g Dir.: Philip Raymond Solomon; Dir.: B. McGibbon Lewis.
Orbit, 34 Greek St., London W.1. Tel: REG 2148.
Oxford University Press, 44 Conduit St., London W.1. Tel: REG 5364. Mgr.: Alan Frank.
UNITED KINGDOM-GALLEY 5
Pacemusic (see Dick James).
James Page (see Tony Calder).
Page One Recs. (see Dick James).
Pan-Musik, 23 Denmark St., London W.C.2. Tel: COV 2816. Dirs.: Oliver Ward & Gerald Benson.
Charlie Parker, 5 Denmark St., London W.C.2. Contacts: A. Paramor, Aubrey Mayhew.
Branch: United States, GPO Box 1958, New York, N. Y.
W. Paxton, 36-38 Dean St., London W.1. Tel: GER 4801. Cable: PAXTOMUSIK. Mg'g Dir.: Leslie Neil; Sales: C. Warsop.
Piccadilly Music Supplies, 66 Neal St., London W.C.2. Tel: TEM 9579. Prop.: Fred Byfield.
Freddie Poser, 46 Maddox St., London W.1. Tel: MAY 1736. Mg'g Dir.: F. Poser.
Keith Prowse (see KPM).
Que, 2 Ascot Parade, Clapham, London S.W.4. Tel: MAC 5368. Dirs.: James Stobart & A. J. W. Mitchell.
R A K Rec., 155 Oxford St., London W.1. Tel: GER 6671. Contact: Mickie Most.
Raintree (see KPM).
Rasa (see Tin Pan Alley).
Red Blood (see Freddie Poser).
Reynolds (see KPM).
Richardson, 8 King Edward Grove, Teddington. Tel: TED 4861. Mg'g Dir.: Norman Richardson.
Robbins, 35 Soho Sq., London W.1. Tel: GER 0068. Dir.: Alan Holmes.
Winthrop Rogers (see Boosey & Hawkes).

Rudall, Carte & Co. (see Boosey & Hawkes).
Saville, Audley House, N. Audley St., London W.1. Tel: MAY 6506. Mg'g Dir.: S. M. Bloch.
Schauer & May, 239 Shaftesbury Ave., London W.C.2. Tel: TEM 3349. Mg'g Dir.: Mrs. Rose Schauer.
Schott, 48 Great Marlborough St., London W.1. Tel: GER 1246. Mg'g Dir.: P. W. Makings.
Schroeder (see Bron Assoc'd).
A. Schroeder, 15 Berkeley St., London W.1. Tel: HYD 2505.
Affiliate: Anim, Shelley.
This company represents: Arch, January, Pitfield Sea-Lark (all USA)
Screen Gems-Columbia, 28 St. James Sq., London S.W.1.
Seventeen Savile Row (see Belinda).
Shadam (see Belinda).
Shadows Music (see Belinda).
Shapiro-Bernstein, 38 Soho Sq., London W.1. Tel: GER 3493. Gen. Mgr.: Cyril Shane.
Sharon (see Ember Recs.).
Skidmore (see Shapiro-Bernstein).
South Eastern (see Southern).
SOUTHERN, 8 Denmark St., London W.C.2. Tel: TEM 4525, 9680. Mg'g Dir.: Robert Kingston. (SEE ADVERTISEMENT)
Sparta (see Ember Recs.).
Speedee (see Lorna).
Springfield (see Chappell).
Stainer & Bell, Lesbourne Rd., Reigate, Surrey. Tel: REI 46791.
Branch: (showroom) 29 Newman St., London W.1. Tel: MUS 2558.
Television (see KPM).
Tin Pan Alley, 37 Soho Sq., London W.1. Tel: GER 8752. Mg'g Dir.: Fred Jackson.
David Toff, 74 Newman St., London W.1. Tel: LAN 0641. Mg'g Dir.: David Toff.
Trafalgar, 1 St. George St., London W.1. Tel: MAL 1892. Dir.: Michael Hall.
Twangy (see Shapiro-Bernstein).
United, 1 Montague St., Russell Sq., London W.C.1. Tel: MUS 5171. Mg'g Dir.: Miss Pauline Wood.
UNITED ARTISTS, 5 Albert Gate Ct., 124 Knightsbridge, London S.W.1. Tel: KNI 9383. Mg'g Dirs.: Noel Rogers & John Spalding. (SEE ADVERTISEMENT)
Universal Edition, 2-3 Fareham St., London W.1. Tel: GER 5203. Mg'g Dir.: Alfred A. Kalmus.
Valando, 50 New Bond St., London W.1.

**KEITH PROWSE MUSIC
PUBLISHING CO. LTD.**

21, DENMARK STREET, LONDON, W.C.2
Telegrams & Cables: MAURITUNES, LONDON, W.C.2
Telephones: TEMPLE BAR 3856 (7 Lines)

PETER MAURICE MUSIC, INC. U. S. A. AL GALICO MUSIC CORP.

101 West 55th Street, New York 19, N. Y.
SUBSIDIARIES & ASSOCIATED COMPANIES

CLINTON MUSIC LTD.	MACMELODIES LTD.	SAM FOX PUBLISHING CO. (LONDON) LTD.
BUDD MUSIC LTD.	MARLBORO MUSIC LTD.	SPANKA MUSIC LTD.
IMPERIA MUSIC CO. LTD.	MOSS-ROSE MUSIC LTD.	TELEVISION MUSIC LTD.
COOPER MUSIC LTD.	MUSICVILLE LTD.	WORLD WIDE MUSIC CO. LTD.
GALICO MUSIC LTD.	RAINTREE MUSIC LTD.	WORLD COPYRIGHTS LTD.
GARNETT MUSIC LTD.	REYNOLDS MUSIC	
LOIS MUSIC LTD.		

OFFICES: FRANCE-ITALY-GERMANY-BELGIUM.
AGENTS: AUSTRALIA-SOUTH AFRICA-SCANDINAVIA-HOLLAND-SPAIN.

THE
INTERNATIONAL
INFLUENCE
OF BILLBOARD
GROWS
AND
GROWS

SUPERB STEREO

**MAGNIFICENT
MONO
INTERNATIONAL
ARTISTS**

DELYSE/ENVOY

RECORDING COMPANY

25-27, MARYLEBONE ROAD LONDON, N.W.1

Warren & Phillips, 57 Wroughton Rd., London S.W.11. Tel: BAT 5324. Mg'g Dir.: H. J. Warren.

Josef Weinberger, 33 Crawford St., London W.1. Tel: PAD 6752. Dirs.: Fred Benson & E. Hauke.

West End Promos., 11 Argyll St., London W.1. Tel: REG 8716. Mg'g Dir.: Christopher Peers; Partners: Harry Robinson & Christopher Blackwell.

White Lodge (see Southern).

George Wiener, c/o Dodd, Harris, 2 W. Artillery Manions, 75 Victoria St., London S.W.1. Tel: ABB 7245. Mg'g Dir.: George Wiener.

Woodside (see Lorna).

World Copyrights (see KPM).

World Wide (see KPM).

LAWRENCE WRIGHT MUSIC CO., LTD.

"You can't go wrong with a Wright Song"
Over half a century of World Hits

"THE DREAM OF OLWEN"

"Theme from 'THE APARTMENT'"

"AMONG MY SOUVENIRS," etc.

LAWRENCE WRIGHT MUSIC COMPANY, LTD.
54, Greek Street, London W.1.

LAWRENCE WRIGHT, 54 Greek St., London W.1. Tel: REG 7111. (SEE ADVERTISEMENT)

● independent record producers

Andes Sound (see Tony Calder Prod'ns).

Belinda Rec'gs, 17 Savile Row, London W.1. Tel: REG 3251. Mg'g Dir.: Franklyn Boyd.

Noel Brown Prod'ns, 26 D'Arbly St., London W.1. Tel: GER 3745. A&R: Noel Brown.

Label: Airborne.

Tony Calder (see Tony Calder Prod'ns).

Tony Calder Prod'ns, 138/147 Ivor Ct., Gloucester Pl., London N.W.1. Tel: AMB 2701, 1811.

Dirs.: Tony Calder & Andrew Oldham.

Contemporary, 52/55 Carnaby St., London W.1. Tel: GER 9602. Mg'g Dir.: Don Arden.

Eric Easton, 1 Little Argyll St., Regent St., London W.1. Tel: REG 2901.

ECONOMIDES REC'G PROD'NS, 1 Albert Gate Ct., 124 Knightsbridge, London S.W.1. Tel: KEN 7671. Mg'g Dir.: Jim Economides. (SEE ADVERTISEMENT)

F C M, 45 Mount St., London W.1.

J C Glasgow Promos., 271 Gallowgate, Glasgow C.4, Scotland. Tel: BELL 3187. Dir.: C. P. Stanton.

Immediate Recs. (see Tony Calder Prod'ns).

Independent Prod'rs Servs. (Fanfare Music), 37 Soho Sq., London W.1. Tel: GER 8752. Dir.: Fred Jackson.

Independent Rec. Prod'ns, 21 Denmark St., London W.C.2. Tel: TEM 3856. Mg'g Dir.: J. J. Phillips.

Independent Rec'g Serv., 16 Granville Pl., High Rd., Finchley, London N.12. Tel: 349-9052. Dir.: Jeff Collins.

London, 235 Regent St., London W.1. Tel: REG 8851.

Alec Noel Prod'ns, 185 Bickenhall Mansions, Baker St., London W.1. Tel: WEL 6512. Dirs.: Scot Engel & John Stewart.

Andrew Long Oldham (see Tony Calder Prod'ns).

Page One Recs., 71-75 New Oxford St., London W.C.1. Tel: TEM 4864. Mg'g Dirs.: Larry Page & Dick James.

Planet Recs., 34 Greek St., London W.1. Tel: REG 2148. Dirs.: Shel Talmy & Arthur Howes.

Que Prod'ns, 2 Ascot Parade, Clapham, London S.W.4. Tel: MAC 5368. Dirs.: James Stobart & A. J. W. Mitchell.

R A K, 155/157 Oxford St., London W.1. Tel: GER 6671. Mg'g Dir.: Mickie Most.

Reaction Recs., 5 de Walden Ct., 85 New Cavendish St., London W.1. Tel: MUS 2216. Mg'g Dir.: Robert Stigwood.

Record Supervision, Lansdowne House, Lansdowne Rd., London W.11.

Ritz, 6 Albert Gate Ct., 124 Knightsbridge, London S.W.1.

S X B Prod'ns, 235 Regent St., London W.1. Tel: REG 8851. Dirs.: Tom Springfield & Eddie Jarrett.

Solar, 102 Geary Rd., London N.W.10. Tel: GLA 6236. Dir.: Jeff Smith.

Lionel Segal. (SEE ADVERTISEMENT).

Scott Solomon, 73-75 New Oxford St., London W.C.1. Tel: TEM 1801. Mg'g Dir.: Philip R. Solomon.

Sound Developments, 96/7 Piccadilly, London W.1. Tel: GRO 5447. Mg'g Dir.: David M. Abrahams. Label: British Decca.

ORLAKE

BRITAIN'S PREMIER INDEPENDENT PRESSING PLANT

★

FULL PROCESSING AND
PRESSING FACILITIES

★

Also production of

LABELS

ALBUM SLEEVES

CATALOGUES

PROMOTIONAL MATERIAL

★

ORLAKE LTD.

Sterling Works

Rainham Road South

Dagenham, Essex

England

DOMinion 7700, 8430, 4471-2

A UNIQUE PRODUCTION COMPANY DEDICATED TO THE
NEEDS OF THE RECORDING AND TELEVISION INDUSTRIES

economides recording productions limited

124 knightsbridge, london, sw1

telephone: knightsbridge 4948

continued

Spot Recs., 64 Moulton St., London W.1. Tel: GRO 7173. Chm.: Arthur Rye; Mg'g Dir.: Norman Austin.

STRIKE, 43 Upper Berkeley St., Suite 15, London W.1. Tel: AMB 3588. Dirs.: Jack Heath & Lionel Segal. (SEE ADVERTISEMENT)

Sulchord, 122/124 Regent St., London W.1. Tel: REG 2813. Dir.: Evelyn Taylor.

Trash to Smash Demos., 13 Milestone Rd., Crystal Palace, London. Mg'g Dir.: D. McAleer.

● distributors

ENGLAND

Ashley Whslers, Ulster House, Town Quay, Southampton, Hants. Tel: Southampton 20301.

Associated Rec'gs, 326 Kensal Rd., London W.10. Tel: LAD 6651. Mg'g Dir.: Marcel Rodd. Branches: 7 Freeman St., Birmingham 5. Tel: MID 3316.—42 Broughton St., Manchester 8. Tel: DEA 2355.

Jeff Collins Rec. Sales, 16 Granville Pl., High Rd., Finchley, London N.12. Tel: 349-9052. Dirs.: J. Collins & D. C. Collins.

Disc Imports, 16 John Dalton St., Manchester 2. Tel: BLA 7292/3.

E M I, 20 Manchester Sq., London W.1. Tel: HUN 4488.

A. C. Farnell, Kenyon St., Sheffield. Tel: 78901.

Gorrings, 55 Buckingham Palace Rd., London S.W.1. Tel: VIC 6666. Mgr.: Brian West.

Lugton, PO Box 44, 209-212 Tottenham Ct. Rd., London W.1. MUS 3261.

F. R Martin, 135 Digbeth, Birmingham 5.

Philips, Stanhope House, Stanhope Pl., London W.2. Tel: AMB 7788.

Selecta, 50 Southwark Bridge Rd., London S.E.1. Tel: WAT 2311. Gen. Mgr.: A. W. Green.

Branches: Leicester Rd., Earl Shilton.—PO Box 4, Selecta House, Morton St., Failsforth, Manchester.—Foundry Ln., Newcastle-on-Tyne 6.

A. Soloway, Knobs Hill Rd., Marshgate Ln., London E.15. Tel: MAR B941.

Tape-Music, 11 Redvers Rd., London N.22.

Vistula Exp. & Imp., 164 Old Brompton Rd., London S.W.5.

Vogue, 9 Albert Embankment, London S.E.1. Tel: REL 8111.

E. A. Wood 7 Freeman St., Birmingham 5.

IRELAND

Associated Rec'gs, 5 Castle Chambers, Rosemary St., Belfast 1. Tel: Belfast 23745.

SCOTLAND

Associated Rec'gs, 669 Gallowgate, Glasgow S.E. Tel: Bridgeton 0326.

● importers & exporters

ENGLAND

Agate, 75 Charing Cross Rd., London W.C.2. Tel: GER 6733. Mg'g Dir.: D. A. Dobell.

C B S, 104 New Bond St., London W.1. Tel: GRO 5301.

Collets, 70 New Oxford St., London W.C.1. Tel: MUS 3224.

Decca, 9 Albert Embankment, London S.E.1.

Delyse, 2527 Marylebone Rd., London N.W.1.

Disc Imports, 16 John Dalton St., Manchester 2. Tel: BLA 7292.

Esquire, 76 Bedford Ct. Mansions, Bedford Ave., London W.C.1.

Hohner Concessionaires, 11 Farringdon Rd., London E.C.1. Tel: HOL 3056. Mgr.: R. Haller.

Lugton, PO Box 44, 209-22 Tottenham Ct. Rd., London W.1. Tel: MUS 3261.

W. Pax'on, 30 Old Compton St., London W.1.

Jay Pender—Vinyl Vendor, 10 Leinster Sq., Rm. 18, Bayswater, London W.2.

Philips, Stanhope House, Stanhope Pl., London W.2. Tel: AMB 7788.

Polydor Recs., 17-19 Stratford Pl., London W.1. Tel: HYD 7401.

Pye (Sales), PO Box 56, 132 Western Rd., Mitcham, Surrey.

R K L Rec. Ents., 13 Gerrard St., London W.1. Tel: GER 6729, 6421, 3402.

Ronnie Scott Club, 47 Frith St., London W.1. Tel: GER 4752, 4239.

Thorpe & Porter, 283 Cricklewood Broadway, London N.W.2. Mg'g Dir.: R. D. Kravitz.

Transatlantic, 120/122 Marylebone Ln., London W.1. Tel: HUN 4353.

Vistula, 164 Old Brompton Rd., London S.W.5.

Vogue, 9 Albert Embankment, London S.E.1. Tel: REL 8111.

Zodiac Rec., 12 Gerrard St., London W.1. Tel: GER 6729, 6421, 3402.

IRELAND

Solomon & Peres, 67-69 Ann St., Belfast 1. Tel: 31616.

● supplies & services

JACKET MANUFACTURERS

Garrod & Lofthouse, 6 Langley St., London W.C.2. COV 3322. Contact: Velia M. Thoma. (SEE ADVERTISEMENT)

MUSIC LICENSING ORGANIZATIONS

British Copyright Protection Assn., 22/23 Little Portland St., London W.1.

Mechanical Copyright Protection Society, 380 Streatham High Rd., London S.W.16. Tel: STR 3181. Cable: Mecolico. Gen. Mgr.: B. W. Pratt; Sec.: J. M. Edwards.

Performing Right Society, 29/33 Berners St., London W.1. Tel: LAN 3864. Gen. Mgr.: R. F. Whaley; Sec.: M. J. Freegard.

PRESSING PLANTS

Allied Recs., 326 Kensal Rd., London W.10. Tel: LAD 6651. Mg'g Dir.: Marcel Rodd.

British Homophone, Excelsior Works, Rollins St., London S.E.15.

C B S, Aylesbury, Buckinghamshire.

Decca, New Malden, Surrey.

ORLAKE Sterling Works, Rainham Rd. S., Dagenham, Essex. Tel: DOM 7700, 8430. Gen. Mgr.: R. Clark. (SEE ADVERTISEMENT)

Philips, Walthamstow Ave., London E.4.

Transcription Mfg. & Rec'g, James' Estate, Western Rd., Mitcham, Surrey.

PROMOTION AND PUBLICITY

Ashley Sinclair Theatrical Ents., 23 Denmark St., London W.C.2. Tel: COV 1729. Dir.: Harold H. Ashley.

George Bartram, Monarch House, 8 Duchess Rd., Edgbaston, Birmingham 16. Tel: EDG 5357. Mg'g Dir.: George Bartram.

David Block, 12 Great Newport St., London W.C.2. Tel: COV 1651. Press Rel. Consultant: David Block.

J C Glasgow Promos., 271 Gallowgate, Glasgow C.4, Scotland. Tel: BELL 3187. Dirs.: C. P. Stanton & M. L. Stanton.

Interpop, 73 Wells St., London W.1. Tel: MUS 0692. Mg'g Dir.: David Cardwell.

Kay Gee, 71 Monmouth St., London W.C.2. Tel: TEM 5067. Mg'g Dir.: Keith Goodwin.

Brian Sommerville, 23 Denmark St., London W.C.2. Tel: TEM 0535. Mg'g Dir.: Brian Sommerville.

RECORDING & TAPE DUP. STUDIOS

ENGLAND

Advision, 83 New Bond St., London W.1.

C B S, 28-30 Theobalds Rd., London W.C.1. Dir.: Jacques Levy.

C T S, 49 Kensington Gardens, London W.2. Tel: BAY 9476. Tech. Dir.: John Elliott; Mgr.: Eric A. Tomlinson.

E M I, 3 Abbey Rd., London N.W.8.

I B C Sound, 35 Portland Pl., London W.1. Tel: LAN 2000. Dir.: Allan Stagg.

Lansdowne, Lansdowne House, Lansdowne Rd., London W.11.

Olympic Sound, 117 Church Rd., Barnes, London S.W.13. Tel: RIV 7961.

Philips, Stanhope House, Stanhope Pl., London W.2. Tel: AMB 7788.

Pye, ATV House, Great Cumberland Pl., London W.1. Tel: AMB 5502.

R G M Sound, 304 Holloway Rd., London N.7.

The Rank Organization, Film Prod'n Div., Pinewood Studios, Iver Heath, Bucks.

Recorded Sound, 27-31 Bryanston St., Marble Arch, London W.1. Tel: GRO 4634, 3726. Mgr.: Leo Pollini.

Saga, 15b Maresfield Gardens, London N.W.3. Tel: HAM 7988. Mg'g Dir.: Marcel Rodd.

Sound News Prod'ns, 18 Blenheim Rd., London W.4. Tape Rec. Hire, 18 Blenheim Rd., London W.4. Tel: 995-1661.

Tape to Disc Trade Transfer Serv., 18 Blenheim Rd., London W.4.

Universal Programmes, 35 Portland Pl., London W.1. Tel: LAN 20000. Dir.: Allan E. Stagg.

SCOTLAND

Craighall, 68 Craighall Rd., Edinburgh 6. Tel: GRA 3685. Mg'g Dir.: R. B. Laing.

TRADE ORGANIZATIONS

Assn. of Musical Instrument Inds., 8 Hollywood Way, Woodford Green, Essex. Tel: LAR 1171.

Assn. of Professional Rec'g Studios, 47 Wattendon Rd., Kenley, Surrey.

British Federation of Banjoists, Mandolinists & Guitarists, 88/92 Rochester Row, London S.W.1. Tel: VIC 5376.

British Institute of Recorded Sound, 29 Exhibition Rd., London S.W.7. Tel: 589-6603.

British Joint Copyright Council, 29/33 Berners St., London W.1. Tel: LAN 3864. Chm: Sir Alan Herbert.

British Rec. Prod'rs Assn., 74 Lower Guildford Rd., Knaphill, Woking, Surrey. Sec./Treas.: J. F. Axtmann.

Crammophone Rec. Retailers Assn., 1 Peckham Park Rd., London S.E. 15. Tel: NEW 3849.

Int'l Federation of the Phonographic Industry, 123 Pall Mall, London S.W.1. Tel: WHI 1752.

Music Directors' Assn., 88 Rochester Row, London S.W.1. Tel: VIC 3755.

The Music Publishers' Assn., 73-75 Mortimer St., London W.1.

Music Trades Assn., c/o James Edwards, Salisbury House, London E.C.3.

Musicians' Union, 29 Catherine Pl., Buckingham Gate, London S.W.1.

National Music Council of Great Britain, 4 Blandford St., London W.1.

Phonograph Operators' Assn., 76b Rochester Row, London S.W.1.

Piano Manufacturers' Assn., 16 River Grove Park, Beckenham, Kent. Tel: BEC 8247.

Pianoforte Publicity Assn., 26 Upper Brook St., London W.1.

Songwriters' Guild of Great Britain, 32 Shaftesbury Ave., London W.1. Tel: GER 1554, 1439. Gen. Sec.: Victor Knight.

● accessories

Lugton, PO Box 44, 209-212 Tottenham Ct. Rd., London W.1. Tel: MUS 3261.

● tape

RAW TAPE MANUFACTURERS

Allied Recs., 326 Kensal Rd., London W.10. Tel: LAD 6651. Mg'g Dir.: Marcel Rodd.

PRERECORDED TAPES

Saga Recs., 326 Kensal Rd., London W.10. Tel: LAD 6651. Mg'g Dir.: Marcel Rodd.

CARTRIDGE MANUFACTURERS

Saga Studios, 15b Maresfield Gardens, London N.W.3. Tel: HAM 7988. Mg'g Dir.: Marcel Rodd.

TAPE PLAYBACK MANUFACTURERS

B S R, Monarch Works, Old Hill, Staffs. Tel: Cradley Heath 69272. Cable: Electronic. Cradley Heath. Chm.: Dr. D. M. McDonald.

URUGUAY

Population: 3,083,855.

Official rate of exchange: \$1 (US) = 16.50 pesos.

Per capita income: \$550 annually.

Number of homes with record players: 90,000.

Record sales: LP's \$3.30; EP's \$1.30.

Type of distribution: Manufacturer to retailer, with a 30% mark-up.

Records imported from US: None.

Stereo sales: 10%.

Origin of music (pop): Tropical 20%; European 25%; Domestic 35%; USA and other 20%.

Radio stations: Montevideo—13 long-wave, 8 long and short-wave.

Television stations: 4 Channels. Alberto Maravi

● record manufacturers

Clave, IEMSA, Maldonado 1049, Montevideo.

AT LAST, MY LIFE'S
AMBITION IS REALIZED...
I'M IN CHARGE OF
THE INTERNATIONAL
VOGUE DISTRIBUTION!



VOGUE P.I.P.
PARIS—VILLETANEUSE
(Seine)
FRANCE
TEL: 752.73.00
Telex: VOGDISC 28.493

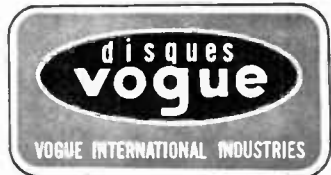

BRANCHES

VOGUE BELGIUM
VOGUE P.I.P. BELGIUM
VOGUE S.A.
35 Bld Barthelemy
BRUXELLES (BELGIUM)
VOGUE GERMANY
DEUTSCHE VOGUE
VOGUE SCHALLPLATTEN
GMBH
ZUR MUHLE 2
5021 Grooskonigsdorf bei
Korn (GERMANY)
VOGUE SWITZERLAND
VOGUE S.A.
70 AVENUE des ALPES
MONTREUX (SWITZERLAND)

DISTRIBUTED THROUGHOUT
THE WORLD

VOGUE
is
TOPS



NEW YORK OFFICE
C/O IRVING CHEZAR
555 MADISON AVENUE
NEW YORK

continued

Tel: 98-5832. Cable: Clalim. Top Exec.: Leon Jurburg.
Label: Clave.
This company represents: Barclay (France), CGD (Italy), Disc Jockey (Argentina), Discomoda (Venezuela), Decca (France), London (Int'l), Marvela (Puerto Rico), Monitor (USA), Panart (USA), Seeco (USA).
Int'l representatives: Francé (Barclay), Italy (CGD), Puerto Rico (Marvela), USA (London, Monitor, Panart, Seeco).

Editorial Antar, Republica 1613, Montevideo. Tel: 40-6300. Cable: Antar. Pres.: Carlos Vallarino; Mgr.: Angel Lisanfi; Int'l: Walter Mandacen.
Label: Antar.

This company represents: Copacabana (Brazil), Cetra (Italy), Ducretet-Thomson (France), H&R (Argentina), 20th-Fox (USA), Les Discophiles Francaises (France), Peerless (Mexico), Pallette (Belgium), RGE (Brazil), Telefunken (Germany), United Artist (USA), Vox (USA), Vanguard (USA).
Int'l representatives: Argentina (Antar), Belgium (Pallette), Brazil (RGE), France (Ducretet-Thomson), Germany (Telefunken), Italy (Cetra), Mexico (Peerless), USA (Vanguard).

Fermata, Constituyente 1903, Montevideo. Tel: 31-9330 & 31-9377. Cable: FERMATA BAIREs.

Palacio de la Musica, 18 de julio 1100, Montevideo. Tel: 80113. Pres.: Ricardo Gioscia; Mgr.: Ricardo Gioscia Jr.
Label: Orfeo.

This company represents: Angel (USA), Decca (USA), Capitol (USA), Liberty (USA), Odeon (Argentina, Brazil, Chile, Peru), Musart (Mexico), Warner Bros. (USA).

Philips Uruguay, 1287 Piso 3, Montevideo. Tel: 95641. Gen. Mgr.: Enrique Lazcano.
Label: Philips.

This company represents: Archiv (Germany), DGG (Germany), Mercury (USA), MGM (USA), Polydor (Int'l), Philips (Int'l), Ri-Fi (Italy).

Praos, 18 de julio 1080, Montevideo. Tel: 95034. Gen. Mgr.: Eduardo Miranda.

Label: Gold Laut.
This company represents: Chantecler (Brazil), Musidisc, Nilser (Brazil), Virrey (Peru).

Siweg S. A., Convencion 1424, Montevideo. Tel: 98-2224. Top Exec.: Jorge Errazquin.
Label: RCA Victor.
This company represents: RCA (USA) and affiliates.

Sondor S. A., Nicaragua 1478, Montevideo. Tel: 27530. Cable: Sondor. Pres.: Enrique Abat; Mgr.: Pablo Echevarria.
Label: Sondor.
This company represents: Columbia.

Tonodisc, Constituyente 1903, Montevideo. Tel: 40-1169. Gen. Mgr.: Nestor Paez.
Label: Tonodisc.

This company represents: Grand Award (USA), Fermata (Argentina), Microfon (Argentina), Tonodisc (Argentina), Tamla-Motown (USA).

● music publishers

Campo (Palacio dela Musica), 18 de julio 1100, Montevideo.

Discoteca, Ibcuy 1276, Montevideo. Tel: 98-5832.
 Edami (Southern and Peer), Juan Jackson 1401, Montevideo.

Fermata, Constituyente 1903, Montevideo. Tel: 40-1169.

● supplies & services

PRESSING PLANTS

APSA (RCA Victor), Av. Italia 4230, Montevideo. Tel: 59-3015.

Editorial Antar, Republica 1613, Montevideo. Tel: 40-6300.

Fimasa, Nueva York 1176, Montevideo. Tel: 96074.

Sondor S.A., Nicaragua 1478, Montevideo. Tel: 27530.

RECORDING STUDIOS

Editorial Antar, Republica 1613, Montevideo. Tel: 40-6300.

Sondor, Rio Branco 1536, Montevideo. Tel: 92670.
 Radio Ariel, Olimar, Montevideo.

MUSIC LICENSING ORGANIZATIONS

Asociacion General de Autores del Uruguay (AGADU), Canelones 1130, Montevideo. Tel: 83188. Gen. Mgr.: Luis Alberto Zeballos.

U.S.S.R.

Population: 1959 census: 208,826,650; latest official estimate: 226,253,000.

Official rate of exchange: \$1 (US)=0.90 rubles.

Records imported from US (factory value): 1964—\$264; 1963—\$1,820, classics and jazz, instrumentals.

Records exported to US (factory value): 1964—\$47,163; 1963—\$16,000; 1962—\$18,100.

● record manufacturers

V/O Mezhdunarodnaya Kniga, Smolenskaya Pl. 32/34, Moscow G-200. Tel: 4-10-22. Cable: Mezhnkniga.
Label: MK.

● importers & exporters

V/O Mezhdunarodnaya Kniga, Smolenskaya Pl. 32/34, Moscow G-200. Tel: 4-10-22. Cable: Mezhnkniga.

VENEZUELA

Population: 8,900,000.

Official rate of exchange: \$1 (US)=4.54 bolivars.

Per capita income: \$850 annually.

Number of homes with record players: 50% of all homes in Caracas; 10 to 15% of all homes elsewhere.

Records imported from US (factory value): 1964—\$157,639.

Records exported to US (factory value): 1964—\$9,775.70.

Average retail price: Stereo LP's—\$5.94; Mono LP's—\$4.84.

Discounting: Approx. 25% at retail.

Stereo sales: About 10% of LP's.

ON TOP SINCE 1894 IN CIRCULATION IN REPUTATION IN PENETRATION

No other music-trade publication gives its advertisers the global exposure, strength of editorial backing and proof of circulation claims that Billboard offers.

The nearly 70 years of international respect for Billboard's quality of journalism, scientific methods of research and high standards of business practice provide advertisers with an unmatched setting of prestige for their message.

With a world-wide circulation twice that of any other music-trade publication, only Billboard offers advertisers incontrovertible proof of circulation figures by opening its files twice every year for audit by the rigid and exacting Audit Bureau of Circulations (ABC).

Their reports detail for every Billboard advertiser just where his message goes throughout the world . . . who receives it . . . and how many receive it.

Basic Information That Every Advertiser Should Not Only Expect—But Demand!

Do You?

**New York • Hollywood • Chicago • St. Louis • Washington
 Nashville • London • Buenos Aires • Rio de Janeiro**

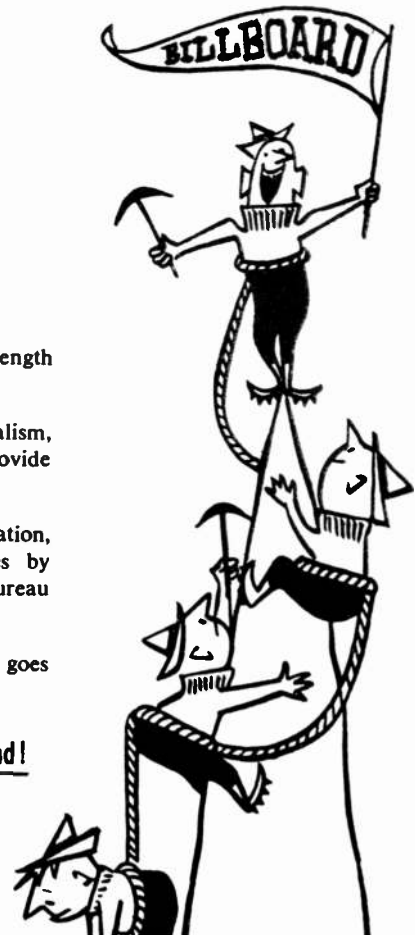

Distribution system: Manufacturer to dealer.

Radio stations: 85.

Television stations: 4.

Jukeboxes: 18,000.

Record clubs: None.

Important regulations: It has been illegal to import foreign records for direct sale. Only classical records may be imported. It is also illegal to import musical tape recordings for re-recording.

● record manufacturers

Aluvenca, Edificio Vega, Rio a Pte. Soublette, Caracas. Cable: Vegasa. Tel: 41-63-67. Gen. Mgr.: Julio Brilllembourg; Sales: Marcelo Manzo; A&R: Manuel Caraballo Gramcko. Labels: Vega, Time.

This company represents: Time (USA).

Hermanos Antor, Ave. El Paso 19, Los Rosales, Aptdo. Postal 13132, Nueva Granada, Caracas. Cable: Contidisco. Tel: 61-02-37 & 61-20-17. Gen. Mgr.: Jose Antor; A&R: Juan Antor; Sales: P. Vidal Sanchez; Int'l: Jose Antor. Labels: Souvenir, Continental.

This company represents: Orfeon (Mexico), Liberty (USA), Puchito (USA), Canadian American (USA), Zafiro (Spain), RCA (USA). Int'l representatives: USA (Liberty), Mexico (Orfeon), Spain (Zafiro).

La Discoteca, Apartado del Este 4720, Caracas. Tel: 34-46-R1. Cable: Ladicoteca, Gen. Mgr.: W. Ricken; Sales: B. Brecht. Labels: Erna, Sonus.

This company represents: CBS (USA, Argentina, Brazil, Mexico), Dot (USA), Gamma (Mexico), Hispavox (Spain), Marvela (Puerto Rico), Musart (Mexico), Plaza (Brazil), RGE (Brazil), Virrey (Peru), Zeida (Colombia).

Distribuidora Nacional De Discos, PO Box 8535, Caracas. Tel: 42-20-19. Cable: Disnadisco. Gen. Mgr.: Jose Pages; A&R: Porfirio Jimenez; Sales: Gumersindo Miranda; Int'l: Gumersindo Miranda. Label: Velvet.

This company represents: Audio Fidelity (USA), Kubaney (USA), Lyrta (Colombia), Gema (USA), Dorado (Colombia).

Int'l representatives: Mexico, Colombia, Peru (Velvet), Spain (Cubalegre), USA (Kubaney).

Fabrica Venezolana (Favedica), PO Box 3402, Caracas. Tel: 49-23-18. Cable: FAVEDICA. Pres.: Cesar Roldan; Prod'n: Benito Vieitez; Sales: Enrique Barros; A&R: Carlos Guerra; Int'l: Stanley Steinhaus.

Labels: Discomoda, Impacto (Budget).

This company represents: Areito (Spain), Carisch (Italy), Cisne (Mexico), Deutsche Vogue (Germany), Durium (Italy), GTA (Italy), Ideal (USA), Lisboa (Portugal), Musidisc (Brazil), Onix (Ecuador), Palma (Spain), Saar (Italy), Sidet (Italy), Style (Italy), Teledisc (Italy), Toshiba (Japan).

(All products appear under the Orbe label.)

Int'l representatives: Austria (Deutsche Vogue), Benelux (Saar), Central America (Indica), Colombia (Fuentes), Ecuador (Onix), Germany (Deutsche Vogue), Italy (Saar), Mexico (Cisne), Peru (Odeon), Portugal (Valentim de Carvalho), Scandinavia (Deutsche Vogue), Switzerland (Saar), USA (Panart, Seeco).

Fonograma, Ave. Paez Qta. Arib, El Paraiso, Cable: Fonograma. Tel: 49-36-13 & 49-38-57. Gen. Mgr.: C. Esparragosa; A&R: Billo Frometa; Sales: Luis Barrois; Int'l: Gloria Baez. Labels: Fonograma-Billo.

This company represents: Kapp (USA), Tropical (Colombia), Nilser (Brazil).

Int'l representatives: Colombia (Tropical), Costa Rica (Indica), Ecuador (Centenario), Puerto Rico (Casa Frago), USA (Miami).

Fuentes, Miranda a Maderero Ed., Local 8, Caracas. Cable: Robogomer. Tel: 41-52-91. Gen. Mgr.: R. Gomez; A&R: A. Segura. Int'l: Roberto Gomez.

This company represents: Fuentes (Colombia), Carrizal (Colombia).

Int'l representatives: Colombia (Fuentes), USA (Fuentes).

Orbe (see Fabrica Venezolana)

Palacio de la Musica, Apartado Postal 3637, Caracas. Cable: Pamusica. Tel: 42-88-26. Gen. Mgr.: Ernesto Aue; A&R: Miguel Angel Pina; Sales: Arlindo Silva; Int'l: Ernesto Aue. Label: Palacio.

This company represents: Imperial (USA), Seeco (USA), UA (USA), Ricovox (Puerto Rico), Falcon (USA), Peerless (Mexico), London Int'l (England), Daro (Colombia), Copacabana (Brazil),

Ariola (Germany), Rapsodia (Portugal), Tico (USA).

Int'l representatives: Mexico (Peerless), USA (Ricovox); all other world markets (Polydor).

Panart de Venezuela, PO Box 9258, Caracas. Cable: Recave. Gen. Mgr.: Ramon Sabat; A&R: Rene Castro Vega; Sales: Hilario Velis; Int'l: Ramon Sabat.

Label: Panart.

This company represents: Calesita (Argentina), Mag (Peru), Meazzi (Italy), Music Hall (Argentina), Panart (USA).

Int'l representatives: Argentina (Music Hall), Colombia (Fuentes), Peru (Mag), USA (Panart).

R C A, Apartado del Este 11275, Caracas. Tel: 33-97-21. Cable: Radiointer. Gen. Mgr.: Clifford W. Slaybaugh; Rec. Sales: Oswaldo Gonzales.

Label: RCA.

This company represents (and is represented by): RCA International.

Ronde de Venezuela, PO Box 4766, Caracas. Cable: Rondesa. Tel: 41-25-78. A&R: Anibal Abreu; Sales: E. Fajardo.

Labels: Ronde, Mara, Encore.

This company represents: Reprise (USA), Everest (USA), Pickwick Int'l (USA), Marper (Uruguay), Discofonia (Argentina), Belart (Mexico), Oriole-Embassy (England), Carvalho-Lisboa (Portugal), Fonopolis (Spain), Clan (Italy), RiFi (Italy), Pathe Marconi (France), Bel Air (France), Le Chant du Monde (France), Teledisc-Dalara (Italy).

Int'l representatives: USA (Panart), Colombia (Fuentes), Brazil (Sonus), Mexico (Belart), Italy (Ri-Fi), France (Le Chant du Monde), England (Oriole).

Siemens, PO Box 3616, Caracas. Cable: Siemens, Tel: 34-85-31. Gen. Mgr.: Henry Alex; A&R: Claudio Behrens; Sales: C. Behrens; Int'l: Henry Alex.

Label: Polydor.

This company represents: Archive (Germany), Deutsche Grammophon (Germany), Philips int'l, MGM-Verve (USA), ABC (USA), Mercury (USA).

Venevox (Industria Nacional del Sonido), PO Box 5141, Caracas. Cable: Electronica. Tel: 34-82-72. Gen. Mgr.: Charles Biederman; A&R: G. Pocovi; Sales: Pierre Casanova; Int'l: Guillermo Pocovi.

Label: Venevox-Diversion.

This company represents: Montilla (USA), Columbia Espanola (Spain), Barclay (France), Ducretet-Thomson (France), Ricordi (Italy), CGD (Italy), Sonoradio (Peru), Alvorada (Portugal), Supraphon (Czechoslovakia), Vox (USA).

● music publishers

Ediciones Cynett, Ave. 200, Edif. Oyon, Aptdo de Correos 8520, Caracas. Tel: 42.71.13. Cable: CYNETT. Contact: Juan Lucas.

Ediciones Musicales Venezolanas, (EDMUVECA), PO Box 8561, Caracas. Cable: Edmuveca. Tel: 41-08-00.

Editora de musica Venezolana Internacional (EVMI), PO Box 8542, Caracas. Cable: Edivemus. Tel: 41-78-19.

Peer Int'l, Ave. Andres Bello, Edificio "Vam," Aptdo. 941, 9 Piso, Caracas. Tel: 54-67-86. Cable: IDROCIIR.

● record distributor

Discos, Este 2, 203 El Conde, Caracas. Contact: Antonio Cortez.

● supplies & services

LABEL AND JACKET MANUFACTURER

Favedica, PO Box 3402, Caracas. Mgr.: Luis Calderon.

PRESSING PLANTS

Favedica, PO Box 3402, Caracas. Mgrs.: Manuel Garcia & Gonzalo Londono.

Grabaciones Antor, Calle Baruta 60, El Valee, Caracas.

Grabaciones de America, (GRAMSA), PO Box 6813, Caracas.

Venevox, PO Box 5141, Caracas. Cable: Electronica.

Venezolana de Grabaciones, PO Box 8569, Rio a Pte. Soublette 7, Caracas. Cable: Cavega.

RECORDING STUDIOS

Favedica, PO Box 3402, Caracas. Mgr.: Cesar Tena.

Fidelis, Calle Branger 12, Los Rosales, Caracas. Cable: Branger.

Vega, PO Box 8569, Caracas. Cable: Cavega.

VIRGIN ISLANDS (U. S.)

Population: 42,000 (St. Thomas, St. Croix & St. John).

Official rate of exchange: Same as US.

Records imported from US: 1965-30,000 units.

Radio Stations: WBNB & WSTA, St. Thomas; WIVI AM/FM, St. Croix.

Television Station: WBNB, St. Thomas.

● record manufacturers

Tony's Rec. Shop, 1 Regjerings Gade, Charlotte Amalie, St. Thomas. Prop.: Antonio J. Benvenuti.

Label: Savan.

Westindy, PO Box 2896, 5 Wimmelskaft Gade, Charlotte Amalie, St. Thomas. Tel: 774-1174.

Mgr.: Bill La Motta.

Label: Westindy.

● music publishers

Westindy (ASCAP), P.O. Box 2896, Charlotte Amalie, St. Thomas. Mgr.: Bill La Motta.

● record wholesalers

Conrad, Main St., St. Thomas.

YUGOSLAVIA

Population: 19,294,000 (1964).

Official rate of exchange: \$1 (US) = 750 dinars.

Records imported from US (factory value): 1964 - \$29,414.

Records exported to US (factory value): 1964 - \$4,281.

Number of homes with record players: 1 million.

Records sold: 7 million (approx.—1964)—LP's—20%; EP's—60%; Sing'es—20%.

Average retail price: LP's—\$3; EP's—\$1.50; Singles —65 cents.

Important regulations: All industry and commerce is state-controlled.

● record manufacturers

Jugoton, PO Box 4, Pokupska Str. Dubrava, Zagreb. Tel: 644-343/729/522. Exec. Dir.: Slavko Kopun; Export Mgr.: Mrgic Stanko.

Label: Jugoton.

This company represents: Amadeo (Austria), Brunswick (USA via DGG, Germany), Broadway (USA via Italdisc, Italy), Coral (USA via DGG, Germany, Cameo-Parkway USA via CGD, Italy), Carisch (via Exportrama, Italy), Clan (via Durium, Italy), Copacabana (via Sabrina, Italy), Decca (England), DGG (Germany), Durium (Italy), Elite (via Turicaphon AG, Switzerland) Fonit (via Exportrama, Italy), Italdisc (Italy), Juke Box (via CGD, Italy), London (via Decca, England), Polydor (via DGG, Germany), Phonorama (via Sabrina, Italy), Primary (via Exportrama, Italy), RCA (via Teldec, Germany), Ronnex (Belgium), Ri-Fi (via Exportrama, Italy), Ricordi (Italy), Sabrina (Italy), Telefunken (via Teldec, Germany) Triola (via Turicaphon AG, Switzerland), 20th Century-Fox (via CGD, Italy), United Artists (via CGD, Italy), Verve (via MGM USA), MGM (USA), Moonglow (USA), Vogue (France).

Int'l representatives: Canada (Comet), France (Vogue), Germany (Internationale Bucher & Zeitschriften), Italy (Durium, Sabrina), Spain (Tempo-Discos), Sweden (Metronome), Switzerland (Turicaphon).

Record Production RTB, Makedonska Str. 21, Belgrade. Tel: 20-277. Cable: PRODUKCIJA PLOGA. Dir.: Slobodan Markovic.

● music publishers

Metronome, Ruzveltova 19, Belgrade. Tel: 342.962. Contact: M. Ristic.

Zabavne Melodie, Optika 10, Belgrade. Contact: M. Kinel.

● importer & exporter

Record Production RTB, Makedonska Str. 21, Belgrade. Tel: 20-277. Cable: PRODUKCIJA PLOGA. Dir.: Slobodan Markovic.

Index to Advertisers

Listed Alphabetically

A guide to valuable sources of music, record and related services and products around the world. This index is provided as an additional service to readers. The publisher does not assume liability for errors or omissions.

Advertiser	Page	Advertiser	Page	Advertiser	Page	Advertiser	Page
A & L DIST.	102	CONSOLIDATED ONE STOP	115	KAPP RECORDS	24	R. J. RECORDERS	149
A & M RECORDS	3	CPR	142	KAY RECORDS	128	ROBBINS, FEIST & MILLER	69
A-1 RECORD SALES	118	CREATIVE SOUND	49 & 148	KELMAR REC. CO.	128	ROPER REC.	49
A & R RECORDING	148	DANCE RECORDS	122	KING CUSTOM REC. SERVICE	52	DAVID ROSEN	100
AB ALPHA	245	DAVIS SALES	81	L. A. DIST.	81	ROULETE RECORDS	31
ABC PARAMOUNT RECORDS	10	DAVON MUSIC	68	LAREDY DIST.	93	ROYAL DISK DIST.	85
ABERBACH (Hamburg)	204	DECCA DISQUES	201	RAY LAWRENCE	142	SALIENT EXPORT	121
ACTION REC. DIST.	81	DECCA (LONDON) RECORDS LTD.	71	PAUL LAZARE	204	SATURDAY MUSIC	173
ADRIAN ASSOC.	148	DEUTSCHE GRAMMOPHON	19, 20, 21, 22	LE BO PRODUCTS	163	SCHROEDER MUSIC	57
ALCO RESEARCH & ENG.	149	DELTA DIST.	88	LIBERTY INT'L	251	ALBERT SCHULTZ	122
ALLENTOWN RECORDS	135 & 136	DELYSE RECORDING	260	LIBRARY RECORDS	40	S. R. SCHWAB	142
ALLIED RECORD CORP.	178	DISC AWARDS	54	LITTLE AL'S	117	SCHWARTZ BROS.	83
ALLIED RECORD SALES	124	DISCOMETRO MUNDIAL	238	LONDON REC. (CANADA)	189	SCEPTER RECORDS	27
ALL-STATE REC. DIST. (III.)	76	DISCO-MUSIC	176	LONGMARK PRODUCTIONS	148	SCREEN GEMS	63
ALL-STATE REC. DIST. (N.J.)	93	DISCOPHON	241	MAGNETIC TAPE DUPL.	160	SEABOARD DIST.	82
ALL TAPES	109	DISCOS MUSART	224 & 225	MALVERNE DIST.	96	SEAWAY STEREO	160
ALPHA DIST.	99	DISCOS OREFEON	228	J. H. MARTIN	86	SEEBURG	4th Cover
ALSCAP	122	DISCOS PEERLESS	222	MARTIN & SNYDER	114	AUGUST SEITH	206
AM BAT RECORDS	116	DISCOS TIZOR	229	MASS. REC. DIST.	90	SERVICE ONE STOP	118
AMBERG FILE	162	DISQUES VOGUE	263	MASTERS RELEASING	52	SESAC	65
AMERICAN RECORD PRESSING	138	D. J. DIST.	80	MELODIE DER WELT	206	S. J. SHAW	128
AMERICAN RECORD SALES	118	DOREMI RECORDS	238	MEMPHIS DELTA DIST.	103	SILVER PLASTICS	127
ANAGON	234	DOUBLE B RECORDS CORP.	118	MERIT MUSIC DIST.	91	SNYDER ALBUM CO.	128
ANDREWS NUNNERY	130	DOVER RECORDS	28	MET RICHMOND REC. SALES	41	HENRY J. SOMMERS	70
APEX-MARTIN	94	DURIUM	217	METRO DIST.	101	SONET GRAMMOPHON	243
APRIL BLACKWOOD MUSIC	67	DYNA PRODUCTS	238	M.G.M. RECORDS	4-5	SOUTHLAND	84
A.R.C. ELECTRONICS	154	EASTERN ALLIED ASSOC. REC. DIST.	120	MIAMI RECORDS	47	SOUTHERN MUSIC	73
ARAGON PRODUCTS	125	ECONOMIDES RECORDING	261	MIDWEST TAPE DIST.	97	SOUTHERN MUSIC & PUBL.	259
ARCHAMBAULT	188	EDITION ALTONA	234	MIDWEST RECORD PRESSING	138	SPARTON OF CANADA LTD.	191
ARC SOUND LTD.	186	EDITION CODA	195	RAY MINER	143	SPECIALTY REC. CORP.	128
ARDMORE & BEECHWOOD	255	ELECTRIC MERCH. OF CALIF.	161	MIRA RECORDS	169	SPOKEN ARTS INC.	43
ARGO REC. LTD.	258	ELTRON EXPORT	122	IVAN MOGULL	75	STANDARD PRESSING	150
ARTPHYL CREATIONS	164	E.M.I. CANADA	190	MONARCH REC. MFG.	49	STAN'S RECORD SERVICE	114
ATLANTIC RECORDS	170	E.M.I. REC. LTD.	16-17	MOSRITE RECORDS	29	STAR TITLE STRIP	110, 115
AUDIO MAGNETICS	155	ENTERPRISE 13	144	MUSIC MERCHANTS	91	STAX RECORDS	30
AUDIO MATRIX	33	EQUINOX MUSIC	75	MUSIC, MUSIC, MUSIC, INC.	74	STEADMAN SALES	116
AURA SONIC	159	DAVID ESKIN	122	MUSKQUERTRIEB	247	STERLING TITLE STRIP	118
BARCLAY RECORDS	199	EVEREST (HI FI) RECORDS	45	NEGRAM	231	STEREO PRODUCTS	166
BARNEY'S ONE STOP	114	FERMATA INT'L	177	NEW DEAL REC. SERVICE CORP.	112	BOB STONE ASSOC.	182
BASART	234	FESTIVAL DISQUES	198	NEW JERSEY ONE STOP	117	STRIKE REC. LTD.	254
BILL BASIN	78	FIDELITY ELECTRIC	105	NEW ORLEANS DIST.	89	SUMMIT DIST.	85
ARNE BENDIKSEN	236	FIESTA RECORDS	47	NINA RECORDS	49	SUPERIOR PLASTICS	139
BERT—CO. CO.	132	FINEBILT MFG.	126 & 127	NIPPON COLUMBIA	221	SWEDEN MUSIC	246
BESTWAY PRODUCTS	130	FINE-TONE AUDIO PRODUCTS	97	JOHN O'BRIEN DIST.	106	TALENT MGT. PROM.	141
BETA DIST.	95	FRANCIS, DAY & HUNTER	249	ONE STOP SERVICE	128	TAPE TOWN	92
BIBLE VOICE	160	FRIENDSHIP MUSIC	219	ORIGINAL ONE STOP	115	TELDEC	203
8180 MUSIC PUBL.	75	DON GABOR ENTERPRISES	133	ORLAKE LTD.	261	TELESISTEMA MEXICO	226
BIGLAND-WHITE AGENCY	181	GARMISA DIST.	86	PARR'S PRINT & LITHO	186	TIP TOP MUSIC	107
BILLINIS DIST.	105	GARROD & LOFHOUSE	260	PATS ONE STOP	120	TONO	193
B.M.I. CANADA	180	GATE CITY ONE STOP	114	ED PENNY ASSOC.	141	TOWN HALL REC. ONE STOP	119
BOVEMA	2nd Cover	GATEWAY RECORDS	146	PEP RECORDS SALES	78	TRAN-CANADA	182
BOURNE MUSIC	66	GAUSS	157	PHILIPS REC (FRANCE)	197	TRINITY REC. DIST.	82
BRAVERMANN-MIRISCH	144	G.E.F. (GROUPE EOIT FRANCO)	190	PHILIPS REC. LTD. (ENGLAND)	257	TURIA RECORDS	35
JULIAN BROWN ENTER.	109	GENERAL DIST.	90	PHILIPS REC (THE NETHERLANDS)	232 & 233	TUTTI MUSIC	196
BURLINGTON MUSIC	258	GENIUS, INC.	55	PHONO RECORD PRESSING	132	UNICORN PRODUCTIONS	143
CALIF. MUSIC	121	GLOBE DIST.	82	PIC-A-TUNE	79	UNITED ARTISTS MUSIC INT'L 60 & 61	143
CALLECTRON	161	GODWIN REC. DIST.	84	PLASTICS PRODUCTS	124	UNITED ARTISTEC. LTD.	256
CAMPUS REC. DIST.	83	GOLDEN WORLD RECORDING STUDIO	145	PLATINUM RECORDS	52	UNITED REC. DIST.	86
CANADIAN MUSIC SALES	190	GOPHER LITHO	160	POLKA TOWN MUSIC	96	U.S.A. RECORDS	86
CAPITOL CUSTOM	131	GREENTREE ELECTRONICS	155	POLYDOR REC.	252	UNITED TAPE CORP.	81
CAPITOL INT'L	37	GREYER INT'L	228	PRIVILEGE DIST.	80	UNIVERSAL AUDIO SALES	147
CAPITOL RECORDS OF CANADA	187	G.T.A. MUSIC	211	PROMOTIONS LTD.	143	UNIVERSAL DIST.	100
CAPITOL RECORDS OF MEXICO	227	JAMIE GUYDEN RECORDS	39	KEITH PROWSE MUSIC	260	UNIVERSAL TAPE DEX CORP.	158
CARAVAN REC. SALES	182	HANS GERIG MUSIKVERLAGE	205	PYE REC. LTD.	250	VEDETTE REC.	216
CARDINAL EXPORT	122	HARBOR EXPORT	122	QUALITY REC. LTD.	184	VICTORIA MUSIKUERLAG	206
CARNIVAL RECORDS	52	HERMITAGE MUSIC	119	QUEEN CITY ALBUM	140	VIRREY INDUSTRIES	237
CARUSELLO	209	HUFFINE DIST.	80	RAINBOW REC.	150	W & G RECORDS LTD.	172
CBS INT'L	7	INDEPENDENT MUSIC SALES	77	RCA OF CANADA LTD.	179, 188	WALCO-LINCK	164
CBS REC. LTD.	254	INT'L CONSOLIDATED	79	RCA ITALIANA	213	WARNER BROS./REPRISE	8-9
CGD INTERNATIONALE	212	INT'L TAPE CARTRIDGE CORP.	153	RCA MEXICANA	223	MORTY WAX	141
CHARTER INDUSTRIES	165	ISLAND RECORD	259	RECORDING INC.	137	WENDY DIST.	92
CHIPS REC. DIST.	100	IVY HILL LITHO	3rd Cover	RECORD MERCHANDISING	78	WESTERN MERCHANDISERS	80
CLEVELAND RECORDING	149	J & J CORP.	92	RECOTON	166	EDWARD R. WHITE	127
CNR	230	DICK JAMES MUSIC	253	REDISCO	25	WHITNEY RECORDING STUDIO	148
COLUMBIA RECORDS OF CANADA	783	JOBETE MUSIC	59	REQUEST RECORDS	34	WIN RECORDS	116
COLUMBIA RECORD PRODUCTIONS	129			TONY RICHLAND	143	WORLD EXPORT	134
COMMANDER PUBLICATIONS	47			RICORDI	215	WORLD MUSIC	175
COMPO OF CANADA	185			RI FI RECORDS	214	Y.R.S. DIST.	92
CONSOLIDATED ONE STOP	113					VINCENT YOUNGANS, INC.	51

Good Companies
to do business with

For a world of top-grade products and services, be sure to check the important messages of the companies listed on these pages. They are among the best in the field.

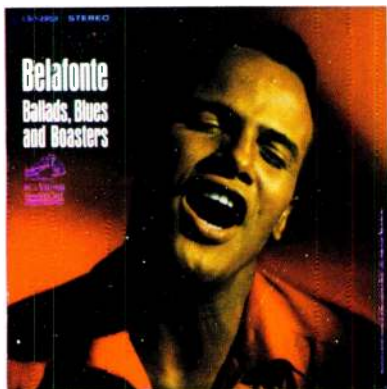

Quality Is Our Most Important Product

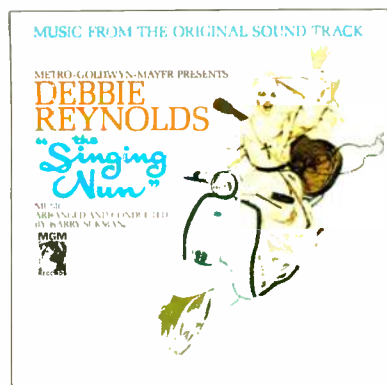

IVY HILL LITHOGRAPH

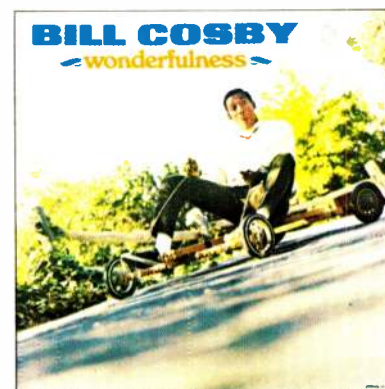

*Largest supplier of
printed material to
the record industry*

COMMUNITY DRIVE
GREAT NECK, NEW YORK
516 HU 7-0200



1919 EAST 51st STREET
LOS ANGELES 58, CALIFORNIA
213 583-8977



THIS COVER SPOT
RESERVED FOR THE
56 OTHER RECORD
COMPANIES IVY HILL
IS PROUD TO SERVE

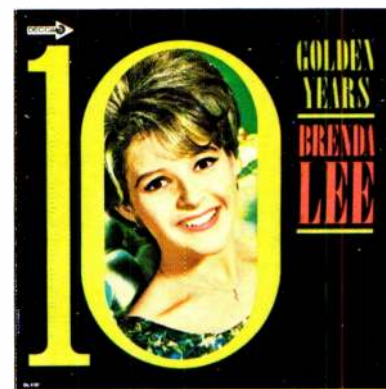

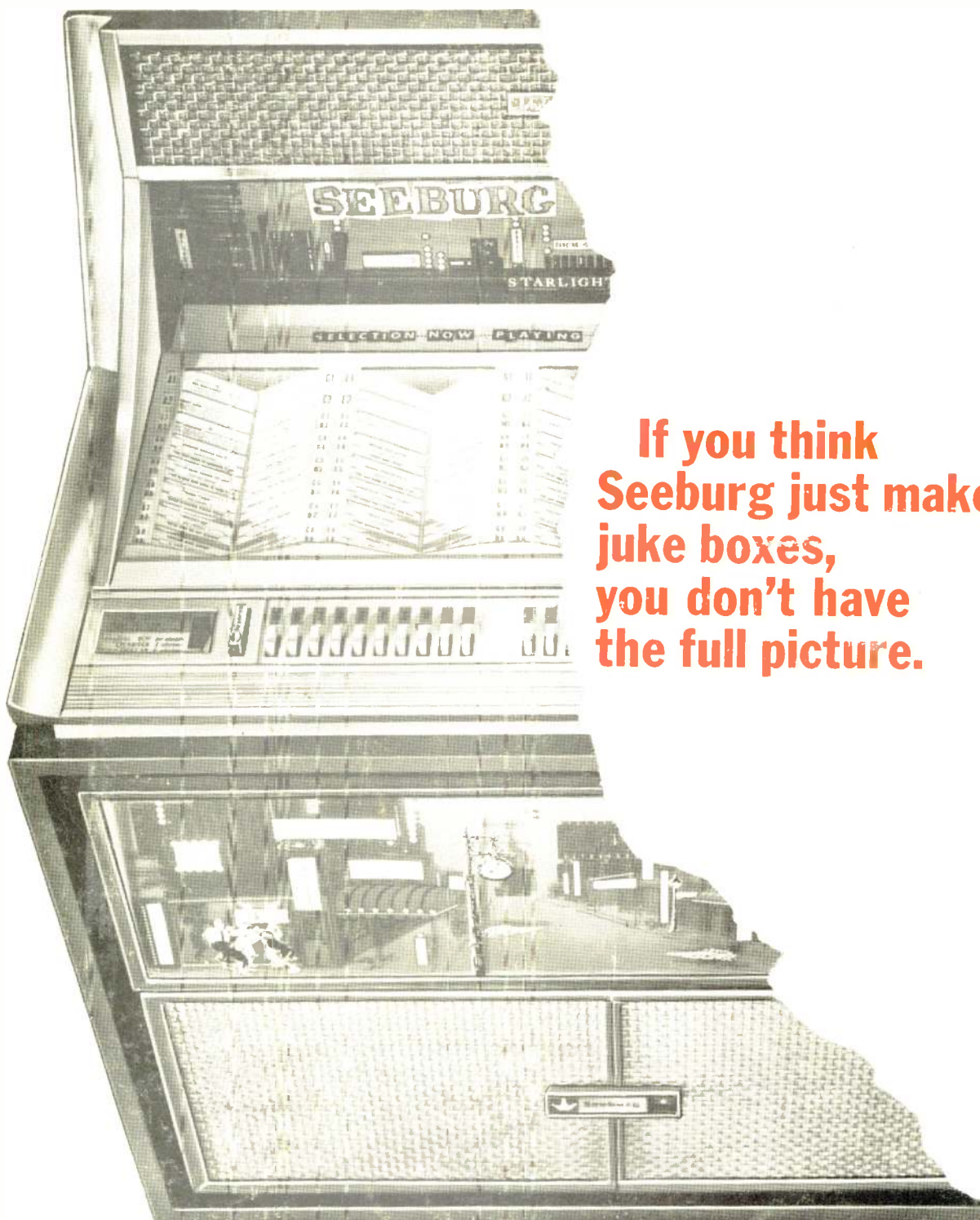

**If you think
Seeburg just makes
juke boxes,
you don't have
the full picture.**

Think of electronic organs. Think of guitars. Think of pianos. Think of hearing aids. Think of all kinds of vending machines. Think of band instruments. Think of background music systems. Think of amusement games. Think of music publishing. Think of phonograph records.

Now you have a better idea what Seeburg is thinking and making.

The Seeburg Corporation

International Headquarters Chicago E0622

Cavalier Division, Chattanooga, Tennessee; Choice-Vend Division, Windsor Locks, Connecticut; Gulbransen Company, Melrose Park, Illinois; Kay Musical Instrument Company, Elk Grove Village, Illinois; Qualitone Division, Minneapolis, Minnesota; H. N. White Company, Cleveland, Ohio; Williams Electronic Manufacturing Corporation, Chicago, Illinois.