

# CATJ

OFFICIAL JOURNAL OF THE COMMUNITY ANTENNA TELEVISION ASSOCIATION  
OCTOBER 1983

## Cable Interconnects Education

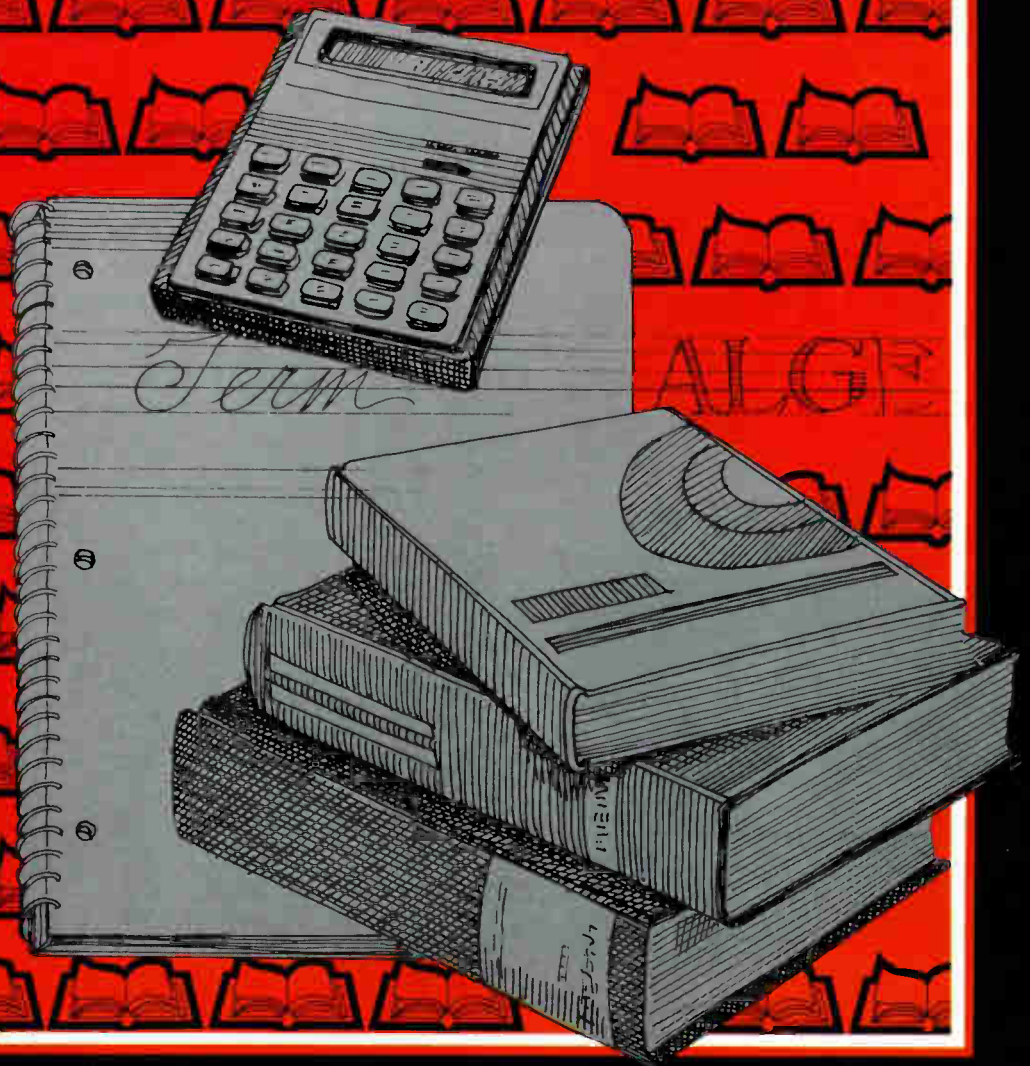

# ALCOA-NEC



## **ALCOA-NEC Communications Corporation is willing.**

ALCOA-NEC (ANCOM) has invested in top quality Direct Broadcast Satellite (DBS) equipment development and production ...plus the expertise to bring DBS service to market.

With DBS, consumers will own inexpensive antennas to receive TV signals directly from a satellite. Current projections see as many as 30 million compact dishes in place by 1990.

The vast resources of ANCOM's two parent companies, ALCOA and NEC, assure a DBS system unmatched for performance. ALCOA's sophisticated metallurgy and knowledge of mass production. NEC's years of experience in satellite electronics and low-cost, high-volume semiconductor applications. Plus extensive experience by both companies in marketing products directly and through distribution to professional users and consumers.

ANCOM is the best choice for any company entering 12GHz broadcasting on any scale. We are ready, willing and able to supply tomorrow's technology today...in the quantities and configurations to fit any individual purchaser's needs.

For more information, call or write for *Tuning in Tomorrow.*

**ANCOM**

**ALCOA-NEC**  
Communications Corporation

130 Martin Lane, Elk Grove Village, Illinois 60007  
Phone: (312) 640-8466  
TWX 910-222-5991 (ANCOM ELGR)

# Speedy Recovery



If you're stuck with equipment failure . . .  
stick a label on it and send it to us!

We're ComSonics. And unsurpassed response times are the special ingredients we've added to the quality repair service the cable industry has come to expect from us for over a decade.

**2-Day Turnaround** — Your damaged equipment is repaired to perfection and on its way back to you in a matter of hours.

**5-Day Turnaround** — We'll get your equipment working through our line, so you can get it back on line, fast.

**14-Day Turnaround** — Even our normal repair time is a priority, because we know in an emergency you can't afford to be left standing by.

Send us satellite receivers, headend, line and test equipment and field strength meters. We repair them all from our extensive inventory of parts.

When your cable equipment is down you don't need sympathy — you need results. You'll be relieved to know the "get well quick" message ComSonics delivers is a guarantee, not a wish!

**Watch your  
equipment repair  
problems  
dissolve!**

Call for your FREE handle on Fast Repair kit today.  
In VA call collect: 1-703-434-5965

**1-800-336-9681**

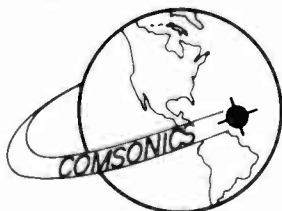

*An Employee Owned Corporation*

**COMSONICS<sup>®</sup>, INC.**

P.O. Box 1106      Harrisonburg, VA 22801  
UPS address — ComSonics Lane at Port Republic Road  
WorldRadioHistory



CATJ, The Official Journal for the Community Antenna Television Association is published as a service for Association Members and others providing services to the industry.

### TABLE OF CONTENTS

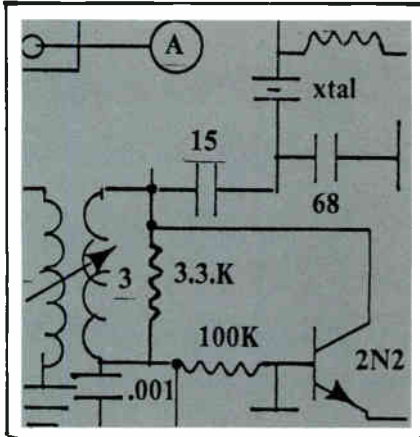

See Page 10

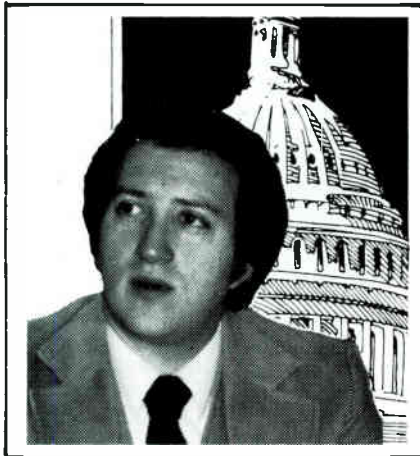

See Page 26

CATA and CATJ dedicate this October 1983 issue to Triple Crown Electronics of Mississauga, Ontario, CANADA, in observance of their tenth anniversary. We extend our congratulations to the growth and progress of this outstanding firm.

- 4 CATA-TORIAL — CATA President, Peter Athanas, discusses PECS — an educational concept designed by CATA member, George Barco, and Joe Gans.
- 6 DESIGN CONSIDERATIONS FOR CATV SYSTEMS — by David Emberson, Triple Crown Electronics Vice President, Mississauga, Ontario, CANADA who discusses the two basic methods of cable system operation which exhibit different merits, disadvantages, but similar results.
- 10 PRACTICAL TWO-WAY — having a problem with electrical noise or ghosting from your head end being in the wrong place?? Steve Richey found a way to solve that problem for his system in Stratford, Oklahoma.
- 20 THE FILTERED EARTH STATION — SEGMENT #17 by Glyn Bostick, Microwave Filter Company. This segment discusses the suppression method best suited to the interface level.
- 26 WASHINGTON UPDATE — Steve Effros, CATA Executive Director, features the situation at the present time with copyright and what steps should be taken — also a look at C-SPAN, PECS, and more!
- 30 FEED FORWARD — by Charles Evans, President, Triple Crown Electronics, Mississauga, Ontario, CANADA. This feature describes the push-pull 50-300 MHz, bi-directional distribution amplifiers with trunk quality integrated circuits.
- 33 “LIL’ dB” — Cartoon #1 in a series depicting the flow of a cable TV signal from its inception, through the cable system to a TV set. This comic strip series was generated by Craig Grisham, who has a broad background in the planning and engineering of laying cable television translines, from the drafting responsibility to the multi-unit engineering and design. We hope that “Lil’ dB” will become a helpful character and displayed in your cable office.
- 34 ASSOCIATES SHOWCASE
- 37 ASSOCIATES ROSTER
- 40 CLASSIFIED ADS

**ON THE COVER:** This month’s cover highlights the state-wide educational system in Pennsylvania. See the CATA-torial and the Washington Update for details.

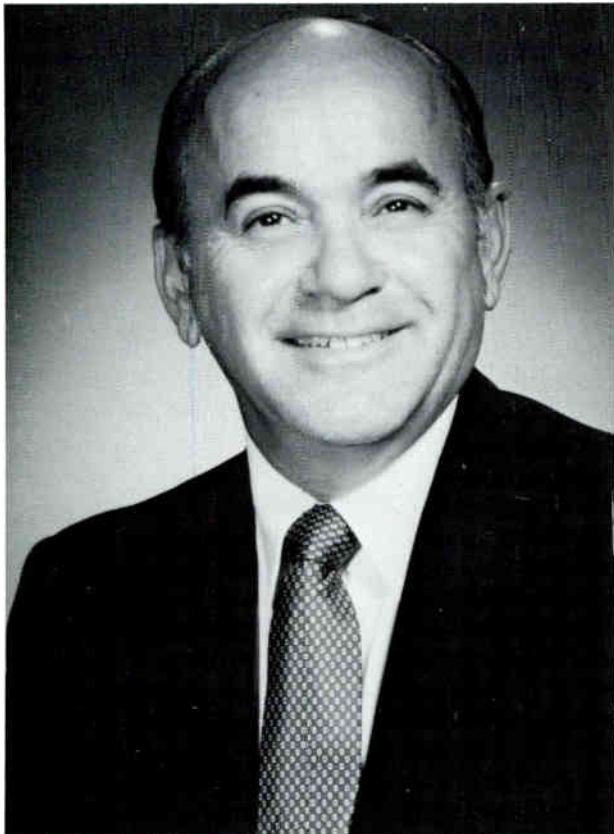

Peter Athanas  
President of CATA

## THEY HAD A DREAM — AND MADE IT WORK!

The Community Antenna Television Association has spent much of its almost ten year life urging government to allow private enterprise, and in our case specifically, cable television, to work. We are constantly saying that the government is mistaken when it thinks that creativity can be mandated or cooperation and quality effort guaranteed by the words in a franchise. Now we have a shining example of the proof of those statements.

It should come as no surprise to anyone that the triumph we are about to describe came about because of private initiative — specifically the efforts of independent cable television pioneers. As you will see, it should also come as no surprise that the consensus is that the government could have never accomplished through regulation what is now a reality.

What are we talking about? Well, the formal name is the Pennsylvania Educational Communications System, or PECS. At its inaugural ceremonies recently it was described as the largest microwave interconnect

system in the world. It spans the state of Pennsylvania interlinking, at the moment, 27 local cable systems serving over 500,000 subscribers. It's estimated that by the end of 1984 over two million subscribers will have access to the system. It includes 22 FM microwave sites, a multi-hop FM network expandable to 10 channels designed by Hughes Microwave and the entire network, designed in the shape of a "lazy figure eight" stretching sideways across the state is capable of full two-way transmission in either direction around the system. It truly is an incredible testament to the creativity and commitment of the cable operators in Pennsylvania. What is even more remarkable is that **NO** government funds were used to build the network, and there were **NO** requirements, franchise or otherwise to assure that the educational network was built!

So how did it happen? Well, it started out as the dream of two independent operators, George Barco, of Meadville, Pa. and Joe Gans of Hazleton, Pa. They became involved in the early '70s with some folks in the state education system in Pennsylvania who were looking at the possibility of a state-wide interconnect. At the time there were some feasibility studies done of using the various parkway right of ways and state police communications towers to do the job. The cable folks decided there was a better way. As it turned out, they were right. Had the state gone ahead with its plan, it would have cost (estimated in 1972 dollars) over \$10 million. The entire system now in place cost just over \$3 million. Joe was convinced that it could be technically done. George had an overriding feeling that his community and state had treated him very well over the years in his capacity as a cable operator and an attorney, and that it was time to return the favor. The two of them decided that one way or another they were going to get this thing done.

Needless to say, everyone told them they were crazy. The project was too big, they were told. You won't get the cooperation of all the other cable operators — was the common refrain. And after all, what are you going to put on the educational system once (if) you do build it? But these two pioneers and the many other cable operators who joined them in the effort decided it could be done, should be done, and would be a benefit to everyone.

The project waxed and waned for many years but the operators kept pushing. The key ingredient that ultimately made it work was the fact that the forward-looking administration at Penn State University also saw the potential, and, importantly, **DID NOT** ask that something be "given" to them for "free" as we are so used to hearing these days in franchise battles. Instead, Penn State came forward and said that if the cable industry would commit to building the physical system, the University would commit its resources to programming an educational channel for the system. That programming is now on 24 hours a day, and provides some of the most innovative educational programming seen anywhere in the country. A partnership had been formed between the educational community and the business (cable) community. And it worked.

Cable operators who are part of PECS have been paying funds into a central account for some time now to pay for the construction of the system. Hughes was contacted and created a microwave system that was expandable and met the foreseeable needs of the system. Penn State got to work and created the programming as well as provided manpower to see that certain parts of the system that was to be headquartered on their State College Pa. campus were ready to go. Cable operators pitched in headend antenna sites, construction crews, and Joe Gans Jr. spent almost 18 months spear-

heading the construction details. And the dream is now a reality.

No government funds. No government edicts. Just a cooperative effort between private enterprise and cable television operators. It started as a dream — primarily, but not solely of two men, two pioneers who have consistently taken the position in their cable careers that this business is more than just a franchise to deliver entertainment programming to the home—they could make a difference. For quite some time there were few who believed them. Then the support started to gel in the cable community in Pennsylvania. The funds and bank loan guarantees started to come — and the resolve to make it really happen developed. And it has.

Of course there are many more people who should be congratulated for this shining example of what we all can do. However we will, for now, focus our attention on **George Barco** and **Joe Gans**, because, according to their peers, they were the ones who were the catalysts for the remaining pioneering operators who joined the effort. And they deserve all the thanks that we can all give them for proving what we have been insisting all along: individual initiative, hard, honest work, and an abiding sense of the community you serve is what makes this industry great. **Thank you gentlemen — from all of us.** □

#### OFFICERS

Peter Athanas, President  
 Carl Schmauder, Vice President  
 Clarence Dow, Secretary/Treasurer

#### DISTRICT DIRECTORS

One	Clarence Dow (Maine)
Two	Michael J. Rigas (Pennsylvania)
Three	David Fox (West Virginia)
Four	John Rhinehart (Tennessee)
Five	Joe Bain (Oklahoma)
Six	Wayne Sheldon (California)
Seven	Carl Schmauder (Oregon)
Eight	Virgil Mehus (Minnesota)
Nine	Peter Athanas (Wisconsin)
Ten	Jim Hays III (Kentucky)

#### VICE DIRECTOR

Lee Holmes (Guam)  
 Richard Gessner (Ohio-District 10)

#### ASSOCIATES' DIRECTORS

Lynn Watson, Showtime, Inc.  
 Ernie Larson, Larson Electronics

#### DIRECTORS EMERITUS

Gene Edwards (Ohio)  
 Chuck Kee (Oregon)  
 William Ridsen (Kentucky)

#### CATJ STAFF

**President and Publisher**  
 G.H. Dodson

**Business and Managing Editor**  
 Celeste Rule Nelson

**Executive Assistant to the Editor**  
 Diane Howard

**Circulation Manager**  
 Lori Biggers

**Contributing Editors**  
 S.J. Birkill, Stephen Effros,  
 Ralph Haimowitz  
 Steven K. Richey

**Art Director/Marketing**  
 Phyllis Crumpler

**Assistant Art Director**  
 Dianna Johnson

#### OFFICES

National Headquarters  
 CATA/CATJ  
 Celeste Rule Nelson, Managing Editor  
 4209 N.W. 23rd, Suite 106  
 Oklahoma City, Ok. 73107  
 (405) 947-7664; 947-4717

CATA (Washington Office)  
 Stephen R. Effros, Executive Director  
 3977 Chain Bridge Rd.  
 Fairfax, Va. 22030  
 (703) 691-8875

CATA (Engineering Office)  
 Ralph Haimowitz, Director  
 518 21st Street S.W.  
 Vero Beach, Fl. 32962  
 (305) 562-7847

The Community Antenna Television Association, Inc. is a nonprofit organization formed under Chapter 19, Title 18 of the Statutes of the State of Oklahoma. As such, no part of its assets or income shall be the property of its members, such assets and income shall be devoted exclusively to the purposes of the Corporation.

The Community Antenna Television Journal (CATJ)—ISSN-0194-5963—is published monthly by Television Publications, Inc., 4209 N.W. 23rd, Suite 106, Okla. City, OK 73107. Subscription price: \$18.00 per year, \$22.00 per year Canada, Mexico, and foreign is \$25.00 per year. Second class postage paid at Oklahoma City.

**POSTMASTER:** Send address change to 4209 N.W. 23rd, Oklahoma City, OK. 73107.

CATJ is a Copyright © 1983 by the Television Publication, Inc. All rights reserved. Qudean reservados todos los derechos. Printed in U.S.A. Permission to reprint CATJ published material must be given by Television Publications, Inc., prior to republication.



---

# Design Consideration For CATV Systems

By: David Emberson  
Triple Crown Electronics

---

In the past, most systems have been operated using one of two basic methods, both of which exhibit different merits, disadvantages but similar results.

As many factors have changed recently, it becomes necessary to evaluate these changes. And in understanding the aspects of these two methods, and in the application of these new developments, it is possible to combine the best of both methods, forming a third method of system operation and — or, design.

## METHOD #1

System operation based on "Input Oriented Levels" was applied to early systems utilizing tube type amplifiers to insure that the input levels were maintained, preserving the signal-to-noise throughout the system.

As most systems carried only a few channels, the only indication of output capability was perceptible Cross-Modulation.

High output levels were more often detected by the resultant "sync clipping", which caused pictures to roll vertically. The lack of Automatic Gain Control (AGC) circuitry and the instability of electron tube circuits caused the amplifiers output levels to vary constantly, usually decreasing as the tubes aged. It was necessary to maintain proper input levels to prevent serious degradation of the system signal to noise.

Output levels of preceeding amplifiers were adjusted to ensure proper input levels to the following amplifier and these input levels were maintained as flat as possible across the spectrum. The output levels of distribution amplifiers were maintained at higher levels closer to the beginning of the system allowing distortion products to increase more quickly to permissible levels, while distribution levels toward the end of the system were

reduced relative to the amplifier cascade by which it was being fed. In this manner an attempt was made to maintain the levels of distortion throughout the system.

Early transistor systems were operated along similar lines, however, because of substantially lower output capabilities, maximum output levels decreased, thus reducing the operating gain of these early transistor amplifiers.

The design and maintenance of such systems was complicated and difficulty arose in allowing the use of the amplifiers maximum output capability because high input levels which could result in the generation of distortion products within the input or intermediate stages of amplification, due to erroneous allocation of Slope and/or Gain controls.

The technician had to understand the amplifier design to be able to accurately determine the operating levels for every distribution amplifier location, or he would constantly refer to his own field notes, which were always being up-dated to permit compensation for line loss changes and temperature fluctuations.

The main advantage of this method was in the full utilization of the capabilities of every distribution amplifier in the system.

## METHOD #2

System operation based on "Output Level Orientation" was used to reduce the incidents described in Method #1. In Method #2 amplifier of a specific type operated at the same output level regardless of its location in the system. The input levels were allowed to vary over a range that was mainly determined by the range of the Slope and gain controls of the amplifier. Typical levels in such system could be as follows:-

---

<i>Amplifier Type</i>	<i>Ch. 2</i>	<i>Ch. 13</i>
Trunk output (DBmV)	+ 25 to + 30	+ 27 to + 38
Trunk input (DBmV)	(+ 10 to + 17 depending on slope)	
Bridger output (DBmV)	+ 34 to + 38	+ 40 to + 48
Line Extender output	+ 34 to + 38	+ 40 to + 48
Line Extender input	(+ 18 to + 30 depending on slope)	

---

(The above levels were also determined by the degree of channel loading on the system).

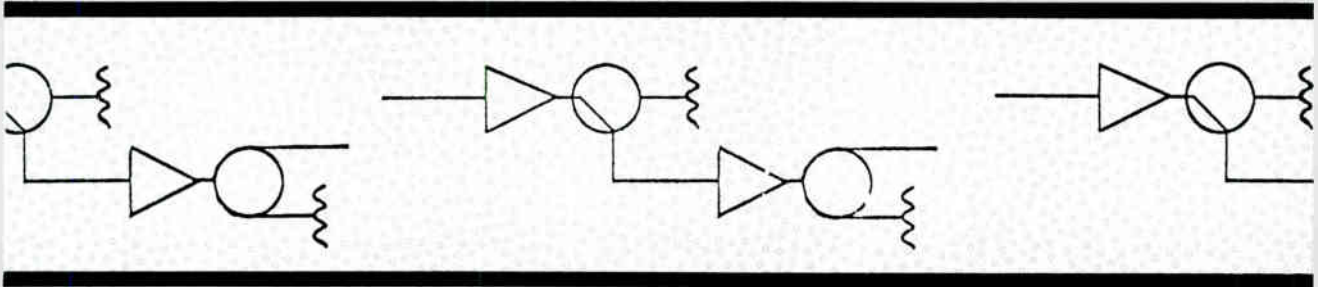

These levels were normally calculated for "worst-case" situations at the end of the system with a fixed number of line extenders permitted. These same operating levels were then applied throughout the entire system to ensure a system would operate within the permissible levels of distortion used in the "worst-case" calculation. While this method contributed to the simplicity of system design, wasted amplifier capability is considerable unless distribution lines are extended beyond the "predetermined number" of allowable line extenders. Provided, of course, that the output levels can be maintained using either thermal level compensation or automatic gain control. Without such controls the maintenance of these extended line extender cascades becomes more difficult with signal and temperature fluctuations.

It is necessary that the designer be aware of the various distortion factors so that he may appreciate the convenience and so use the necessary design charts provided by the systems engineers.

### CURRENT AMPLIFIER DESIGN

During the past four years advances in solid state devices has produced the hybrid broadband amplifier specifically designed for use in CATV amplifiers.

These devices generally surpass the performance of discrete transistor amplifiers.

Many such devices have been produced each exhibiting different performance characteristics for noise figure, gain, bandwidth and output handling characteristics.

Knowing the layout of the system, it is possible to calculate the specifications necessary in each group of amplifiers, to ensure that the permissible distortion levels will be met in any specific location within the system.

### TRUNK/BRIDGES VERSUS LINE EXTENDERS

In reviewing the individual specifications for amplifiers it becomes apparent that line extenders using state of the art IC's can perform as good or better than classical trunk amplifiers using "non-IC" design and will equal state of the art trunk amplifiers in terms of

I.M. performance.

It was suspected that the differences between the Trunk/Bridger Combination and the current high quality line extenders should be very slight.

In the past, manufacturers such as C-Cor produced separate units containing trunk amplifiers and bridger amplifiers in separate housings and coupled the two feeding the bridger amplifier from a feeder port on the trunk amplifier.

Such a configuration was simulated using two current line extenders with "outboard" couplers and splitters, resulting in a two output Trunk/Bridger Combination.

The performance of these line extenders was then directly compared to that of a Trunk/Bridger Combination.

The line extender configurations shown using the outboard couplers splitters in Figure #1 below, —

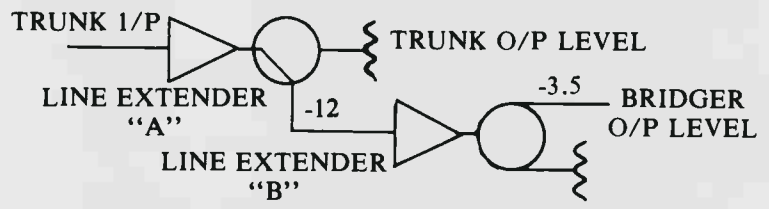

The results of the comparison are shown in chart #1.

Both the trunk amplifier of the Combination and Line Extender "A" were adjusted to the trunk levels previously shown with Channel Two output at +25 DBmV, Channel Thirteen at +29 DBmV and 300 MHz at +31 DBmV.

Current line extenders have almost 30 dB of gain while the required operation for trunk transportation is closer to 20 dB of gain. It is necessary to reduce the gain of the line extender without excessive detriment to the noise factor of the amplifier and this is best accomplished by use of an interstage attenuator.

The Bridger Amplifier of the combination and Line Extender "B" were adjusted for a flat output from channel two to 300 MegaHertz of +49 DBmV on both outputs to facilitate the test set-up. ➤



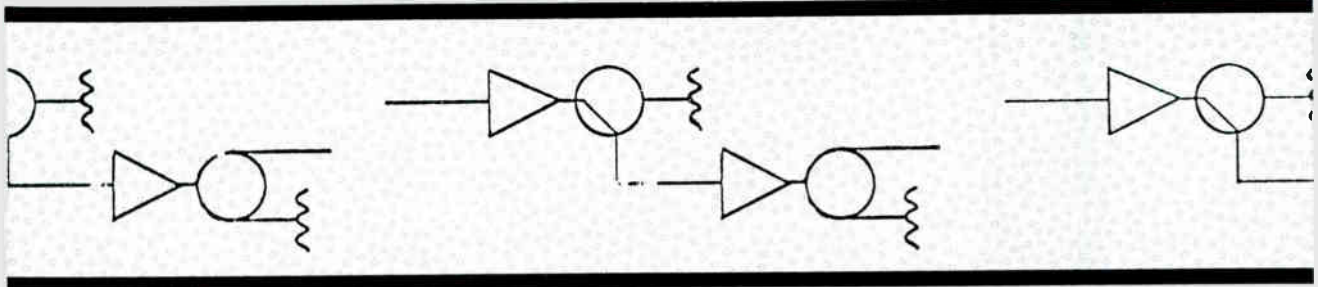

Tests were made using an E1E (RCA) A-B coaxial switch to ensure equal conditions for all measurements.

CHART #1

PARAMETER MEASURED	TC	LE
Bandwidth	50-300	50-300
Frequency Response	+ .25	+ .25
Distortion Characteristics		
Superband Composite T.B./S.O.	-68	-65
Highband Composite T.B./S.O.	-58	-63
Midband Composite T.B./S.O.	-55	-65
Lowband Composite T.B./S.O.	-65	-67

It was noted during the tests for triple beat and second order, that the grass or noise level along the base line of the display decreased about 2 dB for the Line Extender Combination indicating a slight improvement in signal-to-noise ratio over that of the Trunk Combination.

#### POWER CONSUMPTION MEASUREMENTS

Power consumption was also compared using a 60 volt sinusoidal transformer and measuring the voltage drop through a .51 ohm, 1 watt resistor.

The Trunk/Bridger Combination produced a voltage drop of .14 volts indicating a current draw of approximately 275 M.A.

The Line Extender Combination produced a voltage drop of .12 volts indicating a current draw of 235 M.A.

While this is not to be considered an absolute reading, it does indicate the power consumption is almost equal using this particular type of line extenders. These results are expected to vary with different models from various manufacturers.

The passive devices used were of high quality, fused for AC powering and using VSF type connectors to facilitate the assembly of the units. Mating of the units for line installation was easy and the final assembly resulted in quite a visually acceptable package with all the mounting brackets falling "in-line".

Both the Trunk/Bridger Combination and the Line Extenders were capable of two-way operation.

#### SUMMARY

In this particular case the equipment used in the Line Extender configuration were: (a) Triple Crown Line Extenders DL350/DL352 and (b) Anaconda Model 2400 series Couplers and Splitters.

Some of the reasons for using these particular units are as follows: —

##### (a) Line Extenders

(1) The Triple Crown Line Extender contains an inter-stage attenuator, which permits gain reduction of the unit to about 22 dB of gain for the Trunk Amplifier.

(2) The unit is competitively priced and readily available.

(3) The unit is also available with inter-stage AGC.

##### (b) Couplers/Splitters

(1) Fusing is important in system design and the Anaconda 2400 Series Couplers/Splitters use a standard AG type fuse (available at most garages and service stations). The entire system can be fused to permit isolation of areas suffering AC problems.

(2) LED indicators are available to give a visual indication of the powering.

(3) The boards in these units can be changed or replaced without need to change the housing or the connectors.

These two types of units, when mated together, mate quite nicely and permit easy access to the test points of the amplifiers, both input and output.

#### CONCLUSION

This exercise began by comparison of distortion products of amplifiers. The tests, however, resulted in some rather pleasant surprises!

(1) The results of Chart 1 were impressive.

(2) The esthetic appearance of the final assembly is quite acceptable.

(3) A cost savings of approximately 60% can be realized, and cannot be ignored, and the amplifier performance is equivalent or even better.

Knowing that manufacturers of high level line extenders are using the best "state-of-the-art" devices, new and different ideas in System Design may be generated, maintaining BP23 levels while also realizing substantial cost savings. □

# ORDER YOUR SESSION

## TAPES NOW!

Cassettes are \$7.50 each when purchased individually or \$6.50 when purchased in orders of six (6) or more. The extended sessions are \$12.50 for the set.

### THURSDAY, August 11th SESSIONS

Quantity

- 1. Buying & Selling Cable Systems
- 2. Making A Clean Sweep of It
- \*3. Common Cable System Problems

Quantity

- \*4. Washington Update
- 5. Confusing, Consternating, Contraptions...
- 6. Double-Up Systems Channels...

### FRIDAY, August 12th Sessions

Quantity

- 7. The Scramble to Scramble Is On
- 8. Tiering & Packaging Cable Services
- \*9. Cable Antennas For Le\$\$

### SATURDAY, August 13th Sessions

Quantity

- 10. Adult Entertainment...Cable Television
- 11. Creating Effective & Profitable Local Ad Force
- \*12. Everything you wanted to know about the FCC
- 13. Open Forum: Steve Effros, CATA, Exec. Dir.

Quantity

- 14. Somebody's Interfering With My TVRO...
- 15. New Technology on Fiber Optics
- 16. Get Your Daily Paper On Cable

\*Indicates 2 Cassette Sessions

Enclosed you will find our check for \$ \_\_\_\_\_ to cover the tapes and mailing charges.

TOTAL ORDER \_\_\_\_\_ NAME \_\_\_\_\_  
5% Postage Charge \_\_\_\_\_ COMPANY \_\_\_\_\_  
Amount Enclosed \_\_\_\_\_ MAILING ADDRESS \_\_\_\_\_  
CITY/STATE/ZIP \_\_\_\_\_  
AREA CODE/TELEPHONE NO. \_\_\_\_\_

**SEND ORDER FORM AND CHECK TO:  
PERSONALIZED CASSETTE SERVICE  
5600 Brookwood Terrace  
Nashville, TN. 37205**

**PAYMENT MUST ACCOMPANY ORDER**

# BY POPULAR REQUEST CCOS '82 SESSION TAPES

Cassette Tapes are \$6.50 each, except for the sessions that were 1½ hour in duration, requiring two or more cassettes. These extended sessions are \$10.50 each.

\*Indicate 2 Cassette Sessions.

## MONDAY, July 5th Sessions

Quantity

- \_\_\_ 1. Solving Bad Debt Problems
- \_\_\_ \*2. What Is A Cable System
- \_\_\_ 3. Surely Insured

Quantity

- \_\_\_ 4. Let's Analyze The Situation
- \_\_\_ \*5. Refranchising Open Forum
- \_\_\_ \*6. Big Bucks in a Small Town

## TUESDAY, July 6th Sessions

Quantity

- \_\_\_ 7. Advertising On Cable Pays
- \_\_\_ \*8. What Will Two Or Three Degree Spacing Do To Your TVRO Reception?
- \_\_\_ 9. Ad Spots On Satellite Programming

Quantity

- \_\_\_ \*10. Keep That System Equipment Operating Properly
- \_\_\_ 11. Equipment and Interface
- \_\_\_ 12. Find Out What's New On The Birds

TOTAL ORDER \_\_\_\_\_

5% Postage Charge \_\_\_\_\_

Amount Enclosed \_\_\_\_\_

Enclosed you will find our check for \$\_\_\_\_\_ to cover the tapes and mailing charges. Please send the tapes to the following:

**SEND ORDER FORM AND CHECK TO:**

**PERSONALIZED CASSETTE SERVICE**  
**5600 Brookwood Terrace**  
**Nashville, TN. 37205**

NAME \_\_\_\_\_

COMPANY \_\_\_\_\_

MAILING ADDRESS \_\_\_\_\_

CITY/STATE/ZIP \_\_\_\_\_

AREA CODE/TELEPHONE NO. \_\_\_\_\_

**PAYMENT MUST ACCOMPANY ORDER**



*The big news is clustering  
and regional networking.*



## *Hughes AML™ Microwave Systems*

### **NYT CABLE SELECTS HUGHES**

NYT Cable has completed the monumental task of tying together 55 franchises to serve 105,000 suburban subscribers spread across the southern part of New Jersey. To accomplish this, NYT utilized the Hughes AML Microwave System. According to Director of Cable Operations, Dave McDonald, NYT Cable could not have achieved such clustering without an AML. This uniquely cost-effective system is presently serving 35 channels covering 2800 miles of cable plant through 10 hubs—4 from an AML transmitter located at Arney's Mount and 6 from a second transmitter at Audubon, New Jersey. Since the initial installation in 1979, NYT Manager of Engineering, Rich Gregory, reports that they've had no serious problems.

### **THE ROLE OF AN AML IN CLUSTERING**

The fact is, more and more major cable companies like NYT Cable are turning to clustering for regional advertising and to improve profitability by the consolidation of marketing, management, and operations. And when regional clustering is under consideration, Hughes AML Microwave is the only choice. With an AML, you also gain the flexibility to continue to expand easily in any direction—without adding costly equipment. Plus with Hughes you get in-depth training and field support unparalleled in the industry.

### **CALL TODAY**

Find out the full story. Contact the people at Hughes today. **Hughes Microwave Communications Products**, P.O. Box 2999, Torrance, CA 90509, (213) 517-6233.

### **AML—ANY MODULATION LINK**

*Creating a new world with electronics*

**HUGHES**

HUGHES AIRCRAFT COMPANY

# PRACTICAL 2-WAY

One of the problems in a Cable System is that sometimes you put a head end up in the **wrong** place and you find out too late you have the problem of electrical noise or ghosting. The problem came up in our Stratford, Oklahoma system; on the day we checked the site, Channel 4 & 5 were clean of electrical noise. Once we put the system in operation, the electrical noise on 4 & 5 varied from nonexistent to so bad you could hardly see the chan-

By: Steven K. Richey  
TelTran, Inc.  
Azle, Texas

nels — bad enough so that with the best bandpass filter and processors, we had noise spill over into 3 & 6, and sometimes Channel 2. The obvious solution was to move the head end, but this was a problem that we did not feel we wanted to undertake at this time. The second solution was to pick up Channels 4 & 5 at

another location and feed them back to the existing head end. This is the solution we selected to do. On the north side of town, there is a water tower and, when we checked the tower (City water tower), there was a beautiful Channel 4 & 5 on top of it. This is a little system, and the new site is approximately 2 miles from the existing head end. Our initial thought was to run a second cable back for 4 & 5, but then we decided to convert 4 & 5 to sub-band

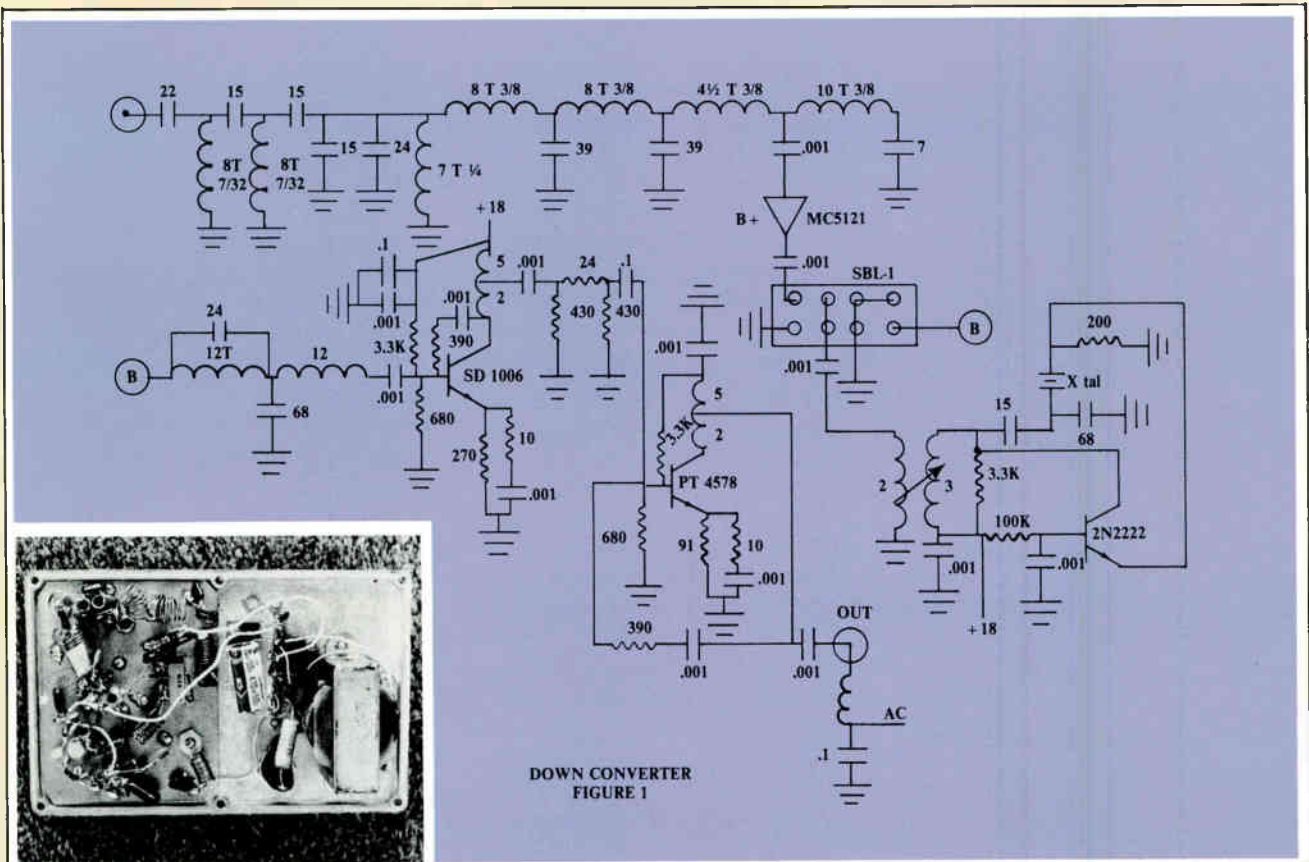

# The Technology of TOMORROW

## from the Innovators – LRC Electronics

LRC Electronics introduces its latest connector engineering innovation—the “K” Series. Designed for ease of installation and total reliability in future systems, the “K” Series features:

- 30db minimum return loss from 0-850 MHz. (LRC will supply test data.)
- Identifying part number permanently stamped on main body of connector.

- Design incorporates LRC's patented seizing mechanism for complete reliability.
- No cold flow of plastic materials —Mechanical holding strength is maintained through temperature cycles of - 100°F to + 200°F.
- Time proven positive stops for elimination of torque specifications.
- Silver plated terminals for excellent RF conductivity.

For more information about the innovative “K” Series, contact your LRC sales representative or call (607) 739-3844.

**AUGAT LRC**

*Quality and Innovation*

LRC Electronics, Inc.  
901 South Avenue  
Box 111, Horseheads, NY 14845





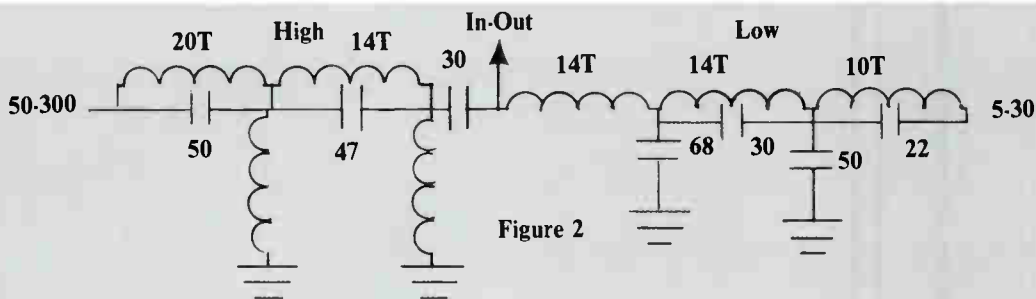

Figure 2

## TERRESTRIAL INTERFERENCE.



ASTI is the first complete professional handbook on the avoidance, diagnosis and suppression of microwave *terrestrial interference* (TI) at TVRO earth stations. This 250 page comprehensive volume was compiled by an engineering team headed by Glyn Bostick, President of Microwave Filter Company, with valuable input from many

industry leaders such as California Amplifier and Scientific Atlanta. The result of their effort is an in-depth exploration of such topics as equipment selection for minimizing TI susceptibility, use of natural and artificial shielding, system filtering, and many other cost effective techniques! Send this coupon now to receive our free brochure on ASTI, and get TI out of the picture!



## BANISHED.

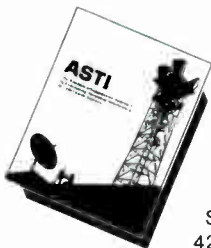

**YES!** Send me the Free brochure on the ASTI Handbook!  
 **YES!** Send me the ASTI Handbook. My payment of \$125 is enclosed:  Check  Money Order  
 Name \_\_\_\_\_ Phone \_\_\_\_\_  
 Company Name \_\_\_\_\_  
 Address \_\_\_\_\_  
 City/State/Zip \_\_\_\_\_

Send to: CATJ Magazine,  
 4209 N.W. 23rd St., Suite 106, Oklahoma City, OK, 73107

## HI-LOW FILTER

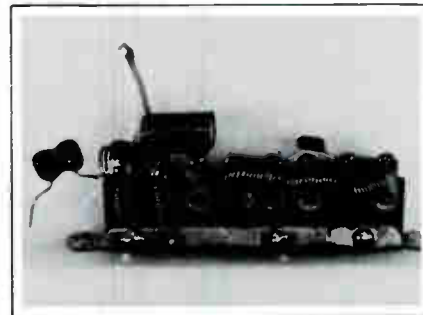

to bring it back up to existing cable to the head end and convert it back to Channel 4 & 5. The only problem with this was the trunk line equipment was not two-way or two-way capable, so we had to modify it **first!**

This article will be about: first, the down converter where we converted 4 & 5 down to subchannel area; second, the up converter; and, third, modifications we made on the amplifiers.

Now we build our own amplifiers but the modification we made can be used on any amplifier ever manufactured. The down converter (**Figure 1**) starts with a simple low pass, high pass filter giving us effective bandpass filter for Channels 4 & 5. Then, in our particular case, we had low inputs of about 3 dB off our antenna so we have 26 dB gain NEC 5121 chip amplifier to bring signal level up before we feed it into the double balance mixer. In the mixer, we mix the 67.25 to 81.75 input frequency with a local oscillator to give us the difference frequency of 8.875 to 23.375. The crystal frequency is **not** that important for this case. We just happened to have two 90.625 crystals in stock. The result-

ant output is fed thru a low pass filter into a two stage amplifier with a 30 MHz bandwidth, and then onto the line at a level of approximately 40 dB.



**LOW-PASS**

We selected this level because we are running the antenna without any type of AGC. This unit is capable of about 55 dB output with two channels, we selected 40 to give us enough room to swing up to 15 dB without any overdrive problems. On the output of the unit, there is an RF choke so that we can cable power this unit, and do not need to have 117 volts at our antenna location. Power supply is a tapped transformer supply that is similar to what we use in the amplifiers that we build. We only had to go thru three amplifiers for this, and we modified them by building filters (Figure 2) and placing them on the input and output of the amplifiers (Figure 3). The filters are basic three pole highpass filter on the input and output to give us 50 to 220 MHz forward bandpass and a 30 MHz cutoff three pole low pass filter. One thing you are going to have to play with, should you do this, is the AC powering because the two will interact; we tied the two low pass filters together and then brought a simple AC choke off the junction of this point to tie the AC back into the power supply (Figure 3). The filters that we outline are simple, easy to use, and need very little adjustment to make them work right. You need to be careful when you are building your high low filters to make sure the

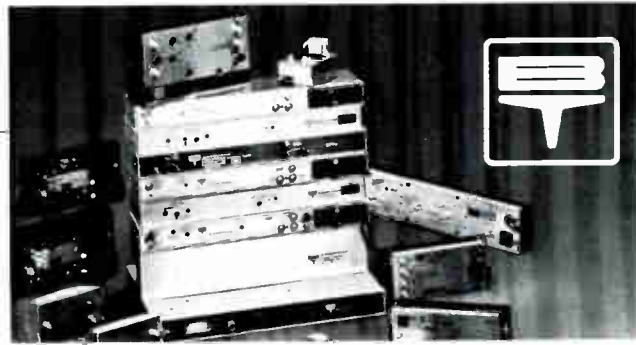

## Look to us for high quality B-T no-wait CATV equipment.

We have it in stock for immediate delivery. Or pick-up.

Blonder-Tongue stock items include: antennas, amplifiers, modulators, converters, filters, headend accessories, traps, processors, preamps, and more. Call us for what you need.

## Davco, Incorporated

**America's Oldest CATV Distributor**

- Same day shipment
- Help when you need it
- Everything you need in one stop
- In business since 1949!



Authorized  
Blonder-Tongue  
Stocking  
Distributor

P.O. Box 2456

Batesville, Arkansas 72501

(501) 793-3816

FOR **RELIABILITY-SERVICE**  
**PROMPT PARTS DELIVERY**  
**"WE EXCELL"**  
**RUGGED!**  
**COMPACT!**

**L-1 CABLE-LINE LAYER**

**MANEUVERABLE  
ONLY 800 LBS.**

**24 1/2" WIDTH  
TRACK SYSTEM  
PROVIDES  
AN IDEAL  
SOLUTION TO  
UNDERGROUND  
HOUSE DROPS**

**PHONE —  
CABLE TV —**



**E  
X  
P  
L  
O  
D  
E  
S  
M  
Y  
T  
H  
I  
S  
B  
I  
G  
I  
S  
B  
E  
T  
T  
E  
R**

**157 SENECA CREEK RD.  
BUFFALO, N.Y. 14224**

**PHONE (716) 675-7373**



**NO LAWN RESTORATION**

**PROVEN FOR 10 YRS.**

OCTOBER, 1983

CATJ

13

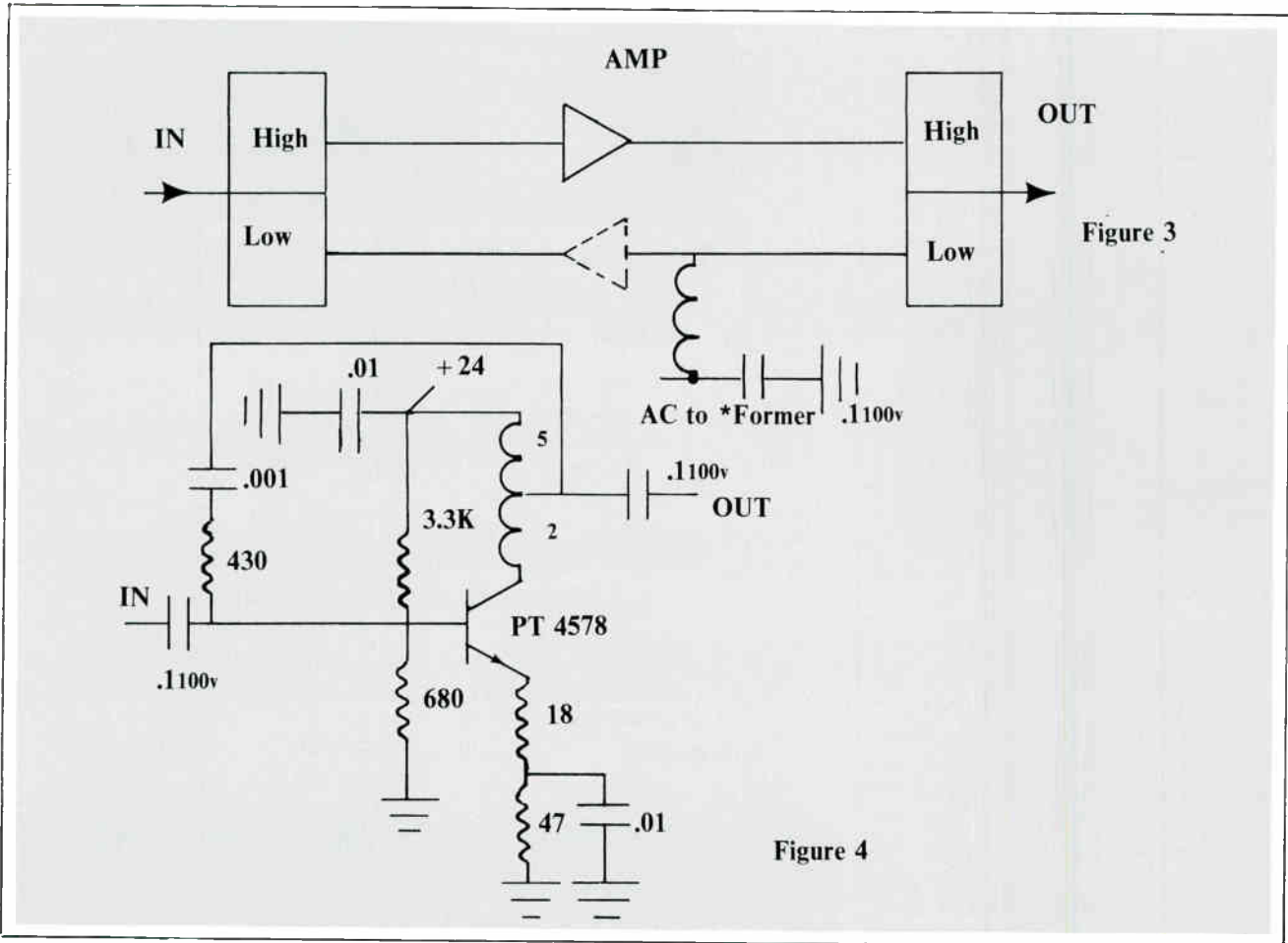

### RETURN AMPLIFIER

capacitors have a working voltage of at least a 100 volts, preferably 500 volts. We use three amplifiers and only one has reverse amplification which (Figure 4) amplifies this to 15 dB of gain. It also has built in equalization, equivalent to 25 dB of cable.

The up converter (Figure 5) consists of a three section low pass filter, followed by a low noise amplifier and a SBL1 double balance mixer mixing again with a 90.625 oscillator. The reconverted Channel 4 & 5 then goes through a high pass filter with a 50 MHz cutoff, amplifier and a two-way splitter. We come out of the two-way splitter into two Microwave Filter bandpass filters, one for Channel 4 and a separate bandpass filter for Channel 5. We are using the bandpass filters to filter out any local oscillator that comes through,

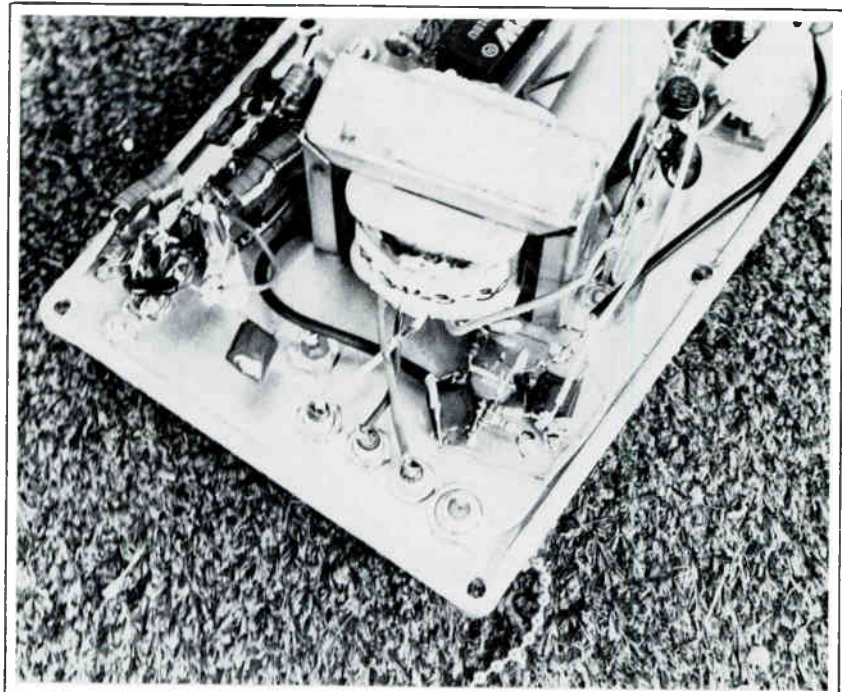



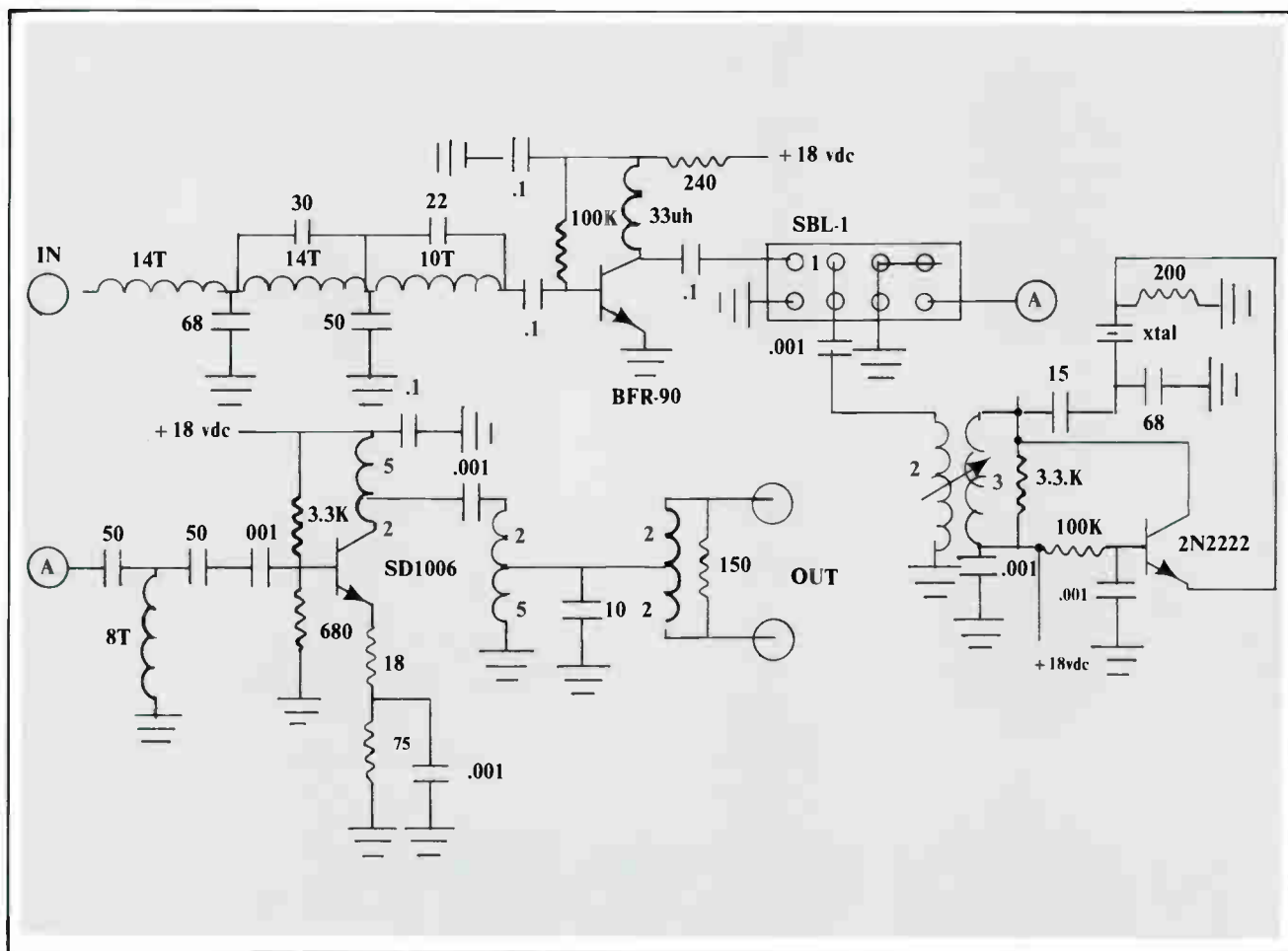

UP CONVERTER FIGURE 5

continued on page 18

and to separate the channels before we feed them into a strip amplifier.

Speaking of local oscillators, when we installed the down converter, we had some problems with the local oscillator getting out into the line, so we built an identical second low pass filter to filter in the input of the up converter in a small box mounted it externally to the down converter, and this solved the problem. Powering up the converters is a simple bridge rectifier transformer and an 18 volt regulator, and the only thing to be careful in using the 18 volt regulators is that **both** input and output (Figure 6) need to be fairly well bypassed to ground with a capacitor. The large 470Uf capacitor on the input is adequate, but the output needs to have 1Mfd capacitor to ground. This is not a project that everybody needs,

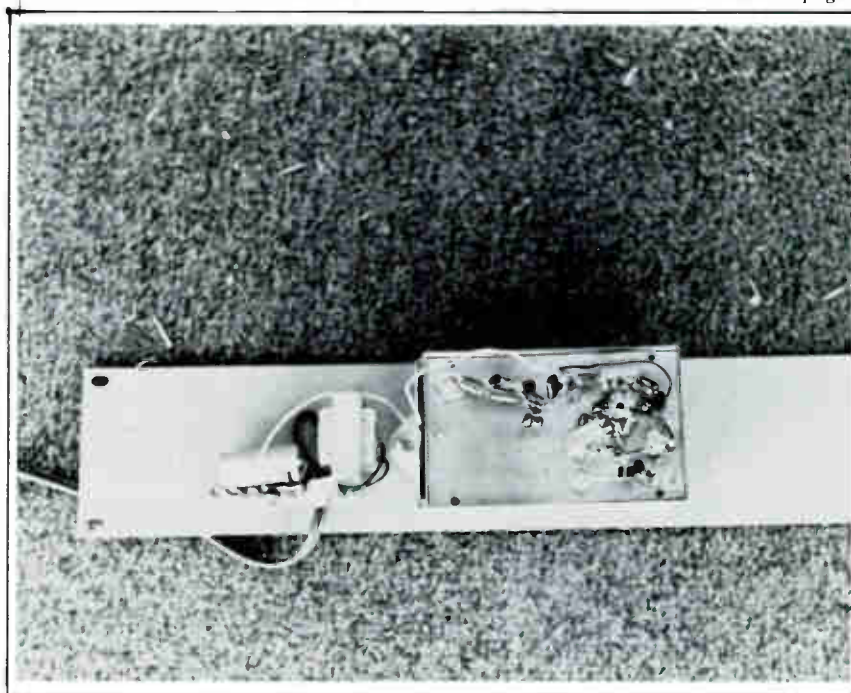

# LETTERS

CATA:

We would like to express our sincere thanks to Peter Athanas, Clarence Dow, the exhibitors and others associated with the Hot Springs, Ark. Seminar for the hospitality and courtesy shown to friends of ours who were allowed to tour the exhibits as guests. Each Seminar we attend seems better than the last and this year was no exception.

Thanks again.

Sincerely  
Pete and Ruth Ingle  
Ingle's TV Cable Co.

Dear Mr. & Mrs. Ingle:

Sometimes after months of hard work and planning for CCOS, we need to have some encouraging words, and you certainly filled that bill!! Thanks for your letter; it makes planning the next one an exciting responsibility.

C.R.N.

## 1983 TECHNICAL TRAINING SEMINAR

### ADVANCED

REVERE, MASSACHUSETTS  
DECEMBER 5-9

HOWARD JOHNSONS MOTOR LODGE  
407 SQUIRE ROAD  
REVERE, MASS. 02151  
PHONE: (617) 284-7200

Located at the junction of Rts. C-1  
and 60, 18 minutes from Logan Airport.  
S - \$47.00  
D - \$53.00

### BASIC

ATLANTA, GEORGIA  
NOVEMBER 7-9

MASTER HOST INN MIDTOWN  
1152 SPRING ST. N.W.  
ATLANTA, GEORGIA 30309  
PHONE: (404) 875-3511

Located at I-75/85 at 14th Street in Atlanta.

S - \$28.00  
D - \$32.00

Sponsored by the SCTA

### HOTEL RESERVATION FORM

NAME \_\_\_\_\_ TELEPHONE \_\_\_\_\_  
ADDRESS \_\_\_\_\_ CITY \_\_\_\_\_ STATE \_\_\_\_\_ ZIP \_\_\_\_\_  
ARRIVAL \_\_\_\_\_ OCCUPANCY \_\_\_\_\_  
ARRIVAL \_\_\_\_\_ DEPARTURE \_\_\_\_\_  
DATE \_\_\_\_\_ TIME \_\_\_\_\_ DATE \_\_\_\_\_

SEND DIRECTLY TO HOTEL  
CATA CATV TECHNICAL TRAINING SEMINAR

FOR SEMINAR REGISTRATION CONTACT  
CATA • 4209 N.W. 23 #106 • OKC, OK 73107 • 405/947-7664

# 10 DAYS FACTORY REPAIR SERVICE

Send your Sadelco Meters direct to the factory for repair.

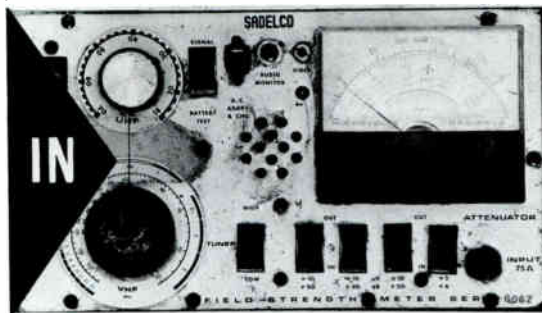

■ 10 work-days, in-out service

■ Repair cost-estimate on request

Trade-in any make SLM . . . we will allow a liberal discount towards the purchase of any new Sadelco Signal Level Meter.

**Sadelco, Inc.** 75 West Forest Avenue, Englewood, New Jersey 07631 201-569-3323  
General representative for Europe: Catec AG Luzern/Switzerland, Habsburgerstr 22. Tel. 041-23-90-56 Telex: TELFI 78168.

**Cable Prep**



A "Must"  
For Cable TV,  
Telephone, Alarm  
System Or Other  
Wiring-Installation  
Personnel Working  
In Homes, Offices,  
Hotels Restaurants, Or  
Similar Areas Having  
Carpeted Areas.

## CARPET CUTTER AND DRILL GUIDE

- Makes opening through carpets and floors quickly and neatly.
- Easy to use.
- Saves time.
- Prevents loose thread entanglement.
- Eliminates insurance claims.

The Carpet Cutter and Drill Guide is 5-3/8" long and comes in two sizes: Part Number 4250 is designed for standard 1/4" drill bits. Part Number 4375 is designed for standard 3/8" drill bits (or carbide tipped 3/8" drill bits for use on concrete or other particularly hard flooring materials beneath the carpeting).

Manufactured by:

**BEN HUGHES**  
COMMUNICATION PRODUCTS CO.

304 BOSTON POST ROAD, P.O. BOX AS,  
OLD SAYBROOK, CT 06475 (203) 388-3559

continued from page 15

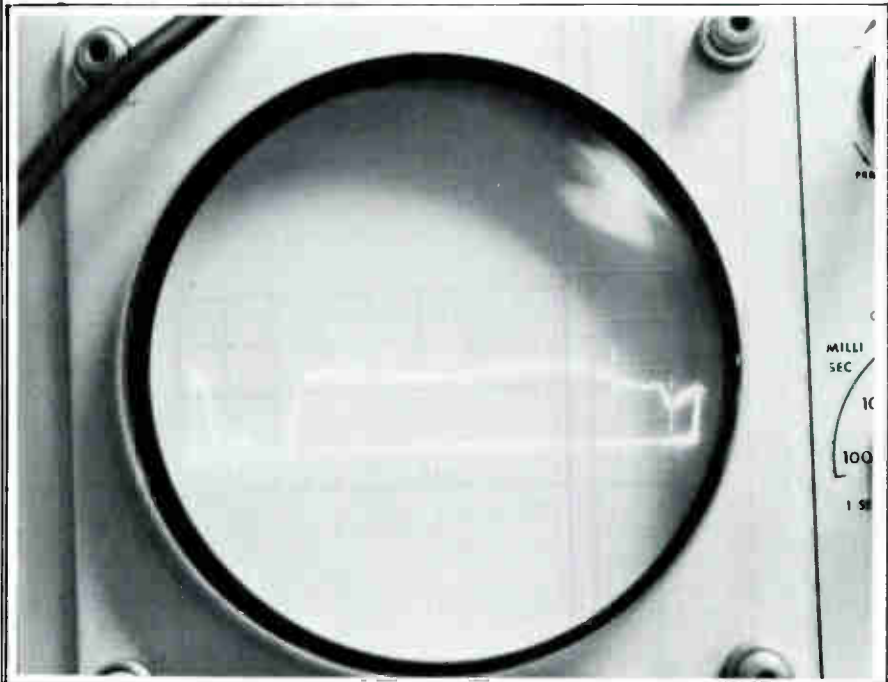

50-220 MHz FORWARD

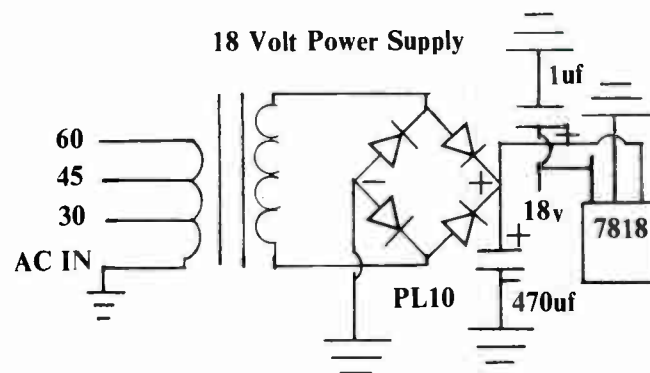

**NOTE:** Transfer may be substituted with a 117 VAC primary 25v secondary 300 ma.

FIGURE 6

but knowing you can do something like it sometimes gives you another answer to the problem. You can change the input frequency by changing the input filter and the local oscillator frequency. So you

are not limited to just 4 & 5. This basic circuit is one that with just a little bit of change could be used on any low band channel. We've got a similar problem like this with one of our other systems, and I was talking



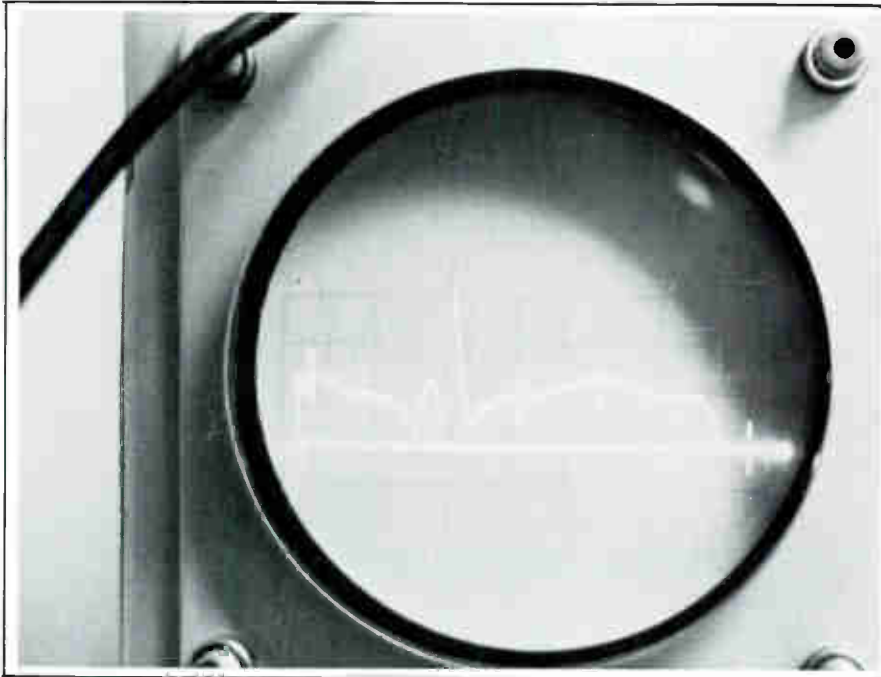

5-30 REVERSE

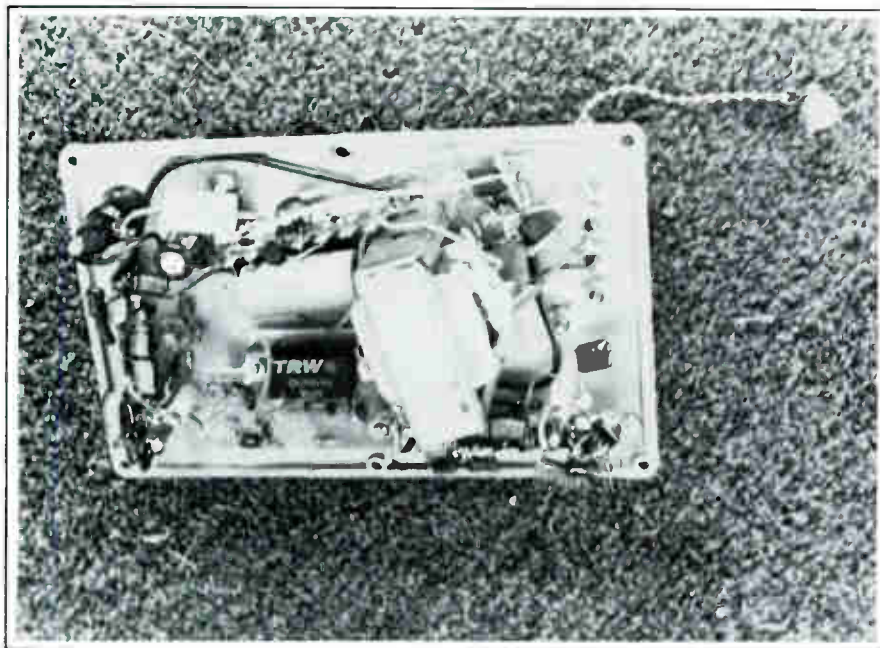

AMPLIFIER WITH FILTERS

to Mr. Hurschel Tyler of Weather Scan this morning about this project and he told me he has an identical problem. Now he is out looking for a site to put his antenna to get Channel 4 & 5 so, it is a **REAL** problem

solver. Good luck if you decide to use this information to solve a problem.

My thanks to Brian Farris, for the schematics, and to Don Thorup for typing the manuscript. □



# GATV EMERGENCY ALERT SYSTEMS

from Monroe Electronics, Inc.



Model 3000R-71

- Security Access
- Local Control
- FCC Registered Coupler

Several different Override Systems are available.



Model 3000P-9 PROGRAM TIMER

Monroe Electronics manufactures other head end controls: Agile Receiver Controllers, Cue Tone Switches, Cue Tone Receivers and Remote Control Cue Tone Encoders.

Write or phone for literature or further information.

**M** MONROE ELECTRONICS, INC.  
**E**

214 Housel Avenue  
Lyndonville, NY 14098  
Phone: 716/765-2254

THE FILTERED EARTH STATION #17  
Terrestrial Interference Avoidance

# A Comprehensive Approach

By Glyn Bostick  
MICROWAVE FILTER COMPANY, INC.

## *Now That Interference Levels are Known — How do we Suppress them for Quality Reception?*

### **Last Time**

We discussed how to convert measured (or estimated) interference levels into relative levels: the ratio of

interference to satellite signal at the downconverter. We expressed this in db, for example, -10 db means that the interference is 10 db below the

satellite signal as seen at the input to the downconverter.

### **This Time**

We'll discuss how to choose the

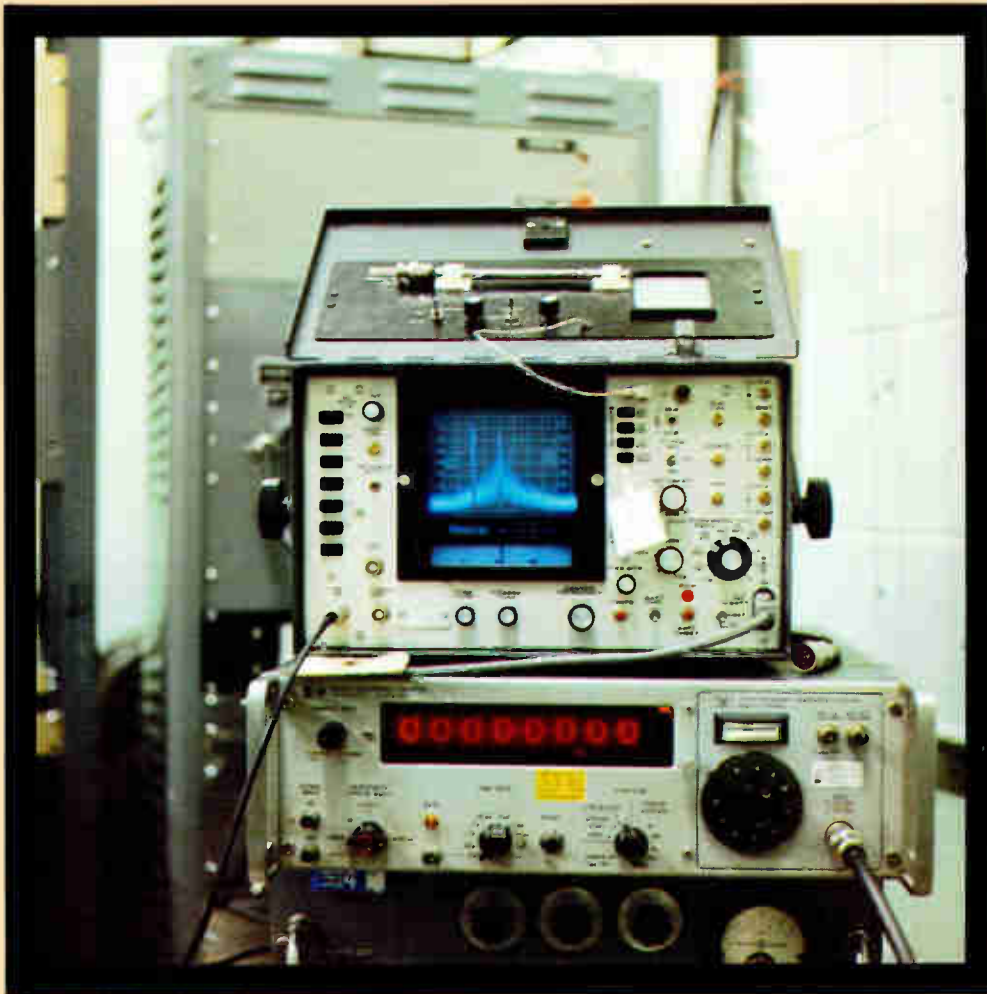

*At the 70 MHz IF band out of the spectrum analyzer looking down-converter. Satellite signal is at*

*center, touching top of screen. Interference carrier is seen 10 MHz to the left (60 MHz). Interference level*

*is -5 db relative (5 db weaker than peak satellite signal).*



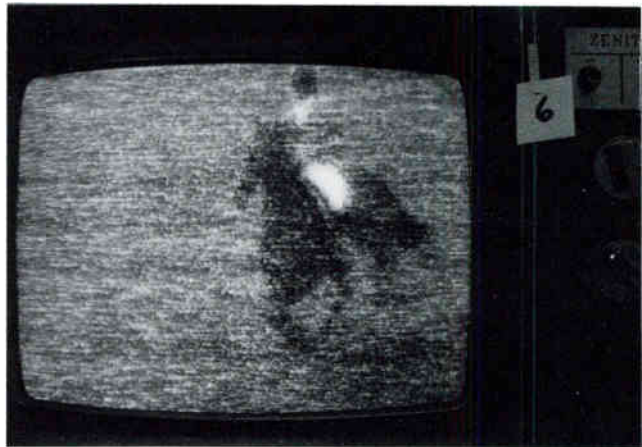

*Relative interfering level is -3 db*

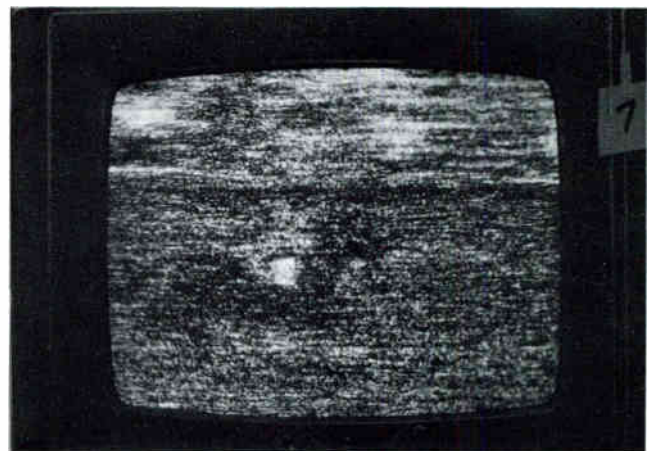

*Relative interfering level is 0 db.*

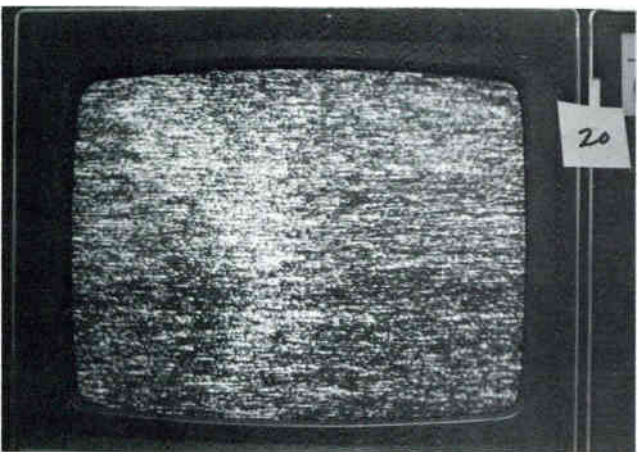

*Relative interfering level is +3 db*

### **EFFECTIVENESS OF IF TRAPS**

The interfering carrier is at -10 MHz with respect to transponder center frequency so we use a 60

MHz IF Trap. In this case, IF traps are effective for 0 db interference. However, their use beyond -3 db is

not recommended, as quality begins to deteriorate rapidly above this level.



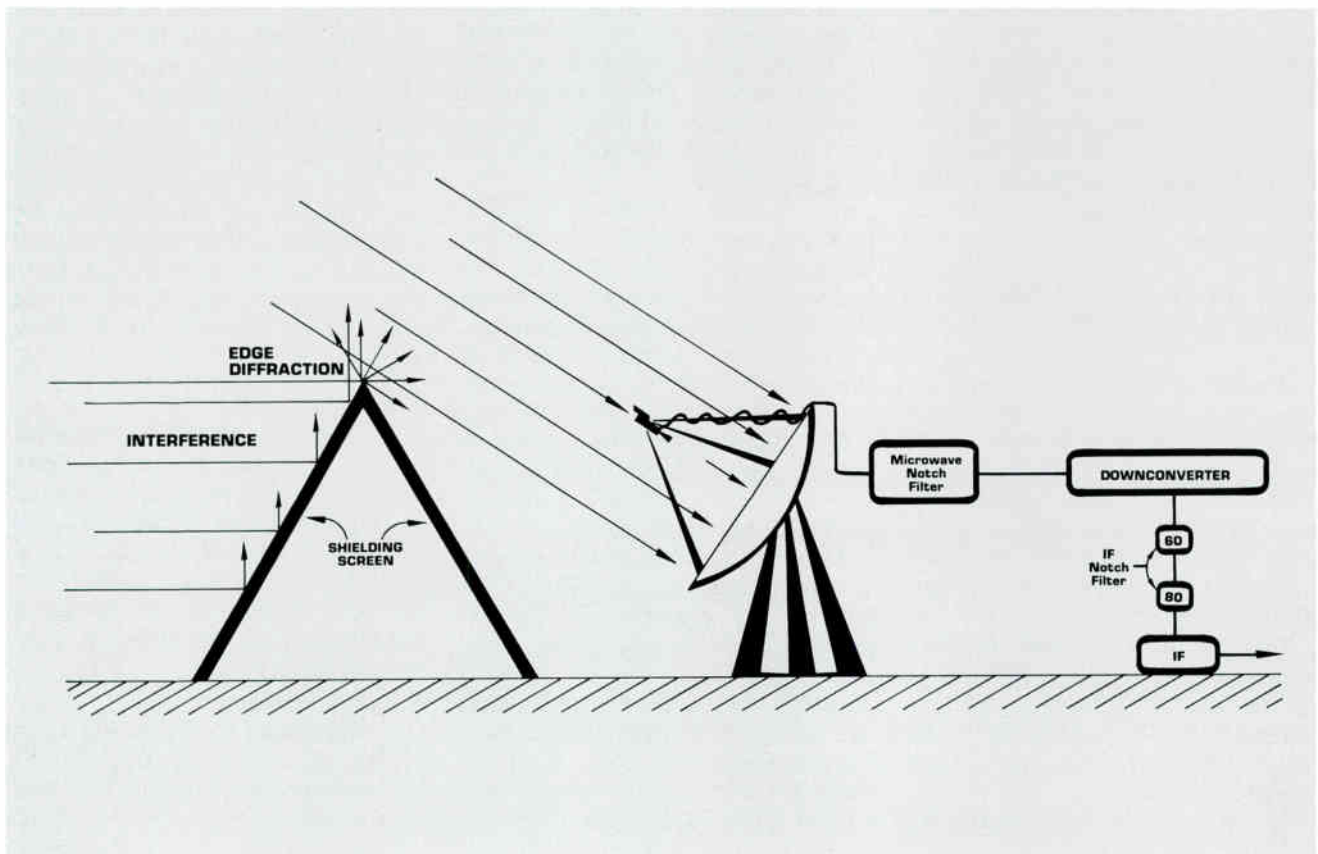

moves off the IF trap frequency. Degradation becomes complete — no picture. This action is triggered from the front end and therefore, IF traps cannot prevent it. While some receivers do not detune until somewhat higher levels are reached, it is best to consider that -3 db is the maximum interference level at which IF traps will be effective.

#### Simple Microwave Notch Filters (25 db)

The most useful narrow band microwave notch filters are made

from WR229 waveguide, with coaxial connectors built into each end of the filter. The high Q of wavelength transmission line gives us a useful notch loss of about 25 db with a 3 db bandwidth of about 4 MHz: compatible with the 3-5 MHz FM deviation of the interference carrier.

Acceptable quality will usually result if the interference is suppressed to -15 db relative. Therefore, the standard 25 db microwave notch filter, placed before the downconverter, is effective.

## CONFIDENCE

When buying or selling a cable television system, you place an enormous amount of trust in your broker. A trust based on integrity, an impeccable reputation, and an impressive track record. You demand and deserve the kind of personal service, responsiveness, and intense effort, that only comes with a company such as ours. We invite you to call for more information and look forward to hearing from you. Charles Greene Associates, 5775 Peachtree-Dunwoody Rd., N.E., Bldg. E, Suite 200, Atlanta, Georgia 30342, (404) 256-0228



**CHARLES GREENE ASSOCIATES**

A Division of AMCOM, Inc.

### COMMUNICATIONS ENGINEER

\$27,123 - \$36,629 annually.

Duties will include operating and maintaining a municipal communications system. Responsibilities will also include assisting in the development of a plan for the integration of cable TV systems operating within Phoenix into the full range of media used by the municipality for its internal communications.

Three years of professional level Communications Engineering experience is required, as is a Bachelor's degree in Electronics or Communications Engineering.

Apply to the address below. Applications will be accepted until a selection has been made.

AN EQUAL OPPORTUNITY/REASONABLE ACCOMMODATION EMPLOYER

**CITY OF PHOENIX**

Personnel Department  
10 N. Third Ave.  
Phoenix, Arizona 85003



tive for levels up to about +10 db.

If, in addition, an IF notch filter is used, this combination can handle levels up to about +22 db. The Microwave notch reduces the interference from +22 db to about -3 db, to unlock the AFC, and the IF trap further suppresses the interference.

## THE 40 db MICROWAVE NOTCH FILTER

In order to retain the narrow 3 db bandwidth but obtain greater notch loss, more resonators must be added to the filter. To maintain good return loss, waveguide notch filters must have an odd number of resonators, so we must go to three resonators. Notch loss greater than 40 db usually results.

This type filter will give adequate suppression for interference levels up to about +25 db: the interference will be suppressed to the -15 db level corresponding to good quality.

By backing up the microwave

notch with the appropriate IF notch filter, it would seem that we should be able to handle interference levels up to about +37 db: microwave suppression of the +37 db interference to -3 db to unlock the AFC so the IF filter can work.

As a matter of good practice, however, we should not depend solely on filters to suppress interference levels stronger than about +30 db. For levels greater than this, we may trigger intermodulation in the LNA: if we are successful in suppressing the carrier itself, we may still see a high noise level over a wide band due to the products produced.

## EXTERNAL SHIELDING

External blockage can be used as a supplement or substitute for filters. For example, if the interference level is just above the IF filter capability, use of external shielding may reduce it well within the capability of the IF filter, making the microwave notch filter unnecessary. Of course, relative cost of the microwave notch filter and

the shielding will be a deciding factor. For interference levels greater than +30 db, where there is danger of LNA intermodulation, external shielding should be used to reduce the interference level below +30 db, the filter capability range. External shielding can be accomplished by locating the antenna to take best advantage of natural shielding from buildings, trees, fences, etc. on the property or by building a blocking screen.

## Next Time

We'll show how various common building materials attenuate 4 GHz interference and will discuss how to locate the antenna to take best advantage of natural shielding from existing structures on the site. We will also show how to design a blocking screen and estimate its suppressing ability.

## Acknowledgement

Many thanks to Carol Ryan for editing and organizing, Dave Skevel for photography, and Rich Green for the sketch. □

# First In Reliability



Weather Scan III

**Impressive quality . . . surprisingly low price. Just \$3295 for the most reliable unit available (at any price!).**

We have been in the cable television business for 23 years . . . and providing weather information systems for the past 16 years. We know what you need and we know how to manufacture it. For reliability and performance.

The Weather Scan III comes complete with Sony AVC-1400 camera with separate mesh vidicon and 2:1 interlace sync. Includes Time, Temperature, Barometric Pressure, Wind Velocity, Wind Direction, plus four card holders. Compact cabinet is just 28" wide, 23" deep and 14" high. For complete information call or write.



## Weather Scan, Inc.

An R.H. Tyler Enterprise

Loop 132 and Throckmorton Hwy. Olney, Texas 76374 Ph. 817-564-5688

# Introducing the LPR A Low Cost Satellite TV Receiver.



**Heavyweight performance  
for a lightweight price.**

Lean, lightweight and low cost. That's the new Microdyne 1100-LPR Satellite TV Receiver! Yet it delivers the same deluxe performance you'd expect from a Microdyne receiver.

The 1100-LPR compromises absolutely nothing on Microdyne's performance, quality and dependability. You get synthesized 24-channel tuning that's stable to one part in  $10^6$  per three months. Plus 80 dB IF rejection. IF demodulation is linear to

within  $\pm 1\%$  over  $\pm 18$  MHz. And it features state-of-the-art SAW filtering technology. All this is backed up by Microdyne's 48-hour service policy.

Yet the 1100-LPR lets you settle for less. Less weight. Less size. Less power.

It weighs but 5 lbs., measures just 10 in. deep and consumes only 20 watts. Which means this compact unit lowers your first costs, your operating costs, even your expansion costs.

Find out more about the new Microdyne 1100-LPR . . . the one receiver priced to perform for your bottom line with top-of-the-line reception. See your nearest Microdyne distributor about it today. Or contact us for his name, address and telephone number.

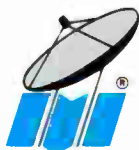

**Microdyne Corporation**

P.O. Box 7213 • Ocala, FL 32672 • Phone: (904) 687-4633 • TWX: 810-858-0307

WorldRadioHistory



# ***COPYRIGHT — ALL FOR TWO AND TWO FOR ALL!***

## **Washington Update**

Steve Effros, Executive Director, CATA



While the principal industry focus right now is on the deregulation effort on Capitol Hill, there is another set of bills quietly progressing through Congress that we are vitally concerned with as well. Copyright. Need we say more? As you know from prior issues there are two principal bills in the hopper right now. On the House side, Congressman Mike Synar of Oklahoma has introduced H.R. 2902. That measure would assure that ALL cable operators, regardless of location, would be allowed to import at least three distant signals before the CRT's recent 3.75% rate increase decision would go into effect. This would benefit operators (regardless of size) in most television markets in the United States. Needless to say, we support the Synar bill! It is getting lots of other support as well. There are over 25 co-sponsors of the bill at this writing, and we are looking for more. If your Congressman has said to you that he is interested in helping your subscribers out in this copyright mess, then let him know **IMMEDIATELY** that one way he or she can do that is by sponsoring H.R. 2902.

Another way they can do it is by also co-sponsoring H.R. 3419. That is a bill introduced in the House by Congressman Sam Hall of Texas that would also give us some relief from the 3.75% rate increase. In the Hall bill, any "Superstation" that could show the CRT it qualified as a "national cable broadcast network" would be exempt from the fee increase. Now this makes a whole lot of sense since to qualify you would have to prove that you are already paying copyright holders increased fees for the right to buy a "national cable broadcast network". There is little question that Ted Turner's WTBS would fit in that category, and if they wanted to do so in the future, WGN and WOR might follow suit. But even if they didn't, passage of the Hall bill, assuming WTBS then qualified, would mean that all cable operators could carry WTBS without it triggering the 3.75% increase. In other words most of the cable industry would be able to carry one more distant signal than they can now carry without paying the increase.

Both of these bills are important to the industry. Both are fully supported by CATA. It is important

to note that while they take different approaches to the issue, they both help us with the 3.75% increase fiasco. There is no incompatibility between the two bills, and ideally we would like to see both of them passed! If your Congressperson has already agreed to co-sponsor one of the two measures, see if you can't convince them to sign on to the other one. If they have not as yet taken a position on either bill, try for co-sponsorship of both! In all probability we will see a melding of the two bills in the future, however for right now we have a chance to get both of them through the House and we should aim for that. The best of all possible worlds would be for both bills to be adopted.

On the Senate side an equivalent to the Hall bill has already been introduced. It is S. 1270 sponsored by Senators DeConcini and Hatch. Action on the Senate side is slower and we are hopeful that the impetus will come from the House. So let's not lose focus on the House effort over S.66 (or its successor) but also keep in mind that there are things you can do right now to keep the ball rolling on the Copyright issue. It isn't going to happen without your help!

## **C—SPAN — CABLE AT ITS BEST!**

The cable television industry has often been criticized for not living up to the expectations of others. We have contributed to this problem by the hype created in the franchising process and sometimes by our own unrealistic enthusiasm for the potential of our industry. Admittedly, cable is the medium of "more". And there is really no reason to apologize for that. In fact we have amply shown that that is what our customers really want — what they are willing to pay for: more movies, more sports, more news, more music (including so-called video music), more (to a limited extent) educational and cultural programming, etc. However there is one thing that cable has that is truly unique and totally ours: C-SPAN — The Cable/Satellite Public Affairs Network. While

C-Span started out, under the able leadership of Brian Lamb, to provide live coverage of the House of Representatives and ultimately, we hope, the Senate, it is now much more than that. Some of the most unique and informative programming available on television today is coming out of the C-SPAN studios. Interview programs, call-in discussions, even a review each morning of the daily headlines in newspapers throughout the country! If you have not watched C-SPAN lately, you should! It is the greatest public affairs programming on television. It garners a small, but exceedingly loyal and vocal audience. An audience, that, we expect will also include many of the decision-makers in your community. It will certainly attract the educators and politicians in your community, and it can be designed and promoted as one of the most worthwhile channels for students to watch as well. C-SPAN is something the cable television industry can be very proud of, and it is something we must all promote.

Have you ever had local officials or educators complain to you that your cable system has not "done anything" for the community — that all you do is bring in "pornography" and "hook the kids" on more rock music? If you haven't heard these complaints yet, it probably means you haven't started your renewal process yet! Have you been criticized for not supplying informative new programming, just "more of the same"? We hear that comment from virtually every national TV critic in the pages of major magazines and newspapers. Is there a way to quiet these critics? Yes. It's called C-SPAN. True, there are times when the programming on C-SPAN is slow — it may even strike you as boring. But that only means you haven't watched it for a long enough time. Once you understand the "flow" of C-SPAN programming, you will find that you tend to have that channel tuned in more often than not! This is especially true in times of national tension such as we are experiencing now. One suggestion from this corner would be that you position C-SPAN right next to one of your "all-news" channels. That way the "news junkies" can flip back and forth between a synopsis of what is going on in Washington and actually watching it themselves!

In terms of what cable operators "should" be doing, we cannot emphasize strongly enough that you should be carrying C-SPAN! There is now a publication, the "C-SPAN Update", that can be subscribed to for a nominal sum each year. You should get copies of it and supply it to your local school system. Entire social studies curricula can be created for students around the viewing of C-SPAN, and it can be one of the most exciting educational uses of television since "Sesame Street"! But it can't and won't happen without your support! You have to carry C-SPAN first. Yes, it costs money. But it is money well spent. The active promotion of C-SPAN in your community will

not only be beneficial for your community, but will also be beneficial for you at renewal time. If all you are considering is the "bottom line", then don't forget that there won't be any "bottom line" if you lose your franchise! We really don't think that is the primary reason for carrying C-SPAN, just as the fact that C-SPAN carriage makes a tremendous difference on legislators on Capitol Hill is similarly not the best reason to carry it. They both help though. The best reason is that C-SPAN is good. It is something that the cable television industry can be very proud of, and it is something we should all support. The way to do that is to carry C-SPAN.

## **PECS — ANOTHER PROUD MILESTONE FOR THE CABLE INDUSTRY**

These are the types of stories we love to tell you about. Sure, we will have another installment in this issue about "cable reality", but this is reality now too — the Pennsylvania Educational Communications System, known as PECS. It started as a dream in the ever inquisitive and innovative eye of two independent cable television operators in Pennsylvania — George Barco of Meadville Master Antenna and Joe Gans of Hazleton, Pa. ▶



**Streamline Your  
Cable Operation**

**DRAMATIC  
HARDWARE  
PRICE BREAKTHROUGH**

Announcing the New  
**TRS-80 Model 12 Microcomputer  
and  
CATV Billing  
Accounts Receivable Systems  
Version 5.0**

<p>for systems up to 6,000 subscribers:</p> <p>TRS-80 Model 12           \$3,999 with two 1.25 meg disk drives</p> <p>DMP 500 Printer           1,795 CATV 5.0 B-A/R Software   2,800   \$8,594</p>	<p>for systems up to 20,000 subscribers:</p> <p>TRS-80 Model 12           \$6,893 with 12 meg hard disk drive</p> <p>DMP 500 Printer           1,795 CATV 5.0-HD B-A/R Software 3,300   \$11,988</p>
---	--

**Radio  
shack**

**(207) 496-2281**

**Associate Store**

**P.O. Box 749**

**Caribou, Maine 00736**

These two pioneers decided, as George put it, that cable and their communities had given them a great deal over the years, and it was time to give something back. So over ten years ago they started working on the creation, in conjunction with State educators, of an educational interconnect for cable television systems throughout the state. EVERYONE thought they were crazy. It couldn't be done, they were told, it would be too expensive, it would not be used, and it was a waste of time. Well, for anyone who knows these two, you will know that that was all they needed to hear to decide that they were going to succeed. On Thursday, September 1 in State College, Pa. there was a ceremony commemorating the completion of the state-wide interconnect.

To our knowledge it is the largest and most technically sophisticated interconnect of cable television systems in the world. The complex double-loop microwave interconnect, with innovative new microwave equipment designed by Hughes, spans the entire state in a "lazy figure eight" pattern. At turn-on there were over 500,000 homes connected to the system. Within a year they expect that number to swell close to two million. The system has interactive capability and full switching facilities from a central hub location on the Penn State campus at State College.

The most important fact about this system,

aside from the fact that it was actually created in the first place is that **NO** government money was used on the \$3 million plus project, and **NO** government mandates, requirements, franchise inducements or participation in any way was involved. This was an absolutely pure example of private initiative combining with educational expertise that will undoubtedly result in wonderful benefits for the people of Pennsylvania for many years to come. It is a great testament to what can happen when government gets out of the way!

Much to the credit, also, of the educational community in Pennsylvania, and particularly Penn State, they too made a commitment to make PECS a reality. While the cable operators individually agreed to join a consortium to build and pay for the physical plant, that could not have been accomplished without an equal commitment from the educators to actually fill the channels available with quality programming. Penn State is spearheading that effort with money and personnel in the form of their "Pennarama" programming service. Once again, this happened because all parties agreed to share in the effort, and they are now reaping the rewards. We'll have more to say about PECS in the next CATAorial in CATJ. For now, however, we can only point with pride to what has been done and congratulate all of those involved for proving that private, volun-

## We've Got The Filter You Need For Your Cable TV System...

## Or We'll Build It, Fast.

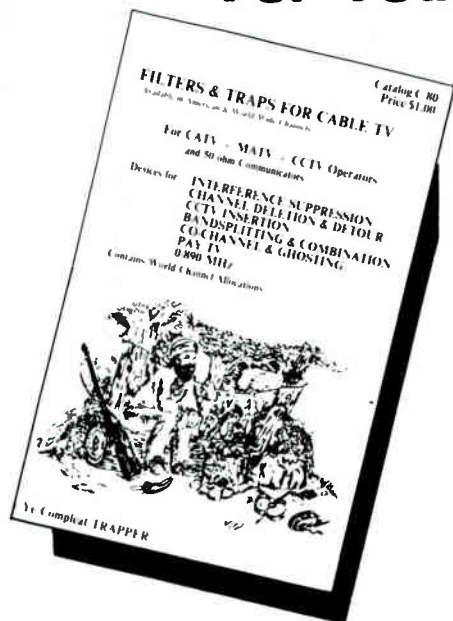

Catalog C/80, a 40-page pillar of the cable TV industry, features filters and traps currently being used in hundreds of CATV, MATV and CCTV systems. Delivery time for most standard products is 10 days or less.

But if you need a one-of-a-kind special and you can't afford to wait, we've still got you covered—we'll design and build exactly what you need for your installation, and we'll work around the clock to deliver it when you need it.

Use our toll free number and talk to the RF or microwave engineer who will design your special filter. He'll give you a prompt, on-line analysis of your specifications, and he'll quote price and delivery time. Before you hang up, you'll know what you need, when you'll have it and how much it will cost—all with just one phone call!

Once you've placed an order, our unique QRC (quick reaction capability) begins to work for you: QRC combines the efficiency of computer-aided design with a dedicated model shop and test labs to insure that your filter will be what you need when you need it.

When you need a filter to do a job exactly as you want it done, and you need it now, Call MFC!

**MFC**  
MICROWAVE FILTER COMPANY, INC.

6743 Kinne St., East Syracuse, NY 13057  
Toll Free 1-800-448-1666 — TWX 710-541-0493  
NY/HI/AK/Canada (Collect) 315-437-3953



tary cooperation toward a realistic goal can work, and has worked. If only other federal, state and local authorities would get that message, we would all be better off!

## AS PROMISED — REALITY MARCHES ON!

We won't spend too much time in this issue bringing everyone back to earth about some of the other realities of cable television. Let's just note a few of the "goings on" in the last month: The Justice Department has finally gotten out of the way, and the Movie Channel and Showtime appear to be on the verge of a merge. The movie partners (with the exception of Warner, which is one of the original owners) are out of the deal at the insistence of Justice. This once again points up how competitive the marketplace for programming really is these days.

If you still don't believe that last point, you should also consider the strong indications that the "Spotlight" movie service is about to stop operations as well. Rumor has it that the owners of "Spotlight", Storer, Cox, TCI and Times Mirror, will be switching out their "Spotlight" customers to the highest bidder among the remaining pay movie channels.

On the franchising front, the latest gimmick, created by the cities is "Rent-A-City"! You remember the old "Rent-a-citizen" debate, don't you? That was where the cities, in the mid-70's started asking in the RFP for "local ownership" and then when we gave it to them, they blasted us for "renting" local civic leaders in order to win the franchise — well now they are at it again, but in an even more blatant fashion. St. Louis has let it be known that they want 20% of the STOCK of the local cable bidder to go to the CITY for "educational and cultural" purposes. Now if that isn't "Rent-A-City", we don't know what is! As we go down the road a piece, let's all remember who started THIS little gimmick!

We not only have cities trying to get a "free" piece of the action from cable operators these days, we have some who want to take over the whole system! In Burlington, Vermont, the mayor (a Socialist by party affiliation) is proposing a study to simply take over the existing Cox cable system with its 16,000 subscribers and make it municipally owned. He wants the "citizens" to have more input and control over programming. Now that is something that CATA has been strongly opposing for years — government ownership of the media simply does not comport with our Constitution and Bill of Rights! Cable is a First

*continued on page 32*

# RING A DING DING & TOOT A TOOT TOOT!

Some manufacturers of TV reception and distribution equipment try to sell products by showing off! They ring the bells and blow the whistles and tell you how their designs can do this and that. They use these bells and whistles to hide the fact that their products are far too expensive for small systems. Most of the special features are simply not required in most head ends.

At Triple Crown, we have designed the most cost-effective line of equipment in the world. Our engineers draw on years of field experience and technical expertise to create products to suit the small and medium sized system perfectly.

The most recent development, the Channelizer System of TV channel modulators, satellite receivers and power supplies, concentrates the state-of-the-art technologies into a neat, no-frills package. This system is already showing many operators savings in the

order of 50%. With this type of cost reduction, the Channelizer System is certain to become a cornerstone in head end racks. (How's that for solid state?)

How can Triple Crown provide quality at such a great saving? It's very simple. We keep the bells and whistles for key chains and provide our customers with basic equipment capable of reliable operation.

When you want the plain goods without ding-a-lings full of hot air, call us first . . .  
because we are!

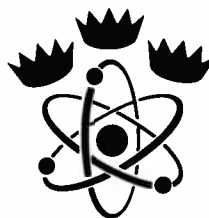

**TRIPLE CROWN  
ELECTRONICS INC.**

**PHONE (416) 629-1111**

**TLX 06-960-456**

4560 Fieldgate Drive, Mississauga, Ontario, Canada L4W 3W6

Amendment speaker, lest anyone forget, and the government should simply not be in that business! Happily, Cox has announced they will fight such a municipal take-over all the way.

Speaking of First Amendment speakers, as we predicted, the Mountain States Legal Foundation has announced that it will appeal the ruling in their case against the City of Denver. They were thrown out of Court on their First Amendment challenge to the granting of de-facto "exclusive" cable franchise because the lower Court said they did not have "standing" to sue. The Appeal will take a while.

Finally, this month in the "reality" column, we revisit the ongoing strife in Omaha, Nebraska at the Cox system there. You will recall from previous issues, we have been following the troubled start of "Indax", the Cox interactive two-way experiment. We have long said that while these technological marvels are nice, they have not been proved in the marketplace and indeed all studies indicate that subscribers are not terribly interested in them — only franchise writers are. Well now comes Omaha, in a revised franchise with Cox that indicates their true interest. They now acknowledge that the system cannot be completed in the time frame originally demanded and promised. However they are not that concerned about the system, only the potential "lost revenue" to the city! Until Cox makes two-way Indax available, it must pay the city \$15,000 a month in addition to its franchise receipts to "... offset the city's revenue losses for not having the service now." How's that! No one has made ANY money on two way services, yet, and here is a city charging \$15,000 per month for so-called "lost revenue"! Their true stripes are beginning to show!

Speaking of all these great new services, we might note that one of the first teletex experiments in the country, the one conducted by the Lexington (Ky) Herald-Leader and TeleCable of Lexington, has been terminated after 16 months of providing three channels of service. The newspaper's publisher said: "Our conclusion is that at this time in Lexington there is insufficient demand among both viewers and advertisers for such a service to make it self-supporting in the foreseeable future". Maybe that will give a clue to Cox — they should demand that the City of Omaha PAY THEM for NOT putting on the "bells and whistles" — after all, it is the subscriber who ultimately will pay for all this folly! Unfortunately it is more and more evident that the great government protectors of the "public interest" have little if any interest in determining how their actions actually affect the public.

#### CABLE SIGNAL LEAKAGE

CATA has been on a long campaign to let you know about the importance of keeping your systems "clean" — of making sure that you continually monitor and correct any signal leakage. So have many other groups working within the cable industry. Recent efforts by the American Radio Relay League (the ham radio operators) to bar us from using certain frequencies has once again brought this issue to the forefront. In the September issue of the SCTE Interval Cliff Paul, the former Chief of the FCC's cable bureau engineering department, spelled out in excellent detail why this issue is so important. We are reprinting it here with the kind permission of the SCTE because we couldn't have said it better ourselves.

### CABLE SIGNAL LEAKAGE — AN EXPERT SPEAKS!

by Clifford H. Paul, P.E.

**Both financially and technically, cable signal leakage is the most devastating problem besetting this industry. Signal leakage, formerly called "radiation," is not a new problem, and has a history beginning as early as 1971. In using the mid and super band frequencies, cable television has drawn the attention of the Federal Aviation Administration, the Department of Commerce, the Office of Telecommunications Policy, and certainly, the Federal Communications Commission. In 1971, these agencies were aware that cable's use of the mid and super bands posed a potential danger of interference to licensed services and began to monitor the performance and efforts of the cable industry.**

**The FAA was particularly concerned with the 108-136 MHz and 225-400 MHz bands. However, it wasn't until 1976 that the first case of interference was documented and the agencies felt growing concern turning into alarm.**

**The 1976 incident was a result of pilot carriers used by the CATV operator in Harrisburg, PA, causing interference with aeronautical frequencies. It was all the FAA needed to request that the FCC shut down all channels of all cable systems using these bands. The cable industry was fortunate that some cool heads at the FCC and FAA along with CATV industry representatives sought more reasonable solutions. In 1978, the FCC promulgated rules in Docket 21006 which added Sections 76.610, 76.611, and 76.613 to Part 76 of the Commission's Rules. The cable industry currently operates under those rules.**

# KNOWING YOU HAVE THE BEST

in cable technical information



Name \_\_\_\_\_

Company \_\_\_\_\_ Title \_\_\_\_\_

Address \_\_\_\_\_

City \_\_\_\_\_ State \_\_\_\_\_ Zip \_\_\_\_\_

## CATA MEMBER

(Must Furnish System Name)

- \$14.00 Enclosed for 1 Year
- \$40.00 Enclosed for 3 Years

## NON MEMBER

- \$18.00 Enclosed for 1 Year
- \$50.00 Enclosed for 3 Years

CANADA/MEXICO SUBSCRIBERS: Add \$4.00 per year to rates given above. All other Foreign Countries add \$7.00 per year to rates given above. Special handling arranged upon request. U.S. CURRENCY ONLY.

Mail to: CATJ Magazine  
Suite 106, 4209 N.W. 23rd  
Oklahoma City, Okla. 73107



# STANDARDIZE

## WITH THE NATIONAL STANDARDS FOR CATV SYSTEMS — GRAPHIC SYMBOLS

In order to help you standardize your grid and map preparation Television Publications is now offering a brochure of National Standards for CATV systems Graphic Symbols.

The symbols in this publication present cable television systems operators and engineers with a uniform means of schematic and system map design throughout the Cable Television Industry. Order one for each of your operators and engineers and get standardized !

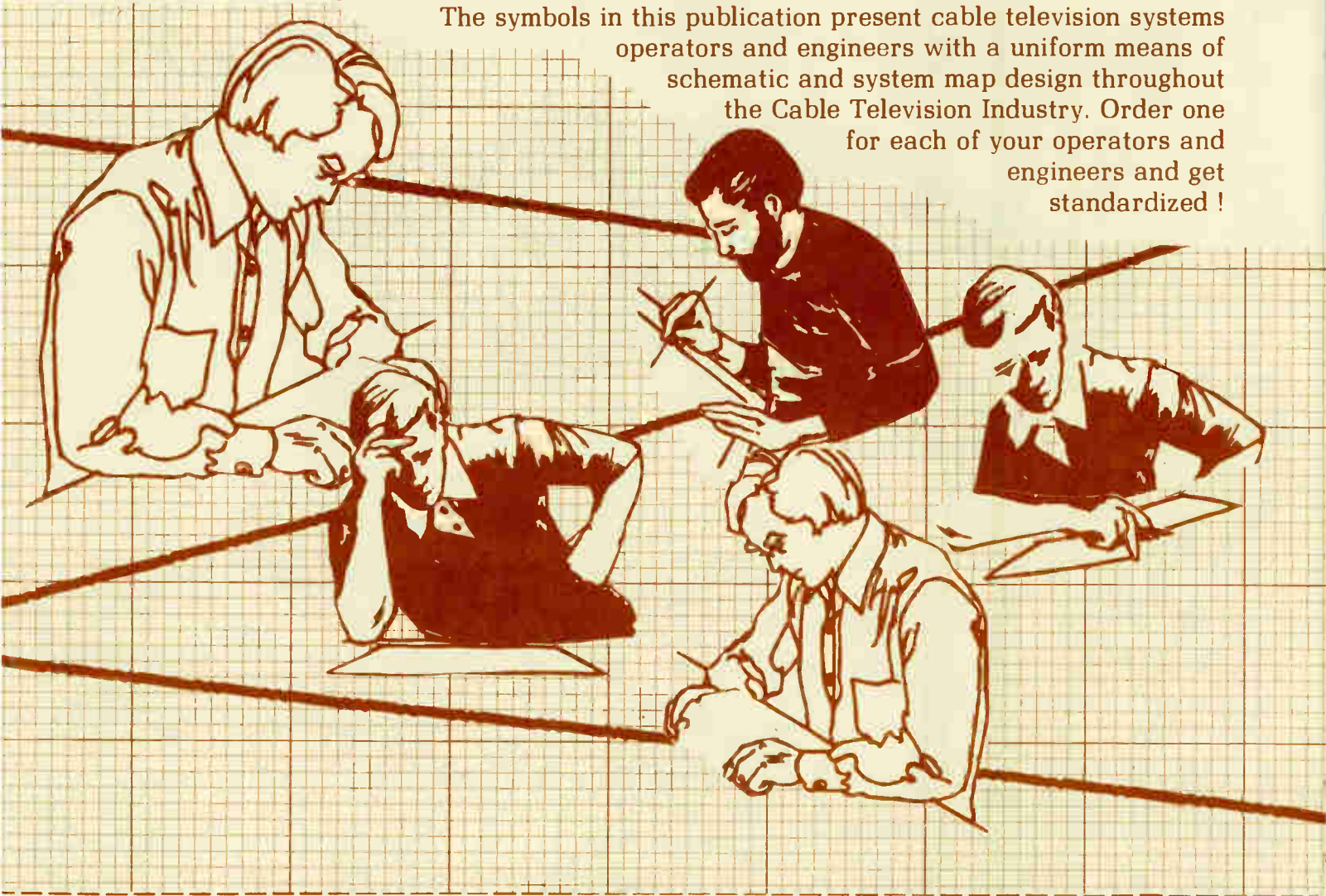

YES! I WANT THE NATIONAL STANDARDS FOR CATV SYSTEMS — GRAPHIC SYMBOLS GUIDE  
SEND TO:

NAME \_\_\_\_\_ SYSTEM NAME \_\_\_\_\_

ADDRESS \_\_\_\_\_ PHONE \_\_\_\_\_

CITY \_\_\_\_\_ STATE \_\_\_\_\_ ZIP \_\_\_\_\_

PRICES  
5.00 each  
40.00 for 10 guides  
90.00 for 25 guides

PLEASE SEND \_\_\_\_\_ SYMBOLS GUIDES. ENCLOSED IS \$ \_\_\_\_\_ FOR MY ORDER.

MAIL TO: TELEVISION PUBLICATIONS, INC. SUITE 106 4209 NW 23 OKLA. CITY OKLA. 73107 405/947-7664  
WorldRadioHistory

Aside from the technical requirements set forth, the FCC made two important points in promulgating these rules: One that the rules were interim rules, and two, that an advisory committee composed of all interested parties should be formed to study the topic of signal leakage and make recommendations to the Commission on what changes in the interim rules might be required. Most everyone thought that the present rules were too restrictive, and much effort was contributed toward the advisory committee study. Rather than go into the work done and the recommendations made, I'd hoped that you'd read the SCTE publication, "A Final Report of the Advisory Committee on Cable Signal Leakage," (TR-2). It provides all the background you'll need to understand the problem.

The committee made numerous recommendations in its report. One of major impact was that the committee felt that there is no need to offset CATV signal carrier from aeronautical communication frequencies provided that there is a proper monitoring program in place to detect and repair any leakage whose signal level is above 20 microvolts per meter at a distance of 3 meters (ten feet). Shortly after the committee released its report, the FCC released Docket 21006, "Further Notice of Proposed Rulemaking." This second rulemaking has not yet been brought before the Commission.

Only three cases of CATV interference were documented between 1978 and September of 1980, when the "Flint Incident" was reported. Commercial aircraft operating at an altitude of 25,000 feet over Flint, MI, reported interference in communications with the air traffic controller in Oberlin, OH. The interfering signal was traced to the cable system in Flint, and close inspection by the FCC's Field Operations personnel showed that the system was leaking very badly. A fine of \$20,000 was imposed on the cable operator and the entire episode made an enormous impact on the staff of the FCC.

Because of the "Flint Incident", the Commission began to rethink the rulemaking that was in progress, and its release has been delayed. Cable operators and the FCC both became painfully aware that not only were many systems leaking above the technical specifications, but that many systems using the aeronautical frequencies had never reported that use, as required under Section 76.610 of the FCC Rules and Regulations. Cable operators caused an avalanche of filings at the FCC to request the clearance of frequencies, and because the applications had to be processed by hand, Commission staff faced a backlog of 600 or more such requests.

In August, 1981, computerized systems were in place at the FCC and the applications became somewhat more manageable and the backlog was quickly reduced. While Commission staff was wrestling with paperwork, the Field Enforcement efforts picked up as the FCC instituted stepped-up inspection of cable systems to drive home the topic of signal leakage to operators. A system of forfeitures (fines) was put into place, and has evolved into the Field Inspector's right to levy fines "on the spot." And while all this was going on, many other services such as Hams, Police, ambulance, mobile radio and forestry, took a new look at their frequencies to determine if CATV was causing harmful interference to their licensed use of the radio spectrum.

I've given you some historical perspective on CATV signal leakage, and you'll be reading more about it in months to come. The danger of cable operators losing use of many mid and super band channels is still with us. It is the obligation of all cable operations personnel, especially the technicians, to redouble their efforts to control signal leakage. The cable television industry must take its responsibility seriously. The loss of large blocks of frequencies will result in the loss of large blocks of revenues. The interrelationships cannot be discounted.

□

LIL' dB - A LESSON IN CABLE TV SIGNAL ©1983 THE BIG SENDOFF

C. GRISHAM

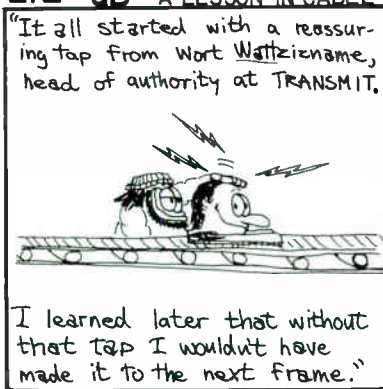



# Showcase

## COMPREHENSIVE CABLE ENTERPRISES

Comprehensive Cable Enterprises is a newly formed company representing contracting and service companies to the cable television industry. As the sales and marketing agent, the Wisconsin-based company procures projects for its client companies. James Brandenburg, owner of CCE, states that more than thirty contracting and service companies have expressed an interest in being represented. CCE has signed agreements with six companies and several others have verbally committed to date.

CCE utilizes utmost discretion when selection client companies. All companies must meet rigid requirements regarding financial stability, quality workmanship, project management and community relations. "We don't represent the first company that fills a specific category," comments Brandenburg. "We want exclusive, cream of the crop companies for all categories of aerial construction, underground construction, installations, engineering, tower, microwave, strandmapping design, splicing, proof of performance, studio engineering, direct sales, marketing, advertising sales, system audit, data processing, billing, collection, public relations and system management consultation."

CCE clients benefit from the service abundantly in that CCE is their sales and marketing department for a lesser fee than a full time salesperson. This allows the company management team to concentrate fully on completion of its current project without the concerns and expense of searching for the next project.

CCE services include: continuous tele-marketing, convention representation, direct mail, trade paper advertising, direct sales calls, press releases, public relation support, paid associate memberships to CATA and NCTA, client newsletters and all labor to produce a business profile and marketing material.

Cable operators find the service most helpful while searching for a quality contracting and service company. One call puts the operator in touch with qualified candidates for all categories CCE represents. CCE's representation of many companies simultaneously saves time and money for the cable executive. Several of CCE's companies have realized a substantial expense reduction budgeted for sales and marketing. Others who were considering the addition of a sales and marketing division to their company find CCE's service the most economical route to go. "This calculates into a direct savings for the operator from lower bids from CCE companies," says Brandenburg.

CCE currently operates from its Madison office covering the entire continental United States. However, it is projecting two regional offices to be opened in early 1984.

"The whole concept makes sense," says Brandenburg. "Equipment manufacturers use distributors to market their products, and people use employment agencies to market themselves. Why not a distributor of intangible services? I am aware of several individuals who are out there searching for projects and when found, they start looking for a contracting or service company to do the job. This is pretty much putting the cart before the horse. With CCE, the cable operator knows up front which company will do the best job."

For more information, contact James M. Brandenburg, 206 Westminster, Madison, Wisconsin 53714, or call (608) 249-3442.

## EAGLE COMTRONICS FEATURES NEW CATV CONVERTER AND BATCH DESCRAMBLING SYSTEM

The Eagle EVSC-2000 CATV Converter with state-of-the-art microprocessor control, programming memory, and infrared cordless control delivers field-proven quality performance.



This converter has a tuning range of 54 to 400 MHz and will accommodate up to 60 CATV channels. The local oscillator is tuned by frequency synthesis, with a quartz crystal reference for ultra-stable tuning control. This signal processing technique ensures optimum picture quality over a wide tuning range.

All channels may be sequentially or directly accessed. Each channel can be independently fine tuned. Last channel viewed can be directly recalled, and favorite channels can be placed in memory. The converter accepts a parental control code to inhibit minors from viewing specific channels. If the unauthorized channel is keyed the converter automatically switches to a "barker" or message channel.

The channel fine tuning, program memory, and parental control features are initiated with the IR remote control. This hand-held infrared remote control unit will

operate at a range of 25 feet and within an angle of 30 degrees. The key pad is designed to be visible under dim lighting conditions. The indicator LED signals to the operator the condition of the battery in the hand-held unit. A switched convenience outlet is supplied for TV set power and on/off.

EAGLE is also offering a Batch Descrambler which removes the premium channels from a system, cleans the mainline in the premium channel area, and re-inserts any descrambled/converted premium channels. Appropriate combinations are used to descramble or scramble an entire building. The unit comes fully assembled, mounted, and ready for the system insertion. Eagle support service efficiently assists system operators in the selection of required channel droppers and band pass filters.

For more information, contact the Sales Department at EAGLE, 635 James Street, Syracuse, New York 13203 or call (315) 428-8635.

## MICRODYNE'S FOUR-CHANNEL SUBCARRIER DEMODULATOR FOR SATELLITE TV AND LOW COST, HIGH PERFORMANCE 24-CHANNEL VIDEO RECEIVER

Microdyne Corporation's new SCB-2 Subcarrier Demodulator recovers audio from FM subcarriers transmitted along with wideband satellite television signals. This companion unit for Microdyne 1100 Series Satellite TV Receivers provides an economical method for recovering up to four additional narrowband audio signals.



Demodulators may be ordered with one, two, three or four subcarrier frequencies between 4.5 and 7.5 MHz to meet individual requirements. The demodulator video input to the SCB-2 is supplied by the companion satellite TV receiver. Front panel audio gain controls vary the 600 ohm balanced audio output levels from 0 to 6.8 volts. This self-contained 1 3/4-inch-high unit mounts in a standard 19-inch rack along with its companion receiver.

Microdyne's new 1100 LPR Receiver is a high performance, low cost 4 GHz satellite TV receiver that offers commercial quality video and high reliability at a competitive price. Designed to the same per-



formance specifications as Microdyne's top-of-the-line receivers, the 1100 LPR features a single conversion 24-channel frequency synthesized tuner with a stability of  $\pm .001\%$ , 3.7 to 4.2 GHz input frequency range, IF demodulation that is linear to within  $\pm 1\%$  over  $\pm 18$  MHz, and SAW filtering technology. This combination of high performance and low cost makes the 1100 LPR the ideal receiver for new systems or for expanding the capabilities of an existing system.

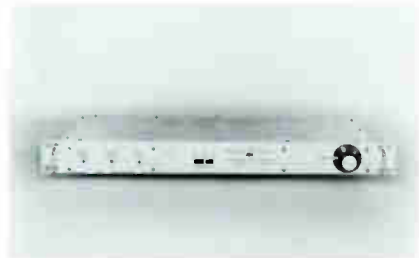

The receiver is just 1 3/4 inches high, 10 inches deep, and fits a standard 19-inch rack. It weighs 5 lbs. and requires about 20 watts of power.

For additional information contact: Earl Currier, Sales Manager, Microdyne Corporation, Marketing Department, 491 Oak Road, Ocala, Florida 32672. (904) 687-4633.

#### QUICKSTALL™ MOULDING DUCT

Poleline Corporation, Subsidiary of RMS Electronics, Inc. is proud to announce another new product — QuickStall™ Moulding Duct. QuickStall™ has a pre-assembled "one piece" construction which consists of the main raceway body with a hinged, tight fitting snap on cover. It is designed to complement the moulding already in place in the home or apartment. QuickStall™ can be painted to adapt to a particular decor, or ordered in pre-colored, impregnated selections (special orders only). Common methods of initial installation include using nails, screws, staples, or glue. The #2700DTA is available with two (2) 3/8" wide foam-backed adhesive strips already applied.

QuickStall™ opens easily for line inspection, servicing raceway splitters, or for installing additional lines. The hinged cover temporarily holds all lines during installation. Its rectangular shaped interior accommodates the shapes of all raceway splitters and some miniature directional couplers. The largest size will hold up to twenty-eight (28) 59U type cables with the cover still fitting evenly.

QuickStall™ is available in two (2) sizes, (#2700DA and #3700DA) in standard colors of brown or beige. It has a full complement of inside and outside corner



pieces, "T"-joints, size reduction fittings and end caps. Please contact your Poleline Corporation or RMS account executive for details, at 50 Antin Place, Bronx, N.Y. 10462 or call (212) 892-6700 or 892-1000.

#### SCIENTIFIC-ATLANTA INTRODUCES TWO NEW ADDRESSABLE MANAGEMENT SYSTEMS

Scientific-Atlanta, Inc., has expanded its Series 8500 subscriber products line with the introduction of System Manager I and System Manager II. These are two computer hardware and software packages for CATV systems using Series 8500 addressable set-top terminals. System Manager I features easy-to-operate software with English-language commands and is designed so that smaller systems can afford the operational benefits of addressability. System Manager II offers much greater subscriber capacity with an expanded software package for larger, departmentalized cable companies.

System Manager I uses an IBM Personal Computer and includes a dot-matrix printer and a CRT display terminal. The system can support three auxiliary terminals for data entry and retrieval.

System Manager II is based on a Hewlett-Packard 1000 A600 computer, with multiple ports for CRTs and line printers. Subscriber disk capacity is determined by the size of the cable operator's data base requirements. System Manager II can be linked with a host computer to establish a single-entry billing interface. It uses a comprehensive software package developed by Gill Management Services.

System Manager I software provides efficient programs for subscriber account management, pay-per-view, converter

histories, testing, inventory control and a converter refresh sequence. Additionally, the cable operator has the flexibility to set up tables to accommodate specific system requirements. Valuable marketing and history reports can be generated by cross-referencing subscriber and converter records.

The software for System Manager II uses preformatted display screens which facilitate accurate keyboard entries. The system accomplishes efficient subscriber account management, pay-per-view, inventory management, converter histories, testing, reporting and additional system security checks which can be programmed to execute automatically on a regular basis. The cable operator can set up tables to fit his business structure and the flexible software allows him to request numerous reports for operations, marketing and engineering.

With the extensive pay-per-view management program, order entry formats can be determined months in advance of program schedules. Pay events can be identified individually or as "tickets" which are series of events (for example, a sports season, mini-series, concert series, etc.). Orders can be taken quickly with minimal keyboard entry. Channel authorizations can be pre-set to activate and deactivate automatically. Because of Scientific-Atlanta's unique global command structure, all terminals authorized for a particular program are activated and deactivated simultaneously at the beginning and end of a program, allowing the cable operator to run back-to-back pay-per-view events on the same channel.

Both systems can serve multiple head-ends. The interface between the computer and the distribution system is an addressable transmitter (ATX), with one located at each headend. The ATX accepts control data from the computer and transmits instructions over the cable to the set-top terminals. If the link between the computer and the ATX fails for any reason, the ATX will keep the addressable set-tops active until the link is restored.

More information is available by writing to Scientific-Atlanta, Inc., P.O. Box 105027 Dept. A/R, Atlanta, Georgia 30348.

#### BLONDER-TONGUE SEMINAR

November 1, 2 and 3, 1983: A Blonder-Tongue MATV/CATV/LPTV/TVRO Technical Seminar will be held at the Ramada-Court of Flags, Orlando, FL. in conjunction with Enjay Associates.

Contact: Betty Karas (201) 679-4000 or Enjay Associates (813) 953-9843. □

# Looking for a 450 MHz rack-mounted head-end amp? Need a 450 MHz instrumentation amp?



## With Broadband's VFA-450 you get both.

Broadband's new VFA-450 is a rack-mountable, wideband amplifier designed to help you in several ways:

**As a two-way head-end amplifier:** You can use it in your system's head-end to buffer your head-end equipment. At the same time it can provide for sweep or other signal injection and recovery of return signals in sub-, mid-, or high-split trunk systems.

**As a one-way head-end amplifier:** By simply removing the plug-in filter or terminating the return recovery port, you can convert the VFA-450 to one-way operation.

**As an instrumentation amplifier:** The VFA-450 is perfect for sweep systems, bench-test situations and field sweep applications. For field sweep use it can be powered by 24 to 30 volts DC.

The unit is available in any gain from 20 to 40 dB. Higher gain versions are suitable for use in distribution systems where rack-mounting is called for.

Broadband-engineered and guaranteed, the VFA-450 is equipped with push-pull hybrid circuitry to deliver maximum output with minimum distortion. Tough and dependable, it offers state-of-the-art performance and flexibility.

For additional information on specifications or pricing, call us toll-free at 800-327-6690, or write Broadband Engineering, Inc., P.O. Box 1247, Jupiter, Florida 33468.

### Features

- Forward bandwidth to 450 MHz.
- 20 to 40 dB gain.
- Push-pull hybrid circuitry.
- Sub-, mid- and high-split capability through use of plug-in diplex filter at output.
- Capable of full channel loading at design bandwidth.
- Plug-in pads and equalizers.
- Variable gain & slope controls.
- -20 dB test points at input and output.
- Response equalization for flatness adjustment.
- -12 dB directional coupler for insertion of sweep or other signals at the output.
- 120 volt AC or 24/30 volt DC powering. DC powering may be connected permanently as standby power in case of AC power failure.
- $\pm 2$  dB flatness.
- Return loss 18 dB minimum.
- Three levels of surge protection.

Distributor inquiries are invited.

See us at the Atlantic Show, Booth Nos. 216-220.

**AUGAT<sup>®</sup> BROADBAND**  
Quality and Innovation

Distributors	Manufacturers	Service Firms
D1—Full CATV equipment line	M1—Full CATV equipment line	S1—CATV contracting
D2—CATV antennas	M2—CATV antennas	S2—CATV construction
D3—CATV cable	M3—CATV cable	S3—CATV financing
D4—CATV amplifiers	M4—CATV amplifiers	S4—CATV software
D5—CATV passives	M5—CATV passives	S5—CATV billing services
D6—CATV hardware	M6—CATV hardware	S6—CATV publishing
D7—CATV connectors	M7—CATV connectors	S7—CATV drop installation
D8—CATV test equipment	M8—CATV test equipment	S8—CATV engineering
D9—Other	M9—Other	S9—Other

# Associate Roster

Note: Associates listed with \* are Charter Members.

**Alpha Technologies,**  
1305 Fraser St. D-G,  
Bellingham, WA 98225  
206—671-7703  
(M9, Standby Power  
Supplies)

**AMCOM, Inc.,**  
Bldg. E, Suite 200,  
5775 Peachtree-  
Dunwoody Rd., N.E.,  
Atlanta, GA 30342  
404—256-0228  
(S9, Brokering &  
Consulting)

\* **Anixter Communications**  
4711 Golf Road,  
Skokie, IL 60076  
312—677-2600  
(D1)

**Apple/Store**  
Rte. #1, Box 156,  
Beaver Dam, WI 53916  
414—885-6249

**The Associated Press,**  
50 Rockefeller Plaza,  
New York, NY 10020  
212—621-1513  
(S9 Automated News  
SVC)

**Automation Techniques,**  
1846 N. 106th E. Ave.  
Tulsa, OK 74116  
918—836-2584  
(M9)

**Avantek, Inc.,**  
481 Cottonwood Dr.,  
Milpitas, CA 95035  
408—946-3080  
(M8, 9 TVRO  
Components)

**Av-Tek, Inc.,**  
Box 188,  
Aurora, NE 68818  
402—694-5201  
(M8)

**BEI**  
P.O. Box 937,  
Olathe, KS 66061  
800—255-6226  
(M9 Character  
Generators)

**Ben Hughes  
Communications**  
P.O. Box AS,  
Old Saybrook, CT 06475  
203—388-3559  
(M6, 9)

**Blonder-Tongue Labs, Inc.,**  
1 Jake Brown Rd.,  
Old Bridge, NJ 08857  
201—679-4000  
(M1, 2, 4, 5)

**Broadband Engineering,  
Inc.,**  
P.O. Box 1247,  
Jupiter, FL 33458  
1-800—327-6690  
(D9, M4, S9)

**Budco, Inc.,**  
4910 East Admiral Place,  
Tulsa, OK 74115  
1-800—331-2246  
(D9, Security &  
Identification Devices)

**CATEL,**  
4800 Patrick Henry Dr.,  
Santa Clara, CA 95054  
408—988-7722

\* **C-COR Electronics, Inc.,**  
60 Decibel Rd.,  
State College, PA 16801  
814—238-2461  
(M1, 4, 5, S1, 2, 8)

**CCS Cable**  
P.O. Box 14710,  
Phoenix, AZ 85063  
602—272-6855  
(M3)

**CWY Electronics,**  
405 N. Earl Ave.,  
Lafayette, IN 74904  
1-800—428-7596  
(M9, D1)

**CableBus Systems,**  
7869 S.W.  
Nimbus Avenue,  
Beaverton, OR 97005  
503—543-3329  
(M1)

**Cable Graphic Sciences,**  
7095 N. Clovis Ave.,  
Clovis, CA 93612  
209—297-0508  
(M9 Character  
Generators)

**Cable Health Network,**  
1950 Spectrum Circle  
Suite B-310  
Marietta, GA 30067  
404—952-4620  
(S4)

**Cable-Text Instruments,**  
Div. of Telpar, Inc.  
P.O. Box 796  
Addison, TX 75001  
214—233-6631  
(M9 Generators)

**Century III Electronics, Inc.**  
610 Neptune Ave.,  
Brea, CA 92621  
714—671-2800  
(M1, 3, 4, 5, 7, 8,  
S1, 2, 8)

**Capscan, Inc.**  
P.O. Box 36,  
Adelphia, NJ 07710  
1-800—CABLETV or  
222-5388  
(M1, 3, 4, 5)

**Channel Master,**  
Ellenville, NY 12428  
914—647-5000  
(M2, 3, 4, 5, 6, 7)

**Comm/Scope Company,**  
P.O. Box 1729  
Hickory, NC 28603  
1-800—438-3331  
(M3)

**Communications Equity  
Associates,**  
851 Lincoln Center,  
5401 W. Kennedy Blvd.,  
Tampa, FL 33609  
813—877-8844  
(S3)

**Comprehensive Cable  
Enterprises**  
206 Westminster Ct.  
Madison, WI 53714  
608—249-3442  
(S1, 2, 4, 5, 7, 8, 9)

**Computer Video  
Systems, Inc.,**  
3678 W. 2105 S. Unit 2,  
Salt Lake City, UT 84120  
1-800—453-8822  
(M9)

**COMSEARCH INC.,**  
11503 Sunrise Valley  
Drive,  
Reston, VA 22091  
703—620-6300  
(S8, S9, Earth station  
placement frequency  
coordination)

**ComSonics, Inc.,**  
P.O. Box 1106,  
Harrisonburg, VA 22801  
1-800—336-9681  
(M8, 9, S8, 9)

**DF Countryman Co.,**  
1821 University Ave.,  
St. Paul, MN 55104  
612—645-9153  
(D1, S1, 8)

**The Disney Channel**  
500 S. Buena Vista,  
Burbank, CA 91521  
213—840-5080  
(S4)

**Ditch Witch,**  
P.O. Box 66,  
Perry, OK 73077  
1-800—654-6481  
(M9)

**The Drop Shop Ltd., Inc.**  
Box 284,  
Roselle, NJ 07203  
1-800—526-4100 or  
1-800—227-0700 (West)  
(D3, 4, 5, 6, 7, 8, 9,  
M5, 6, 7, 8, 9 Plastics)

**Durnell Engineering Inc.,**  
Hwy 4 So.  
Emmetsburg, IA 50536  
712—852-2611  
(M9)

**Eagle Com-Tronics, Inc.,**  
4562 Waterhouse Rd.,  
Clay, NY 13041  
1-800—448-7474  
(M9 Pay TV Delivery  
Systems & Products)

**Eastern Microwave, Inc.,**  
3 Northern Concourse,  
P.O. Box 4872,  
Syracuse, NY 13221  
315—455-5955  
(S4)



# Associate Roster

**Electroline TV Equipment, Inc.,**  
8750-8th Ave.,  
St. Michel,  
Montreal, Canada  
H1Z 2W4  
514-725-2471  
(M4, 5, 7, 9, D7, 9)

**Electron Consulting Associates,**  
Box 2029,  
Grove, OK 74344  
918-786-5349  
(M2, D1, S1, 8)

**Elephant Industries,**  
P.O. Box 3626  
N. Ft. Myers, FL 33903  
813-995-7383  
(M9)

**ESPN,**  
ESPN Plaza,  
Bristol, CT 06010  
203-584-8477  
(S9)

**Franey & Parr of Texas, Inc.,** (Formerly Doherty & Co.),  
One Turtle Creek Village,  
Suite 524,  
Dallas, TX  
214-528-4820  
(S9, Insurance)

**Gardiner Communications Corp.,**  
3506 Security St.,  
Garland, TX 75042  
214-348-4747  
(M9 TVRO Packages, S1, 2, 8)

**General Cable Corp.,**  
1 Woodbridge Center,  
P.O. Box 700  
Woodbridge, NJ 07095  
1-800-526-4385  
(M3)

**Gilbert Engineering Co.,**  
P.O. Box 23189,  
Phoenix, AZ 85063  
1-800-528-5567 or  
602-245-1050

**Group W Satellite Communications,**  
41 Harbor Plaza Dr.,  
P.O. Box 10210,  
Stamford, CT 06904  
203-965-6219  
(S4)

**H & R Communications,**  
Rt. 3, Box 102G,  
Pocahontas, AR 72455  
1-800-643-0102  
(M2, D1, S2, 3, 8)

**Harris Corporation,**  
P.O. Box 1700,  
Melbourne, FL 32901  
305-724-3401  
(M2, 9, S2)

**Heller-Oak Communications,**  
105 W. Adams St.,  
Chicago, IL 60603  
1-800-621-2139 \* 7600  
(S3)

**Home Box Office, Inc.,**  
12750 Merit Dr.  
Dallas, TX 75251  
214-387-8557  
(S4)

\* **Hughes Microwave Communications Products,**  
3060 W. Lomita Blvd.  
Torrance, CA 90505  
213-517-6233  
(M9)

**Ind. Co. Cable TV, Inc.,**  
P.O. Box 3799  
Hwy. 167 N,  
Batesville, AR 72501  
501-793-4174  
(D1)

\* **Jerry Conn Associates, Inc.,**  
P.O. Box 444,  
Chambersburg, PA 17201  
1-800-233-7600  
1-800-692-7370 (PA)  
(D3, 4, 5, 6, 7, 8)

**KMP Computer Services, Inc.,**  
703 Central Ave.,  
Los Alamos, NM 87544  
505-662-5545  
(S4, 5)

**Karnath Corporation,**  
2001 Westridge,  
Plano, TX 75075  
214-422-7981 or 7055  
(S1, 2, 8, 9)

**Katek, Inc.,**  
215 Wood Ave.,  
Middlesex, NJ 08846  
201-356-8940

**Klungness Electronic Supply,**  
P.O. Box 547,  
107 Kent Street,  
Iron Mountain, MI 49801  
1-800-338-9292  
1-800-682-7140 (Mich)  
(D1, 8, S2, 8)

**LRC Electronics, Inc.,**  
901 South Ave.,  
Horseheads, NY 14845  
607-739-3844  
(M7)

**Lash-Ade Company,**  
P.O. Box 147,  
Guntersville, AL 35976  
205-582-6333  
(M9 Cable Protector,  
S9 Equipment Repair)

**Larson Electronics,**  
311 S. Locust St.,  
Denton, TX 76201  
817-387-0002  
(M9 Standby Power)

**Lemco Tool Corporation,**  
Box 330A,  
Cogan Station, PA 17728  
1-800-233-8713  
(M8, 9 Tools)

**Lindsay Specialty Products, Ltd.,**  
50 Mary Street West,  
Lindsay,  
Ontario, Canada K9V 4S7  
705-324-2196  
(M1, 2, 4, 5, 7, 9)

**Magnavox CATV Division,**  
100 Fairgrounds Drive,  
Manlius, NY 13104  
1-800-448-5171 or  
1-800-522-7464 (N.Y.)  
(D4, 5, 7, M4, 5, 6, 7, S3, 8)

**McCullough Satellite Equipment,**  
Route 5, Box 97,  
Salem, AR 72576  
501-895-3167  
(M2, 9, D3, 4, 6, 7)

**Microdyne Corporation,**  
471 Oak Road,  
Ocala, FL 32672  
904-687-4633  
(M9 Satellite TV Receivers)

\* **Microwave Filter Co.,**  
6743 Klnne St., Box 103,  
E. Syracuse, NY 10357  
1-800-448-1666  
(M9 Bandpass Filter)

**Modern Cable Programs,**  
5000 Park St. N.,  
St. Petersburg, FL 33709  
(S4)

**Mullen Communications Construction Co., Inc.,**  
P.O. Box 1387A,  
Green Bay, WI 54305  
414-468-4649  
(S2)

**National Farmers Union Property & Casualty Co.,**  
12025 E. 45th Ave.,  
Denver, CO 80251  
303-371-1760  
(D9, Insurance Service)

**North Supply Company,**  
600 Industrial Pkwy.,  
Industrial Airport, KS  
66031  
913-791-7000  
(D1, 2, 3, 4, 5, 6, 7, 8)

**Octagon Scientific, Inc.,**  
476 E. Brighton Ave.,  
Syracuse, NY 13210  
315-476-0660  
(M9)

Distributors	Manufacturers	Service Firms
D1—Full CATV equipment line	M1—Full CATV equipment line	S1—CATV contracting
D2—CATV antennas	M2—CATV antennas	S2—CATV construction
D3—CATV cable	M3—CATV cable	S3—CATV financing
D4—CATV amplifiers	M4—CATV amplifiers	S4—CATV software
D5—CATV passives	M5—CATV passives	S5—CATV billing services
D6—CATV hardware	M6—CATV hardware	S6—CATV publishing
D7—CATV connectors	M7—CATV connectors	S7—CATV drop installation
D8—CATV test equipment	M8—CATV test equipment	S8—CATV engineering
D9—Other	M9—Other	S9—Other

Note: Associates listed with \* are Charter Members.

**Phasecom Corp.**,  
6365 Arizona Circle,  
Los Angeles, CA 90045  
213—641-3501  
(M1)

**Power and Telephone  
Supply Company, Inc.**,  
530 Interchange Drive  
N.W.,  
Atlanta, GA 30336  
1-800—241-9996  
(D1)

**M/A Com Prodelin, Inc.**,  
P.O. Box 100  
Claremont, NC 28610  
704—459-9762  
(M2, 3, 7, S2)

**Pyramid Industries, Inc.**,  
P.O. Box 23169,  
Phoenix, AZ 85063  
1-800—528-4529  
(M7, 8)

**Quality RF Services, Inc.**,  
825 Park Way, Suite 3,  
Jupiter, FL 33458  
305—747-4998  
(M4, S9)

**RMS Electronics**,  
50 Antin Place,  
Bronx, NY 10462  
1-800—223-8312  
1-800—221-8857 (Poleline)  
(M4, 5, 6, 7, 9)

**Rockwell International**,  
M.S. 402-101,  
Dallas, TX 75207  
214—996-5954  
(M9, Microwave/Satellite)

**Sadelco, Inc.**,  
75 West Forest Ave.,  
Englewood, NJ 07631  
201—569-3323  
(M8)

**Scientific Atlanta, Inc.**,  
3845 Pleasantdale Rd.,  
Atlanta, GA 30340  
404—449-2000  
(M1, 2, 4, 8, S1, 2,  
3, 8)

**Showtime Entertainment,  
Inc.**,  
1633 Broadway,  
New York, NY 10019  
212—708-1600  
(S4)

**Southern Satellite  
Systems, Inc.**,  
P.O. Box 45684,  
Tulsa, OK 74145  
918—481-0881  
(S9)

**Superior Electronics  
Center**,  
2010 Pine Terr.,  
Sarasota, FL 33581  
813—922-1551  
(M4, S9)

**TVC Supply Co., Inc.**,  
1746 E. Chocolate Ave.,  
Hershey, PA 17033  
717—533-4982  
(D1, 2, 3, 4, 5, 6, 7, 8)

**Teledac, Inc.**,  
1575 Taschereau Blvd.,  
Longueuil,  
Quebec, Canada J4K 2X8  
514—651-3716  
(M9 Character  
Generators)

**Tele-Wire Supply Corp.**,  
7 Michael Ave.,  
East Farmingdale,  
NY 11735  
516—293-7788  
(D1, 2, 3, 5, 6, 7, 8, 9)

\* **Texscan Corp.**,  
3169 N. Shadeland Ave.,  
Indianapolis, IN 46226  
317—545-4196  
(M9 Bandpass Filters)

\* **Theta-Com CATV**,  
2960 Grand Avenue,  
Phoenix, AZ 85061  
602—252-5021  
(M1, 4, 5, 7, 8)

\* **Times Fiber  
Communications**,  
358 Hall Avenue,  
Wallingford, CT 06492  
1-800—243-6904  
(M3)

**Tocom, Inc.**,  
P.O. Box 47066,  
Dallas, TX 75247  
214—438-7691  
(M1, 4, 9 Converters)

\* **Toner Cable  
Equipment, Inc.**,  
969 Horsham Rd.,  
Horsham, PA 19044  
1-800—523-5947  
In PA. 1-800—492-2512  
also 1-800—523-5947 (PA)  
(D2, 3, 4, 5, 6, 7)

**Triple Crown  
Electronics, Inc.**,  
4560 Fieldgate Dr.,  
Mississauga, Ontario,  
Canada L4W 3W6  
416—629-1111  
Telex 06-960-456  
(M4, 8)

**Turner Broadcasting  
System**,  
1050 Techwood Dr.,  
Atlanta, GA 30318  
404—898-8500

**Tyton Corp.**,  
P.O. Box 23055,  
Milwaukee, WI 53223  
414—355-1130  
(M6, 7)

**United Press International**,  
220 East 42nd St.,  
New York, NY 10017  
212—682-0400  
(S9 Automated News  
SVC.)

**United Video, Inc.**,  
3801 South Sheridan Rd.,  
Tulsa, OK 74145  
1-800—331-4806  
(S9)

**Viewstar, Inc.**,  
705 Progress Ave.,  
Unit 53,  
Scarborough,  
Ontario, Canada M1H 2X1  
416—439-3170  
(M9 Cable Converter)

**Vitek Electronics, Inc.**,  
4 Gladys Court,  
Edison, NJ 08817  
201—287-3200

**Walsh, Walsh, Sweeney  
& Whitney, S.C.**,  
P.O. Box 1269,  
Madison, Wi. 53701  
608—257-1491  
(S9)

**Warner Amex Satellite  
Entertainment Corporation**,  
1211 Avenue of the  
Americas,  
New York, NY 10036  
212—944-4250  
(S4)

\* **Wavetek Indiana**,  
5808 Churchman,  
Beech Grove, IN 46107  
1-800—428-4424  
TWIX 810—341-3226  
(M8)

**Weatherscan**,  
Loop 132,  
Throckmorton Hwy.,  
Olney, TX 76374  
817—564-5688  
(D9, Sony Equip. Dist.,  
M9 Weather Channel  
Displays)

**Western Towers**  
Box 347,  
San Angelo, TX 76901  
915—655-6262/653-3363  
(M2, 9 Towers)

**Winegard Company**,  
3000 Kirkwood Street,  
Burlington, IA 52601  
1-800—523-2529  
(M1, 2, 3, 4, 5, 7)

**Zenith Radio Corp.**  
1000 N. Milwaukee Ave.  
Glenview, IL 60025  
312—391-8195  
(M1, 6) □

# Classified

## OPPORTUNITIES

### Position Wanted

Chief Engineer with over 15 years cable experience seeking same position in new location in the South, West or Mountain States. Willing to relocate at own expense. 717 662-7145.

### VICE PRESIDENT OF ENGINEERING POSITION

- Do you have extensive experience in all phases of upgrading and rebuilding older plants?
- Have you experience in addressable systems?
- Do you have a proven track record in analyzing capital costs and developing accurate capital expenditure budgets?
- Does your experience include plant and headend maintenance of larger, older systems?

If you can answer "yes" to all of these questions and can provide excellent references, you might be the person we are looking for to become part of our management team. Ideal Florida location and entrepreneurial atmosphere make this an excellent opportunity for a knowledgeable, experienced professional whose associates recognize the importance of the technical aspects of our business.

Please reply with your resume and compensation history, which will be held in confidence: #82583, CATJ, 4209 NW 23, Suite 106, Okla. City, Okla. 73107.

## IRS TAX TIP

### For Single Taxpayers

If you maintained a home for a parent, child, or other relative, you may be able to file as Head of Household and pay less than filing as a single taxpayer.

A public service message from  
the Internal Revenue Service



## ATTENTION! SYSTEM MANAGERS — TECHNICIANS NEEDED

Excellent opportunity for system managers and technicians for our systems in Colorado, Texas, and Oklahoma. Need qualified personnel for these Southwestern locations; good working conditions and opportunity for the right people who want to work and stay actively involved in the cable business. These systems have good equipment to work with and offer excellent situations to grow in the cable business. If interested, send resume to the box number indicated below.

Box 71080  
c/o CATJ  
4209 N.W. 23rd  
Suite 106  
Okla. City, OK 73107

## Your company can help us prevent child abuse.

**Help us get to the heart of the problem.**

**Write: National Committee for Prevention of Child Abuse  
Box 2866, Chicago, Illinois 60690**

- Please send us information on how we can help.
- We want to start helping right now. Enclosed is a check for \$\_\_\_\_\_.

NAME \_\_\_\_\_

TITLE \_\_\_\_\_ COMPANY \_\_\_\_\_

ADDRESS \_\_\_\_\_

CITY \_\_\_\_\_ STATE \_\_\_\_\_ ZIP \_\_\_\_\_



**National Committee for  
Prevention of Child Abuse**

A Public Service of This Magazine  
& The Advertising Council.



CATJ classified advertising is offered as a service by CATA for its membership.

ANY member of CATA may advertise in the CATJ classified section FREE of CHARGE (limit of 50 words per issue — 3 issues per year.)

CATA offers three types of memberships:

- 1.) Systems — paying regular monthly dues based on number of system subscribers.
- 2.) Associate Members — pay an annual fee.
- 3.) Individual Members — pay an annual fee.

NON MEMBERS may also use the Classified section at the rate of 50 cents per word with a minimum charge of \$20.00. Add \$2.00 for blind-box. Non-members should include full payment with the ad insertion.

Deadlines for all Classified Advertising is the 1st of the month for the following month's issue.

Address all Classified material to: CATJ, Suite 106, 4209 N.W. 23rd, Oklahoma City, Okla. 73107.