

Here's the most cost-efficient system yet for measuring frequency response, gain, loss, and input/output return loss. It's only from Wavetek and costs much less than you'd expect.

With our new Bench Sweep System, gain, loss or return loss can be quickly determined by superimposing input and output traces on the Model 1905 Oscilloscope. Time-shared sweep and a set of matched cables (including a built-in cable in the reference channel) eliminate signal-matching problems and

errors caused by system drift. There is also a slope adjustment for each channel.

The signal source is Wavetek's Model 1081, with CW, ΔF , and full sweep modes from 1 to 1000 MHz. It has a digital readout with 1% display linearity, 75-ohm output and a marker system that generates markers at intervals of 1, 10, and/or 100 MHz.

The heart of the system is the Model 1076 Comparator. It features calibrated attenuators, sweep time-sharing, and a logarithmic detector that allows

measurement of return loss to 40 dB. An RF Return Loss Bridge completes the system.

Call your representative for complete specifications and applications information. Wavetek Indiana, Inc., 5808 Churchman, P.O. Box 190, Beech Grove, IN 46107. Or call toll-free, 1-800-428-4424. In Indiana, call (317) 787-3332. TWX 810-341-3226.

WAVETEK

Sweeping 1 MHz to 1 GHz is now fast, easy and reasonable.

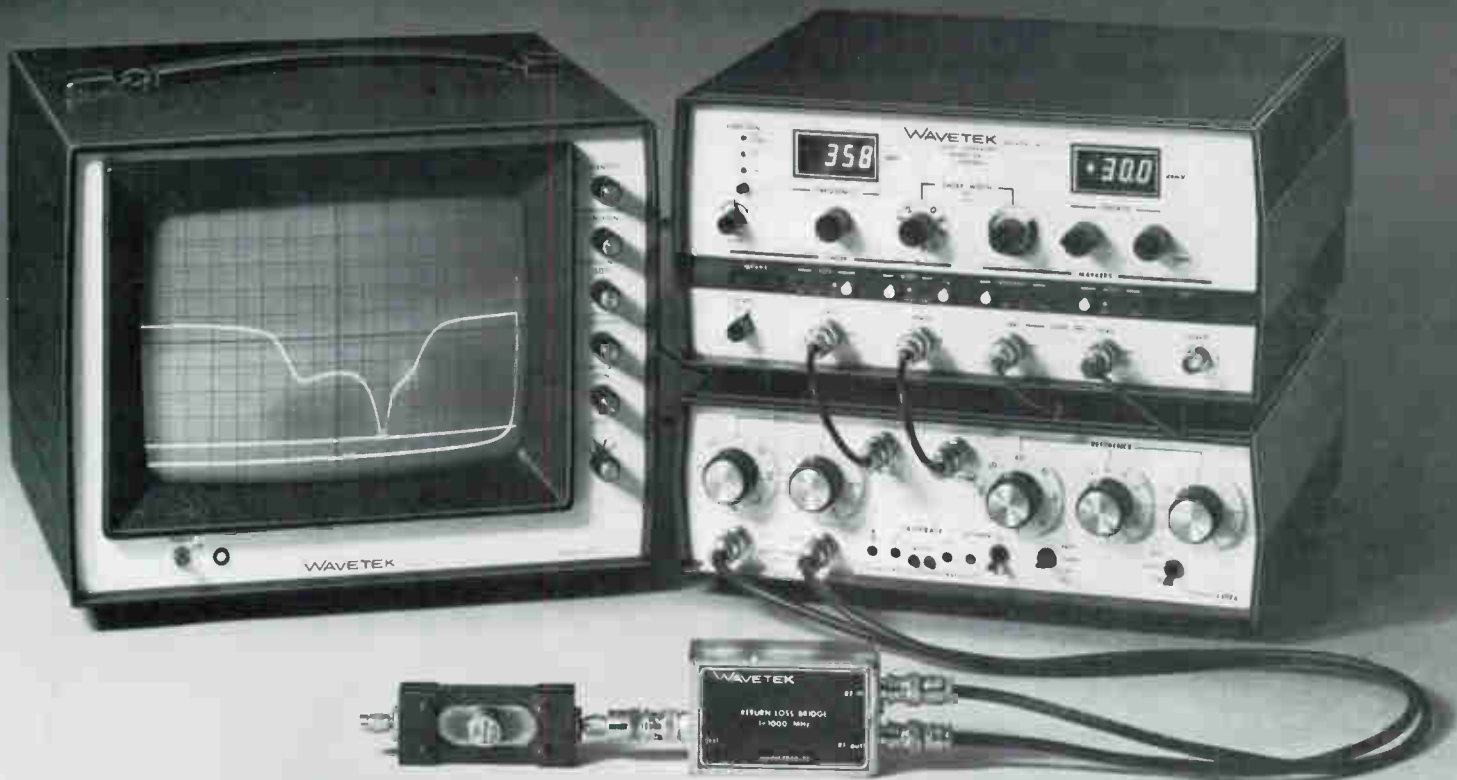

Cable TV Services, (214) 494-3348, TX,AR,LA,OK • CATV Services, (415) 651-4331, CA,OR,WA,AK,NV
ComSe Sales, (404) 963-7870, GA,AL,NC,SC,TN,MS,FL • CWY Electronics, (317) 448-1611, IN,MI,WI,IA,IL,KY
NCS Industries, Inc., (215) 657-4690, Wash.DC.,MD,DE,E. PA,VA,S. NJ • Cable Technology Associates, Inc., (315) 422-9012, NY,CT,RI,MA,VT,N. NJ,NH,ME
WorldRadioHistory

maximum security



against theft,
weather, and
RF radiation

...with security cabinets from
TONER

You get more protection value for your money with TONER lockable apartment house cabinets. Constructed of 14 and 16 gauge steel with 3/8" plywood backboards. Shipped fully assembled. Indoor and outdoor models in five sizes. Now available in 4", 6", and 8" depths.

TONER has the cabinets you need in stock and ready to ship — today!

TONER

cable equipment, inc.

969 horsham rd. • horsham, pa. 19044

800-523-5947

(in pa. 800-492-2512)

CATJ, The Official Journal for the Community Antenna Television Association is published as a service for Association Members and others providing services to the industry.



See Page 24

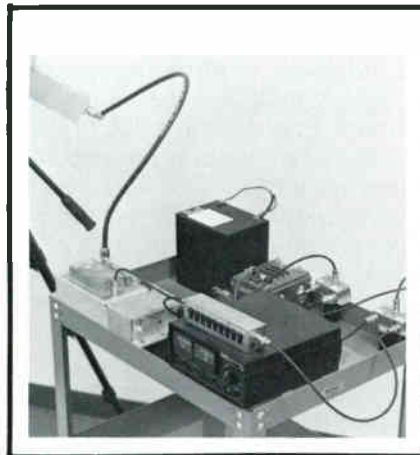

See Page 38

ABOUT THE COVER:

Hot Springs, Arkansas . . . the Arlington Hotel . . . the setting for . . . CCOS '83!



See Page 12

TABLE OF CONTENTS

4 CATA-TORIAL — *Synergy At Work In The Cable Industry . . . a discussion of the different factions within the cable industry that worked together on S.66 by CATA President, Peter Athanas*

6 WASHINGTON UPDATE — *Steve Effros, CATA Executive Director, discusses the adoption by the Senate of S.66 and what now faces cable operators with the House*

12 CCOS '83 — *discussion and explanation of the various sessions, as well as the program and extra activities for the ladies and youth of CCOS.*

LIST OF CCOS '83 EXHIBITORS

18 STEVE BIRKILL ON EXPERIMENTAL TERMINALS — *Mr. Birkill receives many letters from CATJ readers, and has answered one of these in this issue on signal propagation at 6 GHz uplink and 4 GHz downlink on current U.S. and Canadian domsats. (Next month, he will answer inquiries concerning 2 degree spacing of C-Band satellites and information on a 1.5 or 2 metre dish with a low temp LNA/convertor.)*

24 PAY-TV: A PAY-PER-MINUTE SYSTEM PROTOTYPE — *by: Tom Bowling, Bell Northern Research Ltd., Ottawa, Canada*

38 THE FILTERED EARTH STATION — PART #15 — *The Do-It-Yourself Survey by Glyn Bostick, Microwave Filter Company*

44 NEW PRODUCT REVIEW — *Superior Electronics, Sarasota, Florida, presents a report on their Proof of Performance Testing Van, a service deemed valuable to the cable operators who are seeking to gather the data for their FCC reports. A companion article concerning services of Superior follows*

48 SPEEDY EQUIPMENT REPAIR, MODIFICATION, AND CALIBRATION — *a feature describing the repair service being offered by Superior Electronics*

52 ASSOCIATES' SHOWCASE

53 ASSOCIATES' ROSTER

56 CLASSIFIED



Peter Athanas
President of CATA

S.66-SYNERGY AT WORK IN THE CABLE INDUSTRY

The cable industry is basking in the glow of a major victory in the United States Senate. We succeeded in convincing the Senators that the arguments forwarded by many major cities, and, more importantly, the telephone interests were not persuasive, and that S.66, a significant deregulatory bill for the cable industry, was indeed in the public interest. We won the final vote by an overwhelming margin: **87 to 9**. The real vote, however, was much closer — on the principal amendment offered by the telephone industry, the vote was **55 to 44**. It took a lot of effort and a lot of coordination to accomplish that result, and it proved once again what we have been saying for a long time: that the cable television industry is well served by having diverse groups representing it who can coalesce when the need arises. That is exactly what happened in the case of S.66, and it will probably happen again when this issue reaches the House of Representatives. The synergy produced by the combination of forces is impressive, and it is testimony to the healthy state of affairs in the cable television industry.

Synergy, of course, is the result of a combination of forces being more powerful than the sum of their parts. That is what happened in this case. The diverse interests of the industry are ably represented by CATA, NCTA, the State Associations, the Regional Associations and many many individual operator groups. These various components often have the same goals, but sometimes differ with each other. In most cases the **FOCUS** of the individual groups is different. For instance, as is

well known, CATA primarily works with individual cable operators — be they managers or owners of systems at the system level. The NCTA, on the other hand, deals with the major corporations, the big MSO's, at the corporate board room level. Both, of course, have a place. From CATA's point of view, it is just as important to get the local system manager involved and knowledgeable about what is happening in the industry as it is for the President and Chief Operating Officer to know. There is a simple reason for this. When the time comes to talk to a local official, or a state official, or a Congressman, let's say, it may, in some instances be as effective, or even more effective, for the local operator to deliver the cable industry's message than for the CEO to do it.

Of course, both approaches are important. And in the case of the work done on S.66, both were used. That's what produces **synergy**. As President of CATA, I have been asked many times why the industry needs two national trade associations. The assumption always seems to be that a "unified" voice in Washington is always better. As I think is now clear, that is not always true.

First of all, we at CATA believe that it is simply impossible for one group to represent the interests of all cable television operators all the time. It is unrealistic to think that this industry is so monolithic that the problems confronting a cable conglomerate with over 2-million subscribers are always the same as those confronting a 300 or 3000 subscriber system. And that dichotomy also applies to location. The problems that face a major urban operator in the top-25 markets are different from a smaller-market operator or an operator outside of all markets even if that latter system has 25,000 subscribers! There is nothing wrong with recognizing those differences, and assuring that all segments of the industry are represented.

The situation in Washington can usually be characterized by viewing the NCTA as representing the large, urban operations, as well as others, of course, and CATA representing the smaller, non-urban operations. Naturally, both organizations have members active in both areas. However, that does not create an incompatibility nor does it mean that the merger of the two organizations could possibly serve the industry better than the present situation.

Ironically, the broadcast industry is just beginning to recognize what we have seen for a long time. The National Association of Broadcasters is under extreme pressure right now to alter its makeup and change its lobbying techniques precisely because various segments of the broadcast industry have belatedly recognized that one association cannot always represent all interests. A new broadcast lobbying group has just been formed, the "Major Market Television Caucus", to assure that the big major market broadcasters get their interests represented in Washington. The new group is taking pains to point out that it is not being designed as a "rival" to the NAB, but rather as a complement. We

have already accomplished that in the cable television industry with CATA and the NCTA on the national level.

The fact that we can go up to Capitol Hill on an issue such as S.66 and approach it from different angles, seeking the same end result, improves the chances of the cable industry in getting what we are all seeking: **less government control, at any level of government.** We present different viewpoints, different arguments, different perspectives, and they bolster each other. That is synergy. Certainly there are times when we disagree. There are times when the interests of different groups of operators are different — and it is to our credit that we can articulate those differences without the rancor that so often marred our efforts years ago. The fact that we can differ also aids the impact of our synergy when we agree. Ever since CATA introduces its "Corporate Membership" program a year and a half ago, we have experienced a steady increase in membership from large and medium sized MSO's. The strict dues limitations on those members have assured that CATA's focus will remain on the local level, the day-to-day, practical, hands-on level. This has proved to be of benefit to the manager of a large, MSO-owned system, just as it has always been a benefit to the small, stand-alone operator. We intend to keep it that way.

The major victory that I started talking about at the beginning of this month's CATatorial is indeed testimony to the benefit derived by cable's synergy in Washington. Now, however, we must all work **twice** as hard to see that the formula works once again in the **much more difficult** struggle that faces us in the House of Representatives. No matter how much we pat ourselves on the back for past accomplishments, they will not result in practical benefits without further effort. We need your help now to continue that effort. That help must come not only financially, with a sincerely hoped-for decision on your part to join CATA, but also with your active participation in the effort to secure passage of the House equivalent of S.66. **We are asking for both your money and your time.** You will get a far greater return of both if we are all successful in our deregulation efforts. We know you have heard all this before at other times, but, as the saying goes, **"... this is NOT a test!"** The time is now. We are spending money on your behalf at an unprecedented level in an effort to accomplish this legislative goal — we need your support to continue doing so. And as we have always said, the lobbyists in Washington can only do so much — and they have done an incredible amount this time around, but to win the battle it will take **YOUR time and YOUR effort. After all, it is YOUR industry!** □

OFFICERS

Peter Athanas, President
 Carl Schmauder, Vice President
 Clarence Dow, Secretary/Treasurer

DISTRICT DIRECTORS

One	Clarence Dow (Maine)
Two	Michael J. Rigas (Pennsylvania)
Three	David Fox (West Virginia)
Four	John Rhinehart (Tennessee)
Five	Joe Bain (Oklahoma)
Six	Wayne Sheldon (California)
Seven	Carl Schmauder (Oregon)
Eight	Virgil Mehus (Minnesota)
Nine	Peter Athanas (Wisconsin)
Ten	Jim Hays III (Kentucky)

VICE DIRECTOR

Lee Holmes (Guam)

ASSOCIATES' DIRECTORS

Raleigh B. Stelle III, Texscan/Theta Com
 Ernie Larson, Larson Electronics

DIRECTORS EMERITUS

Gene Edwards (Ohio)
 Chuck Kee (Oregon)
 William Risdan (Kentucky)

CATJ STAFF

President and Publisher
 G.H. Dodson

Business and Managing Editor
 Celeste Rule Nelson

Executive Assistant to the Editor
 Diane Howard

Circulation Manager
 Lori Biggers

Contributing Editors
 S.J. Birkill, Stephen Effros,
 Ralph Haimowitz

Art Director/Marketing
 Phyllis Crumpler

Assistant Art Director
 Dianna Johnson

POSTMASTER: Send address change to 4209 N.W. 23rd, Oklahoma City, OK. 73107.

CATJ is a Copyright © 1983 by the Television Publication, Inc. All rights reserved. Qudean reservados todos los derechos. Printed in U.S.A. Permission to reprint CATJ published material must be given by Television Publications, Inc., prior to republication.

OFFICES

National Headquarters
 CATA/CATJ
 Celeste Rule Nelson, Managing Editor
 4209 N.W. 23rd, Suite 106
 Oklahoma City, Ok. 73107
 (405) 947-7664; 947-4717

CATA (Washington Office)
 Stephen R. Effros, Executive Director
 3977 Chain Bridge Rd.
 Fairfax, Va. 22030
 (703) 691-8875

CATA (Engineering Office)
 Ralph Haimowitz, Director
 518 21st Street S.W.
 Vero Beach, Fl. 32960
 (305) 562-7847

The Community Antenna Television Association, Inc. is a nonprofit organization formed under Chapter 19, Title 18 of the Statutes of the State of Oklahoma. As such, no part of its assets or income shall be the property of its members, such assets and income shall be devoted exclusively to the purposes of the Corporation.

The Community Antenna Television Journal (CATJ)—ISSN-0194-5963—is published monthly by Television Publications, Inc., 4209 N.W. 23rd, Suite 106, Okla. City, OK 73107. Subscription price: \$18.00 per year, \$22.00 per year Canada, Mexico, and foreign is \$25.00 per year. Second class postage paid at Oklahoma City.

Steve Effros
Executive Director, CATA

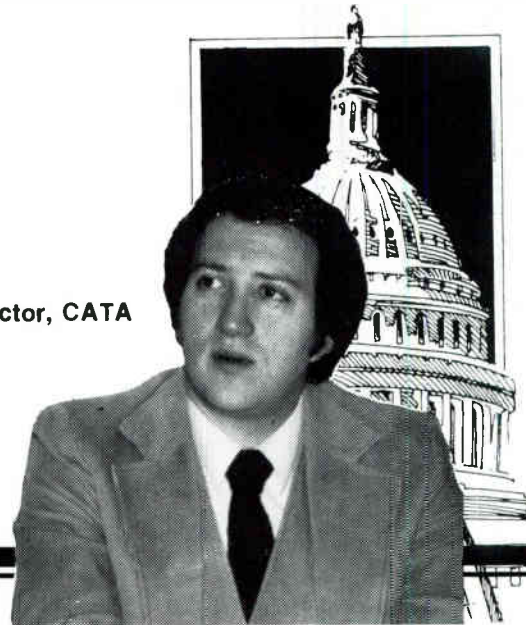

Washington Update

**This Month's Dose of Cable Reality:
PAY PER VIEW PROGRAM LOSES \$3 MILLION
COX SAYS INDAX SERVICE MAY NOT BE READY
FOR 2 MORE YEARS**

Reality, in small doses, is what the cable industry needs most, and, as most of you know by now, CATA has been saying for a very long time now that it does not hurt the industry one little bit to be honest about what we really are, what works, and what doesn't work.

We don't propose to always focus on the negative, but the fact is that the American public, and the mayors and council people we always have to work with have been bombarded for a long time with all the "blue sky" of cable. It comes from the mass media — which most of the time does not do a terribly good job of reporting mundane facts, they like the "sexy" stuff — you know, the headline for instance about Warner-Amex being indicted for showing the Playboy Channel. And they rarely report the other news, such as cable carriage of C-SPAN being one of the most innovative, informative, and unique services on cable. You see lots of reports of cable companies "taking over" in the United States, that cable is big, and getting bigger, that the large conglomerates are running America, etc., but you rarely see the downside news — the experiments

that fail, the trial balloons that don't get off the ground and so on. That is what we are going to report on here. We have to. If we don't we will wind up in many more situations where local city councils at renewal time demand "institutional two-way interactive addressable" systems because they have read somewhere that is what all cable systems are building these days! We will also see a lot more lobbying by our adversaries, and particularly the telephone companies, saying that cable is going to destroy local telephone rates because of our massive incursion into the data business, or the burglar alarm business or whatever. It's nonsense. You know it, we know it, but we have to let the rest of the world know too, or we will never catch up with the Wall Street and consultant hype that has been plaguing us for the past several years. So here goes this month's installment.

Pay-Per-View Doesn't!

One of the claims that is current these days is that the cable industry is massively gearing up for "Pay-Per-View" and that is where the "big" money is going to be very shortly. Well, it's true, some "big" money is floating around in pay-per-view, but it is going in the wrong direction! The most recent effort at PPV was staged by **RSVP** (Reserved Seat Video Productions) which is a joint venture of ESPN and

*Pull more channels out of the hat
with frequency reuse.*

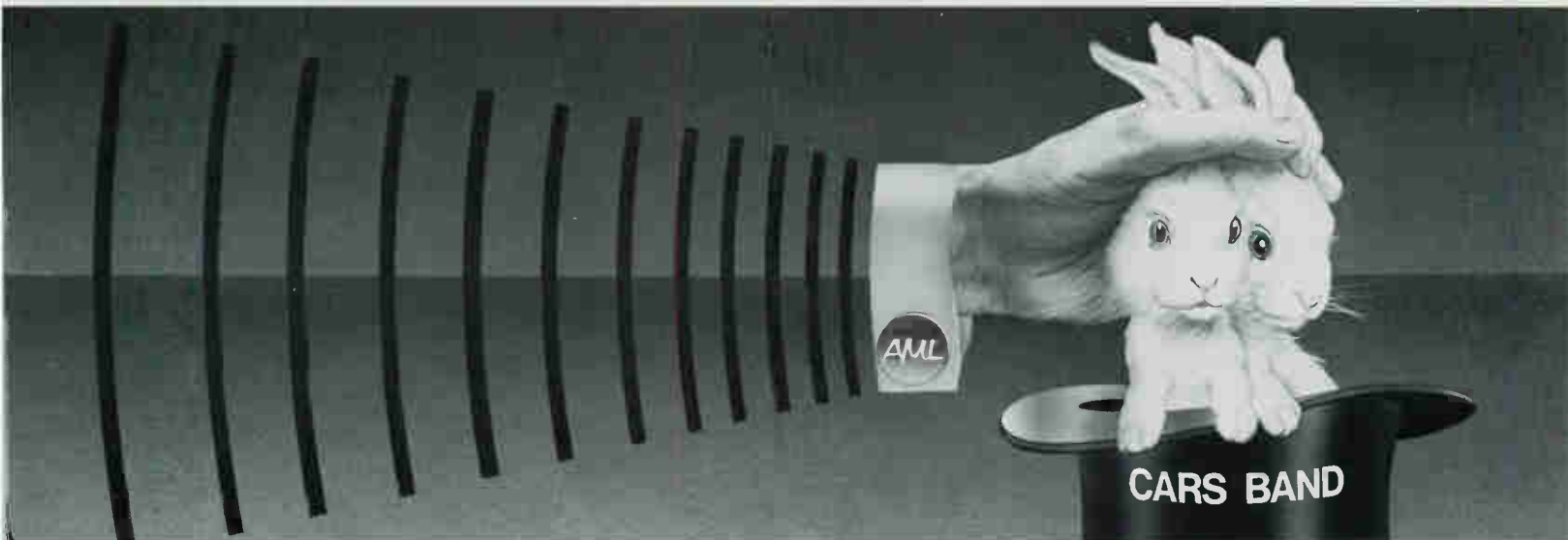

Hughes AML™ Microwave Systems

How can you multiply your capabilities in the spectrum limited CARS band? By utilizing frequency reuse—an amazing piece of magic perfected by Hughes AML Microwave Communications Products in cooperation with major urban cable system operators. This unique system allows the transmission of **more than 100 TV channels** to (and from) 20 or more receive sites.

Here's how it was done in Texas. In order to accommodate dual cable requirements in Dallas, two transmitters at opposite ends of the franchise were installed and are now successfully transmitting 40 channels each to seven hubs. Antenna isolation for different azimuth angles permits reutilization of the same CARS frequency for each transmitter. Further capacity has been reserved for **upstream and downstream** expansion of video and enhanced services.

In Fort Worth, A Hughes AML system is providing 160-channel performance: 40 downstream to each of 5 hubs, plus 24 channels upstream from each of the 5 hubs back to the master headend. Each of the 5 upstream transmissions operate **simultaneously on the same block** of frequencies. Similar frequency reuse installations are being implemented in Florida, Illinois, Virginia, and California.

Call today to find out how you too can improve your performance and expand your capabilities with AML. For more information, contact: **Hughes, Microwave Communications Products**, P.O. Box 2999, Torrance, CA 90509, Phone: (213) 517-6233.

AML—ANY MODULATION LINK

Creating a new world with electronics

HUGHES
HUGHES AIRCRAFT COMPANY

ABC Video Enterprises. It was a four-bout championship boxing extravaganza on May 20, and latest reports indicate that it **LOST \$3 million!** The folks who put it on now admit that PPV may be a little harder to sell than they thought, and that they are cutting back their projections of how many events will be offered on pay-per-view over the next couple of years. Apparently a lot of "details" were forgotten about when folks first got hyped up about pay-per-view. For instance, they forgot about the very limited number of subscribers who presently have the necessary addressable technology in their homes to take advantage of such an event. They also forgot about how much one of these events costs to effectively promote, and the time it might take to make that promotion work. They are now suggesting that it takes at least four months of promotion. That's a far cry from the image of having PPV events every Saturday night!

Speaking of crying —

Several major cities are crying foul, especially New Orleans, at the news from Cox Communications that their highly touted (and franchise winning) "INDAX" service, which was supposed to be something like Warner's "QUBE" service is in deep trouble. It seems that Indax doesn't really work even though Cox has dropped lots of money into the experimental pilot project out in San Diego trying to make it work. Another problem, of course, is that even when they did get it to work, the subscribers, once asked to pay for the service, dropped off in droves! This is another example of where expectations and technology may be far outstripping the actual consumer demand. We'll just quote from a recent article in Multichannel News to give you the flavor of the problems Cox has come up against: ". . . Among the problems the service has faced . . . was a faulty converter and difficulty in developing the information banks and services that are to be available over Indax. Indax's shop-at-home subcontractor recently went out of business and the firm providing banking services also faces financial difficulties. Both firms had been backed financially by American Can Co., which pulled out of the ventures after deciding profitability was too many years away." Well, you get the idea. The City officials in New Orleans are getting it too. They had been promised Indax service from April 1982 on! Cox is making a good-faith effort in all the cities where it promised Indax to show the city fathers that they are really trying to make it work and that they are still spending lots of money to iron out all the wrinkles. It may take some time though. Cox now says maybe by 1985.

IF AT FIRST YOU DON'T SUCCEED, MERGE!

That seems to be the gospel in the cable industry today as the financial reality of the risks that have

been taken, and the marketing reality of the promises that have been made start returning to the roost. Several issues ago we mentioned to you the pending merger of Showtime and The Movie Channel in an effort to compete with HBO more effectively. That one many not happen. The Justice Department has announced that it is against the deal — not because the two channels want to horizontally integrate, but because several movie companies are involved in the deal, and that will result in vertical integration, upon which the department frowns. The deal is not totally dead yet, however, since there may be a way of getting the movie companies out of the deal.

Another merger just announced is between the Cable Health Network and Daytime. Neither channel programmer was making it on its own. They are hoping that a combination of the two on one channel will create a mix of programming that will be successful enough to attract sufficient advertising to pay for the effort. No guarantees, but it looks like they may have a good marriage there. Aren't you all glad you ran out and built 108 channel systems so that you could carry all that programming?

SPORTS — THE COST KEEPS GOING UP

It's no secret that major-league sports is big business. The only folks who apparently still don't know it are in Congress — they still say sports is not a business and that is why the sports teams get immunity from the antitrust laws so that they can carve up the markets in the United States at will. But that's another story. This one is not about the astronomical fees the teams pay for players; it is about the astronomical costs that sports programming is turning out to impose on the cable industry. There are two parts. First, you remember ESPN, those folks who started a sports network for cable and based it on advertiser support — the same folks who even **PAID** cable operators for a while to carry the signal? Well, they found out the hard way that while the cost of the product they were delivering kept going up, the advertising dollars they were getting in did not — at least not fast enough. So a ten-cent per subscriber charge was introduced earlier this year to try to stem the flow of red ink. They have just announced that ten cents won't do it. The price will soon be 13-cents!

And while we are on sports, don't look now, but another sports channel is coming your way — this one from the friendly Group W folks. Their plan is for regional sports pay networks. That will probably work. There are some people who will simply do anything to see certain games, and they are going to take advantage of that. The backlash, however, is predictable. Be prepared for lots of bad press as cable is blamed for taking "**free**" sports off television. Nonsense, of course. The games for broadcast

THIS ADDRESSABLE CONVERTER CAN LEAD YOU TO WHERE THE MONEY IS.



Full headend addressability. That's how Z-TAC® brings cable operators new profit opportunities.

Each Z-TAC converter has its own address, so you can "talk" to over one million individual subscribers from the headend. That means you can turn them "off", turn them back "on", and authorize each converter to receive pay and pay-per-view programming. You control the hardware, the hardware controls the premium programs, you receive the profits.

But the more premium programming you offer, the bigger the temptation to pirate. That's where Z-TAC is downright genius. Zenith's advanced baseband system prevents pirating with video inversion, random rate video inversion, sync suppression, random rate sync suppression, and any combination of these.

Zenith's remote control is another money maker. It's full-function with features found only in an advanced baseband system like Z-TAC, including volume control and mute.



And Z-TAC is the only system that lets you turn the remote control capability on and off from the headend.

Top that off with the best of today's technology—450 MHz capability, dual cable, tiered programming, favorite channel scanning, parental control and Power Reserve, a built-in Ni-CAD battery that eliminates most power failure worries. As for tomorrow, Redi-Plug™ makes the Z-TAC system upgradable to two-way and text.

Z-TAC. The reliable addressable system by Zenith—a world leader in color TV and now a world leader in baseband cable system technology.

For complete information contact Zenith CATV Sales, 1000 Milwaukee Ave., Glenview, IL 60025. Telephone 312-391-8960.

The quality goes in before the name goes on.®

Z-TAC

FROM THE LEADER IN BASEBAND TECHNOLOGY

television have already been locked in by contract for the next five years, but that won't stop the bad press — you may as well get ready for it!

MUNICIPAL OWNERSHIP — SOME INTERESTING FACTS

The "solution", as some local activists see it, is municipal ownership. That is their way to get around the problem of the big bad cable companies who are always making and breaking promises, not doing enough in the way of access, not paying high enough franchise fees, etc. They point to the fact that there already exist some municipally owned systems as proof that such a proposal is sound. They should know the following, found in a study done by Communications Strategies Inc. for the New England Cable Assn.;

Only 11 of 38 existing municipally owned systems have 1,000 subs, only 21% offer a pay channel, and only 39% offer any satellite delivered programming. Over 60% of the systems have fewer than 12 channels, only 14 have any form of local origination, and only 4 provide access. With a record like that, there's no wonder that municipal ownership, once it is carefully looked into, is rejected by a vast majority of folks who even think about it. From our viewpoint, it is not something we would even contemplate — do you really want the government running the

media? Haven't these folks heard of the First Amendment?

GET CREDIT WHERE CREDIT IS DUE!

It's written so well we thought we would just pass along the entire article from a recent issue of the Pa. State Cable Television Association Newsletter;

"Last year the cable industry paid \$148 million in franchise fees to municipal governments, but only a handful of cable operators won public relations points in the process of handing large sums of money over to their local governments. Rudy Cadori, manager of the DuBois Area Cable TV was one of them.

According to the DuBois Courier-Express — and lifted directly from a press release issued by the cable company — DuBois Area Cable paid more than \$22,000 in franchise fees to local municipalities. The article goes on to list how many dollars went to each.

And, though a press release is a perfectly good way to bring attention to the support cable provides local governments, officials at Highland Video in Blairsville are taking things a step further. When they have a meeting with a borough or township official, they hand carry the check and deliver it at the beginning of the meeting. Since this only makes the local officials aware of where the money is coming from, they're also planning on delivering checks during borough council or township supervisor meetings."

Just in case you didn't know, in the fight over S.66 in the Senate a long letter by Mayor Koch of New York was distributed to city officials around the country and to members of Congress. One of the things he complained about was the idea that cable operators, under the bill, would have the right to designate on their bills how much of the money subscribers were paying would go to the franchising authority. Here is what he said: "... legislation should not interfere with a city's right to prohibit a cable operator to indicate the franchise fee on monthly bills to subscribers. This billing practice is intended to create public pressure to force local jurisdictions to lower or eliminate franchise fees."

You bet it is Mr. Mayor! And we find it somewhat incredible that the Mayor of New York would suggest that the best way to govern is to do it secretly so that the citizens don't really know what you are doing to them! Why shouldn't the subscribers know what taxes the city is imposing at their expense? We would go one step further — we would list not only the franchise fee, but the percentage of the bill that goes to pay for the access studios, the mobile vans, the rate regulation costs, and all the other goodies that the city tacks on to the franchise. You must remember that this "complaint" about S.66 comes from a Mayor of a City that is imposing, or trying to impose a 10% franchise fee. □

EXCEPTIONAL VALUES* IN PROFESSIONAL QUALITY

TOOLS rep. by

Choose from a wide range of precision-made, longlasting hand-tools for most electronic assembly and repair work.

Soldering Irons & Accessories • Electronic Shears & Scissors

Weller® • Wiss® • Xcelite®

Electronic Pliers • Screwdrivers • Nutdrivers • Strippers • Cutters

Most are in stock and ready to go. We ship within one workday of receiving your order.



VALUES LIKE THIS

Weller® Controlled-Output Soldering Station Model WTCPN **\$71.50**

Broadband Engineering
211 Commerce Lane
Jupiter, Florida 33458

Call today for pricing and free catalog detailing our complete line of tools and other CATV products & services.

Toll Free: 800-327-6690
Florida: (305) 747-5000

AUGAT® BROADBAND
Quality and Innovation

SCM



ALCOA-NEC Communications Corporation is DBS.

ALCOA-NEC (ANCOM) is ready, willing and able *now* to meet the Direct Broadcast Satellite (DBS) equipment challenge.

With DBS, consumers will own inexpensive antennas to receive TV signals directly from a satellite. Current projections see as many as 30 million compact dishes in place by 1990.

ANCOM is the only company ready *today*, producing and delivering state-of-the-art DBS components. And unlike newcomers to DBS, ANCOM offers the dependability of system integration. One reliable source for all DBS components—from dish to low noise converter to indoor receiver. One source for design and testing, for packaging and distribution. This integrated approach assures fully tested components, designed to install quickly and work efficiently as a system for maximum field performance.

ANCOM is the best choice for any company entering 12GHz broadcasting on any scale. We are ready, willing and able to supply tomorrow's technology today...in the quantities and configurations to fit any individual purchaser's needs.

For more information, call or write for *Tuning in Tomorrow.*

ANCOM

ALCOA-NEC
Communications Corporation

130 Martin Lane, Elk Grove Village, Illinois 60007
Phone: (312) 640-8466
TWX 910-222-5991 (ANCOM ELGR)

See us at SCUC '83 Booths #145 and #146.



Photos courtesy of the Arkansas Department of Parks and Tourism



Here's What's Happening!

TECHNICAL SEMINARS

Making A Clean Sweep Of It —

Terry Bush and Tony Shortt of Wavetek Indiana explain the theory of bench and system sweeping, including sweeping amplifiers, modulators, cable, passive devices, and system trunk. A hands-on laboratory portion of this seminar, which is presented three times, covers video sweeping a modulator, a bench sweep-comparator, alignment of amplifiers, sweeping cable for structural return

loss, and field sweeping system plant. Seating is limited to 30 people for each session.

Top Bath House Row

Left: Magic Springs Amusement Park

Right: The Josephine Tussaud Wax Museum

Common Cable System Problems —

Vice President of Engineering, Bob Luff, and West Coast Director of Engineering, Hugh Bramble, both from Rogers UA Cablesystems present a highly informative program on common cable system problems including noise, intermodulation, hum, co-channel interference, and signal leakage, with “in the trenches” case histories and the resolution of the problems.

Confusing and Consternating Contraptions Called Converters —

Earl Langenberg, Senior Engineer from Rogers UA Cablevision, tells all about converters, their problems, proper use, maintenance, — all of it in this dynamic and highly informative session.

Double-Up System Channels By Channel Bandwidth Compression —

Ron Polomsky, from General Electrics CATV Products Division, discusses the new **GE Comband System** that compresses two video channels into one channel 6 MHz bandwidth for cable transmission and then separates into two programs for use. A wonderful new way to double your channel capacity without adding cable. A must for anyone facing refranchise channel expansion in the near future.

Cable Antennas For Le\$\$ —

Wayne Sheldon, Chairman of CATA's Engineering Committee, will give a “back to basics” session on how to adapt inexpensive rooftop type antennas for use in cable systems, with additional hints on how to “build your own” antennas.

Everything You Wanted To Know About The FCC, But Were Afraid To Ask —

Chris Pappas, FCC Field Specialist, will cover the FCC technical specifications, rules and regulations, and Proof-of-Performance requirements for cable systems. Chris will also talk about the procedures used when the FCC Field Test Van appears at your cable system. Ample time will be provided at the end of this session for a **question and answer period**. In addition, Mr. Pappas will have the FCC Field Test Van on site at the Arlington Hotel to conduct tours and answer questions on the van and its equipment.

Somebody's Interfering With My TVRO Signals —

Glyn Bostick of Microwave Filter Company and Bruce Uerling from Tele-Communications, Inc. cover terrestrial interference of satellite earth stations and the solutions to interference problems — from site planning to filtering.

New Technology On Fiber Optics —

Les Judd from Times Fiber Communications will discuss the latest developments and equipment used in fiber optics, including the Mini-Hub System, where fiber optics is and is not economically feasible, and training programs for fiber optics installers and technicians.

Get Your Daily Paper On Cable —

Richard Kirn from Wire Tele-View Corporation tells about working with a local newspaper to bring the daily news to readers from homes via the cable system with examples of service to three small cable systems. Includes discussion on cost aspects, channel leasing, equipment and interface.

MANAGEMENT SEMINARS

To Know Cable Is To Love Cable —

Nancy Jahnel from Group W Satellite Communications presents the values of **effective training** — a program that gets into the specifics of various training plans and methods of training cable personnel to achieve the greatest potential and effectiveness from your cable system and employees.

Buying And Selling Cable Systems —

Don Russell of Communications Equity Associates and John Whetzel of Northland Communications will present this informative discussion on how to evaluate a cable system for its worth, giving data on when to **buy** or when to **sell** a cable system and how to **go about marketing** a cable system in today's economy.

Washington Update —

CATA's Executive Director, Steve Effros, provides the latest information and strategy on what is happening in Washington, D.C. — the latest legislation concerning cable television and what cable operators need to do to insure the proper regulations and rules are drawn to protect their businesses.

The Scramble To Scramble Is On —

Representatives of the major pay satellite programming will present the latest data on their plans to scramble their signals for security protection for cable operators. Of particular interest will be HBO's presentation keyed toward scrambling this fall and SHOWTIME's plans for scrambling next year.

Tiering & Packaging Cable Services —

CATA Director David Fox moderates a panel discussion on how tiering and packaging of programming can increase subscriber base for more profits. This will surely include some lively discussion about some services who refuse or discourage use of their product as a tier service rather than a basic service.

Creating An Effective and Profitable Local Ad Sales Force —

Nancy Jahnel of Group W Satellite Communications provides a program on the **ways and means** to enter into the field of **local advertising**, to prepare your office personnel, to sell local advertising on your local origination channel, and to use satellite program ad spots as an additional source of income (even for small cable systems), and more.

Adult Entertainment — How It Affects Cable Television —

Katie McEnroe, representing The Playboy Channel, and Norman B. Smith from The Pleasure Channel, will discuss adult entertainment on cable television with other panel members. This program will cover the **benefits** and the **problems** of adult entertainment, with help for the cable operator in overcoming the moral opposition. Sure to be a hot topic at CCOS-83!

Open Forum —

Steve Effros will once again host this popular annual session that provides special up-to-date information on the strategy for such problems as **Copyright** and **Must-Carry Rules**. This session will allow the open exchange between cable operators to express concerns and ask questions about areas affecting cable system operations, both for today and the future. ▶



LADIES ACTIVITIES

Thursday, August 11th
9:30 a.m.
THREE CAPITOL TOUR
sponsored by HBO

Friday, August 12th
10:30 a.m.
Fashion Show Brunch with Entertainment
Ball Room
sponsored by CATA

Saturday, August 13th
10:00 a.m.
Mid-America Museum Tour
\$5.00 each*
(*must register for this tour so that transportation can be provided)

YOUTH ACTIVITIES

Thursday, August 11th
9:30 a.m.
MAGICAL DAY
A visit to the Magic Springs Amusement Park
sponsored by HBO

Friday, August 12th
Pool Party & Lunch
10:30 a.m.
Pool Deck
sponsored by CATA & CATJ

Saturday, August 13th
10:00 a.m.
Mid-America Museum Tour
(in connection with ladies tour)
\$5.00 each*
(*must register for this tour so that transportation can be provided)

TRAVEL INFORMATION

Flight Information — Available service to Hot Springs from the gateway cities of Dallas and Memphis, with commuter service to the Hot Springs Municipal Airport, less than four miles from the downtown area. Flight service into Little Rock with shuttle service to Hot Springs as shown below:

Schedule & Fare
\$12.00 Per Person
(Reservations Required)
1-800-643-1505

Depart	Arrive	Depart	Arrive
Hot Springs	Little Rock	Little Rock	Hot Springs
8:00 AM	9:15 AM	10:30 AM	11:45 AM
10:30 AM	11:45 AM	12:30 PM	1:45 PM
12:30 PM	1:45 PM	2:30 PM	3:45 PM
2:30 PM	3:45 PM	6:15 PM	7:30 PM

Highway Information — Hot Springs is at the hub of three major highways, U.S. 70 and 270 and Arkansas Highway 7 and is just minutes off Interstate Highway 30.

Campground Information —
Arnold's RV Park — 6901 Central Avenue, Highway 7 South

KOA — U.S. 70 at East City Limits
Econo Campground — Highway 70 East

Other Points of Interest in Hot Springs
(brochures available at registration desk)

Bath House Row
Wright's Rock Shop
I.Q. Zoo/Animal Wonderland
Basket House
Josephine Tussaud Wax Museum
Dryden Potteries
and more!

Exhibitors

CATA welcomes the following exhibitors to CCOS '83 and cordially invites you to visit their booths during the exhibit hours: Wednesday, August 10th - 3:00 - 8:00

p.m.; Thursday, August 11th - 12 Noon - 2:00 p.m.; 7:00 - 9:00 p.m.; Friday, August 12th - 12 Noon - 2:00 p.m.; 7:00 - 9:00 p.m.

THE ASSOCIATED PRESS
AUGAT CATV GROUP
AUTOMATION TECHNIQUES, INC.
AVANTEK, INC.
BLONDER-TONQUE LABORATORIES, INC.
C-COR ELECTRONICS, INC.
CCS CABLE
CABLE GRAPHIC SCIENCES
CABLE HEALTH NETWORK
COMSONICS, INC.
THE DISNEY CHANNEL
ESPN
ECA-MANUFACTURING DIV.
EASTERN MICROWAVE
GENERAL CABLE CO.
GROUP W SATELLITE COMMUNICATIONS
HOME BOX OFFICE
HASTINGS AND RICHARDSON COMM., INC.
HUGHES AIRCRAFT COMPANY
IND. CO. CABLE TV, INC.
KMP COMPUTER SYSTEMS, INC.
KLUNGNESS ELECTRONIC SUPPLY

LARSON ELECTRONICS
LEMCO TOOL CORP.
M/A-COM COMM/SCOPE
MICRODYNE CORP.
MICROWAVE FILTER COMPANY
MULLEN COMMUNICATIONS
OAK COMMUNICATIONS SYSTEMS, INC.
SCIENTIFIC/ATLANTA
SHOWTIME ENTERTAINMENT
SOUTHERN SATELLITE SYSTEMS, INC.
SUPERIOR ELECTRONICS CENTER
TELPAR INC.
TEXSCAN CORP.
TIMES FIBER COMMUNICATIONS
TRIPLE CROWN ELECTRONICS, INC.
TURNER BROADCASTING SYSTEM
UNITED PRESS INTERNATIONAL
UNITED VIDEO, INC.
WARNER AMEX SATELLITE ENTERTAINMENT CO.
WAVETEK INDIANA INCORP.
WESTERN TOWERS
ZENITH RADIO CORP.



Readers' letters -1

Reader Joseph A. Centko Jr. of Streator, Ill, is one of several who have recently written to me with specific questions or problems. He writes:

"My question is in regard to "signal propagation" at 6 GHz uplink and 4 GHz downlink on current U.S. and Canadian domsats (this is no doubt applicable to Intelsat series birds also). Is it possible for

these frequencies to experience scattering, reflections, i.e. ionospheric F1/F2 type propagation or elsewhere on the upside link to space or down-side link from space? I am discounting free space loss, point to point microwave fades via telephone back-haul carriers and the like. In conclusion then, does 4-6 GHz exhibit any type propagation in space only links?"

Ionospheric propagation modes

The answer is yes, such effects are present, but their magnitude is such that they are not generally apparent to the casual observer. The influence of the ionosphere on terrestrial communications extends tenuously into the VHF and low UHF ranges. F2 layer propagation has been observed at frequencies as high as the TV broadcast Band I (VHF low band) at times of sunspot maximum, with the BBC's 45 MHz TV transmitter at Crystal Palace, London, being received in Australia and the USA, among other places (see my note in CATJ August 1979).

Sporadic-E is a little-understood but much researched mode, by which frequencies as high as 200 MHz can be reflected from mobile regions of intense ionization in the ionosphere's E region. This is responsible for the very strong "short-skip" signals encountered in the 50 and 28 MHz ham bands and 27 MHz CB, as well as the summertime co-channel interference to low band VHF TV reception and FM radio (Band II).

Trans-equatorial (TE) propagation is a mode which owes its discovery to radio amateurs (see "QST", October 1947) and which permits occasional communication at frequencies into the low UHF range, between stations

symmetrically situated either side of the geomagnetic equator.

Other types of ionisation intense enough to reflect or scatter VHF waves are due to auroral phenomena (towards the geomagnetic poles at times of high solar activity) and meteor trails.

Ionospheric Scintillation

None of these effects has any influence above 1 GHz, and it was fairly safely assumed in the early days of satellite communications that the microwave frequencies employed would pass unattenuated through the ionosphere, that it could be regarded as non-reflective and non-absorptive. But it was soon noticed that large random fluctuations of signal level occurred on earth-satellite paths, particularly on L-Band and S-Band (1.5 thru 2.5 GHz) links to and from stations close to the geomagnetic equator. Fades as deep as 20 dB were observed at these frequencies in equatorial regions, and lesser fades in the auroral (polar) regions.

R. R. Taur of COMSAT Labs has studied the phenomenon of ionospheric scintillation, particularly as affecting C-Band (6 and 4 GHz) earth-satellite links. He has found that the fluctuations occur between geomagnetic latitudes 30°N and 30°S,

Tune in to UTILCO'S STAR PERFORMERS

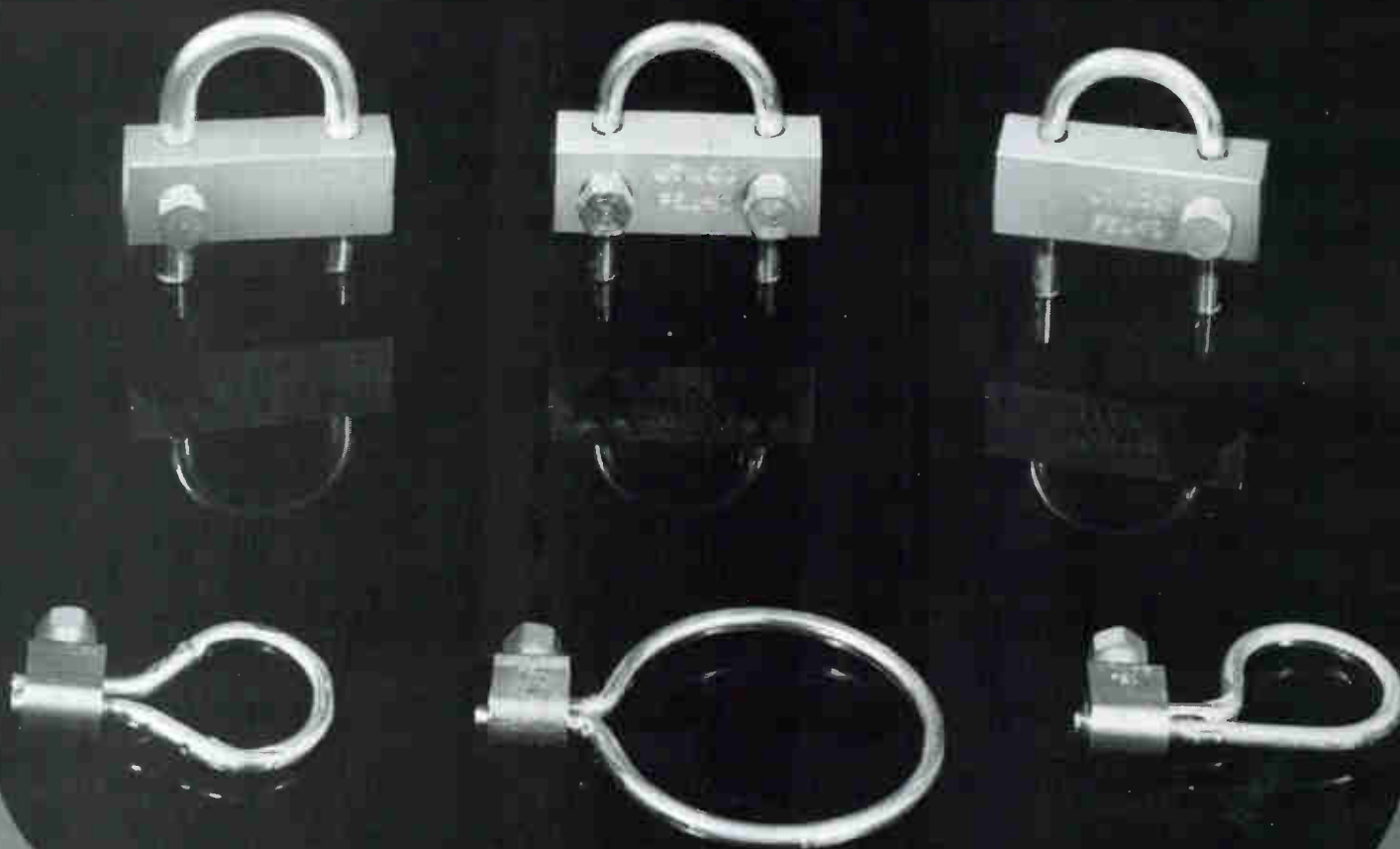

They're locking up cable TV markets everywhere!

Utilco offers a choice of inexpensive pedestal locks to meet your needs. These lightweight, but durable, locks replace regular key locks. Utilco pedestal locks are all-aluminum including the screws. No rust stains on your pedestal cover or worse, the screws rusting out. You simply attach the lock to your pedestal cover, tighten the screw until the head shears



and that's it. The only way these locks will come off is with a bolt cutter or hacksaw.

Utilco, 4730 Madison Road,
Cincinnati, Ohio 45227. Phone
(513) 871-4000. IlSCO Canada,
Ltd., 1050 Lakeshore Road East,
Mississauga, Ontario L5E1E4.
Phone (416) 274-2341.

UTILCO

show a strong diurnal peak about an hour after local sunset and seasonal peaks near the vernal and autumnal equinoxes, and have amplitudes of up to ± 4 dB, with a fading period of the order of 5 seconds. A 3 dB peak-to-peak scintillation for 0.1% of the total time is typical for equatorial stations. Dr. Taur hypothesizes that the scintillation is caused by weak scattering from rather dense ionospheric irregularities, probably related to inhomogeneity produced by the rapid decrease of solar flux after local sunset. [See COMSAT Technical Review Vol. 3 No. 1 (Spring 1973) and Vol. 4 No. 2 (Fall 1974)].

So fading due to ionospheric scintillation is a factor of significance to earth stations in the geomagnetic equatorial region. That lets out the entire USA, since the geomagnetic equator dips southwards where it passes the American continent. If you should use the Intelsat TV services from South America (Brazil, Colombia, Peru, Venezuela and Argentina are on the birds full time) you might

expect to see some variations. In fact their 6 GHz uplinks will be affected, but uplink EIRP control at the earth stations ensures the downlink EIRP is maintained essentially constant.

Faraday rotation

As well as amplitude fluctuation, signals passing through the ionosphere can undergo a change of polarization. The Faraday effect describes the rotation of the plane of a wave's (linear) polarization in passing through a region of free electrons subject to a magnetic field. The amount of rotation depends upon the electron density, the magnetic flux and the signal frequency. This is the Faraday rotation employed by the ferrite antenna polarizers, which switch between horizontal and vertical by a change of current through a magnetizing coil.

In the ionosphere, electron density is a function of solar radiation flux. The ionosphere is at its "coolest" just before dawn, and total rotation on a 4

GHz downlink is about one degree. At the height of the day this value can increase to a maximum of around 6 degrees, or even more at times of heightened solar particle emission (e.g. solar flares). In the 6 GHz uplink band the rotation angle is about half the 4 GHz value and at 12 GHz it is generally considered insignificant compared to tropospheric depolarization mechanisms.

It can be seen that Faraday rotation cannot be overlooked in a linear polarized system at 4 GHz. A "twist" of 5 degrees between day and night can do a lot to spoil the isolation of a carefully set up dual polarization system. Paradoxically the cheap terminal has the advantage here — it is more likely to be equipped with "tweakable" polarization, via feed rotator, Polarotor or ferrite device, while the professional orthocoupled antenna will be aligned correctly for daytime or nighttime, but not both.

Note also that Faraday rotation affects both planes equally — they are both rotated the same way. So or-

Super Savings on Sensational Selection!

PARTS SALE!

Featuring Big Reductions in:

Hybrids • BMK's • Lightning Arrestors • MOV's
RF Transistors • Bridge Rectifiers • Quads

- Guaranteed Performance
- In stock and ready to go. We ship within one workday of receiving your order.
- Reduced prices are in effect June through September and apply to our current inventory. Orders will be filled on a first come-first served basis.

See details and prices in our "Summer Specials" mailer. Make sure you get a copy by calling us today.

Toll Free: 800-327-6690
Florida (305) 747-5000



Broadband Engineering, Inc.
211 Commerce Lane
Jupiter, Florida 33458

AUGAT BROADBAND
Quality and Innovation



Streamline Your Cable Operation

DRAMATIC HARDWARE

PRICE BREAKTHROUGH

Announcing the
NEW TRS-80 Model 12 Microcomputer
And
CATV Billing-Accounts Receivable Systems, Version 5.0

for systems up to 6,000 subscribers		for systems up to 20,000 subscribers	
TRS-80 Model 12	\$3,999	TRS-80 Model 12	\$6,891
with two 1.25 meg disk drives		with 12 meg hard disk drive	
DMP 500 Printer	1,795	DMP 500 Printer	1,795
CATV 5.0 B-A/R Software	2,800	CATV 5.0-HD B-A/R Software	3,300
	\$8,594		\$11,988

Radio Shack
(207)-496-2281

Associate Store
P.O. Box 749
Caribou, Maine 00736

KNOWING YOU HAVE THE BEST

in cable technical information

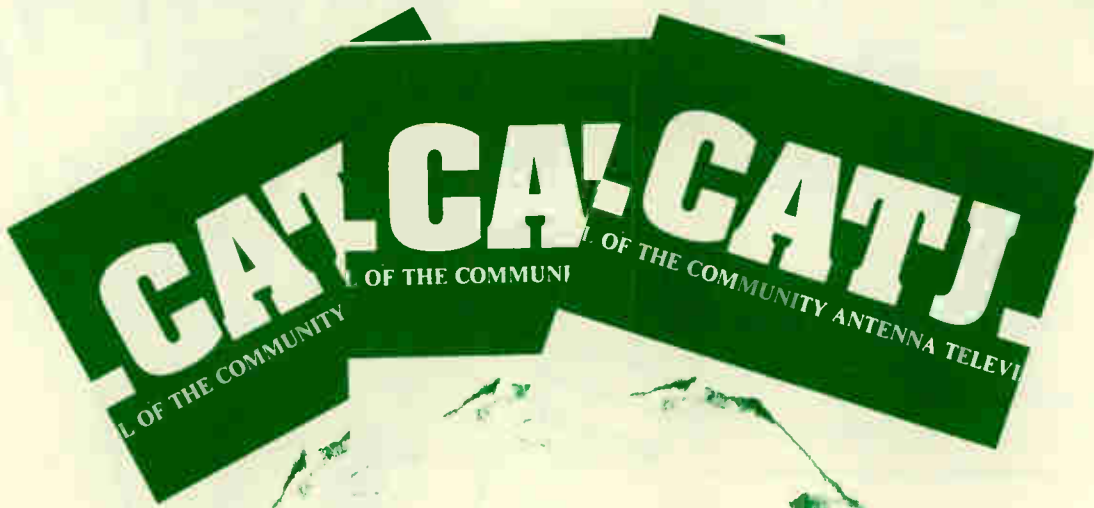

Name _____

Company _____ Title _____

Address _____

City _____ State _____ Zip _____

CATA MEMBER

(Must Furnish System Name)

NON MEMBER

- \$14.00 Enclosed for 1 Year
- \$40.00 Enclosed for 3 Years

- \$18.00 Enclosed for 1 Year
- \$50.00 Enclosed for 3 Years

CANADA/MEXICO SUBSCRIBERS: Add \$4.00 per year to rates given above. All other Foreign Countries add \$7.00 per year to rates given above. Special handling arranged upon request. U.S. CURRENCY ONLY.

Mail to: CATJ Magazine
Suite 106, 4209 N.W. 23rd
Oklahoma City, Okla. 73107

COMMUNITY ANTENNA TELEVISION JOURNAL

CBIC

CITIZENS BAND INTERFERENCE COMMITTEE DIAGNOSTIC WALL CHART

Diagnostic Wall Chart

Instructions
The Diagnostic Wall Chart prepared by the Citizens Band Interference Committee is available from the Citizens Band Interference Committee, 1000 North Lincoln Street, Chicago, Illinois 60610. It is available from the Citizens Band Interference Committee, 1000 North Lincoln Street, Chicago, Illinois 60610. It is available from the Citizens Band Interference Committee, 1000 North Lincoln Street, Chicago, Illinois 60610.

Recognize The Problem
Virtually every form of interference...
Possible Video Distortions
Excessive Video Level
Low Video Level
Inverted Video
Possible Transmission Distortions
Loss of Low Frequency Response (Pronounced Bells)
Loss of High Frequency Response (Burred Picture)
Loss of Sharp Definition (Fuzzy Look)

FCC COMPLIANCE TESTS SUBJECTIVE EVALUATION SYSTEM WALL CHART

HEAD END SIGNAL QUALITY EVALUATION COMPARISON CHART

FM VIDEO TRANSMISSION WALL CHART

This chart gives you a basic introduction to FM transmission, helping you to recognize particular distortions or set up problems, whether observed with a waveform monitor or a video monitor.

HEADEND/INTERFERENCE WALL CHART

has more than 20 off-the-screen photos of typical (and not so typical) off-air headend type problems. Each is identified, and with this chart you can zero in on headend problems in one big hurry. Explains what headend interference looks like and leads you to solutions to eliminate it.

FCC TESTS WALL CHART

is the industry's best training tool for teaching system employees how to recognize everything from cross-mod to HumMod. Has more than 60 off-the-screen photos of typical plant problems; things like Hum Mod (with calibration), signal to noise, co-channel and more.

CB INTERFERENCE WALL CHART

leads you quickly and painlessly to cures to CB interference.

COST FOR EACH IS: \$10.00 or \$35.00 set of 4.

NAME _____
 ADDRESS _____
 CO. NAME _____
 ADDRESS _____
 CITY _____ STATE _____ ZIP _____

I am enclosing a check for \$ _____ for the items marked below.

- A — F.M. Video Transmission Chart
- B — CBIC — Citizens Band Interference Committee Diagnostic Chart
- C — FCC Compliance Tests Subjective Evaluation System Chart
- D — Head End Signal Quality Evaluation Comparison Chart

Mail to: CATJ Magazine
 Suite 106, 4209 N.W. 23rd
 Okla. City, Okla. 73107

Finally, The *TOTAL* Word In *SMATV*...

TULSAT

Tired of trying to piece together a private cable system?
Let the *TOTAL SYSTEM EXPERT* put it all together for you . . .
custom-designed to meet *your* *SMATV* needs.

From small apartment complexes to high-rise hotels, TULSAT
is your *TOTAL* wholesale distributor for state-of-the-art *SMATV*
equipment, affordable prices, expert service
and customized systems.

We feature complete headends
and single components from only
the best manufacturers:

- Sophisticated *Blonder-Tongue*
and versatile *Pico Satellite/*
Transifier headend and
distribution equipment.
- Quality-built *Automation*
Techniques satellite receivers.
- High-performance *Avantek*
and *Chaparral* electronics.
- Sturdy, high-gain *Vidare*
antennas.

TULSAT pre-packages every
system so installation is fast and
easy—and operation is completely
hands-off!

You can depend on TULSAT
to bring your *SMATV* system
together. Call us today for the
TOTAL word in private cable . . .

THE TOTAL SYSTEM EXPERT

1839 N. 105th E. Ave.
Tulsa, OK 74116



TULSAT
Corporation

1-800-331-5997
IN OK: 1-918-836-8348

thogonality is preserved; it is alignment with the earth station's orthogonal planes that is impaired. Then look at circular polarization. With its continuous rotation, the slowly varying (24 hour period) Faraday effect cannot even be measured. CP is effectively immune to its influence.

Tropospheric effects

Having traversed the ionosphere on its way down to us, other hazards lie in wait for the satellite signal. The troposphere is that layer of the at-

mosphere we live in, from ground level up to around 5 miles high. It is in the lower levels of the troposphere that the microwave signals interact with water, from rain drops down to water vapor molecules, and with atmospheric oxygen molecules, to produce another range of harmful propagation effects.

These effects increase rapidly with rising frequency, and are a major factor in the planning of Ku-Band satellite systems, including DBS. At C-Band, both the oxygen and water-vapor contributions are negligibly

small (less than 0.2 dB total for elevation angles down to 10°), and the principal contribution is due to heavy rain in the immediate vicinity of the earth station. (Any atmospheric phenomenon of finite vertical extent will have an effect related to the angle at which it is traversed by the wavefront. The lower the elevation angle, the longer the signal path through the disturbed region.)

Rain attenuation

For very heavy rain conditions, intensity 100 mm/hr, specific attenuation at 4 GHz is given by one source as 0.1 dB/km. At 6 GHz the corresponding figure is 0.65 dB/km. A rain cell of this intensity is comparatively small, giving an effective path length of some 2 to 4 km, depending upon elevation angle. So at the downlink frequency the excess attenuation is only some 0.4 dB, while 2.6 dB may be lost in the uplink. This is fortunate, as again the uplink power may be controlled via a closed loop to maintain constant downlink EIRP (generally to maintain transponder saturation). Another source quotes higher values of attenuation, of 3 dB at 4 GHz and 13 dB at 6 GHz, for the lower elevation angle of 5 degrees.

Higher rainfall rates than this are encountered in some regions, but statistically their occurrence covers a fraction of a percent of the total time (a "cloudburst" is rated at 150 mm/hr, and the world's highest recorded value was in excess of 1000 km/hr over a 3-minute duration). More realistically, 4 mm/hr is classed as "moderate rain", with an effective path length of 6 km at 40° elevation or 22 km at 10° elevation, giving rise to 0.07 dB attenuation at 4 GHz and 0.3 dB at 6 GHz, at the 10° elevation value, and much less at higher angles.

So it is apparent that tropospheric attenuation only becomes a problem under the heaviest rain conditions, and then to the uplink operator, who must increase his EIRP in order to maintain saturation in the satellite transponder. This is often accomplished automatically in the international systems, while the smaller domsat uplinks operate at preset EIRP levels, and in fact may lack the excess of power to overcome uplink

NOT ONE TOWER FAILURE

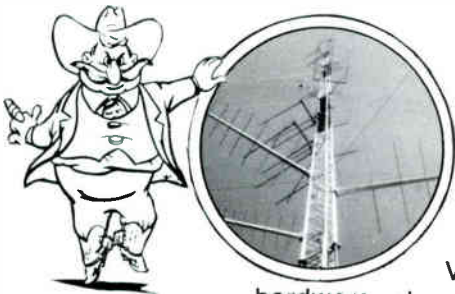

Virtually anyone with a hardware store welding set and a bunch of pipe can "claim" to be a tower manufacturer. When you specify your CATV tower, you should consider the long-term reputation of the supplier, the number of towers he has standing, and how long he has been providing service. WESTERN TOWERS has supplied hundreds of CATV towers from coast-to-coast; up to 600 feet in height. WESTERN TOWERS has been in the communications-supply business for 36 years. We guarantee all materials and workmanship. WESTERN TOWERS is one of the largest suppliers of CATV logs in the nation. There are WESTERN logs on CATV towers today providing quality service today that were installed over 15 years ago! Our log-line-up is complete and the prices are difficult, if not downright impossible to beat.

Before you specify a new CATV tower or CATV antennas, check around. We feel certain our knowhow, reputation, and experience...and our prices...will make you a WESTERN customer for life!

WESTERN TOWERS

915/658-6539 653-3363

320 W. 26TH

SAN ANGELO, TX • 76903

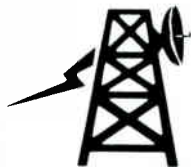

loss under the heaviest rain conditions. In these circumstances transponder EIRP will fall. The effects of uplink versus downlink rain attenuation are clearly distinguishable: If the rain is at the uplink site only the transponder or transponders fed from that site will suffer; if it's at the receive site, all transponders will decline!

And remember, C-Band gets off lightly here — the international terminals of Ku-Band have to employ space diversity to ensure continuity of service. That is to say they must build a second station some miles away from the first to take over traffic if necessary, on the principle that the heaviest rain will not strike both places simultaneously.

Atmospheric noise

Along with rainfall and water vapor (fog, mist, cloud) attenuation goes the increase they make in sky noise temperature. [Any lossy element, including the atmosphere, is also an emitter of thermal radio noise, of noise temperature given by $T = T_0(1-A)$, where A is the loss factor, as a ratio less than 1. So if atmospheric loss totals 0.5 dB (loss factor 0.89) and ambient temperature is 17°C (290K), then additional noise temperature is given by $290(1-0.89)$, = 31.9 K.] This is apparent only at the receive site, particularly for systems with a very low noise temperature. Not only does the signal level decrease, but the noise level increases. The effect is the same, a reduction in carrier/noise ratio and a case of the "sparklies" if you run out of margin.

Atmospheric depolarization

No, we haven't finished yet. Those molecules and droplets in the lower troposphere absorb some energy and they scatter some energy. And associated with the scattering is a loss of polarization purity. Effectively some of the signal energy is converted to the opposite sense of polarization. Horizontal to vertical, left-hand circular to right-hand circular, etc. A dual-polarized frequency re-use system will lose isolation between its co-channel signals. And this time a slight rotation of the feed will do no

good at all. Indeed, the uplink is more susceptible than the downlink (being higher in frequency) so the co-channel interference may be present even as the downlink leaves the satellite. Application of a cancellation technique in dual receivers may be the only way to reduce this form of interference [see "A receiving system using adaptive cancellation to reduce cross-polar interference in dual polarisation satellite links" by O'Neill and Isaacs, IBA (UK) Technical Review No. 18]. Various COMSAT experiments

have yielded circularly-polarized cross-polarization discrimination figures at 4 GHz of below 20 dB for 0.01% of the time at 25° elevation, and as low as 16 dB at 10° elevation. So under those same heavy rain conditions the satellite operators are glad of the frequency offsets between cross-polarized transponders.

Mr. Centko, when you've read this you'll no doubt be wondering how the pictures you see from those birds manage to look much the same hour after hour, day after day! □

Broadband's great little MDA:

Now — a 35-channel, 300 MHz hybrid apartment amplifier for as low as \$89.95*!

6 dB Noise Figure
Minimum Input: -2 dBmV

50-300 MHz Bandwidth
50-440 MHz Bandwidth (not shown)

Equalizer (Available at extra cost)

Plug-in Pad

Capable of full channel loading of designated bandwidth

Cross-Mod @ 48/43 dBmV:
35 Channels -63 dB

Broadband Engineered & Guaranteed

Push-Pull Hybrid Circuitry

Finned Aluminum Housing

Variable Slope Control (0-8 dB)

*Price for 50 units (MDA-300-30-T)

Designed for use in apartment house, hotel and motel CATV or MATV distribution systems, our Multiple Dwelling Amplifier (MDA) also comes in a 54-channel, 440 MHz model at an equally attractive price.

Try as we might, we can't think of a better deal on the market. Traditional Broadband excellence inside and out. Tough and durable. A high quality, dependable performer, the MDA is the cost effective answer to your distribution system's basic needs. It is ideal for multiple dwelling sites requiring a maximum of 30 dB gain.

We don't think you can beat the price — we know you can't beat the performance.

Model	Bandwidth	Gain	Output Capability*
MDA-300-30-T	50-300 MHz	30 dB	+ 49/44 dBmV
MDA-440-40-T	50-440 MHz	30 dB	+ 47/42 dBmV

*Output specified at -60 dB CTB @ 54-channel loading for 440 MHz units and 35-channel loading for 300 MHz units

For additional information on specifications or pricing, call us toll-free at 800-327-6690, or write Broadband Engineering, Inc., P.O. Box 1247, Jupiter, Florida 33468.

AUGAT BROADBAND
Quality and Innovation





PAY TV: a pay per view system prototype

By: Tom Bowling
Bell Northern Research Ltd.
Ottawa, Canada

Pay TV in North America has been growing rapidly and steadily since the U.S. Federal Communications Commission granted the first operator licenses in 1973. That year 35,000 people subscribed to a pay TV service; the next year the total had reached 140,000; in 1975 subscribers numbered close to half a million. Since then the annual rate of subscriber growth has averaged 40 percent. Today pay TV reaches more than 12.8 million Americans and total revenues for the industry are about (U.S.) \$1.5 billion. By 1990 the U.S. industry could have 50 million subscribers and gross annual revenues of (U.S.) \$6 billion.

No comparable figures are available for Canada because the first six pay TV services are being inaugurated in 1983. However, esti-

mates are that in five years some one and a half million Canadian homes will be subscribing to one or more pay TV services.

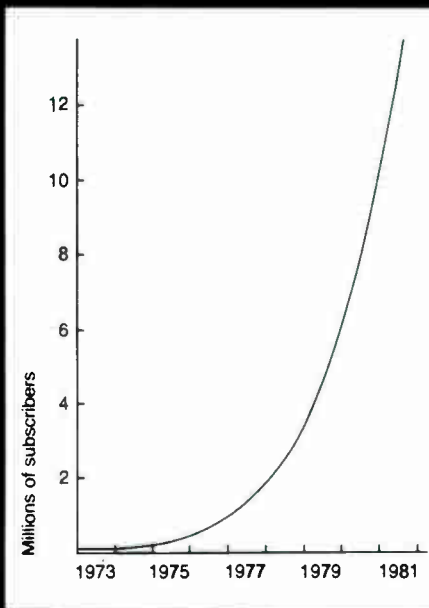

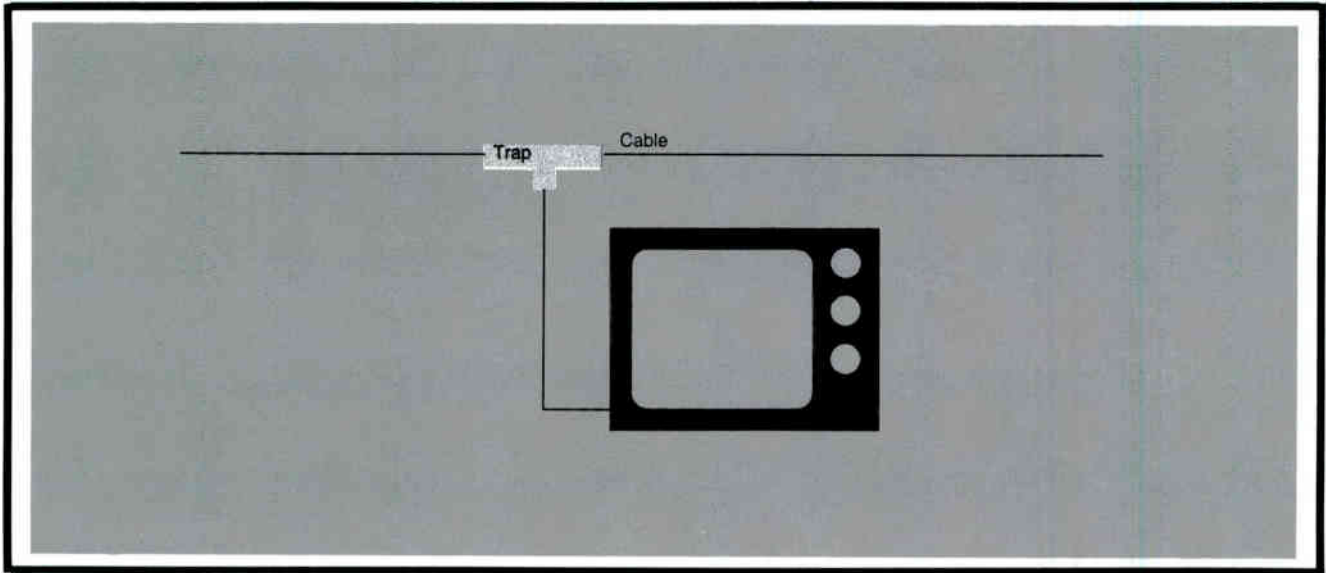

Though pay TV has established its presence, it is still far from its final form.

Shaping it are three chief elements: the signal carrier used, the mode of billing, and the programming. All three elements are evolving as changes in one affect the other two. One thing is certain: programming is and will remain greatly formed by the signal carrier and billing mode used.

As pay TV becomes more widely established, viewers in most areas will be able to choose from several channels, which may be provided by one operator or more. At present pay TV is often offered in conjunction with another service. For example, some U.S. cable companies offer one or more pay channels as an adjunct to their signal-carrying service.

Pay TV can be transmitted over the same signal carriers used by conventional television: conventional broadcast frequencies (known as subscription television), microwave distribution, direct broadcast satellite, and cable.

Subscription television is simply pay TV that is broadcast in the fre-

quency range used by conventional television channels. Subscribers to these systems must attach a signal descrambler to their antenna to receive the one or two channels available in each city. Low power television, a variation on subscription television, operates at the same frequencies but with a maximum range of 24km.

Microwave distribution, also similar to subscription television, uses part of the frequency spectrum around 2.15 GHz, where one or two channels are available. In the near future, a part of the frequency spectrum around 2.5 GHz, which could support another 12 channels, may be opened up in the U.S.

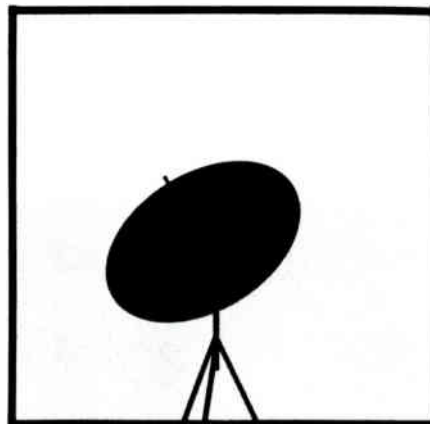

Direct broadcast satellite (DBS) systems differ from the ones above in that they cover a transcontinental, not local, area. DBS can carry many tens of channels.

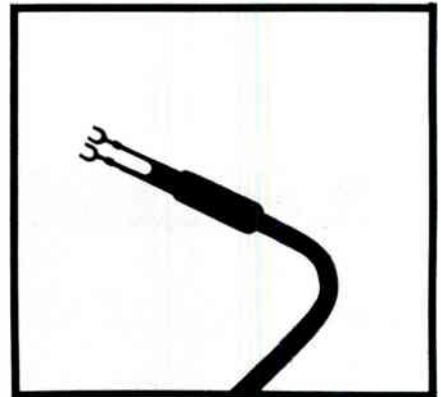

Cable is the best established pay TV carrier in North America. Each cable coming into a home can carry about 50 channels. Cable-based pay TV systems now serve 88 percent of the 12.8 million U.S. subscribers, subscription television serves eight percent, and microwave distribution systems four percent. Though direct broadcast satellite and low power television are capable of carrying pay TV, they are not in commercial use — yet.

All pay TV systems, no matter what signal carrier they use, must in some way control viewers' access to the video signals. Most operating pay TV services do this by scrambling the signals at the source of transmission. Service subscribers are provided with a descrambling mechanism that enables them to watch the programming. (In systems in which signals are not scrambled, viewing is usually controlled by the rental of reception equipment that is too expensive for

Get the ASTI Handbook And Kiss TI Goodbye!

Glyn Bostick and his team of microwave interference fighters have incorporated the ongoing FILTERED EARTH STATION articles into a 200 page reference manual. Available now, for the first time, the ASTI HANDBOOK shows in detail how to avoid and/or suppress terrestrial interference—even at “hopeless” TVRO sites! ASTI works, and it can save you money. Order now and take advantage of pre-publication price!

What Is ASTI?

Terrestrial interference (TI) is fast becoming a major economic consideration for the installers and operators of TVRO earth terminals. Thousands of dollars, even hundreds of thousands, may be at stake when the earth station is turned on—only to discover that TI is degrading or altogether preventing reception of desired satellite signals.

The purpose of this volume is to introduce ASTI — the avoidance/suppression approach to eliminating TI — to the 3.7-4.2 GHz TVRO industry. Conscientious application of ASTI will reduce the possibility that TI will be encountered at turn-on, increase the probability that unavoidable TI can be suppressed, and enhance the effective operating quality of the TVRO system.

The authors, as designers of microwave filter networks and other TI-suppression techniques, have had ample opportunity to test ASTI — it works! Measured over a period of time, the costs are substantially lower than any alternative, especially in terms of dollars saved when the initial or only site can be made operable. Furthermore, both cost and complexity of filtering to eliminate TI are lowered considerably when the essential aspects of ASTI are employed.

About the Authors:

Glyn Bostick is the founder, president and chief engineer of Microwave Filter Company, Inc. Mr. Bostick, who writes CATJ's monthly "Filtered Earth Station" articles, has been designing filters to suppress interference at CATV systems and TVRO earth stations since 1967.

John Fannetti is MFC's senior technical consultant and head of the company's Field Service Division. He has 30 years of engineering and earth station troubleshooting experience.

William Johnson, chief engineer of R&D, has de-



signed many of MFC's CATV and TVRO products. Mr. Johnson earned his BSEE at Syracuse University and is currently engaged in graduate studies there.

Contents Include:

The TI Avoidance/Suppression Approach; Why Satellites; TI Sources; TI Symptoms; Selecting the Antenna for Least TI; TI Susceptibility of Other TVRO Components; How to Select a Site; The Pre-Installation Site Survey; Defensive Installation; Use of Artificial Shielding; Filtering the TVRO; Filtering Special TVRO Systems, SMATV Techniques; Standard TVRO and Satellite Data; Formulas and Derivations...

Order Form

Mail to: CATJ Magazine,
4209 NW 23rd, Suite 106, Oklahoma City, OK 73107

- Pre-publication special \$99* (before 1 July):
- Post-publication \$125* (after 1 July):

PAYMENT MUST BE ENCLOSED

NAME _____

COMPANY _____

STREET _____

CITY, STATE, ZIP _____

PHONE _____

*Outside U.S.A., Draft Drawn
On U.S. Bank

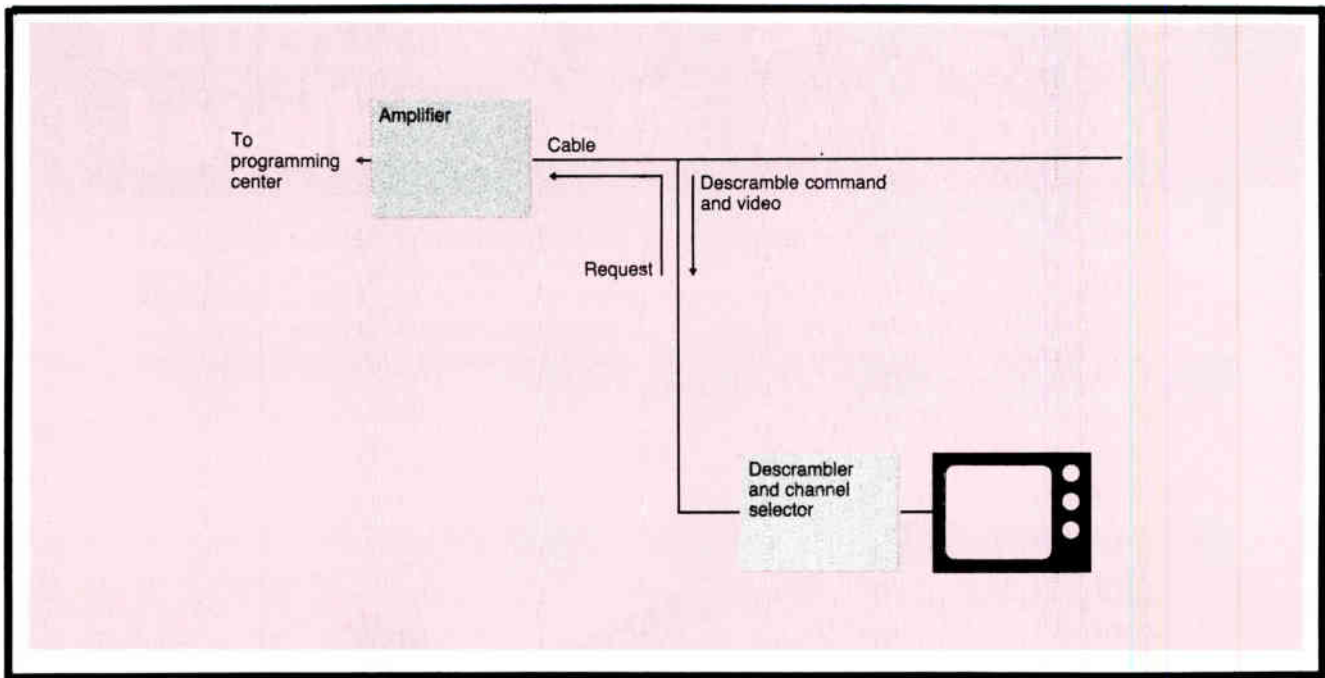

most people to buy. The days of such systems appear to be numbered because the cost of the technology they use is dropping.)

The type of descrambling technology used by a pay TV system effectively determines the way in which the subscriber will be billed for the programming. Two modes of billing are now in use: the pay-per-channel mode in which a subscriber is billed a flat fee, usually monthly, for each pay channel he receives and the pay-per-program mode (often known as pay-per-view) in which the subscriber pays only for the programs he watches.

At present, nearly all pay TV operators use the pay-per-channel billing mode. But already technological change is limiting use of this billing mode to cable systems. In pay-per-channel cable systems, a program transmission center sends the scrambled signal down the cable to the subscriber's home. A trap attached to the cable descrambles the signal, letting the subscriber view the pay channel. Alternatively, a band-stop filter trap prevents viewers who don't subscribe to the pay service from receiving the signals; the trap is removed to permit signal reception.

Pay-per-channel systems predominate because the traps they use

are comparatively inexpensive. But these systems have several problems. Traps can support three channels at most, nowhere close to the 50 that cable can carry. And since the traps are usually located in the subscriber's basement or just outside his home, tampering with them is easy.

Operators of pay-per-channel systems must avoid the turnover that occurs when subscribers ask to be connected to their systems and shortly afterward want to be disconnected. High turnover, known as churn to insiders, pushes up the operator's maintenance, labor, and travel costs. To keep churn low, operators tend to provide programming that appeals to broad audiences — programming not much different from that already available on conventional television.

The chief commercial alternative to pay-per-channel billing has been pay-per-program. Such systems now serve five percent of pay TV subscribers. Pay-per-program systems are of two main types: one-way addressable and two-way addressable. Both use a discrete customer code in the vertical blanking interval of the scrambled video signal to switch on the subscriber's descrambler.

In one-way addressable systems, subscribers send in their requests by mail or telephone them in to the pay

TV operator before the show is aired. The chief problem with these systems is that they go counter to television viewing habits. An axiom of broadcasting is that 60 percent of all viewing is impulsive. Mail requests effectively limit the audience size on these systems to 40 percent of the potential audience.

Telephone requests are more compatible with actual viewing habits. But they threaten to overload both the telephone system and the staff that handles the requests for the pay TV operator. Bell-Northern Research (BNR) has estimated that if, in a town of 35,000 people, less than a thousand phoned the pay TV operator in the hour before a pay program was to be aired, telephone service would be seriously disrupted. And the blocked requests would constitute a loss of business for the pay TV operator.

Two-way addressable technology can be used on cable-based systems to transmit program requests from the subscriber along the cable to the pay TV operator. But many amplifiers are needed to send these requests back to the program transmission center. Existing cable systems would have to be retrofitted with these amplifiers and have expensive request-handling equipment installed at the transmission center. Moreover, two-way addressable

Products of our imagination...

Work like a dream!

Sniffer
RF Leakage
Detection
System

440 MHz
Spectrum
Analyzer

RF Attenuator

Sniffer is the ORIGINAL field proven RF leakage detection system. There is no more accurate or economical way to quickly troubleshoot and pinpoint RF/EMI leakage in your cable system. The convenient, light-weight Sniffer system includes a signal source, and sensing unit, detector, plus a magnetic-mount monopole whip antenna to allow drive-through monitoring at speeds of 25 to 40 MPH.

Leakage costs you signal quality, subscriber revenues and wasted man-hours. But when you've got the Sniffer by ComSonics . . . you've got the original and the best defense!

Model SA440B, 440 MHz Spectrum Analyzer is an economical solution looking for the problem . . . providing you with an exacting CRT display of the frequency content and amplitude of time variant signals.

ComSonics offers you lab grade performance and reliability in a bench unit with comparable features to units costing thousands more: phase locked; 500 KHz-440 MHz; storage display mainframe; zero-scan feature; internal calibration; on-screen dynamic range of 72 dB at 1KHz; and a rigid front cover. The ComSonics' Spectrum Analyzer is as incredible as the money you'll save.

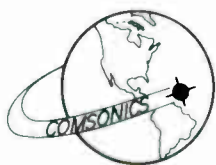

An Employee Owned Corporation
COMSONICS, INC.

ComSonics cable products . . . uncompromising quality from the industry's number one source.

P.O. Box 1106
Harrisonburg, Virginia 22801 WorldRadioHistory
UPS address — 1350 Port Republic Road

1-800-336-9681
In VA call collect: 1-703-434-5965

**Order your
equipment today -
and rest easy!**

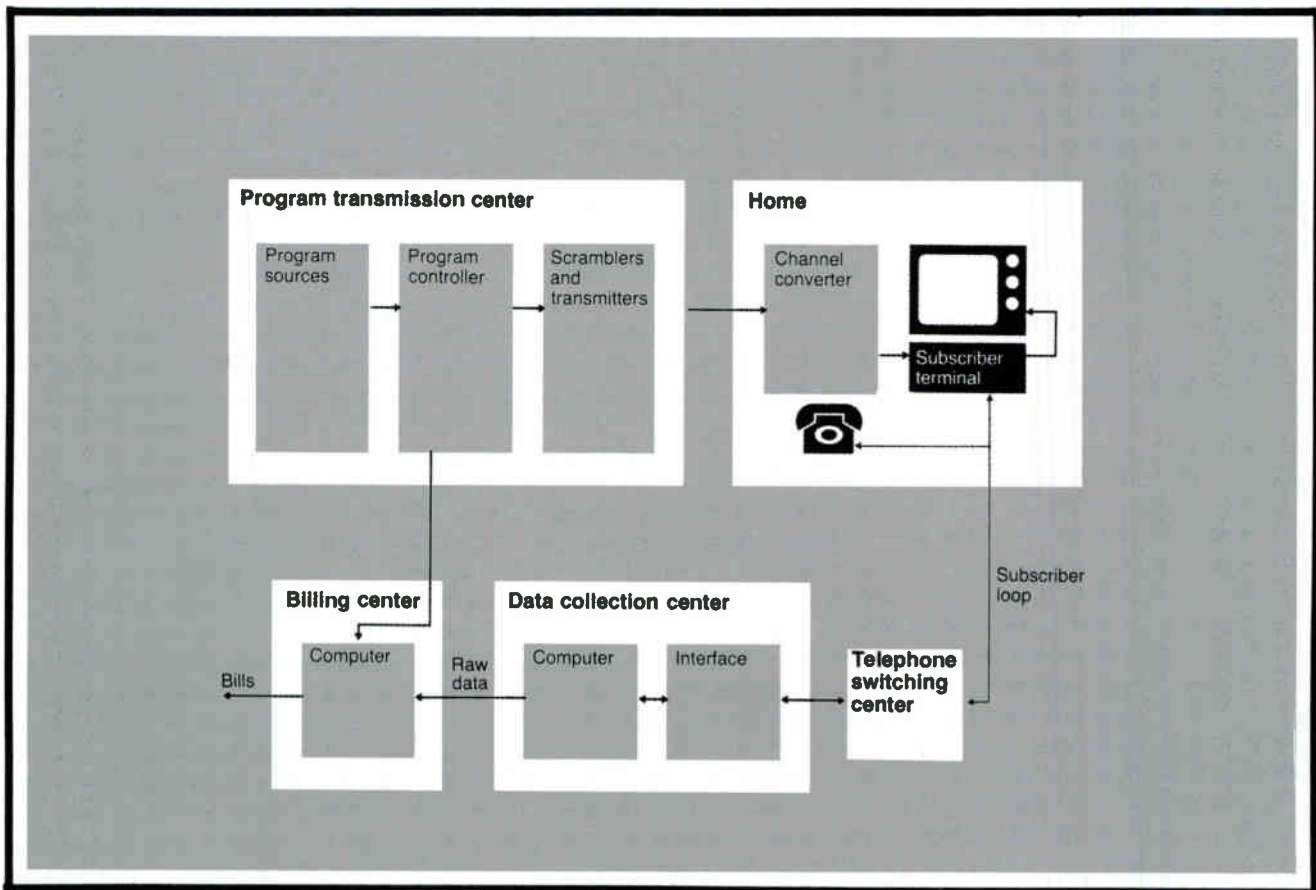

technology cannot be used with through-the-air systems. Cable is well established in Canada, but in the U.S. only 27 percent of homes with television sets are served by cable. According to some estimates, this will rise to only 42 percent by 1990, mainly because of cable's hardware and installation costs. All these factors have caused pay TV operators consistently to prefer pay-per-channel billing to pay-per-program.

The preference of the operators is not necessarily that of viewers. The first concrete evidence of a demand for pay-per-program TV came in 1980 when ON-TV, a Los Angeles subscription television system, detected strong local interest in a championship boxing match. ON-TV decided to offer their subscribers access to the match for \$10. ON-TV's offer was taken up by 117,000 viewers, 47 percent of the potential audience, bringing the company more than \$1.2 million. This included a healthy profit despite ON-TV's costs in offering the match on a one-time pay-per-program basis. Subsequent pay-per-program offer-

ings by ON-TV and other operators have confirmed that a market for pay-per-program television does exist.

The choice of billing modes for pay TV has rested between pay-per-program and pay-per-channel systems. But pay TV could be provided in a third way. At BNR we have developed a pay TV system concept whose billing mode is based on time, rather than on channels or programs. With this mode the subscriber can be billed according to the length of time spent watching, much as a telephone subscriber is billed for a long distance call according to the length of the connection. We call this billing mode pay-per-minute because the minute is the unit of time on which this billing mode would most likely be based.

The pay-per-minute billing mode has been allied with a second system design element: use of the telephone network as a path between the subscriber and the pay TV operation for control and monitoring data. These two design elements combined produce benefits not available with

either pay-per-channel or pay-per-program systems. One such benefit is that special interest programming could be disseminated over any signal carrier — conventional or low power television, microwave, direct broadcast satellite, or cable. A laboratory trial of this prototype system has confirmed that it is technically viable.

From a user's point of view, the prototype system centers on the subscriber terminal. The terminal is connected between the television set and a channel converter, which brings in pay TV signals from an antenna or cable. The terminal is also plugged into an electrical outlet and a standard jack on the subscriber's telephone line.

When the subscriber wants to watch a pay program, he tunes to the pay channel on the converter and turns a key in the terminal. The terminal retrieves an access code held in an internal memory and uses it to decrypt the pay TV signals. (Decryption is described in detail in a later section.) If the subscriber doesn't like the program, he can turn the ter-

DOES YOUR HEAD END GIVE YOU HEADACHES ?

Many system operators suffer from endless head end headaches. The last thing you need is downtime. It can tarnish your image and eat into your profits.

At Triple Crown, we have built a solid reputation on imaginative design, quality workmanship and super service. We have an impressive list of satisfied customers all over the world; people who trust Triple Crown to keep them and their viewers happy.

Since we produced our first 36 channel system, almost a decade ago, Triple Crown has not only kept pace but often lead the field with our innovations. From satellite receivers to channel modulators, our pre-packaged head ends combine the latest technologies with

proven engineering experience. Triple Crown will give you the big system features at a small system price.

If you get head end headaches, take two aspirin and call us in the morning. We can diagnose your systems ailments and prescribe a remedy to please you and your viewers.

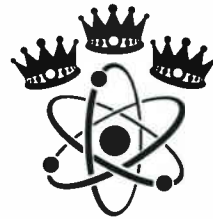

**TRIPLE CROWN
ELECTRONICS INC.**

**PHONE (416) 629-1111
TLX 06-960-456**

4560 Fieldgate Drive, Mississauga, Ontario, Canada L4W 3W6

First In Reliability



Weather Scan III

Impressive quality . . . surprisingly low price. Just \$3295 for the most reliable unit available (at any price!).

We have been in the cable television business for 23 years . . . and providing weather information systems for the past 16 years. We know what you need and we know how to manufacture it. For reliability and performance.

The Weather Scan III comes complete with Sony AVC-1400 camera with separate mesh vidicon and 2:1 interlace sync. Includes Time, Temperature, Barometric Pressure, Wind Velocity, Wind Direction, plus four card holders. Compact cabinet is just 28" wide, 23" deep and 14" high. For complete information call or write.



Weather Scan, Inc.

An R.H. Tyler Enterprise

Loop 132 and Throckmorton Hwy. Olney, Texas 76374 Ph. 817-564-5688

minal off and so avoid running up the full program charge. Otherwise decryption carries on until the end of the program, when a signal from the transmission center causes it to stop.

When the terminal starts to decrypt the signal, it also makes a data record of the viewing in its memory. This record contains what channel was watched, when, and for how long.

on to a billing center. The billing center matches the viewing data against program rates supplied by the one or more pay TV operators on the system. The per-minute rate for one program can differ from the rate for another. For example, the rate set by a pay TV operator for a foreign language film could be lower than the rate for a world championship sports event. The billing center mat-

above the voice band, direct dial up, or even digital. These paths could be used not only for controlling pay TV, but for alarm and security services, energy management systems, electronic shopping and banking, video games, and high quality pay audio services among others. The rest of this article looks in detail at the prototype system and the benefits pay-per-minute billing could bring.

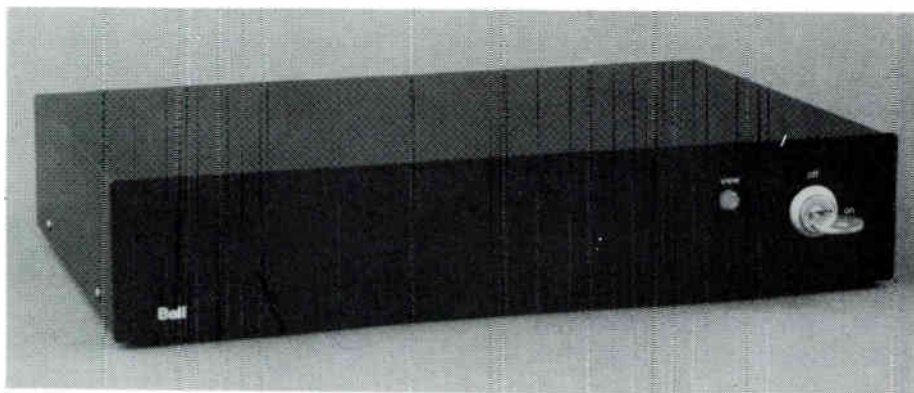

Periodically — probably every month in a commercial system — a data collection center calls into the terminal over the telephone connection and retrieves the viewing records. To avoid ringing the subscriber's telephone, the data collection center in the prototype makes the connection to the subscriber's line by way of a no-test trunk. (This trunk, a facility found in most telephone switching center, is primarily used to test a subscriber's line without ringing the telephone.) If the subscriber's account with the pay TV operator is in good standing, the data collection center inserts a new access code in the terminal so it can descramble the programming during the next billing period. If the account is in bad standing, the new code is not inserted, which denies the subscriber access to pay TV service.

The data collection center can serve about 400,000 subscriber terminals. It is capable of polling all of them in a single night without disrupting telephone service. But a commercial version of the system would probably poll a set number of subscriber terminals each night during the billing period.

The data collection center processes the viewing data and passes it

ches the rate for a program against the amount of time the viewer has watched to determine the charge. Having prepared the bill, the center sends it to the subscriber (who pays it, of course).

The above has described the basic operation of the pay-per-minute system. The prototype that BNR built demonstrated a sound fundamental system design; it also suggested other ways of achieving similar ends. For example, the subscriber terminal could contain a transmitter instead of a viewing memory. When the subscriber turned the key to watch a pay program, the transmitter would send a request over the telephone connection to the programming center to activate the descrambler in the subscriber terminal. When the subscriber finished watching and turned the key back or when the program was over, the transmitter would request the transmission center to turn off the descrambler.

Viewing records and control signaling between the terminal and the transmission center could be sent over different paths through the telephone network. The prototype system uses a test trunk path; other possible signaling paths are in or

Subscriber terminal: If a pay TV service is to be commercially successful, it must be easy to use. Thus ease of use was the overriding concern in designing the subscriber terminal. Lights, dials, meters, and other features that could confuse users were left off, leaving the simple black box design shown. The quest for simplicity took into account several factors. The terminal had to be light and compact so that the user could easily carry it from a telephone store or other retail outlet. The prototype terminal weighs 3 kg and measures 33 cm by 20 cm by 6 cm. A key has been used as the on/off mechanism because it is a universally familiar device — it will not confuse users. It can be removed from the terminal, enabling parents to prevent their children from running up the viewing record and generally control pay TV viewing.

Scrambling: A secure scrambling system is essential for any pay TV service. Without it, signals will be pirated by some viewers, causing the pay TV operator to lose revenue. Recognizing that secure scrambling is critical, BNR has developed a highly secure picture-coding technique. An encoder at the program transmission center fills the video signal's vertical blanking intervals — the line gaps ▶

**First real meter
you can hold in
your hand**

Easy
to read
one dB
resolution
BAR GRAPH

LOW PRICE: \$199.50

HIGH PERFORMANCE

Shows two* individual
Signal Levels in one dB steps
(not an inaccurate composite
signal measuring device).
Measures all channels when used
with a standard TV Set Converter.

*Specify any two channel or pilot
carrier combinations up to 300 MHz.

Available at major CATV Distributors
Call or write for free color brochure

Sadelco, Inc. 75 West Forest Avenue, Englewood, New Jersey 07631 201-569-3323
General representative for Europe: Catec AG Luzern/Switzerland, Habsburgerstr 22. Tel. 041-23-90-56 Telex: TELFI 78168



**We've Got The Filter You Need
For Your Cable TV System...**

Or We'll Build It, Fast.

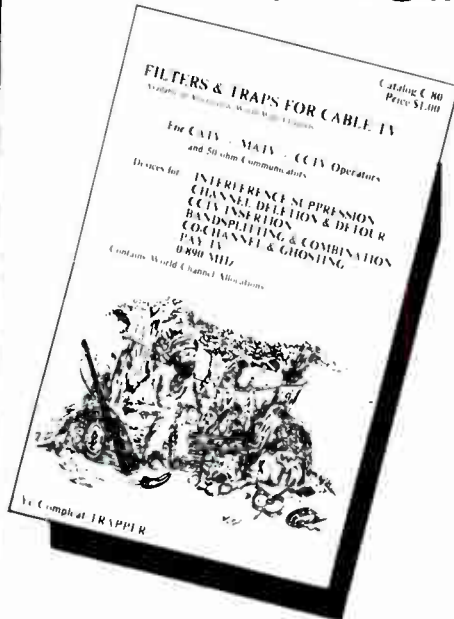

Catalog C-80, a 40-page pillar of the cable TV industry, features filters and traps currently being used in hundreds of CATV, MATV and CCTV systems. Delivery time for most standard products is 10 days or less.

But if you need a one-of-a-kind special and you can't afford to wait, we've still got you covered—we'll design and build exactly what you need for your installation, and we'll work around the clock to deliver it when you need it.

Use our toll free number and talk to the RF or microwave engineer who will design your special filter. He'll give you a prompt, on-line analysis of your specifications, and he'll quote price and delivery time. Before you hang up, you'll know what you need, when you'll have it and how much it will cost—all with just one phone call!

Once you've placed an order, our unique QRC (quick reaction capability) begins to work for you: QRC combines the efficiency of computer-aided design with a dedicated model shop and test labs to insure that your filter will be what you need when you need it.

When you need a filter to do a job exactly as you want it done, and you need it now, Call MFC!

MFC
MICROWAVE FILTER COMPANY, INC.

6743 Kinne St., East Syracuse, NY 13057
Toll Free 1-800-448-1666 — TWX 710-541-0493
NY/HI/AK/Canada (Collect) 315-437-3953

Pay TV service

day	month	program	chan.	min.	code	regular charge	disc.	amount
3	5	BENJI	3	15	1	.15		.15
3	5	FLASH GORDON	3	45	4	4.50		4.50
3	5	NATURE TRAIL	5	10	3	.50		.50
7	5	HOCKEY	3	120	3	6.00		6.00
8	5	OLYMPICS	5	201	2	4.02		4.02

between successive pictures — with picture-like information. If the subscriber terminal is not functioning, the television set attached to it cannot lock onto the picture, which rolls up and down the screen.

Data that tells the terminal when to strip out this false information are contained in a code that is transmitted in the video signal itself. This code is also used to stripe the encoded pictures randomly. A side benefit of this coding technique is that it makes recording programs on a video cassette recorder very difficult.

Viewing grace period: With conventional television, viewers will turn into unfamiliar programs because doing so costs them nothing. But pay TV is different: by tuning into a program (or even a channel), viewers commit themselves to paying for the viewing. Consequently, if viewers are not sure that they will enjoy a program, they won't tune it in. To enable the subscriber to check out programs that interest him, the subscriber terminal can allow a set amount of time to elapse before it begins making a record of the viewing. This period of time, called the grace period, can be two minutes or longer in the prototype design. To prevent the subscriber from quickly tuning out and back in to avoid building up the viewing record, the terminal has been programmed to disregard exits from a pay channel less than two minutes long.

Billing: The bill received by the subscriber would probably be very similar to a long distance telephone bill: it would list each program watched, how long it was watched, the channel that carried it, the rate, the total charge for the program, and the total charge for the billing period. If

the data collection and billing functions were performed by telephone operating companies, the pay TV bill could be appended to the telephone company's monthly bill.

Ratings: The prototype system's structure enables the data collection center to process the viewing data it gathers to rate pay program audience size with near absolute accuracy. The system can produce both quick appraisals of audience size and detailed periodic summaries of viewing patterns both for individual programs and for pay channels. For a quick appraisal, the data collection center's nightly poll could be analyzed to gauge who had been watching. With this size of sample, the poll results would be 95 percent accurate. The rating could be given to the pay TV operator and the program's producers within a few hours of the broadcast.

The detailed periodic summaries can be produced by processing the viewing records collected by the data center to depict viewing patterns for a single program, for a channel over a whole day, or for a channel over the whole billing period. Because the viewing records are time-based, the rating can be produced in the form of a graph that shows the audience size over time. These graphs offer something unique: they will show fluctuations in the size of the audience over the course of a program. If viewers become bored with the program and tune out — which they could do because pay-per-minute would allow them to cut their losses — the graph would show the drop in audience size.

Such graphs could also serve as a diagnostic tool for the program producers, indicating the point at which

the audience became dissatisfied with the program. Conversely, if the audience grew over the course of a program (say during the course of a sports event), the graphs would show it. Present rating methods do not normally show such changes.

Programming: The objections of pay TV operators to pay-per-program systems have been primarily economic. The hardware required for these systems is much more expensive than that for pay-per-channel systems and these systems are effectively limited to operating only with cable, the most expensive signal carrier. These factors push up costs for the pay TV operator.

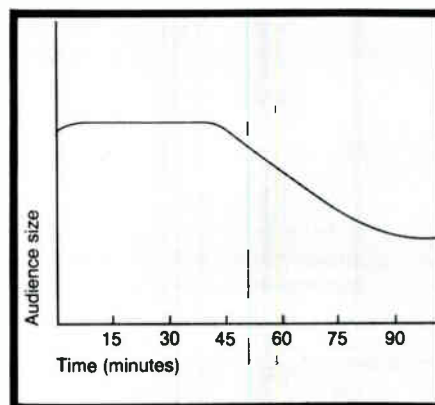

Pay-per-minute offers a viable alternative. Pay TV operators would get a system that works with any kind of signal carrier and a secure signal coding system; they would also get the added benefit of the ratings produced from the viewing records. To the regulatory bodies and the public, pay-per-minute offers a billing mode that lets people pay only for what they watch and is a requisite for special interest broadcasting. Pay-per-minute is not just a technically viable way of providing pay TV, it is one that could make pay TV realize its true potential as a medium.

Pay-per-minute: the technology

A fundamental system design requirement for the pay-per-minute prototype was that it should require minimal alterations to existing equipment for both the pay TV operator and the telephone operating company. Similarly, the subscriber terminal had to be easy to install and use.

Some Things Are As Simple As Black and White!

And Some Are Just Plain MAGIC!

Cable Television is connecting the people of America with an amazing array of services. . .30 years ago it all would have seemed a miracle. . .Today it is simply Magic!

The 1983 Eastern Show is your direct connection with the people making the magic. This year's show features. . .

- Back to Basics management seminars produced by Sheldon Satin Associates
- Hands-on technical workshops
- Nearly 300 suppliers of hardware, programming and services
- All seminars, workshops and exhibits under one roof
- Headline entertainment
- The best accommodations in the nation's most popular convention city

It's as simple as **Black and White** . . .Connecting People is the Magic of Cable Television.

Make Your Connection. . .Plan to Attend!

**The 1983 Eastern Cable Television
Trade Show and Convention**

September 8, 9 & 10

**Georgia World Congress Center
Atlanta, Georgia**

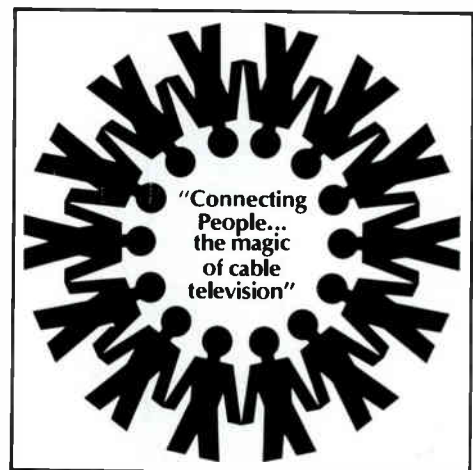

*For further information contact:
Convention & Show Management Co.*

5780 Peachtree-Dunwoody Rd., Suite 460, Atlanta, GA 30342, (404) 252-2454

The prototype system imposes no limit on the number of channels that can be provided with pay-per-minute service. Its head end equipment has an RF component and a logic component for each channel, inserted between each video program source and the combiner by means of conventional RF connectors. The RF component encodes the program signal and modulates control data on to the video signal. These data include the channel code, which is a three-bit fixed code that identifies the pay TV channel number of the head end equipment. This code is permanently set up at installation. A one-bit guard indicator prevents accidental viewing of the pay channel. This indicator is automatically changed at the end of each pay program.

Encoding technique

In BNR's encoding technique, the head end equipment removes some of the horizontal sync pulses in each field of the video signal. The stream of horizontal sync intervals is used as a data channel that carries a descrip-

tion of the scrambling parameters to the subscriber terminal.

The picture is further scrambled by replacing the entire vertical interval of the frame, including the vertical sync and the equalization pulses, with dummy lines. The normal video frame length of 525 lines is modified by the addition or deletion of up to 12 lines. The number of added or deleted lines can be changed every few frames.

A description of how the video has been modified is sent on the data channel. This description is encrypted — that is, the data are substituted and transposed to make them unusable by people or equipment not authorized to have access to them.

To restore the video, the subscriber terminal retrieves a unique code in an internal memory that, in combination with the access code sent by the data collection center, is used to decrypt the data channel. These decrypted data control a descrambler that restores the video signal to normal.

The main components in the prototype's subscriber terminal are a

demodulator, a descrambler, a modulator, a memory, a power supply, a modem, and logic circuitry. These components serve in three main functions: restoring the encrypted signal to a viewable form, recording the pay TV viewing, and communicating with the data collection center.

The subscriber terminal receives pay channel signals on channel 3 from a standard converter. The signals from regular broadcast channels simply pass through the terminal and are unaffected by it. Pay channel signals will do likewise — that is, they will appear in encrypted form on the television screen — unless the subscriber turns the key in the terminal to the on position. When the key is turned, the switches between the demodulator and the memory and signal logic unit are closed. The demodulator, having separated the data in the signal from the video, sends the pay TV channel number to the memory and the encoded data to the signal logic unit.

The memory records the pay TV channel number as well as the time the terminal was turned on; the time could be sent on the video signal or could be generated by a clock in the terminal. To complete the viewing record, the memory records the duration of viewing. This occurs either when the subscriber turns the key to the off position or when the pay TV transmission center signals that the program is over.

At the same time as the memory starts making the viewing record, the signal logic unit combines the unique terminal code with the access code to decrypt the data. The signal logic unit sends the decrypted data to the descrambler, which uses it to restore the picture and to reconstruct the vertical and horizontal synchronizing information. If the subscriber's television set has video inputs, the video and sync information could be fed directly into it. But usually the modulator would remodulate the video and sync information and send it to the television set.

In a commercial version of the system, the data collection center would periodically poll the subscriber terminal, probably once a month. The data collection center

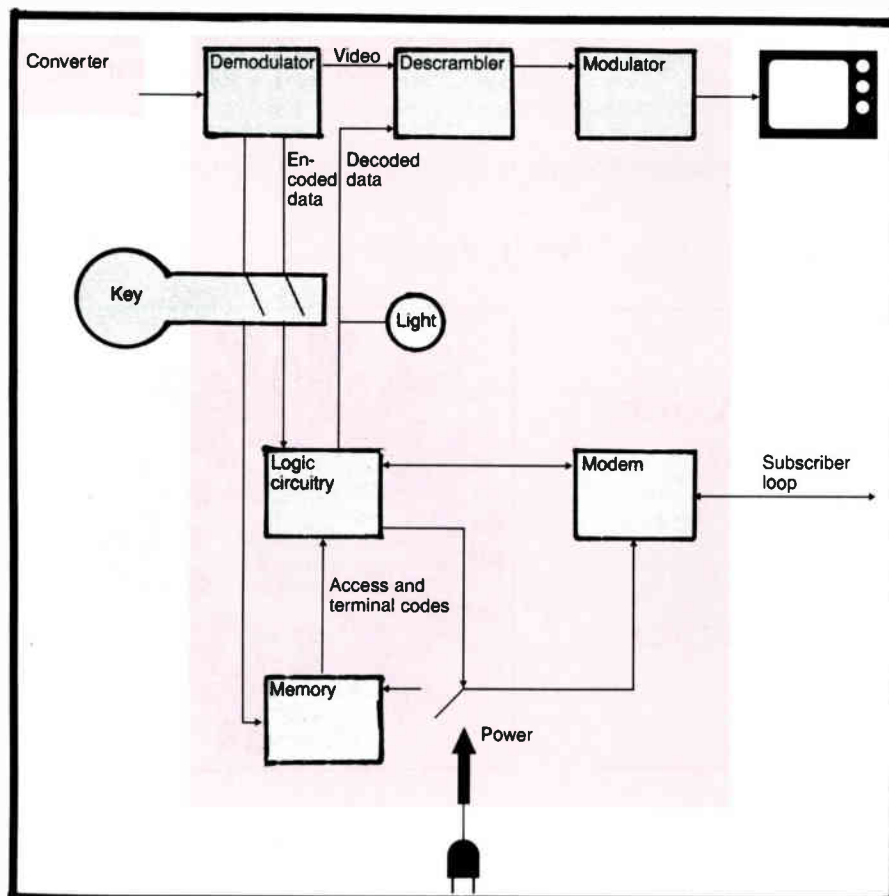

CATA CATV TECHNICAL TRAINING SEMINAR HOTEL INFORMATION

A block of hotel accommodations has been set aside for each seminar at the hotels indicated. Please make your own reservations directly with the hotel by completing and mailing in the hotel reservation form below to the appropriate hotel. For telephone reservations, be sure to include the information that you are attending the CATA CATV Technical Training Seminar to receive the special room rates as indicated.

BASIC

LAKE WORTH, FLORIDA AUGUST 1-3

COUNTRY SQUIRE INN
7859 LAKE WORTH ROAD
LAKE WORTH, FLORIDA 33483
PHONE: (305) 988-5000

Take exit 36 off the Florida Turnpike.
S - \$33.00
D - \$35.00

Sponsored by the SCTA

ATLANTA, GEORGIA NOVEMBER 7-9

MASTER HOST INN MIDTOWN
1152 SPRING ST. N.W.
ATLANTA, GEORGIA 30309
PHONE: (404) 875-3511

Located at I-75/85 at 14th Street in Atlanta.
S - \$28.00
D - \$32.00

Sponsored by the SCTA

ADVANCED

SAN ANTONIO, TEXAS OCTOBER 3-7

LA QUINTA MOTEL
333 NORTH EAST LOOP 410
SAN ANTONIO, TEXAS 78218
PHONE: (512) 828-0781

Located just on the east side of the airport.
S - \$31.00
D - \$37.00

Sponsored by the Texas
Cable Association

REVERE, MASSACHUSETTS DECEMBER 5-9

HOWARD JOHNSONS MOTOR LODGE
407 SQUIRE ROAD
REVERE, MASS. 02151
PHONE: (817) 284-7200

Located at the junction of Rts. C-1 and 60, 18 minutes from Logan Airport.
S - \$47.00
D - \$53.00

CATA wishes to extend their appreciation to the Southern Cable Television Association (SCTA) and the Texas Cable Association, for their cooperation in sponsoring the above indicated seminars.

CUT HERE

HOTEL RESERVATION FORM

Please reserve the following room requirements in the name of the company or individual shown:

NAME: _____ TELEPHONE: _____
(Company or Individual) Area Code

ADDRESS: _____
(P.O. Box or Street No.) (City) (State) (Zip)

NUMBER OF ROOMS: _____ OCCUPANCY: SINGLE DOUBLE

ARRIVAL: _____ DEPARTURE _____
(Date) (Time) (Date)

SEND DIRECTLY TO HOTEL CATA CATV TECHNICAL TRAINING SEMINAR

STANDARDIZE

WITH THE NATIONAL STANDARDS FOR CATV SYSTEMS — GRAPHIC SYMBOLS

In order to help you standardize your grid and map preparation Television Publications is now offering a brochure of National Standards for CATV systems Graphic Symbols.

The symbols in this publication present cable television systems operators and engineers with a uniform means of schematic and system map design throughout the Cable Television Industry. Order one for each of your operators and engineers and get standardized!

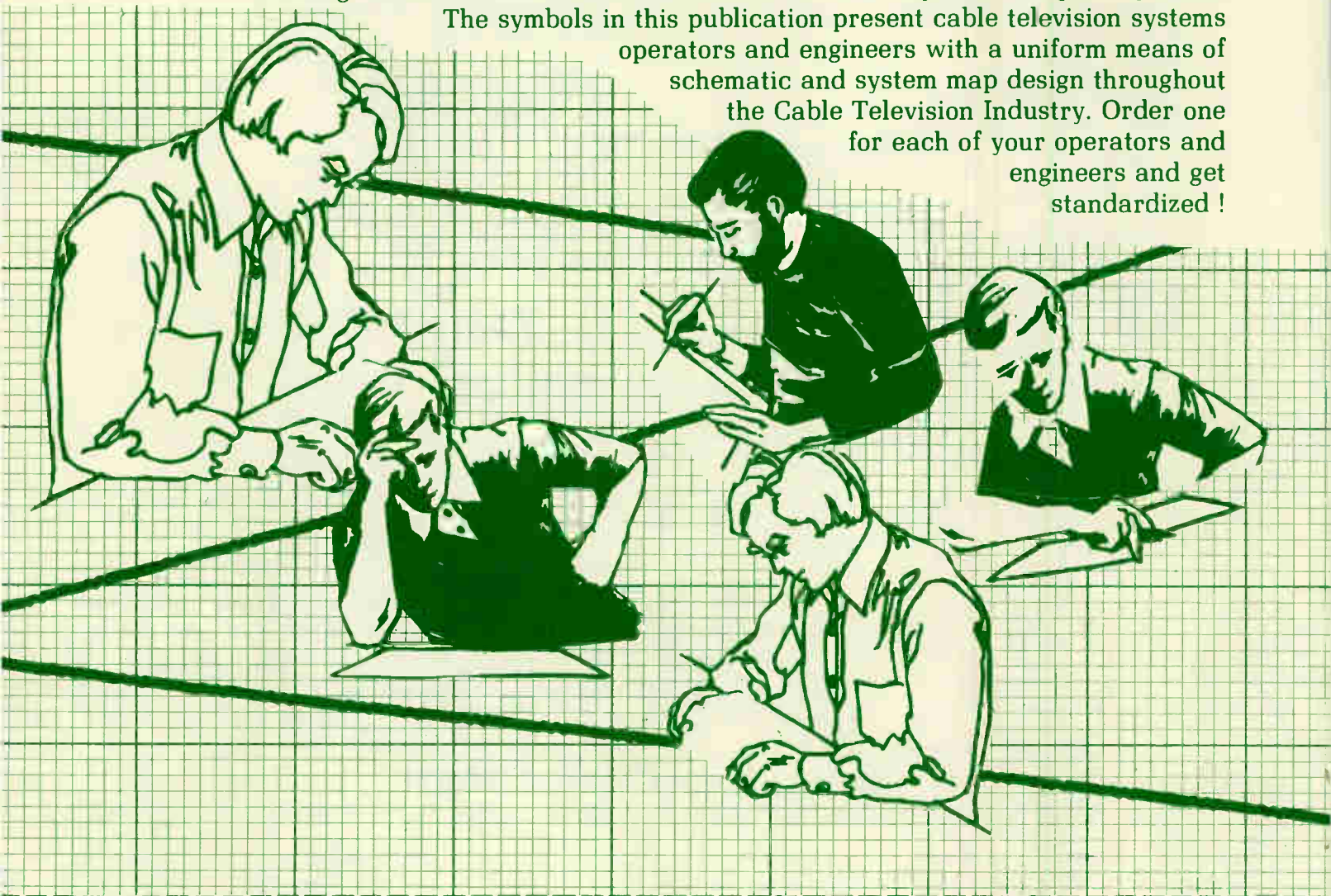

YES! I WANT THE NATIONAL STANDARDS FOR CATV SYSTEMS — GRAPHIC SYMBOLS GUIDE
SEND TO:

NAME	SYSTEM NAME	
ADDRESS	PHONE	
CITY	STATE	ZIP

PRICES
5.00 each
40.00 for 10 guides
90.00 for 25 guides

PLEASE SEND _____ SYMBOLS GUIDES. ENCLOSED IS \$ _____ FOR MY ORDER.

MAIL TO: TELEVISION PUBLICATIONS, INC. SUITE 100 4209 NW 23 OKLA. CITY OKLA. 73107 405/947-7664

communicates with the terminal through the modem. The data collection center verifies the identity of the terminal and the secure access to the memory by using an algorithm based on the terminal's serial number (which would be burned into the memory during manufacturing), the subscriber's telephone number, and the access code. Once these are verified, the data collection center signals the terminal to give it access to the memory. Besides the viewing records, the information in the memory can include status indicators for tampering attempts, power outages, and so on. If the subscriber's account with the pay operator is in good standing, the data collection center transmits the following month's access code. Service is denied to non-creditworthy subscribers by not passing the code.

Data collection center

Polling of subscriber terminals for viewing records is carried out for up to four hours each night by a mini-computer that gains access to the subscriber loops through the switching center. The data collection center performs these functions:

- interfacing with the network and subscriber lines,
- polling,
- communicating with subscriber terminals,
- generating accounting information,
- denying service,
- routine maintenance and checking of trouble reports, and
- participating in the installation and removal of subscriber terminals.

The data collection center in the prototype interfaces with switching centers of all types over no-test trunks. These trunks will accept the address signaling from the data collection center and exchange supervisory information with it so that a silent (no ring) connection is established to the desired subscriber line. If the line is busy, no connection is attempted and the line is tried again later. If the line is idle, the communication procedures described above ensues. Should the subscriber lift the telephone handset to make a call, dial tone is returned to him in less time than it takes to place the handset to the ear.



The data collection center has a list of telephone line numbers that are polled on different nights. Each subscriber terminal is polled on the same date each month. If a connection is not made at the first attempt, a second attempt is made later that night. If unsuccessful again, two further attempts are made towards the end of the month. If these also fail, the number is placed in a troubleshooting file.

Born in England, Tom Bowling received his BSc in engineering from the University of London and his MSc in electronics from the University of Southampton. After national service in the Royal Navy, he moved to Australia, becoming the chief electrical engineer of the Royal Australian Navy's Torpedo Establishment. Returning to the U.K. in 1958, he was appointed deputy technical manager of Marconi Marine. In 1965 he formed his own company, which provided communications systems for railways and hospitals. Tom came to Canada in 1979 to join BNR's systems division. Here he initially worked on pay TV and subsequently has worked on alarm services and teleconferencing. A Fellow of the IEE, Tom keeps up his maritime interests as a lieutenant-commander in Canada's Naval Reserve. □

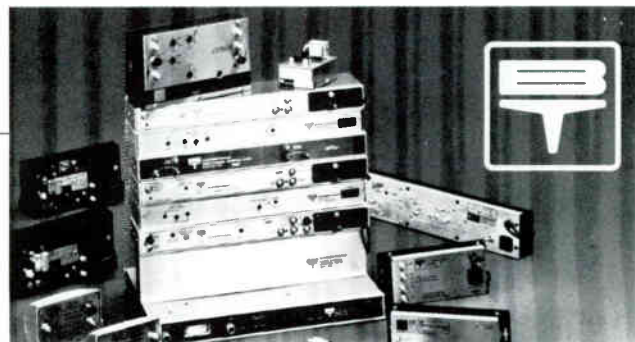

Look to us for high quality B-T no-wait CATV equipment.

We have it in stock for immediate delivery.
Or pick-up.

Blonder-Tongue stock items include: antennas, amplifiers, modulators, converters, filters, headend accessories, traps, processors, preamps, and more. Call us for what you need.

Davco, Incorporated

America's Oldest CATV Distributor

- Same day shipment
- Help when you need it
- Everything you need in one stop
- In business since 1949!



Authorized
Blonder-Tongue
Stocking
Distributor

P.O. Box 2456

Batesville, Arkansas 72501

(501) 793-3816

The "Do It Yourself" Survey

By Glyn Bostick
Weston Scriba
Microwave Filter Co., Inc.

Last Time

In part #14 the many services of the professional frequency coordinator were described. These range from a preliminary, computer-generated description of TI (terrestrial interference) incident on your planned TVRO site to on-site measurements and all the other steps leading to licensing, if desired.

This Time

We present a simple TI measurement kit and show how to make and operate it. As indicated last time, the CATV-TVRO should be licensed for protection against future TI sources and the professional coordinator should play a key role in this process. While the "do it yourself" survey is not a good substitute for the professional survey, for licensing purposes, it can supplement it. A preliminary survey by the CATV system's TVRO engineer can eliminate unworkable sites or find the quietest operating location on the property, and hence cut down on the duration and the cost of the professional survey. For the installing dealer of residential TVRO, who cannot afford professional surveys, the survey kit is a viable "security blanket".

The Purpose of the Survey

The ultimate purpose of the survey is to detect TI and predict the extent of degradation of the desired satellite reception. This requires the measurement of the strength and direction of TI transmission and further calculations to determine its effect on the TVRO. These calculations will be discussed next month (in part #16). For now, we are interested in detecting the field strength (db-watts/meter squared), frequency and direction of all TI carriers.

The "Do it yourself" Survey Kit

The kit consists of a pick-up or sensor (pyramidal horn with a standard LNA attached) and a detector (a calibrated TVRO receiver).

Standard Gain Feedhorn

This pyramidal feedhorn is available from a number of microwave equipment manufacturers.¹ It is available in several gains, 15 db and 20 db being the most common. It is referred to as a standard gain feedhorn because, due to the work published by the National Bureau of Standards, its gain is predictable to a high degree of accuracy when constructed to specific dimensions; it may therefore be used as a secondary gain standard. The enterprising TVRO engineer can even construct his own, although at a purchase price of only about \$250, the effort may not be worthwhile.

The feedhorn should be sealed against moisture (by closing it with a thin sheet of fiberglass or other low-loss dielectric) to preserve the gain calibration and to prevent transmission of moisture to the LNA.



Measuring frequency, azimuth, bearing and polarization of TI with the "do-it-yourself" equipment kit.

Low Noise Amplifier

Any well-built, 50 db TVRO LNA will do for this application, provided it is rugged in construction, sealed against moisture, and has good temperature stability.

Tripod With Antenna Mounting Bracket

The tripod should have a 0-360 degree azimuth indicator and a screw or other provision for anchoring the antenna mounting bracket. The mounting bracket should hold the antenna/LNA combination and have provisions for quickly changing polarization to vertical, horizontal and 45 degrees. There does not appear to be a readily available product on the market, so this bracket can be custom-made from the illustrated sketch. The tripod should be rugged enough to maintain pointing accuracy in mild to medium wind conditions. A commercial brand camera tripod has been found suit-

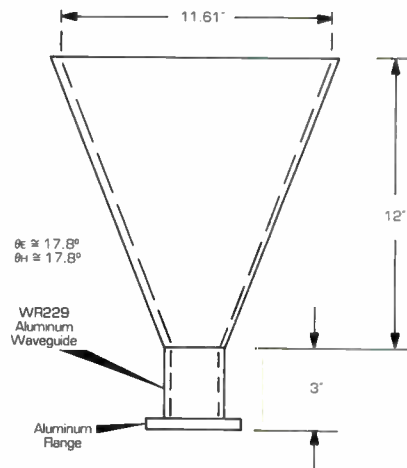
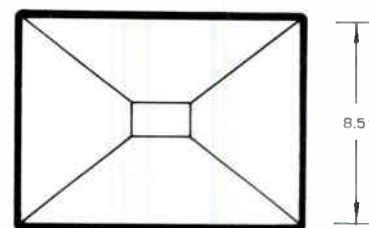
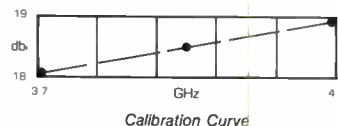

18.5 db. standard gain feedhorn antenna suitable for interference field strength measurement.



A DC-to-AC inverter suitable for supplying AC to a receiver from a battery. (ELECTRONIC PRODUCTS Inc. #BX125).

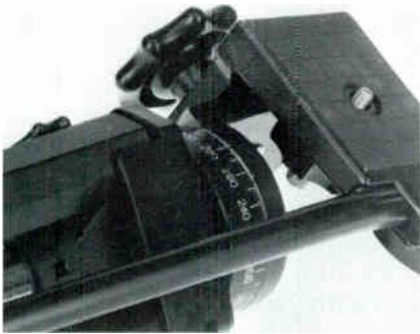

A fluid type video camera tripod makes an ideal feedhorn mount and has a 360° azimuth scale. (VIDEO-COMPACT-PROFILO 4144)

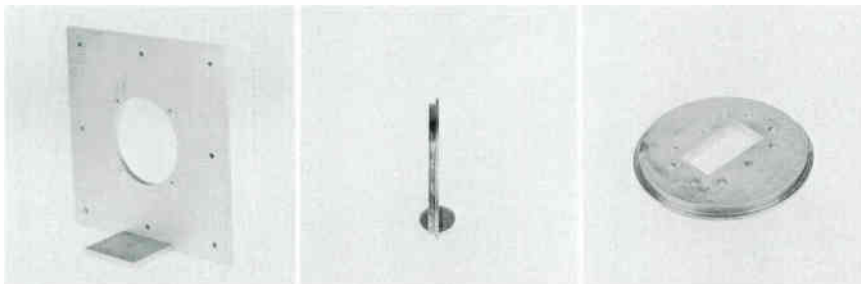

able: "VIDEO-COMPACT-PROFILO 5144", carried by most large distributors or specialty stores handling professional photo equipment and supplies.

Field Strength Meter

The EARTH TERMINALS' TVRO receiver, designed for general residential use, makes an excellent field strength meter. This is a two-box piece of equipment, the downconverter being separate from the "receiver" and connected to it with RG-58/U cable. No alteration to this receiver is required to turn it into a field strength meter. A commercial grade, 50 ohm step attenuator is connected between the downconverter and the receiver. This attenuator should be step adjustable in 1 db steps to a total of about 50 db. The step attenuator should be DC bypassed since the receiver tunes the VTO in the downconverter by means of DC power sent through the 70 MHz cable. The SIGNAL STRENGTH meter on the receiver's front panel is used as

the field strength readout instrument.

Power Supply

The EARTH TERMINALS receiver operates from 110V 60 CPS alternating current. Unless provisions are made for using a long throw cord to the nearest outlet, a battery and DC-AC alternator will be required.

Calibration of the Field Strength Meter

The illustration shows a receiver actually being calibrated. This data may be used for approximate field measurements, although calibration of each individual receiver is advisable.

Operation of the Equipment

The survey equipment is positioned in the exact spot to be occupied by the center of the TVRO antenna. Using a magnetic compass and correction table, the azimuth scale of the tripod is turned to align the "O" azimuth reading with true north. The stage is now set to begin the test sequence:

Search

Plan to swing the feedhorn in increments of 20 degrees (about 3 db beamwidth of a 19 db feedhorn) and to search at each increment.

Increment Test

At a given pointing, use the receiver as a frequency meter to search for TI frequencies.

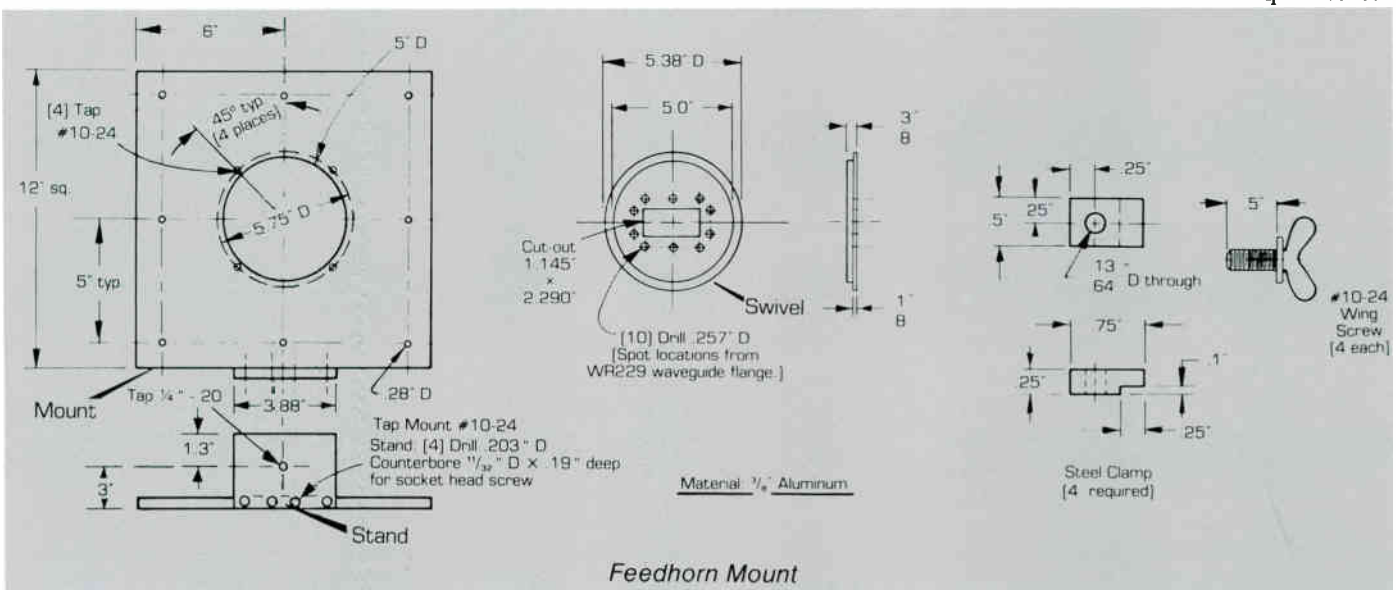

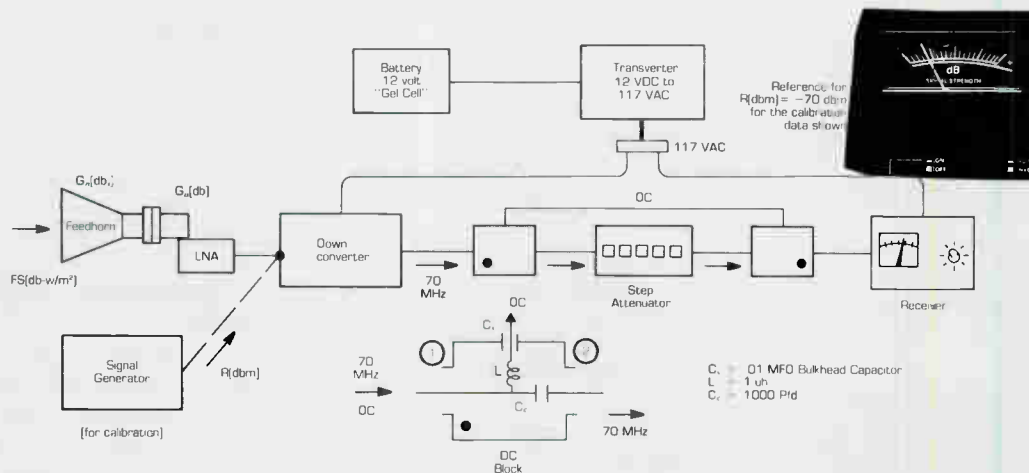

Calibrating the "do-it-yourself" field strength meter (EARTH TERMINALS receiver).

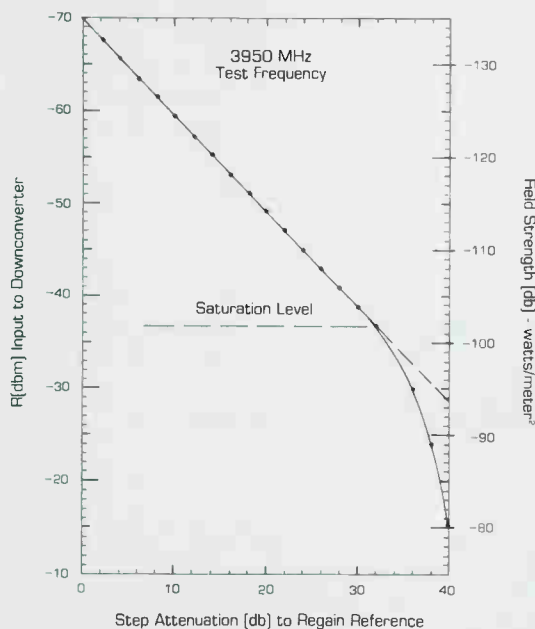

Typical calibration data for an EARTH TERMINALS receiver.

Conversion Table
Step Attenuation Reading to Field Strength

Step Attenuation — A[db]	R[dbm]	FS[db-w/m²]
0	-70.0	-135.0
2	-67.6	-132.6
4	-65.5	-130.5
6	-63.2	-128.2
8	-61.2	-126.2
10	-59.2	-124.2
12	-57.0	-122.0
14	-55.1	-120.1
16	-53.0	-118.0
18	-51.0	-116.0
20	-49.2	-114.2
22	-47.2	-112.2
24	-45.0	-110.0
26	-43.0	-108.0
28	-41.0	-106.0
30	-38.8	-103.8
32	-36.7	-101.7
34	-33.8	-98.8
36	-30.0	-95.0
38	-24.0	-89.0
40	-15.2	-80.2

Remember that they are located midway between the channels. The EARTH TERMINALS tuning knob is free tuning (i.e., has no detents) and has a mark at each channel position, making it an excellent frequency search meter. With the feedhorn positioned for 45 degree polarization so that it

will be sensitive to either vertical or horizontal signals, remove all attenuation from the step attenuator. Then slowly turn the channel selector knob, beginning below channel 1, until a reaction is noted on the signal strength meter. Note: search only between channels and turn knob slowly — tuning is critical.

Adjust the azimuth position to obtain the strongest reading. If the needle pegs, increase attenuation so that the meter indication is always less than full-scale. Then adjust the feedhorn first for vertical polarization and then for horizontal polarization, in each calibrated reference position. Record the fre-

Measured Survey Data Form: 4 GHz Interference

Date _____ Customer _____
 Time _____ Location _____
 Survey# _____ Latitude _____
 Feedhorn Gain (GHz) _____ Longitude _____
 K[db] _____ Sheet _____
 Tester _____ of _____ Sheets

Frequency (MHz)	Polarization	Azimuth	A _f (db)	FS(db) [w/m ²]
[1]				
[2]				
[3]				
[4]				
[5]				
[6]				
[7]				
[8]				
[9]				
[10]				
[11]				
[12]				

quency (which is the average of the two channel frequencies bracketing the knob pointing), the azimuth and the step attenuator reading A_f(db). Before moving on to the next increment, continue searching up the channel scale until all frequencies emanating from the

located source have been identified and measured.

Continuation

Set the feedhorn's azimuth to the next increment and repeat until the full 360 degree circle has been measured.

Multiple Tests May be Necessary

If very strong **TI** is encountered during the survey, you will know their direction and might want to relocate the equipment to take advantage of natural shielding (buildings, trees, fences, etc.) and remeasure. ▶

**Calibration
of an EARTH TERMINALS Receiver
at 3950 MHz**

- (1) Adjust rear screwdriver gain control on receiver for full gain.
- (2) Connect a calibrated signal generator to the downconverter. Set frequency to 3950 MHz and output to -70 dbm. Tune receiver and note reference reading on receiver's signal strength meter (should reach approximately 4 db).
- (3) By inserting step attenuation in 2 db steps, adjust attenuator setting on signal generator to regain the reference reading on the receiver and record the signal generator output. Continue until -40 dbm output of the signal generator is reached.

- (4) Taking into account the exact gain of the feedhorn and amplifier, compute:

$$K(\text{db}) = 3.34 - (G_{\text{hdb}} + G_{\text{adb}})$$

(where G_{hdb} is the feedhorn gain
and G_{adb} is the amplifier gain)

(In our case, we used a standard gain horn having 18.5 dbi and a regular 50 db LNA. Hence:

$$K(\text{db}) = 3.34 - 18.5 - 50 = -65.16)$$

- (5) Use the following equation to relate $R(\text{dbm})$, the signal generator output, to $\text{FS}(\text{db-w/m}^2)$, the received field strength in watts/meter²:

$$\begin{aligned} \text{FS}(\text{db-w/m}^2) &= R(\text{dbm}) + K(\text{db}) \\ &= R(\text{dbm}) - 65 \end{aligned}$$

(note that both $R(\text{dbm})$ and $K(\text{db})$ will be negative db)

- (6) Complete the table and use it to convert field measurements to field strength.

Cable TV Brokerage

AMCOM, INC.

CHARLES GREENE

Mr. Greene will be available for private conferences during the CCOS '83 seminar in Hot Springs, Arkansas. Call his office in advance or contact him during the seminar through the front desk of the Arlington Hotel.

5775 Peachtree-Dunwoody Road, N.E.
Building E, Suite 200 (404) 256-0228 Atlanta, Georgia 30342

Next Time

Part #16 will show how to analyze the TI measurements to deduce the probable effect on satellite signal reception.

Acknowledgements

The authors again thank Bernadette Andaloro for a fast but precise job of meeting CATJ's deadline, Leonard Cardone for building the standard gain horn for our kit, Marian Allen for designing the horn mount, Don Shatraw for receiver calibration, and Terry Owens and Rene Baker for field set-up and trial.

Editor's Note

Portions of this article were reprinted from ASTI — the terrestrial interference handbook — by permission of the publisher, MICROFILCO PRESS DIVISION, Microwave Filter Co., Inc.

FOOTNOTES:

- (1) Many microwave component manufacturers fabricate standard gain feedhorns, but only a few offer them with WR229 waveguide flanges:

WAVELINE
P.O. Box 718
West Caldwell, New Jersey
(201) 226-9100

STRUTHERS ELECTRONICS CORPORATION
4 Dubon Court
Farmingdale, New York 11735
(516) 420-9000

- (2) **EARTH TERMINALS**
One Microwave Plaza
Cincinnati, Ohio 45242
(513) 489-6200

- (3) Step attenuators (50ohm, BNC connectors) are available from:
TEXSCAN CORPORATION
2446 North Shady Lane
Indianapolis, Indiana 46219

KAY ELECTRIC
12 Maple Avenue
Pine Brook, New Jersey 07058 □

NEW PRODUCT REVIEW

Computer Based FCC Proof-of-Performance Testing

Superior Electronics
Center, Inc.

A new concept in accomplishing the annual FCC Proof-of-Performance Tests has been inaugurated by Superior Electronics Center, Inc. of Sarasota, Florida. This cable television electronics repair and calibration service center has equipped a mobile van with the proper test equipment to perform all of the required FCC Proof-of-Performance tests and interfaced the test equipment with an Apple III computer.

The van contains various test panels designed by Superior Electronics and incorporates a Wavetek SAM IV signal level meter and a frequency counter as part of the test equipment used with the computer to complete the tests as required by the FCC. A new Wavetek 1880 System Analyzer will be added to the test set-up in the very near future to provide a better evaluation of the cable system's operational performance.

The complete Proof-of-Performance testing is accomplished within 24 to 36 hours on any cable system, and a completed, hard copy computer print-out of the test results is furnished to the cable operator prior to the departure of the Superior test van



from the system. A cover letter of evaluation of the system performance is provided with the copy of the Proof test, and Superior's field engineer, who performed the tests, will give the system operator a briefing on problem areas where the required test specifications did not meet the minimum standards. In addition, Superior will calibrate the Chief Technician's signal level meter and update the system's Signal Leakage logs as a routine service during the Proof testing.

The present cost for the new, computerized Proof-of-Performance testing for a standard 12 channel cable system is **\$1,000.00 complete**, regardless of the systems location, with a

charge of \$25.00 for each additional system channel over the 12 basic channels. Superior currently has one of these computerized Proof Test Vans in the field and expects to have three more of them operational by the end of this year.

Any cable operator whose system is way out of specifications may contract separately to have Superior send in their System Engineering Support Van to troubleshoot the system, locate problems and correct them for a standard fee of **\$500.00 per day plus expenses**. The average time that they have had to spend in locating and correcting problems in a typical cable system varied between **three to seven days**, unless the cable system was in very bad condition. ▶

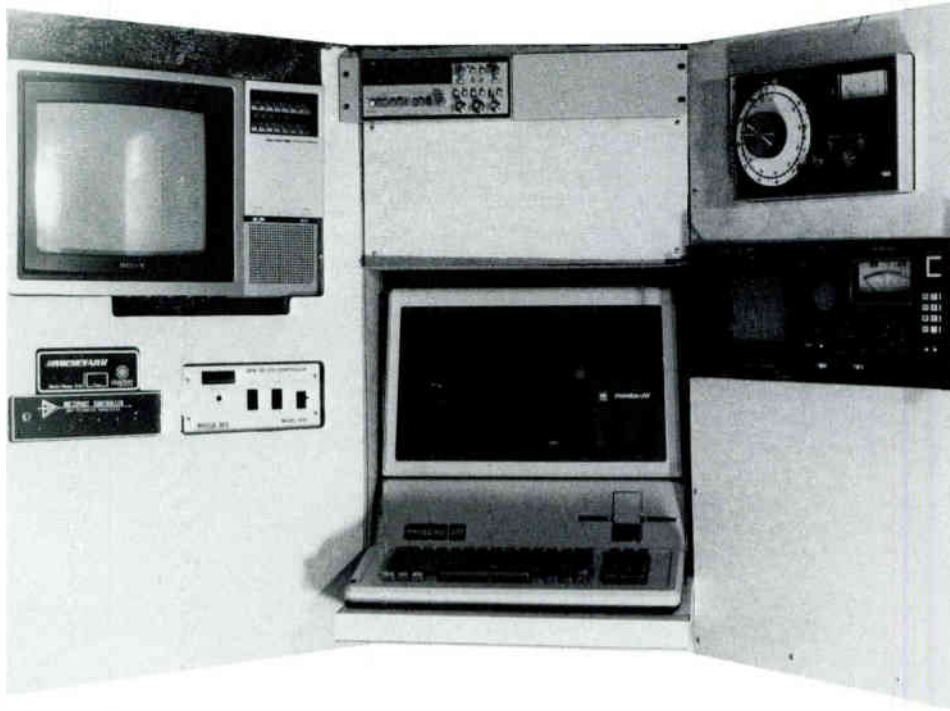

*Interior of
FCC Test Van*

PROOF-OF-PERFORMANCE TESTING



Complete Print-out of Channel Flatness Response

* * OUT OF FCC * * 09:05:17 p.m.
COMPLIANCE Apr 12, 1983
SPECIFICATIONS 23.2°C 73.8°F

FREQUENCY, HUM, CHANNEL RESP, SIGNAL TO NOISE, RADIATION

Channel	frequency	Hum or Repetitive trans.	Channel Response	Signal to Noise	Radiation
2	Visual				
10					

Loc: 1, 2, 3

Part of Computer Print-out showing certain tests that failed to meet FCC minimums

Any cable system operator who does not have the test equipment or technical capabilities to do the annual Proof-of-Performance tests and is required to accomplish these tests by Part 76 of the FCC Rules should investigate the possibilities of having their annual proof done by one of the

reputable companies serving the cable industry in this manner, such as Superior Electronics Center, Inc. that CATJ has featured in this issue.

If the FCC Test Van should arrive at your cable system office, no excuses are acceptable! Don't take a

chance of overlooking this requirement and perhaps being fined.

The Superior people will have a booth a CCOS and have their van on display as well. Plan to stop by and look this over — it would be time well spent! □

Microdyne's New Multiple Feed System Lets You Receive Up To Five Satellites



With new programming constantly being added, you may want to pick up programs from several satellites. Previously, this would involve the expense of another dish. Now with Microdyne's new multiple feed system you may be able to add programming from additional satellites at about 1/5 the cost of a new dish.

The MSF-16 Multiple Satellite Feed System can receive up to five satellites on the same parabolic reflector when the satellites are located in close proximity. In a TVRO system designed with adequate margins, the MSF-16

will provide quality pictures on all feeds.

Existing Microdyne/AFC antennas can be easily retrofitted to accommodate this new system. Only the spars and brackets of the feed support hardware must be changed — no other antenna changes are required. This simple modification can be done by the user or by Microdyne field service personnel.

Even if you purchased your existing antenna from another manufacturer, it may still be possible to modify it for use with the Microdyne

Multiple Satellite Feed System. Please give us a call.



So, whether you are planning a new system or expanding an existing installation, the MSF-16 can provide increased capability while saving both the cost and the real estate required by a second dish.

We have prepared a brochure to help you to determine if the MSF-16 is suitable for your system. For a free copy, write on your company letterhead to Microdyne Corporation, TV Sales, Dept. F, P.O. Box 7213, Ocala, FL 32672.

Microdyne Corporation

P.O. Box 7213 • Ocala, FL 32672 • (904) 687-4633 • TWX: 810-858-0307

SEE US AT THE CABLE-TEC SHOW BOOTH NUMBER 207

REPAIR MODIFICATION AND CALIBRATION

Every cable operator has experienced problems with his equipment and, in many instances, just does not have the capabilities to repair and calibrate it in order to return it to service economically. Usually, we will return an item that fails during the warranty period to the manufacturer for service, but, when we also return non-warranty equipment items as well, the manufacturer's service center frequently becomes overloaded; repair and return time starts looking like the "Twelfth of Never". Most of us need these items far more quickly than that, and, especially, test equipment.

To help cable operators struggling with this dilemma, several independent businesses have been formed to provide cable television system equipment repair, modification, and calibration with a minimum of time delay in turn-around capabilities. One such business is **Superior Electronics Center, Inc.** in Sarasota, Florida.

In 1967, a cable operator named Sam Booth needed help with his Jerrold Starline I equipment, and he explained his problems to Dewayne Lipp who owned Superior Electronics. Dewayne designed several modifications for the Starline I equip-

ment, using discrete components, to improve the reliability and operational efficiency of the equipment without expanding the unit's frequency bandwidth. This marked Superior's entry into the cable television industry.

Today, Superior Electronics still modifies the Jerrold Starline I equipment for cable operators. The housing motherboard is cleaned, tested, and repaired if necessary, while the housing itself is sandblasted to remove corrosion. It is then treated by a process known as glass beading to give it a smooth, glossy finish, and sprayed with a clear seal-coat. All of the component items are stripped from the housing, including the connectors, and new, discrete circuit boards and component items are installed for a complete rebuild of the amplifier. All of the circuit board assembly, component installations, and wiring are done "in-house" instead of being accomplished through a kit-type modification. The completed amplifier, called **SA Revamp by Superior**, has 27 channel capability and a three-year warranty, at a total cost of about \$350.00 (in quantity) for a trunk/bridger amplifier, and, with the addition of AGC, only \$100.00

more. This price includes the housing, amplifiers, equalizers, feeder-maker, and power supply. When the cable operator provides the old Jerrold Starline equipment or housings, the cost is even less.

In addition to the modification of the old Jerrold SA equipment, Superior also does a revamp of the Jerrold ASL amplifiers and the SLE line extenders for 300 MHz operation. The SLE Revamp provides a **minimum gain of 28dB** without any equalization, **± 0.5dB of flatness response**, has an **8dB slope control range**, and is available with **11dB or 20dB thermal compensation, input level attenuation from 3dB to 15dB**, and either **6dB, 12dB, 16dB, or 20dB of fixed equalization**. The cost of the **SLE Revamp** is about **\$118.00** (in quantity), with equalizers running \$8.00, and \$32.00 more for the housing if not supplied by the cable operator. The SLE Revamp is available with both 30 and 60 volt powering.

In the very near future, Superior will also provide a Revamp of the old **TOCOM** line extender with the same technical specifications as the Jerrold SLE Revamp and for approximately the same cost.

A large percentage of Superior's



Revamp Alignment

business is in the repair and calibration of other equipment items used in cable systems including processors, modulators, amplifiers, and test equipment. Amplifier trouble shooting and repair is accomplished in a minimum of time by the use of a special test panel designed and built by Superior, where frequency bandwidths, attenuation, and other of the technical parameters are controlled by the touch of a button. Another test set up accomplishes final testing of active equipment, including distortion testing for crossmodulation and intermodulation. Currently, Superior is offering a \$99.00 special on the repair and calibration of any Installer type signal level meter. This price, plus shipping charges, is the maximum amount that will be charged for this service if repair is possible, and includes parts (fresh long-life batteries as well; carrying case is extra) and labor with a 100-day warranty.

Final calibration and testing of repaired equipment to insure that it meets operational technical standards is accomplished after a twenty-four hour "burn-in" to insure stability of circuits and components in use. The well stocked parts supply area enables Superior to provide an average equipment turn-around in ten days or less, because every one of the most common failure components for all manufacture makes and models of cable television equipment is kept in their parts bins. Exceptions to the 10 day turn-around occur only when the required component item is one that



Note "custom test set" to speed up trouble shooting amplifiers

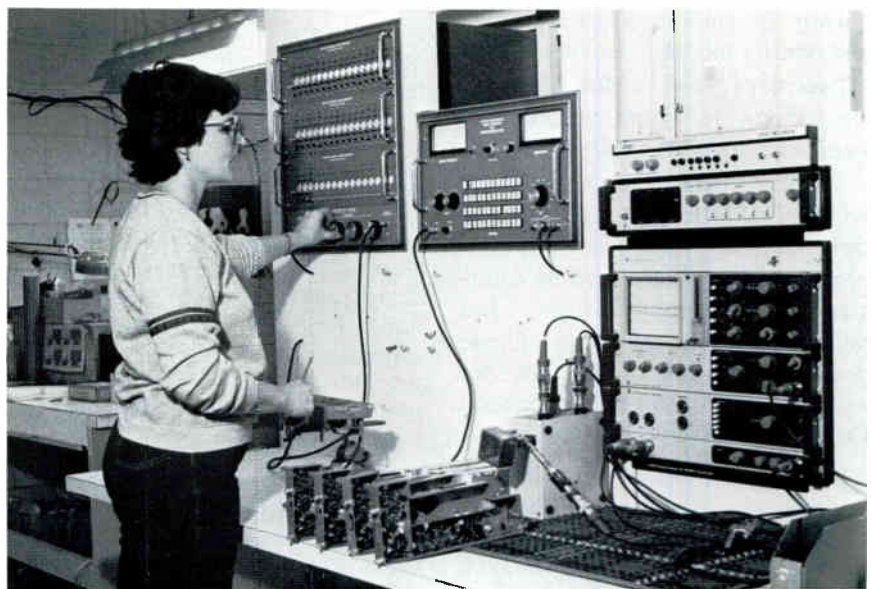

Final test — X-mod and distortion testing

rarely fails, is not normally stocked, and is difficult to obtain from the component manufacturer. In addition to equipment repair and calibration, Superior also sells replacement parts for all line items to the cable operator who wants to do his own repair work "in-house".

A field computerized van to accomplish FCC Proof-of-Performance testing is the newest addition to Superior Electronics' services (see New Product Review p. 44). Assistance in the field to correct cable system problems, such as troubleshooting and alignment of the head-end, sweeping and balancing the cable plant, and resolving co-channel, noise, and distortion problems is another service that is available to the cable operator who finds this beyond his present capabilities.

Superior Electronics Center, Inc. has an outstanding staff of thirty employees under the guidance of Dwayne Lipp's engineering expertise. Key figures among Superior's personnel are Nick Ackerman who has served for sixteen years as Director of Marketing, Ivan Reynolds in Engineering and Research, and Dick Kirn who is an Engineering Consultant.

If some of the above problems are among those that plague your system or if your equipment is in need of repair, modification, or calibration, you might give the services Superior

Electronics provides serious consideration. Those attending CCOS '83 will have an opportunity to visit with

some of their representatives about their repair service.

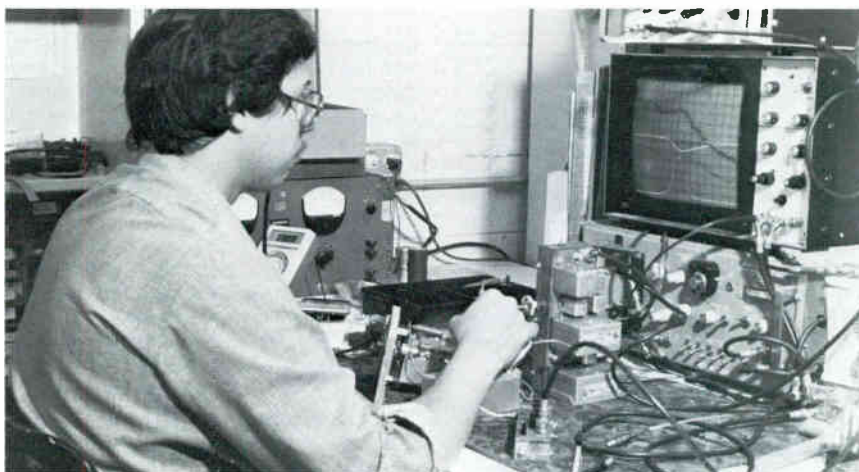

Trouble-shooting and alignment of signal level meter modules

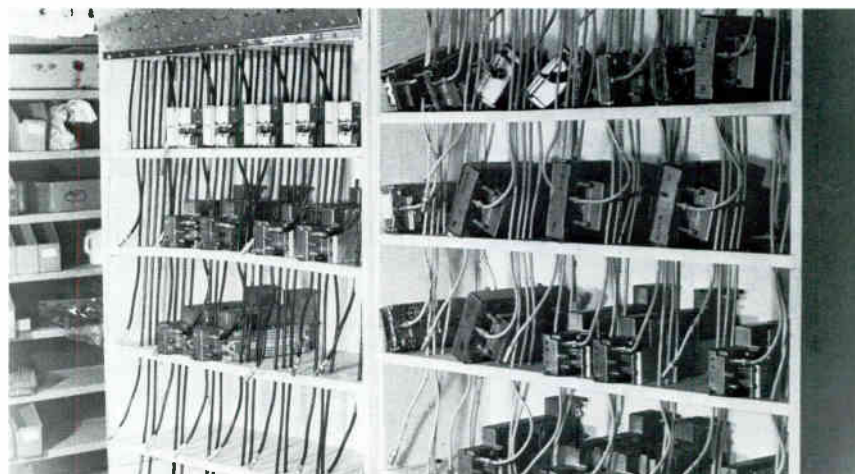

24-Hour Burn-In

LINE WARD CORP.

L-1

CABLE LINE LAYER

PROVEN 10 YRS.

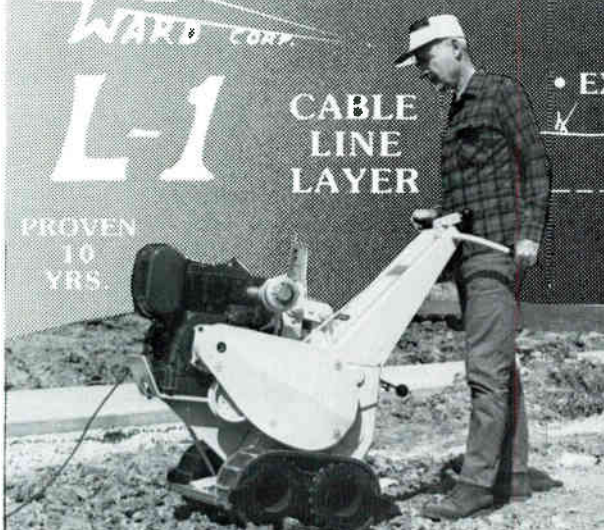

? UNDERGROUND HOUSE-DROPS ?

FOR PHONE-CABLE TV YOUR BUSINESS ?

THEN — "BIG IS NOT BETTER"

- EXCLUSIVE TRACK SYSTEM

MEANS NO LAWN DAMAGE

- ONLY 800 LBS. 24½" WIDTH
- NO TRAILER NEEDED
- COMPACT! MANEUVERABLE!
- FINE LAWN, OR ROUGH TERRAIN, IT WILL GO WHERE THE OTHERS WILL NOT — FAST!

OUT CLASS-OUT PERFORM-OUT PRODUCE ALLOW US TO PROVE THIS.

PHONE 157 SENECA CREEK RD.
(716) 675-7373 BUFFALO, N.Y. 14224

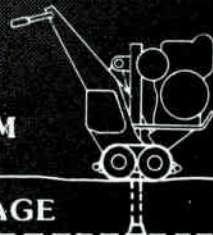

See Us At The Kansas City I-CUEE Show - K89, K90

★ LEMCO TOOL CENTER CONDUCTOR CLEANER

Lemco Tool Corporation has designed a new concept in center conductor cleaning. The all steel construction assures strength and reliability. The split knife has been engineered to glide over the center conductor removing both the dielectric and plastic in seconds. Slide the cleaner on the exposed center conductor, press and pull straight out. Repeat until clean.

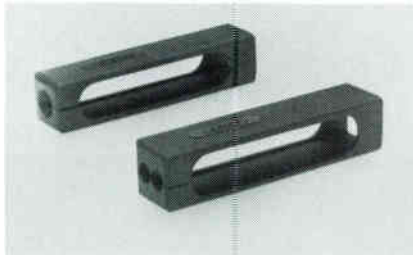

This cleaner keeps the center conductor round. Available in all standard trunk and feeder cable sizes. Approximate weight — 3 oz. length 3 3/4".

Additional information available from:
Lemco Tool Corporation
 R. D. 2
 Box 330A
 Cogan Station, PA 17728
 Toll Free: 800-233-8713
 717-494-0620 (in Pennsylvania)

★ NEW AUDIO/VIDEO MODULATOR AND SINGLE CHANNEL BANDPASS FILTER INTRODUCED BY BLONDER-TONGUE

Blonder-Tongue has announced the availability of its new MAVM (Stock No. 5923) Audio/Video Modulator. The MAVM is an all solid state heterodyne unit that provides a modulated visual and aural RF carrier output on any single VHF, Midband or Superband channel. State of the art circuitry enables the MAVM to offer full feature performance

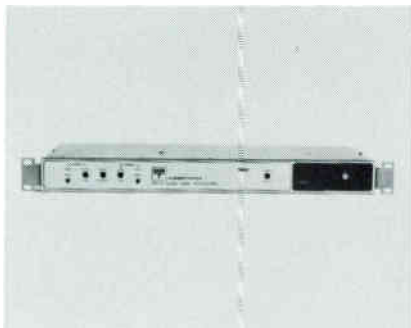

at an economy price level. The MAVM can be used to put sound and color video

on any unused channel of a closed circuit MATV system for surveillance or adding new or premium program channels; to expand channel capacity in small cable systems and add premium channels in an SMATV system. The heterodyne design generates a cleaner channel and insures optimum vestigial sideband selectivity.

I.F. loop-thru capability supplies a padded I.F. output before channel conversion. This allows replacement of standard I.F. output with an alternate source of composite I.F. or use of an All-Call Alert System. The MAVM features a field changeable heterodyne output channel converter board. Channels may be changed by simply removing and replacing a complete channel module. Desoldering, soldering or special tools are not required. The modulator accepts standard polarity (sync negative) of 0.7 to 2.5V p-p level from video sources such as a TV camera, VTR, TV demodulator or satellite receiver.

All controls and indicators are conveniently located on the front panel including video overmodulation and audio overdeviation indicator LED's. The MAVM is a space saving 1 3/4" high and fits a standard 19" EIA equipment rack.

Blonder-Tongue has also announced the availability of its new BPF-d (Stock No. 4417) Single Channel VHF Bandpass Filter which provides extremely high rejection of adjacent channels and out-of-band signals.

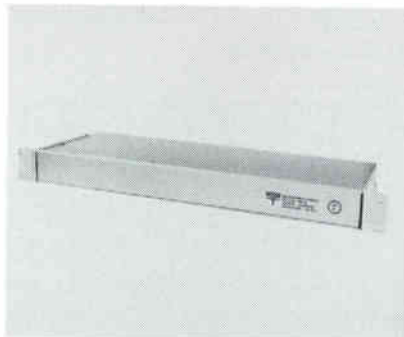

The BPF-d utilizes a six pole helical resonator filter in conjunction with a four resonator trap circuit. The filter section provides exceptional selectivity with a minimum thru-loss while the traps provide superior rejection of the nearest adjacent carriers. The BPF-d is available for all low and high band VHF channels. The BPF-d is a space-saving 1 3/4" high and is designed to fit a standard 19" EIA rack.

For more information, contact Ted Zdzienicki at Blonder-Tongue Laboratories, Inc. at One Jake Brown Road, Old Bridge, N.J. 08857 or call (201) 679-4000, Ext. 349.

★ LRC Electronics, Inc.

LRC Electronics, Inc., Horseheads, New York, introduces the LRC Pressure Tap for use in coaxial cable area networks. This innovation tap can be adapted for almost any size or type of coaxial cable without the use of additional tools.

LRC Electronics feels that its new product will eliminate the problem of short circuiting found in other taps. The LRC Pressure Tap features a cutting tool which works from the side of the cable, removing pieces of insulation and braid without hitting the center conductor. A contact pin is designed to be pushed over the center conductor of the cable and make contact. The tap's all-metal construction assures the radiation integrity of the coaxial system.

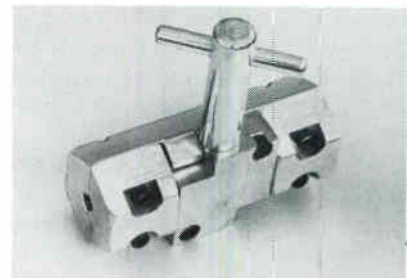

LRC developed the tap in response to the demand for an uninterrupted pressure tap that requires no additional training of its end users, and is cost-effective in application.



LRC Electronics is a subsidiary of Augat. They are located at 901 South Avenue, Horseheads, New York 14845. Telephone (607) 739-3844.

AVTEK EXTENDS WARRANTY ON TIME DOMAIN REFLECTOMETER

W.R. Campbell, Director of Sales and Marketing, AVTEK INC., has just announced in celebration of the first anniversary and the demonstrated field reliability of the Model 2901A TIME DOMAIN REFLECTOMETER cable fault locator, the company will extend the present 90 day warranty to a full one year guarantee.

Associate Roster

ADT Security Systems,
One World Trade Center,
92nd Fl.,
New York, NY 10048
212—558-1444
(M9 Security Equipment)

Alpha Technologies,
1305 Fraser St. D-G,
Bellingham, WA 98225
206—671-7703
(M9, Standby Power
Supplies)

AMCOM, Inc.,
Bldg. E, Suite 200,
5775 Peachtree-
Dunwoody Rd., N.E.,
Atlanta, GA 30342
404—256-0228
(S9, Brokering &
Consulting)

Amplica, Inc.,
950 Lawrence Dr.,
Newbury Park, CA 91320
805—498-9671
(M4)

* **Anixter Communications**
4711 Golf Road,
Skokie, IL 60076
312—677-2600
(D1)

Apple/Store
Rte. #1, Box 156,
Beaver Dam, WI 53916
414—885-6249

The Associated Press,
50 Rockefeller Plaza,
New York, NY 10020
212—621-1513
(S9 Automated News
SVC)

Automation Techniques,
1846 N. 106th E. Ave.
Tulsa, OK 74116
918—836-2584
(M9)

Avantek, Inc.,
481 Cottonwood Dr.,
Milpitas, CA 95035
408—946-3080
(M8, 9 TVRO
Components)

Av-Tek, Inc.,
Box 188,
Aurora, NE 68818
402—694-5201
(M8)

BEI
P.O. Box 937,
Olathe, KS 66061
800—255-6226
(M9 Character
Generators)

**Ben Hughes
Communications**
P.O. Box AS,
Old Saybrook, CT 06475
203—388-3559
(M6, 9)

Blonder-Tongue Labs, Inc.,
1 Jake Brown Rd.,
Old Bridge, NJ 08857
201—679-4000
(M1, 2, 4, 5)

**Broadband Engineering,
Inc.,**
P.O. Box 1247,
Jupiter, FL 33458
1-800—327-6690
(D9, M4, S9)

Budco, Inc.,
4910 East Admiral Place,
Tulsa, OK 74115
1-800—331-2246
(D9, Security &
Identification Devices)

CATEL,
4800 Patrick Henry Dr.,
Santa Clara, CA 95054
408—988-7722

* **C-COR Electronics, Inc.,**
60 Decibel Rd.,
State College, PA 16801
814—238-2461
(M1, 4, 5, S1, 2, 8)

CCS Cable
P.O. Box 14710,
Phoenix, AZ 85063
602—272-6855
(M3)

CWV Electronics,
405 N. Earl Ave.,
Lafayette, IN 74904
1-800—428-7596
(M9, D1)

CableBus Systems,
7869 S.W.
Nimbus Avenue,
Beaverton, OR 97005
503—543-3329
(M1)

Cable Graphic Sciences,
7095 N. Clovis Ave.,
Clovis, CA 93612
209—297-0508
(M9 Character
Generators)

Cable Health Network,
1950 Spectrum Circle
Suite B-310
Marietta, GA 30067
404—952-4620
(S4)

Cable-Text Instruments,
Div. of Telpar, Inc.
P.O. Box 796
Addison, TX 75001
214—233-6631
(M9 Generators)

Century III Electronics, Inc.
610 Neptune Ave.,
Brea, CA 92621
714—671-2800
(M1, 3, 4, 5, 7, 8,
S1, 2, 8)

Capscan, Inc.
P.O. Box 36,
Adelphia, NJ 07710
1-800—CABLETV or
222-5388
(M1, 3, 4, 5)

Channel Master,
Ellenville, NY 12428
914—647-5000
(M2, 3, 4, 5, 6, 7)

Comm/Scope Company,
P.O. Box 1729
Hickory, NC 28603
1-800—438-3331
(M3)

**Communications Equity
Associates,**
851 Lincoln Center,
5401 W. Kennedy Blvd.,
Tampa, FL 33609
813—877-8844
(S3)

**Comprehensive Cable
Enterprises**
206 Westminster Ct.
Madison, WI 53714
608—249-3442
(S1, 2, 4, 5, 7, 8, 9)

**Computer Video
Systems, Inc.,**
3678 W. 2105 S. Unit 2,
Salt Lake City, UT 84120
1-800—453-8622
(M9)

COMSEARCH INC.,
11503 Sunrise Valley
Drive,
Reston, VA 22091
703—620-6300
(S8, S9, Earth station
placement frequency
coordination)

ComSonics, Inc.,
P.O. Box 1106,
Harrisonburg, VA 22801
1-800—336-9681
(M8, 9, S8, 9)

DF Countryman Co.,
1821 University Ave.,
St. Paul, MN 55104
612—645-9153
(D1, S1, 8)

The Disney Channel
500 S. Buena Vista,
Burbank, CA 91521
213—840-5080
(S4)

Ditch Witch,
P.O. Box 66,
Perry, OK 73077
1-800—654-6481
(M9)

The Drop Shop Ltd., Inc.
Box 284,
Roselle, NJ 07203
1-800—526-4100 or
1-800—227-0700 (West)
(D3, 4, 5, 6, 7, 8, 9,
M5, 6, 7, 8, 9 Plastics)

Durnell Engineering Inc.,
Hwy 4 So.
Emmetsburg, IA 50536
712—852-2611
(M9)

Eagle Com-Tronics, Inc.,
4562 Waterhouse Rd.,
Clay, NY 13041
1-800—448-7474
(M9 Pay TV Delivery
Systems & Products)

Associate Roster

Eastern Microwave, Inc.,
3 Northern Concourse,
P.O. Box 4872,
Syracuse, NY 13221
315—455-5955
(S4)

**Electroline TV
Equipment, Inc.,**
8750-8th Ave.,
St. Michel,
Montreal, Canada
H1Z 2W4
514—725-2471
(M4, 5, 7, 9, D7, 9)

**Electron Consulting
Associates,**
Box 2029,
Grove, OK 74344
918—786-5349
(M2, D1, S1, 8)

Elephant Industries,
P.O. Box 3626
N. Ft. Myers, FL 33903
813—995-7383
(M9)

ESPN,
ESPN Plaza,
Bristol, CT 06010
203—584-8477
(S9)

**Franey & Parr of Texas,
Inc., (Formerly Doherty &
Co.),**
One Turtle Creek Village,
Suite 524,
Dallas, TX
214—528-4820
(S9, Insurance)

**Gardiner Communications
Corp.,**
3506 Security St.,
Garland, TX 75042
214—348-4747
(M9 TVRO Packages, S1,
2, 8)

General Cable Corp.,
1 Woodbridge Center,
P.O. Box 700
Woodbridge, NJ 07095
1-800—526-4385
(M3)

Gilbert Engineering Co.,
P.O. Box 23189,
Phoenix, AZ 85063
1-800—528-5567 or
602—245-1050

**Group W Satellite
Communications,**
41 Harbor Plaza Dr.,
P.O. Box 10210,
Stamford, CT 06904
203—965-6219
(S4)

H & R Communications,
Rt. 3, Box 102G,
Pocahontas, AR 72455
1-800—643-0102
(M2, D1, S2, 3, 8)

Harris Corporation,
P.O. Box 1700,
Melbourne, FL 32901
305—724-3401
(M2, 9, S2)

**Heller-Oak
Communications,**
105 W. Adams St.,
Chicago, IL 60603
1-800—621-2139 * 7600
(S3)

Home Box Office, Inc.,
12750 Merit Dr.
Dallas, TX 75251
214—387-8557
(S4)

* **Hughes Microwave
Communications Products,**
3060 W. Lomita Blvd.
Torrance, CA 90505
213—517-6233
(M9)

Ind. Co. Cable TV, Inc.,
P.O. Box 3799
Hwy. 167 N,
Batesville, AR 72501
501—793-4174
(D1)

* **Jerry Conn Associates,
Inc.,**
P.O. Box 444,
Chambersburg, PA 17201
1-800—233-7600
1-800—692-7370 (PA)
(D3, 4, 5, 6, 7, 8)

**KMP Computer
Services, Inc.,**
703 Central Ave.,
Los Alamos, NM 87544
505—662-5545
(S4, 5)

Karnath Corporation,
2001 Westridge,
Plano, TX 75075
214—422-7981 or 7055
(S1, 2, 8, 9)

Katek, Inc.,
215 Wood Ave.,
Middlesex, NJ 08846
201—356-8940

**Klungness Electronic
Supply,**
P.O. Box 547,
107 Kent Street,
Iron Mountain, MI 49801
1-800—338-9292
1-800—682-7140 (Mich)
(D1, 8, S2, 8)

LRC Electronics, Inc.,
901 South Ave.,
Horseheads, NY 14845
607—739-3844
(M7)

Lash-Ade Company,
P.O. Box 147,
Guntersville, AL 35976
205—582-6333
(M9 Cable Protector,
S9 Equipment Repair)

Larson Electronics,
311 S. Locust St.,
Denton, TX 76201
817—387-0002
(M9 Standby Power)

Lemco Tool Corporation,
Box 330A,
Cogan Station, PA 17728
1-800—233-8713
(M8, 9 Tools)

**Lindsay Specialty
Products, Ltd.,**
50 Mary Street West,
Lindsay,
Ontario, Canada K9V 4S7
705—324-2196
(M1, 2, 4, 5, 7, 9)

Magnavox CATV Division,
100 Fairgrounds Drive,
Manlius, NY 13104
1-800—448-5171 or
1-800—522-7464 (N.Y.)
(D4, 5, 7, M4, 5, 6, 7, S3, 8)

**McCullough Satellite
Equipment,**
Route 5, Box 97,
Salem, AR 72576
501—895-3167
(M2, 9, D3, 4, 6, 7)

Microdyne Corporation,
471 Oak Road,
Ocala, FL 32672
904—687-4633
(M9 Satellite TV
Receivers)

* **Microwave Filter Co.,**
6743 Kinne St., Box 103,
E. Syracuse, NY 10357
1-800—448-1666
(M9 Bandpass Filter)

Midwest Corp.,
P.O. Box 226,
Clarksburg, WV 26301
1-800—624-3845
(D1, 2, 3, 4, 5, 6, 7, 8)

Modern Cable Programs,
5000 Park St. N.,
St. Petersburg, FL 33709
(S4)

**Mullen Communications
Construction Co., Inc.,**
P.O. Box 1387A,
Green Bay, WI 54305
414—468-4649
(S2)

**National Farmers Union
Property & Casualty Co.,**
12025 E. 45th Ave.,
Denver, CO 80251
303—371-1760
(D9, Insurance Service)

North Supply Company,
600 Industrial Pkwy.,
Industrial Airport, KS
666031
913—791-7000
(D1, 2, 3, 4, 5, 6, 7, 8)

Oak Industries, Inc.,
Crystal Lake, IL 60014
815—459-5000
(M1, 9 Converters, S3)

Distributors	Manufacturers	Service Firms
D1—Full CATV equipment line	M1—Full CATV equipment line	S1—CATV contracting
D2—CATV antennas	M2—CATV antennas	S2—CATV construction
D3—CATV cable	M3—CATV cable	S3—CATV financing
D4—CATV amplifiers	M4—CATV amplifiers	S4—CATV software
D5—CATV passives	M5—CATV passives	S5—CATV billing services
D6—CATV hardware	M6—CATV hardware	S6—CATV publishing
D7—CATV connectors	M7—CATV connectors	S7—CATV drop installation
D8—CATV test equipment	M8—CATV test equipment	S8—CATV engineering
D9—Other	M9—Other	S9—Other

Note: Associates listed with * are Charter Members.

Octagon Scientific, Inc.,
476 E. Brighton Ave.,
Syracuse, NY 13210
315—476-0660
(M9)

Phasecom Corp.,
6365 Arizona Circle,
Los Angeles, CA 90045
213—641-3501
(M1)

**Power and Telephone
Supply Company, Inc.,**
530 Interchange Drive
N.W.,
Atlanta, GA 30336
1-800—241-9996
(D1)

M/A Com Prodelin, Inc.,
P.O. Box 100
Claremont, NC 28610
704—459-9762
(M2, 3, 7, S2)

Pyramid Industries, Inc.,
P.O. Box 23169,
Phoenix, AZ 85063
1-800—528-4529
(M7, 8)

Quality RF Services, Inc.,
825 Park Way, Suite 3,
Jupiter, FL 33458
305—747-4998
(M4, S9)

RMS Electronics,
50 Antin Place,
Bronx, NY 10462
1-800—223-8312
1-800—221-8857 (Poleline)
(M4, 5, 6, 7, 9)

Reuters,
1212 Avenue of the
Americas, 16th Floor,
New York, NY 10036
212—730-2715
(D9)

Rockwell International,
M.S. 402-101,
Dallas, TX 75207
214—996-5954
(M9, Microwave/Satellite)

**S.A.L. Communications,
Inc.,**
P.O. Box 794,
Melville, NY 11747
1-800—645-9062
(D1)

Sadelco, Inc.,
75 West Forest Ave.,
Englewood, NJ 07631
201—569-3323
(M8)

Scientific Atlanta, Inc.,
3845 Pleasantdale Rd.,
Atlanta, GA 30340
404—449-2000
(M1, 2, 4, 8, S1, 2,
3, 8)

**Showtime Entertainment,
Inc.,**
1633 Broadway,
New York, NY 10019
212—708-1600
(S4)

**Southern Satellite
Systems, Inc.,**
P.O. Box 45684,
Tulsa, OK 74145
918—481-0881
(S9)

**Superior Electronics
Center,**
2010 Pine Terr.,
Sarasota, FL 33581
813—922-1551
(M4, S9)

TVC Supply Co., Inc.,
1746 E. Chocolate Ave.,
Hershey, PA 17033
717—533-4982
(D1, 2, 3, 4, 5, 6, 7, 8)

Teledac, Inc.,
1575 Taschereau Blvd.,
Longueuil,
Quebec, Canada J4K 2X8
514—651-3716
(M9 Character
Generators)

Tele-Wire Supply Corp.,
7 Michael Ave.,
East Farmingdale,
NY 11735
516—293-7788
(D1, 2, 3, 5, 6, 7, 8, 9)

* **Texscan Corp.,**
2446 N. Shadeland Ave.,
Indianapolis, IN 46219
1-800—528-4066
(M9 Bandpass Filters)

* **Theta-Com CATV,**
2960 Grand Avenue,
Phoenix, AZ 85061
602—252-5021
(M1, 4, 5, 7, 8)

* **Times Fiber
Communications,**
358 Hall Avenue,
Wallingford, CT 06492
1-800—243-6904
(M3)

Tocom, Inc.,
P.O. Box 47066,
Dallas, TX 75247
214—438-7691
(M1, 4, 9 Converters)

* **Toner Cable
Equipment, Inc.,**
969 Horsham Rd.,
Horsham, PA 19044
1-800—523-5947
In PA. 1-800—492-2512
also 1-800—523-5947 (PA)
(D2, 3, 4, 5, 6, 7)

**Triple Crown
Electronics, Inc.,**
4560 Fieldgate Dr.,
Mississauga, Ontario,
Canada L4W 3W6
416—629-1111
Telex 06-960-456
(M4, 8)

**Turner Broadcasting
System,**
1050 Techwood Dr.,
Atlanta, GA 30318
404—898-8500

Tyton Corp.,
P.O. Box 23055,
Milwaukee, WI 53223
414—355-1130
(M6, 7)

United Press International,
220 East 42nd St.,
New York, NY 10017
212—682-0400
(S9 Automated News
SVC.)

United Video, Inc.,
3801 South Sheridan Rd.,
Tulsa, OK 74145
1-800—331-4806
(S9)

Video Data Systems,
205 Oser Ave.,
Hauppauge, NY 11787
516—231-4400
(M9)

Viewstar, Inc.,
705 Progress Ave.,
Unit 53,
Scarborough,
Ontario, Canada M1H 2X1
416—439-3170
(M9 Cable Converter)

Vitek Electronics, Inc.,
4 Gladys Court,
Edison, NJ 08817
201—287-3200

**Warner Amex Satellite
Entertainment Corporation,**
1211 Avenue of the
Americas,
New York, NY 10036
212—944-4250
(S4)

* **Wavetek Indiana,**
5808 Churchman,
Beech Grove, IN 46107
1-800—428-4424
TWIX 810—341-3226
(M8)

Weatherscan,
Loop 132,
Throckmorton Hwy.,
Olney, TX 76374
817—564-5688
(D9, Sony Equip. Dist.,
M9 Weather Channel
Displays)

Western Towers
Box 347,
San Angelo, TX 76901
915—655-6262/653-3363
(M2, 9 Towers)

Winegard Company,
3000 Kirkwood Street,
Burlington, IA 52601
1-800—523-2529
(M1, 2, 3, 4, 5, 7)

Zenith Radio Corp.
1000 N. Milwaukee Ave.
Glenview, IL 60025
312—391-8195
(M1, 6)

□

Classified

OPPORTUNITIES

CITY OF PHILADELPHIA ADVERTISEMENT FOR AREA I CATV BIDDERS

The City of Philadelphia, Pennsylvania invites applications for an Area I Cable Television Franchise. Applications shall be prepared and submitted in accordance with a "Request for Proposals" available June 20, 1983 from the undersigned.

Completed proposals must be accompanied by a non-refundable filing fee of \$10,000 and will be accepted until 2:00 P.M., EDST, September 22, 1983 in Room 1020 of the Municipal Services Building.

A non-refundable charge of \$25.00 (checks only) for the City's preparation and handling should accompany each request for a Cable TV Request For Proposals and proposed Franchise Agreement. Checks should be made payable to the "City of Philadelphia".

J.F. McCLOSKEY, JR.
DEPARTMENT OF PUBLIC PROPERTY
1020 MUNICIPAL SERVICES
BUILDING
PHILADELPHIA, PA 19107
(215) 686-4430

INSIDE SALES

If your salary is smaller than your ego, it might be time for a change. The Drop Shop Ltd., is looking to augment it's sales staff in our New Jersey headquarters. We offer a congenial and informal work atmosphere, a full compliment of company paid benefits, and the opportunity to earn what you feel you are worth. We are looking for individuals who have two years sales experience to cable system operators, and a knowledge of drop and installation materials. For more information, call Linda Passzun at:
(201) 241-9300 or (800) 526-4100

BLONDER TONGUE SEMINAR

October 4, 5 and 6, 1983: A Blonder-Tongue MATV/CATV/LPTV/TVRO Technical Seminar will be held at Caesar's World, Atlantic City, NJ in conjunction with L-C-A Sales.

Contact: Craig Kemper (201) 679-4000 or L-C-A Sales (914) 961-4700.



ATTENTION! SYSTEM MANAGERS — TECHNICIANS NEEDED

Excellent opportunity for system managers and technicians for our systems in Colorado, Texas, and Oklahoma. Need qualified personnel for these Southwestern locations; good working conditions and opportunity for the right people who want to work and stay actively involved in the cable business. These systems have good equipment to work with and offer excellent situations to grow in the cable business. If interested, send resume to the box number indicated below.

Box 71080
c/o CATJ
4209 N.W. 23rd
Suite 106
Okla. City, OK 73107

Your company can help us prevent child abuse.

Help us get to the heart of the problem.

**Write: National Committee for Prevention of Child Abuse
Box 2866, Chicago, Illinois 60690**

- Please send us information on how we can help.
 We want to start helping right now. Enclosed is a check for \$_____.

NAME _____

TITLE _____ COMPANY _____

ADDRESS _____

CITY _____ STATE _____ ZIP _____



**National Committee for
Prevention of Child Abuse**

A Public Service of This Magazine
& The Advertising Council.



CATJ classified advertising is offered as a service by CATA for its membership.

ANY member of CATA may advertise in the CATJ classified section FREE OF CHARGE (limit of 50 words per issue — 3 issues per year.)

CATA offers three types of memberships:

- 1.) Systems — paying regular monthly dues based on number of system subscribers.
- 2.) Associate Members — pay an annual fee.
- 3.) Individual Members — pay an annual fee.

NON MEMBERS may also use the Classified section at the rate of 50 cents per word with a minimum charge of \$20.00. Add \$2.00 for blind-box. Non-members should include full payment with the ad insertion.

Deadlines for all Classified Advertising is the 1st of the month for the following month's issue.

Address all Classified material to: CATJ, Suite 106, 4209 N.W. 23rd, Oklahoma City, Okla. 73107.

ADD UNLIMITED PAY CHANNELS TO YOUR SYSTEM WITHOUT LOSING YOUR INVESTMENT IN CONVERTERS.

Now, That's The Ticket!



If you're like most cable systems, you've spent almost \$225,000 on converters. Don't throw away that investment! With Eagle's Descrambler, you can add 15 tiers of service and unlimited channels to your system using your present converter.

Write Your Own Ticket!

Whether you're adding one pay channel, 15 pay channels, or 15 tiers of service with 120 channels, Eagle's Descrambler can handle it all. Select only what you need. In the future, channels can be added to the headend scrambler with our simple plug-in module. The headend unit integrates with all manufacturer's modulators and processors and is compatible with all Standard/HRC/ICC configurations.

The Best Show In Town

Eagle's Descrambler is compatible with all single channel output converters and is factory tuned for channel 2, 3, or 4. The descrambler

has no information on the audio making it ideal for AML transmission.

Private Audiences Only

There are no subscriber controls with Eagle's Descrambler and our unique sync suppression scrambling insures maximum security. In addition, we've developed a tamperproof identification matrix to eliminate concerns about theft of service.

Future Attraction

Addressability? It's coming. Eagle's Descrambler will be ready for addressability when you are ... and the descrambler will be perfectly compatible with our addressable unit. Across the board, we're working to protect your investments.

Add pay channels ... maximize your converter investment ... prepare for addressability ... Eagle's 15 Tier Descrambler. Now, That's The Ticket!



OFFICE ADDRESS: 4562 Waterhouse Road, Clay, N.Y. 13041 (315) 622-3402
MAIL ADDRESS: P.O. Box 2457, Syracuse, N.Y. 13220
IN CANADA: Desklin Sales • Montreal • Toronto • Vancouver (416) 495-1412
77D Steelcase Road West, Markham, Ontario L3R2M4

CALL TOLL FREE TO ORDER 800-448-7474





When budget is a consideration... toast the champions!

RMS passive devices are world renowned for unsurpassed quality. CA-2100 MATCHING TRANSFORMERS, ELECTRO-GROUND™, AND "ECONO-SPLIT" HYBRID SPLITTERS, are no exception!

Designed to meet immediate budgetary requirements, these passive devices are manufactured to the same high performance standards expected from RMS. "Built-in" quality makes them the frontrunners in performance.

RMS

RMS ELECTRONICS, INC., CATV DIVISION: 50 Antin Place, Bronx, New York, 10462
Toll Free: (800) 223-8312 (Continental U.S.A., Puerto Rico, U.S. Virgin Islands) (212) 892-1000 (Call Collect, New York State Only)
WESTERN OPERATIONS: 2901 W. Garry Ave., Santa Ana, Calif., 92704
(714) 662-1041 (Call Collect)

© Copyright 1983 RMS Electronics, Inc.

WorldRadioHistory