

\*\*\*\*\*3-DIGIT 605  
 5103723 D08 9602  
 THOMAS E BRAXTON 719  
 MTS  
 LUCENT BELL LABS/RM 2B-217  
 2000 N NAPERVILLE ROAD  
 NAPERVILLE IL 60563 1443

# Radio World®



**Radio -  
 Mercury  
 Awards To  
 Honor  
 Paul  
 Harvey**

**See Page 31**

Vol 21, No 11

Radio's Best Read Newspaper

May 28, 1997

## USADR Makes PAC With Lucent

*IBOC Proponent Will Use Lucent Technologies Audio Compression Algorithm; Move Applauded by NAB*

by Matt Spangler

**NEW YORK** The two U.S. developers of in-band, on-channel DAB systems have joined forces.

Earlier this month, USA Digital Radio and Lucent Technologies agreed to develop a DAB (digital audio broadcasting) transmission and reception system.

"We have passed a major technical hurdle in the development of a comprehensive system design for American broadcasters and look forward to working with Lucent to complete the development of this technology," said USADR President Bernee Strom.

Lucent had previously developed both an IBOC and an IBAC (in-band, adjacent channel) system with AT&T. The company will also assist USADR

with its forward error correction and modem design.

Through the agreement, USADR will utilize digital audio compression technologies developed by Bell Labs, the research and development arm of Lucent.

USADR replaces the MUSICAM audio coding system from MUSICAM USA that it had been using at 256 kbps with the Bell Labs PAC (Perceptual Audio Coding) algorithm, which it plans on using at a rate of 96 kbps.

In a draft report titled "Technical Evaluations of Digital Audio Radio Systems Performance," released in

See DAB, page 8 ▶

**R**adio stations rallied to the aid of their city in flood-ravaged Grand Forks, N.D.

See Page 6



## NAB Booth Fee Increase Redux

by Matt Spangler

**WASHINGTON** Citing increased costs, the National Association of Broadcasters increased the price of exhibit space for NAB '98 by \$2 per square foot. The new per-square-foot rates are \$29 for members (up 7.5 percent) and \$35 for non-members (up 6 percent). The move rankled some radio manufacturers, as this is the second year in a row that exhibit rates were increased (see RW, Jan. 22).

NAB Senior Vice President of Conventions and Expositions Haidee Calore would not comment specifically on NAB revenue from the show, but she did point out that profits from the spring show go towards the annual operating expenses of the association.

"It (the money) is going right back into the industry," she said. "Pure radio and television manufacturers ... gain the most from the

See BOOTH, page 12 ▶

## EAS Test Triggers Dead Air in Three States

by Bob Rusk

**WASHINGTON** Hundreds of radio stations in Ohio, Florida and Louisiana were forced to transmit nothing but dead air when a closed-circuit Emergency Alert System (EAS) test from the Federal Emergency Management Agency (FEMA) went awry.

The April 21 test, intended for just WLS(AM) in Chicago, affected all the stations in the system when a FEMA operator failed to deselect stations in the other states, according to FEMA spokeswoman Barbara Yagerman.

WLS, a primary entry point station, requested the test as it was completing installation of equipment to receive national level alerts and had no idea that other stations were affected, said Chief Engineer Warren Shulz.

The test was sent using the highest EAS priority code — Emergency Action Notification (EAN) — when the equipment at entry point stations in the other states was activated.

"The stations were seized by this erroneous transmission and locked up," said Bill Glasser, director of engineering at WHBC(AM) in Canton, Ohio, and the state's emergency communications committee chairman. "Primary and local stations all over the state were trying to carry this non-existent national alert message."

"Consequently, stations that were monitoring my station were carrying my air — dead air — and there was no way they could get out of it. The test locked up hundreds of stations."

Dave Szucs, chief engineer at LP-1 station WTAM(AM) in Cleveland, said "it set off a chain reaction throughout Ohio" and also took over stations in Akron, Columbus, Toledo and Dayton.

The test began with tones, followed by a voice that stated "Test, test, test. WLS are you there? Test, 1, 2, 3," said another engineer who heard the broadcast. That was followed by dead air.

One by one, each station finally realized there was not an actual emergency.

See EAS, page 16 ▶

## A to D to A? A2D2A!

20 bit analog to digital & digital to analog conversion.

'Need to make the perfect connection between your analog and digital audio equipment? The A2D2A shatters price barriers to bring 20 bit A/D and D/A conversion technology to production and broadcast studios. Bit by bit, the Harris A2D2A will improve and enable digital audio all around your station. AES/EBU and S/PDIF to and from balanced XLR analog. The A2D2A can perform A/D and D/A conversions simultaneously.



20 Bit Performance

**Harris Corporation  
 Broadcast Division  
 1-800-622-0022  
 FAX: (765) 966-0623**



© 1997 Harris Corp.

Circle (24) On Reader Service Card



# NEWSWATCH

## DARS Satellite Construction Under Way

**WASHINGTON** The satellite-to-car digital radio broadcast system known as DARS is under construction.

Less than 30 days after winning one of two 12.5 MHz slices of S-band spectrum after 26 rounds of bidding, CD Radio Inc. and Space Systems/Loral, a subsidiary of Loral Space & Communications Ltd., began construction on one of the two national satellite radio broadcast licenses. The other channel was won by American Mobile Radio Corp.

Under the contract, Loral will build and deliver two DARS satellites for CD

Radio for launch in 1999, and has the option to build one additional satellite.

CD Radio is developing a satellite-to-car, 50-channel radio service for the delivery of music and other programming to motorists throughout the United States.

## McCain Tries to Nullify Cross-ownership Law

**WASHINGTON** Sen. John McCain (R-Ariz.) introduced a bill last month that would eliminate the newspaper-radio cross-ownership law — dubbing it “a fossil from the age of Walter Winchell and the Dumont Network.” This law prohibits a newspaper from being co-owned with a local radio or television station.

The Commerce, Science and Transportation Committee, of which McCain is chairman, had not held a hearing on the Newspaper Ownership Act at press time.

“The newspaper/broadcast cross-ownership prohibition dates from a day when there was a realistic fear that common control of both media in the same locale could result in the public’s receiving only one point of view on important issues,” McCain said. Today, however, “radio and television outlets abound.”

Meanwhile, the Federal Communications Commission is currently reviewing comments on a notice of inquiry it issued on its daily newspaper cross-ownership waiver policy. FCC

attorney Roger Holberg said that if McCain’s bill were signed into law, it would in effect nullify the commission’s cross-ownership restrictions.

## Study Credits Telecommunications Act for Record Deal Year in 1996

**NEW YORK** A new report attributes the record amount of radio and television station sales in 1996 to federal deregulation.

Veronis, Suhler & Associates’ 1997 “Communications Industry Transactions Report” reported \$44.5 billion in radio/TV mergers and acquisitions, an increase of 400 percent from \$11.5 billion in 1995.

While over \$30 billion of last year’s  
See NEWSWATCH, page 3 ▶

*It Fits Nicely in the Wallet,  
Beautifully in the Studio and  
Flawlessly in the Signal Chain*

**R-5 Console**

**ALCANTARA ENGINEERING**  
200 W. 10th Street, Suite 100, Santa Ana, CA 92701  
949.441.1111



Circle (1) On Reader Service Card

World Radio History

# Index

## STUDIO SESSIONS

- Seagate: 38 Hours on One Drive**  
by Read G. Burqan 17
- Equitek E-100: Mic With a Mission**  
by Rich Rarey 17
- Shifting Gears to Save Careers**  
by Alan R. Peterson 19
- Grease Pencils and Razor Blades**  
by Rich Rarey 20
- New Book Relates Production Tales**  
by Alan R. Peterson 20
- Two New Pro Denon Decks** 26
- Homegrown 'Movie' Soundtracks**  
by Gowan Gray 28

## RUNNING RADIO

- Radio: Vital Link in the Canadian North**  
by James Careless 29
- Burdnoy to Receive Freedom of Speech Award** 29
- Radio-Mercury Awards Will Honor Harvey** 31
- Make Your Station Worth More**  
by Sharon Rae 34
- Meters, Meters, More Meters**  
by Ed Montgomery 35
- National Radio Ranks Low in Car Ad Sales** 37
- Peanuts or Pirates, Make 'em Legal**  
by Kent Waterman 38
- KISS 108 Helps Kids** 39

## FEATURES

- Workbench**  
by John Bisset 42
- AM Antenna Sampling Systems**  
by W.C. Alexander 43
- Sell Yourself With Your Résumé**  
by Sue Jones 47
- FDR Prompted the Media Pool**  
by William J. Ryan 49
- Master Clocks Get a New Face**  
by Tom Vernon 51

## BUYER'S GUIDE

- A New AM Optimod Arrives**  
by John Buckham 53
- IDT Processor Jumps Out**  
by Jordi Roura 53
- Aphex Air Chain Revamps Station**  
by Tom Peterson 54
- WBEB Solves Digital Dilemma**  
by Russ Mundschenk 55
- Win With Processing Solutions**  
by Leroy C. Granlund 55



# War of Words Rages on in D.C.

*A Roundup of News and Commentary Affecting Radio From the Nation's Capital*

by Matt Spangler

**WASHINGTON** The war of (written) words between Federal Communications Commission Chairman Reed E. Hundt and, well, just about everyone else in Washington, wages on.

In March Hundt began a campaign against broadcasters for what he views as "a dramatic increase in self-promotional ads" at the expense of public service announcements. National Association of Broadcasters President Eddie Fritts fired back immediately, pointing out a number of ways in which broadcasters, in particular local stations, serve the public.

Hundt wrote back to Fritts April 18, saying that his criticism was primarily reserved for prime-time TV programming. He also asked Fritts to back up his assertions with some numbers: "For example, what is the time and dollar value of all PSA time contributed by broadcasters over the last decade on a yearly

basis? What is the time and dollar value of all broadcaster self-promotions over the last decade on a yearly basis? What action, if any, should Congress or the FCC take if the decline in PSA time continues?"

Fritts lobbed a response letter at Hundt on May 1, again suggesting that broadcasters serve the public interests in a myriad of ways other than PSAs.

"Some stations may decide that PSAs are the best way to serve the needs of their communities; others may take a different path," he stated. He cited the relief efforts that several Grand Forks, N.D., radio stations have undertaken for flood victims (see related story, page 6) as an example.

Fritts also reminded Hundt that broadcasters are not required to air a set number of PSAs, and therefore NAB has not compiled data on station PSA usage.

Three days after Hundt's letter, NAB announced a partnership with the Beer

geared towards TV) and balancing of ads with PSAs. The FCC is given the rubber stamp for the code, and if broadcasters don't meet the one-year deadline, the commission will have the go-ahead to come up with its own code.

Just before the NAB show in Las Vegas, Fred Meister, president of the Distilled Spirits Council of the United States, suggested that liquor, beer and wine companies devise their own broadcasting code. Hundt agreed that a standard was a good idea, but only if it were developed by broadcasters.

## Territories

Hundt also released a statement late last month saying that more than 240 public interest groups across the nation had filed a petition with the FCC asking it to examine the alcohol advertising issue. He called for a notice of inquiry in order to "gather the facts from all parties concerned."

Sen. Conrad Burns, R-Mont., would rather the FCC be off the moral police beat. Just days after Kennedy unveiled his legislation, Burns wrote to Hundt, pointing out, as many of his Congressional colleagues did, that the Federal Trade Commission has jurisdiction over broadcast advertising. He cited the "Liaison Agreement Between the Federal Communications Commission and the Federal Trade Commission" as the defense for this assertion. Furthermore, because, as we know, most major (TV) networks are not airing the ads, Burns said he had canceled the

See BELTWAY, page 14 ▶

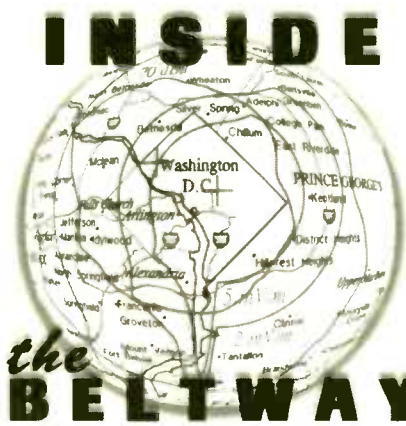

Institute to initiate a radio campaign called the "Safe Holiday Drunk Driving PSAs." These 17 spots feature sports stars such as Tom Kite and Brooks Robinson delivering humorous messages designed to discourage drunk driving and illegal underage drinking. The PSAs will be distributed to 5,000 stations across the nation, and will be broadcast during six major holidays.

And hey, while we're on the subject, Rep. Joe Kennedy, D-Mass., is at it again, introducing the "Voluntary Alcohol Advertising Standards for Children Act" in committee last month. This bill would give broadcasters one year to develop a code that would restrict alcohol advertising based on content, frequency of airing, time of day aired, program placement (yes, it does seem to be

## NEWSWATCH

▶ NEWSWATCH, continued from page 2 deals were in television, radio went from \$1.5 billion in mergers and acquisitions in 1995 to \$13.4 billion in 1996. VS&A says the Telecommunications Act of 1996, which made it possible for a radio group to own up to eight stations within a market, is the primary cause of all this activity.

"Everyone wants to be the first radio station group in each market to own the eight stations," said Christine Balcius, director for radio broadcasting at VS&A.

Some of the major deals of 1996 include Westinghouse's acquisition of Infinity Broadcasting, American Radio Systems' purchase of EZ Communications, Capstar Broadcasting Partners' buying of Shamrock Broadcasting and 12 stations from Colfax and Clear Channel Communications' completion of its purchase of Hefel Broadcasting.

### NPR: New Pricing For Members And Morning Show

**WASHINGTON** The Board of Directors of National Public Radio met on a number of issues last month.

The board voted to get input from its membership at the Public Radio Conference, which will be held June 6-10 in Chicago, on three models for pricing its members' annual assessment. These three models include the current one, which bases program fees on total station revenue, one that bases fees on the number of listener-hours a particular NPR show attracts and a third that combines the two other models.

At its summer meeting in July the board will vote on the final design of the model, which will become effective in FY 1999.

The Distribution/Interconnection

committee will evaluate requests from new facilities to provide services to users of the public radio satellite system as a system uplink, effective Jan. 1, 1998.

Also effective on that date, system uplinks must operate as either a full-service uplink that provides services 24 hours a day, 7 days a week or a limited-service uplink, operating at a minimum of 12 hours a day, 5 days a week.

In other news, NPR has announced the name of its new 5 a.m. program designed to fill the void left by Monitor Radio's Early Edition, which is being sold. "Early Morning Edition," which will begin airing June 30, will be hosted by veteran NPR newsman Carl Kasell.

### Scholars Win NAB Research Grants

**WASHINGTON** The National Association of Broadcasters awarded two university scholars research grants for their work in radio management.

NAB gave \$5,000 each to Kathleen Fox of Ohio University for her topic, "Radio Station Acquisitions: a Case Study Approach to Understanding the Management of Organizational Change," and to Greg Stefaniak of the University of Arkansas for "Managing Single-Market Radio Clusters: Techniques, Problems and Solutions."

The grants are targeted at research on economic, social or policy issues within the broadcast industry.

The proposals are evaluated by an independent panel of academic and industry professionals and by the NAB Committees on Local Radio Measurement and, for television, Television Audience Measurement.

For more information about the studies, contact the NAB Research and Information Group at (202) 429-5389.

# NEURAL WHAT?

Neural Network.

Neural networks are the next step beyond digital. They are a new technology emerging from university laboratories across the country.

Now, neural networks power the most advanced, on-air audio processor you can buy. For under a thousand dollars, you can plug this new technology into your existing Optimod 8100\*.

If you need more power and you need it now, call (800)806-5498. We'll do the rest.



208 West Hamilton Avenue - P.O. Box 20  
State College, PA 16804-0020 - Phone: (800) 806-5498

\* Optimod is a trademark of AKG Acoustics, San Leandro, CA.

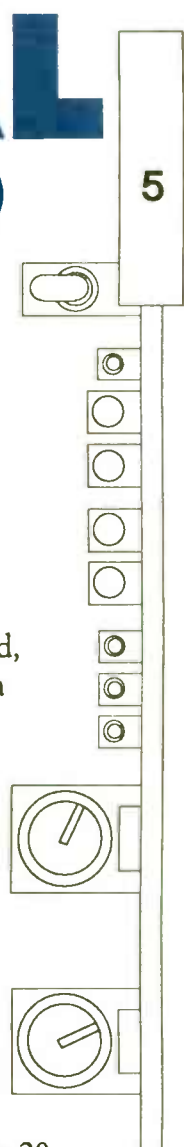



# Stand Up and Be Counted or Be Quiet

**WASHINGTON** You knew it had to happen someday. A group of self-proclaimed radio guerrillas "with nothing but the best interests of radio at heart" stepped forth (sort of) at NAB '97.

They claim, anonymously of course, that they can be "likened to the one or two minutemen who fired the first shots at Lexington." Fairly cheeky words for a spokesman that won't even go on the record. The Minutemen? But then, one can say anything one wants when one's name is not attached to the words.

The group, the Radio Equipment Manufacturers Association of America, claims there is a "groundswell of well over 45 exhibitors" ready to jump ship from the NAB spring show — by all global standards one of the best if not the best broadcast gathering on earth.

Yeah, NAB, the show, has its pros and cons. But however you feel about it, one thing is undeniable — what makes the NAB show work is attendance by NAB members: the broadcasters.

That's right, equipment manufacturers' potential clients attend the show for educational, networking and purchasing reasons.

Why on earth would they walk away from all that to attend a parallel show from a bunch of companies that won't even come out into the open?

Hey, don't get me wrong. Questioning the status quo always is a healthy thing to do, but do it on the up and up if you want to be taken seriously!

★★★

It seems that not all the world is racing ahead with DAB. From our correspondent in Taipei, Kronis Kent Krahn, comes word that DAB is on hold in Taiwan.

At least for another year.

1997 was to mark the first Taiwanese DAB test and a chance for local radio broadcasters to get a taste of the industry's future.

The Directorate General of Telecommunications (DGT) initially planned for the introduction of DAB this year, but a dispute with the military over who has control of the frequencies need-

ed for DAB experiments caused at least a one-year delay in even preliminary tests of the technology.

Department of Radio and TV Broadcast Technology Senior Technician Shih-Yang Cheng said the first DAB tests are now slated for January 1998.

"The military has agreed, in a previous meeting, to release three frequencies for us to do the tests," said Cheng. "That has been the sole cause of the delay, and there is still obvious concern about that agreement and that time frame."

★★★

I couldn't let another issue go by without thanking Bruce Dumont, founder and president of the Museum of Broadcast Communications in Chicago for donating to the **RW and TV Technology** library. His donation: a lovely, three-volume encyclopedia of television put together by Museum Curator Horace Newcomb, Ph.D.

"The Encyclopedia of Television," edited by Newcomb, contains more than 1,000 essays discussing specific programs and people, historic moments and trends, policy disputes, and topics such as violence and tabloid television.

The encyclopedia was unveiled during the Broadcast Education Association Convention. Newcomb presented the set to Louisa Nielsen, executive director of the Broadcast Education Association at the opening reception on April 4.

In accepting the encyclopedia, Nielsen said: "The Museum of Broadcast Communications has taken a huge step toward defining television research and teaching.

"We are delighted to accept the work of more than 300 scholars from around the world."

And before I hear from anyone on why I should care about the history of television, just remember that all the television pioneers were radio pioneers first. The

PAGE FOUR

by Lucia Cobo

history of the two is intertwined.

★★★

Our lead news brief this time out reports that CD Radio is building its

radio broadcast licenses. The other channel was won by American Mobile Radio Corp.

Quick work.

But look at our front page photo and our story on page 6. It is the story told every time a community is beset by disasters: Radio rallies to give aid, comfort and information.

As evinced by daily news reports, Grand Forks, N.D., is traversing some of the darkest moments in its history: snow blizzards that led to inundation that led to fires and homelessness and chaos. Thousand pushed out of their homes by the overflowing waters of the Red River.

Radio stations were as besieged as the community — many losing studio and transmission facilities — but they fought to stay on the air.

The telling of the story (as minuscule a part of the story as it is) reminds me that radio broadcasters are knit into the very fabric of their community, in a way that DARS never will or can be. And as long as that remains so, broadcasters will not lose ground to national-type music services.

★★★

The last bit of news I have for you is internal **RW** news. Buyer's Guide Editor Chris Joaquim is climbing up the ranks to become **Radio World International** managing editor.

I hate to lose her but wish her the best of luck. Our very able editorial assistant, Susan Gary, whose byline you have already seen from time to time in **RW**, will be stepping up to take over Buyer's Guide, working with our technical editor and juggler *par excellence*. Alan Peterson.

Susan also is a fine photographer, and you'll be privy to some of her work in that arena as well in future issues of the paper. Best of luck to Susan in her new role.



DARS system. As reported, the ink was barely dry on the last auction round when CD Radio Inc. and Space Systems/Loral, a subsidiary of Loral Space & Communications Ltd., began construction on one of the two national satellite

**ARC-16: the logical choice for LMA and duopoly transmitter control.**

The ARC-16 is available through:

Equipment Solutions To Keep You Number One

**BSW**  
BROADCAST SUPPLY WORLDWIDE

Phone: 800-426-8434  
Fax: 800-231-7055

**Put us in your sites.**

BURK TECHNOLOGY • 7 Beaver Brook Rd., Littleton, MA 01460 • Phone (508) 486-0086 • Fax # (508) 486-0081 • email control@burk.com

Circle (22) On Reader Service Card

World Radio History



## READERS FORUM

If you have comments for Radio World, call us at (800)336-3045 or send a letter to Readers Forum (Radio World, P.O. Box 1214, Falls Church, VA 22041 or e-mail 74103.2435@compuserve.com or MCI Mailbox #302-7776). All letters received become the property of Radio World, to be used at our discretion and as space permits.

### Kick, yell or join together

Dear RW,  
It was interesting and disturbing to read the article in the April 2 edition of RW titled "EAS: Trial By Wind and Water." I feel it would have been a good idea for RW to have contacted the Arkansas state chairman before printing such information. Arkansas does have an EAS plan, approved by the FCC, a preliminary copy of which was placed personally in the hands of two of the engineers mentioned in the article by the state EAS chairman.

On the day the "killer tornadoes" struck in Arkansas, I was listening to the local FM radio station, KHPA, and they were putting out plenty of weather information (even though power failures took them off the air several times). I was also listening to the NOAA Weather Radio,

which aired mountains of weather info. However, I did not hear any EAS alert signals. It is my opinion that personnel (broadcast and NOAA) have not been properly trained as to what action to take when an emergency occurs.

We are all aware the system is in its infancy and that some people would have liked to see it die at birth. But the old EBS system in Arkansas was dying of old age and we needed a new alert system. EAS looked pretty good to most of us. We can kick, yell and fight, or we can all join together to make the system work. The task should not fall entirely on the station engineer. Management should get involved. Read your equipment operator's manual. If you don't understand it, contact the manufacturer. Train your operators.

*Norm Mason  
Hope, Ark.*

*Norm Mason is president of Broadcast Technical Services Inc. and the Arkansas State EAS chairman and coordinator.*

### Worth paying for

Dear RW,  
Clayton Hewitt makes a plea for free tower space for hams (April 16) in his letter to the editor, based on the fact that amateur radio makes contributions to the public. He calls upon Radio World to "explain exactly what the difference between commercial and public service is." Perhaps someone should explain to Mr. Hewitt the difference between hobby and public service.

I got my ham ticket in 1954 (5ESX) and can understand his desire, but he needs to remember that he's not getting free electricity from the utility company because he is a ham, nor does he get free postage for his QSL cards. I don't get free fuel for my airplane, nor does my wife get free services for her hobbies. If Mr. Hewitt pledges to use his ham rig only in emergency communications, then his plea might have merit.

The local FM station owner paid for his tower. Having owned six radio stations, I know the costs involved in maintaining sticks in the sky, and see nothing wrong in asking others who use them to help in that cost.

Too many times, folks come through the front door and ask for freebies based on the merit of their endeavor but don't think twice about paying others for services rendered. If the service is worth using, it's worth paying for.

*Bennett Strange, Associate Professor  
Louisiana College  
Pineville, La.*

### WTHH, anyone?

Dear RW,  
I'm researching the histories of WTHH-AM and FM, Hartford, Conn., on the air from 1936-1954 and 1948-1950, respectively. The stations were owned by the now-defunct Hartford Times, formerly a division of Gannett papers.

## Nipping at The Heels Of NAB

It is easy to root for the little guy, and it's tempting to root for REMAA, the Radio Equipment Manufacturers Association of America.

The effort by some gear makers to stand up to the National Association of Broadcasters (page 13) brings to mind David-vs.-Goliath metaphors. The manufacturers say that 'the tyrant NAB' has forgotten them in its pursuit of bigger, more profitable conventions. The group even threatens to hold its own competing radio show in Las Vegas next spring.

Should radio people care about this teapot tempest? Yes.

First, despite its name, REMAA claims to speak for you, the "radio station owners, managers, programmers, engineers and radio equipment manufacturers."

Second, the issue affects your wallet. Booth fees, labor costs, and hotel, food and travel expenses add up. Guess who pays for increasing costs? You do, when you buy equipment.

Third, some companies complain that the NAB wants to squeeze radio out of the spring show, a charge NAB denies vehemently. But if exhibitors feel sufficiently unappreciated to pull out of NAB conventions, our choices of equipment become more limited, and we get less for our own registration dollars.

Fourth, high costs of exhibiting can keep out small entrepreneurs, thus robbing us of exposure to creative new products and technologies. As reported on page 1, booth fees were raised again for NAB '98.

REMAA does raise some important points: the perceived non-responsiveness of the NAB Exhibitor Advisory Committee; the emphasis given by NAB to TV and multimedia; the confusion arising from the spring show/fall show situation; the cost to smaller companies of multiple shows and rising costs.

But pause. Remember that NAB offers a world-class convention. It brings thousands of people to these booths. It attracts foreign attendees whom exhibitors otherwise could not hope to reach easily.

Exhibitors benefit in many ways from the NAB marketing machine. Many also have benefited from crossover exposure to the TV and multimedia industries, and are now marketing to those buyers too.

REMAA mutterings about a competing show are either naive or disingenuous. Another convention can only serve to increase buyer confusion even more, and the difficulties of putting up such a show are huge. Does REMAA expect NAB to arrange shuttle bus drop-offs?

REMAA claimed it has 45 'founders.' We regret that those founders have opted to remain anonymous as of press time. By doing so, they leave themselves open to accusations that they are trying to manipulate public opinion to advance their own goals, without facing the consequences.

If REMAA does nothing else, it has won the attention of the NAB. That can only be good. But now it's time to talk. For its part, the NAB seems willing to meet with these manufacturers. We urge REMAA to accept that offer, and for NAB to pay more attention to its radio exhibitors.

—RW

I'd like to ask your readers for help, to please contact me if they have knowledge of the history of the stations. I'm also interested in obtaining articles from the stations, such as photos, newspaper stories, transcriptions or tapes, program listings, program and engineering logs and promotional items. Reach me via e-mail at [TEBZ17A@prodigy.com](mailto:TEBZ17A@prodigy.com), or at the address below.

Some years ago I was given a copy of an article titled "Stations Give Public Service In Hartford Circus Tragedy." I haven't located the source of the story, which would have been dated after July 7, 1944. It could have come from Broadcasting, Variety or Billboard. I'll be grateful for any information concerning this.

*Robert W. Paine  
3875 Bristol Dr.  
Chesapeake Beach, Md. 20732*

### Thank you radio

To our friends in broadcasting:  
Our paths have crossed for so many years that the time has come to express our heartfelt appreciation for all of you. As of April 4, 1997, we are no longer involved with Broadcast Supply Worldwide. Having been a part of the growth of BSW for 34 years collectively, we have enjoyed many friendships and acquaintances, both professionally and personally. It is time to say thank you.

You have made a tremendous impact on our lives. We have grown as individuals through your laughter and the many challenges that we all faced as the broadcast industry transformed into what it is today.

In a business environment where personal relationships emerged on a daily basis, we will miss your voices and correspondence that brought us together. Working together with you was nothing short of satisfying as we shared common goals. Even though it appears that we were only a voice on the phone, we genuinely cared for you individually.

As we journey forward on a soon-to-be discovered path, we hope to join forces with you again in whatever we decide to pursue. Thank you all for your friendships and the business relationships we enjoyed. We wish you all continued success, and our hope is for us to maintain a mutually rewarding working relationship.

*Pat and Bernice Medved  
Tacoma, Wash.*

## - Correction -

*In the April 30 issue, page 19, NSN Network Services Ltd. was incorrectly identified as National Satellite Networks.*

# Radio World

Vol. 21, No. 11 May 28, 1997

telephone: (703) 998-7600  
editorial fax: (703) 820-3245

The editorial staff can be contacted at the phone extensions listed below

<b>Lucia Cobo</b> ext. 115	Editor in Chief
<b>Paul J. McLane</b> ext. 117	Managing Editor
<b>Alan Peterson</b> ext. 135	Technical Editor
<b>Matt Spangler</b> ext. 122	Associate Editor (News)
<b>Christine Joaquim</b> ext. 138	Assistant Editor
<b>Chris Hamaker</b> ext. 147	Assistant Editor
<b>John Bisset</b> <b>Thomas R. McGinley</b>	Technical Advisors
<b>Stevan B. Dana</b>	Publisher/CEO
<b>Carmel King</b> ext. 157	Chief Operating Officer
<b>Marlene Lane</b> ext. 128	Editorial Director
<b>Alan Carter</b> ext. 111	Editor in Chief (International)
<b>T. Carter Ross</b> ext. 137	Editor (International)
<b>Angela Novak</b> ext. 144	Managing Editor (International)
<b>Rogelio Ocampo</b> ext. 121	Latin America Managing Editor
<b>Marguerite Clark</b>	European Editor
<b>Susan Gary</b> ext. 130	Editorial Assistant
<b>Linda Sultan</b> ext. 141	Editorial Assistant

**Contributors:** Lynn Meadows, Frank Beacham, Alan Haber, Bob Rusk, Lee Harris, Dee McVicker, Ty Ford, Sharon Rae, James Careless.

Radio World (ISSN: 0274-8541) is published bi-weekly by IMAS Publishing (USA), Inc., P.O. Box 1214, Falls Church, VA 22041. Phone: (703) 998-7600, Fax: (703) 998-2966. Periodicals postage rates are paid at Falls Church VA 22046 and additional mailing offices. POSTMASTER: Send address changes to Radio World, P.O. Box 1214, Falls Church VA 22041. REPRINTS: Reprints of all articles in this issue are available. Call or write Giselle Hirtenfeld, P.O. Box 1214, Falls Church, VA 22041; (703) 998-7600; Fax: (703) 998-2966. Copyright 1997 by IMAS Publishing (USA), Inc. All rights reserved.

—PRINTED IN THE USA—

**Next Issue of Radio World  
June 11, 1997**



# Radio Lifeline for Flood Victims

by James Careless

**GRAND FORKS, N.D.** When disaster strikes, people turn to radio for life-saving news and information. Nowhere more than in North Dakota, as the floodwaters finally recede from the devastated city of Grand Forks.

The flood was the second of two disasters that struck this northern U.S. community; the first was a blizzard and ice storm which wreaked havoc with Grand Forks.

The April flood was by far the most serious of the two catastrophes. After the Red River dikes broke, the city was inundated by spring runoff. As the streets and buildings filled, electricity was lost. So too was clean water and sewage disposal. Essentially, most of the services that make 20th century living possible were gone.

## Information links

Local station WDAZ(TV) managed to stay on air. It was radio, however, that quickly became the lifeline for this community, relaying information about food, shelter, further flood warnings, and, perhaps most importantly, messages between family and friends split up by the disaster. It was radio that made the difference.

Local radio stations "were faced with the dual challenge of trying to serve their audience of actual or potential disaster victims, while they (the stations) were actual or potential disaster victims," said Phil Cogan, Deputy Director of the Federal Emergency Management Agency



KCNN General Manager Scott Hennen, left, prepares to interview Grand Forks Mayor Pat Owens, right, in a temporary studio.

Office of Emergency Information and Media Affairs.

"They faced a combination of problems associated with high water," he said. These included "transmitters that were inundated, studios that were inundated or inaccessible, terrestrial-studio transmitter links that were provided by the phone company that were inundated and knocked out, phone lines serving the stations — particularly those that were doing talk-based programming —

knocked out, (and) power to antennas (failing, which) not only took the stations off the air but in some cases caused the tower lighting to fail, which presents a hazard to aircraft."

"That was enough," Cogan said, but not everything broadcasters had to cope with. "They also had problems with the stations having difficulty getting their personnel to stations that were isolated by the high waters. In some cases employees couldn't get out, and new ones couldn't get in."

## All about survival

As it happened, most stations were washed out, but a few managed to survive. One survivor, for instance, was KNOX(AM). "The dikes that broke were north of us," said KNOX Sports Director Brain Schultz.

"We got real lucky. For a while we could see water coming, but it got to the road and stopped. By that point the river had crested." Both stations stayed on air thanks to a portable generator loaned to them by FEMA.

KCNN(AM)-KZLT-FM wasn't quite so fortunate. Operating on gasoline-generated power in their downtown office, the stations managed to keep running when the waters rose. However, they were subsequently forced out by chemical fumes when fire swept through nearby buildings.

Meanwhile, NPR station KFJM(FM) held out for a while before the flood overwhelmed its sandbagged transmitter. Retreating, it joined with KCNN-KZLT at the Aerospace Training & Research Center at the University of North Dakota to form the FEMA-organized "Recovery Radio Network" (RRN). Using all three frequencies — which required a standby FEMA FM transmitter when the KFJM unit went under — the stations stayed on round the clock with live emergency programming.

According to volunteer receptionist and critical care nurse Cathy LaBine, the stations makeshift quarters are very makeshift indeed.

"We have a central area that is staffed by DJs from all throughout the city," she said. "It's staffed 24 hours a day. And

there are three mics across from me right now, and they're sitting there, and — you wouldn't believe the mass of little wires and cords and four speakers. Across from them we have three phones, which are manned by volunteers 24 hours a day."

Conditions here are tough. There's no running water — which means drinking bottled water and using outside 'Porta-Potties' — and everybody eats the same food, said Labine. "It's prepared in a quantity so large, they stir it with canoe oars ... (as well) we're eating a lot of canned fruit. One of our radio guys said, 'I can't stand any more fruit cocktail!' because we get fruit cocktail lunch and dinner."

In both cases, KNOX/KZLT and RRN have been carrying the news people both want and need to hear. And as is always the case in such disasters, there have been moments of triumph among catastrophe, of people reaching out to others in the community, said KCNN/KZLT announcer Jim Bowman, a 40-year radio veteran. For instance, "when the power was out, we had a lady call from about 15 miles out in the country, who said 'I'm running out of Coleman fuel. I have no heat. I have no lights. I have a Coleman lantern and a Coleman stove, and that's my source of energy. I've tried two stores and they don't have it; where can I get it?'"

## Immediate response

"We put that on the air; within five minutes she called us back and she said 'I've had 12 calls for Coleman fuel so far. I have one gentleman who's already bringing some out. Thank you.'"

"That was the typical kind of response that we got for every question that we asked," Bowman said. "If there was a need, there was more than one answer to the need. And that, to me, has been the outstanding part of this whole effort is the way the community has responded to the rest of the community's needs."

Radio's vital role through the Grand Forks flood should serve to remind radio broadcasters just how vital their medium is during both natural and man-made disasters. It should also warn them that the time to prepare for disasters is now, not just by checking on equipment, but also by working out emergency staffing plans, and stockpiling a few days' worth of canned food, water and clothing.

## Arbitron Cancels Spring Book in Grand Forks

Grand Forks radio stations can breathe a sigh of relief: there won't be a Spring '97 book after all. Given the chaos in the marketplace, Arbitron has decided not to conduct a spring ratings sweep in the community.

"There's nobody home," said Arbitron Vice President of Communications Thom Mocarsky. "After the levy broke in week three of our 12-week sweep, our contact rates fell through the floor. There's nobody there for us to send diaries to."

Arbitron will resume its rating research in Grand Forks in the fall, when presumably most people will be back in their homes. The good news: it won't be charging Grand Forks stations for the missing Spring book.

## BUSINESS DIGEST

Report business news to: Radio World  
P.O. Box 1214, Falls Church, VA 22041  
or FAX: (703) 998-2966

**RealAudio for Wireless Data Broadcasting:** WavePhore Inc. will license the Progressive Networks RealAudio server and live encoder technologies for the forthcoming broadcast consumer service, WaveTop, set to launch this fall.

WaveTop is set to debut as the first one-way wireless service to deliver live streaming audio to an installed base of 15 million RealAudio players. WaveTop is targeted to the home PC market, where most modems are 28.8 kbps or less. The WaveTop service can deliver a continuous RealAudio feed without need of an Internet or phone connection.

RealAudio will be integrated into the WaveTop RadioTop broadcast, a nationwide FM-like radio station, delivered directly to the PC, which will automatically launch a user's RealAudio player for receiving live streaming audio.

**Premiere '96 Performance:** Last month Premiere Radio Networks Inc. announced the results of its operations for FY 1996 and for the three months ending Dec. 31, 1996.

Cash flow for the year was \$7,292,000, up \$2,273,000 from the same period in 1995. Gross revenue for the year was \$27,147,000, an increase of \$6,390,000 from a year

previous. Operating income was \$4,967,000, a \$1,213,000 jump from 1995. Net income was \$2,436,000, compared to \$2,556,000 a year earlier.

For the fourth quarter, cash flow was \$1,495,000, gross revenue was \$8,004,000, operating income was \$853,000 and the company incurred a net loss of \$595,000.

Premiere President and CEO Steve Lehman said: "During this past year, we made substantial investments in programming, research and other services, and have expanded our affiliate networks."

**Keystone, now Globecast:** Keystone Communications Corp., a broadcast transmission service supplier, has changed its name to GlobeCast.

GlobeCast consists of three business units: GlobeCast North America (formerly Keystone), GlobeCast Northern Europe (formerly Maxat) and GlobeCast Paris (formerly France Telecom Broadcast Services).

These new entities form the first global communications provider for around-the-world or "multi-domestic" broadcasting.

GlobeCast's network consists of extensive satellite and fiber facility combinations, plus studios, editing, playout and complete network management.



# Capstar Becomes Largest Owner

by Bob Rusk

**AUSTIN, Texas** Making good on its promise to acquire \$1 billion worth of radio stations, Capstar Broadcasting Partners went on a buying spree, and in the process became the largest radio group in the nation.

Five deals made public in April involving 112 stations, brings the number of stations Capstar will own to 229 — primarily in mid-to-small size markets.

The \$215 million purchase of Patterson Broadcasting, involving 36 stations, gives Capstar a presence in 10 additional cities. They range from market No. 58, Honolulu, to market No. 206, Ft. Walton Beach, Fla.

"The stations owned by Patterson Broadcasting complement our existing portfolio very well," said R. Steven Hicks, Capstar president and chief executive officer.

"The systems Patterson has developed and put in place at its stations will prove very valuable as they are incorporated into Capstar operations."

James W. Wesley, Jr., Patterson president and CEO, who will join the Capstar senior management team, said that the merger "represents a very attractive opportunity to create a combined enterprise well-positioned to take full advantage of the many strategic opportunities in the rapidly evolving radio industry."

## New England foothold

The \$70 million purchase of the eight-station Knight Quality group allows Capstar to establish a presence in four New England markets: Burlington, Vt.; Manchester, N.H.; Portsmouth-Dover-Rochester, N.H.; and Worcester, Mass.

The \$60 million purchase of eight Mississippi stations from SFX Broadcasting Inc., is a more complex deal. Capstar gets two stations in Biloxi and six in Jackson. Capstar already owns four stations in Jackson and will have to sell some of them to satisfy government ownership limits.

In addition, Capstar will trade three stations in Greenville, S.C., for three SFX stations (two in Wichita, Kan., and one in Daytona Beach, Fla.). This will leave Capstar with one station in Greenville, but gives the company a new presence in the other markets.

In a transaction valued at about \$31 million, Capstar will buy the three Ameron Broadcasting radio stations in Birmingham, Ala.: WERC(AM), WMJJ-FM and WOWC-FM.

Rounding out the deals, the Capstar takeover of Gulfstar Communications in an all-stock transaction was long anticipated. Gulfstar, the largest owner of radio stations in the Southwest, was formed in 1992 by brothers R. Steven Hicks (Capstar president and CEO) and Thomas O. Hicks.

"Since its formation just one year ago, Capstar Broadcasting has achieved spectacular success in assembling an outstanding group of middle-market radio stations across the United States," said Thomas O. Hicks.

"Gulfstar has had a similar degree of success in assembling a strong group of stations in the Southwestern United States, including Texas, Louisiana, Arkansas and New Mexico. By merging these entities, Capstar will have

established a platform in each of its five targeted geographical regions."

Capstar was formed by investment firm Hicks, Muse, Tate & Furst, Inc. (which also formed Chancellor Broadcasting), following R. Steven Hicks' resignation as president and CEO of SFX Broadcasting. With 25 years in broadcasting, Hicks is considered one of the most successful operators of middle-market stations.

## Mission accomplished

In May of 1996, Capstar announced plans to buy "up to \$1 billion of radio station properties." With its latest deals, that goal has been surpassed. The company

does not plan to lay off employees at the stations it is acquiring, a spokesman said, and will bring upper level executives into its management team.

But industry observers wonder if Capstar is getting too big too quickly. Dean Meiszer, president of brokerage firm The Crisler Company, wouldn't be surprised to see the company sell some stations.

"You can't acquire (229) stations in a year and not figure out that some of them just don't fit. They're buying market baskets right now," Meiszer said. "There'll be some spin-offs."

Added Steven Pruett, senior vice See CAPSTAR, page 16 ▶



R. Steven Hicks

# Use the *HotLine*

...when ISDN doesn't make sense

**One-time remotes just got easier!**

Sometimes it's impractical to install a special circuit like ISDN for a one-time remote. However a plain telephone line is usually available. Wouldn't it be nice if you could have high quality two-way audio on that plain line? That's just what you get with the *HotLine*.

**Special introductory price: \$2995**

**Call us for details**  
**800-237-1776**  
<http://www.comrex.com>

**COMREX**  
*We make great connections*

**Wideband two-way audio on POTS**  
**(Plain Old Telephone Service)**

COMREX Corporation, 65 Nonset Path, Acton, MA 01720 USA Tel: 508-263-1800 Fax: 508-635-0401  
 Email: info@comrex.com Fax-on-Demand: 508-264-9973 Toll-free: 800-237-1776 in North America  
 or 0-800-96-2093 in the U.K.



# USADR Partners With Lucent

► DAB, continued from page 1

January by the DAR Subcommittee of the Consumer Electronics Manufacturers Association, the Eureka-147 L-band DAB system at 224 kbps was "rated by expert observers to offer the best audio quality, under unimpaired conditions."

In a ranking of the systems on a scale of 1-5 (see Table 1), the Eureka-147 system scored 4.67, while the next best performing system, the USADR FM system at 256 kbps, scored 4.57. The lab data report stated: "... if (the systems) differ by less than 0.17, this difference is not considered statistically significant since it could too easily be due to chance."

One industry observer noted that the performances of Eureka-147 and the eighth best performing system, which scored 4.12, could be considered statistically insignificant. The fourth and fifth best performing systems, the VOA/JPL S-band, with a score of 4.49, and the AT&T/Lucent IBAC, with a score of 4.48, utilized the PAC algorithm at 160 kbps.

## CD-like quality

Lucent hopes to achieve around a 4.5 score at the lowest possible data rate. "It's not an exact science," said Deepen Sinha, a technical staff member of the Lucent Audio Compression Research division, "but there is some consensus that if you score 4.5 on a 5-point scale, it is often called a CD-like quality."

"As the data rate decreases it becomes easier to do things with available transmission systems," said CBS Radio Vice President of Engineering Glynn Walden. (USADR is a consortium of CBS Corp. and Gannet. Westinghouse Wireless Solutions, sister company to CBS, is assisting in the revamping of the USADR DAB systems.)

The PAC algorithm uses "advanced psycho-acoustic modeling," which USADR likens to a model of how the human ear perceives sound, to achieve lower signal compression ratios. Lucent is currently marketing PAC for Internet audio applications through the company's "elemedia" venture, in the hopes of ultimately providing CD-quality audio at rates of 28.8 and 33.6 kbps, according to Sinha.

## Northern neighbors

Eureka proponents are skeptical about how successful the partnership will be.

The Industry Canada DRB (Digital Radio Broadcasting) Allotment plan of last year officially allocated frequencies in the L-band for digital broadcasting.

**As the data rate decreases it becomes easier to do things with available transmission systems.**

— Glynn Walden

CBS Radio

Canada adopted the Eureka-147 system as its standard.

Steve Edwards, chairman of the Canadian Association of Broadcasters' Engineering Technology Council, said that the USADR system is "going to be very seriously in need of significant improvements if it's going to work at all." Referring to the partnership's goal of attempting to achieve audio compression

at 96 kbps, he said: "They're going to have to try to find an audio system that doesn't exist anywhere yet."

He characterized the difference between the data rates of the Eureka and AT&T PAC systems, as measured by the CEMA testing, as "marginal."

"The goal for everybody, obviously, is to achieve the same transparency of audio quality with less bits," Edwards said. "The difficulty is, if you don't stop that process at some point, you never have a standard."

Walden pointed out the limitations of the Eureka-147 system, which carries five stations on a multiplex. "What they do is put a bunch of radio stations together in one transmission system. It's a channel, and the channel carries five programs. If they could get the same quality at 96 (kbps), then they could send 10 programs on the same channel without getting any more frequencies to transmit on."

## Pros and cons

Gary Shapiro, CEMA president, said that the association is not a proponent of Eureka-147. However, back in February, in an *ex parte* filing with the Federal Communications Commission, CEMA urged the commission to abandon its allocation of S-band for digital satellite radio and instead allot L-band for digital radio. (In its draft report released in January, CEMA maintained that only the Eureka-147 L-band system "offers the audio quality and signal robustness ... that listeners would expect.")

"We want to go with the best system that works," Shapiro said. "I think everyone says L-band is the best solution."

The National Association of Broadcasters, which has offered to facilitate third-party testing of any IBOC systems put forward, has long supported an IBOC solution for digital radio.

"A partnership between USADR and Lucent can only be viewed as an extremely positive development towards that goal," said NAB President Edward O. Fritts.

Likewise, Shapiro saw the partnership as a positive step. "I think it's always valuable when there's a competitive situation between companies for a standardized technology, where you take the best aspects of each company's technology and they agree to work together," he said.

USADR plans on commencing prototype testing, which would include both laboratory and over-the-air tests, of its improved system by January 1998, to conclude in September of that year. The company hopes to begin manufacturing the systems by the summer of 1999.

# OSHA Levies Penalties in Tower Crash

by Lee Harris

**DALLAS** The Occupational Safety and Health Administration (OSHA) proposed \$29,400 in penalties against Doty-Moore Tower Services of Cedar Hill, Texas.

The fines are in connection with the Oct. 12, 1996 collapse of a 1,520-foot TV and radio tower there. Three Doty-Moore employees were killed as they attempted to install a 10,000-pound derrick on the side of the tower in preparation for a TV antenna modification.

Because Doty-Moore is contesting the OSHA findings, the agency would not discuss the specific chain of events leading up to the accident.

OSHA investigators cited Doty-



Part of the Top of the Toppled Tower

Moore for a total of seven serious violations. Four of the violations related directly to the operation and

## OSHA charged that safety procedures were inadequate.

installation of the derrick pole. OSHA charged that safety procedures, training and instruction were inadequate and that there was a failure to follow the manufacturer's design in the use of the derrick installation equipment.

OSHA further charged there was failure to inspect this equipment by persons knowledgeable in its proper installation and use.

The remaining three violations were for inadequate fall protection procedures.

Sherry Moran in the Dallas OSHA office said the case will now go to an independent Occupational Safety and Health Review Commission for a hearing.

The collapsed tower was owned by LIN Television Corp., owner and operator of TV stations KXAS and KXTX.

The tower held antennas for KXTX as well as FM stations, KYNG, KOAI and KRBV. The television station and FM stations quickly relocated to other towers (RW, Nov. 13, 1996).

**Table 1. CEMA Summary of Audio Quality Tests**

System, Compression Scheme	kbps	Diffgrade*
Eureka-147, MUSICAM	224	-0.33
USADR FM-1, MUSICAM	256	-0.43
USADR FM-2, MUSICAM	256	-0.50
VOA/JPL, PAC	160	-0.51
AT&T/Lucent, PAC	160	-0.52
AT&T/Amati, PAC	160	-0.55
Eureka-147, MUSICAM	192	-0.79
AT&T/Amati, PAC	128	-0.88
USADR AM, MUSICAM	96	-2.31
USADR AM, MUSICAM	96	-2.32

\*represents how much the system scored below 5.00

## Stereo Field Mixer

### NANOAMP SERIES™

#### MXS100 Stereo Three Input Mic/Line Mixer

- Quiet Mic/Line Inputs • Phantom Power
- Program/Cue Headphone • Lo-cut Filters
- Slate Mic and Tone Osc. • Bright 3 Color Meters
- Limiter • 10-30 VDC Ext. Power

AUDIO TECHNOLOGIES, INCORPORATED



328 W. Maple Avenue,  
Horsham, PA 19044  
Tel: (215) 443-0330 • (800) 959-0307  
Fax: (215) 443-0394 • <http://www.atiguys.com>



Call or write for free detailed brochure

Circle (3) On Reader Service Card

World Radio History



# Hassled by ISDN

# Loves Zephyr



## Telos Zephyr: The Best Way to Hear from There™

The new voiceover guy lives 1000 miles away, and travel is just not in the budget. The music bed got lost in shipment, and you need it by noon. And it's ratings time again - tomorrow's remote had better impress the heck out of the advertisers.

Radio is complicated. Zephyr makes it easier.

Zephyr is number one among US radio stations for sending high quality audio over ISDN. Once programmed, anyone can Auto-Dial ISDN calls. Not sure what to do next? Press the HELP button for plain English information.

Telos will even help you get your ISDN line ordered. Just call our Customer Support guys or check our web site.



Zephyr is full-duplex for two-way transmission. And don't sweat about what codec is on the other side - with Layer III, Layer II, and G.722, Zephyr can handle whatever is thrown at it.

Zephyr might not get you more vacation time. But if you find some, please be sure to send us a postcard.



- The ideal solution for remote broadcasts, ad hoc networks, voiceovers, distribution of commercials, backup to satellite and microwave links, and many other applications.
- Designed by Telos specifically for radio applications over ISDN.
- Clean, uncluttered front panel for simple operation. Full metering, call duration timer, headphone jack, and mic/line inputs.
- Built-in input protection limiter. When your talent screams, your audio doesn't distort.
- Zephyr has an integrated ISDN terminal adapter designed for the non-technical operator. You can even place a standard voice-grade call to a Plain Old Telephone Service (POTS) telephone.



2101 Superior Avenue, Cleveland, Ohio 44114 • Telephone: 216.241.7225 Fax: 216.241.4103 • <http://www.zephyr.com> • e-mail: [info@zephyr.com](mailto:info@zephyr.com)

Circle (21) On Reader Service Card

World Radio History



# Clinton Wants To End PTFP

*Defenders Say Program Deserves Support, Budget Considered Small by Washington Standards*

by S. D. Yana Davis

**WASHINGTON** The Clinton administration wants to end funding for the Public Telecommunications Facilities Program, popularly known as PTFP among public broadcasters.

It is one of those federal programs that has been in existence a long time — since the 1960s, to be exact. Unlike many federal programs, its budget is very small by Washington standards, less than \$20 million a year.

Last year, PTFP grants to public radio and television stations and educational institutions, amounted to \$15.25 million, according to sources at the NPR National Affairs Office, which monitors legislative activity affecting public broadcasters, and particularly public radio stations.

## Equipment purchases, learning

The grants are used for a variety of purposes, most often purchase of equipment for upgrading service or training connected with broadcasting programs at

public colleges and universities. But grants also fund distance learning programs and radio reading services for print impaired persons, specialized radio stations which broadcast on the sidebands of public radio FMs.

Grantees are typically required to match PTFP grants, which can cover about half to two-thirds the cost of a given project.

PTFP is administered by the National Telecommunications and Information Agency (NTIA), housed within the U.S. Commerce Department. The program represents a source of money for public radio and others not controlled by the Corporation for Public Broadcasting.



Sen. Pete Domenici supports PTFP

However, because NTIA reports directly to an assistant commerce secretary, there is, some critics have charged, plenty of opportunity for political control by presidential appointees.

Which makes it seem odd is that the Clinton team has proposed eliminating funding entirely. The Clintons have been outspoken supporters of public radio and television — they were both contributors to public stations back home in Little Rock, Ark.

But the fate of PTFP is not yet sealed. Congress is, after all, controlled by Republicans who have no interest or imperative to do as a Democratic administration wishes.

Hearings were being conducted by two congressional subcommittees in late April. The subcommittees, chaired by Harold Rogers, R-Ky., in the House, and Judd Gregg, R-N.H., in the Senate, heard voices raised in defense and even praise of PTFP from both within Congress and from the public broadcasting community, said NPR National Affairs staffers.

## Commendable uses

Sen. Pete Domenici, R-N.M., was one of those commending PTFP, which has benefitted stations serving rural areas in his sparsely populated state.

At least one source within the Commerce Department, who spoke on condition of anonymity, indicated that a "number" of members of Congress, on both sides of the aisle, favor continuing funding for PTFP.

NPR National Affairs estimates that about \$54 million has been awarded in PTFP grants since 1984. In FY97, the NTIA received requests for grants from 220 applicants totalling approximately \$50 million, of which about a third were funded.

Several public broadcasting organizations, including NPR, PBS and others are asking an appropriation of \$29 million for the coming fiscal year.

"But we expect to get about half that," said an NPR staffer whose name is withheld by request. "That's the way the process works on Capitol Hill."

Examples of recent PTFP grants to public radio stations include \$80,000 to KNAM(FM) in Flagstaff, Ariz., to activate a repeater FM station in Paige, Ariz. The total project cost was \$117,000, meaning the station had to raise about \$37,000 in the community.

Back east, WZRU(FM) in Roanoke Rapids, N.C., received \$87,000 in PTFP monies toward a total project cost of \$116,000 to upgrade services in its coverage area, which included the first radio reading service for the print impaired in its primary signal area.

See PTFP, page 11 ►

## SHURE The Sound Of Broadcast Professionals

Shure Microphones and circuitry products are used extensively throughout the world by broadcasters who demand nothing but the best. Designed for the rough and tumble world of broadcasting, robust mixers and microphones can be trusted in any application you encounter. When thousands of listeners and (your career) are on the line, settle for nothing less than Shure — proudly represented by BSW.

## Worldwide



SM2



SM7

M367



FP33



SM57



SM58



VP64



SM63LLC



FP22



FP42



FP410



Equipment Solutions To Keep You Number One

**BSW**

BROADCAST SUPPLY WORLDWIDE

7012 27th Street West Tacoma, WA 98466 USA

Phone: 800 • 426 • 8434

Fax: 800 • 231 • 7055

Website: <http://www.bswusa.com>

Circle (4) On Reader Service Card

World Radio History



## INTERNATIONAL UPDATE

# DAB Progresses in Italy

by Andrea Rivetta

**ROME** Private and state radio broadcasters in Italy reached an agreement on the development of digital audio broadcasting in the nation.

Plans were officially unveiled during the La Radio del Futuro conference, held in April in Rome, for the formation of the new Italian DAB Platform, which will represent all the various DAB interests in Italy on the European scene.

It was also decided that DAB broadcasts will go on air first in Turin, followed by Milan later in the summer.

Top officials from the state-run network Radiorai attended the meeting. With the prospects of a new law regulating radio broadcasting on the horizon, the aim of the leading Italian private radio stations is to have the same opportunities with DAB as Radiorai does. All radio broadcasters must present a united front to the Ministry of Post and Telecommunications to obtain the spectrum space needed to develop DAB.

For Radiorai, it became clear that while the public broadcaster has unrivaled technological supremacy in Italy and has a greater capacity to invest funds in DAB, it needs to be able to offer listeners an array of digital channels, including the programs of the leading private radio stations.

The private stations have gone to great lengths to avoid being treated as minor figures in the DAB revolution, which will see the nature of radio broadcasting radically change in the space of a few years.

The leading private national radio stations formed the Club DAB Italia to promote their interest in DAB. The local radio associations also formed divisions dedicated to DAB.

Similarly, the Digital Broadcasting Technology Association was established to foster collaboration between DAB equipment producers and universities.

Participants realize, however, that the leading organization must be the Ministry of Post and Telecommunications. The ministry is the only body with the power to ensure full, effective growth of DAB in Italy, which, more than anything else, will need space on the air-

waves. For the moment, this space is in VHF band III, although later it may also be put into the L band.

Just as the huge number of radio stations in Italy have filled the FM band, there has been a television boom, taking up almost all space on the TV channels.

In order to overcome this problem, Radiorai will initially make some economic sacrifices. As a first step, Radiotelevisione Italiana (RAI), the state-run TV and radio corporation, will allocate some of its VHF band III TV slots to DAB broadcasts. RAI also

will help free up space on VHF band III by acquiring some minor private TV channels.

These moves will make it possible to guarantee DAB service in the major

funding.

Initially, the service will focus on four metropolitan areas — Milan, Naples, Rome and Turin — with a total potential audience of 12 million people.

Turin, the historic home of the RAI laboratory, which has worked on developing DAB for Italy for years, will begin DAB broadcasts by summer. Next will be Milan, partly because it is the Italian adver-

tising capital. DAB broadcasts are scheduled to begin there sometime between late summer and year-end.

■ ■ ■

Andrea Rivetta reports on the industry from Italy for Radio World.

## Private stations have gone to great lengths to avoid being treated as minor figures in the DAB revolution.

Italian cities, which together represent a large potential market.

The stations expected to begin DAB broadcasting are involved in broader-reaching projects linked to special events and thus have access to special state

# A New Standard Emerges In FM Performance

## Solid-State FM Transmitters for the Next Century, Only From Continental

Continental's new solid-state FM transmitters establish a higher standard for audio quality, simplicity of operation and long-term reliability in FM transmission with features like these:

- **Complete redundancy** - all solid-state modules are identical and self-protected; power amplifier and driver modules are completely interchangeable.
- **Simplicity of operation** - a unique, new PC interface for rapid system set-up, plus an easy-to-use, fast-access LCD screen for daily operational monitoring and control.
- **On-air protection** - Continental's patented "Soft-Start" circuitry and automatic power fluctuation protection are built-in.
- **Superb audio performance** - units come with our industry leading 802B FM Exciter as standard equipment. Our new 802D Digital FM Exciter is available as an option.

# 1-800-733-5011

For over 50 years, Continental Electronics has provided excellence in broadcast transmission products worldwide. Refuse to compromise... call Continental first!



## Continental Electronics Corporation

P.O. BOX 270879 • DALLAS, TEXAS 75227-0879 • 214-381-7161 • FAX 214-361-3250

Visit our web site — <http://www.contelec.com>

1 97 107

► PTFP, continued from page 10

In Georgia, Atlanta's Georgia State University received PTFP funds for access facilities and equipment for distance learning and student vocational training.

PTFP was characterized by NPR National Affairs as the "only" source of capital equipment funding at the federal level available to public broadcasters. The program — if it survives this year's round of budget cuts on Capitol Hill — could be critical to public radio stations trying to maintain state of the art equipment and facilities and facing the challenge of conversion to digital broadcasting within the next few years.

Commerce officials expect committee action on PTFP funding sometime in June. NPR National Affairs is optimistic that PTFP will continue to be funded, but they expect no dollar increase in funding levels.



# Jockeying for Space at NAB '98

by Bob Rusk

**LAS VEGAS** The NAB booth selection process goes a lot like the NBA draft. But unlike the draft, where players are chosen to fill the rosters of basketball teams, companies send representatives to a room on the second floor of the Las Vegas Convention Center to select exhibit space for next year's show. The location of a booth can make a difference in how much traffic it attracts, and thus how much business a company does.

RW sat in during one of the many hour-long booth selection sessions held during NAB '97 for the 1998 show. Almost 50 companies made their choices for next year's convention during this one session. In the front of the room, overhead projectors beamed maps of the floor plans for all seven exhibit areas at the LVCC and the Sands Expo Center. Company booth managers sat before the display in rows of chairs, studying floor maps they had received in advance.

Company representatives were called to the microphone one by one to announce their all-important decisions. As spaces were chosen, NAB staffers marked them off on the maps.

Other exhibitors, meanwhile, studied maps in the back of the room, jockeying for the best spot. Joellen Reed of Bradley Broadcast Sales said she wanted to get the same space Bradley had this year, but another company had already taken it.

Her list included four alternate choices, including a space larger than this year's. If a competitor chose first and picked a booth near one of her preferred spaces, Reed would take it off her list.

Changes in available booth sizes from year to year can make the selection process harder on an exhibitor. "The thing that frustrates me the most," Reed said, "is the constant upsizing and downsizing, which changes the configuration of the booths."

Sometimes, the floor layout changes at the last minute, when a company doesn't show up for the convention. That happened a couple of years ago, when a booth adjacent to Bradley's was left empty.

"NAB put down carpet and placed some chairs there, which was good and bad," said Reed. "We had people who took our chairs and dragged them over there. But it also gave us a place to go and sit down with clients."

## Pleased

The booth selection process takes place out of the sight of attendees. Booth managers consider many factors, making decisions that may seem arcane to the outsider. "Should I pick an island booth, or a peninsula, or an 'in-line' booth? Is it true that people tend to turn right when they enter the exhibit hall? Will my competition be located too close to me? Will the neighboring booth tend to help me pull in visitors — or will it distract them?"

Most of all, how much will it cost? Booth fees are a major portion of the expense of exhibiting at a convention of this magnitude.

Jim Blum, Crown Broadcast director of marketing, took his turn at the microphone and selected booth 3816 for NAB '98 — a 20-foot by 30-foot space in the radio/audio hall at the LVCC. It will be

adjacent to the Solid State Logic booth, which at 90-by-90 is a major presence in that hall.

Blum said he was pleased with the selection, his first choice. "It's a little smaller than what we had this year, but is in the location we wanted," said Blum.

The NAB uses a priority point system to determine the picking order among exhibitors. Crown Broadcast, a division of Crown International, held 222 priority points for NAB '98. At this particular session, the points ranged from a low of 201 to a high of 234.

Companies earn 10 points for exhibiting, plus one point for each 100 square feet of indoor space or 300 feet of outdoor space. Points earned for NAB '97, combined with points accrued at past shows, are added to reach the 1998 point total. Exhibitors with two consecutive absences from the annual NAB convention lose all accrued priority points. Those that did not exhibit in 1996 or 1997 have been dropped from the point lists.

Neil Glassman, vice president of Digigram Inc., called the priority point process "an equitable system," even though it works against him for 1998. This was Digigram's first year at an NAB convention. "We will be among the very last to pick," he said.

To help companies that hold few points, the NAB developed a Better

Space Wait List, which allows exhibitors to apply for booths that become available later due to cancellations. Each year, on a pre-published date, exhibitors will rush their Wait List choices to the NAB's Washington office, hoping to be the first

**Neil Glassman,  
vice president of  
Digigram Inc., called  
the priority point  
process 'an equitable  
system.'**

in line for any space that opens up. Companies have been known to use couriers or send employees to wait outside the NAB offices overnight, to assure a favorable spot on that list.

Glassman, a broadcasting industry veteran who has been selecting space since 1983, said, "There are other aspects of the (space selection) process that need correcting."

He said, "In the radio/audio area, there seem to be some design flaws in the booth layouts. There is an increasing number of significantly larger booths, which is pushing more of the smaller exhibitors to the Sands."

## NAB Raises Rates Again

► **BOOTH**, continued from page 1

show being profitable, because the money goes right back into the industry and supporting their customers, which are members."

Comrex Sales Manager Kris Bobo said she did not think manufacturers benefit from NAB channeling show revenue back into the broadcast industry, but was quick to add: "It is a really valuable show for us, and it is worth doing, even with the increase."

Not all exhibitors are indifferent to the rate increase.

In a letter to RW, Symetrix Broadcast Sales Manager Walt Lowery cited media reports that put NAB profit margin for this year's show at greater than 300 percent.

"If I were to apply a similar profit margin to our most popular broadcast item, its list price would double," he stated.

### The voice of dissent

"The NAB may have just discovered how much the market will not bear," said Dave Burns, studio product manager with Harris Corp., which moved from the radio/audio hall to the main LVCC hall for NAB '97.

He accused NAB of having an agenda to move radio vendors exclusively into the fall NAB Radio Show. This belief is shared by the Radio Equipment Manufacturers Association of America, a recently emerged group that hopes to stage its own exhibition (see related story next page).

"That is absolutely incorrect," said Calore. She pointed out that when NAB ran out of space at LVCC two

years ago and had to look to the Sands for additional exhibit space, a number of TV and video manufacturers tried to push the radio manufacturers out to the Sands — a request denied by the associ-



How much would you pay for this?

ation.

The NAB also can point to other large conventions and the competitiveness of NAB rates *vis-à-vis* those conventions.

The Electronic Industries Association, for example, charged \$25 per square foot (prepaid) and \$26 per square foot (everyone else) for its 1996 Winter Consumer Electronics Show, which drew 97,000 to Las Vegas. At its spring show in Atlanta, held in conjunction with COMDEX, EIA charged \$45 per square foot. Roughly 100,000 attended that gathering in 1996.

All the same, Burns said that, in his opinion, the "brand name" radio companies will drop out of the spring show if rates continue to go up, and will instead go to the fall show, at the expense of their international audiences. This is out of the question for Comrex.

"If I had to go only once, I'd just

The NAB's "Rules and Guidelines Governing the 1998 Space Selection Process" state, "The floor plan has been developed on the basis of space requirements, traffic flow considerations, past utilization and the booth allocation proportions developed with your Exhibit Advisory Committee ..."

With radio/audio exhibits again located in both the convention center and Sands in 1998, Glassman said, "Every effort should have been made to keep radio/audio in one place."

But NAB's Director of Media Relations Patti McNeil said space at the radio/audio hall in the LVCC is "always sold out." The choice for NAB, she said, was to put some companies on a waiting list, or create additional room for them at the Sands.

"We feel we are serving our radio/audio exhibitors by giving them a place to exhibit," she said. "We've greatly increased the amount of space for radio/audio exhibitors."

After closely scrutinizing the maps and studying her notes, Joellen Reed of Bradley Broadcast finally was called to the microphone to make her choice.

"Bradley would like, in the convention center radio hall, 1601, for a 20-by-40," she said.

Reed chose a larger booth than this year's 20-by-30 space because she didn't want Bradley to be in the back half of the hall. "I'll be right across from my first choice," she told RW.

"It's in front of the windows, so we'll see daylight. I like this one."

do the spring show, even though it is outrageously expensive," Bobo said.

Lowery said that his company is so fed up with the rate increases that it is considering abandoning NAB shows altogether, and instead putting the money in print advertising. "For what we spend on four-and-a-half days in Las Vegas," he stated, "we could smother the broadcast market with direct mail and print advertising for the entire year!"

Coming back from NAB '97 with only a handful of leads from radio broadcasters, Lowery said that attending it has become prohibitive.

"We can't account for an individual company's foot traffic," said Calore. "That depends a lot on their pre-show marketing, the level of interest in their products and so forth." She also pointed out that there were more than 7,800 radio broadcasters at NAB '97 — more than attended the last stand-alone NAB Radio Show.

The growth of the show is of concern to some radio companies.

"It has grown to the point where it's difficult to project what kind of marketing is going to work for it at this point because every year it's so much bigger," said Kris Bobo.

However, the show generated more than 500 leads for Comrex, which Bobo said was pretty good for the company's product line.

The bottom line, as Lowery saw it, is that there will always be a little grumbling, letter writing campaigns, perhaps even rival organizations springing up, but because of the foot traffic, the spring show — which sold over 762,000 net square feet this year — will continue to sell out.



# Association Springs Up, May Host Convention

by Matt Spangler

**WASHINGTON** A group of disgruntled radio equipment manufacturers plans to compete with the National Association of Broadcasters.

"You can liken us to the one or two Minutemen who fired the first shots at Lexington," said a spokesman from the Radio Equipment Manufacturers Association of America. "One person shooting at the tyrant NAB ... has now evolved into a groundswell of well over 45 exhibitors."

It began with a flyer that appeared in booths in the radio hall the last day of NAB '97. "Our Time is Now!!" it stated. "We believe the time is now to form an association that will deal solely with the interest(s) of radio station owners, managers, programmers, engineers and radio equipment manufacturers."

According to the REMAA spokesman, a radio manufacturer executive who wished to remain anonymous, those 45 "founders" include some of the most prominent exhibitors in the Las Vegas Convention Center radio/audio hall.

REMAA would like to convey that it means business: it was granted non-profit status in the state of New Jersey last month, and it planned on having a website up by mid-May. It can be reached via e-mail at [remaa@usa.net](mailto:remaa@usa.net)

## The 95 theses

The association has two points of contention with NAB. First, it believes that there is not enough interest in radio at the spring show because of the "confusion" generated by having a fall radio-only show as well. Consequently, the association feels radio exhibitors are charged too much for the spring show.

"We believe radio equipment manufacturers should be charged for their floor space based on the amount of radio foot traffic NAB can generate," said the spokesman. Walt Lowery, broadcast sales manager with Symetrix, said that only about one-third of the leads his company generated at NAB '97 were for radio attendees.

Some radio/audio exhibitors are not pleased with the NAB announcement that it is increasing the cost of floor space another \$2 per square foot for NAB '98 (see related story, page 1).

Second, REMAA thinks the radio/audio hall should be TV-free. According to the REMAA spokesman, a number of video-only companies exhibited in the radio/audio hall at NAB '97, and at the booth selection proceedings several more companies claimed space in the hall for NAB '98. NAB has "taken the smallest group of attendees and splintered it," dividing it between the radio/audio hall and the Sands, the spokesman said.

NAB Senior Vice President of Conventions and Expositions Haidee Calore said that of the 173 companies located in the radio/audio hall at NAB '97, only five had a video slant, all of which showed digital audio products at the show. "We do not force exhibitors to be in any given product area," she said. "They self-select during the space selection process as to what will be best for their company."

The problem, said the REMAA spokesman, is due to a breakdown in communication between exhibitors and



Haidee Calore said NAB would welcome the opportunity to talk with REMAA.

NAB, *vis-à-vis* the NAB Exhibitor Advisory Committee.

"We feel the Exhibitor Advisory Committee has of recent note been giving nothing more than good lip service," he

**We believe radio equipment manufacturers should be charged for their floor space based on the amount of radio foot traffic NAB can generate.**

— REMAA

said. "I do not believe that in the past three years the folks on the committee have paid much attention to radio/audio needs, even those folks who are involved in radio/audio. Also, NAB is not truly bound to take any action based on what the advisory committee advises, although they may state otherwise."

When REMAA has its members in place it wants to approach NAB with the idea of replacing the committee as the principal liaison between manufacturers and NAB. REMAA will only come to the table, however, the spokesman said, if it has a guarantee that NAB will not retaliate against any of the companies or individuals involved.

One thing NAB could do, according to REMAA, would be to group radio exhibitors and radio management, engineering, programming and ownership sessions together at the Sands. After all, the association says, "NAB is slowly ... pushing radio/audio to the Sands." (More than 20 new radio/audio exhibitors were in the Sands this year.) REMAA believes this would maximize the foot traffic through the radio exhibits, and provide radio attendees with "a single venue to share ideas and learn from each other."

Calore said that NAB was hoping to have two more radio/audio halls open in the north end of LVCC by NAB '98, but construction delays have pushed back the expansion. It hopes to have all radio/audio exhibitors back at LVCC by NAB '99. The move of 20-odd radio/audio companies to the Sands has

not hurt sales for the alternate venue; it has already sold out for NAB '98, she said.

Furthermore, she said, if the Exhibitor Advisory Committee or a group of manufacturers approached NAB about having the radio component of the show in one central location, the idea would certainly be given its due consideration.

The REMAA spokesman claimed that over 30 companies, both large and small, have committed to withdrawing from NAB if REMAA "demands" are not met. The new association even has rival shows in the works, saying there will be at least one show, "most likely at the same time as NAB and in the same city," and there has been discussion of regional shows as well. "We don't want to go to that point; we'd like to sit down and talk to NAB," the spokesman said.

Calore said that NAB would be happy to enter into a constructive dialogue with REMAA about its concerns.

Though competing with NAB in Las Vegas during its spring show may seem wishful thinking, the REMAA spokesman said that it must be done so in order to bring in international attendees. He said that Las Vegas does have the capacity to handle additional shows during NAB week. He also said that there are enough experts in the radio field not used by NAB during its show to hold seminars, conferences and the like.

## Voice of the manufacturers

But are manufacturers attracted to this new group, or do they think this is just another attempt to unseat NAB?

Dave Burns, studio product manager with Harris Corp., says that, even though its efforts are noble, the rival association would probably fall flat on its face. "I think it would be a failure if they try to do it off premises in parallel (to the Las Vegas

show)," he said. "I think it would be a failure if they tried to do it another city."

Symetrix will adopt a "wait-and-see" attitude to REMAA, according to Lowery. He said that if the new association gets a show off the ground he may attend it as a participant to get a feel for how successful it is at attracting radio attendees, and then, if expenses are low enough, he may give it a trial run as an exhibitor.

Because its booth at NAB '97 did not attract as many attendees from the East Coast as from the West, Lowery likes the REMAA idea of having regional shows. What if NAB were to sponsor regional shows? "We could not afford four NABs," he said, "and I can't imagine them trimming the rates."

Ultimately for Symetrix, which is considering dropping out of the spring show and sinking the money it saves into print advertising, it is a question of where is the best place to spend its money. "Symetrix is not looking for another trade show to attend," he said. "We're looking for the best way to benefit our dealers and ourselves."

As for moving the radio show entirely to the Sands, Burns said: "Looking at it from (the REMAA) point of view, it's probably a good idea. It would hurt us." Harris moved its booth to the TV hall for NAB '97, but kept it close enough to the radio hall to attract its attendees; if the show were moved to the Sands, Burns said the company would not be able to maintain a booth in both locations.

If anything were to wake up NAB, Burns says, it would be for radio attendees to voice their complaints about the shrinking number of radio exhibits in the radio/audio hall. "... if their constituents think that they're not going to have a radio show anymore, of equipment," he said, "then they're going to start beating on (NAB President) Eddie Fritts' desk, and say, 'Wait a minute here, this is a broadcast show, and you're running all the radio people off!'"

## BEXT IS AT IT AGAIN

The company that gave you the first High Performance, Crystal Clear, Cost-Effective, Frequency Agile FM Exciter back in 1985 has a new winner for the Broadcast Industry.

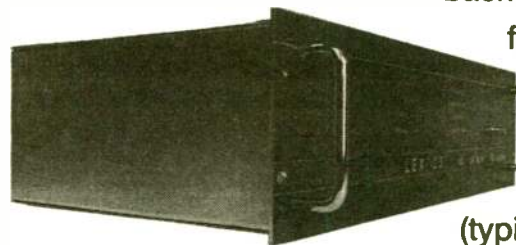

The '97 LEX 25 FM Exciter exceeds 80 dB S/N

(typically better than 85 dB) &

0.03% THD (typically better than 0.02%) and is available at the limited time, rock bottom price of \$1,275. Like all other

**BEXT** Exciters, it is frequency agile, user friendly and meticulously covered by the global **BEXT** 2 year warranty.

Call today for your catalog with **BEXT's** full line of radio & TV exciters, transmitters, amplifiers, boosters, translators and STL's or view it on-line!

**BEXT**

**The Low Power Leader**

1045 Tenth Avenue • San Diego, CA 92101

619-239-8462 • FAX: 619-239-8474

<http://www.bext.com> • E-mail: [support@bext.com](mailto:support@bext.com)

Circle (5) On Reader Service Card



# War of the Words

► BELTWAY, continued from page 3  
Telecommunications Committee's scheduled hearings on the issue.

## Ricochet

But Burns had another hearing in mind to fill the void. He said that he was considering holding a subcommittee review of the FCC application of "public interest provisions," which some allege the commission has used to hold up radio deals in its evaluation of license transfers.

"Because the radio ownership provisions of the (Telecommunications) Act," Burns wrote, "and their legislative history make it very clear that Congress specifically rejected imposition of a public interest test with respect to transfer of ownership determinations, imposition of such a requirement in my view, is in direct violation of the Act."

During a panel session at NAB '97, FCC General Counsel William Kennard ducked the question of whether the commission is delaying its competition reviews in order to factor in the Department of Justice analyses, but he did say that the commission statute requires it to "ensure a diversity of voices" within a given market.

Another item that Chairman Hundt believes is in the public interest is the donation of airtime to political candidates during election cycles. Last month he told the Capitol Hill newspaper "Roll Call" that the FCC was drafting a notice

of proposed rulemaking that examines the prospect of giving free airtime, as a measure of campaign finance reform, to candidates. He said that he expected this to be enacted, either in the form of legislation or regulation, just in time for the 1998 elections.

**Some stations may decide that PSAs are the best way to serve the needs of their communities; others may take a different path.**

—Eddie Fritts  
NAB

"Senator McCain made me promise that we would do this," Hundt told the publication, "and I have promised with pleasure." (The recipient of his pleasure is the co-sponsor of the McCain-Feingold campaign finance reform bill.)

Hundt's fellow commissioner, Rachelle Chong, said that FCC jurisdiction in this matter hits some Constitutional hot buttons as well, and, perhaps not coincidentally, McCain has



Reed E. Hundt

come out against her renomination, as her term is set to expire in June.

But Hundt isn't ignoring *everyone*.

Representatives from as far away as Juneau, Alaska, came for the first meeting of the FCC Local and State Advisory Committee meeting last month. Marilyn Praisner, president, Montgomery County Council, Rockville, Md., said the gathering featured "a good exchange" and FCC staffers present, including Chairman Hundt, came away with "a good understanding" of the issues of concern to the officials present.

The committee was set up so that the commission could exchange ideas with state and local governments about its implementation of the Telecommunications Act of 1996. Dallas City Council member Mary Poss said she sensed that the impetus for setting up the

committee was because the FCC had "taken such a beating in the public relative to local input issues." Nevertheless, she felt that the commission's interest in feedback from the officials was sincere.

Among the issues put on the table at the first meeting were public rights-of-way, over-the-air reception devices and tower siting.

The availability of tower space, and the consequent zoning issues raised, has been a big concern for radio broadcasters due to the rapid buildout of personal communication services and digital television.

Praisner said that the committee suggested that the FCC utilize organizations like the National Association of Counties, the Conference of Mayors, the League of Cities and state associations to resolve those sorts of issues. An executive committee, which will set the agendas for and determine the dates of future meetings, was also established.

## Moving on up

In other commission news, Hundt apparently has his bags packed for the commission move to the Portals complex in Southwest Washington.

In March he testified before the House Committee on Appropriations that the \$30 million line-item addition that the President asked Congress for that extends beyond the FCC's \$189 million FY97 budget was necessary to cover moving expenses. At press time the budget had not been approved.

If all else fails, Hundt could sponsor a large bake sale or hit broadcasters with additional regulatory fees ...

Pristine

# RAPIDFIRE

"...it's fun to use!"

Satisfaction Guaranteed!



"Pristine RapidFire is great, it's fun to use! It's got everything a station would want in a digital system. We use RapidFire in both Live Assist and Auto modes, all day long and it never gives us any trouble."

Matt Sedota, WNMB, North Myrtle Beach, SC

The Next Generation in Broadcast Software

West & International  
310-670-7500  
Fax 310-670-0133



East  
864-292-0300  
Fax 864-292-9030

http://www.pristinesys.com

EAS  
COMPATIBLE

TECHNICAL SUPPORT  
24  
Hours

Pristine RapidFire is the industry's most powerful, fun to use, Digital Studio System! RapidFire will save you thousands of dollars over other high-end digital systems, while offering superior features and bulletproof reliability. RapidFire's *Quick Picks* make it easy to add or change music, commercials, promos, and last minute insertions simply by *point and shoot*. RapidFire masters live assist, walkaway, and satellite operations. Playback three audio sources simultaneously while recording a phone bit or timeshifting a network feed. Call us to find out how easy and affordable it is to harness the power of Pristine RapidFire for your station!

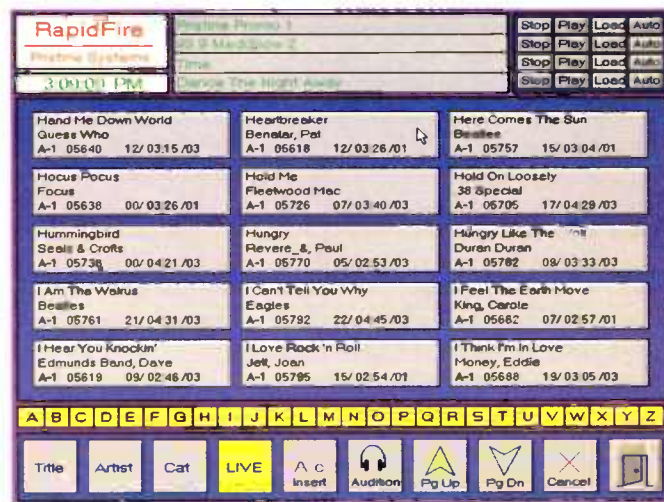

Quick Pick Screen



# DIGITAL FM TRANSMITTERS



## Platinum Z Solid-state FM Transmitters. Full CD-quality sound that sends listeners to a new dimension without sending your budget down the tubes.

The phenomenal CD-quality sound provided by true digital FM generation is now a surprisingly affordable reality.

Harris introduces the CD Series™ Platinum Z™ transmitters. These fifth-generation FM solid-state transmitters are available in 2 to 20 kW models and feature the world-standard DIGIT CD™, digital FM exciter.

The big news for broadcasters is that Platinum Z provides the reliability of solid-state digital technology at a price comparable to conventional tube type transmitters. Platinum Z transmitters feature Z-axis design, utilizing all three dimensions...X, Y and Z axes. Platinum Z transmitters also use innovative Z-plane combining, which enables seamless transmission during maintenance



and enhances redundancy. If you *remove a hot-pluggable RF module from a Platinum Z transmitter at any time, for any reason, the remaining modules will compensate to continue broadcasting at full power.* Incredible RF module MTBF of 250,000 hours further ensures the reliable performance of Platinum Z.

Platinum Z features:

- DIGIT CD exciter (digital or analog input)
- Hot-pluggable RF modules
- Redundant IPA system
- Redundant power supplies
- Broadband design (N+1 capable)
- Life support backup controller
- Dual-output power setting
- Built-in auto exciter switcher
- High overall efficiency

Digital CD-quality performance... solid-state reliability and redundancy...a price comparable to tube type

transmitters...and backed by Harris 24 hour world-wide service!

Is there any reason to consider a transmitter other than Platinum Z?

To discover for yourself how full CD-quality sound can take your listeners and your ratings to the new "Z" dimension *without* blowing a hole in your budget, contact Harris.



### HARRIS CORPORATION BROADCAST DIVISION

U.S. and Canada  
TEL: +1 217 222-8200  
FAX: +1 217 224-1439

Elsewhere  
TEL: +1 217 222-8290  
FAX: +1 217 224-2764



*A new world of broadcast solutions*

**Radio-FM:** DIGIT CD™ - Digital FM Exciter • SuperCiter™ Analog FM Exciter • CD LINK™ Digital STL • Quest, Platinum and Platinum Z Solid State FM Transmitters • HT Single-tube FM Transmitters • FM Antennas **Radio-AM:** DX - Digital Solid State AM Transmitters • GATES® Solid State AM Transmitters **Radio-DAB:** DAB 2000 Transmitters **Studio Products:** Digital and Analog Studio Equipment **Systems:** Mobile and Fixed Studios and Satellite Systems



# Management Challenges

► CAPSTAR, continued from page 7  
 president, Communications Equity Associates, "What remains to be seen is how effective (Capstar) can be in managing a large company made up of small markets.

That's something that hasn't been done in broadcasting.

"In the big markets, there are sophisticated companies with top managers who work to get more of the pie, coming up with ingenious promotions and programming," Pruett said.

"When you get below market 75, the challenges are keeping good managers and offering incentives for them to stay and live in these smaller markets."

And with advertising rates lower in the smaller markets, Pruett wonders if Capstar can get a return on its investment — "both as a return on the purchase price and a return on promotion, air talent or anything else.

"In the small markets, where you have less sophisticated buyers, sales management is a different process than it is in New York, Los Angeles, or Chicago," said Pruett.

### The competition

In market No. 65, Fresno, Calif., and market No. 133, Reno, Nev., where Capstar bought Patterson Broadcasting stations, Lotus Communications also has

a major presence.

Lotus is one of the small group owners that is looking forward to competing with Capstar.

"It seems to me that the less stations you have, the easier they are to manage and the better they can be run," said Howard Kalmenson, Lotus Communications president.

"We're having record earnings in all of the markets where we find (ownership consolidation)."

The Crisler Company's Meiszer said that, despite the Capstar presence, there will still be "plenty of room for the small entrepreneurial operator."

Said Meiszer, "Capstar's challenge will be to not only have the right management team, but the right programming to maintain audience and move advertising time."

# Disaccord Over EAS Mistake

► EAS, continued from page 1  
 Some then pulled the plug on the EAS equipment in order to eliminate the alarm.

At WTAM, according to Szucs, "we took manual intervention and patched around (the equipment). An EOM (end-of-message) was sent after two minutes and then we were able to pull the patch cord."

While most stations got back to regular programming quickly, WQTM(AM) in Orlando, Fla., had dead air for more than an hour. While there is an EAS box at the studios, the station EAS/FEMA box is at the transmitter site, more than 70 miles away, said David Murray, vice president/engineering.

Normally, there wouldn't be a problem having the box that far

## FEMA, the FCC and the Advisory Committee of Radio Engineers have investigated the incident ...

away, but in this case, it locked up and didn't reset itself. A station staff member had to drive to the transmitter and power down the box and power it back up to get audio flowing through it again, said Murray.

In New Orleans, 50 kW powerhouse WWL(AM) and — according to one account — "every other station in town" ended up running the test.

As in past accounts of EAS, there were complaints about this latest foul-up. Glasser has requested a letter of explanation from FEMA.

"A lot of people here in Ohio want answers on why this happened," he said. "They want to know that it isn't going to happen again."

But Szucs said that while many people are chalking this up as another EAS failure, it is actually proof that the system does work. The failure, he pointed out, was due to human error.

FEMA, the FCC and the Advisory Committee of Radio Engineers have investigated the incident and are confident that it won't happen again, said FEMA's Yagerman. "It was not a malfunction of the system," she said.

"To the degree that there was an inconvenience to stations, the agency apologizes. We're committed to making sure that (the system) runs well."

# RoadRunner Breaks the Price Barrier...



**\$2800**

**voice-over**

**sports**

**remotes**

**news**

*The easiest, best sounding, most compatible ISDN codec. PERIOD!*

<b>TECHNICAL FEATURES</b>	Mode: Mono, full duplex, bi-directional
	Algorithms: CCS MUSICAM®, ISO/MPEG Layer II, Layer III and G.722
	Frequency Response: 15 kHz on one ISDN "B" channel 20 kHz on two ISDN "B" channels
	Mixer inputs: 2 - Mic and 1 Mic/Line
	Headphone outputs: Two independent headphone outputs, each with Send and Receive level controls

Now you can have a complete ISDN codec, mixer, headphone distribution amp and ISDN terminal adaptor in a single box. Introducing the new RoadRunner from MUSICAM USA. RoadRunner gives you all the best algorithms, not just one, for compatibility with the codecs you already have. With MUSICAM, Layer II, Layer III and G.722 you can have CD-quality 20kHz mono over one ISDN line, 15 kHz on a single ISDN "B" channel, or the shortest delay with any G.722 codec.

**PLACE YOUR ORDER NOW!**

MUSICAM USA  
 670 North Beers Street, Building 4, Holmdel, New Jersey 07733 USA  
 Tel: 908/739-5600 ask for ext. 163  
 Fax: 908/739-1818 • Fax On Demand: 908/935-2777  
 E-mail: sales@musicamusa.com  
 Internet: http://www.musicamusa.com





# Studio Sessions



**Book Review**

See Page 20

Radio World

Resource for Radio Production and Recording

May 28, 1997

## Seagate: 38 Hours on One Drive

Read G. Burgan

How large a hard drive do you really need? That depends. My first IBM-compatible computer originally had no hard drive at all. When I added a 40 MB hard drive, I could never imagine I would run out of space.

Several computers later, I added a soundcard and SAW digital audio software from IQS. Suddenly, 400 megs didn't cut it anymore.

For the past couple of years I have used one 1.2 GB and one 1.6 GB hard drive on two different computers. They have been adequate, but barely so.

The problem is that state-of-the-art

The internal drive looks like an oversized black egg or an undersized football. It weighs in at 7 pounds, so you do not want to drop this baby on your foot.

Before installing it, there are some considerations. One biggie is *space*.

### Having a hot time

The Elite 23 is 5.75 inches wide and 3.25 inches high. That means you will need two full-height drive bays to accommodate it. Plan on at least three drive bays, and four would be better.

The reason is heat. This hard drive generates some serious BTUs. The instruction booklet states, "Use forced-air ventilation when bench-testing the drive to ensure proper cooling of drive components."

I mounted my hard drive in a full-tower case with one complete open bay beneath it and another over the top of it. In the top bay I mounted a Just Cooler fan. In addition I mounted the probe of a Radio Shack Indoor/Outdoor thermometer to measure the actual heat buildup in the cavity above the hard drive.

A second important consideration is the capacity of your power supply. This hard drive

uses a stiff 1.6 amps under typical use and can draw up to 2.8 A during peak

periods. To play it safe, you should have at least 50 W in reserve. I have a 300 W power supply in my computer.

Ready to install it? Not quite. One more consideration: the operating system. The "original" Windows 95 cannot support a drive this large. To test the drive, I installed Windows NT 4.0; its NTFS file system is able to accommodate very large hard drives. So also is the current OEM version of Windows 95 with FAT 32 that has been installed on many new computers in

the last six months or so.

Technically, a dealer is not supposed to sell the new OEM version of Win 95. But if you purchase a new hard drive — like the Elite 23 — Microsoft will permit a dealer to sell you the OEM version.

One very, very important caveat: The OEM version is NOT an upgrade to Windows 95. It will reformat your drive and you will lose all of your old files. In addition, it can damage some older hard drives.

### Turn of the (Phillips) screw

Actual installation of the hard drive was as easy as any conventional hard

See DRIVE, page 22 ▶

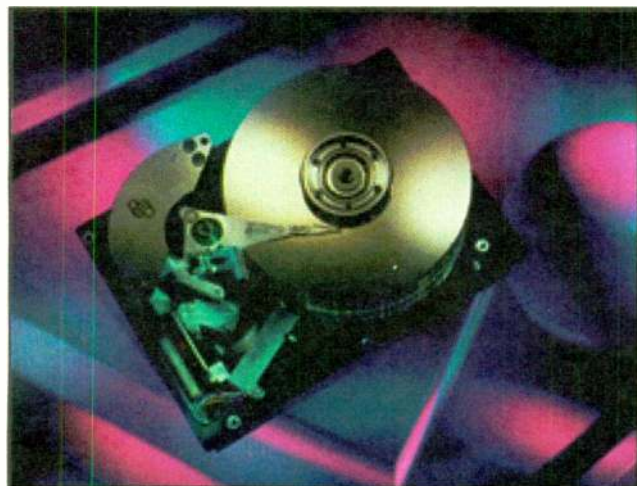

As Big as They Get: Seagate Elite 23

digital editing software like Sound Forge 4.0a provides you with a myriad of options when editing a file. To compare each of the many combinations, you have to save them all, which soon adds up to a lot of megabytes — perhaps even a gig or two.

If you find yourself increasingly short of hard drive space, Seagate's new Elite 23 Hard Drive may be just the answer. The Elite 23 is an Ultra SCSI hard drive with 23 GB of space.

Yes, you read right. *Twenty-three Gigabytes.*

### Whoa ...

This is no ordinary, run-of-the-mill hard drive. I tested Seagate's model ST423451N. The "N" designates the unit as having a maximum transfer rate of 20 MB per second. Units designated "W" or "WD" have a maximum transfer rate of 40 MB/sec.

The drive has a spindle speed of 5,400 RPM, a 2,040 kilobyte cache, an average read seek time of 13 msec, a maximum seek time of 28 msec and a five-year limited warranty — longer than many car warranties.

It features embedded servo heads that essentially eliminate the need for thermal recalibration. This minimizes the likelihood that the hard drive will disrupt the stream of data momentarily and ruin a CD recording.

## Equitek E-100: Mic With a Mission

Rich Rarey

The folks at Conneaut Audio Devices (CAD) have produced possibly the best microphone that ever was made in the great state of Ohio.

The Equitek E-100 has been on the scene for a few years, and will happily find its place as a niche tool, the right choice for the right job.

The E-100 is a handsome, heavy, supercardioid electret condenser mic. CAD says it was designed for recording, broadcast and sound reinforce-

ment. At \$469 it is a fairly good value for fixed position (indoors) applications.

The E-100 is a solid 6 inches tall, about 2.4 inches wide and about 2.1 inches deep, and heavy; with the mounting clip, it felt like a dense couple of pounds, although its published weight is just 21 ounces.

The gold wire mesh windscreen of the mic's active face makes an attractive contrast to the rest of its black body. Its design is "TV friendly."

See E-100, page 25 ▶

### The 628 Digital Voice Processor: Tailor-Made Vocals, One Button Away

- Easy Adjustment With Front Panel Knobs
- 128 Processing Presets
- Independent Metering of Processing Functions
- Optional Remote Controller
- Dual Analog and AES/EBU or S/PDIF Digital Outputs

Are you scrolling through menus with each on-air shift change? Lock in custom processing presets with the 628 Digital Voice Processor. Symetrix introduced voice processors to the audio industry, and now we offer you a complete digital voice processing toolbox. The 628 rolls six separate functions into a single rack space unit:

- Microphone Preamplifier
- Downward Expander/Gate
- De-esser
- 20 Bit A/D Converter
- Compressor/Limiter
- Parametric EQ

An optional remote controller accesses eleven presets, provides a bypass function and eliminates frantic dashes to the equipment rack. Perfect your vocal talent and never lose your work with the 628 Digital Voice Processor.

14926 35th Avenue West, Lynnwood WA, 98037 USA  
Tel: (800)288-8855 / (425)787-3222 - Fax: (425)787-3211  
World Wide Web: <http://www.symetrixaudio.com>



Circle (7) On Reader Service Card



## AMERICA'S HIGHEST BILLING RADIO STATIONS

X 1.	WGN	Chicago	\$ 35,800,000
X 2.	WFAN	New York	35,100,000
3.	WINS	New York	29,300,000
X 4.	WXRK-F	New York	29,000,000
X	KIIS-AP	Los Angeles	29,000,000
X 6.	KRTH-F	Los Angeles	28,500,000
X 7.	KGO	San Francisco	27,800,000
X 8.	WCBS-F	New York	27,300,000
X 9.	KROQ-F	Los Angeles	26,700,000
X 10.	KABC	Los Angeles	26,600,000

NOTE: Revenue totals are gross with no trade. Network compensation is included if known. Estimates are based upon input from managers in each market, surveys sent to group CEO's and my own judgements and formulas.

5 DUNCAN'S RADIO MARKET GUIDE  
Copyright 1996

Others like to brag about their client list. We let Duncan's do it for us.

Nine out of the ten highest billing radio stations listed in Duncan's rely on PR&E. Why? Maybe its our durability. Virtually all of our original BMX consoles are still in service today. Or maybe it's our reliability. After all, downtime and make-goods cost money. Then again, it could be our decades of industry experience. Whatever the reason, our clients are happy. Better yet, they're successful. Just look at the list.

To receive a brochure on the full line of PR&E products and services, contact us at 619-438-3911, e-mail [sales@pre.com](mailto:sales@pre.com) or visit [www.pre.com](http://www.pre.com).



**Air Consoles** PR&E on-air consoles are the first choice of many of the nation's top broadcast personalities.



**Production Consoles** Similar layouts between production and on-air boards let operators work seamlessly on both.



**Digital Workstations** Familiar analog features enable a smooth transition from cut-and-splice to digital editing.



**Cabinetry** We offer a range of studio furniture, including custom, modular and ready-to-assemble designs.



**Integrated Systems** Our turnkey solutions cover your entire project—from design through installation.



PACIFIC RESEARCH & ENGINEERING

Circle (17) On Reader Service Card

World Radio History



# Shifting Gears to Save Careers

Alan R. Peterson

A walk through the exhibit halls at this year's NAB show was a feast for the eyes and ears as well as a torture test for the tootsies. But it was well worth it for the chance to scope out all that new gear and production music, tools designed to make the harried production director's job a lot more creative.

I hesitate to say "easier," as there could now be three or more stations the poor soul must produce for. But that is besides the point.

A curious thing happened when we weren't looking. Technology quietly forced a reversal of procedure for both the air personality and the production director and how they perform their respective jobs. The magic word is "preparation."

## AI's fables

Once upon a time, jocks could get by with almost zero preparation to pull off a show. Granted, entire "time and temp" shows were frowned upon by programming gurus and considered not up to the performance level established by the personality's track record. But it would do in a pinch, when that hangover just would not quit.

Meanwhile, tape cutters had to know — down to the split-second — where an effect would fit and how the copy points would hit the posts in the production music. A stopwatch was every bit as important to own as a box of fresh, single-edge razor blades. Audio preparation, timing and track management were arts unto themselves.

In other words, a jock could survive with little or no preparation, while a production rat's neck was slung in a noose held taut by his or her ability to pre-plan a project critically.

Now look at the latest trends in workstations. Huge memory capacities mean entire sound effect libraries can be stored on hard disks, to be flown in or out with simple mouse clicks.

If one car door slam doesn't sound realistic enough, another one is along to replace it in seconds.

Backtiming to the posts has been replaced by dragging and dropping, trimming and truncating. No longer does the talent have to worry about matching to the music. Now the DAW matches everything to everything else.

Timing and track management are practically things of the past. Unlimited virtual tracks and time-squeeze techniques mean there is unlimited space to experiment and, no matter what, the final product can be crushed down to fit that 59.5-second avail.

In other words, it is no longer necessary to plan and calculate every little nuance of the production. So much of the laborious grunt work that is ancillary to the creative process is now handled by the computer.

## On the air

Meanwhile, across the hall in the air studio, the talent uses the "voice tracking" feature of the live-assist system to automate two or more hours of a shift and still sound convincingly "live." Looking ahead on the music log, the jock finds places to drop live-sounding breaks and interesting content between songs

and stopsets, then programs the computer to "talk up" to the post.

With timely, relatable material (read "show prep"), an air talent can walk away from the studio and do production or station promotions — increasing the talent's worth to the station — and still retain his or her personal "sound" during that time.

When you think about it, this automated voice-tracking differs very little from doing a prerecorded show to tape, music and all, to be delayed and played back later. The listener hears a live-sounding show, and the records never run out. We have all done this before, so now should not be any different.

In a nutshell, a prep-less jock is now inviting disaster, while an overprepared production person is almost a hindrance. The priorities have certainly changed.

Crusty old radio curmudgeon that I am, how do I feel about this current trend? Pardon me for saying so, Willy Marconi, but I think it is about time.

## Howzat again?

My biggest fear for several years has been the return of automated radio the way we all remembered automation: jockless, lifeless, with mechanical-sounding timechecks and bland, pre-packaged talk-ups.

Dead air, jammed tapes and timecheck carts that ended up hours off the correct time. These drawbacks gave station automation a black eye throughout the 1970s and '80s, while deserving but unemployed air talent looked for other work.

The current crop of computerized radio boxes are more dependable and a lot more open-ended, offering possibilities the old robots could not.

But now, instead of putting jocks out of work en masse, many non-satellite systems depend on talented human operators to maintain "stationality," as well as clever programming to keep a successful

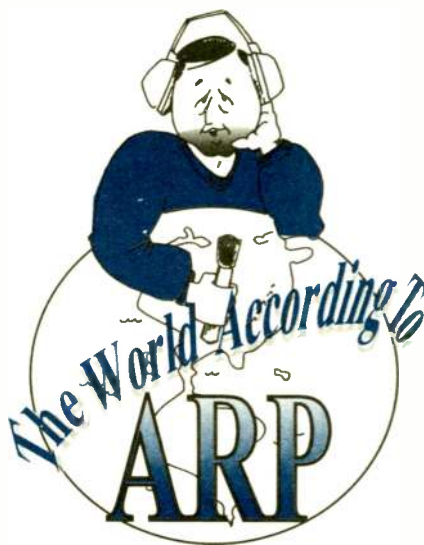

Production people need to keep an open mind and be ready to try and, yes, invent, new ways to make a station sound exciting.

There is no longer one single, inflexible way to hear a spot or promo inside your head. Spend whatever time is needed to prep a project on the DAW, but spend equal amounts of time to make it brilliant. You have the speed and the power now; use it.

You may all but retire your stopwatch, now that graphic displays and edit decision lists tell you what happens and when. At last, you can accomplish what you wanted by the way it feels, not by what the clock demands or the music forces you to do.

But it requires you to throw away some of your previous notions about the job at hand.

## Sound over dogma

Marry yourself to the *sound* of the project, not to a hard timetable of events or an inflexible attitude of "one way" only. Do this, and your work will be in huge demand on every station in town.

For air talent, it means prep, prep, prep, more so now than ever before. Bring in more material than you know you can use. Draw on life experience and always have a compelling or funny story ready.

Know how live-assist systems work, so when the skies cloud over, "you" are not still talking about sunshine. Stock time-and-temp jocks are out of work all across the country for a big reason: uninteresting, passionless shows. Don't be one of them.

So what if your station is partly run by computer? No one will ever know. These things are deliberately designed to sound completely unlike the metal monsters of 1977. Put the effort into doing a great show every day — even one that does not happen in real time — and *strive to sound live*.

station from sounding like a jukebox without a soul.

Skillful jocks can adapt to this new way of doing the job, still be "on the air" and establish a loyal audience for the station. These are the ones who survive.

## They're back ...

There was no way to prevent radio automation from returning, and the time for jocks and production people to complain about it is around eight years past. By now, either you are part of the plan, or being shown the door for "not being a team player."

So what does this mean for the broadcasters who are still in for the long haul? It means reversing and rethinking the ways you used to do things, whether you are an air talent, production rat or both.

The computers are here to stay, gang. For the future of the medium and to preserve your hopefully upwardly-mobile career, change tracks now and pull ahead of those content to gripe about the past.

## The Wizard™ has gone STEREO!

The new DIGITAL FM5A-1 gives The Wizard System unmatched stereo monitoring capabilities. . .



Superlative stereo performance. Linear-phase filters that reveal the true performance of your audio processing. The stability of digital stereo demodulation. The sophisticated graphical presentation of The Wizard. And—with the RS-232 port—operation on site or off.

Contact Belar today for more details on what should be your next modulation monitor

**BELAR ELECTRONICS LABORATORY, INC.**  
119 LANCASTER AVENUE • P.O. BOX 76 • DEVON, PA 19333-0076 USA  
(610) 687-5550 • FAX (610) 687-2686  
Call, write or FAX for more information on Belar AM, FM, Stereo, SCA, and TV monitors.

**Problem:** I have a duopoly. I need back-up transmitters for my stations:

**Solution:** Don't buy two -- buy ONE!

Our Legend Series, Solid State, FM transmitters are Frequency Agile and Broadband. Your engineer can instantly tune one to any frequency!

We've designed the Legend Series to ensure long transistors life with "wind tunnel" cooling & brute force power supplies.

Legend transmitters make great main transmitters too!  
Available from 1KW - 11KW

**Great Products  
Great Solutions!**

"The Transmitter People"

**Energy-Onix**  
BROADCAST EQUIPMENT CO., INC.  
PO BOX 801 ♦ 1306 RIVER ST.  
Valatie, NY 12184  
Phone 518-758-1690 ♦ Fax 518-758-1476  
energy-onix @ energy-onix.com

Circle (9) On Reader Service Card

Circle (8) On Reader Service Card



# Grease Pencils and Razor Blades

Rich Rarey

Every time I attempt to retire old ways, techniques or work habits to embrace the new, the modern and the state of the art, that old knowledge suddenly becomes more valuable.

A case in point: my spouse and I conceived the idea of making a commemorative tape for her brother. We would begin by taking tape from an interview he was in and re-edit the interview to make it, well, just plain silly.

Everyone has done this in their career. Edit someone's breaths and stutters together into a wheezing, tattering string of noises. Or take some victim's answers to the interview questions and reform them into a fairly funny, insensible monologue. The idea occurred to us while on vacation, far away from workstations and studios.

## Roll on down the highway

We had only a Sony D8 to audition a scratchy copy of the original interview, a note pad and pencil, a pair of cheap in-ear phones I bought 10 years ago and miles of lovely New Jersey parkways to view as we hatched a production plan.

It is in moments like this that one wishes DATs could be edited simply by pulling the tape out, biting it in two at the edit point and splicing it together with a plug of well-masticated Doublemint. We seriously gave that plan due consideration, but realized we didn't have enough Doublemint to make all the splices.

After all, the D-8 was on loan, and we were confident that the gum would not seriously damage the heads.

Because in-car editing was impossible, we arranged our itinerary to take us past the National Public Radio New York City Bureau. Then I gave my spouse, a power Sonic Solutions user, the bad news.

"They don't have a Sonics?!" she exclaimed, eyes widening in horror. "You're sure they don't have any workstations? None at all? You're *positive*?!"

No, I told her, we would have to do this production the old-fashioned way, the Joel Tall way: splicing block, grease pencils, razor blades and maybe some spilled blood.

"Oh," I added, "We'll be editing the tape at 7.5 ips. That'll be okay, won't it?"

My lovely spouse, used to the digital realm, a world where 15 ips Dolby SR recordings are considered "minimum quality," suffered the shock well. We settled in front of an old Otari 5050-A, and within a few hours, had whittled the 20-minute interview into three minutes of huffing, gasping, hilarious repartee.

During those hours, I realized that the unconscious editing habits I use now were learned as a teenager.

I once saw an engineer at Kings Mill Recording in Columbus, Ohio, cut short pieces of splicing tape from the dispenser, and line them up at the edge of the recorder's deck plate. I watched, wide-eyed, as he deftly pulled each one up with his razor blade and placed it expertly on the splice, never touching the sticky side of the splicing tape. Thereafter, I applied my splicing tape the same way.

I also realized that analog editing skills atrophy, just as a razor blade rusts over time, but those skills were the only practical way of completing an unexpected task.



What's my point? Never, ever, believe your hard-earned skills will be completely discarded in favor of their modern counterparts. Somewhere, sometime, when you least expect it, you will have reason to call on them again.

## Dis 'n' Data

Congratulations are in order. Last month, we received a notice that the radio documentary "Remorse: The 14 Stories Of Eric Morse" won the prestigious George Foster Peabody Award, broadcasting's highest honor.

The hour-long documentary was produced by David Isay and reported by Chicago teenagers LeAlan Jones and Lloyd Newman. The teens had received acclaim for their reporting in a previous documentary, "Ghetto Life 101."

The lead engineer for both documentaries was NPR's Caryl Wheeler, who wrote for NPR's EUonline about her hours spent assembling, preparing and mixing the material.

In her EUonline feature piece, Wheeler described the differences between the production of "Ghetto Life 101" (analog, multi-machine) and "Remorse" (Digidesign ProTools

workstation) this way:

"At its best, multi-machine mixing is a collaborative physical discipline, a pas de deux between the producer and engineer as they strive to assemble the disparate materials of audio art. The frustration lies in the coordination: controlling multiple tape machines, adjusting levels, re-cueing tapes, listening to the mix and the producer at the same time, and making the process appear seamless and transparent to the listener.

"In a piece like 'Ghetto Life 101,' where the goal is to create an immersion experience for the audience, it's crucial to keep the continuous presence of background ambience beds to enhance the 'You-are-there' illusion. Many of the segments involved rapid crossfades between several :03-:10 second long actualities (often recorded at different times or on different equipment, requiring varying equalization) over two crossfading ambiences, or cross-fading to multiple specific music posts.

"You can hear an example of this in the bus ride sequence of 'Ghetto Life 101.' In this case, choreographing the dance of four hands, five tape machines, processing switches and fader adjustments for one three-minute segment of the mix took hours of studio time and more than 13 passes to perfect."

Wheeler compares these two documentaries and the sharp differences between analog and digital in their respective mixes.

"Both systems have strengths and flaws. The digital advantage is in its flexibility and the ease with which one can make and undo changes, the amazing

degree of control over all aspects and elements of the piece and in the ability to bounce, submix and process without sacrificing to the demons of multiple generations and tape hiss. The physical limits to the ballet of hands, switches and machines are no longer barriers to creativity."

But Wheeler notes something is lost in the process: the serendipity of the moment.

"... When the wild sound and the music hit together, something we might never have heard but for a lucky accident of timing and the 'wrong' fader being up. Qualities like 'warmth' inherent in analog tape recording seem to be lacking in the digital realm. We find ways to include room for chaos and accidents to occur, techniques for spontaneity, the frequencies for color.

"As we continue to learn and develop with these systems, we will learn to be less obsessive about the details, just because we have the power of control. And we'll find ways to keep the organic sense of growth and randomness that help to keep pieces from sounding too sterile and perfected. We will enhance our working relationship to emphasize the creative, collaborative partnership of ears and esthetics. It can always be better, but it has to be alive."

The full text of Caryl Wheeler's feature is on the Features Page of EUonline, and we offer our congratulations to Caryl, David, LeAlan and Lloyd for their award.

'Til next time, I remain,

Your obd'n't eng'r.

■ ■ ■

Rich Rarey is technical director of NPR's "Talk Of The Nation." He can be reached at rrarey@npr.org

## BOOK REVIEW

# New Book Relates Production Tales

Alan R. Peterson

Dennis Daniel and I started writing about radio right around the same time. He started "Tales of the Tape" in Radio and Production (RAP) magazine eight months after I began writing "From the Trenches" in *Radio World*. Only he scored the book deal first.

Seriously, "Tales of the Tape: A Production Director's Odyssey," is a new book published by the National Association of Broadcasters (NAB) and is worthy of your attention.

## One of us

Daniel is a talented production guy who, for years, has been able to make magnificence out of manure. Impossible projects from brain-damaged clients were routinely turned into award-winning campaigns. At a young age, Daniel beat the agencies and won a Clio award with a spot for a New York dentist.

In 1992 I visited Daniel at WDRE-FM (now WLIR-FM), Long Island, N.Y. Hearing his tape was nothing like reading his stories. It was fine, daring and creative work, done with the encouragement of his bosses to push the envelope as far as he could within the limitations of the technology and the social mores of Long Islanders.

His accomplishments led to workshops at NAB conventions, and finally to "Tales of the Tape" in book form, a

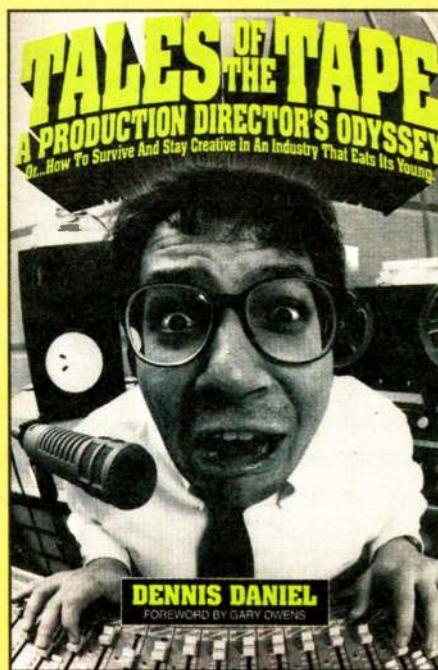

collection of his columns from RAP magazine.

Beginning with the cover parodying the "crapped out" recording tape ad from a couple of years ago, you know you are in for a ride.

Do not expect a how-to book on EQ curves, mic techniques or multitrack alignment procedures. This is a survival guide, steering you through the mined waters of radio advertising. There are lessons on life, station politics and dealing with setbacks, just as there are

lessons on creative, high-imagery radio production.

Here you'll find the "Terrible Twelve" most-overused phrases in radio advertising. Clients from a few steps lower than Heaven. The self-doubts that plague the creative process and the recognition from peers that reassures you that, maybe, you really are on the right track. Everything that you thought only happened to you.

The book follows the ebbs and flows of Daniel's radio experiences. When he was steamed, he wrote about it. When things went his way, readers shared in the celebration. And when a particular burst of brilliance occurred, he made it public knowledge rather than hoard it. He vented his frustrations and warned a grateful body of readers what they could be in for.

The language is remarkably salty for an NAB-published book. And Dennis' reaction to a "flame" letter once published in RAP is reprinted in its entirety, minus names. It seemed appropriate in context in RAP, but in the book it makes Daniel sound fragile and bitter, even five years later.

Especially interesting is the shift in perspective Daniel goes through. He went from production director to head of an advertising/production agency, using all he discovered and developed over the years to move ahead.

But rather than sell out, Daniel

See TAPE, page 26 ▶





## GSC3000 SITE CONTROL SYSTEM

# Set Your Sites High.

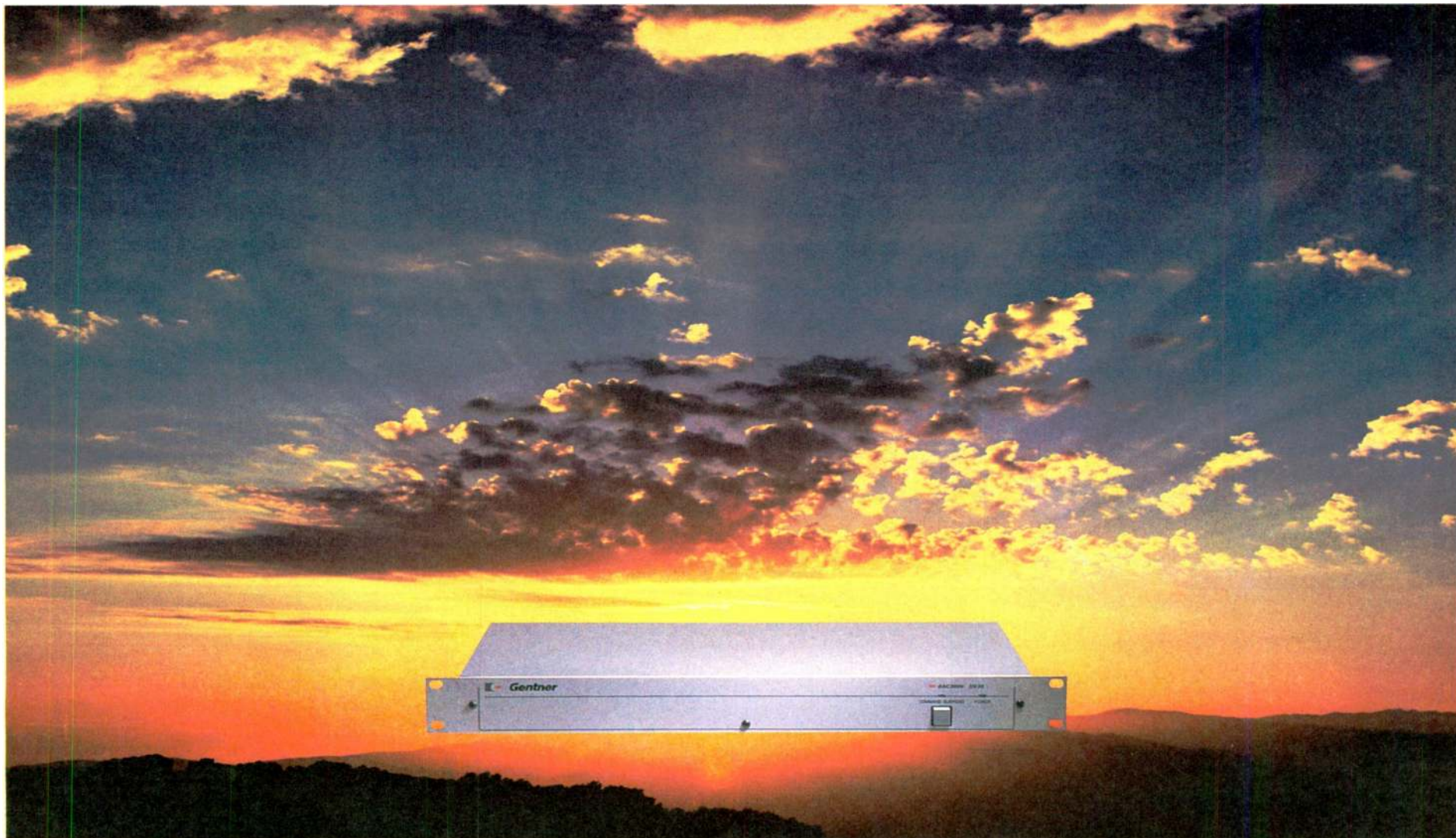

Site control has never been so easy. Gentner's GSC3000 is the next generation in site control.

Building on the breakthrough technology of the VRC2000, Gentner puts you in complete control of multiple sites at one time with the GSC3000!

Control all your transmission sites from a single PC or multiple PCs at different locations with the software that is included with each GSC3000. The limits are up to you. Get the benefits you enjoyed with the VRC2000 plus features that help you adjust to the changing broadcast workplace.

But, Gentner didn't stop there.

They made the GSC3000 the only modular, fully programmable, intelligent, stand alone remote control in the world.

Also, in emergencies, it will capture and log data. This will aid in the diagnosis and analysis of the event sequence that caused the emergency.

In other words: Sit back. Relax. And let the GSC3000 do the work.

Staying in control gets even easier when you accessorize.

Those options available include the Silence Sensor, Temperature Sensor, Wiring Interface, and/or a Command Relay.

It all comes down to this: You can set your sites as high as you want when you purchase a Gentner product— especially the GSC3000 Site Control System.

No matter what your site control needs, we have a solution for you. Call the Harris Broadcast Sales Center today for the details!



***Control all of your sites in the comfort of your office from your computer.***

**Harris Corporation Broadcast Division**

U.S.:

1-800-622-0022

FAX: 765-966-0623

Canada:

1-800-269-6817

<http://www.broadcast.harris.com>



# HARRIS

© 1997 Harris Corp.



# Billions of Bytes

► **DRIVE**, continued from page 17

drive. I interfaced the drive to an Adaptec 2940 Ultra Wide SCSI Host adapter that Adaptec generously supplied for the occasion. I have used several Adaptec SCSI adapters in the past and one of the delights is the ease with which they can be installed and configured.

How does the Seagate Elite 23 perform? Beautifully. I expected it to be noisy, but it is not. When you first turn on the computer, you can hear it rev up to speed; it takes about a full minute to attain operating speed.

When you turn it off, it sounds like a soft turbine engine as it winds down for another minute or so. In operation, it is no noisier than any other hard drive I have used.

With the precautions I instituted, heating has not been a problem either. The digital thermometer reported a temperature in the mid-80s (F) in the cavity

above the hard drive, well within specs.

Performance? The drive has taken all of the digital audio processing I could throw at it without missing a beat. Access time on a drive this large could be a problem, but I have found this drive as fast, and in most cases, faster than the two IDE gigabyte hard drives in the same computer.

Adaptec's SCSI benchmark test shows the drive transferring at nearly 12 MB/sec. SAW has a hard drive test software that indicates the transfer rate of a hard drive for determining how many simultaneous audio tracks the program can run. The Elite 23 tests out at 9,792 Kbytes in the read test. In contrast, the 1 gig IDE hard drives in my computer test out at 4,608 Kbytes.

Running the Ziff Davis WinBench 97 Version 1.0 disk tests on the drives in my computer produced similar results. The Seagate Elite 23 SCSI hard drive

consistently outperformed the one-gigger by a minimum of one-third to as much as double the transfer rate in several tests.

How much can you hold on a 23 gigabyte hard drive? Plenty! A digital stereo WAV file recorded at 44.1 kHz will take approximately 10 MB per minute. That works out to about 38 hours of uncompressed digital audio files, or the equivalent of 38 10.5-inch reels of tape.

If you wanted to store your current playlist, it could hold approximately 760 selections of about three minutes each.

For me, the real advantage is the ability to work on multiple digital audio projects. I can leave them in various states of processing without having to finish up one because there is no room to work on anything else. Depending on your particular situation, you could go for months without worrying about deleting files to make room.

How much does it cost for all of this capacity? A bit, but not as much as you might think. Only a year ago, a 3.0 or 4.0 MB SCSI hard drive would have cost several thousand dollars. Direct Tech

Systems in Eden Prairie, Minn., sells the internal version of the Elite 23 for \$4,015. If you want to avoid the hassle of providing a power supply stout enough to run the drive and enough ventilation to keep it cool, Direct Tech sells an Elite 23 mounted in an external case with power supply and fan for \$4,135.

Now, the big question: how does one back up a 23 GB drive? Darned if I know. Buy lots of tapes or a few zillion CD-Rs, I guess. Better yet, maybe you should buy a second Elite 23, just to serve as a backup.

■ ■ ■

Contact Seagate Technology in California at (800) SEAGATE. Visit the company website at [www.seagate.com](http://www.seagate.com) or circle Reader Service 99.

DirectTech Systems can be reached in Minnesota at (800) 279-5520 or at [www.directtech.com](http://www.directtech.com)

Read Burgan is a freelance writer and a former public radio station manager who can be reached at (906) 296-0652 or through e-mail at [rgb@up.net](mailto:rgb@up.net)

## PRODUCT GUIDE

Companies with new product announcements for Studio Sessions Product Guide should send them to: Radio World, c/o Studio Sessions Editor, P.O. Box 1214, Falls Church, VA. 22041

### TM Century Mixer

TM Century introduced the SM-05 Audio Controller, a lesser-priced version of the computerized audio mixer for the company's Ultimate Digital Studio.

The mixer features five stereo inputs, balanced stereo outputs for program and audition lines and a switchable headphone output.

The proprietary SM-05 couples to a computer via an RS 422 connector. Using it with a digital commercial system, stations can combine hard drive storage with a CD library.

For information, contact TM Century in Texas at (972) 406-6827 or circle Reader Service 115.

### Symetrix Expander/Gate

Symetrix announced development of the two-channel model 562E Windowing Expander/Gate.

The device was created to apply precise triggering to imprecise organic signal sources and to clean up multitrack recordings by eliminating noise and hiss during silent tracks. The Autowindowing feature maintains control over the gate envelope parameters and reduces the pops typically produced by envelope edges.

Sidechain features include high and low Key Filters which narrow the sidechain frequency response, ensur-



ing precise triggering in noisy environments.

For information, contact Symetrix in Washington state at (206) 787-3222 or circle Reader Service 135.

### Pyramid Soundproofing Panels

NetWell Noise Control introduces its new acoustic Pyramid foam absorbing panel system.

The company produces symmetrical 2x2-foot square foam panels with pyramidal geometry, in a range of colors and thickness. The three-inch thick panel has a claimed NRC absorption value of 90 percent.

Company literature suggests the Pyramid panels are suitable for voice-over and editing booths, complete on-air studios, isolation rooms (drum booths) for music

recording and in recording control rooms. NetWell will provide catalogs and product samples by request.

For information, contact NetWell Noise Control at (800) 638-9355 or circle Reader Service 123.

### Enhanced Pyramix Virtual Studio

Version 1.1 of the Pyramix Virtual Studio from Merging Technologies adds new features to this relatively new digital workstation.



Enhancements such as improved scrubbing of audio, reverse playback and user-specified "nudge" settings are all included in the new version.

The audio board used by Pyramix is the Kefren DSP board, with four AT&T 32-bit floating-point DSPs for processing up to 24-bit 48 kHz audio. Software is available in versions for Windows 95 or NT 4.0.

For information, contact Merging Technologies in California at (619) 675-9703 or circle Reader Service 124.

### Roland, AirWorks Alliance

The Roland VS-880 workstation has become a more powerful machine, thanks to an agreement between Roland Corp. and AirWorks. The agreement allows Roland to use AirWorks technology for format conversion and synchronization, making the VS-880 more ver-



satile in the fields of multimedia and video production.

S/Link is a soundfile format converter which supports a number of professional audio and video editing formats and desktop multimedia standards. AutoConform uses machine control to load and retrieve source material and provides users with full audio synchronization. This allows use of the VS-880 with nonlinear video editors such as the Avid Media Composer and Media 100.

Independent radio producers now using the VS-880 can use this technology to branch into mix-for-pix for television production.

For information, contact Roland at (213) 685-5141 or circle Reader Service 129.

### New Steinberg Products

From Steinberg North America come several new products for audio recording and MIDI music creation.

Cubase VST 3.5 for Windows 95 provides up to 32 tracks of digital audio, 128 equalizers in real time and a fully-equipped effects rack with four multi-effects processors, all in software.

Minimum requirements are a 100 MHz Pentium with 16 MB RAM, fast EIDE or SCSI drive and a Windows 95-compatible soundcard.

For Mac users, Steinberg and third-party developers have a series of plug-ins for the Power Mac version of Cubase VST. Products include the Electro Fuzz distortion pedal emulator, WunderVerb3 high-density reverb, Denoiser and Declicker and the Audio Track "swiss army knife" plug-in with compression, gate and five-band parametric EQ.

For information, contact Steinberg North America in California at (818) 993-4161 or circle Reader Service 100.



# It's not only digital. It's PR&E.

Now you can get digital technology and PR&E reliability in the same console. Integrity.<sup>™</sup> It's the first digital on-air board that also speaks fluent analog. All 16 inputs can handle analog signals. Ten can also accept digital inputs at any sample rate. So you can deal with the hodge-podge of equipment in real-world studios. A unique architecture also guarantees a level of reliability other digital consoles can't match. So you can rest assured your signal will stay on the air.

What's more, you get on-board DSP voice processing, remote or local configuration controls, and channel-specific remote control connections. And you can set, save and recall each board configuration at the touch of a button for seamless transitions from show to show.

For a brochure, call us at 760-438-3911, visit [www.pre.com](http://www.pre.com) or e-mail [sales@pre.com](mailto:sales@pre.com)



The LCD displays audio levels, time-of-day clocks, session status and event timers with a Windows<sup>®</sup> interface to powerful configuration management and session-based features.



Integrity's difference is more than just digital. It also offers four special-purpose buses to provide automated mix-minus for telephone and remote feeds, each with IFB.



Integrity uses an array of state-of-the-art floating-point digital signal processors to perform its mixing, routing and other functions.



Each fader has a 10-character alphanumeric display. The display changes when another audio source is assigned, which can happen either manually or at a preassigned time.



PACIFIC RESEARCH & ENGINEERING

Circle (15) On Reader Service Card  
World Radio History



# Products & Services Showcase

For more information on the products shown below, circle the appropriate Reader Service No.(s) on the enclosed Subscription/Reader Service card or contact the advertiser directly.

## The Headphone Amp that Can ...



- Please your talent with plenty of power
- Mount easily at talent station
- Drive high or low impedance phones

The low distortion HSA-100 Headphone Amplifier mounts easily with four mounting holes in its heavy-duty steel front panel. It runs on a  $\pm 15$  to 18 volt power supply.\* Its discrete transistor output can drive impedances as low as 16 ohms! Input level is jumper selectable from -10 to +8 dBm. Ideal for custom applications — call or fax for details.

\* Power pack included (not pictured)

**bdi** Broadcast Devices, Inc.  
5 Crestview Avenue, Peekskill, NY 10566  
broadcastdevices@worldnet.att.net

Tel: (914) 737-5032 FAX: (914) 736-6916

READER SERVICE NO. 34

## AUDIOFAD Professional Studio Faders

### Low Cost Model 9000

Stroke lengths:  
104, 80 and 65mm  
Log, Linear or VCA

Spares available for all Audiofad products including 1040P and 1240P faders

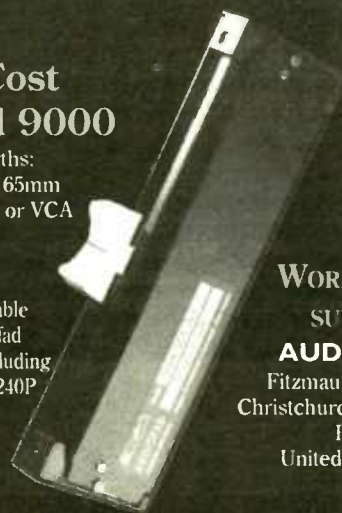

WORLDWIDE SUPPLY

**AUDIOFAD**  
Fitzmaurice Road,  
Christchurch, Dorset  
BH23 2DY  
United Kingdom

Tel: +44 (0) 1202 484358

Fax: +44 (0) 1202 499614

Mail: Internet: 101460.2463@compuserve.com

READER SERVICE NO. 58

Your Bottom Line Is Only as Good as Your Coverage. Shively Can Predict Your Coverage Better than Anyone Else.

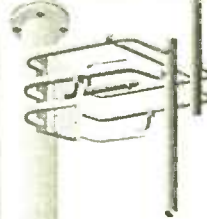

- 30 Years Experience
- Full-Service Provider
- Multi-Station Solutions
- FM & UHF Antennas
- Filters & Combiners

Shively Labs, because ...

... it pays to be heard!

P.O.Box 389, Bridgton, ME 04009 USA  
Tel.: (207) 647-3327 FAX: (207) 647-8273  
e-mail: sales@shively.com  
- An Employee-Owned Company -

READER SERVICE NO. 82

Buy simplicity, reliability and service

## EAS

Price \$1750.00

Equipment required for F.C.C. Jan. 1, 1997 deadline

Phone 614-593-3150

**GORMAN-REDLICH MFG. CO.**  
257 W. Union St. Athens, Ohio 45701

FAX 614-592-3898



- 5 two-way RS-232 inputs/outputs for computer, remote signboard & character generator
- 4 audio inputs on standard models (expandable to 6 audio inputs). All audio inputs & outputs are transformer isolated from encoder-decoder board.
- Automatic interruption of program audio for unattended operation.
- 4 line 40 character LCD display with LED backlighting
- 20 key keypad to program unit, set modulation level, set input levels
- Will handshake with automation equipment.
- 2 year warranty
- 2 minutes of digital audio storage (expandable to 4.5 minutes)
- 25 pin parallel printer port for external printer
- 52 terminals on the rear to interface with other equipment by removable plugs.

Web Site: [www.gorman-redlich.com](http://www.gorman-redlich.com)

◆ Also available: printers, weather radios, antennas for weather radios, crystal controlled synthesized FM digitally tuned radios, remote signboards, cables for interconnection, character generators.

READER SERVICE NO. 106

## S.C.M.S., Inc. Charlotte, N.C.

Low Prices - Experienced Staff  
New and Re-built R.F. and Audio

**THIS MONTH'S SPECIAL**  
**COMREX NEXUS ISDN CODEC**  
**TWO WEEK RENTAL -**  
**\$175/END**  
**CALL FOR EXTENSIVE LIST**  
**OF OTHER ITEMS IN**  
**OUR RENTAL FLEET**

You Know We Know Radio —  
Toll-Free 800-438-6040  
FAX 704-889-4540

READER SERVICE NO. 59

## Affordable Digital Automation

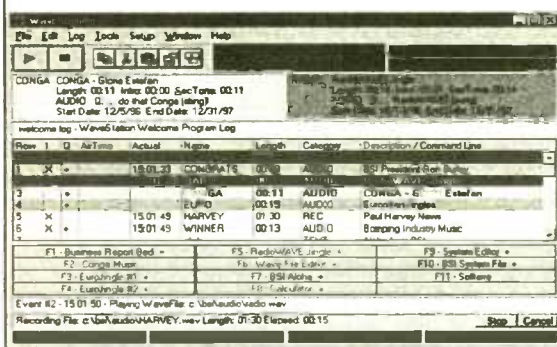

**EASY TO USE!**  
Audio on hard drive  
Interface with sat systems  
Import from traffic systems  
True "rotating carts"  
Smooth segues  
Voice Tracking

Menu driven, no config files!  
Playback & Record  
Full automated or live assist  
Uses standard WAV files  
Built-in Audio Editor  
Windows 3.1 or Win 95  
Time Sync & Time Speak

**BSI** Broadcast Software International **Only \$999**

[www.bsiusa.com](http://www.bsiusa.com) OR **888-BSIUSA1**

READER SERVICE NO. 35

## NEW LOW COST FM TRANSMITTERS & POWER AMPLIFIERS



### PRICES

Exciters	Power Amplifiers
10W.....\$1375	150W.....\$1,815
	300W.....\$2,750
	500W.....\$3,663
	1000W.....\$7,326

All of the above need just 10W drive

**CALL 408-448-3342**  
**FOR DETAILS**

READER SERVICE NO. 107



# E-100 a 'Sensible' Tool

► E-100, continued from page 17

The E-100 has some unique features, too. The microphone can run on conventional +48V phantom power or its two internal NiCad batteries. The NiCads are trickle-charged when the E-100 is phantom-powered, and become fully charged after 12 to 14 hours. The NiCads give about six hours of phantom-free operation, and the application notes state that one can use two 9V alkaline batteries to extended periods when no phantom power is available.

Naturally, one should not apply phantom power when using non-rechargeable batteries.

The batteries are required for operation

Because of this apparent "dulling," the result is less airy and more confined than a U87.

Recording engineer Mark Greenhouse borrowed the E-100 for his tracking session with the Hot Mustard Band.

He used it in front of a clarinet, alto sax and soprano sax. After placing the mic between the keys and the bell, 12 to 16 inches away, he reported that the E-100 sounded warmer than the U87 in this situation.

Greenhouse said, "In the blend of familiar mics, KM84, U87, and so forth, the Equitek had a distinct atmosphere — an ambience, a tonality. It didn't compete in the same range for the same aural

space and I found that useful."

In contrast, the U87 was brighter, clearer and less to his liking for this woodwind application. Greenhouse reported that the E-100 was "a useful tool

for a particular job."

In listening to DAT dubs of the soloed E-100 track and the U87 track, one could hear where the E-100 would be a sensible tool for reed instruments.

It diminished the sound of the keys clacking against their stops and the sharp overtones on the reed's resonance. The E-100 appeared to handle high input levels reasonably well too.

Overall, we found the CAD Equitek E-100 a mic with a mission: a very modest-priced microphone that demands to be used for its inherent characteristics: low frequency ambience, high output and good looks. When used appropriately, it is a good performer too.

■■■

For information, contact CAD in Ohio at (216) 593-1111 or circle Reader Service 50.



## Some may like the low-end ambience of the E-100.

— phantom power notwithstanding — and they provide extra current to the opamp circuitry during high-level acoustic transients. The internal electronics will power-off when the phantom power is removed, and for battery-alone operation this can be defeated by changing an internal jumper.

The E-100 has its relevant controls on its face: Power, High-pass and 20 dB switchable pad. Power must be switched on to use the mic and, as the E-100's output is higher than that of most other mics, the pad will be used more often than not.

CAD claims the mic's output is flat to down to 10 Hz, and they include a TEF-generated response sheet for each microphone. Our evaluation E-100 mic, serial 7467, according to their sheet, has a 2 dB bump at 5 kHz, and a -3 dB down point at about 12 kHz. Response at 20 kHz is down -6 dB.

### Out in the open

In our initial use as a spoken-word microphone, we found the hi-pass switch had to be engaged. To do otherwise made mud of the voice. The E-100's proximity effect compounded this effect.

We compared the E-100 to the Neumann U87, a microphone costing several times the E-100's asking price. The U87 was suspended in an isolating basket, the E-100 on a table stand. The active faces were side-by-side and rolloff for both microphones was engaged. We used familiar voices for our tests and fed the mics' output into identical Benchmark preamps. The signals were recorded into separate DAT channels for easy A/B comparison.

We easily identified the mics by sound alone. The E-100 has a consistently higher low-end ambience, almost a chest-cavity resonance. To my ear, this sounded like a colored warmth, and those using the E-100 for spot production will undoubtedly like this effect, if used properly.

The sound raises the point of taste. Some may like the clarity of a mic like the U87, and others will prefer the low-end ambience of the E-100. On the high spoken-word frequencies, around the sibilant hiss frequency, the E-100 is slightly duller, useful when one speaks with excessive sibilance.

# MASTER CONTROL

The world's finest on-air system.

Live Assist • Voice Tracking • Split Spot Feeds •



Hundreds of Cities Worldwide

Satellite Automation • News & Talk Radio Ready • Novell or NT •



(914) 723-8567 • www.rcsworks.com



## SHORT TAKE

## Two New Pro Denon Decks

Alan R. Peterson

Denon Electronics has two new products useful in both the on-air studio and the production room.

The DN-C680 professional CD player features a large jog dial and shuttle wheel for fast searching and precise cueing. The jog wheel can move through a CD frame-by-frame or in increments of up to 10 frames (1/8 second). An auto-space feature inserts silent spaces between cuts when dubbing CD cuts to tape. The DN-C680 has both analog and AES/EBU digital outputs.

Variable pitch of  $\pm 9.9$  percent is possi-



Denon Duo For Your Studio

ble, adjustable in 0.1 percent steps, and can be altered during playback.

Denon also has the new DN-M1050R MiniDisc recorder and player, which also includes a jog/shuttle wheel for cueing and editing. Cue signal points can be inserted into a recording to trigger external events and control other devices via a parallel remote terminal. An external PC-style keyboard can perform play, record and labeling functions.

An optional Hot Start feature allows up to 20 tracks to be loaded into memory locations and played back instantly.

For information on either product, contact Denon Electronics in New Jersey at (201) 575-7810 or circle Reader Service 51.

## 'Tales' in Paperback

► TAPE, continued from page 20

looked upon it as the end to the means of paying his dues and rising to the height of his craft. Now he calls the shots and cuts the tape. Not a bad life.

And he stands by every word he wrote. Years after his first efforts, it all remains true for present-day production directors forced to turn out "safe," assembly-line fluff.

## Impressions

The marketing guy inside me wished for a more contemporary title. RAP fans have come to know "Tales of the Tape" because most have saved back issues. To potential buyers, the tape reference seems dated, like "My Life on Spark Gap Radio" or "Methods of Gas Lamp Repair."

Many "soundbite" lines from the book would have made better grabbers. "Hey, I Gotta Eat Too" from page 128, "Tickle My Butt with an Ostrich Feather" from page 84 or "You're the Genius. I'm the Bum" from page 134 would certainly catch the eye.

Then a personal jolt: Chapter One is subtitled "Stories From The Trenches" and includes a caricature of Daniel and company in a fox-hole. RW published a similarly-named and artistically-festooned column penned by me from 1989 to 1995.

The parallelism was a little close for me, and when Daniel and I discussed this over e-mail, he was pained by the discovery.

Here was a guy who made his reputation with original ideas, rightfully scoring anyone who would lift his work and be rewarded for it. Then he finds out, whether coincidentally or unconsciously, his own book included an allusion to another radio writer's published body of work. I suspect it was enough to ruin his lunch for a day or two.

In spite of this, I can say your library is not complete without this book. Place it next to your books from Ty Ford and Bruce Bartlett. Those tell you what to do technically, but Dennis' book keeps you from spraying the halls of the radio station with lighter fluid on really bad days.

No less than Gary Owens wrote the foreword. The illustrations by Tony Distefano are reminiscent of classic cartoon art from Warner Bros., Preston Blair and Hanna-Barbera.

They perfectly complement the lunacy Daniel has been put through over the years. Fitting, too: Daniel is a comic book and horror movie fan from way back. As I said, he's one of us.

"Tales of the Tape: A Production Director's Odyssey" lists for \$19.95 (\$14.95 for NAB members) and is available from NAB Services at (202) 429-5373.

IT'S 100% RADIO

Succeeding in  
A NEW  
ERATHE NAB  
RADIO  
SHOWSeptember 17-20, 1997  
New Orleans, Louisiana

At The NAB Radio Show you can take charge of the new era in radio. Help control the destiny of your business and your career. This is radio's most exclusive event, focused on one thing only—your business, the business of radio! Plan now to attend The NAB Radio Show and...

- Supercharge your engineering skills in these cutting-edge certification programs:
  - AM Directional Antenna Workshop
  - RFR Workshop
  - AM/FM Transmitter Workshop
- Interact with the industry gurus on the issues and opportunities facing your station.
- Network with radio's movers and shakers.
- Make the business deals that will take you into the next century.
- Experience ground-breaking technologies first-hand.
- Meet face-to-face with the suppliers that are shaping the new era of radio!

## PLUS, you won't want to miss these exciting events:

- Radio's Opening Reception
- The NAB Marconi Radio Awards Dinner and Show
- The NAB Radio Luncheon and National Radio Award Presentation
- The NAB Career Fair
- And so much more!

## The excitement is building—Register Today!

## For more information:

- **WEB:** Point your web browser to [www.nab.org/conventions/](http://www.nab.org/conventions/) to register on-line or to receive up-to-the-minute conference, hotel and travel information.
- **FAX-ON-DEMAND:** Dial 301-216-1847 from the touch-tone handset of your fax machine and follow the voice instructions.
- **CALL:** 800-342-2460 or 202-775-4970. Want to exhibit? Call 202-775-4988

SUCCEED IN THE NEW ERA OF RADIO

## GET MORE INFO TODAY!

Fax this completed form to 202-429-5343.

Please send me more information on  Attending  Exhibiting

RW

Name \_\_\_\_\_ Title \_\_\_\_\_  
 Company \_\_\_\_\_ Call Letters \_\_\_\_\_  AM  FM  
 Address \_\_\_\_\_  
 City \_\_\_\_\_ State \_\_\_\_\_ ZIP \_\_\_\_\_  
 Country \_\_\_\_\_ Email \_\_\_\_\_  
 Phone \_\_\_\_\_ Fax \_\_\_\_\_



As seen in *Radio World*® and *Pro Audio Review*®

# Slick, Slim Mixer from *intelix*®



## The 8002MCB

is an 8-channel dual-bus rack-mountable mic/line mixer designed for broadcast, sound reinforcement, recording, ENG and studio applications.

Also available, the **MIX-BAG** from Intelix. This convenient package combines the dependability of an 8002MCB with the portability of a lightweight, solid-framed, cloth rack bag, providing mix engineers with compact, durable, high-quality audio performance and complete freedom of operation.

- Durable wood and cloth rack bag.
- On-board professional NICAD batteries power the device for up to ten hours between recharge.

## Small rackmountable

“When you need a small rack-mountable mixer to take with you in the remote van...you should look at the Intelix 8002MCB mic/line mixer.”

— *Radio World*  
Feb. 5, 1997

## For radio or remote

“It would be a natural performer in a radio studio or remote vehicle.”

— *Radio World*  
Feb. 5, 1997

## Unique

“In a world where one mixer manufacturer after another is turning out similar looking designs, the Intelix 8002MCB mic/line mixer is an interesting departure in design and a solid device to boot.”

— *Radio World*  
Feb. 5, 1997

## Tough

“Intelix apparently built the 8002MCB for tough environmental situations...”

— *Pro Audio Review*  
April, 1997

“Intelix’s 8002MCB mixer is a solid, no-frills, eight-input mixer, best suited in situations where space is tight and good performance is required at a low price.”

— *Pro Audio Review*  
April, 1997

## Other Intelix Products Available:

- Remotely controllable mic/line mixers
- Matrix mixers
- Zoned-paging
- Program distribution systems
- Remote controlled monitor mixer systems
- Automatic mic/line mixers

# intelix

Phone: (608) 831-0880 • Fax: (608) 831-1833

8001 Terrace Ave., Middleton, Wisconsin, 53562 USA

Email: [intelix@intelix.com](mailto:intelix@intelix.com) • Web Site: [www.intelix.com](http://www.intelix.com)

## Ask for it from these fine dealers:

Audio Broadcast Group

Continental Electronics

Audio Visual Recorders

Crouse Kimzey

Broadcast Supply Worldwide

Full Compass

Broadcasters General Store

Harris Corporation

Bradley Broadcast

Professional Audio Supply



# Home-grown 'Movie' Soundtracks

**Gowan Gray**

It did not take long after the debut of the Howard Stern movie "Private Parts" for morning jocks everywhere to decide to do their own "movie" parodies on their shows.

By and large, most were funny, but lacked an element of reality that would have made the production work very well: movie sound. Without it, the productions sounded like — well, *production*.

Talent continued to eat the mic just as in the main studio. Stock effects were merely dropped in, making the track sound like last week's car commercial.

An understanding of remote recording techniques — some that a few jocks may not at first fully appreciate — can add realism to these projects, and make you a more creative production person.

Lots of movie and television sound is done by booming a shotgun mic from overhead, normally on a lightweight pole that can be moved quickly.

Why would jocks find this disagreeable? Because it does not allow them to "swallow" the mic as they would in the studio. All that lovely proximity and compression suddenly is gone when the mic is moved to a position outside a jock's intimate performance zone.

But out here, the mic also picks up

indoor room tone or natural outdoor ambience.

Two scenes from "Private Parts" effectively demonstrate this technique. During the argument between Stern and his wife Alison, the soundtrack absolutely rings with real room tone. Note the outdoor ambience in the Frisbee scene in the park: real, real, real.

Your talent should know this is not the setting to deliver that big, throaty announcer voice. If the intent is to get a sound filled with realism, they should play the segment in a natural way.

Again, this could create anxiety for many jocks accustomed to the safety of the studio. Reassure them that you are

striving for a good, clean recording, not to make them sound like fools.

If talent begins to crowd the mic and return to studio technique — or worse, shout so the "faraway" mic can hear them — halt the take and reposition them. Don't let them handle the mic, or the project will quickly turn into an "interview," with gappy dialogue and sounds of mic movement.

## Ketchup for your mic, sir?

How about dinner scenes in movies where dialogue is delivered too softly to be believed? If the performer is not miked with a wireless body unit, a tiny electret is tucked into the floral piece or taped to the salt shaker on the table.

For radio, you need not be so elaborate. A simple omni lavalier mic — the type used by television anchorpeople — works well in hidden mic situations, or even as a group mic to record several people at once. Remember, you want this to be movie quality, not "studio quality."

To get a stereo field, use a stereo mic. It is possible to use two conventional mics in an X-Y, M-S or ORTF combination, but for the sake of simplicity, a prewired stereo mic turns in a good performance.

Record to DAT or MiniDisc rather than cassette. Strive for clean audio with good levels and without depending on a limiter to keep everything in line.

## Location is everything

Go to the park to get the sound of birds, breeze, cyclists. Cut tracks in an empty apartment for lots of room sound. Record in the bedroom, where that Posture-Pedic will act as a broadband absorber of some of that reflection.

Need a stairway effect? That's the place to record it.

Cut tracks in the HVAC room at your station if you need the sound of heavy machinery. The movie "Hunt For Red October" prominently featured the air conditioner at Disney World as the submarine engine.

Need a restaurant sound? Record at a table at a client's eatery. The owner would probably love being part of the action.

## In the mix

Once your "movie" tracks are ready, transfer them into the DAW to massage the overall feel.

The voice-over announcer doing the wraps is the one who gets the mic processing, the proximity ... all the neat stuff your main talent wishes he or she got. Tweak all the levels and add gentle compression so the "movie" tracks hit the meters as hot as the narration does.

Do corrective EQ now. Out "there" with headphones, it is incredibly easy to ruin a track with guesswork EQ.

Finally, apply a touch of limiting to the overall two-track mixdown. For the icing on the cake, have an intern add a badly-read "now playing" local tag with some shaky EQ on the mic.

If you really need to telegraph "this movie is fake," add stock projector noises from a sound effects CD and phone-filter the dialogue. But it is more of a creative challenge to make it sound *real*.

Stern might have done the movie, but the rest of us can have the fun.

Gowan Gray is a former radio production specialist, now involved in audio for cable television production. He can be reached c/o RW.

# 25 Years Strong!

**Inovonics** continues to meet the everyday needs of broadcasters the world over with sensible, top-quality audio-broadcasting products at down-to-earth prices.

## 222 - Asymmetrical AM Processor

Low-cost Compressor/Limiter/Filter assures NRSC compliance. Also available in several versions for international short-wave service.

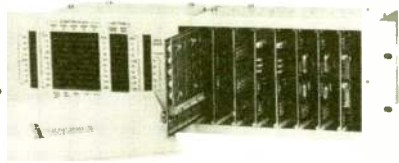

## 250 - Programmable 5-band Stereo Processor

Gated AGC, 5-band Compression and EQ, split-spectrum Limiting—all with colorless, quasi-digital PWM gain control. Manually pre-program several processing presets or place the unit entirely under RS-232 control.



## 255 - "Spectral-Loading" FM Processor

A very aggressive Triband-PWM Stereo Processor tailored for contemporary music formats. Broad parameter control over the gated AGC and 3-band Compressor/Limiter.

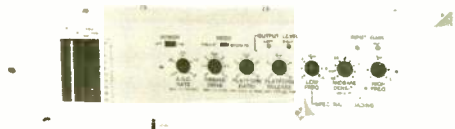

## 260 - FM/TV "Utility" Processor

Stereo "gain-riding" AGC and a split-spectrum Compressor/Limiter control average and peak levels. Ideal for TV-aural and budget FMs.

## 716 - "DAVID-II" FM Processor / Stereo Gen

A tight, smooth AGC/Compressor/Limiter coupled with clean Digital Synthesis of the multiplex baseband signal. Also features internal RDS/SCA combining and a built-in Composite Processor. Outstanding, affordable performance has made "DAVID-II" a popular and legendary product.



## 708 - Digital Synthesis Stereo Generator

A basic Stereo-Gen with impeccable specifications. Includes front-panel metering, internal subcarrier combining and a built-in Composite Processor.

## 530 - Off-Air FM Modulation Monitor

Accurate, easy-to-read display shows total modulation, pilot injection, stereo separation and crosstalk, RF signal strength and multipath distortion. Alarm outputs for overmodulation, carrier and program audio loss. Eight station presets facilitate quick modulation comparisons.

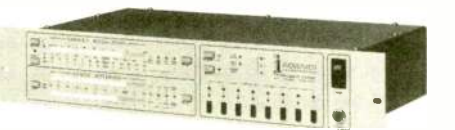

## 630 - FM "Relay" Receiver

A professional receiver for translator (re-broadcast) and other demanding off-air pickups. Features composite MPX and balanced stereo program outputs, synthesized tuning, selectable bandwidth, metering, alarms and remote control.

## 710 - RDS Encoder

A PROM-based "static" RDS/RBDS Encoder. Very easy to set-up and use *without the need for a host computer!* 15 separate memory "frames" may be programmed with station and program ID codes, service flags and radiotext messages. May also be used with a PC for song titles, promos, etc.



## 510 - RDS Decoder/Reader

Use with any mod-monitor to decode and display all RDS/RBDS data groups, and to measure subcarrier injection level with digital precision. An RS-232 interface allows data archiving and analysis.

## Coming Soon:

A Subcarrier Monitor for accurate measurement of SCA, RDS and high-speed data subcarrier injection and SCA deviation. Also: a new AM Processor with innovative features, and a "dirt-cheap" RDS Encoder that no station can afford *not* to be without.

## Inovonics, Inc.

1305 Fair Avenue • Santa Cruz, CA 95060  
Tel: (408) 458-0552 • Fax: (408) 458-0554

www.inovon.com



Circle (13) On Reader Service Card



# Running Radio

Hike the Value of  
Your Station!  
Page 34

Radio World

Resource for Business, Programming & Sales

May 28, 1997

INTERNATIONAL UPDATE

## Radio: Vital Link in The Canadian North

James Careless

For the indigenous peoples of the Canadian North, far from the mainstream stations that dominate southern Canada, radio is a lifeline.

With many of these people living in small, isolated communities scattered across the Yukon, Northwest Territories and northern Quebec, radio is the only medium that can affordably link native groups together through aboriginal languages like Dogrib, South Slavey and Chipewyan.

"I think it would be impossible to overstate the importance of radio in the North," said Barry Zellen, executive director of CKLB in Yellowknife, a native-owned non-profit station that

people in the community to do local programming, using our equipment and preempting programming that is in a different language," Zellen said. "The local station is the communications source for the community," he said. "Anybody that needs to get a message to anybody else will have it played. So the phones ring all the time, people get messages all the time. No one really listens to CBC in these parts, except on the hour they do the language programming."

### Public service information

Similarly, local community stations often transmit a wealth of public service information, said Wally Firth, a pioneering CBC North broadcaster who now lives in the small community of Fort McPherson, Northwest Territories.

For instance, "The nursing station would get on and they would promote good health. They would say when the dentist would be in and doing his visit, that the eye doctor will be in during this time, do this to make appointments and that sort of thing," Firth said.

Unfortunately, the actual power of the equipment being used to transmit these messages often is minuscule. For instance, in the case of CKLB, the station relies on 20 W transmitters that rebroadcast its satellite feed from Yellowknife.

Usually the equipment itself "is often located in one of the Dene band offices," said Zellen, "either in the back room or upstairs in a small attic space." Dene is the group name for the Native American people in the region. In addition to providing purely local communications,

See CANADA, page 30 ►



Photos courtesy of CKLB

Traditional Dene drummers

broadcasts throughout the Western Arctic.

"Historically it has been so close to people's hearts," he said. Before satellite communications arrived in the early 1970s, TV and telephone links between small native communities were virtually nonexistent.

"For those communities, it was radio that would provide them with information daily," Zellen said.

Even with the advent of satellites, the sheer cost of producing local television for such a scattered population means radio remains the dominant local medium in the North.

Radio remains the backbone of native communications in Canada's Arctic region, whether it is the state-run CBC North public service of the Canadian Broadcasting Corp., which offers both English- and aboriginal-language programming, or private non-profit stations like CKLB, which provides a "network feed" via satellite to 28 small communities, or small volunteer stations that insert their own shows on the local downlinked transmitters operated by CKLB.

"Several communities have radio societies where they train

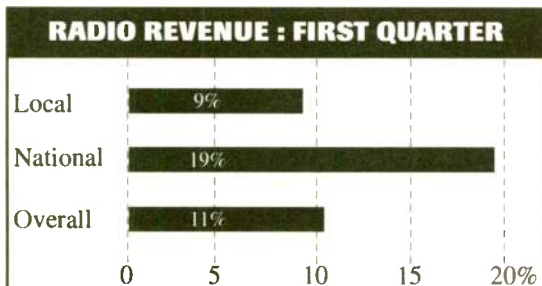

### Sales Growth Continues

Strong gains in national revenue helped fuel continued growth in radio advertising income during the first quarter of 1997. Combined local and national revenue was up 11 percent over the same period in 1996, as shown above.

By region, the biggest gains for national sales last quarter were in the East and Midwest; the best gains in local sales were in the Southwest.

In March alone, radio enjoyed a 13 percent overall revenue gain in comparison to March 1996, with a 21 percent uptick in national revenue and a 10 percent gain in local revenue. The figures are provided by the Radio Advertising Bureau.

## Brudnoy to Receive Freedom of Speech Award

Talk show host David Brudnoy will receive the "Freedom of Speech Award," honoring "continual efforts to preserve our essential right of free speech," from the National Association of Radio Talk Show Hosts (NARTSH).

The award ceremony will take place during the "Talk Show Host of the Year Award" luncheon on June 21 in Los Angeles, part of the NARTSH annual convention.

Brudnoy's show originates on WBZ(AM) in Boston. The CBS Radio Station Group promotes Brudnoy as a "libertarian/conservative," who "recently extended his prominence by revealing his recent struggle with AIDS."

"Brudnoy has demonstrated the talent and courage to address controver-



David Brudnoy

sial, often unpopular, issues," said NARTSH President Blanquita Cullum.

— Chris Hamaker



## Is Your News Feed Eating Away Your Profits?

United Press International's radio network is substantially less expensive than your current news feed!

**How?** For starters, UPI has no required packages. You pay for only the programming you need. With UPI you're never charged for special events coverage.

UPI offers news 24 hours a day, sports 16 times a day, and business all day long, including morning reports live from London, all without network commercials. We also have the industry's widest variety of one-minute features that are topical, timely and keep listeners interested.

Call now to find out how much you can save by gaining the UPI advantage.

UNITED PRESS INTERNATIONAL  
**UPI**  
(800)  
**503-9993**



# Far North Radio

▶ CANADA, continued from page 29  
Northern Canadian radio plays a pivotal role in helping native communities deal with the non-native southern government over major issues.

Make no mistake: "Here in the North, a lot of things are happening," said Judy Kochon, lineup producer for Dene languages at CBC North in Yellowknife.

For instance, in addition to sorting out native land claims, there is the impending division of the Northwest territories into two distinct regions — the eastern, mainly Inuit area of Nunavut, and the western Northwest Territories. This means the

people here "have to make a new government and new constitution for both new territories," Kochon said.

"And then we have different mines coming here, the diamond mines and gold mines," she said. In such circumstances, native communities have a big stake in making sure their traditional hunting, trapping and fishing grounds are not destroyed in the name of southern profits.

According to Kochon, the communities are isolated, and flying people in for meetings with local communities can be too expensive. Therefore, delegates from

different communities head south to lobby by government and business officials.

"The leaders then talk to us and get that information out to the communities through radio," Kochon said.

So potent is radio in this regard, that it has ended up serving both as "a breeding ground for political leadership, and a vehicle for political growth," said Zellen. "Radio has been at the heart of northern politics for some time."

No one knows this better than Wally Firth, who in the 1970s became one of the first natives elected to serve in the Canadian Parliament. Asked about the secret of his success, Firth said, "I was a very popular broadcaster. I enjoyed radio, and people let me know that they enjoyed listening to me, so my name was well-known."

Still, the fact that radio plays a vital role in native life does not mean it's well-funded. In fact, both CBC North and most, if not all, native-run stations survive only with government funding.

Ongoing cutbacks at the federal level have hurt both groups, leaving them scrambling for alternatives.

Publicly owned CBC North has had no choice but to live within whatever budget the government grants it. But non-profit stations like CHON-FM in Whitehorse, Yukon, do have the option of turning to the marketplace for ad revenues, and increasing revenues is what they are doing.

Said CHON Director of Radio Joanne Henry, "We had 100-percent funding for our programming, and now that has been cut. We are relying more on advertising."

Eventually, Henry would like to cut the government apron strings entirely and go fully commercial. "We are trying to get there," she said. "It will not happen soon, but that is our goal."

Unfortunately, market realities stand in

the way of that goal. Not only is the population of the Canadian North scattered across a vast region, but it is fragmented into several language groups. The result is hardly the sort of demographics that lead to huge advertising revenues and a healthy bottom line.

Native broadcasters such as Zellen at CKLB know this. That is why, when it comes to programming in native languages, "three-fourths of the information is in aboriginal languages and about 25 percent of the information is in English. What that allows us to do is maintain a wider audience," he said.

"Say we are broadcasting in Dogrib from 10:00 to 13:00; local news appears in both English and Dogrib, so people can get information in their language as well as in English," Zellen said.

Going commercial is a valiant attempt to cope with decreased government dollars, but it is a tough job in an industry that traditionally has been impoverished.

Referring to the economic health of CKLB, Zellen said, "Historically it has lost so much money that it has not had much trouble maintaining its non-profit status."

Still, if history is anything of a guide, the fact that Canadian native radio is tight for funds does not necessarily mean its survival is on the line.

The number of people who freely give their time as volunteers at the local level, plus the consistent dedication of those running the show, seems to indicate that radio will find a way to continue as a lifeline in the Canadian North.

James Careless is a frequent contributor to RW. He has written recently about CBS Radio coverage of the Super Bowl and the plans made by radio news networks for the inauguration of President Clinton. Reach him at (613) 258-1398.



South Slavey afternoon show host Sarah Gargan interviews an Elder at last year's Deh Cho First Nations annual general assembly in Kakisa, N.W.T.

## Now Radio Listeners Can "Watch"

Their All-Time Favorite Hollywood Stars and Movies

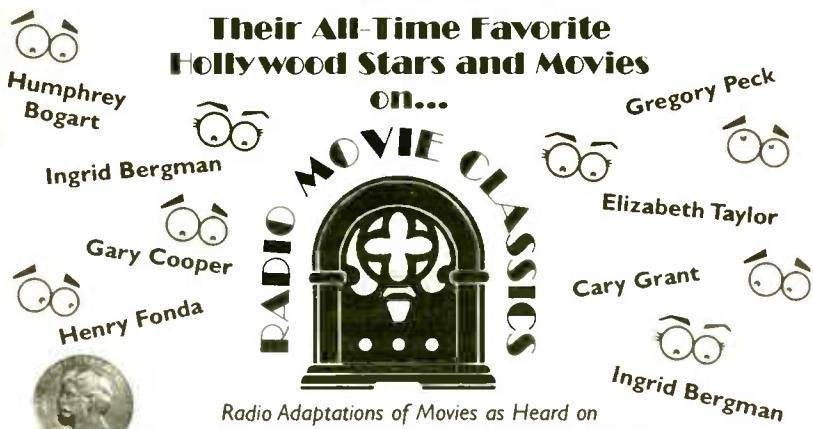

Radio Adaptations of Movies as Heard on The Peabody Award Winning Series, The Lux Radio Theatre

African Queen • Shane • The Maltese Falcon • High Noon • Little Women Laura • Casablanca • Spellbound • It's a Wonderful Life ... And Hundreds More!

Sixty-Minute Format • Weekly • Barter

For More Information and a CD Demo, Contact DAVID P. WEST AT 1-201-385-6566.

e-mail: dbasyndicators@prodigy.com

Another Fine Radio Program From Dick Brescia Associates

Circle (11) On Reader Service Card

## ATTENTION P.D.s

Schedule the best in "CLASSIC RADIO" with

# When Radio Was ...

Hosted by Radio Hall of famer STAN FREBERG, the man who drained Lake Michigan and filled it with hot chocolate



Five shows per week—54 minutes each. **BARTER, NO CASH PAYMENTS!**

For a free CD contact David West.

**DICK BRESCIA ASSOCIATES (201) 385-6566**

Circle (25) On Reader Service Card

## Out of the Comic Strips... Onto the Airwaves...



Superman • Batman & Robin • Tarzan • Dick Tracy  
The Lone Ranger and MANY, MANY more!!!

Thirty-Minute Format • Weekly • Barter

For More Information and a CD Demo, Contact DAVID P. WEST AT 1-201-385-6566.

e-mail: dbasyndicators@prodigy.com

Another Fine Radio Program From Dick Brescia Associates

Circle (48) On Reader Service Card



# Radio-Mercury Awards Will Honor Harvey

*Karmazin Says Radio Creative Has Improved; Cites Mercury Awards as Major Reason*

Creators of the most inventive radio commercials of the past year will be recognized for their work June 11 at the 1997 Radio-Mercury Awards.

Paul Harvey will receive the first Radio-Mercury Awards Lifetime Achievement Award, recognizing "the very best creative use of radio as an advertising medium by an individual or company."

The awards ceremony takes place in New York at the Waldorf-Astoria

Karmazin said in a statement.

The presentation of the Lifetime Achievement Award to Paul Harvey is expected to be a highlight of the night.

"He is among the very best communicators in the history of radio and he has proudly involved himself with the success of his sponsors," Gary Fries, president of the Radio Advertising Bureau and co-chairman of the Radio Creative Fund,

said.

"We sometimes forget the power of an individual and the human voice to

deliver a message. Paul Harvey is the epitome of that ability," Fries said.

Clifford Freeman, chairman and chief creative officer of Cliff Freeman & Partners, is the competition chair.

One of the five prize categories is Hispanic commercials.

Recording star Vikki Carr will join Hispanic radio leaders Raul Alacorn of the Spanish Broadcasting System and McHenry T. Tichenor Jr. of Hefstel Broadcasting Corp. to present the grand prize in the Hispanic competition.

— Chris Hamaker and Paul J. McLane

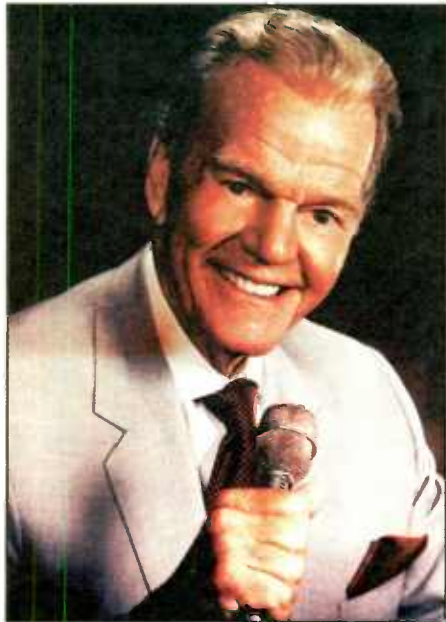

Honoree Paul Harvey



Presenter Vikki Carr

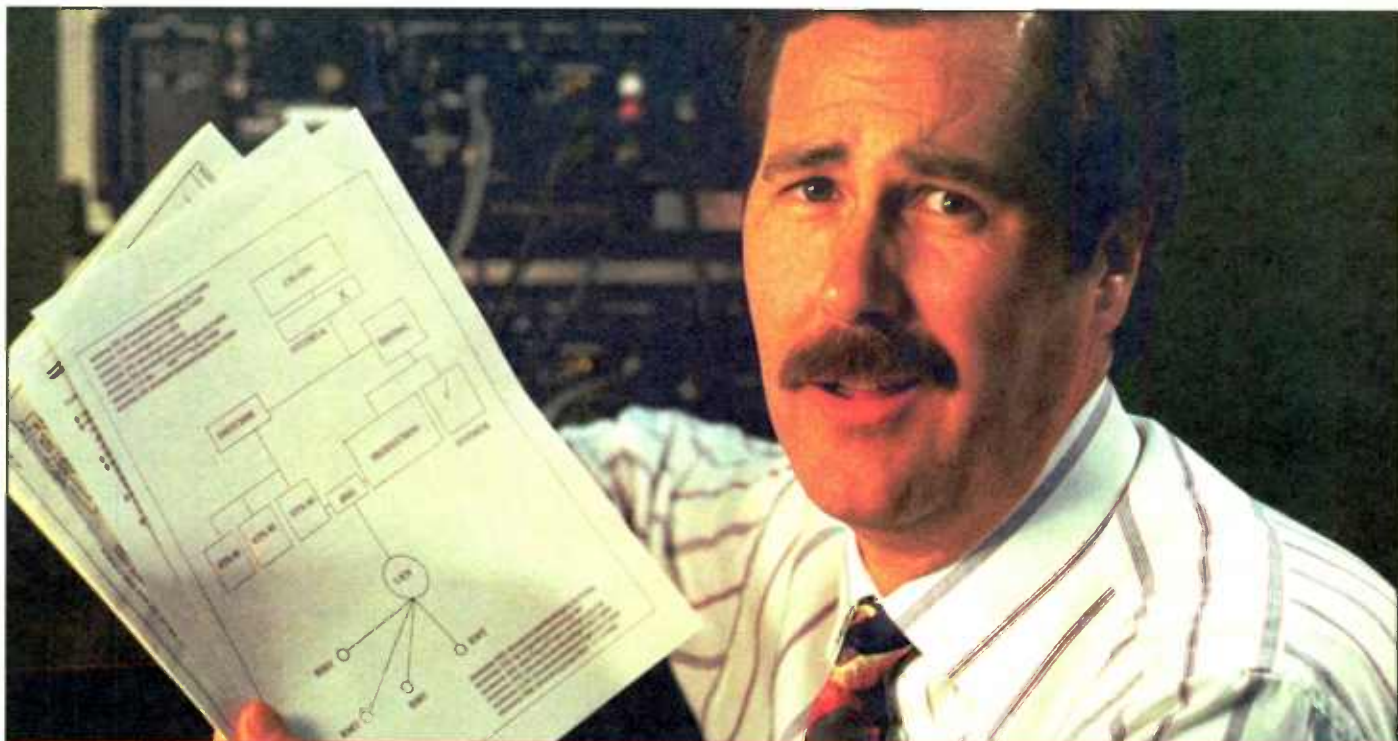

TRYING TO MAKE SENSE OUT OF DIGITAL AUDIO SYSTEMS?

## There is a better way!

It's not easy trying to understand the conflicting claims made by different manufacturers when you're buying a Digital Audio On-Air & Production System, whether a single, multipurpose Workstation or an integrated, multiple studio setup. At one end of the spectrum, you're faced with a wide variety of simple "Cart Machine Replacements," and on the other, products whose complexity confounds even the most seasoned broadcast engineer.

The ENCO DAD<sub>PRO</sub> Digital Audio Delivery System solves the problem! DAD is simply the most powerful On-Air & Production system available, yet its uncomplicated approach and inherent ease of operation makes immediate sense to any user.

- Intuitive On-Screen displays that are immediately familiar to operators. Optional Touchscreen makes operation quick and easy.
- Complete On-Air flexibility with various "Virtual Machines" for Live Assist, Automation, or Satellite Programmed operations. Interface to other equipment plus scheduling and billing packages. Seamless segue and voiceover transitions sound "Live" in all modes. Script capabilities can be included.

- Full production capabilities, including Graphic Cut & Paste Assembly Editing. Includes analog and digital inputs/outputs. Interfaces with most multichannel editing packages.
- Runs on DOS for proven speed, reliability, and compatibility with other equipment; not an operating system originally intended for multimedia applications. This is a professional tool meant to produce efficiency and profits, not entertain the staff!
- Operates on common off the shelf computers and network architecture. You won't be locked into proprietary hardware that may not be available whenever you need service.
- No monthly licensing fees. DAD is an outright purchase. Software upgrades are free for the first year.
- DAD is proving itself everyday in radio and TV facilities worldwide.



Call Your DAD Dealer or ENCO For Complete Information



24555 Hallwood Court, Farmington Hills, MI 48335 USA  
TEL: 800-362-6797 or 810-476-5711 FAX: 810-476-5712

Circle (26) On Reader Service Card



**NEW !!!**

# Digilink III-

## 4 x the power & On Sale !!!!



- **The #1 selling Digilink II has a new big brother !!!**
- **Digilink III has 4 times the processing power of Digilink II with...**
  - **Triple play capability (DL2 is dual play)**
  - **Dual audio outputs for On Air and Cueing (DL2 has one)**
  - **Do On Air & Production from a single workstation !!!**

Digilink III is a *NEW* multipurpose digital audio workstation for Live On Air, Production, and Automation. Fully compatible with the #1 selling and industry standard Digilink II, the Digilink III has four times the raw processing power of the Digilink II and features a second audio output for cueing an audio piece while playing on air.

The triple play and dual output capability of the Digilink III makes it ideal for very sophisticated Live On Air operation -*and*- makes it capable of operating an On Air & Production studio from a single workstation. For fast and complex live on air applications, the DL3 can play 3 files at once so that you can lay down a bed, play a phoner, and drop in a sound effect at the same time. Or, you can be playing on air with crossfade while independently recording, playing, and editing a phoner.

A unique capability of Digilink III is its ability to operate two studios from a single workstation. The most common application would be to use one workstation for both on air and production studios. The DL3 is placed in the production studio while a PCAT computer running Arrakis remote control software is placed in the on air studio.

The production studio has complete single play-record-edit capability while the on air studio can independently use dual play for on air. While not a redundant system, it does provide a dual studio workstation solution for under \$11,000.

To make the DL3 even more easy to use for air, a 99 button Gemini control panel can be added to the system for only \$1,195. It places hundreds of carts at the jocks fingertips and the files assigned to each button change to support up to 40 different jocks. The Smart\*Record feature of the controller even allows you to record a phoner at the push of a button. The DL3 will automatically trim the front and end of the phoner, and then you just push the button again to play it to air. The Gemini control panel makes the Digilink III workstation fast and easy to learn and use.



*The 99 button Gem-6CC control panel places hundreds of carts at your fingertips for only \$1,195*

The powerful Digilink III is fully compatible with Arrakis Digilink II and Trak\*Star workstations so that it may be easily added to an existing network.

*Call now to find out how this amazing new workstation can be made to work for you.*



*The 22,000 series console integrates the 99 button Gemini control panel into an easy to use console*

**for more information call... (303) 224-2248**

*in some areas, call (970) 224-2248*

# Sale !!!

DL3-600 **\$7,995**

(a \$9,995 value)

#1 IN  
STUDIO  
FURNITURE

#1 IN  
AUDIO  
CONSOLES

#1 IN  
DIGITAL  
AUDIO

**arrakis**  
SYSTEMS INC.

2619 Midpoint Drive, Fort Collins, CO. 80525  
Voice- 303-224-2248, Fax- 303-493-1076



## Audio Consoles

The stand-out #1 leader in reliable, high performance, digital ready consoles for radio, Arrakis has several console lines to meet your every application. The 1200 series is ideal for compact installations. The modular 12,000 series is available in 8, 18, & 28 channel mainframes. The 22000 Gemini series features optional video monitors and switchers for digital workstation control.

### 1200 Series Consoles



1200-5	Five ch	\$1,795
1200-10	Ten ch	\$3,495
1200-15	Fifteen ch	\$4,995

### 12000 Series Consoles from \$3,995

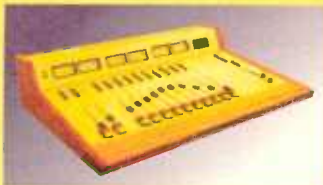

### 22000 Series Consoles from \$6,995



## Digital Workstations

#1 in digital workstation sales, Arrakis has over 1,600 workstations in use around the world.

As a multipurpose digital audio record-play workstation for radio, it replaces cart machines, reel machines, cassette recorders, & often even consoles. Digilink has proven to be ideal for live on air, production, news, and automation applications. Place a workstation in each studio and then interconnect them with a digital network for transferring audio, text, & schedules between studios. Arrakis is the #1 choice of broadcasters.

### Satellite Automation



### CD Automation



Use for Live On Air, Automation, Production, News & Scheduling



### Digilink & Trak\*Star Workstations

## Studio Furniture

With over 1,000 studios in the field, Arrakis is #1 in studio furniture sales for radio.

Using only the finest materials, balanced laminated panels, and solid oak trim, Arrakis furniture systems are rugged and attractive for years of hard use.

Available in two basic product families with literally thousands of variations, an Arrakis studio furniture package can easily be configured to meet your specific requirement, whether it is simply off the shelf or fully custom.

Call Arrakis to find out how easy it is to design and build your next studio.

### Desk\*Star studio furniture systems



### Modlux studio furniture systems

## Complete systems...

As illustrated in the Sony Worldwide Networks master control studio on the right (one of seven Arrakis studios in the Manhattan, New York complex), Arrakis can provide complete major market studios with Arrakis consoles, digital workstations, video-audio switchers, furniture, and system prewiring.

With a choice of several console lines; digital workstations for live air, production, news, and automation; and two major studio furniture product lines, Arrakis can meet broadcasters needs from the compact news studio to the major market network origination center. Complete Arrakis equipped studios can be found around the world from Tokyo, to Moscow, to Japan, to Tahiti. Call Arrakis today for your equipment or studio needs,

**Sony Worldwide Networks**  
Manhattan, New York





# Make Your Station Worth More

Sharon Rae

How can a broadcast manager make his or her radio station more competitive? In today's crowded industry, improving station performance is the key.

"I think AM and FM broadcasters should explore what they can do to enhance their facilities," said Jim Riley, attorney with Fletcher, Heald and Hildreth of Arlington, Va. "There are great opportunities working within the existing FCC rules, and many broadcasters, particularly I think many AM broadcasters, haven't fully explored their opportunities."

Riley said many could upgrade their

stations if they took the time.

Barry Umansky, National Association of Broadcasters deputy general counsel, agreed.

"Stations in large part have control over their destiny," he said. "There are a variety of ways where a station can improve its technical facility and to improve its competitive position, (including) main studio moves, changing cities of licenses, increasing power, increasing their calls of station, or moving to the expanded AM band."

Riley and Umansky were part of a panel discussion on that topic at NAB '97.

Linda Blair, chief of the audio services

division of the Mass Media Bureau at the FCC, said broadcasters have seen improvements in application processing.

"We have made tremendous strides in the last few years to speed up our processing," she said. "We realize that the applications radio broadcasters file are important to their businesses, and we try to move them along as quickly as possible."

Blair said she understands concern over delays in processing, and said her staff considers themselves in a partnership with those they regulate.

"The timeframes are not what we or the broadcasters would like them to be in every case, especially when engineering

matters are involved," she said. "But our engineering staff has gone down by 30 percent over the last four years, and it is very difficult to keep pace."

AM interference reduction agreements can make life easier for station owners. Blair and the panel attorneys concurred that such agreements were an under-used vehicle for improving an AM facility.

## Expanded band

The newly released expanded band allotment plan (RW, April 16) is on the mind of managers.

"Migration to the expanded band has real potential for improving service," said Blair. "Not only for the stations that migrate, but for other stations that will benefit from reduced congestion and interference in the AM band."

The new list of stations eligible to move to the expanded band is the third such list in four years. Will this be the last?

"Absolutely," said Blair. "I do think we have it right this time. I think it bears mentioning that the current allotment plan ... has an awful lot of similarities with the prior allotment plan. I think that goes to show that the errors we made were relatively minor in the grander scheme of things."

The expanded portion of the AM band consists of 10 new channels from 1610 kHz to 1700 kHz, enabling 88 AM sta-

**We have made tremendous strides ... to speed up our processing.**

— Linda Blair, FCC

tions to occupy the new frequencies.

"There is a question as to whether many eligible stations will bother to apply," Gregg Skall of Pepper and Corazzini of Washington said. "Some may feel that the expense of reconstruction does not justify the coverage improvement which might result."

Stations have until June 16 to file an application for a construction permit on their allotted channels.

## Info on the Web

Skall pointed to two other unknowns regarding the expanded band.

"The first is how quickly expanded band radio receivers will reach the general population, allowing for stations that migrate to the expanded to be heard at all," he said. "The second is whether in-band on-channel AM digital audio broadcasting will work."

"A question-and-answer sheet discussing the 'finer points' of expanded band station construction and operation has been sent to each broadcaster listed in the public notice," said Blair. "And a copy of the letter will be posted on the audio services division web page for those who are generally interested in the topic." That website is at [www.fcc.gov/mmb/asd/](http://www.fcc.gov/mmb/asd/)

On the FM side, managers can pursue better facilities in several ways, thanks to recent rule changes. According to Skall, they include upgrade by application, Radio Broadcast Data Systems (RDS), FM translator stations, FM booster stations, Class C3 FM stations, 6 kW power

See VALUE, page 35 ▶

**Scott Studios** Acquires **ELECTRIC WORKS**  
 You Get More Digital Choices from Scott than from Any Two Other Companies!



The Scott System is radio's top-of-the-line digital studio for music on hard drive. Its touch screen is the *easiest* and most powerful for live jocks.

AXS (pronounced ax'-sess) Pro is a live jock's dream, with more features than any other moderately priced digital system. Runs on Win95 and NT.

AXS is radio's premier digital unit at an affordable price. It runs satellites, CD and hard drive, has Power Fill, substitutes satellite voices and sounds great!

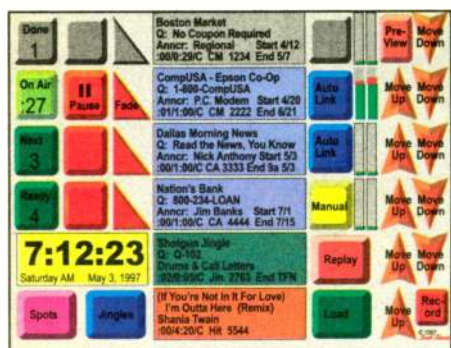

The Scott Spot Box hard drive digital has great audio quality like compact discs, but Spot Box looks and works like "carts"—at low "cart" machine prices.

The Scott Hot Box gives jocks 43 sets of 53 Hot Keys that instantly play sound effects, jingles and comedy. Priced less than "cart" decks.

Scott's Voice Trax in the jocks' lounge lets them pre-record a great show quickly. They hear song and spot starts and ends so their shows air smoothly.

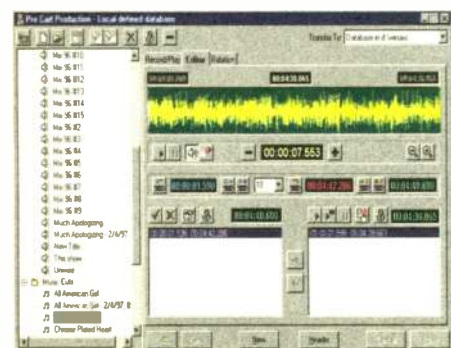

Scott imports production from any WAV digital editor and includes "Laser Blade™"—the best 2-track editor with rotations, start/end dates and times.

WinNews lets any number of news workstations record and edit audio and text on one screen. Complete newscasts are easily sent to the air studio.

Scott Studios delivers your best digital audio systems, with more features and more choices in all price ranges! You get unsurpassed technical features, more installation help and training, and digital audio's largest 24 hour 7 day support staff.

**Scott Studios** Corp.  
 13375 Stemmons Freeway, Suite 400  
 Dallas, Texas 75234 USA  
 (972) 620-2211 FAX: (972) 620-8811  
 (800) 726-8877



► VALUE, continued from page 34  
for Class A FM stations, FM contour protection spacing, and FM city of license change.

**Make no mistake**

Blair suggested that managers submit an application, as clean as possible, to avoid detours in processing.

"If information is missing or inconsistent, we end up having to communicate with you, and that slows things down."

Electronic filing appears to be in the FCC's future.

"...(W)e have been given a very large chunk of money to move us toward electronic filing," said Blair. "I think that within the year, you will find that many types of applications will be filed on an electronic basis. That will kick your application back to you if it's missing information at least to some extent ... It will save you time and us time in the long run."

Roy Russo of the law firm Cohn and Marks of Washington warned of the "devil in the details."

"As it is with most matters of this sort," he said, "every case seems to produce some new issue heretofore unanticipated and therefore unresolved by the FCC and the staff."

The FCC's process on eliminating the freeze on some station upgrades was another topic of interest and concern.

"Some FM upgrade applications are mutually exclusive with other applications," said Blair. "These applications have been 'frozen' because the commission's criteria for selecting among mutually exclusive applicants has been invalidated by the Court of Appeals."

Bill Kennard, the FCC general counsel, recently pointed to pressure from Capitol Hill to auction the spectrum involved in these mutually exclusive cases.

"Assuming that Congress does not require that result, and the agency develops new criteria instead, Bill indicated that we would announce those criteria by mid-August," said Blair. "Until then, we are encouraging parties to settle if at all possible."

**Is it worth it?**

"The FCC has rules and policies in place which provide the means for radio broadcasters to increase the power, coverage and value of their AM and FM stations," Riley said. "Many licensees have not examined the possibilities available under these procedures, although an investment in that examination may produce a handsomely payoff."

Riley emphasized the value of an upgrade.

"Your station may be performing satisfactorily," he said. "There may be no apparent need to consider a significant upgrade of facilities ... On the other hand, your station may today be worth one million dollars. It is certainly possible, based upon recent experience, that a major improvement could multiply that value dramatically."

The sooner, the better, Riley suggested.

"If you wait, upgrades by others may foreclose the future possibility for upgrade of your station."



Sharon Rae is a radio news director in Lansing, Mich., and principal of Rover News Services, as well as a regular contributor to RW. Reach her via e-mail at scohon@aol.com

# Meters, Meters, More Meters

**Ed Montgomery**

*This is the 10th installment in a multi-part series intended "to make the new generation of FM broadcast station managers aware of the equipment for which they are responsible and to help them periodically review how the equipment is operating." The previous part appeared May 14.*

Transmitters and some remote control systems still employ analog meters. All individuals responsible for the operation of the broadcast facility must understand how to read meters accurately.

Digital readouts are quite simple and easy; however, it is important to be able to read the analog meter, understand decimal conversion when necessary and to know whether the reading is positive or negative.

**Basic definitions**

Most readings will involve voltage, current or power. Voltage is electric potential which must be developed to create current or electron flow. Voltage is the creation of a positive and negative difference. When a conductor is connected between these differences, current will flow until the difference balances out. The positive and negative difference is measured in *Volts*.

Current is the movement of electrons and is measured in *Ampères*.

Power is a measurement of opposition to electron flow in the system and the work produced inside the system. Power is measured in *Watts* and is derived from Voltage times Current.

It takes a certain amount of energy to create radio waves. If you were to compare this to conventional work, 746 watts equals one horsepower.

**Proper terms**

Voltage, current and power have several electronic designations. Depending on what manual or book you are reading, the following symbols will be used:

- Voltage: the letters V or E (Electromotive force)
- Current: the letter A for Ampere or I (Intensity of electron flow)
- Power: the letter W for Watts

Readings are taken on the scale of the meter. This is the face of the meter which includes numbers and incremental markings or graduations. Understand exactly what is being read. It is often convenient to simplify the meter by omitting zeros. Prefixes are then used to convert the meter reading to the actual value.

Prefixes normally used for broadcast transmission equipment are:

- Milli, or one-thousandth
- Kilo, or times one thousand
- Mega, or times one million

Thus, a meter may display a reading of 10, but if the meter has "mA" printed on it, the actual reading would be 10 milliamperes. Meter displays normally indi-

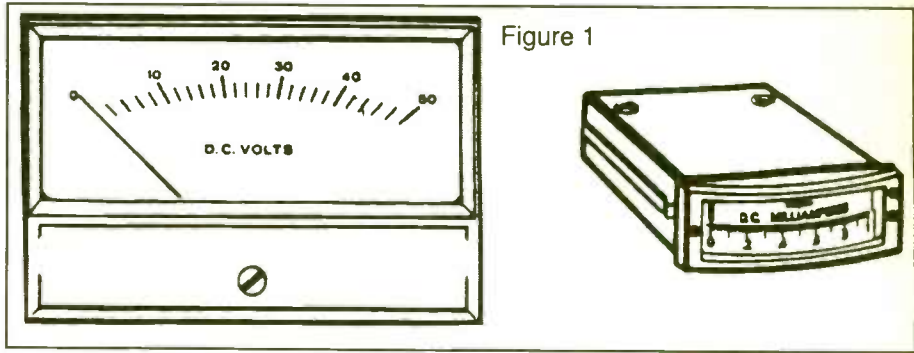

Figure 1

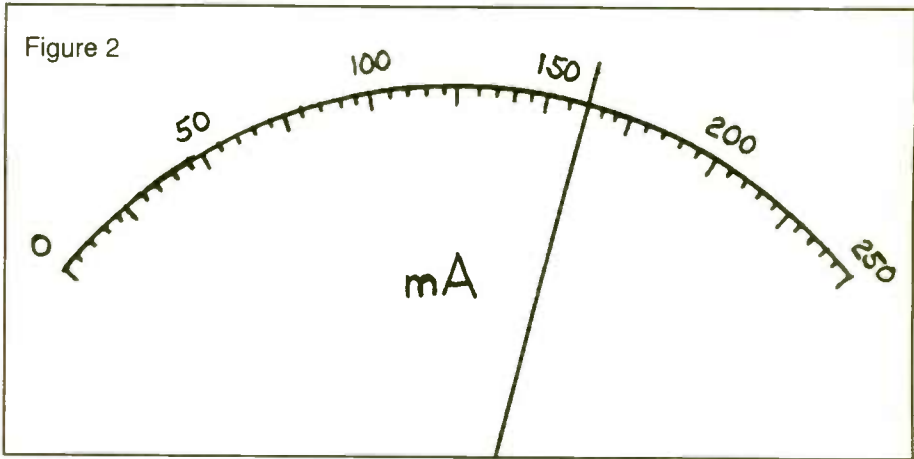

Figure 2

cate clearly whether it is volts, amps or watts that are being measured.

Analog meters can be constructed in a traditional manner with the needle sweeping across the face, or edgewise. See Figure 1.

You also should know how to read

between the numbers on a meter.

Figure 2 shows a meter with a scale from 0 to 250. The graduations on the scale between the numbers are important to understand.

Note that each space BETWEEN numbers See METERS, page 37 ►

**THE LINEAGE CONTINUES...**

## Today's 1900 Series Antenna Monitors



**FEATURES**

- 2 to 12 towers—Modular construction
- Fully Compatible with AM Stereo
- Suited to diplexed arrays
- Moveable Control & Display Panel option
- Jitter-free "True Ratio" Display
- Unambiguous positive or negative angle sign display
- Continuous remote outputs of all phase and ratio measurements
- Microprocessor remote control system compatibility
- From the world's leading antenna monitor manufacturer

For complete information, contact your authorized Potomac distributor, or



932 Philadelphia Avenue • Silver Spring, MD 20910  
Phone: (301)589-2662 • FAX: (301)589-2665

...THE STANDARD FOR THE NEXT GENERATION



# Products & Services Showcase

For more information on the products shown below, circle the appropriate Reader Service No.(s) on the enclosed Subscription/Reader Service card or contact the advertiser directly.

## Take Control Via Telephone



New Features and Rackmount Chassis! \$399 List

### DC-8A Dial-Up Remote Control

- Control, monitoring and programming via touch-tone® telephone
- Control 8 relays and monitor 8 status/pager alert inputs
- Activate up to 3 pagers with the pager alert function
- Beep tones for input and relay status
- Relays retain prior state on power loss and restoration
- Configure relays for latching, interlocking or sustained closure as long as the associated key is pressed
- Auto answer with programmable access code, number of rings and defeatable CPC control (unit hangs up when caller hangs up)
- "Busy" input disables auto answer feature
- Built-in audio hybrid with front panel audio level controls allows you to send and receive audio while controlling the unit
- LEDs for DTMF detection, Off-hook status, ring signal and power
- All input and output connections via screw terminals

Voice 360 428 6099 **BROADCAST**  
Fax 360 428 6719 **tools inc.**

E-mail: [bt@broadcasttools.com](mailto:bt@broadcasttools.com) Internet: [www.broadcasttools.com](http://www.broadcasttools.com)  
READER SERVICE NO. 83

## Protect & organize WITH QUALITY CASES MANUFACTURED BY ELLIS

The best protection for your broadcast equipment



TEL 800-466-3351 **Ellis COMPANY INC.** FAX 317-635-5140

- Tough, hard-shell shipping and carrying cases
- Durable, lightweight padded zipper cases
- Our lifetime warranty endorses our position on quality

### QUALITY MADE IN THE USA

Dealer inquiries welcome

READER SERVICE NO. 60

## Solid State, FM Broadcast POWER AMPLIFIERS

**B-1000** (to 1250 watts)

**B-600** (to 660 watts)

**B-300** (to 350 watts)

Connect the antenna

Connect the exciter

Connect the a.c.

..... Walk away

### P.A. Modules

50W, 150W, 300W, 500W, 700W  
In stock for immediate delivery.

WE OFFER REPAIR SERVICE FOR MMD/AMT MODULES



**Silicon Valley  
POWER**  
AMPLIFIERS

The RF People

115 Phelan Ave., Unit 10, San Jose, CA 95112

1-800-986-9700 or Fax 1-408-986-1438

READER SERVICE NO. 84

## THIS IS A TEST!

### Southern Gospel Music is...

- something you once heard on the transistor radio at your grandmother's house
- popularized by ladies with strange hair-dos
- an entertaining niche format that can make you money

(If you chose "c", pat yourself on the back for looking forward not backward)

### Solid Gospel is...

- ❖ one of the fastest growing satellite music networks in America
- ❖ entertainment-focused 24 hours a day all music format
- ❖ positive, energetic & uplifting southern gospel music
- ❖ incredible audience response with exploding popularity
- ❖ growing advertiser success stories from Nashville flagship station
- ❖ currently in 110 markets

1-800-742-3969

**Solid Gospel**  
Heaven's Music Reaching America

READER SERVICE NO. 85

## Get rid of your %\$#@& patch bays and try this for a switch



Do your audio routing through a Zercom Patch Switch system. Easy to install and use, a Patch Switch system provides you with front panel access to an unlimited number of input sources (by bussing units), Stereo or Mono selection, Phase reversal, signal summing, and a PCB that's set up for easy installation of audio pads. The enclosed audio switches have been tested to over 1,000,000 cycles for dependable performance.

And best of all... it's a Zercom product with a two year warranty.



### The Zercom 'PS-2' Patch Switch

**\$379.00**

P.O. Box 84, Zercom Drive  
Merrifield, Minnesota 56465-0084  
218/765-3151 - Fax 218/765-3900

Available through all major dealers

READER SERVICE NO. 108



## just PRESS THIS BUTTON and 'TALK'

### Talk Show Telephone Systems with a Difference.

Do you need to...

- Save money on systems and phone lines? Have flexible screening capabilities?
- Allow for expansion to multiple studios? Integrate all your phones and intercoms?
- Have a great sound, day after day?

### Modular Integrated Telephone Systems from IDI

MITS features include three users per studio (talent, screeners, or producer each with a private off-air line), dedicated screener positions and built-in screening technology, on-air 5 way conferences, simultaneous multiple caller handling, several work surface options and flexible system configurations. Capabilities like 15 lines/studio, expansion capability to 30 studios, (free) user upgradable software, line sharing, networking and more are all built right into the system. Best of all, MITS is absolutely the friendliest, simplest system to use and own.



**Innovative Devices, Inc.**  
1-800-661-2881 e-mail [info@innovadev.com](mailto:info@innovadev.com)  
web <http://www.innovadev.com>

Call us: We'll help you find an integrated talk show solution that will work for you.



READER SERVICE NO. 109

### The CircuitWerkes DTMF-16 TouchTone Decoder



#### Inexpensive & Convenient Control

- Decodes all 16 DTFM tones.
- Bridging input & high current opto-isolated outputs.
- Jumper selectable beep-tone acknowledges commands.
- Momentary or Interlocked Latching output modes.
- New, two-tone decoder & anti-falsing filter improve reliability & versatility.
- Combine with an AC-2 auto-coupler for an economical dial-up remote control.

The DTMF-16 is perfect for interfacing networks to your automation, controlling remote satellite receivers, repeaters, etc. With a list price of only \$199, the compact, light & rugged DTMF-16 can be put almost anywhere to provide the remote controls that you need. For more info, contact your favorite broadcast supplier or call us.

### CircuitWerkes

6212 SW 8th Place  
Gainesville, Florida 32607  
(352) 335-6555 / fax 331-6999



READER SERVICE NO. 61



# Read 'em With Care

► METERS, continued from page 35 has 10 marks. Each mark on the scale is equal to five units. Because milliamperes are being read (note the mA), this meter is reading 160 mA.

Figure 3 illustrates a scale extending from 0 to 50. Each graduation equals one unit and the meter is reading volts.

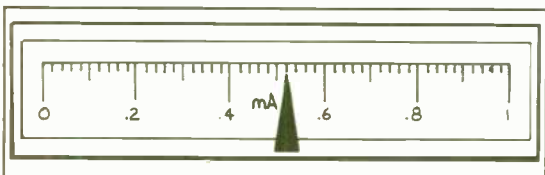
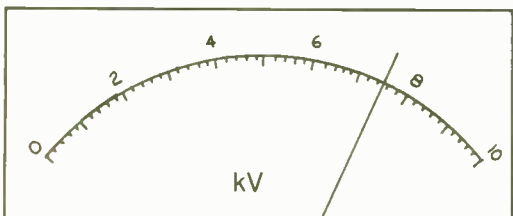
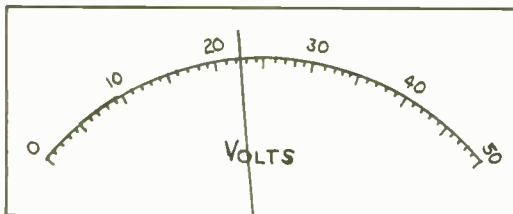

Figures 3-5 (top to bottom)

0 to 10. Each graduation is equal to two-tenths (0.2) and only even numbers are printed on the scale. The larger, unnumbered graduations halfway between the printed numbers represent odd numbers. In this illustration, the needle is between the printed 6 and 8 and clearly to the right of the unnumbered line indicating 7.

Another estimation is in order.

The reading is 7.5, and because the meter is reading kilovolts, the measurement is 7,500 volts. It is important when relating what is being read to the technical staff.

Figure 5 is an "edgewise mount" meter scale. In this case, the meter needle will move horizontally across the scale. Applying the above, you will see this meter is reading .52 mA.

### Watt?

The wattmeter is straightforward to read. Usually it is matched to the power of the transmitter and reads forward and reflected power. This provides information about the transmission line or antenna. Out-of-phase reflected power will reduce the radiated power and cause the transmitter to operate inefficiently and potentially cause damage.

The operating log of the transmitter requires that the final amplifier voltage and current be recorded at intervals defined by the licensee, often every two or three hours. Unattended monitoring systems can sample and record readings far more frequently than this and notify the person in charge if the station exceeds frequency tolerance, modulation levels or licensed power (5 percent above or 10

Because the needle does not line up with any printed mark, we must estimate a reading.

When reading meters like this, position yourself directly in front of the face of the meter. Viewing it from the left or right results in parallax error and produces an incorrect reading. The reading in this illustration is between 22 and 23, so the estimated reading is 22.5 volts.

Figure 4 illustrates a meter scaled from

## National Radio Ranks Low in Car Ad Sales

The third-largest advertiser for national radio, the automotive industry, spends less on radio than it does on most other forms of major media. National



radio ranks second from the bottom, with only 2 percent of the auto industry's budget allocated to it. These findings were reported in an Interep analysis of the automotive industry.

Cable, ranked just above radio, brings in twice the percentage of ad dollars as does national radio.

Ad dollars are not following listening patterns. A 1995 Arbitron/Radio Advertising Bureau survey of people who bought a new car indicated that, between 6 a.m. and 6 p.m. on weekdays, they spent more time with the radio (46 percent) than with television. When the rest of the day was factored in, time spent with television jumped to 52 percent, and radio dipped to 33 percent.

Still, why does the auto industry spend only 2 percent of its advertising money on radio, a medium with which

consumers spend one-third of their day? The numbers suggest that radio has a marketing problem before it.

Donna Reichle, media relations manager for the National Automobile Dealers Association, said, "I think automobile dealers, rightly or wrongly, think radio ads are effective in keeping the dealership's name in the public. But ... dealers think that when a consumer sits down to buy a new or used car, they sit down with the Auto section ... and really study what each dealer has to offer in print."

Acknowledging the importance of auto advertising to radio, Michele Skettino, research director of marketing and communications at Interep, said, "They feel that radio works. They're willing to put some money into it. We feel it can do even more for them if they just allocate a few more percentage points, which are worth hundreds of millions of dollars."

— Chris Hamaker

percent below authorization).

Usually, the readings taken are for plate voltage and plate current, or collector/drain voltage and collector/drain current. The power of the radio signal is a factor of these two parameters, along with the efficiency factor.

The efficiency factor is established by the transmitter manufacturer and is used when calculating power by the "indirect method": the final amplifier's DC voltage multiplied by the current, times the efficiency factor, or:

$$W = V \times I \times \text{Efficiency Factor}$$

**Here is a sample calculation, using the indirect method.**

**Collector Voltage: 105 Volts  
Collector Current: 25 Amps  
Efficiency Factor: 88 percent**

$$105 \times 25 \times .88 = 2310$$

**Transmitter Power is 2,310 W or 2.31 kW.**

Efficiency is a percent figure which must be converted, so 75 percent becomes .75. This gives the transmitter power, but this is not the same as the

### Are you involved in running a radio station? You should know how to read meters.

effective radiated power, which must take into account antenna gain and transmission line loss.



Ed Montgomery is lab director at Thomas Jefferson High School for Science and Technology in Alexandria, Va., and a part-time radio engineer.

He also taught college-level broadcast engineering technology and has written educational columns for RW. Contact him via e-mail at emontgom@lan.tjhsst.edu

## STATION/STUDIO SERVICES

**427 SOUND EFFECTS \$89.00**

For a 5-CD set with a 30-day money-back guarantee.

*Take an extra \$10 off if you mention this*

ad! Send \$79 to Ghostwriters 2412 Unity Ave. N., Dept. RW Minneapolis, MN 55422

For credit card orders call **(612) 522-6256**

READER SERVICE 66

**BUY-OUT MUSIC — \$49**

82 :30 & :60 music beds for ... \$49  
328 :30 & :60 music beds for ... \$198  
120 production effects "Zings, Zaps and Zoodads" for ... \$99  
122 New Lasers & Sweepers for ... \$99

For FREE DETAILS on production music, sound effects, call

**Ghostwriters (612) 522-6256**

READER SERVICE 66

1012 HIT SONGS FROM 1980-1995  
1229 HIT SONGS FROM 1954-1969  
545 HIT SONGS FROM THE 70's  
819 Kickin' COUNTRY HITS  
ON CD FOR ONLY \$599 EACH  
(per set plus shipping)

For complete track listings NOW go to web site: <http://radio-mall.com> or Email: [mediamall@aol.com](mailto:mediamall@aol.com)

Phone or FAX Ghostwriters at 612-559-6524  
Or write Ghostwriters 2412 Unity Ave N., Dept RW Minneapolis, MN 55422-3450

FOR RADIO BROADCAST ONLY!

READER SERVICE 90

## Radio Station Data Base

**100% CASS Certified!**

Addresses, Formats, Phone, FAX Market Size, Ratings & More!  
Also: Group mailing to GMs, PDs, SMs & CEs.

**The Radio Mall  
1-888-97-RADIO  
TOLL FREE**

READER SERVICE 114

Are you reading someone else's copy of Radio World?

If so why not apply for your personal free subscription?

Simply complete the subscription card & return it to us! You'll never have to risk missing an issue of

**Radio World**

We BUILD INTERNET WEBSITES for stations just like yours.

**GET ONLINE NOW!**

**mediacasting.com**

Internet marketing services  
pob 1736 • fond du lac, wi 54936-1736 • 414.926.9620

READER SERVICE 113

### ATTENTION PROVIDERS!

Promote your services to Radio World's 18,000+ readers. Reach Radio Station and Recording Studio owners/managers and engineers with your message. For information on affordable advertising call Simone at 1-800-336-3045, extension 154.



## GUEST COMMENTARY

# Peanuts or Pirates, Make 'em Legal

**Kent Waterman**

Recent coverage about the Rev. Rick Strawcutter of Adrian, Mich., (RW, Jan. 8 and April 30) goes to the heart of a critical, yet unresolved issue that should concern broadcasters throughout America. "Peanut power" stations — under 100 W — plainly have the right to exist. For the NAB and the FCC to deny that right is to run counter to what freedoms we think we have.

In these days of deregulation and massive change in radio, it's time to come to terms with low-power, unlicensed local operations such as Strawcutter's. All can

be accommodated, but only if an important few wish it.

I ran into similar problems 50 years ago as a kid of 12 back in the farming community of Amery, Wisc., (pop. 1,700). My souped-up phono transmitter was designed only to play through our in-home AM radio. With a good antenna, though, and some customization, it was received evenings many, many blocks away.

Amery, 60 miles east of Minneapolis-St. Paul, lacked a local station. It was just not big enough. We were beholden to the behemoths of 'CCO, KSTP, WDGY, WLOL and others in the Twin Cities.

Local advertisers, burgeoning with post-war ad budgets, had nowhere to spend them except our weekly newspaper.

That is, until this kid of 12 got on the air evenings after dinner.

## Pre-teen pirate

It didn't take long for the sales manager of the Amery Ford Motor agency to contact me. Ernie West had an unusually large allotment of new 1950 Ford sedans to sell that fall, yet still had the 1949 models on the lot. He laid down \$10, saying, "Let's put Amery, you and my '49 Fords on the air." I don't recall now just how we produced those spots, what with

an uneditable Recordio disc and RCA wire recorder at our disposal, but we did. And they were hits! Ernie claimed he sold a car that week, thanks primarily to "being on the radio."

Well, news travels fast in a small town. By Thursday, our weekly "Amery Free Press" ran a short clip, with a photo of a tow-headed kid at the mic, spinning discs, trying to sell Ford cars. The next week, one afternoon following school, I was greeted on my doorstep by a serious man in a dark suit, briefcase in hand, wanting to see my transmitter.

That investigator from the Minneapolis FCC Field Office was as embarrassed by the situation as I. He had to travel 60 miles out, 60 miles back to see this reported illegal station run by a kid. I couldn't answer his questions about ERP or ground planes: what does an untutored kid know about a transmitter, other than it worked? I didn't blame him for taking me off the air, nor did I blame the laws governing him.

I could blame nothing but the seductive power of radio, itself.

That small town needed a radio station. Who cares that Amery wasn't "big enough" to support one? Ernie West knew first-hand the value of being heard on the air. It helped to sell a car. What better proof of radio's power?

In the ensuing half-century in the business, I never had an easier sale than old Ernie West, nor a more avid fan of local radio advertising. The big boys at 'CCO or KSTP couldn't have helped Ernie sell, even if he could have afforded them. Folks just didn't drive 60 miles then to buy a car, no matter how well the spots were produced. The magic for Ernie, and for me, was that we could be heard locally, talking to and with the people we saw every day.

Strikes me there's more than a bit of the fight Pastor Strawcutter has at Radio Free Lenawee in Michigan, or that of Steve Dunifer at Free Radio Berkeley.

## The role of NAB

I imagine a city as large as Adrian, Mich., has one or more commercial stations. Certainly Amery has had a viable station for some years. As one who trod both country roads and city streets selling time and producing programs, I wish these stations well. I know it's a tough job. But, too, I know smaller stations don't like competition. Rightly or wrongly, they feel any competition for the listening ear — commercial, religious, counter-culture, whatever — cuts into their prospective audience. On this issue, they're sometimes irrational.

That's why this country doesn't license stations under 100 W. Plainly, the local operations, wanting exclusivity to their franchises, continue to hold sway with the NAB and, by extension, with the FCC.

Detroit and Toledo stations worry not that Strawcutter exists, anymore than KGO Talk Radio in San Francisco, with \$30 million-plus billed last year, worries about Free Radio Berkeley across the Bay. These pros know their competition; they're smart enough to deal with it head on, via format, sound, ratings and the rest. They're successful BECAUSE they compete — outsmarting the competition instead of trying to restrain it.

I, too, believe in an NAB responsive to its membership. But when its small local members are so anti-competitive as to effect a clear monopoly, then the NAB

See PEANUTS, page 39 ▶

**Efficiency: (e-fish'en-see) n.** 1. the most effective use of available resources; 2. great things in small packages; 3. Crown's new FM 2kW amplifier.

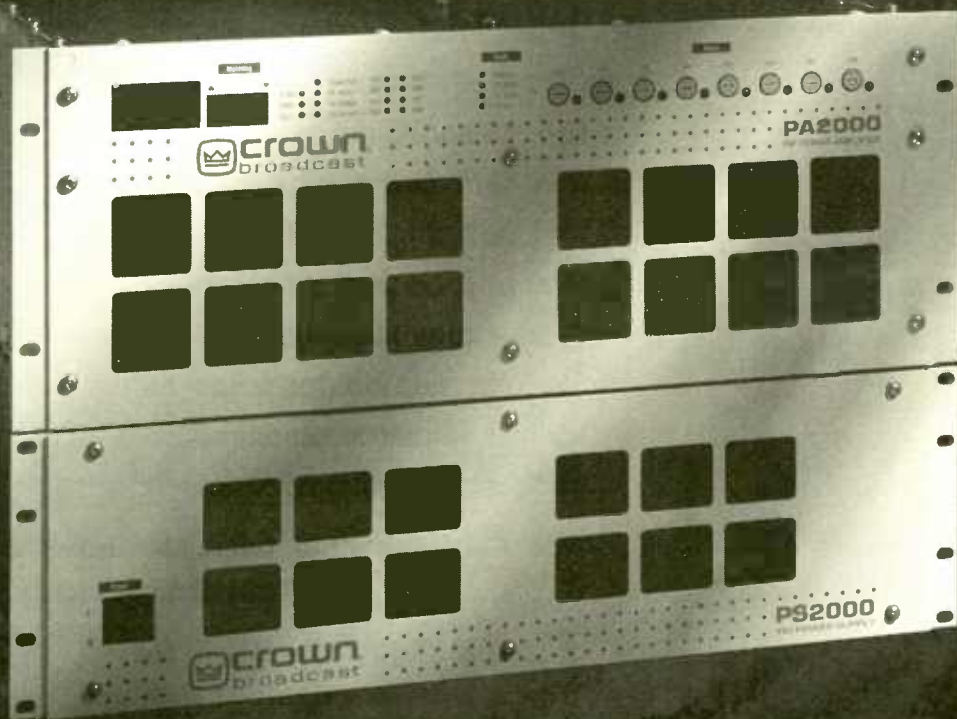

Stop the presses on all dictionaries! We're redefining efficiency with our new 2 kW FM amplifier. This broadband amplifier requires no field or factory tuning and provides 75–80% RF efficiency across the band. The design features hot-pluggable, 500-watt power modules, and a responsive protection mode. The separate DC supply is power factor corrected and 90% efficient. Both units are lightweight and compact for easy installation and overnight shipping if required. Use the amplifier and supply with your existing exciter or upgrade to a Crown exciter for an unbeatable transmitter package.

 **crown**<sup>®</sup>  
broadcast

50  
A R S  
Lasting Values

Phone: 800-294-8050; Fax: 219-294-8222

1718 W. Mishawaka Rd., P.O. Box 1000, Elkhart, IN 46515-1000



# KISS 108 Helps Kids

Jon Bon Jovi, Jon Secada, Lisa Loeb, Richard Marx and Shawn Colvin may generate huge audiences for their individual concerts, but together, along with many other musicians, they make up what its promoters call the biggest radio concert in the United States.

The staff of Evergreen Media's KISS 108, WXKS-FM Boston, have organized the KISS Concert 18 as a fund raiser for The Genesis Fund. The fund is a non-profit organization that aids in the care and treatment of New England children born with birth defects, genetic disorders and mental retardation.

KISS Concert 18 will take place at Great Woods on May 31. This year's goal is \$50,000, a level that has been achieved since 1985.

The concert series has raised more than \$500,000. The money has helped found the Jeffrey Osborne-KISS 108 Hearing and Language Disorder Clinic

important to us because we are not only able to raise greatly needed funds for our organization, we are also able to meet our educational goals through KISS' ability to communicate our message," stated Pamela Spitzer, vice president/director of development and fundraising.

WXKS Vice President and General Manager Janet "Jake" Karger stated, "Communication is a very important part of the music and radio entertainment industry. ... (T)hrough our combined efforts, funding for (the Jeffrey Osborne-KISS 108 Clinic) will help many children to better communicate their needs, wants and desires."

— Susan Gary

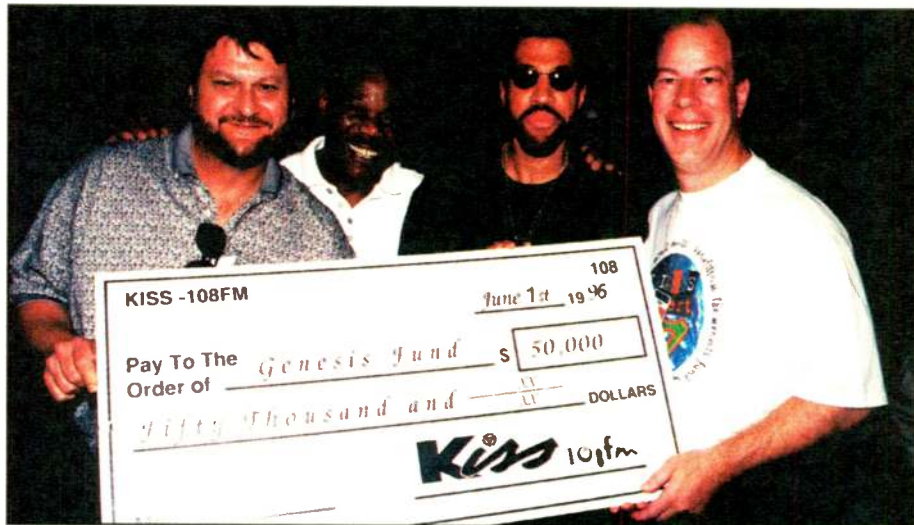

1996: Mercury Records President David Leach, J.J. Wright of KISS-108, Singer Lionel Richie and Evergreen Media CEO Scott Ginsburg



Sister Hazel will perform.

and benefited the Therapy and the Performing Arts music and dance programs. Both are outreaches of The Genesis Fund.

"The KISS Concert is especially

► PEANUTS, continued from page 38 becomes at root un-American. Make no mistake; if the NAB would push for the licensing of under-100 W stations, the Administration and FCC would follow.

Half-a-century after being "busted" for maybe 5 dirty watts on AM in the service of Ford Motors in Amery, Wisc., I have a tough job believing that either today's FCC or an enlightened NAB should care diddly about Pastor Strawcutter. As long as his signal is clean and unobstructive, his message fair and direct, the country beyond Adrian owes it to Adrian and Strawcutter to be heard.

■■■

Kent Waterman wrote about mid-1950's WHA in Madison, Wisc. in RW, Sept. 4, 1996. He is an alum of many San Francisco stations and a retiree of KGO-TV.

Introducing a new development that brings the world closer, faster.



EchoNet is a suite of broadcasting software combining the hottest developments of Internet push technology with the 24-hour-a-day multipoint capabilities of high-speed digital broadcast channels. It is the ultimate in multipoint unicasting to deliver multimedia broadcasting, E-Mail delivery and World Wide Web pages.

### EchoNet HBS Software

The Host Broadcast Server (HBS) is a Windows® NT based machine with EchoNet software pre-installed and pre-configured. Included is a Microsoft® Access database to manage subscribers.

**World Wide Web:** EchoNet HBS software schedules web site retrievals, retrieves pages from the Internet, monitors pages for changes and forwards them over the broadcast channel.

**E-Mail:** The software monitors subscribers' E-Mail mailboxes and confirms the delivery of mail before deletion. It allows the pick-up and delivery of E-Mail from any POP3 mailbox worldwide.

**Audio Broadcasting:** Multiple broadcast audio streams can be established to a user's PC at an effective data rate between 14.4 kb/s and 80 kb/s. Multiple users can listen to one audio program.

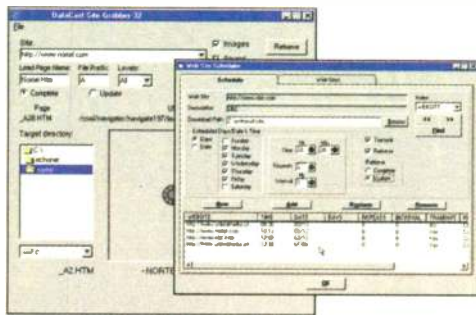

### EchoNet CPS Software

The Client Proxy Server (CPS) is a software module operating on the client's PC and acts as a gateway between the broadcast system and familiar browser, news and E-Mail Internet applications. The software is compatible with POP3 clients such as Netscape Navigator® Mail and Microsoft Exchange. WWW mirrored pages are fully compatible with all HTML 3.2 compliant browsers including Netscape and Microsoft.

Netscape Navigator is a registered trademark of Netscape Communications Corporation  
Internet Explorer is a registered trademark of Microsoft Corp.

To learn more about International Datacasting and our wide range of products, visit our web site at <http://www.intldata.ca>

## INTERNATIONAL DATACASTING

Corporate Headquarters:  
2680 Queensview Drive, Ottawa, Ontario, Canada K2B 8H6 Tel: (613) 596 4120 Fax: (613) 596 4863 E-Mail: [intldata@magi.com](mailto:intldata@magi.com)  
US Sales and Marketing:  
3850 Holcomb Bridge Road, Suite 420, Norcross, Georgia, USA 30092 Tel: (770) 446 9684 Fax: (770) 448 6396 E-Mail: [intldata@ix.netcom.com](mailto:intldata@ix.netcom.com)

Circle (45) On Reader Service Card



# STATION SERVICES

Companies with new product announcements for Running Radio Station Services should send them to: Radio World, c/o Managing Editor, P.O. Box 1214, Falls Church, VA. 22041

## Opera, Chicago-style

Figaro, Figaro, Fiiiiiggaarooooohhhhh!

The eight opening-night performances from the Lyric Opera of Chicago 1996-97 season are available now to public and commercial stations.

Weekly broadcasts began in May and will continue through June. Each opening-night performance is recorded live at the Chicago Civic Opera House. The WFMT Fine Arts Network distributes each recorded broadcast to nearly 400 radio stations. Stations interested in airing all eight performances in the series can discuss with the network a delayed-



start option for the entire series or a shortened series option covering only the June opera feeds.

Listeners can call a 1-800 number to request a free Lyric broadcast guide with details about each opera.

For more information contact David Levin, vice president for network syndication at WFMT in Illinois, (773) 279-2111; or circle Reader Service 76.

## 'Come Back, Shane! Come Back!'

John Wayne in "Red River." Henry Fonda in "My Darling Clementine." Ronald Reagan in "Knut Rockne, All American." No, it's not the latest triple feature at your local repertory theater, or a list of videocassettes in the Classics section of a video emporium. It's classic radio entertainment.

During Hollywood's Golden Age, sev-

eral films were re-created for radio broadcast. Those broadcasts will be available to interested stations beginning July 5.

"Shane," "The African Queen," "The Maltese Falcon" and "National Velvet" are among Lux Radio Theatre and Screen



Directors Playhouse radio dramas, in addition to those listed above, offered for exclusive broadcast by Dick Brescia Associates (DBA), in conjunction with rights holder Radio Spirits Inc.

DBA simultaneously will launch "Radio Super Heroes," a 30-minute program also drawn from the Radio Spirits library that brings comic strip heroes including Batman and Robin and The Green Hornet back to radio.

For information contact Dick Brescia at DBA in New York, (212) 370-1130; or circle Reader Service 77.

## Set Sail for Paradise

"Ports of Paradise" offers a radio getaway to the Pacific Islands. And its appeal is growing. Recent affiliate pickups include stations in American Samoa, Western Samoa and the Marianas Islands.

Executive Producer J. Hal Hodgson

## ports of paradise

said the program caters to an affluent audience. "Our listeners are in the strong 35-plus segment and travel regularly, not just to the South Pacific. Their discretionary income makes them a prime segment for advertisers."

Traditional and contemporary Hawaiian music, as well as other musical styles from the South Pacific, are featured on the program.

"Ports of Paradise" is available on a barter basis, with six minutes for local sales. Additional program information is available via the World Wide Web at <http://www.portparadise.com>

For information contact Executive Producer J. Hal Hodgson at Ports of Paradise of the Aloha Radio Network in California, (800) 223-2564; or circle Reader Service 53.

## Green Is Good

Radio interactivity may be key to good environmental policy. That's why the producers of "The Environment Show" have incorporated a new segment, "Talking Green," that allows listeners to submit their comments and suggestions.

Listeners can dial (888) 49-GREEN and leave their name, phone number and any comments on upcoming topics, announced during each week's program. "The Environment Show," with the assistance of a grant from the W. Alton Jones Foundation, has expanded to a 60-minute format to accommodate the new segment.

Other program segments include "Locking Horns," a four-minute debate on a "hot topic" featuring two opposing

See SERVICES, page 41 ►

# Who Knows what lurks in the minds of the creators at SMARTS Broadcast Systems? The Spider Knows!

The Spider spins through the World Wide Web, weaving together business, operational and audio data. It links spot production, logs, billing and many other station operations into a single, cohesive, cost-effective unit.

The Elvis imitator in Memphis produces a spot that airs in LA 20 minutes later! Your morning man can be anywhere on the planet and be on the air for every shift, and be on multiple stations in the group. Your sales department in Peoria shares promotions and ideas with your sales force in Lincoln.

There are no expensive satellite links, ISDN lines, toll calls or other extraordinary costs—just big savings to your operation month after month, year after year using The Spider and SMARTCASTER Digital Audio!

## We're Changing the World of Broadcasting Via the Internet



P.O. Box 284 Emmetsburg, IA 50536 <http://www.ncn.net/smarts>  
800 747-6278 Fax 800 498 0618 Email [smarts@ncn.net](mailto:smarts@ncn.net)



► SERVICES, continued from page 40 viewpoints; and "Portrait of Place," individual commentaries on environmental settings of special interest to each commentator.

For information contact Mary Winans at National Productions in New York, (800) 323-9262 ext. 104; or circle Reader Service 68.

**Sixty Seconds of Good News**

No more wading through the morning paper or watching the TV morning show to get weather, news and advice. You can get it all in one minute, on your radio.

"The Old Farmer's Almanac" is 60 seconds each day of "good news," including "gardening and planting tips, recipes and cooking advice, do-it-yourself projects, trivia and old-time lore, amazing facts, and of course, weather information."



The program is produced by Jameson Broadcast, which delivers "The Old Farmer's

Almanac" quarterly on CD. The program is market exclusive and offered on a barter basis.

For information contact Robert at Jameson Broadcast in Washington, D.C., (800) 525-2175; or circle Reader Service 70.

**Babe Brings the Bacon to New York**

Some sports broadcasters just sit on a bench; others make a move when opportunity presents itself.

In an effort to move where the sports action is, The Fabulous Sports Babe is moving from her studios in Bristol, Conn., to New York City.

"In New York, anything goes, and that's the way I like it," The Babe, a.k.a. Nanci Donnellan, said.

"If there's one place that can handle

me and understand my personality, it's the Big Apple." ABC Radio Networks proudly promotes The Babe's "in your



face personality."

The program is carried by more than 180 affiliates.

For information contact Kelley Chapman at ABC Radio Networks in Dallas, (972) 776-4644; or circle Reader Service 96.

**The 'Net Gets Groovy**

The ripple effects from the startling comeback of Top 40 radio have reached the Internet.



GroovePlanet, an on-line magazine from ElectricVillage (www.grooveplanet.com), is available to CHR/Top 40 stations with websites.

The magazine, featuring the usual mix of performer profiles, music reviews and news, also has interactive features and sound clips. GroovePlanet is updated every weekday.

Another new on-line publication from ElectricVillage is WasWorld (www.wasworld.com), targeting fans of the oldies format. The Internet generally is not the domain of an older crowd, but WasWorld Editor Scott Cooper stated the format appeals to a younger group than many might think. "One of the best-kept secrets in radio is the significant share of the youth market captured by oldies stations," he said.

For information contact John Simmons at ElectricVillage in California, (408) 477-4491; or circle Reader Service 93.

**She Wants to Make You Rich**

Getting rich is only half the fun. That's the motto of Adriane Berg, host of the newest syndicated talk show from Westwood One Entertainment.

Berg is part of the burgeoning programming arena for financial and legal advice. Her program originated on WABC(AM) in New York.

"The Adriane Berg Show" is the fourteenth talk show syndicated by Westwood One Entertainment.

For information contact Ted Kelly at Westwood One Entertainment in New York, (212) 641-2052; or circle Reader Service 69.

**Satellite Format, Major-Market Carrier**

An AC alternative format, delivered via satellite, recently debuted on KSTB(FM), a top-10 affiliate in Houston. Choice/AC, from Radio One Networks, is an "antidote to the other, somewhat tired, satellite-delivered AC formats that are out there," said KSTB Program Director Tony Mauro.

In addition to AC tracks with proven appeal, Mauro said, the format includes "hits that have crossed over from alternative."

KSTB is the first affiliate for the new Radio One format in a top 10 market.

For information contact Mollie Christensen at Radio One in Colorado, (800) 746-2141; or circle Reader Service 94.

**Quantum FM**

**Solid State**

**Solid Reliability**

from



- Proven reliability
- Maintenance-free FET technology
- Self-contained modules with own power supply regulator
- Compact size reduces shipping costs, allows affordable air shipment
- Power levels between 300 Watts and 6 kW
- Modular design offers buy-only-what-you-need affordability and convenience

For the same price you pay for a tube transmitter, you can now have a superior solid state FM transmitter with high-power, advanced technology exciter and cableless combiner. The modular design of QEI's QUANTUM-Series FM transmitters offers the advantage of buying only the amount of power you need...and means that you can upgrade to higher power levels whenever you're ready.

QUANTUM from QEI-the people who have been designing and building solid state transmitters longer than anyone else in the industry.

You need to know more! Call Jeff Detweiler today toll free (800) 334-9154.

**QEI Corporation**  
One Airport Drive • P.O. Box 805  
Williamstown, NJ 08094

Tel (800) 334-9154  
Fax (609) 629-1751

24-Hour Service Hotline  
(609) 728-2020

**NABOB Honors B.B.**



B.B. King is accustomed to appearing with his Gibson guitar Lucille in hand, but he put down the ax long enough to accept a Pioneer in Music Award from the National Association of Black Owned Broadcasters at NABOB's 13th Annual Communications Awards Dinner in Washington, D.C.

The blues legend is shown with Hal Jackson, group chairman emeritus of Inner City Broadcasting, and Frances W. Preston, president and chief executive officer of BMI, which represents King as a songwriter and sponsored his performer at the event.





Radio World, May 28, 1997

## Charge Fees for Remote Work

**John Bisset**

Thanks to the many readers of this column, *Workbench* is being expanded to once an issue. The column will also be listed by that name in the table of contents, making it easier to locate. As this column depends on your submissions, fax your tips or ideas to (703) 764-0751, or e-mail them to [WRWBENCH@aol.com](mailto:WRWBENCH@aol.com).

★★★

That ugly term "remote season" is on our minds again. As you plan for the remote season, circle Reader Service 101 and get a copy of Soundwave, the production sound newsletter/catalog provided by TAI Audio in Orlando, Fla. In addition to selling and servicing remote

equipment, they also rent a variety of audio products. Their catalog also includes some application notes.

Has remote coverage just sort of been "added" to your duties? Some tips:

First, see if you can negotiate some kind of "service fee" for your time. We've seen technical fees ranging to more than \$100 in medium and large markets. The sales people add the amount to the remote package cost. Getting the ear of your sales manager is a good start.

The next step is to enlist your local college, high school or technical/vocational school to provide you with qualified interns. I could never understand why there were interns for every other department except engineering. When I asked my GM, he told me, "You never asked for one!" Simple solution. So ask.

Nothing helps you get a job more than real-world experience. You must check with the institution to ensure you will be offering a bona fide internship. Then, train your intern in assisting you with remotes. At the very least, you'll have another pair of hands; at the very most, you've got potential part-time assistant material.

While on the subject of interns: We were loaned one a few years back to help us do the close-in proof measurements for an AM. Starting two miles out, measurements are made pulling a rope at specified distances. I dragged this poor kid through corn fields, poison ivy, and bramble patches, and across barbed wire fences.

By the end of the first day, he knew he was not cut out for engineering. He confided that his father, a communications attorney, had told him engineers mostly sat on their butts all day looking at meters and eating donuts at the transmitter site.

As we completed the measurements, we had to cross what had become a very deep creek. I'd found a shallow area, and was scrambling up the opposite bank when I slipped. I twisted my knee and fell into waist-deep water. As I watched the bubbles stream out of the corners of the PI field meter as it sank into the murky water, the intern stood on the opposite bank telling me he couldn't come help me because the water would ruin his new Nike shoes. You can probably guess my reply as I weighed the price of Nikes against an FIM-41!

Needless to say, he "rescued" his internship from certain disaster; and Dave Harry's staff at Potomac dried, cleaned and recalibrated the FIM. If this kid ever advances to a GM's position, he'll either hate his engineer, or hold the engineer in the utmost respect.

★★★

Back in February we wrote about a strange RPU interference problem that surfaced only when it rained. Once again, *Workbench* readers poured out volumes of suggestions. John Marocchi of WVKO(AM)/WSNY(FM), Franklin Communications in Columbus, Ohio, mentioned that if the tower is not grounded, the RF isolator or isocoupler may be at fault. This high-power balun permits spanning the insulator on "hot" or ungrounded towers. A few years back, John had problems with one manufactured by TFT. The balun looked like a small coffee can with Type "N" connectors on either end.

The problem John encountered was that the baluns eventually leaked. As the water level increased, the balun would arc over, causing a static sound. When it gets worse, it shorts the tower to ground. The VSWR is low, initially, and wouldn't

necessarily show up. Since John switched to the FMC Series, manufactured by Kintronic Labs, there have been no further problems. Kintronic's isocoupler is more expensive, but, as John states, "You get what you pay for."

For information on Kintronic Lab's isocouplers, circle Reader Service 122.

John added that if the tower were grounded, and no isocoupler were used, check for arcing up close to the RPU antenna. The noise might be coupled into the RPU antenna.

Gregory Muir of Radish Communications Systems in Boulder, Colo. offered a few other suggestions, in addition to checking the isocoupler. Greg suggests checking to see if the gamma match used on the antenna possesses a DC path to ground. The static problem may be electro-static buildup on the antenna, due to charged rain drops.

Electrostatic leakage without a good DC return path could cause noise. But the problem could also have something to do with the charge eventually finding a leakage path somewhere in the front end of the receiver. The apparent degradation of signal strength may be due to a subsequent breakdown of one or more front-end components (again, leakage) in the receiver, causing a change in the operating point of the input RF amplifier to where it no longer can properly process the weak RF signal.

Back in the 1960s, Greg writes, Motorola Communications and Electronics started to place NE-2 neon bulbs from the antenna input to chassis ground in their then-new "Motrac" solid-state land mobile transceivers, because they were seeing an alarming number of service returns with blown receiver front ends.

They found that quarter-wave dipoles and 5/8-wave loaded whips with loading coils capacitively coupled to ground were to blame. As the vehicle traveled down the highway, even on a dry, sunny day, a serious electrostatic charge would build up on the antenna simply from the friction of the air past the element. Needless to say, the easiest path to ground was down the coax center conductor, across the input coupling capacitor to the first RF amp transistor, and "zzzap" through the junction.

The cure was to install a higher voltage breakdown coupling cap, and place a proportionately lower voltage neon bulb to ground ahead of it. The bulb didn't have to deal with any high levels of RF, because it was on the receiver side of the T/R relay. Since then, most manufacturers are fairly savvy about this situation, and normally design the receiver input matching network to contain some form of DC ground.

■■■

Printed submissions qualify for SBE recertification credit. Fax submissions to (703) 764-0751, or send them via e-mail at [WRWBENCH@AOL.COM](mailto:WRWBENCH@AOL.COM)

### The Indispensable Audio Line Tester for Remotes.

The Qbox® is the all-in-one audio line tester that you'll want in the toolkit every time you go out on a remote.

In one battery powered box you have a microphone, a speaker, a test tone generator, outputs for standard headphones or a 2kΩ earpiece, and voltage presence monitoring for phantom or intercom power.

You can talk into it, listen to it, watch it, and clip it on your belt or cable reel for easy access.

The Qbox is made from a rugged, lightweight industrial composite to withstand the wear and tear of fieldwork. It's powered by a single standard 9V alkaline battery that is easily replaced without tools.

To get your Qbox, call your nearest Whirlwind dealer today for more information, or contact us



The **SPEAKER** selector toggles between the **SOURCE** selections and letting you confirm mic or line level signals from the console.



directly toll-free at 888-733-4396, or fax us at 716-865-8930, or email ([sales@whirlwindusa.com](mailto:sales@whirlwindusa.com)).

Check out our full catalog!  
<http://www.whirlwindusa.com>



Circle (31) On Reader Service Card

World Radio History



FEED LINE

# AM Antenna Sampling Systems

W.C. Alexander

Part XII

This is the 12th installment in a series about AM antenna systems. The previous article appeared April 16.

As we noted last month, a sampling system in a directional antenna provides indication of the relative currents and phases in the elements of the array. The key to a successful sampling system is stability.

In this installment, we continue our discussion of the elements that make up a directional antenna sampling system.

Sample lines

The transmission lines used in a sampling system are critical. In a typical system, all lines are of the same electrical length, exhibiting the same amount of phase shift. Typically, 3/8-inch or 1/2-inch foam coaxial cable is used for sample lines. When we install the system, we lay out and cut the line to the farthest element in the array. We then cut the remaining lines to match the longest. To achieve equal phase shifts in all the lines, we must then measure the electrical length of the lines, either with a time domain reflectometer (TDR) or by measuring the resonant frequency of the transmission line. Through careful measurement and trimming, we can achieve phase shifts within 0.1 degrees from line to line.

Install sampling transmission lines in consistent environmental conditions. For example, if one line is buried underground, all lines should be buried underground. If the last 20 feet of one line is above ground in the transmitter building, the last 20 feet of all the lines should be similarly installed. Excess lengths of line, such as that of lines running to the nearer towers in the array, should be stored in the same conditions as the rest of the lines.

Typically, if the sample lines are buried underground, the excess line is also buried. This maintains a uniform phase shift from line to line. Were all of one line buried, and another line

half-buried and half sitting in direct sunlight, we would expect considerable variation in phase shift between the two lines. This is unacceptable in a directional antenna sampling system.

In selecting a sampling system transmission line, the buyer is confronted with a choice between normal and phase-stabilized line. Phase-stabilized

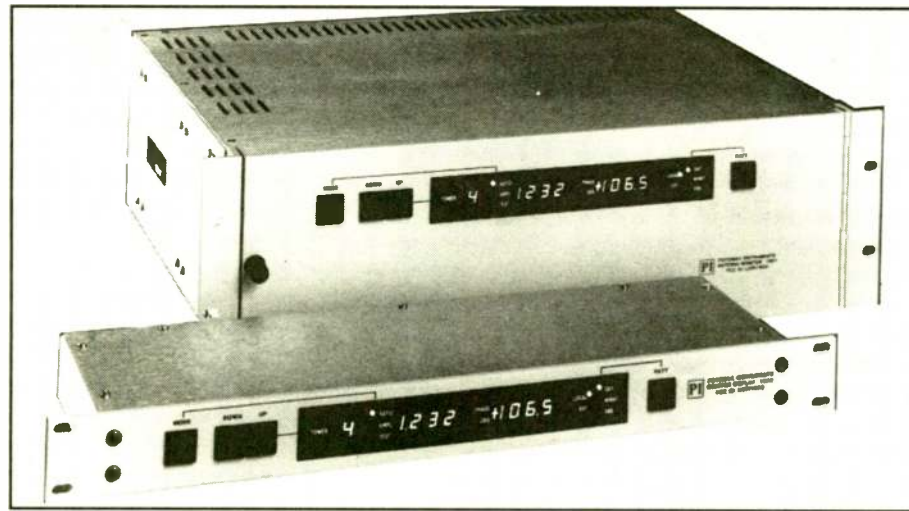

A Popular Antenna Monitor: the 1901 From Potomac Instruments

transmission line has been temperature-treated to achieve a repetitive phase-temperature characteristic for reliable tracking. This is achieved through heat cycling at the factory, which relieves mechanical stresses inherent in the manufacturing process.

Phase-stabilized transmission line is considerably more expensive than normal line, and its value is questionable. After a few weeks or months in service, a normal transmission line becomes naturally phase-stabilized, and if the lines are all installed in the same environmental conditions, the phase shifts of all the sample lines in the system will change by the same amount with temperature variations anyway.

Antenna monitors

The final element in a directional antenna sampling system is the antenna monitor. This device terminates the sample lines and electronically compares the relative currents and phases of the samples. One tower for each mode

of operation is selected as the reference tower, or the tower to which the other tower samples are referenced. The indicated phase of the reference tower is usually zero, and the current ratio is 1.000.

The phases of the other towers in the array are displayed as leading or lagging that of the reference tower.

For example, if one tower in the array indicates -80 degrees on the antenna monitor, that means the current in that sample is lagging 80 degrees behind the current in the reference tower sample.

The currents in the other towers in the array are displayed as a ratio, or a percentage of the current in the reference tower. For example, if one tower in the array indicates a ratio of 0.650 on the antenna monitor, the current in that element is 65 percent of that in the reference tower.

Older antenna monitors could only select and monitor one tower at a time. The loop reference, or calibration of the reference tower current sample, had to be adjusted each time before the remaining ratios were read in order to

ensure accuracy. This type of antenna monitor was difficult (but not impossible) to accommodate with a remote control system.

Modern antenna monitors simultaneously monitor all tower samples. The loop reference is set continuously and automatically. An analog voltage sample representing each tower's ratio and phase is continuously available, making remote monitoring of the antenna monitor easy. These modern monitors also have an amplitude mode, where the actual RMS voltage of the sample is displayed. If the loss of the transmission line and the volts per amp output of the sample transformer (if used) are known, this display can be used to monitor base currents remotely, a handy feature indeed!

Accuracy

Distortions in the sinusoidal current distribution in the towers of a directional array are caused by mutual coupling between the elements. This makes it just about impossible to obtain a sample that resembles the theoretical phases and ratios of the properly adjusted array, no matter how carefully the sampling system is calibrated. With modern moment method computer modeling, however, we can predict closely what the actual driving point ratios and phases should be. With an accurate sampling system and this computer model in hand, the task of setting up an array is much easier.

More important than accuracy, however, is stability. A directional array is set up, and the proper indicated phases and ratios are determined by field strength measurements. A sampling system must indicate changes from properly adjusted indications. This function is even more important than accurate display of the actual currents and phases in the system.



Cris Alexander is director of engineering for Crawford Broadcasting in Dallas. Contact him at (214) 445-1713 or via e-mail at cbceng@compuserve.com

## ARMSTRONG FM TRANSMITTERS



**Engineered for Reliability**

- ◆ Power Levels from 1kW to 30kW
- ◆ High Efficiency, Grounded Grid Single Tube Design
- ◆ Wideband Quarter Wave Cavity for Lowest Synchronous AM
- ◆ Solid State Driver with Patch Around Capability
- ◆ Optional Automatic Power Control & VSWR Foldback
- ◆ Motorized Tuning Controls
- ◆ Advanced Overload & Protection Circuitry
- ◆ Automatic Re-start After Power Failure
- ◆ INEXPENSIVE!



**ARMSTRONG**  
TRANSMITTER CORPORATION

**In New York:**  
4835 N. Street Road • Marcellus, NY 13108  
(315) 673-1269 • Fax (315) 673-9972

**In Florida:**  
1910 N.W. 96th Ave • Miami, FL 33172  
(305) 471-1175 • Fax (305) 471-1182

Circle (32) On Reader Service Card



## AMERICAN MEDIA SERVICES

1836 Barnett  
Weatherford, TX 76087

---

1-800-345-1953 • Fax/1-800-356-1953

For all your audio & video needs!

LOWEST PRICES IN THE COUNTRY

We sell all types of Audio & Video tapes;  
DATs; Cassettes, Audio & Video.  
All types of equipment, Cleaning Supplies;  
Nortronics Heads, Alignment tapes.  
In short, just about everything you need.

Try us, you'll like us!

We still reload Broadcast Carts and sell  
New & Re-manufactured carts.

Circle (44) On Reader Service Card



# Why your worst day in radio is





# the best day to judge AirTime.



It's your typical day-from-hell at the station: The on-air talent is definitely "off." Traffic is in a panic to reschedule commercials. The engineer is nowhere to be found. And today's the day the program director decides to overhaul the format. Sounds like a perfect day for AirTime, the first on-air digital delivery system created for the real world of broadcast, where non-stop stress seems to be the rule, not the exception.

AirTime offers a unique combination of easy

user interfaces to tap the system's real time power: Live Assist touch screens that actually make on-air tasks easier and more productive. Sound Cube looks and feels like an analog cart machine, which means fully digital on-air delivery without all that staff training time. Sound Slate goes even further, putting a complete range of sound effects and audio at your talent's fingertips.

For commercial scheduling, AirTime's touch screens and easy schedule builder lets you

create a commercial once, then access and reschedule it from one powerful database. The same huge, flexible database lets a program director store, organize, and play on-air resources at will. Best of all, AirTime's UNIX-based operating system gives your station complete multi-tasking in real time. So if running one station isn't challenging enough, now you handle even more stations from a single location with AirTime. Just to make your life easier.

**urban**<sup>®</sup>

A Harman International Company

©1997 Urban, Inc. Urban and AirTime are registered trademarks. 1525 Alvarado St., San Leandro, CA 94577 USA Phone 1-510-351-3500 Fax 1-510-351-0500 E-mail [custserv@urban.com](mailto:custserv@urban.com) Web [www.urban.com](http://www.urban.com)

Circle (43) On Reader Service Card  
World Radio History



# Products & Services Showcase

For more information on the products shown below, circle the appropriate Reader Service No.(s) on the enclosed Subscription/Reader Service card or contact the advertiser directly.

## Solve FM Audio Problems Without Disrupting Your Air Chain!



### CLD-2504 Composite Distribution Amplifier

From Modulation Sciences Your FM Audio Authority

Gain flexibility without disrupting your air chain. Drive multiple exciters without modulation shifts and without switching or relay hassles.

The CLD-2504 is a stereo composite distribution amplifier that allows multiple transmitters and alternate stereo generator/processor set-ups without interaction.

Distortion better than 70 dB below 4 V peak-to-peak

Highly immune to RF

More than 40 dB of output isolation; no interaction among loads

Make composite measurements without affecting modulation.

Supports more than 60 dB of stereo separation

Broadband SNR of greater than -80 dB

Four low impedance outputs drive long cable lengths

**PLUS** Modulation Sciences' three year warranty on all parts and labor.

Contact MSI today.

12A World's Fair Drive, Somerset, NJ 08873 USA  
Voice (908) 302-3090 • Fax (908) 302-0206  
Toll Free (800) 826-2603



READER SERVICE NO. 62

What's Hot from Comrex and ABG?

## HotLine POTS Codec

- Two-way wideband audio on standard dial lines
- 4.5 to 10 kHz audio at speeds from 12 to 33.6 kb/s
- Extremely easy to use
- Compact, rugged and lightweight

### HotLine Features:

- 2 audio inputs: Mic/Line (3-pin XLR); Tape (mini-jack)
- 2 audio outputs: Headphone (1/4" jack); Line (3-pin XLR)
- Variable mix of local program and studio return on output
- 2 contact closures
- Quick-dial memory feature

### MIDWEST SALES OFFICE

2342 S. Division Avenue  
Grand Rapids, Michigan 49507  
Phone: 800-999-9281  
Fax: 616-452-1652

REACH US ANYTIME VIA ELECTRONIC MAIL  
internet: support@abg.com  
web site: www.abg.com

### SOUTHEAST SALES OFFICE

P.O. Box 2619  
Smithfield, North Carolina 27577  
Phone: 800-369-7623  
Fax: 919-934-8120

### WESTERN SALES OFFICE

P.O. Box 1638  
Palmdale, California 93550  
Phone: 800-858-9008  
Fax: 805-273-3321



Please call today for ABG pricing and delivery.

For 36 years  
**ABG**  
Audio Broadcast Group Inc.

READER SERVICE NO. 110



## TIRED OF CART MACHINES? NO MORE EXCUSES...!

Replace them with

# DAP

Digital Automation System

Introductory Offer: \$995.00 + s+h

- Will work with ANY 386 or higher IBM compatible
- PCM, ADPCM 4:1, and MPEG 6:1 compatible
- Crossfades, Live Assist, Walkaway, Spoken Hours
- Operated by mouse, keyboard, or pushbuttons

For more information and demos  
DIGITAL LINK 1-800-295-8871  
<http://www.Digital-Link.com>

READER SERVICE NO. 86

## "Real-time" 15 kHz ISDN Audio



When you need to send wideband ISDN audio without long coding delays, look to Comrex. Our "turbo" G.722 codecs deliver 15 kHz bidirectional audio with minimal delay.

List price only \$1500. Call today!

### COMREX® Comrex Corp, USA

Tel: 508-263-1800 Fax: 508-635-0401  
Fax-on-Demand: 508-264-9973 (Doc #101)

READER SERVICE NO. 63

## THE COST EFFECTIVE ALTERNATIVE TO MANUFACTURER SERVICE

### SERVICE, REPAIR & CALIBRATION

- STL's • RPU's • TSL's
- Exciters • Optimods
- AM/FM Monitors
- Remote Control Systems

### SPECIALIZING IN EQUIPMENT BY

- Belar • Marti
- Moseley
- McMartin
- TFT
- And others...

### WE ALSO PROVIDE

Free, over-the-phone technical assistance  
STL loaner/rentals  
PCL 505 Certification



2198 Hubbard Lane, Grants Pass, OR 97527

**(541) 471-2262**

READER SERVICE NO. 87

## Eimac Factory Rebuilds

Have your Eimac tube **REMANUFACTURED** by the trusted original manufacturer.

- Eimac Quality
- Original Specifications
- Factory Testing
- New-Tube Warranty

CPI/Eimac Division  
San Carlos, CA., USA  
(800) 414-8823 or  
fax (415) 592-9988



Available through  
Richardson Electronics  
1-800-348-5580

Replacement Sockets,  
Collets and Repair Parts  
Are Available from Stock

READER SERVICE NO. 57

## Norsat's pioneering spirit made LNBs.

Now we make them more reliable, more stable and smaller.



The first personal earth station built by Norsat in Yukon, Canada in 1977.

Today Norsat provides a wide variety of industry-leading digital and data grade LNBs to radio and TV stations, cable operators and VSAT OEMs worldwide.

As a pioneer in the development of both LNAs and LNBs, keynote historical events include: The establishment of the first private earth station in 1977, delivery of the first commercial produc-

tion units of an all GaAs LNA in 1983, C-band LNBs in 1984

and Ku-band external reference LNBs in 1989. In 1996 Norsat delivered the first 20 GHz Ka-band LNB with a noise figure of less than 1.5 dB.

This innovative and on-going development work has made Norsat the world's #1 commercial LNB supplier.

For next day delivery of all your commercial and consumer LNB needs, contact your

local distributor or Norsat today.



The evolution of Norsat LNBs

## NORSAT

Norsat - A pioneer with a reputation for innovation, reliability and service.

Contact Norsat at:

#302-12886 78th Avenue, Surrey, British Columbia, Canada V3W 8E7  
Canada • Tel 1-604-597-6203 • Fax 1-604-597-6214  
<http://www.norsat.com/> • info@norsat.com

READER SERVICE NO. 111



PERSONNEL LEVEL

# Sell Yourself With Your Résumé

Sue Jones

A résumé is one of your most important marketing tools. It should accurately and fairly represent your talents, skills and experience.

Unfortunately, many people put their résumé together hurriedly when they receive notice that their services are no longer required or when they determine it is time for them to find the next job.

Résumés put together in this way often are disorganized. Some pertinent or distinguishing experience may be excluded. Grammatical and spelling errors sneak in.

All or any of these factors could disqualify you before you even have a chance to talk with a prospective employer.

**Think before writing**

Before you begin to write or rewrite your résumé, think of the reader. Hiring staff is a business endeavor; you should approach your résumé in the same way. Think of ways that your talents and skills can benefit the prospective employer. If you were hiring, you would seek the person best qualified for the position you can offer (getting the best value for your money).

If you are responding to an advertisement or to word of mouth, chances are good that your résumé will not be the only one under consideration. A manager cannot devote 20 to 30 minutes to every résumé. If a manager received 10 résumés in the mail one day and devoted 20 minutes to each, the task would require three hours and 20 minutes. Most résumés get a two-minute review.

The résumé must be organized in a simple manner that conveys the greatest amount of information in two minutes or less.

A résumé by itself usually will not win a job for you. It is only one tool used to market yourself. With it, you distinguish yourself from other candidates to get an interview.

With these concepts in mind, here are some nuts and bolts to help you build a better résumé.

**Better construction**

Emphasize your accomplishments instead of just listing your responsibilities. Your accomplishments describe how well you handled your responsibilities. Concentrate on accomplishments that benefited your employers: cost savings, increased productivity or improved sales. Place a dollar amount on the achievement. For example, you might write: "Improved annual sales by 20 percent by modifying sales approach to a client service problem."

Construction and organization matter. A résumé that is constructed in an easy-to-read format demonstrates to the reader that you have taken a considerable amount of information and organized it so that it can be absorbed quickly. It also highlights your clarity, appreciation for the brever's time and professionalism.

Brevity and clarity are critical. Describe your talents, skills and accomplishments only in enough detail to entice the reader to interview you. Save the detailed description of a cost savings for the interview discussion. Your résumé statement should be: "Reduced overhead

costs by 15 percent." The interviewer most likely will ask how you did that.

Define your skills, knowledge and functional expertise. Think of two- or three-word key phrases that summarize your skills, such as "Client Development" or "Cost Reduction Strategies." List six to 12 of them at the top of your résumé. This is an excellent place to show that you have on-air, program or traffic experience. If this information is highlighted at the top of your résumé, the first 30 seconds of the two-minute review has identified you as someone with multiple and diverse skills.

Limit the résumé to one or two pages.

Describe your best five or six accomplishments in one or two sentences. Place these under the list of skills on the first page. List your chronological job history, with employers and dates, on the second page.

**Structure it carefully**

List your education and credentials separately. If you are a recent graduate, list your education at the top of your résumé. If you have several years of experience, you may prefer to list your education at the end. You may also want to list your education at the end if you did not complete a degree, or wish to

emphasize your career experience instead of a 20-year-old graduation date. If your education was self-financed or you graduated with honors, say so. Be sure to list relevant certifications or licenses.

State your skills and accomplishments in the most positive language, but do not lie or exaggerate. You do not want to have responsibilities that are beyond your abilities, nor does your potential employer want to discover that you cannot do the things you claimed.

Print it on white or neutral paper in easy-to-read type. Unusually colored paper, paper size and funky typefaces will definitely stand out in a stack of résumés. But keep in mind that managers seek people who fit in; they do not hire oddballs. If you wish to demonstrate your creativity, use a standard résumé

See PERSONNEL, page 49 ▶

# Align Audio with Video

With Rane's AVA22 Audio/Video Alignment Delay and Bradley, you get 1/2 frame accuracy and Dolby Time Link!



Rane's AVA 22 Audio/Video Alignment Delay is a fully balanced two input, two output professional audio alignment delay providing a range of 0.0 to 9.5 NTSC frames (8.0 PAL/SECAM frames) on each output. The delay of each output is independently adjustable in field (half-frame) increments and has two nonvolatile memories for easy access to previously stored delay values. The AVA 22 features 3-pln (XLR type) connectors.

Remote terminals on the rear accept external configuration switches, permitting independent stereo bypassing and stereo remote recall of memorie. An internal jumper is provided to reconfigure the remote terminals for independent recall of the two channels' stored memories. The AVA 22 can be operated as two independent channels (dual mono) or as a stereo pair of channels (Link Mode).

Employing the Dolby Time Link 1-bit delta-sigma encode/decode circuit, the AVA22 gives you the same circuit used in many Dolby surround sound decoding units for home theater systems.

Both NTSC and PAL/SECAM broadcast standards are supported. A recessed rear panel switch is available for locking out front panel controls. In this mode, all of the front panel pushbuttons are disabled with the exception of the recall buttons, but the recall buttons remain active so the user may view the stored Delay values without risk of changing them. Internal jumpers can enable bypass while in Front Panel Lockout mode, while the default setting disables bypass. Independent relays provide a fail safe, hard-wired bypass in case of power loss.

Contact your Bradley professional and learn how affordable the Rane AVA 22 can be.



Our Service Makes The Difference

12401 Twinbrook Parkway • Rockville, Maryland 20852 • Toll Free: 800-732-7665 • Tel: 301-231-7800 • Fax: 301-230-6526

E-Mail: [Info@bradleybroadcast.com](mailto:Info@bradleybroadcast.com)



# Products & Services Showcase

For more information on the products shown below, circle the appropriate Reader Service No.(s) on the enclosed Subscription/Reader Service card or contact the advertiser directly.



**ERI**

**SHPX series FM antenna**  
for Single or Multiple frequencies.

- 10 Mhz duplex bandwidth.
- 120 kW input power rating.

**ERI - Electronics Research**  
(812) 925-6000

READER SERVICE NO. 81

**RDL's™ STA-1 Universal Line Amp,  
The Swiss Army Knife Of  
Interface Products**

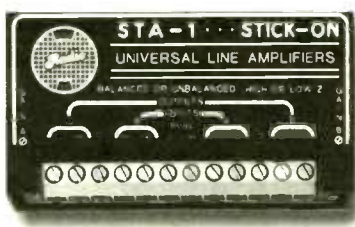

**RDL™**  
Radio Design Labs

**Specialists In Practical™  
Precision Engineering**

USA Phone (800) 281-2683 Europe Phone (+31) 20-6238 983  
USA Fax (805) 684-9316 Europe Fax (+31) 20-6225 287  
Internet Access: www.rdlnet.com

READER SERVICE NO. 64

**AES/EBU Digital Audio**



**NEW! RS-41DA 4x1 AES/EBU Routing System**  
4 input, 1 output digital audio routing switcher.  
Input selections are made via local pushbuttons, or remote control inputs.  
Transformer coupled inputs and outputs, PLL receiver, LOCK indicator.  
Switch timing is synchronized with channel A preamble of the input signal.

**NEW! DDA-104 1x4 AES/EBU Distribution Amplifier**  
1 input, 4 output digital audio distribution amplifier.  
Front panel indicators for LOCK and input signal sampling rate.  
Transformer coupled inputs and outputs, PLL receiver, relocked outputs.

Desktop or rackmount. No AC adapters.  
Broadcast quality throughout. No compromises.

**VIDEOQUIP** Phone: (416) 293-1042  
RESEARCH LIMITED Fax: (416) 297-4757  
Internet: www.videoquip.com

Please call for a free 40 page Phase 3 catalog.

READER SERVICE NO. 88

**Cortana Corporation**

**ENGINEERS! ARE YOU DREADING  
THE '97 LIGHTNING SEASON?**

Let us show you how stations in Florida and Gulf Coast states have solved their problem.

Many stations have recovered the cost of the Stati-Cat System during their first lightning season.

For brochure and/or quote, call or write:

**CORTANA CORPORATION**  
P.O. Box 2548, Farmington, NM 87499-2548

**Voice 505-325-5336**  
**FAX 505-326-2337**



READER SERVICE NO. 112

**ECONCO**

**Econco  
REBUILT POWER TUBES**



Approximately One Half  
the Cost of New

3,000 Hour Unconditional Guarantee

Call for Our Price List

Econco 1318 Commerce Ave. Woodland, CA 95695  
Phone: 916-662-7553 Fax: 916-666-7760 Telex: 176756  
Toll Free: 800-532-6626 From Canada: 800-848-8841

READER SERVICE NO. 80

**THAT-2**  
**Telephone Handset Audio Tap**



- Analog
- Digital
- ISDN
- PBX

RCA & XLR  
Line In and Out

No Batteries or  
AC Needed

**\$225.00**

**JK Audio** Remote  
Broadcast Gear

Call 800 JK AUDIO (800-552-8346)  
815-786-2929 • Fax: 815-786-8502  
www.jkaudio.com

READER SERVICE NO. 56

For over 20 years . . .

You still want 'em!

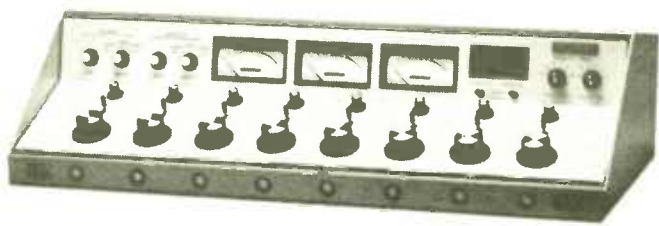

8 Rotary pots . . .

traditional reliability,  
90's audio!

We still build 'em!

The **DURABLE AC-8 Console**  
also available with 6 and 10 channels.

Only from . . .

**AUTOGRAM CORPORATION**  
Plano, Texas (800) 327-6901

READER SERVICE NO. 105



ROOTS OF RADIO

# FDR Prompted the Media Pool

William J. Ryan

*FDR is in the news. One of the first national figures truly to understand the potency of radio, President Roosevelt is the subject of the newest memorial in Washington, D.C.*

Retired journalist William J. Ryan wrote this story at the request of his friend, ABC-TV audio man Gene Larson of Upland, Calif. Larson interviewed Bill Smay and recorded the conversation a few years prior to Smay's death.

We've all seen photos of President Franklin D. Roosevelt ready to deliver one of his famous Fireside Chats with a cluster of microphones covering his desk. These pictures can be identified as being from the early days of his administration. Later pictures show him speaking into only one mic while his address was carried by several radio networks, plus newsreels. What happened?

The answer was given a few years ago by the late Bill Smay, an audio engineer at ABC-TV in Hollywood.

"In those days, everything was heavy equipment," Smay said. "We carried our own power supplies ... ND10's, which were monsters powered by a power pack that was as big and heavy as two automobile batteries and always contained in a big oak box, making that powered pack about 200 pounds.

"Each network and each station and each newsreel company would go into the Oval Office or wherever they were going to do a Roosevelt Fireside and set up our equipment."

Smay said the equipment would be readied in the afternoon.

"Everything had to be completely set up by the time they were going to bring in the president to give us a level and make sure everything was OK.

"They would wheel Roosevelt in. In those days, he was very shy about people seeing him in a wheelchair or on crutches, and he needed both. They would

**Each network, each station, each newsreel company had to set up its own equipment for every 'chat.'**

wheel him in and he would say, 'Are you ready, gentlemen?' and we would say 'Yes,' and he would give us a speech for a level. They would wheel him back and we were all set then for the broadcast at 6 or 7 o'clock."

Smay said NBC, CBS and Mutual would be there, along with several newsreel services and many independent stations.

"It was amazing that Roosevelt would know who everybody was, and he made it a point if there was a new person who came in, he would have (Postmaster General) Jim Farley find out if there were any new people so the president would know their name," he said.

Asked if the president remembered his name, Smay said, "He called me by name once when we were covering (an inaugural) parade.

It was raining and I took off my hat because I liked the old gentleman. I was standing with NBC reporter Morgan Beatty, and Roosevelt saw me as he was waving to the crowd and said, 'Put on your hat, Bill,' real loud.

"I could have melted."  
Smay went to work for NBC in 1943, and the following year joined NBC's Blue Network, which became ABC Radio.

He moved to Hollywood around 1950

and got in on the grass roots of ABC television on the West Coast, eventually working in the studio for the Lawrence Welk Show, General Hospital, the Academy Awards shows, the Olympic Games and other programs.

**The first pool**

The idea of a pool broadcast of FDR's speeches came almost by accident, Smay said.

"He had been out on the Potomac and an emergency arose. They called the yacht back to the Navy Yard in southeast Washington. We wanted to do this thing as quickly as possible, so somebody devised a way of rigging up a great big plank with everybody's microphones and all the cables attached that could be lifted and put across in front of him (FDR) on

See FDR, page 50 ▶

## Résumé Writing

PERSONNEL, continued from page 47  
format. Save the creativity for your demo tape, or bring written samples of creative sales letters to an interview.

**Is it germane?**

Avoid listing irrelevant personal information such as your age, height, weight and marital status. Federal law prohibits discrimination based on many of these factors. Eliminate hobbies unless they are directly related to the job.

Include an objective statement on the résumé and the cover letter. State your objective as a two- or three-word phrase at the top. Examples: "Sales and Marketing Management," "Engineering or Technical Services" or "Broadcast Promotions and Programming."

Eliminate the statement "References Upon Request." Employers assume you will provide them if requested.

Proofread your document carefully, and have someone else review it as well. Spelling and grammatical errors can eliminate you from the short list of candidates quickly.

They demonstrate a lack of attention to detail. Ask for recommendations for improvements in content and readability.

Include a specific cover letter responding to a request to forward your résumé and stating the reasons you are interested in working for that broad-

casting group. Be sure to respond to any specific verbal or advertisement requests.

Sue Jones is a principal in a communications management firm located in the Washington area. Contact her at (703) 503-4999.

D T V

Let **dataworld** give you **ALL** the answers to **YOUR** new channel assignment!

- Received Signal Level Display
- Interference RSL
- Population Studies



800-368-5754 FAX: 301-656-5341  
WWW: <http://dataworld.com>

Circle (41) On Reader Service Card

## FINALLY!

### A Listener Information System for Broadcasters!

NEW!



## Audio OnLine from Henry Engineering

The caller-interactive telephone system that's perfect for:

- Concert information
- Weather/Ski Reports
- School Closings
- Road & Traffic Reports
- Contest Info
- Voting Lines

Audio OnLine answers up to 16 phone lines simultaneously, and lets your listeners choose from dozens of messages!  
Audio OnLine is quick, easy and caller-friendly.

- Answers 2-16 Phone Lines
- Call Counter for Each message
- Hundreds of messages
- Hours of Recording time
- Installs in any 386+ Dos PC\*

Replace those tired cart decks, phone couplers, and other junk with digital technology. Get Audio OnLine...your listeners will love it!

**Contact your Harris Representative today!**  
TEL: 1-800-622-0022  
FAX: 1-317-966-0623  
<http://www.broadcast.harris.com>

\*Computer & monitor not included.



Circle (33) On Reader Service Card



# MARKETPLACE

## Recently Introduced Products for the Radio Broadcast Professional.

Got a product for Marketplace? Mail info and photos to:  
Marketplace, Radio World, Managing Editor, P.O. Box 1214, Falls Church, VA 22041.

### 900 Series Wireless

Audio-Technica's 900 wireless microphone series is available in two configurations.

The ATW-0951 UniPak system is comprised of an ATW-R09 receiver and ATW-T51 body-pack transmitter with a professional HRS connector and Hi-Z input.

The ATW-0952 handheld system, made up of the ATW-09 receiver and ATW-TF2 handheld microphone/transmitter, uses an A-T Hi-Energy dynamic element with a neodymium magnet and double-dome diaphragm for smooth, high-frequency response.

Lightweight and cost-effective, both systems operate on UHF bands above commonly-used TV, cellular and paging frequencies for greater immunity to interference.

For more information from Audio-Technica, contact the company in Ohio at (330) 686-2600; fax: (330) 688-3752; or circle Reader Service 49.

### Get With the Proceedings

DAB testing results. RF exposure guidelines. High Speed Digital Subcarrier. Satellite radio service. DTV.

If you are interested in radio or TV technology, this new volume may be for you. It's as hefty as a phone book, and just as useful.

The 1997 Broadcast Engineering Conference Proceedings from NAB '97 contain technical papers presented at the conference last month. It is available for purchase from the National Association of Broadcasters. The theme for this year's conference was "Keeping Pace With Technology."

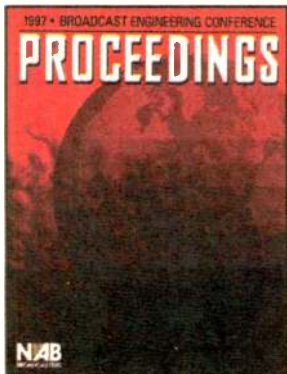

The printed proceedings were compiled as a reference for engineers facing the challenges of digital technologies, facility consolidation, spectrum allocation and opportunities on the Internet. The Society of Broadcast Engineers co-produced the conference.

The proceedings also include papers from The Fibre Channel Seminar at the NAB '97 Electronic Distribution Conference.

The book costs \$75 plus shipping and handling.

To order, call the National Association of Broadcasters at (202) 429-5373.

### Holiday RF/Microwave Probe

Holiday Industries has added to its HI-4000 series of RF probes and meters. The HI-4456 probe adds greater flexibility to the Holiday HI-4000 RF/Microwave Hazard Measurement system for protection against radio frequency and microwave radiation. The HI-4456 provides true RMS E-Field detection and measurement between 300 MHz and 18 GHz, with custom calibration points available up to 40 GHz. The HI-4456 complements the extensive line of probes and sensors for EMF detection and monitoring already available from Holiday.

For more information from Holiday Industries Inc., contact the company in Minnesota at (612) 934-4920; fax: (612) 934-3604; or circle Reader Service 73.

### LBA Telescoping Antenna

LBA recently received a U.S. patent for a telescoping tower that allows deployment without hydraulics or motors.

The tower consists of nesting sections that are mechanically latched with latch clamps as it is erected. The latches automati-



LBA Telescoping Antenna

cally engage as the tower is erected manually from ground level. The locking mechanisms disengage when the section is extended to a release position and the tower can be easily retracted from the ground. Also, the clamp joint has a high degree of electrical conductivity.

The telescoping tower can be used for AM broadcast antennas and for other tower-related needs.

For more information from LBA Technology Inc., contact the company in North Carolina at (919) 757-0279; fax: (919) 752-9155; via e-mail at: lbagrp@lba-group.com; or circle Reader Service 97.

### Valcom Whip Antenna

The Valcom Model V-33070-CL2 is an affordable, heavy-duty, coil-loaded 74-foot whip antenna; though used primarily for maritime and air traffic control applications, it is approved for AM broadcasting.

The fiberglass pedestal base enables the antenna to be mounted to its foundation. The antenna is also made with the same high-strength fiberglass as the base, resulting in an integral base insulator with excellent electrical and mechanical properties.

Available in two models, the standard model is provided with an above-the-base feed-point and the other is with a base feed-

through insulator. Average power rating is 2 kW below 1.5 MHz and 5 kW above 1.5 MHz.

Frequency range is 100 kHz to 30 MHz with tuner and resonant frequency is 100 kHz to 2 MHz (as specified by the customer).

For more information from Valcom, contact the company in Canada at (519) 824-3220; fax: (519) 824-3411; or circle Reader Service 121.

### SSAC Universal Lamp Alarm Relay

SSAC Inc. introduces a Universal Lamp Alarm Relay for 230 VAC systems.

The SCR630T is used to sense a lamp failure on radio towers and other tall struc-



tures. It can be adjusted to meet most obstruction lighting requirements.

It will detect the loss of one lamp out of one, two, three or four, either steadily on or flashing.

Up to four 500-watt flashing beacons or up to four 100-watt or 116-watt side lamps can be monitored with one unit.

Selection of the number of lamps, wattage and their voltages are made via six switches on the unit.

For more information from SSAC Inc., contact the company in New York at (315) 638-1300; fax: (315) 638-0333; or circle Reader Service 145.

## A Closer Look at Internet Audio

Confused by the idea of broadcasting on the Internet?

Or perhaps you are already doing so, and you wonder where the technology will go next. You can get your questions answered at the Audio Engineering Society 14th International Conference in Seattle June 13-15. The focus of the conference, right down to its title [internetaudio.aes.org](http://internetaudio.aes.org), is audio on the Internet.

Claiming that "the advent of Internet audio has eclipsed traditional digital audio," AES will look at topics such as open-platform audio standards, 3D audio perception in vir-



Dr. Elizabeth A. Cohen, President-elect of AES



tual environments, effective design practices and copyright protection over the Internet.

The deadline for registration is June 2. The cost for AES members is \$395, with student members paying \$295.

The registration fee for non-members is \$475.

Call AES at (800) 541-7299, or check its website (<http://internetaudio.aes.org>).

## FDR's News Pool

► FDR, continued from page 49

the back seat of the limo. It was a forest of microphones you couldn't believe.

"But the president noticed all of the struggle getting this big plank up on the car and the cables. He said, 'Surely, with all of our know-how, we could do something about this. This is ridiculous.'

"As a result, the networks started the pool system, with one person doing the feed." He said networks, newsreels and the independent stations cooperated, with the networks working on a rotating basis.

Smay said the White House later installed and supplied the equipment for the pool broadcasts.

In describing the equipment used in the 1930s and '40s, Smay said the pool engineer, when traveling on assignment by plane or train, always kept the mics, mixers, cords and power supplies at his side.

"We would never trust it to a baggage compartment," and would buy an extra set if necessary, he said.

"When we carried all this equipment, we would go into a station like Union Station in Washington and the porters got to know us. They would see all the equipment that had NBC on it in big letters, and the porters ... would run, they wouldn't walk ... away from us. We were handling all this baggage, and it weighed half a ton when you got it together. The Red Caps wouldn't touch it."

Bill Smay retired after a long career with ABC and died in 1994 at the age of 74.

■■■

Bill Ryan is a retired journalist who spent 17 years with UPI. He also worked as a college teacher and administrator. He cites radio history as "one of his great loves." Reach him at (972) 234-6134 or via e-mail at [wryan1807@aol.com](mailto:wryan1807@aol.com)



# Master Clocks Get a New Face

Tom Vernon

*This is the first in a two-part RW series about master clock systems.*

I can still recall my earliest visits to Top 40 radio stations back in the 1960s to just "hang out" and watch the boss jocks do their thing.

Along with the 16-inch turntable, ribbon microphone and teletype machine, another type of equipment long gone is the Western Union clock. Back then, they were something of a mystery to me.

Unseen forces sent pulses down a leased line as the sweep hand ticked off precise one-second intervals. Before WWV was widely used, broadcasters once subscribed to the Western Union Clock Service to maintain accurate time. This was vital when stations had to join the network for hourly newscasts. A relay contact closure at the top of the hour could be used to put a beep on the air or flash a light.

## Vanished species

By the late '60s, all the Western Union clocks were gone. These timepieces remain an interesting footnote in the history of radio equipment, as they were one of the first master clock systems used by broadcasters. Second-generation master clocks came along in the early '70s. They used an internal time base to derive an accurate signal in-house.

These new clocks were possible largely due to technological advances in TTL logic chips and display tubes for the digital readout. Some typical units I recall include the TFT 720, Torpey Controls CLK-5 and the Cooke Engineering Model 724. Today's master clocks use even more-advanced technology and are very different from their predecessors.

Master clocks generally perform two functions. First, they provide an extremely accurate source of time.

Second, they distribute a display of that time to slave clocks throughout the station.

Because many second-generation master clocks remain in service, I will start by describing them.

All master clocks need some sort of time base to derive accurate time. The standard crystal oscillator in most systems is accurate to about one second per month. Temperature-compensated (tempco) crystal oscillators do a little better, staying within three seconds a year.

Beyond internal oscillators, several external sources of accurate time are available as options for signals that are even more accurate.

One of the most common is the 3.579545 MHz color subcarrier sent with television signals. This was a popular choice for television stations or AM-FM-TV combos where the NTSC network subcarrier was readily available.

Another possibility is a 60 Hz rubidium (Rb) standard.

There are several options available with external radio signals. In many locations, you can receive Loran-C, a navigational signal transmitted at 100 kHz.

This frequency is generated by a cesium clock, which is compared to the cesium master clock at the Naval Observatory. Another navigation system, Omega, transmits a very accurate signal at 10 kHz.

The best-known low frequency standard is probably WWVB, which operates at 60 kHz and is received easily throughout most of the continental United States. Funding has recently been allocated for a power increase to 30 kW, which should take place within the next year.

WWV and WWVH are the time and frequency standards with which most broadcasters are familiar. These broadcasts are heard on 2.5, 5, 10, 15 and 20 MHz. Due largely to propagation delay, the accuracy of these signals is limited to about ±1 ms.

There are a couple of ways to use

details on their time codes, check out the National Institute of Standards and Technology web page at [www.bldrdoc.gov/timefreq/pubs/sp432/sp432.htm](http://www.bldrdoc.gov/timefreq/pubs/sp432/sp432.htm)

Remember that the broadcasts are given as Coordinated Universal Time (UTC), or what used to be called "Greenwich Mean Time."

## Turn on the juice

All of this effort gathering and displaying accurate time signals is wasted if the AC power fails. Most master clock systems provide some means of battery

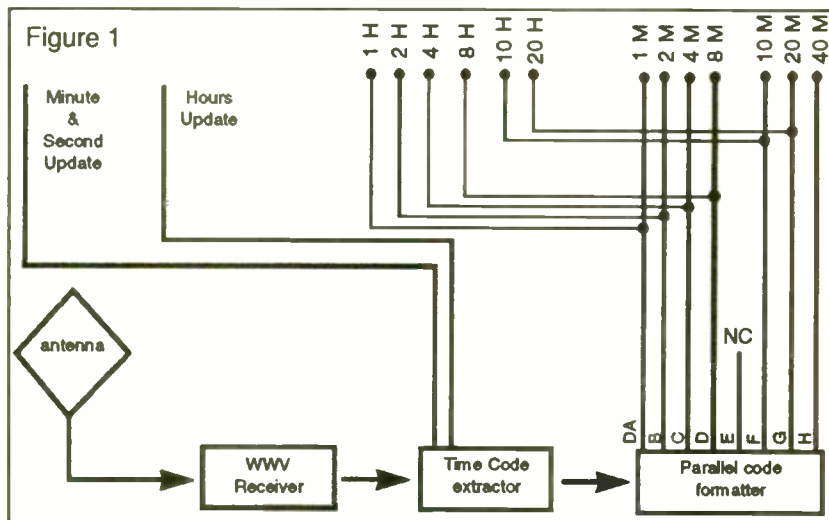

WWV to keep master clocks in line. The easiest is to set all clocks a few minutes ahead, stop them, then listen to a short-wave receiver and manually press the start button on the clock on the appropriate time-beep.

This scheme, while easy, has the disadvantage that the clock should be checked every couple of months (or sooner) and reset if necessary. Who needs yet another maintenance chore?

Also, without a battery backup, your clock's time display will be scrambled during power outages and must be reset.

Fortunately, there is a more elegant way to use WWV or WWVB. Both stations transmit a time code which may be used to update your master clock's display continuously. The WWV/WWVH code is a modified version of the IRIG-H code, and is transmitted on a 100 Hz sub-carrier.

WWVB uses a slightly different scheme. Circuits that will regularly update master clocks to WWV or

backup to keep the system alive until the juice comes back. Usually this includes a built-in trickle charger to keep lead-acid batteries primed.

This may seem like overkill, but a lot of current is needed to keep impulse clocks running. Most battery backup systems will keep things going for about an hour.

Master clock systems provide the means to run several types of slave clocks of both analog and digital variety. The most common is the 12V impulse clock. These clocks are driven by alternating polarity, pulse-per-second signals. A less-common variant uses pulses to advance both the minute and second hands.

Impulse clocks are wired in parallel. Installation requires sufficiently large cable to avoid overloading the clock driver. Installing connectors on the cable leading to the clocks can make life much easier when they must be removed. The impulse outputs of the master clock usually are fused, and can handle about 60

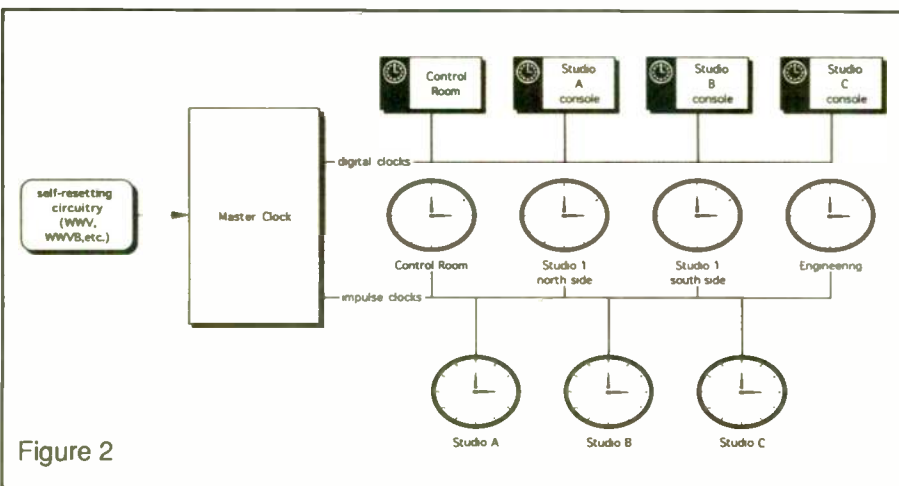

WWVB are easy to fabricate, and a simplified diagram is shown in Figure 1. Should the radio signal becomes unstable, the clock will keep running on its internal time base.

For the latest information on WWV and WWVB, including schedules and

clocks. Synchronous-motor clocks may be driven from an accurate 60 Hz source derived from the master clock's time base. However, the synchronous output usually is not adequate to drive clocks directly, so it must be fed into an amplifier and

distributed via a separate AC system for clocks only. This is a good application for an old audio power amp, but be sure the amp's power supply is clean; ripple interferes with the 60 Hz reference signal.

On the digital side, a parallel BCD output provides information for hours, minutes and seconds, usually synchronized with the master clock's own display. Typically there is enough drive to handle four or five TTL input circuits, although you have to fabricate your own paralleling termination block.

Frequency-Shift Keyed (FSK) serial time information usually is sent out on a 600-ohm balanced line at -10 dBm, making distribution no different than standard audio. Figure 2 shows a typical master clock system.

With some minor tweaks and improvements, such as the state-of-the-art for master clocks until about five years ago. Then, both technology and the market demand changed, altering the face of the clock business.

And that is where our story will continue next time.

## You Read It Here . . .

### One Year Ago

"Get set for a Federal Communications Commission yard sale.

"A newly introduced bill would require that the FCC 'exhaustively license' all available spectrum by selecting bands of unallocated frequencies and auctioning them. The idea is one of many included in the discussion draft of a 'grand spectrum' bill that Sen. Larry Pressler, R-S.D., introduced in May."

— News item, June 12, 1996

### Five Years Ago

"Despite assurances to the contrary, some professionals believe they will be affected by pending legislation that would require a royalty on blank digital tapes and limit digital copying on consumer recorders. ...

"Supporters of the bill admitted there may be some effect on professionals, especially with Digital Audio Tape (DAT)."

— "DAT Bills Could Affect Broadcasters" by John Gatski May 6, 1992

### Ten Years Ago

"Anti-copying legislation under consideration by Congress for digital audio recording may produce an audible effect in recorded music, including compact discs aired on radio stations. Legislation recently introduced in Congress would make mandatory the inclusion of an anti-copying device in digital recording."

— "CDs May Have Audible Notch" by Alex Zavistovich June 1, 1987



# Products & Services Showcase

For more information on the products shown below, circle the appropriate Reader Service No.(s) on the enclosed Subscription/Reader Service card or contact the advertiser directly.

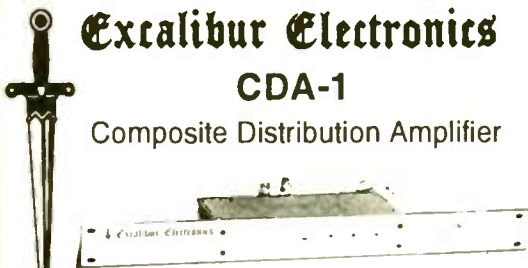

**Excalibur Electronics**  
CDA-1  
Composite Distribution Amplifier

This 1 in, 3 out distribution amplifier allows you to distribute stereo composite and/or subcarrier signals as easily as audio.

- ◆ DC-100 kHz frequency response
- ◆ 90 dB signal/noise ratio
- ◆ +6 dB to -20 dB gain range
- ◆ Individual 20-turn output trimmers
- ◆ 1 3/4" rack mount enclosure

EXCALIBUR ELECTRONICS, INC., CHANTILLY, VIRGINIA  
Please circle our bingo number for a data sheet and a dealer list.

READER SERVICE NO 55

## Control . . .



...almost any piece of equipment, in remote locations, with your phone, cell phone or two way radio using Monroe's 6000 Series DTMF Remote Controls.

for more information give us a call.  
**1-800-821-6001**  
http://www.monroe-electronics.com  
e-mail - monroe@monroe-electronics.com  
716-765-2254 • fax: 716-765-9330  
Lyndonville, New York 14098

**ME MONROE ELECTRONICS** MADE IN USA

READER SERVICE NO. 79

A Broadcast Industry

# BEST BUY

Cartridge Reproducer  
Mono Play Stereo Play  
**\$1050 \$1150**  
(F.O.B. Factory - U.S. \$)

**RELIABLE / RUGGED  
PROFESSIONAL DESIGN**



DL Series

**AUDI-CORD CORPORATION**  
1845 West Hovey Avenue  
Normal, Illinois 61761 USA  
Phone 309-452-9461  
Fax 309-452-0893

Available Through Your Regular Distributor

READER SERVICE NO 103

### REMEMBER THE CORTANA FOLDED UNIPOLE ANTENNA? WE STILL MAKE IT WITH THE SAME HIGH QUALITY MATERIALS AND WORKMANSHIP. IT FEATURES...

- BROAD BANDWIDTH for better sound,
- GROUNDED ANTENNA for lightning & static electricity,
- ELIMINATES ISOCOUPERS in VHF & UHF antenna lines,
- BEST ANTENNA FOR DIRECTIONAL ARRAYS.

ALSO  
DETUNING SYSTEMS FOR ANYTHING THAT DISTORTS YOUR AM COVERAGE PATTERN: TOWERS, POWER LINES, TANKS OR ANY METAL STRUCTURE.

FOR INFORMATION CALL, FAX OR WRITE:

**nott ltd.**  
4001 La Plata Hwy  
Farmington, NM 87401  
phone 505-327-5646 fax 505-325-1142

READER SERVICE NO 65

### WATTCHMAN® TRANSMITTER PROTECTION SYSTEMS



**WATTCHMAN®** protects your transmitter and transmission line system. A permanent 19" rack installation used with any dual socket line section 7/8" through 6 1/8" and elements (additional) to monitor CW, TV, and FM power. Model 81070 features two easily read meters to monitor both forward and reflected power. Abnormal conditions quickly cause transmitter shut down.

**TERMINATING LIQUID/AIR LOADS** (84000/85000 series) available to cover CW power ranges of up to 10,000 Watts over a frequency range of DC to 2.4 Ghz. All models are available with optional thermal overload switches to interface with the user's interlock or warning circuit.

**NEW**

**COAXIAL DYNAMICS, INC.**  
15210 Industrial Parkway  
Cleveland, Ohio 44135 (216) 267 2233  
Toll Free 1-800-COAXIAL (262 9425)  
PAX (216) 267 3142  
Web Site <http://www.coaxial.com>  
Email: [coaxial@apk.net](mailto:coaxial@apk.net)

READER SERVICE NO 89

## The Right Radio Tools!

Lesser products limit your station's sound by their poor performance and RF susceptibility: rock solid Benchmark interfaces have performance way beyond the limits of 16-bit digital!



- The Audio World Interface™ - Recorder Interface/Line Amp
- The Junior Audio Director™ - Stereo Mode Controller
- The Junior Audio Director™ Plus - 8 Channel Mode Controller

The Audio World Interface™ is a two-way recorder interface that is switchable to a line amp or a mono mix amp. The balanced inputs and electronic transformer outputs both have front panel recessed gain controls. The rack mountable chassis includes LEDs to indicate signal overload, switch position, and power presence.

Use it to mate R-DAT and analog recorders, to generate Mono from Stereo, or as a balanced line amplifier to compensate for level mismatches. Superlative performance, versatile operation, and an incredibly low price. make choosing the Audio World Interface™ a no-brainer!



**BENCHMARK MEDIA SYSTEMS, INC.**  
http://www.benchmarkmedia.com Phone 800-262-4675 • 315-437-8119

READER SERVICE NO. 104

## Attention Advertisers

Reach 18,000+ broadcast equipment buying prospects at AM, FM and AM/FM radio stations, networks and groups, recording studios, engineering and consulting firms every month.

Products & Services Showcase appears in every issue of Radio World. For detailed information, contact Christopher Rucas or your sales representative.

**RADIO WORLD**  
Tel: 415-824-3499  
FAX: 415-824-4738



# Buyer's Guide

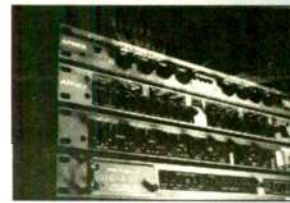

The  
Apdex  
Air Chain

See Page  
54

Radio World

Audio Processing & Delays

May 28, 1997

## USER REPORT

# A New AM Optimod Arrives

by John Buckham  
Chief Engineer  
KLOK(AM)

**SAN JOSE, Calif.** With the Orban Optimod Digital 8200 and 2200 FM processors having become the de facto standard in many stations across the country, it was only time before the wizards at Orban produced a digital processor for AM stations too.

The latest in the lineup of digital audio processors from Orban is the all-new Optimod-AM 9200.

The Optimod-AM 9200 is enclosed in a 2RU chassis with a styled plastic front escutcheon. Indicators and displays include an amber back-lit two-line LCD display with variable contrast, a 10-segment LED bargraph display for input level, broadband AGC gain reduction indicator, five multi-band indicators and output levels for both negative and positive modulation. A large round knob to the right of the display is used to adjust the various parameters of the processor.

## Connections

On the rear apron of the 9200 are XLR input and output connections for analog and digital AES/EBU audio. The 9200 is a monaural box with no plans for stereo operation, which surprised me. Options are given in the AES/EBU mode to process right or left channel, or a sum of both channels. The digital output feeds identical mono audio into left and right channels. The mode bits are set to configure the fed equipment for monaural operation automatically.

As with other Orban digital processors a number of convenient presets are



Chief Engineer Buckham and the Optimod-AM 9200

provided, as well as full control and expert mode that allows precise tailoring to your requirements. One of the most noteworthy inclusions is the expanded tri-band parametric equalization system available under the "Expert Control" mode.

The low and mid bands allow the user to adjust the system to compensate for irregularities in a transmission system. The high band is shelving, however in our case it was left in the "NRSC" preset. The high band will allow preemphasis up to the NRSC spec (75us). Low-pass and high-pass filters are also provided.

The low-pass filter is adjustable from 9.5 kHz down to 4.5 kHz in 500 Hz steps to accommodate international standards. High-pass is adjustable from 50 Hz to 100 Hz in 10 Hz steps.

These settings can be stored in user-definable presets, as well as called in the day/night mode to accommodate differ-

ent phasors, ATUs and transmitters. Other important adjustments such as tilt correction for older high-level rigs are also available.

The 9200 sports the ability to daypart processing by recalling presets from the programmable remote interface connector. With a simple contact closure from your remote control, you can recall any preset.

The remote control interface also allows the bandwidth and transmitter equalization to follow changes of antenna pattern and transmitter operating modes.

In use I found the 9200 to be kinder and gentler than the previous processor, a Greg Labs 2540. I found it necessary to use greater multi-band drive levels and higher clipping values than those to which I was accustomed, to obtain the desired level of loudness. We found the preset EQ helpful in setup of our particular RF plant.

## Compare and contrast

Now that the 9200 is on line, it is possible to perform instant comparisons of 9200 vs. other processors. Listening tests have revealed that the new 9200's sonic signature closely approximates that of the Greg 2540.

I don't think this is a coincidence. Greg Ogonowski was involved in the development of the 9200. Many AM audio experts agree that the Greg 2540, no

longer available, was perhaps the finest AM processor ever. This is indeed a glowing accolade to the 9200's performance.

For more information from Orban, contact the company in California at (510) 351-3500; fax: (510) 351-0500; or circle Reader Service 52.

## Problem:

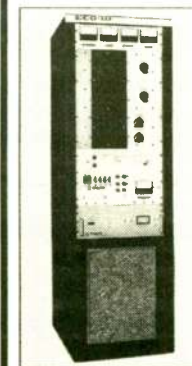

I need a new FM transmitter but prices are so high I may have to settle for a used one.

## Solution:

The **ECO** Series!

Rugged, Feature Packed & Reliable the **ECO** series was built with you in mind.

We've kept the cost low - so low in fact the **ECO** series competes favorably with the total cost of a used transmitter.

**ECO** quality - unsurpassed!

Plus you will experience the benefit of lower operating cost with extra long tube life and lower power consumption.

The most **ECONOMICAL** new transmitter on the market is available in powers from 2KW to 50KW.

Over 150 **ECOs** are already in the field!

Great Products  
Great Solutions!

"The Transmitter People"  
**Energy-Onix**

BROADCAST EQUIPMENT CO., INC.  
PO BOX 801 ♦ 1306 RIVER ST.  
Valatie, NY 12184  
Phone 518-758-1690  
Fax 518-758-1476  
energy-onix @ energy-onix.com

Circle (40) On Reader Service Card

## USER REPORT

# IDT Processor Jumps Out

by Jordi Roura  
Technical Director  
Flash FM & Flash Back

**BARCELONA, Spain** I'd been wanting to get into processing for some time, but I had to wait until a budget was allocated. A trip to the AES in 1996 armed me with information, and I contacted various dealers for trials. At first I was tempted by the digital processors available.

Given our policy of going digital in the studio, I was convinced a fully digital processor could not do the job efficiently and a subtle combination of analog and digital would be far better. As a result I gave the IDT Sound Design a try.

I was impressed by the array of adjustment parameters offered by the Sound Design; I could create the sound I wanted

for my station. We have a wide program range and I could find configurations for each style, either by establishing different presets or finding a compromise to establish my sound signature.

I wanted us to be competitive without sacrificing purity. By careful setting of the expanders, heavy use of the multi-band clippers and light final clipping, I got a sound, though not overly aggressive, that still stood out.

I got the sound I wanted and the Windows-based interface was certainly user-friendly.

With the various passwords and group codes I was sure that my files were protected from inadvertent or malicious intervention. I was in total control of what was going on air and that was a new feeling. In particular, the modem connection was a reassurance because any

modifications needed would not necessitate an urgent trip to the transmitter, nor even to my office.

What particularly impressed me about the IDT was the flexibility. I wanted a seven-band processor at first, but could only afford five. In the next couple of months I will be able to upgrade to seven by adding another two bands.

Also, there are regular upgrades to both hardware and software that give us the chance to improve our sound even more. Not only can I keep up with our competitors, but I can actually beat them at their own game.

With Sound Design, I had faith in broadcast processing again.

For more information from IDT, contact the company in France at +33-472-18-19-20; fax: +33-472-18-19-21; or circle Reader Service 74



## USER REPORT

# Aphex Air Chain Revamps Station

by Tom Peterson  
Chief Engineer  
WIQB-FM

**ANN ARBOR, Mich.** There comes a time when a radio station realizes it has to say good-bye to its old audio processor. That time arrived for alternative rock station WIQB-FM a couple of months ago.

After building a brand-new studio, it became apparent that WIQB-FM had a dull, dirty sound when compared to our competitors. It was also much quieter on the dial. After looking at the old processor that had served us well over the

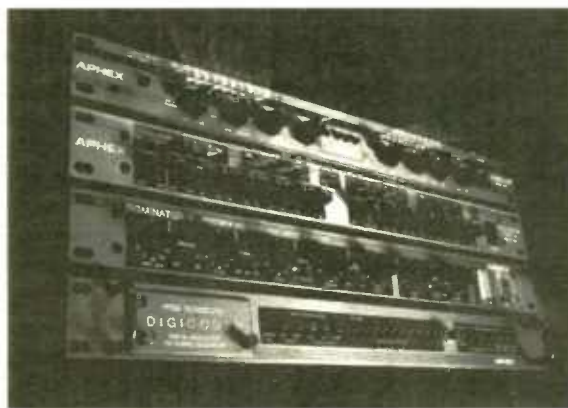

The Aphex Systems Air Chain

years, I decided it needed to be replaced.

## Increase cume

I was persuaded to try the Aphex Air Chain by its advertisement — the one claiming stations will increase listenership in fringe areas with the installation of the Air Chain. With WIQB-FM sitting at Detroit's back door, I figured I would take all the help I can get.

In addition, I was also impressed that the Air Chain's processing "states" are individ-

ual pieces of equipment, rather than different circuit cards kept in a single cabinet.

Specifically, the Air Chain consists of the Aural Exciter, the Compellor Compressor/Leveler, the Dominator II multi-bank peak limiter and the Digicoder stereo generator. Having four separate pieces was an attractive feature because it allows easy bypassing if necessary.

The signal chain is pretty simple. Audio is fed into the Compellor, which feeds into the Aural Exciter and then the Dominator. The Air Chain also allowed easy installation of our EAS system. After the Dominator, I patched in the EAS system and simply routed the output directly into the Digicoder, bypassing the audio processing. It worked like a charm.

The actual installation of the Aphex Air Chain was a snap. Even though the system consists of four units, I still had room left over. Hookup consisted of the typical left and right ins and outs all the way to the stereo generator. To complete the installation, the stereo generator is linked to either the composite STL or FM exciter.

Normal programming is used in setting audio levels. I found the use of an audio generator helpful only in setting L and R balance. The Compellor handles it without distorting.

Another feature I liked about the Aphex Air Chain was the Digicoder. This unit had the ability to switch from stereo operation to mono using the left or right channel at a touch of a button. The Digicoder also allows me to add subcarrier equipment to my composite conveniently without interrupting my on-air system.

When I arranged for the demo, I told only a couple of people that we were going to try a new audio processor. Even though these individuals knew a new system was coming, they still had no idea when it was going to be installed. I did this hoping to get a more accurate evaluation on the system. Once the new system hit the air, it was only a matter of hours before I was asked, "What did you do? The station sounds much better!"

## In stereo

We were now as loud as our competitors, yet our audio was clean and open and actually had depth. The station sounded like it was actually in stereo again. Most processors, when pushed, seem to become dirty and distorted. They are fatiguing and appear to lose stereo imaging. Not so with the Aphex system.

I have noticed another benefit. Our fringe area has fewer multipath problems. WIQB-FM is directional and short-spaced with another station on an adjacent channel. Even in the fringe listening areas, there has been improvement.

I must credit the Digicoder stereo generator for this. The Digicoder seems to have an exceptionally clean baseband output. This unit also has a pre-emphasis peak limiter, which keeps those sudden high-frequency peaks under control, minimizing potential overshoot problems.

Prior to making our final decision, I tried digital, analog and even retrofit kits. All were good in certain areas, but none could come close to our goal for WIQB-FM's air quality. The Aphex Air Chain was the proven audio processor for our station. It provides us with good clean sound without the grunge.

For more information from Aphex, contact the company in California at (818) 767-2929; or circle Reader Service 54.

# "YOU CAN NEVER BE TOO RICH OR TOO THIN."



Model CT-6 Thin

## Your new Radio Systems digital clock won't use up your table space or your budget.

Finally, there's a low cost timing system for your broadcast facility that mounts anywhere. Every model provides accurate time-of-day, a six digit up timer, and functions as a stand-alone or master read-out.



Model CT-6 Desktop - Standard Desktop Cabinet



Model CT-6 Large - Wall-mount with 2" Display

Models provide these features:

- clock or timer operation
- master or slave display
- full remote control
- daylight savings and 1 second adjustments\*
- oven stabilized crystal\*
- top-of-hour and external synchronization inputs\*
- drive for Radio Systems analog clocks\*

\* features of master drive unit when packaged in the desktop model.

## RADIO SYSTEMS INC.

601 HERON DRIVE • P.O. Box 458 • BRIDGEPORT, N.J. 08014-0458 • (609)467-8000 • FAX(609)467-3044 • WWW.RADIOSYSTEMS.COM

Circle (39) On Reader Service Card

World Radio History



USER REPORT

# WBEB Solves Digital Dilemma

by Russ Mundschenk  
Chief Engineer  
WBEB(FM)

**PHILADELPHIA** Until the advent of digital mixing, analog-to-digital converters were not a necessity in a broadcast facility. In fact, the engineer's biggest concern was how to convert the digital signal back to analog for mixing, processing and transmission.

Now it is possible to tie everything together digitally using AES/EBU or other formats, with source integration being digital and not analog.

**Long-term goal**

Our long-term goal in building new digital studios at WBEB is to eventually convert all sources to digital, except for the mics. Because analog cabling is redundant and prone to hum and noise pickup, all analog runs are kept within each studio. Audio from microphone preamps, reel-to-reel tape

machines and the like is all converted to an AES/EBU bitstream and synchronized to a house standard.

All sources (now digital) route through patch bays and concentrate at digital processing units co-located in a common terminal room, where any source may be hard-patched to any destination. External A/D converters are specified because all sources must be digital at this point. Some consoles with built-in A/Ds do not provide digital input patch points and A/D-D/A converters are the digital studio's most upgradeable devices.

With all this in mind, we looked around for an external A/D converter that could accept house synchronization. Back in 1995, the few units that were available were expensive and complex. I called **Benchmark Media Systems** and found out that they were designing such a device. The Benchmark AD2004 not only came with great specifications, but managed to cram four analog (two AES/EBU) channels into a box only one-

third rack width by 1U high.

Benchmark really did its homework. It is important to lock A/D converters and all other AES/EBU devices to a common synchronizing standard. Because this signal may not be as stable as desired, the AD2004 features a proprietary synchronization jitter reduction circuit that cleans up even noisy sources. Should the source become too unstable or lost, the unit noiselessly defaults to its internal time base. Both 44.1 and 48 kHz sample rates are selectable from a front-panel switch.

**An extra step**

Benchmark take a step further than most converter manufacturers. The analog circuits incorporate an esoteric level of analog pre-processing to reduce spurious artifacts created by the A/D converter chip.

The AD2004 provides 20 bits of amplitude resolution. This corresponds to an A-weighted signal-to-noise ratio and dynamic range of better than 110 dB. If that is not enough, the unit can even

quantize signals that are buried 25 dB in noise (135 dB down).

The AD2004 provides precise digital metering of source amplitude. A selectable nine-segment LED display can meter simultaneous peak/peak-hold with a one-eighth second or continuous peak hold duration. The latter may be used to indicate the maximum amplitude of a session and then reset.

Why use such a high-quality converter for broadcast applications? After all, many of us are forced to squash and clip the living daylight out of audio anyway. Dynamic range reduction by audio processing exposes artifacts in low-level material that are normally imperceptible. Limiting and clipping not only create their own artifacts, but amplify existing intermodulation and odd-order harmonic distortion components. Thus the formula: Garbage In = (Garbage Out)<sup>2</sup>.

So what does it sound like? In a word, fabulous! Most of us would like to believe that digital audio sounds great, but turning the elocution of Melodious Mel the Morning Man into 1s and 0s is not easy. Unprocessed vocal material — with its dynamic range and transients — may be the best test of a microphone, pre-amp and A/D converter combination.

WBEB has had seven AD2004s — 28 channels — in use since early 1996 (including serial number 1). We have not had a single problem with these units.

For more information from Benchmark Media Systems, contact the company in New York at (800) 262-4675; fax: (315) 437-8119; via e-mail at: info@benchmarkmedia.com; or circle Reader Service 75.

USER REPORT

# Win With Processing Solutions

by Leroy C. Granlund  
Director of Engineering  
Z Spanish Radio Network

**SACRAMENTO, Calif.** Audio processing has always been an important factor in a radio station's image and success. At one time, the options were few and the decisions were simple. Today's complex mix of analog and digital audio sources, and the wide array of signal transmission technology, have greatly complicated the issue.

You want to stay all-digital? That can be a good decision if every step in the signal path uses the same digital format, compression algorithm and sample rate, and if each piece of equipment is synchronized to the same clock source. In the real world, I have not seen a single case where these conditions exist.

If digital products of different formats or compression algorithms are used in the same audio chain, sound quality may suffer. If sample rates in cascaded equipment are similar but unsynchronized, the difference in frequency can degrade the audio. In the future, as digital audio standards are perfected, these problems will be resolved.

**Analog when appropriate**

My best recommendation is to forget about staying all-digital. Do not be afraid to use digital signals and equipment where available, but mix it with analog where that makes the most sense. This is especially true regarding audio processors.

There is an ever-increasing number of digital audio processors on the market. Most of them sound pretty good in mostly analog audio chains. If fed from digital program sources and used with a digital STL and/or digital exciter, the result can be less than ideal. I have discovered that some of the new analog audio processors on the market are just as good if not better than their digital counterparts, without the compatibility problems.

A significant example of exceptional analog audio processors is offered by

**Processing Solutions Inc.** based in Broadview Heights, Ohio. Owner Jim Somich is a well-respected broadcast engineer and a contributor to *RW*. He started this venture because he was dissatisfied with available audio processing equipment. His efforts have yielded a number of outstanding products, all worthy of your consideration.

The heart of the Processing Solutions product line is the Combinator. This is possibly the world's most versatile and easy-to-operate compressor/limiter, and its panel layout makes the comprehensive instruction book almost unnecessary. This unit actually is manufactured by a German firm and is modified for broadcast use by Processing Solutions.

The Ultraflex II is an outstanding audio source processor, not unlike the familiar Aural Exciter. It can make vintage mechanical recordings sound almost as nice as a CD, and it is a major benefit when doing remote broadcasts over phone lines.

The best part is that it does not over-process good quality sound — such as CDs — if left in the line at all times.

This product is originally manufactured in Germany, imported and modified for broadcast by Processing Solutions. I have found it to be effective when placed ahead of the Combinator. It produces an air sound unrivaled by any of the "big-name" manufacturers.

**Maximum loudness**

Then there is the Fleximod. If your format calls for maximum loudness without overmodulation, you need some kind of composite signal processor. There are several on the market, and you could even use a well-chosen zener diode to catch stray peaks.

Many of these — certainly the zener diode — will end up hurting your air sound and your ratings.

I have tried almost all of the available composite processors, and I found only one that actually improved the air sound. That was and still is the Fleximod.

For more information from Processing Solutions Inc., contact Jim Somich in Ohio at (216) 546-0967; fax: (216) 838-4573; via e-mail: jsomich@ameritech.net; or circle Reader Service 98.

## Affordable Digital Automation

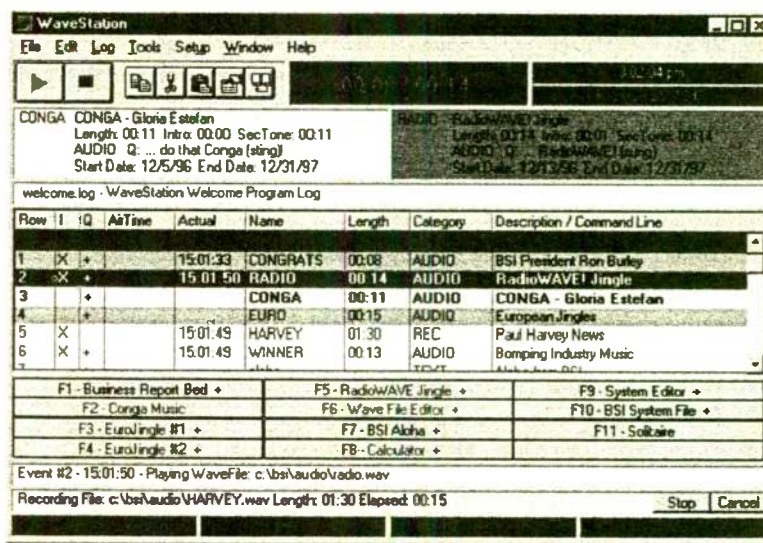

**EASY TO USE!**  
Audio on hard drive  
Interface with sat systems  
Import from traffic systems  
True "rotating carts"  
Smooth segues  
Voice Tracking

Menu driven, no config files!  
Playback & Record  
Full automated or live assist  
Uses standard WAV files  
Built-in Audio Editor  
Windows 3.1 or Win 95  
Time Sync & Time Speak

**24 HOUR  
FREE  
TECH SUPPORT**

**BSI**  
Broadcast Software International

**Try Before You Buy!**

Download the ACTUAL software!

**www.bsiusa.com or 888-BSIUSA1**

**\$999  
complete**



## AEV

**BOLOGNA, Italy** Selecting the correct audio processor has never been more important than in today's competitive radio — a business based on research and continually improving audio quality. **AEV Srl** created the Exclusive FM as a solution for this environment, taking into consideration the new digital radio networks.

Over 40 processing parameters can be adjusted. An optional Stereo Digital Encoder assures excellent stereo separation, but also maximum modulation levels, while fully controlling spurious spikes generated by low-pass filters and pre-emphasis networks used by external encoders.

Features include: independent control for threshold limiting, gain, clipping and attack time, electronically balanced inputs and outputs, 256 processed sounds stored, six level password security code and 10-band processing.

For more information from **AEV Srl**, contact the company in Italy at +39-51-950249; fax: +39-51-950201; or circle Reader Service 71.

## CUTTING EDGE

**CLEVELAND** A complete, fully digital system with stereo encoder, the **Omnia.fm** from **Cutting Edge Technologies** yields a performance and flexibility previously unavailable in a digital broadcast signal.

The harsh, metallic sound qualities



inherent in DSP-based broadcast processors are not heard with the **Omnia.fm**. It delivers highs, bass and loudness with no digital grunge.

The **Omnia.fm** implements HTML protocol output for remote computer interfacing. Instead of requiring a specially-designed, front-end software package, the user can access **Omnia.fm** through any Web-browser on any platform (DOS/Windows, Macintosh, Unix.) Communication can be made via a local serial RS-232, modem, 10BaseT or even the Internet. New processing system software can be downloaded and installed as well.

All processing algorithms and functions are loaded and stored on a PC card, rather than the traditional EPROM set. Using a soft digital signal processing configuration, the host system can actually rearrange the DSPs within software to add or modify processing functions. This eliminates the need to keep all processing algorithms within software restrictions, which previous DSP attempts have done in the past. This is all done on the fly, in software, without the need to physically change anything on the unit.

Functions include: WideBand AGC,

Thunder Boost EQ, Four Band Linear Dynamically Flat, Time Aligned Crossover, Four Band AGC, Four Band Dynamic Peak Limiter and Non-Aliasing Distortion Controlled Final Limiter.

The Stereo Generator includes numeric implementation. Stereo separation is typically greater than 65 dB, while suppression of the 38 kHz carrier is greater than 75 dB.

For more information from **Cutting Edge Technologies**, contact the company in Ohio at (216) 241-3343; e-mail: jcasey@zephyr.com; or circle Reader Service 72.

## EVENTIDE

**LITTLE FERRY, N.J.** Incorporating the suggestions of hundreds of users, **Eventide** enhanced the BD500 digital broadcast delay by improving the automatic catch-up circuitry and optional digital audio I/O.

The BD500 lets the user divide the



total available delay time into several discrete segments (the user decides how many.)

Each time the Dump button is pressed, only the one segment is dumped. For example, if a unit with the standard 8.5 seconds of total memory is set up to provide 3 second dumps, there are three separate dump segments: 3 seconds, 3 seconds and 2.5 seconds.

A new "sneeze" button momentarily edits audio entering the delay, allowing the host time to sneeze, cough or make a short comment without dead air.

The unit also shows not only an exact digital read out of delay time, but also has a "quick-read" bar graph that instantly confirms "you're safe"

at a glance.

The unit features analog XLR-type inputs and outputs, optional AES/EBU digital outputs, and front panel switches (except configure) can be accessed via remote (RS-232 and dry contacts are available).

For more information from **Eventide Inc.**, contact the company in New Jersey at (201) 641-1200; fax: (201) 641-1260; via its website at: <http://www.eventide.com>; or circle Reader Service 78.

## SYMETRIX

**LYNNWOOD, Wash.** The **Symetrix** 422 Stereo ACG/Leveler is an automatic gain controller designed to boost stereo signals that fall below the target output level and pull back those that rise above it.

Intended for use at any point where there is line-level audio, the 422 features a parallel input and output meters



to allow the user to see the input level and adjust it to the desired target output level.

Other features include a threshold control for adjusting sensitivity, a ratio

control to set processing speed, and a separate peak limiter for creating an absolute ceiling.

The 422 makes loud sounds quieter and quiet sounds louder; it solves audio level problems that conventional compressors can't fix.

In addition, it accepts the wide range of console output levels churned out by careless operators and obediently maintains your target output level.

For more information from **Symetrix**, contact the company in Washington at (206) 787-3222; fax: (206) 787-3211; or circle Reader Service 125.

## SUPERSCOPE

**AURORA, Ill.** **Superscope Technologies** has incorporated a wide range of technologies from **Philips**, offering versatility in creating high-quality digital recordings for broadcast applications.

Both the IS5021 and IS5022 digital sound processors include A/D and D/A converters and a sample rate converter in compact, user-friendly packages.

A/D conversion is a high-precision 20-bit process, while the D/A conversion is also high-precision and

completely linear.

The sample rate converter offers 44.1 or 48 kHz output sampling frequency and will convert sampling rates from 15 to 50 kHz.

This capability, as well as the ability to remove DAT jitter, makes either unit ideal for transfer of older DAT recordings.

Quantization Noise Imaging improves 16-bit audio signals by moving noise outside the audible range.

Compression and expansion functions allow further enhancement of the audio signal.

Compression subtly reduces dynamic range, making it appropriate for recording from digital to analog, while expansion will increase the dynamic range of the source material.

The IS5022 comes in a compact, 1U rack-mountable package and is compatible with both AES/EBU and S/PDIF. It also includes balanced XLR and unbalanced RCA I/O.

The IS5021 is a tabletop version; it is S/PDIF-compatible, with unbalanced RCA ins and outs.

For a limited time, **Superscope** is offering both units directly to end users at 50 percent off suggested retail price.

For more information from **Superscope**, contact the company in Illinois at (630) 820-4800; fax (630) 820-8103 or circle Reader Service 67.

April 1994 as regional sales manager, Shannon will now direct the professional division's sales efforts in the U.S. and Canada.

**Broadcast Electronics** has expanded its digital sales staff by hiring **Mark Malleck**, former producer/director of **KidStar Interactive Media** in Seattle.

Malleck will be responsible for **AudioVault** sales and support, in conjunction with recurring programming, and will report to **Susan Dingethal**, director of national sales.

**Luis C. Endara** is now sales manager for **Orban** in Latin America and the Caribbean.

Based in Miami, Endara will oversee sales of all product lines through **Orban's** dealer network in Latin America.

**Orban** Regional Representative for Central America since 1990, he also operated **Tropical Moon(FM)**, Central America's first fully digital FM station.

**World Wide Wadio** promoted **Stewart Sloke** to vice president/production director of the Hollywood-based radio production company and **Brett Hahn** to vice president and creative director.

**World Wide Wadio** is a team of radio directors, producers, writers and sound designers whose clients include **CBS Television**, **Pepsi** and **McDonald's**.

Two award-winning radio journalists have joined **ABC News Radio**: **Karen Chase** has been named correspondent and news anchor, based in New York; and **Pam Coulter** joins **ABC** as a Washington-based reporter and editor.

**Jones Satellite Networks** announced the promotion of **Karen Barich** to director of finance and **Lou Lavaux** to business manager.

**Jones Radio Network** is a provider of live, 24-hour, satellite delivered radio programming.

**Jones** also distributes "The Crook and Chase Country Countdown," as well as the "Crook & Chase CenterStage Specials" and the "Nashville News Source."

**John Casey** has assumed the newly created position of vice president for marketing and sales for **Cutting Edge** and **Telos**.

He will oversee worldwide marketing, sales and advertising for the broadcast and pro audio product lines for both companies.

**Marc Lee Shannon** has been appointed national sales manager, professional products for **Audio-Technica U.S.**

Originally joining the company in



# Radio World Broadcast Equipment Exchange

"Broadcast Equipment Exchange" accepts no responsibility for the condition of the equipment listed or for the specifics of transactions made between buyers and sellers.

## ACOUSTICS

### Want to Sell

#### ACOUSTIC FOAM

Sound Barrier - Diffusers - Bass Traps

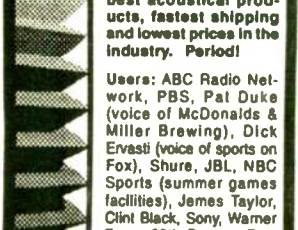

We have absolutely the best acoustical products, fastest shipping and lowest prices in the industry. Period!

Users: ABC Radio Network, PBS, Pat Duke (voice of McDonalds & Miller Brewing), Dick Ervasti (voice of sports on Fox), Shure, JBL, NBC Sports (summer games facilities), James Taylor, Clint Black, Sony, Warner Bros., 20th Century Fox, Maury Povich Show, Hitachi, Toshiba, Universal Studios, ShowCo, Dennis DeYoung (Styx), Mark Lindsay (P. P. & the Raiders), Kansas City Royals & MANY more you've heard of.

**Auralox™ 317-842-2600**

**ASK FOR AURALEX ACOUSTICAL PRODUCTS BY NAME AT ALL MAJOR BROADCAST SUPPLIERS!**

Circle (234) On Reader Service Card

## AMPLIFIERS

### Want to Sell

Ham Radio linear kilowatt parts, roller coils, air-vacuum capacitors, tubes, sockets, meters, dial counters, chassis, panels, cabinets & pwr supply parts. F Yonker, Penn State Univ, 1229 Inverary Pl, State College PA 16801. 814-867-1400.

**Kenwood KA-5700** stereo amp & loudspeaker system, complete, \$345. R Streicher, Pacific Audio-Visual Enter, 545 Cloverleaf Way, Monrovia CA 91016. 818-359-8012.

**McIntosh C-28** preamp, \$395; Soundcraftsmen 450 x 2 pro MOSFET, \$295; SAE 2200 100 w/c blk w/red LED display, \$175; Heathkit tube amp w/5M, \$175; (2) Altec 1590-C 200 W mono block amps, mint w/manual, \$400/pr. B Cobb, Solid State Rcdg, 1044 Lightfoot Rd, Winauma FL 33598. 813-634-1940.

**Peavey PV1.3K**, excel cond w/warranty, 1300 W into 8 ohms, \$500. T Santorelli, SPEC, 684 Sunrise Hwy, W Babylon NY 11704. 516-661-2454.

**Peavy CS800**, as is, \$200. J Price, Price Studio, TX. 214-321-6576.

### Want to Buy

**Harmon-Kardon HKII**, Dynaco MKIV, McIntosh Mc40 & Mc60 tube amps. B Cobb, Solid State Rcdg, 1044 Lightfoot Rd, Winauma FL 33598. 813-634-1940.

## ANTENNAS/TOWERS/CABLES

### Want to Sell

Hughey & Phillips KG-114



## FM-TV-LPTV Antennas

### Factory Direct Sales

Contact Jimmie Joynt

Phone 800/279-3326 972/473/2577

Fax 800/644-5958 972/473-2578

300mm code beacon, excel cond, \$500 ea; Puregas 1500 air dryer, 1500 cu ft/day, gd cond, \$950. E Black, KXXY, 100 NE 28 St, Oklahoma City OK 73105. 405-524-3770.

### S.W.R. FM Antennas

Great Antenna  
Great Price!



(804) 984-4255

**Philips-Dodge 3 bay FM**, 6 kW on 100.3, \$1500. C Jones, WMNY, 7620 Old #6, Santee SC 29142. 803-854-6396.

### 3" HELIAX STANDARD COAXIAL CABLE

50-Ohm, unused, cut to length. Priced below market. Shipped instantly.

Call Basic Wire & Cable  
(NANCY) 800-227-4292  
FAX: 773-539-3500

**Stainless steel tower dissipator**, \$400; 5 kW isocoupler 104.9 MHz, \$500. D Rose, KDUK, POB 432, Barstow CA 92312. 619-256-2068.

**80' tower w/4 sections**, 20' ea, triangle shaped, 3 sided, galvanized section by Magnum, w/guy wire, \$800/pkg +shpg. R Chambers, KSUE, 3015 Johnstonville Rd, Susanville CA 96130. 916-257-2121.

**Andrew transmission line**, 170', 1-5/8" never used, w/Andrew connections both ends, gas pass & gas block connections, \$10/ft. R Chambers, KSUE, 3015 Johnstonville Rd, Susanville CA 96130. 916-257-2121.

**Stainless 420' tower**, 25" face, no hardware, \$6500. R Weaver, WPGW, POB 1440, Portland IN 47371. 219-726-8780.

**CODE BEACON/OBSTRUCTION BULBS**: manufactured in the USA! One year warranty! For more information fax Michael at 606-271-4132.

### Want to Buy

## TOWERS PURCHASED!

Standing in place or dismantled.

Call Signal One Corp.  
423-954-1111  
Attn: Real Estate Mgr.

FAX tower/site info to:  
423-485-8125

## AUDIO PRODUCTION

### Want to Sell

**Shure FP32a** field mixer, full featured, w/case, \$900/trade? Bruce, 406-542-2563.

**Shure M67** mic mixer, \$75; Wilkinson gain control amp, \$50; Wilkinson limiting amp, \$50. H Bertram, America First Radio, POB 88, Madsville WV 26541. 304-328-5810.

**Teac 2A** mixer, 6x2 w/MB-20 meter bridge, \$100. J Borden, Handbasket Prod, 2909 S Logan Ave, Milwaukee WI 53207. 414-482-8954.

**Wards Airliner 14BR** 78 rpm disc cutter w/Shure 9842B mic & blank discs, \$200; Symetrix SX202 dual mic-pre-

amp, balanced in & out, phantom power & phase invert switch, \$125. J Borden, Handbasket Prod, 2909 S Logan Ave, Milwaukee WI 53207. 414-482-8954.

## CASSETTES · CARTS · REELS

### J & I AUDIO/VIDEO

A wholesaler in the Radio and Television market. Now running SPECIALS on audio and video:

**BASF CASSETTES-AMPEX R-Rs**  
**AUDIOPAK, FIDELIPAC & ITC CARTS**  
**DAT & THE NEW R-CD**

For more information call Kris Elliot at  
**1-800-942-1711**

or write to: J&I Audio/Video  
20899 Kelvin Pl.  
Woodland Hills, CA 91367

Circle (233) On Reader Service Card

**Audio Digital/JBL TC-4** digital delay, \$800. M Vanhooser, KSKY, 4144 N Central Expy #266, Dallas TX 75204. 214-827-5759.

**dbx 208 NR** system, \$495. J Price, Price Studio, TX. 214-321-6576.

**Dolby 361** type-A NR, w/road case, \$625; Optimus SCT-50 CD player/cassette recorder, excel cond, \$300. R Streicher, Pacific Audio-Visual Enter, 545 Cloverleaf Way, Monrovia CA 91016. 818-359-8012.

**Tannoy 15" speaker** pair, newly recond, \$1450; vintage recond tube mic pre's & mixers, \$300-\$700; new ADC patch bays " 52 points, \$169; ADC TT bays, \$129 up; new ADC TT or " TRS cords, \$9; Furman " to " patchbays, \$95 ea; like new tape, "x2500" 456, \$15 ea; 1" 456, 226, 250, \$25 ea; Digitec 3.6 sec delay, \$150; new pwr dist/filter rack mt, \$75. W Gunn, Box 2902, Palm Springs CA 92262. 619-320-0728.

### Want to Buy

**Ramko ARA-1612** output boards (2+) to populate a routing switcher. J Olson, KPBX, 2319 N Monroe, Spokane WA 99205. 509-328-5729.

**Compressors & EQs**, tube and solid state. W Gunn, Box 2902, Palm Springs CA 92262. 619-320-0728.

## AUTOMATION EQUIPMENT

### Want to Sell

**Revox A77**, \$150; SMC 452 Carousel, \$300; SMC pwr supply, \$100; Schafer 903E Audiofile parts; ITC 750 r-r, \$150. D Rose, KDUK, POB 432, Barstow CA 92312. 619-256-2068.

**SMC 3060**, 2 racks, 2 Carousels R/S, complete manual & spare parts, \$500. C Jones, WMNY, 7620 Old #6, Santee SC 29142. 803-854-6396.

**Sony-Mag 3000** automation, 5 reels, 2 Carousels, all brains, 3 racks, working when removed in '95, \$1000/BO, u-ship. F Martin, WSNW, 450-B By-Pass 123, Seneca SC 29679. 864-882-9769.

## CART MACHINES

### Want to Sell

**Audi-Cord DL**, stereo R/P, like new, \$500. M Trumble, Trumble & Assoc, 409 Washington #422, Hoboken NJ 07030. 201-795-1201.

**ITC Delta - new pinch rollers: Mono playback (2), record/play (2), stereo record/play (1). MOTIVATED! Spotmaster series 2000 record (1). Wes, 818-798-9128.**

**ITC upgrade PB** to record, amps only-no deck, 3 tone,

stereo, \$175. W Gunn, Box 2902, Palm Springs CA 92262. 619-320-0728.

Great Prices on original equipment tape heads for ITC, BL, Fidelipac, Otari, Tascam & others!  
**(804) 984-4255**

## CONSOLES

### Want to Sell

**Harris Stereo 80**, \$1000. D Rose, KDUK, POB 432, Barstow CA 92312. 619-256-2068.

AMPRO CONSOLES PARTS & SERVICE  
call  
**SEQUOIA ELECTRONICS**  
1-(408) 363-1646  
FAX 1-(408) 363-0957

**Shure M-67** mic mixer, excel cond, will pay shpg, \$175; McMartin MX-5 5 input mono mixer, excel cond, will pay shpg, \$125. D Meyer, 1123 Del Mar, Santa Barbara CA 93109. 805-962-8273.

**Sparta A-15** 5 input rotary pots, mono, gd cond, \$100. E Swanson, WPKR, POB 3450, Oshkosh WI 54903. 414-236-4242.

**Ampex AM10** 6x2 mixer, \$495. J Price, Price Studio, TX. 214-321-6576.

**Autogram AC-8** stereo console, 32 inputs, 8 faders, mint cond, \$3200. K Orchard, 16435 Wimpleton Dr, Victorville CA 92392. 760-243-4733.

**BE 4BEM50** 4 chnl mono in mint cond w/manual, \$450. H

Brand New from

**APHEX**

Sounds Great & IT'S LOUD!!!

**FM Pro 2020  
FM Audio Processor/  
Stereo Generator  
Digital Control,  
set-up screen.**

List From **\$4,995**

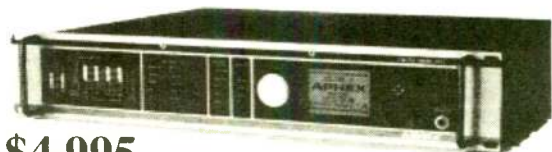

Call Now... Your HE Price is much Lower!

[www.halls.com](http://www.halls.com)

Email [sales@halls.com](mailto:sales@halls.com)

706 Rose Hill Drive, Charlottesville, VA. 22901

**HE HALL Electronics**

(804) 984-HALL (4255) Fax: (804) 984-FAXX (3299)

Circle (232) On Reader Service Card



## CONSOLES continued...

Frost, WBEC, 211 Jason St, Pittsfield MA 01201. 413-499-3333.

Gates Producer 4 chnl, \$250. M Vanhooser, KSKY, 4144 N Central Expy #266, Dallas TX 75204. 214-827-5759.

Ramko DC-5RA 5 chnl console, mono, 10 inputs capacity, \$325. Allan, WSPN Radio, 955 Main St #617, Bridgeport CT 06601. 203-368-2253.

Spirit Live 4 mixing console, 12x4x2, \$1250; Mackie 1604 mixer w/expander, near new cond, \$700. R Streicher, Pacific Audio-Visual Enter, 545 Cloverleaf Way, Monrovia CA 91016. 818-359-8012.

Soundcraft 600 32x16 w/patchbay, mint, \$4950; Tascam 512 12x8 mixer, \$750; Tascam 520 20x8x16 mixer, \$1750; Tascam 30 8x4, \$450; Allen & Heath Syncon 28x24, great sounding, \$5000. W Gunn, Box 2902, Palm Springs CA 92262. 619-320-9728.

Soundcraft Ghost 24x8 w/midi auto & meter bridge, brand new w/warranty, \$5400; Mackie 32x8 w/meter bridge, stand, cover, ec, \$3900; New Road Case for 32x8, \$200; Mackie 24x8 w/meter bridge, ec, \$2700; Tascam M312 12x4x2x1 w/case vgc, \$500; Kawai MX8-SR 8 chnl stereo line mixer, ec, \$250. (NJ) 201-398-1558.

## Want to Buy

Collins 212R1 audio rack pwr

supply, schematics, switches, meters. P Scharrel, KCXL, 310 S La Frenz, Liberty MO 64068. 816-792-1140.

Howe 7500 or parts, any Howe console. D Rose, KDUC, POB 432, Barstow CA 92312. 619-256-2068.

Solid State console, 12+ input priced low & in gd cond. ID Byars, WCPI, 110 S Cours Sq, McMinnville TN 37110. 615-506-9274.

DISCO-PRO  
SOUND EQUIP

## Want to Sell

Fostex EQ, \$100; (4) bass reflex instrument speakers, \$100 ea; portable DJ outfit, \$1000. D Rose, KDUC, POB 432, Barstow CA 92312. 619-256-2068.

RCA Automatic, giant 5"x7" cassette, heavy duty, 2 motors, battleship construction. F Yonker, Penn State Univ, 1229 Inverary Pl, State College PA 16801. 814-867-1400.

RCA-Automatic, giant 5"x7" cassette, heavy duty, 2 motors, battleship construction. F Yonker, Penn State Univ, 1229 Inverary Pl, State College PA 16801. 814-867-1400.

## Want to Buy

Altec 604 8-G duplex loudspeaker. B Cobb, Solid State Rcdg, 1044 Lightfoot Rd, Winauma FL 33598. 813-634-1940.

FINANCIAL/LEASING  
SERVICESFINANCING  
LOANS BY PHONE  
(800) 699-FLEX

- We finance all types of Broadcasting Equipment
- Flexible Credit Criteria
- Flexible Payment Plans
- No Down Payment, No Payments For 90-Days Available

To apply or request additional information call Jeff Wetter.

FLEXLEASE, Inc.

## LIMITERS

## Want to Sell

MicroCon Flexi-Mod system one composite clipper, new, rack mount, \$750. E Swanson, WPKR, POB 3450, Oshkosh WI 54903. 414-236-4242.

Orban 2200 digital Optimod, as new w/digital AES/EAU interface, \$3400. P Christensen, Christensen Prod, 11142 Ralsy Creek S, Jacksonville FL 32225. 904-619-3899.

Orban 245E stereo synthesizer. J Gelo, 941-642-6899.

Roland 49CMP1 SS, limiter/compressor cards (3), \$25/lot; line amps, brdg in, 600 ohm out, mono, new (4),

\$20 ea; 6 W amps, mike & line to spkr, new, \$25 ea. E Davison, 217-793-0400.

## Want to Buy

Teletronix LA-2A's, UREI LA-3A's & LA-4's, Fairchild 660's & 670's, any Pultec EQ's & any other old tube compressor/limiters, call after 3PM CST, 972-271-7625.

## MICROPHONES

## Want to Sell

RCA 74B junior velocity bidirectional ribbon mic, \$350; Turner S33D brushed chrome art-deco style cardioid dynamic, \$125. J Borden, Handbasket Prod, 2909 S Logan Ave, Milwaukee WI 53207. 414-482-8954.

Sony ECM-22 (2) condenser mics in excel cond, \$100 ea; EV 635-A w/cable & clamp, as new, \$50. G Hutchins, Hutchins Snd Prod, 116 Roberta Dr, Hendersonville TN 37075. 615-264-1373.

Countryman TVH tie-clip mic, \$165; AKG D-140 dynamic cardioid mics (3), \$115 ea; Schoeps Collete cable KC5L w/Lemo connector & adaptor, like new cond, \$335. R Streicher, Pacific Audio-Visual Enter, 545 Cloverleaf Way, Monrovia CA 91016. 818-359-8012.

HME-WM 252 wireless w/SM58 mic xmtr, \$125; Telex xmtr & mic WT-200, \$150;

Telex xmtr & mic WT-50, \$150. J Price, Price Studio, TX. 214-321-6576.

Sennheiser MD-421U (5) dynamic cardioid studio mics in excel cond, \$250 ea. H Frost, WBEC, 211 Jason St, Pittsfield MA 01201. 413-499-3333.

Shure PS1 (2) condenser mic pwr supply, \$100 ea; AKG N62E condenser mic pwr supply for 2 mics, \$150/firm; HME wireless 2100 mics (3) & (4) wireless mic diversity antenna system in fair cond, \$300/all. P Paquin, Sound Dynamics Assoc, POB 278, Dennisport MA 02639. 508-760-5882.

RCA 77DX, BK1A, \$395; vintage PA mics, Shure 51 Elvis, \$75, EV731, \$95, EV 630 or 635, \$75, RCA mini 77" shaped, \$295. W Gunn, Box 2902, Palm Springs CA 92262. 619-320-0728.

Electro-Voice microphones #667-A (3), list \$650, foam, shock mounted, \$225 each. Ph: 616-782-9258.

## Want to Buy

Mic's with slugs (call letters), slugs, on-air lights, clocks with call letters & other interesting old mics, etc. 1-800-727-2369.

Neumann, Sennheiser, AKG, many models. W Gunn, Box 2902, Palm Springs CA 92262. 619-320-0728.

RCA 77-DX's & 44-BX's, any other RCA ribbon mics, on-air lights, call after 3PM CST, 972-271-7625.

RCA 77-DX's, 44-BX's, WE KU-3A's On-Air lights, recording lights. Top price paid. Fast response. Bill Bryant Mgmt, 2601 Hillsboro Rd, G12, Nashville TN 37212. 615-269-6131, FAX: 615-292-3434.

## MISCELLANEOUS

## Want to Sell

RF Warning Signs

9"x 12" \$13.95

10"x 19" \$19.95

HE HALL Electronics (804) 984-4255



Becker Mexico 2340 car stereo, AM/FM/LW/shortwave w/cassette, brand new w/wireless remote, \$500 +shpg. J Burns, WALN Cable FM, 3028 S Pike Ave, Allentown PA 18103. 610-791-1818.

General Radio 2 kW Variac heavy duty cased w/spoke wheel knob, 230 V input, 0-240V output. F Yonker, Penn State Univ, 1229 Inverary Pl, State College PA 16801. 814-867-1400.

Johnson Cardwell B/W roller inductors, counter dials, vacuum/air capacitors, Barker-Williamson 5 band output coils & more. F Yonker, Penn State Univ, 1229 Inverary Pl, State College PA 16801. 814-867-1400.

Telfax TX80 sports mixer, \$300; 1929-1945 vintage AM radio collection, \$800; Russco preamps, \$50 ea. D Rose,

KDUC, POB 432, Barstow CA 92312. 619-256-2068.

Johnson Cardwell B/W roller inductors, counter dials, vacuum/air capacitors, Barker-Williamson 5 band output coils & more. F Yonker, Penn State Univ, 1229 Inverary Pl, State College PA 16801. 814-867-1400.

Pabst new hysteresis capstan motor, \$10; Telex new cart motor, \$10; elapsed time meters (2), \$5 ea; pwr sup regulated 5 V, 3 A, \$10; repeat coil 150/600 cast case, \$15; line input xfms 600 ohm to 15 K ohm, \$5 ea & other mike & line xfms. E Davison, 217-793-0400.

WE 520-A audio output transformer, never used, \$200. B Cobb, Solid State Rcdg, 1044 Lightfoot Rd, Winauma FL 33598. 813-634-1940.

McIntosh MAC-1900 receiver, perfect, Victor 212-353-9320.

## Want to Buy

Jazz record collections, 10" LP/12" LP be-bop, swing, dixie, highest prices paid. B Rose, Program Recdgs, 228 East 10th, NYNY 10003. 212-674-3060.

## MONITORS

## Want to Sell

Philips 567 bi-amplified motion feedback 3 way speaker system w/built in pwr amps, 22x13x11, 60 W ea, \$500/pr +shpg. S Lawson, KAK Prod, 928 Hyland Dr, Santa Rosa CA 95404. 707-528-4055.

TFT 844 FM, \$1500; Potomac 19-2 tower antenna monitor, \$900; Delat toroid 5 amp RF meter, \$300. D Rose, KDUC, POB 432, Barstow CA 92312. 619-256-2068.

Used Mod Monitors: McMartin & Belar, many to choose from, tuned & calibrated on your frequency, fully guaranteed. Goodrich ent inc, 402-493-1886.

RECEIVERS &  
TRANSCIEVERS

## Want to Sell

## SCA RECEIVERS—ALL TYPES

Will work to meet your receiver needs

Professional / Table / Portable  
Field Strength Meters  
Reading Service / Ethnic / Data

## DAYTON INDUSTRIAL CORP.

2237 Industrial Boulevard  
Sarasota, FL 34234-3119  
Tel: 941-351-4454 FAX: 351-6081  
E-Mail: SCARadio@aol.com

Realistic DS-160, new, general coverage rcvr w/loudspeaker, manual & in original box, unused. F Yonker, Penn State Univ, 1229 Inverary Pl, State College PA 16801. 814-867-1400.

Realistic DS-160, new, general coverage rcvr w/loudspeaker, manual & in original box, unused. F Yonker, Penn State Univ, 1229 Inverary Pl, State College PA 16801. 814-867-1400.

## CONSULTANTS

**EVANS** Consulting Communications Engineers  
ASSOCIATES  
FCC Applications, Design, Field Engineering & Tower Detuning  
Video/Data/Voice • Statewide Networks • Wide-Area Networks  
EXPERTS IN:  
TV • AM • FM • ITFS • MICROWAVE • PCS • FIBER  
210 S. Main St., Thiensville, WI 53092 (414) 242-6000 FAX (414) 242-6045  
Internet: http://www.evansassoc.com Member AFCCE

**Consulting Communications Engineers EMC Test Lab**  
• FCC Applications and Field Engineering  
• Frequency Searches and Coordination  
• AM-FM-CATV-ITFS-LPTV  
• EMC Test Lab-FCC and European (IEC)  
**OWL ENGINEERING, INC.**  
E-mail: Owleng19@skypoint.com 1-800-797-1338 Fax (612) 785-4631  
8899 Hastings St NE, Minneapolis, MN 55449 (612)785-4115 Member AFCCE

**T. Z. Sawyer Technical Consultants**  
AM-FM-TV-LPTV  
• FCC Applications & Exhibits • Frequency Studies  
• Experimental Authorizations • Class Upgrades  
• AM Directional Antennas • STL Applications  
• High Power Antenna Arrays • Station Inspections  
**1-800-255-2632**  
FAX: (301) 913-5799 • 6204 Highland Dr. • Chevy Chase, MD 20815

**W. LEE SIMMONS & ASSOC., INC.**  
TELECOMMUNICATIONS CONSULTANTS  
Allocation Studies ▼ AM, FM, TV, LPTV ▼ Applications ▼ Appraisals ▼ Inspections ▼ Local & Wide Area Computer Network Microwave Design ▼ Specialized Computer System Designs  
85A Summit Dr, Hilton Head Is., SC 29928  
803-785-4445 fax 803-842-3371 e-mail:wlsimm@IBM.net

**MLJ**  
Moffet, Larson & Johnson, Inc.  
Consulting Telecommunications Engineers  
1110 North Glebe Rd, #800  
Arlington, VA 22201  
(703) 741-3500  
FAX: (703) 741-0312  
Member AFCCE

**PC - SOFTWARE**  
AM FM TV Search Programs  
Signal Mapping—STL Paths  
RFHAZ—US Census PopCount  
FAA Tower—Draw Tower  
**Doug Vernier**  
Engineering Consultant  
1600 Picturesque Drive  
Cedar Falls IA 50613  
**800-743-DOUG**

**MULLANEY ENGINEERING, INC.**  
Consulting Engineers  
•Design & Optimization of AM Directional Arrays  
•Analysis for New Allocation, Site Relocation, And Upgrades AM-FM-TV-LPTV  
Wireless Cable (MDS/MMDS/ITFS/OFS)  
•Environmental Radiation Analysis  
•Field Work  
•Expert Testimony  
9049 Shady Grove Court  
Gaithersburg, MD 20877  
Phone: (301) 921-0115  
Fax: (301) 590-9757  
email: mullengr@aol.com

**E. HAROLD MUNN, JR. & ASSOCIATES, INC.**  
Broadcast Engineering Consultants  
AM - FM - TV  
**WAYNE S. REESE**  
PRESIDENT  
Box 220, 100 Airport Rd.  
Coldwater, MI 49036  
**517-278-7339**

**GRAHAM BROCK, INC.**  
BROADCAST TECHNICAL CONSULTANTS  
Full Service From Allocation to Operation AM/FM/TV AUX Services.  
Field Work, Antenna and Facilities Design  
Over 35 years engineering and consulting experience  
**912-638-8028**  
**202-393-5133**  
www.grahambrock.com

**C.P. CROSSNO & ASSOCIATES**  
CONSULTING ENGINEERS  
P.O. BOX 180312  
DALLAS, TX 75218  
AM, FM & TV Broadcasting  
ANTENNA DESIGN, SYNCHRONOUS, FCC/FAA  
CHARLES PAUL CROSSNO, P.E.  
(214) 321-9140 MEMBER AFCCE

To advertise in  
**Radio World**  
Broadcast  
Equipment Exchange  
Call Simone Mullins at:  
**703-998-7600**  
or FAX:  
**703-998-2966**



RECEIVERS continued...

**EAS FM Crystal Controlled receivers**, New and Used. Also SCA Receivers. Goodrich ent inc, 11435 Manderson St, Omaha NE 68164. 402-493-1886.

**Professional SCA decoder cards**, \$20; SCA radios, \$35 up. 1-800-944-0630.

**RECORDERS**

**Want to Sell**

**STUDER REVOX PARTS/SERVICE**

Cassette-CD Open reel Capstan resurfacing, ALL BRANDS.  
**JM TECHNICAL ARTS**  
30 Music Sq. W. #156  
Nashville, TN 37203 (615) 244-6892

**OTARI MX-5050 MK-III 8 track + 8 channels DBX PRO I NR.** Personal equipment in excellent condition! \$1995 incl shipping/OBO. 615-360-8826 before 8pm CT.

**CLEAN PATCH BAYS NO DOWN TIME**



**VERTIGO BURNISHERS AND INJECTORS RESTORE ORIGINAL PERFORMANCE TO YOUR PATCH BAYS**

**\$34.95 Ea.**

**VERTIGO RECORDING SERVICES**  
12115 Magnolia Blvd #116 818-907-5161  
North Hollywood, CA 91607 fax: 818-784-3763

**ITC 770 2 trk reproducer (4)**, fair cond, 7.5 ips, 10", \$100 ea. E Swanson, WPKR, POB 3450, Oshkosh WI 54903. 414-236-4242.

**Schafer 2 chnl logger**, " tape; Metrotech 400 series 4 chnl, 1 pass logger, " tape; (2) Metrotech 500 series 2 chnl, 2 pass logger, " tape; (2) Dictaphone 4000 series 10 chnl logger, " tape w/time code gen/reader, all working when removed, cond unknown, sold as is, BO +shpg. M Crosby, 408-363-1646.

**Technics RP-9690 remote control box** for RS-1500, 1506 & 1520 r-r's, \$75. D Meyer, 1123 Del Mar, Santa Barbara CA 93109. 805-962-8273.

**Technics RS1520, 10" r-r, 3 speed & pitch control**, excel

cond, \$350. M Trumble, Trumble & Assoc, 409 Washington #422, Hoboken NJ 07030. 201-795-1201.

**Akai Pro MG1214 12 trk recorder/mixer**, new heads, rebuilt transport, \$2200. T Santorelli, SPEC, 684 Sunrise Hwy, W Babylon NY 11704. 516-661-2454.

**Ampex 440c pro tape machines (4)**, 2 trk, 10.5" reel, 1.5-15 ips, vgc, \$800 ea; Ampex 440c transport only, 4 trk, 10.5" reel, 7.5-15 ips, vgc, \$400; Ampex 440c VariSpeed control unit, for servo motor, new cond, \$300; Ampex 350 FT, Inovonics 10.5" reel, 7.5-15 ips, vgc, \$500. A Funk, Masque Snd & Rcdg. 718-421-0582.

**Ampex 601 r-r in red Ampex case**, large w/mixer space, needs a little work, \$100/BO; Viking 76 r-r w/tube R/P electr, \$25. E Davison, 217-793-0400.

**Ampex PR-10 tube electr mic pre mono (2)**, vgc, \$300 ea; Teac X3 \_ trk 7.5-33.75 ips rack mount, vgc, \$200; Revox A-77, 2 trk, 3.75-7.5 ips, rack mount, gd cond, \$200; Shure M688 stereo mic mixer, (4) mic inputs, mint cond, \$150/BO; (2) Tascam 32 r-r, 2 trk, 7.5-15 ips, dbx 150 rol-around, excel cond, low hrs, \$650 ea. A Funk, Masque Snd & Rcdg. 718-421-0582.

**NAD 6240 (4) cassette recorders**, \$75 ea/firm; NAB 6325 (2) cassette decks, gd cond, \$100 ea/firm. P Paquin, Sound Dynamics Assoc, POB 278, Dennisport MA 02639. 508-760-5882.

**Otari MTR10-2, \$2000; MCI JH110B in console**, \$1500; MCI JH110 in console, \$750; Ampex 354-2 tube rcdr, \$1250; Ampex 440, in console, excel cond, \$995; Ampex 300 tube rcdr, \$1750; Ampex 350 tube rcdr, \$1250. J Price, Price Studio, TX. 214-321-6576.

**Revox B77 MKII 2 trk, 7.5 & 15, stereo/mono, gd cond**, \$500. D Noe, KNID, 316 E Willow, Enid OK 73701. 405-237-1390.

**Roberts mono portable recorder**, tube type, similar to the Ampex 600 series, \$200; Akai M7 portable recorder,

stereo, cross-field heads, \$150/BO. M Crosby, 422 Avenida Abetos, San Jose CA 95123. 408-363-1646.

**Tascam MSR-16 16 trk \_" w/dbx, RC-416 full remote**, lw hrs, mint, original boxes & packing, 3 reels new Ampex 456 tape, \$3500. D Sieb, Harvest Prod, 8297 Hillpoint Rd, Cross Plains WI 53528. 608-798-2223.

**MX70 video playback system**, \$900; Gd used \_"x2500' 456 tape, \$20, 1"x2500' 996 & 250, \$35; new MRL short test tapes, \$229 for 2", save \$400. Save on all other formats too. W Gunn, Box 2902, Palm Springs CA 92262. 619-320-0728.

**New & used Ampex 350 style tape transports**, motors & parts, various prices. M Crosby, 408-363-1646.

**Tascam ATR60-2, in stand**, \$1200; Tascam 58, 8 trk, \$1950; Tascam 38 8 trk, \$1650; Otari 5050-8 Mk III, \$1900; Ampex 1200 PURC cards (5), \$125 ea; Custom locator for any deck, \$495; Sony 2 trks, \$195 ea. W Gunn, Box 2902, Palm Springs CA 92262. 619-320-9728.

**Want to Buy**

**Ampex ATR100 taperecorders** for parts. Circuit cards, heads, motors, machine parts, or electronic parts. Call 818-907-5161.

**Ampex machines**, recorder electronics, mixers. W Gunn, Box 2902, Palm Springs CA 92262. 619-320-0728.

**REMOTE & MICROWAVE**

**Want to Sell**

**Comrex Nexus codec**, like new, used twice, 1 yr old (2), \$3500. Dave, WYLI, 233 Pennsylvania Ave, Marietta OH 45750. 614-373-0910.

**RENT IT HERE!**

COMREX New Hot Line ISDN Codecs Frequency Extenders

TELOS Zephyr Digital Phone Hybrids

CCS MUSIC M Prima Codecs

SHURE FP 410 Automatic Mixers

SCOOP REPORTER 7KHz single PD5 line codec

SILVER LAKE AUDIO • 516-763-1776 • FAX: 516-763-1750

**Rent in EUROPE**

**TELOS ZEPHYR** from

**WIRED FOR SOUND**

Europe's Remote Broadcast Specialists

- Technical Management
- Equipment & Engineers
- Production Resources

phone 011 44 181 442 8900

**WE RENT**

**TELOS ZEPHYR**

**CCS "Prima" Codecs**

Frank Grumstein Audio/Video Consultants

**COMREX**

3-line extender

610-642-0978

**REPAIR SERVICES**

**PIKE'S PEAK SATCOM**

- Dart 384
- SA7300 (Dat32)
- SCPC Receivers

Repair Specialist

Low Rates

Fast Reliable Service

Buy, Sell, Trade

**Pike's Peak Satcom**

Tel 719-390-6606

Fax 719-390-6616

Circle (231) On Reader Service Card

**SATELLITE EQUIPMENT**

**Want to Sell**

**Scientific Atlanta CSR-3610 digital sat rcvr**, \$250. Dave, WYLI, 233 Pennsylvania Ave, Marietta OH 45750. 614-373-0910.

**Wegener satellite rcvr** for Jones Network, like new. Kevin, KMCM Rm 1404 E, 332 Minnesota St, St Paul MN 55101. 406-232-5626.

**Microdyne 1100 SCPC rcvr**, \$1000. M Vanhooser, KSKY, 4144 N Central Expy #266, Dallas TX 75204. 214-827-5759.

**SATELLITE SYSTEMS**

**Satellite Equipment for Radio**

**In need of thorough, reliable repair service?**

**Rely on us!**

Satellite Systems is respected industry-wide for prompt, accurate service to radio stations and networks.

Contact us for Ariel and Zephyrus 700 SCPC receivers. Upgrade your Fairchild Dart 384 and Scientific Atlanta 7300/7325 to LNB receivers—use existing equipment as trade-in.

Pre-and post-service technical support along with a 6-month warranty.

Turn to the leader in repair, upgrades, new equipment, used equipment and accessories. We can answer all of your questions.

**SATELLITE SYSTEMS**

615 East Brookside Colorado Springs, CO 80906

Phone: (719) 634-6319 Fax: (719) 635-8151

Circle (230) On Reader Service Card

**Scientific Atlanta 7300 sat rcvr** RF side, 20 kHz SEDAT card, 7.5-15 kHz DATS card, voice cue card, gd working cond, \$1500. D Noe, KNID, 316 E Willow, Enid OK 73701. 405-237-1390.

**Comstream ABR-200 receivers**, \$1250. 914-336-6199.

**STATIONS**

**Start your own commercial radio station with only \$5000 or less!**

Yes it's possible & legal. Part 15 of FCC rules allows low power AM radio stations to operate without a license!! Cover an entire town & bill \$1500 a month!! It has been done!! Order the newsletter booklet that tells you all you need to know to get started for just \$29.99. Send check or money order payable to: WCTD AM 1620, 4 Canal St, Westerly RI 02891 or call 401-348-9222 for more info.

**Want to Sell**

**10K AM in North Central AZ**. 520-774-0864.

**Be a Partner in a Great FM ROCK station**, Chicago Suburban, \$60,000 for 15%. 708-448-4461.

**TAPES/CARTS/ REELS/CD'S**

**BROADCAST CARTRIDGE REBUILDING**

10-100 seconds

Scotch/ITC	\$2.75
AA-4	\$2.10
AA-3	\$2.10
A2	\$1.85

**CARTRIDGE EXPRESS**  
(425) 814-2672  
Ask for Jack

**Want to Sell**

**Classic Rock library** from 60's-70's on vinyl, analog

reels & cassette, BO: empty EIA 7.0" reels, BO. D Pulwers, POB 0198, College Park MD 20742. 703-440-8621.

**Complete MOR, Big Band music library** on short 150 reels or more w/cue sheets in great cond, \$500/BO, u-ship. F Martin, WSNW, 450-B By-Pass 123, Seneca SC 29679. 864-882-9769.

**Denon 970FA CD player**, like new, digital out/analog out, \$1350. K Thomas, Rebel Recdg, 5555 Radio Ln, Jacksonville FL 32205. 904-388-7711.

**Records**, 1100 LP's, Big Band, MOR & Rock & Roll; 1100 45's Contemporary, MOR, Rock & Roll. J Gelo, 941-642-6899.

**Rock & Roll format**, 50's & 60's on 18 10.5" reels; Adult Contemporary on 76 10.5" reels. J Gelo, 941-642-6899.

**Audio production company selling never used 39 CD killer production music library**, \$1700 & superb SFX collection on 31 CD's, \$495 or both for \$1990. Free shipping anywhere! Tel: 331-4694-0684 FAX: 331-4694-0688. Email: radiods@club-internet.fr

**Microtran table top tape degausser**, handles 1"-2" tapes, \$150/BO; mechanical tape timers, Lyrec & Seike/Spotmaster, new & used. M Crosby, 408-363-1646.

**TAX DEDUCTIBLE**

**Rural Jr/Sr HS seeks donation** of any working studio prod equip, need console, cart deck, preamp, CD player, r-r deck, exciter, etc. Receipt will be furnished on request. G Quetel, U-32 HS, RR 2 Box 3315, Montpelier VT 05602. 802-229-0321.

## DISTRIBUTOR DIRECTORY

The following distributors serving the broadcast industry would be glad to help you with any of your requirements.

...Some people get hooked on broadcast equipment big time...they think about it...dream about it...talk about it all the time...for example...us...

**RADIO! The beat goes on!**

**CROUSE-KIMZEY OF ANNAPOLIS**

tops in broadcast equipment

1-800-955-6800

ask for Kathleen

kkannapolis@worldnet.att.net

**CORNELL-DUBILIER MICA CAPACITORS**

FROM STOCK

**JENNINGS VACUUM CAPACITORS**

FROM STOCK

**JENNINGS VACUUM RELAYS**

**SURCOM ASSOCIATES**

2215 Faraday Ave., Suite A  
Carlsbad, California 92008  
(619) 438-4420 Fax: (619) 438-4759



**TEST EQUIPMENT**

**Want to Sell**

**WE Hickok KS15750-L1** three meter tube tester, navy gray aluminum case, 1963 tube roller chart, tests transmitting & receiving tubes; Kin-Tel 202-B microvolt meter, DC, 0.3 mV to 1000 V, tube type, meter mirror scale, zero ctr. F Yonker, Penn State Univ, 1229 Inverary Pl, State College PA 16801. 814-867-1400.

**B&K 1630** 0-30 V, 0-3 A, pwr supply w/manual & box, \$150; Beckman 310 digital VOM, \$50; B&K 707 mutual conductance tube tester, \$125. B Cobb, Solid State Rcdg, 1044 Lightfoot Rd, Winauma FL 33598. 813-634-1940.

**General Radio 1865** digital impedance meter w/go/no go setup w/manual, some ranges not working. BO. M Crosby, 422 Avenida Abetos, San Jose CA 95123. 408-363-1646.

**Kin-Tel 202-B** microvolt meter, DC, 0.3 mV to 1000 V, tube type, meter mirror scale, zero ctr; WE Hickok KS15750-L1 3 meter tube tester, deluxe serial 761, navy gray, aluminum case, 1963 tube chart, mint cond. F Yonker, Penn State Univ, 1229 Inverary Pl, State College PA 16801. 814-867-1400.

**Tektronix DM502A** digital multimeter auto range, \$195; Tektronix DM501A digital multimeter, \$195; HW dist analyzer 33A, \$395; HW 353 patch panel 110 DB attenuator, \$75; Ithaco 4302 dual 24 DB/octave hi-lo pass filter 1/10-1 MHz, \$195; Weston 666 multimeter, \$50; Eico 150 solid state signal tracer, \$100; Heath audio gen 1G-72, \$100. J Price, Price Studio, TX. 214-321-6576.

**Want to Buy**

**Heathkit IO-10** small portable tube type oscilloscope from late 1960s. W Gunn, Box 2902, Palm Springs CA 92262. 619-320-0728.

**TUBES**

**Want to Sell**

**EIMAC, RCA, AMPEREX**, 3-500, 3CX1500A7, 4-400, 4X150A, 4CX250B, 572B, 807, 833C. Westgate 800-213-4563.

**SINCE 1947**

**Rebuilt & New Tubes**



**From 1 kw to 100 kw**

- Experienced Sales Staff
- Reliable Warranty
- Large Stock

800-422-4250 800-422-4277(ca)  
Fax: 818-997-6158



Circle (229) On Reader Service Card

**D and C Electronics Co.**

**NEW TUBES**

We have the alternatives for all your needs, at the lowest prices, direct from OUR STOCK!!!

EIMAC, SVETLANA, PRO-TEK®, EEV and many others.  
(352) 688-2374  
PH: (800) 881-2374  
FAX: (352) 683-9595



**FOR THE BEST PRICE**

& 24 Hr service on transmitting tubes call Goodrich Ent Inc at 402-493-1886 day or night, FAX 402-493-6821.

**SAME DAY CASH!**

Buy/Sell ALL Types of ELECTRON TUBES  
Special: EIMAC 4CX250B \$94.50 ea. - Brand New!

Mike Forman  
1472 MacArthur Blvd.  
Oakland CA 94603  
Ph: 510-530-8840 Fax: 510-530-0858  
Hurry, Limited Quantity!

**ECONCO**

Quality Rebuilt Tubes  
Approximately 1/2 the Cost of New

Call for Our Price List

800-532-6626  
916-662-7553

FAX 916-666-7760

Circle (226) On Reader Service Card



ISO 9001 Certified

The Reliable Manufacturer for

**NEW POWER TUBES**

Triodes  
Tetrodes  
Pentodes

**NEW SOCKETS & REPLACEMENT PARTS TUBE REBUILDING**

Worldwide Availability

Made in U.S.A.

CALL 800-414-8823  
Int'l (415) 592-1221  
Fax (415) 592-9988

Visit our Web Site at  
<http://www.eimac.com>



Circle (228) On Reader Service Card

**RF POWER**

The Best of Two Worlds!



Se Hable Español  
(760) 744-0500 • (888) 744-3500  
Fax: (760) 744-1943  
e-mail: rfp@rfparts.com



Circle (227) On Reader Service Card

**Buy Factory Fresh New Tubes**

- ✓ EIMAC, BURLE, SIEMENS, AMPEREX, NATIONAL, and more
- ✓ Off-the-shelf delivery
- ✓ 24-hour emergency service



1-800-348-5580  
FAX: (708) 208-2550

**ACTION-GRAM**

**EQUIPMENT LISTINGS**

Radio World's Broadcast Equipment Exchange provides a FREE listing service for radio stations and recording studios only. All other end users will be charged. Simply send your listings to us, following the example below. Please indicate in which category you would like your listing to appear. Mail your listings to the address below. Thank you.

Please print and include all information:

Contact Name \_\_\_\_\_  
Title \_\_\_\_\_  
Company/Station \_\_\_\_\_  
Address \_\_\_\_\_  
City/State \_\_\_\_\_  
Zip Code \_\_\_\_\_  
Telephone \_\_\_\_\_

I would like to receive or continue receiving Radio World FREE each month.  Yes  No

Signature \_\_\_\_\_ Date \_\_\_\_\_  
Please check only one entry for each category:

- I. Type of Firm**
- D. Combination AM/FM station
  - F. Recording Studio
  - A. Commercial AM station
  - K. Radio Station Services
  - B. Commercial FM station
  - G. TV station/teleprod facility
  - C. Educational FM station
  - H. Consultant/ind engineer
  - E. Network/group owner
  - I. Mfg, distributor or dealer
  - J. Other \_\_\_\_\_
- II. Job Function**
- A. Ownership
  - G. Sales
  - B. General management
  - E. News operations
  - C. Engineering
  - F. Other (specify)
  - D. Programming/production

Brokers, dealers, manufacturers and other organizations who are not legitimate end users can participate in the Broadcast Equipment Exchange on a paid basis. Line ad listings & display advertising are available on a per word or per inch basis.

WTS  WTB  Category: \_\_\_\_\_  
Make: \_\_\_\_\_ Model: \_\_\_\_\_  
Brief Description: \_\_\_\_\_  
Price: \_\_\_\_\_

WTS  WTB  Category: \_\_\_\_\_  
Make: \_\_\_\_\_ Model: \_\_\_\_\_  
Brief Description: \_\_\_\_\_  
Price: \_\_\_\_\_

\*Closing for listings is every other Friday for the next month's issue. All listings are run for 2 issues unless pressed for space or otherwise notified by listee.

**Broadcast Equipment Exchange**

PO BOX 1214, Falls Church, VA 22041 • Tel: 800-336-3045 • Fax: 703-998-2966

**SVETLANA DEALER**  
U5807, 4CX300, 6146, 833, +++  
Sound In Mind: 800-755-2365  
FAX: 540-249-5064

**REBUILT ELECTRON TUBES**

Partial List: 6623, 23791, TH150, 6425F, 6427, 8550, 6804, 6696, 6697, 5681, 5682, 5671, 7804, 3CX10,000H3, 3CX20,000H3, 4CX5000A, 4CX35,000C

Worn out power tubes purchased

**Vacuum Tube Industries, Inc.**

1-800-528-5014  
508-584-4500 X75

**Want to Buy**

KT-66, 77, 88, 6550, EL34, GZ32, 34, 845, 211, 5AR4, US & British, German, new old stock only. B Cobb, Solid State Rcdg, 1044 Lightfoot Rd, Winauma FL 33598. 813-634-1940.

**We Buy Duds/Used Tubes! Call 630-872-4445**

**TURNTABLES**

**Want to Sell**

Gates CB 1200 TT w/preamp, 3 speed, mint cond, \$135 +shpg. W Tinsley, Airchecks USA, 1123 Holcomb St, Watertown NY 13601. 315-788-0914.

**ADVERTISE!**  
in RADIO WORLD'S  
**BROADCAST EQUIPMENT EXCHANGE**  
CALL  
**703-998-7600**

**SERVICES**

- Terrain Analysis
- FM Studies
- Population Studies
- FCC/FAA Databases
- Contours

**Communications Data Services, Inc.**

800-441-0034  
fax 703-558-0524

Visit our Web Site  
<http://www.comm-data.com>  
Email: Info@comm-data.com

**Tower Sales & Erection**

Turnkey Site Development  
Installation & Maintenance  
AM/FM Broadcast, TV  
Microwave Systems,  
Antennas & Towers



6017 Triangle Dr  
Raleigh, NC 27613  
(919)781 3496  
Gen Contractor #25891 Fax (919)781 6454

**REMOTE EQUIPMENT RENTALS**

**COMREX and GENTNER**  
1, 2 & 3-Line Extender Systems  
Now With The New TELOS ZEPHYR  
MARTI VHF/UHF RPU Systems  
ISDN & Switched-56 Systems  
Call or FAX Dwight Weller  
**WELLER AUDIO-VISUAL ENGINEERING**  
Baltimore, Maryland  
Phone: (410 or 800) 252-8351  
FAX: (410) 252-4261

**Quality Power Tubes**



3CX300A1  
3CX2500A3  
3CX2500F3  
3CX2500H3  
3CX3000A7  
3CX3000F7  
3CX6000A7/YU148  
3CX10,000A3  
3CX10,000A7

3CX10 000H3  
3CX15,000A3  
3CX15,000A7  
3CX15,000H3  
3CW20,000A1  
3CW20,000H3  
3CW20,000H7  
3CW30,000H3  
4CX250B  
4CX250BC  
4CX250BM  
4CX250BT  
4CX250R  
4CX350A  
4CX350AC

4CX400A  
4CX800A  
4CPX800A  
4CX1500A  
4CX1600B  
4CX3500A  
4CX5000A  
4CX5000R  
4CX7500A  
4CX10,000D  
4CX15,000A  
4CX15,000J  
4CW10,000A  
4CPW10,000R  
4X150A

5CX1500A  
5CX1500B  
572B  
5U4G  
6550C (See SV6550C)  
6AS7G  
6BM8  
6L6GC (See SV6L6GC)  
811A  
833A  
8161R  
8560AS  
EF86  
EL34



**Svetlana**  
ELECTRON DEVICES

**Watch this list GROW!**  
• Manufactured in Russia's largest power tube factory •  
Generous warranty based on high quality • Honest prices based on  
quality at low cost • Shipment from USA stock

[www.svetlana.com](http://www.svetlana.com)

Headquarters: 205-882-1344 Fax 205-880-8077 • Marketing & Engineering: 415-233-0429 Fax 415-233-0439

Circle (225) On Reader Service Card



## TRANSMITTERS

### Want to Sell

**Collins 21M 10 kW AM** w/manuals, needs pwr supply transformer, 1954 vintage, BO; Collins KWS-1 amateur xmtr, never used, companion Collins amateur rcvr mdl 75A-4 also avail w/manuals, BO. R Epperson, WPAQ, POB 907, Mount Airy NC 27030. 910-786-6111.

**Two 5,000 W AM xmtrs: 315 R-1 approx. 8-9 yrs old; 820-E-F1 approx. 20 yrs old. Both now on 620 AM. One new/refurbished 4CX5000 Tx tube, \$395. Bids/Orders (201) 895-5500 Fax (201) 361-8584** Both xmtrs in North Jersey, ready for pickup.

**CSI T-1-F 1 kW FM.** D Davis, KMIN, 1217 Valencia NE, Albuquerque NM 87110. 505-255-2431.

**RCA BTF 5000 FM xmtr,** 5000 W 3 phase w/3 phase gas converter w/new tube & tube socket, works gd, \$5000. B Hipsher, WVCT, 968 W City Dam Rd, Keavy KY 40737. 606-528-4671.

**Harris FM 10H** in service, problem free unit, \$11,500. Call 603-668-6400.

**Used McMartin BF-5M, 5 kW FM** tuned & tested on your frequency, completely refurbished; Also: 3.5 kW & 25 kW. Goodrich ent inc, 402-493-1886.

### Want to Buy

**Gates BC-1J 1 kW AM xmtr.** D Davis, Davis Bdctg, 1217 Valencia Dr NE, Albuquerque NM 87110. 505-255-2431.

**RF line panel meter** for Collins 20V-3 AM xmtr, working or not. Scott, WMRO, 701 N Blythe St, Gallatin TN 37066. 615-451-2131.

**500-1000 W solid state w/exciter,** will trade Collins 831D-1. ID Byars, WCPI,

110 S Cours Sq, McMinnville TN 37110. 615-506-9274.

**McMartin AM/FM xmtr,** any model, exciter or stereo modules. Goodrich Ent., 11435 Manderson, Omaha NE 68164. 402-493-1886.

## INCREDIBLE TRANSMITTERS



### TV TRANSMITTERS

1Watt	\$1,114
2Watt	\$1,664
4 Watt	\$2,138
20 Watt	\$3,880
40 Watt	\$5,046
100 Watt	\$6,206
200 Watt	\$9,874
400 Watt	\$13,171
800Watt	\$18,295
1KWatt	\$22,900
2KWatt	\$38,900

### FM RADIO TRANSMITTERS Including Stereo Encoder

1Watt	\$1,138
30Watt	\$1,499
300Watt	\$3,174
600Watt	\$5,960
1KWatt	\$8,716
2KWatt	\$11,905
4KWatt	\$20,741

**TAYLOR**  
The Transmitter People

Taylor Bros. (Oldham) Limited, Lee St. Oldham England. Tel: 0161 652 3221, Fax: 0161 626 1736

### Quality FM Transmitters at Reasonable Prices

20 watt Exciter	\$ 995.00	5 Kw.	\$ 21,990.00
120 watt	\$ 2,500.00	10 Kw.	\$ 25,990.00
300 watt	\$ 2,990.00	15 Kw.	\$ 30,990.00
2.5 kw	\$ 10,990.00	20 Kw.	\$ 35,990.00
STL Transmitter	1,990.00	STL Receiver	\$ 1,790.00
Both	\$ 3,500.00	20 w Translator	\$ 2,500.00

**FM Antennas as low as \$ 395.00 Per Bay**

Contact **Jimmie Joynt / Factory Direct Sales**

Ph. 973/473-2577 800/279-3326 Fax 800/ 644-5958

17194 Preston Rd. #123-297 Dallas, TX 75248

## Radio World

5827 Columbia Pike, 3rd Floor  
Falls Church, VA 22041

PHONE: 703-998-7600 FAX: 703-998-2966

Call Simone Mullins, Classified Ad Manager, to reserve space in the next issue. Use your credit card to pay, we now accept VISA and MASTERCARD.

Select from these categories for best ad positioning:

- |                            |                           |
|----------------------------|---------------------------|
| Acoustics                  | Recorders                 |
| Amplifiers                 | Remote & Microwave Equip. |
| Antennas & Towers & Cables | Repair Services           |
| Audio Production (Other)   | Satellite Equipment       |
| Brokers                    | Software                  |
| Business Opportunities     | Stations                  |
| Cart Machines              | Stereo Generators         |
| CD Players                 | Tapes, Carts & Reels      |
| Computers                  | Tax Deductable Equipment  |
| Consoles                   | Test Equipment            |
| Disco-Pro Sound Equip.     | Transmitter/Exciters      |
| Financial Services         | Training Services         |
| Leasing                    | Tubes                     |
| Limiters                   | Turntables                |
| Microphones                | Positions Wanted          |
| Miscellaneous              | Help Wanted               |
| Monitors                   |                           |
| Receivers & Transceivers   |                           |

Classified Advertising Rates Effective January 1, 1997

	1x	3x	6x	13x
1-9 col inch (per inch)	\$69	66	61	55
10-19 col inch (per inch)	\$52	59	55	50
Distributor Directory	\$105	100	95	90
Professional Card	\$74	68	62	56
Classified Line Ad		\$2.00 per word		
Blind Box Ad		\$15 additional		

To compute ad costs: Multiply the number of ad inches (columns x inches) by the desired rate schedule for your per unit cost. Example: a 3" ad at the 1x rate is \$207, at the 3x rate \$195, at the 6x rate \$183, at the 12x rate \$165, etc.



**ADVERTISE!**  
in Radio World,  
Call 703-998-7600  
**TODAY!**



**WHEN YOU'VE GOT SOMETHING THIS GOOD, YOU CAN'T HELP BUT BLOW YOUR OWN HORN!**



There comes a time when a company knows it has a breakthrough product. And for Energy-Onix, that time is now.

The **ECO 15-30**, Single tube, High Power Grounded Grid Transmitters up to 32 KW.

- ◆ Solid State driver up to 2 KW serves as emergency transmitter
- ◆ Straight Forward field proven control system
- ◆ VSWR Protection & More

◆ BEST OF ALL THEY ARE ECONOMICALLY PRICED!

"The Transmitter People"  
**Energy-Onix**

1306 River St, Valatie NY 12184

**518-758-1690**  
**FAX: 518-758-1476**

## TRANSCOM CORP.

Serving the Broadcast Industry Since 1978

Fine Used AM & FM Transmitters and Also New Equipment  
For the best deals on Celwave products, Andrew cable and Shively antennas.

100 W FM 1985 Harris FM100K	1 KW AM 1975 Harris MW-1
5 KW FM 1969 RCA BTF 5D	50 KW AM 1978 Harris MW50C3 (1100 KHZ)
20 KW FM 1977 RCA BTF 20E1	50 KW AM 1973 Continental 317C
20 KW FM 1973 Collins 831G	50 KW AM 1978 Continental 317C-1
20 KW FM 1974 Harris FM20H/K	50 KW AM 1981 Continental 317C-1
20 KW FM 1967 Collins 830H-1B	50 KW AM 1981 Harris MW-50B
	50 KW AM 1982 Harris MW-50B

1077 Rydal Road #101, Rydal PA 19046  
800-441-8454 • 215-884-0888 • FAX No. 215-884-0738

VISIT OUR INTERNET SITE: WWW.TRCORP.COM  
SEND YOUR E-MAIL REQUESTS TO TRANSCOM@TRCORP.COM



EMPLOYMENT

HELP WANTED

ACCOUNT EXECUTIVE/RADIO SALES: Growing New Jersey radio group is presently interviewing for the position of Account Executive. Qualified applicants must have a college degree, plus a minimum of two years of success in radio sales.

Full-time engineer needed for Mount Rushmore Broadcasting Group. Centralized in Wyoming with stations also in South Dakota and Montana. Must be experienced in transmitters, studios, translators, and CP's. Fax resumes to: 307-473-7461.

ASSISTANT CHIEF ENGINEER with contract engineering firm. AM/AM-DA/FM/LPTV clients on Central California Coast. 2 yrs broadcast experience and technical degree or equivalent required. Resume to: Interstellar Communications, POB 13057, San Luis Obispo CA 93406. FAX: 805-543-3298 or e-mail: wbordeau@slonet.org

Midwest Group seeks chief engineer. Studio, AM, FM, computer, organizational and people skills required. EOE. Resume and salary requirements to: Radio World, POB 1214, Falls Church, VA 22041. Attn: Box #97-5-28-1 RW.

News Director, AM-FM-TV, tapes and resume ASAP to: Mgr, KIKC, POB 1140, Forsyth MT 59327.

Seeking air talent with news ability for locally programmed station. E.O.E., Resume/Tape to: J.R. Reardon, Box 297, Great Barrington MA 01230.

ENGINEERING DIRECTOR

KUNI/KHKE/KUNY/KRNI requires chief engineer to head two-person engineering department for four station, five translator system with state-of-the-art studios and transmitters. EE or BA/BS degree with at least 8 years of experience required. AA degree with ten years experience may be substituted. FCC license or other documentation of tested abilities required; experience with RF, audio, satellite and computer systems necessary. Minimum salary \$35,020 - commensurate with experience; extensive fringe benefits. Applications submitted by June 4, 1997 given first consideration. Additional information provided upon request (319-273-6400, ext. 446).

Send letter of application, resume, and names and phone numbers of three references to: Search Committee Broadcasting Services University of Northern Iowa Cedar Falls, IA 50614-0359 FAX: 319-273-2682 E-mail: Doug.Vernier@uni.edu AA/EEO

Small New Hampshire based communications and media firm seeks regional sales/marketing professional to break new territory—your resume is your ticket. Highly disciplined and focused individual with initiative and imagination who can craft his/her goals and become an integral part of the management team. Compensation is performance based. Fax resume to (603) 668-6470.

TRAFFIC MANAGER/Radio: New Jersey Broadcasting, Inc. seeks a traffic manager for two (2) of its radio stations. Successful applicant should have a minimum 4 years prior traffic management experience, a thorough knowledge of super-log, CBSI or Columbine Systems, inventory control and management. Must be detail oriented and possess extraordinary people skills, college degree preferred. Send resume and cover letter with salary requirements to: Business Manager,

New Jersey Broadcasting, Inc., 55 Horsehill Road, Cedar Knolls, New Jersey 07927. Fax 201-538-3060. No Phone Calls Please! EEO Employer.

POSITIONS WANTED

Experienced, Desire air show w/prod, any format, for creative demo & resume call: 906-226-2962.

Joseph McClane, broadcast graduate, hard-charging & motivated seeking position in East Coast station. 405-677-8147.

News anchor/producer, commercial prod, air talent for adult formats avail now, downsizing casualty. Alex Kuhn, 513-777-8423.

Recent graduate seeks on-air announcer position with religious station, willing to travel. Lyndall, 405-677-6524.

Veteran FM/SM/PD/MD/air talent coming back from early retirement w/new Country format that will make your FM a winner. Will consider all situations & locations, salary, compensation & availability are negotiable. Call 407-246-4534 or write in confidence to: J.B. Russell, POB 1662, Stuart FL 34995.

CE/Computer Tech w/20+ yrs hands on engineering exper seeks CE position in a top 100 market, strong audio, computer networking & RF skills. 704-563-8676.

Let's do something different with your Southeast smaller market radio stations! Write: POB 14706, Greenville SC 29610.

Looking in Texas, bdct school graduate +3 yrs exper on-air, production, interview, call-in, give-aways seeks similar position. Dale, 405-943-7971.

Recent broadcasting graduate looking for opportunity to begin in the industry, on-air exper in NAC format, willing to relocate. Dave, 405-799-4709.

SBE certified technologist, associate engineer will work for experience in the Fairfield county or surrounding areas, extensive experience in digital audio editing & recording. Pete, 203-371-7162.

Young at heart, energetic graduate of bdctg school trained in announcing, CA prod, news reporting & copywriting seeks position w/Oldies, R&R or Classic Rock station in need of my talent, will travel. Mark, 405-787-2134.

ABOUT OUR EMPLOYMENT SECTION

HELP WANTED: Any company or station can run "Help Wanted" ads for \$2/word or buy a display box for \$69/column inch. Payment must accompany insert, use your MasterCard or VISA; there will be no invoicing. Blind box numbers will be provided at an extra charge of \$15. Responses will be forwarded to listee, unopened, upon receipt. Call 703-998-7600 for details.

POSITIONS WANTED: Anyone can run a "Position Wanted" ad, FREE of charge (25 words max), and it will appear in the following 2 issues of Radio World. Contact information will be provided, but if a blind box number is required, there is a \$15 fee which must be paid with the listing (there will be no invoicing). Responses will be forwarded to the listee, unopened.

Mail to: Broadcast Equipment Exchange P.O. Box 1214, Falls Church, VA 22041 Attn: Simone Mullins

ADVERTISER INDEX

This listing is provided for the convenience of our readers. Radio World assumes no liability for inaccuracy.

Table with 4 columns: Page No., Advertiser, Reader Service No., and a second set of Page No., Advertiser, Reader Service No. listing various companies and their corresponding page numbers.

SUBSCRIPTION/READER SERVICE FORM



FREE Subscription/Renewal Card

I would like to receive or continue receiving Radio World FREE each month. Yes No

Signature Date

Please print and include all information:

Name Title

Company/Station

Address

City State ZIP

Business Telephone ( )

Please check only one entry for each category:

- I. Type of Firm
D. Combination AM/FM station
A. Commercial AM station
B. Commercial FM station
C. Educational FM station
E. Network/group owner
F. Recording Studio
K. Radio Station Services
G. TV station/teleprod facility
H. Consultant/wind engineer
I. Mfg, distributor or dealer
J. Other

- II. Job Function
A. Ownership
B. General management
C. Engineering
D. Programming/production
G. Sales
E. News operations
F. Other (specify)

Reader Service

MAY 28, 1997 Use until AUG 28, 1997 Please first fill out contact information at left. Then check each advertisement for corresponding number and circle below.

Table with 3 columns: 1. Recommend, 2. Specify, 3. Approve. Lists numbers 001-024 for reader service tracking.

Copy & Mail to: Radio World, PO Box 1214, Falls Church, VA 22041, or FAX to: 703-820-3310

Table listing staff roles and names: Production Director (Lisa Stafford), Production Manager (Lisa Hoagland), Publication Manager (Heather Nicholson), Classified Coordinator (Lori Pliskaart), Showcase Coordinator (Vicky Baron), Ad Traffic Coordinator (Kathy Jackson), Ad Traffic Assistant (Anastacia Stormetta), Desktop Management (James Cornett), Ad Coordination Manager (Simone Mullins), Circulation Director (Sheryl Unangst), Circulation Manager (Robert Green), Accounts Receivable (Steve Berto).

Advertising Sales Representatives

Table listing advertising sales representatives by region: U.S. East (Skip Tash), U.S. West (Dale Tucker), U.S. Midwest (Sandra Harvey-Coleman), Other Regions (Stevan B. Dana), Latin America (Alan Carter), UK, Ireland (Phil Guy), Europe, Africa, Middle East (Raffaella Calabrese), Asia/Pacific (Eiji Yoshikawa).

Free Subscriptions are available upon request to professional broadcasting and audiovisual equipment users. For address changes, send current and new address to RW a month in advance at P.O. Box 1214, Falls Church, VA 22041. Unsolicited manuscripts are welcomed for review: send to the attention of the appropriate editor.





## THE FUTURE OF RADIO IS HERE NuStar is ON-AIR

Cleaner, Clearer, Quieter  
DIGITAL AUDIO IS THE DIFFERENCE

The sonic quality of WEGR-FM in Memphis is really very good and it just got better. Their NuStar 3000 Series installed quickly and operates flawlessly. The Morning Wake-up Crew, TIM, BEV, and BAD DOG are pictured above at the control surface. Tim Spencer (P.D.) says "The great thing about it is that it's Digital, but operates like the regular Board we're used to. We feel that's important because with the new console, our staff hasn't had any operator miscues at all. The transition was seamless."

**- AND IT'S READY FOR YOU AND YOUR STATION -**

With new equipment technology and your air time on the line  
The Name You Can Trust To Deliver Is:

 **AUDITRONICS**

3750 Old Getwell Road, Memphis, TN 38118 USA  
Telephone: (901) 362-1350 FAX: (901) 365-8629  
www.auditronics.com E-Mail: sales@auditronics.com



# Some Countries Have It ALL!



## WSIX - Nashville, Tennessee "Country Music Station of the Year"

A-500 Studio Furniture delivered March 1993  
A-500 Console S/N 20789 delivered April 1993  
A-500 Console S/N 20792 delivered April 1993  
A-6000 Studio Furniture delivered March 1995  
A-6000 Console S/N 22536 delivered March 1995  
R-16 Console S/N 22557 delivered March 1995  
SP-5 Console S/N 22593 delivered April 1995

1995 Academy of Country Music Award  
1995 Marconi Country Music Award  
1995 Billboard Country Music Award  
1995 Country Music Association Award  
1995 Country Music Association SRO Award  
1995 Gavin Country Music Award  
1996 Gavin Country Music Award  
1996 Academy of Country Music Award

*Wheatstone Model A-6000 Audio Console shown*

 **Wheatstone Corporation**  
tel 315-452-5000 / Syracuse, NY.