



Do You Know the Way?

San Jose plays host to SBE's national convention. See our preview, pp. 33-38.

RUNNING RADIO

Networks Show Gains in 12+

NEW YORK Just-released RADAR 45 results showed that network radio audiences aged 12 and older grew by 0.6 percent in the U.S. since RADAR 44 was released last year.

Eleven of the 15 networks ranked in the spring survey had some kind of audience gain. Among persons aged 12 and older, only the four Westwood One networks' audience declined—with the biggest loser being WONE, posting a decrease of 8.4 percent (see chart).

The biggest gainer was the American Urban Network (up 13.4 percent). American Urban Radio Networks is the combination of Sheridan Broadcasting Networks and the National Black Networks that merged earlier this year. The second biggest gainer was ABC's Excel Network, up 9.2 percent. All other networks showed gains of 4.4 percent or less among persons aged 12 and older.

Adult networks as a group were flat with a 0.8 percent increase. Young adult networks fared only slightly better with a 2.1 percent increase.

ABC's Galaxy, with a 13.5 percent increase among adults 25-54, led all other networks in improvement over RADAR 44. ABC's Excel improved 22 percent with adults aged 18-34, the largest gain of any network.

By common consent, the radio networks agree to release audience information to the press based on the same daypart for all radio networks. The one daypart on which all audiences have reported audience estimates is Monday-Sunday, 6 a.m.-7 p.m. Audience estimates in this article are all based on this common daypart.

There were few surprises in the top 20 network radio programs, network audiences to commercials, within programs, persons aged 12-plus. The top

10 breakdown was: Paul Harvey News and Comment, M-F 8:30 a.m., 6,476,000; Paul Harvey News and Comment, M-F 12:06 p.m., 4,998,000; Paul Harvey's The Rest of the Story, Sat. 8:30 a.m., 3,933,000; ABC Prime News, M-F 8 a.m., 3,524,000; Paul Harvey's The Rest of the Story, M-F 3:06 p.m., 3,508,000; ABC Prime News, M-F 7 a.m., 3,505,000; Paul Harvey News and Comment, Sat. 11:10 a.m., 3,481,000; ABC Prime News, M-

continued on page 28 ▶

USA Digital Presents AM, FM In-Band DAB

Success Credited to DSP Chip from the Military

by Alex Zavistovich

NEW ORLEANS It may be considered a programming show, but the highlight of 1992 NAB Radio Show was technology—in-band digital audio broadcasting (DAB) technology.

DAB developer USA Digital Radio provided fixed on-air tests of its Project Acorn in-band, on-channel systems during the NAB convention here in September. Both FM and an AM technologies were demonstrated. WWNO(FM), an NPR affiliate in Crescent City, provided the channel for the FM demo, and WNOE offered the AM component.

USA Digital said its DAB system will offer AM broadcasters a 96 dB signal to noise ratio, stereo and a frequency response from 20 Hz to 15 kHz. The system also provides a "RBDS-type" data channel capability.

Listening to in-band AM

Those who listened to the demonstration were able to compare the USA Digital in-band AM signal, broadcast from the con-

vention center on 1660 kHz, to the same programming on WNOE's 1060 kHz signal.

For the AM test broadcast, a studio signal was fed from WNOE via a 15 kHz RE8720 stereo tie line digital encoder from RE America. The encoder fed the signal via two standard telco copper pairs to the RE8730 tie line decoder at the convention center.

The digital signal then passed through a Corporate Computer Systems (CCS) MUSICAM encoder. After the requisite error correction and interleaving functions, the now 126 kilobit per second (kbps) bitstream was transmitted via a newly-developed Xetron digital transmitter at 1660 kHz. Power was 50 W.

On the receive end, the signal went through an RF amp to an IF amplifier and digital carrier recovery stage. After

continued on page 3 ▶

FCC Looks at EBS Overhaul

WASHINGTON If you want to file comments on the FCC's new Notice of Proposed Rulemaking (NPRM) to revamp the current Emergency Broadcasting System (EBS), you have a lot of topics from which to choose. Even the EBS moniker itself could be changed under this proposed rulemaking.

In an FCC open meeting on Sept. 17, Helena Mitchell, chief of the EBS, generally outlined the elements of the NPRM. Among the proposals were:

- A new emergency alerting system to replace the current EBS;
- Modernization of EBS equipment to include provisions for automation, remote control, end of message codes, a special alerting codes;
- Inclusion of cable in emergency alerting;
- Self-test, silent test and monthly audible on-air testing of EBS;
- Mandated equipment standards;
- Amendment of the EBS rules to prohibit false and deceptive use of emergency codes; and
- Revision of the EBS test script to reflect these new changes.

Other proposals included renam-

continued on page 7 ▶



90% Off.

Our solid state FM transmitters require just 10% of the routine maintenance needed by tube transmitters. You can't discount that statistic -- or the clean, clear signal our Platinum transmitters provide.

Phone: 217-222-8200 Fax: 217-224-1439

**HARRIS
ALLIED**

"Market" Clarified in Ownership Rules

by John Gatski

WASHINGTON With the release of the final text of the FCC's radio ownership rules, the Commission has defined general policies that were not made specific during the initial announcement in August, including a definition of a radio market.

Following congressional and industry pressure, the ownership limits were revised downward in August after having been expanded in March. The FCC lowered the increased national limits from 30 AMs and 30 FMs to 18 of each. The local limit was set at two AMs and FMs in markets with more than 15 stations, and up to three FMs and AMs in markets with fewer

than 15 stations, provided that the total is less than half of the total stations in the market.

The new rules also allowed an owner to exceed the national limit by three stations per service if the owner holds a non-controlling interest in stations primarily controlled by minorities or small businesses. The intent was to garner financial incentives for small businesses and minorities so they can increase their participation in station ownership.

The ownership rules text defined a radio market as "that area encompassed by the principal community contours (i.e., predicted or measured 5 mV/m for AM stations and predicted 3.16 mV/m for FM

stations) of the mutually overlapping stations proposed to have common ownership."

According to the FCC, "the number of stations in the market will be determined based on the principal community con-

The ownership rules text also defined small business.

tours of all commercial stations whose principal community contours overlap or intersect the principal community contours of the commonly owned and mutually overlapping stations."

For example, the text stated, "If station A and station B have overlapping principal community contours and station A proposed to acquire station B, the number of stations in the market includes not only stations A and B, but also all commercial stations whose principal community contours overlap with those of station A."

The text also defined small business for the purpose of exceeding the national ownership limit via non-controlling interest in a station. A small business is one that has total annual revenues of less than \$500,000 and assets of less than \$1 million, the FCC said.

The FCC also addressed using the 25 percent audience share as a cutoff for avoiding excessive concentration of ownership in a market. "We...affirm our decision under the new ownership limits to evaluate showings of the audience share in approving acquisitions in all but the smallest markets," the FCC said.

Although the NAB and other parties commented that audience share surveys, such as Arbitron's, can be imprecise and thus the concept of audience share may be difficult to measure accurately, the FCC said that independent services like Arbitron provide survey data that "are a probative and accessible measure of market power relevant to the Commission's regulatory concerns."

A Little Bit of MAGIC...



Revealed!

THE R-10 IS BASED ON A SIMPLE PREMISE: Low cost does not have to be synonymous with low quality (as is so often experienced). When you've got Audioarts' experience and expertise, value engineering becomes a task of carefully defining the features required and manufacturing in an efficient manner, utilizing the best of computer and machine technology.

THE RESULTS ARE SELF-EVIDENT: the R-10 is a fully modular console, with the componentry you'd expect to see in a much larger design. *No other console in its price range can even come close!*

The R-10 has gold audio switches, gold edgcard connectors, conductive plastic faders, conductive plastic monitor pots, fully burned-in socket-mounted ICs, industry standard machine control switches and, of course, documentation and instructions that make installation really simple.

With the R-10 you can take advantage of Audioarts' reputation and experience, and be assured that quality and performance will be yours.

AUDIOARTS ENGINEERING

6720 V.I.P. Parkway, Syracuse, NY. (tel 315-455-7740/fax 315-454-8104)

Index

FEATURES

Texas AMs Run on "Phantom Power" by Don McVicker	12
The Forgotten Empire: Are We In Danger of Losing Our Past? by Barry Mishkind	14
Ensuring Remote Control Compliance by Harold Hallikainen	15
Workbench	17
Marconi's Success Tied to Military Interest by George Riggins	18
Less Is More in Digital User Interfaces by Mel Lambert	19
Broadcast Engineers' Future Requires Computer Literacy by John "O" Shepler	20
Power Amplifiers on a Tight Budget by Jim Somich	21
Is That FM a Good Buy? by W.C. "Cris" Alexander	21
The Finer Points of PC-Based Editing by Bruce & Jenny Bartlett	39

RUNNING RADIO

Networks Gain in 12+ by Lucia Cobo	1
Male Vocalists Flex Their On-Air Muscle by Charles Taylor	22
Changing the Links in the Audio Chain by Jeffrey Loughridge	26
Fill Your Files with Fields of Facts by John Cummuta	28
Wired for Phones, PCs and Sound by Edwin Bukont	30
Satellite Control Options: A Further Examination by Karl Baehr and Harry Nelson	31

SBE PREVIEW

SBE Boasts Record Number of Sessions by Jerry Whitaker	33
Sessions Highlight Digital, Regulation 34	
Exhibitor Directory	35

USA Digital Demos In-Band Systems

Acoustic Charge Transport (ACT) Chip, Developed By DARPA, Affords High-Speed System Operation

► continued from page 1

error correction and de-interleaving, the signal, now at 96 kbps, passed through a CCS MUSICAM decoder to a power amp for A/B monitoring in the convention center.

Results encouraging

The listeners were able to compare the AM analog signal versus the in-band digital signal. Most listeners said they were impressed by the digital feed.

part of the USA Digital consortium, along with Gannett Broadcasting and Group W—the technology is possible because of a technology developed by the military.

Defense-related technology

The technology is called "acoustic charged transport" or "ACT," a microchip developed by the Defense Advanced Research Projects Administration (DARPA), Masiello said. The ACT

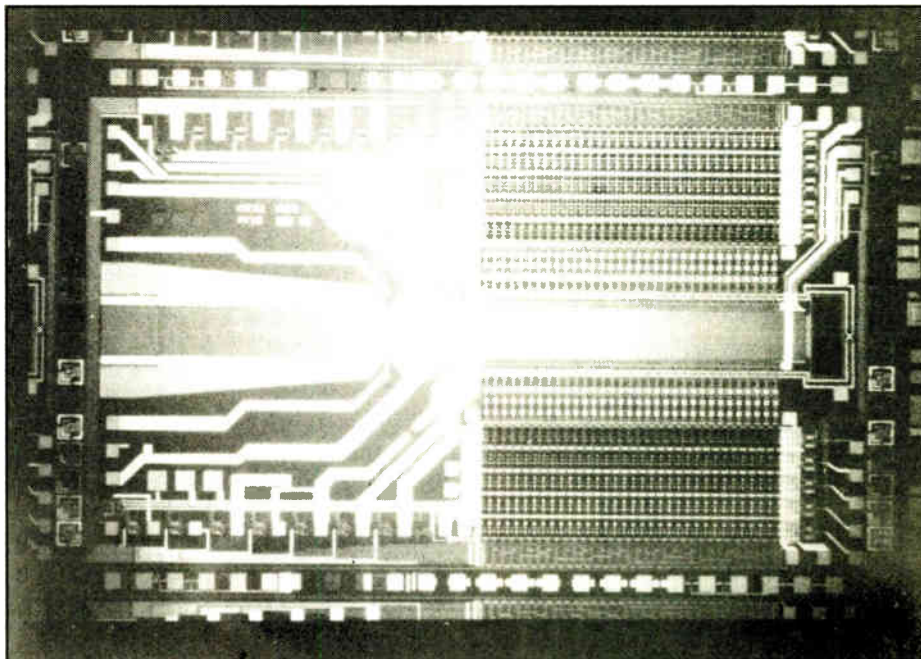

USA Digital attributes the success of its Project Acorn DAB system to this ACT chip, developed by DARPA.

The listeners were able to compare the AM analog signal versus the in-band digital signal. Most listeners said they were impressed by the digital feed.

The FM demonstration was similar to that presented by USA Digital in Las Vegas in April. The digital signal was combined with WWNO's analog signal, and then the digital and analog signals were delivered on-channel, within the WWNO RF mask.

An experimental 2 kW solid state FM transmitter and combining system was provided for the demonstration by Harris Allied Broadcast Division. Other equipment used for the broadcast included a CCS MUSICAM encoder and an EDI digital exciter.

WWNO's analog signal is 50 kW while the DAB signal had an 50 watt ERP. The digital signal was about 40 dB down from the station's analog signal.

According to Tony Masiello, VP of technical operations for CBS—which is

gallium-arsenide chip is capable of digital signal processing speeds of 360 MHz—faster than seven Cray computers, according to USA Digital.

The ACT chip, to be built into DAB receivers, will be available in commercial quantities for \$7 to \$10 each, Masiello said.

In a session on the closing day of the convention, Masiello answered critics' concerns about the Project Acorn system's immunity to multipath. He credited the system's multipath mitigation success to the concept of "hula modulation."

In the Project Acorn DAB scheme, there are 21 carriers to each side of the center frequency, providing redundant information. The FM deviation rate causes the carriers to move back and forth in

the RF mask, and the Acorn system adjusts to this movement with frequency hopping—"doing the hula," as Masiello put it. The diversity of carriers would be sufficient to combat narrow multipath conditions; "hula modulation" is used for mitigation of so-called "stoplight fading."

Although Acorn's developers stressed

they were only showing progress toward an in-band, on-channel DAB system, they are looking toward mobile tests within the next month or two; one such test will likely be held in Washington, D.C.

□ □ □

News Editor John Gatski contributed to this report.

Coast to Coast The Preferred Source

The very best broadcast equipment and service at the very best prices.

► **Equipment Lease Specialists** ◀

BROADCAST SERVICES CO.

The Davis Communications Group, Inc.

Eastern & Central
VOICE 800/525-1037
FAX 919/934-1537

Mountain & Pacific
VOICE 800/523-1037
FAX 805/266-1695

Circle (20) On Reader Service Card



Features:

- 56/64 Kb/s Switchable
- Built-in Power Supply
- Portable or Rack Mount
- Complies with CCITT G.722
- 7.5 KHz Full Duplex Audio
- Ideal for Studio-to-Studio Links

COMREX DIGITAL CODECS provide wideband, two-way audio to put listeners right at the scene for sports, news, weather and more. The Comrex Codec allows broadcasters to take advantage of the new digital telephone services which are fast becoming an excellent low-cost alternative to satellite links or dedicated lines.

Our codecs can be used with switched 56 Kb/s and 64 Kb/s (ISDN) services as well as dedicated digital lines. The versatility and intelligence built into the Codec assure compatibility with virtually any digital telephone network, so all you have to do is plug it in and turn it on.

Call or fax us for complete information plus our useful notes on "How to Order and Use Digital Phone Service."

COMREX

Comrex Corporation
65 Nonset Path, Acton, MA 01720
800-237-1776 508-263-1800
Fax 508-635-0401

Comrex (UK) Ltd.
75 The Grove, Ealing
London W5 5LL, UK
081-579-9143 Fax 081-840-0018



Circle (17) On Reader Service Card

Who's running the ship?

Unattended operation is one way to keep your station profitable, but you still have to mind the store.

The acclaimed Burk Technology ARC-16 Remote Control System is the first step. You can control transmitter and studio from any phone.

But wait. There's more!

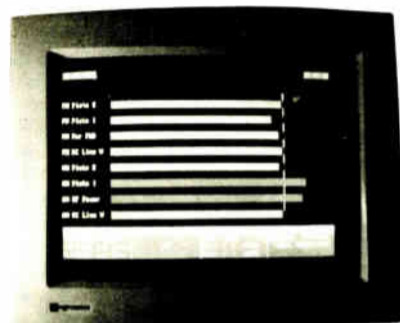

Introducing AutoPilot™ from Burk Technology.

AutoPilot is break-through computer software that makes automatic operation of your studio/transmitter facility a dream come true.

- Automatic power changes
- Automatic pattern changes
- Automatic site changes
- Automatic power trim
- Automatic fault recovery
- Automatic logging

Now your imagination is the only limit.

The new FCC fine schedule is imposing. Why risk a big penalty when AutoPilot can help you stay within the rules?

Call us at 508-433-8877
or toll free at
1-800 255-8090
for more information
and a FREE DEMO.

BURK
TECHNOLOGY

Circle (14) On Reader Service Card

Where Are We Going?

by Alex Zavistovich

WASHINGTON Well, I'm at the halfway mark in the fall season of conventions and trade shows. I've already got the NAB Radio Show under my belt. AES is in full swing, and the SBE is only a week away. My frequent flyer card is seeing some serious action these days.

Of the three shows, the SBE is definitely the most demanding. The technical level is noticeably higher, for one thing. But the toughest part for me is when I'm called on to moderate a session. This is my second year at the helm, this time for a session called "Preparing for a Digital Future."

The trick is analyzing the trends I've noticed in a big-picture kind of way. So lately I've been thinking about key elements in this increasingly digital world.

★★★

Let's think first about technology that's already out there—for example, hard disk storage and playback systems. These PC-based devices can be interfaced with satellite delivery systems for walkaway operation, right down to inserting ad spots from a computerized log. Some of them even have fairly sophisticated editing capability as well, making spots easier to produce. Stations can achieve a level of automation never before possible.

Remember what happened with the first wave of automation equipment for radio, though. Station managers began to realize that they could do the same job with fewer people, and almost overnight on-air jobs became harder to find.

Back then, the air talent was the only group really affected. But those were the years B.C.—"Before Computers."

Now, desktop systems come equipped

with traffic and billing functions built right in. Depending on the penetration of such hard disk products in the industry, I can imagine a time not too far off when traffic, billing and continuity will become an extension of the sales manager's responsibilities, rather than a position all to itself. That consolidation is good for a station's bottom line, but it also spells more people looking for fewer jobs.

★★★

Another area of broadcasting already touched by the digital invasion is program audio processing. Whether we're talking about digitally controlled boxes using ana-



log circuitry or devices that are truly digital through-and-through, the new technology is definitely at work in processing.

Now, some in the industry are asking what will happen to processing once digital audio broadcasting (DAB) takes over. Does it spell a slow ride into obscurity for this category of equipment? After all, DAB promises clean, pure audio quality comparable to CDs. Why then, would we need processing?

This question was thoroughly answered by folks from Cutting Edge, CRL, Genter and Orban at a clinic during the NAB Radio Show, but let me put my two cents in. The question reminds me of a

scene from a recent movie in which a caterer is singing the praises of a wedding cake to the bride's father.

"It's so light, you can't taste it," cooed the caterer.

"Who wants a cake you can't taste?" came the natural reply.

The marriage of broadcasting and digital technology is about the same. Program directors will still have an idea of what a successful station should sound like, apart from the music mix. Signature sounds won't go away just because the transmission environment has changed.

Still, that's not to say that processing won't change, too. Some manufacturers are now soft-pedaling the loudness advantage of their boxes and promoting the improved audio quality you can get from them. So, the cake will be lighter, but you'll still be able to taste it.

★★★

Which brings me, inevitably, to the issue of DAB itself. The USA Digital Radio Project Acorn demos in New Orleans provided a startling glimpse at just how close we are to the reality of DAB in the U.S.

Digital technology offering FM quality on AM is a tantalizing prospect, but AM stations need to remember that signal quality has only been a part of the problem behind FM's increased audience dominance. There has been a programming aspect, as well.

It would be easy to let the promise of DAB distract from the need for more innovative AM programming, or at least a greater awareness of how AM stations can best serve the public interest. After all, if programming was partly responsible for driving listeners away from the band, why should we imagine that the same programming with improved fidelity is going to draw them back?

AM broadcasters can start preparing for a digital future now, by building a programming strategy that will make the best use of the audio benefits to be gained from DAB.

As for FM, some industry players are grumbling again about the dreaded "P"-word: parity. Some FM broadcasters don't want AMs to have audio quality comparable to FM, for fear of losing ground competitively to the amplitude guys. No, we can't have some kind of leveling of the playing field happening here...

Well, the fact is that AM broadcasters are a pretty vocal bunch, and they're not going to let FMs have DAB unless they can get a piece of the action too. And the NAB, in its ameliorating way, will likely agree with the AMs—for proof of that, you need look no further than what's happened with RBDS in the U.S.

So FM broadcasters can prepare for a digital future by understanding that competition will become more fierce than ever when DAB takes hold. AM and FM will have some level of technical parity. In a classic example of Darwinian economics, the strong will flourish, and the weak will downsize. It's a good thing the prices on those hard disk automation systems are coming down...

Of course, I've only scratched the surface here, but I think you see the point. Preparing for a digital future is exciting, and it could be a real bed of roses for a bright company. You just have to watch out for the occasional thorn.

That's it for now. Tune in next time.

Alex

You can measure...
with the best monitor and the most accurate test set.

The FMM-2/FMS-2 series monitors provide an even greater degree of precision measurement than ever before... **You can measure** S/N below 90 dB, **You can measure** crosstalk below 85 dB, **You can measure** separations of better than 70 dB, **You can measure** frequency response to better than 0.25 dB, **You can measure** distortions to lower than 0.01%, and much more... Our uncluttered panels and autoranging voltmeters make these measurements a dream.

BELAR
ELECTRONICS LABORATORY, INC.
LANCASTER AVENUE AT DORSET, DEVON, PENNSYLVANIA 19333
Call or write for more information on Belar AM, FM, Stereo, SCA and TV monitors.

(215)687-5550

Circle (116) On Reader Service Card

READERS FORUM

If you have comments for Radio World, call us at 800-336-3045 or send a letter to Readers Forum (Radio World, Box 1214, Falls Church, VA 22041 or MCI Mailbox #302-7776). All letters received become the property of Radio World, to be used at our discretion and as space permits.

Absentee owner nightmare

Dear RW,

One of my family members contacted me recently asking that I help a young man who was buying a small market AM/FM station. He indicated that he was buying a small-town radio station from an absentee owner. He told me what he was paying and asked me to inspect the operation. He wanted to make sure he was buying a facility that was operating legally.

I made the inspection he requested. The station did not have an operating log. The station had not recorded EBS alerts received or sent. The station did not have a chief operator. No chief operator certificate was posted. The man who took care of engineering problems would not sign off as the chief operator because of the deficiencies. There was no station log. The station's public file was terribly deficient. The last ownership report was in the '80s. There were no programs aired to address community problems.

The AM transmitter site hadn't been mowed in who knows when. The base current meters hadn't been read ever...at least there were no records. The weeds in the field were four feet or higher! The fences around the towers were marginal at best and probably illegal. The transmitter building was full of cobwebs, etc. The transmitter panel was missing. Poor engineering practices were evident almost everywhere. Two of the towers needed painting.

Tower lights had to be visually checked and the technician said he only checked them every week. That's a clear violation! The transmitter output power was way under the allowable 90 percent. The transmitter had been operating under power for several months. The GM was also the main operator. He took off for lunch and left the station unattended. At night he did the same thing and it was my understanding that he did so on weekends, too.

I could not believe the total disregard of all FCC rules and regulations! At most

stations across the land, the operators and owners try very hard to be in compliance. This operation was just the opposite. It just seems unfair to see stations get fined when they are trying, and operations like this one get away scot-free!

After receiving my report, this young man gave some of these findings to an FCC field office. They told him their budget didn't permit them to investigate; they said about the best they could do would be to send a letter asking the station to correct its problems.

The young man who was going to purchase the station thought he was buying a facility that was OK. He doesn't know anything about broadcasting. He has been a computer programmer and wanted to move back to his home town and try his hand at operating the town's radio station. He put \$10,000 earnest money down.

After he told the current owner that he wouldn't buy the station because of all the FCC violations, the owner (a lawyer) told him he would only give him \$5,000 of the earnest money back. The lawyer-owner told him if he expected the other \$5,000 back he would have to hire himself an attorney.

It's my understanding that the GM is attempting to correct some of the deficiencies. I've tried to call the manager and gotten a recording to leave my message. This indicated to me that he was not at the station and it was unattended just like I found it the day I first inspected it!

I'm a broadcaster that has tried very hard to follow the FCC rules throughout my 49 years in this business. I know there are others out there that have lived

SBE '92: Questions & Answers

Over the past year, many questions were raised regarding the Society of Broadcast Engineers (SBE) and its national conference and trade show. Should the event be scrapped? Should the society be re-organized? The debate continues.

For this year's convention, to be held Oct. 14-17 in San Jose, the question is: How has the SBE

executive board addressed its members' concerns in planning the show, and what will the future bring?

Last year's event, unfortunately, lost money. Along with the general membership's concern over recent bylaw revisions, this loss became an emblem of many regional chapters' dissatisfaction with the society and their representation in its decision-making process.

Clearly, the national office is not oblivious to the increased scrutiny it's being subjected to this time around. The board understands the importance of having a better, more successful show this year.

But much of the success of the show will depend on the membership. Success is a tangible thing for conventions and trade shows; it is equated, in general, with high attendance. Therefore, SBE members who want the show to succeed must take the initiative and go themselves.

The SBE-reforming activists that emerged this past year should attend too. In many regional chapter meetings doing away with the national convention was discussed. However, a percentage of the membership never took part in these discussions because they didn't attend the meetings.

Attending the show will offer SBE members the chance to meet with the organization's executives. The SBE membership meeting during the spring NAB show in Las Vegas did much to get complaints out on the table. Face-to-face contact is the most effective way to air grievances, and the show provides such an opportunity.

Whether it's learning about technology or learning more about the SBE and members' role in it, attending the convention this year will answer questions. What does the future have in store for the SBE? For members, it is your responsibility to go, and be part of the answer.

—RW

in fear of the FCC like I have. After I inspected this station, it was very hard to believe what I found. I can't imagine anyone operating a station like this! This experience convinces me that the FCC should be doubly tough on absentee ownership. If the owners don't care any more than this about a radio station operating legally, then they should be inspected and fined!

Name withheld by request

Correction

In the Sept. 9, 1992 issue of RW, the "CCS Gets DCS Patent" *Newswatch* story on page 3 incorrectly identified the company as Computer Concepts Systems. The actual name of the company is Computer Concepts Corporation (CCC).

GUEST EDITORIAL

Engineers Face Crossroads

by Phil Simon

WASHINGTON "Where do we go from here?" The subject comes up whenever I talk with my friends in radio engineering.

Many of us are leaving the business; there are fewer engineers in radio today than 10 years ago. Each of us who leaves a station makes a personal decision to do so, such as:

1. The job doesn't exist anymore. When a station reduces its technical staff, someone has to leave.
2. Stations forget why they need an engineer. I've seen this one many times. A station hires a good engineer because it has major problems that need attention. Once those fires are put out, and the station has a few years of trouble free operation, there's a perception that the engineer is superfluous.
3. Personnel turnover creates personality conflicts. Technical people tend to outlast announcers, programmers and managers; there's just less turnover in engineering. If a new manager has a personality conflict with an existing engineer, it's the engineer who leaves.
4. Some stations make unreasonable demands on an engineer's time. If he has to work 60 hours each week, he'll burn out soon enough. And many would prefer a job that doesn't put them on 24-hour call, tied to a pager.

5. Sometimes an irresistible career opportunity opens up, either in broadcasting or a completely different field.

Perhaps instead of asking, "Why do we leave?" we should be asking, "What do we really want?" Many of us are in radio engineering because we enjoy the work; often we have the freedom to set our own hours; tremendous autonomy; the chance to work with creative people; fairly good compensation (at least in the largest markets); and the excitement of working in show business.

Now let's look at the career paths chosen by technical people who leave radio stations. Actually, a lot of them still work in the business.

Very few engineers become station managers or owners. Some find jobs as the technical director for a radio group; nowadays, that often includes acting as engineer at one of the stations. However, these jobs are rare, and often based in large cities like New York, that many consider undesirable and expensive.

A few become registered professional engineers and work as consultants on FCC issues. The entrepreneurs among us have become independent contractors. Some even specialize, whether in remote broadcasts, turnkey installation projects or station maintenance.

There are many jobs making, selling, and supporting broadcast equipment.

Several engineers have started "garage" manufacturing of broadcast equipment and accessories; some engineers are effective salesmen of broadcast technical products. Equipment manufacturers also hire radio engineers in field service and factory support. And some engineers have found jobs with the companies that operate FM subcarrier networks.

When radio engineers actually leave the business, they usually move into related fields where they can use their technical skills.

The satellite communications business has absorbed many radio people. A few go into two-way sales and service or antenna site management. Others have found their niche in the growing personal computer industry; sales, service, support, and software for PCs will provide many opportunities for technical persons in the future.

We must remember that engineers at radio stations are always subject to the laws of supply and demand. With less demand for engineers, salaries will stagnate and engineers will leave broadcasting. If demand picks up, salaries will rise for those who stay.

If you're considering a career change, you have some decisions to make. Decide what you want from your career, and whether you can find those things in your present job. Only you can shape your future, so plan ahead and prepare for it. The technology of radio keeps changing; but as some doors close, others open.

Radio World

Vol 16, No 19 October 7, 1992

Editor.....Alex Zavistovich
 Managing Editor.....Lucia Cobo
 International Editor.....Alan Carter
 Associate Editor.....Charles Taylor
 News Editor.....John Gatski
 Contributors.....Frank Beacham/N.Y.
 Bruce Ingram, Pamela Watkins, Nancy Reist
 Technical Editor.....John Bisset
 Technical Advisor.....Tom McGinley

Radio World (ISSN 0274-8541) is published semimonthly by Industrial Marketing Advisory Services, Inc., 5827 Columbia Pike, Suite 310, Falls Church, VA 22041. Phone: 703-998-7600. Fax: 703-998-2966. Second-class postage rates are paid at Falls Church VA 22046 and additional mailing offices. POSTMASTER: Send 3579 forms and address changes to Radio World, P>O> Box 1214, Falls Church VA 22041. Copyright 1992 by Industrial Marketing Advisory Services, Inc. All rights reserved.

Next Issue of
Radio World
 October 21, 1992



For A Good Time, Call 1-800-622-0022.

When it comes to getting you broadcast equipment and information, we make good time. Because we're here for you when you need us. With all the information you could ever want. On all the equipment you could ever need.

When you know exactly what you're looking for, we'll give you the right price. And when you're not sure what you need, our broadcast experts are always ready with sound advice.

Of course, it helps that we

have over 5,000 products from more than 240 manufacturers to choose from. And, as we stock over 90% of these products, chances are your order can be shipped within 24 hours.

So, for fast service and

good value on the things you need, call on Harris Allied. We'll make you happy in no time at all.

8:00 a.m. to 8:00 p.m. EST

1-800-622-0022

Fax 317-966-0623

Canada 1-800-268-6817

 **HARRIS
ALLIED**

EBS Chief Takes on System Overhaul

Editor's note: The FCC has a Notice of Proposed Rulemaking pending on EBS. It looks at whether the current EBS should be overhauled, including remote control provisions and shortening of the test tones used to activate the system. It also examines possible new technologies to replace the existing system. RW Editor Alex Zavistovich and News Editor John Gatski recently met with new EBS Chief Helena Mitchell to discuss the current and future status of EBS.

RW: In light of EBS's problems during emergency conditions such as the 1989 San Francisco earthquake and Hurricane Bob in New York, how would you assess the system's effectiveness?

Mitchell: I think it works when the people on the controls know exactly what to do. The problem is that a high percentage of the time that is not the case. When a real emergency comes through...it's not your typical nine-to-five day. You may not have your experienced chief engineer there or your chief operator, or whatever. You may have a part-timer. So when a true emergency strikes, you don't have the person there who can go ahead and activate the system. Consequently, it doesn't work as well as it should.

RW: So this is a training issue?

Mitchell: It's partly training and it's partly the equipment.

There are two aspects to EBS. I look at it from operational and technical aspects. From the operational aspect, it is outdated. People need to be able to understand what the system is. Station personnel need to realize it is for local emergencies and not just for the bomb dropping. We need to have a better system of getting the information out—what we call the daisy chain—to all the stations that are required to have it.

Technically, the equipment is old. A lot of stations have been doing patchwork to try and get it fixed. You have large stations that have invested their own money to buy fancier, up-to-date equipment. So the question is, do you keep pouring money into the old system, or do you go ahead—and now is the perfect time—to create new equipment that is going to be much more reliable and have a lot more features?

It will be interactive between all the different technologies. You're not just talking about broadcasting, you are talking about cable, you are talking about satellite. We have to have some way for them to work together to have EBS service.

RW: At a recent EBS workshop, FCC Chairman Al Sikes hinted during a question and answer session regarding new EBS technologies, that the Commission is interested in a system with an override function, such as RDS. Will the FCC select RDS as the new technology for EBS?

Mitchell: Since we are now in the process of the proposed rulemaking, we can't say what systems we favor or don't favor. What we can say is that new equipment is going to allow for certain universal parameters, certain features that all equipment will have to have. It could be a configuration of several pieces of equipment from systems that are out there. Whatever it is, it will have to be state-of-the-art and allow a great deal of compatibility between cable, broadcasting and satellite.

RW: Currently, the FCC allows communities to implement their own EBS systems. Jefferson County, Texas, a major petrochemical industry area, will convert to RDS this fall. Under the expected FCC changes for EBS, will the FCC continue to allow communities latitude in cus-

tomizing a system to suit local needs?

Mitchell: If their systems can meet what we are requiring, yes. We have about four or five states and counties out there testing other systems. We're looking to them to give us feedback on our proposal.

Also, when you do a Notice of Pro-



**Dr. Helena Mitchell,
Chief of the Emergency
Broadcast System**

Previous experience: Director of Office of Television and Radio, Rutgers University; Vice President for Corporate Development, Systems Associates, Toronto, Canada; Director of Telecommunications Development, National Telecommunications and Information Administration; Management positions, WABC-TV, WNET-TV, WNYC TV/AM-FM. Education: Ph.D. in telecommunications policy, M.S. in secondary education, Syracuse University; B.S. in education, S.U.N.Y. Other accomplishments: Published and edited several papers addressing communications issues.

really is going to improve the ability to save lives.

RW: Even though some of the proposed replacement technologies do not need an audible test tone, does the FCC want to keep using such tones?

Mitchell: Tones will be used to trigger equipment. You can have everything from self testing to silent testing, to audible testing. It will be up to the stations. A station in a major market may still want to do a test four times a month over a year. A station that is automated may test itself silently. So there is going to be a certain amount of flexibility built in.

RW: How does the FCC view off-premise remote control of EBS equipment?

Mitchell: I think with today's technology and stations becoming more automated, you do need to have some way of triggering the system from a remote location. About 75-80 percent of activations are still weather-related, but the rest are what we call high-tech type disasters. We're talking about areas with potential for chemical spills, train derailments. If you have a fire chief or a local official, they could have pagers, and punching a number into the pager could activate the system.

RW: Can stations expect government funding for switching to a new EBS system?

Mitchell: FEMA (Federal Emergency Management Agency) will provide about \$3 million. Senator Hollings (who chairs a U.S. Senate subcommittee that oversees communications legislation) has been talking about setting aside some monies to help revitalize the system. But in reality, for most stations I don't really think we are going to need it.

The new equipment isn't just going to be for EBS. The equipment is going to have lots of bells and whistles, among them the EBS feature. I don't think that the larger stations are going to have problems. I do think that some of the small AMs will have problems. But on the other hand, maybe they won't have to. They don't have to go for the Cadillac version, they can go for the lower end version.

FCC Proposes EBS Revamp

► continued from page 1

ing EBS to take into account the new structure and new technologies associated with it; promoting the use of public service announcements to heighten awareness of EBS; and including other communications technologies in the system, such as amateur radio, wireless cable, satellite, cellular and personal communications networks.

Not addressed in the NPRM was the issue of shortening the EBS test tones from the current 20 seconds. Mitchell said that shortening the tone at this time "may be burdensome to the industry," and speculated it might be taken up at the Report and Order stage of the proceeding.

Pointing out that EBS "was last improved in the 1970s," Mitchell went on to describe a "new operational structure" for the system, under which all EBS participants could work together during emergency situations. Certain classes of stations also could select the level of automation they desire by making known the type of emergency situations on which they would provide information, she said. The goal would be to create a system that had "less reliance on single-station monitoring," Mitchell added.

The NPRM was unanimously accepted

by the FCC commissioners, with little comment; James Quello, Andrew Barrett and Sherrie Marshall each acknowledged that a revisitation of the EBS was due. Ervin Duggan also supported the NPRM, adding that his trip to the South Carolina Broadcasters Association convention earlier this year underscored the industry's concern with revamping the EBS.

Chairman Al Sikes echoed the sentiments of the rest of the Commission, and noted that the cable industry was "especially enthusiastic" about participating in the EBS. Sikes expressed his concern that a revitalized EBS should offer a "high level of assurance of quick notification" in the event of an emergency, and hoped that an overhauled system could be achieved "as quickly as possible."

The FCC's NPRM combines two notices of inquiry (FO 91-301 and FO 91-171) that had been before the Commission since last year. One looked into whether some changes would have to be made to the existing EBS, including shortening the test tones; the other investigated whether EBS should be replaced altogether by new technology such as Colorado's ICEBS system, California's EDIS, the RDS-based SAGE I or the National Weather Service's WRSAME system.

posed Rulemaking, you put your proposal out for comments. If the community comes back to us and says they don't want any of these things, obviously the Commission would have to rethink what it is trying to do. But what we are trying to do, after 20 years, is trying to come up with a system that is state-of-the-art and

4 GREAT WAYS to CLEAN UP YOUR ACT!

- MA1000 MICROMONITOR
10W/Ch Stereo, 25W Mono
Protected Outputs, Balanced inputs
- P1000 TURNTABLE AMPLIFIER
Tight EQ, Lowest Noise
Subsonic filter, Adj Cart Loading
- M1000 DUAL MIKE/PROGRAM AMP
72 dB Gain, Low Noise
Transformer Inputs, XLR Connectors
- L1000 DUAL LINE/ISOLATION AMP
30 dB Gain, High Slew Rate
Balanced Inputs Bridge +24 dBm Lines.



TRANSFORMER OR ACTIVE BALANCED OUTPUTS
SELF POWERED, RF PROTECTED, SINGLE AND DUAL RACK MOUNTING
CALL OR WRITE ED MULLIN FOR FREE DETAILED BROCHURES



**AUDIO
TECHNOLOGIES
INCORPORATED**

328 MAPLE AVENUE
HORSHAM, PA. 19044
(215) 443-0330

Circle (106) On Reader Service Card

State-of-the-Art NAB Tuner Gets a Listen

by John Gatski

WASHINGTON It has been a long time coming, but initial listening impressions of the Denon/NAB SuperRadio reveal a quality tuner that radio stations, as well as consumers, might appreciate.

Just before the NAB Radio Show, **RW** was able to spend an afternoon listening to an early production TU-680 tuner as it sat on the NAB's Science and Technology's laboratory test bench. (Noted audio writer Leonard Feldman will provide a comprehensive technical review of the TU-680's measured performance in an upcoming issue of **RW**.)

The TU-680 is based on the Denon TU-660, a model already a couple of years old. As most readers know by now, there are major differences in the TU-680's AM section. For starters, it meets the NRSC's voluntary "AMAX" quality standard for AM performance, even exceeding the 50 Hz to 7.5 kHz mandated frequency response parameter. This is far from the tin-can sound quality of AM sections in many current receivers.

AMAX specs

FM performance is said to be enhanced a notch or two in the SuperRadio by the use of a high-quality stereo decoder chip, produced by Allegro Microsystems (formerly Sprague Semiconductors). The SuperRadio also has the AMAX-prerequisite external AM antenna connectors (one for a loop antenna, the other for external designs, and a coax FM antenna connector).

Other TU-680 features include 30 presets that allow you to mix and match AM and FM stations, a very effective AM noise blanking switch and an AM wide/narrow band switch. The TU-680 also has Motorola's C-QUAM AM stereo.

How does it sound? Well, as with most markets, there are not an abundance of AM stereo stations in the Washington, D.C. area, but a sampling of the few here revealed solid AM performance.

This is far from the tin-can sound quality of AM sections in many current receivers.

The playback equipment on hand was modest, but of high quality. It included KEF bookshelf speakers and a Denon integrated amp. AM performance depends a lot on the antenna, and the NAB had several that it used for testing the TU-680. Particularly effective for getting full signal strength within NAB's tightly enclosed building was the Sony AN-1 (about \$95) and the tunable Select-N-Tenna by Intensitronics, a Wisconsin company.

In listening to WMZQ's AM stereo country signal, the SuperRadio was impressive in its stereo sound stage: there was definitely a sense of space in the stereo mode. In past subjective AM stereo evaluations done by **RW** editors,

the best sound has been produced with a little equalization in the high end. Nudging up the treble a bit with the TU-680 brought similar results.

Hi-fi AM

With SuperRadio, it is obvious that AM stereo can sound very good, especially if the stations are broadcasting with the NRSC pre-emphasis. Still, in direct com-

and wide/narrow functions of the TU-680. The noise blanking, also produced by Allegro Microsystems, is very effective on most typical home AM noise sources, especially on fluorescent light and appliance noises. It does not seem to audibly affect the frequency response.

NAB Science and Technology Engineer John Marino said that in a test he conducted on the TU-680, the noise blanking would not eliminate computer noise, a pesky problem that probably can only be eliminated with elaborate digital signal processing.

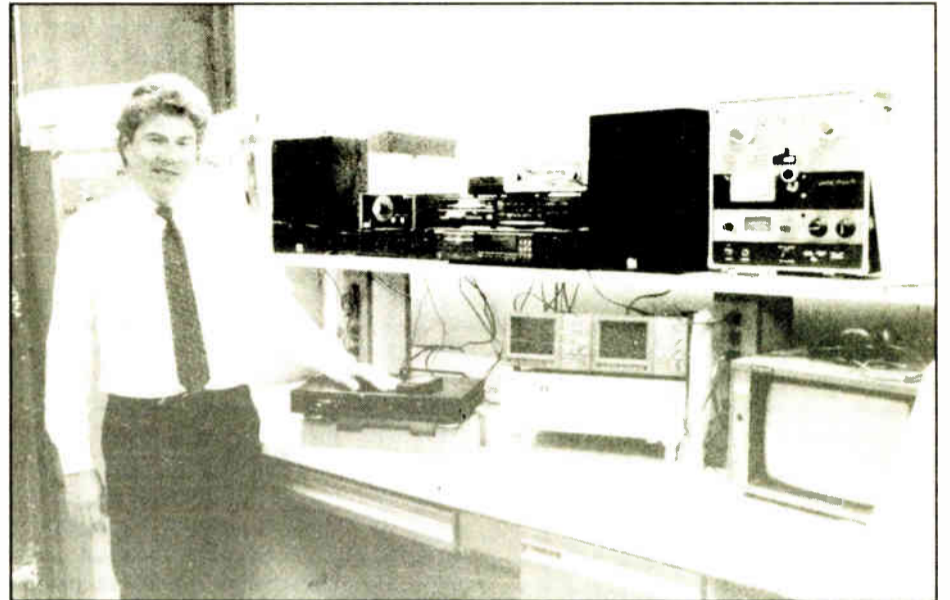

NAB Technical Regulatory Affairs Manager John Marino at the lab with the Denon/NAB SuperRadio

parisons to high-quality FM stereo, a discerning listener can tell the difference: some equalizing of the high end, however, diminishes the difference. And, if you don't continually A/B the two bands, the ears quickly get used to the good quality AM stereo sound. It is hi-fi.

One other observation on sound quality: The bass on the TU-680 is tighter than that of your typical AM radio. Normally, you come to expect a certain lack of definition in the mid-bass of today's receivers with low bass basically non-existent.

Last but not least are the noise blanking

The TU-680's wide/narrow switch reduces the AM bandwidth; the degree of narrowing depends on how strong the signal is, according to Marino, who had evaluated it during the evening hours a day earlier. This feature can make stations more listenable in crowded urban areas or during nighttime hours. Of course, the penalty is diminished fidelity.

Marino said the NAB is quite pleased with the SuperRadio project, which is available to association members for \$499. (List price is \$699 in retail stores.) "It's a perfect tuner to have in radio stations for a monitor," Marino added.

We maintain a Double Standard

Audio Precision offers two different standard-setting product lines.

The automated System One —

the industry standard for bench and factory.

- Graphic results on PC screen with hard copy to printers
- Automated proof procedures & limits testing
- State-of-the-art performance and speed

The self-contained Portable One Plus & Portable One —

for service bench and field.

- Compact and affordable stereo test sets for applications not requiring automation
- Both offer comprehensive capability & high performance in a rugged package
- Portable One Plus adds sweeps, graphs and printer port

The System One and Portable One... two families of test sets designed for different jobs, each with the quality and performance that you have come to expect from Audio Precision.

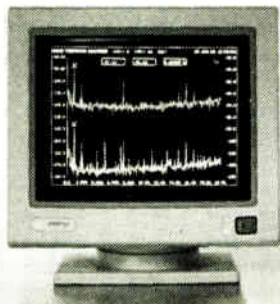

Audio precision

R.O. Box 2209, Beaverton, OR 97075
503/627-0832 1-800/231-7350
FAX: 503/641-8906, TELEX: 283957 AUDIO UR



Circle (17) On Reader Service Card

So Simple.



DAVID is the uncomplicated FM-Stereo Processor/Generator. Yet, like its namesake, it can more than hold its own against the bigger (and *far* more expensive!) competitors.

DAVID is not a compromise. It features gated, "gain-riding" AGC, split-spectrum compression and limiting, active overshoot compensation and digital synthesis of the composite multiplex output. DAVID makes RDS easy too, with a clean output spectrum, an internal combiner and a pilot sync port.

And, because it's simple, it *sounds* great. Just one knob lets you set the processing anywhere from *transparent* to surprisingly *aggressive!*

DAVID: great sound and great specs for only \$1875. We're serious!

Inovonics, Inc.

1305 FAIR AVE., SANTA CRUZ, CA 95060
TEL: (408) 458-0552 FAX: (408) 458-0554



Circle (108) On Reader Service Card
See Us At SBE Booth 529

Bay Area FMs "Synchrocast" Signal

by Nancy Reist

SAN FRANCISCO 98.9 MHz. That frequency sends a shiver down the spines of many veteran San Francisco broadcasters, for in this market it's been associated with the nasty combination of controversy and modest ratings for years.

Whether the station's (now KDBK) troubles have been due to management problems, programming, or the quality of the signal is open to debate. Current owner Viacom Broadcasting Inc. decided to take no chances with KDBK. The company recently hired a new program director, Chris Miller, who on Aug. 3 introduced a format change from adult contemporary to personality-based rock. Viacom also has worked to upgrade the quality of the signal.

The mountainous terrain in the San Francisco Bay Area challenges even the strongest signals. The stations that have operated on 98.9 have been limited to 4.3 kW from the mid-1970s until 1986, when they increased to 6 kW. To make matters worse, the stations have had to contend with interference from KLRS, a first adjacent channel station (99.1

MHz), based in Santa Cruz.

Ted Minnard is chief engineer of KDBK and KDBQ, the stations currently broadcasting on 98.9 MHz and 99.1 MHz.

A double station

He said interference between the two stations used to be a real problem in the southern part of their coverage area. "Truthfully, neither station did the other any good. They were constantly fighting each other in terms of the selectivity of your radio."

Viacom bought the station in 1990 and transformed it to KDBK. The new owner decided to try to turn the interference zone from a liability into an asset by also buying the troublesome KLRS, which became KDBQ. Viacom marketed the two stations together as "Double 99" and broadcast the same programming on both, encouraging listeners in the interference zone to try the other signal when they had poor reception. Minnard called this process "synchrocasting" to differentiate it from AM-FM simulcasts.

Of course, even with the same programming, the two signals can interfere with

each other. Minnard and engineer Bill Brooks are responsible for minimizing the interference and seeing that the signals work together as much as possible. They use delays, a double-hop microwave system, antenna adjustments, and processing to accomplish this.

One technique is a slight delay—roughly 150 microseconds—on the San Francisco signal. The two transmitters are approximately 60 miles apart, Minnard explained. The signal originates from the studio in San Francisco and travels 30 miles to the interference zone via the San Francisco antenna on Mt. Sutro. But it travels 90 miles via the Santa Cruz Loma Prieta antenna—the distance from the studio to the antenna and then back to the interference zone.

"By delaying the main signal, it's like making it travel the same distance that the other signal has to travel and they meet at the interference point at about the same time," Minnard said. "This has a very good effect on the two signals being more listenable at any given time in that specific interference area."

Point A to Point B

The signal travels from the studio to the Santa Cruz transmitter via a double-hop microwave link. Minnard said he uses two varieties of Moseley 6030 units to avoid the standard Part 74 microwave band in congested San Francisco.

The bulk of the processing for both transmitters is done using an Optimod in the main studio. The stereo generators and the high frequency limiters are set at each transmitter site.

Minnard and Brooks also recently installed a new Shiveley antenna for the San Francisco signal to further reduce interference. They switched from a single-bay antenna to a three-bay, half-wave spaced antenna that reduces upward and downward radiation and increases the strength of the signal outward. Minnard said the new antenna should match the Santa Cruz signal better.

Using the new antenna also should reduce interference with the station's East Bay booster, which is located on Wiedeman Hill next to San Ramon. The station plans to install a new booster on Mt. Beacon in Marin County to enhance reception in the northern part of their coverage area.

Both boosters use the Broadcast Electronics system of synchronization. Plans also call for purchase and installation of a new Broadcast Electronics transmitter at the Mt. Sutro site.

Overall, Minnard is pleased with the impact that synchrocasting has had on

signal clarity. "There are still some areas that have interference, where you can notice it to some degree, but it probably isn't five percent of what it used to be. It's just remarkably improved."

Viacom is trying to take advantage of KDBK's enhanced signal with programming improvements. PD Chris Miller said the new rock format places more responsibility on the jocks' abilities to entertain.

Miller is confident that KDBK's new sound will suit San Francisco. He says they are not conducting any formal market research, but the early response has been positive.

Satellite Dropout Pondered

by Paul Rebmann

LAKELAND, Fla. Recent C-band satellite interference attributed to military radar apparently is not confined to Florida, according to industry sources.

The problems encountered by radio stations in Florida, reported in a July 8 *RW* story, have continued, according to area engineers. C-band users in other parts of the country also have reported the same type of interference, which is characterized by brief repetitive outages at 9.8-second intervals. The problems have occurred on the new Scientific Atlanta SEDAT system and its older DATS system, as well as TV and radio analog systems, sources said.

Patrick Uhlenhake, a customer service technician for satellite receiver manufacturer Fairchild, said that an earth station in Arizona has been experiencing the same problem on and off for five years.

It is especially bad in northern Arizona, according to Uhlenhake. Using a spectrum analyzer, he said he has tracked the carrier, which is stronger than the signals from the satellite transponders, sweeping through the C-band spectrum.

At least one station in North Dakota has suffered from what appears to be the same interference, according to Bob Don-

nelly of ABC, who would like all affiliates experiencing these problems to document the times and report them to his office. He said the FCC has been unable to solve the problem, and have reportedly discussed the situation with the Department of Defense.

Rick Rowland, CE at WGUF, Naples, Fla., said he participated in an FCC-coordinated "watch weekend" in late June, during which he called a special number when the interference occurred.

Speculating that the source is "an intermittent in an errant radar transmitter," Donnelly said he has been told that a U.S. Air Force drug enforcement plane is causing the problems.

Rowland and Donnelly said that although the problem is more noticeable on SEDAT, due mainly to the squelching noise, the DATS as well as analog services for radio and television are being effected.

Donnelly said the SEDAT system is not at fault, but it, like other systems, "was not designed to be immune to such massive interfering signals."

Scientific Atlanta and radio network affiliates also have acknowledged unrelated problems with SEDAT that officials blamed on poorly maintained downlink sites by radio stations.

WHEN YOU WANT MORE THAN JUST AN ANTENNA

JAMPRO has been providing the broadcasting industry with state-of-the-art antennas for over 35 years, longer than any other US antenna manufacturer. With over 3000 antenna systems delivered, at JAMPRO you don't just buy an antenna, you invest in experience.

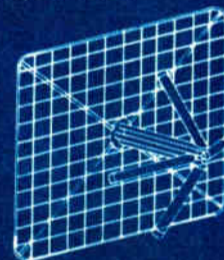

JAHDP CP
Arrowhead
Screen Dipole

THE LEADERS IN ANTENNA TECHNOLOGY

- Complete line of FM & TV broadcast antennas
- RF components, Filters & Combiners
- Modern 7000 ft FULL SCALE test range
- Directional antennas and pattern studies.

Call or fax us your needs today.

(916) 383-1177
Fax (916) 383-1182



6340 Sky Creek Drive
Sacramento, CA 95828

Circle (192) On Reader Service Card

SAS

Introducing the DCA-8 digitally controlled VCA amplifier module from SAS:
COMPLETE AUDIO DISTRIBUTION AND MANAGEMENT SYSTEMS

- Up to 96 digitally controlled VCA channels in one DAS9600 frame.
- Directly compatible with SAS32000 Audio Routing and Mixing Systems.
- Adjust input sensitivity and audio output levels remotely.
- Complete control via modem, RS-232, local control panels, and even DTMF.

Ideal for plant, satellite, and remote distribution. Full summing switcher allows automatic voice-over, mix-minus, IFB, studio intercommunications and more! Superb audio specifications and flexible control.

SIERRA AUTOMATED SYSTEMS & ENGINEERING CORP.

2112 N. Glenoaks Blvd., Burbank CA 91504 TEL: 818-840-6749 FAX: 818-840-6751

Distributed by: **RAM Broadcast Systems, Inc.**

P.O. Box 3100, Barrington, IL 60011-3100 TEL: 800-779-7575 FAX: 708-382-8818 In Canada 800-433-2458

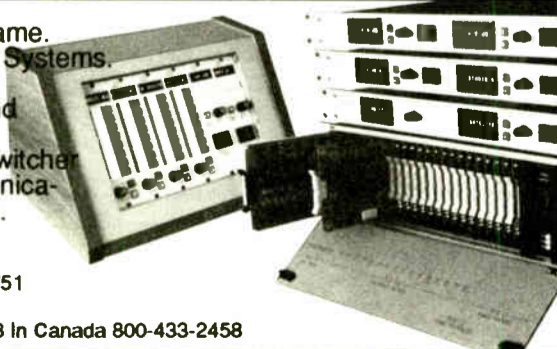

Circle (15) On Reader Service Card

AM "Pirate" Loses Civil Court Trial

by Dee McVicker

MILFORD, Conn. In an unprecedented municipal court judgment, a Milford AM station recently won a civil suit against a man it claims pirated its frequency.

Absent from the proceedings, however, was the FCC, which was not able to devote enough manpower to catch the pirate, a Boston field office spokesman said.

On Aug. 4, the Superior Court in Milford, however, was sufficiently convinced by evidence gathered by the station that it found ham radio operator Paul Matar guilty of interfering in business

relations, and slandering WFIF-AM, a religious-format station, and one of its announcers.

Over \$12,000 in damages were awarded to the religious station, which claimed Matar called its staff "born-again scum," and "thieves" over the airwaves.

Despite the judgment, the station said the broadcasts have continued.

The suit covered a period from January 1990 through August 1991. Testimony by station staff and other witnesses maintained that the pirate would come on the air on WFIF's 1500 kHz frequency after the AM daytimer signed off.

After-hours broadcast

The unauthorized broadcasts made slanderous statements about the religious station, its staff and advertisers, the station charged. The pirate station also made a harassing phone call to an advertiser, according to the station, and replayed unauthorized portions of the Howard Stern morning radio show.

Station Attorney William Secola said WFIF proved that Matar made illegal broadcasts on WFIF-AM's frequency and that he made the harassing phone call to the advertiser. To his knowledge, this is the first pirate radio case to be tried and won without FCC involvement.

Matar denied the allegations and plans to appeal the decision, claiming he did not violate Section 301 of the Communications Act. "I'm going to bring it up on the appeal that I wasn't charged by the FCC. They never came down and charged me on this, and they wouldn't because they never would have traced (the signal) here," he said.

According to Secola, however, Matar was justly charged by the court. He said persuasive evidence included testimony by engineers from WICC-AM/WEBE-FM in Bridgeport, Conn., who said they were able to trace the signal to Matar by using a field strength meter.

The judgment apparently did little good in stopping the broadcasts; the "Vigilante DJ," as the pirate calls himself on the air,

has continued to broadcast illegally, Secola said.

WFIF recently filed another motion in Superior Court, charging Matar for contempt of court. The station also plans to send "relevant" documents to the FCC so the Commission may pursue the matter.

The last resort

"I believe this court judgment is a basis for them (the FCC) to go down and seize the equipment," Secola said.

At press time, the FCC had not received the court judgment, according to Joseph Casey, regional director for the FCC Boston Field Operations Bureau. He said his office has no immediate plans to act based on the judgment.

The station unilaterally pursued the court action in 1990 and 1991 to try and shut down the pirate when FCC efforts

and again in July 1991, FCC field inspectors monitored for piracy, according to Vincent Kajunski of the FCC Boston office, but the effort was unsuccessful.

Not enough money

The FCC conceded that it could not put a full effort into trying to catch the pirate.

"His (the pirate) operation was sporadic enough and with funding levels where they are, we couldn't afford to put somebody down there and have them wait around until he came on," Casey said. "So if we were in the area at the time, we kind of kept our eyes open. But we were never there when he came on so we never got any first-hand evidence of illegal activity."

In August 1991, the station again sent a letter to the FCC requesting action. Enclosed were photographs of Matar's

This may be the first "pirate" radio case to be tried and won without FCC involvement.

failed to silence the broadcasts.

WFIF sent its first letter to the FCC on March 10, 1990, identifying Paul Matar as the one pirating its frequency after the station signed off for the evening.

Although FCC policy provides for a Notice of Apparent Liability to be drawn at the time a pirate is identified, King Hall of the FCC's Signal Analysis Branch said the FCC Boston Field Operations Bureau has no record of issuing this legal instrument.

"To my knowledge, I don't know that we've ever issued a Notice of Apparent Liability strictly on third party, civilian evidence," Casey said. "It's simply too easy to be discounted in court."

The Commission had hoped to catch the pirate during operation when FCC field inspectors made visits to the area on other matters, he added, estimating WFIF to be some 200 miles from the closest FCC field office in Boston.

While in the Milford area in March 1990

residence showing a long-wire antenna and copies of police reports regarding several complaints by WFIF that Matar was pirating its frequency.

The Commission also had reports on file from Ed Butler at WEBE-FM that a pirate was operating in the area on WFIF's frequency.

On August 8, 1991, the Commission finally sent a letter to Matar requesting that he "cease and desist" broadcasting if he was doing so. In the letter, the FCC cited potential penalties of one year imprisonment and/or \$10,000 fine for the first violation and two years imprisonment and/or \$10,000 fine for the second violation.

Matar also was informed that "criminal or administrative sanctions" could be brought against him if he was in violation of FCC rules.

Matar did not respond to the letter. Illegal broadcasts continued on 1500 kHz, along with telephone harassment of WFIF advertisers.

Matar did not, according to FCC documentation, respond to another letter dated May 29, 1992, in which the Commission requested information regarding broadcast equipment in his possession.

In September 1991, Secola sought the injunction restraining Matar from unlawfully interfering with WFIF business, including broadcasting on its frequency. The restraining order was issued by Superior Court during the August 4 judgment against Matar.

Because the unauthorized broadcasts have continued, Secola wrote a letter to the Milford Superior Court on August 7, 1992, requesting that the judge rule on the contempt of court charges. In the letter, Secola stated, "Because of Mr. Matar's obstinance, we will not merely be asking for monetary fines but we will be asking for a period of incarceration."

If the Superior Court again rules in WFIF-AM's favor, Matar could very well be the first person to face imprisonment for conviction of piracy by a municipal court.

Fishing For A Phone Number?

Catch it in the
1992 Radio World Directory Issue

— The Industry Source for Manufacturer, Supplier, NAB and FCC Phone Listings, as well as Product Information, Company Profiles, Buyers Guide Reprints, RW's 1991 Editorial Index, Reference Material, and More...

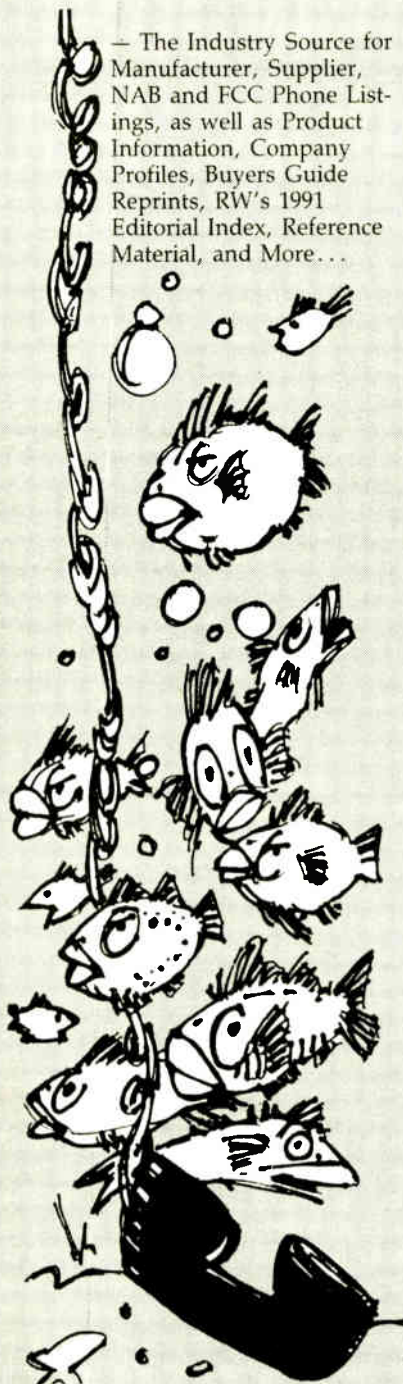

NOW AVAILABLE!!

To order, send \$14.95 to:
Radio World, P.O. Box 1214
Falls Church, VA 22041

SUBSCRIPTION/READER SERVICE FORM

Radio World

FREE Subscription/Renewal Card

I would like to receive or continue receiving Radio World FREE each month. Yes No

Signature _____ Date _____

Please print and include all information:

Name _____ Title _____

Company/Station _____

Address _____

City _____ State _____ ZIP _____

Business Telephone () _____

Please circle only one entry for each category:

I. Type of firm

- D. Combination AM/FM station
- A. Commercial AM station
- B. Commercial FM station
- C. Educational FM station
- E. Network/group owner
- F. Recording Studio
- G. TV station/teleprod facility
- H. Consultant/ind engineer
- I. Mfg, distributor or dealer
- J. Other _____

II. Job Function

- A. Ownership
- B. General management
- C. Engineering
- D. Programming/production
- G. Sales manager
- E. News operations
- F. Other (specify) _____

III. Purchasing Authority

- 1. Recommend
- 2. Specify
- 3. Approve

Reader Service

Oct. 7, 1992 Issue Use Until Jan. 7, 1992

Please first fill out contact information at left. Then check each advertisement for corresponding number and circle below. NOTE: Circle no more than 15 numbers, otherwise cards will not be processed.

- 001 023 045 067 089 111 133 155 177
- 002 024 046 068 090 112 134 156 178
- 003 025 047 069 091 113 135 157 179
- 004 026 048 070 092 114 136 158 180
- 005 027 049 071 093 115 137 159 181
- 006 028 050 072 094 116 138 160 182
- 007 029 051 073 095 117 139 161 183
- 008 030 052 074 096 118 140 162 184
- 009 031 053 075 097 119 141 163 185
- 010 032 054 076 098 120 142 164 186
- 011 033 055 077 099 121 143 165 187
- 012 034 056 078 100 122 144 166 188
- 013 035 057 079 101 123 145 167 189
- 014 036 058 080 102 124 146 168 190
- 015 037 059 081 103 125 147 169 191
- 016 038 060 082 104 126 148 170 192
- 017 039 061 083 105 127 149 171 193
- 018 040 062 084 106 128 150 172 194
- 019 041 063 085 107 129 151 173 195
- 020 042 064 086 108 130 152 174 196
- 021 043 065 087 109 131 153 175 197
- 022 044 066 088 110 132 154 176 198

Copy & Mail to: Radio World, PO Box 1214, Falls Church, VA 22041

BROADCAST ELECTRONICS



The world leader in radio broadcast technology

From its recognized position as the manufacturer of the world's finest FM transmitters driven by the industry-acclaimed FX-50 Exciter, to solid state AM stereo transmitters, digital systems and world class audio consoles, Broadcast Electronics manufactures more products for the radio industry than any other company in the world.

Digital Products

- AudioVAULT™—simultaneous, multi-user digital central storage and satellite controller.
- CORE™—digital program controller and satellite interface.
- Disc Trak™—digital cart machine, record, edit, playback.
- DV-2—RAM based audio storage device.

RF Products

- Solid state AM transmitters.
- Solid state FM transmitters.
- FM transmitters to 70 kW.
- FX50 high performance FM exciter.
- AM stereo generators and monitors.

Studio Products

- Mix Trak 90™—high performance modular consoles.
- Air Trak 100™—configurable linear consoles.
- Air Trak 90™—affordable linear consoles.
- 150/250 Series—rotary consoles.
- Phase Trak 90™—phase correcting cart machine.
- Dura Trak 90™—high value cart machine.
- Splice Trak 90™—splice finder/eraser.
- 5000 Series—3-deck cart machines.
- 2100 Series—economical, playback cart machines.

Broadcast Electronics...your single source for world class radio broadcast technology.



4100 N. 24TH ST., P.O. BOX 3606, QUINCY, IL 62305-3606 U.S.A., PHONE (217) 224-9600, TELEX 250142, FAX (217) 224-9607

Circle (198) On Reader Service Card

World Radio History

OFFBEAT RADIO

Texas AMs Run on "Phantom Power"

by Dee McVicker

MIDLAND, Texas If you've ever secretly thought there was more to a transmitter on the blink than a faulty cable or voltage regulator, here's one hair-raising possibility: ghosts.

And, if that's not enough to give you the heebie-jeebies the next time you're at the transmitter site late at night, consider that your phantom could be a former fellow engineer, who is now looking over your shoulder, scrutinizing your every move.

Talk about scary stories. But according to at least two sources, it's not just fodder

for campfires. Max Howard of Midland, Texas's KMND(AM) said he has seen the spirit of the station's long-deceased chief engineer, Rudy, at least half a dozen times. The ghost, surmised Howard, guards the equipment he custom-made when he built the station in the 1950s.

Haunted studios

Jim Blakemore also revealed stories of another ghost haunting at a neighboring station in Odessa, Texas—KRIG(AM) at the time of the apparitions. Although Blakemore never experienced the hauntings himself while he owned the station

in the early 1980s, his employees complained of cart racks that suddenly twirled around by themselves and a mysterious figure standing in front of the control room window.

Your phantom could be a former fellow engineer.

There are those who believe the figure is the spirit of Bob, KRIG(AM)'s chief engineer in the 1960s and 1970s. As the story goes, "One day the program director woke up and turned the station on. It was going *kerr-cheek, kerr-cheek, kerr-cheek*—the sound it makes when a record runs out," said Blakemore.

The program director arrived at the transmitter building where the studio also was located, to find Bob slumped over the board, dead from heart failure.

The station's current owner, Clyde Butler, says he's heard the stories, but has not experienced the apparitions in the five years since he purchased the station. "I'm here all the time. I come in at five in the morning and am here often times until sign-off at eleven, and I have never seen or heard any problems," he offered.

Help from beyond

At KMND(AM) the ghost stories are not as easily discounted. According to Howard, who knew the deceased, Rudy has reached out from the grave to solve more than one engineering problem.

At times, Rudy's presence has been subtle. "Like when the transmitter would go down, and all of a sudden someone would say push this and do that," revealed Howard.

Other times, Rudy has shown his more mischievous side.

In fact, said Howard, Rudy's antics of blitzing equipment and haunting the DJs

had him concerned enough at one time to try a blue light. A contract engineer who dabbled in the paranormal suggested it after he too saw the ghost, and for a time the blue light seemed to appease Rudy.

Why a blue light? Your guess is as good as ours. The contract engineer has since passed on himself and cannot, at least by earthly means, be reached for comment.

The blue light bulb isn't in use anymore at the station because Rudy sightings have all but disappeared, according to Howard. He thinks this is because most of the equipment custom-made by Rudy has been replaced.

But before the new equipment, he said, "We had an engineer Rudy didn't like, and he really thought I was off my crock. He pulled the (blue) light bulb out and broke it one day. That night, we got put down by lightning."

A coincidence? Maybe, but Howard is convinced that Rudy's spirit has been guarding the station equipment. To prove it, Howard brought in psychic readers.

Something is out there

"I've had several readers go out to the old site where Rudy made the installation on the transmitter," he said. Without being prompted as to why he was there, one psychic pointed out a "warm spot" where an old CCA transmitter had been at one time. The CCA had been installed by Rudy.

Another psychic reader walked away from the site with an equally spooky message from beyond. Recalled Howard, "We were walking out and he said, 'I got a name, but I'm having trouble with it. I'm seeing R-U-D or R-U-B.'" The engineer's name, Howard told the psychic, was Rudy Rubin.

Whether this is proof positive of ghostly visits, even Howard can't say for sure. But he is sure of one thing: KMND(AM) has been visited by an other-world presence that has yet to be adequately explained by more earth-bound means.

Dee McVicker is a free-lance writer and regular contributor to RW. She can be reached at 602-545-7363.

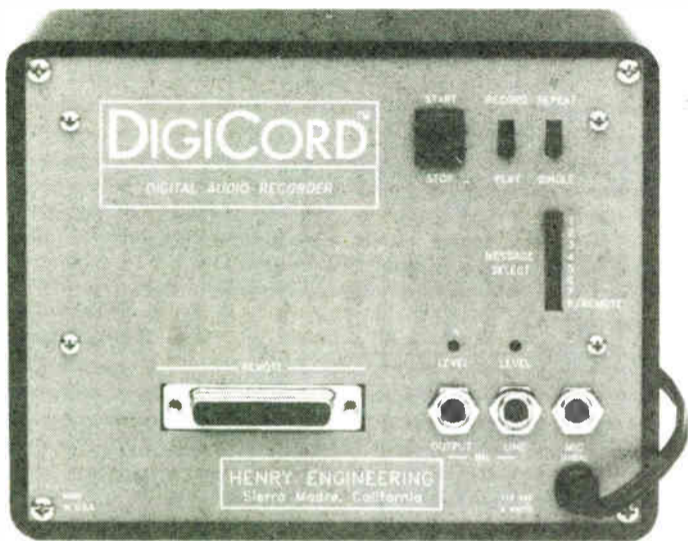
**Digital Storage Space**

Five and one-half minutes of audio with a 5 kHz bandwidth and no moving parts. It's Henry Engineering's latest, cost-effective product—the upgraded DigiCord.

This upgraded DigiCord is perfect for network news delay, weather, EBS, request line playback and any on-air source that doesn't exceed five and one-half minutes.

Up to 16 random-length messages may be recorded. Playback is random-accessible. Messages can be played back in any order. A user selectable

"repeat" mode permits automatic looping.

DigiCord easily records from a mic, tape deck or studio line. Balanced line-level audio in and out. Battery back up. It's digital which means no maintenance and no moving parts to wear out.

For complete details on the upgraded DigiCord, call on Harris Allied. We'll tell all, including how the DigiCord is optionally capable of a 7.5 or 10 kHz bandwidth.

8:00 a.m. to 8:00 p.m. EST
1-800-622-0022
Fax 317-966-0623
Canada 1-800-268-6817

HARRIS ALLIED

Clipping creates **LOUDNESS**
Composite clipping is the **LOUDEST**
The trick is to keep distortion low. . .
Introducing

SE-1 LOW DISTORTION COMPOSITE PROCESSOR
Distortion-canceling circuitry allows more clipping (loudness) with less distortion.
Simple Installation & Setup
Only **\$395.00** Complete!

The SE-1 allows you to increase your loudness up to 6 db over using no composite clipping. Distortion is negligible up to 3 db of clipping with a gentle rise at 6 db.
There is no finer composite processor on the market today.

. . . Loudness WITH Quality

SE SOMICH ENGINEERING
800-334-3925
Processing Tools for Competitive Broadcasters

"Doing things for successful FM translators"



FM TECHNOLOGY ASSOCIATES, INC.

Talk with Howard Enstrom, veteran broadcast consultant who, in the 70s switched to FM translators as a specialty.



FMTA services: Feasibility studies, frequency searches, system design-engineering, FCC applications. Publisher of The SIGNAL SOURCE, bi-monthly newsletter all about FM translators. BEST EQUIPMENT PRICES.

FM TECHNOLOGY ASSOCIATES, INC.
30925 Vista Vista
Mount Dora, FL 32757
(904) 383-3682 FAX (904) 383-4077

INSIGHT ON RULES

Ensuring Remote Control Compliance

by Harold Hallikainen

SAN LUIS OBISPO, Calif. Continuing our review of the FCC's proposed AM station self-inspection form, we get to more questions on remote control.

Question II-B asks, "Can power adjustments be made from all control points?" It appears they are anticipating off-premises control where the operator may have minimal control.

This "power adjustment" reference may be "power change" such as a day/night power change, or could be a "power trim" to compensate for line voltage variations. Checking the 1980 AM rules, section 73.68(a)(4) required remote control equipment to be installed to allow the operator to perform all functions required by the Rules.

This section required us to telemeter certain transmitter parameters, since other sections required those parameters to be logged on a frequent basis (every half hour). This section also required us to remote the "power trim" control required by section 73.40(a)(7).

Rules replaced

During revision of the rules, 73.68 was replaced with 73.1400 (and 73.1410), and 73.40 disappeared. Rule 73.1410(a) requires a remotely controlled station to have sufficient monitoring and control capability at the control point to "allow technical operation in compliance with the Rules...and the terms of the station authorization."

It would appear that as long as the station operates properly, a station has sufficient control and monitoring. This would be the case even without a remote power trim control. However, station inspectors sometimes ask for a demonstration of this control, whether or not it is required by the rules.

Remote meter calibration

The next question asks how often remote meters are calibrated. At one time, 73.67(a)(5) required remote meters to be calibrated at least once a week.

Further, 73.67(a)(5)(iii) required remote meters to agree with local meters within two percent of the reading. Currently, 73.1410(c) requires remote control equipment to be calibrated and tested as often as necessary to ensure proper operation.

There is no specified remote metering accuracy, other than 73.57(d)(2), that requires remote reading RF ammeters to agree with the local meter within two percent of the reading. The FCC has generally been enforcing a two percent tolerance on remote metering.

Also, if a remote meter indicates a station is operating within tolerance while the transmitter metering indicates the station is operating outside of tolerance, the station would probably be cited for the out of tolerance operation and violation of 73.1410(c), since it was not calibrated as often as necessary to ensure proper operation.

Loss of metering

The form then asks if you are aware that whenever a malfunction causes loss of accurate indications of the transmitter operating parameters, use of remote control must be "disconnected" within three hours after the malfunction is first detected (73.1410(e)). The cited rule requires use of remote control to be "discontin-

ued" rather than disconnected.

The Report and Order establishing this rule indicated that "loss of control" was tolerable, but "loss of metering" was not, since you could then not determine whether the transmitter was operating properly.

Of course, if you have telemetry but no control, it is difficult to turn the transmitter off upon discovering an interference-causing condition. This can cause violation of 73.1410(e) by stations that do not have some "fail safe" method of turning off the transmitter.

On many stations, the only "interference-causing" parameter that is telemetered is output power. Minor overpower

operation would seem to cause minimal interference when compared to overmodulation or spurious emissions, which are not required to be routinely monitored.

It would appear, however, that the most critical parameters for many AM stations are the directional array parameters.

Relatively minor variations in these parameters can cause major interference. Further, stations operating by remote control are required to remote the DA parameters by 73.69(a)(1).

Connectors can help

So, what do you do when your remote control is struck by lightning? While

repairs are being made, the FCC requires an operator be at the transmitter site. I'd suggest, however, that as stations replace outdated remote control equipment, the new equipment be installed with connectors in the cables.

Similar connectors can be put on the old remote control equipment. Once the old equipment is off line, it can be restored to like-new condition. If (in many parts of the country, it's "when") the remote control is hit by lightning, the old system can be substituted while repairs are made.

This allows continued legal operation while repairs are made without having to have an operator at the site. Stations often retire old transmitters to standby service. This is also done with old audio processors, old consoles, old STLs, etc. I think it should be done with all equipment.

continued on page 20 ▶

Who Sounds Best In... INDIANAPOLIS?

1 LEVELER
2 LIMITER
3 CLIPPING
4 STEREO GENERATOR
5 COMPOSITE CLIPPER
6 OTHER

LIMITING
15 DB
15 DB
15 DB
15 DB

↑ ↓ SELECT ENTER ESCAPE

10% 133%

Thanks!

AIR CHECK 6-8-92

THE UNITY 2000 DIGITAL AUDIO PROCESSOR

All of the tools of the FM broadcast audio chain in a single chassis.

Call or write for a free brochure and/or demo of the UNITY 2000.

CUTTING EDGE TECHNOLOGIES
2501 West Third Street • Cleveland, OH 44113 • 216.241.3343 • FAX: 216.621.2801

"We've tried several boxes, but the UNITY 2000 is the best by far. It's loud, it's clean, and it KICKS! Just listen to these airchecks!"
Scott Wheeler, Program Director
WHHH, Hoosier 96, Indianapolis

"Saved us a ton of dough AND it sounds better than all the other boxes put together!"
Gary Alan Kline, Chief Engineer
WHHH, Hoosier 96, Indianapolis

Circle (181) On Reader Service Card

GO WITH THE WINNERS.

**DYNAMAX DCR1000 SERIES
DIGITAL CARTRIDGE RECORDER**

"We use the Dynamax DCR1000 Series for tapeless digital production of all commercials as well as On Air playback. Our advertisers love the better sound."

*Rodger Tighe
Chief Engineer
KOSI-FM/KEZW-AM
Denver, Colorado*



DYNAMAX™
BROADCAST PRODUCTS BY FIDELIPAC®

Fidelipac Corporation
□ P.O. Box 808
□ Moorestown, NJ 08057
□ USA
□ 609-235-3900
□ FAX: 609-235-7779

Circle (93) On Reader Service Card

World Radio History

WORKBENCH

Sampling Tower Lights

by John Bisset

FALLS CHURCH, Va. Sampling tower lights on a remote control used to be easy—after sampling the AC and converting it to DC, the sample was fed into one of the analog channels of the remote control. The analog meter would fluctuate in time with the lights.

Try the same trick with the newer digital

enough voltage for the reed relay was obtained. This is a trial-and-error procedure, since each tower light system is different.

As the tower lights flash on, the increased current induces more voltage into the TLK-2, which pulls in the relay. The relay's normally open contacts are fed into the status terminals on a Moseley MRC-1620 or equivalent. The capacitor and resistor series combination acts as de-bouncing components.

The 5K pot is adjusted to the point where the relay stops pulling in with the flashing of the tower lights. By adding the pot and adjusting it in this manner, a failure of any bulb (and not just the beacon) will drop the current enough that the relay will not trigger.

John offered another tip in RF Spectrum, the RF Specialties quarterly newsletter. He suggested installing a 90-degree type "N" connector on your RPU antenna. It's far cheaper to replace an elbow adapter when a jock damages the center pin, since at least one manufacturer "ruggedizes" its antenna by sealing the feed harness and connector inside the boom with a moisture-proof potting compound. The 90-degree elbow also orients the termination in the direction for downward running feedline, which eliminates strain and stress from the connector.

Although RF Spectrum is mailed to every radio station in the U.S., if you're not receiving a copy, contact your local RFS office, or circle Reader Service 143.

★★★

Contract engineers who have multiple site padlocks will enjoy a new product from the Master Lock Company. The Model 175-D is a four combination wheel, "set-your-own-combination" lock. A combination reset key is used to "customize" the combination to whatever four digits you like. Since a new combination can only be changed when the lock is open, it doesn't help for a vandal to own a combination reset key.

The locks are great for tower gates—especially in a directional array (12-tower DAs should get a quantity discount from Master!). But they are useful wherever multiple padlocks are needed. Leave it to a well-known name like Master Lock to offer a "no hassle" lifetime warranty. If the lock ever fails due to a manufacturing defect, not only will they replace it free, but they'll send a check to cover your postage—and no receipt is required, just send them the lock.

★★★

SBE chapters may want to consider a new educational video from the John

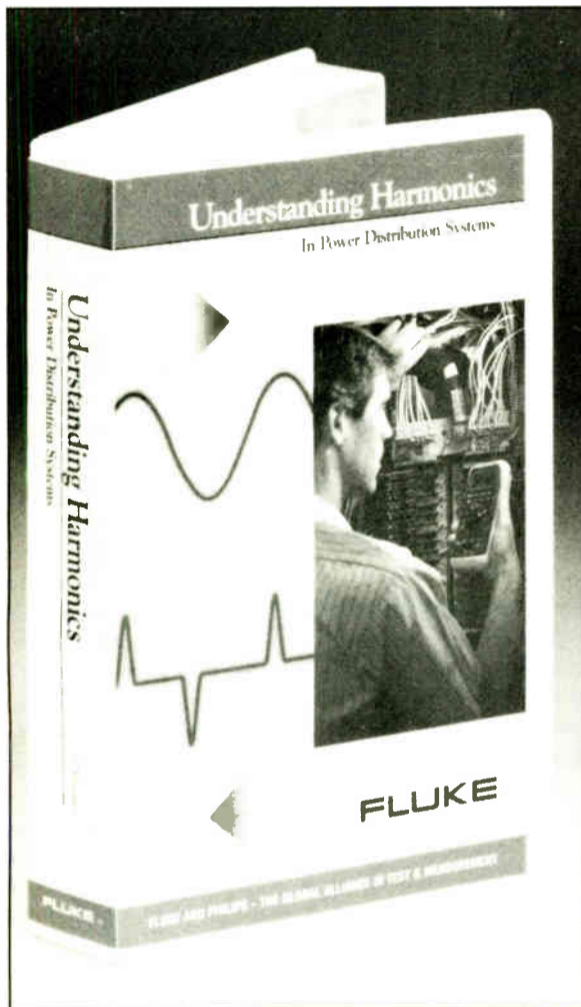

A reasonably-priced video explains harmonics in AC power systems.

remote controls, and the fluctuating voltage won't sit still long enough for the digital display to indicate anything meaningful.

This was the problem John Schneider and the KBRW engineering staff faced in Alaska recently. John manages the RF Specialties office in Seattle, Wash. The

This is a trial-and-error procedure, since each tower light system is different.

station already had a Moseley TLK-2 Tower Light Sample Device, which provided a 15 VDC sample for the remote control. The problem was what to do with the fluctuating voltage.

John's solution was to run the 15 VDC signal into a reed relay, which was in series with a 5K pot (see Figure 1). By playing with the number of turns wrapped around the laminated core,

Figure 1.

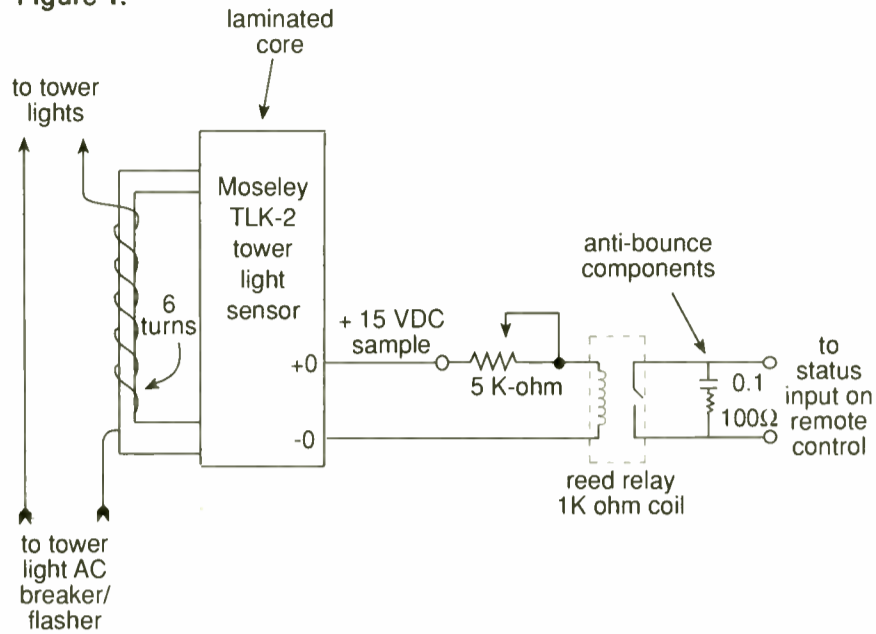

Fluke Manufacturing Company. "Understanding Harmonics in Power Distribution Systems" defines and classifies harmonics and electrical load problems.

It concludes with suggestions for the prevention of AC harmonic problems for both new and existing facilities. For more information on this video, contact the ser-

vice equipment group of the John Fluke Manufacturing Company at 1-800-526-4731, or circle Reader Service 51.

□ □ □

John Bisset is a principal with Multi-phase Consulting, a contract engineering and projects company. He can be reached at 703-379-1665.

TRADE UP TO A CCA

FM BROADCAST TRANSMITTER

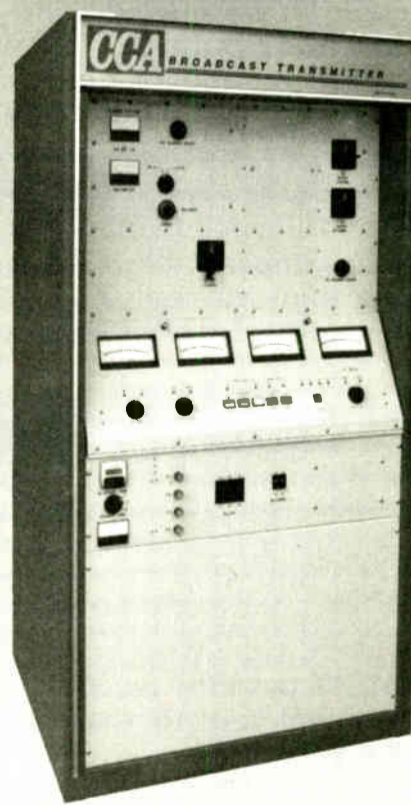

Available Models:

2.5 KW	12 KW
4 KW	20 KW
5 KW	25 KW
8 KW	27.5 KW
10 KW	35 KW

CCA

CCA TRANSMITTERS

P.O. Box 426 • Fairburn, Georgia 30213 • USA
1-404-964-3530 • FAX: 1-404-964-2222

Circle (13) On Reader Service Card

Marconi's Success Tied to Military Interest

by George Riggins

LONG BEACH, Calif. In previous installments, I have described the events leading up to the commercial demonstration of wireless telegraphy by Guglielmo Marconi in England.

We pick up the story again after all the preliminary introductions in England were completed, and Marconi was granted an audience with Mr. William Preece, chief of engineering for the country's General Post Office (GPO). Out of this first meeting with Mr. Preece (later Sir William Preece) of the GPO came the invitation to set up a demonstration of wireless equipment.

It was while assembling the equipment on the roof of the GPO that Marconi became acquainted with George Stevens Kemp. Kemp was a former petty officer in the British Navy who worked on Preece's staff at the GPO. The association of Marconi and Kemp was to continue for many years.

More rigorous testing

After the successful completion of the first demonstrations for Preece in London, additional tests were to be tried at greater distances. The second set of tests were to be conducted on Salisbury Plain, fairly close to Stonehenge.

The equipment was installed on Three Mile Hill and the demonstrations were conducted in the presence of representatives from the GPO, army and navy. In

addition to the equipment that had been used previously in Italy and London, Marconi added two-foot square copper plates for antennas at 25 feet above ground, larger copper plates at 10 feet above ground and 90-foot wires suspended from bamboo poles.

To add insurance, sheets of tinfoil were also used. The distance involved was 1.75 miles. It was this particular demonstration that Marconi felt changed the entire outlook for wireless communication.

He was correct. The success of the demonstrations resulted in many solicitations for financial interests in the work. Some of the solicitations were from what we would call swindlers, con artists, well-wishers and those who always want to be reflected in the light of a successful person. All offers were rebuffed.

Marconi continued to refine the equipment to develop the distances required to make the signal truly worthwhile and commercially useful. Experiments were conducted over water at ever-increasing distances.

Some of the increase in distance was obtained by the use of antenna wires suspended from kites. It was noted that the angle of the wire from the kite had an effect on the direction of the signal.

Duty called

There are several accounts regarding who or what influenced the decision about Marconi's required military service. According to one story, Marconi

was sent a notice with two choices: either return and do the normal three years of service in Italy, or apply for British citizenship.

Cooler heads evidently prevailed. Marconi was appointed an officer in the Italian Navy with service to be performed at the embassy in London. Marconi

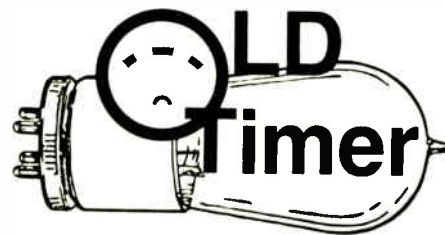

received normal pay for his service but donated his stipend to a children's hospital in London.

On July 20, 1897, the Wireless Telegraph and Signal Co. Ltd. was formed and registered in London. The total stock issue was only 100,000, so the inventor in reality controlled the company (he kept 60,000). The name was soon changed to Marconi's Wireless Telegraph Co. Ltd. Marconi reserved for himself all rights to any use of his developments in Italy.

Marconi was summoned back to Italy by government officials so that a demonstration could be made for the Italian navy. The demonstrations were conducted between ships with tall masts and land-based sites. Masts of over 100 feet seemed to help with the signals.

The land-based masts were set at 120

feet, with good results reported at a range of 12 miles. The Marconi system was adopted by the Italian navy, thus becoming the first navy to install the wireless and use the signals on a regular basis.

One of the first commercial uses of Marconi's wireless was to report the Kingstown Regatta summer yacht races in England. Marconi set up on the steam tug Flying Huntress. The antenna was 65 feet up the mast. Kemp was ashore with a mast of about 120 feet.

The races were reported as they were being sailed for the first time, rather than having to wait for a report after the fact. Kemp phoned the results to a newspaper office in Dublin, about five miles from the receiving station.

By 1899, another frontier presented itself: the English Channel. The equipment for the cross-channel trial was the same as was being used at several installations along the English shores. Marconi was the operator on the French side; there are not records as to who the operator on the English coast was. Many messages in both English and French were sent on the first day.

The next body of water to cross was the Atlantic. Time, effort, improvements in equipment and some interesting advances in theory as well as practical knowledge were necessary to jump this formidable barrier.

□ □ □

George Riggins has experience in radio and electronics dating back to the 1930s. He also is a licensed ham radio operator and has had his own broadcast sales and service company, Riggins Electronic Sales, for more than 20 years. He can be reached at 310-598-7007.

More Power To You.

SERVICE AND SUPPORT

When the Empire State Building's newest tenants needed top quality high power transmission line, they turned to the company that's been on the job at the Empire Broadcast Center for over two decades—MYAT. We delivered TV Channel 41's 8 $\frac{3}{16}$ " 75 Ω line and Channel 25's 9 $\frac{3}{16}$ " 50 Ω waveguide adapters on time, in spec and within budget. Our computer-aided design, manufacturing and testing capabilities can do the same for you.

MAXIMUM VELOCITY AND MINIMUM ATTENUATION

That's what MYAT rigid line and RF components deliver. We manufacture them using pure highest quality copper or aluminum and thoroughly test each one before shipping. Princeton University's Plasma Physics Laboratory evaluated MYAT performance, and chose our components for their research reactor.

RELIABILITY AND LONGEVITY

They're important to you—and to us. So we use non-galling silver plated beryllium copper contact springs, brass elbow reinforcements and virgin Teflon inner supports—MYAT line sections and components are warranted for a full year. That's why you'll find the bright blue MYAT logo in transmitters and systems by Harris, Acrodyne, QEI, Micro Communications and Broadcast Electronics. And at thousands of broadcast stations worldwide. Whether you're planning a new tower, upgrading an older installation, or coping with an emergency, MYAT power is as close as your phone. Put it to work in your RF transmission system.

Contact your RF distributor, or phone us at (201) 767-5380.



**CALL FOR OUR NEW CATALOG.
RIGID LINE: RADIO'S EFFICIENT CHOICE.**

MYAT, INC.

Manufacturers of RF transmission equipment since 1951.
40 Years of Experience, 40 Years of Excellence.

380 Chestnut Street • P.O. Box 425 • Norwood, NJ 07648 • Tel (201) 767-5380 • Fax (201) 767-4147

Circle (45) On Reader Service Card

DIGITAL DOMAIN

Less Is More in Digital User Interfaces

by Mel Lambert

STUDIO CITY, Calif. While gathering materials for a recent marketing survey, I had the opportunity to compare the features and functions of a large number of digital audio workstations. One aspect of this blossoming industry struck me more than any other: user interface designs.

The available options we face in choosing one system over another are quite bewildering.

Although I lack the space here to cover every design approach in anything but a cursory manner, some observations might prove useful if only to provide chief engineers or PDs with some intelligent buying alternatives.

Cacophony of choice

First and foremost, this cacophony of choice is hardly surprising. Given the very nature of the system we are considering—a high-speed computer designed to record, edit and process digital waveforms—the

programmable crossfade profiles, accurate internal source synchronization, plus an easy-to-use librarian function for sorting through sound "clips," and we have a very usable system for the newsroom, jingle production studio, or music editing suite.

What we don't necessarily need, I would contend, are complicated menus of options that require multiple mouse clicks or keyboard equivalents to reach the required functions. Some manufacturers overlook the fact that most radio stations will be using audio workstations on a sporadic rather than continuous basis. As such, their operators may only spend a couple of hours a day at the system, which means that it is all too easy to forget how each of the inter-related systems functions are designed to operate.

OK, it is a simple matter to prepare a crib sheet of the more common editing commands and tape them to the keyboard, for example. But for a digital workstation to become a powerful tool that can enhance our efficiency in editing

entry of vital timecode numbers during setup of manual edit in/out and cue points.

In addition, a set of record/ready plus solo/mute buttons per tape track—with companion indicators of their current on/off status—can greatly speed up the initial recording of material into a workstation, for example, and subsequent overdubbing against source cues.

Radio production usually involves the building of maybe two, four or eight tracks of individual elements that can then be edited, mixed and otherwise processed within the digital domain.

There is no reason why the user interface should not be elegant, simple to remember, yet powerful enough to dramatically enhance our creativity in the production or air studio.

Mel Lambert has been intimately involved with the production and broadcast industries on both sides of the Atlantic for more than a dozen years. Now principal of Media&Marketing, a Los Angeles-based consulting service for the professional audio industry, he can be reached at 818-753-9510.

A product developed in a vacuum stands little chance of appealing to more than a handful of users.

highly individualistic nature of the controlling software comes with the territory.

Sure, an innovative design approach often turns up on second- and third-generation workstations, including object-oriented sound-segment editing, and the use of other icon-based graphics to dramatically reduce the learning curve. (Adding credibility to that age-old adage that imitation—and/or mimicry—is the sincerest form of flattery!)

And, given the size of the average human hand, visual acuity and attention span, there are some basic laws of ergonomics that dictate the size and layout of hardware controllers or mixer surfaces. But just how all of these various buttons and displays should best be laid out in front of us at our workplace is still open to hot debate.

To a certain extent, such profusion of design is a good thing. We can benefit from the talents of software and hardware designers at the leading firms attempting to maximize user convenience, and minimize unnecessary operations.

What happens all too often, however, is that the firm's design department does not maintain a continuous relationship with the intended user. A product developed in a vacuum—or, more realistically, the hallowed R&D labs of the innovating company—stands very little chance of appealing to more than a very small handful of users within the radio industry.

Of the various technical features and functions that separate one workstation from another, it is the user interface that is the most important. Unlike the music and post-production markets, our needs are reasonably modest.

Less is adequate

A random-access workstation for radio production probably needs no more than eight data tracks; with some advance planning, even four simultaneous replay sources would almost certainly prove adequate. Add in sample-accurate editing with

and processing audio material, its operation should be virtually transparent.

Nobody would pretend that a workstation will be as easy to understand and operate as conventional analog technology. After years of experience with a razor blade and splicing block, most of us become extremely proficient at editing audio tape. There is no reason, however, why new technologies should not be as intuitive to understand and use as the more traditional designs.

Simplicity a premium

For me, operating a full-feature digital audio workstation using just a mouse and a video display makes no sense whatsoever. Very few of the primary audio operations involve simple, single-step operations, so why should these become translated into point-and-click sequences? Sure, sorting through lists of previous projects until the required name and or designation is found can be relegated to the menu choice and dialog boxes that we are very familiar with, from word processors and other Mac- or Windows-based software.

Moving around once the project is well underway, however, involves more sophisticated hand-eye coordination, and a more complex number of complementary functions than can be handled comfortably by a simple mouse or keyboard equivalent.

Enhanced parallel functionality can be offered by designs that include some form of dedicated control surface, which includes labels to designate the role each button or knob is currently serving.

On a simple two- or four-channel editor, a dedicated set of "transport controls" that stop, start and move the project backwards and forwards of the current "Now Line" can really speed up user functions. In the same way, a simple scrub-edit wheel provides instant familiarity with conventional rock-and-roll analog editing, while a separate keypad provides easier

SWEET & LOW.

If you're into audio for video, our message is short and sweet: The Tascam BR-20T is the lowest priced 1/4" professional centertrack timecode deck on the market.

The BR-20T is a professional audio-for-video recorder specifically designed for 2-track mastering and video post playback. Its center timecode track employs Tascam's innovative in-line head and timecode optimization system, neatly eliminating the need for timecode level monitoring and adjustments.

Other pro features of the BR-20T include full servo-controlled transport for quick, accurate response and gentle tape handling while under external synchronizer control. Easy, front-panel accessibility to all major audio calibration controls. And gapless/seamless punch in/out and spot erase.

The \$2,999* BR-20T. The sweetest little audio-for-video machine you'll ever see. At the lowest price you'll ever hear.

Check it out, post-haste, at your nearest Tascam dealer.

TASCAM®



© 1990 TEAC America, Inc., 7733 Telegraph Road, Montebello, CA 90640, 213/726-0303. *Manufacturer's Suggested Retail Price.

Circle (98) On Reader Service Card

Q-TIPS

Broadcast Engineers' Future Requires Computer Literacy

by John "Q" Shepler

ROCKFORD, Ill. Chances are that you see yourself as something other than a computer expert. Even so, computers and the closely related technology of digital processing are certainly the future for radio and everyone who works in broadcasting.

The entire computer revolution has taken many stations, even many engineers, by surprise over the last few years. The revolution isn't that new; it started nearly 20 years ago when minicomputers became cheap enough to do billing and traffic for medium-sized stations.

Soon, the program automation acquired a microprocessor brain and was able to talk back and forth with the business computer. Now, nearly every piece of equipment from cart machine to audio processing is digitally based. The computer revolution is over. Computers won.

If you can't lick 'em...

The best way to deal with this situation is head-on. As a broadcast engineer, you need to become as comfortable with PCs and digital signal processing as you are with op-amps, transformers, and ceramic transmitting tubes.

Don't feel bad if you find the detail

overwhelming. It is overwhelming. Just try to understand the listings from a tightly written C or assembly language program. Dealing with computer technology is a humbling experience.

Learning today's digitized radio technology must be done differently. In days past, the license manuals, some library books (especially Navy training manuals), and a few visits to your friendly local station made for a pretty good education. Now you need a lot more knowledge, much of which is best learned interactively. Luckily, the cost of this new education is well within reach.

If you haven't started using a PC for anything yet, that's an excellent place to start. If you can afford about \$1,000, get your own IBM compatible or Macintosh and start working your way through the instruction books.

Too expensive? You can get used machines cheaper or use one at the station for free. For maybe \$100 you can take a course at the local college that will get you comfortable with the computer.

Start training yourself

You need to find a real use for the machine to stay motivated. To start with, try to find some canned programs that will do something useful. Word process-

ing is a good choice because you need to get comfy with the keyboard and monitor anyway.

Next, try a drawing program to make wiring diagrams or schematics. That's easy. Now, how about setting up a spreadsheet to calculate FM transmitter power? Can you get the graphics to draw your AM pattern? Some of the more exciting engineering programs will analyze circuits as well as create schematics and PC board layouts.

Networking and communications will continue to be hot topics. The LAN or Local Area Network interconnects the PCs within the station. You need to learn the inner workings of the software as well as how to plug in the boards and string the cable. Getting the transmitter, remote control, satellite automation, audio workstations, and business systems to easily exchange information could be a great learning experience and a big enhancement to everyone's productivity.

Communications also includes data sent over the satellite and dial-up networks. Get a modem and communications software and begin exploring Bulletin Board Systems. Also try the national network services like Prodigy and CompuServe. You'll quickly become comfortable with having a computer as your assistant.

Digital audio processing

Digital audio is a key skill for the future. What little tape that will be around in 10 years will all be DAT. Chances are your station has already switched from vinyl and carts to compact discs. Are you also switching to digital production and commercial storage?

Digital audio workstations are the most significant development in broadcast audio since the control board. The notion that audio is just stored data on a hard disk somewhere changes the whole way we approach audio production.

Audio processing now becomes mathematical manipulation of digital bit-streams. The tools for editing, production, and special effects are all hidden in the software. When you want a different effect, you no longer buy another box. You buy more software.

Notice that the latest audio processors are digitally based. They are running programs that mathematically manipulate the audio and they're doing it in real time. Do you understand how it's done?

Digital audio takes some getting used to. It's not quite as intuitive as watching waveforms on a scope. You need to get familiar with sampling, aliasing, error correction, dither, and a hundred other principles that have no counterpart in analog audio.

A good place to start is with some basic texts such as "Principles of Digital Audio," by Ken C. Pohlmann. The SAMS and TAB books are far more readable than college texts on the subject. Try your libraries and major bookstores to see what else is available.

I will discuss more digital audio topics in this column, although I promise to do my best to keep it from getting too dry. What I'm hoping to do is cut through the complexity and offer you some of the basics and key concepts needed to deal with this revolutionary change in our business. As strange as it sounds, bits and numbers can actually be fun.

John Shepler is an engineering manager, writer, and longtime RW columnist. He can be reached at 5653 Weymouth Drive, Rockford, IL 61114.

Complying with Remote Rules

► continued from page 15

You should have two radio stations: one on the air and the other as a backup.

I recently received a couple of interesting items in the mail. Pike & Fischer (phone 301-654-6262) is now selling "Broadcast Forms on Disk."

The package asks you the questions appearing on the form. It then prints out the form with your answers on an HP-compatible laser printer. The FCC filing instructions for each question are available online for reference as you fill out the form. The "station package" handles FCC forms 155, 303-S, 313, 395-B and 396. The "301 package" handles forms 155, 301, 307, 313 and 396-A.

Finally, a "comprehensive package" combines the two packages. This seems like a great idea for those filling out lots and lots of FCC forms. There are, of course, other "form generating" software packages out there, but I'm not aware of any others that have "templates" for the FCC forms.

I also received a copy of a Notice of Apparent Liability (NAL) that a non-commercial educational station received. The NAL calls for a forfeiture of \$7,500 for "repeated violations" of the Rules. The violations all dealt with the public inspection file. The Issues/Programs lists for six quarters were missing. The most recent ownership report and renewal application were missing. The "Public and Broadcasting Procedure Manual" was also missing.

The NAL says the forfeiture amount is based on the FCC Policy Statement of Aug. 1, 1991. That statement does indeed set the penalty for failure to maintain public files at \$7,500.

Technical violations—especially those dealing with interference, safety or EBS—will result in larger fines. Non-operational EBS equipment can earn a station a \$12,500 fine.

If you'd like a copy of a 46-page "compliance package," including the FCC Self Inspection Report, an FAA Obstruction Light Outage form, some FCC correspondence regarding inspections and compliance, FCC broadcast inspection forms, and the FCC Denver Broadcast Inspection Summary, send \$5.00 to cover copying and postage to H&F, 141 Suburban Road, San Luis Obispo, CA 93401-7590.

□ □ □

Harold Hallikainen is president of Hallikainen and Friends, a manufacturer of transmitter control and telemetry systems. He also teaches electronics at Cuesta College, San Luis Obispo and is learning Contra dancing. He can be reached at 805-541-0200. He can also be reached on internet at ap621@cleveland.freenet.edu or hhallika@pan.calpoly.edu or through CompuServe at >INTERNET: ap621@cleveland.freenet.edu.

The ENCO DAD486x DIGITAL AUDIO DISTRIBUTION SYSTEM

*Special
Introductory
Price
\$4500

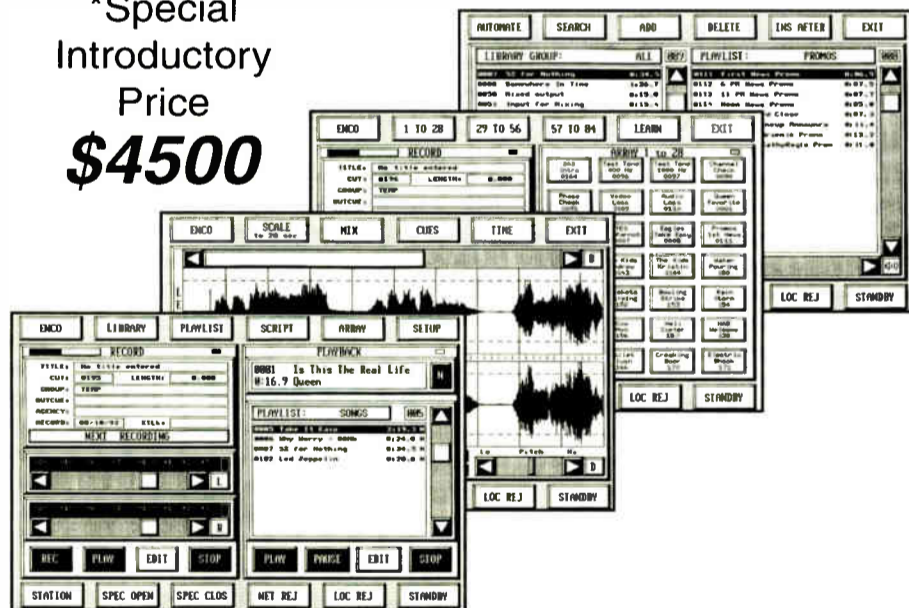

Professional Software for Digital Audio Broadcasting

- Full Bandwidth Stereo Audio Record/Playback
- Intuitive Graphic Audio Editing
- Instant Play "Array" & "Hot" Buttons
- Multiple Playlist Creation & Editing
- Data Compression Options

Operates on Any Common PC/AT 486 System

- Choose Your Own Hardware Source & Options
- Network Multiple Workstations with LAN

ENCO Systems, Inc.

1866 Craighsire Drive • St. Louis, Missouri 63146-4006 USA
Telephone: 800-ENCO-SYS (USA) • 314-453-0060 • Fax: 314-453-0061

Booth #653 NAB New Orleans • Booth #133 SBE San Jose

*Includes S/W and D.S.P. PC adapter

CALL OR FAX FOR SPECS and TURNKEY OPTIONS

BOTTOMLINE BROADCASTER

Power Amplifiers on a Tight Budget

by Jim Somich

BROADVIEW, Ohio Using solid state building blocks is a simple and economical way to update equipment that exhibits anemic performance but is otherwise in good mechanical condition. Whether you have an early solid state design or an even older tube unit, the application of the simple circuits we are discussing will add years of life to classic gear without emptying your wallet.

This month we will look at low and medium wattage power amplifiers that you can easily construct from common parts. Driving a loudspeaker or low impedance headphones requires an amplifier that can deliver both voltage and current (power) to its load.

The typical op-amp is designed as a voltage amplifier and can only supply limited current to a low impedance load without compromising its specs. While there are a few specialized opamps that will deliver respectable power into a 600 ohm load, most opamps deliver their best performance when working into relatively high impedance loads (2K ohms and higher).

Build, don't buy

Instead of purchasing expensive power amplifiers for monitoring, consider constructing some simple power amplifiers

and pocket the profit. Since opamps are simple, convenient and low cost building blocks for the bottom line broadcaster, there is no reason not to use them in most applications, including those requiring power amplification.

Fortunately, with the addition of a current driver stage, all op-amps can supply moderate to large amounts of power for

complementary pairs. They are convenient to use when constructing power amplifiers.

While we could use a pair of complementary power transistors in place of the darlington, the darlington is easy to use, low-cost and quite common. They can also deliver more power to a load than single output devices of the same

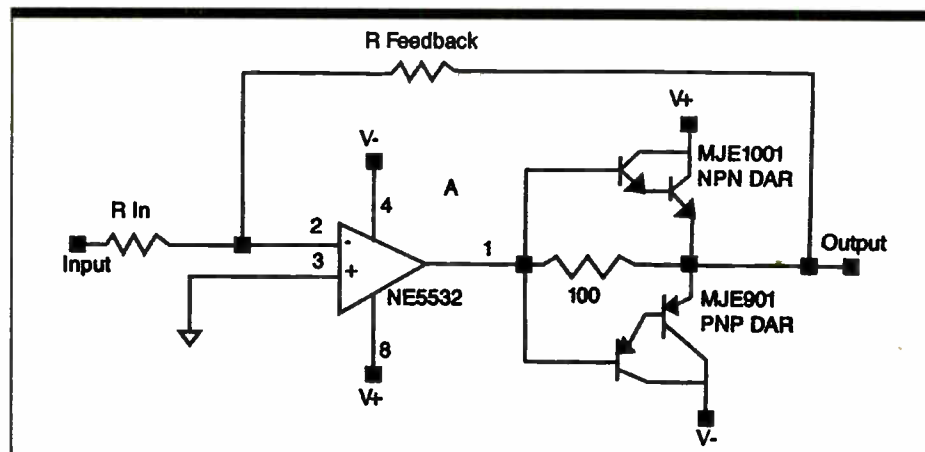

driving headphones, cue speakers or even studio monitors.

Fig. 1 is a schematic diagram of an inverting op-amp stage driving a typical common-emitter complementary symmetry darlington output stage.

Darlington is solid state devices that consist of two transistors in a single package and are designed to work in

physical size.

The topology of this stage is similar to a regular opamp building block except that the feedback is taken from the output of the darlington pair rather than from the opamp output. The formula for gain remains the same:

$$\text{voltage gain} = R(\text{feedback})/R(\text{input}).$$

The complementary symmetry circuit is a class B amplifier, which means that it draws current proportionate to its output power. Class A amplifiers draw the same amount of current with no output as with full output and are much less efficient.

How to use a darlington

Darlington is designed to be used in pairs with opposite polarity in each device. This allows you to drive a complementary pair without a phase inverter. The NPN darlington runs off the positive power supply rail and the PNP off the negative rail.

In our example circuit, a Motorola MJE901 (PNP) and MJE 1001 (NPN) darlington are used. This pair is rated at about 65 volts and will deliver up to 20 watts rms into an 8 ohm load with ± 30 volt rails and adequate heat-sinking. For higher power levels, choose darlington with higher voltage ratings.

A secondary advantage of the complementary symmetry output stage is that harmonic distortion is cancelled in the stage. After the addition of overall negative feedback from the output of the current booster to the input of the opamp, very respectable distortion specifications are possible.

In low to medium power applications, it is usually acceptable to use small heat sinks designed for the TO-3 packages that house the darlington. The best test is to feel the units in actual operation and

FEED LINE

Is That FM a Good Buy?

by W.C. Alexander

Part II of II

DALLAS In this installment of *Feed Line* we will continue to examine technical factors that make an FM station a good buy.

An area I like to examine is a station's transmitter site. Dataworld and BDS offer site check programs that pull up database records for all the AM, FM, TV, and many other types of stations, as well as all towers on record within a pre-determined distance of the site coordinates. This is useful in determining whether the site is at an "antenna farm," whether RFR problems may exist, and generally who the neighbors are.

Take particular note if you find that several stations are on the same tower as the station you are examining. If the tower is not tall, the station may not comply with FCC/ANSI standards for human exposure to RF radiation. Further study may be required. Use OET Bulletin No. 65 as a guide.

Also pay attention to directional AM stations within 3 km of the site; this may add considerable expense to any change in tower structure that you may wish to make down the road, as you will be required to prove that the changes you made did not upset the AM station's directional pattern(s).

Intermod and mixes

One other thing to look for is the possibility of intermod and troublesome mixes. Start by pulling up a list of all the FM stations within 20 km of the center of the target coverage area. Double the frequen-

cy of each station and subtract the frequency of the station you are studying.

If the result is the same as the frequency of any other station on the list, look to see how close the two other stations are to one another. If they are within a short distance of each other and more than twice that distance from the station you are studying, there is a good possibility that "2A-B" problems may exist.

If they do, there will be, in effect, an oval or dog-bone shaped hole in the coverage area of the station you are studying, centering about halfway between the two other stations' sites and encompassing each of the other sites.

It doesn't hurt to run an intermod study as well on any multiple-user or closely adjacent sites in the target coverage area.

Predicted coverage

In my studies, I don't like to use the predicted coverage map provided by the seller or broker, or even the map with the Form 301 engineering, to show my employer an FM station's coverage. Rather, I like to prepare a map myself.

Allow me to repeat here the caution I presented in the last *Feed Line*—be aware of copyright laws with respect to whatever map you choose to show coverage.

You'll want to show the 3.16 mV/m (city grade) contour as well as the interference-free contour (0.5 mV/m for Class B, 0.7 mV/m for Class B1, and 1.0 mV/m for all others). Use either 36 or 72 radials rather than the standard eight, as this gives a much more accurate picture of the coverage.

Begin by calculating the predicted dis-

continued on page 39 ►

determine if they are running too hot. Warm is OK, but if you cannot keep your finger on the device, it is definitely running too hot.

The remedy is to increase heat-sinking or use more ventilation.

Since darlington is a power device and more prone to failure than a voltage amplifier, it is wise to socket-mount them for ease of replacement. Darlington is inexpensive and readily available in various voltage ranges. They are a simple way for you to build power amplifiers at a very low cost.

Jim Somich is president of Somich Engineering and chief engineer of WOIO(TV) Cleveland. He can be reached at 216-526-4561.

NEW AM RULES

AMSTUDY

DAYTIME ALLOCATION STUDY

- Both Dataworld and FCC Databases Studied
- Utilizes NEW (Corrected) Groundwave Curves
- NEW Adjacent Channel Protection Ratios Employed

AMNIGHT

NIGHTTIME INTERFERENCE STUDY

- Utilizes NEW FCC Skywave Propagation with Greatly Improved Accuracy
- Calculates Extent of Nighttime Interference Received (Detailed Individual Night Limit)
- Provides Allowable Vertical Radiation to All Pertinent Stations (AM Night Permissible Radiation)
- Includes All Co-Channel and First Adjacent Records

GWAVE

GROUNDWAVE (Daytime) COVERAGE CONTOUR STUDY

- Utilizes NEW (Corrected) Groundwave Curves
- Allows Input of Measured Soil Conductivity Data
- Counts Population Within Coverage Area Using 1980, 1986 and 1990 Census Data

SKYWAVE

SKYWAVE (Night) COVERAGE CONTOUR STUDY

- All AM Nighttime Coverage Contours Have Changed Size and Shape
- Utilizes NEW FCC AM Skywave Propagation Model
- Counts Population Within Contours Using 1980, 1986 and 1990 Census Data

dataworld®

P.O. Box 30730, Bethesda, Maryland 20824

FAX (301) 656-5341

(301) 652-8822

(800) 368-5754

Oh-Oh!

Call CORTANA

For Affordable Lightning Protection
505-325-5336

P.O. Box 2548, Farmington, N. M. 87499
 FAX 505-326-2337

Circle (23) On Reader Service Card

Circle (18) On Reader Service Card

USAirplay

Male Vocalists Flex Their On-Air Muscle

by Charles Taylor

WASHINGTON Recently, we focused on the dawning of female predominance over the airwaves. The march of the Lipstick Regime, as it were.

That's not to say, mind you, that male vocalists don't also have radio muscle.

In fact, until the last decade, men not only dominated, but governed the winner's circle, commanding a higher level of celebrity status and shaping musical trends almost single-handedly.

Back to the King

In the 1950s, the world's first rock'n'roll phenomenon—Elvis—marked the outset of a string of male radio idols that would fashion the signature of radio's new top 40. Along came Ricky Nelson, Pat Boone, Buddy Holly, Jerry Lee Lewis, Chuck Berry and Little Richard.

Women, meanwhile, were more often than not relegated to the ranks of any number of popular girl groups of the day. And who oversaw these careers? Men, that's who. Male record company executives, male songwriters and singers, and male disk jockeys. Women were admitted by invitation only.

Today, male vocalists stand beside women who not only write and produce their material, but engineer their careers. The difference: men, with a few exceptions, continue to be taken at face value for their music.

Their success is seldom dependent on their hair, their clothing or their keen dance steps. The recent rise of female voices over the airwaves, admittedly, has something to do with the accompanying video industry. Without it, would Madonna, Paula Abdul and Janet Jackson be stars? Billy Joel and Eric Clapton would. (We could argue the case for George Michael and Michael Jackson.)

Most of the male vocalists shaping today's airwaves have been making music for decades (my last list of influential females included only one with longevity: Bonnie Raitt). For your consideration, the 10 male vocalists exerting the most influence on mainstream contemporary radio:

Prince: Some artists have the savvy to reinvent themselves successively. For Prince, the first time has never called for revision. Prince's consistent ability to conjure anew his trademark sound have made him the most innovative artist of our time.

The list of heavyweight careers he has contributed to is a Who's Who of the Industry: Sheena Easton, Sheila E., Sinéad O'Connor,

The Bangles, Madonna, Paula Abdul, Celine Dion and on and on.

Michael Jackson: The undisputed monarch of the medium, but at what price? In its purest form, the music should be the only factor that matters. Jackson has obsessed on image to the point that without a video, his songs come up bland and lacking.

Unfortunately, seeing the video may be worse. It only reinforces how weird the guy is.

Elton John: With the global success of "Don't Let the Sun Go Down" with George Michael, followed by the release of his 35th LP, "The One," John has clinched his status as a core artist on radio around the world. He has weathered countless musical trends, personal ups and downs and image transformations. And yet the piano remains in tune.

George Michael: Including his successes with Wham!, Michael has amassed more top 10 hits than anyone but Madonna, according to Billboard. As an artist, he maintains a tight grip on all elements of the business—songwriting, image, video and voice. His idol is Elton John, a pretty fine figure to emulate.

Bruce Springsteen: For decades, Springsteen could do no wrong, achieving momentous critical and commercial success. Now, industry leaders are claiming the Boss's best work is behind him. Perhaps it is difficult to arouse blue-collar woe from a leather armchair. Historically, however, he does stand as a legend.

Phil Collins: A solid track record as a solo artist and member of Genesis, Collins has the ability to write catchy melodies and lyrics that move the masses. A look at his videos reveal the secret—the

man is having a good time.

Luther Vandross: In the States, Lush Luther is alleged to be the most-often played popular artist during lovemaking. He has produced, written for and sung with the best. An R&B icon who has earned his stature as indispensable.

Clint Black: Country music is more popular than it has been at any time in history, and men continue to hold center stage in the format. Black's songwriting, singing and sex appeal are among the reasons.

He has a lot of company in the new country corral: **Alan Jackson, Travis Tritt, Garth Brooks and Billy Ray Cyrus**, who copped the first country hit to reach the pop top 10 in nearly a decade.

Eric Clapton: The stigma of the aging rock star traditionally takes after a good drag show: a lot of effort to look like something you are not. Clapton has broken type. Not only was "Tears in Heaven" among the most credible songs of his career, he is prepared to turn 50 quite gracefully.

Michael Bolton has stifled the CHR airwaves with his paint-by-numbers melodrama. His pompous persona does little to help. Wanting to write hits is not a crime. Writing hits that are indiscernible from one another is contemptible. When will his string of soundalikes end?

Runners Up: Peabo Bryson: If voices were fabric, his would be silk. **Matthew Sweet** has made progressive rock palatable for AOR stations by blending musical elements of modern rock with traditional 1960s/1970s guitar. Few artists unite these demographics. **Lionel Richie:** There is little variety in his repertoire. However, Richie's longevity without gimmickry is commendable. And let's not forget **John Mellencamp, Richard Marx, Billy Joel, Rod Stewart, Jude Cole and Bryan Adams**, maintaining the accessible rock connection that has fueled CHR radio for 25 years.

RADIOMAIL
START IMMEDIATELY!
No Budget Necessary!
You Can Add
\$472,000
Gross Profit This Year With ...
RADIOMAIL[®]

- Increase Your Sales
 - Improve Your Cash Flow
- Promote Your Station
 - Increase Your Listenership

Contact Greg Spraul
(619) 597-0263 FAX (619) 597-0992

Circle (138) On Reader Service Card



A GREAT GIVEAWAY!

Roll-A-Sign™ disposable plastic banners are a great, cost-effective way to promote your station.

Indoors or out, Roll-A-Sign powers your message across and is an ideal giveaway for a concert, remote, etc. Co-op it with a sponsor and it more than pays for itself!

Depending on your logo's design, you'll get up to 338 banners on a 1,000' roll... just roll 'em off and cut.

Each banner is printed on high quality, sunstabilized plastic film, 4 or 6 mils thick, up to 36 inches wide. Fax us your logo and specifics on color separations, and we'll give you a free quote.

For any questions about quantities, sizes, imprints, colors, etc., call

1-800-231-2417

or FAX: 713-947-2053 or in Texas call collect 713-484-6892

Roll A Sign™ • Reef Industries, Inc. • P.O. Box 750245 • Houston, TX 77275-0245

Circle (77) On Reader Service Card

Good News for Radio Networks

Increase Affiliate Services . . . Without Spending a Dime

No matter what your format, we have news for you! And it's the news your client stations' listeners want to hear. It's news about the economy in a form they understand. How do we know? Simple, we asked them! In a national survey more than 60% of the respondents told us they are paying more attention to business news now than they were six months ago. We also learned that a majority of them use the stock market as an indication of the health of the national economy.

And where are they turning for this information? One place is radio. More than a quarter of the respondents say they turn to radio as a viable source of business and economic news -- making stock market information a key way to reach listeners, particularly the much sought after high SES listener.

So who can give you the most complete stock market information available to radio networks? We can. We're the Nasdaq Stock Market, the second largest stock market in America. For years, we have been providing television networks and stations with daily customized stock market reports. Now Nasdaq has developed a variety of services designed to provide radio networks with this same type of custom, quality information.

And best of all, all of our services are free! Just call Craig Thompson at (202) 728-8268, and let Nasdaq develop a custom, daily stock market report to fit your network's needs. It's a unique way to add to the services you provide your stations without spending a dime.

THE NASDAQ STOCK MARKET
NASDAQ

Because Your Business News Is On Main Street, Not Wall Street

DIGILINK

...a revolution in radio studio technology

THE DIGITAL AUDIO ADVANTAGE...

Introduced in April of last year, Digilink is a digital audio workstation that saves your station money. There is no more routine maintenance, it has a 15 year average life, *and* you have total automation capability for nights... weekends... or whenever you need it. It comes complete in a 5 1/4" high, rack mounted cabinet that converts ordinary analog audio to CD quality digital audio which is stored on a computer hard drive. It does this just like you would store a business letter on your home computer. Digilink can then call up and play any digital audio file in milliseconds off its internal hard drive. Basically, you can think of Digilink as a huge multideck cart machine or cart carousel where you can line up and play thousands of carts or audio cuts sequentially. A single Digilink can therefore replace all of your cart machines in production, On Air, or in automation.

Digilink is a perfect cart or reel machine replacement...

Digilink is the perfect replacement for magnetic tape based cart or reel machines. With Digilink, you can replace your cart machines with CD quality digital audio that requires no calibration, no maintenance, and the media has a 15 year average life. You can replace your reel to reel machines, razor blades, and tape with fast, nondestructive, CD quality, on screen waveform editing. You can cue virtually instantaneously. Digilink even costs less than comparable analog cart or reel machines. Digilink is the perfect audio record and play system for professional radio broadcast applications.

Digilink performs ALL types of automation...

With Digilink you can operate fully live or mix various automation types into your daily programming. You can store all of your audio on hard disk at an incredible price or you can use hard disk for only commercial material recording. Digilink has an internal audio switcher with machine logic control. Digilink therefore supports satellite automation, reel and DAT tape automation, CD automation, and full hard disk automation all out of one compact box. Because Digilink is a computer, you can print out a log of what you have scheduled to play *or* print out a log of what really did play. With Digilink, you can be live on the air with full CD quality audio or program the system and walk away forever. Digilink even interfaces with all major traffic and billing systems through a Digilink import-export routine.

Digilink is engineered and manufactured by Arrakis...

Digilink is not simply a hardware package assembled from parts built by *other* computer manufacturers and run under our software. Arrakis is the *only* manufacturer to build nearly all parts of the digital system in-house. We build our own *Arrakis* DSP board, SCSI board, I-O board, switcher board, cabinet, and cabling. Because Arrakis builds the system and doesn't simply mark up someone else's hardware, Arrakis can offer you Digilink with broadcast features and performance unmatched by anyone *and* at a truly remarkable price !!!

2619 Midpoint Drive, Fort Collins, CO. 80525

..... at an incredible price. !!!!!!!

SALE \$7,995

under \$8,000

for a COMPLETE 6 hour stereo system

whether you lease for under \$300 a month or buy, with Digilink you can literally make money by ...

- reducing maintenance,
- reducing staff demands,
- improving On Air sound,
- improving Production,
and improving all areas of your station performance !!!



FEATURES

- Simultaneous record- play !!!
- Uncompressed CD quality audio or mix 2:1 or 4:1 compression
- Use keyboard, mouse, trackball, or even a touchscreen
- Digital Waveform Editing
- Mix mono and stereo files
- Live Cart Machine replacement
- Reel to Reel machine replacement
- Satellite Automation
- Tape Based Automation
- CD Automation
- Hard Disk Based Automation
- Traffic and Billing Interface
- supports digital networks

SPECIFICATIONS

all tests performed at 1:1 compression

Digital Signal Processing System (DSP)

Sampling System- 16 bit linear PCM, 2 channels
 Sampling Rates- 44.1,32,22kHz, fixed filter on routing switcher
 Compression- 0,2,4...adaptive differential PCM

Controller -

Floppy Disk- 3 1/2" 1.44M capacity, System Hard Disk- 40MB
 Printer Support- IBM compatible, parallel port

Audio Performance- Digital Record playback

THD- .008%, Dynamic Range >85dB,
 Freq Response- (+)(-).5dB 10Hz-15kHz

Physical Specifications

Dimensions- 19" Rack mounted- 19"W x 5 1/4" (3RU)H x 16"D
 Weight- 60lb's , Power- 110/220VAC, 50/60Hz, 100W

Audio Performance- Routing Switcher

THD- .005% typ, S/N < 100dB below +4dBm
 Dynamic Range- >120dB,
 Freq. Response- (+)(-).1dB 20Hz-20kHz

by ARRAKIS SYSTEMS inc.

Voice (303) 224-2248, FAX (303) 493-1076

Changing the Links in the Audio Chain

by Jeffrey Loughridge

Part V of V

RICHMOND, Va. Last month we discussed the proper procedure to follow when making adjustments to your processing, what to listen for, and how and when to listen to the effects of your changes. What do you do after you've tried everything and still aren't happy with your station's sound? Basically, you now have two choices. You can modify or "customize" your existing processing, or you can upgrade all or part of your existing system to a current state-of-the-art system.

If you haven't already tried modifying your processing, this is by far the least expensive route, but is obviously limited to the maximum capabilities of what you have. A reason to consider modifying your processing first is that manufacturers have to design their processors as "mass appeal," to work under all possible circumstances and meet all possible needs.

To achieve this "one size fits all" design, compromises must be made that limit performance and versatility. Because of this, it is not only possible, but often necessary, to customize a processor to suit your exact needs and maximize its effectiveness. There are many established and accepted modifications you can make to virtually any existing processor.

Your engineer may be able to perform

such modifications, or you may wish to use someone who has done them before and is familiar with them. A good starting point for your engineer would be the *Bottomline Broadcaster* columns in *RW*. These columns often discuss various modifications.

Consider upgrading

If you are still unhappy with your air sound, it is probably time to consider upgrading to a current, state-of-the-art system. It is likely that what you are currently using is no longer suited to your needs and is incapable of delivering the quality and sonic impact you demand. The current crop of processors can be grouped into four basic categories:

Analog—These process audio entirely in the analog domain. They may be wideband (one compressor/expander for the entire audio range), or multiband (divides the audio into multiple bands of frequencies and has a compressor/expander for each band. (The signal then typically is routed to other processors, then to your stereo generator.) An example of this type of processor is the "Tailor" Dynamic Equalizer by Hit Design.

Analog with digital control—These process audio entirely in the analog domain, but are controlled by digital circuitry. The devices typically combine wideband and multiband processing in one unit and then feed other processors, or go directly to your stereo generator. Examples of this type are

Gentner's Audio Prism and the CRL Audio Signature.

Digital audio processing and analog stereo generator hybrid—These process entirely in the digital domain (audio is sampled by an A/D (analog to digital) converter, is acted upon by DSP (digital signal processing) chips which process according to software provided by the manufacturer and stored in EEPROM (Electrically Erasable Programmable Read Only Memory), the audio processor.

This program tells the processor how to act overall; you can still alter individual parameters to customize your sound. The digital signal is then converted back to analog in a D/A (digital to analog) converter and is fed to an analog stereo generator. Examples of this type are the Orban Optimod 8200, the Cutting Edge Unity 2000 and Audio Animation's Paragon-Transmission.

As this article is being written, Audio Animation told me the company had a digitally-controlled analog stereo generator ready to be shipped after the NAB Radio Show and were continuing development of a digital stereo generator.

Digital audio processing and digital stereo generator—These process audio entirely in the digital domain. The audio then proceeds, in the digital domain, to the stereo generator which creates the stereo baseband signal, still in the digital domain. The composite output is then converted back to analog in a D/A converter, and is fed to your exciter.

The digital stereo generation eliminates the need for typical stereo generator adjustments such as Pilot Phase and L-R Gain. The stereo generator does include a software adjustment for pilot injection and the ability to test crosstalk for proof purposes as well as an analog output control for baseband level. There are currently only two processors that fall in this category, the Digital Prism and the Lazer, both from Gentner Communications.

The advantage of a DSP system is the abil-

ity to totally reconfigure, or redesign the processor, simply by changing the EEPROM. New ROM programming can change the entire sound and operation of the processor.

Digital advantage

Digital also provides a significant improvement in clarity and transparency on-air. The added definition will give you chills. A disadvantage is the inherent delay caused by digital sampling and processing. Typical delay times run around 4 ms (milliseconds).

This *only* affects the on-air talent if they listen to headphones monitoring off-air. The audience doesn't hear anything different.

Typically, this effect takes a short time to get used to and is no longer an issue. It can become a concern, however, as you add more digital equipment. A digital STL will add a delay of its own, and so on. These delays add up and can become significant. The best solution is to have your engineer connect a headphone tap off the program output of the console and add a compressor and EQ to the headphone feed, in addition to any mic processing you already use.

The additional compressor and EQ simulate the on-air processing and punch up the signal in their headphones. Otherwise, the sound of the Program bus will seem flat because you're not hearing the aggressive processing you use on-air.

As you can see, there are many decisions to make when considering replacement of your processing. If you want to replace your entire system, you might consider one of the full systems that include audio processing and stereo generator functions in one or two boxes. If you want to replace only a part of your system, you obviously don't want to pay for more than you need.

Consultants with caution

This is one time where it is helpful to have consultants familiar with the operation of the boxes you want to test. They can save you the time of climbing the learning curve and let you focus on the sound, then fully educate you on the operation of the one you buy. An independent consultant can also give you the best of each processor.

continued on page 29 ►

Have You Ever Needed Your Computer In Two Places at One Time?

PC-Companion Plus is the answer you've been looking for.



✓ Easier Information Distribution

Now, you can have remote access to your wires and other important data.

✓ Better Physical Security

Locate your computer in a secure area and still have round the clock access to your information.

✓ User Friendly

No complicated software to install. Just plug it in and go.

Distribute your important information without a costly and complicated network. Instead, experience the advantages of having a second keyboard, monitor and mouse up to 250 feet away from your computer. No software to set up means installation is quick and easy. Whether you're in the office or the booth, your computer is still close at hand.

Options include: Audio channel, remote serial printer line, PS/2 or serial mouse.

Note: PC-Companion Plus is not a multi-tasking device. Both users may view the display, but only one should type.

Cybox Corporation

2800-H Bob Wallace Ave
Huntsville, AL 35805 U.S.A.
(205) 534-0011

Fax (205) 534-0010

Made in USA



LOG 14 DAYS OF AUDIO ON ONE DAT, PLAY IT BACK WHILE STILL RECORDING!



MDL-14
RCS TRACKER

The RCS TRACKER records up to 3 audio sources simultaneously, and provides random access to any logged time segment - even by phone - without interrupting the recording.

The RCS TRACKER consistently sounds better, costs less to operate, and is easier to use than any other logging technology.

The RCS TRACKER is a complete hardware-software system.

RCS 2 Overhill Road, Suite 100, Scarsdale, NY 10583
Voice (914) 723-8567 Fax (914) 723-6651

SLEEP EASY WITH WATCHDOG And Automate Your Remotes

By John Schad, President
SMARTS Broadcast Systems

All broadcasters would like to see absolute perfection in every product they purchase. The ideal piece of broadcast equipment would perform flawlessly for hundreds of years, be so easy to operate that no training is ever necessary, and retail for under \$20.00!

We at SMARTS are always striving toward that perfect concept, but we realize that the realities of the world work against us. That's why we developed our latest product, the WATCHDOG.

The WATCHDOG is really a separate computer, with a separate power supply, whose only job is to watch over the SMARTCASTERS at work in the station. Each WATCHDOG can monitor the functions of two SMARTCASTERS so that only one WATCHDOG is needed for AM-FM operations.

These units keep an eye on both SMARTCASTERS. If any type of failure, for whatever reason occurs, the WATCHDOG resets the SMARTCASTER, then checks to see if the problem is gone. Should the problem persist, one more reset is attempted—and if that doesn't fix it, the WATCHDOG can trigger an alarm or auto-dialer to call for help.

The great thing about the WATCHDOG is that it doesn't care about the original problem. Power spikes, brown outs, total power failures, lightning strikes, spikes from lightning strikes, all can cause a computer to 'lock up'. Usually a simple reset fixes the trouble, but if that reset involves a 20 mile drive at 2 a.m., it looms as a much larger problem! WATCHDOG quietly and efficiently takes care of the vast majority of these incidents, then calls out the Marines only if the problem goes beyond the usual limits.

Another great feature—the SMARTCASTER watches the WATCHDOG! If the WATCHDOG goes haywire, the SMARTCASTER detects it and resets the WATCHDOG itself!

In practicality, our systems work reliably week after week, without any WATCHDOG intervention, but this little computer gives our customers the additional security that comes from one highly reliable system watching over another highly reliable system. That's really important for weekend and overnight walk away.

The WATCHDOG is only available from SMARTS and works only with SMARTCASTER.

Small and medium market stations everywhere are wrestling

with cost cutting measures that allow them to remain viable, but not detract from the sound. The industry is lucky to have a good selection of satellite services providing music and talk programming in a wide variety of formats. These services, when teamed up with our SMARTCASTER, have provided an alternative to the labor intensive 'disk jockey approach to radio.' However, the stations have to work at retaining localism in their sound. That's why we invented another member of the SMARTCASTER team called the SMART-TOUCH.

The SMART-TOUCH allows you to do remotes without anyone at the studio! Everything from simple 2 minute inserts from the car dealership to complex hours-long sports broadcasts can be handled with a simple touch tone phone—even a cellular! With the SMART-TOUCH you can leave the network (or other automated music source), play an intro, put the phone line on the air, play spots, monitor the station, monitor the network, play a close, then rejoin the net (or other source) smoothly and easily. It can all be done from any touch tone phone. The SMARTCASTER responds to the touch tone commands just as it does to network cues. The system answers the

phone, is protected by a security code, and will rejoin the net in the event of an accidental disconnect! You no longer need to have anyone 'riding the board' during those evening ball games.

These two little products we make are indicative of our company's dedication to the total picture of producing equipment and services to reduce the cost of your radio operation, thereby making that operation more profitable. SMARTCASTER digital audio, the Jock-In-The-Box, and the Night Watchman CD System, and the SMARTS Billing, Accounting and Traffic program have helped hundreds of stations with that task.

The SMARTCASTER is a total digital audio storage and retrieval system that can work with satellite, CD, even open reel music sources. The Night Watchman and the Jock-In-The-Box are two levels of CD automation that have advanced features that up to now have been impossible in broadcast automation, yet are priced well below conventional prices.

Can we be of service to you? Give us a call so we can talk about everything we offer the radio industry.



SMARTCASTER

DIGITAL AUDIO

SMARTS BROADCAST SYSTEMS
BOX 293, EMMETSBURG, IA 50536.
(800) 747-6278
Phone (712) 852-4047 Fax (712) 852-3061

MARKETING & MANAGEMENT

Fill Your Files with Fields of Facts

by John Cummuta

ALGONQUIN, III. This is the third installment in a series on database marketing. In case you missed one or both of the previous columns, database marketing is the fastest-growing facet of direct marketing, and it can be powerfully used to build both the size and loyalty of your audience.

Database marketing for radio stations has two basic components: building a database containing specific information about specific radio listeners, and using that database to build relationships with those listeners for the purpose of either getting them to

sample your station or keeping them from drifting over to the competition. All of this activity is designed to build and sustain your station's numbers, so you can sell more time and charge more for it.

Filling your database

Last month we talked about some simple database concepts, such as what a typical listener's database record might contain. I also offered the names of a few database programs that could run on your station's PC. There are other, more proprietary programs offered by service vendors in the database marketing industry,

and we'll name some of those later.

In later columns we'll also talk about whether you want to be managing your database yourself or hiring an outside company to do it. But in this issue I want to begin talking about how to get the names of people to put into your database.

First of all, there are two types of radio listener you are interested in: those who already listen to your station and those who presently listen to other stations. In both cases, you'll want to concentrate on the cream of the crop—the heavy listeners. These are the people who add both to your cume and your average quarter hour (AQH). In fact, they make up the largest segment of your AQH.

To find these people among your own listeners should be easy. Anyone who has won a station contest should go directly into your database.

Something you'll learn over time about direct marketing is that the fresher the name, the more responsive the person will be. So, in the beginning, don't bother using names that are more than a year old.

Mark each record

As you enter your contest winners into the database, mark each record as a contest winner. This brings us to another important point about database marketing: You cannot act on information you do not have in

your database. In other words, if you don't have the winners identified in their individual computer records, there is no way you can later create and execute a special promotion aimed at this slice of your listenership, because you will have no way of isolating these people on a mailing list.

In general, you cannot have too much information on each person in your database. Plan the record structure of your database to be able to accommodate every type of information you may ever want to gather on your listeners. It's much easier to work with a database that carries a few rarely used fields than it is to try to add fields later to carry new information. Upfront planning is a critical component of successful database marketing.

OK, let's get back to finding people to put into the database. After you have entered the winners, punch in the rest of the contest entrants. If you have not been keeping this kind of information, you had better start.

There are many business people who, if their business caught on fire, would first save the computer disks or tapes containing their database and worry about everything else in the building after that. Your list of prospects and customers (prospective and current listeners) is one of your business's most valuable assets.

Once you have exhausted the names you already have in-house, it's time to start generating new ones. Here is where radio stations have a great advantage over most database marketing businesses. The others have to buy radio time to generate names

continued on next page

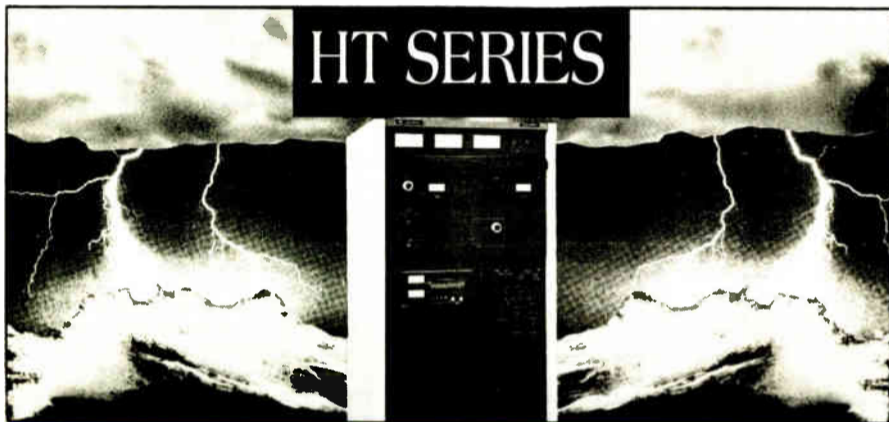

Rugged Performer.

Harris HT Series FM Transmitters From 3.5–35 kW.

HT Series transmitters are engineered to give you high efficiency and unsurpassed performance. HT FM transmitters have proven their reliability and exceptional lightning survival capabilities in installations around the world. Here's why HT Series transmitters are the choice of demanding broadcasters:

- 55 Watt THE-1 FM Exciter with ultra-linear VCO operates at final carrier frequency with inaudible noise and distortion
- Quarter-wave cavity offers twice the bandwidth of folded half-wave designs to pass more of the FM signal without distortion
- Low velocity, high-efficiency direct drive cooling system
- Modular solid-state IPA and conservatively operated final tetrode PA
- High overall efficiency lowers AC power bills
- Broadband solid state RF driver uses FETs for highest reliability
- Solid state controller with automatic RF power control, proportional VSWR foldback, auto-restart
- Opto-isolated remote control/status interface, fully transient protected
- Exclusive FLEXPatch™ design allows easy bypassing of low-level stages to keep you on the air during emergencies

Call Harris Allied today at 800-622-0022 for more information on rugged, reliable, efficient HT Series FM transmitters.

Also available: 100% solid state 250 W, 500 W and 1kW HT Series transmitters.



BROADCAST EQUIPMENT

800-622-0022

Tel (217) 222-8290 • Fax (217) 224-2764 • Telex 650-374-2978 HARIS UR

© 1992 Harris Corporation

Circle (185) On Reader Service Card

Networks Show 12+ Gains In Spring RADAR Results

continued from page 1

F 9 a.m., 3,056,000; ABC Prime News, M-F 6 a.m., 2,906,000; and CBS's The Osgood File, M-F 7:25 a.m., 2,701,000.

Programs ranked 11-20 were broken

News/Music, M-F 10 a.m., 2,566,000; ABC Prime News, Sat. 8 a.m., 2,551,000; ABC Platinum News/Music, M-F 10:30 a.m., 2,533,000; ABC Prime News, Sat. 9 a.m., 2,494,000; CBS's The Osgood File, M-F 6:25

Figure 1. Radar 45 (Spring 1992), Persons 12+ COMMON DAYPART: ALL FULL SERVICE NETWORKS Monday-Sunday, 6am-7pm Average Persons

	PERSONS 12+				
	Radar 45 (000)	Rank	Radar 44 (000)	Rank	% Chg. (%)
Prime (ABC)	5,389	1	5,407	1	0.3
Mutual (WW1)	3,242	2	3,196	2	(1.4)
Platinum (ABC)	2,849	3	2,949	3	3.5
Spectrum (CBS)	2,408	4	2,420	4	0.5
Genesis (ABC)	2,352	5	2,373	5	0.9
Super (US)	2,239	6	2,265	6	1.2
Ultimate (US)	2,045	7	2,088	7	2.1
CBS (CBS)	1,752	8	1,811	8	3.3
NBC (WW1)	1,614	10	1,556	9	(3.4)
WONE (WW1)	1,698	9	1,556	10	(8.4)
Source (WW1)	1,484	11	1,458	11	(1.8)
Power (US)	1,388	12	1,424	12	2.6
Excel (ABC)	1,107	13	1,209	13	9.2
Amer Urban (AUR)	998	15	1,132	14	13.4
Galaxy (ABC)	1,028	14	1,073	15	4.4
Total	31,594		31,920		1.0

Source: RADAR 45, Spring 1992; RADAR 44, Fall 1991; Volume 2, Network Audiences to All Commercials, Daypart Averages, Monday-Sunday 6:00am-7:00pm. ABC Radio Network Research Analysis.

down as follows: ABC Prime News, M-F 10 a.m., 2,679,000; ABC Platinum News/Music, M-F 9 a.m., 2,643,000; ABC Platinum News/Music, M-F 8 a.m., 2,635,000; ABC Prime News, M-F 11 a.m., 2,588,000; ABC Platinum

a.m., 2,373,000; and CBS's The Osgood File, M-F 8:25 a.m., 2,334,000.

If rankings were based only on news personalities, Paul Harvey's five programs would rank one through five.

► continued from previous page
of new prospects or customers, while radio stations can use their own promo time.

Run new contests, offer freebies for anyone who calls in, do whatever you have to do to get someone to give you his or her name, address and phone number. Get even more information if you can.

How much information?

The level of information you want, or can even handle, on each listener depends mostly on the volume of people you are dealing with.

If you are the dominant CHR station in a larger market, you may only have the time or need to communicate with people on a name, address and phone number basis. With that information you can do mailings to your current listeners, as well as use some modern computer techniques (we'll talk more about those in future columns) to find other people in your market just like your best listeners. You can then use the mail or phone to invite these other people to sample you.

If, on the other hand, you are running a smaller cume, niche format or you are in a smaller market—or maybe you're just the new kid on the block—you will want to gather more detailed information about each listener so you can communicate with them in a more personal way.

The buzzword for this is "relationship marketing," and it means maintaining a dialogue with your listeners in such a personal way that they begin to sense a relationship with your station. That can be read as "greater listener loyalty."

Some of the information you may want to gather includes the names of other potential listeners in the household, spouse's name if married, birthday of listener, anniversary date if married, names and ages of children, place and phone number of employment, favorite artists and so on. Hopefully, you can see the promotional possibilities in this information.

You can later use your computerized database system to send birthday and anniversary cards or letters to your best listeners. You can send personalized promotional communications that mention their children. You can even communicate with other family members, asking them to enter the listener into contests for the "best dad, mom, brother, sister, human," whatever comes to mind.

You can automatically enter database people into contests. You can send them personalized notices of upcoming concerts by their favorite artists. The possibilities are limited only by your imagination.

Database marketing can be an incredibly powerful tool in building your station's most valuable resource: its listeners. And I'm serious when I say that using these techniques will soon change from an important new marketing option to an absolute competitive necessity.

You don't want to be the last one on the handwagon, because that's the person who eats all the dust.

John Cummuta is an independent marketing and management consultant, and the author of the Sales Machine database marketing course. He can be reached at 708-658-9107.

Changing Your Audio Chain

► continued from page 26

Be aware that representatives of the particular companies you are considering may be there to make their box sound best. If you or they set up the other processors, the others may not be getting a fair shot. This is clearly a matter of each company's marketing philosophy, since one choosing to send a representative will have a serious advantage over one that doesn't.

The one not represented obviously risks losing the sale with that decision. This should be of no concern to you, except when their loss could be your loss as well. It is important to fully and fairly evaluate all of the processors you want when you make your choice. This is a purchase you will have to live with for many years to come.

A company representative sent to configure the company's equipment has an obvious bias toward that product. Any "independent" consultant should immediately inform you of any interest he or she may have in a particular product—not so you won't hire him or her, but so that you can consider that interest into their comments and observations.

We aren't concerned with opinions here, everyone has those. We are concerned with a financial interest in a product, either through ownership or sales. Consultants may not watch out for your best interest if they have special interests of their own.

I hope you have found this series in some way helpful and informative. If I have helped your station or organization sound better, revealed areas of deficiency that had not been seen before, or answered questions you have had, I will have fulfilled my goals in writing it. I wish you the best and welcome your calls and comments.

Editor's note: Field modifications to equip-

ment may invalidate the manufacturer's warranty. Before attempting any repairs or modifications, consult the manufacturer for advice and guidance.

Jeffrey Loughridge is president of Audio Concepts and Engineering, a technical consulting firm that designs and renovates studios. He can be reached at 1-800-777-4172.



Single Pair Audio
Clark SPA22GS Audio Wire.
Available in 10 Jacket colors—or more.
Highly flexible and very easy to strip.
Bonded foil shield comes off with jacket.



Clark Ribbon Stereo Cables

2 cables in one for left and right channels.
Eliminate shrink tubing and cable ties.
Each line of audio color coded for easy I.D.
Available in various color combinations.

Clark ZCC Series Audio Snake
Ask about our color coded and numbered audio snakes.

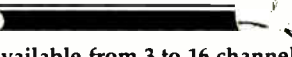

Available from 3 to 16 channels.
These snakes are simply multiples of our SPA22GS audio wire.

WE ARE HAPPY TO CUT CABLES TO LENGTH, AND TERMINATE.
CALL US FOR FREE SAMPLES AND CATALOGUE.
1801 Holste, Northbrook, IL 60062
(708)272-9889, FAX (708)272-9564

Circle (29) On Reader Service Card

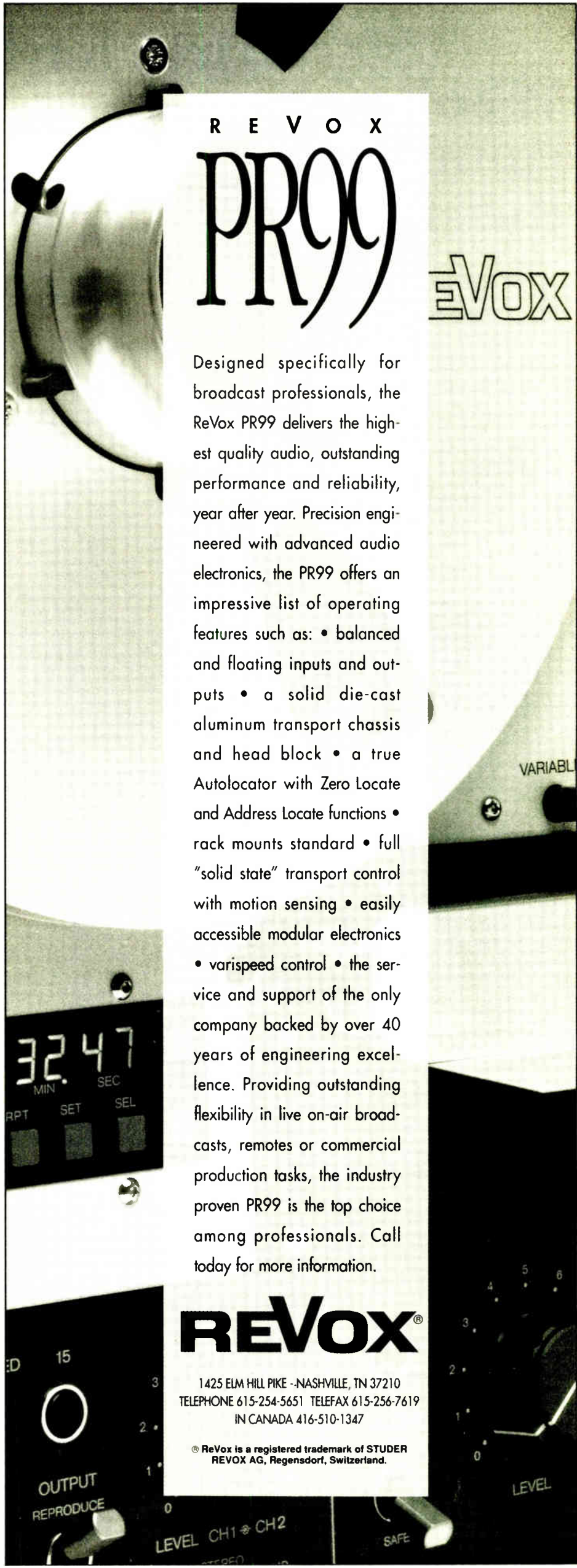

R E V O X
PR99

REVOX

Designed specifically for broadcast professionals, the ReVox PR99 delivers the highest quality audio, outstanding performance and reliability, year after year. Precision engineered with advanced audio electronics, the PR99 offers an impressive list of operating features such as:

- balanced and floating inputs and outputs
- a solid die-cast aluminum transport chassis and head block
- a true Autolocator with Zero Locate and Address Locate functions
- rack mounts standard
- full "solid state" transport control with motion sensing
- easily accessible modular electronics
- varispeed control
- the service and support of the only company backed by over 40 years of engineering excellence.

Providing outstanding flexibility in live on-air broadcasts, remotes or commercial production tasks, the industry proven PR99 is the top choice among professionals. Call today for more information.

REVOX®

1425 ELM HILL PIKE -NASHVILLE, TN 37210
TELEPHONE 615-254-5651 TELEFAX 615-256-7619
IN CANADA 416-510-1347

® ReVox is a registered trademark of STUDER REVOX AG, Regensdorf, Switzerland.

Circle (152) On Reader Service Card

Who's running the ship?

Unattended operation is one way to keep your station profitable, but you still have to mind the store.

The acclaimed Burk Technology ARC-16 Remote Control System is the first step. You can control transmitter and studio from any phone.

But wait. There's more!



Introducing AutoPilot™
from Burk Technology.

AutoPilot is break-through computer software that makes automatic operation of your studio/transmitter facility a dream come true.

- Automatic power changes
- Automatic pattern changes
- Automatic site changes
- Automatic power trim
- Automatic fault recovery
- Automatic logging

Now your imagination is the only limit.

The new FCC fine schedule is imposing. Why risk a big penalty when AutoPilot can help you stay within the rules?

Call us at 508-433-8877
or toll free at
1-800 255-8090
for more information
and a FREE DEMO.

BURK
TECHNOLOGY
Circle (32) On Reader Service Card

Wired for Phones, PCs and Sound

by Edwin Bukont

Part IV of VII

GREENBELT, Md. In this fourth of seven installments, we will look closely at electrical codes and acceptable practices for telephone, computer and audio equipment wiring.

In the previous installment, we discussed some of the electrical codes pertaining to where wires are run. Now we will look at how the codes treat different types of signals and devices used in a studio. In the National Electrical Code (NEC), Section 640, 720, 725, 800 and 810 address equipment and wiring systems used in radio facilities.

As noted in the previous article, special requirements exist for buildings with "common plenum" heating, ventilation and cooling (HVAC) systems. In common plenums and vertical risers your cable will have to be CMR or CMP "plenum" rated; this cable meets certain fire and smoke spread retardant standards, but thus is somewhat more expensive than regular CM grade cable.

The smaller paired cables (2-4 pairs) used for telephone are comparable in price to both the CMR/CMP cable and regular CM cable. For telephones and computers, it is generally cost effective to use CMR cable, which does not require using conduit as well. In your studios however, you will most likely pull multiple runs of larger multipair (9-50 pair) cable between a few dedicated locations.

Your studios will most likely have a dedicated ventilation system that does not require plenum rated cable except if studio wiring crosses through common plenum space such as in a hallway. Use regular CM rated wire in your studios. Because the studios have a closed air system and your walls run from floor to floor, you can pull the wire without conduits.

Current rules

Another area addressed repeatedly throughout the code concerns signal voltages and control of current. Two simple rules best sum up these parts. Rule 1: *Never, ever* mix

audio, telephone, or control wiring with power wiring carrying greater than 50 volts, such as is used in equipment power, lighting and warning lights.

Never mix power and communication wiring in either the same conduit, which is illegal, nor in the same bundle of wires, which is unsafe. Most studio wiring is of either Class 1 or Class 2 restriction.

Rule 2: If a power circuit is remotely controlled, such as an on-air light, and the wiring path from power, to control device, to the load (the light) is not plainly visible, separate it and make it a dedicated circuit. What is intended here is that there should be a means of definite removal of power from a circuit when it is being repaired or if accidental connection may result in fire, injury or death.

One way to meet code is as follows:

Have your electrician wire each on-air or similar warning light directly back to a common NEMA 1 (National Electrical Manufacturers Association) rated utility enclosure. Have your engineer install appropriate relays for each light here. A common power supply for operating the relays should also be located here.

Power to the relay's control supply and to the relay contacts for each light is then obtained by one dedicated circuit from your electrical breaker panel. When work is performed on the system, the breaker is turned off and this disconnects both control and lamp power.

Each lamp has a dedicated wiring run that cannot be mistakenly interrupted or connected. In some jurisdictions, it is even illegal to mount or conceal electrical power strips that are not permanently wired to a service disconnect.

One area we will not cover here, despite its importance to proper audio and control signal flow, is *grounding*. That is a series unto itself. You, however, should not neglect the installation of appropriate grounding for power lines, audio cable shields, lightning protection and ground loop prevention.

Our next area concerns ventilation, access and equipment placement as a function of both codes and practical engineering. As

vacuum tube studio gear began fading from the broadcast scene in the 1970s, the integrated circuit made it possible to incorporate some of the elaborate features of professional equipment into smaller or budget-minded equipment with less power consumption and heat dissipation.

Hot air concerns

Today, what was an option on the high end console in 1980 is demanded as standard equipment by a purchaser of even the least expensive console. Manufacturers now strive to incorporate more features or more powerful amplifiers in less space, with less weight and at lower cost.

The resulting density of components increases the operating temperature and related mechanical stresses upon the components, which in turn leads to premature failure.

While solid state devices generally do not produce as much heat as tubes to achieve a given amount of power or function, solid state does generate significant heat, which must be exhausted. The NEC provides specific guidance related to ventilation and service clearances for power supplies and amplifiers.

While these rules were designed to facilitate safe operation and servicing of tube systems, the rules are equally valid for solid state equipment. Do not bury your equipment in the bottom of some closed cabinet where it will collect dust, overheat and die prematurely.

Room to breathe

Power supplies, amplifiers and record/playback devices all contain motors for mechanical or ventilation systems. Many engineers prefer to use fans for cabinet ventilation as well. These motors will contribute both ambient noise from moving air and induce vibration into your furniture, which can create a background "hum" in the room. Here are three ways to reduce the noise and the necessity of fans:

A. Provide for natural, passive air flow through all equipment cabinets. This can be accomplished by using perforated rack panels, rather than solid panels, to provide spacing between equipment. The panel both allows air to flow into the rack and, by providing a space, allows air to flow around devices.

B. Mount large devices with internal fans in a separate cabinet, near floor level, that does not physically touch the same counter unit on which microphones are mounted. The fans should exhaust away from the operator position, but not directly against a wall or other boundary, as that will increase the noise and heat problems.

C. The pitch, or sound of a fan is inversely proportional to the size of its blades. Therefore, use the largest practical fan to obtain the lowest possible resonant frequency.

Our last topic concerns electrical, telephone and computer wall jack placement in offices. Generally speaking, you should allow one duplex electrical outlet per desk or workstation, unless there will be computer gear, fax machines or similar devices there. If that is the case, allow a quad electrical outlet at that location. Most codes require an electrical outlet every six feet, within three feet of a corner or doorway and at least one outlet per uninterrupted linear wall. The idea here is to discourage staff from stretching extension cords across doors or passageways.

continued on page 32 ►



It's the 1992 Radio Hall of Fame Induction Gala and Broadcast.

It's Radio's Big Night. And it's your chance to be a part of it all. On the evening of Sunday, November 15, Paul Harvey will host the induction ceremony originating from the landmark Chicago Cultural Center, new home of the Radio Hall of Fame. The first-ever national broadcast of the Radio Hall of Fame Induction Ceremonies will be fed live via satellite to WGN (Chicago), WBZ (Boston), KDKA (Pittsburgh), KOA (Denver) and a growing list of stations around America. To join the network free of charge or to find out how you can attend, call 312-943-8888. Because this year, there's something big in the air.



UPLINK

Satellite Control Options: A Further Examination

by Karl Baehr
and Harry Nelson

ALBUQUERQUE, N.M. This month we continue with our look at satellite and automation hardware. Let's look at two satellite control options: the "Desk Jockey" from Rodman & Brown, a computer system, and the "Auto-Jock" from Mountain America Satellite Radio, an enhanced "magic box" system.

A strength of the Rodman & Brown organization is the fact that everyone associated with it comes from a broadcast background. In fact, many have worked at the network level. This insight of knowing what goes on in the network control room, engineering, etc., is reflected in the Desk Jockey. We talked with Doug Thompson at Rodman & Brown.

RW: *The Desk Jockey appears to have been well thought out. What would you say are some of the distinct advantages of your system over others in the marketplace?*

Thompson: Though all systems are similar, we do offer that added network insight which we feel is valuable. The Desk Jockey is broadcast oriented and features "good human engineering." We call a cart a cart, etc. We also have the lowest learning curve in the market.

Both of the systems we offer are very easy to learn and use. The hardware is all top quality, commercial grade components—very durable and designed specifically to function in a broadcasting environment.

RW: *With regard to the hardware, what if there is a problem, does a user have to go through you to get the replacement?*

Thompson: No, our hardware is not proprietary. A user can go to a local supplier to get replacements if needed. We do provide suggested specifications for any replacement parts, though; they should not just go out and buy something because it's cheap and it fits.

RW: *Another quick hardware question. A broadcast environment creates a unique set of parameters as far as computer operation is concerned. Interference, long-term, endless operation—is the Desk Jockey built to take it? How?*

Thompson: Aside from the actual components, we utilize twin cooling of the hardware, power conditioning on the Desk Jockey and a state-of-the-art external audio switcher which eliminates some of the "audio pollution" problems inherent with internal switchers. The Desk Jockey also uses solid state switching, not relays which can be audible on air.

RW: *There are companies out there using terms like "user friendly," "multi-tasking," and offering around-the-clock support, training, etc. What user support services do you offer?*

Thompson: First of all, Rodman & Brown offers true stereo simultaneous record and play. You can do production anytime without interruption, not just between breaks.

We offer free on-site training and installation by qualified engineers, and a 24-hour technical support service 365 days a

year that is responsive to our clients. The absolute longest it has ever taken for us to get back to someone who needed tech support is 13 minutes. It's all part of the service.

RW: *Many people who are getting into computers or a computer system for the first time feel that if they have a problem they can sit down with the manual and figure it out themselves. Can a user work through most problems with the Desk Jockey?*

Thompson: Let me emphasize that there are no dumb questions as far as we are concerned. We offer an around-the-clock tech service because problems and questions can arise at any time. Our service is immediate and I would highly recommend that a client call us and ask first, don't just try something and hope it works.

RW: *What's the difference between The Desk Jockey and the Desk Jockey Lite?*

Thompson: Primarily configuration and storage capacity. The Desk Jockey features a tower-styled CPU, seven hours of stereo storage, a higher resolution monitor, uninterruptible power supply, and printer.

The Lite is a standard desktop CPU, VGA monitor, two and a half hours of stereo storage, no uninterruptible power supply or printer. Both are fine units; it really depends on an individual stations' needs and budget.

RW: *How many are out there now?*

Thompson: We currently have 50 units in the field and are averaging about one new unit per week.

Rodman & Brown does offer a leasing program and "no hassle" pricing. They have also just added time-based recording to the Desk Jockey.

In our efforts to cover the spectrum of available satellite and automation systems we ran across a unique, versatile and cost effective unit called the "Auto-Jock." This unit, manufactured by Mountain America Satellite Radio, could be a good first step for a station that cannot afford a computer, but needs more than just open and close relay boxes. We talked with Carl Watkins about his Auto-Jock.

RW: *How would you describe the Auto-Jock? Basically it appears to be an enhanced switch box. Is that an accurate assessment?*

Watkins: The Auto-Jock is an "intelligent switcher" that offers a great deal more versatility than standard switch or relay boxes. The Auto-Jock can interface and manage multiple sources to fill breaks—up to 13 in fact—as opposed to one source with other switchers. Break recognition and a real-time, 60-minute internal clock are a couple of the other features.

RW: *How truly versatile is the Auto-Jock? Will I outgrow it quickly, or is it a unit that can run my station for years to come?*

Watkins: The Auto-Jock does about anything you would want to do with a satellite station. It can schedule and manage a

continued on page 32 ►

RAB, NAB Cooperate

NEW ORLEANS The Radio Advertising Bureau (RAB) will increase its sales and marketing programs for radio executives at the National Association of Broadcasters' (NAB) two annual conventions. In return, the NAB will provide management sessions at the RAB's Managing Sales Conference to be held in Dallas, Feb. 4-7.

The announcement was made at a joint press conference held here during the NAB Radio Show in September.

RAB President Gary Fries believes the associations can work together to benefit the members. "We feel it is a positive forward motion for the industry. The roles of the NAB and the RAB do not overlap," he said.

At the invitation of the NAB, the RAB will program extensive radio sales and management sessions at the 1993 NAB Convention, to be held April 19-22 in Las Vegas, and will expand its sales and marketing sessions at the NAB's 1993 Radio Show, to be held Sept. 8-11 in Dallas.

Eddie Fritts, president and CEO of the NAB, also is pleased with the arrangement. "There should be a continuing close cooperation between the two organizations," he said. "We are very pleased with

this partnership. We think it will be very beneficial to our members."

The RAB also will conduct the second in a new series of exclusive Certified Radio Sales Managers Seminars (CRSM) immediately before the spring convention. The seminar—an extension of the



RAB President and CEO Gary Fries

RAB's Certified Radio Marketing Consultant (CRMC) program—will be by invitation only for executives of RAB member stations.

Registration for either the RAB programs at NAB, or the NAB convention itself, will include admission to the other. The conference will run all day on Tuesday April 20 and Wednesday April 21.

C-QUAM® AM Stereo

World-Class Radio.

With the whole world turning to Stereo, why in the world broadcast in AM Mono?

Join the stereo world community with C-QUAM... broadcasting in 17 countries (B), the national standard in 5 (S).

For details on the Motorola C-QUAM AM Stereo System, call Don Wilson collect at 708/576-3592. Fax 708/576-5479.

MOTOROLA
C-QUAM® SETTING THE INDUSTRY STANDARD

C-QUAM® IS A REGISTERED TRADEMARK OF MOTOROLA, INC.

Circle (83) On Reader Service Card

STATION SERVICES

News and Services for Business, Programming and Sales

The Weather Channel Radio Network Launched

ATLANTA Cable TV's The Weather Channel expanded its programming to provide customized weather reports and local forecasts to radio stations throughout the U.S. The Weather Channel will provide stations with live or recorded feeds on a barter basis.

Television cross promotion is included

as part of the network affiliation program. Each station will be identified several times daily on The Weather Channel as an official local source for the forecasts.

The new network is operated and represented by John T. Brady and Associates, a marketing and communications firm.

For information contact Brady at 212-688-2424; or circle **Reader Service 35**.

Griffin Report Adds Nine Markets

RIDGEWOOD, N.J. The Griffin Reports expanded its distribution of syndicated qualitative and product usage reports into nine new markets. The new subscribing markets include: St. Joseph, Mo.; Shreveport, La., and Albuquerque, N.M.

The Griffin Reports provide sales support for radio station sales departments by providing original local market information that is detailed and specific to the market. The information provided includes preferred shopping locations, automobiles, dining habits, financial institutions and recreational choices.

For information contact Craig Harper

at 800-723-4743; or circle **Reader Service 100**.

Talk Show Targets Unemployed

TRENTON, N.J. Management consultant and lecturer David Vine developed a radio interview and call-in program targeted to people interested in small business ownership and entrepreneurship.

The program airs on Mondays and Tuesdays, 7-8 p.m., on WTTM(AM) Trenton. Information on syndication opportunities can be obtained through Vine.

For information contact Vine at 609-989-4747; or circle **Reader Service 128**.

Critical Mass Media Introduces New Products

CHICAGO Critical Mass Media and Steve Casey Research have collaborated to develop three new products for radio station operators. "Variety Control" and "Instant Replay" join "DataCall" on the list of services available from Critical Mass Media.

Variety Control uses cluster analysis to show how the songs you play appeal to the different tastes of your audience.

Using a PC, Variety Control enhances weekly call-out and auditorium music tests.

Instant Replay performs advanced Arbitron diary listener analysis on your PC. DataCall sorts your listener database by core listener, peripheral, or even nonlisteners. DataCall maximizes the cost-efficiency of a database.

For information contact John Martin at 708-501-4644; or circle **Reader Service 157**.

Brite Voice Develops Marketing Tool

WICHITA, Kan. Brite Voice Systems is offering Radio DIALog, a marketing tool designed to turn radio into an interactive, two-way medium.

Radio DIALog enables stations to set up a response mechanism for their listeners to leave comments and find out more about advertisers products and services. In addition, the system allows stations to provide value-added features for advertisers. Callers use a touch-tone telephone to access the system.

For information, contact Linda Steele at 316-652-6500; or circle **Reader Service 94**.

Call Later.

Our extended hours make it easier to call on the service, selection and support of Harris Allied, the nation's largest supplier of broadcast equipment.



Eastern

8:00 am - 8:00 pm



Central

7:00 am - 7:00 pm



Mountain

6:00 am - 6:00 pm



Pacific

5:00 am - 5:00 pm

800-622-0022

HARRIS ALLIED

Options for Satellite Control

► continued from page 31

tremendous amount of sources, it is cost effective, simple to install and operate. The Auto-Jock is adaptable to any satellite format, and format or network changes are easy. We do offer around-the-clock support.

RW: Has the Auto-Jock been around for awhile?



DO YOU KNOW YOUR MARKET? YOUR COMPETITION DOES!

DATAWORLD MAPS CAN

- Depict your coverage!
- Market orient your sales people!
- Target your ethnic/demographic markets!
- Identify marginal signal areas!
- Plot any special requirements!

MAP OPTIONS

- SHADOWING (TERRAIN SHIELDING)
- CONTOUR COVERAGE
- POPULATION DENSITY
- ZIP CODE BOUNDARIES
- RECEIVED SIGNAL LEVEL
- SPECIAL REQUIREMENTS

dataworld
A Service of DW, Inc.

(301) 652-8822 (800) 368-5754

Watkins: The original version was released in 1986. We updated in 1989 and are exploring new options for another upgrade. There are about 30 units in operation. As a further statement on the versatility and durability of the Auto-Jock, we do have stations still using their original units from 1986.

Two unique system options for satellite stations: the Desk Jockey(s) from Rodman & Brown, and the unique Auto-Jock from Mountain America. Pricing for these systems: \$10,995 for the Desk Jockey Lite; \$14,995 for the Desk Jockey; \$1,495 for the Auto-Jock. You can contact Doug Thompson at Rodman & Brown at 708-983-0977. You can call Carl Watkins at Mountain America at 208-785-5940.

As mentioned last time, before you buy any system, make sure that system will meet your needs. If it does not, then it is not an option no matter what the price.

Next month in *Uplink*, we will take a look at satellite formats: What's out there, what's coming and how they differ from each other. We welcome your questions or comments as always.

Karl Baehr, is president of KBE Broadcasting By Design, a consultancy offering a variety of services to satellite affiliates. Baehr is a former programmer and air personality. Harry Nelson is president of Harry Nelson & Associates, a satellite consultancy and an Operations Manager at Satellite Music Network for nearly a decade, programmer and former air personality of the year. Harry Nelson can be reached at 800-67-RADIO and Karl Baehr can be reached at 505-828-0488.

Wiring for Your Studio

► continued from page 30

I prefer to mount all outlets (power, telco, computer) horizontally just above the base molding. I do this because all of the common furniture systems sold today have full-length skirts that prevent you from getting behind the modular furniture to access wall outlets.

Even furniture systems with raceway have little room for all of the necessary wires to each desk. Prepare ahead for initial, and changes to, construction by installing empty boxes for telco and computers.

Have your electrician connect a length of ENT conduit from the box to just above the wall header and leave two pull strings in the tube. Mount electrical, telco and computer wall outlets within a few inches of each other to reduce the myriad of extension cords. Of course, local code enhancements may require you to do otherwise.

□ □ □

Editor's note: Field modifications to equipment may invalidate the manufacturer's warranty. Before attempting any repairs or modifications, consult the manufacturer for advice and guidance.

Always use the utmost care and follow good engineering practices when working with or around electrical equipment. RW will not assume responsibility for any loss or injury.

Edwin Bukont is the CE at WPGC-AM-FM Morningside, Md. (Washington). He can be reached there at 6301 Ivy Lane, Suite 801, Greenbelt, MD 20770.

Circle (114) On Reader Service Card

SBE CONVENTION PREVIEW

SBE Boasts Record Number of Sessions

by Jerry Whitaker
SBE Vice President

SAN JOSE Final preparations are underway for the 1992 SBE National Convention to be held at the convention center in San Jose, Calif., Oct. 14-17.

The focus of the SBE National Convention has always been the technical sessions. A record number are scheduled for this year, including nine Ennes workshops. The show floor will be well-represented, with major broadcast equipment manufacturers in attendance.

For the past couple of national SBE shows, special manufacturer-conducted workshops have been scheduled in conjunction with the convention. Presented under the auspices of the Ennes Foundation, the 1992 workshops will be held Wednesday, Oct. 14, the day before the formal opening of the convention. Each of the sessions is designed to provide detailed maintenance and operational instruction on key types of equipment.

The workshops are intensive, hands-on sessions conducted by factory instructors. Attendees learn how to repair, operate and install specific types of equipment, sharpen their technical skills or polish up on management techniques.

Because of the interactive format,

seating is limited to 25 persons per session. Most of these workshops will last a half day, but one is designed as a full-day session. Upon completion of the Ennes Workshops, attendees will receive an Ennes Engineering Workshop certificate.

There also will be a comprehensive examination of the future of the Emergency Broadcast System. An "EBS Summit Conference" is scheduled for the opening general session of the technical seminar program (Thursday, Oct. 15).

Broadcast engineers have been absorbed with the EBS since its beginnings. Many engineers and SBE chapters have been involved in implementing, supporting, and recently calling for changes in the EBS. In recognition of the need for change, the FCC issued two notices of inquiry (NOIs) last year seeking to determine whether the EBS should be modified, and in what manner.

In one of the NOIs, four systems were singled out as having promise. Two of these systems have their roots in local SBE chapter work (ICEBS, EDIS). Another system, WRSAME (developed by the National Weather Service) is similar to the ICEBS. The fourth system,

SAGE I, is an RDS-based FM subcarrier data system that displays listener and other information on an LCD, printer, or terminal attached to an FM radio.

EBS and SBE

SBE responded to that NOI, commenting on the general goals of the systems, and on certain technical considerations with regard to current EBS modulation specifications.

The EBS session will provide a forum for all viewpoints. An overview of each system will be provided, and representatives will be available to answer questions from the audience. Officials from the FCC also will be in attendance to discuss regulatory considerations. To complete the program, SBE's official position in the EBS matter will be outlined.

As a way of putting the EBS question into perspective, a first-hand account will be given of the role the system played in the recent Los Angeles riots.

The centerpiece of the convention will be the annual Saturday night banquet and awards ceremony. Julius Barnathan,

Senior Vice president for technology and strategic planning for ABC, is the scheduled speaker. Barnathan, who recently retired from full-time service at the network, is well-known for his views on the business of broadcast engineering.

Off hours

Besides the serious technical issues undertaken at SBE national conventions, there will be plenty of time for some relaxation and sightseeing.

Visitors to San Jose will delight in the many things to see and do. San Jose is home to museums for people of all ages, including the Rosicrucian Egyptian Museum and the Tech Museum of Innovation. In fact, San Jose is the capital of the West Coast technology corridor known as Silicon Valley—with an impressive list of high-tech firms.

Nearly 50 award-winning wineries offer a variety of adventures, ranging from free tasting to outdoor concerts, harvest festivals to special dinners. San Jose's abundant sunshine also allows for a variety of colorful outdoor festivals and events, many featuring San Jose's cultural heritage and diversity.

Tours Scheduled for SBE Spouse Program

SAN JOSE The SBE will be offering a special two-day spouse program in conjunction with the national convention that will provide a scenic view of San Jose and surrounding areas. While members are learning about the advances in broadcast technology, their spouses or guests can enjoy the sights of San Jose.

The spouse program is open to the spouses and guests of those who are paid registrants for the technical conference, exhibitors, and those attending the exhibits only. There will be a one time charge of \$65 for the two-day program. The hospitality suite for the program will be at the Fairmont Hotel where a continental breakfast will be served. Breakfast will begin at 8:30 a.m. on Thursday and Friday. Immediately following breakfast (9:30 a.m.), the shuttle bus will depart from the Fairmont.

On Thursday, Oct. 15, departure from the Fairmont will be at 9:30 a.m. for a scenic drive to the "city by the bay." This is a great opportunity to explore the many fascinating sites of San Francisco.

The guided tour will include the Civic Center, Union Square, Nob Hill, Chinatown, North Beach, Pier 39 and Fisherman's Wharf, where participants will have free time for lunch and browsing. In the afternoon the spouses

will take in the Marina District with a great view of the Golden Gate Bridge, and then on through Golden Gate Park. The tour will return to the Fairmont at approximately 5 p.m.

On Friday, Oct. 16, the day will begin at 9:30 a.m. at the Fairmont where participants will board a bus headed on a tour of San Jose. The stops will include the San Jose Convention Center, St. Joseph's Cathedral, the San Jose Museum of Art and the Tech Museum of Innovation. Spouses may visit all of these places at their leisure.

The next stop will be the Winchester Mystery House. This beautiful yet bizarre 160-room Victorian mansion is filled with such oddities as stairs that lead to the ceiling, doors that open into walls and legends of ghosts and spirits.

After this intriguing visit, participants will continue on to the quaint town of Los Gatos, where they can have lunch on their own at one of the many unique restaurants and browse the stores and boutiques that abound in Old Town and along Santa Cruz Avenue. There will be a wine tasting at one of the two wineries located within the city limits of San Jose before participants return to the hotel at approximately 5 p.m.

TRUE BLUE FOR THE MORNING ZOO.



Drive time is your busiest time, so make sure your spots, liners and music are on the car more stations count on.

audiopak
BROADCAST CARTRIDGES

P.O. Box 3100 • Winchester, VA 22601
Tel: (800) 522-CART or (703) 667-8125
Fax: (703) 667-6379

Circle (110) On Reader Service Card

QEI QEI QEI QEI QEI QEI QEI QEI QEI QEI

WHY QEI?

24 Hours.



Our 24 hour service hotline number is 609-728-2020.

Call us toll free at 800-334-9154 for all the facts on QEI

"New Reliables" FM transmitters from 1kw to 30 kw.

Power Up.



With our FMQ 3.5/5/10 kW or 20/30 kW FM transmitters, you can upgrade power in the field.

Call us toll free at 800-334-9154 for all the facts on QEI "New Reliables" FM transmitters from 1kw to 30 kw.

No Extras.



We never charge you extra for single phase power. Not on our FMQ 10000 or our FMQ 20000B—not even on our 30 k FMQ 30000B.

Call us toll free at 800-334-9154 for all the facts on QEI "New Reliables"

FM transmitters from 1kw to 30 kw.

Less is More.



All of QEI's FM transmitters have no plate blockers or sliding contacts.

Call us toll free at 800-334-9154 for all the facts on QEI "New Reliables" FM

transmitters from 1kw to 30 kw.

Free.



Our FREE spares kits include every solid state component of the transmitter, exciter and remote control.

Call us toll free at 800-334-9154 for all the facts on QEI "New Reliables" FM transmitters from 1kw to 30 kw.

The Longest.



Our PA tube warranty is the longest in the business — 15,000 hours.

Call us toll free at 800-334-9154 for all the facts on QEI "New Reliables" FM transmitters from 1kw to 30 kw.

Single Phase 30 kW.



Our new FMQ 30000B is the only 30 kW transmitter available with a single phase power supply.

Call us toll free at 800-334-9154 for all the facts on QEI "New Reliables" FM transmitters from 1kw to 30 kw.

Built-in Backup.



QEI's constant 50 Ohm interstage impedance lets you bypass the IPA or PA in the unlikely event of a problem.

Call us toll free at 800-334-9154 for all the facts on QEI "New Reliables" FM transmitters from 1kw to 30 kw.

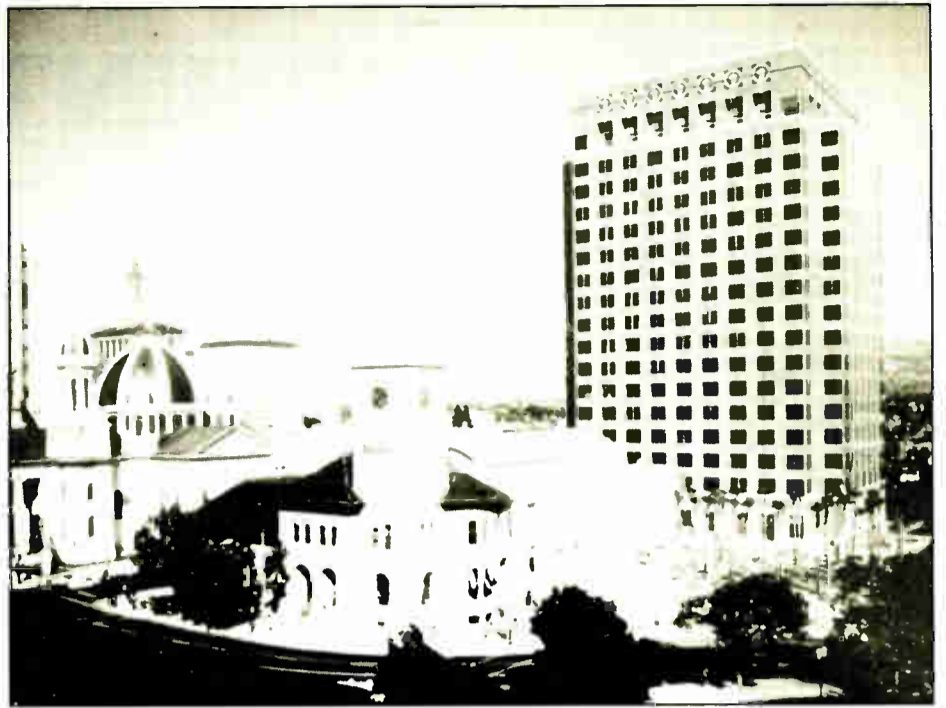

Those attending the 1992 SBE Convention will be treated to the sights of San Jose.

SBE Conference at a Glance

Wednesday, October 14:

9 a.m.-noon

Ennes Engineering Workshops

1 p.m.-4 p.m.

Ennes Engineering Workshops

Thursday, October 15:

8:30 a.m.-noon

Morning Engineering Session:

"Regulations: Jumping Through the Hoops"

1:00 p.m.-5:00 p.m.

Afternoon Engineering Session:

"The Regulatory Agenda"

5:30 p.m.-6:00 p.m.

SBE Membership Meeting

6:00 p.m.-7:30 p.m.

Chapter Chair Meeting and Member's Forum

7:30 p.m.-9:30 p.m.

Attendee-Exhibitor Reception

Friday, October 16:

8:00 a.m.-10:00 a.m.

Morning Radio/TV Engineering Sessions

10:00 a.m.-4:00 p.m.

Exhibit Floor Open

4:00 p.m.-6:00 p.m.

Afternoon Radio/TV Engineering Sessions

6:00 p.m.-7:00 p.m.

Ham Radio Reception

7:00 p.m.-9:00 p.m.

Night Owl Session:

"SBE Frequency Coordination Committee Update and Open Forum"

Saturday, October 17:

8:00 a.m.-10:00 a.m.

Morning Radio/TV Engineering Sessions

10:00 a.m.-4:00 p.m.

Exhibit floor open

4:00 p.m.-5:30 p.m.

Afternoon Radio/TV Engineering Sessions

6:00 p.m.-7:00 p.m.

SBE Reception

7:00 p.m.-9:00 p.m.

SBE Banquet

9:00 p.m.-10:00 p.m.

Reception

QEI CORPORATION
ONE AIRPORT DRIVE • P.O. BOX D • WILLIAMSTOWN, N.J. 08094
TEL (800) 334-9154 • (609) 728-2020 • FAX (609) 629-1751

QUALITY • **E**NGINEERING • **I**NNOVATION

SBE Exhibitor Directory

Editor's note: This information was correct as of press time, but is still subject to change. For additional information, contact the SBE.

Company Booth
3M705

a

Ampex Recording Media Corp.333
Architectural &
Broadcast Eng.(unassigned)
Audio Precision113
Avid Technology120

b

BEXT Inc.627
Bird Electronic Corp.227
Broadcast Consultant519
Broadcast Electronics, Inc.618
Broadcast Engineering403
Broadcasters General Store125
BTS516

c,d

C-COR/Comlux, Inc.501
California Switch & Signal704
CANCOMM628
Canon USA127
CCA Electronics, Inc.322
Clark Wire & Cable318
Comark Communications, Inc.521
Computer Concepts Corp.718
COMREX Corporation327
Control Concepts Corp.502
Current Technology, Inc.323
Delta Electronics, Inc.418
Dielectric Communications532
Diversified Marketing330
Dolby Laboratories, Inc.616
Dynatech Video Group400

e,f

EEV, Inc.523
Electronics Research, Inc.401
ENCO Systems, Inc.133
Fidelipac Corp.315
FOR-A Corp. of America706-708
Fujinon, Inc.528

h,i,j

Harris-Allied308
HM Electronics, Inc.715
Holaday Industries, Inc.(unassigned)
Hotronics, Inc.331
Hughey & Phillips, Inc.533
Inovonics, Inc.529
Intraplex, Inc.500
ITS Corp.117

k,l

Jampro Antennas, Inc.701
Kavouras, Inc.620-622
LDL Communications, Inc.228-226
Leitch, Inc.300-304
LEMO USA, Inc.629
LORAL Microwave NARDA129
Lowel-Light Manufacturing526

m,n,o

Maxwell Safety Products, Ltd.716
Microwave Radio Corp.423
Moseley Associates, Inc.621
Neutrix, A.G.105
Northern Technologies, Inc.420
NPR Satellite Services222
NUCOMM, Inc.422
NWL Capacitors332

Odetics Broadcast200

p,q,r

Pacific Radio Electronics328
Panasonic Comm. & Systems Co.508
PESA Chyron Corp.503
Philips Components126
Pioneer Communications108
Polyphaser Corp.427
Radiation Systems, Inc.326
Radio Computing Services601
Radio Systems, Inc.229
Rohde & Schwarz517

ROHN714

s,t

Sachtler Corp. of America604
SCALA Electronic Corp.119
SCTE(unassigned)
Sennheiser Electronic Corp.515
Shively Labs214
Sigma Electronics, Inc.610
Sony Corp. of America208
Tektronix, Inc.319
Television Technology Corp.416
Telex Communications, Inc.111

TFT, Inc.121-123

The Great American Market608
Tinsley Laboratories633

v,w,z

Varian Associates, Inc.726-730
Videomedia605
Vinten Broadcast, Inc.431
VMI, Inc.603
Weynand Training Intl.531
Wheatstone Corp.109
Winsted Corp.405
Wohler Technologies600-602
Zack Electronics, Inc.221-223

PURE DIGITAL.



Bottom Line Orientation.

Creating a "sound" that attracts and holds the largest possible audience is the bottom line in the radio business. And the new OPTIMOD-FM Digital 8200 is a technological breakthrough with bottom line impact.

Digital Makes the Best Even Better.

The power of digital propels the 8200 to new levels of performance and functionality. OPTIMOD-FM 8200 is a *true* digital audio processor—the audio is digitized and all control functions are digital.

What is the value of digital processing and control? In addition to a better sound, digital makes the OPTIMOD-FM more user-friendly, more programmable, more flexible. Simply put, because the OPTIMOD-FM is easier to adapt to a station's programming needs, it will produce more benefit, more of the time.

The Processor with Multiple Personalities.

With most conventional processors, multiple processing configurations require multiple boxes. With the 8200's Multiple Variable Processing (MVP) architecture, processing configurations can be

changed with the push of a button—select the protection MVP for total transparency, or the two-band MVP for an improved version of the traditional open, bright and natural OPTIMOD-FM sound which helped make thousands of stations successful. Choose the optional multi-band MVP and meet the challenge of competitive major-market processing with selectable speeds to match any format.

Power. Potential. Profitability.

Take advantage of the power, potential and profitability of the OPTIMOD-FM 8200. Call your dealer now for a personal, hands-on evaluation of the 8200.

The OPTIMOD-FM 8200 is a technological breakthrough with bottom line impact. The power of OPTIMOD—in pure digital.

Use the 8200's Automatic Preset Switching to automatically change the processing on a programmed schedule. Ideal for dayparting or multi-format stations.

OPTIMOD-FM

D I G I T A L

orban

A Division of AKG Acoustics, Inc.
1525 Alvarado Street
San Leandro, CA 94577 USA
Tel: (1) 415/351-3500
Fax: (1) 415/351-0500

© 1991 AKG Acoustics, Inc.
Orban and Optimod are registered trademarks of AKG Acoustics, Inc.
AKG is a registered trademark of Akustische U. Kino-Geräte Ges.m.b.H. Austria.

Circle (180) On Reader Service Card

Products & Services Showcase

For more information on the products shown below, circle the appropriate Reader Service No.(s) on the enclosed Subscription/Reader Service card or contact the advertiser directly.

Improve Your Voice!

Clear the cobwebs out of your mic signal path with the new **Benchmark MP-3 Mic Preamp**

- 1 dB noise figure
- THD = 0.005% (2 kHz at A=40 dB)
- Variable gain +26 to +65 dB
- Balanced output
- +48 V Phantom power input
- Jack mount anywhere!

\$95

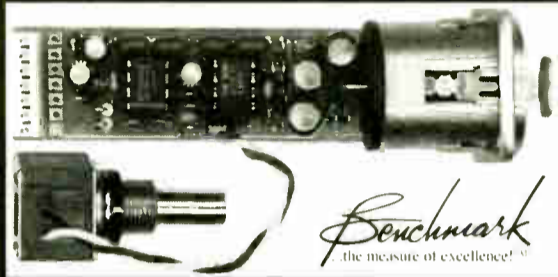

Benchmark
the measure of excellence!

Contact your pro audio dealer or call
BENCHMARK MEDIA SYSTEMS, INC.

800/262-4675 315/437-6300 FAX 315/437-8119

READER SERVICE NO. 41

The ENCO DAD486x

DIGITAL AUDIO DISTRIBUTION SYSTEM

*Special Introductory Price
\$4500

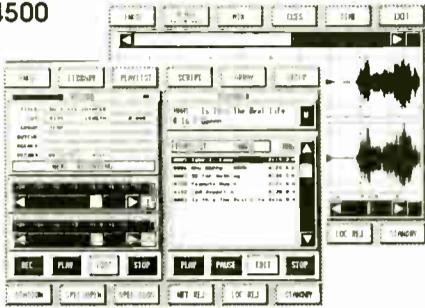

Full audio bandwidth Stereo Record/Play, Graphic Audio Editing, and Multiple Playlist capabilities. Up to 168 Instant Play Buttons for Live Assist. Runs on common PC/AT 486 systems, single station or LAN.

ENCO Systems, Inc.

1866 Craigshire Drive • St. Louis MO • 63146-4006
Tel: 800-ENCOSYS or 314-453-0060
Fax: 314-453-0061

READER SERVICE NO. 197

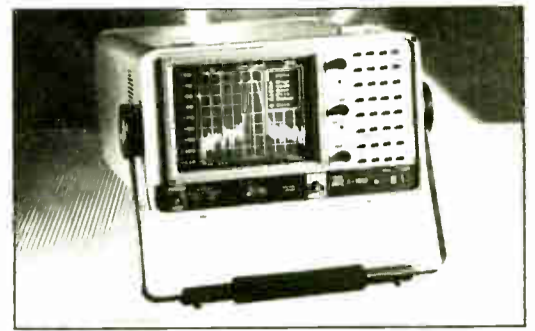

A-7550...10 kHz to 1 GHz PORTABLE SPECTRUM ANALYZER

Synthesized tuning and phase locked frequency stabilization enable accurate swept frequency measurements over calibrated span widths from as wide as 100 MHz/div to as narrow as 1 kHz/div. A standard 300 Hz resolution bandwidth filter and peak hold mode provide NRSC measurement capability. Other A-7550 features include:

- +30 to -120 dBm measurement range
- DC operation from 12 to 30 volts (Built-in battery optional)
- Optional built-in tracking generator
- Optional built-in AM/FM/SSB receiver
- Optional IEEE-488 or RS-232 interfaces.

For more information or a demonstration of the A-7550 contact:



IFR SYSTEMS, INC.

10200 West York St., Wichita, Kansas 67215
Phone (316) 522-4981 Ext. 207. FAX (316) 524-2623
DIRECT FACTORY RENTAL PLAN AVAILABLE

READER SERVICE NO. 164



Econco REBUILT POWER TUBES



Approximately One Half
the Cost of New

3,000 Hour Unconditional Guarantee

Call for Our Price List

Econco 1318 Commerce Ave. Woodland, CA 95695
Phone: 916-662-7553 Fax: 916-666-7760 Telex: 176756
Toll Free: 800-532-6626 From Canada: 800-848-8841

READER SERVICE NO. 147

WireReady™

Offering a real choice for today's radio news

STOP WASTING PAPER

SAVE TIME & MONEY

COMPUTERIZE YOUR NEWS

- Print just what you need
- Split-Screen editing
- Easy-to-Install
- Simple-to-Use



Manages: AP, UPI, Reuters, ABC, CBS, NBC, NOAA, CNN, and many others.
Hundreds of Users: AM/FM music, AM news/talk, State Networks, U.S. Gov't agencies.

WireReady Newswire Systems Inc.

31-H Union Ave., Sudbury MA 01776 USA

(508) 443-8181 (800) 833-4459 FAX (508) 443-5988

READER SERVICE NO. 50

SUPERIOR TRANSIENT PROTECTION

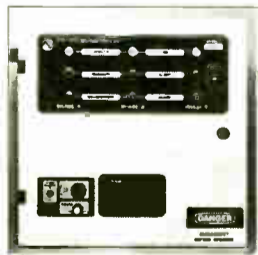

TCS-SERIES

- Two Stage Protection
- Silicon Avalanche Diodes
- Field Repairable
- 3 Year Replacement Warranty

A Silicon Avalanche based transient control system with redundant back-up stage, non-degrading and extremely fast response time to voltage transients makes this device critical in protecting transmitters, rack equipment, master control rooms, etc.

NORTHERN TECHNOLOGIES, INC.
The Leader in Power Protection Systems

15602 E. Marietta Lane, Spokane, WA 99216-1820

1-800-727-9119

READER SERVICE NO. 154

Music on Demand™

Interactive Request Line Technologies.
Turning your phone lines into money lines.

NEW INCOME

Guaranteed through advertiser sponsorships.

NEW DOLLARS

created using 900 based information lines.

Build database for direct mail, listener loyalty programs &

SALES OPPORTUNITIES

Barter, joint venture or purchase plans available.
Customized programming available.

RADIOACTIVE
RADIO NETWORK INC.

Call Steve Williams

1-305-525-9750

Ft. Lauderdale, Florida

READER SERVICE NO. 111

World Radio History

If you haven't tried this pre-amp,
you don't know how good your
microphones can sound.



If you read ads for microphone pre-amps
you'll find they all, regardless of price,
promise the same things: low distortion, low noise,
and great noise rejection.

PROMISES... PROMISES

Sontec promises you something better.
Install our MPA-1 pre-amp. If it's not cleaner and
more transparent than what you're now using,
just return it for credit. Now that is a promise!

Sontec Electronics

Audio Drive, Goldbond VA 24094 USA
703-626-7256 FAX: 703-626-7257

READER SERVICE NO. 66

Sessions Focus on Digital, Regulation

Thursday, October 15

Morning Sessions

Regulations: Jumping through the Hoops
Session Moderator: John Battison, Consultant

8:30 a.m. Planning the Future for Broadcast Engineers

Presenter: Jerry Whitaker, SBE
An examination of what broadcast engineers can do to increase their value to station management, and improve their standing in the broadcast industry. Significant industry trends will be examined, and a frank evaluation given for the next five years.

9:00 a.m. NAB: Looking Toward the Future

Presenter: Andy Butler, NAB
A summary of NAB's current positions on and involvement in emerging technologies.

9:30 a.m. Environmental Standards: What You Need to Know

Presenter: Doug Lung, KVEA
Participants include: Robert Greenberg, FCC; Robert Cleveland, FCC; Robert Surette, Shively Labs; James Hatfield, Hatfield-Dawson; Richard Tell, Richard Tell Associates; Dane Ericksen, Hammett and Edison. A panel discussion examining current antenna characteristics, and how to deal with the new ANSI RF radiation guidelines.

11:00 a.m. FOB Enforcement Panel

Presenter: Dane Ericksen, Hammett & Edison
Participants include: Chris Imlay, SBE Legal Counsel; Serge Marti-Volkoff, FCC; Thomas Van Stavern, FCC; Richard Smith, FCC.

A free-for-all discussion of current enforcement efforts and how they affect radio and TV broadcasters.

12:00 p.m. Directors Lunch: An informal gathering outside the session hall for all attendees. Get to know your SBE Officers and Directors better.

Afternoon Sessions

The Regulatory Agenda
Session Moderator: Jerry Whitaker, SBE

1:00 p.m. EBS Summit Conference

Presenter: Richard Rudman, KFWB
Participants include: Gerald Lebow, Sage Alerting Systems; Richard Smith, FCC; Ted DeLozier, FEMA. Briefings will be presented on: Weather Radio Specific Area Message Encoder (WRSAME), Improved Colorado Emergency Broadcast System (ICEBS), California Emergency Digital Information Service (EDIS).

2:30 p.m. Advanced Broadcast Coverage Prediction Model

Presenter: Gerhard J. Straub, Hammett & Edison
How to combine a terrain data base, the 1990 Census data, and an advanced propagation model into a powerful engineering tool.

3:00 p.m. Remote Control Rules: One More Time

Presenter: John Reiser, FCC
An inside look at the FCC's current approach to remote control operations.

3:30 p.m. FCC Roundtable Discussion

Presenter: Dane Ericksen, Hammett and Edison
Participants include: Dave Bennett, FCC; Robert Greenberg, FCC; Robert Cleveland, FCC; Serge Marti-Volkoff, FCC; Richard Smith, FCC; Thomas Van Stavern, FCC; John Reiser, FCC. Your opportunity to fire questions at top FCC experts, and get straight answers.

4:30 p.m. Integrated Satellite Operations Networking

Presenter: Bill Sepmeier, National Supervisory Network
How advanced digital compression can permit the establishment of cost-effective regional networks for radio and TV. Small scale networking is one way to meet the

challenges of the 1990's.

5:00 p.m. Arm-Waving Math

Presenter: Larry Albert, Murray State University
When exact formulas are not easily found, you may be able to get a close approximation with simple math and common sense.

6:00 p.m. SBE Membership Meeting

6:30 p.m. Chapter Chair Meeting and Members' Forum

7:30-9:30 p.m. Attendee Reception
The reception will be held at the San Jose Museum of Technical Innovation (The Tech).

Friday, October 16

Morning Sessions

Planning for a Digital Future

8:30 a.m. Is Digital Processing Better Because It's Digital?

Presenter: Frank Foti, Cutting Edge Technologies
With digital technology embracing the broadcast industry by storm, the area of signal processing has been slow in keeping up.

9:00 a.m. The Digital Radio Station: The Promise of Tomorrow

Presenter: Kelly Hannig, Gentner
Broadcasters today are facing a technical

revolution that offers digital equipment and systems featuring superior performance, consistency, control, and cost-effectiveness. This paper provides a check on where the technology is today.

9:30 a.m. Real World Applications of Digital Audio Compression

Presenters: Kent Malinowski and William Koos, Jr., Scientific-Atlanta Broadcast Radio and Data Systems
A white paper discussing recent advancements and future direction of digital audio compression technology and its impact on broadcast distribution, DAB and other applications.

Afternoon Sessions

New Ways of Solving Old Problems

4:00 p.m. FM Translators: Case Studies of What They Can Do

Presenter: Doug Vernier, broadcast consultant
Translators for FM service have been around for a long time. This paper examines the latest FCC rules relating to translators, and presents case studies of several installations.

4:30 p.m. Frequency Extension of Audio on Multiple Telephone Lines Using Digital Processing

Presenter: Elaine Jones, Gentner
This paper will discuss how the overall performance of analog and digital telephone frequency extension systems compare, and the real differences perceived by the listener.

5:00 p.m. Bring 'Em Back Alive

Presenter: John Collinson, WDAF/KYYS Radio

continued on page 38 ▶

CHECK ALL YOUR AUDIO IN ONE RACK SPACE

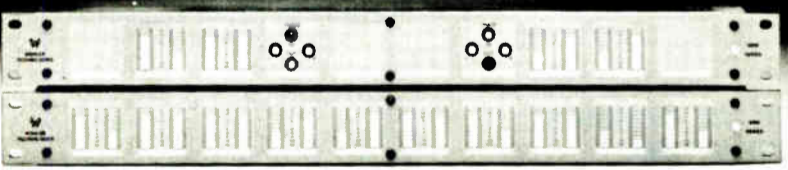

Two of many possible MSM configurations.

Only the Wohler MSM Series lets you...

- Monitor levels for up to 20 audio sources at a glance. Tri-color, 10-segment LED display instantly indicates signal level and potential overload problems. Level displays are VU or PPM selectable, with DIP-switch calibration presets at -6, 0, +4, and +8 dBv.
- Detect stereo-to-mono phase cancellation problems in up to 10 stereo pairs by substituting IPI-1 indicators. Relative intensity of top (green) and bottom (red) LEDs reveals the 'phase' (polarity) relationship between signals of a stereo pair. Left and Right LEDs indicate signal present and overrange. Overage thresholds are user presettable.
- Mix phase and level in same chassis, with level metering and 'phase' indication for up to five stereo pairs. Or leave windows empty to form groups related to system layout. For example, you can configure an MSM with 3 groups of 4 channel meters each for placement under a triple video monitor.

Call or write today for details on the MSM Series, and on the Wohler AMP Series of monitor panels: power amplifiers and speakers in one unit for hi-fi sound in one or two rack spaces!

Wohler Technologies
Innovative Audio Monitoring Systems
1349 Kansas Street San Francisco 94107 / 415-285-5462 Fax 415-821-6414

Circle (107) On Reader Service Card

\$ports + MARTI = Revenue



RPT-30 RPU Transmitter

Don't miss valuable sports revenue by not having a Marti.

Marti has been bringing back live sports remote broadcasts for over 34 years. Put Marti's proven reliability to work for you.

Contact your broadcast products dealer for more details.

VISA
MasterCard

MARTI Electronics
1501 N. Main, Cleburne, TX 76031
Phone: (817) 645-9163 FAX: (817) 641-3869

Circle (195) On Reader Service Card

Sessions Highlight Regulation

► continued from page 37

As the RF spectrum becomes ever more congested, extracting your remote broadcast from a sea of intermod is an ongoing challenge.

5:30 p.m. Designing a Recording Studio

Presenter: Sergio Beristain, President, AMI-TRA

A discussion of the key issues in audio design with emphasis on acoustics.

6:00 p.m. Ham Radio Reception

7:00 p.m. Night Owl Session: SBE Frequency Coordination Committee Update and Open Forum

Session Moderator: Richard Rudman, Chair, SBE NFCC

Panelists will include: Howard Fine, NFCC; and Gerry Dalton, NFCC

Saturday, October 17

Morning Sessions: Transmitter Clinic

Session Moderator: John Battison, consultant

8:30 a.m. Improving the Intermodulation Distortion Characteristics of Your Present AM Transmitter

Presenter: Timothy Cutforth, P.E., VIR James Engineers

High level plate modulated transmitters suffer from some inherent nonlinearities. This paper describes practical modifications and adjustments that can dramatically reduce audible intermodulation distortion, and thereby increase both the clarity and loudness of transmitters presently in service.

9:00 a.m. The Pseudo-Brewster Angle and the AM Broadcaster

Presenter: Ron Nott, Nott Ltd.

A method of calculating the pseudo-Brewster Angle (PBA) will be presented in this paper, along with a Basic computer program that includes frequency effects.

9:30 a.m. Improving FM Modulation Performance by Tuning for Symmetrical Group Delay

Presenter: Geoffrey Mendenhall, Broadcast

Electronics

This paper describes a procedure to optimize the modulation performance of any FM transmitter by tuning for symmetric group delay.

Afternoon Sessions

New Technology for Radio

Session Moderator: Michael Starling, National Public Radio

4:00 p.m. Digital Radio: Progress and Decisions

Presenter: Skip Pizzi, Broadcast Engineering
An update on recent events in the field of digital radio broadcasting in the U.S. and abroad, including standard-setting activities, broadcast format developments and survey results.

4:30 p.m. Practical Digital STL for Congested Markets

Presenter: Shau K. Ng, TFT;

This paper postulates that a 15-level digital modulation process is capable of placing the information required by modern broadcasters into a bandwidth consistent with present and future band utilization plans.

5:00 p.m. Field Experience with VPSK Digital STL

Presenter: Harold Walker, Pegasus Data Systems

VPSK modulation compresses the RF bandwidth required for digital audio and video transmission by 10:1 or more. Field experience with the system is discussed in this paper.

6:00-7:00 p.m. SBE Reception

An informal reception for all SBE members, their spouses and invited guests.

7:00 p.m. SBE Banquet

Featured speaker at the banquet will be Julius Barnathan, senior VP, technology and strategic planning, ABC.

Ennes Workshop Schedule

Tuesday, October 15

Morning Radio-Related Workshops: What You Need to Know About Power Conditioning.

Sensitive broadcast equipment demands a well-planned electronic distribution system. This workshop will discuss the requirements and options available to broadcasters.

Afternoon Radio Workshops: Contract Engineering: Planning a Successful Business.

This half day session will be moderated by Chip Morgan. Participants will get straight talk about how to run a successful contract engineering firm. This idea-packed session features the authors of "Working from Home," Paul and Sarah Edwards, former SBE National Treasurer Bill Harris, SBE Council Chris Inlay, and a financial expert (to be announced).

NRSC-2: What It Is and How to Comply.

Presented by Delta Electronics, this half-day session will include both lecture and hands-on elements. Participants will learn how to measure splatter with both a spectrum analyzer and a splatter monitor. Participants also will see the differences between measuring for NRSC-2 compliance using regular programming and pulsed WSASI noise.

Getting Into BBS.

Terry Baun and Fred Baumgartner will chair this half-day workshop, which will hopefully lead to a national SBE network of chapter BBS systems.

SEE SPOTS RUN.

On-screen traffic log display

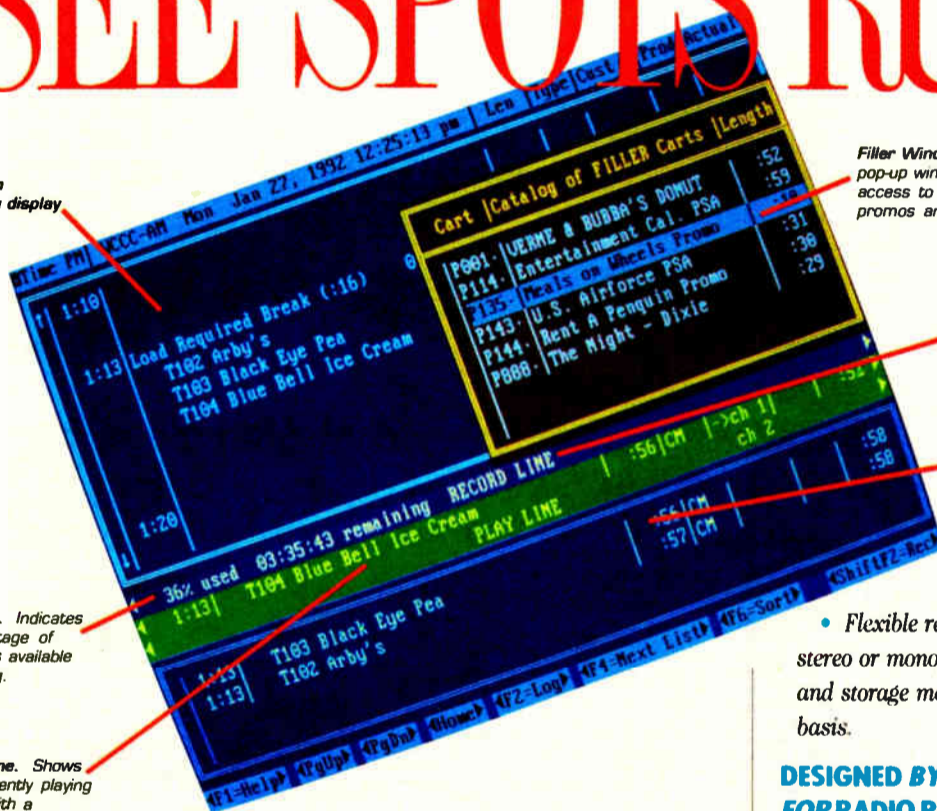

Filler Window. This special pop-up window gives you quick access to PSAs, jingles, promos and other fillers.

Record Line. Shows what DCS is currently recording.

Queue Window. Just click on a listing, to place recordings in the queue for playing.

"Gas Gauge". Indicates what percentage of the system is available for recording.

The Play Line. Shows what's currently playing on-the-air, with a count-down timer.

- Flexible recording options -- choose stereo or mono, varying sample rates and storage methods on a cut-by-cut basis.

DESIGNED BY RADIO PEOPLE FOR RADIO PEOPLE.

Computer Concepts is one company you can count on---we've provided automated business systems to the radio industry for over seventeen years. We know how radio stations work and how to make them work more efficiently. That's why the DCS interface is so easy to learn, so simple to use.

ASK ABOUT OUR AFFORDABLE ENTRY-LEVEL SYSTEM.

To find out more about our entry-level system, or to receive a free DCS demo disk, call or FAX us today. You'll soon see one thing very clearly. You just can't manage as well without us.

FREE UPDATED DEMO DISK!
(800) 255-6350
OR FAX (913) 541-0169

Computer Concepts CORPORATION

8375 MELROSE DR. LENEXA, KS 66214

ADVANCED FEATURES ENGINEERS DEMAND...

- **Digital Audio Editing.** The quickest and most flexible real-time editing function available makes editing news stories and commercial cuts simple.
- **Satellite /Live-Assist Operation.** Total support, including automatic back-fill of breaks.

- **Support of multi-cut "cuts"**
- **Complete audit of all DCS activity -- airplay of audio, relays, etc.**

...PLUS FEATURES OTHERS DON'T OFFER!

- **Simultaneous Play/Record features.** Handle three stereo sources simultaneously -- overlap two spots for a tight segue, and record from another source at the same time.
- **High quality data reduction, without distortion**
- **No pre-allocation of disk space required.**

Replace the chaos of carts with the speed and precision of the Digital Commercial System (DCS) from Computer Concepts.

By combining a standard industrial-grade PC with an advanced stereo audio board, DCS lets you program a day, a weekend, even entire weeks!

AUTOMATE EVERYTHING, FROM PRODUCTION TO BILLING.

Production Studio. DCS simplifies board work and replaces the muddy sound of analog tape with crisp CD sound quality.

Control Room. No more manual logs! DCS handles all your paperwork automatically, posting a commercial's actual airtime next to that listing. And DCS interfaces with traffic!

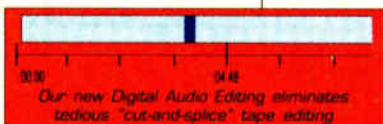

Circle (56) On Reader Service Card

LINE OUT

The Finer Points of PC-Based Editing

by Bruce Bartlett
with Jenny Bartlett

ELKHART, Ind. In the past few columns, we've been looking at an example of a digital audio editor: the Turtle Beach 56K system. We covered its components, how to install it, and how to record and edit.

Let's say you recorded a soundfile, such as a group of songs you want to edit into a concert promo, onto hard disk. Within that soundfile, you defined several zones. Each zone is a part of a song. Now you're ready to assemble a playlist—a sequence of zones.

Assemble a playlist

Here's how you might put one together. First, choose "playlist" from the list of options. The names of the zones you defined appear in a window. Now simply click on the names of the zones you want to hear, and drag them into the playlist window in the order you want them played.

You can repeat zones, re-order them, insert spaces between them, or do crossfades—all with the click of a mouse.

Want to remove Verse 2 in a song? Define two zones, one before Verse 2 and one after. Put these two zones in a playlist, one after the other, and play them. The head that reads the hard disk will skip over Verse 2 without missing a beat.

With the Turtle Beach system, playlist events can be triggered by SMPTE time, a MIDI note, mouse or spacebar. You can generate MIDI note events at selected times.

What's more, you can create a playlist from the zones in up to four different soundfiles. The playlist might have two zones from soundfile 1, four zones from soundfile 2, and one zone from soundfile 3.

Once your playlist is done, play it and record it back onto your DAT machine. There's your edited recording. It might be short segments of several songs, or an edited voice-over.

Speeding the process

Any digital-audio editor runs the hard disk a lot, and this is time consuming. You'll have to wait whenever you do a destructive edit, which changes the soundfile data on disk. Destructive edits such as cut, paste, delete, or mix will test your patience, taking a few seconds to a few minutes.

Crossfades are not destructive, but long ones can take several minutes to calculate.

There are ways to speed up operations. One is to edit the playlist rather than the sound track. Let's give an example. Suppose that a voice-over you recorded contains a flubbed sentence, and you want to remove it.

You could delete the sentence from the soundfile, but the computer will take several seconds to calculate this process. Instead, define two zones on either side of the sentence and play them from the playlist. The playlist manipulates pointers to the data on disk, so it works very fast.

If you want to edit one portion of an entire production, record only that portion onto hard disk, not the entire pro-

gram. After editing the portion, dump it back to DAT.

How to prevent errors

Turtle Beach offers some suggestions that can reduce data errors during recording. First, try these tips to prevent fragmentation of the data on disk: format the soundfile disk each time you start a new project. Run a disk defragmenter program. Pre-size the soundfile (tell the program how long the soundfile will be).

If an error is reported during recording, re-record the program. Chances are it will record error-free the next time. Also, use a hard drive with faster throughput. A transfer rate of 500 kilobit per second (kbps) will result in some errors, but a rate of 1.8 Mbps can allow an error-free recording.

Time compression and SMPTE chase lock are not yet available with the Turtle Beach system, but will be eventually.

We've now worked with a typical digital audio editing system. If you use one, you'll wonder how you ever got along with the old razor blade and splicing block.

Bruce Bartlett is a microphone engineer and technical writer for Crown International, and the author of Stereo Microphone Techniques, published by Focal Press. Jenny Bartlett is a technical writer. Bruce can be reached at 219-294-8388.

Extra Features Found in 56K:

- Realtime analyzer
- 3-D waterfall-type realtime analyzer (a plot of spectrum vs. time)
- Pencil cursor—lets you redraw a waveform to remove clicks
- Markers—insert them into a soundfile
- Equalization—four bands of EQ with adjustable frequency and bandwidth, plus a graph showing the response of the equalizer
- Playback speed control—affects both speed and pitch
- Zone reverse—play a zone backwards
- Undo an edit—restore the audio program
- Crossfade—can be used to smooth the transition between two zones or soundfiles that are butted against each other
- Invert the polarity of one channel
- SMPTE and MTC generator/reader/converter
- Automation of a multimedia production or a spot by triggering sound effects and MIDI music at selected SMPTE times
- Mixing of up to three soundfiles or zones to a fourth soundfile
- Two utilities that check the hard-disk access time and data transfer rate (throughput).

Is That FM a Good Buy?

► continued from page 21

to the contours. There are many public domain computer programs that handle this task nicely as well as online programs on Dataworld and BDS, or you can use the graph in the FCC Rules.

Next, factor in any short-spacings that may indicate interference within the normally protected contour. You will have to find the distance to the interfering contour from the site of the other station (be sure to use the F(50,10) graph to calculate interfering contours) along the appropriate radials.

If there is an overlap, you will have to perform several iterations to find the point at which the necessary desired-to-undesired (D/U) ratio occurs. For example, for a co-channel short-spaced station, the ratio is specified in FCC Rule 73.215 as 20 dB. Normally, a Class C station's 1 mV/m (60 dBu) F(50,50) contour would not be overlapped by a co-channel station's 0.1 mV/m (40 dBu) F(50,10) contour, but if overlap does exist, you might find that not until your station's 1.2 mV/m contour does the co-channel station's interfering signal level become more than 20 dB down. Adjust the distance to the predicted interference-free contour accordingly on the affected radials.

Finally, factor in any terrain. If a ridge line effectively blocks coverage beyond, stop your contours at that point, using the ridge line itself as the contour line.

Plot both contours on the map, labelling

them neatly so as to give your map a professional appearance. Mark any other features of interest, such as principal community (city of license), target coverage areas, transmitter site, downtown areas (where tall buildings may cause shadows and multipath), and the like.

The report

Finish your study by writing a comprehensive report of your findings. Be careful to avoid using "engineer-ese": use language that your boss will understand. Point out the reasons for any differences in the coverage you have predicted and the coverage represented to be true by the seller or broker. Note any likely trouble spots and state the reasons for your findings. Also note any potential for upgrade or improvements, stating what would be required to achieve any improvement, including a guesstimate of cost.

With your report and map in hand, your boss will be walking into (or away from) the potential deal with his eyes open. If he walks away as a result of your findings, be glad that the problems you found weren't discovered after the deal was closed.

Finally, be prepared to back up your conclusions with hard facts. Sellers sometimes react strongly to reports critical of their properties, and you may have to defend your findings.

Cris Alexander is director of engineering for Crawford Broadcasting. He can be reached at Box 561307, Dallas, Texas 75356.

Digital automation for station owners

You don't make hasty decisions. You do your homework. It's how you got to where you are today.

You owe it to yourself to understand why companies like Bonneville Broadcasting chose Desk Jockey digital automation systems over all others when they did their homework.

Do your homework, and make the call.

You don't need another headache.

You need a Desk Jockey.

the
Desk Jockey™

Digital automation that makes sense



**BROADCASTERS
GENERAL STORE**
2480 S.E. 52nd St., Ocala, FL 34480
(904) 622-9058

Circle (12) On Reader Service Card

Radio World

Broadcast Equipment Exchange

"Broadcast Equipment Exchange" accepts no responsibility for the condition of the equipment listed or for the specifics of transactions made between buyers and sellers.

AMPLIFIERS

want to sell

Microtrak 6401, (2) phono pre-amp, \$50 ea. M Guidotti, Monument Media, 1170 Park Grove Dr, Milpitas CA 95035. 408-946-9466.

Radio Design STA-1 universal line amp, new bal/unbal stereo to mono, \$50. P Russell, Bowdoin Coll, Sills Hall, Brunswick ME 04011. 207-725-3066.

BGW #100 30 watt stereo amps (3), \$150/BO each. 816-532-0460.

Apt-Holman preamp & Apt Pwr Amp One, \$500. P Wells, KJQY, 625 Broadway #1200, San Diego CA 92101. 619-238-1037.

Marantz 6-B, excel cond, \$995; pair Mdl 9's, BO. Dave, 305-866-6048.

Edecor 50 W mono PA, rack mount, \$65. G Wächter, KFYI, 631 N 1st Ave, Phoenix AZ 85003. 602-258-6161.

Quad 50E 50 W, mono, new cond w/manuals & cords, BO. J Thornton, Maple Island Music, 1010 Hwy 104 S, Glenwood MN 56334. 612-762-1501.

Marantz 7T pre-amp, \$125; Yamaha C3 pre-amp, like new, \$150. J Parsons, 904-532-0192.

Marantz 2130 quartz-locked tuner w/scope, 3250B control preamp, 140 amp w/VO meters, \$695; Mdl 2270 tuner, pre-amp & amp rcvr, \$125. J Price, 214-321-6576.

Decent, low-med wattage stereo audio, \$100-\$150. P KJQY, 625 Broadway #1200, San Diego CA 92101.

Shaffer/Ampex, (2) transistorized play elect for Ampex R-R, \$25 ea+s/h. D Morgan, KNXX, Box 969, Grand Junction CO 81501. 303-241-9230.

Harmon Kardon CA-40 tube amp, 40 W, \$100. E Davison, 217-787-0800.

Altec 1608 200 W mixer, \$150; (4) 1590s, \$120 ea; 1567, \$75. C Elmasian, Tri-Core, 27503 Five Mile, Livonia MI 48154. 313-427-0832.

RCA, Altec tube mic pre's & tube amps & mixers; Langevin AM-16's, sale or trade. Tracy Eaves, 615-821-6099 (evenings before 10PM EST).

New 250 W solid state amp, \$1800. Call for details. Bill Hoffman, 518-583-9490.

want to buy

Cutter w/feedback to work w/Grampin cutter head, mono, up to \$300. H Sewell, Oakridge Music, 2001 Eltron Rd, Ft Worth TX 76118. 817-838-8001.

ANTENNAS & TOWERS

want to sell

ERI G5CPS-8 on ground in Santa Fe, on 95.5, BO. J Curtis, KFRO, POB 4299, Longview TX 75606. 903-663-3700.

Hard Line Parts, 4 1/16", (4) elbows, (2) 3 1/8" to 4 1/8" adaptors, (2) field flanges, 4 1/16" hanger kits, \$1900+s/h; ERI G4CPH, tuned to 96.1 MHz, 10 bays ctr fed, 500 W operating heaters, mounting brckts, \$6500+s/h. C Murray, 503-484-9400.

Anixter-Mark 4' & 8' grid 890 to 960 MHz, \$1500/BO. 816-532-0460.

Phelps-Dodge 42-158-50 FM harmonic filter for parts w/CSI FM 3000E, 1 5/8" flanged, 2" piped in, 6' long w/bullet & hdwr, \$75/trade. Sidney, WDM, POB 357, Dover ME 04426. 207-564-2642.

ERI 37CP6 circ polar 6-bay FM tuned to 102.1 MHz w/deicers. J Church, WLUM, 2500 N Mayfair, Milwaukee WI 53226. 414-771-1021.

ERI FML-3E 3-bay CP on 104.9 w/1 5/8 conn, BO. A Kilgore, 205-275-8839.

Gorman Redlich AM direc mon, \$1000. J Randolph, WMGE, Box 1230, Danville KY 40422. 606-236-2711.

Andrews 87N (3) female N-conns for HJ7-50A Heliac, \$50 ea; (10) 44ASW male N-conns for FSJ4-50B Heliac, \$25 ea; (10) 74N for LDF-50/HJ4-50 Heliac, N male, \$25. A Olean, Univ of S ME, 96 Falmouth St, Portland ME 04103. 207-780-4424.

Gates FMC 4A 4-bay, side mount, pressurized, tuned to 103.1 w/deicer, \$1000. B Derking, KNDY, RRR3, Marysville KS 66508. 913-562-2361.

Collins phasor, 3-twr, cabinets match Collins 21E xmt, 5 kW/1 kW DA-2, 1280 kHz, (2) cabs w/ATUs, excel cond, \$10000/part out. P Berger, WNAM, POB 707, Neenah WI 54957. 414-727-2040.

H&P (2) 300mm code beacons, excel cond, \$500 ea + s/h. J Weitzman, New World Radio LP, POB 27781, Washington DC 20038. 202-682-3536.

Potomac Inst PM 190 3-twr phase/current monitor, \$500. CD, KVV, POB 459, Woodville TX 75799. 409-283-3734.

Used towers bought and sold. Call 1-800-643-6988.

want to buy

101.5 FM 2-4-bay; 60-100' self-supporting tower/monopole. P Lopeman, 414-482-1959.

770' FM on 92.7, 93.9, & 98.7 MHz. G Violet, Violet Comm, 331 Lookout Pt, Hot Springs AR 71913. 800-676-1736.

600', on ground, gd cond. K Austin, KFXI, 1101 Hwy 81 N, Marlow OK 73055. 405-658-9292.

8-bay FM that can be tuned to 103.3 MHz. R Murphy, 800-582-7625.

Dehydrator for air Dielectric cable. C Brescia, WNBZ, Box 211, Saranac Lake NY 12983. 518-891-1544.

3-twr array phasor, 1290 kHz w/5000 W day/night power rating. D Wolfe, 714-684-1991.

ER/RCA FM ant & number of bays tuned to 106.1 or 99.7 MHz. D Lacy, Min States Bdcg, 1885 Ponder Hts Dr, CO Spgs CO 80906. 719-636-2470.

AUDIO PRODUCTION

want to sell

Ashley CL50, (2) peak detectors/compressors/limiters, superb cond, BO. Jim, Paragon Bdc Svcs, 509 3rd St, Peckville PA 18452. 717-383-1118.

Rane HC-6 6-chnl stereo headphone amp, \$200+s/h; (3) Gentner 96-BA-AB patch bays, loose jack on 1, 1 wired to Molex, \$350 ea/\$900 all+s/h; (3) Fostex 3010 RCA patch bays, 32 ea, in Crown walnut rack, \$70 per bay/\$210 all+s/h. D Crepps, IBS, 29672 Silver St, Val Verde CA 91384. 805-294-9441.

CBS 443-Audimax R11Z tube-type auto-level control w/spare memory mod, BO/trade for broken UREI LA-3A. J Roper, Imperial Sound, 383 N Studio St, Terre Haute IN 47803. 812-877-2663.

dbx stereo NR unit, rack mount, \$100. M Guidotti, Monument Media, 1170 Park Grove Dr, Milpitas CA 95035. 408-946-9466.

Eventide H910 harmonizer, gd cond w/manual, \$400. J Addie, WFM, 303 E Wacker Dr, Chicago IL 60601. 312-565-5033.

dbx 163X stereo strappable, over easy compressor/writer, HI-2 & line level inputs, single slides control, new, \$80. B Harwell, Compact DJs, 1861 Brown Blvd #630, Arlington TX 76006. 817-649-3535.

Ashly SC 66 stereo para EQ, great cond w/manual, \$300. D Bailey, Rock Shoppe Prod, 3422 Beech St, Rowlett TX 75088.

TEAC A-1200 stereo, gd cond, \$3000; Fidelipac carts: 40 & 70 sec, \$1.50 ea; 3:30, \$2 ea. M Delgado, KLAT, 1415 N Loop W #400, Houston TX 77008. 713-865-4518.

Shure SR107 3rd octave audio, equalizers (3), \$100/BO each. 816-532-0460.

Altec 3/4 octave rack mount graphic EQ, \$95. G Wächter, 602-258-6161.

Eventide H949 Harmonizer, excel cond, \$795. B Mountjoy, WXRC, POB 938, Hickory NC 28603. 615-543-5849.

dbx 118 expander/compressor, \$100; Phase Linear 1000 audio corrolator, \$100; dbx 110 subharmonic Boombox w/crossover, \$125. R Glenn, WJGR, 1718 Shannadoc, Wimauma FL 33598. 813-634-1940.

CASSETTES • CARTS • REELS

J & I AUDIO/VIDEO

A wholesaler in the Radio and Television market.

Now running SPECIALS on audio and video:

BASF CASSETTES-AMPEX R-Rs

AUDIOPAK, FIDELIPAC & ITC CARTS

For more information call Kris Elliot at

1-800-942-1711

or write to: J&I Audio/Video

20899 Kelvin Pl.

Woodland Hills, CA 91367

Circle (4) On Reader Service Card

BBE 822 sonic maximizer, BO. Tom, KMXN, 499 Humboldt St, Santa Rosa CA 95404. 707-544-5693.

Lexicon Prime Time reverb, \$150; (2) dbx 177 Type 1 NR units, \$200 ea; UREI copper time cube, BO. J Kry, 513-556-4444.

Shure RTS-5000, \$150/BO; Shure 610 cut EQ fdbk controller, \$50/BO; Technics SH-9010 para EQ, 5 band, stereo, \$350. E Davison, 217-787-0800.

MCI JH110A 2-trk in stand w/sound & vision remote/locator, \$1200; Orban 674A paragraphic stereo EQ, \$600; Fostex 3070 comp/limiter, \$150; Fostex 3180 reverb, \$50. W Gunn, 619-320-0728.

Prophet 600 synthesizer, \$450; Spectro Acoustics rack mount 200 W amp, \$150; Crown VFX2 electronic crossover, \$125. W Gunn, 619-320-0728.

TT (Bantam) ADC patchbays, 144 pts, 1 rack sp, \$129; Tannoy HPB385A 15" coaxial monitor pair in cabinet, \$1750; Altec 436A tube compressors, Daven attn, both \$700. W Gunn, 619-320-0728.

Publison Infernal Machine 90 stereo in/out, stereo pitch shifting, dig delay, echo, .05 memory, excel cond, BO. R Kaufman, Pams Prods, POB 462247, Garland TX 75046. 214-271-7625, after 3PM CDT.

Roland SPH323 phaser, \$75; Rockmann sustainer & stereo chorus/delay, \$350/both. W Gunn, 619-320-0728.

want to buy

AKG 414 P48 like new, \$675; Dynaco 410, 400 W amp, \$400; dbx 1BX expander, \$135. W Gunn, 619-320-0728.

WANTED

DEAD OR ALIVE!

PULTEC EQ'S

Fairchild & Teltronix Limiters; Neumann, Telefunken, AKG, RCA, & Schoeps microphones. Tube McIntosh or Marantz amps & pre-amps, Sontec, ITI, & Lang EQs. Neve or API equipment. Boxes of old tubes: Urei, Orban, United Audio, DBX, & other outboard gear. Ampex ATR102s or 104s. Parts for MCI JH110/114 recorders. Altec 604s/crossovers/Tannoy speakers. JBL 2231; Altec 288h drivers; Misc. equipment of all types.

Please Call: Dan Alexander Audio 5935 Market St. Oakland, CA 94608 1-(415) 644-2363 FAX: 1-415-652-4022

Altec 1628A auto mic mixer & 1588C mic preamp modules. A Olean, WMPG, 96 Falmouth St, Portland ME 04027. 207-780-4974.

Eventide mic proc/spec effects proc. Heritage Radio, POB 16, Boston MA 02167. 617-969-9966.

Fairchild 600 conac or 602 Conex high freq limiters. J Gangwer, 942 32nd St, Richmond CA 94804. 415-644-2363.

AUTOMATION EQUIP

want to sell

IGM 400 w/cables & manual, \$250; SMC DP-1 w/control head. (2) AS-16 & AS-20 switchers, (2) LA-246, (2) MA-4, RAC controllers & 2 spare brains for parts, cables & manuals, \$1000; (2) Gates/Schafer RA-1 w/250 interfaces, (3) ACSO Schafer random access programmers, \$100 ea/\$400 all. K Carlson, KMUT, 1100 Blue Lakes Blvd N, Twin Falls ID 83301. 208-733-1100.

IGM Go-Cart (4) 42-tray, \$2500; (2) 78-tray, \$3000, stereo, 3-tone, in svc. working; Cetec 7000 w/all options, 16 inputs, dual pwr splys, extras, \$5000. R Klotz, WCNO, POB 3434, Lake Isabella CA 93240. 619-379-5636.

BE16 complete syst for tape/sat, 3000 events software, gd cond, \$6000. D Brown, KVLE, POB 832, Gunnison CO 81230. 602-645-8181.

X-7 Systemation. R Murphy, 800-582-7625.

Shaeffer 903E (5) ITC 750 stereo PB, 4/48 cart audiophiles, (5) ITC singleplays, excel cond. BO. J Curtis, KFRO, POB 4299, Longview TX 75606. 903-663-3700.

SMC 250RS needs heads & cleaning, \$150 +s/h. D Lacy, Mtn State Bdcg, 1885 Ponder Hts Dr, CO Spgs CO 80906. 719-636-2470.

Schafer 800S w/(5) mdl AG 440 Ampex stereo PB units w/TTD-4A cue time delays, rblt hds, rack mounted, very gd cond, \$5500. L Weidman, WGRC, 150 Buffalo Rd, Lewisburg PA 17837. 717-523-1190.

SMC syst in (3) racks w/3060 10-source prog, AS-10 switcher, (3) RS250 Carousels, (2) Otari ARS1000 reel PBs, dual SMC TS-25 tone sensor, PDC-3 time announce control, (2) 721 dual play cart plyrs, LA-246 stereo AGC amp, LA-246 mono amp, PSA-1 pwr sply, RC-10 rem ctrl w/50' cable, SMC 790 mono cart R/P nds work, all manuals, spare parts & 80 reels 80s C&W music, \$5500. D Sports, 912-739-3035.

Systemation X7D cass w/(6) Nakamichi MR2 cass decks, nds 2 Commodore computers to run, BO. Tom, KMXN, 499 Humboldt St, Santa Rosa CA 95404. 707-544-5693.

IGM-EC syst Alpha 250 UPS, (4) stereo Go-Cart 24s, (2) racks w/A/C, Panduit & (2) side panels, PC422 I/O cards, interconn cabling & spare parts kit, BO. L Martino, 714-684-1991.

Tape-a-thon Chnl Caster w/(5) 10-1/2" R-R, gd cond, \$1000. R Swafford, IAM, 610A S Battlefield, Springfield MO 65807. 417-883-7513.

SMC 350 Carousels (4) w/random access controller, \$400 ea/BO; (2) SMC 722 cart plyrs, rack mounted, \$150 ea/BO; (2) Revox A77 R-R tape P/R, \$200 ea; (2) 19" equip racks, BO. D Quinlan, KYRE, 316 Lawrence Ln, Yreka CA 96097. 916-842-4158.

SMC 250 (4) Carousels, 1 for parts, \$150 ea +s/h; (2) SMC 350 Carousels, 1 for parts, \$200 ea; (5) Harris racks & 2 end panels, \$500. F Konwinski, WSOY, 1100 E Pershing Rd, Decatur IL 62524. 217-877-5371.

BUSINESS OPPORTUNITIES

Music service business with 2 complete format libraries plus recording equipment, tremendous potential, great price. J Gelo, 813-642-6899.

Midtown NYC (2) audio prod studios, 24 trks, great oppor. 212-949-9198.

CAMERAS (VIDEO)

want to sell

RCA TK-761 (4) w/cases, cables, CCU & (4) TD-8 stands; Ampex VPR-1, \$5000 all. C Elmasian, Tri-Core, 27503 Five Mile, Livonia MI 48154. 313-427-0832.

Hitachi FP15 (2) color, 3-lube Saticon, 1-1/2 & 4-1/2" viewfinders, rear servo zoom & manual focus ctrls, rem ctrl units & cables, ext pwr sply, case, svc manual, extender cards, 10:1 Hitachi zoom lens, \$3500 +s/h; Hitachi FP21 color 3-lube 1-1/2" view finder, Anton ball brckt, case, svc manual, extender cards, camera plate, VTR cable, \$2000 +s/h. D Hurd, Harding Univ, 805 Park St, Searcy AR 72149. 501-279-4658.

CART MACHINES

want to sell

BE 505 Spotmaster mono, play, BO/trade old cass deck. J Roper, Imperial Sound, 383 N Studio St, Terre Haute IN 47803. 812-877-2663.

Viking/Telex NAB-style bckgrnd music plyrs w/amps & cabs, mono, hds & spds changeable, pick up in IL, free. E Davison, 217-787-0800.

ITC RP series w/counterp R/P, mono, e-tones, great cond. Jim, Paragon Bdc Svcs, 509 3rd St, Peckville PA 18452. 717-383-1118.

ITC RP mono rec, rack mount w/new hds, \$500/BO. K O'Malley, 804-446-2731.

Fidelipac/Dynacart CTR 100 w/splice, erase tone func, stereo rec. BO. G Brown, WJBM, 1010 Shipman, Jerseyville IL 62052. 618-498-2185.

ITC 99B, (8), new, \$1595 ea. J Addie, WFM, 303 E Wacker Dr, Chicago IL 60601. 312-565-5033.

BE 5310 stereo rec amp w/aux tones for triple deck cart, gd cond, \$750. R Cowell, KNTR, POB 308, Ferndale WA 98248. 206-384-5117.

Sine Systems

Dial Up Remote Control

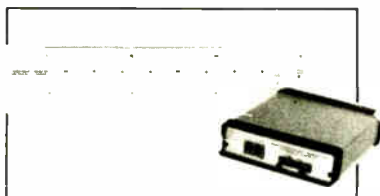

Complete 8 channel expandable system costs less than \$1,500!

New Features For 1992!

Automatic transmitter power control

Alarm dial out for six telephone numbers

Timed functions for PSA, PSSA or other uses

Optional RS-232 computer interface

Software update for older units available for less than \$100!

THE SMART CHOICE!

HE HALL
Electronics

1305-F Seminole Trail
Charlottesville, VA. 22901
(804) 974-6466

Mastercard & Visa Welcome

Circle (63) On Reader Service Card

ITC

REPAIR — REFURBISHMENT

Direct Factory Cartidge Machine Repair Service
Upgrades or Refurbishment
All Work Warranted

Call The ITC Technical Service Department
Toll-Free at



(800) 447-0414
(309) 828-1381



International Tapetronics Corporation
2425 South Main Street
Bloomington, IL 61704



CART MACHINES...WTS

BE 2100 & 2300 PBs & R/Ps, all mono w/tones & manuals. D Albanese, WEEI, 529 Main St, Boston MA 02129. 617-242-5900.

Tapecaster X700RPS, gd cond, \$595; (2) Tapecaster X700PS, \$395 ea. A Ishkanian, Advent Dup, 132 Arbor Oak, Ashland VA 23005. 804-752-6942.

ITC 3D, (1) mono, single tone; (1) stereo w/new hds, BO. B Eddy, WRRR, Box 374, St Marys WV 26170. 304-684-3400.

ITC 99B, (8), \$1595 ea. J Addie, 312-565-5033.

ITC Delta series stereo cart plyr, new, guar. \$1450. M Hoffman, Laurelwood, Rt 3 Box 281-14, Charlottesville VA 22903. 804-823-6314.

ITC 3D clean, just svcd, 3-deck, \$1000; ITC 99B stereo R/PB, great shape, \$2000. P Van Houten, KBBY, POB 5600, Ventura CA 93005. 805-656-6300.

ITC 99B (8), \$1295 ea. J Addie, 312-565-5033.

BE 5300C tripledeck, stereo, PB, mint less than 50 hrs, BO. R Kaufman, Pams Prods, POB 462247, Garland TX 75046. 214-271-7625, after 3PM CDT.

want to buy

ITC/BE/Audicord, any cond. P Lopeman, 414-482-1959.

Tone board for ITC Delta III triple decker, not working OK. K Austin, KFXI, 1101 Hwy 81 N, Marlow OK 73055. 405-658-9292.

CASSETTE & REEL-TO-REEL RECORDERS

want to sell

Ampex ATR-700 (2) 1 FT w/2T play, (1) 2T w/1/4-T play, 1 drive motor just rbt, \$800 ea/\$1500 pr. B Eddy, WRRR, Box 374, St Marys WV 26170. 304-684-3400.

Tascam 80-8 8-trk, 1/2", great cond, orig pkg, \$1000+freight. Katherine, Linden, 229 N Henry St, Alexandria VA 22314. 703-549-4424.

EXPERT REVOX REPAIRS

Fast Turnarounds -- Competitive Rates
15 yrs mod. for A&B77's \$350
Capstan shaft resurfacing, \$35
JM TECHNICAL ARTS
30 Music Sq. W. #5
Nashville, TN. 37203 (615) 244-6892

Otari MX55 1/2-trk 1/4" w/low hrs, 15/Tips w/rolling stand, perf cond, \$2800. A Jacobson, Work of Art, 197 Floral Blvd, Floral Pk NY 11001. 516-328-6543.

Tascam 32-2B, 1/2-trk, 101/2"; DX-20 dbx I NR; Taoco 4400 2-chnl reverb syst; Soundcraftman RR 2212 2-chnl 10-band EQ; Paia 6790 dual limiter; TEAC PB 64 patch bay mounted in 5" rack w/wheels, \$1000; Marantz Superscope CD-330 port AC/DC dolby stereo rec w/soft case, \$150. C El-Amin, Antillana Syst Intl, 2548 W Division St Ste 200, Chicago IL 60622. 312-772-7707.

Tape-Athon play, 7" & 10 1/2" bi-direc bckgrnd music plyrs w/spares, pickup in IL, free. E Davison, 217-787-0800.

Otari 8-chnl multi-trk rec in console, \$2200; 2-chnl in port case, like new, \$1000; remote control for 8-chnl, \$150; MCS cass deck w/dbx, new, \$275; Revox A77 rec suitcase, parts only, \$150. D Curtis, Creative Sound, 2810 W 4th St, Appleton WI 54914, 414-733-2299.

Otari MX-5050B stereo 2-trk, excel cond, little use, remote & manual, \$1495 ea. B Mounjloy, 615-543-5849.

ITC 99B/RPSE stereo R/P w/ELSA, mint, little use, \$2495; Delta III stereo triple deck, excel cond w/manual, \$1795. B Mounjloy, 615-543-5849.

Otari MX5050 BIII-2, less than 25 hrs use, in box, \$2500. M Collazo, Carrier Plus, POB 171, Stewartville NJ 08886. 800-755-3948.

Denon DTR-80P port DAT rec, 4 mos old w/wired rem ctrl, leather case, AA batt pack, AC adapter, \$800. B Harwell, Compact DJs, 1861 Brown Blvd #630, Arlington TX 76006. 817-649-3535.

Crown GCSX tube-type, bal inputs, excel cond, \$425. G Becker, 813-960-8153.

Ampex ATR700, \$800; TEAC X1000R, new cond, \$400; TEAC A3300SX, new, \$450; Pioneer RT701 w/new heads, \$300; TEAC A3340S, 4-chnl, 4-trk, \$800; Telex 230 & RP110, \$250. J Parsons, 904-532-0192.

TEAC X200R bi-direc R/P 1/4" trk, 10-1/2" R-R, gd cond, \$450. R Swafford, IAM, 610A S Battlefield, Springfield MO 65807. 417-883-7513.

Otari MX-5050 swivel/tilt floor stand, \$50; Scotch 8260 1" tape on 10-1/2" metal NAB reel, \$8 ea. G Wachter, 602-258-6161.

Tape-a-thon Librarian w/(2) 10-1/2" R-R, gd cond, \$600. R Swafford, IAM, 610A S Battlefield, Springfield MO 65807. 417-883-7513.

Ampex, ITC, Scully Reel-to-Reel Tape Recorder Spare Parts, Accessories, Motor Remanufacturing.

VIF INTERNATIONAL
PO Box 1555
Mtn View CA
94042

Direct order line (800) 848-4428
in area code 408
dial 739-9740
Telex 62922869 ESL UD
FAX: 1-408-739-0809

Scully 284B-8 1" 8-trk, 31/2-30 IPS w/V576 var spd mod, manuals perf cond, \$3000; MCI JH110A, 9 yrs old, 7 1/2, 15, 30 IPS, gd cond, \$2500. T Sherry, 408-244-3848.

Technics RS1500 2 trk; Sony/MCI JH110C on roll around metal cabinet, both excel cond; LPB dist amp DA1-16, new & SAE 500A impulse NR sound system, new. J Gelo, 813-642-6899.

Ampex MM1200 8-trk remote AL control box, \$4500; Otari MTR-10-2C stereo rec, \$3995; MCI/Sony JH110B stereo big reels in console, \$2000; MCI JH110A stereo in console, \$1295; Ampex ATR700 stereo, \$695/BO; Scully 280B mono in console, \$895; Ampex PR01-2 stereo w/354 elect, \$295; Ampex 440 transport, recond bearings, brakes, \$395; TEAC X10R stereo rec dual capstan drive bidirect, \$395. J Price, 214-321-6576.

Ampex 600 full-trk, port, gd cond, BO. J Inghram, WGCA, POB 467, Quincy IL 62306.

MCI JH110BX 2-trk stereo w/remote in orig roll-around 4-trk cab, \$1600. P Wells, KJQY, 625 Broadway #1200, San Diego CA 92101. 619-238-1037.

Fostex 250-AV 4-trk, board combo w/Dolby C. \$400/BO+s/h; Otari CR-705 remote for MX-5050/MKIII/21/2-trk, \$100. D Crepps, IBS, 29672 Silver St, Val Verde CA 91384. 805-294-9441.

Technics SV DA10 DAT machines (6 only)-NEW in box \$750 44.1 mod, rack kit available, too. Demo Marantz CDR-1 CD Recorder, \$5500. Klay Anderson Audio, 801-272-1814.

Tascam 32 2-trk & 38 8-trk, like new, \$2000/both; Teac 3340 4-trk, 1/4" deck, \$375; Tascam 80-8 never really used/perfect, \$1600; DX-8 dbx for 80-8, \$300. W Gunn. 619-320-0728.

Otari MX-70 16-trk 1", mint cond, \$10,500. W Gunn, POB 2902, Palm Springs CA 92263. 619-320-0728.

Ampex ATR800 mono, like new, \$1200 & AG440-8 1" 8-trk; Otari 7800 1" 8-trk, \$2900. W Gunn. 619-320-0728.

want to buy

Otari/Tascam. P Lopeman, 414-482-1959.

MCI/Sony capstan & reel motors, any cond., recdg heads, most mfgs. machines, new, used. Relapped then sold. Amp Services, 224 Datura St No 614, W Palm Beach FL 33401. 800-826-0601, in FL 305-659-4805.

Scully '100' recorders, record/play amplifiers, 8, 16, 24 track heads. Sequoia Electronics, 1131 Virginia Ave, Campbell CA 95008. 408-866-8434.

Ampex ATR100 taperecorders for parts. Circuit cards, heads, motors, machine parts, or electronic parts. Call 818-907-5161.

CD's

want to sell

Sony CDP3000 Pro w/(2) transports, 1 control console, scrub wheel, +4 bal XLR outs, \$1500. J Addie, 312-565-5033.

Denon DN950FA (6) plyrs, used 18 mos, \$750 ea. C Murray, 503-484-9400.

Soundcraftsman Pro-CD 750 CD plyr, BO. Tom, KMXX, 499 Humboldt St, Santa Rosa CA 95404. 707-544-5693.

want to buy

Hold-down spinner from junked plyr, any brand, pref door-mounted, top-loading type. Sidney, WDME, POB 357, Dover ME 04426. 207-564-2642.

COMPUTERS

want to sell

BM Quietwriter 2 printer w/sheet feeder, Xerox Diablo daisywheel. P Wells, KJQY, 625 Broadway #1200, San Diego CA 92101. 619-238-1037.

Mac 86 MS-DOS co-proc kit w/card for Mac, software & manual, new, \$235; HP 92286J Math/Elite font cart for HP LaserJet/Plus/500/Series II, \$25; Serial 8 port to 1 port auto switch, \$95; IBM PS/2 1 mb 80ns SIMM memory, \$23 ea/\$80 for 4. G Wachter, KFYI, 631 N 1st Ave, Phoenix AZ 85003. 602-258-6161.

Mitsubishi AM-1301 color mon, 13" screen, RGB input, immac, \$150. S Lawson, KAK Prods, 928 Hyland Dr, Santa Rosa CA 95404. 707-528-4055.

Superior Elec Stabaline regulator, used 6 mos, \$150+s/h. B Lord, Lord Bdctg, 13313 SE 208th St, Kent WA 98042. 206-631-2374.

EMPLOYMENT

POSITIONS WANTED

Looking for personable air talent? Not a robot/screamer, 12 yrs exper, top 50 mkt, ad lib easy. Art, 517-288-2664.

Experienced, Christian manager/announcer/public relations director w/10 years experience. Strong administrative, technical and production skills. Seeks position in NE or SE. Write to: Radio World, POB 1214, Falls Church VA 22041. Attn. Box #09-23-01RW.

Energetic & spontaneous prof team ply w/8 yrs on air/prom/exp seeks pos at AOR/AC/oldies/country, pref West. Robin, 602-481-8209.

Engr w/25+ yrs major mkt exper & excel refs, seeks stable long term employment. C Wilkinson, 214-544-3799.

Witty DJ relocating to N VA, 3 yrs on air exper, any shift, tape avail. M Hart, 4107 Conrad Rd, Alexandria VA 22312.

Ambitious air personality sks FT pos, any format, in SE Mich/NNW Ohio, reliable team plyr. H Byrne, 614-772-6886.

Bright, hardworking mmarketable AT w/3 yrs on air, 2 in drive time, seeks pos in rated rock/country midwest mkt. Jared, 612-693-2817.

Freelance engr w/heavy duty exper for any job, anywhere w/great refs, audio, RF, auto, xmtrs, ants/construction, US/intl. 813-849-3477.

CONSOLES

want to sell

Eddor 4-chnl auto remote/field mixer, 1 rack unit high, \$145. G Wachter, KFYI, 631 N 1st Ave, Phoenix AZ 85003. 602-258-6161.

Sparta M-15 5-pot mono w/#5 multiple input. D Morgan, KNZZ, Box 969, Grand Junction CO 81501. 303-241-9230.

Vintage mixer, TT combo, Scully R-R, antique remote controls, limiters, BO; high-pwr isocoupler on 902.5, BO. D Nadon, WLYT, 30 Howe, Haver Hill MA 01831. 508-374-4733.

Auditronics 200 series blue face mods, (2) mic input, gd cond, \$125 ea; 1 mono line output, gd shape, \$125; (3) stereo line output, \$150 ea/\$750 all. M Guthrie, 813-855-5642.

TEAC 2A like new, \$150; Pyramid PR8800, 8 in, 2 out, new, \$400; Sony MX16, 8 in, 4 out, \$200. J Parsons, 904-532-0192.

Gates Dynamote 70 4-chnl solid statesman mono mixer w/AC pwr sply, \$50. A Clean, WMPG, 96 Falmouth St, Portland ME 04027. 207-780-4974.

Audio Technica ATC 820 stereo, 8x2+effects in llight case, \$795. J Price, 214-321-6576.

Op-amp Labs 1604, 16 inx4 bus, \$4000; RCA BC-18, very clean, dual-chnl BC-18 board, 8 chnls, 32 inputs, \$500. K Carlson, KMUT, 1100 Blue Lakes Blvd N, Twin Falls ID 83301. 208-733-1100.

Auditronics 200 TEL hybrid for 200, \$150. P Hall, WOOD, Baylor School Rd, Chattanooga TN 37405. 615-266-5117.

SoundWorkshop Loges 8 16-chnl rec/mix, \$1500. D Coffman, WSOR, 940 Tarpon St, Ft Myers FL 33916. 813-334-1393.

Phase Audio DC-01 dub CD to cart/phone to cart, \$100. D Bailey, Rock Shoppe Prod, 3422 Beech St, Rowlett TX 75088.

Neotek Series I 16x4x2 w/patch bay & wiring harness, BO. D Gaydos, NYU, 721 Bwy 11th Flr, NY NY 10003. 212-998-1663.

Tapco 6000R, 6x1 w/reverb, rough, works, \$100. E Davison, 217-787-0800.

JBL 7510A pro series 16-chnl 5-1/4" rack mount auto, \$335; Eddor AM-400 4-chnl auto field, \$145. G Wachter, 602-258-6161.

Ramko Research & Micotrak audio, 13 input monaural w/talkback, 19" rack mount, new, \$250 ea + \$15 s/h. 818-769-5544.

Spectra Sonic audio w/10 input, 5 mic, 5 stereo, reverb sends & return, pwr sply, mon amps w/(4) #700 amp cards w/rem tape mach panel, \$1200/BO. J Krys, 513-556-4444.

Gates Diplomat 10 pot/20 chnl & McMartin B501 5 pot/10 chnl, clean, no mods, \$500 ea +s/h. CD, KVLL, POB 459, Woodville TX 75979. 409-283-3734.

GE audio ctrl bd w/8-chnl stereo, ext mon, gd cond, \$1000; (2) QRK 6-chnl, audio ctrl bd, \$750; RCA mono, 6-chnl audio ctrl bd, gd cond, \$400. J Kennedy, 407-388-0065.

Interface 300 16x8 mixer w/manual, works but rough, \$700. A Olean, Univ of S ME, 96 Falmouth St, Portland ME 04103. 207-780-4424.

Autogram IC-10B factory refurbished and ready for operation, \$4500. Call 806-372-5130.

want to buy

Arrakis/Tascam/BE/Ramsa. P Lopeman, 414-482-1959.

Howe console manual w/parts list & drawings, urgent. K Austin, KFXI, 1101 Hwy 81 N, Marlow OK 73055. 405-658-9292.

8-chnl w/0.25 V AC audio output & 10-25 W, 60 Hz & AC 120 V. F Smith, 615-624-7126.

Ramsa WR-8724 test jig. E Stewart, WDCI, POB 371, Bridgeport WV 26330. 304-842-8644.

McCurdy SS7500 stereo slide pot, Danner-type, PCF 5K/85-2. S Boyley, CKPL, 571 West St, Brantford W3T 5P8 Canada.

DISCO & SOUND EQUIP

want to sell

Duntech Sovereigns 2001 light oak, line cond, \$6000+s/h. Dave, 305-866-6048.

Fostex 4010 time code reader/gener, \$800; Roland M-160 16-chnl line mixer, \$500; (2) NAK MR-2B cass decks, \$500 ea; Valley People line matching interface w/rack kit, \$225; Fostex Metal 2 trk stand, \$150; Revox HS-77 R/PB, 2-trk, \$450; ARP Pro Soloist w/Anvil case, \$150; ARP string ensemble w/Anvil case, \$150. T Campana, 313-553-4044.

Numark CD5020, new/used pro dual xport CD plyr w/19" mount, remote control 16X oversample, orig manuals & packaging, \$850; Roland DR550 great drum mach, 64 preset patterns, MIDI, tape interface, \$200+s/h. B Jon, KTTX, 659 FM 331, Bellville TX 77418. 409-865-2000.

UREI LA-3A (2) in side-by-side rack frames, excel cond w/manuals, \$800 both. B Mounjloy, 615-543-5849.

EV HDJ board, Akai turntable, Audio Art Parametric EQ, EV mic, \$250. B Poole, POB 335, Cashtown PA 17310. 717-334-6039.

dbx 208 NR system plus 216 & 224 systems, \$850. J Price, 214-321-6576.

Radio CE/ASEE, ham, GCC general, former CE, Boston/Houston/Miami/Ft Laud, comp literate. 415-221-2000.

Ex-Armed Forces Radio DJ eager to get back into radio. Box 195, Spana Way WA 98387. 205-536-2070.

Take charge, revenue, ratings, driven GM, 25 yrs sales, prog expert, new construction upgrades, prefer south/midwest. John, 502-247-0090.

Ex-college station mgr now DJ/news at small AM ready to move anywhere/any shift. 167 Lake St, Saranac Lake NY 12983. 518-891-3915.

Entry Level Consultant avail for small mkt sat, auto/basic turnaround, exper, all replies confid. Spiritradio, Box 275, Comstock Park MI 49321.

Over 25 yrs exper in small mkt radio/TV as news dir & GM seeking similar pos in AL/MS/TN. Bill, 803-245-2127.

HELP WANTED

NEW start-up 25KW FM in central VA seeks sales oriented Manager to direct sales and assist in management of new station. Must have strong sales background and references. Excellent new facility. Send resume to: WFXQ, POB 305, Chase City VA 23924. 804-372-3996. EOE.

SOUND YOUR BEST ON THE AIR!

CART MACHINE SERVICES:
CART MOTORS REBUILT to quiet flutter-free perfection-shafts resurfaced
Single \$110.00 Triple \$130.00
CART HEADS RELAPPED guaranteed to perform like new
Same day turnaround
Replacement heads and motors available

REEL TO REEL SERVICES:
HEADS RELAPPED and precise digital/optical
ASSEMBLY ALIGNMENTS performed for maximum response & head life
CAPISTAN & REEL MOTORS REBUILT for MCI, OTARI and more.

For peak performance from your recording equipment, call The Audio Magnetic Professionals.

AMP SERVICES
224 Datura Street, Suite 614, West Palm Beach, FL 33401
Call 1-800-826-0601 for "Same Day Service" in Florida (407) 659-4805
Authorized Parts Dealers for: MCI • OTARI • TEAC/TASCAM

SCULLY TAPE RECORDERS
PARTS AND SERVICE
SEQUOIA ELECTRONICS
1131 Virginia Ave.
Campbell, CA 95008
(408) 866-8434

Ampex AG-350 mono/cons, \$350; AG-440 mono/cons, \$400; Sony TC854-4S w/dbx 154, \$800; (3) Crown decks, mono quad, \$450 all. J Krepol, JVK Studios, 7 Dustin Dr, Claymont DE 19703. 302-798-4076.

Ampex 350 (2), \$100 ea; RCA RT21 stereo rec, \$150. F Konwinski, WSOY, 1100 E Pershing Rd, Decatur IL 62524. 217-877-5371.

Ampex AG-440B 1" 8-trk, multi-trk in roll around console, gd cond, BO; Otari Mark II-IV 1/2" 4-trk, multi-trk, mint, less than 50 hrs, BO. R Kaufman, Pams Prods, POB 462247, Garland TX 75046. 214-271-7625, after 3PM CDT.

DISCO...WTS

Star heavy-duty fiberglass road cases w/key locks, 18"x20"x20-1/2", 11x28x21, 15x25x14, 10x25x20, new; Audix 8x2 rcdg studio console, excel cond. J Krepl, JVK Studios, 7 Dustin Dr, Claymont DE 19703. 302-798-4076.

Klipsch Lascales horns in road cases, will handle 300 W per chnl, excel cond, BO. R Kaufman, Pams Prods, POB 462247, Garland TX 75046. 214-271-7625, after 3PM CDT.

Dolby 301 A-type stereo, discrete, \$500. W Gunn. 619-320-0728.

want to buy

McIntosh tube gear, JBL 4343 mon spkrs, Harmon-Kardon tube gear, SAE 2800 EQ, dbx 120 XOS. R Glenn, WJGR, 1718 Shannadoc, Wimauma FL 33598. 813-634-1940.

FINANCIAL SERVICES

EQUIPMENT Financing, Lease Purchase Option. Need equipment for your radio, television or cable operation? New or Used. No down payment. Carpenter & Associates, Voice 504-764-6610 Fax 504-764-7170.

IMMEDIATE FINANCING ON ALL RADIO EQUIPMENT

- Easy to qualify
- Fixed-rate, long-term leases
- Any new or used equipment & computers
- 100% financing, no down payment
- No financials required under \$50,000
- Start-up financing
- References available

Call Mark Wilson (800) 275-0185

EXCHANGE NATIONAL FUNDING

Use Our Experience For Your Business

LIMITERS

want to sell

Gregg 5-band stereo proc & AM 4-band proc, \$4500 for FM, \$3500 for AM. C Haynes, WJMI, 1850 Lynch St, Jackson MS 39203. 601-948-1515.

CRL APP-400 audio proc, \$200; CRL-PMC 300A peak mod controller, \$300, both excel cond. S Manuel, WWJB, 55 W Fort Dade, Brooksville FL 34601. 904-796-7469.

CRL AM-4 system with SPF-300 pre-amp, filter, \$2500/BO; CBS Lab Audimax 4440 & Volumax 4000, BO; FM AFC-Peak limiter #310, BO. 816-532-0460.

Moseley TFL-280 (2) stereo FM vgc, \$150 ea. M Guidotti, Monument Media, 1170 Park Grove Dr, Milpitas CA 95035. 408-946-9466.

Gentner AFC-1 proc card for 8100A, perf cond w/instructions, \$100; Dorrrough 310, clean w/manual, \$125; Hnat Hindes A-Maze w/manual, \$525. P Hall, WDDO, Baylor School Rd, Chattanooga TN 37405. 615-266-5117.

Mod Sci Composite Clipper w/pilot restoration, \$750. T Kolnar, WAIT, 8600 Rte 14, Crystal Lake IL 60012. 815-459-7000.

We buy Optimod 8000A's and 8100A's 414-482-2638

UREI 1176 (2) for mono/stereo. J Kryz, 513-556-4444.

Gentner Lazer/Prizm used 2 mos. D Fearn, WKSZ, 1001 Baltimore Pk, Media PA 19063. 215-565-8900.

dbx 166 dual-gated, \$450. B Derking, KNDY, RR3, Marysville KS 66508. 913-562-2361.

CBS Audiomax AGC, \$100; (2) Orban 145E stereo syn, \$100 ea; Orban stereo reverb, \$300. J Kennedy, 407-388-0065.

Inovonics 222 NRSC/AM preemphasis low pass audio proc, \$945; (2) UREI LA-3A audio tvtrs w/manuals, excel cond, \$800 pair. B Mountjoy, WIRC, POB 938, Hickory NC 28603. 615-543-5849.

Audimax 4450A; FM Volumax 4111; CBS stereo peak controller, black panel; Audimax CBS lvi ctrl, black panel, \$75 ea w/manuals +s/h, all need work but complete. F Konwinski, WSOY, 1100 E Pershing Rd, Decatur IL 62524. 217-877-5371.

Gates Solid Statesman, BO. Tom, KMXN, 499 Humboldt St, Santa Rosa CA 95404. 707-544-5693.

Mod Sci CP803 stereo comp, \$300. M Hendrickson, Hedberg Grp, POB 249, Blue Earth MN 56013.

UREI LA-4 comp/limiter, \$275; UREI 1176 peak, \$275; dbx 163x comp/limiter, rack, \$125. G Wachter, 602-258-6161.

want to buy

Optimod 8000/8100, any cond. P Lope-man, 414-482-1959.

Harris/Gates M-6629 solid statesman AGC amp. C Brescia, WNBZ, Box 211, Saranac Lake NY 12963. 518-891-1544.

IMP (2) tri-band w/limiting & AGC, \$500. J Kennedy, 407-388-0065.

Optimod 8000A/8100A. T Goliher, WPFB, 4505 Central Ave, Middletown OH 45044. 513-422-3825.

MICROPHONES

want to sell

AKG D224E (4), (2) new, excel cond, \$200 ea. P Russell, Dowdoin College, Sills Hall, Brunswick ME 04011. 207-725-3066.

RCA 88, mint cond, BO. R Miller, KUAU, Box 575, Lahaina HI 96767. 808-572-5534.

Sennheiser MD211, \$125; HME-WM 252 wireless w/SM58, \$195; Telex-WHM 500 wireless, \$150. J Price, 214-321-6576.

AKG D110 lavalier, new, \$35; Shure 571 lavalier, new, \$45; misc hand & desk paging mics, new & used, \$20 ea. E Davison, 217-787-0800.

Nady 501 wireless w/2 mics, chnl D, 209.15 MHz, \$500/BO+s/h. D Crepps, IBS, 29672 Silver St, Val Verde CA 91384. 805-294-9441.

RCA 77DX classic, restored & new ribbon, \$700. K Carlson, KMUT, 1100 Blue Lakes Blvd N, Twin Falls ID 83301. 208-733-1100.

EV RE-20, \$300. K Thomas, Rebel Prods, 5555 Radio Ln, Jacksonville FL 32205. 904-388-7711.

Crown PZM, \$60; Neumann AC phantom pwr sply for 4 mics, \$75. G Wachter, KFYI, 631 N 1st Ave, Phoenix AZ 85003. 602-258-6161.

Altec 639A, \$350; Shure 555W, \$100; American D9AT, \$350. C Elmasian, Tri-Core, 27503 Five Mile, Livonia MI 48154. 313-427-0832.

Comrex wireless syst, 2-chnl RS & (2) 2-chnl TX, operates on 450.2 & 450.4, \$1000. M Aldridge, RSE, 5587 Tucker Rd, Ooltewah TN 37363. 615-396-2893.

Shure 540 SPL length 12" dynamic omni for interviews, \$25 ea/5 for \$100. E Davison, 217-787-0800.

Telefunken M921 dual (2-way, not front/back) nickel capsules, card-oid, classic tube mic; Neumann KM84 pair, mint, \$1100. W Gunn. 619-320-0728.

EV 676 supercardioid mics 3/\$200; EV RE10 mic, \$125. W Gunn, 619-320-0728.

Desk mics (hiZ), EV-Shure mic stands, also baby booms (3); tubes, new (32) RCA, GE, Sylvania; Sams tube sub books #8 & #6; RCA tube manual; Sony head demagnetizer (new); jack femal connectors; EV 502 transformer primary/secondary. Mr. Oliver, 212-874-7660/0274. Call afternoons till 10PM.

Telefunken U-47, Neumann U-67, KM-54 mint; RCA ribbon mics (2) KU3A's 10,0001, (3) 77-DX, (1) 44-BX, (2) BK-5; Altec tube mics M-11, M-20, M-30; 639 film version mic ect. Trade or sale. Tracy Eaves, 615-821-6099 (evenings before 10PM EST).

want to buy

EV RE-20/Sennheiser 421/Neumann. P Lopeman, 414-482-1959.

RCA 77DXs/44BXs ribbon, chrome/TV grey, gd cond, BO. R Kaufman, Pams Prods, POB 462247, Garland TX 75046. 214-271-7625, after 3PM CDT.

MISCELLANEOUS

want to sell

Cornell-Dubilier 80mfd @450 V V electrolytic capacitors, axial leads, 3.75"x1", \$2 ea+\$2.50 ship per dozen. D Nachodsky, ACME Specs, 3305 Parktowne Rd, Baltimore MD 21234. 410-668-6287.

Symetrics T101 tele interface, new, \$250; Henry Mix-Minus, new, \$75. S Manuel, WWJB, 55 W Fort Dade, Brooksville FL 34601. 904-796-7469.

Altec 15095 & 4588 1588B plug ins, 1579A. J Parsons, 904-532-0192.

Road cases, (3) military built, 19" mountings, BO. R Meyers, Benchmark, 4700 SW 75 Ave, Miami FL 33155. 305-264-5963/FAX 305-264-2357.

Microwave Filter Co 2903-7/13 phase-attenuator box, using 2 ants, \$150. S Marshall, CE, WDME, POB 357, Dover-Foxcroft ME 04426. 207-564-2642.

Henry Matchbox Interface amps (2), \$95 ea; (2) Superrelays, \$110 ea; Telecart II, \$125+s/h, all used 6 mos. B Lord, Lord Bctgy, 13313 SE 208th St, Kent WA 98042. 206-631-2374.

BE subcarrier gener, 67 kHz, excel cond, \$500; SCA mon, nds repair, \$100. G Kauffman, 319-243-1390.

RF coils/capacitors, gd cond, some fixed, tunable with rotating shaft, air variables, micas, will sell indiv/whole. R Egan, WIZM, POB 99, La Crosse WI 54602. 608-782-1230.

1936 Crosley WLW AM/SW rcvr w/PA syst. M Hauff, KDFO, Box 16351, Minneapolis MN 55416.

Jazz record collections, 10" LP/12" LP be-bop, swing, dixie, highest prices paid. B Rose, Program Recdgs, 228 East 10th, NNYNY 10003. 212-674-3060.

Radio transformers by Chicago, UTC, Triad, Peerless, Freed, Sola, send list. J Gangwer, 942 32nd St, Richmond CA 94804. 415-644-2363.

MONITORS

want to sell

TFT #753 AM with 755 pre-selector, \$1750/BO, McMartin TG-2/EBS, AMR-1 rec, EBS-2 mon, \$350/BO. 816-532-0460.

Motorola 1410 AM stereo mod monitor, BO. Tom, KMXN, 499 Humboldt St, Santa Rosa CA 95404. 707-544-5693.

Gates GTM-88F FM freq monitor, BO. J Michaels, WMVR, POB 889, Sidney OH 45365. 513-498-1055.

want to buy

101.5 stereo/mono mod, Belar/McMartin; EBS. P Lopeman, 414-482-1959.

Belar AMM-1 AM mod mod; EBS mon/gen, TFT/equiv. R Miller, KUAU, POB 575, Lahaina HI 96767. 808-572-5334.

Belar AMM-1/AMM-2 working AM, mod tuneable to 1570 kHz, under \$500; TFT 7604 EBS RX/gen, under \$500. R Miller, KUAU, Box 575, Lahaina HI 96767. 808-572-5334.

Any older McMartin mod monitors. C Goodrich, 11435 Manderson, Omaha NE 68164. 402-493-1886.

MOVIE PROD EQUIP

want to sell

Bell & Howell 500 & 1500 series 16mm proj's, (1) autotape, (2) manual, \$150 ea. Katherine, Linden, 229 N Henry St, Alexandria VA 22314. 703-549-4424.

RECEIVERS & TRANCEIVERS

want to sell

Zephyrus 300 w/304 mainframe, 391 rcvr, 321 demod, card tuned to .33 MHz, new, excel cond, \$650. M Vanhooser, 214-827-5759.

AM STEREO RECEIVERS

Portable, Home/Studio, Auto
RRADCO GROUP
708-513-1386

RECEIVING/ RECORDING STUDIO EQUIPMENT

(2) DOWNLINK STUDIOS for SALE or LEASE

- BENCHMARK Audio Dist Proc & Pkg System
- SAS Audio Routing Switch
- YAMAHA YPDR 601 CD Recorder
- TASCAM 2 & 8 Trk Rcdr, CD & Cass Player
- DOURROUGH Stereo Test Set
- SATELLITES . . . and MUCH MORE!

Call 617/267-8600 for complete configuration

LIKE NEW! • Immediate Delivery

EQUIPMENT REMARKETING COMPANY • Boston, MA

Shallco 8200-2B3 (2) rotary faders, 10K, (1) 600/600 oh, w/cue detents; Davon 600/600 fader; (3) Langevin RMS-1430, \$35 ea; Switchcraft Bantam bay, T/R/S w/cords, \$50; x" T/S patchbay w/cords, \$25; (2) 214-20 Christmas Trees, \$10 ea; rotary attenuator scale plates & knobs, mics console switches, \$10. M Guidotti, Monument Media, 1170 Park Grove Dr, Milpitas CA 95035. 408-946-9466.

JVC 4-DD5 CD-4 quadraphonic disc demod, never used, \$75/BO; Lafayette LT-725 AM/FM/SCA stereo tuner, tweaked, \$125/BO. D Pulwers, 703-751-9346.

Phase Master T-5000-A2 single- to 3-phase pwr converter, cass machines. R Murphy, 800-582-7625.

Viking RP10-22, (2) tape head pre amps, solid state, \$35 ea; Telephones w/head-set jacks, 6-button key & one line, TT & rotary, \$50 ea. E Davison, 217-787-0800.

Rotron Blowers for Eloom, CCA, CSI, McMartin, Harris, rebuilt & new.
Goodrich Enterprises Inc.
11435 Manderson St., Omaha, NE 68164
402 493 1886 FAX 402 493 6821

Echo Plate #2, gd shape, \$500; Fisher reverb units w/3 spring ea, \$100 ea. H Sewell, Oakridge Music, 2001 Eiton Rd, Ft Worth TX 76118. 817-838-8001.

JBL D16R2405 replacement diaphragm for #2405 tweeter, new, \$50. J Roper, Imperial Sound, 383 N Studio St, Terre Haute IN 47803. 812-877-2663.

Kleig 2 kW (100) focusing fresnels w/bamdoors, clamps, 2000 W, \$150 ea; 1000 W studio scopes, \$150 ea. 212-969-0240.

want to buy

Wisconsin AM/FM/TV stations history, print/tapes/photos for WI book of bctgy history. D Kerl, WHRM, 3200 Park Rd, Wausau WI 54401. 715-845-1319.

PHONE: 703-998-7600 FAX: 703-998-2966



Call Simone Mullins, Classified Ad Manager, to reserve space in the next issue. Use your credit card to pay, we now accept VISA and MASTERCARD.

Radio World®

5827 Columbia Pike, Ste 310
Falls Church, VA 22041

Select from these categories for best ad positioning:

- | | | |
|----------------------------|---------------------------|-------------------------|
| Acoustics | Consoles | Stereo Generators |
| Amplifiers | Disco-Pro Sound Equip. | Switchers (Video) |
| Antennas & Towers & Cables | Financial Services | Tapes, Carts & Reels |
| Audio Production (Other) | Limiters | Tax Deductible Equip |
| Autom n Equip. | Microphones | Test Equipment |
| Brokers | Miscellaneous | Transmitters/Exciters |
| Camera: (ideo) | Monitors | Tubes |
| Cart Mac s | Movie Production Equip. | Turntables |
| Cassette t -R Recorders | Receivers & Tranceivers | TV Film Equip. |
| CATV-MAT Equip. | Remote & Microwave Equip. | Video Production Equip. |
| CD's | Satellite | Video Tape Recorders |
| CD Players | Software | Positions Wanted |
| Computers | Stations | Help Wanted |

Display Rates for Classified Advertising Effective January 1, 1991

	1x	3x	6x	12x
1-9 col inch (per inch)	\$55	53	50	45
10-19 col inch (per inch)	50	48	45	40
Distributor Directory	90	85	80	75
Professional Card	60	55	50	45
Classified Line Ad	\$1.50 per word			
Blind Box Ad	\$10 additional			

To compute ad costs: Multiply the number of ad inches (columns x inches) by the desired rate schedule for your per unit cost. Example: a 3" ad at the 1x rate is \$165, at the 3x rate \$159, at the 6x rate \$150, at the 12x rate \$147, etc.

ACTION-GRAM

Equipment Listings

Radio World's Broadcast Equipment Exchange provides a FREE listing service for all broadcast and pro-sound end users. Simply send your listings to us, following the example below. Please indicate in which category you would like your listing to appear. Mail your listings to the address below. Thank you.

Please print and include all information:

Contact Name: _____ I would like to receive or continue receiving Radio World FREE each month. YES NO

Title _____

Company/Station _____ Signature _____ Date _____

Address: _____ Please circle only one entry for each category:

City _____ State _____ Zip _____

Phone Number: _____

Brokers, dealers, manufacturers and other organizations who are not legitimate end users can participate in the Broadcast Equipment Exchange on a paid basis. Line ad listings & display advertising are available on a per word or per inch basis. Call 1-800-336-3045 for details.

I. Type of Firm

D. Combination AM/FM station	F. Recording studio
A. Commercial AM station	G. TV station/teleprod facility
B. Commercial FM station	H. Consultant/ind engineer
C. Educational FM station	I. Mfg. distributor or dealer
E. Network/group owner	J. Other _____

II. Job Function

A. Ownership	D. Programming/production
B. General management	E. News operations
C. Engineering	F. Other _____

WTS: WTB: Category: _____

Make: _____ Model #: _____

Brief Description: _____

Price: _____

*Closing for listings is the first and third Fridays for the next month's issue. All listings are run for 2 issues unless pressed for space or otherwise notified by listee.

Broadcast Equipment Exchange
PO Box 1214 • Falls Church VA • 22041 • 703-998-7600 • FAX: 703-998-2966

RECEIVERS...WTS

Radio Control Service

24-hour Transmitter Site Monitoring
Licensed Operators

Save Money & Keep Your Walk-Away Station FCC Legal with R.C.S.

- Power/Pattern Change
- Nightly Tower Light Check
- EBS Activation and Receive
- Transmitter readings logged as often as you request

And more, all for one low monthly fee.

Call **RCS**
915-672-1113

Yaeso FTC-2025 25 W VHF, 10-chnl, PL encode, mobile brckt, \$50. P Russell, Bowdoin Coll, Sills Hall, Brunswick ME 04011. 207-725-3066.

Magnum/Dynalab FT-101 FM tuner for rack mounting, modified for super sensitivity w/Toko 110, 150 kHz ceramic filters, \$425+\$85/h. B Elving, box 336, Esko MN 55733-0336. 218-879-7676.

SCA RECEIVERS—ALL TYPES

Reading Service / Ethnic / Data
Professional, Portable, Table

DAYTON INDUSTRIAL CORP.
(Manufacturer)
4411 Bee Ridge Rd. #319
Sarasota, FL 34233
Tel: 813 378 5425 FAX: 3394

Marti SCR-8H subcarrier rcvr & SCG-8H subcarrier gener, \$695; McMartin BFM1531R SCA gener, \$400. R Johnson, KWWR, 1705 Liberty St, Mexico MO 65265. 314-581-2900.

Marti MR 30/150/170 tube-type w/pwr sply, \$150. J Michaels, WMVR, POB 889, Sidney OH 45365. 513-498-1055.

Tube tuner, AM/FM mono, selective, works, \$20; SCA McMartin TN-77, XTAL controlled, \$25. E Davison, 217-787-0800.

want to buy

Proton 300A. 215-644-7796.

REMOTE & MICROWAVE EQUIP

want to sell

Moseley 950 STL pkg w/505 FX & TX, (2) 6' Scale ants, \$5850. P Clarocci, WAIT, 8600 Rte 14, Crystal Lake IL 60012. 815-459-7000.

AKG R25 w/30' cable for BX-25 reverb unit, \$50/trade TEAC RC-170 remote. J Roper, Imperial Sound, 383 N Studio St, Terre Haute IN 47803. 812-877-2663.

Moseley PBR-30 w/manuals & spare cards, \$320. P Hall, WOOD, Baylor School Rd, Chattanooga TN 37405. 615-266-5117.

COMREX RENTALS

1, 2 and 3-Line Systems
Call Steve Kirsch for details
Silver Lake Audio
(516) 623-6114

Marti STL-8 trans. & R-200 rec 950MHz, \$1250/BO. 816-532-0460.

Motorola Tough Talker cell phone, transportable, bag phoe, 3 hrs talk time @3 W pwr, 1 yr old, excel cond, \$275+\$8/h. G Violet, Violet Comm, 331 Lookout Pt, Hot Springs AR 71913. 800-676-1736.

Moseley MRC 1600 pkg. D Siddall, WLOI, 9021/2 Lincoln Way, LaPorte IN 46350. 219-362-6144.

Moseley TRC-15AW w/Hallikainen Tel 171 dig metering conversin system, gd cond, \$1000. R Cowell, KNTR, POB 308, Ferndale WA 98248. 206-384-5117.

Moseley MRC-1600, nds work, \$1000; Marti RMC-20, removed from svc, \$300. G Arroyo, 407-830-0800.

Moseley TRC-15 15-chnl xmtr rem ctrl w/Hallikainen dig update kit, \$795; Moseley TRC-15 xmtr rem ctrl w/factory analog metering, \$595. B Mountjoy, WIRC, POB 938, Hickory NC 28603. 615-543-5849.

RENTALS RENTALS RENTALS

COMREX 3-line extender

Frank Grundstein 215-668-6434
Audio/Video Consultants 215-642-0978

TFT 7610-C & R w/chnl expander & spare parts, \$1000. G McClintock, WNCM, 1300 VVCR Ave, Nashville TN 37218. 615-255-1300.

Moseley 505 STL system, late model, certified for new rules, good condition. Call 806-372-5130.

want to buy

Any make/type composite STL w/ or w/o parabolic ants, reasonable. J Phillips, WBUC, POB 1484, Lima OH 45802.

RPU system/STL, pref Moseley 505/606. P Lopeman, 414-482-1959.

Moseley MRC1600. S Beeny, KBMS, Hwy 54, Osage MO 65065. 314-348-2772.

Stereo STL that meets new standards. Bob, 603-448-0500.

SATELLITE EQUIPMENT

want to sell

Wegener 1601 mainframe w/pwr sply, new cond, little use, \$200/BO. John, 509-826-0100.

LNB 25', C band, \$155. G Wachter, KFYI, 631 N 1st Ave, Phoenix AZ 85003. 602-258-6161.

SERVICES

Tower Sales & Erection

Turnkey Site Development
Installation & Maintenance
AM/FM Broadcast, TV,
Microwave Systems,
Antennas & Towers

TOWERCOMM

Communications Specialists
Ben Wall
President
Ger. Contri. tel: #25891 Fax (919)781 6454



Lic. No. 357096
Installation & Maintenance of
Broadcast & Communications
Towers & Antennas
Donald J. Tenns
(916) 362-6846
(916) 638-8833
9723 Folsom Blvd. Suite A
Sacramento, CA, U.S.A. 95827 FAX: (916) 638-8858

BROADCAST DESIGN & CONSTRUCTION, INC.

- Facility Relocation
 - R.F. Systems
 - Soundproof/Acoustical
 - Custom Cabinetry
- 24 HOUR EMERGENCY SERVICE
(313) 465-3226



When cost and quality count!
NORTH STAR TOWER
Tower Construction & Maintenance
Canton, NY
315-386-4932
FAX: 315-379-0961



Columbia Career Consultants
Serving the staffing needs of the broadcast industry on a national basis. Call us today to discuss your employment needs!
317-923-1550
1815 N. Meridian St., 101
Indianapolis, IN 46220

AM FM TV

Addresses, Mailing lists,
Data Discs, Mailings to P.D.'s
& General Managers. For
details, call **The Radio Mall**
1-800-759-4561!

SPECIALIZING IN ERECTION,
REPAIRING, PAINTING
AND MAINTENANCE
RADIO, TWO-WAY, T.V. TOWERS
AND FLAG POLES
ASTEPELEJACK CO.
PAINTING AND STEEPLEJACK
CONTRACTORS
FULLY INSURED FOR YOUR PROTECTION
DON HIGLEY 3722 ROMA
713-462-6105 HOUSTON, TEXAS 77080

Communications
Data Services, Inc.
Richard P. & Richard L. Biby, Principals
Real World Propagation™ Studies
Online/Remote Access Services
3 Arc Second Terrain Data
1990 Population Data
FCC & FAA Databases
For more information call:
(703) 534-0034 • (800) 441-0034

FROM STOCK
Low Pass Filters
Directional Couplers
CONNECTICUT
MICROWAVE CORPORATION
10 B Trackside Business Park
Cheshire, Connecticut 06410
203-250-9678 fax: 203-250-9688

ROHN.
Broadcast Towers
Furnished & Installed
Guyed or Self-Supporting
Solid or Tubular
20 Year Warranty!
Call Mike Fleissner
toll free
1-800-225-ROHN

REMOTE EQUIPMENT RENTALS
COMREX and GENTNER
1, 2 & 3-Line Extender Systems
MARTI and TFT
450, 455 & 161 MHz RPU Systems
SWITCHED-56 SYSTEMS
Call or FAX Dwight Weller
WELLER AUDIO-VISUAL
ENGINEERING
Phone: 410-252-8351 FAX: 252-4261

CONSULTANTS



Where In The World Are You?
Reach radio professionals worldwide by advertising in Radio World's international edition. Call Simone for more information.
1-800-336-3045

MIRKWOOD ENGINEERING
Rural & Remote Site
Field Engineering
50 Park Ave.
Claremont, NH 03743
603/542-6784

T.Z. Sawyer Technical Consultants
1-800-255-AMDA
AM Directional Antenna Proofs
AM-FM-TV-LPTV
FCC Applications & Exhibits
Station Inspections
6204 Highland Drive
Chevy Chase, MD 20815-6610
Telefax 301-913-5799

Congratulations You've found THE CARD!
Radio Systems Engineering
"For all your Engineering Needs"
AM - FM - TV - Translators - LPTV
FCC Applications - Design - Installation
Call, fax, or write **today!**
(800) 551-1667
fax: (702) 898-8731
4289 Roanridge - Las Vegas, NV 89120

MULLANEY ENGINEERING, INC.
Consulting Engineers
•Design & Optimization of AM Directional Arrays
•Analysis for New Allocation, Site Relocation, And Upgrades
AM FM TV LPTV
Wireless Cable
(MDS/MMDS/ITFS/OFS)
•Environmental Radiation Analysis
•Field Work
•Expert Testimony
9049 Shady Grove Court
Gaithersburg, MD 20877
Phone: (301) 921-0115
Fax: (301) 590-9757

Moffet, Larson & Johnson, Inc.
Consulting Telecommunications Engineers
Two Skyline Place
5203 Leesburg Pike # 800
Falls Church VA 22041
703-824-5660
800-523-3117
Member AFCCCE

Consulting Communications Engineers
• FCC Data Bases
• FCC Applications and Field Engineering
• Frequency Searches and Coordination
• AM-FM-CATV-ITFS-LPTV
OWL ENGINEERING, INC.
1306 W. County Road. F.
St. Paul, MN 55112
(612)631-1338 "Member AFCCCE"

W. LEE SIMMONS & ASSOC., INC.
BROADCAST TELECOMMUNICATIONS CONSULTANTS
1036 William Hilton Pkwy
Ste 200F
Hilton Head Is., SC 29928
1-800-277-5417
803-785-4445
FAX: 803-842-3371

EVANS ASSOCIATES
Consulting Communications Engineers
FCC Applications, Design & Field Engineering
Broadcast Engineering Software
216 N. Green Bay Rd.
Thiensville, WI 53092
(414) 242-6000
Member AFCCCE

PC - SOFTWARE
AM FM TV Search Programs
Contour Mapping-STL Paths
RF HAZ-1990 POP Count
FAA Tower-Draw Tower
Doug Vernier
Broadcast Consultant
1600 Picturesque Dr
Cedar Falls, IA 50613
800-743-DOUG



Without Advertising a Terrible Thing Happens...
... NOTHING

Contact Radio World Newspaper for availabilities

P.O. Box 1214 Falls Church VA 22041

1-800-336-3045



SATELLITE...WTS

NEED CASH?

We buy:
Fairchild DART 384
 Scientific Atlanta
 7300/7325
 Unistar
 AM Only/FMT 41
 Oldies AC-II/CNN
 Microdyne
 1100 Series
 SPCP

We sell quality
 Reconditioned
 units with a
 30 Day
 Guarantee

New Avcom &
 Microphase SPCP
 Satellite Systems
 (719) 634-6319
 (Fax) 635-8151

Drake ESR2240 rec, \$200/BO; DX DSA-654TM with KU LNB, \$350/BO; Wegener 1624 with 1602 frame, \$400/BO. 816-532-0460.

Wegener 1601 mainframe, oldies, very gd cond, \$3500. Mark, KQWB, Box 1301, Fargo ND 58107. 218-236-7900.

TV antenna dehydrators, \$2500 ea/trade for Ku-band exciter. 212-969-0240.

Wegener 1601-50 mainframe w/1645-46 tone decoder cards & 1606-02 downconverter w/dual thumbwhl xponder selector, 3.7-4.2 GHz-70 MHz & pwr sply, \$795. B Mountjoy, WXR, POB 938, Hickory NC 28603. 615-543-5849.

want to buy

Fairchild/Sci Atl dig DAT/SEDAT, \$2000. B Vinikoor, WNTK, POB 2295, New London NH 03257. 603-448-0500.

Tuner cards for Wegener 1601-05 rcvr for 4.47, 4.65, 5.01 & 5.2 freqs. L Wise, KNEO, POB 845, Neosho MO 64850. 417-451-5636.

Ku-band exciter, working. 212-969-0240.

SOFTWARE/DATABASES

want to sell

Ron Balonis' Broadcast Engineer's Computer Toolbox? Write: **COMPUTER TOOLBOX**, 118 Rice Street, Trucksville, PA 18708. Or, call it up: 1-717-696-1490 <300/1200/8/N/1>.

STATIONS

want to sell

Class C2 FM in Clifton/Safford Arizona. Terms available, \$395,000. S Greeley. 602-855-1051.

POWERFUL PC SOFTWARE

COUNTOP 1990 US Census

Find coverage area population
INTERCHK (FCC's FMOVER)

Uses graphics to display Service & Interference contours over US map

QCHANNEL & FCC FM database

FM channel search program

SEARCHFM & FCC FM database

Deluxe graphics over Map, Mouse & zoom

CONTOUR (w/NGDC interface)

Flexible FCC contour generating program

PLOTPATH — STL PROGRAM

Graphic sign of STL systems

PLOTCC M for HP plotters

Professional contour plotting program

SEARCH 1 — SEARCHTV

FAATOWER — HAZ — Plot Tower

AM, FM & TV databases & more

(Send for full software list & descriptions)

DOUG VERNIER—Broadcast Consultant

1600 Picturesque Dr., Cedar Falls, IA 50613

800-743-DOUG

See Us At SBE Booth 519

want to buy

50 kW AM in Capital City, clear chnl, mid/low dial pos, unld time non dir, days dir, nights, sale/lease. 501-470-1525.

MUST SELL DUE TO HEALTH

Ohio full time AM. Small amount down or discount for cash. POB 69, Bellefontaine OH 43311

Midwest AM sale/contract. L Weatherford, V103, Box 67, Covington IN 47932. 317-793-4844.

Class "A" FM. Exclusive in County of 170,000, city 8,000. License, transmitter bldg, land, tower partially up. Cash/terms/BO. 314-586-4090.

WANT TO BUY AM STATION

Off-air or negative cash OK. Prefer 5 kW or above. Must be in top 100 market.

708-416-1500

STEREO GENERATORS

want to sell

BE FS-30, excel cond w/manual, factory tuned, new, \$2000. G Thomas, KNYD, POB 1924, Tulsa OK 74101. 918-455-5693.

Rood/Marcom 203, \$400; Moseley SCG-2 185 kHz subcarrier gen, \$100. P Wells, KJOY, 625 Broadway #1200, San Diego CA 92101. 619-238-1037.

FS-30 stereo generator, excellent condition, \$2205. Call 918-455-2955.

want to buy

CCA SG-1E schematic & assoc svc info. L DuPree, KQID, 1115 Texas Ave, Alexandria LA 71301. 318-445-1234. Call collect.

SWITCHERS (VIDEO)

want to sell

Dielectric 50000 motorized coaxial. D Donovan, 512-994-7700.

TAPES/CARTS & REELS

want to sell

Audiopak, (847) A-2, AA-3, AA-4, new & used, \$1 ea; (19) Scotch, used, \$1 ea. D Davis, KMBA, 5000 Marble Ave NE, Albuquerque NM 87110.

Scotch & Capitol 10 1/2", 7 & 5", MT reels & boxes, \$100 ppd in USA. E Davison, 217-787-0800.

Ampex, (20) 1/2" slightly used, gd cond, no splices w/boxes, \$200/BO+s/h. Ken, 419-243-1000.

AGFA/PEM 9100, 468/2400" 1/2" on metal reels, \$15 ea/\$1200 all+s/h. D Crepps, IBS, 29672 Silver St, Val Verde CA 91384. 805-294-9441.

Disc recs, needles, blanks, rec xcriptions. B Davies, Virgo Prods, 5548 Elmer Ave, N Hollywood CA 91601. 818-761-9831.

Stereo tapes/CDs. P Lopeman, 414-482-1959.

Jon Arthurs "Big John and Sparkie" & "No School Today" radio programs from 50's. R Meyers, Benchmark, 4700 SW 75 Ave, Miami FL 33155. 305-264-5963/FAX 305-264-2357.

CALL 1-800-DAT-TAPE OR 1-800-245-6000
 AMERICA'S LARGEST DAT TAPE SUPPLIER

SONY PRO	TEK	DENON	BASF
DT 20 "0 99	DAR 60	R2001	DAT 20 "99
SONY	DAR 120	R6001	KN TAVE ALDICH
DT 60 "89	AMPE X	R9001	KE 120
DT 90R "99	DAT 120 "0 99	H 2001	KE 30
DT 200R "89			KE 60
MARTEL			KE 90
H 100 "84			KE 120
JVC			KE 150
H 200K "84			KE 180

VISA MC NO EXTRA CHARGE
 WE'LL BEAT ANY PRICE!
 4.95 SHIPPING ANY SIZE ORDER!
 TAPE WORLD 220 SPRING ST BUTLER PA 16003-0361
 WE STOCK OVER 400 DIFFERENT AUDIO & VIDEO TAPES

Circle (60) On Reader Service Card

Scotchart IIs (575) 31/2 min, oldies rec from CD, \$2 ea+s/h. B Lord, Lord Bdcg, 13313 SE 208th St, Kent WA 98042. 206-631-2374.

Ampex 642 (500) 1-1/4" & 10-1/2" NAB; 200 poly cass boxes. B Derking, KNDY, RR3, Marysville KS 66508. 913-562-2361.

Oldies library w/Christmas on 10", BO. J Kennedy, 407-388-0065.

TAX DEDUCT EQUIP

Low pwr educ radio seeks working donations of equip, will pay s/h. Dr. Newcomb, Grand River Radio, 19130 Nelson-Parkman, Garrettsville OH 44231. 216-548-2053.

MARATHON PRODUCTS COMPANY

Audio Cartridge Rebuilding Division

Rebuilding/reloading, like new, all brands, any length up to & including 3.5 minutes, \$1.75 ea. FOB out plant, 48 hrs delivery.

New NAB Marathon cartridges prices on request.
 35 Years professional experience!
 Lifetime member AES R.D. MYERS Sr.
 Manufacturers of Audio Devices, Continuous Tape Mag.

**69 Sandersdale Rd.
 Charlton, MA 01507**

1-508-248-3157 or 1-508-853-0988

Circle (80) On Reader Service Card

A&D

Cartridge Rebuilding Service

We clean, load & pack. Serviced within 10 work days! Work guaranteed!
 3706 Vold Ct., Eau Claire, WI 54701
 (715) 835-7347

want to buy

Cash for Orr radio, Irish band A/V tapes & boxes, 3, 5, 7 & 10" reels; Orrtronic Car Mate; Aeromate tape plyrs. H Norman, 205-825-0390.

Donate your old Broadcasting & Cable Marketplace to non-prof educ, rcpt given. Dr Newcomb, 216-348-2053.

Educ FM would apprec any donation of xmtrs/CD plyrs/excilers, any repairable equip. D Sanford, 206-371-3483.

Eng student desiring donation of old bdcet equip (anything) in repairable cond, will pay all shipping charges, EE student at Purdue. C Gill, POB 371, Indianapolis IN 46206. 317-923-2800.

DISTRIBUTOR DIRECTORY

The following distributors serving the broadcast industry would be glad to help you with any of your requirements

... getting tired of the price/quality/performance puzzle? ...
 ... That's our game.
RADIO! The beat goes on!
CROUSE-KIMZEY OF ANNAPOLIS
 tops in broadcast equipment
1-800-955-6800
 ask for Kathleen

CORNELL-DUBILIER MICA CAPACITORS
 FROM STOCK
JENNINGS VACUUM CAPACITORS
 FROM STOCK
JENNINGS VACUUM RELAYS
SURCOM ASSOCIATES
 2215 Faraday Ave., Suite A
 Carlsbad, California 92008
 (619) 438-4420

SWR INC.
 SYSTEMS WITH RELIABILITY
FM-Antennas
 Outstanding performance and quality you can be sure of. All antennas are completely tested on SWR's test range. Custom directional patterns are available.
Contact JIMMIE JOYNT
800-279-3326

This Space Available
 Call Simone for details
1-800-336-3045

This Space Available
 Call Simone for details
1-800-336-3045

Transmitters FM-TV-LPTV
 Translators FM-TV-LPTV
 STL Transmitters
 Receivers and Antennas
 Exciters-TV & FM
 Stereo Generators
 - Financing Available -
Factory Direct Sales
CALL 719-531-0124

TRANSCOM CORP.
 Serving the Broadcast Industry Since 1978
 Fine Used AM & FM Transmitters and Also New Equipment
 For the best deals on Celwave products, Andrew cable and Shively antennas.

1 kW FM	1964 Gates FM1C	1 kW AM	1982 Cont. 314R1
1 kW FM	1978 Collins 831C2	2.5 kW AM	1982 CCA 2500D
2.5 kW FM	1978 CCA 2500R	2.5 kW AM	1976 McMartin BA2.5K
3 kW FM	1975 CCA 3000D	5 kW AM	1968 Harris BC5H
3 kW FM	1974 Harris FM3H	5 kW AM	1972 CCA AM5000D
15 kW FM	1975 AEL 15KG	5 kW AM	1977 RCA BTA 5L
25 kW FM	1988 TTC 25,000	50 kW AM	1977 CCA AM 50000D
30 kW FM	1981 BE FM-30		

1077 Rydal Road #101
 Rydal PA 19046
800-441-8454 • 215-884-0888 • FAX No. 215-884-0738

Circle (131) On Reader Service Card

TAX DEDUCTIBLE...

Monte Vista Christian School, would appreciate any donations of used radio equipment along with used TV broadcast equipment. T Quinn, 408-475-0423.

**TEST EQUIPMENT
want to sell**

Leads & Northrup decade resistance box from .01-20K ohms, perf. \$50. E Davison, 217-787-0800.

Potomac FIM-71 field strength meter, 45-225 MHz, factory recalib. G Gilbreath,

**RADIO
RESOURCES**

1201 S. Sharp Street
Baltimore, MD 21230

- New and quality pre-owned broadcast equipment for sale
- Test and remote equipment available to rent for a day or a month
- Call and ask us how to turn your excess equipment into **\$\$\$CASH\$\$\$**

Call Steve, Chuck or Scott

**1-800-54-RADIO
1-800-547-2346**

9AM-6PM E.S.T.

Circle (2) On Reader Service Card

800-551-1667.

HP 403B AC voltmeter, \$100; HP 353A patch panel, \$50; URM-26B RF signal generator, 4-420 MHz, \$100. K O'Malley, 804-446-2731.

Westcom Hameg HM103-3 oscilloscope, used 6 mos, \$295+s/h. B Lord, Lord Bldg, 13313 SE 208th St, Kent WA 98042. 206-631-2374.

HP 5035T Logic Lab w/proto board mounted to sloping case w/pwr sply, logic switches & HP carry case, \$45; HP 1741A 100 MHz dual trace storage scope, great cond, \$695; Tek 5441 storage scope w/(2) 5042 delaying time base plug-ins & 5A22 differential probe amp, \$695; Heath/Zenith SM-2420 600 MHz freq counter, gd cond, \$85. G Wachter, KFYI, 631 N 1st Ave, Phoenix AZ 85003. 602-258-6161.

Tek FG507/TM515 function gen w/load case, \$1000; Tek DC508a/TM503 1.8 GHz freq counter, \$550; Sounder phase check set, BO; HP 400FL AC voltmeter, BO; Pulse Dynamics pulse generator, \$50. P Wells, KJQY, 625 Broadway #1200, San Diego CA 92101. 619-238-1037.

Tek DC505A freq counter/timer, \$250; DC508A counter, \$250; SG sine wave generator, \$395; DM502A dig multimeter auto range, \$75; DM501A dig multimeter, \$95; HP 333A dist analyzer, \$695; HP 353 110dB attenuator patch panel, \$85; Waveform 520-A RMS/DBM sensitive volt meter, \$100; Ithaco 4302 dual 24 dB/Octave Hi-pass filter 1/01 to 1 MHz, \$295; Wavetek 30

function generator, \$135; Weston 666 multimeter, \$45; Eico 150 solid state signal tracer, \$85; Sorenson DCR20-25 pwr sply w/2-meter rack mount; Heath AG-72 audio generator, \$85; RCA WT-501A, \$35. J Price, 214-321-6576.

Tellabs 4008 (6) EQ cards & pwr sply, BO. J Kennedy, 407-388-0065.

HP 206A audio generator, rack mount w/manual, \$150+s/h. F Konwinski, WSOY, 1100 E Pershing Rd, Decatur IL 62524. 217-877-5371.

Patch bays (4) ADC single inputs (24) rack mount; Dynakit pre-amp PAS 2; manuals for Ampex recorders 601, 351, 350 also for Gotham PBF 150 W amp & Neuman lathe 131 disc cutter. Mr. Oliver, 212-874-7660/0274. Call afternoons till 10PM.

want to buy

Johnson SCA field strength meter, portable, working/not. S Callahan, WCEG, 66 Cambridge St, Middleboro MA. 508-946-1530.

Belar FM stereo mod mon. Bob, 603-448-0500.

**TRANSMITTERS
want to sell**

NEC FBN-9200E 20 kW FM w/25 kW dummy load, BO. R Miller, KUAU, POB 575, Lahaina HI 96767. 808-572-5334.

NEC 4763 25 kW w/25 kW dummy load, \$20K/BO. R Miller, KUAU, Box 575, Lahaina HI 96767. 808-572-5334.

Exciters: McMartin B-910 tuned and calibrated to your frequency, guaranteed: Mono, stereo, SCA. Goodrich Ent. Inc. 11435 Manderson St., Omaha NE 68164. 402-493-1886 FAX: 402-493-6821

GE BC-375 100 W AM w/TV-5B tuning unit, unmodified w/BC-206A & manual, \$50. P Russell, Bowdoin Coll, Sills Hall, Brunswick ME 04011. 207-725-3066.

Marti 40 RPU 40 W solid state, 170.15 kHz, \$995. G Erway, KKSBB, POB 40309, Santa Barbara CA 93140. 805-967-6672.

**CAPACITORS
OVERNIGHT**

- Power Supply computer grade up to 450 VDC
 - Transmitting-MICA Sangamo, Comell-Dubiler
 - Oil Filled Non-PCB Oval, Rectangular
- 1-800-323-0460**
FAX 1-802-425-3664
Kellner Electronics, Inc.
Charlotte, VT 05445

Circle (9) On Reader Service Card

Gates TE-3 exciter, solid state, 10 W output w/Optimod interface, \$500. K Carlson, KMUT, 1100 Blue Lakes Blvd N, Twin Falls ID 83301. 208-733-1100.

TTC AM 10 kW, solid state exciter & audio driver tuned to 1140 kHz, very gd cond, 5 yrs old, \$25K; Gates BCSP AM, 5 kW, nds plate xformer winding repair, fair cond, tuned to 1140 kHz, \$2500. G Arroyo, 407-830-0800.

Harris TE3, compos input, stereo gen mod incl but not used, spare mod, osc mods, (2) spare RF pwr amp mods, \$950. J Inghram, WGCA, POB 467, Quincy IL 62306.

Harris HT 3.5 FM w/THE ONE exciter, on 95.3 MHz, \$24995+s/h. C Murray, 503-484-9400.

Harris 5 kW, 10 yrs old, in svc, new tubes, tuned to 105.5, excel cond. D Donovan, 512-994-7700.

Harris STX-1B AM C-Quam exciter, limiter & manual, gd cond, \$1950; CCA FM-20000DS 20kW FM w/CCA exciter, gd cond, \$17500. B Barry, WAMB, 1617 Lebanon Rd, Nashville TN 37210. 615-889-1960.

FM Transmitters

500W QEI 675T500
1 kW Harris 1 H 3
2.5 kW Collins 831-D

PMA Marketing, Inc.
"Transmitting Savings to You"
414-482-2638 FAX 483-1980

Harris BC10H, 1983 AM, like new, 10 kW. Tom, 715-234-9059, \$25000.

1 kW or 5 kW TV transmitters for Chs 23 and 27 UHF band. Call Hector, 305-386-8384.

RCA BTA50F 50 kW AM, excel cond w/pwr supply, books, layouts, \$12K. 716-751-6187.

10W or 100W TV transmitters in groups of four (4). For use in the 2500-2700 mHz band. Need antennas, quadruplexers, etc. Call Hector, 305-386-8384.

50 kW AM Transmitters

One Continental 317C-1 in good condition, optional/spare parts. One Harris MW-50A in good condition, optional/spare parts. One Gates MW-50 upgraded to MW-50A in good condition, optional/spare parts. Available now! Call 816-372-5141.

RCA BTA-5L AM, low hrs, used as back-up, excel cond, \$10K/BO. K Allford, KJR, 190 Queen Anne Ave, Seattle WA 98109. 206-285-2295.

Harris SX-1 solid state 1000 W, 1140 kHz with load, manuals, spare parts. Excellent condition, \$9500/BO. 816-532-0460.

RCA BTA5F 5 kW, excel cond w/books, layouts, \$7500. 716-751-6187.

Motorola 1300 AM stereo exciter, BO. Tom, KMXN, 499 Humboldt St, Santa Rosa CA 95404. 707-544-5693.

Gates BCIT 1000W AM, \$700; BCIF 1000 W AM, \$600. J Randolph, WMGE, Box 1230, Danville KY 40422. 606-236-2711

CCA FM20G. B Derking, KNDY, RR3, Marysville KS 66508. 913-562-2361.

FM 1987/newer, 20 kW within 1000 miles of Houston, on/close to 94.7 MHz. CD, KVLL, POB 459, Woodville TX 75979. 409-283-3734.

Gates TE-3 Statesman FM, solid state, all mods w/manual, nds min work, \$175; CCA FM10DS solid state exciter & oscillator w/tube-type output, computer w/pwr sply & manual, BO; Gates cab shell w/all panels, 32" 34" 78", BO. J Michaels, WMVR, POB 889, Sidney OH 45365. 513-498-1055.

RCA BTF 3B 3 kW, \$3000. A Burges, WNZN, Carr. Vieja del Vigia #83, Ponce PR 00731. 809-840-1588.

TDD-5 AM tuned to 530 kHz, 1-50 W, very gd cond, \$500; Precision 100 MW-AM tuned to 530 kHz w/booklet, \$200 + \$10 s/h. F Smith, 615-624-7126.

Marti RPT-40L transmitter & Marti R-30 base receiver, both in very good condition, 166.25-MHz, \$850/both. 816-635-5959.

Harris MS-15 exciter, very gd cond. 816-635-5959.

**NEW
McMARTIN
BF-5K**
Lowest priced
tube replacements

5500 W FM, broadband grounded grid output circuit, VSWR protection, excellent efficiency 75-80% automatic recycling & overload status. Fully remote controlled. FCC approved to 5500 watts.

**Goodrich
Enterprises Inc.**
11435 Manderson Street
Omaha, NE 68164
402-493-1886
FAX: 402-493-6821

Used & New Transmission Line, many sizes & lengths, many like new. 412-733-1994.

MVDS video diagnostic system for Broadcast Electronics transmitter, excellent condition, \$3230. Call 806-372-5130.

Broadcast Electronics FM-20000B transmitter, excellent condition. Call 806-372-5130.

want to buy

2.5 to 5.0 kW FM, ltd budget, can fix broken one; exciter, pref QEI 675/Harris MS/MX-15 or BE FX-30. P Lopeman, 414-482-1959.

1930s/1940s vintage AM, not more than 250 W, cheap. George, 419-529-8427.

100 W FM, late mdl. R Murphy, 800-582-7625.

**WE BUY
MOSELEY PCL-303, 505, & 606's
414-482-2638**

Collins 831 10-25 kW FM, gd working cond, pref Continental/Harris. R Wesley, WKDO, POB B, Liberty KY 42539. 606-787-7331.

10 kW, gd cond. G Spicer, RPV, Box 8085, Mitchell IL 62040. 618-797-2299.

Harris MW1A AM. H Hoeflicker, KRFS, Rt 2 Box 149, Superior NE 68978. 402-879-4741.

**WANTED
RCA Transmitters
BTF-5E, 10E or 20E
414-482-2638**

Modulation xformer for RCA BTA-10U/BC-10P, gd cond. G Arroyo, 407-830-0800.

5/10 kW AM, gd cond, tuned to 1470. Tony, 203-634-1470.

**USED TV
TRANSMITTERS,
antennas, cable,
rigid line, etc.
one watt to 110 kW.
Best FM Line
BUY — SELL**

**BROADCASTING SYSTEMS
602-582-6550
FAX: 602-582-8229
Kenneth Casey**

CSI/CCA 1-15 kW AM. J Wilkinson, KONY, POB 2588, St George UT 84770. 801-673-1210.

AMPFET P-400 solid state, used, tuned to 530-540 kHz; any 250 W AM solid state. F Smith, 615-624-7126.

**Doing business
without advertising
is like winking in the
dark; you know what
you're doing, but
nobody else does.**

Low pwr AM/FM pref tunable, usable w/o extra equip w/console. Heritage Radio, POB 16, Boston MA 02167. 617-969-9966.

McMartin AM/FM xmtr, any model, exciter or stereo modules. Goodrich Ent., 11435 Manderson, Omaha NE 68164. 402-493-1886.

**TUBES
want to sell**

Eimac 4CX3500A, used, 5000 hrs use, not rbl, \$500. T Peterson, Peterson Eng, Box 22, Big Rapids MI 49307. 616-796-7776.



FACTORY NEW TUBES
Sales Under Cost
Because Overstock

4CX1000A \$220.00
4CX1500B \$270.00

Other types:
Please Call, Will Beat
Anybody's Price
Subject to Prior Sales
Whichever Come First

**CALL
1-800-783-2555**
JoLida Tube Factory
Annapolis Junction, MD

FM BROADCASTERS!!
We can meet all your
FM transmitter needs!!

SOLID STATE
Amplifiers and transmitters are available at the popular levels of 25, 100, 300, 500, 1000, 1500, 2000, 2500, 3000, 4000 and 4500 watts. All units are broadbanded and designed for local and remote operation.

ZERO BIAS GROUNDED GRID TRANSMITTERS

SINGLE TUBE—MEDIUM POWER
Offered at 1.5, 3.5, 5.5, 7.5 and 12KW. These transmitters include a broadbanded solid state IPA, which can be used as emergency transmitters and a single zero biased grounded grid triode in their PA.

TWO TUBE—HIGH POWER
These transmitters utilize two grounded grid triodes and are available at standard outputs of 15, 22, 25, 30, 40 and 50KW.

"The Transmitter People"
Energy-Onix

752 Warren Street, Hudson, New York 12534
(518) 828-1690 FAX (518) 828-8476

A Wise Enterprise
Circle (177) On Reader Service Card

PETER DAHL CO.

Save \$\$

Heavy Duty Replacement Transformers, DC Filter chokes and capacitors for AM & FM transmitters manufactured by: AEL, CCA, CSI, COLLINS, CONTEL, CONTINENTAL, BAUER, GATES, GE, HARRIS, ITA, McMARTIN, RAYTHEON, RCA, SINGER, SINTRONIX, WILKINSON. Many other models also available.

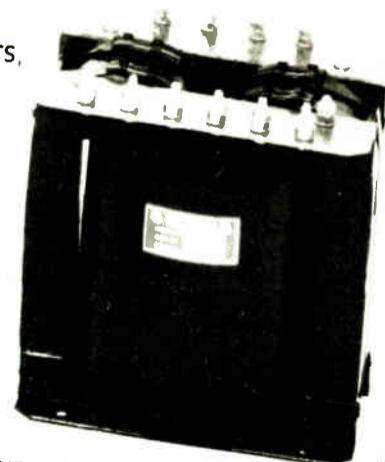

**FAST Delivery
and FREE
Technical
Support.**

5869 WAYCROSS AVENUE EL PASO, TEXAS 79924
(915) 751-2300 TELEX: 76-3861 PWDCCO
FAX: (915) 751-0768

Circle (166) On Reader Service Card

TUBES...WTS

REBUILT ELECTRON TUBES

Partial List: 6623, 23791, TH150, 6425F, 5604, 6696, 6697, 5681, 5682, 5671, 7804, 3CX10,000H3, 3CX20,000H3, 4CX5000A, 4CX35,000C

Vacuum Tube Industries, Inc.

1-800-528-5014
508-584-4500 X75

4-1000A, 8877, 4CX250B, 4CX1500B, 4CX3000A & more. We carry large inventory all major brands, Eimac, Ampere, RCA, etc. Call Stew 1-800-842-1489.

For the Best Prices

& 24 Hr service on transmitting tubes call 402 493 1886 day or night. FAX 402 493 6821. TELEX 940103 WU PUB TLX BSN

ECONCO

Quality Rebuilt Tubes

Approximately 1/2 the Cost of New

Call for Our Price List

800-532-6626

916-662-7553

FAX 916-666-7760

Circle (5) On Reader Service Card

Audio generator, TE22 (Lafayette), Sen-core translator tester (portable); Cannon plugs, male & female 3 prong (new); new & used cable w/Cannons or without. Mr. Oliver, 212-874-7660/0274. Call afternoons till 10PM.

want to buy

Eimac/Varian 3CX1000A7, new/pulls for rsrch proj, full output. R Stankus, Mid-Lo Bldg, 10616 Savoy Rd, Richmond VA 23235. 804-320-1130.

ELECTRON TUBES

Vacuum Tube Industries, Inc.

1-800-528-5014

508-584-4500 X75

3CX3000A7. P Lopeman, 414-482-1959.

Eimac 4CX1000. Bob, 603-448-0500.

TUBE REBUILDING

FREELAND PRODUCTS

Since 1940

SAVE ABOUT 50%

-We buy dud tubes-

800-624-7626

504-893-1243

FAX 504-892-7323

TURNTABLES

want to sell

RCA 70D 16" transcription, 78 & 33 w/orig tonearm & extra Ortofon arm, \$300. G Lombardo, Lombardo Sound, 61 Stephenville Pkwy, Edison NJ 08820. 908-549-8078.

want to buy

Tone arms for QRK drilled for Shure M-232, cheap. Sidney, WDME, POB 357, Dover ME 04426. 207-564-2642.

Studio disc lathes & rcdg gear by Fairchild, Westrex, Gramplan & Presto; hi-fi tube gear; 45/78 recs. K Gutzke, Custom Rcdg, 7134 15th Ave S, Minneapolis MN 55423. 612-866-6183.

VIDEO PROD EQUIP

want to sell

Onyx JS-05, (4) video amps for CCTV cams, \$25 ea. P Russell, Bowdoin Coll, Sills Hall, Brunswick ME 04011. 207-725-3066.

Sony CUM 1250 12" color video mon w/UHF/VHF tuner & manual, excel cond, \$250. R Glenn, WJGR, 1718 Shannado-cy, Wimauma FL 33598. 813-634-1940.

want to buy

RCA TK 31, 44, TKP 45, TK76 circuit manuals for N Elec & Cohu sync gens; Ku & C-band excitors; RCA DX77 mic; Quantel 1550 TBC; Hitachi 24-pin cable.

F Jodry, 6 Van Horn St, Demarey NJ 07627.

VIDEO TAPE RECORDERS

want to sell

JVC CR4400LU port ., \$150. D Bailey, Rock Shoppe Prod, 3422 Beach St, Rowlett TX 75088.

Sony VO-4800, BO. John, 509-826-0100.

JVC CR4400 port 3/4" rec, pwr sply & batt, Portabrace case, \$750 +s/h; Singer/Grallex 16mm carbon arc proj, \$1500 +s/h. D Hurd, Harding Univ, 805 Park St, Searcy AR 72149. 501-279-4658.

Sony SLO-323 Betamax I 2-chnl, large qty, excel cond, \$75 ea + \$15 s/h. 818-769-5544.

want to buy

Circuit boards & cables for Ampex VR3000; Ampex VPR2, 20 or 3 for parts & cables; lens, circuit manual, cables, parts & access. F Jodry, 6 Van Horn St, Demarey NJ 07627.

This Month's Crossword



by Steve Walker

solution in next issue of RW

- Across**
- Postscript
 - Used with reel-to-reels
 - Genus of flower
 - "The Phantom"
 - In the month preceding the present one; abbr.
 - Title; ownership paper
 - Additions
 - Murphy Brown's TV show
 - Ocean State
 - Microwave system used for broadcasting football games, etc
 - Leave out
 - Plural pronoun
 - "The world's strongest AM transmitter"
 - Fortune teller
 - Feminine pronoun
 - Participate in a game
 - Portable One
 - Material previously used in manufacture of transistors
 - Government organization regulating employment practices
 - Male offspring
 - Measure
 - Approximation of arrival time
 - Intercom system
 - StarStation
 - "A little bit of magic"
 - Teletype
 - Capital is Bismark, abbr.
 - Recording room

- Down**
- Iraqi missile
 - Temporary, unpaid worker
 - Rear
 - International governing body
 - Gamble
 - Ratio useful in determining dynamic range
 - RS-700
 - Bullfight cry
 - "Very affordable. Very Reliable"
 - Aged
 - Michigan lake
 - Objects created for aesthetic significance out of imagination of creator
 - Light Prices/Heavy Deals
 - Warner Bros. skunk
 - Personal pronoun
 - Capitalistic superpower
 - "Set it and forget it"
 - Smells
 - Talking horse
 - Field of study devoted partially to robotics
 - Despoil
 - Very Good
 - Prepared
 - Roamer, wanderer
 - Mummified king
 - Barnum
 - Short for process describing the addition of a signal to a carrier
 - Powered up
 - Santa Claus' favorite word

ABOUT OUR EMPLOYMENT SECTION

HELP WANTED: Any company or station can run "Help Wanted" ads for \$1.50/word or buy a display box for \$55/column inch. Payment must accompany insert, use your MasterCard or VISA; there will be no invoicing. Blind box numbers will be provided at an extra charge of \$10. Responses will be forwarded to listee, unopened, upon receipt. Call 800-336-3045 for details.

POSITIONS WANTED: Any individual can run a "Position Wanted" ad, FREE of charge (25 words max), and it will appear in the following 2 issues of Radio World. Contact information will be provided, but if a blind box number is required, there is a \$10 fee which must be paid with the listing (there will be no invoicing). Responses will be forwarded to the listee, unopened.

Mail to: **BROADCAST EQUIPMENT EXCHANGE**
PO Box 1214, Falls Church, VA 22041
Attn: Simone Mullins

ADVERTISER INDEX

This listing is provided for the convenience of our readers. Radio World assumes no liability for inaccuracy.

Page No.	Advertiser	Reader Service No.	Page No.	Advertiser	Reader Service No.
32	Harris-Allied Broadcast Equipment	71	32	Harris-Allied Broadcast Equipment	185
28	AMP Services	106	28	Harris-Allied RF Products	164
41	ATI	22	36	IFR Systems, Inc.	108
7	Arrakis	17	8	Inovonics	4
24,25	Audio Precision	110	40	J&I	192
8	Audiopak	19	9	Jampro	9
33	Auditronics	116	45	Kellner	80
13	Belar	41	44	Marathon	195
4	Benchmark Media Systems	198	37	Mart	83
36	Broadcast Electronics	20	31	Motorola	45
11	Broadcast Services	12	18	Myat	171
3	Broadcasters General Store	14	23	NASDAO	154
39	Burk Technology	32	36	Northern Technologies	180
4	Burk Technology	13	35	Orban/AGG/dbx	166
30	CCA Electronics	29	45	Peter Dahl, Co.	161
17	Clark Wire & Cable	56	34	OEI	111
29	Computer Concepts Corp.	176	36	Radio Active	119
38	Comrex	183	26	Radio Computing Service	—
3	Continental Electronics	23	30	Radio Hall of Fame	138
14	Cortana	181	22	Radio Mail	2
21	Cutting Edge	37	45	Radio Resources	77
15	Cybox	114	22	Reef Industries	68
26	Dataworld	18	27	SMARTS Broadcast Systems	15
32	Dataworld	147	9	Sierra Automated Systems	11
21	Econco	5	12	Sornich Engineering	66
36	Econco	197	36	Sontec	152
46	Enco	117	29	Studer	60
36	Enco	177	44	Tape World	98
20	Energy Onix	191	19	Tascam	131
45	FM Technology	93	44	Transcom	44
12	Fidelipac	50	2	Wheatstone	145
16	Gerstman Software	63	47	Wheatstone	91
36	Hall Electronics	25	48	Wheatstone	107
40	Harris-Allied Broadcast Equipment	7,54	37	Wohler Technologies	—
1	Harris-Allied Broadcast Equipment	—			
6	Harris-Allied Broadcast Equipment	—			
12	Harris-Allied Broadcast Equipment	—			

Publisher Stevan B. Dana
Associate Publisher Carmel King
Marketing Consultant Al Leon
Production Director Kim Lowe
Production Manager Julianne Stone
Production Lisa Lyons, Lisa Mamo

Ad Coordinator Regan Deatherage
Ad Coordination Manager Simone Mullins
Circulation Director Tiana Hickman
Circulation Manager Rebecca Seaborg
Accounts Receivable Steve Berto

Advertising Sales Representatives

U.S. East: Skip Tash 703-998-7600 Fax: 703-998-2966
U.S. West: Dale Tucker 916-721-3410 Fax: 916-729-0810
International: Stevan B. Dana +1-703-998-7600 Fax: +1-998-2966
Italy: Dario Calabrese +39-2-753-0274 Fax: +39-2-753-2697
Europe: John Tilly +44 71 226 8585 Fax: +44 71 226 8586
Japan: Eiji Yoshikawa +81-3-3350-5666 Fax: +81-3-3356-6200
Taiwan: Polo Chang +011-886-2-736-0027 Fax: +011-886-2-738-4822

Free Subscriptions are available upon request to professional broadcasting and audiovisual equipment users. For address changes, send current and new address to RW a month in advance at P.O. Box 1214, Falls Church, VA 22041. Unsolicited manuscripts are welcomed for review; send to the attention of the appropriate editor.

Just RIGHT!

4-TRACK PRODUCTION doesn't have to be complicated. The **MR-40** has just the features most stations are looking for: 4-track bus assign for your tape recorder; program assign so you can transfer direct to your 2-track—or go right on-air! It has machine Start/Stops just below the fader like an on-air console, but also includes a 3-band equalizer section so you can have the tone control that a normal radio console couldn't provide. It even has a stereo send bus that follows stereo channel balance controls—ever so important for today's stereo effects devices.

Mono modules have both mic and line inputs: mic for recording and line for track playbacks. Subgroup channels provide fader control for

record levels and also have a second track playback path for really quick sessions. And of course the MR-40 has an on-air type monitor section, complete with control room, headphone and studio outputs plus all the necessary muting and tally functions you'd want. It even has a built-in cue speaker and power amplifier.

Small format doesn't mean we've cut corners either: all audio switches are gold contact, assign buttons are LED illuminated, all ICs are double burned-in and all circuits are double-tested—we don't take any chances with reliability! The **MR-40** is a perfect blend of excellence in engineering and sensible size. It's just right for 4-track. So contact Audioarts.



MR-40 Audio Mixing Console



AUDIOARTS® ENGINEERING

6720 V.I.P. Parkway, Syracuse, NY, 13211 (tel 315-455-7740/fax 315-454-8104)

Circle (185) On Reader Service Card
World Radio History

Wheatstone's Finest

We've taken all that we know, all that you've asked for, and the very best of today's technology and components to bring you our finest radio console: the A-6000.

The A-6000 has all the features you could need (or even MIGHT need) but with a family of over 125 input module combinations, you're free to choose the features you DO need: like a built-in routing switcher with individual alpha channel displays, so you can configure your console to suit changing program requirements; Wheatstone's exclusive Bus-Minus™ system, the ultimate tool for news and sports events; four mix-minus busses, bringing real power to talk formats; logic controlled program and mix-minus busses, giving you complex function from simple switch commands; a full array of stereo and mono send controls for studio or effect

mixes; and of course, an equalizer option for your production suite. You can even add features later; you can relocate any module anywhere in the mainframe at any time, preventing obsolescence as format needs change.

And while Wheatstone is well known for superior technical performance, the A-6000 surpasses even our own previous consoles in virtually every measurement category.

The A-6000 has the appearance, features and power to excite the most demanding program and production staff; its engineering, performance and thoughtful design will help your technical staff achieve excellence. So contact Wheatstone, the people with knowledge, experience and a commitment to excellence.



Wheatstone Corporation

A-6000

6720 V.I.P. Parkway, Syracuse, NY 13211 (tel 315-455-7740/fax 315-454-8104)

Circle 133 on Reader Service Card

World Radio History