

*****3-DIGIT 857
J750737 D11 9007 9880 977
BARRY NISHKIND
2033 S AUGUSTA PL
TUCSON AZ 85718

Radio World®

Vol 15, No 1

Radio's Best Read Newspaper

January 9, 1991

CCIR Agrees on Spectrum

by Mike Starling

SYDNEY, Australia A consensus on spectrum requirements for proposed digital radio services was achieved by 15 nations and two broadcasting unions at the CCIR Joint Interim Working Party 10-11/1 meeting, held here Nov. 19 to 23.

The CCIR is the technical arm of the United Nations-sponsored International Telecommunications Union (ITU). The conference report concluded that at least 60 MHz of bandwidth near 1500 MHz would best implement new satellite and land-based digital radio services.

The conference report will highlight the recently developed U.S. technical system that was pioneered by Stanford Telecommunications for Satellite CD Radio and dubbed "Advanced Digital System III."

Advanced Digital System III

Despite initial opposition from the European Broadcasting Union (EBU) and Canada, extensive information on the U.S.-developed Satellite CD Radio/Stanford Telecom digital technology proposal was included in the conference report.

The European-developed Eureka dig-

ital audio technology is termed Advanced Digital System II in CCIR Report 955, the reference technical compendium that the Sydney reports will modify upon approval by the CCIR-WARC preparatory meeting scheduled for Geneva in March 1991.

Despite not having been fully prototyped or publicly demonstrated, as has the Eureka technology, the Satellite CD Radio proposal theoretically has greater spectrum and power efficiency. These specifications are possible through the use of a "Dynamic" Single Channel Per Carrier (DSCPC) modulation system.

Less costly than Eureka

DSCPC is less complex and less costly due to its ability to process data on a single carrier at a time versus processing simultaneously the data on some 448 carriers under the Eureka approach.

The conference adopted a materially identical link budget for both the Eureka and Satellite CD Radio systems, noting that actual tests of the U.S.-based system would provide additional empirical data concerning the DSCPC technology's transmission attributes.

With all spectrum from 3 kHz through 300 GHz currently allocated, finding at

least 60 MHz of spectrum for a worldwide allocation will be difficult and contentious.

Most nations agreed that roughly 60-67 MHz would be necessary to provide for their envisioned services, with the Soviet Union expressing interest for up to 120 MHz.

While a few nations stated their preference for the 2400 MHz option of the three bands under consideration (UHF-TV, 1500 MHz, and 2400 MHz), the upper UHF-TV spectrum consistently has been rejected as a home for Broadcasting Satellite Service (sound).

Despite favorable technical characteristics, television's current heavy use of the spectrum and advanced television's anticipated spectrum needs have stirred opposition to use of the upper UHF band.

Japan, the United Kingdom, United States and Canada

have expressed reservations about supporting the 1500 MHz proposal due to

(continued on page 12)

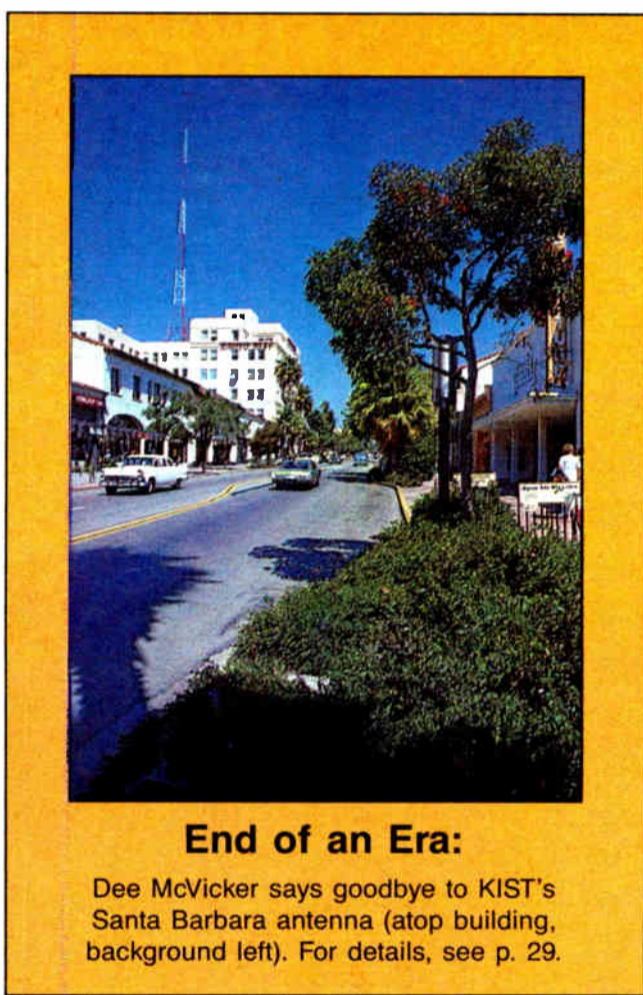

End of an Era:

Dee McVicker says goodbye to KIST's Santa Barbara antenna (atop building, background left). For details, see p. 29.

We are pleased to announce that



has been acquired by
FIDELIPAC CORPORATION
and will operate as the
Broadcast Audio Division of Fidelipac
in Moorestown, New Jersey.



DYNAMAX®
BROADCAST PRODUCTS BY FIDELIPAC®

Fidelipac Corporation
P.O. Box 808 • Moorestown, NJ 08057
TEL: (609) 235-3900 • FAX: (609) 235-7779

SCI Amends DAB Plan

by Judith Gross

WASHINGTON Strother Communications Inc. (SCI), the leading proponent of a terrestrial DAB system, has amended its test plans to include systems other than the European-developed Eureka 147 system.

SCI's original plans called for testing Eureka on UHF channels in Boston and Washington, D.C. But while it appeared likely SCI would get FCC authorization for those tests, an eleventh-hour filing was made by the Association for Maximum Service Television (MSTV), opposing UHF-TV frequencies. A similar filing was made soon after MSTV's by local Washington station WETA-TV.

In the meantime, Stanford Telecommunications (Stanford Telecom), which developed a DAB plan via satellite with terrestrial repeaters for Satellite CD Radio, modified its system to include

spread spectrum technology for multipath reduction and changes to its antenna design.

The changes in the Satellite CD Radio (Stanford Telecom) system more closely duplicate the advantages claimed for the Eureka system and have led to a CCIR group meeting recently in Sydney putting both systems on equal footing for evaluation purposes.

SCI President Ron Strother said the modified Stanford Telecom plan meant that it, too, could be implemented terrestrially and less expensively than the previous satellite proposal. Those changes, in addition to the fact that the Stanford Telecom plan is U.S.-developed, make it an attractive system to test along with the Eureka system, he said.

"We are interested in testing all DAB systems, including power-multiplexing and other systems compatible with

(continued on page 12)

NEWS BRIEFS

FCC Eyes Spectrum

WASHINGTON The FCC will initiate action to reserve spectrum to meet the requirements of new technologies, according to FCC Chairman Al Sikes.

In a recent speech, Sikes underscored the need to set aside spectrum for any new technologies, without impinging on the needs of existing users.

Sike's announcement is similar to a provision of legislation

introduced into Congress last year, freeing government spectrum for private use.

New AM Chief Named

WASHINGTON The FCC has named James R. Burtle as the Mass Media Bureau's new AM branch chief.

Burtle formerly worked in the FM branch, field engineering enforcement and the Low Power Television branch of the FCC.

AM Rule Relaxed

WASHINGTON The FCC has relaxed a 1989 AM rule that increased limits on low power AM emissions for such services as college radio stations and travel information services.

The Commission originally adopted the stricter limit to bring uniformity to Part 15 of the rules governing operation of radio frequency devices that do not require a license.

NRB Convention Scheduled

WASHINGTON The National Religious Broadcasters' 48th annual convention will take place

Jan. 25-29, in Washington, D.C.

The convention will begin on Friday night and will end with the annual banquet on Tuesday night. To accommodate the media, the NRB news media center will open at 2 p.m. on Friday, Jan. 25.

For more information, contact Brandt Gustavson: 201-428-5400, or FAX: 201-428-1814.

UST Regulations Enacted

WASHINGTON Stations should begin considering the new Environmental Protection Agency (EPA) financial responsibility regulations for underground storage tanks (USTs).

The regulations will take effect on Oct. 26, according to an NAB report.

The report stated that under the new rules, "a broadcast station with an auxiliary generator-sized underground tank generally will be required to maintain an annual financial assurance of at least \$500,000."

The financial requirements can be satisfied by any one of six mechanisms: insurance or risk retention group coverage, surety bonds, guarantees, letters of credit, financial test of self-insurance, trust funds or an individual state mechanism or fund that may be adopted in the future.

For more information, contact the NAB at 202-429-5241.

FCC Cites EEO Violations

WASHINGTON WTCB-FM in Orangeburg, S.C., was fined \$10,000 for "willful and repeated violations" of the Commission's affirmative action provision. The station has denied the allegations and has appealed the fine.

The FCC also upheld a \$10,000 fine against WSCQ-FM, in West Columbia, S.C. The station had filed an appeal, contending its fine was more severe than those of stations committing more serious violations.

Comments Deadline Extended

WASHINGTON The reply comments deadline for the FCC's proposed AM improvement rulemaking (Docket 87-267) was extended 30 days from Dec. 17 to Jan 17.

The docket includes numerous proposals to help AM including qualification standards for the expanded band and new methods for interference reduction.

INDEX

A Guide to RF Rule Compliance by Harold Hallikainen	13
Principles of Power Multiplexing by Lex Felker	14
The Erosion of Engineers by Barry Mishkind	16
Understanding RF Amplifiers by Ed Montgomery	19
Data Compression Call to Arms by Mel Lambert	20
How to Handle an Ownership Change by John "Q" Shepler	21
Ten-Four, Good Buddy! by Bruce Bartlett	27
Workbench	28
Kissing KIST's Tower Goodbye by Dee McVicker	29
SBE and Old Friends Revisited by George Riggins	33

WE SURPRISED OURSELVES!



AUDIOARTS® A-50 RADIO CONSOLE!

We wanted to know if it really was possible to build a high quality low-cost radio console. We found the answer to be quite exciting! We've come out with the A-50 console and even given it its own trade name: AUDIOARTS. This console comes complete with machine control functions; individually programmable channel logic; program, audition and telephone outputs; control room and studio monitors; as well as headphone and cue power amplifiers. It's also designed so you can expand or add accessory modules as your needs grow.

The A-50 is cost effective through clever engineering and the latest advances in electronic assembly procedures. It was developed by the same design team that creates our other high end equipment. Its performance is light years beyond the competition.

Imagine the benefit that our major market experience can bring to your station. Take advantage of Wheatstone's expertise and reputation. Call us today for immediate action!

 Wheatstone Corporation

6720 V.I.P. Parkway, Syracuse, NY 13211 (TEL 315-455-7740 / FAX 315-454-8104)

Filings Object to Satellite CD

by Alan Carter

WASHINGTON Although each had different reasons, broadcast and mobile radio interests were united in their opposition to an FCC application by Satellite CD Radio for permission to operate a digital audio radio service.

Broadcasters said it is premature for the Commission to act pending other proceedings delving into digital audio broadcasting (DAB). They also noted their opposition to a satellite service

rulemaking where it questioned problems with the transmission system, receiver complexities and "a basic conflict with . . . the establishment of universal, yet locally oriented broadcast service in this country."

Before the Commission should act, the NAB stated that proceedings on preparation for the 1992 World Administrative Radio Conference (WARC-92) and the DAB Notice of Inquiry (NOI) should be finalized.

CBS said that granting the application

set no rules and regulations.

From mobile radio interests such as Communications Satellite Corp. (COM-SAT), came the argument that Satellite CD Radio's proposed frequency band is better suited to "meet critical mobile-satellite safety and business service needs that are of greater significance than the incremental improvement in radio listening quality and coverage that digital audio radio services could provide."

Motorola said the spectrum is urgently needed for development and expansion of other emerging land mobile services.

Other opposition came from one of Satellite CD Radio's potential competitors, Radio Satellite Corp., which said the service should be regulated as a mobile satellite service and not on a private carrier basis.

What little support there was on file came from parties such as Stanford Telecom, which owns 22 percent of Satellite CD Radio; the University of Colorado Graduate Telecommunications Program, which is involved in satellite research for NASA; and Loral, an aerospace and electronics manufacturer recently acquired by Ford Aerospace.

Motorola said the spectrum is urgently needed for development and expansion of other emerging land mobile services.

as opposed to terrestrial.

Mobile radio interests opposed the move, arguing that the spectrum cited by Satellite CD Radio, 1429-1525 MHz, is not currently available for broadcast satellite service. They said the band is designated for co-primary use by fixed and mobile operations.

Common carrier

The FCC sought comments on the application filed in the Satellite Radio Branch of the Common Carrier Bureau. Satellite CD Radio also filed a petition for rulemaking in the Mass Media Branch.

The Common Carrier Bureau application requests the authority to construct, launch and operate a digital audio radio service using a two-satellite system, along with terrestrial repeaters. Satellite CD Radio would not operate the radio service, but sell it to programmers.

The NAB underscored its opposition to a satellite-based or "hybrid" proposal. The group referred to comments on the

would compromise the Commission's efforts on DAB and approving the service for satellite before terrestrial "threatens irreparable harm to the system of free, locally based over-the-air radio broadcasting."

Emmis also said it is too early to act and questioned whether the move is an attempt to usurp the Commission's authority to establish frequency allocations and characteristics, and technical requirements for authorized services.

Opposing satellites

In a joint filing representing 22 groups including Shamrock Broadcasting, the consensus was that the FCC should wait until the DAB notice is complete before taking action. The group also maintained their opposition to a satellite-based service, which it filed in the NOI.

The Association for Broadcast Engineering Standards questioned whether Satellite CD Radio wants to provide a direct aural broadcast satellite service, a service for which the FCC has

At Full Compass our policy is to be less expensive on high quality.



SL-P1200 or SL-P1300 Professional Compact Disc Player
 Studio/disco CD player • Professional cueing capability • High resolution digital filter • Rocker control for DJs • Pitch control • Zinc-cast frame

Technics



ST-G450 Digital Tuner
 Class AA • DC Circuit Construction • 24 Channel Random Access Preset Memory • Wide Band Quadrature Detector • Signal Strength LED Indicator

PRICES TOO LOW TO ADVERTISE!
1-800-356-5844



5618 Odana Road Madison, WI 53719
 Consultation 608/271-1100

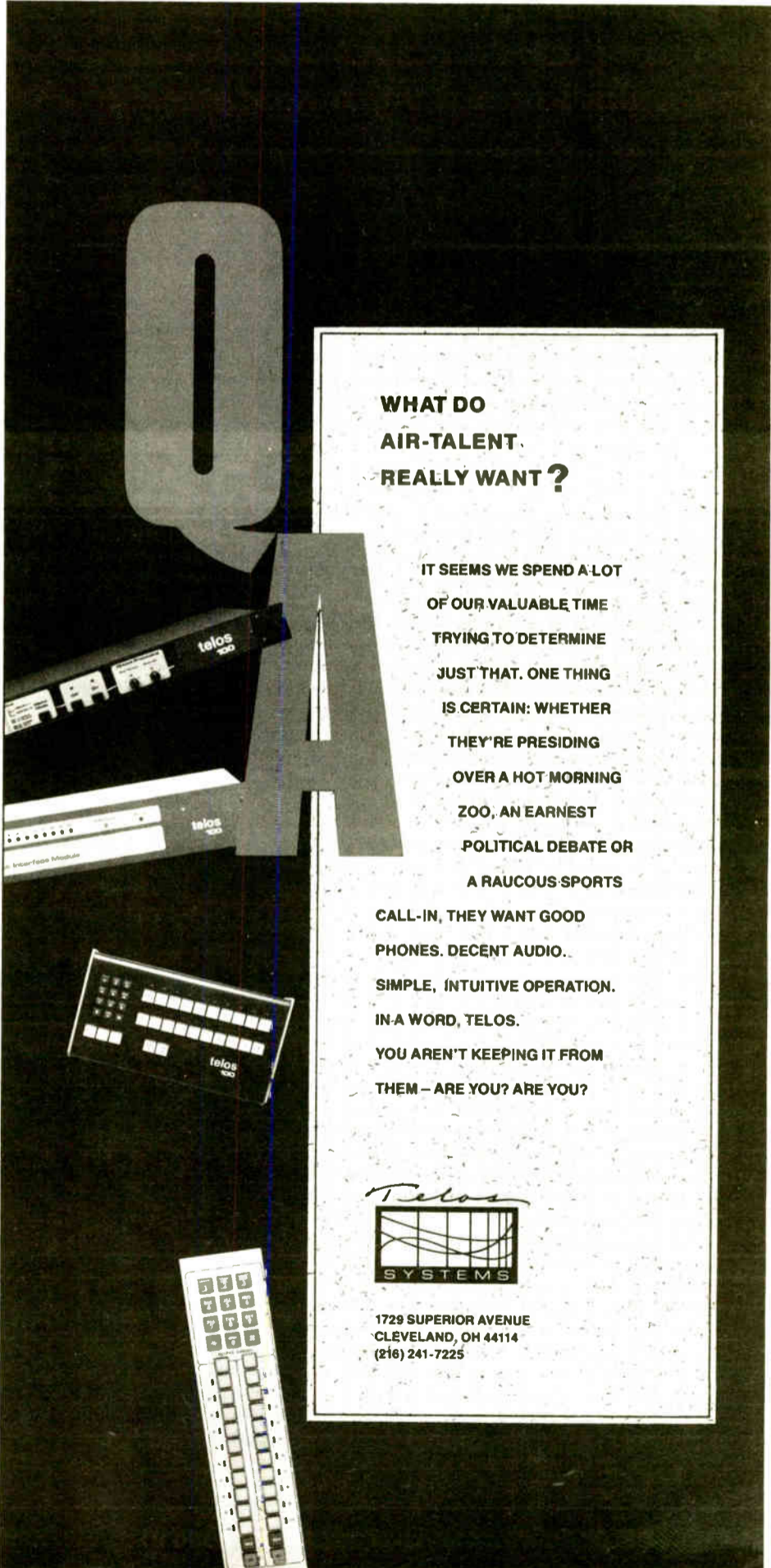

WHAT DO AIR-TALENT REALLY WANT ?

IT SEEMS WE SPEND A LOT OF OUR VALUABLE TIME TRYING TO DETERMINE JUST THAT. ONE THING IS CERTAIN: WHETHER THEY'RE PRESIDING OVER A HOT MORNING ZOO, AN EARNEST POLITICAL DEBATE OR A RAUCOUS SPORTS CALL-IN, THEY WANT GOOD PHONES. DECENT AUDIO. SIMPLE, INTUITIVE OPERATION. IN-A WORD, TELOS. YOU AREN'T KEEPING IT FROM THEM - ARE YOU? ARE YOU?

Teles
 SYSTEMS

1729 SUPERIOR AVENUE
 CLEVELAND, OH 44114
 (216) 241-7225

File It Under "E" For "Enough"

by Judith Gross

FALLS CHURCH, Va. Are the filings finished yet? I mean, AM, DAB, WARC, Satellite CD Radio, where does it end?

This looks to be the year the FCC takes action on some pretty heavy items. And DAB stuff heats up—but you knew that. Got to say I find some of the wild num-



bers being tossed about prediction-wise, pretty interesting.

For instance: some manufacturers look at the politics and say, "heck, it's at least 20 years off." Then you go up to the highest rungs of the NAB ladder and you hear: "15 to 20 years."

NAB DAB task force chairman Alan Box tells JG it's "10 to 12 years," a research NAB staffer writing for the association's weekly tip sheet says "five to 10 years," and some of the DAB system proponents are claiming "two to three years." Who do ya believe?

I don't own a crystal ball or anything, but I'll go out on a limb here. I think some experimental testing will begin this year, and the spectrum issues will be ironed out by late 1992 or early 1993 (with the FCC's usual deliberation time).

Look for the equipment folks to be gearing up in '93, applications for allotments to be filed that year and the first stations on-air in 1994. Now I know that sounds fast, and maybe I'm pushing things here. So if I'm wrong, I'll buy each of you a beer. But if I'm right, you can send me a keg—the imported variety.

Meanwhile the politics heat up. Strother Communications, which has been pushing for FCC authorization to

test Eureka 147 for a terrestrial DAB system for the US has met with opposition from proponents of HDTV.

See, Strother wants to test Eureka on UHF-TV channels. Maximum Service Television said "uh-uh." Now WETA-TV, on channel 26 right around the corner in Alexandria, says Strother's plan to use channel 40 in the D.C. area will cause interference to its signal.

Just a quick aside on this HDTV on UHF spectrum thing. First off, Strother only wants to test it there. He didn't say that's where DAB spectrum will be allocated.

And another thing. I know lots of bucks have been spent on HDTV and all, but did anybody ever bother to ask the viewing public if they really want it all that badly?

I mean, it's already clear how the listening public feels about CD-quality audio and all. But with TV viewing on the decline, how important is it to get 1000+ lines and a wide screen? Hardly anyone batted an eye when they switched to CCD cameras.

So anyway, Strother is still confident about getting test authorization, and about DAB being suited for a terrestrial system. But there's another wrinkle.

Stanford Telecom recently amended Satellite CD Radio's proposal for a plan for 100 DAB channels—66 satellite and 34 terrestrial. The new plan solves some of the multipath stuff with frequency-hopping and it begins to resemble Eureka more and more.

Now Strother says Eureka isn't the only game in town and he'd like to explore Stanford Telecom's new concept, but in a terrestrial, non-satellite way. Now it's Stanford Telecom, which owns 22% of Satellite CD Radio and not Sat CD itself that Strother is interested in working with.

But wouldn't it be interesting if two of the major DAB system proponents in this country ended up on the same side of things?

Broadcast Investment Analysts has done a survey of the car of the future, which the company plans on releasing

right about now. I got some early info from the BIA folks and what I heard was mighty encouraging.

Some 93 percent of the folks asked about what features they'd like in their cars in the year 2000 said they wanted an AM/FM radio. Hmmm. Wonder if they asked them about a DAB model?

The other good news is that some 90 percent said they would not want a fax machine in the car. I'm happy to hear not everybody feels they have to take all their work with them all the time wherever they go.

On the subject of car phones, the numbers were more even, with 43 percent of the folks saying "yes," 56 percent saying "no." Makes sense to me. I'd like

tional sales rep, was trying to interest WPLJ in a program but was having tough luck getting his calls returned. (You know the routine). A whole year went by and no luck. Non-plussed, Phil set up one of his company's own signs right across the street from the radio station's offices.

It was also right under the gyros take-out place and next to Sushi King, but never mind that. The day after the sign went up, WPLJ ad manager Debbie Alpi finally did call him. They have a meeting set up this week. So it pays to advertise.

Meanwhile the sign is still up, although considering its location it's probably ripe with graffiti by now. Just had



Food? Fumes? Garbage? Must be New York!

to have one just for those times when I'm late to work. You know: "Gee, the freeway is backed up today. Yeah. Sorry, I won't make it in until noon."

But when it comes to aggressive communications, you gotta hand it to Transportation Displays Inc. You've seen TDI's work on the sides of buses and such. Well one display in none other than Noo Yawk, at a corner in midtown near Penn Station, did it's appointed job.

Phil, the TDI account exec and na-

to run this pix of my hometown streets so you could see it. Look at those streets. The take-out ethnic food, the garbage, the traffic, the exhaust.

Ah, the Big Apple: nothing like it. Wait a minute, is that person on the right getting his pocket picked?

Heard a juicy tidbit? Spill your guts to Earwaves by faxing JG at 703-998-2966, writing to PO Box 1214, Falls Church VA 22041, or calling 703-998-7600. Who knows, you could win a coveted RW mug.

Transmitter Control can be a Bear

You need to make sure you can stay on the air and stay legal. At the same time, you need to keep operating costs under control.

Choosing the right remote control system is the first step.

The ARC-16SA* from Burk Technology lets you control your transmitter from any phone. You can establish off-premises control points for unattended operation, or supervise non-technical operators by phone.

The annual savings can be thousands of dollars.

The ARC-16SA is part of a modular system. For full-time control, add a studio unit. Multi-site options make it easy to control several transmitter sites or even control studio equipment such as program automation.

Call now for your copy of our new catalog, then ask us to show you how we can improve your operation and your bottom line.

Call TOLL FREE
1-800 255-8090

BURK
TECHNOLOGY

7 Lomar Drive, Pepperell, MA, 01463 (508) 433-8877

Circle 91 On Reader Service Card

World Radio History

READERS FORUM

If you have comments for *Radio World*, call us at 800-336-3045 or send a letter to Readers' Forum (Radio World, Box 1214, Falls Church VA 22041 or MCI Mailbox #302-7776). All letters received become the property of Radio World, to be used at our discretion and as space permits.

Expanded band considerations

Dear RW,

We at Crawford Broadcasting are mostly in agreement with Steve Crowley in the Nov. 21, 1990 "Consultants Corner" column regarding expanded AM band rules.

The FCC has proposed a set of rules which would move to the expanded band many of the stations that cause large amounts of interference at night. As Crowley points out, this is entirely unfair to many stations, particularly those that have been around since dirt.

Crawford would encourage the Commission (and has in comments) to take a second look at these proposed expanded band rules. Stations that receive large amounts of interference should be considered for migration, not those who cause this interference. In addition, the FCC should look at daytime interference caused/ received as well as nighttime. Many stations were "sandwiched in" in the 1950s and 1960s, and consequently have daytime service areas much smaller than the size of their normally protected contours. Stations in this situation tend to cause considerable daytime interference as well, and to "muddy-up" the overall daytime allocation scheme.

We suggest that the FCC commission a study by an independent engineering firm to look at all the alternatives before the stone tablets are etched for expanded band. Regardless of future rule changes and corrective measures, we really get only one chance to do this right.

W.C. Alexander, DE
Crawford Broadcasting Company
Dallas, Texas

UL mark not needed

Dear RW,

Not too long ago I opened my *Radio World* to discover Underwriters Labs (UL) could make its mark in the world of radio broadcast (RW, Oct. 10, 1990). My, my—what an opportunity for UL to "save" all of us.

The concept of product safety is important to me, as it should be to all of us. I would also welcome UL or any other safety certification program, if I felt they could make a significant contribution to our industry. In fact, I feel UL could make no significant contribution in product safety, and could increase product cost while driving manufacturers crazy with the whole bureaucratic process.

Let's back up and take a certain product . . . say a cartridge tape machine. I am unaware of any major safety issues in the power supply of such machines (the primary side of the power supply, to include the transformer, is the issue here). Competition is so high I would estimate a product would be driven out of the marketplace if a serious issue like that were to occur.

For the sake of argument, let's say a manufacturer were to make a cart machine that was totally unsafe. Would the UL mark prevent it from coming to the marketplace? No. UL cannot force anyone to place the UL mark on a product or prevent it from coming to the market.

So what's the real advantage? In our industry, very little, if any. The one thing you can depend on is that if we have a UL standard for broadcast equipment every marketing department could pressure its company to have the mark on its products. In some circles this is known as the "me too" syndrome. Guess who will pay for the product submission to UL or the factory visits and the new manufacturing controls?

Remember, all of this is being done in the name of safety, right? That little sticker will cost a bundle and we will pay for it. I am sure your station manager will be happy to see the cost of products go up because of all this. What tangible difference in the product could you describe to him as the reason?

I am very proud of the products on the market now and the safety as well as overall quality that manufacturers have designed into them. I just don't think technical products used in radio stations should be UL listed and carry the UL mark. It doesn't add any value while increasing the product overhead cost.

In an effort to benefit from the new UL standard, let's look at a reasonable compromise. Manufacturers could "design"

Happy New Year! Holiday celebrations have given way to acceptance of the job at hand, and a re-dedication to the business of radio. Now's the time to contemplate what lies ahead in 1991, and to attach actions to those thoughts.

The year to come promises to be an exciting time, but it offers a challenge to the industry to take a hard look at itself and work to improve.

Certainly, if ever there was a time to look ahead it's now—the introduction of new technology throughout the past year has given the radio community something to look forward to. The industry is poised on the cutting edge.

The ramifications of technological changes will make for a fascinating and important NAB convention in April. Look for innovative technology to appear alongside transitional products, as well as the usual broadcasting staples.

Ring In The New

FCC would do well to clean out its in-box of any pressing issues.

Without resorting to guess-work, the broad-based AM improvement docket, the potential action on FM directional antennas and one of the several DAB filings before the Commission all seem ripe for action.

As important as the technological and regulatory changes it could herald, however, is a new year's sense of making things right again. Problems of the past, both economic and competitive, are best addressed with an open-minded attitude about the future.

Make a commitment to begin turning things around now. Transform the plans that might have seemed out of reach into goals that can be implemented. By the end of 1991, with bold measures facilitated by careful planning, the industry will see a reaffirmation of the steady, healthy growth curve it has seen before.

Remember, though, that without a measured first step, without action, goals can never be fulfilled, and reality will always fall short of expectations.

Take the step. Ring out the old. Ring in the new.

—RW

Radio World

Vol 15, No 1 January 9, 1991

Editor, Alex Zavistovich
Editorial Consultant, Judith Gross
International Editor, Alan Carter
Associate Editor, Charles Taylor
News Editor, John Gatski
Reporters, Benn Kobb, Frank Beacham/L.A.
Editorial Assistant, Debra Green
Technical Editor, John Bisset
Technical Advisor, Tom McGinley

Production Director, Kim Lowe
Chris Freter, Lisa Roach,
Julianne Stone, Lisa Stafford
Ad Production Coordinator,
Regan Deatherage

Publisher, Stevan B. Dana
Associate Publishers, Arthur Constantine
Carmel King

Ad Coordination Manager, Simone Mullins
Circulation Manager, Tiana Hickman
Accounts Receivable, Valerie Mason

Advertising Sales Representatives:
Eastern U.S., Art Constantine
800-336-3045, Fax: 703-998-2966
Western U.S., Jack Ducart
800-336-3045, Fax: 703-998-2966

Radio World (ISSN: 0274-8541) is published semimonthly by Industrial Marketing Advisory Services, Inc., 5827 Columbia Pike, Suite 310, Falls Church, VA 22041. Phone: 703-998-7600, Fax: 703-998-2966. Second-class postage rates is paid at Falls Church VA 22041 and additional mailing offices. POSTMASTER: Send 3579 forms and address changes to Radio World, P.O. Box 1214, Falls Church VA 22041. Copyright 1991 by Industrial Marketing Advisory Services, Inc. All rights reserved.

Free subscriptions are available upon request to professional broadcasting and audiovisual equipment users. For address changes, send current and new address to RW a month in advance at the above address. Unsolicited manuscripts are welcomed for review; send to the attention of the appropriate editor.

Next Issue
Radio World
January 23, 1991

to the standard. This would mean every attempt was made to incorporate the standard into the product's design as well as its manufacture, but none of the expense was incurred, such as you would have if the product carried the UL mark (UL Listed).

This is the more common ground we should be working for. It lets the manufacturer use the UL standard as a tool and make the claim the product was designed to the standard—they just can't place the UL mark on the product.

This is also the approach many test and measurement companies take. They also have a UL standard they can use. Many of the companies do not list their products with UL because of the expense, product market contribution and regulatory requirements.

I might add that the Canadian Standards Association (CSA) will also be happy to help anyone place their mark on a product. Any broadcaster can submit to CSA for certification under their category or model certification programs. CSA is much more reasonable to deal with in obtaining certification, yet providing very similar requirements.

In closing, I hope some of the broadcast manufacturers as well as station managers read this and temper the actions they take. I also hope we as engineers don't push the manufacturers to fix a wheel that's not broken.

Daniel Remy
Dryan Communications
Colorado Springs, Colo.

Change the call-sign rules

Dear RW,

There is no reason in the world, as far as I can determine, that the FCC could not issue four-letter call signs to broadcast stations from the groups AAAA through ALZZ and NAAA through NZZZ. No reason, that is, except the FCC's own red tape, which says that such a move would be against the rules, and the rules say you can't change the rules!

The FCC told me a couple of years ago that those call sign groups are reserved for the military, and there's no way they'll ever be issued to broadcast stations. There are two arguments against that position.

First, even if a broadcast station in Kansas was issued the call sign NECK, and some Navy vessel at sea was using the same call sign, even the most casual listener could still tell which was which, because of the differences in their location, schedule, emission types, and the content of their transmissions. Second, there have already been amateur radio call signs issued which begin with AA through AL and NA through NZ, and there is sometimes very little to distinguish amateur transmissions from military communications!

If you owned a broadcast station, wouldn't you like to have a call sign like NEWS, NICE, ABLE, AFRO, ALSO, NOVA, etc.? Hardly any catchy words start with the letter K, and not many more start with the letter W.

I think the FCC should be pressured to change the rules! So far I haven't been able to sell the idea by myself.

Andrew Dart
Andy's Bureau of Standards
Duncanville, Texas

Gentner's dealers

Dear RW,

I would like to clear up an inaccuracy in the Dec. 12, 1990 issue of *Radio World* (p. 19). Gentner products are *not* sold exclusively by Harris Allied.

Our U.S. dealers include Audio Broadcast Group, Audio Media, Bradley Broadcast, Broadcast Services, Broadcast Supply West, Crouse Kimzey, Electronic Industries, Giesler Broadcast Sales, Harris Allied, Midwest Communications Corp., Northeast Broadcast Labs, Parcom, Professional Audio Supply, RF Specialties, and SCMS.

Russell Gentner, CEO
Gentner Electronics Corp.
Salt Lake City, Utah

**TAKE
THE
LEAD**
WITH HARRIS ALLIED

#1 audiopak BROADCAST CARTRIDGES

FOR ALL

In cart machines, everyone has a different preference. Inside those machines, the clear favorite is Audiopak: The world's #1 selling tape cartridge. Only bona fide Audiopak carts are loaded with real Audiopak tape.

That's how "workhorse" A-2s, "stereo" AA-3s and "digital-ready" AA-4s deliver consistency, reliability and unsurpassed audio performance—batch after batch after batch. And that's why you can be sure that we'll always fill your Audiopak order with the genuine original—never an imitation.



**HARRIS
ALLIED**

For all your needs, everything from carts to consoles to satellite and RF equipment, the leader is Harris Allied. We're the one source you can call for everything in radio. And starting this month, we'll be making it even easier for you to get whatever you need, whether it's supplies, capital equipment, service, parts—or just some good advice from an experienced field sales representative. So for great prices and fast delivery on Audiopak carts (and 5000 more items), just call 800-622-0022—it's that simple.

**HARRIS
ALLIED**
BROADCAST EQUIPMENT

With expanded staff and services . . . our lead keeps on growing!

800-622-0022

FAX 317-962-8961

STUDIO EQUIPMENT ■ HARRIS RF PRODUCTS ■ SATELLITE GEAR ■ TURNKEY SYSTEMS

IN CANADA 800-268-6817

HARRIS ALLIED ©1991

"Call me, I'm interested." Circle 15.

"Send me literature." Circle 129.

Enhancing the Depth of Stereo

by John Gatski

WASHINGTON The search for live-sounding, three-dimensional music is an eternal pursuit.

Sound reproduction may have improved to the point that it rivals live music in frequency response, but technology has not yet succeeded in providing satisfactory musical depth reproduction.

Other than quadrasonic—the 1970s-era technology that required encoded music, a special decoder and four speakers—little has been accomplished in improving the soundstage since basic stereo was invented.

Recent digital technology, however, has given us a myriad of new technologies ranging from the music encoding processes known as QSound and BASE (Bedini Audio Spacial Environment) to the elaborate enhancing technology of SRS (Sound Retrieval System) and Dolby Pro Logic. These indeed may approach the soundstage of live music.

The good news for broadcasters is that most of these technologies are compatible with traditional radio broadcasting.

Thank you, digital

The new technologies can be attributed to the advent of digital signal processing (DSP) and scientific research on the human auditory system, according to acoustic researchers and engineers.

One process that has received considerable media attention is Archer Communications' QSound, which is said to add extra dimension to the music through time and phase manipulation. QSound has been added to popular recordings such as Madonna's "Immaculate Collection" and record companies have promised more QSound-encoded recordings by next year.

Unlike other stereo enhancing techniques—such as Dolby Pro Logic, DSP or SRS—no additional speakers, special amplifier or receiver are needed

to enjoy the benefits, the company claims.

The process will work as well over FM stereo radio. The company already is offering technical support for radio stations that want to play QSound-encoded material.

I'm not sure if QSound actually improves stereo as much as stereo did mono, but in my own listening tests of a QSound-encoded Madonna hit on CD,

Sony was so impressed that it has included SRS in its high-end television line and Soundcraftsman has committed to producing an SRS audio preamplifier. I have not listened to SRS yet, but plan to at this month's Consumer Electronics Show (CES) in Las Vegas.

The SRS hardware, contained within the playback equipment (amp, receiver, etc.), allows the listener to enjoy a deepened sense of soundstage without hav-

CUE and REVIEW



the music evoked a certain sense of depth. Like stereo, though, the listening area requires proper speaker placement and you must sit in the "sweet spot" for the system to be effective.

As far as broadcasting is concerned, some informal questions have been raised about QSound's compatibility with mono radios, according to NAB Staff Engineer Stan Salek.

Salek said a few engineers have reported seeing strange readings from their phase meters when airing QSound, but nothing to warrant a major investigation.

Audiophile technology

Another new stereo-sound device—BASE, from Gamma Electronics—either can be encoded at the music source, or a BASE decoder-equipped stereo can reproduce an enhanced soundstage from ordinary recordings or radio broadcasts, according to the company.

Then there's SRS. Developed by Hughes Electronics, the system already is a favorite of many in the audio press.

ing to sit in a particular place, according to Hughes spokesman Joe Allrich.

Basically, Allrich explained, the decoder takes the input signal and processes the L+R and L-R in accordance with the way the human ear receives sounds from different locations. SRS hardware will work with FM stereo broadcasts and even AM stereo with just two speakers, he added.

Other popular technologies that enhance the musical soundstage require not only special equipment (Yamaha and other add-on DSP units, for example), but also more speakers. With Dolby Pro Logic, a decoder, encoded material and additional speakers are required.

It is likely that processes such as QSound may appeal to broadcasters more than others; QSound does not require listeners to invest in any other equipment to add to their current FM receivers, he said.

Society of Broadcast Engineers President Brad Dick commented that radio stations are likely to try less costly

sound-enhancing technologies like Q-Sound, which requires investment in software only.

He noted also that station managers would want to judge the success of such technology among consumers before they deem it worth the expense to promote.

Dick is probably right. Most consumers appreciate and understand normal stereo, but beyond that, they may become confused and indifferent toward any of the new technologies. Station managers are likely to keep a close eye on consumer reaction to these products.

Despite these early caveats, it is encouraging that new technologies have emerged to make music more live-sounding. Whether it is FM, AM, records, tapes or CDs, stereo enhancement can serve to make the source sound better. And isn't that the bottom line?

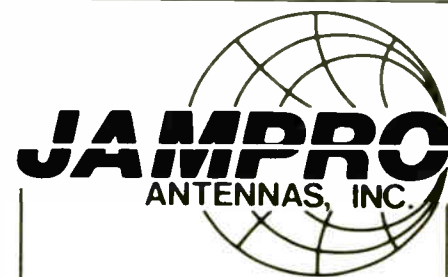

For Excellence In Antennas

- A complete line of TV and FM Broadcast Antennas
- Modern 7,000 ft. test range facilities
- Innovative Engineering Careful construction
- Two Year Warranty on Product and Workmanship



With over 1500 delivered, we've helped more stations penetrate their market.

FCC Directionals
Pattern Studies
Multi-Station Arrays
Full Scale Measurement

JAMPRO ANTENNAS, Inc.
6939 Power Inn Road
Sacramento, CA 95828
(916) 383-1177 TELEX 377321

Your Problem Solvers

from **ATI**

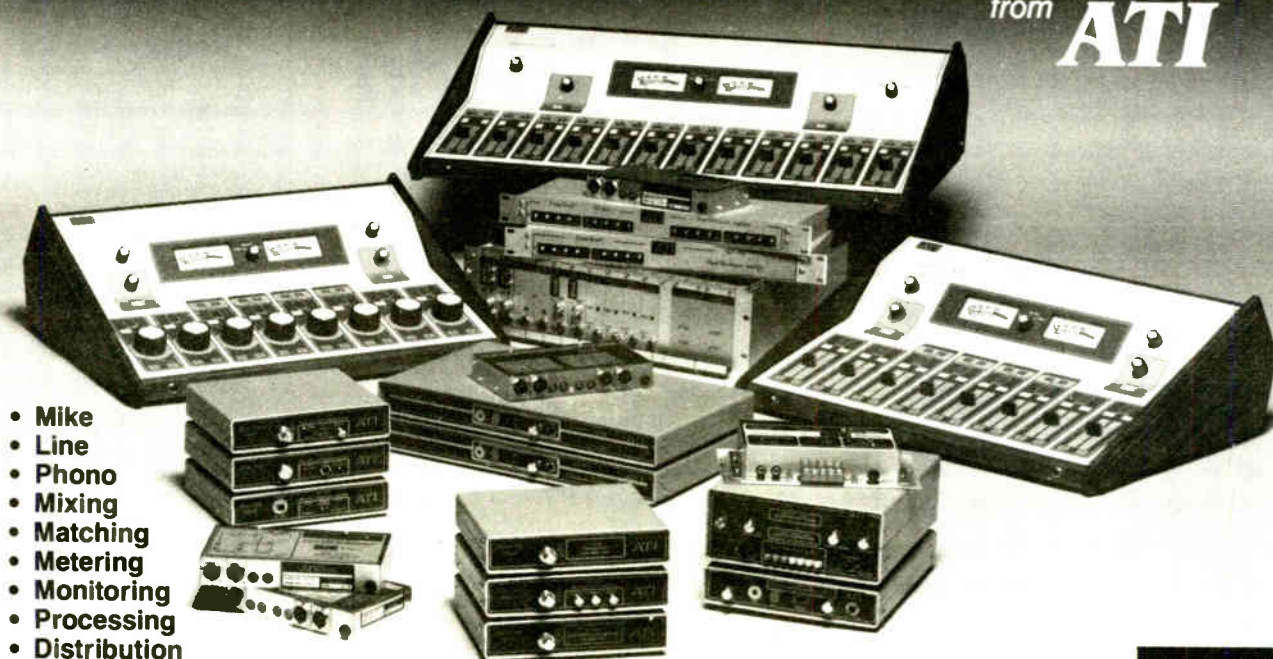

- Mike
- Line
- Phono
- Mixing
- Matching
- Metering
- Monitoring
- Processing
- Distribution
- Rack Mounting

AUDIO TECHNOLOGIES, INC.

328 W. Maple Ave., Horsham, PA 19044 • (215) 443-0330 • FAX (215) 443-0394



Circle 121 On Reader Service Card

World Radio History

Circle 60 On Reader Service Card

Digital Cable Radio: A Broadcast Concern

Editor's note: RW's West Coast correspondent Frank Beacham takes a look at the reactions of traditional broadcasters to the development of digital cable radio in the final part of this series.

by Frank Beacham

Part III of III

LOS ANGELES Will digital cable radio become a threat to traditional over-the-air broadcasters? The answer, from knowledgeable industry insiders, is both "yes" and "no."

"It is and it isn't directly competitive with radio broadcasting," said John Abel, VP of operations for the NAB. "It is not directly competitive because the majority of our audience is mobile, out of home and cable's reach."

But, Abel conceded, the new digital cable services could take in-home listeners away from radio broadcasters. He predicted that digital cable radio's most significant effect will be to condition the audience to the delivery of high quality digital sound, previously attainable only from compact disc.

"It is going to be a stimulus that will cause people to have higher and higher expectations for quality sound," he said.

More important than the quality of the sound is the fact that digital audio is not subject to multipath and other kinds of

interference which plague terrestrial broadcast systems, Abel said.

"Consumers will ask 'if cable's got it, why doesn't my local broadcaster have it?'" he predicted.

Abel said digital cable could be a serious threat to broadcasters. "No, I don't think it's particularly good for broadcasters," he said. "If we don't get into digital audio broadcasting, it will be bad."

Will localism survive?

A major issue in the transition to digital is local versus nationally-delivered programming, according to Abel. He emphasized strongly that the local radio station is important and should be preserved.

That perspective is shared by at least one of digital cable radio's pioneers.

"I don't think anyone is going to give up his radio to subscribe to our service," said Jerry Rubinstein, chairman of International Cablecasting's Digital Radio Express. "In the morning I'll turn on my radio to hear some news, what the weather is like and how the freeway will be. But by the time I get home at night, I don't want to hear some disc jockey hammering at me and I may want to hear a format of music I can't even find on radio."

Radio is mainly "a mobile force" and does an excellent job at that, Rubinstein added. "I don't think we are to the ex-

NAB to Host NHK

WASHINGTON A new FM multiplexing system will be among the technologies that Japanese corporation NHK will showcase during its 1991 technology exposition, scheduled to run concurrently with the NAB show next spring.

The event will mark the first time the company has scheduled its annual technology exhibit outside of Japan.

The 6,000 square foot exhibition, entitled "NHK 1991 Technology Open House," will be shown April 15-18, at the 1991 HDTV World Exhibition & Convention in Las Vegas.

NHK's presentation will include items never before shown in the U.S., as well as prototypes of the newest in radio and television technology, according to NAB.

NAB Science and Technology Senior VP Michael Rau said NHK will show newly developed hardware for a digital FM multiplexing system, which is a data service on an FM subcarrier, that was discussed at the 1990 IBC show in England.

Also, the NHK exhibit will be the largest High Definition Television (HDTV) show to date, the NAB noted.

Some planned TV exhibits include a three-dimensional "stereoscopic" television, and a wall-mounted 33" flat screen TV.

clusion of radio, nor do I think we are to the exclusion of the compact disc. We are a premium service and won't get the majority of listeners. We'll eventually have people who will know when they want to listen to us and when they want to listen to radio."

However, Jerrold Communications, in promoting its new CD-quality service, Digital Cable Radio (DCR), is not subtle in pointing out the deficiencies of traditional radio.

"Broadcast radio stations are at the mercy of the advertising dollar, resulting in dilution of their formats to appeal to a larger audience and the need to interrupt their programming for 'messages from our sponsors,'" a DCR product overview statement stressed.

DCR also noted that in many regions of the U.S., the broadcast industry continues to be plagued with environmental factors and FCC regulations that limit transmission so that reception is poor or even blocked. The new network is targeting its service at "music lovers" who have "become extremely frustrated with the interruptions of broadcast radio," according to the company.

One company betting on a strong future for over-the-air broadcasting is Los Angeles-based Westwood One, the nation's largest radio network and syndicator of programming. "We don't see dig-

ital cable radio as a threat. We consider it part of the evolution of the broadcast industry," said Westwood's Technical Operations Director Bob Demuth.

Keep over-the-air broadcasting

"I believe the technology is moving toward what the consumer wants, and that's CD-like sound quality," Demuth said. "Though the technology exists even for addressable receivers in cars, I do not see pay services taking over the market."

"Broadcasters don't want to rule themselves out of existence," Demuth continued. "The NAB is not going to sit by and let their individual market-based economic platforms be disassembled. I believe as soon as there is a digital superstation there will be 20 major markets that can also broadcast digital stereo locally. I think broadcasters will protect themselves by keeping pace with the technology and offering the same technical quality to the consumer."

After years of market research and testing, Digital Radio Express and Digital Cable Radio will join Digital Planet of Carson, Calif. in launching their services on a widespread basis in 1991.

All three services will utilize cable television systems to deliver multiple channels of digital audio programming to the home at a cost ranging between \$7 and \$10 per month.

NEW!

LEVEL A 0.59 dBm LEVEL B 0.47 dBm PHASE A-B 0.1 deg

FUNCTION: AMP NOISE, THD+NOISE, IMD, W+T, AC MAINS CHECK, LEVEL, PHASE, RATIO, STALK, GEN. LOAD

PORTABLE ONE

AUDIO PRECISION QUALITY IN A PORTABLE TEST SET

PORTABLE—AFFORDABLE—EASY TO USE

Just press a button and take a measurement!

- amplitude
- phase
- two-channel level
- noise
- frequency
- amplitude ratio
- THD + N
- wow & flutter
- crosstalk
- IMD*
- generator load
- AC mains check

The Portable One—a two-channel analyzer at the price of single channel competitors!

\$4,000*

Audio precision

P.O. Box 2209, Beaverton, OR 97075
503/627-0832 1-800/231-7350
FAX: 503/641-8906, TELEX: 283957 AUDIO UR

SUBSCRIPTION/READER SERVICE FORM

Radio World

January 9, 1991 Issue Use until April 9, 1991

FREE Subscription/Renewal Card

I would like to receive or continue receiving Radio World FREE each month. YES NO

Signature _____ Date _____

Please print and include all information:

Name _____ Title _____

Company/Station _____

Address _____

City _____ State _____ ZIP _____

Business Telephone () _____

Please circle only one entry for each category:

I. Type of Firm

D. Combination AM/FM station F. Recording studio
A. Commercial AM station G. TV station/teleprod facility
B. Commercial FM station H. Consultant/ind engineer
C. Educational FM station I. Mfg, distributor or dealer
E. Network/group owner J. Other _____

II. Job Function

A. Ownership D. Programming/production
B. General management E. News operations
C. Engineering F. Other (specify) _____

III. Purchasing Authority

1. Recommend 2. Specify 3. Approve

Reader Service

Please first fill out contact information at left. Then check each advertisement for corresponding number and circle below. NOTE: Circle no more than 15 numbers, otherwise card will not be processed.

001 023 045 067 089 111 133
002 024 046 068 090 112 134
003 025 047 069 091 113 135
004 026 048 070 092 114 136
005 027 049 071 093 115 137
006 028 050 072 094 116 138
007 029 051 073 095 117 139
008 030 052 074 096 118 140
009 031 053 075 097 119 141
010 032 054 076 098 120 142
011 033 055 077 099 121 143
012 034 056 078 100 122 144
013 035 057 079 101 123 145
014 036 058 080 102 124 146
015 037 059 081 103 125 147
016 038 060 082 104 126 148
017 039 061 083 105 127 149
018 040 062 084 106 128 150
019 041 063 085 107 129 151
020 042 064 086 108 130 152
021 043 065 087 109 131 153
022 044 066 088 110 132 154

Circle 21 On Reader Service Card

DAB Spectrum Irks HDTV Groups

by Alan Carter

WASHINGTON When the FCC recently proposed that UHF spectrum could be reallocated for digital audio broadcasting (DAB) spectrum, it apparently struck a nerve among concerned parties, including High Definition Television (HDTV) proponents.

The proposal came during the FCC's second Notice of Inquiry (NOI) on the 1992 World Administrative Radio Conference (WARC-92).

Across the board, comments on the FCC's NOI that were directed toward WARC rejected use of 728-788 MHz and said spectrum need is more pressing for HDTV.

If any consensus can be found among the filings from broadcast interests, it focused on the 60 MHz bandwidth around 1500 MHz. This, however, was not what the FCC had in mind. The Commission cited only 32 MHz bandwidth at 1493-1525 MHz.

Commenters maintained that the FCC's third proposal of 2390-2450 MHz was inappropriate because of increased power requirements.

Not just a complement

The filings also questioned the notice's intent when it refers to a terrestrial DAB service as "complementary" to a satellite service. Some parties wanted to know where stand-alone digital terrestrial services fit into the picture.

Among the filings, National Public Radio (NPR) said that the FCC-recommended 32 MHz limitation may not accommodate all existing terrestrial radio broadcasters with a simulcast digital channel and also meet the needs for public radio expansion.

Domestic broadcast satellite service (BSS) sound proponents and the recent multinational CCIR conference in Sydney, Australia, recommended nearly identical spectrum requirements of 60 MHz near 1500 MHz, NPR said.

With a different spectrum view, the NAB said it is premature for the FCC to

identify how much spectrum is required, if any, and what frequency bands may be preferred for BSS sound.

Too many questions remain to be answered concerning DAB in the U.S. on policy, service and implementation, the NAB argued. "The formation of a United States policy on BSS (sound) is something that cannot and should not be

permit terrestrial DAB to operate with a total bandwidth that would be much less than full CONUS (Continental U.S.) satellite service. CONUS service may require up to 60 MHz nationwide, with no U.S. frequency re-use possible.

NAB noted it is conducting a spectrum study that was to be completed by the end of the year.

Commenters maintained that the FCC's third proposal of 2390-2450 MHz was inappropriate because of increased power requirements.

rushed," NAB stated.

"Where, as in BSS (sound), there is the possibility that the entire radio broadcasting industry would be forever altered, the Commission cannot responsibly establish a position without careful consideration and understanding."

The use of the word "complementary" to describe terrestrial delivery is not something NAB likes, according to its filing.

"There exist technical, economic and policy justifications to employ DAB in the United States through terrestrial means only, rather than through satellite-only or satellite/terrestrial hybrid systems, and the flexibility to consider these needs should remain open during the pendency of WARC-92 deliberations," the NAB stated.

Terrestrial is better

A terrestrial-only method could re-use frequencies nationwide, NAB suggested. And since coverage and interference limitations could be well-defined, ownership diversity and program voices would be maximized, the comments added.

If, for example, a DAB system were conceived to be a replacement system accommodating all existing radio broadcast stations, NAB said technology exists to

GIGA Airs In Japan

TOKYO Japan's Radio GIGA became the world's first digital audio broadcasting (DAB) service to go on the air when it began offering unscrambled satellite service in November.

Radio GIGA transmits on the 15 GHz band and requires a special \$900 receiver (which has been selling for as low as \$650) and a 25-inch receiving antenna. The service will be free until mid-1991 when the signals will be scrambled, requiring a \$4.60 per month basic fee to receive the programming.

A variety of music types are being broadcasted to the home listeners as well as natural sound effects, according to Radio GIGA.

The service does not yet work in automobiles because of the limited power of the current satellite. Radio GIGA did not reveal whether the system will later be upgraded to provide mobile reception.

"Doing things for successful FM translators"



FMTA

FM TECHNOLOGY ASSOCIATES, INC.

Talk with Howard Enstrom, veteran broadcast consultant who, in the 70s switched to FM translators as a specialty.

FMTA services: Feasibility studies, frequency searches, system design-engineering, FCC applications. Publisher of The SIGNAL SOURCE, bi-monthly newsletter all about FM translators. BEST EQUIPMENT PRICES.

FM TECHNOLOGY ASSOCIATES, INC.
30925 Vista Vista
Mount Dora, FL 32757
(904) 383-3682 FAX (904) 383-4077



The NAB also was among the long list of commenters that said no to using UHF spectrum because of HDTV.

NBC added that the need for BSS (sound) has not been established in the U.S.

While saying no to using UHF, CBS argued terrestrial cannot be considered a secondary service.

High definition

Other opposition to using UHF came from the Association for Maximum Service Television, the Association of Independent Television Stations, the Advanced Television Systems Committee and one proponent of an HDTV transmission system, General Instruments.



- ONE -

company, and only one, offers truly comprehensive support to the broadcast industry. In 1991 we're backing you with more products, more people, more personal service than ever.

Technology keeps changing, and changing more quickly. We're meeting the challenge by responding faster than ever before to your needs—for advice, equipment, training and support.

Now more than ever, no one gives you more choices—or more help in making the right choices—than Harris Allied. That's what we mean by taking the lead.



HARRIS ALLIED
BROADCAST EQUIPMENT

FAX 317-962-8961

800-622-0022

IN CANADA 800-268-3817

With expanded staff and services... our lead keeps on growing!

HARRIS ALLIED ©1991
"Call me, I'm interested." Circle 38.

Circle 33 On Reader Service Card

"Send me literature." Circle 79.

Introducing

THE WIZARD™ from Belar FM Digital Modulation Analyzer



Belar, the world leader in RF test and measurement systems, brings you a new generation in FM modulation measurement. The WIZARD™ features include:

- Menu driven—16 character alphanumeric display
- Deviation in percent—0.1 or 1 percent increments
- Deviation in kHz—0.1 or 1 kHz increments
- Up to 0.1% accuracy—function of demodulator calibration
- Self calibration to external calibrating signal
- Pre-set peak mod—adjustable in 0.5% increments
- Pre-set PPM—adjustable from 0 to 100 PPM
- Variable peak hold time—adjustable in 0.5 second increments
- Peak weighting mode—time constants are menu selected
- Real time mode or past time mode
- Provision for pilot injection measurement from FMS-2
- Provision for pilot modulation measurement from FMS-2
- Provision for SCA injection measurement from SCM-2
- Silent sentry alarm—adjustable in time and threshold
- Will accept external alarms—such as off frequencies from FMM-4A
- Alarms read on menu—menu will cycle if two or more are present
- Modulation adjust on two ports—adjustable in 0.5% increments
- RS-232 port—provides computer graphs and remote operation
- Three level password protection—look only, change, and manager
- Either infinite window histogram or sliding window histogram
- Optional FM precision demodulator that will remotely self calibrate
- One rack height panel space—including precision demodulator

Sample PC Output

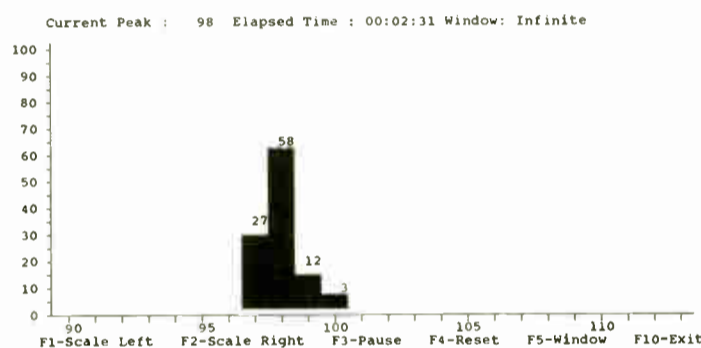
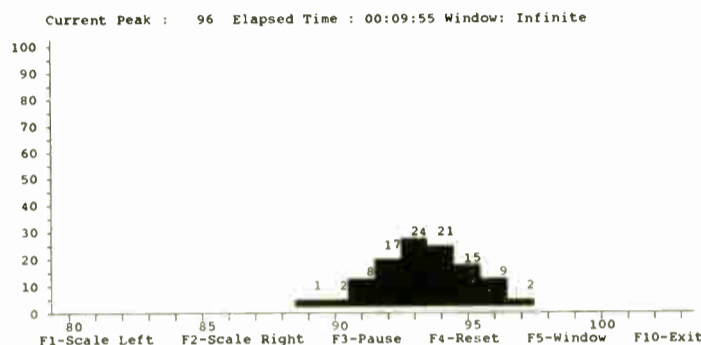

Communications Options Plot Help Exit

Histogram Window

+	1	46	1	43	1	+
90	95	100	105	110		

Elapsed Time : 00:04:12 Window : Infinite

F1-Scale Left F2-Scale Right F3-Pause F4-Reset F5-Window

Remote Display

% Peak Modulation	Peak Mod [100.0]	Menu
100.0	75.0 - KHZ DEV	

F6 - Menu Left F7 - Menu Right F8 - PARAM UP F9 - PARAM DOWN

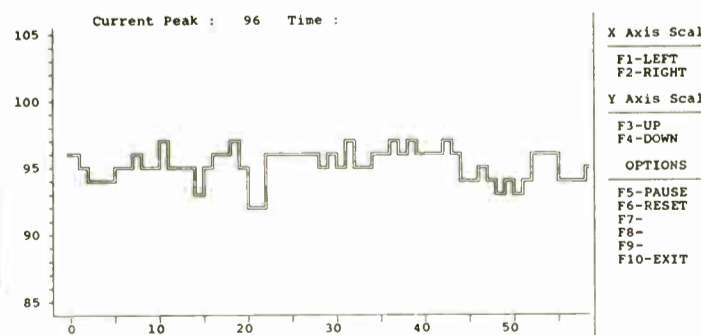

Sample Setup Menus

- ^ SELF CALIBRATION ^
V MENU PARAMETER V
- ^ SAVE CONFIG ^
V MENU PARAMETER V
- ^ BLANK - ON ^
V MENU PARAMETER V
- ^ TIME MODE - REAL ^
V MENU PARAMETER V
- ^ DEV 75.0 KHZ ^
V MENU PARAMETER V
- ^ HOLD 1.0 SEC ^
V MENU PARAMETER V
- ^ PEAK MOD 100.0 % ^
V MENU PARAMETER V
- ^ REMOTE - OFF ^
V MENU PARAMETER V
- ^ INFINITE - ON ^
V MENU PARAMETER V
- ^ PILOT INJ 9.0 % ^
V MENU PARAMETER V
- ^ SCA INJ 10.0 % ^
V MENU PARAMETER V
- ^ PK WEIGHT - OFF ^
V MENU PARAMETER V
- ^ RES- 1.0 PERCENT ^
V MENU PARAMETER V
- ^ PPM THRESH 10 ^
V MENU PARAMETER V
- ^ PPM COUNT 10 ^
V MENU PARAMETER V
- ^ SENTRY 10.0 % ^
V MENU PARAMETER V
- ^ SENTRY 30.0 SEC ^
V MENU PARAMETER V
- ^ MOD ADJ- 0.5 % ^
V MENU PARAMETER V

For details, price and delivery information, contact Belar or your authorized Belar dealer

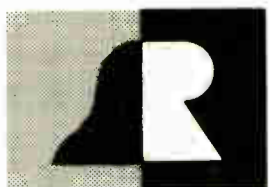

BELAR ELECTRONICS LABORATORY, INC.

LANCASTER AVENUE AT DORSET, DEVON, PENNSYLVANIA 19333 • 215-687-5550 • FAX: 215-687-2686

Circle 62 On Reader Service Card

FCC Weighs FM Antenna Rule

by John Gatski

WASHINGTON Can an FM omnidirectional antenna be considered directional? Some broadcast engineering firms believe that ambiguous FCC rules allow such assumptions.

The FCC is now weighing comments made by engineering firms, the NAB and other groups in consideration of a request for a declaratory ruling concerning FM directional antennas. Engineering firm Hammett and Edison initiated the request in 1989.

The declaratory ruling request stems from a 1987 petition for rulemaking that the Commission then addressed in its FM allocation docket (MM 87-121). Hammett and Edison, however, was not satisfied with the Commission's handling of the FM directional antenna issue and subsequently requested the declaratory ruling.

Hammett and Edison's concern stemmed from the Commission's simple FM directional definition: "...an antenna that is designed or altered for the purpose of obtaining a non-circular radiation pattern."

The definition does not take into account an antenna environment, which means that some omnidirectional antennas may be considered directional, Hammett and Edison asserted.

Redefine directional

The firm has asked the FCC to redefine a directional antenna as "one that is intended to have a significantly directional pattern, usually for the purpose of protecting the coverage area of another FM station or stations."

The requested FCC rulemaking also would require FM directional antenna measurements to be verified by a professional engineer, a move that both support and opposition, based on comments.

Other suggested changes include an omnidirectional antenna definition in which the maximum horizontal plane effective radiated power does not exceed the average power by more than 2 dB, and a maximum radiation limit to 2 dB above the licensed power for omnidirectional and directional antennas.

Hammett and Edison emphasized that current licensees should be "grandfathered" under the old rules.

Along with requested changes, the firm also submitted 40 measured FM antenna radiation patterns, mostly from omnidirectional antennas, to the Commission for a ruling on whether they are "directional" under the current rules.

Hammett and Edison contend that an omnidirectional antenna can exhibit directional effects based on a variety of conditions, including tower mounting

locations.

The NAB agreed with Hammett and Edison's filing. "Since these rules rely on the performance of directional antenna to prevent interference and since the rules do not adequately consider pattern distortions caused by side-mounting antennas on towers, the NAB urges the FCC to review these matters," the association's filing said.

Unnecessary rule change

Several groups filed comments opposing Hammett and Edison's request for a declaratory ruling based on the proposed rule changes and the procedures it was filed under.

Minnesota Public Radio (MPR) ques-

tioned Hammett and Edison's decision to ask for a declaratory ruling.

"Rather ... as originally contemplated by Hammett and Edison in its previously filed petition for rulemaking, any changes in the rule should be considered in a rulemaking proceeding with full opportunity for public comment and should not enter through the side door of a declaratory ruling request," MPR said.

Despite Hammett and Edison's statement that the submitted omnidirectional radiation patterns from individual stations could be interpreted as directional under the current rules, MPR said it has concluded they would not.

"It is clear that under the Commis-

sion's current definition, none of Hammett and Edison's radiation patterns were produced by a directional antenna and that classifying any of the antennas as directional would involve a substantive change in the definition of a directional antenna," MPR said.

John Furr and Associates strongly disagreed with the proposal to require professional engineering directional measurements in order to be licensed.

"I do not believe that anything in the registration certification process qualifies one to be an expert in antenna range measurements," said John Furr, the firm's president.

"The Commission has not and does not now require a professional engineer for AM directional measurements, which are more complicated than FM antenna measurements," Furr added.

Other firms that supported the filing included Cohen, Dippell and Everist.

Comparative Renewal Revised

by Charles Taylor

WASHINGTON The FCC has limited the amount of payoffs that are made to settle competing applications for new station construction permits or changes to existing facilities.

With the rule change, payments to applicants will be limited to "legitimate and prudent out-of-pocket expenses" up to the point where the hearing process for applicants begins, the FCC ruled. After that point, payments are prohibited.

The action, taken at a Dec. 13 meeting, is part of the Commission's efforts to cut abuses of the comparative renewal process.

The FCC said the cap will "help deter sham applications and prevent the exploitation of the comparative process, while expediting the hearing process through early settlements."

Permitting applicants to recover expenses before the trial phase begins will encourage bona fide applicants to apply

because they will be able to recoup expenses at a time when they realistically can determine their probability of success, according to the FCC.

Parties seeking approval of a settlement before a trial begins must submit certifications containing the following: assurance they have not received and will not receive any money or other considerations in excess of their legitimate expenses; specification of the exact nature and amount of any consideration paid or promised; and submission of an

itemized accounting of the expenses for which they seek reimbursement.

The new rules also require submission of terms for any oral agreement relating to the dismissal or amendment of the application.

Applicants dismissing or withdrawing after the trial phase has begun must certify that they have received no consideration.

For information on docket 90-263, contact Gina Harrison at the FCC: 202-632-7792.



- TWO -

ways we're keeping up with today's fast-changing technology:

Fast telephone access to every Harris Allied product and service, including RF, studio and satellite products, parts and service, plus total systems planning, installation and management.

An expanded field sales team. Familiar people with experience you can trust, ready to help you find the best options in RF and studio equipment.

Now more than ever, no one gives you more choices—or more help in making the right choices—than Harris Allied. That's what we mean by taking the lead.



FAX 317-962-8961 **800-622-0022** IN CANADA 800-268-3817

With expanded staff and services... our lead keeps on growing!

HARRIS ALLIED © 1991
"Call me, I'm interested." Circle 122.

"Send me literature." Circle 141.

Oh-Oh!

Call CORTANA

For Affordable Lightning Protection
505-325-5336
P.O. Box 2548, Farmington, N. M. 87499
FAX 505-326-2337

Circle 11 On Reader Service Card

Noble Broadcast Group

WANTED
DIRECTOR OF ENGINEERING
WBAB AM/FM, L.I., N.Y.

REWARD
All new studios, new building and excellent career path opportunity.
Contact: Dennis Ciapura
SR VP, Tech Ops
Inquiries Confidential

4891 Pacific Highway
San Diego, California 92110-4082
(619) 291-8510

AN EQUAL OPPORTUNITY EMPLOYER



Bring your station into the 90's with CAT-LINK—the digital STL/TSL.

"It's a dream system—we get specs like the microwave wasn't even there. CAT-LINK has completely eliminated the STL delay."

Jeff Andrew, WGCI-FM, Chicago

"CAT-LINK solved all our problems in 4 minutes—2 minutes to install each end. Performance has been impeccable."

Paul Christensen, WIVY-FM, Jacksonville, FL

"CAT-LINK makes money for us, and it improves the sound of the station."

Mike Callaghan, KIIS-FM, Los Angeles CA

"CAT-LINK has held up through extreme heat, a hostile RF environment and nasty summer lightning storms."

Dick Byrd, WZGC-FM, Atlanta GA

Two-way multi-channel communications

CAT-LINK digitizes the entire composite signal with no data compression, so you can run the stereo generator and processing at the studio, where they really belong. At the same time, CAT-LINK sends and receives up to four customized auxiliary channels with no crosstalk—SCAs, control channels, voice communications, RS232 data, AM audio, transmitter readings and satellite or remote program feeds. What's more, CAT-LINK gives you extra capabilities like transmitter building surveillance via closed circuit TV and an analog telemetry channel.

Transparent digital transmission

CAT-LINK encodes the fully processed composite signal, then decodes it at the transmitter. You always get full stereo separation, without the phase or amplitude variations that plague two-channel STLs. Dynamic range is up to 84 dB, and your processed composite signal can use virtually all of it. You hear clear, clean, undistorted audio—all the time.

No audible delays

CAT-LINK's real-time digital encode/decode process doesn't introduce audible delays as data compression can. Jocks can monitor on-air without problems.

Flexible signal path options

- 23 GHz

Stations across the country are avoiding 950 MHz problems by using 23 GHz with CAT-LINK. They've stopped worrying about frequency congestion and interference, repeater-induced signal degradation, and fresnel zone clearance fading. 23 GHz dish sizes also reduce wind loading and tower space requirements.

- DS1 (T1) Data Line

CAT-LINK is cutting phone bills for stations that don't have a clear microwave path. With CAT-LINK, a single bidirectional DS1 line replaces multiple Class A telco lines, providing multi-channel STL and TSL over the same link. Already available virtually anywhere, DS1 service is getting cheaper every day.

- Fiber Optic

CAT-LINK and its optional fiber optic modem provide direct connection to discrete fiber.

- Twisted Pair

CAT-LINK will drive up to 5000 feet of twisted pair wire without repeaters. Four wires provide full two-way multi-channel capabilities.

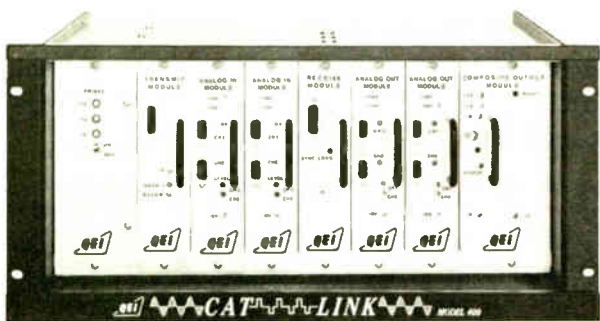

Turn the weak link in your signal chain into one of the strongest.

Call QE1 toll-free at 800-334-9154 for more information on CAT-LINK—the digital STL/TSL for the 90's...and beyond.

QE1 CORPORATION
ONE AIRPORT DRIVE • P.O. BOX 805 • WILLIAMSTOWN, N.J. 08094

24 HOUR SERVICE HOTLINE (609) 728-2020
TEL (800) 334-9154 • FAX (609) 629-1751

QUALITY • **E**NGINEERING • **I**NNOVATION

Circle 110 On Reader Service Card

CCIR Reaches Accord On Spectrum Issues

(continued from page 1)

current domestic usage. Canada, however, appears to be leaning toward formal 1500 MHz endorsement.

Reportedly, European nations are equally divided between supporting either the 1500 MHz or 2400 MHz proposals.

Despite these problems, the conference rallied to Soviet delegate Mark Krivocheev's midweek appeal to "finally inaugurate BSS sound and to support a

worldwide 1500 MHz allocation."

Several input studies indicated that a 2400 MHz satellite allocation would not be economically practical due to roughly seven times greater costs. Some delegates suggested the band might not be technically attractive for decades.

Canada's leadership

In June 1990, the WARC-92 agenda was modified to include a provision for "complementary terrestrial broadcasting" within the proposed BSS (sound) allocation. The definition of that phrase has been the subject of continuing controversy.

One interpretation is that this definition only provides for the needed terrestrial gap fillers in urban markets (to overcome shadowing effects of tall buildings). Others, however, contend stand-alone stations independent of the satellite signal could be authorized.

The concept advanced by Canada is that the BSS (sound) allocation could be used as the new digital radio terrestrial band envisioned to eventually replace AM and FM broadcasting.

Sharing with one to two dozen satellite channels would result in minimal additional spectrum requirements, according to Canadian studies.

Unlike the WARC preparatory activities in the U.S. that have scrupulously avoided attempting to either define the range of options or precise meaning of the term "complementary terrestrial broadcasting," the CCIR report provides extensive treatment to all of the currently contemplated delivery concepts.

All options, ranging from a purely satellite-based service to satellite with gap fillers, as well as stand-alone stations with gap fillers and coverage extenders, were described in Canadian-drafted sections of the conference report.

Receiver issues

The Japanese delegates insisted on keeping alive the possibility of implementing an FM-based satellite radio service that might permit listeners in some countries to purchase an inexpensive add-on antenna and downconverter so that existing FM radios could receive satellite radio signals.

Most delegates, however, felt that the significant power, efficiency, qualitative and service flexibility advantages of the digital radio systems would discourage serious discussion of the traditional FM approach in developed nations.

The final Sydney report also emphasized the need for a worldwide technical standard to facilitate compatibility between satellite and stand-alone terrestrial broadcasting, regardless of whether adjacent or widely separated allocations are eventually adopted.

Several input documents expressed doubts as to the usefulness of a terrestrial stand-alone service at 1500 MHz due to foliage absorption, restricted building penetration characteristics, doppler limitations, and gap-filler spacing limits at those frequencies.

Mike Starling is senior engineer for National Public Radio in Washington, D.C., and a frequent contributor to RW.

SCI Makes Change to Test Plans

(continued from page 1)

existing FM spectrum," Strother noted. "We want it to be a total DAB test."

On a related note, the NAB's DAB task force has turned down a request by Strother to underwrite the DAB demonstration at the NAB spring convention in Las Vegas.

"We decided it should be an exclusively NAB-Eureka 147 demonstration without outside participation," DAB task force chairman Alan Box said.

He emphasized that the task force's decision was not meant to slight SCI or other proponents, but that the group's desire is not to be aligned with any one participant.

Because SCI's plan is to test other systems of DAB delivery as well as Eureka, "we are comfortable in that we would rather not be associated with a test that only includes Eureka," Strother said.

SCI planned to file its test plan amendment with the FCC along with replies to MSTV's and WETA-TV's objections.

WIRELESS CABLE DATABASE

(ITFS - MDS - MMDS - OFS
A1 Thru H3 Plus 1, 2 & 2A)

**CURRENT
ALL 50 STATES
ON-LINE
24-HOUR ACCESS
CALL NOW!**

dataworld®
A Service of DW, Inc.

P.O. Box 30730, Bethesda, Maryland 20814

FAX (301) 656-5341

(301) 652-8822 (800) 368-5754

Circle 66 On Reader Service Card

A Guide to RF Rule Compliance

by Harold Hallikainen

SAN LUIS OBISPO, Calif. Last month we looked at some of the rationale for the RF radiation exposure limits of ANSI C95.1-1982. The FCC has published OST Bulletin 65 to help you determine compliance with the ANSI guideline. You can get a copy of OST 65 by calling NTIS at 800-336-4700. The publication costs \$17 plus \$3 for handling.

Determining compliance

Probably the best way to determine compliance with FCC requirements is by making measurements in all areas that humans will occupy. The FCC will, however, accept predictions. For simplicity, the predictions are generally a "worst case" analysis, so any errors in the modeling of the system result in the actual field strength being below that predicted.

OST Bulletin 65 has several charts to aid in evaluating compliance for AM and FM stations. The OST 65 limits take into

account radiation reflection by the surface of the earth, the radiation pattern of typical antennas (not isotropic).

INSIGHT ON RULES

The ground reflection increases the field strengths by up to 100 percent (by creating standing waves).

Since some of the power is absorbed instead of being reflected, the EPA assumes the field strengths will increase 60 percent due to ground reflection, resulting in a power density increase (proportional to field strength squared) of 156 percent.

A typical FM antenna is designed to radiate the maximum power density towards the audience (assumed to be on the horizon unless beam tilt is used). This reduces "downward" radiation below that of an isotropic source. In tests around FM broadcast facilities, the actual power density was less than that predicted by the EPA model, demonstrating it as a worst case model, but not as restrictive as an isotropic model would be.

AM antenna radiation limits

For AM stations, the NEC (Numerical Electromagnetic Code) models linear antennas. Independent of frequency or

tower height, both the electric and magnetic field strength are predicted to meet ANSI specifications 12 meters from a tower being fed with 50 kW. If the power is decreased by a factor of four (to 12.5 kW), the ANSI limit distance would decrease by a factor of two (to 6 meters), since the power density is inversely proportional to the square of the distance.

Towers with high voltage at the base (those close to 0.5 wavelengths long) have a high electric field at the base. The limits are expressed in Figure 1.

For AM directional antennas, a worst case analysis can be accomplished by assuming that the full transmitter power is going into a single unspecified antenna element. For example, a 5 kW three-tower DA would have fences restricting access five meters from each tower base.

Assuming the full power is driving each tower allows us to consider only the radiation from that one tower and ignore the radiation from the other towers, simplifying the analysis. If we wanted a more exact analysis, we'd have to sum the fields from each tower, taking into consideration the power into each tower, the distance from it and the phase relationship with the fields from the other towers.

OST 65 also includes graphs for various tower heights (0.1, 0.25 and 0.5 wavelength) relating the maximum expected electric and magnetic field

strength for 1 kW input at various distances from the tower, measured two meters above the ground.

Transmitting equipment radiation

The above discussion has been restricted to radiation from the antenna.

Figure 1.

Station Power (kW)	Distance to ANSI Limit (meters)
<= 0.5	< 0.2
1.0	3
2.5	4
5.0	5
10	7
25	9
50	12

The transmitting equipment (transmitter and phasing equipment) also radiate. OST 65 does not make any predictions as to radiation from anything other than the antenna.

I've spoken to transmitter manufacturers, phasor manufacturers, consulting engineers and the FCC regarding radiation from other sources. It's been quite interesting.

Bob Weirather at Harris pointed out that most recent transmitters radiate less
(continued on page 36)

Notice to Our Readers

The second installment of Tom Osenkowsky's series on AM non-d and directional antennas has been rescheduled to appear in the Jan. 23 issue of RW.



- THREE -

ways we can make your equipment budget work harder:

Financing options including a variety of lease plans that make your equipment acquisitions easy and economical.

Used equipment exchange to turn your out-of-date gear into something you can always use—dollars.

Competitive pricing on everything we sell—over 5000 audio, studio and satellite products from more than 250 manufacturers.

Now more than ever, no one gives you more choices—or more help in making the right choices—than Harris Allied. That's what we mean by taking the lead.



FAX 317-962-8961

800-622-0022

IN CANADA 800-268-3817

With expanded staff and services... our lead keeps on growing!

HARRIS ALLIED ©1991
"Call me, I'm interested." Circle 20.



- FOUR -

ways we can multiply your resources:

The broadest range of broadcast technology. Industry-leading RF products, plus over 5000 audio, studio and satellite products from more than 250 manufacturers.

Fully integrated field sales assistance. Our enlarged team of field sales experts provides in-person technical advice and consultation on both RF and studio products.

Faster-than-ever sales and service response. Rapid access to every Harris Allied product and service by telephone.

A total commitment to customer support. Used equipment exchange, leasing and other financial alternatives. Non-stop parts and service availability to keep you on the air. Systems assistance from a simple renovation to a complete turnkey operation. Broadcast Tech—the industry's only dedicated training facility.

Now more than ever, no one gives you more choices—or more help in making the right choices—than Harris Allied. That's what we mean by taking the lead.



FAX 317-962-8961

800-622-0022

IN CANADA 800-268-3817

With expanded staff and services... our lead keeps on growing!

HARRIS ALLIED ©1991
"Call me, I'm interested." Circle 26.

"Send me literature." Circle 55.

Principles of Power Multiplexing

by Lex Felker

WASHINGTON Untapped spectrum capacity: Is it the solution to the FCC's digital radio allocation problems or modern day alchemy?

For John Leonard, president of Kintel Technologies Inc., his company's "power multiplex" scheme is not a perpetual motion machine. Rather, Leonard views it as a practical and convenient solution to the problem of finding the spectrum capacity needed to launch a terrestrial digital audio service.

You've heard of time division mul-

tiplexing, frequency division multiplexing, even code division multiplexing. But what is "power multiplexing?" I found the answer buried within the six

FELKER'S FORUM

volumes of pleadings filed in the FCC's digital radio proceeding, in a seven-page comment and technical appendix filed by Leonard. As described in these comments, the power multiplex system re-

lies on the "capture effect" inherent in frequency modulation.

If nothing else, the scheme is marvelously elegant in its simplicity. At the transmitter, two (or more) co-frequency angle modulated carriers are combined, at different power levels. As far as I can tell, there is no particular phase relationship required of these carriers, nor is there any orthogonality present among them.

Demodulation technique

The demodulation described in the comments is somewhat more complicated, but no less straightforward. The stronger of the carriers—the dominant carrier—captures the receiver's discriminator and is demodulated in the normal fashion. The lower powered co-channel signals are attenuated substantially and do not contribute significantly to the demodulated audio signal.

To demodulate the lower-powered modulated carrier in a two-carrier multiplex system, an out-of-phase replica of the dominant carrier must be mixed with the incoming signals to "cancel out" the dominant carrier. The weaker signal is then demodulated normally.

It is claimed that a deep null in the dominant carrier's signal power is not required, so long as in the resulting signal, the "weaker" carrier, is sufficiently strong to capture the receiver's discriminator.

Too good to be true?

As unusual as the system sounds, years of surprises have taught me to not be too quick to trash a technical idea just because it is unconventional. Nevertheless, as I pondered this idea, a few questions surfaced that I hope will be addressed in further papers on the concept.

First, I wonder how sensitive the system's performance is to the dominant carrier's modulation index. Apparently, the power multiplex proponents believe that carriers with small differences in power levels (on the order of 1 dB or less) can be effectively isolated. FM systems with large mod indices (i.e., those whose deviation far exceeds the highest modulating frequency) enjoy substantial noise improvement and high capture ratios.

Today's FM broadcast systems, however, have relatively small modulation indices—on the order of 1.40 or less. Although I have not yet researched this point carefully, given these modest index values, I would be surprised if such differences in carrier powers would be

sufficient for an FM broadcast signal to capture a receiver discriminator.

Second, I am curious as to how the two co-channel signals would be isolated at the transmitter so as to avoid crosstalk, intermodulation products and the generation of other interfering signals. As a practical matter, it is not uncommon for stations on different frequencies and employing different transmitters to interact significantly with one another.

I would imagine that under the power multiplex scheme, these problems would be exacerbated.

Finally, I question how adjacent and co-channel interference might be affected by the use of a power multiplexing scheme. Inasmuch as the first order interference effects are primarily a function of total radiated power, I presume that regardless of how a station's power

... the power multiplex system relies on the "capture effect" inherent in frequency modulation.

was divvied up among various carriers, the sum of all powers transmitted by stations employing power multiplexing would still be capped at the maximum authorized by the Commission.

Under these circumstances, I wonder how many stations might be willing to employ the technique with the knowledge that coverage from their main channel could suffer.

Hardware demonstrates concept

Is the power multiplexing system a dream come true, or just too good to be true? As I indicated above, it is not uncommon for unusual designs to represent true technical innovation.

In a brief conversation, Leonard told me that some prototype equipment has been built that confirms the theoretical construct above. I look forward to the publication of hard test results along with a more detailed description of the underlying theory and answers to the questions posed above.

■ ■ ■

Lex Felker is a technology/engineering consultant with the law firm of Wiley, Rein & Fielding in Washington, and a former Mass Media Bureau chief for the FCC.

Clean up your act with the



DYNAMAX[®]
BROADCAST PRODUCTS BY FIDELIPAC[®]

Stereo Play
\$2050 list

Stereo R/P
\$3050 list

The CTR90 from Fidelipac offers a combination of features not found on any other broadcast cart machine, including Dynamic Noise Reduction, Dolby HX Pro, front panel metering, modular construction, toroidal power transformer, both XLR and "D" connectors, and more. Now available from

The Preferred Source...

BROADCAST SERVICES/EME

The Davis Communications Group, Inc.

800/525-1037

RADIO PRODUCTS
DIVISION

Four Oaks, NC 27524
FAX 919/934-1537

**AS-101
Audio Switcher**

- Illuminated and legendable control buttons
- Instant or overlap switching
- Front panel accessible level controls
- Options include: RS-232 interface, remote control, relay-follow-switch outputs
- Network proven quality and reliability!

10 stereo in
1 stereo out

P.O. Box 1342 Bellingham, WA 98227
(206) 734-4323 (206) 676-4822 (FAX)

Conex Electro-Systems, Inc



RPU

Modulation Monitor



EBS



Remote Control



STL



TSL

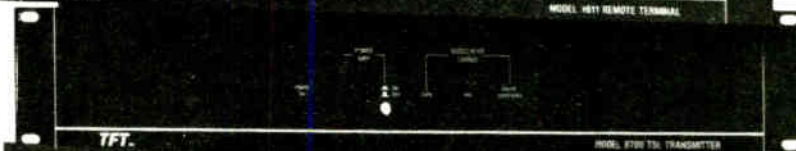

RECITER™



After 20 years of sound accomplishments, it's time we gave you some credit.

Your response to our innovations helped us reach two decades of success. We've enjoyed worldwide acceptance to our advances in Modulation Monitors, STL, RPU, EBS, RECITER™ and the Synchronous FM Booster Systems.

Now, we'd like to show our appreciation with a 20th Anniversary Cash Back Program. When you buy 2 or more types of equipment you'll qualify for a special refund from the factory. The chart below shows the amounts you can earn. For detailed information, contact your local dealer or the Marketing Department of TFT (1-800-347-3383).

For sure, we intend to give the industry more innovations during the next 20.

20TH ANNIVERSARY CASH BACK PROGRAM

You will receive the amount shown below for each type of equipment

When You Buy:	RECITER Models	STL Models	RPU Models	MOD Monitors	EBS Models	TSL Models	REMOTE CONTROLS	CIRCLE AND ADD ACROSS	Maximum Cash Back:
2 types of equip.	\$ 520	300	230	170	100	130	260		820
3 types	\$ 830	480	370	270	160	240	420		1,730
4 types	\$1,250	730	550	410	250	360	630		3,160
5 types	\$1,560	910	690	510	310	450	780		4,450
6 types	\$1,770	1,030	780	580	350	520	890		5,570
7 types	\$1,880	1,090	830	620	380	550	940		6,290

Qualifications: Buy 2 or more types of equipment at the same time. Amount of cash back must be confirmed by TFT at time of order. Invoice for each order must be paid in full.

Valid in U.S.A. & Canada. Offer expires July 1, 1991. TFT reserves the right to disqualify any order that does not meet the program qualifications.



TFT Inc.
3090 Oakmead Village Drive, P.O. Box 58088
Santa Clara, CA 95052-8088
Tel 408-727-7272, FAX 408-727-5942, 1-800-347-3383

Sound Quality for 20 Years

Circle 146 On Reader Service Card

World Radio History

The Erosion of Engineers

by Barry Mishkind

TUCSON, Ariz. Go ahead, take an opinion survey. Ask a hundred managers about their engineering department and what it means to them.

Press a bit and most will eventually tell you that they see engineering as an expense to be minimized, both from the salary point of view as well as capital costs.

Technically, they have a point.

Engineers don't sell time. And every morning jock knows that engineers don't get ratings points, the jocks do. So why put any more money into engineering than one is forced to put there?

OK, sure, there *are* some managers who understand the essential relationship between the engineering department and the success of a broadcast station. A few of them even speak "tech."

On the other hand, if you listen to engineers talk, you'll hear lots of complaints about lack of respect.

The erosion of engineering importance has had many manifestations. A number of engineers have left for other industries where they receive more respect, better money or shorter hours—or all three.

As mentioned, there are lots of exceptions around the country. Many stations, in markets of

all sizes, have set solid budgets for technical matters and pay their engineers well.

Nevertheless, the majority of engineers are caught in the middle, often working for several stations in order to make ends meet. And horror stories regarding work situations are not hard to find.

Horrors!

Recently, an engineer took a full-time job at a radio station in the west. It was an AM/FM combo that "just needs a little maintenance." Not one piece of equipment was less than eight years old; you probably

can guess which was older, the engineer or the transmitter. The salary: \$600 per month (sigh).

ECLECTIC ENGINEER

One local radio station sought a contract engineer. Basically, the station asked for 24-hour coverage, with 10 hours a week of maintenance. They offered \$400 per month (heavier sigh!).

Another engineer had a total antenna failure at his station. Through some inventive engineering, he was able to get the station back on the air in a few hours. Using an antenna borrowed from another station, he even managed operation at about seven or eight dB down until the replacements arrived.

Imagine his surprise when the station manager accused him of causing the failure on purpose to sabotage the station's ratings (agonized sigh!).

Is there a solution?

A first reaction would be to indeed wonder why any self-respecting engineer would work for such stations. The quick answer is the engineer's need to eat from time to time. The more complete answer is that there are more people out there that desire to work in broadcasting than there are jobs.

Some simply work for what they can get. Regarding the efforts of those trying to improve engineering fees as naive, these people find it easy to underbid others in the marketplace.

Listening to engineers talking or reading the broadcast echoes on the nation's computer BBSs, one can easily sense the frustration. Isn't there some way to get rid of the bad guys and educate stations to provide decent pay, benefits and respect?

Prospects for a quick change may not be real bright, but they are not totally dark, either. In recent times the FCC has reduced much of the regulation of the past, allowing the marketplace to determine the level of engineering at a station. Has the industry responded?

The NAB is basically an owner's association, so it reflects the desires of its members. Engineering is not one of its highest priorities.

The SBE has come along with its certification program. But this has yet to prove to be a leading concern for the majority of station managers.

Perhaps the best news has been the recent increased attention by the FCC to field inspections. Inspectors are conducting sweeps around the country, citing many of the stations that have been paying too little attention to the rules.

A number of stations have
(continued on page 36)



When you need extra hands mixing audio, Shure's AMS can help.

Until recently, you needed outstanding hand-ear-eye coordination to mix audio in multiple-microphone broadcast situations.

Now there's a system that gives you broadcast-quality audio when you can't cover all the faders at once. It's the Shure Automatic Microphone System (AMS), featuring patented direction-sensitive gating.

The Shure AMS continuously compares audio signal levels from two matched unidirectional condenser microphone cartridges located back-to-back in each AMS microphone. The rear-facing cartridge monitors ambient sound, while the front-facing cartridge handles sound from the desired source. When the front cartridge output exceeds the rear cartridge output by 9 dB, the AMS mic channel gates on automatically in .004 seconds.

Because of this unique gating concept, an AMS microphone channel will *only* gate on

when addressed from within a 120-degree "window of acceptance" centered at the front of the microphone. AMS mics not addressed from within this angle remain off. So the number of open microphones is kept to a minimum automatically, with no need for manual control.

Since the Shure AMS automatically keeps track of the number of open microphones and adjusts the overall gain to compensate, your broadcast level stays constant as mics open and close, without troublesome gain-riding.

Direction-sensitive gating makes the



SHURE®

The Sound of the Professionals...Worldwide.

Circle 151 On Reader Service Card

Shure AMS the best system to use in multiple-mic situations, from panel talk shows to game shows to hearings on Capitol Hill. More and more broadcast engineers are discovering the advantages of having broadcast-quality multiple-microphone



audio without the headaches of manual mixing or the time-consuming setup of so-called automatic mixers.

With AMS you not only get all the advantages of a truly automatic microphone system, you also get the broadcast-quality audio and reliability of Shure microphones.

For a comprehensive AMS literature packet, call us at 1-800-257-4873. For AMS technical support, call Michael Pettersen at 1-708-866-2512.

C270

C274

C278

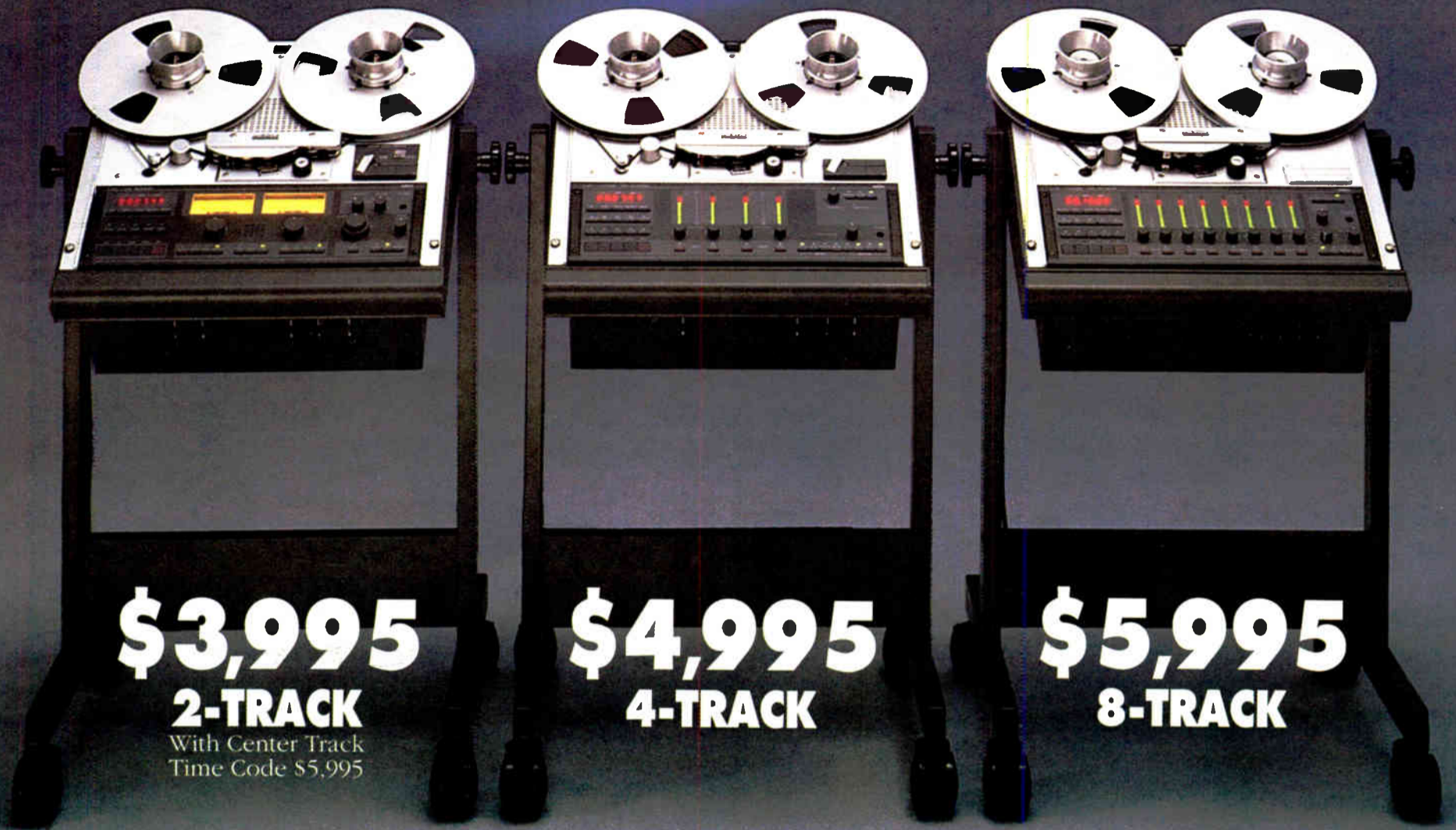

\$3,995
2-TRACK
 With Center Track
 Time Code \$5,995

\$4,995
4-TRACK

\$5,995
8-TRACK

REVOX OPEN REEL RECORDERS. HIGHER QUALITY. LOWER PRICES.

THE C270 SERIES This exciting new line of recorders provides you with all the traditional Studer Revox benefits—mechanical precision, electronic sophistication, supreme sound quality and superior support—adding up to state-of-the-art analog recording technology. The C270 is available in 2, 4 and 8-track versions with or without remote/autolocator.

BEST BUY Compare the “street” price and performance of any C270 Series machine with the competition, and you’ll find there is no competition. The die-cast deck plate and head block, the precision mechanics and a host of powerful features tell you any C270 Series machine will last as long as you need a reel-to-reel in this emerging era of digital workstations. And in the digital future, you’ll need analog recorders that will sound good—for a long time. That’s why your last reel-to-reel should be a Studer Revox.

TIME CODE . . . OR NOT The C270 2-track version offers optional center track time code for effortless synchronization to picture or sound. The C274 4-track and C278 8-track are both equally adaptable to production or post. The optional remote/autolocator stores 18 start/stop addresses and provides full transport and channel remote control to fit into any professional studio environment.

LOGGING TOO For station logging applications, special super low speed versions of the C274 and C278 are available with built-in time/date code generator and reader with search capabilities, providing up to 25 hours of continuous audio on one reel of tape.

Call your Studer Revox Professional Products Dealer—or Studer Revox direct—to discuss all the details. Or simply call **800-366-4900** to receive our C270 series color booklet.

C270 Remote/Autolocator



STUDER REVOX

Studer Revox America, Inc. • 1425 Elm Hill Pike • Nashville, TN 37210 • (615) 254-5651
 New York (212) 255-4462 • Los Angeles (818) 780-4234
 Studer Revox Canada Ltd., Toronto (416) 423-2831

Circle 51 On Reader Service Card
 World Radio History

© 1990 Studer Revox America, Inc.



Take the RS 2000 \$50.00 user test drive!

"What do I get if I buy an RS-2000?"

You get a better cart machine, with phase correction, front panel azimuth adjust, three cue tones, fast forward, splice finder, timer, the industry's first flutter correction, DC motor, massive deck plate, excellent audio specifications . . . and you'll save hundreds of dollars over competing brands!

"And if I still prefer an older brand?"

We'll refund your money, PLUS a check for \$50.00 . . . just for trying ours first.

"Why is Radio Systems doing this?"

Because, just like the auto makers say, we think that once you try the RS-2000, you won't want any other cart machine. It's that good a machine! But even if you do return the RS-2000, you'll receive \$50.00 as our way of saying thanks.

The small print: Test drive a RS-2004 Stereo Record/Play cart machine for up to 30 days. And if you still prefer another brand, return the RS-2000 in mint condition and include a proof-of-purchase for a qualifying new stereo record/play cart machine purchased and delivered within 30 days of RS-2000 return. We'll refund your money plus \$50.00. Qualifying machines include all new stereo record/play models from ITC, Fidelipac, Pacific Recorders, Otari, and the Phase-Trak and Dura-Trak lines from Broadcast Electronics. Complete rebate rules are available from Radio Systems; offer subject to change without notice.



Model RS-2004 Stereo Record/Play

RADIO SYSTEMS INC. 110 High Hill Road □ P.O. Box 458 □ Bridgeport, NJ 08014-0458 □ 609/467-8000 □ 800/523-2133 □ FAX 609/467-3044

Circle 114 On Reader Service Card

World Radio History

Understanding RF Amplifiers

This is the ninth in a 12-part series called Amplifier Fundamentals. Northern Virginia Community College will offer 1.2 CEUs (continuing education units) to registered students who successfully complete the course and an examination mailed at its conclusion.

Successful completion of the course and the final exam will also earn 1.3 professional credits toward recertification under the maintenance of certification provisions of the SBE Certification Program. To register, contact the Director of Continuing Education, Annandale Campus, 8333 Little River Turnpike, Annandale, VA 22003, or call 703-323-3159. The fee for the course is \$35.

by Ed Montgomery

Part IX of XII

ANNANDALE, Va. Radio frequency (RF) amplifiers are identified as amplifiers handling frequencies above 20,000 Hertz (cycles-per-second). Unlike audio amplifiers, which are designed to handle frequencies within the range of hu-

man hearing, RF amplifiers are designed to handle one frequency or a small band of frequencies surrounding a center frequency or carrier.

function, it is important to understand the concept of resonance. In electronics, voltage and current are out-of-phase in coils and capacitors. Simply put, the phase shift for a coil is exactly opposite that of a capacitor. A circuit that contains a coil and capacitor will have one optimum operating frequency. This is illustrated in Figure 2.

In Figure 1, all of the amplifiers contain resonant circuits that will be tuned to the oscillator frequency. The output of the power amplifier must be tuned to the load, which in this case is an antenna. An antenna is a much different load than a speaker. The speaker, acting as a load for an audio amplifier, is a coil interacting with a permanent magnet and a paper cone to create sound waves.

Complete circuit for current

The speaker creates a complete circuit for current to flow through. This is not the case with a radio frequency amplifier. The antenna is an open circuit. Its length is a factor of the frequency the

frequency in Hertz. Any frequency can be a radio frequency. Frequencies above 20,000 Hz are most often used though, because it becomes quite impractical to make antennas at low frequencies.

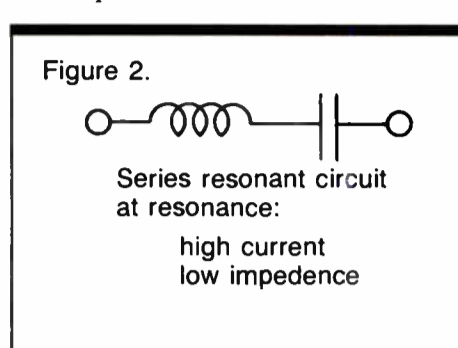

Referring back to Figure 1, the modulator is a special RF amplifier that adds the information one wishes to transmit. In this case, audio is used. The modulator can affect the oscillator's output in various ways. The amplitude can be modulated (AM) to create additional power in sidebands (frequencies adjacent to the oscillator's frequency).

The frequency of the oscillator can be modulated (FM), causing the power in the oscillator frequency to be reduced and distributed in sidebands. Other

fier is required to build the signal. As illustrated in Figure 1, the driver stage amplifies the signal to a level where the power amplifier can deliver the prescribed current to the antenna to create the proper strength radio wave.

Tunable amplifiers are used in receivers to detect the desired radio signal and reject all others. In this type of circuit, the desired incoming signal is selected or tuned by varying either the coil or capacitor in the resonant circuit.

(continued on page 20)

methods of modulation include phase modulation, frequency-shift keying and digital transmission.

Amplifier design limit

Any amplifier design has a limit for how much it can increase the magnitude of a signal. Often, more than one ampli-

Figure 3.

$$(\text{wavelength}) \lambda = \frac{300,000,000}{f}$$

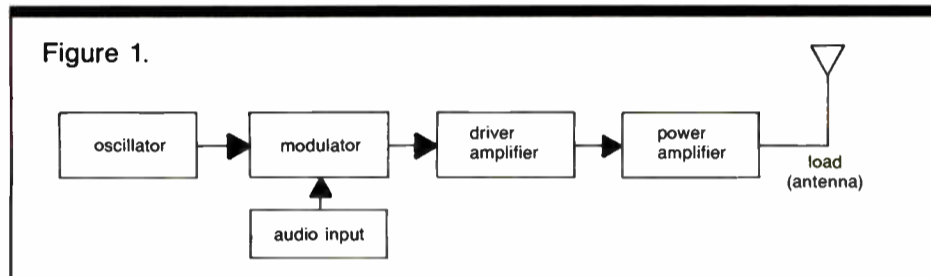

man hearing, RF amplifiers are designed to handle one frequency or a small band of frequencies surrounding a center frequency or carrier.

Figure 1 is a block diagram illustrating an RF amplifier chain designed to transmit audio information. Most RF amplifiers are controlled by an oscillator. Usually made of quartz for accuracy and stability, the crystal oscillator usually sets the operating frequency for the chain.

To fully understand how RF amplifiers

amplifier is operating on.

The antenna is combined with a capacitor that creates the power amplifier's tuned load. Often the antenna's size can be reduced by using a fraction of the entire wavelength.

Wavelength is an electrical property that occurs with any signal that is amplified and sent through a transmission line. Figure 3 is a formula for determining the electrical length of a wave.

The Greek letter "lambda" is the sign

The Preferred Source...
 solves *your* studio problems
 with Henry Engineering



Now available with all-metal cases, from...

RADIO PRODUCTS DIVISION
800/525-1037
 Four Oaks, NC 27524
 FAX 919/934-1537

BROADCAST SERVICES/EME
 The Davis Communications Group, Inc.

It's Not Just A Phase We're Going Through.

The tremendous success of the Tannoy PBM series of reference monitors is by no means coincidental. Since the introduction of the world renowned NFM-8 nearfield monitor, much time and effort has been spent on discerning the needs of the mixing engineer and the applied requirements of "playback monitors". The PBM Line exemplifies this commitment to excellence in reference studio monitoring. These compact loudspeakers sport robust poly cone mid-bass transducers utilizing efficient long-throw, high power voice coils. The low frequencies are carefully controlled by optimally tuned ports located on the rear of the loudspeakers. Hi frequencies are provided by Hi Power ferro fluid cooled polyamide dome tweeters which extend H.F. bandwidth beyond 20KHZ. The driver accompaniment is knitted

together by means of a precision hardwired crossover unit, utilizing robust low loss components, and heavy-duty input terminals which will accept standard 3/4" spaced banana plugs and the majority of high quality, specialist audio cables. Transducers and crossover assemblies are neatly housed in a stylish, high density, partial wrap cabinet, specially designed to minimize unwanted cabinet resonance, and high frequency reflection. In summarizing, we have left the best feature of all for last "price versus performance."

TANNOY
 Professional Products



TEC AWARD WINNER

TANNOY

Tannoy North America, Inc. 300 Gage Ave., Unit 1, Kitchener, Ont., Canada, N2M 3C8
 Telephone (519) 745-1158 Telex 069-55328 Fax (519) 745-2364

Data Compression Call to Arms

by Mel Lambert

Part III of III

STUDIO CITY, Calif. In this, the third and final installment in my overview of the various objective and subjective implications of digital audio data compression schemes, I'd like to summarize primary considerations, as well as discuss the need for our industry to become more actively involved in the standardization process.

There must be a healthy dialogue between the manufacturers of these various coding technologies, the users of

such hardware (stations and music/news origination services) and the organizations responsible for recommending

DIGITAL DOMAIN

standardized practices. Without it, I fear that we run the distinct risk of closing our minds too early to the kinds of data reduction techniques best suited to broadcasters' short-, medium- and long-term requirements.

Reducing the amount of spectrum and

storage space required to carry or store full bandwidth audio involves a certain number of compromises. The performance of any data-compression system is based on the degree of sonic transparency that it exhibits in real life applications.

16-bit PCM audio signals

Techniques now exist for reducing the data rate of standard 16-bit PCM audio signals to the equivalent of 64, 96, 128 or 256 kbps, enabling them to be carried over standard ISDN, fractional T-1 channels and switched 56 k-band lines, or to increase the capacity of hard disk drives by several orders of magnitude.

Data compression technologies fall into one of two primary categories: temporal domain (coding level-change differences, rather than instantaneous levels measured every sampling period); and frequency domain (data being assigned to important bands of information, particularly the critical low frequencies).

Potential subjective and technical considerations include encoding delay, asynchronous operation, stereo imaging, generational losses, auxiliary data capacity, compatibility with existing PCM systems, pre-echo within decoders, immunity to random/sequential errors and the simplicity of hardware implementation.

We should also make an important distinction between techniques designed for use in professional and consumer applications. While the former includes the various recording and transmission techniques, we might consider for passing a data-compressed signal around a broadcast facility, or via STL links, satellite channels or backhauls. The latter are intended for country-wide satellite radio, digital audio broadcast and other such over-the-air techniques.

In this case, cost/complexity considerations become of critical importance. One or two of the proposed data-reduction schemes are designed to be implemented in expensive DSP hardware, and without a radical breakthrough in the chip manufacturing industry, probably would prove too expensive for consumer-based systems.

Single standard

It goes without saying that, as with all technical considerations, the adaptation of a single standard for data reduction would be a useful concept to explore.

Standardized analog recording formats and equalization (reel-to-reel and cartridge) allow easy interchange of broadcast software; standardized connectors/interfaces greatly simplify the passage of analog/digital signals around a facility. Similarly, the adoption of a single data-compression technique would make life a whole lot easier for broadcasters.

Data from hard disk recorders, for example (continued on page 22)

MICROWAVE MONSTER EATING YOUR DISH?

You Probably Need Our **EXCLUSIVE** Block Band TI Filters!

Used by over 3000 commercial TVRO installers and operators:

- SMATV builders such as Spectradyne.
- CATV MSO's such as Warner, TCI, ATC, Viacom and others.
- Program providers such as HBO, TBC and others.
- TV/FM Broadcasters such as NBC.
- Motels/Universities/Government/Industry.

Most TVRO systems are now block downconverted, with LNB and no 70 MHz loop-out on the receiver. Neither microwave (4GHz) notches or 70 MHz filters are applicable. Block band filters can ALWAYS be installed in the coax cable, to suppress the TI before it hits the receiver. Their batting average is over 90% - we know, because we sell them MONEY BACK!

But, in the rare case they don't tame the monster, our FREE in-house consultants know ALL the Monster's tricks - and have a solution for each one of them - most of them available OVERNIGHT if necessary:

- Telephone Microwave
- Coastal Navigation Radar
- VHF Ingress
- Aircraft Altimeter Signals
- Railroad Microwave
- False TI (Low Signal)
- Airport Radar
- Common Carrier

Having A Problem NOW? Up Against A DEADLINE? Call Your FREE TI Consultant TODAY - And Sleep Tonight!



Before



After



Before



After

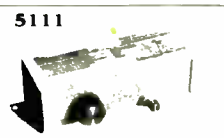

Single Receiver

Block band TI notchers: tunable single receiver or multiple carrier models for CATV/SMATV. Models for all blocks.

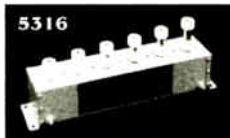

Multiple Receiver

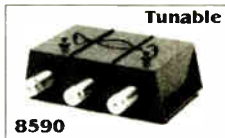

8590

Tunable or single channel block pass filter clears up pictures due to weak transponder signal. (Single channel 8730)

Ask for your TI First Aid Handbook and Filter Catalog MTV/87.



- TI Sources/Symptoms
- Cures For 500 Receivers
- Exclusive Block Filters
- Exclusive 4 GHz Filters
- Notches For 70 MHz or Any IF
- Side Lobe Reducers
- TI Site Test Equipment

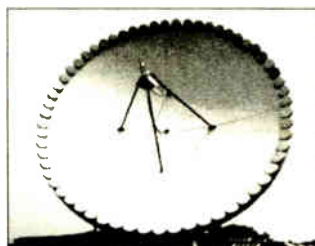

"Stick-on Absorber Kit, reduces side lobes - the gateway to all microwave TI!"

MICROWAVE FILTER COMPANY, INC. • 6743 KINNE STREET • EAST SYRACUSE, NY 13057

Toll Free (US/Can): 1-800-448-1666 • Collect (NY/AK/HI): 315-437-3953 • FAX: 315-463-1467 • Telex: 249-613

An RF Amp Overview

(continued from page 19)

Digitally tuned circuits may replace the capacitor with a reverse-biased "varactor" diode to select the desired frequency.

The input to the receiving amplifier is an antenna that has intercepted a variety of magnetic waves. The first section of the tunable amplifier is a resonant circuit that includes the antenna. Summarizing amplifier operation, the desired radio signal is amplified to a point where it is strong enough to be converted to an audio signal and amplified.

Radio frequency amplifiers can be narrowband, keeping most of their frequencies around the crystal's frequency, or they can be broadband amplifiers covering several hundred MHz, a requirement for cable television distribution systems.

Ed Montgomery currently is an electronics teacher in the Fairfax County school system. He has taught broadcast engineering at Northern Virginia Community College and worked as broadcast engineer for several radio stations. He can be reached at 703-971-6881.

How to Handle an Ownership Change

by John "Q" Shepler

Part II of II

ROCKFORD, III. D-Day is approaching. The landing party from the new parent company will arrive within the week. Are you ready?

Review your status toward making that important first impression. Does all the equipment work? Does at least all the important equipment—what the new owners will hear on the air—work? Good.

Q-TIPS

How about the transmitter? Is it clean? In tune? Maintenance logs up to date? Excellent.

Clean up the shop area, too. It looks good to have a project in the works on the bench. Just get rid of the trash and put away the tools you aren't presently using. A little polish here and there spells "professional" to an outsider.

Of course, you aren't going to work miracles in a matter of a few weeks. Especially because your budget will most likely be frozen by the present ownership. Something else you should know: They already have seen your operation as it *really* is. The new people had a good look some weekend when you weren't around. They were probably introduced as country club friends of the GM.

It's still worth the bother to spruce up. Just don't get into a frazzle because everything isn't perfect. Do what you can, then document what you can't. Presenting the new owner with a detailed list of the station's equipment status, especially a checklist with a few items checked off already, is bound to be impressive.

The first impression will be your appearance. How you smile and shake hands, how you answer the first questions and how the physical plant looks are all important. Pass this hurdle and you are in positive impression territory.

Now come the second impressions. It's a day or two into the ownership transition. You have been summoned to the management office for a review of your operation. Hang in there.

It is helpful to know that the new people are also in an uncomfortable spot. They have to make this operation work and they don't know any of the present staff or what you can do. They will appreciate your easing the pain.

In a few days, maybe a week or two, things will start to return to normal. The new people have formed their initial opinions, but major changes have not been launched yet. This is a good time for a terrific third impression. Ask how you can better fit into the plan. Ask what problems still need solutions. Volunteer. Ask as little for yourself or your organization as you can get by with. This will be seen as team play, not weakness.

What if it all crumbles?

Yes, your well-rehearsed plans could all be for naught. The management at corporate headquarters decided on the

first visit that you were out and their fair-haired protege was in. Them's the breaks.

Think about this ahead of time and you might still salvage something from the ashes. It is possible that you will be called into the office one day and told your services aren't required anymore. Resist the urge to storm out in righteous indignation.

Instead, try to cut a deal. Ask what your severance will be, as though you expect it. Unless you have made a horrible impression, you will probably get some notice as well some goodbye pay.

Now the incredibly hard part. Calmly ask what sort of reference you can expect. It will probably be the standard "good," but even if it's bad, offer to help with the transition. Show the new engineer around, etc. In other words, try to win them over for a good reference and as much severance pay as you can get. Then exit gracefully and put your life back together somewhere else.

How to avoid doomsday

The last section was a horror scenario. Getting canned unexpectedly is about the worst that can happen. Less severe, but plenty painful, is the slow agonizing death that comes from having your budget decimated and your pride ground into the dirt.

This isn't fiction. The walking wounded of merger-mania will be all too happy to give you an earful, and you will probably hear it too late. The only way to avoid becoming the next victim is to build a contingency plan before the worst comes to pass.

Ideally, you want to expect the best but be prepared for the worst. You are already primed to expect the best. Now, how to prepare for the worst?

First, don't panic. Don't be one of those people who bail out at the first sign of trouble only to find themselves in hotter water somewhere else. You have little to lose by just sitting tight until the situation is clearly headed one way or the other.

You need to protect your income, not your job. Get staged for a move. Update your resume. Call your friends to get a line on what may be opening up. Being able to step quickly into another job is probably the best strategy you will have to protect your lifestyle and your future.

Still expect the best

Enough of this paranoia. The new owners will arrive shortly and you will make a great impression. In fact, in six months or so you will be asked to join the corporate staff.

As you walk into the next acquisition for their first D-Day, be sure to praise that nervous engineer who has just spent nights and weekends for a month striving to make a lasting first impression. You remember how it was.

■ ■ ■

John Shepler is an engineering manager, broadcast consultant, writer and regular RW columnist. He can be reached at 815-654-0145.

The Cost Of Going Digital...

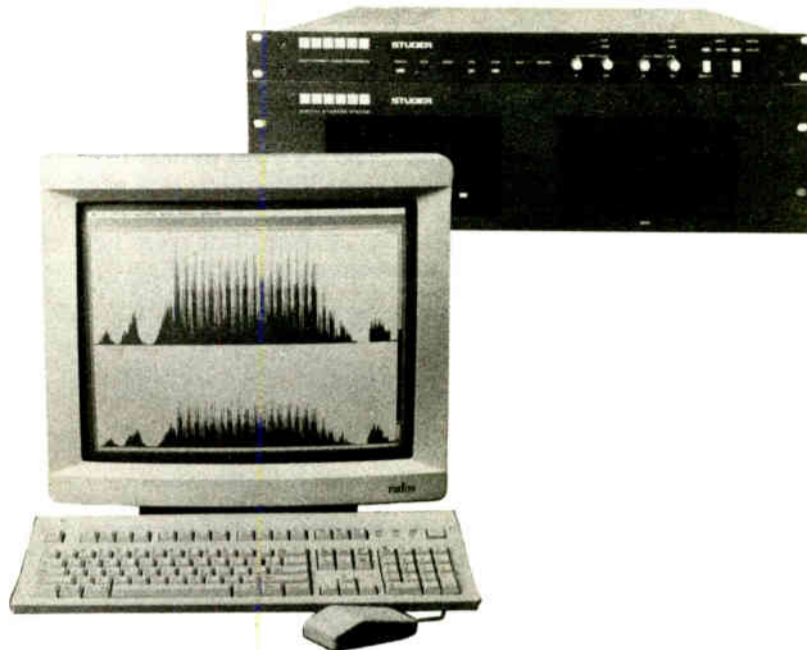

...Is Less Than You Think.

If your preparing to spend up to \$60,000.00 on a digital workstation ...Wait! For roughly one third of that you can get a complete system that doesn't limit you to only four or eight tracks.

Do yourself a favor. Call BSW and ask about the Dyaxis digital workstation from Studer. You won't believe the power and control that's available to you for as little as \$12,000.

Designed to work with an Apple Macintosh™ computer, Dyaxis features high power recording and editing capability, simple operation and total creative control.

Dyaxis takes multitrack productions to a new level with the ability to create, edit and mix an unlimited number of soundtracks. It can record and play back up to 12 hours of stereo digital audio with 16-bit resolution. On line digital signal processing including level control, equalization, pan and time scaling, allow you to manipulate audio to your hearts content.

Dyaxis adds speed and efficiency to any production and opens up a whole new horizon of creative potential.

Talk to us toll free today for more information.

BSW®

BROADCAST SUPPLY WEST

America's Full-Time Broadcast Supplier

1-800-426-8434

ORDERS • INFORMATION • SPECIFICATIONS

BSW • 7012 27th Street W • Tacoma, WA 98466 • FAX 206-565-8114

Circle 58 On Reader Service Card

Taking Action on Compression

(continued from page 20)

ample, could be plumbed directly into an STL link, for example, and stations could readily exchange data via fiber-optic and other serial links, not to mention the good ol' economy of scale that a single standard would mean to manufacturing costs.

The one drawback in adopting a single data coding standard, however, is that the industry for such hardware is simply not mature enough to have innovated sufficient design solutions for us to make an unambiguous selection.

And even the types of applications relevant to such technologies have yet to

be fully investigated. Quite simply, I would suggest, we do not even know what we should be listening or testing for, let alone fully understand every real-world application to which data-coding systems will be put.

Against this background, I find the recent deliberations of the International Standards Organization (ISO) regarding recommended techniques for data compression, to be less than reasonable.

ISO system evaluation

As RW readers may already be aware, during this past summer, extensive ISO evaluation tests were held at Swedish

Broadcasting in Stockholm, with a view to determining a data compression standard for data storage, transmission and eventual broadcast.

Of the various technologies tested by ISO, two designs came out ahead in its evaluations: ASPEC was found to be the best subjective performer, but difficult to implement in current hardware, while the second-placed MUSICAM was determined to be a better performer in terms of ease-of-implementation for encoder and decoder units.

Because both ASPEC and MUSICAM algorithms were considered to be reasonably equal in terms of overall performance/implementation, ISO recommended that the developers of these two systems combine the best components of both coding algorithms into a new coding standard.

All of this represents a laudable attempt at rationalizing a potentially confusing technical situation, but it is a solution that is far less than satisfactory for the developers of coding schemes that were not part of the ISO evaluation sessions.

For reasons that are too complex to explain easily within this column, several of the systems now being offered to our industry were not included within the ISO tests. In essence, ISO invited applications from existing coder designers, and then divided these into four categories: overlapping transform coders; non-

overlapping transform coders; ADPCM coders utilizing fewer than eight sub-bands; and ADPCM coders with more than eight sub-bands.

Of the fewer than one dozen systems offered for testing by ISO, only MUSICAM and ASPEC were evaluated in full.

Too few broadcasters are fully aware of the exact ISO testing procedures and, to date, our industry is too inexperienced with digital audio data compression in general to be deciding on standards for professional and DAB applications.

Pros and cons

Without a free and healthy interchange of opinions regarding the pros and cons of the various systems, I find it less than reasonable for us to consider, let alone implement, a single standard for data coders.

I would encourage all readers of RW to audition for themselves the currently available algorithms from the various equipment vendors, and perform comparison tests.

Then, if sufficient consensus exists, there might come the time for the adoption of a single standard for such techniques, and one that will serve the subjective and objective requirements of U.S. broadcasters and music/news origination services.

■ ■ ■

Mel Lambert has been intimately involved with the production and broadcast industries on both sides of the Atlantic for more than a dozen years. Now principal of Media&Marketing, a consulting service for the professional audio industry, he can be reached at 818-753-9510.



BUY

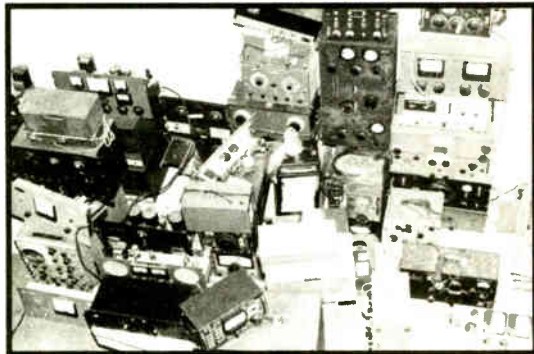

SELL



TRADE



Our Used Equipment Exchange can stretch your equipment budget—it's just one of the ways that Harris Allied gives you more. We've expanded to put more people and more resources to work for you: That's what we mean by taking the lead.



FAX 317-966-6321

317-962-1471

BUY—SELL—TRADE

With expanded staff and services... our lead keeps on growing!

HARRIS ALLIED ©1991

"Call me, I'm interested." Circle 13.

"Send me literature." Circle 87.

World Radio History

Ellason E250 Color Radar

Real-time local radar coverage for your entire audience.



- Detects snowfall as well as rain and thunderstorms.
- Five selectable ranges up to 200 miles.
- Operator selection of antenna tilt, receiver gain, two separate graphic overlays, and automatic operations.
- Optional larger antenna to provide better snow detection.
- Picture storage to determine weather changes.

For complete information, call 314/532-3031, or write Ellason Weather Radar, 747 Spirit of St. Louis Blvd. Chesterfield, MO 63005.

1-800-727-2327



ELLASON WEATHER RADAR

Circle 103 On Reader Service Card

Who's Setting The Pace For FM Transmitter Technology?

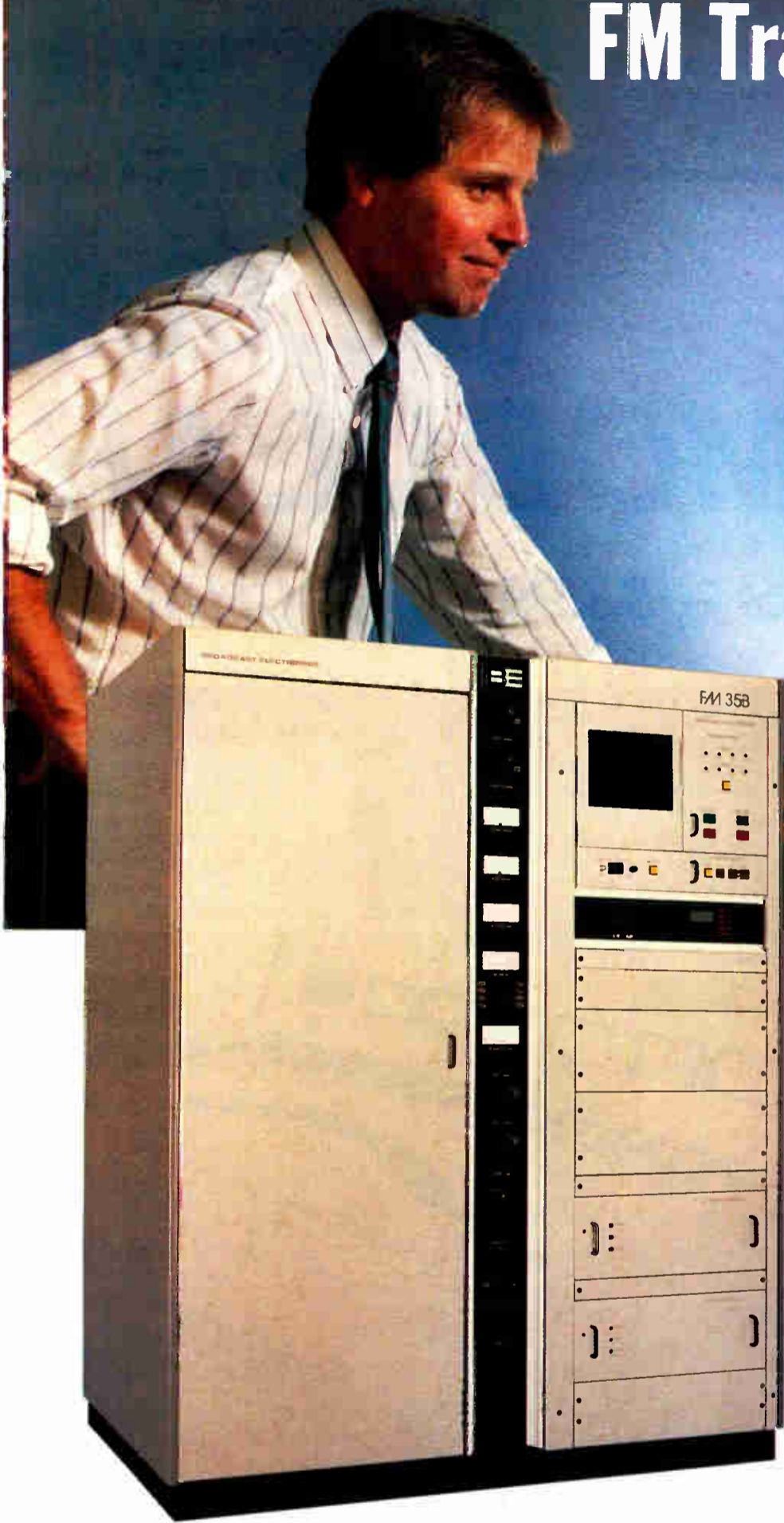

When it comes to making claims about technological developments in FM transmitters, the record is very clear.

Broadcast Electronics:

First to introduce a Proportional VSWR Foldback System.

First to introduce "PWM Automatic Power Control" with "Soft Start".

First to offer a built-in synchronous AM test port.

First to design a single tube high power 30kW FM Transmitter.

First to introduce a single tube 10kW FM Transmitter with a 4CX7500A tube.

First to introduce a single tube 3.5kW FM Transmitter with a 4CX3500A tube.

First to introduce a Microprocessor Video Diagnostic System.

First to offer built-in, PC based, transmitter remote control.

First to offer a standard synchronous FM booster option.

And, Broadcast Electronics again sets the world standard for FM Exciters with the new FX 50 which stands alone in audio performance with 93 dB S/N and .003% THD and IMD.

State of the Art Leadership

Stereo technology, only B.E. designs it all - AM, FM and TV stereo generators.

Broadcast Electronics is the only major FM transmitter manufacturer who designs and manufactures its own solid state intermediate power amplifier (IPA).

All products are backed by B.E.'s 24 hour parts and service and a strict quality assurance program.

The result of this commitment to state-of-the-art innovation is a complete line of RF products, designed to provide you with years of reliable service. Certainly it's clear who **is** setting the standards for FM transmitter technology!

Patented Innovations

Broadcast Electronics has the largest and most skilled engineering staff dedicated to the radio broadcast equipment industry. Significant FM transmitter design patents awarded to B.E.:

- Folded Half-wave Output Cavity, patented 1982.
- Internal Second Harmonic Suppressor, patented 1982.
- Broadband Input Impedance Matching Circuit, patented 1985.

Put our engineering expertise to work for you. Call (217) 224-9600 for the Broadcast Electronics Representative in your area.

BE BROADCAST
ELECTRONICS INC.

4100 N. 24th ST., P.O. BOX 3606, QUINCY, IL 62305-3606 U.S.A., PHONE (217) 224-9600, TELEX 250142, FAX (217) 224-9607

Circle 131 On Reader Service Card
World Radio History

NEW NEW NEW

SERIES CONSOLES

S - \$6,499 /18 CHANNELS - \$8,893



224-2248

FEATURES

- Totally Modular Console-Input modules, Output modules, Option modules
 - Ease of Service
 - Ease of Installation
 - Ease of Expansion
- Three Mainframe Sizes-8 channels, 18 channels, 28 channels
 - Full Metering
 - Timer on All models
 - Talkback to "2" studios
- Ultrahigh Quality Construction and design
 - Penny and Giles 3000 Series slide faders
 - VCA's
 - ITT Schadow switches
 - Gold connectors-IC's socketed-regulated power supply
- 3 Stereo Output Buses
- 2 Internal Mix-minus Buses for 'Telephone'
- Option Modules-D.A.'s, Mono Mixes, Remote Selectors, Etc.
- Comprehensive Logic system
 - Start and stop sources by isolated internal reed relays
 - Remote channel On and Off control with Tally lamps for turrets
 - Flashing OFF switches for cart machine status
 - Three muting buses for Control room and two studios
 - Timer reset selectable on each module
 - Monitor DIM function during cue and talkback



arrakis
SYSTEMS, INC.

**NEW
NEW
NEW
NEW
NEW**

NEW NEW NEW

Circle 48 On Reader Service Card

World Radio History

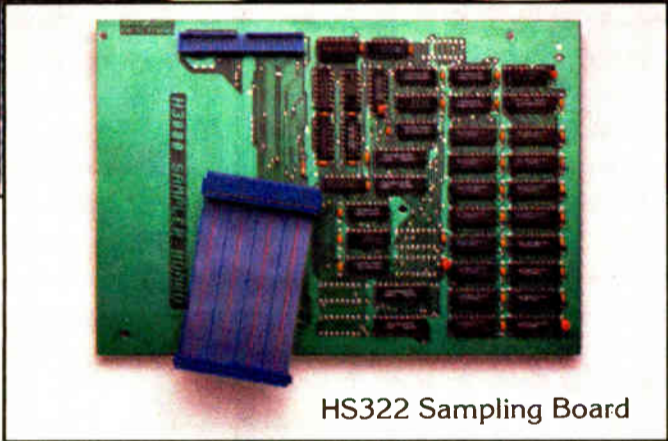
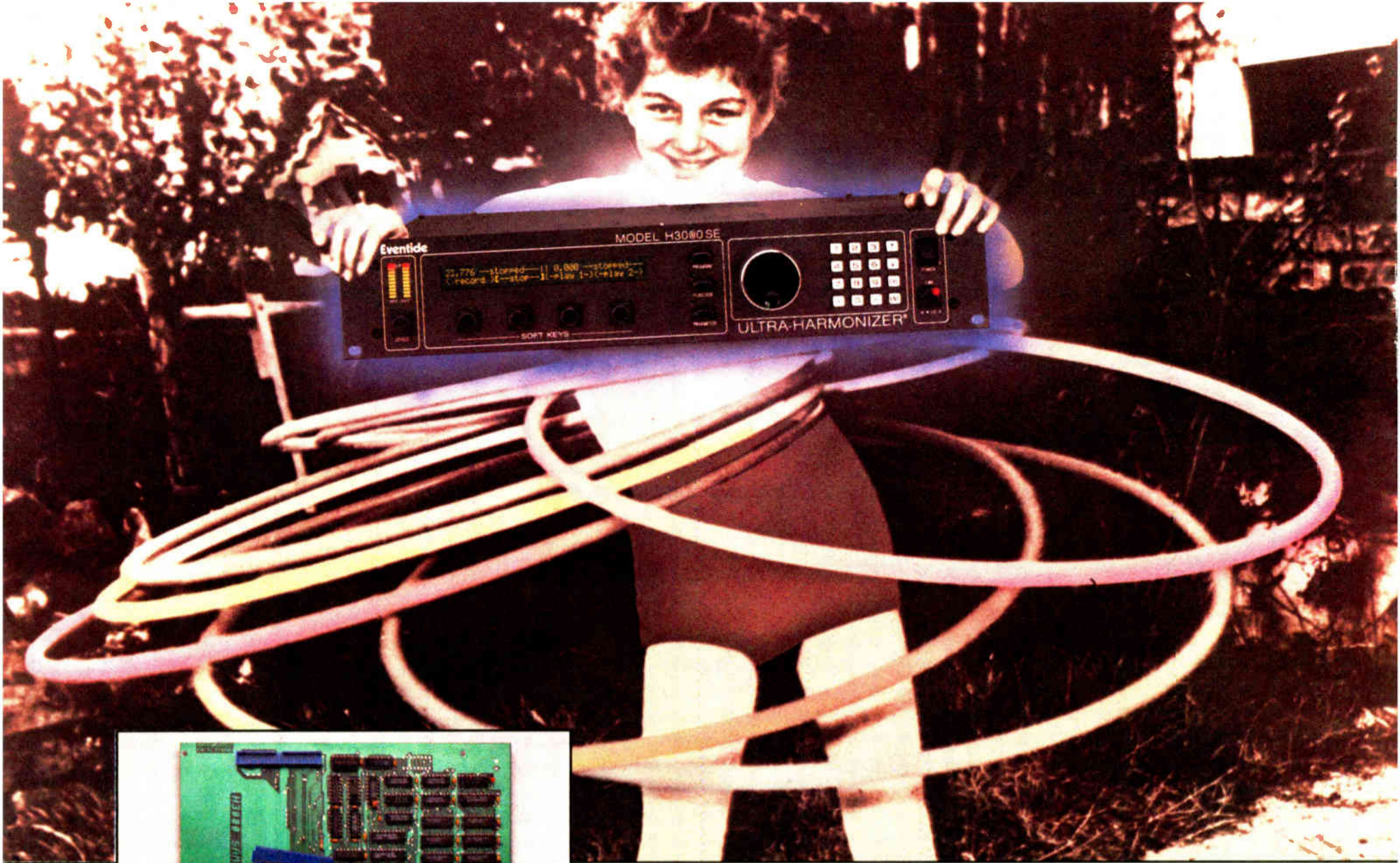

HS322 Sampling Board

Looping Is Only Our Newest Trick.

Eventide engineers just can't stop teaching the Ultra-Harmonizer® new tricks. First the built-for-broadcast effects and TimeSqueeze® capabilities of the H3000B. Next, eight new algorithms and 200 new presets in our SE ConKit. Now, 11.8 seconds of stereo or 23.7 seconds of mono sampling with the HS322 Sampling Board option. For \$995, the HS322 adds 16 bit 44.1 kHz sampling to any Ultra-Harmonizer. And Eventide's unique pitch change technology makes it easy to do things no ordinary sampler can. Change playback length without changing the pitch, to make music or background loops happen fast. Change playback pitch without changing length, to add authority to a voice or impact to a sound effect. The HS322 can also work like an ordinary sampler if you want to change pitch and length simultaneously.

The HS322 board records two stereo or mono sounds, with the flawless audio quality that's made the H3000 a radio favorite. You also get

fast, flexible, precise control. Start recording and playback manually, via MIDI or audio trigger. Edit Start, Stop and Loop points using the famous Eventide Knob to "rock" audio, or enter locations on the keypad.

Impressed? Ultra-sampling is just part of the H3000's best trick—the way it keeps your original investment growing in power and performance, without making you buy a whole new box. Production and air talent keeps getting more and more out of the H3000—because we keep putting more into it. So, if you're ready for more than just another "fad box," talk to your broadcast distributor. And sample the future.

Eventide®
the next step

One Alsan Way • Little Ferry, New Jersey 07643
Tel (201) 641-1200 • Fax (201) 641-1640

Sample responsibly: Credit and compensate your sources.

Ten-Four, Good Buddy!

by Bruce Bartlett

ELKHART, Ind. How do you best connect an unbalanced, semi-pro device operating at -10 dBV nominal level to a balanced, professional device operating at +4 dBm nominal level?

Dan Polen of Seattle asked me that question. He wanted to connect the output of a Tascam 688 recorder-mixer to the

the shield to pin 1.

Now to the level mismatch. The Tascam output level, -10 dBV, is 11.8 dB less than the Sony's desired input level, +4 dBm. I suggested that Dan set the Tascam level to peak around 0 VU (or 0 dB on a peak meter) and turn up the gain on the Sony DAT recorder until the peak level reads -5 dB. That's assuming the Sony has enough reserve gain to make up for the low-level signal.

This will result in 11.8 dB more noise than if both units were the same level, but the results may be acceptable. A better solution is to use an interface box that matches -10 to +4.

Why the difference?

Let's explain the difference between the two signal levels. Generally, audio equipment with balanced (3-pin) connectors works at a higher nominal line level than equipment with unbalanced (phono) connectors. There's nothing inherent in

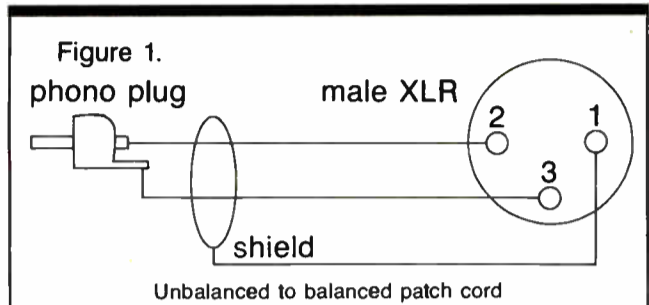

input of a Sony TCD Pro 10 DAT recorder. This situation presents two interfacing problems: connectors and levels. The semi-pro Tascam unit has unbalanced phono-jack line outputs; the professional Sony DAT machine has balanced XLR-

connectors. There's nothing inherent in

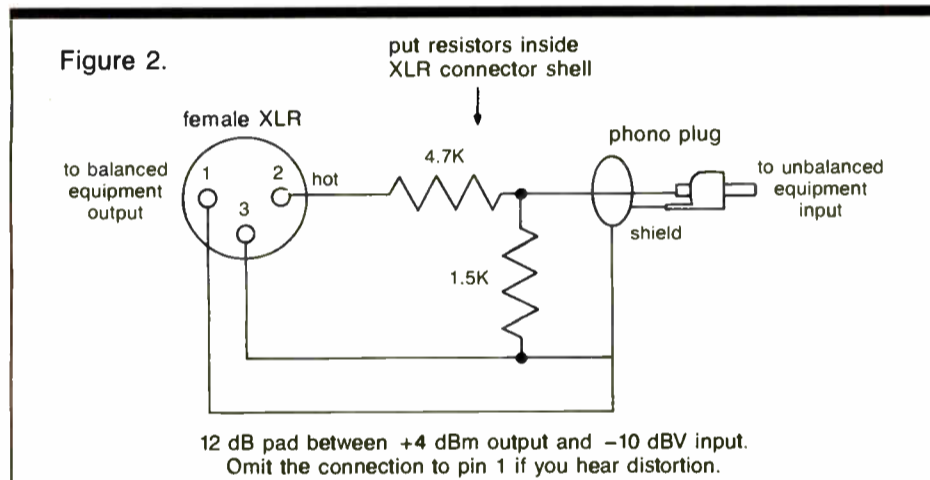

type line inputs. Also, the Tascam level is -10; the Sony, +4.

One suggested connection is shown in Figure 1. Use a two-conductor shielded cable. Connect the two center conductors to the unbalanced signal hot and ground. Do not connect the shield at the unbalanced end. At the XLR-type connector, solder the center conductors to pins 2 and 3, and

balanced or unbalanced connections that makes them operate at different levels; they're just standardized at different levels.

For balanced equipment, the nominal (normal) input and output levels are +4 dBm (1.23 volts); for unbalanced gear, the levels are -10 dBV (0.316 V).

In other words, when a balanced output

recorder reads 0 VU on its meter with a steady tone, it is producing 1.23 V at its output connector. This voltage is called +4 dBm when referenced to 1 milliwatt. When an unbalanced-output recorder reads 0 on its meter with a steady tone, it

P ref=the reference power, 1 milliwatt.

For example, if the measured power is 2.5 milliwatts, this level is:

$$10 \log (2.5/1) \text{ or } +4 \text{ dBm}$$

$$E = \text{SQR}(PR)$$

$$= \text{SQR}(.0025 \times 600)$$

$$= 1.23 \text{ V}$$

So +4 dBm=2.5 milliwatts=1.23 V across 600 ohms.

Signal level can also be measured in dBV, or decibels referenced to 1 volt:

$$\text{dBV} = 20 \log V/V \text{ ref}$$

where V=the measured voltage and V ref=1 V.

As an example, if the signal measures 0.316 V, the level is 20 log (0.316/1) or -10 dBV.

There's an 11.8 dB difference between (continued on page 30)

LINE OUT

is producing 0.316 V at its output connector. This voltage is called -10 dBV when referenced to 1 V.

On the level

Let's touch on the math behind these figures. Signal level can be measured in dBm, or dB referenced to 1 milliwatt:

$$\text{dBm} = 10 \log P/P \text{ ref}$$

where P=the measured power and

Let the CIA listen to your competition and playback only the commercials!



Spying was never so Easy! When you hook up the RUSSCO CIA-1 to a radio & a cassette player, it records only the speech, filters out the music! Makes the sales manager's job a lot easier. This little spy practically pays for itself!

New! Only \$299.



The RUSSCO Newsroom stereo mixer works right & easy!

The compact 505S gives you 5 channels of easy mixing. 4 channels with preamps, 1 channel accepts 5 balanced, hi-level inputs. Cues on any channel with fast Mod-Pots. 2 VU meters. Great specs, terrific performance and an economical price of only \$2239.

Match up a CD player Cheap!

You'll save money with the CD100 impedance matching amplifier that interfaces inexpensive CD & cassette players to your professional console. The Least expensive on the market.

Only \$79.



Call for our catalog at (209) 291-5591.



ELECTRONICS INCORPORATED

5690 E. Shields Ave., Fresno, Calif. 93727

TURNTABLES, TONEARMS, DIST. AMPS, PREAMPS, MIXERS & MORE.

Broadcast equipment, furniture and systems.

Serving the unique needs of the broadcast industry for over 30 years.

- Over 100 equipment lines.
- Pre-wires and systems.
- Call for our new product catalog.

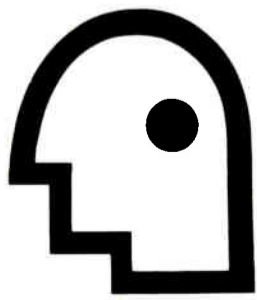

Call us today!
1-800-999-9281

AUDIO
broadcast group inc

Audio Broadcast Group, Inc.
2342 S. Divison Avenue Grand Rapids, MI 49507-3087
Phone (616) 452-1596 • FAX (616) 452-1652

Circle 97 On Reader Service Card

Circle 36 On Reader Service Card

WORKBENCH

Swabs, Screwdrivers And Shorted Stubs

by John Bissett

FAIRFAX, Va. You've just pulled the PA tube, and before inserting the new tube, you decide to take a gander down into the tube socket. Your heart sinks as you spy a piece of fingerstock lying at the bottom, just waiting to short something out.

What was planned as a brief one-hour overnight maintenance session now mushrooms into a true "all nighter" as you prepare to tear the socket apart—after all, no pair of needle-nose pliers will reach that far down.

Before you resort to more drastic means, look around for either a long thin-bladed screwdriver or even a long cotton cleaning swab. Next, grab a piece of tape—whatever you have on hand, just make sure it's sticky. With a single-edged blade, knife or other cutter, trim a 1/8-inch wide strip of tape and form it around the end of the screwdriver or swab. You've created an emergency retriever which can be used to grab the

finger stock (or anything else that's down there).

While talking about long screwdrivers, we received a cautionary note from Jon Bennett at KAMU-TV/FM in College Sta-

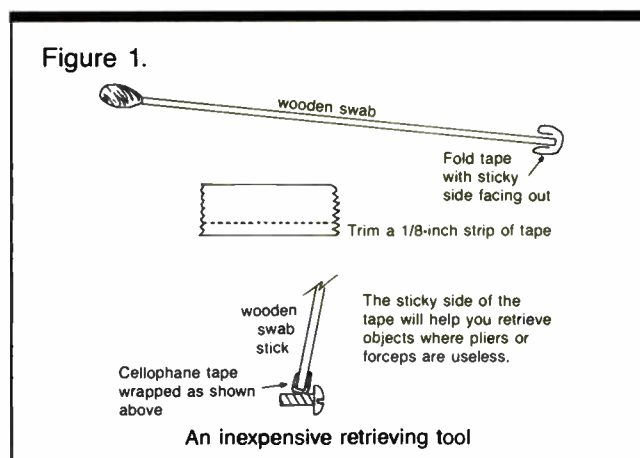

tion, Texas. He cautions that many screwdrivers being sold nowadays have magnetic "screw-holding" tips, which

may be great if you're a carpenter or electrician, but can really play havoc in a radio station.

Jon admits to these magnetic-tipped drivers having plenty of uses, but damaging expensive alignment tapes is not one of them. You might try marking the magnetized drivers by slipping a half-inch sleeve of red shrink tubing around the shaft. John can be reached at 409-845-5611.

The Xcelite R3322 "greenie" has earned its way into every engineer's pocket! The small blade works great for adjusting the tension cams on the older Scotchcarts and newer ITC Cart II. However, trusting a programming type with a greenie can be likened to lighting a powder magazine!

Xcelite comes to the engineer's rescue with a Phillips blade version of the same screwdriver. The Phillips blade fits nicely into the life extension cam, yet insures that the screwdriver won't be used for other things—like tweaking pots. Not that you

don't trust the air staff, but now there is no temptation.

At one station with no assigned

Figure 2.

$$\lambda_{FT} = \frac{984}{F \text{ MHz}}$$

Basic formula for determining the distance of one wavelength

$$\text{one wavelength} = \frac{984}{105.9}$$

$$\text{one wavelength} = 9.29 \text{ feet}$$

$$1/4 \text{ wavelength} = 2.32 \text{ feet}$$

$$\begin{aligned} \text{convert to inches} &= 2.32 (12) \\ &= 27.8 \text{ inches} \end{aligned}$$

FM exciter shorted stub protection

production director, we secured one of these Phillips drivers to a string in the production room, right next to the instructions on how to adjust the cam. The Xcelite part number is P12S.

Our friends at Electronic Industries in Oshkosh, Wisc. sell the Xcelite line, (continued on page 33)

EXPERIENCE COUNTS . . .

Continental Electronics Installations At Master Antenna Facilities.

SENIOR ROADS TOWER GROUP Houston, Texas

7 OF 12 TRANSMITTERS

KFMK 27.5 kW (2)
KIKK 27.5 kW (2)
KKBQ 27.5 kW (2)
KLLO 27.5 kW

TELETOWER PROJECT Houston, Texas

2 OF 2 STATIONS

KLTR 27.5 kW / 21.5 kW (Aux)
KMJQ 50 kW

BRODIE LANE TOWER SITE Austin, Texas

2 OF 2 STATIONS

KHFI 35 kW
KPEZ 21.5 kW

MONTGOMERY TOWER PARTNERS Montgomery, Alabama

4 OF 4 STATIONS

WBAM 35 kW
WHHY 35 kW
WLWI 35 kW
WSYA 35 kW

LOADSTAR TOWER PROJECT New Orleans, Louisiana

4 OF 4 STATIONS

WEZB 35 kW
WLNG 35 kW
WMXZ 35 kW
WQUE 35 kW

GANNETT TOWER PROJECT Miami, Florida

8 OF 10 STATIONS

WEDR 50 kW
WHQT 25 kW
WLVE 25 kW (2)
WPOW 25 kW
WQBA 21.5 kW
WSHE 25 kW
WTMI 25 kW (2)
WZTA 25 kW (2)

MILLER TOWER SITE Dallas, Texas

6 OF 6 STATIONS

KKDA 40 kW
KLTU 40 kW
KLUV 40 kW
KOAI 45 kW
KZPS 40 kW
WRR 40 kW

LOADSTAR TOWER PROJECT Orlando, Florida

3 OF 3 STATIONS

WJHM 25 kW
WJYO 55 kW
WOCL 55 kW

LOADSTAR TOWER PROJECT Jacksonville, Florida

3 OF 4 STATIONS

WAIV 40 kW
WFYV 27.5 kW
WQIK 35 kW

OLDSMAR TOWER PROJECT Tampa, Florida

2 OF 2 STATIONS

WKRL 40 kW
WUSA 40 kW

SUMMIT TOWER PROJECT Atlanta, Georgia

2 OF 3 STATIONS / 4 OF 5 TRANSMITTERS

WSTR 35 kW (2)
WVEE 40 kW

LOXLEY TOWER SITE Mobile, Alabama

3 OF 3 STATIONS

WBLX 275 kW
WGCX 275 kW
WJLQ 275 kW

SHOREVIEW TOWER PROJECT Minneapolis, Minnesota

6 OF 8 STATIONS

KDWB 25 kW
KEEY 25 kW
KLXK 25 kW
KQRS 25 kW
WLLO 25 kW
WLTE 25 kW (2)

BITLOW TOWER PROJECT Orlando, Florida

3 OF 3 STATIONS

WHTQ 50 kW
WSSP 50 kW
WSTF 50 kW

LOADSTAR TOWER PROJECT Ft. Lauderdale, Florida

2 OF 2 STATIONS

WJQY 40 kW
WKQS 50 kW

When experience counts you can count on Continental transmitters. This track record reflects the quality of Continental transmitters and our commitment to the broadcaster. May we assist you in planning your new facility around a new Continental transmitter?



Continental Electronics Corporation

P.O. BOX 270879 DALLAS, TEXAS 75227-0879 214-381-7161 TELEX: 73-398 FAX: 214-381-4949

Kissing KIST's Tower Goodbye

by Dee McVicker

SANTA BARBARA, Calif. Of all the earthquakes that have shaken Santa Barbara in the past 45 years, not one has succeeded in shaking down the old Benjamin Franklin tower.

But now, because of man-made forces, KIST's legendary AM tower is coming down.

Atop the old Benjamin Franklin Building since shortly after World War II, the tower has fallen victim to FCC section 1.1307 and skyrocketing property values.

Although a complete RF survey has not been done on the tower's building, now called the Balboa, there is little doubt that KIST's old tower site will not meet the RF occupational exposure levels as stated in the FCC rules. Currently, some 100 employees work in the building, and RF exposure is likely to exceed the recommendations of the American National Standards Institute (ANSI).

In addition, said KIST CE Doug Allan, the cost of lease renewal on the downtown site has quadrupled, making it practical to dismantle the 45-year-old landmark and move the station's signal elsewhere.

Thus, on Jan. 7, 1991, the 180-foot Ideco-Dresser will be taken down, leaving a void in the city's skyline.

The tower, then and now

A backdrop to several movies made as far back as the 1940s, the Ben Franklin tower greeted countless motorists as they drove over the grade from Montecido to Santa Barbara. Its beacons also have navigated more than one airline pilot making the descent into Santa Barbara's airport.

But more importantly, KIST's old tower has stood for 45 years of radio history.

"This is the station that everybody grew up with," said Allan. "It was the Top 40 station in the 1970s; in fact, in 1974, 1975 and 1976, cumulative listening

audience was more than the next three stations in this market combined. KIST literally owned the market, and in the 1970s and early 1980s, it had 15 mobile units on the street."

OFFBEAT RADIO

From what Allan has been able to determine, the tower was erected in the 1940s by Dwight D. Eisenhower's personal and naval aide Harry Butcher, who signed on the station.

"They went down to the middle of the fifth floor with steel and concrete to mount it," said Allan, adding that the brace for the tower is two-and-a-half floors deep.

Although the station is licensed for a 1 kW omnidirectional pattern, the best the building could offer was a ground system that fans out on the top of the building. Grounding wire connect one leg of the U to the other and radials fasten to the sides of the building.

According to Jim Stanley of Stanley Broadcast Engineering, which was contracted for KIST's tower move, the tower system design is the work of Loyd C. Sigmon, the station's first engineer.

"He was the person who built KMPC in Los Angeles" Stanley said. "He worked for the Signal Corps in the Army and retired at the rank of colonel, and when the war ended in 1946, he and Harry Butcher got together and put this tower on the building."

Signal deterioration

Much has changed since that time, including KIST's tower and grounding system. Over the years, roof repair on the aging building has deteriorated the tower's grounding system—and signal. Radials have been accidentally clipped short, and worse, a few months ago Al-

lan discovered radials that had been incorrectly grounded by repairmen.

"We found that some of them had been drilled through the walls and hooked right to the building's steel in the elevator shaft. No wonder they were getting us in their computers," he said, referring to bank computers located on the bottom floor. "The whole building was pulsating."

Normal wear also has caused some damage to the tower. At the base, hairline cracks have shown up over the years, caused not by earthquakes but by normal weathering. Two years ago, the station was required by the local building department to fiberglass the base.

"They decided that if we kept it totally dry, we wouldn't have any more deterioration. So we got a guy up here and the base of the tower is now coated and wrapped in fiberglass—like a boat bottom," Allan said.

Surprisingly, earthquakes have done little to rattle the 45-year-old tower. Allan recalls one earthquake in particular: "I was in one up there (at the top of the building) that knocked the rotating cart racks off the desks onto the floor. It did that much and the tower—the base—didn't even crack."

Made of heavy-weight steel, comparatively thick compared to today's guy-wire supported tower, the old Ideco-Dresser has survived more than its share of rumbling and shaking over the years.

"Nobody makes these anymore," commented Allan, speculating that there probably are only one or two towers left in the country like it.

Stanley agreed, adding that the dismantling of the tower is "really unfortunate because it's an oddity; there's just a few of these types of towers remaining." But in the interest of progress, Stanley is optimistic that KIST's new tower will benefit the station overall. "Our expectations as well as the expectations of the FCC are that the signal will proba-

bly be better on the ground," he said.

Located within a mile of the old Benjamin Franklin building, KIST's new tower is a mono-pole, shunt-fed 200 footer that the station will be sharing with KSPE-AM. In addition to taking advantage of diplexing technology (which Stanley feels will be the wave of the future for stations making tower moves in congested markets), KIST also will be gaining for the first time the omnidirectional pattern for which it is licensed.

Beginning on Jan. 7, 1991, shortly after the holidays, the nesting-type tower will be collapsed and unceremoniously lifted off the old Benjamin Franklin Building with a crane.

■ ■ ■

Dee McVicker is a free-lance writer and regular contributor to RW. To inquire about her writing service, call 602-899-8916.

DRY AM-FM LOADS



MORE LOAD FOR LESS BUCKS



DPTC-50KFM

NOW ONLY \$5,975

ALWAYS IN STOCK

IDEAL FOR 35-55 kW
TRANSMITTERS

ELECTRO IMPULSE LABORATORY, INC.
1805 CORLIES AVENUE, PO BOX 278
NEPTUNE, NJ 07754-0278

FAX: 908-776-6793
PHONE: 908-776-5800

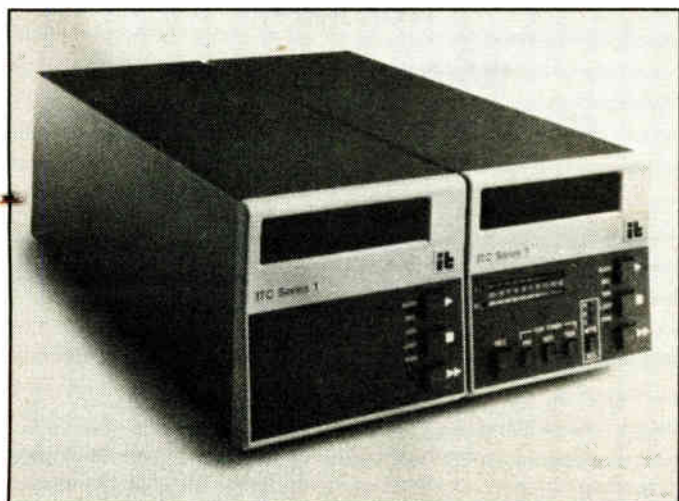

Stereo Play \$1875 List

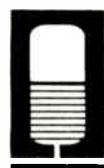

BROADCAST SERVICES/EME

The Davis Communications Group, Inc.

The Preferred Source ... for all ITC products.

ITC Series 1 The last cart machine you'll ever buy...

An ITC Series 1 cart machine placed in service today will perform well into the next century. ITC has set the standard for long-term reliability, outstanding factory support and unsurpassed performance. We've priced the Series 1 to fit every budget.

Call today:

800/525-1037

An Unbalanced Balancing Act

(continued from page 27)

+4 dBm and -10 dBV. How did we get that? By converting both levels to voltages:

$$\begin{aligned} \text{dB} &= 20 \log V1/V2 \\ &= 20 \log (1.23/0.316) \\ &= 11.8 \text{ dB} \end{aligned}$$

So, +4 dBm is 11.8 dB higher in voltage than -10 dBV.

A cable carrying a nominal -4 dBm signal will have a signal to noise ratio 11.8 dB better than the same cable carrying a -10 dBV signal. This is an advantage in environments with strong radio frequency or hum fields. But in home recording studios with short ca-

bles, the difference is negligible.

Connecting a +4 dBm output to a -10 dBV input might cause distortion if the signal peaks of the +4 equipment exceed the headroom of the -10 equipment. If this happens, use a pad as shown in Figure 2 to attenuate the level 12 dB. The pad also converts from balanced to unbalanced.

You may have to substitute a stereo phone plug for the 3-pin connector. If you hear distortion with this circuit in use, remove the connection to XLR pin 1.

You don't always need that pad. Many pieces of equipment have a +4/-10 level switch. If your equipment does not have a +4/-10 level switch, another solution

is to use a level-matching interface such as one made by Sescom or Rane.

Sescom's interface is called the Model SB-1 Mark II Stereo Balance Box. The SB-1 lets you interface a two-channel semi-pro device (with -10 dBV level) to a professional device (with +4 dBm level).

To convert an unbalanced -10 signal to a balanced +4 signal, you connect each channel of your -10 signal to an RCA phono connector on the SB-1. Its input impedance is 100 kilohms.

An amplifier in the unit boosts the

than 15 kilohms.

The SB-1 comes in a 1 3/4" rack-mount case, and is available with both plain and rack-mount end panels. It can be powered from either 120 V or 220 V AC. Noise is 101 dB below rated output, and frequency response is ± 1 dB from 20 Hz to 20 kHz. Distortion is less than 0.2 percent at 20 Hz, maximum rated output.

Sescom recommends that you float the cable shield from XLR pin 1 if you hear hum due to ground loops.

Rane's solution

Rane has several products that interface -10 to +4. According to Larry Winter, VP of marketing at Rane, "None of these products has the *single* purpose of converting line levels. They are either equalizers or mixers or preamps with additional functions. However, products such as the FPS 28 Flex Program Splitter can convert two or more channels simultaneously, which makes them feasible for stereo broadcasts."

The Rane FPS 28 is a two-in, eight-out splitter/distribution amp. Each output level is individually adjustable, and a master level control affects the overall level of the two busses before the splits.

The inputs can handle mic or line level signals. Phantom power is provided, and a ground-lift switch prevents hum from ground loops.

If you need to equalize a signal while converting its level, or mix in other signals, the Rane EQ and mixer modules will do the job. As we've seen, there are many ways to match -10 and +4.

■ ■ ■

Bruce Bartlett is a microphone project engineer and technical writer with Crown International. He can be reached at 219-294-8000.

... another solution is to use a level-matching interface such as one made by Sescom or Rane.

level 0 dB to 30 dB (gain is user adjustable), and the output signal is passed through a transformer to a male XLR-type connector. The recommended load impedance is greater than 600 ohms and maximum output level is +18 dBm.

To convert a balanced +4 signal to an unbalanced -10 signal, you connect your +4 signal to a female XLR-type connector in the SB-1. Its input impedance is 600 ohms. After being padded down, the signal goes through a 1:1 transformer and appears at an RCA phono jack. The recommended load impedance is greater



**THERE'S A LOT OF TALK ABOUT MIC PROCESSORS...
HERE'S THE ONE MOST PEOPLE ARE LISTENING TO!**



For over 4 years the Valley Model 400 has been an industry favorite. Here's why:

- Ultra low noise, low distortion **discrete** mic preamp
- 3-Band Equalizer specially contoured for spoken word
- Post EQ patch-point for additional processing effects
- Exclusive use of the **patented** Valley TA-101 VCA as the central audio processing block
- Proprietary **Linear Integration Detection** Compressor processes the voice for consistent level control without compromise to the on-air personality's delivery
- Complementary interactive Expander eliminates background noise
- Effective De-essing for both "normal" and "heavy" sibilance problems
- Easy-to-read LED gain reduction meter
- Switch selectable input/output VU metering with adjustable reference level
- Variable output gain control
- Switch selectable mic/line output level
- It's backed by Valley's 21-year record of customer satisfaction
- In stock at Harris Allied

HARRIS ALLIED
BROADCAST EQUIPMENT

FAX 317-962-8961

800-622-0022 IN CANADA 800-268-3817

With expanded staff and services... our lead keeps on growing!

HARRIS ALLIED © 1991

"Call me, I'm interested." Circle 41.

"Send me literature." Circle 81.

World Radio History

CRL SPOTLIGHT



Have a news/talk/sports format?

Want to improve coverage of your station?



MBL-100 AM NEWS/TALK PROCESSOR

The MBL-100 news/talk AM audio processor was designed for you. The MBL-100 provides very high levels of average modulation density or loudness. The added density it provides helps to overcome noise and interference problems. The MBL-100 is useful for filling in null areas and reducing the effects of powerline reradiation. And if your antenna bandwidth or symmetry is not that great, the 7.5 kHz bandwidth of the MBL-100 will make life easier for your transmitter. The MBL-100 is designed to give your station better coverage area. To learn more about the MBL-100 call or write now for details. The MBL-100 is available on our two week trial program.



Circuit Research Labs, Inc.
2522 West Geneva Drive
Tempe, Arizona 85282-3192 U.S.A.
(800) 535-7648 (602) 438-0888 FAX (602) 438-8227
Bulletin Board System (602) 438-0459

Circle 17 On Reader Service Card

RADIOMIXER.[®] For everyone who thought a PR&E console was out of reach.

You've tried, but your console budget just can't accommodate a Pacific Recorders BMX—not this time. So you're probably thinking about settling for a copy, even though it won't have the standard-setting features, performance and long-term reliability that have made our BMX consoles so successful.

Fortunately, you don't have to settle. Radiomixer is genuine PR&E. All the way from its high quality components to its efficient BMX-style layout, comprehensive telephone mix system and unique Off Line Mix Matrix. Yet its manufacturer-direct price is no higher than the "clones."

How did the PR&E engineering team build a less expensive console without lowering our standards? Let's start with what we didn't do:

We didn't compromise on quality. Radiomixer uses the highest caliber components throughout, including our standard professional-spec meters, faders, and switches. Plus the best-sounding VCA technology in the industry. To keep Radiomixer's cost down, we've limited the number of different module types and mainframe sizes, and simplified the construction of the card frame, mainframe and modules.

The final result? In less than a year, Radiomixer has quietly become one of our most popular consoles. In fact, it's now one of the best-selling boards in broadcasting. Our color brochure will tell you more of the reasons why, and help you configure a Radiomixer for your particular application. To get your copy, call PR&E direct at 619-438-3911.



PACIFIC RECORDERS & ENGINEERING CORPORATION
2070 Las Palmas Drive • Carlsbad, CA 92009 • Tel 619-438-3911 • Fax 619-438-9277



© 1990 Pacific Recorders
& Engineering Corporation

Circle 116 On Reader Service Card

The 2-track...re-invented!

We've been building ultra-reliable, high performance 2-track machines since 1968, so when we say the new MTR-15 is the most sophisticated 2-track we have ever built, we've said a mouthful.

Developed to meet the needs of those who are using the latest noise reduction systems to press analog to the limit, the MTR-15

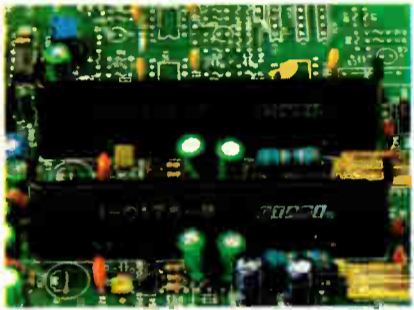

High slew-rate operational amplifiers and premium components contribute to the MTR-15's superb sonic performance.

delivers superb sonic quality, plus dozens of operational features you thought you'd never find on a 2-track.

For example, record and reproduce Auto-Alignment™ for 4 different tape formulations is

built-in. And 4 speeds are standard. A PWM reel servo system

keeps things running smoothly and accurately. Speaking of accuracy, for audio post applications a chase synchronizer

is available. And, of course, every MTR-15 is equipped with Otari's 37-pin standard parallel interface, with RS-232-C/RS-422-A serial interfaces optional. And so you can choose exactly the machine you need, 1/4" or 1/2" versions are available, plus a 1/4" with center track time-code.

To make the MTR-15 easy to use, we've included a four-point locator, plus a user-definable transport control button arrangement. The MTR-15 is at home in a rack mount or on a table top when space is at a premium, or in its

optional floor-standing console with meterbridge.

And when you add *HX Pro, a built-in tape timer, internal monitor speaker, 12.5" reels, and AES/NAB/IEC equalization presets, plus a tremendous variety of options, including autolocators, a voice editing module, and a

chase synchronizer, you understand why we say the MTR-15 is the 2-track re-invented for the 90s.

Call 415-341-5900 for complete information on this new Otari.

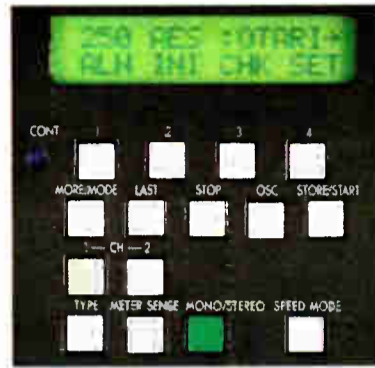

An automatic record and reproduce alignment system drastically reduces set-up time.

OTARI

*Trademark Dolby Laboratories Licensing Corporation.



SBE and Old Friends Revisited

by George Riggins

LONG BEACH, Calif. I was interested to find a certification study guide—or shall we say a list of questions and answers—on computer disk at a price from the national office of SBE.

I also was amazed to find a printed study guide for certification exams available for a lower price from the national office of SBE. Yes, I have seen Q&A sheets, but not from SBE's national headquarters.

Where are those who were so vocal about the so-called memory courses that were the vogue in the days when any aspiring young disk jockey had to have a First Phone in order to get a job in the industry? It has always been my contention that is not how one got or gets the piece of paper, but what she/he did with the opportunities available after the piece of paper was in hand.

The first gig was probably a little "coffee pot" out in the boonies. Soon came the realization that there was only one

Number One Jock in any market, but there were lots of opportunities for technical people. On-the-job training was the



way to learn, and it started when the first piece of equipment was put in service.

In my years I have met many good technical people who got started with

the help of Don Martin, Bill Ogden, De Vry, National Schools, Cleveland Institute, CREI, RCA Institute, junior colleges, colleges and universities. I have met a few who did nothing more than read the Rider Q&A Manual. Each organization had its individual methods of helping us learn the basics, but our real experience came from OJT.

Granted, there were a few shady operators that taught the "exam" by having students memorize a poem. Others were strictly a question and answer routine, while some actually taught some theory while teaching the potential candidate

how to take a test.

SBE in the question and answer business? Call national headquarters for the prices of the study material. I have asked for more information—the request was to one of the national officers—but so far nothing has materialized in my mail box.

WorkRite radio

Last month, I mentioned the WorkRite Co. Not much was really said about the company and the products that were made for the fledgling radio industry. The company made components and complete receivers, according to the advertisements. One of the items was the "WorkRite 180° Super Variocoupler."

The Variocoupler was the first of many parts developed by Vernon H. Meyer (continued on page 35)

From the Workbench

(continued from page 28)

along with most other brands of electronic parts. They've got a new catalog which provides a good description of most electronic parts. You can obtain a copy by calling 414-235-8930.

★★★

Ken Branton is one of the walking encyclopedias of engineering troubleshooting knowledge at Continental Electronics. He recently related a solution to a problem involving FM driver sections using the 4CX-250 driver tubes. After about a year of use, the transmitter would experience a driver overload along with the loss of the exciter power transistor.

It appeared that whatever was happening in the tube was causing either a spike or some kind of harmonic garbage to be coupled back down the line into the exciter, blowing the power transistor. The fix? Install a quarter wave shorted stub!

All Continental transmitters come with just such a stub standard. Engineers with older transmitters may want to consider installing such a safety net for their rig—especially if a solid state exciter is used. In their new exciters, Continental uses a small diameter white coax rolled in a three-inch circle and mounted inside the exciter chassis.

You don't have to be fancy about it—a quarter wave shorted stub, made out of RG-58 and fitted onto a bnc "T" adapter at the exciter output will work just fine. In measuring the length for your frequency, measure from the center of the "T" to the end of the coax.

Calculation is easy using the formula in Figure 2. If you'd rather order a shorted stub kit, they are for sale from Continental. Contact Ken Branton at 214-388-5800. This is a protection device that should work for anyone's exciter.

■■■

John Bisset recently left Delta Electronics to concentrate on Multiphase Consulting, a contract engineering company. He can be reached at 703-379-1665.

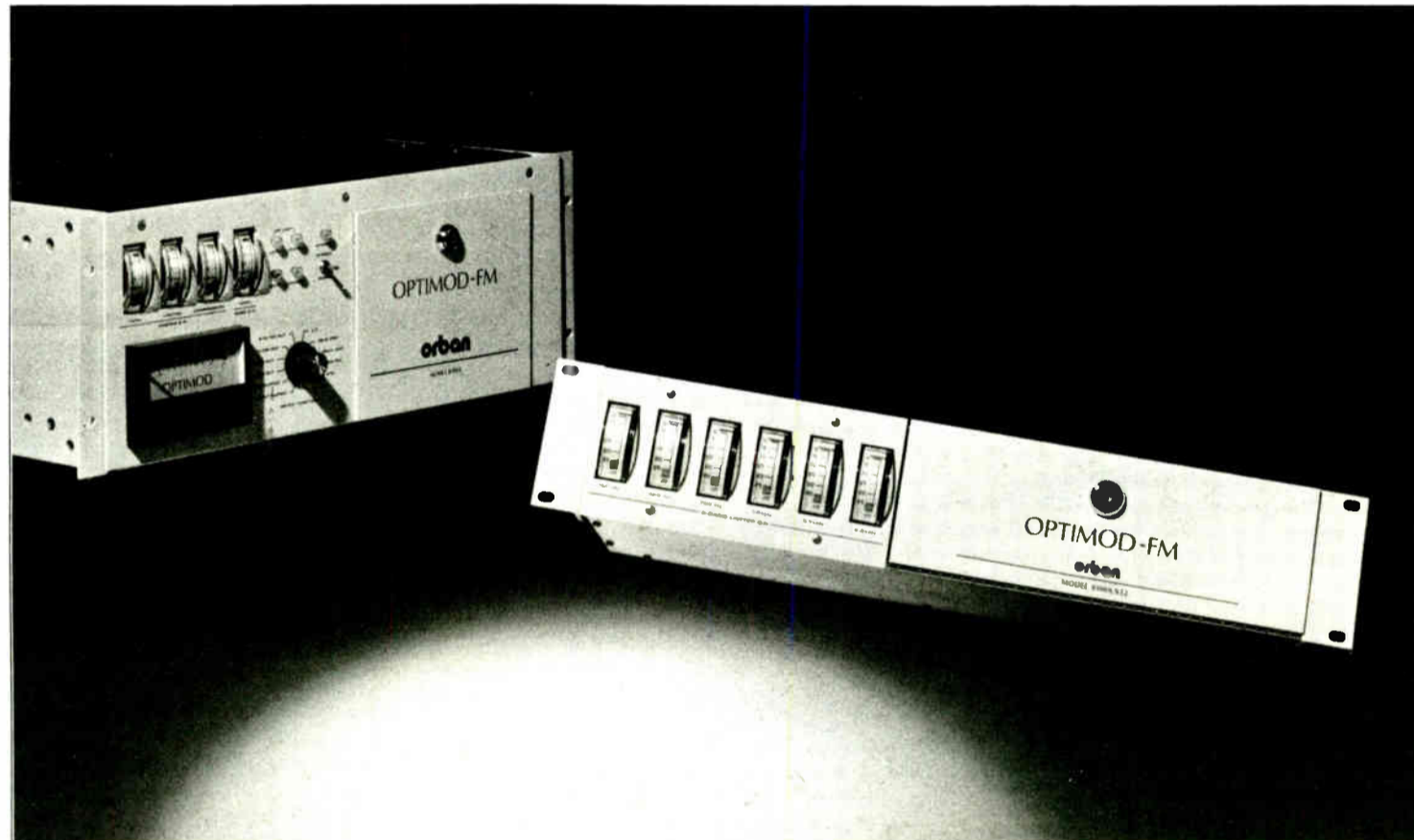

First Class Sound. Affordable Price.

Orban's popular XT2 Six-Band Limiter Accessory for OPTIMOD-FM® 8100A has been chosen by many major-market stations seeking a "highly processed" sound that's also clean, natural, and easy to listen to. What's particularly significant is how many have chosen the XT2 after comparing it to "another unit" — which costs twice as much!

How does Orban provide superior performance at a modest price? Simple — the XT2 uses your host OPTIMOD-FM's power supply and much of its circuitry to achieve efficiency, economy, and performance so high that the XT2 would be the processor of choice even if cost were no object.

The XT2 provides bass, presence, and brilliance equalization, plus density and clipping controls, to let you precisely tailor the sound to your station's format and target audience.

Ask your Orban Dealer for information about Orban's powerful First Class winner — the XT2. Or write, call, or FAX us directly.

orban

a division of AKG Acoustics, Inc.

1525 Alvarado Street, San Leandro, California 94577 USA
Telephone (1) 415/351-3500 FAX (1) 415/351-0500

® OPTIMOD is a registered trademark of AKG Acoustics, Inc.

Circle 2 On Reader Service Card

World Radio History

UNCOMPROMISING QUALITY SUPERIOR PERFORMANCE



*ESL-V Eraser/
Splice Locator*

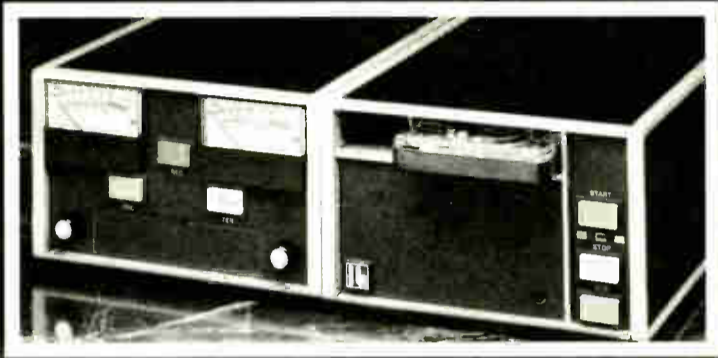

99B Series Recorder/Reproducer

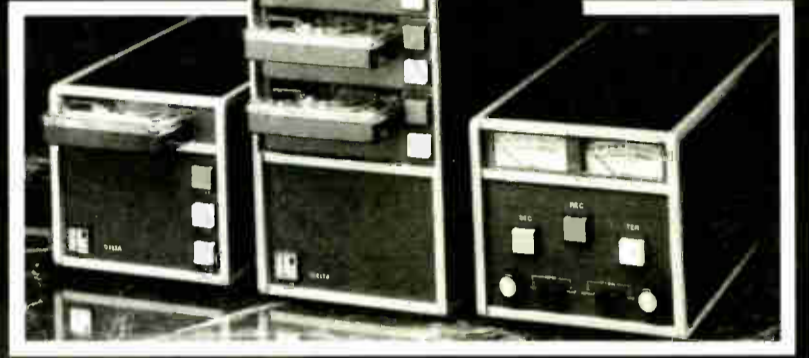

*DELTA I Reproducer, DELTA III Triple-Deck Reproducer,
DELTA IV Record Amplifier*

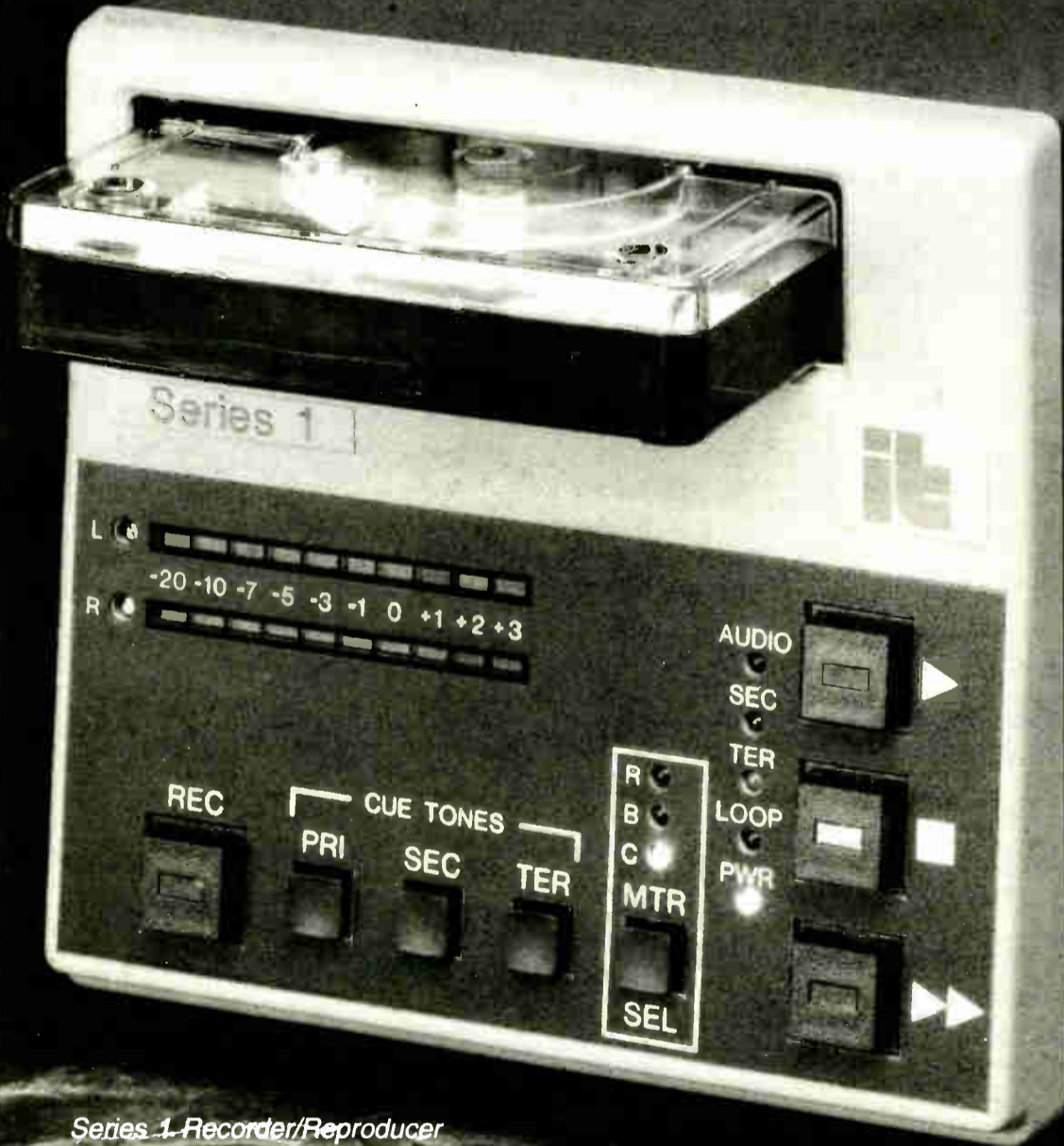

Series 1 Recorder/Reproducer



Series 1 Reproducer

Whatever your needs or budget, there's an ITC machine to suit your requirements. From the world standard 99B Series, to the popular Delta Series, to the new and innovative Series 1. Each built to ITC's uncompromising standards of quality and performance.

For more information, contact:

International Tapetronics Corporation
P.O. Box 241
Bloomington, IL 61702-0241

TEL: 309-828-1381
FAX: 309-828-1386

For 21 years, ITC has set the standards for cartridge machine quality and performance, providing over 17,000 machines to broadcasters worldwide.

International Tapetronics Corporation
P.O. Box 241
Bloomington, IL 61702-0241



Circle 118 On Reader Service Card

World Radio History

Reflecting on Radio's Salad Days

(continued from page 33)

and his company. At the same time the Variocoupler was introduced, in March of 1922, a hydrometer and binding posts also were being advertised for the growing radio "build-it-yourself market." In April 1922, the company started advertising two more items, a switch and a variometer. In August of 1922 a Super Rheostat was born.

The WorkRite Co. continued developing new products for the enthusiast who wanted to build his own receiver. To hedge the market, WorkRite started building its own line of receivers.

There was one major problem with building receivers at this time. RCA controlled most of the patents in the radio field and was not inclined to do much in the way of licensing. Enter Professor Louis A. Hazeltine of Stevens Institute.

Prof. Hazeltine developed a tuned radio frequency circuit and coined the term "Neutrodyne." The Neutrodyne circuit employed a neutralized triode in a TRF configuration.

WorkRite Products Co. was one of the original 14 companies licensed to use the Neutrodyne circuit, according to Mr. Harold A. Wheeler, former chairman of Hazeltine and author of "Hazeltine the Professor." These original licensees formed the Independent Radio Manufacturers Association.

WorkRite continued to develop products and added the Neuroformer

and Neutrodon, a neutralizing condenser. By December 1923 the company was marketing a neutrodyne kit for \$17.50. On the West Coast, an associate company, Kruger and Co., was selling ready-to-use receiving sets.

WorkRite continued to prosper and by 1926 had eight different receiver models and the Neutrodyne kit available. It was not long after the introduction of the 1926 models that financial problems evidently began at WorkRite. The advertising budget was cut and by the time the 1927 line-up of receivers was announced, there were only three.

In the summer of 1927, WorkRite was supposed to combine with several other companies in order to guarantee RCA a minimum royalty fee of \$100,000, but the merger was never consummated. In 1929 the business was sold and Mr. Meyer headed west for retirement. As stated last month, Mr. Meyer resurrected the WorkRite Co. in 1936 and operated the company for several more years.

WLW revisited

A phone call from George Stevenson of WSM about some interesting station call signs resulted in a bit of trivia. It seems that there is another Blaw-Knox Vertical radiator still in use. This second Blaw-Knox antenna is slightly taller than the WLW antenna because the frequency of the second station is slightly lower on the band. This second Blaw-Knox tower

is an impressive sight as one drives south on Interstate 65 from Nashville.

The tower sits on a very nice green knoll, with the base slightly higher in elevation than the interstate. The tower is hard to miss unless the clouds are low or there is ground fog.

Mr. Stevenson reported that there was supposed to have been a third tower of the same design used in Europe before WWII, but that the European tower did not survive the war. Yes, the second tower of the Blaw-Knox design is used by WSM in Nashville, Tenn.

David Burns of Harris Allied sent an obituary notice about Floyd Lantzer,

who worked for the Crosley interests in Cincinnati for 40 years. Mr. Lantzer started at WSAI while the station was still owned by the U.S. Playing Card Co.

Mr. Lantzer stayed with the station when it was purchased by Crosley and later became associated with WLW. Mr. Lantzer is credited with putting WLW's 500,000 W plant on the air and operating the high-power station for four years. In addition to his commercial work, Mr. Lantzer held the amateur call of W8JRM. Floyd N. Lantzer became a silent key on Oct. 27, 1990.

George Riggins has experience in radio and electronics dating back to the 1930s. He also is a licensed ham radio operator and has had his own broadcast sales and service company, Riggins Electronic Sales, for more than 20 years. He can be reached at 213-598-7007.



NEWS ADVANTAGE!

Stations that cater to news in their market are enjoying rating increases this fall. Listeners want to know what is going on locally and around the world. Local radio has no competition in this valuable service. Your station can be part of this public service with satellite receivers from Harris Allied.



COMTECH 3.8

Network Recommended Top Performer

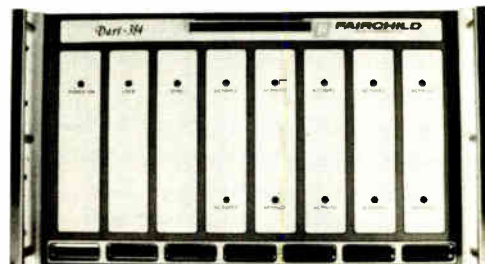

FAIRCHILD DART 384

Tops in Digital Since 1983



WEGENER 1800 SERIES

The People Who Invented High Performance Audio Subcarriers



MICRODYNE 1100-PCDR(5)

The Feature-Loaded SCPC



MICRODYNE 1100-FFC(X1)R(DC)L

Now more than ever, no one gives you more choices in satellite equipment—or more help making the right choices—than Harris Allied. More people; expanded resources: That's what we mean by taking the lead.



FAX 317-962-8961

317-962-8596

IN CANADA 800-268-6817

With expanded staff and services... our lead keeps on growing!

GATES

HARRIS
GATES AM

DURABILITY

SIMPLICITY

RELIABILITY

PERFORMANCE

Traditional value,
today's technology.

Affordable Gates Series 1, 2.5, 5 kW solid state AM transmitters.

AM broadcasters know the Gates name stands for durability, simplicity, reliability and performance. We knew those traditional values are still popular. But even we couldn't have guessed *how* popular. Since its introduction, the Gates Series has become the first choice of AM stations from 1 to 5 kW. Here are some of the reasons:

- Reliable 100% solid state design
- Simple IC logic control
- Built-in analog multimeter
- Six adjustable power levels
- Output matching network
- Bandpass output network
- 130% positive peaks w/patented Polyphase Pulse Duration Modulation

- ColorStat™ front panel diagnostics
- Open collector and dry contact remote control compatibility
- Short and long term VSWR protection with power cutback
- AC restart and fault memory
- Low maintenance "chimney" air handling

Call Harris/Allied Radio RF Sales today at 217-222-8200, Ext. 3110 for more information on the transmitters than bring one of radio's proudest traditions up to date—the affordable Gates Series.

Harris Allied Broadcast Equipment
 Radio RF Sales • P.O. Box 4290
 Quincy, IL USA 62305-4290

Circle 18 on Reader Service Card

HARRIS ALLIED ©1991
"Call me, I'm interested." Circle 8.

"Send me literature." Circle 101.

Calculating RF Rule Compliance

(continued from page 13)

than 80 dB below what would be radiated by an isotropic radiator. If we make a few assumptions (such as using the far field equivalent), we can calculate the power density 1 meter from the transmitter (80 dB below 50 kW is 500 μ W).

500 μ W spread over the surface area of a sphere with a radius of one meter would give us 39.8 microwatts per square meter or 3.98 nanowatts per square centimeter—well below the 900 mW per square centimeter for AM and the 1 mW per square centimeter for FM.

Ben Dawson and Jim Hatfield of Hatfield & Dawson said that stations may have excessive leakage from transmitters with glass windows. They also said the distance limits in OST 65 are very conservative, which is to be expected, since they are "worst case."

They have found that radiation from a tower generally exceeds that from the coupling unit at the base of the tower, so a fence at the OST 65 suggested distance should be adequate to meet the ANSI guidelines for radiation from both the tower and the coupling unit. Sealed phasor cabinets have generally met the ANSI spec. Open panel phasors or those

with painted doors (preventing a good RF seal) should be measured.

Shielding of AC magnetic fields

Magnetic radiation is amazing. A conductive but non-magnetic shield (permeability close to that of air) will have no effect on a DC field. However, with an AC magnetic field, Lenz's law states that the changing field will cause a current in the conductor that will generate a field that opposes the change in field.

If, for example, the magnetic flux is increasing at 1 weber per second, a current would be induced in a perfect conductor. This current would generate an opposing magnetic field, also increasing at 1 weber per second. On the "outside" of the shield (away from the generator), this opposing field cancels the originat-

ing field, resulting in no AC field outside the shield.

Inside the shielded enclosure, the polarity of the field is the same as that created by the generator, but is "traveling" away from the shield. This creates a magnetic field that is twice the magnitude of the incident wave at the shield. The "incident" and "reflected" waves are propagating in opposite directions.

Adding these waves results in "standing waves," where the field strength of the magnetic and electric field strengths take on minimum and maximum values, depending upon where in the shielded box the measurement is made.

Next month we'll try to use Smith charts in a non-traditional manner.

■ ■ ■

Harold Hallikainen is president of Hallikainen and Friends, a manufacturer of transmitter control and telemetry systems. He also teaches electronics at Cuesta College, San Luis Obispo. He can be reached at 805-541-0200.

**TAKE
THE
LEAD**
WITH HARRIS ALLIED

**Single
Source
Systems
Expertise,
Worldwide
Capabilities**

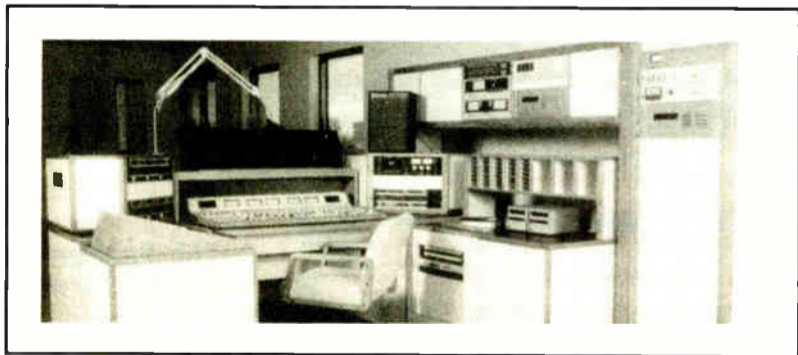

Systems planning, installation and management assistance are just some of the ways Harris Allied has expanded to help you meet the challenges of the future: That's what we mean by taking the lead.

**HARRIS
ALLIED**
SYSTEMS

FAX 217-224-2764

217-222-8290

IN CANADA 800-268-6817

With expanded staff and services... our lead keeps on growing!

HARRIS ALLIED © 1991

"Call me, I'm interested." Circle 28.

"Send me literature." Circle 83.

Circle 120 On Reader Service Card

World Radio History

Engineering Erosion

(continued from page 16)

gotten wise after an inspection and re-evaluated their engineering program. That's good news for engineers who are prepared to deal with the opportunities opened up at those stations that finally recognize the false economies they have been pursuing.

But that requires education. Engineers must have the knowledge to care for the station's needs. The SBE is trying to educate the industry to see the benefits of good engineering. Some chapters are even running programs to educate their

members, not simply pushing the certification test.

Perhaps most important is the educational commitment of the working engineer. Is he ready for the challenges presented in the field? And where and how can he get the needed education?

We'll explore this issue more next month.

■ ■ ■

Barry Mishkind, aka RW's "Eclectic Engineer," is a consultant and contract engineer in Tucson. He can be reached at 602-296-3797, or on FidoNet 1:300/11.

CCA

Evolution.

CCA has delivered more than 3,000 Broadcast Transmitters over the past 25 years. For 25 years our designs have been refined and improved. The result is the Evolution of the world's most perfected, most tested, most reliable, Radio Transmitter.

- * Grounded Grid Triode
- * Longest Tube Life
- * Auto Power Control
- * VSWR Power Foldback
- * Single Phase Optional

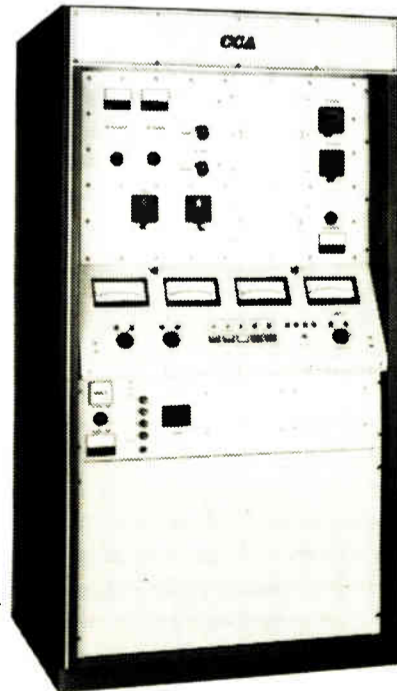

CCA Electronics, Inc.

P.O. Box 426

Fairburn, GA 30213

(404)964-3530 FAX (404)964-2222

Broadcast Equipment Exchange[®]

"Broadcast Equipment Exchange" accepts no responsibility for the condition of the equipment listed or for the specifics of transactions made between buyers and sellers.

AMPLIFIERS

Want to Sell

McIntosh 75 tube power amp w/manual, \$325. D Lundy, Lundy Tape Duplicators, Cumberland Gap Pkwy, Heidrick KY 40949. 606-546-6650.

RCA BA-44, monitor amp, BA-48 line amp, never used, \$100 ea. R Humphrey, WLTJ, 7 Parkway Ctr, Pgh PA 15220. 412-922-9290.

Bogen 30 W RMS stereo integrated amp, tube type, BO. M Saady, First City Recd, 141-60 84th Rd, 3E, Briarwood NY 11435. 718-846-2062.

Ampex 601 amp, JBL speaker, heavy case, mint cond, \$100/BO. B Baker, Pinetucket Recd, 747 Wire Rd, Auburn AL 36830. 205-826-0390.

Gates M5546A compressor expander amp, BO. A Terry, WODY, Box 545, Bassett VA 24055. 703-629-5900.

Radio Systems PA-1 stereo phono preamps (2), \$125 ea. G Fullhart, WVK5, 4665 West Bancroft, Toledo OH 43615. 419-531-1681.

Bosak CMA-150 rack mount pwr amps (4), no fans they are silent, 150 W/8 ohms/ch, new pwr caps, very fine sound, \$800/all. P Appleton, Appleton Stds, 1000 NW 159 Dr, Miami FL 33169. 305-625-4435.

Bogen MO-100 (3) pwr amps, \$50 ea; Eico HF-85 stereo preamp, \$35, all in gd cond. E Davidson, Beatty TeleVisual, 135 N Illinois, Springfield IL 62702. 217-787-0800.

Audionics Point Zero III 100+ RMS rack mount, silver w/handles, gd cond, \$125. R Glenn, WIER, 1718 Shenandoah, Wim. FL 33598. 813-634-1940.

Dynaco PAT-4 stereo preamps (3), gd cond, \$30 ea. B Weiss, KLSI, Kansas City MO 64111. 816-753-0933.

Langevin B102 mono, \$250; Pilot AA904 mono tube, \$100; Scott Lab 210 mono tube, \$150; Dynakit PAS2 tube preamp (3), \$100; Dynakit FM3 tube tuner, \$100; Dynakit FC35 tube amp/preamp, \$150; (3) Altec 351-C solid state 50 W, \$100/ea; Realistic stereo tube, Lyne 7, earliest Radio Shack equip label: Technical Apparatus Co., Boston 17, Mass, BO. W Kremer, Kremer Kraft, 301 SW 16th, Ft Lauderdale FL 33315. 305-524-5652.

McIntosh MC-240 in excel cond, \$500. Z Masoomian, WQXR, 141 Park Ave, Arlington MA 02174. 617-646-2037.

Threshold Stasis-2, 200 Wch Class A, patented Stasis output stage w/48 outputs, 83 lbs, rackmount, smooth snd, \$1475/BO. R Katz, Allegro Snd, 15015 Ventura, Sherman Oaks CA 91403. 213-859-5543.

McIntosh MC-2500, silver, \$2875/BO; MC-2500, black, fact sealed, \$3475/BO; MC-240 (2), \$975 ea/BO; MC-40 (3), MC-225 (2), \$475 ea/BO. R Katz, Allegro Snd, 15015 Ventura, Sherman Oaks CA 91403. 213-859-5543.

Bogen CHB-35A 35 W, \$50. Clark, WFAS, Secor Rd, Hartsdale NY 10530. 914-693-2400.

Marti PGM-20 line amp, \$50; Spotmaster 1x5 mono DA, \$50. P Wells, KJQY, San Diego CA. 619-238-1037.

UREI 6260 amp, Carver PM-200 amp, both in gd cond, BO. N Kuvshoff, Compact DJs, POB 2913, Salisbury MD 21802. 301-548-5352.

Rane MA6 multi chnl amp, 100 W chnls, \$550. M Norman, KCCU, 2800 W Gore, Lawton OK 73505. 405-581-2425.

McIntosh MC-60 (2), 60 W tube amps, consecutive serial number, gd cond, \$750. P Patton, WAPO, 29 W Main, Jasper TN 37347. 615-942-5611.

Teac audio amp w/VU meter. Richard Lynn, 615-459-6616.

Want to Buy

Tube amps & remote mixers incl RCA OP-6, OP-7, BA series & WE 22D remote mixer. B Davies, Virgo Prod, 5548 Elmer Ave, N Hollywood CA 91601. 818-761-9831.

WE, Westrex, Marantz tube amp catalogs, specs, ads relating to above items. D deForrest, 7441 Wayne, Ste 10-D, Miami Beach FL 33141. 305-866-5401.

McIntosh tube tuners, preamps, amps in any cond, working or not. R Glenn, WIER, 1718 Shenandoah, Wim. FL 33598. 813-634-1940.

WANTED: Old, new, used Western Electric, Altec, McIntosh, Dynaco, Marantz, Electro Voice, RCA, Jensen, Langevin, JBL, Ampex, Levinson, Tannoy, Telefunken, Westrex, AR, HK; TUBES, speakers, amplifiers. Call Maury Corb, 12325 Ashcroft, Houston TX 77035. 713-728-4343 or Fax 713-723-1301.

WE 86, 91, 92, 118, 124, 142, 143, any cond. D deForrest, Insight Prod, 7441 Wayne Ave, Ste 10-D, Miami Bch FL 33141. 305-866-5401.

WE, Mac, Marantz, etc. W Kremer, Kremer Kraft, 301 SW 16th, Ft Lauderdale FL 33315. 305-524-5652.

RENTAL EQUIPMENT

Get The Equipment You Need Today At The Price Even The Tightest Budget Can Afford!

AM, FM, AND TV FIELD STRENGTH METERS
AUDIO TEST SYSTEM
IMPEDANCE BRIDGES
TELEPHONE FREQUENCY EXTENDERS

And much much more...
Call for rates and availability

RADIO RESOURCES
1-800-54-RADIO
1-301-783-0737

Scully '100' recorders, record/play amplifiers, 8, 16, 24 track heads. Sequoia Electronics, 1131 Virginia Ave, Campbell CA 95008. 408-866-8434.

ANTENNAS & TOWERS

Want to Sell

Dielectric 4-1/16" rigid sections w/spring hangers, 4-1/16" field flanges, also some 3" rigid spring hangers. C Murray, KMGCE, 925 Country Club Rd, Eugene OR 97401. 503-484-9400.

Tower bracket, 1'4"x1'8" for Rohm 25; (2) tower brackets. A Garza, Foster Comm, 2524 Sherwood Way, San Angelo TX 76901. 915-949-2112.

ICE KRACKERS, INC.

Inexpensive permanent protection of guy wire anchor hardware from guy wire ice slides. Average cost \$400 for 400-foot tower. ICE KRACKERS sized by guy wire diameter. All sizes available.

273 Circle Drive, Springfield, IL 62703
(800) 747-8921 or at WSSU-FM (217) 786-6516
Ask for Jim Newbanks

Jampro JSCP-8 93.3 MHz, broadband, will tune, recently on air w/480' of Andrew 4" heliax, coax is 18 mos old, 55 kW rating, both in excel cond, will sell separately, BO. P Parks, KYKR, POB 5488, Beaumont TX 77726. 409-838-3911.

Soft drawn uninsulated #10 copper wire, approx 2600', 2 full reels of 100' ea & (3) partials; 74' of 5/8" heliax; 141' of 5/8" heliax; 50' RG 8/U coax; various runs of 27 pair multi-cable shielded; punch blocks, jack panels & pandumit. A Garza, Foster Comm, 2524 Sherwood Way, San Angelo TX 76901. 915-949-2112.

ERI G5CPS 10 bay, no deicers & 1° of beam tilt, tuned to 100.7 MHz, BO. Eddie, KCFX, 10800 Farley Ste 310, Overland Park KS 66210. 913-661-0101.

Shively 6810 6 bay w/1.5 yr old deicer, BO. Eddie, KCFX, 10800 Farley Ste 310, Overland Park KS 66210. 913-661-0101.

Phelps Dodge HFM-LP5 tuned to 89.5 MHz w/4 bays CFM, \$1500. D Karrs, KOPN, 915 E Broadway, Columbia MO 62201. 314-874-5676.

THE HALL
Electronics
THE BEST DEALS ON QUALITY
REBUILT & BRAND NEW
BROADCAST EQUIPMENT
We BUY & TRADE equipment too!
Please phone or send for our latest flyer.
10:00AM-6:00PM EST
804-974-6466 1305-F Seminole Trail
FAX 804-974-6450 Charlottesville, VA 22901

Circle 74 on Reader Service Card

Andrew 4" heliax, 480', 18 mos old, BO. P Parks, KYKR, POB 5488, Beaumont TX 77726. 409-838-3911.

ERI G4-CPH-10 10 bay CP high power FM tuned to 96.1 MHz, w/500 W deicers, all functioning & mounting brackets, makes 100,000 W ERP H&V w/20 kW xmtr. C Murray, KMGCE, 925 Country Club Rd, Eugene OR 97401. 503-484-9400.

ERI FML-2 2-bay, one at 96.7 & one at 92.7. M Ripley, KOZE, Box 936, Lewiston ID 83501. 208-743-2502.

Cortana folded unipole, upper skirt. A Garza, Foster Comm, 2524 Sherwood Way, San Angelo TX 76901. 915-949-2112.

FM ERI type G5CPS-2AE 2-bay rototiler, 32 kW, complete w/shorting stub, input transformer, face mounts for Rohm 55-G tower, on 98.3 MHz, in excel cond, in storage, BO. T Baun, WFMR, W172 N 7348 Shady Ln, Menomonee Falls WI 53051. 414-255-3100.

Jampro JA Series HP antenna system (4) 50 ohm bays using power divider, used on 94.5 MHz, gd back-up. C Murray, KMGCE, 925 Country Club Rd, Eugene OR 97401. 503-484-9400.

Cablewave 250' 35" transmission line w/o connectors, (2) 550' 7/8" transmission line w/connectors, pressurized. Eddie, KCFX, 10800 Farley Ste 310, Overland Park KS 66210. 913-661-0101.

Andrew HF7-50A air dielectric heliax approx 326' w/87R gas pass & 87G gas barrier, last off reel, 2 yrs old, splice, on reel ready to ship, \$1850. D Kelly, KWPN, Box 84, W Point NE 68788. 402-372-5423.

Jampro JSCP-10 in excel cond, 9 yrs old, on 93.3 MHz, BO. P Parks, KYKR, POB 5488, Beaumont TX 77726. 409-838-3911.

Harris 2-bay CP FM tuned to 92.1, you ship, BO. G Perich, WVXR, POB 1, Jacksonville FL 32234. 904-259-2272.

Andrew HF7-50A air dielectric heliax approx 326' w/87R gas pass & 87G gas barrier, last off reel, 2 yrs old, splice, on reel ready to ship, \$1850. D Kelly, KWPN, Box 84, W Point NE 68788. 402-372-5423.

Jampro JSCP-10 in excel cond, 9 yrs old, on 93.3 MHz, BO. P Parks, KYKR, POB 5488, Beaumont TX 77726. 409-838-3911.

Harris 2-bay CP FM tuned to 92.1, you ship, BO. G Perich, WVXR, POB 1, Jacksonville FL 32234. 904-259-2272.

Andrew HF7-50A air dielectric heliax approx 326' w/87R gas pass & 87G gas barrier, last off reel, 2 yrs old, splice, on reel ready to ship, \$1850. D Kelly, KWPN, Box 84, W Point NE 68788. 402-372-5423.

Jampro JSCP-10 in excel cond, 9 yrs old, on 93.3 MHz, BO. P Parks, KYKR, POB 5488, Beaumont TX 77726. 409-838-3911.

Harris 2-bay CP FM tuned to 92.1, you ship, BO. G Perich, WVXR, POB 1, Jacksonville FL 32234. 904-259-2272.

Andrew HF7-50A air dielectric heliax approx 326' w/87R gas pass & 87G gas barrier, last off reel, 2 yrs old, splice, on reel ready to ship, \$1850. D Kelly, KWPN, Box 84, W Point NE 68788. 402-372-5423.

Jampro JSCP-10 in excel cond, 9 yrs old, on 93.3 MHz, BO. P Parks, KYKR, POB 5488, Beaumont TX 77726. 409-838-3911.

Harris 2-bay CP FM tuned to 92.1, you ship, BO. G Perich, WVXR, POB 1, Jacksonville FL 32234. 904-259-2272.

Andrew HF7-50A air dielectric heliax approx 326' w/87R gas pass & 87G gas barrier, last off reel, 2 yrs old, splice, on reel ready to ship, \$1850. D Kelly, KWPN, Box 84, W Point NE 68788. 402-372-5423.

Shively 6813 2 bay CP FM w/heating elements, 5 yrs old, you ship, \$2000/BO. J McDermott, KCVQ, POB 800, Carmdenton MO 65020. 314-316-2763.

Phelps-Dodge 3-bay, 107.1 ready to ship. D Sports, WCLA, POB 427, Claxton GA 30417. 912-739-3035.

Side lights for towers w/globes (11), \$40 ea; side light for tower w/out globe, \$40; (20) tower control boxes for lights, \$100 ea; (2) Huey Philips side lights, \$40 ea; photo electric lighting control Fiser Pierce/Sigma Instrument 63305/DA 120 V load 300 W; Rohm tower beacon, \$600; (2) RF tower lighting chokes CSC M-600-160-2, \$100 ea. Delta Bdctg, POB 430, Helena AR 72342. 501-338-8361.

Cortana folded unipole, upper skirt. A Garza, Foster Comm, 2524 Sherwood Way, San Angelo TX 76901. 915-949-2112.

FM ERI type G5CPS-2AE 2-bay rototiler, 32 kW, complete w/shorting stub, input transformer, face mounts for Rohm 55-G tower, on 98.3 MHz, in excel cond, in storage, BO. T Baun, WFMR, W172 N 7348 Shady Ln, Menomonee Falls WI 53051. 414-255-3100.

Jampro JA Series HP antenna system (4) 50 ohm bays using power divider, used on 94.5 MHz, gd back-up. C Murray, KMGCE, 925 Country Club Rd, Eugene OR 97401. 503-484-9400.

Cablewave 250' 35" transmission line w/o connectors, (2) 550' 7/8" transmission line w/connectors, pressurized. Eddie, KCFX, 10800 Farley Ste 310, Overland Park KS 66210. 913-661-0101.

Andrew HF7-50A air dielectric heliax approx 326' w/87R gas pass & 87G gas barrier, last off reel, 2 yrs old, splice, on reel ready to ship, \$1850. D Kelly, KWPN, Box 84, W Point NE 68788. 402-372-5423.

Jampro JSCP-10 in excel cond, 9 yrs old, on 93.3 MHz, BO. P Parks, KYKR, POB 5488, Beaumont TX 77726. 409-838-3911.

Harris 2-bay CP FM tuned to 92.1, you ship, BO. G Perich, WVXR, POB 1, Jacksonville FL 32234. 904-259-2272.

Andrew HF7-50A air dielectric heliax approx 326' w/87R gas pass & 87G gas barrier, last off reel, 2 yrs old, splice, on reel ready to ship, \$1850. D Kelly, KWPN, Box 84, W Point NE 68788. 402-372-5423.

Jampro JSCP-10 in excel cond, 9 yrs old, on 93.3 MHz, BO. P Parks, KYKR, POB 5488, Beaumont TX 77726. 409-838-3911.

Harris 2-bay CP FM tuned to 92.1, you ship, BO. G Perich, WVXR, POB 1, Jacksonville FL 32234. 904-259-2272.

Andrew HF7-50A air dielectric heliax approx 326' w/87R gas pass & 87G gas barrier, last off reel, 2 yrs old, splice, on reel ready to ship, \$1850. D Kelly, KWPN, Box 84, W Point NE 68788. 402-372-5423.

Jampro JSCP-10 in excel cond, 9 yrs old, on 93.3 MHz, BO. P Parks, KYKR, POB 5488, Beaumont TX 77726. 409-838-3911.

Harris 2-bay CP FM tuned to 92.1, you ship, BO. G Perich, WVXR, POB 1, Jacksonville FL 32234. 904-259-2272.

Andrew HF7-50A air dielectric heliax approx 326' w/87R gas pass & 87G gas barrier, last off reel, 2 yrs old, splice, on reel ready to ship, \$1850. D Kelly, KWPN, Box 84, W Point NE 68788. 402-372-5423.

Jampro JSCP-10 in excel cond, 9 yrs old, on 93.3 MHz, BO. P Parks, KYKR, POB 5488, Beaumont TX 77726. 409-838-3911.

Harris 2-bay CP FM tuned to 92.1, you ship, BO. G Perich, WVXR, POB 1, Jacksonville FL 32234. 904-259-2272.

Rohn 25 140' guyed AM on ground w/insulator, guys, painted, excel cond, \$900. D Barton, KMHI, POB K, Manti UT 84642. 801-835-7301.

Tower, 330', 24" face. J Stevens, WLAW, 56 Wansley, Laurel MS 39440. 601-649-1840.

Scala HDCA-10 (2) 10 element yagis w/stacking harness, cut to 185.9 MHz; Scala HDCA-5 (2) 5 element yagis w/stacking harness, cut to 99.3 MHz. P Lierman, KCSP, 601 W Collins Dr, Casper WY 82601. 307-265-5414.

RF switch, Andrew 4 port motorized, (2) 3-1/8", (1) 6", excel cond. Goodrich Ent, 11435 Mancerson, Omaha NE 68164. 402-493-1886.

Micro Communications 90063 6 bay FM panel antenna tuned to 92.3 MHz, just removed from operation, BO. J Bennett, Great Trails, 717 E David, Dayton OH 45429. 513-294-3333.

Utility Tower 300' + AM tower, 24" face w/all appendages, guys, lights w/beacon, jonny balls, flasher unit, etc plus transformer; ATU in metal housing, BO. H McDonald, Broadcast Associates, POB 807, Veradale WA 99037. 509-924-8298.

Kintronics 5 kW weatherproof tuning unit, new capacitors & coils, excel cond, \$800. D Barton, KMHI, POB K, Manti UT 84642. 801-835-7301.

Gates 1 kW 2 tower phasor complete w/new coils & capacitors, excel cond, BO. D Barton, KMHI, POB K, Manti UT 84642. 801-835-7301.

Harris/ERI FML 1E 1 bay, CP FM, tuned to 92.1 w/transformer, 1/4 wave stub & brackets, pre 1981 mdl, \$1000; Harris/ERI FML 3E 3 bay, CP FM, tuned to 92.1 w/transformer & (2) interbay lines, post 1981 mdl, \$3000; Cablewave 200' & 7/8" foam heliax cable w/type N female connectors w/split kit, \$250. J Fellows, KCMA, 2021 S Lewis Ste 760, Tulsa OK 74104. 918-747-9999.

Want to Buy

LPTV VHF & UHF antennas & transmission line, 1-3/8" & larger, 60'-600'. M Ernst, WBUD TV, 720 Fairhill Dr, Louisville KY 40207. 502-893-6656.

Rigid coax, 50 pieces of 20'3-1/8", Andrew or Celwave accepted, can fax info. E Anderson, WEAS, 912-234-7264 or fax: 912-233-7247.

FM 6-10 bay tuned or tunable to 90.5. M Schwarzbauer, Family Educ Bdctg, 1715 Michigan, Sturgeon Bay WI 54235. 414-743-6665.

Tax credit avail or cash for tuned 89.7 FM antenna, cable & de-icer for community charity. Rev Sylvester Williams Jr, ICU Ministries, POB 3931, South Bend IN 46619. 219-287-4700.

UHF TV translator antennas on old chnl 70-83 band; Scala SL-8 or parapanel; Bogner B4, B8, B16 or B24; Emcee DGA-10 corner reflectors. J Powley, 1536 Logan, Altoona PA 16602. 814-944-8571.

JHF TV bndct/translator antennas; Scala parapanel, any channel; Scala SL-8 chnls 19-23, 32-46, 60-64; Bogner B Series chnls 20-30, 31-42, 55-69 or Bogner LPS 1, 2 & 4; Thomas UHF panels any chnl. J Powley, 1536 Logan, Altoona PA 16602. 814-944-8571.

10 bay FM on or near 98.3 MHz; 440' of 1-5/8" heliax; 10 kW FM xmtr. R Paskvan, KBSB, 3516 Mill, Bemidji MN 56601. 218-751-3077.

Antenna, line, xmtr, need 10 bay FM on or near 98.3 MHz; 440' of 1-5/8" heliax; 10 kW FM xmtr. R Paskvan, KBSB, 3516 Mill, Bemidji MN 56601. 218-751-3077.

Jampro JCP FM elements (3) w/heaters tuned to 107.3 MHz, connection cables w/out pwr divider, \$1500/BO. A Wasilewski, KMWX, POB 1460, Yakima WA 98902.

Potomac Instruments AM-19 2-tower antenna monitor, avail in late January, \$3500. J Bisset, Multiphase Consulting, 703-379-1665.

280' 24" face tower in gd cond, w/lights, you remove, BO. S Newberry, WHHT, Box 457, Glasgow KY 42142. 502-651-6050.

Shively 6810-4D 4-bay high pwr 40 kW tuned to 100.7 MHz, has de-icers, \$5000/BO; Cablewave 3-1/8" heliax 300' w/EIA flanges, \$3000/BO. B Hansen, WMXP, 224 North Ave, Pittsburgh PA 15209. 412-821-6140.

50 kW phasor & 4-tower ATU's w/(4) 200' G-17 towers, contain Delta metering & sampling pattern 450 MHz colinear array, \$300. E Swanson, WZTR, 520 W Capitol, Milwaukee WI 53212. 414-964-8300.

Rigid coax, Andrew or Celwave accepted, 50 pieces 20' 3-1/8", can fax info. E Anderson, WEAS Inc, 2515 Abercorn, Savannah GA 31401. 912-234-7264.

FM CP 3 bay or 6 bay on 100.9 MHz. J Crawley, WLSC, Box 680, Lebanon KY 40033. 502-465-5762.

AUDIO PRODUCTION

Want to Sell

Henry Engineering Mix-Minus Plus, \$100/BO. G Fullhart, WVK5, 4665 West Bancroft, Toledo OH 43615. 419-531-1681.

Pultec EQP1, EQD1A3, EQ4. M Block, Production Block, 2838 N Front, Harrisburg PA 17110. 717-233-4155.

AUDIO . . . WTS

Lang PEQ-2A (2) program EQ's, solid state, \$300 ea; Pultec HLF-3C filter set, passive, \$200; will sell all for \$700 plus shipping. D Glasser, Airshow Inc. 7021 Woodland, Springfield VA 22151. 703-642-9035.

Altec 9880A active filter, \$150. D Lundy, Lundy Tape Duplicators, Cumberland Gap Pkwy, Heidrick KY 40949. 606-546-6650.

Digital Audio TC-4 bdct digital audio processor delay unit w/catch-up card, 4 mos old, excel cond. \$1100. R Sherman, WKBM, 32401 S Rte 53, Wilmington IL 60481. 815-476-5855.

UREI 527A 27 band 1/3 octave graphic EQ's (2). \$600/both; UREI Cooper time code 14 & 16 MS stereo delay unit, \$300; Maestro rack mount flange doubler delay unit, \$200. J Krepol, RNDL, 6147 Walker St, Philadelphia PA 19135. 215-624-1050.

Want to Buy

WANTED DEAD OR ALIVE! PULTEC EQ'S

Fairchild & Teletronix Limiters; Neumann, Telefunken, AKG, RCA, & Schoeps microphones. Tube McIntosh or Marantz amps & pre-amps. Sontec, ITI, & Lang EQs. Neve or API equipment. Boxes of old tubes; Urei, Urban, United Audio, DBX, & other outboard gear. Ampex ATR102s or 104s. Parts for MCI JH110/114 recorders. Altec 604s/crossovers/Tannoy speakers, JBL 2231; Altec 288h drivers; Misc. equipment of all types.

Please Call:

Dan Alexander Audio
5935 Market St.
Oakland, CA 94608
1-(415) 644-2363
FAX: 1-415-652-4022

Pultec, Altec, Fairchild, WE, etc. tube compressors & EQ's. W Kremer, Kremer Kraft, 301 SW 16th, Ft Lauderdale FL 33315. 305-524-5652.

AUTOMATION EQUIP

Want to Sell

SMC ESP2 incl (6) Otari ARS 100 R-R's, (2) 452 bi-directional stereo Carousels, (4) racks, control system, remote control w/CRT, dual play cart, printer, 2-1/2 yrs old, BO. L James, KYQQ, POB 650, Wichita KS 67201. 316-265-1065.

SMC DP-1, complete system, DP-1 programmer, AS-16 switcher, (5) 350 Carousels, (2) 710 cart machines, 721 dual cart machine, TS-25 dual sensor, remote control, \$5500. J Keane, KAPS, Box 70, Mt Vernon WA 98273. 206-424-7676.

Schafer 800T automation controller for parts, AG 440 PB, (2) Scully 270 PB, large rack, (2) Gates Criterion PB, all for \$800/BO. F Mccrton Jr, KMGZ, POB 7953, Lawton OK 73506. 405-536-9530.

SMC MSP-10 w/(2) stereo 452 bi-directional Carousels, (2) racks w/network card, SA-1 Silence Sence unit, almost new, will help buyer set up if within 75 mi of NW Florida, buyer pays shipping, \$10,000. Scott, 904-892-3158.

IGM EC system w/BAI monitor panel & (2) IGM stereo Instacart interface units, \$2500. S Bush, KTKK, 3595 S 1300 W, Salt Lake City UT 84119. 801-264-8250.

Harris System 90 automation system including (5) ITC 750 R-R decks, stereo; SMC 24 bin Carousel, mono; (2) IGM 42 bin Go-Cart, stereo; IGM 78 bin Go-Cart, stereo; ITC 3D PB cart deck, stereo; logging encoder; Texas Instruments 700 ASR electr data terminal; (4) AMCO equip racks, recently rebuilt & upgraded, works great. WGER, 6165 Bay Rd, Saginaw MI 48604. 517-792-1063.

Cetec/Schafer 903 automation brain w/pwr supply & control head in equip rack; IGM 48 tray stereo Instacart; SMC/Schafer mono 250 Carousel in rack, \$4000 plus shipping. M Persons, WUJY, Box 706, Brainerd MN 56401. 218-828-1244.

Automated Broadcast 25 Hz sensors (3), ea runs 2 decks, \$85. P Wells, KJQY, San Diego CA, 619-238-1037.

Format Sentry 12B automation systems (2). w/updated software, ready to ship, \$2500 ea. B Schloss, KRRO, 1704 S Cleveland, Sioux Falls SD 57103. 605-335-6500.

IGM Basic A, complete, 12 yrs old, just removed from service, working well, w/(2) 42 tray Go-Carts, ITC 3-deck, ITC single, R-R, will demo at Hutchinson MN, \$6500. D Gander, KJKR, Box 10, Hutchinson MN 55350. 612-567-2140.

SMC 350RSB Carousel, recently overhauled, will consider trade for cart machines, \$1500/BO. D Brintnall, KBUF, 1309 E Fulton, Garden City KS 67845. 316-276-2366.

Cetec 7000 w/(3) Audiofiles & Level II memory, S Cichorsky, KPRL/KDDB, POB 7, Paso Robles CA 93447. 805-238-1230.

IGM Basic III in excel cond, clean complete w/manuals, \$4000; 48 tray Instacart system, \$5000; (3) Otari R-R PB tape machines, \$500 ea. Delta Bdctg, POB 430, Helena AR 72342. 501-338-8361.

Microprobe automation controller, 6 source w/manual, BO. R Coleman, WGEN, 1003 S Oakwood, Geneseo IL 61254. 309-944-4633.

Complete SMC DPI-C automation system w/(4) 350 RSB Carousels, (4) SMC/Otari R-R PB's, SMC dual cart, single play deck, (4) matching equip racks, logging w/X-tel printer, digital programmer w/brain & remote encoder w/monitor & all manuals. D Kulbel, KCIIM, 1119 E Plaza, Carroll IA 51401. 712-792-4321.

BE SAT-16 complete w/SAT 16 microprocessor, (4) stereo Go-Cart 24, printer, racks. J Bennett, Great Trails, 717 E David, Dayton OH 45429. 513-294-3333.

Schafer 903E stereo automation system w/(4) Ampex AG440 stereo PB's, (3) stereo IGM 42 Go-Carts, (6) cabinets, Extel printer, full memory & 901 control unit w/keyboard, manuals, excel stock of spare parts, gd cond, must sell as complete unit. S Thomas, KJOY, 110 N El Dorado, Stockton CA 95202. 209-948-5569.

Schafer 900 stereo, junked out operating system, all decks & pwr supply avail at \$1000/deck. V Clayton, CEC Inc, 1380 Oakcrest, Provo UT 84604. 801-375-1357.

Satcuc 400 switchers for Unistar formats by Colorado Magnetics (2), \$500 ea. H Widsten, KGNB, 1540 Loop 337 North, New Braunfels TX 78130. 512-625-7311.

Otari ARS-1000 (2) like new, less than 2 yrs use, \$1800 ea. D Canipe, WSMV, POB 99, Valdese NC 28690. 704-874-0000.

Brain for a SMC automation system w/ESP-1 Brain & programmer, DS-20A switcher, PDC-4a superclock, pwr supply w/battery support, AL-1 memory loader, Extel printer, Rac-31 remote control, Green SMC rack, (2) TS-25 dual tone sensor units, BO. J Hartmeyer, WCLT, POB 880, Newark OH 43055. 614-345-4004.

Harris 9000 Series w/(5) ITC 770 R-R's, (3) 48 tray IGM Instacarts, mono, \$25,000/BO. B Chesson, WSTV, 320 Market, Steubenville OH 43952. 614-283-4747.

SMC Mini pro w/Otari interface; Harris System 90 automation Brain & switcher. R Lan-ton, WDUV/WBRD, 813-749-1420.

Harris 9000 w/CRT keyboard, \$1500; (2) new style Instacarts, \$8000 ea; (2) older style Instacarts, \$4000 ea; (2) 42 slot Go-Carts, \$2000 ea; (2) Criterion play only cart machines, \$75 ea; Extel AH 11-R printer w/9 cases or paper, \$50; Sony remote B&W video monitor included w/Harris 9000, (3) racks, \$100 ea, all cables, interfaces & manuals included, BO. D Greer, WDDZ, Ste 1830 Genesee Twrs, Flint MI 48502. 313-787-0130.

Sono-Mag 250 Carousels (3), two work, one for parts; w/72" Schafer rack, \$600/BO. C Edwards, WWJM, 210 S Jackson, New Lexington OH 43764. 614-342-1988.

SMC DAS 6/12 digital audio switcher, (2) SMC CH4 programmers, (2) Magnavox computer monitor 80, SMC MSP-12, (3) SMC mono Carousels, racks, cables, etc. \$15,000. P Berger, WNNAM, POB 707, Neenah WI 54957. 414-727-2040.

New 452 stereo bi-directional Carousel, w/MSP-12/system programmer, desk mount control head & CRT display w/SA-1 silence alarm package & racks, (3) Carousels, assume lease payment of \$476.05/mo, complete automation package. J Jernigan, WVAW, 1234 Airport Rd, Destin FL 32541. 904-654-5102.

Satellite service automation system, full day walk-a-way time, 5 yrs old, SMC MSP-1 w/2 liner carts & RTR ad playback. \$5600. D Doelitzsch, WDDD, Marion IL. 618-997-8123.

Format Sentry FS12C plus 7 SMC Carousels, fully integrated w/IBM computer, 4 racks & working perfectly, on air now, \$14,500. P Anderson, KZBQ, 208-234-1290.

Want to Buy

Commercial insertion equip & cart machines, low to mid price range. M Ernst, WBUO TV, 720 Fairhill Dr, Louisville KY 40207. 502-893-6656.

Insta-Cart or Go-Cart machines, Mandel, KAMP, POB 1018, El Centro CA 92244. 619-352-2277.

BE Sat 16-X interface card 908-6810 for Instacart, source cable 945-6433 for Instacart, source cable 945-6430 for Go-Cart, surce cable 945-6462 for satellite SMN. L Maierhofer, WTGC, 101 Armory Blvd, Lewisburg PA 17837. 717-523-3271.

Manual for a Gates AMS-10, any info desperately needed, will pay per page fee on copies. A Branch, KYAY, 2402 Woodridge, Decatur GA 30033. 404-325-7847.

Automation system, must be ready to go on air, very reasonable price for educ station. D Parsons, KLUH, POB 1313, Poplar Bluff MO 63901. 314-686-1663.

BUSINESS OPPORTUNITY

Want to Sell

GOLDEN OPPORTUNITY!

25 yr old Broadcast Manufacturer for Sale in sunny California. Full line of Audio Equipment, well established brandname. Modern 7,500 sf plant avail. Price negotiable with qualified buyer. Tremendous growth possible.

**PHONE U.S.A.
(209) 291-5591
FAX (209) 291-9601**

CAMERAS (VIDEO)

Want to Sell

Sony DXC 1640 tube camera w/case, \$700/BO; (2) RCA TK-630 w/CCU, BO; Sharp XC 700 w/case & access, shop manual, battery, pwr supply, overhauled w/one new tube, \$1800/BO. T Quinn. 408-475-0423.

Hitachi KP-C100U color chip CCTV w/low time & white balance, \$125. P Russell, Bowdoin College, Still Hall, Brunswick ME 04011. 207-725-3066.

Hitachi FP-C1 w/15x1, AC adapter, case, shooting cable, Anton Bauer charger, Sony VO-6800 w/Porta Brace & batteries, \$8500/BO; Panasonic AG-7400 w/Porta Brace, batteries, AC adapter, \$1700. A Pagan, Metrovision, POB 595013, Miami FL 33159. 305-828-9471.

Panasonic 300 CLE ENG package w/Porta-Brace case, \$5900. V Michael, WHOT, 575 Montgomery Pk, S Williamsport PA 17701. 717-326-8200.

RCA TK76B w/PS, case, manual, working, \$500/FOB; JVC KY-1900CH w/PS, case, manual, working, \$450/FOB. K Kuespert, A-V Prod, 1794 Russell, Baroda MI 49101. 616-422-2235.

Sony DXC 1200 studio color cameras (2) w/tripod, head, dollies, \$1200; Ampex 3-tube color w/CCU, cables, \$800; Hitachi 3-tube color w/CCU, cables, \$800; (2) Norelco PC 70 systems, complete, \$500. J Krepol, RNDL, 6147 Walker, Philadelphia PA 19135. 215-624-1050.

Sharp XC-800 3 tube, color, 2L image enhancer, 54 dB S/N, 600 line hor, resolution w/AC adapter, new Pro-BC battery, extender card, case, \$2850/BO. R Jensen, Telectable Prod, 5812 21st St, Racine WI 53406. 414-632-3131.

Sony BetaCam RVP 3A, Fujinon lens, Nalpak case, Gitzo sticks, O'Connor fluid head, mech excel, cosmetic fair, \$10,000 pkg. TJ Worrell, Multimedia, 7620 W 78th, Minneapolis MN 55439. 612-942-9681.

Ikegami ITC-730A, Canon J13 x 9B lens, batteries, charger, AC, case for all manuals, mech excel, cosmetic fair, \$5000 pkg. TJ Worrell, Multimedia, 7620 W 78th, Minneapolis MN 55439. 612-942-9681.

RCA TK-76 3-plumbicon bdct camera, just overhauled, excel cond, Canon 20:1 zoom, case, AC, batts, etc, w/BVU-110 cable, \$1800; JVC KY-2000 3-satcon camera, gd cond, 10:1 zoom, AC adapter, case, etc, \$1600. Ugly George Satellite TV, 314 West 52 St, Nyny 10019. 212-677-2200.

CART MACHINES

Want to Sell

SMC 590 R/P, \$250; BE 2000 play for parts. WJAG, 309 Braasch, Norfolk NE 68701. 402-371-0780.

ITC 99A mono, excel cond, meets full factory spec, splice finds, bulk erases, does head alignment by microprocessor automatically, \$1200. E O'Donnell, WIBW, POB 119, Topeka KS 66601. 913-272-3456.

ITC PDII mono cart play decks (8), excel, \$400 ea; Spotmaster 500C mono cart recorder, \$200. M Persons, KKIN, Box 930, Aitkin MN 56431. 218-829-1326.

Audi-Cord A Series dual R/P w/dub feature, stereo, \$1250. E Douglas, KUNQ, POB 30, Houston MO 65483. 417-967-3353.

BE 500-C (8) mono R/P, \$400 ea or \$2500/all. J Linn, WHKS, 62 N Main, Port Allegany PA 16743. 814-642-7004.

SMC 792 stereo R/P. A Garza, Foster Comm, 2524 Sherman Way, San Angelo TX 76901. 915-949-2112.

ITC RP Series (3), stereo, 3-tone, \$750/BO. G Fullhart, WVKs, 4665 West Bancroft, Toledo OH 43615. 419-531-1681.

ITC SP w/rack mount, \$800; ITC PD-II w/record, \$1000; UMC Beaucart II, \$500 ea. Clark, WFAS, Secor Rd, Hartsdale NY 10530. 914-693-2400.

Otari CTM-10SR stereo R/P, FF, splice find, 3-tone, cue erase, Dolby HX-Pro, brushless PLL servomotor, \$2700/firm. G Stivers, KECH, POB 2158, Ketchum ID 83340. 208-726-5324.

ITC PD-II mono cart recorder, works, \$350. T Ray, WVIC, Hartford CT. 203-522-1080.

BE 3200RP R/P, 3 tones, direct drive capstan, mono, manual, like new, \$750. R Rocks, KEMC, 1500 N 30th, Billings MT 59101. 406-657-2941.

ITC 3D stereo w/WRA record amp & spare motor, \$2500. B Weiss, KLSI, Kansas City MO 64111. 816-753-0933.

GET THE BEST OF BOTH WORLDS
WITH
BARRETT ASSOCIATES, INC.



CHOOSE FROM 240
LINES OF NEW EQUIPMENT

OR

CHOOSE FROM OUR
RECONDITIONED AND
GUARANTEED PRODUCTS

CALL 1-800-748-5553
FOR MORE INFORMATION



barrett associates, inc.
BROADCAST EQUIPMENT

PHONE: 703-998-7600 FAX: 703-998-2966



Call Simone Mullins, Classified Ad Manager, to reserve space in the next issue. Use your credit card to pay, we now accept VISA and MASTERCARD.

Radio World®

5827 Columbia Pike, Ste 310
Falls Church, VA 22041

Ad deadlines are the first Friday of each month for the following month's issue

Select from these categories for best ad positioning:

- Help Wanted
- Consoles
- Stations
- Positions Wanted
- Computers
- Stereo Generators
- Amplifiers
- Disco-Pro Sound Equip.
- Switchers (Video)
- Antennas & Towers & Cables
- Financial Services
- Tapes, Carts & Reels
- Audio Production (Other)
- Limiters
- Test Equipment
- Automation Equip.
- Microphones
- Transmitters
- Brokers
- Miscellaneous
- Tubes
- Cameras (Video)
- Monitors
- Turntables
- Cart Machines
- Movie Production Equip.
- TV Film Equip.
- Cassette & R-R Recorders
- Receivers & Transceivers
- Video Production Equip.
- CATV-MATV Equip.
- Remote & Microwave Equip.
- Video Tape Recorders

Classified Advertising Display Rates Effective January 1, 1991

	1x	3x	6x	12x
1-9 col inch (per inch)	\$55	53	50	45
10-19 col inch (per inch)	50	48	45	40
Distributor Directory	90	85	80	75
Professional Card	60	55	50	45
Classified Line Ad	\$1.50 per word			
Blind Box Ad	\$10 additional			

To compute ad costs: Multiply the number of ad inches (columns x inches) by the desired rate schedule for your per unit cost. Example: a 3" ad at the 1x rate is \$165, at the 3x rate \$159, at the 6x rate \$150, at the 12x rate \$147, etc.

CART . . . WTS

ITC 99B mono recorder, \$1750; ITC RP mono recorder, 3 tones, \$775; ITC SP mono player, 3 tones, \$475; UMC 11-113 mono repro, 3 tones, \$375. P Wells, KJQY, San Diego CA, 619-236-1037.

Stereo 48 tray Instacarts (2) w/interleave for Format Sentry automation, ready to ship, \$3000 ea/BO. B Schloss, KRRO, 1704 S Cleveland, Sioux Falls SD 57103. 605-335-6500.

SpartaMatic 200RP; Sony TC-102 portable; RCA portable; Magnacord S-36 type rack mt in portable case w/schematic; Magnacord S-36 (2) complete (1) missing, reel motors for parts w/schematics; Magnacord PT-6 type. K Hart, WIEZ, RD 3 Box 1414, Millington PA 17059. 717-436-9089.

Gates Criterion mono R/P, gd cond, \$300; ATC/Gates Criterion, mono/play, gd cond, \$200. B Clark, Bullitt Bldg, Rt 1 Bardstown Rd, Mt Washington KY 40047. 502-538-4784.

ITC Premium & PD-II, both PB & RPB, mono, (7). D Doelitzsch, WDDD, Marion IL. 618-997-8123.

Gates mono, (5), one fits w/spare module w/(3) Gates mono, CPD, CDR, cart record amps. Richard Lynn, 615-459-6616.

McCarta stereo PB cart decks w/tones (4); Tapecaster 700P; Tapecaster 700RP. R Lankton, WDUV/WBRD, 813-749-1420.

ITC stereo 3D triple deck w/all tones, \$1395. B Mountjoy, WIDD, POB 1240, Elizabethton TN 37644. 615-543-5849.

Otari CTM-10 R/P, 5050BII in a smaller box, stereo, FF, splice find, all tones, selective erase, test oscillator, PB deck w/separate record elect box, \$2700/firm. G Stivers, KECH, POB 2158, Ketchum ID 83340. 208-726-5324.

Want to Buy

Collins dual tape, stereo, play, record, also manuals. J Panza, LL&S, POB 9847, Kansas City MO 64134. 816-763-9820.

HEAD RECONDITIONING

Restore your worn heads to original (new) performance specifications at a fraction of the replacement cost. Our laboratory services include:

- Digital/Optical & Electrical inspection
- Precision recontouring of heads
- Complete digital/optical alignment of assembly
- Exclusive "Audio Magnetic Head Test Report"™ & Data Sheets

We also carry a full line of replacement heads and parts. Our 25 years of experience and reputation are unmatched in the industry.

JTRP MAGNETIC SCIENCES
 249 Kennedy Road
 P.O. Box 121 • Greendell, NJ 07839
 Tel (201) 579-5773
 Fax (201) 579-6021

Circle 34 on Reader Service Card

ITC

REPAIR — REFURBISHMENT

Direct Factory Cartridge Machine Repair Service
 Upgrades or Refurbishment
 All Work Warranted

Call The ITC Technical Service Department
 Toll-Free at

(800) 447-0414
(309) 828-1381

International Tapetronics Corporation
 2425 South Main Street
 Bloomington, IL 61704

ITC triple deck 3D's, mono or stereo, ITC record units, stereo. R Dymont, Group D, 8402 Lake Ave, Cincinnati OH 45236.

Gates Criterion (2) 150 Hz detector cans. J David, KMPL, POB 907, Sikeston MO 63801. 314-471-1520.

MOTORS REBUILT

All CART & MCI

We guarantee quiet, flutter free performance when we meticulously rebuild your motor.

Single Decks	\$150.00
Triple Decks	\$175.00
MCI CAPSTAN	\$400.00
MCI REEL	\$200.00

Metal shaft resurfacing on other motors available.

Audio Magnetic / Professionals

AMP SERVICES INC

224 Datura Street, Suite 614
 West Palm Beach, FL 33401
 1 (800) 826-0601
 In Florida (407) 659-4805

Authorized
 OTARI, SONY, TEAC Parts Dealers

HEADS RELAPPED

All CART & MULTITRACK

You have started to notice a loss of high end, excessive oxide shedding, or possibly even visible signs of wear on your heads. You are now sacrificing your recording quality.

We recommend our head relapping and assembly alignment services. For a fraction of replacement cost, we guarantee full performance restoration to factory specifications.

Let us help you "Keep Ahead" in the industry.

Audio Magnetic / Professionals

AMP SERVICES INC

224 Datura Street, Suite 614
 West Palm Beach, FL 33401
 1 (800) 826-0601
 In Florida (407) 659-4805

Authorized
 OTARI, SONY, TEAC Parts Dealers

ITC 3D capstan motor. R Yaw, KOJM, POB 7000, Havre MT 59501. 406-265-7841.

ITC stereo PB's, must be willing to sell cheap. P Lotsif, KAVV, Box 42977, Tucson AZ 85733. 602-889-9797.

CASSETTE & REEL-TO-REEL RECORDERS

Want to Sell

Crown SX-711 FT (2), \$100 ea; Telex Viking TD 235 stereo decks (2) 7-1/2, 7, 15 ips, \$150/pr; MCI JH 110 stereo 7-1/2, 15 & 30, roll around console, \$2800; Ampex AG 440-B FT, roll around console, \$850. D Lundy, Lundy Tape Duplicators, Cumberland Gap Pkwy, Heidrick KY 40949. 606-546-6650.

Scully 280B stereo mounted on table w/wheels, amps, on rack, mint cond, working when removed from service, \$2000. L Pereira, Radio Ribatejo FM, POB 5334, Newark NJ 07105. 201-484-8574.

Sony TC-277-4 4 chnl quad deck, needs work, \$40; Sony TC-650 3-head stereo 1/4" recorder, solenoid driver, \$100. P Russell, Bowdoin College, Sill Hall, Brunswick ME 04011. 207-725-3066.

Marantz PMD-221 portable mono 3-head, still under warranty, like new, \$195. J Ellingson, J Ellingson Voice, 913 Warwick Dr, Cedar Falls IA 50613. 319-277-8535.

Revox A-77 (10) in various conditions, \$200 ea/\$1500 all; ITC ELS-IV bulk eraser/splice finder, \$400/BO. G Fullhart, WVK, 4665 West Bancroft, Toledo OH 43615. 419-531-1681.

Otari MX-5050 Mk III 1/2" Pro, 4 trk w/factory roll around floor stand, low hrs, mint cond, \$3400. K Stallings, SLP & Co, 19 West 36th, NY NY 10018.

Scully 270 2 trk stereo, R/P, works gd, \$500. WJAG, 309 Braasch, Norfolk NE 68701. 402-371-0780.

Ampex 350 (2) in excel cond; Magnecord, solid state in own cabinet, excel cond; Gates rack mt cabinet; (2) Gates TT's; several old mt RCA mics, BO. R Raines, Dixie Snd Sids, Rt 8 Box 491, Corinth MS 38834. 601-287-6783.

Scully 280 FT (2), \$500 ea or \$800/both. J Linn, WHKS, 62 N Main, Port Allegany PA 16743. 814-642-7004.

Record elect for ITC 750 R-R deck; mono record elect for ITC RP series cart deck. WGER, 6165 Bay Rd, Saginaw MI 48604. 517-792-1063.

Otari 5050BII in excel cond, \$1800. G Arroyo, WQNC, 2483 John Young Pkwy, Orlando FL 32804. 407-293-0000.

Telex Series 235 stereo tape duplicator system, 1 master w/complete spare & 4 slaves, in new cond, \$600. J Krepol, RNDL, 6147 Walker St, Philadelphia PA 19135. 215-624-1050.

Ampex AG-350 FT in console, gd cond, \$400; Crown 801 FT portable w/matching speaker/amp, vgc, \$250. B Weiss, KLSI, Kansas City MO 64111. 816-753-0933.

Ampex 351 deck, no heads, \$150; Ampex 400 deck, no heads, \$200; Ampex 400 deck plus original tube electr, FT, \$400; Ampex AG440 1/2 trk stereo w/electr, excel cond, \$1500; brush sound mirror, BK403, prof mdl w/(3) reels paper tape & original BA 106 mic, excel cond, \$500. W Kremer, Kremer Kraft, 301 SW 16th, Ft Lauderdale FL 33315. 305-524-5652.

Studer port case for A77 w/m on spkrs & pwr amps, excel cond, \$275. R Katz, Allegro Snd, 15015 Ventura, Sherman Oaks CA 91403. 213-859-5543.

Magnecord w/record amps, (2), one newly record & one cond unknown, BO. R Coleman, WGEN, 1003 S Oakwood, Geneseo IL 61254. 309-944-4633.

Revox PR 99 R-R's (2) w/rack mounts, ready to go, \$500 ea. B Schloss, KRRO, 1704 S Cleveland, Sioux Falls SD 57103. 605-335-6500.

Ampex 351 w/Inovonics amps, \$800 ea; Ampex AG-600 portable w/case, \$100; Scully 280B w/amp in rack, \$500; MCI JH-110B w/Ruslang cabinet, \$2600 ea. Clark, WFAS, Secor Rd, Hartsdale NY 10530. 914-693-2400.

Teac V417C stereo w/Dolby B, C memory & soft touch controls, \$130. W Dougherty, WLD Recdgd Sld, Rt 1, Mill Spring MO 63952. 314-998-2377 alt 5:30 PM.

MCI JH 110 2 trk in roll-around (2); MCI JH 110 4 trk 1/2" in roll-around; (2) Metrotech 500 mono w/electr. D Johnson, WFYR, 130 E Randolph Ste 2303, Chicago IL 60601. 312-861-8132.

Technics SV-100 records digital audio on any NTSC VCR, VTR w/AC pwr supply & manual, \$500. P Patton, WAPO, 29 W Main, Jasper TN 37347. 615-942-5611.

Dictaphone 5612 logger tape system. D Johnson, WFYR, 130 E Randolph Ste 2303, Chicago IL 60601. 312-861-8132.

Ampex AG-440C 4 trk, 1/2", in roll around stand, gd cond, \$1200/BO. J Bible, KEZO, 11128 John Gall, Omaha NE 68137. 402-592-5300.

MCI/Sony JH-110A (6) 1/4" 1/2 trk 1980, may need heads, just removed from service, working, well maintained, also many new repair parts & motors & books, \$1500 ea. T Nelson, WCAL, St Olaf College, Northfield MN 55057. 507-663-3328.

Studer HS-77 MK IV special fact order FT mono, 15-7.5 ips, only 10 hrs use, wood case, excel cond, \$475/BO/trade. R Katz, Allegro Snd, 15015 Ventura, Sherman Oaks CA 91403. 213-859-5543.

Nakamichi 1000-ZXL computer-controlled w/NR-100 Dolby C, rack mount w/rosewood case, low hrs, excel cond, \$1475/BO. R Katz, Allegro Snd, 15015 Ventura, Sherman Oaks CA 91403. 213-859-5543.

Teac A4300SX 7" 2 speed in gd cond, \$300/BO. C Springer, KLMR, POB 890, Lamar CO 81052. 719-336-2206.

METROTECH
DICTAPHONE
LOGGERS

—PARTS—
 and Service

SEQUOIA
ELECTRONICS

1131 Virginia Ave
 Campbell CA 95008
(408) 866-8434

Sony/MCI JH110B, (2) to trade for ICOM R9000 rcvr. D Solinske, WSUN, 877 Executive Cir Dr, St Pete FL 33702. 813-576-1073.

Magnecord DPB-60 R/P, Viking R/P, Roberts R/P, \$75/all plus shpg. B Elliott, WRFK, 915 E Fourth, Charlotte NC 20204. 704-338-9970.

Otari MK-5050BII, w/all factory mods, no wear on heads w/service man & rack mounts, low mileage, \$1850. P Appleson, Appleson Sids, 1000 NW 159 Dr, Miami FL 33169. 305-625-4435.

Ruslang R-R push carts, (3) adjustable decks, castered base, woodgrain finish w/black facing, \$450 ea/BO. A Wasilewski, KMWX, POB 1460, Yakima WA 98902.

Ampex 350 stereo rcd, \$425; (4) Scully 265 repro decks, \$250 ea or \$900/all; (2) Inovonics 370 R/P electr, \$425/pr; MCI JH-110B FT stereo for 14" reels, \$2500. P Wells, KJQY, San Diego CA, 619-238-1037.

3M M56 8 chnl 1" tape pro-studio recorder w/all remote, sel-sync, Dolby A interface cables & new tape stock, \$2900; Audix MXT1000 8 chnl master mix down console, \$1500, or both for \$4000. J Krepol, RNDL, 6147 Walker St, Philadelphia PA 19135. 215-624-1050.

Sony PCM-2500 A & B, DAT's (2), 1990, new, BO. I Seredni, KNVR, 407 W 9th, Chco CA 95928. 816-753-1197.

INTRODUCING

HE HALL

Electronics

ITC Replacement Audio & Cue Cards

Update your ITC Premium Series Cart Machines to State-of-the-Art Performance Levels & Greatly Improve Reliability Too!

Call for Specs, Pricing & ITC Rebuilding Services

(804) 974-6466
 1305-F Seminole Trail
 Charlottesville, VA 22901

Circle 72 on Reader Service Card

Otari MX 5050 BII2 tape player/recorder (2), one w/new tape heads, \$1200 & one without new heads, \$1000, both in use. L Armer, KBOM, 500 Montezum, Santa Fe NM 87501. 505-912-0088.

Scully 270 PB's (5), fair cond, \$300/all or \$75 ea. B Elliott, WRFK, 915 E Fourth, Charlotte NC 21204. 704-338-9970.

Technics RS 1500 US 3 speed isoloop, 1/2 trk stereo R/P, 1/4 trk play 10.5" reels, never used w/all factory warranty, \$899. G Chapkis, Digital Prod, POB 22122, Denver CO 80222. 303-689-9114.

Ampex AG-350 mono 1/4" in console, \$500; Ampex AG-440 mono 1/4" in console, \$500; Sony TC854-S 4 chnl 4 trk w/sync & dbx-154 type 1, \$950; Crown SX-701, \$250; Crown 800TX w/4 chnl 4 trk heads & HRI electronics, \$300. J Krepol, RNDL, 6147 Walker, Philadelphia PA 19135. 215-624-1050.

CLEAN PATCH BAYS
NO DOWN TIME



VERTIGO BURNISHERS AND INJECTORS RESTORE ORIGINAL PERFORMANCE TO YOUR PATCH BAYS

\$34.95 Ea. Please write for additional information on and order form.

VERTIGO RECORDING SERVICES
 11115 Magnolia Blvd. #116 818-907-5161
 North Hollywood, CA 91607 FAX: 818-784-3763

Revox A77 1/2 trk stereo, 3-3/4-7.5 ips, low hrs since factory overhaul w/service manual, \$650. F Ostrand, Ostrand Prod, 5 Grandview, Cornwall/Hud NY 12520. 914-534-4025.

Nagra 4.2 w/single preamp, new xtal sync, leather case, manual, refurbished & set to specs. R Sumner, CAVU Corp, 3322 Applegate Ct, Annandale VA 22003. 703-560-0233.

Sony TC854-R R-R 4 trk, \$100. P Russell, Bowdoin College, Sills Hall, Brunswick ME 04011. 207-725-3066.

Magnecord 1021R mono relay control, gd cond, \$300; Revox A77 (2), one in gd cond the other in poor cond, \$400/both. B Clark, Bullitt Bldg, Rt 1 Bardstown Rd, Mt Washington KY 40047. 502-538-4784.

Ampex 440 Series stereo PB's w/reproduce electr (5); Scully 280B stereo R/P w/all electr ir. roll around cabinets (2); Crown 700 Series R-R reproducers (2); ITC 750 Series reproducers (3); Magnecord 1021 w/electr (2); Telex 230 Series 7" R/P w/electr (2). R Lankton, WDUV/WBRD, 813-749-1420.

Roberts 977 stereo tape deck, stand-up tube type, cond unknown, \$50; Pioneer RT-101L 10" R-R 4 trk stereo in excel cond, \$300; Pioneer RT-707 7" R-R 4 trk stereo w/auto-reverse in excel cond, \$300, plus shipping charges on all items. J Emmel, WWAX, 509 Third St, Peckville PA 16452. 717-383-1118.

Revox B-77 4 trk stereo, 3-3/4 & 7.5 ips, no visible head wear, excel cond, \$600 plus shpg. C Kocsis, PGE Recordings, 2826 Raymond, Falls Church VA 22042. 703-237-2590.

Ampex 601 in custom woodgrain cabinet; Ampex AG440B in roll around cabinet; Comex Bleepmaster 875 program delay 3 or 6 sec delay w/remote switch; (2) Ampex R-R's, mdl unknown. Richard Lynn, 615-459-6616.

Technics RSB-85, \$199. G Chapkis, Digital Prod, POB 22122, Denver CO 80222. 303-689-9114.

Want to Buy

Ampex MR-70 2 trk in gd original cond; Ampex NAB test tape, 15 ips; pair of RCA ribbon mics. D deForrest, 7441 Wayne, Ste 10-D, Miami Beach FL 33141. 305-866-5401.

Otari, MCI, Ampex, Studer or Scully 8 trk and/or 2 trk stereo. R Dymont, Group D, 8402 Lake Ave, Cincinnati OH 45236.

Carry case for Sony TCD-5M or TCD-5 Pro II portable recorders. R Schneider, POB 80795, Springfield MA 01136. 413-736-5853.

Inovonics 376 2 trk PB only elect. M Addey, Kaleb Sounds, 210 Riverside Dr, NY NY 10025. 212-865-3108.

Ampex MR-70 2 trk in gd, original cond. D deForrest, Insight Prod, 7441 Wayne Ave, Ste 10-D, Miami Bch FL 33141. 305-866-5401.

MCI/Sony capstan & reel motors, any cond., recd heads, most mfgs, machines, new, used. Relapped then sold. Amp Services, 224 Datura St No 614, W Palm Beach FL 33401. 809-826-0601, in FL 305-659-4805.

Ampex ATR100 taperecorders for parts. Circuit cards, heads, motors, machine parts, or electronic parts. Call 818-907-5161.

COMPUTERS

Want to Sell

Tandy Mdl 4 TRS-80 computer w/2 floppy drives, 5 meg hard drive, daisy wheel 410 printer & software, \$650. R Allen, WRBS, 3600 Georgetown Rd, Baltimore MD 21227. 301-247-4100.

TRS-80 mdl 4 microcomputer w/(4) 360K dbl sided drives, 3 internat, 64K RAM, RS-232 port, software packages; Radio Shack DMP-1000 dot matrix printer; Radio Shack mdl 100 laptop computer with 36K RAM, internal 300 baud modem, RS-232 port, printer port, built-in software for text, telecom, Basic; Teletype w/keyboard, paper tape reader/punch, stand. K Hart, WIEZ, RD 3 Box 1414, Millington PA 17059. 717-436-9089.

MacIntosh SE 20 meg hard drive w/monitor, keyboard & \$5000 worth of software, 3 mos old. G Chapekis, Digital Prod, POB 22122, Denver CO 80222. 303-689-9114.

CONSOLES

Want to Sell

McCurdy SS8500 Series, 11 stereo faders, 11 machine controls, 4 program busses & meters, digital clock & up/down timer, 4 EQ chnls, XLR I/O wiring & numerous other deluxe features & controls, clean, \$4950. W Clark, 318 E Calhoun, Macomb IL 61455. 309-837-2244.

BE 8BES100 8 chnl, stereo mixer, spare cards/parts, gd cond, \$550. G Hill, KEWB, 1536 Market, Reading CA 96002. 916-243-5392.

McMartin B-500 5-chnl stereo, needs work, \$200/BO. G Fullhart, WVK, 4665 West Bancroft, Toledo OH 43615. 419-531-1681.

LPB Signature II S-20 10 chnl stereo, step attenuators w/manual, mint cond, \$2500. S Horner, KKUR, 255 W Stanley, Ventura CA 93003. 805-654-0577.

INVITATION FOR BID #1263-2

The Maricopa County Community College District is accepting sealed bids for "16 Channel On-Air Console". PTFP Grant. Written, sealed bids will be received at the office of the Purchasing Agent, 3910 East Washington Street, Phoenix, Arizona 85034, until 3:00 P.M. (MST) February 15, 1991. Mark the outside of the envelope with bid number, name and time of bid opening.

For further information, call the Purchasing Office, 602-392-2333, and ask for Frank Urtuzuastegui.

Broadcast Audio System 20, 12 stereo inputs, P&G faders, 7 band EQ on ea input, 3 stereo outputs, 3 remote inputs addl on ea fader, ext redundant pwr supplies, excel cond, 5 yrs old, \$6200. M Graziano, Cath Comm, 65 Elliot, Springfield MA 01105. 413-732-4546.

Circle 128 on Reader Service Card

CONSOLE . . . WTS

BE 4BEM 50 Spotmaster, w/4 pots, mono solid state; Ramko SC-5M, 5 pot, mono solid state; Ramko DC 8M 8 pot stereo solid state; Collins 212 F-2 6 pot mono tube type. A Garza, Foster Comm, 2524 Sherwood Way, San Angelo TX 76901. 915-949-2112.

Norcom Maxi-Tel 4 chnl telephone/remote mixer, rotary dial-up, (4) mic inputs, switchable to line level inputs, (4) headphone outputs, radio monitor in, record out, A/C or battery power. LED clock & timer, \$300. B Fisher, KPOK, 122 S Main, Bowman ND 58623. 701-523-3883.

Bauer 910 8 chnl mono, \$400; Bauer 912 5 chnl stereo, \$400. WJAG, 309 Braasch, Norfolk NE 68701. 402-371-0780.

BE 4S-5DA 4 chnl stereo mixer, 12 inputs, monitor, cue & headphones, amps w/manual, excel cond, \$550. G Hill, KEWB, 1538 Market, Reading CA 96002. 916-243-5392.

BE 4M50 4 chnl mono board, excel cond, manual, \$250. P Russell, Bowdoin College, Sill Hall, Brunswick ME 04011. 207-725-3066.

Audio Interface Systems 8 pot mono dual chnl, one in excel cond & one for parts, \$500/BO. J Linn, WHKS, 62 N Main, Port Allegany PA 16743. 814-642-7004.

Gates Gateway 8 chnl mono for parts, BO. E Douglas, KUNQ, POB 30, Houston MO 65483. 417-967-3353.

Maxi-Tel remote sports console & Telex CS-75 Sportcaster headset w/mic, \$275. S Bush, KTKK, 3595 S 1300 W, Salt Lake City UT 84119. 801-264-8250.

Dugan System automatic mic mixers (3) 6x1 auto or manual, 19" rack mount, \$125 ea. D Lundy, Lundy Tape Duplicators, Cumberland Gap Pkwy, Heidrick KY 40949. 606-546-6650.

GE BC1A in gd cond, needs minor work, \$50 plus shpg. G Heidenfeldt, 2880 W Lake, Wilson NY 14172. 716-751-6187.

Snake, 16 phantom-pwr'd inputs w/xt ps, 250' Belden 19-pair cable w/mil connectors & stainless steel strain reliefs, 10' Neumann XLR snake mates w/box or Belden snake, excel cond, \$575/BO/trade. R Katz, Allegro Snd, 15015 Ventura, Sherman Oaks CA 91403. 213-859-5543.

Gates MI-5136 remote mixer, old but appears to be complete, \$50 plus shpg. B Elliott, WRFX, 915 E Fourth, Charlotte NC 20204. 704-338-9970.

Shure M67/M67S mixer/prod master combination, excel cond, \$400/set. T Ray, WTIC, Hartford CT. 203-522-1080.

Altec 250T3 12 chnl stereo, gd working order, \$1750/BO. K Kushnr, Empire Comm, 2120 Bluebell, Santa Rosa CA 95403. 707-545-8300.

LPB Citation C-10S 10x3, stereo, \$2500. P Wells, KJQY, San Diego CA, 619-238-1037.

Quantum QM-8, 8 inputs, 4 busses, quad & stereo mon, +4 dBm nom, +30 dBm max, Irg Triad input xfms, Duncan linear faders, audiophile quality, excel cond, \$475/BO/trade. R Katz, Allegro Snd, 15015 Ventura, Sherman Oaks CA 91403. 213-859-5543.

North East Ohio combo looking for specialists who can rebuild an RCA BC-8A stereo/dual chnl console/let mdi MI-11667A. B Wolf, WFUN/WREC, 3226 Jefferson Rd, Ashitabula OH 44004. 216-993-2126.

Sparta A-10B monaural, mint cond, \$400; Gates Studioette monaural, gd for parts, \$100. B Weiss, KLSI, Kansas City MO 64111. 816-753-0933.

Auditronics 110A Grandson, 18 inputs, 4 outputs, 3 band EQ, 2 echo sends, 8 VU's, \$3900/BO. Mr. Freeman, Pranava Prod, 1227 Sierra Alta Way, Los Angeles CA 90069. 213-457-8390 aft 1PM.

LPB Signature II S-15A 8 chnl mono, excel cond, \$1200/BO. K Kushnr, Empire Comm, 2120 Bluebell, Santa Rosa CA 95403. 707-545-8300.

RCA BC7 in gd cond, works but needs wiring work, BO. J Ballentine, WSBF, POB 2156, Clemson SC 29632. 803-653-5222.

Yamaha PM 700 12x2x2 mixer & PM 400 8x2 mixer, both \$900; UREI 527A 27 band graphic EQ's (2), both \$700. J Krepol, RNDL, 6147 Walker St, Philadelphia PA 19135. 215-624-1050.

UREI Mod One 10 chnl stereo, OK cond, \$850 plus shpg. B Elliott, WRFX, 915 E Fourth, Charlotte NC 20204. 704-338-9970.

Ampro AC-6-SB 6 mixer dual chnl, gd for small prod or on air use, \$700 plus shpg. B Elliott, WRFX, 915 E Fourth, Charlotte NC 20204. 704-338-9970.

Arrakis 2000 SC's, (2) stereo, both in use, on-air board, \$1250, production board, \$1750. L Armer, KBOM, 500 Montezuma, Santa Fe NM 87501. 505-982-0088.

Ramsa WR-8816, 16x4x2x1 prod console w/EQ floor stand, outboard pwr supply, new; Harris stereo 5, Solid State 5 chnl; McMartin 500 Solid State 5 chnl stereo; UREI mod one 10 chnl Solid State stereo; RCA 100 Solid State 4 chnl stereo. R Lankton, WDUV/WBRD, 813-749-1420.

McMartin B0592, 5 ch stereo, excel cond. Goodrich Ent, 11435 Manderson, Omaha NE 68164. 402-493-1886.

Sonex, 1/2 rolls. Richard Lynn, 615-459-6616.

Gates Produce mono, modified w/switches & cue pots, manual & modifications, \$300. B Clark, Bullitt Bdctg, Rt 1 Bardstown Rd, Mt Washington KY 40047. 502-538-4784.

Collins 212T-1 audio control system, mint cond w/manual, \$595; Shure SR101 Series 2 portable audio mixer, rack mt in portable case, excel cond w/manual, \$395. R Sumner, CAVU Corp, 3322 Applegate Ct, Annandale VA 22003. 703-560-0233.

Gates 10 chnl stereo Executive, gd cond, \$1000; Gates 10 chnl mono Diplomat, missing pwr transformer; Gates 8 chnl mono President, missing pwr transformer & most cards, gd for spare parts, \$500/both. B Mountjoy, WIDD, POB 1240, Elizabethton TN 37644. 615-543-5849.

Yamaha PM-700 2x2x2 PA mixing board, \$400; Yamaha PM-400 8x2 PA mixing board, \$200; Shure 8x1 pro-rack mount mixer w/reverb, \$200. J Krepol, RNDL, 6147 Walker St, Philadelphia PA 19135. 215-624-1050.

Ramko DC 8M5 8 chnl, stereo 18 inputs, excel cond, \$3800. R Trumbo, KNLF, POB 117, Quincy CA 95971. 916-287-4144.

Want to Buy

McCurdy 8500, 8600, 8550, 8650; Ward-Beck R1200, R2000; Auditronics 110, 200 or 300; Harris M-90 or ADM stereo boards. R Dymont, Group D, 8402 Lake Ave, Cincinnati OH 45236.

Howe Audio 9000 parts needed desperately. H Gordon, WGY, 1430 Balltown Rd, Schenectady NY 12309. 518-381-4851.

DISCO & SOUND EQUIPMENT

Want to Sell

Sequential Circuits 6 trak, all original programs, Midi Arpeggio stacks, cables, excel cond, \$300/BO. N Brecher, Traxx, 192 Kelton, Brighton MA 02135. 617-739-9261.

Mobile DJ system, top quality components w/JBL speakers, complete w/xtensive library, SASE for complete list, \$11,000. American Music Formats, 15205 W Lynwood, New Berlin WI 53151. 414-784-5463.

Eventide H969 Ultra Harmonizer w/warranty card, \$1750; (28) play stereo Scully tape heads, \$25 ea; several Magnecord Presto lapped play heads. S Russell, Russell Music, 80410 Klett Dr, Decatur MI 49045. 616-782-9258.

Fisher MC 708 audio component system; Marantz TT; Auditronics 132 multi-trk, multi-head large reel machine tape duplicator w/carrying case; xmr breaker box, 200 VAC 200 A; (6) formica 7 wood turntable cut-outs for Technics SP-15 TT's. A Garza, Foster Comm, 2524 Sherwood Way, San Angelo TX 76901. 915-949-2112.

Graphic EQ, 12-band stereo, like new w/papers, \$85; Holmes 75 W bass amp, \$140. W Dougherty, WLD Recdg Std, Rt 1, Mill Spring MO 63952. 314-998-2377.

Burwen DNF-1201 dynamic noise filter, vgc, shipping included, \$160. P Combs, Only Son Prod, 2316 Forest Home Ave, Dayton OH 45404. 513-236-2340.

JBL Century L-100 in excel cond, \$325; JBL D-120 12" low freq drivers (2), new cones, excel cond, \$125/pr. R Glenn, WIER, 1718 Shenandoah, Wim Fl 33598. 813-634-1940.

UREI 518 electr crossover, 6 cards, rack frame & PS excel, \$250. P Appleson, Appleson Stds, 1000 NW 159 Dr, Miami FL 33169. 305-625-4435.

Studio Sound S-305 passive filter sets (2), matched pair, rack mount, very rare, \$175 ea. R Katz, Allegro Snd, 15015 Ventura, Sherman Oaks CA 91403. 213-859-5543.

Complete mobile disco/sound reinforcement system, turnkey business opportunity w/CD players, mixers, elec. crossovers, lighting system, all cables, road cases & 32" Ford high cube van w/2 ton hydraulic lift gate, inventory list & photos avail. serious inquiries only, \$35,000. P Appleson, Appleson Stds, 1000 NW 159 Dr, Miami FL 33169. 305-625-4435.

Roland DEP-5 digital multi-effects processor, excel cond, \$450. M Golladay, Circle Sound, Rt 2 Box 386, Newton Grove NC 28366. 919-594-1679.

dbx 500 sub harmonic synthesizer. R Lankton, WDUV/WBRD, 813-749-1420.

Orban 111b reverb unit, new, \$288; Mic Mix XL-210 reverb unit, new, \$288. G Chapekis, Digital Prod, POB 22122, Denver CO 80222. 303-689-9114.

Altec 604-E (pair) in excel cond only; also JBL Paragon wanted. D deForrest, Insight Prod, 7441 Wayne Ave Ste 10-B, Miami Beach FL 33141. 305-866-5401.

Digital reverb for small recording studio. W Dougherty, WLD Recdg Std, Rt 1, Mill Spring MO 63952. 314-998-2377 aft 5:30 PM.

FINANCIAL SERVICES

Want to Sell

EQUIPMENT FINANCING "LOANS BY PHONE"

- NO FINANCIALS REQUIRED FOR TRANSACTIONS UNDER \$35,000
• NEW OR USED EQUIPMENT
• \$2,000 to \$200,000
• NO DOWN PAYMENT
• SALE-LEASEBACK EQUIPMENT FOR WORKING CAPITAL
TO APPLY OR REQUEST ADDITIONAL INFORMATION CONTACT MARK WILSON

EXCHANGE NATIONAL FUNDING (800) 275-0185 FAX: (214) 235-5452

LIMITERS

Want to Sell

Orban Optimod 8000A in excel cond, low hrs, used as backup, \$1200. L Maierhofer, WTGC, 101 Armory Blvd, Lewisburg PA 17837. 717-523-3271.

CRL SEP 400A & PMC 300, two each, excel cond, \$600 ea; Kahn stereo exciter w/pwr side tuned to 1140 kHz, excel cond. G Arroyo, WONO, 2483 John Young Pkwy, Orlando FL 32804. 407-293-0000.

Aphex aural exciter type 3 2 chnl stereo single rack space, excel, \$175. B Fisher, KPOK, 122 S Main, Bowman ND 58623. 701-523-3883.

CRL APP-300A, BO; CRL PMC-300A, BO; Pacific Recorders Multi-Max audio compressor/limiter mdl MX/AM, BO; Auto-Jock for automation, \$1000. Mandell, KAMP, POB 1018, El Centro CA 92244. 619-352-2277 between 7-8 AM or 12-1 PM.

CRL PMC 300A peak mod controller, \$450. W Nauman, WLWJ, 400J Royal Commerce, Royal Palm Beach FL 33411. 407-793-5555.

Optimod 8000A \$1495 & UP 414-482-2638

CBS Labs Audimax stereo limiter, 1 side chnl not working; Universal Audio BL-40 Modulimiter; Dorrough DAP 310 audio processor. A Garza, Foster Comm, 2524 Sherwood Way, San Angelo TX 76901. 915-949-2112.

Harris MSP-90 dual chnl AGC/compressor, \$800/BO. J Linn, WHKS, 62 N Main, Port Allegany PA 16743. 814-642-7004.

CRL PMC 300A set-up w/Radio Design Labs NRSC 1 pre-emphasis & 10 kHz audio filter to meet NRSC 1 standards, complete manuals, \$750. B Fisher, KPOK, Box 477, Lowman ND 58623. 701-523-3883.

UREI BL-40 Modulimiter (2), excel, \$300 ea. M Persons, KKIN, Box 930, Aitkin MN 56431. 218-829-1326.

Collins 26U-1 peak limiter in gd cond. A Terry, WODY, Box 545, Bassett VA 24055. 703-629-5900.

Aphex 102A type C dual chnl aural exciter, still under warranty, \$170. J Ellingson, Ellingson Voice-Overs, 913 Warwick, Cedar Falls IA 50613. 319-277-8535.

Dukane Medallion dynamic range limiter, chrome face 19" rack mount, +4 & +10 lim & gate, 150, D Lundy, Lundy Tape Duplicators, Cumberland Gap Pkwy, Heidrick KY 40949. 606-546-6650.

Marti CLA-40H compressor/limiter, \$100. E Douglas, KUNQ, POB 30, Houston MO 65483. 417-967-3353.

Collins 310Z-2 FM exciter, in operation since 1976. H Hoppe, WHMH, Sauk Rapids MN 56303. 612-252-6200.

CRL FM 4G, SMP-800, (2) SEP-400 B, SPP 800, SG 800, excel cond, \$4200. P Urso, 603-332-0930.

Gregg Labs 2530 tri-band compressor, upgraded w/5534 IC's, \$350; Inovonics 222 NRSC processor, as new, \$400. P Patton, WA-PO, 29 W Main, Jasper TN 37347. 615-942-5611.

Gates Solid Statesman AGC's (2), \$250/pr. H Widsten, KGNB, 1540 Loop 337 North, New Braunfels TX 78130. 512-625-7311.

Harris MSP 100 audio processor. D Johnson, WYFR, 130 E Randolph Ste 2303, Chicago IL 60601. 312-861-8132.

Moseley TFL-280 audio (2), \$500; Harris AM & AGC Solid Statesman (2), \$500. R Coleman, WGEN, 1003 S Oakwood, Geneseo IL 61254. 309-944-4633.

CBS 4450A Audimax automatic level control w/manual, \$250; CBS 4000A Volumax automatic peak limiter, manual, \$250. R Yaw, KOJM, Box 7000, Havre MT 59501. 406-265-7841.

Texar RCF-1 Opt 5 card w/board, faceplate & manual, \$175. R Rocks, KEMC, 1500 N 30th, Billings MT 59101. 406-657-2941.

Orban Optimod 8000A in gd cond, recently removed from service, \$1500. G McCoy, KZEN, Box 100, Central City NE 68826. 308-946-3816.

Dolby 334 FM processor; (2) RCA BA-45 AGC, (2) RCA BA-43 pgm amps in rack mount mainframe; Volumax 4000A. R Lankton, WDUV/WBRD, 813-749-1420.

Harris MSP 90 (2), stereo AGC modules, stereo FM limiter modules, \$800 ea/BO. D Greer, WDZZ, Ste 1830 Genesee Twrs, Flint MI 48502. 313-767-0130.

Optimod 8000A, good condition, recently checked, \$1,400. Call Mr. Ericson, 212-477-2489.

Want to Buy

dbx 117 or 119 consumer stereo compressor in gd working cond. Glenn, 1105 Turtle Creek, Paso Robles CA 93446.

Orban 8100 wanted, will trade 8000. A Stevenson, WHZT. 217-355-9402.

Versa-Count or similar, used, cheap but repairable, programmable FM exciter. J Crawley, WLSK, Box 680, Lebanon KY 40033. 502-465-5762.

Automated Bdct Control Sta-Max. Pat Parks, KYKR, 27 Sawyer, Beaumont TX 77702. 409-838-3911.

MICROPHONES

Want to Sell

Beyer M500 cardioid ribbon, like new in box w/graph, \$150; Beyer M160 cardioid ribbon mics (2), like new in box w/graph, \$150 ea; EV 668 boom dynamic cardioid, new wind-screens & mounts, like new (2), \$150 ea. D Lyon, Lytec Recdg, 29539 Linda, Livonia MI 48150. 313-427-6043.

Ross RM-7HC/C, uni-directional perfect, cord w/1/4" plug, cover. N Brecher, Traxx, 192 Kelton, Brighton MA 02135. 617-739-9261.

RCA KV3A ribbon cardioid boom mix in shock mount, gd cond, \$600; EV 666 dynamic cardioid mics w/cable & stand adaptor, gd cond, \$75 ea; Altec M49-M50 cardioid/omni condenser mics w/windscreen, AC supply & stand adaptor, gd cond, \$130 ea. D Lyon, Lytec Recdg, 29539 Linda, Livonia MI 48150. 313-427-6043.

RCA KV3A ribbon cardioid boom mix in shock mount, gd cond, \$600; EV 666 dynamic cardioid mics w/cable & stand adaptor, gd cond, \$75 ea; Altec M49-M50 cardioid/omni condenser mics w/windscreen, AC supply & stand adaptor, gd cond, \$130 ea. D Lyon, Lytec Recdg, 29539 Linda, Livonia MI 48150. 313-427-6043.

HME professional VHF wireless mic system, System 85 mic, RX-722 rcvr & Excalibur carrying case, \$495. W Clark, 318 E Calhoun, Macomb IL 61455. 309-837-2244.

U87 w/shock, \$1250; SM81 w/shock, \$160; AKG 202, \$125; RE 20 w/shock, \$320; TOA wireless leveler, \$60, all in mint cond. D Kocher, DLK Snd Std, 1901 Hanover, Allentown PA 18103. 215-432-0520.

EV 664, BO. E Douglas, KUNQ, POB 30, Houston MO 65483. 417-967-3353.

Altec 639B ribbon mics (2). S Russell, Russell Music, 60410 Klett Dr, Decatur MI 49045. 616-782-9358.

RCA classic ribbon mics, send for list. B Davies, Virgo Prod, 5548 Elmer Ave, N Hollywood CA 91601. 818-761-9831.

Neumann U-67 w/power supply, \$750. W Nauman, WLWJ, 400J Royal Commerce, Royal Palm Beach FL 33411. 407-793-5555.

Sony C-37P w/case, mint cond, \$600; Beyer M280N ribbon (pair), vgc, \$400; Amperie SR80-H classic studio ribbon mic, works, \$250; RCA Veracoustic classic ribbon mic w/art deco case, works, \$300; Bruno Labs PRL1 large classic ribbon mic, works, \$300, BO on entire lot. G Titcomb, Easy St Recdg, 2 Easy St, Woodbury CT 06798. 203-263-0785.

RCA Jr velocity, \$450; Turner dynamic U9S, \$100; Collins mobile MM1, \$100, all new in box. J Burgwyn, WJAD, Box 7397, Rocky Mt NC 27804. 919-443-4101.

AKG C460B preamp w/CCK-22ULS cardioid & CK-4 figure eight capsules, \$550 plus shipping. D Glasser, Airshow Inc, 7021 Woodland, Springfield VA 22151. 703-642-9035.

Shure SM-61LC (2) in vgc, built in isolation & pop filter w/cases & spec sheet, \$160/pr or \$85 ea. W Dougherty, WLD Recdg Std, Rt 1, Mill Spring MO 63952. 314-998-2377 aft 5:30 PM.

RCA 44A on original stand, gd cosmetics, works, \$500; RCA 77C black & chrome, gd cosmetics, works, \$400; (2) RCA 74 Junior, gd cosmetics, need ribbons, \$100/ea; Shure Tri-Polar, 3 crystal, rare, original, works, BO; Asiatic D104 excel comm mic on original stand, excel cond, \$75; EV RE16, dynamic cardioid, vgc, \$60; EV RE55, dynamic omni, fine cond, \$75; EV RE20, poor cosmetics, works fine, \$30. W Kremer, Kremer Kraft, 301 SW 16th, Ft Lauderdale FL 33315. 305-524-5652.

Sennheiser MD-421 (2); AKG D-1000E mics (2), all in gd cond, BO. N Kuvshioff, Compact Djs, POB 2913, Salisbury MD 21602. 301-548-5352.

Telefunken tube CM-61 by Shoeps, very rare, uses old plug-in tube, w/custom pwr supply, mint cond, \$2475/BO. R Katz, Allegro Snd, 15015 Ventura, Sherman Oaks CA 91403. 213-859-5543.

Shure W15HT/58/W20R wireless mics (2), handheld 177 & 183 MHz, SM58 heads, new, \$525 ea. E Davison, Beauty TeleVisual, 135 N Illinois, Springfield IL 62702. 217-787-0800.

Neumann KM-88, rare 3-pattern wireless capsules, hot-setup percussion mic, mint cond, w/orig case, \$875/BO. R Katz, Allegro Snd, 15015 Ventura, Sherman Oaks CA 91403. 213-859-5543.

Sennheiser MD-421U w/case & clamp, vgc, \$200; EV RE-20 w/case & clamp, gd cond, \$200, plus shipping on both. J Emmel, WWAX, 509 Third St, Peckville PA 16452. 717-383-1118.

Crown PCC-160 Cardioid condenser boundary mic in original box, used only few weeks, \$200. S Swanson, KBNL, Box 440029, Laredo TX 78044. 512-724-9211.

RCA ribbon mics including (1) 44-BX; (1) 77-D; KU3A10,0001; BK-11; BK-5; SK-46; WE839A, will trade for other high quality condenser, dynamic, ribbon mics & audio equip. Tracy Eaves, 615-821-6099 (evenings).

Want to Buy

Four threaded lower collars, pipe thread & compression springs & rings for RCA 74-B mics. C Lund, Cycle Sound & Video, 167 Madison, Waterbury CT 06706. 203-756-7761.

Classic mics, EV, Telefunken, Neumann, etc, will trade. G Titcomb, Easy St Recdg, 2 Easy St, Woodbury CT 06798. 203-263-0785.

Neumann Z40, Z140, Z240 matrix transformers. E Kelly, Mobile Master, POB 61, Glenelg MD 21737. 301-596-9101.

Original RCA 77-DX mic desk stand; also need pattern ID plate for back w/2 screws. C Lund, Cycle Sound & Video, 167 Madison, Waterbury CT 06706. 203-756-7761.

Neumann SM 69 or SM 69fet, prefer SM 69fet w/NS69 power supply/remote control, satin finish, no swivels, will trade Neumann TLM 170. E Kelly, Mobile Master, POB 61, Glenelg MD 21737. 301-596-9101.

RCA 44's, 77's, WE & other ribbon mics, working or not. B Davies, Virgo Prod, 5548 Elmer Ave, N Hollywood CA 91601. 818-761-9831.

RCA 44 or 77 velocity mics, complete & functional only, send details, price. D deForrest, Insight Prod, 7441 Wayne Ave Ste 10-B, Miami Beach FL 33141. 305-866-5401.

<

RCA BK-5B w/windscreen, gd cond. R Laine, Box 10665, Golden CO 80401. 303-238-7830.

MISCELLANEOUS

Want to Sell

Andrew dehydrator, BO. Eddie, KCFX, 10800 Farley Ste 310, Overland Park KS 66210. 913-661-0101.

Vaco modems (2) units for sending data on telco dial up lines. C Murray, KMGE, 925 Country Club Rd, Eugene OR 97401. 503-484-9400.

Extel AH11R printer for parts or repair, \$30; Hygain scanner, works gd, \$30. WJAG, 309 Braasch, Norfolk NE 68701. 402-371-0780.

Ruslang RL-500 tape transport, blk/wood-grain finish w/casters, \$100. P Parks, KLV1, 27 Sawyer, Beaumont TX 77702. 409-838-3911.

Kato 50 kW 3 phase AC generator, 151 A at 208-240 V, supercharged diesel engine w/less than 150 hrs operation, spare voltage regulator, \$12,000. P Parks, KYKR, POB 5488, Beaumont TX 77726. 409-838-3911.

Extel 1 AF 11 R printer w/stand & book; GE AP printer; Smith Corona 101 universal tractor feed. A Garza, Foster Comm, 2524 Sherwood Way, San Angelo TX 76901. 915-949-2112.

Kraco RPU ground plane 161.7 mHz, \$100; (4) patch panels double, \$50 ea. Delta Bdctg, POB 430, Helena AR 72342. 501-338-8361.

B&W 210 audio gen, \$200; B&W 410 dist meter, \$300; Kintronic isocouplers FMC-75 at 103.9, \$2500; Kintronic FMC-05B at 450.65, \$1000; Eventide delay BD-931 6.4 sec, \$800; GE dist meter, \$100; Heathkit oscill 10-4560, \$200; Elgin ERC-16645-4 recorder connectors, \$60 ea. Clark, WFAS, Secor Rd, Hartsdale NY 10530. 914-693-2400.

RCA PG201, 16mm sound projector, exceptionally smooth running, projector cosmetics excel, case cosmetics fair, \$175; (3) Altec N500 crossovers, excel cond, \$75/ea. W Kremer, Kremer Kraft, 301 SW 16th, Ft Lauderdale FL 33315. 305-524-5652.

Cummins 4B 3.9GC diesel generator, 40 kW, 4 cylinder, liquid cooler, 6 mos old, 417 hrs, excel cond, \$7900. M Fleisher, WWBE, 333 Chestnut, Mifflinburg PA 17844. 717-966-1098.

Harrison 6200 B DC pwr supply, 150; HP 0-40 V .75A, 0-20V 1.5A. M Norman, KCCU, 2800 W Gore, Lawton OK 73505. 405-581-2425.

Telephone System, Executone 'Encore' recently removed from computer store, 12 phones, punch blocks, options, cords, installation jacks, etc., priced low. Goodrich Ent. Inc, 11435 Manderson St, Omaha NE 68164. 402-493-1686.

Metal 2' free standing letters KKRC & 1' free standing letters RADIO, w/mounting hardware, \$100 plus shpg. B Schloss, KRRO, 1704 S Cleveland, Sioux Falls SD 57103. 605-335-6500.

Cinema Engineering 9205-A bulk eraser. R Robinson, 203-269-4465.

Radio Shack 17-604 NiCad battery for 17-200/1050 CT-300, 301 cellular phones, new \$15. P Russell, Bowdoin College, Sills Hall, Brunswick ME 04011. 207-725-3066.

Gray 20"x19" equip racks (2); (15) various sized metal cart racks; Gates 6' equip rack. R Lynn, 615-459-6616.

Tellabs dual wideband repeat coil module 4425, still in box; dual row patch bay. Richard Lynn, 615-459-6616.

Gentner SPH4, Bantam patch panel, ITC eraser/splice finder ESL IV & other items, BO. D Doelitzsch, WDDD, Marion IL. 618-977-8123.

VHS video sales training tapes (6) 30 topics, \$1500. R Trumbo, KNLF, POB 117, Quincy CA 95971. 916-287-4144.

Anvil cases (10), 13 space, 22.75"x24", EIA rackmount, 2" foam lines shock mounted, mech excel, cosmetic poor, \$300 ea. TJ Worrell, Multimedia, 7620 W 78th, Minneapolis MN 55439. 612-942-9681.

Cushman Snowcat small two-man, for deep powder snow w/trailer, gd cond, BO. D Barton, KMTI, POB K, Manti UT 84642. 801-835-7301.

Extel weather wire printer. R Lankton, WDUV/WBRD, 813-749-1420.

Rotron Blowers for Elcom, CCA, CSI, McMartin, rebuilt & new. Goodrich Enterprises Inc. 11435 Manderson St., Omaha, NE 68164 402 493 1886 FAX 402 331 0638

Rack bays (2), 77" rack space, 82" overall, 17" deep, black wrinkle finish, one 61.5" rack space, 68" overall, 18" deep, gray finish w/yellow formica glued to sides. K Hart, WIEZ, RD 3 Box 1414, Mifflintown PA 17059. 717-436-9089.

Harmon-Kardon mixers, new DPR7; Meissner mixer live inputs-battery; Cannon plugs, 3 prong, male & female; 40 new tubes & resistors cheap; Lafayette TE22 audio gen; Senecore transistor & diode tester; manuals for Ampex, Pultec, Altec & others. Mr. Oliver 212-874-7660 in afternoons.

FREE 56-PG CATALOG
Complete line of audio modules and accessories for all engineered sound & broadcast applications



MODULAR AUDIO PRODUCTS
1-800-333-7697
1-516-345-3100
FAX 516-345-3106

DIV OF MODULAR DEVICES INC
1 RONED RD • SHIRLEY NY 11967

Circle 53 on Reader Service Card

Gramplan cutter heads, 1D feedback (tand-berg); patch bays (4) 24 inputs single, also patch cords; Daven 600 ohms attenuators (silent) (8) excel; Presto 6N cutter lead screws; Edital blocks for recorders 1/2"; EV 12TRX speakers (2) & cabinets. Mr. Oliver, 212-874-7660 in afternoons.

Want to Buy
AM-RF around 1400 kHz, EBS decoder, plug in mods for Gatesway II mono console. Bill, 904-678-8943.

Glass dial plate for 1968 HH Scott 388 rcvr. Clark, WFAS, Secor Rd, Hartsdale NY 10530. 914-693-2400.

New FM seeks quality used studio/xmtr gear, 1 kW xmtr, boards, etc. B Jackson, WCD, Box 12369, Albany NY 12212. 518-374-0898.

Wire marking machine. M Starin, WJYY, 457 Varney, Manchester NH 03102. 603-625-1165.

Digital VT Series video terminals & key-boards. P Russell, Bowdoin College, Sills Hall, Brunswick ME 04011. 207-725-3066.

Jazz record collections, 10" LP/12" LP bebop, swing, dixie, highest prices paid. B Rose, Program Recdgs, 228 East 10th, NYNY 10003. 212-674-3060.

MONITORS

Want to Sell
General Radio Type 1931-A was operational when removed, BO. A Terry, WODY, Box 545, Bassett VA 24055. 703-629-5900.

FM mod mon, stereo in gd working cond. R Lark, WJCE, Box 1260, Amery WI 54001. 715-268-7185.

Gates stereo mod monitor GTM 665 103.1, \$100; FM freq monitor GTM 88F 103.1, \$50; Pilot SCA freq comparator, \$25. Delta Bdctg, POB 430, Helena AR 72342. 501-338-8361.

McMartin 5500 aural mod monitor, TV chnl 6, \$250 plus UPS. J Crawley, WLSK, Box 680, Lebanon KY 40033. 502-465-5762.

General Radio 681-B AM freq deviation meter. K Hart, WIEZ, RD 3 Box 1414, Mifflintown PA 17059. 717-436-9089.

Motorola 1310 AM stereo mod mon in excel cond. G Ciapper, KKKR, POB 9032, Gresham OR 97030. 503-667-1230.

McMartin FM mod monitors, TBM3500B main chnl, TBM2200A stereo, TBM2000B SCA, TBM4500A, all or part tuned & tested. Goodrich Ent, 11435 Manderson, Omaha NE 68164. 402-493-1886.

Belair FM mod monitors, FMM-1, FMS-1, SCM-1, RFA-1 all clean & current calibration; McMartin TBM3700, TBM2200 FM mod monitors. B Lankton, WDUV/WBRD, 813-749-1420.

QEI 675T200 RF & SWR monitor & PA voltage & amp monitor, fwd & rev SWR switch, 19" rack mount, 3" high, translator & up to 200 W use, \$125. S Lawson, KAK Prod, 928 Hyland, Santa Rosa CA 95404. 707-528-4055.

Want to Buy
FM stereo monitor, gd, late mdl; also FM EBS rcvr. S Larson, KJLY, Box 72, Blue Earth MN 56413. 507-526-3233.

Any older McMartin mod monitors. C Goodrich, 11435 Manderson, Omaha NE 68164. 402-493-1886.

Want to Buy
Any older McMartin mod monitors. C Goodrich, 11435 Manderson, Omaha NE 68164. 402-493-1886.

MOVIE PROD EQUIP

Want to Sell
Siemens 2000 16mm interlock projector, excel cond, \$575; B&H 70DR 16mm camera w/3 lenses & case, mint cond, \$325. G Ormond, GFO Prod, 432 East X St, Tumwater WA 98501. 206-352-8028.

Canon Scoopie 16mm motion picture camera, zoom, etc w/charger, excel cond, \$750/BO. K Kushnir, Empire Comm, 2120 Bluehill, Santa Rosa CA 95403. 707-545-8300.

Arriflex 16S 16mm w/120mm Angenieux pwr cord, lens shade & flight case, mint cond, \$1500. R Williamson, R Williams Prod, 2809 Ross Ave S Ste 305, Dallas TX 75201. 214-871-9011.

Want to Buy
Film cameras & accessories, especially Arriflex, Bolex & Eclair, also film sound items, Nagra & Stellavox recorders, reasonably priced editing & lighting equip. H Biller, 108 Hamilton, Silver Spring MD 20901. 301-565-2798.

RECEIVERS & TRANSCEIVERS

Want to Sell
McMartin TR-66A SCA rcvr, WGER, 6165 Bay Rd, Saginaw MI 48604. 517-792-1063.

Motorola two-way system, not working, BO. E Douglas, KUNQ, POB 30, Houston MO 65483. 417-967-3353.

Kenwood TH-21 1 W 2 meter hand-held w/vice manual, \$25. P Russell, Bowdoin College, Sills Hall, Brunswick ME 04011. 207-725-3066.

Want to Sell
McMartin TR-66A SCA rcvr, WGER, 6165 Bay Rd, Saginaw MI 48604. 517-792-1063.

Motorola two-way system, not working, BO. E Douglas, KUNQ, POB 30, Houston MO 65483. 417-967-3353.

Kenwood TH-21 1 W 2 meter hand-held w/vice manual, \$25. P Russell, Bowdoin College, Sills Hall, Brunswick ME 04011. 207-725-3066.

Adcom SCPC agile demodulator, works in Harris 6550 satellite rcvr, gd cond, \$350. W Long, WWMY, 7819 Natl Serv Rd, Greensboro NC 27409. 919-688-9450.

Motorola Pagets Pageboy II's, Director II's & monitors, VHF system w/chargers, \$40-90 ea, all in working order. K Kushnir, Empire Comm, 2120 Bluebell, Santa Rosa CA 95403. 707-545-8300.

Macintosh MR71 tube tuner in Pan-Loc case, all Mac tubes near mint cond, \$400. W Kremer, Kremer Kraft, 301 SW 16th, Ft Lauderdale FL 33315. 305-524-5652.

AM STEREO RECEIVERS
Portable, Home/Studio, Auto
RRADCO GROUP
708-513-1386

Scientific Atlanta 7300/7325 2-piece, rack mounted rcvr & processing unit at 15.0 kHz, BO. G Fields, KDXI, Drawer 1306, Mansfield LA 71052.

Communications Company 450.00 MHz antenna bases (2), not top whips or mounting hardware, have coax leads w/N-type connectors, \$200 ea or \$350/pr. A Wasilewski, KMWX, POB 1460, Yakima WA 98902.

Scientific Atlanta digital audio satellite rcvr w/downconverter, 15 K dual audio card, 7.5 K dual audio card, cue card, spare pwr supply, \$4500/BO. T Ray, WTIC, Hartford CT. 203-522-1080.

McIntosh MR 77 FM stereo tuner, excel cond, \$450. G Gabriele, WFOG, 215 Brooke, Norfolk VA 23510. 804-622-6771.

Motorola Micor N04RTB broadband tuned to 455.15 mHz, wiring for Marti compander board, has excel intermod rejection, \$100. E Swanson, WZTR, 520 W Capitol, Milwaukee WI 53212. 414-964-8300.

High quality micro-miniature 87 kHz SCA decoder, about 1" square, prewired & ready to install, \$15. D Jackway, 5742 Fair oak, Springfield MO 65810. 417-881-1846.

Janiel SP2000 stereo sat rcvr processor, 2 chnl stereo rcvr; (2) Janiel BCR2000 sat TV rcvr; Microdome 1100-FFC sat rcvr; Microwave Assoc (MAACOM) VR-3X sat rcvr; Maacom 4/MS sat rcvr, 6.26.8/1.2/2.4. R Lynn, 615-459-6616.

Scientific-Atlanta 7300 wideband w/PSIdemod BSSC/downconverter/BPST rcvr/decoder modules; Scientific-Atlanta 7325 digital processing unit w/(3) 15 kHz dual audio decoders, (2) voice cue decoders, DMX, pwr supply. R Lynn, 615-459-6616.

Grundig Satellite 650, 1.6-30 MHz, 30 W audio, 60 memories, quartz clock, like new, original box, \$650. R Thomas, Rebel Recdgs, 5555 Radio Ln, Jacksonville FL 32205. 904-388-7711.

GE Exec II 40 W VHF on 2 meter repeater w/Hamtronics COR-4 board, \$300. P Russell, Bowdoin College, Sills Hall, Brunswick ME 04011. 207-725-3066.

EMPLOYMENT

To place ads in this section, use the ActionGram form. To respond to box numbers, write Radio World, PO Box 1214, Falls Church, VA 22041, Attn: _____

POSITIONS WANTED

GM w/26 yrs exper, looking for NE small market. K Watts, POB 152, Big Flats NY 14814. 607-562-7522.

CE w/big production voice & over 15 yrs of hands-on eng exper, seeks position w/production in a competitive top 100 market. G Morgan, 704-563-8676.

Program/Announcer, worked South FL major markets, 5 yrs on air, 20 yrs related, creative voices, prod skills, Gospel stations included, all formats, markets, open relocate correct offer, owner chain, create own niche, will program Gospel. V Harris, 305-758-3732.

Operations director/PD, knowledgeable about all facets of radio, 20 yrs exper, oldies, country, AC or newstalk formats preferred. Stacy Richardson, 918-835-2777.

FCC licensed engineer, 29 yrs exper seeking contract work, studio/xmtr design, construction, maint. D Parrish, 813-772-5875.

Ancr w/6 yrs exper in north med mkts looking for position, hard worker & team player. Brian, 612-560-6569.

Radio engineer w/major market exper seeking new challenges in new locations. Reply to: Engineer, POB 4882, Ocala FL 32678.

Exper air personality seeking FT position, exper in news, morning & afternoon drive, prefer Christian or A/C but will work in other formats. Jason, after 4PM CST. 918-476-8849.

My dollars, time & mgmt, buy all or part of your station, community oriented. M Rimmerman, 215 Wendwood, Statesboro GA 30458. 912-681-6378.

Seeking GM position w/option, small market, 29 yrs radio/23 mgmt exper, strong personnel, engrg, sales, news, sports, avail now, Wisconsin, midwest, references, personal/business. Rod, 608-647-4869.

Announcer w/5 yrs non-comm exper seeks comm FT position in St Louis MO or PT in NW GA. Eric. 404-924-7780.

GM exper in sales, programming & engineering looking for position in Northeast. B Mooney, 207-942-1108.

Production Director w/lots of writing & engineering exper now available, worked on Network programming & in NY market. B Ranes, 718-526-6501.

Experienced CHR/AC jock w/blazing energy, deep pipes, warm personality & great sense of humor seeks upstate NY FM w/No. 1 goals. Wayne, 716-338-1439.

Notre Dame grad, advanced degree, college baseball/basketball/football play-by-play exper, underwriting/sales, news, PR, 8 yrs exper, seeks university sports or bdctg position, teaching or professional staff. Len, 219-762-3351.

Exper DJ/Sportscaster seeks On-Air position music/sports-baseball, football, P/BPcolor, will relocate. Phil, 415-587-3426 or 415-948-9250.

Metro NY 10-year air personality wishes to stay here, wants to provide listeners w/entertainment, companionship & smiles, will consider production work. Zal, 718-871-5419.

Student engineer w/resume, seeking engrg, prod, air shift employment in PA area, college & some exper, trainable, eager to work & learn, references avail. Askey, RD 3 Box 433, Bernville PA 19506. 215-488-7704.

Annc, Jock, started young, still going strong, AOR, CHR, AC, C&W exper, MD, OP, News, Sports, even cow chip bingo, will relocate to larger market. M Doyno, 1328 High St Ste 1, Wmspt PA 17701. 717-323-7832.

HELP WANTED

Small Market Network TV has an opening for a TV maintenance technician. The applicant will be responsible for maintaining video & audio systems, including audio tape cartridge & 3/4" U-matic tape, & associated equipment in TV broadcasting. The applicant should also have RF knowledge on UHF television transmitters, UHF 2-way, 2 gHz microwave/ENG truck, & general transmission techniques. Certification in radio service, or prior broadcast experience is preferred. This position is full time with all normal benefits. The station is an Equal Opportunity Employer. Write to: Radio World, POB 1214, Falls Church VA 22041. Attn: RW 91-01-01.

TV Station in small market has a full time opening for a Master Control Operator. The applicant must have knowledge of television or radio operations. Duties will include M.C.R. switching, newscast switching, production, and legal operation of stations transmitter. Opens 1 Jan 1991. EOE. Reply with resume & employment history to: Radio World, POB 1214, Falls Church VA 22041. Attn: RW 90-01-02.

BROADCAST AUDIO SALES, CONSOLES

Expanding sales team looking for self motivated individual. Engineer/technician experience in operation/architecture of audio consoles a must. Sales ability, computer operation, and knowledge of manufacturing helpful. Broadcast knowledge required. Send resume to: WHEATSTONE CORPORATION, 6720 VIP Parkway, Dept. E, Syracuse NY 13211 (No calls, please)

Keymarket Communications Group is expanding its operations & needs engineers at all levels of qualification. Resume in confidence to:

Lynn A Deppen DOE,
2743 Perimeter Parkway,
Bldg. 100, #250
Augusta, GA 30909
EOE

BROADCAST AUDIO SALES

Subcarrier (above video) product line includes highest performance equipment on the market for STL, ENG and satellite audio. Excellent opportunity for an individual who enjoys a small company environment. Familiarity with television audio and/or video microwave systems helpful. Proven sales ability essential. Send resume to:

TECTAN, Inc.
P.O. Box 271872
Concord, CA 94527-1872

No phone calls, please.

TECHNICAL COORDINATOR
(Satellite Ground System Project Engineer)
(Two Positions)

National Public Radio seeks tech people to refurbish & enhance satellite distribution system. Work w/team to write specs & documentation, evaluate vendors, test hardware/software, assist local radio station personnel install/debug satellite audio & data equip & oversee network control center construction/installation. 3 yrs bdct station or satellite terminal operations or maintenance exper, digital audio familiarity, computer literacy & demonstrated ability to communicate in writing. Fixed term appointments through end of 1993. Salary negotiable. Open until filled. Resume to Mr. Chris Howze, Personnel, NPR, 2025 M St, NW, Washington, DC 20036. EOE/AA

EMPLOYMENT SECTION

HELP WANTED: Any company or station can run "Help Wanted" ads at the flat rate of \$25 per listing per month (25 words max). Payment must accompany insert; **there will be no invoicing.** Blind box numbers will be provided at an extra charge of \$5. Responses will be forwarded to listee, unopened, upon receipt. Call 800-336-3045 for display rates.

POSITIONS WANTED: Any individual can run a "Position Wanted" ad, **FREE** of charge (25 words max), and it will appear in the following 3 issues of Radio World. Contact information will be provided, but if a box number is required, there is a \$5 fee which must be paid with the listing (**there will be no invoicing**). Responses will be forwarded to the listee, unopened.

Mail To: **BROADCAST EQUIPMENT EXCHANGE**
PO Box 1214, Falls Church, VA 22041

WE'RE BUYING!
INTERESTED???
Then call Jim or Chuck
@ 317-962-1471 @
ALLIED EQUIPMENT EXCHANGE
BUY We selectively buy used radio equipment
SELL We sell used and new radio equipment
TRADE We take trade-ins for used and new radio equipment
Allied has served broadcaster needs since the 60s! Our veteran broadcasting salesmen will "horse trade" with you—give them a try today!
HARRIS ALLIED EQUIPMENT EXCHANGE
317-962-1471

CONSULTANTS

EVANS ASSOCIATES
Consulting Communications Engineers

FCC Applications, Design & Field Engineering
Broadcast Engineering Software

216 N. Green Bay Rd.
Thiensville, WI 53092

(414) 242-6000
Member AFCE

W. LEE SIMMONS & ASSOC., INC.

BROADCAST TELECOMMUNICATIONS CONSULTANTS

1036 William Hilton Pkwy
Ste 200F
Hilton Head Is., SC 29928

(803) 785-4445

SOFTWARE
FM CHANNEL SEARCH

FM Database pool
MSDOS
EGA Graphics-Color
Broadcast Technical Consulting

V Doug Vernier
Broadcast Consultant
1600 Picturesque Drive
Cedar Falls, IA 50613
319-266-8402

MAGRILL ENGINEERING
Radio Engineering Consultants

FCC Applications - Upgrades
Pre-purchase evaluations
Station planning & Design
Turnkey systems - Field service

Experienced, Economical & Fast

(904) 591-3005

Barry Magrill P.O. Box 1010
President Fairfield, FL 32634
Member IEEE

RP Communications
Telecommunications

FCC Application Preparation
Custom Audio Console
Design & Modification
Digital & Analog Recording
& Broadcast Facilities Design
High Quality Field Recording

77 1/2 Intervale Ave.
Burlington, VT 05401

802-862-7447

NEW

**WE NOW ACCEPT
VISA &
MASTERCARD**

Consulting Communications Engineers

- FCC Data Bases
- FCC Applications and Field Engineering
- Frequency Searches and Coordination
- AM-FM-CATV-ITFS-LPTV

OWL ENGINEERING, INC.

1306 W. County Road. F,
St. Paul, MN 55112
(612)631-1338 "Member AFCE"

RADIO SYSTEMS ENGINEERING

FCC Applications • Design
• Installation • Field Service

Experienced & Affordable

4289 Roanridge
Las Vegas, Nevada 89120

24 Hr: **(702) 454-2085**
FAX: **702-458-2787**

Moffet, Larson & Johnson, Inc.
Consulting Telecommunications Engineers

Two Skyline Place
5203 Leesburg Pike # 800
Falls Church VA 22041

703-824-5660
800-523-3117

Member AFCE

THIS SPACE AVAILABLE

Call Simone Mullins
at 1-800-336-3045

AVIATION CONSULTANTS

- FAA Obstruction Analysis
- FM EMI Evaluations
- Expert Witness Service
- Tower Marking & Lighting

WALTER WULF & Assoc.

(404) 881-6786
P.O. Box 77028
Atlanta, GA 30357

MULLANEY ENGINEERING, INC.
Consulting Engineers

- Design & Optimization of AM Directional Arrays
- Analysis for New Allocation, Site Relocation, And Upgrades
- AM FM TV LPTV Wireless Cable (MDS/MMDS/ITFS/OFS)
- Environmental Radiation Analysis
- Field Work
- Expert Testimony

9049 Shady Grove Court
Gaithersburg, MD 20877
Phone: **(301) 921-0115**
Fax: **(301) 590-9757**

Huntsville Antenna Engineering

There is hope for AM radio!
AM station unipole antennas with circular polarization & beam tilt.
Broadband your present AM tower Series R shunt fed.

205-353-9232 205-353-6747

Kenneth Casey
Consulting Radio Engineer

Broadcast Studies
Transmitters
Tower Erection
Turnkey Construction

UNITED COMMUNICATIONS
Dave Robinson
Consultant

PO Box 635
Cleveland TN 37364 **(615)478-5566**

SHOULDN'T YOU BE HERE?

Call 1-800-336-3045

GOODRICH enterprises, inc.
Parts and technical service for all MCMARTIN TRANSMITTERS, CONSOLES EXCITERS, RECEIVERS TRANSMITTER AND INDUSTRIAL TUBES.

11435 Manderson St.
Omaha, Nebraska 68164 U.S.A.
PH:010-1-402-493-1886 FAX:010-1-402-331-0638
TELEX: 940103 WUPUBLX BSN

THIS SPACE AVAILABLE

Call Simone Mullins
at 1-800-336-3045

SERVICES

FM TRANSMITTERS
3, 5, 12, 20, 25KW
\$24,000 TO \$46,000

FM-AM Transmitter Installation
Maintenance and Field Service

BROADCAST EQUIPMENT
REFURBISHED & REPAIRED

BROADCAST TECHNICAL CONSULTANT

TELO TECHNOLOGY
Stanwood, WA. 98292
206-387-3558

FCC's Engineering
AM, FM and TV Data Bases for your PC

Call today to request a free sample.

Communications Data Services

6105 E Arlington Blvd
Falls Church VA 22044
(703) 534-0034

Steven L. Delay
AM/FM Broadcast Field Service

International & Domestic

Ground Systems Field Intensity
Broadcast Studios Measure
Turnkey Transmitting
Construction Facilities
AM Directionals Purchase
Microwave Evaluations

RR1-236 Pawnee, IL 62558
24 HR. 217-498-7339
FAX 217-498-8197

CLOUD NINE BBS

300 to 19200 Baud
N-8-1
Multi-Node System

(713) 855-4382

FCC Information
On-Line Call Sign Search
On-Line Engineering Formulas
Messages, Conferences, Files, Doors

TOWER SERVICES
Light Replacement
Routine Maintenance
Ground Systems
Painting
20 years Experience

John Nix

PO Box 13244 Salem, OR 97309
503-581-4056
1-800-321-4056

BROADCASTING & ELECTRONIC SERVICES LABS

PO BOX 178
NEWTON, UT 84327
801-563-3088

BROADCAST EQUIPMENT
REFURBISHED & REPAIRED
AUDIO, VIDEO, RE. DIGITAL

15 YRS EXPERIENCE

SPECIALIZING IN ERECTION,
REPAIRING, PAINTING
AND MAINTENANCE
RADIO, TWO-WAY, T.V. TOWERS
AND FLAG POLES

A STEEPLEJACK CO.
PAINTING AND STEEPLEJACK
CONTRACTORS

FULLY INSURED FOR YOUR PROTECTION

DON HIGHLEY 3722 ROMA
713-462-6105 HOUSTON, TEXAS 77080

RF Components

Field phasing
modifications
and installation

Call **Dave Gorman**
215-249-9662

POB 401
Dublin PA 18917

MIRKWOOD ENGINEERING

Rural & Remote Site
Field Engineering

50 Park Ave.
Claremont, NH 03743

603/542-6784

T & W

Tower/Antenna
Erection • Maintenance

* 24 Hr. Emergency Service *

Hurlock, MD
301-376-3555

TENCO TOWER

Lic. No. 357096

Installation & Maintenance of
Broadcast & Communications
Towers & Antennas

Donald J. Tenns

(916) 362-6846
(916) 638-8833
9723 Folsom Blvd. Suite A
Sacramento, CA, U.S.A. 95827 FAX: (916) 638-8858

PARAMOUNT
COMMUNICATION SYSTEMS

INSTALLATION AND SERVICE OF BROADCAST
ANTENNA SYSTEMS/TOWER MAINTENANCE & ERECTION

WESTMONT, NJ (609) 869-0222

WIDEST & FINEST CHOICE OF PRODUCTION MUSIC & SFX

PROMUSIC

Call For Our Free Demo & Information On
BROADCAST Plus
Annual Rates.

1-800-322-7879

**Complete Service for Lightning Protection,
Grounding and Power Conditioning**

We Guarantee NO Strikes

Call Lightning Eliminators & Consultants, Inc.

 6687 Aropohoe Road
Boulder, Colorado 80303
(303) 447-2828
FAX (303) 447-8122

CONTACT RADIO WORLD NEWSPAPER FOR AVAILABILITIES.

P.O. Box 1214 • Falls Church VA • 22041

1-800-336-3045

RECEIVERS . . . WTS

Heathkit FM-4 FM tuner in desktop metal cabinet; Fisher FM-90X FM tuner, signal strength meter, high impedance outputs. K Hart, WIEZ, RD 3 Box 1414, Millifintown PA 17059. 717-436-9089.

McMartin TRE6B (6) SCA rcvrs on 67 kHz, all solid-state, simple crystal change to your freq. P Lierman, KCSP, 601 W Collins Dr, Casper WY 82601. 307-265-5414.

Want to Buy

BC-474A rcvrxmtr, AVT-112 aircraft xmtr, AVR-20 aircraft rcvr, tech manual for MAR radio set. M Starin, WJYY, 357 Varney, Manchester NH 03102. 603-625-1165.

REMOTE & MICROWAVE EQUIP

Want to Sell

Terracom TCM-7 TV microwave link on 13 GHz, \$4900. T Hopkins, Cape Fear Enter, Rt 1, Box 269-A, Faison NC 28341. 919-594-0172.

Moseley PCL 505/C type approved, stereo composite, tuned to 949.500 MHz, set, BO; Moseley PCL 505/C type approved, stereo composite, tuned to 951.5 MHz, set, BO. Eddie, KCFX, 10800 Farley Ste 310, Overland Park KS 66210. 913-661-0101.

FOR YOUR NEXT REMOTE EVENT RENT THE GENTNER EFT-3000 3-line frequency extender package with Shure SM-7 studio mics. For more info call: Dwight Weller WELLES AUDIO-VISUAL ENGINEERING P.O. Box 4040, Baltimore, MD 21093 (301)252-8351

Scientific Atlanta 7300 & 7325 digital audio rcvr & processor unit w/1 dual 15 kHz & 1 voice cue decoder, like new, \$5950. W Clark, 318 E Calhoun, Macomb IL 61455. 309-837-2244.

Marti RPT-25P & R-50450 UHF remote pickup xmtr & rcvr, setup for telemetry operation, \$995. W Clark, 318 E Calhoun, Macomb IL 61455. 309-837-2244.

- NEW AND USED - Satellite Receive Only ANTENNAS PLUS! Receivers/Demodulators • Wegener • Fairchild • Harris • Scientific-Atlanta • Microdyne • Avcom • Prodelin For ALL Network Affiliations WE BUY • SELL • TRADE Flexible Lease Financing! TELCOM GROUP INTL PH. (505)883-4737 FAX (505)889-0078 OVERNIGHT DELIVERY AVAILABLE

Modulation Assoc ASAT freq agile SCPC satellite rcvr, \$1200. S Bush, KTKK, 3595 S 1300 W, Salt Lake City UT 84119. 801-264-8250.

Marti STL-8 STL xmtrs & rcvrs. WGER, 6165 Bay Rd, Saginaw MI 48604. 517-792-1063.

Micro Controls PTS-10C composite STL systems, 949.0 MHz, excel, \$2000. M Persons, KKIN, Box 930, Aitkin MN 56431. 218-829-1326.

Anixter Mark STL dish, 8', 6', 4' & mini reflector, call for details, BO. Eddie, KCFX, 10800 Farley Ste 310, Overland Park KS 66210. 913-661-0101.

Comrex LXT & LXR in excel cond, sold as package, \$850/both. D Dobrowski, WSSM-TV, POB 9089, Downers Grove IL 60515. 708-971-1829.

Silver Lake Audio now has available for rental: 3-LINE COMREX 2-LINE COMREX • PORTABLE DAT plus much more at reasonable rates! Call Steve for details (516) 623-6114

Zephyrus Open House Party downlink package w/dish (2) rcvrs & (2) LNB's, complete, \$1750. D Lane, WMVO, POB 348, Mt Vernon OH 43050. 614-397-1000.

Harris 6550 sat rcvr, complete w/pwr supply & 779 & 76.7 IF cards, manual, \$1500. R Yaw, KOJM, Box 7000, Havre MT 59501. 406-265-7841.

SPACE AVAILABLE Call 1-703-998-7600

TFT 7700-B in excel cond, trans & rcvr on 997.50, will sell 7601 remote control w/packages, has 192 & 67 kHz SCA cards; Marti RPT-2, RPT30, all fully companded, will sell as package or separate. T Edmisson, WDKN, 106 E College, Dickson TN 37055. 615-446-0752.

Pulse Dynamics remote bdct telephone w/(4) mics & one aux level input, \$100. M Persons, KKIN, POB 930, Aitkin MN 56431. 218-829-1326.

Moseley PCL606C composite rcvr only, excel cond. Goodrich Ent, 11435 Manderson, Omaha NE 68164. 402-493-1886.

Complete redundant Marti STL package, w/(2) TX's, (2) RX's, TX/RX splitter/combiner, custom audio switcher & (2) Mark SH872GN antennas, avail late January, BO. J Bisset, Multiphase Consulting, 703-379-1665.

Scientific Atlanta 7325 digital processing unit w/150 digital audio decoder & voice cue decoder, 7300 wideband BPSK rcvr w/vari- ous crystals, \$5500. G Ayers, WWIT, POB 1369, Canton NC 28716. 704-648-3588.

Micro Controls PTS-10C composite STL, 949.0 MHz, excel cond, \$2000; Micro Controls DRCR-9 remote control, \$1500; Micro Control 20017/R 455.02 MHz STL, \$1000. M Persons, KKIN, POB 930, Aitkin MN 56431. 218-829-1326.

Want to Buy

7.5 kHz dual audio card for Fairchild/Comtech Dart 384 digital satellite rcvr, or will trade 15 kHz card for same. S Bush, KTKK, 3595 S 1300 W, Salt Lake City UT 84119. 801-264-8250.

Ku-band TV satellite uplink, MPA, exciter, etc, truck unnecessary. U George, Satellite TV, 314 W 52nd, NNYN 10019. 212-677-2200.

Marti VHF RPU freq close to 161.70 otherwise any will do, could use xmtr & rcvr. J Boswell, 205-222-8849.

Harris 6550 chassis, pwr supply, down converter, agile FM demod, need immediately. RJ Miller, WRVI, Virden IL 62690. 217-965-3388.

TV satellite uplink, prefer Ku-band, exciter, HPA, etc, truck unimportant. Ugy George, Satellite TV, 314 W 52 St, NNYN 10019. 212-677-2200.

STATIONS

Want to Sell

Class A FM w/CP to upgrade to 50,000 W, located half way between Jackson & Nashville TN, near the Loretta Lynn Dude Ranch, must sell immed due to health reasons, \$200,000, terms avail to exper bdct w/gd credit & bank ref, serious inquiries only. B Coleman Jr, WIST, POB 460, Lobelville TN 37097.

Private investor will fund new stations or acquisition of existing stations, must show gd potential debt or equity investment. M Ernst, WBUJ TV, 720 Fairhill Dr, Louisville KY 40207. 502-893-6656.

AM and/or FM radio stations for sale in central Arkansas or will sell percent to active working partner. Vivian, 501-470-1525 or 501-568-5448.

For Sale By Owner in Youngstown-Warren Ohio market. 1 kW, 830 AM, excellent dial position, regional signal reaches Cleveland to Pittsburgh. Price \$300,000-terms. Call daytime, Patrick Engrao, 412-981-3275, evenings call Robert Zippay, 412-347-3597.

SOUTH TEXAS CLASS A FM OIL RICH AREA \$ 249,000 414-482-1959

FM 67 kHz subcarrier avail, Class A FM station xmtr locate in Queens County, NY, greater Nassau, Queens, Westchester & Southern Connecticut coverage. J Caracciolo, WDFE, 1600 Stewart, Westbury NY 11590. 516-832-9400.

Class B FM in Northern California, 3 county coverage, BE automation system installed, AC format. R Trumbo, KNLF, POB 117, Quincy CA 95971. 916-283-4144.

10 kW clear channel AM & Class A FM, can be upgraded to Class C-2-50 kW, either of both, owner financing possible to qualified buyers. 501-470-1525.

Midwest FM (2), upgrade avail to C-3, will finance w/down; also (1) AM FT, serious inquiries only. Radio, POB 459, St Charles MO 63302.

NEEDED! AM,FM,LPTV STATIONS. DARK & CP'S OK. HAVE BUYERS! 614-459-3020. POB 1424, DUBLIN OH 43017

Olympic City/Atlanta Metro, AM station w/10 acres of land at tower/xmtr site & all station equip, \$350,000. PO Box 52682, Atlanta GA 30355.

BROKER AM AND FM RADIO STATIONS HAVE BUYERS AND SELLERS FINANCIAL PACKAGE AVAILABLE 1-813-747-7373 ALL INFORMATION CONFIDENTIAL

CPs for AM/FM combo located in resort area between major Montana markets, 10 kW AM, 50 kW FM w/possible upgrade, some equip included in package, BO. H McDonald, Broadcast Associates, POB 807, Veradale WA 99037. 509-924-8298.

Partners/Investors wanted for new high-power FM in mountain states & for AM/FM combo in deep south, \$10K minimum, serious inquiries only. L Fuss, KOOZ, POB 159, Fayetteville GA 30214. 404-460-6159.

Class IV AM for sale in SW Oregon. Fast growth area. Joint venture. Active/inactive. \$10K min. M. Gottesman. 3377 S-lano Ave., #312; Napa, CA 94558. No calls.

Want to Buy

AM or FM, dark or troubled OK, owner financing w/llite or no down. E.M., POB 652, Mishawaka IN 46544.

Exper owner seeks new TV stations, troubled or dark & CP's, full power & low power, outright sale or joint venture. M Ernst, WBUJ TV, 720 Fairhill Dr, Louisville KY 40207. 512-893-6656.

Small AM or FM station for sale or take over in US w/small down or complete buyout, dark stations given equal consideration, trying to turn into family operation. S Neumann, 1240 Riverbreeze Blvd, Ormond Beach FL 32176. 904-441-6956.

AM, FM or LPTV problem station, turn arounds, daytimers, dark, etc, send complete details w/price & terms. J Powley, 1536 Logan, Altoona PA 16602. 814-944-8571.

Broadcast consultant w/extensive exper in all phases of broadcasting seeking to buy radio station, must be owner financed, AM's OK, ready to purchase today. Call 609-387-1275.

CP, dark, etc, for Christian programming. P Morton, WMNV, Box 57, Rupert VT 05768. 802-394-7858.

Looking for AM, FM, or combos to take over with no down. J Ballard, ALL Prod, POB 1786, Apl Vly CA 92907. 619-2617787.

Seeking financing assistance for station start-up, willing to get started but no collateral or money. J Ballard, ALL Prod, POB 1786, Apl Vly CA 92907. 619-261-7787.

STEREO GENERATORS

Want to Sell

Harris-STX-1B, Harris built C-QUAM AM stereo exciter & BE AS-10 C-QUAM monitor, currently on-air w/manuals, \$6500. P Patton, WAPQ, 28 W Main, Jasper TN 37347. 615-942-5611.

CCA SG-10 stereo gen, \$175 plus \$15 shipping. M Gollub, WMJS, Box 547, Prince Frederick MD 20678. 301-535-2201.

RCA BTS-101 (2); RCA BTX-101 SCA. R Lankton, WDUV/WBRD, 813-749-1420.

SWITCHERS (VIDEO)

Want to Sell

Echeiab SE-2 w/keyer, matte, \$600/BO. R Jensen, MPI Productions, 5812 21st St, Racine WI 53906. 414-632-3131.

Telemation TPS-12x3, working, \$150/FOB. K Kuaspert, A-V Prod, 1794 Russell, Baroda MI 48101. 616-422-2235.

TAPES, CARTS & REELS

Want to Sell

Complete library of movies & cartoons, 270+ titles, all on VHS tape, \$500 plus shipping. D Dr-browski, WSSM TV, POB 9089, Downers Grove IL 60515. 708-971-1829.

U-matic cassettes, like new, one pass only 5/10 min lengths, \$2 ea; 15/20/30 min, \$3 ea, plus shpg, cassettes includes library cases, some shipping cases approx 500 avail. J Powley, 1536 Logan, Altoona PA 16602. 814-944-8571.

ScotchCart II 3-7 min, new & used. Clark, WFA5, Secor Rd, Hartsdale NY 10530. 914-693-2400.

Adult contemporary music reels, 10.5", some in metal, BO. P Urso, 603-332-0930.

Fidelipac Mastercart, several hundred in various lengths, commercial thru music, \$2 plus shipping ea/BO. C Condon, KLZX, 180 S 320 W Ste 400, Salt Lake City UT 84101. 801-580-3025.

A&D Cartridge Rebuilding Service We clean, load & pack. Serviced within 10 work days! Work guaranteed! 3706 Vold Ct., Eau Claire, WI 54701 (715) 835-7347

Telex/Viking M4 & M6, new, double & single coated lubed cart tape, free shipping. E Davison, Beatty TeleVisual, 135 N Illinois, Springfield IL 62702. 217-787-0800.

Carousel cart rack woodgrain, 240 trays, \$175; Lazy Susan wire cart rack, 200 trays, \$50. Delta Bdctg, POB 430, Helena AR 72342. 501-338-8361.

ABC wire cart racks (3) on floor stands, holding 500 carts ea, \$225 or all for \$600; Capitol A-2 carts (342) in fair to gd cond, \$1.20 ea; Scotchcart II's w/easy listening/jazz library (1178), well recorded in stereo, \$2/ea or \$2100/all; L.E.L. alignment gauges (1 set) for Ampro cart decks, \$15. P Wells, KJQY, San Diego CA, 619-238-1037.

Fidelipac carts (600), all lengths & conds, extra shells & parts, tape in gd to poor cond, most shells are usable, gray carts, \$500/all. H Widsten, KGNB, 1540 Loop 337 North, New Braunfels TX 78130. 512-625-7311.

Reels, 175 boxed 10" reels of bulk erased high quality tape, \$350 plus shpg. A Lia, KDLM, Box 746, Detroit Lakes MN 56501. 218-847-5654.

Audiopak AAA Super carts, 5000+, new shells, various lengths, take all or part, \$3 ea. R Allen, TM Century, 14444 Beltwood Pkwy, Dallas TX 75244. 800-937-2100.

Scotchcart II AC library & nostalgia, new in 1988. BO. P Urso, 603-332-0930.

NEW WE NOW ACCEPT VISA & MASTERCARD

Audiopak AA-3 carts, in all popular music lengths, 2:00 thru 4:00, hundreds ready to sell, none over 2.5 yrs old, \$2 ea. R Sather, KPYP, 88 Union, Memphis TN 38103. 901-529-0098.

Want to Buy

Capps or other hot stylus kit for Presto 80-G recording lathe; Van Epps R-D-2 instruction manual/information needed to set-up, gd photo copy OK. C Lund, Cycle Sound & Video, 167 Madison, Waterbury CT 06706. 203-756-7761.

RCA, Presto disc recorders & assoc equip incl blanks, needles & pre-recorded transcriptions. B Davies, Virgo Prod, 5548 Elmer Ave, N Hollywood CA 91601. 818-761-9831.

NAB alignment tape, 15 ips. D deForrest, In-sight Prod, 7441 Wayne Ave Ste 10-B, Miami Beach FL 33141. 305-866-5401.

Capital Production Music 500 series old prod music libraries for TV/motion pictures/radio, especially Capital Q Series 500, other libraries considered, for personal music collection. S Richards, Super Sonic Prod, 1401 NE 149th, N Miami Bch FL 33162. 305-949-2040.

TAX DEDUCT EQUIP

Christian educ foundation seeks donation or low cost FM radio station equip, need everything, tax receipt given. D Parks, KSOH, POB 19039, Spokane WA 99219. 509-233-2024.

FM Christian non-profit station seeking 10K xmtr, 6-10 bay antenna tuned to 90.5, studio equip. M Schwarzbauer, Family Educ Bdctg, 1715 Michigan, Sturgeon Bay WI 54235. 414-743-6065.

Bdct training school for underprivileged needs any AM bdct equip for training students unable to attend regular bdctg schools, able to pay shipping on small items. F Smith, The Bdct Training School For the Underprivileged, 2408 Chamberlain, Chattanooga TN 37404. 615-6247126.

Enclosed rack, 6', for xmtr, also exciter, Harris MS15 or equiv, working carts & play & R/P or sound PA equip. A Hagler, KMUD, POB 135, Redway CA 95560. 707-923-2513.

Any/all bdct gear for new station, audio & RF, pieces & parts, will pay shipping. KGNV, Rt 2 Box 45, Washington MO 63090. 314-239-0401.

Equip for missionary radio station in South Pacific, FM xmtr 500 W or 1 kW, audio consoles stereo or mono, STL xmtr/rcvr, cart machines, R-R's, many other items, call or write for list, tax-deductible receipt for all donations. J Goldring, Calvary Chapel-Spring Valley, 3400 S Jones, Las Vegas NV 89102. 702-364-9350.

Educ FM needs equip of any type, will also trade. C Hubbleing, KTEQ, 501 E St Joseph, Rapid City SD 57701. 605-3942231.

Eng student desiring donation of old bdct equip (anything) in repairable cond, will pay all shipping charges, EE student at Purdue. C Gill, POB 371, Indianapolis IN 46206. 317-923-2800.

Monte Vista Christian School, would appreciate any donations of used TV broadcast equipment. T Quinn, 408-475-0423.

TEST EQUIPMENT

Want to Sell

Nems-Clarke Type 120E field intensity meter in gd cond. M Ripley, KOZE, Box 936, Lewiston ID 83501. 208-743-2502.

The VISION MOBILE STUDIO Increase your MOBILITY, VISIBILITY, PROFITABILITY . . . with a powerful, compact, fully equipped, easy to use mobile remote broadcasting studio, designed for your needs. VISION MOBILE STUDIOS VOYAGER RV CENTER, INC. 79 OLD PALATINE ROAD WHEELING, ILLINOIS 60090 PHONE: 1-708-537-1770 FAX: 1-708-537-1899

LAUX satellite system w/(2) 8705 audio terminals, LNA LC0106, 70 MHz downconverter. (2) runs of 25-30' ea of RG/59 U coax, 9' parabolic dish for 4 GHz, w/books. A Garza, Foster Comm, 2524 Sherwood Way, San Angelo TX 76901. 915-949-2112.

Marti RR30/150 receiver tuned to 161.70 MHz, \$450. E Douglas, KUNQ, POB 30, Houston MO 65483. 417-967-3353.

TFT 7610 digital remote R&C, \$1500; Moseley TRC-15 system control, \$1600; Scientific Atlanta 10' satellite dish w/feed assembly, \$400. Delta Bdctg, POB 430, Helena AR 72342. 501-388-8361.

Gates Attache 70; custom made 5 chnl remote mixer. K Hart, WIEZ, RD 3 Box 1414, Millifintown PA 17059. 717-436-9089.

TOWER LIGHT FAILURE MONITOR • Immediately notifies the operator of tower light failure. • Ties into existing remote control equipment, or uses an automatic dialer. • One day memory, to inform daytime operator of failure the previous night. • Memory is automatically reset daily. \$299.00 (Includes 1 year warranty & full documentation) Flying Fur Industries 4910 Four Star Court Fort Collins, CO 80524 303-484-2704

MARATHON PRODUCTS COMPANY

Audio Cartridge Rebuilding Division

Rebuilding/reloading, like new, all brands, any length up to & including 3.5 minutes, \$1.75 ea. FOB our plant, 48 hrs delivery.

New NAB Marathon cartridges prices on request. *35 Years professional experience!* Lifetime member AES R.D. MYERS Sr. Manufacturers of Audio Devices, Continuous Tape Mag.

69 Sandersdale Rd.,
Charlton, MA 01507
1-508-248-3157 or 1-508-853-0988

TEST . . . WTS

Tek 504 oscilloscope, vgc, strong tube, \$300/BO. B Baker, Pinetucket Recdg, 747 Wire Rd, Auburn AL 36830. 205-826-0390.

Tek 1410 NTSC test gen w/modules, \$2900; Tek 529 waveform monitor, \$325. T Hopkins, Cape Fear Enter, Rt 1 Box 269-A, Faison NC 28341. 919-594-0172.

Sencore VA62 signal gen/analizer w/VC-63 video head test accessory, \$2600. L Teffeltter, KPCC, 1570 E Colorado, Pasadena CA 91106. 818-578-7132.

Sound Technology AN-1 stereo simulator, \$350. M Persons, KKin, Box 930, Aitkin MN 56431. 218-829-1326.

HP 654A test oscillator & 334A distortion analyzer, both w/fresh calibration, \$1700/both. B Hildebrand, Computraffic, 8604 Hedgebur, St Louis MO 63114. 314-427-2727.

HP 3550B test set incl HP audio oscillator, HP patch panel & HP DB meter, excel cond, \$500. G Arroyo, WONO, 2483 John Young Pkwy, Orlando FL 32804. 407-293-0000.

HP 5245L electr counter & HP 5253B freq converter, \$275/both plus \$20 shipping. M Gollub, WMJS, POB 547, Prince Frederick MD 20678. 301-535-2201.

Leader 3060D digital storage oscilloscope dual trace, real time storage, on screen readout, cursers, GPIB. D Groth, WPDH, POB 416, Poughkeepsie NY 12602. 914-471-1500.

Complete audio proof equip including B&W 410 dist meter, B&W 210 audio oscillator, Gates/Harris stereo gain set, all manuals, very clean, \$1000/BO. D Sports, WCLA, POB 427, Claxton GA 30417. 912-739-3035.

Multi use freq counter new in box, \$950. D Wolf, West Star Comm, 122 Crane, Panama City Bch FL 32413. 904-233-2051.

Leader LPM-880 radio freq pwr meter, scales 0-5 W, 0-20 W & 0-120 W, range 1.8-500 MHz, new, \$125. S Lawson, KAK Prod, 928 Hyland Dr, Santa Rosa CA 95404. 707-528-4055.

Eico 425 push pull oscil; Eico 1032 regulated pwr supply; 12 V pwr supplies, (2) separate units; Eico 1120 capacitor substitution box; Waveforms mdl 510-B oscil; RCA IF7084 small parts drawer cabinet; B&K Dynajet 607 tube tester in portable case; Precision 612 tube tester; B&K 907 transistor equip analyst; Precision E-200-C signal gen; US Army Signal Corps BC-221-N freq meter. K Hart, WIEZ, RD 3 Box 1414, Mifflintown PA 17059. 717-436-089.

RMT 506 mainframe, rack mount w/DM-502A freq counter, SG-505 audio signal gen, SC-502 oscil & AA-501 audio analyzer, avail late January. BO. J Bisset, Multiphase Consulting, 703-379-1665.

HP 5245L electronic counter & HP 5253B freq converter, \$275/both plus \$20 shipping. M Gollub, WMJS, Box 547, Prince Frederick MD 20678. 301-535-2201.

Tek 323 portable, solid state 4 MHz single trace oscilloscope, AC or NiCad powered, w/manual & probe, \$450; Tek 454 portable 150 MHz dual trace oscilloscope, cal sweep delay, mod 163, mint cond w/manual, \$625; Tek 520A NTSC vectorscope, gd CRT, w/manual, \$1895; Tek 529/RM529 TV waveform monitors, w/manual, \$425 ea. R Sumner, CAVU Corp, 3322 Applegate Ct, Annandale VA 22003. 703-560-0233.

Tek 1L20 spectrum analyzer plug in module in mdl 132 portable pwr supply unit; Singer MF 500/UR-3 spectrum analyzer; B & W 410 dist meter. R Lankton, WDUV/WBRD, 813-7491420.

B&W 400 tube type dist analyzer, \$50 plus UPS; HP 200C tube type audio oscillator 20 Hz to 2 MHz, \$50 plus UPS. J Crawley, WLSK, Box 680, Lebanon KY 40033. 502-465-5762.

Sony-Tek 335 dual trace portable oscil, w/case, probes, manual, like new, \$750. B Dorsey, TVS, 195 Tenth Ave, Nyny 10011. 212-675-0437.

Sencore VA-62, VC-63, NT-64, complete video gen/analizer, \$2200. L Clinton, KARN, POB 4189, Little Rock AR 72214. 501-661-7500.

NLS MS-15 15 MHz single trace oscilloscope w/case, probe, book & battery, gd cond, \$150. M Persons, KKin, POB 930, Aitkin MN 56431. 218-829-1326.

Want to Buy

Complete board A3, reciprocal amp for HP 8690B sweeper, also want 8698B & 8699B plug-ins. Herb, CFQC TV, 216 First Ave N, Saskatoon, Sask S7K 3W3, Canada. 306-249-1656.

HP 606B tech manual. M Starin, WJYY, 457 Varney, Manchester NH 03102. 603-625-1165.

Potomac Instruments FIM-41 field intensity meter. F Spaulding, 883 San Simeon Dr, Mtn View CA 94043. 415-961-5018 voice/efax.

Book for Radio Specialties 1163-50-5 FM deviation meter. M Persons, KKin, POB 930, Aitkin MN 56431. 218-829-1326.

TRANSMITTERS

Want to Sell

Harris/Gates BC 1H 250/500/1000 W, very clean, excel cond, tuned for 900 kHz, BO; Collins 500A-1 presently being used as auxilliary, 250/500 W, BO. A Terry, WODY, Box 545, Bassett VA 24055. 703-629-5900.

Continental 816R3 25 kW, gd cond, tuned to 100.7 MHz, less exciter, BO. Eddie, KCFX, 10800 Farley Ste 310, Overland Park KS 66210. 913-661-0101.

MARTI STL-8's
Discreet \$1995
414-482-2638

Gates M6095 10 W exciter, \$200/BO. J Linn, WHKS, 62 N Main, Port Allegany PA 16743. 814-642-7004.

Kahn STS-1 stereo exciter w/pwr side, tuned to 1140 kHz, excel cond, \$2600; Collins 20V tuned to 1090 kHz in gd cond, \$1500. G Arroyo, WONO, 2483 John Young Pkwy, Orlando FL 32804. 407-293-0000.

LEASING AVAILABLE
ON USED
TRANSMITTERS
AMERICAN BROADCAST
FINANCIAL CORPORATION
414-482-2638

Collins 310Z-2 exciter, 94.3 MHz, excel, \$4000; QEI 7775 ATS System, excel, \$500. M Persons, KKin, Box 930, Aitkin MN 56431. 218-829-1326.

Emcee TTS-20 (2) 20 W TV xmtrs in the 2 GHz region w/RCA color TV modulators, excel cond, BO. P Parks, KLVJ, 27 Sawyer, Beaumont TX 77702. 409-838-3911.

Plate transformer for Gates FM-10G xmtr. S Cichorsky, KPRL/KDDB, POB 7, Paso Robles CA 93447. 805-238-1230.

RCA BTA 50F fully operational wall tubes, schematics, floor layouts in storage for immed removal, w/electrostatic air filter, solid state rectifiers, magnaphase lightening protection system & many more extras, \$14,000 plus shpg. G Heidenfeldt, 2880 W Lake, Wilson NY 14172. 716-751-6187.

Harris FM-35K, only 2-yrs. old, like new; Continental 802A, exciter, excel; McMartin B910 exciter, low price; USED LINE- like new, 1 5/8", 3" & 3.5", plus 3" rigid. Priced to sell.
(816) 635-5959.

New modulation xfomer for BTA 5F xmtr in original crate, \$600 plus shpg. G Heidenfeldt, 2880 W Lake, Wilson NY 14172. 716-751-6187.

Collins 831G-1 20 kW in mint cond, completely recond, all new cap's, no PCB's, new control cards, 97.1 MHz, spare parts & manuals, avail 1/91. R Kazda, Parker Comm, 2826 IDS Ctr, Minn MN 55402. 612-349-6500.

Johnson Thunderbolt 1 kW linear exciter, uses 4-400 tubes, w/case, gd cosmetics, all original, Johnson knobs, BO; Gonset Communicator III, 6 meter transceiver, 110 AC, 6/12 VDC, original manual, gd cosmetics, works, \$75; Knight KN3560 tube CB 12V/110V, blue/silver, near mint, works, \$75. W Kremer, Kremer Kraft, 301 SW 16th, Ft Lauderdale FL 33315. 305-524-5652.

Harris AM MW-1A 1977 in excel cond on 1500 kHz, used at 250 W, now on-air, call for availability, \$9500. R Coleman, WGEN, 1003 S Oakwood, Geneseo IL 61254. 309-944-4633.

McMartin BA1K 1 kW AM. Goodrich Ent. Inc, 11435 Manderson St, Omaha NE 68184. 402-493-1886.

Phasemaster T-10,000-A-2-AS (2) for 3-phase conversion, handles 20 kW FM xmtr or 25 kW AM xmtrs, \$2800 ea. G Arroyo, WONO, 2483 John Young Pkwy, Orlando FL 32804. 407-297-1140.

Harris STX-1B & STM-1B AM stereo exciter & monitor operating true C-QUAM system, excel cond, BO. B Bailey, KJEF, POB 1248, Jennings LA 70546.

RCA BTA 5F, excel cond in storage for immed shipment, w/all floor layouts, manuals, tubes, \$9000 plus shpg. G Heidenfeldt, 2880 W Lake, Wilson NY 14172. 716-751-6187.

ARMSTRONG TRANSMITTER

FINEST REBUILT TRANSMITTERS

We're the leading re-manufacturer of transmitters worldwide.

Transmitters are available:

- Tuned & Tested on YOUR Frequency
- Guaranteed and Installed
- Completely Re-manufactured
- Expedited Service Available

Trade-Ins gladly accepted - **WE DELIVER!**
See your choice in transmitters WORKING in our huge new showroom BEFORE you take it home!



**NO ONE ELSE OFFERS YOU THIS!
SEE & TEST IT ALL YOU WANT!**

ARMSTRONG TRANSMITTER CORP.

5046 Smoral Road Syracuse NY 13031
Phone 315-488-1269 FAX 315-488-1365

Circle 45 on Reader Service Card



High performance at affordable prices.

- New front panel programmable composite STL's.
- New directly programmable FM composite receivers
- New options for synchronous boosters and translators
- New FM exciters, transmitters, amplifiers: 2W to 30kW
- Same old price, quality service and reliability

Bext, Inc.
739 Fifth Avenue,
San Diego, CA 92101
619-239-8462

Telex 229882 Fax 619-239-8474

RF-300A 300 W MosFET pwr amp, module 48 V, new for 60-165 MHz; EST-300 300 W xmtr, solid state, harmonic filter & pwr adjust. C Springer, KLMR, POB 890, Lamar CO 81052. 719-336-2206.

FM TRANSMITTERS

Cetec 690 Exciter
BE FX-30 Exciter

1 kW Gates 1G
5 kW Harris 1H
10 kW Harris 10H
20 kW RCA BTF-20E1

AM TRANSMITTERS

20 W LPB-25C
1 kW Collins 20V2
10 kW CCA 10

"The Best Prices Worldwide"
PMA MARKETING, INC
414-482-2638

Home brew 50 W AM, set to your freq, adjusts 5-50 W, \$500. J Cunningham, KEOR, Rt 2 box 113B, Stonewall OK 74871. 405-265-4496.



FIRST FOR ALL YOUR FM NEEDS:

- Exceptional FM Exciter Performance
- Advanced Line of 1kW to 8kW Total Solid State FM Transmitters
- Full Line of FM Transmitters from 150 Watt to 50kW to Meet All Your FM Needs
- Excellent Financing Available

TTC
813-684-7724

FINEST REBUILT TRANSMITTERS

FM TRANSMITTERS

1 kW	Gates	FM1B
1 kW	ITA	1000B
1 kW	RCA	BTF1D
1 kW	Collins	830D1
1 kW	RCA	BF1E
1 kW	Harris	FM 1H
2.5kW	Collins	831D1
2.5kW	Continental	814R2
3 kW	RCA	BTF 3E
3 kW	G.E.	3KW
3.5kW	B.E.	3.5A
3.5kW	McMartin	BF 3.5K
5 kW	RCA	BTF-5D
5 kW	RCA	BTF-5E
10 kW	RCA	BTF10D
10 kW	Gates	FM10B
10 kW	Harris	FM 10H
20 kW	CCA	20,000E
20 kW	Collins	831G1
20 kW	RCA	BTF-20E1
25 kW	Wilkinson	25000
25 kW	McMartin	BF25K
25 kW	Harris	FM-25K
30 kW	McMartin	BF30K

AM TRANSMITTERS

250W	RCA	250GL
1 kW	Gates	BC1F
1 kW	Gates	BC1T
1 kW	Gates	BC1J
1 kW	CCA	1000D
1 kW	Collins	20V2
1 kW	Collins	820D1
1 kW	McMartin	BF-1K
1 kW	Harris	MW-1A
1 kW	Bauer	707
1 kW	Gates	8C-1G
5 kW	Gates	BC5E
5 kW	RCA	BTA5T
5 kW	Collins	21E
5 kW	RCA	BTA-5L
5 kW	Harris	BC-5H
5 kW	Wilkinson	5000E
5 kW	Collins	820E/F
5 kW	Gates	BC-5P2
10 kW	RCA	BTA10H
10 kW	Harris	BC-10H
50 kW	RCA	50G
50 kW	GE/Canada	50KW
50 kW	Continental	317B

ARMSTRONG TRANSMITTERS
5046 Smoral Road
Syracuse, NY

(315) 488-1269
FAX (315) 488-1365

TRANSCOM CORP.

Fine Used AM & FM Transmitters and Also New Equipment

For the best deals on Celwave products, Andrew cable, Shively & Comark antennas.

1978	CCA 2500R, 2.5 kW FM	1974	Harris BC1H1, 1 kW AM
1983	Wilkenson 10000E, 10 kW FM	1981	McMartin BA2.5K, 2.5 kW AM
1980	Harris FM10K, 10 kW FM	1966	Cont. 315B, 5 kW AM
1973	RCA BTF 20E1, 20 kW FM	1980	McMartin BA5K, 5 kW AM
1972	Harris/Gates FM20H3, 20 kW FM	1972	CCA AM5000D, 5 kW AM
1971	Harris FM20H3, 20 kW FM	1977	RCA BTA 5L, 5 kW AM
1975	Collins 831G2, 20 kW FM	1972	RCA BTA 10U, 10 kW AM
1986	Cont. 314R1, 1 kW AM	1980	Cont. 316F, 10 kW AM

201 Old York Rd. • York Plaza Ste 207
Jenkintown PA 19046
215-884-0888 • FAX No. 215-884-0738

Circle 108 on Reader Service Card

PETER DAHL CO.

Save \$\$

Heavy Duty Replacement Transformers, DC Filter chokes and capacitors for AM & FM transmitters manufactured by: AEL, CCA, CSI, COLLINS, CONTEL, CONTINENTAL, BAUER, GATES, GE, HARRIS, ITA, McMARTIN, RAYTHEON, RCA, SINGER, SINTRONIX, WILKINSON. Many other models also available.

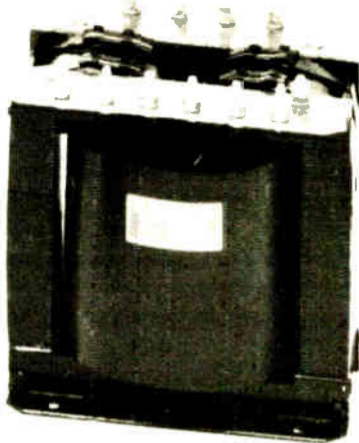

FAST Delivery and FREE Technical Support.

5869 WAYCROSS AVENUE EL PASO, TEXAS 79924
(915) 751-2300 TELEEX: 76-3861 PWDCO
FAX: (915) 751-0768



Circle 143 on Reader Service Card

TRANSMITTERS ... WTS

Gates FM M-6095 exciter & M-6148 xmtr, 10 W, exciter gd cond, w/manual, 91.5 MHz, stereo gen needs some work, \$250/BO. D Ransom, Box 6073, Riverton WY 82501. 307-857-6866.

Sintronix FM 10 w/full metering, filters, cabinet, 89.3, \$1000. Clark, WFAS, Secor Rd, Hartsdale NY 10530. 914-693-2400.

Continental 814R-1, 2.5 kW FM, 510R-1 exciter, 103.3 MHz, excel cond, \$12,000. L Bush, KWOW, 400 Bowden, Waco TX 76710. 817-776-2640.

Jetricon TDD-5, carrier current or low pwr xmtr set to your freq, US Gov't surplus, rugged, 20-50 W AM. J Cunningham, KEOR, Rt 2 Box 113B, Stonewall OK 74871. 405-265-4496.

AEL FM 5K, working when removed. S Chichorsky, KPRL/KDDB, POB 7, Paso Robles CA 93447. 805-238-1230.

CCA FM-10DS 107.1 exciter, vgc w/manual, \$400. D Sports, WCLA, POB 427, Claxton GA 30417. 912-739-3035.

Collins 831C, 2.5 kW, great cond, \$10,000. G Herpin, KRTY, 106 Royce St, Los Gatos CA 95030. 408-354-6622.

NEW McMARTIN BF-5K
Lowest priced tube replacements

5500 W FM, broadband grounded grid output circuit, VSWR protection, excellent efficiency 75-80% automatic recycling & overload status. Fully remote controlled. FCC approved to 5500 watts.

Goodrich Enterprises Inc.
11435 Manderson Street
Omaha, NE 68164
402-493-1886
FAX: 402-331-0638

Collins 30K-4 2.30 MHz, 300 W CW or phone, fair cond, will trade for FM exciter, FM deviation meter or \$800. J Cunningham, KEOR, Rt 2 Box 113B, Stonewall OK 74871. 405-265-4496.

Motorola 1300 AM stereo exciter, excel cond. G Ciapper, KKGR, POB 9032, Gresham OR 97030. 503-667-1230.

Thompson CSF 334583 chnl 2 TV xmtr w/synthesized offset, 10 W, excel working cond. R Paskvan, KBSB, 3516 Mill, Bemidji MN 56601. 218-751-3077.

Bext TEX20-NV 20 W in excel cond, \$2000. T Edmison, WDKN, 106 E College, Dickson TN 37055. 615-446-0752.

Gates BC-5B 5 kW AM tuned to 560 kHz gd cond w/spares, \$2500/BO. D Barton, KMTI, POB K, Manti UT 84642. 801-835-7301.

CCA VSWR watchdog, \$150 plus \$10 snipping. M Gollub, WMJS, Box 547, Prmcse Frederick MD 20678. 301-535-2201.

McMartin BK-50 50 kW, uses 4 tubes will come w/all electrical boxes, conduit, AC wiring & oversize external exhaust system, avail early 1991 & modified for AM stereo, BO. J Bisset, Multiphase Consulting, 703-379-1665.

Bird 8897 5 kW load 50 ohm, mint cond, \$800. B Clark, Bullitt Bldg, Rt 1 Bardstown Rd, Mt Washington KY 40047. 502-5384784.

Dummy load 20 kW air cooled electro w/wattmeter & 31/8" section. Goodrich Ent., 11435 Manderson, Omaha NE 68164. 402493-1886.

Gates FMIC 100 W, 96.7 MHz, gd cond, \$300/BO or will trade for equip. C Hubbing, KTEQ, 501 E St Joseph, Rapid City SD 57701. 605-394-2231.

RCA BTE 15A FM exciters (2). R Lankton, WDUV/WBRD, 813-749-1420.

CSI/CCA FM-3000E 3 phase plate transformer only, 4600 volt secondary for up to 3.5 kW xmtr, gd cond, \$375. K Fitzgerald, WKBG, POB 792, Great Bend PA 18821. 717-879-9925.

Collins 310Z-2 FM exciter, 94.3 MHz, excel cond, \$2000. M Persons, Kkin, POB 930, Aitkin MN 56431. 218-829-1326.

Collins 21-E in gd cond on skids, needs finals w/1000 W cutback on 1380 kHz, \$4500; Gates BC-F 1 kW w/500 W cutback on 1260 kHz, many spares, all gd iron & finals, \$1000. T Edmison, WDKN, 106 E College, Dickson TN 37055. 615-446-0752.

Bext has some show units at sale price. Full 2 yr warranty, like new. Exciters, amplifiers STL's. First come first served only. Call for details. Bext, 619-239-8462.

Wilkinson FME10 exciter. Condition unknown, \$40. Call Mr. Ericson, 212-477-2489.

McMartin B-910 FM exciter's. C Goodrich, 11435 Manderson, Omaha NE 68164. 402-493-1886.

Want to Buy

Low power FCC approved under Part 15 xmtr or leaky wire RF system for talking billboards, AM or FM quantities OK. B Baker, Pinelucket Recgd, 747 Wire Rd, Auburn AL 36630. 205-826-0390.

Harris or Continental 1984 or later, prefer solid state, for 50 kW AM station, can fax info. K Faulkner, WGUN, 404-939-8258 or fax: 404-939-0795.

FM 5 or 10 kW in gd working cond. R Lark, WXCE, Box 1260, Amery WI 54001. 715-268-7185.

AM, 5 kW, no PCB's. J Roach, KARY, Box 1310, Prosser WA 99350. 509-786-1310.

2-5 kW, can fax info. E Anderson, WEAS, 912-234-7264 or fax: 912-233-7247.

LPTV 10-100 W VHF, 100 W-2 kW JHF. M Erns, WBUJ TV, 720 Fairhill Dr, Louisville KY 40207. 502-893-6654.

Any FM greater than 5 kW CW power wanted not for over air use at reasonable price. D Randall, 321 Sandbank, Chesire CT 06410. 203-272-6774.

WANTED

AM and FM Transmitters, all powers. Finders fee for locators. DON'T take the chance of not being paid, sell to the oldest broadcast supply house in Latin America.

GUARANTEE RADIO SUPPLY CO.
1314 Iturbide
LAREDO, TX 78040
(512) 722-3233
(512) 727-8458 (fax)

FM 1 kW in fair-gd cond, can rebuild if needed, some cash, some tax credit possible. B Raithman, KSDC, 200 N Monroe, Eugene OR 97402.

USED TV TRANSMITTERS, antennas, cable, rig.c line, etc one watt to 110 kW. Fair market price paid. Turnkey handling.

BROADCASTING SYSTEMS
602-582-6550
FAX: 602-582-8229
Kenneth Casey

RCA TTU-1B or TTU-2A UHF TV xmtrs for parts: GE TT-24-A 100 W or TT-20-A 1 kW JHF for parts; RCA instruction manuals for TTU-10A UHF TV xmtr. J Powley, 1536 Logan, Altoona PA 15602. 814-944-8571.

Low band 2-6 VHF TV xmtr, 100 W to 11 kW, exper eng can handle removal. J Powley, 1536 Logan, Altoona PA 16602. 814-944-8571.

UHF & VHF TV translators, 10-100 W, will consider old UHF band 70-83 equip; low band 2-6 VHF TV xmtr, 100 W to 11 kW. J Powley, 1536 Logan, Altoona PA 16602. 814-944-8571.

Crystal for 96.3 MHz for Gates M6095 exciter. S Olszowka, WKQW, 234 Elm, Oil City PA 16301. 814-676-8254.

2/5 kW xmtrs wanted, MW or later, can fax info. E Anderson, WEAS Inc, 2515 Abercorn, Savannah GA 31401. 912-2337247.

Harris MS15 FM exciter or equiv, 91.1 w/composite input, with or w/o stereo or SCA cards, to \$1000. A Hagler, KMDU, POB 135, Redway CA 95560, fax: 707-923-2655.

CRL AM4 mono audio processing system w/CRL SPF-300 NRSC adapter, excel cond, \$2400. M Persons, Kkin, POB 930, Aitkin MN 56431. 218-829-1326.

McMartin AM/FM xmtr, any model, exciter or stereo modules. Goodrich Ent., 11435 Manderson, Omaha NE 68164. 402-493-1886.

TOP DOLLAR

For Your Old Transmitter, STL or Exciter! Call for a quote. We arrange quick dismantling & removal PCB's? No Problem Call Us.

ARMSTRONG TRANSMITTER CORP.
5046 Smoral Rd
Syracuse, NY
(315) 488-1269
FAX (315) 488-1365

TUBES

Want to Sell

Tubes including 12AT1A/AX7's, 6AL5, 6H6, 6SJ7, & 1612's plus more. R Bickle, KOAK, POB 465, Redoak IA 51566. 712-623-2584.

ECONCO

Quality Rebuilt Tubes

Approximately 1/2 the Cost of New

Call for Our Price List
800-532-6626
916-662-7553
FAX 916-666-7760

Amperex 3CX100A5/7289 never used, stocked by mistake, \$30. D Sports, WCLA, POB 427, Claxton GA 30417. 912-739-3035.



FACTORY NEW TUBES

3CX1000A3, 3CX1500A7, 3-500Z, 4CV100000C, 4CX10000A, 4CX1500B, 4CX10000D, 4CX250B, 4CX300A, 4CX35000C, 4CX350A, 4CX5000A, 4-400A, 4-400C, 572B, 6146B, PL328/TH328, PL347/TH347, 807, 813, 833A, 833C, and more.....

CALL 1-800-783-2555
PENTA LABS/ JOLIDA INC.

Vintage radio/TV tubes, Send SASE w/list of your tube needs. M Starin, WJYY, 457 Varney, Manchester NH 03102. 603-825-1165.

Penta Labs Super Premium output tubes w/increased plate dissipation, new w/warr, individually tested, KT88, \$18, EL34, \$9, matching quantity pricing avail, also fabled 12AX7B's. R Katz, Allegro Snd, 15015 Ventura, Sherman Oaks CA 91403. 213-859-5543.

For the Best Prices
& 24 Hr service on transmitting tubes call 402 493 1886 day or night. FAX 402 331 0638. TELEEX 940103 WU PUB TLX BSN

EIMAC/Penta Labs new & used power grid tubes of all types. Also oil caps & vacuum variables. Buying tubes & duds. Howell Sales, 216-747-1841.

ELECTRON TUBES

Partial List: 6623, 23791, TH150, 6425F, 5604, 6696, 6697, 5681, 5682, 5671, 7804, 3CX10, 000H3, 3CX20, 000H3, 4CX5000A, 4CX35, 000C

Vacuum Tube Industries, Inc.
1-800-528-5014

3CX1500A7, 4CX5000A, 6146B, 4CX250B, 4CX3100A & more. We carry large inventory all major brands, Eimac, Amperex, RCA, etc. Call Stew 1-800-842-1489.

We buy electron tubes.

Contact us if you have any for sale.
PATH ENTERPRISE
507 Superior Ave.
Newport Beach CA 92663
714-722-6733 FAX: 714-722-6508

Want to Buy

RCA-6181 & 8501 & GE GL-6183 used as final in RCA & GE UHF TV xmtrs. J Powley, 1536 Logan, Altoona PA 16602. 814-944-8571.

TUBE REBUILDING

FREELAND PRODUCTS

Since 1940
SAVE ABOUT 50%
—We buy dud tubes—
800-624-7626
504-893-1243
FAX 504-892-7323

6072/6072A, no RCA, need 1000 unused tubes, send brand, quantity & price. R Katz, Allegro Snd, 15015 Ventura, Sherman Oaks CA 91403. 213-859-5543.

REBUILT ELECTRON TUBES

Partial List: 6623, 23791, TH150, 6425F, 5604, 6696, 6697, 5681, 5682, 5671, 7804, 3CX10, 000H3, 3CX20, 000H3, 4CX5000A, 4CX35, 000C

Vacuum Tube Industries, Inc.
1-800-528-5014

Amperex 6252, one, cheap, even used, \$10 or so. A Branch, KAY, 2402 Woodridge, Decatur GA 30033. 404-325-7847.

Amperex 6076 xmtr pwr tube, Gates FM5B, will need (2) soon. L Perkins, KWVR, 107 SW 1st, Enterprise OR 97828. 503-4264577.

TURNABLES

Want to Sell

Turntable, 16", \$25. WJAG, 309 Braasch, Norfolk NE 68701. 402-371-0780.

RCA later mdls, (2) w/stands, preamps & tonearms, \$150/both plus shpg. B Elliott, WRFX, 915 E Fourth, Charlotte NC 28204. 704-338-9970.

Technics SP-10 MK II, new in original box, \$800. B Weiss, KLSI, 3101 Bdwy, Ste 460, Kansas City MO 64111. 816-753-0933.

Studer A727 prof CD player, rackmount (2), recently factory refurbished, \$1200 ea. B Robinson, KLXK, 2110 Cliff Rd, Eagan MN 55122. 612-452-6200.

QRK 12C (2) in excel cond w/new felts, Micro-Trak tonearms & Stanton cartridges, \$100/ea. G Hutchins, WZAP, POB 369, Bristol VA 24203. 703-669-6950.

Rusco Studio Pro Model B, 2-speed transcription TT, console mountable, new tonearm & counter weights, missing stylus & tonearm plate, \$500/BO. A Wasilewski, KMWX, POB 1460, Yakima WA 98902.

Technics SL-1200MK2 (2) w/Encore Series P100 stereo preamp & extra needles, carts, \$300/ea set. J Glogowski, KYND, POB 19886, Houston TX 77224. 713-373-1520.

THIS SPACE AVAILABLE

CALL 1-703-998-7600

Rek-O-Kut G2 17", excel cond, \$75; (2) Rusco Studio Pro B, new idlers, excel cond, \$150/ea. W Kremer, Kremer Kraft, 301 SW 16th, Ft Lauderdale FL 33315. 305-524-5652.

RCA Rumble Buddy puck drive 3 speed (3). R Lankton, WDUV/WBRD, 813-749-1420.

Technics SP-15 w/base, arm, cart & stereo preamp (2), very little use, 5 yrs old, \$700 ea. D Doelitzsch, WDDD, Marion IL. 618-997-8123.

Gemini DJQ-1500 TT, similar to Technics SL1200 MKII, w/cartridge, stylus care kit. K Hart, WIEZ, RD 3 Box 1414, Mifflintown PA 17059. 717-436-9089.

Bogen/Lenco B50-16; Columbia 204 record changer in portable in case. K Hart, WIEZ, RD 3 Box 1414, Mifflintown PA 17059. 717-436-9089.

Want to Buy

Shure, Rek-O-Kut, etc. 16" in gd cond w/shell. J Panza, LL&S, POB 9847, Kansas City MO 64134. 816-763-9820.

Technics SLP1500 MK II. K Thomas, WQIK, 5555 Radio Ln, Jacksonville FL 32205. 904-388-7711.

VIDEO PROD EQUIP

Want to Sell

Microtime 1020 TBC w/manual for 3/4 or 1", works great, \$1400. Dave, Pathfinder Prod, 17094 McGuffie, Salinas CA 93907. 408-663-5192.

Quanta 7A character gen w/shop manual, \$2500/BO; Sony MX20 8 trk audio mixer, \$700; Sony RM555 multi recorder remote control, \$400/BO; Tek RM529 waveform mon, \$750; Fuji lens N10x10, \$250/BO; Videome dia Z-6000C edit controller, \$1000/BO; RCA telecine system w/(2) 16mm projectors & TK 27 camera, BO; 3M image enhancer w/R-B-G outputs, \$700/BO; JVC S-62 tube color camera, \$400/BO; Sony DXC 1610 tube camera w/case, \$700/BO; (2) RCA TK-630 cameras w/CCU, BO; numerous JVC CR 4400 3/4" portapaks, \$400-\$1000. T Quinn. 408-475-0423.

Panasonic VY 922 special effects gen, BO. D Lundy, Lundy Tape Duplicators, Cumberland Gap Pkwy, Heidrick KY 40949. 606-546-6650.

Conrac 5222/RS25 reference monitors, NTSC 525 line, 60 Hz, large screen, several, \$400/BO or will trade for film equip. H Biller, 108 Hamilton, Silver Spring MD 20901. 301-565-2798.

Paltex Abner ABR-1A A/B roll editor w/CRT display, time code, cables for JVC 6600/8250, will work w/600/850, \$2750/BO. R Jensen, MPI Productions, 5812 21st St, Racine WI 53906. 414-632-3131.

Panasonic WJ4600 special effects gen, excel cond, \$350/BO. B Baker, Pinelucket Recgd, 747 Wire Rd, Auburn AL 36630. 205-826-0390.

Sony BCR-4, telecine adapter, high resolution unipler for film to video transfer, gd cond, \$50; Froehlich 190-300 stereo video control center, interconnect (3) VCRs & (4) audio sources, lighted passive switcher, audio volume control, replace patch panel w/rotating switcher, \$50. W Watrous, Watrous Video, 739 S Orange, Sarasota FL 34236. 813-366-3316.

BEE

VIDEO . . . WTS

Entire system including 1/2" & 3/4" VCR's, SEG, dist amps, sat rcvr, audio, cables, cameras, TBC, titler, audio mixers, 2-way radios, monitors, connectors, microwave STL/TSL & remote, more, for complete list call. J Andrist, TV-31. Box 273, Omak WA 98841. 509-826-0100.

Sony VO8800 3/4" w/time code gen w/Porta-Brace case, \$4500; Sony PVM 5300 3 screen monitor, \$800. V Michael, WHTO, 575 Montgomery Pk, S Williamsport PA 17701. 717-326-8200.

Idea 1VT-7 digital TBC, \$1900; Sony editing system, complete w/BVE 500 & (2) BVU 200 editing machines, \$1500. V Michael, WHTO, 575 Montgomery Pk, S Williamsport PA 17701. 717-326-8200.

JVC RM82U prof video editing controller for JVC 3/4" editors, excel cond, \$325. G Ormrod, GFO Prod, 432 East X St, Tumwater WA 98501. 206-352-8028.

Ultra Vision 2000 3 gun video projection machine by Image Amplification, needs HV transformer, gd tubes, \$200; Sony SL2000 Beta R/P deck w/tuner/color camera. P Russell, Bowdoin College, Sills Hall, Brunswick ME 04011. 207-725-3666.

Liquidation sale including Microwave STL-TSL, Sony VO-5600 & VO-4800, Fortel TBC CCDHP, Panasonic AG-6300.s, AG6100.s, NV-A500 edit controllers, NV-8500 editor, Panasonic WVD5000 cameras, JVC GX5-700 cameras, tripods & dollies, Knox Chromafont 200 titler, B&W & color monitors, used 3/4" tapes, ch 35 transmit antenna, Panasonic WJ-5500B SEG & more, for complete list or prices call. J Andrist, KOTV, Box 273, Omak WA 98841. 509826-0100.

Sony Hi-band GCS-50 edit pak, twin decks, edit cntr, GCS-1 camcorder, cables, like new, \$1700. G Jackson, TV 13, 142 Main, Nashua NH 03060. 603-883-7435.

Perrott PE 300 dual, \$250; PE 100, \$385, dual silver zinc minichargers. R Sumner, CAVU Corp, 3322 Applegate Ct, Annandale VA 22003. 703-560-0233.

CMX Edge editor, A/B roll BetaCam or BVU 800 interface, mech excel, cosmetic gd, \$4000 pkg. TJ Worrell, Multimedia, 7620 W 78th, Minneapolis MN 55439. 612-942-9681.

VIDEO TAPE RECORDERS

Want to Sell

JVC CR4400U 3/4 port recorders (4) w/access, \$800 ea/BO; (3) Sony RM-430 edit controllers, \$500/BO; JVC BR-6400U VHS recorder, \$1500/BO. T Quinn, Monte Vista Std, 208 Cherry, Capitola CA 95010. 408-475-0423.

RCA TR-70 2" R-R VTR, BO. J Becknell, WCSC, POB 186, Chas SC 29402. 803-723-8371.

JVC BR6200U portable VHS recorder, 2 chnl audio, insert editing, audio mixing, wireless remote, (3) NBP1 Nicads, AC/charger, custom case, \$675. B Hines, IPS Inc, Rd 1 Box 413A, Export PA 15632. 412-468-4115.

Sony VO-2600 3/4", \$500; Sony VO-2610 3/4", \$550; Sony VO-5800 3/4", \$2500; Sony BVU-110 3/4" portable, \$2150. R Jensen, MPI Productions, 5812 21st St, Racine WI 53906. 414-632-3131.

Sony VO-5850 editing systems w/Convergence controllers, U-matic, gd cond, \$3000 ea; Sony BVU-110 portable U-matics w/time code, \$600 ea; Sony BVU-50 port recorders, \$295 ea; Sony BVU-200, \$700 ea. U George, Satellite TV, 314 W 52nd, NY NY 10019. 212-677-2200.

RCA video heads & spare parts, call for list. J Becknell, WCSC, POB 186, Chas SC 29402. 803-723-8371.

RCA TCR-100 & spare parts w/manuals & spare heads; (1000) 2" RCA carts, BO. J Becknell, WCSC, POB 186, Chas SC 29402. 803-723-8371.

Sony edit systems, VO5850, VO5800, RM440, \$6000/BO; VO2860, 2260, RM 430, \$2300/BO; RM400 controller, \$200; RM430 controller, \$400, other misc equip. T Quinn. 408-475-0423.

JVC CP5000U 3/4" U-matic player, remote plus approx 30 KCS tapes, great cond, \$575. B Hines, IPS Inc, Rd 1 Box 413A, Export PA 15632. 412-468-4115.

JVC CR-4400 3/4" portable in gd cond w/Porta-Brace case, AC adapter/charger, \$500. R Jensen, Telecable Prod, 5812 21st St, Racine WI 53406. 414-632-3131.

Sony VP-1000, \$100; VP-1200, \$120; VP-2000, \$200; VO-2630, \$350; VO-2850, \$300; VO-3800, \$300; RM400, \$200; BVE 500, \$350; BVE 500A, \$400; AV 3600, \$200; AV 3650, \$250; Panasonic NV-9100, \$200. J Krepol, 6147 Walker, Philadelphia PA 19135. 215-624-1050.

JVC 3/4 w/editor control, several repairable units or for parts, \$50 ea/FOB. K Kuespert, A-V Prod, 1794 Russell, Baroda MI 49101. 616-422-2235.

Sony BVU-110 3/4" bdct portables, time code, soft case, gd cond, \$795; Sony BVU-50 3/4" record only bdct portables, soft case, T.C. avail, \$195. Ugly George Satellite TV, 314 W 52 St, Nyny 10019. 212-677-2200.

Sony VO-5850 editing systems w/ECS-90 controllers, time code, gd cond, \$5000 ea; Ampex VPR-2B 1" VTR's w/slo-mo & dynamic tracing TBC.s, \$16,000 ea or (3) for \$40K. Ugly George Satellite TV, 314 W 52 St, Nyny 10019. 212-677-2200.

Ampex VPR 2B w/TBC 2B, console, color monitor, presently in service, one w/stereo audio kit, \$17K, one standard audio, \$15K. R Beierle, KFVR, POB 1738, Bismarck ND 58502. 701-2555757.

Sony BVU 110, no batteries/AC supply, mech excel, cosmetic gd, \$2000. TJ Worrell, Multimedia, 7620 W 78th, Minneapolis MN 55439. 612-942-9681.

ADVERTISER INDEX

This listing is provided solely for the convenience of our readers. Radio World assumes no liability for inaccuracy.

Page No.	Advertiser	Reader Service No.	Page No.	Advertiser	Reader Service No.	Page No.	Advertiser	Reader Service No.
24-25	Arrakis Systems	48	12	Dataworld	66	34	ITC	118
7	ATI	121	47	Dolby	127	7	Jampro	60
27	Audio Broadcast Group	97	29	Electro Impulse Lab	6	20	Microwave Filter	22
8	Audio Precision	21	22	Elision Weather Radar	103	11	Noble Broadcast Group	
10	Belar	62	26	Eventide	134	33	Orban	2
23	Broadcast Electronics	131	1	Fidelipac	76	32	Otari	111
14	Broadcast Services	124	3	Full Compass	43	31	Pacific Recorders	116
19	Broadcast Services	82	9	FM Technology	33	12	QEI	110
29	Broadcast Services	107	6	Harris-Allied/Audiopak	15,129	18	Radio Systems	114
21	BSW	58	9	Harris-Allied	38,79	27	Russco Electronics	36
4	Burk Technology	91	11	Harris-Allied	122,141	16	Shure	151
36	CCA Electronics	120	13	Harris-Allied	20,86	17	Studer Revox	51
14	Conex	95	13	Harris-Allied	26,55	19	Tannoy	102
28	Continental Electronics	148	22	Harris-Allied	13,87	3	Telos	105
11	Cortana	11	30	Harris-Allied/Valley	41,81	15	TFT	146
30	CRL	17	35	Harris-Allied	18	2	Wheatstone	64
			36	Harris-Allied	28,83	48	Wheatstone	68

Advertising Sales Representatives:

Eastern U.S., Art Constantine: 800-336-3045 Fax: 703-998-2966
Western U.S., Jack Ducart: 800-336-3045 Fax: 703-998-2966

ACTION-GRAM

Equipment Listings

Radio World's Broadcast Equipment Exchange provides a FREE listing service for all broadcast and pro-sound end users. Simply send your listings to us, following the example below. Please indicate in which category you would like your listing to appear. Mail your listings to the address below. Thank you.

Please print and include all information:

Contact Name: _____

Title _____

Company/Station _____

Address: _____

City _____ State _____ Zip _____

Phone Number: _____

Brokers, dealers, manufacturers and other organizations who are not legitimate end users can participate in the Broadcast Equipment Exchange on a paid basis. Listings are available on a \$25/25 word basis. Call 1-800-336-3045 for details and complete display rates.

I would like to receive or continue receiving Radio World FREE each month. YES NO

Signature _____ Date _____

Please circle only one entry for each category:

I. Type of Firm

- D. Combination AM/FM station
- F. Recording studio
- A. Commercial AM station
- G. TV station/teleprod facility
- B. Commercial FM station
- H. Consultant/ind engineer
- C. Educational FM station
- I. Mfg, distributor or dealer
- E. Network/group owner
- J. Other _____

II. Job Function

- A. Ownership
- D. Programming/production
- B. General management
- E. News operations
- C. Engineering
- F. Other _____

WTS: WTB: Category: _____

Make: _____ Model #: _____

Brief Description: _____

Price: _____

WTS: WTB: Category: _____

Make: _____ Model #: _____

Brief Description: _____

Price: _____

WTS: WTB: Category: _____

Make: _____ Model #: _____

Brief Description: _____

Price: _____

WTS: WTB: Category: _____

Make: _____ Model #: _____

Brief Description: _____

Price: _____

703-998-7600

Broadcast Equipment Exchange PO Box 1214 Falls Church VA 22041

FAX: 703-998-2966

Dolby SR improves the medium for your message.

TAPE RECORDERS

Dolby SR provides the performance attributed to digital systems while maintaining such analog virtues as economy, editing ease, and tape interchange.

CARTS

Along with their familiar ruggedness and all-around utility, carts with Dolby SR capture the full dynamics of all your source material, digital or analog.

1-INCH VTR'S

With Dolby SR, video can sound as good as it looks. Signal purity is maintained through the multiple tape generations necessary in today's post-production techniques.



DISCRETE STL'S AND RPU'S

Dolby SR improves headroom and lowers noise, while suppressing the effects of interference and fade.

TV STL AUDIO SUB-CARRIERS

With Dolby SR, there's no need to re-allocate subcarrier frequencies or replace existing equipment in order to deliver high quality audio to the transmitter.

SATELLITE AUDIO

Dolby SR improves analog channels without audible side effects yielding performance rivaling digital systems.

Listeners today expect better sound wherever they go — at home, at the movies, in the car. To keep up with their expectations, you need Dolby SR. Two channels, with the compact, easy-to-operate Dolby Model 363 (shown). Or up to 24 channels, with Dolby Laboratories' multitrack products.

Dolby SR dramatically reduces noise, increases headroom, and lowers distortion from initial production to final transmission. That means you can deliver your message today with the clarity you've been expecting from the technology of tomorrow.

Something Very Good Just Got **BETTER!**



A-32EX On-Air Console

Finally engineers confined to tight budgets can choose a console that won't compromise station reliability or signal integrity. After all, the A-32 is a Wheatstone console. It borrows from the componentry and design of our larger A-500 consoles, currently installed in major markets all over the country, from frontline independents to national networks.

Our new A-32EX is even better, with ample expansion room for additional inputs and a powerful family of accessory modules, including our new MP-32 talkshow module (that neatly interfaces multiple hybrids, tape recorders, announcer mics and studio-to-caller feeds), our ICM-32 six station intercom module (letting you communicate with other console locations and announce studios), and our SC-20 studio module (to provide comprehensive studio monitor, automatic muting, and talkback functions), plus multiple line selector and machine control modules, and a complete family of studio turret components.

The A-32EX console features modular construction, a fully regulated rackmount power supply, logic follow, full machine control and of course, an all-gold contact interface system. It has two mic channels and fourteen stereo line modules, each with A/B source select and Program/Audition bus assign, plus Cue switches on the line modules. Standard features include Program and Audition VU meters, digital timer, and a monitor module for control room and headphone functions. The console is also available in a smaller version (the A-20) with two mic channels and eight stereo line input modules.

The A-32EX is a perfect choice for stations planning an upgrade in signal quality and control room image. It's also a natural choice for the newsroom. So profit from Wheatstone's experience and reputation—call us today for immediate action!

 **Wheatstone® Corporation**

5720 V.I.P. Parkway, Syracuse, NY, 13211 (TEL 315-455-7740 / FAX 315-454-8104)

Circle 68 On Reader Service Card

World Radio History