

*****5-DIGIT 85710
J750970 DOB 9004 5431 442
TOM MILLER
ASST CE
KTZR
2033 S AUGUSTA PL
TUCSON AZ 85710

AES Show Preview
Pages 17-23

RadioWorld®

Vol 14, No 17

Radio's Best Read Newspaper

September 12, 1990

Battle For Spectrum Begins

by Benn Kobb

Washington DC The Senate Committee on Commerce, Science and Transportation on 2 August plunged into the question of spectrum shortages in the Emerging Telecommunications Technologies Act (ETTA) of 1990, bill S.2904. The House has approved a companion bill, H.R. 2965.

The legislation would require the federal government to review its own spec-

trum usage and turn over as much as 200 MHz of unused or under used frequencies to the FCC for distribution to the private sector. DAB, HDTV and digital portable phones head the list of possible recipients.

At the first hearing, witnesses from government and industry debated whether hundreds of megahertz of spectrum is in fact available in government allocations, and whether the US needs a new DAB band.

"There are now no vacant government frequency bands," said Janice Obuchowski, administrator of the National Telecommunications and Information Administration (NTIA) and the president's chief telecommunications advisor.

The government should not be asked to release free spectrum to entrepreneurs who will make millions in profits, she testified, while taxpayers foot the bills for

agencies to move their radio systems to other frequencies.

Nevertheless, Obuchowski and FCC Chief Engineer Tom Stanley agreed that 200 MHz was an acceptable target to shoot for. She said the Bush administration objects to having the 200 MHz figure imposed as a mandatory requirement "before the tools are in place" to determine how to achieve the reallocation.

(continued on page 12)

AM Text Supported

by Charles Taylor

Washington DC The FCC stance that it's time to initiate some hard hitting changes in the AM band has generally met with industry enthusiasm and appreciation following the release of the Commission's 106-page proposed AM rulemaking 18 July.

The text on MM docket 87-267 makes bold moves toward reducing AM interference on the existing band by changing protection limits and making plans to reduce the number of stations, while suggesting stereo and non-simulcasted programming to make the service more aggressive.

Comments on the proposal are due 15 October, however, the industry already is formulating opinions.

Commission showed leadership

"I think the Commission showed some leadership in coming up with this. For once, they really generated some ideas of their own," said Group W Director of Engineering Glynn Walden. "I think they've got some interesting ideas on how to foster growth on the band."

"I think it will be helpful," echoed Glen Clark, president of Glen Clark & Associates broadcast technical consultants. He cautioned, however, "The

(continued on page 9)

The 89th AES convention opens in LA Sept. 21, with the theme of "Creating Illusions in Sound." For pre-view coverage, see p. 17.



FM DA Opponents Ask For FCC Freeze

by Charles Taylor

Washington DC Broadcasters don't like new short-spaced FM directional antenna rules any better now than they did when the FCC adopted them in December 1988, and they've taken another opportunity to restate their position before the Commission.

The latest round of filings is another in a series encouraging the FCC to accept a petition for reconsideration filed by the Association of Broadcast Engineering Standards, engineering consultants du Treil, Lundin & Rackley, Greater Media, Mullaney Engineering and the NAB.

In the recent comments, NAB primarily restated the strong view that the FCC should "abandon all notions" of using FM directional antennas and contour protection in commercial FM broadcasting and urged the Commission to institute a comprehensive technical proceeding on the issue.

Evolution, not revolution

But engineering consultant Cohen, Dippell and Everist maintained in its latest round of comments that such a proceeding might be too much. "(We) do not oppose initiation of technical studies to improve the technical criteria.

(continued on page 10)

SIMPLY BETTER

TRY IT — SATISFACTION GUARANTEED

MAXIMUM PERFORMANCE and Type AA-4 COMPATIBILITY

TRUER HIGHS LESS SHEDDING **TOUGHER SHELL LOW ABRASION**

CALL YOUR FIDELIPAC DEALER FOR SPECIAL INTRODUCTORY PRICING

Fidelipac Corporation • PO Box 808 • Moorestown, NJ 08057 USA • Tel: 609-235-3900 • Fax: 609-235-7779

NEWS BRIEFS

Root Indicted in Florida

Jacksonville FL Thomas Root, the communications attorney pilot whose plane mysteriously crashed off the Bahamas last year, was indicted here 13 August and charged, along with three others, with fraudulent FM investment schemes.

A 50-count indictment was returned by a grand jury charging Root and three executives of Sonrise Management Services with racketeering, securities

fraud, organized fraud, sale of unregistered securities and grand theft, according to Associated Press.

Root, 37, handled applications for investors of Sonrise, a Columbus, GA-based company that touted Christian principles in sales literature.

The defendants allegedly sold fraudulent investment opportunities in FM radio license applications pending before the FCC.

Root already faces up to 35

years in prison and \$1.25 million in fines on a guilty plea to federal felony charges of misrepresenting clients. In addition, a North Carolina grand jury indicted him in June on 455 counts of securities fraud and other charges.

Telex Acquires McCurdy Digital Intercom

Minneapolis MN Telex Communications Inc. has acquired the central matrix intercom and audio system product lines from McCurdy Radio Industries of Toronto.

This is another in a series of strategic acquisitions and

product developments positioning Telex as an intercommunication source to the broadcast, teleproduction and commercial sound industries, according to TCI President Jeffrey Wetherell.

One year ago, Telex acquired RTS Systems shortly after Telex announced the development of a wireless intercom system. The McCurdy product line will be managed out of the RTS division in Burbank, CA.

Telex, both directly and through its RTS division, has specialized in conference or party line intercommunications with some capabilities in small matrix or point-to-point com-

munications. With the addition of McCurdy's digital central matrix products, the company said it now can offer point-to-point communications for systems of all sizes up to 600x600 and with capabilities beyond.

VOA Station Delay Lifted

Negev Desert ISRAEL A two-year delay imposed on construction of a radio transmitting station here to be used by the Voice of America (VOA) has been lifted.

The Israeli National Planning Board, which decided in May to delay the station for two years while it conducted studies on its impact on migratory birds, changed its mind in August, giving a go ahead for the \$270 million facility.

The station, a joint project with the US Board for International Broadcasting (BIB), has been in planning for more than five years. VOA intends to use it to broadcast programming in at least 20 languages.

Opposition peaked in February when the Society for the Protection of Nature in Israel said at a congressional hearing that the project is in the pathway of the major bird flyway connecting Europe and Asia with Africa. Environmentalists also claimed the station threatened thousands of desert plants.

According to published reports, US government pressure prompted the Israelis to reverse their decision, in a 19-to-6 vote.

VOA would employ six of 16 transmitters and 22 of 37 antennas at the station. Peak height of the antennas is 558'.

WE SURPRISED OURSELVES!

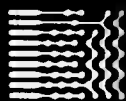

AUDIOARTS® A-50 RADIO CONSOLE!

We wanted to know if it really was possible to build a high quality low-cost radio console. We found the answer to be quite exciting! We've come out with the A-50 console and even given it its own trade name: AUDIOARTS. This console comes complete with machine control functions: individually programmable channel logic; program, audition and telephone outputs; control room and studio monitors; as well as headphone and cue power amplifiers. It's also designed so you can expand or add accessory modules as your needs grow.

The A-50 is cost effective through clever engineering and the latest advances in electronic assembly procedures. It was developed by the same design team that creates our other high end equipment. Its performance is light years beyond the competition.

Imagine the benefit that our major market experience can bring to your station. Take advantage of Wheatstone's expertise and reputation. Call us today for immediate action!

 Wheatstone Corporation

6720 VLP Parkway Syracuse NY 13211 TEL 315-455-7740 FAX 315-454-8104

INDEX

AES Show Preview	17
Ethics in Equipment Purchasing by Barry Mishkind	24
Learning the Allotment Shuffle by Lex Felker	25
An Overview of Amplification by Ed Montgomery	26
Early Radio: West and Midwest by George Riggins	30
From Shipping Crate To Transmitter Shack by Anthony Kord	31
Cleaning Up a Muddy Signal by John Shepler	32
The Basics of Data Reduction by Mel Lombert	33
Understanding DAT Technology by Bruce Bortlett	34
EAS: Colorado's EBS Alternative by Fred Boumgortner	39
Workbench	40
Canada's Theater of the Mind by Dee McVicker	42
Remote Meters, Then and Now by Harold Hollikainen	44
AES Show Preview	17

DAB Group To Study Spectrum

by Alan Carter

Montreal CANADA The NAB Digital Audio and Satellite Sound Broadcasting Task Force, here in early August to hear DAB over-the-air tests, has authorized a spectrum analysis for the new service and has approved the formation of an engineering advisory group.

The task force was in Montreal 8-9 August to take advantage of the first North American DAB broadcasts being conducted this summer across Canada by the Canadian broadcasters using the European developed Eureka 147 technology.

With the task force were NAB executives including President and CEO Eddie Fritts, Executive Operations VP John Abel, General Counsel Jeff Baumann, Government Relations VP Jim May and Science and Technology Senior VP Michael Rau.

A clear sound

"I was very impressed," said EZ Communications President Alan Box, chairman of the task force. The difference between analog AM and "AM" via DAB was "quite noticeable," he said, and there was no multipath during broadcasts of FM stations.

Box said the demonstration showed that DAB will be "one new frequency where everyone is pretty much equal."

Box admitted the entrance of DAB into

US broadcasting has the potential to change the entire scope of radio and will not be an easy transition. "I think there clearly will be a lot of disagreement as DAB moves forward," he said.

"It will bring about change for broadcasting," Box said, "but what that change will be is too early to tell."

Box also noted that the issue will be "tough" for NAB, with its broad range of membership. But the DAB debate cannot be backed away from, he added.

Engineering aspect

While the task force, composed of NAB Radio Board members representing management, is designed to address political issues, Box said the engineer advisory group will be able to consider technical aspects of DAB.

He hoped to have the group named by Radio '90 show, which opens 12 September in Boston. Engineers interested in being considered for the advisory group are asked to call Science and Technology Senior VP Michael Rau.

Gannett Radio Engineering VP Paul Donahue, who heads an ad hoc industry group called the Committee for Digital Radio Engineering, praised the NAB's desire to bring in engineers and conduct spectrum analysis.

"I think it's good they're taking a proactive stance," he said. "At last, they're recognizing the importance of the issue."

The future of the ad hoc group de-

pends on the direction of the task force's engineering advisory group, Donahue said. He noted that the NAB has incorporated several positions of the committee into its statement on DAB.

But Donahue also said, "There's a lot of time for a lot of different forums."

tion on DAB for Radio '90, and Box said he hoped the planned over-the-air demonstrations at the 1991 NAB convention in Las Vegas could accommodate more people than the Canadian tests.

"I think we need to allow as many people as possible to hear DAB," Box said.

WARC position discussed

The task force also discussed the position the US should take at the 1992 World Administration Radio Conference (WARC)



NAB Radio Board Vice Chairman Richard Novik (l) and Chairman David Hicks (r), members of the DAB task force, stand in front of the minibus used in Canada's DAB tests.

In asking for a request for proposals to study spectrum availability, the task force said the project should determine how much spectrum is needed to accommodate existing AM and FM licensees. It also will assess the relative spectrum efficiencies between satellite distribution, which the NAB opposes, and terrestrial approaches, which the NAB supports.

The task force has scheduled informa-

along with a presentation the group is expected to be asked to make to the Office of Space Commerce, a division of the Commerce Department that is exploring a worldwide satellite-based DAB system that would be used by Voice of America, with commercial aspects.

For information from NAB, contact the Science and Technology Department at 202-429-5346.

The "Reel" Thing



The Tascam BR-20 sets a new standard in its class. This professional two-track features servo motors, independent reel size selection, built-in monitor speaker, full editing facilities, and more. And you know that nobody builds recorders more reliably than Tascam.

Manufacturer's list is only \$2399, and Bradley is offering special introductory pricing. You can pay more for a recorder, but you can't get a more solid, versatile machine than the BR-20.

Also available is the BR-20T with center track time code. Call or fax your Bradley professional today for details and prompt delivery.



Bradley

BROADCAST

8101 CESSNA AVENUE • GAITHERSBURG, MARYLAND 20879-4177
TOLL FREE: 800-732-7665 • MD & DC: 301-948-0650 • FAX: 301-330-7198

Where Service and Engineering Make the Difference

Circle 18 On Reader Service Card

SPLICE TRAK 90™

Stop worrying about strange noises & things that go bump.



Start prepping carts the *right* way. Get worry-free deep erasure and splice detection with any NAB standard cart. No more noises lurking on improperly erased tape. No more thumps left by bulk erasers. No more bumps from mislocated tape splices. Just perfect carts every time, with our new ST-90 Splice Trak.

- Handles tape smoothly and safely at a fast 27 1/2 ips.
- Dual heads erase to a depth of 85 dB.
- Same reliable Phase Lok V head block, long-life low-voltage solenoid and positive cart guidance system as used in BE cart machines.

What you get out of your cart machines depends on what you put into them. Call us at (217) 224-9600 or ask your Broadcast Electronics distributor for info on the advanced ST-90 Splice Trak cart preparation system.

* F.O.B. Quincy, IL. Exclusive of sales or use tax.

BE BROADCAST ELECTRONICS INC

4100 North 24th Street • P.O. Box 3606 • Quincy, IL 62305
Tel: (217) 224-9600 • Fax: (217) 224-9607 • Tlx: 250142

Circle 128 On Reader Service Card

The Last Long Days of Summer

by Judith Gross

Falls Church VA Here it is. As I write this. The end of a long, lazy hot summer. At least in concept.

Our troops are in the Persian Gulf. Congress is vacationing on the golf course and the entire city of Washington DC looks like somebody put up a "Gone Fishin'" sign.

The word in the industry is that it's slow, as well. Guess it comes as little surprise that things are in a bit of a slump. You've heard the figures and forecasts. But let's not give in to the gloom, OK?

Hang in there and let's see if we don't pull it out before too long. Bet we'll do better than the Mets. (Thought youse guys were gonna come through this year.)

Speaking of baseball, I got a kick out of WJRZ, the Tom's River, Joisey station that offered George Steinbrenner the position of GM of the station's softball team, the Sharks. Maybe he can do for them what he did for the Yankees. Seems the infamous among us don't fade away. They just end up in radio.



I'm taking a deep breath before the show circuit starts in earnest, right about now. Radio '90 is at the starting gate and I'm geared up to hear the latest buzz on DAB. Also looking forward to some of that delicious New England lobster.

Have to congratulate the DC chapters of SBE and AES. John Reiser, a member of both, put together a hot program a few weeks back on the latest digital plans being tossed about, including Strother's plan to test the Eureka system, Satellite CD Radio's proposal and the tests in Canada. It had to be a first. Hope

the other chapters will follow suit.

And just a humble little question for SBE national. How come there's nothing slated on DAB at the St. Louis convention? It's too far-reaching to ignore.

It won't be all business at Radio '90. The radio networks (what's left of them) usually find a way to have a little fun. ABC Radio is going to set one night of its hospitality suite aside for a "Twin Peaks" theme, based on the David Lynch TV show. Expect the usual: doughnuts (probably arranged by flavor) and eyepatches. But please don't invite Laura Palmer!

In Los Angeles, at AES we'll see how the other side of the digital coin, production, is doing with the latest in workstations. Check our preview in this issue for more details.

I was pleased to hear that the SBE is hosting a special meeting for female broadcast engineers at its convention in St. Louis. Sandra Woodruff from KFNB has helped put this one together. I'll be there to help the networking along. But my guess is that, unfortunately, we won't need a very big room. I hope I'm wrong about that, though.

All right, all you manufacturers who have been keeping mum on your new gizmos. I've got my tape recorder handy and my exhibit hall shoes polished. I'll be scoping it all out and spilling the beans in the next few issues, so watch out.

While the industry chews on the FCC's AM improvement proposals, I've heard some positive reaction to those provisions encouraging some AM stations to buy out others so interference can be reduced and the remaining AMs can be stronger.

Seems there are some healthy AMs who are looking for stations to buy and some struggling AMs looking

they're having trouble finding a name for?), but you were wrong. Just when you thought it had been too watered down, the NAB Executive committee met and decided to include AM stereo as a provision for the mark after all.

Seems there's some doubt now whether Congress will go ahead and require receiver manufacturers to insure that radios with FM stereo include AM stereo (the Radio Improvements Act). So, not to take any chances, the execs decided we'd better include it as a provision for the cert mark. Way to go.

And those wacky guys on Capitol Hill are at it again. It seems that a new Senate bill (S.2637) would restrict and in some instances eliminate the use of lead in all industries as a consumer and environmental protection measure.

The bill would ban lead concentration greater than 0.1%, according to an article in *Electronics Business*. Of course you know that electronics solder uses lead in a 4:6 ratio to tin.

As the magazine pointed out, it's hard to fathom how lead in electronics components is harming the general public. (OK, which one of you Senators has been licking the solder?) The Bill isn't that far along and I'm sure the electronics industry will have its say about it. So don't worry... yet.

And we haven't seen the end of the trend to featuring radio in the movies. A new release, *Pump Up the Volume*, is a story about a high school kid's pirate station and his troubles with the FCC. I heard that when the movie was released, the film folks had an anti-FCC party in Hollywood. (No comment. That one is too easy.)

And I know you didn't get to half of the summer activities you'd planned. Me neither. Don't despair. Take a last long drag on the lemonade and catch a few of those rays before fall kicks in. Indian summer is on its way.

Heard a juicy tidbit? Spill your guts to Earwaves by faxing JG at 703-998-2966, writing to PO Box 1214, Falls Church VA 22041, or calling 703-998-7600. Who knows, you could win a coveted RW mug.

Strong, standalone 10 kW seeks gentle, directional daytimer for synchronous transmission. Prefers talk to rock. Must have healthy audio chain and realistic bottom line. No network entanglements, please.



to be bought out. One engineer suggested somebody start a "matchmaking" service.

Or better still, how about a personals column, like in the upscale magazines?

Wholesome midwestern clear desperately seeking unattached geographically-desirable directional with night power for mutual 24-hour talk. Multi-array acceptable—but not too tall. I have great demos.

Ambitious but struggling all-nighter in search of knight-in-shining-armor Class I to share adjacents and compatible formats. Long-term, meaningful commitment desired. Help me before I go dark.

PCB-free cool jazz college daytimer ready to party with 5 kW and up in close proximity. Hip studio, happening talent, great specs. No all-night talkers. Let's make music together.

Also on AM, you thought you'd heard it all on that certification mark for improved AM radios (you know, the one

Transmitter Control can be a Bear

You need to make sure you can stay on the air and stay legal. At the same time, you need to keep operating costs under control.

Choosing the right remote control system is the first step.

The ARC-16SA* from Burk Technology lets you control your transmitter from any phone. You can establish off-premises control points for unattended operation, or supervise non-technical operators by phone.

The annual savings can be thousands of dollars.

The ARC-16SA is part of a modular system. For full-time control, add a studio unit. Multi-site options make it easy to control several transmitter sites or even control studio equipment such as program automation.

Call now for your copy of our new catalog, then ask us to show you how we can improve your operation and your bottom line.

Call TOLL FREE
1-800 255-8090

BURK
TECHNOLOGY

7 Lomar Drive, Pepperell, MA, 01463 (508) 433-8877

READERS FORUM

If you have comments for *Radio World*, call us at 800-336-3045 or send a letter to Readers' Forum (Radio World, Box 1214, Falls Church VA 22041 or MCI Mailbox #302-7776). All letters received become the property of Radio World, to be used at our discretion and as space permits.

Gammon-bashers are wrong

Dear RW:

The recent comments of Eric Bueneman in the 8 August RW concerning Gammon's move-in at Sandy Springs, Georgia are just plain wrong. Not just five minutes ago, I ran the proposed C3 on my own database and found that the proposed upgrade meets all the requirements of 73.207 of the Commission's rules.

Translators (such as the one cited by Bueneman licensed to Coyners, GA) are licensed under part 74 of the Rules and are secondary services. Moreover, the Commission's own rules state that allotments are made by the minimum distance requirements.

His comments about Sandy Springs being unincorporated are irrelevant as well. The Commission's designation of a community eligible to receive an FM allotment is somewhat flexible. Back in the Dark Ages (when full service AM assumed its proper role in society) the FCC allotted channel 259C to Kannapolis, North Carolina.

In my database there is no "effective date" for this allotment but I can assure the readers of RW that this was done when Kannapolis was the world's largest

unincorporated place. Kannapolis also has two AMs as well, one of which was issued its license when the Commission was more like a bunch of feudal lords rather than a branch of the government. I suppose the Commission erred in allowing those 30,000 or so non-people in Kannapolis to have its first FM service.

That being said, any decent first-year law student could look through the FCC Reports and find more cases of this taking place. There is ample precedent for providing an FM allotment to a community of substantial size which is not necessarily "chartered" under the laws of a particular Commonwealth or state. (For the record, Kannapolis is now an incorporated city under a mayor-council form of government.) Interested parties may want to look at the allotment history of Massachusetts, whose political subdivisions baffle me to this day.

What really fires me up about Bueneman is the long winding diatribe about which market requires what format. I'm also hacked about the attitude of certain broadcasters who want to penalize Gammon for playing by the rules of capitalism.

Bueneman's comments reek almost of socialism, and while I am willing to die for his right to state his case, I (and most broadcasters) vigorously oppose any kind of format allocation. The determination of format by Bueneman, Gammon or anyone else should be determined solely by the pressures of the free market economy governed by the pricing mechanism. If enough of you Gammon-bashers out there get together, I'm sure that it can be arranged for the FCC (or a heretofore unknown branch of the government) to return to the days of yore when you had to send in your rate card, percentage of records played, and so on.

Both Anniston and Atlanta are over-radioed, in the sense that most people who hold licenses have the poor taste to "slivercast" towards that economic Nirvana "soft adult contemporary danceable hits" (and country, and urban) rather than taking any real risks. In that sense, they are under-radioed too. This is great fodder for high school debate, by the way. The debate team, your audience, has turned its ears elsewhere.

But we, as broadcasters, have failed to look at the real enemy, the cassette tape (which everyone I know from 35 down prefers to radio, any day). This wonderful device (and as a broadcast professional, I'm guilty of using it too) allows me to immediately receive entertainment programming, not available on any radio station, which meets the needs and issues of my age group.

It's real simple, people: the marginal utility of one C-90 cassette tape exceeds the opportunity cost of the next highest valued alternative: silence. Slivercasting class "C" FMs come somewhere below that.

We want the information about goods and services available in our community, and the issues which affect us daily, in short, an outlet of local expression.

If Gammon is smart enough to run the

Now that the industry has had a chance to digest the massive rewrite of AM technical rules it's time for open debate to begin.

The lengthy document shows that the Commission is ready to take a hard line to reduce interference on the AM band and help put the struggling service in a better competitive position.

Many of the ideas put forth in the NPRM—technical and non-technical—are controversial and will not be easily decided.

More stringent protection ratios, a requirement for stereo transmission and elimination of program simulcasting are a few areas where there is certain to be disagreement.

Time To Speak Up For AM

Other proposals, such as offering incentives for thriving stations to buy out ailing AMs, appear to be gaining acceptance more readily.

The Commission broke from past policy in creating a model for the expanded AM band. By putting aside special interest preferences in favor of interference

reduction, the FCC has clearly defined new priorities.

Thus, the NPRM becomes even more critical, not just to existing broadcasters but to a future band which is now only in the formative stages.

Because of this, and because AM is literally fighting for its survival, it is crucial that the merits of all the proposals put forth be weighed carefully and that all factions of the industry are heard.

While it's true that new technologies, such as DAB, may change the shape of all of radio's future, an improvement in the state of AM will help many stations immediately and the entire band during the transition to newer services.

It is imperative that the industry meet the challenge the Commission has proposed by evaluating each recommendation and submitting comments by the 15 October deadline.

The FCC has attempted to breathe new life into AM by giving the industry the opportunity to change technical policies and correct past mistakes.

It is a chance that those concerned about AM's future can't afford to miss.

—RW

Radio World

Vol 14, No 17 September 12, 1990

Editor, Judith Gross

Associate Editor, Alex Zavistovich

News Editor, Alan Carter

Reporters, Charles Taylor, John Gatski

Benn Kobb, Frank Beacham/L.A.

Editorial Assistant, Marissa Friedman

Technical Advisor, Tom McGinley

Production Director, Kim Lowe

Chris Freter, Lisa Roach,

Bill Spencer, Julianne Stone

Ad Production Coordinator, Jeanne Pearson

Publisher, Stevan B. Dana

Associate Publishers, Arthur Constantine

Carmel King

Ad Coordination Manager, Simone Mullins

Circulation Manager, Tiana Hickman

Accounts Receivable, Valerie Mason

Advertising Sales Representatives:

East & Midwest, Art Constantine

800-336-3045, Fax: 703-998-2966

West Coast, Pat Macsata

415-786-2198, Fax: 415-786-2754



Radio World (ISSN: 0274-8541) is published semimonthly (except February, which has 3 issues) by Industrial Marketing Advisory Services, Inc., 5827 Columbia Pike, Suite 310, Falls Church, VA 22041. Phone: 703-998-7600, Fax: 703-998-2966. Second-class postage rates is paid at Falls Church VA 22041 and additional mailing offices. POSTMASTER: Send 3579 forms and address changes to Radio World, P.O. Box 1214, Falls Church VA 22041. Copyright 1990 by Industrial Marketing Advisory Services, Inc. All rights reserved.

Free subscriptions are available upon request to professional broadcasting and audiovisual equipment users. For address changes, send current and new address to RW a month in advance at the above address. Unsolicited manuscripts are welcomed for review; send to the attention of the appropriate editor.

**Next Issue
Radio World
September 26, 1990**

engineering on 400 potential move-ins, he is assuredly smart enough to do something with a move-in that will 1) provide diversity in the marketplace of Atlanta, whether or not it is licensed to Sandy Springs, Powder Springs, or Squeaky Springs and 2) increase the number of homes using radio, which is good for everyone.

Let's let Gammon take the risk, and let's not penalize him for the prime directive that keeps the US the greatest country on earth: Those who take risks shouldn't be crucified for making a profit. Perhaps the Tom Gammons of the world will get this industry off its collected butt and elevate FM radio to something more than a jukebox for Yuppie nostalgia.

York David Anthony, CE

WADE (AM)

Wadesboro, NC

On another subject, the 11 July issue included an article by George Riggins in which he discusses "W" call signs still in use west of the Mississippi River. There are five in Texas: WTAW, WOAI, WRR-FM, WBAP and WACO. The WBAP transmitter is no longer in Grapevine. It is now in or near Mansfield, TX. I'd like to point out that WOAI is probably the westernmost station with a "W" call sign, since San Antonio is about one degree farther west than Norfolk, NE.

By the way, let me be the first to tell you that there's going to be another leap second at the end of the year. I just got my notification the other day.

Andrew Dart

Andy's Bureau of Standards
Duncanville, TX

More on Gammon plan

Dear RW:

I just finished reading Eric Bueneman's letter in the 8 August issue of *Radio World*, and felt a reply to Mr. Bueneman's position was in order.

First of all, translators are a secondary service (see FCC Rule 74.1203). Translators are not protected from any changes in the table of allotments, even those that might put the translator out of existence. If and when a new full power station on 100.5 began operation in the Atlanta area, the translator would be history.

As for WUSY (FM) in Cleveland, TN, Mr. Bueneman is apparently unaware that WHMA-FM in Anniston and WUSY are currently short-spaced to one another, in accordance with the terms of a 1987 agreement between the two stations. Moving WHMA-FM to Sandy Springs actually increases the separation between WHMA-FM and WUSY, thereby decreasing the short-spacing.

(continued on page 15)

**GET IT
RIGHT**
FROM HARRIS ALLIED

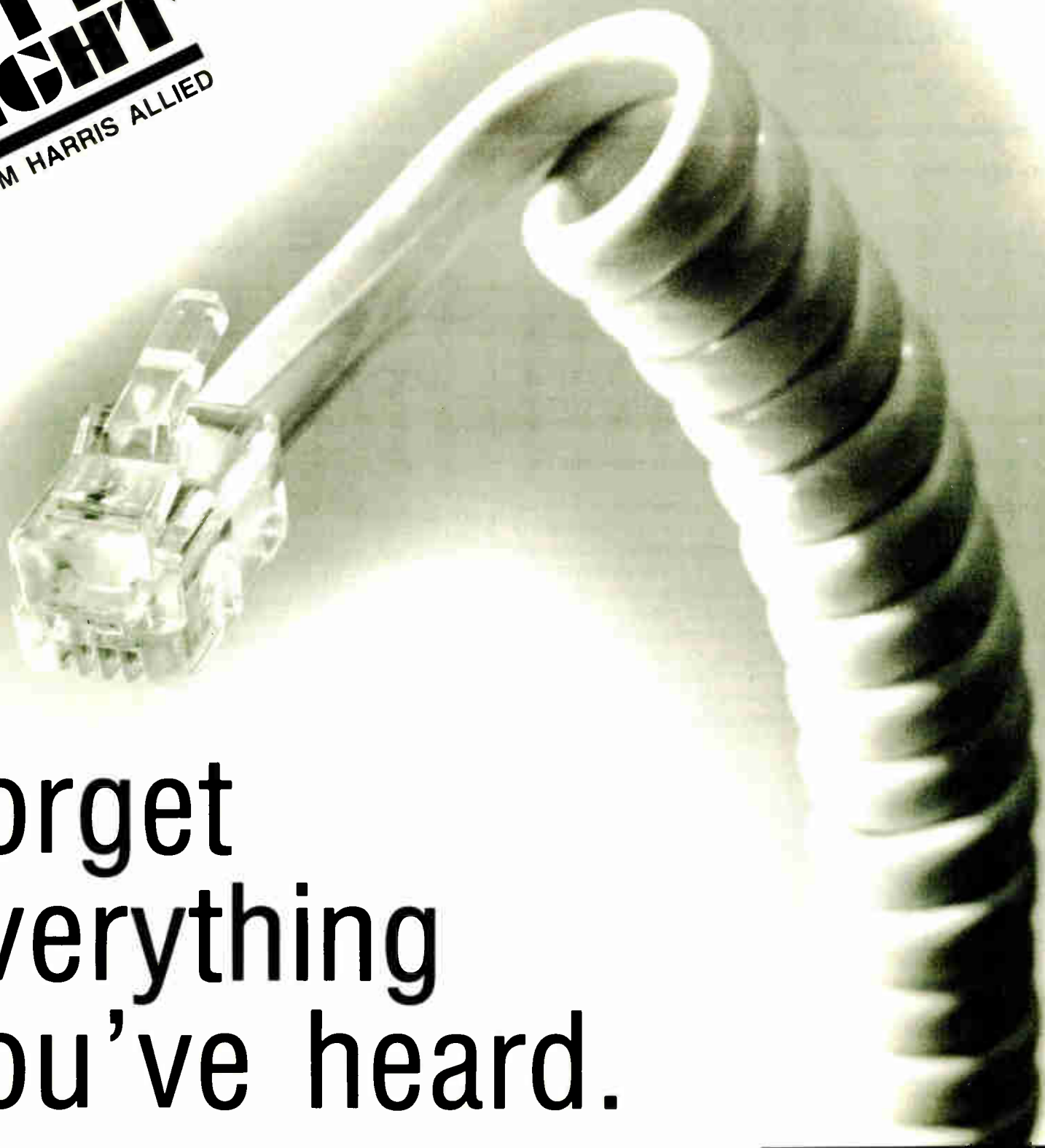

Forget everything you've heard.

That's what you'll do when you hear the new Telemix 2000 on-air phone system. Gentner's digital hybrid technology delivers the cleanest, clearest sound that ever came out of a telephone line. The optional Frequency Extender actually gives you a broader range of audio than the telephone line holds. It gets rid of that tinny "telephone sound" by augmenting the low end for full, natural voice quality.

Telemix 2000 not only gives you clearer sound, but more control. You can record calls on-air or off-air, talk to callers on or off the air, conference calls together, even put extended-frequency remote signals

on the air. Hands-free, one-button operation means you'll never have to take off the headphones or leave the mic.

Telemix 2000 is easy to work with right from the start. It comes fully assembled, tested and ready to install. Gentner even has custom control panels to match most consoles or studio furniture at no extra cost.

Make your phones work harder—and your work easier. Our new white paper, "Getting the most out of your phone system with today's technology," will show you how. Call your Allied representative today for your copy—before you forget.



SBE '90 - ST. LOUIS

Telemix 2000 is just one of the exciting new-technology analog and digital products you'll see in Harris Allied booth #910, October 4-7.

SEE YOU THERE!

**HARRIS
ALLIED**
BROADCAST EQUIPMENT

800-622-0022

CANADA 800-268-6817

STUDIO EQUIPMENT • HARRIS RF PRODUCTS • SATELLITE GEAR • TRADE-INS • TURNKEY SYSTEMS

© 1990 HARRIS/ALLIED

"Call me, I'm interested." Circle 73.

"Send me literature." Circle 125.

NAB Battles Spectrum Fees

by John Gatski

Washington DC War has been declared on a possible resurrection of broadcaster spectrum fees, which NAB warned could put some stations out of business.

NAB Government Relations VP Jim May said the NAB has launched an all-out attack on spectrum fees prior to any possible official acknowledgement of the proposal by the White House or congressional budget negotiators, who reportedly are considering a 4% fee on gross annual revenues.

"It's nearly impossible to change their (budget negotiators) minds, once they have agreed on it," May said.

Beating the drums

The NAB is drumming up opposition to spectrum fees by sending out do-it-yourself packages to its members. The kits explain various options in fighting the proposed spectrum fees including a letter-writing campaign to local congressmen and senators.

A decision whether to levy spectrum

fees is likely when the budget summit resumes between White House staff and key congressional leaders in early September, congressional sources said.

The NAB believes added emphasis will be placed on spectrum fees by the presi-

dent's budget staff in light of the severity of the federal budget deficit and recent events in the Middle East that have prompted higher oil prices.

A decision whether to levy spectrum fees is likely when the budget summit resumes.

dent's budget staff in light of the severity of the federal budget deficit and recent events in the Middle East that have prompted higher oil prices.

Iraq's attack on Kuwait has resulted in higher gas prices, which will likely kill any gas tax hike proposals. A gas tax increase is a considered prime revenue source, according to federal budget officials.

"That means there is going to be even more pressure (to consider the spectrum fees) as a result of that," May noted.

The Congressional Budget Office (CBO) has estimated that spectrum fees could

raise \$1.7 billion in fiscal 1991. The NAB, however, said the fees would have a devastating effect by increasing the number of stations operating at a pre-tax loss from 3,250 to 4,180 and would likely drive some of them out of business.

Smaller and larger station managers agreed with the NAB's pessimistic view of spectrum fees.

"I don't think we need anymore fees. Most of the smaller stations are just barely making it," said Ed Moynahan, GM of KMOZ in Rollas, MO.

Big market stations would feel the pinch of a spectrum fee, too, according to KIKK GM Craig McGee of Houston.

"The market is completely flat. We are not having 8-9% increases like we are used to seeing in radio," McGee said. "I definitely believe it could hurt a lot of the smaller operators."

Penalizing stations

New York City's WNEW GM Ted Utz said the US government should learn to put its own finances in order instead of penalizing broadcasters with a spectrum fee.

"It obviously would be a major burden on us," Utz said.

Spectrum fees were proposed, but dropped, as an option by legislators in 1989. As in 1989, the spectrum fee proposal has its detractors in Congress.

In a recent letter to White House Chief of Staff John Sununu, Telecommunications and Finance Subcommittee members Rep. Matthew Rinaldo (R-NJ) and Rep. Norm Lent (R-NY) said that trying to fight the deficit via spectrum fees could undermine the public interest intent of broadcast licenses.

TV Marti Continues

Washington DC President Bush has called the 14-week test of TV Marti a success and is now deciding whether to make the controversial US news and information service into Cuba permanent.

But the Association of Maximum Service Television (MSTV) has called the data the White House used to justify TV Marti into question.

As of 1 August, Congress had 30 days to respond to a presidential report from Bush, who will decide whether TV Marti is to become permanent. The service remains on the air, although the hours have been reduced from three to two and a half.

TV Marti has drawn the ire of the

NAB, Florida broadcasters and others who fear Cuban retaliation against AM stations through powerful transmitters. Some members of Congress also have come out against TV Marti.

Despite much criticism from the broadcast community, Bush said that TV Marti's unusual broadcasting configuration—a transmitter perched within an Air Force balloon 10,000' above south Florida—is technically feasible.

The President's report acknowledged that Cuba has successfully jammed the signal to most of Havana where the broadcast is aimed, but outlying areas can receive the mix of pro-western news and entertainment.

Your Problem Solvers

from **ATI**



- Mike
- Line
- Phono
- Mixing
- Matching
- Metering
- Monitoring
- Processing
- Distribution
- Rack Mounting

AUDIO TECHNOLOGIES, INC.

328 W. Maple Ave., Horsham, PA 19044 • (215) 443-0330 • FAX (215) 443-0394

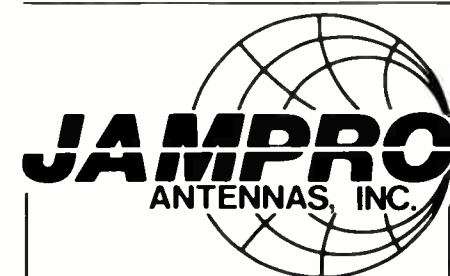

For Excellence In Antennas

- A complete line of TV and FM Broadcast Antennas
- Modern 7,000 ft. test range facilities
- Innovative Engineering Careful construction
- Two Year Warranty on Product and Workmanship



With over 1500 delivered, we've helped more stations penetrate their market.

FCC Directionals
Pattern Studies
Multi-Station Arrays
Full Scale Measurement

JAMPRO ANTENNAS, Inc.
6939 Power Inn Road
Sacramento, CA 95828
(916) 383-1177 TELEX 377321

Varian Poised To Sell Continental Division

by Charles Taylor

Palo Alto CA Varian Associates has reached a tentative agreement to sell its Continental Electronics to a Houston-based electronics company.

Tech-Sym, a designer, developer, producer and vendor of advanced electronic systems and components, tentatively agreed to purchase the division for an undisclosed price, it was announced 3 August.

Continental, which manufactures and sells high-power radio frequency transmitters, had been on the block since May, when Varian announced an across-the-board "repositioning" that included the sale of several non-core businesses and product lines.

According to Varian, the company intends to focus on the component aspects of its operations rather than systems. It will retain core businesses that manufacture electron devices, analytical instruments, semiconductor process equipment and medical therapy equipment.

Tech-Sym, listed on the New York Stock Exchange, owns five electronics companies that manufacture products ranging from seismic equipment for oil

exploration to microwave components. It was founded in the 1950s as Metric Systems Corp., which manufactures computer equipment, radar and controls for shipboard electronics for the US Navy.

Continental, which will be the company's first broadcast entity, will continue to operate as is with no intended changes in operations or personnel, according to Wendell Gamel, chairman of Tech-Sym.

"We own these companies and we allow them to operate pretty independently. We have nine people in headquarters—we're not bureaucrats," Gamel said. "We think broadcasting is a good business and one that will be here for a long time and a straightforward sort of business. We were approached and we made an offer."

Continental reported sales of \$9 million in the first nine months of fiscal 1990.

The final agreement is subject to approval by the companies' boards of directors.

Still for sale by Varian is its TVT Ltd. The company designated a 29 September deadline.

For information from Continental, call Walt Rice at 214-381-7161.

PROOFS IMPROVED

FM and TV-BTSC AUDIO PROOF TESTING is reduced from hours to minutes with System One from Audio Precision... Automatic proofs run properly at constant deviation, plotting the required generator amplitude... and when finished, the results are stored in graphic form for your records.

SPLIT SITE proofs are simple with System One's available separate generator and analyzer configuration. With immediate capability to view and control both instruments, it's like being in two places at once.

THE REST OF THE TIME System One is the universal audio test set for maintaining any audio device or channel... STLs, consoles, carts, cassettes and RDATS, digital recorders and workstations... System One is the only product that can completely test both your analog and digital audio.

Call 800/231-7350 for our 36 page color catalog... and when you're ready our representative will arrange for an on-site demonstration.

Audio precision

P.O. Box 2209, Beaverton, OR 97075
503/627-0832, 800/231-7350
FAX: 503/641-9806
TELEX: 283957 AUDIO UR



AM Mark Revised

by Alan Carter

Washington DC AM stereo and variable bandwidth may be included as part of the NAB/EIA certification mark for improved AM radios after all.

The NAB Executive Committee, meeting here 14 August, approved a revised list of criteria for the yet-to-be-determined identification mark NAB and the Electronic Industries Association want manufacturers to use to identify improved receivers.

Other criteria the NAB governing body accepted were NRSC, AM and FM bands, AM noise blanking, an external antenna and the expanded AM band from 1605 kHz to 1705 kHz.

The AM stereo provision was originally rejected by manufacturers as be-

ing too costly. But now that legislation that would mandate AM stereo on radios which receive FM stereo is before Congress, the inclusion of it in the certification mark is a more likely possibility.

The stance adopted by the executive committee said that radios with FM should have AM, and those with FM stereo should include AM stereo.

The next step is to "reconnect" with EIA, according to NAB Staff Engineer Stan Salek, coordinator of the National Radio Systems Committee, where the certification mark originated.

In other certification mark news, Salek said four new IDs are under review after the initial one, "IQ," was found in conflict with Bell Atlantic's IQ telephone service.

Antenna Project Ends

by John Gatski

Washington DC The NAB does not plan any further testing in the near future of its anti-skywave antenna, despite the fact that it was found to be only 30% effective.

NAB Staff Engineer Kelly Williams said all data from the tests, completed in early August, has not been analyzed but he confirmed the initial results presented to the NAB Executive Committee meeting here 14 August.

Asked if NAB will fund the project further, Williams said, "Not in the immediate future."

A full report on the skywave antenna tests was expected at Radio '90 in Boston, opening 12 September.

The \$100,000 project was tested on varying ground systems in late June. In early August, receive tests were made and further ground systems testing was

completed.

The antenna, designed by consultant Ogden Prestholdt, was supposed to reduce nighttime interference by tuning out skywave in any desired direction.

Prestholdt declined to discuss details of the tests but noted that he was "puzzled" by the varying propagation measurements taken during the tests.

Williams, however, said the project was not a disappointment.

"We are looking at ways of improving AM service, and this is one of those ways," he said.

He pointed to another NAB project, the low-profile antenna that is being tested through computer modeling.

Williams said the results of the computer modeling are very encouraging and the low-profile project's status would be updated during the radio show.

For information, contact Kelly Williams at the NAB, 202-429-5337.

The Stations we equip in Baltimore or Dallas, New York or Los Angeles all have something in common.

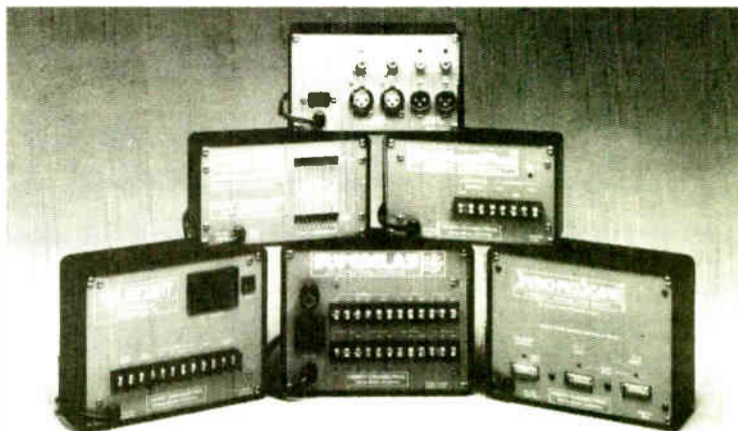

CHECK US OUT
Major market players love our major market products.
Henry ties it all together.

BROADCAST SERVICES/EME

The Davis Communications Group, Inc.

Rt 3, Box 45E, Four Oaks, NC 27524
800/525-1037

AM Rejuvenation Plan Praised

(continued from page 1)

Commission is correct in assuming we need radical changes for this to be effective, but they need to realize that just because something is radical does not mean it will be effective."

One proposal that Clark strongly opposed was the Commission's suggestion that a first adjacent channel protection ratio of 16 dB be instituted for daytime operation. Currently, first adjacents are offered no protection.

"With 16 dB, you're going to find just about every station in America is going to be in violation. Essentially, they're putting a straight jacket on every station. The price we'd pay is a lot more painful than what they're trying to protect."

With 16 dB protection, protection would extend from a station's .5 mV/m to another station's .079 mV/m contour. Clark commented, "To protect a station today to a half mV/m contour is really senseless. Anyone who thinks anybody is listening at that contour is fooling himself. Most receivers today are not that sensitive."

Both Clark and Walden also disagreed with a proposal—being dubbed the Ratchet Clause—to institute a requirement that any AM nighttime currently creating certain levels of interference would have to reduce its calculated nighttime limitation by 10% when applying for upgrades or transmitter relocations.

"If you have an AM that is profitable and the landlord is going to quadruple your rent, which would put you in debt, forcing you to relocate, you shouldn't have to take a signal loss. That has nothing to do with upgrading or financial gain," said Clark.

Impact of digital

One issue not dealt with in the docket but prompting discussion is the influence that digital audio broadcasting (DAB) may have on AM's future. The technology has emerged in recent months as a possible replacement service for both AM and FM. Would it render recent attempts at improvement moot?

"Digital is brand new and will be front and center for a long time. But we have the momentum going with AM now and we've got to see that through," warned

David Hicks, NAB's Radio Board vice chairman and CEO/president of Hicks Broadcasting. "If all of the bands operate at their peak performance with the highest technical achievement possible, there's room for all three in the foreseeable future."

Added Group W's Walden, "I'd say we've got 10 or 15 years to get this improvement done and continue to make a living with this until DAB takes over. But if we don't push for improving AM, we're only going to accentuate its decline."

Clark, however, theorized that DAB will be more of a threat to FM than AM because of the battle over superior music delivery, which is not as relevant to

become mandatory within a designated number of years, it asked.

Frank Hilbert, manager of AM stereo and the modulation systems lab at Motorola, supported AM stereo for all stations, and stressed the importance of requiring manufacturers to include AM stereo circuitry on receivers.

If implemented, Hilbert said, "at least it'll give AM a chance, because you can't go stereo without making a significant improvement in quality and performance."

Added Hicks, "I think stereo is really necessary to get a good foundation for AM, except in cases of extreme financial difficulty. We've gone too long without too much direction. (The NAB Radio

"I'd say we've got 10 or 15 years to get this improvement done and continue to make a living with this until DAB takes over."

AM. "Many AM stations are successful in the face of FM competition," he said. "The fact that FM has better fidelity than these stations really isn't a factor. With DAB, to the degree that these AMs are immune from FM's attack, they will be immune from DAB."

However, Alan Box, head of the NAB's Task Force on Digital Audio and Satellite Sound Broadcasting and president of EZ Communications, said that AM and FM service eventually will move into digital spectrum. In the meantime, he agreed that AM deserves attention.

"We're looking realistically at seven to 10 years before digital totally saves the day for AM, but I think there needs to be something in between," he said.

Stereo, yes, yes, yes

Among the more demanding proposals within the text is a move to implement stereo across the band. The FCC queried whether expanded band stations should be required to transmit in stereo or whether it should be regarded as an allocation preference. In the existing band, should stereo transmissions

Board) voted in June for AM broadcasters to move in a stereo direction."

Hicks also supported a manufacturers' standard for stereo: "It's the only way we're going to move this ahead, and the sooner the better. It's going to be up to the manufacturers, since we can't order a (stereo transmission) standard."

Simulcasting draws opposition

The Commission's proposal to put an end to AMs simulcasting FM programming met some opposition when released, and continues to draw a divided viewpoint from the industry.

"A mandate on separation at this time would not be to the best benefit of improving the technical aspects of AM," Hicks said. "We have to have all the resources first, like stereo and NRSC. Once we've had a chance to clean up technically, then simulcasting can follow suit. Right now, we need some breathing room."

According to CBS Technical Operations Director Tony Masiello, "What we have to do is clean up the band and make good sounding radios first. Get the quality up

first, then work on the programming."

As a case in point against the total abolishment of simulcasting, he explained that his WCAU AM and FM in Philadelphia, on 17 August, changed call letters to WOGL AM and FM and began simulcasting portions of its FM oldies format on the AM, striking the AM's talk format.

"We put in a brand new Harris DX-50 transmitter in the AM and a new air studio with PR&E equipment and the like. We're stereo, which we weren't before. We have this station sounding great," Masiello said. "The statement that CBS is making is that we've made quite a commitment to this."

"There is nothing wrong with sharing programming on AM and FM—totally shared is not right, but if you have something that is worthwhile, there's no reason why we can't share it on AM, especially when our nighttime coverage on AM far outweighs the FM's."

Give up the frequency

But according to Art Suberbielle, chairman of the NAB's AM Improvement Committee, a member of the NAB Radio Board and president and GM of KANE-AM, "An end to simulcasting is a good proposal, because the practice does nothing to induce listening on the AM band. It's the same as asking how many copies of a publication or a letter do you need?"

"Why not give the frequency to someone who can innovate it or give up the frequency to cut interference?" he said.

Regarding allocation of stations to the anticipated AM expanded band, the Commission gave preference to those AMs that are found to cause the most interference on the existing band.

Numerous broadcasters had petitioned that minorities, daytimers and public radio stations deserve allocation preference.

"I think the FCC bit the bullet and did what was necessary to hopefully alleviate some pre-existing interference problems on the AM band," said Suberbielle. "Any entrepreneur or minority who wants to get into AM broadcasting can certainly find properties at bargain basement prices on the existing band right now."

"The FCC is very correct in its stance," added Hicks. "It's a good approach to clean up the whole spectrum."



Join the Comrex Parade...

"We get right on the scene with our Comrex/cellphone combo," says Williamson, whether it's Purdue football tailgate parties and stadium interviews or play-by-play sports at home and away. Covering the Frankfort High School marching band at the Disney World New Year's

parade is a perfect example. With three Comrex frequency extender/cellphone remote broadcast units, WASK can be spontaneous and flexible with its remote broadcast programming. It's easy. The cellphone provides direct

connection and the portable Comrex equipment turns the telephone sound into broadcast quality.

Farm Director Skip Davis roams the country for live coverage of what's new at state and county fairs, and often broadcasts his regular farm & commodity reports from wherever he happens to be. "What you can do with this gear is limited only by your imagination," says Davis.

And WASK finds it easier to think creatively now that the station is no longer tied to the limitations and cost of fixed line service.

Call today to hear what Comrex can do for your station.



COMREX

Specialists in Remote Broadcast Audio Transmission

Comrex Corporation

65 Nonset Path, Acton, MA 01720

1-800-237-1776 / (508) 263-1800 / Fax: (508) 635-0401

Second Look at FM DAs Urged

(continued from page 1)

"However," it added, "(We) believe that improvements identified in such a proceeding will generally be evolutionary rather than revolutionary. An undertaking of this magnitude would be expected to require an inordinate period of time to complete and would have a significant impact upon FCC resources."

The firm said that the undertaking likely would require congressional funding, "with uncertainty of success at a time of budget restrictions."

Not even anecdotal evidence

Among the only parties strongly supporting the Commission's action—and opposing the request to reconsider—was Tschirhart Broadcasting in Houston. The NAB, it said, "does not submit so much as anecdotal evidence that the FCC propagation assumptions are so flawed as to require a freeze."

The company added that it would be unfair for the FCC to put a freeze on directional antennas now, because "many broadcasters have assumed that these rules were settled and made plans accordingly."

Each time the NAB has moved to delay or rescind protection guidelines, the FCC has failed to approve it. This should be no different, Tschirhart said.

Along with the filings was a dispute about the nature of the opposition to the Commission's original action. du Treil, Lundin & Rackley issued a separate statement saying its position on the issue had been inaccurately represented by the NAB.

According to the engineering firm, the NAB issued a press release that incorrectly linked the firm to some viewpoints NAB said were shared by the five groups in the joint filing.

First, it said, NAB erred in saying that du Treil, Lundin & Rackley subscribed to the view that FM directionals were technically unsound. Said firm President Robert du Treil, "FM directional antennas are actually preferable to non-directional antennas from an engineering standpoint. At least some form of pattern modeling must be undertaken."

NAB also seeks suspension of the FCC's new rules pending Commission review,

with which du Treil disagreed. "The new rules provide the only means for some stations to change transmitter sites or improve their facilities," he said. "It's important that stations have this last resort."

More support for reconsideration

Also filing comments were Guy Gannett Publishing Co., licensee of WSSP-FM in Cocoa Beach, FL, and JJ Taylor Cos., licensee of WEAT-FM in West Palm Beach, FL.

Guy Gannett, in its comments, said that a comprehensive proceeding is necessary to re-examine the technical assumptions underlying contour protec-

tion and their adequacy to accurately predict interference.

"Specifically, Gannett opposes the grant of assignments under the contour protection rules in areas of the country where 'ducting' interference is a significant problem," it wrote. "Gannett supports the joint parties' recommendation to suspend the application and use of the (new rules)."

The company added that contour protection would lead to an unacceptable increase in overall interference in the FM band. Adherence to distance separation standards, it said, is particularly acute in the southern coastal regions of the US, where ducting is more prevalent.

Taylor disagreed, however, saying that the station actually was trying to prevent Taylor's WEAT from taking advantage of the new rules.

FCC Clarifies STL Extension Rule

by John Gatski

Washington DC Due to reported confusion among some engineers, the FCC has clarified its recent STL policy that extended the amount of time radio stations have to upgrade their STLs.

According to the Commission's Engineering Policy Branch, the recent amendment to Section 74.550 allows stations to continue using non-type notified STLs until 1 July 1993, and also applies to stations that make changes to their transmitter, antenna or studio.

The FCC clarified its policy regarding STLs when *Radio World* received calls from stations that said they were told they could only continue to use the non-

type notified STLs if no changes were made to the studio, transmitter or STL location.

Engineers were under the impression that if modifications were made to a station, newer, type notified STL would have to be used.

According to FCC Engineering Branch Policy Chief Jim McNally, however, stations can continue to use their current non-type notified STLs until the 1 July 1993, deadline, even if changes are made to the transmitter, antenna, studio or STL location.

"Section 74.550 as amended in the order simply indicates that operation of the 944-952 MHz equipment, which has not been approved under the equipment authorization program, may continue until 1 July 1993," McNally said.

Although the rule does not specifically state current 944-952 MHz equipment can continue to be used, the intent has been interpreted as such, McNally explained.

"The rule presumes that licensees of new or modified STL facilities will elect to use new equipment and requires that such equipment marketed after 1985 be

type notified. But it does not preclude a licensee acquisition and use of used, non-type notified 944-952 MHz STL equipment until 1 July 1993," McNally said.

When the Commission amended its STL rules, part of the reason for the extension was the expectation of imminent availability of digital equipment, McNally noted. "The FCC did not want to force licensees to invest in analog equipment when digital equipment was expected shortly," he said.

Despite the extra time stations have to upgrade their STLs, McNally warned STL users not to purchase and install non-type notified STLs close to the 1 July 1993, deadline because there will be no more extensions.

The FCC made its original STL mandate in 1985 giving stations five years to upgrade to type notified/accepted STLs on the 944-952 MHz band. However, the deadline was extended from 1990 to 1993 in January when National Public Radio (NPR) and the Society of Broadcast Engineers (SBE) pressured the FCC to allow stations to have more time to upgrade to type notified/type accepted STLs.

CRL SPOTLIGHT

Have a
news/talk/sports
format?

Want to improve
coverage of your station?



MBL-100 AM NEWS/TALK PROCESSOR

The MBL-100 news/talk AM audio processor was designed for you. The MBL-100 provides very high levels of average modulation density or loudness. The added density it provides helps to overcome noise and interference problems. The MBL-100 is useful for filling in null areas and reducing the effects of powerline reradiation. And if your antenna bandwidth or symmetry is not that great, the 7.5 kHz bandwidth of the MBL-100 will make life easier for your transmitter. The MBL-100 is designed to give your station better coverage area. To learn more about the MBL-100 call or write now for details. The MBL-100 is available on our two week trial program.



Circuit Research Labs, Inc.
2522 West Geneva Drive
Tempe, Arizona 85282-3192 U.S.A.
(800) 535-7648 (602) 438-0888 FAX (602) 438-8227
Bulletin Board System (602) 438-0459

LOW PRICES

(too low to print!)

Full Compass Systems always offers discounted discount prices on highest high quality Shure products, but

now for a limited time only Full Compass will throw in a perfectly FREE T-Shirt with every Shure mic or mixer purchased. Clearly, a great deal! But HURRY! T-Shirt supply large, but limited.



M267



SM7

SHURE BUY IT
AT

1-800-356-5844
Consultation: 608-271-1100
5618 Odana Road • Madison, WI 53719



#1 FOR ALL

Which cart machines do you put in your racks? Everyone has a different preference. Which carts do you put in your machines? The clear favorite is the genuine Audiopak broadcast cartridge, the

world's best selling tape cartridge. The #1 choice of demanding broadcasters across the country and around the world.

No matter what brand of machine they play them in, broadcasters know they can always count on Audiopak. That's because only bona fide Audiopak carts are loaded with real Audiopak tape. You expect consistency, reliability and unsurpassed audio performance.



You get them all with every batch of Audiopak carts — "workhorse" A-2s, "stereo" AA-3s and "digital-ready" AA-4s. Just as you have for years.

That's a record no "lookalike" cart will ever be able to match. So if you want all the clarity and phase stability your cart machines were designed for, don't take chances. Make sure they're playing "the only blue that's true" — genuine Audiopak carts. Look for our new Quality Assurance seal and the molded-in Audiopak logo on black A-2s as well as blue AA-3s and AA-4s. They're your guarantee of genuine Audiopak performance.

audiopak[®]
BROADCAST CARTRIDGES

**The cart the world
counts on, cart after
cart after cart.**

P.O. Box 3100
Winchester, VA 22601
Tel: (800) 522-CART or
(703) 667-8125
Fax: (703) 667-6379

Gammon Defends Relocation

Media Entrepreneur Places Ad to Explain Ethical And Legal Motives Behind Planned Station Move

by Charles Taylor

Vienna VA Tom Gammon is weary of those who don't believe.

When the broadcaster filed with the FCC in February to relocate his WHMA-FM 90 miles from Anniston, AL, to Sandy Springs, GA, under new city-of-license rules, he was bombarded by criticism that the action was a sly attempt to invade the lucrative Atlanta market.

Since then, Gammon, who owns Crown Broadcasting here, has been on the defense, relentlessly trying to prove that his move is legal, ethical and just a noble attempt at good business.

In July, Gammon took out a full-page advertisement in broadcasting trade publications trying to make his point clear.

"Like you, my living has depended on a healthy, vibrant broadcasting industry," he stated. "Recently, there's been a lot of publicity suggesting that I'm up to something that will hurt our business. It's not so, and I want you to know it."

According to Gammon's attorney Kevin Boyle with Latham & Watkin, the ad was placed in the hopes of alleviating "an incredible amount of very emotional disin-

formation being spread by opponents. He figured this was the best way the public could find out the truth and the advantages of what he is trying to do."

In the ad, Gammon explained that after spending \$500,000 for nationwide engineering studies to search out geographic situations where the new city-of-license rules might be applied, he

"If it goes in the tank, Tom Gammon is not going to smile and just walk away from it. Some of his reaction may be legal."

took advantage of three potential opportunities, including the Anniston to Sandy Springs move.

This proposal, he says, will provide a first local station to Sandy Springs—a community of more than 77,000 people—reach and serve the Atlanta market, add a new, first FM radio service at Lineville, AL, "and most importantly, add a full-service FM station in Anniston, so that it loses no service.

Over a million people will receive improved radio service. Three new local radio stations are created. No one loses."

Subvert Communications Act

But the NAB and a number of Atlanta broadcasters have cried foul on the proposition, claiming that Gammon's move represents, according to the NAB, "nothing more than a thinly veiled effort to subvert Communications Act requirements and relocate a radio station to a much larger market."

The groups added that if successful,

In the ad, Gammon maintained that less than 10 site move changes have been filed in the year since the Commission passed its city-of-license rules and that his engineering research showed that only between 14 and 16 FMs near the top 150 markets could technically change their cities of license to enhance their value while complying with FCC rules.

Only 58 really could do it

In another document, Gammon said that within an examination of "thousands of theoretical possibilities," a total of only 58 stations nationwide could viably enhance service while providing economic benefit to the station.

In a reply to supplemental comments filed in July with the Commission, Great American Television and Radio, WSB and Summit-Atlanta Broadcasting, responded that even with 58 potential moves, "there are 58 compelling reasons for the Commission to reconsider the current formulation of its community of license modification policy."

Said Boyle, "I can't say what will happen if this doesn't go through. If it goes in the tank, Tom Gammon is not going to smile and just walk away from it. Some of his reaction may be legal."

The FCC's response, he added, isn't expected for several months. "There are other things on the Commission's agenda that they have deal with first. It will certainly be at least the end of the summer before they get to this."

For information, contact Crown Broadcasting at 703-506-0990.

Ease of Carts, Quality of CD?

Rugged CD Cartridge, instant cueing, full remote & EOM connections and Digital Display make the DENON 950FA easy to use.

Real time D/A conversion, four times oversampling and active balanced outputs provide unparalleled CD performance.

YES!!



**DENON
950-FA
CD CART PLAYER™**

For friendly service, fast delivery and great value contact your nearest Northeast sales office. They have all the details.



**NORTHEAST
BROADCAST LAB, INC.**

"Serving The Broadcast Industry Since 1961"

Main Office

P.O. Box 1179 • S. Glens Falls, NY 12803
Tel: 518-793-2181

Mid-Atlantic New England Southwest
Tel: 215-322-2227 Tel: 603-483-1002 Tel: 214-612-2053

Spectrum Hearings

(continued from page 1)

Pentagon spokesman Lt. General James Cassidy Jr. of the Joint Staff testified that vacating military use of the 225-400 MHz band alone would cost more than \$20 billion. Displacing a single radar system would cost \$350-550 million, he said.

IEEE witness Robert Powers said that military mobile radio channels use four times the bandwidth needed by newer private sector systems. In the 7 and 8 GHz satellite bands, Powers said, government utilization is estimated to be less than one-tenth that of commercial use.

However, speaking for at least one segment of broadcasters, National Public Radio President Douglas Bennet supported the legislation and requested that 20% of current or new spectrum made available through ET TA be set aside for

the exclusive use of public radio stations for DAB.

"Less than one-half of the current non-commercial FM allocation has been assigned to public radio stations," he said. "Existing spectrum allocations are not adequate to provide a nationwide public radio system. This set-aside would make up for this deficiency, allow public radio to expand its services to unserved and under served audiences, and take advantage of technological advances as they occur."

Bennet described the advantages of DAB and warned that "radio may become stranded as the last analog audio format unless broadcasters and policy makers are prepared to tackle head-on the challenges and opportunities that DAB represents." The additional spectrum is necessary in order to support the transition of radio stations from analog to DAB, he said.

Subcommittee Chairman Sen. Daniel Inouye (D-HI) asked Bennet what would happen to the FM spectrum when the transition period is over.

"It could be a long time," the NPR president replied. "Our position is that the spectrum ought to be used for optimum purposes, and what that would look like after a 20-year transition period is very hard to project today."

The legislation faces action by the full committee before consideration by the Senate and reconciliation with the House bill if passed.



Lindos

LA100 Audio Analyser

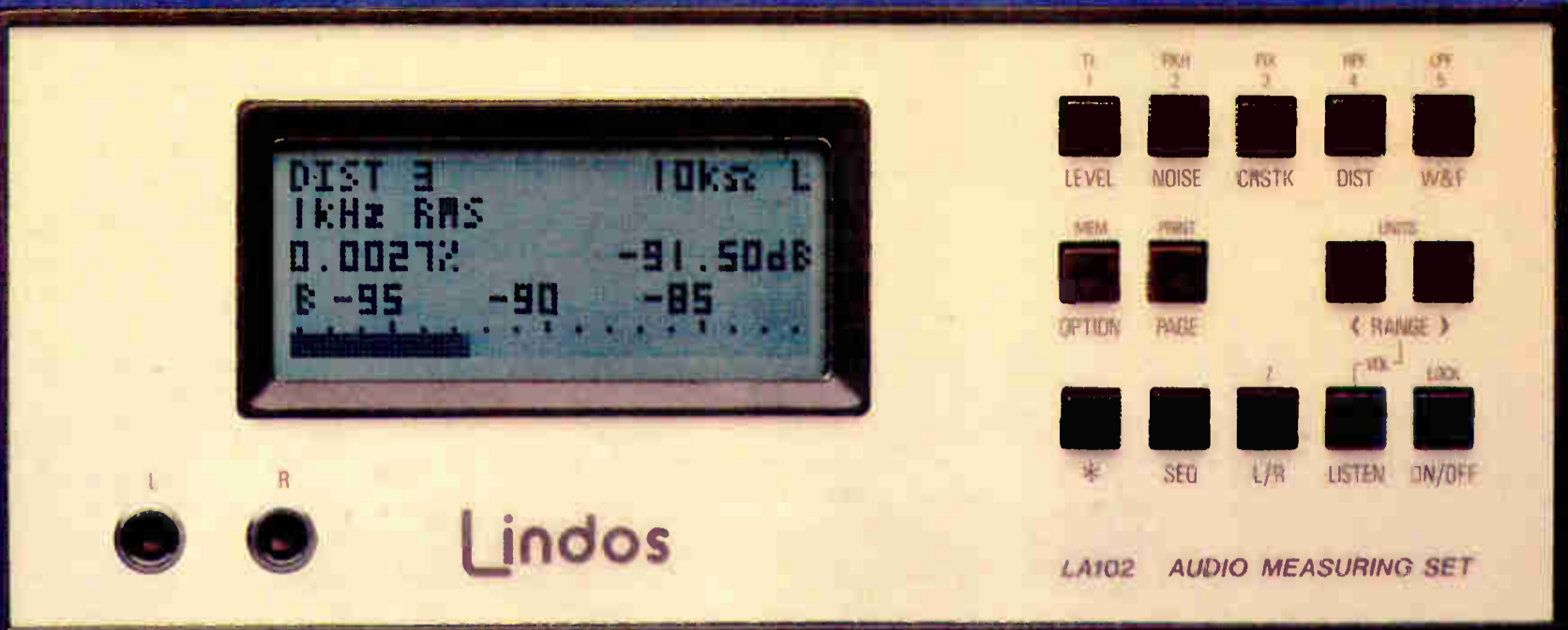

Sound sense in audio measurement

The Lindos LA100 Audio Analyser is a versatile audio measurement system comprising the LA101 Synthesized Oscillator and the LA102 Audio Measuring Set available as separate portable units or combined in 19" rack mount form (2U high).

- **Automatic sequence testing** (using FSK transmitted over the signal path) permits lines, tape machines and other systems to be completely evaluated in less than a minute. The results with pass/fail indication may be displayed on the graphic LCD or printed on any standard printer. Test sequences, tolerance limits and configuration settings can be easily entered into non-volatile memory using the front panel keyboard or a PC.
- **Superb accuracy** is achieved by the use of laser-trimmed resistors combined with software calibration (no trimmers, no drift).
- **Synthesized low distortion oscillator** (0.003% THD) with quartz stability can generate accurate tone bursts and frequency sweeps with no amplitude bounce.
- **Extreme Versatility:** Measurements including level, frequency, noise, crosstalk, distortion, frequency response, phase, jitter, wow & flutter, speed, rumble and quantising distortion.
- **Mains and rechargeable battery operation.**
- **PC Compatible:** RS232 interface built-in. PC Support software provides disk storage etc.
- **Fully floating and electronically balanced oscillator outputs and balanced inputs.**
- **Test tapes and discs** will be available soon but our smart test modes can be used with tones and sweeps on your existing tapes and discs to plot frequency response graphs.
- **Proven in use worldwide:** Launched in the UK 5 years ago; all major UK broadcast and telecommunications organizations have over 100 units.
- **\$5200 including LA101 Oscillator, LA102 Measuring Set and air mail delivery.**

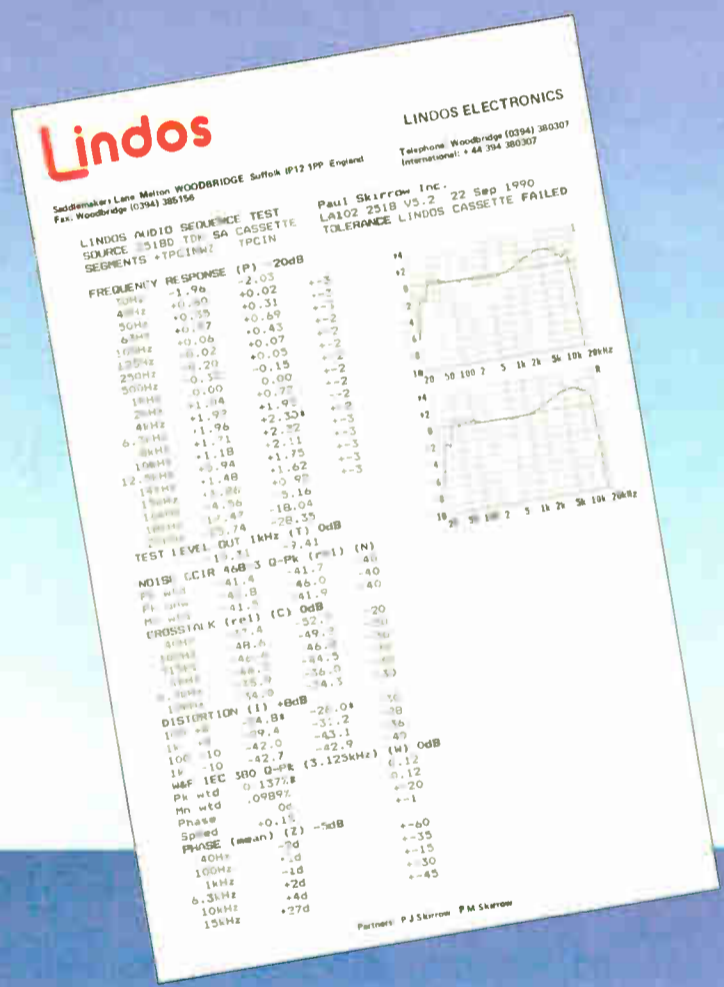

Output: 5Hz-38kHz, -100dBu to +26dBu in 0.01dB steps, 10Ω, 75Ω or 600Ω, two channels, XLR sockets. Level accuracy: ±0.03dB, 5 frequency and 5 level presets. **Input:** -110 to +28dBu (with fast autoranging), two channels, XLR sockets. Accuracy ±0.05dB. **Level:** true rms 2-100kHz, 22-22kHz (-3dB), VU, PPM, VU A weighted, rms A weighted. **Noise:** CCIR 468-4 weighted & unweighted quasi-peak, CCIR/ARM, CCIR rms, weighted & unweighted rumble (BS4852). **Residual noise:** -97dBu (CCIR weighted, q-peak). **Crosstalk:** 40, 100, 315, 1k, 6.3k, 10k, 15kHz, 80-400, 1.8k-21k, 12k-21kHz (12dB/octave bandpass filter). **Distortion:** 40, 100, 1k, 6.3k, 10kHz THD & 315Hz (3rd harmonic). **Wow & flutter:** IEC386, DIN45507 weighted & unweighted quasi-peak, weighted & unweighted rms. **Oscillator weightings:** RIAA, CCIR, 50μs and 5 user weightings. **Tone-bursts** fully programmable, 0.1ms resolution. **Monitor:** built in. **Scope/phones output:** BNC socket. **Battery life:** 5 hours.

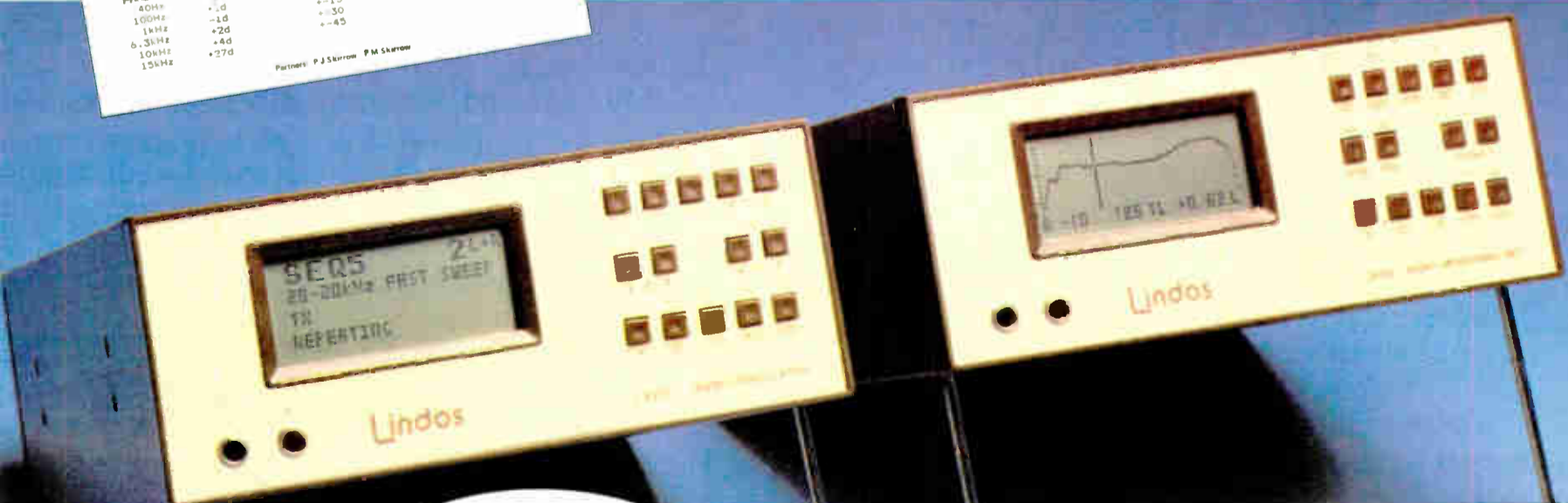

**Booth 1414
AES, Los Angeles
22-25 Sep 1990**

Please telephone or fax for a leaflet:
LINDOS ELECTRONICS, Saddlemakers Lane, Melton,
WOODBRIDGE, Suffolk IP12 1PP, ENGLAND.
Tel: 011 44 394 380307 (24 hrs) Fax: 011 44 394 385156
To order: for ex-stock delivery mail your order with a check for \$5200 (or transfer to account 50579335 at Barclays Bank PLC, 4 Church St, Woodbridge, Suffolk, UK. Sort code: 20-98-07).

Built for Business.



The Revox PR99 MKIII Professional Recorder

The **PR99** means business and in today's high-pressure, competitive environment, your station can't settle for anything but the very best. Featuring advanced audio electronics, the PR99 MKIII professional recorder outlasts and outperforms all others. With its superior construction, this recorder was built for long-term dependability, easy maintenance and the highest quality audio. And our reputation for service and technical support remains unsurpassed in the industry.

Take note of these PR99 features: • a solid die-cast aluminum transport chassis and head block • record and playback heads built to the same tolerances as the heads for Studer multitracks

- easily accessible modular electronics for tough, reliable performance
- an Autolocator with digital counter in hours, minutes and seconds
- rack mounts standard.

With ease and versatility, this no-nonsense machine stands up to the rigors of daily station operations. Whether taping news call-ins, downlinking or uplinking satellite feeds, producing commercial spots or remote recording—whatever your station needs, the PR99 delivers!

For value and performance over the long haul, Play a Pro. The one built for business.

STUDER REVOX

Studer Revox America, Inc.
1425 Elm Hill Pike • Nashville, TN 37210 (615)254-5651
New York (212)255-4462 • Los Angeles (818)780-4234
Studer Revox Ltd., Toronto (416)423-2831

Call your Studer Revox Professional Products Dealer for more information about the complete line of Studer Revox Professional Products.

More Readers Forum

(continued from page 5)

Mr. Bueneman also matter-of-factly states that WHMA-FM's country format "cannot successfully compete in the Atlanta market." On what does Mr. Bueneman base this? Does he have research to back up his claim? When Y106 went country, there are those who said they'd never beat WKHX, but they did. And who's to say WHMA-FM would program country after the move?

Mr. Bueneman states that "the Anniston/Gadsden market needs a country and western music FM station, to compete with WAAX (FM) and WJXL (AM)." However, if you were to ask WAAX and WJXL, I'm sure they'd love to have this powerful competitor moved out of town. Mr. Bueneman also overlooks Emerald Broadcasting's proposal to add a new 25 kW Class C3 allocation to Anniston if WHMA-FM is relocated.

Mr. Bueneman further asserts that if Emerald is successful in moving WHMA-FM to Georgia, "a set number of jobs should be set aside for entry level (on-air) and disabled (off-air) applicants." This is the most asinine suggestion I've heard in ages. Emerald complied with all FCC rules when they petitioned to relocate WHMA-FM to Sandy Springs. Even the suggestion that they be burdened with employment restrictions is absolutely ridiculous.

I guess everyone is entitled to their opinion, but it's foolish to formulate an opinion (and have it published) when you don't have all the facts.

Larry G. Fuss,
Broadcast Consultant
Contemporary
Communications
Fayetteville, GA

More on shared and western calls

Dear RW:

Recent RW issues have addressed the old technique of synchronizing carriers of co-channel AM stations, à la WBZ/WBZA in Boston and Springfield, but they've not mentioned synchronization of the modulating audio, too. Here are some recollections.

In the days when WBBM, Chicago, and KFAB (then Lincoln, NE) were synchronizing carriers, both carried CBS network programs during nighttime prime hours. WBBM had a cabinet full of lumped impedances for delaying the CBS audio delivered to the Chicago transmitter, to duplicate the network land-line delay from Chicago to Lincoln, so that both transmitters were modulated synchronously.

The stations split the chain

breaks. As I recall, WBBM took the first half ("WBBM Air Theatre, Wrigley Building, Chicago") while KFAB was silent; then KFAB identified while WBBM was silent. Or vice versa.

The scheme wasn't greatly successful at my location, about 70 miles northeast of Lincoln and 350 miles west of Chicago. KFAB was our "local" CBS source during the day, but echo from WBBM and skywave

interactions usually made it unlistenable at night.

On another subject, the Old Timer has researched the history of a few "W" calls past or current west of the Mississippi river. There used to be a considerable number of them. Among those I heard regularly while growing up are/were:

IA: WOI, Ames (non-commercial AM owned by Iowa State U.); WMT, Cedar Rapids;

WHO, Des Moines; WSUI, Iowa City (non-commercial AM owned by U. of Iowa); WOC, Davenport (on the Miss. river; was transmitter on IL side?); WDBQ, Dubuque (also on the river).

In KS there was WIBW, Topeka; in MN: WCCO, Minneapolis-St. Paul (on the river—transmitter to the east?); in NE: WOW, Omaha and WJAG, Norfolk; in OK: WKY, Oklahoma City; in SD: WNAX, Yankton; and in TX: WOAI, San Antonio; WBAP and WFAA, both Dallas-Ft. Worth.

In checking a 1967 Broadcasting Yearbook (the oldest I have)

I note these other "W" calls west of the Mississippi then:

KS: WREN, Topeka; MN: WAYL, Minneapolis (east of the river?); WCTS; WDGY; WLLO; WMIN; WMKT; WPBC; WWTC; WCAL, Northfield; in ND: WDAY, Fargo; in OK: WNAD, Norman; WBBZ, Ponca City; in TX: WTAW, College Station; WRR, Dallas and WACO, Waco.

Some of these calls have associated FM and/or TV facilities. Yours for nostalgia!

R.H. Coddington, Author
Modern Radio Broadcasting
(TAB Books; 1969)
Richmond, VA



When you need extra hands mixing audio, Shure's AMS can help.

Until recently, you needed outstanding hand-ear-eye coordination to mix audio in multiple-microphone broadcast situations.

Now there's a system that gives you broadcast-quality audio when you can't cover all the faders at once. It's the Shure Automatic Microphone System (AMS), featuring patented direction-sensitive gating.

The Shure AMS continuously compares audio signal levels from two matched unidirectional condenser microphone cartridges located back-to-back in each AMS microphone. The rear-facing cartridge monitors ambient sound, while the front-facing cartridge handles sound from the desired source. When the front cartridge output exceeds the rear cartridge output by 9 dB, the AMS mic channel gates on automatically in .004 seconds.

Because of this unique gating concept, an AMS microphone channel will *only* gate on

when addressed from within a 120-degree "window of acceptance" centered at the front of the microphone. AMS mics not addressed from within this angle remain off. So the number of open microphones is kept to a minimum automatically, with no need for manual control.

Since the Shure AMS automatically keeps track of the number of open microphones and adjusts the overall gain to compensate, your broadcast level stays constant as mics open and close, without troublesome gain-riding.

Direction-sensitive gating makes the

Shure AMS the best system to use in multiple-mic situations, from panel talk shows to game shows to hearings on Capitol Hill. More and more broadcast engineers are discovering the advantages of having broadcast-quality multiple-microphone



audio without the headaches of manual mixing or the time-consuming setup of so-called automatic mixers.

With AMS you not only get all the advantages of a truly automatic microphone system, you also get the broadcast-quality audio and reliability of Shure microphones.

For a comprehensive AMS literature packet, call us at 1-800-257-4873. For AMS technical support, call Michael Petersen at 1-708-866-2512.



SHURE®

The Sound of the Professionals®... Worldwide.



SATISFACTION GUARANTEED.

What's going on in the console business?

Last year, when we introduced the RS-Series consoles, our pricey competitors fought back by advertising that their consoles were "Designed — Then Priced", implying that for what our consoles cost, they couldn't be well made.

Then more than 250 broadcasters bought RS-Series consoles. And they all loved them. More than 38% bought another.

So this year the competition changed their ads. Now the headlines cry "We Surprised Ourselves", and sure enough, they go on to admit that it does seem possible to build a quality, mid-priced console.

So, while the competition scrambles to cheapen up their pricey consoles, we invite you to take advantage of our experience and reputation for real value.

Buy an RS-Series console and use it for up to 30 days. And if for any reason you're not 100% satisfied, send it back. We'll refund your money — in full.

Get a great console — at a great price — with absolutely no risk.

It's an offer we can afford to make, because we didn't re-engineer the affordable quality console — we invented it.

RADIO SYSTEMS INC.

110 High Hill Road □ P.O. Box 458 □ Bridgeport, NJ 08014-0458 □ 609/467-8000 □ 800/523-2133 □ FAX 609/467-3044

AES Show Preview

Los Angeles

Sept. 21-25, 1990

On Exhibit at the AES

The following is a list of selected AES convention exhibitors of special interest to radio stations.

Accurate Sound Corp.	1004	JRF Magnetic Sciences	330
Agfa Corp.	114-120, 227-239	JVC Professional Products Co.	121, 122, 123
AKG Acoustics	226-230, 327-331	Klark-Teknik Electronics Inc.	826-838, 927-939
Alpha Audio	700-706	Lexicon, Inc.	Room 208
Ampex Recording Media Corp.	212, 214, 313, 315	Lindos Electronics	1414
AMS Industries Plc.	336, 338, 437, 439	Neutrik USA, Inc.	342, 344
Aphex Systems Ltd.	708, 710, 809, 811	New England Digital Corp.	Room 214 A, B, C
Ariel Corp.	549, 551	Orban — A division of AKG	226, 228, 230, 327, 329, 331
A.R.T.	240, 242	Otari Corp.	512-520, 613-621, 612A-620A, 612-620, 713-721
Audio Accessories Inc.	247	Panasonic Comm. & Systems	Room 206
Audio Precision	20, 21, 27, 28	Peavey Electronics Corp.	806, 808, 810, 907, 909, 911, 906A, 908A, 910A
Audio-Technica U.S. Inc.	301	RPG Diffusor Systems Inc.	341
B.A.S.E.	Room 101	Saki Magnetics Inc.	627
BASF Corp. Information Sys.	440, 442, 444, 541, 543, 545	Sennheiser Electronics Corp.	609, 611
Beyerdynamic	601, 603	Sescom Inc.	206
BGW Systems Inc.	216	ZShure Brothers Incorporated	107, 108, 213, 215
Bose Corp.	Room 216B	Sonex Acoustical/Ilbruck Inc.	43, 44, 50, 51
Bruel & Kjaer Pro Audio	7	Sony Corp. of America	300-310, 401-411, 400A-410A, 400-410, 501-503, 500A-10A
BrystonVermont	418, 420	Sound Technology	139
Carver Corp.	1417	Studer Revox America Inc.	111-113, 221-225, 220A-224A, Rm. 209
Crown International	200, 202	Sunkyong Magnetic/America Inc.	920, 922, 924, 1021, 1023, 1025
D & R Electronics b.v.	748, 750, 849, 851	Summit Audio Inc.	1421
DIC Digital	848, 850, 949, 951	Switchcraft Inc.	1117
Digidesign	1109, 1111	Symetrix, Inc.	901, 903
DOD Electronics	523, 525, 422, 424	Tannoy-TGI North America Inc.	926, 928, 930
Dolby Laboratories Inc.	326, 328, 427, 429	Tascam	103, 104, 105, 106, 205, 207, 209, 211
Dorrugh Electronics	940	TDK Electronics Corp.	85, 86, 92, 93
E-mu Systems Inc.	Room 211B	Telex Communications Inc.	734, 736, 738, 835, 837, 839
Electro-Voice Inc.	Room 205	3M/Professional A/V Products	412, 414, 513, 515
Eventide Inc.	208, 210	360 Systems	1403, 1404
Fostex Corp. of America	820, 822, 824, 921, 923, 925	Turtle Beach Systems	52
Fujii International Inc.	946	Valentino Inc.	35
Gefen Systems	445	Yamaha Corp. of America	318, 320, 322, 324, 419, 421, 423, 425
Gentner Electronics Corp.	1308		
Gotham Audio Corp.	712, 714, 716, 813, 815, 817		
JBL Professional	430-438, 531-539		
Jensen Transformers	605		

AES booth numbers were correct at time of publication. Radio World assumes no liability for errors.

Pro Interface Efforts

by John Gatski

Washington DC Efforts are underway to facilitate the acceptance of the AES/EBU interface in professional digital audio equipment.

The Audio Engineering Society (AES) and European Broadcasting Union (EBU) are revising the standard to make it easier to implement, according to Robert Finger, chairman of the AES Working Group for Input/Output Interfaces.

The interface standard revision process should be complete by early 1991, Finger said.

Not catching on

The interface, originally known as AES-3 1985 and adopted in 1985, has not been embraced quickly by manufacturers because of complicated interface circuitry, lack of commercial grade ICs and specification confusion.

Many companies have used consumer interfaces in their equipment that have similarities to the AES/EBU digital audio interfaces, but have incorporated shortcuts such as consumer-grade ICs and connections that have created incompatibility problems.

Richard Cabot, who also sits on the AES Working Group for Input/Output Interfaces, said the AES and EBU have worked toward more straightforward specifications.

"They are working on enhancements to clear up the confusion," said Cabot, who also is VP of Audio Precision.

With a revision of the AES/EBU interface standard and education for professional users and engineers about the standard through new engineering guidelines, there should be fewer prob-

lems, according to Finger.

"The revision should clarify some of the language, tighten up specifications for electrical parameters and provide a new allocation for reserved bits," Finger said.

A mismatch

Much of the confusion and compatibility problems have stemmed from try-

(continued on page 18)

Fishing For A Phone Number?

Catch it in the

1990 Radio World Annual

—The Industry Source for Manufacturer, Supplier, NAB and FCC Phone Listings, as well as Product Information, Company Profiles, Buyers Guide Reprints, RW's 1989 Editorial Index, Reference Material, and More...

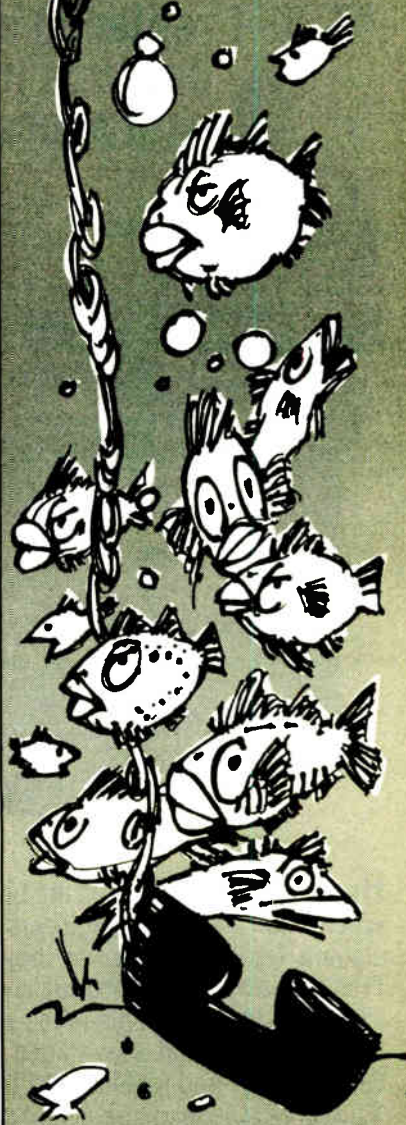

Send \$14.95 for each Annual to:

RW 1990 Annual
P.O. Box 1214
Falls Church, VA 22041



Stereo Play \$1875 List

BROADCAST SERVICES/EME

The Davis Communications Group, Inc.

The Preferred Source... for all ITC products.

ITC Series 1

The last cart machine you'll ever buy...

An ITC Series 1 cart machine placed in service today will perform well into the next century. ITC has set the standard for long-term reliability, outstanding factory support and unsurpassed performance. We've priced the Series 1 to fit every budget.

Call today:

800/525-1037

Big League Audio on a Budget

by Frank Beacham

Hollywood CA The late Orson Welles, one of the great pioneers of radio produc-

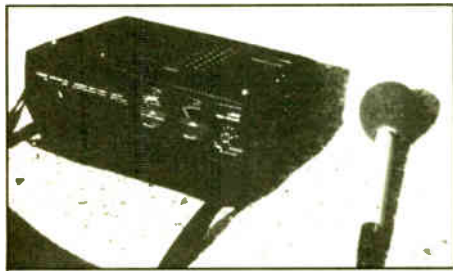

The Marantz PMD-430 recorder has proven itself in the field many times over.

tion, returned to the medium again in his final years after having a brilliant career in the theatre and film. The reason: Unlike theatre or film, audio gave him total creative control of the production process at a cost he could easily afford.

Having had the opportunity to work with Welles, I learned the incredible creative potential of the audio medium and how blessed we are in these times to have such high quality yet affordable technology with which to work.

For the time being forget the current buzz words like "DAT," "digital," "workstation," and "disk." Think instead of the incredible advances in analog technology, which in recent years, have allowed us to do audio production on a shoestring. I'm talking here about

broadcast-quality audio on a barebones system that can be yours for less than \$1500.

The equipment I'm about to describe was not designed for professional broadcast use. It's more in the high end consumer or industrial category. But used with a combination of care and skill, the production path I'm about to describe works so well it might surprise many die hard broadcast engineers.

The gear can be used across the board for a range of programming, from audio documentaries to radio drama. In fact, programming I've made with this equipment has been successfully released on digital laser discs with absolutely no one even questioning the quality of equipment I used.

My favorite field cassette recorder is the Marantz PMD-430. This proven 2.9 pound portable has dbx Type II noise reduction that results in a 75 dB signal to noise ratio and offers 35 Hz to 17 kHz frequency response when used with metal tape.

It has a nice big VU meter, built-in speaker, tape monitoring and a list price of \$599. I've been using one for six years without a glitch. In fact, it has saved me several times when far more sophisticated gear has bitten the dust in the field.

I'm hesitant to recommend good inexpensive microphones since the choices are so abundant and my audiophile friends will turn up their noses. How-

ever, for mono use you can't beat the time proven, durable Electro-Voice 635A hand mike. And for the realism of stereo recording, Shure Brothers has set a new low price standard for mid-side recording with its under \$1000 VP88 stereo condenser model.



Tascam's 688 MIDI studio combines a 10 channel mixer with an eight track cassette recorder.

As for inexpensive, personal audio editing equipment, you can't beat the current generation of cassette-based multitrack cassette systems from companies such as Tascam, Yamaha, Fostex and others. I recently edited a broadcast documentary on Tascam's Porta One Mini Studio, which is a four-track recorder/mixer combination. I found the sonic quality excellent.

With accessories, the Porta One cost just under \$600 with discounts. It offers four input channels adjustable from microphone to line level, a two-band equalizer on each input channel and dbx Type II noise reduction. Though this model has punch-in and out capabilities, the use of these features leaves an annoying gap that is a nuisance though it can be worked around.

If I were doing it over again, I'd purchase Tascam's new Model 688 with 10 channel mixer and eight-track cassette recorder. Not only does this model offer MIDI capability, but it offers gapless punch in and out, computer memory for board positions and an edit rehearsal mode. List price is \$3299, but, as with all the products mentioned here, it is sub-

stantially discounted at the retail level.

Just as the camera doesn't make the photographer, neither does the equipment make the sound recordist. Recording is an art as well as a science.

The days are gone when it was cost prohibitive for an individual to produce high quality audio programming on his or her own time. Today's analog gear is cheap, reliable and sonically impressive. All that's left now are the excuses.

Frank Beacham, a Hollywood, CA-based writer, director and producer, used the gear described in this article to record the radio documentary, *The Mercury Company Remembers with Leonard Maltin*. It appears on the laser disc release, *Theatre of the Imagination: Radio Stories* by Orson Welles and the Mercury Theatre.

Interface In Works

(continued from page 17)

ing to use consumer equipment with professional equipment, Finger explained.

"People think there is only one standard," he noted. "That's one of the reasons they mix and match with the consumer equipment."

The main consumer interface is the IEC 958 standard, which was modeled closely after the AES-3 1985, but with important differences that do not allow it to work with AES-3, Finger said.

The primary difference between consumer and the AES/EBU interface is the utilization of the status bytes, which contain information about what is being transmitted, according to Cabot.

The consumer interface also uses status bytes to convey information, but the bytes do not represent the same information as the AES/EBU standard.

The AES/EBU interface revision also will address transmitter/receiver impedance mismatches that cause problems when making long cable runs, Cabot added.

"THE-1 replaced all these excitors because it sounds as good as it specs." -- Ron Frillman, *Manager, Radio RF Sales, Harris Broadcast Div.*



Here's proof that THE-1 is the best-sounding FM exciter you can buy. When we invited Chief Engineers to evaluate the Harris THE-1 at their stations for 30 days, dozens took us up on the offer. They listened to THE-1 side by side with virtually every FM exciter on the market. They heard real improvements in the sound of their stations. At the end of the month-long test, they traded in their excitors—some older, some quite recent—and traded up to THE-1.

To date, over 500 stations worldwide have discovered the THE-1 difference. Prove it to yourself—call Harris Allied Radio RF Sales today at 217-222-8200, Ext. 3110.

Harris Allied Broadcast Equipment • Radio RF Sales
P.O. Box 4290 • Quincy, IL USA 62305-4290
Tel (217) 227-8200, Ext. 3110 • Fax (217) 222-7041

HARRIS ALLIED

Circle 100 On Reader Service Card

MORE RADIO PROS ARE TAPING TO THE NTH DEGREE WITH DIC//DAT.

The radio world is turning to DIC//DAT, the one DAT best suited for airplay. Ultra-consistent tape. Ultra-strong shell.

For ultimate performance even faced with the most... enthusiastic use.

Call toll-free for information

1-800-DAT-1-DIC.

In New Jersey, 201-224-9344

DIC
DIC Digital



SHOWN ACTUAL SIZE

See Us At AES Booth 848

Circle 151 On Reader Service Card

Swiss Family **NEUTRIK**

Europe's most innovative audio test equipment is the newest in the U.S.A.

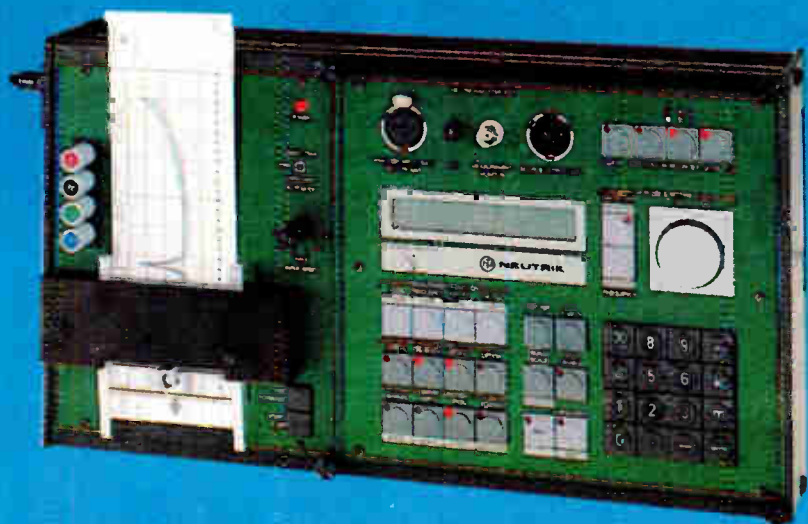

The value packed 3000 Audiograph Modular System.

Capable of a wide variety of audio measurement tests for broadcast, manufacturing or studio applications. Hard copy results are provided by the 3000 Audiograph's precision chart recorder. Over 2500 units in use world-wide, everyday.

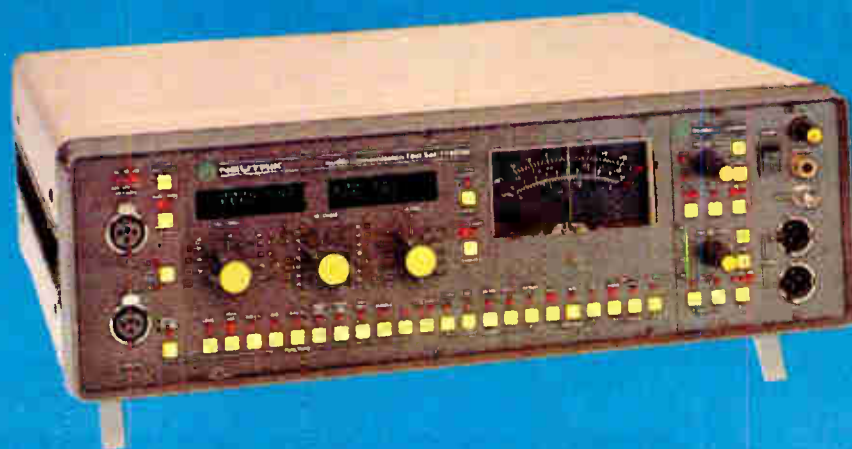

The Neutrik TT402A Audio and Transmission Test System.

A standard among European broadcasters. Capable of delivering a vast array of audio test data via finger tip front panel buttons or through user-friendly computer software. Options available put this instrument at the top of the class.

Introducing the new A1 Audio Test System.



The A1 audio test system is the only instrument providing the capabilities of 7 separate pieces of equipment: sweep generator, level frequency, cross talk, noise, distortion, wow and flutter, curve tracer and an audio measurement oscilloscope. Communication and hard copy available through RS232 interface or centronics port. Accuracy and reliability that is portable for the audio lab, broadcast, manufacturing, service and studio user.

High quality Neutrik test systems are serviced in the United States and backed with a 1 year warranty.

Meet your audio testing needs accurately and in budget with Neutrik.

NEUTRIK

USA, INC.

CONNECTORS
AUDIO TEST SYSTEMS
INFOMATIC SYSTEMS

Neutrik AG • Im alten Riet 34 • FL-9494 SCHAAN • Furst en tum Liechtenstein • 011-41-75-29666
Neutrik USA, Inc. • 195-S3 Lehigh Ave. • Lakewood, NJ 08701 • Phone: 908-901-9488 • FAX: 908-901-9608

DAT Suit Lands Sony in Court

by John Gatski

New York NY The sticky fight over consumer DAT recorders remains entrenched as music publishers and Sony ready for battle in court.

Several music publishers filed suit last July against Sony, the first manufacturer to sell consumer DAT recorders in the US with the capability to digitally record CDs.

In preliminary court papers filed here, Sony said DAT recorders are fundamentally identical to analog recorders, which have not been opposed by publishers for the last 30 years.

Sony and the Electronic Industries Association (EIA) also believe court precedent should help Sony's case.

Not a first

Sony was sued in the 1970s when it introduced consumer video. The US Supreme Court eventually decided that the consumer had a right to tape copyrighted material off the air for private use, a precedent Sony and other DAT manufacturers are likely to use in their fight against the publishers, legal experts said.

Music publishers have countered that DAT is not the same as analog tape

recorders because of their "good-as-original" quality.

The litigation cloud hanging over DAT has hurt the market penetration of the consumer units since their introduction in 1987. The price has remained high and audiophiles have been reluctant to buy the units that could not digitally record compact discs.

The long-promised court battle could continue to hinder consumer DATs market penetration and also affect professional DAT recorders by keeping prices high and software scarce.

Now for sale

Early in summer, Sony began marketing its less-than-\$1000 consumer DAT recorders that contain the recently developed Serial Copy Management System (SCMS). SCMS allows a DAT recorder

to digitally record CDs onto a blank tape, but that copy cannot be copied.

The SCMS technology was approved last year by foreign manufacturers, EIA and the Recording Industry Association of America in an international agreement.

Manufacturers had hoped SCMS finally would satisfy publishers threatening litigation and finally allow consumer DAT to flourish.

However, song publisher groups quickly denounced SCMS-equipped DAT machines, maintaining that the technology did not address royalty compensation to artists.

Before consumer DAT machines capable of digitally recording CDs are allowed to be sold, publishers declared, a royalty system, perhaps a levy on blank tapes, must be worked out to compensate artists for lost royalties from illegal taping.

Publishers contend that SCMS-equipped DAT machines allow the potential for illegally circulated, "perfect" DAT copies of copyrighted CDs.

GET IT RIGHT
FROM HARRIS ALLIED

CARTS GALORE & MORE!!

LOOK AT THESE BEAUTIES

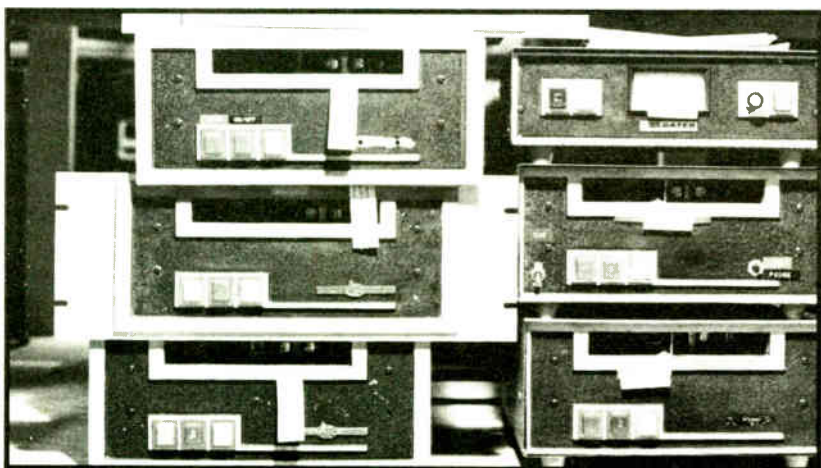

AND HERE ARE MORE GOODIES



BUY! SELL! TRADE!

Allied has been serving the needs of broadcasters for new and used radio equipment since the late 1960's. We take trade-ins and buy and sell selected used equipment — so save some \$\$ and check us out today!

HARRIS ALLIED
EQUIPMENT EXCHANGE

317-962-1471

FAX 317-966-6321

635 SOUTH E ST. • P.O. BOX 1487 • RICHMOND, IN 47374

© HARRIS/ALLIED 1990

DAT Timecode Due

by John Gatski

Washington DC A professional DAT timecode standard should be approved by the International Electrotechnical Institute (IEC) very soon, based on preliminary approval in the spring by the body's parent committee and working group last spring.

The standard was approved last May in Turkey and was issued under the body's six month rule, which means that by November it should become the IEC professional timecode format, according to AES Digital Audio Recorder Study Group Chairman Robert Finger of Panasonic.

The standard's adoption should clear the way for manufacturers to produce timecode-capable professional DAT recorders for eager engineers and producers who have been waiting for the units since DAT's introduction.

The IEC professional DAT timecode format will allow all timecode formats from film and videotape to be recognized and recorded on DAT.

The strong consensus on the standard by IEC members should give incentive

for companies to add it to the professional equipment as soon as possible.

The timecode format recommended by the IEC parent committee and working group is based on a design developed mainly by Japanese electronics giants NHK, Matsushita and Sony. Fostex also contributed.

The IEC timecode technique translates the input information (hours, minutes, seconds and video frames) into a universal time reference located in the DAT subcode.

Besides adding timecode for DAT use, IEC timecode-equipped DAT recorders will accept any of the timecode standards including the SMPTE 30/29.97 fps, EBU 25 fps and the 24 fps film rate. The codes are then converted into the universal DAT reference code, given a time day tag and a source identification.

During playback, the DAT timecode-equipped machines allow the timecode to be reconstructed back to the SMPTE, EBU or the film standard for synchronization back to film or video.

Other timecode formats previously adopted by DAT manufacturers include the SMPTE/EBU 80-bit code that is recorded onto an accompanying analog track and Fostex's timecode that converts data from a house-sync editing system or timecode generator and records it onto the DAT digital subcode.

Fostex was the first company to develop timecode-based coding on the DAT subcode, a method the NHK, Sony and Matsushita timecode also incorporates.

Fostex is planning to incorporate the IEC timecode into its newer units and modify the older ones to be compatible, according to the company.

Oh-Oh!  Call CORTANA

STAT!  The Affordable Lightning Prevention System

- Charge dissipation with 1/8" type 304, sharpened stainless steel rods
- Won't bend from ice severe weather
- Provide a continuous low-resistance discharge path for static electricity

Cortana Corporation

Write for a Free Brochure.
P.O. Box 2548, Farmington, N.M. 87499
Call (505) 325 5336

 **CANCOMM**
Supplier of Broadcast Products

The FM Booster Specialist



Call Eric Lane
(408) 354-4468

WHY YOU SHOULD PAY MORE FOR LESS.

**New Name-
Same Great Cart!**
The ITC Cart II Cartridge, formerly ScotchCart® II

Less phase jitter caused by poorly tracking tape, because the naturally lubricated concave guides gently position the tape and allow the cartridge machine to perform critical guidance.

Less tape noise and signal loss with our 100% laser-inspected, high output, low noise tape which delivers better frequency response and keeps signal-to-noise ratio high, harmonic distortion low.

Less wow and flutter or stop cue overshoot, because there's no rotating hub to wear out, warp or rattle.

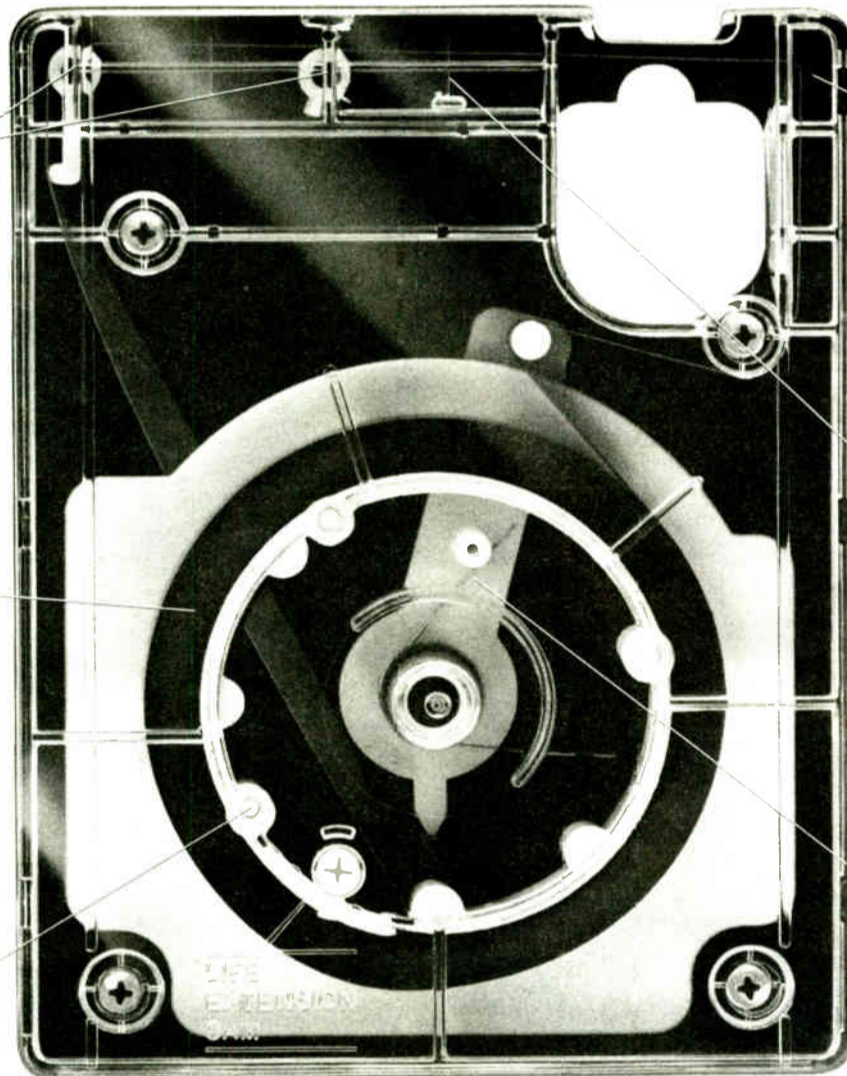

Less chance of the cartridge cracking or breaking, because the tough polycarbonate cover withstands repeated use and abuse.

Less head wear, tape steering and modulation noise, because there aren't any pressure pads to add friction.

Less chance of tape destruction, because our patented dynamic tension control system ensures proper tape-to-head contact, and provides constant tension to control looping and prevent twisting.

The ITC Cart II Cartridge, formerly ScotchCart® II

With broadcast cartridges, like everything else, you get what you pay for. With ITC Cart II cartridges, you get a revolutionary design that delivers trouble-free operation, superb sound quality and a life expectancy that's second to none.

We have renamed the cartridge due to trademark considerations, but only the name has changed, the cartridge and tape are the

same. New name, same great cartridge and performance.

For a complete listing of ITC Cart II dealers, call ITC toll-free at 800-447-0414 (in Illinois, call collect 309-828-1381.) Or write to ITC at P. O. Box 241, Bloomington, IL 61702-0241.

Because a cheaper cartridge may be more trouble than you can afford.

ScotchCart® II is a registered trademark of 3M



Circle 96 On Reader Service Card

World Radio History

Workstations Set Show Abuzz



AKG DSE 7000 Workstation

The AKG DSE 7000 digital audio workstation incorporates a computer system unit, a controller and a color monitor into a workstation equivalent to the size of a professional tape recorder.

Features include multispeed search capability, a scrub wheel, seven auto/loc points, two sends/returns, a connector for six-function remote control and status control.

Hardware consists of 20 MHz Intel 80386 with 1MB DRAM, high capacity floppy drive, 150MB ESDI hard disk, serial communication and parallel printer ports, ten input mixer, a 14" EGA color monitor, word processor and custom console.



Alpha DR-2 Hard Disk Recorder

The DR-2 HD Edit Controller from Alpha Audio is equipped with Boss/2—a 12 MHz 286 with EGA color graphics, a 20M hard disk, 1.2M floppy, two common ports plus printer port and a keyboard touch pad for machine speed control.

Track time of the DR-2 is 15-60 minutes stereo at 44.1 kHz, with optional hard disks for up to eight hours of stereo.

The DR-2 features a proprietary design with multi video sync, external SCSI port and an internal time code reader/generator.

New Model AT825 X/Y Stereo Field Recording Unidirectional Condenser Microphone



Point and shoot stereo!

Good stereo audio is now as simple as good mono. Because, now you can hold great stereo in one hand. Create stereo ambience on every ENG remote. Pick up stereo music or audience reaction in your studio without needing a degree in acoustics...just one carefully-placed microphone.

In the field, a single camera-mounted AT825 creates well-balanced stereo, while the talent may use a mono lavalier or hand-held microphone as usual. Fed to a stereo mixer, the ambient sound microphone provides authentic stereo for greater realism and impact. Even commercials can come alive with stereo.

Inside the AT825 windscreen, two precision unidirectional microphone capsules create a remarkably stable stereo image and true directionality – the result of closely matched, very uniform cardioid patterns. When mixed to mono, there are no peaks or dips in centered sound sources, due to careful electro-acoustic matching of the element pair.

Each capsule is surrounded by acoustic foam, minimizing both transmitted and wind noise. An outdoor wind screen is also included. The AT825 frequency response is peak-free from 30 to 20,000 Hz with a switchable low-

pass filter built in. It can withstand SPLs up to 130 dB with less than 1% distortion. The AT825 can be powered from an AA battery or phantom power.

Find out how easily you can add stereo to every shoot. Write, call, or fax today.

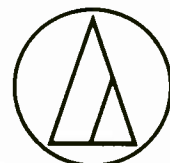

audio-technica.

Audio-Technica U.S., Inc.
1221 Commerce Drive, Stow, OH 44224
(216) 686-2600 • FAX (216) 688-3752



AMS AudioFile Plus

AMS has an updated audio editor, the AudioFile Plus HD recorder/editor, which includes eight simultaneous inputs, 16 outputs and read/write optical drives.

A self-powered control surface with screen, keyboard, jog wheel, soft controls, card rack and disc drive mainframes is included in the AudioFile Plus hardware. Transputer open-architecture allows multiple processing.

Optional I/Os include AES/EBU, SPDIF, PCM 701, F1, 1610 eight input, rewritable M/O archiving, extension monitors and a control surface pad.

Ediflex Systems Audiflex

The Ediflex Systems Audiflex has an IBM 386 with Microsoft Windows, a 19" NEC color multisync screen, one 600MB removable M/O disk per track and a 380M hard disk library storage.

It uses rewritable optical disks for audio and controls up to four video or audio transports. Wild recording to any track or direct to memory is possible.

Track time is 220 minutes for the first side of four disks. Four disks record on both sides for a total of 440 minutes, but they must be flipped. The maximum number of disks per system is eight.

Digital Dynamics ProDisk-464

The ProDisk-464 from Digital Dynamics provides a track time ranging from 120 minutes to 720 minutes at 44.1 kHz, from 30 minutes up to three hours per track.

The ProDisk-464 generates a SMPTE EDL for editing, in addition to featuring auto punch in/out, cut, copy, paste, erase and fill capabilities. Waveform display and editing to the sample level are additional options.

New England Digital PostPro SD

The standard PostPro system consists of four 300MB Winchester hard disks offering eight tracks with over 28 minutes of recording time at 44.1 kHz.

The PostPro SD also is equipped with a Mac-based EditView audio editing program, auto-punch in/out, scrubbing, auto-assembly via MIDI, SMPTE and CMX.

Soundmaster Syncram

The Soundmaster Syncram is a DOS-compatible 80386 with an 80387 co-processor, 40MB hard disk and choice of two floppies, keyboard and optional monitor.

The Soundmaster features 10 times play speed for B/U, real time digital processing with EQ, reverb, delay echo, pitch change, looping, track and event slip and auto or manual punch in/out.

Lexicon OPUS

The OPUS and the OPUS/e audio production facility from Lexicon records, edits, time-aligns, mixes and processes audio signals all in the digital domain.

The OPUS/e is a proprietary 386 equipped with a dedicated controller for editing. The edit controller is furnished with meters, display, soft keys and a jog wheel.

Additional features include a digital 8x2 mixer, real time capability, level, pan, crossfade capability and simultaneous eight-track recording.

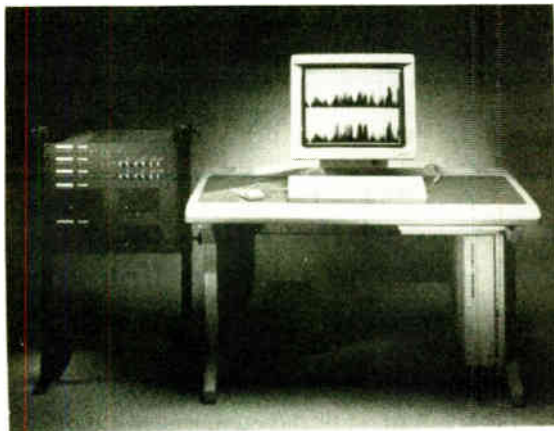

Studer Revox Dyaxis

The Dyaxis 2+2 hard disk digital recording and editing system from Studer Revox is equipped with an integrated data RDATA subsystem that stores all soundfiles as well as editing information.

Dyaxis also communicates with and transcodes between all major digital formats including DASH, AES/EBU, PD, SPDIF, S/P DIF and 601.

Options for the Dyaxis include a MIDI time code box, word clock and system sync for reading/writing VITC.

Digital Audio SoundStation II

Soundstation II from Digital Audio Research provides rack-mounted editing capabilities with a proprietary touch screen display/controller.

It features 44.1 kHz standard or 48 kHz optional sampling with 60-960 minute storage capacity at 44.1 kHz.

External machine control, Wordfit automatic ADR synch, N/D editing, cut and paste, track slipping and house or word synch are standard characteristics.



Symetrix DPR 100

The DPR 100 digital processing recorder from Symetrix provides 40 channels of recording in blocks of eight with real-time level control, equalization, compression, limiting and gating, plus dynamic recall of all parameters.

Record and edit events are locked to SMPTE/EBU and VITC timecode, house sync and/or external word clock. Track time is 206 minutes for eight tracks at 44.1 kHz expandable to 1440 minutes.

Turtle Beach Softworks 56K

The Turtle Beach Softworks 56K digital recording system includes components such as an IBM compatible computer, a 56K-PC digital signal processor card, a 56K-D digital audio interface and a 56K analog/digital converter.

Features include a two-track system with N/D editing, real-time EO and frequency analysis, MIDI and SMPTE (read/write), digital level scaling, reversing, phase inversion and manual or automatic crossfades.

WaveFrame AudioFrame

The AudioFrame is equipped with a 25 MHz computer with 4MB RAM, 40MB hard disk, 1.2MB floppy, a keyboard, mouse, and a 19" monitor with color option.

The AudioFrame provides simultaneous eight track recording, N/D editing and real-time events. The sampler can use EDL 8mm backup on systems with disk recording or sampling.

FM Harmonic Low Pass Filters
500 - 50,000 Watts

Delivery: 30 Days (Faster For Your Emergencies)

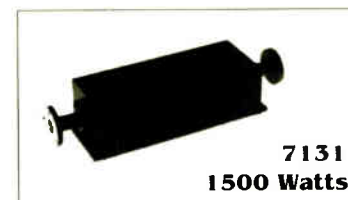
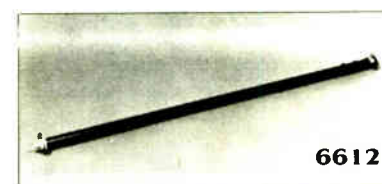

Model #	Watts
6612	6,000
6516	15,000
7772	30,000
7455	50,000

fm TRANSMITTERS
FROM CONTINENTAL

- COMPACT AND EFFICIENT
- SOLID-STATE DRIVER
- EXCLUSIVE SOFT START™
- AUTOMATIC POWER CONTROL
- TOTALLY SELF CONTAINED
- TRANSTAT™ READY

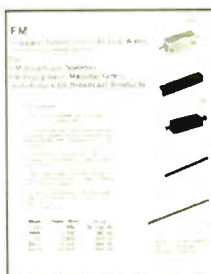
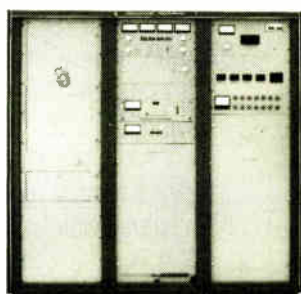

Bulletin #14

Full Details In Bulletin #14!

Also, request BTV/87 which describes TV/FM/MMDS Broadcast Filters & Combiners for service radio bands.

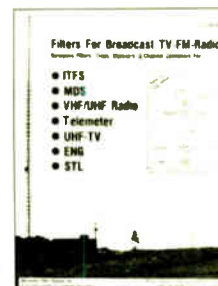

Catalog BTV/87

Need A Special Filter? Call Us Today!

"We make Filters In A Hurry For Customers In Trouble!"

Microwave Filter Company, Inc.
6743 Kinne St. • E. Syracuse, NY 13057
Toll Free(US/Can.): 1-800-448-1666 • Collect(NY/AK/HI): 315-437-3953
FAX: 315-463-1467 • Telex: 249-613

varian 
continental electronics division 

P.O. Box 270879 Dallas, Texas 75227 • (214) 381-7161 FAX: (214) 381-4949

Ethics in Equipment Purchasing

by Barry Mishkind

Tucson AZ What's wrong with the following scenario?

The engineer is going through the exhibits at the NAB show. As he stops to look over one of the booths, a salesman walks up to him and asks, "Are you an engineer?"

After admitting that he is, the engineer is told, "We have a new program that should really interest you. It's a special deal to reward our loyal customers."

ECLECTIC ENGINEER

Naturally, the engineer is interested. As a professional he is always looking for ways to maximize the technical budget at his station.

So, he inquires as to the reward, and finds out that the company has started a cash rebate program. For every dollar of equipment he buys there is a rebate of five cents.

To him personally.

An ethical question

What is your initial response to this scenario? If you're an engineer, do you feel that because you are going to buy things anyway, you might as well get the benefits?

The salesman would quickly back you up on this by saying that the company pays the rebate from the net sale, so

there is no penalty to the station.

Perhaps the station manager has rejected your request for a raise in salary or an increase in your contract fees. This might be the perfect way to get things "even" again: No one is hurt, and you get what you "deserve."

On the other hand, many of you managers might already be simmering a bit. Knowing that the company can't give away something it didn't get, you say "Hey, wait a minute, that 5% is ours, not his."

And it would be true.

You managers know that negotiating a sales price ends up in a different place when there is an extra 5% that must be paid out of the proceeds. The money doesn't just materialize.

How would you handle such a situation if it presented itself to you?

A real issue

We are not just talking theory here. The approach described above was made to me not long ago, while I walked the NAB floor with another engineer.

As we are probably very tired of hearing, the '80s became for many the Decade of Greed, the opportunity to "get your own." And make no mistake, we live in a capitalistic economy. As the current events in Eastern Europe reveal, many people like it that way.

But, have ethics become a relic of the past, or is society truly obsessed with the famous line from the movie *Wall Street*: "Greed . . . is good!"?

The answer has a lot to do with

whether or not the SBE, or any other group, can maintain the image of professionalism among broadcast engineers.

While we do not operate under the same sort of administered oath of integrity some professionals do, our employers deserve to know that the counsel we offer is for their benefit, and not necessarily our own. Of course, there is a trap we can fall into if we are not careful.

Over the years, I have developed relationships with a number of suppliers and manufacturers. I trust them. I feel their products are the best available for the price. I like their customer support policies.

Yet, suppose company X comes and

In at least one instance I know of, the engineer actually changed the purchase of a 20+ kW FM transmitter because the manufacturer the owners chose wouldn't pay him his "consulting fee."

Telling the owners of the "problems" they'd have with their first choice, he had them cold. Most owners don't have the expertise to tell when they're being sand-bagged.

True, the transmitter he recommended may not have been a "bad" one. But, was his action ethical? Further, if an engineer controls the purchases of a half dozen or more stations, there are manufacturers that will make a special effort to cultivate influence.

There probably won't be any congressional hearings on this sort of "transmit-ola," but it doesn't help our industry.

My advice to engineers who are approached in such a way, is that their first

Have ethics become a relic of the past, or is society truly obsessed with the famous line from the movie *Wall Street*: "Greed . . . is good!"?

says, "You've done over \$100,000 of business with us, so we'd like to reward you." It might be a dinner. Then again, it might be a rebate program such as described above.

The question is: How objective can we remain if cash becomes involved?

Those who succumb

Personally, I won't change my recommendations over a dinner. Even with drinks. And I refuse to continue a discussion once my income has become the focal point.

On the other hand, it is obvious from the confidence of the salesman who approached me that he has had takers.

This can affect stations in many ways. For example, there are many cases over the years of local engineers who have demanded as much as 15% kickbacks from manufacturers in return for specifying their products.

duty is to the owner of the station. Be honest and discuss the implications of such arrangements.

You may decide to change suppliers. Or, you may simply make your position known clearly, and put the 5%, or whatever, back to the station's benefit.

But I have some advice for managers, too. And that is not to force an engineer to even have to consider such situations. Pay a fair wage for engineering services. Remember a good engineer actually can *save* you money by looking after your interests. This salary is not a good place to save a few bucks. And it may even cost you dearly in the long run—if your engineer finds the temptation of a kickback irresistible.

Barry Mishkind, aka RW's "Eclectic Engineer," is a consultant and contract engineer in Tucson. He can be reached at 602-296-3797, or on FidoNet 1:300/11.

CCA

Evolution.

CCA has delivered more than 3,000 Broadcast Transmitters over the past 25 years. For 25 years our designs have been refined and improved. The result is the Evolution of the world's most perfected, most tested, most reliable, Radio Transmitter.

- * Grounded Grid Triode
- * Longest Tube Life
- * Auto Power Control
- * VSWR Power Foldback
- * Single Phase Optional

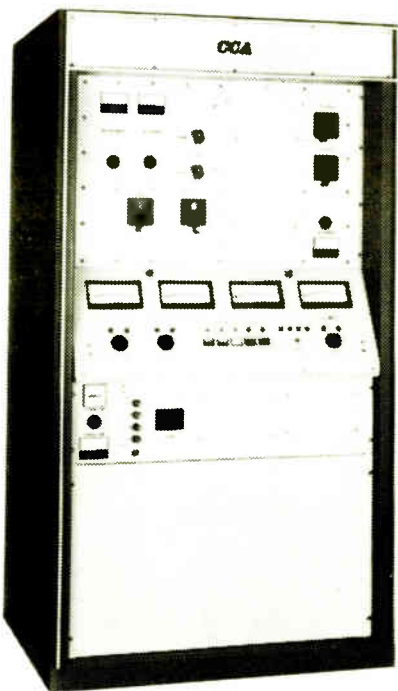

CCA Electronics, Inc.
P.O. Box 426
Fairburn, GA 30213
(404)964-3530 FAX (404)964-2222

Circle 76 On Reader Service Card

The Clear Choice CELLCAST REMOTE BROADCASTS SAVE TIME AND MONEY

Keep your remote crew on the move and making money with the all new, ever-portable Cellcast Remote Broadcast Studio.

It's simple—your crew arrives on location, calls the station and ZAP!, they're on the air. You'll never wait on costly, inconvenient land lines again.

Cellcast remote broadcasting combines the best features of an 832 channel cellular telephone and a professional mixing console into one convenient package.

Save time and money, give us a call today!

Cellcast
REMOTE BROADCAST STUDIO

RETAIL PROMOTIONS, NEWS, SPORTS. CALL 1-800-852-1333.

Tri-Tech, Inc., 2415 East Skelly Drive, Tulsa, Oklahoma 74105, 918-425-5588

Circle 132 On Reader Service Card

Learning the Allotment Shuffle

by Lex Felker

Washington DC When media entrepreneur Tom Gammon proposed a complex set of new and altered FM broadcast allotments, he sparked a flame of controversy that promises to grow into a major brouhaha, with the FCC at the center.

At the time a seemingly inconsequential minor modification of the FCC's allotment procedures, the proposal raises the issue of whether existing FM broadcasters should be permitted to "trade" their allotment for one specifying a new community of license, without placing their existing authorizations at risk.

If approved, the proposal would permit the movement of a rural station into an urban/suburban market.

Allotments and upgrades

In all the broadcast services, the Commission maintains "allotments" in which particular channel/class/community combinations are specified.

Unlike the AM broadcast service where applicants specify their own allotments, FM is a "tabled" service. The Commission maintains a table of allotments in its rules and regulations.

FELKER'S FORUM

As is true for all the FCC's rules, the allotment table can be changed (to add a new channel to an existing community or to add a new channel/community combination, for example) through a rulemaking proceeding. Such a procedure is fairly routine, with the Commission acting on scores of rulemaking petitions each year.

Originally, there were only three classes of stations, and the process was fairly simple. Prospective broadcasters picked the maximum class of station that would "fit" into the table, as determined by the FCC's co- and adjacent channel mileage interference criteria. Because the FCC had ruled that changes in a licensed allotment would trigger the acceptance of competing applications, upgrades were never attempted.

The Commission's Docket 80-90 decision to double the number of station classes and add nearly 700 allotments to the FM table complicated things substantially. During the rule makings in which these new allotments were actually established, prospective broadcasters proposed ingenious schemes to "shuffle" existing and proposed allotments in a way that permitted the establishment of higher classes of stations.

Retreat from earlier policies

Subsequently, through a series of rule changes in the mid '80s, the Commission retreated from its earlier upgrade policies to allow existing licensees to take advantage of these new station classes, under certain circumstances. The FCC made it clear, however, that any changes in the allotment table to specify another community would subject the petitioning licensees to competing applications.

The final stage of the Commission's policy metamorphosis occurred in the

waning days of Dennis Patrick's chairmanship. The FCC concluded a proceeding, begun a year earlier, in which it developed procedures to allow FM (and television) licensees to change their community of license.

The Commission thought the channel congestion that currently exists in major markets would be an effective barrier to the gradual movement of rural stations to urban areas. Nevertheless, the FCC wanted to ensure that the new policy would not eventually undercut the "fair, efficient, and equitable distribution of radio service" goals of Section 307(b) of the Communication Act of 1934, as amended.

For this reason the agency limited these changes to instances where the proposed allotment arrangement both was preferred over the existing configuration based on existing comparative criteria and would not deprive a community of its only broadcast outlet. However, in a stinging dissent, Commissioner James Quello expressed his view that these criteria would not be adequate to prevent "set(ing) in motion the entire table of allotments . . ."

The uproar

It wasn't long before the adequacy of these criteria was put to the test. Tom Gammon, an ambitious broadcaster who had developed a highly successful brokerage firm during the '80s "go-go" days, proposed a complex set of allotment changes to permit a station currently licensed to a rural Alabama market to move to a community near Atlanta. (Gammon subsequently petitioned for a similar allotment change in Nevada.)

Gammon claims that the proposed configuration offers two new first local services while not depriving the Alabama community of an aural service.

Many broadcasters, in Atlanta and elsewhere, have expressed dismay and outrage at the proposal. Although apparently very few changes in community of license have been filed, there is a fear that the Gammon proposal is just the first of scores of such changes that could fundamentally alter the fabric of American broadcasting. Petitions have been filed both to oppose the allotment and to seek Commission reconsideration of its original decision.

Commission response

As this article is being written, these matters are pending at the FCC, although action on the reconsideration petitions is expected reasonably soon. Communications clairvoyants are predicting that the Commission will do some kind of an about-face on the rule change.

The only currently sitting Commissioner that was part of the group that changed the rule is Jim Quello, and he dissented to the action. Moreover, the changes proposed by Gammon and others, while few in number, nevertheless call into question the Commission's conclusion that opportunities for rural stations to move into urban markets were essentially non-existent.

I was involved in the discussions that resulted in the change originally, and I would be disappointed to see the FCC reverse its policy completely. In all fairness, however, I will concede that I had

not completely foreseen the inventive allotment changes that have been proposed. My intuition still tells me that the number of such changes is very small.

Such a conclusion may defy proof, and I acknowledge that this is an issue on which reasonable minds may differ.

I look forward to seeing how the Commission will analyze the facts.

■ ■ ■

Lex Felker is an engineer/technology consultant with the law firm of Wiley, Rein & Fielding, Washington, DC. He can be contacted at 202-429-7000.

THE BIGGEST PENNY PINCHER IN RADIO SINCE JACK BENNY.

Mr. Benny certainly knew a great bargain when he made one. And we think he'd appreciate the brilliance of the bargain-priced Tascam BR-20 Broadcast Production Recorder.

The BR-20 is built to do one thing—broadcast production—and to do it exceedingly well. It's a rugged, reliable 2-track with features that make every job easier and more efficient. Like independent reel-size selection. Splice block. Built-in monitor speaker. Independent L/R record for monitoring on one track while recording in sync on the other for overdubs and voiceovers. Fader start. And Quick Cue with Auto-Repeat.

The \$2,299* BR-20. It's got everything you need in a broadcast production recorder. Including a price even your station manager can live with.

Come see it today at your nearest Tascam dealer.

TASCAM®



© 1990 TEAC America, Inc., 7733 Telegraph Road
Montebello, CA 90640 213/726-0303.

*Manufacturer's Suggested Retail Price.

An Overview of Amplification

This is the first in a 12-part series called Amplifier Fundamentals. Northern Virginia Community College will offer 1.2 CEUs (continuing education units) to registered students who successfully complete the course and an examination mailed at its conclusion.

Successful completion of the course and the final exam will also earn 1.3 professional credits toward recertification under the maintenance of certification provisions of the SBE Certification Program. To register, contact the Director of Continuing Education, Annandale Campus, 8333 Little River Turnpike, Annandale, VA 22003, or call 703-323-3159. The fee for the course is \$35.

by Ed Montgomery

Part I of XII

Annandale VA The electronic communications age began with the telegraph, sending information over wires. Soon afterwards, Alexander Graham Bell sent voice communication through the telephone.

Bell discovered, however, that intricate changes in voice signals would not travel as far as the telegraph pulse. Signal loss due to resistance in the wires made the voice signal unintelligible beyond a few hundred miles. The telegraph signals went farther because they were less complex and could be boosted periodically with repeater coils.

It was not until 1906 when Dr. Lee De

Forrest invented the "audion" that long distance voice communication became a reality. The "audion" or triode tube permitted signal amplification.

The function of amplification circuitry is to take a very low input signal and reproduce it as accurately as possible at a desired level. The amplifier can be designed to increase voltage, current or the combination of the two: power.

Amplifier design determines what frequency range the circuitry will handle. There are small-signal amplifiers and power amplifiers. Amplifiers operate in various classes, designated by how

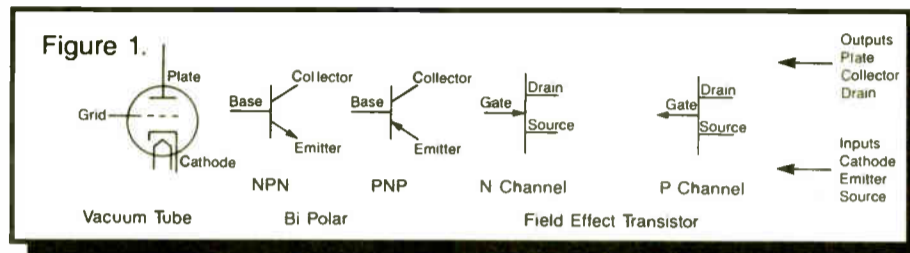

much power they consume.

Common to all amplifiers is that the reproduction of the input signal requires an active device to be employed in the circuitry. Figure 1 illustrates three active devices used to amplify signals. All have one thing in common: The majority of the current in the device will flow from the input to the output.

A small voltage change on the grid of the triode, or the gate of a field effect

transistor, will result in a large change in current between the cathode and plate of the tube and the source and drain of

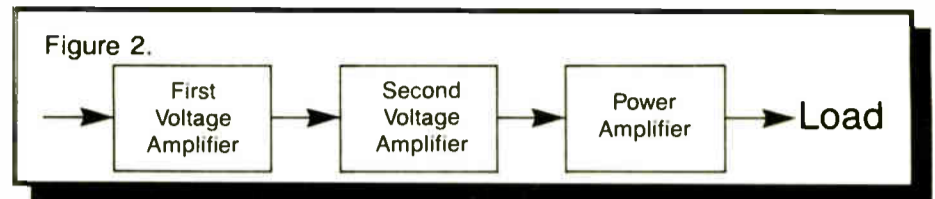

the field effect transistor. A small change in current flowing between the base and emitter of the transistor will result in a large change in current between the

put for the power amplifier. It is often a transducer converting the electric signal into some other form of energy. Audio amplifiers use a loudspeaker which, through magnetic principles, converts a varying electric current into audio frequency sound waves.

The load for a radio frequency ampli-

fier is the antenna that radiates a varying magnetic field. For a video amplifier, the load can be a cathode-ray tube or liquid crystal display. All loads must exhibit the same characteristics the power amplifier output does. Known as impedance, it is measured in ohms.

Voltage, current and gain

Output power is measured in watts (W). This is a combination of voltage, current and impedance and is defined as the rate of doing work. It is a measurement of the mechanical work performed by an electrical source. There are 746 W in one horsepower.

Another term used with amplifiers is gain. Gain is a measurement of the output of the amplifier compared to the input signal level.

Figure 3.

$$A_V = V_{OUT} / V_{IN} = \text{Voltage Gain}$$

$$A_I = I_{OUT} / I_{IN} = \text{Current Gain}$$

$$A_P = P_{OUT} / P_{IN} = \text{Power Gain}$$

Figure 3 illustrates the equations determining voltage, current, and power gain. Gain is often expressed in decibels (dB). This is a logarithmic measurement that corresponds to the way we hear and visualize things.

For example, if a loudspeaker's output were increased by a factor of 10—from .1 W to 1 W—you would notice a difference in loudness. If the output were increased by another factor of 10—to 10 W—you would notice another increase and sense the second increase to be far greater than the first, yet the ratio of input to output is the same.

An excellent reference to go along with this course is *Electronics, Principles and Applications*, by Charles A. Schuler, published by McGraw-Hill. The *ARRL Handbook* is also an excellent study source.

Ed Montgomery currently is an electronics teacher at Thomas A. Edison High School in Fairfax County. He has taught broadcast engineering at Northern Virginia Community College and worked as a broadcast engineer for several radio stations.

Computer Automation

A-Bus Low Cost Data Acquisition and Control

Measuring, Sensing, Switching and Governing.

A-Bus is a system for connecting equipment and sensors to a computer. From measuring voltage levels, to sensing switch closure, to activating relays, to controlling position, you can have complete computer control. A-Bus is designed to help you automate, whether it's an extensive remote application, or a simple repetitive chore.

When nothing else will do.

Sometimes you're presented with a unique problem, where the normal solution just doesn't fit. The A-Bus system was designed to be adaptable to whatever computer you have, expandable beyond your needs, and modular to fit your project exactly. This was required by a major radio station in San Francisco. Their remote transmitters were blocked by hills. A-Bus devices were connected to the repeaters atop the hills. The main studio could test and adjust the antennas for optimum performance.

The bottom line.

When budgets are tight, it's nice to know that the A-Bus was designed carefully to keep it affordable. This was very important to a small college radio station. They couldn't afford an expensive automation system, but inexperienced announcers required careful supervision to ensure FCC compliance. With the low-cost A-Bus system installed, the station manager had more time to spend on important tasks.

Support.

Alpha Products has produced thousands of systems, and they are being used by customers all over the world. Our recent customers include KSFO, KFRC, KBIA, WMJX, WBNX-TV, KETA-TV, and the Sun Radio Network. We are committed to reliability and customer satisfaction: our team of engineers stands ready to help you with any questions you might have. A-Bus components are stocked and available for immediate delivery.

A Sampling.

Relay Card, 8 SPST, 3A @120VAC: \$142. Fast 12-bit A/D, 8 analog inputs, 0-5V, 10µS conversion: \$179. Digital Input, 8 opto isolated: \$65. Touch-Tone decoder: \$87. TTL I/O, 24 lines: \$65. Also: Latched Input, Serial Multiplexing, D/A, Clock, Stepper Motor Control, etc.

Call for our Catalog
(800) 221-0916

242-Q West Avenue, Darien CT 06820 (203) 656-1806 (fax 203 656 0756)

ALPHA Products

Circle 72 On Reader Service Card

DATAWORLD MAPS®

**DO YOU KNOW YOUR MARKET?
YOUR COMPETITION DOES!**

DATAWORLD MAPS CAN

- Depict your coverage!
- Market orient your sales people!
- Target your ethnic/demographic markets!
- Identify marginal signal areas!
- Plot any special requirements!

MAP OPTIONS

- SHADOWING (TERRAIN SHIELDING)
- POPULATION DENSITY
- CONTOUR COVERAGE
- SPECIALS

dataworld®

A Service of DW, Inc.

Fax (301) 656-5341

(301) 652-8822

(800) 368-5754

Circle 11 On Reader Service Card

World Radio History

Discover
the
Difference



orban

orban



orban

PHASE TRAK 90™

The perfect cart machines for an imperfect world.

PHASE TRAK 90 PLAYBACK &
PHASE TRAK 90 RECORD/PLAYBACK



Do you really need a cart machine as good as Phase Trak 90? In a perfect world, perhaps not. After all, there'd be no tape skew or phase error in an ideal universe. So, you wouldn't need the continuous non-encoded phase correction circuitry* we developed for Phase Trak 90 cart machines. This BE-exclusive process is so effective, it actually cleans up stereo carts that sound dull on ordinary machines, while assuring consistently clear mono performance. In a perfect world, tape formulation and performance

would be consistent from batch to batch and brand to brand. There'd be no need for the Record/Playback Phase Trak 90's Automatic Tape Analysis system with Learn Mode.

On a fault-free planet, all audio formats would be created equal. Then you wouldn't need Phase Trak 90's superior cartridge guidance system, Phase Lok V head block and CD-quality sound, including our Dynafex® noise reduction system that audibly improves stereo signal-to-noise performance.

And of course, in a perfect world DJs would always treat

cart machines with care and respect. So you could get by without Phase Trak 90's robust, fully modular design featuring a solid die-cast front panel, machined 1/2"-thick aluminum deck plate, cool DC servo motor drive, Hall effect switches and gold-to-gold interconnects. Phase Trak 90: Quite simply, the best cart machine ever made for the real world. If that's where you live and work, call Bob Arnold at (217) 224-9600, or ask your Broadcast Electronics distributor for more information.

* Patent Pending
Dynafex is a registered trademark of Circuit Research Labs, Inc.



4100 North 24th Street • P.O. Box 3606 • Quincy, IL 62305
Tel: (217) 224-9600 • Fax: (217) 224-9607 • Tlx: 250142

Circle 89 On Reader Service Card

World Radio History

NEW NEW NEW

SERIES CONSOLES

S - \$6,499 /18 CHANNELS - \$8,893



224-2248

FEATURES

- Totally Modular Console-Input modules, Output modules, Option modules
 - Ease of Service
 - Ease of Installation
 - Ease of Expansion
- Three Mainframe Sizes-8 channels, 18 channels, 28 channels
 - Full Metering
 - Timer on All models
 - Talkback to "2" studios
- Ultrahigh Quality Construction and design
 - Penny and Giles 3000 Series slide faders
 - VCA's
 - ITT Schadow switches
 - Gold connectors-IC's socketed-regulated power supply
- 3 Stereo Output Buses
- 2 Internal Mix-minus Buses for 'Telephone'
- Option Modules-D.A.'s, Mono Mixes, Remote Selectors, Etc.
- Comprehensive Logic system
 - Start and stop sources by isolated internal reed relays
 - Remote channel On and Off control with Tally lamps for turrets
 - Flashing OFF switches for cart machine status
 - Three muting buses for Control room and two studios
 - Timer reset selectable on each module
 - Monitor DIM function during cue and talkback



arrakis
SYSTEMS, INC.

**NEW
NEW
NEW
NEW
NEW**

**NEW
NEW
NEW**

Early Radio: West and Midwest

by George Riggins

Long Beach CA Controversy continues to rage over which current "W" call is farthest west in the USA. WJAG, 97°26'48" west, still keeps the record.

So far, I have not found a "W" prefix issued west of El Paso, TX. In El Paso, however, was a station with the call sign WDAH. Its assigned frequencies were 268 meters (1119.4029 kc) and 360 meters (833.3333 kc). WDAH was owned by Mine and Smelter Supply from its sign-on in 1922 until it was purchased or otherwise acquired by Trinity Methodist Church in 1923.

The first time a power was listed for WDAH was in 1926: 50 W. Not much by the standards of today, but without interference that much RF will go a long way.

In 1929 the ownership was listed as Eagle Broadcasting and both the frequency and power had changed. The new power was 100 watts, and the frequency had been moved to 1310 kc (228.9 meters). Interesting to note that at about 1929-1930 the listings were changed from being stated in meters to kilocycles. (For those of you in the younger set, the term "cycle" was replaced by "Hertz" to denote the wavelength of radio propagation and the pitch of audio.)

The WDAH call for the El Paso station stayed in the listings for the US through 1939. Ownership passed from Eagle Broadcasting to Tri-State Broadcasting in 1930.

In 1936, WDAH and KTSM were the only stations in El Paso, TX, with 100 W

of power on a frequency of 1310 kc. Both were owned by Tri-State Broadcasting Co. By 1942 the WDAH call had disappeared.

Does anyone know why Tri-State chose to keep the "K" prefix rather than the "W"?

From K to W and back

The 14 November 1947 issue of *United States Air Force Radio Data and Flight Information* lists KTSM on 1380 and KROD on 600 as the only El Paso stations. Both stations had an authorized power of 1000 W.



The coordinates of KTSM were given as 106°24'37" W, 3 miles ESE of El Paso. If my recollections of the geography of El Paso are any good, that should put the transmitter location somewhere in the Rio Grande flood plain.

Late flash! A call from Roger of WBAP corrects me on one assumption. In my mind I have kept the WBAP transmitter at the first location northeast of Fort Worth where it shared time with WFAA. The correct location for the WBAP transmitter and antenna farm is near US Highway 287 at Mansfield, TX. The coordinates for the site are; 32°36'38" N, 97°10'11" W. Thanks to Roger for correcting my records.

Another controversy has arisen over the West Coast calls of KQW and KWG. Bud Kress of KFBK, Sacramento, CA sends along the information that KWG officially went on the air 21 November 1921 and was ahead of KQW.

According to Tom Kneitel's *Radio Station Treasury, 1900-1946*, KWG's license was issued on 7 December 1921. There is no additional data given to indicate that KWG had operated as an experimental station prior to the official license date.

KQW is given credit for operating as an experimental station under the calls of "6XE," "6XF," and other identifications prior to 1912. The regular license for KQW was issued on 9 December 1921.

Radio pioneer

According to Erik Barnouw in his book *A Tower in Babel, A History of Broadcasting in the United States*, Professor Charles D. Herrold started a College of Engineering in 1909 in which radio became the main attraction. "Doc" Herrold was soon transmitting from the Garden City Bank Building in San Jose and promptly took up voice experiments.

By 1912 there were regular listener reports in response to the weekly broadcasts, which consisted of news bulletins and records from a local music store. The voice quality was listed as good at the start of the program and steadily deteriorated as the carbon microphone slowly burned, eventually causing the broadcast to cease for the evening.

"Doc" Herrold continued his experiments with his station until World War I, when all non-government radio activity ceased. During the 1915 Panama Pacific Exposition from San Jose, "Doc" conducted broadcasts and talked to Lee De Forrest and others at the exposition demonstrating radio.

"Doc" Herrold was never successful in reviving his "station" after the war, and eventually sold to the Second Avenue Baptist Church. The Church later turned over the station operation to a commercial operator who sold it to the present owners, Columbia Broadcasting System. CBS continues to operate the station under the call KCBS, in San Francisco.

This short explanation is the reason the present owners take credit for the station dating back to the 15 W school station that started intermittent operation in 1909.

An old timer remembers

When we last left Al Smith, he was recounting how he had just started full time with KMMJ in Clay Center, NE. As

59 YEARS AGO World Congress Tells Results

Copenhagen.

At the conclusion of the International Radio Congress at the Christiansborg Palace here it was announced that definite conclusions had been reached on eight points, namely, comparison of frequency standards, standardization of wave meters, reduction of disturbances within common wave bands, methods of annulling foreign currents in receivers, further organization of commercial radio telephone services between movable and fixed stations, stabilization of wave bands of senders for various radio electrical services, recommendations regarding the latest developments of technique, and reduction of radio disturbances general.

The congress will make recommendations to the Madrid congress to be held in 1932 and the results obtained in Copenhagen will serve as a basis for deliberation in Madrid. One of the unsettled problems is more effective utilization of the available wavelengths, which will be considered by the national committees and later to be acted on by the Madrid congress.

O.1 Per Cent. Separation for Short-Wave Band

Washington.

The Federal Radio Commission has adopted a new general order (No. 117) repealing two previous general orders (Nos. 62, 88 and 88 amended) relating to the separation between frequencies in the short wave bands, from 1,500 to 2,300 kc.

By repealing the old orders and adopting the new, the Commission does away with the plan calling for a 0.2 per cent separation. It was pointed out at the Commission in this connection that the International Technical Consulting Committee, meeting at The Hague in September, 1929, recognized that radio telegraph stations could operate on frequencies separated by about 0.1 per cent, which, in effect, would double the number of available frequencies.

The engineering division of the Commission has been engaged for some time in preparing an allocation based on this separation, covering the entire short wave spectrum. The adoption of the new order opens the way for the assignment of many additional stations.

Reprinted from *Radio World* July 18, 1931.
Editor's note: The *RW* of old, printed for a time in the 1920s and 1930s and today's *RW* are unrelated except in name.

Al explained, his duties at the station consisted primarily of looking after the power supplies for the 1000 W Western Electric transmitter.

AS: "The transmitter was powered by a motor generator. A large three-phase motor drove a filament generator, a bias generator and a plate voltage generator. The station had a spare generator set. We
(continued on page 33)

CRL SPOTLIGHT

Audio Noise Problems?
...Your solution is a dynafex®
noise reduction system.



Ever wished for a simple, yet effective way to remove audio noise? Our dynafex® system is a unique combination of downward expansion and dynamic audio filtering providing up to 30 dB of noise reduction. To use, set the threshold that you want dynafex® to start working at—then listen to how quiet things get. Plus, because dynafex® is a single ended system, it will remove noise from sources that companded systems cannot. Thought of some noisy applications?

We offer two models: Our DX-1 (mono) is for mic. or line level sources, and features extended threshold range. Our DX-2 (stereo/2 channel) is for line level applications. Find out how much noise dynafex® will make you miss. Call or write for more information. Our units are also available on a two week trial.

dynafex® is a registered trademark of CRL, Inc.



Circuit Research Labs, Inc.
2522 West Geneva Drive
Tempe, Arizona 85282-3192 U.S.A.
(800) 535-7648 (602) 438-0888 FAX (602) 438-8227
Bulletin Board System (602) 438-0459

Circle 113 On Reader Service Card

**AS-101
Audio Switcher**

- Illuminated and legendable control buttons
- Instant or overlap switching
- Front panel accessible level controls
- Options include: RS-232 interface, remote control, relay-follow-switch outputs
- Network proven quality and reliability!

10 stereo in
1 stereo out

P.O. Box 1342 Bellingham, WA 98227
(206) 734-4323 (206) 676-4822 (FAX) **Conex Electro-Systems, Inc**

Circle 20 On Reader Service Card

From Shipping Crate To Transmitter Shack

by Anthony Kord

Westerly RI "Will you be working in the garbage can today, honey?" my wife asks as I leave in the morning.

There's something at least mildly humbling about your family thinking you work in a garbage can. Even the general manager has been known to ask when

Breaker boxes, shelving and other wall mountables also install quickly with sheet metal screws or bolts.

Since the shipping crate was guaranteed to be air and water tight, careful attention was given to cooling WWRX's 25 kW transmitter. A cutting torch made the necessary air intake openings, to which were attached slanting air filter mounts.

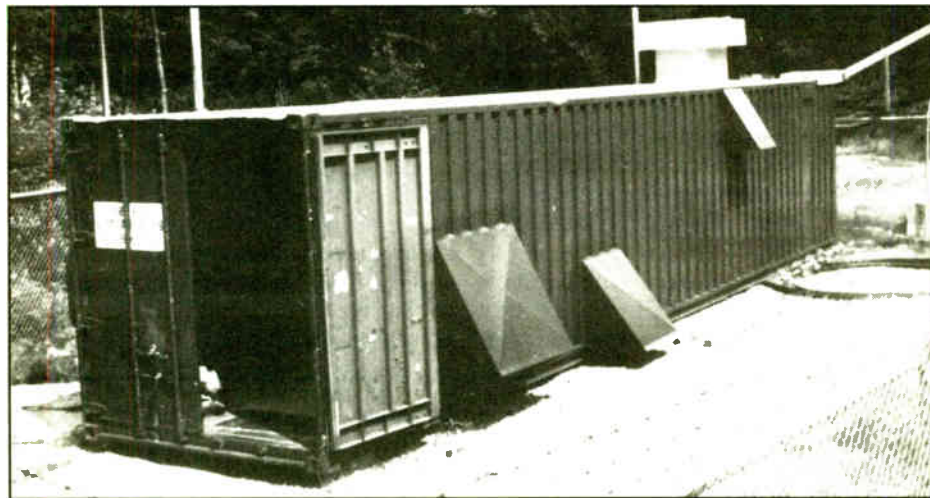

Metal shipping crates offer a low-cost alternative to cinderblock transmitter shacks.

I'll next be visiting the canister. To these less than sympathetic questions I sigh and politely respond that the correct title for the WWRX transmitter building is "overseas shipping crate."

Whatever you call it, an overseas shipping crate accommodates broadcast transmitting equipment quite handsomely. Its low cost, ease of installation and excellent RF shielding make the shipping crate shack a viable alternative to the standard cinder block transmitter building.

What is it?

The overseas shipping crate is a large steel box, eight feet wide, nine feet tall and forty feet long, generally used—you guessed it—for overseas shipping. Apparently the two-way radio folks have been using them for years to house their transmitters.

A tractor trailer leasing and sales firm in the Providence area supplied the WWRX transmitter shack. Our only requirements were a level site and cinderblocks upon which to rest the structure. The crate was in place within a day, at the modest cost of \$3500. Compared to the average month long wait and \$10,000 price tag of a cinder block transmitter building, the shipping crate shack looks rather attractive.

Another time and money saver: Because the crate is not considered a permanent structure by many towns, a permit is often not required. Of course, check local ordinances before installing your shack.

Things are looking crate

More shipping crate advantages reveal themselves upon installation. Although the roof of the shack is flat, the inside is corrugated for strength. Mounting most objects to the ceiling is therefore easily accomplished with self tapping sheet metal screws.

Electricians enjoyed this feature when installing AC boxes and lighting fixtures.

Transmitter exhaust is ducted directly to a 1500 cfm wall-mounted exhaust fan, while a ceiling fan provides backup cooling. These ventilation techniques have proven quite effective, for even with 25 kW of generated waste heat, temperatures inside the shack on a hot summer's day are often a few degrees cooler than outside air. Adjustable registers keep wintertime temperatures comfy by allowing some exhaust heat to warm the shack.

The shipping crate shack's all metal construction keeps RF levels to a near minimum inside. While no quantitative measurements have been made, test equipment is much better behaved inside the shipping crate than at WWRX's old concrete transmitter building. The shack's RF shielding abilities are also an important consideration with today's stringent non-ionizing radiation exposure rules.

That sinking feeling

WWRX has discovered that a non-permanent structure has only one drawback: It's sinking! The minimal 1" sink over the past year on our very soft site is not unexpected, though, because the structure's entire weight is resting on six cinderblocks. In particularly soft locations a bit of site preparation before delivery would probably all but eliminate that sinking feeling.

With all of its advantages, the overseas shipping crate could make a dandy home for your next transmitter. Beware though—your family may tell the neighbors that you work in a garbage can.

You'll eventually learn to smile and take these comments in stride. You'll know that the overseas shipping crate saved you time and money, and made your construction job a bit easier as well.

■ ■ ■
Anthony Kord is Director of Canister Operations of WERI/WWRX/WHIM. He can be contacted at 401-596-7728.

The Ultimate One Liner



Comrex Single-line Frequency Extension

Let's face it, the telephone can provide the broadcaster with a convenient, cost effective audio link between remote locations and the studio. However, due to the limited frequency range of standard phone lines, you may be sacrificing audio quality for convenience. The Comrex LXT/LXR basic one-line frequency extension system can greatly improve the program audio quality of your phone remotes. The LXT/LXR system provides a direct coupling between your audio sources and the phone line and allows the line to pass low frequency information, giving you more natural sounding audio. A one-line frequency extension system from Comrex is still one of the most cost-effective ways to provide a high quality remote link to your studio. Call BSW toll free for more information.

BSW[®]

BROADCAST SUPPLY WEST

America's Full-Time Broadcast Supplier

1-800-426-8434

ORDERS • INFORMATION • SPECIFICATIONS
BSW • 7012 27th Street W • Tacoma, WA 98466 • FAX 206-565-8114

Cleaning Up a Muddy Signal

Harmonic and Intermodulation Distortion: What It Is and What to Do to Keep It to a Minimum

by John "Q" Shepler

Rockford IL When we speak of audio

Consider a mirror. The mirror on your wall is linear. It gives a reflection of exactly how things look. A funhouse

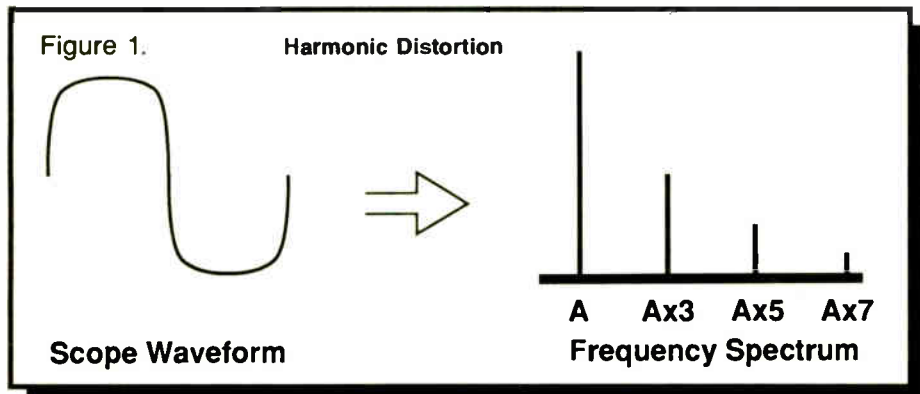

distortion, we're generally talking about something that muddies the program audio or otherwise makes the signal sound bad. To get the most from your audio, you need to understand distortion, what causes it and how to track down and eliminate distortion sources.

mirror is non-linear. It is bent back and forth so that the image is a gross distortion of reality.

Distortion is different than amplification or equalization. Once distortion gets into a signal it is almost impossible to get out. That's because most distortion is uncontrolled. We have little or no idea how the signal got distorted, so there is no way to know how to compensate for it. The best solution is to find out what component in the system is distorting and fix it.

Harmonic distortion

There are two basic types of distortion, plus some variations. The distortion that is audible enough to be objectionable to most listeners can be either harmonic or IM distortion.

Harmonic distortion is caused by

changing the shape of a sine wave. Clippers are good at creating this type of distortion. Harmonic distortion gets its name because the distorting of the waveform creates extra frequency components at multiples, or harmonics, of the original frequency.

Figure 1 shows a clipped sine wave as it would appear on an oscilloscope. To the right is the spectrum of that waveform as it would appear on a spectrum analyzer. Notice the extra signals added by the distortion. These are usually the odd harmonics, or the fundamental times 3, times 5, times 7, etc.

Odd harmonics add a raspiness to the signal. For instance, most of the power of a voice is in the mid audio range, say 1 kHz or 2 kHz. Harmonic distortion adds many other frequencies. Most of the power will be odd multiples of 1 kHz or 2 kHz.

This boosts the energy in the band of 3 kHz to 7 kHz, which makes the speaker sound lispy. If everybody at

peaks are cut.

A THD or total harmonic distortion analyzer is another good instrument to have around. It works by filtering out the fundamental frequency with a notch filter. Whatever's left must be distortion frequencies. One half to 1% distortion is barely acceptable these days. Your equipment is capable of much more and should provide a signal at the transmitter of 0.1% or better.

IM distortion

The other major type of distortion is called IM or intermodulation distortion. IM is exactly like AM transmitter modulation, except it is occurring within your audio. How can that be?

Remember that distortion is caused by non-linearity. AM modulators and detectors are also based on non-linearity. Non-linear mixing of signals results in amplitude modulation, which adds sidebands.

See Figure 2. The AM waveform is the result of two tones, A and B, which go through a non-linear amplifier and wind up modulating each other. If A is 100 Hz and B is 1000 Hz, then sideband signals of 900 Hz (B-A) and 1100 Hz (B+A) would be added to the audio mix. You

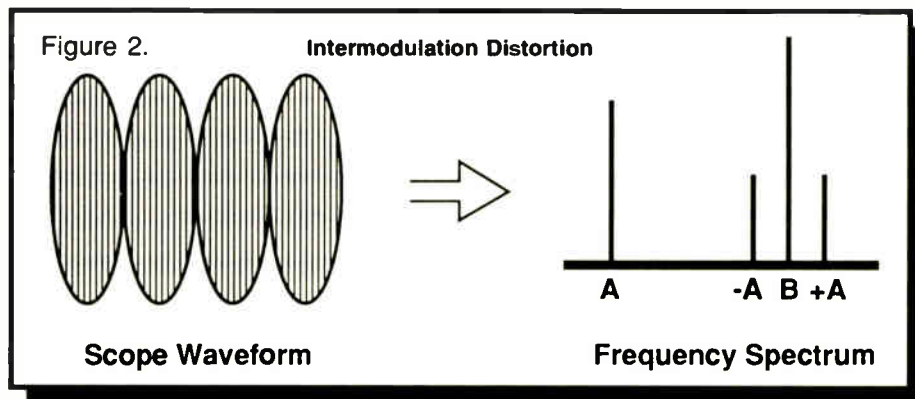

your station sounds like Sylvester the Cat, suspect something is clipping. Too much composite clipping also gives the signal a raspy edge.

Sources of clipping

Clipping can be deliberate, as in an audio processor, or it can be caused by circuit failure or improper adjustments.

Too little headroom is a primary source of clipping. The power supply voltage of any amplifier is limited. Once the output voltage peaks reach the power supply voltage, they can increase no more. Any stronger signal will be clipped.

The same thing can happen when power supplies fail. Sometimes they don't go to zero. They fail at half or quarter supply voltage, which means that most of the signal sounds fine. It is the peaks that sound bad.

You can detect severe clipping with a scope. The peaks of the signals will look chopped off. Triangular waveforms are best for clipping tests, since it is easy to see exactly where the sharp

can imagine what happens in typical signal audio where there are many, many frequencies that can modulate each other.

IM distortion is generally heard as a lack of clarity or definition when more than one instrument is playing. Listen for a piano solo that sounds OK, followed by a general mushiness when other instruments join in. The mushiness is caused by all the extra sideband frequencies mixing in.

IM distortion can be measured by an IM analyzer. This instrument provides two standard tones and filters to remove them from the output. The remaining signals are the resulting IM distortion products.

What to do about distortion

For gross distortions you can probably track down the culprit with headphones. Also try patching suspected equipment in and out of the audio chain. Bench checks on a suspected unit will then prove low power supply voltage or a bad component.

For more subtle problems you need help in the form of some good instruments. Get yourself at least a good THD meter and preferably an audio analyzer that will check both THD and IM. Measure each box and compare against the published specs.

With today's low distortion audio designs, the out of spec distortion makers will show themselves very quickly.

John Shepler is an engineering manager, broadcast consultant, writer and regular RW columnist. He can be reached at 815-654-1245.

Q-TIPS

Distortion is caused by non-linearity. In a perfect amplifier, the output is exactly the same as the input, only larger. In a distorted amplifier, the output does not look exactly like the input. It doesn't sound like the input, either.



You can measure...

with the best monitor and the most accurate test set.

The FMM-2/FMS-2 series monitors provide an even greater degree of precision measurement than ever before... You can measure S/N below 90 dB, You can measure crosstalk below 85 dB, You can measure separations of better than 70 dB, You can measure frequency response to better than 0.25 dB, You can measure distortions to lower than 0.01%, and much more... Our uncluttered panels and autoranging voltmeters make these measurements a dream.

BELAR CALL ARNO MEYER (215) 687-5550
ELECTRONICS LABORATORY, INC.
LANCASTER AVENUE AT DORSET, DEVON, PENNSYLVANIA 19333
Call or write for more information on Belar AM, FM, Stereo, SCA and TV monitors.

SA 990 OP AMP
FOR HIGH PERFORMANCE AUDIO

- HIGH RELIABILITY
- VIBRATION TESTED
- HIGH QUALITY COMPONENTS
- FROM STOCK
- APPLICATION NOTES

Summit Audio Inc.
P.O. Box 1678, Los Gatos, California 95031 U.S.A.
408 395 2468 FAX 408 395 1403

The Basics of Data Reduction

by Mel Lambert

Studio City CA Despite the sonic and operational advantages offered to broadcasters by digital audio, the technology suffers from one operational drawback: it is disk drive and spectrum hungry. At the standard sampling rate of 44.1 kHz, a mono audio signal will devour 88.2 kbytes of disk space per second, which translates to around 5.29 MB per minute.

DIGITAL DOMAIN

To carry two channels of stereo audio via even the most simple modulated carrier would require a signal bandwidth of just over 1.4 MHz—a large chunk of the ether compared to the conventional amount of spectrum space required for 15 kHz FM transmissions. (This goes some way to explaining why current PCM processors require a videocassette deck to record their data output: Few other cost-effective storage devices can provide a comparable bandwidth!)

In these days of imminent digital audio broadcasting (DAB), using both terrestrial and satellite techniques—not to mention improving the quality of long-haul transmissions and STLs—methods of saving spectrum space are receiving increased attention.

And it is perhaps fortunate—or technological synchronicity—that several leading manufacturers currently offer high-quality systems that enable the sonic equivalent of conventional 16-bit digital audio to be achieved with trans-

mission and recording channels that require one-quarter or one-eighth the bandwidth.

In other words, a full bandwidth mono signal can now be carried over a 128 kbaud (kbits per second) line, using fractional Telco T-1 channels or even switched 56-kbaud links. Also, the capacity of random-access hard disk drives can be quadrupled, with concomitant cost savings and potential reductions in system complexity. (Just around the technical corner are two-bit systems that will offer 8:1 data compression ratios.)

This month's column will consider the basic features of data coders, and provide a necessarily brief overview of two primary design philosophies. In subsequent columns, I plan to cover specific design approaches in greater detail.

Coding and the ear

Fundamental to the way in which all data-reduction systems work is an understanding of the characteristics of our hearing response. Loud, strident sounds tend to mask out low-level signals of similar frequencies, for example, and hearing sensitivity is biased towards low frequency sounds.

Because of the ear's tendency towards lower frequencies, tests have shown that few signals can be considered musical that have a fundamental frequency above approximately 4 kHz. If this redundant data can be removed—or a way found to encode it that requires less than the full 16 bits normally associated with conventional PCM data transfer—we can effectively reduce the bit count, sometimes quite dramatically.

The current design approaches for

data reduction center on two topologies: Sub-band ADPCM, which performs a time-domain analysis of the program material; and Transform Coding, which analyzes the signal in the frequency domain.

Of the various commercially available data-reduction or compression systems, Audio Processing Technology's apt-X 100 four-bit system utilizes sub-band ADPCM, while Dolby Laboratories' AC-2 digital system is based upon transform coding. Neither of these techniques reduce the sampling frequency. This both ensures full compatibility with existing

digital I/O formats and digital links, and implies consistent frequency response and bandwidth performance.

Sub-band ADPCM

Adaptive Differential Pulse Code Modulation (ADPCM) is a technique combining conventional linear PCM and Adaptive Differential coding. The technique reduces the bit rate of PCM by coding level differences between samples, rather than the absolute level of each sample.

According to the characteristics of the
(continued on page 37)



W H Y Q E I ?

24 Hours.



Our 24 hour service hotline number is 609-728-2020.

Call us toll free at 800-334-9154 for all the facts on QEI "New Reliables" FM transmitters from 1kw to 30 kw.

Power Up.



With our FMQ 3.5/5/10 kW or 20/30 kW FM transmitters, you can upgrade power in the field.

Call us toll free at 800-334-9154 for all the facts on QEI "New Reliables" FM transmitters from 1kw to 30 kw.

Single Phase 30 kW.



Our new FMQ 30000B is the only 30 kW transmitter available with a single phase power supply.

Call us toll free at 800-334-9154 for all the facts on QEI "New Reliables" FM transmitters from 1kw to 30 kw.

Less is More.

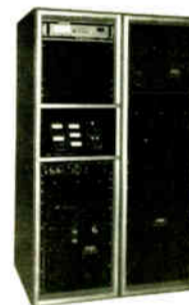

All of QEI's FM transmitters have no plate blockers or sliding contacts.

Call us toll free at 800-334-9154 for all the facts on QEI "New Reliables" FM transmitters from 1kw to 30 kw.

Free.



Our FREE spares kits include every solid state component of the transmitter, exciter and remote control.

Call us toll free at 800-334-9154 for all the facts on QEI "New Reliables" FM transmitters from 1kw to 30 kw.

The Longest.



Our PA tube warranty is the longest in the business — 15,000 hours.

Call us toll free at 800-334-9154 for all the facts on QEI "New Reliables" FM transmitters from 1kw to 30 kw.

West and Midwest

(continued from page 30)

ran on one set on one day and the other set the next day. It was my job to clean the generator set that was not in use.

"The transmitter had a water cooled final. We used the heat from the radiators connected in the system to warm the transmitter room in the winter. The antenna was an 'L' type between two 150' steel self-supporting towers. This was a daytime only station on WSB, Atlanta's clear channel. No interference was present between the stations during the day. At night we disconnected and grounded the antenna.

"The voltage developed by the dust storms would cause a very large spark at this grounding. The dust was the big problem in the generators and transmitter. There was no air conditioning. We had the windows open as much as possible in the summer.

"Crystal control ovens had to be kept at a temperature well above room temperature for some degree of frequency stability. They were kept at 55° Centigrade. The announcers would look at the thermometer and read 55° and say, 'it sure must be nice and cool in the transmitter,' thinking it was Fahrenheit.

"Previous to crystal control, the frequency of the station's carrier was set by a highly accurate calibrated wavemeter. KMMJ still had it in the transmitter room. I think the frequency could be ad-

justed to within 1000 cycles in this method, but it was a problem to maintain this accuracy.

"About this time I enrolled in an engineering course from Capitol Radio Engineering. I took about all they had to offer over a period of about 20 years. Later that year I was again unemployed."

OT: Why were you unemployed?

AS: "I think the reason was that the operator had to copy the news for broadcasting at about 25 wpm (words per minute) on a typewriter. I think it was Transradio Press. The announcers hated it when I had the job of copying the news. They had a lot of blank areas to fill—like re-creating a baseball game from a wire ticker."

OT: So what did you do?

AS: "So I went back to repairing radios for a while."

Al was out of radio for a few months before going to work at KMA in Shenandoah, IA. We will pick up with Al next month as he begins his stint at KMA.

■ ■ ■

George Riggins has experience in radio and electronics dating back to the 1930s. He is also a licensed ham operator and has had his own broadcast sales and service company, Riggins Electronic Sales, for over 20 years. He can be reached at 213-598-7007.

QEI CORPORATION
ONE AIRPORT DRIVE • P.O. BOX D • WILLIAMSTOWN, N.J. 08094

TEL (609) 728-2020 • FAX (609) 629-1751

QUALITY • **E**NGINEERING • **I**NNOVATION

Understanding DAT Technology

This New Compact Format Is Giving Established Competition a Run for Its Money—Here's Why

by Bruce Bartlett

Elkhart IN More and more engineers are mastering to DAT instead of open-reel tape. A DAT machine records digital audio onto a small cassette by using a rotating head, similar to the head in a VCR.

Why record with this new format? DAT sound quality is potentially as good as a compact disc. What you put in, you

get out, virtually without any added hiss, distortion or wow and flutter. machines). When a DAT machine is used to record your stereo mixes, the DAT stereo master sounds as clean as your multitrack tapes.

Because a single DAT tape runs for two hours, you can usually record an entire live concert on a single cassette. No more frantic tape swapping! Plus, portable DAT recorders are light and easy to carry and DAT cassettes are much smaller than tape reels.



DAT recorders, like this Fostex model, record digital signals on tape by pulse code modulation in a helical scan.

get out, virtually without any added hiss, distortion or wow and flutter.

DAT outperforms open-reel (I've measured a 79 dB S/N on some portable DAT

A major drawback of DAT tape is that you can't edit the tape by splicing it. If your DAT master tape needs to be edited or resequenced, you must copy from one



The rear panel of the Fostex D-20 features timecode, digital and external sync inputs and outputs.

DAT machine to another, changing the order of selections and deleting noises during the copying process.

Tight edits are impossible unless you use a digital audio editor, such as the Sonic System by Sonic Solutions. This is a hard disk based editing system with software that runs on a Macintosh II. You play your DAT tape, record it on hard disk, use a mouse and computer screen to edit the selections and record a new edited DAT tape off the hard disk.

There are other drawbacks with DAT machines. In some units, the quality of the analog electronics and D/A converters is relatively poor (due to budget constraints). The archival ability of DAT tape is not yet established.

Yet another drawback: You can't leader the DAT tape to provide silent spaces between songs. That is, you can't splice in leader tape just before a song starts and just after it ends to eliminate noises that occurred just before or after each song.

There are ways around the leadering problem, and they will be covered in the next installment of *Line Out*. First, let's review the features and operation of the DAT recorder itself.

DAT overview

The DAT transport is very fast. A two hour tape winds in about 45 seconds.

A DAT cassette itself is about half

the size of a standard analog cassette, measuring 73x54x10.5mm (about 3"x2"x3/8"). Its tape is 3.81 mm (0.150") wide, the same as an analog audio cassette.

LINE OUT

DAT tapes can record up to two hours of audio on a tape about 60 meters (196.85 feet) long. Four hours recording time is possible with special formats. Blank tapes use a metal-powder oxide, while prerecorded tapes use a barium-ferrite oxide. On one end of the cassette is a sliding tab you can set to prevent accidental erasure. The shell has a hinged door that flips open to expose the tape.

When you load the cassette, two spindles enter the two hubs from below the cassette and lock it into place. Then the tape is drawn into the machine and wrapped around a rotating drum, in which are mounted the record and playback heads. This is similar to the loading mechanism used in video cassette recorders.

Recording process

How is the audio signal recorded? If the signal is analog, it enters the analog connectors in the DAT recorder. The analog signal passes through an analog-to-digital (A/D) converter. This converter measures, or samples, the voltage of the audio waveform several thousand times a second. Each time the waveform is sampled, a binary number (made of 1s and 0s) is generated that represents the voltage of the waveform at the instant it is measured.

The longer the binary number (the more bits), the greater the accuracy of the measurement. In other words, short binary numbers provide poor resolution of the waveform's amplitude; long binary numbers provide good resolution. Sixteen-bit resolution is standard, but some units have 20-bit resolution for better linearity and dynamic range.

Professional DAT machines have digital inputs and outputs for direct digital-to-digital copies.

PCM scanning

The digital signal is recorded on tape by pulse code modulation (PCM) in a helical scan. Although the linear tape speed is slow, the tape speed as seen by the record head is very high, so the ultrasonic digital signal can be recorded. During playback, a D/A converter converts the recorded digital signal back into an analog audio signal.

During recording (A/D conversion),
(continued on page 43)

RF SPECIALTIES GROUP

LEADERS IN RF SYSTEMS FROM COAST TO COAST

A. RF Specialties of Washington, Inc.
19237 Aurora Avenue N.
Seattle, WA 98133
Phone (206) 546-6546
FAX (206) 546-2633
John Schneider

B. RF Specialties of California
3463 State Street, Suite 229
Santa Barbara, CA 93105
Phone (805) 682-9429
FAX (805) 682-5170
Sam Lane

C. RF Specialties of Missouri
R.R. #2, Box 152H
Kearney, MO 64060
Phone (816) 635-5959
FAX (816) 635-4508
Chris Kreger

D. RF Specialties of Texas
P.O. Box 7630
Amarillo, TX 79114
Phone (806) 372-4518
FAX (806) 373-8036
Don Jones & Tim Hawks

E. RF Specialties of Pennsylvania, Inc.
121 Conneaut Drive
Pittsburgh, PA 15239
Phone (412) 733-1994
FAX (412) 327-9336
Tom Monahan

F. RF Specialties of Florida
P.O. Box 397
Niceville, FL 32578
Phone (904) 678-8943
FAX (904) 729-2744
Bill Turney

Each Office is Independently Owned and Operated

FOR ALL YOUR BROADCAST EQUIPMENT NEEDS, CALL THE SPECIALIST NEAR YOU

SYSTEM DESIGN COMPETITIVE PRICING

GOT A FIELD PROBLEM ?

GET A SESCOM IL OR TR SERIES

IN-LINE TRANSFORMERS
PADS OR FILTERS
SOLVE YOUR MATCHING PROBLEM

47 UNITS TO SOLVE YOUR EXACT PROBLEM

XLR'S TO XLR'S
XLR'S TO PHONE
MINI PHONE
RCA
RCA'S TO RCA'S

SEND FOR FREE CATALOG

SESCOM INC.
2100 WARD DR.
HENDERSON NV 89015 U.S.A.
702-565-3400, 800-634-3457, FAX 702-565-4828

HE SAID,



“You can write almost anything you want about this machine and put my name under it.” SO WE DID.

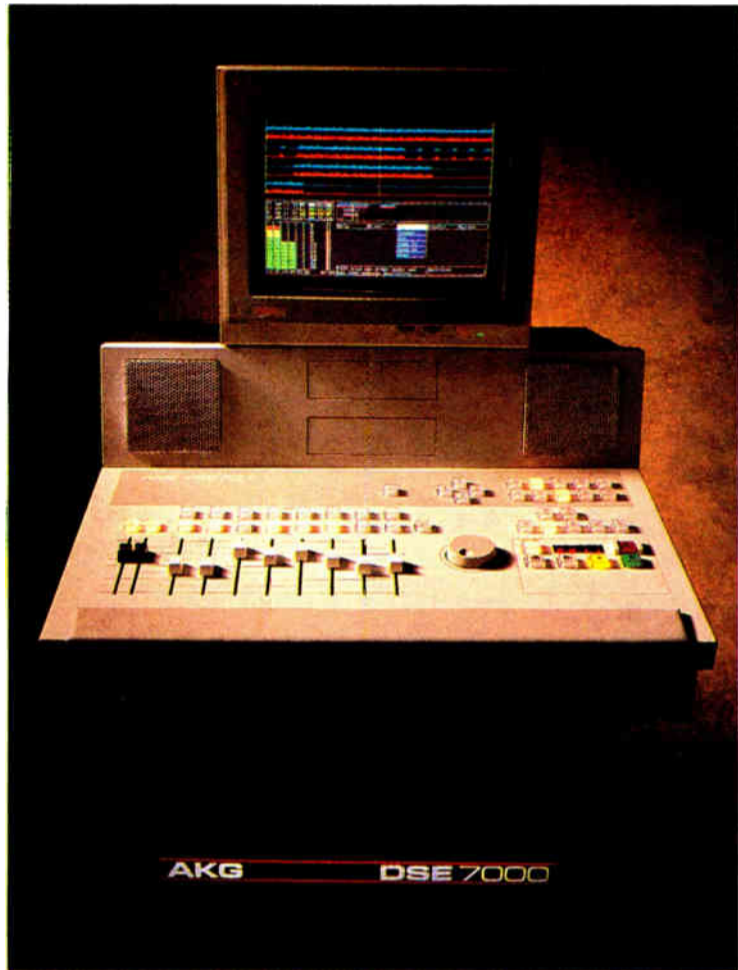

THE DIGITAL SOUND EDITOR. STATIONS FROM BOSTON TO SAN DIEGO ARE MAKING IT THE HOTTEST BOX IN RADIO.

Dan McCoy was the first production director in radio to use the DSE 7000, and he saw it revolutionize the way production is done at

WZOU-FM,



one of the top stations

in Boston. A spot that used to take an hour to produce now takes 20 minutes. Without tape.

Without razors. Without a single dB of generation loss. Even agency dubs now go right to the

DSE for levels, sound enhancement



and tags; then onto carts. Creativity has exploded, too. With the DSE's instant UNDO feature,

the fear of trying new things is gone. You simply try another take, assemble a different edit,

or test a new effect. If you don't like the results, UNDO it instantly. No wonder WZOU has

designed their production facility around the DSE.

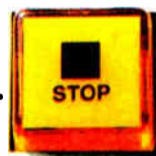

And no wonder Dan McCoy calls

this machine “the most impressive thing that's ever happened to radio.” His words, not ours.



1525 ALVARADO STREET, SAN LEANDRO, CALIFORNIA 94577, USA. (415) 351-3500. FAX: (415) 351-0500



DSE 7000 • THE NEW SPEED OF SOUND



See Us At AES Booth 226

World Radio History

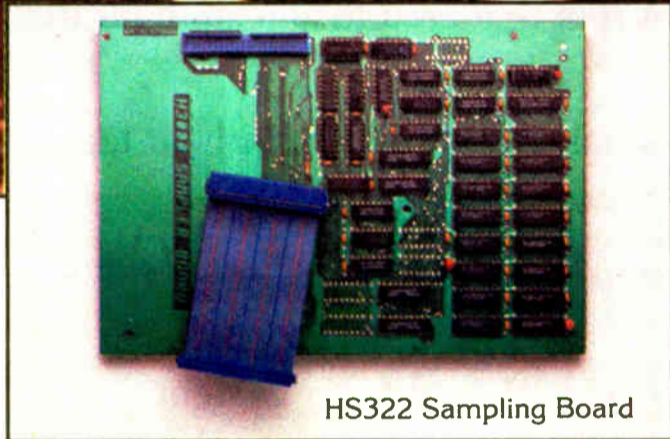
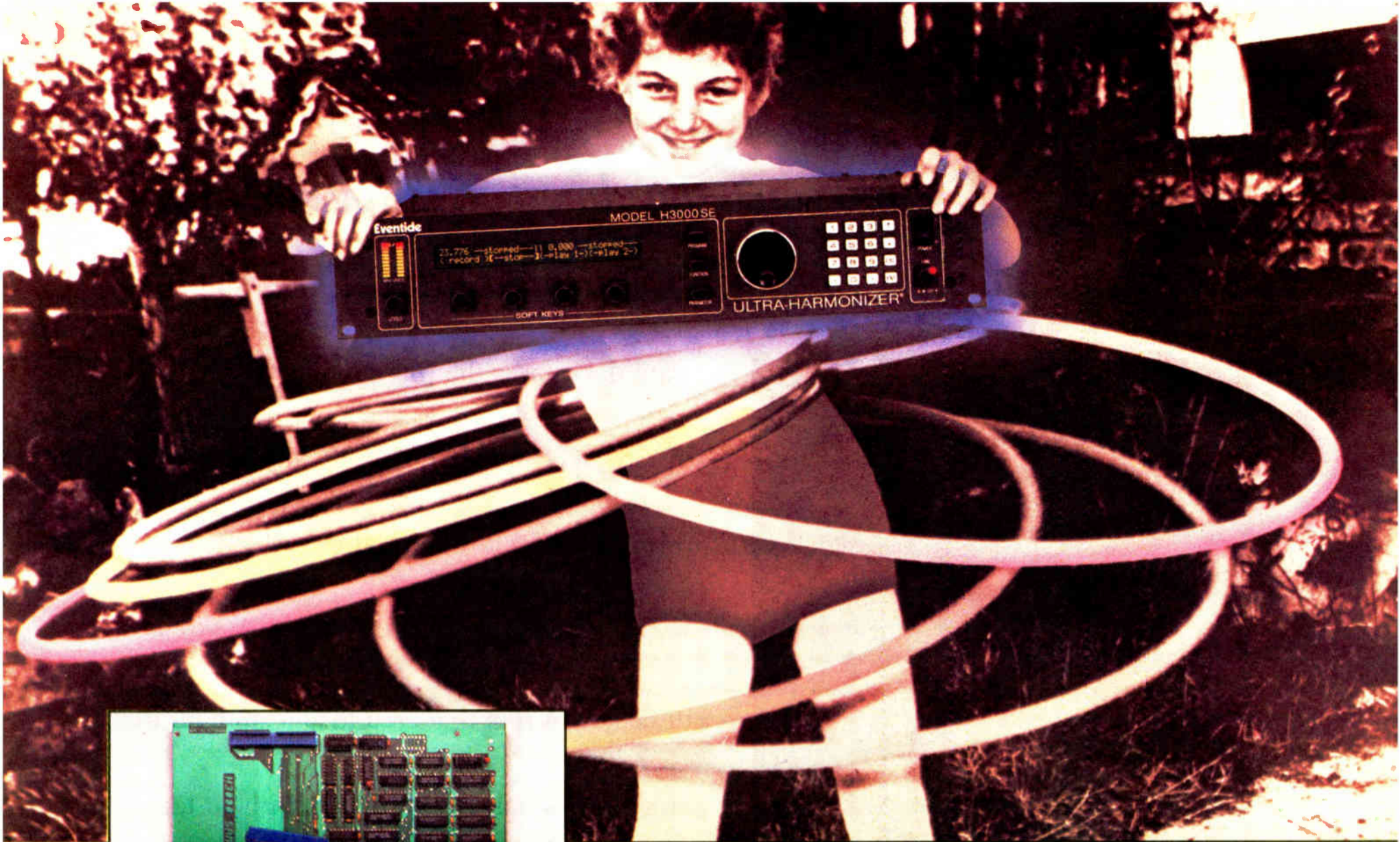

HS322 Sampling Board

Eventide engineers just can't stop teaching the Ultra-Harmonizer® new tricks. First the built-for-broadcast effects and TimeSqueeze® capabilities of the H3000B. Next, eight new algorithms and 200 new presets in our SE ConKit. Now, 11.8 seconds of stereo or 23.7 seconds of mono sampling with the HS322 Sampling Board option. For \$995, the HS322 adds 16 bit 44.1 kHz sampling to any Ultra-Harmonizer. And Eventide's unique pitch change technology makes it easy to do things no ordinary sampler can. Change playback length without changing the pitch, to make music or background loops happen fast. Change playback pitch without changing length, to add authority to a voice or impact to a sound effect. The HS322 can also work like an ordinary sampler if you want to change pitch and length simultaneously.

The HS322 board records two stereo or mono sounds, with the flawless audio quality that's made the H3000 a radio favorite. You also get

Looping Is Only Our Newest Trick.

fast, flexible, precise control. Start recording and playback manually, via MIDI or audio trigger. Edit Start, Stop and Loop points using the famous Eventide Knob to "rock" audio, or enter locations on the keypad.

Impressed? Ultra-sampling is just part of the H3000's best trick—the way it keeps your original investment growing in power and performance, without making you buy a whole new box. Production and air talent keeps getting more and more out of the H3000—because we keep putting more into it. So, if you're ready for more than just another "fad box," talk to your broadcast distributor. And sample the future.

Eventide®
the next step

One Alsan Way • Little Ferry, New Jersey 07643
Tel (201) 641-1200 • Fax (201) 641-1640

Sample responsibly: Credit and compensate your sources.

Data Reduction Design Ideas

(continued from page 33)

audio signal, ADPCM adapts the step size represented by each quantizing interval, so that rapid changes in level caused by high frequencies or transients can be accommodated, thereby enabling an overall reduction in bit rate.

Additional split-band techniques, such as sub-band coding, can be used to exploit spectral redundancies within the audio spectrum. During sub-band coding, the signal is split into a number of independent bands, and the accuracy of the quantization is varied in each band according to the input signal energy.

The critical regions of the audio spectrum thus can be coded more accurately, with enhanced quantizing energy being concentrated on the high sensitivity, low frequency region. (In other words, less valuable resources are spent on coding areas of the audio spectrum where human hearing is more tolerant.) In addition, high energy regions are coded more accurately than PCM, resulting in a lower coding noise floor.

While increasing the number of sub-bands will enhance the coding system's ability to resolve finer components, increases in complexity, interband leakage and sub-band delay will offset any signal-to-noise advantage that results from the use of more bands.

Transform coding

Transform Coding, in essence, involves an analysis of the frequency content of a time block. Having split the spectrum into a hundred or so bands, the most important criteria can be coded, emphasizing the more sensitive low frequencies and identifying the fundamental frequencies.

To reduce the bit rate, any redundant information—frequencies that will be masked by our hearing—can be identified and extracted prior to coding. (The data generated by the coder describes the frequency content and level of the signal at those frequencies.)

To effectively minimize the number of bits required by a Transform Coding system, a series of pre-programmed models of "typical" music signals need to be held in both the encoder and decoder. As well as data that describes the audio signal, information is also included within the resultant bitstream to describe the "best-fit" computational model that most closely mimics the kind of signals being input to the decoder.

Operational considerations

While there is no denying that existing data reduction systems greatly enhance the available bandwidth of digital transmission links, in addition to increasing the recording capacity of hard-disk recorders, there are also some operational drawbacks. As with most computational processes, small anomalies can be produced by these and other systems.

Consider, for example, the copying of encoded material. While compressed audio data, like conventional PCM signals, can be passed through several generations without incurring any degradation, multiple passes into and out of the analog domain will result in some spectral anomalies.

As with analog noise reduction, digital coding should be used for critical mastering stages and transmission links,

rather than as a routine process every time the signals are to be transferred from point A to point B, or stored to hard disk. (It has been estimated that, under ideal conditions, audio quality will remain acceptable within between five and 10 complete analog/coded digital/analog passes.)

Also, there are small but finite computational delays involved in processing or encoding the signals—around 3-5 milliseconds for sub-band techniques, which are faster because they operate in the time domain, and in the region of 40-50 milliseconds for transform techniques.

If all signals are coming from the same

source—a random-access recording system, for example, or a multichannel production center—these delays may not be problematic. If, however, several live sources are being combined with coded signals, then some way of establishing highly accurate synchronization might need to be considered.

Also worth considering is the fact that coded information cannot be edited directly using conventional random-access techniques. Again, its usefulness in hard disk based systems might be limited if signals need to be converted to 16-bit PCM signals prior to random-access editing and signal processing. (I

understand that several new high-speed transcoding techniques are now being developed that will allow direct, real-time editing of coded signals, although these may be a while off for routine applications.)

Such reservations notwithstanding, there is no denying that the current generation of digital data compression systems will enhance the available palette of techniques and technologies available to the radio broadcaster and in-house production facility.

■ ■ ■

Mel Lambert has been intimately involved with the production and broadcast industries on both sides of the Atlantic for the past dozen years. Now principal of Media&Marketing, a consulting service for the professional audio industry, he can be reached at 818-753-9510.

"AP NewsDesk Put An End To Wading Through Reams Of Paper."

— Norm Hall, News Director
KKDA-AM/KKDA-FM, Dallas, Texas

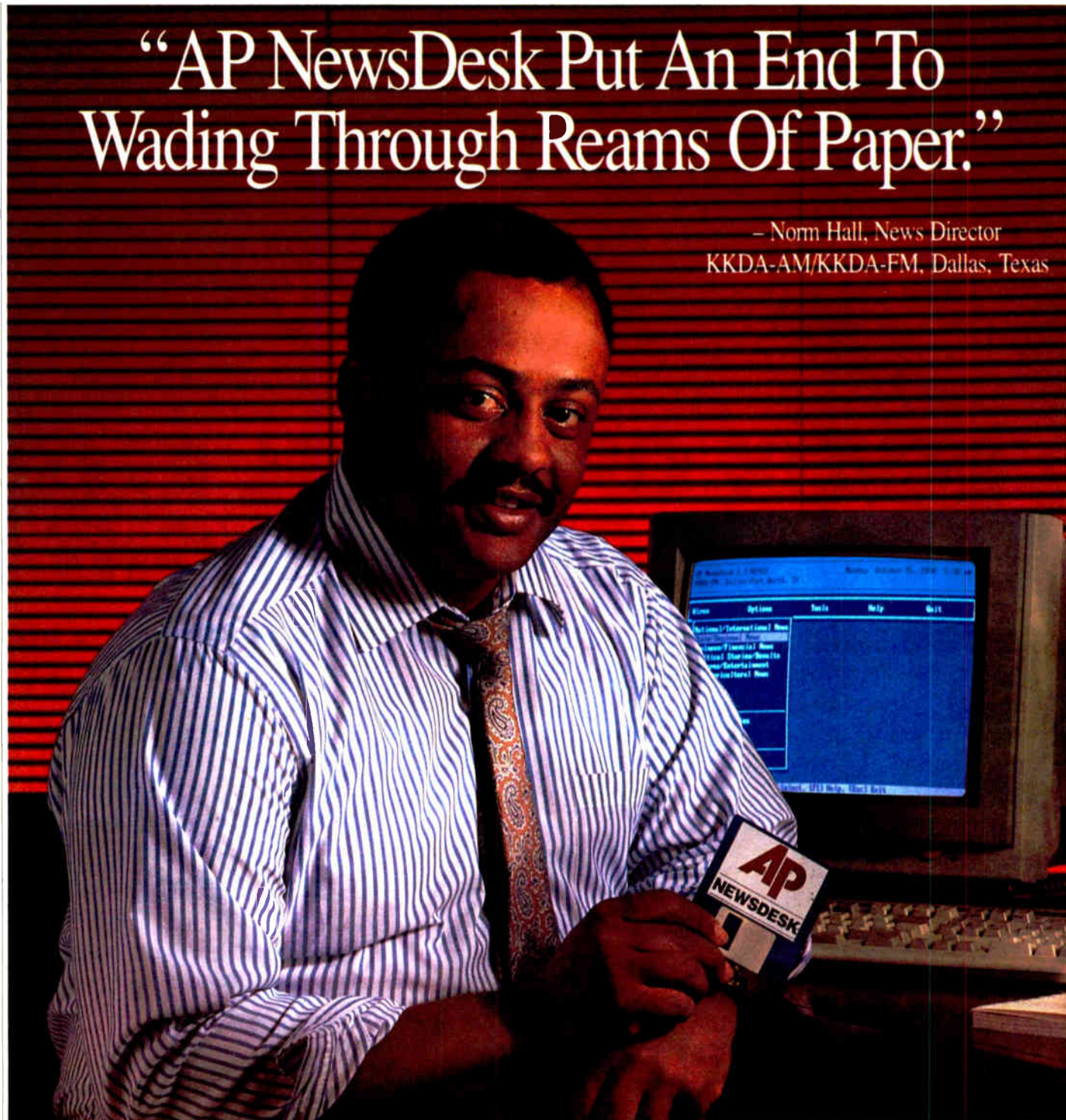

AP's comprehensive, real-time news services can't move fast enough for most stations. But who can stay ahead of all that information?

Now, with AP NewsDesk, you can say good-bye to the time-consuming task of shuffling through page after page of wire copy. And say hello to complete control of your station's news flow.

Designed to run on any IBM-compatible personal computer, AP NewsDesk is easy to use and allows you to review, edit and print only the information you need.

AP NewsDesk. The news management solution that puts an end to pushing paper.

See for yourself why AP NewsDesk is broadcasting's best-selling news management software. For a free demo disk and more information, call the AP Broadcast News Center Marketing Department at 1-800-821-4747.

AP Associated Press
Broadcast Services

C270

C274

C278

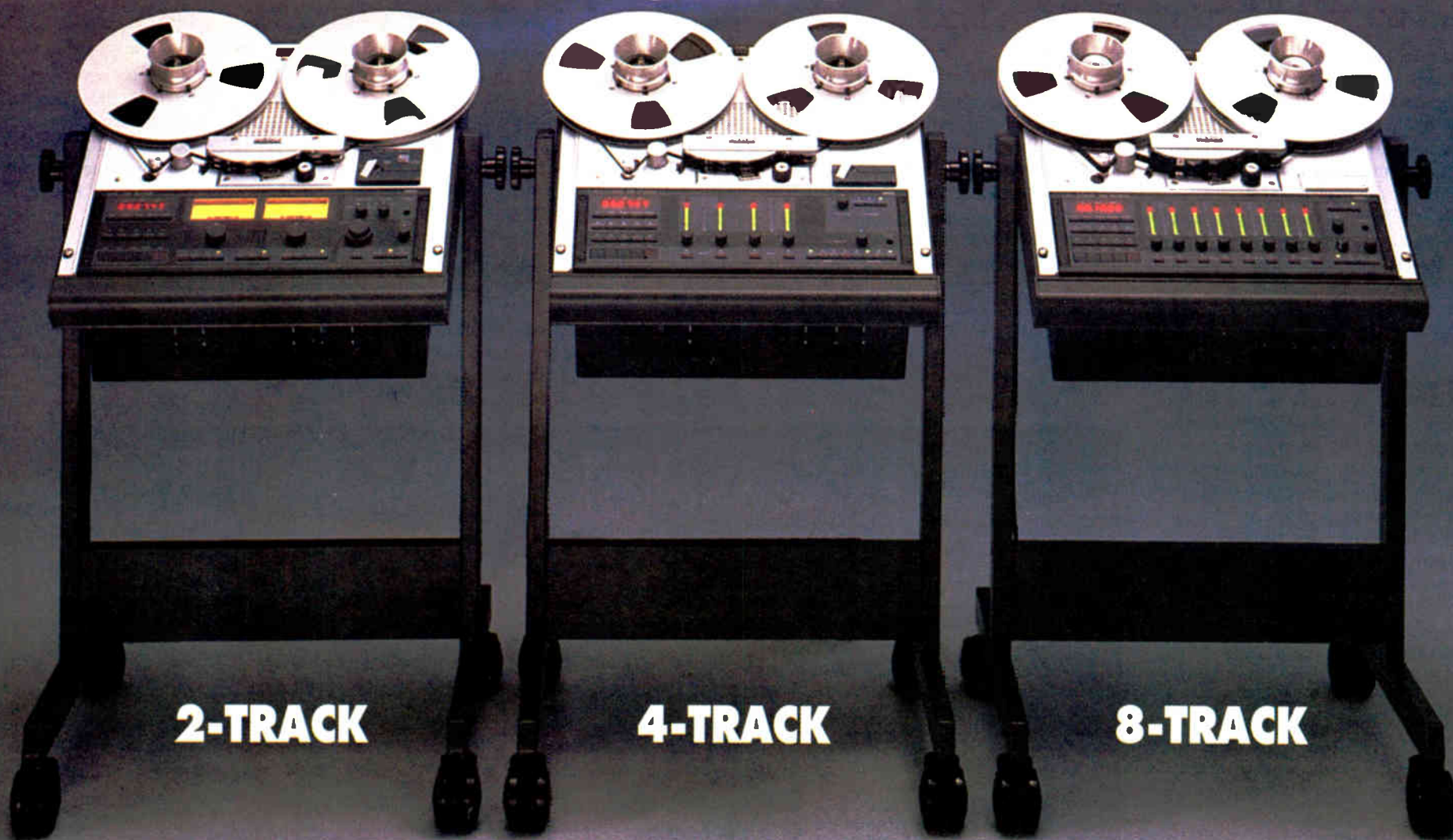

2-TRACK

4-TRACK

8-TRACK

REVOX OPEN REEL RECORDERS. YOU'RE ON THE RIGHT TRACK.

THE C270 SERIES This exciting new line of recorders provides you with all the traditional Studer Revox benefits—mechanical precision, electronic sophistication, supreme sound quality and superior support—adding up to state-of-the-art analog recording technology. The C270 is available in 2, 4 and 8-track versions with or without remote/autolocator.

BEST BUY Compare the performance of any C270 Series machine with the competition, and you'll find there is no competition. The die-cast deck plate and head block, the precision mechanics and a host of powerful features tell you any C270 Series machine will last as long as you need a reel-to-reel in this emerging era of digital workstations. And in the digital future, you'll need analog recorders that will sound good—for a long time. That's why your last reel-to-reel should be from Studer Revox.

TIME CODE . . . OR NOT The C270 2-track version offers optional center track time code for effortless synchronization to picture or sound. The C274 4-track and C278 8-track are both equally adaptable to production or post. The optional remote/autolocator stores 18 start/stop addresses and provides full transport and channel remote control to fit into any professional studio environment.

LOGGING TOO For station logging applications, special super low speed versions of the C274 and C278 are available with built-in time/date code generator and reader with search capabilities, providing up to 25 hours of continuous audio on one reel of tape.

Call your Studer Revox Professional Products Dealer—or Studer Revox direct—to discuss all the details. Or simply call **800-366-4900** to receive our C270 series color booklet.



C270 Remote/Autolocator

STUDER REVOX

Studer Revox America, Inc. • 1425 Elm Hill Pike • Nashville, TN 37210 • (615) 254-5651
New York (212) 255-4462 • Los Angeles (818) 780-4234
Studer Revox Canada Ltd., Toronto (416) 423-2831

See Us At AES Booth 111

© 1990 Studer Revox America, Inc.
Circle 139 On Reader Service Card

World Radio History

EAS: Colorado's EBS Alternative

A Look at How EAS Involves Other Media and The Functions of the System's Priority Levels

by Fred Baumgartner
Part II of II

Indianapolis IN In our introductory look at EAS, a system being tested in Colorado in the hopes of bettering the EBS, I explained that it uses DTMF at a 12% higher frequency.

The EAS can also provide priority and location information and scan eight sources looking for activation.

Let's look at how the EAS can involve other media and take a closer look at its priority levels.

When the EBS was developed, cable was in its infancy and "closed circuit" services for background music were limited. Today, at any given time, a large number of people will be in commercial environments or viewing cable.

The EAS system can easily be inte-

This is dealt with in much the same way as a priority two, but it allows broadcasters even greater flexibility.

A *priority zero* EAS alert is a closed circuit test. It serves two purposes. First, it can be used to carry advisories. Second, it allows off-line testing of individual EAS communications links, without having to carry the EAS test signal on the air (unless that is the link that is being tested).

Each decoder provides contacts and audio to drive a recorder (an inexpensive cassette is practical). The tape is then available to the operator for replay or critical listening. The tape can also serve as the running log of activations and tests.

No escape and no wolf cry

Human nature naturally turns repeated behavior into routine. Operators develop "muscle memory" and fre-

The EAS uses four priority levels. The result is that the EAS avoids the "cry wolf" effect.

grated into any service where the audio can be interrupted (EAS does not solve EBS's limitations when it comes to the hearing impaired; although it facilitates the use of a text system that will). Many cable systems have a group audio intercept function, most accessed by dial-up telephone.

The EAS's ability to target makes it very palatable for cable and other similar media use. EBS is tested too often to be useful in institutional environments like schools; the EAS decoder is cheap enough to be practical.

The EAS uses four priority levels. The result is that the EAS avoids the "cry wolf" effect and allows the option of using several levels of automation, tailored to the station or service.

A *priority one* EAS alert must fit three criteria. It must be immediate, life threatening and not part of a continuing emergency. The priority one activation is the only level that activates the full speed and power of the EAS system.

Ideally, the priority one EAS captures the transmitter feed of each broadcast station or other communications channel (i.e., cable, background music, NWS station, etc.) and passes itself on to do the same to each and every involved station or outlet.

A *priority two* EAS alert is a weather emergency that does not fit one or more of the criteria for a priority one EAS.

A station with a working weather department would not allow this to be aired directly. An automated station, or one without a weather presence in an area where weather is important, would likely permit the priority two EAS to be automatically rebroadcast by the station.

A *priority three* EAS alert is a non-weather emergency that does not fit one or more of the criteria for a priority one EAS.

quently reset the EBS decoder before they know whether it is a test or not. Any program director will tell you that the EBS tones guarantee that a significant number of listeners (some say 1/3) will tune elsewhere long before a real EBS message can be sent.

The EAS tones are attention getting, but not as long, obnoxious, or frequent as the EBS.

Since a priority one is carried in real time and simultaneously on (hopefully) all participating stations, there is no escape... punching the buttons on the radio or the remote produces the same message everywhere across the dial.

The EBS resembles a child's game of telephone—it is hoped that operators will correctly interpret the message received and repeat it accurately. Using tape and the NWS does improve this situation somewhat in the EBS, but EAS allows broadcasters to avoid the problem entirely.

EBS leaves the encoders in the hands of the station operators. EAS puts the encoders in the hands of the governmental or public safety body that has the authority to activate the EAS system.

While the EAS is capable of establishing an emergency network, it is also capable of ending one automatically. A one second stop tone returns everything to normal, or aborts the process at any point. A three minute time-out timer will shut down any decoder should a fault occur and the system not reset.

Colorado's test

The EAS system was born of necessity and conceived of by members of Denver SBE Chapter 48 while working with state officials. At this writing, the Colorado Broadcasters Association is finalizing plans to finance a medium scale test of the system (the prototypes were demon-

strated at the CBA's summer meeting last year).

It is very unlikely that EBS will be replaced outright by EAS or any other technology. When a system proves itself to be superior it would seem logical that EBS would be retired.

EAS makes provisions for a 23-second pause and automatic tripping of the EBS tone encoder. With the EAS system fully functional, the EBS tone encoder serves no useful purpose and becomes a waste of time. As each link in the chain acquires EAS decoders, the EBS decoders and encoders can be left on line, or re-

moved as the current rules require. For as long as the EBS is required, EAS can manage and supercharge it.

EAS is a potentially global system. There is no reason the system could not be used on the national level as easily as on the state or local level. And, the cost of the EAS decoders is so low that it could even be an affordable technology for the third world.

■ ■ ■

Fred Baumgartner is engineering manager at Indianapolis' WTTK and WTTV-TV. Previously, he was at KWGN-TV and KHOU/KSYX in Denver.

GET IT RIGHT
FROM HARRIS ALLIED

NEW

ONLY THE BEST!
— IN SATELLITE —
— for you!

WEGENER — SERIES 1800 Stereo Radio Network Receiver



The Series 1800 Stereo Radio Network Receiver is a commercial C/Ku band satellite receiver that is designed for use in stereo radio networks using either FM2 subcarrier or video subcarrier transmission technology. The Series 1800 receiver accepts the L-band output from an LNB and features synthesized, dip switch controlled transponder and subcarrier frequency selection. The receiver provides six (or optionally fifteen) function contact closures for remote signalling or the control of automated commercial insertion equipment.

MICRODYNE 1100 PCDR-5



The PCDR-5 features more agility than any other SCPC demodulator from Microdyne. Exceptional flexibility is provided by the front panel five-section push-button switch assembly, which allows you to select wideband (high fidelity) or narrow band (broadcast voice grade). Companding and frequency selections are all front panel available. Also features: Synthesizer 10kHz step tuning, balanced audio outputs, settable expander ratios, choice of de-emphasis — and more!

FAIRCHILD DART 384

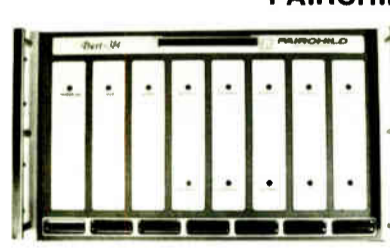

The DART 384 is a stable crystal-controlled down converter with remote program selection and transponder selection — its advanced state of the art electronics will take you into the next century via its compatibility to receive satellite digitally broadcast material. It's a truly unique switchable audio receiver.

IN STOCK — NO WAITING — CALL NOW!!

Short of Cash?
Consider Leasing!
Call Now for Details



HARRIS ALLIED
SATELLITE EQUIPMENT
317-962-8596
FAX 317-962-8961

3712 NATIONAL RD. WEST • P.O. BOX 1487 • RICHMOND, IN 47375

©HARRIS/ALLIED 1990

WORKBENCH

Edit Station on a Budget

by George Thomas, Jr., CE
WJDS/WMSI and WJDX-AM

Jackson MS Need to put together another small production room or maybe an editing station for the news depart-

M-267 mixers around too.

We needed a reliable setup that would allow for balanced and unbalanced tape recorders, balanced feeds from satellite, telephone, etc.

The quality of the Shure mixer would be sufficient for the purpose but it only had four balanced line or mic level inputs. We had at least 10 sources. Some were +4 balanced and the others -10 unbalanced. We didn't have any spare match boxes for the consumer equipment and didn't really want to buy them for this project.

Fortunately, there was a very simple and inexpensive solution. Shure has placed an RCA phono jack labeled "Mix Bus" on the rear of their mixers. This is normally used for connecting two or more of the mixers together. Each additional mixer adds four more channels to the total. That's great if you have the extra mixers and use only balanced equipment.

We built an unbalanced passive mixer and plugged it into the Shure's mix bus. All that's needed is a 10K ohm pot and a 27K ohm buildout resistor for each channel, and a few RCA jacks and hardware.

Now we had four 600 ohm balanced mic or line inputs and as many 10K ohm -10 inputs as we wanted to add. The cart machines and line feeds were connected directly to the Shure's inputs. Everything else

was unbalanced so it was connected to the "Mixer Expander."

Figure 1 shows the simple schematic of the Expander. I found a bud box with a sloped front panel that the mixer would bolt on top of perfectly. Although it probably wasn't necessary, I used shielded cable inside the expander box for extra RF immunity.

The pots that are in the Shure are less than desirable for daily use. We replaced them with better central lab units and

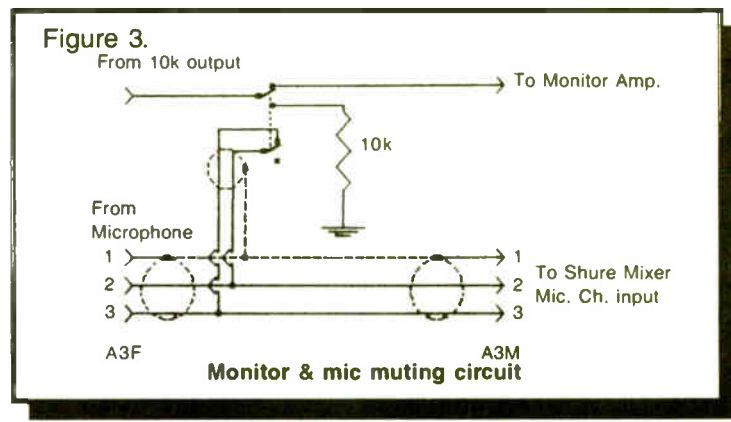

changed to larger knobs so all would match. This was the only change made to the mixer and was not absolutely necessary. If

you don't want to void the warranty, use the original pots.

Figure 2 shows how to handle the outputs. A divider network is constructed of 100 ohm resistors. This provides one 600 ohm balanced output and several 10K ohm unbalanced outputs that are transformer isolated to prevent ground loops.

Provisions for adding a microphone muting circuit are shown in Figure 3. A DPDT switch is used to mute the monitor amp whenever the microphone is engaged, and conversely mute the microphone when in the other position. This works just like any other broadcast console. The microphone channel's pot may be left up and mic audio won't appear in the mix while the switch is off.

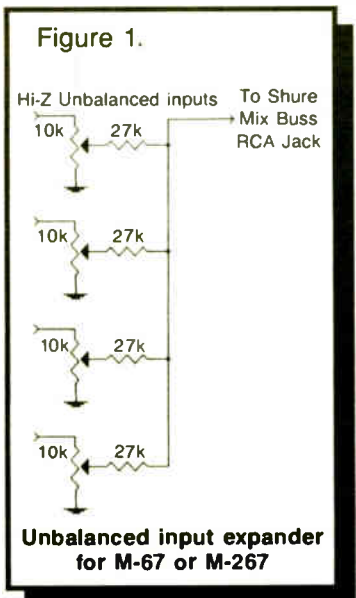

ment? If you've already got a spare Shure M67 or M267 and some extra tape recorders then you're in business.

WJDX needed two such stations for the news room. We had several Tascam unbalanced reel machines (removed from the production room earlier), two consumer cassette decks and cart machines. We had just begun to use RPU instead of telephone lines for remote broadcasts, so there were a few Shure

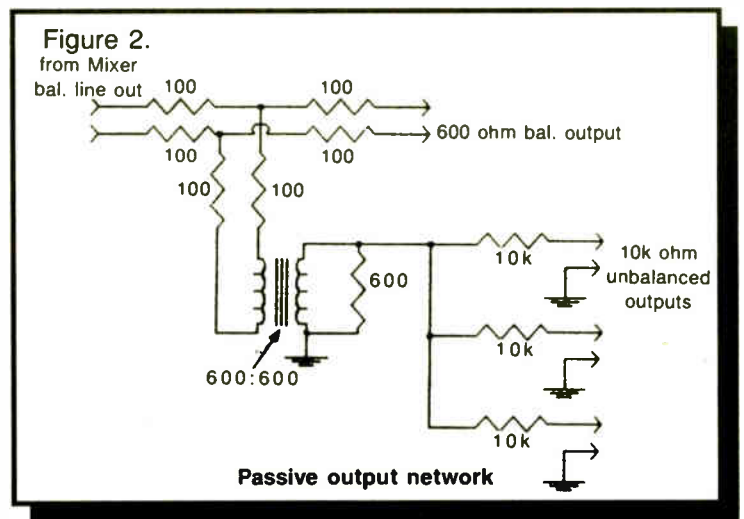

Touchtone for a Telos 10

by Ernie Swanson, CE
WZTR

Milwaukee WI Do you wish to add a touchtone pad to your Telos 10? At WZTR, we chose a Pipo PK1 tone pad. It is color-matched to the switch console and is small.

It is mounted with two screws to the right of the switches. The screws are long enough to mount a printed circuit board underneath the pad inside the switch blank housing.

An amplifier was constructed to boost the DTMF audio suitable for the Telos 10 AMX input. It is two stages: each LM 741 IC chips. The amp is transformer coupled to the Telos 10. This mounts under the PK1.

To avoid the AGC action of the Telos 10 we coupled the first AMX input stage of the Telos 10 with a tantellum capacitor and

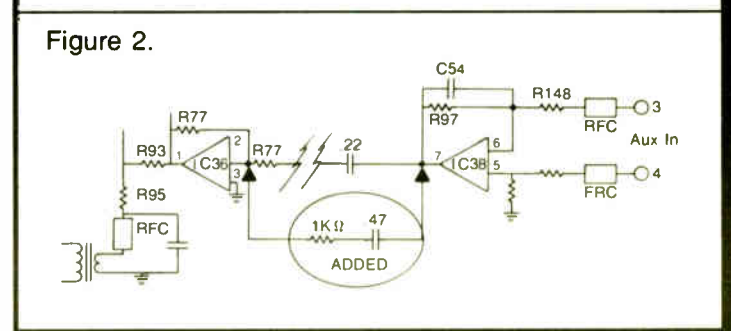
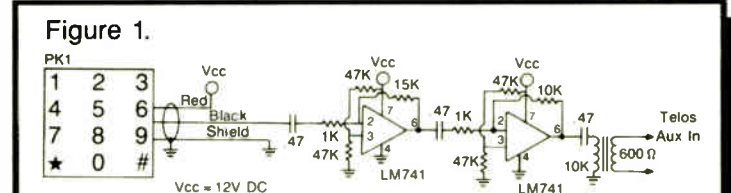

a 1K resistor to the input of the last stage going to telephone line.

We find good levels to the tones. The levels are balanced and clean. Power is supplied by

a 13.8 volt DC supply. The Pipo PK1 DTMF encoder is available from Pipo Communications, PO Box 2020, Pollock Pines, CA 95726-2020. Phone 916-644-5444, FAX 916-644-7476.



Serving the broadcasting industry for over 40 years!



OTARI
ARS-1000-Auto
Rewind with
25Hz Sensor

**INVENTORY REDUCTION
SPECIAL PRICE
\$1775⁰⁰**

- Professional Performance
- Complete with 25Hz Tone Sensing
- Adjustable Stop Delay
- Automatic Rewind with Busy Response
- Integrated Stereo Amplifiers
- Dual Tape Speed
- Transformer Voltage Controlled Torque Motors
- Capstan Motor is Hysterisis Synchronous
- All Electronic Circuits, Including Power Supply

SONO-MAG CORPORATION
1833 W. Hovey Ave., Normal IL 61761-4394
Phone 309-452-5313 FAX 309-452-2521

**WRITE OR CALL
SMC FOR OTHER
SPECIALS**



We Need Your Tech Tips!

RW's new *Workbench* page needs your quick fixes, short build-it projects and favorite tech tips. You've spent those late nights perfecting them; now let us know.

Send it on 5 1/4" floppy in WordPerfect or ASCII or MCI mail to: 302-7776. Or FAX us at 703-998-2966 or mail it to PO Box 1214, Falls Church VA 22041.

Share your expertise with your engineering colleagues by getting your tech tips published in *Radio World* and get paid while you help others.

INTRODUCING

RS CART 2000.

A great *new* cart machine.

With so many good cart machines on the market today, how do you make a new one better?

Begin by including every important cart machine feature: 3 cue tones, fast forward, XLR connectors, active phase correction, front panel azimuth adjust, LED VU and phase meters, full logic, remote control, and more. You'd have to buy every other machine available to assemble all these features.

Next, build it to last. That means long life heads, 1/2" thick deck plate, direct drive Nidec motor, massive toroidal power supply, newly designed positive cart hold-down and guidance systems, and precision head-block assembly.

Finally, distinguish it with features no other unit has. The RS-2000 is the first cart machine to offer flutter correction, splice finder, and timer on all models.

But features aren't important if the engineering isn't top-notch. The RS-2000 was created by industry-renowned design engineer Mike Sirkis. So this "new" machine carries more than a decade of cart machine experience.

One last note: since the RS-2000 is built, sold and supported exclusively by Radio Systems, it carries one more trademark—**VALUE**. Every RS-2000 model is very affordable.

Call toll-free today for details.

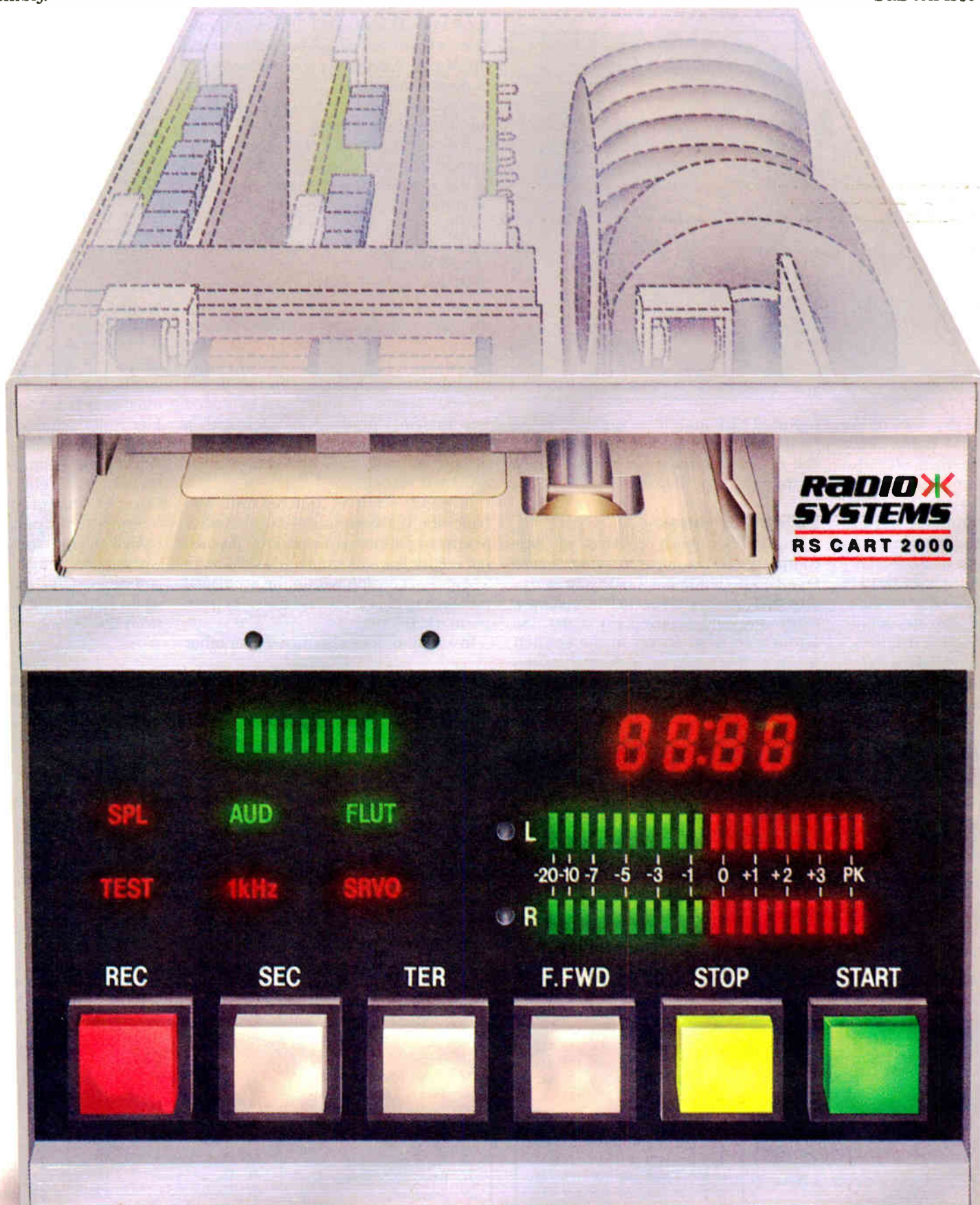

Canada's Theater of the Mind

by Dee McVicker

Toronto, Ontario CANADA In Studio G, as on Star Trek's "Holo Deck," there are no physical boundaries. Here, sound technicians can stomp through grass barefoot, tip teacups in an aristocratic gathering or light an imaginary cigarette.

Located in what used to be the chapel of a girl's school here, Studio G is the unseen stage for *Radio Drama*, a series of radio shows produced by the Canadian Broadcasting Corporation (CBC).

Its radio theatrics have been a Canadian tradition since the early '30s, when listeners tuned in to *Radio Drama* while riding the train home from work or

libraries," said *Radio Drama* Recording Engineer Glen McLaughlin. But, he noted, intricate audio effects "are all done live because you can't get the proper timing from a library."

OFFBEAT RADIO

The studio has a host of objects to animate and create drama. This includes beds for creaking effects, telephones, counter tops, sand pits, windows and a myriad of items that can be used to create and improvise everyday sounds for effects. About the only thing missing,



Actors Donald Davis (l) and Douglas Rain (r) perform in *Radio Drama*'s "The Trials of Ezra Pound."

hanging out laundry to dry. One of the few programs of its kind today, *Radio Drama* has survived The Big Screen and television. And it has done so without the benefit of a visual stage.

Radio Drama relies on audio effects and theatrical dialogue to audibly express its Shakespearean art form of drama. According to Damiano Pietropaolo, head of *Radio Drama*, the medium of radio liberates the program to "create whole universes in the mind of the listeners."

To do this, sound technicians often work in real time, animating real objects. "Ambience and things like that we can get off of any number of CD or R-DAT

reported McLaughlin, is running water. "But," he quickly added, "tubs of water can be brought in if we need to do a swimming pool scene."

Pedestrian noises

Studio G, which consists of four rooms—including a control room and a tape room—lends itself easily to everyday, pedestrian noises such as clanking silverware and rapping on doors. As actors read from scripts in the spirited dialogue that is typical of dramatic radio productions, sound effects technicians create background noises for scripted occurrences.

Surface and footstep sounds, which are called for in most scripts, can be created on beds of real gravel, grass, sidewalk or blacktop surfaces. "When we require footsteps for a sound effect in a drama, we actually have a sound effects technician walk on the gravel and then we mix the sound in," explained Pietropaolo.

Generally, scripts that call for these special effects—and most, if not all, do—will require at least 12 tracks of the studio's full 24 tracks. "Sometimes more," commented McLaughlin, "depending on the complexity."

On the other hand, hard to duplicate sounds that aren't as closely timed in a script are usually left to the electronic media of CD, cart, DAT and even vinyl. The "whoosh" of rush-hour traffic or the rumblings of airplane travel are two good examples that *Radio Drama* sound effects technicians would be hard-pressed to duplicate in the studio.

That's not to say that *Radio Drama* technicians wouldn't hesitate to make a trip to the airport to get a hybrid recording of rumbling jet engines. They would, and have.

Mood music

Music, key in setting the dramatic mood, typically is performed in the studio. The recordings of musical talent are assembled onto 24 tracks, and then mixed down to two tracks to overlay onto the master multitrack. In addition, several "layers" of music can be mixed into the final production, each with a frequency response that is characteristic of how it would typically sound in its intended setting.

A good example, pointed out McLaughlin, is a recent script that called for Muzak in a supermarket setting. Recording engineers took great pains to create a Muzak recording within the acoustical parameters of background music in a supermarket.

In addition, they also mixed in another

music recording that created the mood of the scene. The latter was mixed in at a more dominant frequency response to sweep the listener along in the plot of the drama.

A dead end

Studio G is divided into two sections: the "dead end" and the "live end." The dead end is used primarily for scenes that require very little audio reverbera-



Rudi Quammie Williams, co-composer of music in the episode "Afrika Solo," plays a shekere in the recording studio.

tion, or reflections, such as outdoor scenes. In contrast, the live end of the studio, with its wooden floors and glass fixtures, makes good use of audio reverb for indoor scenes.

When it comes to post production, most of it is left to modern technology. Electronic editing of vocal tracks, for instance, is usually done on an AMS Audiophile editor for the reverberated, melodramatic effect typical of the dialogue in such productions.

Some audio parameters can be controlled by the studio's Quantec digital workstation, which runs on a Macintosh computer. Creating the ambience of a room setting, for instance, can be done from the Quantec. "A couple of memo-

(continued on page 45)

ADVERTISER INDEX

This listing is provided solely for the convenience of our readers. *Radio World* assumes no liability for inaccuracy.

Page No.	Advertiser	Reader Service No.	Page No.	Advertiser	Reader Service No.	Page No.	Advertiser	Reader Service No.
35	AKG/Orban		46	Broadcast Trans-		23	Microwave Filter	
06	Allied Broadcast	73 & 125		mission Systems	61	Co	146	
20	Allied Broadcast	16 & 83	31	BSW	2	49	Modular Audio	
39	Allied Broadcast	78 & 130	04	Burk Technology	33	Products	144	
44	Allied Broadcast	116 & 124	20	Cancomm	92	19	Neutrik	50
26	Alpha Products	72	24	CCA Electronics	76	12	Northeast	
53	Armstrong		09	Comrex	14	Broadcast	120	
	Transmitter	121	30	Conex	20	43	Orban	133
28-29	Arrakis Systems	114	23	Continental		54	Peter Dahl Co.	81
37	Associated Press			Electronics	44	33	QEI	141
	Broadcast	74	20	Cortana	107	16	Radio Systems	80
07	ATI	111	10	CRL	70	41	Radio Systems	45
08	Audio Precision	63	30	CRL	113	34	RF Specialties	35
22	Audio-Technica		26	Dataworld	11	34	Sescom	109
	U.S.	53	18	DIC Digital Supply		15	Shure	122
11	Audiopak	30		Corp.	151	40	Sono-Mag	55
47	Barrett Associates	39	36	Eventide	119	14	Studer Revox	23
32	Belar	137	01	Fidelipac	60	38	Studer Revox	139
03	Bradley Broadcast	18	10	Full Compass	102	32	Summit Audio	40
03	Broadcast		18	Harris	100	45	Tannoy	135
	Electronics	128	44	Hnat Hinds	104	25	Tascam	7
08	Broadcast Services	87	21	ITC	96	53	Transcom	150
17	Broadcast Services	57	07	Jampro	42	24	Tri-Tech	132
27	Broadcast		13	Lindos Electronics	117	02	Wheatstone	27
	Electronics	89				55	Wheatstone	62
						56	Wheatstone	25

Advertising Sales Representatives:

East Coast, Art Constantine: 800-336-3045 Fax: 703-998-2966
 Midwest, Art Constantine: 800-336-3045 Fax: 703-998-2966
 West Coast, Pat Macsata: 415-786-2198 Fax: 415-786-2754

SUBSCRIPTION/READER SERVICE FORM

Radio World

September 12, 1990 Issue Use until December 12, 1990

FREE Subscription/Renewal Card

I would like to receive or continue receiving **Radio World** FREE each month. YES NO

Signature _____ Date _____

Please print and include all information:

Name _____ Title _____

Company/Station _____

Address _____

City _____ State _____ ZIP _____

Business Telephone () _____

Please circle only one entry for each category:

I. Type of Firm

- D. Combination AM/FM station
- A. Commercial AM station
- B. Commercial FM station
- C. Educational FM station
- E. Network/group owner
- F. Recording studio
- G. TV station/teleprod facility
- H. Consultant/ind engineer
- I. Mfg, distributor or dealer
- J. Other _____

II. Job Function

- A. Ownership
- B. General management
- C. Engineering
- D. Programming/production
- E. News operations
- F. Other (specify) _____

III. Purchasing Authority

- 1. Recommend
- 2. Specify
- 3. Approve

Reader Service

Please first fill out contact information at left. Then check each advertisement for corresponding number and circle below. NOTE: Circle no more than 15 numbers, otherwise card will not be processed.

- 001 023 045 067 089 111 133
- 002 024 046 068 090 112 134
- 003 025 047 069 091 113 135
- 004 026 048 070 092 114 136
- 005 027 049 071 093 115 137
- 006 028 050 072 094 116 138
- 007 029 051 073 095 117 139
- 008 030 052 074 096 118 140
- 009 031 053 075 097 119 141
- 010 032 054 076 098 120 142
- 011 033 055 077 099 121 143
- 012 034 056 078 100 122 144
- 013 035 057 079 101 123 145
- 014 036 058 080 102 124 146
- 015 037 059 081 103 125 147
- 016 038 060 082 104 126 148
- 017 039 061 083 105 127 149
- 018 040 062 084 106 128 150
- 019 041 063 085 107 129 151
- 020 042 064 086 108 130 152
- 021 043 065 087 109 131 153
- 022 044 066 088 110 132 154

DAT Technology Fundamentals

(continued from page 34)

three sampling frequencies are used (the sampling frequency is the rate at which the DAT machine samples or measures the analog audio signal):

- 48 kHz (standard rate)
- 44.1 kHz (used for playing commercial DAT tapes, or when you want to cut a compact disc from a DAT tape). Commercial DATs and CDs are recorded at 44.1 kHz.
- 32 kHz (allows longer recording time or 4-channel mode).

During playback (D/A conversion), the sampling frequency switches automatically to the rate recorded on tape. Thus, both consumer and professional DAT recorders can play tapes at any of the three frequencies.

Consumer DAT machines have a copy-inhibiting process called SCMS. It lets you record a digital signal at 44.1 kHz to make one digital copy of a commercial DAT or CD, but prevents regenerations from that copy. That is, you can't make subsequent digital copies of the copy. Not long ago, consumer decks recorded only at 48 kHz to discourage digital cloning of CDs and commercial DAT tapes.

All DAT tapes and recorders are compatible, so that a tape made on one machine should play on any other.

DAT features

Some DAT machines come in two parts: a tape transport and a digital audio processor. Most DATs cost upwards of \$800, though prices are expected to drop as the supply increases.

A DAT has conventional cassette transport controls, plus a number of unique controls and features. Some of these features are described below.

Subcodes. This is information on tape independent of the audio signal. Subcodes tell the machine the number of each selection or program, where each selection starts and whether or not to play each one. The three main types of subcodes are Program Numbers, Start IDs and Skip IDs.

Program Numbers are assigned to selections in order, and can then be used to locate them.

A Start ID marks the beginning of each selection. It can be written manually or automatically. Manual Start IDs can be placed anywhere, say, to mark cues. Automatic Start IDs are put on tape whenever there is enough signal applied, after a silence of three or more seconds.

A Skip ID makes the machine skip the selection. This ID can only be written manually. Whenever the machine senses a Skip ID during playback, it stops and fast winds to the next Start ID and begins playing. This function can be turned on and off.

Subcodes can be recorded or erased without altering the audio program. You can enter them during recording or playback. If the cassette's safety tab is set to prevent accidental erasure, you can't record or erase subcodes.

Search. When you enable the search function, the machine fast winds to the selected Program Number.

Memory rewind or Return to Zero. When enabled, this function rewinds the tape to a preset "0" position on the tape counter.

SDIF-2 connectors. These are digital-

audio connectors that send and receive data according to the Sony Digital Interface standard.

AES/EBU connectors. These are digital-audio connectors that send and receive data according to AES or EBU standards.

LED or LCD display window. This displays tape running time, remaining time on the tape, or elapsed time for the current selection. Also included are peak-reading bargraph meters or LEDs. Unlike with an analog tape deck, "0" on the meter is absolute maximum recording

level. If your peaks are reaching 0, that level is too high.

Pro indicators

The following indicators are found on professional units, but seldom on consumer units.

Error indicator. This indicates a loss of data. The electronics will correct for this loss.

Sampling frequency indicator. This shows the frequency at which the machine is sampling audio signals.

Subcode information indicator. This indicates subcode information (described earlier).

Search mode indicator. This shows whether the search mode is activated.

Next time we'll cover DAT controls and several techniques for mastering to a DAT recorder.

■ ■ ■

Bruce Bartlett is a microphone project engineer and technical writer with Crown International. He can be reached at 219-294-8000.



Chuck Steak - Our overzealous food critic. EQ Number: 72.



Doggie Demento - Always a dot off center. EQ Number: 7.



Earl E. Bird - Awake only with headphones on. EQ Number: 19.



Wool-man Jack - One howling party dude. EQ Number: 49.

We make everyone sound great, day, after day, after day.

The span between the basso growl of your morning talent and the punch demanded by your evening party animal is measured in seconds and digits—two seconds and two digits, to be exact.

Every talent on the station has worked out the optimum combination of parametric EQ, compression and de-essing for their personal requirements, and we've given them a number between 00 and 99—their personal number—to achieve this combination at the touch of a

button. They just punch in the number when they sit down, and all of their processing is reset instantly, exactly, repeatably.

We keep all that processing safely out of harm's way; no need to twist any dials because when their number's on the readout, they know they'll sound their doggoned best.

Call the folks at Orban for more information about their 787 multi-processor. It brings a whole lot of mike processing under control.



The Orban 787A Programmable Multi-Processor

orban
a division of AKG Acoustics, Inc.

1525 Alvarado Street
San Leandro, CA 94577 USA
Telephone 415 / 351-3500
FAX 415 / 351-0500

LISTEN TO THE DIFFERENCE.

Remote Meters, Then and Now

A Review of FCC Rules Violations May Help Stations As the Commission Ponders a Change

by Harold Hallikainen

San Luis Obispo CA Last month I wrote a bit about a preliminary Notice of Proposed Rulemaking floating around the FCC. The Federal Register explanation says the Commission will "consider relaxing the rule pertaining to the distance a transmitter must be from the duty operator."

It appears the FCC is considering

removing the requirements of 73.1550(a)(3)—that extension meters must be sufficiently close to the operator so that deviations from normal can be observed. In addition, 73.1860(b) requires duty operators to be able to observe meters and monitors from the duty position.

Reviewing my 1988 rules violation database (call me for a copy), I found 23 violation notices (either FCC form 790,

793 or Notice of Apparent Liability) issued for operators not being able to observe meters from the duty position.

Stations were cited for having the remote control "down the hall," having the transmitter in another building 40 feet away (and no extension metering, a \$300 fine) and having the operator on the first floor of a building and the transmitter on the second (again, with no extension metering, \$500 fine).

Other violations included having the AM remote control in the FM control room while the AM operator was in the AM control room, having the duty operator at a desk in the office while the remote control remained in a studio and having a window shade and papers taped to glass between the operator and the transmitter, obstructing the view of the transmitter meters.

Meters in hindsight

At one time, some stations installed "rear view mirrors" so the operator could see the transmitter meters behind her/him. The FCC then allowed for the meters to be in a 360° arc about the operator, but still readily visible.

INSIGHT ON RULES

I think the Commission originally expected operators to glance at the transmitter meters every few seconds, just as one might look at the speedometer of a car. With the introduction of remote control, however, it was obvious that operators would give the transmitter somewhat less attention.

The original remote controls (and most current systems without a CRT display) would show only one parameter at a time, so it took more than a "glance" to determine if there were significant parameter variations. The Commission recognized that only one parameter at a time was available at remote control points in the remote control rules, which required stations to continuously monitor the modulation level indicator when other readings were not being taken

(1980 73.67(a)(8), 73.274(a)(8)).

When the FCC proposed authorizing remote control of VHF television stations in 1969, they proposed requiring telemetry alarms on all parameters if the operator were employed for duties other than the continuous attendance of the transmitter (see Federal Register, 23 January 1969, page 1061). However, this requirement was not included when VHF's were finally authorized to operate by remote control in 1971.

At that time, however, all stations were required to log parameters at least every 30 minutes. Operators were expected to periodically observe the meters to insure

The proposed rule making would allow required metering and controls to be anywhere within 30.5 meters of the duty operator.

the transmitter was operating properly.

These rule changes somewhat relaxed the "continuous observation" expectation, although the meters still had to be readily visible to the operator. The meters (or single meter or display for a remote control system) may have been presenting a very limited view of the transmitter (just the modulation level), but they had to be visible!

Extension meter proposal

When the FCC considered adopting rules for extension meters (Federal Register, 4 January 1974, page 1070), it proposed requiring stations to extend plate voltage and current meters, and output power meters (for FM, or antenna or common point current for AM). In addition, the modulation monitor and antenna monitor were to be located at the duty operator position.

When the rules were adopted (Federal Register, 1 November 1974, page 38653), modulation monitors could be located at the duty position or could be extended to the duty position (giving the operator an indication of the meter and peak flasher). Further, antenna monitors could be at the duty operator position,

(continued on next page)

GET IT RIGHT
FROM HARRIS ALLIED

WE ARE —

S Y S T E M S

Y

When you work with Harris Allied Systems, you're free to focus managerial attention on long-term goals, while we oversee the myriad details involved in the planning and layout, construction and installation of your new or newly-renovated facility. From transmitter buildings (prefabricated or constructed on site) to transmitter installations, towers, antenna systems, satellite systems and even terrestrial microwave networks, the experts at Harris Allied Systems will ensure total system integration and optimal performance.

Y

S

S

T

T

E

E

M

M

S Y S T E M S

ONE SOURCE WITH THE INTEGRATED RESOURCES, THE COMPREHENSIVE DESIGN EXPERTISE AND THE UNPARALLELED WORLDWIDE CAPABILITIES YOU NEED: HARRIS ALLIED SYSTEMS.

Talk with the folks who are here to help you with your small or large projects — plan with confidence!

HARRIS ALLIED
S Y S T E M S
217-222-8200
FAX 217-224-2764

P. O. BOX 4290 • QUINCY, IL 62305-4290

©HARRIS/ALLIED 1990

Live! . . . in concert!
ALL the Time

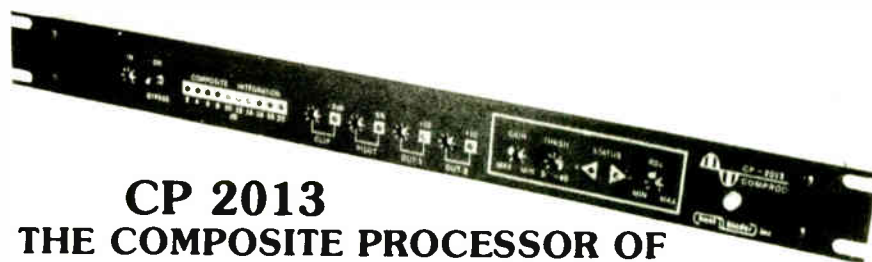

CP 2013
THE COMPOSITE PROCESSOR OF THE FUTURE HERE TODAY

- ★ Low second harmonic clipper — flat to 420KHz!
- ★ Separation exceeding 60 dB
- ★ Ultra smooth, fast acting AGC, builds stereo image without the grunge!
- ★ 1½ dB louder than any other composite clipper
- ★ Multiple outputs plus remote control

AVOID THE RUSH — CALL NOW

hnat hinds inc

42 Elaine Street • R.R. 1 • Thompson, Connecticut 06277 • (203) 935-9066 • (203) 935-9242

Bringing Drama to the Airwaves

(continued from page 42)

ries (in the Quantec) are a living room with furniture and a living room without furniture," said McLaughlin. In addition, Quantec offers selection of various room sizes, the degree of audio reflection, and even the direction of those reflections.

Computer-simulated reality

The advantage of post production of room settings, commented McLaughlin, is a more realistic simulation than can be accomplished on the floor.

This is especially true of productions that require tight editing, where it becomes increasingly difficult to keep a consistent reverberation on the floor. Without post production on some productions, said McLaughlin, "you'd hear the reverb problems in the editing."

Studio G also has on hand a host of sound effects equipment for post production, including a Harmonizer and spring reverb. These devices are not often used, but they lend a feeling to the production when the script calls for them. "When we're trying to simulate something in the '70s or '60s, we resort to the technology that was used at that time," commented McLaughlin.

Studio G gets a good many shows coming in from Vancouver and a number of other CBC studios where *Radio Drama* shows are also staged. These are usually sent on DAT, or VCR recordings. Then, said McLaughlin, "we add the

tops and tails" to make it ready for syndication to CBC's radio network and its some 600,000 *Radio Drama* fans.

In the upcoming year, Studio G will be giving up its stage to a new *Radio Drama* studio being built by CBC. Currently, McLaughlin is awaiting an all-digital console that is expected to arrive within the week. The plan, he said, is to complete an all-digital studio as technology permits. Most of the existing equipment in *Radio Drama's* Studio G

will not be making the move.

McLaughlin admits that although the old school is a historical landmark, he agrees with Pietropaolo that an exciting new generation of *Radio Drama* requires a more technically suited studio facility.

"The third generation dramatists," observed Pietropaolo, "have grown up in a completely electronic media world." This will no doubt influence and bring to *Radio Drama's* new stage more electronic wizardry. "As we look down the road to digi-

tal technology, the way we produce our dramas will be very different from the way we produce them now."

It will be interesting to see if the glass breaker, the old creaking doors and the gravel beds make the move to the new tech environment along with the digital editors.

■ ■ ■

Dee McVicker is a free-lance writer and regular contributor to RW. To inquire about her writing service, call 602-899-8916.

Rules for Remotes

(continued from previous page)

extended to the duty operator position or be located at the transmitter (which was within 100 feet and one floor above or below the duty operator position).

Such a location would require the operator to go to the antenna monitor at least once every three hours to make required log entries. This was a very significant departure from past policy in that the operator could not glance at the monitor from the duty position to determine any deviations from normal indication.

Somewhere between 1974 and 1980 this allowance in the Rules got lost. By 1980, the operator had to have antenna monitor indications at the duty position.

The proposed rule making would allow required metering and controls to be anywhere within 30.5 meters of the duty operator. This would eliminate the requirement for extension metering. It would also allow stations to put the remote control "down the hall" and out of the operator's view.

The FCC would require stations to operate within the terms of license. It is up to the station (within limits) to determine how that is done.

■ ■ ■

Harold Hallikainen is president of Hallikainen & Friends, a manufacturer of transmitter control and telemetry systems. He also teaches electronics at Cuesta College, San Luis Obispo. He can be reached at 805-541-0200.

It's Not Just A Phase We're Going Through.

The tremendous success of the Tannoy PBM series of reference monitors is by no means coincidental. Since the introduction of the world renowned NFM-8 nearfield monitor, much time and effort has been spent on discerning the needs of the mixing engineer and the applied requirements of "playback monitors". The PBM Line exemplifies this commitment to excellence in reference studio monitoring. These compact loudspeakers sport robust poly cone mid-bass transducers utilizing efficient long-throw, high power voice coils. The low frequencies are carefully controlled by optimally tuned ports located on the rear of the loudspeakers. Hi frequencies are provided by Hi Power ferro fluid cooled polyamide dome tweeters which extend H.F. bandwidth beyond 20KHZ. The driver accompaniment is knitted

together by means of a precision hardwired crossover unit, utilizing robust low loss components, and heavy-duty input terminals which will accept standard 3/4" spaced banana plugs and the majority of high quality, specialist audio cables. Transducers and crossover assemblies are neatly housed in a stylish, high density, partial wrap cabinet, specially designed to minimize unwanted cabinet resonance, and high frequency reflection. In summarizing, we have left the best feature of all for last "price versus performance."

TANNOY
Professional Products



TEC AWARD WINNER

TANNOY®

Tannoy North America, Inc. 300 Gage Ave., Unit 1, Kitchener, Ont., Canada, N2M 2C8
Telephone (519) 745-1158 Telex 069-55328 Fax (519) 745-2364

Broadcast Equipment Exchange®

"Broadcast Equipment Exchange" accepts no responsibility for the condition of the equipment listed or for the specifics of transactions made between buyers and sellers.

AMPLIFIERS

Want to Sell

ITA RCFMA-1A tube type FM RF amp, \$40; McMartin TBM 2500A tube type FM RF amp, \$20. B Umberger, WNLT, 813-446-0957.

MacIntosh MC40 (2), 40 W classic tube amps, new tubes, excel cond, \$1000/pair. J Zelinger, Z Productions, 847 Twelfth St, Santa Monica CA 90403. 213-395-9636.

McIntosh C-4 mono tube preamp in gd working cond, w/D-8A power supply, \$250 plus shpg. L Hoover, L.A.S. 325 Saude, Essington PA 19029. 215-521-2933.

Edcor HA-400 headphone amp, \$75. C Hall, WZOU, 235 Bear Hill, Waltham MA 01254. 617-290-0009.

AIWA MX-100U, 55 W/chnl, 4 inputs & mic input for mic mixing, LED pwr output meter, vgc, \$175. L Hoover, Logical Audio Solutions, 325 Saude, Essington PA 19029. 215-521-2933.

QSC 1400 stereo pwr amp, 200 W/chn at 8 ohms, 300 W/chn at 4 ohms, 600 W mono, fan cooling, balanced/unbalanced inputs, \$400. R Ross, AP Lab, 88 Sherman 2nd Fl, Brooklyn NY 11218. 718-965-2420.

Nikko Alpha 230 120 W/C, stereo rack mount, pro power amp, black, like new, \$250. C Keith, ALI, 9 Roxbury, Keene NH 03431. 603-352-8560.

Spotmaster 5-input stereo audio DA; Marti PGM-20 line amp; APT Holman phone preamp/control center. P Wells, KJQY, San Diego CA. 619-238-1037.

Harris GTM-88R RF amp, 104.9 MHz, \$100. R Coleman, WGEN, Box 67, Geneseo IL 61254. 309-944-4633.

Dynakit PAS 2 tube preamp, excel, \$100; Dynakit SCA 35 tube amp, excel, \$150; Langevin mono tube amp, uses 4 GLG's, \$150; Pilot AA 904 tube mono, excel, \$100. Kremer Kraft, 301 SW 16th St, Ft Lauderdale FL 33315. 305-524-5652.

Spotmaster BETMS-200 solid state stereo TT preamp, \$150. A Garza, Foster Comm, 2824 Sherwood Way, San Angelo TX 76901. 915-949-2112.

Want to Buy

WE, Westrex, Marantz amps, preamps & other vacuum-tube electronics. D deForrest, Insight Prod, 7441 Wayne Ste 10-D, Miami Bch FL 33141. 305-866-5401.

Dick Smith Electr Cat K-3442, 100 W high pwr amp PCB kit, prefer kit but will buy completed unit w/ pwr supply or enclosure. R Jordan, Southland Rec, 812 Young, Selma AL 36701. 205-874-8009.

Tube amps & remote mixers incl RCA OP-6, OP-7, BN series, BA & 80 series amps. B Davies, 5548 Elmer, N Hollywood CA 91601. 818-761-9831.

WE amps in working cond. D deForrest, 7441 Wayne Ste 10-D, Miami Bch FL 33141.

FM RF amp 250-500 W output, 10 W input on 10 W drive w/schematics. F Magliore, POB 370681, Miami FL 33137.

WE, Westrex, Marantz tube amp catalogs, specs, ads relating to above items. D deForrest, 7441 Wayne Ste 10-D, Miami Beach FL 33141. 305-866-5401.

Scully '100' recorders, record/play amplifiers, 8, 16, 24 track heads. Sequoia Electronics, 1131 Virginia Ave, Campbell CA 95008. 408-866-8434.

ANTENNAS & TOWERS

Want to Sell

Phelps Dodge CPM-12 12-bay high power antenna on 101.9, \$3500. D Miller, KATP, 810 N Pierce, Amarillo TX 79107. 806-373-6777.

**FM-ANTENNAS
ALL POWER LEVELS
1 TO 12 BAYS
1-800/279-3326
J & L ASSOCIATES
P.O. BOX 25966
Colorado Springs, CO 80936**

Collins remote meter/control panel 631 series, \$100; Potomac remote meter panel RMP-19, \$150; ERI isocoupler 3-1/8" flanges, tunable, \$500. W Blackwelder, KNUE, POB 7935, Tyler TX 75711. 214-581-0606.

Phelps Dodge 300' of 7/8" air dielectric Helix w/flanges, gd cond; ERI 402 isocoupler, 10 kW; (3) ERI sample loops & isolation coils for AM directional monitoring, gd cond; Kintronics 3 wire lighting choke, new; Gates 2 wire lighting choke, in gd cond. C Gennaro, WJMT, 1018-A E Main, Merrill WI 54452. 715-536-6262.

Harris/ERI FML-3E, 92.1 M, gain 1.5588, 3 bay circular, tower mounts, end feed, on ground, excel cond, \$2150. L Halstead, KPNY, #2 Elmwood Grove, Gering NE 69341. 308-635-1996.

FM ANTENNAS

1 BAY	\$1,500
2 BAY	2,300
3 BAY	3,150
4 BAY	4,000

MORE BAYS AVAILABLE
All warranted, tuned
and tested

ARMSTRONG TRANSMITTER CORP.
5046 Smoral Road (315) 488-1269
Syracuse, NY FAX (315) 488-1365

AM Utility tower, 300', 26", all accessories, including beacon, side lights, flasher unit, guy wires & jony balls, plus hardware, dismantled & ready to load, located in the Pacific Northwest. M-R-S, 110 North 2nd Ave #39, Chula Vista CA 92010.

Dielectric 6-bay, 1-5/8" FM antenna line tuned to 93.5 MHz; 10 kW isocoupler 1-5/8" line; 300' 1-5/8" helix transmission line; Scala CL-FM yagi antenna for translator tuned to 93.5 M, new; 40 & 50' Andrews LDF-50A coax line. E Neaman, KUMU, 441 N Nimitz Hwy, Honolulu HI 96817. 808-531-4511.

PIRod 60, 110' tower complete w/4 level strobe system, \$130,000. A Warmus, 216-659-4440.

Gates FMA-4 4-bay hor 10 kW tuned to 103.1, changes in adj up to 1 MHz plus or minus, BO over \$2000. A Branch, KYAY, Box 1979, Decatur GA 30031. 404-325-7847.

Fort Worth 300' CATV tower, on ground, in Plover WI, fair cond, \$500. R Kotas, WSPF, 10934 Bird Song La, Bokeelia FL 33922. 813-489-9580.

Collins 2-bay dual polarized face mount FM antenna on 102.3, \$1200; Electronic Research Type 402 isocoupler on 102.3, \$600. W Christensen, KLOH, Box 458 West Hwy 30, Pipestone MN 56164. 507-825-4282.

Gates/ERI FMA-8B 8 bay horizontal on 94.5 M, complete, BO. F Hellon, GNB Inc, Rt 1 Box 72, Plymouth IL 62367. 217-392-2340.

Gates ERI cycloid 3 bay, circuitry pwr/w/nt, interbay sections & de-icer, tuned to 95.3 MHz, BO. F Weller, POB 267, Logan UT 84321. 801-752-5141.

ERI 2 bay 1-5/8" 92.7 M. J Phillips, WZOM, 408-1/2 Clinton, Defiance OH 43512. 419-782-8591.

Harmonic filter, 1-5/8", \$250. M Guidotti, KKL, 143 Fifth St, Ste 5, Colusa CA 95932. 916-458-5558.

Comark CSW-318 3-1/8" 4 port motorized coaxial switch, never used, \$2700; Electro Impulse DPTC-25 KFM forced air cooled dry dummy load, never used, \$3450. D Eressy, WFCC, POB 1308, W Chatham MA 02609. 508-945-4855.

Dielectric A50000-203 3-1/8" motorized coax switch, vgc, BO; MCI 61103 1-5/8" coax switch, solenoid control, gd cond, BO. B Webster, WLIT, 150 N Michigan, Chicago IL 60601. 312-329-9002.

Scala CL-FM yagi antenna for translator tuned to 93.5 MHz, new; Kay Industries T-12000A rotary phase converter, 2 hrs of srvc; Andrews LDF-50A coax line, 40' & 30'. E Neaman, KUMU, 441 N Nimitz Hwy, Honolulu HI 96817. 808-531-4511.

Andrew LDF5-50A, 250', 7/8" foam helix, new, still on reel, connectors & hoisting kit, \$4,650/ft plus shpg. B Brown, WMNI, 1458 Dublin, Columbus OH 43215.

ERI 8 bay, Class C FM, 98.5. Regina Dean, KUAR, Univ of Ark at LR, Little Rock AR 72204. 501-589-8485.

Broadcast Transmission Systems

Sells and Erects
Tower/Antennas, Too
In Stock Now:
260' Utility model 240
Several H & P light kits with controls
200' Rohn 45G complete
(512) 448-0058

Phelps Dodge CFM-LP2 2-bay circular polarization w/radomes tuned 100.9. J Eck, KSAJ, POB 69, Abilene KS 67410. 913-263-1263.

Prodelin 3 1/8" rigid line EIA flanges, 19.5' length, 12 yrs old, gd cond, on ground & avail now, BO. M Doyal, 3625 N Hall St #1300, Dallas TX 75219. 214-522-0979.

Phelps Dodge 3 bay antenna system 1039 w/deicers. J Carroll, 523 Meadow Rd, Towas MI 48764. 517-362-3417.

90' 3-1/8" end sections, \$150; UHF harmonic filter & directional coupler on channel 49, BO; 3 bay antenna on 95.1 MHz, \$1000. C Haynes, 1850 Lynch St, Jackson MS 39203. 601-948-1515.

H57-50A 1-5/8" Helix, 250'. J Carroll, 523 Meadow Rd, Towas MI 48764. 517-362-3417.
RCA 4 bay FM antenna BFC-4B w/radomes on 94.5 MHz, \$500. C Hall, WZOU, 235 Bear Hill, Waltham MA 01254. 617-290-0009.

Scala parafactor, \$100; dbx 142 & 140 NR, \$150 ea; Orban Optimod 8100A/ST studio chassis, \$500; Tripp Lite SB-BC-2000 AC inverter, \$200. C Hall, WZOU, 235 Bear Hill, Waltham MA 01254. 617-290-0009.

Andrew LDF4 50A coaxial 1/2 line, 125', \$200. C Haynes, WJMI, 1850 Lynch, Jackson MS 39203. 601-948-1515.

Dielectric 6 bay 1-5/8" FM tuned to 93.5 MHz; 10 kW isocoupler 1-5/8" line; 300' 1-5/8" Helix transmission line. E Neaman, KUMU, 441 N Nimitz Hwy, Honolulu HI 96817. 808-531-4511.

Potomac Instruments AM-10 two tower, gd cond. B Bie, 80 N Tillman St, Memphis TN 38111. 901-458-5818.

LDF 5-50 Helix, 250'. J Carroll, 523 Meadow Rd, Towas MI 48764. 517-362-3417.

50 kW AM antenna tuning unit, (2) ITT 25 KV CVFP-2000-255 variable caps, CFED-1000-255 fixed cap, 0-50 amp RF base meter w/TC & switch, BO. T Jordan, Cape Fear Bldg, POB 35297, Fayetteville NC 28303. 919-864-5222.

Cortana folded unipole for AM upper skirt, \$500. A Garza, Foster Comm, 2824 Sherwood Way, San Angelo TX 76901. 915-949-2112.

HE HALL Electronics
THE BEST DEALS ON QUALITY REBUILT & BRAND NEW BROADCAST EQUIPMENT
We BUY & TRADE equipment too!
Please phone or send for our latest flyer.
10:00AM-6:00PM EST
804-974-6466
FAX 804-974-6450
1305-F Seminole Trail
Charlottesville, VA 22901

Harris FMA-4 hor 10 kW pwr in, all parts, gd cond, BO, will crate & ship. A Branch, KYAY, 2402 Woodridge, Decatur GA 30033. 404-325-7847.

Jampro JSCP-5 antenna, 99.3 MHz w/mounting brackets, 1-5/8" EIA flange, on 300' tower, excel cond, buyer removes, \$1500. C Sigmon, WBZK, POB 398, York SC 29745. 803-684-4241.

Rohn 180' self-supporting tower, standing but not in service, you remove, BO. E Histed, WONH, POB 1104, Honesdale PA 18431. 717-253-1616.

Andrews 300' 1-5/8" coax, no known defects, on 300' tower, buyer removes, \$1800; also 300' 24' face guyed tower, 21 yrs old. Keep painted, gd cond, heavy material & heavy duty, buyer removes, \$9500. C Sigmon, WBZK, POB 398, York SC 29745. 803-684-4241.

PiRod #24 440' solid tower, 5 yrs old, complete lightning kit. M St Cyr, 3585 29th SE, Grand Rapids MI 49512. 616-949-8760.

Andrew 1861 reducer, 3-1/8" to 1-5/8", \$160; 1061A 90° elbow, 1-5/8" A-3-1/2", B-6", \$145; 1062A 90° elbow, 3-1/8", A & B 4-1/2", \$255; 75AN 7/8" to N, female, \$45; 23167 3-1/8" male to male, 9-1/2", \$140. D Agnes, WCLW, 26501 Emery Ind Pkwy, Warrensville OH 44128. 216-464-0900.

World Tower 429' w/30"-24" face, 1.5 yrs old, solid leg, to Ohio code, w/lighting package, you remove plus \$15,000. B Carr, WRED, 1201 Fremont Pk, Woodville OH 43469. 419-837-9696.

Stainless 24" face 360' tower, complete lightning kit. M St Cyr, 3565 29th SE, Grand Rapids MI 49512. 616-949-8760.

Scala FMO-Z, excel cond w/cables, tuned to NCE, \$350. T O'Laughlin, O's Own Prod, Rt 1 Box 41, Barneveld WI 53507. 608-924-2001.

Want to Buy

Need 3-1/8" to TYPE N female reducer thats reasonably priced & in working order. K Brown, Box 808, Riverton WY 82501. 307-856-2922.

ERI FML type, post 781 FML bays on or near 92.1 MHz, must be in gd cond. J Fellows, KCMA, 2021 S Lewis, Ste 760, Tulsa OK 74104. 918-747-9999.

One-bay circularly polarized antenna on 93.3 & 6-bay on 100.3. L Fuss, KOQZ, POB 159, Fayetteville GA 30214. 404-460-6159.

UHF TV bdc/translator antennas; Scala parapanels, any channel; Scala SL-8 chnl 19-23, 32-48, 60-64; Bogner B Series chnl 20-30, 31-42, 55-69 or Bogner LPS 1, 2 & 4; Thomas UHF panels any chnl. J Powley, 1536 Logan, Altoona PA 16602. 814-944-8571.

Circularly polarized 2-bay FM, tuned to 91.1 or close. W Wilson, KJTY, 2519 NW Topeka Ave, Topeka KS 66617. 913-357-8888.

UHF TV translator antennas on old chnl 70-83 band; Scala SL-8 or parapanels; Bogner B4, B8, B16 or B24; Emcee DGA-10 corner reflectors. J Powley, 1536 Logan, Altoona PA 16602. 814-944-8571.

AUDIO PRODUCTION

Want to Sell

Conex AS101 10x1 routing switch (2), never used, as new, \$590; Conex AS401 remote control boxes for AS101 routing switch, new, (6), \$99. D Eressy, WFCC, POB 1308, W Chatham MA 02609. 508-945-4855.

MEI Digisound, 2 hard drives, remote keyboard, configured for 10 kHz, 175 minutes mono, 86 minutes stereo, \$8000. D Greer, WZZZ, Genesee Towers, Ste 1830, Flint MI 48502. 313-767-0130.

Eventide BD955 digital delay w/15 kHz bandwidth, 6.4 sec delay, \$2500. J Littlejohn, WYSY, POB 2010, Aurora IL 60507. 708-851-4600.

Sequential Prophet 600 MIDI synthesizer w/software upgrade, \$350. P Cibley, Cibley Music, 138 E 38 St, NY NY 10016. 212-986-2219.

Orban 222A stereo spatial enhancer, mint cond, \$400. R Ross, AP Lab, 88 Sherman, 2nd Fl, Brooklyn NY 11218. 718-965-2420.

CASSETTES - CARTS - REELS

J & I AUDIO/VIDEO

A wholesaler in the Radio and Television market.
Now running SPECIALS on audio and video:
BASF CASSETTES - AMPEX R-R's AUDIOPAK, FIDELIPAC & 3M CARTS
For more information call person-to-person collect:
Kris Elliot at 818-992-4288
or write to: **J&I Audio/Video**
20899 Kelvin Pl., Woodland Hills, CA 91367

Circle 97 on Reader Service Card

Shure M267, excel cond, (2), \$390; Gantner EFT9000, excel cond, \$640; Henry UTC controller, never used, \$350. D Eressy, WFCC, POB 1308, W Chatham MA 02609. 508-945-4855.

Lexicon digital delay processor, \$300. C Hall, WZOU, 235 Bear Hill, Waltham MA 01254. 617-290-0009.

Studer Dyaxis digital editing system w/760 MB hard drive, DSP accelerator card & MacIntosh II cx w/radius pivot monitor, less than 50 hrs use. T Jones, KNXR, 220 South Broadway, Rochester MN 55904. 507-288-7700.

Yamaha SPX-90 digital effects unit, like new, \$475. Davis, MCP Studios, POB 521, Newberry SC 29108. 803-276-0639.

Want to Buy

Tube limiters, compressors & EQ's, especially Fairchild 660 & 670, Teletronix LA2A & LA3A; Pultec EQs or NABECs; Lang EQs, Sontec & SPI EQs, etc; other vintage tube signal processing equip. J Kreines, DeMott/Kreines Films, 5330 Kennedy, Millbrook AL 36054. 205-285-6179.

WANTED DEAD OR ALIVE! PULTEC EQ'S

Fairchild & Teletronix Limiters; Neumann, Telefunken, AKG, RCA, & Schoeps microphones. Tube McIntosh or Marantz amps & pre-amps. Sontec, ITI, & Lang EQs. Neve or API equipment. Boxes of old tubes; Urei, Orban, United Audio, DBX, & other outboard gear. Ampex ATR102s or 104s. Parts for MCI JH110/114 recorders. Altec 604s/crossovers/Tannoy speakers. JBL 2231; Altec 288h drivers; Misc. equipment of all types.

Please Call:

Dan Alexander Audio
2944 San Pablo Ave.
Berkeley, CA 94702
1-(415) 644-2363
FAX: 1-415-644-1848

Attention FM CP Holders!

We'll Build Your 3 kw Class A
For **LESS Than \$100,000**
GUARANTEED

We Include All This:

- Up to 300 ft support tower with necessary Transmission Line and new 4-bay FM antenna
- FM transmitter with solid state exciter and stereo generator
- All necessary monitors and audio processing equipment
- Equipment rack and digital remote control unit
- A complete and fully equipped control room as well as a completely equipped 4-track production room

ALL you supply are transmitter building, & remodeled studio site.....We'll do the rest!

Similar savings on construction of B1, C3, C2, and C1 FM facilities, too.

CALL (512) 448-0058 Today For Complete Details

BROADCAST TRANSMISSION SYSTEMS

7008 Lock Lommond Austin, Texas 78749

AUTOMATION EQUIP

Want to Sell

IGM Instacarts, one mono, one stereo, both 48 trays, \$3000/both; Otari ARS-1000 R-R reproducer, near mint cond, w/25Hz sensor, \$1000; Schafer blue equip rack, \$100; IGM 12 tray instacart, \$750; IGM Go-Cart 24, \$1500. G Gaskey, KWHO, 261 Main Ste 6, Weed CA 96094. 916-938-3828.

SMC MSP-1 for live assist, satellite, or RTR automation, 4 yrs old, perfect cond, \$3400. Can include Otari ARS-1000's & ITC 3-D & SP cart machines. D Doelitzsch, WDDD, 1 Bdct Ctr, Marion IL 62959. 618-997-8123.

Sentry controller w/PC card, (2) IGM Go-Carts 78 tray, IGM Go-Cart 24 tray, (3) IGM racks, software included, \$12,500. T Noordyk, WSHN, 517 N Beebe, Fremont MI 49412. 616-924-4700.

Live-Assist Tape System including (4) IT 750 Series PB only, stereo 25 Hz tone detect card, M.W. Persons mini-mixer includes count-up clock, cabling & hardware interfacing, \$2300. G Elmer, Slew Tech, 1617 N Poinsetta Pl Ste 205, Hollywood CA 90046. 213-851-0870.

Cetec Series 7000, 2x48 carts, (4) reels, (2) terminals, B Wilson, WLSM, POB 111, Louisville MS 39339. 601-773-3481.

Satcue 400 switchers (2) for Unistar formats, mint cond, \$500 ea. D Igou, KGNB, 1540 Loop 337 N, New Braunfels TX 78130. 512-625-7311.

DS-20 audio switcher; RP-1000 brain; time clock (4); 350-RSB Carousels; racks w/drs, pwr sup, wiring, etc (2); spare cards for Carousels, switcher & brain, extender card, all manuals, wiring charts, schematics, etc. \$8000/all. Call C Ferguson, 701-852-4646.

Schafer 901-902 automation system w/(6) Teac/Schaferdeck R-R's & I/O cards, (6) cart I/O cards, (3) rack cabinets. E Nearman, KUMU, 441 N Nimitz Hwy, Honolulu HI 96817. 808-531-4511.

Auto-Jock for automation, the economical & simple way. C Mandel, KAMP, POB 1018, El Centro CA 92244. 619-352-2277.

Systemation X7 full system w/Nakamichi MR-1 & MR-2 decks, excel cond, BO. L Wheeler, 4350 Johnson Dr, Fairway KS 66205. 816-531-2535.

Harris 9002, (2) CRT terminals, racks, (4) Otari ARS-1000 R-R's, (2) IGM Go-Cart 24, spare parts, fully loaded, super clean, \$7500. G Gaskey, KWHO, 261 Main, Ste 6, Weed CA 96094. 916-938-3828.

Schafer 8000 automation controller, minicomputer w/CRT terminal, loggers, 3 rack cabinets, complete extra system for backup, \$1500/both plus spare parts; SMC Carousels if purchased w/Schafer 8000 (4), \$500 ea. G Gaskey, KWHO, 261 Main, Ste 6, Weed CA 96094. 916-938-3828.

Complete automation system including CD28M, CD12C, CD28A, CD28P, (5) CD25S, (5) Revox A-77, (3) CD24R, IGM Instacart, Perma Power UPS, Pioneer Centrex monitors, 4-bay rack w/rear doors, cabling, manuals & schematics, spare parts & source cards, \$15,000. G Elmer, Slew Tech, 1617 N Poinsetta Pl Ste 205, Hollywood CA 90046. 213-851-0870.

SMC ESP2, 2 yrs old and on air, includes (4) Carousels, (9) Otari R-R's w/25 Hz sensors, (2) cart PB units, (6) racks, (2) Amdek video monitors & studio remote unit, \$30K. L James, KWKL, POB 650, Wichita KS 67201. 316-265-1065.

SMC RP-1000 brain, DS-20 switcher, PDC-3A clock, pwr supply, TS-25 tone sensor, (4) Otari ARS-1000DC, (4) BE auto rewinds, (4) SMC 352-RSB Carousels, (3) SMC racks w/doors, manuals, parts, SMC remote control, unlimited walkaway w/auto rewind units. E Nichols, KMCR, POB 189, Montgomery MO 63361.

Otari ARS-1000 w/25 Hz decoder (4), \$1000; IGM Go-cart 24, \$2500; SMC RP-1000 Brain w/DS-20 switcher & clock & TAC-1 time announce, \$2700; (2) SMC 250 Carousel, one w/electr random select, one w/Schafer random access, \$350; SMC 721 dual cart PB in drawer, \$500; SMC 710 single cart PB in drawer, \$250. J Wenstrom, Wynne Bldg, 503-882-4656.

Robot Jock CD600 60 CD player (4), Toshiba drive, will interface w/IBM. C Keith, ALI, Box 313, Keene NH 03431. 603-352-8460.

Conex DS25B, dual 25 Hz sensor, never used, \$350. D Eressy, WFCC, POB 1308, W Chatham MA 02609. 508-945-4855.

Schafer automation system, older style, working, \$400. E Moody, KJEM, 216 N Main, Bentonville AR 72712. 501-273-9039.

McCurdy Cue System satellite decoded for Fairchild application w/time zone switcher, 2 mos old, \$1500. J Michaels, WJOD, POB 276, Galena IL 61036. 815-777-2555.

Schafer 903 w/(3) Carousels, dual cart machine, network card for satellite, plus extras, \$6000. Tom, 509-522-5412.

Schafer 901-902 automation system w/(6) Teac/Schafer deck R-R's & I/O cards, (6) cart I/O cards, (3) rack cabinets. E Nearman, KUMU, 441 N Nimitz Hwy, Honolulu HI 96817. 808-531-4511.

Live-Assist tape system including (4) ITC 750 series, PB only, stereo, 25 Hz tone detect card, M.W. Persons mini-mixer w/count-up clock, cabling & hardware interfacing, \$3000 (equip in St Cloud MN) G Hoppe, WHMH, 1617 N Poinsetta Pl Ste 205, Hollywood CA 90046. 213-851-0870.

SMC MSP automation system w/(4) Otari R-R's, (3) SMC 350 Carousels, SMC 721 dual cart PB's, (3) SMC equip racks, all clean, on air now, avail now, \$16,500. J Wenstrom, Wynne Bldg, 1338 Oregon, Klamath Falls OR 97601. 503-882-4656.

Complete automation system including CD28M, CD12C, CD28A, CD28P, (5) CD25S, (5) Revox A-77, (3) CD24R, IGM Instacart, Perma Power UPS, Pioneer Centrex monitors (pr), 4-bay rack w/rear doors, cabling, manuals & schematics, spare parts & source cards, \$15,000 (equip in St Cloud MN) G Hoppe, WHMH, 1617 N Poinsetta Pl Ste 205, Hollywood CA 90046. 213-851-0870.

SMC MSP full feature 2000 event for satellite format, tape service, or live assist, remote control, 4 yrs old, like new cond, \$3200. D Doelitzsch, WDDD, 1 Broadcast Ctr, Marion IL 62959. 618-997-8123.

Harris 9000 automation system w/CRT-70X keyboard, (2) new style & (2) old style Instacarts, (2) 42 slot Go-Carts, (4) ITC 750 R-R's, Sony remote video monitor, (2) Criterion large cart machines, play only, Extel printer w/5 cases of paper, (4) racks, all cables & interfaces & manuals, presently in service, \$37,000. D Greer, WDDZ, Genesee Towers, Ste 1830, Flint MI 48502. 313-767-0130.

Complete IGM EC System Instacart 48-mono, black rack, uninterruptible pwr sup, Is-latron, cables, exc cond, \$7000. D Klahr, 609-692-8888.

ESP-1 automation system including (5) SMC 350 series Carousels; (2) SMC 721 dual play decks, (4) Revox A-77, Extel printer, AL-1 cassette memory loader, PDC-4A superclock, PSB-3 pwr supply, DS-20A switcher, ESP-1 programmer, RAC-31 remote control, (4) equip racks, (2) TS-25 tone sensor units, was operational when removed from service in 3/90, \$11,000 plus shipping. J Hartmeyer, WCLT, POB 880, Newark OH 43055. 614-345-4004.

Automated Broadcast Controls complete automation system w/(5) Otari R-R's, (3) ABC Carousels, will sell all or parts; SMC 581 time announce dual cart machine. D Smith, WFCB, POB 94, Chillicothe OH 45601. 614-773-3000.

ABC Network tone decoder, \$200. M Hold-erfield, WOOF, POB 1427, Dothan AL 36302. 205-792-1149.

MEI Satmaster 1000 event satellite programmer w/(2) Carousels, gd working cond, will sell, lease, rent, or trade for FM xmt, \$6000. C Crisler, KAFM, Box 41971, Memphis TN 38174. 901-722-7304.

Systemation cassette system w/everything needed to run including (5) cassette decks, BO. R Jensen, KCKR, Box 368, Kanab UT 84741. 801-644-5868.

Satcue 400 switchers for Unistar formats by Colorado Magnetics (2), \$500 ea. H Widsten, KGNB, 1540 Loop 337 North, New Braunfels TX 78130. 512-625-7311.

Schafer 7000, w/(5) Otari ARS1000, (3) Sono-Mag Carousels, (4) ITC cart machines, just out of service in gd cond. BO. W Long, WWMY, 7819 Natl Service Rd, Greensboro NC 27409. 919-668-9450.

Harris System 9000 incl event controller for 12 sources, source cards, all system computer cards, pwr supply, cables for (4) Otari ARS-1000 stereo reel decks plus (4) Carousels, data entry CRT workstation, fully operational when removed, Carousel 24 cartridge units which may need some work, standard system equip racks, buyer pickup, bank cashiers check only. BO. A Kaplan, KWED, 609 E Court, Seguin TX 78155. 512-379-2234.

Microprobe 100 6 source automation programmer, \$800. R Coleman, WGEN, Box 67, Geneseo IL 61254. 309-944-4633.

MW Sensors 25 Hz decoder; automated bdct Sequencer 16 w/expander. P Wells, KJQY, San Diego CA. 619-238-1037.

ATC/Gates stereo in gd working cond, \$2000. G Williamson, WASK, Box 7880, Lafayette IN 47903. 317-447-2186.

Want to Buy

Insta-Carts or Go-Carts or Carousels. C Mandel, KAMP, POB 1018, El Centro CA 92244. 619-352-2277.

Controller cards for Automated Bdct Controls, automation system, maybe interested in other parts for same. B Stevenson, KCRF, 100 Fisher, Trinidad CO 81082. 719 846-3355.

Automation brain for limited duty. C Keith, ALI, Box 313, Keene NH 03431. 603-352-8460.

Complete automation system for use w/Satellite Music Network. D Thibodeaux, WHNK, 215 Centerville, Ste 351, Brentwood TN 37007. 615-737-9143.

CAMERAS (VIDEO)

Want to Sell

Sony BVP-3A w/BV1A beta back, full set ENG equip, mics, batteries, chargers, batt life, tripod, etc, \$18,000 plus shpg. 305-891-3582.

Ikegami ITC-240 3 tube studio cameras (2), bdct quality, gd cond, \$2000/ea or \$3500/both. L Mintzmyer, KOOD, POB 9, Bunker Hill, KS 67626. 913-483-6990.

Want to Buy

GE B&W studio camera; RCA TK-42/43. B Gentry, KA21VY, 622 Plymouth, Mattdale NY 13211. 315-455-7257.

TK-86, TK-76 & HL-79 camera cases, (34) needed for reworking into remote kits for air travel, will pay freight, donation preferred but can pay a reasonable price. J Hart, 502-762-2052.

Old RCA, Dumont, GE, etc. tube type TV cameras; Phillips, Bendix, RCA, CBS, etc. early portable camera equipment. A Weiner, 14 Prospect, Yonkers NY 10705. 914-423-6638.

CART MACHINES

Want to Sell

SMC 570 PB unit. E Nearman, KUMU, 441 N Nimitz Hwy, Honolulu HI 96817. 808-531-4511.

Sparta MC 104 PB's (4) plus spare in cabinet w/spare pwr supply, 150 Hz & 8 kHz Q-tones, \$700. L Beigel, On-Cue Record, POB 85042, Los Angeles CA 90072. 213-466-3595.

ITC Premium RP rack mount, mono, excel cond w/low hrs & manual, \$1150; ITC late mdl premium SP mono, less than 5 yrs old w/low hrs, rack mount w/manuals (4), \$875. D Doelitzsch, WDDD, 1 Bdct Ctr, Marion IL 62959. 618-997-8123.

BE cart winder w/timer, \$125. W Blackwelder, KNUJ, POB 7935, Tyler TX 75711. 214-581-0606.

ITC R/P 3 tone, \$700. J Wenstrom, Wynne Bldg, 503-882-4656.

ITC RP Series cart machine wall tones, \$845. P Willey, POB 560, Bennington VT 05201. 413-663-3419.

BE 5301 mono triple-deck cart machine, working cond but needs top motor bearing, \$500. B Bicoy, POB 65, Medford MA 02153. 617-629-8476.

ITC RP cart recorder, \$850; ITC cart rack mounts, will work w/Premium series cart machines, \$20. G Gaskey, KWHO, 261 Main, Ste 6, Weed CA 96094. 916-938-3828.

Audicord DL-RS stereo R/P, new, remote control connections, plugs, \$1100. D Stubbs, The Sound Saloon, 1611 E Charleston Ste 1, Las Vegas NV 89104. 702-366-1696.

ITC RP Premium stereo; RP Premium mono; SP high speed cue mono; (2) BE 2000 RP mono; Sparta RP mono & delay; Spotmaster 505; Gates Criterion. J Phillips, WZOM, 408-1/2 Clinton, Defiance OH 43512. 419-782-8519.

ITC Premium series record amp, mono, \$300. J Littlejohn, WWSY, POB 2010, Aurora IL 60507. 708-851-4600.

SMC 721 dual, \$600 & 710 single, \$300, cart PB's; SMC 250 Carousel w/random select electr, \$350; ITC RP 3 tone cart recorder, \$700. J Wenstrom, Wynne Bldg, 1338 Oregon, Klamath Falls OR 97601. 503-882-4656.

ITC Premium R/P mono, rack mount, gd cond, \$1150 3 tone; (4) Premium SP, mono rack mount, 3 tone, \$800 ea; Premium 3-D triple deck, mono, 3 tone, rack mount, gd cond, \$1000, all have manuals. D Doelitzsch, WDDD, 1 Broadcast Ctr, Marion IL 62959. 618-997-8123.

Sine Systems RFC-1/B "DIAL UP"

Remote Control Complete systems starting at less than \$1,400.00!

H E HALL Electronics
804-974-6466

Harris Criterion 3 deck stereo play, excel cond, w/150 Hz tone, \$900. R Statham, WSTU, 1000 Alice Ave, Stuart FL 34994. 407-692-1000.

Gates Criterion 80 mono R/P, 2 cue tones, new prollor & lamps, total mech & elect alignment, desktop cabinet, excel cond, \$650/BO. J Stack, WMPO Radio, 614-992-6485.

Gates Criterion 80 mono PB only, desktop cabinet, gd cond, \$450/BO. J Stack, WMPO Radio, 614-992-6485.

ITC stereo R-P, mint, mono high speed cue, mono R-P Premium, needs work. BO: BE RP 2000 mono (2), \$750; Gates Criterion, Sparta, Spotmaster, \$150 ea. J Phillips, WZOM, 408 Clinton, Defiance OH 43512.

Entire inventory of tape cartridge equip including approx 600 Fidelipac 300 gray carts, 75¢ ea; Spotmaster 5301-A, \$600; wire cart rack, \$75; ITC triple play cart deck, \$600; (2) BE Series 3000, \$800 and much more, call for more information. E Moody, KJEM, 216 N Main, Bentonville AR 72712. 501-273-9039.

Tepecaster RP 700, gd cond, \$295. A Ishkarian, Advent Duplication, 9725 Riggs Rd, Adelphi MD 20763. 301-439-7222.

SMC 570 cart PB unit. E Nearman, KUMU, 441 N Nimitz Hwy, Honolulu HI 96817. 808-531-4511.

Otari ARS-1000 stereo PB w/25 Hz tone sensor, low hrs in excel cond, \$1000 ea. D Doelitzsch, WDDD, 1 Broadcast Ctr, Marion IL 62959. 618-997-8123.

UMC/Beau mono PB (2); UMC/Beau mono RP (2); ITC SP mono (2). D Smith, WFCB, Box 94, Chillicothe OH 45601. 614-773-3000.

BE Spotmaster ten spot mdl 610CR (3), rack mountable, unused, \$1695 ea. L Schrecongost Rcdg, POB 1032, Indiana PA 15701. 412-349-5706.

ITC RP recorder, stereo, all 3 tones, mint cond, w/rack mount & manual, \$1500. B Watson, KSAK, Walnut CA. 714-946-6249.

Pacific Recorders Tomcat recorder w/Max-trax heads, excel cond, w/7-1/2 or 15 ips speeds, full featured, \$3000. D Greene, KXEZ, 3500 W Olive Ste 250, Burbank CA 91505. 818-955-7000.

Ampro 2500 Series, (2) rec. (3) PB, all 3 tones, FF on rec decks, gd cond, BO. M Black, WEOS, Hobart College, Geneva NY 11436. 315-781-3456.

Tepecaster 700RP delay/record, \$100. R Coleman, WGEN, Box 67, Geneseo IL 61254. 309-944-4633.

DENON

DENON's Successor to the CD CART PLAYER™, the new DN-950FA



Call for Quote
In Stock at
NORTHEAST BROADCAST LAB
(518)-793-2181/(215)-322-2227
(603)-483-1002/(214)-612-2053

Pacific Recorders Tomcat PB's (6) w/Max-trax heads, excel cond, \$1000/ea. D Greene, KXEZ, 3500 W Olive Ste 250, Burbank CA 91505. 818-955-7000.

ITC 99B mono rcd; ITC SP mono deck; (2) ITC RP mono recs; UMC PB mono deck. P Wells, KJQY, San Diego CA. 619-238-1037.

Want to Buy

ITC 3-deck working cond, mono, all tones. R Yaw, Box 7000, Havre MT 59501. 406-265-7841.

PR&E Micromax stereo recorder. H Landsberg, 818-355-3656.

Erase/apply finder in gd working cond; cart-winder w/timer in gd working cond. B Goldsen, WABJ, 121 W Maumee, Adrian MI 49221. 517-265-1500.

Ampro CT5500 Tri-Deck monaural, 3-tone, must be mechanically sound. J McAulay, KITH, 21810 Hwy 18, Apple Valley CA 92307. 619-247-1111.

CASSETTE & REEL-TO-REEL RECORDERS

Want to Sell

Otari MX5050 MKIII 2 trk, less than 60 hrs used w/roll-around stand, remote & manual, cash & carry, pick-up only, \$1400. G Finerman, Fintronics, 18 W Maple, Suffern NY 10901. 914-357-5419.

Studer B-77 1/4 trk, excel cond, recently checked out, \$500/BO. R Herman, Frontier Radio Network, POB 9292, Austin TX 78766. 512-280-5691.

ITC 770 Series PB units, gd cond, one for \$600, (2) for \$1000, plus shpg. L Jones, Mediaworks, POB 625, Columbia SC 29202. 803-765-1133.

Tascam 22-2 w/manual, needs some repair, \$375. W Blackwelder, KNUJ, POB 7935, Tyler TX 75711. 214-581-0606.

Ampex 440 deck w/Schafer stereo solid state PB elects, \$250; Teac/Tascam 32-2, 2 trk, stereo, dual capstan recorders, factory rack mounts (4), new cond, \$750 ea. G Gaskey, KWHO, 261 Main, Ste 6, Weed CA 96094. 916-938-3828.

MC1 R/P console R-R (2), complete w/mic/line meter bridge, pwr supply, tape drive elec. one unit is less capstan, \$350/BO. C Woodrome, KVLL, 100 Spring Valley, Woodville TX 75797. 409-283-3734.

Otari MX 5050-II (2), 75-15 1/2 trk, one w/rack mounting & one in wood case, both excel cond, \$1500 ea. R Rhodes, Roger Rhodes Music, POB 1550, Nyny 10101.

Scully 280B (6), gd cond, rack mountable, \$1800; Scully 280B (2) sets R/P electronics, BO. T Ray, WTIC, 1 Financial Plaza, HTFD CT 06103. 203-522-1080.

Ampex 350 mono, w/Inovonics solid state rack mount, \$500. A Baker, 804 E 38th St, Indianapolis IN 46205. 317-925-7371.

Ampex AG 350 mono w/solid state rack mount, \$800. A Baker, 804 E 38th St, Indianapolis IN 46205. 317-925-7371.

Inovonics 375 (4) & a mdl 370 w/Ampex R-R electronics; (3) Ampex 350's & one 354 R-R transports; (2) Teac R720 R-R transport. E Nearman, KUMU, 441 N Nimitz Hwy, Honolulu HI 96817. 808-531-4511.

Revox A77, \$350. J Wenstrom, Wynne Bldg, 503-882-4656.

Magnecord 1022 stereo (2), transports for parts, electr OK; (2) Magnecord 1021 mono, transports for parts, electr OK; Magnecord 1021 mono, in port case, gd cond; Ampex AG-600, mono, in port case, gd cond; (4) Scully 270's for parts, BO on all items. D Igou, KGNB, 1540 Loop 337 N, New Braunfels TX 78130. 512-625-7311.

Ampex 440 FT recorder in roll around cond, \$1250. B Blynder, TVA Inc, 11024 SW 112 Ave, Miami FL 33176. 305-595-9898.

ITC 750 R/P 2 trk, fair cond, \$250. A McCarty, 600 E Main, Valaville CA 95660. 707-446-0200.



PRE-HALLOWEEN SPECIAL

RECORDERS . . . WTS

Inovonics 375 (2) w/R/P electr, like new w/interconnect cables, ZTR R/P head stacks avail, \$400; Inovonics tension control for Ampex 351-354-440 tape recorders, all installation, wiring & sensors & manual, \$300; Ampex 440-C R/P electrics w/spare VU meter, cards avail w/7.5-15 or 15-30 ips EQ cards, \$225. W Helander, MRT Recdg, 4311 Miranda, Palo Alto CA 94306. 415-948-0972.

Ampex 440 B mono R/P (4); (2) Ampex 440 B stereo R/P; (2) Metrotech 500 PB; (5) Otari PG; Ampex 351 electronics. D Smith, WFCB, POB 94, Chillicothe OH 45601. 614-773-3000.

Audiometrics AMCD5-1000 multiplay CD players w/SMC automation controller, live assist CD playing system, gd cond wall schematics & manuals, BO. J Glass, WZOK, POB 6186, Rockford IL 61225. 815-399-2233.

ITC 750 R/P 2 trk, fair cond, \$250. A McCarty, 600 E Main, Valaville CA 95660. 707-446-0200.

MCI JH110-B 1/4" 2-trk, excel cond, lw hrs; 7-1/2, 15/30 ips in roll around stand, \$2650/BO. T Keenan, 11105 Knott Ave, Cypress CA 90630. 714-892-9469.

Scully 280 2 trk, portable cases, vgc, \$900. F Virtue, Virtue Studios, 1618 N Broad, Philadelphia PA 19131.

Technics RS-631 w/Dolby timer, LED peak indicators & mic line mixing, wooden side panels, gd cond, \$150. L Hoover, Logical Audio Solutions, 325 Saude, Essington PA 19029. 215-521-2922.

Otari ARS-1000 (4) w/25 Hz detectors, excel cond, \$750 ea. T Jordan, Cape Fear Bldg, POB 35297, Fayetteville NC 28303. 919-864-5222.

ITC 750 (2), play only, stereo, \$500 ea. J Littlejohn, WYSS, POB 2010, Aurora IL 60507. 708-851-4600.

Scully 280B mono R/P, excel cond, w/manuals, \$500. R Statham, WSTU, 1000 Alice Ave, Stuart FL 34994. 407-692-1000.

Ampex 601 (3), mono, 7.5, portable case, al-so 620 speaker amp, \$100 ea. S Cislser, 728 Zorn Ste 10, Louisville KY 40206. 502-895-5596.

Otari 5050BII R/P decks (2), \$1800 ea; (2) Otari 5050B2HD R/P decks, \$1300 ea; (2) Otari remote control units, \$75 ea; (4) Scully 270 PB decks, \$400 ea; (2) Crown 800 R-R's, \$300 ea; ITC 850 mono R/P deck, \$550; M.W. Persons 25 Hz tone detector, \$75. E Moody, KJEM, 216 N Main, Bentonville AR 72712. 501-273-9039.

Ampex 350 R-R transports (3); Ampex 354 R-R transport; (2) Teac R720 R-R transports. E Neaman, KUMU, 441 N Nimitz Hwy, Honolulu HI 96817. 808-531-4511.

Otari ARS1000 w/tone detect, clean & complete, \$900/BO. B Webster, WLIT, 150 N Michigan, Chicago IL 60601. 312-329-9002.

Scully 280B-2 recorder/reproducers, gd cond (2), \$750/both. G Nelson, KSYM, 1300 San Pedro, San Antonio TX 78284. 512-733-2793.

Dokorder 7050 7" auto-reverse, built in amp & pair of speakers, gd cond, \$150. L Hoover, Logical Audio Solutions, 325 Saude, Essington PA 19029. 215-521-2933.

Nagra 4.2 7" lid, xtal sync, internal resolver, phantom-T power preamps, A/C supply, extras incl Senn preamp, headsets, PDM leather case, hi impact vinyl carrying case, \$4800. G Lombardo, 61 Stephenville Pkwy, Edison NJ 08820. 201-549-8078.

HEAD RECONDITIONING

Restore your worn heads to original (new) performance specifications at a fraction of the replacement cost. Our laboratory services include:

- Digital/Optical & Electrical inspection
- Precision recontouring of heads
- Complete digital/optical alignment of assembly
- Exclusive "Audio Magnetic Head Test Report™" & Data Sheets

We also carry a full line of replacement heads and parts. Our 25 years of experience and reputation are unmatched in the industry.



Inovonics 375 (4) & 370 w/Ampex R-R electronics. E Neaman, KUMU, 441 N Nimitz Hwy, Honolulu HI 96817. 808-531-4511.

Scully 280 14" R-R, \$250. C Hall, WZOU, 235 Bear Hill, Waltham MA 01254. 617-290-0009.

Otari MX 5050-BSD 1/2" 8 trk, low hrs, mint cond, calibration tape & xtrs, \$2700. C Volpe, 540 Stemmens Run Rd, Baltimore MD 21221. 301-391-6927.

CLEAN PATCH BAYS NO DOWN TIME



VERTIGO BURNISHERS AND INJECTORS RESTORE ORIGINAL PERFORMANCE TO YOUR PATCH BAYS

\$34.95 Ea. Please write for additional information and order form today.

VERTIGO RECORDING SERVICES
12115 Magnolia Blvd. #116 818-907-5161
North Hollywood, CA 91607 Fax 818-784-3783

Ampex 350 14" transport w/original 350 electr, vgc, \$600. L Watson, WCDV, 227 E Forest Ln, Palatine IL 60067. 708-397-2525.

Stellavox SP-7 portable, similar to Nagra, 7-1/2, 15, 30 ips, 2-trk stereo, takes 10" reels, pilot tone for film sync, w/pwr supply, reel adaptors, manuals, carrying case, mint cond, \$1000/BO. B Watson, KSAK, Walnut CA. 714-946-6249.

3M M58 8 chnl 1" tape pro-studio recorder w/full remote, sel-sync, Dolby A interface cables & new tape stock, \$2900; Audix MXT1000 8 chnl master mix down console, \$1500, or both for \$4000. J Krepol, RNDL, 6147 Walker St, Philadelphia PA 19135. 215-624-1050.

Studer A820 1/4 2 trk, all hard & software updates, immaculate cond, no head wear, very low hrs w/remote, \$9500 plus shpg. R Cannata, Cantrax Recorders, 2119 Fidler, Long Beach CA 90815. 213-498-6492.

Scully 285 repro decks (4); Ampex 354 RF stereo recorder; Ampex 350 w/Inovonics 370 R/P electr; 1 pr Inovonics 370 R/P electr; MCI JH-110B FT stereo for 14" reels. P Wells, KJOY, San Diego CA. 619-238-1037.

AKAI M75E older type R-R, works fine, one VU off scale, but does not affect operation, \$100. J Cunningham, KEOR, Rt 2 Box 113B, Stonewall OK 74871. 405-265-4496.

SCULLY TAPE RECORDERS —PARTS— and Service

SEQUOIA ELECTRONICS

1131 Virginia Ave
Campbell CA 95008
(408) 866-8434

Telex Series 235 stereo tape duplicator system, 1 master w/complete spare & 4 slaves, in new cond, \$600. J Krepol, RNDL, 6147 Walker St, Philadelphia PA 19135. 215-624-1050.

ITC 750 PB (2), \$300 ea; ITC 750 PB for parts only, \$50. R Coleman, WGEN, Box 67, Geneseo IL 61254. 309-944-4633.

Roberts 997 stereo open reel recorder, tube type, cond unknown, \$35; Ampex 601 open reel recorder, tube type, cond unknown, w/manual, \$50; Ampex 601, no case, \$45. C Sigmon, WBZK, POB 398, York SC 29745. 803-684-4241.

Magnecord 1022 stereo (2); (2) Magnecord 1021 mono, transports for parts on both these pairs, electronics OK; (4) Scully 270's for parts only, BO on any items. H Widsten, KGNB, 1540 Loop 337 North, New Braunfels TX 78130. 512-625-7311.

Garner 2056 1 master, 5 slave, 1/4" stereo 60 ips, 7-1/2 or 10 reels, manual, D Agnes, WCLV, 26501 Emery Ind Pkwy, Warrensville OH 44128. 216-464-0900.

Crown S/P logger for parts, \$25. C Sigmon, WBZK, POB 398, York SC 29745. 803-684-4241.

Want to Buy

ITC 3D & low price reel. E Nichols, KMCR, POB 189, Montgomery MO 63361.

ITC-750 stereo PB deck for spare, fair-gd working cond. K Browall, Box 808, Riverton WY 82501. 307-856-2922.

Marantz or Sony PMD 201, 221 or Walkman Pro portable in gd cond. M Markiewicz, 415 Pawnee, Flagstaff AZ 86001. 602-525-1514.

Scully 250-2 1/4" 1/2 trk erase & record heads, w/service manual or schematics. M Sokol, 121 E Baltimore St, Hagerstown MD 21740. 301-791-2562.

Ampex MR-70 2 trk in gd working cond. D deForrest, 7441 Wayne Ste 10-D, Miami Bch FL 33141. 305-866-5401.

MCI JH110B or C, 1/4" 1/2 trk stereo; Casio CFX-200 scientific calculator watch. B Umberger, WNL1, 51 S Main, Ste 957, Clearwater FL 34625. 813-446-0957.

Ampex MR-70 2 trk in gd original cond; Ampex NAB test tape, 15 ips; pair of RCA ribbon mics. D deForrest, 7441 Wayne, Ste 10-D, Miami Beach FL 33141. 305-866-5401.

Ampex ATR100 taperecorders for parts. Circuit cards, heads, motors, machine parts, or electronic parts. Call 818-907-5161.

MCI/Sony capstan & reel motors, any cond., recdg heads, most migs, machines, new, used. Relapped then sold. Amp Services, 224 Datura St No 614, W Palm Beach FL 33401. 800-826-0601, in FL 305-659-4805.

CONSOLES

Want to Sell

Quantum QM-8 8 chnl, quad output, \$900. W Blackwelder, KNUW, POB 7935, Tyler TX 75711. 214-581-0606.

Collins 121M-1 w/8 pots mono console. B Umberger, WNL1, 813-446-0957.

Micro-Trak 6444B stereo, new; Ampro AC85; BE 150A 8 chnl prod, new; Ramsa WR-130; Heathkit mic mixer. J Phillips, WZOM, 408-1/2 Clinton, Defiance OH 43512. 419-782-8591.

Gately 16x8 w/EQ 4 effects buss quad monitoring cannon connectors for line & mic inputs and outputs, \$2800. A Baker, 804 E 38th St, Indianapolis IN 46205. 317-925-7371.

BE 4M50 mono 4 chnl mixer, little use, \$400. P Russell, Bowdoin College, Sills Hall, Brunswick ME 04011. 207-725-3066.

Gates Producer whew replacement pots, dual chnl w/q switch, not installed, 4 ch mono, could modify for stereo or mix minus, \$150. L Beigel, On-Cue Record, POB 85042, Los Angeles CA 90072. 213-466-3595.

Teac/Tascam 2, slide pot, 6 chnl, \$150. G Gaskay, KWHO, 261 Main, Ste 6, Weed CA 96094. 916-938-3828.

Sparta A15 5-pot news console. E Neaman, KUMU, 441 N Nimitz Hwy, Honolulu HI 96817. 808-531-4511.

BE 8M20, mono 8 chnl, gd cond, \$600. D Igou, KGNB, 1540 Loop 337 N, New Braunfels TX 78130. 512-625-7311.

Ramco DC8MS, 8 chnl 20 input stereo board, excel cond, \$3850.00. R Trumbo, KNLF, POB 117, Quincy CA 95971. 916-283-4144.

Harris Medalist 10 10 chnl, stereo, excel cond, \$1800. D Miller, KATP, 810 N Pierce, Amarillo TX 79107. 806-373-6777.

Russco 505-S stereo 5 chnl, \$700; Gates Producer 4 chnl mono, needs work, \$75. W Blackwelder, KNUW, POB 7935, Tyler TX 75711. 214-581-0606.

Harris Criterion 90 stereo play all tones, mint cond, \$995. P Willey, POB 560, Bennington VT 05201. 413-663-3419.

Harris stereo 5 console, vgc cond, \$695. P Willey, POB 560, Bennington VT 05201. 413-663-3419.

Cetec remote console, (2) TT's, 5 chnl mixer & cabinets, old Gates remote mixer/TT's cabinets, \$200; (2) BE 5M250 mono consoles, excel cond, \$900 ea; Shure M67 mixer, \$75; Gates Dualux 12 chnl console, \$250; Gates stereo 80 console w/pwr supply, \$1000. E Moody, KJEM, 216 N Main, Bentonville AR 72712. 501-273-9039.

Sound Workshop 1280 12 chnl board w/parametric EQ, excel cond, 12x8x2, complete monitoring section. C Volpe, 540 Stemmens Run Rd, Baltimore MD 21221. 301-391-6927.

BE stereo 8 chnl w/Daven pots, \$1000; BE mono 8 chnl, \$850; BE mono 4 chnl, \$300; Collins stereo 8 chnl, \$1250; Gates stereo Yard, \$300; McCurdy stereo 8 chnl, \$900. C Haynes, WJMI, 1850 Lynch, Jackson MS 39203. 601-948-1515.

BE 150A 8 chnl dual mono prod & air board, new in box; Ampro AC-85 8 chnl stereo board, original box & manual, BO; Micro-trak 6444B stereo mixer board, new, \$400; Ramsa 8 chnl stereo board WR-130. J Phillips, WZOM, 408 Clinton, Defiance OH 43512. 419-792-8591.

Sparta A15 5 pot news console. E Neaman, KUMU, 441 N Nimitz Hwy, Honolulu HI 96817. 808-531-4511.

Wheatstone Audio Arts 24 input 8 buss factory patch bay, mint cond, trades considered, \$10,000. D Kocher, DKL Snd Std, 1901 Hanover, Allentown PA 18103.

Peavey MK3-16 portable, stereo, \$1000/BO; Quantum Audio Labs QM 1010 16/8 w/some documentation, avail in 10/90, \$2000/BO; Quantum Audio Labs QM 8 portable, stereo, w/manuals, \$500/BO. D Christian, Pacific Lutheran Univ, 121st & Park Ave South, Tacoma WA 98447. 206-535-7265.

Auditronics 300 series 4 trk, \$8000; Autogram R-TV 20 chnl stereo, \$7500. C Hall, WZOU, 235 Bear Hill, Waltham MA 02154. 617-290-0009.

Tapco C-12 portable, stereo, 12 in & 4 out w/manuals, \$1000/BO; K LH Burwen TNE 7000A & DNF 1201A transient noise eliminator & dynamic noise filter w/manuals, \$600/BO. D Christian, Pacific Lutheran Univ, 121st & Park Ave South, Tacoma WA 98447. 206-535-7265.

Gates II 8 chnl mono solid state (2); Collins Autogram IC-10 10 chnl stereo; Ramsa 8 chnl stereo DC-38-8S; Teac 3 8 chnl 4 out; lg qty modules & parts for RCA BC 7 & 8 consoles; RCA BC 2 console shell. D Smith, WFCB, POB 94, Chillicothe OH 45601. 614-773-3000.

Tascam 312B 12x4x2, less than 20 hrs use, \$3000/BO. B Hansen, WFBM, 3055 S Fourth, Springfield IL 62703. 217-528-3033.

Gateway 80 solid state 8 chnl mono, sell or trade. L Fuss, KOZ, POB 159, Fayetteville GA 30214. 404-460-6159.

Teac M-09 4 chnl mixing console, vgc, \$120. W Dougherty Jr, WLD Recording, Rt 1 Music Valley, Mill Spring MO 63952. 314-998-2377.

RCA BC6B 10 chnl, 2 line console, tube type, fair cond, BO. L Watson, WCDV, 227 E Forest Ln, Palatine IL 60067. 708-397-2525.

Micro-Trak Sport III dial-up remote sports mixer, mixes 2 mics, 1 line level, 1 spotter mic, A/C or battery pwr, VU meter, (3) headphone outputs, compact, briefcase format, nice cond. B Fisher, KPOK, Box 477, Bowman ND 58623. 701-523-3883.

McCurdy SS8550 series custom console, 1980, 12 faders, 3 program busses, timer & dual redundant pwr supply, dist amp outputs, second talent turret, mic on/off/headphone control. B Umberger, WNL1, 51 S Main Ste 957, Clearwater FL 34625. 813-446-0957.

Yamaha PM 700 12x2x2 mixer & PM 400 8x2 mixer, both \$900; UREI 527A 27 band graphic EQ's (2), both \$700. J Krepol, RNDL, 6147 Walker St, Philadelphia PA 19135. 215-624-1050.

ADM V1203, full EQ, 12x3 audio board, like new, compressor/limiters in master output chnl only lacking talkback module, fully loaded, computer interface, \$3000 plus shpg. S Sonnenblick, 305-891-3582.

RCA BC19A 4 chnl stereo, \$500. L Schrecongost Rodg, POB 1032, Indiana PA 15701. 412-349-5706.

BE 4-mixer mono console, \$500. R Coleman, WGEN, Box 67, Geneseo IL 61254. 309-944-4633.

Sparta 3310 dual mono audio console, 10 rotary mixers, program, audition & cue outputs, vgc, \$850. R Beierle, KFVR-TV, POB 1738, Bismarck ND 58502. 701-255-5757.

BE 8M20, 8 chnl mono, gd cond, \$450. H Widsten, KGNB, 1540 Loop 337 North, New Braunfels TX 78130. 512-625-7311.

Want to Buy

Schematic for Tascam 2A & Tascam Portastudio 05; also need meter bridge for Tascam 2A mixer. R Mize, KZMK, 3514 Kings Court Way, Sierra Vista AZ 85635. 602-458-9631.

Stereo console, 10 or 12 channel in gd cond. KGHT, 7515 Geyer Springs Rd, Little Rock AR 72209. 501-568-5448.

API & Neve consoles, also API & Neve EQs, anything considered, especially API 550A & 550B's. J Kreines, DeMott/Kreines Films, 5330 Kennedy, Millbrook AL 36054. 205-285-6179.

DISCO & SOUND EQUIPMENT

Want to Sell

JBL 4350 (2) 15", (1) mid, (1) horn, (1) tweeter w/electronic crossover for biamp application, vgc, \$2400/BO. R Nelson, 14083 SW 142 St, Miami FL 33186. 305-253-9240.

UREI 529 room EQ's (2), excel cond, \$250. F Virtue, Virtue Studios, 1618 N Broad, Philadelphia PA 19131.

Lexicon V224-4.4 echo unit, excel cond, \$3200. F Virtue, Virtue Studios, 1618 N Broad, Philadelphia PA 19131.

JBL 4350 speakers, electrically perfect, need refinishing, new cones, diaphragms w/crossover, \$3200/BO; perfect pair Dynaco ST-70s/PAS-2 preamp, \$375; NAD2140 40 Wch, mint, \$240. R Nelson, Tropical Bldg, 14093 SW 142, Miami FL 33196.

ARCOR

2 Channel—Red and Green

DZ2202
Zip Stereo™ 2-Channel Shielded
Pair Audio Cable

IN STOCK

\$199.00 / M

NORTHEAST BROADCAST LAB
(518)-793-2181/(215)-322-2227
(603)-483-1002/(214)-612-2053

Community Light & Sound RS440 (1 pr) 4-way speakers w/Community VB790 bass bins, in Anvil cases, excel cond, \$1600. J Kreines, 5330 Kennedy Ave, Millbrook AL 36054. 205-285-6179.

JBL 4312 L+R monitors (6), like new, balance of warranty applies, wall packing, we pay UPS, \$275 ea. C Keith, ALI, Box 313, Keene NH 03431. 603-352-8460.

JBL 4312 L+R studio mix-down, 3 way monitors, real walnut, like new, balance of 5 yr warranty applies, we pay UPS, \$275 ea. C Keith, ALI, Box 313, Keene NH 03431. 603-352-8460.

Attec co-axial speakers, 604 series, gd cond w/x-overs, send price & details. D deForrest, 7441 Wayne Ste 10-D, Miami Bch FL 33141.

Aleais or LXP-1 stereo digital reverb in gd shape for small recording studio. W Dougherty Jr, WLD Recording, Rt 1 Music Valley, Mill Spring MO 63952. After 5:30 PM. 314-998-2377.

FINANCIAL SERVICES

EQUIPMENT FINANCING "LOANS BY PHONE"

- NO FINANCIALS REQUIRED FOR TRANSACTIONS UNDER \$35,000
- NEW OR USED EQUIPMENT
- \$2,000 to \$200,000
- NO DOWN PAYMENT
- SALE-LEASEBACK EQUIPMENT FOR WORKING CAPITAL

TO APPLY OR REQUEST ADDITIONAL INFORMATION CONTACT MARK WILSON



LIMITERS

Want to Sell

Orban 8000A, \$1600; CBS Volumax 400, \$150; CBS Audimax III, \$150; DAP 310 tri-band, \$250; (2) Harris/Gates 944 Solid Statesman, \$300, all in mint/excel cond. D Igou, KGNB, 1540 Loop 337 N, New Braunfels TX 78130. 512-625-7311.

CBS stereo 520 4450A. E Neaman, KUMU, 441 N Nimitz Hwy, Honolulu HI 96817. 808-531-4511.

CBS FM stereo level control; Optimid 8000; CBS Audiomax; CBS Volumax; CRL AC 400. J Phillips, WZOM, 408-1/2 Clinton, Defiance OH 43512. 419-782-8591.

Orban 9000A w/manual, \$1200. R Ingram, KKMV, POB 4076, Beaumont TX 77704. 409-833-4400.

CRL AM4 mono (4), 3-1/2 yrs old, excel cond, purchase one or all, BO. M McNeil, Guardian Comm, 800 Compton, Ste 33, Cincinnati OH 45231. 513-931-8080.

Allison Research Gain Brain 700, single chnl, rack mount, Kepex 500, BO; Dorrough 310 DAP AGC peak limiter, update card, BO; Inovonics 230 multiband audio processor, update card, BO. T Liston, WOBL, Box

LIMITERS . . . WTS

UREI LA4, \$300; Audimax 4440 auto level, \$150; Marti CLA-40H, \$200; Gates Sta-Level, \$75. C Haynes, WJMI, 1850 Lynch, Jackson MS 39203. 601-948-1515.

PR&E Multimax processors (3), \$200 ea; (2) PR&E multimiters, \$200 ea; Hnat-Hindes 104 peak limiter, \$50. C Hall, WZOU, 235 Bear Hill, Waltham MA 02154. 617-290-0009.

Harris AM limiter, \$500; Harris ME-1 mod enhancer, \$150; Harris AM tri band AGC, mdl MSP 90, \$1250; Gates Sta Level, \$85. E Moody, KJEM, 216 N Main, Bentonville AR 72712. 501-273-9039.

Dorough DAP 310 AM processor. D Smith, WFCB, Box 94. Chillicothe OH 45601. 614-773-3000.

Orban Optimod 8000A, just rebuilt, like new, \$1750. K Krueger, KGTS, 204 S College, College Place WA 99324. 509-527-2991.

Dorough DAP 610 (2), set up for AM, may be converted, \$1000 ea/BO. J Littlejohn, WYSY, POB 2C10, Aurora IL 60507. 708-851-4600.

CRL Systems FM4G consisting of SPP-800 Stereo Prep Processor, (2) SEP-400B Spectral Energy Processors, SMP-800 Stereo Modulation Processor & SG-800 Stereo Generator, excel cond, \$4500. B Dickerson, WEAG-FM, 904-964-5001.

CBS Volumax 410, \$80. B Umberger, WNLT, 51 S Main Ste 957, Clearwater FL 34625. 813-446-0957.

Aphex 700 studio Dominator, less than 20 hrs use. T Jones, KNXR, 220 South Bldg, Rochester MN 55904. 507-288-7700.

Orban/Texas/Kahn, 222A stereo spacial enhancer, slot 5 card to use w/Prisms, Power Side, complete system, BO. D Doughty, H&D Bdc Group, POB 781, Utica NY 13503. 315-797-1330.

Radio Design Labs NRSC A, pre-emphasis & 10 kHz audio filter w/pwr supply & complete manual, \$200. B Fisher, KPOK, Box 477, Bowman ND 58623. 701-523-3883.

Gentner RCF-1 replacement card #5 for Optimod 8100A when using Prisms, \$300. M Holderfield, WOOF, POB 1427, Dothan AL 36302. 205-792-1149.

CRL PMC 300A in excel cond, replacing whener unit. must sell. B Fisher, KPOK, Box 477, Bowman ND 58623. 701-523-3883.

Orban Optimod 8000A, gd cond, just removed from service, \$1600. A McEwing, WGLY, RR 1 Box 1040, Waterbury VT 05676. 802-244-5683.

Gates FM Top-Level, stereo, \$75. T O'Laughlin, O's Own Prod, Rt 1 Box 41, Barnevelld WI 53507. 608-924-2001.

CBS audiomax 3 compressor, \$80; CBS audiomax 3S, stereo, \$170; Collins 900-F1 FM SCA mon, \$50; Collins 900-C2 FM stereo mon, \$400; CBS DPE-450 dynamic presence EQ, \$80; Sola Line conditioner, 8.34 amps, mdl 6C128. B Umberger, WNLT, 51 S Main, Ste 957, Clearwater FL 34625. 813-446-0957.

CRL PMC-300A peak mod controller, \$500. K Lane, KVRP, Box 1118, Haskell TX 79521. 817-864-8505.

CBS Volumax/CBS Audimax III, rebuilt, \$250/pr; Gates Solid Statesman limiters (2), \$250/pr. H Widsten, KGNB, 1540 Loop 337 North, New Braunfels TX 78130. 512-625-7311.

CRL Systems FM4G incl SPP-800 stereo preparation processor, (2) SEP-400B's spectral energy processors, SMP-800 stereo mod processor & a SG-800 stereo gen, all in excel cond, 4 yrs old, \$4500. B Dickerson, WEAG, 1421 S Water, Starke FL 32091. 904-964-5001.

Optimod 8000A
\$1495 & UP
414-482-2638

Want to Buy

Altec 436 A, B or C & Altec 438 A, B or C cheap. J Gangwer, 942 32nd St, Richmond CA 94804. 415-644-2363.

Optimod 8100A (2). R Roberts, KPUP, 1188 Padre Dr, Salinas CA 93901. 408-758-5400.

Orban 8100. D Brooks, WCIC, 3263 Court St, Pekin IL 61654.

Fairchild 660 or 670, Teletronix LA2A, LA3, other tube compressors & limiters; & other vintage tube signal processing equip. J Kreines, 5330 Kennedy Ave, Millbrook AL 36054. 205-285-6179.

MICROPHONES

Want to Sell

Sennheiser 421's (2) in metal boxes. J Phillips, WZOM, 408-1/2 Clinton, Defiance OH 43512. 419-782-8591.

Sennheiser 2003 diversity UHF wireless receiver, new, \$2500. B Blynder, TVA Inc, 11024 SW 112 Ave, Miami FL 33176. 305-595-9898.

RCA Classic ribbon mics, send for list. B Davies, 5548 Elmer, N Hollywood CA 91601. 818-761-9831.

RCA 77DX ribbon mic, gd cond, complete w/shock mount, works. BO. E Duellman, WOMT, POB 1385, Manitowoc WI 54221. 414-682-0351.

Neuman U87 w/shock mount, mint cond, \$1300. D Koehler, DKL Snd Std, 1901 Hanover, Allentown PA 18103.

AKG 451-Eb condenser mics w/case, windshield & stand clip, mint cond, \$250/ea or \$450/pr. C Butler, Butler Bdc Srvc, 1775 Bartlett Ave, Orange Pk FL 32073. 904-264-8169.

AKG LBB super shotgun, perfect, belt pack PS, full case, response certification, fantastic pattern, \$480. L Watson, WCDV, 227 E Forest Ln, Palatine IL 60067. 708-397-2525.

Sennheiser MD-421 dynamic mics w/case & stand mount, mint cond, \$225/ea or \$400/pr. C Butler, Butler Bdc Srvc, 1775 Bartlett Ave, Orange Pk FL 32073. 904-264-8169.

EV RE-16 dynamic mics w/case & stand clip, excel cond, \$125/ea or \$225/pr. C Butler, Butler Bdc Srvc, 1775 Bartlett Ave, Orange Pk FL 32073. 904-264-8169.

Shure SM-61's in vgc w/cases & windscreens, \$160/pr. W Dougherty Jr, WLD Recording, Rt 1 Music Valley, Mill Spring MO 63952. 314-998-2377.

RCA 44BX, 74B, 77DX; Brush Sound Cell crystal; Eastern sound ribbon mdl 50, BO individually or for lot. P Weber, Weber Studio, 102 Southgate Blvd, Melbourne FL 32901. 407-724-9590.

Syncon AU7A, mint cond, w/custom pwr supply for 2 mics, w/documents. R Robinson, 203-269-4465.

RCA 44-A on original desk stand, vgc, \$575/BO; RCA 77DX on orig desk stand, \$500/BO; RCA 74 JRs (2), gd cond, need ribbons, \$150; EV RE 16, \$75; EV RE 55, excel, \$80. Kremer Kraft, 301 SW 16th St, Ft Lauderdale FL 33315. 305-524-5652.

Altec Bird Cage (2); WE 8 Ball; EV 647 vintage mics, BO. M Massey, WKHX, 360 Interstate N, Atlanta GA 30339. 404-955-0101.

EV RE20, \$375. B Hansen, WFMB, 3055 S Fourth, Springfield IL 62703. 217-528-3033.

RCA SV, works, want to trade for other gear; also Ft, SCO2000, trade for Casio DA-2 DAT. T Hill, WBJC, 2901 Lib Hights Ave, Baltimore MD 21215. 301-396-0404.

EV 1776 (2), (2) extra batteries, gd cond, \$100/both. R Swan, WROY, POB 400, Carmi IL 62821. 618-382-4161.

RCA ribbon mics including (1) 44-BX; (1) 77-D; KU3A10,0001; BK-11; BK-5; SK-46; WE639A, will trade for other high quality condenser, dynamic, ribbon mics & audio equip. Tracy Eaves, 615-621-6099 (evenings).

Want to Buy

RCA 44s, 77s & other ribbon mics, working or not, also WE. B Davies, 5548 Elmer, N Hollywood CA 91601. 818-761-9831.

Fairchild F22 power supplies (2) or AU7 condenser mics, buy or trade, also schematics on these. J Edwards, WRET, POB 4069, Spartanburg SC 29305. 803-599-0201.

Schematic for Altec 21B mics. R Robinson, 203-269-4465.

Vintage mic for antique radio display, all types. D Koehn, KNEN, Box 937, Norfolk NE 68701. 402-379-3300.

Vintage tube condenser mics, Neumann, Telefunken, Schoeps, AKG & classic ribbon mics, RCA 77s, 44s; Telefunken ELAM 250s or 251s, any cond; AKG C12s & C24s, any cond; Neumann U47, U48, M249B, KM56, U67, etc, any cond. J Kreines, Demott/Kreines Films, 5330 Kennedy Ave, Millbrook AL 38054. 205-285-6179.

Vintage mics by Altec, Neumann, Sony, RCA, etc. Kremer Kraft, 301 SW 16th St, Ft Lauderdale FL 33315. 305-524-5652.

Will buy or trade for RCA 4 AA condenser mike no major missing parts please. J Webb, 15117 Hamlin, Van Nuys CA 91411. 818-769-6738.

MISCELLANEOUS

Want to Sell

Okidata 192 printer. E Nearman, KUMU, 441 N Nimitz Hwy, Honolulu HI 96817. 808-531-4511.

Military rack cabinets (3) 6', 19", \$75/all. G Gaskey, KWHO, 261 Main, Ste 6, Weed CA 96094. 916-938-3828.

Video radio sales training tapes, 30 topics on 16 VHS tapes, \$1500. R Trumbo, KNLF, POB 117, Quincy CA 95971. 916-283-4144.

Rotron Blowers for Elcom, CCA, CSI, McMartin, rebuilt & new. Goodrich Enterprises Inc. 11435 Manderson St., Omaha, NE 68164 402 493 1886 FAX 402 331 0638

Broadcasting collectables, including NBC Huntley-Brinkley report bumper slide, etc. P Dowie, Good Sound, 171 Drexel, Lnsdn PA 19050. 215-626-9322.

Tandy computers, mdl 600HD & mdl #2, in excel working cond, also (2) Tandy printers, sold together or separate, BO. F Fess II, WLRB, 119W Carroll, Macomb IL 61455. 304-833-5561.

Bird 100 W load, 43, 2-slugs; ESE 301AE timer; McKay base & head. J Phillips, WZOM, 408-1/2 Clinton, Defiance OH 43512. 419-782-8591.

RCA, Presto Etc, 16" disc recorders & other equip including blanks, needles & pre-recorded discs. B Davies, 5548 Elmer, N Hollywood CA 91601. 818-761-9831.

Dale SPA 200 power arrester (2) for 3 phase wiring systems, new, BO. C Phillips, WXVO, POB 987, Clinton TN 37717. 615-457-2697.

LEL SF101 splice finder, poor shape, motor works, not finding splice now, \$40. B Umberger, WNLT, 813-446-0957.

HP Thinkjet ink jet printer, \$100. P Cibley, Cibley Music, 138 E 38 St, Nyny 10016. 212-986-2219.

Henry Engineering logic converter, \$75; (30) Seimms 66B blocks, \$10 ea; (3) Technics bases for SP-15 or SP-25, \$100; (2) Technics bases for SP-10 Mark II, \$100 ea. C Hall, WZOU, 235 Bear Hill, Waltham MA 01254. 617-290-0009.

EV RE-20 shock mounts (3), \$25 ea; Sansui QSE-5B quadruphonic encoder, \$100. C Hall, WZOU, 235 Bear Hill, Waltham MA 01254. 617-290-0009.

Cinema Engineering/Aerovox 9205 bulk eraser, BO. R Robinson, 203-269-4465.

Hilomast MK9, 30' telescoping pneumatic mast w/vehicle bearings. E Duellman, WOMT, POB 1385, Manitowoc WI 54221. 414-682-0351.

Extel AH/PIIR, like new cond, BO. J Anderson, WKCU, 2192 Hwy 72 East, Corinth MS 38834.

Fon-Box telephone interface for talk shows, etc, gd cond, \$100. D Doelitzsch, WDDD, 1 Broadcast Ctr, Marion IL 62959. 618-997-8123.

Okidata 192 printer; CCA 20 kW FM harmonic filter, 3-1/8" line. E Neaman, KUMU, 441 N Nimitz Hwy, Honolulu HI 96817. 808-531-4511.

Library tech manuals for Sony, Panasonic, JVC, etc, loose leaf, several years, all consumer products, approx 26 volumes, \$200 firm. S Cisler, 728 Zorn Ste 10, Louisville KY 40206.

Extel AH/PIIR teleprinter, like new cond w/stand, BO. J Anderson, WKCO, 2192 Hwy 72 East, Corinth MS 38834. 601-286-8451.

Pelco VS508H 8-position sequential CCTV switcher, new, original packing, \$600/BO. A Allegra, Calvary Baptist Church, 1380 Valley Forge, Lansdale PA 19446. 215-368-4444.

Extel AH11R solid state printers (2), vgc working cond, standard size paper, approx 25 new spool ribbons & all power cords, sold separately or together. A Wasilewski, KMWX, POB 1460, Yakima WA 98907. 509-248-1460.

Tandy Mdl II computer, keyboard, 3-drive expansion bay, \$400. C Sigmon, WBZK, POB 398, York SC 29745. 803-684-4241.

Kato 50 kW 3 phase generator, Perkins diesel engine w/50 gallon day tank, less than 50 hrs running time, \$20,000/BO or trade for 25 or 35 kW FM xmtr. P Parks, KYKR, 27 Sawyer, Beaumont TX 77703. 409-838-3911.

Equipment racks (2). P Wells, KJQY, San Diego CA. 619-238-1037.

Connecticut readers: tag sale 9/22-23/90 for a Gates Stereo Staterman, Klipsch Cornwalls, RCA mono cart R/PS, Phase Linear amps & much more, send SASE for complete list & directions. Doc Rock Productions, 3700 Durham Rd, Guilford CT 06437.

1975 Coachmen 22' camping trailer converted to mobile unit, tandem axle, (2) TT's, console, internal & external sockets, AM/FM monitor, heatpump, range, refrigerator, \$2750. C Sigmon, WBZK, POB 398, York SC 29745. 803-684-4241.

Harmon-Kardon mixers, new DPR7; Meissner mixer five inputs-battery; Cannon plugs, 3 prong, male & female; 40 new tubes & resistors cheap; Lafayette TE22 audio generator; Sencore transistor & diode tester; manuals for Ampex, Pultec, Altec & others. Mr. Oliver, 212-874-7660 in afternoons.

Grampan cutter heads, 1D feedback (tandberg); patch bays (4) 24 inputs single, also patch cords; Daven 600 ohms attenuators (silent) (8) excel; Presto 6N cutter lead screws; Capps disc cutting needles (new) & some used; heating styluses (2) w/watt meters; Ed-ital blocks for recorders 1/2" & 1/4". Mr. Oliver, 212-874-7660 in afternoons.

Want to Buy

Schematic & service info for Olivetti electronic typewriter w/TV screen mdl ETV-240; main flat drive belt for Pioneer RT-909 R-R. Q Morrison, KHLQ, 913 Kanoehua, Hilo HI 96720. 808-961-0651.

Lafayette radio catalogs, any yr before 1978. A Peterson, 117 Park Ln Ste 64, New Milford CT 06776.

FREE 56-PG CATALOG
Complete line of audio modules and accessories for all engineered sound & broadcast applications



MODULAR AUDIO PRODUCTS
1-800-333-7697
1-516-345-3100
FAX 516-345-3106
DIV. OF MODULAR DEVICES INC
1 RONED RD • SHIRLEY NY 11967

Circle 144 on Reader Service Card

Western Union studio clock, wall clock w/wired light, brown case, cream color face, red hands. T Heathwood, Heritage Radio, POB 16, Boston MA 02167.

NBC Hotline decoder unit. J Haynes, Haynes Bdc Svcs, 81 Knox, Millinecket ME 04462. 207-723-9190.

Blind & paralyzed young man would like donations of any receiver or word processor, call or write. R Les, 5909 W 6th St, Apt 1, Los Angeles CA 90036. 213-938-5347.

Equip necessary for construction of upgrade to 5 kW AM daytime directional on 1380 KHz including Continental/Harris 5 kW xmtr, 5 kW 2-tower phasing unit in cabinet & antenna tuning units, 160' guyed tower, 16-20" face, (2) tower phase monitor, Delta CPB-1 common point bridge, Delta OIB-1 operating impedance bridge, 5 or 10 kW AM dummy load, (2) Delta TCA-10 & TCA-20 RF ammeters w/current transformers, etc, if you have any of the equip needed for this upgrade call between 8:30AM & 10PM, leave name, number, equip description & asking price. 512-696-5615.

OTARI MTR12-I
1/2" 4 Track
Demo, like new

One Only
List \$13,255.
SPEC. \$9,999.
CWO

NORTHEAST BROADCAST LAB
(51B)-793-2181/(215)-322-2227
(603)-483-1002/(214)-612-2053

Early WWII vintage radar equip, complete systems and/or pieces. A Weiner, 14 Prospect Dr, Yonkers NY 10705. 914-423-6638.

Jazz record collections, 10" LP12" LP bebop, swing, dixie, 'highest prices paid. B Rose, Program Recods, 228 East 10th, Nyny 10003. 212-674-3060.

MONITORS

Want to Sell

Ball Miratel 7-007-0200 AM air monitor, BO. T Liston, WOBL, Box 277, Oberlin OH 44074. 216-774-1320.

Gates M5774 tube type AM mod mon, \$30; Gates 88F FM freq mon, \$30; McMartin TBM 3500 tube type FM mon, \$30; Collins 900 F1 FM SCA mon, \$100; Collins 900 C2 FM stereo mon, \$500. B Umberger, WNLT, 813-446-0957.

McMartin tuner mdl TR-55 SCA, \$50; Marti PGM 20H program line amp, \$65; RCA AM mod mon, \$100; TFT 713 AM freq & mod mon, \$750; TFT EBS rcvr w/FM rcvr, \$325; TFT 704A remote meter, \$50; Plectron FM rcvr 155.49 MHz, \$35. E Moody, KJEM, 216 N Main, Bentonville AR 72712. 501-273-9039.

McMartin TBM 2000A SCA monitor for 67 KHz, \$400. J Littlejohn, WYSY, POB 2010, Aurora IL 60507. 708-851-4600.

TFT 760 AM EBS rcvr/decoder/gen, BO. B Webster, WLIT, 150 N Michigan, Chicago IL 60601. 312-329-9002.

McMartin TBM-3500 FM, cond unknown, \$50; Gates GTM-88F freq, cond unknown, \$125. C Sigmon, WBZK, POB 398, York SC 29745. 803-684-4241.

Harris FT-80 FM mod mon, 104.9 MHz, \$450; Harris FS-80 FM stereo mon, 104.9 MHz, \$450. R Coleman, WGEN, Box 87, Geneseo IL 61254. 309-944-4633.

TFT 730A SCA subcarrier mod mon, \$900/BO. D Lerner, 115 W 23rd, Nyny 10011. 212-463-0798.

McMartin AM10K prefer 1982 or later. R Payne, 774 Roswell St, Marietta GA 30060. 404-424-9850.

Any older McMartin mod monitors. C Goodrich, 11435 Manderson, Omaha NE 68164. 402-493-1886.

MOVIE PROD EQUIP

Want to Sell
Nagra III internal xtal, rolloff filter, Sennheiser 605 w/KAT 15, leather case, ATN pwr supply, excel cond, \$1350; & new Bell & Howell 70 DR w/Anvil case, 1" Comat, instructions, \$325. J Kreines, 5330 Kennedy Ave, Millbrook AL 38054. 205-285-6179.

Want to Buy

Mitchell 35 & 16mm cameras & accessories, other professional 16/35mm cameras, incl Ar-riflex, Aaton, CP, etc; optical printers, Research Products 1000, 1001, & Acme & Ox-berry; cine lab equipment; upright Moviolas, especially 35mm. Westrex 35mm; optical recorders, & RCA & Maurer optical recorders; CP16s any condition; good cine optics (Zeiss, Ultra-T, Angenieux, Cooke, etc); also need Zeiss 9.5mm Distagon, reasonable, need not be mechanically mint. J Kreines, DeMott/Kreines Films, 5330 Kennedy Ave, Millbrook AL 36054. 205-285-6179.

RECEIVERS & TRANSCEIVERS

Want to Sell

AM STERO RECEIVERS
Portable, Home/Studio, Auto
RRADCO GROUP
708-843-8481

DISTRIBUTOR DIRECTORY
The following distributors serving the broadcast industry would be glad to help you with any of your requirements.

SPENCER
Broadcast & Communications
AUDIO—VIDEO—RF
Where Service is #1
Now in our 11th year
CALL 602-242-2211
FAX 843-2860

country, top 40, news, urban, talk, jazz, the classics

CONSULTANTS

GOODRICH enterprises, inc.
 Parts and technical service for all
 MCMARTIN TRANSMITTERS, CONSOLES
 EXCITERS, RECEIVERS
 TRANSMITTER AND INDUSTRIAL TUBES.
 11435 Manderson St.
 Omaha, Nebraska 68164 U.S.A.
 PH: 402-493-1886 FAX: 402-331-0638
 TELEX: 940103 WUPUBLTX BSN

PCBoards
P-C-B ARTWORK MADE EASY!
 create and revise your circuit artwork
 in a flash with PCBoards Software
 For IBM's or Compatibles
LAYOUT — SCHEMATIC — AUTO-ROUTER
 \$99.00 ea. Demo Pkg. \$10.00
PCBoards 2110 14th Ave. S.
Birmingham, AL 35205 (205) 933-1122

THIS SPACE AVAILABLE
Call Simone Mullins at
1-703-998-7600

EVANS ASSOCIATES
 Consulting Communications Engineers
 FCC Applications, Design
 & Field Engineering
 Broadcast Engineering Software
 216 N. Green Bay Rd.
 Thiensville, WI 53092
(414) 242-6000
 Member AFCCE

W. LEE SIMMONS & ASSOC., INC.
 BROADCAST TELECOMMUNICATIONS CONSULTANTS
 1036 William Hilton Pkwy
 Ste 200F
 Hilton Head Is., SC 29928
(803) 785-4445

SOFTWARE
FM CHANNEL SEARCH
FM Database pool
MSDOS
EGA Graphics-Color
Broadcast Technical Consulting
Doug Vernler
 Broadcast Consultant
 1600 Picturesque Drive
 Cedar Falls, IA 50613
319-266-8402

MAGRILL ENGINEERING
 Radio Engineering Consultants
 FCC Applications - Upgrades
 Pre-purchase evaluations
 Station planning & Design
 Turnkey systems - Field service
 Experienced, Economical & Fast
(904) 591-3005
 Barry Magrill P.O. Box 1010
 President Fairfield, FL
 Member IEEE 32634

AVIATION CONSULTANTS
 • FAA Obstruction Analysis
 • FM EMI Evaluations
 • Expert Witness Service
 • Tower Marking & Lighting

WALTER WULFF & Assoc.
(404) 881-6786
 P.O. Box 77028
 Atlanta, GA 30357

MEYER GOTTESMAN
 Broadcast consultant/engineer
 FM, TV and LPTV applications.
 Frequency studies, transmitter field
 service, etc. We go anywhere! Former
 CE Boston, Houston, Miami and Ft.
 Lauderdale. Former HARRIS
 transmitter field engineer.
 3377 Solano Ave., #312
 Napa, CA 94558
 Tel: (415) 221-2000 (anytime)
 FAX (415) 387-2425 (days)

Consulting Communications Engineers
 • FCC Data Bases
 • FCC Applications and Field Engineering
 • Frequency Searches and Coordination
 • AM-FM-CATV-ITFS-LPTV
OWL ENGINEERING, INC.

 1306 W. County Road. F,
 St. Paul, MN 55112
(612)631-1338 "Member AFCCE"

Looking for a position in radio or television?
Looking for personnel for your station?
I can help! Reasonable rates. Free information.
Full Service Consulting
Bill Elliott
 48 Imperial Avenue
 Pittsfield, MA 01201
413-442-1283

Huntsville Antenna Engineering
 There is hope for AM radio!
 AM station unipole antennas with circular polarization & beam tilt.
 Broadband your present
 AM tower Series R shunt fed.
 205-353-9232 205-353-6747
Kenneth Casey
 Consulting Radio Engineer

new station construction field service AM directionals
RON KROB
 broadcast technical consultant
 4910 Four Star Court
 Fort Collins, CO 80524 303 484 2704

RADIO SYSTEMS ENGINEERING
 FCC Applications • Design
 • Installation • Field Service
Experienced & Affordable
 4289 Roanridge
 Las Vegas, Nevada 89120
24 Hr: (702) 454-2085
FAX: 702-458-2787

Moffet, Larson & Johnson, Inc.
 Consulting Telecommunications Engineers
Two Skyline Place
5203 Leesburg Pike # 800
Falls Church VA 22041
703-824-5660
800-523-3117
 Member AFCCE

DISPLAY YOUR CONSULTANT'S CARD HERE AND BE SEEN BY OVER 21,000 READERS

SERVICES

BRENTLINGER BROADCAST ENGINEERING, INC.
 Charles Jayson Brentlinger
 President
 COMPUTERIZED REPORTS
 ALLOCATION STUDIES • AM • FM
 AM DIRECTIONALS • AUDIO • STL
 SATELLITE COMMUNICATIONS
 4338 East Acoma Drive
 Phoenix, Arizona 85032
(602)867-0181

HARMON'S TOWER SERVICE, INC.
 Maintenance, Painting,
 Antenna & Equipment
 Installation,
 Winch Services
435 B Broadway
Columbus, GA. 31901
(404) 327-1074

FCC's Engineering
AM,FM and TV Data
Bases for your PC
Call today to request a free sample.
Communications Data Services
 6105 E Arlington Blvd
 Falls Church VA 22044
(703) 534-0034

Steven L. Delay
 AM/FM Broadcast Field Service
International & Domestic
 Ground Systems Field Intensity
 Broadcast Studios Measure
 Turnkey Transmitting
 Construction Facilities
 AM Directionals Purchase
 Microwave Evaluations
RR1-236 Pawnee, IL 62558
24 HR. 217-498-7339
FAX 217-498-8197

BROADCAST COMPUTER DATABASE BBS
300 to 19200 Baud
N-8-1
Multi-Node System
(713) 937-9097
 FCC Information
 On-Line Call Sign Search
 On-Line Engineering Formulas
 Messages, Conferences, Files, Doors

BROADCASTING & ELECTRONIC SERVICES LABS
PO BOX 178
NEWTON, UT 84327
801-563-3088
 BROADCAST EQUIPMENT
 REFURBISHED & REPAIRED
 AUDIO, VIDEO, RF, DIGITAL
15 YRS EXPERIENCE

TOWER SERVICES
Light Replacement
Routine Maintenance
Ground Systems
Painting
20 years Experience
John Nix
 PO Box 13244 Salem, OR 97309
 503-581-4056
1-800-321-4056

SPECIALIZING IN ERECTION,
 REPAIRING, PAINTING
 AND MAINTENANCE
 RADIO, TWO-WAY, TV, TOWERS
 AND FLAG POLES
A STEEPLEJACK CO.
 PAINTING AND STEEPLEJACK
 CONTRACTORS
 FULLY INSURED FOR YOUR PROTECTION
 DON HIGHLAY 3722 ROMA
 713-462-6105 HOUSTON, TEXAS 77080

MIRKWOOD ENGINEERING
 Rural & Remote Site
 Field Engineering
 50 Park Ave.
 Claremont, NH 03743
603/542-6784

T & W
Tower/Antenna
Erection • Maintenance
 • 24 Hr. Emergency Service •
Hurlock, MD
301-376-3555

 Lic. No. 357096
 Installation & Maintenance of
 Broadcast & Communications
 Towers & Antennas
Donald J. Tenns
 9723 Folsom Blvd. Suite A
 Sacramento, CA, U.S.A. 95827
 (916) 362-6846
 (916) 638-8833
 FAX: (916) 638-8858

PARAMOUNT
 COMMUNICATION SYSTEMS
 INSTALLATION AND SERVICE OF BROADCAST
 ANTENNA SYSTEMS/TOWER MAINTENANCE & ERECTION
WESTMONT, NJ (609) 869-0222

WIDEST & FINEST CHOICE OF PRODUCTION MUSIC & SFX
PROMUSIC
 Call For Our Free Demo & Information On
BROADCAST Plus
 Annual Rates.
1-800-322-7879

RF Components
 Field phasing
 modifications
 and installation
 Call Dave Gorman
215-249-9662
POB 401
Dublin PA 18917

THIS SPACE AVAILABLE
 Call Simone Mullins
 at 1-800-336-3045

**Contact Radio World Newspaper for availabilities:
 P.O. Box 1214 • Falls Church VA • 22041**

RECEIVERS . . . WTS
Heathkit HW 100 10-80 M SSB xcvr 100 W, \$125. A McCartry, 600 E Main, Valaville CA 95660. 707-446-C200.

Moseley RPL-2 RPU rcvr tuned to 161.67 & 161.76; McMartin EBS AM rcvr tuned to 760, tone gen & tone decoder. E Neaman, KUMU, 441 N Nimitz Hwy, Honolulu HI 96817. 808-531-4511.

McMartin EBS system w/AM-R1 AM rcvr, EBS-2 monitor & TG-2 EBS 2 tone gen, as is, \$200. C Haynes, WJMI, 1850 Lynch, Jackson MS 39203. 601-948-1515.

Motorola Micor FM 2-way transceiver less accessories, mdl T43RXA1900AA, 162-174 MHz, 12 VDC, \$150. B Dickerson, WEAG, 1421 S Water, Starke FL 32091. 904-964-5001.

GE Phoenix SX & GE MPI handheld, hand-held charger stand & belt case, one has mobile mike & one has base mike, dual freq, 460, 470 UHF, \$1600/BO. T Trotzer, KGY, POB 1249, Olympia WA 98507. 206-943-1240.

Hammarlund VHF transceiver, 35 W, cond unknown, \$50. C Sigmon, WBZK, POB 398, York SC 29745. 803-684-4241.

Dynakt FM-3 tube tuner, \$100; Pilot 380 tube stereo tuner, \$90; MacIntosh MR71 stereo tube tuner in Panloc case, near mint cond, \$400; Knight KN 2560 tube CB, excel, \$75; Gonset communicator III orig manual & bill of sale, nice, works, \$65. Kremer Kraft, 301 SW 16th St, Ft Lauderdale FL 33315. 305-524-5652.

Two-way radio, hand-held & mobile UHF radios for shows or remotes, can put on your freq, Icom, Motorola, GE, some fancy, some simple, from \$175. R Nelson, Tropical Bdcg, 14093 SW 142, Miami FL 33192.

Fairchild Dart 384 digital audio receiver terminal, in service less than 1 yr, \$4300. E Sears, WXLW, POB 22300, Indianapolis IN 46222. 317-925-6494.

Want to Buy

Schematic for Avcom 100 EBS encoder/decoder, will pay reasonable copying & shipping. D Grant, WLAV, 50 Louis NW, Grand Rapids MI 49503. 616-456-5461.

REMOTE & MICROWAVE EQUIP

- NEW AND USED -

Satellite Receive Only ANTENNAS

PLUS! Receivers/Demodulators

- Wegener
- Fairchild
- Harris
- Scientific-Atlanta
- Microdyne
- Avcom
- Prodelin

For ALL Network Affiliations WE BUY • SELL • TRADE
 Flexible Lease Financing!
TELCOM GROUP INTL
 PH. (505)883-4737 FAX (505)889-0078

OVERNIGHT DELIVERY AVAILABLE

Moseley TRC-15; CRL audio processing APP-300A & PMC-300A; Pacific Recorders Multimax MX/AM audio compressor/limiter; Belar AM-2 mod mon. C Mandel, KAMP, POB 1018, El Centro CA 92244. 619-352-2277.

Scientific Atlanta 7.5 kHz dual audio decoder card for CBS, NBC, ABC mainframe rcvr/demod, excel cond, \$500. H Ginsberg, Communications Eng Inc, 12 Beech St, Essex Junction VT 05452. 802-878-8796.

Moseley MRC 1600 4 yrs old, includes cards for both subcarrier or telephone line operation, \$2200. R Watson, WXCO, POB 778, Wausau WI 54401. 715-845-8218.

Moseley TR-55A telemetry rcvr, \$50. C Hall, WZOU, 235 Bear Hill, Waltham MA 02154. 617-290-0009.

Wegener 1806-24 stereo rcvr w/tone decoder, 6 mos old, comes w/Henry Eng NetCommander set for Drake Chenault, avail as package or separate, \$1900. B Downs, KTSR, Box 3248, Bryan TX 77805. 409-846-1150.

Stationmaster PD-455 450 MHz fiberglass co-linear, new, in original carton, \$465. D Eressy, WFCC, POB 1308, W Chatham MA 02609. 508-945-4855.

Henry Network Commander currently configured for Drake Chenault, 6 mos old, new cond, \$700. B Downs, KTSR, Box 3248, Bryan TX 77805. 409-846-1150.

TFT 7601-C & 7601-R digital remote control for AM, FM & TV xmters w/10 chnl of raise/lower or off control & display of telemetry from a remote site w/manual, \$1500/BO. J Strong, WJFM, 120 Wildwood Dr, Mt Zion IL 62549. 217-864-4141.

Martel RMC-2 remote control system, \$950. C Haynes, WJMI, 1850 Lynch, Jackson MS 39203. 601-948-1515.

Moseley MRC-1600 in excel cond, \$2500. B Williamson, WALL, One Broadcast Pl, Middletown NY 10940. 914-343-7400.

Macom 23 GHz audio/video link w/Macom MA-2300 xmtir w/dish, Macom MA-2300 rcvr w/dish, dbx digital audio processor system, \$6000 package. C Hall, WZOU, 235 Bear Hill, Waltham MA 02154. 617-290-0009.

Symetrix TI-101 (2) telephone interface/hybrids, like new, \$450/both or \$250 ea. M Holderfield, WOOF, POB 1427, Dothan AL 36302. 205-792-1149.

Microdyne/Scientific Atlanta 5 meters satellite receive antenna (3), one w/dual feed, one w/who simulsat dual feeds & one SIA Cas-segrain dual feed, \$1000/BO. M Comer, Box 1285, Colonial Beach VA 22443. 804-224-9711.

Wegener 1806-03 Ku-Band downlink incl dish, excel cond, BO. J Bartels, KANO, 100 E Main, Anoka MN 55303.

Anderson satellite switcher, works w/any satellite music network format, like new cond, \$200. B Hearst, WWCH, POB 688, Clarion PA 16214. 814-226-8600.

ABC Network decoder, excel cond, \$200; interface for Revox deck for auto rec w/above, \$100. M Black, WEOS, Hobart College, Geneva NY 14436. 315-781-3456.

Burk TC-8 remote control w/dialup & voice (2), wire modem, excel cond, 1 yr old, \$2000/BO. M Black, WEOS, Hobart College, Geneva NY 14436. 315-781-3456.

Harris 6550 satellite rcvr chassis w/PS & down converter, no demod cards, mint cond, \$400. H Widsten, KGNB, 1540 Loop 337 North, New Braunfels TX 78130. 512-625-7311.

Wilbur 7-30-357/367 35' heavy duty telescoping mast w/12 V compressor, braces for rear bumper installation, video showing mounting & operation avail, all in gd cond, \$3000. B Peretic, WYED TV, 919-553-1700.

Do you have an upcoming remote? We now have available for rental:

2-LINE COMREX WIRELESS MIC • PORTABLE DAT plus much more... at reasonable rates!

Silver Lake Audio
 2590 Hillside Ct. Baldwin, NY 11510
 (516) 623-6114

Martel RMC-2AX dial up type remote control unit, works w/phone line or SCA, complete studio/xmtir units w/manual, \$495. J Moore, KENO, Box 388, Roswell NM 88201. 505-625-2098.

Rust 108-1C & 108-0C studio & transmitter remote control units w/manuals, \$500. A Garza, Foster Comm, 2824 Sherwood Way, San Angelo TX 76901. 915-949-2112.

Now In Stock!

FINE QUALITY audiopah
 BROADCAST & CARTRIDGE
CARTRIDGES

Call us for the **BEST Prices!**

HE HALL Electronics
 (804) 974-6466

Want to Buy

Martel STL-8 or 10. J Stanford, WYLD, 2228 Gravier, New Orleans LA 70119. 504-822-1945.

Any FSR, Gentner, Telos, telephone hybrid coupler, gd quality, donations acknowledged. A Allegra, Calvary Baptist Church, 1380 Valley Forge, Lansdale PA 19446. 215-368-4444.

Inventory Clearance
ELECTRO VOICE Sentry 100 Studio Monitor

 Spec. \$195. CWO
 While they last
NORTHEAST BROADCAST LAB
 (518)-793-2181/(215)-322-2227
 (603)-483-1002/(214)-612-2053

STATIONS

Want to Sell
AM daytimer, early sign on, 1000 W, bldg & residence & 4.59 acres. LaVerne McBeath, KJBC, 1903 S Larrea Rd, Midland TX 79701. 915-684-5152.

Southern California daytimer in high growth area, \$1.5 mil/negotiable. M Sadacca, POB 1317, Crestline CA 92325. 714-882-2575.

TOP 100 MARKET CLASS-A FM \$695,000
 414-482-1959

Partner/Investor for licensed FM start-up, Class C2 radio station for Taos & northern New Mexico. Scheduled November on air date. Francis, 505-377-6450.

Receiver's sale: KESP Santa Barbara accepting offers cash or terms to qualified 1/3 down, 1988 gross \$411,000, 1989 gross \$508,000, for information call G Erway, 407-283-6871.

Financing needed for 13 KW AM, 50 KW FM, located between major Montana markets, take lien or corporate shares, excel opportunity. M-R-S, 110 N 2nd Ave #39, Chula Vista CA 92010.

AM construction permit 880 kHz at Mone-ta, Smith Mountain Lake VA, tower site firm, studios avail, great area potential, will work w/buyer to build. L Williams, Rt 1 Box 314, Wirtz VA 24184. 703-647-1530.

Class B FM, northern California, gd revenue, 3 large county coverage area. R Trumbo, KNLF, POB 117 Quincy CA 95971. 916-283-4144.

EMPLOYMENT

To place ads in this section, use the ActionGram form. To respond to box numbers, write Radio World, PO Box 1214, Falls Church, VA 22041, Attn: _____

HELP WANTED

WJMI/WOAD Jackson MS seeking engineer w/exp in RF & studio maintenance, start \$20,000/yr. C Haynes, 601-948-1515.

Chief Engineer, KLON-FM, Long Beach, CA. Experienced professional, implement power increase, oversee studio, transmitter maintenance, frequent live music broadcasts for non-commercial station. Contact personnel 213-430-6960.

Maintenance Engineer for AM/FM radio stations needed with good RF & studio maintenance skills. FCC General Class or SBE certification required. Please send resume w/salary history to: Beverly Osborne, Personnel, Inner City Broadcasting Corp, 801 Second Ave, New York NY 10017. EOE.

Retired or Semi-retired salesman, wanting the challenge of getting clients for very small market in Southwest Arizona. B Burdette, Quartzsite AZ. 602-927-5111.

Chief engineer w/big production voice & over 15 yrs of hands-on engineering exper, seeks CE pos w/production in a competitive top 100 mkt. G Morgan, 704-563-8676.

Operations/Production Mgr currently employed, seeks challenging new pos, will relocate, extensive travel ok. D Smith, POB 11902, Baltimore MD 21207. 301-591-2128.

Enthusiastic female seeking on-air position, music programs, news, traffic, also comfortable w/production, music research & programming. Tracey, 708-852-1049 or 309-792-3956.

Radio Vet w/22 yrs exper, seeks on-air w/C&W or AC in South Georgia, gd references. B Rachels, 516 Colton, Thomasville GA 31792.

Bdct eng would like to do repair & new work, FM only in NW Virginia area, 25 yrs w/FM sta's. V Pat, Box 232, Weyers Cave VA 24486.

Engineer 20 yrs AM, FM, satellite, automation, bubble gum, baling wire. P Morton, POB 57, Rupert VT 05768. 802-394-2858.

DOE, CE, 29 yrs exper in station, corporate, contract & consulting firm partner positions. Texas, Louisiana, Oklahoma preferred. Right offer other areas possible. Reply to Radio World, POB 1214, Falls Church VA 22041. Attn: Box 90-08-04RW.

Chief Engineer/Assistant chief seeks pos w/major Southeast radio station, FCC generalist class license, SBE certification, amateur EXTRA license, 14 yrs of radio & TV bdct engineering exper, excel ref, quality workmanship, hard-working & hands-on, exper in all aspects of AM/FM radio engineering. H Ginsberg, 12 Beech St, Essex Junction VT 95452. 802-878-8796.

Producer/Engineer w/radio prod/prog exp, former recording studio owner, seeks program/engineer position. Z Nicall, 6404 Hollywood Blvd 4th flr, Hollywood CA 90028. 213-464-2145.

Dedicated air talent/production specialist seeks challenging position, 5 yrs exper including ops mgmt, team worker, eager learner, gd communicator. Randy 919-842-7635.

Humble on-air, great voice, production, timing, charisma, excel study, sports background, news, seeks South Carolina FT midlands position. AC, Urban, CHR, Herb, 803-534-8285.

CE/Asst CE, FCC general, ham, ASEE, nondrinker, nonsmoker, heavy theory, former CE Boston, Houston, Miami, Ft Lauderdale, avail now. M Gottesman, 3377 Solano Ave, Ste 312, Napa CA 94558. 415-221-2000 X11.

Sports anchor/PBP w/16 yrs exper in small mkt seeks position in medium or major mkt in Texas, sports pro. D Blanton, 817-665-0765.

Looking for PT engineering work in the greater Mobile AL area. C Strozier, 205-928-9406.

17 yr vet has high-tech system for new FM's, save money, make money, dominate market, gain national recognition, reduce overhead, much more. Joe 517-379-4803.

Eleven year pro seeking work in Midwest, solid background in news, sports (P-B-P) & programming. Sam, 218-894-3395.

News reporter in mkt 192 seeks move up, 2 yrs exper in AC/News talk, strong anchor skills, conversational, East Coast but will consider. Matt, 919-452-1133.

Ten year satellite TV C/Ku TVRO technician seeks FT or consulting position in mid-Atlantic area, experienced Unistar, Comtech & Tridom VSAT installer. M Comer, Box 1285, Colonial Beach VA 22443. 804-224-9711.

Have a construction permit? I will get you on the air...construction/hiring/training air & sales staff/programming. Will do programming changes for existing stations. Ritchey Communications, 512-828-9252.

Tampa contract temporary w/22 yrs bdct, audio, RF, telco includes Power Pig construction & AM remotes, also Sony trained editor, Bosch 3-D DVE, self employed MATV. AJ Anello, 813-933-6009.

Personality w/4 yrs exper, seeks on-air position in small or medium mkt, MD & background in AOR, CHR & AC formats, will relocate. N Adams, 97 N 100 W #4, Logan UT 84321. 801-752-1907.

30 yr veteran in radio engineering & equipment sales seeks agreement w/organization to provide field sales &/or engineering support on an expense plus basis. L Darrigo, 803-650-3466.

27 yr bdctr looking for mgmt/buy in option. Owner/mgr, sales, announcing, production, CE experience, great turnaround record, prefer NC-SC-VA areas. B Hull, POB 741, Mt Airy NC 27030. 919-786-4675.

CE/Asst CE, SBE, FCC, Asst CE in LA for 2 yrs, seeks position on West Coast but will consider all. T Brooks, 7201 Haven Ave, Ste E-333, Rancho Cucamonga CA 91701. 818-574-7053.

POSITION ANNOUNCEMENT
ENGINEER TV-RADIO (SALARY: \$42,938-\$45,842)
 Responsible for the maintenance of color TV Studio and small format (1/2", 3/4") color equipment and a campus-wide RF distribution system. Responsible for maintenance of TVRO Satellite System. The applicant will maintain a Class A FM station, do yearly proof of performance testing (as well as design new TV and radio systems). Responsible for the repair of other media equipment, maintenance of additional college electronic equipment. Ability to work with a diverse student/faculty/administration population. Some evening and weekend work is required.
QUALIFICATIONS Demonstrated ability and several years appropriate experience in maintenance of all aspects of radio, audio and TV equipment. Comprehensive knowledge of FM radio station and engineering functions. Bachelor's degree with either SBE Certification or FCC General Class License. Masters Degree in Engineering or a related field preferred, with either SBE Certification or FCC General Class License. Competitive salary and excellent benefits.
 Send cover letter, resume, names, addresses and telephone numbers of three references postmarked by October 15, 1990 to
Harold Bellinger, Affirmative Action Office
Nassau Community College
 Garden City, NY 11530 - 6793
 AFFIRMATIVE ACTION/EQUAL OPPORTUNITY EMPLOYER

Major suburban NYC combo seeks engineer. Experience & ticket required. Salary commensurate w/abilities. Resume to GM, WHUDWLNA, Box 188, Peekskill NY 10566.

Midwest Class B FM/5K stereo AM searching for CE. Strong hands-on in studio & RF maintenance & construction necessary. Also, strong organizational skills a must for this super-busy high profile combo. Excellent salary for successful qualified candidate. Resume w/reference now to: Radio World, POB 1214, Falls Church VA 22041. Attn: Box #90-09-04RW.

Warm water, sand, sun, palm trees, take charge engineer, 3 powerful FM's in Virgin Islands, re-location assistance, salary, tremendous benefits, commensurate w/exp. Fax 809-775-6063.

POSITIONS WANTED

Award winning sports director needs bigger challenge, college/pro PBP, 11 yrs exper. Chip, 409-846-5474.

EMPLOYMENT SECTION

HELP WANTED: Any company or station can run "Help Wanted" ads at the flat rate of \$25 per listing per month (25 words max). Payment must accompany insert; there will be no invoicing. Blind box numbers will be provided at an extra charge of \$5. Responses will be forwarded to listee, unopened, upon receipt. Call 800-336-3045 for display rates.

POSITIONS WANTED: Any individual can run a "Position Wanted" ad, FREE of charge (25 words max), and it will appear in the following 3 issues of Radio World. Contact information will be provided, but if a box number is required, there is a \$5 fee which must be paid with the listing (there will be no invoicing). Responses will be forwarded to the listee, unopened.

Mail To: **BROADCAST EQUIPMENT EXCHANGE**
 PO Box 1214, Falls Church, VA 22041

WE'RE BUYING!
 INTERESTED???
 Then call Jim or Chuck @ 317-962-1471 @ **ALLIED EQUIPMENT EXCHANGE**
BUY We selectively buy used radio equipment
SELL We sell used and new radio equipment
TRADE We take trade-ins for used and new radio equipment
 Allied has served broadcaster needs since the 60s! Our veteran broadcasting salesmen will "horse trade" with you—give them a try today!

317-962-1471

STATIONS . . . WTS

LPTV 1000 W Goleta, Santa Barbara CA, trade, sell, or take partner, BO. G Erway, 3450 SE Martinique, Stuart FL 34997. 407-283-6871.

FM CP for college town, no other radio station in city or county, price includes engineering for C-3 upgrade, \$25,000. D Ballard, KLF, 4410 10th, Lubbock TX 79416. 806-791-1747.

AM / FM / TV BROADCAST OWNERS SELLING? BUYING?

Let our network of brokers assist you in acquiring or divesting your AM/FM/TV or cable properties.

- Your transaction given professional discreet attention.
- Broadcast Brokers experienced in appraising, negotiation and financing your station.
- We have lenders with loan portfolios up to \$500,000,000.00.

+ FCC Licensed Engineers
+ Brokers Licensed by State R.E. Commissions
+ Graduate Appraisers
+ Certified Public Accountant on Staff
+ Member, Society of Broadcast Engineers

May We Have the Opportunity to Assist You? Call for a Confidential Discussion of your Transaction Needs

THE JESSE NEAL BROWDER COMPANY INC.

BROADCAST BROKERS/APPRISERS
202 Whistlewood Ct.
Woodstock, GA 30188
404-928-7906
SPECIALIZING IN THE SOUTHEAST

AM/FM station, 10,000 W AM, Class A approved for Class C FM, western resort area, gd market, popular program & community reception, priced to sell, terms & information on request. J Gayer, West Engineering, 815 Reed St, Lakewood CO 80215. 303-233-8433.

Combo AM/FM & stand alone FM stereo, Class A, some financing avail to qualified buyer, real estate included, \$925,000. G Shurden, 601-843-4091.

BROADCAST APPRAISALS

FOR ANY PURPOSE
+ PRESENT VALUE
+ LOAN VALUE
+ TAX VALUE
+ ESTATE TRANSFERS

Graduate Appraiser
FCC License # PG-6-3024
Georgia Real Estate Broker
License #134955
SBE Certified Senior
Broadcast Engineer

THE JESSE NEAL BROWDER COMPANY INC.

404-928-7906
SPECIALIZING IN THE SOUTHEAST

AM daytimers (2), WFIC, Collinsville-Martinsville VA, 1 kW & WPUV, Pulaski VA, 5 kW, includes real estate, owner financing. L Williams, Rt 1 Box 314, Wirtz VA 24184. 703-647-1530.

Want to Buy

First time buyer looking for small market AM or FM w/little or nothing down & owner financing in NJ, PA, OH & DE. M Gehring, 7 Crestview Dr, Oil City PA 16301. 814-676-3077.

AM fulltime near metro or AM daytimer in small town or LPTV. B Turner, 1000E 3rd, Del Rio TX 78840.

AM/FM/LPTV, owner financing, monthly note plus percentage of gross. Norm, 904-892-4038.

AM or FM East of the Mississippi w/nothing down & owner financing, will consider small cities. Rev P Fleming, POB 1792, Torrington CT 06790. 203-482-9355.

AM, FM or LPTV problem stations, turn arounds, daytimers, dark, etc, send complete details w/price & terms. J Powley, 1536 Logan, Altoona PA 16602. 814-944-8571.

CP's, turn arounds & dark stations. L Fuss, KOOZ, POB 159, Fayetteville GA 30214. 404-460-6159.

LPTV or small market AM, dark or troubled OK, owner financing w/little or no down. B Turner, 1000 E Third, Del Rio TX 78840.

STEREO GENERATORS

Want to Sell

Harris STX-1B & STM-1B AM stereo gen & monitor, both modified for Motorola C-Quam, excel cond, \$7500/BO. B Bailey, KJEF, POB 1248, Jennings LA 70546. 318-824-2934.

Moseley 20A234 26 kHz subcarrier gen, \$30; **Moseley 20A2345** 26 kHz sub-carrier demod, \$30, cards only in an aluminum box on both. B Umberger, WNLT, 813-446-0957.

Harris MS-15R digital stereo gen w/overshoot control, \$800; **BE FC-30** SCA gen on 67 kHz, \$350. J Littlejohn, WYSY, POB 2010, Aurora IL 60507. 708-851-4600.

CCA FM 10DS working when removed from service, \$300/BO. J Stack, WMPO Radio, 614-992-6485.

Moseley SCG-9 stereo gen, \$500. R Coleman, WGEN, Box 67, Geneseo IL 61254. 309-944-4633.

SWITCHERS (VIDEO)

Want to Sell

Sigma Electronics VSS-120 (4) like new, 12x1 w/stereo audio follow, \$100 ea. P Russell, Bowdoin College, Sills Hall, Brunswick ME 04011. 207-725-3066.

Arrakis router switcher, 16 stereo in, 8 stereo out, rack mount, includes power supply & connectors, 5 yrs old, \$600. D Doelitzsch, WDDD, 1 Broadcast Ctr, Marion IL 62959. 618-997-8123.

TAPES, CARTS & REELS

Want to Sell

Beta & 3/4" cassettes, sometimes 1", both large & field size avail, 1/2" s are BC(T)5s, 5 min commercial or 1 hr at Beta 3 speed. P Dowie, Good Sound, 171 Drexel, Lnsdn PA 19050. 215-626-9322.

Easy listening music reels, 10.5", no dupes, all in vgc w/play sheets (250), \$10 ea. J Wenstrom, Wynne Bdcg, 503-882-4656.

A&D Cartridge Rebuilding Service

We clean, load & pack. Serviced within 10 work days! Work guaranteed!
3380 Bately Ave., Eau Claire, WI 54701
(715) 835-7347

Audiopak AA-4, music lengths, like new, \$2.25 ea. R Thomson, KDKB, 1167 W Javelina, Mesa AZ 65202. 602-897-9300.

Fidelipac carts (530), brown/clear shell, \$500; **Audiopak AA-3** carts (300), blue/clear shell, \$450. W Blackwelder, KNUE, POB 7935, Tyler TX 75711. 214-561-0606.

Easy listening music, 250 reels, all vgc, no duplicates, \$10/reel or BO. J Wenstrom, Wynne Bdcg, 1338 Oregon, Klamath Falls OR 97601. 503-882-4656.

Sound Ideas Series 1000 sound effects pkg on reels, 712" ips, excel cond, \$550/BO. T Keenan, 11105 Knott Ave, Cypress CA 90630. 714-892-9469.

Metal reels 10" (60), \$60. J King, POB 2308, Roswell NM 88201.

Metal reels & boxes, (28) 14" in perfect cond, \$140. H Widsten, KGNB, 1540 Loop 337 North, New Braunfels TX 78130. 512-625-7311.

Complete nostalgia/big band format w/2780 stereo cuts on 129 metal reels of Ampex 406, includes 10 reels of big band era Christmas music, comes w/extensive reel sheets, artist, title separation schedules, runs on (3) 10.5 machines, in perfect cond, \$30/reel or trade for equip. S Callahan, WFTI, 1120 Pinellas Bayway, Tierra Verde FL 33715. 813-866-3544.

Fidelipac carts (580), all lengths & conds, extra shells & parts, tape in gd to poor cond, most shells are usable, gray carts, \$500/all. H Widsten, KGNB, 1540 Loop 337 North, New Braunfels TX 78130. 512-625-7311.

Nortronics 9125, 9102, 9103 (2) complete sets, play, record, erase, mono for Ampex 350-351, new. D Agnes, WCLV, 26501 Emery Ind Pkwy, Warrensville OH 44128. 216-464-0900.

AC vocal CD library, great variety of artists, many are Greatest Hits albums; new NAC instrumental CD library, light jazz & new age artists, sold as libraries not individual discs, half price. Nancy Grubbs, KAT-G, 3910 IH 35 South, Ste 300, Austin TX 78704. 512-448-0947 or fax 512-440-0947 for lists.

ABCO wire cart racks (3) on floor stands, holds 500 carts ea; (342) Capitol A-2 carts in fair to gd cond; (36) Capitol A-2 carts, new; (1178) Scotchcart II's in gd cond, containing adult pop/fite jazz library well recorded in stereo; (143) Scotchcart II's, new, all 3.5 or longer; one set of LEL alignment gauges for Ampro cart decks. P Wells, KJCY, San Diego CA. 619-238-1037.

Easy Listening music library, new, 113 instrumental, 88 vocal, \$1000; Beautiful music library, older, 129 vocal/instrumental, \$200. R Coleman, WGEN, Box 67, Geneseo IL 61254. 309-944-4633.

MARATHON PRODUCTS COMPANY

Audio Cartridge Rebuilding Division

Rebuilding/reloading, like new, all brands, any length up to & including 2.5 minutes, \$1.50 ea. FOB our plant, 48 hrs delivery.

New NAB Marathon cartridges prices on request.
35 Years professional experience!
Lifetime member AES R.D.MYERS Sr.
Manufacturers of Audio Devices, Continuous Tape Mag.

69 Sandersdale Rd.,
Charlton, MA 01507

1-508-248-3157 or 1-508-853-0988

Want to Buy

Scotch/Ampex/Agfa 1" wide audio tape used once & bulk erased, either reels or hubs, boxed or un-boxed. T Houston, Custom Audio Recording, 929 California Ave, Bakersfield CA 93304. 805-324-0736.

Classical record library on 78 rpm classical records, pre-recorded R-R tapes, airchecks, etc. D deForrest, 7441 Wayne Ste 10-D, Miami Bch FL 33141.

Blank, small hole recording discs, 10" & smaller, used in 1940's & 50's, aluminum, glass or cardboard base OK. T Edwards, KOZY, Box 597, Grand Rapids MN 55744. 218-326-3446.

TAX DEDUCT EQUIP

Ohio University campus station seeks audio equip of any kind for use in studio & prod room, will pay shipping & send tax deductible receipt. D Harlett, WNWG, West Green Office, Athens OH 45701. 614-597-5885.

High school station in need of cart machines, consoles, R/R, TT's, etc. J Kelly, SCS High School, Ovid NY 14521. 607-869-9636.

R-R tape decks, 10" tapes, VCR's, stereos, TV's. H Saina, Elderly & Disabled, 1213 Pine, Chester PA 19013. 215-497-3990.

Good used bdct equip from cartridges to antenna, Marti or Moseley STL & remote pickup equip. R Joseph, Island Comm, 7712 NW 5th St, Ste 4-J, Plantation FL 33324. 305-424-1734.

Broadcast training school for the underprivileged is in very bad need of any AM bdct equip, tax receipt for the full amount of each donation which will include all shipping costs. F Smith, WCHV, 2408 Chamberlain Ave, Chattanooga TN 37404. 615-624-7126.

Disabled person needs cart machine, TT's, RTR's & CD's for low-watt non-commercial community station, can pay shipping. B Wise, 1632 12th Ave, Oakland CA 94606. 415-261-4798.

Eng student desiring donation of old bdct equip (anything)in repairable cond, will pay all shipping charges. EE student at Purdue. C Gill, POB 371, Indianapolis IN 46206. 317-923-2800.

Monte Vista Christian School, would appreciate any donations of used TV broadcast equipment. T Quinn, 408-475-0423.

TEST EQUIPMENT

Want to Sell

TFT 760-04, 01, 03, very little use, tone generator/decoder, AM rcvr, works perfectly, \$700. T Coucke, KNLS, POB 475, Anchor Point AK 99556. 907-235-8262.

HP 205AG audio signal gen, BO; International Instrument 600 ohm T network analyzer, BO; HP 325B noise dist analyzer, BO. T Liston, WOBL, Box 277, Oberlin OH 44074. 216-774-1320.

RCA WO-91B oscilloscope; Hickok 600A tube tester. E Nearman, KUMU, 441 N Nimitz Hwy, Honolulu HI 96817. 808-531-4511.

B&W 410 tube type dist meter, \$25. B Umberger, WNLT, 813-446-0957.

HP antenna VSWR test equip incl HP608C signal gen, \$350; HP 415B VSWR meter, like new, \$325; directional couplers, \$100-\$450, slotted line, prices incl packing & UPS within continental US. P Onnigian, 1236 40th Ave, Sacramento CA 95822. 916-381-4469.

RCA WO-91B oscilloscope; Hickok 600A tube tester. E Nearman, KUMU, 441 N Nimitz Hwy, Honolulu HI 96817. 808-531-4511.

Potomac Instruments SD-31 RF synthesizer/detector, excel cond, \$1750; Potomac Instruments FIM-21 AM field intensity meter, excel cond, \$1800. H Ginsberg, Communications Eng Inc, 12 Beech St, Essex Junction VT 05452. 802-878-8796.

Leader LBO 524, complete w/manuals, probes, needs no calibration, 40 MHz, hardly used, \$600. D Eresy, WFCC, POB 1308, W Chatham MA 02609. 508-945-4855.

Tektronix 520 vectorscope, strong tube, rackmount, recent recalibration, \$900. G Sive, Video Connection, 31844 Rancho Amigos, Bonsall CA 92003. 619-749-7662.

Potomac Instruments FIM 21 field strength meter, 54-1.6 MHz, gd working cond. G Clarke, Sound Medium Inc. 203-238-7910.

TEST EQUIPMENT

Why Buy When You Can Rent?
POTOMAC, DELTA, BIRD.
Other Equipment Available
Call For Rates and Availability

RADIO RESOURCES

1-800-54-RADIO
1-800-547-2346
301-859-1500

Cushman CE-5 service monitor, 512 MHz AM/FM w/deviator & wideband preselector plug ins, mint, \$1050; Ballentine 500 MHz freq counter, 0.1-10 sec gate, \$125; Davis 7208, 600 MHz freq counter, \$100; Tek RTM 502, new, \$265. R Nelson, Tropical Bdcg, 14093 SW 142, Miami FL 33192.

Tektronix 1L30 spectrum analyzer plug-in, 1.0-10.4 GHz, 105 dBm sensitivity at 20 kHz dispersion, for Tektronix 530, 540 & 550 series oscilloscopes, also incl a Narda micro-line coaxial directional coupler mdl 22836 w/20 dB down pickoff, \$800. B Dickerson, WEAG, 1421 S Water, Starke FL 32091. 904-964-5001.

Want to Buy

Tektronix 520 vectorscope, working or not. B Geniry, KA21VY, 622 Plymouth, Mattydale NY 13211. 315-455-7257.

Complete board A3, reciprocal amp for HP 8690B sweeper; also want 8698B & 8699B plug-ins. Herb, CFQC TV, 216 First Ave N, Saskatoon, Sask S7K 3W3, Canada. 306-373-7919.

TRANSMITTERS

Want to Sell

Harris MS-15 exciter, \$2500; TTC Mdl X exciter, new, \$4500; TTC FM-300J solid state 300W FM xmr, new, \$7500; Sintronics 10W solid state FM exciter, \$850. G Gasky, KWHQ, 261 Main, Ste 6, Weed CA 96094. 916-938-3828.

Elcom Bauer 605C 5 kW FM single phase, one tube w/exciter, new, \$25,000/BO. V Michael, 575A Montroney Pike, Williamsport PA 17701. 717-323-6200.

Harris FM-40K (2), center cabinet, (2) MS-15 exciters, combiner, reject load, etc, on air now at 101.3 MHz, avail late June, will split into (2) 20 kW's, \$60,000 complete/BO. J Buckham, KIOI, 700 Montgomery, San Francisco CA 94111. 415-956-5101.

Collins 20V-2 completely rebuilt solid state lower deck. Dale, 503-774-0459.

CCA 10,000D AM 10 kW, gd cond on 1210, BO. J Stanford, WYLD, 2228 Gravier, New Orleans LA 70119. 504-822-1945.

Gates AM BC1G, excel cond, \$2500/BO. WRDN, Box 208, Durand WI 54736.

RCA-50H 50 kW in great cond, \$15,000. V Stone, WMMO, POB 81, Cascade VA 24069. 804-685-3128.

Homebrew 50 W AM, 19" rack mount style, 8-34" by 11", 32 lbs, \$700. J Cunningham, KHKC, Rt 2 Box 113B, Stonewall OK 74871. 405-265-4496.

Sparta 680 FM exciter w/681 meter panel, not working, \$200. B Umberger, WNLT, 813-446-0957.

RCA BTE-15 w/SCA gen & stereo gen w/crystal. Dale, 503-774-0459.

RCA BTA-50H 3-plate transformers & complete set of schematics, you pick-up at site, non-PCB. D Niccum, KCKN, POB 670, Roswell NM 88202. 505-622-6450.

Collins 830 FM, xmr, exciter, 4 bay antenna & 165' feedline, all tuned to 95.3 MHz; Gates 250 AM xmr on 1520 kHz, all working fine when removed, BO. C Veirs, WBHT, POB 198, Brownsville TN 38012. 901-772-3700.

TRANSMITTERS FM - AM - LPTV ALL POWER LEVELS 1-800-279-3326 J & L ASSOCIATES P.O. BOX 25966 Colorado Springs, CO 80936

LPB AM-30/TCU-30 30 W carrier on 830 MHz, excel cond, \$700/BO. Neu-Comm, 1240 Riverbreeze, Ormond Bch FL 32176. 904-441-6956.

RCA BTF-3B 3 kW FM on 98.5 MHz, for parts, BO. D Hancock, POB 234, Hanover PA 17331. 717-637-3831.

FOR SALE

- Continental 802A Exciter, Like New
- Mc Martin B910 Exciter, With Stereo Gen and SCA Gen. Low Low Price
- Moseley MRC-1600 Remote Control, New W/Full Warranty. Priced at cost!
- Shively 6810 Eight Bay w/Heaters. Mid-Band

(816)-635-5959

Gates FM1B, 1 kW, clean, vgc, just removed from service, \$2500. M Guidotti, KKKL, 143 Fifth St, Ste 5, Colusa CA 95932. 916-458-5558.

FM 3 kW transformer, never used. D Smith, WFCB, Box 94, Chillicothe OH 45601. 614-773-3000.

Radio Systems TR-20/CP-15 20 W carrier on 820 MHz/530 MHz, excel cond, \$600/BO. Neu-Comm, 1240 Riverbreeze, Ormond Bch FL 32176. 904-441-6956.

CAPACITORS OVERNIGHT

- Power Supply computer grade: up to 450VDC
 - Transmitting - MICA Sangamo, Cornell-Dubilier
 - Oil Filled Non-PCB Oval, Rectangular
 - Relays - Filters - Transistors Any Parts starting with 1N or 2N
- 1-800-323-0460**
FAX 1-802-425-3664
Kellner Electronics, Inc.
Charlotte, VT 05445

Harris MW 1 in excel cond on 1340, \$9000; Bauer 1 kW AM, gd cond, \$4000. E Moody, KJEM, 216 N Main, Bentonville AR 72712. 501-273-9039.

RCA TTU-60 UHF xmr/diplexer system w/Townsend exciter operating on ch 19 currently, avail Spring 1991, BO. D Roden, 1701 Monte Sand Blvd, Huntsville AL 35801. 205-533-3676.

FINEST REBUILT TRANSMITTERS

FM TRANSMITTERS

1 kW	Gates	FM1B
1 kW	ITA	1000B
1 kW	RCA	BTF1D
1 kW	Collins	830D1
1 kW	RCA	BTF1E
1 kW	Harris	FM 1H
2.5kW	Collins	831D1
2.5kW	Continental	814R2
3 kW	RCA	BTF 3E
3 kW	G.E.	3KW
3.5kW	B.E.	3.5A
3.5kW	McMartin	BF 3.5K
5 kW	RCA	BTF-5D
5 kW	RCA	BTF-5E
10 kW	RCA	BTF10D
10 kW	Gates	FM10B
10 kW	Harris	FM 10H
20 kW	CCA	20,000E
20 kW	Collins	831G1
20 kW	RCA	BTF-20E1
25 kW	Wilkinson	25000
25 kW	McMartin	BF25K
25 kW	Harris	FM-25K
30 kW	McMartin	BF30K

A&B EST-300, 300 W, solid state RF amp, new. C Springer, KLMR, POB 890, Lamar CO 81052. 719-336-2206.

CSI EX-20F 20 W freq programmed, excel cond w/instruction manual, \$1995. T Scott, WWI/Q, 6568 143rd Ave, Holland MI 49423. 616-394-12

TRANSMITTERS! TRANSMITTERS! TRANSMITTERS!

AT LAST!

Quality Rebuilt AM & FM Transmitters Delivered, Matched To Your Antenna, and Placed On The Air. And, For No More Than You'd Pay For a Transmitter In Pieces From The Other Guys.

When you buy a BTS transmitter, we deliver it on our company truck. We place it in your transmitter building. And, the *very best* transmitter engineer in America places it on the air for you. When we're finished, you know how it will sound because it's On the Air. No other way of buying a used transmitter makes sense. Overseas and Alaskan/Hawaiian services are available, too!

We'll take your old transmitter and other broadcast gear in trade!

Complete turnkey station construction available!

Broadcast Transmission Systems
7008 Lock Lommand Austin, Texas 78749
(512) 448 - 0058

UHF & VHF TV translators, 10-100 W, will consider old UHF band 70-83 equip; low band 2-6 VHF TV xmitr, 100 W to 11 kW. J Powley, 1536 Logan, Altoona PA 16602. 814-944-8571.

Late mdl 1 kW AM wanted, no junk. L Fuss, KOOZ, POB 159, Fayetteville GA 30214. 404-460-6159.

Low power AM, 250-300 W, rack mount, for standby, will consider BC250GY. J David, KMPL, POB 907, Sikeston MS 63801. 314-471-1520.

BROADCASTING EQUIPMENT "AM, FM, TV"

All powers and conditions. We dismantle and pick up.

TRANSMITTERS STUDIOS STL

I.B.S.

International Broadcast Supply
1771 N. Powerline Road.
Pompano Beach, FL 33069
Tel. 305-977-9111
FAX. 305-977-0488

RCA TTU-1B or TTU-2A UHF TV xmitrs for parts; GE TT-24-A 100 W or TT-20-A 1 kW UHF for parts; RCA instruction manuals for TTU-10A UHF TV xmitr. J Powley, 1536 Logan, Altoona PA 16602. 814-944-8571.

AM 250-500 W for auxiliary use, anything but basket cases considered. J McAulay, KITH, 21810 Hwy 18, Apple Valley CA 92307. 619-247-1111.

McMartin older B-910 FM exciter. C Goodrich, 11435 Manderson, Omaha NE 68164. 402-493-1886.

McMartin AM/FM xmitr, any model, exciter or stereo modules. Goodrich Ent., 11435 Manderson, Omaha NE 68164. 402-493-1886.

TUBES

Want to Sell

3CX3000A7 power tube, just rebuilt, BO. C Springer, KLMR, POB 890, Lamar CO 81052. 719-336-2206.

ECONCO

Quality Rebuilt Tubes

Approximately 1/2 the Cost of New

Call for Our Price List
800-532-6626
916-662-7553

FAX 916-666-7760

EIMAC 4-400A, (2), approx 1000 hrs, \$125 ea. M Guidotti, KKLK, 143 Fifth St, Ste 5, Colusa CA 95932. 916-458-5558.

For the Best Prices

& 24 Hr service on transmitting tubes call 402 493 1886 day or night. FAX 402 331 0638. TELEX 940103 WU PUB TLX BSN

3B28, \$10; 575A, \$30; 813, \$40; 837, \$20, others, all new. R Humphrey, WLTJ, 7 Parkway Ctr, Pittsburgh PA 15220. 412-921-8254.

ELECTRON TUBES

Partial List: 6623, 23791, TH150, 6425F, 5604, 6696, 6697, 5681, 5682, 5671, 7804, 3CX10, 000H3, 3CX20, 000H3, 4CX5000A, 4CX35, 000C

Vacuum Tube Industries, Inc.

1-800-528-5014

3CX1500A7, 4CX5000A, 6146B, 4CX2508, 4CX3000A & more. We carry large inventory all major brands, Eimac, Amperex, RCA, etc. Call Stew 1-800-842-1489.

ARMSTRONG TRANSMITTER

FINEST REBUILT TRANSMITTERS

We're the leading re-manufacturer of transmitters worldwide.

Transmitters are available:

- * Tuned & Tested on YOUR Frequency
- * Guaranteed and Installed
- * Completely Re-manufactured
- * Expedited Service Available

Trade-Ins gladly accepted - **WE DELIVER!**
See your choice in transmitters WORKING in our huge new showroom BEFORE you take it home!

**NO ONE ELSE OFFERS YOU THIS!
SEE & TEST IT ALL YOU WANT!**

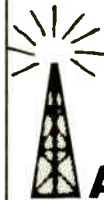

ARMSTRONG TRANSMITTER CORP.

5046 Smoral Road Syracuse NY 13031
Phone 315-488-1269 FAX 315-488-1365
Hablamos Español: 305-471-1180



On parle français—Hablamos español—Turkçe konuşabiliriz

Circle 121 on Reader Service Card

TRANSMITTERS ... WTS

BE FM 3.5A w/FX-30 exciter, upgrading to C2, will remove 9/90. B Bailey, KJEF, POB 1248, Jennings LA 70546. 318-824-2934.

Harris STX-1B AM stereo exciter, Harris STM-1B AM stereo monitor, both operating true C-QUAM system, excel cond. B Bailey, KJEF, POB 1248, Jennings LA 70546. 318-824-2934.

Want to Buy

1 kW FM, complete, 103.7 M or near, call or write. V Danielson, HRVC Honduras, RR2 Box 2791, Arlington MN 55307. 612-964-2838.

TOP DOLLAR

For Your Old Transmitter, STL or Exciter!
Call for a quote
We arrange quick dismantling & removal PCB's? No Problem Call Us.

ARMSTRONG TRANSMITTER CORP.
5046 Smoral Rd
Syracuse, NY
(315) 488-1269
FAX (315) 488-1365

250-500 W FM xmitr or pwr amp for auxiliary, have exciter, hi miles ok if in gd wrking cond. K Browell, Box 808, Riverton WY 82501. 307-856-2922.

Any FM model & equip related to put up new 88.9 FM station in Lorain OH including 300' tower, ss or guyed. C Arroyo, Box 436, Arcibo PR 00720. 809-878-0070.

Collins 1965 21M, 10/5 kW AM, new tubes. B Bie, 80 N Tillman, Memphis TN 3811. 901-323-2679.

Harris, Continental 1982 or later, AM 10K. R Payne, 774 Roswell St, Marietta GA 30060. 404-424-9850.

1 kW FM looking for good, used, reliable, any or all. Ken, POB 617, Cuba MO 65453. 314-239-6800.

WANTED

AM and FM Transmitters, all powers. Finders fee for locators. DON'T take the chance of not being paid, sell to the oldest broadcast supply house in Latin America.

GUARANTEE RADIO SUPPLY CO.

1314 Iturbide LAREDO, TX 78040
(512) 722-3233
(512) 727-8458 (fax)

FIRST FOR ALL YOUR FM NEEDS:

- Exceptional FM Exciter Performance
- Advanced Line of 1kW to 8kW Total Solid State FM Transmitters
- Full Line of FM Transmitters from 150 Watt to 50kW to Meet All Your FM Needs
- Excellent Financing Available

TTC
813-684-7724

Harris 1976 FM 2.5 H3 2500 W FM w/TE-3 exciter w/stereo gen, spare driver tube, new, (2) finals, \$8000. R Parker, WTAZ, 332 Detroit, Morton IL 61550. 309-263-0102.

Bext has some show units at sale price. Full 2 yr warranty, like new. Exciters, amplifiers, STL's. First come first served only. Call for details. Bext. 619-239-8462.

QE1 675 broadcast FM exciter, new, never used on the air, \$1950 plus shipping. Davis, 802-656-1916 or 527-7230.

FM TRANSMITTERS
10 kw
RCA BTF-10E1
Excellent Condition
Located in Top 5 Market
Operated at 50% Power
as Main/Alternate Main
Other Power Levels always Available: 1-5-20 kw
Leasing to qualified buyers
The Best Prices Worldwide
414-482-2638

Want to Buy

RCA 6181 & 8501 & GE GL-6183 used as final in RCA & GE UHF TV xmitrs. J Powley, 1536 Logan, Altoona PA 16602. 814-944-8571.

We buy electron tubes.
Contact us if you have any for sale.

BETHPAGE ASSOC.

507 Superior Ave.
Newport Beach CA 92663
714-722-6733

European receiving tubes, EL3N, HM309, EBF-2, EF9, EF43 & others, also buying multiband European auto radios by Telefunken, Becker, Blaupunkt. W Wilkes, Box 103, Briston, PA 16620. 814-378-8526.

TUBE REBUILDING

FREELAND PRODUCTS

Since 1940
SAVE ABOUT 50%
—We buy dud tubes—
800-624-7626
504-893-1243
FAX 504-892-7323

REBUILT ELECTRON TUBES

Partial List: 6623, 23791, TH150, 6425F, 5604, 6696, 6697, 5681, 5682, 5671, 7804, 3CX10, 000H3, 3CX20, 000H3, 4CX5000A, 4CX35, 000C

Vacuum Tube Industries, Inc.

1-800-528-5014

TRANSCOM CORP.

Fine Used AM & FM Transmitters and Also New Equipment
For the best deals on Celwave products, Andrew cable, Shively & Comark antennas.

1975	CCA 2500R, 2.5 kW FM	1986	Cont. 314R1, 1 kW AM
1975	Harris FM5H3, 5 kW FM	1974	Harris BC1H1, 1 kW AM
1975	RCA BTF 10ES1 10 kW FM	1981	McMartin BA 2.5 k, 2.5 kW AM
1972	CCA 20000DS, 20 kW FM	1979	Harris MW5A, 5 kW AM
1976	RCA BTF 20E1, 20 kW FM	1966	Cont. 315B, 5 kW AM
1983	Wiik. 25000E, 25 kW FM	1978	Collins 828E1, 5 kW AM
1976	CCA AM-50,000D, 50 kW AM	1981	McMartin BA5K, 5 kW AM
		1972	CCA AM5000D, 5 kW AM

201 Old York Rd. • York Plaza Ste 207
Jenkintown PA 19046
215-884-0888 • FAX No. 215-884-0738

PETER DAHL CO.

Save \$\$

Heavy Duty Replacement Transformers, DC Filter chokes and capacitors for AM & FM transmitters manufactured by: AEL, CCA, CSI, COLLINS, CONTEL, CONTINENTAL, BAUER, GATES, GE, HARRIS, ITA, McMARTIN, RAYTHEON, RCA, SINGER, SINTRONIX, WILKINSON. Many other models also available.

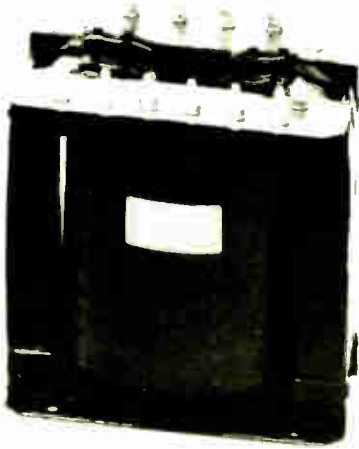

FAST Delivery and FREE Technical Support.



5869 WAYCROSS AVENUE EL PASO, TEXAS 79924
(915) 751-2300 TELEX: 76-3861 PWDCO
FAX: (915) 751-0768

Circle 81 on Reader Service Card

TURNTABLES

Want to Sell

Technics SH 10B3 TT base, \$150. B Umberger, WNLIT, 813-446-0957.

Russco Studio-Pro TT's w/arms, \$225. W Blackwelder, KNUE, POB 7935, Tyler TX 75711. 214-581-0606.

Ramko TT preamp, \$25. C Hall, WZOU, 235 Bear Hill, Waltham MA 01254. 617-290-0009.

Russco Cue-Master (2), 33/45/78 TT's, BO. T Liston, WOBL, Box 277, Oberlin OH 44074. 216-774-1320.

Gemini 1500 II (2), clone of Technics 12301, new w/AT cartridge w/boxes, etc, \$229 ea. C Keith, ALI, 9 Roxbury, Keene NH 03431. 603-352-8460.

Technics SP10MKII (2) in working cond complete w/F/SP10MKII, IV bases, \$800 ea; Audio Technica APT12T tonearms (2) in working cond, \$250 ea. M Lashutka, WOBC, Oberlin College, Oberlin OH 44074. 216-775-8107.

Harris CB1204 TT's (2) w/arms & cartridges, \$25 ea. R Coleman, WGEN, Box 67, Geneseo IL 61254. 309-944-4633.

Russco Studio Pro B (2), excel new idler wheels, \$150/ea; Rek-O-Kut G-2 new old sock, \$100; Grey viscous damped 12" arm, \$35. Kremer Kraft, 301 SW 16th St, Ft Lauderdale FL 33315. 305-524-5652.

Sony CDP-620es CD player. P Wells, KJQY, San Diego CA. 619-238-1037.

Want to Buy

Thorens TT plays 33, 45 & 78's, w/cart. J Gangwer, 942 32nd St, Richmond CA 94804. 415-644-2363.

Dual 1218, need a hard shell. A McCartney, 600 E Main, Valaville CA 95660. 707-446-0200.

Presto 80-G & 92-B service info, on lathe & amp, photo copies OK. C Lund, Cycle Sound, 167 Madison St, Waterbury CT 06706. After 5:30 PM. 203-756-7761.

TV FILM EQUIP

Want to Sell

Collectable/usable film snd recording equip including Pro 600 mag head, MA-11, orig mic, PS, cables & book; Auricon NR optical snd amp; Magnesync DR-1 monitor panel only w/book; Neumade film measuring machine mdl DS16D w/circular dial plus traditional footage counter; Frezzi pwr pack; Siemens interlock proj, BO. P Dowie, Good Sound, 171 Drexel, Lnsdn PA 19050. 215-626-9322.

VIDEO PROD EQUIP

Want to Sell

CBS NTSC 5500A; CBS chroma keyer 7000; CBS image enhancer; CBS sensor-RC. J Phillips WZOM, 408-1/2 Clinton, Defiance OH 43512. 419-782-8591.

JVC KA-3U component back adapter, Beta-cam or M format for KY series cameras, perfect cond, \$495; Panasonic WV-6000, S1-System high resolution saticon, gen locable camera w/complete ENG package, like new, \$795; JVC RM 70-U remote control unit for 34" systems, perfect cond, \$295. D Brennan, Custom Video, 3596 Lorna Ridge Dr, Birmingham AL 35216.

Microtime 1020 TBC, w/manual, \$1500. Dave, 17094 McGuffie, Salinas CA 93901.

Sony GSL-50 Editpak hi-band Beta edit system RM-50 edit ctrlr, cables, like new, \$3500. G Jackson, Clocktower 216, Nashua NH 03060. 603-883-7435.

Otari EC-201 hand-held time code reader for location work, \$250. P Cibley, Cibley Music, 138 E 38 St, Nyny 10016. 212-986-2219.

Panasonic AG-A750 edit control w/cables, mint cond, \$580; Convergence CI-90 TC reader/burn-in unit, excel cond, \$380; Panasonic WJ-810 time/date gen w/stop watch function, \$250. Hilary, Vidcom, 412-327-1333.

Sony VPH-1020Q professional big screen projector to 100" or larger, mint, portable case, RGB/composite interface for graphic computer displays, manuals, \$4800. S Cislter, 728 Zorn Ste 10, Louisville KY 40206.

Microtime 1020 TBC, all manuals, excel cond, \$1500. D Lahey, Pathfinder, 17094 McGuffie, Salinas CA 93907. 408-663-5192.

Otari EC-201 portable hand-held SMPTE time code reader, \$250. P Cibley, Cibley Music, 138 E 38th, Nyny 10016. 212-986-2219.

Want to Buy

Solid state, rack mount color studio monitor, working or not. B Gentry, KA21VY, 622 Plymouth, Matydale NY 13211. 315-455-7257.

Video production editing, ENG or the entire bus, we will buy, sale, trade or consign. Call 301-840-0296.

Early RCA, Dumont, GE color & B&W monitors. A Weiner, 14 Prospect Dr, Yonkers NY 10705. 914-423-6638.

VIDEO TAPE RECORDERS

Want to Sell

JVC CR4400U 3/4 port recorders (4) w/access \$800 ea/BO; (3) Sony RM-6300 edit controllers, \$500/BO; JVC BR-6400U VHS recorder, \$1500/BO. T Quinn, Monte Vista Std, 208 Cherry, Capitola CA 95010. 408-475-0423.

JVC CR-850U 3/4" w/address trk time code \$6000/ea. A Baker, 804 E 38th St, Indianapolis IN 46205. 317-925-7371.

Sony VO-5600 (3), \$1200; Sony VP 7000 source player, \$1000; Panasonic BT-1900N underscan monitor, \$350; Tek 528A waveform, \$1500, all like new. B Dorsey, 212-675-0477.

Sony VP700 3/4" video player, vg cond, BO; NSS-4 channel share switcher & 1 lll' moneymaker used for cable ad insertion, BO. D Staats, POB 1346, Parkersburg WN 26102. 304-863-3319.

Sony SLO-340 portable Betamax; JVC HR4100AU portable VHS, both w/AC adaptor, \$200 ea. S Cislter, 728 Zorn Ste 10, Louisville KY 40206.

Panasonic AU300 B M1, bdct quality editor decks w/TBC, (5) almost new, \$4495/ea. C Wiegand, 7758 Lafayette Rd, Newark OH 43055. 614-967-0059.

Ampex 1200B 2" quad (2) to trade plus big box of manuals & spares for RCA TP-66 film chain projector, Mid-Atlantic area please. P Badger, WVES, Box 104, Birdsnest VA 23307. 804-442-4037.

JVC CR6600U 3/4" recorder, feeder deck for JVC edit system, low hrs, nice shape, new drum, \$950. J Kreines, 5330 Kennedy Ave, Millbrook AL 36054. 205-285-6179.

Ampex 1" VR-7500X R/P; Ampex 1" VP-4900C play only, Ampex 1" R/P for parts, all look very gd, stored several years, \$500/BO. B Perry, Ainsley Comm, 1520 Market, Little Rock AR 72211. 501-221-1380.

Ampex VR 1200 C (2), \$1000 ea. L Schrecongost Rcdg, POB 1032, Indiana PA 15701. 412-349-5706.

Want to Buy

Panasonic AG-2200 in gd cond. W Dalzell, 3033 Locust St, St Louis MO 63103. 314-531-3555.

Early Ampex slow motion recorder. A Weiner, 14 Prospect Dr, Yonkers NY 10705. 914-423-6638.

ACTION-GRAM

Equipment Listings

Radio World's Broadcast Equipment Exchange provides a FREE listing service for all broadcast and pro-sound end users. Simply send your listings to us, following the example below. Please indicate in which category you would like your listing to appear. Mail your listings to the address below. Thank you.

Please print and include all information:

Contact Name: _____
Title _____
Company/Station _____
Address: _____
City _____ State _____ Zip _____
Phone Number: _____

Brokers, dealers, manufacturers and other organizations who are not legitimate end users can participate in the Broadcast Equipment Exchange on a paid basis. Listings are available on a \$25/25 word basis. Call 1-800-336-3045 for details and complete display rates.

I would like to receive or continue receiving Radio World FREE each month. YES NO

Signature _____ Date _____
Please circle only one entry for each category:

- I. Type of Firm**
- D. Combination AM/FM station
 - E. Commercial AM station
 - F. Commercial FM station
 - G. Educational FM station
 - H. Network/group owner
 - F. Recording studio
 - G. TV station/teleprod facility
 - H. Consultant/ind engineer
 - I. Mfg, distributor or dealer
 - J. Other _____
- II. Job Function**
- A. Ownership
 - B. General management
 - C. Engineering
 - D. Programming/production
 - E. News operations
 - F. Other _____

WTS: WTB: Category: _____

Make: _____ Model #: _____

Brief Description: _____

Price: _____

WTS: WTB: Category: _____

Make: _____ Model #: _____

Brief Description: _____

Price: _____

WTS: WTB: Category: _____

Make: _____ Model #: _____

Brief Description: _____

Price: _____

WTS: WTB: Category: _____

Make: _____ Model #: _____

Brief Description: _____

Price: _____

*Closing for listings is the first Friday of the previous month. All listings are run for 3 months unless otherwise notified.

703-998-7600

Broadcast Equipment Exchange • PO Box 1214 • Falls Church VA 22041 FAX: 703-998-2966

Something Very Good Just Got **BETTER!**



A-32EX On-Air Console

Finally engineers confined to tight budgets can choose a console that won't compromise station reliability or signal integrity. After all, the A-32 is a Wheatstone console. It borrows from the componentry and design of our larger A-500 consoles, currently installed in major markets all over the country, from frontline independents to national networks.

Our new A-32EX is even better, with ample expansion room for additional inputs and a powerful family of accessory modules, including our new MP-32 talkshow module (that neatly interfaces multiple hybrids, tape recorders, announcer mics and studio-to-caller feeds), our ICM-32 six station intercom module (letting you communicate with other console locations and announce studios), and our SC-20 studio module (to provide comprehensive studio monitor, automatic muting, and talkback functions), plus multiple line selector and machine control modules, and a complete family of studio turret components.

The A-32EX console features modular construction, a fully regulated rackmount power supply, logic follow, full machine control and of course, an all-gold contact interface system. It has two mic channels and fourteen stereo line input modules, each with A/B source select and Program/Audition bus assign, plus Cue switches on the line modules. Standard features include Program and Audition VU meters, digital timer, and a monitor module for control room and headphone functions. The console is also available in a smaller version (the A-20) with two mic channels and eight stereo line input modules.

The A-32EX is a perfect choice for stations planning an upgrade in signal quality and control room image. It's also a natural choice for the newsroom. So profit from Wheatstone's experience and reputation—call us today for immediate action!

 **Wheatstone Corporation**

5720 V.I.P. Parkway Syracuse, N.Y. 13211 (TEL 315-455-7740 / FAX 315-454-8104)

Circle 62 On Reader Service Card
World Radio History

It's Handled!

Customize your A-500 Console with Wheatstone's powerful accessory modules! We've handled auto-sequencing, telephone call-ins, and intercom requirements. Our auto-sequencing line input will take the rush out of back-to-back carts. Our multiphone module can handle 3 callers, 3 mics and reel-to-reel machine control all at once. Our new 8-station intercom module will link up all your studios and talent positions...

AUTO-SEQUENCING: The SL-500as input module allows the DJ to automatically sequence through a pre-loaded bank of cart or CD machines. All audio and machine control functions are handled by the module's logic circuitry. When the first ON switch is pressed, that module's associated machine automatically starts to play; when it has finished the channel is turned OFF, the next programmed module is turned ON, and its machine starts to play. Dead air and missed spots can be a thing of the past with this sequence function.

TELEPHONE/TALK SHOW: The MP-500 multiphone module offers a totally new way of handling telephone talkshow functions. Operation is simple: when the announcer wishes to do a phone segment he simply activates the MP-500 module and all mute, level, combining, and machine control functions are handled automatically. The MP-500 permits conferencing between 3 callers and 3 microphones, and provides separate multitrack tape feeds for various mic/caller signal combinations, permitting simple track punch-ins to replace razor and tape edits. This module eliminates complicated announcer set-ups, miscalls, and feedback problems.

COMMUNICATIONS: The ICM-500 module is part of a completely integrated intercom system; a family of modules available for all Wheatstone broadcast and production consoles. It even includes a rackmount version for your equipment room or remote hook-ups. It allows direct communication between 8 locations in your facility. Your intercom needs are handled by simply plugging in this module set.

TAKE ADVANTAGE of our expertise and reputation. Call Wheatstone. Let our application engineers handle your toughest requirements.

 **Wheatstone**® Corporation

6720 V.I.P. Parkway, Syracuse, NY, 13211 (tel 315-455-7740/fax 315-454-8104)

Circle 25 On Reader Service Card

World Radio History

