

SOUND COMMUNICATIONS

Volume 38 Number 1

January 27, 1992

MONEY IN BOARDROOMS

In these recessionary times how can you outpace your competition? Rep Dave Taylor explains how to make presentations to prospective clients, what kind of systems sell best and how to fit them to your client's needs, new markets within the industry and how to get paid. **42**

CONFERENCING TODAY

When is the speakerphone a conference system? Technical improvements will bring full audio conferencing systems to those currently screeching into the squawk box. **22**

CAD TOPICS

Our continued coverage of CAD software for design and installation purposes reveals a plethora of upgrades major manufacturers. **73**

IN THIS ISSUE

• TeleCon XI

Videoconferencing, video telephones, distance learning: corporate uses are increasing and technology is driving new products. **30**

• The Contractor and Teleconferencing

The same customers in the same geographic areas that you have serviced for years are most likely looking for a teleconferencing system. **38**

• Processing Loudspeakers

They're loved and they're hated, praised and denigrated. What's the truth about processing loudspeakers? Our series begins this month: The State of the Science. **15**

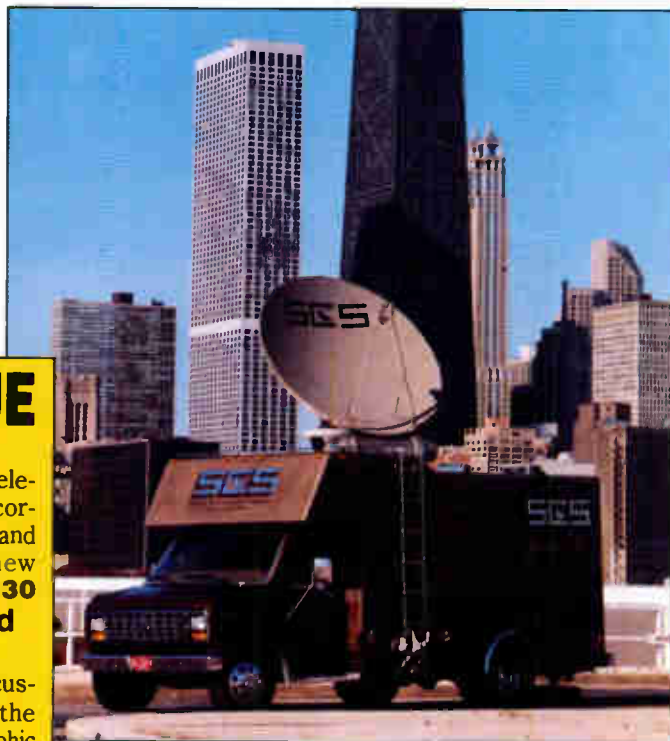

SPANNING THE GLOBE

The same technology that's been used covering the Persian Gulf War and other major events is rapidly becoming necessary for corporate presentations where video conferencing is involved. Sound contractors are looking to satellite receiver installation

in homes, bars, motels and other commercial facilities. **52**

JOB DOCUMENTATION

Lose the labels and you'll lose time and face. A contractor reports on how to document the job — for easy installation, renovation — and billing. **59**

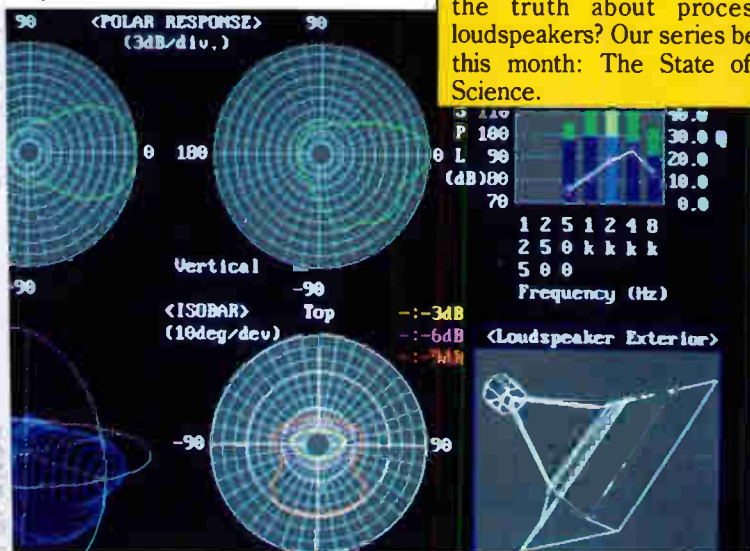
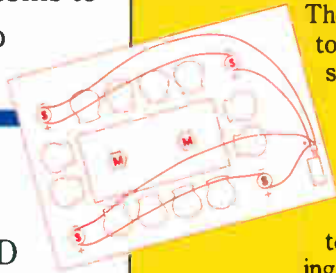

Microphones

for

ALM™ 16

Electret Condenser Podium Microphone

△ The ALM™ 16 microphone offers a unique combination of features which ideally suit it to virtually any lectern, podium, rostrum, or similar application. A wide frequency response is subtly tailored for natural voice reproduction with optimum articulation. Off-axis rejection is carefully engineered for effective suppression of feedback and effects of reverberation. △ For positioning, the arm consists of an 18" length of flexible tubing with the two flexible ends permitting a nearly infinite choice of microphone positions, while preserving a neat and clean appearance.

every

application.



ACM™ 1

Miniature Unidirectional Microphone

△ The ACM™ 1 is a very small, unidirectional condenser microphone designed primarily to be suspended over choirs, instrumental ensembles, or stage areas for sound reinforcement and/or recording. △ The small size allows one or more ACM 1 mics to be hung or "flown" in virtually any application with no distraction or sight-line obstruction. It can also be easily concealed in scenery or props when desired. △ The very uniform, cardioid polar response is highly effective in suppressing feedback and unwanted sound as well as minimizing undesirable coloration of off-axis sources. A subtly rising high frequency response characteristic is incorporated into the design to compensate for the high frequency roll-off inherent in this kind of pick up.



ASM™ 1

Unidirectional Microphone

△ Specifically designed for low profile, surface mounted microphone applications. The ASM™ 1 consists of a wide range unidirectional condenser capsule, so mounted in its rugged housing that it becomes part of the acoustical boundary when placed on a flat reflective surface. △ The excellent performance, low profile, and rugged construction of the ASM 1 make it an ideal choice for many applications such as footlight areas for stage productions, on conference tables or TV news desks, on church altars, as a "plant" microphone on walls or ceilings of sets, and in any number of related situations. For instrumental music applications it may be mounted to the side of a grand piano lid, used in front of or inside kick drums, or in front of instrument amps.



PEAVEY

ARCHITECTURAL ACOUSTICS ©

Peavey Architectural Acoustics. A company dedicated to supplying the market with the best "permanent installation" sound products available, both in quality and price. From zone amplifiers, receivers, mixers, speakers, and microphones to accessories. All the products you need to meet your sound contractor needs whether it be for churches, offices,



retail outlets, gymnasiums, schools, auditoriums, grocery stores, or factories. For more information call/write:
Peavey Electronics Corporation • 711 A Street, P.O. Box 2898,
Meridian, MS 39302 2898 • (601) 483-5376 • Telex 504115 • FAX (601) 484-4278

Sharp presents two new LCD Color Video Projectors. They're both brighter and lighter.



XG-1500 ceiling mount



XG-1100 portable

LCD PROJECTION SYSTEMS

SHARP VISION™

Now you can brighten up your presentations with two new convergence-free professional LCD video projectors from Sharp.

Both the XG-1100 (portable model) and XG-1500 (ceiling-mount model) are brighter, lighter and more compact. And, because they are Solid State LCD, they also set up in seconds.*

The XG-1100, with its top-mounted carry handle and optional carrying case, is a smooth traveler. And the XG-1500, with its back-lit wireless remote and space-efficient design, is a natural for any ceiling, wall or even shelf-mount installation.



Both models incorporate industrial-type BNC video inputs as well as an S-Video terminal, so they connect easily to a wide variety of sources—including many PCs. Plus, for improved compatibility, the XG-1500 also features built-in RGB.

With both XG-1100 and XG-1500, you also get a 20"-100" zoom lens, a convenient scan reversal switch (for rear-projection use), as well as 3-wire (grounded) power cord. And, with a readily available long-throw lens, VGA or Mac II™ graphics interface, these projectors are all set for almost any special multimedia application.

*Sharp's Twin-TFT Solid State LCD technology means absolutely no technical set-up

Contact your local authorized Sharp Professional Products dealer for a demonstration. Or call (201) 529-8731 or FAX: (201) 529-9636. Once you do, you'll see why Sharp Solid State LCD color video projectors leave CRT 'tube' projectors in the dark.

Simulated screen image



SHARP.
FROM SHARP MINDS
COME SHARP PRODUCTS™

© 1991 Sharp Electronics Corporation, Professional Products Division, Sharp Plaza, Mahwah, NJ. 07430-2135
Circle 209 on Reader Response Card

World Radio History

LETTER FROM THE EDITOR

Wishes and Plans for the Coming Year

Someone complained about me the other day. Really. A reader (manufacturer) told a couple of people here that these letters from the editor "aren't technical." We didn't know they were supposed to be. If they were, I wouldn't write them. Technical esoterica and nuts and bolts info are left here to those better qualified. That's why we have engineering resources on staff.

My purpose in writing these letters is simply to let you know what we're doing. If it's not helpful, well skip over it and go to the meat of the magazine in the following pages.

What I want to say this month is very simple: Happy New Year.

The past year has been euphoric for almost no one. And the next year is frequently marred by predictions of "blood-letting," to quote my most famous local newspaper. This industry is fortunate in being one of small businesses on the whole which have traditionally been short on fluff and have traveled lean. Lean and mean may be the phrase for 1992, as insecurity and conservation of resources become the dominant patterns.

I said that these letters are written to tell you what we're doing. What are we doing in 1992? Well for one thing, we're strengthening what we view as our mission to service our readers. We're planning more articles telling you what your colleagues are doing. We're planning more writing by experts on the hows and whys of what's going on technically in product and in business aids. (No I don't write these articles, as you know. Engineers and others who really use them write about them.)

We're strengthening our "Product Check" feature, in which you our readers tell us what equipment they're using in which kinds of jobs. There are always some surprises in that section, and we appreciate your interest.

We will continue to travel to myriad conventions to bring back to you the information you may want and help you stem the

tide of travel. This industry is an unusual one. There is only one show that is completely on-target and, in our view, pretty necessary to the contractor.

But there are many other trade meetings that are of peripheral interest, particularly in hard times when everyone is looking for expansion and protection in diversification.

In this month's issue of Sound & Communications, we offer reports on two of those trade shows — TeleCon and The MultiMedia Show. Systems, products and seminars show up there that are appropriate and hard to find in the core businesses of sound contracting.

This month we are attending both the Consumer Electronics Show and the NAMM Show. Next month, we will go to Infocomm.

We'll report on these shows as we see their relevance to you in the coming months.

February brings the Infocomm show, this year in Washington, D.C. This convention has come on as an important place to see relevant multimedia products, particularly for presentation functions; we've seen contractors searching out the home theater and conference room products that they need there. Along with high technology such as HDTV and the War of the Walls (every videowall in comparison acts), the showings at Infocomm indicate the future of the conference room and other applications — at least as far as technology goes. As for the economy, and business in general — well, let's go back to my original statement: Happy 1992.

Now you can go on to read the rest of this magazine. Let's get technical.

Best Regards,

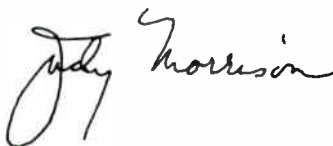

Judith Morrison
Editor in Chief

SOUND COMMUNICATIONS

Publisher/Editorial Director
Vincent P. Testa
Editor-in-Chief
Judith Morrison
Technical Editor
Mike Klasco
Associate Editor
Steve Jacobs
Research Assistant
Kathleen Coppola O'Connor
Contributors
**Jeff Ader, Keith Bose, Elizabeth Brown,
Brian Hinman, Tom McCarthy,
Thomas J. O'Malley, Neil Shaw, Dan Sweeney**
Technical Council
Dr. Mort Altshuler
*Professor Audiology, Hahnemann University,
Chief of Audiology, V.A. Hospital, Phila, PA*
C. Leroy James
Rees Associates, Inc.
Richard N. Jamieson
Jamieson and Associates, Inc.
Russell Johnson
Artec Consultants, Inc.
Joel Lewitz
Lewitz and Associates
William Parry
Maryland Sound Industries, Inc.
Daniel Queen
Daniel Queen Associates
Jon Sank
Cross Country Consultants
Neil Shaw
Paul Veneklasen Associates
William R. Thornton
Phd, PE
Art Director
Joyce Dolce
Artists
**Alicia Celli, Janice Pupelis,
Scott Schlemmer, Colleen Warenik**
Production Manager
Michelle Montoya
Typography
Christina Buckley
Diane Catanzaro
Circulation Director
Arturo Lizarraga
Advertising Manager
John Carr
Classified Ad Manager
Tom Dorsam
Traffic Manager
Ron Perone

Director of Sales and Marketing
Nancy Davis

Editorial and Sales Office
Sound & Communications
25 Willowdale Avenue
Port Washington, New York 11050
(516) 767-2500
FAX: (516) 767-9335



Sound & Communications • DJ Times
Post • Producers Quarterly
Sound & Communications Blue Book
The Music & Sound Retailer • The Retailer Red Book
The Music & Sound Buyer's Guide
CES-TV News • NAB-TV News • NAMM-TV News
NSCA-TV News • CROSSTALK / AES-TV News

Otari now has the products, and the pricing to make your next installation easier, faster and more profitable.



When you want your installations to *stay* installed, or when service contracts are a part of your business, Otari's legendary reliability makes our products an obvious choice.

With a selection of audio recorders from 2 to 32 tracks, a high performance cart machine, and a complete line of audio and video duplicators, you can choose *exactly* what's



right for the application, and for your budget. What's more, these new machines will satisfy your present clients and win new ones with their advanced features.

For example, your customers will appreciate the convenience of a voice editing module that maintains normal pitch at twice normal speed, and the ability to select EQ and reference fluxivity values at the flip of a switch. Then there's that famous Otari sound that comes from features like



transformerless balanced inputs/outputs, and gapless, seamless, punch-in, punch-out.

Before you begin your next installation, let us show you that Otari is *serious* about your business with our Sound Contractors Resale Program. Call Otari at 415-341-5900.

OTARI[®]

© Otari 1991

CONTENTS

Volume 38 Number 1

January 27, 1992

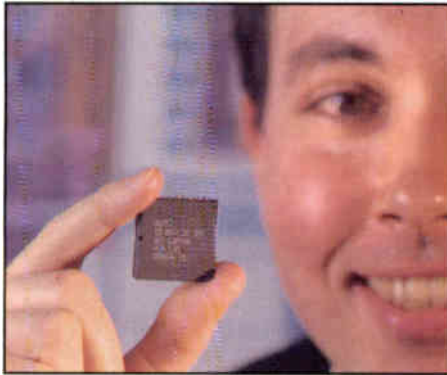

22



33

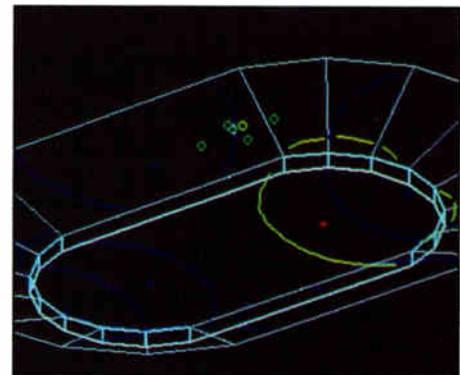

73

FEATURES

15 PROCESSING LOUDSPEAKERS

By Dan Sweeney and Mike Klasco

A little over 10 years ago, dedicated electronic signal processing established itself. Now processing is everywhere. This is the first article of a series.

22 FULL-DUPLEX AUDIOCONFERENCING

By Brian Hinman

As prices fall and technology progresses, new markets may be opening up for teleconferencing systems.

42 THE BOARDROOM MARKET

By Dave Taylor

Boardroom Installations was the topic when CEDIA members attended this rep's seminar. How to make money and deal with quirky clients were among the topics discussed.

59 JOB DOCUMENTATION

By T.G. McCarthy

Since jobs don't often have a standard structure to them, documentation can be difficult. Flexibility is the key.

DEPARTMENTS

4 LETTER FROM THE EDITOR

9 NEWSLETTER

12 THE ANSWERMAN: HEARING AND FEEDBACK

30 TRADE SHOWS: TELECON XI

By Mike Klasco

33 FIRST PERSON: SIMULTANEOUS TRANSLATIONS FOR CORPORATIONS

By Jeff Ader

38 GUEST COLUMN: TELECONFERENCING: THE NEXT FRONTIER

By Thomas J. O'Malley

50 TRADE SHOWS: MULTIMEDIA EXPO

By Neil Shaw

52 TELECONFERENCING: SATELLITE TECHNOLOGY

By Keith Bose

62 SALES & MARKETING: DISC SYSTEMS FOR THE COMPUTER-SHY

By Elizabeth Brown

64 PRODUCTS

67 LITERATURE

67 PEOPLE

68 NEWS FROM AROUND THE INDUSTRY

73 CAD TOPICS: SOFTWARE UPDATE

By Mike Klasco

76 AD INDEX

76 MARKETPLACE

78 PRODUCT CHECK: FACTORIES/WAREHOUSES

SOUND COMMUNICATIONS

Being born into a famous family is no free ride.

Standards are high.
Expectations are great.

So when Shure unveiled its L Series Wireless Microphones a few years ago, we knew they had to be better than good.

They were. In fact, the L Series has emerged as one of the most affordable, trouble-free lines in the business. One that includes nearly every kind of wireless – from hand-held to lavalier to instrument systems – with both diversity and non-diversity receivers.

The all-new, L11 body-pack transmitter is a prime example. With its compact surface mount construction, the L11 is the smallest unit in its class. Battery life is 40 to 50% greater. And its crystal clear output signal lets you operate more systems simultaneously than ever before.

Of course, the L11's reliability is a given. After all, we have a family reputation to uphold.

For information on the L Series of wireless microphones and accessories, call 1-800-25-SHURE. The Sound of the Professionals®... Worldwide.

SHURE

The Only Wireless That Lives Up To Its Name.

**THE SHURE WIRELESS
L SERIES**



SHURE

L4 DIVERSITY WIRELESS REC

POWER

What sound does a loudspeaker make when it's on backorder?



No sound at all, obviously.
But you may hear loud noise from customers
whose requirements can't wait.

At Quam, we don't like backorders any more than you do... in fact, we won't tolerate them! To give you total protection from backorders, we keep 60,000 speakers in stock at the factory, so we can always ship, within 24 hours of your order, any standard item, including line matching transformers and ceiling grills or speaker/transformer/baffle assemblies. So when you deal with Quam, your work schedule won't be delayed because the

Quam:
The Sound
Decision

speakers you need are missing from your shelf. Nor will you have to tie up cost in inactive inventory to guard against shortages. Nor will you ever have to worry about a speaker causing a call-back. At Quam, we believe in allowing sound contractors the peace of mind that comes from having a totally reliable source for speakers.

Doesn't that sound good to you?

234 E. MARQUETTE ROAD • CHICAGO, ILLINOIS 60637
PHONE: 1 (312) 488-5800 FAX: 1 (312) 488-6944

Circle 207 on Reader Response Card
World Radio History

NEWSLETTER

MARK IV MULTI-BRAND ON TRACK

The Mark IV Interface modular mixing consoles become available this month in limited quantities under several Mark IV brand names. Apparently having resolved claims by Soundcraft as to intrusion of design, Mark IV embarks on its plan to provide in certain product classifications similar products with different distribution and marques. The product takes aim at the Delta series from Soundcraft and was designed by Dynacord with consulting input from DDA, Altec and Electro-Voice. It is produced in Germany by Dynacord, but some of the major parts were tooled at Electro-Voice and are supplied from the United States.

The Interface line marks Altec Lansing's first entry into the market for high quality modular mixing consoles. According to Dave Merrey, president of Altec, "Our customers have been asking for this type of product for some time so we are obviously excited that we can make it available to them."

When Mark IV Audio was first formed, it essentially had no products of its own, and one employee — president Bob Pabst. In the past several years, several staff positions have been apportioned to Mark IV Audio, and joint R & D and other efforts have taken place. Mark IV now consists of Altec Lansing, DDA, Dynacord, Electro-Voice, Gauss/Electro Sound, Klark-Teknik, Midas, University Sound and Vega.

PRESIDENT BUSH VISITS PEAVEY

As part of what was perceived as a campaign tour of the south, President Bush visited Peavey Electronics in December where he spoke to some of the company's 2,000 employees. Company president Melia Peavey presented Bush with "The Chief," an acoustic guitar that can also be played electrically. In an interview shortly before Bush's visit, Vincent P. Testa, publisher of Sound & Communications magazine, asked Hartley Peavey, chairman and ceo, what he would tell Bush if he had a chance to talk privately with him. "If I get the moment with the man," Peavey said, "I'm going to stress one thing: education. I think our educational system doesn't work. The analogy I use is, 'Have you ever seen a house that's been painted so much that the paint was literally falling off of its own weight? That's our educational system. Just slap on another coat of whitewash.'"

Hartley Peavey has served on the federal Industry Sector Advisory Committee that advises the Commerce Department dealing with world markets. Peavey Electronics was also selected among several hundred companies to accompany Commerce Secretary Mosbacher to Japan as part of the Japan Corporate Program.

LANDMARK RETROFIT

Broadway's Mark Hellinger Theater, a landmark status building recently purchased by the Times Square Church, is being retrofitted by SIA Acoustics. According to Craig Janssen of SIA, planned renovations should be approved by New York City regulators and should result in an "unusual and interesting design." The console is being moved to the middle of the theater; and pre-existing equipment which the church acquired in the sale is being used. The church has a full gospel choir.

AUDIO-TECHNICA TELECONFERENCING

Audio-Technica U.S. is entering the audio teleconferencing market with the DT100 Digital Teleconference System. The DT100 offers digital signal processing together with proprietary software and automatic line nulling, allowing full duplex conversation.

KING NAMED TO HALL OF FAME

Larry King has been named the 1992 inductee into the Broadcasting Hall of Fame. The induction will take place April 13 at the All-Industry Luncheon of the National Association of Broadcasters during the NAB convention.

NEWSLETTER

AUDIO/VISUAL DESIGN DIVISION FORMED

Manny's Music, one of the leading musical instrument retailers, has formed 48th Street Audio/Visual Design and appointed Burt Rosen as the vice president, director of operations. The new division "meets the demands of the burgeoning residential/industrial audio and video system design and installation market," according to the company. In making the announcement, Ian Goldrich, vice president of Manny's Music, said, "We have formed 48th Street Audio/Visual Design to open a new market for us which draws upon the expertise in technology, design and installation we have gained from successfully operating Manny's Music and [subsidiary] Audiotechniques.

VOICE COILS FROM RUSSIA

Tom McCauley of McCauley Sound has reported that he has entered into a joint venture to produce voice coils in Russia.

SMPTE SPONSORS MULTI-MEDIA

The Society of Motion Picture and Television Engineers is developing and promoting technical sessions, workshops, and a specific exhibition area called "Multi-Media World" within the 1992 SMPTE Technical Conference and Equipment Exhibit in Toronto. According to Stanley N. Baron, SMPTE engineering vice president, "The challenge of the 1990s is to sort out the essential issues concerning interoperability between all of the imaging media that affect technologies and industries."

Toward that end, SMPTE has begun working on a protocol that would permit the interformat translation of moving images created under different standards for different industries. A study is being undertaken on the requirements for a hierarchy of digital images to facilitate format translation. The work is a cooperative effort with the Advanced Television Systems Committee and the Institute of Electrical and Electronic Engineers Committee on Communications and Information Policy.

VSI PURCHASE OF IAT INTERNATIONAL

VSI Enterprises Inc. and IAT/AG, Switzerland, the exclusive European distributor of VSI products, have disclosed completion of a letter of intent for VSI to purchase an IAT subsidiary called IAT International Inc. (IAT-US). Under the agreement, IAT-US would have exclusive North American rights to make, sell and sublicense a PC/workstation videoconference product developed by IAT/AG and known as "Ibikos." At the closing, IAT-US would have principal assets including \$750,000 cash plus the Ibikos license. Ibikos is a multimedia, full spectrum, interactive communications workstation enhancement combining voice, data and video communications. It operates on Windows 3.0 and provides full motion video, joint editing and expansion options.

The board of directors of VSI Enterprises has elected Paul A. Scott, president and chief executive officer, chairman and has expanded the board to seven members. New board members are Judy Farrow, Philippe Bodart and Joep M. J. deKoning. Farrow is senior investment research analyst for Technology Funding, Inc., a venture capital firm. Bodart is coo of I.A.T./AG. DeKoning represents the interests of RIT Capital Investments plc, one of VSI's largest shareholders. He is the founder of the Batavia Group Ltd. and was a member of the corporate finance department of Kidder Peabody & Co. Ginger Ausban has been named treasurer for VSI Enterprises and its subsidiary Videoconferencing Systems Inc. Ausban also holds the positions of corporate secretary and controller.

CHINN TO SYMETRIX

Rick Chinn has been appointed applications engineer of Symetrix, Inc. Chinn was previously sales and marketing manager of AudioControl Industrial. He was with MicroSoft, John Fluke Mfg, and EV/Tapco before that.



It never forgets a face.



The only video entry system that takes a picture.

Digitally records eight images without film or tape! Introducing the Telecall TD-BM, Telecall's newest video entry system, now with an eight-image memory. Simply push one button to set auto record mode and the infrared LED camera will automatically record images of the next eight callers at the door, even in total darkness. You also have the option to take a candid manual photo while talking to a caller on the intercom. Photos, along with their dates and times, can be reviewed any time with the push of a button.



All the convenience and security of Telecall's excellent attended systems, plus a memory! Like all Telecall video entry systems, the TD-BM allows positive visual identification of callers, direct two-way communication and door control from one remote location. Even monitor the entryway anytime with the push of a button. This sophisticated system uses only 2 wires for easy installation. With the TD-BM's photographic memory, complete security was never so easy.



The Leader In Intercom Technology

For more information, call toll-free 1-800-752-2860 U.S.A. and Canada

14620 N.E. 95th St., Redmond, WA 98052 FAX (206) 881-3085 In WA State (206) 881-2742

Circle 211 on Reader Response Card

World Radio History

Hearing Conservation Events; Feedback in Clubs

Dear Answerman,

I am interested in finding out the phone and address of the National Hearing Conservation Association. Can you help?

**Steve Tocidlowski
Television Equipment
Association Inc.**

Dear Steve:

The National Hearing Conservation Association's headquarters are: NHCA, 900 Des Moines St., Suite 200, Des Moines, IA 50309, (515) 266-2189.

The NHCA holds a conference each year along with the National Institute for Occupational Safety and Health, and with the University of Kentucky. More often than not, readers of Sound & Communications are part of the noise problem, rather than part of the solution. Perhaps learning about hearing protection would be beneficial, not only for users of our sound systems, but also to ourselves. Additionally, noise surveys are a big business and can be a source of income. This year, the Hearing Conservation Conference is being held at the Omni Netherland Plaza Hotel in Cincinnati April 1-4. Registration is being coordinated by the University of Kentucky. Contact Ms. Elizabeth Haden, (606) 257-3972.

The Hearing Conservation Conference has numerous papers on hearing protection devices, covering ratings, effectiveness, comfort, and so on. Other papers include an introduction to active noise cancellation, which is the reduction of noise through anti-sound, a technology that has only recently become commercially viable. One of the seminars is on Practical Noise Control, a business that sound contractors ought to take a close look at.

While the Hearing Conservation Conference is primarily intended for audiologists,

hearing conservation is an area worth exploring for both acousticians and sound contractors. The Answerman himself is heavily into this business, and has found that noise surveys and the design of corrective measures is quite lucrative. And the Answerman has found out that using local sound contractors to implement his designs works out just fine.

Dear Answerman,

We're still having turntable acoustic feedback problems in dance club sound systems. What can we do?

An Anonymous Reader

ANSWERMAN

Dear Reader,

Feedback can get into the system through the turntables, CD players, and even the cassette deck. Basically, feedback results when the output of the components of the sound system is somehow fed back into its input.

The most common problem is turntable feedback. Turntables can skip due to the floor shaking caused by dancing, as well as the deep bass from the speakers. In either case, the sound and vibration energy reaches the turntable and causes the cartridge to mistrack the grooves in the record. The disruptive energy can travel to the turntable in two ways, one through the air (this would mostly be the bass from the speakers), and secondly, through the building structure.

Getting the turntable to track records better, even when the sound levels are high, can be a combination of some simple as well as complex solutions. Lets start with the easy way out. "Disco Duty" phonograph cartridges, such as those from Stanton, are sturdy designs, as they must withstand backcueing. A side effect of this capability is that they need higher tracking force than cartridges intended for home use. By using too light a tracking force, the cartridge's ability to accurately play a disk when the sound system is at a high level is not so good. The first fix that should be tried is to increase the tone arm's tracking force toward the upper limits that the cartridge manufacturer recommends. The reality is that a cartridge tracking at 3.5 grams causes far less record wear and sounds better than the same cartridge mistracking at 1.5 grams. But remember not to exceed the manufacturer's suggested maximum force.

Increasing the tracking force will often help the turntable work at higher sound levels, but does not provide much help from bouncy floors. The rubber feet and internal suspensions on most turntables (such as the Technics 1200) are simply too stiff to prevent skipping if the floor is not stable. If you are designing the control booth for an existing facility, be sure to walk the area where you intend to set up the turntable. If you can bounce on the floor, you are likely to have problems.

Look for a more rigid spot, which will be over a beam, or near a corner of the room. You can upgrade the turntable with better vibration isolation feet. These are manufactured by Allsop (NAVCOM isolation feet) and Monster ("footers") and cost about \$50 — \$60 a set. Allsop has recently introduced a cheaper version for about \$30 a set.

LightSPEED™

Professional Audio Instruments

LightSPEED Technologies
Introduces the *Next Generation*
in VHF High Band
Cordless Microphone Systems:

NEW!



IMPULSE 3000D

TSQ™ Tone-coded Squelch
and Dual-Tuner Diversity with Remote Functions
in a "FULL METAL JACKET".
Indestructible ... *Warranted for 5 Years!*



IMPULSE 2000D

TDX™ Dual-Tuner Diversity
... eliminates multi-path distortion
and dropouts.



IMPULSE 900

Non-Diversity
... professional value.

Anti-interference Technical Breakthrough!

IMPULSE Series
with—TSQ™ Tone-coded Squelch
(Complies with FCC parts 90 and 74)

**The New Generation of Impulse Series
Receivers acknowledge only the tone-
code of their counterpart transmitters.**

- Never spurious interference when transmitters are off.
- Absolutely NO on/off shock noise.

Questions? ... Call TOLL FREE
1-800/732-8999

©1991 LightSPEED Technologies, Inc.
LightSPEED, TDX and TSQ are trademarks of LightSPEED Technologies, Inc.

LightSPEED Technologies, Inc.

P.O. Box 19479 * Portland, Oregon 97280 U.S.A. * 503/244-0608 * FAX 503/244-8527

Circle 215 on Reader Response Card

World Radio History

BUILT TO HANDLE A LIFETIME OF QUICK CUES, REVIEWS AND SHUTTLES. EVERY DAY.



The TASCAM 112B is a broadcast deck that doesn't know the meaning of the word "downtime."

And, while not as full-featured as the industry standard TASCAM 122MKII that inspired it, the 112B is a top-end machine built to get the job done. Day-part after day-part. Book after book. Year after year.

The "B" in 112B is for "balanced," as in +4 dBm balanced XLR Ins and Outs.

But that's just the beginning.

The 112B also features Cue & Review for quick and convenient open-reel style cueing and shuttling in both the fast-forward and rewind modes. Two long-wearing permalloy heads (erase and record/repro) for crisp, clean sound. Choice of Dolby[®] B, C and HX-PRO for enhanced sonic quality. And, at only \$749, a suggested retail price that even the most money-minded station manager would find hard to ding.

You asked us to build a broadcast deck as rugged and reliable as the 122MKII, but with fewer features and a lower price.

We did.

Now all you have to do is call or write TASCAM and put the hard-working 112B to work for you.

TASCAM.

© 1991 TEAC America, Inc., 7733 Telegraph Road, Montebello, CA 90640. 213/726-0303
*Dolby B, C and HX-PRO are registered trademarks of Dolby Laboratories Licensing Corporation.

Circle 220 on Reader Response Card

For extreme cases, more complex solutions will be needed. One solution is to anchor the console to a stable foundation, and this can work if the club is in the basement or first floor. Solid supports for the console can pass through the floor to the foundation, but care must be taken that the supports (or anything else that is part of this structure) does not come into contact with the resonating structure. If the installation is in a wood frame building, too far away from anything solid, then a super compliant suspension may have to be used. "Live" floors can have a resonant frequency of less than 1 Hz and excursions of $\frac{3}{8}$ -inch, which is way beyond the isolation that can be obtained from isolation feet.

Instead, solutions must be used that are similar to what vibration engineers use in HVAC systems (Heating-Ventilation-Air-Conditioning). A suspension is used that has greater compliance than the structure the sensitive equipment is sitting on. While HVAC units typically use large springs, sometimes as large as 5 inches high, for suspending turntables in clubs, the Answerman suggests using four sets of elastic bands, one end mounted to the corners of a frame and the corners of the turntable on the other end. The frame should be of heavy construction and designed to slip into either mobile or permanent DJ consoles. A suspended weight is mounted to the turntable support to dynamically damp the turntable from bouncing when the DJ cues a record. The Answerman has used these many times over the years, but usually only in desperate situations, such as in dance clubs in cruise ships or in DJ consoles in unstable buildings located over subways. If you need one of these, give me a call (516-767-2500). Excepting the worst situations, I recommend you buy the fancy isolation feet and try to set up the control console in a corner of the room.

CD Player Feedback

CD feedback is similar to turntable feedback. CD players are less likely to feed back. *(continued on page 72)*

Processing Loudspeakers

The State of the Science Ten Years On

BY DAN SWEENEY AND MIKE KLASCO



The Bose 802-C system controller.

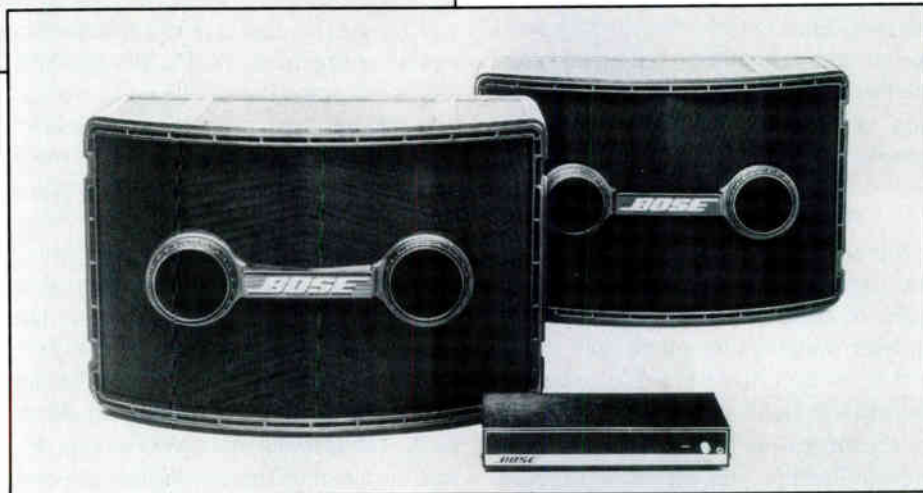

The Bose model 802 with 802-E active equalizer.

It seems a very long time ago that dedicated electronic signal processing established itself in the professional loudspeaker industry, but the revolution actually began relatively recently — just a little over 10 years ago. Today, processing is everywhere, and processing electronics packages are offered by many companies in the business, even by those whose marketing stances had once been overtly anti-process. Indeed, it is hardly an exaggeration to say that the setup and manipulation of processing modules is now just another dimension of the sound installation procedure.

Understanding processing options is fast becoming essential to maintaining a professional standing in the industry. During the next five years processing electronics will rapidly pass through two to three generational developments, and processing speaker systems will certainly find many

new applications. As processors gain in power and flexibility and make greater contributions to total system performance, the exercising of processing options will become almost equivalent to making component decisions.

Such options are apt to be very extensive, because processors will increasingly incorporate digital circuitry with user programmable functions. Operator programmable functions may include control of crossover point, slope, and filter class, ad-

justment for bass build up in different size arrays, long or short throw top-end response due to air humidity absorption, or even processor memory locations to accommodate settings for specific rooms or types of events. Even time-offset can be under operator control, perhaps with the option of including compensation for the propagation time for the sound from speakers in front of the stage to arrive after the performers'. Protection modes may include flexible attack and release

Dan Sweeney is a freelance writer in the Los Angeles area covering the sound and communications industry.



Meyer's M-3T control electronics unit for the MSL-3A.

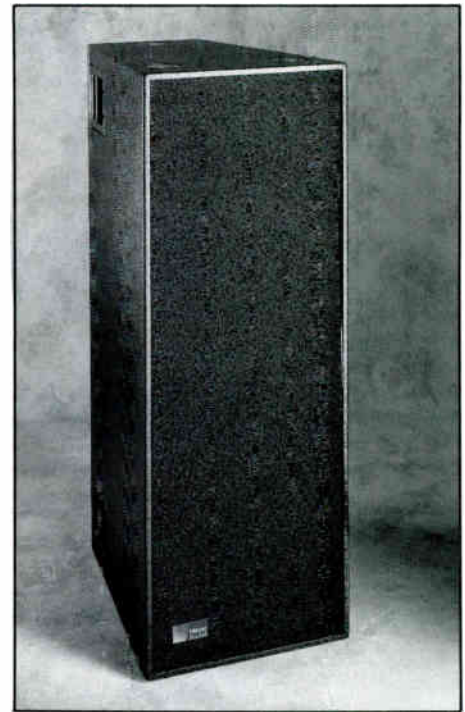

Meyer Sound's MSL-3A reinforcement loudspeaker system.

times, with separate characteristics for woofer and the compression driver/horn outputs. And, in fact, the transition to such programmable digital signal processing is already well under way, though analog processors still dominate the marketplace. Future digital signal processors may boast adaptive filtering technology, which holds the promise of automatic self-equalization, feedback suppression and even cancellation of distortion and excessive room reverberation.

PROTO-PROCESSING

If processors are defined to be any active circuits used to shape phase, amplitude, or frequency response of a loudspeaker system, then processors of one sort or another may be said to go back to the work at Bell Labs in the 1930s. During the forties and fifties, equalizers, compressor/limiters and filters were introduced into the recording industry, and by the 1960s the basic arsenal of processing components was established. Initially, however, such devices found a home in the recording rather than in the playback chain, and it wasn't until the early sixties that any degree of integration between speaker systems and dedicated processors was achieved.

In the mid sixties, KLH introduced a table radio and a compact home stereo system that had complementary equalization built into the amplifier to linearize the response of the extended range 4-inch

acoustic suspension speakers. Around the same period, JBL began offering plug-in equalization modules for its SE400 power amplifier. Specific modules were designed for a number of JBL consumer speakers as well as for some models made by other manufacturers.

JBL took this approach much further in a product known as the PL-100, of which a pilot run was made in the early sixties. The PL-100 was a processor-amplifier combination with plug-in modules to match a number of the company's more popular consumer loudspeakers of the time. The PL-100 consisted of a built-in electronic crossover, an equalizer, and loudspeaker protection circuitry, and was arguably the first processing system of approximately modern configuration. The PL-100 had no commercial impact, but the product did indicate the growing awareness among design engineers of the possibilities inherent in an integrated, processor-based systems approach to loudspeaker design.

During the late 1960s, biampification began to appear in recording studio monitors and sound reinforcement speakers. One consumer product from Philips, the "David," was biamped and the woofer featured motion feedback. About the same time, Bose brought out its equalized direct/reflecting system in the 901 consumer product, and, several years later, a pro audio version of the latter called the 800 (the latest version is the 802).

Loudspeaker protection appears to have

been the last major processing function to be manifested within a loudspeaker system context. In the seventies KLH developed a circuit for some of its consumer speakers which boosted and extended the bass response of a sealed-box woofer system while limiting the input signal level in the bass to prevent overdriving. Implementation was rather sophisticated, and digital circuits were used to monitor bass levels at input. In some versions of the KLH module, voice coil temperature was also computed and overall limiting was applied to the system. The modules and loudspeaker systems in which they were utilized worked rather well, and were fairly successful commercially. In fact, a few of the present day processor speakers use a very similar approach in "modeling" voice coil temperatures.

KLH had no presence in pro audio, but similar ideas were eventually taken up by others, notably McCune Sound which engineered and constructed its own speaker systems for the rental market. John Meyer, a McCune alumnus and president of the then fledgling Meyer Sound Laboratories, introduced his first products around 1980. One of these, the UM-1, ushered in the processing era, the UM-1 stage monitor.

The UM-1 set the pattern for subse-

quent loudspeaker designs from the company, and introduced basic technologies which were employed in successful and influential products not only from Meyer Sound but from a host of other manufacturers. The UM-1 had all of its electronics in one box (originally the P-1, and later the P-1A) and included a quasi Bessel type electronics crossover, phase correction, limiting, and sliding high and low frequency filters which variously restricted power to the tweeter, and protected the woofer from overexcursion. The UM-1 was followed shortly by a compact sound reinforcement speaker called the UPA-1 employing similar processing and a trapezoidal cabinet shape for ease in clustering. The UPA-1 has served as a model for many other processor speakers; it is highly compact with extended bass and capable of high acoustic output, it is road worthy, and flyable with optional rigging hardware.

The UPA-1 was rapidly accepted by the industry and was followed shortly by sound

reinforcement speakers from Renkus-Heinz using somewhat different processing. Renkus-Heinz has introduced a few different series of processor speakers, but

Following pioneering efforts the processing loudspeaker concept gradually gained acceptance in the industry and has been taken up in one form or another by many of the speaker manufacturers.

one of their original contributions was the application of processing to large concert speaker systems. More recently Electro-Voice has matched their Deltamax pro-

cessors with a number of concert sound Manifold series products. Another contributor to the art of processor speakers is Ken DeLoria, the founder of Apogee Sound. As with John Meyer, Ken DeLoria also learned his lessons working at McCune Sound.

Following the pioneering efforts in pro sound by Meyer, Renkus-Heinz, and Apogee, the processing loudspeaker concept gradually gained acceptance in the industry and has been taken up in one form or another by many of the speaker manufacturers involved in sound reinforcement so that over the course of the past 10 years the processing speaker changed its status from that of a novelty to that of an acceptable option. Processor speakers now come in many flavors with a number of firms offering 2-way and 3-way front-of-house models, stage monitors, subwoofers, and multi-box high output systems.

Even as processing speakers prolifer-



CAL SWITCH

CALIFORNIA SWITCH & SIGNAL, INC.

Makes Buying Easier

With

Switchcraft®

A Raytheon Company

Adapters
Connectors
Jack Panels
Jacks
Plugs
Switches

** We Stock The Complete
Switchcraft Line **

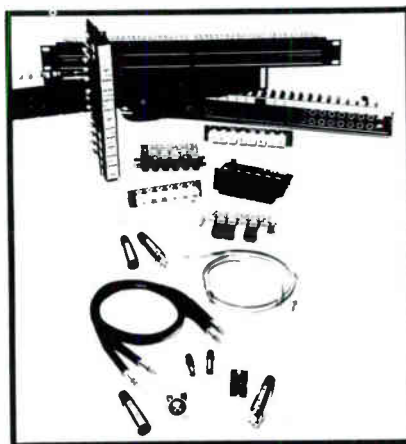

We Offer
Fast Delivery
Custom Assembly
Custom Engraving
Custom Modification

Call (800) CAL- SWCH Today !

13717 South Normandie Avenue • Gardena, California 90249 • (310) 538-9830 • FAX: (310) 327-2741

Circle 248 on Reader Response Card

January 1992 17



The JBL Array Series model 4892 concert loudspeaker system.

JBL's ES52000 digital controller.



ated, they met with a certain disdain from some quarters. "In many cases processing is just a way to get more output out of inferior drivers," is a commonly expressed sentiment. But a close look inside of literally any of the processor speakers mentioned in this article will reveal, without exception, power magnetic structures, flat wire voice coils, high grade cones, and cast aluminum woofer baskets. Others in the industry speak derisively of a processed sound, of dynamic artifacts that are a by-product of the processing. For example, when crossover points shift dynamically, the radiation pattern is altered along with the speaker's power response. This can result in a change in the sonic balance of the reverberant sound field. Another phenomenon is that when each speaker has its own processor, minor variations in production tolerances between processors in their limiter thresholds and other dynamic processing can cause interactions and audible artifacts. A number of recently introduced processors do not dynamically move crossover points nor dynamical-

ly shift other parameters. Instead, they focus on optimization of the static equalization, crossover network, and limiter-protection characteristics through being operator programmable for the speaker.

In some quarters, the term "processor" has become tainted while the non-derogatory term is "controller." A few examples of what it is now in vogue to call "controllers" are the new JBL 5200, the Yamaha C-20 and the EAW MX300i CCEP. The JBL 5200 is intended for new Array series speakers, the Yamaha C-20 is for the YST Sound Reinforcement line and the MX300i CCEP for selected EAW speaker systems. Since these units do not use feedback "sense" wires from individual speakers, a single processor is used for each channel, rather than for each speaker, eliminating mistracking interaction artifacts.

Processing itself is a complex subject and one can only delineate the issues in the processing debate by considering individual processing techniques and strategies. The best place to start would

appear to be those processing functions concerned with speaker protection, both because protection circuits are the most widely used of signal processors, and because their effects are the most criticized.

LOUDSPEAKER PROTECTION, THE PRIME PROCESSING RATIONALE

Processing initially recommended itself for one reason: higher continuous output levels. Processor speakers are certainly not all of a kind, but most processor modules have as at least one of their design goals to protect the speakers while permitting higher SPLs than could be sustained with similar drivers in an unprocessed system.

On the simplest level, biamplication, the oldest form of signal processing in common use in the industry, will generally allow higher output from the same set of drivers than will passive frequency division simply because amplifier clipping is more apt to be confined to the woofer with its generally greater heat dissipation.

Limiting and compression, of course, will provide much more positive protection to drivers by preventing absolutely the passing of destructive voltages through the loudspeakers' motor circuits, and not surprisingly, limiting and compression circuits have become a prime focus of processor design.

The practical effects of limiting and compression on average output levels are too obvious to require comment, but the related topic of the audibility of compressor/limiter artifacts is a rich area for controversy. Certainly similar considerations have been present in the broadcast and recording fields where limiting and compression are ubiquitous, but protecting a loudspeaker from overexcursion and burnout is a very different proposition from avoiding tape overload or overmodulation of a broadcast transmitter.

The trick in designing compressor/limiters to work with loudspeakers has been to make the compressor/limiter sufficiently aggressive to respond to potentially dangerous signal conditions without audible overshoot or pumping, and without

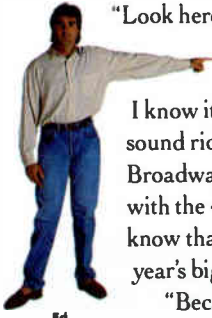

Ed
Sound Engineer

"Look here, I know the PM3000.

"I know it's at the top of the list of the best live sound-reinforcement consoles.

I know it's written into all those big concert tour sound riders. I know it's in the major theaters on Broadway. I know it's in the 5,000-seat churches with the 400-seat choirs. And I also happen to know that it's in all those T.V. trucks producing this year's biggest sporting events. And I know why.

"Because the PM3000 is flexible. Because it's logically put together. Because it performs. Because it's a pleasure to use. Because everyone likes working with it.

"But, here's the news.

"There are two more PM series consoles. And they start at a mere \$5,500 MSRP. So obviously, they're for those situations where you want the best console available. But you don't have the space or the budget to get the 3000.

"The PM1800A was just updated. So it has an improved signal-to-noise ratio (6 dB better). And 0dB insert points for easy gain matching with external processors. It's got 8 groups, 6 aux sends and 4 mix matrices. It even has the same mute grouping feature you find on the 3000. But that's not the end of it.

"The PM1200 has the same roots. But in a more compact format. It's got 4 groups plus stereo, 4 aux buses, and 4 mute groups. You can get 16, 24, or 32 input channels and you still get two additional full-function stereo input channels.

"Obviously, they're both ripoffs of the Yamaha PM3000."

YAMAHA®

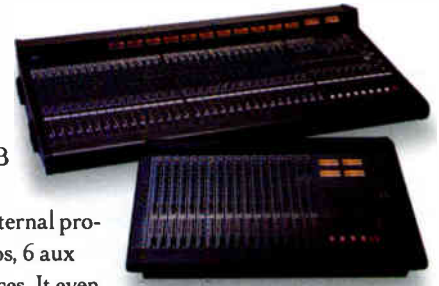

"Obviously,
they're both
ripoffs of
the Yamaha
PM3000."

Ed and his opinions are a composite of several obviously brilliant and successful sound engineers. © 1991 Yamaha Corporation of America, Professional Audio Products, P.O. Box 6600, Buena Park, California 90622-6600. (714) 522-9011.

the liability of an obviously compressed, patently processed sound. In pursuit of these ends manufacturers have devoted countless man hours of design work to the determination of compressor/limiter attack and release times and to the reduction of limiter artifacts. Each manufacturer has its own approach to compression/limiting, and a couple — E-V in its Deltamax products, and Apogee in its PAR (positive amplifier return) circuit — have included two-stage compression with different thresholds and time constants for each stage.

Another enhancement to look for in a processor is multi-band limiting. Splitting the audio bandwidth into smaller bands in order to use the most appropriate time constants has been one of the elements behind many successful signal processors, classic examples being Dolby A (four bands of noise reduction), Orban's Opti-mod broadcast limiters (with some models having six bands!), and the dbx 3BX, to



The Yamaha C20 digital system controller.

name a few. Multi-band limiting is especially appealing when designing electronic crossovers, as you are already committed to band-splitting circuitry. Each limiter can have its time constants optimized for the woofer or the compression driver, so the most effective and transparent protection can be achieved.

The manner in which fault conditions are sensed by the compressor/limiter has also been the focus of considerable design activity. Several companies, such as Meyer, Renkus-Heinz, and Apogee, link sensing circuits to the output of the power amplifier rather than extrapolating from input voltages. Digital processors promise even further refinements to limiting action through feedforward operation. By "looking ahead," which is really achieved by delaying the signal a millisecond or two, the limiter can anticipate transients and eliminate overshoot. This technique was first developed for "look-ahead side chains" in record cutting systems decades ago.

Almost all processor modules made today use some form of limiting or compression, but the industry is divided on whether protection should be subtle, but progressive, versus hard limiting circuits which remain completely disengaged at all but the highest signal levels.

The processors from Meyer Sound, Electro-Voice, Renkus-Heinz, and Apogee, go far beyond simple limiting and compression, and draw on a much more extensive bag of tricks for protecting speakers. Meyer developed a unique sliding filter topology to protect its speakers, and uses it today in such speakers as the UPA-1B, MSL-3, and UPM-1 compact sound reinforcement speakers. In the face of dangerously high input levels, the processor begins to filter out sub-bass and high treble, bringing the high pass and low pass filters closer together with increasing level, and thus protecting the tweeter from over-

For hot voice coils, the cool solution.

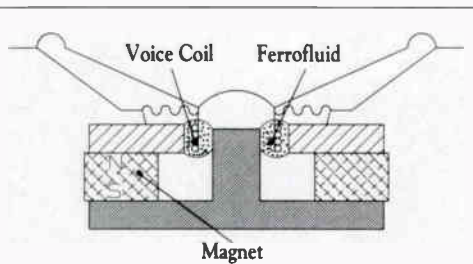

Introducing the APG 900 Series — ferrofluids designed specifically to safely withstand 200 degree centigrade temperatures in speaker voice coils while maintaining long-term

thermal stability. Offered in the low to medium viscosity range, APG 900 ferrofluids are ideal for all high efficiency speaker systems. This Series complements our existing product line of high viscosity ferrofluids widely used in tweeter and mid-range drivers. Call or fax us today. And, our in-house audio lab will help you with the speakers you have designs on.

Ferrofluidics

40 Simon Street, Nashua, NH 03061 Call: (603) 883-9800 Fax: (603) 883-2308

Circle 270 on Reader Response Card

heating and the woofer from overexcursion. Filter movement in either case is limited to less than an octave and was intended to be inaudible in the region of voice. Filtering action in depressing the highs and sub-bass with increasing level roughly approximates the Fletcher-Munson curve so that the perceived frequency response of Meyer systems is said to be flat at all listening levels.

Renkus-Heinz, another processing progenitor, also advocates sliding filters, but takes a somewhat different approach. Renkus-Heinz slides the crossover point, not the bandpass filters, moving the point progressively lower after a threshold input level occurs. The Renkus approach, utilized in such loudspeakers as the SR-1A and SR-2A full range sound reinforcement speakers, is predicated on the performance of compression drivers. Compression drivers are linear well down into the mid-range, but are vulnerable to overexcursion

at high drive levels, and so by restricting midrange inputs at the highest levels, the driver can be taken low and still played loud.

The sliding filter designs of Meyer and Renkus-Heinz heralded the beginning of the modern period in integrated processing, but, at the same time, have tended to generate the most criticism. No one questions the ability of these circuits to milk the last decibel out of a given driver, but detractors claim processor induced changes in spectral balance with rising input level sound unnatural and speaker directivity and power response are inevitably modulated.

Proponents of these design techniques, which include a significant number of sound designers and sound reinforcement mixing engineers, maintain that the drivers in well-designed processor speakers are sufficiently well matched to permit such a processing strategy. Other considerations

are that the artifacts are only audible at sound levels that would not have been achievable without the processing and that the processors that were the worst offenders have long been refined into more graceful performing products.

Yamaha's new YST series uses a combination of transducer design techniques in conjunction with a digital controller incorporating a multi-band limiter to maintain safe operation at elevated levels. Aside from the limiter protection, protection from overexcursion in the woofer is mechanical; that is, the transducer is designed so the voice coil cannot physically bottom out. Control of the woofer's motion is enhanced by a separate amplifier speaker servocontrol interface which will be discussed in the last segment of this series.

Next month we will continue our examination of processor speakers with a detailed survey of specific products, features and functions. ■

SOUNDSPHERE LOUDSPEAKER HITS HOME RUN IN CINCINNATI ...

If you didn't register for The NSCA Trade Show at the Hyatt Regency Cincinnati, you missed hearing a single Soundsphere #168 loudspeaker providing background music to four levels of the large atrium. This includes the lounge bar where music in the evening, emitting from the speaker, provides piano-bar type ambience.

Richard Carlson, the Hyatt general manager stated, "The Soundsphere speaker in the four-story atrium lobby of the Hyatt Regency Cincinnati has really enhanced the hotel's atmosphere. The system is clean and crisp in quality, and is a pleasant addition to our Sun-garden Lounge, our restaurant Findlay's and all the public areas into which it reaches."

The baseball theme of banners and the large Cincinnati Reds cap is continued in the permanent "Home run," a floating White #168 Soundsphere loudspeaker. Allen Volz of Industrial Communications and Sound, the contractor, mentioned that "it was a very easy and simple installation."

Many other hotel, mall and office building atriums have Soundsphere loudspeakers to solve the problem of even distribution of voice page and background music in these highly reverberant environments. In many instances they are color coordinated to the design scheme of the location.

There are 5 different models of Soundsphere loudspeakers to help you solve problems in difficult environments. Call us to assist with your next challenging situation.



SOUNDSPHERE A PRODUCT OF
SONIC SYSTEMS, INC.
737 Canal Street • Bldg 23B • Stamford, CT 06902 • USA • Tel (203) 356-1136

Circle 252 on Reader Response Card

January 1992 21

Full-Duplex Audioconferencing Systems:

An Important New Meeting Tool

BY BRIAN HINMAN

The speakerphone is a staple in today's corporate conference room, taking a place alongside the ubiquitous whiteboard and overhead projector. Yet, considering its crucial role in so many meetings, speakerphone technology has progressed very little over the last few years. Capable of sound quality only a little better than a 78 rpm record, it is an embarrassment in an age when "state-of-the-art" is usually synonymous with "dazzling."

All this is about to change. Within the next couple of years, it will be possible to turn any conference room into a high-quality teleconferencing facility for a minimal outlay. How? Through audioconferencing systems utilizing full-duplex acoustic echo cancellation technology. This technology enables clear voice communications in two directions simultaneously.

Full-duplex audioconferencing systems represent a dramatic improvement over the current generation of speakerphones. Today's speakerphone is an option for the "deluxe" business telephone. Typically, 20 percent or so of the total number of telephones in a company have the speakerphone option. However, virtually all of the telephones installed in conference rooms

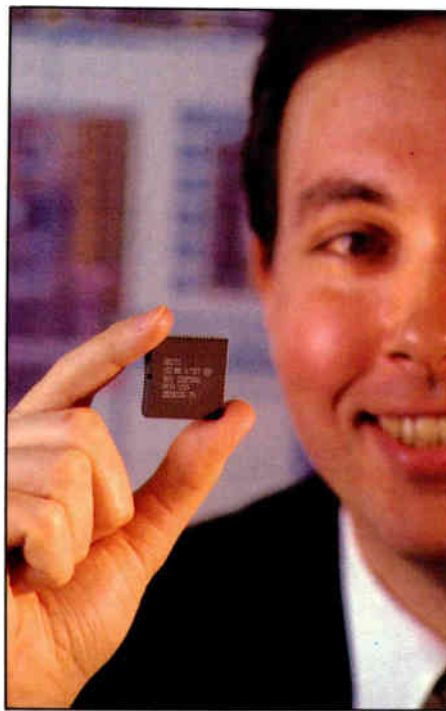

Brian Hinman, president and CEO of Polycom, Inc. and friend.

have this option. Typically, users move the speakerphone, which has a long cord attached, from a credenza to the conference table to create an ad hoc teleconferencing room. Unfortunately, the speakerphone in the business telephone was never designed for this application.

Ideally, everyone sitting around the table should be able to converse with distant conference participants by speaking at a normal level, and interacting in free form. For example, in a face-to-face meeting, a person often begins talking over the last words of the current speaker as a way of gaining the floor. There also tends to be conversation among people sitting next to one another.

The standard speakerphone cannot provide this kind of natural, open-air communication. Instead, people find themselves shouting to the distant conference participants, in order to activate the microphone circuit. If someone makes the mistake of coughing or rustling papers, the distant speaker may "drop out," and they are forced to repeat themselves. Teleconferencing should be easier than this.

A step beyond the speakerphone is today's conventional audioconferencing system. But these, too, have their problems, chiefly because they utilize the same "half-duplex" technology employed in speakerphones. While they may be more sensitive than low-cost speakerphones, they still do not allow both ends of a conversation to be carried on simultaneously. Beyond this technology limitation, most of today's audioconferencing systems are also comparatively expensive — typically priced at \$3,000 and up. Consequently, they are cost-justifiable for only the most elaborate conference rooms.

Brian Hinman is president and CEO of Polycom, Inc. in San Jose, California. He was previously founder and vice president of engineering of PictureTel.

A PROFESSIONAL WIRELESS SYSTEM PRICED SO COMPETITIVELY IT HAS

NO COMPETITION

Presenting Concert Series II

We're serious. Nothing comes close to our new Concert Series II.

Why? Because we've achieved new technical breakthroughs to come up with the most cost-effective, fully professional wireless system ever created.

Our new high performance Concert receiver features truly outstanding True Diversity performance. A brand new *dbx IC that measurably reduces noise while extending transmitter battery life up to 17 hours. Plus balanced and unbalanced Outs and removable antennas in a solid metal 19" rackmount chassis.



The compact and rugged Concert hand-held and belt pack transmitters offers audio professionals everything they *need*.

Exceptional sound, fail-safe RF performance, a full complement of controls. Plus a selection of popular hand-held, lavalier and wireless headset mics to choose from.

Bottom line. If you can find a professional wireless system with all these high quality features at a price this low, we'll buy it.

Because when it comes to competition for the Concert II, there simply isn't any.

SAMSON®
WE ARE THE WIRELESS FUTURE®

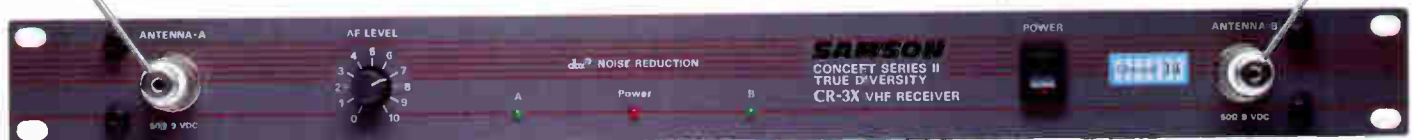

© 1991 SAMSON

Samson Technologies Corp., P.O. Box 9068, Hicksville, NY 11802-9068 Tel: 516.932.3810 Fax: 516.932.3815
*dbx is a registered trademark of Carillon Industries.

Circle 203 on Reader Response Card

Full-duplex Audioconferencing System Block Diagram

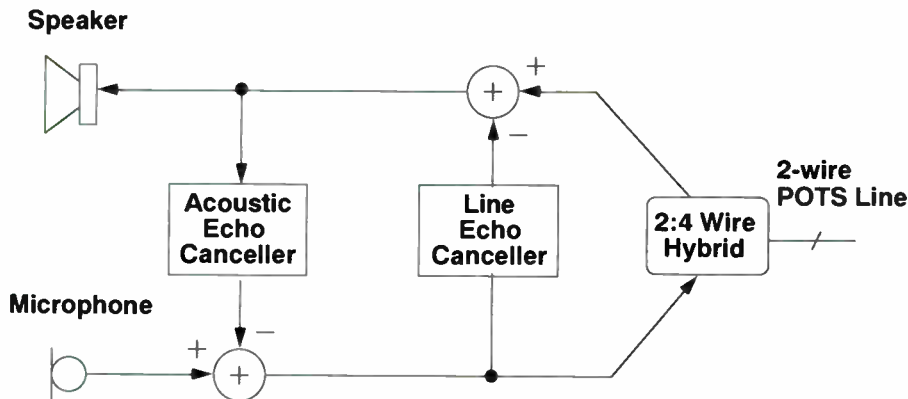

The next generation of full-duplex audioconferencing systems represents a milestone in the ongoing effort to achieve clear, hands-free telephone communications. They are a far cry from today's speakerphones, which use "echo suppression" techniques in an attempt to overcome the common phenomenon of echo or howling. With echo suppression, the speakerphone makes a decision as to whether to activate the loudspeaker or the microphone. The two elements are never allowed to be active at the same time. Echo suppression was used for years to solve electrical echo problems in the telephone network.

More recently, about 10 years ago, companies like Tellabs perfected another, more effective technology — line echo cancellation. Unlike echo suppression, an echo canceller tries to mimic the exact response of the electrical echo. If this can be accomplished precisely enough, the simulated echo is mathematically subtracted from the line echo. In this way, an echo canceller does not need to make a decision to allow either transmit or receive signals to pass, since both are allowed to pass. Today, all coast-to-coast telephone calls are processed by echo cancellers.

Given its superiority over echo suppression, why hasn't echo cancellation technology become widespread in speakerphones? Quite simply, because cancellation of acoustic echo presents a tougher problem than telephone line echo cancellation: acoustic echoes are of greater magnitude than electrical network echoes (up to +10 dB versus -6 dB), they have greater duration (100 milliseconds versus 32 milliseconds), and the echo response changes

as people move about in the room. In addition, the early audioconferencing systems with acoustic echo cancellation were difficult to maintain; they required careful calibration and had the tendency to go unstable in the presence of periodic sounds. Finally, acoustic echo cancellation has carried an unacceptably high price tag for price-sensitive speakerphone applications. Until recently, acoustic echo cancellation has been used primarily with expensive videoconferencing systems.

About three years ago, engineers and research scientists began to crack the real-world problems associated with acoustic echo cancellation. The real world is not nearly as friendly as the laboratory

environment. What happens if the conference room is highly reverberant? What happens if the system is used in a bridged conference call with a mixture of telephones and audioconferencing systems? What happens if the system is used next to a noisy overhead projector? In each case, engineers have been challenged to ensure satisfactory operation. While the technology is not yet perfected, acoustic echo cancellation has crossed the threshold of acceptability. It offers advantages over echo suppression that now outweigh the remaining limitations.

Within the last two years, new audioconferencing systems have been introduced using full-duplex technology. The general market awareness about these products has been quite low, despite their clear-cut superiority. Users who have tried a properly implemented full-duplex audioconferencing system will rarely settle for a speakerphone in their conference room. In fact, the experience is so new and refreshing that it actually encourages users to want to schedule more remote conferences — with the result that communication among dispersed co-workers is closer than ever before. Teleconferencing not only makes workers more productive, it

Half-duplex Speakerphone System Block Diagram

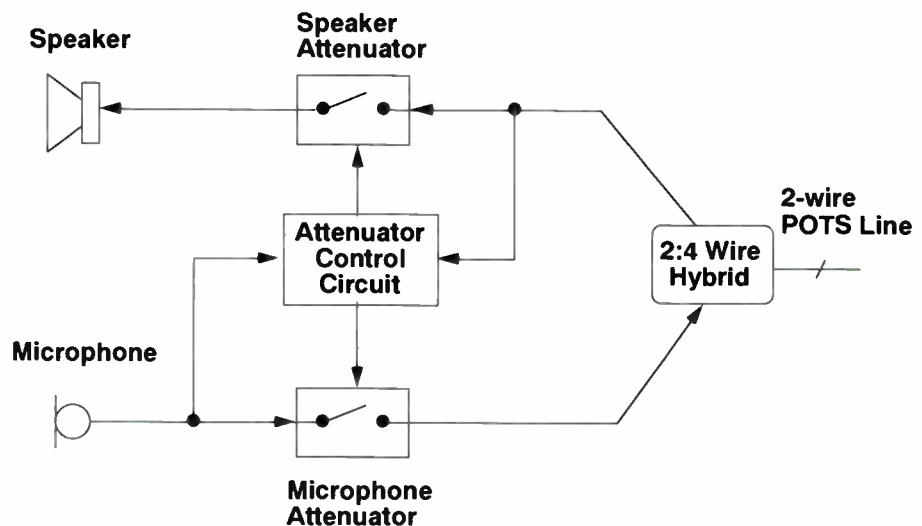



**IF YOU SELL
THROUGH
MANUFACTURERS'
REPRESENTATIVES**

**IF YOU ARE THINKING
ABOUT SELLING
THROUGH
MANUFACTURERS'
REPRESENTATIVES**

YOU NEED THIS BOOK!

YOU NEED THIS TAPE!

**OPERATIONS MANUAL FOR
MANUFACTURERS'
REPRESENTATIVE FIRMS**

"THE UNIQUE ADVANTAGE"

Understand the operating dynamics of the rep companies you rely on to bring your goods to market. Review the guidebook they rely on — their How-To book on operating a sales representative firm.

A new video cassette explaining the Manufacturers' Representative system and the benefits it provides to marketers and buyers.

- "Hands-on" advice, dozens of valuable forms, work-sheets, checklists, from 25 successful reps, plus consultants and academics who know the rep business inside-out.

IDEAL FOR:

- Sales managers pondering how to achieve market coverage
- Sales managers seeking to improve the operations of their rep Sales forces
- Manufacturers' Representatives for recruiting — orienting — training new personnel
- Buyers and purchasing managers who want to work more effectively with the sales people who call on them

- Covers
 - Organization and General Procedures
 - Administration and Operations
 - The People in Your Business
 - Sales Management

This unique 12-minute videotape features live interviews with prominent Lockheed purchasing executive Elaine Whittington, past president of the NAPM, as well as with a sales manager whose company switched away from reps and soon came back. It provides a comprehensive overview of multiple-line selling and the advantages it provides to buyers as well as sellers.

The content of the videotape is not industry-specific; the videotape can be effectively used in any environment or industry where multiple-line selling is practiced — or could be.

**ORDER ONE
OR BOTH —
RISK FREE**

**SAVE \$15⁰⁰
WHEN YOU
BUY BOTH!** 

If not satisfied, you can return in 15 days for a full refund. Send back the coupon, or order by phone **(708) 208-1466**, for same-day shipment.

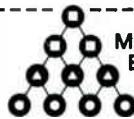

**Manufacturers' Representative
Educational Research Foundation
P.O. Box 247
Geneva, Illinois 60134**

- Please send me a copy of the Operations Manual for Manufacturers' Representative Firms. Price is \$149.95, including postage and handling.
- Please rush me a videotape of The Unique Advantage. Price is \$29.95, including postage and mailing.
- Send both at the special combination price of \$164.95 . . . a \$14.95 saving
- I enclose my check for \$ _____ payable to Manufacturers' Representatives Educational Research Foundation. (Sorry . . . at this low price we cannot bill you.)
- Charge to my Visa Mastercard

Account No. _____ Expires _____

Name: _____

Company: _____

Address: _____

City: _____ State: _____ Zip _____

Rep Association Affiliation (if any) _____

helps to reduce corporate travel costs. Audioconferencing combined with facsimile can replace a large number of short business trips among people who work together on a regular basis.

One of the new products, the NEC Voicepoint, is priced at \$1,295. It connects to a standard phone line and requires a separate telephone for setting up the calls. Some users have complained about low transmit and receive volume levels, but the general feedback has been quite positive. Another product, the AcoustiLink, recently introduced by Coherent, offers integrated dialing control, and is priced at \$2,900. The AcoustiLink will be available for shipment in the first quarter of 1992.

The current round of audioconferencing products are by no means the end of the road. Single-chip digital signal processors

(DSPs) are about to revolutionize the audioconferencing market. With a DSP, audioconferencing manufacturers are given much greater flexibility in optimizing the technology for the hands-free conference room application. The tough problems mentioned earlier can be addressed on a case-by-case basis in a DSP, all through software algorithms. Processing power on the latest DSPs is so great, there is more than enough horsepower to tackle the most difficult situations. The rate of technology advancement is purely limited by the rate that scientists can envision mathematical solutions to the remaining application problems! This is an exciting time in audioconferencing technology.

One of the industry's first DSP-based full-duplex audio conferencing systems will soon appear from Polycom, Inc. while

most audioconferencing systems rely on application specific integrated circuits (ASICs) whose algorithm carrying capacity is comparatively limited, Polycom by using DSP technology, can program many different algorithms into its software, giving the system the ability to adapt itself to virtually any combination of room and sound variations.

More than a century after the invention of the telephone, natural hands-free voice communications is at last becoming a reality. As prices for full-duplex audioconferencing systems fall into the range of \$1,000, many managers will decide to upgrade their existing conference room speakerphones. By the end of this decade, half-duplex speakerphones in conference rooms will have gone the way of chalkboards. ■

How To Reach 22 Million Hard-Of-Hearing Americans...Sennheiser Infrared.

The Perfect Solution for Providing an Assistive Listening System While Complying with the ADA.



Cinemas and Live Theatres
Retirement Communities



Houses of Worship
Municipal and Legislative Facilities



SENNHEISER

Sennheiser Electronic Corporation 6 Vista Drive, P.O. Box 987, Old Lyme, CT 06371 (203) 434-9190, Fax (203) 434-1759
Manufacturing Plant: D-3002 Wedemark, Germany AudioLink® is a trademark of the National Captioning Institute, Inc. SEC, Inc. SE-IR 11/91

Circle 255 on Reader Response Card

FREE INFORMATION

GET MORE FACTS ON PRODUCTS IN THIS ISSUE.

These Reader Response Cards are your **FAST AND EASY** way to get additional information. Just circle, detach and mail!

Please Send
FREE
INFORMATION
on all items



SOUND COMMUNICATIONS

NAME: _____ TITLE: _____
 COMPANY: _____
 STREET: _____
 CITY: _____ STATE: _____ ZIP: _____
 SIGNATURE: _____ DATE: _____
 TELEPHONE: () _____

Do you wish to receive (continue receiving <i>Sound & Communications</i>)? <input type="checkbox"/> Yes <input type="checkbox"/> No	
1 Primary Job Function (only one):	
<input type="checkbox"/> A Management/Owner	<input type="checkbox"/> 6 Architect/Designer
<input type="checkbox"/> B Engineering/Technical Mgt	<input type="checkbox"/> 7 Engineering/Acoustical Consulting
<input type="checkbox"/> C Sales/Marketing	<input type="checkbox"/> 8 Maintenance/Service
<input type="checkbox"/> D In-House Maintenance/Service	<input type="checkbox"/> 9 Dealer/Distributor/Rep
<input type="checkbox"/> E Field Installation/Maintenance	<input type="checkbox"/> M Manufacturer
<input type="checkbox"/> F Consultant	<input type="checkbox"/> O Other _____
<input type="checkbox"/> G Advertising/Promotion	3 Your purchasing authority:
<input type="checkbox"/> H Other _____	<input type="checkbox"/> A Final approval/Buyer
2 Primary business of company (only one):	<input type="checkbox"/> B Recommend/Specifier
<input type="checkbox"/> 1 Contractor—Engineered Sound/Acoustical	<input type="checkbox"/> C No Direct Authority/User
<input type="checkbox"/> 2 Contractor—Interconnect/Intercom	4 Intensity of your product need:
<input type="checkbox"/> 3 Contractor—Fire/Alarm/Safety	<input type="checkbox"/> 1 Have salesman call
<input type="checkbox"/> 4 Electrical Contractor	<input type="checkbox"/> 2 Need within 3-6 months
<input type="checkbox"/> 5 Pro Audio/Studio/Reinforcement	<input type="checkbox"/> 3 Future projects
	5 Number of employees at your company:
	<input type="checkbox"/> A 1-3 <input type="checkbox"/> B 4-10 <input type="checkbox"/> C 11-25 <input type="checkbox"/> D 26-100
	<input type="checkbox"/> E over 100

1/92 EXPIRES 4/92

NEW PRODUCTS:		43	60	77
(Please Circle)		44	61	78
		45	62	79
1	15	29	46	63
2	16	30	47	64
3	17	31	48	65
4	18	32	49	66
5	19	33	50	67
6	20	34	51	68
7	21	35	52	69
8	22	36	53	70
9	23	37	54	71
10	24	38	55	72
11	25	39	56	73
12	26	40	57	74
13	27	41	58	75
14	28	42	59	76
				93

ADVERTISING PRODUCTS:		243	260	277
(Please Circle)		244	261	278
		245	262	279
201	215	229	246	263
202	216	230	247	264
203	217	231	248	265
204	218	232	249	266
205	219	233	250	267
206	220	234	251	268
207	221	235	252	269
208	222	236	253	270
209	223	237	254	271
210	224	238	255	272
211	225	239	256	273
212	226	240	257	274
213	227	241	258	275
214	228	242	259	276
				293

Please Send
FREE
INFORMATION
on all items

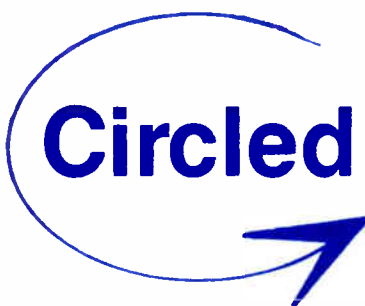

SOUND COMMUNICATIONS

NAME: _____ TITLE: _____
 COMPANY: _____
 STREET: _____
 CITY: _____ STATE: _____ ZIP: _____
 SIGNATURE: _____ DATE: _____
 TELEPHONE: () _____

Do you wish to receive (continue receiving <i>Sound & Communications</i>)? <input type="checkbox"/> Yes <input type="checkbox"/> No	
1 Primary Job Function (only one):	
<input type="checkbox"/> A Management/Owner	<input type="checkbox"/> 6 Architect/Designer
<input type="checkbox"/> B Engineering/Technical Mgt	<input type="checkbox"/> 7 Engineering/Acoustical Consulting
<input type="checkbox"/> C Sales/Marketing	<input type="checkbox"/> 8 Maintenance/Service
<input type="checkbox"/> D In-House Maintenance/Service	<input type="checkbox"/> 9 Dealer/Distributor/Rep
<input type="checkbox"/> E Field Installation/Maintenance	<input type="checkbox"/> M Manufacturer
<input type="checkbox"/> F Consultant	<input type="checkbox"/> O Other _____
<input type="checkbox"/> G Advertising/Promotion	3 Your purchasing authority:
<input type="checkbox"/> H Other _____	<input type="checkbox"/> A Final approval/Buyer
2 Primary business of company (only one):	<input type="checkbox"/> B Recommend/Specifier
<input type="checkbox"/> 1 Contractor—Engineered Sound/Acoustical	<input type="checkbox"/> C No Direct Authority/User
<input type="checkbox"/> 2 Contractor—Interconnect/Intercom	4 Intensity of your product need:
<input type="checkbox"/> 3 Contractor—Fire/Alarm/Safety	<input type="checkbox"/> 1 Have salesman call
<input type="checkbox"/> 4 Electrical Contractor	<input type="checkbox"/> 2 Need within 3-6 months
<input type="checkbox"/> 5 Pro Audio/Studio/Reinforcement	<input type="checkbox"/> 3 Future projects
	5 Number of employees at your company:
	<input type="checkbox"/> A 1-3 <input type="checkbox"/> B 4-10 <input type="checkbox"/> C 11-25 <input type="checkbox"/> D 26-100
	<input type="checkbox"/> E over 100

1/92 EXPIRES 4/92

NEW PRODUCTS:		43	60	77
(Please Circle)		44	61	78
		45	62	79
1	15	29	46	63
2	16	30	47	64
3	17	31	48	65
4	18	32	49	66
5	19	33	50	67
6	20	34	51	68
7	21	35	52	69
8	22	36	53	70
9	23	37	54	71
10	24	38	55	72
11	25	39	56	73
12	26	40	57	74
13	27	41	58	75
14	28	42	59	76
				93

ADVERTISING PRODUCTS:		243	260	277
(Please Circle)		244	261	278
		245	262	279
201	215	229	246	263
202	216	230	247	264
203	217	231	248	265
204	218	232	249	266
205	219	233	250	267
206	220	234	251	268
207	221	235	252	269
208	222	236	253	270
209	223	237	254	271
210	224	238	255	272
211	225	239	256	273
212	226	240	257	274
213	227	241	258	275
214	228	242	259	276
				293

SOUND COMMUNICATIONS

FAST ACTION CARD

NO POSTAGE
NECESSARY
IF MAILED
IN THE
UNITED STATES

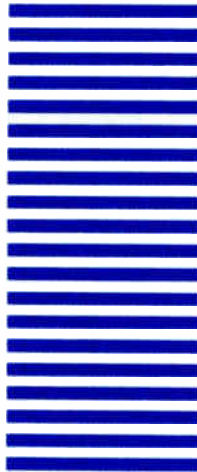

BUSINESS REPLY CARD
FIRST CLASS MAIL PERMIT NO. 1217 BOULDER, CO

POSTAGE WILL BE PAID BY ADDRESSEE
TESTA COMMUNICATIONS, INC.

SOUND COMMUNICATIONS

P.O. BOX 8302
Boulder, Colorado 80329-8302

NO POSTAGE
NECESSARY
IF MAILED
IN THE
UNITED STATES



BUSINESS REPLY CARD
FIRST CLASS MAIL PERMIT NO. 1217 BOULDER, CO

POSTAGE WILL BE PAID BY ADDRESSEE
TESTA COMMUNICATIONS, INC.

SOUND COMMUNICATIONS

P.O. BOX 8302
Boulder, Colorado 80329-8302



Now, create over 200 different sound systems with the all new xLAS series of modular main frames & programmable plug-ins!

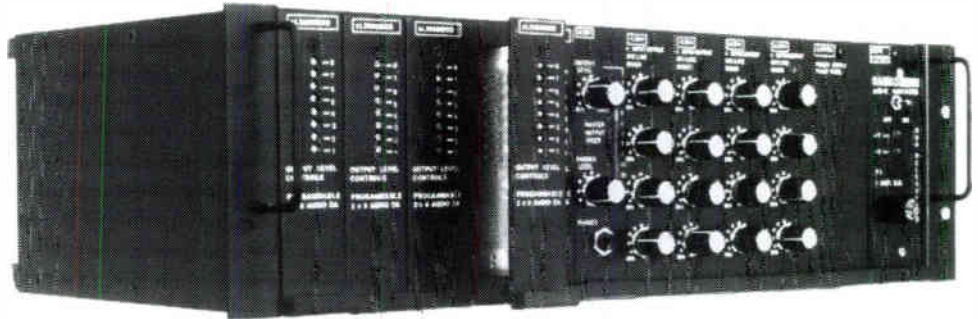

The xLAS-1, xLAS-3, & the xLAS-10. Audio systems so versatile, imagination may be their only limitation.

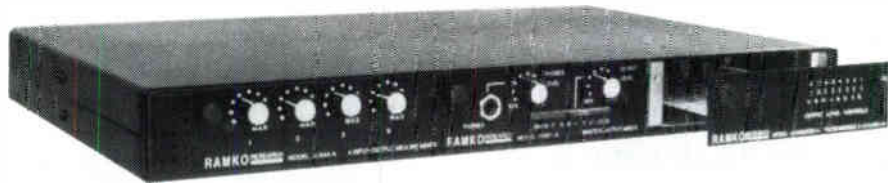

Let your imagination go.

Imagine a system where you can create: An audio distribution amp from 2 in 8 out to 20 in 80 out with on board programming for mono, stereo, mixed stereo or any other combination; A full function 24 channel mic/line mixer; Or even an eight channel mixer with compression/limiting, EQ, and an eight output distribution amp....all in the same package!

Eliminates jury-rigging & all the wiring associated with separate components.

Three different main frames allow you to choose from one module, three module or ten module capability. Containing their own back plane bussing system, the configuration of choice can be easily assembled by simply setting the module's programming switches and plugging in the module. No more rat's nest external wiring or mish mash system set ups. And, their compact size allows them to go places where no separate component system can. In addition, all units are table top, bracket, or rack mountable for ease of installation.

Only sixteen modules create hundreds of variations.

- Dual 1 x 4 audio DAs.
- Compressor/noise gate.
- 4 in/out mic/l mixer.
- Master output mixer.
- 4 x 4 switcher mixer.
- 2 input HI/LO shelving filter.
- Remote controlled quad VCAs.
- Digitally controlled 8 x 1 switcher.
- Digitally controlled dry contact machine contol.

- Intelligent zone paging.
- Quad variable audio delay lines.
- Programmable room combining.
- And much, much more.

The versatility of the systems is derived from both the unique multi-bussing arrangement on the back planes and the programming DIP switches on the plug-in modules. Thus, by simply selecting the appropriate switch setting, all of the mixing, routing & interconnects are achieved internally without any external lash ups. Additionally, external contacts are provided for special outside world applications.

Installation couldn't be easier.

All rear terminations are via unique plug-in barrier strips which are wire captive and require no spade lugs or other type of terminal installation. Simply insert the wires into the block, tighten the screws, and plug the block into the back panel. The back panel also features individual label holders which accept the hook-up labels supplied with each module.

Pricing & quality that makes anything else a high priced alternative.

The xLAS series is the result of over twenty years of designing professional audio products for the most discerning users. Thus, you will find that all module edge connectors and sockets are plated



with precious metals; all ICs are socketed for ease of service; only the highest quality components are used throughout and performance is nothing less than state of the art.

List pricing starts at a low \$127 for the main frames and \$158 for the modules with substantial discounts available for qualified dealers & contractors.

Don't delay, call today.

Call TOLL FREE:

(800) 678-1357

or FAX: (916) 635-0907 for further information and let the xLAS series start saving you money & time and solve a lot of other problems in the process.

RAMKO RESEARCH

3501-4 SUNRISE BLVD.
RANCHO CORDOVA, CA 95742

Circle 202 on Reader Response Card

World Radio History

TRADE SHOWS

TELECON XI: THE ELEVENTH ANNUAL TELECONFERENCING USERS CONFERENCE

By Mike Klasco

TeleCon XI was held in San Jose California on November 13th to 15th. This was the first time I attended. It is just a bit smaller than NSCA, but far more mature and better attended than the MultiMedia show Neil Shaw and I attended the following week. (Neil will report on that show).

I think many of our readers would have enjoyed visiting this show. The scope of it was teleconferencing — videoconferencing, video telephones, and distance learning. A few trends stood out, one was that videophones (after a number of false starts) are going to become commonplace, another was that teleconferencing is rapidly expanding into videoconferencing, and that DSP (digital signal processing) techniques for controlling room acoustics have made deeper inroads in teleconferencing than any other field of audio.

VIDEOPHONES

My first experience with videophones was when I was 14, when they made their debut at the New York World's fair in 1964. The AT&T phone "booth" was egg-

Mike Klasco is the Technical Editor of Sound & Communications magazine.

30 Sound & Communications

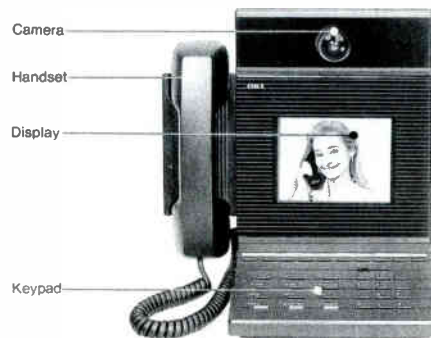

The OKI videophone.

DSP TECHNIQUES FOR CONTROLLING ROOM ACOUSTICS HAVE MADE DEEPER INROADS.



Coherent's integrated DSP teleconferencing system.

shaped and worked only with a few other experimental sites that were linked with dedicated lines.

Videophones reappeared toward the end of the 1980s with Panasonic and Mitsubishi introducing consumer units for about \$500 that displayed still-frame black and white

low resolution images, but connected directly to conventional phone lines. These products did not do well, and Sony followed with its "Face-to-face still-image transceiver" in 1990, which was another not-quite-ready for prime time story. These phones inevitably caught you in an awkward pose (scratching your head, your mouth open, etc.) and the still-frame format really did not add anything to the communication.

At TeleCon XI a number of firms introduced videophones that would transmit moving images, and would work in conjunction with a modem over a standard phone line. The key to live action and color over our plain-vanilla analog phone service is data compression. Integrated chip sets are becoming available that constantly analyze the video, pull out the resolution, color range, etc. from the periphery of the image, plus many other tricks, all in order to reduce the data required to send the image.

Various firms were demonstrating working systems; picture quality was okay, but anything that moves quickly tends to look jumpy.

During the last few years various manufacturers, such as OKI, have also introduced true digital videophones that operate over dedicated ISDN lines, but these are expensive (\$7000+) and for limited commercial markets.

VIDEOCONFERENCING

Videoconferencing (in effect, video telephones for groups) is transmitted by dedicated fiberoptic lines, microwave, satellite,

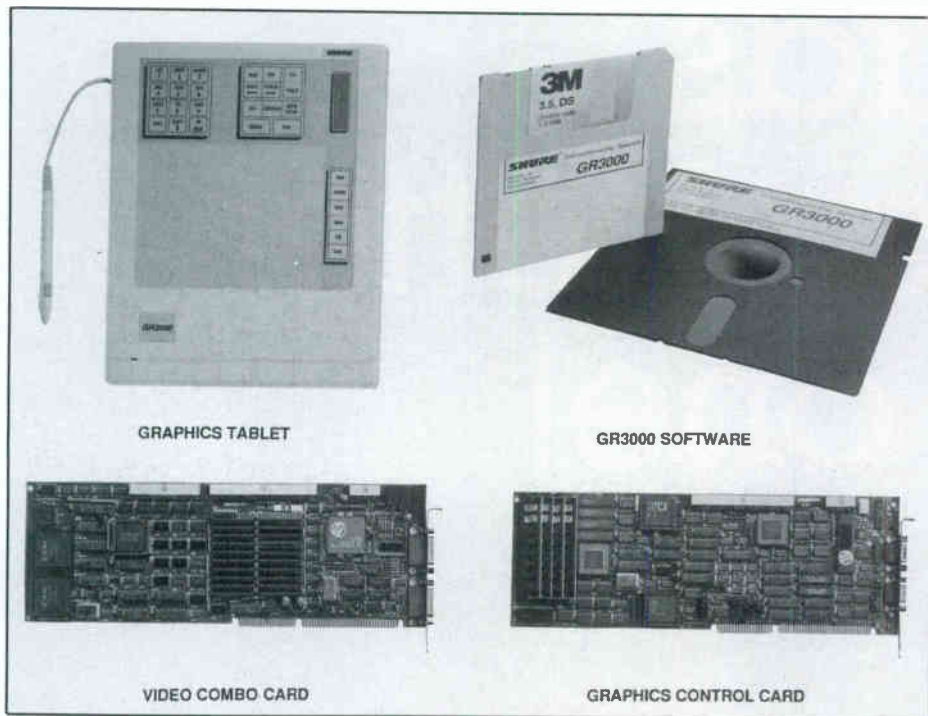

Shure's GR3000 interactive "audiographic" teleconferencing system.

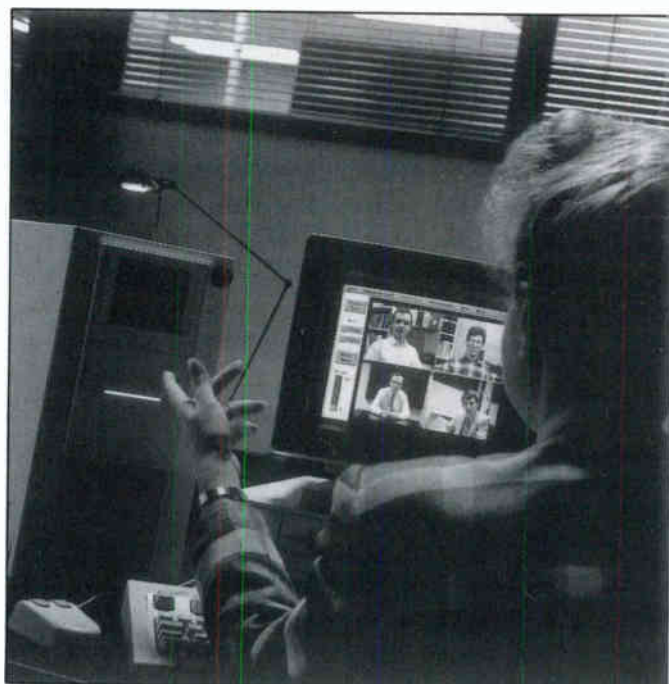

MPR's full motion videoconferencing systems combine computer, fiberoptic and video technology.

and ISDN lines. Sharp was displaying their S-VHS vcr, VHS camcorder, high resolution LCD camera and pro products including the Optonica line of monitors. Many outfits were showing packaged videoconferencing systems, such as Video-Telecom, Vidicom, MediaExpress, and OKI's Jupiter 2000 (with acoustic echo cancellation, discussed below). Most of

these systems used two side-by-side 35-inch direct view monitors, one for data, the other for visual communications. Another market that was represented at the show and is using these technologies for one-way communications is remote classrooms. A variation of this is two-way communication systems from Audience

(continued on page 72)

DELTA COM 2600 School & Institutional Intercom Systems



- Solid State/Modular Design
- Dual-Channel Capability
- Two-Channel Telecom Option
- Selective Time-Tone Option
- Includes AM-FM Cassette
- Lightweight — Small Size
- No Hidden Extras—Completely Factory-Assembled

U.L. LISTED

DELTA COMMUNICATIONS, INC.
7852 78th Avenue SW
Tacoma, WA 98498
(206) 582-2201

Dealer Inquiries Welcome

Circle 287 on Reader Response Card

The Strong Silent Type

Pivotelli Swivel Supports may be designed to look sleek and stylish. But there's a lot of muscle behind them. For openers, their solid steel construction and durable nylon finish combine to make them virtually indestructible in normal use. Their powerful rubber-lined clamping arms securely hold cabinets up to 47" wide and weighing as much as 176 pounds. And they're backed by a five-year parts and labor guarantee. The best in the business.

Little wonder more builders, architects and engineers are specifying Pivotelli Supports for commercial and industrial applications every day.

Pivotelli
Division of Grant Products, Inc.

Outstanding Performance in a Supporting Role.

Pivotelli/USA, 25 Commercial St.
P.O. Box 560, Medford, MA 02155
1-800-548-5040 (In MA: 617-391-4097)
Fax: 617-391-7819

Circle 291 on Reader Response Card

4 Heads are far better than one!

The basic cardioid microphone has long been the backbone of sound reinforcement, but there are times when only another pickup pattern will do. Yet you may not know which pickup pattern is truly ideal until you try several under actual acoustic conditions.

Now UniPoint® gives you full freedom of choice. With each of our six basic models, you can now choose from cardioid, supercardioid, omnidirectional and our new subcardioid polar patterns. And if requirements ever change, just change the capsule.

Best of all, every "a" series or later UniPoint or UniPlate® microphone can accept the new capsules. If an installation is picking up a bit too much reverb, or doesn't have a deep enough null to reject a nearby speaker, update the installation in moments by simply replacing the capsule. No soldering, no tools.

No other line of low-visibility microphones gives you this remarkable versatility. And no other line offers the low noise, dynamic range, and small size of true UniPoint design.



Indeed, the best keeps getting better...and far more versatile. Ask your A-T representative to explain the details today.



audio-technica

Audio-Technica U.S., Inc.
1221 Commerce Drive, Stow, OH 44224
(216) 686-2600 • Fax (216) 686-0719
In Canada call: (800) 258-8552

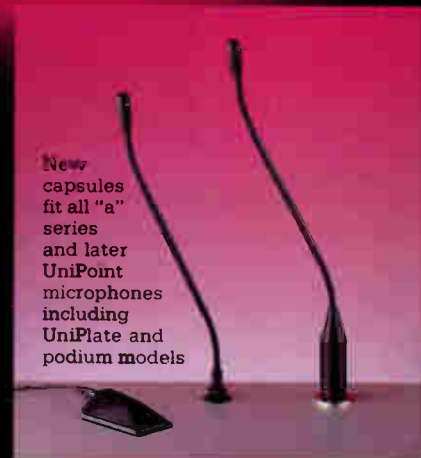

SIMULTANEOUS TRANSLATIONS FOR CORPORATIONS

By Jeff Ader

When we provide simultaneous interpretation for meetings in large hotel ballrooms and convention halls, I like to use a wireless broadcasting system consisting of a transmitter with small, personal-sized radio receivers.

It can be "AM," like the Sony Conference System, "FM" like the Williams Portable, or an infrared system. There are many systems to choose from depending on the application and the size of the space being used.

BODY MOVEMENT AND HAND GESTURES ALLOW THE INTERPRETER BETTER ABILITY TO CONVEY THE TRUE CONTEXT.

For smaller meetings in corporate conference centers and boardrooms, I prefer the Sony Wired Conference System. Each "Delegate Unit" has a built-in condenser microphone that lights up when used and swivels out from the unit. There is an

Jeff Ader is Senior Audio Technician with Simultaneous Wireless Interpretations.



Steve Crouser, an SWI technician, testing the system from the interpreter's booth.

on/off switch, two earphone jacks, volume control, channel select, record output to tape the proceedings and a built-in speaker that allows the system to be used in a public address capacity. When any earpiece is inserted into the unit it cancels the P.A. capability. The units can be daisy-chained to the system control in four rows of 15 units per row.

This system eliminates unsightly mic cables, snakes, mixers, speakers and missing the first few words of the person giving the speech when the meeting starts. It can be used in conjunction with the Sony Wireless system and other wired and wireless equipment such as a lavalier

mic for podium and overhead presentations that require the presenter to move around the room.

The interpreters' booth is set up in a corner of the room far away from the conference table to eliminate distractions from the proceedings. It is important to note that it is very helpful for the interpreters to have some line of sight to the people speaking. Body movement and hand gestures allow the interpreter better ability to

HE DECIDED TO FOREGO THE PODIUM LAVALIER MIC.

convey the true context of what is being said.

As a rule I ask the meeting planner to allow me a few minutes before the meeting starts, to explain the operation of the equipment and to include a special reminder to turn the unit on when they speak and off when they are finished talking. The reason for this is that when more than one mic is on, the room ambience becomes more apparent to the interpreters and can be distracting to them. Simultaneous interpretation requires a great deal of concentration.

At a recent Merrill Lynch meeting the company's World Financial Center facilities in New York City, an interpreter took her shoe off and used it to bang on the booth window to signal me that a presenter had forgotten to turn on his mic. This is why I usually patrol the perimeter of the room, always at the ready, finger poised. This doesn't happen too often but it sure keeps me on my toes.

For a U.S./Russian conference on "Energy Efficiency," one of the Russian presenters was so enamored of his delegate unit that when it was his turn to present his paper, he decided to forego the podium lavalier mic and tried to take his delegate unit with him, pulling the whole row off the table.

**WHEN MORE THAN ONE
MIC IS ON, THE ROOM
AMBIENCE BECOMES
MORE APPARENT TO THE
INTERPRETERS.**

For conference room meetings it is especially important to have enough time to set up and test every aspect of system

operation. Equipment failure can result in the meeting being cancelled. Many people fly in from other countries just for one of these meetings; a revision of their schedule can be disastrous for all the parties involved.

At a recent two day conference, IBM decided to use a conference site in Connecticut on the first day and one at Mt. Pleasant, New York on the second day. It was essential for me to get in as early as possible on the second day, for set up. Fate dealt me a cruel blow when a secretary conveyed the wrong instructions to me and I wound up at the IBM offices in Yonkers, instead of Mt. Pleasant. There I was, waiting for someone to show up and let me in or identify me for the security people. At 7:30 a.m. there aren't many people around who are privy to what is supposed

to be going on. My set-up time had dwindled to almost an hour when miraculously the conference coordinator showed up. When he spied me, his jaw dropped and his color reddened. By the time I had finished telling him what happened, we were in our cars, engaged in a car chase to Mt. Pleasant, where I did a record

**I DID A RECORD
BREAKING SET-UP IN 45
MINUTES.**

breaking set-up in 45 minutes with only one minute to spare. Sometimes this job can be hazardous to your health.

Menlo Scientific, Ltd.

Acoustical Consulting
and design services for
sound contractors

Contact Michael Klasco

Menlo Scientific, Ltd.
39 Menlo Place
Berkeley, California 94707

(415) 528-1277

FAX (415) 526-8087

Circle 254 on Reader Response Card

THE 2nd ANNUAL
INTERNATIONAL
DJ WEST
expo
RETURNS TO

LOS ANGELES, CALIFORNIA

Monday — Thursday, May 4, 5, 6, & 7, 1992
Sheraton Universal Hotel

Any questions about the workshops or other events — just call the DJ Times hotline (516) 767-2500 or FAX (516) 767-9335

Return this form below before April 13, 1992, and your badge and tickets will be waiting for you at the Pre-Registration desk at Sheraton Universal Hotel.

Discount Hotel Reservations available through the Sheraton Universal Hotel, with 1992 International DJ Expo/West affiliation.

I am a . . .

- Club DJ
- Mobile DJ
- Radio DJ
- Radio PD/MD
- Sound Contractor/Installer
- Lighting Installer/Designer
- Club Owner/Manager
- Architect/Designer
- Audio Equipment Dealer/Distributor
- Lighting Equipment Dealer/Distributor
- Record Tape, CD Retailer/Distributor
- Record Company
- Independent Promoter/Manager Agent
- Artist
- Media
- Manufacturer's Rep
- Other

YES! Register me now for the 1992 DJ EXPO/West in Los Angeles (on May 4, 5, 6, & 7, 1992)

<input type="checkbox"/> EXHIBITS ONLY Before Feb 25.....Free (Tues, Wed, Thurs) After Feb 25.....\$25.00	XXX
<input type="checkbox"/> DAILY PASS (Includes all special events) Monday.....\$125.00 (9 Sessions & 3 Workshops. There are no exhibits today) Tuesday.....\$100.00 (Exhibits, 6 Sessions & 1 Workshop) Wednesday.....\$100.00 (Exhibits, 6 Sessions & 1 Workshop) Thursday.....\$75.00 (Exhibits, 3 Sessions & 1 Workshop)	
<input type="checkbox"/> FULL EXPO PASS (4 Days) (Includes sessions, work-shops, exhibits and all special events) Register by Feb 25....\$135.00 Register by April 13....\$175.00	
On-Site Registration (\$225.00) TOTAL	\$

Make Check Payable to: 1992 International DJ Expo/West
25 Willowdale, Ave., Port Washington, NY 11050
(516) 767-2500 Fax: (516) 767-9335

- Check or money order enclosed. US funds only, please.
- Charge my MasterCard/VISA account

Card Number _____ Expires Day _____

Signature — required for charge orders

NAME _____
TITLE _____
COMPANY _____
ADDRESS _____
CITY _____ STATE _____
COUNTRY _____ POSTAL ZIP _____
Daytime telephone _____ (include country and city code if outside the USA)
FAX number _____ (include country and city code if outside the USA)



Equipment used in SWI installations: The Sony SX5000B control unit for conference systems (left). The Shure M-68FC 4-channel mixer and the Sony wireless transmitter, the SX-1310.

Features Like These Are Usually Found Only In Larger Mixing Consoles.

Mic/Line switching for optimal level adjustment.

Three-band EQ with sweepable mid frequency center.

Rear-panel channel insert points on separate racks.

High-gain (84dB Channel input to program output) ensures full output with low level or distant mics. Optional Precision input transformers are available.

Better than 130dBu Equivalent Input Noise.

10-Segment LED meters for quick, accurate visual monitoring of all signals.

Switchable Phantom Power for Condenser Mics

Separate Mono Output level

Headphone Out w/ Level control

Switchable Meter Functions

2 Aux sends per channel greatly increase flexibility when interfacing signal processing units.

Utilizes the same mic-preamp chip found in top recording consoles to provide exceptional, low-noise performance.

Transformer Isolated +24dBm 600 ohm Balanced XLR Stereo Program Outputs w/ Left and Right Master Controls.

Our MM-508 Offers Them In Just Three Rack Spaces.

100 Fernwood Avenue, Rochester, NY 14621 • Toll Free: 800-828-6308 • 716-544-5191 • FAX: 716-266-4589

ASHLY

Circle 253 on Reader Response Card

I really don't have much to complain about. It's interesting work and I get to meet people from all over the world. The

FOR CONFERENCE ROOM MEETINGS IT IS IMPORTANT TO HAVE ENOUGH TIME TO SET UP.

subject matter covered at meetings is always interesting and I get a chance to see behind the scenes of what could be oppor-



An AKG mic used for a seminar at J. P. Morgan on Wall Street that was covered by SWI.

tunities for growth and change in our world: Issues as diverse as the Church's stand on abortion, the ancient "science" of soul travel, building bridges of understanding between the Haitian and

I WOUND UP AT THE IBM OFFICES IN YONKERS, INSTEAD OF MT. PLEASANT.

Korean communities in Brooklyn, New York, and the regional directors meeting of International Planned Parenthood Federation.

Well, I'll say goodbye for now. My associates and I have a three technician, six language job coming up and a lot of coordinating to do. ■

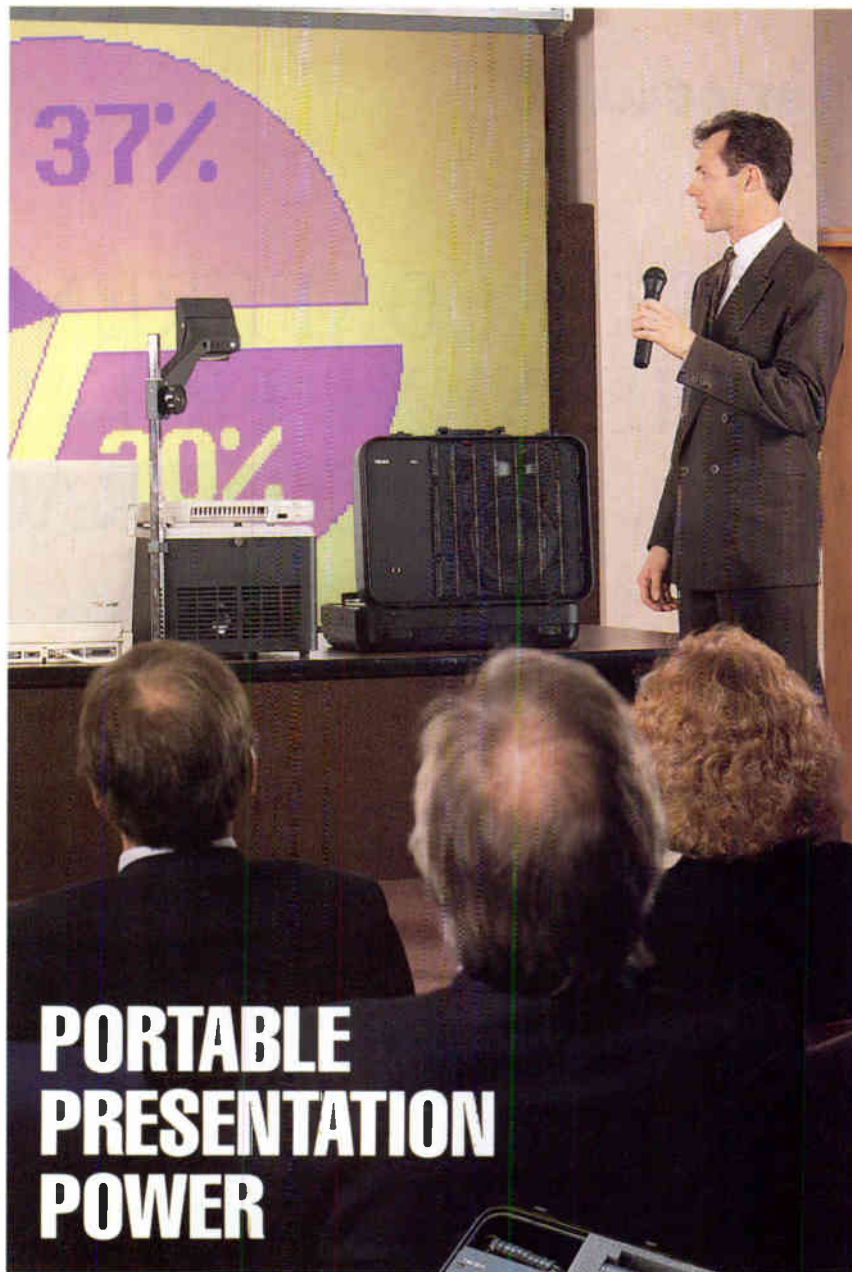

PORTABLE PRESENTATION POWER

Portable sound system featuring a built-in wireless receiver.

When you present in an unfamiliar location, you never know what kind of sound system (if any) you'll encounter. Why take a chance when you can carry quality sound with you!

The all new Telex PAS-1 is a completely self-contained unit with wireless microphone receiver, amplifier/mixer and detachable speaker all in a rugged carrying case. A powerful 50 watt amplifier and high efficiency speaker allows the PAS-1 to easily fill large areas with sound.

The PAS-1 can be used with

wired or wireless mics and auxiliary input sources. Full, easy-to-use control panel affords complete control over final program mix. Unit can be powered from either an AC wall outlet or external battery.

For more information, call or write: Telex Communications, Inc. 9600 Aldrich Av. S., Minneapolis, MN 55420, (612) 887-5550.

©1991 Telex Communications, Inc.



TELEX®

Circle 221 on Reader Response Card

TELECONFERENCING — THE NEXT FRONTIER FOR THE CONTRACTOR

By Thomas J. O'Malley

When was the last time you sat around with your employees, associates or association colleagues and grumbled about how slow business has been lately?

I'm not a Wall Street economist and I would not have to be one to realize that you're right about your assessments of the economy. New schools or additions on them, wings being added to health care facilities, factory expansions, office building construction and etc. — all traditional financial music to your ears — have just about gone the way of the dinosaur.

I'm also a communications professional, in a segment of our communications industry referred to as Teleconferencing. My employment experience with Dukane Corp., a major American communications manufacturer, and various sound and communication contracting firms in the Chicago area, including Northern Communications and Sound, Inc., give me some basis to speak from regarding business opportunities for contracting firms in an emerging field of communications — teleconferencing.

Thomas J. O'Malley is Vice President, Sales of Teleconferencing Systems International, Inc. of Elk Grove Village, Illinois which manufactures and markets a line of audio teleconferencing systems.

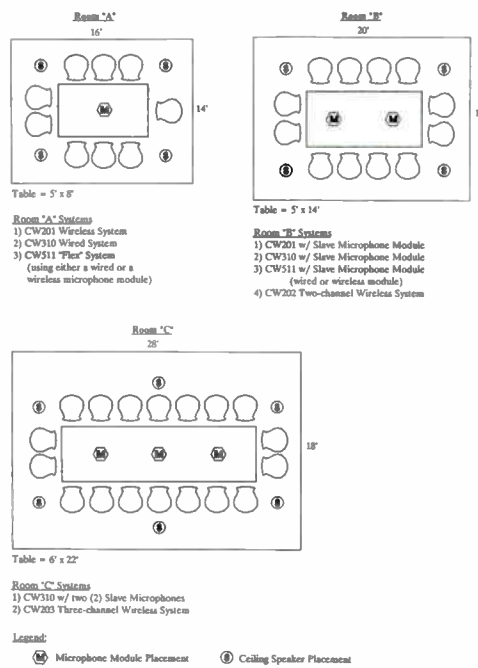

Suggested conference room coverage using TSI's Conferencer Systems.

The same customers in the same geographic areas that you have serviced for years by providing paging, background music, intercom, nurse call, CCTV, fire alarm, conference room sound systems and telephone systems to are most likely now looking for someone to provide them with a teleconferencing system. Why? There are a number of reasons. They are probably looking for someone to help them because it's not a service offered by your firm. Typically, a manufacturer will sell

these organizations directly because there are no structural distribution channels in place at this time in the industry.

In business and industry, staffing and travel budgets are being cut but corporate demands remain the same — profits and efficiency. In health care, because of lower patient censuses, staffing and seminars for employees are being cut back but institutional demands remain the same — profits, efficiency and higher standards of training of employees due to technology. In education, enrollments are the same or going up in many districts and universities, but additional classes and staffing for them are being rejected by local political action groups or state governments who cannot fund these programs.

What do these markets all have in common? A need for teleconferencing. Teleconferencing is simply defined as meeting from a distance utilizing telecommunications as a medium. Whether two people (or groups) wish to conduct a meeting, or several people (or groups) at various locations wish to conduct a meeting, the technology is available to provide this service.

Teleconferencing can be carried on in various formats:

- Audio systems ranging from user installed tabletop systems to contractor or factory installed two-way interactive video systems.
- Video systems ranging from PC-based graphic systems and still image systems to one- and two-way videoconferencing systems.

Teleconferencing signals (either audio

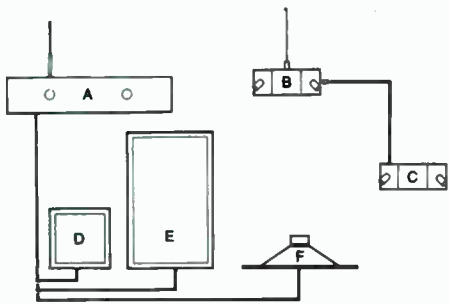

Note: A. Wireless System Control Unit
 B. Wireless Microphone Module
 C. Optional Slave Microphone Module (MS)
 D. Portable Matching Speaker (SD)
 E. Optional Deluxe Bookshelf Speaker (SB-D)
 F. Optional Ceiling Speaker (SC)

Example of TSI Conferencer System — the model 201 wireless system.

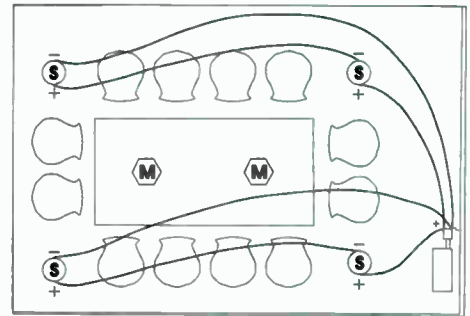

Ceiling speaker wiring guide for TSI.

and/or video) can be transmitted in various ways and at various speeds, depending on the technology used by utilizing:

- Dial up phone lines
- Microwave
- Satellite transmission (C & Ku Bands)
- T1
- ISDN (where available)

Because of the wide variety of products and services now available, businesses are sharing the same in-house teleconferencing facilities for management meetings, engineering meetings, marketing meetings and training meetings. Health care facilities are sharing systems for administration meetings, in-service programs

and seminars for their staff provided by various associations, pharmaceutical and equipment providers as well as on-line medical support programs to other facilities. Educational districts and institutions in both urban and rural areas are extending the classroom through teleconferencing and sharing programs with each other not only to accomplish their educational responsibilities within budgets but to enrich the curriculum and provide better education.

With a slight shifting of your marketing direction, your organization should be able to expand its business opportunities within your existing market and with many of your existing customers.

There are numerous teleconferencing products and systems manufacturers like the one I am affiliated with who would be eager to expand their distribution in this

growth field.

Putting together the right system components, pulling speaker wires, microphone cables, coaxial cables and telephone lines and connecting them is your firm's expertise. Selling and installing these teleconferencing systems should be an evolutionary movement in your organization in order to expand your business and fulfill your customers current communication requirements.

The opportunity today to broaden your product and service offering by providing teleconferencing is as logical as your decision may have been back in the '70s and '80s to provide telephone systems to your customers. ■

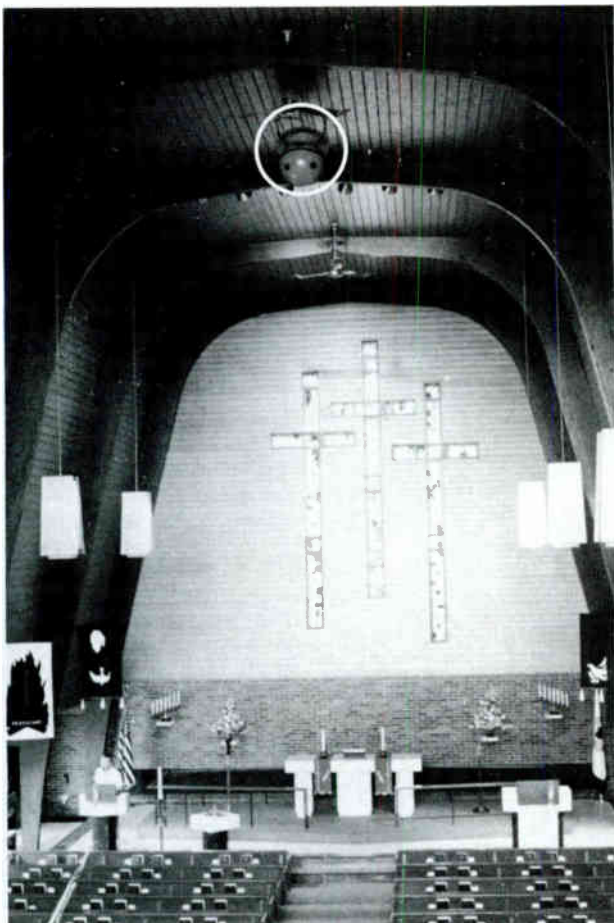

"...excellent voice clarity and beautiful music reproduction!"

Pastor Don F. Thomas

The Prince of Peace Lutheran Church, Ida, MI, has used a Sand colored Soundsphere #2212-1 loudspeaker for a few years. Pastor Don F. Thomas has been delighted with the improvements. He stated "there is no comparison between the former system and what we have now. The single Soundsphere loudspeaker produces excellent voice clarity and beautiful music reproduction. It also achieves very even sound distribution in my church. With it, we now do a lot more speaking by church members with wireless mikes from various areas of the church with good results. Even special programs done with children are now clearly heard in the church."

This Soundsphere installation was done by Monroe Sound in Monroe, MI. They have also installed Soundsphere loudspeakers in many other local churches, gyms, and auditoriums. A representative of Monroe Sound stated that, "Soundsphere speakers are a quick and easy installation. My employees can finish more jobs in a shorter time period resulting in improved cost efficiency for the church and for the company."

Write or call direct for further information.

SOUNDSPHERE A PRODUCT OF
SONIC SYSTEMS, INC.

737 Canal Street • Bldg 23B • Stamford, CT 06902 • USA • Tel (203) 356-1136

Circle 251 on Reader Response Card

World Radio History

THE POSSIBILITIES

The Flex System from Rane: A Powerful New Approach to Modular Signal Processing



FLEX

Flexibility, no matter how you spell it, means power. It's the power to meet varied needs. To meet budgets with optimum performance. To efficiently accommodate system growth. Long into the future.

Flexibility is the essence of Rane's new FLEX System. The first universally compatible, cost effective, modular approach to signal processing and routing. With no special requirements. And no dead ends.

Each Flex module is an HR (Half Rack) compatible, UL/CSA/VDE approved, self-contained processing unit. Each capable of being EIA rack-mounted either horizontally or vertically, with inexpensive, readily available hardware. Or simply set on a shelf, stand-alone fashion.

HIGH-POWERED COMPATIBILITY. Using standard 3-pin, 1/4" or barrier strip connectors, FLEX modules are directly compatible with professional audio gear. And since they are remote powered—via Rane's proposed power supply standard—troublesome ground loops, hum and agency approval problems are solved up front by design.

ENDLESS POSSIBLE COMBINATIONS FOR CUSTOM DESIGNS. The FLEX non-exclusive modular concept makes it inherently expandable

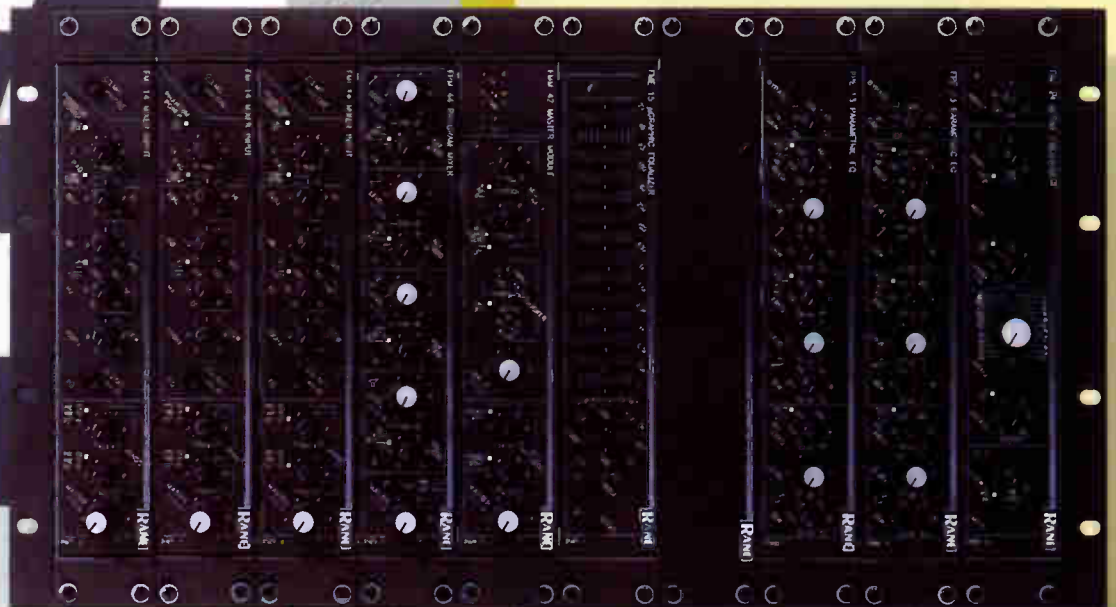

ARE STAGGERING!

and upgradeable. It boasts a large and growing number of functions and components to choose from. Mixers. Preamps. Splitters. Crossovers. Dynamic controllers. Equalizers. Amplifiers. Line drivers. And much more under development.

And thanks to Rane's efficient bus design, system wiring is greatly simplified in even complex mixing and splitting layouts.

COST EFFECTIVE CAPABILITIES. Modular flexibility. Uncompromising performance. All without a premium price. That's the FLEX System manifesto. There is no expensive mainframe to buy; you only pay for the functions you want, when you want them.

Say, for example, you only need a 3 channel mixer with one channel of crossover. The FLEX System delivers. And when your needs expand, just add more modules. No need to obsolete old equipment for a loss.

Whether you use two modules or twenty modules, the FLEX System remains cost effective. And supremely flexible. Year after year.

SUPERLATIVE PERFORMANCE, RANE RELIABILITY. The design and performance of each and every Flex module is, in a word, superlative. Every model carries top-grade studio specifications, utilizing the best components available. The result is unsurpassed performance and reliability.

Our HR compatible modules may be compact, but they're stuffed with more top-notch features than you would have thought possible. For example, the **FMI 14 Mixer Input module** measures only 1.75" x 10.5", yet it boasts a -128dB EIN mic stage, switchable phantom power, true 20dB pad, powerful 3-way EQ section, insert loop, two source-selectable Aux sends and balanced master channel outputs. A single DIN cable, supplied with each module, routes the Master and Aux buses from unit to unit for quick and clean hook-up.

+15/-20dB boost/cut, 2-octave down to 1/30th-octave bandwidth range for notch capability, and a full 10Hz-20kHz frequency sweep range for unprecedented flexibility.

The **FME 15 MicroGraphic Equalizer** brings Interpolating Constant-Q filter performance to the Flex line, pioneered by our full-sized GE 30

current balanced outputs, and you've got a powerful, flexible new crossover standard.

This is but a sampling of the innovative Flex Modules to be released this year. We encourage you to obtain separate, detailed data sheets on the many FLEX System modules. Then compare these with the best standard equipment available. You'll discover that FLEX offers the best of all worlds: compact, cost effective, flexible, uncompromising performance.

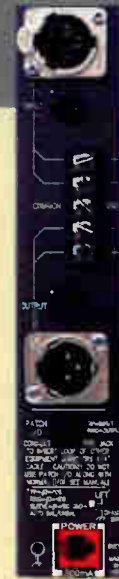

The **FMM 42 Master Module** not only provides Aux returns and mixing, but features extra mic and stereo line inputs with ducking capability for paging and other applications.

For even more mixing flexibility, the **FPM 44 Program Mixer** allows 4 separate mic or line inputs to be mixed to 4 output programs, with pre or post fade switch selection for the Aux sends. Both the direct balanced/unbalanced terminal strip and the DIN Flex bus inputs and outputs can be used simultaneously for easy expansion and integration into larger systems.

Carrying on a fine tradition of innovative equalizer technology, Rane sets yet more new standards with the Flex Series. The **FPE 13 Parametric Equalizer** provides 3 separate bands, each capable of

model which has set new industry standards. Minimized filter interaction, smooth combined response and fully balanced three-pin and terminal strip input/output are but a few of the features. Both the FME 15 and the FPE 13 also provide an exclusive Patch I/O jack which allows direct connection to an insert loop jack with a single 1/4" TRS patch cable.

The **FAC 24 Active Crossover** is the next generation to follow in the respected footsteps of our AC 22 and AC 23 designs. In addition to the proven 24dB/octave Linkwitz-Riley performance, the FAC 24 features a true 24-position frequency selector switch to provide plug-in card accuracy and repeatability with the convenience of a knob. Add to this a built-in CD Horn EQ section, electronic phase alignment, summing LF input and three-pin high-

FLEX MODULAR SIGNAL PROCESSORS SERIES

RANE

10802-47th Ave. W.
Everett, WA 98204
(206) 355-6000

Circle 210 on Reader Response Card

The Boardroom Market

How to Make Money

BY DAVE TAYLOR

At last year's CEDIA convention, Dave Taylor spoke to attendees on Boardroom Installation. We've excerpted his comments here.

The boardroom market is not only boardrooms. It's training rooms, auditoriums, conference rooms, executives offices, executive suites, hotel complexes.

What might normally be found in a boardroom or a training room or an auditorium? One of the things you might normally find is video. Now there are different kinds of video, you all know. Corporate video usually includes 3/4 inch videotape recorders, 1/2 inch VHS, 1/2 inch SVHS, laser disc. There are other things — film to video transfers, slide to video transfers. A lot of corporate boardrooms are using one medium to project whatever information they want to use. And they've chosen video projectors. They can use that to show slides. To show documents, with a document camera. They can use that to show computer information, cable TV, television, security information. There are audio products that are normally in corporate boardrooms. Cassette players. Sometimes these cassette players are interfaced to slide shows. CD players. Voice reinforcement, for people making presentations. Program reinforcements for

video tape shows. Another thing that people are using more and more today is the teleconference. The teleconferencing world integrates video, voice, telephone and remote control.

The guy who outfits his home may think he wants to have the same stuff in his boardroom whether or not he ever uses it. So, virtually everything you might find in a person's home may someday end up in a boardroom. There are also things that are in a boardroom that you probably won't find in a home like the video conferencing

The guy who outfits his home may think he wants to have the same stuff in his boardroom whether or not he ever uses it.

capabilities, and some fairly sophisticated remote control capabilities.

What kinds of boardroom sales are there? First is the negotiated sale. A guy says hey, I've got something at the office I want you to take care of. Will you help me do it? You sit down, you figure out his requirements, you find what he wants to do. You negotiate a price and you do the project. That's the one you like to do most — it's the most profitable.

The next one is slightly less optimum. The owner decides he wants to have a new boardroom or upgrade the boardroom and so he hires or has his AV coordinator sit down and write a generic — I'll say *spec* but it's not a spec. It may be a one or two page or one to two paragraph description of what the owner wants this boardroom to do. He may just say, look we want to have a boardroom, we want to show VSH video. We want to show slides and we want to interface to a computer and use our video projector.

This kind of owner spec'ed system still gives you a lot of flexibility to go in and make that design your design. And that's where you'll win these projects. If you do it right. You don't have to win the project on low price. You do it right, you win the project because your design most closely meets what he wants.

Later, we'll go over the dreaded consultant spec. These guys are the ones that drive the big projects. It's a whole different ballgame dealing with consultants. No longer are you dealing directly with the owner. In fact you probably don't even get to talk to the owner. And you have to deal with an architect sometimes, or maybe sometimes you can't. Sometimes you have to deal with an electrical contractor, maybe you're not supposed to — or a general contractor or an interior designer or maybe you're not supposed to. They're all different. The consultants drive the big projects, the 50 thousand-, the 100

Dave Taylor is with Total Marketing in Fort Worth, Texas. Among his lines is AMX.

thousand-, the 500 thousand-dollar boardroom systems. And they're also the guys who do the integrated building systems so that if there's a boardroom in a building where they're putting in an auditorium, not only do you land a boardroom project, you get to do all the audio and video of the entire building. Consultants are a special breed of people.

The bad thing about a negotiated project is that the owner has entrusted you with the design and implementation integration of the system. If you don't do it the way he wants, or if you're not clear about what you want to do, you haven't communicated well, you haven't documented yourself well, you can end up at the end of the project with a system that you think exactly meets everything you discussed with him. And then he turns it on and says, "Well this is not what I want. And don't you remember I told you to do this and I thought we agreed on that." The benefit though is that with a negotiated project you have the benefit of a relationship with this person, or you've been referred by someone. So he has learned to trust your judgment and your recommendations. Now there are some benefits to doing it this way. You don't have to two-

The bad thing about a negotiated project is that the owner has entrusted you with the design and implementation integration of the system.

step anything. You're selling a product that you're familiar with, the technicians are familiar with, so you have an advantage there, selling your own product. You have the opportunity to establish a budget with him. You have the opportunity to define the system requirements. That's also a responsibility. You're selling him a bunch of boxes from all different sources and they do all different kinds of things. But to him it's one big box with a ribbon on it and it's

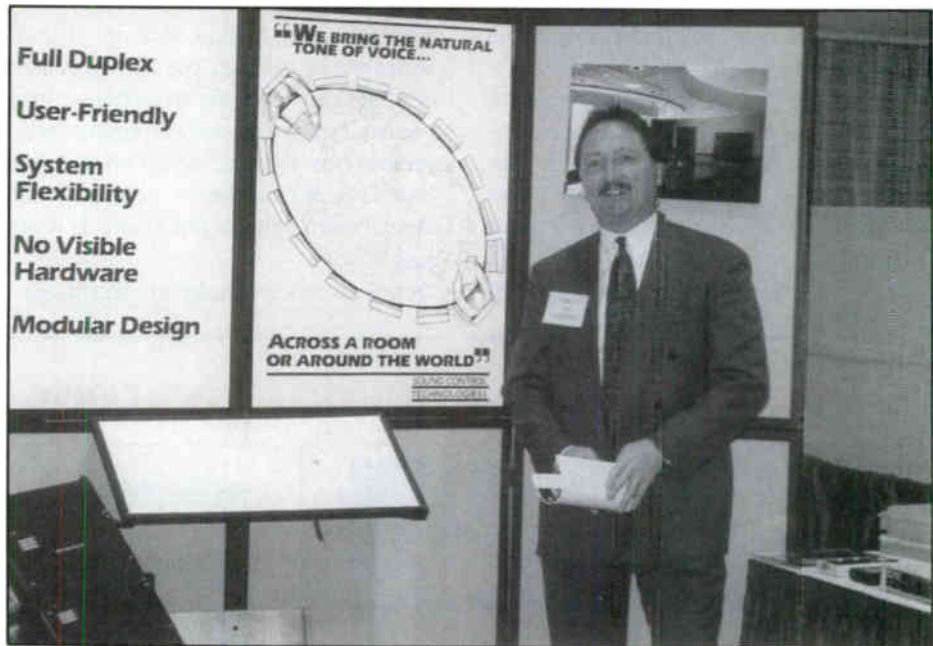

Dave Taylor of Total Marketing.

800-446-NSCA

NSCA WORKSHOPS • EXHIBITS
EDUCATION & MORE...

EXPO  **'92**

ANAHEIM CALIFORNIA
CONVENTION CENTER
APRIL 27TH, 28TH, 29TH

*"The ONLY show for Electronic
Systems Contractors...National
Sound & Communications Association"*

his box. Your responsibility is to put the correct pieces in this box.

In essence, you're the manufacturer of his boardroom system. Your responsibility there lies in communication with the owner to make sure you are getting the one he needs. You can establish a level of quality if you want. If he wants some real high dollar stuff, and then inexpensive

things for some things, it's up to you. There are a lot of things you have to define. Does he want voice reinforcement or does he want a system that will do program reinforcement or does he want two systems — one for voice and one for programming? Does he need delay in this room? Is it big enough?

In the corporate boardroom, the presen-

tation is there for one purpose only — to help further business. Many people may use the facility, so you can't generally design it for one application. It has to be flexible enough so that any number of people can come in and be comfortable with it very quickly and feel at ease. Sometimes people making presentations in the boardroom have their jobs on the line. Or a two million dollar sale is on the line. So the idea with media and media control in the boardroom is to keep it simple and straightforward. Make it so that the media and the equipment enhances the message and doesn't interfere with it, doesn't distract his audience from understanding the message.

While you're designing a corporate boardroom system one of the most important things to think about once you've established what he wants to do, what he wants to use, and what he's showing is how does he control all of this.

Again, it's your responsibility to determine how the user wants to use the facility. Does he want to have one big button on the wall that he pushes, or does he want to have 50 buttons, one button for every function that he wishes to access, or does he want some combination? For the presenter who's just coming in, the poor guy from accounting, say he's making a presentation to the board of directors who can see a big 50 button control panel when all he needs is one button — he's going to spend half of his presentation worrying, "When I'm ready, I hope I hit the right button."

It's your responsibility to help define these kinds of things. And if you do, your owner will appreciate it, will realize that you're working in his best interest. Your job is to help him look good. That locks you into the project. Who's going to be using this? Is this a room for a bank board of directors? If it is, the chances are that there may be a bunch of 60 or 65 year old men in there who don't see so well, don't hear too good. You have to take that into consideration. You've got to make sure you have enough lights. When you're designing the remote control panel, are the buttons big enough? What about the audio system?

PRESENTATION SUPPORT SYSTEMS



FOR ALL YOUR PRESENTATION NEEDS

Chief's complete line of carts, stands, tables, cases, lift mechanisms, ceiling mounts and presentation easels all incorporate practical and distinctive proprietary features to accommodate your individual needs. Call or fax today for a full line catalog or detailed literature on any of our products.



Circle 256 on Reader Response Card
CHIEF MANUFACTURING, INC.

14310 Ewing Ave. S. Burnsville, MN 55337 612-894-6280 FAX 612-894-6918

See us at INFOCOMM Booth #1647

World Radio History

NEW!



West Penn Wire
**BLACK
COBRA**

SNAKE CABLE
Multi-Pair
Individually
Shielded/Jacketed

Now there's a solution to the special interference problems facing today's broadcast, recording and performing arts audio systems.

It's new Black Cobra audio snake cable from West Penn Wire.

Black Cobra cable interconnects console board equipment and other audio components for recording studios, radio and television stations, post-production facilities, and sound system installations. Ideal for use as line level microphone snakes, Black Cobra's individually jacketed and shielded pairs provide top protection against signal interference.

Black Cobra cable features:

- UL approved for CL2 applications per NEC 1990
- Individually shielded and jacketed pairs: 4 through 52
- Loose tube construction for high flexibility
- Non-reflective black matte finish on PVC outer jacket
- Numbered PVC inner jackets for easy identification

When it comes to signal integrity, sound and picture clarity in audio and video transmissions, so many professionals trust West Penn Wire's shielded cable.

Best of all, Black Cobra is available from stock for immediate delivery.

West Penn offers a complete selection of low voltage electronic cable. All backed by the dependable quality, service, competitive pricing and engineering assistance you've come to expect from West Penn Wire.

For more information, contact your local West Penn Wire distributor or call West Penn Wire today on **800-245-4964** (in PA 800-222-8883). Write West Penn Wire, P.O. Box 762, 2833 West Chestnut Street, Washington, PA 15301.

WOW
WEST PENN WIRE

**THE WIRE
GROUP**
INTERCONNECT SYSTEMS PRODUCTS

NEW TO THE U.S.

OptimAudio
The Source For

WHARFEDALE

FORCE Series
hi performance
professional
loudspeakers



WHITELEY

Integrated
amplifiers,
telephone
interconnects
for public
address



DESIGN/PLANNING

*We are looking for key
dealers wishing to share the
success of fine products.*

CALL US

1-800-989-0802

733 Canal St., Stamford, CT. 06902

Circle 290 on Reader Response Card

Phantom in a tube!

Now your phantom-powered condenser microphones work with almost any input. Simply put the new CP8508 supply in series with the microphone line, plug it into 120V AC power, and *Voila!*

The CP8508 powers a single microphone, providing 24V phantom power easily and quickly. It's perfect for upgrading a system that lacks a built-in phantom power supply. Or, if you have several microphones to install, use our CP8506 4-channel 48V supply. Either way, you'll have the power you need where you need it, at minimum cost.

You can trust Audio-Technica to solve your toughest microphone problems. Ask your A-T representative for more details today.

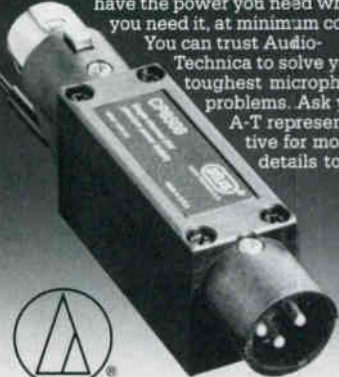

audio-technica

1221 Commerce Dr., Stow, OH 44224
(216) 686-2600 • Fax (216) 686-0719
In Canada call: (800) 258-8652

Do you really have to have an audio system that has a response that's this wide? When these guys only hear this much? These are things that you have to determine. If you ask your owner these things, make him think about them, he's going to think in his mind, this guy really is looking out for my best interest. He's thinking about what I need, not what he thinks I need. Make sure you ask the questions.

Does the presenter like to stand behind a podium and hang on. If he does, he may want to run all of these boardroom functions from a permanently mounted control panel right in the podium. Does he like to wander around and do different things? If that's the case, you may want to provide him with a wireless remote control that has one button that will step through a bunch of features. Or maybe they have two different presenters — one does this and the other does that.

Once you define all of these things, the owner begins to understand what's involved in his boardroom and he's much more likely to not fall out of his chair when he sees the pricing for this. Because he understands what actually is involved. Every chance you get you should make sure that the owner knows that what you're doing is for him specifically. Continue to work on that relationship.

Give him your proposal in a nice binder with his name on it, if you can afford it. If you have a CAD system or if you have a simple CAD or MAC drawing system, do some basic one line drawings with his name on it, his company name on it, something that personalizes it to him.

If you're going to charge for consulting, you need to establish that the very first minute you start talking with him. You have to say, If you want me to help you to design this room, if you choose to do this, then the standard consulting fee is. . . .

There's usually a couple of stages. You have a meeting. You determine the scope of what their project is. From that you can give them either a set fee figure that gives them a certain number of hours, or you charge them on an hourly basis. And then that allows you to go onto what the consultants call programming or actually

sitting down and specifically deciding or determining everything that goes in there.

If you do the design and you let yourself be known as a consultant, then you have certain responsibilities for that design later on. You have to make sure you're aware of your responsibilities.

A lot of times you run into a company which does not want you to consult and then bid on a job, because they feel the consultant should only be a completely disinterested third party. You can't be objective if you're also bidding on it. And there's a very valid set of reasons for that. They hire a consultant. It's a consultant's job to protect the client from bad workmanship, from the project not being installed correctly.

Now the consultant can also protect the contractor from the owner's misunderstanding of what he's supposed to have.

Presentation is the key. These guys that you're dealing with are all people. They have a responsibility within the company to see that when this boardroom is done it meets the needs of the people that are going to use it. They have a lot of responsibility and pressure on them to not screw up.

When you turn a boardroom or auditorium over to the owner he stands and pushes the buttons — and man that's his system. Now, if you approach the control of equipment correctly, he is so pleased that he thinks that he just got the neatest thing in the world and it's irrelevant how much it costs. He knows that the VCR is \$600, the cassette player is \$200 and the CD player is however much. But it's all the stuff he doesn't understand, which is the control interface and the things that make the lights, the drapes, and the curtains go. He has no concept how much these things are worth. There's where you get some of your points. You also get some of your points back by putting in an engineering fee. You can charge a consulting, you also put an engineering fee in there because you have to tell the owner, "Look you've got 50 different brands of equipment, we've got to integrate it into one system while we have an off-the-shelf control system. There's a lot of engineering and interfacing

that has to take place.” In fact, there is. But you can charge a significant percentage for that.

Another thing that you can charge for on a negotiated project is you can say, “Look, the system is this much, now if you want complete record documentation, you have to provide it, we charge x dollars for that. If you want drawings, we charge y dollars for that. If you want training which are z dollars for that, if you want video tape training, it’s this much.” You can use that as a way to increase your sales or you can give these things away as an enticement to get the project. Not only will we give you the system for this much, but we’ll also include all the documentation, required training, video tape of training — that kind of stuff.

Typically, in large projects that are generally consultant driven, the standard payment form is that you’re working for a general contractor and an electrical contractor. In that case you get paid 30 days after you invoice them for your received equipment or goods. As soon as you receive the stuff from the factory you can invoice the general contractor. Thirty days later he’s supposed to pay you. It’s usually 45 days later. It’s a form of progress payment. There’s usually 10 percent retained out of every check that’s paid to you 30 days after the system is signed off on. A \$500,000 project or \$100,000 or \$50,000 project — that’s a lot of money to float. They take two, three, six months or a year between the time you agreed to do the project and the time it’s signed off on. Now, if you’re negotiating the deal yourself with the owner, it’s not uncommon to get a third with the order, a third on completion, and a third on acceptance. We’ve seen people get 50 percent up front.

And it’s not unusual for a boardroom project to be six months between inception to sign-off.

There’s a real neat niche market that the industrial people are not approaching at all — and that’s the CEO’s office. Because he’s got the same stuff in his office that he put into his house and that’s his own personal little thing and he wants to play with it.

You may have the best relationship in the world with the owner; it’s not always the owner who determines who does the project. It may be the general contractor.

CONSULTANT PROJECTS

Consultants are the drivers of the big projects. As I mentioned earlier \$50,000 and up to \$100,000, you may develop the

project yourself or consult it. Once it goes beyond that, 90 percent of the time the consultant is the one you have to deal with. There tends to be in the industrial AV sound contractor world an almost adversarial relationship between the contractor and the consultant. The consultant does things real weird — puts all these odd things in there. Sometimes the consultant

EVERY MAJOR TRADE SHOW ON VIDEO

NSCA-TV NEWS
AES-TV NEWS/CROSSTALK
CES-TV NEWS
NAMM-TV NEWS
NAB-TV NEWS

CALL FOR INFORMATION

516
767-2500







Television news
programs covering
the conventions
that are of import.

ORDER THEM NOW!

TESTA COMMUNICATIONS
25 Willowdale Avenue
Port Washington, NY 11050

is actually paid based on the total value of the project. So some consultants add things here and there and everywhere else build up the price. And the installing contractor says, "We could have done this for a lot less money and a lot more straightforward."

Consultants are good guys though. Because first of all they're driving the sale. You don't have to spend any time with the

owner talking him into it. You don't have to spend any time helping him realize how much money this is going to cost. You don't have to spend any time defining what the owner wants to do.

The consultant has the power in most cases to select who gets a chance to bid on the project. Consultants — it's almost as though they are about to participate in an immaculate conception. They've got

this idea. They're selecting who is going to mother or father their idea. Their child is the beautiful system they've convinced the building owner, the company owner, he needs to have.

A consultant's background can be real varied. He can have 16 degrees in all kinds of things including HVAC, noise control, room acoustics, video, whatever. He can measure anything that makes a picture or a sound and tell you whether it works right or not. We have one consultant that specified a certain relay because it's quieter than any other relay. And he spent two weeks trying to find this relay. You'll have good consultants who are very clear in their specifications. You'll have bad consultants. We saw a consultant spec recently that said there's supposed to be a remote control system in the facility and the devices you're controlling are these four things. Well, is it wireless, is it hard wired, touch panel, does it have to be on an anodized face plate? What functions do you want? Who knows. It can be a \$500 control that's just an infrared, a \$100 dollar infrared learner control, or a \$5,000 completely programmable software driven remote control system.

A consultant's background can be real varied. He can have 16 degrees in all kinds of things including HVAC, noise control, room acoustics, video, whatever. He can measure anything that makes a picture or a sound.

The best thing you can do is to bring it to the consultant's attention. You write one price down. You say what is your intent. Because intent is very important in these projects.

Some people actually win projects by reading the specification and responding only to the wording of the spec. Generally,



FOUL WEATHER GEAR.

Perfectly suited to their environment, TOA's lineup of weather-resistant speakers takes the worry out of damp, humid and temperature-extreme installations. With ABS or polypropylene shells, zinc-coated brackets and stainless hardware, their sturdy constitution doesn't sacrifice sonic performance — woofers, CD horns and high efficiency drivers deliver uniform dispersion patterns and smooth frequency response. There are five models with 20-120 WRMS input power so that you can take on the elements like a duck takes to water.



TOA ELECTRONICS, INC., 601 GATEWAY BLVD.,
SOUTH SAN FRANCISCO, CA 94080
415/588-2538 • 800/733-7088

Circle 249 on Reader Response Card

they're able to do that at a significantly lower price. The good contractors will try to respond to the intent of the spec. If you don't respond to the intent of the spec, chances are you'll never get a chance to

A good consultant has a big broad background in lots of things. Some of you may not be as strong in audio as you are in video or vice versa. You maybe don't know anything about computer interfacing. The consultants can assist you — the good ones.

bid for that consultant again. They can make your life difficult.

So, it's your responsibility to clarify these things and if you don't, you may not pay for it in dollars and cash, but you will probably not get a chance to do anything again for that consultant or the owner.

Consultants work more and more directly with the contractor on a design/build basis. And it's not a bad way to go. The consultant can work with you and help design what has to happen. The consultant will then come to you and say okay, this is what we want to do. What kinds of products do you carry that can meet these needs; we'll put them in there. The consultant can also help you in doing documentation. They do it all the time for big specs. That's a big, big burden off your back. You may not have CAD and somebody to sit down at the computer and draw this stuff up. The consultant can do that. And it's just another way to make money. These guys are doing it anyway.

It's also good in that it protects you when the system is done and the owner says, "This is not what I wanted." And the consultant says, "Oh yes it is. We agreed. Here's documentation right here."

Consultants have people calling on them telling them about products that are avail-

able or soon to be available that you might not know about. That might exactly fit an application that you have. A good consultant has a big broad background in lots of things. Some of you may not be as strong in audio as you are in video or vice versa. You maybe don't know anything about video which is slides, film and those kinds of things and sometimes computer interfacing or what not. The consultants can

assist you — the good ones.

Now there are two types of bad consultants. There are the bad ones who don't do enough; who aren't smart enough to really be effective. And there are the other consultants who are the complete opposite, who do too much. And they put in stuff that's too weird. So, it's just like contractors. There are good ones and bad ones. ■



PLAN FOR THE UNEXPECTED.

Because you can never be too well prepared, the TOA AX-1000 mixer has eight input ports with a choice of 37 modules — including mic, line, aux, BBE, I/O and bridging — making design, upgrades and changes, quite literally, a snap. Advanced circuitry lets you tailor the gain sharing to match the acoustic conditions ... so each mic gets maximum available gain for intelligibility. It's completely automatic, completely modular, completely silent, completely reliable. Just what you'd expect from TOA. A versatile, forward-thinking mixer that helps you look very well prepared indeed.



 TOA

ENGINEERED SOUND PRODUCTS FROM:
TOA ELECTRONICS, INC., 601 GATEWAY BLVD.,
SOUTH SAN FRANCISCO, CA 94080
415/588-2538 • 800/733-7088

Circle 250 on Reader Response Card

World Radio History

NEW ENTRIES ON THE MULTIMEDIA SCENE

By Neil Shaw

The fourth annual MultiMedia Expo was held in northern California at the San Jose Convention Center from November 18th to the 20th.

MultiMedia is a grab-bag of emerging technologies, including, and often combining, personal computers, computer-aided animation, motion video (often processed through data compression), interactive compact and laser disc media, and video networks. It is tough to limit or define what multimedia is, but for sure it is no longer bands of slide projectors.

PROFESSIONAL WORKSHOPS, LED BY INDUSTRY LEADERS AND SCHMOOZERS, OFFERED A CHANCE TO BECOME FAMILIAR WITH IMPLEMENTATION STRATEGIES.

Paper sessions (called SuperSessions by the conference organizers) included 12 papers. One, The MPC (The Multimedia PC Marketing Council), was concerned with generating widespread acceptance of the MPC trademark, which the members

Neil A. Shaw is a Senior Associate with Paul S. Veneklasen and Associates, Consultant in Acoustics and Audio/Visual Systems, Santa Monica, California.

of the council hope will become just like the VHS trademark. The MPC trademark is designed to be a symbol of plug-and-play functionality, covering all the basic standards of hardware and software. The MPC trademark was originally spearheaded by the Microsoft Corporation. Original members of the MPC marketing council include AT&T Computer systems, CompuAdd Corporation, Creative Labs, Media Vision, NEC Technologies, Olivetti, Philips Consumer Electronics Corporation, Tandy Corporation, Video Seven and Zenith Data Systems.

THE MPC TRADEMARK IS DESIGNED TO BE A SYMBOL OF PLUG-AND-PLAY FUNCTIONALITY.

Other papers presented included sessions specific to manufacturers — Silicon Graphics (computer graphics), IBM Corporation (multimedia technology), RasterOps/Truevision (graphics arts and videographics), MacroMind (multimedia software and technology), Philips Interactive Media (CD-I, compact disc-interactive), Intel Princeton Operation (DVI, video data compression), Sony Corporation (multimedia products), Autodesk (modeling, paint and animation software), AT&T (computers, peripherals, software and communication technology) and Apple Computer (hardware and software).

The over 29 seminars included sessions on multimedia telecommunications and networking; voice command, synthesis and annotation technology; production tools; video networking; compression

technology; Hypertext and Hypermedia; fax + voice + E-mail = MultiMail; and multimedia databasing.

Nighttime sessions included sessions that focused on items from Apple QuickTime to making multimedia affordable (what a concept!).

Professional workshops, led by industry leaders and schmoozers, offered a chance to become familiar with implementation strategies of multimedia, equipment choices and criteria for selection of same, development of multimedia presentations and the software needed to produce multimedia presentations.

The exhibits enabled one to see, hear and experience multimedia. Exhibits included: the Multimedia and Videodisc Monitor — a supplier of books, studies, videos and software, more than 70 products to help you through the multimedia maze; On-Site CD, a CD audio and ROM recording service; Goal Systems, who developed market advanced software for online application systems, specifically their Syllabus authoring and presentation system software for use with graphical user interface (GUI) technology; Walden House, a New York based company that offers a theater, gallery, events and offices for lease, as well as production services for multimedia things; Haukom Associates, who offer consultation in the development of interactive media; OWL International who presented their GUIDE series of products — hypermedia products for MS-DOS and Macintosh, reader products (software presentation software for text data), and multimedia developer products and consulting services; Yamaha who showed their new multimedia PC large

scale integration (LSI) sound solution integrated circuits, a family of digital-to-audio converters, CD-I controllers and processors, MIDI products and synthesizers; Electrohome display systems for large scale display of multimedia video; Sony — who showed their component recording video (CRV) laser videodisc recorders and introduced their Vbox print-to-video kit.

One particularly dramatic exhibit was the "with design in mind" micro theater — a virtual projection system that uses ordinary video and a patented optical system to create a very convincing 3-D presentation. Selectras showed their computer controlled S-VHS videocassette recorder and computer/VCR interface; IEV International showed a preliminary version of its versatile Revolution desktop editing software, scheduled for a January 1992 release; Vision Imaging presented

disc); Nautilus presented their multimedia information services available on CD-ROM, a way of presenting in an easy and

**IEV INTERNATIONAL
SHOWED A PRELIMINARY
VERSION OF ITS
VERSATILE REVOLUTION
DESKTOP EDITING
SOFTWARE, SCHEDULED
FOR A JANUARY 1992
RELEASE.**

inexpensive manner hundreds of megabytes of information via a personal computer; and, Interactive Media Technologies

showed their IMTX 8000 media integrator, an interface box for the Apple Macintosh that provides broadcast quality, frame accurate deck control, video switching, audio switching and mixing, RS170A sync generation (NTSC video), and SMPTE time code reading and writing, all in a serially controlled device.

Multimedia is still an immature technology. How Sound & Communications readers will find application for these multifaceted processes in their designs and installations is only beginning to gel. Perhaps Multimedia will work as an adjunct to teleconferencing, such as with a new system that Shure has introduced, or as sophisticated interactive information systems (in airports, museums, etc.), or as an enhanced presentation tool for boardrooms. ■

**YAMAHA SHOWED THEIR
NEW MULTIMEDIA PC
LARGE SCALE
INTEGRATION (LSI) SOUND
SOLUTION INTEGRATED
CIRCUITS, A FAMILY OF
DIGITAL-TO-AUDIO
CONVERTERS, CD-I
CONTROLLERS AND
PROCESSORS, MIDI
PRODUCTS AND
SYNTHESIZERS.**

their multimedia authoring software, which supports a wide array of hardware — image processors, display cards, videocapture boards, sound boards, compression boards, scanners, printer and optical storage devices; AdLib showed their Gold 100 stereo sound cards; Optical Media International's intelligent compact disc solutions for professional compact disc publishers and manufacturers were presented in their booth (this equipment allows you to make any type of compact

**The BLUE BOOK is a
thoughtful and inexpensive
token of appreciation
for your employees
and customers.**

**Additional copies of
THE 31ST ANNUAL BLUE BOOK
are \$12.00 plus shipping
and handling**

**SEND YOUR CHECK OR MONEY ORDER TO:
ARTURO LIZARRAGA, CIRCULATION DIRECTOR**

THE BLUE BOOK

25 Willowdale Avenue
Port Washington, NY 11050

SATELLITE TECHNOLOGY AND HOW IT'S LINKING THE WORLD

By Keith Bose

On a rainy and windy night in January 1990, Michelle Birnbaum was the program producer on shift at News 12 Long Island TV.

It was a night with only routine programming: local events, talking heads, financial analysis, mostly taped stuff. They keep a radio scanner going in the producer's corner to cover police and fire bands to monitor any local events that could lead to a story.

At 9:45 PM the police and fire bands from all the local precincts and fire districts crackled into life. There was an airplane crash, probably a little plane, possibly a medium size plane. . . maybe a big one, an airliner, somewhere near the shore in Huntington...no, maybe Oyster Bay. After a few minutes and a telephone frenzy, Michelle Birnbaum dispatched the station's satellite truck. An airliner had crashed on a woody hillside near the shore line of Long Island Sound.

What happened next was that a teleconference was set up. The News 12 satellite truck reached the crash site of Avianca Flight 052 a half hour after the crash. The first step for the television crew was to level the truck and actuate the antenna mechanism on top of the truck to cause the Ku band antenna dish to point to the CONUS SBS III satellite orbiting 22,743.2 miles above the earth's equator at exactly 95 degrees west longitude. The News 12 crew knew where to look for SBS

Keith Bose is freelance writer in the New York area who covers topics in the telecommunications field.



The Satellite Communication Systems (SCS) satellite truck can send and receive two TV signals simultaneously to Ku band satellites. It contains a complete complement of equipment for uplink and downlink control.

Dave Springer of News 12 Long Island.



RENEW

CONTINUE YOUR
FREE
SUBSCRIPTION

TO

SOUND
COMMUNICATIONS

FILL ALL THE
QUESTIONS AND
MAIL YOUR
NEW
SUBSCRIPTION
OR RENEWAL
TODAY.

FOR YOUR FREE
SUBSCRIPTION TO BE
PROCESSED THE FORM
MUST BE COMPLETED
PROPERLY, SIGNED AND
DATED FOR THOSE
QUALIFIED INDIVIDUALS.

YES! I WANT TO STAY ON TOP OF THE INDUSTRY BY RECEIVING
A COPY OF **SOUND & COMMUNICATIONS** EVERY MONTH

NEW RENEWAL
 1 Year \$15.00 3 Years \$37.50 (Savings \$7.50)
 Payment Enclosed Bill My Credit Card Visa MC AE
(Foreign: Add \$10 for delivery) Card # _____ Expires: _____
 DO YOU WISH A FREE SUBSCRIPTION? YES NO — COMPLETE BELOW:

Signature _____ Date _____
Name _____ Title _____
Company _____
Address _____
City _____ State _____ Zip _____

(1) Do you wish to receive **Sound & Communications**?
Yes No
(2) Primary Job Function (only one):
 A Management/Owner
 B Engineer/Technical Mgt.
 C Sales/Marketing
 D In-House Maintenance/Service
 E Field Installation/Maintenance
 F Consultant
 G Advertising/Promotion
 H Other _____
(3) Primary business of company (only one):
 1 Contractor—Engineered Sound/Acoustical
 2 Contractor—Interconnect/Intercom
 3 Contractor—Fire/Alarm/Safety
 4 Electrical Contractor
 5 Pro Audio/Studio/Reinforcement
 6 Architect/Designer
 7 Engineering/Acoustical Consulting
 8 Maintenance/Service
 9 Dealer/Distributor/Rep
 M Manufacturer
 O Other _____
(4) Your purchasing authority:
 A Final approval/Buyer
 B Recommend/Specifier
 C No Direct Authority/User
(5) Number of employees at your company:
 1-3 4-10 11-25
 26-100 Over 100

1/92 EXPIRES 4/92

YES! I WANT TO STAY ON TOP OF THE INDUSTRY BY RECEIVING
A COPY OF **SOUND & COMMUNICATIONS** EVERY MONTH

NEW RENEWAL
 1 Year \$15.00 3 Years \$37.50 (Savings \$7.50)
 Payment Enclosed Bill My Credit Card Visa MC AE
(Foreign: Add \$10 for delivery) Card # _____ Expires: _____
 DO YOU WISH A FREE SUBSCRIPTION? YES NO — COMPLETE BELOW:

Signature _____ Date _____
Name _____ Title _____
Company _____
Address _____
City _____ State _____ Zip _____

(1) Do you wish to receive **Sound & Communications**?
Yes No
(2) Primary Job Function (only one):
 A Management/Owner
 B Engineer/Technical Mgt.
 C Sales/Marketing
 D In-House Maintenance/Service
 E Field Installation/Maintenance
 F Consultant
 G Advertising/Promotion
 H Other _____
(3) Primary business of company (only one):
 1 Contractor—Engineered Sound/Acoustical
 2 Contractor—Interconnect/Intercom
 3 Contractor—Fire/Alarm/Safety
 4 Electrical Contractor
 5 Pro Audio/Studio/Reinforcement
 6 Architect/Designer
 7 Engineering/Acoustical Consulting
 8 Maintenance/Service
 9 Dealer/Distributor/Rep
 M Manufacturer
 O Other _____
(4) Your purchasing authority:
 A Final approval/Buyer
 B Recommend/Specifier
 C No Direct Authority/User
(5) Number of employees at your company:
 1-3 4-10 11-25
 26-100 Over 100

1/92 EXPIRES 4/92



FOR YOUR **FREE** SUBSCRIPTION
ALL YOU NEED TO DO, AS A PROFESSIONAL
IN OUR SOUND AND COMMUNICATION INDUSTRY,
IS TO COMPLETE THE CARD BELOW AND
MAIL IT. THIS QUALIFICATION IS NECESSARY
FOR AUDIT PURPOSES. DO NOT MISS
A SINGLE ISSUE. MAIL YOUR CARD
TODAY.

Place
Stamp
Here

SOUND COMMUNICATIONS

25 Willowdale Avenue
Port Washington, NY 11050

Place
Stamp
Here

SOUND COMMUNICATIONS

25 Willowdale Avenue
Port Washington, NY 11050

"People love to sing and Pioneer Laser Karaoke offers the ideal venue."

*Trent Esperti, Barwinkles
Long Beach, CA*



"Pioneer has the best and most reliable equipment."

*Susan Apple Manegold
Apple Entertainment
Seattle, WA*



"Pioneer Laser Karaoke has increased our business 100%."

*Jon Spradlin, Cat's Meow
New Orleans, LA*



INSTALL LASER KARAOKE AND CLIENTS WILL SING YOUR PRAISES.

It's not often that an installation leaves bar owners and hotel managers singing.

But then again, it's not often that they see a crowd-drawing money-maker like Pioneer Laser Karaoke.

Now it's your turn. Install Laser Karaoke and let their praises be music to your ears. And put an extra ring in your cash register.

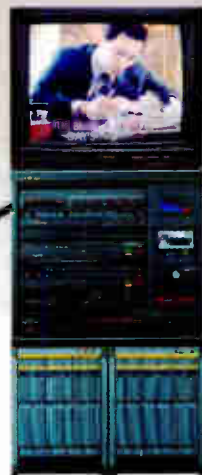

For more information, call (800) 421-1404 and ask for Laser Karaoke. And be one step ahead of your clients when they call to ask what's new and different.

LaserKaraoke®

PIONEER
The Art of Entertainment

© 1991 Pioneer Laser Entertainment, Inc.
2265 East 220th St., Long Beach, CA 90810
Circle 216 on Reader Response Card

III. A blip on a scope in the control panel in the truck showed that the antenna was on target.

Dave Springer, News 12's senior satellite truck operator, explains: "Some expensive satellite trucks even have Loran C navigational receivers to locate the truck exactly on the ground and calculate the direction to pick up the satellite. But if we know roughly where to point the dish, once we get a blip, we know we have a satellite and that we are pointing at the equatorial rim that contains the satellites. Then we can follow along the rim to find SBS III, which is the one we are looking for."

SBS III was launched on November 11, 1982. It is a Hughes HS 376 type weighing 1300 pounds, capable of 12,500 two-way telephone conversations or 10 color TV transmissions. News 12 leases time on SBS III by the minute. The News 12 truck at the crash site will send a camera signal up to SBS III from where it will be relayed back to earth and received all over the world through other satellites or ground links. The signal from the truck will also carry voice signals from the News 12 commentator on the scene, or distant commentators may add comments.

Programmers all over the world will run live scenes or tape as they come in. Tape from a station morgue may be interspersed with live scenes, or an "expert" may hastily be summoned to present a talking head that will sustain interest while the camera crew on the spot seeks live shots. Celebrities of the news media are skilled at providing patter to match the scenes and fill gaps in the action. The possibilities of the teleconference are limited only by a programmer's ingenuity, the talents of the participants and available equipment. TV network professionals can hold an audience enthralled from a live event by skillfully combining scenes. Even in a simple setup, good programming control can make a dull subject interesting. A corporate teleconference may be a single individual over a video channel with others connected by voice only. Good programming can hold interest.

On the night of the Avianca crash the satellite truck from the little TV station on Long Island was the exclusive source of drama for the world and fed video to all of the networks. Trucks from the network flagship stations did not arrive until much later.

The Persian Gulf War in 1991 was a still better example of satellite communication in action. Satellite feeds were set up by CNN and other networks using portable equipment. But such dramatic viewing does not reveal that many routine private and corporate satellite operations go on every day.

A SATELLITE INSTALLATION OR A SATELLITE TRUCK CAN SERVE ON CALL FOR BOTH A TV STATION AND AS A TELECONFERENCE- ING FACILITY.

Transponders are getting busier as time goes on. Springer of News 12 Long Island says, "I see more traffic every day. Much of it is corporate teleconferencing, but there is also more commercial programming of every kind. CONUS [the transponder lessee] can be helpful in many ways. Their technicians and engineers are our human tie-in to the transponder."

Any ground station within the footprint of a satellite can receive the transponder signal. Likewise an uplink can be established that will downlink a signal throughout the footprint. The returning signal may then be used by recipients as desired. The signal may be sold to users who may be network stations and edited and controlled for home television subscribers.

The typical geosynchronous satellite transponder is capable of receiving a 36 MHz band and retransmitting a 36 MHz band at a different carrier frequency. When the first communication satellites went up several years ago for use of radio amateurs, the amateurs would simply pick an

unused portion of the transponder's spectrum and send out a call. Another amateur within the satellite's footprint would receive the call and respond. Now with formal commercial geosynchronous satellite broadcasting, either one half or one quarter of a transponder spectrum is assigned to each lessor. This wide bandwidth makes it possible to send studio quality video and allow sidebands for voice and control. A satellite control center can monitor and tweak the transponder from the ground. In practice a control center is always on duty.

Some transponder space is in constant use for telecommunication, ordinary telephone conversations, or computer data. Spare frequency space can be leased for teleconferencing. A satellite installation or a satellite truck can serve on call for both a TV station and as a teleconferencing facility. A satellite truck can be used for teleconferencing and also be on standby for spot news coverage. Teleconferencing now meets with a host of applications: employee training, legal testimony, auctions, sales, political campaigns and financial transactions are just a few.

Although microwaves or fiber optics can be used to get a camera signal from a remote location to a permanently installed satellite facility, the best way is to get the camera as close as possible to the transmitting dish. This is the advantage of the satellite truck. From the satellite dish the signal can go anywhere in the world through a link of satellites.

Simple forms of satellite trucks can be home-built by trained technicians. Components such as the dish and associated RF equipment, ac power plants and other gear can be assembled on a truck chassis. But this is a challenging task, and most trucks are now built to order by specialized manufacturers. Trucks may be required to operate hundreds of miles from the home base. The chassis should be qualified for at least two tons of equipment and give a reasonably comfortable ride.

A typical truck will contain two 6.5 kW ac generators together with heating and air conditioning systems. The roof

mounted antenna dish is usually controlled in three axes from inside the truck. In this way the signal can be observed from the interior RF equipment and the antenna positioned, although it's possible to aim the antenna manually. Satellite RF equipment will include exciters for transmission, low noise amplification for reception and monitoring equipment. The complement of terminal equipment will include video and audio switching, cellular phones and fax, and a host of auxiliary equipment.

The satellite vehicle furnished by Satellite Communication (SNS) Systems of Wauconda, Illinois is an example of a vehicle that has worked a number of network TV events and is also in use for corporate teleconferencing. The SCS truck is built on a Ford E-350 chassis with a 11,800-pound gross vehicle weight. It is available to specifications. It is capable of

uplinking two simultaneous video signals on the same satellite using two 300-watt transmitters, or the two can be phase-combined for a single 500-watt transmission. The use of two transmitters and exciters provides redundancy in case of malfunction from any cause within the link. Two video and four audio signals may be received from the satellite providing stereo audio. Ports for external cameras and monitors with video editing are available.

Most transponders now have space for communication between a truck and the various agencies and control centers. One example is Skyswitch, which is a dedicated series of voice channels on GTE's GSTAR 1, 2 and 3 satellites which cover the United States. Robert Tomczak, president of SCS, points out another feature of the SCS truck: "We are equipped with Skyswitch. Skyswitch may be compared with cellular

telephones: channels are available for use wherever there is an uplink and a footprint. Our trucks have a four-channel PBX to tie into Skyswitch. A Skyswitch connection may be separately dialed up using a five-watt transmitter without using the video channels. As soon as the antenna is on one of the GTE satellites, contact can be made to establish feed times, production issues and so on. In disaster areas all telephones may be out. Even cellular telephones may be inoperative. Skyswitch is then available for emergency communication with the outside world. The satellite is always there."

The versatility of mobile uplinks and monitoring centers such as this SCS truck is contributing thrust for a new industry that is growing all over the world. Ironically, the United States is losing its lead in home satellite receivers. Even those in

else
**LOOK WHAT QUAM
HAS FOR YOU!**



ROUND BACKBOX ENCLOSURES
ERD-8 Series

- Seam and leak free
- Radius corners to provide improved audio response
- Fire retardant materials eliminate mechanical and acoustical resonances
- Shape of units permits nesting

Ask for FREE Tech Spec TS-37

Quam-Nichols Company

234 East Marquette Road, Chicago, Illinois 60637
Phone: 1 312 488-5800 • FAX: 312 488-6944

Circle 280 on Reader Response Card

Winsted®
**FREE
CATALOG**



Video Furniture Systems

Big, full color catalog includes complete descriptions, pricing and ordering information on:

- Editing Consoles ● Video Consoles
- Equipment Cabinets ● Micro Computer Stations
- Tape & Film Storage Systems

Winsted Systems ... Preferred by
Professionals Worldwide

THE WINSTED CORPORATION
10901 Hampshire Ave. So. • Minneapolis, MN 55438
612-944-8556

Phone Toll Free **(800) 447-2257**

FAX: 612-944-1546

Circle 282 on Reader Response Card

formerly Soviet-controlled countries are now rushing to buy into the technology. Satellite service now covers the world. Although it is possible to stick a small Ku band dish out a window and receive a satellite, home satellite reception in the United States must compete with the billions of dollars already invested in TV

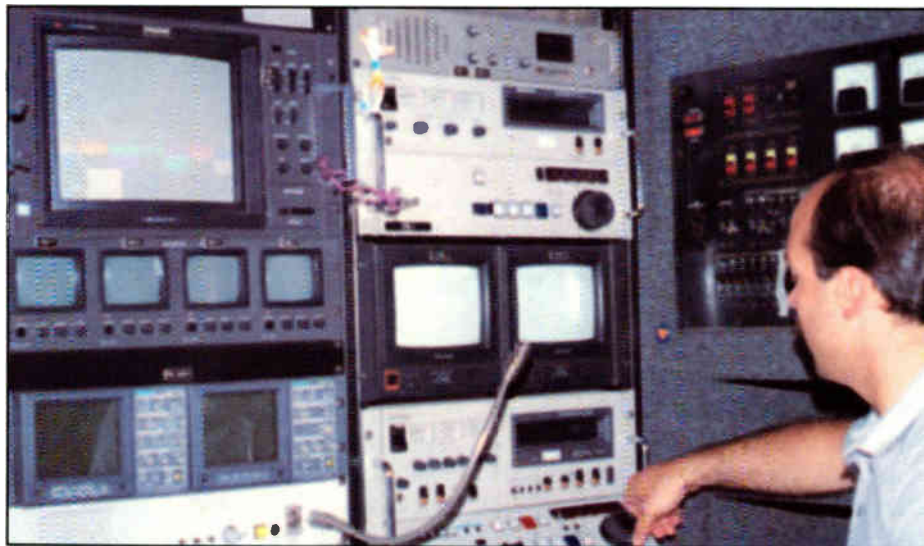

Dave Springer seated in the control booth that is within the News 12 Long Island satellite truck.

Their Eyes Are Watching

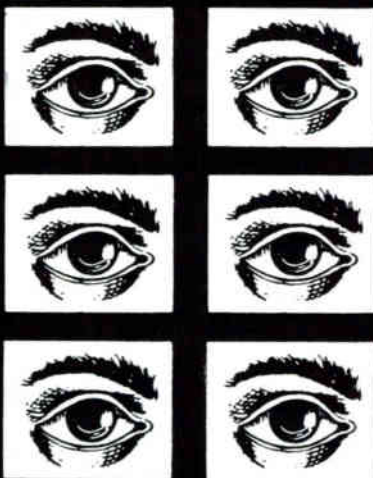

Put your company in front
of the industry.

PLACE YOUR AD TODAY IN
**SOUND
COMMUNICATIONS**
GROWING MARKETPLACE

FOR RATES AND INFORMATION CONTACT
SANTIAGO QUINONES AT: **516 • 767 • 2500**

FAX: 516 • 767 • 9335

cable systems. And cable system owners are not ready to declare obsolescence.

To compete with cable, the home satellite receiver industry is trying to go where cable can't. Home satellite reception is most likely in areas that cannot economically be covered by cable or where the home user is willing to pay for more channels, versatility of selection and superior reproduction. One feature is the sound reproduction. The wide bandwidth of the satellite transponder allows both video and audio to be of studio quality even though commercial programs will be reproduced many times before reaching the home by cable or line of sight broadcast. This means that a satellite receiver can feature Dolby sound and noise reduction schemes with good advantage. The wide bandwidth available from the transponder allows for digital stereo audio. The home receiver may be designed with the versatility to receive both analog and digital stereo.

Sound contractors, in areas that span the home satellite market, are reaching into satellite receiver installation in homes, bars, motels and other commercial facilities. The next step is to provide uplink teleconference facilities either on call or on contract. Large corporations and other institutions are often willing to contract for their own wholly owned links.

The military was the first to develop satellite communication and recognize its importance. Satellite communication is a mainstay in times of war and disaster. But the important contribution to the world's rapidly changing political and social scene is that the satellite is linking far reaching sporting, entertainment and important news events that bring together the world's people. It is no longer possible to neglect satellite technology. ■

Job Documentation

Labels, Cables and Computers Keep the Job Straight — and Maintainable. Part One

BY T. G. McCARTHY

One challenge that Sound Contractors continually face is that of effective job documentation. This article discusses the method that the company I work for has adopted as policy. Today I'll give an overview of what we do and why we do it, then next month I'll review some low cost computer programs that help make our documentation work even easier.

Gathering and maintaining accurate job documentation is often difficult for sound contractors because our jobs don't have a standard form or structure. Many of us deal with more than one type of system, often combining sound reinforcement, intercom, paging, alarms, and who knows what all into a specific package that does what a particular client needs to have done. That means a successful documentation system has to be flexible. Costs are all over the map too; from low budget to gold plated, and the low budget jobs especially set limits on how much documentation it's practical to do.

So how do we help protect our client's investment by keeping track of what we have done and do it at a price he can afford to pay? Nowadays equipment is so reliable that it may be years before a system needs service, and by the time it does all the people with first hand knowledge of the installation may have moved on. Servicing

a failed amplifier or whatever, is no problem; we just fix it and wire it back into the system the same way it was when we found it. But what if we need to know where the wires go and what's on the other end of them?

How do we help protect our client's investment by keeping track of what we have done and do it at a price he can afford to pay?

Over the years, our company has tried a number of approaches to the documentation problem and most of them failed because they were too expensive, too complicated to maintain or didn't put the information in the hands of the people who needed it when they needed it. We know for example, that very few of the jobs we do can support a draftsman who will produce complete sets of "as built" drawings. And if such drawings were produced, who would keep them up-to-date through subsequent modifications and additions? The reality is that most of the job drawings that we have are bid documents and shop drawings. Experienced installers an-

notate and update drawings or whatever "official" paper they have at hand as they proceed with the installation. And if they don't have official paper handy, they scribble information on anything they can find, like the back of an envelope. It's a good thing they do too, because those penciled notes are valuable, but that doesn't mean the job is fully documented.

Once in the office, all the information ends up in a job file. There may have been several sets of prints in use, and if so, each set will have its own collection of pencil notes. Some notes may predate others but the obsolete ones may not have been deleted. Details that were clear to the person who wrote them may be incomplete or unclear to people who read them (or even to the person who wrote them with the passage of a little time). It's not practical to compile all the raw data at the time it is deposited, so we just dump it all into the job file for future reference. As time passes and changes are made, more notes pile into the file. You get the picture; before long it's like an archeological dig to try and decipher the structure of the job. Consequently the information is only used as a last resort.

The situation can get more complicated: We are sometimes called on to service or modify an installation done by another company. Perhaps they are out of business, or for some other reason documentation is not available. How do we gather what we need without spending too much

T. G. McCarthy heads up North Star Sound in Minneapolis, Minnesota.

of our time and the client's money doing it?

Well, as an old parish priest, Father O'Sullivan, once told me: "The perfect is the enemy of the good." I don't know where he got it, but that observation pointed directly to what was wrong with our previous attempts at practical job documentation. We had been trying to produce presentation quality when what we needed was timely "industrial grade" information.

Once we understood that, the solution was simple. It requires an almost insignificant amount of extra field work, improves the quality of the data that comes back to the office and is useful even to people who do not have access to the office files.

You get the picture; before long it's like an archaeological dig to try and decipher the structure of the job.

There are only three key components to the method: The first is to label each cable. Second, date everything. Third, keep a cable list.

The most important item is labeling. Given an installation with the cables labeled, a worker with a functional knowledge of a system can reconstruct its layout; often in less time than it takes to decipher the hodge podge data contained in a job file. That means that a service call or even a small modification can be performed on the fly; the technician can go right to the job without having to stop by the office to sort through a job folder.

When we label our cables we don't usually write specific name tags for them, we just use numbers. If we want specific labels like "Contact closure from boiler alarm," that's in addition to the number; not instead of. There are several reasons: preprinted numbers are available for the

purpose. They adhere to cable reliably, are legible (often from several viewing angles) and the writing doesn't fade into oblivion with time. The technique is easy to administer and it's easy to tell how many cables there are in the installation.

We had been trying to produce presentation quality when what we needed was timely "industrial grade" information.

Observing a few elementary precautions makes the labeling procedure go smoothly:

1. Be sure that each cable gets numbered on both ends (with the same number).
2. Don't duplicate numbers. That is, don't use the same number on more than one cable.
3. Keep an up-to-date cable list.

A little applied imagination paints horror pictures of problems that might result from number duplication. Fortunately that's not too difficult to avoid. We like to do it by using cards that contain just two sets of numbers (available from Brady,

When we label our cables we don't usually write specific name tags for them, we just use numbers.

Panduit and others and stocked by virtually all electrical supply houses). The card stays with the job, and since each number only appears twice, unless a different number is assigned to each end of the same cable nothing can possibly go wrong. There is a built-in check too: If a cable does get cross numbered the error will probably be caught because, unless two

cables get cross numbered there will be two orphan numbers left over upon completion of the installation. They will be the other halves of the numbers on the ends of the incorrectly labeled cable.

When an installation is completed, the number card is left on site, typically in the back of the main rack. Then years down the line a technician can glance at the card and see how many cables there are in the installation. Or in a more practical vein, it will be easy to trace the wiring and, if circuits are to be added, continue the numbering sequence. Then even more years down the line we can show up, cable list in hand, and by comparing it with the numbers remaining on the card determine if and how many cables have been added.

Years down the line a technician can glance at the card and see how many cables there are in the installation.

We may not know what they are, but we will have an idea of whether we're talking major addition or minor modification and that's a lot more than we'd know otherwise. Even if the intermediate technician didn't label his or her work, we can still get an idea of what's been done by the presence of un-numbered cables.

We found it important to stress to installers that unless the job specifications call out a definite numbering sequence they should not try to maintain a pre-planned grouping. Sometimes the first impulse is to set blocks of numbers aside for specific purposes: 1 to 32 for console inputs; 33 to 43, console outputs; etc. Sometimes it works out that way naturally and that's fine. But we instruct our people to assign numbers as the cables come to hand. There is usually no particular benefit in doing it the other way and it makes the job more work to plan.

Labels do not eliminate the need for other notes because we still want as much pertinent information as we can get. The key word is "pertinent," and the biggest help in sorting out pertinence is to sort by date. Given two conflicting notes, it's usually safe to assume that the latest one is correct. Or if I'm wondering why something was done the way it was done, knowing the date will often clear up the mystery. (I recently had cause to wonder why loud-speaker lines for an industrial plant paging system were run in a giant U through a group of connected buildings rather than taking the shortcut through the building between the arms of the U. It turned out that it wasn't because the installers were asleep on the job, it was because the company didn't own the center building when the paging system was put in. As soon as

Each tier supports the ones above it and adds to the confidence level.

I learned that, the cable route became obvious. But meanwhile we wasted a lot of time trying to find a link that didn't exist. Had the date of the center building installation been known, a full man day would have been saved.)

The third component of our job documentation system, the cable list, is just an extension of the labeling component. It tabulates, by cable number, what each cable's function is, where it starts and where it ends. No great formality needed here, a yellow legal pad works admirably. If someone wants to clean it up and formalize it later, they can type or word process it in the office. (Actually, we do clean it up because we like to keep job files on computer disks, but that's another story for another time.)

It's easy to see how this three tiered system works. Each tier supports the ones above it and adds to the confidence level. The upper one, cable labels, can stand alone. With almost no other information, someone on site can quickly determine how a system is hooked up and how it's supposed to operate. The job notes of tier

two provide information about the installation that is especially useful in the sales and engineering offices for planning modifications and additions. Because the notes are dated, conflicts can be resolved and a history constructed. The final element, the cable list, is the ultimate. Using it I can draw an accurate one line diagram, determine which inputs and outputs are

used, how many spare pairs there are and where they go, along with all kinds of other details that are either spelled out or are clearly implied. Actually I could get along with just the cable list. But then how would we draw up a cable list without first having labels to base it on? ■

(This is the first in a series to be continued. Next part: Label Program Review.)

• COMING IN MARCH • COMING IN MARCH •

SOUND & COMMUNICATIONS

WILL BE FEATURING

THE WORSHIP CENTER

■ What contractors are doing to enhance their Church business.

■ We will be bringing you the latest on the Worship Center of the '90s.

PLUS *NSCA*

This pre-show issue will be covering what's in store for this year's annual convention.

THE LATEST NEWS

SPACE RESERVATION: FEB 19
 MATERIALS DUE BY: FEB 24
 For Further Information Contact:
John Carr
516-767-2500
 or FAX 516-767-9335
 For Editorial Consideration Contact:
 Judith Morrison

*Don't miss our NSCA issue coming in April

COMING IN MARCH • COMING IN MARCH • COMING IN MARCH • COMING IN MARCH • COMING IN MARCH • COMING IN MARCH •

DISC SYSTEMS FOR THE COMPUTER-SHY

By Elizabeth Brown

Pharmaceutical companies aren't the first place most people look for creative multimedia ideas but AV Specialist, Ron Zaro always looks out for the "wow factor" anyway.

Recently, at Eli Lilly's Indianapolis headquarters, Zaro showcased Lilly's Cray supercomputer with its schizophrenic video display.

Guides show company visitors into a small theater, where a single pushbutton starts one of two videos stored on disc. In one, an LCD screen activated by the disc controller during the video clears to illuminate the actual Cray at work. In the



Museum Technology's video disc control unit in use.

IMPROVING CONNECTIONS BETWEEN THE VISITOR AND THE HARDWARE HAS BECOME PRACTICALLY IMPERATIVE.

second, the computer remains hidden behind the dark screen. Staffers decide which to play, depending on the Cray's mood that day.

Is this button-activated system the wave of the future? With the recent developments in interactive video, improving connections between the visitor and the hardware has become practically imperative.

Elizabeth Brown is the Marketing Manager for Museum Technology Source, Inc.

Touchscreens involve people to a greater degree than ever before, yet interactive discs have their disadvantages. Many programs are more frustrating than rewarding involving an endless series of choices before giving visitors the desired information. In addition, creating custom interactive programs is an expensive proposition which isn't always cost-effective.

Many nonprofit and smaller-budget installations go with visitor-activated displays built around video discs instead. These often consist of a video disc player hooked up to a controller, speakers and/or a high-quality monitor. Like a "video juke box," the systems offer a choice of prepro-

grammed selections from the video disc.

The two most important advantages of visitor-activated disc systems are flexibility and reliability. Programming the video disc controller is done on site, using something as familiar as a personal computer. Pushbuttons or other sensors are programmed with the first and last frame numbers for a section of the disc. This means that the "juke box" selections can be changed as often as necessary and can be any length (as long as the total time doesn't exceed 60 minutes). For example, retailers can store several promotions on one disc, playing the appropriate segments different times or for different audiences. They can skip over outdated products or selling points, and distribute copies to other locations. Pushbuttons can be reprogrammed on the same disc or on new discs without relying on the factory. This

VISITORS CAN SELECT THE PROGRAM THAT BEST SUITS THEIR INTERESTS AND/OR LEARNING LEVEL.

puts the video disc within the reach of the computer-phobic.

Providing a choice of viewing options has its advantages. Choosing among different videos makes a display more personal (and memorable) than a tape. In public information kiosks, for example, visitors can select the program that best suits their interests and/or learning level. Multilingual programs can be run from a single display with pushbuttons labeled in the cor-

responding languages. Most importantly, the message, not the medium, remains the focus of the presentation.

Visitor-activated disc systems aren't simply cost-effective substitutes for interactive ones. Computer-driven displays just don't suit many installations. To present one or several videos, all that's needed is a disc controller. Basically, controllers allow the selective viewing of certain video disc segments, continuously or on demand. Either a behind-the-scenes operator, such as the computer staff at Eli Lilly, or the visitors themselves can choose which video to watch.

DISCS OFFER TERRIFIC SOUND BUT, IN SOME INSTANCES, CABINETRY MAY OBSCURE THE SPEAKERS ON THE VIDEO MONITOR.

Visitors make the choice at the New York Aquarium on Coney Island. In one exhibit, continuous underwater footage attracts visitors to a video screen. Underneath, a row of pushbuttons invites them to choose videos of various sea creatures' behaviors. The pushbuttons, which light up while playing, correspond to segments on a video disc made specifically for the exhibit. A similar compact disc system controls sound in other Aquarium galleries. Ambient sound starts automatically, recreating the feel of fishing villages and crashing waves. Museum Technology Source, Inc., supplied and installed both controllers.

How do you put a disc system together? Getting a video disc made from a master tape is the first step. The costs involved, once a major obstacle for some, is decreasing as disc technology becomes more familiar. Since discs last longer than tapes, view them as a long-term investment: in fact, smaller museums may already be considering video disc for archival purposes to supplement less durable materi-



The VDC-200A video disc control unit from Museum Technology Source, Inc.

als. Pioneer Electronics distributes a free guide to the technical requirements of disc-making and can be obtained by writing to them at 600 East Crescent Avenue, Upper Saddle River, New Jersey 07458. Disc systems work best with a Level III video disc player.

Systems that get used daily should be easy to control. Ideally, the staff should be able to activate the entire system with a single switch. Therefore, the monitor must be controlled by a master power strip. Good choices can be found in the NEC PV series. Most displays will demand a 13-, 19- or 25-inch screen. The controller should be nonthreatening, both for the operator and the public: too many pushbuttons tend to drive visitors away. More than six buttons is probably too many.

HOW DO YOU PUT A DISC SYSTEM TOGETHER? GETTING A VIDEO DISC MADE FROM A MASTER TAPE IS THE FIRST STEP.

The buttons themselves add a tactile incentive to the display. These should be the toughest you can find: children's museums and science museums can vouch for the constant wear and tear that "hands-on" exhibits receive. Illuminated buttons have the advantage of indicating which video is being played. To interrupt or not to interrupt is another question. You may want to have the buttons interrupt the video at any point, but it's best to factor in a delay time of four to six seconds. This discourages the random "button-hopping" which can annoy small crowds.

Achieving maximum sound quality can be a little tricky. Discs offer terrific sound but, in some instances, cabinetry may obscure the speakers on the video monitor. Smaller installations often use auxiliary speakers designed for automobiles, since they fit easily into exhibit cases.

Disc-based displays, an underappreciated medium, don't have to be technologically complex or wildly expensive. Impressed with the ability to prompt external AV equipment, a low-maintenance track record and simple day-to-day operation, businesses and not-for-profits are making the most of visitor-activated discs. Zaro sees many more applications for the systems at Eli Lilly. Video disc control systems, he says, "came to the rescue and made it easy for us." ■

Super screen!

New AT8104a metal pop filter slips over any UniPoint® microphone, then locks permanently in place. Add the external foam windscreen to reduce wind noise in outdoor applications, and further control pops from even the closest talkers.

The AT8104a insures secure, noise-free performance. Ask your A-T representative for more details today.

audio-technica®

1221 Commerce Dr., Stow, OH 44224
(216) 686-2600 • Fax (216) 686-0719
In Canada call: (800) 258-8552

PRODUCTS

Audio-Technica Teleconferencing; Samson Wireless



DSP Teleconferencing

Audio-Technica U.S., Inc. has introduced the DT100 digital teleconferencing system. The DT100 offers digital signal processing together with proprietary software and automatic line nulling. This allows full duplex conversation without speakerphone

blocking effect, audio distortion or feedback.

Features include digital filtering, a digital automatic gain control, a noise gate/downward expander and automatic acoustic ducking.

Circle 1 on Reader Response Card

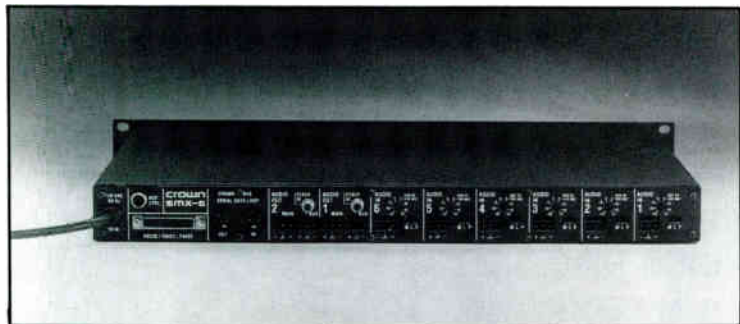

Intelligent Multiplexer

Crown has introduced the SMX-6 multiplexer which has the ability to switch and route its six inputs, two summed outputs and two relay switched output busses. In addition, an option adds a control bus to the unit allowing it and the IQ System 2000 to function with other outboard equipment.

The unit has eight level detectors on the inputs and outputs that have been added in pre-fader positions starting at the inputs. On the outputs, the level detectors can be used to display the sum of all six channels.

Circle 2 on Reader Response Card

Extended Lows

McCauley Sound has released a line of extended low loudspeakers for high power applications. The design is "tightly-damped" and features balanced cone rigidity and double-spider suspension to prevent cone overexcursion.

The 18-inch speaker handles 450 watts rms from 20 Hz to 800 Hz. The 15-inch 6242 is rated at 400 watts rms from 1.2 kHz to 25 Hz. The 12-inch 6232 is capable of 400 watts rms with a range of 40 Hz to 2 kHz.

Circle 3 on Reader Response Card

Video Entry

Telecall America has introduced a video entry system that takes a picture. The TD-BM digitally records eight images without film or tape. Pushing a button sets auto record mode and the system automatically records the images of the next eight callers at the door in light or dark conditions. Manual photos can be taken while talking to the caller on the intercom. The photos with their dates and times can also be reviewed.

Circle 4 on Reader Response Card



Seventeen-Hour Batteries

Samson has introduced its Concert Series II wireless system that incorporates dbx IC and other technology to attain a battery life of 17 hours or more in its transmitters.

This technology is incorporated in the handheld and belt pack systems for guitar and lavalier configurations.

Circle 5 on Reader Response Card



Vented Bass Horn

Community has introduced a compact vented bass horn with dual 15-inch drivers. The VB764GP loudspeaker uses a specially designed horn that is part of a one piece molded fiberglass faceplate.

The plywood enclosure measures 39½ inches high by 25 inches wide and 23¾ inches deep, and weighs 135 pounds.

Circle 6 on Reader Response Card

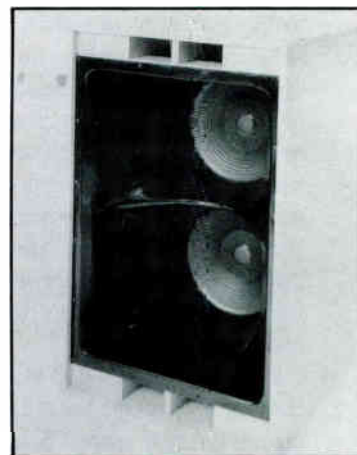



Ramsa's WP-1400 power amplifier.

Amplifier Series

Ramsa has introduced the WP-1000 series power amplifiers. The class H circuit design of the WP-1200 and WP-1400 continuously evaluates the amplifier's input signal. Matsushita's engineers installed the

amplifiers' output transistors in a wind-tunnel style heat sink. A servo-control system monitors heat sink temperature and automatically varies the fan speed to keep the amplifier at a low operating temperature.

Circle 7 on Reader Response Card



Multi-Room Controller

Audioaccess has introduced a six-zone controller, the MRX. Among the design's features are installation using four-conductor wire, an AM/FM tuner section and six 40-watt per channel amplifiers with six separate zone controllers providing six zones with independent control of source and volume level without affecting another zone.

Circle 8 on Reader Response Card

Ultraband Modulator

ChannelPlus has introduced Ultraband models D1V/UB and D2V/UB to its "D" series of digital frequency agile modulators. The modulators add in-house generated audio/video signals on Ultraband channels to multi-room video systems. The digitally-tuned modulators convert baseband video/audio signals to a cable channel between 65 and 111 (Ultraband).

Circle 9 on Reader Response Card



Compression Driver

JBL's 2446 is a high-frequency compression driver, replacing the 2445. The 2446 incorporates JBL's Coherent Wave phasing plug as well

as a titanium diaphragm with radial rib topology and 3-D diamond pattern suspension.

The 2446 is available in 16- and 8-ohms impedance.

Circle 10 on Reader Response Card



RACOM MODEL 1700X MULTI-LINE PAGING CONCENTRATOR



Racom Model 1700X

The Racom Model 1700X MPC MULTI-LINE PAGING CONCENTRATOR can be used anywhere audio has to be concentrated from multiple inputs to a single output.

This version of our popular 1700X records audio or pages simultaneously from up to five sources. The 1700X will concentrate these audio sources and play them sequentially on a common output.

FEATURES:

- 19" Rack Mount
- Up to 5 inputs, 1 output
- Playback activates transistor switch
- 24 Minutes storage time

ALSO AVAILABLE:

- Feed-Back Eliminator
- Telephone Record Then Page
- Multi-Line Digital Announcers for sports, concerts, and any other entertainment information.

**CUSTOM CONFIGURATIONS AVAILABLE
PLEASE CALL WITH YOUR APPLICATION**



Circle 283 on Reader Response Card

Raw Frame Entry

Klipsch and Associates has introduced the K-1200, K-1500 and K-1800 series of 12-, 15- and 18-inch woofers. The introduction marks the company's entry into the "raw frame" component marketplace.

Materials and magnet structures are designed for high efficiency. Klipsch claims the speakers need as little as 25-percent of the power required by other woofers to generate a given SPL.

Circle 11 on Reader Response Card



Klipsch and Associates K-1500 series of woofers.



Compact CCD

The HV-C10 is a three CCD camera from Hitachi with 1/2-inch micro lens technology. Its IT CCDs contain 360,000 pixels (722 x 584). Its Micro Lens Array technology is designed to increase the light-gathering capability of each chip. The size of the camera head is 3.9 inches x 4.1 inches x 6.1 inches as a result of custom ICs. A serial remote control can control the camera from a personal computer.

Circle 15 on Reader Response Card

Full Function DMMs

The Instrumentation Products Division of Beckman Industrial Corporation has introduced the lowest priced, pocket-size digital multimeters offered by the company. The models include updated models DM15XL, DM10XL and new model DM5XL.

Features include .7-inch LCD numerals, 10A current fusing and a warning beeper when test leads are placed in the wrong input jacks.

Circle 13 on Reader Response Card



Wireless Intercom

HM Electronics (HME) has expanded its Series 8000 wireless intercom product line with the System 8112 wireless intercom with telephone interface. The unit is a self-

Circle 12 on Reader Response Card

contained wireless system that can be interfaced with cabled intercoms. The System 8112 can also be interfaced with telephone-intercom hybrids and auto attendant systems.



Switch, Blend and Mix

Uptown Technologies has introduced new features to its Flash system. Flash is a 4 x 1 stereo switcher with a passive design that allows you to switch, blend or distribute a number of signals without adding switching noise or distortion.

The new features allow for selection from signal crossfade and cascade mode through DIP switches, or selection of a number of stereo or mono switching functions through MIDI.

Circle 14 on Reader Response Card



Sampling Mixer

Gem Sound has released its "budget-priced" sampling mixer, the PDM-50. The 19-inch, rack-mountable, six-channel mixer incorporates digital circuitry enabling users to get eight-second samples of selected program material from input sources with the push of a button. Sampled material can be looped for continuous playback or triggered on command with a touch of the unit's start/stop button.

Circle 16 on Reader Response Card

LITERATURE

Contact East Testing; Winsted Security

A-Z Videoconferencing

KJH Communications has published the title, "We've Got to Start Meeting Like This," a reference for those involved in researching or implementing videoconferencing.

Author Edward A. Daly brings 25 years of experience to the book which covers aspects from designing a videoconference system to preparing a business case for the expenditure.

Circle 17 on Reader Response Card

Noise Problems

Scantek, Inc. has released a catalog describing Soundplan from Braunstein & Berndt. Soundplan is designed to offer solutions to various types of environmental noise problems.

Circle 18 on Reader Response Card

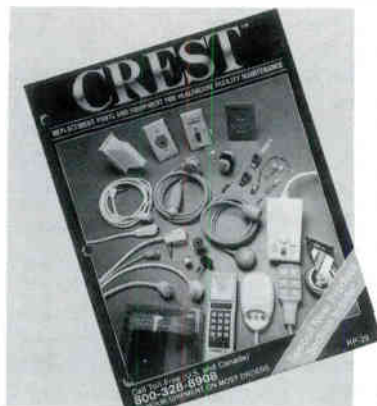

Healthcare Parts

Crest Electronics has released a 240-page catalog including replacement parts and components to keep hospitals, nursing homes and medical clinics in repair. A new product section includes call cords, Executone nurse call parts and bed controls.

Circle 21 on Reader Response Card

Security/Correctional Support

A full-color catalog of security support systems is available from the Winsted Corporation. The 44-page catalog includes information, specifications and pricing on Winsted's line of security furniture, including Winsted's Pro Grey colors.

Circle 19 on Reader Response Card



Test Equipment, Tools and Supplies

Contact East has introduced the Fall 1991 catalog featuring test instruments and tools for engineers, managers, technicians and hobbyists. Products included are for testing, repairing and assembling electronic equipment. EPROM programmers, power supplies, tool kits and portable digital scopes are highlighted.

Circle 20 on Reader Response Card

PEOPLE

Toole at Harman; Ito Assumes Presidency

Harman Appoints Toole

Author, lecturer and research specialist, Dr. Floyd Toole, has been appointed Vice President of Acoustical Research for Harman International, the parent company of JBL, Infinity, Pyle, Audax, EPI and automotive OEM lines of loudspeakers.

Toole's responsibilities include working with the Harman International companies in the area of technical measurement of loudspeaker performance as it relates to research and the marketing of Harman International products.



Toole

Before joining Harman, Toole held the position of Senior Research Officer in the Acoustics and Signal Processing Group for the National Research Council of Canada.

President of Yamaha

Masaaki (Matt) Ito has been named President of Yamaha Electronics Corporation, USA. Ito adds the presidency to the title of Chief Operating Officer.



Ito

since 1967 and has devoted most of

his career to the company's international business.

Jensen at RPG

RPG has announced the appointment of Troy Jensen as General Manager. For the past seven years Jensen was affiliated with the New York-based acoustical and theater consultancy, Peter George Associates.

Jensen's responsibilities include providing an on-line technical liaison with acoustical consultants and architects, as well as coordinating RPG's domestic and international manufacturer's rep organization.

Philips Promotes

Philips Interactive Media of

America (PIMA) has announced promotions for seven of the company's executives. As senior vice president for marketing, Emiel N. Petrone is responsible for all marketing aspects of PIMA. Craig Cox has assumed the position of senior vice president for finance and administration. David McElhatten has become senior vice president for production.

In the area of product planning Laura Cohen assumes the position of senior vice president for product planning and creative affairs and Sarina Simon becomes senior vice president for product planning and development. Charlie Golvin is now vice president for technical services and Bob Schaulis has been appointed vice president for international product management.

Closed Circuit Elections, Cable Meeting

CCTMA Election

The membership of the Closed Circuit Television Manufacturers Association has elected Herman Kruegle chairman through 1992. Kruegle said, "We will be working with other organizations to create an accredited training program for CCTV security practitioners. . . . In addition, we plan to build upon our engineering committee's work to date by releasing an EIA/CCTMA minimum performance CCTV system standard." Kruegle is vice president of Visual Methods, Inc. in Westwood, New Jersey. The CCTMA is a division of the Electronic Industries Association.

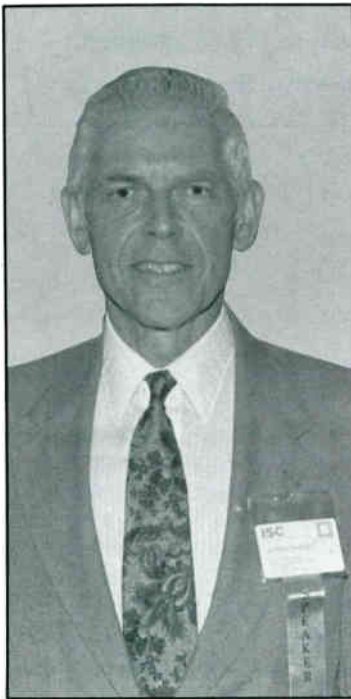

Herman Kruegle

In addition, the CCTMA has elected the following committee chairmen: Charlie Pierce, vice chairman and education committee chairman; Ed Dean, engineering committee chairman; Ron Thomas, membership and scope committee; Vic Houk and Jack Fernandes, exhibits/shows co-chairmen, and Lou Valente, public relations chairman.

Cablemakers Meet

The First Annual Congress of the International Cablemakers Federation was attended by 120 delegates from 73 companies. ICF was established in 1990 "to foster more effective utilization of power and communications cable." Speaking to the group, Graham J. Sharman of McKinsey & Co. said that the worldwide cable industry represents \$60 billion in annual turnover and directly employs over one million people. The 1992 Congress of the ICF will take place in Florence, Italy in October, 1992.

SPARS Code Retired

The Society of Professional Audio Recording Services has recommended that the SPARS Code be discontinued. The code was introduced in the mid-eighties to help identify which portions of the recording process were digital and which were analog. The code "ADD" on recorded product, for example, would indicate that the original recording was analog and that it was mixed to a digital format and mastered digitally. "The SPARS code no longer fairly reflects the complexity of the technology we use today," said Pete Caldwell, SPARS chairman of the board and president of Doppler Studios in Atlanta.

Russin Forms Consultancy

Mort Russin has announced the formation of The M.S. Russin Group, Ltd. in Delray Beach, Florida. The consulting firm specializes in the areas of remote positioning devices, including video robotics, optical interface and equipment for videoconferencing. Most recently, Russin was associated with Vicon Industries where he developed a video robotic and videoconferencing program. He has also served as a director of Fujinon; broadcast vice president of

Ikegami USA, and national sales and marketing manager for Hitachi Denshi and Rank Precision Industries. He began his career with the Engineering Research and Development Labs at CBS.

Washburn Moves

Washburn has opened a new corporate headquarters in Vernon Hills, Illinois as a base of operations for its Washburn, SoundTech and Oscar Schmidt divisions. The company has also opened a guitar factory in downtown Chicago.

Sharp Intros New Active Matrix

Sharp has introduced a multimedia-capable computer projection panel featuring 185,000 true colors and full motion capability. The unit is reportedly compatible with all popular PCs and graphics cards. The QA-1050 TFT Computer/Video LCD projection panel uses a full 640 x 480 dot 10.4 inch thin film transistor color LCD with an active matrix system. The display time is 30 frames per second. A 19-key infrared wireless remote control unit is included. An adaptor enables connection with vcr's, videodisc players and cameras. The suggested retail price is \$6,500.



Sharp Electronics QA-1050

JBL Installs

JBL Professional has announced several installations using the company's equipment. Crocco's Sports Club in Fort Lauderdale installed a high energy dance floor system, a restaurant system, and a game room using Urei and JBL mixers, power amps and speakers. The products were sold and installed in TM custom cabinets by TM Sound and Lighting.

TM Sound and Lighting also installed sound systems in the sanctuary and classroom sound systems of Science of Mind Center in Wilton Manors, Florida. The systems use JBL and Urei speakers and power amps.

Shades, a nightclub in Orange Park, Florida has installed a system incorporating JBL Professional components. The product was sold by First Coast Entertainment, Inc.

Bryston to Studio

After Belmont Mall studio was struck by lightning, the studio purchased four Bryston amplifiers and one Bryston crossover. Ross Alexander of Synergetics assisted in the evaluation of the equipment along with Harris Audio of Miami. The Bryston amps are driving Urei 813s. Other equipment purchased include an Eventide H-3000SE Harmonizer and a BSS BPE-402.



Scott Goodman of Samson and Paula Abdul

Abdul and Samson

Paula Abdul is relying on Samson Technologies for her wireless microphone systems for her world tour. Samson has supplied Abdul with 12 wireless systems, including six handheld and headset UHF systems. The other six are Samson Broadcast systems to be used for guitars and other instruments.

Cornell Medical College Adds Projection

The Professional Systems Division of NEC Technologies, Inc. has announced the installation of seven GraphicSmart HR Projections Systems at Cornell Medical College's pathology department in New York. Dr. Steven M. Erde, director of the Office of Academic Computing at the college, said the NEC system met the department's high resolution, computer-generated display requirements for X-ray and CAT scan images. Ace Audio Visual of New York installed and serviced the GP-5000 projectors — six in various classrooms within the pathology department and a seventh unit at the college's auditorium.

Interactive Fax

News-On-Fax service by DataFax offers customized news retrieval programs including major news headlines and a personal news portfolio. The full text of stories can be delivered any time to subscribers. The DataFax Automated Portfolio System provides a real-time customized securities portfolio report by fax. The Portfolio Service is available 24 hours a day via fax machine from dataFax Communications Corp. DataFax says it is the only company approved to transmit facsimile information from all the major market. The service is accessed by touch tone telephone, with information received via fax.

DAT Used in Post

JVC Professional Products Company has announced that Crawford Post Production in Atlanta has installed JVC DS-DT900N digital audio tape decks in each of Crawford's four audio studios. Steve Davis, Crawford senior audio engineer, said, "The fact that it has serial machine control means the DS-DT900N can interface with editors without a lot of custom wiring and without having to purchase synchronization. . . . [And] time code makes all the difference."



Denon Intros Long Length 8MM

Denon has introduced the P6-150 Ultra High Grade 8mm tape with 150 minute recording time in standard play and five hours in long play. The tape uses a new film base material claimed to be 40 percent more elastic than current industry standards. The film, polyethylene naphthalate (PEN), allows a base thickness reduction of 20 percent while carrying the same magnetic coating thickness as 120-minute tapes. Denon's Ultra High Grade 8mm videotapes use a metal particle high density SAP formulation which the company says yields 1.5 dB higher RF output level at 5 mHz, extended RF frequency response, 1.3 dB higher color signal to noise ratio and 1.2 dB higher video s/n. A new high durability and dispersibility binder system is also used along with a new Smooth Surface Treatment back-coating system.

Tannoy at Olympics

Tannoy has announced that NBC will install 14 Tannoy System 15 DMT reference monitors inside broadcast control rooms being built for the 1992 Summer Olympics in Barcelona. The control rooms are part of a 40,000 square foot editing/studio facility being constructed by NBC in Barcelona's International Broadcast Center. The facility will take feeds from NBC facilities located at 30 venues, including outside broadcast vans for editing and live broadcast, using seven pairs of Tannoy System 15 DMT monitors to reference a variety of audio sources and the broadcast's final mix emanating from any of three main broadcast control rooms and four control rooms dedicated to 24-hour pay per view broadcasts for cable.

Celestion in Germany

Celestion Lautsprecher, the German arm of Celestion International, has supplied loudspeakers for two clubs: one in the East and one in the West, both installations by the Lippstadt based company Amcon. The West German installation was in Bochum, at Prater, a series of four clubs within a club. Amcon installed a total of 86 Celestion cabinets at the venue. In Leipzig, at the Lollypop, a new club, Celestion supplied a total of 26 boxes, all controlled by two SRC1 controllers.

Sony Projector

Sony has introduced a two piece color video projection system for the consumer market. The VPH-1000Q offers 650 lines of resolution, three 5.5 monochrome CRTs, a cathode gun, specially tinted liquid coolant filter at the surface of the tube. A Dual Focus arrangement is a glass lens group; a second lens group of aspherical acrylic elements provides corner focus. A Super Bright system, according to the company, "provides the same outstanding picture brightness found in Sony's professional projectors."



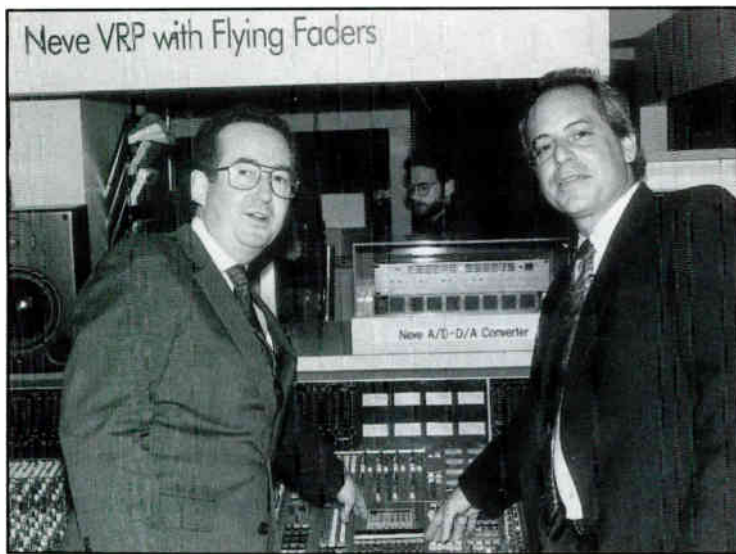

Left to right: Barry Roche, president of Siemens Audio, Inc. (Neve) and Gerry Block, ceo of Timeline.

TimeLine Product for Neve

TimeLine has introduced the Console Control Unit, a miniature keypad which mounts directly into standard Neve, SSL, Euphonix and other consoles. The CCU operates the TimeLine System Supervisor multiple machine controller which interfaces to standard console automation software. Using Lynx Time Code Modules, The CCU controls up to six analog or digital audio tape recorders, vtr's or sprocketed film transports.

Meyer at Klinghoffer Opera

The Brussels production of the opera Death of Klinghoffer used a variety of loudspeakers supplied by Meyer Sound Laboratories. The set design consists of a silver pipe structure 40 feet high and 20 feet upstage designed to look like an oil refinery. The open design of the set caused problems for sound designer Jonathan Deans, requiring the speakers and microphones to be camouflaged. Deans removed the horns from Meyer Sound Labs model UPM-1 reinforcement cabinets and painted them with silver grease paint. The painted horns were mounted directly onto fittings on the pipe staging. The hornless cabinets were set offstage in the proscenium and used separately for low end. Additional UPA UltraSeries loudspeakers were used for music reproduction. Principal performers wore wireless microphones and, via MIDI commands through a sequencer, levels and delays were changed to give the effect of the voice coming directly

from the mouth. The opera features both an orchestra and an electronic MIDI keyboard system. The programming was done by John Adams and Jonathan Deans.

Software for Fostex

Fostex Corporation of America has announced that recent versions of MIDI software packages have been preprogrammed to work with Fostex machines. The Fostex recorders are MIDI controllable recorders that enable the user to control all functions from basic transport to punch in/out and locate operations from the computer. The new versions of C-Lab's Creator and Notator software as well as the Steinberg/Jones Cubase software package allow for control of the Fostex R8, G16S and G24S MIDI controlled multitrack recorders.

Health Club Sound

BBE has announced that the BBE 422A Sonic Maximizer has been used by Knoxville Media Design in the second of five pilot test site installations for New York's Health Club Television Network. "Increased clarity and intelligibility were important considerations due to the amount of ambient noise and acoustic clutter within the facility." The Vertical Club in Manhattan features satellite/S-VHS based programming, delivered throughout the club via 75 to 100 color monitors. Similar systems are scheduled for installation in Los Angeles, Atlanta and Cincinnati.



Left to right: Sal Raia; Bill Wilke, Keith Parker of Keith Parker and Associates; Tom Brown, Richardson Electronics sales manager.

REP NEWS Richardson Rep of the Year

Richardson Electronics' Security Systems Division has presented its "Rep of the Year" award to both Keith Parker and Associates and the Protection Systems rep companies. In making the presentation, Sal Raia, vice president and general manager for Richardson, said the reps "are subject to growing pressure placed on them to sell more product and limit the number of lines they carry. In times of falling prices and lower profits, we appreciate those product representatives who have not taken the approach of attempting to increase their profits by cutting back on their support services."

Marketing Concepts Territory Expanded

Whitenton Industries, Inc., the manufacturer of Juice Goose and OnePower brands of power distribution and conditioning equipment, has announced that Marketing Concepts, its central United States rep, has expanded its territory to include Texas, Louisiana, Oklahoma, Arkansas, Kansas, Missouri, Nebraska and Iowa.

JLCooper Makes Rep Appointments

JLCooper has announced the appointment of Northshore Marketing as its representative for the northwestern United States and British Columbia. Northshore Marketing was established in 1979 by Lew Barrett. The company will handle the Washington, Oregon, Montana, Idaho, Alaska and British Columbia territories for the JLCooper line of console automation and MIDI interface products.

Quad Tech Sets Pace

Gold Line has issued a press release stating that Quad Tech Marketing has "set sales pace in midwest." The manufacturer notes that Extended Play Sound & Lighting, a touring company in Merriam, Kansas; and Solid State Communications in Topeka and All Systems in Shawnee Mission have added Gold Line products to their equipment inventories. All the sales were handled by Quad Tech Marketing Associates of Mission, Kansas, Gold Line's rep for Nebraska, Iowa, Kansas, Missouri and southern Illinois.

Enright Adds Lines

The Enright Company, the representative firm headquartered in southern California, has added key lines: Toshiba Professional Video Systems Group, Philips Commercial/Industrial Sales, and Vicon Professional and CCTV. Enright covers California, Arizona, Nevada and Hawaii.

BURLE Appoints Tulsa Rep

BURLE Industries Security Products Division has appointed Graham/Davis Inc. as manufacturers' representative for the full line of Burle security products. Operating out of its Tulsa, Oklahoma office, Graham/Davis is responsible for Burle sales in Oklahoma and Arkansas. The rep firm has served electronics systems manufacturers since 1983. Principals are Herb and Vicki Davis, and Jim and Gail Graham.

Rebel Named By Atlas

Atlas/Soundolier has appointed Rebel International of Canterbury, N.S.W., Australia as exclusive export agent for Australia, and distribution agent for its loudspeakers and communication system accessory products in the Asian Basin and Pacific Rim. Rebel Audio was organized in July 1987 to serve the broadcast/recording studio and custom audio system installation markets. It later expanded its focus to support the sound contracting, security and MI market segments, and began distributing Atlas/Soundolier signalling devices, electronic equipment housings and microphone stands in 1990. Several months ago the firm merged with Ampower Australia, and now represents a range of locally manufactured 100V/70V amplifiers, preamp/mixers and portable PAs. Since its appointment as Atlas/Soundolier distribution agents, Rebel has established master distributor agreements for Thailand, Malaysia, Singapore and Hong Kong.



Dennis P. Grant, Carlberg-Warren & Associates.



Carmen L. Bolduc, Carlberg-Warren & Associates.

Carlberg-Warren Adds Staff

Carlberg-Warren & Associates, Inc. has announced the appointment of two key staff members to the company's expanding activities as manufacturers representatives for the security, sound, signal and audio/video industries. Dennis P. Grant and Carmen L. Bolduc have been appointed. Kelly Carlberg, president of Carlberg-Warren, said, "These appointments are consistent with our company's resolve to provide quality service to our clientele and as a direct result of newly acquired representation for two important manufacturing lines." The lines are West Penn Wire Corporation and Northern Computers, Inc. Other lines of Carlberg-Warren include Burle Security Products, GTE Security Lighting, and International Fiber Systems, Inc. The firm covers California, Nevada, Arizona, New Mexico and Texas.

LOOK WHAT ^{else} QUAM HAS FOR YOU!



WALL-MOUNTED AMPLIFIER SHELVES

- Facilitate mounting of amplifiers, tuners, DBS receivers and other electronic equipment
- Available in three sizes
- Built of 18 gauge steel

Ask for FREE Tech Spec TS-32A

Quam-Nichols Company

234 East Marquette Road, Chicago, Illinois 60637
Phone: 1 (312) 488-5800 • FAX: 1 (312) 488-6944

Circle 281 on Reader Response Card

Linkage.

LED signs that network.

From high-traffic retail settings to industrial communication, LaBelle offers a network that can work alone or with existing audio systems to help any business broadcast information better, faster and to larger audiences than ever before.

Find out how selling LED networks will increase your profits.

Call 1-800-558-9526.

 **LaBelle**
Display Sciences Group



Circle 284 on Reader Response Card

THE ANSWERMAN

(continued from page 14)

back than are turntables, but they definitely are not immune. The feedback sound is often somewhat different from turntables for a number of reasons, but usually the sound will become muddy, and at a slightly higher sound level mistracking occurs.

Mistracking generally takes the form of skipping, looping (repeating short segments of music) and the sound cutting off and on. The isolation feet suggested for turntables is often enough of a solution to solve the problem, along with disc stabilizers. A number of more expensive disc players (from Pioneer, TEAC, Nakamichi, and Sansui) use a special disk clamp that aids the CD players in keeping the CD stable, even when there is high vibration. As far as I know, only the expensive TEAC/Tascam CD-601 and CD 701 use internal disk stabilizers.

There are aftermarket disk stabilizer solutions from Allsop and Monster that attach to the CD. The Allsop is a band that fits over the edge of the CD while the Monster is a ring that bonds to the unused side of the CD. The Allsop band is removable and easier to accurately apply to the CD. These devices are controversial as to how effective they are. I have been doing some testing for Allsop and to my surprise, the CD bands seem to have helped out in a number of cases where I had mistracking and looping problems.

Cassette Deck Feedback

How can your cassette deck cause feedback? Actually this is a different type of feedback than the problems we have covered so far. In many club systems the cassette deck (or DAT — Digital Audio Tape deck) is connected to both an input and the tape output. If the DJ mistakenly opens both the cassette input and cassette tape output, the system will feed back and oscillate, creating a nasty screech, and this can be damaging to both the sound system, your nervous system and job security. If you have an off-the-tape (3 head deck) then you will be able to listen to the output without feedback, but this is best done with headphones anyway. ■

72 *Sound & Communications*

TELECON

(continued from page 31)

Response Systems which featured full audio and video send and limited audience response (such as for education or polling), or the Digiscore automatic scoring response system Fleetwood.

TELECONFERENCING ADVANCEMENTS

Echo cancellers have been used on phone lines for quite a while. These originally were limited to cancelling out your voice from looping back to you from the receiving party. A few years ago NEC introduced a DSP-based acoustic echo canceller which was far more ambitious — it attempted to deal not only with the echo on the phone line, but also the echoes in conference room acoustics. NEC introduced two models, one with wider bandwidth, although both were expensive and intended for permanent installations.

At the show, NEC introduced an all-in-one DSP acoustic echo-cancelling teleconferencing unit, VoicePoint, featuring this technology for portable applications and at a lower price point. A conceptually

INTEGRATED CHIP SETS ARE BECOMING AVAILABLE THAT CONSTANTLY ANALYZE THE VIDEO.

similar unit was introduced by Coherent, in their AcoustiLink. Coherent, as well as a half dozen other established and start-up firms, also introduced DSP-based acoustic echo-cancelling teleconferencing systems. Sound Control Technology has been promoting the Teleplex series III system developed in affiliation with Jaffe Acoustics which already boasts quite a few installations. Gentner displayed People-LINK, their DSP full-duplex system. TAI, another teleconferencing equipment supplier, introduced the DSP TLC3000 which featured full-duplex voice operation under computer "fuzzy-logic" control.

Other sophisticated audio technology was shown by Shure in their ST6300 type 2, which combines a "smart" automatic mic mixer with an optional digital echo canceler (ST2AC). Shure's ST3000 portable system is a very popular and cost effective portable teleconferencing system

A NUMBER OF FIRMS INTRODUCED VIDEOPHONES THAT WOULD TRANSMIT MOVING IMAGES.

and uses a seven-inch diameter three-mic device. Teleconferencing Systems International displayed their wireless teleconferencing and distance learning systems. Dan Dugan, the father of automatic mic mixers, showed his new mic mixer, which is configured as an add-on to your existing

THE AUTO MIC MIXER/LOGIC CONTROLLED AMPLIFIER SHOULD BE OF REAL INTEREST TO TELECONFERENCING DESIGNERS.

mixer. Lectrosonics exhibited wireless boundary mics, modular rack frame controllers, and their automatic mic mixer and logic-controlled amplifier. The auto mic mixer/logic controlled amplifier should be of real interest to teleconferencing designers as the logic controlled amplifier turns off the nearby speakers whenever the auto mic mixer turns on the local mic.

Crestron, a major supplier of media controllers, introduced their new integrated teleconferencing controllers which combine audio, video (including camera movement), lighting and environmental control. AMX was exhibiting their ACCESS multi-function controllers for boardrooms systems, controllers, and remote controls.

Well, I am sure half of the exhibitors have been left out. Next time you better go see the show for yourself! ■

ENGINEERING SOFTWARE UPDATES

By Mike Klasco

Just about everybody who has some sort of audio related CAD software managed to show a new release either during the NSCA or the AES. Here is a quick run through of what is happening.

JBL's CADP2 1.0

JBL officially released their Windows-based sound system design program at the AES. Promising reduced design and computational time, the Complex Array Design Program, Generation 2, is a sophisticated program that requires sophisticated hardware. CADP2 offers true 3-D modeling, a wide range of graphically displaying sound coverage, various RT60 calculations, echograms and Level-Time-Path, and intelligibility (%ALcons, with RASTI to follow in a later release). CADP2 works on IBM compatible-MS-DOS computers of 286 class or above with 4 meg of RAM, VGA graphics or higher, mouse or other pointing device, and math coprocessor IC.

JBL has been sending me beta copies of CADP2 during its development and I described the program in the May issue of *Sound & Communications*. After I have had time to digest the release version, I will review this program in the first quarter of 1992, along with tricks and techniques to get the best performance out of your existing hardware with this demanding and sophisticated software.

AcoustaCADD 2.0

Altec/Mark IV talked a bit at the NSCA Convention about AcoustaCADD 2.0, although you should not expect to see this released until way into 1992. Most of the work is being concentrated on speaker directivity measurements that include additional data which enhance the accuracy of STI/RASTI predictions. A hint of what they are working on can be gained from reading the papers given by Mark IV's engineers at the AES.

Bose Modeler 4.0

In Modeler 4.0 the drawing tools for 3-D room modeling now include curved surfaces. This is a first for any of the sound system design programs and I can think of many past instances where this would have been a Godsend. The number of surfaces to create a room model have also

**A HINT OF WHAT THEY
ARE WORKING ON CAN
BE GAINED FROM
READING THE PAPERS
GIVEN BY MARK IV'S
ENGINEERS AT THE AES.**

been expanded. Still other room modeling tools have been added. The speaker database resolution has been increased from one octave bandwidth in 3.0 to $\frac{1}{3}$ octave in 4.0. Enhanced accuracy in the spatial resolution has been provided with the option of 1 degree spacing. Magnitude and phase data is now available for use with

the complex speaker interference calculations (I wonder if this is also used to refine the accuracy of the program's STI predictions?). Quite a few other developments have been included in Modeler 4.0 and I look forward to updating my last review (of Modeler 3.0) after I have had a chance to work with Modeler 4.0.

Perhaps just as important as the software enhancements that Bose has introduced with this software release are the new developments in the hardware that Modeler runs on. As the only sound system software program that is Macintosh-based, Modeler has carried with it platform specific (hardware) advantages and disadvantages compared to the design programs that are MS-DOS/IBM compatible. During the last few years Macintosh desktop computers have greatly benefited from value engineering and now offer comparable value to MS-DOS/Windows compatible hardware platforms. On the other hand, if you use your software when you are "on the road," then Mac-based programs have suffered a serious disadvantage. The only Apple Mac portable has been expensive (over \$4,000), computationally slow, heavy and awkward.

At Comdex, the computer industry trade show held at the end of October, Apple introduced a line of Mac portables that offer every bit as much performance, portability, and value as Toshiba, NEC, Sharp and others offer in their MS-DOS portables. Three laptop portable Macs are coming in the PowerBook series. The PowerBook 100 weighs about 5 pounds, costs \$2,300, has a 20 meg hard drive but does not have an internal floppy disk drive.

The PowerBook 140, at \$2,900, does have a floppy drive, but (like the model 100) does not have a floating point processor, which will prevent you from running a few of Modeler's computationally intensive features. The PowerBook 170 is Apple's top portable at \$4,600 and offers the floating point processor, memory, and power that you would expect in a desktop unit.

QUITE A FEW OTHER DEVELOPMENTS HAVE BEEN INCLUDED IN MODELER 4.0.

While we are on the topic of Modeler and hardware, Bose gave a demonstration of Auralization at the AES. Auralization is the ability to "listen" to the sound of a room imposed on a recording. The system Bose demonstrated was a prototype which processes data from Modeler to derive a binaural headphone representation. The system is expensive and still in the development stage.

Renkus-Heinz EASE 1.1, 1.4, 2.0

EASE 1.1

In the fall Renkus-Heinz released EASE 1.1 which has a number of useful improve-

IF YOU USE YOUR SOFTWARE WHEN YOU ARE "ON THE ROAD," THEN MAC-BASED PROGRAMS HAVE SUFFERED A SERIOUS DISADVANTAGE.

ments over 1.0 (which is the version I have reviewed). 1.1 was distributed free of charge to all registered EASE users. The

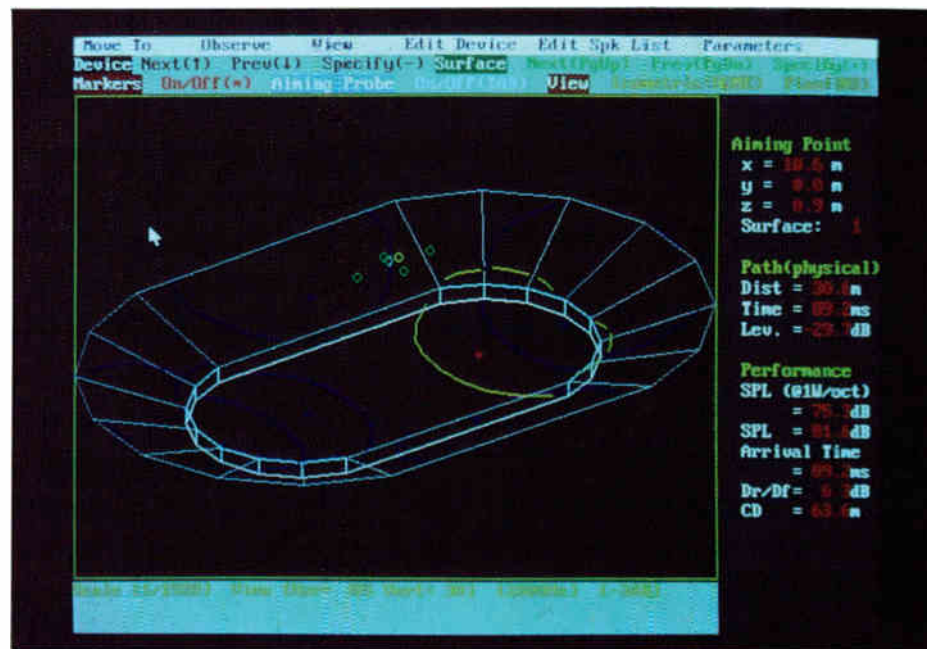
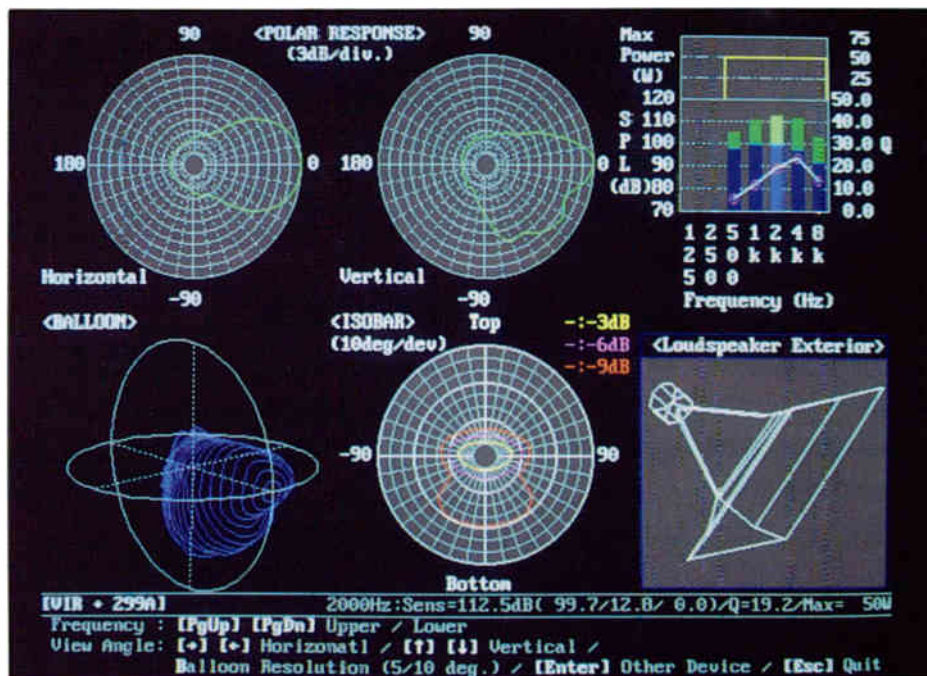

Two screen shots from the updated AcoustaCADD 2.0 from Altec Lansing.

RAM memory requirements have been reduced so printer utilities like Pizzaz or Hijaak will work consistently. The increased memory space that has been freed up also allows more accurate room reflection simulations with higher numbers

of reflections. Additionally, the %ALcons and directivity calculations have been refined, the AutoCAD exchange updated, and the speaker database has been expanded to include most manufacturers that have polar data.

The user interface is less cluttered, with mouse operation, fewer key strokes to access to speaker and surface material databases, single keystroke to main menu, and generally more intuitive operation.

Additionally, physical speaker drawings for most Renkus-Heinz speakers for use with AutoCAD are provided along with a cluster design table for Renkus-Heinz speakers and horns.

EASc

This is a simpler and lower cost version that will be released in January 1992 for the user who has no need for all the advanced acoustical analysis capabilities of EASE. It retains the accuracy of EASE, same speaker and wall materials database, but will feature simplified room entry.

Articulation loss predictions will be shown in isoline form. Like EASE, EASc

THE SYSTEM PROCESSES DATA FROM MODELER TO DERIVE A BINAURAL HEADPHONE REPRESENTATION.

will be an open format database program offered without restrictions to anyone engaged in the design or installation of sound systems. The project price is \$500, and no renewal fees or fixed termination periods (you buy it — it's yours!).

EASE 2.0

EASE 2.0 is a major EASE update and is scheduled for release during the second quarter of 1992.

Highlights include: improved user interface; simplified method of room entry;

DXF AutoCAD file interchange (EASE now has import but no export); provisions for nonsymmetrical speaker data entry (such as special horns from Altec and JBL as well as a number of one-box systems); automatic cluster design; postprocessing files for EARS and/or Hyperception auralization programs.

EARS, Electronically Auralized Room Simulator program, is scheduled for release along with EASE 2.0.

EARS features: Hi-Fi quality sound, with excellent binaural simulation, which if used with headphones allows localization of the apparent sound in all directions. EARS will take its input from EASE 2.0 or from TEF measurements. The latter is particularly helpful for work with scale models. EARS will also be configured to work with the Ariel DSP boards including the SYSid hardware, the DSP-16. ■

Your Professional Connection

For Quality Response Use the

MARKETPLACE

ACOUSTICAL / SOUND AND TELEVISION SYSTEMS ENGINEERS

Major audio-visual consulting engineering firm is seeking engineer to design acoustic systems.

SOUND SYSTEM DESIGN AND SALES

Seeking distributor for Michigan and surrounding areas. Seeking individual experienced in selling and bidding of commercial and residential sound systems. Offer training, support and benefits. Reply to: Sound Systems Class, 11050

EQUITY/OWNERSHIP SITUATION WANTED

Two individuals with strong technical experience in sound systems seeking equity or total ownership in a profitable business.

FOR SALE

Tef System 12 — upgraded with battery backup, extensive software including many programs. Mic. stand, printer, cables. Must sell. Call: 9416-6600

WANTED

ELECTRONIC SERVICE TECH
 ■ Established Clientele ■ Excellent Opportunity
 Contact: [redacted] 9416-6600

SITUATION WANTED

Experienced audio professional seeking related business opportunities in VA. Formal training in engineering and sound. pro sound. h...

MANUFACTURER'S REPS

Sound & Communications
 25 Willowdale Avenue
 and significant...

Leading manufacturer of Horn/Speaker Assemblies and Baffles seeks...

Every Month in *Sound & Communications*

MAXIMUM SUPPORT



Raxxess

Sliding Shelf

Perhaps the heaviest duty sliding shelf on the market (call for specs), the SLS-1 locks out in two positions, ensuring that an accidental bump doesn't put your valuable equipment on the floor. Occupies a single rack space and comes with front and rear rack ears. Two-space rear rack rail also provided.

One and two space fixed shelves and a variety of other rack accessories also available. **CALL, FAX or WRITE.**

Raxxess

P.O. Box 417, Riverside Station
 Paterson, NJ 07544-0417
 (201) 523-1425 • FAX (201) 523-1658

Circle 286 on Reader Response Card

AD INDEX

Company	Page	RS #
Ashly Audio	36	253
Audio Technica	32,46,63	—
Cal Switch	17	248
Chief Manufacturing	44	256
Cord Lox	77	229
Delta Communications	31	287
DJ Expo	35	—
Ferrofluidics	20	270
Freed International	77	222
JBL Professional	CIV	—
Kelvin Electronics	77	230
LaBelle Industries	71	284
LightSPEED Technologies	13	215
Manufacturers' Reps. Ed Research Foundation	25	—
Mellotone	77	228
Menlo Scientific	34	254
Music Supply Company	77	223
NSCA	43	—
Opamp Labs	77	227
Optim Audio	46	290
Otari	5	209
Peavey-Architectural Acoustics	CII	204
Pioneer Laser	55	216
Pivotelli	31	291
Qualitone	77	224
Quam-Nichols	8,57, 207,280, 71	281
Racom	65	283
Ramko Research	29	202
Rane Corporation	40/41	210
Raxxess Metalsmiths	75	286
RCI Systems	CIII	217
Samson Technologies	23	203
Sennheiser Electronics	26	255
Sharp LCD	3	209
Shure Brothers	7	206
Sonic Systems/Soundsphere	21,39	251,252
Tascam	14	220
Telecall Communication Systems	11	211
Telex Communications	37	221
TOA Electronics	48,49	249,250
West Penn Wire	45	214
Winsted Corporation	57	282
Yamaha Pro Audio	19	212

FREE INFORMATION

Use the Reader Service Card opposite page 26. Just circle the RS# of products that interest you. Detach, and Mail!

HELP WANTED

SALES

Sell music/sound/communication systems. Estab. Co. recession resistant product, LA territory. Self starter. Minimum 1 year outside sales. Fax or mail resume to:

**K. Simonsen
Muzak**

**3500 San Fernando Rd
Burbank, CA 91505
Phone: (818) 767-1802
FAX: (818) 767-6139**

Muzak, Sunny Southern California Year round average temp 75 degrees

Muzak, the leader in sound communications, is looking for EXPERIENCED music salespeople for permanent position in LA and Orange Counties in CA. Salespeople with proven production is a requirement.

SEND RESUME including the last three years salary history to:

**Muzak
c/o Sales Administration
1130 N. Kraemer Blvd. #H
Anaheim, CA 92806
EOE**

WANTED:

MANUFACTURER'S REPRESENTATIVES

Power Protection Products mfr is seeking independent sales reps to represent our line in the security & audio/visual markets.

Please send resume to:

**Kalglo Electronics Co., Inc.
Dept SC
6584 Ruch Road
Bethlehem, PA 18017**

EQUIPMENT FOR SALE

INTERCOM LINE FOR SALE

A well established line of quality Intercom Products is for sale. Columbia Scientific Industries Corp. has been manufacturing intercoms since 1968 for bank and restaurant drive-ins, for cashiers, x-ray rooms, prisons and many other applications.

**Contact CSI
Mr. Jim Cotton
P.O. Box 203190
Austin, TX 78720
(512) 258-5191**

How To Place a Sound & Communications Ad

Print or type copy indicating capital letters and bold type. All rates are based on column inch.

1X rate for a classified ad is \$57. (Includes borders, typesetting and company logo if desired.)

1X rate for a marketplace ad (product) is \$88. Frequency discount available. Call for information.

CLASSIFIEDS

- | | |
|---|--|
| <input type="checkbox"/> Business Opportunities | <input type="checkbox"/> Employment Wanted |
| <input type="checkbox"/> Equipment for Sale | <input type="checkbox"/> Facility for Sale |
| <input type="checkbox"/> Help Wanted | <input type="checkbox"/> Miscellaneous |

MARKETPLACE

- All product and services

Sound & Communications Ads Get Results!

Company Name _____ Name _____

Address _____ Phone _____

Method of Payment Check Enclosed Visa American Express MC

Card # _____ Exp. Date _____

Signature _____

Mail or Fax Copy to
**Sound & Communications Marketplace
25 Willowdale Avenue, Port Washington, NY 11050
Phone: 516-767-2500 FAX: 516-767-9335**

MARKETPLACE

SKB ATA Rack Mounts at an Affordable Price



Meets ATA class 300, Cat. 1 Spec. available in 2U - 12U sizes and is half the weight of conventional wooden racks. Call your local dealer for a demo or fax for the name of your nearest distributor.

434 West Lavers Place, Orange, CA 92667 (817) 847-5400 FAX (817) 847-6319



Circle 222 on Reader Response Card

Cord Fox

VELCRO CORD-TIES



- Over 20 Standard Designs
- 18 Colors Available
- Custom Printing
- Can Build to Your Specs!

Toleto Fasteners International

170 Mace St. E-6 (619) 426-3725
Chula Vista, CA 92011 FAX (619) 422-2084

Circle 229 on Reader Response Card

INSTALLERS!

EASY KARY®
Wire Reel Holders



- 3 SIZES
- All Steel Construction



Carry like a briefcase

PUSH-PULL RODS Get cable through impossible places. Extends 45'. Light weight. Flexible



SPEAKER & TILE SUPPORTS



SPEAKER ENCLOSURES



ALL STEEL LIGHT WEIGHT but STRONG for all 4" and 8" SPEAKERS in ALL types of CEILING

U.L. LISTED FREE SAMPLES

30 DAY FREE TRIAL

INSTANT OPEN ACCOUNT

The Audio Serviceman's Right Arm. Check the complete sound system from MIC to SPEAKER TESTSET TS-1A ... and much, much more.

CALL OR WRITE FOR CATALOG

MUSIC SUPPLY CO., INC.

809 North Madison • Dallas, TX 75208

ALL 50 STATES 1-800-527-1522

FAX 214-946-9155 Local 214-946-8450

800-527-1522

Circle 223 on Reader Response Card

One Stop!

Great Prices
Great Service

EVERY DAY SINCE 1958!



Qualitone

FREE! 164 pg. Dealer/
Contractor Catalog.
800-431-2490

696 Locust Street Box 214 Mount Vernon, New York 10552

Circle 224 on Reader Response Card

FLAME RESISTANT ACOUSTIC GRILLE FABRICS

Meeting Fire Code Safety Standards.

ALL FABRICS INVENTORIED AND AVAILABLE FOR IMMEDIATE SHIPMENT

CALL OR WRITE FOR YOUR FREE SAMPLE FOLDER AND PRICE SHEET

MELLOTONE®

Mills: Post Office Box 145 • 108-East Church Street
Blacksburg, SC 29702 • (803) 839-6341
Fax (803) 839-2911

Circle 228 on Reader Response Card

Free Catalog & Audio/Video Applications
Routing Switchers (SI-AV) (24, 16, 12, 8, 4, 2 stations)

Press Boxes
1-in/18-out
Video/Audio
2-in/24-out Audio

Video & Audio Dist. Amps.
RGB-Sync Dist. Amps.

OPAMP LABS WC (213) 934-3566
1033 N Sycamore Av LOS ANGELES CA, 90038

Circle 227 on Reader Response Card

RIP-TIE®
Velcro® Cable Wraps

FAST EASY TIDY

800-348-7600
P.O. Box 77394 San Francisco, CA 94107

Circle 226 on Reader Response Card

EQUIPMENT

EQUIPMENT FINANCING

- ◆ No Down Payment
- ◆ True Lease or \$1.00 Buyout
- ◆ Fixed Rates, Long Terms
- ◆ No Financial Statements Required
- ◆ New or Used Equipment
- ◆ for Transactions Under \$50,000

CreditLease

Commercial Equipment Financing

To apply or request additional information contact
Chris Simpson or John McMIndes

(713) 686-4794

AC/DC VOLTAGE PRO 400
AC/DC CURRENT
DIODE TEST LOGIC TEST
LED TEST GOOD/BAD \$69.95
5 FREQ RANGES
5 CAPACITANCE RANGES
LOW BATTERY Warning
CONTINUITY TEST/BUZZER
TRANSISTOR CHECKER
20 MHz FREQ COUNTER
2 YEAR WARRANTY PARTS-LABOR

KELVIN Electronics
(516) 349-7620 1(800) 645-9212
FAX (516) 349-7830 VISA M/C

Circle 230 on Reader Response Card

The Source for the Latest Information on Models, Prices, Specs.

The Music & Sound Buyer's Guide

ORDER YOUR COPY NOW!

For each copy send \$7.95 plus \$2.00 postage and handling.

THE MUSIC & SOUND BUYER'S GUIDE

25 Willowdale Avenue
Port Washington, NY 11050

PRODUCT CHECK:

INTERCOMS & SECURITY FACTORIES/WAREHOUSES

Products used most frequently in factory/warehouse installations ...

... NOW IN PROGRESS

PRODUCTS

- Intercoms
- Paging
- Microphones
- Speakers
- Amplifiers
- Burglar Alarms
- Cameras
- Camera Mounts
- Video Monitors

FIRST PLACE

AIPHONE
TOA
SHURE
ATLAS/SOUNDOLIER
TOA
RADIONICS
BURLE
VICON
BURLE

SECOND PLACE

BOGEN
DUKANE
AUDIO-TECHNICA
QUAM-NICHOLS
CROWN
ADEMCO
VICON
PELCO
VICON

THIRD PLACE

DUKANE
UNIVERSITY SOUND/BOGEN*
BOGEN/ASTATIC*
JBL
DUKANE/BOGEN*
FDI
PANASONIC
BURLE
PANASONIC/JAVELIN*

* indicates tie

... IN LAST SIX MONTHS

PRODUCTS

- Intercoms
- Paging
- Microphones
- speakers
- Amplifiers
- Burglar Alarms
- Cameras
- Camera Mounts
- Video Monitors

FIRST PLACE

AIPHONE
BOGEN
SHURE
ATLAS/SOUNDOLIER
TOA
RADIONICS
BURLE
VICON
BURLE

SECOND PLACE

DUKANE
DUKANE
AUDIO-TECHNICA
QUAM-NICHOLS
BOGEN
ADEMCO
VICON
PELCO
PANASONIC

THIRD PLACE

BOGEN
TOA
BOGEN/E-V*
JBL
CROWN
FDI
PANASONIC
BURLE/JAVELIN*
VICON

* indicates tie

SURVEY METHODOLOGY

1. The sampling pool for the survey consists of sound and communications contractors from Sound & Communications' subscription list. Only contractors within the United States and Canada are called.
2. In a telephone survey, contractors/installers selected at random are asked to identify what brand they used for various products in installations completed in the past six months and those in progress. A different type of installation is highlighted each month.
3. On completion of the survey, results are tabulated and the product brands are ranked on a scale from one to three, with number one having the most votes. Separate rankings are made for installations occurring in the past six months and for those in progress.
4. An asterisk (*) denotes a tie for that ranking.

Copyright © 1991 SOUND & COMMUNICATIONS PUBLISHING, INC. Reprint of any part of contents without permission forbidden. Titles Registered in the U.S. Patent Office. Sound & Communications (U.S. P.S. 943-140) (ISSN #0038-1845) is published monthly by Sound & Communications Publications, Inc., 25 Willowdale Avenue, Port Washington, N.Y. 11050. 516-767-2500. President, Vincent P. Testa. Subscription rates: U.S.—1 year \$15.00, 3 years \$37.50. All other countries—1 year \$25.00, 3 years \$67.50. Subscriptions outside of U.S. must be paid in American currency. Second-class postage paid at Port Washington, NY and at additional mailing office. POSTMASTER: Send address changes to Sound & Communications, 25 Willowdale Avenue, Port Washington, NY 11050.

The Secret is out!

RCI Systems...more than just great plates & panels.



RCI
SYSTEMS INC

5615 Fishers Lane
Rockville, MD 20852-5200

**SPECIALISTS IN DESIGN AND CREATION OF YOUR
CUSTOM AUDIO/VIDEO PRODUCT NEEDS.**

Clockwise from top left; BM-24 Passive Media Mult Box-compact/portable 24 XLR output plus 8 mini plug; BM-30-M Active Media Mult Box-compact portable 30 XLR balanced output, 20 hr. battery + charger/auto AC/DC switch-over; PB-424-ND Patch Bay-56 ports fully wired 30 horizontal accessed screw terminal blocks; RL-1 Racklight; AVD Series Custom Wall Plates; RI-440 Dual Channel "Pre-Adapter" 2 channel level matching amplifier; AVD Series Custom Panel; MX820F Clearcom Selector Matrix; ASP-10-T Amplifier Substitution Unit active switching network/one stereo amplifier may be substituted for any of 5 stereo amps; Custom MXN52 5x2 Precision Mixer With Slave.

301-984-1800 • FAX 301-984-6175

Circle 217 on Reader Response Card
World Radio History



Even Our Smaller Systems Can Fill A Big Hall.

SR4700 Series

You've seen and heard our big systems, installed in major venues around the world and on tour with some of the

biggest names in the music business. The SR4700 Series Loudspeaker Systems are equally at home on the road or in the hall.

Their legacy comes from Cabaret® Series, a prime player in small to medium club sound reinforcement since the seventies. Their influence is Concert

Series™, the new standard in packaged JBL systems. With

Cabaret as the starting point and

Concert Series as our current direction, we listened to your comments and suggestions, turning them into the sound system of the nineties and beyond.

The SR4700 Series is pure pro audio. Pure JBL components, the same caliber as those in our larger systems, including the Vented Gap Cooling™ low frequency drivers and the 2445J compression driver. Pure JBL enclosures, five times stronger than traditional designs, and protected by plastic-coated steel grills and super-durable fabric-laminated plywood cabinets. Pure JBL sensibility, interlocking enclosures with heavy-duty steel handles and recessed input connectors, so they travel tighter, set-up easier and last longer.

SR4700 Series, pure JBL. Be the first in line to hear them today at your local JBL dealer.



JBL Professional
8500 Balboa Boulevard, Northridge, CA 91329 USA
A Harman International Company